

XEROX

**WORD PROCESSING
APPLICATIONS and REFERENCE GUIDE**

820 INFORMATION PROCESSOR

XEROX WORD PROCESSING software is based on MicroPro International software, licensed to XEROX by MicroPro. Portions of the material in this manual are copied from, or are derivative works based on copyrighted material of MicroPro, and are used with their permission.

CP/M is a registered trademark of Digital Research Inc.

WARNING: This equipment generates, uses, and can radiate radio frequency energy and if not installed and used in accordance with the instructions manual, may cause interference to radio communications. As temporarily permitted by regulation it has not been tested for compliance with the limits for Class A computing devices pursuant to Subpart J of Part 15 of FCC Rules, which are designed to provide reasonable protection against such interference. Operation of this equipment in a residential area is likely to cause interference in which case the user at his own expense will be required to take whatever measures may be required to correct the interference.

**WORD PROCESSING
APPLICATIONS and REFERENCE GUIDE**

TABLE OF CONTENTS

APPLICATIONS & FEATURES	1
CURSOR MOVEMENT	
Cursor Introduction	2-1
Scrolling the File	2-4
Using Find	2-5
DIRECTORY	
The Directory Menu	3-1
Changing Disk Drives	3-2
Deleting a File	3-2
Renaming a File	3-3
Running a Program	3-4
Changing the HELP Level	3-10
Scrolling a Long Directory	3-10
Turning the Directory Off and On	3-11
Editing A Program	3-11
EDITING	
Checking Disk Space and Number of Files	4-1
Recalling a Document File for Editing	4-2
Deleting (Erasing) Text	4-4
Inserting Text	4-5
Discarding Editing Changes	4-8
Using Find and Replace	4-9
Working With Blocks of Text	4-13
More About Blocks of Text	4-14
Deleting A Block of Text	4-15
Moving Text To A New Location	4-16
Copying (Duplicating) Text in a Document File	4-17
Copying Text Into A New Document File	4-20

FORMATTING

Formatting Introduction	5-1
Changing Margins & Tabs	5-3
How to Use the Ruler Line When Editing	5-9
Using Wide Margins	5-11
Typing Block (Automatic) Indent Text	5-13
Editing Block (Automatic) Indent Text	5-15
Typing Outline Format	5-18
Editing Outline Format	5-21
Changing Line Spacing	5-23
Turning Justify Off	5-27
Changing Pitch	5-29
Changing Paper Length	5-31
Changing Top and Bottom Margins	5-32

HELP

Cancelling A Command	6-1
The Help Key	6-1
Changing the Help Level	6-1
Correcting Mistakes	6-2
Recovering A Bak File	6-3

MULTI-PAGE DOCUMENTS

Automatic Page Breaks	7-1
Required Page Breaks	7-2
Saving Frequently	7-3
Printing Multi-Page Documents	7-4
How to Keep Text From being Split Between Pages	7-9
Typing Long Document	7-10
Editing Long Documents	7-10

PAGE NUMBERING

Omitting Page Numbers	8-1
Changing the Page Number Location	8-2
Changing the Page Number	8-3
Adding Text to the Page Numbers (Headers & Footings)	8-3

PRINTING

Stopping the Printer	9-1
Stop Commands	9-2
The Print Questions	9-3

STATISTICAL TABLES

Using Decimal Tabs	10-1
Underlining Columns	10-2
Editing Statistical Tables	10-7

TEXT TYPING FEATURES

Centering Text	11-1
Underlining Text	11-3
Bolding and Double Striking Text	11-9
Typing Super and Subscripts	11-11
Typing a Letter and Envelope	11-12
Using Standard (Boilerplate) Text	11-14

OTHER

Dot Commands	12-1
Using Dot Commands	12-10
Exception Keys	12-16

SYSTEM COMPONENTS

Introduction	14-1
Unpacking the 630	14-2
Installation	14-4
Familiarization	14-6
Preparation for Operation	14-8
Operating the Model 630 Printer	14-11
Special Considerations	14-12
Specifications	14-16
Forms Tractors	14-19

DIAGNOSTICS	15-1
--------------------	------

MESSAGES	16-1
-----------------	------

PROBLEM SOLVING	17-1
------------------------	------

INDEX

APPLICATIONS AND FEATURES

After completing the exercises in the **Word Processing Handbook**, you may want to know more about your system. The first twelve sections of this manual are designed to teach you more about the 820's features and are referred to as the APPLICATION chapters.

The chart on the next page shows you what is covered in each of the APPLICATION chapters (white tabs) of this manual.

We suggest that you go through the sections marked RECOMMENDED on the chart. These sections cover features that are basic to almost any type of work you may do on your 820.

After that, you can go through the sections that cover features you know you'll use on your job. For instance, if you type letters with envelopes, you'll want to cover the section that explains the best way to type letters and envelopes.

When you finish the training, there's a questionnaire at the end of this section for you to fill out and mail in.

Before you begin

Make sure you have back up copies of your Word Processing and Programs software disks. If you, or someone in your office, has not made a copy of the software disks, please do so now, following the directions below.

Before you do any of the practice exercises in this manual, you should copy the Training Disk that came with your 820 onto another disk and work with the copy. In this way, the original Training Disk can be saved as a back up copy.

To make back up copies of your disks:

- you'll need three new or reusable discs for 5¼" disk systems;
two for 8" disk systems
- turn to page 1-4
- follow the instructions to copy disks
- return to this page and continue

When you have made back up copies of your disks, turn to the chart on the next page and go through the chapters marked RECOMMENDED. Then, select any other sections that cover the type of work you do. The chart has space for you to mark the sections you want to cover.

You may notice as you use the 820 that there may be more than one way to give a particular instruction to the system. For instance, on the Directory Menu, pressing the up cursor (arrow) key gives the same instruction as typing an A. The chapter titled OTHER has a list of these "exception" keys.

APPLICATIONS CHART

CURSOR MOVEMENT

Cursor Introduction	2-1	Recommended
Scrolling the File	2-4	Recommended
Using Find	2-5	Recommended

DIRECTORY

The Directory Menu	3-1
Changing Disk Drives	3-2
Deleting a File	3-2
Renaming a File	3-3
Running a Program	3-4
Changing the HELP Level	3-10
Scrolling a Long Directory	3-10
Turning the Directory Off and On	3-11
Editing A Program	3-11

EDITING

Checking Disk Space and Number of Files	4-1	Recommended
Recalling a Document File for Editing	4-2	Recommended
Deleting (Erasing) Text	4-4	Recommended
Inserting Text	4-5	Recommended
Discarding Editing Changes	4-8	Recommended
Using Find and Replace	4-9	Recommended
Working With Blocks of Text	4-13	
More About Blocks of Text	4-14	
Deleting A Block of Text	4-15	
Moving Text To A New Location	4-16	
Copying (Duplicating) Text in a Document File	4-17	
Copying Text Into A New Document File	4-20	

FORMATTING

Formatting Introduction	5-1	Recommended
Changing Margins & Tabs	5-3	Recommended
How to Use the Ruler Line When Editing	5-9	Recommended
Using Wide Margins	5-11	Recommended
Typing Block (Automatic) Indent Text	5-13	Recommended
Editing Block (Automatic) Indent Text	5-15	Recommended
Typing Outline Format	5-18	
Editing Outline Format	5-21	
Changing Line Spacing	5-23	
Turning Justify Off	5-27	
Changing Pitch	5-29	
Changing Paper Length	5-31	
Changing Top and Bottom Margins	5-32	

APPLICATION & FEATURES

APPLICATIONS CHART

HELP

Cancelling A Command	6-1
The Help Key	6-1
Changing the Help Level	6-1
Correcting Mistakes	6-2
Recovering A Bak File	6-3

MULTI-PAGE DOCUMENTS

Automatic Page Breaks	7-1	Recommended
Required Page Breaks	7-2	Recommended
Printing Multi-Page Documents	7-4	Recommended
How to Keep Text From being Split Between Pages	7-9	
Typing Long Document	7-10	
Editing Long Documents	7-10	

PAGE NUMBERING

Omitting Page Numbers	8-1
Changing the Page Number Location	8-2
Changing the Page Number	8-3
Adding Text to the Page Numbers (Headers & Footers)	8-3

PRINTING

Stopping the Printer	9-1	Recommended
Stop Commands	9-2	
The Print Questions	9-3	

STATISTICAL TABLES

Using Decimal Tabs	10-1
Underlining Columns	10-2
Editing Statistical Tables	10-7

TEXT TYPING FEATURES

Centering Text	11-1	Recommended
Underlining Text	11-3	Recommended
Bolding and Double Striking Text	11-9	
Typing Super and Subscripts	11-11	
Typing a Letter and Envelope	11-12	
Using Standard (Boilerplate) Text	11-14	

HOW TO MAKE BACK UP COPIES OF YOUR DISKS

Before you can make a copy of a disk, you need to prepare a new disk for use in the 820. The INIT program is used to prepare a disk for use in the 820. Follow the steps below to initialize your new disks.

The following procedure is for systems using 5¼" disks

OBTAIN three new disks and take any write protect tapes off (if you don't have any new disks, previously used disks will do)

TURN the 820 system on, or press the RESET button if it is already on

PUT the Word Processing disk in the **A** (left) drive

PUT the Programs disk in the **B** (right) drive

TYPE A and **PRESS RETURN**

WAIT for the Directory Menu to be displayed

PRESS the **B** key, then type **B:** and press **RETURN** to change to disk drive **B**

PRESS the **H** key, type the word **INIT** and press **RETURN**

Wait for the message **ENTER DISK DRIVE TO BE INITIALIZED**

REMOVE the Program disk in the **B** (right) drive

INSERT one of the new disks in the **B** (right) drive, type **B** and press **RETURN** twice

Wait for the message **0 FLAWED SECTORS** (If the disk has flawed sectors, don't use it -- get another disk and initialize it, using steps below)

REMOVE the disk in the **B** (right) drive

CONTINUE to initialize all your disks as follows:

- Press **RETURN**
- Insert another disk in the **B** drive
- Type **B** and press **RETURN** twice
- Remove the disk when the **FLAWED SECTORS** message appears

WHEN all disks are initialized, return to the Directory Menu as follows:

- Press the SPACE bar
- Wait for the "Touch any key..." message
- Press the SPACE bar again

After initializing your disks, you are ready to copy the Word Processing, Programs and Training disks onto the initialized disks.

CHECK that the Directory Menu is on the screen and your Word Processing disk is in the **A** (left) drive

INSERT your Programs disk in the B (right) drive

PRESS the **B** key, then type **B:** and press RETURN to change to disk drive B

PRESS the **H** key

TYPE the word **COPY** and press RETURN

Wait for the message that tells you to insert the disks to be copied

REMOVE the Program disk from the B (right) drive

INSERT an initialized disk in the **B** drive

PRESS the RETURN key

Wait for the COPY COMPLETE message

REMOVE both the Word Processing disk and the copy. Put a label on the copy that says "Word Processing"

COPY the Programs disk as follows:

- Insert the Programs disk in the **A** (left) drive
- Insert an initialized disk in the **B** (right) drive
- Press RETURN twice
- Wait for the COPY COMPLETE message
- Remove both disks and label the copy "Programs"

COPY the Training disk as follows:

- Insert the Training disk in the **A** (left) drive
- Insert an initialized disk in the **B** (right) drive
- Press RETURN twice
- Wait for the COPY COMPLETE message
- Remove both disks and label the copy "Training Disk"

INSERT the Word Processing copy disk in the **A** drive and press the SPACE bar

PUT the original disks in the disk holders at the back of this manual

The following procedure is for systems using 8" disks

OBTAIN three new disks and put write protect tapes on the disks (if you don't have any new disks, previously used disks will do)

- **TURN** the 820 system on, or press the RESET button if it is already on
- **PUT** the Word Processing disk in the **A** (left) drive
- **PRESS** the **A** key and RETURN
- **WAIT** for the Directory Menu to be displayed
- **PRESS** the **H** key
- **TYPE** the word **INIT** and press RETURN

Wait for the message ENTER DISK DRIVE TO BE INITIALIZED

- **INSERT** one of the new disks in the **B** drive, type **B** and press RETURN twice
Wait for the message 0 FLAWED SECTORS (If the disk has flawed sectors, don't use it -- get another disk and initialize it, using steps below)

REMOVE the disk in the **B** (right) drive

CONTINUE to initialize all your disks as follows:

- Press RETURN
- Insert another disk in the **B** drive
- Type **B** and press RETURN twice
- Remove the disk when the FLAWED SECTORS message appears

WHEN all disks are initialized, return to the Directory Menu as follows:

- Press the SPACE bar
- Wait for the "Touch any key..." message
- Press the SPACE bar again

After initializing your disks, you are ready to copy the Word Processing, and Training disks onto the initialized disks.

CHECK that the Directory Menu is on the screen and your Word Processing disk is in the **A** (left) drive

PRESS the **H** key

TYPE the word **COPY** and press RETURN

Wait for the message that tells you to insert the disks to be copied

INSERT an initialized disk in the **B** drive

PRESS the RETURN key

Wait for the COPY COMPLETE message

REMOVE both the Word Processing disk and the copy. Put a label on the copy that says "Word Processing"

COPY the Training disk as follows:

- Insert the Training disk in the **A** (left) drive
- Insert an initialized disk in the **B** (right) drive
- Press RETURN twice
- Wait for the COPY COMPLETE message
- Remove both disks and label the copy "Training Disk"

INSERT the Word Processing copy disk in the **A** drive and press the SPACE bar

PUT the original disks in the disk holders at the back of this manual

(This page intentionally left blank)

CURSOR MOVEMENT

The cursor is your "pointer" on the screen. It shows you where the action is. That is, if you type a character, it will be placed at the cursor location. If you touch the DEL (delete) key, the character the cursor is on will be deleted.

When you are typing or editing a document file, you use the cursor keys (arrow keys to right of keyboard) to move the cursor up, down, right or left one character at a time. There are other ways to move the cursor -- some of them much faster than using the cursor keys.

The cursor movement commands are located on the Go To Menu. The Go To Menu is the #1 menu on the Main Menu. To bring up the Go To Menu, you press CTRL & 1 when the Main Menu is on the screen. The Go To Menu is shown below.

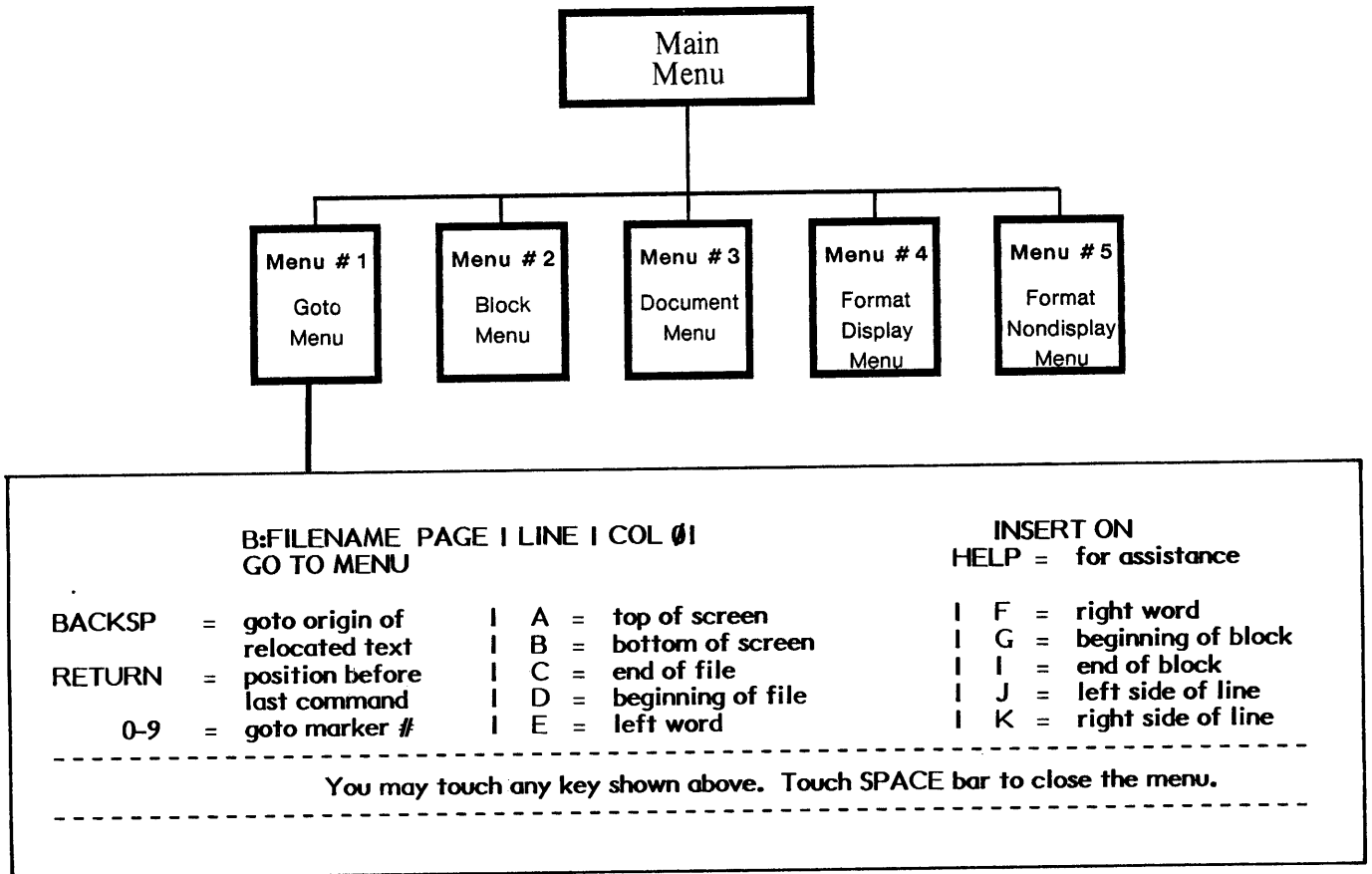

Some of the most commonly used commands on the Go To Menu are listed below.

A = top of screen
B = bottom of screen
C = end of file
D = beginning of file
J = left side of line
K = right side of line

Read the steps below to find out how moving the cursor works. If you want to practice the steps, do the exercise on the next page.

Here's how it works ...

You must have a file on the screen to move the cursor

To move the cursor to Top of screen:

- Press CTRL & 1 + A

To move the cursor to Bottom of screen:

- Press CTRL & 1 + B

To move the cursor to End of file:

- Press CTRL & 1 + C

To move the cursor to Beginning of file:

- Press CTRL & 1 + D

Practice Exercise

This exercise will give you a chance to practice using the commands on the Go To Menu to move the cursor. You'll use a document file that is already recorded on your Training Disk.

BEGIN with the Directory Menu on the screen

MAKE sure your Word Processing Disk is in Drive A and your training disk is in Drive B

CHECK that the Directory of the B disk is displayed. (If it is not, press the **B** key, type **B:** and press RETURN).

BRING the document file named **EDIT** to the screen

- Press the **A** key
- Type **EDIT**
- Press RETURN

MOVE the cursor to the end of the file using the Go To Menu command

- Press CTRL & I
- Look at the menu and notice that C = end of file
- Press the **C** key

MOVE the cursor back to the beginning of the file

- Press CTRL & I
- Look at the menu and notice that D = beginning of file
- Press the **D** key

ON YOUR OWN, try using some of the other commands on the Go To Menu

(Note: The 0-9 command only works after you set a place marker; BACKSP only works after you've moved text; and G and I only work when you have a block of text marked. All other commands work at any time. If you give a command that cannot be carried out, a message will display asking you to press the ESC key.)

PRACTICE moving the cursor with the cursor (arrow) keys

MOVE the cursor back to the beginning of the file

LEAVE the document file on the screen while you read the next three pages, then continue with the exercise on page 2-7

SCROLLING THE FILE

In addition to moving the cursor on the screen, you can scroll the text up and down the screen. This is done with the Main Menu on the screen.

B:FILENAME PAGE LINE COL				INSERT ON	
MAIN MENU				HELP	= for assistance
1 = go to menu		7 = delete this line		E = change help level	
2 = block menu		8 = insert line here		F = scroll up screenful	
3 = document menu		9 = insert mode (on/off)		G = scroll down screenful	
4 = format (display)		0 = repeat next command		J = find	
5 = format (nondisplay)		= = scroll up line		K = find & replace	
6 = reformat paragraph		- = scroll down line		L = repeat find & replace	

You may type now --or-- give a command using CTRL + (any key shown above).

The most useful scroll commands are **F** and **G** which will scroll the screen up or down a screenful at a time:

F = scroll up screenful
G = scroll down screenful

If you want to scroll only one line at a time, you can use the **=** and **-** keys, as shown below.

(=) = scroll up line
(-) = scroll down line

Read the steps below to find out how scrolling works. If you want to practice these steps, there's a practice exercise on page 2-7.

Here's how it works ...

You must have a file on the screen to scroll text.

To scroll text up a screenful:

- Press CTRL & F

To scroll text down a screenful:

- Press CTRL & G

To scroll text up one line:

- Press CTRL & = (equal key on the keyboard)

To scroll text down one line:

- Press CTRL & - (hyphen key)

USING FIND

The **find** command on the Main Menu can be used to find a specific word or words in a document file. When you give the find command, the system will ask you to type in the word or words you want to search for. Then it will look through the document file, locate the text that matches what you typed and move the cursor to that point. The cursor will go to the end of the matched text.

B:FILENAME PAGE LINE COL				INSERT ON	
MAIN MENU				HELP	= for assistance
1	= go to menu	7	= delete this line	E	= change help level
2	= block menu	8	= insert line here	F	= scroll up screenful
3	= document menu	9	= insert mode (on/off)	G	= scroll down screenful
4	= format (display)		= repeat next command	J	= find ←
5	= format (nondisplay)	=	= scroll up line	K	= find & replace
6	= reformat paragraph	-	= scroll down line	L	= repeat find & replace

You may type now -or- give a command using CTRL + (any key shown above).

The find command has several options that you can use. The most useful options are:

U = ignore case
B = search backwards
W = whole words only

Typing **U** (ignore case) will find the word regardless of whether it is typed in upper or lower case. For instance, if you tell the system to find "the" using the **U** option, it will find **THE**, **The** and **the**.

Typing **B** (search backwards) will tell the system to look backward through the document file from the cursor position. Normally, the system looks forward.

Typing **W** (whole words only) will tell the system to find the word only if it is a whole word and not part of another word. For instance, if you use the whole word option to find "other", the system will find only the word **other** and not words like **brother**, **mother**, **otherwise**, etc.

Read the steps below to find out how to use the find command. If you want to practice using find, do the exercise on the next page.

Here's how it works ...

You must have a file on the screen to use find.

To find a word:

- Press CTRL & J
- Type the word or words to be found
- Press RETURN twice

To find a word (using one or more of the options):

- Press CTRL & J
- Type the word or words to be found
- Press RETURN
(If you don't remember the options, you can type a question mark and RETURN to bring them to the screen)
- Type the option(s) to be used: **U**, **B** or **W**
- Press RETURN

Practice Exercise (cont'd)

This exercise is continued from page 2 - 3. It shows you how to use **find** and how to scroll the screen. Remember, when you use **find**, the system will search forward from the cursor position (unless you use the search backward option).

USE find to locate the first occurrence of the word "the"

- Press CTRL & J
- Type **the**
- Press RETURN
- Type ? and RETURN (to bring the options to the screen)
- Type U (to find the word whether it appears in upper or lower case)
- Type W (to find the word only if it is a whole word)
- Press RETURN

When the system finds the word "the", it will position the cursor behind it.

MOVE the cursor back to the beginning of the file

- Press CTRL & 1
- Press the D key

ON YOUR OWN, pick another word and use **find** to move the cursor to it

TRY using CTRL & F (to scroll the screen up)

LOOK at the Main Menu and give the command to scroll the screen down
Did you press CTRL & G?

SAVE the document file

- Press CTRL & 3
- Press the G key

(This page intentionally left blank)

WORKING WITH THE DIRECTORY

The **DIRECTORY** is a list of all the files on a disk. The **DIRECTORIES** of your Word Processing and Program disks show the names of the software files on the disks. These files should never be deleted or renamed.

The **DIRECTORIES** of the disks you record document files on will show the name of each file on the disk.

THE DIRECTORY MENU

The Directory Menu shows what you can do when the **DIRECTORY** is on the screen.

This is the Directory Menu

A = WORK ON A DOCUMENT FILE	H = run a program. . . for:
B = change disk drives	checking disk space, copying a
C = delete a file	disk & seeing B drive directory
D = turn directory off (ON)	ESC key = restart software
E = edit a program	HELP key = change help level
F = print a file	CTRL (-) = scroll directory down
G = rename a file	CTRL (=) = scroll directory up

You may touch any key shown above.

DIRECTORY of disk A:
BDIR.COM PIP.COM STAT.COM XWS.COM WSMSG.S.OVR WSOVLY1.OVR

The **Word Processing Handbook** showed you how to use:

A = WORK ON A DOCUMENT FILE
B = change disk drives
F = print a file

The other commands you'll use frequently on the Directory Menu are:

C = delete a file
G = rename a file
H = run a program

The **delete** command is used to delete (erase) files that you no longer need. Deleting files makes room for new files on the disk. The **rename** command is used to give a file a new name. If you want to work with a back-up (BAK) file, you'll need to rename it before you can use it.

You'll use the **run a program** command to:

Copy a document or disk (to make a back-up copy)
Initialize a new disk (to prepare it for recording)
Check the space left on a disk (before you type or edit a document)

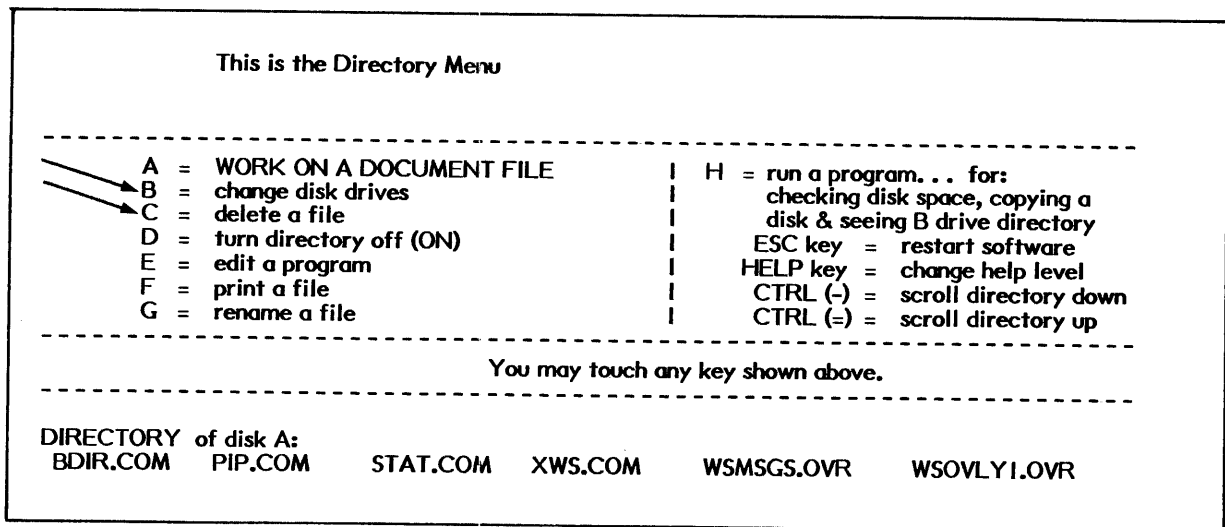

CHANGING DISK DRIVES

The letter **B** is used to give the **change disk drives** command. This command is used to switch the action from one disk drive to the other.

The screen shows the DIRECTORY of the active disk drive. When you switch to the other disk drive, the screen will show the DIRECTORY of the disk in that drive. Be careful not to change disk drives while you are editing or printing a document file.

To change disk drives:

- With the Directory Menu on the screen, press the **B** key
- Type **B:** to go to the B disk drive
Or, type **A:** to go to the A disk drive
- Press RETURN
- Wait for the system to change disk drives and display the DIRECTORY of the disk in the new drive.

DELETING A FILE

The letter **C** is used to give the **delete a file** command. This is the command you use to delete (erase) document files that you no longer need. You'll find it easiest to delete files if you have the Directory of the disk with the files on the screen. You can use the instructions above to change disk drives before deleting files.

To delete a file:

- With the Directory Menu on the screen, press the **C** key
- Type the name of the file to be deleted
- Press RETURN

Note: If you are deleting files on your Training Disk, be sure to delete only the files that have .BAK after their names.

This is the Directory Menu

<p>A = WORK ON A DOCUMENT FILE B = change disk drives C = delete a file D = turn directory off (ON) E = edit a program F = print a file G = rename a file</p>	<p>H = run a program. . . for: checking disk space, copying a disk & seeing B drive directory ESC key = restart software HELP key = change help level CTRL (-) = scroll directory down CTRL (=) = scroll directory up</p>
---	---

You may touch any key shown above.

DIRECTORY of disk A:
 BDIR.COM PIP.COM STAT.COM XWS.COM WSMSG.S.OVR WSOVLY1.OVR

RENAMING A FILE

The letter **G** is used to give the **rename a file** command, which will give a file a new name (title). This is particularly useful if you want to recall a BAK (back-up) file. Since you cannot recall a file that has BAK in its name, you must rename the file and then recall it.

To rename a file:

- Begin with the Directory Menu on the screen
- Put the disk with the file to be renamed in the **B Drive**
- Check that Directory B is displayed, if not, change drives
- Press the **G** key
- Type the **name of the file** you want to rename
- Press RETURN
- Type the **new name** (do not include .BAK in the name)
- Press RETURN

This is the Directory Menu

<p>A = WORK ON A DOCUMENT FILE B = change disk drives C = delete a file D = turn directory off (ON) E = edit a program F = print a file G = rename a file</p>	<p>H = run a program. . . for: ← checking disk space, copying a disk & seeing B drive directory ESC key = restart software HELP key = change help level CTRL (-) = scroll directory down CTRL (=) = scroll directory up</p>
---	---

You may touch any key shown above.

DIRECTORY of disk A:
 BDIR.COM PIP.COM STAT.COM XWS.COM WSMMSG.S.OVR WSOVLY1.OVR

RUNNING A PROGRAM

The letter **H** is used to give the **run a Program** command. Programs are simply a set of instructions to the system that tell it to perform a task automatically. The programs on your Word Processing disk are:

- | | |
|-----------------|---|
| STAT.COM | - used to find out the amount of room left on a disk |
| PIP.COM | - used to copy a document file from one disk to another |
| BDIR.COM | - used to view the Directory of the disk in B drive |

The programs on your 5¼" Programs disk are:

- | | |
|--------------------|--|
| COPY.COM | - used to copy an entire disk onto another disk |
| INIT.COM | - used to prepare (initialize) disks before recording on them |
| INSTALL.COM | - used to modify the software for use with a different printer |

If your system has 8" disk drives, the programs on the 5¼" programs disk will be located on the Word Processing disk.

To run one of the programs on your Word Processing Disk, you press the **H** key, type the name of the program and press RETURN.

To run one of the programs on your 5¼" Programs disk, you insert the Programs disk in the B drive (Word Processing disk should be in A drive), press the **H** key, type **B:** and the name of the program and press RETURN.

It is best to have the Directory of the Word Processing disk (drive A) on the screen when you start to run a program. Step-by-step instructions for the programs are given on the following pages. Instructions for using the **INSTALL** program are in the **REFERENCE** chapter of this manual.

Checking Disk Space (STAT)

It is extremely important that you check the amount of room on your disk before you begin typing or editing a document. Use the STAT program to check disk space. The amount of space will be given in bytes. An average page of typing takes about 2K bytes, so you can divide the number of bytes by 2 to find out how many pages can be put on the disk. You should never try to type or edit a document on a disk that has less than 3K bytes left on it. If there is not enough room on the disk, your file will not be saved.

To check the disk space (STAT):

- Check that the Directory Menu is on the screen
- Be sure the disk you will be typing on is in the B Drive
- Check that the Directory of the B disk is on the screen
- Press the H key
- Type **STAT**
- Press RETURN
- Wait a few seconds, then note the number of bytes remaining on the disk
- Press the SPACE bar and wait for the Directory Menu to return

You can also use the STAT program to find out the exact size of each file on the disk. When you want to edit a document file, you must be sure that you have enough space on the disk for the newly edited file and the back-up (BAK) file. This means that if a file presently takes up 4K, you'll need to have at least 4K remaining on the disk to edit it.

To check the disk space and the size of each file (STAT):

- Check that the Directory Menu is on the screen
- Be sure the disk you will be typing on is in the B Drive
- Press the H key
- Type **STAT**
- Press the SPACE bar and type **B:*.***
- Press RETURN
- Wait a few seconds, then note the number of bytes for each file and the number of bytes remaining on the disk (as shown below)

RECS	BYTES	EXT	ACC	
1	2K	1	R/W	B:NAME1
2	3K	1	R/W	B:NAME2

Bytes remaining on B:76k (5 1/4" drives)

Bytes remaining on B:236K (8" drives)

- Press the SPACE bar and wait for the Directory Menu to return

Checking the Number of Files on a Disk (BDIR)

There are two ways to check the number of files on a disk in drive B. You can change to the B drive and then count the number of file names. Or, you can use the BDIR program to display the file names without changing from the A drive.

To check the number of files on disk B (BDIR):

- Check that the Directory Menu is on the screen
- Be sure the disk you want to check is in Drive B
- Press the H key
- Type **BDIR**
- Press RETURN
- Count the document file names displayed on the screen
- Press the SPACE bar to return to the Directory Menu

Copying a File to Another Disk (PIP)

If you want to copy all the files on a disk to another disk, use the COPY program that is on the Program disk. If you want to copy only one file to another disk, use the PIP program on the Word Processing disk.

To copy a file from one disk to another (PIP):

- Check that the Directory Menu is on the screen
- Insert the disk that you will copy to (destination) in Drive B
- Press the H key
- Type PIP
- Press RETURN
- Wait for an asterisk to display
- Remove the Word Processing disk
- Insert the disk with the file that you want to copy in Drive A
- Type B:=A:filename (substitute your file's name)
- Press RETURN
- Wait for an asterisk (*) to appear on the screen
- Press CTRL & C
- Remove the disk in Drive A
- Insert the Word Processing disk in Drive A
- Press the SPACE bar

Note: If the destination disk has a document with the same title, the program will copy the new file over the old one. The old file will be erased.

Copying an Entire Disk (COPY)

When you want to make a copy of everything on a disk, you use the COPY program on the Program disk. Make sure that the disk you are copying to has already been initialized (see initialize on page 3-9). If there is anything recorded on the disk, the new material will be copied over it. So make sure you use a disk that doesn't contain material you want.

When you want to make a back up copy of your software disks, you'll use the COPY program to copy the entire software disk onto another disk. The program will display a message if there are any errors in the material it is copying.

The following procedure is for systems using 5¼" disks

To copy an entire disk (COPY):

- Check that the Directory Menu for A is on the screen
- Insert the Program disk in Drive B
- Press the H key
- Type B:COPY and Press RETURN
- Wait for the message that tells you to insert the disks to be copied
- Remove the Word Processing disk
- REMOVE the Program disk
- Insert the disk to be copied (source disk) in Drive A
- Insert to disk to copy to (destination) in Drive B
- Press RETURN
- Wait for the COPY COMPLETE message
- Press the SPACE bar to go back to the Directory Menu
(If you want to copy another disk, press RETURN instead of SPACE and follow the messages on the screen)
- Remove the disk in Drive A and insert the Word Processing disk
- Touch the SPACE bar again

The following procedure is for systems using 8" disks

To copy an entire disk (COPY) :

- Check that the Directory Menu for A is on the screen
- Press the H key
- Type COPY and Press RETURN
- Wait for the message that tells you to insert the disks to be copied
- Remove the Word Processing disk
- Insert the disk to be copied (source disk) in Drive A
- Insert disk to copy to (destination) in Drive B
- Press RETURN
- Wait for the COPY COMPLETE message
- Press the SPACE bar to go back to the Directory Menu
(If you want to copy another disk, press RETURN instead of SPACE and follow the messages on the screen)
- Remove the disk in Drive A and insert the Word Processing disk
- Touch the SPACE bar again

Preparing (Initializing) a New Disk (INIT)

Before you can use a new disk, you need to initialize it. Initializing a disk puts a Directory on the disk and prepares it so the 820 can record information on it. You use the INIT program to initialize a new disk. When you get a new box of disks, it's a good idea to initialize the whole box when you first open it.

You can also use the INIT program to completely erase a previously used disk.

The INIT program will check the disk for flawed (damaged) sectors and display a message to tell you whether or not the disk has flaws.

Be sure the disk is not Write Protected before you try to initialize it. If you are initializing a 5¼" disk, the Write Protect tape should be removed, and, when initializing an 8" disk, the Write Protect tape should be on.

The following is for systems using 5¼" disks

To initialize a disk (INIT):

- Check that the Directory of A is on the screen.
- Insert the Programs disk in Drive B
- Press the H key, Type B:INIT and press RETURN
- Wait for the message ENTER DISK DRIVE TO BE INITIALIZED
- Remove the Programs disk
- Put the disk to be initialized in Drive B
- Type B and press RETURN twice
(The program will display plus signs as it initializes the disk; then it will verify that none of the sectors are flawed. When it is finished, it will display a message that tells you the number of flawed sectors.)
- Wait for the # FLAWED SECTORS message
(If you want to initialize another disk, press RETURN, remove the disk in Drive B, insert another disk, type B and RETURN twice.)
- Press the SPACE bar when finished initializing
- Wait for the message "Touch any key to return to Directory Menu"
- Press the SPACE bar
- Wait for the Directory to return to the screen

The following is for systems using 8" disks

To initialize a disk (INIT):

- Check that the Directory of A is on the screen.
- Press the H key, Type INIT and press RETURN
- Wait for the message ENTER DISK DRIVE TO BE INITIALIZED
- Put the disk to be initialized in Drive B
- Type B and press RETURN twice
(The program will display plus signs as it initializes the disk; then it will verify that none of the sectors are flawed. When it is finished, it will display a message that tells you the number of flawed sectors.)

- Wait for the # FLAWED SECTORS message
(If you want to initialize another disk, press RETURN, remove the disk in Drive B, insert another disk, type B and RETURN twice.)
- Press the SPACE bar when finished initializing
- Wait for the message "Touch any key to return to Directory Menu"
- Press the SPACE bar
- Wait for the Directory to return to the screen

This is the Directory Menu

<p>A = WORK ON A DOCUMENT FILE B = change disk drives C = delete a file D = turn directory off (ON) E = edit a program F = print a file G = rename a file</p>	<p>H = run a program... for: checking disk space, copying a disk & seeing B drive directory ESC key = restart software HELP key = change help level CTRL (-) = scroll directory down CTRL (=) = scroll directory up</p>
---	---

You may touch any key shown above.

DIRECTORY of disk A:
 BDIR.COM PIP.COM STAT.COM XWS.COM WSMMSG.S.OVR WSOVLY1.OVR

CHANGING THE HELP LEVEL

The HELP key can be used to **change the help levels**. Normally, the menus are shown on the screen to help you remember the different commands. This is help level 3. If you can remember the commands and don't need the menus on the screen, you can change to help level 2. See the HELP section of this manual for more information.

SCROLLING A LONG DIRECTORY

The = (equal) and - (hyphen) can be used with the CTRL key to scroll the titles on a Directory up and down the screen.

This is the Directory Menu

<p>A = WORK ON A DOCUMENT FILE</p> <p>B = change disk drives</p> <p>C = delete a file</p> <p>D = turn directory off (ON)</p> <p>E = edit a program</p> <p>F = print a file</p> <p>G = rename a file</p>	<p>H = run a program. . . for: checking disk space, copying a disk & seeing B drive directory</p> <p>ESC key = restart software</p> <p>HELP key = change help level</p> <p>CTRL (-) = scroll directory down</p> <p>CTRL (=) = scroll directory up</p>
---	---

You may touch any key shown above.

DIRECTORY of disk A:
 BDIR.COM PIP.COM STAT.COM XWS.COM WSMGS.OVR WSOVLY1.OVR

TURNING THE DIRECTORY OFF AND ON

The letter **D** is used to give the **turn directory off (ON)** command. This command removes the DIRECTORY from the screen, and returns it to the screen after the command has been removed. When you press the **D** key, it will turn the DIRECTORY off. When you press the **D** key again, it will turn it back on. We recommend that you leave the Directory on.

To turn the Directory off or on:

- Begin with the Directory Menu on the screen
- Press the **D** key
 (This will turn the Directory OFF if it is on. Or, ON if it is off.)

EDITING A PROGRAM

The letter **E** is used to give the **edit a program** command. You use this command when you want to recall any file that is not a document file and edit it using the Word Processing features. If you work only with document files, you'll have no need for this command.

Some of the word processing features will be different when you edit a program.

1. There will be no automatic page breaks inserted in the file.
2. Automatic carrier returns (word wrap) will not be inserted.
3. Tabs will be set every 8 spaces (and cannot be changed). Tabs will be a single character (09 hex), as opposed to the multiple spaces entered in word processing, and will be compatible with CP/M.
4. Justification will be turned off.
5. The status line will show FILE CHARACTER and FILE LINE for the position of the cursor.
6. The dot print commands (period in column 1) will not be checked during editing.

(This page intentionally blank)

EDITING

Any document file that has been stored on disk can be recalled and edited. When you edit a document, you will end up with two copies of the document on the disk. The original copy will be stored as a BAK (back-up) file and the edited copy will be stored under the original title.

CHECKING DISK SPACE AND NUMBER OF FILES

It is extremely important that you check the amount of room on your disk before you begin editing a document file. If there is not enough room on the disk to save two copies of the document file, your editing changes will not be saved.

The amount of space on a disk is shown to you in "K bytes". (The K means thousand and each byte is a character.) A page of typing takes about 2K bytes. To find out how many pages you can type on a disk, divide the number of bytes by 2. If there is not enough room on the disk to edit a document file, you can copy it to another disk, or delete some of the files on the disk to make more room.

To check the amount of room on a disk, you use the **H** command on the Directory to run the **STAT** program. The **STAT** program is simply a set of instructions that tell the 820 to look at your disk and tell you how much room there is on the disk.

This is the Directory Menu

A = WORK ON A DOCUMENT FILE B = change disk drives C = delete a file D = turn directory off (ON) E = edit a program F = print a file G = rename a file	H = run a program... for: ← checking disk space, copying a disk & seeing B drive directory ESC key = restart software HELP key = change help level CTRL (-) = scroll directory down CTRL (=) = scroll directory up
--	--

You may touch any key shown above.

DIRECTORY of disk A:
BDIR.COM PIP.COM STAT.COM XWS.COM WSMGS.OVR WSOVLY1.OVR

Read the steps below to find out how to check disk space. If you wish to practice this, there is an exercise on page 4-3.

Here's how it works ...

To check disk spaces:

- Begin with the Directory Menu on the screen
- Put the disk you will be editing in the **B** drive
- If the Directory of B is not displayed, press the **B** key, then type **B:** and press RETURN
- Press the **H** key
- Type the word **STAT**
- Press RETURN
- Check the number in the DISK SPACE REMAINING message
- Press the SPACE bar to return to the Directory

EDITING

4-1

7/1/81

It is also extremely important that you check the number of document files on your disk before you begin editing. You can only have 32 document files on a 5¼" disk, and 64 document files on an 8" disk. . If you try to edit a document file on a disk that already has the maximum number of document files on it, your editing changes will not be saved.

To count the number of files on a disk, change to the B drive so the **DIRECTORY** of disk B is on the screen. Then count the file names before you recall a file for editing.

If the maximum number of document files are on a disk, you should delete some of the files to make room for your edited file, or you can copy the file to another disk and edit it there. Instructions for copying and deleting files are given in the **DIRECTORY** section of this manual.

RECALLING A DOCUMENT FILE FOR EDITING

When you are ready to revise a document file, you recall it to the screen using the **WORK ON A DOCUMENT FILE** command on the Directory Menu. Be sure the Directory of the B disk is displayed at the bottom of the screen before you begin to edit a document file.

The exercise on the next page gives you a chance to practice recalling a document.

Practice Exercise

This exercise will give you a chance to use the STAT and BDIR programs to check disk space and the number of files on a disk. The exercise uses one of the documents on your training disk.

BEGIN with the Directory Menu on the screen and the Word Processing Disk in Drive **A**

MAKE sure your training disk is in the Drive **B**

CHANGE to Drive **B**

- Press **B**
- Type **B:**
- Press **RETURN**

CHECK the number of files on the **B** disk (if there are 32 on a 5¼" disk, or 64 on an 8" disk , you'll need to delete one of the BAK files, using the instructions on page 3-2)

CHECK the disk space on the **B** disk

- Press the **H** key
- Type the word **STAT**
- Press **RETURN**
- Check the **SPACE REMAINING** (if it is less than 4K, delete one of the BAK files, using the instructions on page 3-2)
- Press the **SPACE** bar to return to the Directory Menu

RECALL the document file **EDIT**

- Press the **A** key
- Type **EDIT**
- Press **RETURN**

Now that the document file is on the screen, you could make editing changes. For this exercise, you'll simply save the file again, without changing it.

SAVE the document file

- Press **CTRL & 3**
- Press the **G** key

DELETING (ERASING) TEXT

You learned in the **Word Processing Handbook** that you can use the BACKSPACE and DEL (delete) keys to erase characters. The BACKSPACE key backs up the cursor and erases the character to the left. The DEL key erases the character that the cursor is on.

You can use the BACKSPACE and DEL keys to erase text, spaces, carrier returns, etc. You can also use the **delete this line** command on the Main Menu to delete the line where the cursor is. If you delete text in the middle of a paragraph, you should use the **reformat paragraph** command to rearrange the line endings.

B:FILENAME PAGE LINE COL		INSERT ON	
MAIN MENU		HELP	= for assistance
1	= go to menu	E	= change help level
2	= block menu	F	= scroll up screenful
3	= document menu	G	= scroll down screenful
4	= format (display)	J	= find
5	= format (nondisplay)	K	= find & replace
6	= reformat paragraph	L	= repeat find & replace

You may type now -or- give a command using CTRL + (any key shown above).			

Read the steps below to see how deleting works. You can use the exercise on page 4-6 to practice deleting.

Here's how it works ...

To correct errors while typing:

- Press the BACKSPACE key once for each character to be deleted

To delete text after typing:

- Move the cursor to the first character to be deleted
- Press the DEL key once for each character to be deleted
Or, press CTRL & 7 to delete the entire line

To reformat a paragraph:

- Move the cursor to the first character of the paragraph
- Press CTRL & 6

NOTE: If there is a word in the paragraph that needs to be hyphenated, the system will stop and ask you where you want to hyphenate it. You can type a hyphen, or use the left arrow key to move the cursor to the left and then type a hyphen. If you do not want to hyphenate the word, you can press CTRL & 6.

INSERTING TEXT

Inserting text is very easy on your system. Basically, you place the cursor at the position where the text should be inserted and type the new text. If you add text to a paragraph that is already typed, you'll need to use the **reformat paragraph** command after typing the new text. This command will rearrange the line endings in the paragraph.

When you insert a new paragraph in front of existing text, you can use the **insert line here** command before you type the new text. This command tells the system to insert a carrier return to separate the new text from the existing text.

B:FILENAME PAGE LINE COL				INSERT ON ←
MAIN MENU				HELP = for assistance
1 = go to menu		7 = delete this line		E = change help level
2 = block menu		8 = insert line here		F = scroll up screenful
3 = document menu		9 = insert mode (on/off)		G = scroll down screenful
4 = format (display)		Ø = repeat next command		J = find
5 = format (nondisplay)		= = scroll up line		K = find & replace
6 = reformat paragraph		- = scroll down line		L = repeat find & replace

You may type now -or- give a command using CTRL + (any key shown above).				

The "insert mode" should be left ON for most editing. When it is on, the message INSERT ON shows at the top of the screen. If you turn the insert mode OFF, any characters you type will replace (strikeover) characters on the screen, thus erasing them. The **insert mode (on/off)** command is used to turn the insert mode on or off.

Read the steps below to see how inserting text works. Use the practice exercise on page 4-6 to practice on a document file.

To insert text in a paragraph:

- Move the cursor to the point where the text will be added
- Type the new text
- Move the cursor to the beginning of the paragraph
- Press CTRL & 6 to reformat the paragraph

To insert a new paragraph:

- Move cursor to point where paragraph will go
- Press CTRL & 8
- Type the paragraph
- Press RETURN if you want two RETURNS between paragraphs (It is not necessary to reformat)

To add text to the end of the document:

- Press CTRL & I + C to go to the end of the document
- Type the new text

Practice Exercise

Now that you have an understanding of the basic editing features, you may wish to practice them. The exercise below uses one of the documents on your training disk.

MAKE sure your training disk is in the B disk drive

IF the Directory of B is not displayed, change to drive B

- Press B
- Type **B:**
- Press RETURN

CHECK the number of files on the B disk

- Count the number of file names (if there are 32 on a 5¼" disk, or 64 on an 8" disk, you'll need to delete one of the BAK files, using the instructions on page 3-2)

CHECK the disk space on the B disk

- Press the **H** key
- Type the word **STAT**
- Press RETURN
- Check the **SPACE REMAINING** (if it is less than 4K, delete one of the BAK files, using the instructions on page 3-2)
- Press the **SPACE** bar to return to the Directory

RECALL the document file **EDIT**

- Press the **A** key
- Type **EDIT**
- Press RETURN

If you have typed document files with different margins, the Ruler Line will not match the text in this file. Page 6-8 in the **FORMATTING** section of this manual explains how to work with the Ruler Line when editing. For now, move the cursor to the first line of the paragraph and press **CTRL & 4 + F** to change the Ruler Line to match the text.

You'll make the editing changes shown on the next page.

If you know anyone who is a perfectionist, then you can relate to this:

Have you ever wondered why people have ~~such~~ a hard time making up their minds? Sometimes an author will change a sentence ~~three or~~ four times before he's satisfied with it. It's almost as though writing were like cooking a good soup: you have to work at it until the "flavor" is right.

or anyone who can type

When you have a Xerox 820, you can easily make the changes necessary to get the "flavor" right. Then when the "recipe" is perfect, you can print it out in final form. It's a whole lot easier than retyping or writing the document out by hand.

DELETE the word **such** in the first line

DELETE the words **three or** in the second line

REFORMAT the paragraph

- Move the cursor to the beginning of the paragraph
- Press CTRL & 6

INSERT the words **or anyone who can type** in the first line of the second paragraph

REFORMAT the paragraph

- Move the cursor to the beginning of the paragraph
- Press CTRL & 6

INSERT a new paragraph in front of the first paragraph

- Move the cursor to the beginning of the document file
- Press CTRL & 8 (to insert a carrier return)
- Type the handwritten paragraph
- Press RETURN once at the end of the paragraph

SAVE the document file

- Press CTRL & 3
- Press the G key

DISCARDING EDITING CHANGES

Should you make a mistake while editing and want to start over from the beginning, you can do so easily. The **document menu** on the Main Menu is used to save document files.

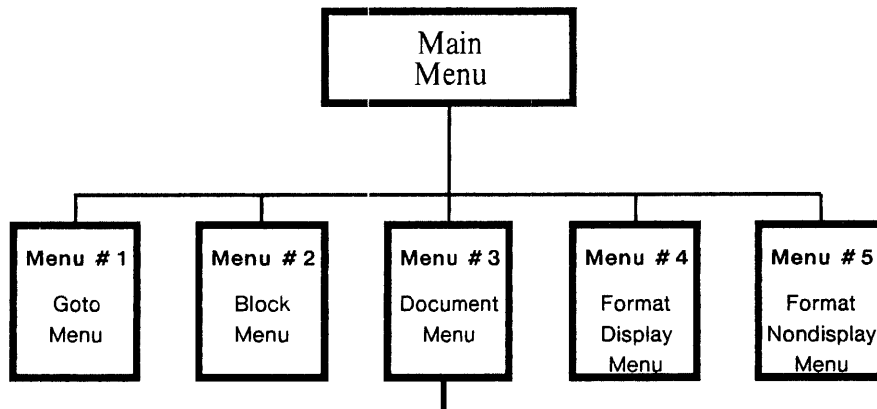

B:FILENAME	PAGE	LINE	COL	Ø	INSERT ON
DOCUMENT MENU					HELP = for assistance
ESC = erase screen; don't save anything					SAVE FILE and . . .
A = change disk drives					G = display the directory
B = delete a file					H = re-display the file
C = file directory on/off					I = re-set all settings

You may touch any key shown above. Touch SPACE bar to close the menu.					

The **document menu** can also be used to tell the system that you do not want to save the document file on the screen. To do this, you use the command **ESC = erase screen, don't save anything**.

Pressing CTRL & 3 and then the ESC key will remove the document file from the screen without saving anything. If the document file is a new (never before saved) file, it will simply be discarded. If the document file has been recalled for editing, the editing changes will be discarded, but the original document file will remain unchanged and still have its original name.

Read the steps below to see how it works. There's a practice exercise on page 4-11, if you want to try this.

Here's how it works ...

To discard the document file on the screen:

- Check that the Main Menu is on the screen
- Press CTRL & 3
- Press the ESC key
- Press the Y key
- Wait for the Directory Menu to return

USING FIND AND REPLACE

There may be times when you need to change one word or phrase to another wherever it appears in a document. For example, if you had typed a report about the **Smith** Company and then found out that it should have been the **Smyth** Company, you would need to change the word Smith to Smyth everywhere it appeared in the document.

The **find & replace** command on the Main Menu can be used to replace a word or group of words with another word or group of words. When you give the find & replace command, the system will ask you to type in the word or words to be found. Then it will ask you to type in the replacement word(s). After that it will search through the document and replace the old words with the new words.

B:FILENAME PAGE LINE COL Ø				INSERT ON		
MAIN MENU				HELP	=	for assistance
1	=	go to menu		7	=	delete this line
2	=	block menu		8	=	insert line here
3	=	document menu		9	=	insert mode (on/off)
4	=	format (display)		Ø	=	repeat next command
5	=	format (nondisplay)		=	=	scroll up line
6	=	reformat paragraph		-	=	scroll down line
					E	= change help level
					F	= scroll up screenful
					G	= scroll down screenful
					J	= find
					K	= find & replace
					L	= repeat find & replace

You may type now -- give a command using CTRL + (any key shown above).

The find & replace command has several options you can use. The options can be brought to the screen by typing ? (question mark) after you type the find and replace words. The most useful options are:

G = replace in entire file
N = replace w/o asking
U = ignore case
W = whole words only

The **G** (replace in entire file) option can be used if the cursor is not positioned at the beginning of the document file. Normally, find will search from the cursor position to the end of the file. If you use the **G** option, the system will go back to the beginning of the document, rather than starting at the position of the cursor.

The **N** (replace w/o asking) option can be used to tell the system to make all the replacements without stopping each time to ask you if you want this word replaced. Normally, the system will stop to let you decide if a word should be replaced.

The **U** (ignore case) option can be used to find the word regardless of whether it is typed in upper or lower case. For instance, if you tell the system to find "the" using the **U** option, it will find **THE**, **The** and **the**.

The **W** (whole words only) option can be used to tell the system to find the word only if it is a whole word and not part of another word. For instance, if you tell the system to find "other" using the **W** option, it will find the word "other" when it appears alone. It will not find **brother**, **mother**, **otherwise**, etc.

Read the steps below to learn about find and replace. If you wish to practice using find and replace, there's a practice exercise on page 4-11.

Here's how it works ...

To find and replace words:

- Be sure the Main Menu is on the screen
- Press CTRL & K
- Type the word or words to be replaced
- Press RETURN
- Type the new word(s)
- Press RETURN
- If you want to use any options, type the option letters, or type ? and RETURN to display the options on the screen. Type the letters of the options you want to use
- Press RETURN to start the find & replace action

After using find and replace, you'll need to reformat the document if the replacement text had a different number of characters than the original text. To reformat the entire document, you'll use the **repeat next command** and **reformat** commands on the Main Menu.

Here's how it works ...

To reformat the entire document:

- Press CTRL & 1 + D to move the cursor to the beginning of the document
- Press CTRL & 0 (zero)
- Press CTRL & 6

If a word needs to be hyphenated, the reformat will stop. You can type a hyphen or use the left cursor key to move the cursor and then type a hyphen. (If you don't want to hyphenate a word, press CTRL & 6.)

Touching any key cancels the repeat command. After hyphenating a word, you'll need to start the reformat again:

- Press CTRL & 0 (zero)
- Press CTRL & 6

More About Find and Replace

Other options available for find and replace are **# of times** and **search backwards**. Search backwards tells the 820 to find and replace the text between the cursor position and the beginning of the document file. (Remember, the option **replace in entire file** is normally used to act on the whole file, regardless of the cursor position.)

The **# of times** option can be used to tell the 820 to make the replacement a certain number of times. For instance, you would use this if you wanted to replace only the first three occurrences of a word in the file. By typing the number 3 in the options, the find and replace action will stop after it has found the first three occurrences.

Practice Exercise

This exercise gives you a chance to practice using find and replace with the various find and replace options. After you have made the replacements, you'll reformat the entire file to be sure that the line endings are correct for the new text. The exercise also gives you a chance to practice removing the file from the screen without saving the revisions.

MAKE sure your training disk is in the B disk drive

IF B Directory is not displayed, change to drive B

- Press B
- Type **B:**
- Press RETURN

CHECK the number of files on the B disk

- Count the file names (if there are 32 on a 5¼" disk, or 64 on an 8" disk, you'll need to delete one or more of the BAK files, using the instructions on page 3-2)

CHECK the disk space on the B disk

- Press the **H** key
- Type the word **STAT**
- Press RETURN
- Check the **SPACE REMAINING** (if it is less than 4K, you'll need to delete one or more BAK files, using the instructions on page 3-2)
- Press the **SPACE** bar to return to the Directory Menu

RECALL the document file **EDIT**

- Press the **A** key
- Type **EDIT**
- Press RETURN

FIND and **REPLACE** the word "flavor" with the word "taste" (use the options **replace in entire file** and **ignore case**)

- Press **CTRL & K**
- Type **flavor**
- Press RETURN
- Type **taste**
- Press RETURN
- Type **?** and press RETURN (to bring up the options)
Notice that **G** = replace in entire file and **U** = ignore case
- Type **GU**
- Press RETURN
- Each time the 820 stops at the word "flavor", press the **Y** key to replace it

EDITING
4-11

Practice Exercise (cont'd)

USE find and replace again to replace the word "the" with the word "THE"

This time use the options **N = replace w/o asking**, **G = replace in entire file**, **W = whole words only** and **U = ignore case**

- Press CTRL & K
 - Type **the**
 - Press RETURN
 - Type **THE**
 - Press RETURN
 - Type **NGWU**
 - Press RETURN
- The 820 will automatically make all the replacements without stopping and asking.

REFORMAT the document file

- Press CTRL & 1 + D (to move the cursor to the beginning of the file)
 - Press CTRL & 0 (zero -- to give the repeat command)
 - Press CTRL & 6
- If the 820 asks you to make a hyphenation decision, press the hyphen key, then press CTRL & 0 and CTRL & 6 again to restart the reformat.

REMOVE the document file from the screen without saving the editing changes

- Press CTRL & 3
- Press the ESC key
- Press the Y key

WORKING WITH BLOCKS OF TEXT

The **block menu** on the Main Menu is used to work with blocks of text. A block of text can be any amount of text: a sentence, a paragraph, several paragraphs, or an entire page. You can delete a block of text, or move or copy it to another location in the document, or copy it into a new document file.

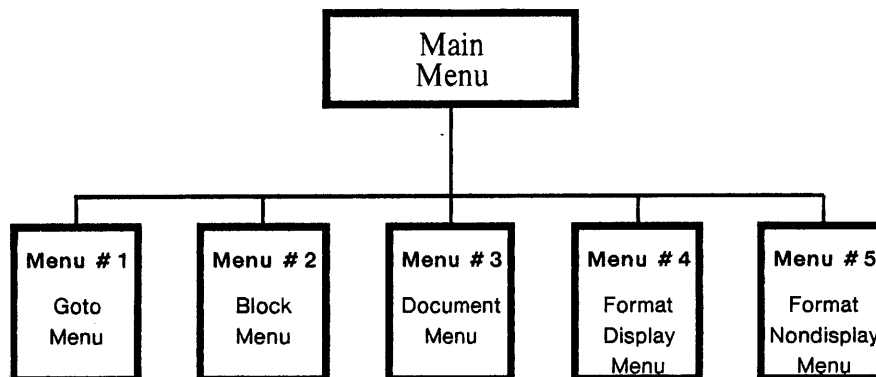

B:FILENAME	PAGE	LINE	COL	Ø	INSERT ON
MAIN MENU					HELP = for assistance
1 = go to menu		7 = delete this line			I E = change help level
2 = block menu		8 = insert line here			I F = scroll up screenful
3 = document menu		9 = insert mode (on/off)			I G = scroll down screenful
4 = format (display)		Ø = repeat next command			I J = find
5 = format (nondisplay)		= = scroll up line			I K = find & replace
6 = reformat paragraph		- = scroll down line			I L = repeat find & replace

You may type now -or- give a command using CTRL + (any key shown above).

To work with a block of text, you mark the beginning and the end of the block. This tells the 820 how much text you want to work with. The commands on the Block Menu used to mark the beginning and end of a block of text are:

- A = mark block beginning
- B = mark block ending

Read the steps below to learn about marking blocks. There's a practice exercise on page 4-18 that you can use to practice marking blocks.

Here's how it works ...

To mark a block of text:

- Begin with the file on the screen
- Position the cursor at the beginning of the block (under the first character)
- Press CTRL & 2
- Press the A key
- Move the cursor to the end of the block (after the last character)
- Press CTRL & 2
- Press the B key

The beginning and end of the block will be marked on the screen by the block markers as shown below. The beginning block marker looks like a B in parentheses and the end block marker looks like a K in parentheses.

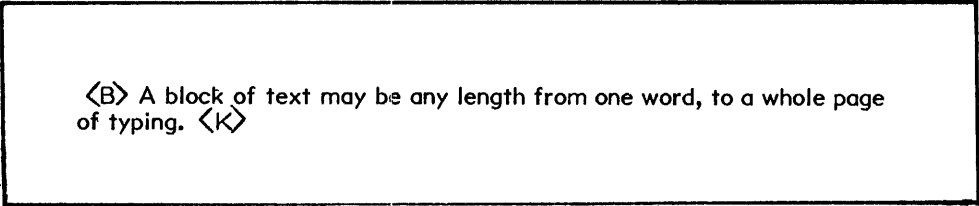

 A block of text may be any length from one word, to a whole page
of typing. <K>

MORE ABOUT BLOCKS OF TEXT

Block markers cannot be erased while the document file is on the screen. However, when you store the file, they will automatically be removed.

You can have only one set (beginning and end) of block markers in a file. You can change the location of the markers as often as you like. To do this, simply move your cursor to a new position and give the block mark commands. This will move the block markers from the original location to the new location.

The Block Menu has a **block marker display (on/off)** command. You can use this command to remove the block markers from the display. That is, the markers will remain in the file, but will not show on the screen. However, it is recommended that you leave the **block marker display ON** at all times.

DELETING A BLOCK OF TEXT

You can quickly delete (erase) a large amount of text by marking it as a block and then using the delete block command on the Block Menu (#2 on the Main Menu). Before you can use the delete block command, you need to mark the beginning and end of the block.

B:FILENAME PAGE LINE COL #		INSERT ON	
BLOCK MENU		HELP = for assistance	
A = mark block beginning	D = delete block ←	G = block marker	
B = mark block ending	E = move block	display (on/off)	
C = copy block	F = save block in	0-9 = assign a marker #	
	another file		

See GO TO MENU to find place markers 0-9.
You may touch any key shown above. Touch SPACE bar to close the menu.

The command used to delete a block of text is:

D = delete block

When you mark a paragraph as a block, be sure you include the punctuation and carrier returns at the end.

Read the steps below to learn about deleting blocks. You can use the practice exercise on page 4-18 to practice this.

Here's how it works ...

To delete a block of text:

- Mark the beginning and end of the block (steps on page 4-14)
- Press CTRL & 2
- Press the D key

MOVING TEXT TO A NEW LOCATION

Frequently editing changes call for moving text from one location to another. Perhaps the first paragraph is to be put at the end, or a paragraph in the middle of the document is to be moved to the beginning. You can use the block move command to move it quickly and easily from its old location to the new location.

Moving text is a two step process. First, you mark the beginning and end of the block of text. Then you move the cursor to the new location for the text and give the move command. The commands that you'll use are on the Block Menu (#2 on the Main Menu).

B:FILENAME PAGE LINE COL BLOCK MENU		INSERT ON HELP = for assistance	
A = mark block beginning		D = delete block	
B = mark block ending		E = move block	
C = copy block		F = save block in another file	
		G = block marker display (on/off)	
		0-9 = assign a marker #	

See GO TO MENU to find place markers 0-9.
You may touch any key shown above. Touch SPACE bar to close the menu.

When you mark a paragraph as a block, be sure you include the punctuation and carrier returns at the end. Moving these with the paragraph will separate it from other text in its new location.

Read the steps below to learn about moving blocks. There's a practice exercise on page 4-18 if you wish to practice doing this.

Here's how it works ...

To move a block of text:

- Mark the beginning and end of the block (steps on page 4-14)
- Move the cursor to the new location
- Press CTRL & 2
- Press the E key

COPYING (DUPLICATING) TEXT IN A DOCUMENT FILE

There may be times when you want to duplicate text already typed in your document. For example, you may have a note or a reference repeated in several places throughout a document. You could type the text over again each time. Or, you could type the text once and then use the block copy command to duplicate the text at each location.

Copying text is a two step process. First, you mark the beginning and end of the block of text. Then you move the cursor to the location where you want it copied and give the copy block command. The text will be copied to the new location and remain in the original location as well.

The commands you'll use are on the Block Menu (shown on the opposite page).

A = mark block beginning
B = mark block ending
C = copy block

Read the steps below to learn about copying blocks. There's a practice exercise on page 4-18 if you wish to practice doing this.

Here's how it works ...

To copy a block of text:

- Mark the beginning and end of the block of text (steps on page 4-14)
- Move the cursor to the new location
- Press CTRL & 2
- Press the C key

When you copy a paragraph, you'll need to include the carrier returns at the end of the paragraph. The returns will separate the paragraph from any text in the new location for the paragraph.

Practice Exercise

This exercise will give you a chance to practice working with blocks. You'll delete a block of text, move a block of text, and copy a block of text so that it appears twice in the document file. You'll use the document file named **EDIT** on your training disk. If you used this file for the exercise on page 4-4, the file will have three paragraphs (shown below). If you did not do the exercise, the file will have only two paragraphs. The exercise will work with either two or three paragraphs.

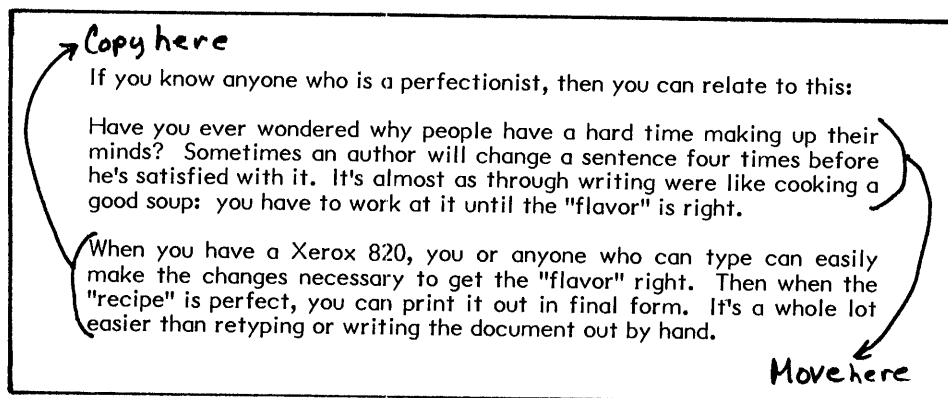

MAKE sure your training disk is in the B disk drive

IF B Directory is not displayed, change to drive B.

- Press B
- Type **B:**
- Press RETURN

CHECK the number of files on the B disk

- Count the number of file names (if there are 32 on a 5¼" disk, or 64 on an 8" disk, you'll need to delete one or more of the BAK files, using the instructions on page 3-2)

CHECK the disk space on the B disk

- Press the **H** key
- Type the word **STAT**
- Press RETURN
- Check the **SPACE REMAINING** (if it is less than 4K, you'll need to delete one or more BAK files, using the instructions on page 3-2)
- Press the **SPACE** bar to return to the Directory

RECALL the document file **EDIT**

- Press the **A** key
- Type **EDIT**
- Press RETURN

FOLLOW the steps on the next page to make the changes.

Practice Exercise (cont'd)

COPY the last paragraph to the beginning of the document file

- Move your cursor to the first character of the last paragraph (under the **W** in When)
- Press CTRL & 2, then **A** (to mark the block beginning)
- Move your cursor to the end of the block (the second line below the paragraph, so you move the two returns at the end of the paragraph with the text)
- Press CTRL & 2, then **B** (to mark the end of the block)
- Move your cursor to the beginning of the document file
- Press CTRL & 2, then **C** (to copy the block)

MOVE the paragraph beginning with "Have you ever wondered why ..." to the end of the file

- Move your cursor to the first character of the paragraph (under the **H** in Have)
- Press CTRL & 2, then **A** (to mark the block beginning)
- Move your cursor to the end of the block (to include the two returns at the end of the paragraph you'll need to move the cursor under the first character **W** of the next paragraph)
- Press CTRL & 2, then **B** (to mark the block ending)
- Move your cursor to the end of the file
- Press CTRL & 2, then **E** (to move the block)

DELETE the first paragraph in the file

- Move your cursor to the first character of the paragraph (under the **W** in When)
- Press CTRL & 2, then **A** (to mark the block beginning)
- Move your cursor to the end of the block (the space below the paragraph)
- Press CTRL & 2, then **B** (to mark the end of the block)
- Press CTRL & 2, then **D** (to delete the block)

SAVE the document file

- Press CTRL & 3, then **G**

COPYING TEXT INTO A NEW DOCUMENT FILE

There may be times when you want to copy a portion of a document file into a new file so that you can work with it. For instance, you might have a statistical table that you want to put in two different reports.

You can use the Block Menu (#2 on the Main Menu) to copy text from one document to another. The commands that you'll use are:

A = mark block beginning
B = mark block ending
F = save block in another file

It is important to note that the copied text will replace any text already typed in the other document file. Therefore, you'll need to copy the text into a new document file before you type anything else in it.

Read the steps below and on the next page to learn about copying text. There is no practice exercise for copying text, but you can try this on your own if you wish.

Here's how it works ...

To mark a block of text:

- Begin with the file on the screen
- Position the cursor at the beginning of the block
- Press CTRL & 2 + A (to mark the beginning of the block)
- Move the cursor to the end of the block
- Press CTRL & 2 + B (to mark the end of the block)

To copy a block of text to another file:

After marking the block of text,

- Press CTRL & 2
- Press the F key
- Type the name of the other file
- Press RETURN

Note: If the name you typed belongs to a file already on the disk, the screen will display the message:

THE FILE CALLED: "name" ALREADY EXISTS. SHOULD I WRITE OVER IT?
(Y/N)

If you type **Y**, the block of text will replace any text in the file. If you type **N**, the block text will not be copied. You can then give the CTRL & 2 + F command again and type a different file name.

You can also copy all the text in one document file into another. The file that you are copying to can have text already typed in it. The text that is copied into it will be placed at the cursor position and will not erase anything.

This is a useful feature if you want the entire contents of one document file copied into another. However, this feature cannot be used to copy selected portions of a file; it will copy the entire file. You can delete unwanted text after copying it, if you so desire.

When you do this, you need to be careful that the resulting document does not become too long. The MULTI-PAGE DOCUMENT section gives you rules for working with long documents. It is best to keep all your documents shorter than 10 pages.

The command on the Document Menu (#3 on the Main Menu) that you'll use is:

E = read another file into this one

Here's how it works ...

To copy an entire file into another file:

- Bring the file that will receive the copied material (destination file) to the screen
- Move your cursor to the point where the copied material should be added
- Press CTRL & 3
- Press the E key
- Type the name of the file to be copied
- Press RETURN

If you do not remember the name of the file that you want to copy from, you can display the Directory and then give the copy command.

Here's how it works ...

With a file on the screen,

To display the Directory:

- Press CTRL & 3
- Press C key (to display the Directory)

To remove the Directory:

- Press CTRL & 3
- Press C key (to remove the Directory)

(This page intentionally left blank)

FORMATTING

The "format" of a document refers to the way it looks on the page. The margins and tabs used for the document are part of the format.

As you can see from the picture, other factors also affect the way a document looks on a page. Some of these are the line spacing, the length of the paper and the number of lines on a page, the pitch that the document is printed in, and whether or not the right margin is justified.

The picture below shows a document that was typed with margins of 1 and 80, with a tab at 6, double line spacing, justify on, and paper length set at 66.

The 820 has standard settings for each of the format items. The standard settings are given on the next page.

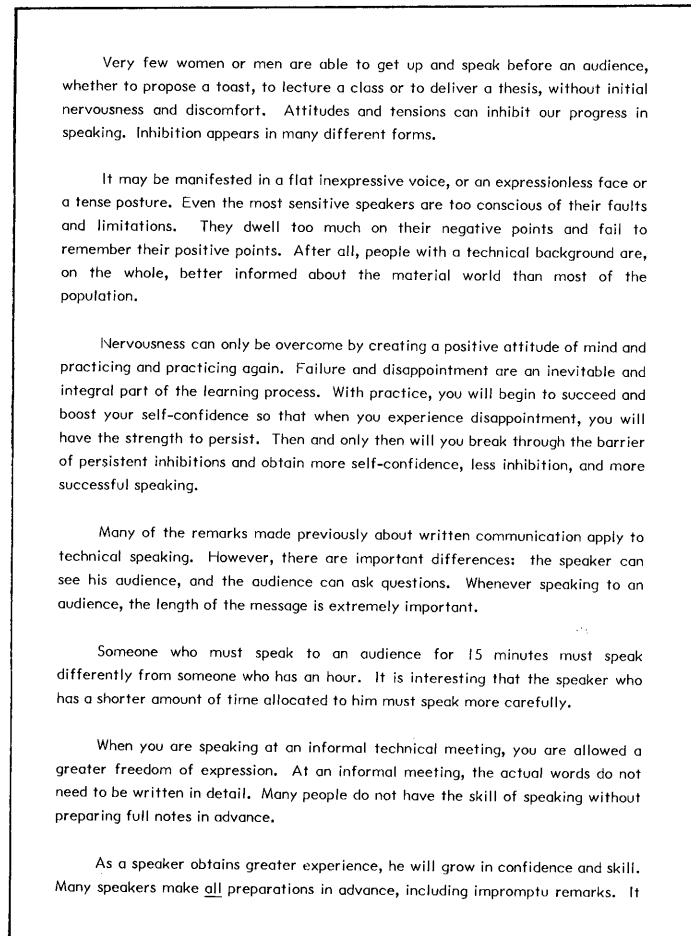

Standard Format Settings

When you load Word Processing, it gives you the standard format settings shown below.

Standard Format Settings:

MARGINS	1 and 65
TABS	6, 11, 16, 21 ... (every 5 spaces)
LINE SPACING	Single
PITCH	10
JUSTIFICATION	On
TOP AND BOTTOM MARGINS	1 inch
PAPER LENGTH	11 inches

This section of the manual tells you how to use and change the standard format settings. It also explains how to indent the first line of a paragraph and how to indent all the lines of a paragraph, how to type an outline format, and how to type a document with wide margins.

Note: The left margin of 1 will print 8 spaces to the right of 0 on the printer's paper scale. Keep this in mind when you insert paper in the printer.

CHANGING MARGINS & TABS

The margin and tab settings are shown on the Ruler Line (or Screen Ruler) in your document. (The Ruler Line is under the Main Menu, as shown in the second picture below.) As you type, your text will be positioned according to the margins and tabs on the Ruler Line. If you change the settings on the Ruler Line, text you type after the change will be positioned using the new margins and tabs.

The picture below shows how text is positioned to match the settings on the Ruler Line. On the Ruler Line, **L** is the left margin, **R** is the right margin, and **|** is a tab.

The Ruler Line setting positions are referred to as columns. When text is indented with the tab key (or by setting a new left margin), the system will automatically insert spaces in front of the text to position it at the correct column.

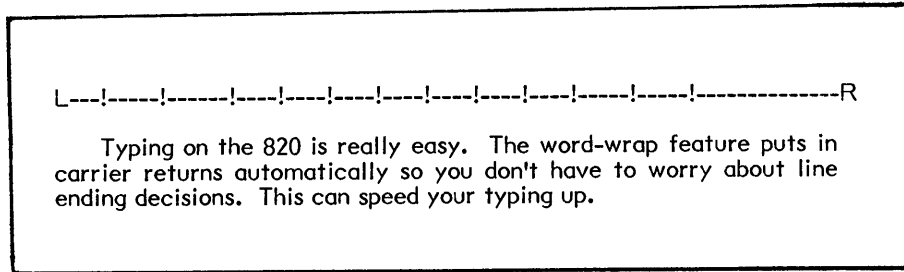

You should always check the Ruler Line before you start typing to make sure it has the correct margins and tabs for your document.

You can easily change the settings on the Ruler Line by using commands on the **format (display)** menu on the Main Menu.

B:FILENAME PAGE LINE COL 0		INSERT ON
MAIN MENU		HELP = for assistance
1 = go to menu	7 = delete this line	E = change help level
2 = block menu	8 = insert line here	F = scroll up screenful
3 = document menu	9 = insert mode (on/off)	G = scroll down screenful
4 = format (display)	0 = repeat next command	J = find
5 = format (nondisplay)	= = scroll up line	K = find & replace
6 = reformat paragraph	- = scroll down line	L = repeat find & replace

You may type now -or- give a command using CTRL + (any key shown above).

L-----|-----|-----|-----|-----|-----|-----|-----|-----|-----|-----R

When you press CTRL & 4 with the Main Menu on the screen, the Format (Display) Menu, shown below, will be brought up. From this menu, you can make changes to the margins and tabs.

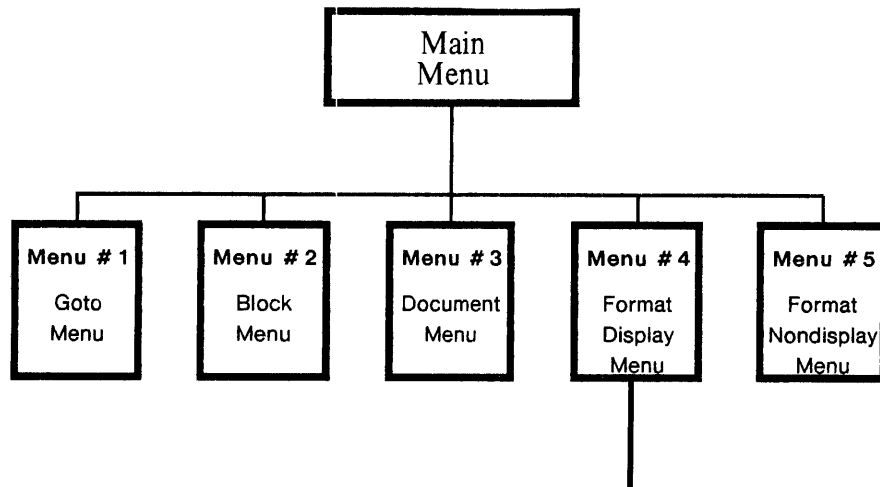

B:FILENAME PAGE LINE COL #		INSERT ON	
FORMAT (DISPLAY) MENU		HELP = for assistance	
TAB = automatic indent	F = settings from a line	L = change line spacing	
A = center the line	G = clear tab(s)	M = pagination off (ON)	
B = margin release	H = hyphenation help	N = display printer codes off (ON)	
C = set right margin	J = turn syllable hyphen off (ON)	O = ruler off (ON)	
D = set left margin	K = justify off (ON)	P = word wrap off (ON)	
E = set tab(s)			

 You may touch any key shown above. Touch SPACE bar to close the menu.

The commands you will use most often are:

- C = set right margin
- D = set left margin
- E = set tab(s)
- G = clear tab(s)

Read the information below to learn about changing margins and tabs. If you want to practice this, there is an exercise on page 5-7.

Here's how it works ...

Begin with the file on the screen.

To set the left margin:

- Press CTRL & 4 to bring up the Format (Display) Menu
- Press the **D** key
- Type the new margin setting (i.e., to set the margin at 10, type 10)
- Press RETURN

To set the right margin:

- Press CTRL & 4 to bring up the Format (Display) Menu
- Press the **C** key
- Type the new margin setting
- Press RETURN

To clear all the tabs (before you set new ones):

- Press CTRL & 4 to bring up the Format (Display) Menu
- Press the **G** key
- Press the **A** key and RETURN

To clear only one tab:

- Press CTRL & 4 to bring up the Format (Display) Menu
- Press the **G** key
- Type the tab setting to be cleared (i.e., to clear a tab set at 15, type 15)
- Press RETURN

To set a new tab:

- Press CTRL & 4 to bring up the Format (Display) Menu
- Press the **E** key
- Type the tab setting (i.e., to set a tab at 15, type 15)
- Press RETURN
- Repeat the steps above for each tab setting

The tab key is used to indent text to the tab settings. Each time you press the tab key, it will indent the line one tab setting. The tab key only indents the first line of a paragraph. The steps for indenting all the lines of a paragraph are given on page 6-13 (Typing Block Indent Text).

After Changing the Margins and Tabs

When you type text in the document file, the text will be positioned using the margins and tabs on the Ruler Line. Any text you typed before changing the Ruler Line will not be affected by the change.

When the document file is saved on disk, the Ruler Line will not be stored with the file. Therefore, when you work on the next document file, the Ruler Line will show the settings used in the last file.

If you want the Ruler Line to return to the standard settings after you save a document, you can give the 820 a **re-set all settings** command. The re-set all settings command, CTRL & 3 + I, is used to save the file and return the Ruler Line to the standard settings.

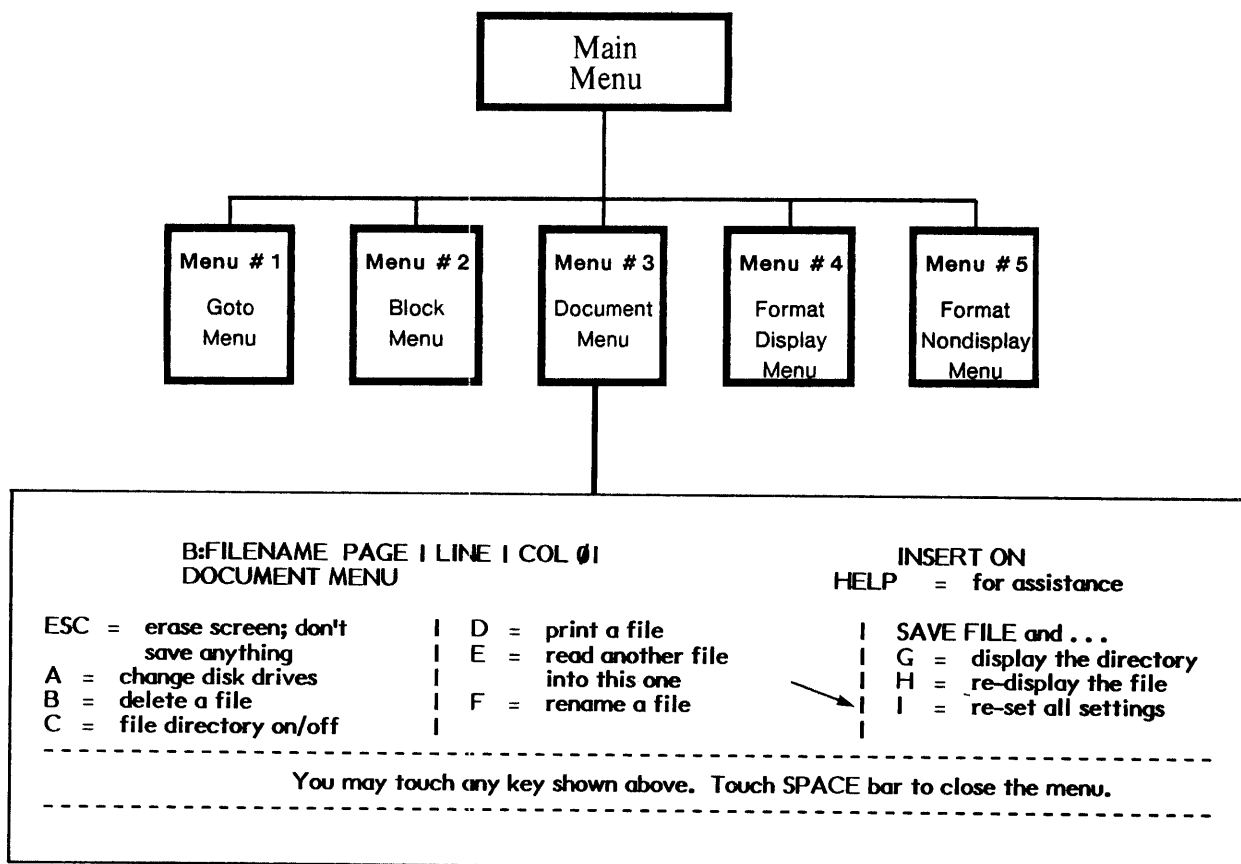

Practice Exercise

Now that you've read about changing margins and tabs, you may wish to practice it. The document you'll type is shown on the next page. Use the instructions below to start the document file.

MAKE sure your training disk or an initialized disk is in the B Drive

IF the B Directory is not displayed, change to drive B

- Press B
- Type **B:**
- Press RETURN

CHECK the number of files on the B disk

- Count the files (if there are 32 on a 5¼" disk, or 64 on an 8" disk, you'll need to delete some of the files, using the instructions on page 3-2)

CHECK the disk space on the B disk

- Press the **H** key
- Type **STAT**
- Press RETURN
- Check the **SPACE REMAINING** (if it is less than 4K, delete one or more of the files, using the instructions on page 3-2)
- Press the **SPACE** bar to return to the Directory

START a new document file named **MARGINS**

- Press the **A** key
- Type **MARGINS**
- Press RETURN

CHANGE the left margin to 20

- Press **CTRL & 4**
- Press the **D** key
- Type **20** and RETURN

CONTINUE with the instructions on the next page.

Practice Exercise (cont'd)

Time in the office consists of:

Productive time spent by the secretary and the time spent by the dictator. The time required for dictation and typing accounts for 55% of the cost of a business letter.

Nonproductive time which is caused by interruptions during a jobs production or time lost due to vacation or illness.

CHANGE the right margin to 60

- Press CTRL & 4
- Press the C key
- Type 60 and RETURN

SET a tab at 28 (you'll also need to clear the other tabs)

- Press CTRL & 4
- Press G and then A and RETURN (to clear tabs)
- Press CTRL & 4
- Press E and type 28 and press RETURN (to set a tab)

TYPE the first paragraph of the document shown above

PRESS the TAB key

Notice that the cursor moves to the first tab on the ruler.

TYPE the second paragraph of the document. Be sure you end with a RETURN.

USE your cursor keys to move the cursor to the left of the left margin

The spaces to the left of the margin were inserted by the system to position the text at Column 20 (the left margin).

WATCH the number in the COL counter as you move the cursor right and left

You can always tell where a character will print by moving your cursor to it and looking at the COL counter.

SAVE your document and return the Ruler Line to the standard settings

- Press CTRL & 3
- Press the I key

HOW TO USE THE RULER LINE WHEN EDITING

The Ruler Line will always show the standard settings or the settings you used last. Therefore, when you recall a document file, the Ruler Line may show settings that do not match the text in the file. Since the settings may be different from one document to the next, you should always check the settings on the Ruler Line before you start typing or editing a document.

Your system provides a quick way to reset the Ruler Line when you recall a document file that has different margins and tabs. The Format (Display) Menu has a **settings from a line** command that will change the margins to match the line where the cursor is. To use this command, you simply move the cursor to a line of typing that is the proper line length and press CTRL & 4 + F. (Note: If there is an exclamation point (!) on the line, the system will also set a tab at that position.)

After you set new margins, you can quickly set a tab at a new position by moving the cursor to the position and pressing CTRL & 4 + E + ESC.

B:FILENAME PAGE LINE COL		INSERT ON	
FORMAT (DISPLAY) MENU		HELP = for assistance	
TAB = automatic indent	F = settings from a line	L = change line spacing	
A = center the line	G = clear tab(s)	M = pagination off (ON)	
B = margin release	H = hyphenation help	N = display printer	
C = set right margin	J = turn syllable	codes off (ON)	
D = set left margin	hyphen off (ON)	O = ruler off (ON)	
E = set tab(s)	K = justify off (ON)	P = word wrap off (ON)	

You may touch any key shown above. Touch SPACE bar to close the menu.

Read the information below to learn how to change the Ruler Line after the file is typed. You can practice this in the exercise on the next page.

Here's how it works ...

To change the margins to match a line:

- Bring the document file to the screen
- Position the cursor on the first full line of typing
- Press CTRL & 4
- Press the F key

To clear tabs:

- Press CTRL & 4 + G
- Press A and RETURN

To set a tab:

- Move the cursor under the first indented (tabbed in) character
- Press CTRL & 4
- Press the E key and then press the ESC key

Practice Exercise

In this exercise, you'll recall a document file that was typed with margins of 10 and 70, with a tab at 17. The Ruler Line will show different margins and tabs, because the Ruler Line settings are not stored with the document. (You won't need to check disk space for this exercise because you won't be making any revisions to the file.)

MAKE sure your training disk is in the B disk drive

IF the directory of B is not displayed, change to drive B

- Press B
- Type **B:**
- Press RETURN

RECALL the document file **RULER**

- Press the **A** key
- Type **RULER**
- Press RETURN

NOTICE that the Ruler Line is shorter than the text (margins at 20 and 60)

CHANGE the margins to match the text

- Move the cursor to the second line of the paragraph (this is the first full line of typing)
- Press CTRL & 4
- Press the **F** key

NOTICE that the margins moved out to the width of the text on the cursor line

SET a tab for the indented text on the first line of the paragraph

- Press CTRL & 4 + G + A and RETURN to clear all tabs
- Move the cursor under the first character of the first line
- Press CTRL & 4 + E + ESC

SAVE the document file

- Press CTRL & 3
- Press the **I** key (to return the Ruler Line to the standard settings)

USING WIDE MARGINS

The standard setting for margins is 1 and 65. There may be times when you want to use a right margin greater than 65.

The 820's screen can show up to 80 characters on a line (margins of 1 and 79). If you set a right margin greater than 79, any characters typed after the 79th will be shown on the next line. However, when the line is printed, it will print as one long line.

To tell you that a line is continued onto the next line, your screen will display a + (plus sign) as the 80th character on a long line (see the picture below). The plus sign will not print; it only shows on the display to let you know the line is continued.

The 820 can accommodate documents with wide margins just as easily as documents with narrow margins. All you need to do is decide what margins you want in your document and set them on the Ruler Line. Then type the text, letting the 820 put in the returns for you at the end of each line.

If you have a Xerox (Diablo) 630 printer, you can print up to 130 characters on a line using 10 pitch (the standard pitch). If you change to 12 pitch, you can print up to 156 characters on a line.

If you are using some other printer, the 820 system will allow you to print up to 240 characters on a line.

Note: If you want to turn the paper horizontally to print a document that is over 8½ inches wide, you'll need to change the paper length. The standard paper length is 11 inches. When you turn the paper horizontally, you'll need to change the paper length to 8½. Directions on changing paper length are on page 5-31.

Practice Exercise

If you wish to practice typing a document file with a right margin wider than 80, follow the directions below to type the example shown on the opposite page.

MAKE sure your training disk or an initialized disk is in the B Drive

IF the B Directory is not displayed, change to drive B

- Press B
- Type **B:**
- Press RETURN

CHECK the number of files on the B disk

- Count the files (if there are 32 on a 5¼" disk, or 64 on an 8" disk, delete some of the files from the disk)

CHECK the disk space on the B disk

- Press the **H** key
- Type **STAT**
- Press RETURN
- Check the **SPACE REMAINING** (if it is less than 4K, delete some of the files from the disk)
- Press the **SPACE** bar to return to the Directory Menu

START a new document named **WIDE**

- Press the **A** key
- Type **WIDE**
- Press RETURN

CHANGE the right margin to 100

- Press **CTRL & 4**
- Press the **C** key
- Type **100** and RETURN

TYPE the text shown in the example on page 5-11 (DO NOT touch the RETURN key until the end of the paragraph -- let the 820 put in the returns)

Notice that the system splits a long line of text into two lines

STORE the document

- Press **CTRL & 3**
- Press the **I** key (to return to Ruler Line to standard settings)

TYPING BLOCK (AUTOMATIC) INDENT TEXT

Block (or automatic) indent means that all lines of a paragraph are indented, as shown in the first picture below.

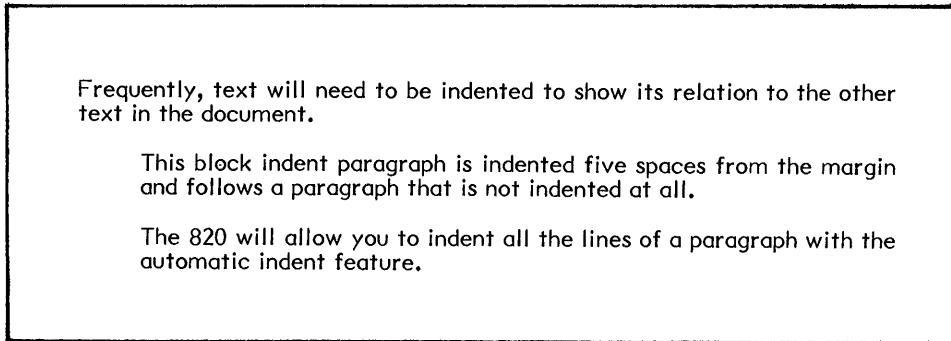

Your system will automatically indent every line of a paragraph when you press CTRL & 4 before you press the TAB key. By pressing CTRL & 4 before you press the TAB key, you are telling the system, "I want to indent every line of this paragraph." You can then type the paragraph without pressing the RETURN key until the end of the paragraph. Pressing the RETURN key cancels the automatic indent and moves the typing position back to the left margin.

When you press CTRL & 4, the Format (display) Menu will be brought to the screen. You can see that it shows **TAB = automatic indent**.

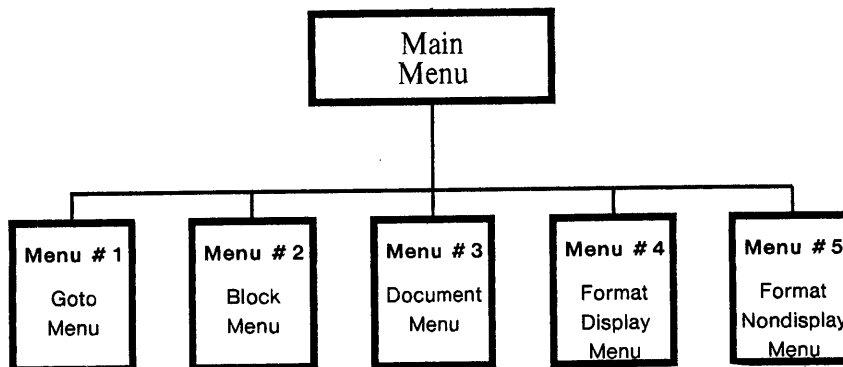

B:FILENAME PAGE | LINE | COL 01

FORMAT (DISPLAY) MENU

<p>TAB = automatic indent</p> <p>A = center the line</p> <p>B = margin release</p> <p>C = set right margin</p> <p>D = set left margin</p> <p>E = set tab(s)</p>	<p>F = settings from a line</p> <p>G = clear tab(s)</p> <p>H = hyphenation help</p> <p>J = turn syllable hyphen off (ON)</p> <p>K = justify off (ON)</p>	<p>INSERT ON</p> <p>HELP = for assistance</p> <p>L = change line spacing</p> <p>M = pagination off (ON)</p> <p>N = display printer codes off (ON)</p> <p>O = ruler off (ON)</p> <p>P = word wrap off (ON)</p>
---	--	---

You may touch any key shown above. Touch SPACE bar to close the menu.

Read the information below to learn how to use automatic indent. There is a practice exercise for this on page 5-16.

Here's how it works ...

Begin with the file on the screen.

To indent every line of a paragraph:

- Press CTRL & 4
- Press the TAB key
- Type the paragraph (do not return within the paragraph)
- End the paragraph by touching RETURN

If you need to indent a paragraph more than one tab, you will need to repeat the CTRL & 4 + TAB command for each tab. The automatic indent feature will insert enough spaces in front of the text to move it over to the correct tab setting. You can think of the automatic indent feature as temporarily resetting the left margin.

EDITING BLOCK (AUTOMATIC) INDENT TEXT

Block (automatic) indent paragraphs can be edited just like any other text. However, the steps to reformat the paragraph after editing is slightly different.

Before reformatting a block indent paragraph, you must tell the system that it is an indented paragraph. You do this by pressing CTRL & 4 + TAB (automatic indent), before you press CTRL & 6 (reformat).

Read the information below to learn about editing indented paragraphs. You can practice this in the exercise on the next page.

Here's how it works ...

Make the editing changes as you normally would.

To reformat a block indent paragraph:

- Move the cursor under the first character of the paragraph
- Press CTRL & 4 + TAB
- If the paragraph is indented more than one tab level, press CTRL & 4 + TAB once for each tab level
- Press CTRL & 6 to reformat the paragraph

Practice Exercise

This exercise will give you a chance to work with block (automatic) indent paragraphs. To see how easy they are to type and edit, type a short document file and then make a few editing changes.

Frequently, text will need to be indented.

This block indent paragraph is indented five spaces from the margin and follows a paragraph that is not indented at all.

The 820 will allow you to indent all the lines of a paragraph with the automatic indent feature.

MAKE sure your training disk is in the B Disk Drive

IF the B Directory is not displayed, change to drive B

- Press B
- Type **B:**
- Press RETURN

CHECK the number of files on the B disk

- Count the files (if there are 32 on a 5¼" disk, or 64 on an 8" disk, delete some of the files, using the instructions on page 3-2)

CHECK the disk space on the B disk

- Press the **H** key
- Type **STAT**
- Press RETURN
- Check the **SPACE REMAINING** (if it is less than 4K, delete some of the files using the instructions on page 3-2)

START a new document file named **BLOCK**

- Press the **A** key
- Type **BLOCK**
- Press RETURN

CHECK to be sure there is at least one tab setting on the Ruler Line

Practice Exercise (cont'd)

TYPE the first line in the document and RETURN twice

INDENT the next paragraph

- Press CTRL & 4
- Press the TAB key
- Type the paragraph. Do not touch RETURN until the end of the paragraph

The steps below will show you how to edit and reformat an indented paragraph. You'll be adding the phrase shown in the picture below.

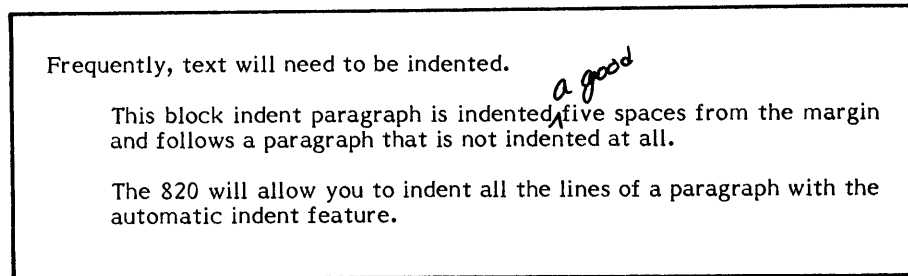

MOVE the cursor between **indented** and **five** and type the text shown above

MOVE the cursor to the first character in the paragraph (the **T** in **This**)

REFORMAT the paragraph

- Press CTRL & 4 + TAB to tell the system this is an indented paragraph
- Press CTRL & 6

SAVE the document file

- Press CTRL & 3 + G

TYPING OUTLINE FORMAT

When you type an outline like the one shown below, you'll use the block (automatic) indent tab to indent the various levels of the outline material. If you have not covered the sections TYPING BLOCK (AUTOMATIC) INDENT TEXT and EDITING BLOCK (AUTOMATIC) INDENT TEXT (pages 5-13 through 5-15), you should do so before continuing.

- A. The outline format is frequently used to show the relationship between a list of facts about a subject.
- B. In the outline format, facts that have less weight are indented under the heading that they apply to.
 - I. Normally, the outline begins at the left margin with roman numerals. Upper case alphabetic characters are indented one level and numbers are indented two levels.

The automatic indent command is given by pressing CTRL & 4 + TAB. You'll need to repeat the command once for each indent level desired. To number the paragraphs in the outline, you can give the indent command before and/or after typing the paragraph number (or letter).

Read the information below to learn about typing outlines. You can practice typing an outline in the exercise on the next page.

Here's how it works ...

To type the first paragraph shown above:

- Type A.
- Press CTRL & 4
- Press the TAB key
- Type the paragraph (do not return until the paragraph end)

To type the third paragraph shown above:

- Press CTRL & 4
- Press the TAB key
- Type I.
- Press CTRL & 4
- Press the TAB key
- Type the paragraph (do not return until the paragraph end)

Practice Exercise

If you wish to practice typing a short outline, follow the directions below and on the next page to type a short outline. When you have typed the outline, leave it on the screen while you read about Editing an Outline on page 5-20.

MAKE sure your training disk or an initialized disk is in the B Drive

IF B Directory is not displayed, change to drive B

- Press B
- Type **B:**
- Press RETURN

CHECK the number of files on the B disk

- Count the files (if there are 32 on a 5¼" disk, or 64 on an 8" disk, delete several of the files, using the instructions on page 3-2)

CHECK the disk space on the B disk

- Press the **H** key
- Type **STAT**
- Press RETURN
- Check the **SPACE REMAINING** (if it is less than 4K, delete one or more of the files, using the instructions on page 3-2)
- Press the **SPACE** bar to return to the Directory Menu

START a new document named **OUTLINE**

- Press the **A** key
- Type **OUTLINE**
- Press RETURN

The outline you'll type is on the next page.

Practice Exercise (cont'd)

- A. The outline format is frequently used to show the relationship between a list of facts about a subject.
- B. In the outline format, facts that have less weight are indented under the heading that they apply to.
 - I. Normally, the outline begins at the left margin with roman numerals. Upper case alphabetic characters are indented one level and numbers are indented two levels.

TYPE the first paragraph shown above

- Type **A.**
- Press CTRL & 4
- Press the TAB key
- Type the paragraph (do not return until the paragraph end)
- Press RETURN twice to end the paragraph

TYPE the second paragraph, repeating the steps above

TYPE the third paragraph

- Press CTRL & 4
- Press the TAB key
- Type **I.**
- Press CTRL & 4 + TAB again
- Type the paragraph (do not return until the paragraph end)

LEAVE the file on the screen while you read about **EDITING AN OUTLINE** on the next page. Then continue with the exercise on page 5-22.

EDITING OUTLINE FORMAT

The text in an outline can be edited just like any other text. When you have made the editing changes, you'll need to position the cursor on the first character in the paragraph (not on the number or letter in front of the paragraph) before reformatting. You'll also need to press CTRL & 4 + TAB once for each indent level and then give the reformat command.

In the example below, you would position the cursor on the word Normally rather than on the number 1. to begin reformatting. You would then give the CTRL & 4 + TAB command twice (once for each indent level) before pressing CTRL & 6 to reformat.

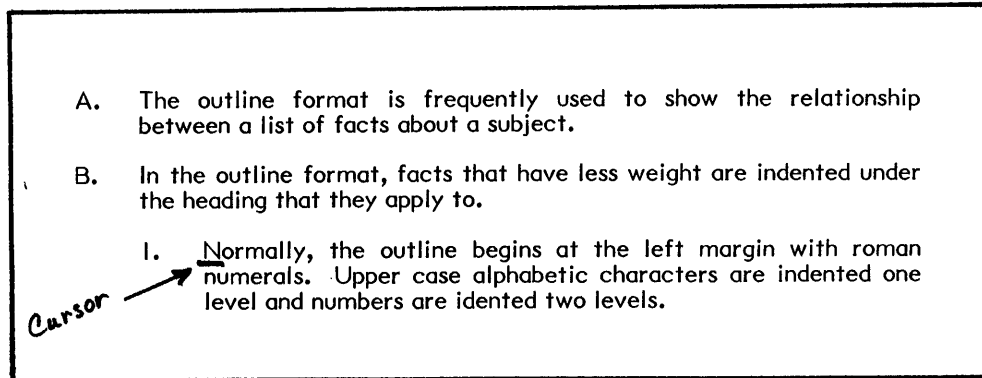

When you reformat a document that has an outline type format, you'll need to reformat one paragraph at a time. You cannot use the continue reformat command (CTRL & 0 plus CTRL & 6).

Practice Exercise (cont'd)

This exercise is continued from page 5-20 and shows you how to edit and reformat outline text.

(or a specification format)

- A. The outline format is frequently used to show the relationship between a list of facts about a subject.
- B. In the outline format, facts that have less weight are indented under the heading that they apply to.
 - I. Normally, the outline begins ~~at the left margin~~ with roman numerals. Upper case alphabetic characters are indented one level and numbers are indented two levels.

MOVE the cursor to the first line and **ADD** the text shown above

REFORMAT the paragraph

- Move the cursor under the **T** in "The"
- Press CTRL & 4 + TAB
- Press CTRL & 6 to reformat

MOVE the cursor to the third paragraph and delete the text as shown above

REFORMAT the paragraph

- Move the cursor under the **N** in "Normally"
- Press CTRL & 4 + TAB
- Press CTRL & 4 + TAB again
- Press CTRL & 6 to reformat

STORE the document file

- Press CTRL & 3
- Press the **G** key

CHANGING LINE SPACING

It is very easy to change the line spacing on your system. You can choose any line spacing from 1 (single) to 9. You'll probably use 1 (single) and 2 (double) most often.

The **change line spacing** command is on the Format (display) Menu, shown below. Typing CTRL & 4 from the Main Menu brings the Format (display) Menu to the screen. This is the same menu used for changing margins and tabs.

B:FILENAME	PAGE	LINE	COL	Ø	INSERT ON
FORMAT (DISPLAY) MENU					HELP = for assistance
TAB = automatic indent		F = settings from a line	→	L = change line spacing	
A = center the line		G = clear tab(s)		M = pagination off (ON)	
B = margin release		H = hyphenation help		N = display printer	
C = set right margin		J = turn syllable		codes off (ON)	
D = set left margin		hyphen off (ON)		O = ruler off (ON)	
E = set tab(s)		K = justify off (ON)		P = word wrap off (ON)	

You may touch any key shown above. Touch SPACE bar to close the menu.

Any text that you type after giving the change line spacing command, will have the new line spacing. When the line spacing is set at any number other than one (single), the message LINE SPACING # will show at the top of the screen next to the words INSERT ON.

If you want to change line spacing and type a new document file, you simply bring the document file to the screen and use the change line spacing command before you type text in the document.

If you want to change line spacing in a document file that has already been typed, you bring the file to the screen, change the line spacing and then **reformat**. You can use the **repeat** command (CTRL & 0) with the **reformat** command to reformat the entire document file.

Read the information below to learn about changing line spacing. You can practice this in the exercise on page 5-25.

Here's how it works ...

To change line spacing for a new document file:

- Bring the new document file to the screen
- Press CTRL & 4
- Press the L key
- Type the number for the new line spacing (1 = single, 2 = double, etc.)
- Type the text in the document

To change line spacing in a document file after it is typed:

- Bring the document file to the screen
- Move the cursor to the position where the new line spacing should start (to change it for the entire file, make sure the cursor is at the beginning)
- Press CTRL & 4
- Press the L key
- Type the number for the new line spacing (1 = single, 2 = double, etc.)
- Reformat the entire file as follows:
 - Press CTRL + 0 (zero)
 - Press CTRL & 6
 - (If the system stops for hyphenation, insert the hyphen and then press CTRL & 0 and CTRL & 6 again).

After Changing Line Spacing

When you select a line spacing greater than one (single), the system will insert the carrier returns between the lines of text. If you change the line spacing and then reformat, the system will add or subtract carrier returns between lines to give you the new line spacing.

It is important to remember that line spacing, like the Ruler Line, is not recorded in your document file. If you change the line spacing in your files, it is a good idea to always check the line spacing before you type or edit a document file.

You can change the line space setting back to single when you save a file by giving the SAVE FILE and **re-set all settings** command. To do this, you press CTRL & 3 + I. This command changes all the format settings (such as the Ruler Line and Line Spacing) back to the standard settings for the next file that you type. It does not affect the formatting in the document file that is saved.

Practice Exercise

This exercise will give you a chance to change the line spacing before you type a new document file. It will also show you how to change the line spacing and reformat the file with the new line spacing.

Many studies have been made on what can be done to make a document easy for people to read.

Results have shown that double line spacing and short line lengths seem to help people read text quickly and easily. Double spacing a document also makes it appear less "heavy."

MAKE sure your training disk is in the B Disk Drive

IF the B Directory is not displayed, change to drive B

- Press B
- Type **B:**
- Press RETURN

CHECK the number of files on the B disk

- Count the files (if there are 32 on a 5¼" disk, or 64 on an 8" disk, delete several of the files, using the instructions on page 3-2)

CHECK the disk space on the B disk

- Press the **H** key
- Type **STAT**
- Press RETURN
- Check the **SPACE REMAINING** (if it is less than 4K, delete several of the files, using the instructions on page 3-2)
- Press the **SPACE** bar to return to the Directory

START a new document file named **SPACING**

- Press the **A** key
- Type **SPACING**
- Press RETURN

CHANGE the line spacing to double

- Press **CTRL & 4**
- Press the **L** key
- Type the number **2**

NOTICE the message **LINE SPACING 2** appears at the top of the screen

Practice Exercise (cont'd)

Many studies have been made on what can be done to make a document easy for people to read.

Results have shown that double line spacing and short line lengths seem to help people read text quickly and easily. Double spacing a document also makes it appear less "heavy."

TYPE the two paragraphs shown above

Notice that carrier returns are inserted to make double line spacing.

Now that you've typed a short document file in double spacing (2), you can change the line spacing back to single (1) to see how you change line spacing in a file that is already typed.

MOVE the cursor back to the beginning of the document file.

CHANGE the line spacing to single

- Press CTRL & 4
- Press the L key
- Type the number 1

REFORMAT the document file using the **repeat** command

- Press CTRL & 0 (zero)
- Press CTRL & 6

NOTICE that the reformat removes the extra carrier returns to make the line spacing single

STORE the document file

- Press CTRL & 3
- Press the G key

TURNING JUSTIFY OFF

The Justify feature makes the right margin even, just like the left margin. It does this by inserting spaces between the words on a line to make the line reach the right margin. Your system will automatically justify every line of a paragraph, unless you turn the Justify feature off.

Text that is justified has a right margin that is perfectly even -- just like the left margin. This gives the document a nicely finished appearance, and some people think it makes the document look more "professional" (as through the document were typeset).

Text that is not justified has a right margin that is "ragged" -- that is, not even like the left margin. Ragged right text is easy to read, and some people prefer it over justified text. It seems to be a matter of personal opinion.

The command used to turn Justify off (or on again) is on the Format (Display) Menu. When Justify is on, the command will be followed by the word (ON) as shown below. When Justify is off, the command will be followed by the word (OFF).

B:FILENAME PAGE LINE COL 01		INSERT ON	
FORMAT (DISPLAY) MENU		HELP	= for assistance
TAB = automatic indent	F = settings from a line	L = change line spacing	
A = center the line	G = clear tab(s)	M = pagination off (ON)	
B = margin release	H = hyphenation help	N = display printer	
C = set right margin	J = turn syllable	codes off (ON)	
D = set left margin	hyphen off (ON)	O = ruler off (ON)	
E = set tab(s)	K = justify off (ON)	P = word wrap off (ON)	

You may touch any key shown above. Touch SPACE bar to close the menu.

To type a new document file with Justify off, simply turn it off before you type any text. To change justification in a file that has already been typed, you'll need to turn Justify off and then reformat the document.

Read the information below and on the next page to learn about changing Justify.

Here's how it works ...

To turn Justify off in a new document file:

- Bring the new document file to the screen
- Press CTRL & 4
- Press the K key
- Type the text in the document

To turn Justify back on again:

- Press CTRL & 4
- Press the K key

To change Justify in a document file after it is typed:

- Bring the document file to the screen
- Press CTRL & 4
- Check the Justify command to see if it is ON or OFF -- if it already shows the setting you want, simply reformat the file
- Press the **K** key if you want to change the Justify setting
- Reformat the entire file as follows:
 - Press CTRL + 0 (zero)
 - Press CTRL & 6
 - (If the system stops for hyphenation, insert the hyphen and then press CTRL & 0 and CTRL & 6 again).

Justify, like the Ruler Line, is not recorded in your document. If you turn Justify off, it will stay off until the system is turned off or the software reloaded. Then it will automatically be turned back on. **If you want Justify turned off in your document files, it is best to check to be sure it is off before you type or edit a file.**

Note: There is no practice exercise for changing the Justify feature, however, you can experiment with turning it off in your documents if you want your text unjustified.

CHANGING PITCH

Your system can print documents in two pitches: 10 (pica) and 12 (elite). Ten pitch is the standard pitch and 12 pitch is the alternate pitch. This means that all of your documents will be typed and printed in 10 pitch unless you tell the system to change to 12 pitch.

Pitch can be changed before or after you type a document file. To change pitch, you use the **format (nondisplay)** menu (5 on the Main Menu). Looking at the menu (shown below), you'll see the commands **A = other pitch** (which would be 12 pitch) and **N = standard pitch** (which is 10 pitch).

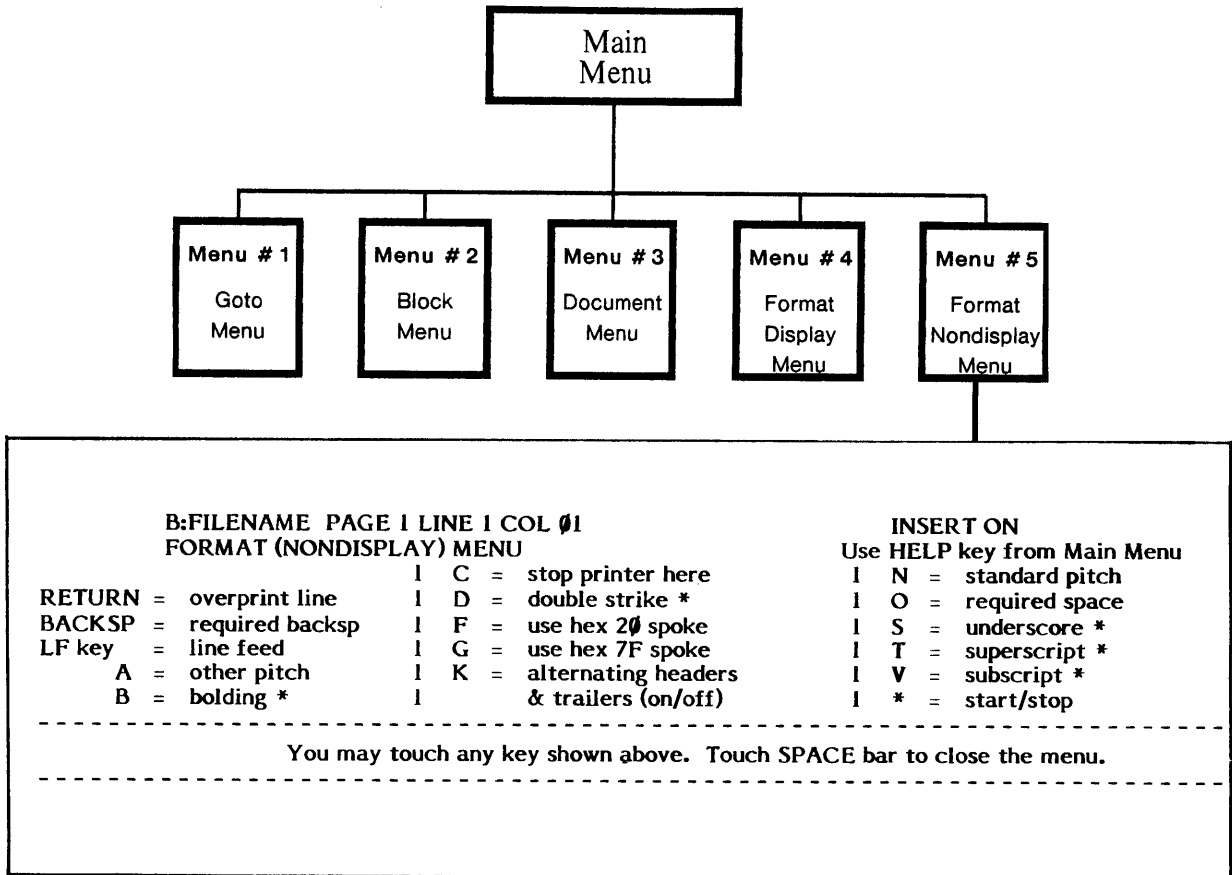

The pitch change commands will show on the screen as **^A** or **^N**. When you use either of the pitch change commands, be sure the command is on a line by itself.

When the document file is printed, you'll need to check the print wheel to be sure it matches the pitch recorded in the file.

Read the information below to learn about changing pitch. If you'll be doing this on your job, you can use the steps to type one of your own documents.

Here's how it works ...

To change pitch in a new document file:

- Bring a new document file to the screen
- Press CTRL & 5
- Press the A key (to change to 12 pitch)
- Press RETURN
- Type and save the document
- Be sure you have a 12 pitch print wheel on the printer when you print the document

To change pitch in an existing (already typed) document file:

- Bring the document file to the screen
- Position your cursor at the beginning of the document, or at the point where you want the pitch changed
- To change to 12 pitch, press CTRL & 5 + A and RETURN
To change to 10 pitch, press CTRL & 5 + N and RETURN, or delete the CTRL A if there is one
- If desired, change margins and tabs, and reformat

To change pitches within a document:

If you want to change pitches within a document, you'll need to use CTRL & 5 + C to tell the printer to stop at each pitch change so you can change the print wheel. You may also wish to change margins and tabs each time you change pitches, to keep the text properly aligned on paper when it prints.

- Type the text up to the point of the pitch change
- Press CTRL & 5 + A (to change to 12 pitch)
- Press CTRL & 5 + C (to tell the printer to stop at this point)
- Change the margins, if desired
- Type the 12 pitch text
- Press CTRL & 5 + N (to change back to 10 pitch)
- Press CTRL & 5 + C (to tell the printer to stop at this point)
- Change the margins, if desired
- Type the 10 pitch text

Pitch changes are recorded in your document file. Therefore, you do not need to check the pitch each time you edit a file. However, you will need to check the pitch of the print wheel if you use different pitches for different documents.

The pitch will automatically go back to standard (10), when you store a document file. If you want all your documents typed in 12 pitch, you'll need to give the change pitch command each time you begin a new file.

CHANGING PAPER LENGTH

The paper length is automatically set for 11 inch paper. As you type a document, your system will count the number of lines typed and break your document into separate pages so that your typing does not print off the bottom of the paper.

If you want to use paper that is not 11 inches long, you'll need to tell the system the new length. To change paper length, you simply type the paper length instruction in the document. You must type it at the very beginning of the document.

The paper length instruction is ".PL" followed by the length of the paper in lines. There are six (6) lines to an inch, so 11 inch paper has 66 lines and 8½ inch paper has 51 lines.

Therefore, the paper length instruction for 11 inch paper is **.PL 66**

The paper length instruction for 8½ inch paper is **.PL 51**

The paper length instruction must be typed at the left margin and must be followed by a carrier return. When the system sees a period (.) in column 1, it knows that this is part of a special instruction. It will act on the instruction, and it will not print the instruction when you print your document file. The paper length instruction is referred to as a "dot" command, because it is given by typing a period (dot) at the left margin.

The picture below shows the paper length instruction used to type a document file on 8½ inch long paper.

.PL 51

PUBLIC SPEAKING

Very few women or men are able to get up and speak before an audience, whether to propose a toast, to lecture a class or to deliver a thesis, without initial nervousness and discomfort. Attitudes and tensions can inhibit our progress in speaking. Inhibition appears in many different forms.

It may be manifested in a flat inexpressive voice, or an expressionless face or a tense posture. Even the most sensitive speakers are too conscious of their faults and limitations. They dwell too much on their negative points and fail to remember their positive points. After all, people with a technical background are, on the whole, better informed about the material world than most of the population.

Note: There is no practice exercise for changing paper length. You can try it in one of your own documents if you like.

CHANGING TOP AND BOTTOM MARGINS

The top and bottom margins refer to how much space is left at the top and bottom of the page. The top and bottom margins work together with the paper length to determine how many lines of text will go on each page. For example, the 820 is automatically set to use 11 inch paper with 1 inch top and bottom margins, so you get 9 inches of typing (54 lines) on the page.

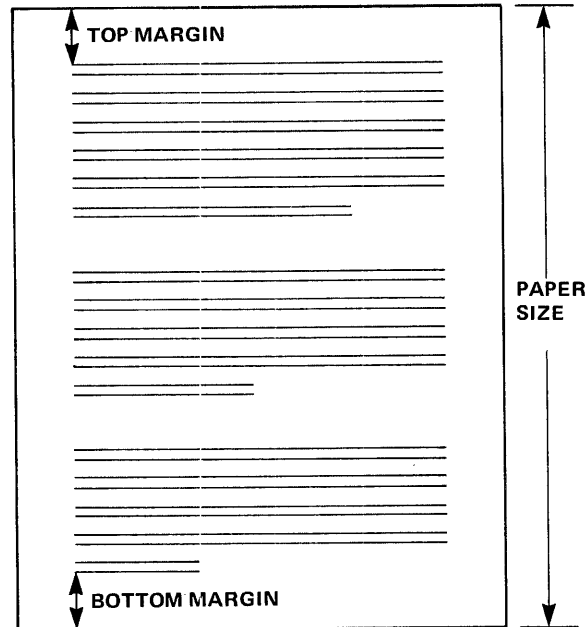

The 820 uses one inch top and bottom margins, unless you tell it you want something else. The instruction to change the top margin is ".MT" and the instruction to change the bottom margin is ".MB"

The top and bottom margin settings are given in lines per inch. Since there are six lines of typing to the inch, the setting for a one inch top margin would be **.MT 6** and the setting for a one inch bottom would be **.MB 6**. The settings for two inch margins would be **.MT 12** and **.MB 12** as shown below.

The top and bottom margin instructions must be typed at the left margin (in column 1) and must be followed by a return. It is a good idea to put these commands at the beginning of the document, as shown in the picture below.

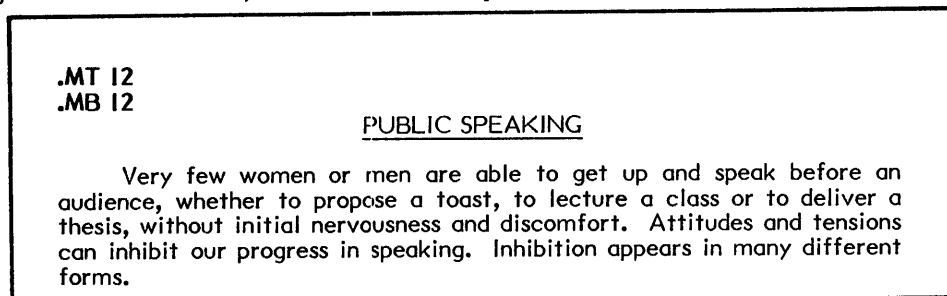

Note: There is no practice exercise for top and bottom margin changes. You can try it on your own if you like.

HELP

This section is designed to tell you what help is available when working with your 820. It is a good idea to read through the section so you know what it covers. There are no practice exercises, but you can refer to the instructions in this section any time you need help while doing your own work.

CANCELLING A COMMAND

There may be times when you want to tell the system to stop an action (like reformatting or find and replace) or to cancel a command (such as **run a program**). You can do this by pressing CTRL & U and then pressing the ESC key.

THE HELP KEY

The HELP key can be used while typing a document to bring more information to the screen.

If you press the HELP key when the Main Menu is on the screen, you'll see more information about each of the commands on the Main Menu and Menu #5. If you press the HELP key when one of the other menus (#1 through #4) is on the screen, you'll see more information about the commands on that specific menu.

When HELP information is on the screen, you can touch the SPACE bar to bring up more information. To remove the HELP information from the screen, you press CTRL & U and then press ESC.

CHANGING THE HELP LEVEL

The HELP level refers to the menus you see on the screen. Normally, the menus are shown on the screen to help you remember the different commands. This is HELP level 3. If you want to remove the Main Menu from the screen, you can set the HELP level to 2. HELP level 2 allows you to see 22 lines of typing on the screen.

Here's how it works ...

To change the HELP level from the Directory Menu:

- Press the HELP key
- Press the 2 key (for level 2)
Or, press the 3 key (for level 3)

To change the HELP level from the Main Menu:

- Press CTRL & E
- Press the 2 key (for level 2)
Or, press the 3 key (for level 3)

CORRECTING MISTAKES

Your system offers you several ways to correct mistakes.

If you make a typing error, you can touch the BACKSPACE key to backspace out the error before typing the correct characters.

If you forgot to check the number of files on the disk, you can bring the Directory to the screen before you save the document file. You can then count the files on the Directory. If there are 32 on a 5¼" disk, or 64 in an 8" disk, you can delete one of them to make room for the file you are working on.

Here's how it works ...

To change disk drives and display the Directory while in a file:

- Press CTRL & 3
- Press the A key (to change disk drives)
- Type B:
- Press RETURN

- Press CTRL & 3
- Press the C key (to display the Directory)
- Count the number of files on the Directory

To delete a file:

- Press CTRL & 3
- Press the B key
- Type the name of the file to delete
- Press RETURN

To go back to the A drive and remove the Directory:

- Press CTRL & 3
- Press the A key (to change disk drives)
- Type A:
- Press RETURN

- Press CTRL & 3
- Press the C key (to remove the Directory)

If you get the DISK FULL message while typing or editing, you can bring the Directory to the screen while typing the document. You can then delete some of the files on the disk to make room for the file you are working on.

Follow the steps above to change disk drives, display the Directory, and delete files.

If you don't want to save the document on the screen, (perhaps you made some editing changes in error) you can discard the file without saving it. If it is a new file, nothing will be saved on your disk. If it is a previously saved file that you were editing, only the original file will be on your disk.

Here's how it works ...

To discard the document file on the screen:

- Press CTRL & 3
- Press the ESC key
- Press the Y key

If you want to keep the original version of an edited file, you can recover the BAK file as explained below.

RECOVERING A BAK FILE

When you edit a document file, the edited file is stored under the original title and the last edited version of the file is stored as a BAK (back-up) file. For example, when a file named LETTER is edited, the edited file will be stored on the Directory as LETTER. The back-up original file will be stored as LETTER.BAK.

You cannot recall or use a file that has BAK in its title. However, you can rename the file and then use it like any other file.

Here's how it works ...

If the B Directory is not displayed, change to drive B

- Press B
- Type **B:**
- Press RETURN

To rename a file:

- Be sure the Directory Menu is on the screen
- Be sure the disk with the BAK file is in Drive B
- Press the G key
- Type the **name of the file** (for instance, LETTER.BAK)
- Press RETURN
- Type the **new name** of the file (do not include .BAK in the name)
- Press RETURN

(This page intentionally blank)

MULTI-PAGE DOCUMENTS

Frequently, the documents you type are longer than one page. Your 820 will automatically break a long document file into pages as you type it.

When you print the document file, you can tell the 820 to stop printing between pages so you can insert a clean sheet of paper. Or, if you have continuous form paper, the 820 will automatically advance the sheets of paper so that each page is correctly printed.

AUTOMATIC PAGE BREAKS

The number of lines that the 820 will put on each page is determined by the length of the paper and the size of the top and bottom margins. Normally, the 820 will put 54 lines on each page. This is because the paper length is set at 66 lines and the top and bottom margins are each set at 6. ($66 - 12 = 54$) If you want to change these settings, you can learn how to do it in the FORMAT section of this manual.

As you type, the 820 will insert page breaks after the correct number of lines. The page break will be displayed on the screen as a dotted line with a **P** on the end, as shown below.

----- P

If you add or delete lines from the file when making editing changes, the 820 will automatically move the page breaks to new locations.

REQUIRED PAGE BREAKS

Automatic page breaks are inserted by the 820 each time you type a full page of material.

You can also insert a required page break in your document file when you want a page to end at a certain position. A required page break will always begin a new page at the point where it is typed in the file. Unlike an automatic page break, it will not move when you add or delete lines during editing.

Required page breaks are useful when you need to type a title page, or a reference page, when you want a page break between sections of a document, or anytime you want to begin a new page.

To insert a required page break in your document file, you type ".PA" at the left margin, followed by a RETURN. When the 820 sees a period (.) at the left margin, it knows that this is a special command, called a dot command. It will act on the command, but it will not print the command. The picture below shows a required page break in a document file.

The **.PA** command will put the dotted page break line in the file. When you print the file, the 820 will always begin a new page at the position of the **.PA**. If you delete the **.PA**, the dotted line (page break) will automatically disappear.

It may be manifested in a flat inexpressive voice, or an expressionless face or a tense posture. Even the most sensitive speakers are too conscious of their faults and limitations. They dwell too much on their negative points and fail to remember their positive points. After all, people with a technical background are, on the whole, better informed about the material world than most of the population.

.PA

-----P
Nervousness can only be overcome by creating a positive attitude of mind and practicing and practicing again. Failure and disappointment are an inevitable and integral part of the learning process. With practice, you will begin to succeed and boost your self-confidence so that when you experience disappointment, you will have the strength to persist. Then and only then will you break through the barrier of persistent inhibitions and obtain more self-confidence, less inhibition, and more successful speaking.

Read the information below to learn about required page breaks. You'll have a chance to practice them in the exercise on page 7-5.

Here's how it works ...

To insert a required page break:

- Bring the file to the screen and type text that will come in front of the break
- Press RETURN, type **.PA** and press RETURN again
- Continue typing text as you normally would

SAVING FREQUENTLY

When you type or edit a document file that is longer than one page, it is a good idea to save your typing regularly. Perhaps, you'll want to save the file after every page, or after every two pages. In this way, your typing won't be lost if there is a power failure or some other kind of error.

The 820 has a command that allows you to save a file without actually removing it from the screen. This means that you can give the save command and then continue typing. The command is on the Document Menu.

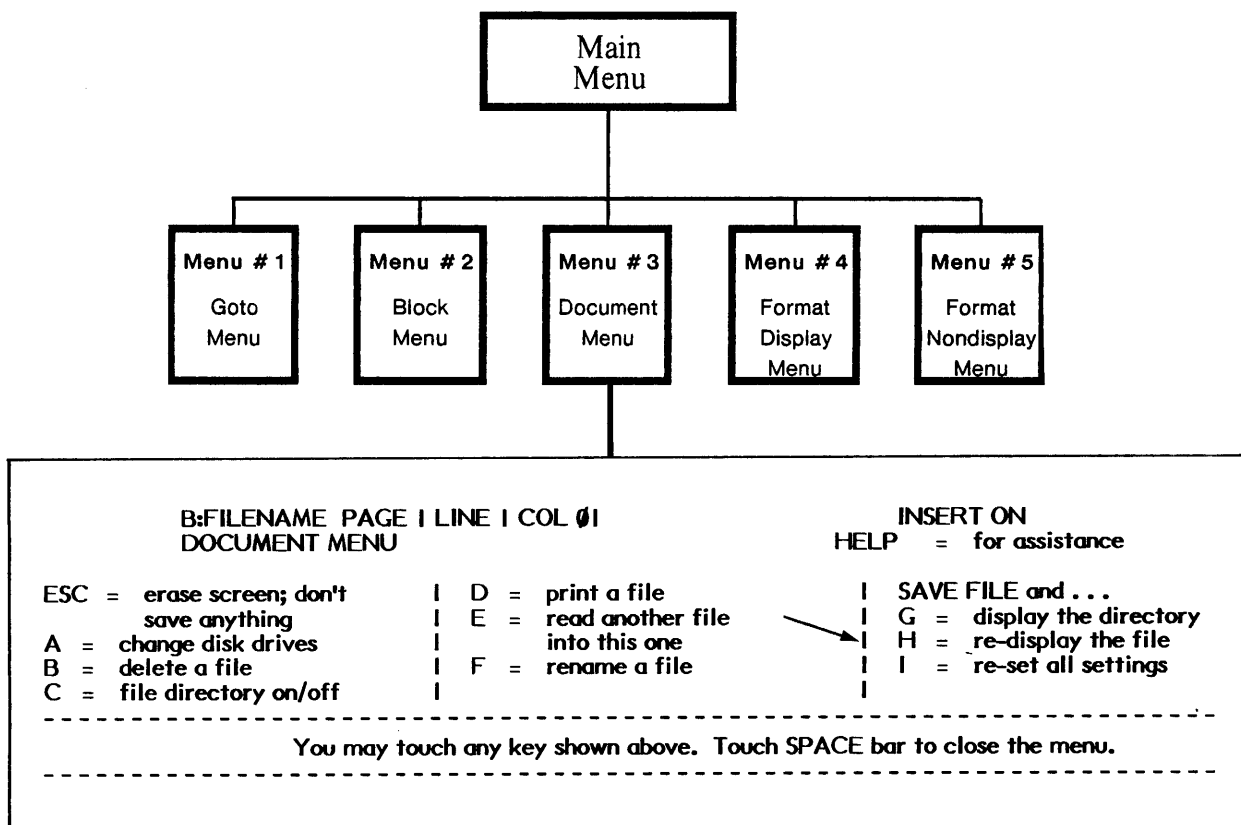

Read the information below to learn about saving without removing the file from the screen. You'll get a chance to practice this in the exercise on page 7-5.

Here's how it works ...

After typing a page or two in a file,

To save a file without removing it from the screen:

- Press CTRL & 3
- Press the H key
- Wait for the beginning of the file to be displayed
- Press CTRL & 1 and RETURN to move the cursor to its location before you saved the file

PRINTING MULTI PAGE DOCUMENTS

When you print a file that has more than one page, you need to tell the 820 whether you have cut (single) sheet paper or continuous form (fanfold) paper. One of the questions it will ask you before it prints is PAUSE FOR PAPER CHANGE BETWEEN PAGES?

If you have continuous form, you'll want the 820 to advance the paper automatically between pages without stopping after each page, so you'll press RETURN (or N for "no") to answer this question.

If you have cut sheet paper, you'll want the 820 to stop at the end of each page, so you'll press Y to answer "yes" to the PAUSE FOR PAPER CHANGE question.

Read the information on the screen to learn about printing. You'll have a chance to practice this in the exercise on the next page.

Here's how it works ...

After typing and saving a multi-page file, begin with the Directory Menu on the screen and the disk with the file in the B Drive

If the B Directory is not displayed, change to drive B

- Press B
- Type B:
- Press RETURN

To print a file without stopping for paper change:

- Press **F** from the Directory Menu
- Type the filename
- Press RETURN **eight** times

To print a file and stop between pages:

- Press **F** from the Directory Menu
- Type the filename
- Press RETURN **five** times
- Press the **Y** key
- Press RETURN twice

Each time a page prints out, the 820 will stop and wait for you to insert paper. When you've put a new sheet of paper in the printer, pressing the **F** key will tell the 820 to print the next page.

Practice Exercise

Now that you've read about page breaks, you may want to practice using them. The exercise below steps you through typing a document file that has an automatic page break and a required page break. The exercise also shows you how to use the save and redisplay the file command. Before you type the file, you'll change the line spacing to double (2), so you won't have to type as much text. (If you want more information about line spacing, a complete explanation of changing line spacing is given on page 5-23 of this manual.)

MAKE sure your training disk is in the B disk drive

IF the B Directory is not displayed, change to drive B

- Press B
- Type **B:**
- Press RETURN

CHECK the number of files on the B disk

- Count the number of file names (if there are 32 on a 5¼" disk, or 64 on an 8" disk, you'll need to delete one of the BAK files, using the instructions on page 3-2)

CHECK the disk space on the B disk

- Press the **H** key
- Type the word **STAT**
- Press RETURN
- Check the **SPACE REMAINING** (if it is less than 9K, delete several of the BAK files, using the instructions on page 3-2)
- Press the **SPACE** bar to return to the Directory Menu

START a new document file named **PAGES**

- Press the **A** key
- Type **PAGES**
- Press RETURN

CHANGE the line spacing to double

- Press **CTRL & 4**
- Press the **L** key
- Type **2**
(The top right side of the screen should show **LINE SPACING 2**)

Practice Exercise (cont'd)

The document you'll type is shown on the opposite page. Notice that there is a stop sign near the end of the text in the first box. This is the point where the 820 will insert a page break. The stop sign indicates that you should stop typing long enough to look at the page break on your screen.

TYPE the document shown on the opposite page up to the last paragraph

Notice that the dotted line and P are inserted in the text, indicating the end of the first page and the beginning of the second.

FINISH typing the text shown in the first box on the opposite page

At this point, you can practice using the **save and redisplay the file** command. This command will save everything that you've typed so far and allow you to position the cursor where you stopped typing last. Then you can type the last page of the file.

PRESS CTRL & 3

Notice the command **H = re-display the file** at the right of the screen

PRESS the **H** key

The 820 will save the file on disk, then display the file beginning and a message telling you to type CTRL & 1 and RETURN to move the cursor to its location before the file was saved.

PRESS CTRL & 1 and RETURN

Now that you've typed the main text in the document, you're ready to type the reference information at the end of the document. The reference information is shown in the second box on the opposite page. You'll put in a required page break to make sure the reference information is always printed on a page by itself.

TYPE .PA and press RETURN

Notice that this puts a page break line in your document file

TYPE the text shown in the second box on the opposite page

CONTINUE with the instructions on page 7-8

The manuscript hand of the Venetian scribes, which Nicholas Jenson followed as his model, developed apart from gothic lettering. It had evolved from roman capital letters. In formal writing and inscriptions, the early Romans used square capitals with slight modifications, in the form of our upper-case alphabet. For correspondence and documents not requiring formal writing, large cursive or running capitals were used.

Many national styles in writing developed as learning was carried from Rome through the rest of the known world. The influence of the roman characters might have been lost, however, had not Emperor Charlemagne taken an interest in the revival and spread of ancient learning. The calligraphy of this school became the model for the rest of Europe.

By the tenth century, the use of letter forms from which we derive our lower case was quite universal. However, the letters did not assume the fixed form with which we are familiar until they were cast in types by Jenson.

In crediting Jenson with our style of roman type face, it would be unfair to overlook other early printers who experimented with roman letter forms, or who modified the early gothic letters. The first German types were angular and pointed; later types became more rounded. A semi-gothic face, tending distinctly toward roman, was used in 1460 by John Mentelin, the first Strassburg Printer.

The humanistic manuscripts, that is, manuscripts of classical literature produced by Venetian scribes, were Jenson's models. He did not copy the handwriting of scribes letter for letter, but created a font of related letters legible and pleasing in effect. He clearly recognized that mechanical perfection is not as desirable as the composite appearance of the page.

Appreciation is expressed for the help of International Paper Company in the preparation of this report, portions of which are drawn from its publication, Pocket Pal - A Graphic Arts Production Handbook, Tenth Edition, June 1970.

The next step is to save and print the file. Since you changed the line spacing to double, you should use the CTRL & 3 + I command when you save the file. This will return the line space setting to single for the next file you type.

SAVE the document file

- Press CTRL & 3
- Press the I key

WAIT for the Directory Menu to display

IF the B directory is not displayed, change to drive B

- Press B
- Type **B:**
- Press RETURN

When you print a file that has more than one page, you need to use the print option that will PAUSE FOR PAPER CHANGE BETWEEN CHANGES, so you can insert a new sheet of paper. The PAUSE option is turned on by pressing the Y key. If you have continuous form paper, simply press RETURN instead of Y.

PRINT the document file

- Insert a clean piece of paper in the printer
- Press the F key
- Type **PAGES**
- Press RETURN six times
- Press the Y key (to pause between pages)
- Press RETURN again
- Each time the printer stops, insert a new piece of paper and press the F key

HOW TO KEEP TEXT FROM BEING SPLIT BETWEEN PAGES

Sometimes a page break may fall in the middle of a paragraph, or it may leave one line of a paragraph on a page by itself. Or the page break may fall between the paragraph and a heading that preceded it.

You can tell the 820 to keep the text together and not split it between pages by putting a ".CP" command in the file. The **.CP** command must be typed at the left margin. When the 820 sees a period (.) at the left margin, it knows that this is a special command, called a dot command. The 820 will act on the command, and it will not print the command when you print the file.

Along with the **.CP** command, you'll need to type a space and a number, as shown below. The **.CP** and number tell the 820, "don't put a page break in the next number of lines". For instance, if you type **.CP 6** in front of a paragraph, the 820 will keep the next six lines on the same page. If the 820 can't fit all the lines on the page, it will move them all to the next page.

The document below shows how the **.CP** command can be used to keep paragraphs and headings together on the same page. Notice that you need to type a new **.CP** command for each group of text that you want to keep together.

.CP 5
Heading

Paragraph headings should not be separated from the text that they refer to. It makes a document very hard to read if the heading is on the bottom of one page and the paragraph is on the top of the next.

.CP 5
Another Heading

Paragraph headings are often the first thing that people look at when they review a document. The paragraph headings tell them what information is covered and in what order.

There is no exercise for using the **.CP** command. However, you can practice on your own if you wish.

TYPING LONG DOCUMENTS

It is a good idea to keep your document files shorter than 10 pages. This will ensure that no file becomes so large that it can't be edited. (Remember, when you edit a file, you'll need double the room on the disk because the 820 saves both the edited version and the original.) It will also make editing easier, as editing a very long file can be slow.

If you need to type a document longer than 10 pages, divide it into sections and type each section as a separate document file. The PAGE NUMBERS section of this manual explains how to start page numbering with a number other than one. Using this feature, you can print page numbers that run consecutively through a long document even though the document is stored as several different files.

The most important thing to remember about typing long document files, is to **make sure you have enough room on the disk** before you begin typing or editing the file. Remember, each page of typing will take at least 2K bytes of disk space. Be sure you check the space on the disk regularly.

EDITING LONG DOCUMENTS

Before you begin editing a file, you should check the space on the disk to be sure you have enough room for both the edited file and the original (BAK) file. You may find it easiest to copy a long document file onto a disk by itself to ensure that there is adequate space for editing changes. Remember, if a file takes up 20K bytes on the disk, you should have at least 20K bytes of space remaining before you begin to edit the file. (The DIRECTORY section of this manual explains how to use STAT to check the length of each file and the space remaining.)

Always move forward through a long file when making editing changes. If you need to move the cursor back to the beginning of the file, use the **save and redisplay** command below. (Note: If you attempt to move the cursor backwards through a large amount of text, you may get a disk full message.)

To save the file and redisplay the cursor at the beginning of the file:

- Press CTRL & 3
- Press the H key
- Wait for the beginning of the file to be displayed
- Press one of the cursor keys or any key on the keyboard to remove the message at the top of the screen

When you do a find and replace in a long document file, you should start with the cursor at the beginning of the file. If it is not there, you can use the steps above to save the file and redisplay it with the cursor at the beginning.

PAGE NUMBERING

The 820 will automatically number pages for you. If you don't want page numbers, you can tell the 820 to omit them.

The page numbers automatically start with the number one on the first page of a document file. If you want to start page numbering with a number other than one, you can tell the 820 to change the page number.

The page number automatically prints centered at the bottom of the page. If you want the page number printed in some other location, you can tell the 820 to change the page number location.

You can also tell the 820 to put text with the page numbers. For instance, the word "Page" in front of the number; or the words "First Draft" at the top of the page. This type of text is referred to as Headers and Footings.

This chapter tells you how to do all of the above.

OMITTING PAGE NUMBERS

There may be times when you don't want your document to print with page numbers on it. You can easily tell the 820 to omit the page numbers.

The omit page number command is given by typing **.OP** at the left margin (in column 1) followed by a RETURN. When the 820 sees a period (.) in column 1, it knows that this is a special command, called a dot command. It will act on the command, but it will not print the command.

The picture below shows the omit page number command **.OP** typed at the beginning of a document file.

<p>.OP</p> <p>It may be manifested in a flat inexpressive voice, or an expressionless face or a tense posture. Even the most sensitive speakers are too conscious of their faults and limitations.</p> <p>They dwell too much on their negative points and fail to remember their positive points. After all, people with a technical background are, on the whole, better informed about the material world than most of the population.</p>
--

If you want to start page numbering on a page further back in the file, you can type **.PN** on the page where you want a page number. Remember, the **.PN** must be at the left margin and must be followed by a RETURN.

CHANGING THE PAGE NUMBER LOCATION

The commands you use to change the location of the page number are also dot commands.

To move the page number location at the bottom of the page, you use the **.FO** command. After typing **.FO** at the left margin, you move the cursor to the position where you want the page number to print and type a pound sign (**#**). (There must be at least one space between the **.FO** and the **#**.) When the file prints, the page numbers will print at the location of the pound sign.

For example, the document below shows a **#** at the right margin. When the file prints, the page numbers will print at the right margin on the bottom of each page.

```
.FO                                     #
```

It may be manifested in a flat inexpressive voice, or an expressionless face or a tense posture. Even the most sensitive speakers are too conscious of their faults and limitations.

They dwell too much on their negative points and fail to remember their positive points. After all, people with a technical background are, on the whole, better informed about the material world than most of the population.

To put the page number at the top of the page, you use the **.HE** command, plus a pound sign (**#**). After typing the **.HE** command at the left margin, you move the cursor to the position where you want the page number to print and type the pound sign (**#**). There must be at least one space between the **.HE** and the **#**.

When you use the **.HE** command to print page numbers at the top of the page, you'll also need to use the **.OP** command to tell the 820 not to print page numbers at the bottom of the page.

The document below shows the **.OP** command and the **.HE** command with the pound sign (**#**) centered in the document. The page numbers will print centered at the top of each page.

```
.OP  
.HE                                     #
```

It may be manifested in a flat inexpressive voice, or an expressionless face or a tense posture. Even the most sensitive speakers are too conscious of their faults and limitations.

They dwell too much on their negative points and fail to remember their positive points. After all, people with a technical background are, on the whole, better informed about the material world than most of the population.

It is important to remember that the **.HE** and **.FO** commands (plus the space after them) take up four spaces on the line. When you position the pound sign (**#**), you need to move it four spaces past the position where you want the page number printed.

CHANGING THE PAGE NUMBER

Normally, the page numbers begin printing with the number one on the first page. There may be times when you want to change this number. For example, if you typed and saved a long document in 10 page sections, you'd want the second section to begin printing with the number 11.

To change the page number, you use the `.PN` command followed by a space and the number you want printed on the page.

For example, to begin page numbering with the number 11, you'd type `.PN 11` at the left margin and follow it with a RETURN.

ADDING TEXT TO THE PAGE NUMBERS (Headers & Footings)

There may be times when you want to print text at the top or bottom of every page in the file. For example, you may want to print the word "Page" in front of the page number, or you may want to print the word "Draft" or "Preliminary" at the top of every page. You can do this by using the `.HE` and `.FO` commands.

The `820` will allow you to put one full line of text in the `.HE` and `.FO` commands. You have the option of including a page number in the text or leaving it out. To include a page number, you type a pound sign (`#`) at the location where you want the page number. The text and the pound sign must be separated from the `.HE` and `.FO` commands by at least one space.

The example below shows the command to center the word "Page" and the page number at the bottom of each page.

```
.FO                               Page #

    It may be manifested in a flat inexpressive voice, or an expressionless
    face or a tense posture. Even the most sensitive speakers are too
    conscious of their faults and limitations.

    They dwell too much on their negative points and fail to remember
    their positive points. After all, people with a technical background are,
    on the whole, better informed about the material world than most of the
    population.
```

It is important to remember that the `.HE` and `.FO` commands (plus the space after them) take up four spaces on the line. When you position the text on the page, you need to move it four spaces past the position where you want it printed.

There are no practice exercises for working with page numbers. If you wish, you may practice creating the examples shown in this chapter on your own.

PRINTING

Files are printed from the Directory Menu. The print command is given by pressing the **F** key and typing **B:** and the file's name. The 820 will then ask you several questions. The only one you need to be concerned about is the PAUSE BETWEEN PAGES FOR PAPER CHANGE question. If you have continuous form (fanfold) paper, you'll answer this question by pressing RETURN or typing N for "no". If you have single (cut) sheet paper, you'll answer this question by typing Y for "yes".

It is best not to type or edit another file while you're printing.

Here's how it works ...

To print a file using cut sheet paper:

- Start with the Directory of B on the screen
- Put the disk with the file to be printed in Drive B
- Put paper in the printer
- Press the **F** key
- Type the file's name
- Press RETURN **six** times
- Press the **Y** key
- Press RETURN again

If the file has more than one page in it, the printer will stop after printing each page. You'll need to insert another sheet of paper and press the **F** key to start the printer again.

To print a file using continuous form paper:

- Start with the Directory of B on the screen
- Put the disk with the file to be printed in Drive B
- Make sure the printer has paper in it
- Press the **F** key
- Type **B:** file's name
- Press RETURN eight times

Note: There is no practice exercise for printing files. If you wish, you may use the instructions above to print a file from your disk.

STOPPING THE PRINTER

You can stop the printer before it has finished printing a file by pressing the **F** key. After a few seconds, the printer will stop. To restart the printer, you press the **N** key. If you don't want to finish printing the file, you can press the **Y** key to "abandon" (permanently stop) printing of that file.

STOP COMMANDS

If you want the printer to stop printing at a specific location in a file, you can put a printer stop command in the file when you type it. The stop command can be used to stop the printer so you can change print wheels in the middle of a file.

When the file is printed the printer will stop at the command. You can restart the printer by pressing the F key.

The printer stop command is on the Format (Nondisplay) Menu -- #5 on the Main Menu. The command is given by pressing CTRL & 5 + C and will show on the display as a C.

B:FILENAME PAGE 1 LINE 1 COL 01			INSERT ON
FORMAT (NONDISPLAY) MENU			Use HELP key from Main Menu
	1	C = stop printer here	1 N = standard pitch
RETURN = overprint line	1	D = double strike *	1 O = required space
BACKSP = required backsp	1	F = use hex 20 spoke	1 S = underscore *
LF key = line feed	1	G = use hex 7F spoke	1 T = superscript *
A = other pitch	1	K = alternating headers	1 V = subscript *
B = bolding *	1	& trailers (on/off)	1 * = start/stop

You may touch any key shown above. Touch SPACE bar to close the menu.

Here's how it works ...

To put a printer stop command in a file:

- Start with the Directory of B on the screen and a disk in Drive B
- Press the A key, type a file name, and press RETURN
- Type any text that you want printed before the stop command
- Press CTRL & 5 + C (to give the stop command)
- Type the text you want printed after the stop command (You can put more stop commands in the file if you like)
- Save the file

To print the file:

- Be sure the Directory Menu is on the screen and the disk in Drive B
- Press the F key
- Type the file name, and press RETURN
- Answer the print questions as you normally would (see previous page)
The file will print up to the first stop command. If you want to change the print wheel, do so when the printer stops.
- Press the F key to start printing again

Note: There is no practice exercise for using stop commands. If you wish, you may use the instructions above to type and print a file.

THE PRINT QUESTIONS

Before you print a file, the 820 will ask you questions to determine how you want the file printed. These questions and their meanings are explained below:

DISK FILE OUTPUT? (Y/N): Asks if you want the file put on the disk in the printer format instead of printing it on paper. You'll normally answer no to this question by pressing RETURN or typing **N**.

START AT PAGE NUMBER (RETURN = beginning)? Asks if you want to start printing at a page other than the first page. You can use this question to print out a portion of a file, instead of the whole file. To start printing at a page other than the first one, type the page number and press RETURN. To start printing at the first page, press RETURN (without typing a page number).

STOP AFTER PAGE NUMBER (RETURN = end)? Asks if you want to stop printing on a page that is not the last page in the file. To stop printing before the end of the file, type the number of the last page you want printed and press RETURN. To print through the end of the file, press RETURN (without typing a page number).

USE FORM FEEDS? (Y/N): Asks if you want the printer to advance a blank form before it prints the file. You'd only answer yes if you were using continuous (fanfold) paper and wanted a blank sheet in front of your file. To answer yes, type a **Y**. You'd normally answer no by pressing RETURN or typing **N**.

SUPPRESS PAGE FORMATTING? (Y/N): Asks if you want to print the dot commands in the file instead of using the commands to format the file. Normally, you'd press RETURN or **N** to say no. If you want the commands printed, you press **Y** to say yes.

PAUSE FOR PAPER CHANGE BETWEEN PAGES? (Y/N): Asks if you want to stop after each page so you can insert a new sheet of paper. Press **Y** to answer yes and stop after each page. If you have continuous form paper, press RETURN or **N** to print the file without stopping.

Touch RETURN key to start the printer. This means that the 820 is ready to print the file as soon as you press RETURN. Check that there is paper in the printer and press RETURN.

(This page intentionally left blank)

STATISTICAL TABLES

The 820 makes typing tables easy with its decimal tab. When using the decimal tab, all numbers will automatically be aligned at the decimal point, as shown in the example below.

USING DECIMAL TABS

Decimal tabs are set on the Ruler Line. To set a decimal tab, you give the tab setting command (CTRL & 4 + E), type a pound sign (#) and the column number for the tab and press RETURN.

The decimal tab will show on the Ruler Line as a # instead of a ! like a regular tab as shown in the example below.

When you're ready to type a statistical table, you set a decimal tab for each column in the table. The tab should be set at the point where you want the decimal point to print. Looking at the example below, you can see that the two # (decimal tabs) on the Ruler Line are over the decimals in the columns.

L	--!	-----#	-----#	-R
Office Supplies				
Paper		\$1,250.00		\$2,450.00
Envelopes		345.00		675.00
Postage		3,600.00		5,700.00

You can also use the decimal tab to align numbers that don't have a decimal point in them. Simply set a decimal tab at the point where you want the last character in the number to print. The 820 will automatically align the numbers at the tab, even though there are no decimal points in the number.

Before you set your decimal tabs, it's a good idea to clear all the other tabs from the Ruler Line.

Read the information below to learn about setting decimal tabs. There's a practice exercise on page 10-3 that will give you a chance to practice using them.

Here's how it works ...

To set a decimal tab:

- Begin with your file on the screen
- Press CTRL & 4
- Press the E key
- Type # and the column number for the tab setting
- Continue to set a tab for each column of numbers in the table

UNDERLINING COLUMNS

The columns of numbers may be underlined, using the underline (underscore) command on the Format (Nondisplay) Menu. The underline command is given by pressing CTRL & 5 + S.

The underline command is a start/stop command, so you'll need to give the command before you type the number and again at the end of the number. If you're underlining several columns of numbers, you can give the underline command before typing the first column, then type all of the columns before giving the stop underlining command.

The underline command will only underline printing characters. It will not underline the spaces between the columns. If you want an underline to be wider than the number in the column, you'll need to use the underline (shift + hyphen) key to type several underlines in front of the number.

Read the information below to learn about underlining columns. There's a practice exercise on the next page that will give you a chance to practice doing this.

Here's how it works ...

To underline a column or group of columns:

- Begin with a file on the screen
- Type any material up to the column to be underlined
- Press CTRL & 5 + S (to give the underline command)
- To make the underline wider than the number, type several underlines
- Type the number to be underlined
- Continue tabbing and typing all numbers to be underlined
- Press CTRL & 5 + S (to end the underlining)

CENTERING HEADINGS OVER COLUMNS

When you need to center headings over columns, you'll need to type the columns first and then go back and center the headings over them.

To center a heading, you simply space over to the column and type the heading. You can add or delete spaces in front of the heading until it is centered over the column on the screen.

Practice Exercise

When you've read about typing a statistical table, you may want to practice typing one before you do one on your own. This exercise will step you through typing the table on the next page.

MAKE sure your training disk or an initialized disk is in the B drive

IF the B Directory is not displayed, change to drive B

- Press B, then type **B:** and press RETURN

CHECK the number of files on the B disk

- Count the files (if there are 32 on a 5¼" disk, or 64 on an 8" disk, delete several of the files, using the instructions on page 3-2)

CHECK the disk space on the B disk

- Press the **H** key
- Type **STAT**
- Press RETURN
- Check the **SPACE REMAINING** (if it is less than 4K, delete one or more of the files, using the instructions on page 3-2)
- Press the **SPACE** bar to return to the Directory Menu

START a new document named **TABLE**

- Press the **A** key
- Type **TABLE**
- Press RETURN

SET the margins to 1 and 65, if they are not set there now

CLEAR all the tabs by pressing **CTRL & 4 + G + A** and RETURN

SET a decimal tab at 31

- Press **CTRL & 4**
- Press the **E** key
- Type **#31** (the # tells the 820 to set a decimal tab)
- Press RETURN

Notice the tab shows on the Ruler Line as #

Food Products	1,200.00	2,300.00	440.00
Paper Products	345.00	1,345.00	1,200.00
Plastics	<u>2,000.00</u>	<u>3,000.00</u>	<u>450.00</u>

SET a decimal tab at 46

- Press CTRL & 4
- Press the E key
- Type #46
- Press RETURN

SET another decimal tab at 62

TYPE the words **Food Products**

TAB once and type **1,200.00**

TAB once and type **2,300.00**

TAB and type **440.00** and RETURN

TYPE the next line on your own

Now you're ready to type the last line of the table. This line will need to be underlined, so you'll give the underline command before typing the numbers in the columns.

TYPE the word **Plastics**

PRESS CTRL & 5 + S (to give the underline command)

TAB and type the number **2,000.00**

You'll notice that the number does not appear aligned on the screen. The underline marker (S) throws the alignment off on the screen, however, the number will be properly aligned when you print the file.

TAB and type the next two numbers

PRESS CTRL & 5 + S (to end the underlining)

PRESS RETURN

After typing the table, you can type headings over the columns. The headings and instructions are on the next page. The instructions will tell you to insert a blank line at the beginning of the file, then space over and type the headings.

Practice Exercise (cont'd)

	1977	1978	1979
Food Products	1,200.00	2,300.00	440.00
Paper Products	345.00	1,345.00	1,200.00
Plastics	<u>2,000.00</u>	<u>3,000.00</u>	<u>450.00</u>

MOVE your cursor to the beginning of the file

PRESS CTRL & 8 (to insert a blank line)

PRESS the SPACE bar until the cursor is over the **2** in the first column

TYPE the heading **1977**

PRESS the SPACE bar until the cursor is over the **3** in the second column

TYPE the heading **1978**

PRESS the SPACE bar until the cursor is over the **4** in the third column

TYPE the heading **1979** and press RETURN twice

SAVE the file by pressing CTRL & 3 + G

PRINT the file so you can see how the underlines print

EDITING STATISTICAL TABLES

When you type a statistical table, the 820 puts the correct number of spaces between each column to align the numbers. When you edit the table, you must be careful not to add to or delete the spaces that align the columns.

Editing tables is made easier by turning the INSERT mode off. The insert mode command is on the Main Menu. You turn insert mode off by pressing CTRL & 9. You turn it back on by pressing CTRL & 9 again. The message INSERT will display at the top of the screen to let you know that insert mode is on. If there is no message, it means insert mode is off.

When the insert mode is off, any character you type will strike over (replace) the character at the cursor position. After editing a statistical table be sure to turn the insert mode on again.

(This page intentionally left blank)

TEXT TYPING FEATURES

This 820 has several text typing features that will help speed your typing and give your work a nicely finished look:

- To help you emphasize text, the 820 provides you with underlining and bold or double strike printing. (The heading on this page is bold printing.)
- To help center headings correctly, the 820 has an automatic center feature.

CENTERING TEXT

The 820 has an automatic center command that will center text between the margins on the Ruler Line. This can save you a great deal of time, as it is much faster than centering text manually.

The Format (Display) Menu (#4 on the Main Menu) has the center command on it, as shown below. To automatically center text, you type the text first and then give the center command.

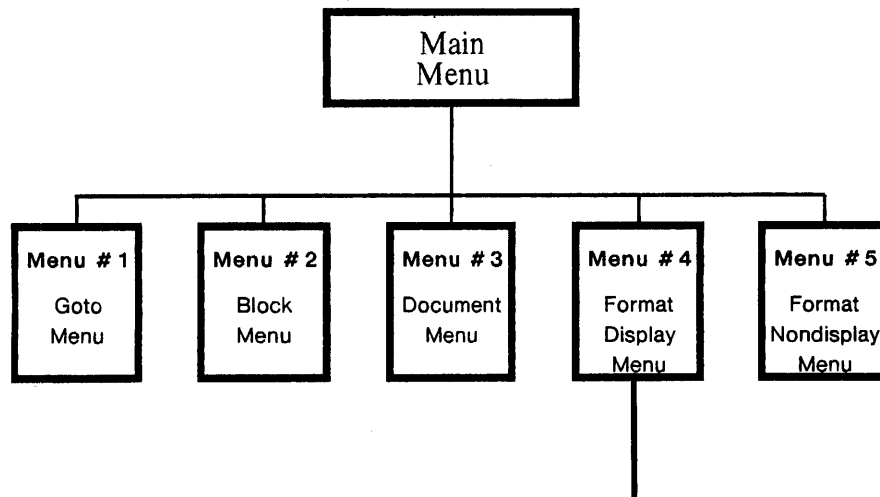

B:FILENAME PAGE LINE COL 0		INSERT ON
FORMAT (DISPLAY) MENU		HELP = for assistance
TAB = automatic indent	F = settings from a line	L = change line spacing
A = center the line	G = clear tab(s)	M = pagination off (ON)
B = margin release	H = hyphenation help	N = display printer
C = set right margin	J = turn syllable	codes off (ON)
D = set left margin	hyphen off (ON)	O = ruler off (ON)
E = set tab(s)	K = justify off (ON)	P = word wrap off (ON)

You may touch any key shown above. Touch SPACE bar to close the menu.

When the 820 centers the text, it will insert the correct number of spaces in front of the text to center it. If you edit the centered text, you'll need to give the center command (CTRL & 4 + A) again. The 820 will automatically recenter the text by adding or deleting spaces.

Read the steps below to find out how text is centered. If you want to practice centering text, you can do so in the exercise on page 11-5.

Here's how it works ...

Begin with a file on the screen,

To center text:

- Type the text to be centered
- Press CTRL & 4
- Press the A key
- End with a RETURN

UNDERLINING TEXT

The 820 will underline any amount of text that you choose. The underline command works as a start/stop command, which means that you must tell the 820 where to start the underlining and where to stop it. You can tell the 820 to underline single words, sentences, paragraphs or whole pages.

The underlining will not show on the screen as underlining. All that you'll see is the start and stop markers (S), as shown below.

This is the way ^ Sunderlined^S text
will look on the screen.

When you print the file, the text will be underlined (as shown below) and the start/stop markers will not print.

This is the way underlined text
will look when printed.

The underline command is shown as underscore on the Format (Non-display) Menu. It has an asterisk (*) after it to indicate that it is a start/stop command. That is, the first time you give the command it will start underlining, and the second time you give the command it will stop underlining.

B:FILENAME PAGE LINE COL Ø	INSERT ON
FORMAT (NONDISPLAY) MENU	Use HELP key from Main Menu
RETURN = overprint line C = stop printer here	N = standard pitch
BACKSP = required backsp D = double strike *	O = required space
LF key = line feed F = use hex 20 spoke	S = underscore *
A = other pitch G = use hex 7F spoke	T = superscript *
B = bolding * K = alternating headers	V = subscript *
	* = start/stop

You may touch any key shown above. Touch SPACE bar to close the menu.

You can easily remove the underlining from text without erasing the text. Simply delete the start and stop underline markers (the S). Be sure that you delete both the markers. If you don't, underlining will print in the wrong place in your document.

Read the steps below to find out how text is underlined. If you want to practice underlining text, you can do so in the practice exercise on page 11-5.

Here's how it works ...

To underline text while typing:

- Type up to the point where the underlining is to begin
- Press CTRL & 5
- Press the S key (to turn on underlining)
- Type the text to be underlined (do not space after the last word)
- Press CTRL & 5
- Press the S key (to turn off underlining)
- Continue typing

To add underlining to text that is already typed:

- Move the cursor to the first character of the text to be underlined
- Press CTRL & 5
- Press the S key
- Position the cursor after last character to be underlined
- Press CTRL & 5 + S again

To remove underlining from text:

- Move the cursor in front of the S (underline marker)
- Press the DEL key
- Move the cursor in front of the second S (underline marker)
- Press the DEL key

Note: You can also erase the underline marker by placing the cursor to the right of it and pressing the BACKSPACE key.

Practice Exercise

Now that you've read about centering and underlining, you may wish to practice using them. The steps below show you how to use each of these features.

MAKE sure your training disk is in the B disk drive

IF the B Directory is not displayed, change to drive B

- Press B
- Type **B:**
- Press RETURN

CHECK the number of files on the B disk

- Count the number of file names (if there are 32 on a 5¼" disk, or 64 on an 8" disk, you'll need to delete some of the files, using the instructions on page 3-2)

CHECK the disk space on the B disk

- Press the **H** key
- Type the word **STAT**
- Press RETURN
- Check the **SPACE REMAINING** (if it is less than 4K, delete several of the files, using the instructions on page 3-2)
- Press the **SPACE** bar to return to the Directory Menu

START a new document file named **TEXT**

- Press the **A** key
- Type **TEXT**
- Press RETURN

CONTINUE with the steps on the next page

Practice Exercise (cont'd)

DOG DAYS

Are They Really for the Dogs?

When I was a child growing up in Minnesota, there occurred a phenomena which I never quite understood. Every summer, right in the middle of the swimming season, the lakes would fill up with fine green algae that was quite fragrant.

It fact, it was so fragrant, that not even my dog would go swimming. I could never understand why people referred to this as "dog days." It seemed to me that they were not pleasant for either dogs or people.

UNDERLINE and type the first line in the document above

- Press CTRL & 5
- Press the S key (to turn on underlining)
- Type **DOG DAYS** (do not space after the word DAYS)
- Press CTRL & 5 + S (to turn off underlining)

CENTER the first line

- Press CTRL & 4 + A
- Press RETURN twice

TYPE, underline and center the next line

- Press CTRL & 5
- Press the S key (to turn on underlining)
- Type **Are They Really for the Dogs?**
- Press CTRL & 5 + S (to turn off underlining)
- Press CTRL & 4 + A
- Press RETURN twice

TYPE the first paragraph up to and including the words **Every summer,**

Follow the steps on the next page to underline the words **right in ...**

Practice Exercise (cont'd)

UNDERLINE the phrase **right in the middle of the swimming season**

- Press CTRL & 5 + S
- Type **right in the middle of the swimming season** (do not space after the phrase)
- Press CTRL & 5 + S
- Type , and the rest of the paragraph

CONTINUE typing the rest of the document, underlining words as required

(To underline a word, press CTRL & 5 + S, type the word without spacing after it, and press CTRL & 5 +S again.)

SAVE the document file

- Press CTRL & 3
- Press the G key

PRINT the document file

- Press the F key
- Type **TEXT**
- Press RETURN eight times

Notice that the printed document has underlining at the locations where you typed the commands in the file.

You have finished the Recommended sections of **TEXT TYPING FEATURES**. The remainder of this chapter covers other features and applications.

BOLDING AND DOUBLE STRIKING TEXT

The 820 has the ability to print any amount of text in bold. Bold text is struck twice at the printer (the second time just a fraction of an inch over) to make it appear darker and heavier, as shown below.

You can use **bold text** to emphasize text.

Like underlining, the bold command is a start/stop command that is marked on the screen with a **B**. When the file is printed, the text will print bolded and the bold markers will not print.

Double strike is similar to bold, except that the text will not appear quite as heavy when printed. The printer will strike the characters twice to make the characters darker, but it will not move over a fraction of an inch to make the characters heavier. The double strike start/stop marker is a **D**.

The bold and double strike commands are on the Format (Non-display) Menu (#5 on the Main Menu).

B:FILENAME PAGE 1 LINE 1 COL 01		FORMAT (NONDISPLAY) MENU		INSERT ON	
				Use HELP key from Main Menu	
RETURN =	overprint line	1 C =	stop printer here	1 N =	standard pitch
BACKSP =	required backsp	1 D =	double strike *	1 O =	required space
LF key =	line feed	1 F =	use hex 20 spoke	1 S =	underscore *
A =	other pitch	1 G =	use hex 7F spoke	1 T =	superscript *
B =	bolding *	1 K =	alternating headers & trailers (on/off)	1 V =	subscript *
		1		1 *	start/stop

You may touch any key shown above. Touch SPACE bar to close the menu.

Like underlining, the bold and double strike commands can be added to a file after it is typed, and can be deleted without erasing the text itself.

Read the steps below to learn about bolding and double striking. If you want to practice them, see the note at the bottom of the page.

Here's how it works ...

To bold or double strike text while typing:

- Type up to the point where the bolding or double striking is to begin
- Press CTRL & 5
- Press the **B** key to start bold or the **D** key to start double strike
- Type the text
- Press CTRL & 5
- Press the **B** key to stop bold or the **D** key to stop double strike
- Continue typing

To add bold or double strike after the text is typed:

- Move the cursor to the first character of the text
- Press CTRL & 5
- Press the **B** key to start bold or the **D** key to start double strike
- Position the cursor after last character to be double struck
- Press CTRL & 5
- Press the **B** key to stop bold or the **D** key to stop double strike

To remove bold or double strike from text:

- Move the cursor in front of the first marker (the **B** or **D**)
- Press the DEL key
- Move the cursor in front of the second marker
- Press the DEL key

Note: You can also erase a bold or double strike marker by placing the cursor to the right of it and pressing the BACKSPACE key.

Note: There is no practice exercise for bolding and double striking. If you wish, you may retype the document used for the underlining exercise. Give the document a new name and substitute the bold and double strike (CTRL & 5 + B and CTRL & 5 + D) commands for the underline commands.

TYPING SUPER AND SUBSCRIPTS

The superscript command is used to raise a character or group of characters, one-half line above the line of typing, as shown below. Superscripts are frequently used for footnote notations.

The subscript command is used to lower a character, or group of characters, one-half line below the line of typing, as shown below. Subscripts can be used to type scientific notations or formulas.

A superscript is often used to denote a footnote.¹

A subscript is used to type a formula like H₂O.

The super and subscript commands are on the Format (Non-display) Menu. Like the underline command, they are start/stop commands. This means that you give the command before you type a super or subscript, and you give the command again at the end of the super or subscript.

For example, to type "footnote¹" you type "footnote", press CTRL & 5 + T, type the number 1, and press CTRL & 5 + T again. This will raise the number one from the line of typing, and then return to the line of typing again.

The superscript start/stop markers display on the screen as ^ T

The subscript start/stop markers display on the screen as ^ V

Read the steps below to find out how to type super and subscripts.

Here's how it works ...

To type a superscript:

- Type the text up to the superscript
- Press CTRL & 5
- Press the T key (to turn on superscript)
- Type the superscript text
- Press CTRL & 5 + T again (to turn off superscript)

To type a subscript:

- Type the text up to the subscript
- Press CTRL & 5
- Press the V key (to turn on subscript)
- Type the subscript text
- Press CTRL & 5 + V again (to turn off subscript)

Note: There is no practice exercise for super and subscripts. If you wish, you may type the example above on your own.

TYPING A LETTER AND ENVELOPE

The 820 can save time when you type letters and envelopes. You only need to type the address once. Then you can use the block copy feature to copy the address onto a separate page so you can print it on the envelope.

Below is a complete set of steps for typing a letter and envelope. Any time you need to type a letter and envelope, you can refer back to these steps

The steps take you through setting new margins and tabs, marking the address as a block while you type the letter, and then copying the address block to a separate page. The steps also include an instruction to tell the 820 not to print page numbers on your letter and envelope. If you want page numbers on your letter, wait until you have finished typing the letter before giving the omit page number instruction.

If you wish to practice typing a letter and envelope, use any letter you have in your office and follow the steps below to type it.

If the B Directory is not displayed, change to drive B

- Press B, then type B: and press RETURN

START a new document file for the letter

- Check that the disk in the B drive has room for your letter
- Press the A key
- Type a name for the letter, then RETURN

SET new margins for the letter (this step is optional)

- Press CTRL & 4
- Press the D key, type the new left margin and RETURN
- Press CTRL & 4
- Press the C key, type the new right margin and RETURN

CLEAR and **SET** new tabs (this step is optional)

- Press CTRL & 4
- Press the G key, the A key and RETURN (to clear all tabs)
- Press CTRL & 4
- Press the E key, type the first tab setting and RETURN
Repeat step above if you need more tabs

TYPE .OP and RETURN (to tell the 820 not to print page numbers on your letter -- if you want page numbers on your letter, skip this step)

TYPE the date and press RETURN five times

TYPE the address, using the block commands to mark it as a block

- Press CTRL & 2 + A (to mark the block beginning)
- Type the address and two RETURNS
- Press CTRL & 2 + B (to mark the block end)

TYPE the rest of the letter (be sure to end with a RETURN)

PUT in a required page break at the end of the letter

- Type **.PA** and RETURN

CHANGE the margins for the envelope.

- Press CTRL & 4
- Press the **D** key, type **40** and RETURN
- Press CTRL & 4
- Press the **C** key, type **120** and RETURN

IF you did not put an **.OP** command in the letter (to omit page numbers), you should type **.OP** and RETURN now

COPY the address to the envelope page

- Press CTRL & 2
- Press the **C** key
- Press CTRL & 6 (to move the address over to the new margins)

SAVE the letter and envelope

- Press CTRL & 3
- Press the **I** key (to save the file and reset the ruler line)

PRINT the letter and envelope

- Insert your letter paper in the printer
- Press the **F** key
- Type the name of the letter file
- Press RETURN six times
- Press the **Y** key
- Press RETURN

The first page of the letter will print. If this is a two page letter, insert another piece of paper, and press the **F** key.

After the letter has printed:

- Insert an envelope (align the left edge of the envelope with the arrow on the paper scale)
- Press the **F** key

USING STANDARD (BOILERPLATE) TEXT

Standard (or boilerplate) text refers to any text that does not change from one document to the next. Some examples of standard text are:

A standard document, such as a form letter, will or a sales proposal

Standard paragraphs or sections of text that are put together to create documents or letters

When you add other information to the standard text (for instance, the name and address on a form letter), you create a customized document.

Your 820 can save you time when your job calls for working with standard text. You only need to type the standard text once to record it on disk. After that, you can use the text on the disk to make customized documents.

When you create the customized document, you'll copy the standard text to the customized document. This will allow you to customize the standard text and still keep a master copy of the standard text on the disk for future use.

When using 5¼" disks, the most important thing to remember when working with standard text is that you must keep your documents short. A 5¼" disk has room for about 40 pages of typed material (less than 40 if the pages have more than 2,000 characters on them). You'll need to have room on the disk for both the standard and custom document files, plus BAK (backup) files if you do any editing.

We recommend that your standard document files be no longer than 5 to 6 pages. With a standard document file of this length, you'll have room on your disk for the standard document files, plus 4 to 6 custom document files.

When working with standard documents, be sure to check the amount of room on your disk regularly. When a disk is almost full, copy your standard document file to another disk and continue working with it there. (Use the PIP program to copy; instructions on page 3-7.)

Creating Standard Documents

It is best to type each standard document on a disk by itself. If you have a new disk or a disk that you want to completely erase, use the INIT program to prepare it for use in the 820 (instructions on page 3-9).

Type and save the standard document as you would any other document file. It is best to give the file a name that is easy to remember.

If you are going to customize the document by typing information within the standard text, you can type **XX** at the location where the custom information will be added. You can then use the **find** command on the Main Menu to search to each **XX** in the file so you can type in the custom information.

Read the steps below to find out how to create a standard document file. There is no practice exercise, but you can use the steps to practice on your own if you like.

Here's how it works ...

To create a standard document:

- Start with the Directory of B on the screen and a blank disk in Drive B
- Press the A key
- Type a name for the standard document file
- Press RETURN
- Type the standard text (do not include any custom information)
- Save the file by pressing CTRL & 3 + G

Customizing Standard Documents

When you're ready to customize a standard document, you'll start by typing a name for the custom document file and bringing the new file to the screen. You'll then use a command on the Document Menu to put the text from the standard document into the file on the screen.

After you've put the standard text in the file on the screen, you can add any custom information (such as name and address, etc.). If you put custom information within the standard text, you'll need to reformat to rearrange the line lengths and make the right margin even. Be sure you check that the Ruler Line has the settings you want before you reformat.

Read the steps below to find out how to customize a standard document file. There is no practice exercise, but you can use the steps to practice on your own if you like.

Here's how it works ...

To create a custom document:

- Start with the Directory of B on the screen
- Make sure the disk in Drive B has the standard document file on it
- Check disk space and the number of titles to be sure you have room for the new custom document file
- Press the A key
- Type a name for the new custom document file
- Press RETURN
- Press CTRL & 3 + E (to put the standard text in the file on the screen)
- Type the name of your standard file
- Press RETURN
(This will copy the standard document file into the file on the screen.)
- Check that the Ruler Line matches the margins and tabs of the standard text
(To change the margins, you can move the cursor to a full line of typing and press CTRL & 4 + F)
- Add any custom information necessary
(If you add material within the standard text, be sure to reformat.)
- Save the file by pressing CTRL & 3 + G

Standard Paragraphs

Standard paragraphs are used to create a custom document. The standard paragraph text will remain the same, but the order that the paragraphs appear in may vary.

You can easily create standard paragraphs on your 820 by typing and saving each paragraph as a separate document file. To make the paragraphs easier to work with when you put them in a customized document, use the same margin and tab settings.

When using 5¼" disks, you will have room to type 15 to 20 standard paragraphs, plus 5 to 10 customized document files. It is best to keep a copy of the standard paragraphs on a disk by themselves. You can then copy them all onto a new disk each time you need more disk space for creating customized documents.

When working with standard paragraphs, you'll need to remember to check the number of files on the disk regularly. A 5¼" disk can only have 32 document files, and an 8" disk can have 64 document files.

The steps for creating standard paragraphs are the same as for creating standard documents on the previous page.

The steps for creating a custom document are also very similar to those on the previous page. The only difference is that you'll repeat the step (CTRL & 3 + E) for each standard paragraph that you want put in the custom file.

DOT COMMANDS

The DOT COMMANDS are special commands to the printer, typed in a file.

A dot command consists of a period in column 1 and a two-letter code. Some of the codes will be followed by a number, line of text, etc. The dot command shows on the screen but does not print.

A dot command can be on any line. However, the .LH, .PL, .MT, and .MB commands, should be placed at the beginning of the file, in front of any text.

--- Vertical Page Layout ---

<u>Function</u>	<u>Command</u>	<u>Description</u>
Line Height	.LH n	Sets line height in <u>1/48ths</u> of an inch on daisy wheel printers. The standard setting for .LH (Line Height) is 8, which gives 6 lines per inch; .LH 6 yields 8 lines per inch, .LH 12 gives the same spacing as 1½ line spacing on a typewriter, etc. The .LH command can be used in place of the single, double, triple spacing command on the Format (display) Menu. If .LH is used when printing on a printer incapable of incremental spacing, page breaks are nevertheless determined as though the command took effect.
		Note: All subsequent commands that are set in a number of lines will be interpreted as using the new line height. Previously set values (top margin, paper length, etc.) will remain the same in inches.
Paper Length	.PL n	n is the number of <u>lines</u> on a entire page, including the top and bottom margins (6 lines per inch if no .LH has been given). The paper length must match the form in use if you use continuous form paper. The standard setting is 66 lines or 11 inches.
Top Margin	.MT n	n is the number of <u>lines</u> from the top of the paper to the beginning of the body of the text on the page.

Note: The page heading, if in use, and the heading margin, will be printed in this space. See .HM and .HE, below. The standard top margin is 3 lines. The "top of the page" for the first page printed is wherever you position the paper before starting the printer if the USE FORM FEEDS option is not selected in the print option. (Selecting USE FORM FEEDS will advance the paper a full sheet - 66 lines - before printing.)

OTHER FEATURES

Bottom Margin **.MB n** n is the number of lines at the bottom of a page not used for text. The page number or footing, if in use, is printed within the bottom margin. (See **.FM** below.) The standard bottom margin is 8 lines.

Note: The maximum number of lines on the page used for the body of the text is the paper length, minus the top and bottom margins. If the line height (**.LH**, above) is changed after these commands are given, the same number of inches, not lines, of text continues to be printed. Fewer lines are, of course, used for particular pages where **.PA** or **.CP** commands (below) invoke page breaks. The top and bottom margin values may be adjusted to give the desired number of text lines on a page, and to vertically center the text on the page.

REMINDER: The preceding commands, **.LH**, **.PL**, **.MT**, and **.MB**, will only be interpreted correctly (with respect to page break display during editing) if they appear at the beginning of the file.

Heading Margin **.HM n** n is the number of blank lines between the page heading, if used (see **.HE**), and the body of the text. Note that the heading and the heading margin appear within the top margin space. If a value greater than the top margin less 1 is specified, the top margin less 1 is used. The standard heading margin is 2 lines.

Footing Margin **.FM n** n is the number of lines between the end of the portion of the page used for text, and the page number or footing (see **.FO**). Note that the footing margin and the page number or footing appear within the bottom margin space. The standard footing margin is 2 lines.

--- HORIZONTAL PAGE LAYOUT ---

Most horizontal formatting, such as the margins and tabs, is done during editing, and does not involve dot commands. The following dot commands are provided to control those aspects of horizontal formatting that are done at the printer.

<u>Function</u>	<u>Command</u>	<u>Description</u>
Page Number Column	.PC n	<u>Column</u> at which the page number is printed when no footing (see .FO) is in use and .OP is not in effect. May be set to print page numbers at left, right, or center, etc., at the bottom of the page (additional page number positioning options are provided thru the use of # within the .HE and .FO commands, as described on page 12-5).
Page offset	.PO n	<u>Number of columns</u> the entire document is indented from the printer's left margin, in addition to all indentation in the file. This allows you to offset the text from the left of the paper and allows putting narrow paper near the center of wide printer carriages. The standard page offset is 8 columns.

— PAGINATION —

<u>Function</u>	<u>Command</u>	<u>Description</u>
Page	.PA	Start new page unconditionally.
Condi- tional Page	.CP n	Start new page if there are less than n lines (of the current height) left on the current page. Use to keep blocks of text together, to prevent paging just after a title, in the middle of a paragraph, etc. Using lots of .CP commands can make the document always print well paginated regardless of insertions or deletions as .CP's have no effect when not needed.

— PAGE HEADINGS, PAGE FOOTINGS, AND PAGE NUMBERS —

Function	Command	Description
Heading	.HE text	<p>All text in a line beginning with the command .HE is used as a page heading for following pages until another .HE command is given. The heading may be changed as often as desired. The standard heading is blank; the heading may be changed back to blank by entering an .HE command with no text on the same line. To print a heading on the first page, an .HE command <u>must precede</u> all text in the file.</p> <p>When composing a heading (or footing) on the screen, bear in mind that the characters ".HE" do not print. Thus, the heading will print 4 columns to the left of where it appears on the screen.</p> <p>NOTE: See "Special Characters" information after .FO section.</p>
Footing	.FO text	<p>The rest of the line beginning with .FO is used as a page footing for the current and following pages. As many .FO's commands as desired may be given; the most recent footing will be used when the bottom of each page is encountered.</p> <p>The characters #, /, and <u>Control K</u> are interpreted in footing text as described below.</p> <p>When no .FO command, or .FO with no text after it, has been given the Xerox 820 Information Processor will print the page number in the footing line at the column specified with the .PC command (center of the page unless suppressed with the .OP command). When a footing is in effect, <u>no page number</u> is automatically printed. <u>If you wish the pages to be numbered, include</u></p>

a # at the desired position in the heading or footing.

The following special characters are interpreted in headings (.HE) and footings (.FO) only:

Tells the printer to print the current page number. May also be used to position page number wherever desired at top or bottom of page.

/ Tells the system to print the next character **without special interpretation** -- use /# to print a # (number sign) in heading or footing, // to print a / (slash).

K Left - Right Heading/Footing Control: This command is used within heading and footing commands to print on the right side of odd-numbered pages and on the left side of even-numbered pages.

Control+K tells the system to ignore the following spaces up to next non-space character if page number is even; may be used to cause page number or other heading or footing text to appear on corner of page farthest from binding. Note that a control-K is entered into the file by typing control-5, K.

Omit Page numbers	.OP	Suppresses the printing of page numbers in the footing line if no footing has been given. If a footing has been specified, .OP has no effect; .OP also does not affect printing of page numbers where a # appears in the heading or footing.
Number pages	.PN	.PN (without a number) turns page numbering back on after a .OP command. .PN has no effect if there is an .FO command.
Page Number	.PN n	.PN with a number turns page numbering back on (if it has been turned off with .OP), and sets the page number to appear at the bottom of the current page and/or if a # is encountered as the page heading or footing is printed. May also be used to start

OTHER FEATURES

numbering with a number higher than 1. The standard starting page number is 1; the page number increases by 1 each page whether or not the page is actually printed. .PN affects the printout page number only; those displayed at the top of the screen during editing always start from 1.

--- MISCELLANEOUS DOT COMMANDS ---

Function	Command	Description
Char- acter Width	.CW n	<p>On daisy wheel printers, this command sets character width in 1/120ths of an inch, for either the normal or other character pitch, whichever is currently in effect. (Normal and other pitch are selected from the Format (non-display) Menu.) Has no effect on non-daisy printers. Allows unusual character spacings -- for example, spacing characters farther apart than normal for emphasis in a title. The standard (normal) pitch is 10 characters to the inch (equivalent to .CW 12); the alternate (other) pitch is 12 characters to the inch (.CW 10).</p> <p>NOTE: Changing the character width or pitch does not affect previously specified page offset (.PO) or page number column (.PC) values, nor previously specified heading (.HE) or footing (.FO) texts (except when the Format (non-display) Menu is used to place CTRL + A or CTRL + N within the actual heading or footing texts). Subsequent .PO, .PC, .HE, and .FO commands will be interpreted in terms of the character width and pitch in effect when the .PO, .PC, .HE, or .FO is encountered.</p>
sub/ super- script roll	.SR n	<p>Number of 1/48ths of an inch the carriage is rolled before printing a subscript or superscript on a daisy wheel printer. The standard is 3/48.</p>
<p>Justification Off (.UJ OFF or .UJ O) Justification On (.UJ ON or .UJ 1)</p>		<p>When Justification is off, all spaces, including "soft" spaces are printed exactly as they appear in the file. Spaces added to justify lines on the screen print as they appear on the screen rather than being evenly distributed between words in 1/120ths of an inch on daisy printers. Justification is normally on. Turning Justification off might be useful, for example, to make a columnar table print</p>

OTHER FEATURES

with the columns aligned as they appear on the screen even if soft spaces were inadvertently put in the table lines by reformatting (CTRL 6) or word wrap.

Bidirectional Print Off (.BP OFF or .BP 0)

Bidirectional Print on (.BP ON or .BP 1)

Bidirectional Print (printing alternate lines right to left) is normally on for daisy printers. Turning bidirectional print off might in some cases produce better quality output when the printer's character registration or paper feed is a little sloppy.

IGnore

.IG text
.. text

Either of these specify that the rest of the line is comment material and should not be printed.

Any dot command is also treated as a comment by the printer; however, the screen displays a ? in the rightmost screen column for unknown dot commands.

USING DOT COMMANDS

Page Headings: Use the .HE command to specify the text of a one-line heading to be printed at the top of each page. Example:

.HE USING DOT COMMANDS

When composing a header on the screen, bear in mind that the ".HE" takes four columns that won't print, so the header will display four characters to the right of where it will print. A right-aligned heading may be produced, for example, by entering spaces between the .HE and the header text.

.HE

Section 5

If you wish the page number to be printed at the top of the page, give a .HE command with a "#" in the position where you wish the page number printed. For example, if you want the word "Page" followed by the page number at the top left of each page, use the following dot command:

.HE Page #

When composing a heading containing a #, bear in mind that the number of columns occupied by the page number will depend on the number of digits in the page number. When printing the page number at the top of the page but not using a footing (no .FO command), it is necessary to give a .OP command to prevent the Xerox 820 Information Processor from printing the page number again at the bottom of the page.

The heading may be changed as often as desired. To go back to no heading, give a blank heading:

.HE

Each .HE takes effect at the NEXT page to be encountered; if it occurs before any text has been printed on the current page (for example, immediately after a .PA command), it will be used on the current page.

The number of lines between the heading and text can be changed with the .HM (heading margin) command. This command moves the heading, without altering the page length or the position of the text on the page; the heading margin falls within the top margin.

No heading will be printed if the top margin (.MT) is set to zero.

Underline, Bold and other enhancements invoked by print control characters may be used in headings (and footings). Print controls in .HE (and .FO) commands do not affect the body of the text, nor do those in the body of the text affect the heading (or footing). If you vary the character width, the heading (or footing) will be printed in the character width that was in effect when the .HE (.FO) command was given. However, if CTRL & 5 + A or CTRL & 5 + N is used within the heading (or footing), the pitch in effect at each time the heading is printed will be used.

Page Footings: The .FO command may be used to specify a line of text to be printed at the bottom of each page. Use of this command is similar to use of the .HE command (preceding). The most recently specified footing is used when the bottom of each page is encountered. If the footing contains a #, the page number will be printed in place of the #.

The .FM (footing margin) command may be used to specify the number of blank lines between the bottom of the text area and the footing line. The footing margin lies within the bottom margin; varying the footing margin moves the footing up and down without changing the number of lines of text on the page. No footing will be printed if the bottom margin (.MT) is set to zero.

The Standard Footing is the Page Number: If no footing is in effect (no .FO command given, or most recent .FO command has no text after ".FO"), the Xerox 820 Information Processor will print the the page number in the footing line unless suppressed with a .OP command. The page number is centered at the column specified with the .PC command; the standard is column 33 (or column 30 if a 64-column wide screen is used, reflecting the narrower standard margins used in the edit function), so as to be centered under text typed using the standard margins.

Page Numbering: The Xerox 820 Information Processor numbers the pages in each file from 1 up as the file is printed. The page number may be changed as desired with the .PN command. For example, if a file represented the second chapter of a large document, and there were 23 pages in the first chapter, you might want to put

```
.PN 24
```

at the beginning of the chapter two file, so that its pages would be numbered from 24 up as it was printed.

Note that .PN affects the page numbering at printout only; the page numbers displayed in the status line during editing always start with 1 and increase by 1 each page.

The maximum page number your system will accept is 65533. (For the other dot commands, the maximum is 255.)

The page number may be positioned wherever desired in the heading or footing line by using a # in the .HE or .FO command. If no footing is specified, the page number is printed in the footing line. This page number printout may be turned off with .OP, and turned on with .PN (no number need

be given after .PN unless it is also desired to set the page number). The column at which the page number prints in the footing may be changed with .PC n. For example, if you wanted to center the page number under text 80 columns wide (as formatted during editing) you could use:

.PC 40

The following footing command would have the same effect:

.FO #

Left-Right Page Numbers: By using the special character CTRL & 5 + K in a .HE or .FO command, you can make your system print page numbers (or other heading and/or footing texts) at the right hand side of odd numbered pages but at the left hand side of even numbered pages. An example of the following footing is shown below:

.FO 10-#

The above footing prints as

.FO 10-#

on even numbered pages, putting "10-" and the page number on the lower left corner of the page, and, on odd numbered pages, as

.FO 10-#

Pagination: Page break control is used for two purposes: to force the following text to begin at the top of a page, as at the beginning of a chapter, and to prevent going to a new page in an inappropriate place (such as in the middle of a table or after a Section title but before the beginning of the text after the title). You may also wish to prevent page breaks one or two lines into a paragraph, as the entire paragraph prints on the next page.

For the first case, where a new page is always desired, use the page command:

.PA

For the second case, it is usually desired to have a page break occur only when less than a certain number of lines remain on the current page. For these cases, use the "Conditional Page" (.CP) command. The command looks at the number of lines remaining on the current page, and causes a page break only if too few remain. For example, if you have a table 10 lines long, put

.CP 10

above it. This will cause a page break during printout (and also display the page break line on the screen) only if fewer than 10 lines remain on the current page. That is, the following 10 lines, containing your table, will print on the current page if they will fit, otherwise a new page will be begun, with the 10-line table at the top.

Using .CP instead of .PA reduces the need to check pagination and move dot commands as the document is updated. For example, if a page break fell in the middle of the table in the previous example and you corrected this by inserting a .PA above it, you would need to find and remove the .PA later if you made an insertion above the table. **.PA always causes a page break even if it falls at the top of a page.** On the other hand, a .CP 10 that falls more than 10 lines above the bottom of a page has no effect and may be left in the document. It will take effect whenever revisions preceding it make the table fall near the bottom of the page.

As another example, we suggest always putting .CP 5 (or so) above each Section title. This starts a new page if fewer than 5 lines remain on the page, so that a section title will not appear as the last line on a page or with only two or three lines of text after it. If you enter these as a matter of habit when initially typing documents, then as the document is revised it will always print well-paginated even if you do not review the pagination after each edit.

Paper Length: The Xerox 820 Information Processor assumes 66 lines to the page, corresponding to 11-inch (letter size) paper at 6 lines per inch. If you wish to use different sized paper (like legal size), specify the number of lines on each COMPLETE PIECE OF PAPER with the .PL command. This is not the number of lines of text printed, but the form length. The paper length may be set shorter than the actual length only if your printer has a tractor form feed and the USE FORM FEEDS option is selected every time print is initiated.

Top and Bottom Margins: The Xerox 820 Information Processor leaves a number of blank lines at the top of each page and a blank area at the bottom of each page. The number of lines of text printed on each page, if no page break is caused by a .PA or .CP command, is equal to the paper length (.PL), less the top and bottom margins. To increase the amount of text on a page, decrease the top or bottom margin; to decrease the amount of text, increase one or both margins.

Position of Text on the Page: The text can be moved up or down on the page either by changing the top (.MT) and bottom (.MB) margins by the same amount, or by moving the paper in the printer. The standard top and bottom margins approximately center the text vertically on the page if the paper is positioned with the print head two or three lines down from the top of the page when printing is initiated.

If you are loading single (cut) sheets, such as letterhead, you may want to move the text up (smaller top margin) so that you can roll each sheet under the paper bail.

The text can be moved horizontally on the page by changing the Page Offset. The Xerox 820 Information Processor prints 8 spaces (in addition to any at the left margin in the file) at the beginning of each line. To move the text to the left edge of your printer carriage, put the following at the beginning of the document:

```
.PO 0
```

Interaction with Dynamic Page Break Display: When possible, use the .PL, .MT, .MB and .LH commands once only at the beginning of the file, so that

dynamic page break display will accurately show the printout page breaks on-screen while editing.

Changing Line Height: On daisy wheel printers, the line height may be specified in 48ths of an inch with the .LH command. For example, to print 8 lines per inch instead of the usual 6, use the command:

.LH 6

When the line height is changed on a daisy-wheel printer, margins and paper length are not affected. They remain the same in inches, regardless of the line size. However, subsequent .PL, .MT, .MB, .HM, and .FM commands are interpreted (converted to inches) in terms of the new line height.

Thus, if you use the .LH command, carefully consider the order in which .LH and other vertical format commands are given. For example, .LH 6 followed by .MT 4 yields a 1/2 inch top margin (4 lines of 6/48 each), whereas .MT 4 followed by .LH 6 yields a top margin of 2/3 inch, because the .MT command, appearing first, is interpreted using the standard line height of 8/48 of an inch.

The print function will handle as many changes of line height as you wish, but for dynamic page break display to work, you must set the line height only at the beginning of the file.

Hint: To achieve varying line heights without interfering with the dynamic pagination, set the line height to 4 (one-half of normal) at the beginning of the file, then use double-spaced text for close-spaced printout, and triple or quadruple spaced text for wider line spacing. The CTRL & 4 + L command, can be used to cause automatic double, triple, etc. spacing as text is entered or reformatted.

Changing the Character Pitch: The width of each character printed (how far the print head moves between characters) can be varied in two ways: with the CTRL & 5 + N and CTRL & 5 + A print control characters, which may be imbedded mid-line to allow switching between two character widths, and (on a daisy wheel printer) with the .CW command, which allows setting any character width, but only between lines. These can interact, as will be described shortly.

When a page offset (.PO), page number column (.PC), heading (.HE), or footing (.FO) is specified, it is interpreted in the current character pitch; subsequent pitch changes do not alter the page offset, page number position, or the character spacing in previously specified page headings or footings.

Pitch Changing on a Daisy Wheel Printer is accomplished with the CTRL & 5 + N and CTRL & 5 + A print command and/or the .CW command:

Control & 5 + A Selects other (alternate) pitch, which is 12 characters per inch.

Control & 5 + N Selects normal (standard) pitch, which is 10 characters per inch.

.CW n

Sets the character width to n 120ths of an inch for normal or other pitch, whichever is in effect, without affecting the other pitch.

EXCEPTION KEYS

On the Xerox 820 Information Processor, some keystrokes from the keyboard may perform the same function as other keystroke sequences. The list below gives the equivalent keystrokes for each menu.

DIRECTORY MENU

<u>Defined keystroke</u>	<u>Equivalents</u>
A	Up cursor
B	Down cursor
C	Right cursor
D	Left cursor
H	BACKSPACE
I	CTRL + J, Shift + J, LINEFEED
ESC	CTRL + ,
HELP	Shift + 6
CTRL (-)	Shift - (or underline)
CTRL (=)	Z

Other keystrokes execute no command.

- (a) Copy can be reached by pressing 'I' or TAB. The PIP utility is the recommended copy routine.
- (b) Merge-print is reached by pressing 'J'. Merge-print functions are not included. A message appears telling user to press ESC.

MAIN MENU

<u>Defined Keystroke</u>	<u>Equivalents</u>
CTRL + 1	CTRL + Q
2	R
3	S
4	T
5	U
6	V
7	W
8	X
9	Y
0	P
-	None
=	Z
A	Up cursor
B	Down cursor
C	Right cursor
D	Left cursor
E	None
F	None
J	LINEFEED
CTRL + K	None

OTHER FEATURES

12-16

L	None
M	None
TAB	CTRL + I
BACKSPACE	CTRL + H
HELP	None
RETURN	CTRL + M
PAD KEYS 0-9,+,-	None
DELETE	None
ESCAPE	None

- (a) Delete to beginning of line can be reached with **CTRL + N** then **A**.
- (b) Delete to end of line can be reached with **CTRL + N** then **B**.
- (c) Delete right word can be reached with **CTRL + N** then **C**.

CTRL + 5 - FORMAT (NONDISPLAY MENU)

TAB	I
RETURN	M
LINEFEED	J
BACKSPACE	H
A	Up cursor
B	Down cursor
C	Right cursor
D	Left cursor
P	CTRL + 0 (on keyboard)
Q	1
R	2
S	3
T	4
U	5
V	6
W	7
X	8
Y	9

ALL OTHER SUBMENUS (CTRL + 1 = CTRL + 4)

<u>Defined Keystroke</u>	<u>Equivalents</u>
A	Up cursor
B	Down cursor
C	Right cursor
D	Left cursor
E	None
F	None
G	None
H	BACKSPACE
I	TAB
J	LINEFEED
K	None
L	None
M	RETURN

N	None
O	None
P	CTRL + 0
TAB	I
BACKSPACE	H
RETURN	M
ESCAPE	None
SPACE Bar	None

Document Menu

- (a) COPY reached by **CTRL + 3** then **J**. PIP is recommended copy routine.

Format (Display) Menu

- (a) Variable tabs **CTRL + 4** then **Q**

Format (nondisplay) Menu

- (a) Overstrike **CTRL + 5** then **X**
- (b) Ribbon color change **CTRL + 5** then **Y**
- (c) Page break inserted with **CTRL + 5** then **L**
- (d) Print next line over current line reached by **CTRL + 5** then **M**
- (e) Line feed reached by **CTRL + 5** then **J**
- (f) Other keystrokes

Pressing:

- . Z closes menu without doing anything
- . Any alphabetic character other than those already described places that letter in the field.
- . 0-9 and other characters (!, #, etc.) place that character in the file.
- . DELETE places 'tilde' in the file.
- . ESCAPE Places ',' in the file.
- . TAB - tabs over.
- . Cursor characters places A, B, C, or D in file.
- . HELP places '-' in file.

Go to Menu

- (a) Continuous scroll up/down reached by **CTRL + 1** then **W** or **Z**.

Place Markers

While typing or editing a document file, you may want to mark certain locations so that you can easily return to them. You can do this by putting Place Markers at these locations. You can have up to 10 Place Markers in a file. The Place Markers will stay in the file as long as it is on the screen. When you save the file on disk, the markers will be removed.

To put a Place Marker in a file, you move the cursor to the desired location and press CTRL & 2 to bring up the Block Menu, shown below. Then you type any number from 0 to 9. The Place Marker will be placed in the document file at the position of the cursor. The marker will display as the number you typed surrounded by brackets.

B:FILENAME PAGE LINE COL #		INSERT ON	
BLOCK MENU		HELP = for assistance	
A = mark block beginning	D = delete block	G = block marker	
B = mark block ending	E = move block	display (on/off)	
C = copy block	F = save block in	0-9 = assign a marker #	
	another file		

See GO TO MENU to find place markers 0-9.
You may touch any key shown above. Touch SPACE bar to close the menu.

When you want to move to a Place Marker, you press CTRL & 1 to bring up the Go To Menu, shown below, and then type the marker number. The cursor will immediately move to the location of the marker.

B:FILENAME PAGE LINE COL #		INSERT ON	
GO TO MENU		HELP = for assistance	
BACKSP = goto origin of	A = top of screen	F = right word	
relocated text	B = bottom of screen	G = beginning of block	
RETURN = position before	C = end of file	I = end of block	
last command	D = beginning of file	J = left side of line	
0-9 = goto marker #	E = left word	K = right side of line	

You may touch any key shown above. Touch SPACE bar to close the menu.

Here's how it works ...

To put a place marker in a document file:

- Move the cursor to the position where you want the marker
- Press CTRL & 2
- Type the number for the marker (0-9)

To go to a place marker from anywhere in the file:

- Press CTRL & 1
- Type the number of the marker (0-9)

Place markers will be removed from the document file when you store it.

Section 13 -- REFERENCE

13.1	Introduction to INSTALLATION	1
13.2	Printer Installation Considerations	1
13.2.1	Daisy Printers and Teletype-like Printers	1
13.2.2	Communications Protocol	3
13.2.3	Printer Drivers	5
13.2.4	Recap of Printer-Related Installation Selections	7
13.2.5	Printer Configuration	8
13.3	The Word Processing and Program Disks	8
13.4	Installation Procedure	9
13.4.1	Getting Started	10
13.4.2	Installation Options	12
13.4.3	The Terminal Menu	13
13.4.4	The Printer Menu	14
13.4.5	The Communications Protocol Menu	15
13.4.6	The Driver Menu	16
13.4.7	Completing INSTALL	18
13.4.8	INSTALL's Patcher	19
13.4.9	INSTALL Error Messages	20
13.5	Introduction -- Modification by Patching	22
13.5.1	Printer Type and Related Items	23
13.5.2	Printer Function Strings	23
13.5.3	Printer Driver Flags	26
13.5.4	Printer Drivers	27
13.5.5	Communications Protocols	29
APPENDIX A: SPECIFIC PRINTERS		30
APPENDIX B: MODIFICATION BY PATCHING - PRINTER PATCH AREA		37

REFERENCE

Contents

This page intentionally left blank.

13.1 Introduction to Installation

Your Word Processing software is installed to work with a Diablo Model 630 printer. The "installation" procedure is used to set up the Word Processing software to work with a wide variety of other printers. For most cases, installation is accomplished by entering choices from menus, as described in this section. For exceptional printers, and for achieving refinements in installation, there are extensive provisions for "patching" by a programmer (see Appendix B: Modification by Patching).

13.2 Printer Installation Considerations

13.2.1 Daisy Printers and Teletype-like Printers

Word Processing supports two classes of printers: daisy wheel and similar printers, and "Teletype-like" printers (i.e., most other printers). In this section, the general characteristics and capabilities of these printers will be discussed as well as other considerations relating to printer installation. Appendix A: Specific Printers gives additional specific information for each particular printer supported. Section 13.4 describes the actual installation procedure you can use once you know what choices you wish to make. If you know which choices you want to make, go directly to Section 13.4.

Daisy Wheel and Similar Printers: These are printers capable of incremental horizontal and vertical motion, allowing use of variable line height, variable character spacing, subscripts, and the rest of Word Processing's print enhancements. "Microspace Justification" is automatic when printing on a daisy wheel or similar printer. Since the control sequences are different for **each** daisy wheel or similar printer, the Word Processing software must be installed for the specific printer. Word Processing can be installed via "menu" selection as will be detailed in Section 13.4.

You can choose from the printers listed below:

"O.E.M."	NEC 5500 printer
Daisy	Diablo 1300 series Hy-Type II printer
Printers	Qume Sprint 3 printer with adapter
	Diablo 1610/1620
	Diablo 1640/1650
	Qume Sprint 5
	NEC Spinwriter 5510/5520

Selecting any one of the above printers from the menu installs Word Processing to make use of all capabilities of that printer. Word Processing will print bidirectionally if any of the above printers are selected.

"OEM" Daisy Printers: Word Processing may be installed to drive the NEC 5500, Diablo Hy-Type II 1300 series, and Qume Sprint 3 (with cable adapter) OEM printers with a single menu selection (as will be described in Section 13.4). Users of OEM printers may disregard the rest of Section 13.2.

"Serial" Daisy Printers: The printers not noted as "OEM" in the list on the previous page are usually supplied with a "Serial" interface. When using a serial daisy printer with Word Processing, you will generally wish to set the printer and the computer interface to 1200 baud (120 characters per second). This is the highest transmission speed supported by these printers. Such printers operate far below their speed capability with Word Processing when set to 300 baud (30 characters per second) or less. Use of 1200 baud generally requires use of a "communications protocol" to prevent loss of characters; use of a communications protocol usually precludes access to the printer as the "CP/M List Device". Read Sections 13.2.2 and 13.2.3 carefully, and check Appendix A: Specific Printers with regard to your printer, **before** attempting to install Word Processing to drive one of these printers at 1200 baud. The CP/M list device driver design for the 820 supports the ETX/ACK communications protocol.

"Teletype-like" Printers: This class includes almost all printers other than daisy wheel and similar printers -- that is, any printer that prints ASCII printing characters (hex codes 20 through 7F) and responds to carriage return and line feed codes.

Using a Teletype-like printer, Word Processing can underscore, overstrike, double strike, and overprint. Boldface is printed with three strikes. Subscripts and superscripts are printed in the line below or above if that line is blank, otherwise they print in the line in which the codes appear.

Variable line height is not available. A choice of two character pitches and two ribbon colors is available through special installation. Right-justification of printout on a Teletype-like printer is accomplished by inserting whole spaces between words.

A daisy wheel or similar printer will operate with Xerox Word Processing installed for a Teletype-like printer, but only the Teletype-like printer capabilities will be available, and bidirectional printing will not occur.

Two menu selections are provided for Teletype-like printers:

- A. Any Teletype-like Printer
- B. Teletype-like Printer That Can Backspace

Selecting **A** or **B** installs Word Processing to make use of the basic capabilities common to all Teletype-like printers. Use of additional capabilities for specific printers, such as pitch change or ribbon color change, can be enabled via special installation. Selection **B** produces faster printing of underscore, boldface, double strike, and backspace. Choose this selection if you know your printer can backspace; if you are in doubt as to whether your printer can backspace, selection A will also work.

Other Printers: Generally, Word Processing is installed for printers that are **not** Teletype-like **nor** among the specific daisy wheel and similar printers supported by making one of the two "Teletype-like" selections during the installation procedure.

Both of the "Teletype-like" printer selections assume the printer will return the carriage without advancing to the next line when sent a carriage return code that is not followed by a line feed code. If your printer cannot return its carriage without advancing to the next line, but can backspace (Selection B), overprint lines will not print correctly, but Word Processing will be otherwise operational. If your printer cannot return the carriage without feeding to the next line, nor backspace, use Selection A and avoid use of underscore, overstrike, boldface, double strike, backspace, and overprint.

If your printer can return the carriage without advancing the paper, but does these functions under control of characters other than the standard ASCII carriage return and line feed codes, Word Processing can be made fully operational with your printer by having a **programmer** "patch the appropriate control strings".

Another selection on the Printer Menu, "Half-Line Feed Printers", is intended to facilitate installation for printers that can advance the paper one-half line at a time; the half-line advance is utilized in printing subscripts and superscripts. After making this selection, patches by a **programmer** will probably be required.

13.2.2 Communications Protocols

A "communications protocol" is a means by which a serial printer can tell Word Processing when to stop transmitting characters (while those already received by the printer are printed), and when to resume transmitting.

Communications protocols are not pertinent to "OEM" printers; users with NEC 5500, Diablo Hy-Type II, or Qume Sprint 3 OEM printers may disregard this section.

A communications protocol is not necessary with most Teletype-like printers, as the interface hardware normally handles signalling when the printer is ready to receive the next character. Users with Teletype-like printers generally do not need to read this subsection.

A communications protocol is not necessary with a serial daisy wheel or similar printers interfaced at 150 baud (15 characters per second) or less, and generally not at 300 baud (30 characters per second). However, if you have such a printer interfaced at that speed, you will want to change it to 1200 baud when you discover how slowly it prints.

A communications protocol is always necessary with a serial daisy wheel or similar printer interfaced at 1200 baud (120 characters per second). The only exception is a NEC 5510/5520 with a special cable, as noted in Appendix A: Specific Printers. If no communications protocol is installed, the printer's buffer will overflow and characters will be lost. Usually, the printer buzzes when this occurs. Some daisy printers stop printing completely under these conditions.

In this section, the available communications protocols will be described. See Appendix A: Specific Printers for information relating to your printer. The protocols supported by Word Processing are "ETX/ACK protocol" and "XON/XOFF protocol".

ETX/ACK Protocol: Under this protocol, Xerox 820 WP sends a "message" consisting of a specified maximum number of characters, followed by an "ETX" character. After printing all characters up to the ETX, the printer transmits an "ACK" character back to the computer, thus signalling Xerox 820 WP that another message may be transmitted. All daisy wheel and similar printers supported by Xerox 820 WP can use this protocol; some printers require specific option selections to activate it. See Appendix A: Specific Printers as well as the printer manufacturer's documentation.

XON/XOFF Protocol: Under this protocol, the printer transmits an "XOFF" character (DC3 ASCII code) to the computer when Word Processing should stop transmitting characters. It then transmits an "XON" character (DC1 ASCII code) when transmission may resume. XON/XOFF protocol is supported as an alternate protocol by some daisy wheel and similar printers; we suggest using XON/XOFF instead of ETX/ACK only if other considerations, such as other software to be run necessitates its use, or if you have an unusual printer that will perform XON/XOFF but not ETX/ACK.

Both communications protocols require that the Xerox 820 Processor be able to receive characters from the printer as well as transmit characters to the printer. This complicates installation when a communications protocol is to be used. The normal method of accessing a printer, the CP/M "list device", provides only for transmission of characters from the Xerox 820 Processor to the printer.

13.2.3 Printer Drivers

Users with NEC 5500, Diablo Hy-Type II, and Qume Sprint 3 OEM printers may disregard this subsection (selection of OEM printer / I/O Master interface combination during installation automatically selects the required driver). However, users who wish to drive a serial daisy printer at 1200 baud must read this section carefully.

The normal method whereby a program accesses the printer under the operating system -- the "list output device" -- does not support receiving characters from the printer, as required by "communications protocols" (preceding subsection).

Also, the list output device does not allow Word Processing to determine whether the printer is busy or ready to receive another character. Determination of whether the printer is busy ("Printer busy test") is not essential to Word Processing operation, but is desirable as it improves keyboard response and printer speed during concurrent editing and printing.

To handle communications protocols and printer busy tests, as well as accommodate special cases, Word Processing provides several ways to access the printer. Each way of accessing the printer is termed a Printer Driver. When installing Word Processing, one of the following printer drivers may be chosen. The following paragraphs discuss each printer driver in detail. Selecting the desired printer driver is accomplished during installation by selecting from a menu.

- CP/M "List Output" Device (LST:) (printer must support ETX/ACK)
- CP/M "TTY:" Console Device
- CP/M "CRT:" Console Device
- Port Driver (direct input/output by Word Processing)
- Custom Subroutines

CP/M List Output Device (LST:): This driver outputs characters to the printer via the printer driver in your operating system. The list output device is the simplest way to access your printer if your printer does not require communications protocol (preceding subsection) but does support ETX/ACK protocol. If your printer requires a communications protocol (as all daisy wheel and similar printers interfaced at 1200 baud do), you may wish to choose a different Word Processing printer driver option, or you may wish to make use of Word Processing's provisions for installation of a user-supplied list device character input routine.

The "CP/M list output device" choice will work correctly from Word Processing only if your operating system can already output characters to the printer as the list device. Suitable installation of the operating system is often necessary to enable it to drive a specific printer. Of course, such system installation is not necessary for Word Processing use unless Word Processing is installed to do printer output via the CP/M list device.

The "list output device" (LST:) is a "logical" device which can be assigned to one of several "physical" devices. To verify that your operating system drives your printer and that LST: is indeed assigned to the printer, type H (run a program) from the Directory Menu and type PIP LST: = B:filename. (Filename is some document file you have on a data disk that is in drive B.

Standard CP/M has no provision for inputting characters from the list output device, as required by the communications protocols, nor does it have a uniform provision for a printer busy test. However, the list device driver designed for the 820 has a provision to receive characters from the printer and to do the printer busy test.

Caution: Do not attempt to install or use code IN THE OPERATING SYSTEM to implement ETX/ACK protocol when driving a Diablo or Qume daisy wheel printer. For Word Processing to work with these printers under this protocol, the protocol MUST be executed by Word Processing.

Alternate Consoles: In many versions of CP/M the "console" is a logical device (CON:) which can be assigned to any one of four physical devices, usually called "TTY:", "CRT:", "BAT:", and "UL1". The terminal is one of the "physical" consoles and must be the active one when Word Processing is invoked; Word Processing can then access the printer as an alternate console. Word Processing can be installed to access the printer as the TTY: or CRT: console devices by making an appropriate selection at the Printer Driver menu (Section 13.4.2), the other two physical consoles can be accessed via patching.

Accessing the printer as an alternate console allows inputting characters from the printer, as required by communications protocols, without system software modifications or patching. The TTY: or CRT: printer driver is often the most convenient printer driver choice when a communications protocol is required, as by a daisy wheel printer set to 1200 baud. Accessing the printer as an alternate console does not provide a printer busy test unless a **programmer** installs a subroutine.

TTY: Alternate Console Device Printer Driver: This driver accesses the printer as a "TTY:" console device. This driver will support communications protocols and may be used if your operating system supports multiple consoles and the terminal being operated is not the "TTY:" device.

CRT: Alternate Console Device Printer Driver: Similar to the preceding, this driver accesses the printer as the "CRT:" console device. This driver will support communications protocols and may be used if your operating system supports multiple consoles and the terminal is not the "CRT:" device.

Port Driver: Word Processing's "port driver" bypasses the operating system and does input-output directly to the printer interface. The port driver supports character input from the printer and includes a printer busy test; the port driver thus handles communications protocols (preceding subsection) and allows Word Processing to provide the best keyboard response during concurrent editing and printing.

Installation of the port driver requires that you specify whether your printer interface uses "I/O ports" or is "memory mapped". You should enter "I/O ports". Installation of the port driver requires determination of the output data port number, output status port number, output status bits, and, if a communications protocol is to be used, the input data port, input status port number, and input status bits. If you don't know the port numbers for your interface, the Word Processing installation program can be directed to search for the ports (as will be detailed later). In most cases, the search will find the port numbers correctly. If you don't know the status bits, they can also be determined by the INSTALL program.

Custom Subroutines Printer Driver: Choosing this printer driver selection causes Word Processing to call user-codes, user-installed subroutines to output to the printer, input from the printer (for communications protocols), and determine whether the printer is busy. This choice may be used when the CP/M list device won't work (e.g. because a communications protocol, and thus printer character input, is required) and the port driver won't work (e.g. because an unusual printer uses several data or status ports). 820 Word Processing is installed in this format for the 630 Printer.

After selecting "Custom Subroutines" during the INSTALL program, it is up to the user to code and install the necessary routines.

13.2.4 Recap of Printer-Related Installation Selections

OEM Printer None of the complications discussed in this section are pertinent. Choose "I/O Master / OEM Printer" at the INSTALL program's printer menu (as will be described in Section 13.4.4). INSTALL will present no further printer-related selections.

Teletype-like (non-daisy) Printer: If your operating system can already drive the printer, specify "Teletype-like" at the printer choice menu, specify "None" for communications protocol, and specify "CP/M list output device" for printer driver. Alternately, you may wish to use the port driver for better keyboard response during concurrent editing and printing.

(Serial) Daisy Wheel or Similar Printer Interfaced at 300 Baud (30 characters per second) or Less: If your operating system can already drive the printer, choose the specific printer type at the printer menu, specify "None" for communications protocol, and specify "CP/M list output device" for printer driver. Or use the port driver if desired, for better keyboard response during concurrent editing and printing. You will want to change your printer to 1200 baud as soon as possible so Word Processing will print faster.

(Serial) Daisy Wheel or Similar Printer Interfaced at 1200 Baud (120 characters per second): You will need to use a communications protocol and a driver that can input as well as output characters. See Appendix A: Specific Printers for specific discussion of your printer. Specify the particular printer type at the printer menu. Specify ETX/ACK protocol, and set the printer to match, unless unusual considerations dictate using a different protocol.

For printer driver, we suggest using the port driver. However, you may wish to consider using the TTY: or CRT: alternate console driver. The CP/M list output device printer driver cannot be used with a communications protocol unless you patch in your own Printer Character Input routine.

Exception: If your 1200 baud printer is a NEC Spinwriter 5510/5520, you may be able to use a special cable instead of using a communications protocol (see Appendix A: Specific Printers). If you use the special cable, you may specify "None" for protocol and "List output device" or "Port driver" for printer driver.

13.2.5 Printer Configuration

Some printers have option switches which must be correctly set. These switches may be on an external control panel, on a control panel under the printer cover, or buried on circuit boards inside the printer. Common switches include:

AUTO LF or LOCAL LF (makes printer line feed upon receiving a carriage return code): **MUST BE OFF.**

AUTO CR (makes printer start a new line if an overlong line is printed): **OFF** recommended.

SPEED: must match the rate at which your computer transmits characters.

PARITY: set to ignore parity ("M" position on some printers).

Communications Protocol: a "communications protocol" must be used with (serial) daisy wheel and similar printers interfaced at 1200 baud (120 characters per second), as discussed previously. With many printers, use of a communications protocol requires setting switches or adding jumpers on circuit boards inside the printer. See Appendix A: Specific Printers and your printer manufacturer's documentation.

FORM LENGTH: should be set to match paper in use if **USE FORM FEEDS** printer option is to be used.

SET TOP: press after positioning paper at top of form, if **USE FORM FEEDS** print option is to be used.

13.3 The Word Processing and Program Disks

The disks you receive upon purchasing Word Processing contain the following files that will be needed to install Word Processing for your printer.

Word Processing disk

XWS.COM

Word Processing; installation for your printer is achieved by running the **INSTALL** program as described in Section 13.4. If you have purchased the Diablo Model 630 printer, **XWS.COM** does not need to be changed.

Program disk

INSTALL.COM

Word Processing installation program; used to install (customize) Word Processing for your printer .

Make a backup of these disks by copying them to other disks and storing the originals safely (see Section 13.4).

13.4 Installation Procedure

Your 820 Word Processing software is set up for a Diablo Model 630 printer. If you have a different printer, you must go through this installation procedure to change the Word Processing software to work with your printer. You'll use the INSTALL program to do this; it is on the program disk. The program will present menus from which **you** will make the appropriate selection for your printer; in other words, these instructions are **guidelines** for you to follow -- you'll have to read the information (printed within the instructions **and** on the screen) to make the proper choices.

The instructions for the installation procedure are set up as described below.

As this is a relatively long procedure to write out, the instructions are broken into sections like: Getting Started, Installation Options, the Terminal Menu, etc. The Getting Started section tells you which disks you need, how to load the disks, and some more information about the INSTALL program.

Instructions you **must** follow exactly are written:

"TYPE U"

When **you** must make a selection, the instructions are written:

"CHOOSE one selection from the Printer Menu"

The screen messages are shown here as you will see them on the screen. To make sure they stand out from the rest of the instructions, the screen messages are outlined by a box, as shown below.

Do you want a normal first-time INSTALLation of XEROX WP?
(Y = yes; N = display other options):

13.4.1 Getting Started

You'll need your Word Processing software disk, your Program software disk, and a blank disk so you can make a copy of your Word Processing software. You need to make a copy so if anything goes awry, you've got another disk.

TURN ON your system or **PRESS** the **RESET** button to start from scratch

INSERT the Word Processing disk in drive A (left) and the Program disk in drive B

PRESS the **A** key, then press **RETURN**

When the Directory Menu is on the screen, **PRESS** the **H** key

TYPE B:INIT and **PRESS RETURN**

Wait for the message

ENTER DISK DRIVE TO BE INITIALIZED

REMOVE the Program disk from drive B (right)

REMOVE the write protect tab from the blank disk, if it is on

INSERT the blank disk, **PRESS** the **B** key and **PRESS RETURN**

Wait for the message

Ø FLAWED SECTORS

Note: If the FLAWED SECTORS message has any number other than Ø, do not use that disk for copying your software. You can use it for anything else, but get another blank disk and repeat the procedure above.

When you have a disk with Ø FLAWED SECTORS, **PRESS** the **SPACE BAR** twice. After a minute, the screen will display the Directory Menu again.

REMOVE the initialized disk and **INSERT** the Program disk in drive B again

PRESS the **H** key

TYPE B:COPY and **PRESS RETURN**

Wait for the message

INSERT SOURCE DISK IN DRIVE A
INSERT DESTINATION DISK IN DRIVE B
TYPE RETURN WHEN READY

REMOVE the Program disk and **INSERT** the initialized disk in drive B (right)

PRESS RETURN

When you see the COPY COMPLETE message, go on to the next page.

What you'll do in this section is tell the system you want to run the INSTALL program and answer the first two questions the program presents. The INSTALL program works with the XWS.COM software file on the Word Processing disk. As you go through this procedure and answer more questions and make your selections, the system will **change** the XWS.COM file to work with your printer.

REMOVE both disks. Put the original Word Processing disk away.

INSERT the Word Processing COPY in drive A (left) and **INSERT** the Program disk in drive B (right)

PRESS the RESET button to start from scratch

PRESS the **A** key, then **PRESS RETURN**

When you see the Directory Menu on the screen, **TYPE H** to run a program

TYPE B:INSTALL and **PRESS RETURN**

Note: This program takes approximately three (3) minutes to load. The system will make a clicking noise as it reads the disks. You don't have to do anything until you see the message:

Do you want a normal first-time INSTALLation of XEROX WP?
(Y = yes; N = display other options): █

TYPE Y

The message you see (below) is a description of what the system is going to do to set up your specific printer. You don't have to be concerned with understanding this description, all you have to do is confirm that this is what you want to do.

This will INSTALL the WSU.COM on the current drive, save the result on file WS.COM on the current drive, and then run the INSTALLED XEROX WP. OK (Y/N): █

TYPE Y

Please go on to the next page.

13.4.2 Installation Options

This will INSTALL the WSU.COM on the current drive, save the result on file WS.COM on the current drive, and then run the INSTALLED XEROX WP. OK (Y/N): Y
WSU.COM NOT FOUND ON CURRENT DISK

***** XEROX WP INSTALLATION OPTIONS MENU *****

- A INSTALLation of a distributed XEROX WP, INSTALLing WSU.COM, producing WS.COM, and then running the INSTALLED XEROX WP.
- B INSTALLation or re-INSTALLation of a XEROX WP COM file of your choice, placing the newly INSTALLED XEROX WP in a file of your choice, and then exiting to the operating system.
- C Same as B except run the INSTALLED XEROX WP.
- D Modification of the INSTALLation of a XEROX WP COM file of your choice. The modified XEROX WP replaces the original file. The modified XEROX WP is then run.

PLEASE ENTER SELECTION (A, B, C, or D): █

TYPE B

Filename of XEROX WP to be INSTALLED? █

TYPE XWS.COM and PRESS RETURN

Filename for saving INSTALLED XEROX WP? █

TYPE XWS.COM and PRESS RETURN

Please go on to the next page.

13.4.3 The Terminal Menu

```
PLEASE ENTER SELECTION (A, B, C, or D): B

Filename of XEROX WP to be INSTALLED? XWS.COM

Filename for saving INSTALLED XEROX WP? XWS.COM

          LOADING XEROX WORD PROCESSING

          ***** XEROX WP TERMINAL MENU #1 *****

A  Lear-Siegler ADM-3A           C  Lear-Siegler ADM-31
D  Hazeltine 1500                E  Microterm ACT-IV
F  Beehive 150/Cromemco 3100     G  Imsai VIO
H  Hewlett-Packard 2621 A/P      I  Infoton I-100
J  Processor Tech Sol / VDM      K  Soroc IQ-120
L  Perkin-Elmer 550 (Bantam)     2  Terminal Menu #2
3  Terminal Menu #3             Z  none of the above
U  no change

PLEASE ENTER SELECTION (1 LETTER): █
```

TYPE U

```
Previous selection kept unchanged:

OK (Y/N): █
```

TYPE Y

Please go on to the next page.

13.4.4 The Printer Menu

OK (Y/N): Y

***** PRINTER MENU *****

(More specific info is displayed after choice is entered.)

- A Any "Teletype-like" printer (ie almost any printer)
- C "Teletype-like" printer that can BACKSPACE
- D DIABLO 1610/1620 daisy wheel printer
- E DIABLO 1640/1650 daisy wheel printer
- F QUME Sprint 5 daisy wheel printer
- G NEC Spinwriter 5514/5520 thimble printer
- I "Half-Line-Feed" Printer
- M I/O Master / O.E.M. Printer Combination
- U no change
- Z none of the above

PLEASE ENTER SELECTION (1 LETTER): █

CHOOSE one selection from the Printer Menu (NOTE: **you** must pick the appropriate selection for your printer)

If you selected **M**, neither communications protocol nor driver selection is necessary. Please **TYPE Y** and go to page 13-18.

Since we don't know which selection you picked, please read the information on your screen -- it tells you about your selection. If, after reading, you decide you don't want that selection, **TYPE N**. The Printer Menu will redisplay and you can pick again.

OK (Y/N): █

When you're satisfied with your printer selection, **TYPE Y**

Please go on to the next page.

13.4.5 The Communications Protocol Menu

Note: The message you see above the Communications Protocol Menu may be different than the one shown below.

```
OK (Y/N): Y

Most Teletype-like printers use no communications protocol.

***** COMMUNICATIONS PROTOCOL MENU *****

A "Communications Protocol" is necessary with some printers
to prevent printer buffer overflow and character loss.

E  "ETX/ACK" Protocol
X  "X-ON/X-OFF" Protocol
N  NONE required (or handled outside of XEROX WP)
U  no change

PLEASE ENTER SELECTION (E, X, N, B, or U): █
```

CHOOSE one selection from the Communications Protocol Menu

Note: There is no **B** on the Menu. If you enter **B**, the program will go back to the Terminal Menu.

```
Since we don't know which selection you picked, please read
the information on your screen -- it tells you about your
selection. If, after reading, you decide you don't want that
selection, TYPE N. The Communications Protocol Menu
will redisplay and you can pick again.

OK (Y/N): █
```

When you're satisfied with your protocol selection, **TYPE Y**

Please go on to the next page.

13.4.6 The Driver Menu

Note: The message you see above the Driver Menu may be different than the one shown below.

With no protocol, the usual driver selection (below) is L

***** DRIVER MENU *****

Or, how should XEROX WP send characters to your printer?

- L CP/M "List" device (LST:)
- T CP/M primary console device (TTY:)
- C CP/M secondary console device (CRT:)
- P Port Driver (Direct I/O to 8-bit ports)
- N Parallel Centronics Printer Driver
- O Centronics Driver on TRS-80 Model-2
- Q Serial Driver on TRS-80 Model-2
- S User-installed driver subroutines
- U no change

PLEASE ENTER SELECTION (L, T, C, P, N, O, P, S, B or U): █

CHOOSE one selection from the Driver Menu

Note: The PLEASE ENTER SELECTION choices are not exactly the same as the choices listed in the menu. **P** is listed twice, and no **Q** is listed. If **Q** is your selection, you can type a **Q** and the software will recognize it. Also, if you enter **B**, the system will go back to the Terminal Menu. XEROX WP is configured using the **S** format. If you select **L**, your printer must support ETX/ACK functions.

If you picked **L, T, C, N, O, Q, S,** or **U**, please go on to the next page.

If you need to modify the printer driver, select **P**. The INSTALL program will then ask additional questions in order to determine how to access your printer. The first of the additional questions requires you to specify whether your printer is connected to "I/O ports" or "Memory Mapped Ports". Enter **I** for "I/O Ports". The remaining questions determine the input and output data and status ports, and the status bits. Enter **A** to have the INSTALL program accept the information from you. Listed below are the recommended port assignments.

- Output Data Port - 05
- Output Status Port - 07
- Output Status Bit - 04
- Input Data Port - 05
- Input Status Port - 07
- Input Status Bit - 01

Since we don't know which selection you picked, please read the information on your screen -- it tells you about your selection. If, after reading, you decide you don't want that selection, **TYPE N**. The Driver Menu will redisplay and you can pick again.

OK (Y/N):

When you're satisfied with your driver selection, **TYPE Y**

Please go on to the next page.

13.4.7 Completing INSTALL

ARE MODIFICATIONS TO XEROX WP NOW COMPLETE?

IF THEY ARE ANSWER YES TO THE NEXT QUESTION.
IF YOU WISH TO MAKE ADDITIONAL PATCHES TO XEROX WP'S
USER AREAS, ANSWER NO TO THE NEXT QUESTION.

OK (Y/N): ■

If you TYPE **N** for "no", the "Patcher" will be activated. The patcher permits additional custom modifications. Description of the patcher and further information about this procedure can be found in the Patching section beginning on page 13-19.

If you are finished with the modifications, TYPE **Y**

CONFIRM TERMINAL AND PRINTER SELECTIONS:

I/O Master / O.E.M. Printer
"ETX/ACK" protocol
User-installed printer driver

OK (Y/N): ■

Check your selections. When you type a **Y**, the system will rewrite the XWS.COM software file to work with your printer. If the selection are incorrect, enter an **N** or **B** and the INSTALL program will go back to the beginning of the program to let you make the selections again. For those choices you do not wish to change, enter a space and INSTALL will keep the previous selection.

If the selections are correct, TYPE **Y**

The system will make a whirring noise. Then you'll see the message shown below.
Note: your selections are probably different.

LOADING XEROX WORD PROCESSING

I/O Master / O.E.M. Printer
"ETX/ACK" protocol
User-installed printer driver

After a short wait, the Directory Menu will appear on screen.

13.4.8 INSTALL's Patcher

INSTALL's patcher facilitates making special installations and modifications to Word Processing. Installation of Word Processing for printers not shown on INSTALL's menus, and other situations in which patching might be necessary or desirable (see Appendix B: Modification by Patching).

The patcher permits examining and/or changing any byte in XWS.COM. The location of each byte to be changed may be specified by hexadecimal address or by label name. The contents of each specified byte is displayed in hexadecimal and a new value may be entered in hexadecimal.

INSTALL's patcher is accessed by answering N at the message shown below. As noted in Section 13.4.7, this message appears after the printer selections and before the final confirmation.

ARE MODIFICATIONS TO XEROX WP NOW COMPLETE?

IF THEY ARE ANSWER YES TO THE NEXT QUESTION.
IF YOU WISH TO MAKE ADDITIONAL PATCHES TO XEROX WP'S
USER AREAS, ANSWER NO TO THE NEXT QUESTION.

OK (Y/N): █

When N is entered, a summary of the patching process will be displayed on your terminal, followed by the message:

LOCATION TO BE CHANGED: █

Enter the desired address in hexadecimal, or enter the desired label followed by a colon. A label may be followed by a "+" and a hexadecimal number to access the location that many bytes after the label. Examples of valid answers:

25B (hexadecimal address)
CTRAIL: (label)
CTRAIL:+2 (label plus numeric offset)

INSTALL will then display the address in hexadecimal and the present contents of the indicated byte, and prompt you for the data with which you wish to replace it. The screen line will appear as follows:

ADDRESS: aaaaH OLD VALUE: nnH NEW VALUE: █

Where aaaa represents the hexadecimal address and nnH represents the value that is presently occupying the byte at that memory address. Enter the hexadecimal value with which you wish to replace the old value, or press RETURN only to make no change.

You will then be prompted to enter a new location. To access the next address, enter RETURN only; to terminate patching, enter zero (type 0 and press RETURN).

13.4.9 INSTALL Error Messages

NOT ENOUGH MEMORY TO RUN INSTALL.
OR YOUR OPERATING SYSTEM IS NOT
RELOCATED TO MAKE ALL RAM AVAILABLE.

The system has a problem. Press the RESET button and start over.

NOT ENOUGH MEMORY TO RUN WORD PROCESSING,
OR YOUR OPERATING SYSTEM IS NOT
RELOCATED TO MAKE ALL RAM AVAILABLE.

Option B was not selected at the Installation Options Menu. Start over and choose Installation Option B.

XWS.COM NOT FOUND ON CURRENT DISK

This message occurs during "normal" installation if the file XWS.COM is not found on the logged drive. For example, if XWS.COM is not on the disk in any drive, or if the logged drive is B: but file XWS.COM is on the disk in drive A. Start over.

THAT FILE DOES NOT EXIST

Either XWS.COM was mistyped or something happened to your XWS.COM file. Under Installation Option B, this message indicates that no file was found with the name you entered. This message usually indicates that the name was mistyped, the drive was omitted, or the desired disk was not in the drive. After displaying the message, INSTALL asks for the file name again, allowing you to reenter the name.

INCORRECTLY FORMED FILENAME

XWS.COM was mistyped.

UNEXPECTED END OF FILE DURING READ

Something happened to your XWS.COM file. Make a new copy of the Word Processing disk and start over.

DISK FULL
DISKETTE DIRECTORY FULL

XWS.COM was mistyped or XWS.COM was not typed twice. Erase any new files on WP disk and start over.

ERROR CLOSING FILE

This message should not occur; it indicates a system failure- or that you changed disks while the INSTALL program was recording the installed Word Processing.

THIS VERSION OF INSTALL IS INCOMPATIBLE WITH THE VERSION OF WORD PROCESSING YOU ARE TRYING TO INSTALL

This message can occur when using one release of the Program Disk with a different release of the Word Processing Disk.

13.5 MODIFICATION BY PATCHING

Modification by patching is used in installing Word Processing for printers that require special control strings or modifications to one of Word Processing printers drivers, and for achieving refinements in installation, such as supporting special features of specific non-daisy printers.

Since basic installation is achieved with the INSTALL program as described previously, most users should not need to patch.

"Patching" means modifying Xerox Word Processing by changing the contents of bytes in XWS.COM. Patching is accomplished with INSTALL's patcher. The rest of this section is written primarily for the reader who already understands patching, usually an assembly language programmer.

Listings in Appendix: Appendix B of this manual contains an absolute assembly listing of the user-patchable portions of Xerox Word Processing containing all printer-related patch items for non-daisy printers, plus many used for both daisy and non-daisy printers.

The listing is commented heavily; read it for a detailed description of each item. The following paragraphs give a general description of the module, and hit a few high points of the details, but do not attempt to duplicate the detailed information contained in the program comments.

The module whose listing is supplied was combined with the rest of the program with a linking loader after assembly; it contains external references whose values are not shown in the listing. Generally, these are in locations there will be no need to change.

Modifications in the printer patch area are used to support optional printer features, to install unusual printers which are similar to, but not exactly, "Teletype-like", and do not support ETX/ACK type communications protocols or has no protocols. Modifications in the printer patch area are also used to handle unusual installation requirements with regard to the transmission of characters from (as required by communications protocol Section 13.2.2) and to the printer.

This manual does not cover patching to support the features of daisy-wheel printers. The INSTALL program performs complete installation to support all available features of the common daisy wheel and similar printers. Patching for such printers is extremely complex due to the interaction of many features and the requirements of bidirectional printing, variable character width, and variable line height.

However, all aspects of transmission of characters to and from serial daisy wheel and similar printers are accessible and documented in this section.

The assembly listing, in Appendix B, shows all modifiable items relating to Teletype-like and other non-daisy printers, and all modifiable items relating to transmission of characters to and from Teletype-like printers and serial daisy wheel and similar printers.

The rest of this section will follow the approximate order of items in the listing, to facilitate relation of the text to the listing. Users making an installation requiring a communications protocol (Section 13.2) will probably be first interested in the printer driver patch items; these are described in Section 13.5.4.

13.5.1 Printer Type and Related Items

POSMTH (Printer OverStrike MeTHod): Determines how overprinting, as required for boldface, double strike, underscore, backspace, etc is achieved.

If POSMTH contains FF hex (as set by **INSTALL** when "Any Teletype-Like Printer" is selected), Word Processing will overprint by sending a carriage return code (see item **PSCR**) followed by another complete line, containing spaces in columns not to be overprinted. Several overprint lines for the same document line will be sent if necessitated by the user of multiple enhancements or boldface.

If POSMTH contains zero (as set by **INSTALL** when "Teletype-like Printer That Can Backspace" is selected), Word Processing will overprint by backspacing (see item **PBACKS**) then sending the character to be overstruck as each character position requiring multiple strikes is encountered. POSMTH=0 produces faster printing than POSMTH=FF for printers that can backspace; also, POSMTH=0 will allow printing underline, boldface, backspace, etc on printers that can backspace but cannot return the carriage without line feeding.

If any daisy wheel or similar printer is selected in **INSTALL**, POSMTH will be set to 1 and should not be altered.

BLDSTR: This location contains the number of strikes of each character used for the "boldface" print enhancement. For Teletype-like printers, it may be increased or decreased to yield darker or lighter boldface; for daisy wheel and similar printers it should not be altered.

DBLSTR: This location contains the number of strikes (normally 2) used of for the "double strike" print enhancement; it may be increased for darker "double strike" or reduced to 1 for no double strike, on any printer type.

13.5.2 Printer Function Strings

Patchable strings for a number of mandatory and optional printer functions are provided. Each string consists of the number of characters, followed by the character values. When altering a string, make sure you set the number of characters correctly. The optional string items should have a zero "number of characters" if the optional function is not installed.

PSCRLF: This is the character string, normally carriage return, line feed, sent to advance a non-daisy printer to the beginning of the next line. The characters in the string may be altered as required by unusual printers; the count may be increased to send nulls (zeroes) (up to a total of 10 characters) after the character string is sent if the printer requires a delay while the carriage returns and the paper advances.

PSCR: This is the character string, normally carriage return only, used to return the carriage of a non-daisy printer to the beginning of the same line. This string is used to permit overprinting for underline, boldface, etc. if POSMTH (above) is FF hex; it is also used whenever a carriage return without a line feed is encountered in the document, if POSMTH is FF or 0.

PBACKS: This is the character string, normally an ASCII "backspace" character, used to backspace a non-daisy printer. This string is transmitted if POSMTH (above) is zero in order to permit printing a character in the same position as the preceding character for underline, boldface, backspace, etc. Note that if POSMTH is not zero this string is never transmitted and thus the printer need not be capable of backspacing.

PSHALF (Optional): This is a character string to return the carriage and advance the paper one-half line, for non-daisy printers with this capability but without the capability of advancing the paper backwards a fractional line (see also ROLUP and ROLDOW below). If installed, the half-line advance will be used to printer subscripts and superscripts one-half line below or above, respectively, the rest of the line.

Example: If the printer advances one-half line for each line feed code sent, install the sequence "carriage return, line feed" at PSHALF and the sequence "carriage return, line feed, line feed" or "carriage return, line feed, carriage return, line feed" at PSCRLF. Note: The **INSTALL** Printer Menu selection "Half-Line-Feed Printers" sets PSHALF and PSCRLF to the foregoing strings; this selection is otherwise identical to the selection "Teletype-Like Printer that can BACKSPACE".

ROLUP (Optional): This is a character string to roll the carriage UP (move the paper down) a fractional line, for non-daisy printers with this capability. If ROLUP and ROLDOW are installed, subscripts and superscripts will be printed by moving the carriage up and down in the course of printing a line.

ROLDOW (Optional): If ROLUP (preceding) is installed, then the string to roll the carriage down (paper up) a fractional line should be installed at ROLDOW.

PALT (Optional): A string may be installed here to set the printer to an alternate character pitch (character width), for non-daisy printers with this capability. An alternate pitch print (Control A) in the document will then invoke transmission of this string. Note: Word Processing contains the necessary logic to restore normal pitch while printing page offsets, headings, etc., that were specified when normal pitch was in effect.

PSTD (Optional): If PALT (preceding) is installed, then the string to restore the printer to its normal character pitch should be installed at PSTD.

USR1 through **USR4** (Optional): These strings may be installed to invoke otherwise unsupported special functions of your printer (e.g. changing character fonts or activating a sheet feeder) in response to the User Printer Function print control characters (Control Q, W, E, and R) imbedded in your document. For character pitch changes, **PALT** and **PSTD** should be used in preference to **USR1** through **USR4**. If you have a daisy printer, **USR1** through **USR4** control strings should be installed with great caution, and tested thoroughly, as complex interactions with Word Processing operation of the printer are likely to occur despite the fact that Word Processing always prints forward when printing a line containing a user printer function control. For some printers, **INSTALL** may define one or more of these control; check Appendix A with regard to your printer.

RIBBON and **RIBOFF** (Optional): These strings may be installed by the user to allow selection of alternate ribbon color with the Control Y print control on non-daisy printers with this capability; for daisy wheel and similar printers, **RIBBON** and **RIBOFF** are set appropriately by **INSTALL**.

PSINIT (Optional): This is a string transmitted to the printer at the start of printing. For non-daisy printers, you may add any desired controls, e.g. to turn the motor on or select a line spacing or character pitch. **INSTALL** puts a carriage return in this item; add your bytes and increase the count appropriately. For daisy printers, this item is appropriately set by **INSTALL** puts a carriage return in this item; add your bytes and increase the count appropriately. For daisy printers, this item is appropriately set by **INSTALL** and should not be altered.

PSFINI (Optional): Similar to **PSINIT**, this string is sent at the conclusion of printing.

PRINIT and **PRFINI** (Optional): These are subroutines called at the beginning and end of printing, respectively; they may be used to perform printer assignment or special initialization functions that cannot be performed by transmitting a character string. Space is provided for a **JMP** only; see the end of the listing for space to put your subroutine.

13.5.3 Printer Driver Flags

CSWTCH: Value determines which of the printer drivers (Section 13.5.5) is used to transmit characters to (and possibly from) the printer:

- 0: CP/M "List Output" Device driver use only if printer supports ETX/ACK protocol
- 1: Word Processing Port Driver
- 2: User-installed Printer Driver Subroutines - XWS.COM is configured in this format
- 3: OEM Daisy Wheel and Similar Printer Driver
- 4: Alternate Console Printer Driver

CSWTCH applies to all printers. CSWTCH is set by INSTALL in accordance with the choice made at the "Printer Driver" menu.

HAVBSY: This location should be non-zero if the printer driver in use has a "printer busy test" implemented, or zero if no provision has been installed for determining when the printer is ready to accept a character. When non-zero, Word Processing will not output to the printer until the printer is ready, and Word Processing will check more often whether the printer is ready to accept a character. When non-zero, Word Processing will not output to the printer until the printer is ready, and Word Processing will check more often whether the printer is ready to accept a character. Thus, a correctly installed printer busy test, plus a non-zero value in HAVBSY, cause the printer to run more steadily when editing is being performed at the same time as printing, while improving keyboard response in editing because the printer output routine will never "hang" while waiting for the printer to be ready to accept a character.

INSTALL set HAVBSY non-zero if the port driver is selected, or zero if another driver is selected. The user should set HAVBSY non-zero after adding a busy test to the CP/M list device driver or the alternate console driver, or after installing custom driver subroutines that include a printer busy test.

13.5.4 Printer Drivers

Code for four distinct printer drivers is provided, and thus accessible to user modification. Location CSWTCH, described above, determines which driver is called.

Driver Entry Points: Word Processing must be able to input from the printer as well as output to the printer when a "Communications protocol" (as required for daisy wheel and similar printers at 1200 baud) is in use. Also, Word Processing's performance improves when a "printer busy test" is available to determine whether the printer is ready to accept an output character. Thus, each driver has three entry points, defined as follows:

Printer Busy Test: This entry should return the carry flag set (1) if the printer is NOT ready to accept a character; the carry flag should be returned clear (0) if the printer is ready to accept a character or if the busy test is not implemented. If this entry is implemented, HAVBSY (above) should be non-zero; if not implemented, HAVBSY should be 0.

Print Character: This entry should output the character in the A register to the printer. If HAVBSY is non-zero, this entry is not called until the printer busy test entry returns the carry flag clear.

Input Character From Printer: This entry need be implemented only if a communications protocol (Section 13.2) requiring input from the printer is to be used. This entry should return the carry flag set (1) if no character has been received from the printer since last called, or return the character in the A register and the carry flag clear (0) if a character has been received.

Specific descriptions of the printer drivers follows.

CP/M List Device Driver: The "Print character" entry point to this driver is implemented to make the appropriate operating system call to print the character. The "Printer busy" and "Input character from printer" entries are not implemented, as standard CP/M provides no system calls for these purposes; space is provided at LIBSY and LISINP respectively for patching in

JMP instructions to user-installed subroutines for these purposes. See the end of Section 13.5.3 with regard to finding space into which to patch added subroutines.

If you add a "Printer busy test" routine, patch HAVBSY to a non-zero value.

If you use a communications protocol with the List output driver, you must code and patch in an "Input character from printer" routine, and put a JMP to it at LISINP.

*Note: Xerox 820 CP/M list driver is designed to support both printer busy and receive character available function internally.

Word Processing Port Driver: The "Port driver" does direct hardware I/O to any printer interface using at most one output data port, one output status port, one input data port, and one input status port. The ports may be I/O ports or memory mapped ports. The port driver includes implemented printer busy test and printer character input routines. When the port driver is selected during installation, the INSTALL program will accept the port numbers and status bits from the operator, or, on request, try to find them experimentally. (See Section 13.4.2.1)

The port driver code is provided, and thus accessible for further modification if desired. Note that the port driver as shown in the listing access I/O ports with "IN" and "OUT" instructions, but that a NOP is present after each to allow substitution of "LDA" and "STA" instructions for memory-mapped I/O. INSTALL makes this substitution if memory-mapped I/O is specified.

Alternate Console Printer Driver: The alternate console driver will drive a printer interfaced to be one of the four physical console devices (TTY:, CRT:, BAT:, and UC1:) other than the terminal, under operating systems which support multiple console devices and device assignment via IOBYTE. The alternate console driver supports character input from the printer, making it convenient for use with communications protocols (as required for daisy wheel printers interfaced at 1200 baud); the alternate console driver does not include a printer busy test unless added by the user at location ACBSY (if you add a busy test, be sure to patch HAVBSY non-zero).

The alternate console driver entries work by changing IOBYTE, doing the console input or output, then restoring IOBYTE. The IOBYTE console field value used for printer access is taken from location **CONFIE**. CONFIE is set to 0 by the INSTALL program when the TTY: printer driver is selected, or to 1 when the CRT: console driver is selected. One of the other two console devices may be accessed by patching CONFIE to 2 or 3.

USER-supplied Printer Driver Subroutines: Space is provided at PUSEND, PUBSY, and PUINP for patching in JMPs to user-codes and user-installed printer character output, printer busy test, and printer character input routines. See the end of the listing for space into which to patch your routines. You may patch over the other drivers if you do not expect to use them at a later date. Note that the printer character input routine is mandatory if a communications protocol is installed; otherwise, this routine is not needed. Also patch HAVBSY non-zero if the busy test entry is implemented, or zero if it is not implemented.

XWS is installed using this format.

CSWTCH must be set to 2 to cause Word Processing to call the user-installed printer driver subroutines; this patch may be achieved by selecting "User Subroutines" in **INSTALL** before patching in your routines.

OEM Daisy Printer Driver: The OEM printer driver is pre-configured to drive certain "OEM" daisy printers through the Micropro "I/O Master" interface addressed at ports F8-FA hex. Modification of this driver should not normally be necessary; the OEM driver is not included in the listing in Appendix B.

INSTALL sets CSWITCH to 3 to invoke the OEM daisy printer driver when "I/O Master Interface / O.E.M. Printer Combination" is selected at the Printer Menu.

13.5.5 Communications Protocols

A communications protocol (Section 13.2) is normally used with a (serial) daisy wheel or similar printer interfaced at 1200 baud; in these cases, the communications protocol items are correctly set by the **INSTALL** program. However, the communications protocol logic will function with any printer (except an OEM daisy printer, for which it is not pertinent). For an unusual Teletype-like printer that requires a protocol, you may wish to patch these items.

PROTCL: Determines type of communications protocol. The types of protocols are defined in the program comments and also in Section 13.2:

- 0: None
- 1: ETX/ACK (and see EAKBSZ, next)
- 2: XON/XOFF

PROTCL is set by **INSTALL** in accordance with the selection made at the "Communications Protocol" menu.

EAKBSZ: This location contains the message length for ETX/ACK protocol; it must be equal to or less than ONE-HALF OF the printer's buffer size, as Word Processing keeps two "messages" active at a time. The default value (127) assumes the printer can hold a buffer of at least 254 bytes; be sure to reduce it if you install ETX/ACK protocol for a non-daisy printer with a smaller buffer. When a daisy wheel or similar printer is installed with ETX/ACK protocol, **INSTALL** automatically sets EAKBSZ for the buffer capacity of the particular printer selected.

APPENDIX A: SPECIFIC PRINTERS

A.1 Daisy Wheel and Similar Printers

Features: All printers described in this section support all of Word Processing's print enhancements and other features, except as noted in individual descriptions below. All printers described here will print bidirectionally, "formed" text will be printed with Justification.

Choice of Typewheels: The interchangeable typewheels for daisy printers come in many choices of characters and character arrangements. The printed characters will match those seen on the screen during editing only if the typewheel in use contains the standard ASCII characters in the standard ASCII order. Some typewheels have other character graphics; many have a different character arrangement so that, for example, a period in the document will print as some other character. Some compatible typewheels for each printer are listed below.

A.1.1 OEM Daisy Wheel and Similar Printers

Word Processing can drive the following "OEM (Original Equipment Manufacturer) daisy wheel and similar printer models.

Diablo Hy-Type II 1300 Series
Qume Sprint 3 (with cable adapter)
Nec Spinwriter 5500

The OEM printers provide simple installation and unexcelled performance with Word Processing and are generally the least expensive to buy; their chief disadvantage is that they are more difficult to drive from other software than other types of printers.

The above printers have a 24-bit parallel interface using a very different command structure from that of all other printers supported by Word Processing. One installation selection specifies any of these printers, selects the OEM printers driver in Word Processing, and specifies the "I/O Master" interface board. When installed for an OEM printer, Word Processing accesses the printer interface directly. No operating system routines are used, and many installation complications are thus avoided. A "printer busy test" is provided, resulting in good response when editing and printing simultaneously.

Interfacing: For any of the OEM printers listed above, use an interface board with the OEM printer ports addressed at F8 though FA hex. Connect the interface board to the printer with a cable (using an adapter as noted below with the Qume Sprint 3).

An IMSAI Pio-4 board addressed at ports F8 though FB may be used; the cable required is the same as the cable previously supplied by IMSAI, plus an additional conductor bringing the printer's "data 1/2" bit to bit 4 or port F9.

Installation: To install Word Processing to drive any of the OEM printers listed above through either of the interfaces listed above, select "I/O Master /OEM Printer" at Install's printer menu (Section 14.4.2). The same selection works with all the supported OEM printers and interfaces. The OEM daisy printer driver is pre-configured for the standard OEM printer port numbers and bit assignments used with the "I/O Master" interface. (Extensive modification would be required to drive another interface or to change the port numbers.

Diablo Hy-Type (1300 Series)

Compatible Typewheels include:

Diablo 38100	Courier 10
Diablo 38107	Courier 72
Diablo 38101	Pica 10
Diablo 38102	Elite 12
Qume 82167	Prestige Elite 12

Qume Sprint 3

Interfacing: The cable adapter (available from Qume) that provides a Diablo-compatible termination from this printer's connector is necessary in order to mate with the MicroPro printer cable.

Compatible Typewheels for the Qume Sprint 3 are as listed above for the Diablo Hy-type II

NEC Spinwriter 5500

This is the Hy-Type-II-compatible version of NEC's OEM thimble printer.

The NEC 5500 will buzz and stop printing if the (carbon) ribbon is used up, the paper runs out, or the cover is opened. Install a new ribbon, new paper, or close the cover, and printing will continue with no character loss.

A.1.2 Serial Daisy Wheel and Similar Printers

The descriptions in this section apply to the following printers, which have "serial" interfaces:

Diablo 1610/1620/1640/1650
Qume Sprint 5
Nec Spinwriter 5510/20

Some of the manufacturers also supply equivalent versions with an 8-bit parallel interface; installation should be similar to the serial versions and the descriptions here should be generally applicable.

Controls: Most serial daisy wheel and similar printers have a control panel including some or all of the following switches:

AUTO LF: must be **OFF**.

AUTO CR: should be **OFF**.

Line Spacing 6/8 Lines per inch
Character Pitch 10/12 Characters per inch

These switches have **NO EFFECT** on printing under Word Processing. Character and line spacing under Word Processing always default to 6 lines per inch and 10 characters per inch respectively, and may be modified via print directives imbedded in each document. After printing with Word Processing, the printer is left set to the switch settings for use with other software, except as noted below.

FORMS LENGTH: Set to match length of paper in use -- commonly 11 inches or 66 lines; setting does not matter if USE FORM FEEDS print option will not be used and you don't wish the FF switch to work.

SET TOP: Depress after positioning paper at top of form; necessary only if USE FORM FEEDS print option is to be used or you wish the FF switch to work.

FF or FORM FEED: Depress to feed paper to top of form, e.g. after aborting print.

Installation: All daisy wheel and similar printers interfaced at 1200 baud (120 characters per second) must be installed with a "communications protocol" (as discussed in Section 14.2) in order to avoid buffer overrun and consequent character loss (a possible exception for the NEC is noted below). At speeds slower than 1200 baud, these printers print slowly; you will find the effort invested to install one of these printers with a communications protocol rewarding because of the markedly increased printing speed.

CAUTION: Do not attempt to use ETX/ACK communications protocol implemented in your operating system when driving a Diablo or Qume printer from Word Processing. It won't work. If your operating system already can drive a Diablo or Qume printer at 1200 baud through the use of ETX/ACK protocol, the portion of the operating system which implements the protocol must be disabled or bypassed when printing from Word Processing. This limitation does not apply to XON/XOFF protocol, nor to NEC printers. (The reason for this limitation is that if an "ETX" inserted in the character stream happens to fall within an "escape sequence" being transmitted to the printer, the printer will not recognize it as an ETX, and not respond with an ACK; nor will the printer interpret the escape sequence correctly. Keeping the ETX's out of the escape sequences is practical only in the program generating the character stream; Xerox WP contains the necessary special code.

Diablo 1610/1620

Features: The spoke 20 and spoke 7F features of Word Processing are not supported by these printers.

After printing, Word Processing leaves these printers set for 6 lines per inch and 10 characters per inch. To set the character spacing according to the printer's "spacing 10/12" switch before use of other software, depress the "Clear" button. If other software has printed on the printer since it was

powered up and before Word Processing prints, you may, in unusual cases, find it necessary to press the printer's "clear" button, or to turn the printer off and on, before Word Processing will print correctly (this is because the Diablo 1510/20 has not provision for a full reset initiated from the system).

Installation: When installing Word Processing to use a Diablo 1610/1620 printer interfaced at 1200 baud (120 characters per second), specify "ETX/ACK" protocol, and a driver capable of inputting characters. No settings are required on the printer for ETX/ACK operation. These printers do not support XON/XOFF protocol.

Compatible Typewheels for the Diablo 1610/1620 include:

Diablo 38100	Courier 10
Diablo 38107	Courier 72
Diablo 38101	Pica 10
Diablo 38102	Elite 12
Qume 82167	Prestige Elite 12

Diablo 1640/1650

Features: Form feeds cannot be used with the Diablo 1640 and 1650: the USE FORM FEEDS questions does not occur in the print initiation dialog when Word Processing has been installed for a 1640 or 1650.

Installation: When installing Word Processing to use a Diablo 1640/1650 printer interfaced at 1200 baud (120 characters per second), specify "ETX/ACK" protocol, and a driver capable of inputting characters. A switch setting may be necessary inside the printer to enable ETX/ACK protocol. These printers also support XON/XOFF protocol (Diablo calls it DC1/DC3 protocol); a switch setting is necessary inside the printer to enable this protocol (Switch 3 on HPR04 circuit board) or as described in your Diablo manual.

Compatible Typewheels for the Diablo 1640 are as listed above for the Diablo 1610/20 above.

Qume Sprint 5

Installation: When installing Word Processing to use a Qume Sprint 5 interfaced at 1200 baud (120 characters per second), specify "ETX/ACK" protocol, and a driver capable of inputting characters. No settings are required on the printer for ETX/ACK operation. The Qume Sprint 5 does not support XON/XOFF protocol.

Compatible Typewheels for the Qume are as listed above for the Diablo 1610/20.

NEC Spinwriter 5510/5520

Features: The "spoke 20 spoke 7F" features are not supported on, nor relevant to, these printers.

When Word Processing is installed for a NEC spinwriter 5510/5520, two of the User Printer Function print control characters are defined as follows to permit access to additional characters on NEC print thimbles (typing elements with more than 94 graphics:

CTRL Q sends "shift out" code to printer; changes to alternate character definitions, as described in your NEC documentation, until CTRL W is encountered in document.

CTRL W sends "shift in" code to printer; restores normal character definitions after use of CTRL Q.

The NEC 5510/5520 will buzz and stop printing if the (carbon) ribbon is used up, the paper runs out, or the cover is opened. Install a new ribbon, new paper, or close the cover, then press the "Reset" switch, and printing will continue with no character loss.

Installation: When installing Word Processing to use a NEC Spinwriter 5510/5520 at 1200 baud (120 characters per second), a communications protocol or a special cable must be used to prevent buffer overrun and character loss. The NEC printer is extremely versatile; we know of four possible solutions to the buffer overrun problem:

1. Check that the printer is set to use ETX/ACK protocol (switch 4 OFF on DIP switch SW 1 on the circuit board behind the control panel, or as described in the NEC documentation). In the Word Processing installation dialog, specify ETX/ACK protocol and a driver that can input characters from the printer (as discussed in Section 14). We suggest this as the normal solution.
2. Set the printer for XON/XOFF protocol (switch 4 ON on DIP switch SW1 on the circuit board behind the control panel, or as described in the NEC documentation). In the Word Processing installation dialog, specify XON/XOFF protocol and a driver that can input characters from the printer (as discussed in Section 14).
3. ETX/ACK or XON/XOFF protocol implemented in a printer driver installed in your operating system may also be used with a NEC printer. In this case, specify "None" for protocol in the Word Processing installation dialog.
4. This is a hardware solution, requiring fabrication of a cable adapter. It may not work in all cases; if it works in your case it has the advantages that it works with other software in addition to Word Processing, and that no communications protocol, nor a printer driver that can input characters, need be specified in Word Processing installation.

Make up a cable adapter which runs the printer's "Reverse Channel" signal (line 19 of EIA connector) into the "request to Send" line (pin 4 of EIA connector) of the computer's serial interface. Check that the printer is set to produce a "low" signal on buffer full (switch 5 OFF on DIP switch SW1 on the circuit board behind the control panel, or as described in the NEC documentation). This signal will cause the USART in the computer's serial interface to stop sending characters when the printer cannot accept them, without any special software considerations.

REFERENCE

A.2 Teletype-like (Non-daisy) Printers

The term "Teletype-like" printer includes almost any printer designed to be connected to a microcomputer. The printer should return the carriage to the beginning of the line without advancing the paper upon receipt of a "carriage return code", advance the paper one line upon receipt of a "line feed" code, and print the appropriate character upon receipt of ASCII codes 20 through 7E hex. With such a printer, Word Processing will not Microspace Justify nor print using variable line height nor variable character pitch. Subscripts and superscripts are printed in-line, or in the line below or above if it is a blank line; boldface is printed by overprinting the same characters three times; backspace is supported only if the printer can backspace.

If your printer has an AUTO LF switch, make sure it is **OFF**.

The following special features of specific Teletype-like printers may be supported via special installation (patching) done by the user as discussed in Section 15.:

- Choice of TWO character pitches via CTRL+A and CTRL+N print controls
- Choice of two ribbon colors via CTRL+Y print Control
- Ability to feed paper up and down a fractional line for superscripts and subscripts
- Up to 4 other special features via CTRL+Q, CTRL+W, CTRL+E, CTRL+R print controls

Any printer shown explicitly in Word Processing's printer selection menu should be installed with the appropriate selection, rather than as "Teletype-like", to make its full capabilities available.

"Any Teletype-like Printer": This menu selection will drive any printer meeting the above description, with the limitations noted above. Use it when no other selections match or when in doubt about the applicability of other selections.

"Teletype-like Printer That Can Backspace": This menu selection is preferred for printers that can back up the carriage to the preceding character position on the same line upon receipt of an ASCII "backspace" code (08 hex). Use of this selection will yield faster printing of underline, boldface, and double strike, and make the "backspace" print control available.

A.3 Other Printers

Printers That Cannot Return the Carriage without Advancing the Paper, such as Selectrics: Limited support of these printers is provided. If printer can backspace, install as "teletype-like printer that can backspace" and avoid use of overprint lines. Other print enhancements will work as described for "Teletype-like printers. If printer cannot backspace, install as "Any Teletype-like printer" and avoid use of underline, strike out, double strike, boldface, backspace, and overprint lines in your documents.

"Half-Line-Feed Printer": This menu selection is provided for use with printers that advance one-half line at a time, such as a Selectric with a half-line ratchet. Backspacing capability is also assumed by this menu selection, but no ability to feed paper backwards is required. The half-line advance is utilized to print superscripts and subscripts half a line above and below, respectively, the rest of the text. Two line feeds are transmitted between lines where no subscripts and superscripts appear. Depending on the characters your interface is equipped to respond to, patching may be required after this selection is made.

PRINTER PATCH AREA

TITLE USER4 08/26/80 PRINTER PATCH AREA

;
;ITEMS IN THIS FILE ARE NORMALLY SET AS REQUIRED BY THE
;INSTALL PROGRAM, OR USED WITHOUT CHANGE.

;
;THERE IS NORMALLY NO NEED TO REFER TO THIS LISTING IN
;ORDER TO MAKE XEROX WP OPERATIONAL, AS THE INSTALL
;PROGRAM WILL SET ESSENTIAL ITEMS AS REQUIRED
;FOR ALL NORMAL INSTALLATIONS.

;
;MODIFICATIONS SOME USERS MAY WISH TO MAKE IN ITEMS
;LISTED HERE INCLUDE:

- ;
;
1. ADDING CONTROL SEQUENCES FOR A TELETYPE-LIKE (NON-DAISY) PRINTER TO SUPPORT ADDITIONAL FEATURES, E.G.:
CHARACTER PITCH CHANGE
RIBBON COLOR CHANGE
PARTIAL LINE MOTION (FOR SUBSCRIPTS).
 2. MODIFYING OR ADDING TO THE DRIVER CODE USED TO SEND CHARACTERS TO AND FROM THE PRINTER, FOR THE FOLLOWING OR OTHER REASONS, IN CASES WHERE XEROX WP IS PORT DRIVER (WHICH CAN BE FULLY SET UP BY ANSWERING INSTALL'S QUESTIONS) CANNOT BE USED/
 - A) ALLOW RECEIVING CHARACTERS FROM PRINTER,
FOR PRINTERS WHICH REQUIRE ETX/ACK
PROTOCOL TO OPERATE AT MAXIMUM BAUD
RATE;
 - B) ALLOW XEROX WP TO DETERMINE IF PRINTER IS
READY TO RECEIVE A CHARACTER, FOR BETTER
PERFORMANCE IN CONCURRENT PRINTING:
 - C) INSTALLING A CUSTOM DRIVER FOR PRINTER
NOT SUPPORTED BY USER'S OPERATING SYSTEM
NOR SUPPORTABLE WITH XEROX WP'S PORT
DRIVER.

PAGE 63 ;SETS PAGE LENGTH

PRINTER PATCH AREA

0000'

; ENTRIES

ENTRY POSMTH,BLDSTR,DBLSTR,PSCRLF,PSCR,PSHALF,PBACKS
ENTRY PALT,PSTD,ROLUP,ROLDOW, RIBBON,RIBOFF
ENTRY USR1,USR2, USR3,USR4
ENTRY PSINIT,PSFINI, SOCHR,ULCHR
ENTRY PRINIT,PRFINI, CSWTCH,HAVBSY
ENTRY LIBSY,LISEND,LISINP, POBSY, POSEND, POINP
ENTRY POSTAT,POMASK,POOM,POOP,POINSK,POIM,PISTAT,POIP
ENTRY PUBSY,PUSEND,PUINP
ENTRY ACBSY,ACSEND,ACINP,ACFIN,ACSTAI,ACSTAR,CONFIE
ENTRY PROTCL,EAKBSZ

; EQUATES

0100 TBASE EQU 1 00H ;WHERE PROGRAM IS LOADED FOR NORMAL CP/M

0000' ASEG ;ABSOLUTE CODE, FOR USER LISTING

ORG TBASE+590H ;BEGINS AFTER END OF USER3

0003 IOBYTE EQU TBASE-100H+5 ;BDOS SYSTEM CALL ENTRY POINT,
;ASSIGNMENTS STATUS BYTE, USED BY
;ALTERNATE CONSOLE PRINTER DRIVER.

0005 BDOS EQU TBASE-100H+5 ;BDOS SYSTEM CALL ENTRY POINT,
;USED IN CP/M LIST DEVICE PRINTER
;DRIVER.

0005 LISTF EQU 5 ;CP/M LIST OUTPUT SYSTEM CALL FUNCTION #,
;USED BY CP/M LIST DEVICE PRINTER
;DRIVER.

0008	BS	EQU	8	;BACKSPACE CHARACTER
000A	LF	EQU	10	;LINE FEED
000C	FF	EQU	12	;FORM FEED
000D	CR	EQU	13	;CARRIAGE RETURN
007F	DEL	EQU	7FH	;DELETE OR RUBOUT

REFERENCE

13-38

PRINTER PATCH AREA

;ITEMS RELATING TO ALL PRINTERS

```
;
; PRINTER CHARACTERISTICS AND PRINTING METHOD
;
;PRINTER TYPE / OVERSTRIKE METHOD **** VERY
; IMPORTANT: DETERMINES METHOD OF DOUBLE
; STRIKE, UNDERLINE, ETC, AND WHETHER DAISY-
; LIKE PRINTER CAPABLE OF MICROSPACE JUSTIFY.

;POSMTH=FF HEX;
; PRINTER CAN OVERPRINT ONLY BY CARRIAGE
; RETURN WITHOUT LINE FEED.
;POSMTH=0:
; PRINTER CAN OVERPRINT BY BACKSPACING AS WELL AS ; BY
CARRIAGE RETURNING.
; NOTE: WITH POSMTH=0, CR-OVERPRINT IS USED
; ONLY FOR OVERPRINT LINES IN FILE. FOR
; PRINTERS THAT CAN BACKSPACE BUT NOT RETURN
; CARRIAGE WITHOUT LINE FEED (EG SELECTRIC),
; USE POSMTH=0 AND DON'T USE OVERPRINT LINES.
;POSMTH=1:
; PRINTER IS A DAISY WHEEL OR SIMILAR INCREMENTAL
; PRINTER. CAN PRINT WITHOUT SPACING;
; CAN SPACE AND ROLL IN SMALL INCREMENTS.
; MICROJUSTIFICATION OCCURS ONLY IF POSMTH=1.
```

```
0690 01 POSMTH: DB 1H
;FF SEND CR THEN ANOTHER WHOLE LINE
;00 SEND BACKSPACE THEN CHAR TO
; PRINT OVER LAST CHAR SENT
;01 DAISY WHEEL PRINTER WITH ALL NECESS
; ITEMS IN USER4 AND USER5 INSTALLED.

0692 02 BLDSTR: DB 2;NUMBER OF STRIKES FOR ;"BOLDFACE"
;SET 3, 4, 5, ETC FOR DARKER "BOLDFACE"
;ON NON-DAISY PRINTER. FOR DAISY
;PRINTERS, 2 IS USED - DON'T CHANGE.

0692 02 DBLSTR: DB 2;NUMBER OF STRIKES FOR "DOUBLE
;STRIKE". INCREASE AS DESIRED.

0693 00 00 00 DB 0,0,0 RESERVED
```

PRINTER PATCH AREA

```

; ***** USER-PATCHABLE FUNCTION
;  STRINGS FOR NON-DAISY PRINTERS *****

;EACH STRING CONSISTS OF THE NUMBER OF BYTES,
;FOLLOWED BY THE BYTES TO BE SENT.
;IF FUNCTION IS NOT AVAILABLE,
;NUMBER OF BYTES SHOULD BE ZERO.

; ITEMS ON NEXT N PAGES APPLY ONLY WHEN
; POSMTH (ABOVE) IS 0 or FF, NOT 1.
;
;STRING TO ADVANCE TO NEXT LINE, USED WHEN
;CR,LF ENCOUNTERED IN FILE.
;
; IF YOUR PRINTER REQUIRES NULLS SENT
; AFTER CARRIAGE RETURN (FOR DELAY),
; INCREASE COUNT SO SOME OF
; FOLLOWING ZEROS ARE SENT.
;
; IF YOUR PRINTER AUTO LINE-FEEDS AFTER
; CR CODE, REMOVE LF. (IF POSSIBLE,
; TURN OFF AUTO-LF IN YOUR PRINTER
; INSTEAD, FOR GREATER FLEXIBILITY OF
; XEROX WP USE).
;
0696      02                PSCRLF:   DB          ;NUMBER OF
                                           CHARACTERS
0697      0D                DB CR      ;1ST CHAR: CARR RET
0698      0A                DB LF      ;2ND CHAR: LINE FEED
0699      00 00 00 00      DB 0,0,0,0 ;SPACE FOR 8
069D      00 00 00 00      DB 0,0,0,0 ;..MORE CHARS

;
;STRING TO RETURN CARRIAGE TO BEGINNING
;OF SAME LINE, TO OVERPRINT.
;
;USED FOR UNDERLINE, DOUBLE STRIKE, ETC IF
; POSMTH (ABOVE) IS FF.
;AND WHEN CR WITHOUT LF IS ENCOUNTERED
; IN FILE IF POSMTH IS FF OR 0.
;ALSO USED WHEN POSMTH IS FF AND BACKSPACE
;(CONTROL H?) IS ENCOUNTERED IN FILE.
;
06A1      02                PSCR:     DB 2      ;2 CHARS: CR AND A NULL,
                                           ;TO ALLOW A LITTLE TIME
                                           ;FOR CERTAIN PRINTERS.
06A2      0D                DB CR      ;CARRIAGE RETURN
06A3      00                DB 0       ;NULL, FOR DELAY
06A4      00 00 00 00      DB 0,0,0,0 ;SPACE FOR 4
                                           ;MORE CHARS.

```

REFERENCE

13-40

PRINTER PATCH AREA

```

;NON-DAISY STRINGS. . .
;
; STRING TO DO CARRIAGE RETURN AND HALF LINE
; FEED, FOR PRINTERS THAT CAN DO HALF LINE FEED
; DOWNWARD BUT NOT UPWARD. USED TO PRINT
; SUBSCRIPTS AND SUPERSCRIPTS AT HALF-LINE
; INTERVALS IF ROLUP (BELOW) NOT INSTALLED
; AND POSMTH IS FF OR 0.
;
; FOR EXAMPLE, FOR A SELECTRIC THAT ALWAYS
; FEED HALF LINES, INSTALL ONE CRLF HERE,
; TWO IN "PSCRLF" ABOVE.
;
06A8      00      PSHALF:  DB 0
06A9      00 00 00 00      DB 0,0,0,0,0,0
06AD      00 00
;
;STRING TO BACKSPACE, IE TO OVERPRINT LAST
;CHAR PRINTED.
;
;USED FOR UNDERLINE, DOUBLE STRIKE, ETC IF
;POSMTH (ABOVE) IS 0. ALSO USED WHEN BACKSPACE
;(CONTROL H?) ENCOUNTERED IN FILE IS POSMTH IS 0.
;
06AF      01      PBACKS:  DB 1
06B0      08      DB BS      ASCII BACKSPACE
06B1      00 00 00 00      DB 0,0,0,0
```

REFERENCE

13-41

PRINTER PATCH AREA

```
                ;NON-DAISY STRINGS . . .
                ;   ****THE FOLLOWING ARE OPTIONAL
                ;   STRINGS, PERMITTING USE OF ADDITIONAL
                ;   FEATURES IF SUPPORTED BY YOUR PRINTER.
                ;
                ;STRING TO SET ALTERNATE CHARACTER
                ;WIDTH, IF AVAILABLE.
06B5           00
06B6           00 00 00 00
                ;
                ;PALT:   DB 0           0 CHARS: NOT AVAILABLE
                ;           DB 0,0,0,0
                ;
                ;STRING TO RESET TO STANDARD CHARACTER WIDTH
                ;
06BA           00 00 00 00
06BE           00
                ;
                ;STRING TO ROLL CARRIAGE UP A PARTIAL LINE
                ; WITHOUT ALTERING CARRIAGE COLUMN,
                ; IF AVAILABLE, FOR USE BEFORE SUPERSCRIP
                ; AND AFTER SUBSCRIPT. ROLDOW SHOULD ALSO
                ; BE INSTALLED TO ROLL CARRIAGE SAME AMOUNT
                ; IN OTHER DIRECTION. APPLIES IF POSMTH-FF OR 0.
                ;
06BF           00 00 00 00
06C3           00
                ;
                ;STRING TO ROLL DOWN, AS AFTER SUPERSCRIP,
                ; IF AVAILABLE. USED ONLY IF ROLUP ALSO
                ; INSTALLED.
                ;
06C4           00 00 00 00
06C8           00
                ;
                ; *****USER-PATCHABLE ITEMS FOR BOTH
                ;   BOTH DAISY AND NON-DAISY PRINTERS
                ; *****
                ;
                ; STRINGS FOR USER-DEFINED FUNCTIONS 1-4,
                ; INVOKABLE
                ; WITH PRINT CONTROL CHARACTERS IMBEDDED IN
                ; FILE.
                ; USE ONLY WITH EXTREME CAUTION AND VERY
                ; THOROUGH
                ; TESTING ON DAISY PRINTRS, AS XEROX WP'S
                ; CONTROL
                ; SEQUENCES AND YOURS COULD EASILY INTERFERE.
                ; LINES CONTAINING CONTROLS THAT INVOKE THESE
                ; ALWAYS PRINT FORWARD EVEN IF BIDIRECTION
                ; PRINT IS ON.
```

06C9	00	;	USR1:	DB 0
06CA	00 00 00 00			DB 0,0,0,0
06CE	00		USR2:	DB 0
06CF	00 00 00 00			DB 0,0,0,0
06D3	00		USR3:	DB 0
06D4	00 00 00 00			DB 0,0,0,0
06D8	00		USR4:	DB 0
06D9	00 00 00 00			DB 0,0,0,0

PRINTER PATCH AREA

```

;DAISY / NON-DAISY ITEMS. . .
;STRINGS USED BY BOTH DAISIES AND NON-DAISIES
;AUTOMATICALLY PATCHED FOR DAISIES BY ;INSTALL
PROGRAM;
;MEDDLE WITH CAUTION FOR DAISY PRINTERS.
;
; CHANGE RIBBON COLOR (OPTIONAL)
;
06DD 00 RIBBON: DB 0 ;CHANGE TO ALTERNATE COLOR
06DE 00 00 00 00 DB 0,0,0,0
;
06E2 00 RIBOFF: DB 0 ;CHANGE BACK TO BLACK
06E3 00 00 00 00 DB 0,0,0,0,
;
; STRING TO INITIALIZE PRINTER. SENT AT
; START OF PRINTING, MAY BE USED TO TURN MOTOR
; ON, SET STANDARD CHARACTER SIZE AND LINE
; HEIGHT, OR OTHER FUNCTIONS FOR YOUR SPECIFIC
; HARDWARE. ALWAYS PATCHED BY INSTALL ; PROGRAM,
; ADD YOUR BYTES AFTER INSTALLATION.
;
06E7 01 PSINIT: DB 1 ;NUMBER OF CHARACTER
DB CR ;CARRIAGE RETURN, TO MAKE SURE
;CARRIAGE STARTS AT LEFT EDGE
;OF PAPER.
06E9 00 00 00 DB 0,0,0
06EC 00 00 00 00 DB 0,0,0,0 ;UP TO 16 CHARACTERS . .
06FO 00 00 00 00 DB 0,0,0,0 ;. . TOTAL TO SEND . .
06F4 00 00 00 00 DB 0,0,0,0 ;. . TO PRINTER
;
; STRING SENT TO PRINTER AT CONCLUSION OF
; PRINTING, EG TO TURN MOTOR OFF.
;
06F8 00 PSFINI: DB 0
06F9 00 00 00 00 DB 0,0,0,0
06FD 00 00 00 00 DB 0,0,0,0
0701 00 00 00 00 DB 0,0,0,0
0705 00 00 00 00 DB 0,0,0,0 ;UP TO 16 CHARS
;
0709 00 00 DB 0,0 ;RESERVED
;
; CHARACTER USED FOR "STRIKEOUT" PRINT
; ENHANCEMENT
; (INVOKED W/CONTROL X? PRINT CONTROL)
070B 2D SOCHR: DB '-'
;
; CHARACTER USED FOR "UNDERScore" PRINT
; ENHANCEMENT
; (INVOKED W/CONTROL S? PRINT CONTROL)
070C 5F ULCHR: DB '-'
;

```

REFERENCE

```

; CUSTOM PRINTER INITIALIZE SUBR, CALLED BEFORE
; STRING (PSINIT OR DINIT) IS SENT. USE FOR
; ANYTHING THAT CAN'T BE ACCOMPLISHED WITH
; A STRING, SUCH AS ASSIGNMENT OR INITIALIZING
; A SPECIAL DRIVER INSTALLED IN YOUR BIOS.
;
070D 00 PRINIT: NOP ;INITIALLY NULL. PATCH A JMP
070E 00 NOP ;TO YOUR ROUTINE HERE. SEE END
070F C9 RET ;OF USER1.MAC RE FINDING PATCH
;SPACE.
;
; CUSTOM PRINTER FINISH (CLOSE) SUBR. CALLED
; AFTER STRING (PSFINI OR DFINI) IS SENT.
;
0710 00 PRFINI: NOP
0711 00 NOP
0712 C9 RET
0713 00 00 00 00 DB 0,0,0,0 ;RESERVED

```

PRINTER PATCH AREA

; ***** FLAGS RELATING TO TRANSMISSION
; OF CHARACTERS TO PRINTER *****

;ITEMS ON THIS PAGE RELATE TO ALL PRINTERS.

0717 03 CSWTCH: DB 3 ;WHERE TO SEND EACH OUTPUT
;CHARACTER:
; 00 TO CP/M LIST DEVICE.
; HAVBSY SHOULD BE 0 (UNLESS YOU
; INSTALL A "BUSY" ROUTINE AT LIBSY)
; 01 TO INSTALL-PROGRAM-PATCHABLE PORT
DRIVER
; 02 TO USER SUBROUTINE, ENTRY POINTS
PUBUSY, PUSEND, AND PUINP.
; 03 TO OEM DAISY PRINTER DRIVER. FORCES
POSMTH=1.
; 04 TO ALTERNATE CONSOLE PRINTER DRIVER.

0718 FF HAVBSY: DB OFFH ;NON-ZERO PRINTER DRIVER
; AS INSTALLED AND PATCHED
; HAS A "BUSY" TEST SEPARATE FROM
; "PRINT A CHARACTER". IF NON-ZERO,
; CONCURRENT EDITING AND PRINTING
; WILL PERFORM BETTER; MUST BE ZERO
; IF CAN'T FIND OUT WHETHER PRINTER
; IS BUSY (AS WHEN CHARACTERS ARE
; OUTPUT THROUGH CP/M "LIST" DEVICE).

0719 00 DB 0 ;RESERVED FOR EXPANSION

REFERENCE

13-46

PRINTER PATCH AREA

```

; ***** PRINTER DRIVERS PER SE *****
; THERE ARE FIVE DRIVERS, CORRESPONDING TO
; CSWTCH (PREVIOUS PAGE) = 00, 01, 02, 03, 04.
;
; EACH OF THE DRIVERS HAS THREE ENTRIES:
; 1.     BUSY STATUS ENTRY. RETURNS CY=1 IF
;         PRINTER IS NOT READY. IF UNIMPLEMENTED,
;         RETURN CY=0. HAVBSY SHOULD BE 0 IF
;         UNIMPLEMENTED AND FF
;         IF IMPLEMENTED.
; 2.     SEND CHARACTER (A REGISTER) ENTRY.
; 3.     INPUT A CHAR TO A, OR RETURN CY=1 IF NO
;         INPUT CHARACTER READY. THIS ENTRY IS USED
;         ONLY FOR ETX/ACK AND XON/XOFF
;         BUFFER FULL PROTOCOLS IMPLEMENTED WITHIN
;         EDITOR (SEE "PROTCL" BELOW).
;
; THESE ROUTINES MAY CLOBBER ALL REGISTERS.
;
; PRINTER DRIVER TO OUTPUT TO CP/M LIST
; DEVICE. ONLY CALLED IF CSWITCH=00.
;
LIBSY:      ;BUSY TEST ENTRY - BUSY TEST MAY BE
;           ;ADDED HERE IF YOUR OPERATING SYSTEM
;           ;ALLOWS DETERMINING WHETHER PRINTER
;           ;IS READY. PATCH HAVBSY TO FF IF USED.

071A      00          NOP
071B      B7          ORA A      ;RETURN CY=0 TO SAY
071C      C9          RET        ;. . NOT BUSY.

          LISEND: ;OUTPUT CHARACTER (A) TO LIST DEVICE

071D      5F          MOV E,A    ;CHARACTER IN E FOR CP/M
071E      0E 05      MVI C, LISTF ;FUNCTION # IN C
0720      CD 0005    CALL BDOS ;CALL SYSTEM
0723      B7          ORA A      ;CLEAR CY FLAG
0724      C9          RET        ;RETURN TO CALLER

          LISINP: ;INPUT CHARACTER TO (A) OR RETURN CY=1
;           ;IF NONE. THIS FUNCTION IS NOT SUPPLIED
;           ;BY OPERATING SYSTEM, USER MUST SUPPLY
;           ;SUBROUTINE IF ETX/ACK OR XON/XOFF
;           ;PROTOCOL IS TO BE USED.

0725      00          NOP
0726      37          STC      ;IF NO ROUTINE INSTALLED, SAY
0727      C9          RET        ;. . NO CHARACTER READY.

```

REFERENCE

13-47

PRINTER PATCH AREA

```

; PRINTER DRIVERS...
;
;PORT DRIVER. CALLED ONLY IF CSWITCH=1.
;
; DOES I/O DIRECT TO HARDWARE PORTS. PORT NUMBERS AND
;STATUS BITS MAY BE SET AS DESIRED BY ANSWERING QUESTIONS
;ASKED BY THE INSTALL PROGRAM AFTER CHOOSING "PORT ;DRIVER".
; INITIALLY SET UP TO USE PORT 4 FOR DATA, PORT 5 BIT 0
;ON TO INDICATE READY FOR OUTPUT, PORT 5 BIT 1 ON TO
;INDICATE INPUT CHARACTER READY.
; SELECTING PORT DRIVER IN INSTALL SETS HAVBSY TO FF.
;
POBSY:      ;PORT DRIVER STATUS ENTRY
;BUSY TEST CODE:
0728      DB      DB (IN) ;"IN" INSTRUCTION
0729      05 POSTAT: DB 5   ;PATCH OUTPUT STATUS PORT # HERE
072A      00      NOP ; - PORT 5 SHOWN AS EXAMPLE
072B      E6      DB (ANI);MASK BIT(S) OF INTEREST -
072C      01 POMASK: DB 1   ;BIT 0 SHOWN AS EXAMPLE.
072D      EE      DB (XRI);COMPLEMENT BITS WHICH MUST
072E      01 POOM:  DB 1   ;BE 1 FOR PRINTER READY.
;NOW HAVE NON-ZERO IF PRINTER NOT RDY
072F      37      STC ;SAY NOT READY
0730      CO      RNZ ;RETURN IF NOT READY
0731      B7      ORA A  ;CLEAR CARRY: SAY READY
0732      C9      RET ;RETURN

          POSEND: ;PORT DRIVER SEND CHAR ENTRY
0733      D3      DB (OUT)
0734      04 POOP: DB 4   ;OUTPUT DATA PORT PATCHED HERE -
0735      00      NOP ;PORT 4 SHOWN AS EXAMPLE.
0736      C9      RET

          POINP:  ;PORT DRIVER INPUT CHAR ENTRY,
;USED IF PROTCL=1 OR 2 ONLY.
0737      DB      DB (IN)
0738      05 PISTAT: DB 5   ;PATCH INPUT STATUS PORT # HERE
0739      00      NOP
073A      E6      DB (ANI)
073B      02 POINSK: DB 2   ;MASK BITS OF INTEREST - B1 SHOWN
073C      EE      DB (XRI);COMPLEMENT BITS THAT ARE ON WHEN
073D      02 POIM:  DB 2   ;INPUT CHARACTER IS READY
;NOW HAVE NZ IF INPUT CHARACTER NOT READY
073E      37      STC
073F      CO      RNZ ;RETURN CY=1 IF NO CHAR READY
;CHARACTER IS READY, INPUT IT
0740      DB      DB (IN)
0741      04      POIP:  DB 4; PATCH INPUT DATA PORT # HERE
0742      00      NOP
0743      B7      ORA A  ;CLEAR CRY
0744      C9      RET ;RETURN WITH CHAR IN A

```

PRINTER PATCH AREA

;PRINTER DRIVERS...

```

0745    00 00 00 00    DB 0,0,0,0,0,0 ;RESERVED
0749    00 00 00 00
;
;USER-SUPPLYABLE PRINTER OUTPUT SUBROUTINES
;CALLED ONLY IF CSWITCH=2.
;
; THIS MAY BE USED WHERE SPECIAL INTERFACE
; REQUIREMENTS NECESSITATE A MORE COMPLEX
; ROUTINE THAN THE PORT DRIVER ABOVE.
;
; SPACE IS PROVIDED HERE ONLY FOR THE JMPS TO
; THE ROUTINES; PATCH OVER DRIVERS ABOVE, OR
; IN "MORPAT" AREA
; FOR MORE SPACE,
; SEE "PBG MEN" AND ASSOCIATED COMMENTS AT
; END OF
;
074C    C3    PUBSY: NOP    ;ENTRY POINT TO USER-SUPPLIED
; ROUTINE TO RETURN CY=1 IF
; PRINTER IS NOT READY.
074D    33    ORA A    ;IF UNIMPLEMENTED, RET CY=0.
074E    EA    RET
;
074F    C3    PUSEND: NOP    ;ENTRY POINT TO USER-SUPPLIED
0750    36    NOP    ; ROUTINE TO PRINT CHARACTER,
0751    EA    RET    ; IN A REGISTER.
;
0752    C3    PUINP: NOP    ;ENTRY POINT TO USER-SUPPLIED
; ROUTINE TO INPUT CHARACTER,
; OR RETURN CY=1 IF NONE READY
; USED ONLY IF PROTCL IS 1 OR 2.
0753    39    STC    ;IF UNIMPLEMENTED, SAY NO CHAR RDY.
0754    EA    RET

```

; THE PRINTER DRIVER FOR CSWTCH=3 IS NOT IN USER4.

```

0755    00 00 00 00    DB 0,0,0 ;RESERVED

```

PRINTER PATCH AREA

;PRINTER DRIVERS...

```

;
; "ALTERNATE CONSOLE" PRINTER DRIVER
;   CALLED ONLY IF CSWTCH=4.
;
; THIS DRIVER ALLOWS ACCESS TO PRINTERS REQUIRING
; CHARACTER INPUT (FOR A COMMUNICATIONS PROTOCOL)
; WITHOUT PATCHING IN A DRIVER, UNDER OPERATING
; SYSTEMS WHICH SUPPORT MULTIPLE CONSOLES SELECTED
; VIA THE "IOBYTE" I/O ASSIGNMENTS BYTE.
;
; THIS DRIVER IS SELECTED BY SETTING CSWTCH TO 4.
;
; THE SPECIFIC CONSOLE DEVICE TO BE USED IS SELECTED
; BY SETTING ITEM "CONFIE" BELOW TO 00, 01, 02, OR 3.
;
; "HAVBSY" SHOULD BE 0 WHEN USING ALTERNATE CONSOLE
; DRIVER, UNLESS YOU ADD A BUSY TEST ROUTINE.
;

```

```

ACBSY: ;ENTRY POINT FOR OUTPUT BUSY TEST.
;NO ROUTINE SUPPLIED, AS NORMAL OPERATING SYSTEM
; DOES NOT PROVIDE CONSOLE OUTPUT BUSY FUNCTION.

```

```

0758 00          NOP
0759 B7          ORA A      ;RETURN CY=0 TO SAY "NOT BUSY"
075A C9          RET

```

```

ASCEND: ;ENTRY POINT TO SEND CHARACTER IN A TO PRINTER

```

```

075B CD 0777  CALL ACSTAR  ;SET IOBYTE TO ALTERNATE CONSOLE,
;SAVING ORIGINAL IOBYTE IN B.
075E CD 0000* CALL COUCH##  ;OUTPUT CHARACTER (A) TO CONSOLE,
;PRESERVING REGISTERS.
0761 C3 076E  JMP ACFIN   ;GO RESTORE IOBYTE AND RETURN.

```

```

ACINP: ;ENTRY POINT TO RETURN CONSOLE INPUT CHARACTER
;IN A REGISTER, OR RETURN CY=1 IF NO CHAR READY.

```

```

0764 CD 0777  CALL ACSTAR  ;SAVE AND SET IOBYTE
0767 CD 0000* CALL CONSTA## ;THIS SUBROUTINE RETURNS 0 IN
;A AND Z FLAG SET IF NO CHARACTER
;IS READY AT CONSOLE. SAVE BCDEHL.
076A C4 0000* CNZ INCHR## ;IF CHARACTER READY, GET IT TO A.
;ELSE 0 IS LEFT IN A.
076D 57          MOV D,A      ;PUT VALUE TO RETURN IN D FOR NOW
;FALL THRU TO ACFIN ON NEXT PAGE TO RESTORE IOBYTE,
;RETURN D IN A, CY=1 IF NO CHAR READY, ELSE CY=0.

```

REFERENCE

13-50

PRINTER PATCH AREA

;PRINTER DRIVES... ALTERNATE CONSOLE DRIVER...

ACFIN: ;ALTERNATE CONSOLE DRIVER COMMON EXIT ROUTINE

```
076E 78      MOV A,B      ;ORIGINAL IOBYTE, SAVED BY "ACSTAR"
ACSTA1: ;"ACSTAR" SUBROUTINE JOINS HERE
076F 32 0003 STA IOBYTE   ;SET NEW IOBYTE OR RESTORE ORIGINAL
0772 7A      MOV A,D      ;RESTORE A REGISTER
;RETURN CY=1 IF A=0: THIS IS NEEDED AT EXIT FROM
;"ACINP" ROUTINE, DOES NO HARM IN OTHER CASES.
0773 B7      ORA A      ;TEST FOR NON-ZERO, CLEAR CY FLAG
0774 C0      RNZ      ;IF NON-ZERO, RETURN CY FLAG CLEAR
0775 37      STC      ;ELSE SET CARRY FLAG
0776 C9      RET      ;FOR A=0 RETURN CY=1
```

ACSTAR: ;COMMON ENTRY SUBR FOR ALTERNATE CONSOLE
; DRIVER

```
0777 57      MOV D,A      ;SAVE A IN D, FOR ASCEND.
0778 3A 0003 LDA IOBYTE   ;GET I/O ASSIGNMENTS STATUS BYTE
077B 47      MOV B,A      ;SAVE INITIAL IOBYTE IN B
077C E6 FC   ANI OFCH   ;ZERO THE "CONSCLE" PART OF IOBYTE
077E F6      DB (ORI)   ;SET DESIRED CONSOLE BITS
077F 01      CONFIE: DB USER OR INSTALLATION SET DESIRED
;CONSOLE BITS HERE:
; 00 = TTY: PHYSICAL DEVICE
; 01 = CRT: PHYSICAL DEVICE
; 02 = BAT: PHYSICAL DEVICE
; 03 = UC1: PHYSICAL DEVICE
; NEW IOBYTE VALUE IS NOW IN A
0780 C3 076F JMP ACSTA1 ;GO SET IOBYTE FROM A, RESTORE A
;FROM D, AND RETURN TO CALLER.
```

PRINTER PATCH AREA

```

0783      00 00 00      DB 0,0,0      ;RESERVED
;
; ***** PRINTER COMMUNICATIONS PROTOCOL *****
;
; APPLICABLE IF CSWTCH=0, 1, OR 2.
; APPLICABLE FOR ALL POSMTH VALUES.
;
; THREE BUFFER FULL PROTOCOLS ARE SUPPORTED:
;
; NO PROTOCOL: (PROTCL=0): NO PROTOCOL EXECUTED IN
; XEROX WP: USE IF NONE REQUIRED OR IF HANDLED
; ELSEWHERE, EG IN OPERATING SYSTEM OR IN USER
; DRIVER ROUTINES.
;
; ETX/ACK PROTOCOL (PROTCL=1): WS TRANSMITS "ETX" AT EN
; OF STRING OF CHARACTERS, PRINTER RESPONDS WITH
; "ACK" WHEN ALL OF THESE CHARACTERS HAVE BEEN
; PRINTED. DRIVER MUST BE ABLE TO INPUT CHARACTERS.
;
; XON/XOFF PROTOCOL (PROTCL=2): PRINTER
; SENDS "XOFF" WHEN WS SHOULD STOP SENDING,
; "XON" WHEN TRANSMISSION SHOULD BE RESUMED.
; DRIVER MUST BE ABLE TO INPUT CHARACTERS.
;
0786      00          PROTCL: DB 0      ;0=NO PRINTER BUFFER FULL PROTOC
;                                ;1=ETX/ACK PROTOCOL. SET EAKBSZ BELOW
;                                ;2=XON/XOFF PROTOCOL
; USE 0 FOR MOST TTY-LIKE PRINTERS AND FOR SERIAL
; DAISY PRINTERS INTERFACED AT 300 BAUD OR SLOWER.
; FOR DIABLO AND QUME AT 1200 BAUD, USE 1.
; FOR NEC AT 1200 BAUD, USE 1 OR 2 AND CONFIGURE THE
; PRINTER APPROPRIATELY, OR USE 0 & CABLE ADAPTER.

0787      7F          EAKBSZ: DB 127 ;ETX/ACK MESSAGE LENGTH (1/2 PRINTER'S
;                                ;BUFFER SIZE), APPLICABLE ONLY IF ;PROTOCL=1,
;                                ;AUTOMATICALLY PATCHED FOR DAISY ; PRINTERS.

0788      00 00      DB 0,0          ;RESERVED FOR EXPANSION
078A      00 00 00 00 DB 0,0,0,0     ;RESERVED FOR EXPANSION
078E      ALABEL EQU $ ;ASSEMBLER SHOULD PRINT 78E

                                END      ;NEXT MODULE LOADS AT 790H

```

PRINTER PATCH AREA

Macros:

Symbols:

ACBSY	0758I	ACFIN	076EI	ACINP	0764I	ASCEND	075BI
ACSTAI	076FI	ACSTAR	0777I	ALABEL	078E	BDOS	0005
BLDSTR	0691I	BS	0008	CONFIE	077FI	CONSTA	0768*
COUCH	075F*	CR	000D	CSWTCH	0717I	DBLSTR	0692I
DEL	007F	EAKBSZ	0787I	FF	000C	HAVBSY	0718I
INCHR	076B*	IOBYTE	0003	LF	000A	LIBSY	071AI
LISEND	071DI	LISINP	0725I	LISTF	0005	PALT	06B5I
PBACKS	06AFI	PISTAT	0738I	POBSY	0728I	POIM	073DI
POINP	0737I	POINSK	073BI	POIP	0741I	POMASK	072CI
POOM	072EI	POOP	0734I	POSEND	0733I	POSMTH	0690I
POSTAT	0729I	PRFINI	0710I	PRINIT	070DI	PROTCL	0786I
PSCR	06A1I	PSCRLF	0696I	PSFINI	06F8I	PSHALF	06A8I
PSINIT	06E7I	PSTD	06BAI	PUBSY	074CI	PUINP	0752I
PUSEND	074FI	RIBBON	06DDI	RIBOFF	06E2I	ROLDOW	06C4I
ROLUP	06BFI	SOCHR	070BI	TBASE	0100	ULCHR	070CI
USR1	06C9I	USR2	06CEI	USR3	06D3I	USR4	06D8I

No Fatal error(s)

PRINTER PATCH AREA

```

;
; SPACE FOR USER-ADDED SUBROUTINES
;
02E0 00 00 00 00 MORPAT: DB 0,0,0,0
02E4 00 00 00 00 DB 0,0,0,0 ;ADDITIONAL SPACE THAT MAY
02E8 00 00 00 00 DB 0,0,0,0 ;BE USED FOR USER PATCHES,
02EC 00 00 00 00 DB 0,0,0,0 ;FOR EXAMPLE FOR A CURSOR
02F0 00 00 00 00 DB 0,0,0,0 ;POSITIONING SUBROUTINE, OR
02F4 00 00 00 00 DB 0,0,0,0 ;FOR "INISUB" OR "UNISUB"
02F8 00 00 00 00 DB 0,0,0,0 ;SUBROUTINES.
02FC 00 00 00 00 DB 0,0,0,0 ;FOR YET MORE SPACE,
0300 00 00 00 00 DB 0,0,0,0 ;SPACE, SEE "PBGMEM", NEXT.
0304 00 00 00 00 DB 0,0,0,0
0308 00 00 00 00 DB 0,0,0,0
030C 00 00 00 00 DB 0,0,0,0
0310 00 00 00 00 DB 0,0,0,0
0314 00 00 00 00 DB 0,0,0,0
0318 00 00 00 00 DB 0,0,0,0
031C 00 00 00 00 DB 0,0,0,0
0320 00 00 00 00 DB 0,0,0,0
0324 00 00 00 00 DB 0,0,0,0
0328 00 00 00 00 DB 0,0,0,0
032C 00 00 00 00 DB 0,0,0,0
0330 00 00 00 00 DB 0,0,0,0
0334 00 00 00 00 DB 0,0,0,0
0338 00 00 00 00 DB 0,0,0,0
033C 00 00 00 00 DB 0,0,0,0
0340 00 00 00 00 DB 0,0,0,0
0344 00 00 00 00 DB 0,0,0,0
0348 00 00 00 00 DB 0,0,0,0
034C 00 00 00 00 DB 0,0,0,0
0350 00 00 00 00 DB 0,0,0,0
0354 00 00 00 00 DB 0,0,0,0
0358 00 00 00 00 DB 0,0,0,0
```

REFERENCE

13-54

PRINTER PATCH AREA

```
;
; PROVISION FOR EXTENDED PATCHING
;
; PBGMEM POINTS TO BEGINNING OF MEMORY TO USE FOR
; WORKING STORAGE.
; IF YET MORE SPACE IS NEEDED FOR
; PATCHES, INSTALL FIRST,
; PUT YOUR ADDED CODE
; WHERE PBGMEM POINTS AND INCREASE PBGMEM TO POINT
; BEYOND YOUR PATCHES. BE SURE TO USE A LARGE ENOUGH
; "SAVE" COMMAND!
; -- SAVE SIZE REQUIRED IS much LARGER THAN FOR XWS.COM
; WITHOUT ADDED PATCHES!
```

```
035C 0000* PBGMEM: DW MEMORY ;An indefinite amount of code may
;be added here AFTER INSTALLation.
;Do not add code before INSTALLing,
;as INSTALL will delete it!
```

(This page intentionally left blank.)

DIABLO 630 PRINTER

INTRODUCTION

Diablo Systems has combined the simplicity and reliability of a newly designed daisy wheel printer with the latest microelectronic technology to produce the Model 630 Printer.

The Model 630 is a universal RS 232-C interface printer. It will support a heavy work load using conventional serial data interchange techniques and protocols.

The Model 630 can use all Diablo and Xerox plastic and metal print wheels.

The Model 630 can use many of Diablo's present paper handling devices, such as forms tractors, sheet feeders, etc.

SYSTEM COMPONENTS

14-1

7/1/81

UNPACKING THE 630

1. Take the printer and all accessories out of the carton and remove the plastic dust bag. Place the Model 630 on a desk or table.

NOTE: The weight of the Model 630 is centered toward its right rear (as you look at it); thus it is easiest to lift by holding it at the right-rear and left-front.

2. Inspect the Model 630 and any accompanying accessories for evidence of shipping damage. Immediately notify the shipping agent of any damage to the unit or its parts.
3. Remove the access cover. It is held in place by magnetic latches in front and small tabs in back.
4. Remove the plastic bag and the CAUTION tag attached to the paper bail by cutting or removing the tie wrap (nylon strap).
5. Remove or cut the following shipping restraint items if installed (see pictures on opposite page):
 - a) Rubber band securing the cover open switch actuator.
 - b) Rubber band securing the paper cradle to the paper pressure rollers (if no platen is installed).
 - c) Tie wrap (nylon strap) holding the carriage to the right printer frame.

CAUTION: DO NOT cut any other tie wraps!

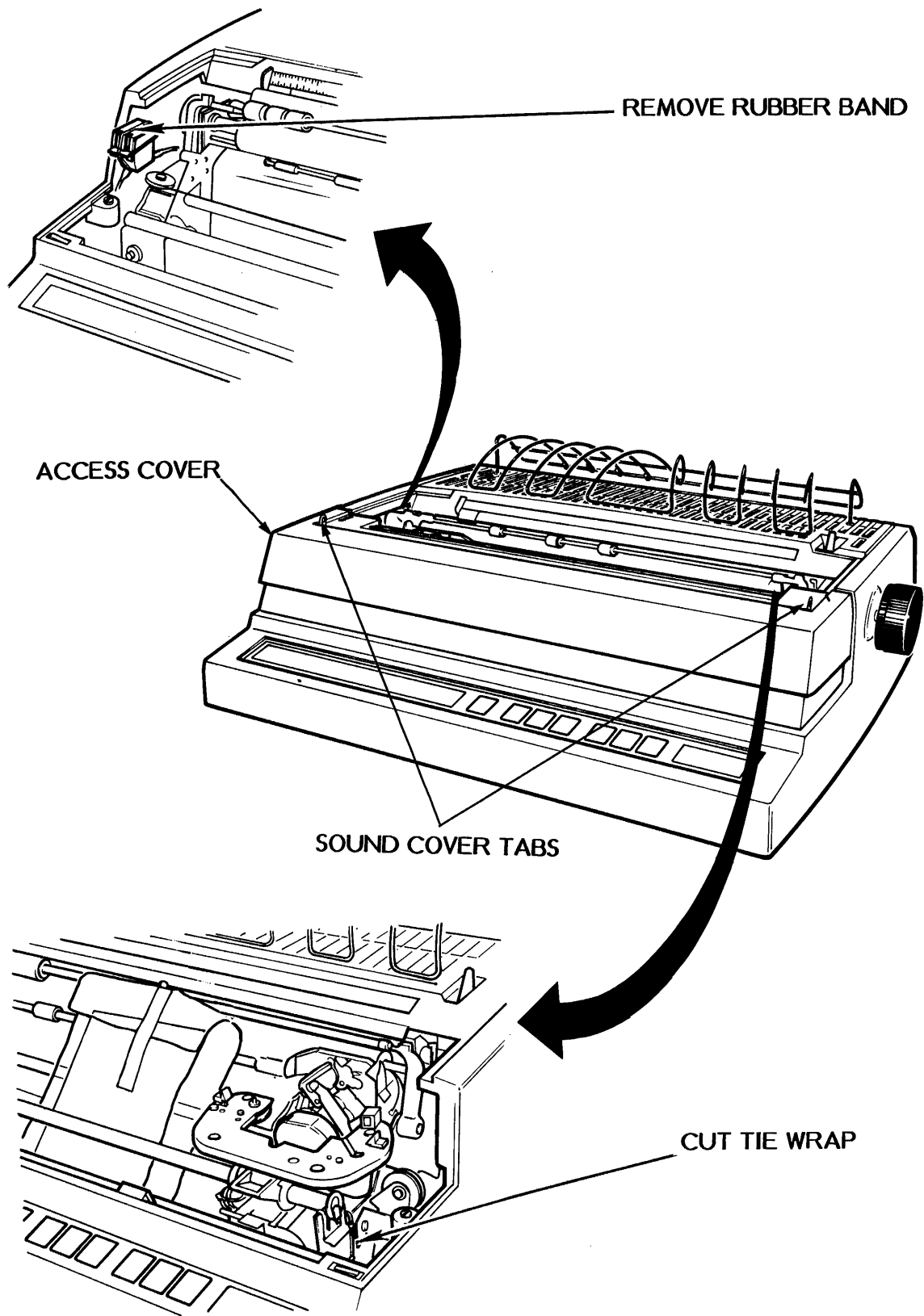

REMOVING SHIPPING RESTRAINTS

SYSTEM COMPONENTS

INSTALLATION

1. Place the Model 630 on your desk or table. Look at the two cords. One printer cord plug fits the large outlet on the back of the printer; the other plug fits the large outlet on the back of the 820's screen. One power plug fits the smaller outlet on the back of the printer; the other plug fits a wall outlet.
2. Check the ON/OFF switch on the back of the printer -- it must be OFF!
3. Plug the printer cord into the large outlet (right side, looking at back -- see picture on the opposite page) on the back of the printer. Tighten the screws on the plug.
4. Plug the L-shaped end of the power cord into the small outlet (left side, looking at back -- see picture on the opposite page) on the back of the printer.

Plug the other end of the power cord into the wall outlet. **DO NOT** turn on the printer yet.
5. If the platen has been removed, reinstall it by lowering it down into place while pressing down on both platen release levers.

NOTE: Make sure the platen's releasable drive gear end is on the right (as you view it).
6. Install the platen knob on the right end of the platen - thru the hole in the top cover. Engage the knob on the platen shaft, rotate the knob until its slot fits over the cross pin on the platen shaft, then push against the knob to snap it into place.
7. Install a print wheel and ribbon (see instructions on Pages 14-8 and 14-9).
8. Install the access cover. It is held in place by magnetic latches in front and small tabs in back.
9. Install the sound cover. Insert the sound cover pivot shaft in the tabs located on the top of the access cover.

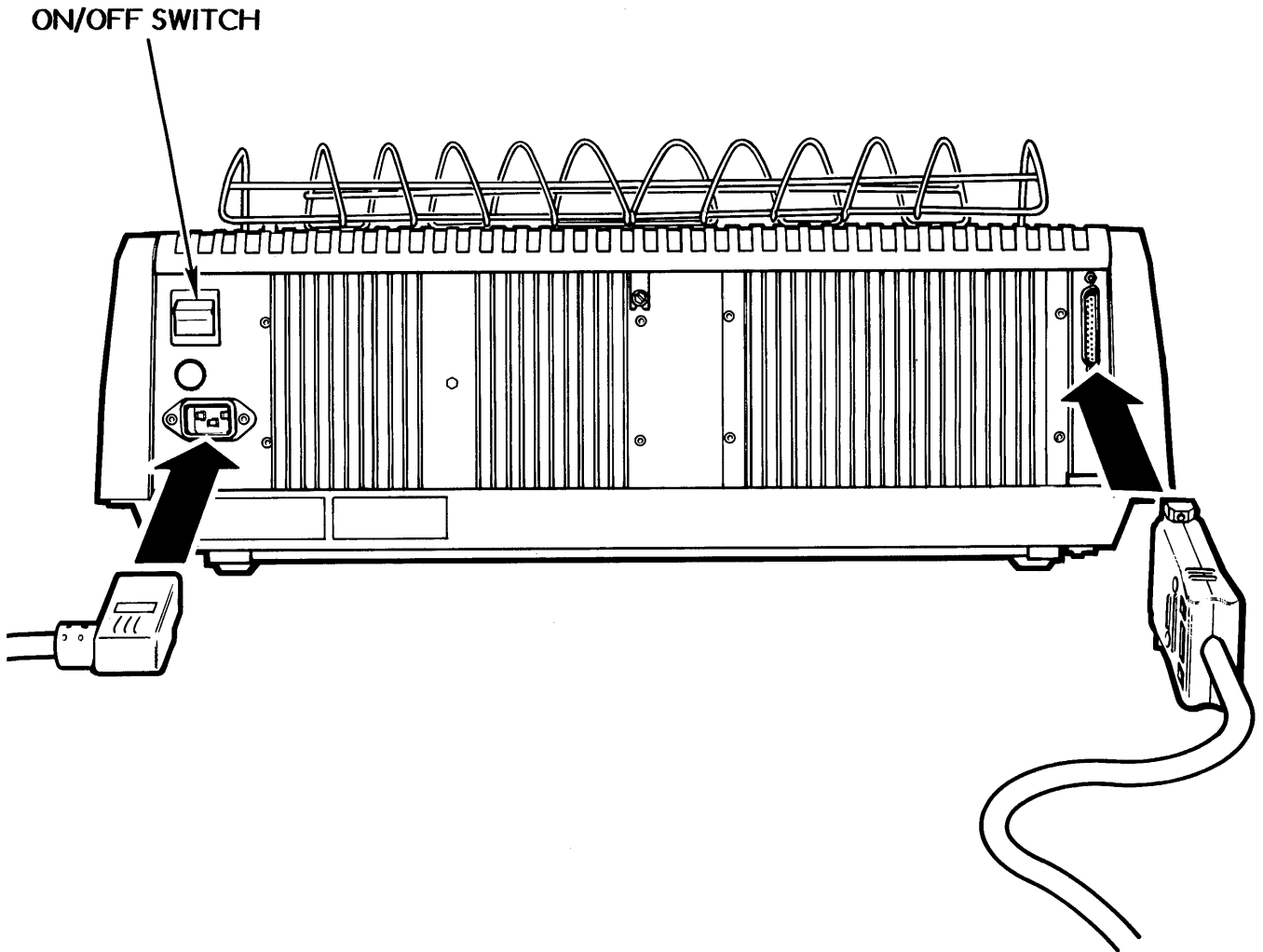

BACK OF PRINTER

FAMILIARIZATION

(See picture on opposite page)

1. Control Panel - Operator control switches and indicators.
2. Access Cover - Operator access to internal controls and for changing print wheels and ribbons.
3. Platen - similar to those on standard office typewriters. There is a hand knob on the right side only.

Paper Handling Features

4. Platen Knob - This knob, when pushed in (to disengage the drive gear), allows the operator to rotate the platen to insert and position paper.

Platen Release Latches - These two latches are pressed down simultaneously to insert a platen or to release the platen for removal.
5. Paper Bail - The paper bail holds the paper against the platen for optimum print quality and quietness. The bail must be pulled forward (away from the platen) when inserting paper.
6. Paper Release Lever - This lever releases paper roller pressure when pulled forward, allowing the paper to be positioned manually. Returning this lever to its back position reestablishes paper roller pressure.
7. Paper Guide - A movable guide for aid in inserting paper.
8. Paper Scales - There are two scales associated with the Model 630. One is a column indicator, located on the top cover; the second is a paper scale mounted on the access cover. These scales aid the operator in centering and spacing paper and copy.
9. Power Indicator Light - This light indicates that the power is on.

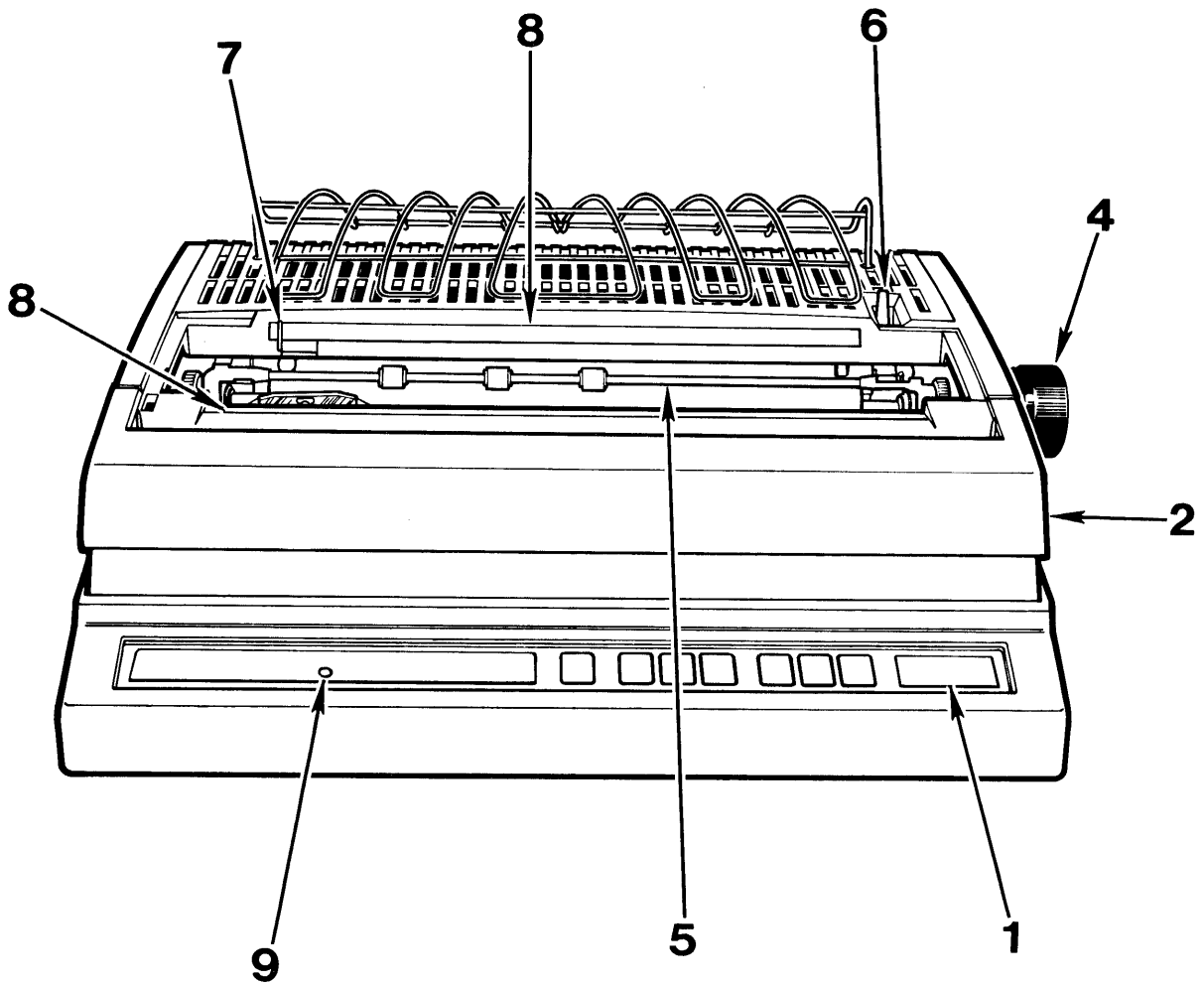

630 PRINTER

PREPARATION FOR OPERATION

Installing a Print Wheel

CAUTION: Ensure that power to the Model 630 is turned OFF!

1. Grasp the print hammer guide (orange stripe) and pull it toward you to tilt the print wheel mechanism away from the platen and card guide.
2. Rotate the print wheel motor hub to bring the hub's alignment tab to the upper part of its arc of travel.
3. Grasp the print wheel (metal or plastic) by its rubber hub and place it on the print wheel motor hub. Align the wheel's alignment slot with the hub's alignment tab, and push the wheel firmly to fully seat it on the motor hub.
4. Tilt the print wheel mechanism back to its operating position.

Removal of the print wheel is simple. Tilt the print wheel mechanism toward you, grasp the print wheel by its rubber hub and pull it free of the print wheel hub.

Note: Diablo print wheels are rugged and dependable, but they can be damaged. Use care when handling them to avoid bending the "spokes". Always store print wheels in their plastic containers when they are not installed in the printer.

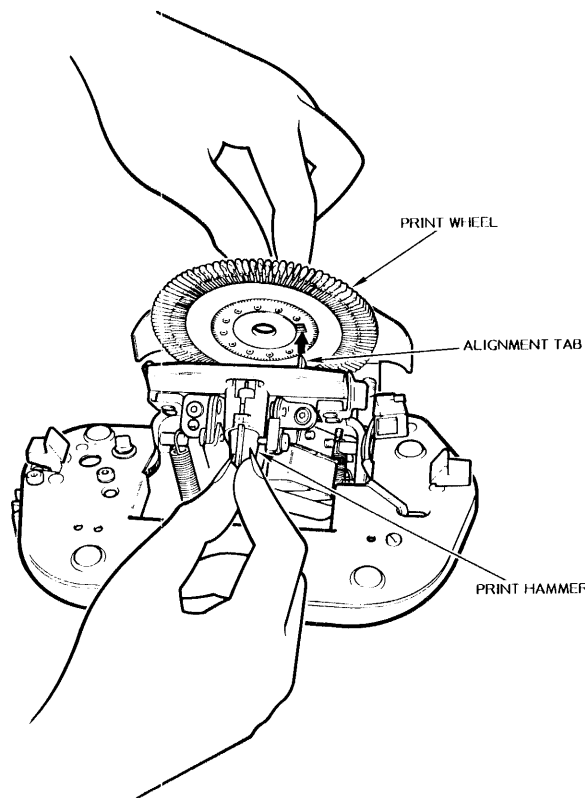

INSTALLING PRINT WHEEL

Installing a Ribbon Cartridge

1. Open the plastic envelope and take out the ribbon cartridge. Note the small knob on the top surface of the cartridge for advancing the ribbon manually. Use this knob to take up any slack in the exposed portion of the ribbon and to make sure the ribbon is tight and straight.
2. Hold the cartridge in one hand with the exposed ribbon toward the platen. Lower the cartridge down over the print hammer guide (orange stripe). Be sure the exposed ribbon is straight and located between the card guide and print wheel. Push the cartridge down firmly until both latches have snapped into position. Rock the cartridge back and forth on the platform to ensure that the ribbon is free to move up and down. Turn the ribbon advance knob a turn or two to ensure that the ribbon is tight, straight and ready to operate.

The ribbon cartridge may be removed by pressing down on both latches simultaneously. The cartridge will be raised up slightly and may be grasped easily and lifted out of the printer.

Note: When a ribbon cartridge is nearly empty, a yellow cross-hatched pattern will appear on the visible back side of the ribbon. The Model 630 will stop printing, sound its alarm and the RIBBON/PAPER light will come on if printing is attempted with the ribbon in the warning (yellow) zone.

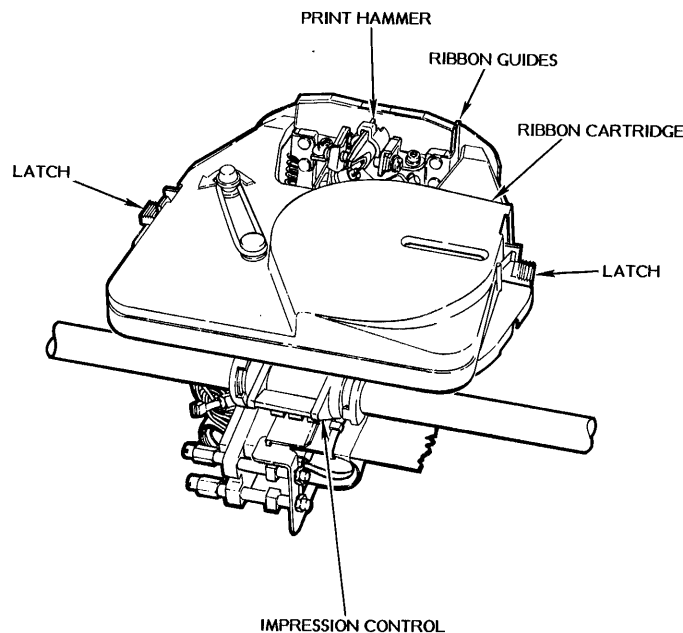

INSTALLING A RIBBON

SYSTEM COMPONENTS

14-9

Inserting Paper or Forms

Inserting paper or forms into the Model 630 is accomplished in much the same manner as in a standard typewriter. Paper is inserted down behind the metal paper out bail and platen while the platen is turned manually to bring the paper around and up in front of the platen. The front paper bail (Item 5, page 14-6) aids in guiding the paper back over the platen to the rear when pulled forward. The paper release lever at the right-hand side of the printer may be pulled forward to release roller pressure after paper insertion so the paper can be properly aligned in the printer. After paper is positioned, both the front paper bail and paper release lever are returned to their operating positions.

Paper Thickness/Print Intensity Adjustment

The two-position Multicopy lever located at the front of the carriage assembly adjusts for paper thickness and print intensity. Setting the lever to its upper position moves the carriage close to the platen, and actuates a switch to the proper setting for light and medium weight paper and form sets of up to two carbon copies. For heavier paper or form sets of up to five copies, the Multicopy lever is set to its lower position. This rocks the carriage away from the platen slightly, and deactivates the switch to enable an increased print intensity.

To avoid the possibility of ribbon damage, the Multicopy lever should always be set at its upper position when printing on single sheets of paper using carbon ribbons.

OPERATING THE MODEL 630 PRINTER

Preliminary Steps

Install a print wheel, a ribbon cartridge and insert a sheet of paper - as outlined on pages 14-8, 14-9 and 14-10.

Move the carriage manually to the right a short distance.

Move the power ON/OFF switch at the right rear of the printer to ON.

The POWER indicator should glow; the carriage should move to the left slowly, and then back to the right, to stop at the first print position; and the print wheel should rotate and stop at its "home" position (i.e., the "flag" on metal print wheels should be at the top if the Print Wheel Select switch - under the access cover - has been properly set). This entire process is called the INITIALIZATION, RESET or RESTORE sequence. It clears all volatile memory, resets all position counters and sets the Model 630 to print the first character.

Paper Handling Accessories

-Forms Tractor/Pin Feed Platen: These devices facilitate precision handling of the continuous or manifold paper forms and are provided in both unidirectional and bidirectional versions.

-Mechanical Front Feeder: This device also mounts on top of the Model 630. It is intended for use with difficult, multipart forms and the heavier ledger card stocks.

-Bottom Feed: The Model 630 can be configured for feeding continuous or manifold forms up thru the bottom of the machine. It must be used with either a pin feed platen or a forms tractor.

SPECIAL CONSIDERATIONS

1. Cleaning Print Wheels

Print Wheels used with carbon ribbons seldom need cleaning. Both Plastic Print Wheels and Metal Print Wheels used with cloth ribbons will require an occasional cleaning.

Remove the print wheel and clean with toluene or naphtha* and a soft brush or wiper. DO NOT clean with water. DO NOT get solvent on the hub or damper ring (metal wheels). Be careful not bend the "spokes".

2. Changing Ribbons During Operation

As outlined on page 14-9, the Model 630 will stop printing, the RIBBON/PAPER light will appear, and the alarm will sound upon reaching the end of a carbon ribbon. Should this happen during receipt and print out of data from a host system, the operator should open the access cover, replace the ribbon cartridge as described, close the access cover, and then touch the Control Panel RESET switch to resume printing.

3. Cleaning The Print Hammer

Remove the print wheel and ribbon cartridge as described. Locate the movable print hammer inside its guide, as shown on page 14-8. Push the hammer out to the rear, to expose as much of the head as possible. Use toluene or naphtha* and a wiper or brush to remove any accumulated ink or other substances, and wipe dry.

* Toluene and naphtha are available at most drug stores.

** 90% isopropyl alcohol may be used as a solvent for cleaning the print hammer.

Setting The Switches Under The Access Cover (left to right)

The 630 Printer has been factory preset to the proper switch positions for use with a Xerox 820 Information Processor. For use with other print wheels, the available setting positions are as follows:

1. Print Wheel Select Switch. Set this switch to match the particular type of print wheel being used. This ensures your text will print correctly and prevents possible print wheel damage or excessive wear.

PRINT WHEEL SELECT:

0:	88 Metal
2:	92 Metal
3:	96 Metal
4:	96D Metal
5:	APL Metal
6:	APL Plastic
7:	Plastic
1,8,9:	Optional

2. Spacing Select Switch. This switch selects the horizontal spacing for character printout. Set this switch to 1 for 10 Pitch PWS or 2 for 12 Pitch PWS.

0:	Proportional
1:	10
2:	12
3:	15
4 - 9:	Self Test

For use with the Xerox 820 Information Processor in WP, the switches to the right of Print Wheel and Spacing switches should all be positioned toward the front of the printer, except for the BAUD switch marked 120. It should be positioned toward the back.

Setting The Operating Switches

These six switches are located in the right-hand area of the control panel where they are accessible to the operator with all covers on the machine. These are membrane type momentary action switches actuated by a touch of the finger.

1. RESET Switch. This switch will restore the Model 630 to normal operating status following a printer check or an error condition, and clears all error indicators.
2. SCROLL Switch. Touching this switch advances the paper a small amount to give the operator a clear view of the last printed line. The paper is automatically returned to the last printing position when the switch is released.
3. LF Switch. Touching this switch initiates a single or a double line feed operation, as selected by the DOUBLE L.F. MODE SWITCH. Action is repeated if the switch is held activated longer than 600msec. A line feed code will not be transmitted.
4. FF Switch. Touching this switch initiates a form feed to the next top-of-form position. A form feed code is not transmitted.
5. HERE IS Switch. Touching this switch causes a special "Here Is . ." message of up to 31 characters to be transmitted over the communications link when operating in remote ASCII mode with the fully featured HPRO5 option installed. This is not used with the Xerox 820 Information Processor.
6. BREAK Switch. Touching this switch causes a Break (250msec space) to be transmitted over the communications link when operating in remote mode.
7. (Audio Alarm). This device buzzes briefly to indicate the occurrence of various errors or operating conditions.

Reading The Control Panel Indicators (left to right)

1. POWER. Indicates that AC power is applied to the Model 630.
2. PRINT CHK*. Indicates that a print operation has been called for while the printer is in a "check" condition. A check condition occurs when a print wheel or carriage movement command has been received but cannot be successfully completed due to a malfunction. This condition disables the Model 630 until a restore sequence clears the check condition.

RESET. Note that if the problem causing the check condition has not been corrected when a restore sequence has been initiated, the check will reappear as soon as printing is attempted.

3. PARITY. Indicates detection of any of the following types of error:
 - Incorrect parity sensed on received character.
 - A framing error (no stop bit) detected on a received non-break character.
 - A serial data character detected with an excess number of bits.

When a parity error is detected, a DEL character is substituted for the erroneous character.

This indicator functions only if the PARITY ENABLE switch (under the access cover) is ON.

4. OVFL*. Indicates that the Model 630's print input memory (buffer) is too full (has overflowed). Protocol has not been used properly.
5. RIBBON/PAPER*. Indicates end of ribbon has been reached or that the printer is out of paper, and printing has been attempted.
6. COVER*. Indicates that printing was attempted with the sound cover open.

* - These errors cause a Break to be transmitted when the Model 630 is in Remote mode if DC1/DC3 protocol has not been selected.

SPECIFICATIONS

Print Speed: Up to 40 characters per second with metalized print wheels.

Character Set: 88, 92 or 96 printable characters per print wheel. Switch selectable program support for APL and all ENGLISH language print wheels.

Print Wheels:

Metal	-88 character Xerox -96 character Diablo and Xerox
Plastic	-96 character Diablo

Character Spacing: 10 and 12 pitch.

Column Spacing: 1/120 inch (.21mm) minimum.

Print Line: 13.2 inches (335.3mm)
132 columns 10 pitch
158 columns 12 pitch
198 columns 15 pitch

Paper Width: 16.53 inches (419.9mm) maximum
- friction feed without Top Paper Out switch.
16.00 inches (406.4mm) maximum
- friction feed with Top Paper Out switch.
15.25 inches (387.4mm) maximum
full width with optional forms tractor (14.75 inches/-374.7mm between holes). 3.25 inches (82.55mm) minimum with forms tractor (2.75 inches/69.85mm between holes).

Carriage Speed: 400msec maximum for 13.1 inches (332.77mm) of motion.

Tabulation: Left or right.

Line Spacing: 1/48 inch (.53mm) minimum.

Paper Feed: Bidirectional, except with unidirectional forms tractor and uni-directional pin feed platen.

Paper Feed Speed: 4 inches (101.6mm) per second plus 40msec (typical) settling delay time.

Sensors: End of ribbon, top paper out, and cover open.

Paper Thickness:

- .000 - .101 inch (.254mm) at low setting (1-3 part forms)
- .010 - .027 inch (.254 - .686mm) at high setting (4-6 part form).

Other Features: Self-test; host program control thru escape sequences; data receive/transmit speed selection.

Power Requirements: Strappable for operation from nominal 100, 120, 220 or 240 volt (+10%/-15%) AC inputs, 49-61 Hz. 350W maximum power consumption. Factory preset for 120 VAC.

CHECK YOUR MODEL 630's SERIAL PLATE FOR PROPER INPUT POWER.

This page intentionally left blank.

FORMS TRACTORS

The unidirectional and bidirectional forms tractors are very similar except the unidirectional does not have the reverse drive sprockets required for bidirectional paper feeding.

Unidirectional Forms Tractor - This unit mounts on top of the printer cover where it engages the platen shaft for alignment and drive. It requires use of a friction feed platen. It is adjustable to any paper width from 2-3/4" (69.85mm) to 14-1/2" (368.3mm) maximum as measured between the pin feed drive holes.

Bidirectional Forms Tractor - This unit mounts on top of the printer cover where it engages the platen shaft for alignment and drive. It requires use of a friction feed platen. It is adjustable to any paper width from 2-3/4" (69.85mm) to 14-1/2" (368.3mm) maximum as measured between the pin feed drive holes. It also features both forward and reverse pin feed paper drives to enable feeding paper in either direction.

Forms Tractor Installation

Note: If your Model 630 has a sound panel, it must be the special sound panel designed for use with the forms tractors.

- 1) If you have one, swing the sound panel forward to its open position.
- 2) Pull the paper release lever and paper bail forward toward the front of the Model 630 (see Picture, page 14-7).
- 3) Holding the forms tractor at both ends, depress the two latch release levers on the tractor and lower it onto the platen shaft (see Picture, page 14-21). As the tractor is being lowered, guide the paper release actuator fork on the tractor over the paper release lever on the Model 630.
- 4) Release the latch levers to clamp the tractor assembly onto the platen shaft. Check to see that both ends of the tractor are firmly latched.
 - a) Bidirectional forms tractors: Swing the paper support rack forward then backward to make sure the paper release lever stays inside the release actuator fork. If the paper release lever slips out, remove the forms tractor and repeat steps 2 through 4 of this installation procedure.
 - b) Unidirectional forms tractors: The unidirectional tractor is equipped with adjustable supports. Adjust these to hold the back of the tractor to its forward position, and check to see that the paper release lever on the Model 630 snaps in its backward position. Swing the paper support rack back to its normal position; the paper release lever should be pulled to its forward position. This releases the paper tension, which is necessary when operating with the forms tractor.

Forms Tractor Removal

- 1) Remove any paper from the forms tractor.
- 2) Swing the sound panel forward.
- 3) Depress the two latch release levers (see Picture, page 14-21) and lift the tractor straight up.

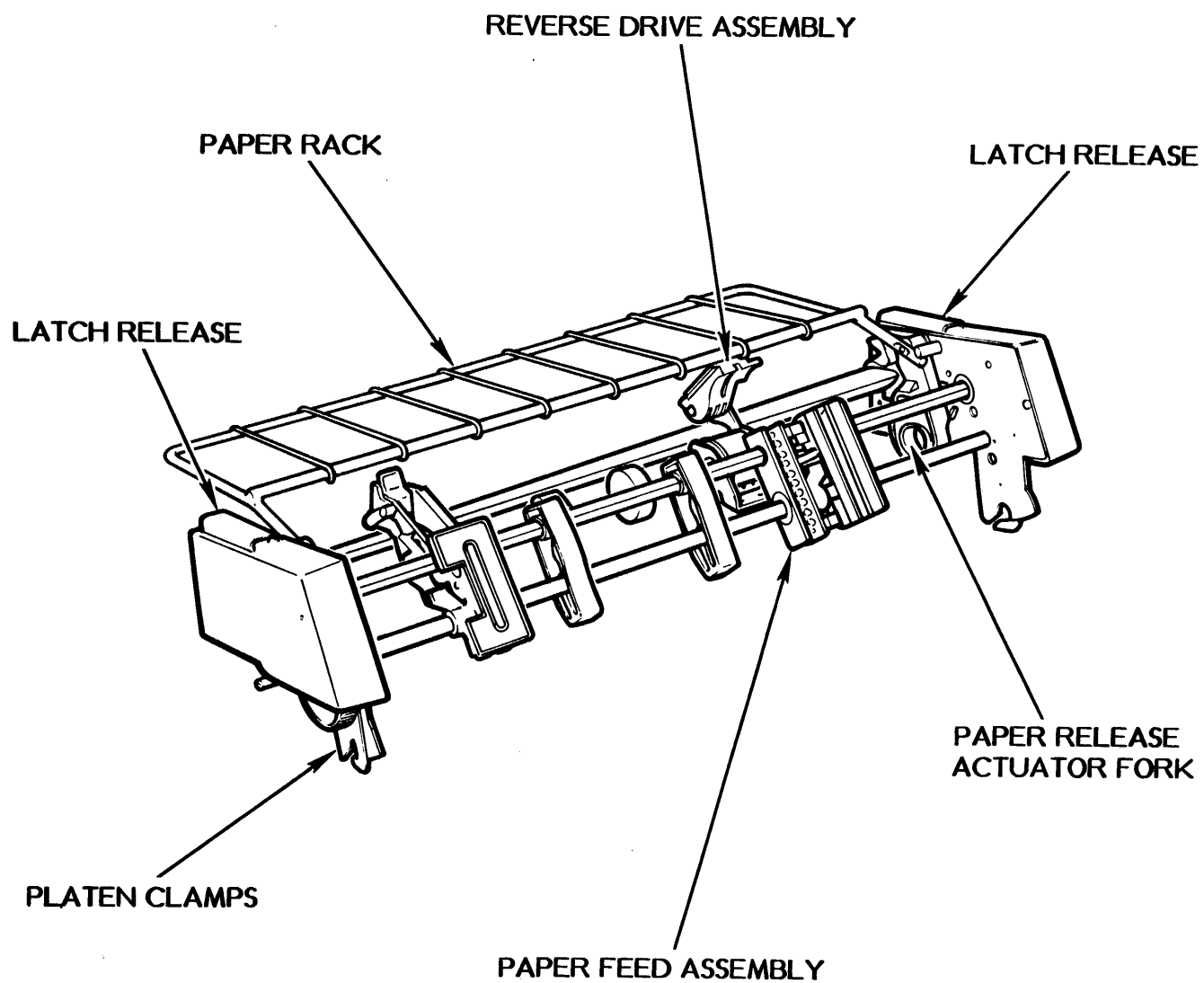

Loading Paper into the Bidirectional Forms Tractor

To adapt the following procedure to a unidirectional tractor, simply disregard the steps relating solely to the reverse drive assemblies.

- 1) If you have one, swing the sound panel open.
- 2) Adjust the two pin feed assemblies to the appropriate form width by loosening the feed assembly lock levers and sliding the feed assemblies to the left or right as necessary.

Note: The two feed assemblies on the bidirectional forms tractor each consist of a pin feed forward drive belt and a reverse drive sprocket joined together by a metal bracket. The unidirectional forms tractor is equipped only with the forward drive belt assemblies.

- 3) Swing the paper support rack on the tractor to its forward position. This allows convenient access for engaging the paper onto the reverse drive sprockets; it also moves the pressure release lever backward so the platen will be able to grip the leading edge of the paper and pull it around to the forward drive assemblies.
- 4) Open the gates on the reverse and forward drive assemblies.
- 5) Bring the leading edge of the continuous form paper up over the rear of the Model 630 and hook the pin feed holes along each side of the paper onto the feed pins on the reverse drive sprockets. (Be certain that the paper is aligned straight on the sprockets.) Close the gates over the reverse drive sprockets to hold the paper in place on the feed pins.
- 6) Slowly rotate the platen to feed the leading edge of the paper down behind the paper bar, down around and then up in front of the platen.
- 7) Swing the paper rack back. This moves the paper release lever on the printer to release the grip of the platen on the paper.
- 8) Grasp the leading edge of the paper and pull it up while manually turning the platen until the leading edge is above the forward drive assemblies on the tractor.
- 9) While gently creating tension on the paper by pulling up on the leading edge, fit the side holes in the paper onto the feed pins of the forward drive belts. Close the gates to hold the paper in place on the feed pins. Be certain that the paper is aligned straight.
- 10) Move the paper bail back toward the platen. (The bail will be held away from the platen slightly; this is proper when operating with the forms tractor.)
- 11) Rotate the platen 2 or 3 turns forward and backward to check that the paper is feeding properly through the drive assemblies.
- 12) Close the sound panel.

DIAGNOSTICS

Your 820 comes with a Diagnostic Exerciser disk. You can use this disk to check that your 820 is in proper working order. The disk will check the different components of the system and display a message if it finds a malfunction.

It's a good idea to check your system when you first install it. If you experience any problems while using the system, you can use the Diagnostic Exerciser to check the system and find out if it needs to be serviced (repaired).

When you use the Diagnostic disk to check out your system, you'll need to have an initialized disk to put in the other disk drive. (An initialized disk is a disk that has been prepared for use in the 820. The Training Disk packaged at the back of this manual is an initialized disk). If you just installed your 820, you can use the Training Disk along with the Diagnostic Exerciser to check out the system.

Before you run diagnostics, you'll need to put paper in your printer (use two sheets, so that the paper covers the width of the platen). If you have a Model 630 printer, be sure you turn it on. The On/Off Switch is on the back of the Model 630 printer.

HOW TO BEGIN:

OPEN the disk drives (you should have either the 5 $\frac{1}{4}$ " or the 8" disk drives shown below)

5 $\frac{1}{4}$ " DISK DRIVES

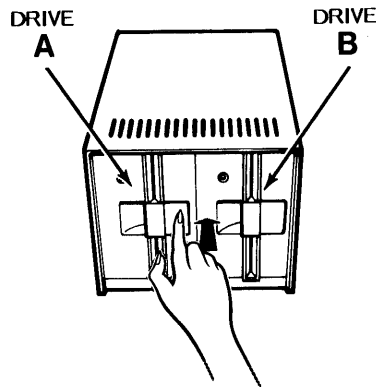

8" DISK DRIVES

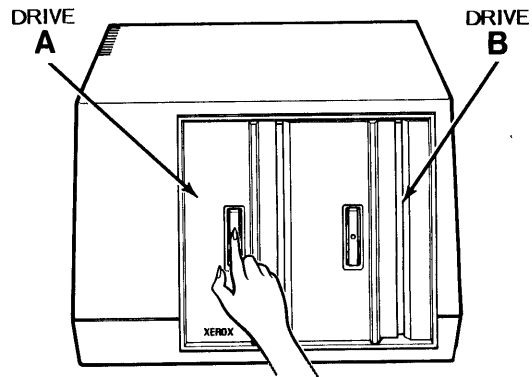

REMOVE any disks

IF you have a 630 printer, turn it on (switch is on the back right corner)

INSERT two pieces of paper in the printer

TO RUN DIAGNOSTICS:

LOCATE the on/off switch on the left side of the disk drives (shown below)
(The 5¼" disk drives does not have a ON/OFF switch)

LOCATE the ON/OFF switch under the right side of the screen (shown below)

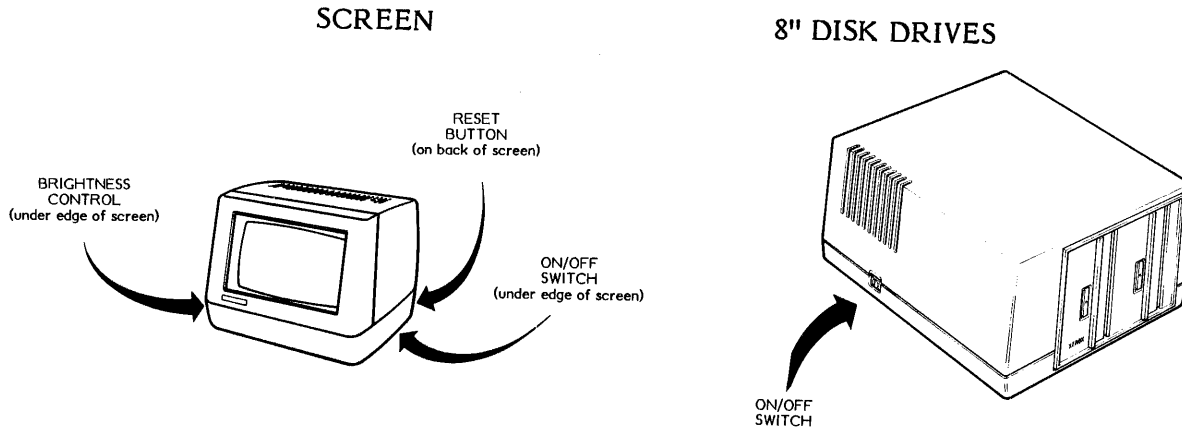

TURN the 8" disk drives on -- if your system has 8" drives, they must be turned on for your system to operate

TURN the screen on -- if it is already turned on, press the RESET button at the back of the screen

WAIT for the word XEROX to appear on the screen. If it does not appear after a few seconds, try adjusting the brightness control (shown above)

If nothing appears on the screen, your system needs servicing

CHECK that both the Training Disk and the Diagnostic disk are **not** write protected. The 5¼" disks are write protected when the tapes are removed, and the 8" disks are write protected when the tapes are not removed.

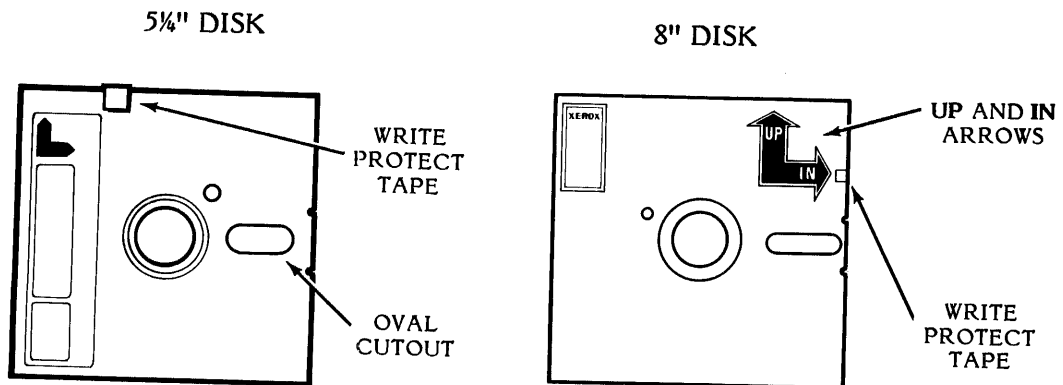

INSERT the **Diagnostic** disk in the left drive (Drive A) and close the drive

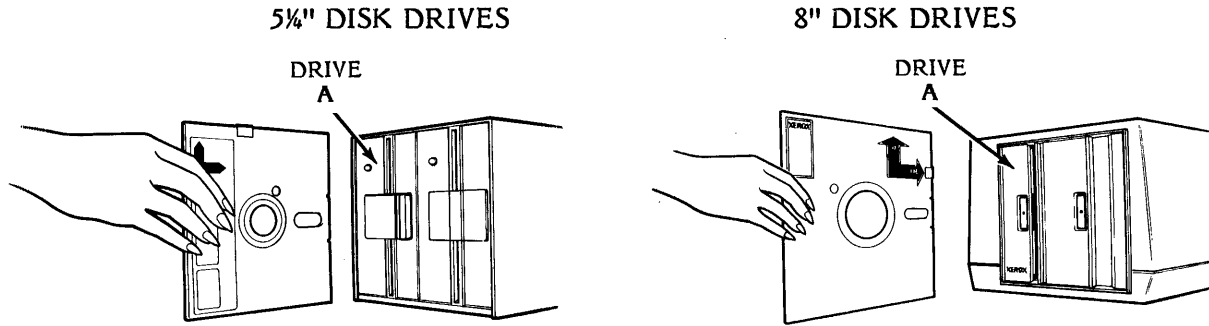

INSERT the Training Disk (or any initialized disk) in the right drive (Drive B) and close the drive

TYPE A and press RETURN

The diagnostic disk will begin to check out the system. Be careful not to touch any keys on the keyboard while the test is running. Touching a key can stop the test.

As the test runs, you'll need to watch for error messages on the screen.

WATCH for the screen to show the result of the first memory test. After a short wait, the screen should show:

```
PASSES COMPLETE = 0001 ; COUNT OF ERROR BYTES = 0000  
PASSES COMPLETE = 0001 ; COUNT OF ERROR BYTES = 0000
```

If the COUNT OF ERROR BYTES does not equal 0000, your system needs to be serviced.

WATCH the screen for the results of the second memory test. The screen should show:

```
PASSES COMPLETE = 0001 ; COUNT OF ERROR BYTES = 0000  
PASSES COMPLETE = 0001 ; COUNT OF ERROR BYTES = 0000
```

If the COUNT OF ERROR BYTES does not equal 0000, your system needs to be serviced.

CONTINUE with the instructions on the next page.

WATCH your screen for the results of the disk test. The disk drives will click during this test. When finished the screen should show:

0 read/write error detected
0 seek errors detected

WATCH the screen test as it displays the screen test. The test pattern should fill the screen with characters. (The boader around the test pattern will remain black.)

If there are missing characters or irregularities in the test pattern, your system needs to be serviced.

If you do not have a printer, the test will end here. Skip the next two (2) steps and go to the step beginning with the word **REMOVE**

WAIT for the printer to finish printing its test pattern. (If you have an 88 or 92 character wheel on the 630 Printer, the test pattern will have blanks in some places.)

If the test pattern did not print the alphabet and numbers, or if the characters were not properly aligned on the paper, your system may need to be serviced.

LOOK for the message "DIAGNOSTIC COMPLETE. RESET TO CONTINUE"

REMOVE the Diagnostic disk and the initialized disk, and place them back in their disk envelopes. Your manual has a disk holder at the back that you can use for storing your Diagnostic Exerciser disk.

PRESS the **RESET** button on the back of the acreen.

The illustration on page 15-2 shows the location of the RESET button

If all the test messages corresponded with those shown in the instructions, your 820 is hooked up correctly and in proper working order. If you are new to the 820, the Word Processing Handbook will tell you how to use the word processing features.

ERROR MESSAGES

*****WARNING: YOU ARE EDITING THE SAME FILE AS YOU ARE PRINTING.**

Reason 1: This message displays when you attempt to edit the file that is currently being printed.

Action 1: Please wait. The system may allow you to edit the same file that is being printed.

SORRY, I DON'T HAVE ENOUGH MEMORY TO WORK ON A FILE AND PRINT RIGHT NOW.

Reason 1: There is not enough memory to print and edit at the same time right now.

Action 1: Terminate either the print or the edit and resume when the other function is completed.

BLOCK LENGTH LIMIT (Press ESC)

Reason 1: This message displays when there is a limited amount of text that can be block-moved, block-copied, or block-deleted at a time. Usually, the system will allow about 500 characters to be worked with at one time, the size of the block depends on **your** computer capacity. If the block is too long, the system will also give a BLOCK TOO LONG error message.

Action 1: Divide the block in half (or smaller) by moving the block end symbol.

BDOS SEEK ERROR DRIVE NOT READY

Reason 1: This message displays if you do not close the disk drive(s).

Action 1: Check the disk latch on both drives. Be sure they are shut (press the left side).

BDOS ERR R/O (Press ESC)

Reason 1: This message displays when you remove the disk at the wrong time, especially when the system is editing or printing a file.

Action 1: Remove disks only when at the Directory Menu.

**SOURCE DISK ERRORS
DESTINATION DISK ERRORS
TRACK DATA COMPARE ERRORS**

Reason 1: This message displays when an error occurs while copying one disk to another disk.

DISK COPY UTILITY VER 1.2

Action 1: ● INSERT SOURCE DISK IN DRIVE A
● INSERT DESTINATION DISK IN DRIVE B
● TYPE RETURN WHEN READY
(The system displays the message, copying disk . . .
PLEASE WAIT

Result 1: ● The system tells you where the error(s) occurred. The following will appear on screen

bios read error bad crc trk/sect = 23/0C
bios read error bad crc trk/sect = 25/0C

● COPY COMPLETE
2 SOURCE DISC ERRORS
0 DESTINATION DISC ERRORS
0 TRACK DATA COMPARE ERRORS

Action 2: ● ENTER RETURN TO CONTINUE OR SPACE TO EXIT

Result 2: The space bar is pressed and a message displays, Please insert system disk and touch any key.

Action 3: ● Insert the System Disk
● Touch any key

Result: After a keystroke is touched, the light appears in the left drive (A) and the information on the screen disappears and the Directory menu returns to the screen.

*****I CAN'T EDIT A FILE WHOSE TYPE IS BAK OR "\$\$\$". IF YOU RENAME THE FILE (CHANGE THE TYPE), THEN I CAN WORK WITH IT.**

Reason 1: This message displays when you try to edit a back up file.

Action 1: Rename the file and then recall to the screen to edit.

*****SORRY, YOU DON'T HAVE A MARKER WITH THAT NUMBER**

Reason 1: This message displays when the command to move the cursor to a place marker is given, but that particular place marker number has not been set.

Action 1: Press the **ESC** key to release the error. You may give the command again using a different place marker # or use some other method to move the cursor to the desired position in a file.

*****SORRY ... I CAN'T FIND THE BEGINNING OF THE BLOCK. EITHER IT'S NOT MARKED OR YOU'VE TURNED OFF THE BLOCK MARKER DISPLAY.**

Reason 1: This message displays when a go to beginning of block command has been given but the beginning of the block has not been marked.

Reason 2: Error E6 also occurs after hiding (undisplaying) the block beginning marker or with block hide/display.

Action 1: Press the **ESC** key to release the error. Mark the block beginning (CTRL & 2 + A) and repeat the go to command.

Action 2: Again, you press the **ESC** key to release the error. Redisplay the marked block (CTRL & 2 + G) and repeat the go to command.

*****SORRY ... I CAN'T FIND THE END OF THE BLOCK. EITHER IT'S NOT MARKED OR YOU'VE TURNED OFF THE BLOCK MARKER DISPLAY**

Reason 1: This message displays when the end of the block is not marked.

Action 1: Press the **ESC** key. Then place the cursor on the **CHARACTER AFTER** the last character you want to mark and type CTRL & 2 + B. Then repeat copy or move command.

Action 2: Again, you press the **ESC** key to release the error. Redisplay the marked block (CTRL & 2 + G) and repeat the go to command.

*****ERROR E9: I CAN'T HANDLE A BLOCK THIS BIG. PLEASE DESIGNATE A SMALLER BLOCK.**

Reason 1: This message displays when the amount of text between the beginning and end markers is more than the system can handle. Only a limited amount of text (approximately 500 characters) can be moved, copied, or deleted at a time.

Action 1: Press the **ESC** key to release error. Divide the block in half by moving the end of block marker. Then repeat the move, copy, or delete command. If you get the same message, reduce the size of the block again (by moving the end of block marker).

*****OH NO -- YOUR DISK IS FULL, PLEASE MAKE ROOM ON THE DISK BY DELETING ANOTHER FILE**

There are several reasons this message may display. Read all four reasons first and pick the one that fits your situation, then follow the action.

Reason 1: The cursor was being moved backward in a large file to get back to the beginning and the system's memory is temporarily overloaded.

Action 1: Press **ESC**. In this case, get back to the beginning by SAVING with **CTRL & 3 + H**. The screen will display a message at the top of the file: **To send cursor to position before you saved the file, type "CTRL + 1 then RETURN" before typing anything else.**

Action 2:

- Press **ESC**
- Go to the #3 (Document) Menu (**CTRL & 3**)
- If you are on Drive A, change to the B disk drive (**CTRL & 3 + A**)
- Display the Directory for Disk B (**CTRL & 3 + G**)
- Delete any files you can (**CTRL & 3 + B**)
NOTE: If you see a file with **.\$\$\$**, it is a file that cannot be deleted.
- Then type **CTRL + 1**

Result: The system saves the file and positions the cursor at the beginning of the file.

Prevention: Do not use cursor keys to work backwards in a long file.

Reason 2: The cursor was being moved forward in the file, or the **DISK FULL** error occurred **while** saving. You have three choices for solving this reason. Please read all of them before you decide what to do.

- Action 1:
- Press ESC
 - Go to the #3 (Document) Menu (CTRL & 3)
 - If you are on Drive A, change to the B disk drive (CTRL & 3 + A)
 - Display the Directory for Disk B (CTRL & 3 + G)
 - Delete any files you can (CTRL & 3 + B)
NOTE: If you see a file with .\$\$\$, it is a file that cannot be deleted.
 - Then Save.

OR

Press ESC. If deleting files will not allow you to complete your edit, and you will not lose much work, cancel or discontinue the edit (CTRL & 3 + ESC), make more disk space available (delete unwanted files or copy some files to another disk), then repeat the edit.

OR

Press ESC. If you have made several changes or additions, and you do not wish to cancel the edit, and cannot make enough room to complete the edit by deleting files, one of the following **severe** measures may work.

- a. Delete unchanged portion of the file until saving does not indicate a DISK FULL error.
- b. **Severe consequences involved;** use only with **extreme caution** and only if you have a lot of work at stake: if the entire original file has been read, that is, if you can do a CTRL & 1 + C (end of file) command and see the end of the file on the screen, delete the input file with the CTRL & 3 + B (delete a file) command. Then save. (CTRL & 3 + B). The system may respond with a fatal error F29, in which case your file will have type \$\$\$ (which means a temporary file only). Use the Rename command to reestablish the type as soon as possible. There will not be a BAK file. Make room for disk space and make a backup copy after renaming.

Prevention: **ALWAYS CHECK DISK SPACE**

Reason 3: If a DISK FULL message occurs after a block write command (CTRL & 2 + F), the above recoveries will not work.

Action 1: Press ESC. Delete (CTRL & 3 + B) the file written, as it is incomplete and not "closed". If you can make additional space by deleting other files, you may try the block write again. Then continue with the edit.

Result: Occasionally, pressing the ESC key will cause another DISK FULL error to occur. If that happens, your disk is really full and you will be unable to recover the new or edited material under any circumstances.

Prevention: **ALWAYS CHECK DISK SPACE.**

Reason 4: This message displays if the disk is really full. To prevent full disks, check your file sizes and disk space frequently with the system STAT command, and keep a lot of extra space on each of your disks.

Action 1: From the Directory, press H. Type STAT, space once, type B: and RETURN. Within a few seconds, your system will tell you how many remaining **BYTES** are left on the disk.

***** FATAL ERROR F28: EITHER I MADE A MISTAKE OR YOU CHANGED DISKS AT THE WRONG TIME**

Reason 1: Gave save command to put a document on a write protected disk.

Action 1: When the Directory Menu is on screen, press ESC to reload the software. Unfortunately, the material you typed is gone.

Prevention: Type B: (to save files on the disk in Drive B) in front of all filenames.

*****FATAL ERROR F29: RENAME FAILURE SYSTEM FAILURE, OR YOU CHANGED DISKS**

Reason 1: The above messages displays to indicate some sort of operating system error has occurred.

Reason 2: You changed the disk in a drive during an edit.

Reason 3: You deleted the input file or the work file with the (CTRL & 3 + B) command.

Action 1: When the Directory Menu is on screen, press ESC to reload the software. Unfortunately, the material you typed is gone.

THE FILE CALLED Filename.typ ALREADY EXISTS. SHOULD I WRITE OVER IT? (Y/N):

Reason 1: This message displays if the file specified to be **copied to** already exists.

Action 1: Press Y to erase the existing contents of the file and continue with the copy.

OR

Press N to leave the existing file unchanged. When the NAME OF FILE TO COPY TO? displays, type a new filename and RETURN.

I ALREADY HAVE A FILE CALLED Filename.typ

Reason 1: This message displays when a new file name specified in the rename command already exists. No two files can have exactly the same name

Action 1: Select a different name or rename the existing file. From the Directory Menu, type a G to rename a file.

THE FILE NAMED Filename.typ IS ON THE OTHER DISK

Reason 1: This message displays if you type B: in front of the filename you want to rename and then A: in front of the new file name.

Action 1: Make sure you are on the same disc drive (Drive B) when renaming a file.

FIRST ... I HAVE TO FINISH PRINTING

Reason 1: This message displays when an ESC command from the Directory menu, or a CTRL & 3 + G command while editing, is given while the print function is active. Printing will continue; the exit to the system occurs when the printing is complete.

Action 1: Wait for printing to finish or cancel the exit command, by typing CTRL + U.

I'LL SAVE THIS WHEN I FINISH PRINTING

Reason 1: This message displays if a save command is given when that file is being edited and also being printed.

Action 1: Type CTRL + U then ESC to continue editing then WAIT until the printing is complete, then save (CTRL & 3 + G).

*****INTERRUPTED*** Press ESC Key**

Reason 1: This message displays when CTRL + U (the interrupt command) is pressed. The "interrupt" command tells the system to discontinue an action or remove a sub-menu.

Action 1: Press the **ESC** key to remove the message.

**NAME OF FILE TO PUT BLOCK IN: B:Filename
THE FILE CALLED: B:Filename.typ ALREADY EXISTS
SHOULD I WRITE OVER IT? (Y/N):**

Reason 1: This message displays when moving a block of text from one file to another file. If a file already exists with the filename you typed, you can write over it or you can rename the file.

Action 1: If you want to retain the file, say **yes** to the system by typing "Y". If you do not want to overwrite (delete) the other file, say **no** to the system by typing "N".

***** NOT FOUND: string *** Press ESC Key**

Reason 1: This message displays when the system cannot find the requested text.

Action 1: If a string displays a NOT FOUND, press the **ESC** key to remove the message. Check the location of the cursor, check the string for mistakes, and repeat the command.

**THE DISK YOU TOLD ME TO USE FOR THE PRINT FILE IS FULL. I'M
GOING TO PAUSE UNTIL YOU CLEAR MORE ROOM ON THE DISK OR
CANCEL THE PRINT COMMAND.**

Reason 1: This message displays when the disk on which the print output file is being written becomes full. This automatically causes the print to pause. **PRINT PAUSE** appears at the top of the screen. You have reached your limit of 32 files and editing capabilities have utilized all the disk space available.

Action 1: More disk space has to be made on the disk before you can do any more printing from the disk. Deleting files from the disk that are no longer needed will free up disk space.

TOO LITTLE MEMORY TO COPY WHILE EDITING

- Reason 1: This message displays when your system does not have enough memory available to copy files while editing.
- Reason 2: This message displays when the disk on which the print output file is being written becomes full. This automatically causes the print to pause. **PRINT PAUSE** appears at the top of the screen. You have reached your limit of 32 files and editing capabilities have utilized all the disk space available.
- Action 1: If you want to copy a file, you must first end (CTRL & 3 + G) or abandon (CTRL & 3 + ESC key) the current file.
- Action 2: More disk space has to be made on the disk before you can do any more printing from the disk. Deleting files from the disk that are no longer needed will free up disk space.

SERIOUS ERROR F27

- Reason 1: This message displays when you try to put more than 32 files on the disk at one time..
- Action 1: Unfortunately, the file was not saved on the disk and you will have to type the file again.
- Prevention: Always check the available disk space before starting a new file or editing a previous one.

WAITING TO PRINT

- Reason 1: This message displays when you attempt to print a file and your printer has not been turned on.
- Action 1: Turn the printer on. It is located at the back of the printer on the upper right-hand side.

WORD TOO LONG TO FIT MARGINS -- PLEASE HYPHENATE

- Reason 1: This message displays when a line is formed with more characters than the system can fit between the currently set left and right margins with no word break (space or hyphen).
- Action 1:
- Hyphenate (-)
 - Move cursor to end of word and press RETURN to keep word on same line
 - CTRL & 0 + 6, puts the word on next line and continues reformatting.

UNACCEPTABLE Filename.type HAVE ENTERED

Reason 1: Filename or filetype was too long or there are unacceptable characters in name.

Action 1: Enter file title which conforms to allowed names.

FILE NOT FOUND

Reason 1: A copy, rename, print command was attempted with a non-existent file or the filename was misspelled.

Action 1: Check disk.

OVERLAY FILE Filename.typ NOT FOUND

Reason 1: Something happened to the files on the Word Processing disk.

Action 1: Make a new copy of Word Processing disk.

I DON'T HAVE THIS PROGRAM OR I CAN'T FIND THAT PROGRAM

Reason 1: When trying to run a utility program, either the name was misspelled or something happened to the program.

Action 1: Retype name or check disk and make new copy of disk.

THERE'S NO PROGRAM IN THAT FILE

Reason 1: Something happened to disk with utility program.

Action 1: Make new copy of disk.

PLEASE LET ME FINISH PRINTING BEFORE RUNNING THE PROGRAM

Reason 1: Word Processing may not be able to run the program and print at the same time.

Action 1: Exit then run a program command and wait for print to finish.

*****WARNING: YOUR DISK IS FULL. ',OEH
I AM DELETING THE OLD BACKUP FILE (.BAK).', OEH
I NORMALLY DELETE THE BACKUP AFTER YOU FINISH EDITING.**

Reason 1: The disk is getting full. Usually the old backup file is not replaced until the new file is saved so that if something happens there is still a backup file.

Action 1" Do not use disk again until some files have been deleted or copied to another disk.

I CAN'T DISPLAY PAGE BREAKS IN A PROGRAM FILE.

Reason 1: When editing a program, pagination was turned on.

Action 1: Enter ESCAPE to clear message. Pagination is then turned off.

PLEASE HYPHENATE THIS WORD; IT'S TOO LONG TO FIT ON THE LINE.

Reason 1: A word has been entered that's longer than the line length (defined) by margins.

Action 1: Hyphenate the word or make margins wider.

THIS "PAGE BREAK DISPLAY" COMMAND BELONGS AT THE BEGINNING OF YOUR FILE.

Reason 1: A dot command that changes page lengths (such as .PL) should be at beginning of file.

Action 1: Move command from entered position to top of file.

**ERROR 1: PLEASE RESET AND TRY AGAIN
IF IT HAPPENS AGAIN, PLEASE CHECK YOUR REFERENCE MANUAL.
'WE HAVE A PROBLEM HERE. PLEASE TRY TO SAVE ANY WORK AND
THEN PRESS THE',
'RESET BUTTON. IF THIS HAPPENS AGAIN, PLEASE CHECK YOUR REFER-
ENCE GUIDE FOR THIS ERROR MESSAGE.
'SOMETHING'S WRONG. PLEASE LOOK THIS NUMBER UP IN YOUR
REFERENCE GUIDE.**

Reason 1: System problem.

Action 1: These errors should not occur. If one does occur, save immediately and reset. Restart the software and check your file. If it has been garbled, erase it and use the BACKUP file.

DISK DRIVE NOT READY

Reason 1: This message displays if you do not close the disk drive(s).

Action 1: Check both disk drives, be sure they are closed.

DISK ERROR

Reason 1: This message displays when a disk drive cannot read or write on a disk.

Action 1: Be sure that the disk(s) is/are inserted in the drive(s) properly.

Action 2: Be sure the disk drives are connected to the back of the screen (see installation card).

PROBLEM SOLVING

PROBLEM: FULL DISK

Reason 1: The cursor was being moved backward in a large file to get back to the beginning and the system's memory is temporarily overloaded.

Action 1: Press ESC. In this case, get back to the beginning by SAVING with CTRL & 3 + H. The screen will display a message at the top of the file: **To send cursor to position before you saved the file, type "CTRL + 1 then RETURN" before typing anything else.**

Action 2:

- Go to the 3 Menu (Document)
- If you are on Drive A, change disc drive
- Display the Directory
- Delete some files
- If you see a file with \$\$\$, it is a file that cannot be deleted.
- Delete another document and the system automatically reinstates the BAK (backup) file.

Result: The system saves the file and positions the cursor at the beginning of the file.

Prevention: Do not use cursor keys to work backwards in a long file.

Reason 2: The cursor was being moved forward in the file, or the DISK FULL error occurred while saving.

Action 1: Press ESC. First delete any unneeded files (CTRL & 3 + B from the Main Menu). You could also delete any file that you know you could replace later. Continue with your edit, and remember to make more disk space after saving (e.g. by copying some files to a different disk).

Action 2: Press ESC. If deleting files will not allow you to complete your edit, and you will not lose much work, cancel or discontinue the edit (CTRL & 3 + ESC), make more disk space available (delete unwanted files or copy some files to another disk), then repeat the edit.

Action 3: Press ESC. If you have made several changes or additions, and you do not wish to cancel the edit, and cannot make enough room to complete the edit by deleting files, one of the following **severe** measures may work.

- a. Delete unchanged portions of the file until saving does not indicate a DISK FULL error. Then recover these portions from the **BAK** file or from a previous backup copy.

- b. **Severe consequences involved;** use only with **extreme caution** and only if you have a lot of work at stake: if the entire original file has been read, that is, if you can do a CTRL & 1 + C (end of file) command and see the end of the file on the screen, delete the input file with the CTRL & 3 + B (delete a file) command. Then save. (CTRL & 3 + B). The system may respond with a fatal error F29, in which case your file will have type \$\$\$ (which means a temporary file only). Use the Rename command to reestablish the type as soon as possible. There will not be a BAK file. Make room for disk space and make a backup copy after renaming.

Prevention: **ALWAYS CHECK DISK SPACE**

Reason 3: If a DISK FULL message occurs after a block write command (CTRL & 2 + F), the above recoveries will not work.

Action 1: Press ESC. Delete (CTRL & 3 + B) the file written, as it is incomplete and not "closed". If you can make additional space by deleting other files, you may try the block write again. Then continue with the edit.

Result: Occasionally, pressing the ESCAPE key will cause another DISK FULL error to occur. If that happens, your disk is really full and you will be unable to recover under any circumstances.

Prevention: **ALWAYS CHECK DISK SPACE.**

PROBLEM: DISK SPACE

Reason : Checking disc space lets you know whether or not there is enough space on the disk to create a file or edit a file.

Action: Before starting a new file or editing a file, always check your disc space by running the STAT program for checking disc space.

Result: You will know whether to continue using the present disc or to start a new one.

Prevention: Make sure the Word Processing disk is in the left drive and your working disk is in the right drive.

From the Directory Menu, press H.

Type STAT, space once, type B: and RETURN

Within a few seconds, your system will tell you how many remaining **BYTES** are left on the disk.

See page 3-5 in the Reference Guide for more information.

PROBLEM: HYPHENATION. You do not want to hyphenate but you want to keep reformatting

Reason 5: During editing, if a repeat reformat command has been given and the system asks for a hyphenation decision, the keystroke cancels the reformat command.

Action 1: If you do not want to hyphenate at that time, type a CTRL + O, CTRL + 6 and the action will continue.

Action 2: However, if you are reformatting and a hyphenation decision is encountered; type in the hyphen. **REMEMBER**, you have to repeat the command given after any keystroke that interrupts the action.

PROBLEM: SOFTWARE WON'T LOAD

Reason 6: The left side of the console is referred to as the "A" drive. It is also the side the "software" is inserted. The right side of the console is referred to as the "B" drive. It is where the "working disc" is normally inserted. If you have not inserted the discs according to the above reasons, you cannot load the software.

Action: Make sure you have loaded the correct discs in the proper drives.

Result: You can now load your software.

PROBLEM: PITCH

Reason 7: If you forgot to change your printwheel and change the setting on the printer, that's why your file will not print correctly.

Action: If you want to print in 10 pitch, change pitch - 10 to 12 or if want to print in 12 pitch, change pitch - 12 to 10.

Prevention: **Be sure you change your printwheel and change the setting on your printer before you print a file.**

(This page intentionally left blank)

INDEX

-A-

Active disk drive 3-2
 Add text 4-5
 Print to Finish 16-1
 Arrow keys 2-1
 Automatic indent 5-13
 Automatic tab 5-13

-B-

Back up copies 1-4
 BACKSPACE key 4-4
 BAK (back-up) file 6-3
 BDIR 3-6
 BDOS Err R/O 16-1
 Beginning block marker 4-14
 Bidirectional Print Off 12-13
 Bidirectional Print On 12-13
 Block copy 4-17
 Block indent 5-13
 Block length limit 16-1
 Block markers 4-14
 Block marker display (on/off) 4-14
 Block menu 4-13
 Block move 4-16
 Boilerplate 11-14
 Bolding 11-9
 Bottom Margin 12-2, 5-32

-C-

Canceling a Command 6-1
 Centering Headings Over Columns 10-2
 Centering Text 11-1
 Change disc drives 3-2
 Change the help levels 3-10
 Change line spacing 5-23
 Change the margins 5-9
 Changing the Paper Number 8-3
 Characters on a line 5-11
 Character width 12-12
 Check disk space 3-5
 Check the Number of Files 3-6
 Clear tab(s) 5-5
 Column headings 10-2
 Columns 10-1
 Columns of numbers 10-2
 Conditional page 12-8
 Continuous form 7-4
 Continuous form paper 9-1
 Copying a File 3-7
 Copy block 4-17
 Copying an Entire Disk 3-8
 COPY program 3-8
 Copying One Disk To Another Disk 16-1
 Copying text 4-17
 Copying Text to Another File 4-20
 Correcting mistakes 6-2
 Corrections, how to make 4-1
 Cursor 7-9
 Cursor 2-1
 Custom document 11-15
 Cut Sheet Paper 9-1

-D-

Damaged sectors 3-9
 Decimal Tabs 10-1
 Delete block 4-15
 Delete a file 3-2
 Deleting Text 4-4
 DEL key 4-4
 Delete this line 4-4
 Deleting A Block of Text 4-15
 Diagnostics 15-1
 Directory 3-1
 Directory Menu 3-1
 Discarding Editing Changes 4-8
 Duplicate text 4-17
 Dot Commands 12-5
 Double Striking 11-9

-E-

Erase document files 3-2
 Edit a Program 3-11
 Editing Revising 4-1
 Editing Statistical Tables 10-7
 End block marker 4-14
 ESC = erase screen 4-8
 Editing a .BAK File 16-2
 Editing indented paragraphs 5-15
 Editing long documents 7-10
 Envelope 11-12
 Equivalent keystrokes 12-1
 ERROR E5 16-2
 ERROR E6 16-2
 ERROR E7 16-3
 ERROR E9 16-3
 ERROR E11 16-3
 ERROR E12 16-4
 Exception keys 12-1

-F-

FATAL ERROR F28 16-6
 FATAL ERROR F29 16-6
 FILE B: EXISTS -- OVERWRITE 16-6
 FILE B: ALREADY EXISTS 16-7
 FILE B: NOT ON SAME DRIVE 16-7
 Find 2-5
 Find & Replace 4-9
 Find options 2-5
 Finishing Print Before Exit 16-7
 .FO 8-2, 8-3
 Footing 12-9
 Footings 8-3
 Footing Margin 12-6
 Format (Display) Menu 5-4
 Format (non-display) Menu 11-3
 Formatting 5-1

-G-

Go To Menu 2-1

-n-

.HE	8-2, 8-3
Headers	8-3
Heading	12-9
Headings over columns	10-2
Heading Margin	12-6
HELP	3-10
Hyphenate	4-4

-o-

Omit Page Numbers	12-10
Omitting Page Numbers	8-1
.OP	8-1
Other Pitch	5-29
Outline	5-18
Outline Editing	

-I-

IGnore	12-13
Ignore case	2-5, 4-9
Indent all lines	5-13
INIT program	3-9
Initialize	3-9
INSERT TEXT	4-5
Insert line here	4-5
Insert mode	4-5
Insert mode (on/off)	4-5
Insert text in a paragraph	4-5
Insert a new paragraph	4-5
Interrupted	16-7

-P-

.PA	7-2
Page	12-8
Page Breaks	7-1, 7-2
Page layout	5-1
Page Number	12-10
Page number, changing	8-3
Page Number Column	12-7
Page Number Location	8-2
Page Numbering	8-1
Page offset	12-7
Paper Length	5-31, 12-5
Pause for Paper Change	7-4
PIP	3-7
Pitch	5-29
.PL	5-31
.PN	8-1, 8-3
Place Markers	12-19
Plus sign	5-11
Pointer	2-1
Print Questions	9-3
Print Output Disk Full	16-8
Print Wheel	20-8
Printer stop command	9-2
Printing Multi Page Documents	7-4
Printer, 630	20-1

-J-

Justify	5-27
Justification off	12-12
Justification On	12-12

-K-

K bytes	4-1
Keep Together Feature	7-9

-R-

Read Another File Into This One	4-21
Rearrange the line endings	4-4
Recall a BAK	3-3
Recalling A Document File	4-2
Recovering a BAK File	6-3
Re-display the file	7-3
Reformat a block indent	5-15
Reformat paragraph	4-4
Rename a File	3-3
Repeat command	5-23
Replace in entire file	4-9
Replace w/o asking	4-9
Required Page Breaks	7-2
Re-set all settings	5-6
Reset the Ruler Line	5-9
Ribbon Installation	20-9
Right Margin	5-3
Right margin even	5-27
Ruler Line	5-3, 5-6
Ruler Line When Editing	5-9
Run a Program	3-4

-L-

Left Margin	5-3
Letter and Envelope	11-12
Line Height	12-5
Line Spacing	5-23
Line Spacing #	5-23
Lines on each page	7-1
Long document file	7-1

-M-

Margins	5-5, 5-9
Margin and Tab Setting	5-3
Mark a block of text	4-14
Move block	4-16
Moving Text	4-16
.MB	5-32
.MT	5-32

-N-

Name of File To Put Block In	16-8
New Disk	3-9
No Page Numbers	8-1
Not Found	16-8
Number (#) Flawed Sectors	3-9
Number (#) of Times	4-10
Number pages	12-10

-S-

Six (630) Printer	
Save and redisplay	7-3
Save block in another file	4-20
Saving Frequently	7-3
Screen Ruler	5-3
Scrolling	2-4
Search	2-5

Search backwards	2-5, 4-10
SERIOUS ERROR F27	16-9
Set a tab	5-9
Set tabs(s)	5-4
Settings from a line	5-9
Size of each file	3-5
Split Between Pages	7-9
Standard Documents	11-14
Standard Format Settings	5-2
Standard Paragraphs	11-16
Standard pitch	5-29
Standard text	11-14
Start and Stop Markers	11-3
STAT program	3-5
Statistical table	10-1
Stop Commands	9-2
Stopping The Printer	9-1
Subscript	11-11
Superscript	11-11
Sub/Superscript Roll	12-12

-T-

Tables	10-1
Tabs	5-5, 5-9
Too Little Memory To Copy	16-8, 16-9
Top Margin	5-32, 12-5
Turn Directory off (ON)	3-11
Typing Long Documents	7-10

-U-

Underlining Columns	10-2
Underlining Text	11-3
Underscore	11-3

-W-

Waiting To Print	16-9
Whole words only	2-5
Wide Margins	5-11
Word Too Long	16-9

