

SPERRY UNIVAC

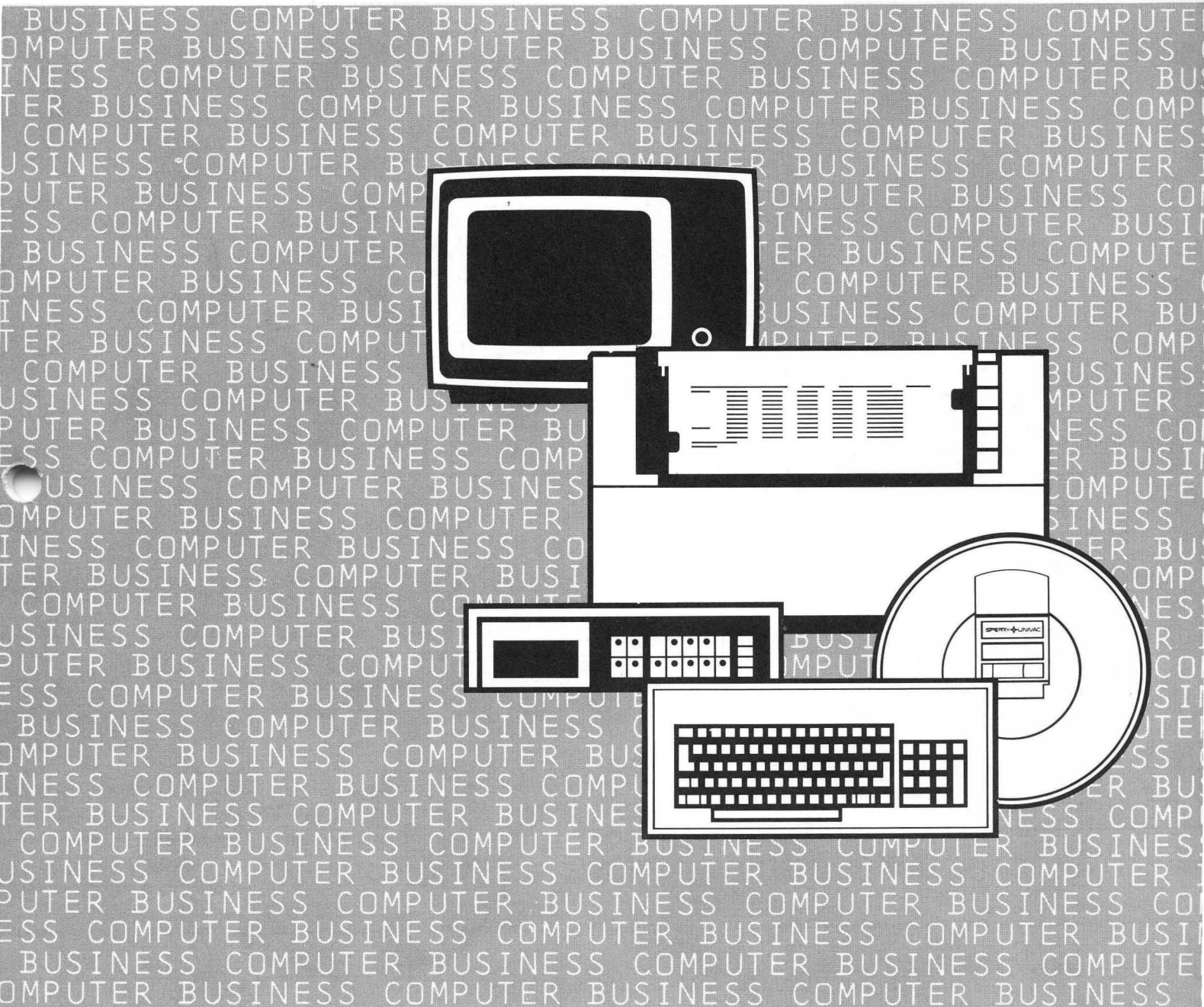

BC/7 BUSINESS COMPUTER

System Description

This document contains the latest information available at the time of preparation. Therefore, it may contain descriptions of functions not implemented at manual distribution time. To ensure that you have the latest information regarding levels of implementation and functional availability, please consult the appropriate release documentation or contact your local Sperry Univac representative.

Sperry Univac reserves the right to modify or revise the content of this document. No contractual obligation by Sperry Univac regarding level, scope, or timing of functional implementation is either expressed or implied in this document. It is further understood that in consideration of the receipt or purchase of this document, the recipient or purchaser agrees not to reproduce or copy it by any means whatsoever, nor to permit such action by others, for any purpose without prior written permission from Sperry Univac.

Sperry Univac is a division of the Sperry Corporation.

FASTRAND, SPERRY UNIVAC, UNISCOPE, UNISERVO, and UNIVAC are registered trademarks of the Sperry Corporation. ESCORT, PAGERWRITER, PIXIE, and UNIS are additional trademarks of the Sperry Corporation.

This document was prepared by Systems Publications using the SPERRY UNIVAC UTS 400 Text Editor. It was printed and distributed by the Customer Information Distribution Center (CIDC), 555 Henderson Rd., King of Prussia, Pa., 19406.

Contents

1. INTRODUCTION	1
2. OVERVIEW OF BC/7 FAMILY	3
2.1. FAMILY CONCEPT	3
2.2. BC/7-600 SERIES	3
2.3. BC/7-700 SERIES	4
2.4. BC/7-800 SERIES	4
2.5. BC/7-900 SERIES	5
3. SYSTEM SOFTWARE	6
3.1. INTERACTIVE OPERATING SYSTEM	6
3.2. CONCURRENCY	7
3.3. FILE HANDLING	7
3.4. DATA ENTRY UTILITY	9
3.5. INQUIRY	10
3.6. SYSTEM CONTROL LANGUAGE	10
3.6.1. Menu Selection	10
3.6.2. SCL Functions	11
3.6.3. System Security	12
3.7. DISK FILE MANAGEMENT	12
3.7.1. File Definitions	12
3.7.2. I/O Interfaces	12
3.7.3. File Sections	12
3.7.4. I/O Buffers	13
3.7.5. Record Work Areas	13

3.7.6.	System File Catalog	13
3.7.7.	File Sharing	13
3.7.8.	Sequential Access	13
3.7.9.	Direct Access	14
3.7.10.	Indexed Access	14
3.7.11.	Libraries	14
3.8.	UTILITIES	14
3.8.1.	Editors	14
3.8.2.	Sort/Merge	15
3.8.3.	Data File Services	15
3.8.4.	Program File Services	16
3.8.5.	System Support Facilities	17
3.8.6.	Data Entry Utility	18
3.9.	PRINT SPOOLING	18
3.10.	LANGUAGES	19
3.10.1.	RPG II	19
3.10.2.	ESCORT	19
3.11.	APPLICATION SYSTEMS	21
3.11.1.	Accounting Management System (AMS)	22
3.11.1.1.	General Ledger	22
3.11.1.2.	Accounts Payable	23
3.11.1.3.	Accounts Receivable	25
3.11.1.4.	Payroll	26
3.11.2.	Wholesale Application Management System (WAMS)	28
3.11.3.	Sales Accounting System (SAS)	31
3.11.4.	Manufacturing Application Management System (MAMS)	31
3.12.	COMMUNICATIONS EMULATORS	34
4.	HARDWARE	36
4.1.	ARCHITECTURE	36
4.2.	PROCESSORS	38
4.2.1.	Control Processor	38
4.2.2.	Macro Processor	39
4.2.3.	Input Output Support Processor	39
4.3.	SYSTEM BUS, MAIN STORAGE, AND DMA	40
4.3.1.	System Bus	40
4.3.2.	Main Storage	40
4.3.3.	General Description of DMA Controllers	41
4.3.3.1.	Direct Memory Access for High Speed Devices	41
4.3.3.2.	Microcoded Communications Line Adapter	42
4.3.3.3.	Shared Direct Memory Access Controller	42

4.4.	SYSTEM CONSOLE	42
4.5.	WORKSTATION	43
4.6.	WORKSTATION PRINTER	44
4.7.	PRINTER SUBSYSTEMS	45
4.7.1.	0786 Character Printers	45
4.7.2.	0789 Line Printers	46
4.8.	DISK SUBSYSTEMS	46
4.8.1.	2366/2898 Diskette Drives	47
4.8.2.	Industry-Common Drives	48
4.8.3.	Cartridge Disks	48
4.8.4.	Fixed Disks	49
4.9.	MAGNETIC TAPE SUBSYSTEM	51
4.10.	MICROCODED COMMUNICATIONS LINE ADAPTER	52
4.11.	PUNCH CARD EQUIPMENT	53
4.11.1.	Card Reader	53
4.11.2.	Card Punch	54
4.12.	CONFIGURATIONS	55
5.	OPERATING ENVIRONMENT	60
FIGURES		
1-1.	BC/7 Business Computer	1
3-1.	Illustration of System Partitions	8
3-2.	BC/7 Workstation Menu	11
3-3.	Example of an ESCORT Program	20
3-4.	General Ledger Report	23
3-5.	Accounts Payable Report	25
3-6.	Accounts Receivable Report	26
3-7.	Sample Draft and Stub	28
3-8.	Reprint - Pick Slip	29
3-9.	Order Entry Screen	31
3-10.	Typical Network Connection Methods for BC/7	35
4-1.	BC/7 Processor Schematic	37
4-2.	BC/7 Central Processing Unit (BC/7-600, BC/7-700, BC/7-800, and BC/7-900)	38
4-3.	BC/7 Console CRT	42
4-4.	BC/7 Workstation	43
4-5.	0774 Workstation Printer	44
4-6.	0786 Character Printer	45

4-7.	0789 Line Printer	46
4-8.	Diskette Drives	47
4-9.	Cartridge Disk Drives	48
4-10.	Fixed Disk Subsystem	50
4-11.	0871 Magnetic Tape Unit	51
4-12.	Microcoded Communications Line Adapter	52
4-13.	0719 Card Reader	53
4-14.	0608 Card Punch	54
4-15.	SPERRY UNIVAC BC/7-600 Series	55
4-16.	SPERRY UNIVAC BC/7-700 Series	56
4-17.	SPERRY UNIVAC BC/7-800 Series	57
4-18.	SPERRY UNIVAC BC/7-900 Series	58
4-19.	SPERRY UNIVAC BC/7-900 Series with Fixed Disk	59

TABLES

3-1.	Main Storage User Program Capacity	9
4-1.	Summary of Diskette Specifications	47
4-2.	Summary of Cartridge Disk Specifications	49
4-3.	Summary of Fixed Disk Specifications	50

1. Introduction

The SPERRY UNIVAC BC/7 Business Computer is a family of small- to medium-scale, general-purpose digital computer systems designed around the same principles employed by very large systems, but miniaturized so as to result in comprehensive computing systems of unusual economy.

Figure 1-1 depicts a typical BC/7 model (in the BC/7-700 series). In the photo, from left to right are: a line printer, a nonimpact character printer (for hard copy of the CRT display), the CRT display, four diskette drives, the keyboard used with the CRT display, and a cartridge disk drive cabinet (showing three disk cartridges stored on top). The CPU occupies a small space in the cabinet to the left of the chair. The CRT, keyboard, and nonimpact printer combine to form the workstation. The CRT is resting on the system control console consisting of a 5-inch display and 14 switches.



Figure 1—1. BC/7 Business Computer

Specifically intended for the general business market, the BC/7 concept stresses these business benefits:

- Ease of installation
 - Compact/low power
 - Experienced installation personnel
 - Proven software
- Ease of comprehension
 - Abundant documentation
 - Programmed learning material
 - Software prompting
- Ease of use
 - Menu selection
 - Multiple choice answers
 - English displays
 - Typewriter-style keyboard responses
- Ease of application
 - Proven application programs
 - Unusual flexibility
 - Familiar terminology
- Ease of expansion
 - Onsite expansion
 - Modularity

2. Overview of BC/7 Family

2.1. FAMILY CONCEPT

The SPERRY UNIVAC BC/7 family consists of four series of systems: the BC/7-600 series, BC/7-700 series, BC/7-800 series, and BC/7-900 series.

- The BC/7-600 systems are characterized by being entirely diskette-based, and feature low cost configurations.
- The BC/7-700 systems are disk-based and can use magnetic tape and diskettes for data file storage and I/O.
- The BC/7-800 systems are also disk-based and use all the mass storage offered with the BC/7-700, but the processor contains twice as much main storage, permits two additional workstations, and features an operating system capable of two concurrently executing application programs, concurrent print spooling, and rollout of either application program.
- The BC/7-900 systems feature a more powerful operating system and a faster CPU. The operating system supports the concurrent execution of four application programs and print spooling. The faster CPU is supported by 256K bytes of main storage with a 2-byte access time of 500 nanoseconds.

2.2. BC/7-600 SERIES

The SPERRY UNIVAC BC/7-600 series of systems are low-cost diskette-based business computers suitable for first-time users or those who require low volume data processing at distributed locations. Each BC/7-600 system features an interactive operating system that permits one program to execute in 48K bytes of main storage or two programs (a standard application and a small utility) in 64K bytes, the maximum amount permitted.

A BC/7-600 series system may be configured as small as a single workstation, character printer, two 1-megabyte (MB) diskette drives, and 48K bytes of main storage. This model can perform many basic accounting tasks as offered in Sperry Univac proprietary application programs, or can be programmed by the user in RPG II and ESCORT. The addition of a data communications adapter to this configuration enables the BC/7 to transmit computer data to another system through the public telephone network.

Larger systems permit more complex programs and greater volumes of data to be processed. A BC/7-600 series system can be expanded to 64K bytes of main storage with six workstations, a line printer, six 1-MB diskette drives, and a communications adapter. With such a configuration, an application program and either a communications program or an inquiry or data entry program can execute concurrently. Multiple workstation applications are feasible with this system, and a workstation can be at a remote location using the public telephone network.

Throughout the BC/7-600 series range of systems, the interactive operating system features ease of use through large-screen displays of questions and messages that are fashioned to ease operator interaction with the system. Operator response and control is through a conventional typewriter-style keyboard that is part of each workstation.

2.3. BC/7-700 SERIES

Both experienced and first-time users will find the SPERRY UNIVAC BC/7-700 series meets their expectations as capable performance data processing systems that fit well in a wide variety of work environments. Common to all models of the BC/7-700 series is an interactive operating system that prompts the operator through large screen English text displays. Using menu-style displays that permit the operator to respond in English (or sometimes with just a single keystroke), the operating system keeps track of jobs to be run and jobs that have been run, executes two programs at once (an application program and a small utility), converses with up to four workstations at once, and communicates with another system across the country.

A BC/7-700 series system can be configured with as little as 48K bytes of main storage, one workstation, 5MB of cartridge disk (2.5MB fixed, 2.5MB removable), and a character printer. Many of the application programs in the Sperry Univac repertoire, as well as user-written RPG II programs, can be profitably applied with this system. With the addition of a communication adapter, the system offers a low-cost means of geographically distributing the data processing needs of a corporation.

More disk cartridge storage, diskette or magnetic tape, main storage, workstations, and a line printer give larger models the ability to handle more complex jobs requiring greater amounts of data. Models with 64K bytes of main storage (the maximum amount) can support 2-program execution (one application and one utility) and multiple workstation jobs, where some workstations can be across the country.

2.4. BC/7-800 SERIES

Although more appealing to accomplished users, the SPERRY UNIVAC BC/7-800 series can be profitably utilized by ambitious first-time data processing system users. Beginning with a configuration of 128K bytes of main storage, 10MB disk cartridge (5MB fixed, 5MB removable), one workstation, and a character printer, the BC/7-800 series system can be expanded to 40MB disk cartridge (or 20MB and two magnetic tape drives), six workstations, and two printers. A data communication adapter can be substituted for one mass storage or four low speed I/O subsystems.

The BC/7-800 series features an interactive operating system capable of supporting two application programs and print spooling concurrently. In place of one application program, a utility such as inquiry or data communication can be executed. One ESCORT or RPG II compilation can be conducted while another program is being executed. If the need arises to execute a third job ahead of two that are currently in process, a command from an operator at a workstation can invoke a roll-out of the low priority job and roll-in and execution of the more urgent work. Like all BC/7 models, user control of the system is eased by the generous use of menu-type displays, questions and prompting statements in English, and operator responses through conventional typewriter-style keyboards using English or sometimes a single keystroke.

While the BC/7-800 series is intended primarily for stand-alone use, data communications does permit the distribution of data processing as widespread as the conventional telephone network permits. In addition to placing BC/7 models at needed locations, workstations can be placed anywhere that is served by the common telephone network.

2.5. BC/7-900 SERIES

For more advanced data processing users, there is the SPERRY UNIVAC BC/7-900 series. Based on a CPU and main storage that is twice as fast as the other BC/7 series, the BC/7-900 series can handle twice as many jobs, concurrently, as can the BC/7-800 series. With 256K bytes of main storage and a 2-byte access time of 500 nanoseconds, BC/7-900 models can concurrently execute four application programs, including ESCORT and RPG II compilations and data communication. At the same time, the system can print previously spooled data, and spool additional print data from the four executing programs. Programs may be interactive or batch, and as many as six or eight workstation operators may be using the system at one time, depending upon the system mass storage configuration.

The BC/7-900 operator interface provides the same functional capability as the other BC/7 series, but more advanced features are included to enhance system control and monitoring. English displays and operator responses via keyboard are the standard means of operator/machine interaction. Control of the system may be assigned to any workstation. Other workstations may initiate and terminate jobs through menu interfaces (as on other BC/7 models). Workstations may be used to initiate batch jobs, and can then be withdrawn from those jobs and used for other jobs. The system will maintain a log, at the discretion of the user, of all system usage.

Beginning with a minimal configuration of a CPU, three or four workstations, 20MB of disk mass storage, and a line printer, the BC/7-900 series offers growth capabilities to eight workstations, and 140MB of disk mass storage. Certain BC/7-900 models may have up to two tape drives (or one to four diskette drives), and two printers (line and character types). The maximum configuration depends upon the mass storage chosen. All BC/7-900 models execute four jobs and print spooling concurrently. Punched card devices and data communication are available in place of one mass storage or four low-speed I/O subsystems in order to shift the emphasis of the role of the BC/7-900.

A fixed disk configuration of the BC/7-900 provides support for up to 100MB of fixed disk mass storage and eight workstations. An additional 40MB of cartridge disk mass storage can also be obtained, thereby making a total of 140MB of disk mass storage available with this configuration of the BC/7-900. This BC/7-900 version features a multiprocessor architecture consisting of a system processor (SP) with 256KB of main storage and an input/output support processor (IOSP) with 32KB storage for fixed disk and system printer control. Other printers can be configured on workstations as remote printers.

File load/unload for the fixed disk is provided via either diskette or cartridge disk mass storage.

Whether in a stand-alone business data processing application or a data communication remote job application, the BC/7-900 series possesses the unique capability of being adaptable to many business environments. From simple RPG II reports to involved job streaming of batch, interactive, and data communication application programs, the BC/7-900 series performs reliably, quickly and efficiently. As the hub of data processing or as a tributary in a system of data processing distribution, each BC/7-900 model can provide an economical solution in many business applications.

3. System Software

3.1. INTERACTIVE OPERATING SYSTEM

The Interactive Operating System (IOS) for the BC/7 has been designed with two major objectives in mind:

- Ease of use
- Efficiency

IOS functions as a large segmented utility program, servicing the user programs in many ways. RPG II and ESCORT user application programs communicate with IOS whenever input/output operations are required, for job initiation and termination, for file management and control, and for general resource management, through standard interfaces. In many ways, IOS on the BC/7 is more typical of a large-scale operating system than a small scale business system. However, such design would be incomplete in this system without special attention having been paid to the operator interfaces and mode of operation.

The small business system market requires that computer systems be operated by those not schooled in data processing techniques, and with a minimum amount of training. This is accomplished on the BC/7 in several ways:

- The commands to the BC/7 are short and simple.
- Dialog between the operator and the BC/7 is in English.
- Previously written and stored procedures can be changed by introducing parameters at run time.
- Menu selection techniques are used to simplify operator control.
- BC/7 utilities are run in a step-by-step manner.
- Application programs can operate in a step-by-step manner, where each step is graphically explained to the operator so that, for example, the operator need not remember codes.
- Data entry for the application programs is done on a "fill in the blanks" basis, where the field names appear on the workstation screen.
- Validity checking of data for type, ranges, etc., is done at input time.

3.2. CONCURRENCY

The BC/7 is designed to have up to four program partitions (Figure 3-1). With the BC/7-600 and BC/7-700 series, partition 1 can be used for general application and utility programs and partition 2 can be used to run (a) concurrent data entry, (b) concurrent inquiry, or (c) BC/7 communications.

With the BC/7-800 series, partitions 1 and 2 can execute any combination of programs except two BC/7 communications programs.

With the BC/7-900 series, any combination of programs (except two or more data communication programs) may be executed concurrently. Concurrent execution of programs implies that the necessary hardware-support facilities, such as workstations and tape drives, are available to each program.

Certain application program modules, such as Order Entry processing, may be restricted to one partition (refer to the current version of the user manuals for restrictions).

Multiple compilers (RPG II or ESCORT) can run concurrently if the user assigns different library names for compiler output (RPG II) or the DEFLIB formats (ESCORT).

Up to four workstations can be attached to any partition, depending upon the program being executed and the maximum system hardware configuration.

Main storage user program capacity is shown in Table 3-1.

3.3. FILE HANDLING

The BC/7 supports advanced handling techniques that result in easier and more efficient operation. The following are the access techniques supported, as well as the file and field naming conventions:

- Sequential files are supported on all devices.
- Direct access on disk files allows pure random access, plus record skipping capability on sequential-type access.
- Indexed access allows the random access of a file, based on a key field within the records.
- Programs address files by name, and the user need not be concerned with their actual location on disk.
- Disk file management, including the maintenance of space allocation tables for disk space assignment, and other housekeeping, is done by the BC/7 software.

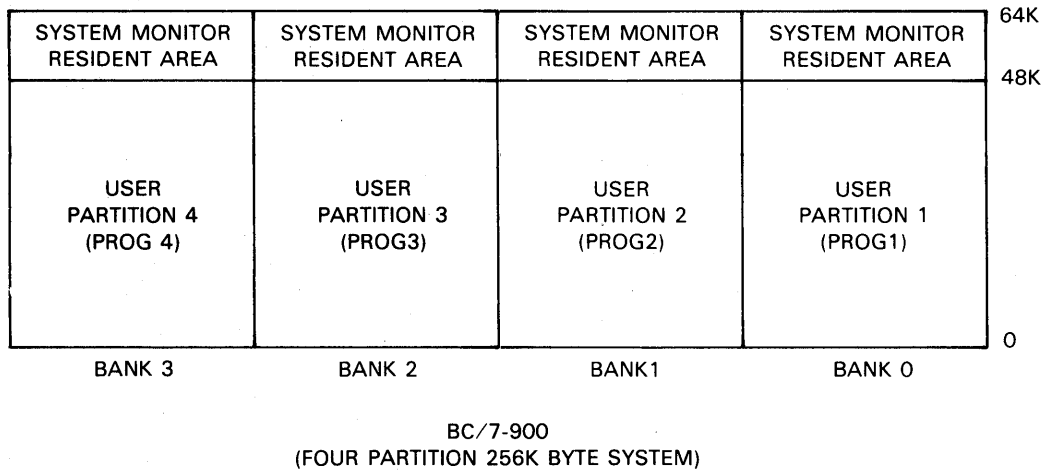
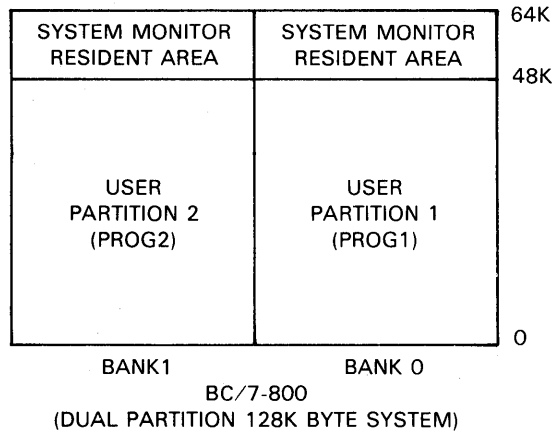
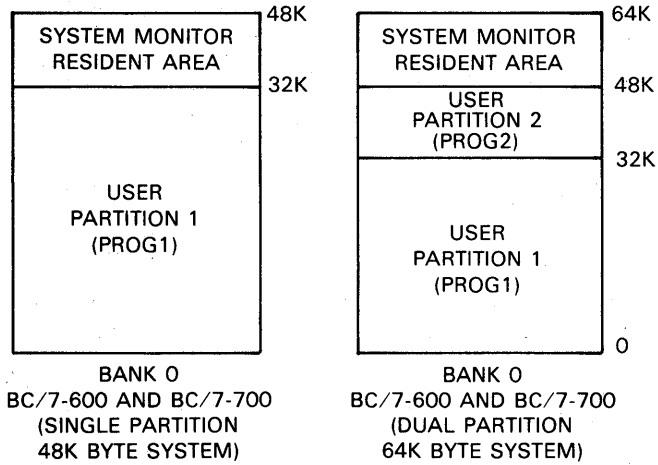

NOTE:

Refer to Table 3-1 for user program capacity.

Figure 3-1. Illustration of System Partitions

Table 3—1. Main Storage User Program Capacity

System Composition	Partition 1	Partition 2	Partition 3	Partition 4
48K bytes	32K	-	-	-
64K bytes, single partition (No tape support)	48K	-	-	-
64K bytes, single partition (With tape support)	46K	-	-	-
64K bytes, dual partition (No tape support)	32K	16K	-	-
64K bytes, dual partition (With tape support)	32K	14K	-	-
128K bytes	48K	48K	-	-
256K bytes	48K	48K	48K	48K

3.4. DATA ENTRY UTILITY

The entry of data into programs on the BC/7 can be handled in one of two ways:

- directly into the application program; or
- indirectly through concurrent data entry.

The application programs, in accepting data directly, can do extensive editing and checking on that data during the input phase, when the source document is in front of the operator. Validation requiring master file data is done in this manner.

The SPERRY UNIVAC concurrent data entry utility offers a convenient method of allowing several operators to build and modify files on the BC/7 without disturbing application programs running concurrently. The following chart illustrates some examples of the distribution of workstation assignments among those programs, and should not be interpreted as a configurator for any particular application.

	Partition	Number of Operators			
		BC/7-600	BC/7-700	BC/7-800	BC/7-900
Application program	1	1 or 2	1 or 2	1 or 2	1 or 2
Concurrent data entry*	2	1 to 2	1 to 4	1 to 4	1 to 4
Application program	3	-	-	-	1
Application program	4	-	-	-	1

*See 3.8.6 for details of the data entry system.

3.5. INQUIRY

It is important in a small business system that the user have all of the information he would earlier have had, in one manner or another, on written records, journals, or registers. In a small business system, much of the information needed will be on periodic reports generated by the various application systems. However, those reports may not always satisfy the requirements of the moment, and since the information is in the data base on disk, a way is needed to access that information at any time.

The BC/7 software provides the user the opportunity to inquire into the data base at any time, so that there is no need to wait until the primary job has terminated. The inquiry can result in single-line or multiple-screen answers on the workstation.

3.6. SYSTEM CONTROL LANGUAGE

The System Control Language (SCL) is used to control and operate the BC/7. SCL commands are simple English verbs that specify programs to be executed and identify the files to be used. SCL commands fall into seven categories:

- Job Definition
- SCL Control
- File Definition
- System Control
- Utility Program Support
- Language Processor Calls
- Disk Support

3.6.1. Menu Selection

In general, the operator will neither see nor need to know the SCL or the rules of syntax for the language, since predefined procedures are stored on disk, and the operator chooses the correct procedure from a list, or menu. (See Figure 3-2.)

Menu selection can be several levels deep, so that the choice of an item from the main menu can cause another menu to be displayed with still more specific choices available. After selection of a procedure, parameters can be introduced into the job stream from the workstation, thereby allowing general purpose procedures to be written.

Both menu items and requests for parameters are in English text; thus, it is unnecessary for the operator to remember program names and the order and type of parameters used for the procedures.

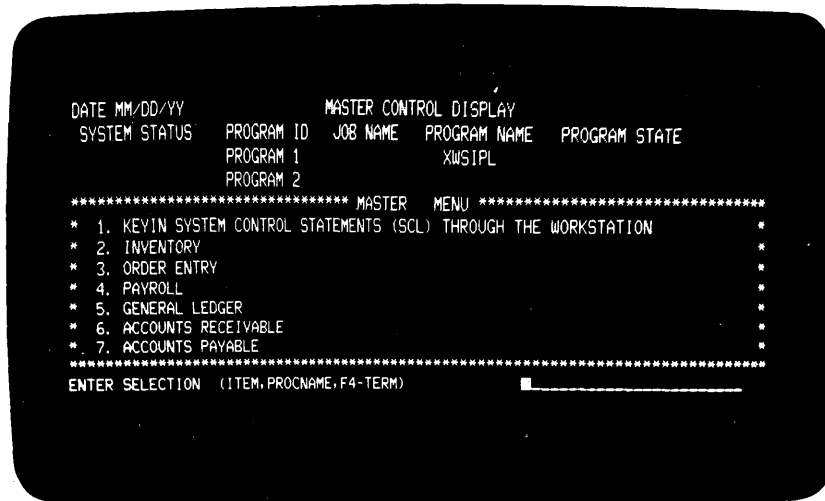

Figure 3—2. BC/7 Workstation Menu

3.6.2. SCL Functions

- Defining a Job for Execution

A job or job stream is defined as a logical set of programs to be done as a group, one after the other. A job may be stored on disk and called by a special command, obviating the introduction of a whole set of statements when a job is to be run.

- Describing a File to the System

The FILE statement is used to define a new file to the system or to override previously defined information about an existing file.

- SCL Control

This class of statements allows for operator communication with the SCL, including parameterization of the job stream and run-time decision making for taking alternate paths through a job stream.

- System Control

System control statements are used to set various system options, including date and modes of operation.

- Support of Utility Programs

As noted in 3.8, a number of utility programs are included with BC/7. To facilitate their use, special SCL verbs are provided.

- Calling Language Processors

The two SCL statements, RPG and ESCORT, are used to invoke the compilers on the BC/7.

- Disk Utility Calls

Three SCL statements call special utilities for disk maintenance.

3.6.3. System Security

File and information access limitations are accomplished, if desired, by assigning limited menu selections to users. Since the menu selections control the scope of a user's access to programs, security is accomplished in a simple fashion. A user, for example, can have access to certain information in a file (e.g., name, address, etc.), but he cannot run a program that would change other fields (salary, rate, etc.) in the same file.

3.7. DISK FILE MANAGEMENT

The BC/7 File Management System (FMS) is a part of the operating system providing for the management of data files, program libraries, system files and working files, and a system file catalog.

The FMS provides the interface through which system and user programs request tape and disk I/O operations. The objectives behind its design are to provide a simplified interface and to assure program independence from specific device type, thus allowing peripheral device changes to be made without affecting operations.

The FMS provides support for sequential, direct, and indexed file structures; for opening and closing files, retrieving records, and writing records; for controlling certain functions of I/O, specifying I/O buffering, and waiting for the completion of I/O operations; and for loading indexed files.

3.7.1. File Definitions

Each file contains a file definition table, which is a list that:

- describes the characteristics of the file;
- identifies options to be taken by file management; and
- contains addresses of the program's I/O buffers, record work area, and function parameter areas.

3.7.2. I/O Interfaces

Programs interface to the FMS through I/O control calls. File management takes care of the opening and closing of files, as well as handling buffering, blocking, deblocking, and other general processes.

3.7.3. File Sections

BC/7 disk files are composed of sections, which are made up of sectors. A disk sector is fixed, by hardware and software conventions, at 256 characters each. A file section can be from one to four sectors in length, so the number of characters contained in a single file section can be 256, 512, 768, or 1024. A record within a file must reside within a file section, but more than one record can be "blocked" into a single file section. For example, a data file with records of 100 characters each can be arranged so that five records are blocked into a single file section of 512 bytes. If, on the other hand, a file section size of 256 bytes were used for that same file, then 56 bytes would be unused in each file section. (In the case of the 512-byte section, only 12 bytes out of each file section would be unused.)

3.7.4. I/O Buffers

I/O buffers are the input or output main storage areas used by the file. The user has the option of building or processing records inside these areas or having them moved to or from record work areas. The file management routines transfer data between the file sections or devices and the I/O buffers and do blocking/deblocking inside the I/O buffers.

3.7.5. Record Work Areas

I/O records can be processed or built in work areas instead of the I/O buffers when a user program defines the work area address. If the address is defined, file management subroutines will move the requested record to or from these work areas.

3.7.6. System File Catalog

The system file catalog is a master directory that contains information about all files/libraries within the BC/7. It is maintained and used by utility programs and file management.

System file catalog support provides the following advantages for the user:

- Central, automatic control over the assignment of files, including multivolume allocation
- System messages identifying disk or diskette volumes to be mounted for specific jobs or tasks
- A cross-reference of file names to volume numbers for improved system control
- Reduced operator setup time and record keeping

System file catalog entries added as new files are allocated and deleted as files are deallocated.

3.7.7. File Sharing

File management controls the sharing of files on disk by more than one program. A second program can open a file even if it is already opened by another program running on the BC/7. Software record locking prevents the same record from being changed by more than one program at a time.

3.7.8. Sequential Access

Sequential access is a method of writing or reading records within a file in a serial sequence. Sequential access implies reading of the file in the same order as written, one record at a time.

FMS also provides the capability to update records in a disk sequential file without copying the file.

3.7.9. Direct Access

Programs can begin processing at a place in the file other than the beginning, interrupt the normal processing sequence by skipping ahead, or access a record in the file in a random manner by "noting the point" in the FMS request. In this manner, a sequential file can be treated as a random file using the relative record number as the index.

3.7.10. Indexed Access

Indexed access is supported through the use of two files: a data file and an index (key) file.

Indexed access is a method of writing or reading records by their associated index within the data file, or writing or reading records within a data file in a physically serial manner. When using the index, the records can be accessed either directly or in sequential index order. Otherwise, the access is the same as sequential access. The mode of access can be alternately selected during the processing of a file.

The index file contains an entry for each record in the data file. The index file is used to locate data records directly or in alphanumeric order. Indexed access can support individual record updates, inserts, and deletes within the file without affecting other records within the file. The entries in the index file are sorted in sequential index order at file close time to ensure fast file access the next time the file is used.

3.7.11. Libraries

Libraries are built by a utility program using the direct access method. A library contains a directory and library elements. A library directory contains element definitions and their relative reference points in the library file. A library element is a sequential record string that can be source code, executable object code, an SCL procedure, or format descriptors for data entry, inquiry, or the ESCORT language.

3.8. UTILITIES

The BC/7 utilities are individual programs set apart from the resident operating system and, as such, are called via special SCL commands. The utility programs are described in 3.8.1 through 3.8.6.

3.8.1. Editors

Editors are provided to allow the building and maintenance of SCL procedures and source elements. A special editor is forms-oriented for RPG source language work. The editors allow for the creation of new elements either from scratch or through copying pieces of other elements.

3.8.2. Sort/Merge

The sort allows the user, through sequence specification parameters, to rearrange, omit, and reformat records from any type of file; and to output the results to any type of file through the use of a temporary work file controlled by the sort package. Basically, three types of sorts are supported:

- Record Sort

Output can contain the following:

- Key fields only
- Key fields plus data fields
- Data fields only

- Address-out Sort

Output will contain a 1-byte flag, 4-byte address (note/point format), and up to a 127-byte key field. Input must be from disk. The output of this SORT version will be a file that constitutes the index file portion of the index access mechanism.

- Summary Sort

All but one record of records with identical keys will be dropped; when this option is used, specified fields in those records dropped will be added to the corresponding field of the record retained.

The sort can be called in two ways, externally or internally.

1. External calls are entered by the operator, with an SCL statement followed by sort sequence specifications.
2. Internal calls to the sort are executed by BC/7 software in order to maintain keys of indexed files in sequence.

3.8.3. Data File Services

These utilities allow for the manipulation of data files. They include the following functions:

- File

This reserves space for a file.

- Copy

This program enables copying a volume, a file, or selected records of a file to another volume or file. Optionally, printing and reorganization of a file can also be performed, where reorganization means writing the records on the output in the same sequence as their index.

- Compare

This utility enables testing a volume, file, or library element by comparing a copy to the original. A formatted printout of the results of the comparison is produced.

- **Delete**

This utility eliminates references to a file in the volume index. The volume index is marked, indicating the file space is available.

- **Erase**

This is used to reset the contents of a file to binary zero.

- **Rename**

This utility is used to change the name of a file.

- **Repro**

This utility is used to reproduce a card deck. The new card deck can be a reformatted version (edited) of the initial deck or a straight transcription.

- **List**

This utility provides a listing of a card deck. The listing can be either a transcription of the card deck or a reformatted version.

3.8.4. Program File Services

These utilities are provided to permit the user to create and maintain libraries, which are defined in 3.7.11.

- **Functions**

- Reserve space for a library
- Delete a library or program within a library
- Copy a library, removing the deleted elements
- Create an element (secondarily, print the element created)
- Rename an element
- Add or replace elements by name in a library
- Add all elements of a library to another library
- Patch a correction into an executable element
- Add, replace, or delete statements in a source procedure element
- Print a library or selected elements
- Build a procedure (proc) using punched cards

3.8.5. System Support Facilities

These utilities are provided as aids in debugging, fault detection, and general system operation. They are divided into the following areas:

- Disk and Diskette Preparation

Functions:

- Assign identification to a volume
- Write track and sector addresses on disk
- Perform surface analysis to check for defective tracks
- Assign alternate tracks for defective ones

- Alternate Track Assignment

Function:

Using information regarding a defective track, this program:

- Performs surface analysis on that track and assigns an alternate track if available
- Prints the incorrect data of the defective tracks
- Transfers data to an alternate track

- Rebuild

Function:

This program rebuilds incorrect data, using information supplied by the user to correct data in a defective track, or to enter data into a newly-assigned alternate track.

- Display

This prints the entire volume index or lists elements of library files. Among others, the volume index contains the following information about each file.

- ID of the file
- Location – starting track number and size
- Status – permanent or temporary
- Type of file
- Date of creation

3.8.6. Data Entry Utility

The data entry utility provides the capability to create and maintain data files on diskettes and/or disk cartridges directly from a workstation. The BC/7 communicates with the operator in a conversational mode, aiding him in entering the data correctly and easily. Input and output specifications are initially entered under control of a format description utility program that allows the operator to describe the details of data entry and display processing. These descriptions are referenced during data entry to define field and record attributes, as well as to validate field-specified contents. The format descriptions reside in a library stored on disk(s) or diskette(s).

Workstations may be utilized to initially "set up" a work sequence. After preparatory procedures, there are five modes of operations:

- Enter Data
- Search/Modify Data
- Append Data
- Verify Data
- Display Accumulators

The BC/7-600 and BC/7-700 data entry systems share sufficient capacity to permit simultaneous operation from up to four workstations. Each workstation may be operating in a different mode, but only one mode is permitted with each file at any one time. The BC/7-800 and BC/7-900 data entry system permits use of up to six workstations; BC/7-900 systems with fixed disk allow up to eight workstations to be used.

Data is grouped as fields, records, and batches. Data files are made up of a variable number of data records up to 256 characters in length for the BC/7-600 and BC/7-700, and up to 1024 characters in length for the BC/7-800 and BC/7-900. Records consist of multiple fields and, consequently, the maximum single field length is equal to the maximum record size. A batch is defined as a complete data entry job.

The data entry software operates in any program partition (see 3.2) and will be interruptible for those systems that permit rollout under normal rollout, rollin procedures (except when in partition P2 of a BC/7-600 or BC/7-700 series model).

3.9. PRINT SPOOLING

Print spooling and output writing functions are integrated into the operating system of the BC/7-800 and BC/7-900 systems. The spooling facility supports a maximum of six open print files in the BC/7-800 systems (two for each of the active partitions, plus two for the rolled out partition) and eight open print files in the BC/7-900 systems (two for each of the four active partitions). The output writer supports a single online printer.

All spooled printer files are written to a dedicated, online system disk file. The spooling function runs as an extension to user and utility programs, while the output writer runs as an asynchronous system task.

A utility program is also provided that enables the user to display the contents of the queue of spooled files and options are provided so that the user can alter the spool queue and direct the operations of the output writer.

A single spool file must be allocated and cataloged before the spooler and output writer can be used. Space for report files is dynamically allocated and released automatically by the spooler and output writer. The spool file must reside on a single disk volume.

3.10. LANGUAGES

3.10.1. RPG II

RPG II provides an easy-to-use method for writing programs. This method of problem solving can be used to efficiently deal with a wide variety of data processing problems. RPG II is written on specification sheets (e.g., file description, input specifications, calculation specifications, output specifications) that are designed as a guide to help the programmer make the appropriate entries in the appropriate places. Each RPG II program uses the same general program logic. The term program cycle is used to refer to all of the RPG II logic functions performed each time a record is processed. Each program cycle performs the operations indicated on the input, calculation, and output specifications.

BC/7 RPG II has been enhanced by the addition of data communication commands. These enable the user to access remote devices within the structure of an RPG II application program. Remote devices are connected through communication interfaces.

The user-written application program runs in main storage and controls the transfer of data between the BC/7 and the remote device. This includes aspects of communication protocol required by the particular device, such as polling, selection, and acknowledgement.

The application program has a command interface to the MCLA-resident line control program (LCP) through RPG II. Commands have been defined for stand-alone SEND and RECEIVE operations, as well as a combined SEND-RECEIVE, and various line control functions. The user program sets the parameters for these commands and dispatches them by way of an EXCPT or READ operation.

The RPG II communication software consists of two components – the line control program and the line handler initialization program (LHIP).

3.10.2. ESCORT

ESCORT is a new high-level, general purpose application programming language intended for interactive BC/7 Business Computers.

ESCORT programs can be written in the form of an interactive dialog in which the user responds to a prompting and diagnostic program and can invoke tutorial assistance to define his application. ESCORT does not require extensive training on the part of user personnel and is the easiest to use of the BC/7 languages. (See Figure 3-3.)

The simplicity of the ESCORT language is unprecedented in the computer industry. There is no other language developed to date that is as simple to use and yet as powerful in enabling inpromptu reporting from a terminal. With ESCORT, no information on disk master files need be difficult to extract and summarize; the user does not need to wait for a program to be written and debugged in order to get his needed information. ESCORT allows three types of programming:

- Report program generation
- Data entry program generation
- Transaction program generation

```

***GLOBAL-D
SELECT DATA OF CUSTFILE OUTPUT TO PRINTER [" "]
IF CRCODE IS EQUAL TO 8 OR 9
AND LPAYDATE IS LESS THAN 770701

```

a. Sample program

CUSTNUM	CUSTNAME	CRCODE	LPAYDATE	YTD SALES	TOTAL DUE	LPAY AMT
10234	RAHMAN & SCHWARTZ, INC.	8	770512	1000.00	800.00	200.00
10324	GARRISON MFG CO INC	8	770216	542177.00	246559.00	100000.00
10326	SPORTGOODS INC.	9	770112	35678.00	20000.00	15000.00
10328	MILLER-HILL INC	9	760809	3452.00	5467.00	800.00
10333	CAMPING SUPPLIES CO.	9	770106	3678.00	2000.00	1678.00
10334	GLENVIEW DISTRIBUTORS	8	761230	64728.90	73890.56	13000.00
10398	WILLINNG & ABLE	9	770417	20000.00	15000.00	5000.00
10426	BLEIGH & SACKETT DISTR	9	770115	53247.88	23765.50	8250.00
10431	KNORR MACHINE PARTS	8	770205	600.00	400.00	200.00
10444	PLASTIC FITTINGS	8	770604	400.00	100.00	300.00
10447	MILNOR MFG CORP	9	770228	17687.80	54980.50	1000.00
10448	ABC CANDY & TOBACCO	8	770105	1000.00	0.00	1000.00
10450	LOWELL STATIGNERS	8	770323	25000.00	25000.00	0.00
10473	RADCLIFFE HARDWARE	8	760930	0.00	5413.50	1500.00
10482	MILKLOS IMPORTERS INC	9	770115	7600.00	7600.00	0.00
10493	LINCOLN TOOL & DIE	9	770105	400.00	6855.50	500.00
10494	RGRH & LAUTHMUND CO.	8	770215	2000.00	1500.00	500.00
10496	HAUSER HOSPITAL SUPPLIES	9	770201	3000.00	2000.00	1000.00
10500	MOSTLY CANDY COMPANY	8	770505	2789.00	2789.00	0.00
10501	SHIPLEY CANDY & TOBACCO	8	761215	256.50	1024.90	300.00
10503	BAGEUT LINEN SUPPLIES	8	770626	45671.00	51234.00	2000.00
10504	BARTON & SEDGLEY	8	770321	4000.00	2500.00	1500.00
10508	A-Z BARBER SUPPLY	9	770430	76549.00	0.00	76549.00
10511	TRI-STATE DISTRIBUTORS	8	761123	0.00	6754.00	200.00
10515	STIRLING METAL WORKS	8	770303	1000.00	1000.00	0.00
10517	SOUTHSIDE PARTS	9	770315	476.40	3289.67	300.00
10527	GRAVELY MGNMENT CO	9	760930	1567.00	1567.00	0.00
10530	BRADFORD TOOL CO	8	761215	0.00	77865.23	10000.00
10538	THE TOOL LENDING LIBRARY	9	770505	4500.00	2000.00	2500.00
10542	WILLIAMS & TOMLINSON	8	761123	0.00	8673.25	1000.00
10550	GENERAL PROVISIONS INC	9	770404	2300.00	1000.00	13000.00
10552	KITCHNERS FOUNDRY	8	770202	1000.00	1000.00	0.00
10556	TYSON & REVERE, SUPPLIERS	9	770115	542.90	7568.66	1000.00
10603	WURLDS END TOOL & DIE	9	770601	3500.00	1000.00	2500.00
10622	PILTDOWN MFG CO	9	760416	0.00	4532.50	276.85
10631	LEE & LEVIN TIRE CO	8	770315	76892.00	88990.46	15000.00
10631	JAY KAY DISTRIBUTORS	9	770401	0.00	7652.90	800.00
10637	FURE & AFT SUPPLY CO	8	761226	900.00	16000.00	2000.00
10639	SEAN UBERWERK & CO	8	770102	846.80	7863.70	540.00
20000	LINDSAY & KRAUS	8	761215	3746.50	5500.00	500.00
22180	SPORTS INC	9	770130	3348.50	8629.43	678.00

b. Report resulting from sample program

Figure 3—3. Example of an ESCORT Program

The user can write very simple programs that can have the following functions:

- Creation or replacement of a file
- Addition of records to a file
- Prompting at workstation during entry (fill in blanks)
- Validation of input data for
 - Range
 - Relationship with other data fields
- Replacement of records
- Removal of records
- Updating of records
- Merging of files
- Prompting of input data (fill in blanks)
 - Standard format
 - User specified format
- Selection of data by field values or combination of values
- Directing output to workstation, printer, punch, or disk
- Listing only required fields
- Totaling of certain fields
- Sorting the selected records

3.11. APPLICATION SYSTEMS

With the BC/7 Business Computer, Sperry Univac offers a powerful and complete set of application systems that permit users to move their data processing to the BC/7 with minimal effort.

Central to the application programs is a new technique called PIXIE method. The PIXIE method allows the programmer to define names and computational formulas outside the programs, thus allowing unprecedented adaptation without program modification. All the BC/7 application programs are written so that a call is made to the PIXIE method at each point where a calculation is required that may be installation-dependent. Thus, specific calculations are easily defined and changed by the BC/7 programmer.

3.11.1. Accounting Management System (AMS)

3.11.1.1. General Ledger

General Ledger (G/L) provides for the control of accounting records, including an audit trail of entries and the balancing and validation of all bookkeeping entries. With BC/7 G/L, balance sheets are maintained and income statements are produced (Figure 3-4).

BC/7 G/L has the following features:

- All debits and credits balanced to zero
- All account numbers checked against chart of accounts
- Books always kept in balance
- Multicompany, multidivisional, multidepartment record keeping
- Consolidated account reports
- Comparative reports
- Reports by account and subaccount

Several features ensure G/L accuracy:

- All data validated before file update
- All entries posted through G/L
- All activity documented through audit trail
- History files posted through G/L

G/L provides the following reports:

- Trial Balance
- Journal Entries
- Balance Sheet
- Profit and Loss Report
- Special Financial Statements
- Comparative Statements

AS OF 2/29/76		ANY COMPANY		RUN DATE 3/01/76		PAGE 1			
--- GENERAL LEDGER TRIAL BALANCE ---									
*** CURRENT YEAR ***									
				--- CURRENT PERIOD ---		--- YEAR-TO-DATE ---			
COMP	DIV	DPT	ACCT-SUB	PERIOD	ACCOUNT DESCRIPTION	DEBIT	CREDIT	DEBIT	CREDIT
001			1000		ASSETS				
001			1100		CURRENT ASSETS				
001			1110-01		CASH IN BANK-BANK 1	1,000.00		12,000.00	
001			1110-02		CASH IN BANK-BANK 2			20,000.00	
001			1200		ACCTS RECEIVABLE	96,000.00		242,000.00	
001			1300		PREPAID EXPENSES				
001			1350		RESERVE FOR BAD DEBT				
001			1400		INVENTORIES			50,000.00	
001			1995		TOTAL CURRENT ASSETS			50,000.00	
001			2000		FIXED ASSETS			50,000.00	
001			2100		LAND			100,000.00	
001			2200		BUILDING & EQUIPMENT				
001			2300		TOTAL FIXED ASSETS				
001			2400		DEPRECIATION				15,000.00
001			2490		NET FIXED ASSETS				15,000.00
001			2500		LONG TERM RECEIVABLES				15,000.00
001			2600		OTHER ASSETS				
001			2995		TOTAL ASSETS				
001			3000		LIABILITIES				
001			3100		CURRENT LIABILITIES				
001			3110		NOTES PAYABLE			70,000.00	
001			3120		ACCTS PAYABLE		15,000.00	100,000.00	
001			3210-NY		STATE SALES TAX-NY				
001			3210-PA		STATE SALES TAX-PA			50,000.00	
001			3220-NYC		CITY SALES TAX-NYC				
001			3310-NY		STATE WAGE TAX-NY				
001			3310-PA		STATE WAGE TAX-PA				
001			3320-PHL		CITY WAGE TAX-PHL				
001			3330		FEDERAL WITHHOLDING TAX				
001			3340-01		FICA TAX-EMPLOYEE				
001			3340-02		FICA TAX-EMPLOYER				
001			3350		FEDERAL U.C.				
001			3360-NY		STATE U.C.-NY				
001			3360-PA		STATE U.C.-PA				
001			3499		TOTAL CURRENT LIAB				
001			3500		LONG TERM LIABILITIES				
001			3600		DEBT				
001			3700		LIABILITIES				
001			3990		TOTAL LONG TERM LIAB				
001			3995		TOTAL LIABILITIES				
001			4000		CAPITAL				
001			4100		COMMON STOCK				25,000.00
001			4200		EXCESS OF PAR VALUE				
001			4300		RETAINED EARNINGS, PRIOR YEAR				
001			4390		INCOME FOR CURRENT PERIOD				
001			4400		TOTAL CAPITAL				
001			4995		TOTAL LIABILITIES & CAPITAL				
001			5000		REVENUES				
001			5100-01		SALES-DOMESTIC		52,000.00	102,000.00	
001			5100-02		SALES-FOREIGN		48,000.00	98,000.00	
001			5200		RETURNS				

Figure 3-4. General Ledger Report

3.11.1.2. Accounts Payable

BC/7 Accounts Payable (A/P) includes all functions needed to process payments and maintain posting distribution for G/L. The files contain all required information on vendors, such as name, address, all purchases for the current year's business, purchase agent's number, and vendor salesman's name and telephone number. Even payments made outside A/P can be posted to the general ledger and check register listing (Figure 3-5).

Operational Functions

Daily or Weekly:

- Add new invoice data to A/P file
- Add external payments to A/P file
- Validate all data before file update

Weekly:

- Cash requirements forecast
- Aging of open invoices by vendor
- Selection of invoices to be paid by date due
- Changing selection of payments (add new or delete invoices)
- Vendor disbursements

Monthly:

- Disbursement reconciliation
- General ledger distribution
- Vendor purchase analysis

Year End:

- 1099 tax forms

Reports

- Vendor Name and Address
- Input Control Register
- Cash Requirements
- Aging
- Selection of Payments
- Invoice Payments
- Payment Register
- Vendor Disbursements Journal
- General Ledger Distribution
- Payment Reconciliation
- Vendor Purchase Analysis
- 1099 Tax Forms

AS OF 3/02/75		APPLE DISTRIBUTION COMPANY				RUN DATE 4/01/75 PAGE 1	
--- ACCOUNTS PAYABLE INVOICES SELECTED TO BE PAID ---							
VENDOR NO.	DATE DUE	VENDOR NAME	INVOICE NO.	GROSS AMOUNT	DISCOUNT	NET AMOUNT	CUMULATIVE
2	0/00/00	BAKER AND BAKER COMPANY	2	1,200.00	.00	1,200.00	1,200.00
2	2/25/75	BAKER AND BAKER COMPANY	01	100.00	.00	100.00	1,300.00
2	2/26/75	BAKER AND BAKER COMPANY	01	12.00	.00	12.00	1,312.00
2	2/27/75	BAKER AND BAKER COMPANY	01	22.00	.00	22.00	1,334.00
2	2/28/75	BAKER AND BAKER COMPANY	02	1,800.00	.00	1,800.00	3,134.00
2	1/00/00	BAKER AND BAKER COMPANY	CM1234	55.00-	.00	55.00-	3,079.00
VENDOR TOTALS				3,079.00 *	.00 *	3,079.00 *	
3	6/05/75	CASTER AND CAMBER COMPANY	4	6,000.00	.00	6,000.00	9,079.00
VENDOR TOTALS				6,000.00 *	.00 *	6,000.00 *	
TOTAL REGULAR INVOICES				9,079.00 **	.00 **	9,079.00 **	

SP - ON RIGHT SIDE OF REPORT MEANS INVOICE IS SETUP FOR 2 OR MORE PAYMENTS

Figure 3—5. Accounts Payable Report

3.11.1.3. Accounts Receivable

BC/7 Accounts Receivable (A/R) includes all functions needed to bill and maintain the A/R files. The files contain all required information on customers, such as name, address, balance, discount, tax information, aging, credit limits, month-to-date, year-to-date and prior year sales, and order information.

Operational Functions

Daily:

- Add new invoice data to A/R file
- Enter cash receipts (either open item or balance forward)
- Customer bill-to file maintenance

Monthly:

- Aging of accounts
- Service charge accounting
- Printing of monthly statements
- Removal of completed invoices from the A/R master file

Maintenance (at any time):

- Add or delete customers from the master file
- Change name, address, or other customer information
- List all customers for a mailing
- Perform sales analysis
- Compute cash expectancy report showing invoice amounts outstanding

Reports

- Daily Invoice Register
- Daily Cash Receipts Register (Figure 3-6)
- Monthly A/R Aging Report
- Monthly Customer Statements
- Invoice Adjustments
- Cash Expectancy Report
- A/R History
- Sales Analysis Report
- Customer Master List
- Additions and Changes to Master File

AS OF 12/31/75		ABLE DISTRIBUTION COMPANY					RUN DATE 12/31/75 PAGE 1		
--- I N V O I C E R E G I S T E R ---									
JOURNAL SALE									
INVOICE NO.	CUST NO.	CUSTOMER NAME	REFERENCE NO.	INVOICE DATE	DISCOUNT DATE	SALES CODE	INVOICE GROSS	DISCOUNT AMOUNT	INV REMARKS LESS DISC
	SALES TAXABLE	SALES EXEMPT	TOTAL SALES	TAX AMOUNT	FREIGHT AMOUNT	OTHER CHARGE			
55	1000 50.00	ERIE SCIENTIFIC		12/01/76 PA	12/01/76	0	50.00	5.00	45.00
58	1000 30.00	ERIE SCIENTIFIC		12/01/76 PA	12/01/76	0	30.00	3.00	27.00
123456	3150 25.00	THE PICK UP COMPANY		12/30/75 PA	12/30/75	0	30.00		30.00
	105.00		105.00	5.00			110.00	8.00	102.00

Figure 3-6. Accounts Receivable Report

3.11.1.4. Payroll

BC/7 Payroll being unusually flexible, allows the following types of user-prescribed features:

- Multicompany, multidivisional payrolls
- Up to nine types of pay, such as regular pay, overtime pay, shift pay, mileage pay, bonuses, etc., computed in any manner

- Up to 10 types of deductions, which may also be computed in any manner
- Up to 7 hour-fields for each employee, which can be used for any type of accumulated hours, such as regular, overtime, holiday, etc., as the user requires
- Up to four types of accumulated hours, which can be used to accrue and generally keep track of allowed vacations, sick leave, etc.
- Special calculations for additional, minimum, and alternate federal, state, and city withholding
- Calculations of up to 4096 city taxes
- The ability to pay in multiple checks if desired
- Subtotals by department or division if desired
- Payment stubs that include year-to-date information on all hours, pay, and deductions (Figure 3-7)

Payroll provides the following reports:

- Payroll Edit List
- Payroll Register
- Payment Drafts
- W-2 Forms
- Master File List
- Next Pay Period Worksheet
- Labor Distribution
- 94/A Report
- Bond Purchases
- Payroll Analysis
- Job Labor Cost
- Payroll Journal Entry
- Employee Earnings Statement

PAY PERIOD ENDING 09/27		EMPLOYEE NUMBER 1001		EMPLOYEE NAME MARTINA BRISTER		DEPARTMENT - RATE 01 4.630	
*** EARNINGS ***				*** DEDUCTIONS ***			
TYPE		PERIOD	Y-T-D	TYPE		PERIOD	Y-T-D
REGULAR HOURS		32.00	464.00	FEDERAL TAX		4.75	352.62
OVERTIME HOURS			18.00	SOCIAL SECURITY		8.67	133.06
SICK HOURS		8.00	21.50	PA. INCOME TAX		2.96	46.83
VACATION HOURS			40.00	PHILA. WAGE TAX			22.19
REGULAR PAY		148.16	2108.08	MEDICAL INS.		2.32	26.26
OVERTIME PAY			166.53	SAVINGS CLUB		1.00	3.00
SICK PAY		37.04	65.92	UNITED FUND		1.00	29.00
VACATION PAY			164.80	OCCUPATION TAX			10.00
GROSS PAY		185.20	2340.53	NET PAY		164.50	
000100		DRIVE SAFELY ABLE DISTRIBUTORS INC.				9/28/76	

 ABLE DISTRIBUTORS INC. <small>426 Industrial Drive Anytown U.S.A. 23466</small>		PAYROLL ACCOUNT 3-17 310	
		CHECK NO. 000100	CHECK DATE 9/28/76
ONE HUNDRED SIXTY FOUR AND 50/100 DOLLARS			
PAY TO THE ORDER OF:		CHECK AMOUNT	<div style="border: 1px solid black; padding: 2px; display: inline-block;">\$164.50</div>
MARTINA BRISTER 1488 GEORGES LANE SOUTHAMPTON, PA 18966		NOT NEGOTIABLE	

Figure 3-7. Sample Draft and Stub

3.11.2. Wholesale Application Management System (WAMS)

BC/7 WAMS is a fully integrated application system designed to give the user complete control of the order, billing, and inventory processes. WAMS provides for:

- Entering orders
- Producing pick slips
- Open order changes
- Reprinting of open and invoiced orders

- Inventory control
- Inventory sales analysis (turnover)
- Customer sales information
- Automatic credit checking
- Tax records
- Freight records
- Commission records

BC/7 WAMS has some important features that ensure accurate results and ease of use. For instance, input regarding customers and inventory is checked for validity against the respective files at the time the order is entered, thus eliminating time-consuming "backtracking" when errors are made but found much later.

Availability of inventory items is also checked at order entry time. At the user's option, the ship-via, ship-to, terms code, and price fields may be modified at order time, or used as received from the master files. Invoices or pick slips may be reprinted as long as they remain open (Figure 3-8).

WAMS allows for quantity discounts, customer discounts, and "specials". Freight charges and tax calculations are done through PIXIE method, and are easily modified by the user when new rates apply.



ABLE DISTRIBUTORS INC.
406 Industrial Drive, Ardmore, U.S.A. 20865

BILL TO:
WORLDWIDE NEWS CORP.
10123 REDWOOD AVE.
EAST BUILDING
HARRISBURG, PA 12345

SHIP TO:
ABC RETAIL SALES & RENTAL
12539 ADMIRAL BLVD.
SHIPPING DOCK DROP
PHILADELPHIA, PA 19102

SALESMAN	CLERK	SHIP VIA											
01	001	TOSE FRGT.											
CUSTOMER NO	CUSTOMER P O	TERMS	ORDER DATE	ORDER NO	PAGE	OPEN ORDER -- POSSIBLE C/L EXCEPTION							
50	10-4554	10-NFT-30	12/05/75	15	1 of 1								
PRODUCT NUMBER	DESCRIPTION	S U M	LOC A T I O N	Q U A N T I T Y	C O D E	L I S T	Q U O T E	N E T	EXTENDED AMOUNT	COMMISSION		PROFIT ANALYSIS	
										UNIT	EXTENDED	UNIT	EXTENDED
	3050 SHEET ROCK		SH N/A	25	10 *	18.200	*	15.56	155.60	.155	1.55	13.905	139.05
	21000 CHAIR - STD		PC WHSE	5	5 *	13.650	*	11.67	58.35	.116	.58	2.054	10.27
WEIGHT 112.50 LB		REPRINT-PICK SLIP		ORIG. ORDER 14		SUBTOTAL		213.95		COMMISSION %		1.0	
						TAX		12.84		COMMISSION TOTAL		2.13	
						F.E.T.		21.00		PROFIT %		69.8	
						FREIGHT. HDLG		30.68		PROFIT TOTAL		149.32	
						TOTAL		278.47		DISCOUNT TOTAL		120.30	

Figure 3-8. Reprint — Pick Slip

WAMS has the following modules:

- Order Entry

Creation of an order utilizing customer input and access to disk data base files. Completed orders may be either invoiced, or left "open" with the production of a pick slip.

- Update Open Order

Modification or deletion of an open order on order records that have not been invoiced.

- Invoice Reprint

Reprint of any invoices or open order, and invoicing of open orders.

- Sales Journal

Production of a daily report that details the invoices and profitability of the daily functions. Detail of the daily tax liability by tax jurisdiction.

- Item Master File Close

Update of the item master file following the performance of the daily recap report.

- Daily Recap Report

Production of the daily recap report. Allows a change of the total inventory-availability dollar figure.

- Delete Order Maintenance

Removal of deleted order records from the disk files.

- Invoiced Order Maintenance

Check of status of invoiced order. Either transfer desired orders to a separate unit or create an archives record.

- Open Order Memorandum

Preparation of a report that details the pertinent information about each open order (Figure 3-9).

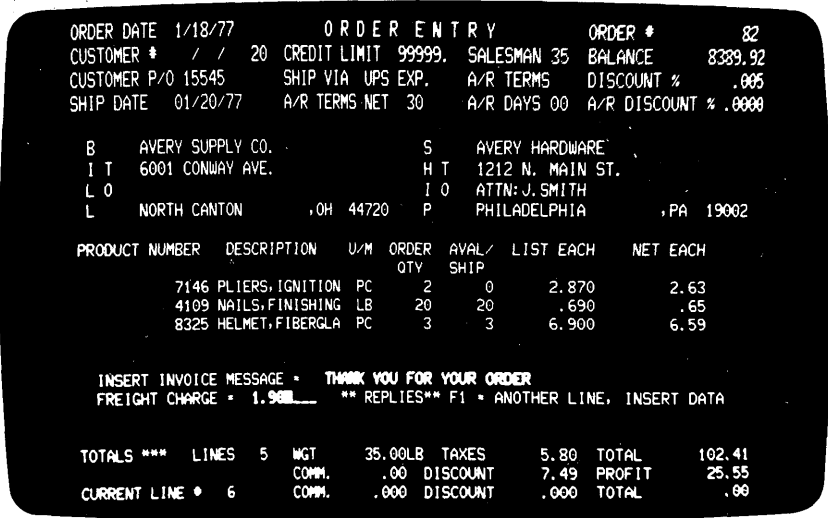

Figure 3—9. Order Entry Screen

3.11.3. Sales Accounting System (SAS)

SAS is functionally the same as the WAMS, with the exception that the inventory module is not provided. All other aspects of order entry and receivables are included.

3.11.4. Manufacturing Application Management System (MAMS)

BC/7 MAMS is workstation driven and interactive. MAMS provides accurate, timely, and complete information for management use in optimizing resources and improving cash flow. MAMS comprises four modules. It includes Bill of Material/Inventory Control, Scheduled Receipts, Product Costing, and Material Requirements Planning. The Bill of Material/Inventory Control Module is the basic building block. The other modules can be installed separately, or in combination, to fit the user's needs and timing.

Bill of Material/Inventory Control

- Interactive input and update through CRT workstation
- Bill of material cost explosion
- Bill of material quantity explosion
- Single level bill of material
- Summarized bill of material
- Single level, where used
- Indented, where used
- Summarized, where used

- ABC class
- Reorder point/reorder quantity
- Min/Max parameters
- Safety stock
- Perpetual inventory
- Stock status
- Cycle/physical inventory
- Transaction history audit
- CRT inquiry/input
- YTD inventory status
- On order/allocated quantities
- CRT inventory

Scheduled Receipts

- Interactive input and update
- Open purchase order control
- Blanket purchase orders
- Multiple releases
- Multiple items per order
- Open manufacturing (shop) orders
- Component part allocations
- Bill of material substitutions
- Shop paper/pick list
- Shop order entry/maintenance
- Purchase order entry/maintenance
- Part number/open order list
- Order number/open order list
- Stock status

Product Costing

- Incremental cost rollup
- Assist labor and burden cost changes
- Costed cycle/physical inventories
- Cost of production
- ABC analysis
- ABC reclassification
- Cost list
- Fiscal/current cost variance
- Inventory cost analysis

Material Requirements Planning

- Interactive input
- Master schedule
- Lot sizing
- Lead time offset
- Time-phased allocations
- Regenerative
- CRT file inquiry

3.12. COMMUNICATIONS EMULATORS

Emulators allow the BC/7 to be used in existing or new communications networks involving remote batch operations.

Emulators are programs that are loaded into the main storage area of the system and make the system appear and function as another type of communication device. For example, when the system is initialized as an RBT using the DCT 2000 emulator, the system function is virtually the same as if it were a DCT 2000 in a communications environment. Consequently, you can use a BC/7 in any communications network that would have supported a DCT 2000. Using emulators allows one hardware device configuration (the BC/7) to have a wide range of applications in communications without any changes in the basic hardware or to the programs currently available with the host computer systems (Figure 3-10). All networks can be 4-wire; modems can be full duplex, but the emulators are as follows:

- DCT 1000 emulator
Network supported is half-duplex, synchronous on 2- or 4-wire communication lines.
- DCT 2000 emulator
Network supported is half-duplex, synchronous on 2- or 4-wire communication lines.
- RMS-1 emulator
Network supported is half-duplex, synchronous on 2- or 4-wire communication lines.
- FDR emulator
Network supported is full-duplex, synchronous on 4-wire communication lines, or 2- or 4-wire half-duplex communication lines.
- IBM 2780/3780 emulator
Network supported is half-duplex, synchronous on 2- or 4-wire communication lines.
- HASP workstation emulator
Network supported is half-duplex, synchronous on 2- or 4-wire communication lines.

A separate RPG II command-driven line handler program is also available for data communications. User-written programs can use the line handler to host-control or emulate batch and interactive terminals, in addition to those listed in this paragraph (3.10.1). However, in this case, Sperry Univac support is limited to the performance of the RPG II compiler.

**POINT-TO-POINT NETWORK
USING DIALED CONNECTIONS**

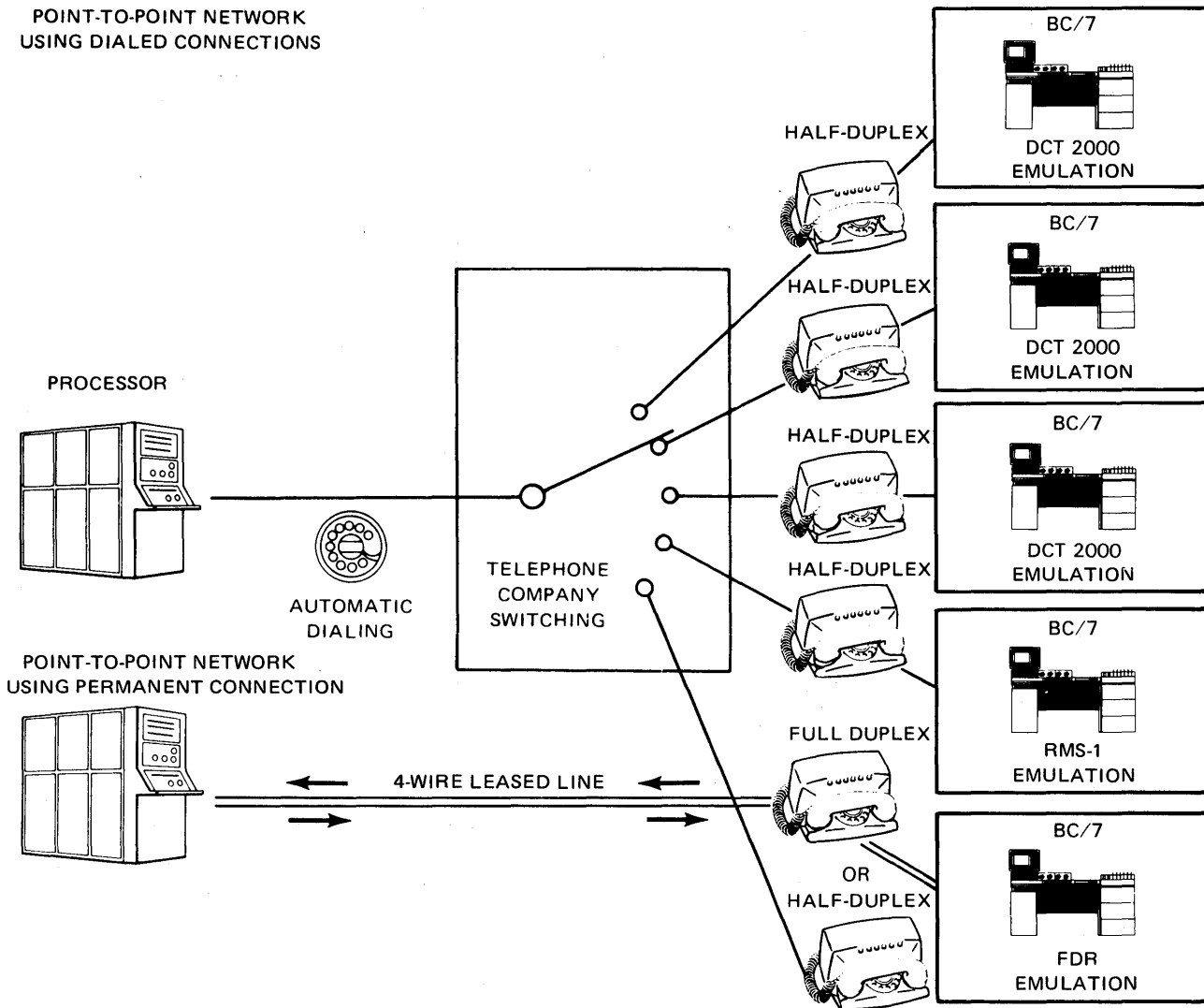

**MULTIPOINT NETWORK USING
PERMANENT CONNECTIONS**

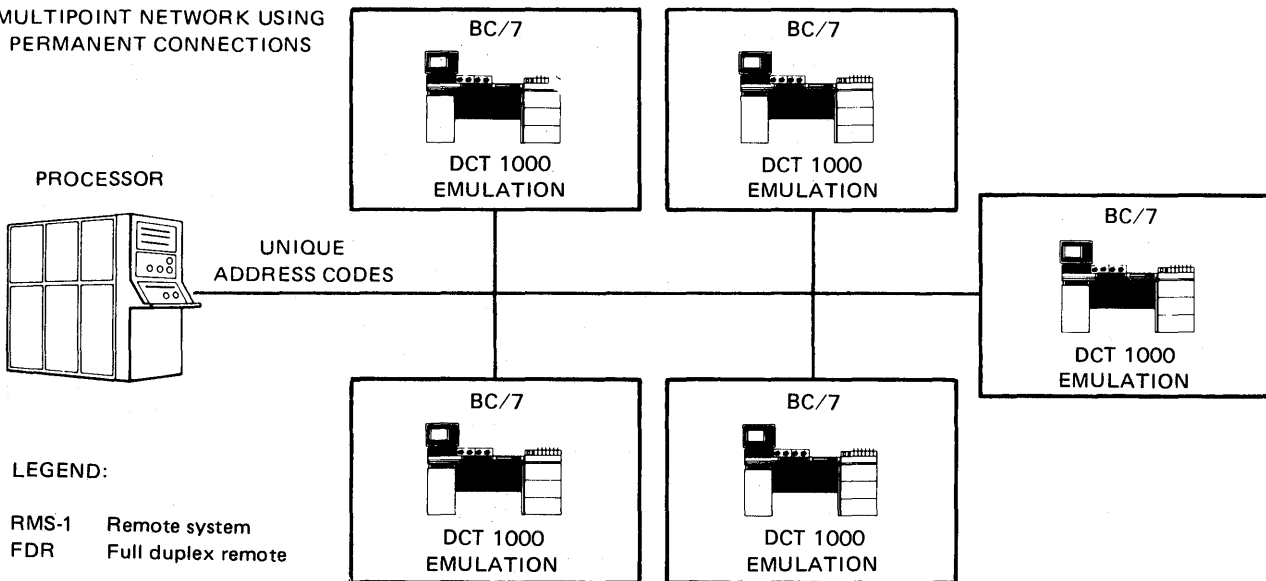

Figure 3-10. Typical Network Connection Methods for BC/7

4. Hardware

This section describes the architecture of the BC/7, including the central processing unit (CPU), main storage, and the system bus, as well as the I/O capabilities and the specifications of the available peripherals.

The BC/7 is designed with several important criteria in mind. Among these are:

- Interactive operation: immediate response to user requirements
- Simplicity of operation: English language interaction
- Total systems: hardware and software to solve user problems
- Concurrently running programs and rollout/rollin to smooth out data processing peaks

Together, these provide total system cost effectiveness in the areas of reliability, availability, and service.

4.1. ARCHITECTURE

The architectural concept behind the BC/7 organization is to provide processing power that matches application requirements. Each BC/7 processor is designed around the system bus, to which all devices (including the control processors and macro processor, main storage, and the input/output DMAs) are connected (Figure 4-1).

Connections to I/O devices are in three forms:

- DMA (Direct Memory Access)
- SDMA (Shared Direct Memory Access)
- MCLA (Microcoded Communications Line Adapter)

The DMA is designed for mass-storage devices. The SDMA allows multiplexing of up to four low-speed devices (printers, workstations) into a common DMA connection. The MCLA is used for BC/7 communication, but is not required to communicate data to any workstation.

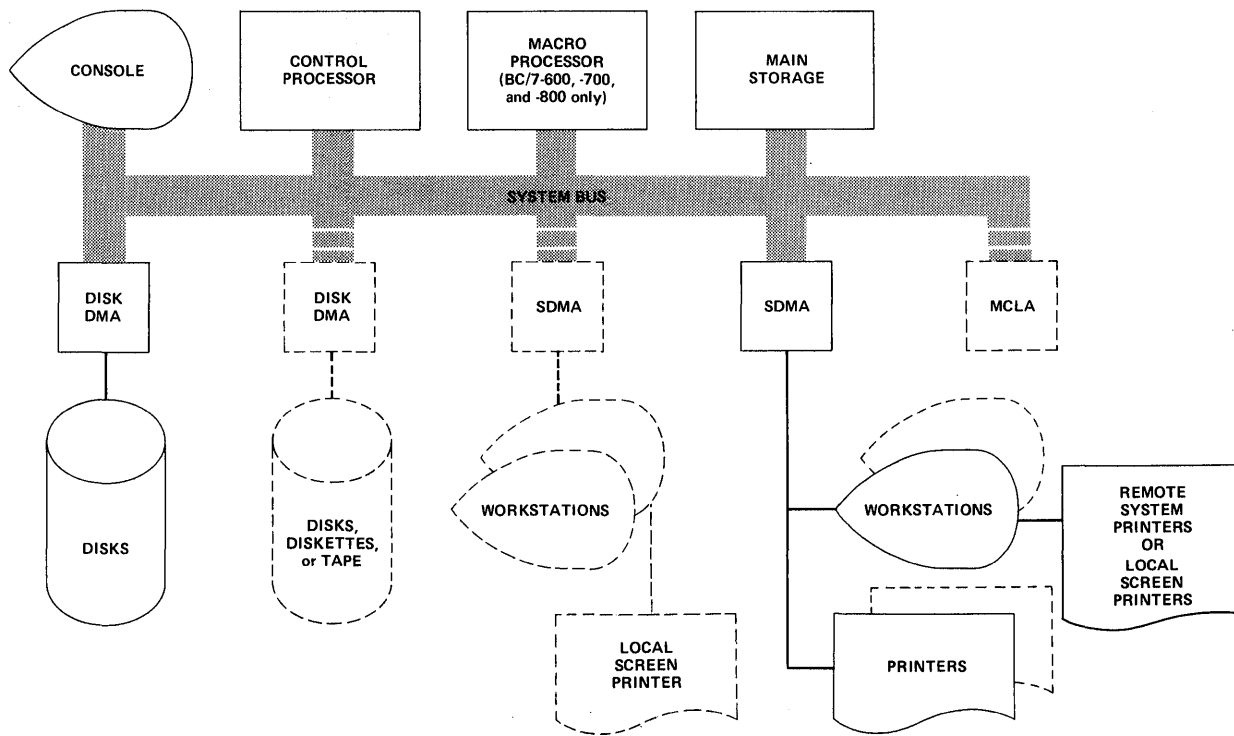

a. General configuration

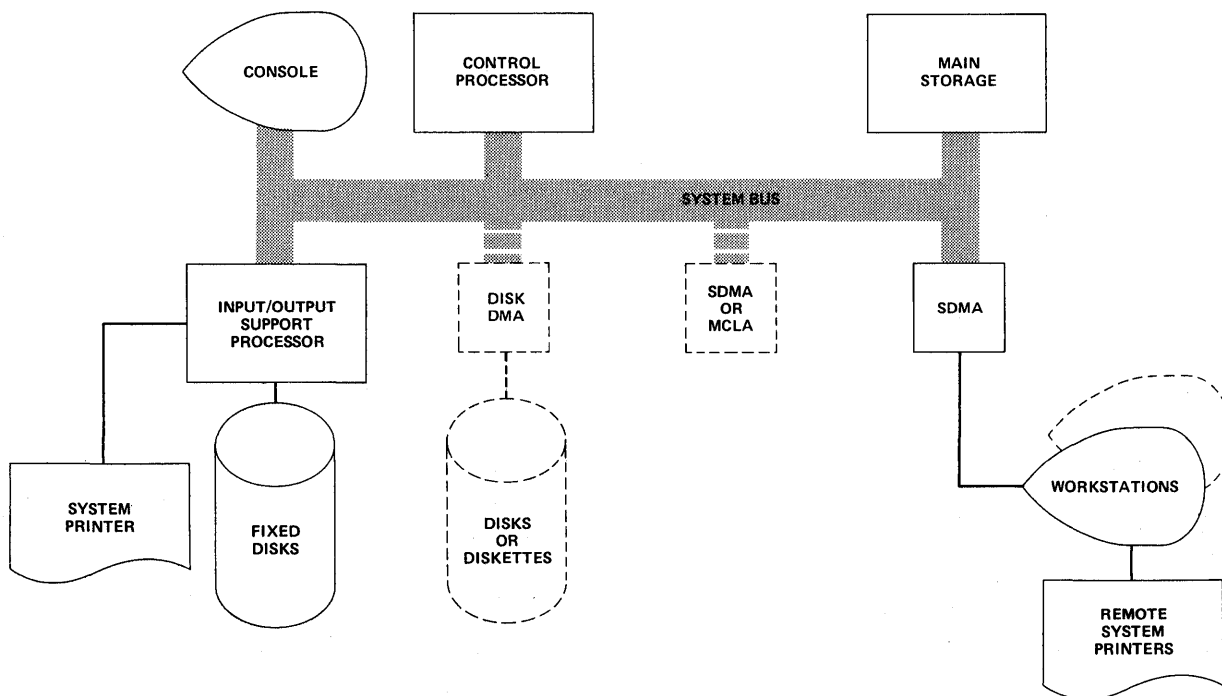

b. BC/7-900 architecture with fixed disk

Figure 4-1. BC/7 Processor Schematic

4.2. PROCESSORS

Depending upon the model, a BC/7 system may contain a control processor, a macro processor, or a single processor combining both functions, housed in a desk-style cabinet called the CPU (Figure 4-2). All BC/7-600, BC/7-700 and BC/7-800 series systems contain one control processor and one macro processor. The processors handle all arithmetic and I/O functions through the system bus.

BC/7-900 systems that include the fixed disk subsystem contain a control processor and an input output support processor (IOSP). The IOSP handles the I/O for the fixed disk and system printer. Other versions of the BC/7-900 contain a single processor combining the control and macro processing functions. In these systems, the control processor handles the arithmetic and I/O functions through the system bus.

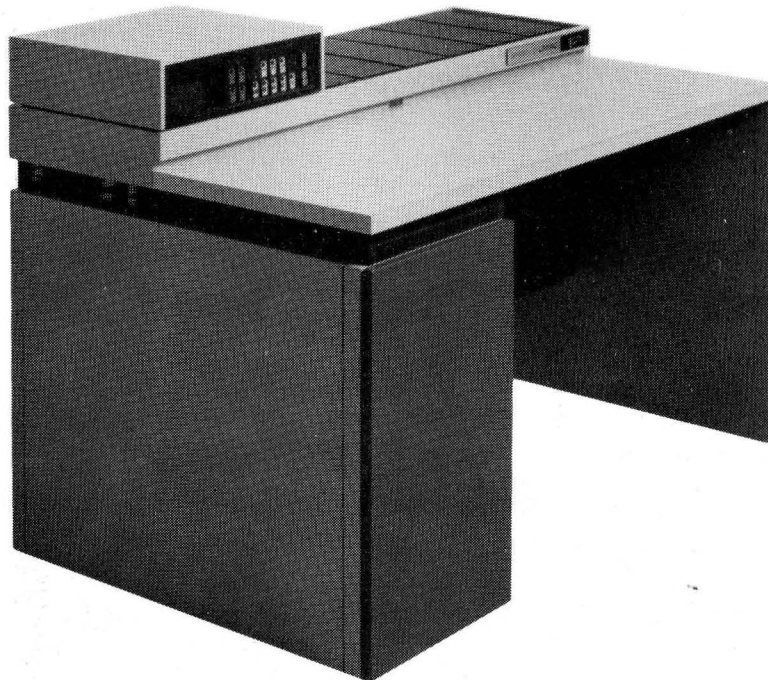

Figure 4-2. BC/7 Central Processing Unit (BC/7-600, BC/7-700, BC/7-800, and BC/7-900)

4.2.1. Control Processor

The control processor with the BC/7-600, 700, and 800 is an 8-bit parallel binary processor; the BC/7-900 processor is a 16-bit parallel binary microprogrammed processor. Both use an 8-bit accumulator, six 8-bit programmable work/index registers, and an 8-bit external data path. It has 16-bit immediate operators for initializing the work/index registers. There is a 16-bit program counter and a 16-bit programmable stack pointer that can use any part of main storage as the stack store.

The stack automatically saves the content of the program counter when certain transfer instructions are executed. These instructions are used when interrupts occur and for calling subroutines.

For comparison purposes, the basic control processor clock cycle for the BC/7-600, 700 and 800 series processor is 500 nanoseconds. On the BC/7-900 series, the processor clock cycle is 250 nanoseconds. Instruction execution times range from 2 to 9 microseconds on the BC/7-600, 700, and 800 series, while on the BC/7-900 series the instruction execution times range from 750 nanoseconds to 6 microseconds. In addition, the BC/7-900 series control processor supports several new instructions not previously supported on the BC/7-600, 700 or 800 processors, and also includes the macro processor function.

The external address space is directly addressable via the address bus. The general address space has four modes of addressing:

1. Direct
2. Register
3. Register indirect
4. Immediate

An 8-line automatic priority interrupt facility allows the processor to respond to internal or external events. The content of the program counter is automatically saved.

The internal machine code for the BC/7 is 8-bit ASCII.

4.2.2. Macro Processor

The macro processor is used only in the BC/7-600, 700, and 800 series CPUs. It is a microprogrammed processor designed to interpretively execute macro-level operations generated by the compilers. The macro processor is designed to optimize the execution of arithmetic and logical operations.

The macro processor resides in the processor complex, interfacing with the system bus in the same fashion as the DMA facilities and the control processor. It also has a control interface with the control processor. The macro processor is activated by special operation codes in the programs being run. Upon activation, the macro processor puts the control processor in a wait or halt state until it completes the required function. Upon completion of the function, status concerning that function is stored in main storage, and the control processor resumes processing. No user programming is required for this facility.

In the BC/7-900 series, the function of the macro processor is integrated within the control processor. Operations previously executed by the macro processor are executed by the control processor, thereby centralizing the processing power and control of the system.

4.2.3. Input Output Support Processor

The input output support processor (IOSP) is used only on BC/7-900 systems with the fixed disk peripheral subsystem. The IOSP is a programmable facility which provides the interface to the system for the fixed disk I/O controller and the printer I/O controller.

The IOSP consists of a microprocessor, a programmable direct memory access (DMA) facility, and local storage. The IOSP also includes a system bus interface and two I/O controller bus interfaces.

The IOSP microprocessor can address the local storage directly and by means of an external base register; it can address all of main storage. The IOSP microprocessor initializes the DMA facility by issuing output-type instructions to load the required parameters. Similarly, the system bus and the I/O controller buses are managed by the microprocessor by issuing input and output instructions to the appropriate registers. Data transfers to the I/O controllers are always handled by the DMA facility. No user programming is required for this facility.

4.3. SYSTEM BUS, MAIN STORAGE, AND DMA

4.3.1. System Bus

The system bus is the center of transfer between all devices on the BC/7, including the processor and main storage, main storage and I/O devices, and the control and macro processors.

For the BC/7-600, 700, and 800, the bandwidth is 1 megabyte per second, but to achieve this rate, the processors must be locked out during the transfers. By stealing machine cycles, a transfer rate of 400 kilobytes per second (kbps) will cause minimum processor slowdown. Typical instruction mixes permit transfer rates up to 600 kbps without significant slowdown for the BC/7-900 processors.

An external device can gain control of the system bus to make a full record data transfer directly to or from main storage. A priority circuit assigns the bus to the requesting device. Transfers to main storage are done on a cycle stealing or instruction overlap basis.

4.3.2. Main Storage

BC/7 storage is dynamic metal oxide semiconductor (MOS).

- Capacity and Modularity
 - 48K bytes (BC/7-600 and BC/7-700 series systems only)
 - 64K bytes (BC/7-600 and BC /7-700 series systems only)
 - 128K bytes (BC/7-800 series systems only)
 - 256K bytes (BC/7-900 series systems only)

- Interface and Timing

Main storage interfaces to the system bus. A summary description is as follows:

- Address 16-bit address (64K bytes); one, two or four banks
- Data 8 bits, bidirectional

Access and cycle times are defined by system bus and processor requirements. The main storage module meets the processor timing requirements without causing it to wait for data from main storage or for cycle completion. Approximate timing at the storage module terminal is as follows:

- Read access time 500 nanoseconds
- Read, write, refresh 1 microsecond for BC/7-600 and 700
 cycle time 500 nanoseconds for BC/7-800 and 900

The storage chips are dynamic and must be refreshed periodically. Refresh logic is internal to the storage module. One storage cycle is preempted every 32 microseconds (every 23 microseconds for the BC/7-800 and 900) to perform the refresh operation. The BC/7-900 series control processor accesses main storage records on a 16-bit word basis (two bytes) in one cycle.

■ Error Detection

Main storage will generate a parity bit for each 8-bit byte of write data received from the processor via the data bus. The parity bit is stored with the data byte and checked when the data is read. If a parity error is detected, the main storage module will generate an interrupt to the processor. If an attempt is made to address a nonexistent storage location (a storage card that is not plugged into the BC/7), an addressing error will result. For the BC/7-900 series, data sent to main storage by the control processor is checked for correct parity. If parity is not correct, the data is not stored and an interrupt is generated.

4.3.3. General Description of DMA Controllers

The input/output (I/O) structure of the BC/7 permits the exchange of data and control information between the processor, main storage, and peripheral devices over the system bus.

Peripheral devices are interfaced to the system bus through the following controllers, or direct memory access (DMA) devices, which monitor and maintain overall supervision of the devices that are attached:

- Direct Memory Access (DMA) Controller
- Microcoded Communications Line Adapter (MCLA)
- Shared Direct Memory Access (SDMA) Controller

4.3.3.1. Direct Memory Access for High Speed Devices

The direct memory access (DMA) controllers interface mass storage devices, such as diskettes, cartridge disks, and tape to the BC/7. They contain the logic and timing required to initiate commands and control the transfer of data to or from the devices.

Disk(ette) DMAs accommodate a maximum of either four diskette drives or two cartridge disk drives. The controllers share their resources among the attached devices. Commands that do not require the use of data transfer resources permit concurrent operations on more than one device. Those commands requiring the transfer of data make the controllers busy to any additional commands until the data transfer is completed.

A tape DMA is used to interface the 0871 Magnetic Tape Units with the BC/7. Tape is not supported when the BC/7-900 is configured with fixed disk/IOSP.

4.3.3.2. Microcoded Communications Line Adapter

The microcoded communications line adapter (MCLA) is used only for processor-to-processor communication (it is not used for remote workstations). An MCLA displaces any of the four types of DMAs and may link either one or two other processors to the BC/7.

4.3.3.3. Shared Direct Memory Access Controller

The shared direct memory access (SDMA) controllers interface low/medium speed peripheral devices, such as workstations and printers, to the system bus. Each SDMA is capable of interfacing a maximum of four such devices to the BC/7. Once a data transfer sequence has been initiated by the system, the SDMA remains busy to any other input or output requests until the data transfer is completed.

4.4. SYSTEM CONSOLE

The BC/7 console and main electronics are housed in a single pedestal desk of modern design. The desk functions not only as the control center for the BC/7, but as a general work area.

The processor and other electronics are housed in the pedestal. A raised portion of the left rear corner of the desk contains a 5-inch CRT screen that presents data on two 16-character lines, and displays BC/7 messages in English to the operator. (See Figure 4-3.) A group of pressure-sensitive buttons allows for initial program load and operator communication to the BC/7. The cabinet also contains space to house up to six diskette units.



Figure 4—3. BC/7 Console CRT

4.5. WORKSTATION

The 3545 workstation consists of a 12-inch (diagonal) screen, or cathode-ray tube (CRT), keyboard, a microprocessor, and memory. (See Figure 4-4.)

The CRT displays up to 1920 characters out of its own storage, or buffer, on 24 lines of 80 characters each. The characters include numbers, uppercase and lowercase letters, punctuation, and special characters.

The keyboard is a standard "QWERTY" typewriter keyboard, with which typists are familiar. In addition, a 10-key numeric keypad is included. Other special keys are used in cursor control, screen erase, and communication with the CPU.

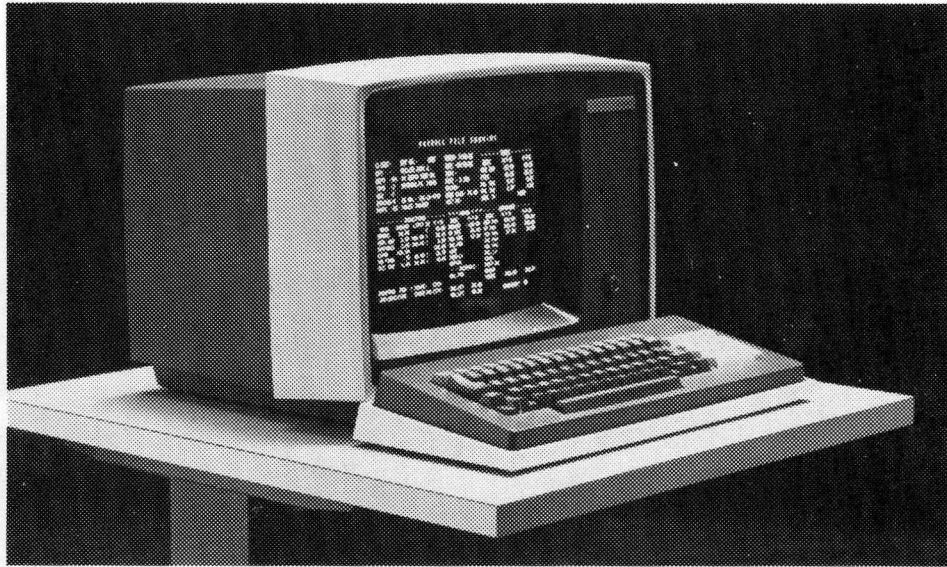

Figure 4-4. BC/7 Workstation

The workstation has many built-in features that aid in speed of input and keep incidence of input errors to a minimum. Foremost is the protected field feature, which allows the operator to enter data only into those fields that are designated by the controlling programs. The workstation positions the cursor on the field to be entered and, upon entry, verifies and edits each field as entered, giving the operator immediate validity checking.

4.6. WORKSTATION PRINTER

The SPERRY UNIVAC 0774 workstation printer is a nonimpact printer (NIP), operating at 300 characters per second on electrographic paper. One printer may be attached to each workstation to produce hard copies of the screen displays. (See Figure 4-5.) The NIP is not a remote printer; it is under the local control of its associated workstation.

Another means of acquiring a printout at a workstation is by placing a BC/7 system printer at the remote location where a workstation is located. For this purpose, an 0786 printer may be used. A remote system printer may be used for any BC/7-800 and BC/7-900 system printing task, such as bills of material, invoices and picking slips, but cannot be used by the output writer for print spooling jobs. The remote system printer cannot be used to make hard copies of the CRT display. The two varieties of printers (workstation printer and remote system printer) exclude each other at any specific workstation but may be intermixed in the overall BC/7 system configuration.

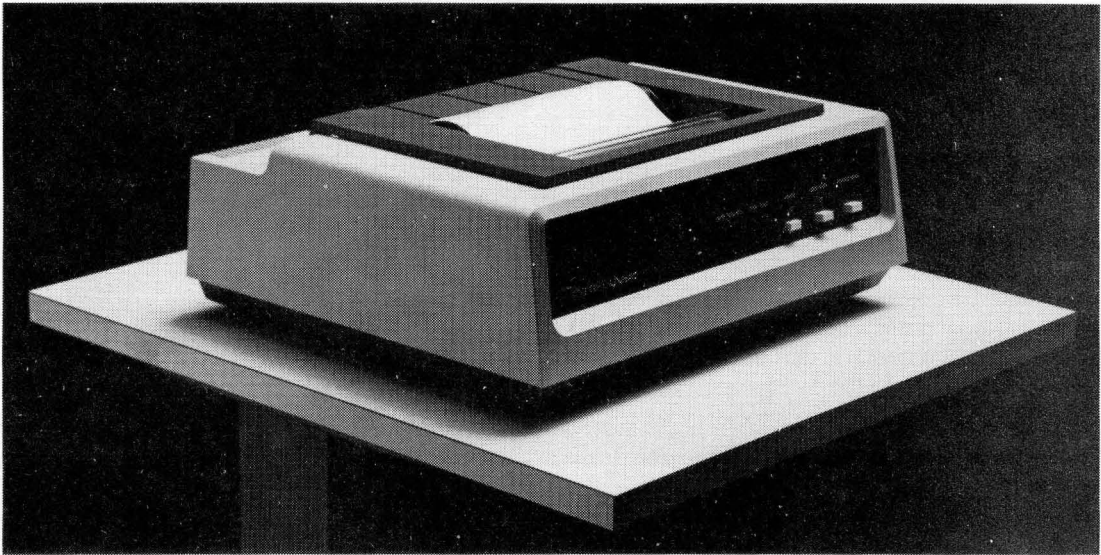

Figure 4-5. 0774 Workstation Printer

4.7. PRINTER SUBSYSTEMS

Character printers are available, along with three speeds of line printers.

4.7.1. 0786 Character Printers

There are two models of the SPERRY UNIVAC 0786 character printer. One prints at a speed of 200 characters per second from left to right unidirectionally. The second model also prints 200 characters per second, but it does so using an intelligent bidirectional method, starting the next line at the optimum position, and printing in either direction. (See Figure 4-6.)

The 0786 printer can be used either onsite, or at a remote location.

Printing is done using a 7 x 7 dot matrix, with characters spaced at 10 characters per inch. Lines are spaced six or eight to the inch vertically. Up to 6-part paper, with widths varying from 1.6 to 15.3 inches, may be used.

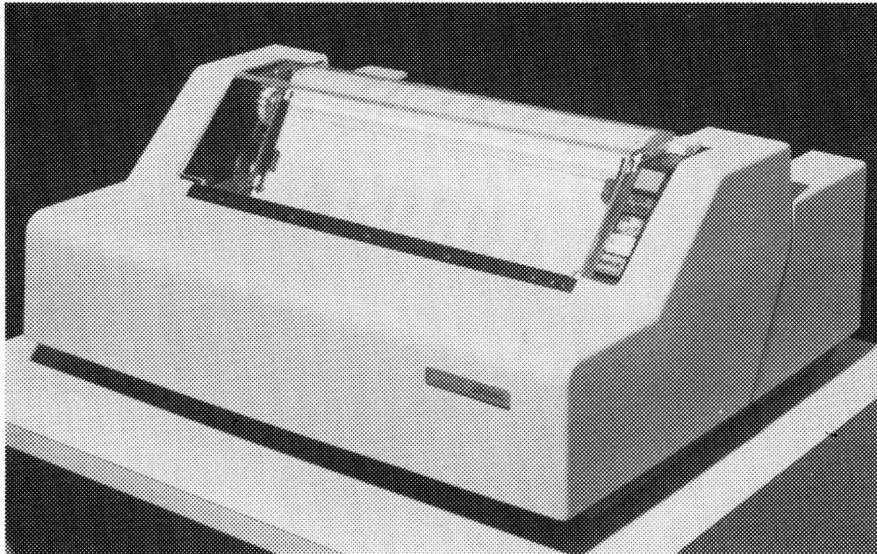

Figure 4—6. 0786 Character Printer

4.7.2. 0789 Line Printers

The SPERRY UNIVAC 0789 Printer Subsystem (Figure 4-7) is a freestanding line printer designed for direct connection to a system processor controller interface. Optionally, the printer may be used as a remote workstation printer. This impact (hammer) type printer uses a flexible metal print band that continuously moves horizontally across the column positions.

Designed to fulfill a need for a practical, low cost, line printer, the 0789 printer also produces excellent print quality and horizontal alignment.

The printer has 132 print positions and produces an original and up to five copies at either 6 or 8 lines per inch.

The printer is capable of printing from 180 lines per minute (lpm) to 640 lpm with a 48-character set. The 180 lpm printer can be upgraded to 300 lpm. Printer replacement is required to increase the print rate to 640 lpm.

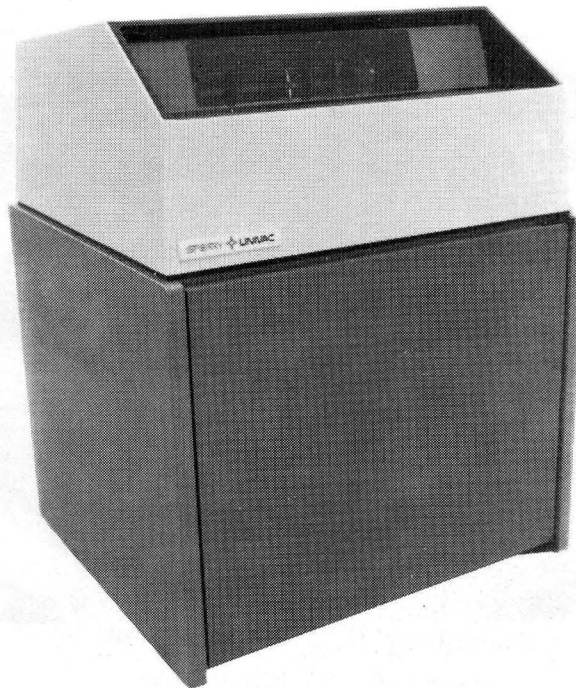

Figure 4—7. 0789 Line Printer

4.8. DISK SUBSYSTEMS

The BC/7 offers a variety of disk subsystems, ranging in capacity from 2 MB using diskettes through 140 MB using sealed and cartridge disks. Diskette drives are housed in the console desk, and cartridge disk drives are housed in freestanding cabinets.

4.8.1. 2366/2898 Diskette Drives

The diskette is a small, cost effective, online storage device. Each drive holds one diskette that is about the size of a 45 rpm record. (See Figure 4-8.)

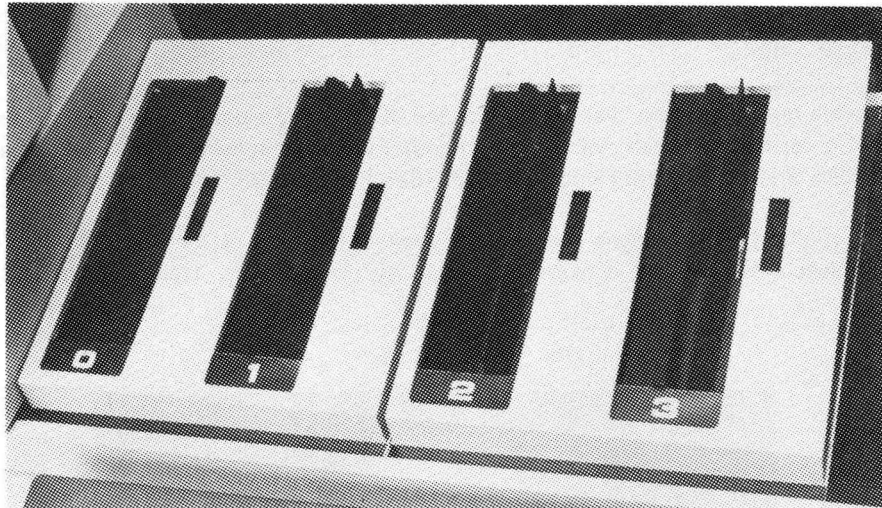

Figure 4-8. Diskette Drives

Each diskette can store a nominal 0.25, 0.5, or 1.0 MB of information – data programs or operating work areas. Diskettes are divided into sides, tracks, and sectors as listed in Table 4-1. A single head moves from track to track on command, reading from or writing to the diskette.

Table 4-1. Summary of Diskette Specifications

Characteristics	.5 MB Diskette	1 MB Diskette	Industry Common Diskette
Capacity/unit (MB nominal)	.5	1	0.25
Speed (rpm)	360	360	360
Rotational latency (avg ms)	83.3	83.3	83.3
Arm movement (avg ms)	115	115	115
Transfer rate (kB/s)	62.5	62.5	31.25
Sector size (bytes)	256	256	128
Sectors/track	26	26	26
Tracks	74	74	74
Sides/unit	1	2	1

Two advantages of the diskette over other mass storage media are the compartmentalization of data and the speed of changing a diskette on a drive. Compartmentalization of data means that the data files associated with an application program are not on a larger disk with others, and that backup, maintenance, and (in general) operational simplicity are enhanced.

4.8.2. Industry-Common Drives

These drives read diskettes containing 0.25 MB of information. Recording density is less than that of the SPERRY UNIVAC diskettes and the sectors are 128 bytes in length (Table 4-1).

4.8.3. Cartridge Disks

Cartridge disks provide higher capacity disk storage for the BC/7. They are available in three versions: 5, 10, and 20 MB (see Table 4-1 for fixed and removable proportions). Recording is on four or eight surfaces in each drive, two on each fixed disk and two on the removable disk. (See Figure 4-9.)

A greater speed is realized on cartridges than with diskettes. Rotation of the disks is 2400 rpm and average latency is 12.5 milliseconds. Average arm movement is 40 milliseconds. Transfer rate is 312.5 kbps (Table 4-1).

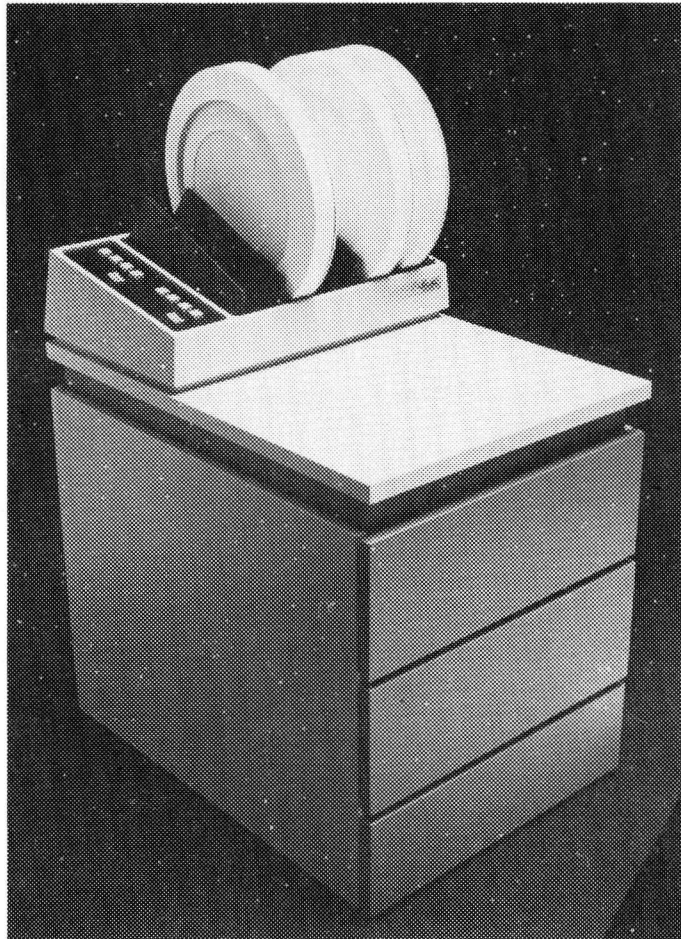

Figure 4—9. Cartridge Disk Drives

Table 4—2. Summary of Cartridge Disk Specifications

Characteristics	5 MB Cartridge	10 MB Cartridge	20 MB Cartridge
Capacity/unit (MB nominal)	2.5 fixed 2.5 removable	5 fixed 5 removable	15 fixed 5 removable
Speed (rpm)	2400	2400	2400
Rotational latency (avg ms)	12.5	12.5	12.5
Arm movement (avg ms)	40	40	40
Transfer rate (kB/s)	312.5	312.5	312.5
Sector size (bytes)	256	256	256
Sectors/track	24	24	24
Tracks	200	400	400
Sides/unit	4	4	8

4.8.4. Fixed Disks

The 8402 fixed disk subsystem available with certain BC/7-900 systems provides the highest capacity of disk storage available with the BC/7 family (Figure 4-10). One fixed-disk storage drive can be connected to a BC/7-900 system. This drive is available in one of three capacities; these are 50 MB, 75 MB, or 100 MB (Table 4-3).

Rotation of the fixed disks is 3600 rpm and average latency is 8.3 milliseconds. The average arm movement is 35 milliseconds; the transfer rate is 1 megabyte/second. Fixed disks are valuable not only for their higher capacity but for the greater access speeds that are needed for some installations.

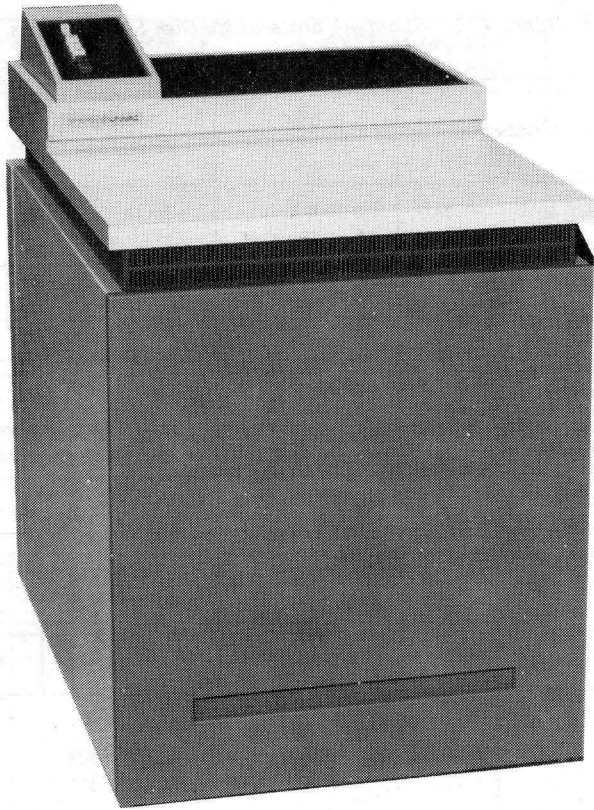

Figure 4—10. Fixed Disk Subsystem

Table 4—3. Summary of Fixed Disk Specifications

Characteristic	50 MB	75 MB	100 MB
Capacity/unit (MB nominal)	50.4	75.6	101.2
Speed (rpm)	3600	3600	3600
Rotational latency (avg ms)	8.3	8.3	8.3
Arm movement (avg ms)	35 ¹	35	35
Transfer rate (MB/s) to IOSP	1	1	1
Sector Size (bytes)	256	256	256
Sectors/track	52	52	52
Capacity/track (bytes)	13,312	13,312	13,312
Tracks/cylinder	14	14	14
Cylinders/volume	34	34	34
Volumes	8*	12*	16*

*Plus one volume for system use.

4.9. MAGNETIC TAPE SUBSYSTEM

SPERRY UNIVAC 0871 Magnetic Tape Units (Figure 4-11) may be included in BC/7 for reading and writing of 9-track NRZI or phase-encoded tape. Transfer rates are 20 kilobytes (KB) and 40 KB for NRZI and phase-encoded tape, respectively.

The 0871 unit provides an added advantage of completely automatic tape loading, which helps ensure ease of operation and maximum efficiency. No tape threading is required by the operator.

Tape is not supported on BC/7-900 systems configured with fixed disk.



Figure 4-11. 0871 Magnetic Tape Unit

4.10. MICROCODED COMMUNICATIONS LINE ADAPTER

Data communications is provided for the BC/7 by a hardware feature that can be installed in the processor cabinet (Figure 4-12). This feature, the microcoded communication line adapter (MCLA), contains the necessary logic to interface the processor to the communication line modem, and a microprocessor with associated memory. The microprocessor is programmed to relieve the CPU of the burden of line protocol chores, and the program is loaded into its main storage by the CPU. In the CPU, software controls the transmissions and receptions that take place through the MCLA.

The BC/7 uses a variety of protocols for data transmission. Depending upon the application, data is communicated in blocks of multiples of bytes or in a continuous binary stream (transparent mode). The MCLA can interface to one or two modems with EIA RS232C or MS 188-100 characteristics, and operates in synchronous mode with modem clock (1200 to 9600 bps) or asynchronous mode with internal clock (50 to 9600 bps). Operation is permitted with only one modem at a time. Dialed or nondialed operation using 2-wire or 4-wire lines is acceptable; the MCLA is half-duplex. Automatic answering is available as a feature.

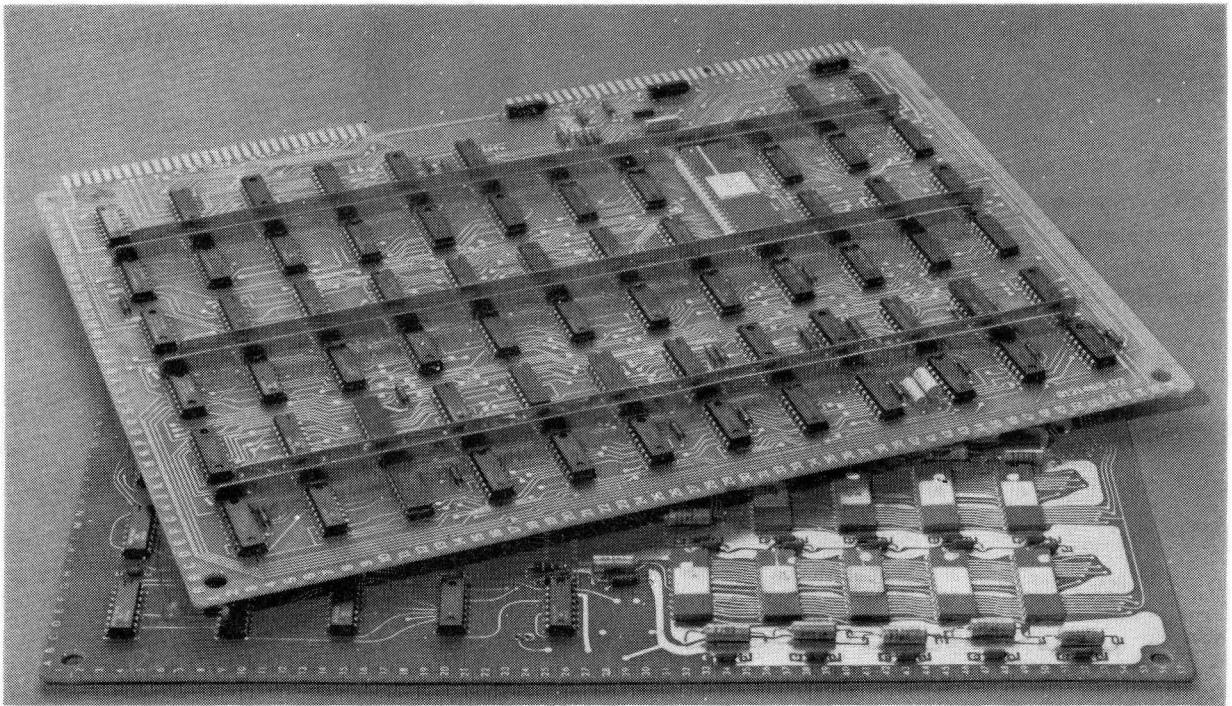

Figure 4-12. Microcoded Communications Line Adapter

4.11. PUNCH CARD EQUIPMENT

4.11.1. Card Reader

The SPERRY UNIVAC 0719 card reader (Figure 4-13) utilizes the latest in solid state technology and miniaturization to keep them on the job longer and make them less conspicuous. Using light emitting diodes (LED) and phototransistors, 80-column cards can be reliably read at 300/600 cards per minute. Reading reliability is enhanced by multistrobing read stations. Proper card registration is ensured by additional electronic detection.

A simplified card transport mechanism moves cards column-wise from hopper to stacker with no change in card direction or orientation. Hopper and stacker capacities (1000 cards each) facilitate processing cards a full box at a time, and are front-loaded/unloaded so the operator needn't walk around the machine to attend to it.

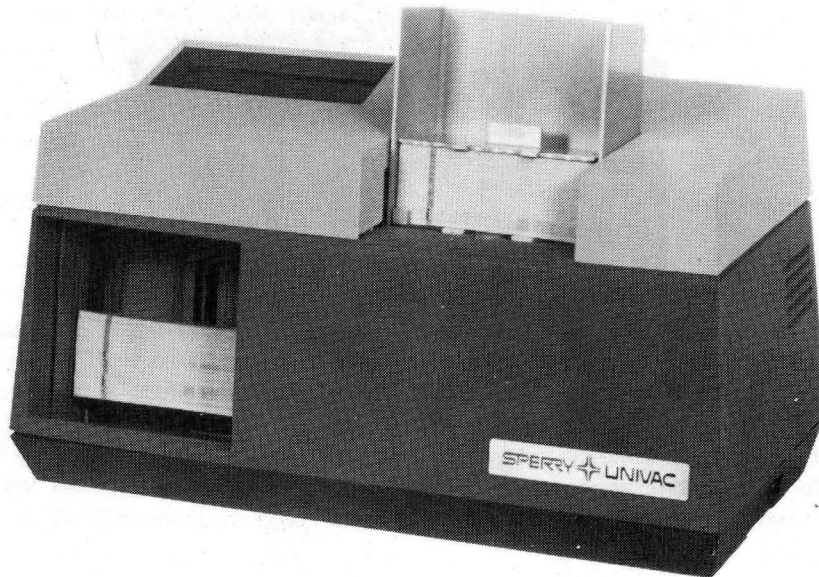

Figure 4-13. 0719 Card Reader

4.11.2. Card Punch

To minimize idle machine time, the SPERRY UNIVAC 0608 card punch (Figure 4-14) employs a technique of advancing partially punched cards to the output stacker as soon as all the data for that card has been punched, rather than waiting until column 80 has been reached for every card. For this reason, the punch operates at 75 to 160 cards per minute; 75 cards per minute if column 80 must be punched, 160 cards per minute if column 28 is the last column to be punched. Electronic card registration and mispunch detection ensure quality punching.

The input hopper and output stacker capacities of 700 cards facilitate processing cards a full box at a time.



Figure 4-14. 0608 Card Punch

4.12. CONFIGURATIONS

Figures 4-15 through 4-19 depict the basic BC/7 family configurations in solid lines, and expansion equipment in dashed lines. In each configurator, rules that govern the permissible configurations are noted. For more specific information about the various BC/7 family members, consult a Sperry Univac Business Systems representative.

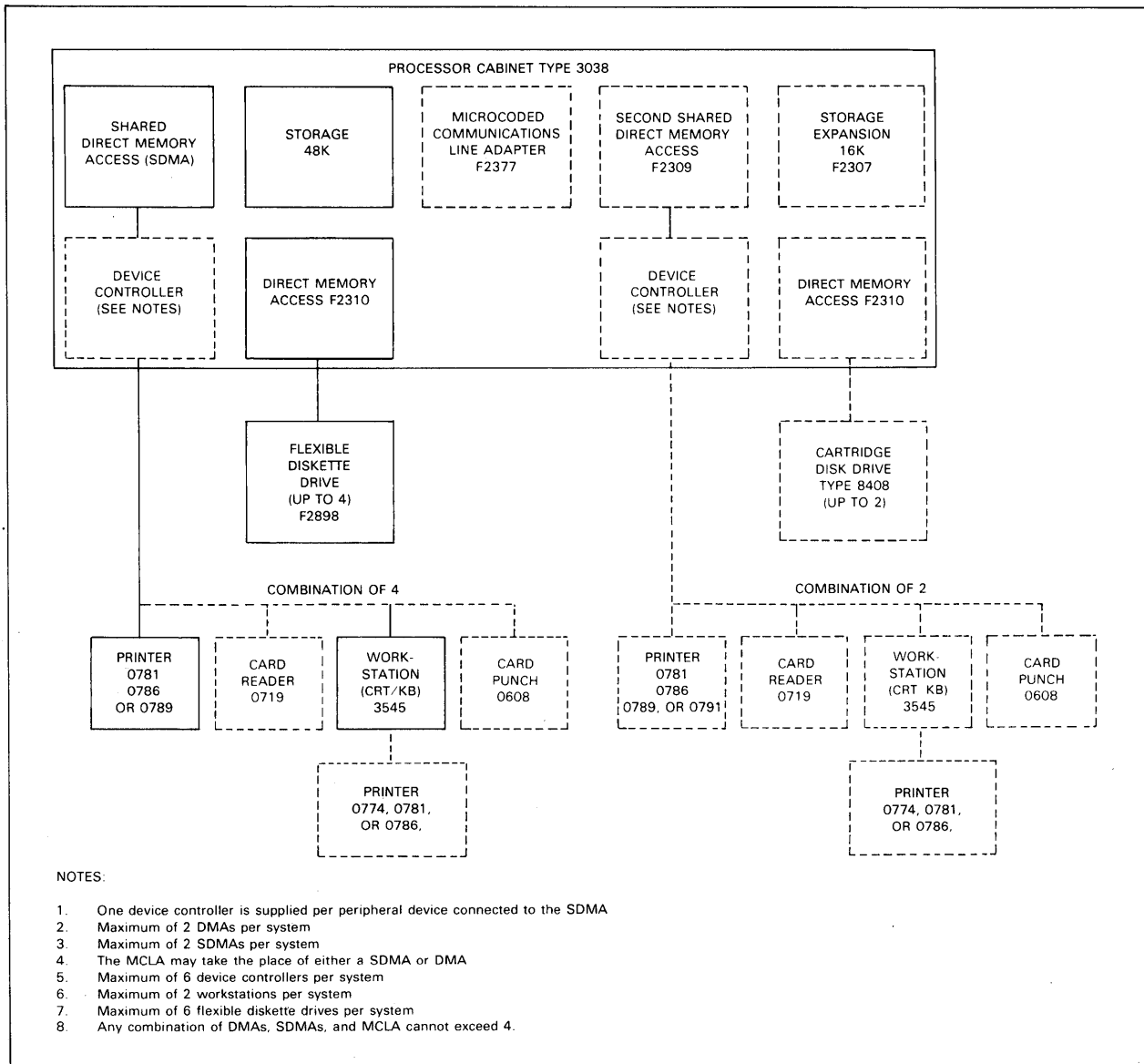

Figure 4-15. SPERRY UNIVAC BC/7-600 Series

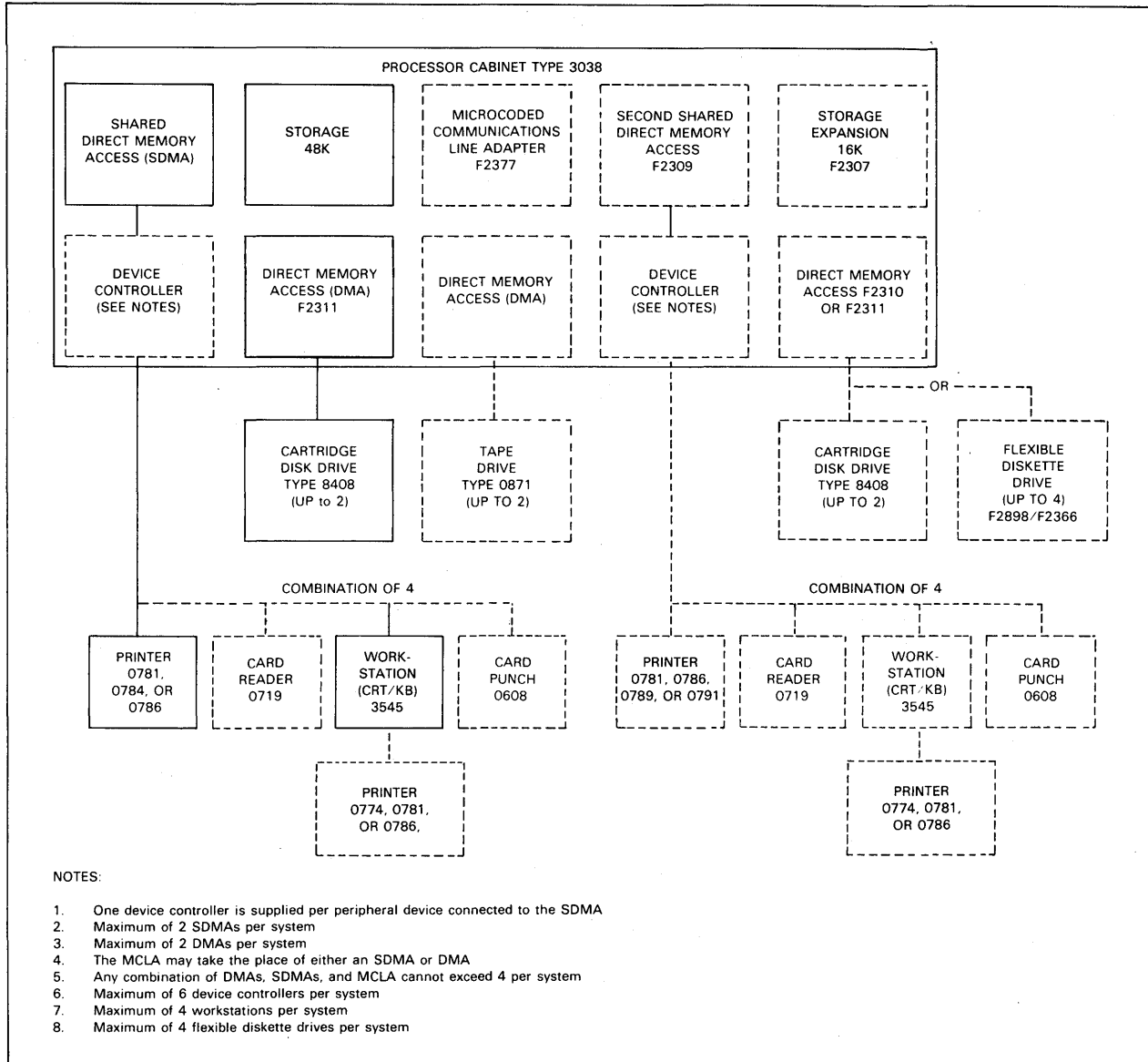

Figure 4-16. SPERRY UNIVAC BC/7-700 Series

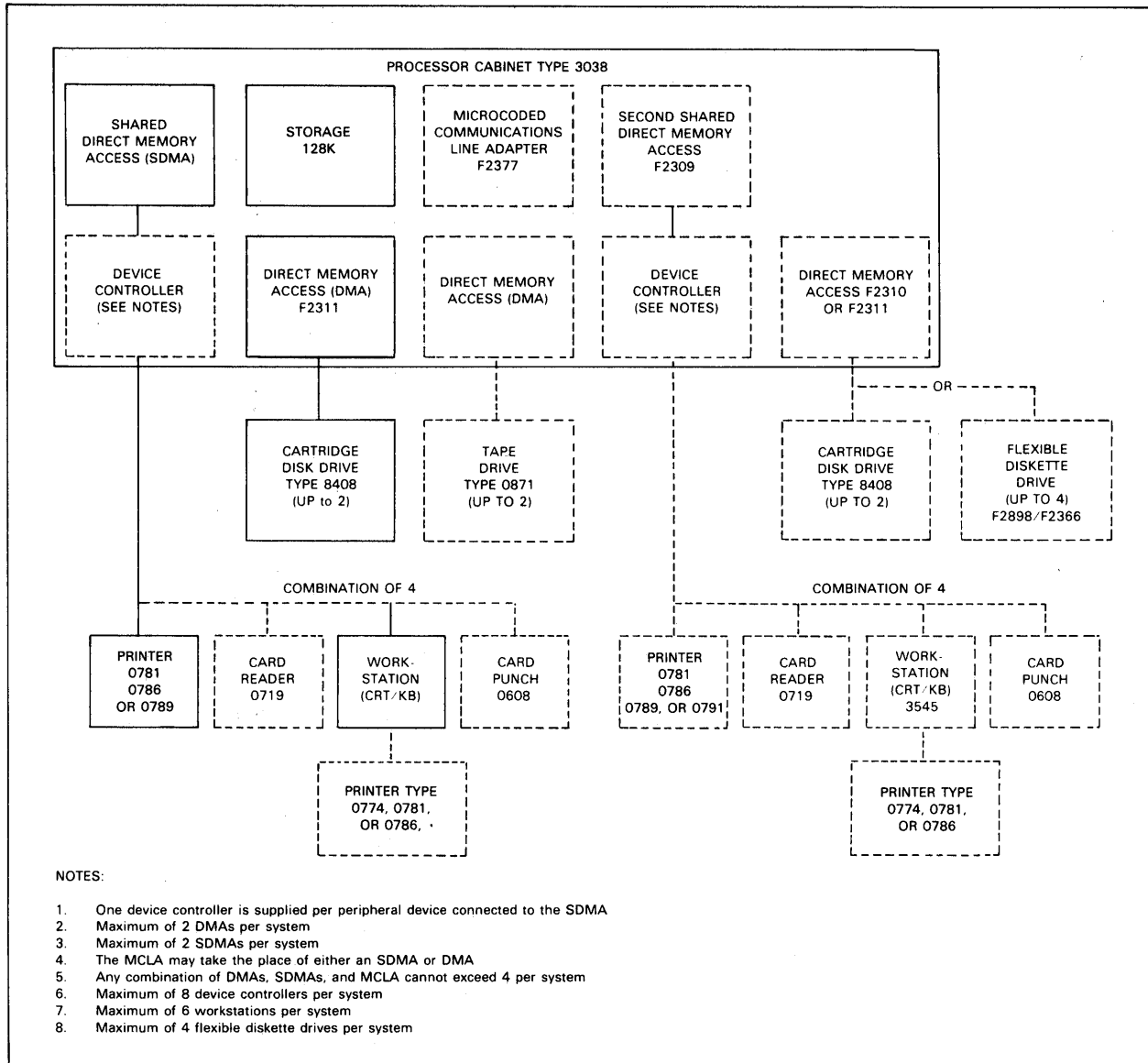

Figure 4-17. SPERRY UNIVAC BC/7-800 Series

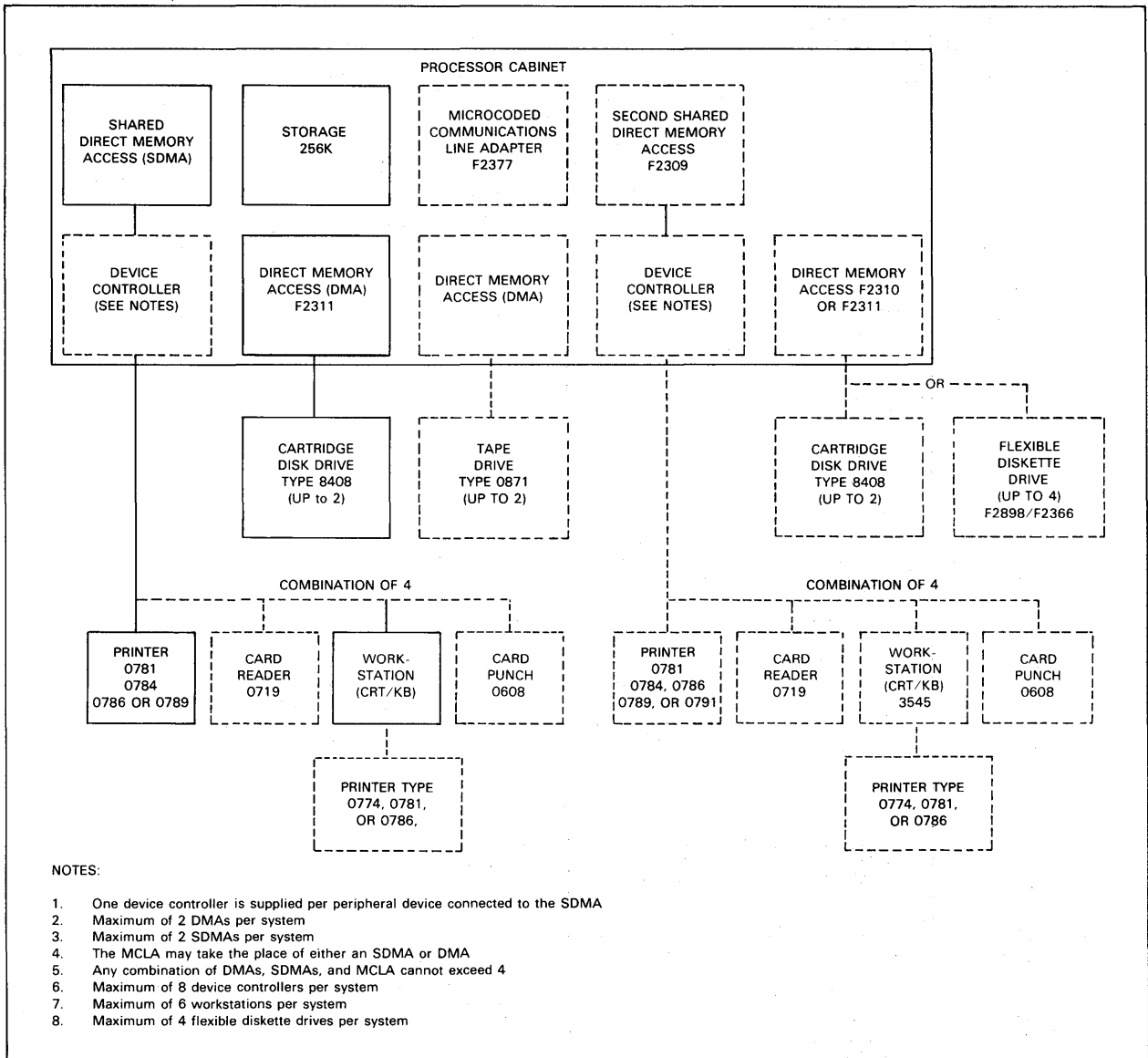

Figure 4—18. SPERRY UNIVAC BC/7-900 Series

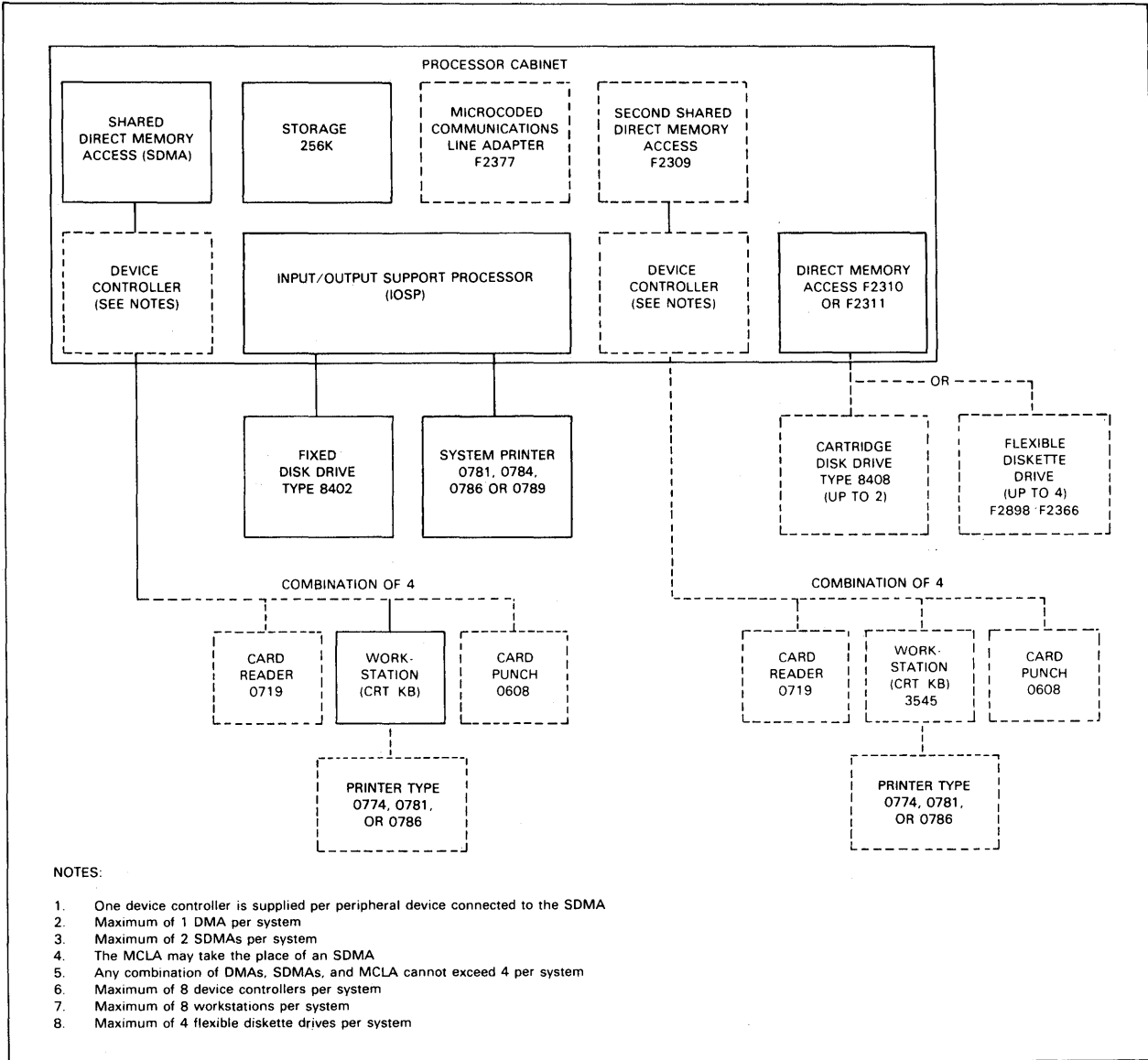

Figure 4—19. SPERRY UNIVAC BC/7-900 Series with Fixed Disk

5. Operating Environment

The SPERRY UNIVAC BC/7 Business Computer system can be operated on 120 volts. A system, comprising four workstations, a line printer, and a 20-MB cartridge disk drive would require approximately 2.5 kVA.

The operating environment, in terms of temperature and humidity, should comply with the recommendations of the federal government in the interest of energy conservation. While the system will function well despite variations from these norms, certain extremes should be avoided. Temperatures below 60° F (15.5° C) or above 90° F (32.2° C) or relative humidity below 25 percent or above 80 percent or condensation at any temperature may result in unpredictable performance due to paper, diskette, disk, or tape characteristics. The typical system described will dissipate about 8300 Btu/hr. Thus, the BC/7 will operate reliably in a normal, comfortable, employee-oriented office environment.

The typical system described should be allocated at least 300 square feet, which provides a service clearance of about 3 feet around the system.