

UNIVAC[®]

1108

MULTI-PROCESSOR SYSTEM

**DISPLAY
CONSOLE**

C O M P O N E N T
D E S C R I P T I O N

This manual is published by the Univac Division of Sperry Rand Corporation as a rapid and complete means of keeping recipients apprised of UNIVAC Systems developments. The information presented herein may not reflect the current status of the product effort. For the current status of the product, contact your local Univac Representative.

The Univac Division reserves the right to make such additions, corrections, and/or deletions as in the judgment of the Univac Division are required by the development of its respective Systems.

UNIVAC is a registered trademark of Sperry Rand Corporation.

Other trademarks of Sperry Rand Corporation appearing in the text of this publication are:

PAGEWRITER

CONTENTS

CONTENTS	1 to 2
1. INTRODUCTION	1-1 to 1-1
2. DISPLAY CONSOLE DESCRIPTION	2-1 to 2-6
2.1. GENERAL	2-1
2.2. CONFIGURATION	2-3
2.3. DISPLAY CONSOLE COMPONENTS	2-4
2.3.1. Keyboard and CRT Display Unit	2-4
2.3.2. PAGERITER	2-5
2.3.3. Day Clock	2-5
2.3.4. Operator's Control and Indicator Panel	2-6
3. PROGRAMMING	3-1 to 3-4
3.1. DISPLAY CONSOLE/CPU INTERFACE	3-1
3.1.1. Code/Symbol Relationships	3-1
3.2. WORD FORMATS	3-2
3.2.1. Function Words	3-2
3.2.2. Input Words	3-3
4. OPERATION	4-1 to 4-6
4.1. OPERATOR'S RESPONSIBILITIES	4-1
4.2. CONTROLS AND INDICATORS	4-1
4.2.1. Operator's Control and Indicator Panel	4-1
4.2.2. PAGERITER	4-5
4.2.2.1. PAGERITER Control Panel	4-5
4.2.2.2. PAGERITER Maintenance Panel	4-6
4.2.2.3. PAGERITER Power Control Panel	4-6
4.2.3. CRT Display Unit	4-6

FIGURES

2-1. Display Console	2-1
2-2. Display Console, Block Diagram	2-3
2-3. Keyboard and CRT Display Unit	2-4
2-4. PAGERITER	2-5
3-1. Function Word Format	3-3
3-2. Input Word Formats	3-3
4-1. Operator's Control and Indicator Panel	4-1
4-2. PAGERITER Control Panel	4-5

TABLES

2-1. CRT Display and Keyboard Characteristics	2-2
2-2. PAGERITER Characteristics	2-2
2-3. Display Console Components	2-3
3-1. Code/Symbol Relationships	3-1
4-1. PAGERITER Control Panel	4-6

1. INTRODUCTION

This manual contains preliminary information to meet the immediate needs of the programmer and operator of the Display Console for the UNIVAC 1108 Multi-Processor System.

Background information for the UNIVAC 1108 Central Processor Unit (CPU) and the Main Storage is contained in "UNIVAC 1108 Multi-Processor System Processor and Storage Reference Manual," UP-4053 (current version).

This manual is divided into three basic sections.

- Display Console Description
- Programming
- Operation

2. DISPLAY CONSOLE DESCRIPTION

2.1. GENERAL

Components of the UNIVAC 1108 Display Console are:

- a four-bank, 63-character keyboard;
- a cathode ray tube (CRT) display which can accommodate up to 16 lines of 64 characters each;
- a PAGERITER which prints up to 80 characters per line at a rate of 25 characters per second;
- a Day Clock which displays the time of day; and
- the associated indicators and control required for operator-CPU communication.

The Display Console (see Figure 2-1) is a free-standing input/output device for exercising certain programming options and for monitoring CPU operations. The keyboard, CRT, PAGERITER, and Day Clock can communicate with the CPU over an I/O channel. It also has adequate desk top space for the operator's use.

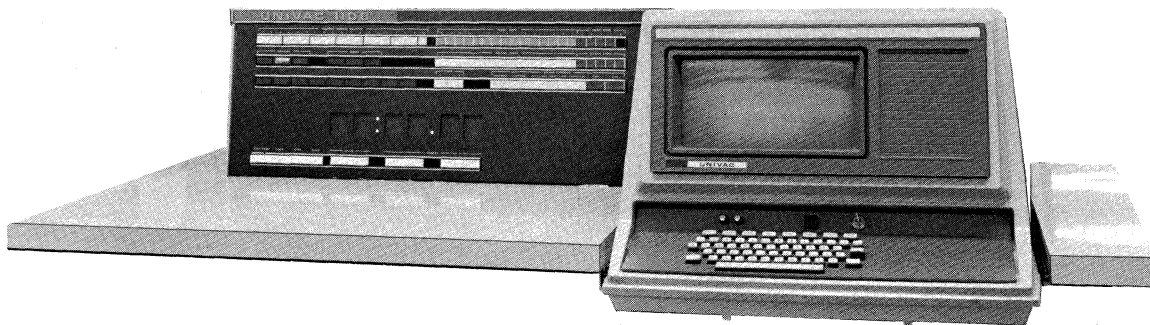

Figure 2-1. Display Console

The capabilities and characteristics of the individual units of the console are presented in Tables 2-1 and 2-2.

CHARACTERISTICS	
Display:	
Viewing Area	10 inches wide by 5 inches high
Buffer Character Capacity	1024
Display Format	16 lines, 64 symbols per line
Symbol Size	0.113 inch wide by 0.150 inch high
Symbol Set	60 output symbols plus space/erase and new line
Character Generation	Closed stroke, maximum 8 per character.
Scan Method	Digital
Regeneration Rate	60 times per second
Keyboard	Basic alphanumeric typewriter: 47 character keys (see 3.1.1) space bar 2 function keys 63 characters 8 interrupt keys

Table 2-1. CRT Display and Keyboard Characteristics

CHARACTERISTICS	
Maximum Line Length	80 characters
Character Spacing	10 per inch
Line Spacing	6 per inch (single space)
Character Size	0.072 inch wide by 0.100 inch high
Printing Speed	25 characters per second
Carriage Return Time	225 milliseconds or less

Table 2-2. PAGEWRITER Characteristics

2.2. CONFIGURATION

A block diagram of the console is illustrated in Figure 2-2. The subsystem types are listed in Table 2-3.

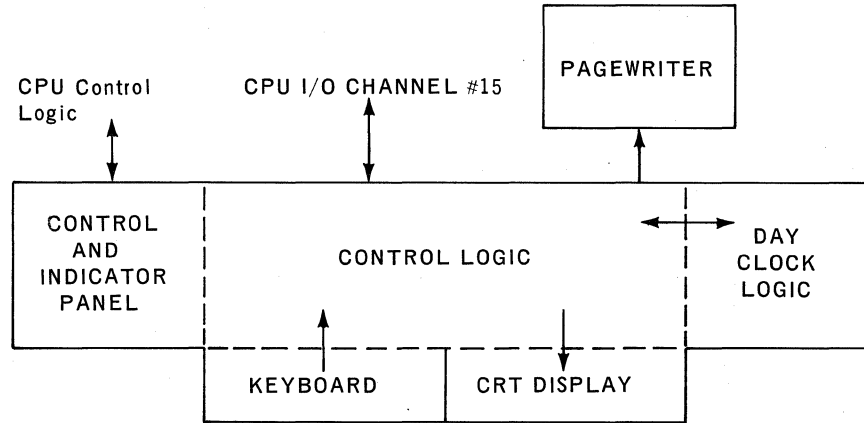

Figure 2-2. Display Console, Block Diagram

SUBSYSTEM COMPONENT	TYPE NUMBER	
	60HZ	50HZ
CONTROL INDICATOR PANEL WITH CRT DISPLAY AND PAGEWRITER	4009-99	4009-98

Table 2-3. Display Console Components

2.3. DISPLAY CONSOLE COMPONENTS

A description of each of the console components is given in the following paragraphs.

2.3.1. Keyboard and CRT Display Unit

This unit (see Figure 2-3) consists of a viewing screen and a four-bank keyboard resembling a typewriter keyboard.

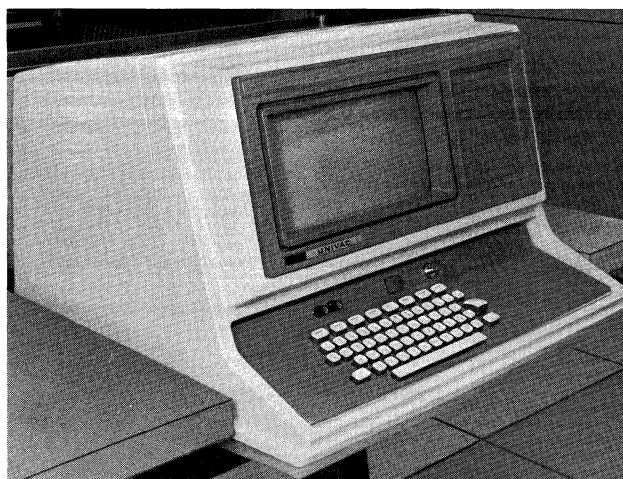

Figure 2-3. Keyboard and CRT Display Unit

The keyboard consists of 7 keys, plus the space bar, used to encode 63 of the 64 six-bit Fieldata characters, 2 function keys, and a row of 8 interrupt keys. Data entered from the keyboard is made available to the CPU, one character at a time, on the I/O channel connecting the subsystem to the CPU. Each character is accepted by an input buffer in the CPU and immediately sent back by the control program as output to the console for display on the CRT. No direct communication exists between the keyboard and the CRT or the PAGERITER. However, as keys are pressed, the corresponding characters are normally displayed by the control program on the CRT before formal release to the control program so that the operator can recompose and edit his entire message by using an appropriate interrupt key.

The 8 interrupt keys are used to generate an External Interrupt signal with a unique status code for each key. The specific purposes of these codes are defined by the software conventions adopted by the control program. The CPU can be forced to recognize inputs from the console when one of the interrupt keys is pressed.

All output data from the CPU for display on the CRT is transferred a word at a time from the CPU output buffer to the console disassembly register. The word is then disassembled into six-bit character codes and stored in sequential locations in the 1024-character CRT buffer memory. Since the display is character addressable under program control, the first character of each output message may be placed in any of 64 character positions in any of the 16 lines. The character codes are periodically read from the CRT buffer memory and used to drive generators that control display of the symbols on the face of the CRT.

2.3.2. PAGEWRITER

The PAGEWRITER (see Figure 2-4) is mounted on a pedestal cabinet which houses its associated circuits and power supply. The PAGEWRITER uses the Fielddata code/symbol relationship standard which is applicable to other UNIVAC 1108 system components. Its maximum line length is 80 characters; the printing rate is 25 characters per second. Horizontal spacing of characters is ten to the inch. Vertical spacing is six lines per inch.



Figure 2-4. PAGEWRITER

The PAGEWRITER is intended for use as a logging device to record all CRT transactions between the control program and the operator. Printable symbols are given in Table 3-1.

2.3.3. Day Clock

The Day Clock displays the time of day to the operator in hours, minutes, and hundredths of a minute, and also makes this time available to the CPU. The high order bit positions of each Day Clock input word contain the current Day Clock reading. The Day Clock turns on a Day Clock Request signal (separate from and independent of the Input Data Request signal associated with the keyboard data keys) at 600-millisecond intervals.

The CPU responds to each Day Clock Request signal by storing the Day Clock Input word (see 3.2.2 for format) at main storage location 216g. The Day Clock also generates a separate Day Clock Interrupt signal which is independent of keyboard activity. It interrupts the CPU once every six seconds. For each Day Clock Interrupt the current time of day is stored at address 216g. The instruction at address 217g is performed when the CPU recognizes the Day Clock Interrupt signal. Both of these main storage addresses are biased by the contents of the Memory Select Register (MSR).

2.3.4. Operator's Control and Indicator Panel

The Operator's Control and Indicator Panel includes fault, disable, and mode indicators for the CPU and the associated main storage modules. It includes displays and controls associated with the Program Address Counter, with selecting and releasing jumps and stops, with the CPU's Memory Select Register (MSR), and with the time display of the Day Clock. It also includes a set of system controls associated with the CPU and all subsystems connected logically to the CPU.

3. PROGRAMMING

3.1. DISPLAY CONSOLE/CPU INTERFACE

Communication between the CPU and the Display Console is over CPU input/output channel #15. Output data is sent to the console a word at a time (36 bits parallel). The control logic of the console will disassemble the word into 6-bit characters to be transferred to the CRT buffer memory or to the PAGEWRITER as specified by the most recently received function word.

3.1.1. Code/Symbol Relationships

Table 3-1 shows the relationship between the symbol shown on the face of each keyboard data key and the data code sent to the CPU when that key is pressed. It also shows the symbol displayed on the CRT or printed on a PAGEWRITER when each of the 64 possible six-bit codes is sent to the display console by the CPU. Of the 47 data keys, 45 are used for 60 display symbols by applying an upper case (capital) shift to 15 keys.



CPU CODE (OCTAL)	SYMBOL	CPU CODE (OCTAL)	SYMBOL
00	SS (See Note 1.)	50	*
01	[51	(
02]	52	"
03	NL (New Line) (See Note 2.)	53	:
04	(See Note 3.)	54	?
05	(space bar) No Display (See Note 4.)	55	!
06	A	56	,
through	through		(comma)
37	Z	57	
40)	60	0
41	-	61	1
42	+	through	through
43	<	71	9
44	=	72	'
45	>		(apostrophe)
46	— (underscore) (See Note 5.)	73	;
47	\$	74	/
		75	.
			(period)
		76	
		77	↑

Table 3-1. Code/Symbol Relationships (Sheet 1 of 2)

- Note 1: The data code 00_g can be supplied as input to the CPU by depressing the keyboard key labeled “ $\text{\$}$ ”. If the CPU sends the data code 00_g as output for the CRT or for a PAGERITER, the code will be discarded (completely ignored).
- Note 2: The data code 03_g can be supplied as input to the CPU by depressing the keyboard key labeled “NL”. The data code of 03_g from the CPU for the New Line function combines the “carriage return” and “line feed” actions for the CRT display and for the PAGERITER. A symbol will not be displayed or printed.
- If the 03_g code is sent for the CRT, it is not stored in the buffer memory. Instead, the character position counter for the CRT buffer memory is cleared to 00_g (the first character position of a line) and the line number counter for the CRT buffer memory is incremented by one. There is no erasing of any character being displayed in this case.
- If the 03_g code is sent for a PAGERITER, it initiates a combination “carriage return” and “line feed” action at the PAGERITER. Separate “carriage return” and “line feed” functions are not available.
- Note 3: The data code 04_g can not be supplied as input to the CPU. If the CPU sends the code 04_g as output for the CRT or for a PAGERITER, the code will be discarded (completely ignored).
- Note 4: The data code 05_g can be supplied as input to the CPU by pressing the space bar at the bottom of the keyboard. If the CPU sends the data code 05_g as output for the CRT, it is stored in the buffer memory and displayed as a blank character position. If the CPU sends the data code 05_g as output for a PAGERITER, it is detected as such and a blank character position is produced.
- Note 5: Two symbols can not be displayed or printed in the same position. The 46_g can not be used to underscore a displayed or printed symbol.

Table 3-1. Code/Symbol Relationships (Sheet 2 of 2)

3.2. WORD FORMATS

The selection of an output device and the symbols displayed or printed is controlled by function words and output data words. Input from the Display Console to the CPU is provided by input data words, status words, and Day Clock input words.

3.2.1. Function Words

A function word must be sent to the console preceding each output message from the CPU to specify whether the message is to be displayed on the CRT or printed on the PAGERITER.

The format of the function word is illustrated in Figure 3-1.

Bit positions 5 through 0 of each input data word contain the 6-bit data code (shown in Table 3-1) corresponding to the keyboard data key pressed. An input data word is made available to the CPU when a keyboard data key is pressed.

Bit positions 5 through 0 of each status word contain the status code corresponding to the event being reported. Possible status codes are:

- 01_8 through 10_8 Generated by pressing of the INTRUPT 1 through INTRUPT 8 keys.
- 11_8 through 16_8 Generated if a function word which selects the PAGEWRITER is received at a time when the PAGEWRITER is not ready.
- 20_8 Generated when a function word is received which contains a function code of 00_2 or 11_2 in bit positions 35 and 34.

Details on the Day Clock Input words are provided in 2.3.3.

4. OPERATION

4.1. OPERATOR'S RESPONSIBILITIES

The Display Console operator is responsible for the following:

- Turning on and turning off the console as required.
- Observing and responding to indications appearing on the various operator control panels.

4.2. CONTROLS AND INDICATORS

Controls and indicators on the components of the Display Console and PAGEWRITER are described in the following paragraphs.

4.2.1. Operator's Control and Indicator Panel

A layout of the Operator's Control and Indicator Panel is shown in Figure 4-1. The various control switches and indicators on this panel (grouped under the "section" labels shown on the layout) are described in the following text.

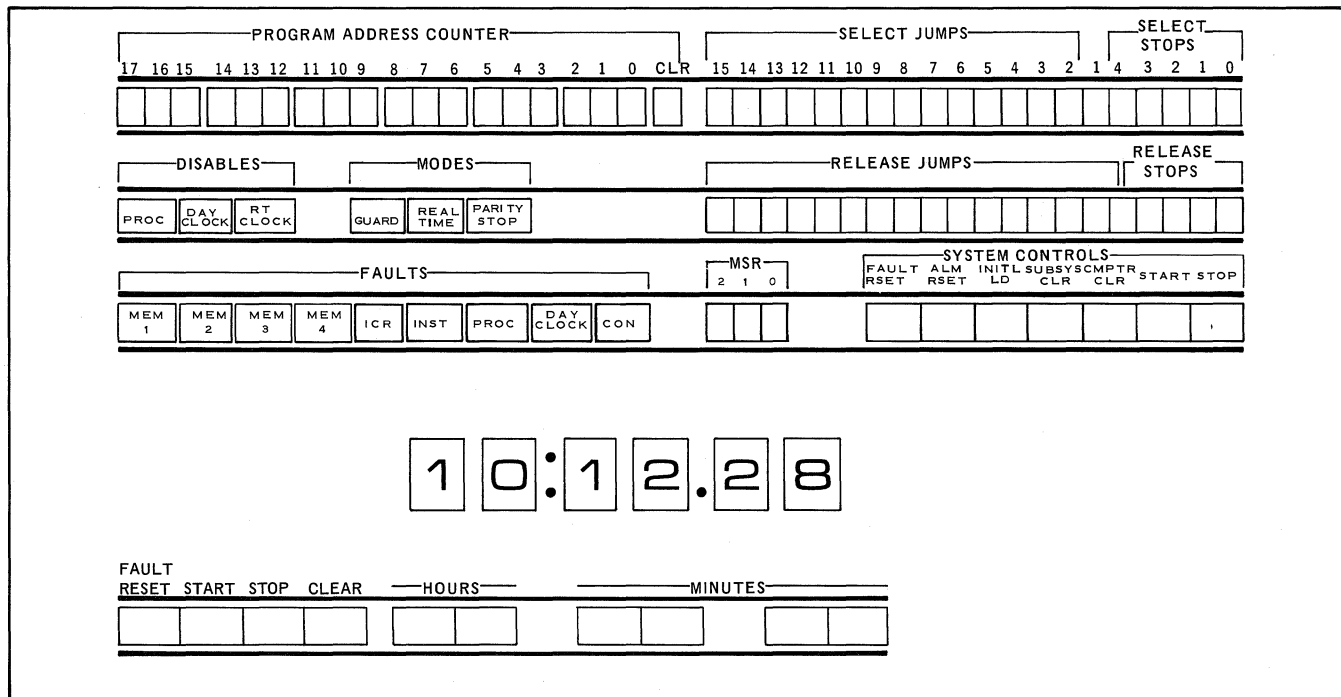

Figure 4-1. Operator's Control and Indicator Panel

■ PROGRAM ADDRESS COUNTER

This section contains 18 switch-indicators (labeled 17 through 0) and one switch labeled CLR. The indicators display the contents of the 18-bit Program Address Counter (P-register) in the control section of the CPU. The P-register normally contains the address of the next instruction to be performed. Pressing the CLR switch clears the P-register to all zeros. Pressing any of the 18 switch-indicators sets the corresponding bit position of the P-register to a 1 bit. All 18 indicators and 19 switches are disabled while a program is running.

■ DISABLES

This section contains three indicators as follows:

PROC	When lit, indicates that a switch on the CPU Maintenance Panel or a Main Storage Maintenance Panel has been set to prevent normal operation.
DAY CLOCK	When lit, indicates that Day Clock request and interrupt lines have been disabled.
RT CLOCK	When lit, indicates that decrementation of the real time clock register has been disabled. (The real time clock register is an addressable control register in the CPU. Its purpose is to monitor the running time of a program, routine, or subroutine and to inform the Executive program when the time exceeds a predetermined limit.)

■ MODES

This section contains three indicators as follows:

GUARD	When lit, indicates that the storage protection feature of the UNIVAC 1108 is active.
REAL TIME	When lit, indicates that certain controls on the Operator's Control and Indicator Panel are disconnected as a result of setting a switch on the CPU Maintenance Panel or the Availability Control Unit. When the REAL TIME indicator is lit, the only controls which have any affect on processor operation are the SELECT JUMPS switches, the RELEASE JUMPS switches, the RELEASE STOPS switches, and the keyboard with its eight associated interrupt switches.
PARITY STOP	Lights when the STOP ON PARITY switch on the CPU Maintenance Panel is set; indicates that the processor will stop on parity errors. Overridden by the MEMORY FAULT INTERRUPTS Disable Switch.

■ FAULTS

This section contains nine indicators as follows:

MEM 1, MEM 2, MEM 3, MEM 4	Each of these four main storage fault indicators, when lit, indicates detection of a parity error in one of up to four Main Storage Modules or module pairs.
ICR	When lit, indicates detection of a parity error in a control register.
INST	When lit, indicates detection of an illegal f-field in an instruction in the control section of the CPU.
PROC	When lit, indicates a power, air, or temperature failure in either the CPU or a Main Storage Module or Main Storage Module pair.
DAY CLOCK	When lit, indicates that a voltage transient may have caused an incorrect time readout.
CON	When lit, indicates detection of an air flow fault within the console or an abnormal setting of a switch on the Display Console Maintenance Panel.

■ SELECT JUMPS AND RELEASE JUMPS

The 15 SELECT JUMPS switch-indicators and the 15 RELEASE JUMPS momentary-contact switches are used in conjunction with the Jump-on-Keys instruction. Pressing a SELECT JUMPS switch lights the indicator and enables a corresponding jump when called for in the program. Pressing a RELEASE JUMPS switch extinguishes the corresponding SELECT JUMPS indicator and disables the jump.

The SELECT JUMPS switches provide a means of varying the program being run; for example, they enable bypassing a subroutine which calculates a monthly total while processing a weekly run. The programmer informs the operator which SELECT JUMPS switches must be set for his program. The lights indicate which switches are set. The switches can be set and released while the processor is operating, even while in the Real Time Mode.

■ SELECT STOPS AND RELEASE STOPS

Pressing one of the four SELECT STOPS switch-indicators (labeled 1 through 4) lights its indicator and causes the CPU to stop when the a-field of a Halt-on-Keys-and-Jump instruction contains a 1 bit corresponding to the SELECT STOPS switch. The SELECT STOPS indicator labeled 0 lights when a programmed unconditional stop occurs.

When the specified conditions are met by a Halt instruction, the CPU stops and the appropriate one of the five RELEASE STOPS switch-indicators (labeled 0 through 4) is lit. Pressing the lit RELEASE STOPS switches extinguishes the corresponding SELECT STOPS indicators and starts the CPU at the "jump-to" address specified by the Halt-Jump instruction which caused the stop.

Regardless of the setting of the SELECT STOPS switches and the contents of the a-field of a Halt instruction, no stop will occur when the CPU is set to operate in the Real Time Mode. However, if the CPU stops as a result of a Halt instruction and the Real Time Mode is then set, the RELEASE STOPS switches must be used to start the CPU.

■ MSR (Memory Select Register)

The three MSR switch-indicators are used to set a desired value in the MSR of the CPU and to display the contents of the MSR. The value in the MSR is used to select the Main Storage Module (for noninterleaved addressing) or the Main Storage Module pair (for interleaved addressing), referenced as an interrupt handling routine entrance when an interrupt occurs. The contents of the MSR can also be modified under program control.

■ SYSTEM CONTROLS

This section contains seven momentary-contact switches as follows:

FAULT RSET	When pressed, clears all fault indicators on the panel, except the DAY CLOCK FAULT.
ALM RSET	When pressed, turns off the audio alarm which was turned on by one of several fault conditions.
INITL LD	When pressed, loads a portion of main storage with a predetermined program from the subsystem selected at the CPU Maintenance Panel and starts the running of that program.
SUBSYS CLR	When pressed, clears the I/O section of the CPU and sends a Master Clear signal to each subsystem which is connected logically to any I/O channel of the CPU.
CMPTR CLR	When pressed, clears all CPU registers required to start the CPU.
START	When pressed, starts execution of the CPU program with the instruction at the location specified by the Program Address Counter.
STOP	When pressed, stops execution of instructions, but allows previously specified I/O data transfers to continue.

■ TIME DISPLAY

This set of six projection-type indicators displays the time-of-day in hours, minutes, and hundredths of minutes. It is driven by a 24-hour (DAY CLOCK) counter which automatically cycles from 23:59.99 to 00:00.00.

■ DAY CLOCK CONTROLS

The following 10 momentary-contact switches control operation of the Day Clock. They are disabled when the REAL TIME mode switch on the CPU Maintenance Panel is set for real time operation.

FAULT RESET	When pressed, extinguishes the DAY CLOCK FAULT indicator.
START	When pressed, starts the Day Clock running.
STOP	When pressed, stops the Day Clock to permit setting it.
CLEAR	When pressed, clears the counters for the Day Clock to all 0 bits.
HOURS (2) and MINUTES (4)	These six switches are used to step the six-digit positions of the Day Clock counter to set the time display to the appropriate time of day.

An Operational Use Time Meter is available as an option for placement at any convenient location on the console. This meter runs whenever the CPU is running. It displays the accumulated running time up to 9999.99 hours and then cycles to 0000.00 hours.

4.2.2. PAGEWRITER

The PAGEWRITER is equipped with a Control Panel, a Maintenance Panel, and a Power Control Panel.

4.2.2.1. PAGEWRITER Control Panel

The PAGEWRITER Control Panel (Figure 4-2) permits the operator to control and monitor printer operations. Table 4-1 describes the operation of each component.

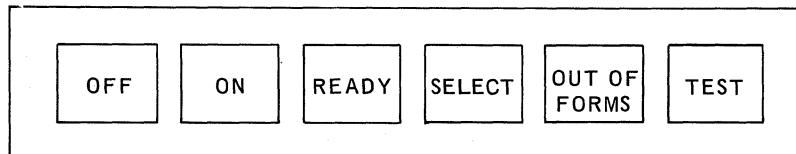

Figure 4-2. PAGEWRITER Control Panel

MARKING	FUNCTION
OFF (switch-indicator)	Used to remove DC power from PAGEWRITER. Lights when DC operating power is removed from PAGEWRITER.
ON (switch-indicator)	Used to apply power to PAGEWRITER. Lights when power is applied.
READY (switch-indicator)	Momentary-action switch. Lights when PAGEWRITER is ready to operate. Will not light if one or more of the following conditions occurs: out of paper, power failure, interlock open, or print actuator failure. Pressing of this switch clears the PAGEWRITER buffer memory.
SELECT (indicator)	Lights when PAGEWRITER is selected for operation.
OUT OF FORMS (indicator)	Lights when PAGEWRITER is out of paper.
TEST (switch-indicator)	When pressed, permits offline printing for maintenance purposes. Lights when PAGEWRITER is being tested for proper phasing.

Table 4-1. PAGEWRITER Control Panel

4.2.2.2. PAGEWRITER Maintenance Panel

There are four switches on the PAGEWRITER Maintenance Panel, under the mechanism cover. They are: Off-Line, Move Ribbon, Move Carriage, and Manual Paper Feed. These switches are for test purposes only.

4.2.2.3. PAGEWRITER Power Control Panel

The PAGEWRITER Power Control Panel in the electronic module portion of the PAGEWRITER pedestal comprises a main-power circuit breaker, three auxiliary circuit breakers, print-actuator circuit breaker, and a three-wire male receptacle for incoming power.

4.2.3. CRT Display Unit

The CRT Display Unit includes a viewing screen and a keyboard, both of which have been described in Section 2, an On-Off switch, and two display controls.

- On-Off switch requires a key to operate. It applies power to the CRT and places it in an operating state.
- Focus control is used to focus the symbols on the viewing screen.
- Brightness control is used to adjust the intensity of the symbols being displayed.

