

CUSTOMER ENGINEERING

NEWS LETTER

January 30, 1958

SUPPOSE YOU WERE SIGNING!!

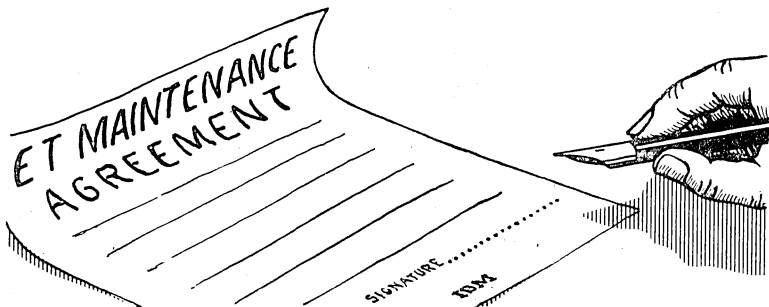

YOU own the ET!! YOU pay for the ET's maintenance!! What would YOU expect from a service contract?? These points will sell YOU on the value of a Maintenance Agreement.

A Maintenance Agreement gives YOU peace of mind and relieves YOU of any worry regarding ET performance. It protects a capital investment

Most ET operators are women, normally not technically minded, and yet they are responsible for YOUR ET. The Maintenance Agreement places the responsibility of servicing the ET in the hands of a highly skilled Customer Engineer.

YOUR ET receives more usage, dirt, and abuse than almost any other piece of office equipment - YOU should consider it first for maintenance service.

Are YOU operating on a budget?? Then a Maintenance Agreement is a natural for YOU since YOU will know the exact expense for the next year.

The cost of YOUR maintenance service can be charged off as operating expense on YOUR tax return.

MODEL B HEKTOWRITER SERVICE HINTS

The following adjustments have been found helpful for improving ribbon feed on the Model B Hektowriter.

1. Increase the carriage tension to approximately 3.5 pounds.

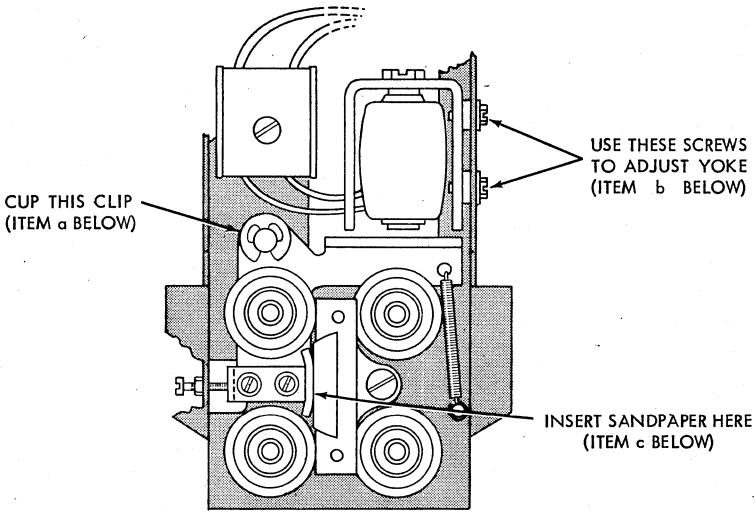

2. Eliminate play in the auxiliary carriage magnet armature as follows:
 - a. "Cup" the magnet armature C clip slightly so that a slight pressure is exerted downward on the armature.
 - b. Adjust the magnet yoke by means of its 2 supporting screws so that the armature contacts the yoke squarely. A slight angle at this point will result in the armature being cocked when attracted to the magnet and ribbon slippage may result.
 - c. Insure that the brake shoe contacts the rubber brake squarely. The shoe can be formed slightly to effect this condition. If the rubber pad does not appear to have a flat surface, insert a fine grade of sandpaper between the brake shoe and pad and sand the pad until a flat surface is attained.

3. Adjust the air gap between the magnet armature and its stop to approximately .012" to .015".
4. Insure that there is some clearance between the shoulder of the friction disk assembly (area just above the large C clip) and the bottom shoulder of the reverse lock assembly (part in top flange assembly with square hole through center.)

NOTE: To insure that the tab lever will be unlatched at the right end of the carriage, relocate the tab rack R.H. fulcrum wire stop to the left of its normal position. It should be positioned so that, with the carriage moved to the extreme left (against the new carriage final stop) the tip of the tab lever will contact the approximate center of this stop.

Whenever it is necessary to remove end play in the auxiliary carriage, or if one of the platen knobs is closer than the other to the auxiliary carriage frame, either condition may be corrected in the following manner: Form slightly either "Collar" of the auxiliary carriage (where auxiliary carriage bears against inside shoulder of platen knob.) Care should be exercised in forming so that the collars contact the inside platen shoulders squarely. Sharp corners will damage the platen shoulders. End play will cause partial overlapping of the first character typed after carriage return.

* * * *

CORRECTIONS ET REF MANUAL - HEKTOWRITER SECTION

Page 5, Paragraph 2: Delete paragraph 2. Substitute as follows: By turning off the Hektowriter switch located on the R.H. side frame and tilting the attachment to the rear, the machine can be used for normal typing. (Figure 4)

Page 11, Wiring Diagram: Delete the word "Micro-switch." Substitute the words "Toggle Switch."

* * * *

REPOSITIONING INDICATOR LUBRICATION

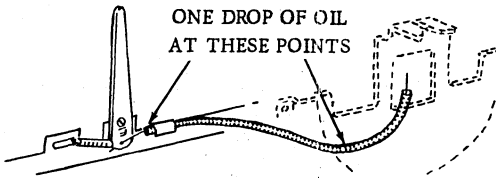

It is very important, when installing a Repositioning Indicator, that the wire (Pt. #1110239) be lubricated with #6 oil to prevent its breaking. Lubrication should be applied only at the points shown on the accompanying drawing. Extreme caution must be taken to insure that only one small drop of oil is placed at these 2 points. An excess amount of oil applied to the wire and cable may result in its transfer to the paper in the ET. This method of lubrication has been tested and found to greatly extend the life of the Repositioning Indicator wire.

* * * *

FLAT KEYPLATE

The Model B keyplate is now manufactured in a manner which reduces the amount of "bow" that was formerly in this part. This improved method of manufacturing greatly facilitates assembly of new Model B ET's and should reduce the number of service calls on ET's as a result of binding key buttons.

* * * *

PLANT ALIGNING SAMPLE WITH CHANGEABLE TYPEBARS

All new Model B ET's with changeable typebars are now shipped with an additional Plant aligning sample showing a strike-up of all changeable typebars. This change was recently initiated as an additional effort by the Plant to improve this special feature and ET quality.

* * * *

CORRECTIONS: Parts Catalog: Model 1B - Carriage and Rails Assembly page 5, Item H. Change Part #1108883 to read Pt. #1108833.

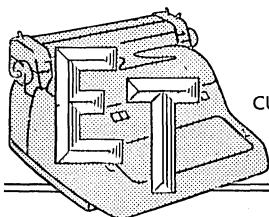

CUSTOMER ENGINEERING

NEWS LETTER

March 31, 1958

REDUCING MARGIN SET LEVER BENDING

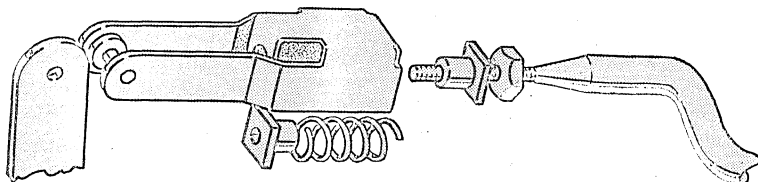

News Letter #35 pointed out that 2 springs installed in the margin stops would usually prevent bending of the margin stop spring in school ET installations.

Bending of the margin set lever, another problem frequently encountered in school installations by operators unfamiliar with setting margins, can be alleviated by the following procedure:

Remove the adjustable clevis that connects the margin set connecting link to the margin set key lever.

The spring loaded clevis (#1105838), formerly used with the universal bar trip link, (Parts Catalog, Cam and Typebar Section) is assembled as shown in the accompanying illustration. This is accomplished by moving the plunger (#1104419) to the other end of the clevis (#1104421) which in effect changes this clevis from a pushing type of clevis to a pulling type. It will be necessary to replace the clevis spring with a heavier compression spring (#1093650) with 3 loops removed.

(over)

When installing the spring loaded clevis on the connecting link, place an additional plunger at the lower end of the clevis as shown in the illustration. This is placed in an opposite direction to the plunger already installed in the clevis. This will allow better movement of the link in the lower clevis hole. It is also suggested that a lock nut (#1091057), be placed below the lower plunger to prevent loosening.

The spring loaded clevis should be adjusted to properly set margins, yet not allow over depression of the margin stop. The flat side of the clevis should be up as illustrated.

NOTE: If the threaded end of the connecting link hangs in the small non-threaded hole of the clevis, it will be necessary to remove either a portion of the threaded link or the small section of the clevis which contains the hole.

Spring loading prevents bending of the margin set lever when a margin stop has reached the limits of its travel. The spring relief allows the lever to ride upon a margin stop rather than bend.

* * * *

PREVENTING BACKSPACE CLEVIS FROM "PULLING OUT"



The backspace side link rear pin clevis may be prevented from pulling out of the bell crank hole by forming the clevis so that the clevis pin will favor the rear of the bell crank hole. The clevis should be formed in the area shown in the illustration. It will be necessary to pinch the clevis pin through the clevis hole after it is formed. This adjustment procedure causes the pin to lock in the clevis hole during each backspace operation preventing the clevis from pulling out of the bell crank. NOTE: Forming of the pin will result in breaking the pin from the clevis.

* * * *

MARGIN STOP SPRING INSTALLATION

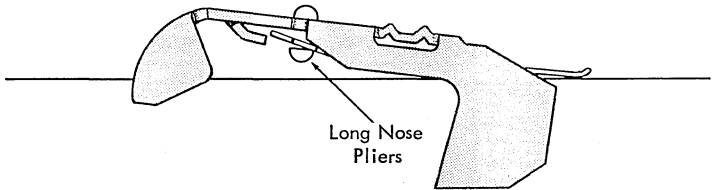

Replacement of margin stop springs in Model A and BET's without removing the margin stop may be accomplished in the following manner:

The old spring must be removed and the new spring inserted from the rear of the machine with the carriage extended to either the extreme left or right and the stops moved to the left or right to clear the feed rolls.

Raise the margin stop from the margin rack. With the long nose pliers, twist and pull out the old spring.

Slide the new spring under the margin stop on top of the margin rack slightly past its normal position.

The "T" portion of the spring will lie on the lower inclined plane of the margin stop so that it will readily snap into its normal position when the spring is compressed with the long nose pliers. The small 3" screw driver may also be used to guide the spring into position and the spring may be kept from shifting with the forefinger.

This method, which has been used successfully in several Branch Offices, requires a certain amount of practice but may help save time when you become familiar with it.

* * * *

TABBING THROUGH THE LEFT HAND MARGIN

Operators desiring to tabulate "through" a left hand margin to a set tab stop near the left hand margin may occasionally find that the carriage locks on the tab stop. This condition, a result of friction between parts throughout the tab mechanism, may be reduced by one or a combination of the following methods:

Reduce the downward tension of spring (#1090162) on the governor control lever bracket assembly.

Increase the tension of the tab lever to rear frame spring (#150655). This results in helping to restore the tab lever to normal position when the margin lever is under the left hand margin stop.

Polishing of the top of the margin lever plate, bottom of the left hand margin stop (at point of contact with the margin lever plate), the tab latch and the bottom of tab lever "window" will also help to reduce the problem.

* * * *

ORDERS FOR TYPEBARS AND KEYBUTTONS

Part numbers were released for certain "Special Character Typebars" and their associated Keybuttons, December 1, 1957. They have been stocked in all Parts Distribution Centers to facilitate processing Emergency and Rush Orders. These are the most popular typebars in given positions, proven by customer demand. Please use these new numbers, listed on Page C-15 of the Parts Catalog, for all future orders.

* * * *

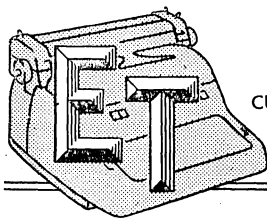

CUSTOMER ENGINEERING

NEWS LETTER

May 29, 1958

RECENT ET IMPROVEMENTS

THE REPOSITIONING INDICATOR CABLE BRACKET now has the cable clips extruded from the bracket material as shown in the illustration. This improvement allows the cable to be crimped in to position on the bracket which prevents cable movement and provides more stability to the short cable.

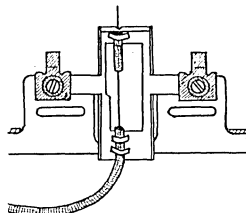

The top of the cable bracket is now rounded to reduce the possibility of the ribbon hanging on the cable. The wire hole in the Repositioning Indicator lever (# 1110240) has been lowered one tenth of an inch to provide more movement to the indicator wire. This change results in the wire dropping below the top of the cable when not being used.

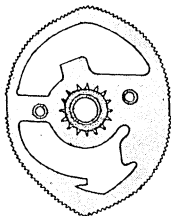

THE SHIFT CAM bearing is now being serrated to the cam body to prevent slippage of the cam bearing from the cam. This method of assembly replaces that of soldering the cam bearing to the cam.

THE PUSHER AND LEVER ASSEMBLY now has additional material added to the shift pusher lever to prevent possible interlocking of pusher and snubber levers. The absence of this added surface previously allowed the shift to "hang up" occasionally. The part number remains the same.

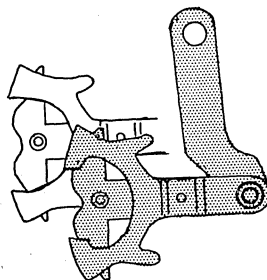

THE MARGIN STOP SPRING has been made harder to reduce bending.

THE DETENT ARM ASSEMBLY ROLLER wear has been corrected by additional case hardening of the rollers.

Each of these improvements will result in a better product for our customers and greatly reduce service time.

* * * *

PILING PROBLEMS??? THEN READ THIS!!!

Several Branch Offices indicate that type piling problems have been eliminated by removing the escapement pawl shim or by forming the escapement pawl spacer counter clockwise. The escapement pawl shim is placed on all Standard ET's to compensate for possible tolerance build-up in the escapement mechanism and to insure the proper angle of the pawl in the escapement rack. Whereas this method of assembly results in reducing the tolerance build-up, it may occasionally result in excessive tolerances in the escapement mechanism. This additional tolerance forces the escapement pawl tail to get behind the spacer. Removal of the shim or form of the pawl spacers shortens the distance traveled by the pawl spacer, allowing it to rebound from the escapement pawl stop and clear the escapement pawl tail.

* * * *

TOOL BAG INITIAL STOCK

Future shipments of initial stock for the CE's tool bags will not include 01 parts. Any 01 parts needed for the tool bag may be requisitioned from the local Branch Office Stockroom.

* * * *

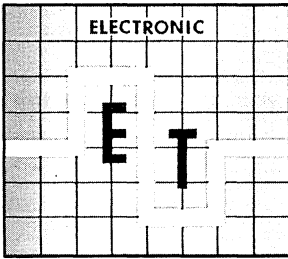

MODEL 632 - RELAYS

Preventive maintenance on relays is important to preclude machine troubles. Although cleaning of points is the most frequent requirement of duo relays, note that each is adjusted properly as it is being cleaned. Armature air gap, contact air gap, and contact strap tension can be quickly checked.

It is recommended that maintenance be made in blocks; that is, clean or replace the points in one area then operate the machine on a functional test tape before progressing to another area. In this way any problems resulting from cleaning or adjusting will be localized.

During the extensive testing of the Model 632 prior to its announcement, much valuable experience was gained by the ET Testing Laboratory. Some of that information is being printed here for assistance to the ETC Customer Engineers.

The list below indicates cleaning factors or replacement factors for relay points, as required during testing. Those at the top of the list represent the most troublesome and should receive the most attention during inspection. Example: On Machines #1 - 10 relay point 18 BU n/o required 8 times as many cleanings as 4 BU n/o.

On Machines #1 - 10 the relays addressing memory will require frequent cleaning or replacement to prevent losing bits from digits.

Wire Contact Relay Points That Required Replacement Relays Addressing Memory

		<u>A Time</u>	<u>B Time</u>
289			
291	S1	320	332
292	S2	322	333
295	S3	313	324
309	S4	319	330
310	S5	317	329
312	S6	316	327
323	S7	315	326

MACHINES #1 - 10

DUO-RELAY POINTS THAT REQUIRED CLEANING

WIRE CONTACT RELAY POINTS THAT REQUIRED REPLACE.

Relay Points	Cleaning Factor	Relay Points	Replacement Factor	Relay Points	Replacement Factor
18 BU n/o	8	210-12	9	210-8	1
18 BL n/o	"	249-3	7	210-9	"
18 AU n/o	"	210-11	3	217-2	"
18 AL n/o	"	217-5	"	217-3	"
30 AU n/o	5	110-4	2	218-5	"
31 BU n/o	"	172-2	"	246-3	"
XBL n/o	"	175-2	"	238-1	"
16 AU n/o	4	180-2	"	249-12	"
XBU n/c	"	204-3	"	F - 3	"
11 BU n/o	3	210-3	"	1' - 1	"
16 AL n/o	"	210-10	"	2' - 1	"
16 BU n/o	"	217-1	"	4' - 1	"
30 BU n/o	"	218-4	"	8' - 1	"
9 BU n/o	2	F - 5	"		
16 BL n/o	"	105-4	1		
17 BU n/o	"	109-3	"		
36 BL n/o	"	132-4	"		
XBL n/c	"	149-1	"		
YBL n/o	"	152-1	"		
YBL n/c	"	155-1	"		
YBU n/c	"	158-1	"		
4 BU n/o	1	198-7	"		
4 BL n/o	"	195-3	"		
4 BU n/c	"	195-6	"		
11 AU n/o	"	195-7	"		
15 AL n/o	"	195-8	"		
17 AU n/o	"	204-2	"		
29 AL n/o	"	210-1	"		
29 BU n/o	"	210-5	"		
35 AU n/o	"	210-6	"		
36 AL n/o	"	210-7	"		

MACHINE #11 AND ABOVE

DUO-RELAY POINTS THAT REQUIRED CLEANING

WIRE CONTACT RELAY POINTS THAT REQUIRED REPLACE.

Relay Points	Cleaning Factor	Relay Points	Cleaning Factor	Relay Points	Replacement Factor
2 BU n/o	9	4 BL n/o	2	201-12	7
2 AU n/o	8	12 BU n/o	"	168-4	4
2 AL n/o	6	29 BU n/o	"	101-2	"
1 BU n/o	"	11 AL n/c	"	103-2	"
28 BL n/c	"	26 BL n/o	"	164-5	"
29 BL n/o	"	1 BU n/c	1	164-4	3
1 AU n/o	5	1 BL n/c	"	164-10	"
2 BL n/o	"	3 AL n/o	"	171-4	"
8 BU n/o	"	4 BL n/c	"	201-11	"
29 BL n/c	"	5 AU n/c	"	106-2	2
3 AU n/o	4	10 BL n/c	"	196-1	1
4 BU n/o	"	13 BU n/o	"	121-1	"
5 BU n/c	"	14 AL n/o	"	121-6	"
11 BU n/o	"	14 AL n/c	"	143-1	"
29 BU n/c	"	15 BU n/o	"	157-1	"
1 AL n/o	3	16 BU n/o	"	164-1	"
4 AL n/c	"	17 BU n/o	"	164-3	"
5 BU n/o	"	18 BU n/o	"	164-9	"
10 BL n/o	"	27 BL n/o	"	171-2	"
15 AU n/o	"	28 BL n/o	"	171-5	"
26 AL n/o	"	28 BU n/c	"	189-6	"
28 BU n/o	"	29 AL n/c	"		
28 AL n/o	"	2 AL n/c	"		

HEKTOWRITER ADJUSTMENT HINTS

As a result of recurring ribbon feed problems, the adjustment for the ribbon clutch has been amended to read as follows:

Adjust the ribbon friction clutch so that a pull of 4 1/2 to 5 1/2 ounces is required to turn the upper spool (measured by wrapping string around the take-up spool segment and attaching scale) when the lower supply spool is held fast.

In cases of severe feed difficulties, it may be helpful to increase the tension somewhat beyond the 5 1/2 ounce specification. If this is done, it may be necessary to increase the carriage main spring tension beyond that specified in News Letter #51 (approximately 3.5 pounds) in order to overcome the added ribbon drag.

The following may be used to minimize over and underprinting.

Reposition the plastic guide strip up or down from its present location by means of the eccentric knurled bearing knobs.

If step one fails to eliminate either or both conditions, remove part of the lower, upper or both "lips" by filing sanding, stoning, etc.

* * * *

ETC PROTOTYPE PARTS LIST

On page two of this Parts List, delete Part #316541-Tape-Plastic Program.

This is to be obtained and stocked as a DP supply item in the Branch Office. It cannot be ordered from the Lexington Plant.

* * * *

STICKING INTERPOSERS

Skipping of units on Executive ET's occasionally may be a result of a build up of dirt in the interposer cage between interposers. Several Branch Offices have found that flushing of the interposer cage with IBM Cleaning Fluid and relubricating with a mixture of IBM #6 oil and IBM Cleaning Fluid frequently corrects the problem.

Reports received indicate that this procedure is especially helpful when the 2 unit interposer tends to pull the 3 unit interposer forward.

* * * *

REPOSITIONING INDICATOR CABLE CLIP

The cable clip, (part #1110453) used for holding the repositioning indicator cable to the dust cover, should be placed on the dust cover with the T (stamped on clip) on top. Placing the clip on the dust cover in this manner will prevent interference of the clip with the bottom of the L.H. carriage end cover during carriage movement.

* * * *

PLEASE NOTE THIS CORRECTION

In the small Parts List and Reference Material booklet - page 7A, under IBM 632 Electronic Typing Calculator. Change Model Code 63 to 67.

* * * *

PARTS CATALOG CORRECTION

Tabular Mechanism - Models A and B Figure 1 - Page 4
Item #41:1000711 Plate, Friction Governor
Add: Model A except 1/45 Executive.
1093726 Plate, Friction Governor.
Add: Model B and Model's A and B 1/45 pitch.

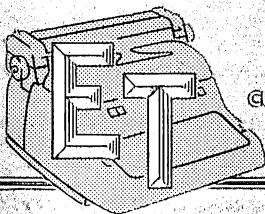

CUSTOMER ENGINEERING

NEWS LETTER

July 17, 1958

A Helping Hand

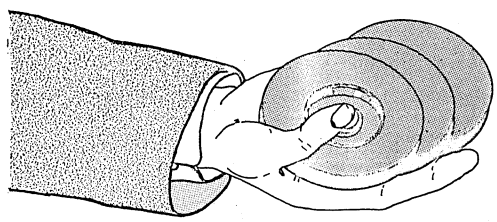

521, 522, 523 CARBON PAPER RIBBONS!!!

IBM Developed!!! IBM Engineered!!! IBM Manufactured !!!

NOW we have 3 new IBM manufactured ribbons which give cleaner, sharper results with the entire range of type styles and bond paper. The carbon paper ribbons that all ET CE's have been waiting for!!! These new ribbons are superior to our present line of ribbons with the following distinctive advantages:

- Uniformity of color!! Latest Manufacturing processes!!!
- Cleaner sharper write!! Excellent short run on most paper masters.
- Easier to erase!! Extra quality at no change in price!!!

The 521, 522, and 523 ribbons replace 8 other non-IBM manufactured ribbons as follows:

- | | |
|--------------------|---------------------------|
| 530, 510, 5111 | Replaced by 521 |
| 520, 540, 5211 | Replaced by 522 |
| 550, 523 (1010915) | Replaced by 523 (1010674) |

Here's an improvement for our customers and a welcomed helping hand for all CE's!!!



RIBBON TRACKING ADJUSTMENT

Peening of cam levers is suggested in the Model A1 Section of the Reference Manual, page 52, for improving ribbon tracking.

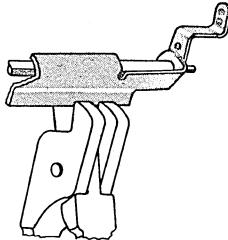

A much easier method for improving ribbon tracking is that of forming the ribbon lift bail with the 3 prong aligning pliers as illustrated. It will be necessary to detach the clevis of the ribbon bail to cam release link to properly make this adjustment. The bail may be formed toward the cam lever tip for more throw or formed away from the cam tip for less throw.

* * * *

LEAD CORDS WITH PIG TAILS NO LONGER AVAILABLE

ET lead cords with the pig tail grounding (Pt. # 1076962 and # 1077104) will no longer be supplied on IBM ET's or for part replacement. This method of grounding is no longer acceptable. It will be necessary to use one of the following 3 conductor lead in cords where grounding is required.



Part No.
1076978



Part No.
1106000



Part No.
1106001

CREAKING COG BELTS

Several Branch Offices have found that a light coating of #17 grease on the drive and driven cog belts greatly reduces the creaking noise occasionally found on ET's in quiet locations. A light application of #17 grease to the neoprene belts does not appreciably harm the nylon backing used on the belt teeth nor the cord inside the belts. NOTE: Excessive amounts of grease will result in a dirty inside cover and side frame.

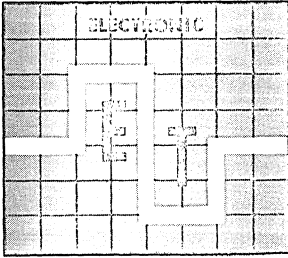

PROGRAM TAPE

Burrs on the bottom leading edge of the hole in the Program Tape can cause the star wheel to skip over the hole. The burrs can be caused by a dull program tape punch. Judicious sharpening of the punch or replacement is recommended. Light sandpapering of the lower side of burred program tape will usually suffice as an emergency repair until the tape punch can be corrected.

* * * *

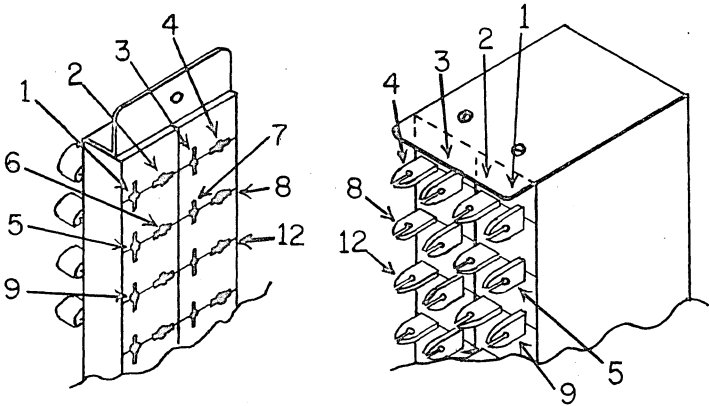

ELCO CONNECTOR PIN LOCATIONS

* * * *

CORRECTION: ETC Prototype Parts List - page 1 of 5, Items 6 and 7 should be changed to read as follows:

<u>PRICE</u>	<u>PART NO.</u>	
6.30	333265	Diode - Type F or IN-92 (Used in RC networks.)
6.40	335353	Diode - Type J (Glass, with wire leads.)

* * * *

METER BATTERIES

The instruction sheet accompanying meters supplied by IBM recommends replacement of batteries every six months. Many meters returned for repair have contained old batteries that are leaking in the meter. This leakage causes corrosion and necessitates complete removal and replacement of battery contacts. It is recommended that a "dating label" system be used to show the date batteries were replaced. The label may either be Pressure Sensitive Tape, or one of the service stickers available in all offices. The label should be placed in a conspicuous location either on the meter or on the carrying case.

* * * *

DUO RELAY ADJUSTMENT

When inspecting the Duo Relays in the 632, remember, any adjustment of the armature air gap will effect the relay pick and drop time. This adjustment should be changed only when it has been found to vary widely from the listed specifications or when it is causing a faulty timing condition. During manufacturing the air gap is adjusted to obtain proper pick and drop times.

* * * *

GRAM GAGE

Direct readings may be taken using the long, thin spring blade supplied with the gram gage #450459. Higher readings may be taken using the 10X blade. This is the shorter and thicker blade which multiplies each reading by 10. To insure accurate readings, the load must be applied at the small hole near the end of the blade. A 2X blade is also available for DP but is not required.

* * * *

CORRECTION: BUFFER TEST TAPE

The Buffer Entry Test Tape Program, (ETC #10046 and above) should read, FW 10 and Punctuate in field four. This will correct the program to correspond with the indicated punches.

* * * *

CHECK POINTS FOR EXECUTIVE SKIPPING

Effective reduction of skipping problems in Executive ET's frequently necessitates a very thorough investigation of the problem.

A list of check points are listed below with illustrations which will assist in locating such problems:

1. Binds in interposer bellcrank.
2. Pawls held partially out of the escapement rack by tab lever not restoring, bind in carriage release mechanism, or binds in pawl release lever.
3. Interposers or pawls not vertical.
4. Binds between pawls and pawl block.
5. Long or short escapement pawls.
6. Springs off interposers.
7. Escapement pawl spring bracket rubbing under side of rail.
8. Space bar cam repeating.
9. Worn escapement pawls especially #4 and #8 (tip of pawl).
10. Binds in the latch releasing lever or insufficient clearance between it and the springs lugs of pawls.
11. Chipped escapement rack tooth if skipping occurs in one place.
12. Escapement pawl block shifting. (Backspace failure would also be detected).
13. Too much interposer motion, side to side, in cage.

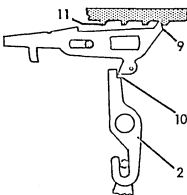
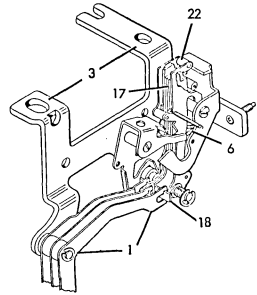

NOTE: If either the 2 unit interposer or the interposer cage requires replacement between the following serial numbers, it will be necessary to replace both the cage and the two unit interposer.

1/32 Escapement	# 125,846 - # 136,000
1/36 Escapement	# 129,000 - # 135,000
1/45 Escapement	# 134,373 - # 150,000

Replacement of both parts is necessary since the 2 unit interposer was made slightly wider in these serial number ranges.

14. Tension tape bracket (Part # 1071209) hitting the intermediate grouping lever.
15. Back space aligning link adjusted too short.
16. Bind in grouping.
17. Expand interposer goes back with the two unit interposer.
18. Interposer and cage binds on shaft.
19. Two unit interposer pulling three unit interposer. (See News Letter # 53).
20. Gummy escapement rack (slides pawl before a tooth contacts it).
21. Excessive oil on interposers.
22. It is possible for the interposers to hit the top spacer of the interposer cage if they are raised too high. This would show up as type crowding. Interposer bellcrank links should be adjusted to prevent this from happening.

If all items mentioned above fail to uncover a reason for failure it might be wise to check for burrs on the interposer. A trouble such as this would cause erratic spacing throughout the course of the day. If this is evident, it is then necessary to replace all interposers and cage or entire left rail brace. A B/M is set up for the rail brace and all parts pertaining to the interposer. (See CEM #465).

If erratic spacing is only prevalent in the mornings it is possible that foreign matter is mixed with the lubricant. This is sometimes hard to detect as the machine has corrected itself by the time the Customer Engineer arrives. A quick method of correcting this, is to flush the interposers with cleaning fluid.

It is possible, on rare occasions, to have interposers of another pitch installed. The 1/32 pitch has no markings, the 1/36 has one notch and the 1/45 has two notches. (Note Illustration) There are no markings on the cage.

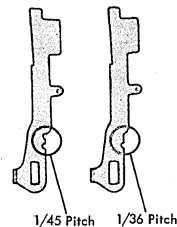

There are so few adjustments in the interposer area that it may be possible to have a build up of tolerances between component parts. If this condition exists, replacement of the rear rail brace and all parts pertaining to the interposer is necessary.

*

*

*

*

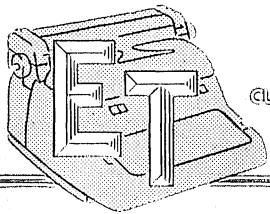

CUSTOMER ENGINEERING

NEWS LETTER

August 29, 1958

MODEL B "FRONT READ" STROKE COUNTER

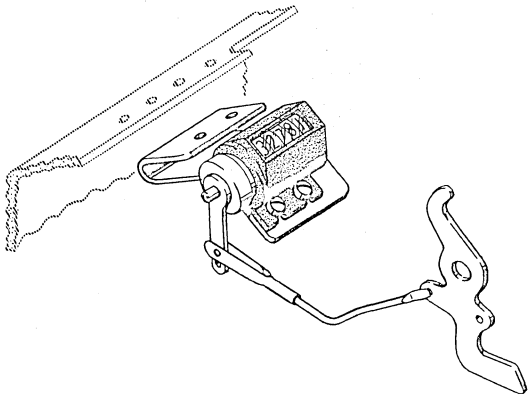

Installation of a front read stroke counter on Model B ET's can be accomplished by using the parts now available in the Model A Dec Tab stroke counter Bills of Material listed in CEM #274. The Dec Tab stroke counter Bills of Material mounting holes are slotted, which allows movement of the stroke counter for better visibility of the counter face. The Dec Tab stroke counter Bills of Material are listed below for your convenience:

<u>B/M NO.</u>	<u>DESCRIPTION</u>
1102015	Stroke Counter Installation 10:1 Dec Tab
1102016	Stroke Counter Installation 100:1 Dec Tab
1102017	Stroke Counter Installation 240:1 Dec Tab

Installation of the Model A stroke counter on Model B ET's necessitates mounting the counter in the holes nearest the margin set bracket. It is also necessary to form the link from the escapement pawl trip lever to the stroke counter under the left hand rail brace. Forming of the Model A counter bracket slightly upward will improve visibility of the counter.

(over)



Any interference between the stroke counter and the carriage return tab interlock may be overcome by elongating the holes on the rear frame.

The counter bracket, part number 1073977, which is included in the Bill of Material will not be used when converting to a front read stroke counter.

The Model B stroke counter can be made "front read" by using the Model A bracket and a pin clevis, part number 1070020, in place of the hole type clevis. If the Model B stroke counter is used, the extension link on the counter arm will not be necessary. The pin clevis is connected directly into the stroke counter link hole. Care should be exercised to make certain no binds are encountered. Use of the Model B stroke counter on a Model B ET necessitates use of the following parts, in addition to the counter.

4	4236	Screw
1	1076805	Connecting Link
1	1076806	Mounting Bracket
1	1070020	Pin Clevis
*	*	*

CORRECTION CEM 459

Part Number 1108175 Feed Finger, Pin Feed Platen - should read 1108179.

* * * *

MODEL B 1 CE MANUAL OF INSTRUCTION

Chart on page 5 - reverse headings under "Power Roll Speed." Left column should read "FPM" and right column should read "RPM."

* * * *

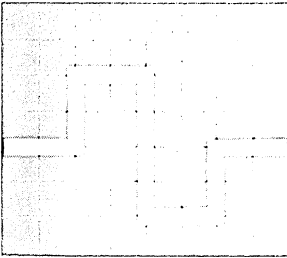

OSCILLOSCOPE PROBE TIP

A special plastic covered probe tip is available to reduce the possibility of shorting between tube socket terminals on the electronic panel. This probe, part number 450778, is available from the DP Parts

Distribution Center, Mechanicsburg, Pennsylvania. Some oscilloscopes may already have these probe tips for DP use. If not, it is recommended that one be obtained for 632 servicing.

* * * *

POWER CORDS

A three conductor power cord is standard on all 632 machines shipped from the Lexington Plant. On Plant orders requesting a two prong plug, the ground wire will be cut off flush with the plug. This will permit future grounding of the machines in the event that the customer's requirements change.

* * * *

CORRECTION: 632 Electronic Prints #1127000-A Page:06-01A

(a) Unit A-8 pin 8 (D-14) shows a WRITE PULSE from H7-3 page 01-01B. This should be corrected to read "B" Time from; R7-3 page 01-02B.

(b) Unit A-8 pin 6 (D-14) shows a line from P7-4 page 03-01A. This should be labeled WRITE PULSE and corrected to read from H-7-3, page 01-01B.

* * * *

FAILURE TO C.S.H.A.

When testing the ETC by pulsing through the electronics on digit, failure to CSHA correctly will occur due to a different pulse that stops the electronics in this position. This pulse will not occur when the selector switch is in the "RUN" position.

* * * *

TUBE REPLACEMENTS

A list of interchangeable tube types is being printed to show the relationships between various tube numbers. In emergency conditions it may be possible to substitute one of the listed receiving tubes, obtained locally. Tubes used in the IBM 632 must fall within narrower specification limits than those required for receiving tubes. For this reason a receiving tube should never be left in a machine. It should be replaced with the proper IBM tube as soon as one can be obtained.

TUBE REPLACEMENT CHART

<u>IBM PART NO.</u>	<u>TUBE NO.</u>	<u>COMMENTS</u>	<u>NEAREST RECEIVING TUBE EQUIVALENT (EMERGENCY ONLY)</u>
304994	1684 5844 1216	Interchangeable with each other	6J6
2100844	6887	IBM Part #98877 (5726) near-equivalent	6AL5
317261	5965 7062 2024		12AU7
300704	2D21		(2D21 may be available at electronic parts wholesaler)
252550	6350 6463	Interchangeable with each other	
	*	*	*

NEW DIODE PLUGGABLE UNIT

All Model 632's above serial #10046 use a new pluggable unit, D-14. Positions 1, 2, 7, 9, 11 and 12 of this unit have a diode clipped in the Normal direction. Add D-14 to the diode chart in the pluggable unit diagram sheets.

ESCAPEMENT PAWL SPRING BREAKAGE

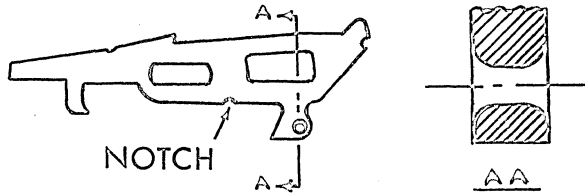

The Executive escapement pawl spring hole now has a smoother surface on the countersunk hole to reduce escapement pawl spring breakage. These pawls may be identified by a small notch in the back edge of the pawl, as illustrated. All pawls shipped from the Plant, as replacement parts, now have the smooth hole .

* * * *

"HEKTOWRITER" RIBBON FEED ADJUSTMENT

Occasionally, short feeding of the "HEKTOWRITER" ribbon may be a result of the typebar tripping the escapement too late. When short feeding of the ribbon occurs and all other adjustments are found to be correct, adjust the escapement trip link to trip the escapement pawl when the typebar is 1/2" from the platen. This adjustment allows the carriage to begin its travel sooner with the result that a slightly higher voltage will be present across the magnet at any given point of travel.

* * * *

"HEKTOWRITER" AUXILIARY CARRIAGE LATCHING

If the auxiliary carriage latches are hard to operate and do not allow sufficient space for an easy latching or unlatching operation, the trouble may be a result of the protruding ends of the plastic ribbon guide. This trouble may be eliminated by cutting off the protruding ends evenly along the back of the clamping plate.

* * * *

MID CENTURY N n N ALIGNMENT

The above shows the proper relationship of the upper case "N" with respect to the lower case "n" in the Mid Century type style. When Mid Century type is properly aligned, the lower case characters are approximately 1 unit closer to the right side of the upper case characters. This is characteristic of the Mid Century type style design as the lower case characters are positioned slightly to the left of center on the type slugs.

NOTE: Do not attempt to align the lower case "n" in the center between upper case "N's". Attempts to align a complete set of Mid Century type in this manner will result in misalignment of the entire set of type.

All type styles should be aligned per instructions contained in the Model B1 Reference Manual, pages 64 and 65.

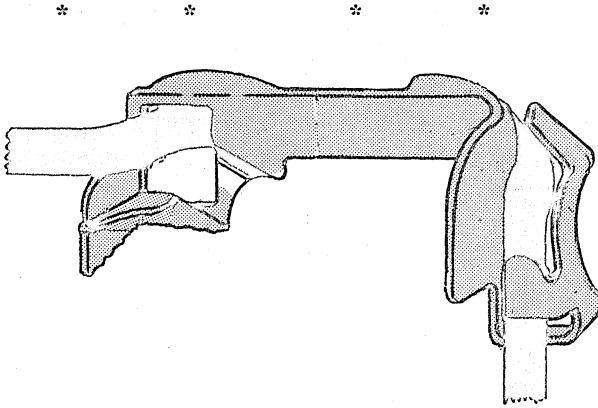

THIS COULD BE A TIME SAVER FOR YOU

The accompanying picture illustrates a method of feeding carbon paper ribbon through the corner guides to prevent ribbon breakage on ET's using envelopes, card applications, etc. Feeding the ribbon in this manner moves the ribbon away from the platen and the leading edge of heavy cards as they feed around the platen.

* * * *

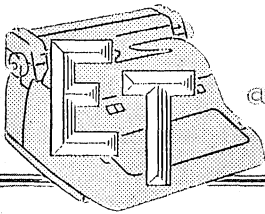

CUSTOMER ENGINEERING

NEWS LETTER

October 10, 1958

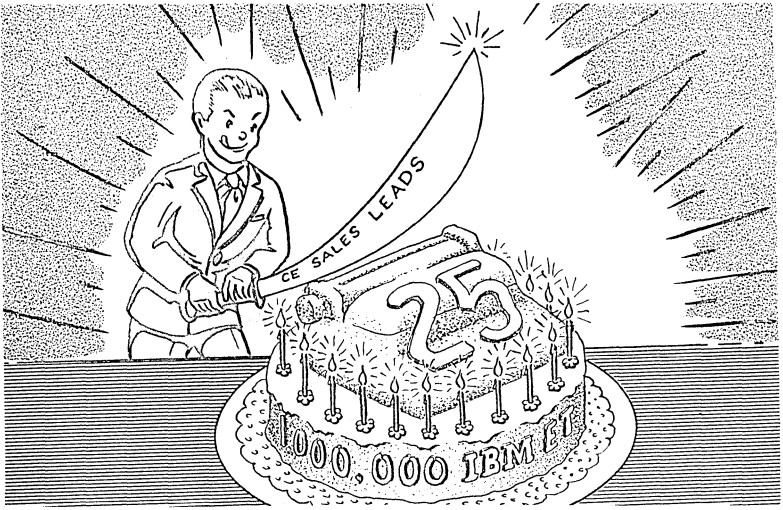

GET IN THE CE-LEBRATION!

With the words, "you ain't seen nothing yet," Jim Boaz, ET CE Manager, served notice to ET Salesmen that ET Customer Engineering would be a part of the September - October ET Sales Sell-ebriation Contest. All ET Customer Engineers now have a chance to enter into a National Sales Contest by supplying sales leads to ET Salesmen!! A contest which has prizes for four Customer Engineers in each District during each month of the contest!! A total of eight prizes per District. This is the first time in the history of the ET Division, that ET Customer Engineers have had a chance to really "get into the act." Participation by Customer Engineers in this contest not only gives CE's an opportunity to win valuable prizes, but also gives each CE an opportunity to show-off our ET Sales-Service Team!! So now's the time to really CE-lebrate!! Now we have a chance to load ET Salesmen up with more sales leads, than they have seen during 25 years of a million typewriters!!

Cut yourself a slice of the 25th Anniversary Sales Sell-ebriation contest cake by handing in more sales lead cards!!



Service Savers

DEFLECTOR HIGH SPOTS

High spots on deflectors may be located by placing chalk on the platen in the general area where marking is occurring. By rotating the platen, the chalk will be transferred to the high spots on the deflector.

REAR COVER NOISE

Rear cover noise may be prevented on Model A and B ET's, which do not have the rear frame rubber grommets, by installing 2 rubber basket shipping grommets on the rear frame. The shipping grommets are slotted and can easily be slipped on the rear frame in approximately the same position as the regular grommets.

CARRIAGE BINDS??--OR IS IT THE MAINSPRING?

Occasionally the loop of the tension tape, which connects to the lug of the mainspring drum, may rub the mainspring and retard movement of the carriage during normal typing operations. This condition may appear to be a binding carriage and can be overcome by merely forming the mainspring lug away from the mainspring.

EASIER ALIGNMENT OF "END" BARS

Filing of the leading edge of the throat of "end" typebars (underscore, letters A, Q, etc.) so that the edge is slightly rounded rather than having sharp edges will assist in alignment of these characters. The rounded edge permits better typebar entrance into the center guide. This method of alignment may be used when all other methods fail.

* * * *

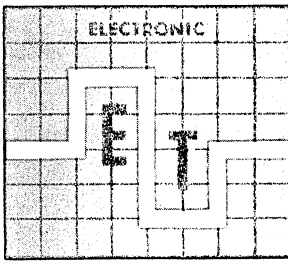

PLUGGABLE UNIT DIAGRAM CORRECTIONS

The tube used in Unit S1-1 Part #1119984, should be changed from #5844 to read Tube #5965. Pin #5, connecting to the cathode through a 20 K-1 watt resistor, should be changed to pin #4.

DUO-RELAY CONTACTS

Two methods are currently employed to attach the duo-relay contacts to the straps. One gives the appearance of a flat riveting, leaving a slight round hump in the center. The second method has a center punched appearance with little or no apparent flattening. The latter method has been successfully used for the last two years in DP machines. If a loose contact is suspected, use a small pin-knife or tweezers to test it. Once a contact is turned or moved, the bond between the contact and strap is broken and eventual trouble may be expected. This damage may result from using pliers or other large tools for testing.

NEW PROGRAM LEVEL

All Model 632 demonstrators, Serial #11 through 19 and 10001 through 10045 have been modified to correspond to the new program level (B/M #1270979). This change allows a column shift operation during a multiply cycle. Buffer is now available at "A" time and the multiplication formula is reversed (new formula is Buffer times A = B). It should be noted that the locations of calculation I, calculation II and auto functions on the program tape did not change. New multiply and functional test tapes are required to properly check the machine operation. Each 632 Customer Engineer was sent copies of the suggested test tapes. Additional copies are available from the Lexington Technical Engineering Department. Each 632 Customer Engineer should have these tapes punched, tested and ready for servicing these machines. Former buffer, add and subtract test tapes still operate.

TRIGGER PROBLEMS

For proper triggering of the Tektronix 310 oscilloscope, start with both knobs of the stability control turned to the right, adjust the Red Knob counterclockwise until the trace disappears. Next move the Black Knob counterclockwise until the trace reappears.

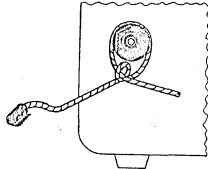

When this fails to obtain the desired stability, or if the trace fails to reappear, the trigger input voltage may be too high. To obtain the proper trigger level, simply loop the trigger lead around the trigger input terminal and tighten the terminal cap against the lead insulation. This forms a capacitive connection, and provides a more stable trigger action for high levels.

CAUTION: The tip or bare end of the trigger lead must be taped or insulated to prevent possible contact with the scope frame or ground terminal. This is also necessary to prevent an accidental shock.

COMMA PUNCTUATION

Comma punctuation is an optional feature. The Standard Model 632 will not have the comma Relay #182 installed, unless specified on the machine order. Should a customer's requirements change, the comma may be added locally. This will require the addition of Relay 182 and removal of two jumpers. (182-2 o/s to 182-2 n/c) and (182-4 o/s to 182-4 n/c). Refer to sections 33A, 34A and 41 of the relay wiring diagrams, print #1127000-A.

To remove or add commas on the 632 demonstrator (Serial #11 to 10045) use Relay #195 and its jumpers in the same manner as above. To change machines #1-10, use Relay #122 and its jumpers.

FRICTION GOVERNOR ADJUSTMENT

Occasionally on Model A ET's it is necessary to adjust the tab governor pawl closer to the friction governor plate to overcome failure of the pawl to latch up on tabulation. With the pawl adjusted closer to the friction governor plate, it may drag on the plate, when not tabulating. This is caused by looseness in the friction governor pawl.

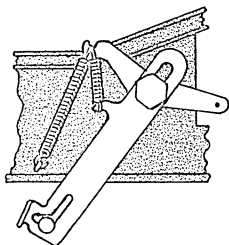

Installation of a spring Part #1071318, and cotter pin, Part #33345, on Model A ET's as shown in the illustration will assist in reducing the play and eliminate erratic operation of the tab friction governor pawl. This change permits a finer adjustment to the tab governor pawl operating link and a positive friction governor pawl operation.

This condition can also be reduced by forming the U portion of the Governor Control Lever Bracket #1100409 toward the right (looking at rear of the ET). Forming the bracket in this manner provides more throw to the tab friction governor pawl and a positive governor action.

CORRECTION: PARTS CATALOG

Cam and Typebar Mechanism Section

- Page 2: Replace D-9 with D-4
- Page 3: Delete D-9 1071556 Stop L.H. Cam Knockout Bar
Delete R.H. in Reference D-4

The screw slots have been lengthened which permits using one cam stop on both sides.

RESPECT 115 volt circuits !!

Occasionally, we read reports of people being electrocuted on comparatively low voltages. The following facts may help you understand the shock potential of 115V 60 cycle circuits.

Current rather than voltage, determines the intensity of the shock. For example, if 60 cycle AC is passed through a person from hand to hand, or from hand to foot, the result will be as follows:

- (a) At about one ma. (0.001 amp.) the shock is felt.
- (b) At about 10 ma. (0.010 amp.) the shock is strong enough to prevent a person from "letting go."
- (c) At about 100 ma. (0.100 amp.) the shock is fatal if it lasts for one second or more.

The above figures are approximate because everyone has a different resistance to electrical shock. The resistance of the human body changes under different conditions. For instance, when the skin is dry, the body offers a high resistance to current flow. When the skin is wet, the body offers a much lower resistance to current flow. The resistance of the body may be high enough to protect a person from a fatal shock, even with the body across both sides of a 115V 60 cycle line. If the body is extremely wet, the body resistance may be as little as 300 ohms.

If .1 amp is enough to be fatal and the body resistance can be as low as 300 ohms, we immediately realize by OHMS LAW that 115V 60 cycle circuits can supply more than enough current to be fatal.

$$E = IR$$

$$E = .1 \text{ amp.} \times 300 \text{ ohms} = 30 \text{ volts.}$$

It has also been found that 60 cycle AC is somewhat more dangerous than currents of lower frequencies, including DC, which is zero frequency. The difference is not very large, however, and the same measures that are used for protection against 60 cycle shock should be used as protection against shock from DC.

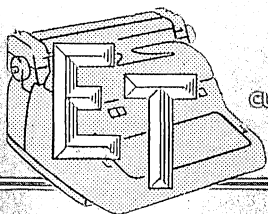

CUSTOMER ENGINEERING

NEWS LETTER

November 27, 1958

Sufficient copies of this issue of the ET News Letter have been sent to all Branch Offices for each TE Customer Engineer. October TE Suggestion Award winners can be found on the Suggestion Award insert in this issue.

Electric Time Electric Typewriter

The recent announcement of the sale of IBM Time Equipment to the Simplex Clock Company will result in several changes here at the Lexington Plant.

Several weeks ago the ET Parts Order Department became the responsibility of ET Customer Engineering. Mr. R. J. (Dick) Austin, formerly Manager of TE Customer Engineering at the Endicott Plant, has been appointed as the new manager of this department. Requests for assistance in ordering ET Parts should be directed to Mr. R. J. Austin, Department 892, Lexington Plant.

The exact date of the move of TE replacement parts to Lexington will be announced at a later date.

TE technical personnel from the CE Department in Endicott will be moved to the Lexington CE Department January 1, 1959. These technicians will be available to assist all Customer Engineers on Time Equipment problems.

We are looking forward to the opportunity of working with all TE Customer Engineers. Learning to function as one service team is a challenge which we gladly accept.



Service Savers

The service hints listed below and on pages 3, 4 and 5 may be found helpful to you in correcting ET service problems. These are tools, not rules.

ANOTHER CHECK POINT FOR CARRIAGE BINDS

Type piling may occasionally be caused by the main spring gear assembly lugs contacting the power frame. This condition can be overcome by inserting a thin washer (Part #1090240) on the stud between the power frame and the retaining clip behind the main spring holder.

TIME SAVER

The clevis on the connecting link between the 3 unit spacebar keylever and spacebar interposer can be easily adjusted through the shift lock button hole or the A keybutton hole in the keyplate. Removal of the shift button will allow more light in the area of the clevis.

"COCKED" PIN-FEED PLATEN RATCHET HOUSING

Unequal tightening of the 4 pin-feed-platen-ratchet-housing set screws will result in a cocked ratchet housing. This condition causes the platen to be eccentric on the left end. The "cocked" ratchet housing condition can be overcome by the following procedures:

1. Loosen pin wheel set screws.
 2. Turn housing 1/8" turn on shaft
 3. Tighten locknut (Part #308459) against the ratchet housing. This will hold housing in its correct position.
 4. Tighten set screws equally.
 5. Replace locknut against the pin wheel nut.
-

QUICK CHECK FOR BINDING TYPEBARS

Eliminating the Universal bar tension from the typebars will assist in locating typebar binds. This can be accomplished by the following steps;

1. Move the multiple-copy lever to the rear.
 2. Move the carriage to the extreme right.
 3. Hold the universal bar to the rear with the thumb at the escapement trip link connection.
 4. Raising and lowering individual typebars will readily reveal any binds.
-

EXECUTIVE ESCAPEMENT PAWL SPRING REPLACEMENT

The following procedure may be found helpful when replacing Executive escapement pawl springs:

1. Remove rear cover, L. H. carriage end cover, platen and margin set finger. Position carriage to extreme right, over the margin lever, to expose the escapement pawls. On Model A ET's it will be necessary to loosen the final stop before the carriage can be moved to the right.
 2. Open up spring end loop slightly so that it can be more easily hooked into pawl hole. Do not open the loop more than necessary, as this may cause spring to slip off of pawl or catch on adjacent spring.
 3. Place the pawl spring on the small spring hook or on a wire that has a slightly smaller diameter than the spring. A paper clip, with a hook formed on the end, will hold the spring while it is being located on the pawl.
 4. A piece of cardboard or heavy paper can be used, as illustrated, to hold the pawl out so that the spring can be easily inserted.
 5. Maneuver spring onto pawl.
-

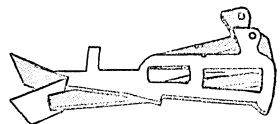

A QUICK SPRING HOLDER

The spring screw starter (#9002145) can be used effectively to hold small springs while they are installed in hard-to-get-at places by the following method:

1. Open screw starter blades.
2. Stretch springs slightly and push on starter blades.
3. Lock blades of starter.

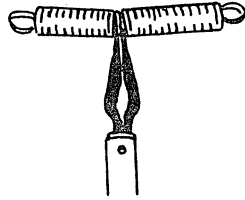

CAM BEARING SUPPORT ADJUSTMENT

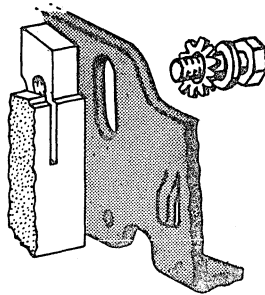

Tolerance build-up in the cam bearing support, side frames and eccentric adjustment bushing may occasionally result in insufficient cam to power roll clearance adjustment. This problem can be overcome by replacing the eccentric adjustment bushing (#1110187) with a flat washer (#1107864) and star washer (#76574). The flat washer should be placed next to the head of the screw and the star washer placed against the side frame, as illustrated above.

MARGIN SET FINGER HANGING UNDER MARGIN STOP

Occasionally, when an operator is setting a margin, the margin set finger hangs under the margin stop, resulting in carriage lock-up. This is caused by the inside ends of the margin stops contacting each other with sufficient force to cam one margin stop on top of the other. The margin set finger then slides under the raised margin stop, resulting in carriage lock-up.

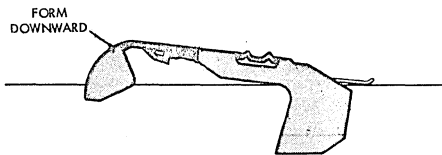

This condition can be greatly reduced by forming the inside ends (camming surfaces) of the margin stops downward.

Spring loading the margin set connecting link as described in News Letter #52 will also help to alleviate this problem.

CORRECTION ET PARTS CATALOG

"HEKTOWRITER" Section, Figure 2, Page 5, remove the following parts:

<u>Reference No.</u>	<u>Part Number</u>	<u>Description</u>
64	6505163	Bracket Assembly Roller
65	6505161	Spacer
66	6505102	Roller Assembly Ribbon Guide
67	11118	Screw

These parts are no longer used on the "HEKTOWRITER" Attachment because the WTC Engineering Department has ascertained that these parts are not essential for proper ribbon feed.

CORRECTION ET PARTS CATALOG

Carriage and Rails Section, Model 1B, Figure 1, Page 5, Reference G-9 and Carriage and Rails Section, Model 4B, Figure 1, Page 4, Reference G-9: Change #38281 to #1078469.

How Do YOU Order Typebars ??

Plant records reveal that many typebar and keybutton orders continue to be received at the Plant by the Type Available Catalog numbers rather than the INDIVIDUAL PART NUMBERS assigned to commonly ordered typebars and keybuttons. Individual typebar and keybutton part numbers can be found in the Cam and Typebar Section of the ET Parts Catalog, pages C-9, C-10, C-11, C-12, C-13 (revised) C-15 and in the Small Parts List and Reference Material Booklet, Pages 69, 70 and 70-A.

A portion of one of these ET Catalog pages (C-10) is illustrated below:

POS	CHAR	EXEC. MODERN PH	EXEC. DOC. PE	EXEC. SEC. P.S.	EXEC. BOLD PO	EXEC. MID CENTURY P.F.	EXEC. BOLDFACE 2 PB	KEY BUTTONS GRAY (HONGLAIRE)	KEY BUTTO:3 BLUE
O	W/\$	1078023	1074153	1078106	1078169	1260658	1260720	1105057	1075057
	Y/\$	1078022	1074152	1078105	1078168	1260659	1260721	1105056	1075056
1	Q	1076501	1074154	1078107	1078170	1260660	1260722	1105017	1075017
2	A	1076502	1074155	1078108	1078171	1260661	1260723	1105001	1075001
3	*/1	1078024	1074156	1078109	1078172	1260662	1260724	1105043	1075043
3	@/2	1076503	1074157	1078110	1078173	1260663	1260725	1105027	1075027

For example, to order one Executive Modern typebar, Letter Q, position 1 and one Model B keybutton (Q), the Parts Order Department at the Plant requires only the following information:



PARTS AND SUPPLIES REQUISITION

FORM 10-3748-10
1034148-1-57

TO: ENDICOTT PLANT
 KINGSTON PLANT

POUGHKEEPSIE PLANT

Lexington Plant RUSH

PLANT ORDER NO. _____

GROUP CODE		USA		999		November 30, 1958		999-002	
OTHER		BRANCH OFFICE NAME		BR. OFF. NO.		DATE		BR. OFF. REG. NO.	
BRANCH OFFICE STOCK LOCATION	QUANTITY	PART NUMBER	DESCRIPTION			MACHINE TYPE	FOR PLANT USE ONLY		
			FOR ET TYPE REQUISITIONS				USP CODE	REFERENCE	
TYPE BAR POS.	STYLE OF TYPE	TYPE CHAR.	CATALOGUE NUMBER						
	1	1076501	Typebar						
	1	1105017	Keybutton						

This typebar is already assembled, plated and ready for shipment when your order is received at the Plant. Your order will be expedited when you use these part numbers. Order by typebar and keybutton part numbers whenever possible. This will save time and cost both in your office and in the Plant!!!!

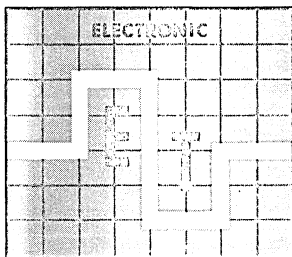

INCREASING STORAGE GROUPS

Gaining information in one or more storage groups when multiplication and ROCS in C_1 is followed by add or subtract in

C_2 may be attributed to timing between relays five and eight. If the brass jumper between the hold coil terminals of relay five is missing, or if the hold coil is open, it will result in a timing condition causing selection of improper storage groups. A shorted selenium diode in the hold circuit of storage selection relays may cause the same trouble.

Relay points 5 AL n/o and 8 BU n/c should be adjusted for a minimum amount of rise to further insure that the relays for C_1 are dropped before those for C_2 are picked.

DUO-RELAY MAINTENANCE

A very slight amount of #6 oil on the duo relay armature pivots and on the pad where the contact pedestals rest, will prevent a slow pick. CAUTION: Excessive oil may cause the armature to stick to the brass armature stop.

A relay that is allowed to become dry will rust at the pivots or feel rough under manual operation. Maintenance inspections should include lubrication once or twice a year, as required for the location and amount of operation.

GROUNDING THE IBM 632

If at all possible, every IBM 632 should have an electrical ground connection to the frame. All machines are equipped with a three wire power cord for this purpose. In cases where a customer specifically orders a two prong plug, it will be supplied as follows:

1. The three wire cord will have the third or ground wire cut off flush with the end of the cord at the point of entry into the plug.

2. The third wire or ground will be disconnected from the frame of the machine and taped. This will visually indicate to the Customer Engineer that the machine is not grounded.

Any machine now installed using a two prong plug should be modified as per item 2 above. Refer to ETC CEM #1A.

WIRE CONTACT RELAY TERMINALS

Wire contact relays using a crimp type connection for the pick and hold terminals no longer require the Epoxy Resin bonding cement. This was temporarily employed to secure the terminal in the yoke, however, recent design changes provide a slight chamfer in the end of the terminal to insure its position in the yoke.

If a relay terminal becomes loose, a small amount of cement (household cement or equivalent) may be applied at the crimp of the terminal. This will result in a permanent repair and prevent replacement of the relay.

Until existing relays are used, machines and parts orders will be supplied with both bonded and non-bonded crimp type relay terminals.

BROKEN TUBE SOCKET TERMINALS

A quick method for repairing a broken or defective tube socket terminal is to replace only the terminal. This may be accomplished without removal of the complete socket by clipping off the old terminal at the rear and pushing it through the socket. Install a new terminal, part #2104271, from the front side, resolder the wires and you're through!

CEM INFORMATION

CEM #8, Page 2. Add (under machines affected) "Prior to serial #10105." B/M # 1270978 "Price \$2.50".

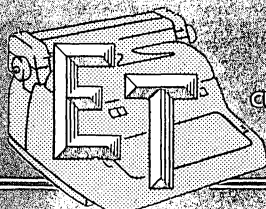

CUSTOMER ENGINEERING

NEWS LETTER

December 25, 1958



Thank You

for making 1958 a year of unparalleled progress in improving our Service

for enthusiastic Sales cooperation

for meeting the challenge of new products

for being major contributors to the growth of the ET Division - thus making more opportunities for all ET people

In this Season of Christmas and as we approach the New Year we sincerely wish you and your families

HAPPINESS

HEALTH

PROSPERITY

James E. Boag

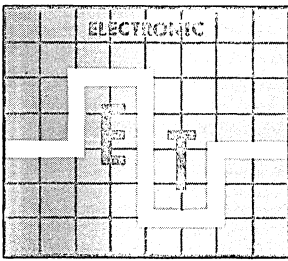

POWER SUPPLY SAFETY CHANGE

The first safety change called for taping the terminals of the large power resistor (located on the main transformer). The tape was then to be laced to prevent loosening.

Some machines between serial number 10170 and 10208 may have reached the Field without this safety change. The tape and lacing must be installed on all machines in this group.

INTERMITTENT FAILURES

Two tools that may assist in locating the cause of intermittent failures are:

VIBRATION and **HEAT**

Mild vibration or flexing may help locate.....

1. Loose, cold soldered, or unsoldered connections.
2. Poor contact in tube sockets or relay bases.

Blocking the air intake with cardboard or paper will increase the temperature within the electronic gate and may help locate a failure that occurs only when the machine is thoroughly warmed up. The thermal cut-out switch will prevent accidental overheating.

LOCK - UP

If a 632 locks up while typing a number, the trouble may be in the magnet unit of the ET. Relay #225 must pick to allow the electronic set-up relay (101) to pick. If a typebar does not operate, #225 will not be picked and a lock-up will thus occur.

Failure to type a particular numeral after the machine has been idle (such as overnight) may be caused by a sticky substance on the armature or brass stop bail. Once the armature breaks loose it may operate satisfactorily until after the next idle period. Clearance between the push rods and the tails of the cams or too much clearance between the armatures and coils may cause failure.

PROGRAM INFORMATION

A multiplication involving a negative number as the multiplier ("A" time storage group) is not recommended. High order nines increase the multiplication time significantly and may be objectionable to our customers. (-1 is in storage as 9999999999).

Also, remember that the product of a multiplication must not exceed 10 digits. If a nine is accumulated in the 11th digit position of the resultant storage group, the number would be interpreted as negative by the 632.

Never round-off and column shift a negative number. Such a column shift operation would move the 9 from the 11th position down to the 9th or 8th depending on the number of column shifts (2 or 3). This puts a zero in the 11th position and the negative complement would be read out as a positive number.

LOOSE POWER SUPPLY PANELS

All demonstrator machines should be checked and if necessary, lockwashers and flat washers should be installed under the mounting bolts of both power supply panels and transformers. After shipment of any machine, a good visual check should be made for any loose screws or components before power is applied.

OSCILLOSCOPE SAFETY PRECAUTIONS

All diagnostic and repair work utilizing an oscilloscope must be performed with the oscilloscope ground connected to the frame ground of the machine being serviced. Connecting the oscilloscope ground terminal to a point other than the machine frame creates a safety hazard because a voltage difference would exist between the oscilloscope case and the machine frame. Any service technique which involves connecting the oscilloscope ground terminal to a point other than the machine frame is to be discontinued immediately. (To check output pulses from the switch cores at their load resistors or to check output of the sense winding, an additional ground wire must be attached to the respective common points.)

555 BLACK "MYLAR" CARBON RIBBON

The ET Sales Department recently announced the availability of a new "MYLAR" Backed Carbon Paper Ribbon which offers the following advantages:

1. 1200 feet long - Reduces the number of ribbon changes.
2. "MYLAR's" greater strength prevents ribbon breakage - An advantage for CE's.
3. Uniform clean, sharp write on correspondence - Satisfactory results with most paper plates and other reproduction processes - Another improvement for ET Customer Engineers.

The same carbon ribbon feed adjustments as used with the acetate ribbon apply when using a "MYLAR" ribbon.

Less ribbon breakage with sharper, cleaner write characteristics make the "MYLAR" ribbon another step toward "Impression Perfect."

TAKE THIS SERIOUSLY

Extreme caution should be taken by all ET Customer Engineers to make certain that the ET line cord is unplugged from the line voltage when working on any portion of the electrical circuit of the typewriter.

This safety precaution is important for the following reasons: PLEASE NOTE.....

1. The single pole typewriter switch when in the "OFF" position breaks only one side of the line voltage. The other side of the line, possibly remaining "hot", could result in a severe shock if the body is grounded.
2. All ET's used on 115V AC have a charge of 230-250 volts across the condenser terminals. Contact with any portion of the condenser circuit with the body grounded could result in a severe shock.

Be sure that the line cord is unplugged when working on any portion of the ET electrical circuit.

Service Savers

A QUICK REPAIR

Over tightening of the carbon-ribbon-rewind-pulley screw in the power roll pulley may result in stripping the threads in the power roll pulley. If a new power roll pulley is not immediately available, the screw may be held tight by placing a nut (Part #7341) on the end of the screw inside the power roll pulley. Sufficient room remains inside the pulley, after the nut is added to adjust the pulley for proper power roll end play.

Addition of the nut permits proper adjustment of the carbon ribbon pulley tension until a replacement power roll pulley is obtained.

PIN FEED PINS NICKING SCALES

Adjustment of pin feed platen sectors for thick forms occasionally requires that the pins protrude as they pass the front paper scales. This results in the pins catching on and nicking the front paper scales during roll back.

This condition can be easily overcome by forming a dimple in the front scales with the 3 prong aligning pliers at the sector pin contact point.

MODEL -A CKO LINK REPLACEMENT

This can be more easily accomplished by installing the link in backwards in Model A ET's. The hooked end of the link is placed in the intermediate bellcrank with the coiled loop to the rear of the ET. The clevis end of the link is placed in the CKO lever where it can readily be adjusted.

Installation of the link in this manner makes removal of the CKO lever unnecessary.
