

**IBM / Apple  
Enterprise Networking Guide  
For SNA Products**

Document Number Z325-6027-0

3000  
100  
017

**Note!**

Before using this information and the products it supports, be sure to read the general information under "Notices" on page iii.

**First Edition (October 1991)**

Publications are not stocked at the address given below. If you want more IBM publications, ask your IBM representative or write to the IBM branch office serving your locality. If you want more Apple publications, ask your Apple representative.

A form for your comments is provided at the back of this document. If the form has been removed, you may address comments to:

IBM Corporation  
Department B17  
P.O. Box 12195  
Research Triangle Park, North Carolina 27709  
U.S.A.

IBM may use or distribute any of the information you supply in any way it believes appropriate without incurring any obligation to you.

© Copyright International Business Machines Corporation 1991. All rights reserved.

Note to U.S. Government Users — Documentation related to restricted rights — Use, duplication or disclosure is subject to restrictions set forth in GSA ADP Schedule Contract with IBM Corp.



---

## Notices

The information contained in this document is distributed on an 'as is' basis without any warranty either expressed or implied. The use of this information or the implementation of any of these configurations is a customer responsibility and depends on the customer's ability to evaluate and integrate them into the customer's operational environment. While each item has been reviewed by IBM and Apple for accuracy in a specific situation, there is no guarantee that the same or similar results will be obtained in a different environment. Customers attempting to adapt these configurations to their own environments do so at their own risk.

Any reference to an IBM licensed program in this licensed document is not intended to state or imply that only IBM's program may be used.

IBM may have patents or pending patent applications covering subject matter described in this document. The furnishing of this document does not give you any license to these patents. You can send inquiries, in writing, to the IBM Director of Commercial Relations, International Business Machines Corporation, Purchase, New York, 10577.

References in this publication to IBM products, programs, or services do not imply that IBM intends to make them available in all countries in which IBM operates.

---

## Trademarks

The following terms, denoted by an asterisk (\*) at their first occurrence in this publication, are trademarks of the IBM Corporation in the United States or other countries:

AS/400	CICS/VS	DB2
ES/9000	ES/9370	IBM
MVS/XA	NetView	OS/2
OfficeVision	OS/400	Personal System/2
PS/2	RISC System/6000	SAA
System/370	System/390	Systems Application Architecture
VM/SP	VTAM	

The following terms, denoted by two asterisks (\*\*) at their first occurrence in this publication, are trademarks of Apple Computer Inc.:

the Apple logo	Apple	AppleShare
AppleTalk	EtherTalk	LaserWriter
LocalTalk	Macintosh	MacDFT
Macintosh Coprocessor Platform	TokenTalk	SNA•ps

The following term, denoted by two asterisks (\*\*) at its first occurrence in this publication, is a trademark of Texas Instruments:

NuBus



---

# Contents

<b>Notices</b> . . . . .	iii
Trademarks . . . . .	iii
<b>About This Document</b> . . . . .	vii
How This Document Is Organized . . . . .	vii
Documentation Sources . . . . .	vii
Procedures Used In This Study . . . . .	viii
Hardware Used In Configurations . . . . .	viii
Software Used In Configurations . . . . .	ix
Configuration Components Cross-Reference . . . . .	x
<b>Section 1. Introduction to SNA•ps</b> . . . . .	1
Background . . . . .	1
SNA•ps . . . . .	1
Connecting to IBM . . . . .	2
AppleTalk/SNA Gateways . . . . .	3
Apple Adapter Cards . . . . .	3
Peer-Peer Networks . . . . .	4
Version Details . . . . .	4
Packaging and Order Information (Version 1.0) . . . . .	4
<b>Section 2. Apple Network Product Installation Overview</b> . . . . .	7
AppleTalk . . . . .	7
SNA•ps . . . . .	11
<b>Section 3. 3270 Terminal Emulation Paths</b> . . . . .	13
Path 1: MVS Host Attachment via 3745 Token Ring LAN . . . . .	14
Path 2: MVS Host Attachment via 3745 SDLC Connection . . . . .	22
Path 3: AS/400 Host Attachment via Token Ring LAN . . . . .	30
Path 4: AS/400 Host Attachment via SDLC Connection . . . . .	42
Path 5: VM Host Attachment via Token Ring LAN . . . . .	54
Path 6: VM Host Attachment via SDLC Connection . . . . .	64
Path 7: VM Host Attachment via DFT Workstation Adapter . . . . .	72
Path 8: MVS Host Attachment via Macintosh Token-Ring Gateway . . . . .	78
Path 9: MVS Host Attachment via Macintosh Token Ring Gateway with Multiple LAN Clients . . . . .	88
Path 10: MVS Host Attachment via Macintosh SDLC Gateway . . . . .	98
Path 11: MVS Host Attachment via Macintosh SDLC Gateway with Multiple LAN Clients . . . . .	108
Path 12: MVS, VM, and AS/400 Hosts via Multiple SNA•ps Gateways . . . . .	118
Path 13: MVS, VM, and AS/400 Hosts via Token Ring SNA•ps Gateway . . . . .	132
Path 14: MVS Host Attachment via 3174 SDLC Gateway . . . . .	152
Path 15: MVS Host Attachment via 3174 DFT Connection . . . . .	162
Path 16: MVS Host Attachment via OS/2 Extended Edition SDLC Gateway . . . . .	172
<b>Section 4. IBM Peer-to-Peer Networking Paths</b> . . . . .	187
Path 17: OS/2 Extended Edition Over Token Ring LAN . . . . .	188
Path 18: AS/400 Host Over Token Ring LAN . . . . .	202
Path 19: OS/2 Networking Services/2 with AS/400 Network Node (Token Ring) . . . . .	214
<b>Appendix A. Apple Products Datasheets</b> . . . . .	235
<b>Appendix B. VTAM Logon Mode Table Definitions</b> . . . . .	285

Logon Mode Table Entries for LUs	285
Logon Mode Table Entry for Printer on VM	286
Logon Mode Table Entry for Printer on MVS	286
<b>Appendix C. NCP Gen Listing</b>	<b>287</b>
<b>Bibliography</b>	<b>293</b>
VTAM V3R3 Publications	293
NCP V5R4 Publications	293
NetView 2.2 Publications	294
AS/400 Publications	296
OS/2 Extended Edition V1.3 Publications	297
Networking Services/2 Version 1.0 Publications	297
Apple Publications	298

---

## About This Document

The purpose of this document is to provide information to be used in supporting IBM\* and Apple\*\* networking requirements. This document describes the configurations (paths) that were verified during an interoperability study that used IBM and Apple products in an SNA network environment. The study was conducted by IBM and Apple at the IBM Multivendor Network Facility in Research Triangle Park, North Carolina, during September 1991. For each path, this document includes a path description, a list of the hardware and software that was used, configuring and operating procedures, observations made during the study, and a configuration diagram.

The section for each path also includes examples of some of the screens that appeared on the Macintosh\*\* ilci during the study of that path. These screens are valid samples of what was seen in the environment of this study, but, because of differences in the environment (for example, size of the network), are not necessarily exact copies of what any customer will see.

---

## How This Document Is Organized

This document contains the following sections:

- Section 1, "Introduction to SNA\*ps" on page 1, which gives an overview of Apple/SNA networking.
- Section 2, "Apple Network Product Installation Overview" on page 7, which describes how to install AppleTalk\*\* and SNA\*ps\*\*.
- Section 3, "3270 Terminal Emulation Paths" on page 13 and Section 4, "IBM Peer-to-Peer Networking Paths" on page 187, which describe each of the paths that provide IBM model 3270 terminal emulation and IBM peer-to-peer networking. Each description includes text describing the path, a description of the procedure that was used to configure the path, any observations that would be helpful for a customer to know, and a diagram of the configuration used.
- Appendix A, "Apple Products Datasheets" on page 235, which contains selected Apple product documentation.
- Appendix B, "VTAM Logon Mode Table Definitions" on page 285, which contains VTAM\* definition statements for the logon modes that were used in the paths.
- Appendix C, "NCP Gen Listing" on page 287, which contains definition statements for the NCP that was used in the paths.

---

## Documentation Sources

See "Bibliography" on page 293 for information on books related to products that were used in this study.

---

\* Trademark of International Business Machines Corporation.—see "Notices" on page iii for lists of all trademarks used in this document.

\*\* Trademark of Apple Computer Inc.—see "Notices" on page iii for lists of all trademarks used in this document.

---

## Procedures Used In This Study

For each of paths in Section 3, "3270 Terminal Emulation Paths" on page 13, certain procedures were used to verify the configuration. Four 3270 terminal emulation sessions were started to each host in a given configuration. Each of the four sessions was configured as a different 3270 display type (3278 models 2, 3, 4, and 5) to check out various screen sizes. Both color and monochrome displays were used. After logging on to these sessions, a full screen read/write exerciser was started that compared sent and received data that was randomly generated and included extended 3270 display attributes such as blinking, underscore, and reverse video. Host file transfers that used ASCII, EBCDIC, and binary executable data were sent, received, and compared in those configurations that included VM or MVS hosts. Many of these test paths also checked out host printing using the 3287 printer emulation by spooling host files to RSCS (for VM), JES (for MVS), or printer (for AS/400). In each of the configurations, the operational status of all PU and LU sessions were verified using NetView.

In Section 4, "IBM Peer-to-Peer Networking Paths" on page 187, APPC file send/receive programs were run on each end system in the configuration. Two conversations were started through an LU 6.2 session to provide parallel data pipes for bi-directional transfers. The APPC programs were based on samples provided with IBM OS/2<sup>\*</sup> Extended Edition and Networking Services/2.

Any variations from these tests are noted in the "Observations and Hints" section of each path. The goal of the process was to check general functionality of the SNA•ps product, not to be a full system test.

---

## Hardware Used In Configurations

The following hardware was used in the paths that are included in this document:

- IBM 4381
- IBM ES/9370<sup>\*</sup>
- IBM 3745
- IBM 3174
- IBM AS/400<sup>\*</sup>
- IBM Personal System/2<sup>\*</sup> (PS/2<sup>\*</sup>)
- IBM Token-Ring Network Adapter/A
- IBM Multiprotocol Adapter/A
- Apple Macintosh IIci
- Apple Macintosh IIx
- Apple LaserWriter<sup>\*\*</sup> IIINTX printer
- Apple TokenTalk<sup>\*\*</sup> NB Card
- Apple EtherTalk<sup>\*\*</sup> NB Card
- Apple Serial NB Card
- Apple Coax/Twinax Card
- Apple Token Ring 4/16 NB Card

---

<sup>\*</sup> Trademark of IBM Corporation—see "Notices" on page iii for lists of all trademarks used in this document.

<sup>\*\*</sup> Trademark of Apple Computer Inc.—see "Notices" on page iii for lists of all trademarks used in this document.

---

## Software Used In Configurations

The following IBM software was used in the paths that are included in this document:

- MVS/SP JES2 Version 2 Release 2.0 (MVS/XA<sup>\*</sup>)
- VM/SP<sup>\*</sup> Release 6
- VTAM Version 3 Release 3
- NCP Version 5 Release 3
- NetView Version 2 Release 2
- OS/400<sup>\*</sup> Version 2 Release 1
- OS/2 Extended Edition V1.30.1 CSD WR05016
- OS/2 SAA Network Services/2 (NS/2) Version 1.0
- RSCS Version 2 Release 3
- 3174 Configuration Support B4
- JES/328X Print Facility

The following Apple software was used in the paths that are included in this document:

- Macintosh System Software Version 7.0
- SNA•ps 3270 V1.1 (beta)
- AppleTalk Internet Router
- SNA•ps 3270
- SNA•ps Gateway/64 V1.1 (beta)
- SNA•ps 3270 Gateway Client V1.1 (beta)
- SNA•ps APPC APDA kit

---

\* Trademark of IBM Corporation—see “Notices” on page iii for lists of all trademarks used in this document.

**Table 1. Configuration Components**

Path (Page)	3745	3174	OS/2	NS/2	DFT	MVS	VM	AS/400	SDLC	Token Ring	Ethernet	Local-Talk	APPC	APPN
1 (14)	X					X				X				
2 (22)	X					X			X					
3 (30)								X		X				
4 (42)								X	X					
5 (54)							X			X				
6 (64)							X		X					
7 (72)					X		X							
8 (78)	X					X				X	X	X		
9 (88)	X					X				X	X	X		
10 (98)	X					X			X	X	X	X		
11 (108)	X					X			X	X	X	X		
12 (118)		X			X	X	X	X	X	X		X		
13 (132)	X					X	X	X		X		X		
14 (152)	X	X				X			X	X				
15 (162)		X			X	X								
16 (172)	X		X			X			X	X				
17 (188)			X							X			X	
18 (202)								X		X			X	
19 (214)			X	X				X		X			X	X



---

## Section 1. Introduction to SNA•ps

---

### Background

IBM customers today find themselves in the position of integrating equipment from multiple vendors into their existing SNA network environment. Reasons for this integration include investment protection, wide install base, diversity of equipment and operating platforms, predictable network performance, network and system management, and automation. In addition, customers wish to maintain access to their corporate applications and central data repositories, such as CICS/VS\*, OfficeVision\*, and DB2\*. Compliance with IBM's System Application Architecture\* (SAA\*) is also important for new application development. With the emergence of the LU6.2 protocol, customers are also developing new applications with the easy to use CPI-C interface over peer-peer (APPN) networks. Finally, customers seek to integrate desktop systems which provide intelligence and graphical interfaces to the end user community.

---

### SNA•ps

Apple Computer has developed a software product that provides SNA interoperability and network support for Macintosh systems and AppleTalk networks. This product is called SNA•ps (System Network Architecture protocols and services) and is available in a number of packages tailored to fit different Macintosh environments. The SNA•ps product provides SNA network protocols for 3270 terminal emulation, file transfer, and printer support. Also, IBM Low Entry Networking (LEN) is supported via an APPC (Advanced Peer-Peer Communication) programming interface. An interface for 3270 data stream programming (HLLAPI) is also available. In addition, the SNA•ps product provides SNA data flows over the AppleTalk protocol. This allows AppleTalk LAN workstations to participate in the SNA network without the need for a direct SNA connection. The package provides the Macintosh user with desktop windows for each 3270 session. The number of concurrent sessions is limited only by memory on the Macintosh client. Figure 1 on page 2 shows a typical Macintosh desktop with several 3270® windows active.

---

\* Trademark of International Business Machines Corporation.—see "Notices" on page iii for lists of all trademarks used in this document.

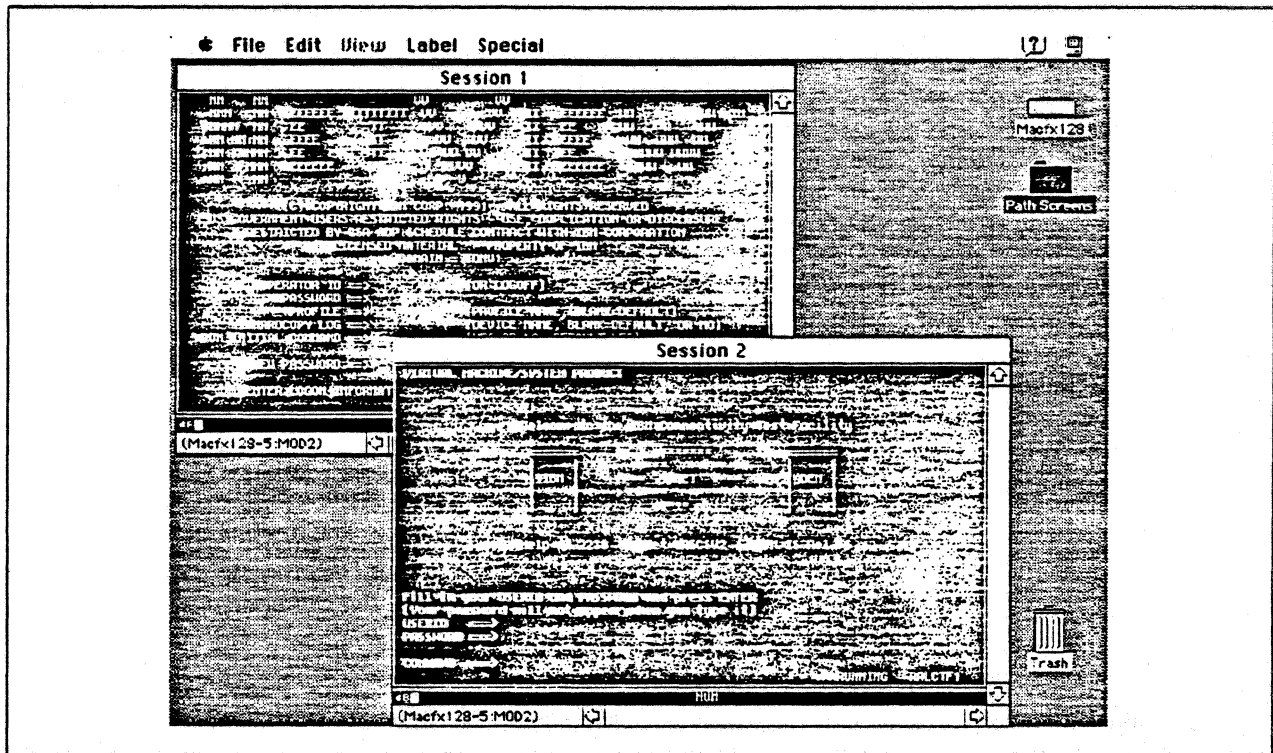

Figure 1. SNA•ps 3270 Emulation

## Connecting to IBM

The SNA•ps package allows a Macintosh system to connect to an IBM host or network using a number of methods. First, an Apple Coax/Twinax Card<sup>1</sup> can be installed in a Macintosh and then used to attach to an IBM workstation controller, which could be a System/370<sup>\*</sup> or System/390<sup>\*</sup> channel device such as a 3174 model 01L. Or, the coax attachment could be provided using an integrated adapter, such as the workstation adapter feature available on certain models of the ES/9000<sup>\*</sup> family of processors. A common method for providing IBM coax connectivity is through a token ring LAN-attached controller such as the 3174 model 63R. In the above cases, SNA•ps can provide SNA DFT (distributed function terminal), non-SNA DFT, or CUT (control unit-terminal) modes of operation, depending on the specific configuration. For example, a token ring-attached 3174 must always be configured for SNA DFTs since VTAM is used to support these devices. Paths 7 and 15 are connected in this manner.

Another connection method supported by SNA•ps uses the SDLC (Synchronous Data Link Control) protocol. Generally, this protocol is used to support remote locations which have a need to connect back to the customer data center. Modems are used in this configuration and may be either leased (always connected) or switched (connected upon demand). An Apple Serial NB Card is needed to provide the SDLC attachment for the Macintosh system. The serial card actually has four ports and can connect up to four different IBM hosts or networks simultaneously, one per port, with a single adapter. Paths 2, 4, and 6 show examples of SDLC-attached network environments.

A third method for SNA attachment provided by the SNA•ps product allows a Macintosh to connect to the IBM network using a token ring LAN. Traffic flows between the IBM host and the Macintosh on the

<sup>1</sup> Although the Apple Coax/Twinax Card has a twinax connector, SNA•ps does not support it. There are third party products available which can utilize the twinax feature on this adapter. See your Apple dealer for more information.

<sup>\*</sup> Trademark of International Business Machines Corporation.—see "Notices" on page iii for lists of all trademarks used in this document.

LAN using SNA protocols over logical link control (LLC), an IEEE standard (802.2). This connection differs from the coax type mentioned above in that the Macintosh is connected directly to the LAN using an Apple Token Ring 4/16 NB Card or Apple TokenTalk NB Card rather than a coax connection through a 3174 attached to the LAN. As in the case of the SDLC configuration, multiple hosts can be reached from one token ring adapter card, independent of other connections. Paths 1, 3, 5 and 13 provide detail on token ring configurations.

IBM 3270 communication gateway products, such as the OS/2 Communications Manager, the 3174, or the AS/400, can be used in conjunction with SNA•ps to connect various workstation systems to an IBM host using a variety of communications connections. For example, path 16 shows how an OS/2 system can be used to connect Macintosh systems on a token ring LAN to a remote IBM host using the SDLC protocol. This type of configuration is used where a variety of end user systems exists on the LAN, all of which have a common requirement for IBM host connectivity. These systems could be DOS, OS/2, or Macintosh systems; all can share the common gateway to the host.

---

## AppleTalk/SNA Gateways

The SNA•ps product provides great flexibility for Macintosh users that are connected together with some type of AppleTalk network who have a need for IBM host access. AppleTalk is a network protocol that operates on Ethernet, Token Ring, and LocalTalk<sup>\*\*</sup> (RS-423) LANs and allows Macintosh users to share files, printers, and application resources. Apple products that provide LAN services include System Software 7.0, AppleShare<sup>\*\*</sup>, and LocalTalk printers. Most Macintosh systems installed today are interconnected with AppleTalk networks. In these environments, the SNA•ps product offers a gateway function between the AppleTalk network and the SNA network. This gateway function can be shared among the Apple user community just like files and printers. In addition, SNA•ps supports multiple SNA gateway cards and systems on single or interconnected AppleTalk networks.

For example, the SNA•ps product can be installed on a Macintosh system that has an SNA connection to an IBM MVS host. This Macintosh is then also connected to other Apple systems using a LocalTalk network. An additional SNA•ps system can then be added to that network, which is in turn connected to a different IBM host using one of the supported connection methods. This additional gateway can be attached to the same AppleTalk network as the first SNA gateway system. The Macintosh clients on the AppleTalk network can use either SNA•ps gateway to access the IBM systems. In fact, a Macintosh client can access multiple SNA gateway connections simultaneously and therefore can be connected to different IBM host systems at the same time. The AppleTalk/SNA gateway support provides a large degree of configuration flexibility for the Apple user community in need IBM host and network access.

---

## Apple Adapter Cards

The SNA•ps product supports the following NuBus<sup>\*\*</sup> (NB) adapter cards:

- Apple Token Ring 4/16 NB Card
- Apple TokenTalk NB Card
- Apple Serial NB Card
- Apple Coax/Twinax Card

Any NuBus-based Macintosh system can use these adapters with the SNA•ps product. These cards utilize the Macintosh Coprocessor Platform<sup>\*\*</sup> (MCP). Each of these cards has an on-board processor that handles the network interface and protocol stacks. The Macintosh system board processor is

---

<sup>\*\*</sup> Trademark of Apple Computer Inc.—see “Notices” on page iii for lists of all trademarks used in this document.

<sup>\*\*</sup> Trademark of Texas Instruments—see “Notices” on page iii for lists of all trademarks used in this document.

therefore relieved from the overhead associated with the network and mainly is responsible for the user interface portion, such as the 3270 terminal emulation windows or an LU 6.2 application program. Each card also has random access memory (RAM) in which to load the SNA•ps code. The minimum MCP memory requirement for SNA•ps when running on Token Ring or SDLC is one megabyte (1MB).

Since most Macintosh systems have multiple card slots, more than one adapter card may be installed in a SNA•ps machine and therefore can provide more than just a single IBM host or network gateway connection per system. For example, the Macintosh IIx has five slots and therefore could contain two coax adapters, two serial SDLC adapters, and a token ring adapter. Path 12 depicts a single Macintosh system with three host connections using three adapter cards.

---

## Peer-Peer Networks

Macintosh systems can participate in IBM advanced peer-peer networks (APPN) using the APPC application programming interface (API) available with SNA•ps. Applications may be written on the Macintosh which communicates with other LU 6.2 nodes, such as an AS/400, OS/2 workstation, RISC System/6000<sup>\*</sup>, IBM mainframe, DOS PC, or another Macintosh. The SNA•ps package allows an AppleTalk client to use the APPC API across an AppleTalk/SNA gateway. This allows distributed applications using LU 6.2 to run on a Macintosh client anywhere in the network.

---

## Version Details

Details contained within this document were obtained using a beta-level release of Version 1.1 of SNA•ps. This version differs from SNA•ps Version 1.0 in two significant areas: printer emulation and 16Mbps Token Ring support. Version 1.1 adds an SNA 3287 printer emulation function. It also adds the support for the Apple Token Ring 4/16 NB Card. Some minor changes may also appear in the release-level code. Token ring configurations running at 16 Mbps speeds were tested with an engineering level version of the Apple Token Ring 4/16 NB Card card which utilizes the IBM Token Ring chip set. In certain configurations, software compatibility with the Apple TokenTalk NB Card was tested. Check the footnotes and the Observations and Hints section in each path for additional information. See your Apple marketing representative for details on availability and support of these and other Apple products.

---

## Packaging and Order Information (Version 1.0)

SNA•ps is available in several different packages, depending on the network configuration, user session requirements, and method of IBM network attachment. See Appendix A, "Apple Products Datasheets" on page 235 for additional Apple product literature.

SNA•ps 3270, order number M0499LL/A, is an entry-level package, providing up to five DFT sessions for terminal and printer emulation along with an easy-to-use configuration program called SNA•ps 3270 Manager. All connection types are supported. Both the adapter gateway component and the 3270 emulation program are bundled together; however, the APPC API is not provided. This is the replacement package for current MacDFT<sup>\*\*</sup> users.

SNA•ps Gateway/8, order number M1037LL/A, provides the adapter gateway component for all supported connection types. Up to 8 concurrent 3270 and/or APPC sessions are supported thru the

---

\* Trademark of International Business Machines Corporation.—see "Notices" on page iii for lists of all trademarks used in this document.

\*\* Trademark of Apple Computer Inc.—see "Notices" on page iii for lists of all trademarks used in this document.

gateway. Also included is a configuration application, SNA•ps Config, and a session administration program, SNA•ps Admin. The 3270/APPC support is available in a separate package, SNA•ps 3270 GC (Gateway Client), order number M1220LL/A.

SNA•ps Gateway/32, order number M1037LL/A, provides the adapter gateway component for all supported connection types. Up to 32 concurrent 3270 or APPC sessions are supported thru the gateway. Also included is a configuration application, SNA•ps Config, and a session administration program, SNA•ps Admin. The 3270/APPC support is available in a separate package, SNA•ps 3270 GC (Gateway Client), order number M1220LL/A. Additional MCP memory is required.

SNA•ps Gateway/64, order number M1037LL/A, provides the adapter gateway component for all supported connection types. Up to 64 concurrent 3270 or APPC sessions are supported through the gateway. Also included is a configuration application, SNA•ps Config, and a session administration program, SNA•ps Admin. The 3270/APPC support is available in a separate package, SNA•ps 3270 GC (Gateway Client), order number M1220LL/A. Additional MCP memory is required.

SNA•ps 3270 GC (Gateway Client), order number M1220LL/A, provides the 3270 and APPC session support for the Macintosh client. Attachment may be direct (on the gateway machine itself) or distributed via AppleTalk. The total number of concurrent sessions is limited by available memory in the client system.

APPC Developer's Kit<sup>2</sup>, order number R0012LL/A, available through the Apple Developer's Association (APDA), provides the SNA•ps APPC programming interfaces, documentation, and sample programs.

3270 Developer's Kit, order number R0013LL/A, available through the Apple Developer's Association (APDA), provides the SNA•ps 3270 programming interfaces (HLLAPI), documentation, and sample programs.

---

<sup>2</sup> APDA orders can be placed by calling one of the following telephone numbers: United States - (800) 282-2732, Canada - (800) 637-0029, International - (408) 562-3910.



---

## Section 2. Apple Network Product Installation Overview

The SNA•ps Gateway acts as a communications server for client programs running on Macintosh computers on AppleTalk networks. Just as an AppleShare™ file server on an AppleTalk network provides access to shared files for network clients, the SNA•ps gateway is an LU session server that provides its clients with access to sessions on an IBM host. The clients can reside on the same machine as the gateway or on other Macintosh computers connected to the gateway computer over an AppleTalk network. This client-server design permits Macintosh computers without NuBus™ expansion slots, such as Macintosh Portable computers, to connect to SNA environments.

AppleTalk is a network protocol that is supported on Ethernet (IEEE 802.3), Token Ring (IEEE 802.5), and LocalTalk (RS-422) local area networks. SNA•ps uses AppleTalk protocols to provide client access to the SNA gateway across a LAN. "AppleTalk" describes the process of setting up a Macintosh for the various kinds of LAN environments.

After AppleTalk is set up on the gateway machine and client machines where appropriate, then the SNA•ps product components can be installed. An example of SNA•ps installation is provided in "SNA•ps" on page 11.

---

### AppleTalk

The SNA•ps product requires that the AppleTalk network machine name be specified. To do this, choose Control Panels from the Apple menu, then double click on the Sharing Setup Control panel. Figure 2 on page 8 shows the name *Macfx116* as the name that was entered in the Macintosh Name field. A Macintosh name is necessary because the default gateway identifiers for the adapter cards are in the format "machine\_name-slot number"; for example, MACFX116-3 specifies the adapter card in NuBus slot 3 of the Macintosh known as MACFX116.

---

\*\* Trademark of Apple Computer Inc.—see "Notices" on page iii for lists of all trademarks used in this document.

\*\* Trademark of Texas Instruments—see "Notices" on page iii for lists of all trademarks used in this document.

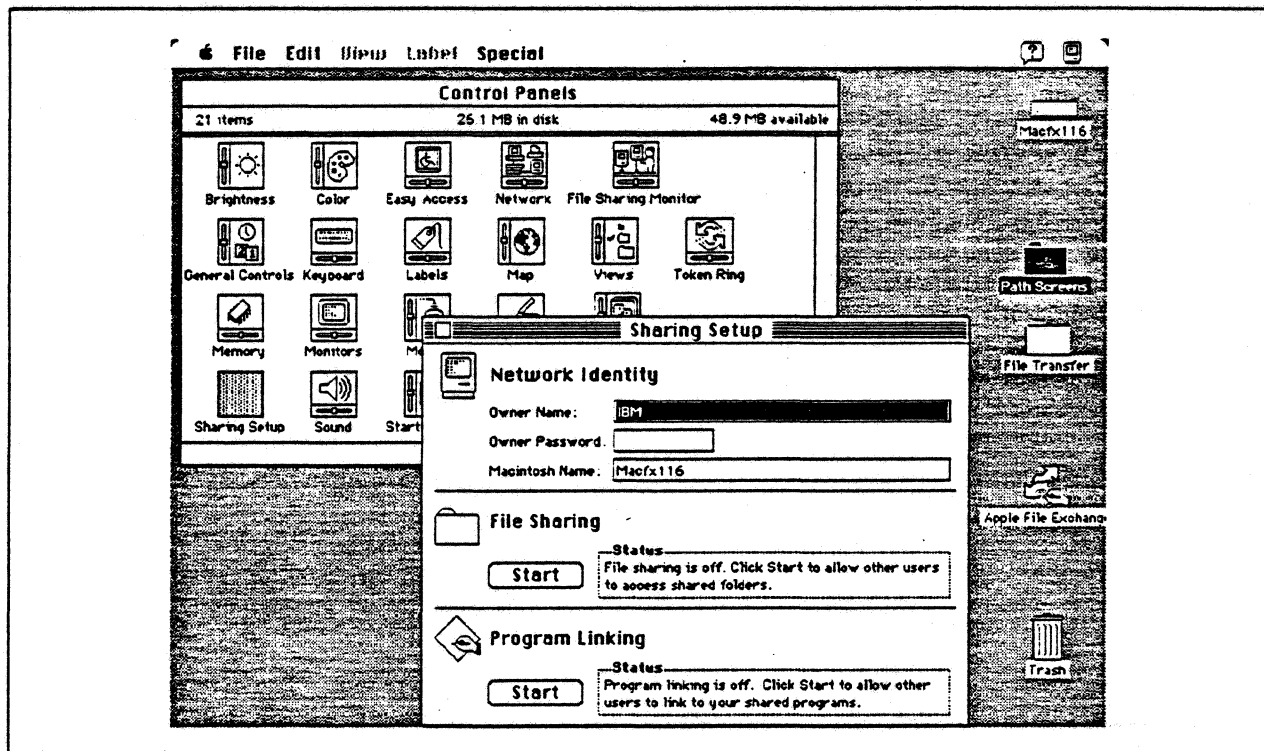

Figure 2. Setting Network Identity in the Sharing Setup Control Panel. (The Macintosh name needs to be specified before installing SNA\*ps)

## LocalTalk

Each Macintosh comes with LocalTalk for AppleTalk installed on the system. The LocalTalk connector is integrated with the system board and requires no additional adapter cards. By purchasing LocalTalk cables for your system, you can connect your Macintosh to other Macintosh computers or printers. No additional customization is required for attachment to the LocalTalk network. The *LocalTalk Cable System Owner's Guide* provides reference information about LocalTalk cables, hardware and installation.



## EtherTalk

To install and use EtherTalk, the following components are required:

- A member of the NuBus (NB) family of Macintosh computers
- An Apple EtherTalk NB Card
- EtherTalk software (device drivers)
- An Ethernet LAN attachment (10Base 2, 10Base 5, 10Base T)

or

- A Macintosh LC personal computer
- EtherTalk software (device drivers)
- An Apple Ethernet LC Card
- An Ethernet LAN attachment (10Base 2, 10Base 5, 10Base T)

The *Apple EtherTalk NB User's Guide*, which comes as part of the Apple EtherTalk NB Card product package, provides information about installing and operating EtherTalk on an AppleTalk network system. Briefly, the adapter is installed with following steps:

1. Shut down the system if it is running.
2. Insert the Ethernet card in the system unit
3. Power on the machine and bring up the operating system
4. Insert and start the Network Products Installer
5. Install the EtherTalk drivers
6. Restart the system

After the product is installed, EtherTalk needs to be selected as the network type since LocalTalk is the default. To select EtherTalk, choose Control Panels from the Apple menu. Double click on the Network icon, then click on the EtherTalk icon. Figure 3 shows the Network Control Panel with the EtherTalk icon highlighted, indicating that it was selected as the network type.

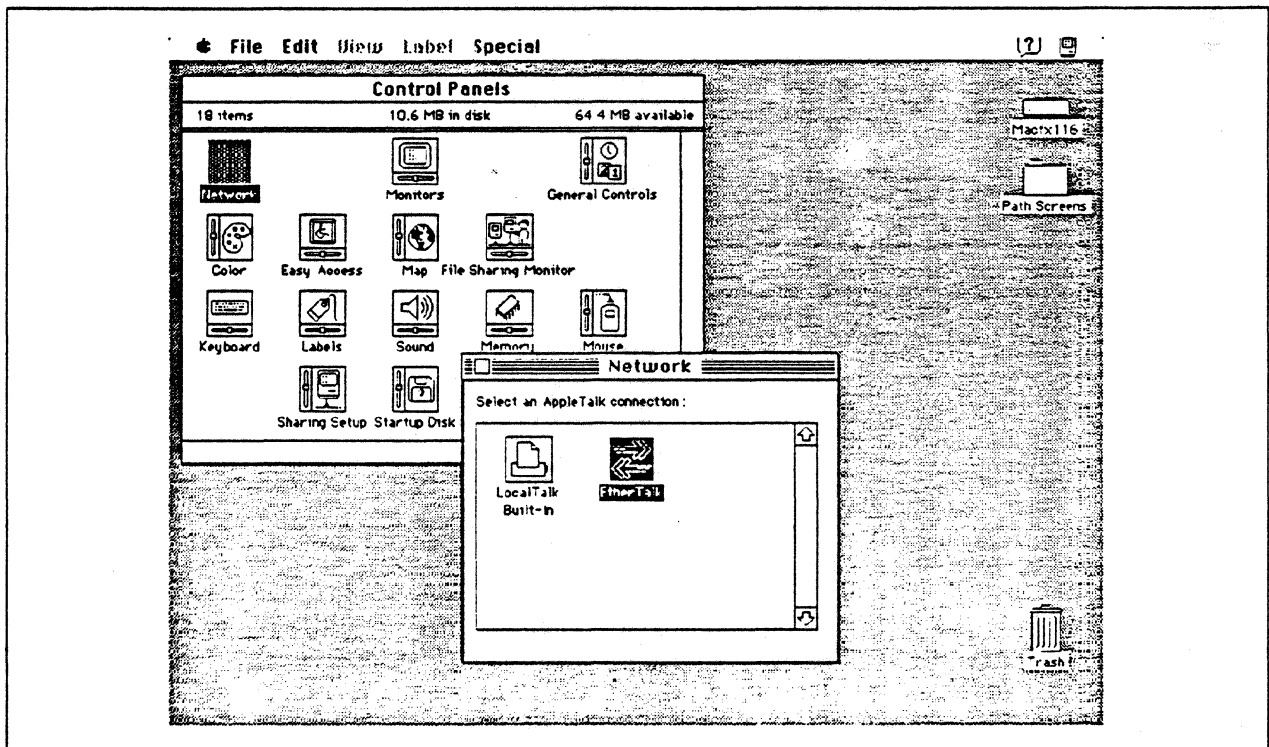

Figure 3. Selecting EtherTalk in the Network Control Panel

## AppleTalk Installation

### TokenTalk

To install and use TokenTalk, the following components are required:

- A member of the NuBus (NB) family of Macintosh computers
- The Apple Token Ring 4/16 NB Card or the Apple TokenTalk NB Card
- TokenTalk software
- A Token Ring LAN attachment (DB-9 connector)

The *Apple TokenTalk NB User's Guide* provides information about installing and operating TokenTalk on an AppleTalk network system. Briefly, use the following steps to install the adapter:

1. Shut down the system if it is running.
2. Insert the Token Ring card in the system unit
3. Power on the machine and bring up the operating system
4. Insert and start the Network Products Installer
5. Install the TokenTalk drivers
6. Restart the system

After the product is installed, you need to select TokenTalk as your network type because LocalTalk is the default. To select TokenTalk, choose Control Panels from the Apple menu. Double click on the Network icon, then click on the TokenTalk icon. Figure 4 shows the Network Control Panel with the TokenTalk icon highlighted, indicating that it was selected as the network type.

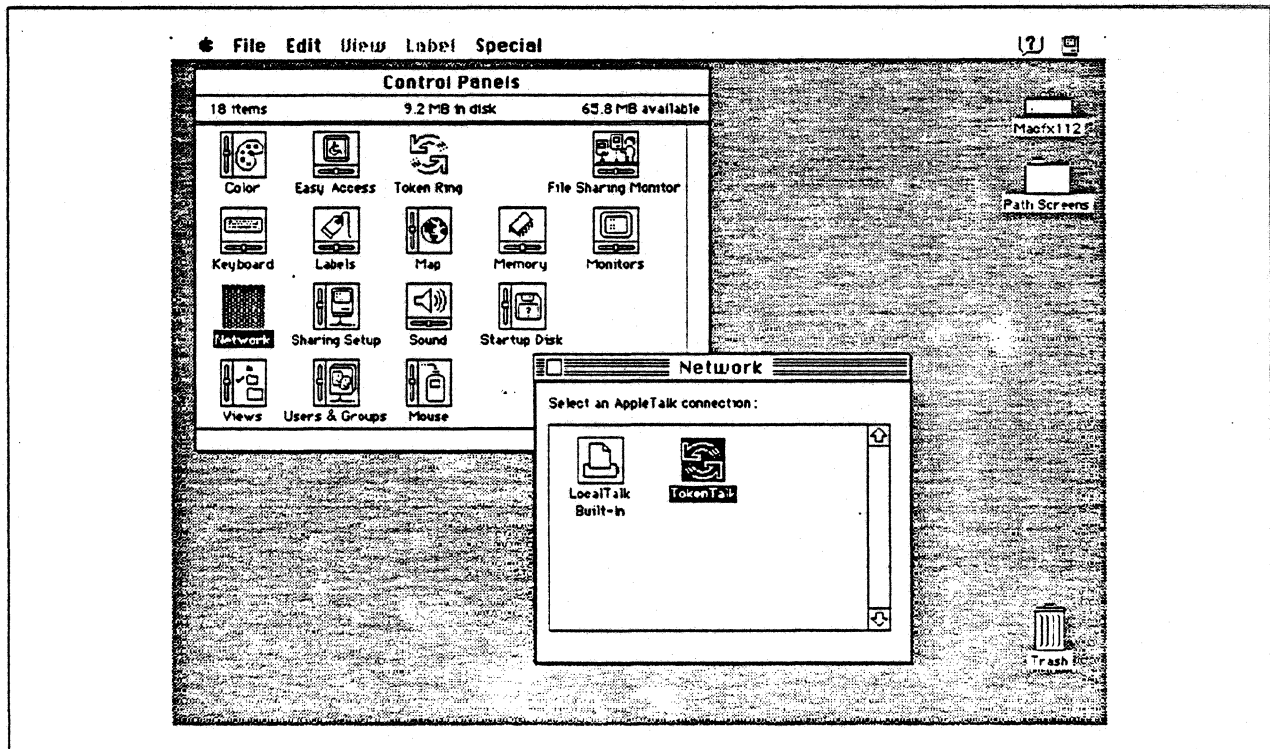

Figure 4. Selecting TokenTalk in the Network Control Panel

The Token Ring address of the Token Ring NB card can be changed or displayed by choosing Control Panels from the Apple menu. Double click on the Token Ring panel, then click on Other Settings. The default address and the current address of the Token Ring card are displayed. Use this panel to change to an appropriate locally-administered adapter address if necessary for your particular network environment.

---

## SNA•ps

The SNA•ps product consists of four software components that run on Macintosh computers:

- SNA•ps Gateway, which runs on an intelligent communications card installed in a Macintosh II computer, works with other SNA•ps programs to provide you with gateway services. The SNA•ps Gateway is visible to you through the SNA•ps configuration and management programs.
- The SNA•ps 3270 Manager program lets you configure and manage a gateway for 3270 terminal emulation using a single connection to a single host.
- The SNA•ps Config program lets you create more complex configurations that may involve multiple lines, hosts and Advanced Program-to-Program Communication (APPC) connections.
- The SNA•ps Admin program provides a complete set of management features for SNA•ps Gateways running any configuration created by SNA•ps 3270 Manager or SNA•ps Config. SNA•ps Admin lets you know the status of SNA•ps Gateways on your AppleTalk network.

The SNA•ps Gateway runs on an intelligent communications card such as the Apple TokenTalk NB Card, the Apple Serial NB Card, or an Apple Coax/Twinax Card. This card needs to be installed before you install the SNA•ps Gateway.

The *SNA•ps Administrator's User's Guide* describes how to install the SNA•ps Gateway and Management software. The *SNA•ps User's Guide* describes how to install the 3270 Client software and the SNA•ps Gateway that is packaged with the SNA•ps 3270 product.

The following example describes installing the SNA•ps 3270 client and gateway component of the SNA•ps 3270 product on the same Macintosh.

1. Insert the backup copy of the SNA•ps 3270 Install disk into your disk drive, then double click the disk icon to open it.
2. Double click the Installer application to start the installation. A dialog box appears, welcoming you to Installer and briefly explaining the Installer application. Click OK.
3. The Easy Install dialog box appears, indicating the target drive where the software will be installed. If you click the Install button, you will install the SNA•ps 3270 software including CUT and NLCA. In this example, we are showing the installation of the gateway component and the 3270 client, so we clicked on the Customize button. The screen shown in Figure 5 on page 12 appears.

In this example, we selected the SNA•ps 3270 Client, System 7 and the SNA•ps 3270 Gateway and Admin, System 7. Click the Install button. When a message appears that tells you that the installation was successful, click Restart.

Whether you use the SNA•ps 3270 Install or the SNA•ps Gateway Install, the installation creates a SNA•ps folder on the hard disk that you specify during the installation. You will find the SNA•ps 3270 Client and Gateway Management software in this folder.

## SNA•ps Installation

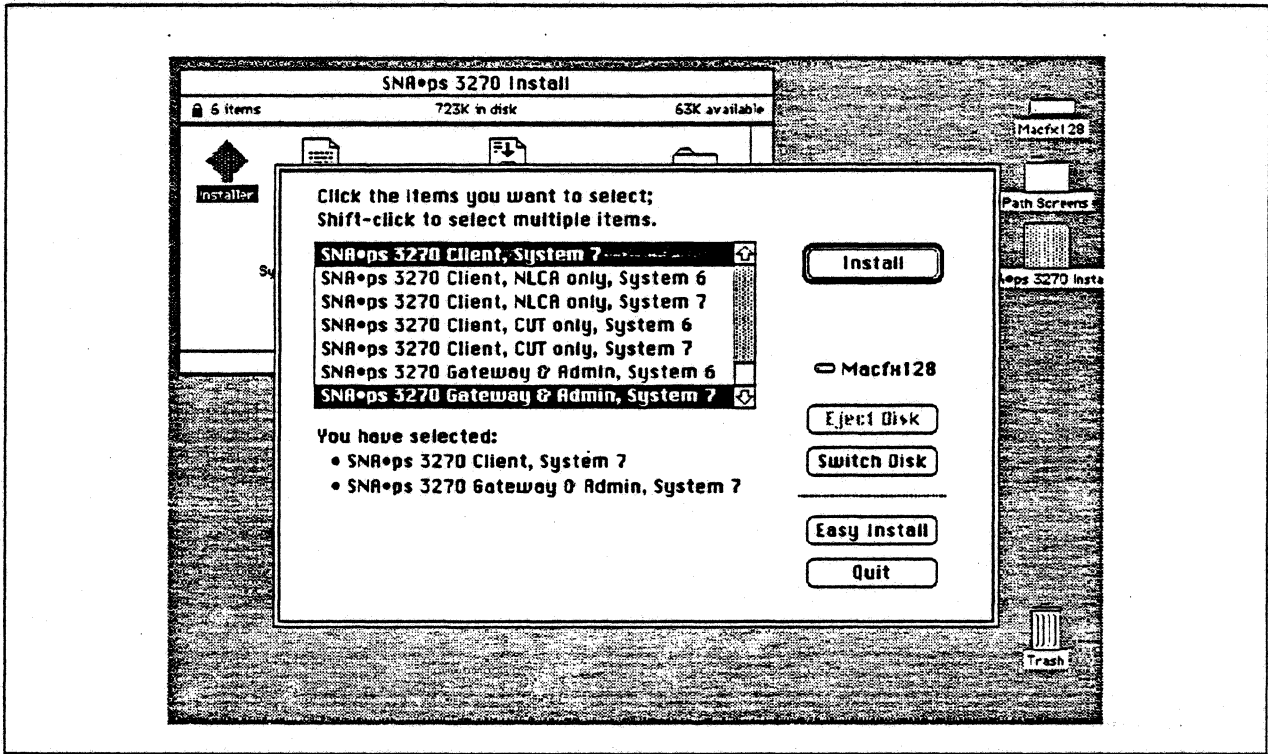

Figure 5. Installing the SNA•ps 3270 Package Using Customize Option

---

## Section 3. 3270 Terminal Emulation Paths

The following paths are included in this section:

- "Path 1: MVS Host Attachment via 3745 Token Ring LAN" on page 14
- "Path 2: MVS Host Attachment via 3745 SDLC Connection" on page 22
- "Path 3: AS/400 Host Attachment via Token Ring LAN" on page 30
- "Path 4: AS/400 Host Attachment via SDLC Connection" on page 42
- "Path 5: VM Host Attachment via Token Ring LAN" on page 54
- "Path 6: VM Host Attachment via SDLC Connection" on page 64
- "Path 7: VM Host Attachment via DFT Workstation Adapter" on page 72
- "Path 8: MVS Host Attachment via Macintosh Token-Ring Gateway" on page 78
- "Path 9: MVS Host Attachment via Macintosh Token Ring Gateway with Multiple LAN Clients" on page 88
- "Path 10: MVS Host Attachment via Macintosh SDLC Gateway" on page 98
- "Path 11: MVS Host Attachment via Macintosh SDLC Gateway with Multiple LAN Clients" on page 108
- "Path 12: MVS, VM, and AS/400 Hosts via Multiple SNA•ps Gateways" on page 118
- "Path 13: MVS, VM, and AS/400 Hosts via Token Ring SNA•ps Gateway" on page 132
- "Path 14: MVS Host Attachment via 3174 SDLC Gateway" on page 152
- "Path 15: MVS Host Attachment via 3174 DFT Connection" on page 162
- "Path 16: MVS Host Attachment via OS/2 Extended Edition SDLC Gateway" on page 172

---

## Path 1: MVS Host Attachment via 3745 Token Ring LAN

### Path Description

This configuration consists of the SNA•ps product running on an Apple Macintosh that is connected to an IBM MVS host through an IBM Token-Ring (IEEE 802.5) local area network.

The configuration is shown in Figure 6 on page 15. The MVS host is attached to the Token Ring using an IBM 3745 Communications Controller which has the 16/4 Mbps Token-Ring Interface Card (TIC) feature. An Apple Token Ring 4/16 NB Card is used in the Macintosh for Token Ring LAN attachment. The Macintosh is defined in a VTAM switched major node as a PU type 2 to the MVS host.

This configuration provides the Macintosh user with up to 5 LU sessions for 3270 terminal and printer emulation.

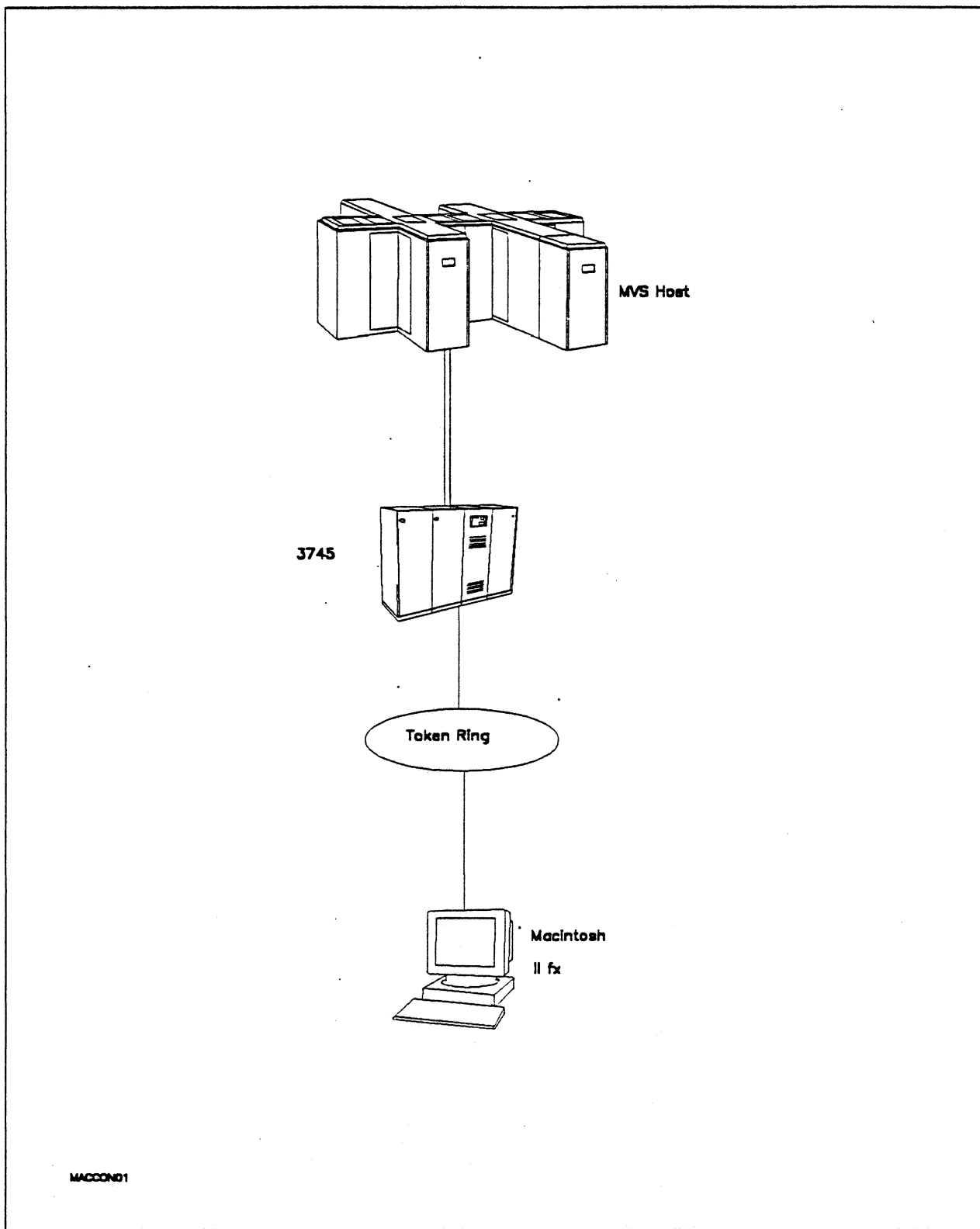

MACCOND1

Figure 6. Path 1 Configuration - MVS Host Attachment via 3745 Token Ring LAN

## Hardware and Software

The following section describes the hardware and software that was used for this path.

### MVS Host

- 4381 system
- MVS/SP JES2 Version 2 Release 2.0 (MVS/XA)
- VTAM Version 3 Release 3
- OEMI channel
- JES/328X Print Facility

### 3745

- 16/4 Mbps Token Ring adapter (TIC) type 2 feature #4770
- Channel adapter feature #1561
- NCP Version 5 Release 3

### Token Ring

- 16 Mbps<sup>3</sup>

### Macintosh IIfx

- System Software 7.0
- SNA•ps 3270 V1.1 (beta)
- Apple Token Ring 4/16 NB Card with MCP memory expansion kit (1MB total)
- LaserWriter IINTX printer
- Total memory - 4M
- Hard disk - 80M

---

<sup>3</sup> Compatibility with the 4 Mbps Apple TokenTalk NB Card was also verified.



## Configuration Details and Operating Procedures

The following section contains details of how the configuration is defined and the procedures that are used.

### MVS Host (VTAM and NCP Definitions)

DIALAPPL VBUILD TYPE=SWNET

\*

TOAAP1	PU	ADDR=04,	C
		IDBLK=00A,	C
		IDNUM=37451,	C
		PACING=0,	C
		VPACING=0,	C
		IRETRY=YES,	C
		MAXDATA=265,	C
		SSCPFM=USSSCS,	C
		DISCNT=NO,	C
		PUTYPE=2,	C
		MAXOUT=7,	C
		MODETAB=ISTINCLM,	C
		DLOGMOD=SNX32702,	C
		USSTAB=TPOUSS	
TOAAP102	LU	LOCADDR=2,DLOGMOD=SNX32702	* 3278 MODEL 2 *
TOAAP103	LU	LOCADDR=3,DLOGMOD=SNX32703	* 3278 MODEL 3 *
TOAAP104	LU	LOCADDR=4,DLOGMOD=SNX32704	* 3278 MODEL 4 *
TOAAP105	LU	LOCADDR=5,DLOGMOD=SNX32705	* 3278 MODEL 5 *
TOAAP106	LU	LOCADDR=6,DLOGMOD=SCS	* 3287 SCS PRINTER *

Refer to Appendix C, "NCP Gen Listing" on page 287 for the complete NCP gen listing.

### Macintosh

1. Start the SNA•ps 3270 Manager program. The Network Gateway Status window appears.
2. Choose New Configuration from the File menu. A dialog box appears (refer to Figure 7 on page 18) in which you select the type of card to be configured. Click on the radio button for Token Ring (which is the default), then click OK.
3. Figure 8 on page 19 is an example of the dialog box in which the configuration information is entered. For this path, the VTAM statements defined 4 display LUs and 1 printer LU. The XID value corresponds to the IDBLK-IDNUM values defined on the VTAM PU definition statement. For the Address field, enter the LOCADD value from the NCP LINE definition statement for the 3745 Token Ring adapter card.
4. Click on the LU Settings button to display the LU settings. Verify that the Address field corresponds to the LOCADDR on the VTAM LU definition statement. (Reference Figure 9 on page 19.) Click OK.
5. Choose Save Configuration from the File menu. Save this configuration file as *path01*.
6. In the Network Gateway Status window, select the Token Ring gateway to be configured. Choose Select Configuration from the Gateway menu. Select *path01*, then click on the Select button to assign *path01* to the Token-Ring gateway. (Reference Figure 10 on page 20.)
7. To start the gateway, in the Network Gateway Status window select the Token Ring gateway with *path01* specified as the configuration. Choose Start Gateway from the Gateway menu. Click Start to confirm that you want the gateway started. (Reference Figure 11 on page 20.)
8. When the gateway has been started, the Status column of the Network Gateway Status contains "Started".

## Path 1

9. Start the SNA•ps 3270 application.
10. Choose Connect from the Session menu. Select the gateway that was started in step 7 on page 17. Click on the Sessions button to display the specific LUs. Select a session, then click OK to connect the session to the SNA•ps gateway. (Reference Figure 12 on page 21.)
11. At this point, the logon screen specified in the VTAM definition is displayed if the VTAM line, PU, and LUs have been activated.

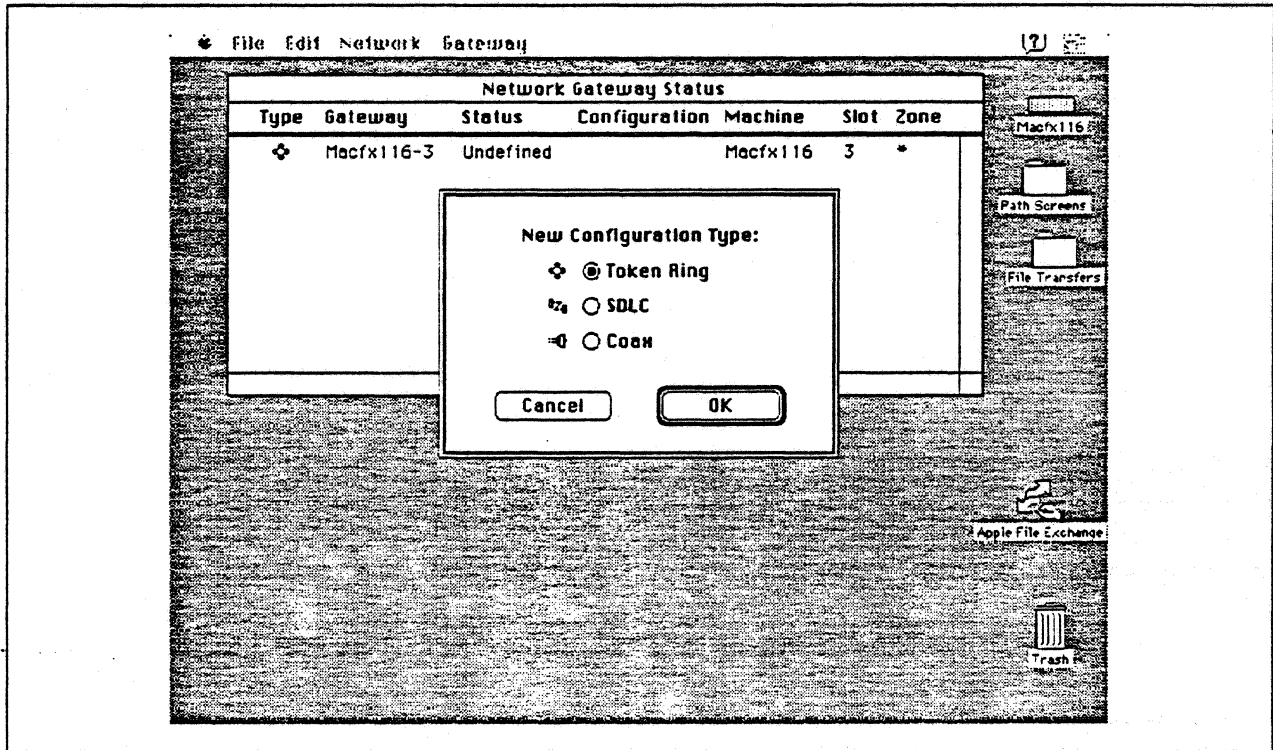

Figure 7. DLC Type Selection for Upstream Connection

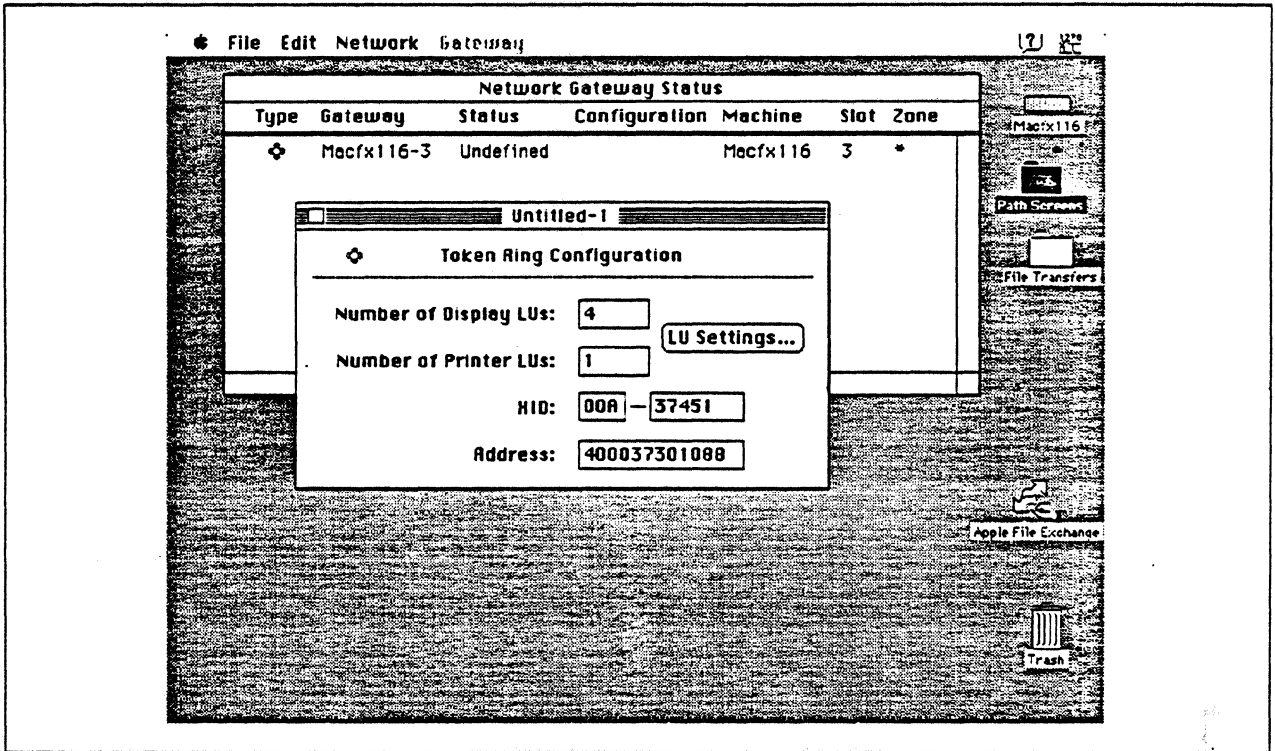

Figure 8. Token Ring Gateway Configuration Parameters

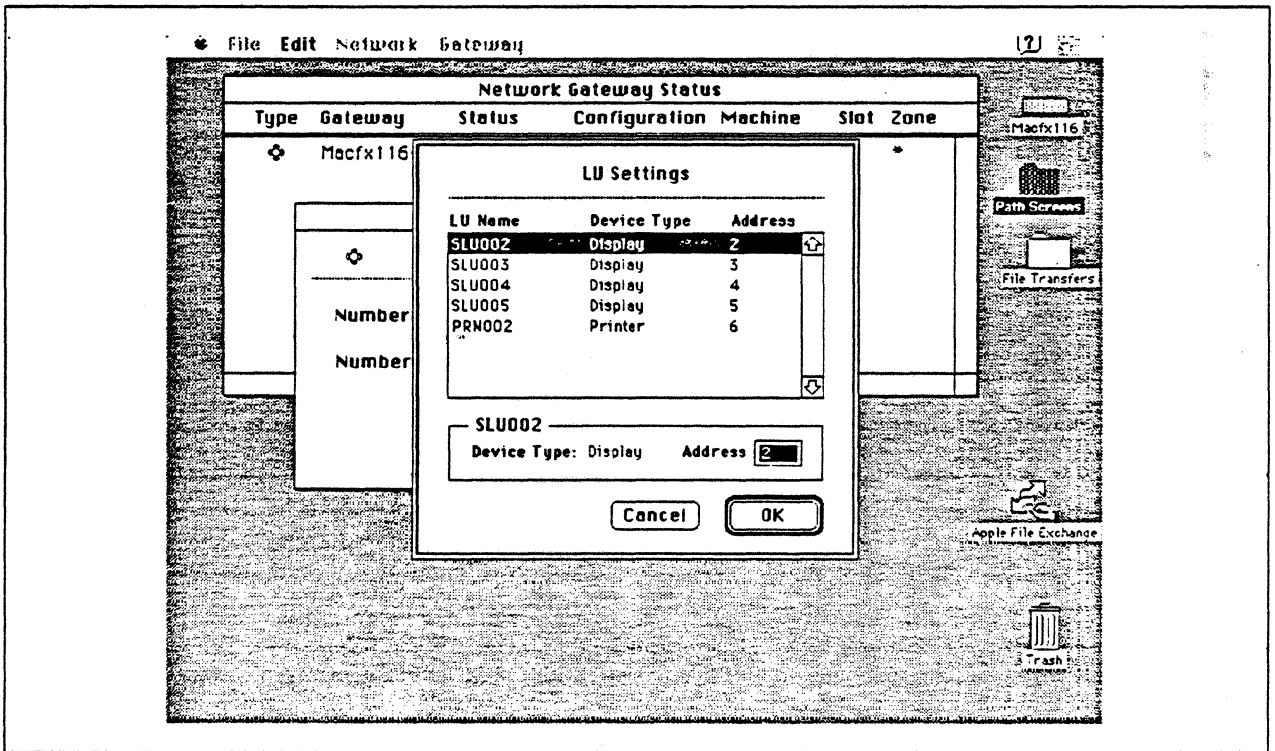

Figure 9. LU Settings

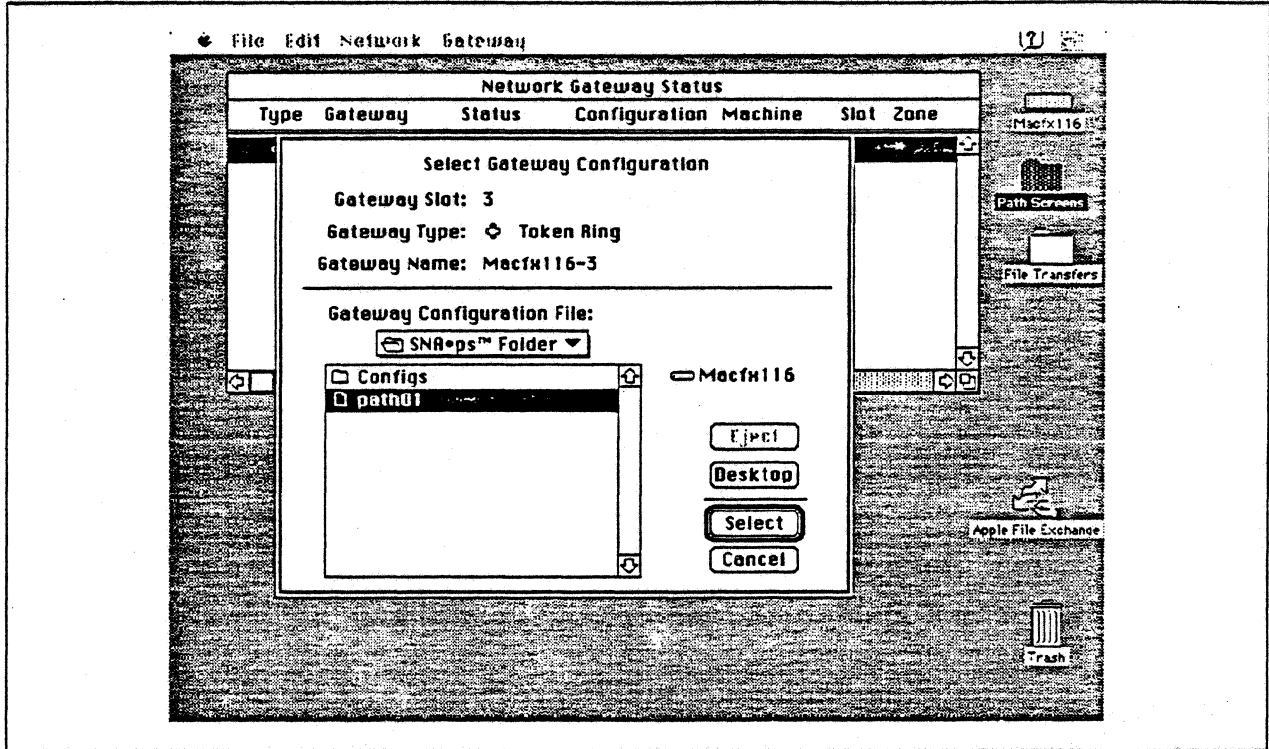

Figure 10. Gateway Configuration Selection

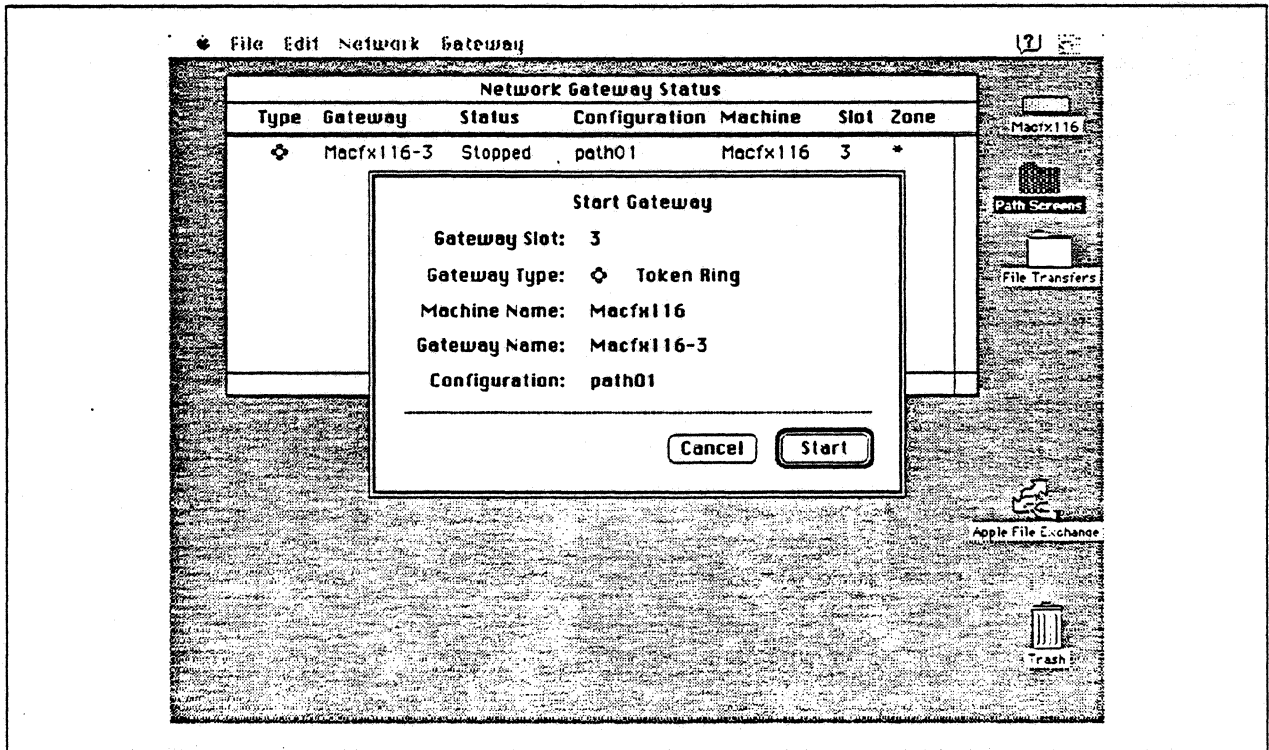

Figure 11. Starting the Gateway

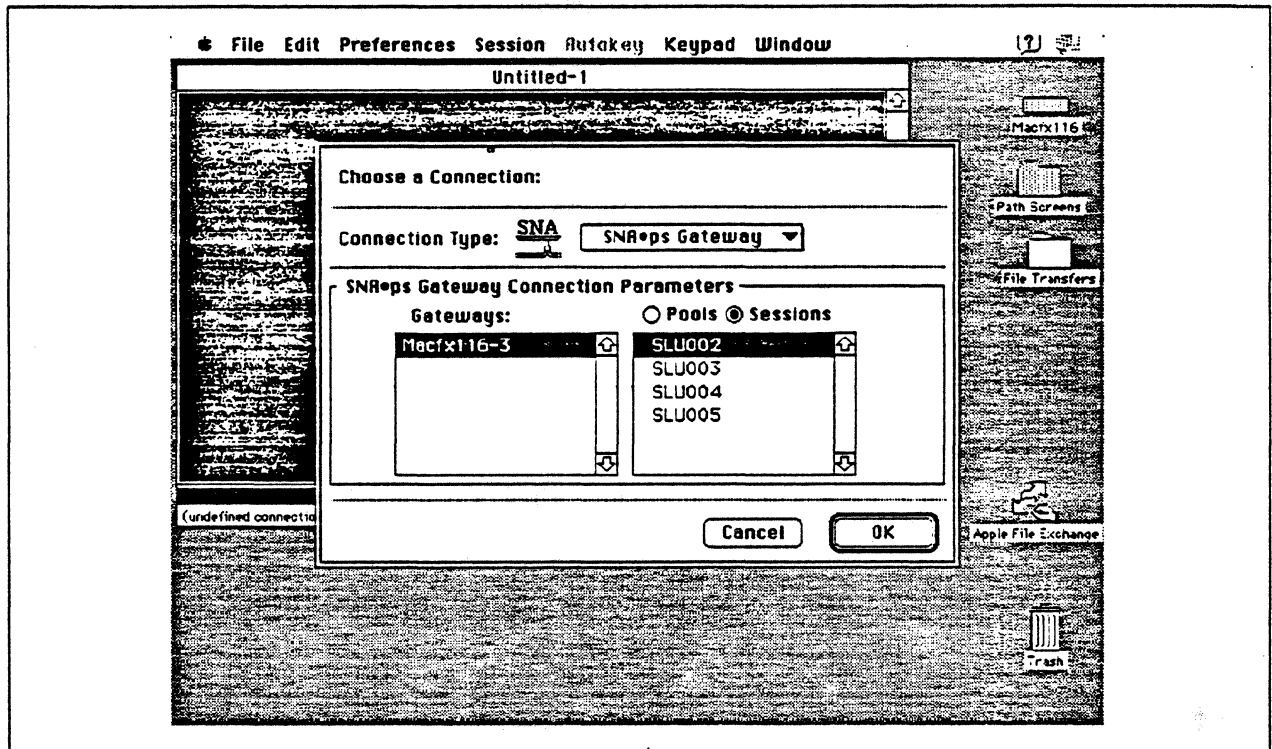

Figure 12. Choosing the Connection

## Observations and Hints

Four display LU sessions and a printer LU session were verified.

The operational status of all PU and LU sessions was verified using NetView.

Print files were sent from the host to the LaserWriter for printing.

---

## Path 2: MVS Host Attachment via 3745 SDLC Connection

### Path Description

This configuration consists of the SNA•ps product running on an Apple Macintosh that is connected to an IBM MVS host through a remote SDLC communications link.

The configuration is shown in Figure 13 on page 23. The MVS host is accessed with an RS-232 line interface card (LIC) on an IBM 3745 Communications Controller. An Apple Serial NB Card is used in the Macintosh for SDLC attachment. The Macintosh is defined as a PU type 2 on a nonswitched line in the NCP gen for the 3745.

This configuration provides the Macintosh user with up to 5 LU sessions for 3270 terminal and printer emulation.

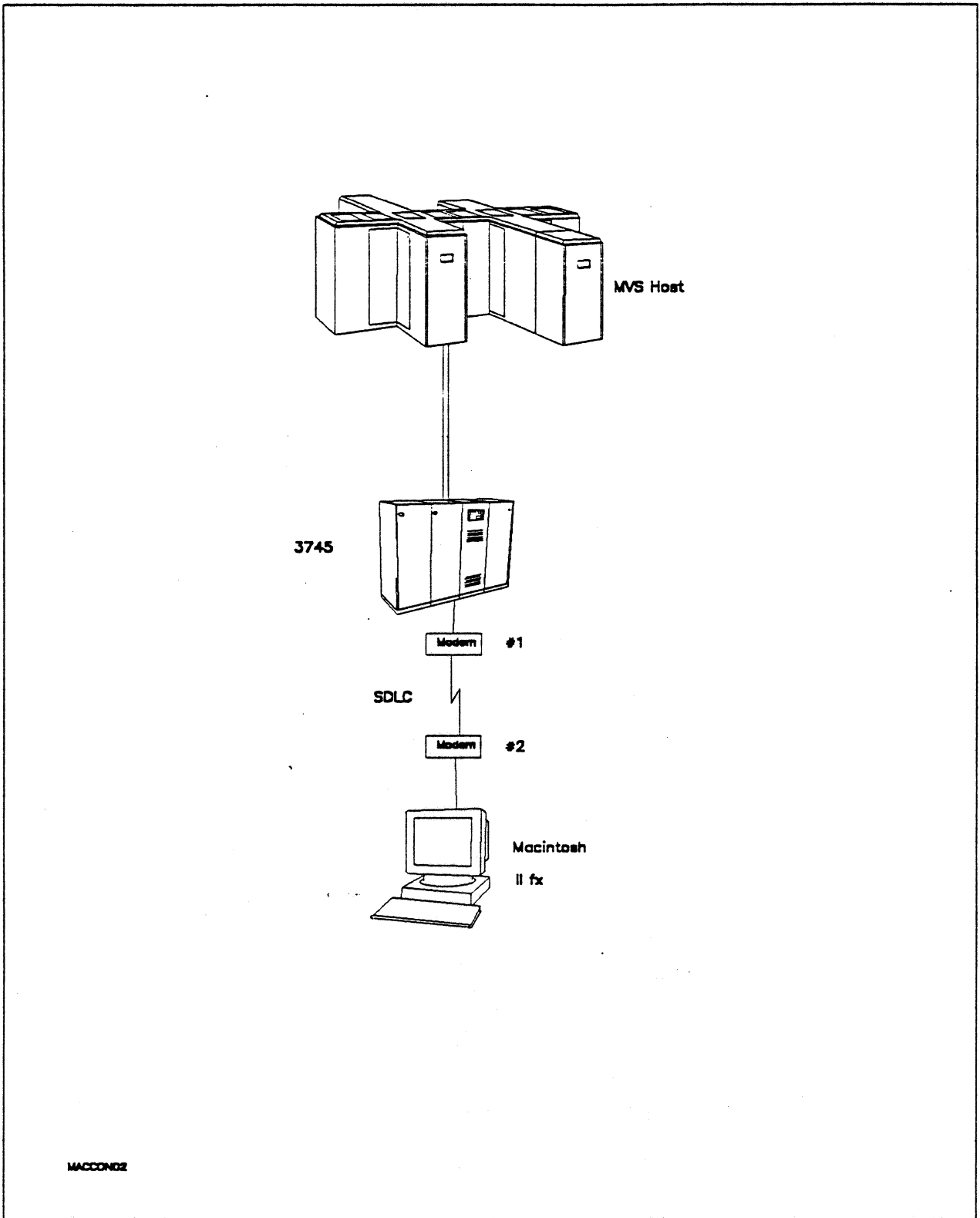

Figure 13. Path 2 Configuration - MVS Host Attachment via 3745 SDLC Connection

## Path 2

### Hardware and Software

The following section describes the hardware and software that was used for this path.

#### MVS Host

- 4381 system
- MVS/SP JES2 Version 2 Release 2.0 (MVS/XA)
- VTAM Version 3 Release 3
- OEMI channel
- JES/328X Print Facility

#### 3745

- Line interface card (LIC) type 1 feature #9911
- Channel adapter feature #1561
- NCP Version 5 Release 3

#### Modems #1 and #2

- 19.2 Kbps
- SDLC
- RS-232
- NRZI
- Leased

#### Macintosh IIfx

- System Software 7.0
- SNA•ps 3270 V1.1 (beta)
- Apple Serial NB Card with MCP memory expansion kit (1MB total)
- RS-232 serial cable
- LaserWriter IINTX printer
- Total memory - 4M
- Hard disk - 80M



## Configuration Details and Operating Procedures

The following section contains details of how the configuration is defined and the procedures that are used.

**MVS Host (VTAM and NCP Definitions):** VTAM uses PU T03014P1, which is defined by the following section of the NCP gen.

```

GR30APP  GROUP  CLOCKNG=EXT,DIAL=NO,          +
                LNCTL=SDLC,MAXDATA=521,       +
                MAXOUT=7,PASSLIM=3,PAUSE=0.2,  +
                PUTYPE=2,REPLYTO=2,SERVLIM=2,  +
                TYPE=NCP
*
T03014L  LINE  ADDRESS=(014),ANS=CONT,DUPLEX=FULL,NRZI=YES
*
          SERVICE  ORDER=(T03014P1)
*
T03014P1  PU  ADDR=C1,                        C
            PACING=0,                          C
            VPACING=0,                          C
            IRETRY=YES,                         C
            MAXDATA=265,                       C
            SSCPFM=USSSCS,                     C
            DISCNT=NO,                          C
            PUTYPE=2,                           C
            MAXOUT=7,                           C
            MODETAB=ISTINCLM,                   C
            DLOGMOD=SNX32702,                   C
            USSTAB=TPOUSS
T0301402 LU  LOCADDR=2,DLOGMOD=SNX32702      * 3278 MODEL 2 *
T0301403 LU  LOCADDR=3,DLOGMOD=SNX32703      * 3278 MODEL 3 *
T0301404 LU  LOCADDR=4,DLOGMOD=SNX32704      * 3278 MODEL 4 *
T0301405 LU  LOCADDR=5,DLOGMOD=SNX32705      * 3278 MODEL 5 *
T0301406 LU  LOCADDR=6,DLOGMOD=SCS           * 3287 SCS PRINTER *

```

Refer to Appendix C, "NCP Gen Listing" on page 287 for the complete NCP gen listing.

### Macintosh

1. Start the SNA\*ps 3270 Manager program. The Network Gateway Status window appears.
2. Choose New Configuration from the File menu. A dialog box appears (refer to Figure 14 on page 26) in which you select the type of card to be configured. Click on the radio button for SDLC, then click OK.
3. The SDLC Configuration dialog box appears. For this path, the VTAM statements defined 4 display LUs and 1 printer LU. In the Address field, enter the SDLC address that corresponds to the PU ADDR field in the NCP leased line definition. Because this is a leased line, the Gateway XID field is not specified. (Refer to Figure 15 on page 27.)
4. Click on the LU Settings button to display the LU settings. Verify that the Address field corresponds to the LOCADDR in the LU definition statement that VTAM and NCP use. (Reference Figure 16 on page 27.) Click OK.
5. Choose Save Configuration from the File menu. Save this configuration file as *path02*.
6. In the Network Gateway Status window, select the SDLC gateway that you want to configure. Choose Select Configuration from the Gateway menu. Select *path02*, then click on the Select button to assign *path02* to the SDLC gateway. (Reference Figure 17 on page 28.)

## Path 2

7. To start the gateway, in the Network Gateway Status window select the SDLC gateway with *path02* specified as the configuration. Choose Start Gateway from the Gateway menu. (Reference Figure 18 on page 28.) Click Start to confirm that you want this gateway started.
8. When the gateway has been started, the Status column of the Network Gateway Status contains "Started".
9. Start the SNA•ps 3270 application.
10. Choose Connect from the Session menu. Select the gateway that was started in step 7. Click on the Sessions button to display the specific LUs. Select a session, then click OK to connect that session to the SNA•ps gateway. (Reference Figure 19 on page 29.)
11. At this point, the logon screen specified in the VTAM definition is displayed if the VTAM line, PU, and LUs have been activated.

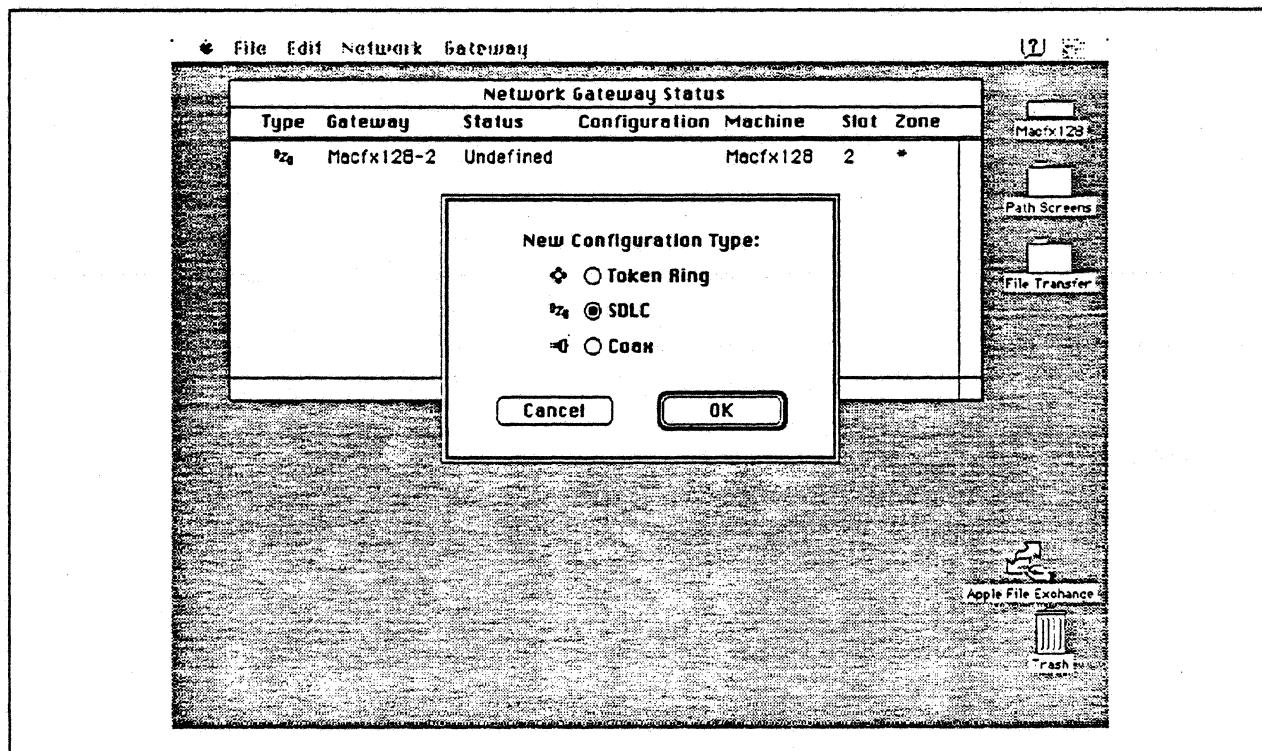

Figure 14. DLC Type Selection for Upstream Connection

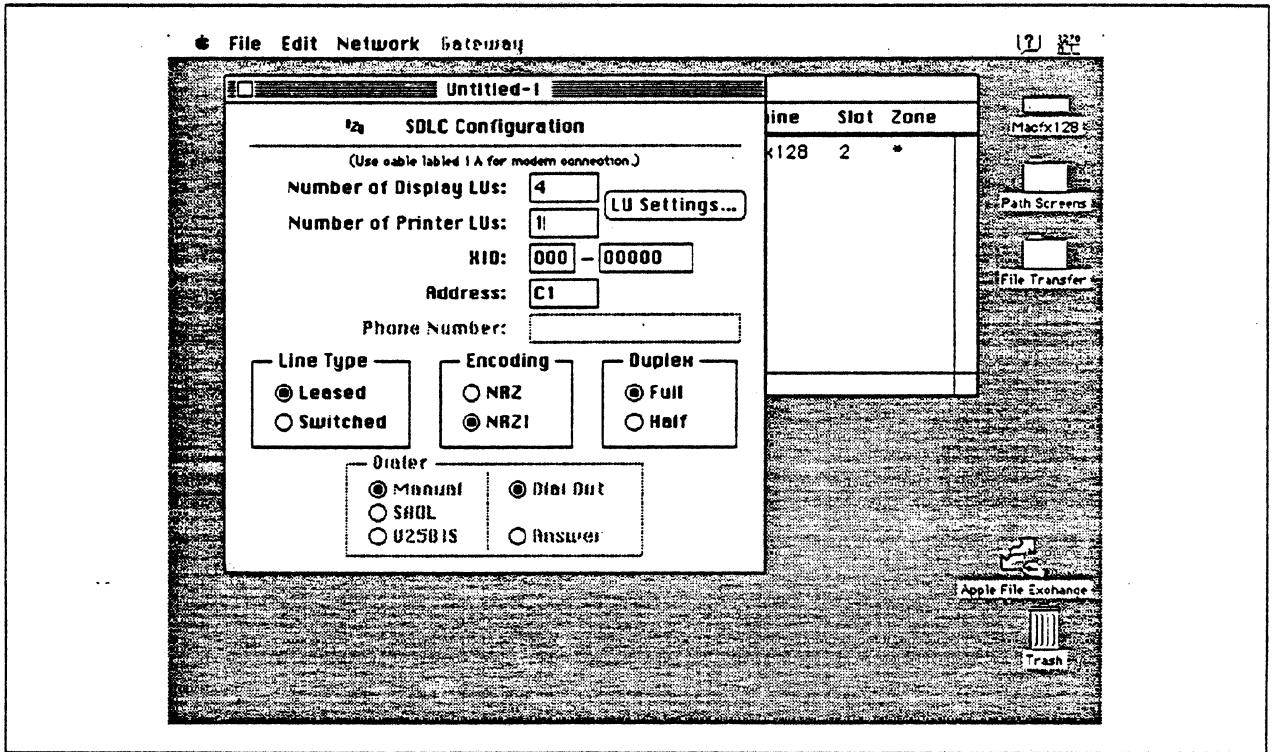

Figure 15. SDLC Gateway Configuration Parameters

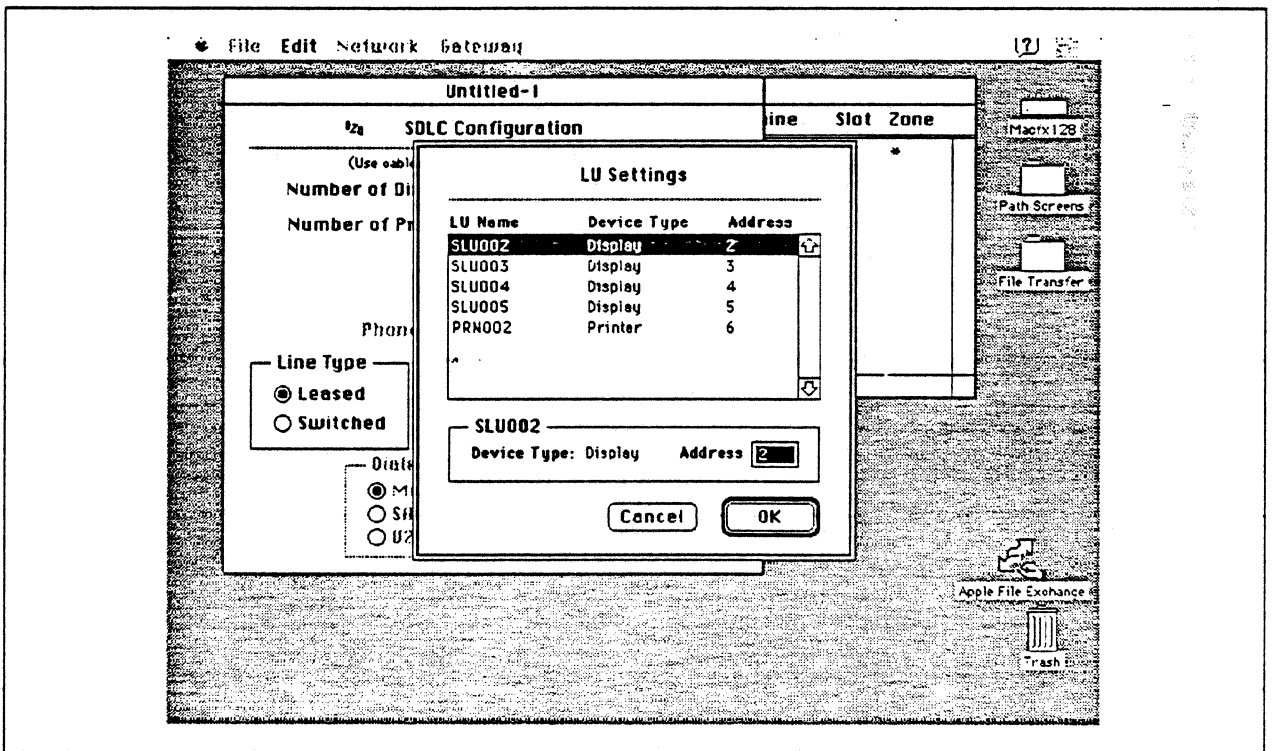

Figure 16. LU Settings

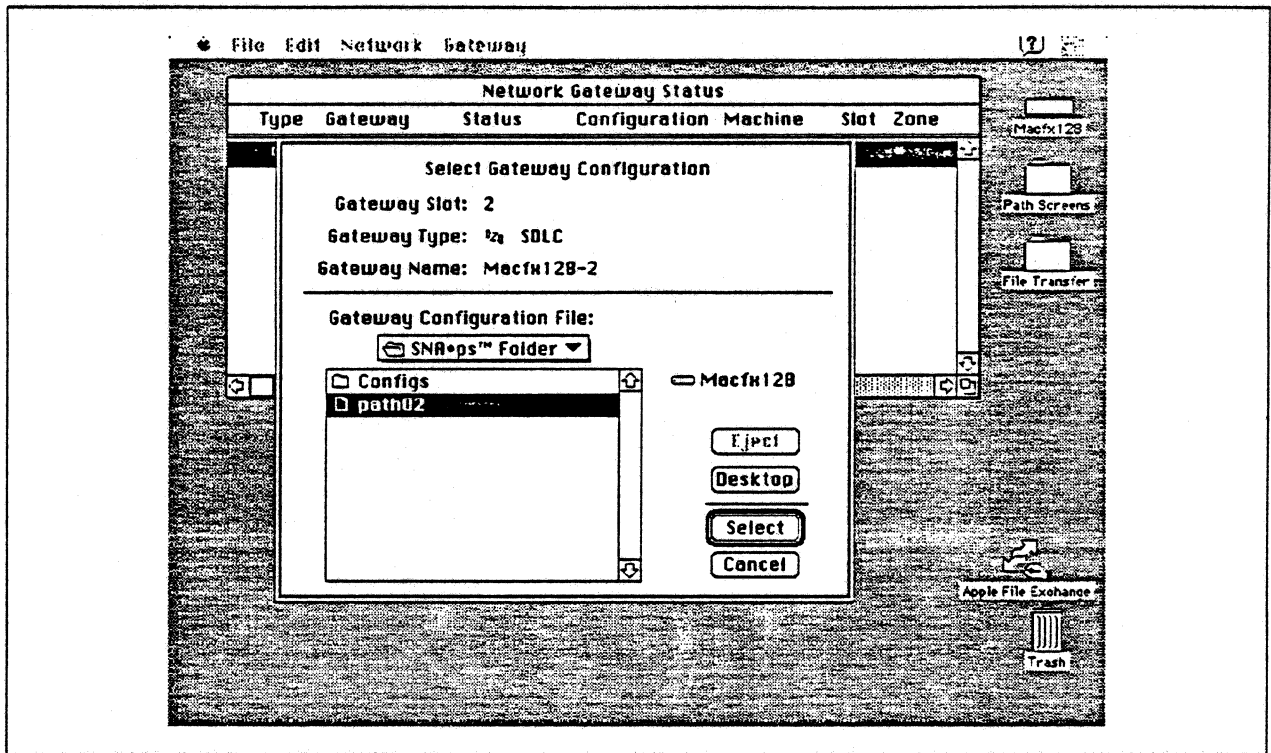

Figure 17. Gateway Configuration Selection

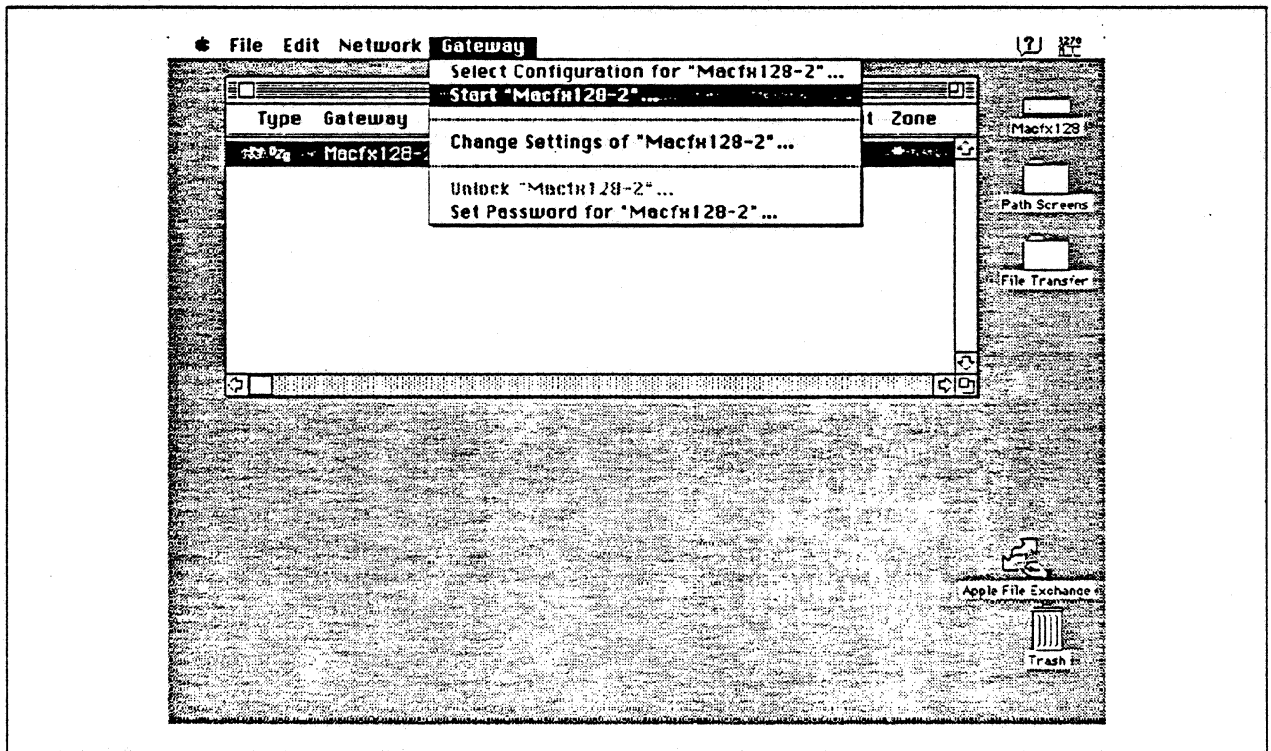

Figure 18. Selecting Start from Gateway Menu

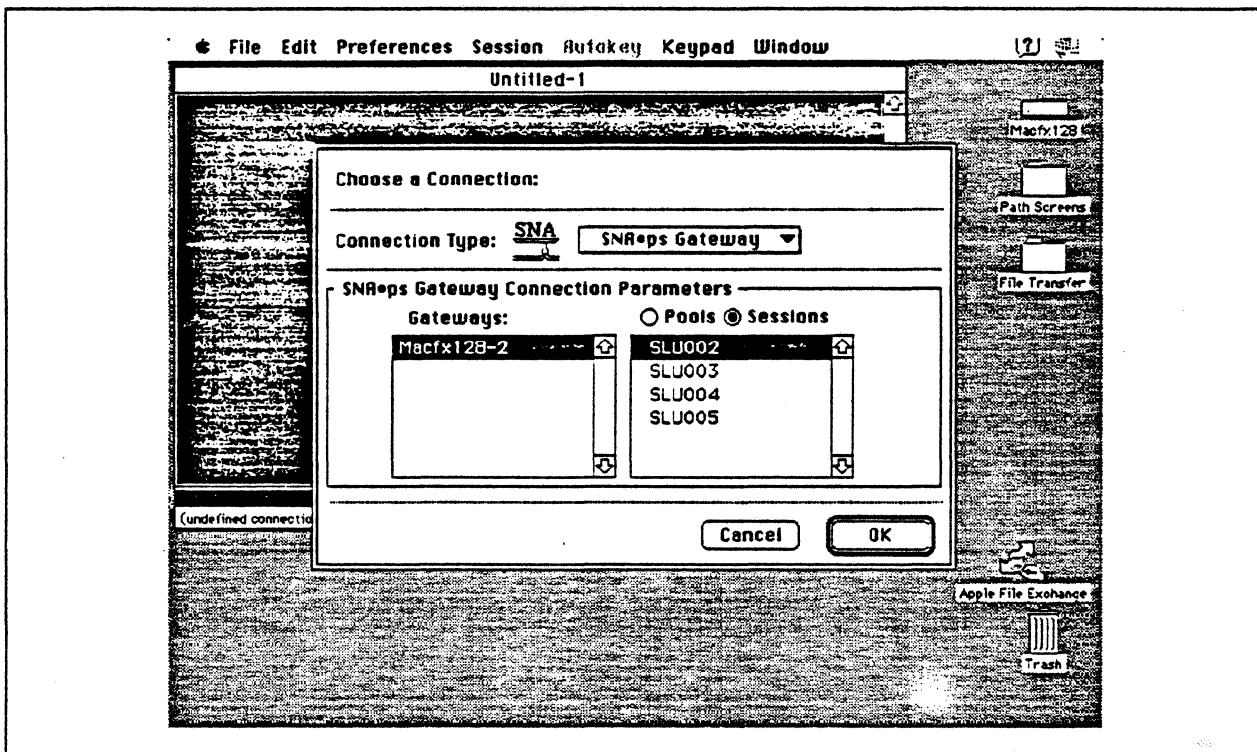

Figure 19. Choosing the Connection

### Observations and Hints

Four display LU sessions and a printer LU session were verified.

The operational status of all PU and LU sessions was verified using NetView.

Print files were sent from the host to the LaserWriter for printing.

---

## Path 3: AS/400 Host Attachment via Token Ring LAN

### Path Description

This configuration consists of the SNA\*ps product running on an Apple Macintosh that is connected to an IBM AS/400 through an IBM Token Ring (IEEE 802.5) local area network.

The configuration is shown in Figure 20 on page 31. The AS/400 is attached to the Token Ring using a 16/4 Mbps Token Ring interface card. An Apple Token Ring 4/16 NB Card is used in the Macintosh for Token Ring LAN attachment. The Macintosh appears as a PU type 2 to the AS/400.

This configuration provides the Macintosh user with up to 5 LU sessions for 3270 terminal and printer emulation.

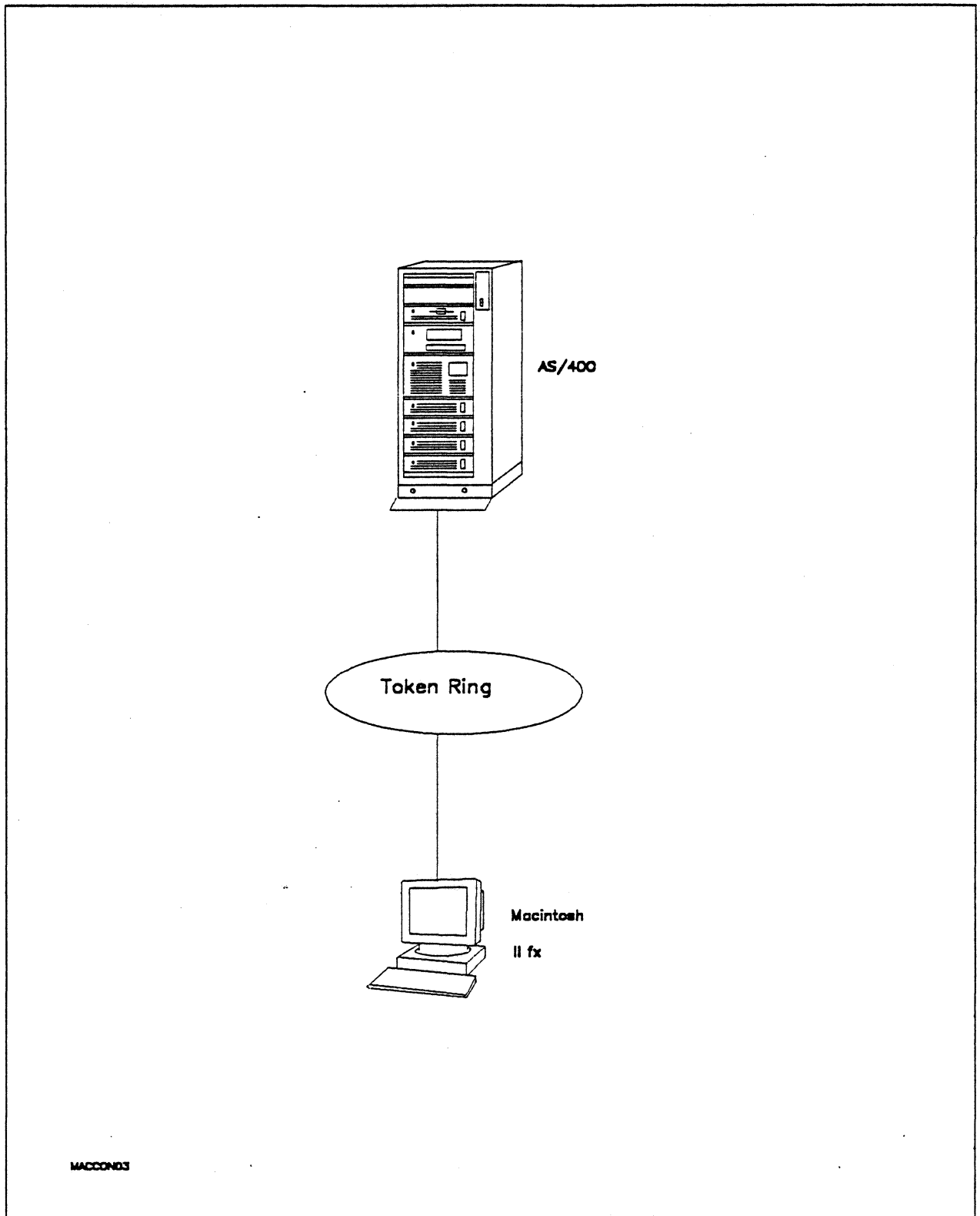

Figure 20. Path 3 Configuration - ASI400 Host Attachment via Token Ring LAN

## Hardware and Software

The following section describes the hardware and software that was used for this path.

### AS/400

- 9406 system
- 16/4 Token-Ring Adapter (feature #2626)
- OS/400 Version 2 Release 1

### Token Ring

- 16 Mbps

### Macintosh IIfx

- System Software 7.0
- SNA•ps 3270 V1.1 (beta)
- Apple Token Ring 4/16 NB Card with MCP memory expansion kit (1MB total)
- LaserWriter IINTX printer
- Total memory - 4M
- Hard disk - 80M

## Configuration Details and Operating Procedures

The following section contains details of how the configuration is defined and the procedures that are used.

**AS/400:** The following list contains the objects (Line Description; Controller Description and Device Descriptions) used for this path.

### Line Description - LAN

```

Line description . . . . . : TRNLIN031
Option . . . . . : *BASIC
Category of line . . . . . : *TRLAN

Resource name . . . . . : LIN031
Online at IPL . . . . . : *NO
Vary on wait . . . . . : *NOWAIT
Maximum controllers . . . . . : 50
Line speed . . . . . : 16M
Maximum frame size . . . . . : 2057
TRLAN manager logging level. . . . : *MIN
  Current logging level. . . . . : *MIN
TRLAN manager mode . . . . . : *OBSERVING
Log configuration changes . . . . . : *NOLOG
Token-ring inform of beacon . . . . : *YES
Local adapter address . . . . . : 400040300000
Exchange identifier . . . . . : 05640300
Early token release. . . . . : *NO
Error threshold level . . . . . : *OFF
Text . . . . . : Connection to Token-Ring

```



Line description . . . . . : TRNLIN031  
 Option . . . . . : \*SSAP  
 Category of line . . . . . : \*TRLAN

SSAP	Maximum Frame	Type	SSAP	Maximum Frame	Type
04	*MAXFRAME	*SNA	14	*MAXFRAME	*SNA
08	*MAXFRAME	*SNA	18	*MAXFRAME	*SNA
0C	*MAXFRAME	*SNA	1C	*MAXFRAME	*SNA
10	*MAXFRAME	*SNA	20	*MAXFRAME	*SNA

Line description . . . . . : TRNLIN031  
 Option . . . . . : \*APPN  
 Category of line . . . . . : \*TRLAN

Link speed . . . . . : 4M      \*\* see Observations and Hints \*\*  
 Cost/connect time . . . . . : 0  
 Cost/byte . . . . . : 0  
 Security for line . . . . . : \*NONSECURE  
 Propagation delay . . . . . : \*LAN  
 User-defined 1 . . . . . : 128  
 User-defined 2 . . . . . : 128  
 User-defined 3 . . . . . : 128  
 Autocreate controller . . . . . : \*YES  
 Autodelete controller . . . . . : \*NONE

Line description . . . . . : TRNLIN031  
 Option . . . . . : \*TMRRTY  
 Category of line . . . . . : \*TRLAN

Recovery limits:  
 Count limit . . . . . : 2  
 Time interval . . . . . : 5

**Controller Description - RWS**

Controller description . . . . . : APPLE01  
 Option . . . . . : \*BASIC  
 Category of controller . . . . . : \*RWS  
 Controller type . . . . . : 3174  
 Controller model . . . . . : 0  
 Link type . . . . . : \*LAN  
 Online at IPL . . . . . : \*NO  
 Character code . . . . . : \*EBCDIC  
 Maximum frame size . . . . . : 265  
 Exchange identifier . . . . . : 00A40301  
 SSCP identifier . . . . . : 050000000000  
 Initial connection . . . . . : \*ANS  
 LAN remote adapter address . . . . . : 1000E0017CBC  
 LAN DSAP . . . . . : 04  
 LAN SSAP . . . . . : 04  
 Text . . . . . : For Apple Macintosh

Controller description . . . . . : APPLE01  
 Option . . . . . : \*SWTLINLST  
 Category of controller . . . . . : \*RWS  
 Switched lines . . . . . : TRNLIN031

### Path 3

Controller description . . . . . : APPLE01  
Option . . . . . : \*DEV  
Category of controller . . . . . : \*RWS  
Attached Devices . . . . . : APPLE0100  
APPLE0101  
APPLE0102  
APPLE0103  
APPLE01P6

Controller description . . . . . : APPLE01  
Option . . . . . : \*TMRRTY  
Category of controller . . . . . : \*RWS  
Disconnect timer . . . . . : 120  
LAN frame retry . . . . . : \*CALC  
LAN connection retry . . . . . : \*CALC  
LAN response timer . . . . . : \*CALC  
LAN connection timer . . . . . : \*CALC  
LAN acknowledgement timer . . . . . : \*CALC  
LAN inactivity timer . . . . . : \*CALC  
LAN acknowledgement frequency . . . . . : \*CALC  
LAN max outstanding frames . . . . . : \*CALC  
LAN access priority . . . . . : \*CALC  
LAN window step . . . . . : \*NONE  
Recovery limits:  
Count limit . . . . . : 2  
Time interval . . . . . : 5

#### Device Description - DSP

Device description . . . . . : APPLE0100  
Option . . . . . : \*BASIC  
Category of device . . . . . : \*DSP  
Device class . . . . . : \*RMT  
Device type . . . . . : 3278  
Device model . . . . . : 4  
Local location address . . . . . : 02  
Online at IPL . . . . . : \*NO  
Attached controller . . . . . : APPLE01  
Keyboard language type . . . . . : USB  
Drop line at signoff . . . . . : \*NO  
Print device . . . . . : \*SYSVAL  
Output queue . . . . . : \*DEV  
Printer file . . . . . : QSYSPRT  
Library . . . . . : \*LIBL  
Maximum length of request unit . . . . . : \*CALC  
Text . . . . . : Display LU for Mac

**Device Description - DSP**

```

Device description . . . . . : APPLE0101
Option . . . . . : *BASIC
Category of device . . . . . : *DSP
  Device class . . . . . : *RMT
  Device type . . . . . : 3278
  Device model . . . . . : 4
  Local location address . . . . . : 03
  Online at IPL . . . . . : *NO
  Attached controller . . . . . : APPLE01
  Keyboard language type . . . . . : USB
  Drop line at signoff . . . . . : *NO
  Print device . . . . . : *SYSVAL
  Output queue . . . . . : *DEV
  Printer file . . . . . : QSYSVRT
    Library . . . . . : *LIBL
  Maximum length of request unit . . : *CALC
  Text . . . . . : Display LU for Mac

```

**Device Description - DSP**

```

Device description . . . . . : APPLE0102
Option . . . . . : *BASIC
Category of device . . . . . : *DSP
  Device class . . . . . : *RMT
  Device type . . . . . : 3278
  Device model . . . . . : 4
  Local location address . . . . . : 04
  Online at IPL . . . . . : *NO
  Attached controller . . . . . : APPLE01
  Keyboard language type . . . . . : USB
  Drop line at signoff . . . . . : *NO
  Print device . . . . . : *SYSVAL
  Output queue . . . . . : *DEV
  Printer file . . . . . : QSYSVRT
    Library . . . . . : *LIBL
  Maximum length of request unit . . : *CALC
  Text . . . . . : Display LU for Mac

```

**Device Description - DSP**

```

Device description . . . . . : APPLE0103
Option . . . . . : *BASIC
Category of device . . . . . : *DSP
  Device class . . . . . : *RMT
  Device type . . . . . : 3278
  Device model . . . . . : 4
  Local location address . . . . . : 05
  Online at IPL . . . . . : *NO
  Attached controller . . . . . : APPLE01
  Keyboard language type . . . . . : USB
  Drop line at signoff . . . . . : *NO
  Print device . . . . . : *SYSVAL
  Output queue . . . . . : *DEV
  Printer file . . . . . : QSYSVRT
    Library . . . . . : *LIBL
  Maximum length of request unit . . : *CALC
  Text . . . . . : Display LU for Mac

```

## Path 3

### Device Description - PRT

```
Device description . . . . . : APPLE01P6
Option . . . . . : *BASIC
Category of device . . . . . : *PRT
  Device class . . . . . : *RMT
  Device type . . . . . : 3287
  Device model . . . . . : 0
  Advanced function printing . . . . . : *NO
  Local location address . . . . . : 06
  Online at IPL . . . . . : *NO
  Attached controller . . . . . : APPLE01
  Form feed . . . . . : *CONT
  Printer error message . . . . . : *INQ
  Message queue . . . . . : QSYSOPR
    Library . . . . . : *LIBL
  Maximum length of request unit . . . : *CALC
  Text . . . . . : Printer LU for Mac
```

### Macintosh

1. At the Macintosh, start the SNA•ps 3270 Manager program. The Network Gateway Status window appears.
2. Choose New Configuration from the File menu. A dialog box appears (refer to Figure 21 on page 37) in which you select the type of card to be configured. Click on the radio button for Token Ring (which is the default), then click OK.
3. Figure 22 on page 37 is an example of the dialog box in which you enter the configuration information. For this path, the AS/400 statements defined 4 display LUs and 1 printer LU. In the XID field, enter the value that corresponds to the exchange identifier parameter in the APPLE01 controller description on the AS/400. For the Address field, enter the value that corresponds to the AS/400's local adapter address in the TRNLIN031 line description.
4. Click on the LU Settings button to display the LU settings. Verify that the Address field corresponds to the local location address in the AS/400 device description. (Reference Figure 23 on page 38.) Click OK.
5. Choose Save Configuration from the File menu. Save this configuration file as *path03*.
6. In the Network Gateway Status window, select the token ring gateway to be configured. Choose Select Configuration from the Gateway menu. Select *path03*, then click on the Select button to assign *path03* to the Token Ring gateway. (Reference Figure 24 on page 38.)
7. To start the gateway, in the Network Gateway Status window select the Token Ring gateway with *path03* specified as the configuration. Choose Start Gateway from the Gateway menu. Click Start to confirm that you want this gateway started. (Reference Figure 25 on page 39.)
8. When the gateway has been started, the Status column of the Network Gateway Status contains "Started".
9. Start the SNA•ps 3270 application.
10. Choose Connect from the Session menu. Select the gateway that was started in step 7. Click on the Sessions button to display the specific LUs. Select a session, then click OK to connect that session to the SNA•ps gateway. (Reference Figure 26 on page 39.)
11. At this point the AS/400 logon screen is displayed.
12. You may now logon to the AS/400. Refer to "Observations and Hints" on page 40 for important keyboard differences.

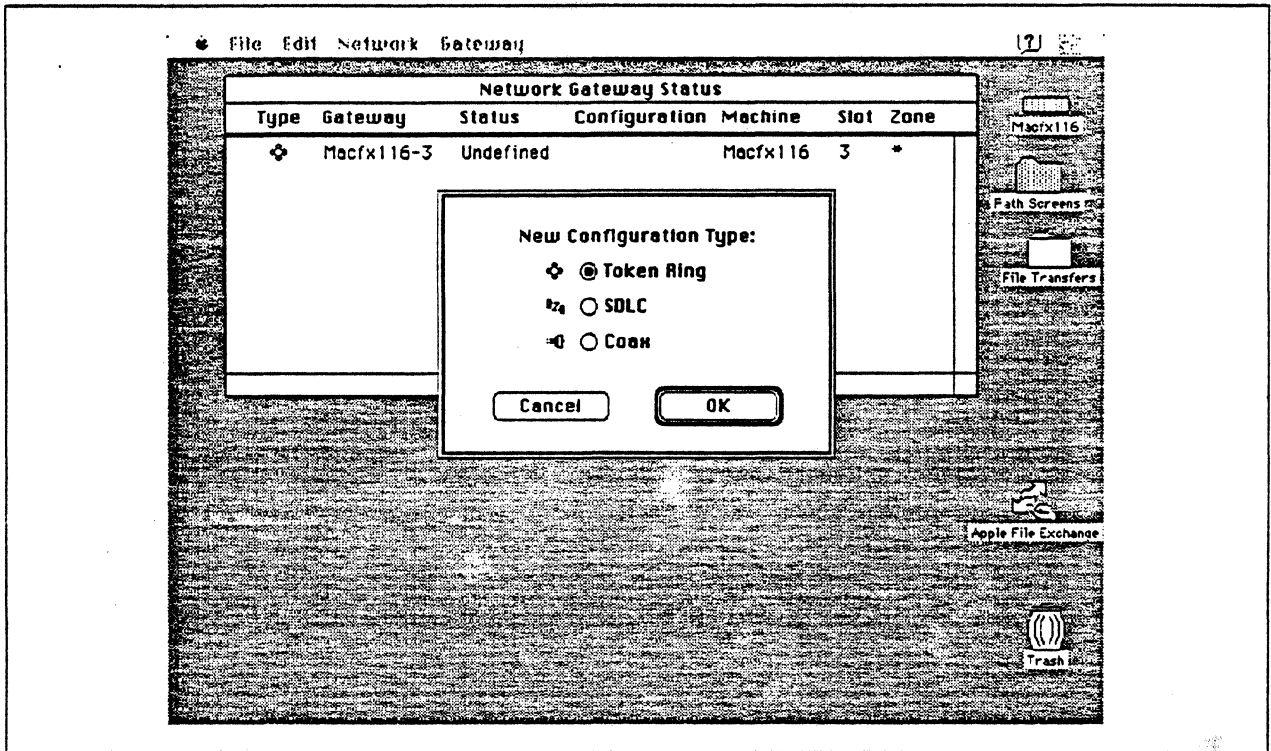

Figure 21. DLC Type Selection for Upstream Connection

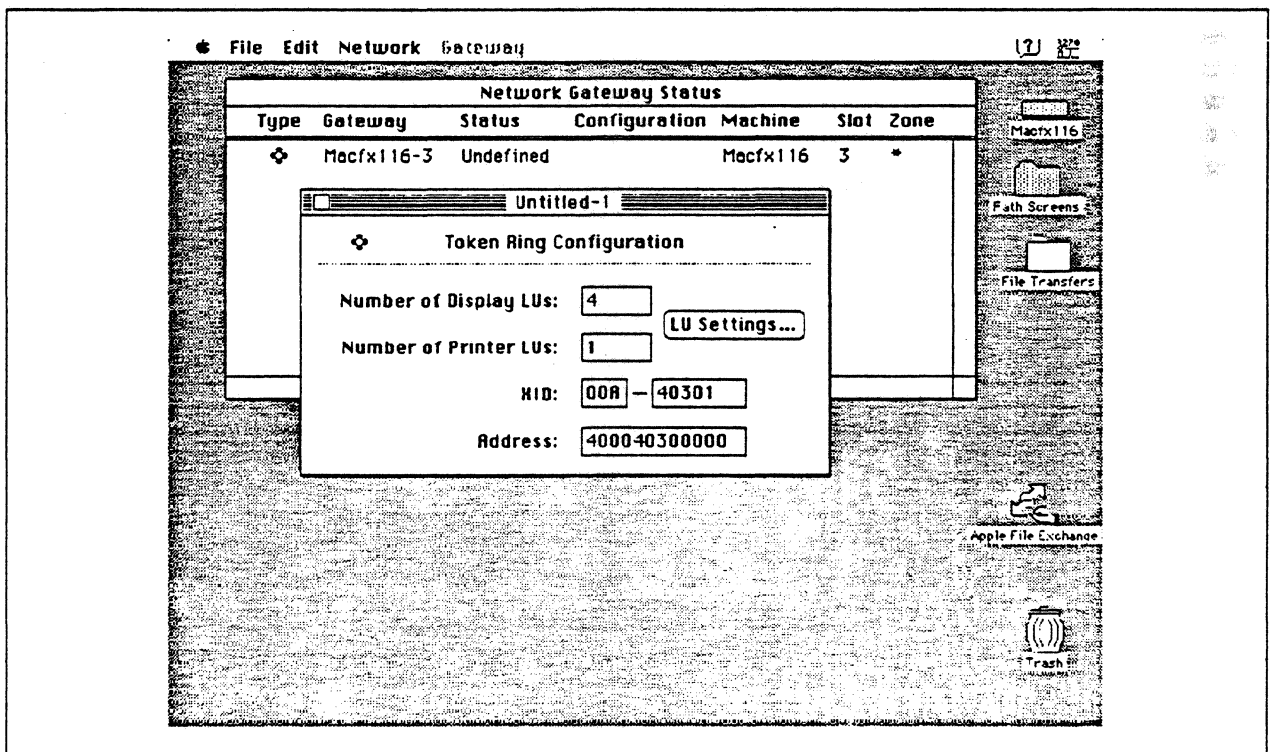

Figure 22. Token Ring Gateway Configuration Parameters

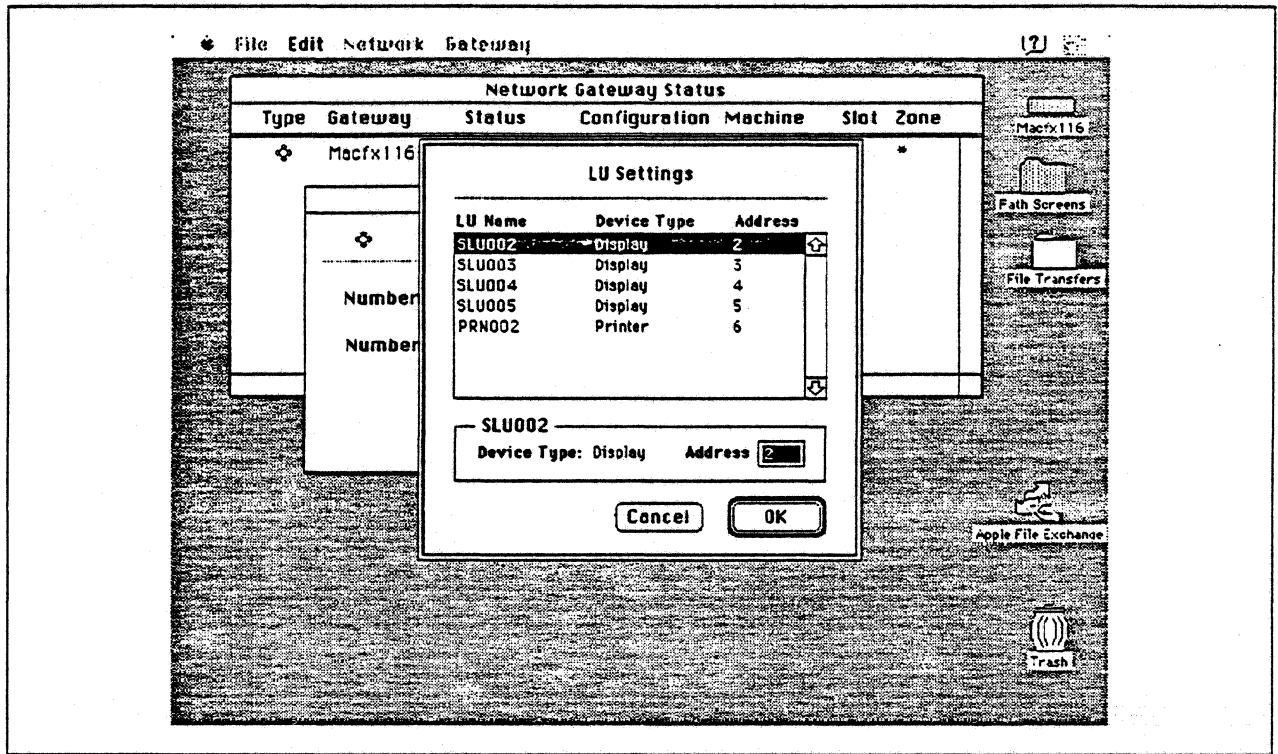

Figure 23. LU Settings

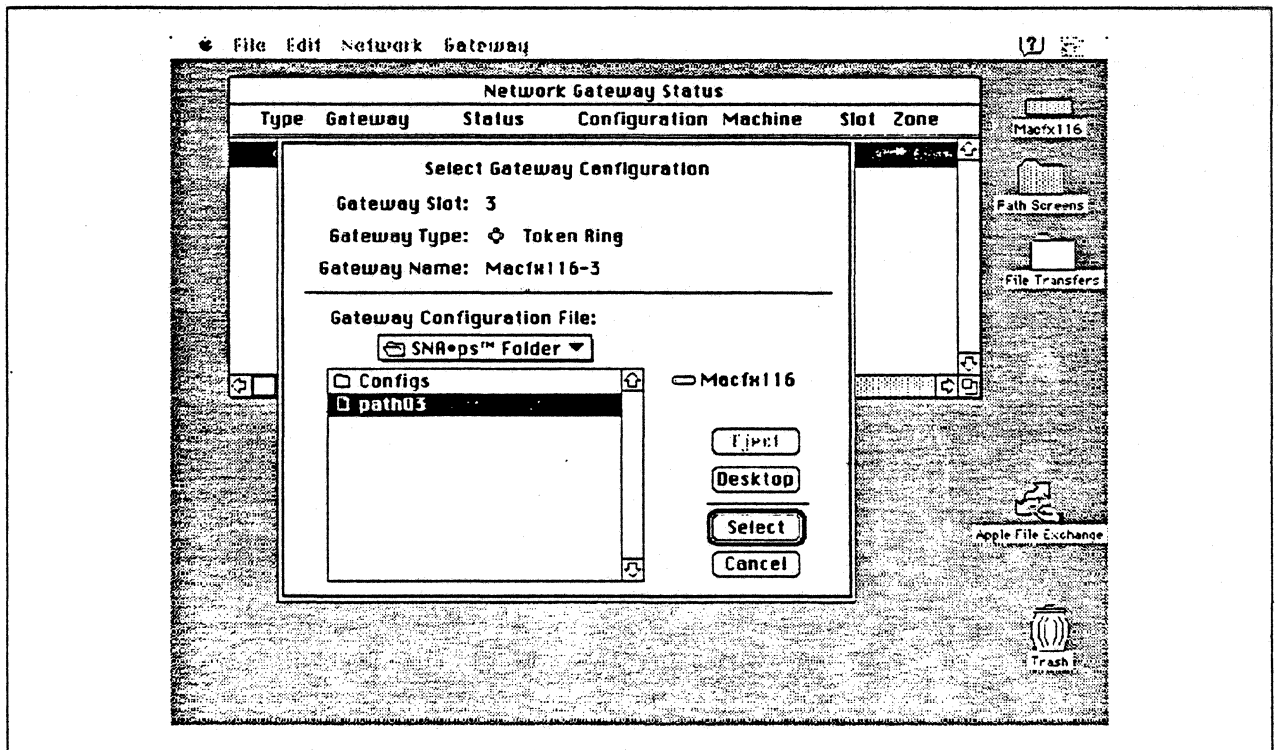

Figure 24. Gateway Configuration Selection

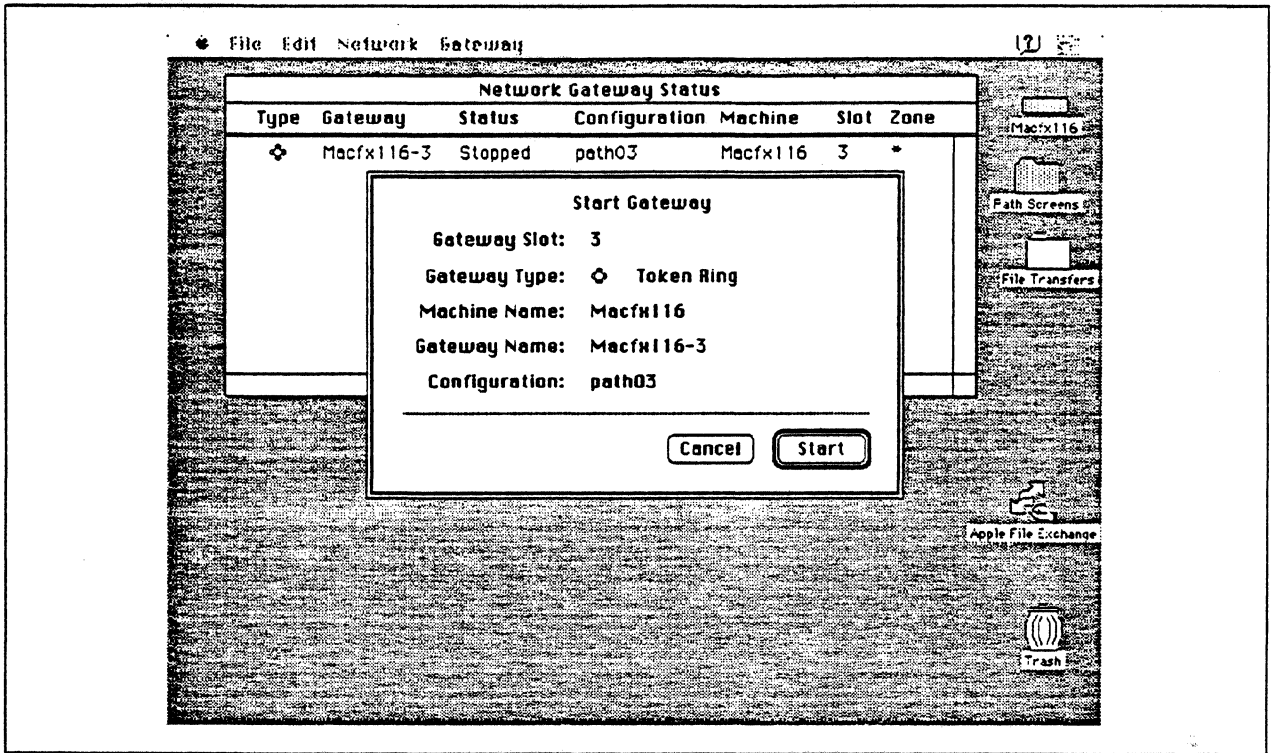

Figure 25. Starting the Gateway

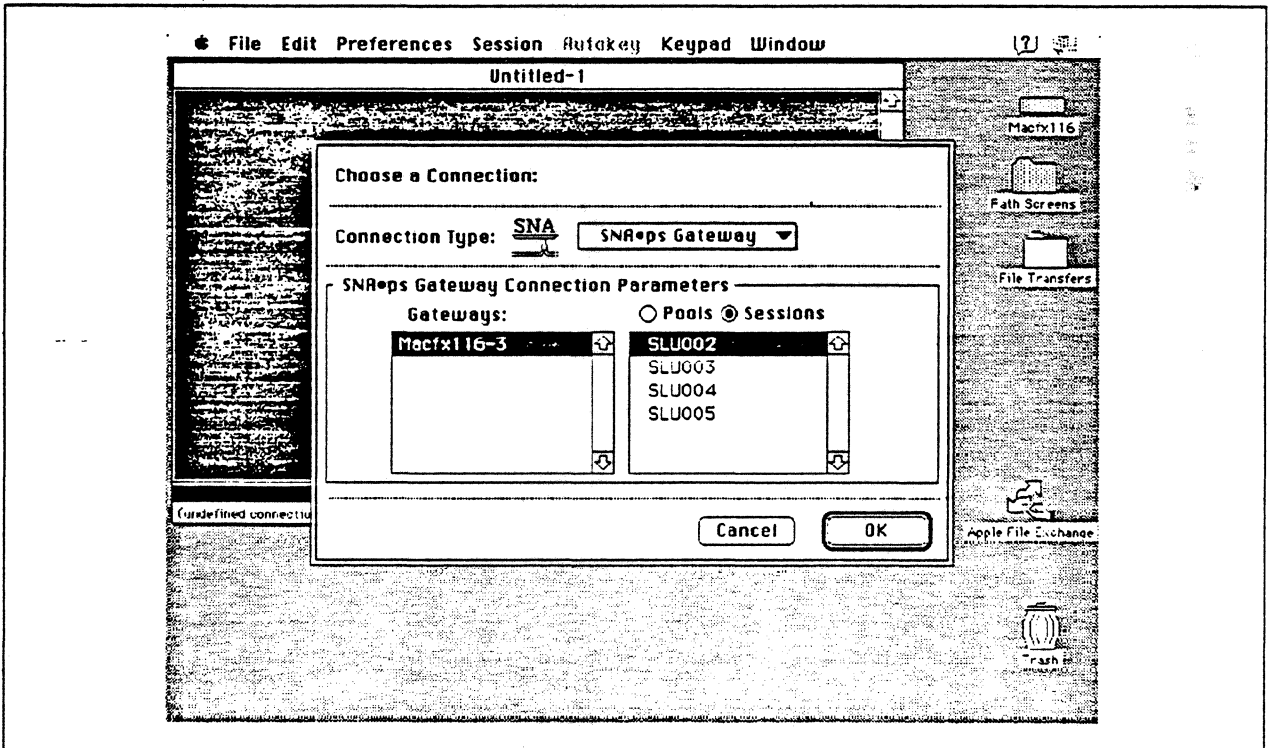

Figure 26. Choosing the Connection

## Observations and Hints

If VARY ON is issued for the AS/400 controller description before the Macintosh gateway has been started, the controller description and its associated device descriptions should go to the VARY ON PENDING state.

In the AS/400 controller description, the LAN remote adapter address (1000E0017CBC) corresponds to the Token Ring address of the Token Ring NB card.

An AS/400 file was printed at the printer LU associated with the Macintosh.

In the AS/400 line description there is a parameter called "line speed" and a parameter called "link speed". The line speed parameter determines the actual rate at which the token-Ring adapter will run. The link speed parameter is used only for lines that are attached to APPC or host controller descriptions that specify APPN(\*YES). This parameter is used to define line characteristics for use by APPN in class-of-service processing; it does not necessarily represent the actual line speed. The value selected for this parameter and the class of service selected for a session determine route selection through an APPN network. If you are using APPN but do not plan to tailor the route selection process, use the default values.

There are keyboard mapping considerations for this path. By way of background, the traditional remote controller for an AS/400 environment is a 5250-type controller, examples of which are the IBM 5294 and IBM 5394. These controllers are designed for a twinaxial cabling environment and support a 5250 data stream, which is different than the 3270 data stream supported on IBM's 3270 family of controllers. Also, the 5250 family of controllers only supports the 5250-type twinaxial terminals which utilize the 5250 data stream. Because some customers that already have remote-attach 3270 controllers want to be able to use these existing controllers on their AS/400s, IBM supports 3274 SDLC and 3174 SDLC and Token-Ring attachment of these controllers. With this capability, you can see AS/400-type screens on a 3270-type terminal. However, the 3270 keyboard and the 5250-type keyboards are different. As an example, there is a HELP key on a 5250-type terminal that is not present on 3270-type keyboards. Because of these keyboard differences, a keyboard mapping scheme provides the necessary 5250 keyboard functions through the 3270 keyboard. Refer to the *Application System/400 Communications: Remote Work Station Guide* for a discussion of this keyboard mapping capability. Keep in mind that this manual provides keyboard mapping information for someone using a real 3270 terminal. For our configuration we have a Macintosh computer instead of a 3x74 controller and 3270 terminals. The real Macintosh keyboard is not like either a 3270 keyboard or a 5250 keyboard, so a second level of keyboard mapping needs to be considered. Apple provides a keyboard mapping facility with their 3270 emulation capability that allows you to easily map your Macintosh keyboard to provide the 5250 keyboard functions that you need to interact with the AS/400. Refer to the *SNA\*ps 3270 User's Guide* for instructions on how to utilize this keyboard mapping capability.



41  
42  
43  
44  
45  
46  
47  
48  
49  
50  
51  
52  
53  
54  
55  
56  
57  
58  
59  
60  
61  
62  
63  
64  
65  
66  
67  
68  
69  
70  
71  
72  
73  
74  
75  
76  
77  
78  
79  
80  
81  
82  
83  
84  
85  
86  
87  
88  
89  
90  
91  
92  
93  
94  
95  
96  
97  
98  
99  
100

---

## Path 4: AS/400 Host Attachment via SDLC Connection

### Path Description

This configuration consists of the SNA•ps product running on an Apple Macintosh that is connected to an IBM AS/400 through a remote SDLC communications link.

The configuration is shown in Figure 27 on page 43. An RS-232 adapter is used on the AS/400 for SDLC attachment. An Apple Serial NB Card is used in the Macintosh for SDLC attachment. The Macintosh appears as a PU type 2 to the AS/400.

This configuration provides the Macintosh user with up to 5 LU sessions for 3270 terminal and printer emulation.

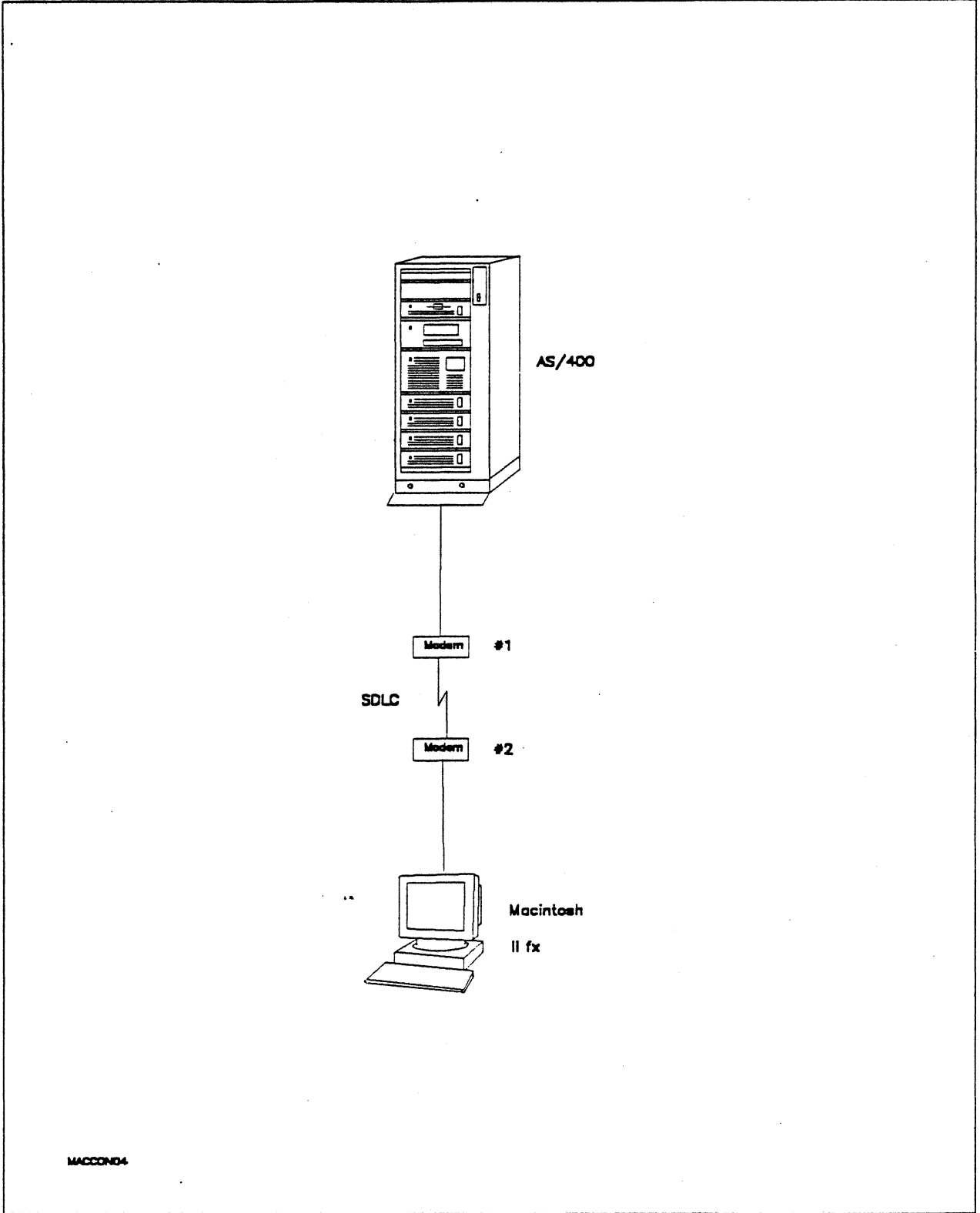

Figure 27. Path 4 Configuration - AS/400 Host Attachment via SDLC Connection

## Path 4

### Hardware and Software

The following section describes the hardware and software that was used for this path.

#### AS/400

- 9406 system
- EIA 232/V.24 Communications Adapter
- OS/400 Version 2 Release 1

#### Modems #1 and #2

- 19.2 Kbps
- SDLC
- Leased
- RS-232
- NRZI

#### Macintosh IIfx

- System Software 7.0
- SNA•ps 3270 V1.1 (beta)
- Apple Serial NB Card with MCP memory expansion kit (1MB total)
- RS-232 serial cable
- LaserWriter IINTX printer
- Total memory - 4M
- Hard disk - 80M

### Configuration Details and Operating Procedure

The following section contains details of how the configuration is defined and the procedures that are used.

**AS/400:** The following list contains the objects (Line Description; Controller Description and Device Descriptions) used for this path.

Line Description - SDLC

```

Line description . . . . . : APPLE02
Option . . . . . : *BASIC
Category of line . . . . . : *SDLC

Resource name . . . . . : LIN072
Online at IPL . . . . . : *NO
Data link role . . . . . : *PRI
Physical interface . . . . . : *RS232V24
Connection type . . . . . : *NONSWTPP
Switched network backup . . . . . : *NO
Exchange identifier . . . . . : 05615366
NRZI data encoding . . . . . : *YES
Maximum controllers . . . . . : 1
Clocking . . . . . : *MODEM
Line speed . . . . . : 19200
Modem type supported . . . . . : *NORMAL
Modem data rate select . . . . . : *FULL
Autoanswer type . . . . . : *DTR
Maximum frame size . . . . . : 265
Error threshold level . . . . . : *OFF
Duplex . . . . . : *FULL
Modulus . . . . . : 8
Text . . . . . : Macintosh non-swt connection

```

```

Line description . . . . . : APPLE02
Option . . . . . : *CTL
Category of line . . . . . : *SDLC

```

Attached Nonswitched Controllers . . : APPLE02

```

Line description . . . . . : APPLE02
Option . . . . . : *APPN
Category of line . . . . . : *SDLC

```

```

Link speed . . . . . : 9600      ** see Observations and Hints **
Cost/connect time . . . . . : 0
Cost/byte . . . . . : 0
Security for line . . . . . : *NONSECURE
Propagation delay . . . . . : *TELEPHONE
User-defined 1 . . . . . : 128
User-defined 2 . . . . . : 128
User-defined 3 . . . . . : 128

```

```

Line description . . . . . : APPLE02
Option . . . . . : *TMRRTY
Category of line . . . . . : *SDLC

```

```

Maximum outstanding frames . . . . . : 7
Nonproductive receive timer . . . . . : 320
Idle timer . . . . . : 30
Connect poll timer . . . . . : 30
Poll cycle pause . . . . . : 0
Frame retry . . . . . : 7
Data Set Ready drop timer . . . . . : 6
Clear To Send timer . . . . . : 25
Remote answer timer . . . . . : 60
Recovery limits:
  Count limit . . . . . : 2
  Time interval . . . . . : 5

```

**Path 4**

**Controller Description - RWS**

```
Controller description . . . . . : APPLE02
Option . . . . . : *BASIC
Category of controller . . . . . : *RWS
  Controller type . . . . . : 3174
  Controller model . . . . . : 0
  Link type . . . . . : *SDLC
  Online at IPL . . . . . : *NO
  Switched connection . . . . . : *NO
  Switched network backup . . . . . : *NO
  Attached nonswitched line . . . . . : APPLE02
  Character code . . . . . : *EBCDIC
  Maximum frame size . . . . . : 265
  Exchange identifier . . . . . : 00A40301
  SSCP identifier . . . . . : 050000000000
  Station address . . . . . : C1
  Text . . . . . : Macintosh non-swt connection

Controller description . . . . . : APPLE02
Option . . . . . : *DEV
Category of controller . . . . . : *RWS
  Attached Devices . . . . . : APPLE0200
                              APPLE0201
                              APPLE0202
                              APPLE0203
                              APPLE02P6

Controller description . . . . . : APPLE02
Option . . . . . : *TMRRTY
Category of controller . . . . . : *RWS
  Device wait timer . . . . . : 120
  SDLC poll priority . . . . . : *NO
  SDLC poll limit . . . . . : 0
  SDLC out limit . . . . . : *POLLMT
  SDLC connect poll retry . . . . . : *NOMAX
  SDLC NDM poll timer . . . . . : *CALC
Recovery limits:
  Count limit . . . . . : 2
  Time interval . . . . . : 5
```

**Device Description - DSP**

```
Device description . . . . . : APPLE0200
Option . . . . . : *BASIC
Category of device . . . . . : *DSP
  Device class . . . . . : *RMT
  Device type . . . . . : 3278
  Device model . . . . . : 4
  Local location address . . . . . : 02
  Online at IPL . . . . . : *NO
  Attached controller . . . . . : APPLE02
  Keyboard language type . . . . . : USB
  Drop line at signoff . . . . . : *NO
  Print device . . . . . : *SYSVAL
  Output queue . . . . . : *DEV
  Printer file . . . . . : QSYSVRT
  Library . . . . . : *LIBL
  Maximum length of request unit . . . : *CALC
  Text . . . . . : Display LU for Mac
```

**Device Description - DSP**

```

Device description . . . . . : APPLE0201
Option . . . . . : *BASIC
Category of device . . . . . : *DSP
  Device class . . . . . : *RMT
  Device type . . . . . : 3278
  Device model . . . . . : 4
  Local location address . . . . . : 03
  Online at IPL . . . . . : *NO
  Attached controller . . . . . : APPLE02
  Keyboard language type . . . . . : USB
  Drop line at signoff . . . . . : *NO
  Print device . . . . . : *SYSVAL
  Output queue . . . . . : *DEV
  Printer file . . . . . : QSYSVRT
    Library . . . . . : *LIBL
  Maximum length of request unit . . : *CALC
  Text . . . . . : Display LU for Mac
  
```

**Device Description - DSP**

```

Device description . . . . . : APPLE0202
Option . . . . . : *BASIC
Category of device . . . . . : *DSP
  Device class . . . . . : *RMT
  Device type . . . . . : 3278
  Device model . . . . . : 4
  Local location address . . . . . : 04
  Online at IPL . . . . . : *NO
  Attached controller . . . . . : APPLE02
  Keyboard language type . . . . . : USB
  Drop line at signoff . . . . . : *NO
  Print device . . . . . : *SYSVAL
  Output queue . . . . . : *DEV
  Printer file . . . . . : QSYSVRT
    Library . . . . . : *LIBL
  Maximum length of request unit . . : *CALC
  Text . . . . . : Display LU for Mac
  
```

**Device Description - DSP**

```

Device description . . . . . : APPLE0203
Option . . . . . : *BASIC
Category of device . . . . . : *DSP
  Device class . . . . . : *RMT
  Device type . . . . . : 3278
  Device model . . . . . : 4
  Local location address . . . . . : 05
  Online at IPL . . . . . : *NO
  Attached controller . . . . . : APPLE02
  Keyboard language type . . . . . : USB
  Drop line at signoff . . . . . : *NO
  Print device . . . . . : *SYSVAL
  Output queue . . . . . : *DEV
  Printer file . . . . . : QSYSVRT
    Library . . . . . : *LIBL
  Maximum length of request unit . . : *CALC
  Text . . . . . : Display LU for Mac
  
```

## Path 4

### Device Description - PRT

```
Device description . . . . . : APPLE02P6
Option . . . . . : *BASIC
Category of device . . . . . : *PRT
  Device class . . . . . : *RMT
  Device type . . . . . : 3287
  Device model . . . . . : 0
  Advanced function printing . . . . . : *NO
  Local location address . . . . . : 06
  Online at IPL . . . . . : *NO
  Attached controller . . . . . : APPLE02
  Form feed . . . . . : *CONT
  Printer error message . . . . . : *INQ
  Message queue . . . . . : QSYSOPR
  Library . . . . . : *LIBL
  Maximum length of request unit . . . : *CALC
  Text . . . . . : Printer LU for Mac
```

### Macintosh

1. At the Macintosh, start the SNA•ps 3270 Manager program. The Network Gateway Status window appears.
2. Choose New Configuration from the File menu. A dialog box appears (refer to Figure 28 on page 49) in which you select the type of card to be configured. Click on the radio button for SDLC, then click OK.
3. Figure 29 on page 49 is an example of the dialog box in which you enter the configuration information. For this path, the AS/400 statements defined 4 display LUs and 1 printer LU. Because this is a leased line, the XID value is not used. For the Address field, enter the address of the Macintosh, which corresponds to the station address parameter in the AS/400 controller description.
4. Click on the LU Settings button to display the LU settings. Verify that the Address field corresponds to the local location address in the AS/400 device description. (Reference Figure 30 on page 50.) Click OK.
5. Choose Save Configuration from the File menu. Save this configuration file as *path04*.
6. In the Network Gateway Status window, select the SDLC gateway to be configured. Choose Select Configuration from the Gateway menu. Select *path04*, then click on the Select button to assign *path04* to the SDLC gateway. (Reference Figure 31 on page 50.)
7. To start the gateway, in the Network Gateway Status window select the SDLC gateway with *path04* specified as the configuration. Choose Start Gateway from the Gateway menu. (Reference Figure 32 on page 51.) Click Start to confirm that you want this gateway started.
8. When the gateway has been started, the Status column of the Network Gateway Status contains "Started".
9. Start the SNA•ps 3270 application.
10. Choose Connect from the Session menu. Select the gateway that was started in step 7. Click on the Sessions button to display the specific LUs. Select a session, then click OK to connect that session to the SNA•ps gateway. (Reference Figure 33 on page 51.)
11. At this point the AS/400 logon screen is displayed.
12. You may now logon to the AS/400. Refer to "Observations and Hints" on page 52 for important keyboard differences.



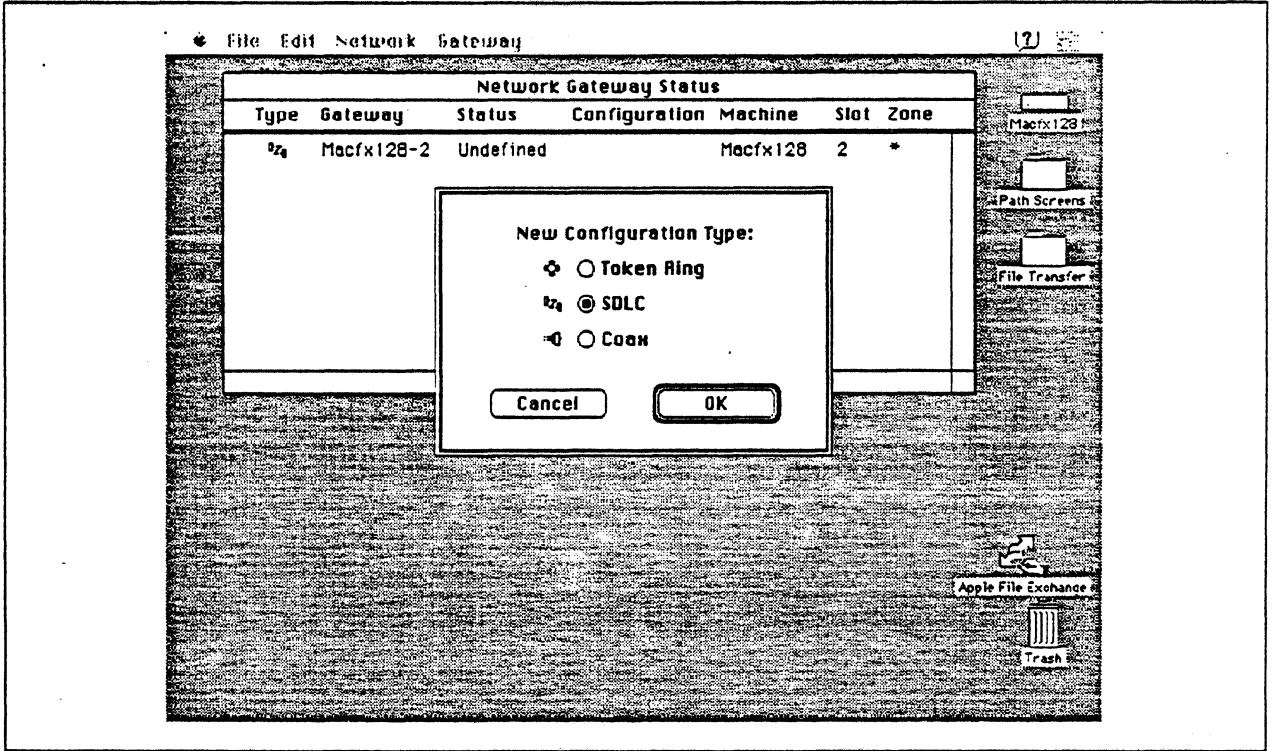

Figure 28. DLC Type Selection for Upstream Connection

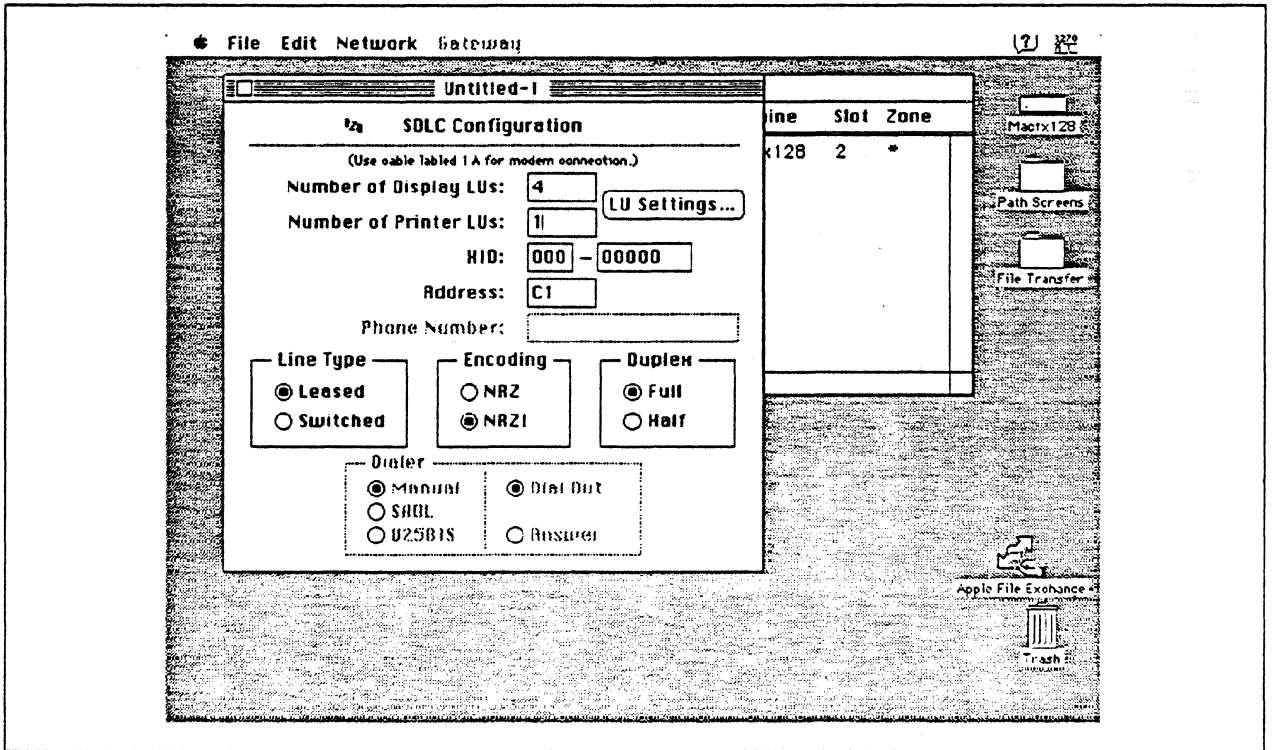

Figure 29. SDLC Gateway Configuration Parameters

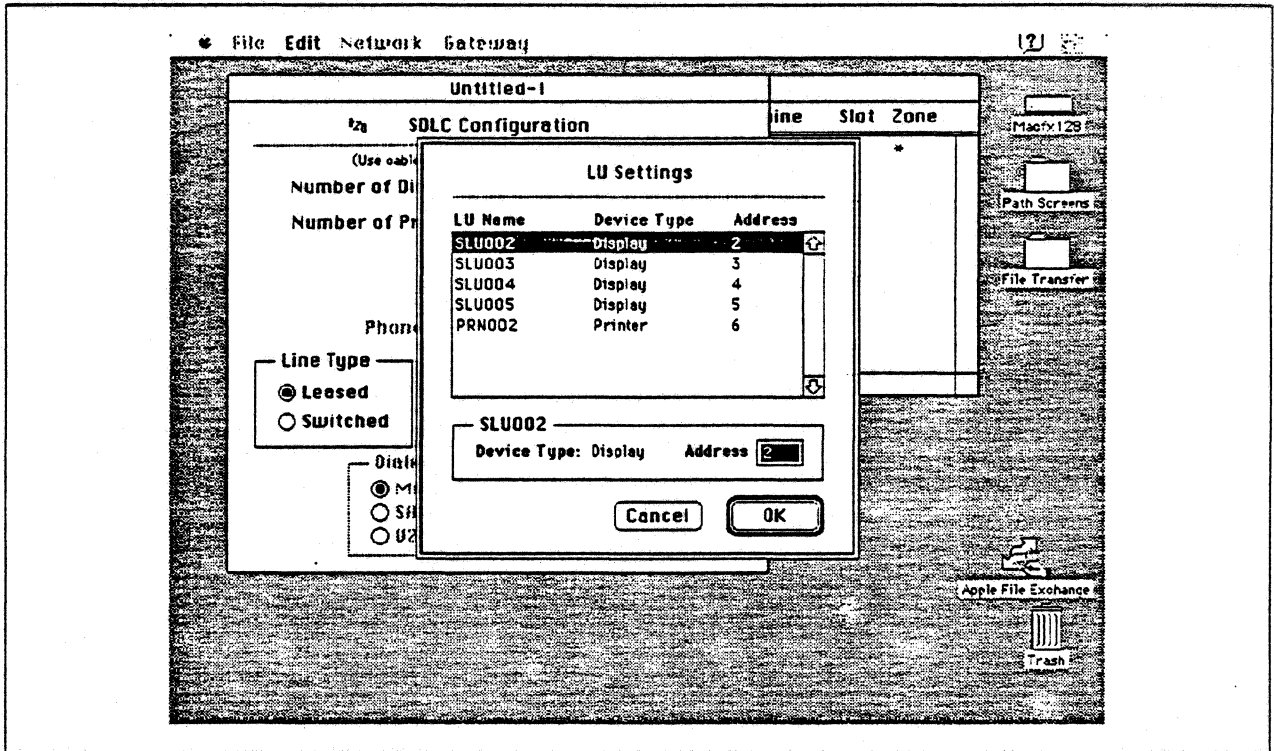

Figure 30. LU Settings

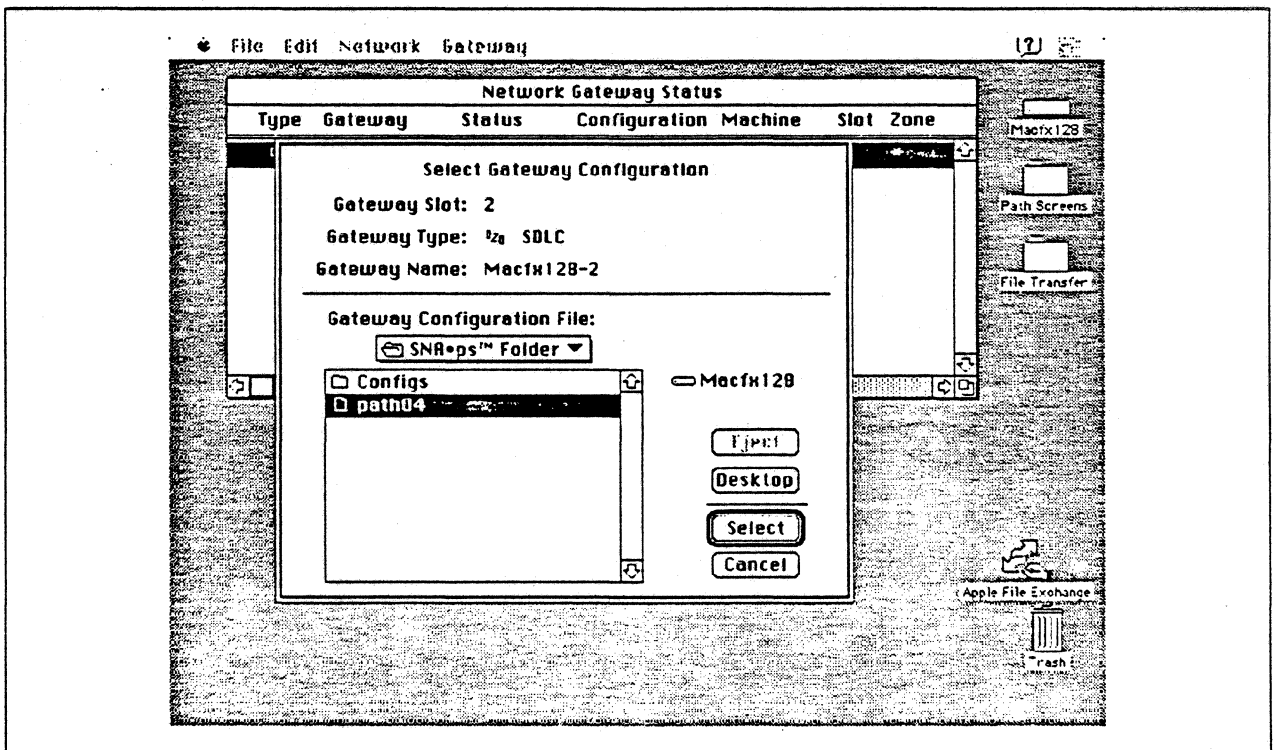

Figure 31. Gateway Configuration Selection

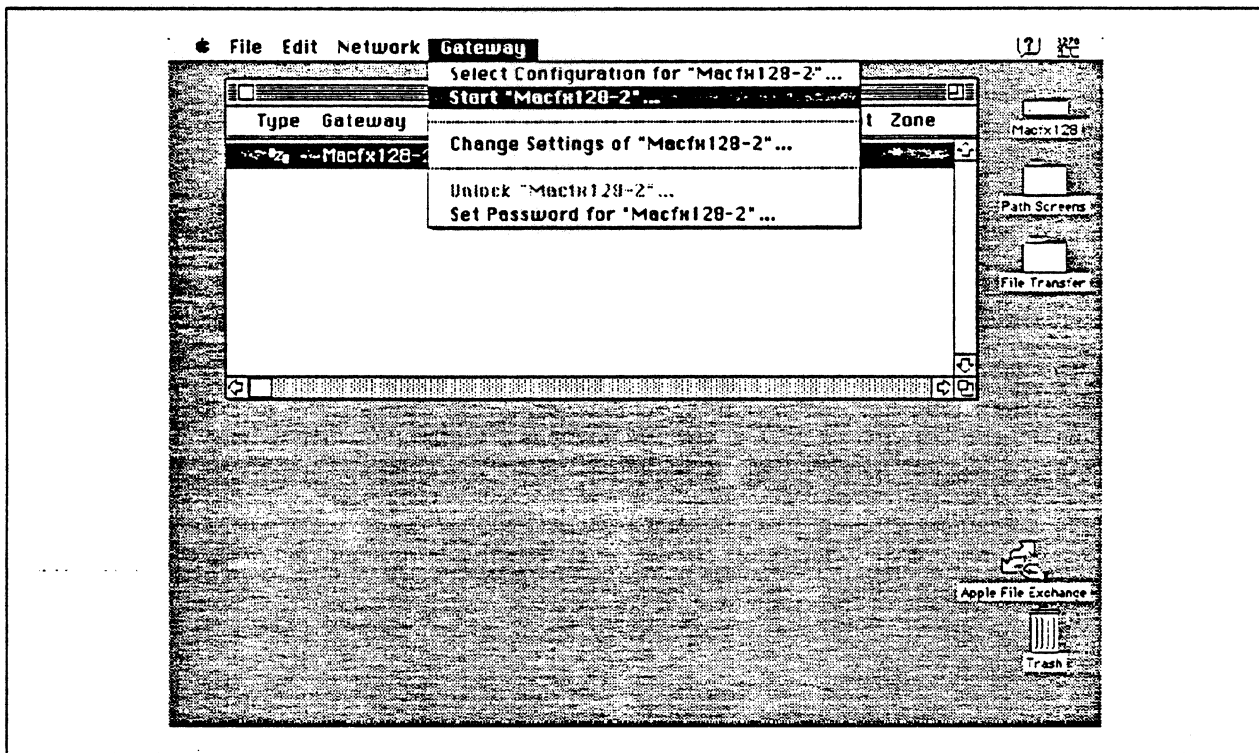

Figure 32. Starting the Gateway

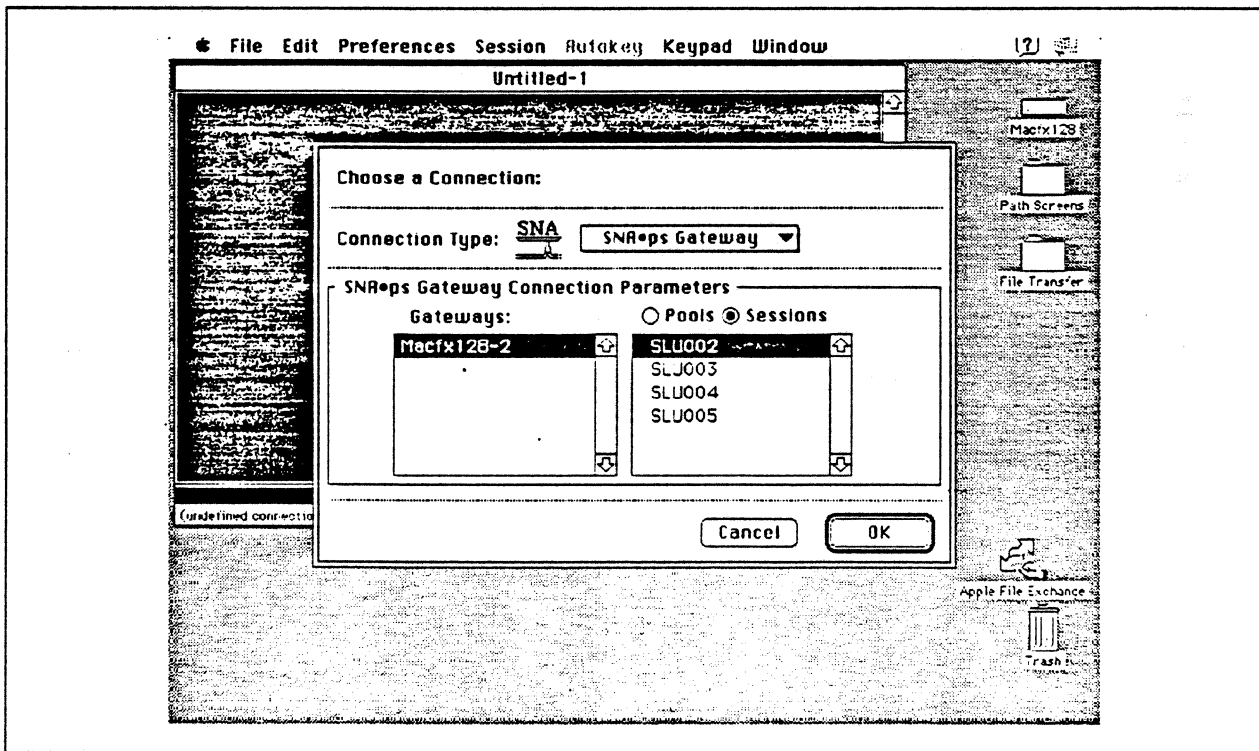

Figure 33. Choosing the Configuration

## Observations and Hints

When you VARY ON the AS/400 SDLC line, because the modem connection is configured for non-switched, the line should go to the VARIED ON state indicating that the AS/400 SDLC adapter has sensed the DSR signal on the RS-232 interface.

If you VARY ON the AS/400 SDLC line before the Macintosh gateway has been started, the controller description and its associated device descriptions should go to the VARY ON PENDING state.

An AS/400 file was printed at the printer LU associated with the Macintosh.

In the AS/400 line description there is a parameter called "line speed" and a parameter called "link speed". The line speed parameter determines the actual rate at which the token-Ring adapter will run. The link speed parameter is used only for lines that are attached to APPC or host controller descriptions that specify APPN(\*YES). This parameter is used to define line characteristics for use by APPN in class-of-service processing; it does not necessarily represent the actual line speed. The value selected for this parameter and the class of service selected for a session determine route selection through an APPN network. If you are using APPN but do not plan to tailor the route selection process, use the default values.

There are keyboard mapping considerations for this path. By way of background, the traditional remote controller for an AS/400 environment is a 5250-type controller, examples of which are the IBM 5294 and IBM 5394. These controllers are designed for a twinaxial cabling environment and support a 5250 data stream, which is different than the 3270 data stream supported on IBM's 3270 family of controllers. Also, the 5250 family of controllers only supports the 5250-type twinaxial terminals which utilize the 5250 data stream. Because some customers that already have remote-attach 3270 controllers want to be able to use these existing controllers on their AS/400s, IBM supports 3274 SDLC and 3174 SDLC and Token-Ring attachment of these controllers. With this capability, you can see AS/400-type screens on a 3270-type terminal. However, the 3270 keyboard and the 5250-type keyboards are different. As an example, there is a HELP key on a 5250-type terminal that is not present on 3270-type keyboards. Because of these keyboard differences, a keyboard mapping scheme provides the necessary 5250 keyboard functions through the 3270 keyboard. Refer to the *Application System/400 Communications: Remote Work Station Guide* for a discussion of this keyboard mapping capability. Keep in mind that this manual provides keyboard mapping information for someone using a real 3270 terminal. For our configuration we have a Macintosh computer instead of a 3x74 controller and 3270 terminals. The real Macintosh keyboard is not like either a 3270 keyboard or a 5250 keyboard, so a second level of keyboard mapping needs to be considered. Apple provides a keyboard mapping facility with their 3270 emulation capability that allows you to easily map your Macintosh keyboard to provide the 5250 keyboard functions that you need to interact with the AS/400. Refer to the *SNA•ps 3270 User's Guide* for instructions on how to utilize this keyboard mapping capability.



---

## Path 5: VM Host Attachment via Token Ring LAN

### Path Description

This configuration consists of the SNA•ps product running on an Apple Macintosh that is connected to an IBM VM/SP host through an IBM Token-Ring (IEEE 802.5) local area network.

The configuration is shown in Figure 34 on page 55. The VM host is attached to the Token Ring using the ES/9370 integrated 16/4 Mbps Token-Ring interface card. An Apple Token Ring 4/16 NB Card is used in the Macintosh for the Token Ring LAN attachment. The Macintosh is defined in a VTAM switched major node as a PU type 2.0 to the VM host.

This configuration provides the Macintosh user with up to 5 LU sessions for 3270 terminal and printer emulation.

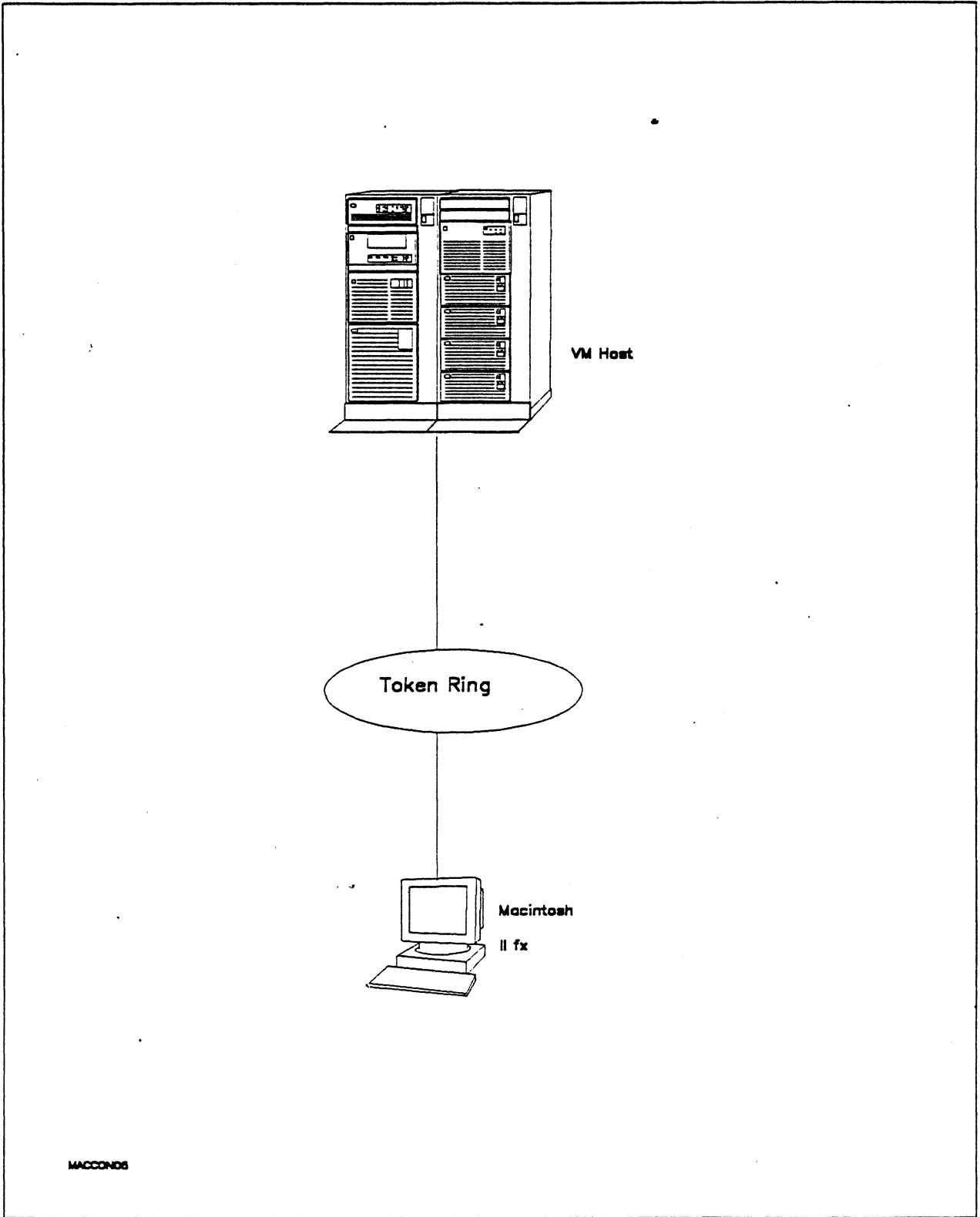

Figure 34. Path 5 Configuration - VM Host Attachment via Token Ring LAN

## Hardware and Software

The following section describes the hardware and software that was used for this path.

### VM Host

- 9375 system
- 16/4 Integrated Token-Ring Adapter feature # 6130/6134
- VM/SP Release 6.0
- VTAM Version 3 Release 3
- RSCS Version 2 Release 3

### Token Ring

- 16 Mbps<sup>4</sup>

### Macintosh IIfx

- System Software 7.0
- SNA\*ps 3270 V1.1 (beta)<sup>5</sup>
- Apple Token Ring 4/16 NB Card with MCP memory expansion kit (1MB total)
- LaserWriter IINTX printer
- Total memory - 4M
- Hard disk - 80M

---

<sup>4</sup> Compatability with the 4 Mbps Apple TokenTalk NB Card was also verified.

<sup>5</sup> This path was also verified with SNA\*ps 3270 V1.0.



## Configuration Details and Operating Procedures

The following section contains details of how the configuration is defined and the procedures that are used.

### VM Host (VTAM Definitions)

#### Switched Major Node

APPLE1 VBUILD TYPE=SWNET,MAXGRP=4,MAXNO=400

\*

PUAPP1	PU	ADDR=04,	X
		IDBLK=00A,	X
		IDNUM=93701,	X
		DISCNT=NO,	X
		IRETRY=YES,	X
		LANSW=YES,	X
		MAXPATH=1,	X
		PUTYPE=2,	X
		MAXOUT=7,	X
		MAXDATA=265,	X
		MODETAB=ISTINCLM,	X
		USSTAB=AUSSTAB,	X
		DLOGMOD=SNX32702,	X
		PACING=0,	X
		VPACING=0,	X
		ISTATUS=ACTIVE	

PATH GRPNM=GROUPLAN

APP1LU1 LU LOCADDR=2

APP1LU2 LU LOCADDR=3,DLOGMOD=SNX32703

APP1LU3 LU LOCADDR=4,DLOGMOD=SNX32704

APP1LU4 LU LOCADDR=5,DLOGMOD=SNX32705

APP1LU5 LU LOCADDR=6,MODETAB=RSCSTAB,DLOGMOD=RSCSPRT3

#### LAN Major Node

TRLAN VBUILD TYPE=LAN

\*

PORTA00	PORT	CUADDR=A00,	X
		MACADDR=400000937062,	X
		LANCON=(6,5),	X
		MAXDATA=1496,	X
		SAPADDR=4	

\*

GROUPLAN GROUP LNCTL=SDLC,DIAL=YES

\*

LANLINE0 LINE ISTATUS=ACTIVE,CALL=IN

PULAN000 PU

:

LANLINEF LINE ISTATUS=ACTIVE,CALL=IN

PULAN00F PU

## Macintosh

1. Start the SNA•ps 3270 Manager program. The Network Gateway Status window appears.
2. Choose New Configuration from the File menu. A dialog box appears (refer to Figure 35 on page 59) in which you select the type of card to be configured. Click on the radio button for Token Ring (which is the default), then click OK.
3. The Token Ring Configuration dialog box (refer to Figure 36 on page 59) appears. For this path, the VTAM statements defined 4 display LUs and 1 printer LU. The XID value corresponds to the IDBLK-IDNUM values defined on the VTAM PU definition statement. For the Address field, enter the MACADDR value that was specified on the PORT definition statement in the LAN major node that defines the VM Token Ring adapter card. Click OK.
4. Click on the LU Settings button to display the LU settings. (Figure 37 on page 60 appears.) Verify that the Address field corresponds to the LOCADDR on the VTAM LU definition statement. Click OK.
5. Choose Save Configuration from the File menu. Save this configuration file as *path05*.
6. In the Network Gateway Status window, select the Token Ring gateway to be configured. Choose Select Configuration from the Gateway menu. Select *path05*, then click on the Select button to assign *path05* to the Token Ring gateway. (Reference Figure 38 on page 60.)
7. To start the gateway, in the Network Gateway Status window select the Token Ring gateway with *path05* specified as the configuration. Choose Start Gateway from the Gateway menu. Click Start to confirm that you want this gateway started. (Reference Figure 39 on page 61.)
8. When the gateway has been started, the Status column of the Network Gateway Status contains "Started".
9. Start the SNA•ps 3270 application.
10. Choose Connect from the Session menu. Select the gateway that was started in step 7. Click on the Sessions button to display the specific LUs. Select a session, then click OK to connect that session to the SNA•ps gateway. (Reference Figure 40 on page 61.)
11. At this point, the logon screen specified in the VTAM definition is displayed if the VTAM line, PU, and LUs have been activated.

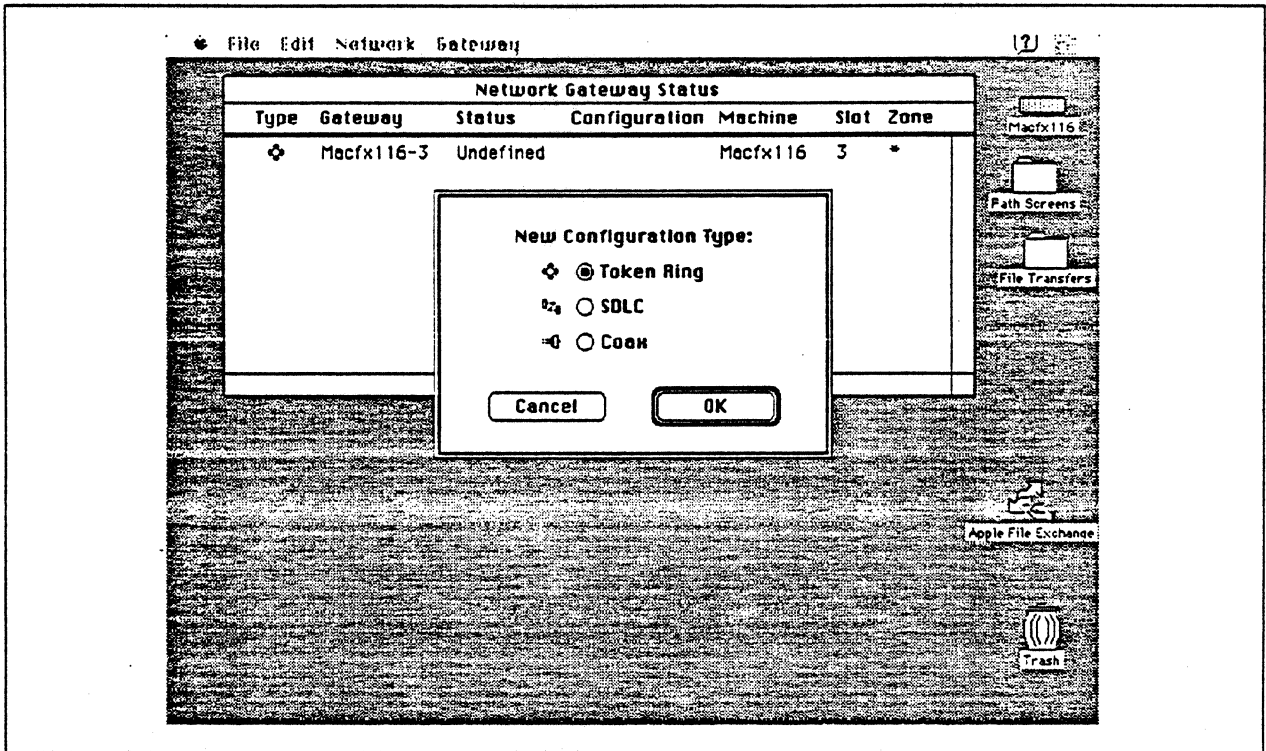

Figure 35. DLC Type Selection for Upstream Connection

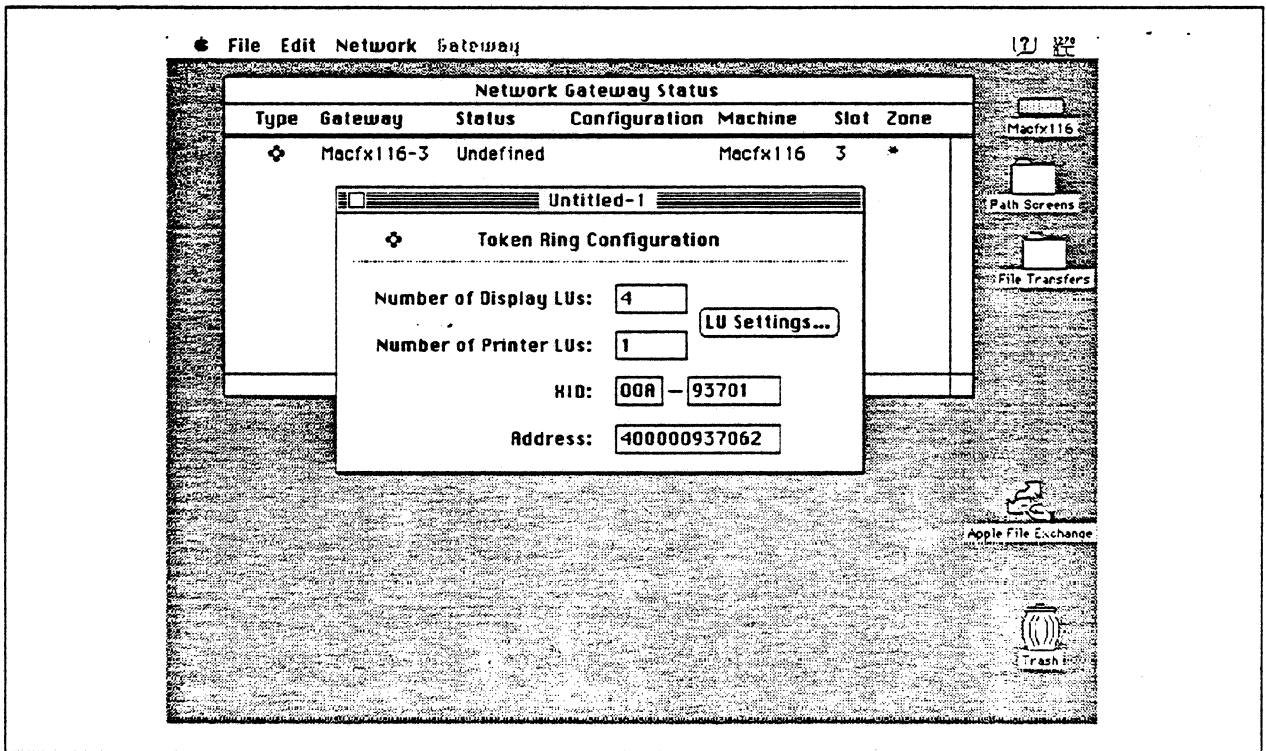

Figure 36. Token Ring Gateway Configuration Parameters

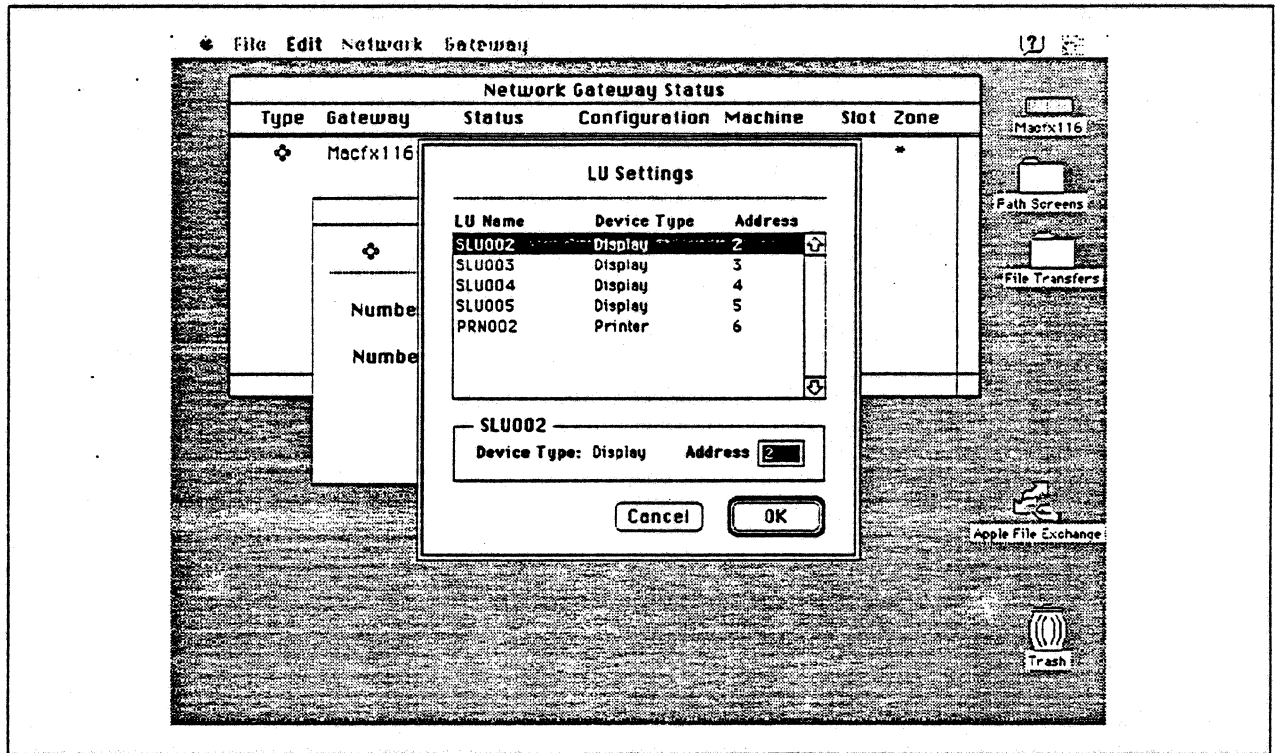

Figure 37. LU Settings

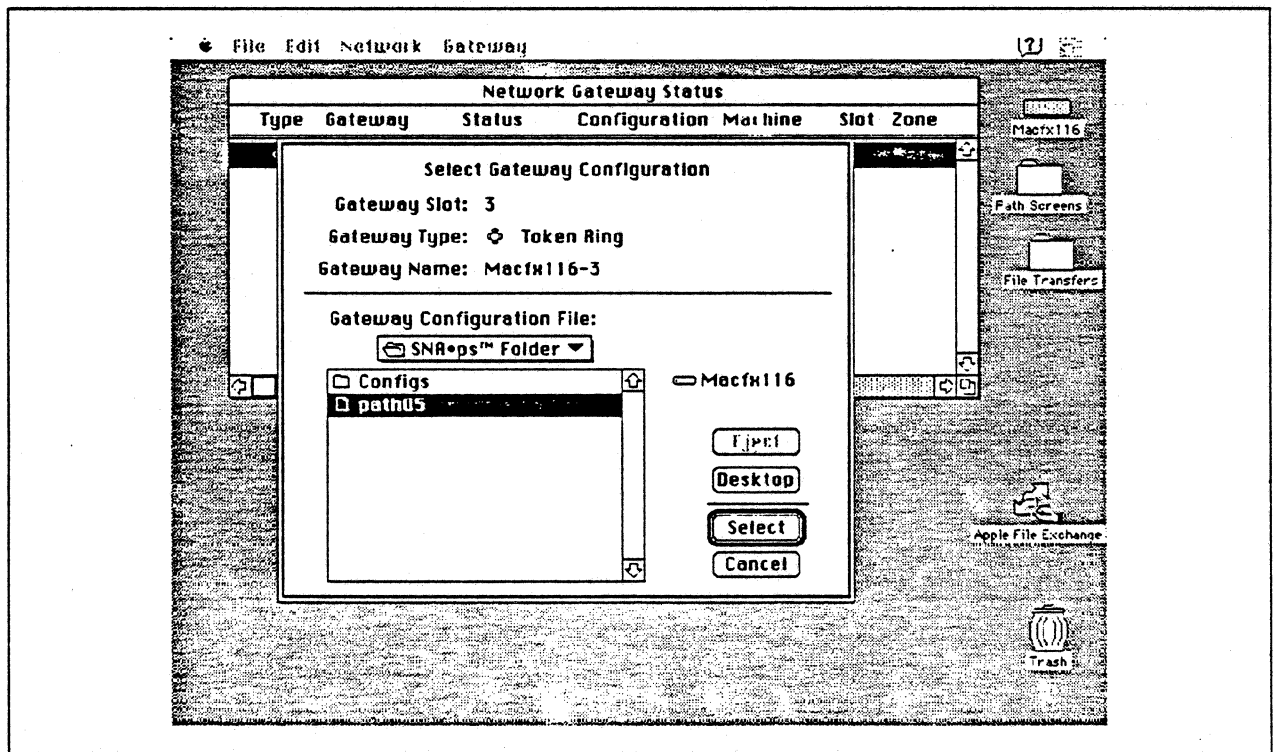

Figure 38. Gateway Configuration Selection

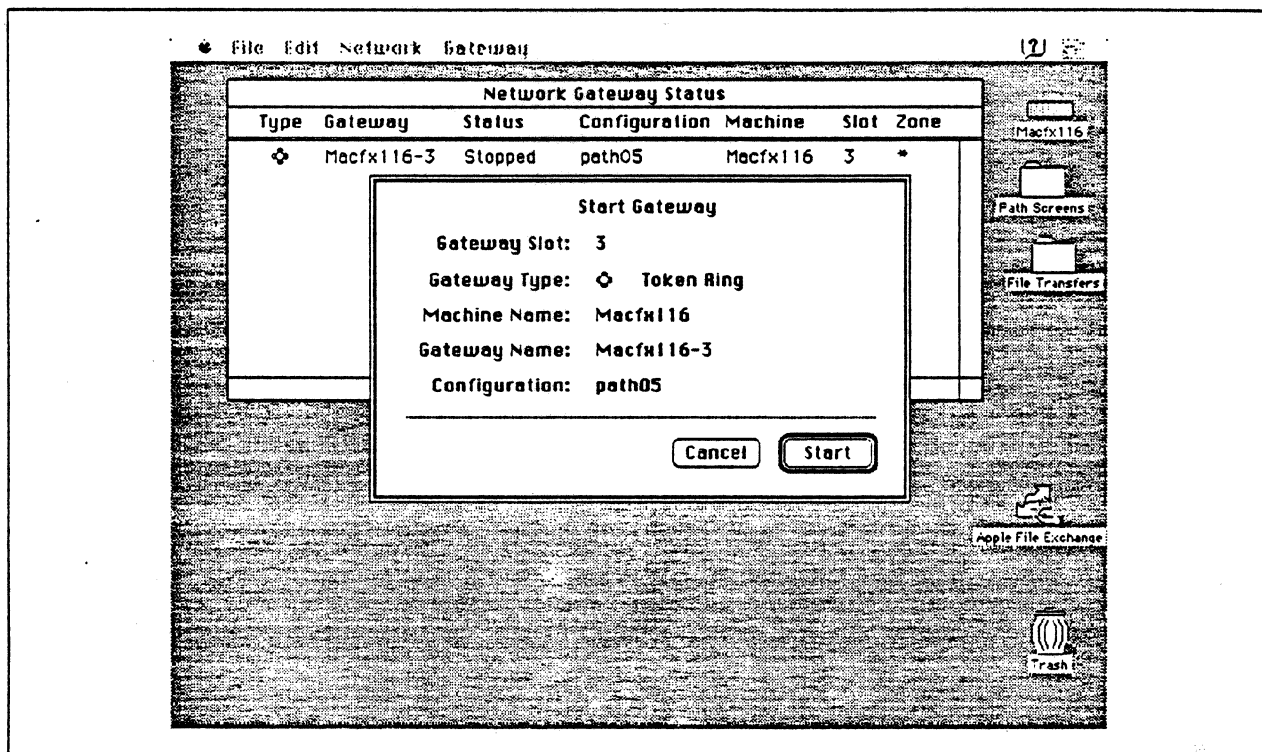

Figure 39. Starting the Gateway

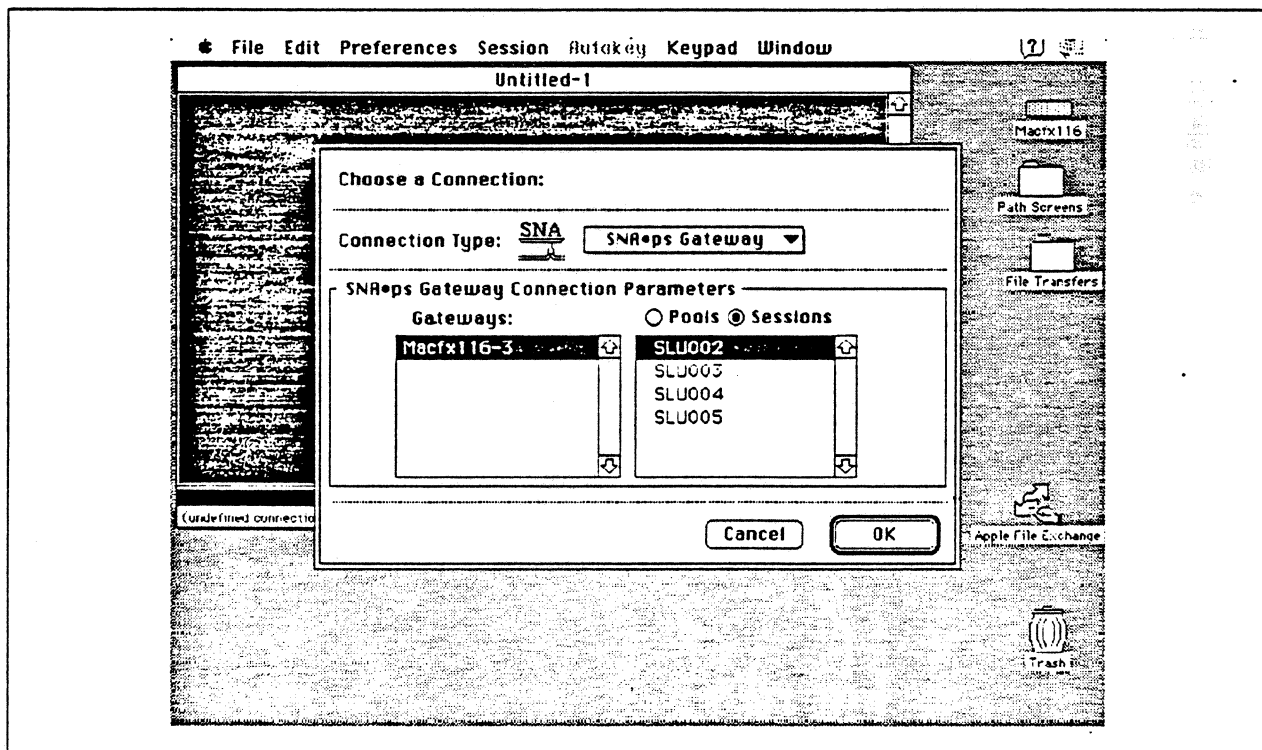

Figure 40. Choosing the Connection

## Observations and Hints

Four display LU sessions and a printer LU session were verified.

The operational status of all PU and LU sessions was verified using NetView.

Print files were sent from the host to the LaserWriter for printing.



---

## Path 6: VM Host Attachment via SDLC Connection

### Path Description

This configuration consists of the SNA\*ps product running on an Apple Macintosh that is connected to an IBM VM/SP host with a remote SDLC communications link.

The configuration is shown in Figure 41 on page 65. The VM host is accessed using the ES/9370 Integrated Communications Adapter (ICA) configured as an SDLC line with an RS-232 interface. An Apple Serial NB Card is used in the Macintosh for SDLC attachment. The Macintosh is defined in a VTAM channel-attachment major node as a PU type 2 on a nonswitched SDLC line to the VM host.

This configuration provides the Macintosh user with up to 5 LU sessions for 3270 terminal and printer emulation.



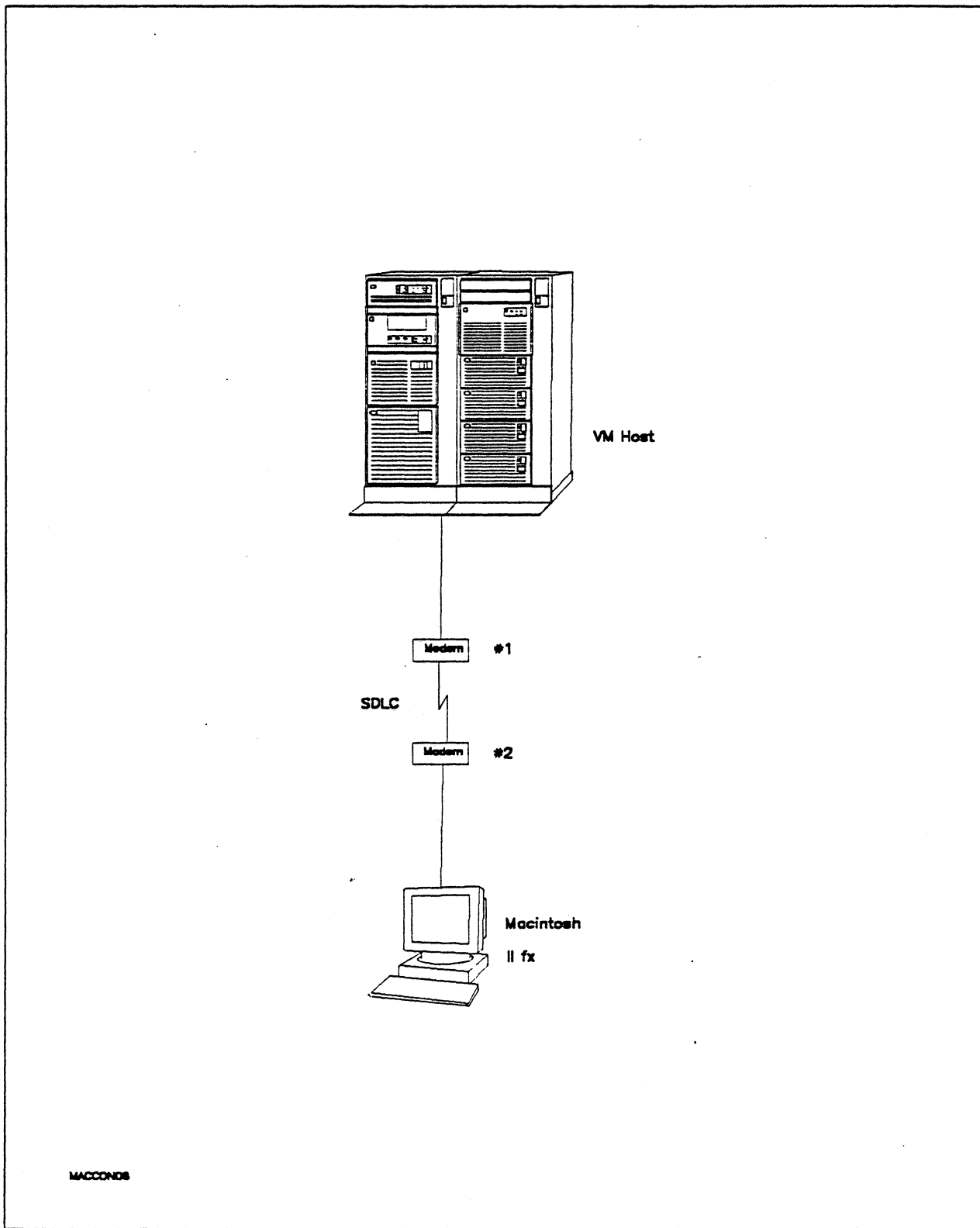

Figure 41. Path 6 Configuration - VM Host Attachment via SDLC Connection

## Path 6

### Hardware and Software

The following section describes the hardware and software that was used for this path.

#### VM Host

- 9375 system
- Integrated Communication Adapter feature #6130/6031
- VM/SP Release 6.0
- VTAM Version 3 Release 3
- RSCS Version 2 Release 3

#### Modems #1 and #2

- 19.2 Kbps
- SDLC
- RS-232
- NRZI
- Leased

#### Macintosh IIx

- System Software 7.0
- SNA\*ps 3270 V1.1 (beta)<sup>6</sup>
- Apple Serial NB Card with MCP memory expansion kit (1MB total)
- RS-232 serial cable
- LaserWriter IINTX printer
- Total memory - 4M
- Hard disk - 80M

---

<sup>6</sup> This path was also verified with SNA\*ps 3270 V1.0.

## Configuration Details and Operation Procedures

The following section contains details of how the configuration is defined and the procedures that are used.

### VM HOST (VTAM Definitions)

```

APPLE780 VBUILD TYPE=CA
*
APPGR780 GROUP LNCTL=SDLC,           X
          DIAL=NO,                   X
          ISTATUS=ACTIVE
*
APPLN780 LINE ADDRESS=780,           X
          RETRIES=7,                 X
          ISTATUS=ACTIVE,           X
          PUTYPE=2,                 X
          MAXOUT=7,                 X
          MAXDATA=265,             X
          MODETAB=ISTINCLM,        X
          USSTAB=AUSSTAB,         X
          DLOGMOD=SNX32702
APPPU780 PU   ADDR=C1
ALU78001 LU   LOCADDR=2
ALU78002 LU   LOCADDR=3,DLOGMOD=SNX32703
ALU78003 LU   LOCADDR=4,DLOGMOD=SNX32704
ALU78004 LU   LOCADDR=5,DLOGMOD=SNX32705
ALU78005 LU   LOCADDR=6,MODETAB=RSCSTAB,DLOGMOD=RSCSPRT3

```

### Macintosh

1. Start the SNA•ps 3270 Manager program. The Network Gateway Status window appears.
2. Choose New Configuration from the File menu. A dialog box appears (refer to Figure 42 on page 68) in which you select the type of card to be configured. Click on the radio button for SDLC, then click OK.
3. The SDLC Configuration dialog box (refer to Figure 43 on page 69) appears. For this path, the VTAM statements defined 4 display LUs and 1 printer LU. In the Address field, enter the SDLC address that corresponds to the ADDR field in the VTAM PU definition statement. Because this is a nonswitched line, the Gateway XID field is not specified.
4. Click on the LU Settings button to display the LU settings. Verify that the Address field corresponds to the LOCADDR on the VTAM LU definition statement. (Reference Figure 44 on page 69.) Click OK.
5. Choose Save Configuration from the File menu. Save this configuration file as *path06*.
6. In the Network Gateway Status window, select the SDLC gateway to be configured. Choose Select Configuration from the Gateway menu. Select *path06*, then click on the Select button to assign *path06* to the SDLC gateway. (Reference Figure 45 on page 70.)
7. To start the gateway, in the Network Gateway Status window select the SDLC gateway with *path06* specified as the configuration. Choose Start Gateway from the Gateway menu. (Reference Figure 46 on page 70.) Click Start to confirm that you want this gateway started.
8. When the gateway has been started, the Status column of the Network Gateway Status contains "Started".
9. Start the SNA•ps 3270 application.

## Path 6

10. Choose Connect from the Session menu. Select the gateway that was started in step 7. Click on the Sessions button to display the specific LUs. Select a session, then click OK to connect that session to the SNA•ps gateway. (Reference Figure 47 on page 71.)
11. At this point, the logon screen specified in the VTAM definition is displayed if the VTAM line, PU, and LUs have been activated.

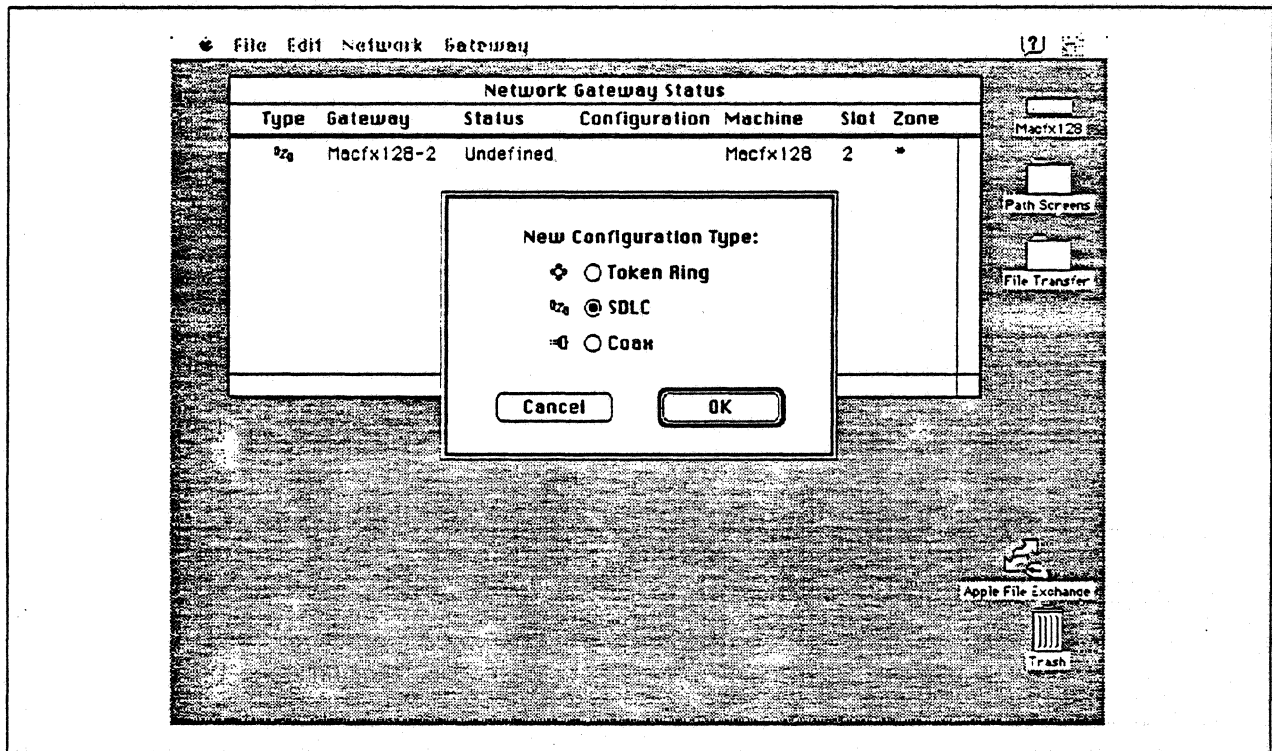

Figure 42. DLC Type Selection for Upstream Connection

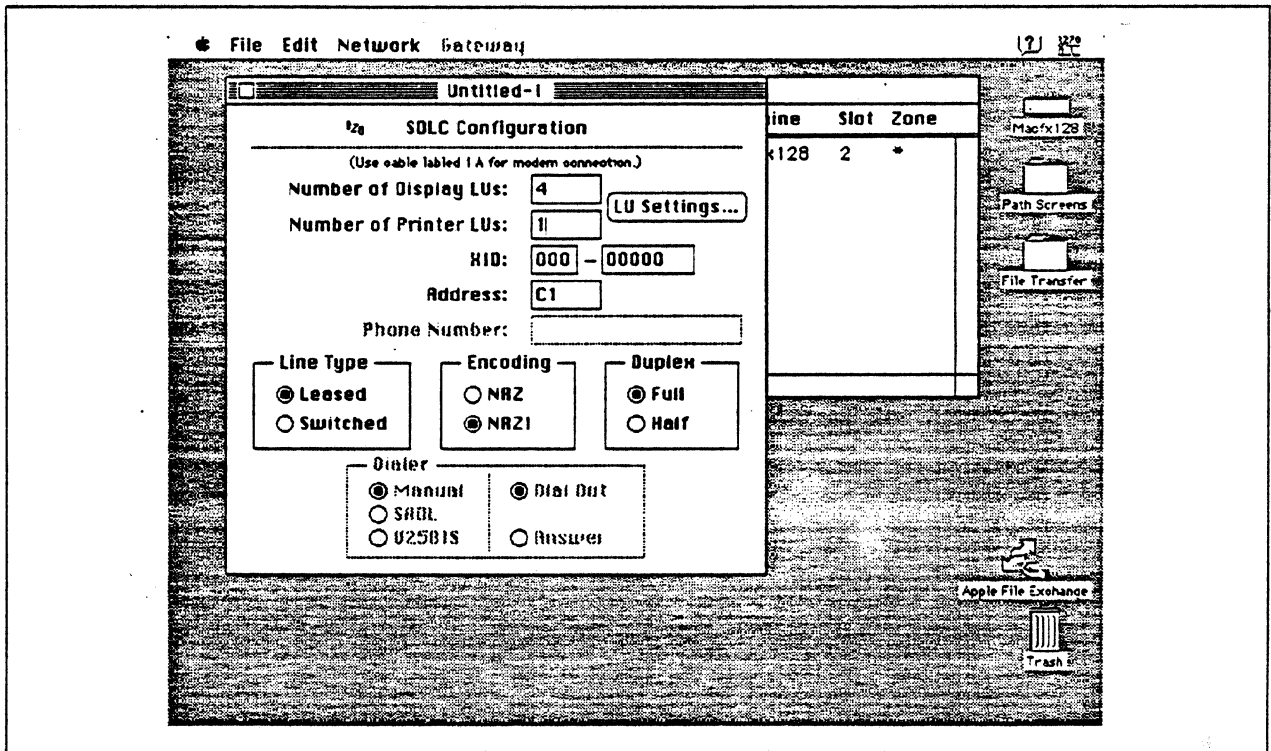

Figure 43. SDLC Gateway Configuration Parameters

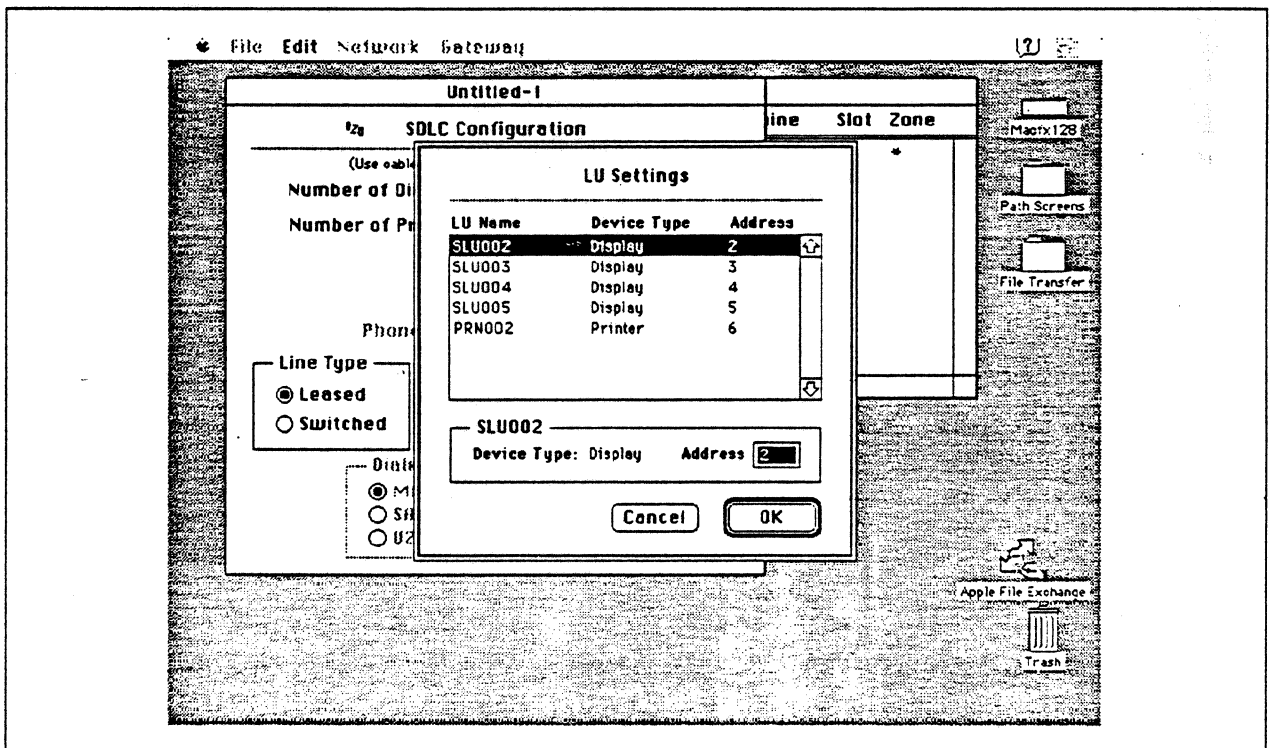

Figure 44. LU Settings

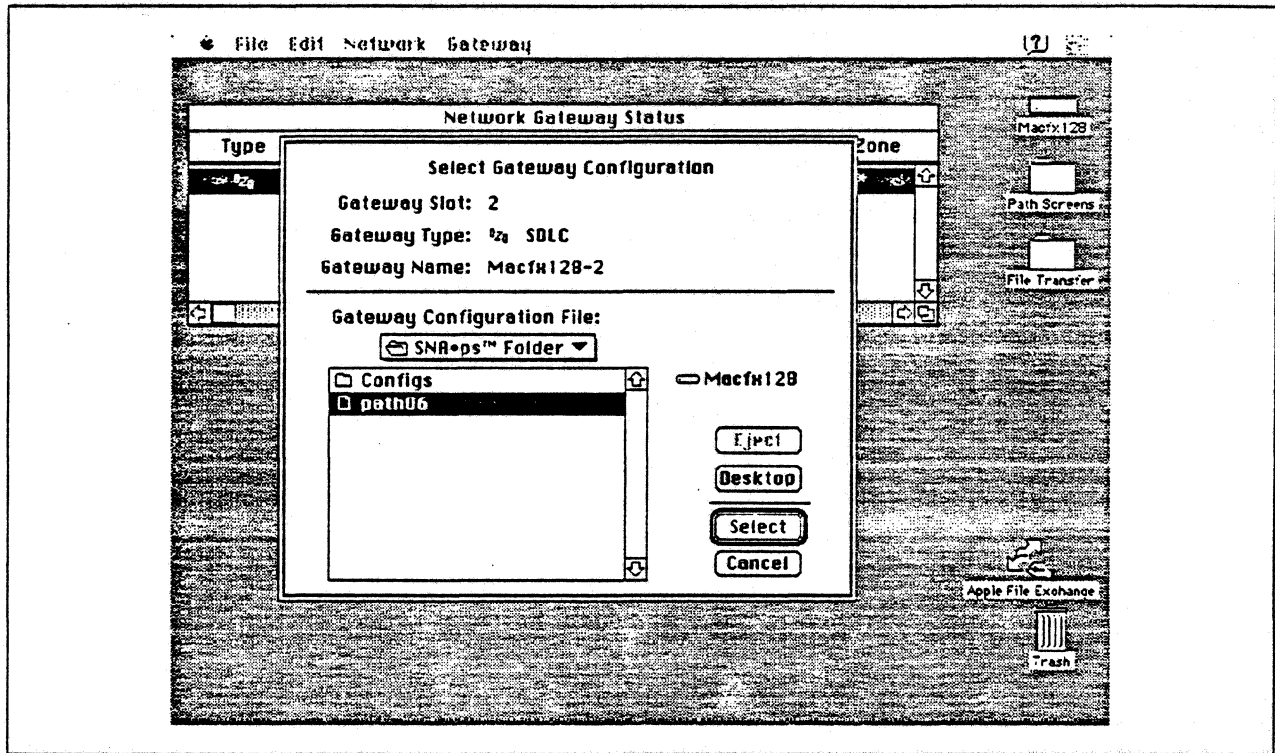

Figure 45. Gateway Configuration Selection

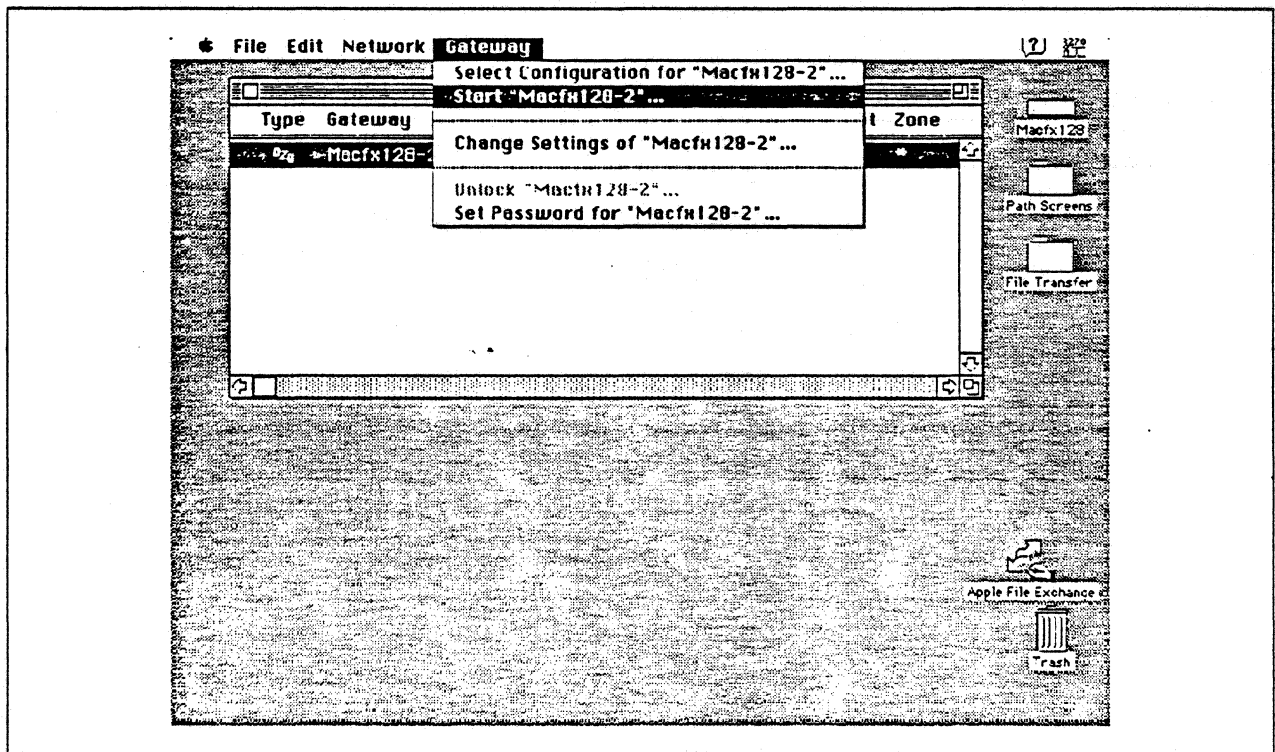

Figure 46. Starting the Gateway

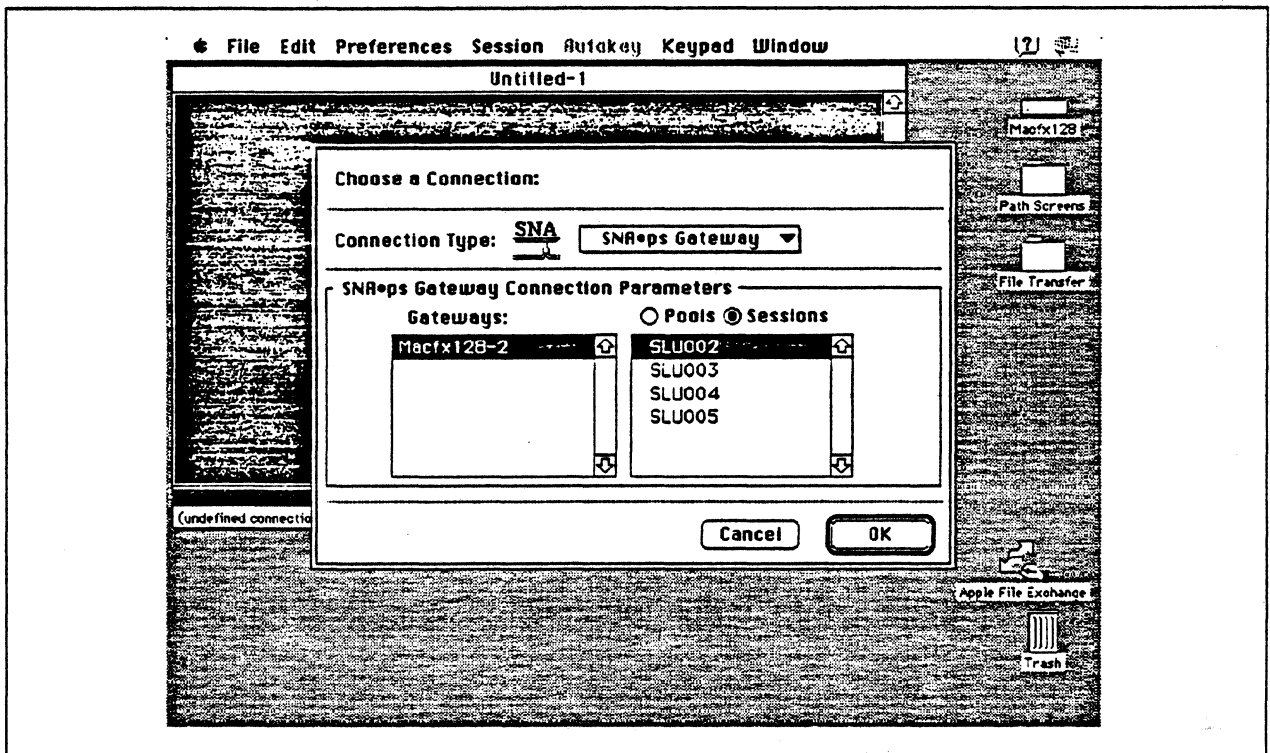

Figure 47. Choosing the Connection

## Observations and Hints

Four display LU sessions and a printer LU session were verified.

The operational status of all PU and LU sessions was verified using NetView.

Print files were sent from the host to the LaserWriter for printing.

---

## Path 7: VM Host Attachment via DFT Workstation Adapter

### Path Description

This configuration consists of the SNA•ps product running on an Apple Macintosh that is connected to an IBM VM/SP host using distributed function terminal (DFT) support over a coaxial connection.

The configuration is shown in Figure 48 on page 73. The VM host supplied the DFT coax connection using the ES/9370 integrated Work Station Controller. An Apple Coax/Twinax Card is used in the Macintosh for coax attachment. This particular configuration is set up for non-SNA DFT (NLCA) support. Support is also available for an SNA DFT connection; however, the configuration data for SNA DFT is not recorded in this path. See "Path 15: MVS Host Attachment via 3174 DFT Connection" on page 162 for details on an SNA DFT configuration.

This configuration provides the Macintosh user with up to 5 sessions for 3270 terminal emulation.



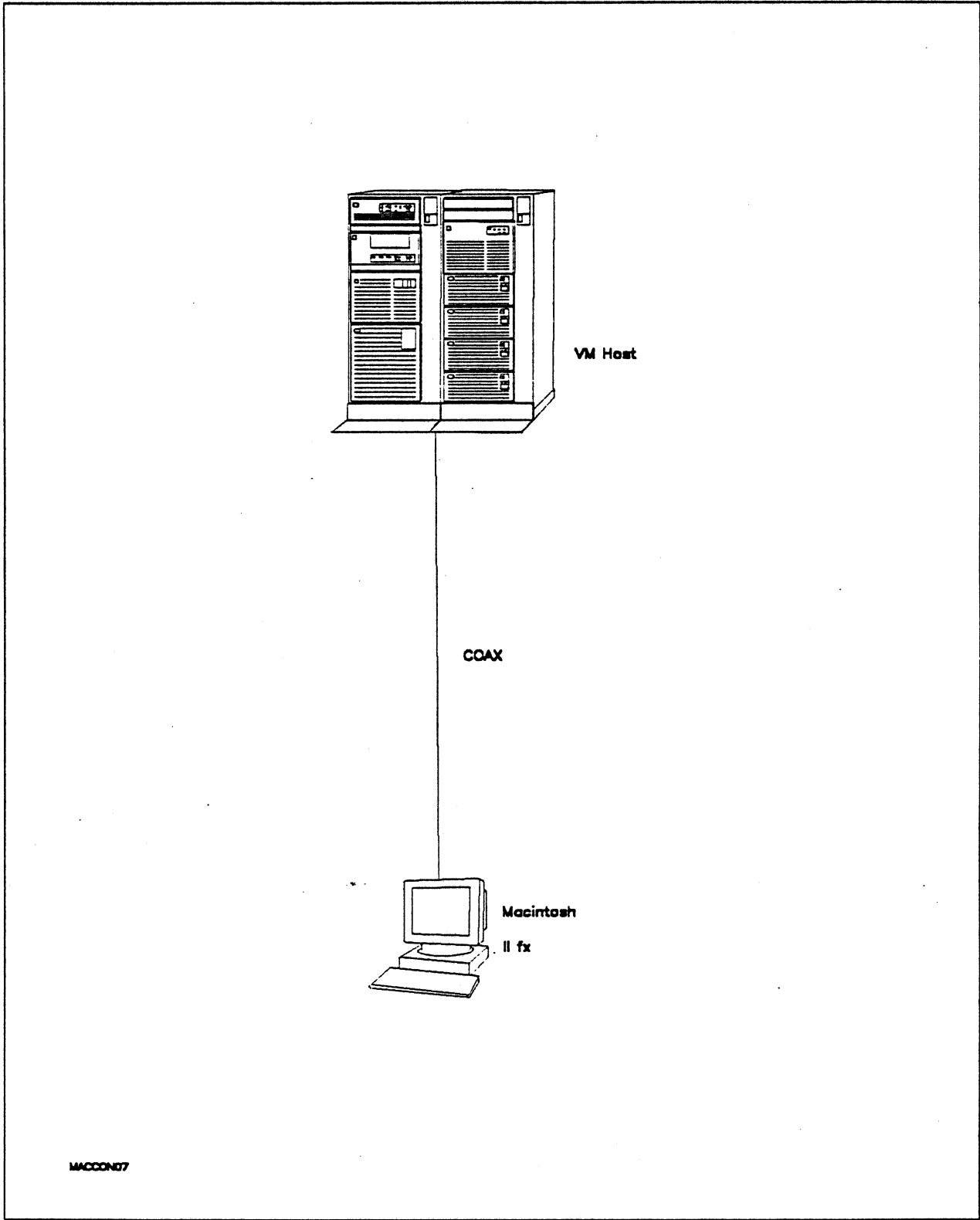

Figure 48. Path 7 Configuration - VM Host Attachment via DFT Workstation Adapter

## Path 7

### Hardware and Software

The following section describes the configuration that was used for this path.

#### VM Host

- 9375 system
- Workstation Adapter feature #6020/6021
- VM/SP Release 6.0
- VTAM Version 3 Release 3
- RSCS Version 2 Release 3

#### Macintosh IIfx

- System Software 7.0
- SNA•ps 3270 V1.1 (beta)
- Apple Coax/Twinax Card
- Total memory - 4M
- Hard disk - 80M

### Configuration Details and Operating Procedure

The following section contains details of how the configuration is defined and the procedures that are used.

#### VM Host

##### DMKRIO ASSEMBLE

```
*****
* DMKRIO DEFINITIONS FOR COAX ATTACHED TERMINALS
*****
      EJECT
DMKRIO  CSECT
      PRINT NOGEN
      COPY OPTIONS
*****
*                C H A N N E L   Z E R O                *
*****
      SPACE
GRAF   RDEVICE ADDRESS=(002,14),DEVTYPE=3278,MODEL=2
*****
*                C O N T R O L   U N I T S                *
*****
      SPACE
RCTLU0 RCTLUNIT ADDRESS=000,CUTYPE=3274,FEATURE=32-DEVICE
*****
*                C H A N N E L S                *
*****
      SPACE
RCHANNEL ADDRESS=0,CHTYPE=BLKMPXR
      END
```

**Integrated Workstation Adapter Configuration Data**

Model / Attach

101 - 0

Non-SNA Host

110 - 1	116 - 2	121 - 00	123 - 0
125 - 00000100	127 - 0 0	132 - 0 0 0 0	136 - 0 0 0 0
137 - 0 0 0 0	138 - 0	141 - A	165 - 0
166 - B	168 - 0	173 - 00000000	175 - 000000
178 - 0			

117: Port Assignment

LT=

116= 2

LT1 LT2 LT3 LT4 LT5							LT1 LT2 LT3 LT4 LT5							
C@ #IS P S1 S2 S3 S4							C@ #IS P S1 S2 S3 S4							
00	000						01	001						
02	002	003	004	005			03	006	007	008	009			
04	010	011	012	013			05	014						
06	015						07							
08							09							
10							11							
12							13							
14							15							
16							17							
18							19							
20							21							
22							23							
24							25							
26							27							
28							29							
30							31							

PAM Definition

Entry	Printer Port	Mode	Class
			7 8
			01234 56789 012345
1	01	2	.....
2	—	—	.....
3	—	—	.....
4	—	—	.....
5	—	—	.....

Display Port

Entry	0	1	2	3
	01234 56789	01234 56789	01234 56789	01
1	X.XXX XX...	.....	.....	.....
2	.....	.....	.....	.....
3	.....	.....	.....	.....
4	.....	.....	.....	.....
5	.....	.....	.....	.....

**Macintosh**

1. Start the SNA•ps 3270 program by double clicking the application icon. An untitled session document appears.
2. Choose Connect from the Session menu. A connection dialog box appears. Click on the Connection Type pop-up menu to list the connection options. Click on SNA•ps NLCA to select this as the connection type. (Refer to Figure 49.)
3. The dialog box displays a list of the Coax/Twinax cards that are installed in the Macintosh. The cards are listed by slot number. In Figure 50 on page 77, Slot 5 appears in the list of coax cards because one Coax Card had been installed in the Macintosh in slot 5. Select Slot 5, then select DFT Session Pool. Click OK to connect the session to the VM host. The VM screen should then appear.

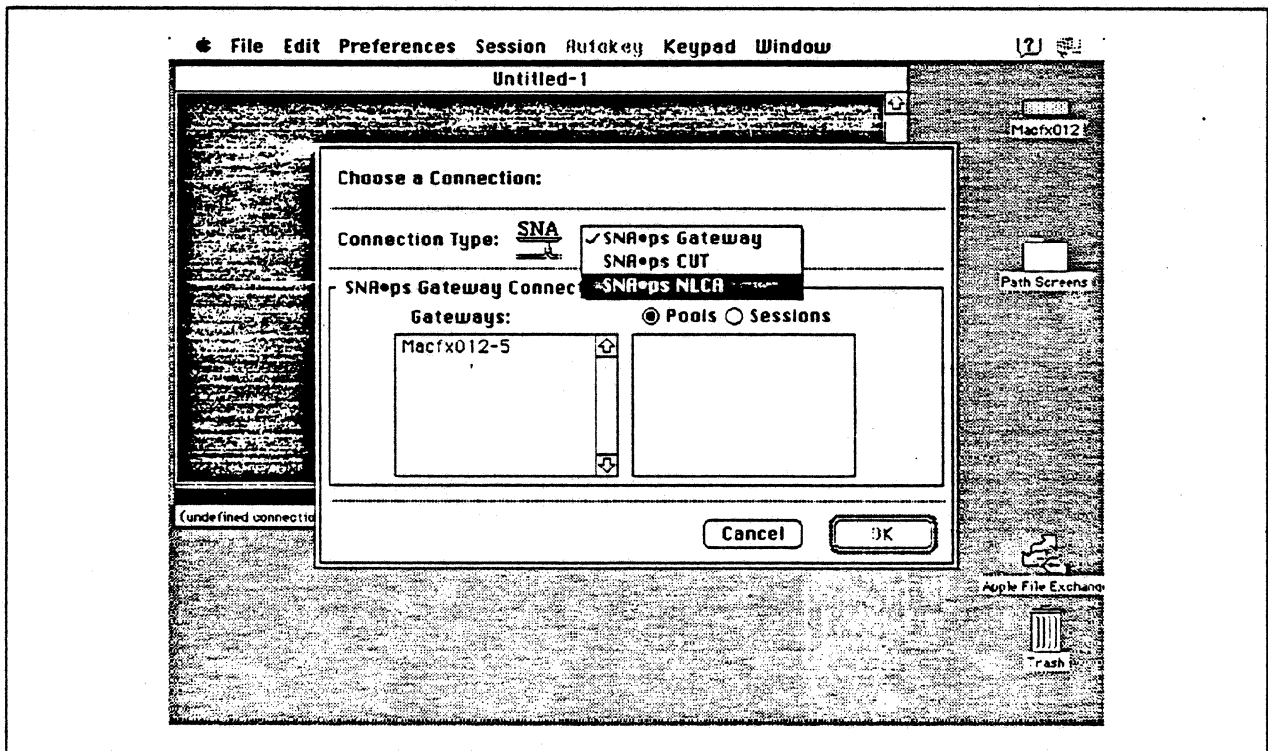

Figure 49. Choosing SNA•ps NLCA as Connection Type

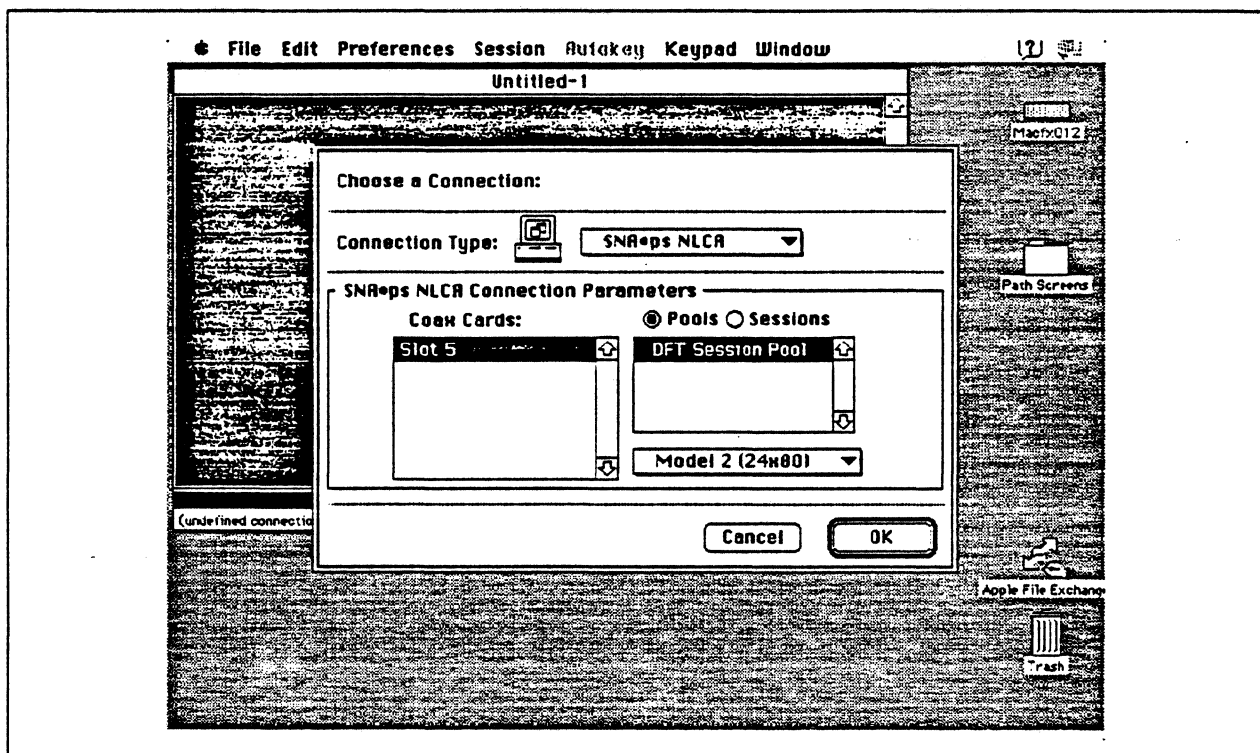

Figure 50. Selecting a SNA•ps NLCA Connection

## Observations and Hints

The NLCA option must be selected when installing SNA•ps 3270 software, as described in the *SNA•ps 3270 User's Guide*. If you do not select NLCA at that time, you will not be able to select NLCA as a connection type.

Four display LU sessions were tested. Printer emulation is not supported with the NLCA option.

---

## Path 8: MVS Host Attachment via Macintosh Token-Ring Gateway

### Path Description

This configuration consists of the SNA•ps product running on an Apple Macintosh that is connected to an IBM MVS host through an IBM Token-Ring (IEEE 802.5) local area network. The Macintosh provides AppleTalk to SNA Gateway function for AppleTalk clients.

The configuration is shown in Figure 51 on page 79 through Figure 53 on page 81. The MVS host is attached to the token ring using an IBM 3745 Communications Controller which has the 16/4 Mbps Token-Ring Interface Card (TIC) feature. An Apple Token Ring 4/16 NB Card is used in the Macintosh IIfx for Token Ring SNA LAN attachment. The Macintosh IIfx is defined in a VTAM switched major node as a PU type 2 on the MVS host.

For the Macintosh IIfx AppleTalk-attached clients, the three supported AppleTalk LAN types (Ethernet, LocalTalk, Token Ring) are shown as Paths 8A, 8B, and 8C. The Macintosh IIfx uses the same adapter cards for AppleTalk attachment as the clients in each of the following configurations. In Path 8A, an Apple EtherTalk NB Card is used to connect to the Ethernet LAN. In Path 8B, the LocalTalk connector on the system unit is used. In Path 8C, an Apple Token Ring 4/16 NB Card is used to connect to the Token Ring LAN.

This configuration provides 64 LUs through the SNA gateway machine to AppleTalk clients for 3270 terminal and printer emulation.

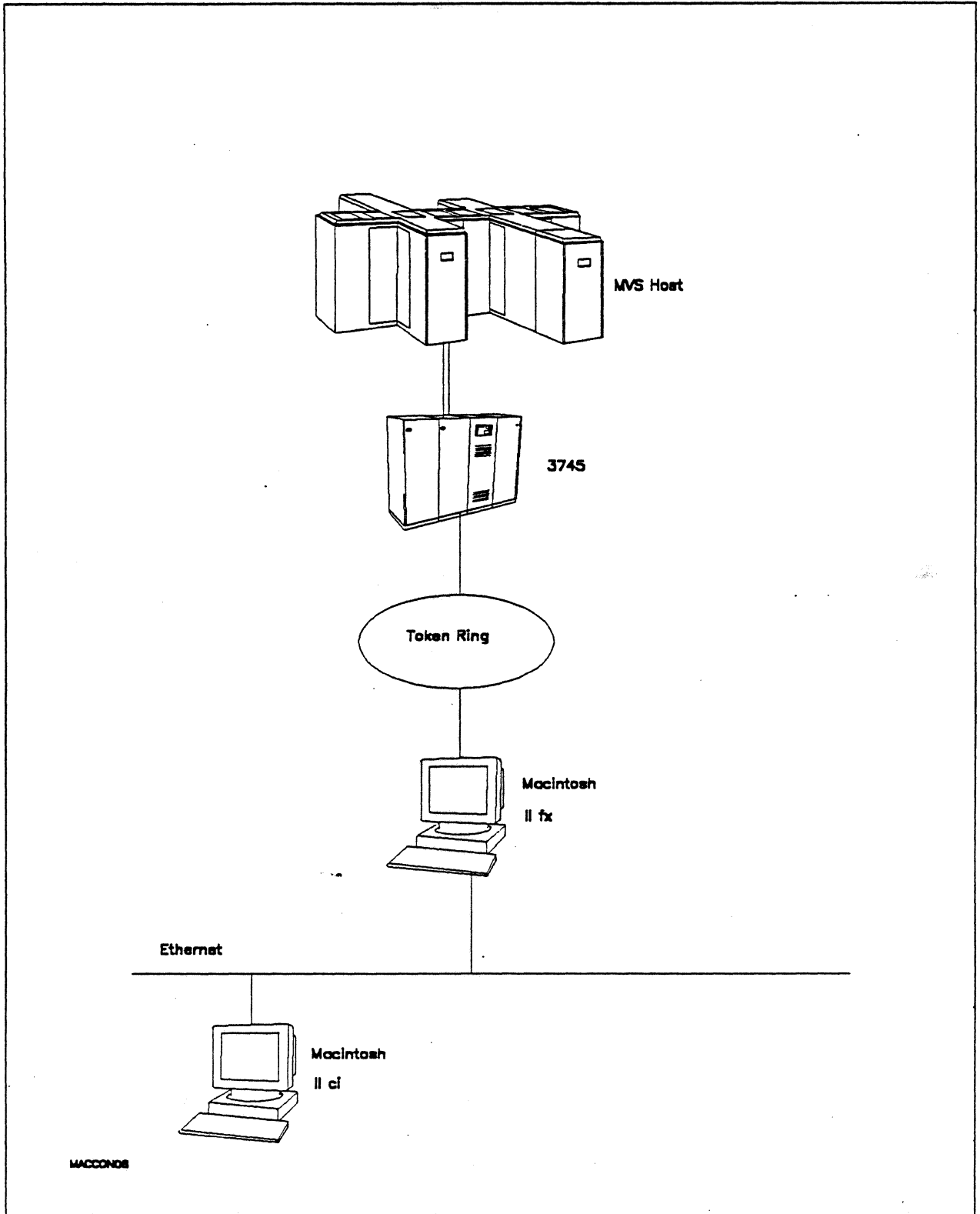

Figure 51. Path 8A Configuration - MVS Host Attachment via Macintosh Token-Ring Gateway with EtherTalk Clients

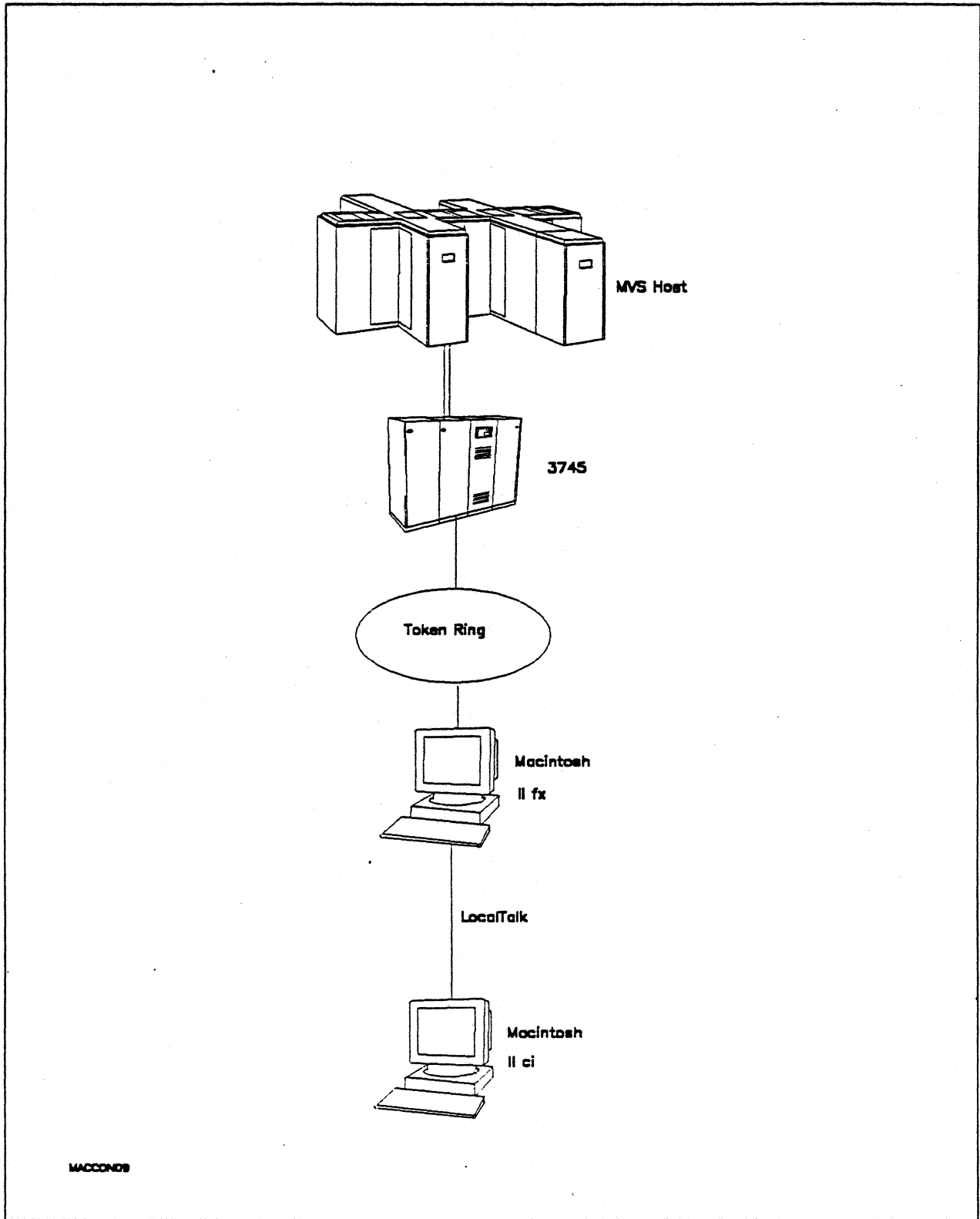

Figure 52. Path 8B Configuration - MVS Host Attachment via Macintosh Token-Ring Gateway with LocalTalk Clients



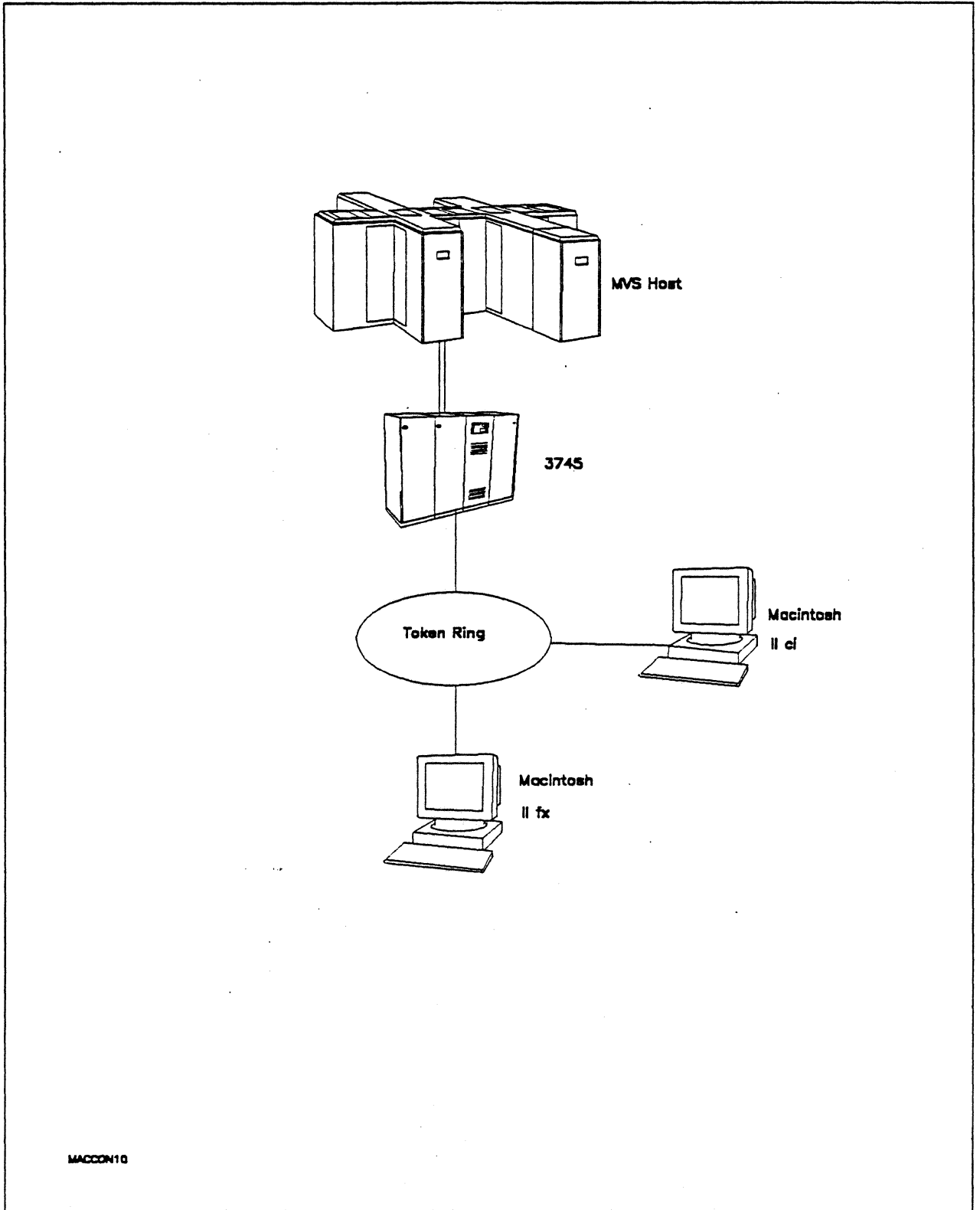

Figure 53. Path 8C Configuration - MVS Host Attachment via Macintosh Token-Ring Gateway with TokenTalk Clients

## Hardware and Software

The following section describes the configuration that was used for this path.

### MVS Host

- 4381 system
- MVS/SP JES2 Version 2 Release 2.0 (MVS/XA)
- VTAM Version 3 Release 3
- OEMI channel
- JES/328X Print Facility

### 3745

- 16/4 Mbps token ring adapter (TIC) type 2 feature #4770
- Channel adapter feature #1561
- NCP Version 5 Release 3

### Token Ring

- 16 Mbps

### Macintosh IIfx (Gateway)

- System Software 7.0
- SNA•ps Gateway/64 V1.1 (beta)
- Apple Token Ring 4/16 NB Card with MCP memory kit (1MB total) - all paths
- Apple EtherTalk NB Card (Path 8A)
- LocalTalk cable (Path 8B)
- LaserWriter IINTX printer
- Total memory - 4M
- Hard disk - 80M

### Macintosh IIfx (Client)

- System Software 7.0
- SNA•ps 3270 Gateway Client V1.1 (beta)
- Apple Token Ring 4/16 NB Card (Path 8C)
- Apple EtherTalk NB Card (Path 8A)
- LocalTalk cable (Path 8B)
- Total memory - 5M
- Hard disk - 80M

## Configuration Details and Operating Procedure

The following section contains details of how the configuration is defined and the procedures that are used.

### MVS Host (VTAM and NCP Definitions)

DIALAPPL VBUILD TYPE=SWNET

\*

TOAAP2	PU	ADDR=04,		C
		IDBLK=00A,		C
		IDNUM=37452,		C
		PACING=0,		C
		VPACING=0,		C
		IRETRY=YES,		C
		MAXDATA=1033,		C
		SSCPFM=USSSCS,		C
		DISCNT=NO,		C
		PUTYPE=2,		C
		MAXOUT=7,		C
		MODETAB=ISTINCLM,		C
		DLOGMOD=SNX32702,		C
		USSTAB=TPOUSS		
TOAAP202	LU	LOCADDR=2,DLOGMOD=SNX32702	* 3278 MODEL 2 *	
TOAAP203	LU	LOCADDR=3,DLOGMOD=SNX32703	* 3278 MODEL 3 *	
TOAAP204	LU	LOCADDR=4,DLOGMOD=SNX32704	* 3278 MODEL 4 *	
TOAAP205	LU	LOCADDR=5,DLOGMOD=SNX32705	* 3278 MODEL 5 *	
TOAAP206	LU	LOCADDR=6,DLOGMOD=SCS	* 3287 SCS PRINTER *	
TOAAP207	LU	LOCADDR=7,DLOGMOD=SNX32702	* 3278 MODEL 2 *	
TOAAP208	LU	LOCADDR=8,DLOGMOD=SNX32702	* 3278 MODEL 2 *	
:				
TOAAP263	LU	LOCADDR=63,DLOGMOD=SNX32702	* 3278 MODEL 2 *	
TOAAP264	LU	LOCADDR=64,DLOGMOD=SNX32702	* 3278 MODEL 2 *	
TOAAP265	LU	LOCADDR=65,DLOGMOD=SNX32702	* 3278 MODEL 2 *	

The token ring is defined by the TO30T1PG and TO30T1G1 GROUP definition statements in the NCP gen. Refer to Appendix C, "NCP Gen Listing" on page 287 for the complete NCP gen listing.

### Macintosh

1. Start the SNA•ps Config program by double clicking the application icon. The SNA•ps Config resources window appears.
2. In the SNA•ps Config resources window, click the New button below the Lines box. A dialog box appears (refer to Figure 54 on page 85) in which you select the type of card to be configured. Because Token Ring is the default for card type and is the desired upstream DLC type for this path, click OK.
3. The dialog box for a Token Ring line appears (refer to Figure 55 on page 85). For this path, change the Maximum I-Field Length to the MAXDATA value specified on the VTAM PU definition statement, then click OK.
4. In the Lines box in the SNA•ps Config resources window, select *LINE01*, which is the name of the Token Ring line that was created in step 3, then click the New button under Partners. The Token Ring Partner dialog box appears. In the Link Address field, enter the LOCADD value from the NCP LINE definition statement for the 3745 Token Ring adapter card. In the Gateway XID field, enter the IDBLK-IDNUM values specified on the VTAM PU definition statement (reference Figure 56 on page 86). Click OK.
5. In the Partners box in the SNA•ps Config resources window, select *HOST01*, which is the name of the Partner that was created in step 4, then click the New button under 3270 Resources. A dialog box appears in which you can create a 3270 LU. For this path, 64 LUs were created. The LU created with the LU ID of 6 was a printer LU to match the VTAM configuration. All the remaining LUs were created with a device type of Display. Figure 57 on page 86 shows the Config resources window after the creation of 64 LUs.
6. Choose Save As from the File menu. Save this file as *path08*.
7. Start the SNA•ps Admin program by double clicking the application icon. The Network Gateway Status window appears. In the Network Gateway Status window, select the Token Ring gateway to be configured, then choose Select Configuration from the Gateway menu. Select *path08*, then click on the Select button to assign *path08* to the Token Ring gateway.
8. To start the gateway, in the Network Gateway Status window select the Token Ring-gateway with *path08* specified as the configuration. Choose Start Gateway from the Gateway menu. Click on Start to confirm that you want this gateway started. When the gateway has been started, the Status column of the Network Gateway Status window contains "Started."
9. Start the SNA•ps 3270 client program by double clicking the application icon. An untitled session document appears. Choose Connect from the Session menu. Select the gateway that was started in step 8, then click on the Session button to display the specific LUs. Select a session, then click OK to connect that session to the MVS host via the SNA•ps gateway (refer to Figure 58 on page 87).

**Note:** This step was performed first on an EtherTalk client, then on a LocalTalk client, and finally on a TokenTalk client machine, as shown in Figure 51 on page 79 through Figure 53 on page 81.

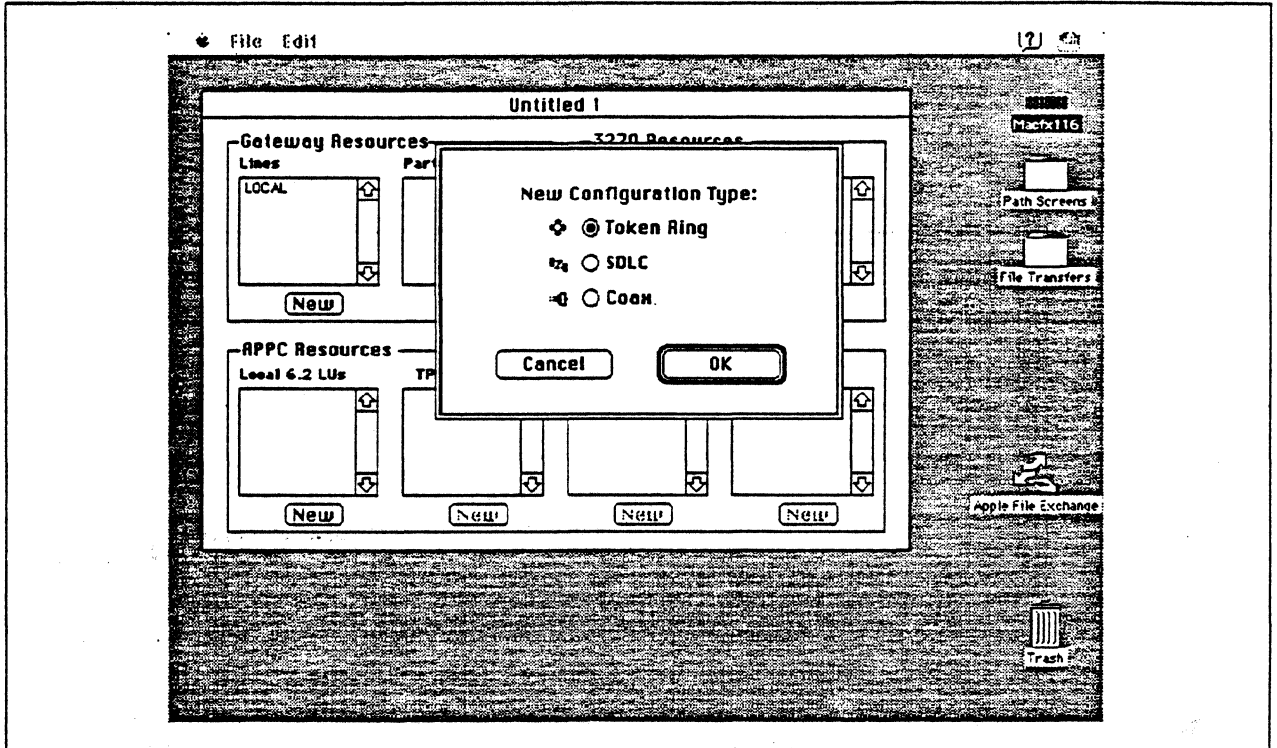

Figure 54. DLC Type Selection for Upstream Connection

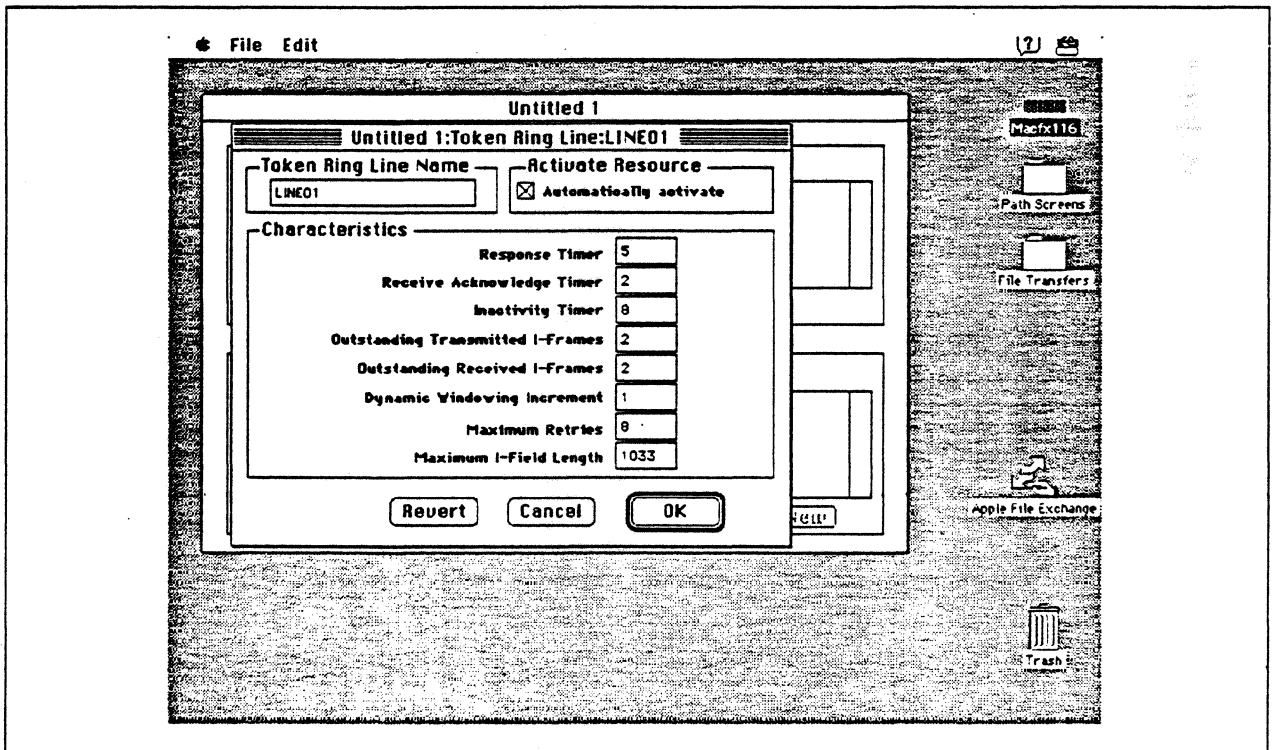

Figure 55. Token Ring Line Configuration Parameters

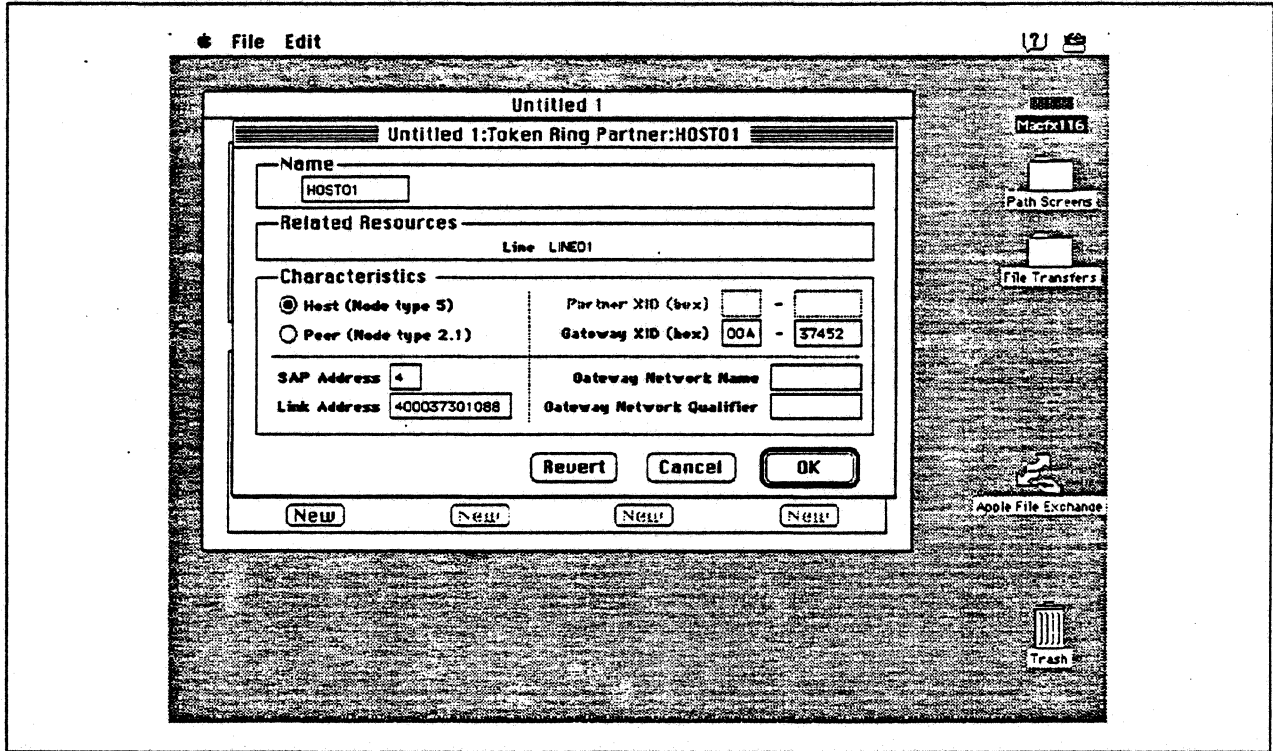

Figure 56. Token Ring Partner Configuration Parameters

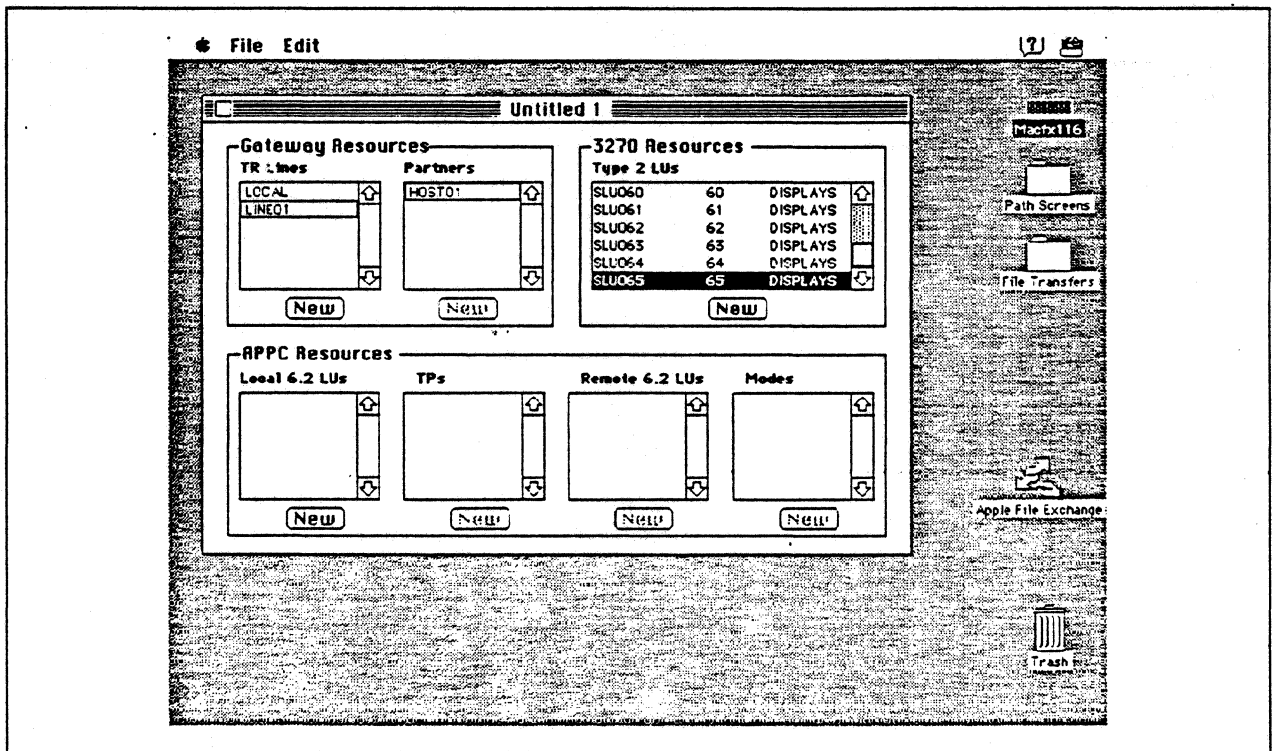

Figure 57. SNA\*ps Config Window After Creating 64 LUs

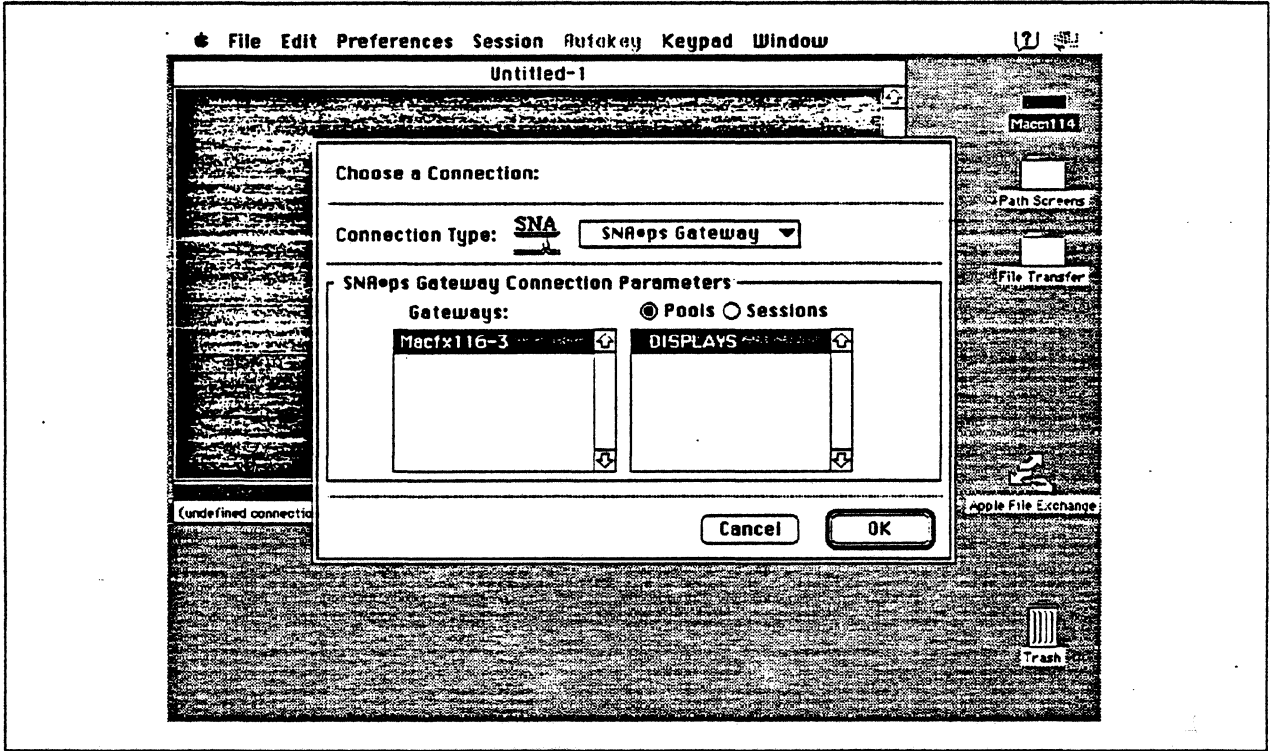

Figure 58. Choosing the Connection

### Observations and Hints

If you want to also use the Macintosh IIfx gateway machine as a client, install both SNA•ps 3270 V1.1 (beta) and SNA•ps 3270 Gateway Client V1.1 (beta) on that machine.

Four LU sessions were tested with each client machine.

In this path, there are clients that access the SNA•ps gateway via EtherTalk, TokenTalk, and LocalTalk. For information on installing those products or selecting the media to be used to access the gateway from the client machine, see Section 2, "Apple Network Product Installation Overview" on page 7.

---

## **Path 9: MVS Host Attachment via Macintosh Token Ring Gateway with Multiple LAN Clients**

### **Path Description**

This configuration consists of the SNA•ps product running on an Apple Macintosh that is connected to an IBM MVS host through an IBM Token-Ring (IEEE 802.5) local area network. The Macintosh provides AppleTalk to SNA Gateway function for AppleTalk clients. In this configuration, AppleTalk clients from multiple LANs and media (EtherTalk, LocalTalk, and TokenTalk) can share the same AppleTalk/SNA gateway at the same time.

The configuration is shown in Figure 59 on page 89. The MVS host is attached to the token ring using an IBM 3745 Communications Controller which has a 16/4 Mbps Token-Ring Interface Card (TIC). Several adapters are installed in the Macintosh IIx system to handle the multiple LAN types. An Apple Token Ring 4/16 NB Card is used in the IIx for SNA Token Ring LAN attachment as well as for Token Ring AppleTalk attachment (multiple protocol stacks can run in the Apple Token Ring 4/16 NB Card simultaneously). For EtherTalk, an Apple EtherTalk NB Card is used. LocalTalk is supplied through the system board connector. The AppleTalk Internet Router software product is used to logically interconnect the multiple AppleTalk LANs. The Macintosh IIx is defined in a VTAM switched major node as a PU type 2 on the MVS host.

For Macintosh IIci (A), an Apple EtherTalk NB Card is used to connect to the Ethernet LAN. For the Macintosh IIci (B), an Apple Token Ring 4/16 NB Card is used to connect to the Token Ring LAN. For the Macintosh IIci (C), the LocalTalk connector on the system unit is used.

This configuration provides 64 LUs through the SNA gateway machine to AppleTalk clients for 3270 terminal and printer emulation.



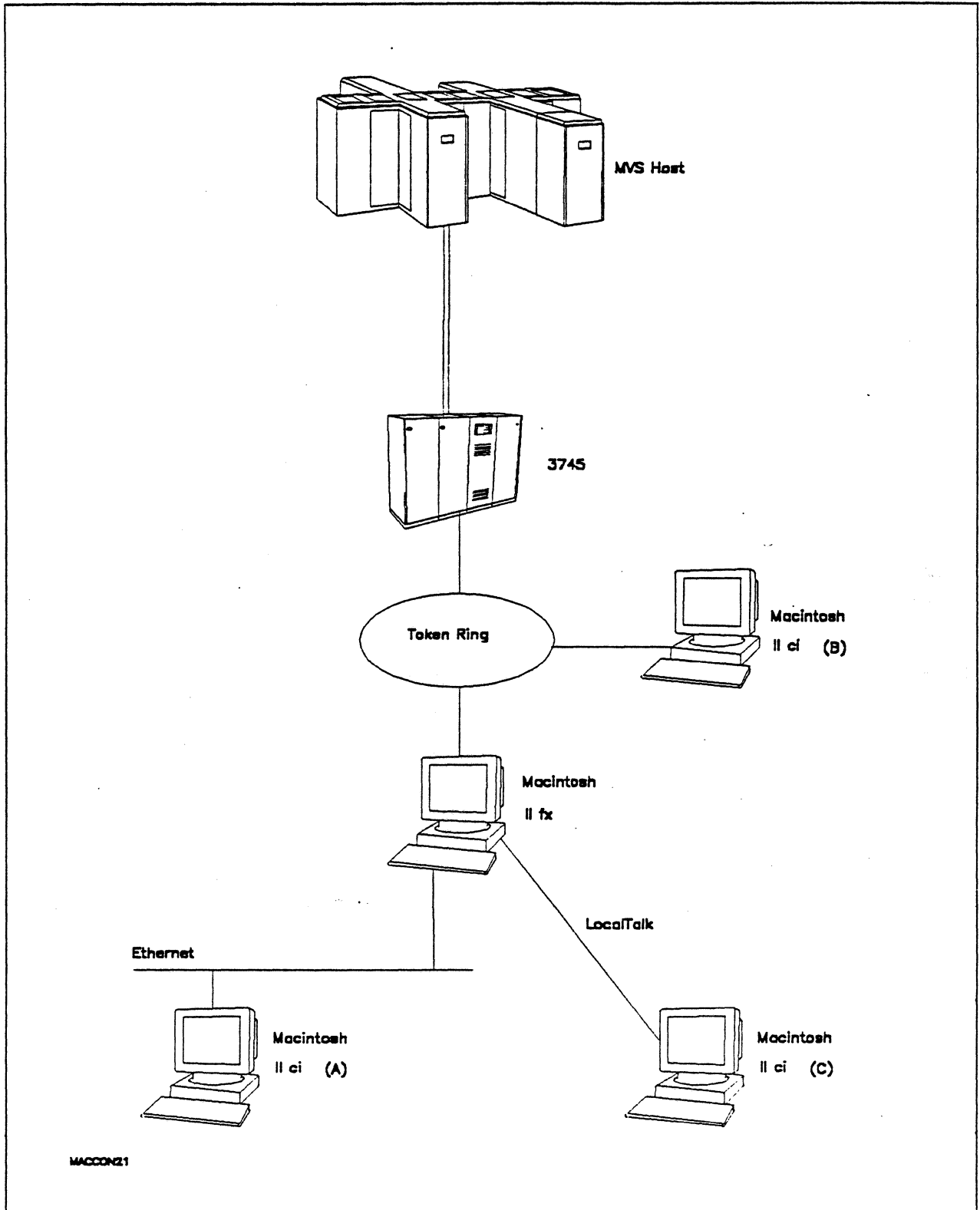

Figure 59. Path 9 Configuration - MVS Host Attachment via Macintosh Token Ring Gateway with Multiple LAN Clients

## Hardware and Software

The following section describes the configuration that was used for this path.

### MVS Host

- 4381 system
- MVS/SP JES2 Version 2 Release 2.0 (MVS/XA)
- VTAM Version 3 Release 3
- OEMI channel
- JES/328X Print Facility

### 3745

- 16/4 Mbps token ring adapter (TIC) type 2 feature #4770
- Channel adapter feature #1561
- NCP Version 5 Release 3

### Token Ring

- 16 Mbps

### Macintosh IIfx (Gateway)

- System Software 7.0
- SNA\*ps Gateway/64 V1.1 (beta)
- Apple Token Ring 4/16 NB Card with MCP memory kit (1MB total)
- Apple EtherTalk NB Card
- LocalTalk cable
- AppleTalk Internet Router
- LaserWriter IINTX printer
- Total memory - 4M
- Hard disk - 80M

### Macintosh IIci (Client)

- System Software 7.0
- SNA\*ps 3270 Gateway Client V1.1 (beta)
- Apple EtherTalk NB Card (Macintosh A)
- Apple Token Ring 4/16 NB Card (Macintosh B)
- LocalTalk cabling (Macintosh C)
- Total memory - 5M
- Hard disk - 80M

## Configuration Details and Operating Procedure

The following section contains details of how the configuration is defined and the procedures that are used.

### MVS Host (VTAM and NCP Definitions)

DIALAPPL VBUILD TYPE=SWNET

```

*
TOAAP2  PU  ADDR=04,           C
          IDBLK=00A,          C
          IDNUM=37452,        C
          PACING=0,           C
          VPACING=0,          C
          IRETRY=YES,         C
          MAXDATA=1033,       C
          SSCPFM=USSSCS,     C
          DISCNT=NO,          C
          PUTYPE=2,           C
          MAXOUT=7,           C
          MODETAB=ISTINCLM,   C
          DLOGMOD=SNX32702,    C
          USSTAB=TPOUSS
TOAAP202 LU  LOCADDR=2,DLOGMOD=SNX32702 * 3278 MODEL 2 *
TOAAP203 LU  LOCADDR=3,DLOGMOD=SNX32703 * 3278 MODEL 3 *
TOAAP204 LU  LOCADDR=4,DLOGMOD=SNX32704 * 3278 MODEL 4 *
TOAAP205 LU  LOCADDR=5,DLOGMOD=SNX32705 * 3278 MODEL 5 *
TOAAP206 LU  LOCADDR=6,DLOGMOD=SCS      * 3287 SCS PRINTER *
TOAAP207 LU  LOCADDR=7,DLOGMOD=SNX32702 * 3278 MODEL 2 *
:
TOAAP265 LU  LOCADDR=65,DLOGMOD=SNX32702 * 3278 MODEL 2 *

```

Refer to Appendix C, "NCP Gen Listing" on page 287 for the NCP gen listing.

## Macintosh

1. Start the SNA•ps Config program by double clicking the application icon. The SNA•ps Config resources window appears.
2. In the SNA•ps Config resources window, click the New button below the Lines box. A dialog box appears (refer to Figure 60 on page 93) in which you select the type of card to be configured. Because Token Ring is the default for card type and is the desired upstream DLC type for this path, click OK.
3. The dialog box for a Token Ring line appears (refer to Figure 61 on page 93). For this path, change the Maximum I-Field Length to 1033, then click OK.
4. In the Lines box in the SNA•ps Config resources window, select *LINE01*, which is the name of the Token Ring line that was created in step 3, then click the New button under Partners. The Token Ring Partner dialog box appears. In the Link Address field, enter the LOCADD value from the NCP LINE definition statement for the 3745 Token Ring adapter card. In the Gateway XID field, enter the IDBLK-IDNUM values specified on the VTAM PU definition statement (reference Figure 62 on page 94). Click OK.
5. In the Partners box in the SNA•ps Config resources window, select *HOST01*, which is the name of the Partner that was created in step 4, then click the New button under 3270 Resources. A dialog box appears in which you can create a 3270 LU. For this path, 64 LUs were created. The LU created with the LU ID of 6 was a printer LU to match the VTAM configuration. All the remaining LUs were created with a device type of Display. Figure 63 on page 94 shows the Config resources window after the creation of 64 LUs.
6. Choose Save As from the File menu. Save this file as *path09*.
7. Start the SNA•ps Admin program by double clicking the application icon. The Network Gateway Status window appears. In the Network Gateway Status window, select the Token Ring gateway to be configured, then choose Select Configuration from the Gateway menu. Select *path09*, then click on the Select button to assign *path09* to the Token Ring gateway.
8. To start the gateway, in the Network Gateway Status window select the Token Ring gateway with *path09* specified as the configuration. Choose Start Gateway from the Gateway menu. Click on Start to confirm that you want this gateway started. When the gateway has been started, the Status column of the Network Gateway Status window contains "Started."
9. The AppleTalk Internet Router must be installed on the SNA•ps gateway machine to be able to have more than one AppleTalk network active at the same time. For a picture of network information for the router installed on the SNA•ps gateway machine, refer to Figure 64 on page 95.
10. Start the SNA•ps 3270 client program by double clicking the application icon. An untitled session document appears. Choose Connect from the Session menu. Select the gateway that was started in step 8, then click on the Session button to display the specific LUs. Select a session, then click OK to connect that session to the MVS host via the SNA•ps gateway (refer to Figure 65 on page 95).

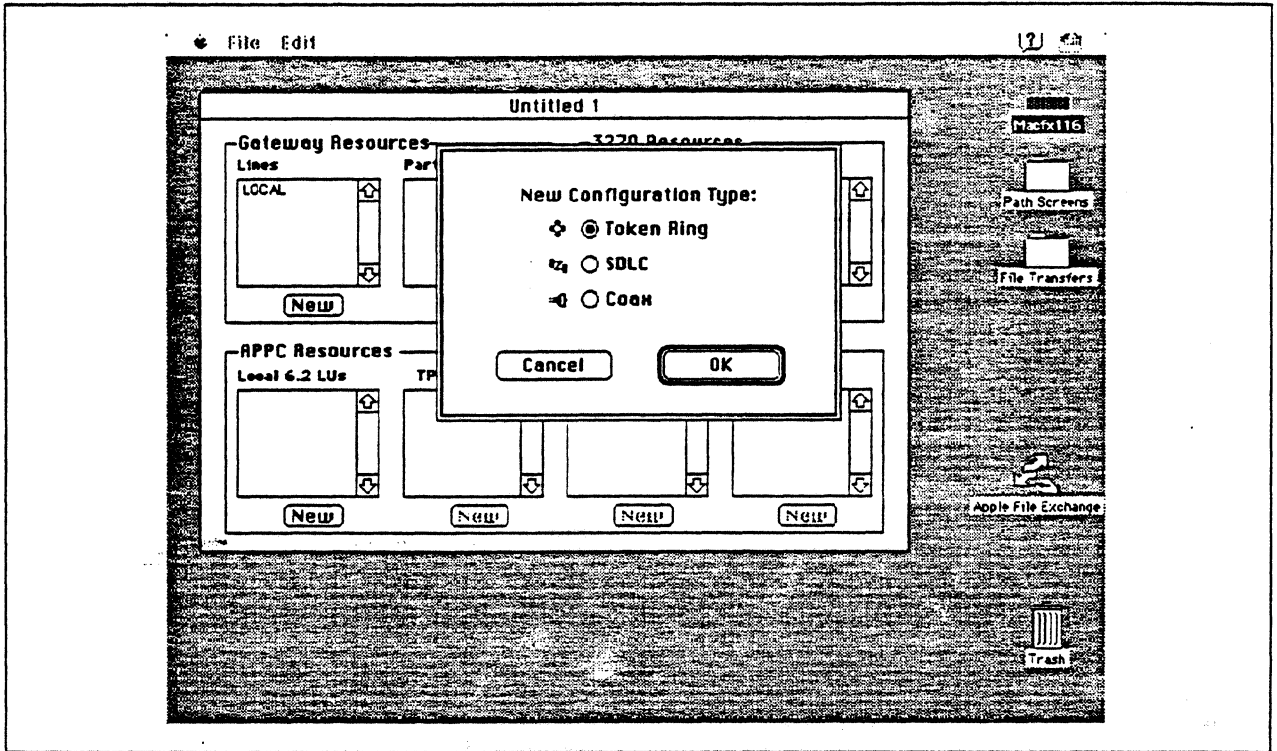

Figure 60. DLC Type Selection for Upstream Connection

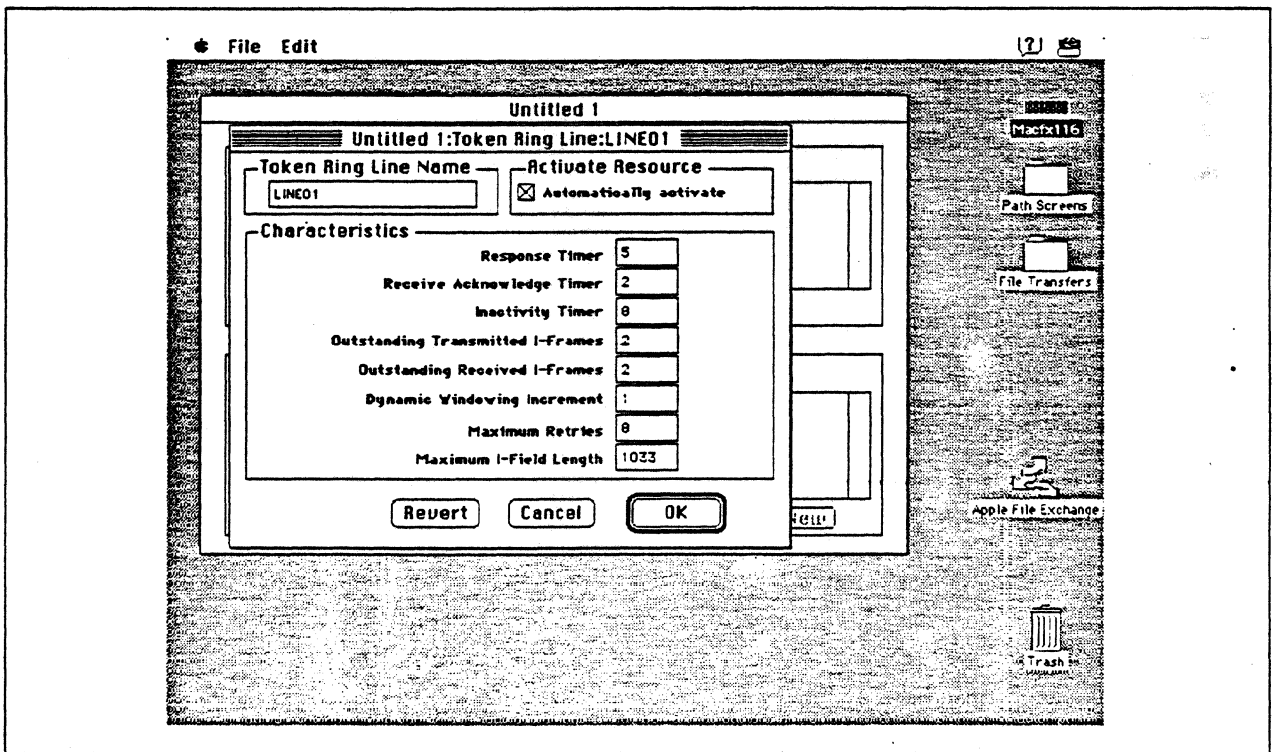

Figure 61. Token Ring Line Configuration Parameters

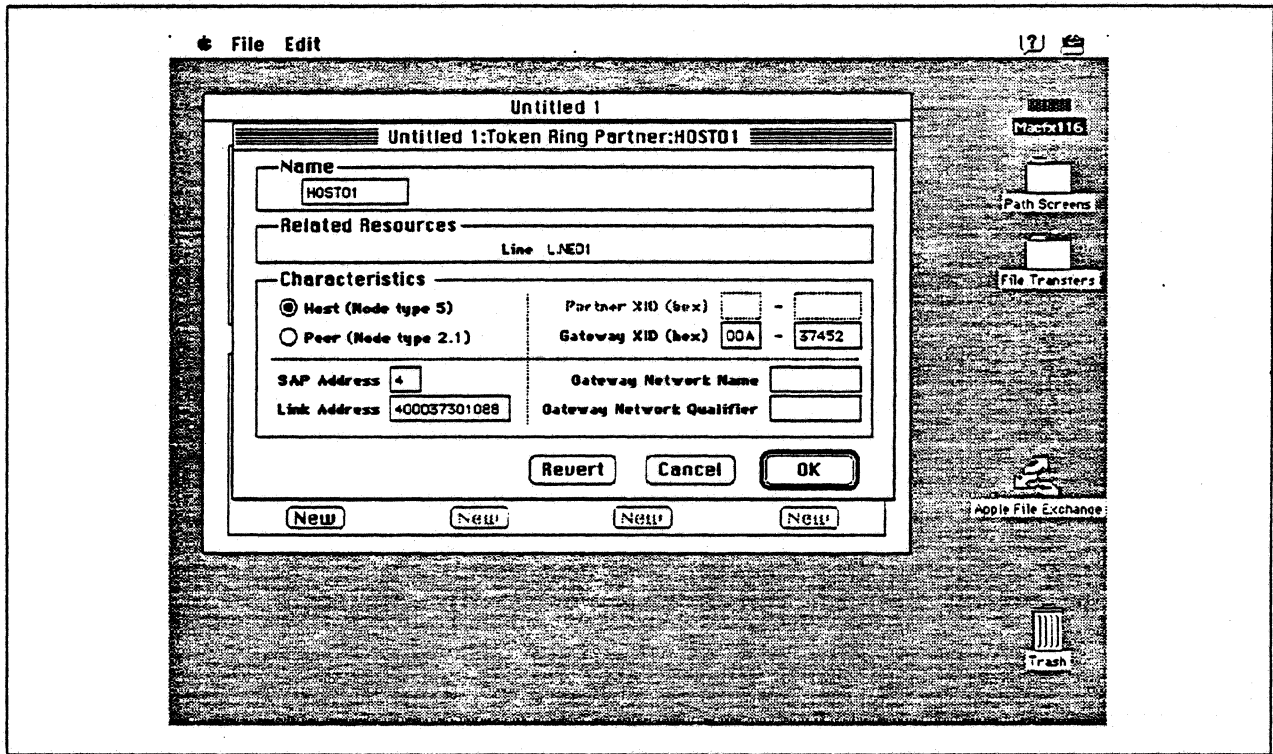

Figure 62. Token Ring Partner Configuration Parameters

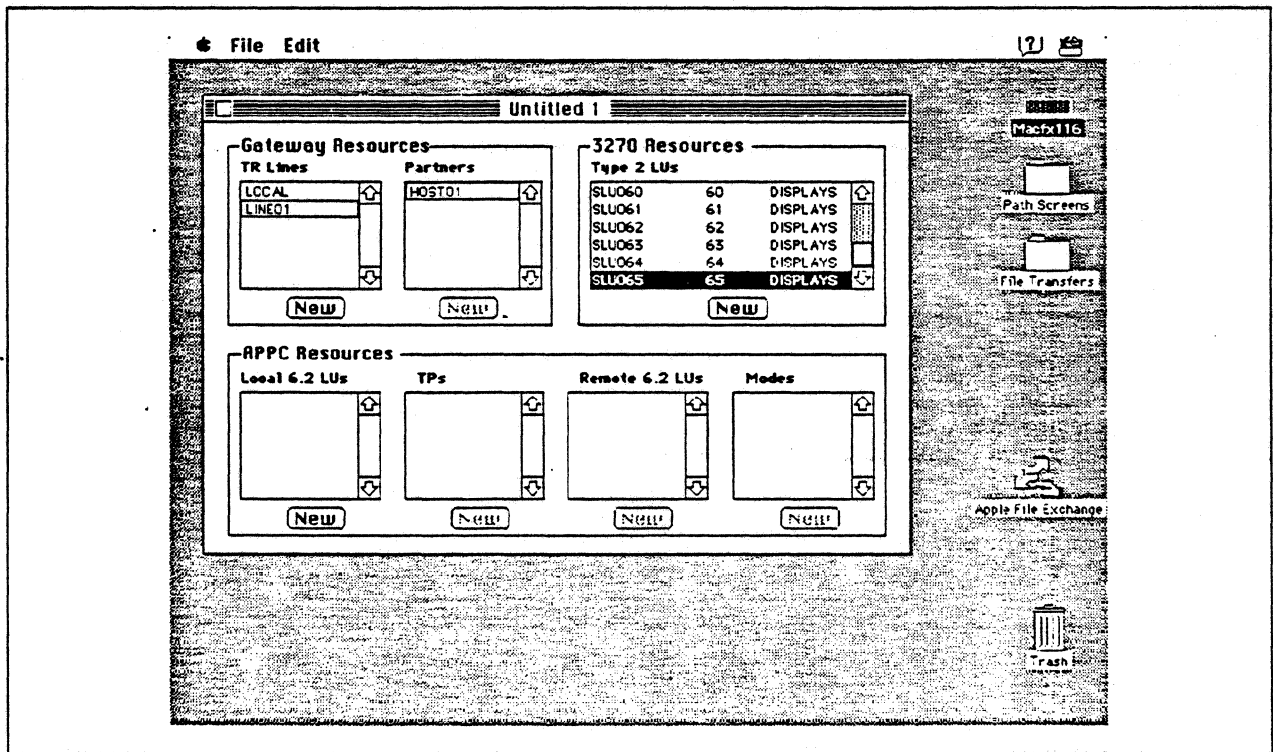

Figure 63. SNA\*ps Config Window After Creating 64 LUs

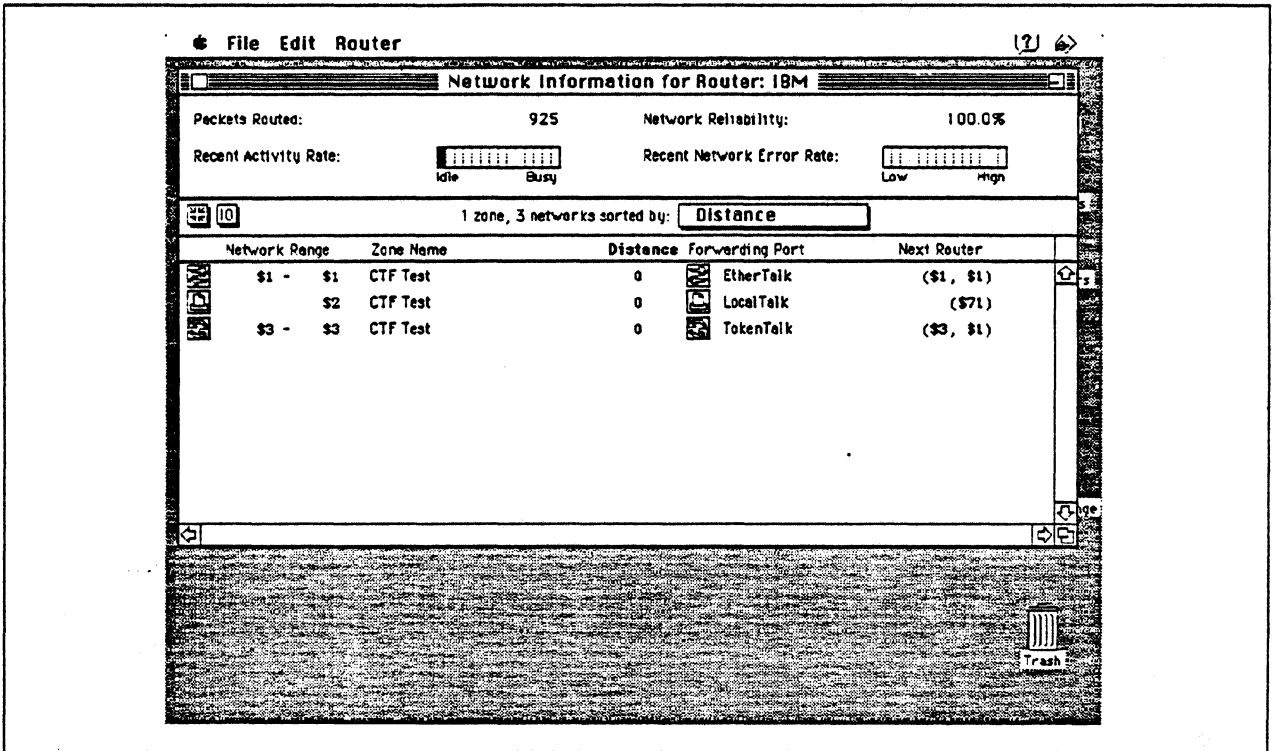

Figure 64. Network Information for AppleTalk Router

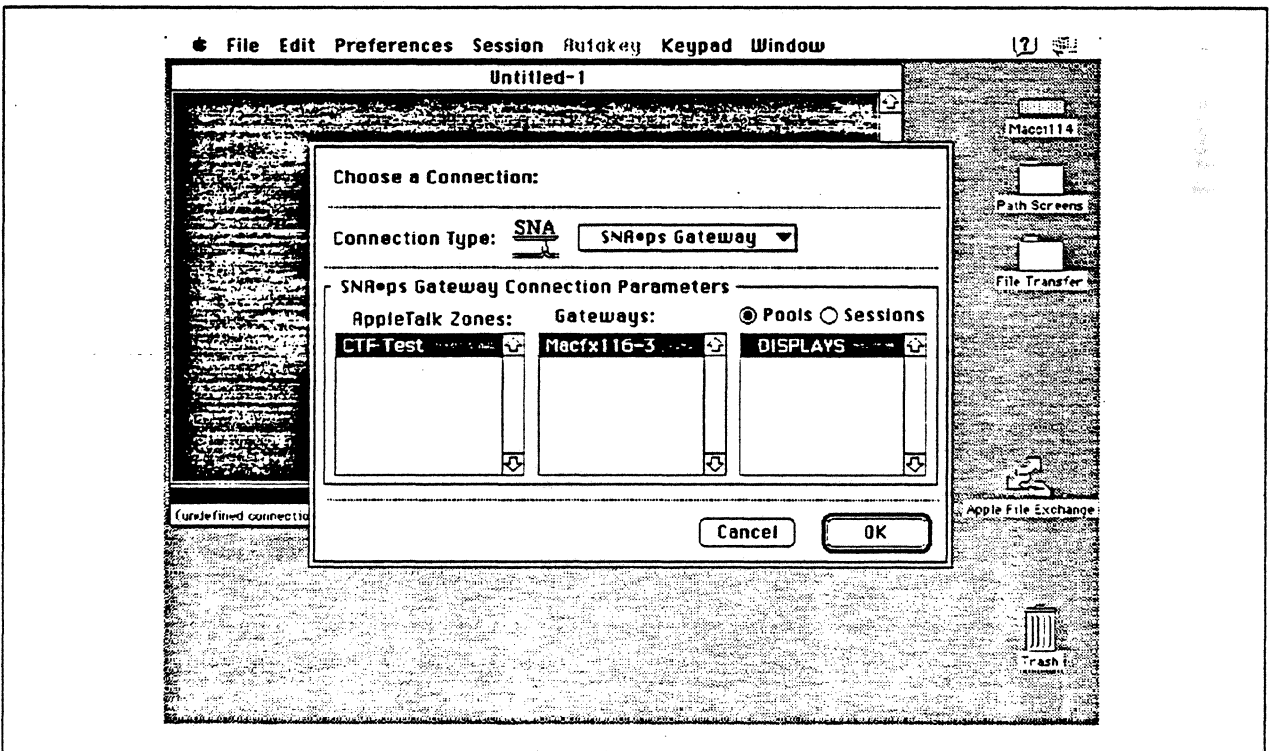

Figure 65. Choosing the Connection

## Observations and Hints

If you want to also use the Macintosh IIx gateway machine as a client, install both SNA•ps 3270 V1.1 (beta) and SNA•ps 3270 Gateway Client V1.1 (beta) on that machine.

Four displays and one printer session were simultaneously running on each of the three client types.

In this path, we have clients that access the SNA•ps gateway via EtherTalk, TokenTalk, and LocalTalk. For information on installing those products or selecting the media to be used to access the gateway from the client machine, see Section 2, "Apple Network Product Installation Overview" on page 7.





---

## Path 10: MVS Host Attachment via Macintosh SDLC Gateway

### Path Description

This configuration consists of the SNA•ps product running on an Apple Macintosh that is connected to an IBM MVS host using a remote SDLC communications link. The Macintosh provides AppleTalk to SNA Gateway function for AppleTalk clients.

The configuration is shown in Figure 66 on page 99 through Figure 68 on page 101. The MVS host is accessed through an IBM 3745 Communications Controller using an RS-232 Line Interface Card (LIC). The SNA remote SDLC connection to the 3745 is supported with an Apple Serial NB Card. The Macintosh is defined as a PU type 2 on a nonswitched line in the NCP gen for the 3745.

For the Macintosh Ilici AppleTalk-attached clients, the three supported AppleTalk LAN types (Ethernet, LocalTalk, Token Ring) are shown as Paths 10A, 10B, and 10C. The Mac IIfx uses the same adapter cards for AppleTalk attachment as the clients in each of the following configurations. In Path 8A, an Apple EtherTalk NB Card is used to connect to the Ethernet LAN. In Path 8B, the LocalTalk connector on the system unit is used. In Path 8C, an Apple Token Ring 4/16 NB Card is used to connect to the Token Ring LAN.

This configuration provides 64 LUs through the SNA gateway machine to AppleTalk clients for 3270 terminal and printer emulation.

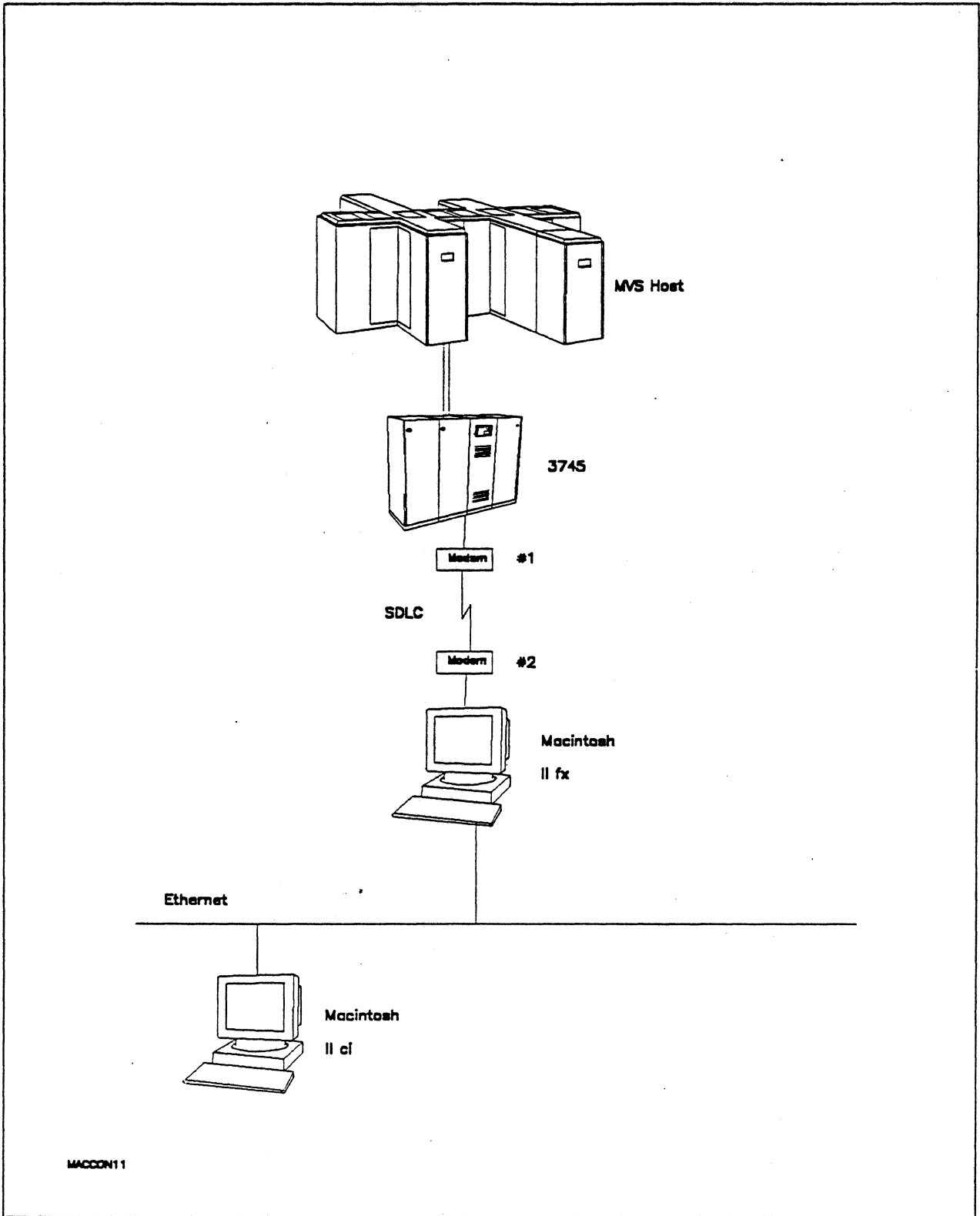

Figure 66. Path 10A Configuration - MVS Host Attachment via Macintosh SDLC Gateway with EtherTalk Clients

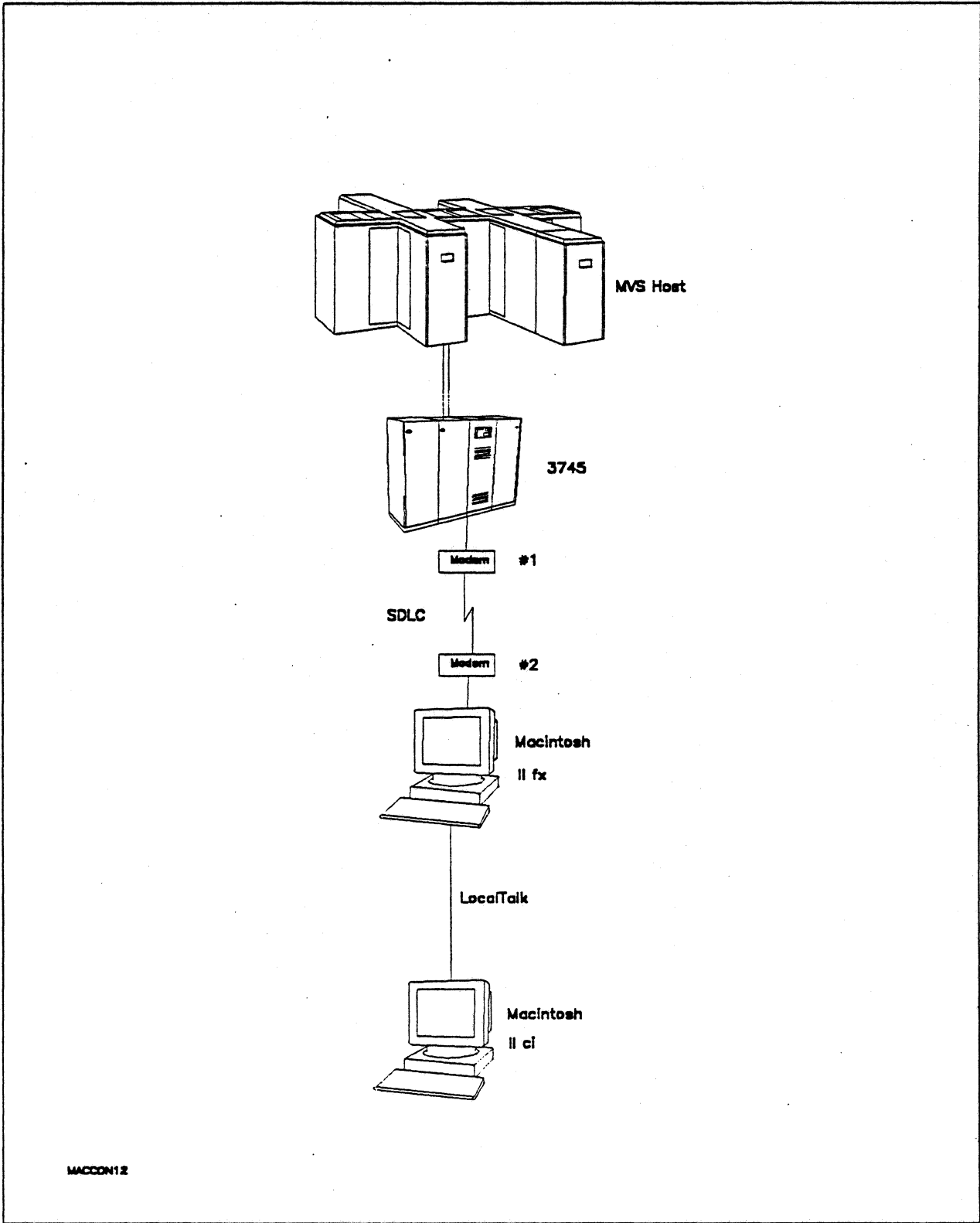

Figure 67. Path 10B Configuration - MVS Host Attachment via Macintosh SDLC Gateway with LocalTalk Clients

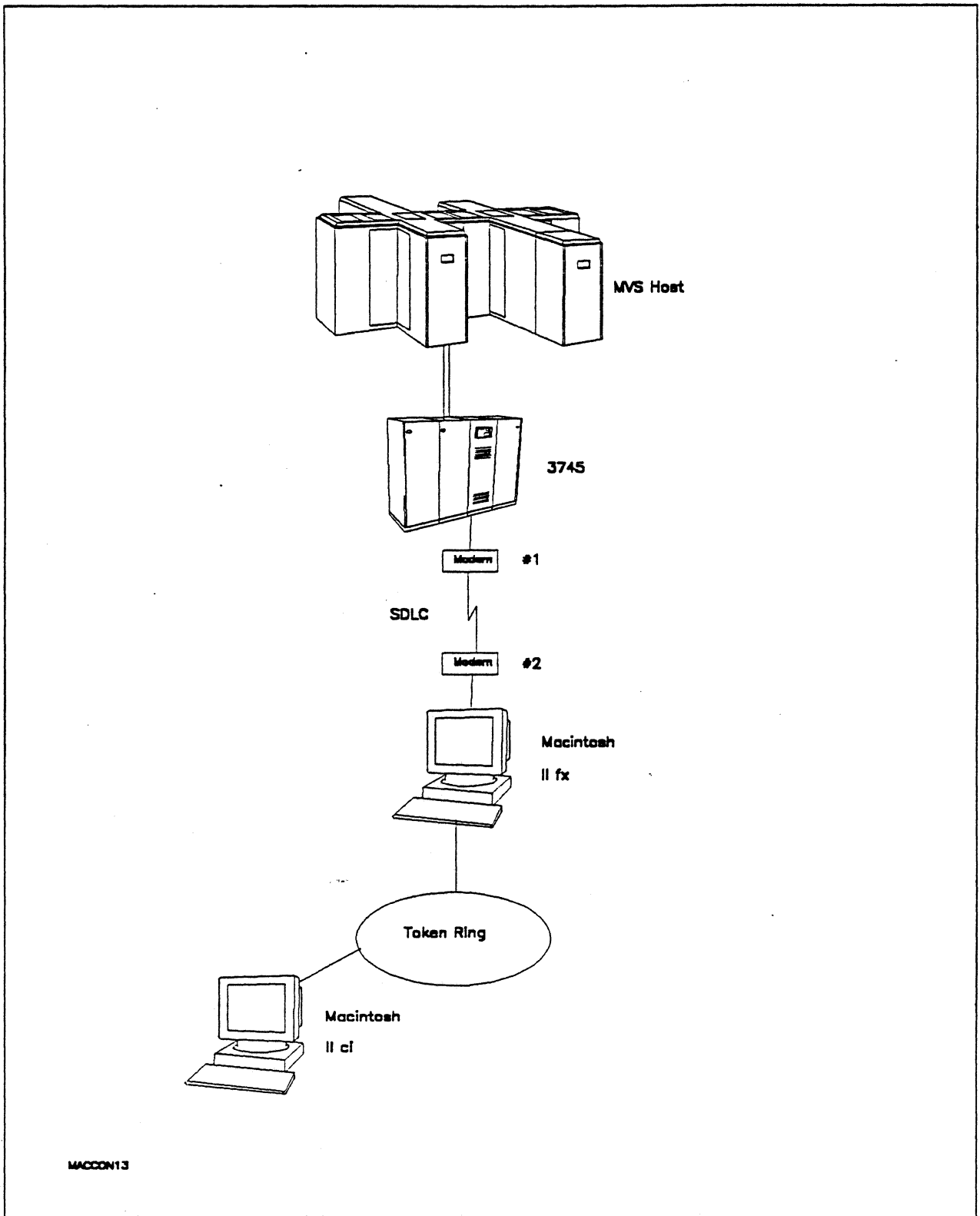

Figure 68. Path 10C Configuration - MVS Host Attachment via Macintosh SDLC Gateway with TokenTalk Clients

## Hardware and Software

The following section describes the hardware and software that was used for this path.

### MVS Host

- 4381 system
- MVS/SP JES2 Version 2 Release 2.0 (MVS/XA)
- VTAM Version 3 Release 3
- OEMI channel
- JES/328X Print Facility

### 3745

- Line interface card (LIC) type 1 feature #9911
- Channel adapter feature #1561
- NCP Version 5 Release 3

### Modems #1 and #2

- 19.2 Kbps
- SDLC
- RS-232
- NRZI
- Leased

### Macintosh IIx (Gateway)

- System Software 7.0
- SNA•ps Gateway/64 V1.1 (beta)
- Apple Serial NB Card with MCP memory expansion kit (1MB total) - all paths
- Apple Token Ring 4/16 NB Card (Path 10C)
- Apple EtherTalk NB Card (Path 10A)
- LocalTalk cable (Path 10B)
- LaserWriter IINTX printer
- Total memory - 4M
- Hard disk - 80M

### Macintosh IIci (Client)

- System Software 7.0
- SNA•ps 3270 Gateway Client V1.1 (beta)
- Apple Token Ring 4/16 NB Card (Path 10C)
- Apple EtherTalk NB Card (Path 10A)
- LocalTalk cable (Path 10B)
- Total memory - 5M
- Hard disk - 80M

## Configuration Details and Operating Procedure

The following section contains details of how the configuration is defined and the procedures that are used.

**VM Host (VTAM and NCP Definitions):** VTAM uses PU T03015P1, which is defined by the following section of the NCP gen.

```

**
GR30APP GROUP CLOCKNG=EXT,DIAL=NO,           +
          LNCTL=SDLC,MAXDATA=521,           +
          MAXOUT=7,PASSLIM=3,PAUSE=0.2,     +
          PUTYPE=2,REPLYTO=2,SERVLIM=2,     +
          TYPE=NCP
*
T03015L LINE ADDRESS=(015),ANS=CONT,DUPLEX=FULL,NRZI=YES
*
      SERVICE ORDER=(T03015P1)
*
T03015P1 PU  ADDR=C1,                        C
             PACING=0,                       C
             VPACING=0,                      C
             IRETRY=YES,                     C
             MAXDATA=521,                   C
             SSCPFM=USSSCS,                 C
             DISCNT=NO,                     C
             PUTYPE=2,                       C
             MAXOUT=7,                      C
             MODETAB=ISTINCLM,              C
             DLOGMOD=SNX32702,              C
             USSTAB=TPOUSS
T0301502 LU  LOCADDR=2,DLOGMOD=SNX32702     * 3278 MODEL 2 *
T0301503 LU  LOCADDR=3,DLOGMOD=SNX32703     * 3278 MODEL 3 *
T0301504 LU  LOCADDR=4,DLOGMOD=SNX32704     * 3278 MODEL 4 *
T0301505 LU  LOCADDR=5,DLOGMOD=SNX32705     * 3278 MODEL 5 *
T0301506 LU  LOCADDR=6,DLOGMOD=SCS          * 3287 SCS PRINTER *
T0301507 LU  LOCADDR=7,DLOGMOD=SNX32702     * 3278 MODEL 2 *
T0301508 LU  LOCADDR=8,DLOGMOD=SNX32702     * 3278 MODEL 2 *
:
T0301564 LU  LOCADDR=64,DLOGMOD=SNX32702    * 3278 MODEL 2 *
T0301565 LU  LOCADDR=65,DLOGMOD=SNX32702    * 3278 MODEL 2 *

```

Refer to Appendix C, "NCP Gen Listing" on page 287 for the complete NCP gen listing.

## Macintosh

1. Start the SNA•ps Config program by double clicking the application icon. The SNA•ps Config resources window appears.
2. In the SNA•ps Config resources window, click the New button below the Lines box. A dialog box appears (refer to Figure 69 on page 105) in which you select the type of card to be configured. Select SDLC, which is the desired upstream DLC type for this path, then click OK.
3. The dialog box for an SDLC line appears (refer to Figure 70 on page 105). Change the Maximum BTU Length to the MAXDATA value specified on the NCP PU definition statement, then click OK.
4. In the Lines box in the SNA•ps Config resources window, select *LINE01*, which is the name of the SDLC line that was created in step 3, then click the New button under Partners. The SDLC Partner dialog box appears. In the Link Address field, enter the SDLC address that corresponds to the ADDR value specified in the NCP leased line definition. Because this is a leased line, the Gateway XID field is not specified (reference Figure 71 on page 106). Click OK.
5. In the Partners box in the SNA•ps Config resources window, select *HOST01*, which is the name of the Partner that was created in step 4, then click the New button under 3270 Resources. A dialog box appears in which you can create a 3270 LU. For this path, 64 LUs were created. The LU created with the LU ID of 6 was a printer LU to match the VTAM configuration. All the remaining LUs were created with a device type of Display. Figure 72 on page 106 shows the Config resources window after the creation of 64 LUs.
6. Choose Save As from the File menu. Save this file as *path10*.
7. Start the SNA•ps Admin program by double clicking the application icon. The Network Gateway Status window appears. In the Network Gateway Status window, select the SDLC gateway to be configured, then choose Select Configuration from the Gateway menu. Select *path10*, then click on the Select button to assign *path10* to the SDLC gateway.
8. To start the gateway, in the Network Gateway Status window select the SDLC gateway with *path10* specified as the configuration. Choose Start Gateway from the Gateway menu. Click on Start to confirm that you want this gateway started. When the gateway has been started, the Status column of the Network Gateway Status window contains "Started."
9. Start the SNA•ps 3270 client program by double clicking the application icon. An untitled session document appears. Choose Connect from the Session menu. Select the gateway that was started in step 8, then click on the Session button to display the specific LUs. Select a session, then click OK to connect that session to the MVS host via the SNA•ps gateway (refer to Figure 73 on page 107).

**Note:** As shown in Figure 66 on page 99 through Figure 68 on page 101, this step was performed first on an EtherTalk client, then on a LocalTalk client, and finally on a TokenTalk client machine.



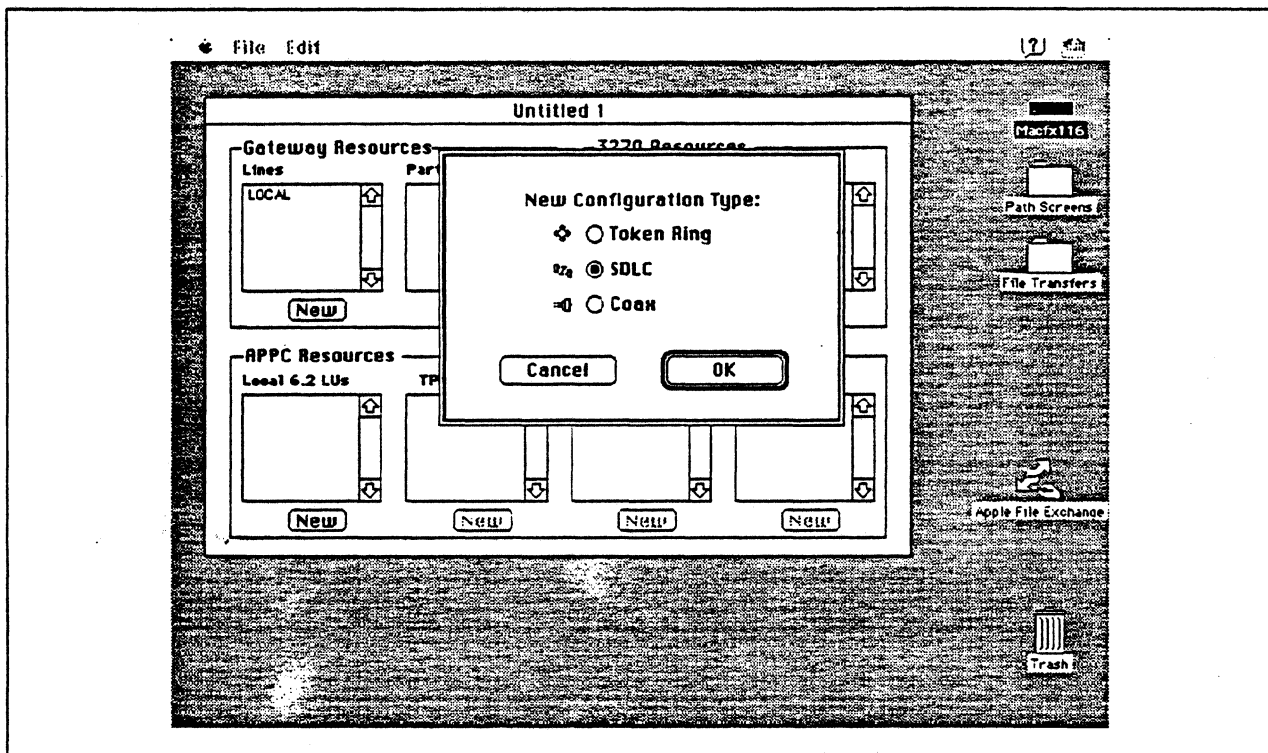

Figure 69. DLC Type Selection for Upstream Connection

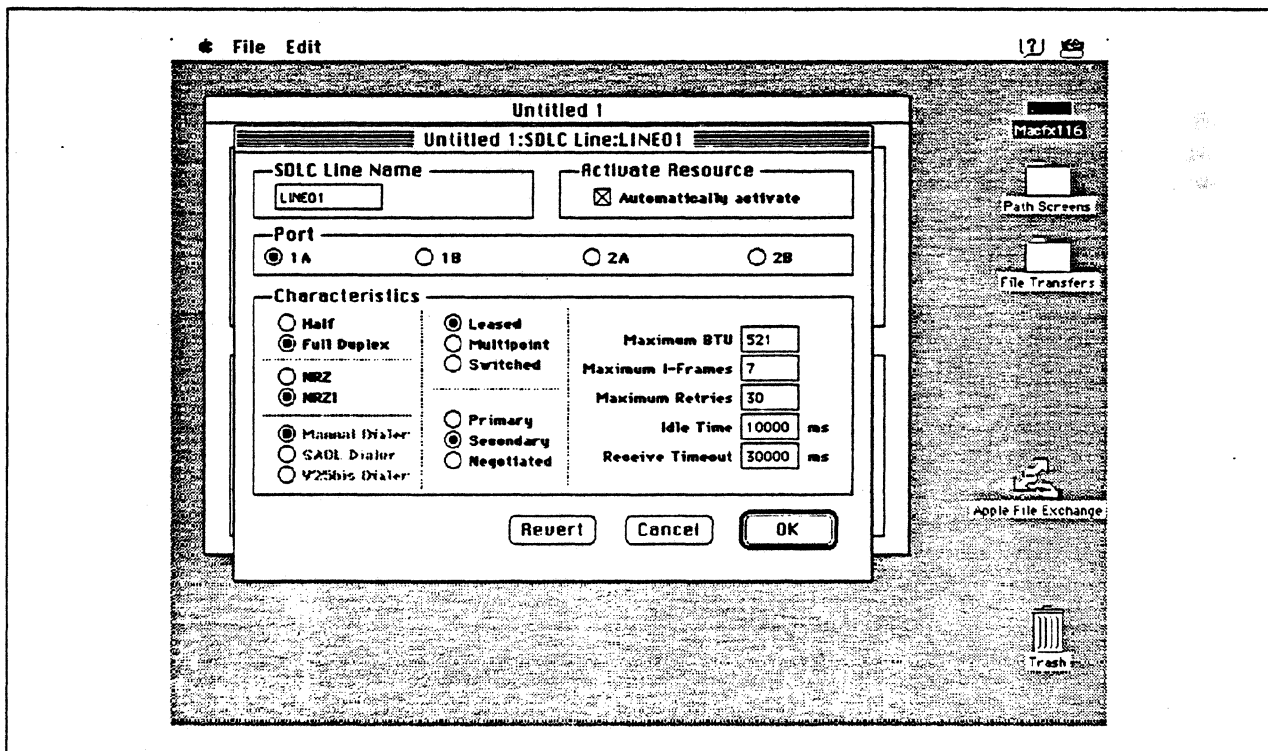

Figure 70. SDLC Line Configuration Parameters

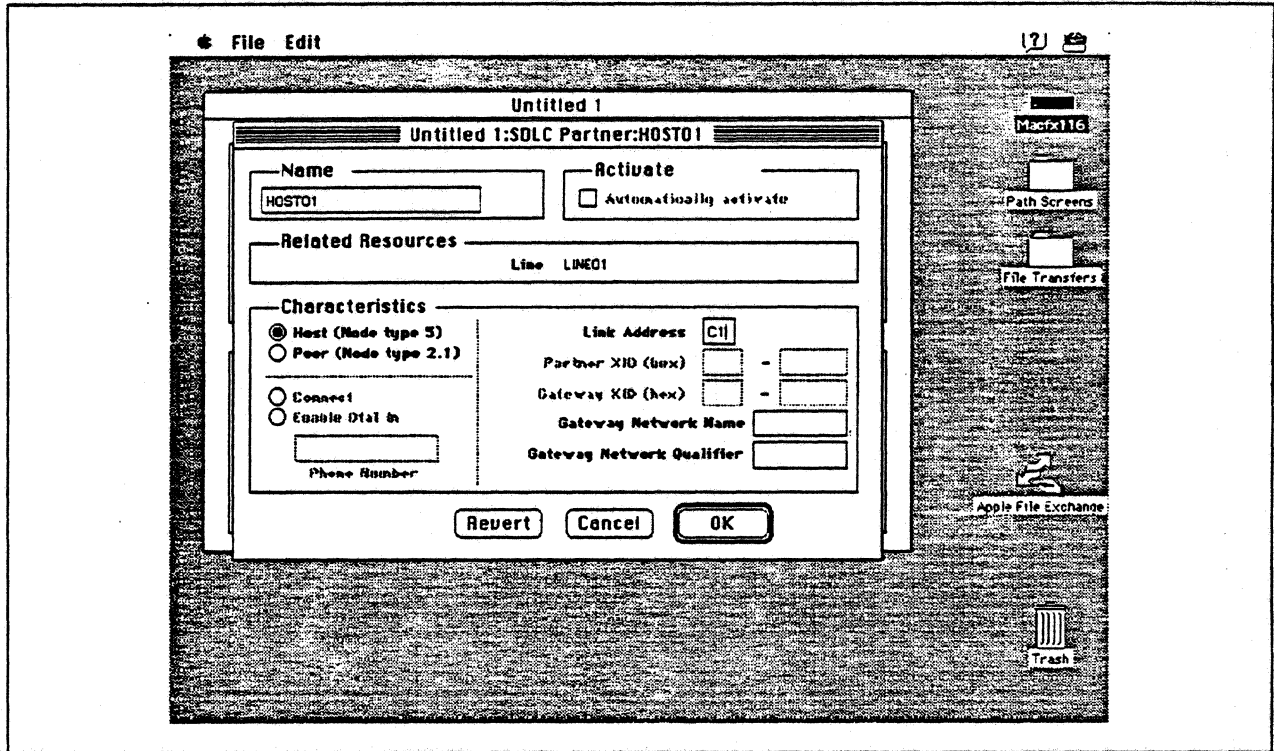

Figure 71. SDLC Partner Configuration Parameters

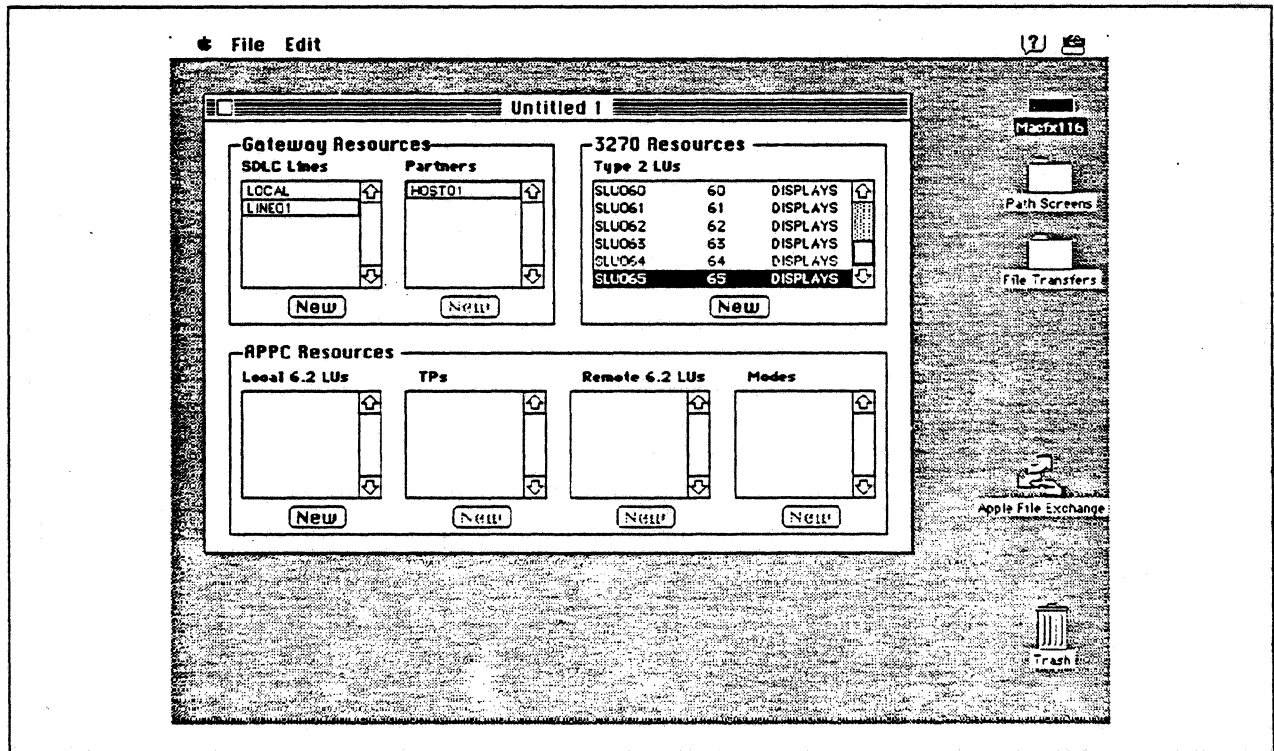

Figure 72. SNA\*ps Config Window After Creating 64 LUs

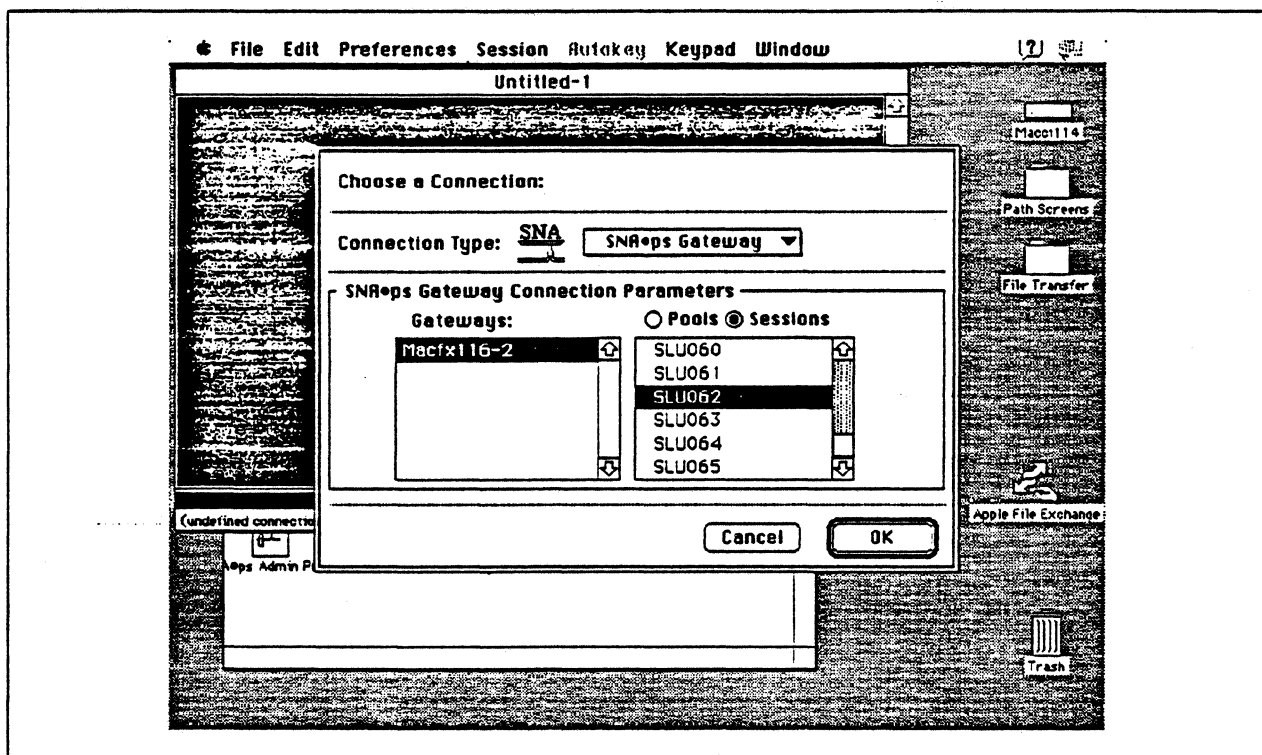

Figure 73. Choosing the Connection

## Observations and Hints

If you want to also use the Macintosh IIx gateway machine as a client, install both SNA•ps 3270 V1.1 (beta) and SNA•ps 3270 Gateway Client V1.1 (beta) on that machine.

Four display LUs and a printer were run in this path.

In this path, there are clients that access the SNA•ps gateway via EtherTalk, TokenTalk, and LocalTalk. For information on installing those products or selecting the media to be used to access the gateway from the client machine, see Section 2, "Apple Network Product Installation Overview" on page 7.

---

## **Path 11: MVS Host Attachment via Macintosh SDLC Gateway with Multiple LAN Clients**

### **Path Description**

This configuration consists of the SNA•ps product running on an Apple Macintosh that is connected to an IBM MVS host using a remote SDLC communications link. The Macintosh provides AppleTalk to SNA Gateway function for AppleTalk clients. In this configuration, AppleTalk clients from multiple LANs and media (EtherTalk, LocalTalk, and TokenTalk) can share the same AppleTalk/SNA gateway at the same time.

The configuration is shown in Figure 74 on page 109. The MVS host is accessed through an IBM 3745 Communications Controller using an RS-232 Line Interface Card (LIC). Several adapters are installed in the Macintosh IIx system to handle the multiple LAN types. The SNA remote SDLC connection to the 3745 is supported with an Apple Serial NB Card. An Apple Token Ring 4/16 NB Card is used in the IIx for Token Ring AppleTalk attachment. For EtherTalk, an Apple EtherTalk NB Card is used. LocalTalk is supplied through the system board connector. The AppleTalk Internet Router software product is used to logically interconnect the multiple AppleTalk LANs. The Macintosh is defined as a PU type 2 on a nonswitched line in the NCP gen for the 3745.

For the Macintosh IIci (A), an Apple EtherTalk NB Card is used to connect to the Ethernet LAN. For the Macintosh IIci (B), an Apple Token Ring 4/16 NB Card is used to connect to the Token Ring LAN. For the Macintosh IIci (C), the LocalTalk connector on the system unit is used.

This configuration provides 64 LUs through the SNA gateway machine to AppleTalk clients for 3270 terminal and printer emulation.

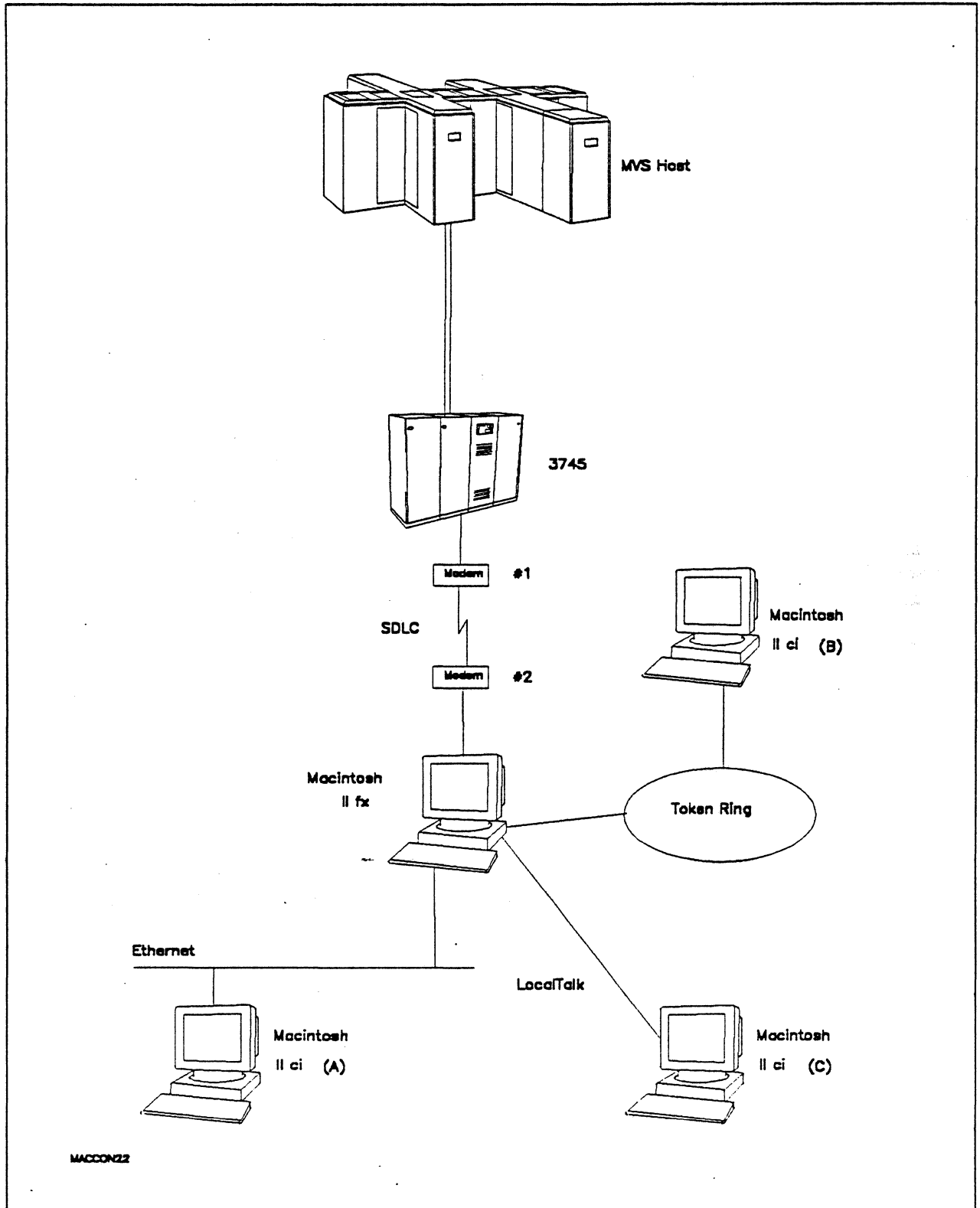

Figure 74. Path 11 Configuration - MVS Host Attachment via Macintosh SDLC Gateway with Multiple LAN Clients

## Path 11

### Hardware and Software

The following section describes the configuration that was used for this path.

#### MVS Host

- 4381 system
- MVS/SP JES2 Version 2 Release 2.0 (MVS/XA)
- VTAM Version 3 Release 3
- OEMI channel
- JES/328X Print Facility

#### 3745

- Line interface card (LIC) type 1 #9911
- Channel adapter feature #1561
- NCP Version 5 Release 3

#### Modems #1 and #2

- 19.2 Kbps
- SDLC
- RS-232
- NRZI
- Leased

#### Token Ring

- 16 Mbps

#### Macintosh IIfx (Gateway)

- System Software 7.0
- SNA•ps Gateway/64 V1.1 (beta)
- Apple Serial NB Card with MCP memory expansion kit (1MB total)
- Apple Token Ring 4/16 NB Card
- Apple EtherTalk NB Card
- RS-232 serial cable
- LocalTalk cable
- AppleTalk Internet Router
- LaserWriter IINTX printer
- Total memory - 4M
- Hard disk - 80M

#### Macintosh IIfx (Client)

- System Software 7.0
- SNA•ps 3270 Gateway Client V1.1 (beta)
- Apple EtherTalk NB Card (Macintosh A)
- Apple Token Ring 4/16 NB Card (Macintosh B)
- LocalTalk cable (Macintosh C)
- Total memory - 5M
- Hard disk - 80M

## Configuration Details and Operating Procedure

The following section contains details of how the configuration is defined and the procedures that are used.

**MVS Host (VTAM and NCP Definitions):** VTAM uses PU TO3015P1, which is defined by the following section of the NCP gen.

```

**
GR30APP  GROUP  CLOCKNG=EXT,DIAL=NO,          +
              LNCTL=SDLC,MAXDATA=521,         +
              MAXOUT=7,PASSLIM=3,PAUSE=0.2,   +
              PUTYPE=2,REPLYTO=2,SERVLIM=2,   +
              TYPE=NCP

*
T03015L  LINE  ADDRESS=(015),ANS=CONT,DUPLEX=FULL,NRZI=YES
*
*  SERVICE ORDER=(T03015P1)
*
T03015P1  PU   ADDR=C1,                       C
              PACING=0,                       C
              VPACING=0,                      C
              IRETRY=YES,                    C
              MAXDATA=521,                   C
              SSCPFM=USSSCS,                 C
              DISCNT=NO,                     C
              PUTYPE=2,                      C
              MAXOUT=7,                      C
              MODETAB=ISTINCLM,              C
              DLOGMOD=SNX32702,              C
              USSTAB=TPOUSS

T0301502  LU   LOCADDR=2,DLOGMOD=SNX32702    * 3278 MODEL 2 *
T0301503  LU   LOCADDR=3,DLOGMOD=SNX32703    * 3278 MODEL 3 *
T0301504  LU   LOCADDR=4,DLOGMOD=SNX32704    * 3278 MODEL 4 *
T0301505  LU   LOCADDR=5,DLOGMOD=SNX32705    * 3278 MODEL 5 *
T0301506  LU   LOCADDR=6,DLOGMOD=SCS        * 3287 SCS PRINTER *
T0301507  LU   LOCADDR=7,DLOGMOD=SNX32702    * 3278 MODEL 2 *
T0301508  LU   LOCADDR=8,DLOGMOD=SNX32702    * 3278 MODEL 2 *
:
T0301564  LU   LOCADDR=64,DLOGMOD=SNX32702  * 3278 MODEL 2 *
T0301565  LU   LOCADDR=65,DLOGMOD=SNX32702  * 3278 MODEL 2 *

```

Refer to Appendix C, "NCP Gen Listing" on page 287 for the complete NCP gen listing.

## Macintosh

1. Start the SNA•ps Config program by double clicking the application icon. The SNA•ps Config resources window appears.
2. In the SNA•ps Config resources window, click the New button below the Lines box. A dialog box appears (refer to Figure 75 on page 113) in which you select the type of card to be configured. Select SDLC, which is the desired upstream DLC type for this path, then click OK.
3. The dialog box for an SDLC line appears (refer to Figure 76 on page 113). Change the Maximum BTU Length to the MAXDATA value specified on the NCP PU definition statement, then click OK.
4. In the Lines box in the SNA•ps Config resources window, select *LINE01*, which is the name of the SDLC line that was created in step 3, then click the New button under Partners. The SDLC Partner dialog box appears. In the Link Address field, enter the SDLC address that corresponds to the value specified in the ADDR field of the NCP PU definition. Because this is a leased line, the Gateway XID field is not specified (reference Figure 77 on page 114). Click OK.
5. In the Partners box in the SNA•ps Config resources window, select *HOST01*, which is the name of the Partner that was created in step 4, then click the New button under 3270 Resources. A dialog box appears in which you can create a 3270 LU. For this path, 64 LUs were created. The LU created with the LU ID of 6 was a printer LU to match the VTAM configuration. All the remaining LUs were created with a device type of Display. Figure 78 on page 114 shows the Config resources window after the creation of 64 LUs.
6. Choose Save As from the File menu. Save this file as *path11*.
7. Start the SNA•ps Admin program by double clicking the application icon. The Network Gateway Status window appears. In the Network Gateway Status window, select the SDLC gateway to be configured. then choose Select Configuration from the Gateway menu. Select *path11*, then click on the Select button to assign *path11* to the Token Ring gateway.
8. To start the gateway, in the Network Gateway Status window select the SDLC gateway with *path11* specified as the configuration. Choose Start Gateway from the Gateway menu. Click on Start to confirm that you want this gateway started. When the gateway has been started, the Status column of the Network Gateway Status window contains "Started."
9. The AppleTalk Router must be installed on the SNA•ps gateway machine to be able to have more than one AppleTalk network active at the same time. For a picture of network information for the router installed on the SNA•ps gateway machine, refer to Figure 79 on page 115.
10. Start the SNA•ps 3270 program by double clicking the application icon. An untitled session document appears. Choose Connect from the Session menu. Select the gateway that was started in step 8, then click on the Session button to display the specific LUs. Select a session, then click OK to connect that session to the MVS host via the SNA•ps gateway (refer to Figure 80 on page 115).

**Note:** This step was performed simultaneously on an EtherTalk client, on a LocalTalk client, and on a TokenTalk client machine, as shown in Figure 74 on page 109.



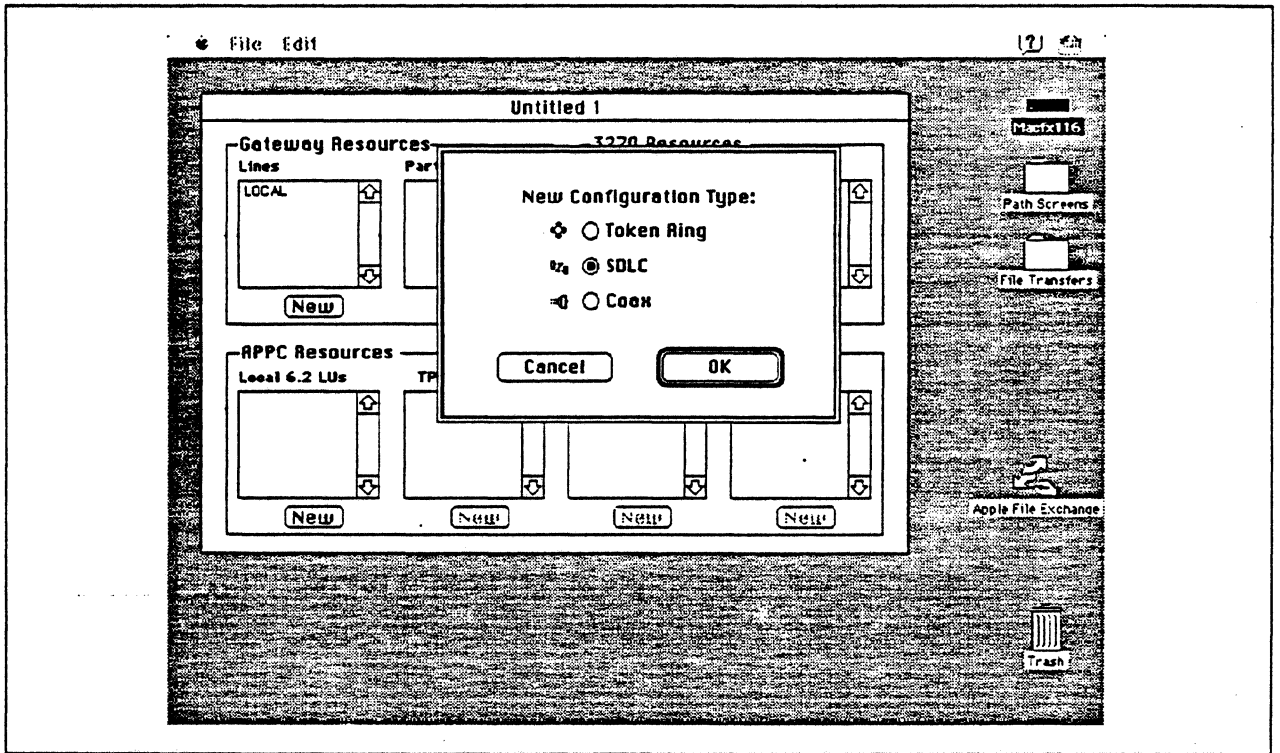

Figure 75. DLC Type Selection for Upstream Connection

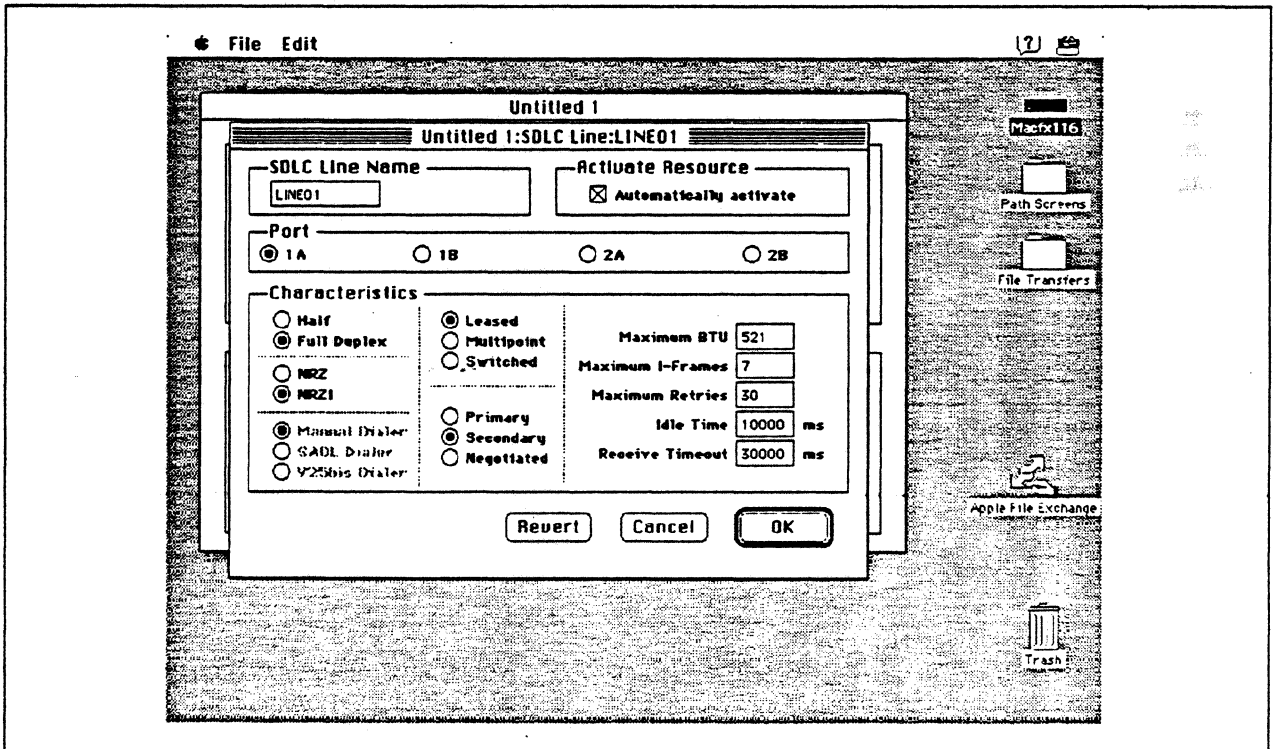

Figure 76. SDLC Line Configuration Parameters

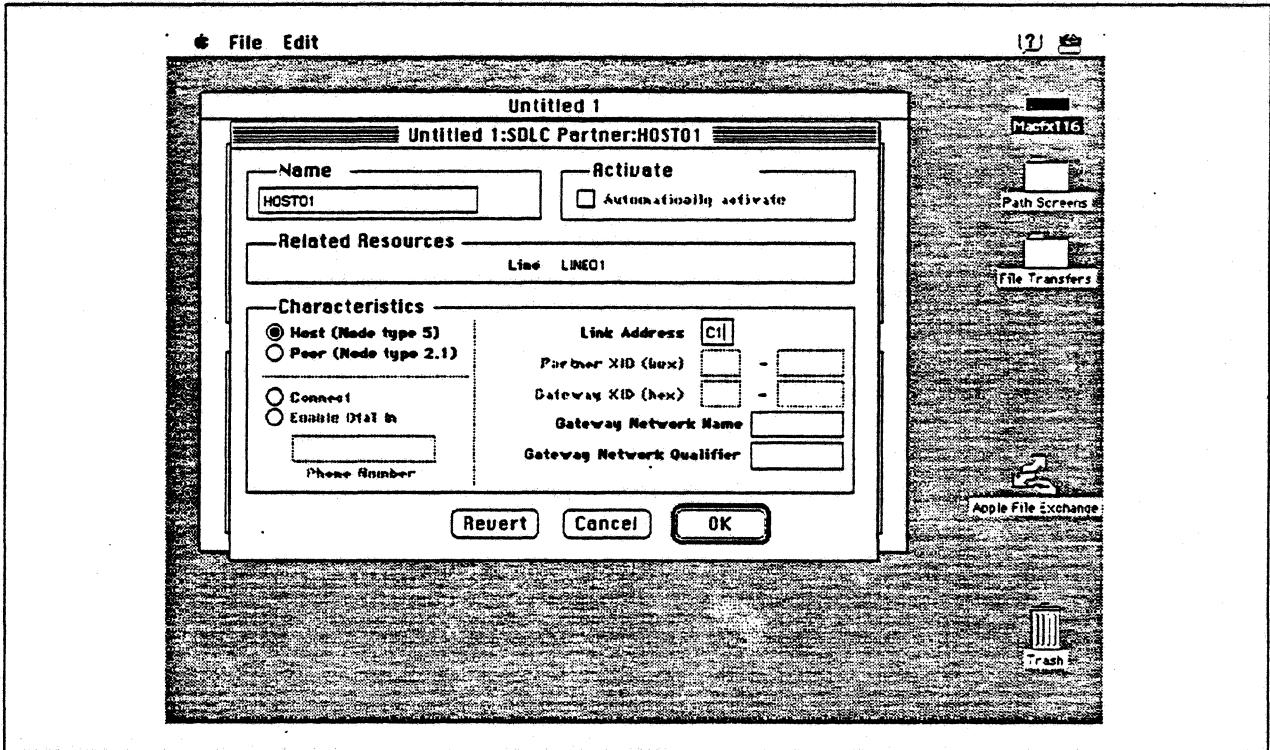

Figure 77. SDLC Partner Configuration Parameters

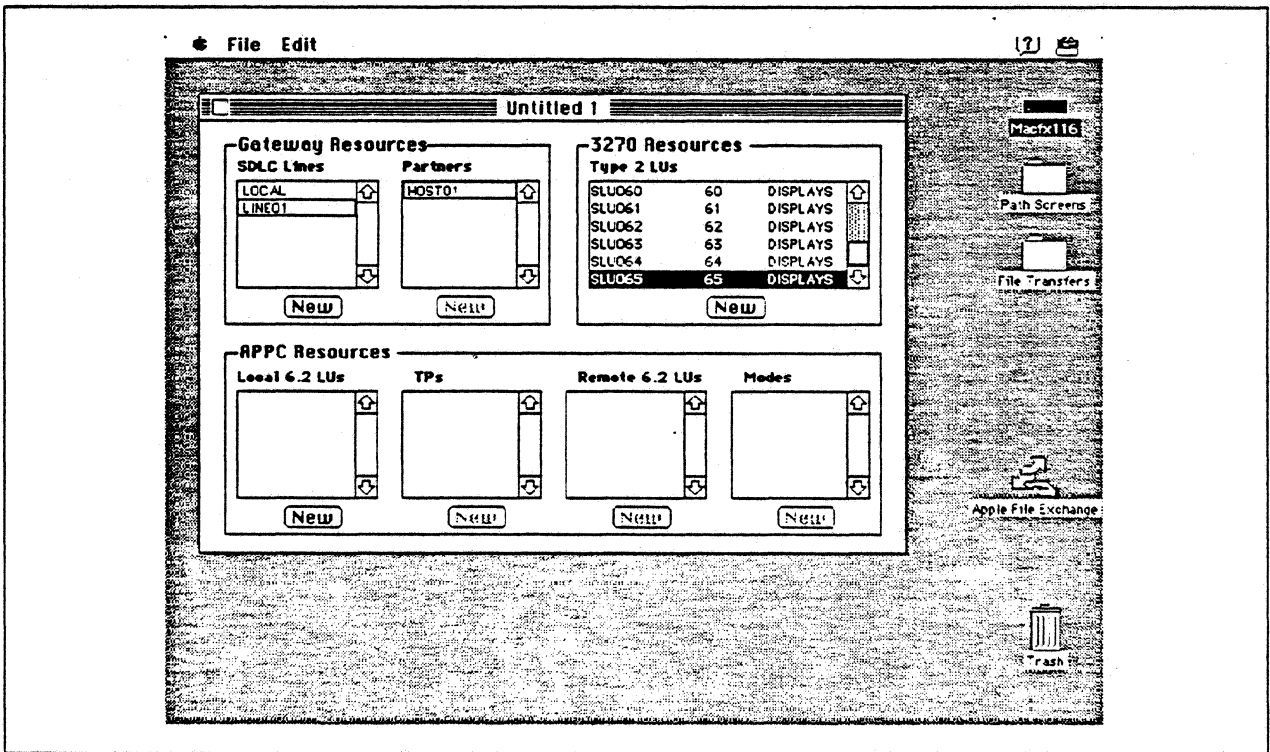

Figure 78. SNA-ps Config Window After Creating 64 LUs

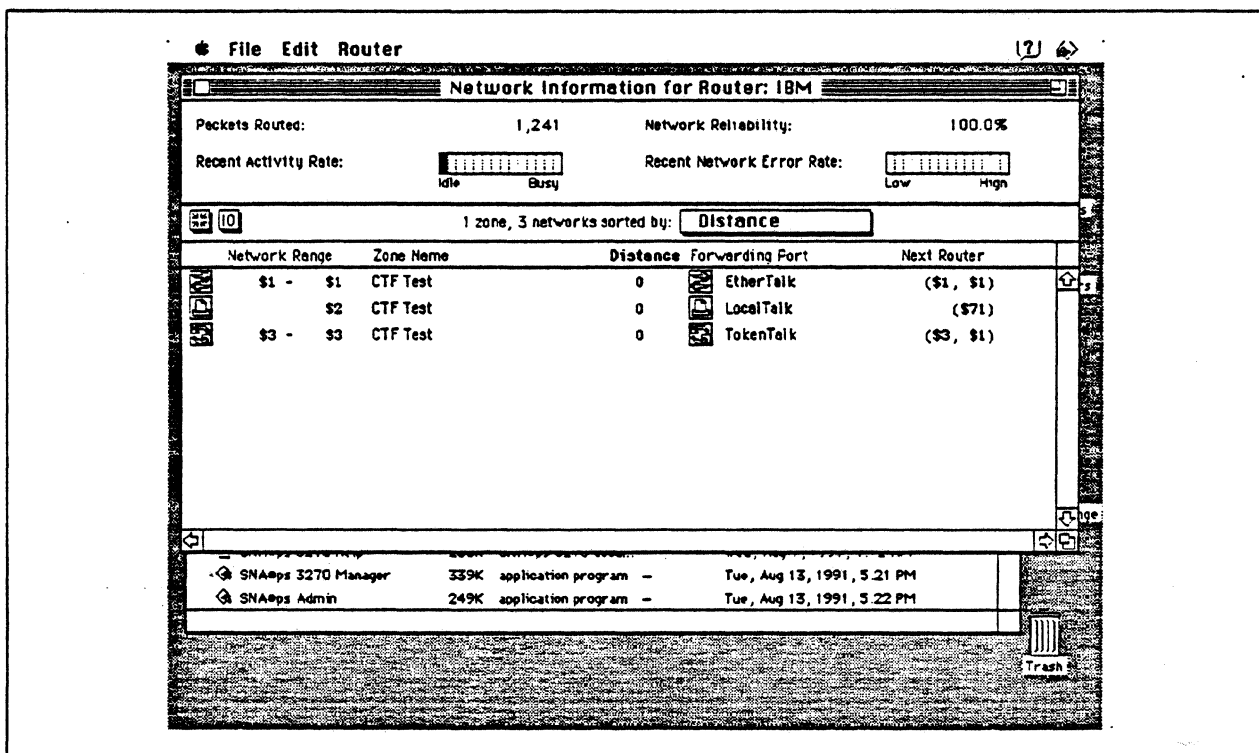

Figure 79. Network Information for AppleTalk Router

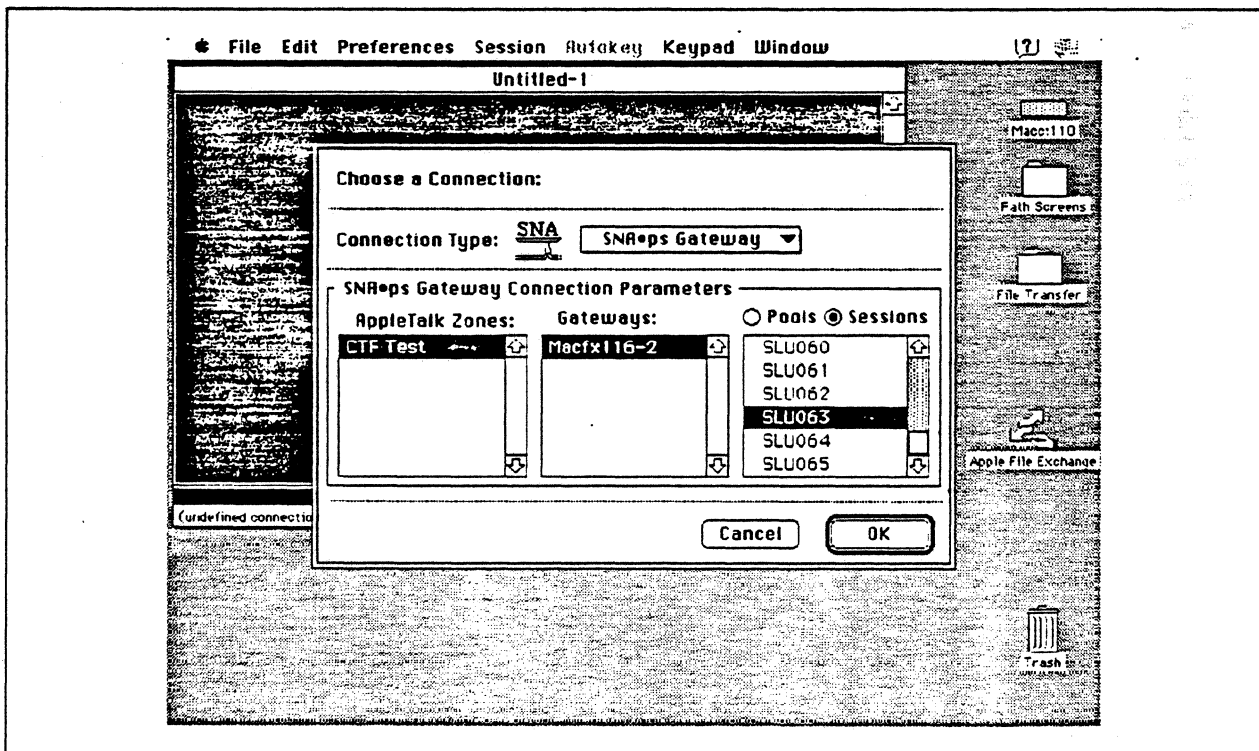

Figure 80. Choosing the Connection

## Observations and Hints

If you want to also use the Macintosh IIx gateway machine as a client, install both SNA•ps 3270 V1.1 (beta) and SNA•ps 3270 Gateway Client V1.1 (beta) on that machine.

Four display LUs and a printer were run in this configuration.

In this path, there are clients that access the SNA•ps gateway via EtherTalk, TokenTalk, and LocalTalk. For information on installing those products or selecting the media to be used to access the gateway from the client machine, see Section 2, "Apple Network Product Installation Overview" on page 7.



---

## Path 12: MVS, VM, and AS/400 Hosts via Multiple SNA•ps Gateways

### Path Description

This configuration contains the SNA•ps product running on an Apple Macintosh concurrently connected to three different IBM systems: an IBM MVS host through a 3174 coax connection; an AS/400 host through a remote SDLC communications link; and a IBM VM host connection via an Token-Ring (IEEE 802.5) local area network. The Macintosh provides AppleTalk to SNA Gateway function for AppleTalk clients.

The configuration is shown in Figure 81 on page 119. The 3174 is channel-attached to the MVS host. The AS/400 uses an RS-232 communications adapter to provide the SDLC line connection. The VM host is attached to the Token Ring LAN using the ES/9370 integrated 16/4 Mbps Token-Ring Interface Card.

The Macintosh IIfx uses an Apple Token Ring 4/16 NB Card for the SNA Token Ring LAN attachment, an Apple Serial NB Card for the SDLC line connection, and an Apple Coax/Twinax Card for coax attachment to the 3174. The Macintosh IIfx client connects to the AppleTalk/SNA gateway using a LocalTalk connection.

This configuration provides up to 64 LUs through each SNA Gateway connection to AppleTalk clients for 3270 terminal and printer emulation.

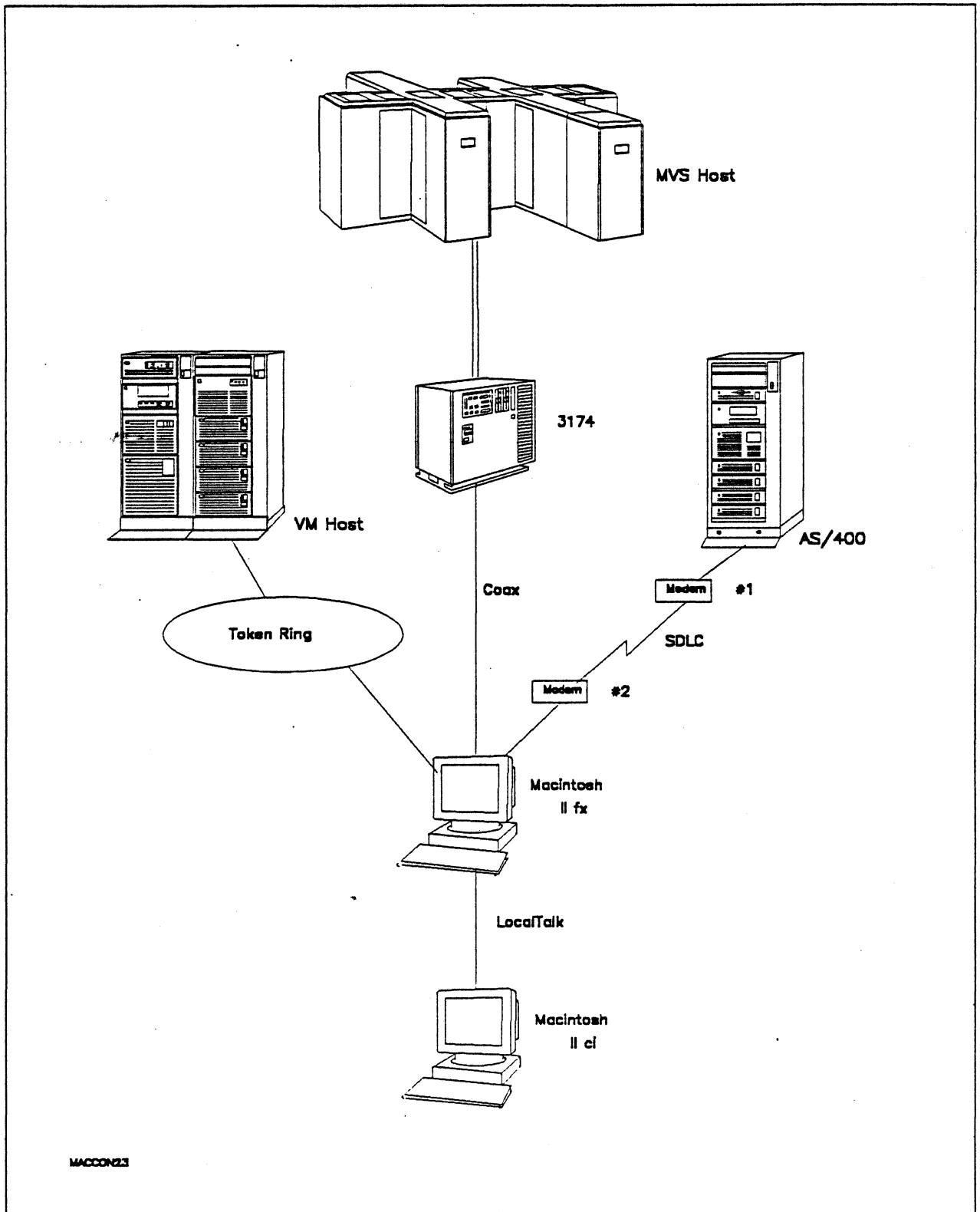

Figure 81. Path 12 Configuration - Multiple Host Gateway with LocalTalk Clients

## Hardware and Software

The following section describes the hardware and software that was used for this path.

### MVS Host

- 4381 system
- MVS/SP JES2 Version 2 Release 2.0 (MVS/XA)
- VTAM Version 3 Release 3
- OEMI channel
- JES/328X Print Facility

### VM Host

- 9375 system
- 16/4 Integrated Token-Ring Adapter feature #6130/6134
- VM/SP Release 6.0
- VTAM Version 3 Release 3
- RSCS Version 2 Release 3

### AS/400

- 9406 system
- EIA 232/V.24 Communications Adapter
- OS/400 Version 2 Release 1

### Token Ring

- 16 Mbps

### 3174

- Model 01L
- Configuration support B4

### Modems #1 and #2

- 19.2 Kbps
- SDLC
- RS-232
- NRZI
- Leased

### Macintosh IIfx (Gateway)

- System Software 7.0
- SNA•ps Gateway/64 V1.1 (beta)
- Apple Token Ring 4/16 NB Card with MCP memory expansion kit (1MB total)
- Apple Coax/Twinax Card
- Apple Serial NB Card with MCP memory expansion kit (1MB total)
- RS-232 serial cable
- LocalTalk cable
- LaserWriter IINTX printer
- Total memory - 4M
- Hard disk - 80M



## Macintosh Ilci (Client)

- System Software 7.0
- SNA•ps 3270 Gateway Client V1.1 (beta)
- LocalTalk cable
- Total memory - 5M
- Hard disk - 80M

## Configuration Details and Operating Procedure

The following section contains details of how the configuration is defined and the procedures that are used.

### VM Host (VTAM Definitions)

#### Switched Major Node

APPLE1 VBUILD TYPE=SWNET,MAXGRP=4,MAXNO=400

```

*
PUAPP1  PU  ADDR=04,                X
          IDBLK=00A,                X
          IDNUM=93701,              X
          DISCNT=NO,                X
          IRETRY=YES,               X
          LANSW=YES,                X
          MAXPATH=1,                X
          PUTYPE=2,                  X
          MAXOUT=7,                  X
          MAXDATA=265,              X
          MODETAB=ISTINCLM,         X
          USSTAB=AUSSTAB,           X
          DLOGMOD=SNX32702,         X
          PACING=0,                  X
          VPACING=0,                 X
          ISTATUS=ACTIVE
          PATH GRPNM=GROUPLAN
APP1LU1  LU  LOCADDR=2
APP1LU2  LU  LOCADDR=3,DLOGMOD=SNX32703
APP1LU3  LU  LOCADDR=4,DLOGMOD=SNX32704
APP1LU4  LU  LOCADDR=5,DLOGMOD=SNX32705
APP1LU5  LU  LOCADDR=6,MODETAB=RSCSTAB,DLOGMOD=RSCSPRT3

```

#### LAN Major Node

TRLAN VBUILD TYPE=LAN

```

*
PORTA00  PORT  CUADDR=A00,          X
          MACADDR=400000937062,     X
          LANCON=(6,5),             X
          MAXDATA=1496,             X
          SAPADDR=4
*
GROUPLAN GROUP LNCTL=SDLC,DIAL=YES
*
LANLINE0  LINE  ISTATUS=ACTIVE,CALL=IN
PULAN000  PU
:
LANLINEF  LINE  ISTATUS=ACTIVE,CALL=IN
PULAN00F  PU

```

**MVS Host (VTAM Definitions):** The following VTAM statements define the locally-attached 3174.

```

L3174  VBUILD  TYPE=LOCAL
TOL960  PU      CUADDR=960,           C
          ISTATUS=ACTIVE,           C
          DLOGMOD=SNX32702,         C
          MODETAB=ISTINCLM,         C
          PACING=7,                 C
          PUTYPE=2,                 C
          SSCPFM=USSSCS,            C
          USSTAB=TPOUSS
TOL96002 LU    LOCADDR=02
TOL96003 LU    LOCADDR=03
TOL96004 LU    LOCADDR=04
TOL96005 LU    LOCADDR=05
:
TOL96056 LU    LOCADDR=56
TOL96057 LU    LOCADDR=57
    
```

**AS/400:** The following list contains the objects (Line Description; Controller Description and Device Descriptions) used for this path.

**Line Description - SDLC**

```

Line description . . . . . : APPLE02
Option . . . . . : *BASIC
Category of line . . . . . : *SDLC

Resource name . . . . . : LIN072
Online at IPL . . . . . : *NO
Data link role . . . . . : *PRI
Physical interface . . . . . : *RS232V24
Connection type . . . . . : *NONSWTPP
Switched network backup . . . . . : *NO
Exchange identifier . . . . . : 05615366
NRZI data encoding . . . . . : *YES
Maximum controllers . . . . . : 1
Clocking . . . . . : *MODEM
Line speed . . . . . : 19200
Modem type supported . . . . . : *NORMAL
Modem data rate select . . . . . : *FULL
Autoanswer type . . . . . : *DTR
Maximum frame size . . . . . : 265
Error threshold level . . . . . : *OFF
Duplex . . . . . : *FULL
Modulus . . . . . : 8
Text . . . . . : Macintosh non-swt connection

Line description . . . . . : APPLE02
Option . . . . . : *CTL
Category of line . . . . . : *SDLC

Attached Nonswitched Controllers . . : APPLE02
    
```

```

Line description . . . . . : APPLE02
Option . . . . . : *APPN
Category of line . . . . . : *SDLC

Link speed . . . . . : 9600    ** see Observations and Hints **
Cost/connect time . . . . . : 0
Cost/byte . . . . . : 0
Security for line . . . . . : *NONSECURE
Propagation delay . . . . . : *TELEPHONE
User-defined 1 . . . . . : 128
User-defined 2 . . . . . : 128
User-defined 3 . . . . . : 128

Line description . . . . . : APPLE02
Option . . . . . : *TMRRTY
Category of line . . . . . : *SDLC

Maximum outstanding frames . . . . . : 7
Nonproductive receive timer . . . . . : 320
Idle timer . . . . . : 30
Connect poll timer . . . . . : 30
Poll cycle pause . . . . . : 0
Frame retry . . . . . : 7
Data Set Ready drop timer . . . . . : 6
Clear To Send timer . . . . . : 25
Remote answer timer . . . . . : 60
Recovery limits:
  Count limit . . . . . : 2
  Time interval . . . . . : 5

```

**Controller Description - RWS**

```

Controller description . . . . . : APPLE02
Option . . . . . : *BASIC
Category of controller . . . . . : *RWS
  Controller type . . . . . : 3174
  Controller model . . . . . : 0
  Link type . . . . . : *SDLC
  Online at IPL . . . . . : *NO
  Switched connection . . . . . : *NO
  Switched network backup . . . . . : *NO
  Attached nonswitched line . . . . . : APPLE02
  Character code . . . . . : *EBCDIC
  Maximum frame size . . . . . : 265
  Exchange identifier . . . . . : 00A40301
  SSCP identifier . . . . . : 050000000000
  Station address . . . . . : C1
  Text . . . . . : Macintosh non-swt connection

Controller description . . . . . : APPLE02
Option . . . . . : *DEV
Category of controller . . . . . : *RWS
  Attached Devices . . . . . : APPLE0200
                             APPLE0201
                             APPLE0202
                             APPLE0203
                             APPLE02P6

```

Path 12

Controller description . . . . . : APPLE02  
Option . . . . . : \*TMRRTY  
Category of controller . . . . . : \*RWS  
Device wait timer . . . . . : 120  
SDLC poll priority . . . . . : \*NO  
SDLC poll limit . . . . . : 0  
SDLC out limit . . . . . : \*POLLMT  
SDLC connect poll retry . . . . . : \*NOMAX  
SDLC NDM poll timer . . . . . : \*CALC  
Recovery limits:  
Count limit . . . . . : 2  
Time interval . . . . . : 5

Device Description - DSP

Device description . . . . . : APPLE0200  
Option . . . . . : \*BASIC  
Category of device . . . . . : \*DSP  
Device class . . . . . : \*RMT  
Device type . . . . . : 3278  
Device model . . . . . : 4  
Local location address . . . . . : 02  
Online at IPL . . . . . : \*NO  
Attached controller . . . . . : APPLE02  
Keyboard language type . . . . . : USB  
Drop line at signoff . . . . . : \*NO  
Print device . . . . . : \*SYSVAL  
Output queue . . . . . : \*DEV  
Printer file . . . . . : QSYSPRT  
Library . . . . . : \*LIBL  
Maximum length of request unit . . : \*CALC  
Text . . . . . : Display LU for Mac

Device Description - DSP

Device description . . . . . : APPLE0201  
Option . . . . . : \*BASIC  
Category of device . . . . . : \*DSP  
Device class . . . . . : \*RMT  
Device type . . . . . : 3278  
Device model . . . . . : 4  
Local location address . . . . . : 03  
Online at IPL . . . . . : \*NO  
Attached controller . . . . . : APPLE02  
Keyboard language type . . . . . : USB  
Drop line at signoff . . . . . : \*NO  
Print device . . . . . : \*SYSVAL  
Output queue . . . . . : \*DEV  
Printer file . . . . . : QSYSPRT  
Library . . . . . : \*LIBL  
Maximum length of request unit . . : \*CALC  
Text . . . . . : Display LU for Mac

**Device Description - DSP**

```

Device description . . . . . : APPLE0202
Option . . . . . : *BASIC
Category of device . . . . . : *DSP
  Device class . . . . . : *RMT
  Device type . . . . . : 3278
  Device model . . . . . : 4
  Local location address . . . . . : 04
  Online at IPL . . . . . : *NO
  Attached controller . . . . . : APPLE02
  Keyboard language type . . . . . : USB
  Drop line at signoff . . . . . : *NO
  Print device . . . . . : *SYSVAL
  Output queue . . . . . : *DEV
  Printer file . . . . . : QSYSVRT
    Library . . . . . : *LIBL
  Maximum length of request unit . . : *CALC
  Text . . . . . : Display LU for Mac

```

**Device Description - DSP**

```

Device description . . . . . : APPLE0203
Option . . . . . : *BASIC
Category of device . . . . . : *DSP
  Device class . . . . . : *RMT
  Device type . . . . . : 3278
  Device model . . . . . : 4
  Local location address . . . . . : 05
  Online at IPL . . . . . : *NO
  Attached controller . . . . . : APPLE02
  Keyboard language type . . . . . : USB
  Drop line at signoff . . . . . : *NO
  Print device . . . . . : *SYSVAL
  Output queue . . . . . : *DEV
  Printer file . . . . . : QSYSVRT
    Library . . . . . : *LIBL
  Maximum length of request unit . . : *CALC
  Text . . . . . : Display LU for Mac

```

**Device Description - PRT**

```

Device description . . . . . : APPLE02P6
Option . . . . . : *BASIC
Category of device . . . . . : *PRT
  Device class . . . . . : *RMT
  Device type . . . . . : 3287
  Device model . . . . . : 0
  Advanced function printing . . . . : *NO
  Local location address . . . . . : 06
  Online at IPL . . . . . : *NO
  Attached controller . . . . . : APPLE02
  Form feed . . . . . : *CONT
  Printer error message . . . . . : *INQ
  Message queue . . . . . : QSYSOPR
    Library . . . . . : *LIBL
  Maximum length of request unit . . : *CALC
  Text . . . . . : Printer LU for Mac

```

3174: The configuration data follows.

\_\_\_\_\_ Model / Attach \_\_\_\_\_

098 - \_\_\_\_\_  
 099 - LSSMVS CHANNEL CONNECTED 3174  
 100 - 01L  
 101 - 5

\_\_\_\_\_ Local (SNA) \_\_\_\_\_

LOCL

104 - 60	105 - 00	108 - 23D2127	110 - 2 0000	116 - 2_
121 - 01	123 - 0	125 - 00000100	126 - 00000000	127 - 0 0
132 - 0 0 0 0	136 - 1 1 1 1	137 - 0 0 0 0	138 - 2	
141 - A	150 - 0	165 - 0	166 - A	168 - 0
173 - 00100000	175 - 000000	179 - 0 0 0		
213 - 1	215 - 00000	220 - 3		
222 - 1	223 - 10	224 - 2	225 - 4	

\_\_\_\_\_ Common SNA \_\_\_\_\_

60/LOCL

500 - 0                      501 - \_\_\_\_\_                      502 - \_\_\_\_\_

\_\_\_\_\_ 117: Port Assignment \_\_\_\_\_

LT=

116=2

60/LOCL

Host addresses						Host addresses							
Port	IS	1	2	3	4	5	Port	IS	1	2	3	4	5
26-00	002	013	014	015	_____	_____	26-01	003	016	017	018	_____	_____
26-02	004	019	020	021	_____	_____	26-03	005	022	023	024	_____	_____
26-04	006	025	026	027	_____	_____	26-05	007	028	029	030	_____	_____
26-06	008	031	032	033	_____	_____	26-07	009	034	035	036	_____	_____
26-08	010	037	038	039	_____	_____	26-09	_____	_____	_____	_____	_____	_____
26-10	_____	_____	_____	_____	_____	_____	26-11	_____	_____	_____	_____	_____	_____
26-12	_____	_____	_____	_____	_____	_____	26-13	_____	_____	_____	_____	_____	_____
26-14	_____	_____	_____	_____	_____	_____	26-15	_____	_____	_____	_____	_____	_____
26-16	011	040	041	042	_____	_____	26-17	_____	_____	_____	_____	_____	_____
26-18	_____	_____	_____	_____	_____	_____	26-19	_____	_____	_____	_____	_____	_____
26-20	_____	_____	_____	_____	_____	_____	26-21	_____	_____	_____	_____	_____	_____
26-22	_____	_____	_____	_____	_____	_____	26-23	_____	_____	_____	_____	_____	_____
26-24	012	043	044	045	_____	_____	26-25	_____	_____	_____	_____	_____	_____
26-26	_____	_____	_____	_____	_____	_____	26-27	_____	_____	_____	_____	_____	_____
26-28	_____	_____	_____	_____	_____	_____	26-29	_____	_____	_____	_____	_____	_____
26-30	_____	_____	_____	_____	_____	_____	26-31	_____	_____	_____	_____	_____	_____

\_\_\_\_\_ Device Definition \_\_\_\_\_

800 Printer Authorization Matrix (PAM) - 0 0  
 801 Logical Terminal Assignment - 0  
 802 Prompts for Extended VPD - 0

## Macintosh

1. This path uses configurations created as described in Path 4, Path 5, and Path 15.
2. Start the SNA•ps Admin program by double clicking the application icon. The Network Gateway Status window appears.
3. Select the SDLC gateway. Choose Select Configuration from the Gateway menu. Select *path04*, then click on the Select button to assign Path 4 to the SDLC gateway. Choose Start Gateway from the Gateway menu, then click Start to confirm the gateway start operation. When the gateway has been started, the Status column of the Network Gateway Status window contains "Started."
4. Select the Token Ring gateway. Choose Select Configuration from the Gateway menu. Select *path05*, then click on the Select button to assign Path 5 to the Token Ring gateway. Choose Start Gateway from the Gateway menu, then click Start to confirm the gateway start operation. When the gateway has been started, the Status column of the Network Gateway Status window contains "Started."
5. Select the Coax gateway. Choose Select Configuration from the Gateway menu. Select *path15*, then click on the Select button to assign Path 15 to the Coax gateway. Choose Start Gateway from the Gateway menu, then click Start to confirm the gateway start operation. When the gateway has been started, the Status column of the Network Gateway Status window contains "Started."
6. At this point, all three gateways should show a status of "Started."
7. Start the SNA•ps 3270 client program by double clicking the application icon. An untitled session document appears. Choose Connect from the Session menu, then select the gateway that was started in step 3. Click on the Session button to display the specific LUs. Select a session, then click OK to connect the session to the AS/400 via the SNA•ps SDLC gateway (reference Figure 83 on page 128).
8. Select New from the File menu to get a new session document. An untitled session document appears. Choose Connect from the Session menu, then select the gateway that was started in step 4. Click on the Session button to display the specific LUs. Select a session, then click OK to connect the session to the VM host via the SNA•ps Token Ring gateway (reference Figure 84 on page 129).
9. Select New from the File menu to get a new session document. An untitled session document appears. Choose Connect from the Session menu, then select the gateway that was started in step 5. Click on the Session button to display the specific LUs. Select a session, then click OK to connect the session to the MVS host via the SNA•ps Coax gateway and the channel-attached 3174 (reference Figure 85 on page 129).

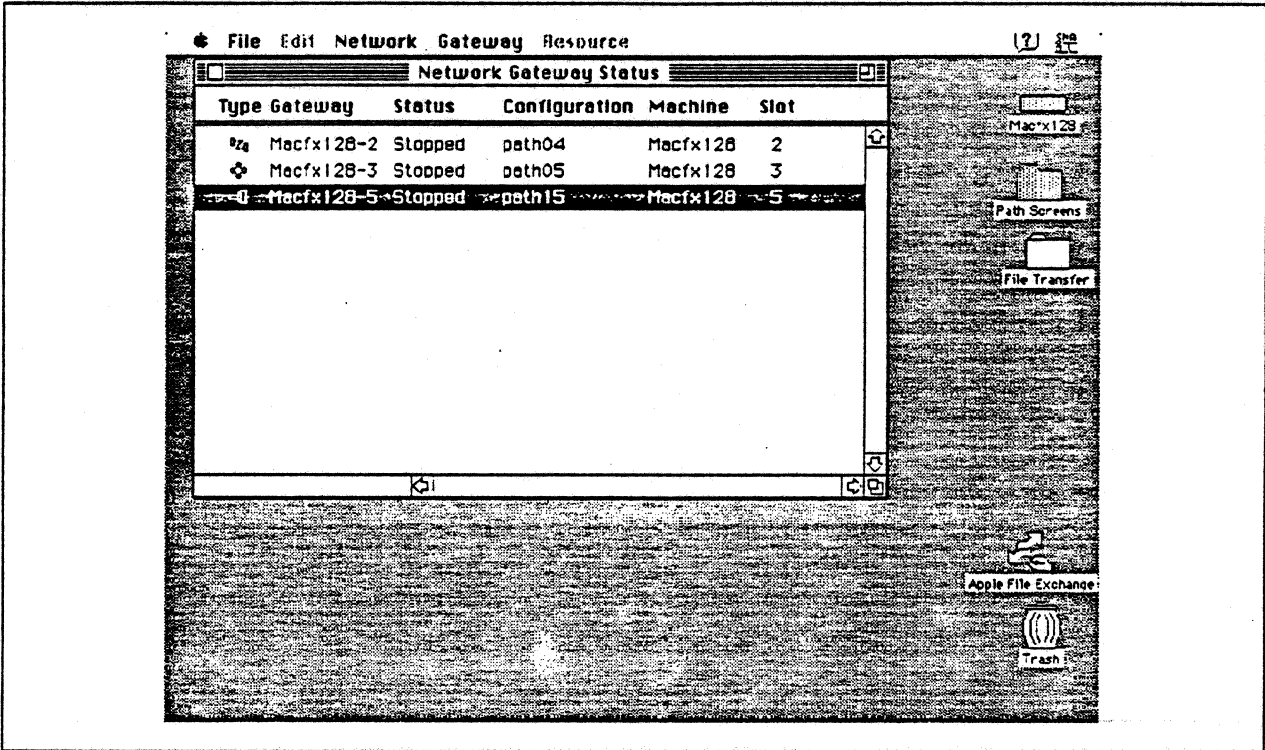

Figure 82. Network Gateway Status Window. Three started gateways are displayed.

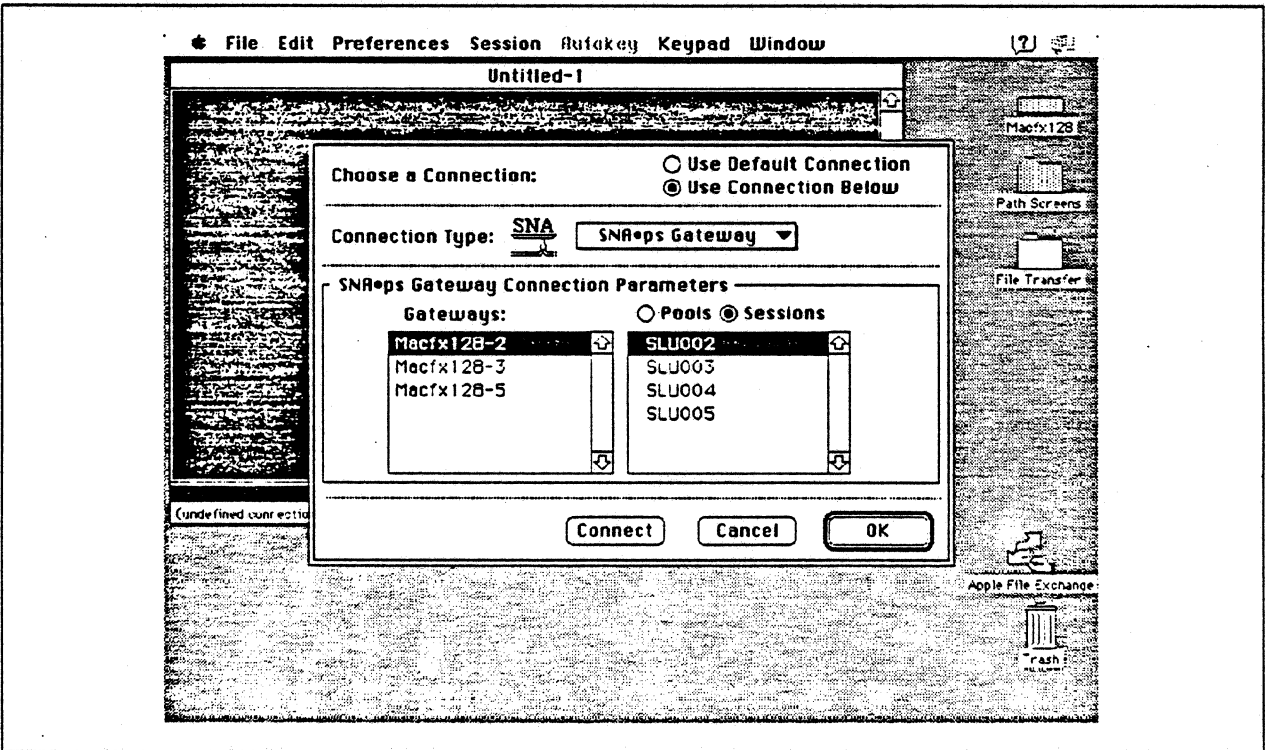

Figure 83. Choosing a Connection With The SDLC Gateway



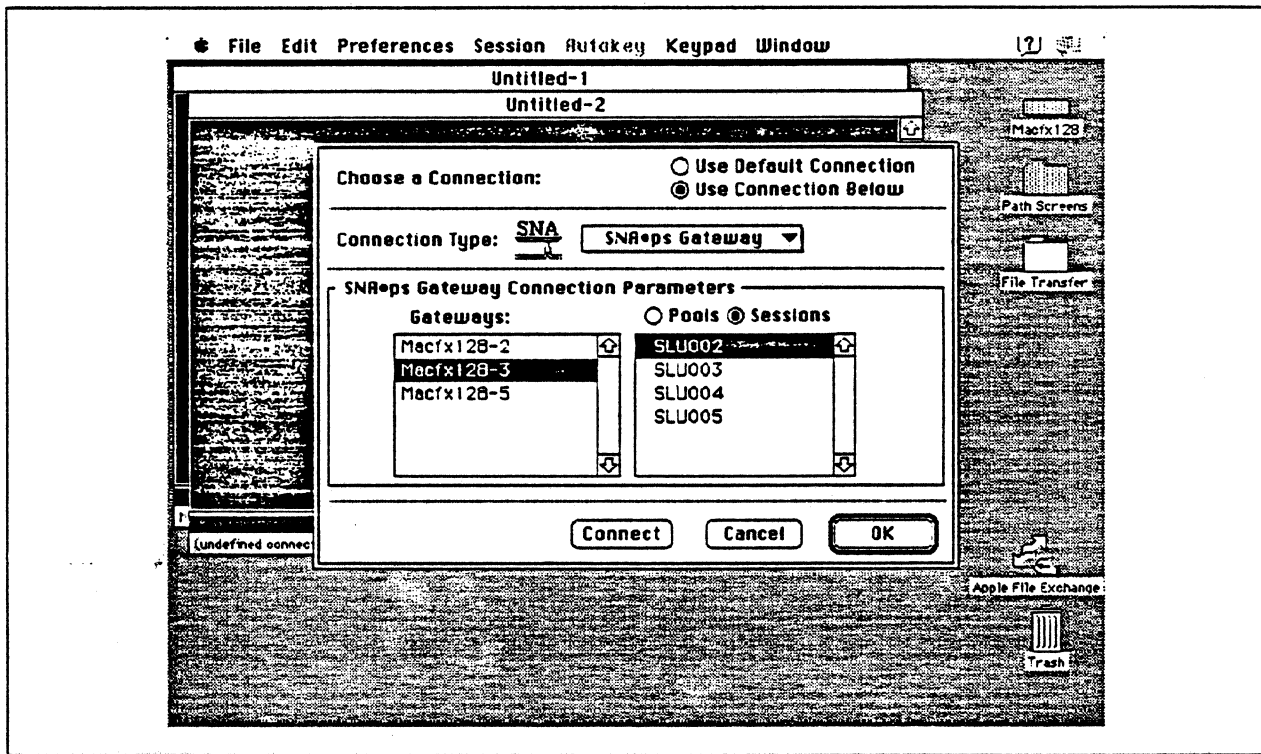

Figure 84. Choosing a Connection With The Token Ring Gateway

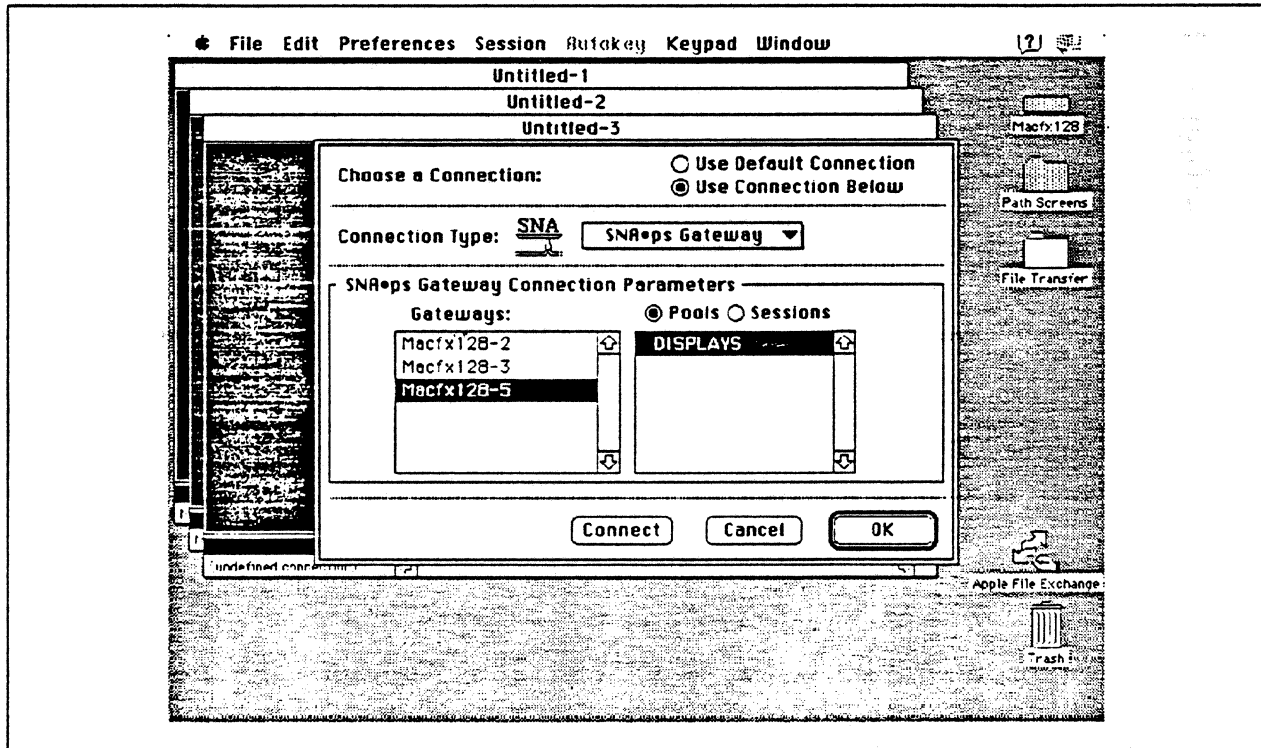

Figure 85. Choosing a Connection With The Coax DFT Gateway

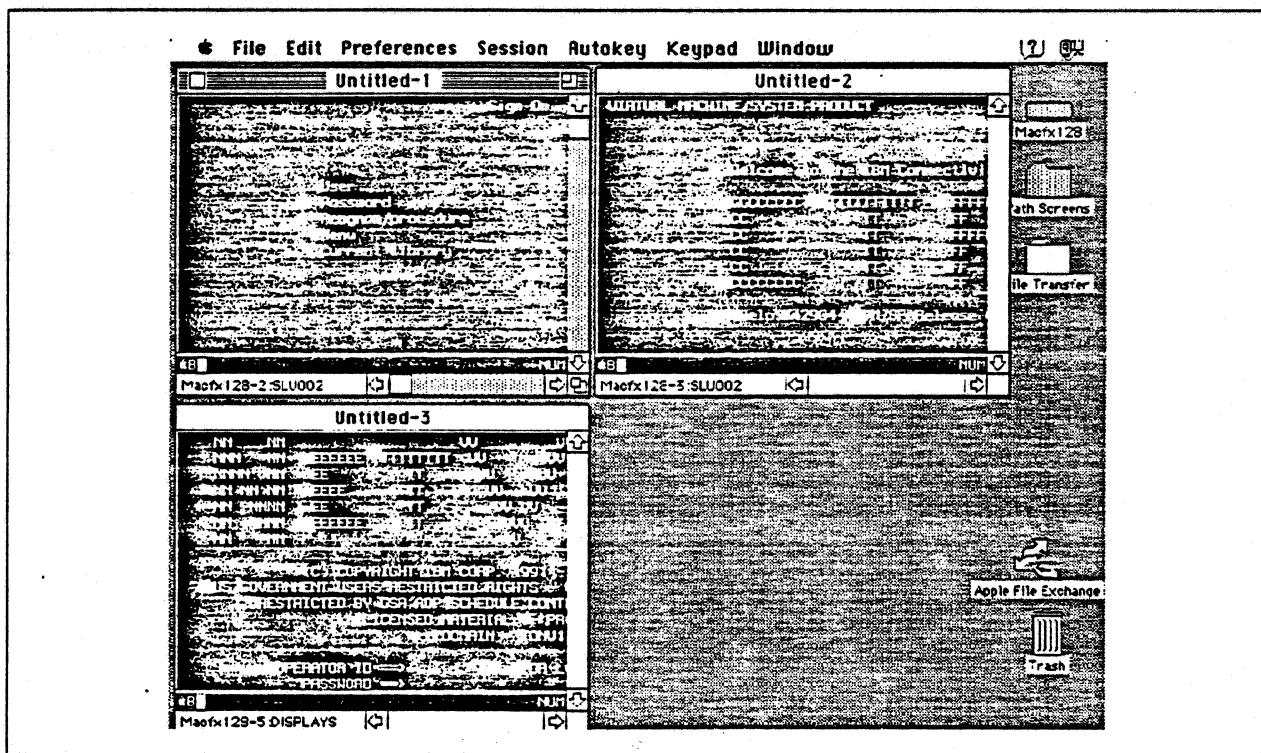

Figure 86. Session Documents Showing Sessions With AS/400, VM, and MVS

## Observations and Hints

If you want to also use the Macintosh IIx gateway machine as a client, install both SNA•ps 3270 V1.1 (beta) and SNA•ps 3270 Gateway Client V1.1 (beta) on the machine.

This path shows multiple gateways in one Macintosh. For variety, this path demonstrates three types of gateways (SDLC, Token Ring, and Coax); however, there is no reason there could not be multiple gateways of the same connection type.

An AS/400 file was printed at the printer LU associated with the Macintosh.

Although only five LUs were used on each gateway card connection, the configuration will support up to 64 LUs. To create AS/400 descriptions for the rest of the 64 LUs, copy one of the sections headed either "Device Description - DSP" (for additional display LUs) or "Device Description - PRT" (for additional printer LUs). For each additional LU, change the device description and local location address in the copied description to a new unique name and local address.

There are keyboard mapping considerations for this path. By way of background, the traditional remote controller for an AS/400 environment is a 5250-type controller, examples of which are the IBM 5294 and IBM 5394. These controllers are designed for a twinaxial cabling environment and support a 5250 data stream, which is different than the 3270 data stream supported on IBM's 3270 family of controllers. Also, the 5250 family of controllers only supports the 5250-type twinaxial terminals which utilize the 5250 data stream. Because some customers that already have remote-attach 3270 controllers want to be able to use these existing controllers on their AS/400s, IBM supports 3274 SDLC and 3174 SDLC and Token-Ring attachment of these controllers. With this capability, one can see AS/400-type screens on a 3270-type terminal. However, the 3270 keyboard and the 5250-type keyboards are different. As an example, there is a HELP key on a 5250-type terminal that is not present on 3270-type keyboards. Because of these keyboard differences, a keyboard mapping scheme provides the necessary 5250 keyboard functions through the 3270 keyboard. Refer to the *Application System/400 Communications: Remote Work Station Guide* for a discussion of this keyboard mapping

capability. Keep in mind that this manual provides keyboard mapping information for someone using a real 3270 terminal. For our configuration we have a Macintosh computer instead of a 3x74 controller and 3270 terminals. The real Macintosh keyboard is not like either a 3270 keyboard or a 5250 keyboard, so a second level of keyboard mapping needs to be considered. Apple provides a keyboard mapping facility with their 3270 emulation capability that allows one to easily map the Macintosh keyboard to provide the 5250 keyboard functions that you need to interact with the AS/400. Refer to the *SNA•ps 3270 User's Guide* for instructions on how to utilize this keyboard mapping capability.

---

## **Path 13: MVS, VM, and AS/400 Hosts via Token Ring SNA•ps Gateway**

### **Path Description**

This configuration consists of the SNA•ps product running on an Apple Macintosh concurrently connected to an IBM MVS host, an AS/400, and a VM host using an IBM Token Ring (IEEE 802.5) local area network. The Macintosh provides AppleTalk to SNA Gateway function for AppleTalk clients.

The configuration is shown in Figure 87 on page 133. The MVS host is attached to the Token Ring through an IBM 3745 Communications Controller using a 16/4 Mbps Token-Ring Interface Card (TIC). The AS/400 is attached to the Token Ring using a 16/4 Mbps Token-Ring interface card. The VM host is attached to the Token Ring with an ES/9370 integrated 16/4 Mbps Token-Ring interface card.

The Macintosh IIx uses an Apple Token Ring 4/16 NB Card for SNA Token Ring LAN attachment. The Apple Macintosh IIci client connects via an AppleTalk LocalTalk interface to the Apple Macintosh IIx (provided on each system unit).

This configuration provides up to 64 LUs, divided among the upstream host SNA connections, through the gateway machine to AppleTalk clients for 3270 terminal and printer emulation.

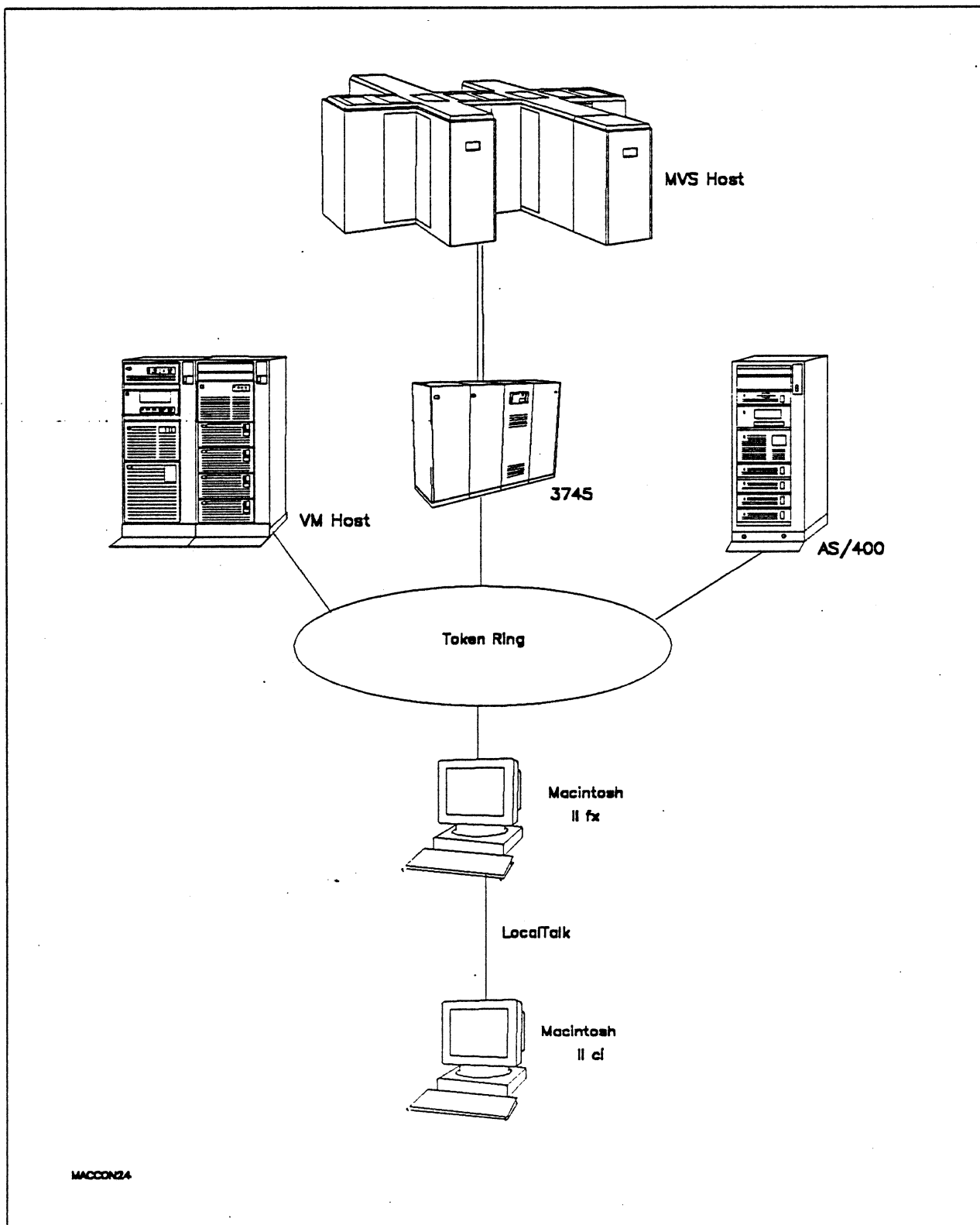

Figure 87. Path 13 Configuration - Multiple Host Configuration (Token Ring)

## Hardware And Software

The following section describes the hardware and software that was used for this path.

### MVS Host

- 4381 system
- MVS/SP JES2 Version 2 Release 2.0 (MVS/XA)
- VTAM Version 3 Release 3
- OEMI channel
- JES/328X Print Facility

### VM Host

- 9375 system
- 16/4 Integrated Token-Ring Adapter feature #6130/6134
- VM/SP Release 6.0
- VTAM Version 3 Release 3
- RSCS Version 2 Release 3

### 3745

- 16/4 Mbps token ring adapter (TIC) type 2 feature #4770
- Channel adapter feature #1561
- NCP Version 5 Release 3

### Token Ring

- 16 Mbps

### AS/400

- 9406 system
- 16/4 Token-Ring Adapter feature #2626
- OS/400 Version 2 Release 1

### Macintosh IIfx (Gateway)

- System Software 7.0
- SNA\*ps Gateway/64 V1.1 (beta)
- Apple Token Ring 4/16 NB Card with MCP memory expansion kit (1MB total)
- LocalTalk cable
- LaserWriter IINTX printer
- Total memory - 4M
- Hard disk - 80M

### Macintosh IIci (Client)

- System Software 7.0
- SNA\*ps 3270 Gateway Client V1.1 (beta)
- LocalTalk cable
- Total memory - 5M
- Hard disk - 80M

## Configuration Details and Operating Procedure

The following section contains details of how the configuration is defined and the procedures that are used.

### VM Host (VTAM Definitions)

#### Switched Major Node

```

APPLE1  VBUILD TYPE=SWNET,MAXGRP=4,MAXNO=400
*
PUAPP1  PU  ADDR=04,                                X
          IDBLK=00A,                                X
          IDNUM=93701,                               X
          DISCNT=NO,                                 X
          IRETRY=YES,                                X
          LANSW=YES,                                 X
          MAXPATH=1,                                 X
          PUTYPE=2,                                  X
          MAXOUT=7,                                  X
          MAXDATA=265,                               X
          MODETAB=ISTINCLM,                          X
          USSTAB=AUSSTAB,                            X
          DLOGMOD=SNX32702,                           X
          PACING=0,                                  X
          VPACING=0,                                  X
          ISTATUS=ACTIVE
          PATH GRPNM=GROUPLAN
APP1LU1  LU  LOCADDR=2
APP1LU2  LU  LOCADDR=3,DLOGMOD=SNX32703
APP1LU3  LU  LOCADDR=4,DLOGMOD=SNX32704
APP1LU4  LU  LOCADDR=5,DLOGMOD=SNX32705
APP1LU5  LU  LOCADDR=6,MODETAB=RSCSTAB,DLOGMOD=RSCSPRT3

```

#### LAN Major Node

```

TRLAN    VBUILD TYPE=LAN
*
PORTA00  PORT  CUADDR=A00,                            X
          MACADDR=400000937062,                       X
          LANCON=(6,5),                                X
          MAXDATA=1496,                                X
          SAPADDR=4
*
GROUPLAN GROUP LNCTL=SDLC,DIAL=YES
*
LANLINE0 LINE  ISTATUS=ACTIVE,CALL=IN
PULAN000 PU
:
LANLINEF LINE  ISTATUS=ACTIVE,CALL=IN
PULAN00F PU

```

**MVS Host (VTAM and NCP Definitions)**

DIALAPPL VBUILD TYPE=SWNET

```

*
TOAAP1  PU      ADDR=04,                C
              IDBLK=00A,                C
              IDNUM=37451,              C
              PACING=0,                  C
              VPACING=0,                  C
              IRETRY=YES,                 C
              MAXDATA=265,                C
              SSCPFM=USSSCS,              C
              DISCNT=NO,                   C
              PUTYPE=2,                    C
              MAXOUT=7,                    C
              MODETAB=ISTINCLM,           C
              DLOGMOD=SNX32702,           C
              USSTAB=TPOUSS
TOAAP102 LU    LOCADDR=2,DLOGMOD=SNX32702 * 3278 MODEL 2 *
TOAAP103 LU    LOCADDR=3,DLOGMOD=SNX32703 * 3278 MODEL 3 *
TOAAP104 LU    LOCADDR=4,DLOGMOD=SNX32704 * 3278 MODEL 4 *
TOAAP105 LU    LOCADDR=5,DLOGMOD=SNX32705 * 3278 MODEL 5 *
TOAAP106 LU    LOCADDR=6,DLOGMOD=SCS     * 3287 SCS PRINTER *
    
```

The token ring is defined by the TO30T1PG and TO30T1G1 GROUP definition statements in the NCP gen. Refer to Appendix C, "NCP Gen Listing" on page 287 for the complete NCP gen listing.

**AS/400:** The following list contains the objects (Line Description; Controller Description and Device Descriptions) used for this path.

**Line Description - LAN**

```

Line description . . . . . : TRNLIN031
Option . . . . . : *BASIC
Category of line . . . . . : *TRLAN

Resource name . . . . . : LIN031
Online at IPL . . . . . : *NO
Vary on wait . . . . . : *NOWAIT
Maximum controllers . . . . . : 50
Line speed . . . . . : 16M
Maximum frame size . . . . . : 2057
TRLAN manager logging level. . . . . : *MIN
  Current logging level. . . . . : *MIN
TRLAN manager mode . . . . . : *OBSERVING
Log configuration changes . . . . . : *NOLOG
Token-ring inform of beacon . . . . . : *YES
Local adapter address . . . . . : 400040300000
Exchange identifier . . . . . : 05640300
Early token release. . . . . : *NO
Error threshold level . . . . . : *OFF
Text . . . . . : Connection to Token-Ring
    
```



Line description . . . . . : TRNLIN031  
 Option . . . . . : \*SSAP  
 Category of line . . . . . : \*TRLAN

SSAP	Maximum Frame	Type	SSAP	Maximum Frame	Type
----	-----	---	----	-----	---
04	*MAXFRAME	*SNA	14	*MAXFRAME	*SNA
08	*MAXFRAME	*SNA	18	*MAXFRAME	*SNA
0C	*MAXFRAME	*SNA	1C	*MAXFRAME	*SNA
10	*MAXFRAME	*SNA	20	*MAXFRAME	*SNA

Line description . . . . . : TRNLIN031  
 Option . . . . . : \*APPN  
 Category of line . . . . . : \*TRLAN

Link speed . . . . . : 4M      \*\* see Observations and Hints \*\*  
 Cost/connect time . . . . . : 0  
 Cost/byte . . . . . : 0  
 Security for line . . . . . : \*NONSECURE  
 Propagation delay . . . . . : \*LAN  
 User-defined 1 . . . . . : 128  
 User-defined 2 . . . . . : 128  
 User-defined 3 . . . . . : 128  
 Autocreate controller . . . . . : \*YES  
 Autodelete controller . . . . . : \*NONE

Line description . . . . . : TRNLIN031  
 Option . . . . . : \*TMRRTY  
 Category of line . . . . . : \*TRLAN

Recovery limits:  
 Count limit . . . . . : 2  
 Time interval . . . . . : 5

#### Controller Description - RWS

Controller description . . . . . : APPLE01  
 Option . . . . . : \*BASIC  
 Category of controller . . . . . : \*RWS  
 Controller type . . . . . : 3174  
 Controller model . . . . . : 0  
 Link type . . . . . : \*LAN  
 Online at IPL . . . . . : \*NO  
 Character code . . . . . : \*EBCDIC  
 Maximum frame size . . . . . : 265  
 Exchange identifier . . . . . : 00A40301  
 SSCP identifier . . . . . : 050000000000  
 Initial connection . . . . . : \*ANS  
 LAN remote adapter address . . . . : 1000E0017CBC  
 LAN DSAP . . . . . : 04  
 LAN SSAP . . . . . : 04  
 Text . . . . . : For Apple Macintosh

Controller description . . . . . : APPLE01  
 Option . . . . . : \*SWTLINLST  
 Category of controller . . . . . : \*RWS  
 Switched lines . . . . . : TRNLIN031

Path 13

Controller description . . . . . : APPLE01  
Option . . . . . : \*DEV  
Category of controller . . . . . : \*RWS  
Attached Devices . . . . . : APPLE0100  
APPLE0101  
APPLE0102  
APPLE0103  
APPLE01P6

Controller description . . . . . : APPLE01  
Option . . . . . : \*TMRRTY  
Category of controller . . . . . : \*RWS  
Disconnect timer . . . . . : 120  
LAN frame retry . . . . . : \*CALC  
LAN connection retry . . . . . : \*CALC  
LAN response timer . . . . . : \*CALC  
LAN connection timer . . . . . : \*CALC  
LAN acknowledgement timer . . . . . : \*CALC  
LAN inactivity timer . . . . . : \*CALC  
LAN acknowledgement frequency . . . : \*CALC  
LAN max outstanding frames . . . . . : \*CALC  
LAN access priority . . . . . : \*CALC  
LAN window step . . . . . : \*NONE  
Recovery limits:  
Count limit . . . . . : 2  
Time interval . . . . . : 5

Device Description - DSP

Device description . . . . . : APPLE0100  
Option . . . . . : \*BASIC  
Category of device . . . . . : \*DSP  
Device class . . . . . : \*RMT  
Device type . . . . . : 3278  
Device model . . . . . : 4  
Local location address . . . . . : 02  
Online at IPL . . . . . : \*NO  
Attached controller . . . . . : APPLE01  
Keyboard language type . . . . . : USB  
Drop line at signoff . . . . . : \*NO  
Print device . . . . . : \*SYSVAL  
Output queue . . . . . : \*DEV  
Printer file . . . . . : QSYSVRT  
Library . . . . . : \*LIBL  
Maximum length of request unit . . . : \*CALC  
Text . . . . . : Display LU for Mac

**Device Description - DSP**

```

Device description . . . . . : APPLE0101
Option . . . . . : *BASIC
Category of device . . . . . : *DSP
  Device class . . . . . : *RMT
  Device type . . . . . : 3278
  Device model . . . . . : 4
  Local location address . . . . . : 03
  Online at IPL . . . . . : *NO
  Attached controller . . . . . : APPLE01
  Keyboard language type . . . . . : USB
  Drop line at signoff . . . . . : *NO
  Print device . . . . . : *SYSVAL
  Output queue . . . . . : *DEV
  Printer file . . . . . : QSYSPRT
    Library . . . . . : *LIBL
  Maximum length of request unit . . . : *CALC
  Text . . . . . : Display LU for Mac

```

**Device Description - DSP**

```

Device description . . . . . : APPLE0102
Option . . . . . : *BASIC
Category of device . . . . . : *DSP
  Device class . . . . . : *RMT
  Device type . . . . . : 3278
  Device model . . . . . : 4
  Local location address . . . . . : 04
  Online at IPL . . . . . : *NO
  Attached controller . . . . . : APPLE01
  Keyboard language type . . . . . : USB
  Drop line at signoff . . . . . : *NO
  Print device . . . . . : *SYSVAL
  Output queue . . . . . : *DEV
  Printer file . . . . . : QSYSPRT
    Library . . . . . : *LIBL
  Maximum length of request unit . . . : *CALC
  Text . . . . . : Display LU for Mac

```

**Device Description - DSP**

```

Device description . . . . . : APPLE0103
Option . . . . . : *BASIC
Category of device . . . . . : *DSP
  Device class . . . . . : *RMT
  Device type . . . . . : 3278
  Device model . . . . . : 4
  Local location address . . . . . : 05
  Online at IPL . . . . . : *NO
  Attached controller . . . . . : APPLE01
  Keyboard language type . . . . . : USB
  Drop line at signoff . . . . . : *NO
  Print device . . . . . : *SYSVAL
  Output queue . . . . . : *DEV
  Printer file . . . . . : QSYSPRT
    Library . . . . . : *LIBL
  Maximum length of request unit . . . : *CALC
  Text . . . . . : Display LU for Mac

```

Device Description - PRT

```

Device description . . . . . : APPLE01P6
Option . . . . . : *BASIC
Category of device . . . . . : *PRT
  Device class . . . . . : *RMT
  Device type . . . . . : 3287
  Device model . . . . . : 0
  Advanced function printing . . . . . : *NO
  Local location address . . . . . : 06
  Online at IPL . . . . . : *NO
  Attached controller . . . . . : APPLE01
  Form feed . . . . . : *CONT
  Printer error message . . . . . : *INQ
  Message queue . . . . . : QSYSOPR
  Library . . . . . : *LIBL
  Maximum length of request unit . . . : *CALC
  Text . . . . . : Printer LU for Mac
    
```

Macintosh

1. Start the SNA•ps Config program by double clicking the application icon. The SNA•ps Config resources window appears.
2. In the SNA•ps Config resources window, click the New button below the Lines box. A dialog box appears (refer to Figure 88 on page 142) in which you select the type of card to be configured. Because Token Ring is the default for card type and is the desired upstream DLC type for this path, click OK.
3. The dialog box for a Token Ring line appears (refer to Figure 89 on page 142). For this path, change the Token Ring Line Name to *MVSLINE*.
4. In the Lines box in the SNA•ps Config resources window, select *MVSLINE*, which is the name of the Token Ring Line that was created in step 3, then click the New button under Partners. The Token Ring Partner dialog box appears. For this path, change the Name field to *MVSHOST*. In the Link Address field, enter the LOCADD value from the NCP LINE definition statement for the 3745 token ring adapter card. In the Gateway XID field, enter the IDBLK-IDNUM values that were specified on the VTAM PU definition statement (refer to Figure 90 on page 143), then click OK.
5. In the Partners box in the SNA•ps Config resources window, select *MVSHOST*, which is the name of the Partner that was created in step 4, then click the New button under 3270 Resources. A dialog box appears in which you can create a 3270 LU. (Refer to Figure 91 on page 143.) For this path, 5 LUs were created. *MVSDISP* was entered as the Pool name. The LUs were assigned names *MVS02* through *MVS06*. The LU that was created with the LU ID of 6 was a printer to match the VTAM configuration. All the remaining LUs were created with a device type of Display. Figure 92 on page 144 shows the Config resources window after the creation of these 5 LUs.
6. In the SNA•ps Config resources window, click the New button below the Lines box. A dialog box appears in which you select the type of card to be configured. Because Token Ring is the default for card type and is the desired upstream DLC type for this path, click OK.
7. The dialog box for a Token Ring line (Figure 93 on page 144) appears. Change the Token Ring Line Name to *AS400LIN*.
8. In the Lines box in the SNA•ps Config resources window, select the name of the Token Ring line that was created in step 7, then click the New button under Partners. The Token Ring Partner dialog box appears. For this path, change the Name field to *AS400*. In the XID field, enter 00A40301, which corresponds to the EXCHID parameter in the APPLE01 controller description on the AS/400. In the Address field, enter 400040300000, which corresponds to the AS/400's local adapter address in the TRNLIN031 line description. (Refer to Figure 94 on page 145.) Click OK.

9. In the Partners box in the SNA•ps Config resources window, select the name of the Partner that was created in step 8, then click the New button under 3270 Resources. A dialog box appears in which you can create a 3270 LU. (Refer to Figure 95 on page 145.) For this path, 5 LUs were created. *AS400DSP* was entered as the Pool name. The LUs were assigned names *AS40002* through *AS40006*. The LU that was created with the LU ID of 6 was a printer LU to match the AS/400 Remote Workstation configuration. The other LUs were created with a device type of Display. Figure 96 on page 146 shows the Config resources window after the creation of these 5 LUs.
10. In the SNA•ps Config resources window, click the New button below the Lines box. A dialog box appears in which you can select the type of card to be configured. Because Token Ring is the default for card type and is the desired upstream DLC type for this path, click OK.
11. The dialog box for a Token Ring line appears (refer to Figure 97 on page 146). Change the Token Ring Line Name to *VMLINE*. Click OK.
12. In the Lines box in the SNA•ps Config resources window, select the name of the Token Ring line that was created in step 11, then click the New button under Partners. The Token Ring Partner dialog box appears. For this path, change the Name field to *VM*. In the Link Address field, enter the *MACADDR* value from the *PORT* definition statement in the LAN major node for the VM token ring adapter card. In the Gateway XID field, enter the *IDBLK-IDNUM* values defined for the VTAM PU. (Refer to Figure 98 on page 147.) Click OK.
13. In the Partners box in the SNA•ps Config resources window, select the name of the Partner that was created in step 12, then click the New button under 3270 Resources. A dialog box appears in which you can create a 3270 LU (refer to Figure 99 on page 147). For this path, 5 LUs were created. *VMDISP* was entered as the Pool name. The LUs were assigned names *VM02* through *VM06*. The LU that was created with the LU ID of 6 was a printer LU to match the VTAM configuration. The other LUs were created with a device type of Display. Figure 100 on page 148 shows the Config resources window after the creation of these 5 LUs.
14. Choose Save As from the File menu. Save this file as *path13*. (Refer to Figure 101 on page 148.)
15. Start the SNA•ps Admin program by double clicking the application icon. The Network Gateway Status window appears. In the Network Gateway Status window, select the Token Ring gateway to be configured. Choose Select Configuration from the Gateway menu. Select *path13*, then click on the Select button to assign *path13* to the Token Ring gateway.
16. To start the gateway, in the Network Gateway Status window, select the Token Ring gateway with *path13* specified as the configuration. Choose Start Gateway from the Gateway menu. Click Start to confirm that you want this gateway started. When the gateway has been started, the Status column of the Network Gateway Status window contains "Started."
17. Start the SNA•ps 3270 client program by double clicking the application icon. An untitled document appears. Choose Connect from the Session menu. Select the *AS400DSP* pool (refer to Figure 102 on page 149), then click OK to connect that session to the AS/400. Choose New from the File menu. Again, an untitled session document will appear. Choose Connection from the Session menu. Select the *MVSDISP* pool (refer to Figure 103 on page 149), then click OK to connect that session to the MVS host. Choose New from the File menu. Again, an untitled session document will appear. Choose Connection from the Session menu. Select the *VMDISP* pool (refer to Figure 104 on page 150), then click OK to connect that session to the VM host.
18. Choose Tile from the Window menu. Three session documents are tiled on the screen showing access to three different IBM partners. (Refer to Figure 105 on page 150.)

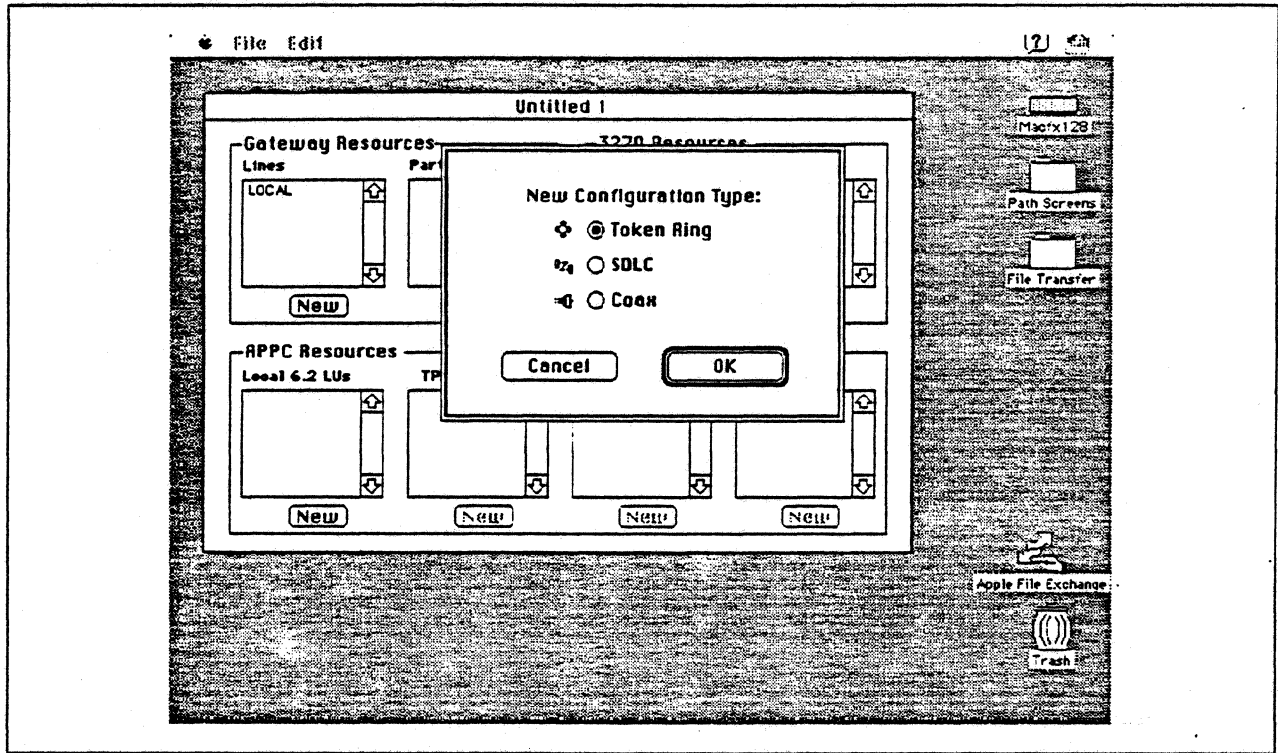

Figure 88. DLC Type Selection for Upstream Connection

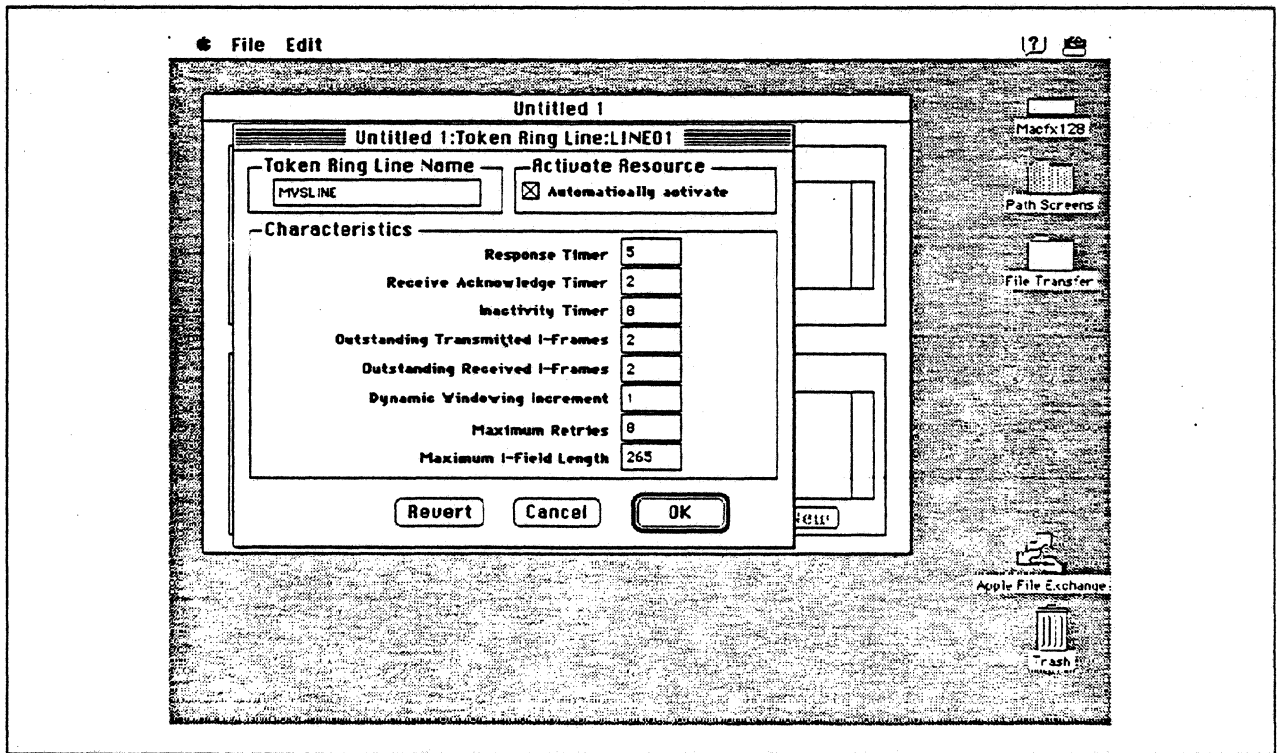

Figure 89. Token Ring Line Configuration Parameters

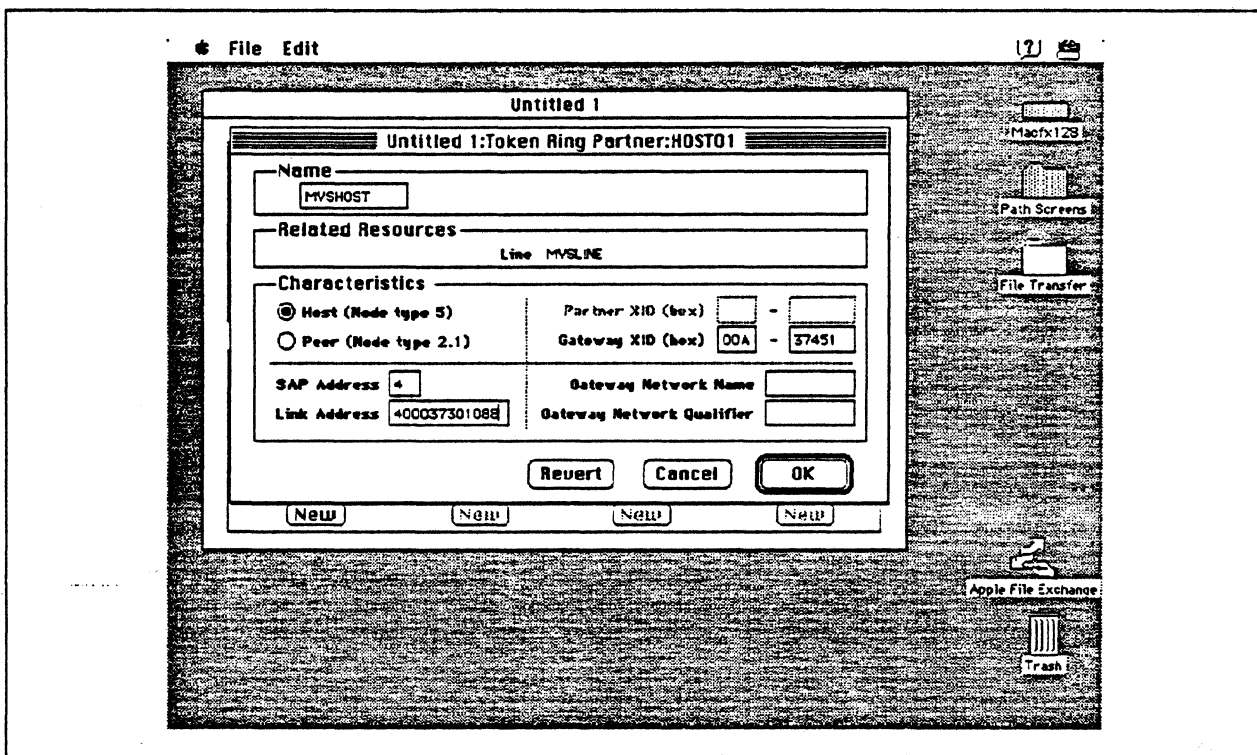

Figure 90. Token Ring Partner Configuration Parameters

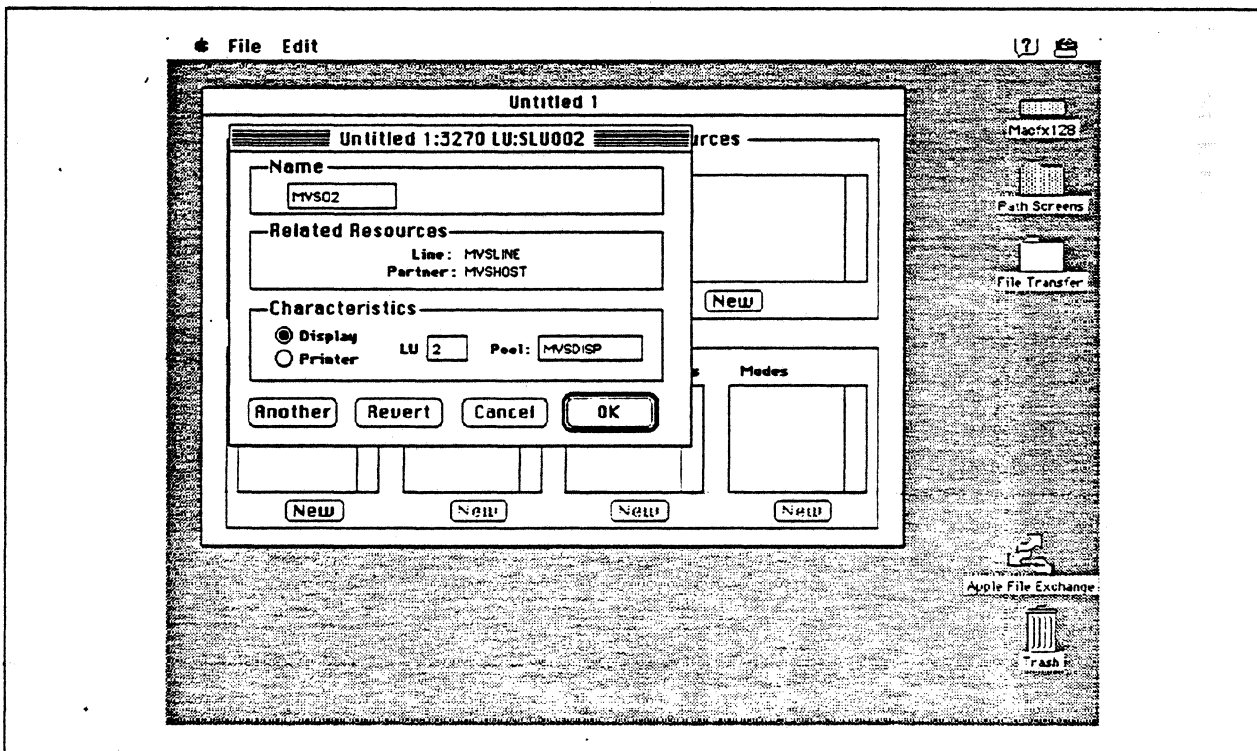

Figure 91. Configuring a 3270 LU

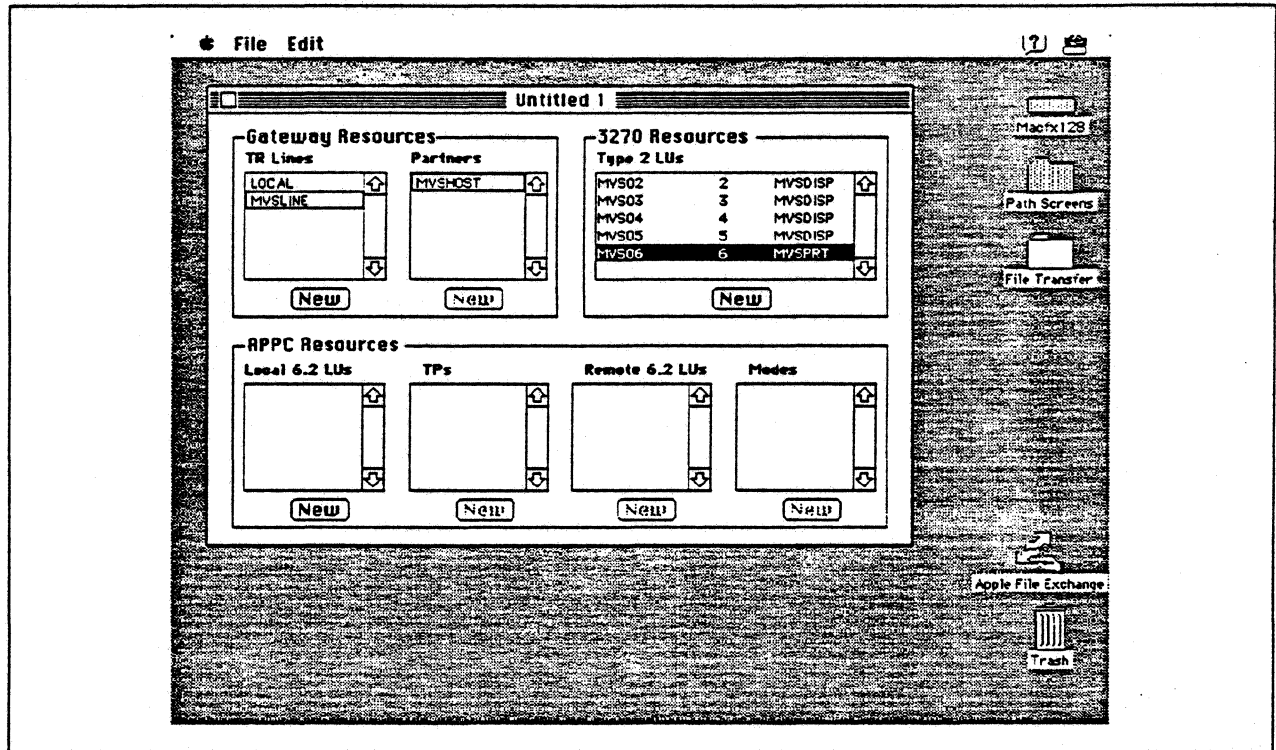

Figure 92. SNA\*ps Config Window After Creating LUs for MVS Host

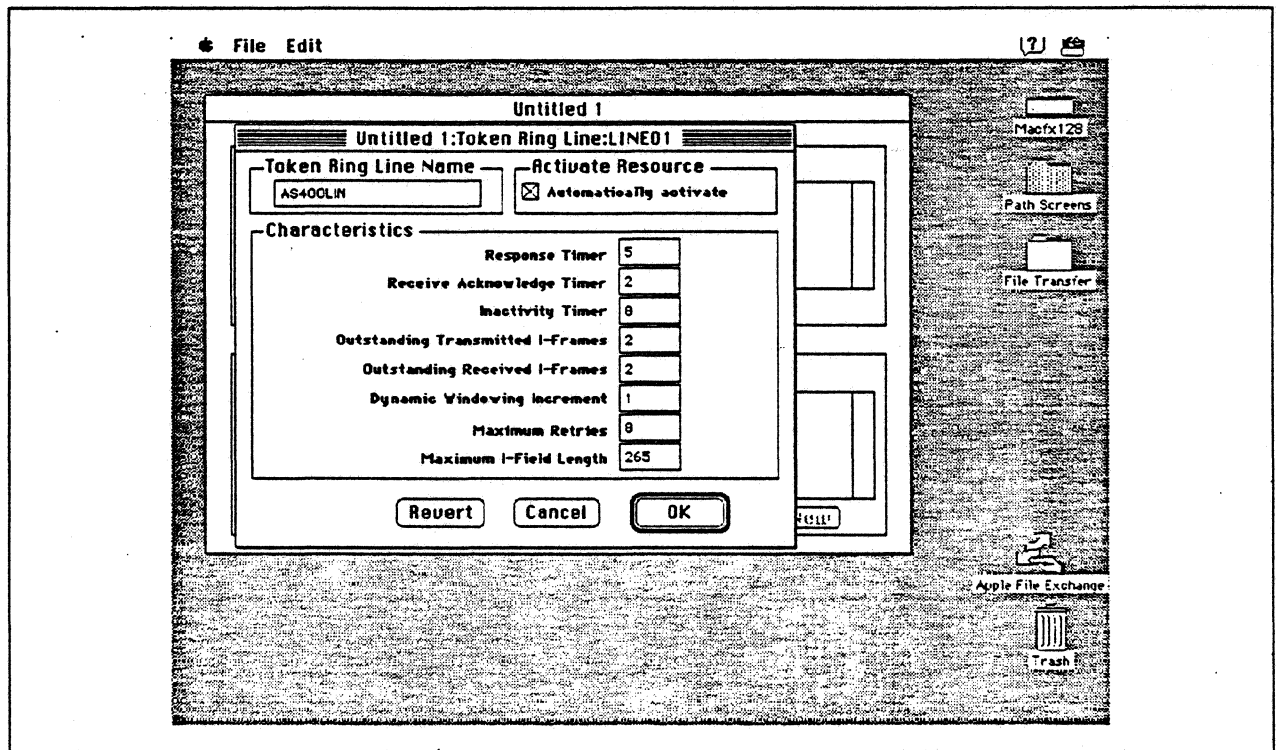

Figure 93. Token Ring Line Configuration Parameters



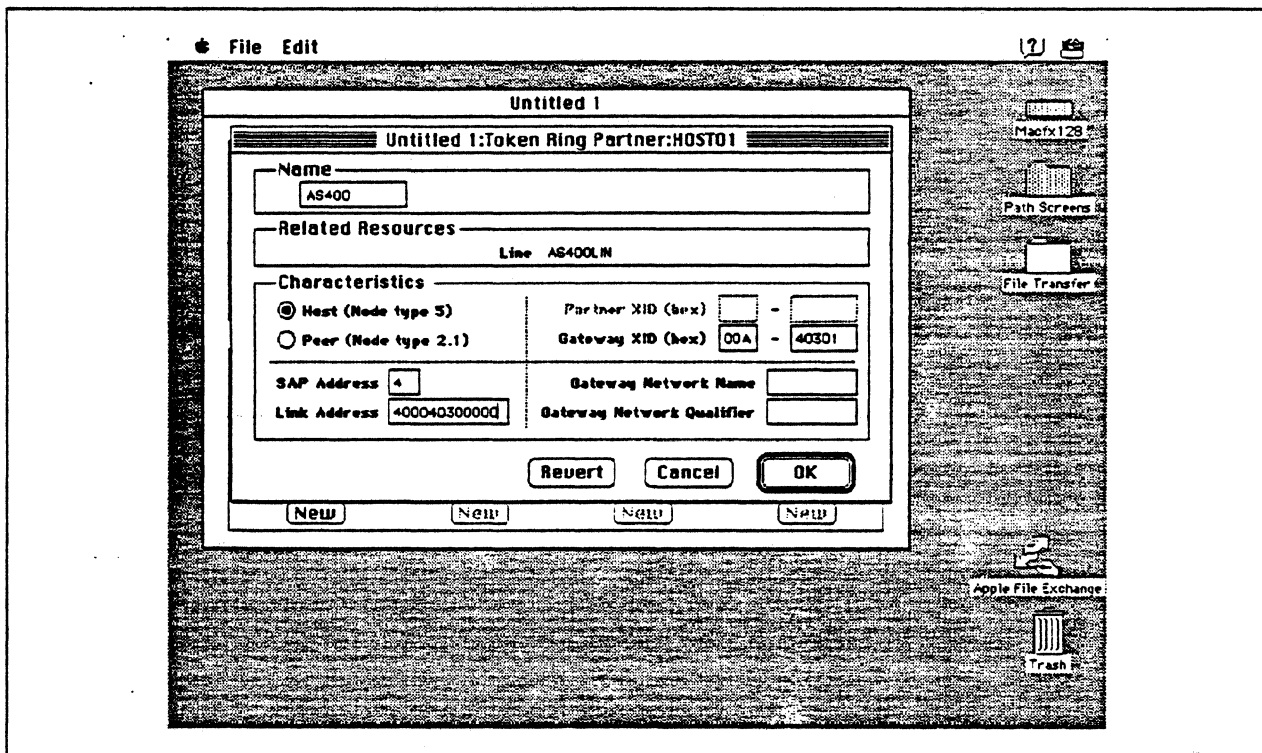

Figure 94. Token Ring Partner Configuration Parameters

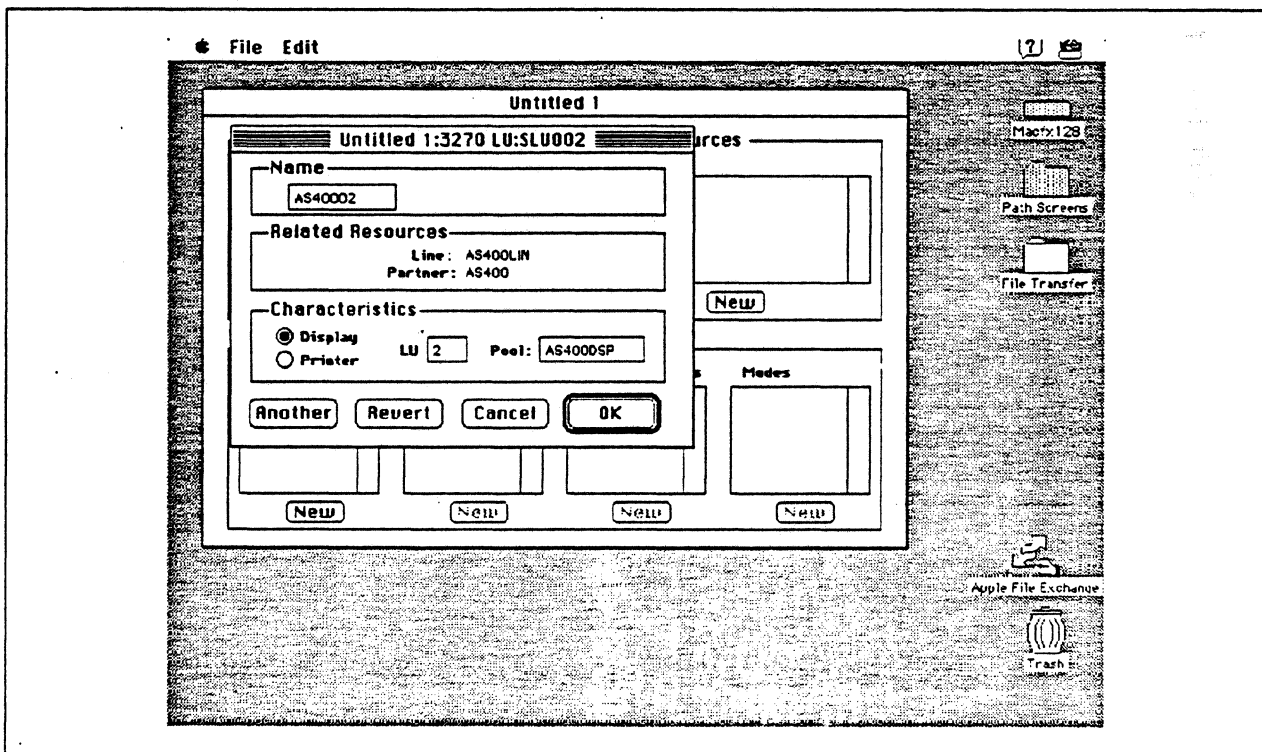

Figure 95. Configuring a 3270 LU

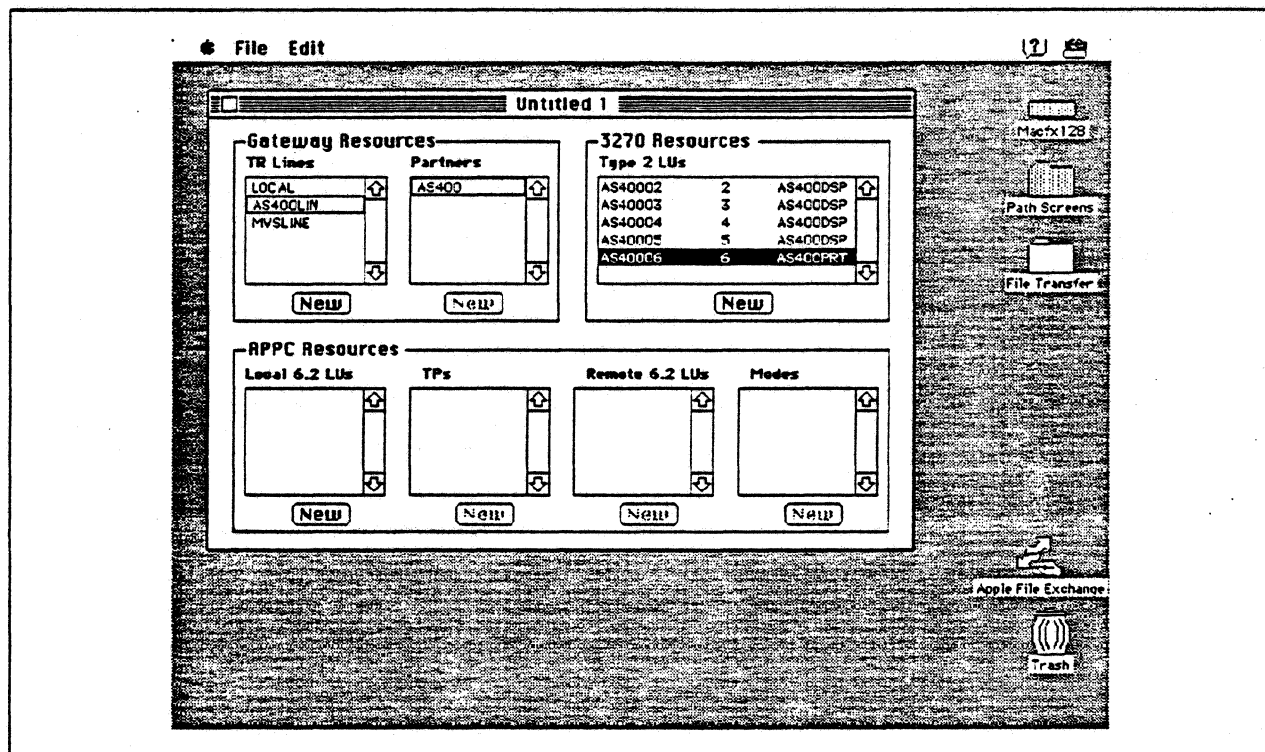

Figure 96. SNA\*ps Config Window After Creating LUs for Partner AS/400

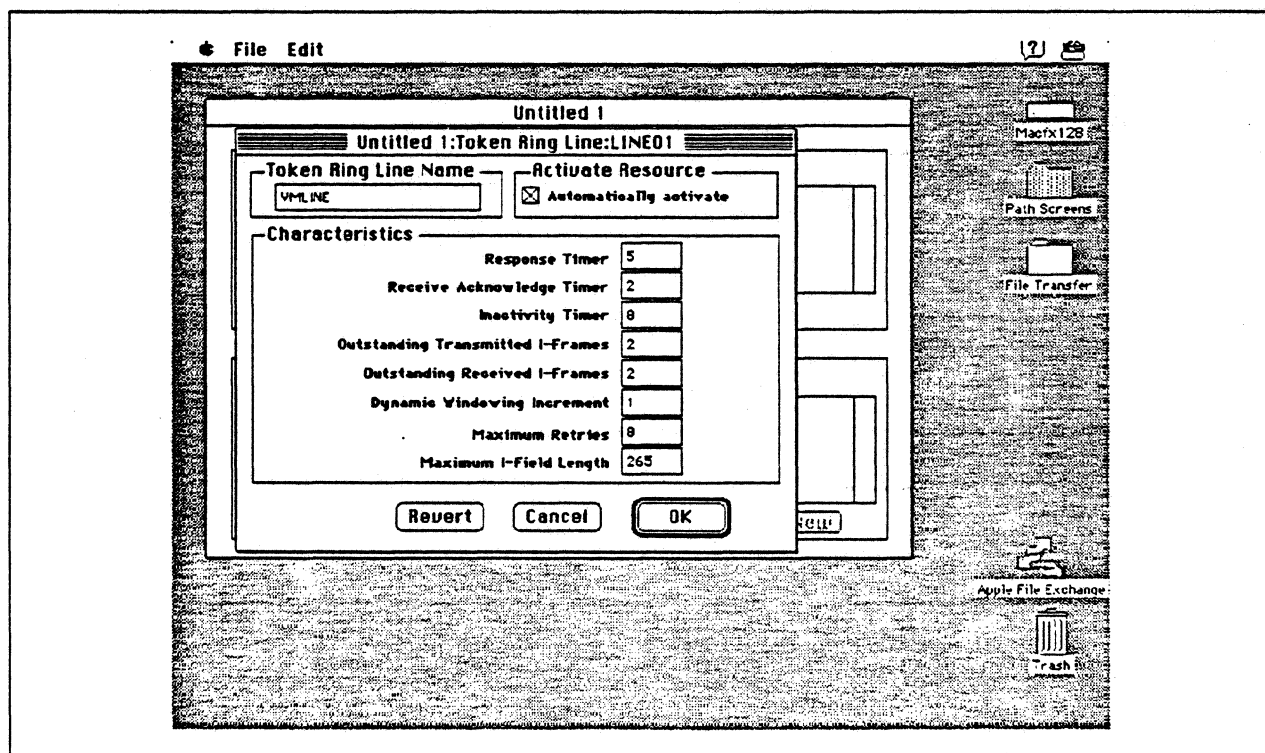

Figure 97. Token Ring Line Configuration Parameters

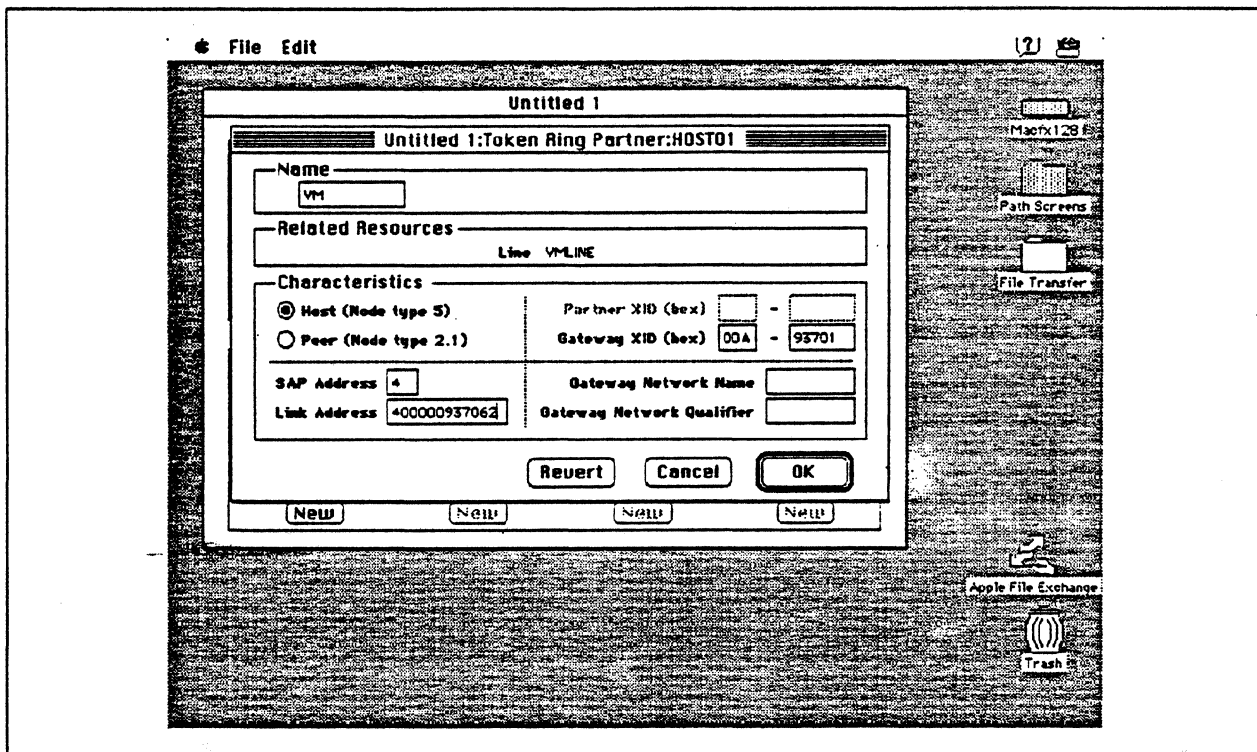

Figure 98. Token Ring Partner Configuration Parameters

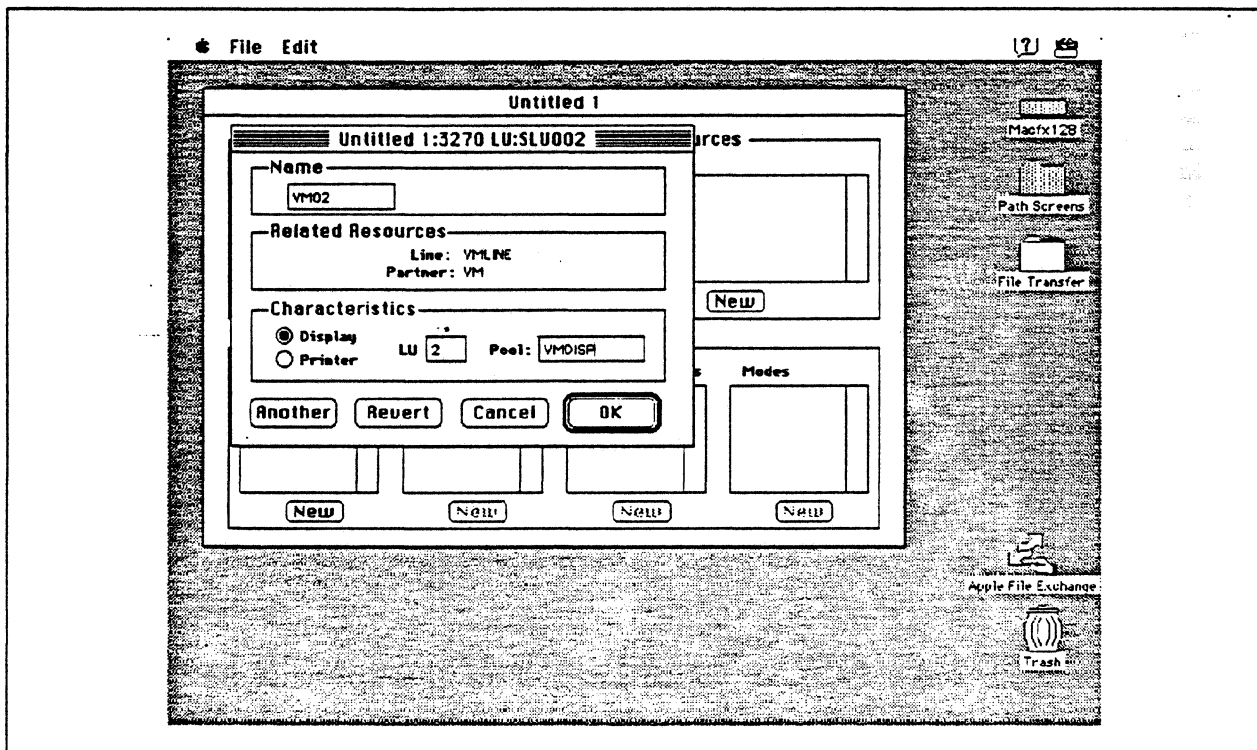

Figure 99. Configuring a 3270 LU

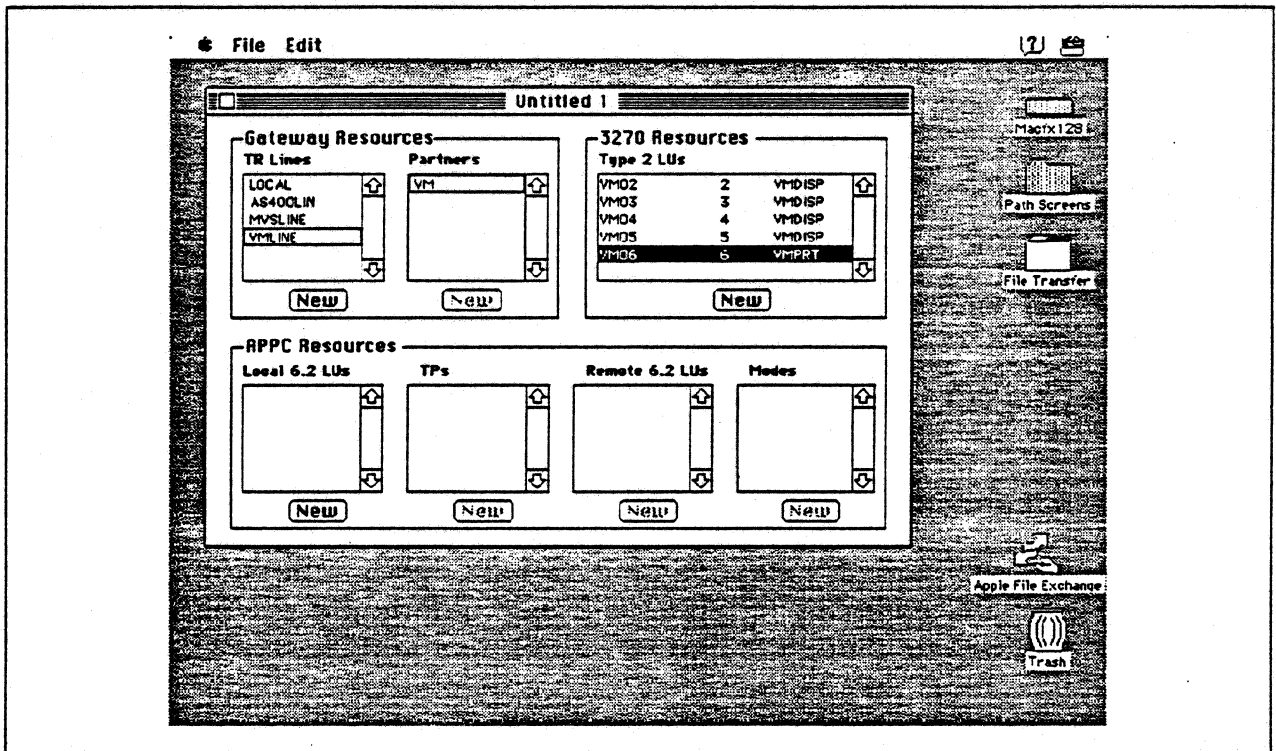

Figure 100. SNA\*ps Config Window After Creating LUs for VM Host

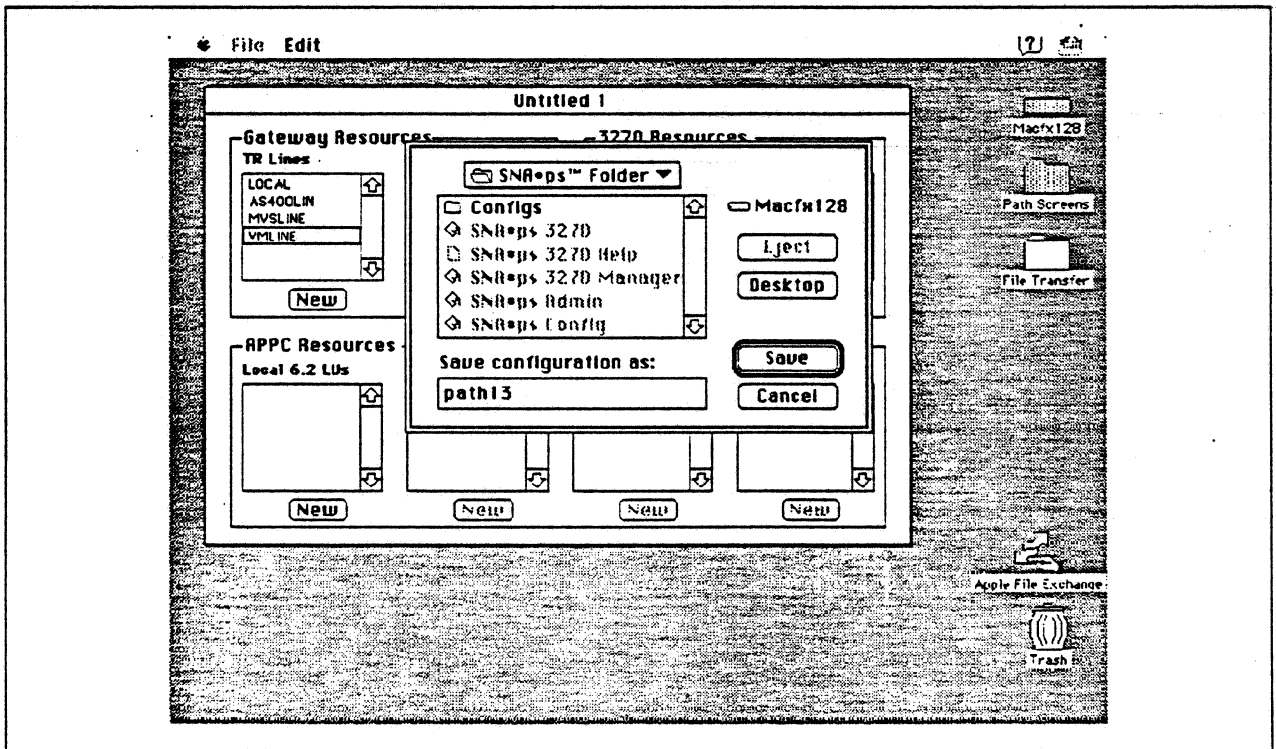

Figure 101. Saving the Configuration File as Path 13

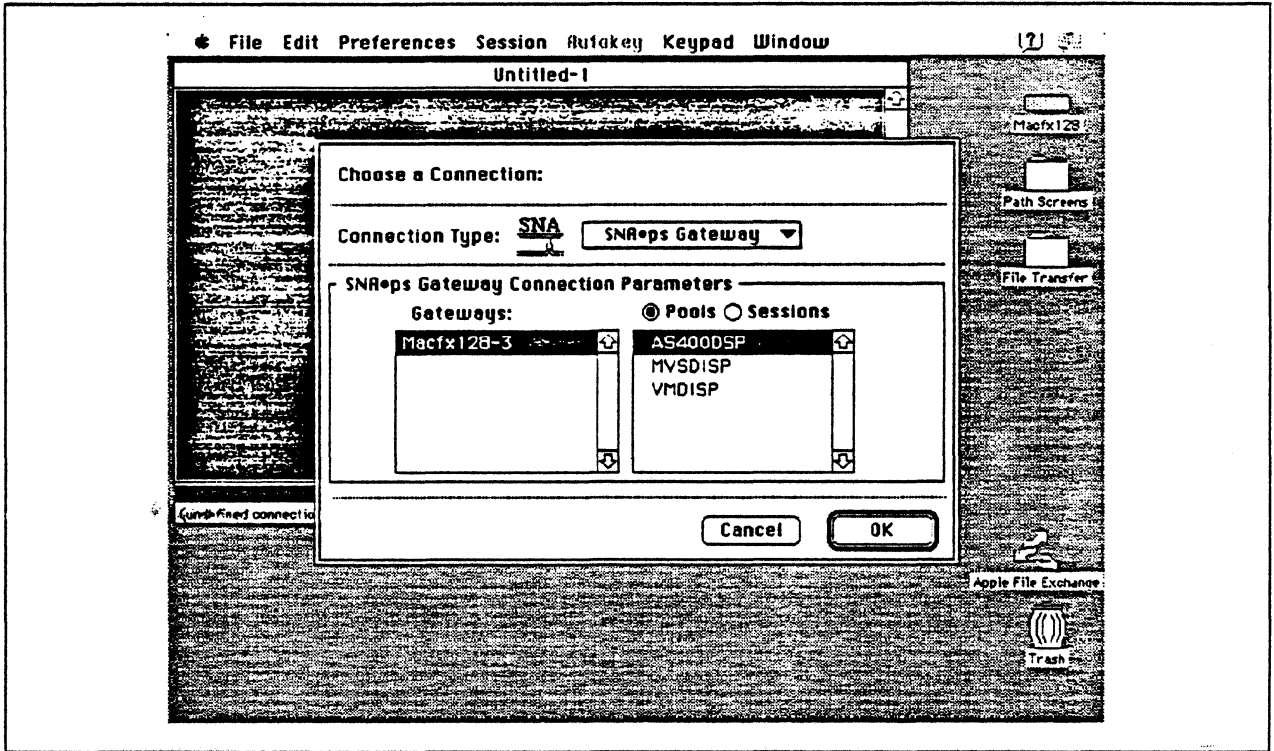

Figure 102. Choosing the AS/400 Connection

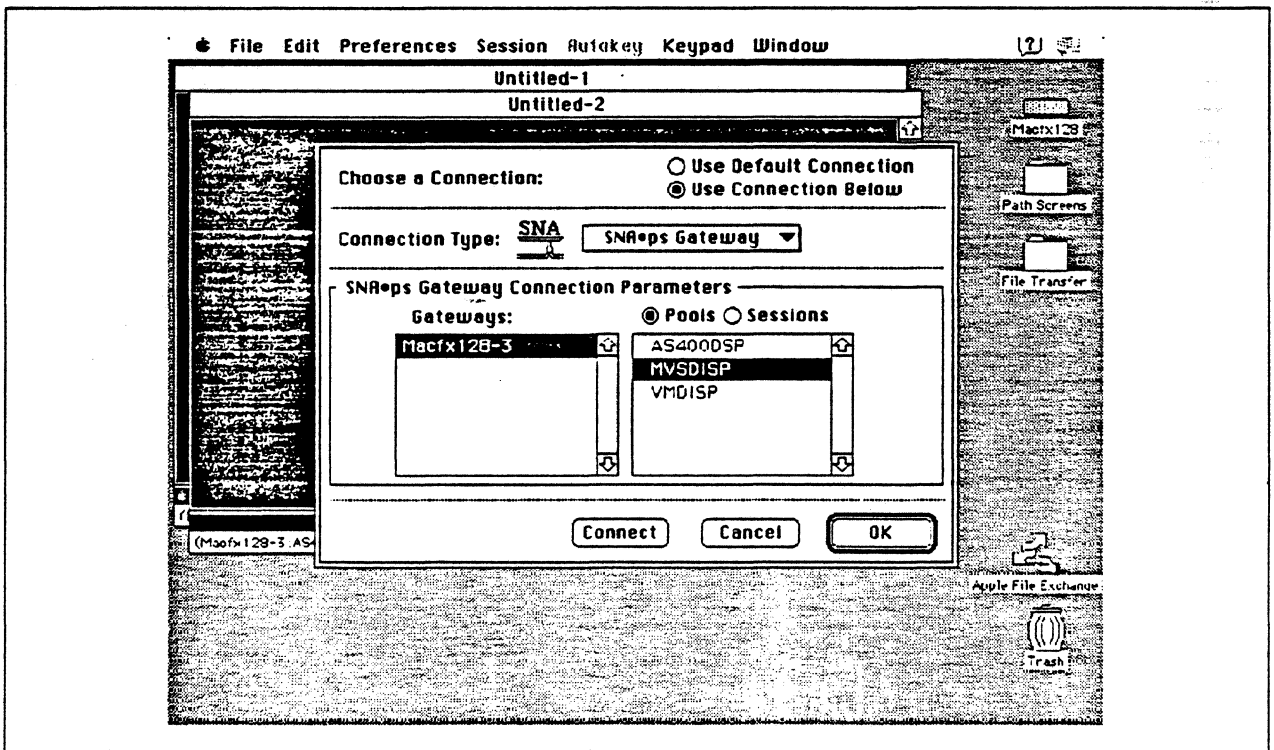

Figure 103. Choosing the MVS Connection

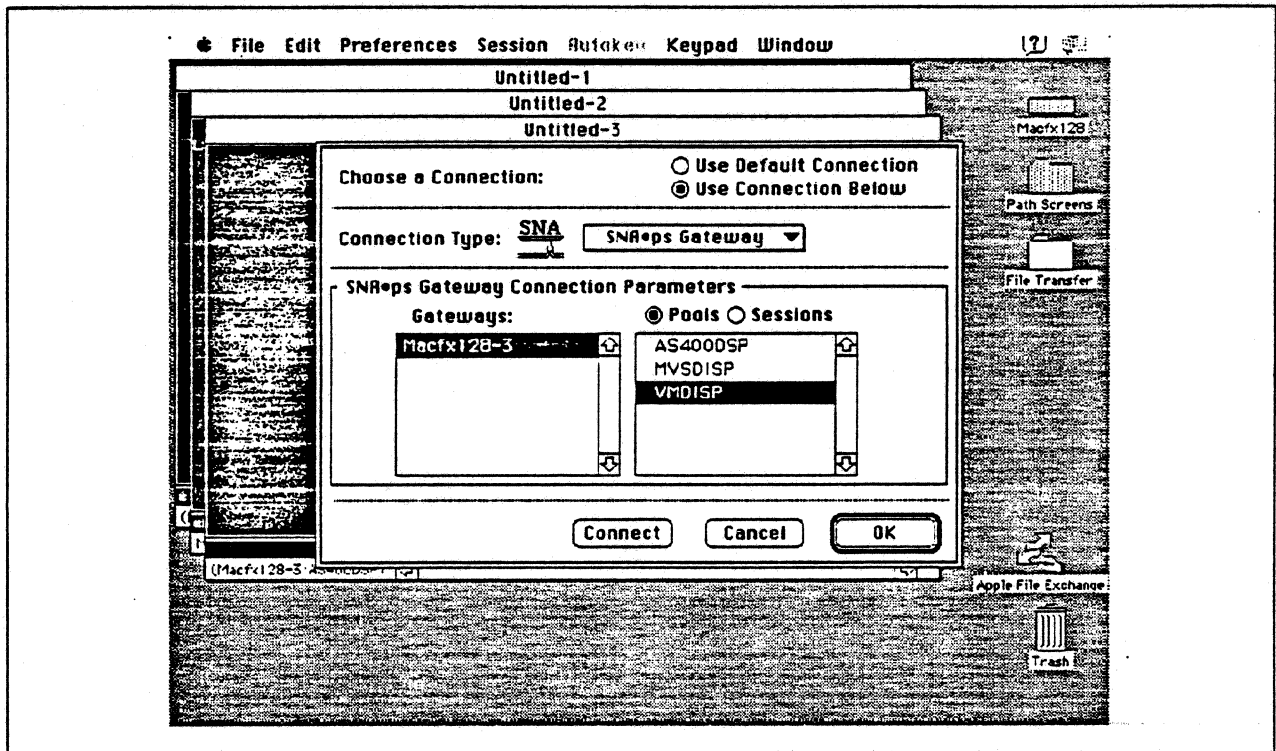

Figure 104. Choosing the VM Connection

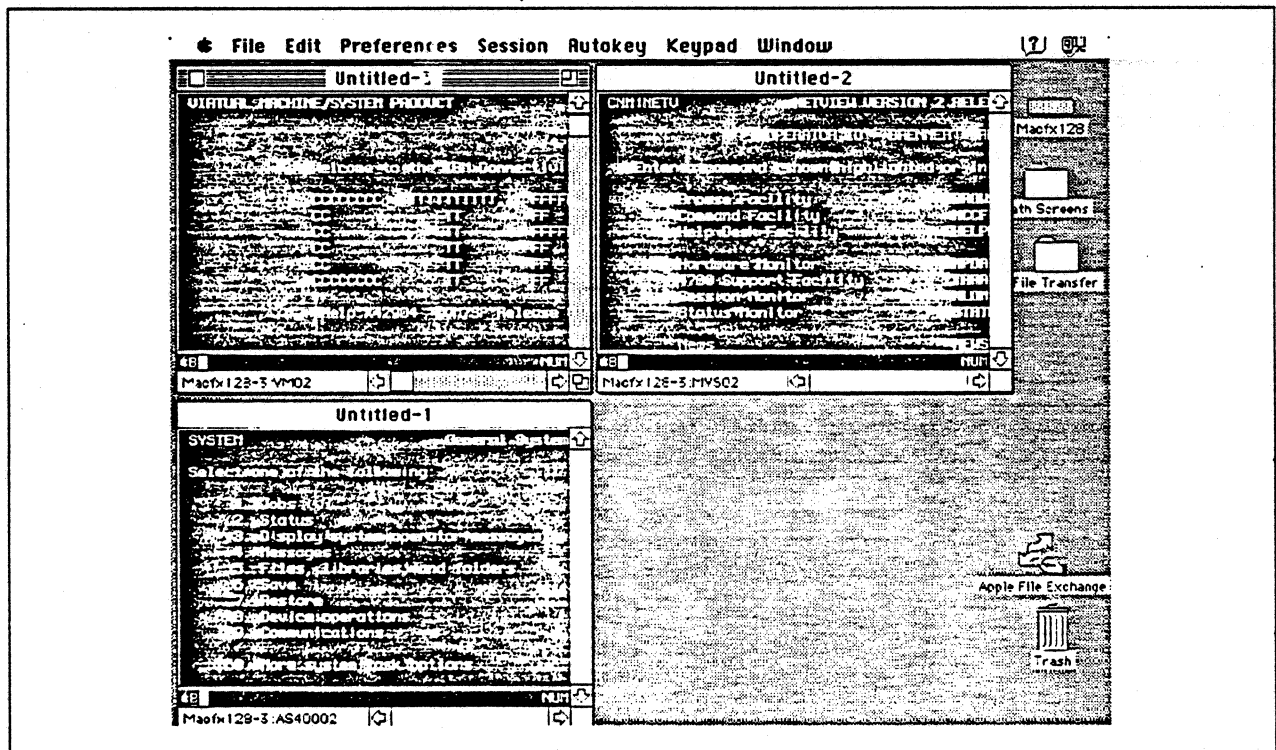

Figure 105. Sessions to Three IBM Partners



## Observations and Hints

If you also want to use the Macintosh IIx gateway machine as a client, install both SNA•ps 3270 V1.1 (beta) and SNA•ps 3270 Gateway Client V1.1 (beta) on that machine.

If the maximum l-field length differs from the MAXDATA value specified in definitions on the host, session establishment negotiates to the lower value.

An interesting feature of this configuration is the capability of sharing a real printer device among multiple printer LUs defined on each host connection. In this case, a file was printed from the MVS host, the VM host, and the AS/400 to each of their respective LU printers; all three of these actually printed on the same LaserWriter printer.

We only configured four LUs and one printer for each host. However, a maximum of 64 total for all hosts is valid.

There are keyboard mapping considerations for this path. By way of background, the traditional remote controller for an AS/400 environment is a 5250-type controller, examples of which are the IBM 5294 and IBM 5394. These controllers are designed for a twinaxial cabling environment and support a 5250 data stream, which is different than the 3270 data stream supported on IBM's 3270 family of controllers. Also, the 5250 family of controllers only supports the 5250-type twinaxial terminals which utilize the 5250 data stream. Because some customers that already have remote-attach 3270 controllers want to be able to use these existing controllers on their AS/400s, IBM supports 3274 SDLC and 3174 SDLC and Token-Ring attachment of these controllers. With this capability, you can see AS/400-type screens on a 3270-type terminal. However, the 3270 keyboard and the 5250-type keyboards are different. As an example, there is a HELP key on a 5250-type terminal that is not present on 3270-type keyboards. Because of these keyboard differences, a keyboard mapping scheme provides the necessary 5250 keyboard functions through the 3270 keyboard. Refer to the *Application System/400 Communications: Remote Work Station Guide* for a discussion of this keyboard mapping capability. Keep in mind that this manual provides keyboard mapping information for someone using a real 3270 terminal. For our configuration we have a Macintosh computer instead of a 3x74 controller and 3270 terminals. The real Macintosh keyboard is not like either a 3270 keyboard or a 5250 keyboard, so a second level of keyboard mapping needs to be considered. Apple provides a keyboard mapping facility with their 3270 emulation capability that allows you to easily map your Macintosh keyboard to provide the 5250 keyboard functions that you need to interact with the AS/400. Refer to the *SNA•ps 3270 User's Guide* for instructions on how to utilize this keyboard mapping capability.

---

## Path 14: MVS Host Attachment via 3174 SDLC Gateway

### Path Description

This configuration consists of the SNA•ps product running on an Apple Macintosh connected to an IBM MVS host via an IBM 3174 Token Ring-to-SDLC gateway. The Macintosh provides AppleTalk to SNA Gateway function for AppleTalk clients.

The configuration is shown in Figure 106 on page 153. The 3174 attaches to the MVS host with a remote SDLC communications link to an IBM 3745 Communications Controller using an RS-232 line interface card (LIC). The 3174 attaches to the Token Ring with a 16/4 Token-Ring adapter. An Apple Token Ring 4/16 NB Card is used in the Macintosh IIx for SNA Token Ring LAN attachment. The Macintosh IIx is defined as a downstream PU (DSPU) to the 3174, and as one of two controllers defined on a multipoint line in the 3745 NCP gen on the MVS host. The 3174 is the other controller in this definition.

This configuration provides up to 64 LUs through the 3174 gateway to Apple SNA•ps clients for terminal and printer emulation.



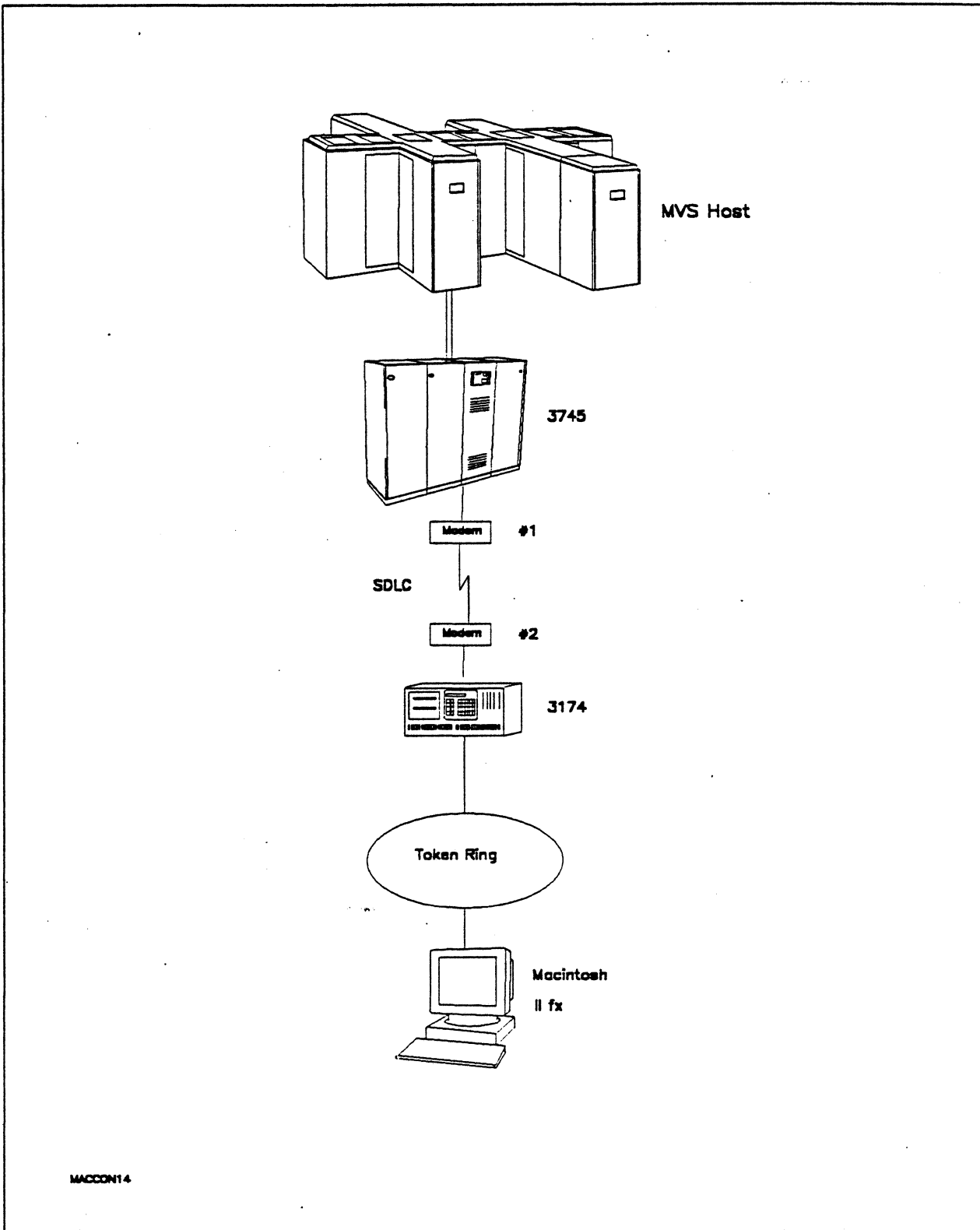

Figure 106. Path 14 Configuration - MVS Host Attachment via 3174 SDLC Gateway

## Path 14

### Hardware and Software

The following section describes the hardware and software that was used for this path.

#### MVS Host

- 4381 system
- MVS/SP JES2 Version 2 Release 2.0 (MVS/XA)
- VTAM Version 3 Release 3
- OEMI channel
- JES/328X Print Facility

#### 3745

- Line interface card (LIC) type 1 #9911
- Channel adapter feature #1561
- NCP Version 5 Release 3

#### Modems #1 and #2

- 19.2 Kbps
- SDLC
- RS-232
- NRZI
- Leased

#### Token Ring

- 16 Mbps

#### 3174

- Model 61R
- Configuration support B4

#### Macintosh IIfx

- System Software 7.0
- SNA•ps 3270 Gateway Client V1.1 (beta)
- Apple Token Ring 4/16 NB Card with MCP memory expansion kit (1MB total)
- LaserWriter IINTX printer
- Total memory - 4M
- Hard disk - 80M

## Configuration Details and Operating Procedure

**MVS Host (VTAM Definitions):** VTAM uses PU definitions from the following section of the NCP gen.

```
GR30APP GROUP CLOCKNG=EXT,DIAL=NO,          +
          LNCTL=SDLC,MAXDATA=521,          +
          MAXOUT=7,PASSLIM=3,PAUSE=0.2,    +
          PUTYPE=2,REPLYTO=2,SERVLIM=2,    +
          TYPE=NCP
```

```
*
T03009L LINE ADDRESS=(009),ANS=CONT,DUPLEX=FULL,NRZI=YES
*
```

```
SERVICE ORDER=(T03009P1,T03009P2)
```

```
* 3174 PU DEFINITION
```

```
*
T03009P1 PU  ADDR=C1,                      C
             PACING=0,                      C
             VPACING=0,                     C
             IRETRY=YES,                    C
             MAXDATA=521,                   C
             SSCPFM=USSSCS,                 C
             DISCNT=NO,                     C
             PUTYPE=2,                       C
             MAXOUT=7,                       C
             MODETAB=ISTINCLM,               C
             DLOGMOD=SNX32702,               C
             USSTAB=TPOUSS
```

```
T0300912 LU  LOCADDR=2,DLOGMOD=SNX32702    * 3278 MODEL 2 *
T0300913 LU  LOCADDR=3,DLOGMOD=SNX32702    * 3278 MODEL 2 *
T0300914 LU  LOCADDR=4,DLOGMOD=SNX32702    * 3278 MODEL 2 *
T0300915 LU  LOCADDR=5,DLOGMOD=SNX32702    * 3278 MODEL 2 *
T0300916 LU  LOCADDR=6,DLOGMOD=SCS         * 3287 SCS PRINTER *
```

```
* APPLE PU DEFINITION
```

```
*
T03009P2 PU  ADDR=C2,                      C
             PACING=0,                      C
             VPACING=0,                     C
             IRETRY=YES,                    C
             MAXDATA=521,                   C
             SSCPFM=USSSCS,                 C
             DISCNT=NO,                     C
             PUTYPE=2,                       C
             MAXOUT=7,                       C
             MODETAB=ISTINCLM,               C
             DLOGMOD=SNX32702,               C
             USSTAB=TPOUSS
```

```
T0300922 LU  LOCADDR=2,DLOGMOD=SNX32702    * 3278 MODEL 2 *
T0300923 LU  LOCADDR=3,DLOGMOD=SNX32703    * 3278 MODEL 3 *
T0300924 LU  LOCADDR=4,DLOGMOD=SNX32704    * 3278 MODEL 4 *
T0300925 LU  LOCADDR=5,DLOGMOD=SNX32705    * 3278 MODEL 5 *
T0300926 LU  LOCADDR=6,DLOGMOD=SCS         * 3287 SCS PRINTER *
```

Path 14

3174: The configuration data follows.

\_\_\_\_\_ Model / Attach \_\_\_\_\_

098 -  
 099 - CTF LAB SDLC GATEWAY MAC TO HOST VIA TOKENRING  
 100 - 61R  
 101 - 2

\_\_\_\_\_ SDLC \_\_\_\_\_

SDLC

104 - C1	105 - C2	108 - 2306424	110 - 2 0000	116 - 2_ _
121 - 01	123 - 0	125 - 00000100	126 - 00000000	127 - 0 0
132 - 0 0 0 0	136 - 1 1 1 1	137 - 0 0 0 0	138 - 0	
141 - A	150 - 1	165 - 1	166 - A	168 - 0
173 - 10100000	175 - 000000	179 - 0 0 0		
213 - 1	215 - 06424	220 - 3		
310 - 0	313 - 1	317 - 0	318 - 0	340 - 0
365 - 0	370 - 1			

\_\_\_\_\_ Token-Ring Gateway \_\_\_\_\_

C1/SDLC

900 - 4000 3174 6105 04    905 - 1                    908 - IBMLAN  
 911 - 1                                    912 - 00

\_\_\_\_\_ 940: Ring Address Assignment \_\_\_\_\_

C1/SDLC

		Entry 001 of 001			
S	Ring Address	SAP	T	S	Ring Address
C1	4000 3174 6105	04			
C2	1000 E001 7D1D	04	0		

\_\_\_\_\_ Common SNA \_\_\_\_\_

C1/SDLC

500 - 0                    501 - \_\_\_\_\_                    502 - \_\_\_\_\_

## Macintosh

1. Start the SNA•ps Config program by double clicking the application icon. The SNA•ps Config resources window appears.
2. In the SNA•ps Config resources window, click the New button below the Lines box. A dialog box appears (refer to Figure 107 on page 158) in which to select the type of card to configure. Because Token Ring is the default for card type and is the desired DLC type connection to the 3174, click OK.
3. The dialog box for a Token Ring line appears (refer to Figure 108 on page 158). For this path, change the Maximum I-Field Length to 521, then click OK.
4. In the Lines box in the SNA•ps Config resources window, select *LINE01*, which is the name of the Token Ring line that was created in step 3, then click the New button under Partners. The Token Ring Partner dialog box appears. In the Link Address field, enter the ring address of the 3174 token ring adapter card. Enter 00A 00000 in the Gateway XID field. The screen treats Gateway XID as a required field, so something must be entered. However, the XID will not be used, because this path does not require XID exchange (refer to Figure 109 on page 159). Click OK.
5. In the Partners box in the SNA•ps Config resources window, select *HOST01*, which is the name of the Partner that was created in step 4, then click the New button under 3270 Resources. A dialog box appears in which to create a 3270 LU (refer to Figure 110 on page 159). For this path, 5 LUs were created. The LU created with the LU ID of 6 was a printer LU to match the MVS/VTAM configuration. All the other LUs were created with a device type of Display. Figure 111 on page 160 shows the SNA•ps Config resources window after the creation of five LUs.
6. Choose Save As from the File menu. Save this file as *path14*.
7. Start the SNA•ps Admin program by double clicking the application icon. The Network Gateway Status window appears. In the Network Gateway Status window, select the Token Ring gateway to configure. Choose Select Configuration from the Gateway menu. Select *path14*, then click on the Select button to assign *path14* to the Token Ring gateway (refer to Figure 112 on page 160).
8. To start the gateway, in the Network Gateway Status window select the Token Ring gateway with *path14* specified as the configuration. Choose Start Gateway from the Gateway menu, then click Start to confirm the gateway start operation. When the gateway has been started, the Status column of the Network Gateway Status window contains "Started."
9. Start the SNA•ps 3270 client program by double clicking the application icon. An untitled session document appears. Choose Connect from the Session menu, then select the gateway that was started in step 8. Click on the Session button to display the specific LUs. Select a session, then click OK to connect the session to the MVS host via the SNA•ps gateway (Figure 106 on page 153 shows the configuration that has been established).

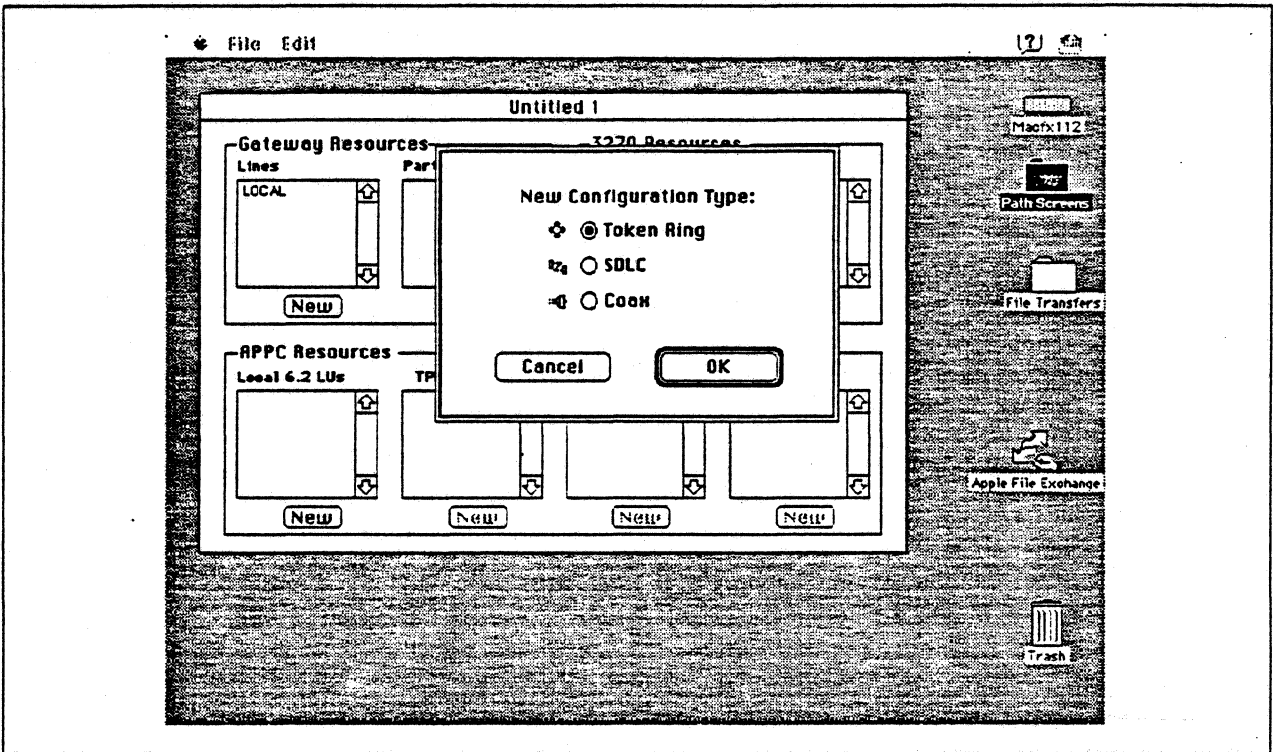

Figure 107. DLC Type Selection for Upstream Connection

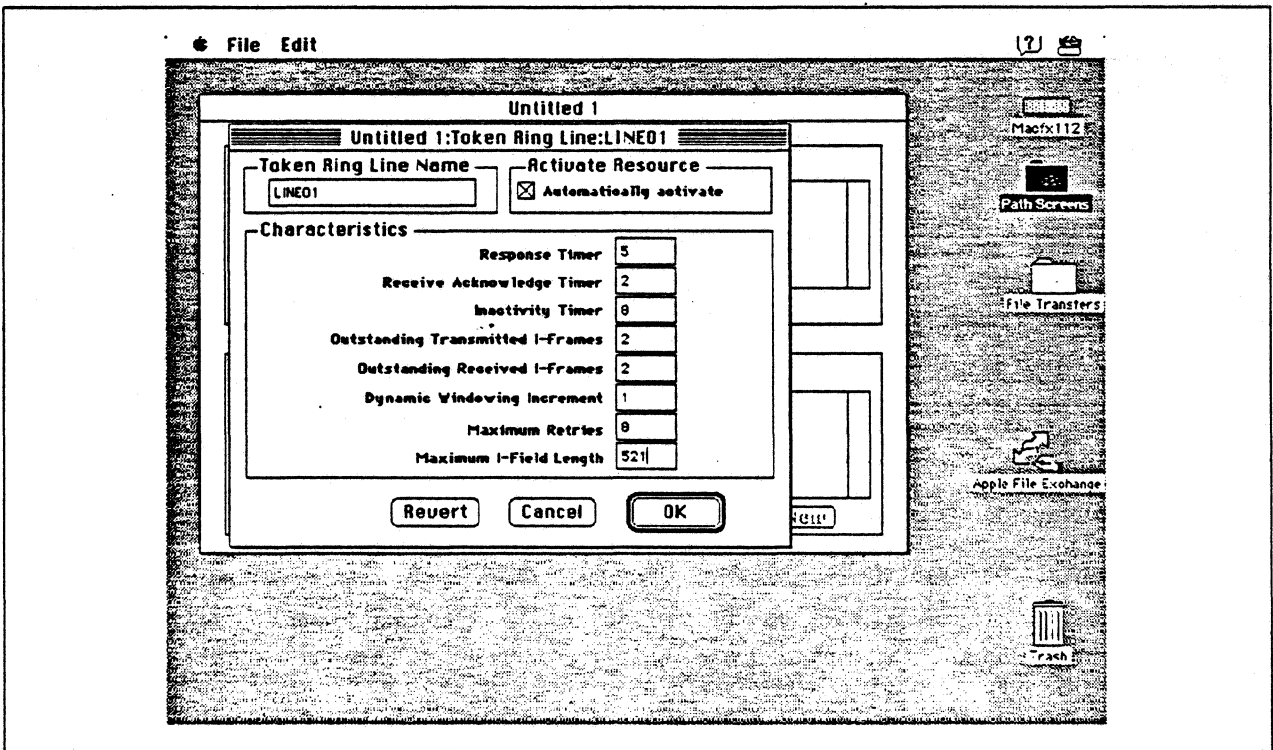

Figure 108. Token Ring Line Configuration Parameters

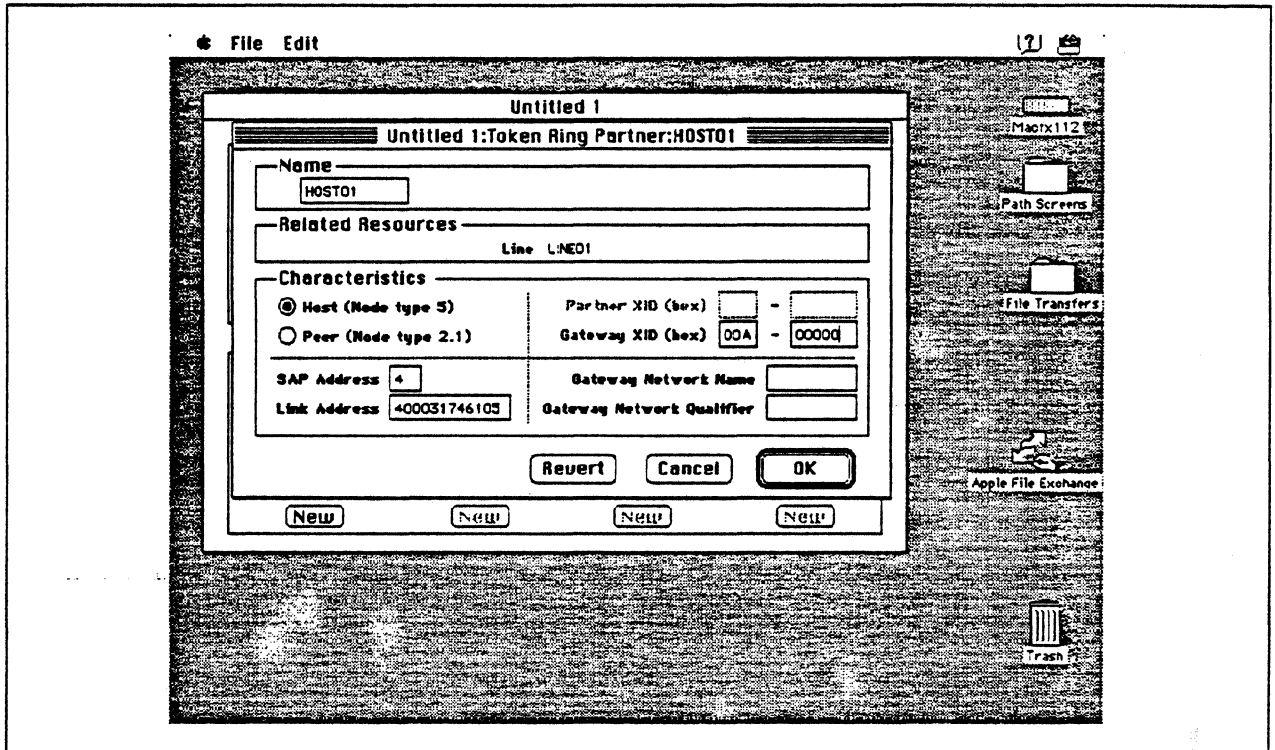

Figure 109. Token Ring Partner Configuration Parameters

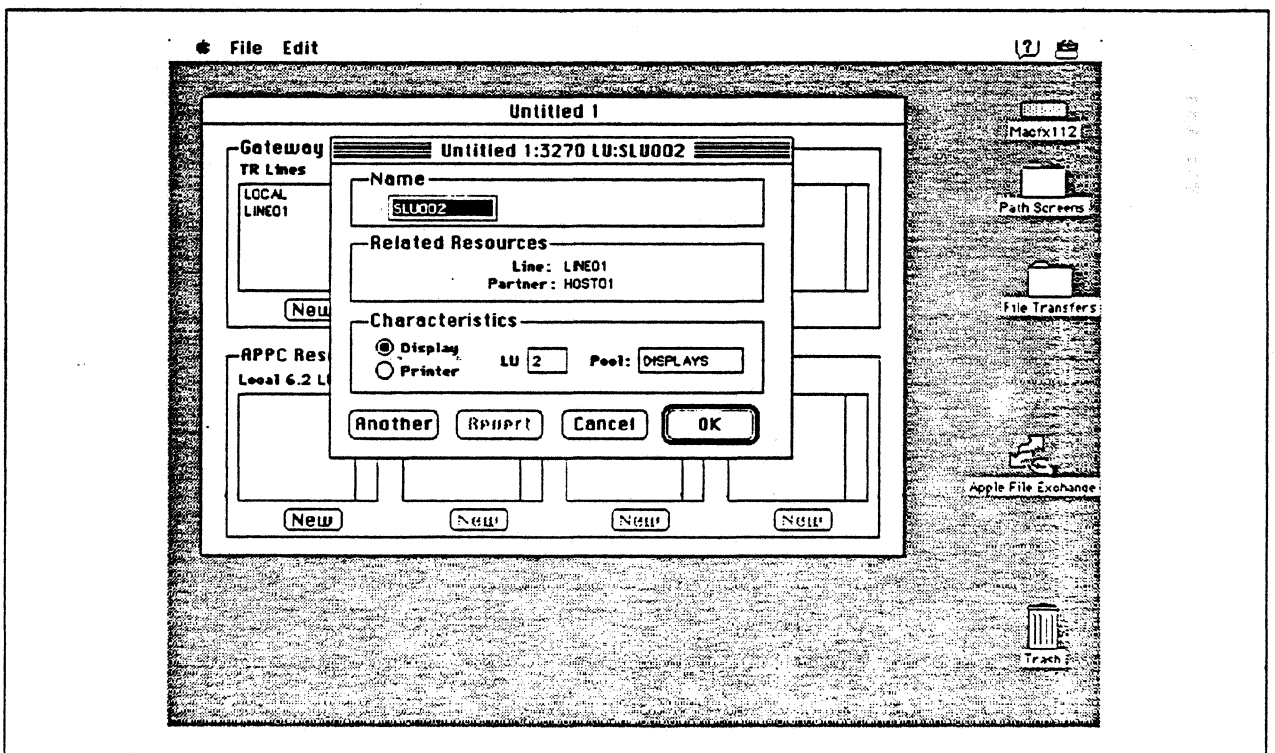

Figure 110. Configuring a 3270 LU

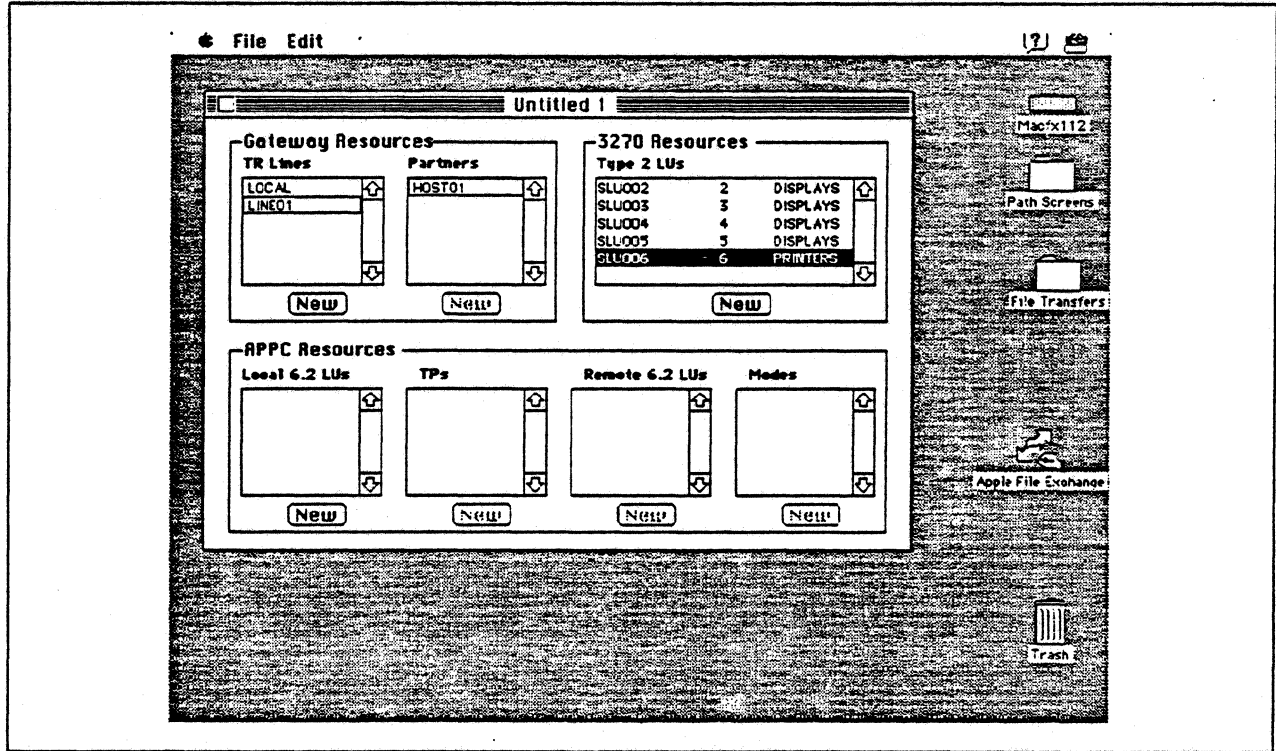

Figure 111. SNA\*ps Config Window After Creating 4 Display LUs and 1 Printer LU

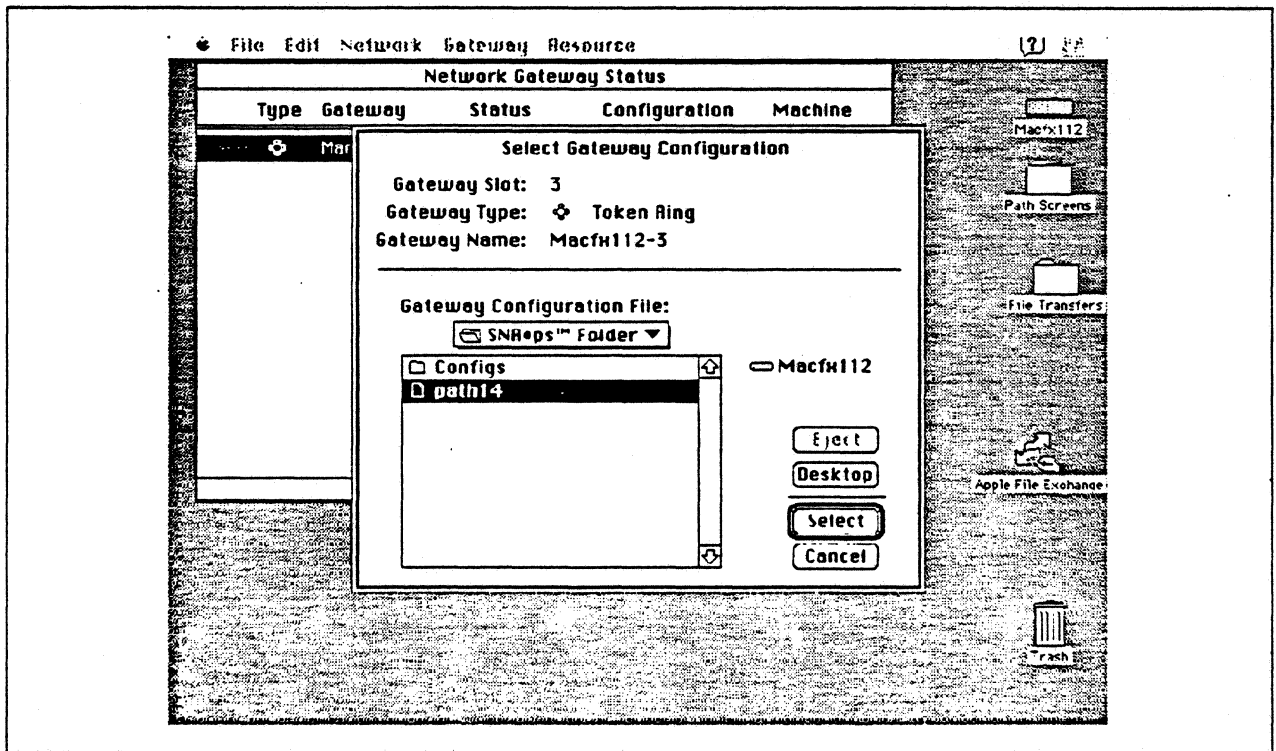

Figure 112. Gateway Configuration Selection



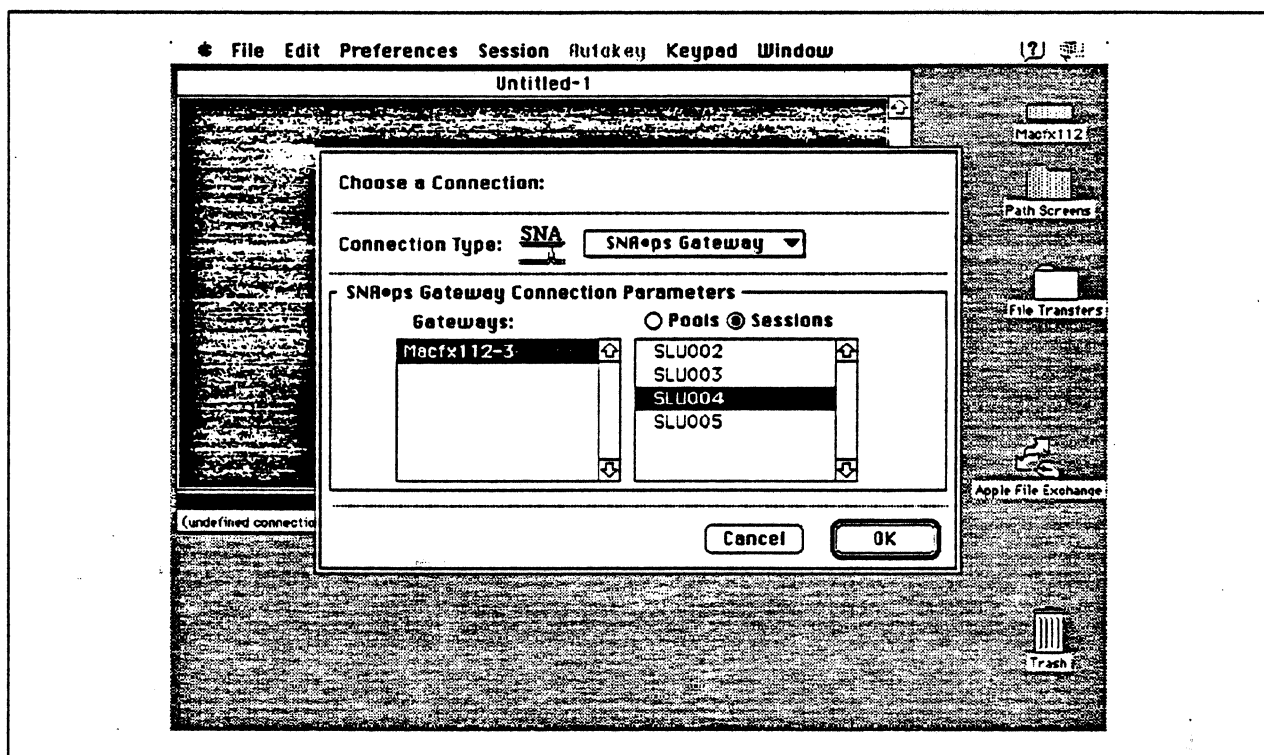

Figure 113. Choosing the Connection

## Observations and Hints

Four display LUs were verified in this configuration. However, a total of 64 display and printer LUs are supported through the SNA\*ps gateway machine.

More than one Macintosh gateway could be downstream of the 3174 in this configuration as well as other PU type 2 systems such as PC/3270 or OS/2 Communications Manager.

---

## Path 15: MVS Host Attachment via 3174 DFT Connection

### Path Description

This configuration consists of the SNA•ps product running on an Apple Macintosh connected to an IBM MVS host via a 3174 with SNA distributed function terminal (DFT) support.

The configuration is shown in Figure 114 on page 163. The 3174 was channel attached to the MVS host. An Apple Coax/Twinax Card was used in the Macintosh for coax attachment to the 3174.

This configuration provides the Macintosh client with 5 LUs for 3270 terminal and printer emulation.

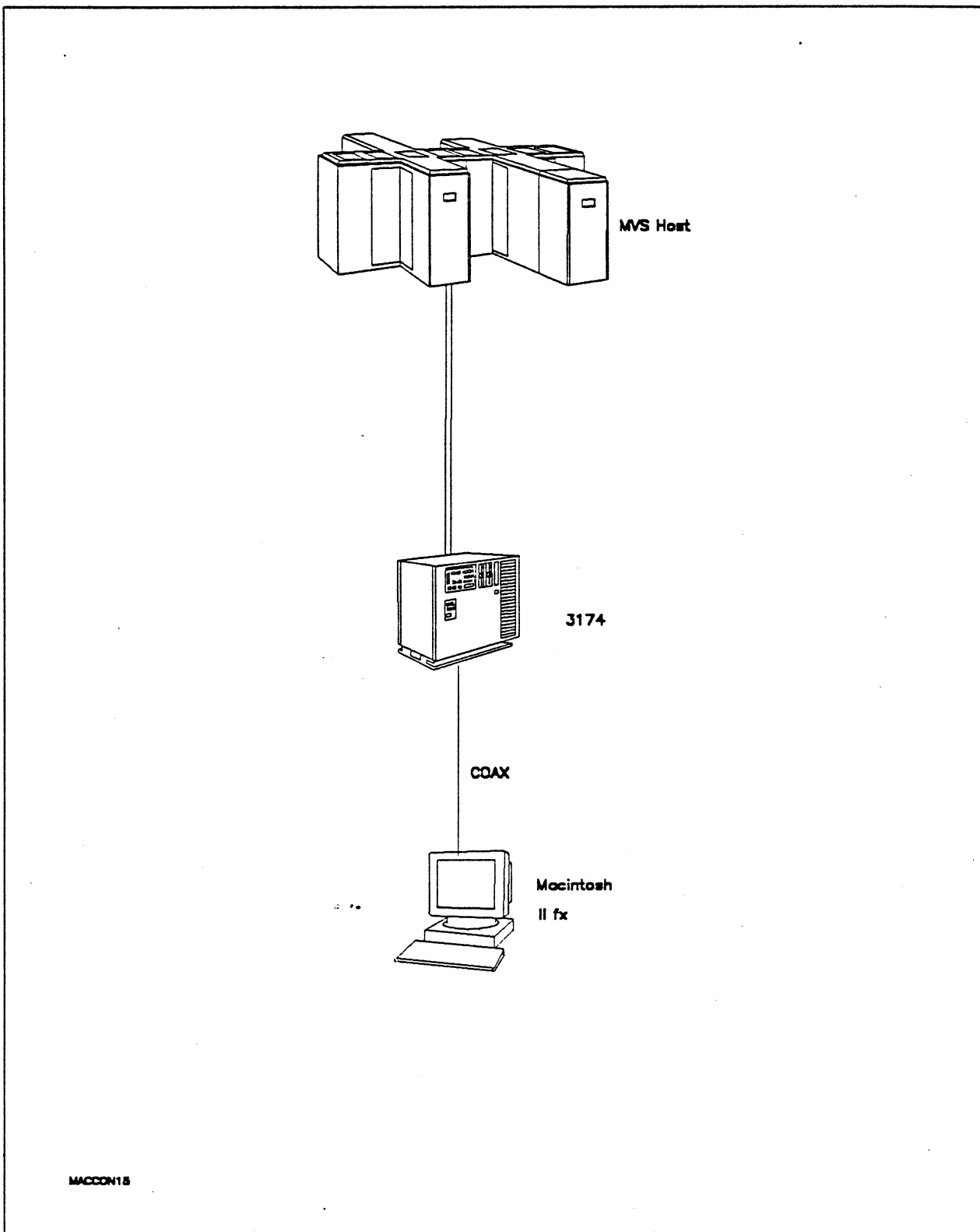

Figure 114. Path 15 Configuration - MVS Host Attachment via 3174 DFT Connection

## Hardware and Software

The following section describes the hardware and software that was used for this path.

### MVS Host

- 4381 system
- MVS/SP JES2 Version 2 Release 2.0 (MVS/XA)
- VTAM Version 3 Release 3
- OEMI channel

### 3174

- Model 01L
- Configuration support B4

### Macintosh IIx

- System Software 7.0
- SNA•ps Gateway/64 V1.1 (beta)
- SNA•ps 3270 Gateway Client V1.1 (beta)
- Apple Coax/Twinax Card
- Total memory - 4M
- Hard disk - 80M

## Configuration Details and Operating Procedure

**MVS Host (VTAM Definitions):** The following VTAM statements define the locally-attached 3174.

```
L3174  VBUILD  TYPE=LOCAL
TOL960  PU      CUADDR=960,           C
          ISTATUS=ACTIVE,           C
          DLOGMOD=SNX32702,         C
          MODETAB=ISTINCLM,         C
          PACING=7,                 C
          PUTYPE=2,                 C
          SSCPFM=USSSCS,            C
          USSTAB=TPOUSS

TOL96002 LU    LOCADDR=02
TOL96003 LU    LOCADDR=03
TOL96004 LU    LOCADDR=04
TOL96005 LU    LOCADDR=05
:
TOL96056 LU    LOCADDR=56
TOL96057 LU    LOCADDR=57
```

3174: The configuration data follows.

\_\_\_\_\_ Model / Attach \_\_\_\_\_  
 098 - \_\_\_\_\_  
 099 - LSSMVS CHANNEL CONNECTED 3174  
 100 - 01L  
 101 - 5

\_\_\_\_\_ Local (SNA) \_\_\_\_\_  
 LOCL  
 104 - 60      105 - 00      108 - 23D2127      110 - 2 0000      116 - 2\_ \_  
 121 - 01      123 - 0      125 - 00000100      126 - 00000000      127 - 0 0  
 132 - 0 0 0 0      136 - 1 1 1 1      137 - 0 0 0 0      138 - 2  
 141 - A      150 - 0      165 - 0      166 - A      168 - 0  
 173 - 00100000      175 - 000000      179 - 0 0 0  
 213 - 1      215 - 00000      220 - 3  
 222 - 1      223 - 10      224 - 2      225 - 4

\_\_\_\_\_ Common SNA \_\_\_\_\_  
 60/LOCL  
 500 - 0      501 - \_\_\_\_\_      502 - \_\_\_\_\_

\_\_\_\_\_ 117: Port Assignment \_\_\_\_\_  
 LT=      116=2      60/LOCL  

Host addresses						Host addresses							
Port	IS	1	2	3	4	5	Port	IS	1	2	3	4	5
26-00	002	013	014	015	_____	_____	26-01	003	016	017	018	_____	_____
26-02	004	019	020	021	_____	_____	26-03	005	022	023	024	_____	_____
26-04	006	025	026	027	_____	_____	26-05	007	028	029	030	_____	_____
26-06	008	031	032	033	_____	_____	26-07	009	034	035	036	_____	_____
26-08	010	037	038	039	_____	_____	26-09	_____	_____	_____	_____	_____	_____
26-10	_____	_____	_____	_____	_____	_____	26-11	_____	_____	_____	_____	_____	_____
26-12	_____	_____	_____	_____	_____	_____	26-13	_____	_____	_____	_____	_____	_____
26-14	_____	_____	_____	_____	_____	_____	26-15	_____	_____	_____	_____	_____	_____
26-16	011	040	041	042	_____	_____	26-17	_____	_____	_____	_____	_____	_____
26-18	_____	_____	_____	_____	_____	_____	26-19	_____	_____	_____	_____	_____	_____
26-20	_____	_____	_____	_____	_____	_____	26-21	_____	_____	_____	_____	_____	_____
26-22	_____	_____	_____	_____	_____	_____	26-23	_____	_____	_____	_____	_____	_____
26-24	012	043	044	045	_____	_____	26-25	_____	_____	_____	_____	_____	_____
26-26	_____	_____	_____	_____	_____	_____	26-27	_____	_____	_____	_____	_____	_____
26-28	_____	_____	_____	_____	_____	_____	26-29	_____	_____	_____	_____	_____	_____
26-30	_____	_____	_____	_____	_____	_____	26-31	_____	_____	_____	_____	_____	_____

\_\_\_\_\_ Device Definition \_\_\_\_\_  
 800 Printer Authorization Matrix (PAM) - 0 0  
 801 Logical Terminal Assignment - 0  
 802 Prompts for Extended VPD - 0

## Macintosh

1. Start the SNA•ps Config program by double clicking the application icon. The SNA•ps Config resources window appears.
2. In the SNA•ps Config resources window, click the New button below the Lines box. A dialog box appears (refer to Figure 115 on page 166) in which the type of card to configure can be selected. Click the radio button next to Coax, then click OK.
3. SNA•ps Config displays a message that tells you creating a Coax configuration will create a Coax line, a Coax partner, and five Coax LUs (refer to Figure 116 on page 167). Click OK.
4. Figure 117 on page 167 shows the Config resources window after the creation of the Coax resources.
5. Choose Save As from the File menu. Save this file as *path15* (refer to Figure 118 on page 168).
6. Start the SNA•ps Admin program by double clicking the application icon. The Network Gateway Status window appears. In the Network Gateway Status window, select the Coax gateway to be configured. Choose Select Configuration from the Gateway menu. Select *path15*, then click on the Select button to assign *path15* to the Coax gateway (refer to Figure 119 on page 168).
7. To start the gateway, in the Network Gateway Status window select the Coax gateway with *path15* specified as the configuration. Choose Start Gateway from the Gateway menu (refer to Figure 120 on page 169), then click Start to confirm to start this gateway. When the gateway has been started, the Status column of the Network Gateway Status window contains "Started."
8. Start the SNA•ps 3270 client program by double clicking the application icon. An untitled session document appears. Choose Connect from the Session menu, then select the gateway that was started in step 7. Click on the Session button to display the specific LUs. Select a session, then click OK to connect the session to the MVS host via the SNA•ps gateway (Figure 114 on page 163 shows the configuration that has been established).

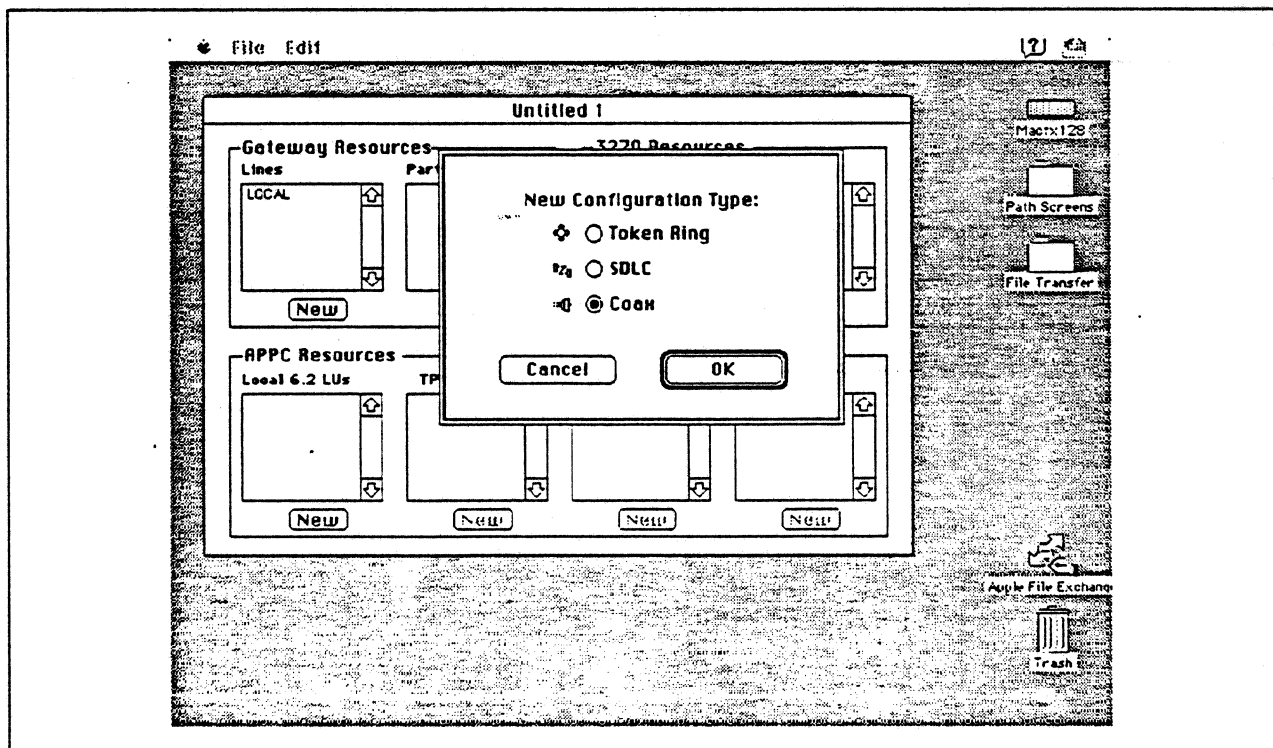

Figure 115. DLC Type Selection for Upstream Connection

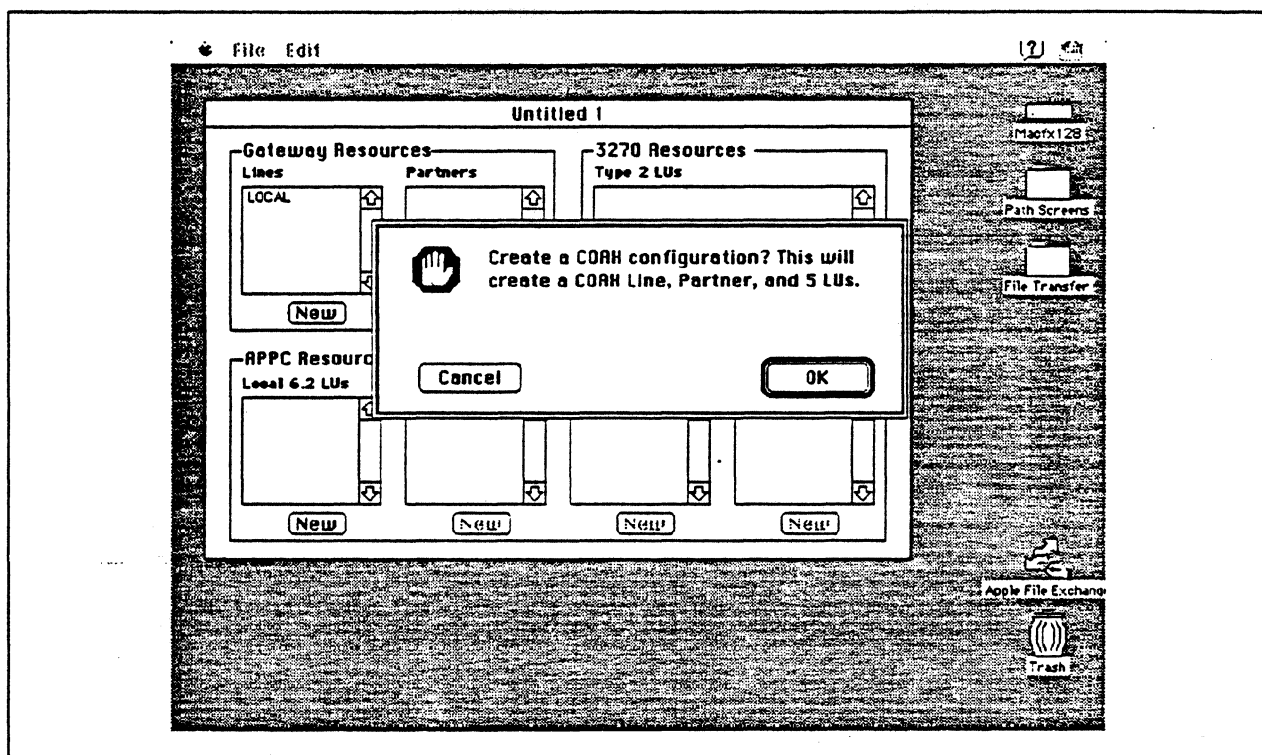

Figure 116. Coax Configuration Screen

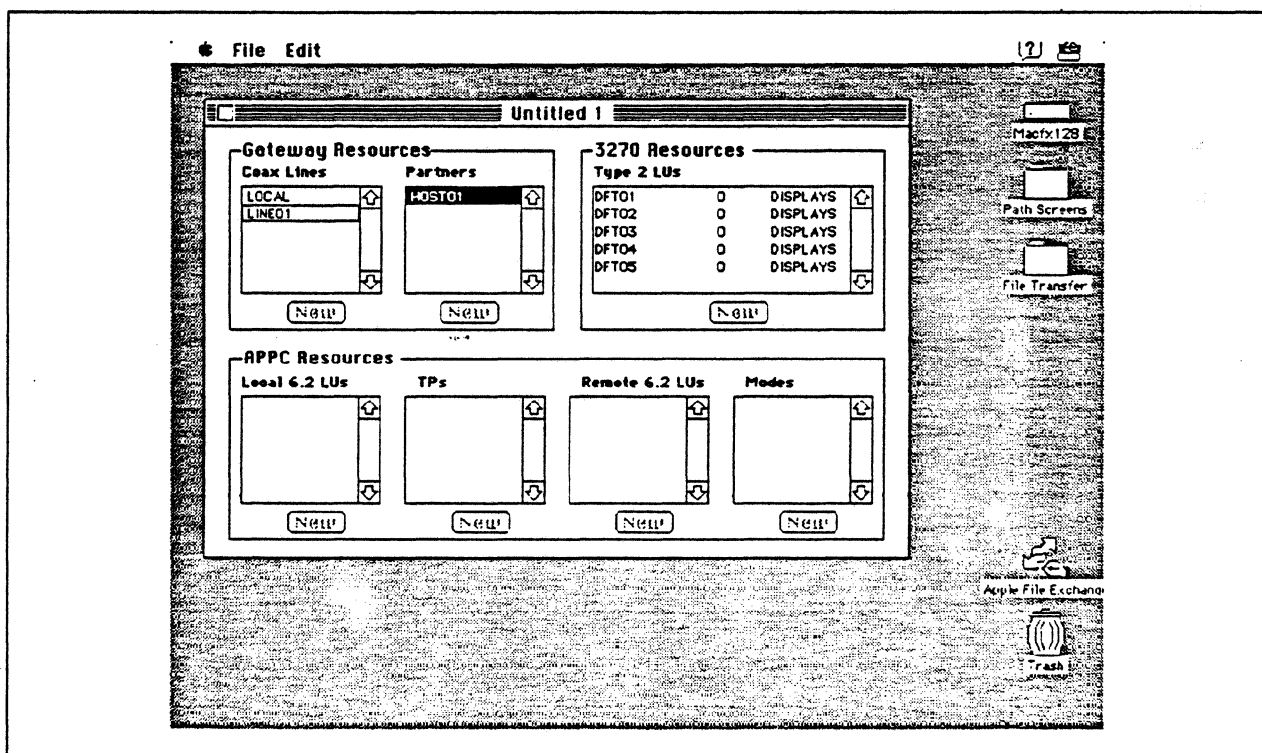

Figure 117. SNA\*ps Config Window After Accepting Coax Configuration Default

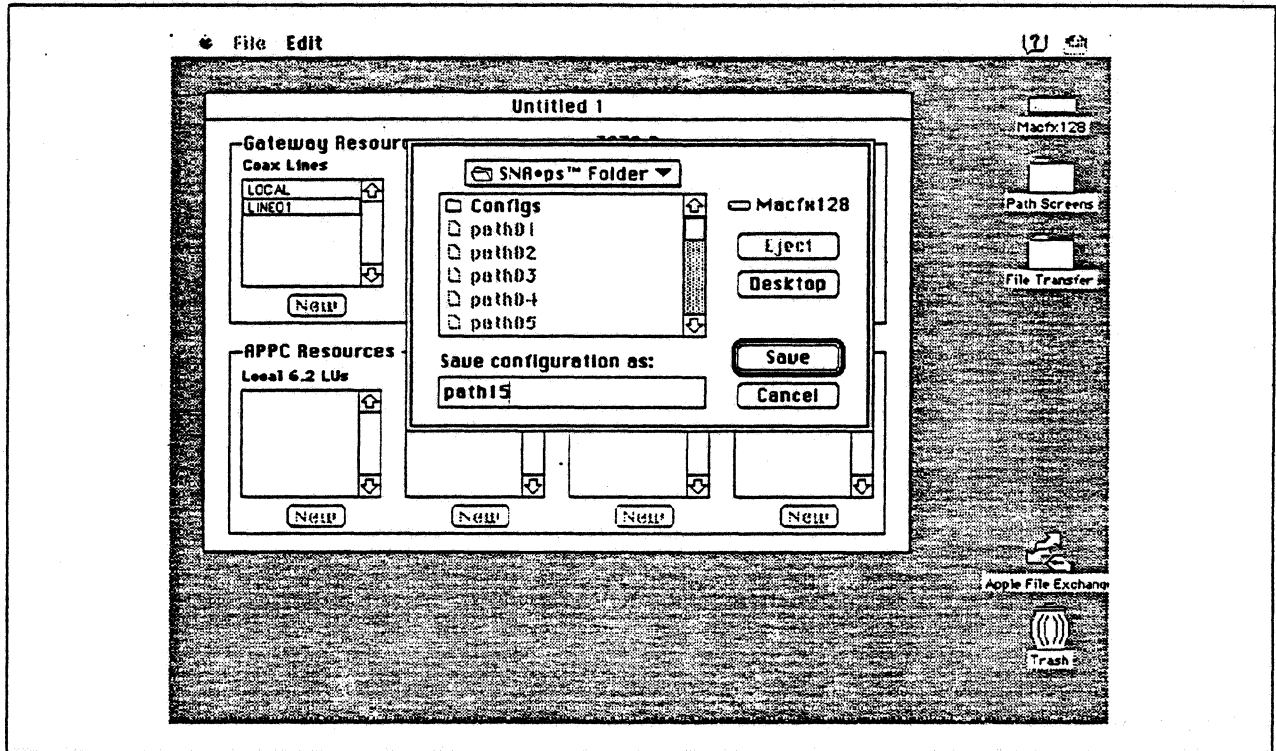

Figure 118. Saving the Configuration File

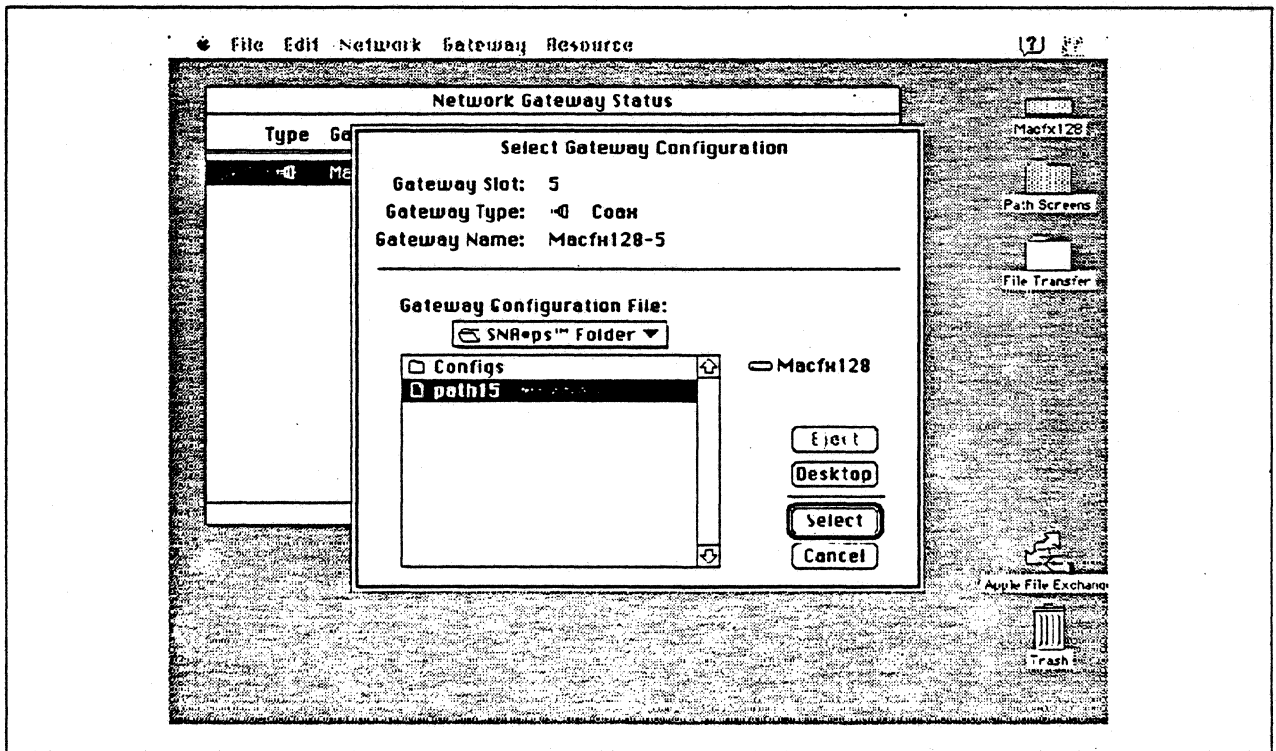

Figure 119. Gateway Configuration Selection



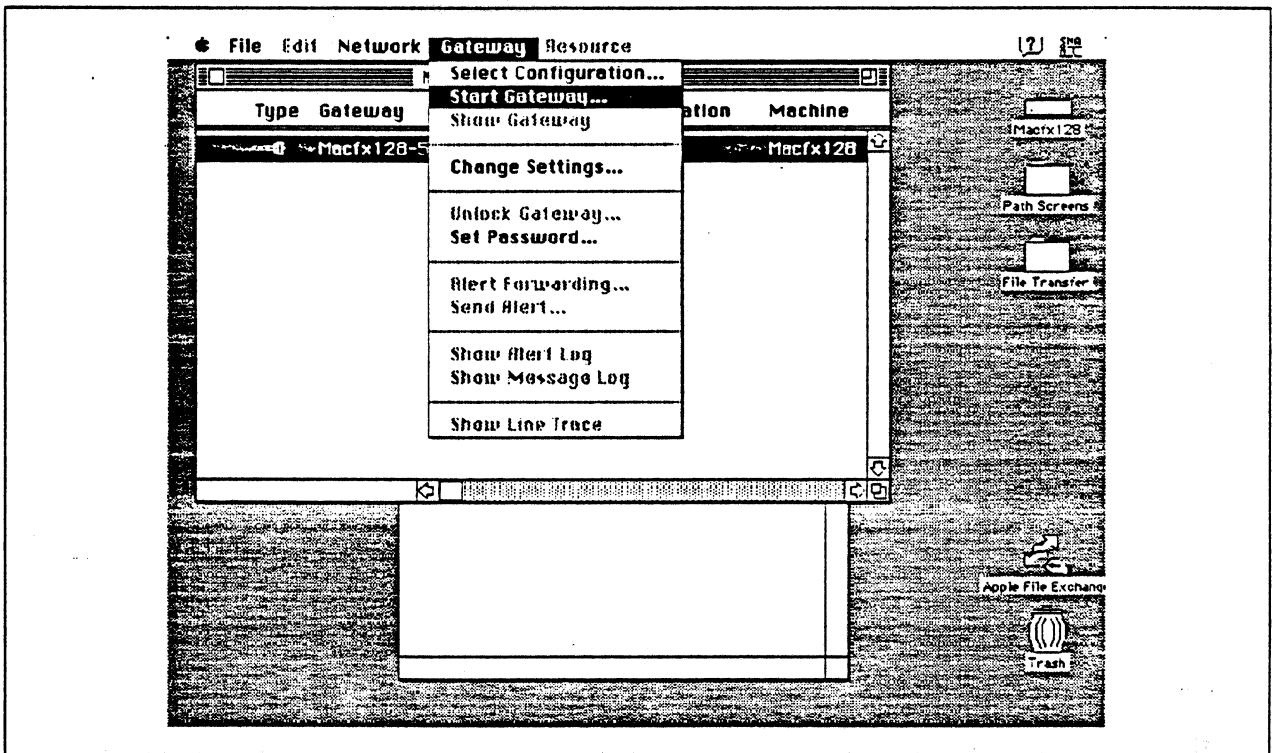

Figure 120. Starting the Gateway

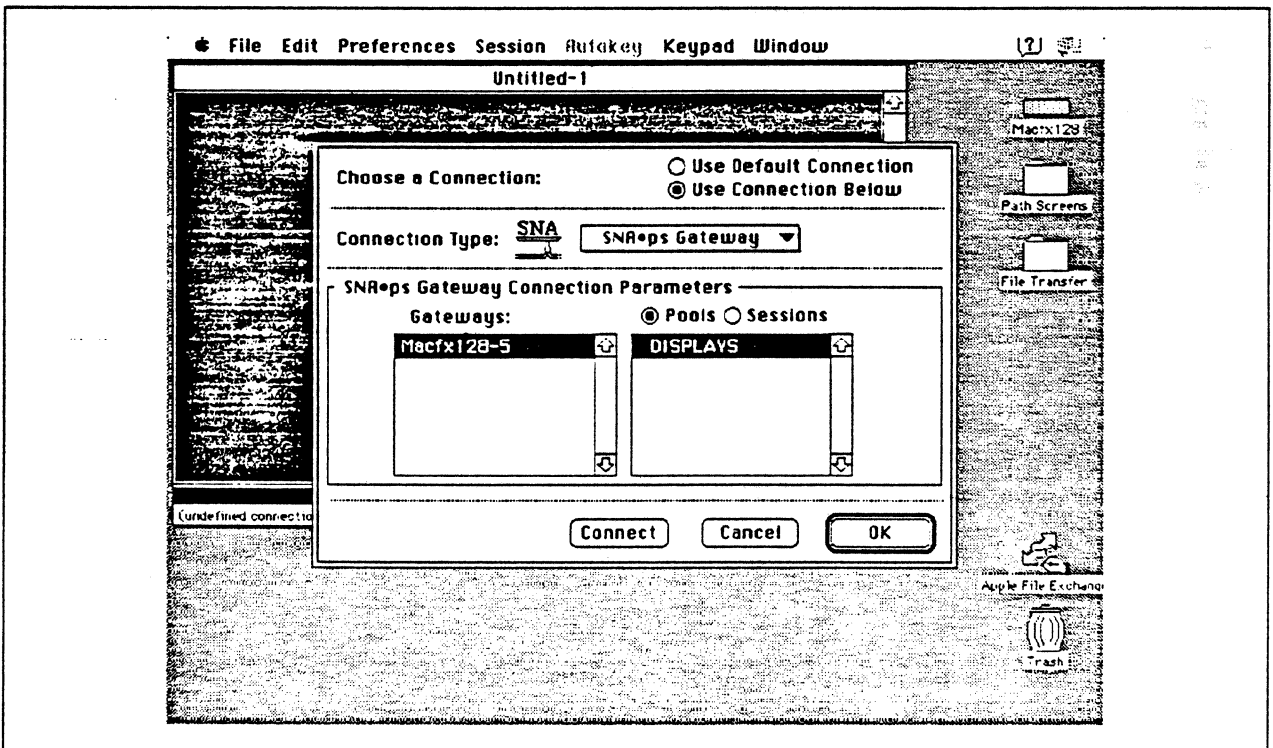

Figure 121. Choosing the Connection

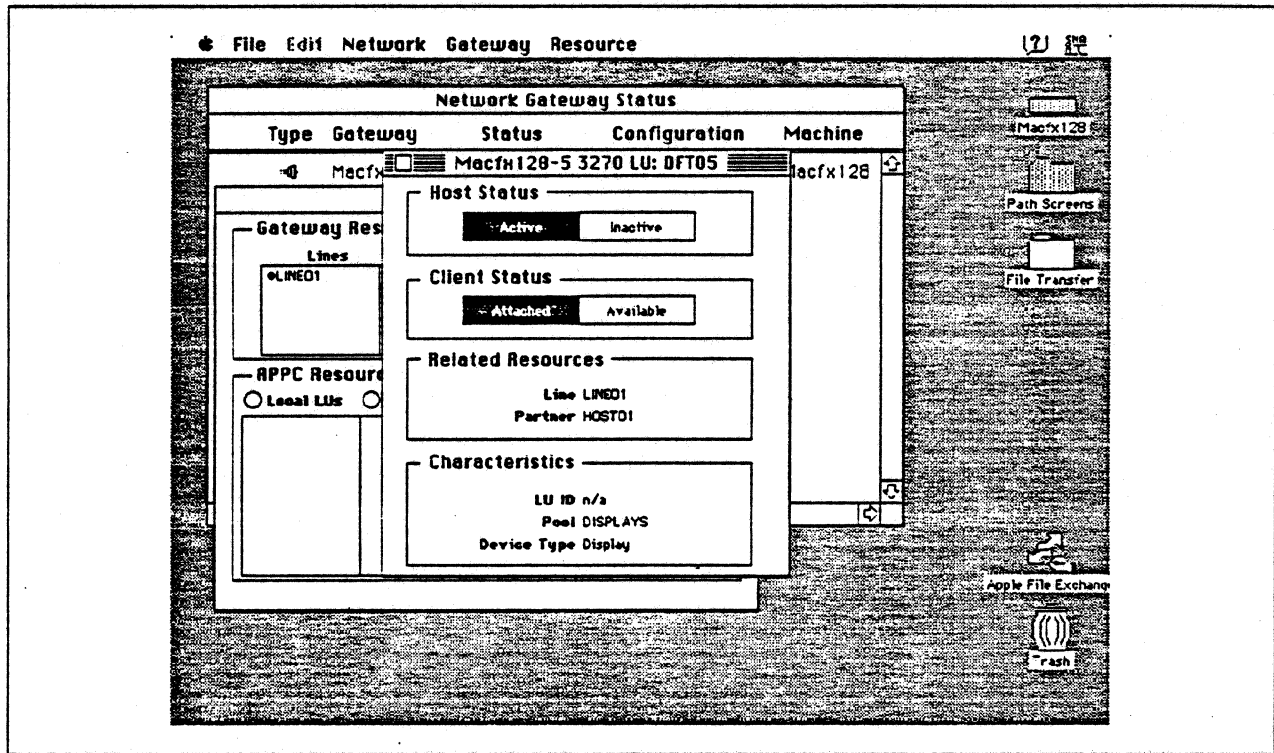

Figure 122. Displaying 3270 LU Status

### Observations and Hints

A printer was not included in this configuration, although it is supported. The four defined display LUs were verified.

This Macintosh SNA•ps Gateway can offer the coax SNA LUs to AppleTalk clients but is limited to 5 LUs per Apple Coax/Twinax Card.



---

## Path 16: MVS Host Attachment via OS/2 Extended Edition SDLC Gateway

### Path Description

This configuration consists of the SNA•ps product running on an Apple Macintosh connected to an IBM MVS host through an IBM OS/2 Extended Edition SDLC-to-Token Ring Communications Manager gateway.

The configuration is shown in Figure 123 on page 173. The OS/2 system attaches to the MVS host over an RS-232 remote SDLC connection link to a 3745 Communications Controller with a line interface card (LIC). The OS/2 system attaches to the Token Ring LAN with an IBM 16/4 Token-Ring Adapter/A. An Apple Token Ring 4/16 NB Card was used in the Macintosh for SNA Token Ring LAN attachment. The OS/2 gateway system is defined as a PU type 2 on a nonswitched line in the NCP gen for the 3745.

This configuration provides AppleTalk clients with up to 64 LU sessions for 3270 terminal and printer emulation.

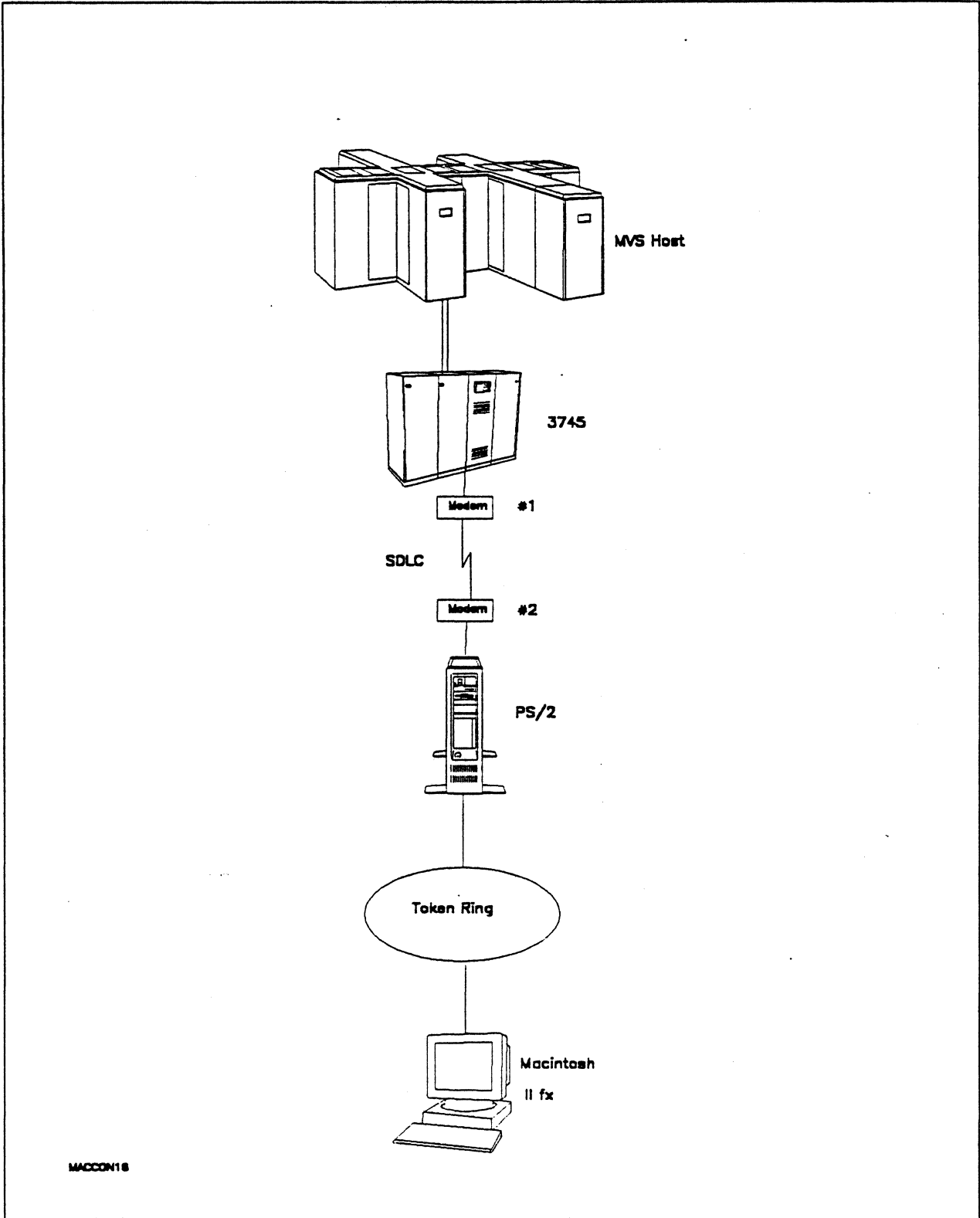

Figure 123. Path 16 Configuration - MVS Host Attachment via OS/2 Extended Edition SDLC Gateway

## Hardware and Software

The following section describes the hardware and software that was used for this path.

### MVS Host

- 4381 system
- MVS/SP JES2 Version 2 Release 2.0 (MVS/XA)
- VTAM Version 3 Release 3
- OEMI channel

### 3745

- Line interface card (LIC) type 1 #9911
- Channel adapter feature #1561
- NCP Version 5 Release 3

### Modems #1 and #2

- 19.2 Kbps
- SDLC
- RS-232
- NRZI
- Leased

### Token Ring

- 16 Mbps

### PS/2

- OS/2 Extended Edition V1.30.1 CSD WR05016
- Total System Memory - 8M
- IBM Multi-Protocol Communications Adapter/A
- IBM Token-Ring Network 16/4 Adapter/A
- Integrated Fixed Disk Controller

### Macintosh IIfx

- System Software 7.0
- SNA•ps 3270 Gateway Client V1.1 (beta)
- SNA•ps Gateway/64 V1.1 (beta)
- Apple Token Ring 4/16 NB Card with MCP memory expansion kit (1MB total)
- Total memory - 4M
- Hard disk - 80M

## Configuration Details and Operating Procedure

**MVS Host (VTAM and NCP Definitions)** VTAM uses PU TO3015P1, which is defined by the following section of the NCP gen.

```

**
GR30APP  GROUP  CLOCKNG=EXT,DIAL=NO,          +
          LNCTL=SDLC,MAXDATA=521,            +
          MAXOUT=7,PASSLIM=3,PAUSE=0.2,      +
          PUTYPE=2,REPLYTO=2,SERVLIM=2,      +
          TYPE=NCP
*
T03015L  LINE  ADDRESS=(015),ANS=CONT,DUPLEX=FULL,NRZI=YES
*
          SERVICE  ORDER=(T03015P1)
*
T03015P1 PU  ADDR=C1,                          C
          *PACING=0,                            C
          VPACING=0,                            C
          IRETRY=YES,                          C
          MAXDATA=521,                         C
          SSCPFM=USSSCS,                      C
          DISCNT=NO,                          C
          PUTYPE=2,                            C
          MAXOUT=7,                            C
          MODETAB=ISTINCLM,                   C
          DLOGMOD=SNX32702,                   C
          USSTAB=TPOUSS
T0301502 LU  LOCADDR=2,DLOGMOD=SNX32702      * 3278 MODEL 2 *
T0301503 LU  LOCADDR=3,DLOGMOD=SNX32703      * 3278 MODEL 3 *
T0301504 LU  LOCADDR=4,DLOGMOD=SNX32704      * 3278 MODEL 4 *
T0301505 LU  LOCADDR=5,DLOGMOD=SNX32705      * 3278 MODEL 5 *
T0301506 LU  LOCADDR=6,DLOGMOD=SCS           * 3287 SCS PRINTER *
T0301507 LU  LOCADDR=7,DLOGMOD=SNX32702      * 3278 MODEL 2 *
:
T0301565 LU  LOCADDR=65,DLOGMOD=SNX32702    * 3278 MODEL 2 *

```

Refer to Appendix C, "NCP Gen Listing" on page 287 for the complete NCP gen listing.

**OS/2 Extended Edition and Communications Manager:** It is assumed that OS/2 Extended Edition with Communications Manager has been previously installed.

1. Start Communications Manager. The last screen previously used in Communications Manager appears. If this screen is not the Communications Manager Main Menu, hit escape until that panel is shown.
2. To configure Communications Manager, select "Advanced" from the action bar, select option 4 (Configuration..), enter a configuration file name (for this example GATEWAY was used) and hit the enter key. Various profiles that can be configured are presented.
3. Select option 4 (SNA feature profiles) and hit the enter key. Another panel containing a list of SNA-related profiles is presented. Select the "SNA base profile..." option and configure with the values shown below:

```
SNA Base Profile
Physical unit (PU) name . . . . . : PS0S221
Network name. . . . . : USIBMT0
Node ID (in hex). . . . . : 29810
Auto-activate APPC attach manager . . . . . : No
```

Hit enter to save the profile information.

- 4. Select the "Data Link Control (DLC) profiles..." option, select "IBM Token-Ring Network..." option, select Adapter 0 and Create and then configure with the values shown below:

```
IBM Token-Ring Network DLC Adapter Profile
Adapter number . . . . . : 0
Load DLC . . . . . : Yes
Maximum number of link stations. . . . . : 4
Percent of incoming calls. . . . . : 50%
Free unused link . . . . . : Yes
Congestion tolerance . . . . . : 80%
Maximum RU size. . . . . : 1024 bytes
Send window count. . . . . : 2
Receive window count . . . . . : 1
C&SM LAN ID. . . . . : IBMLAN
Send alert for beaconing . . . . . : No
```

Hit enter to save the profile information.

- 5. Select the "Data Link Control (DLC) profiles..." option for a second time, select "SDLC..." option, select Adapter 0 and Create and then configure with the values shown below:

```
SDLC DLC Adapter Profile
Adapter number . . . . . : 0
Load DLC . . . . . : Yes
Free unused link . . . . . : No
Maximum RU size. . . . . : 0521 bytes
Send window count. . . . . : 7
Receive window count . . . . . : 7
Line type . . . . . :
  Nonswitched
Data set ready timeout . . . . . : 5 minutes
Link station role. . . . . :
  Secondary
Local station address (in hex) . . . . . : C1
XID repoll count . . . . . : 10
Non-XID repoll count . . . . . : 7
Line mode. . . . . :
  Constant request to send
NRZI. . . . . : Yes
Modem rate . . . . . :
  full speed
```



Hit enter to save the profile information.

6. Select the "SNA gateway profiles..." option, the "Host connection..." option, the Create option, and configure with the values shown below:

```

Create/Change SNA Gateway Host Connection Profile (1 of 2)

Use the spacebar to select.

DLC type. . . . . DLC type. . . . .
    SDLC...
Permanent connection. . . . . No
Auto-logoff timeout
(minutes). . . . . 999
  
```

7. Hit enter when screen input is complete, then select "Adapter 0" and press enter. When the "Create/Change SNA Gateway Host Connection Profile (2 of 2)" appears, press enter without entering anything on this screen.
8. Select the "SNA gateway profiles..." option again, the "Workstation LU..." option, the Create option (input a unique configuration name), and configure with the values shown below:

```

Create/Change SNA Gateway Workstation LU Profile

Use the spacebar to select.

LU name at workstation . . . . . : MAC02
Comment. . . . . :
    (Macintosh Client      )

PU name of workstation . . . . . : MACFX128
LU pooling . . . . .
    Dedicated...
LU local address
at workstation (hex). . . . . : 02
DLC type . . . . . :
    IBM Token-Ring Network...
  
```

9. Press the Enter key when screen input is complete. The following screen will appear.

```

Specify Dedicated LU Parameters

Use the spacebar to select.

LU local address
at host (hex) . . . . . 02

Auto-logoff. . . . . No
  
```

10. Press enter when screen input for this screen has been completed. The following screen will appear.

```

Specify Link Information

Use the spacebar to select.

Adapter number . . . . . Adapter 0
Destination address . . . . . 1000E0017CBC

Note: For ETHERAND, the address format may need to be reversed.

Press F1 for more information.
    
```

11. Press enter when screen input for this screen has been completed. One Workstation LU has been created.

**Note:** Repeat steps 8 through 10 for each of the workstations on the network that will be using the SNA Gateway.

12. When all of the Workstation LUs have been defined, press the "F3" function key to return to the Communication Configuration Menu and select "LAN feature profile" option.

13. Select the following from the LAN Profile Configuration panel:

```

LAN Profile Configuration

Adapter number . . . . . 0
Interface. . . . . IEEE 802.2...
    
```

14. Select "IBM Token-Ring Network 16/4 Adapter /A" from the Specify LAN Adapter Type panel and use the following values to configure the IEEE 802.2 Token-Ring Profile:

```

IEEE 802.2 Token-Ring Profile (1 of 2)

Adapter number and version . . . . . : 0 - 16/4 /A
Load LAN support . . . . . : Yes
Use universally
  administered address . . . . . : Yes
Maximum number SAPs. . . . . : 5
Maximum link stations. . . . . : 24
Maximum number group SAPs. . . . . : 0
Maximum members per group SAP. . . . . : 0
Maximum number of users. . . . . : 4
Transmit buffer size . . . . . : 1944 bytes
Number of transmit buffers . . . . . : 2
Receive buffer size. . . . . : 96 bytes
Minimum receive buffers. . . . . : 47
System key (hex characters). . . . . : (      )
    
```

## IEEE 802.2 Token-Ring Profile (2 of 2)

```

Adapter number and version . . . . . : 0 - 16/4 /A
Adapter "Open" options
    Wrap interface . . . . . : No
    Contender. . . . . : No
    Override token release default . . . . . : No
Group 1 response timer (T1). . . . . : 015 x 40 ms.
Group 1 acknowledgement timer (T2) . . . . . : 003 x 40 ms.
Group 1 inactivity timer (Ti). . . . . : 255 x 40 ms.
Group 2 response timer (T1). . . . . : 025 x 40 ms.
Group 2 acknowledgement timer (T2) . . . . . : 010 x 40 ms.
Group 2 inactivity timer (Ti). . . . . : 255 x 40 ms.
Number of queue elements . . . . . : 800
Number of Global Descriptor
    Table selectors. . . . . : 30

```

15. Hit enter to save the profile information. Press the F3 key to return to the Communications Manager Menu.

Configuration of the profiles required for Communications Manager is now complete.

**Note:** After the necessary profiles are configured, the following steps must be performed:

1. Use the Verify option of Communications Manager to check the configuration for potential errors. Use the Message option to check for error messages if the verify fails. The configuration file must pass verification before it can be used.
2. Select option 4, "Specify new configuration file name default...", from the Communications Manager Main Menu. Specifying the configuration file will point Communications Manager to the configuration file that was just created when it is activated.
3. Exit Communications Manager (Exit, then select option 2 Exit Immediate, then select Yes).
4. Restart Communications Manager, which causes it to use the new configuration file that was created.

## Macintosh

1. Start the SNA•ps Config program by double clicking the application icon. The SNA•ps Config resources window appears.
2. In the SNA•ps Config resources window, click the New button below the Lines box. A dialog box appears (refer to Figure 124 on page 181) in which the type of card being configured can be selected. Because Token Ring is the default for card type and is the desired DLC type connection to the PS/2, click OK.
3. The dialog box for a Token Ring line appears (refer to Figure 125 on page 181). For this path, change the Maximum I-Field Length to 521, then click OK.
4. In the Lines box of the SNA•ps Config resources window, select *LINE01*, which is the name of the Token Ring line that was created in step 3, then click the New button under Partners. The Token Ring Partner dialog box appears. In the Link Address field, enter the adapter address of the PS/2 token ring adapter card. (See "Observations and Hints" on page 185 for help.) Enter 00A 00000 in the Gateway XID field. The screen treats Gateway XID as a required field, so some value must be entered. However, the XID will not be used, because this path does not require XID exchange (refer to Figure 126 on page 182). Click OK.
5. In the Partners box in the SNA•ps Config resources window, select *HOST01*, which is the name of the Partner that was created in step 4, then click the New button under 3270 Resources. A dialog box appears in which one can create a 3270 LU (refer to Figure 127 on page 182). For this path, 64 LUs were created. The LU created with the LU ID of 6 was a printer LU to match the MVS/VTAM configuration. All the other LUs were created with a device type of Display. Figure 128 on page 183 shows the SNA•ps Config resources window after the creation of five LUs.
6. Choose Save As from the File menu. Save this file as *path16* (refer to Figure 129 on page 183).
7. Start the SNA•ps Admin program by double clicking the application icon. The Network Gateway Status window appears. In the Network Gateway Status window, select the Token Ring gateway to be configured. Choose Select Configuration from the Gateway menu. Select *path16*, then click on the Select button to assign *path16* to the Token Ring gateway (refer to Figure 130 on page 184).
8. To start the gateway, in the Network Gateway Status window select the Token Ring gateway with *path16* specified as the configuration. Choose Start Gateway from the Gateway menu, then click Start to confirm to start this gateway. When the gateway has been started, the Status column of the Network Gateway Status window contains "Started."
9. Start the SNA•ps 3270 client program by double clicking the application icon. An untitled session document appears. Choose Connect from the Session menu, then select the gateway that was started in step 8. Click on the Session button to display the specific LUs. Select a session, then click OK to connect the session to the MVS host via the SNA•ps gateway (Figure 123 on page 173 shows the configuration that has been established).
10. Start Communications Manager if it is not already started.

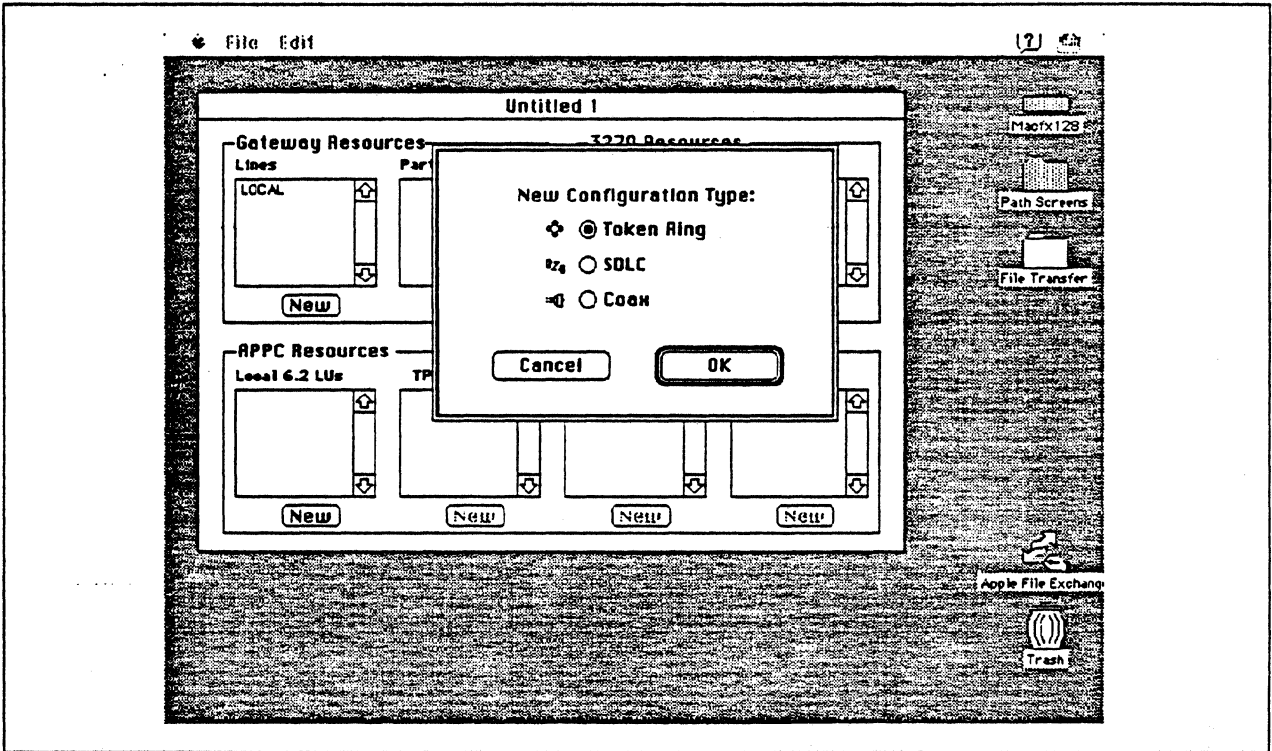

Figure 124. DLC Type Selection for Upstream Connection

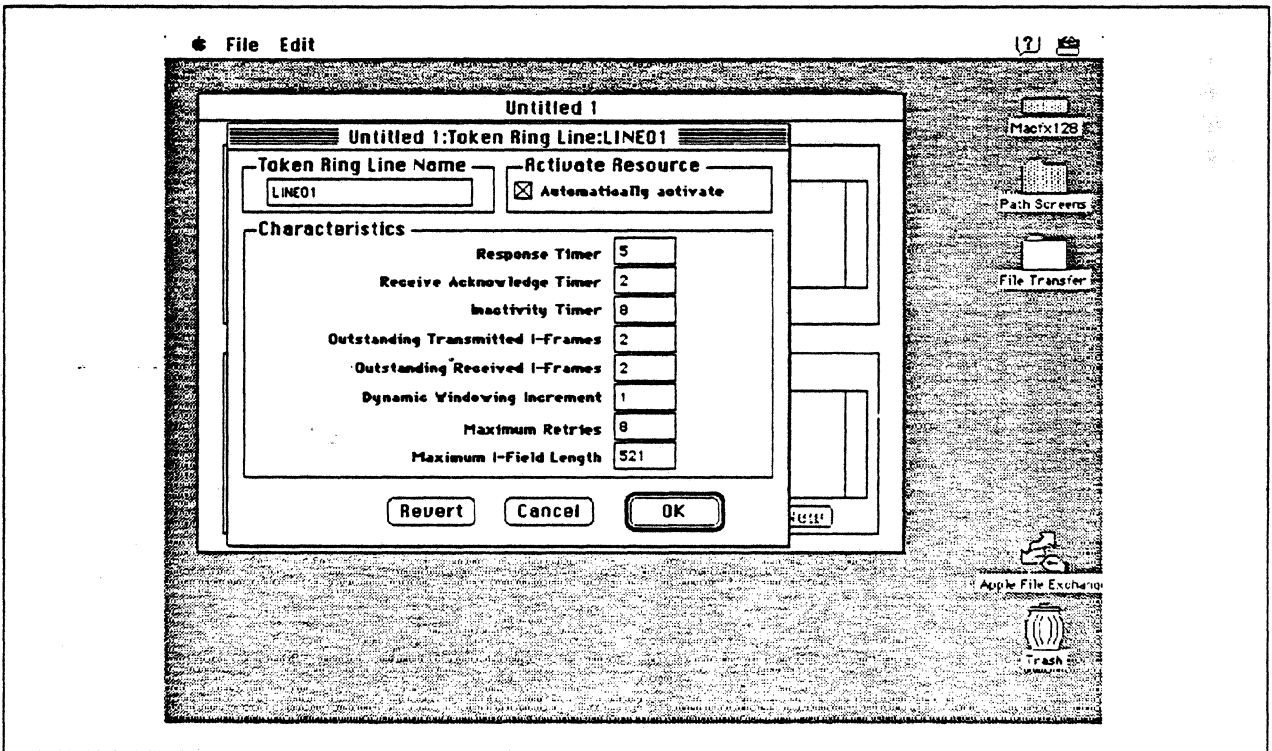

Figure 125. Token Ring Line Configuration Parameters

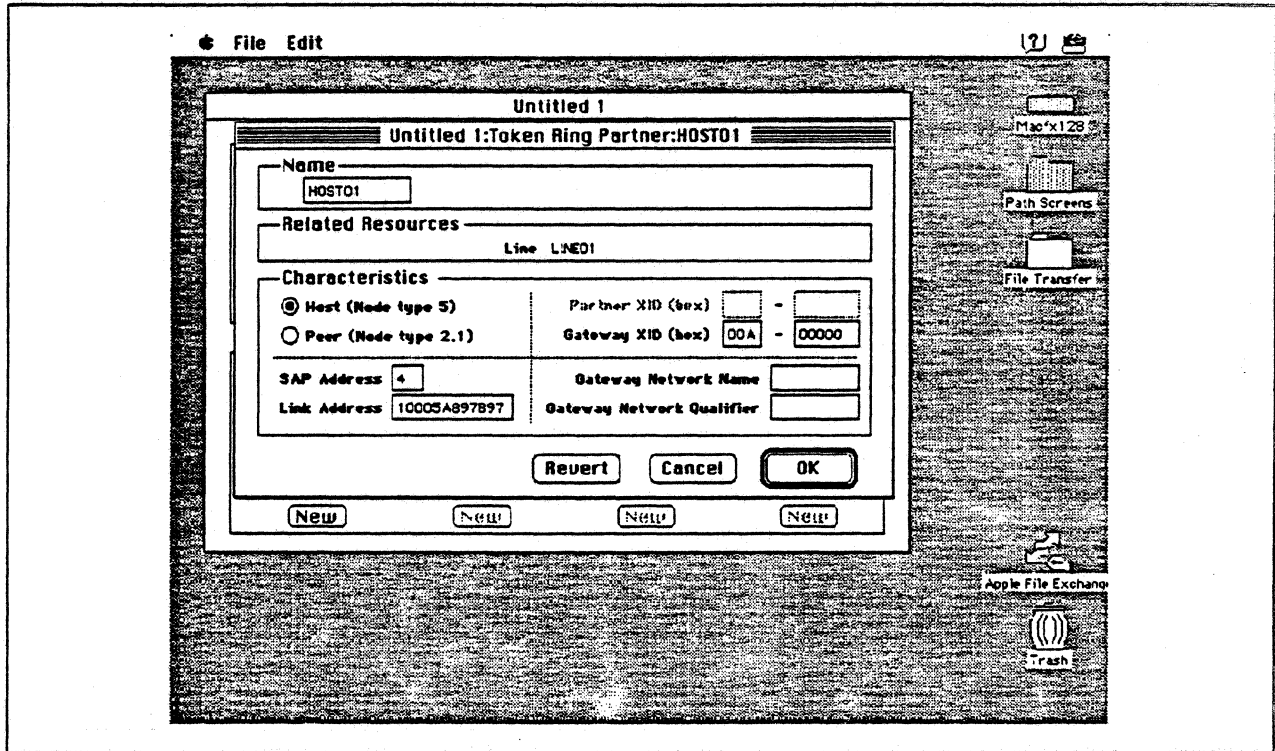

Figure 126. Token Ring Partner Configuration Parameters

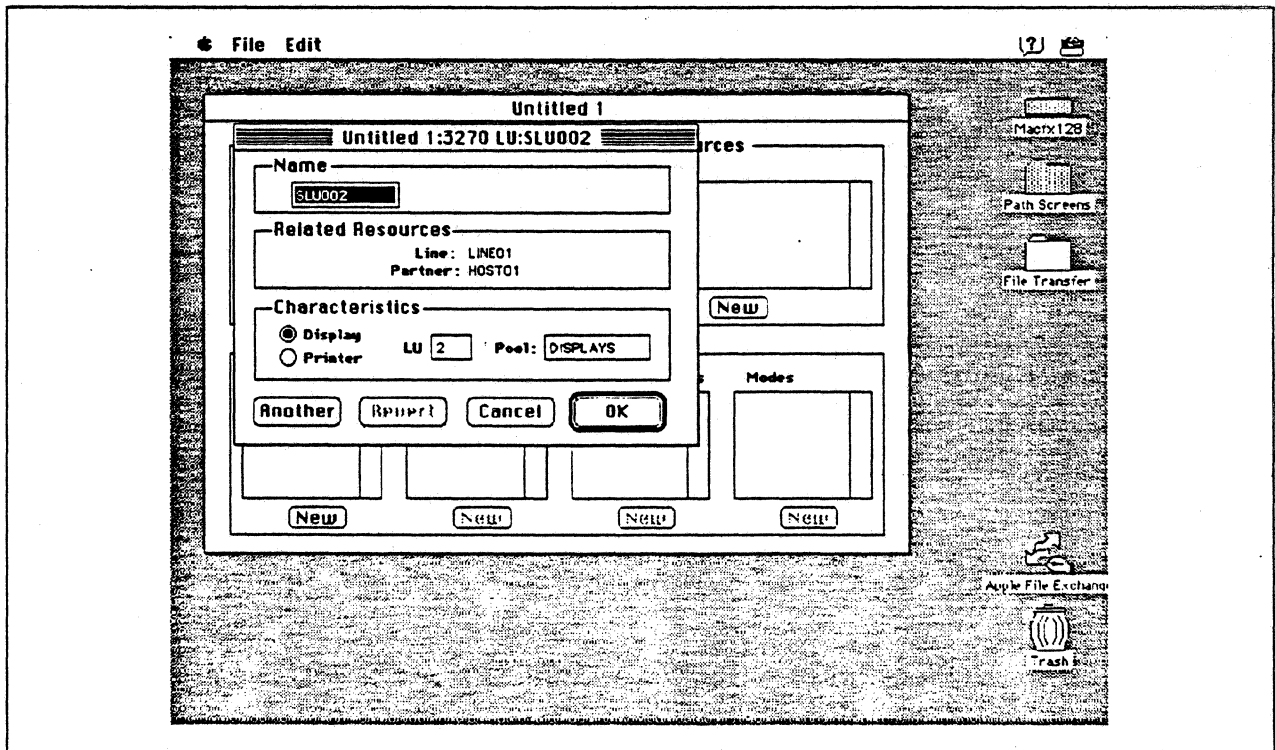

Figure 127. Configuring a 3270 LU

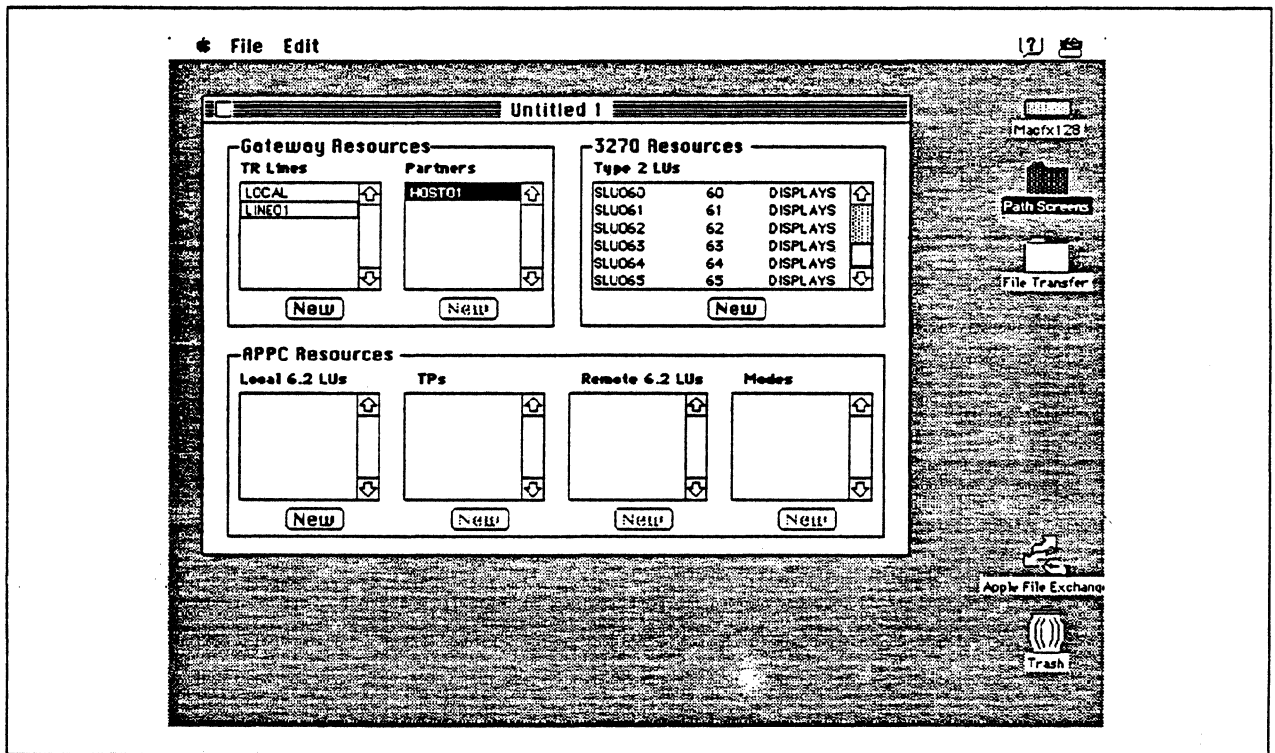

Figure 128. SNA•ps Config Window After Creating 64 LUs.

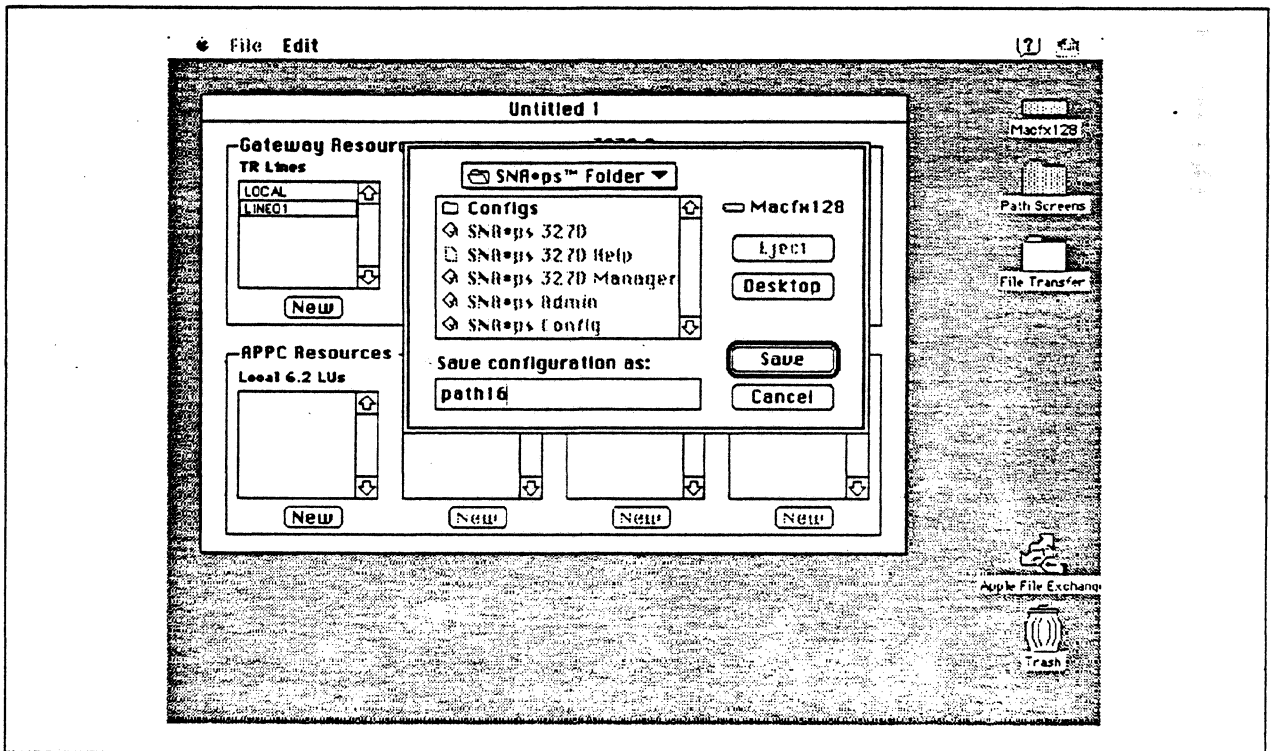

Figure 129. Saving the Configuration File

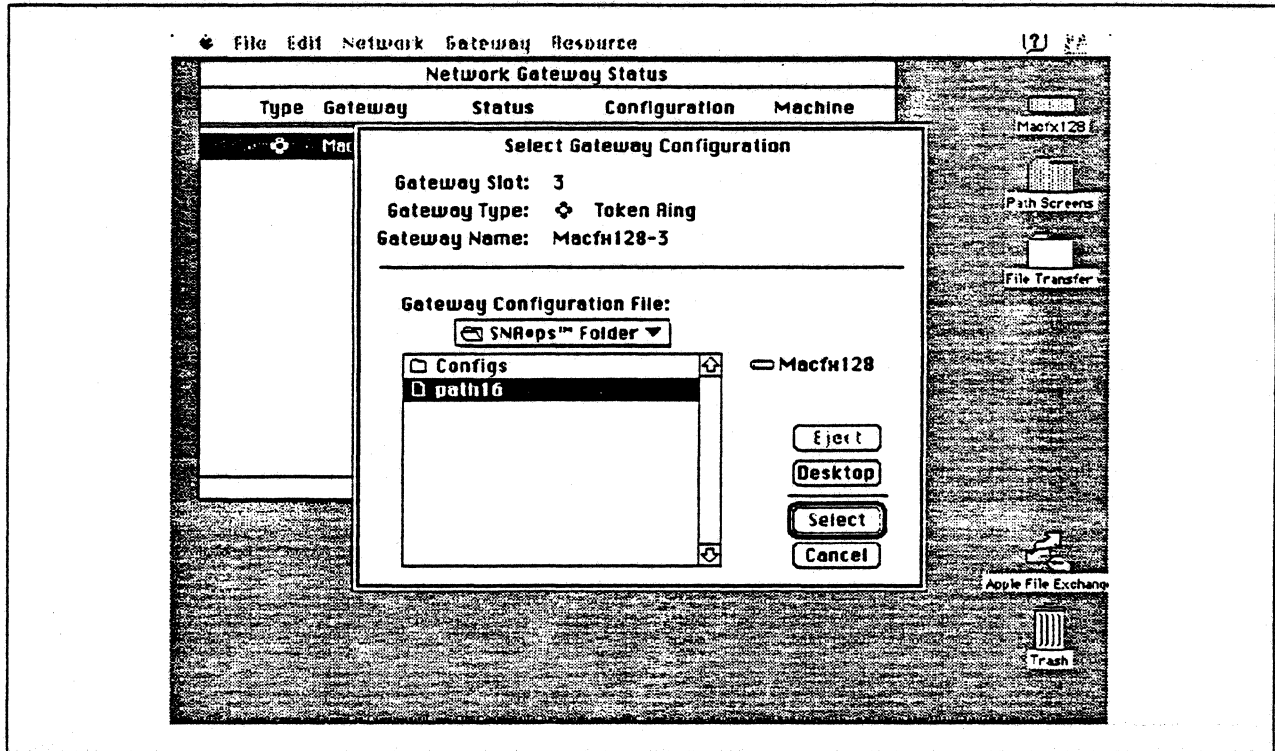

Figure 130. Gateway Configuration Selection

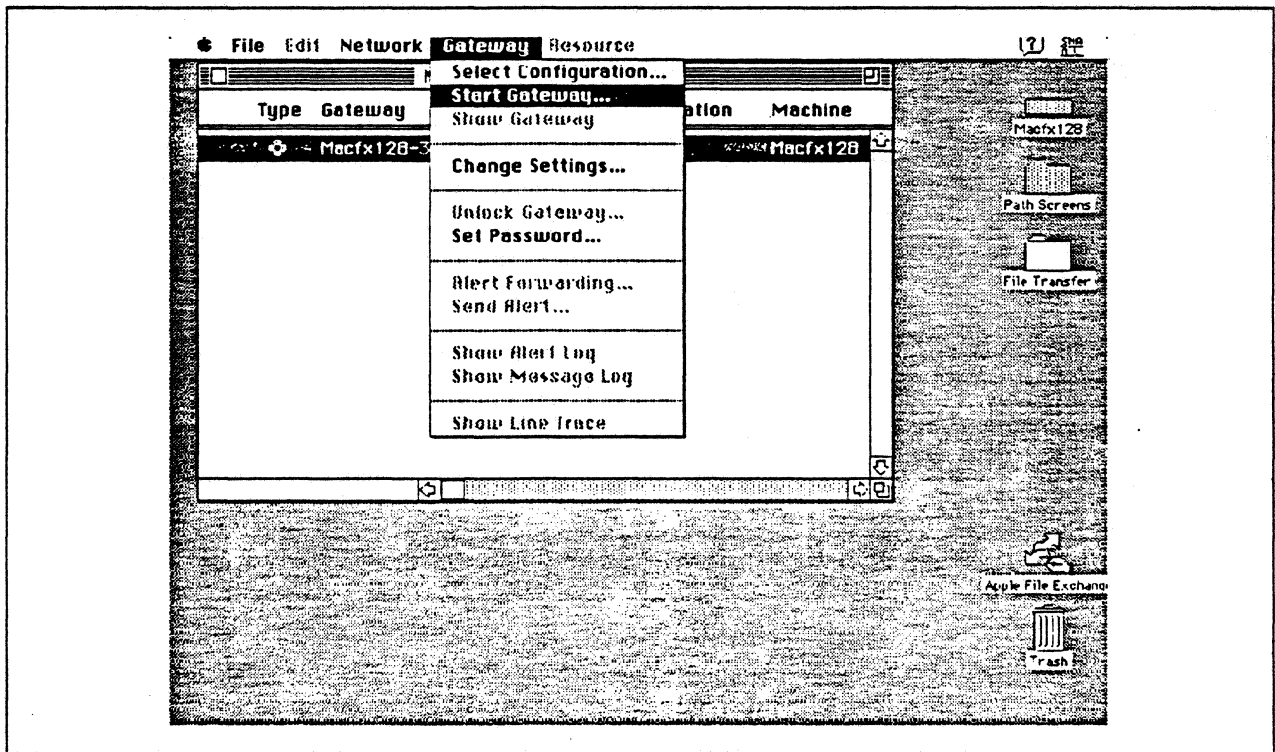

Figure 131. Starting the Gateway



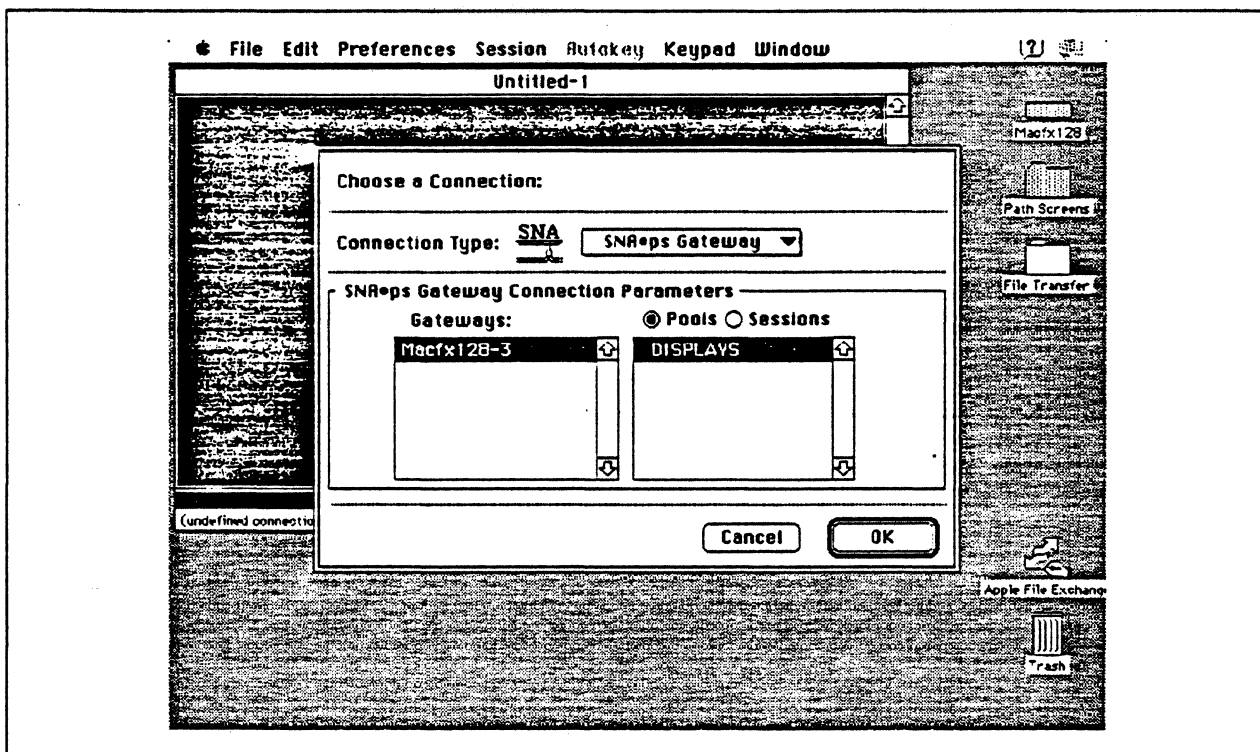

Figure 132. Choosing the Configuration

## Observations and Hints

This configuration used the SNA\*ps client code on the same machine as the SNA\*ps Gateway. However, any AppleTalk client could also use this gateway.

Four display LUs were verified in this path; a total of 64 display and printer LUs were configured. The printer emulation was configured but not used here.

To find the adapter address of the PS/2's token ring adapter, in an OS/2 window with C:\CMLIB as the working directory, issue the command `type acslan.log`. The adapter address is displayed as the node address.

The I-frame parameter shown in Figure 125 on page 181 is set to 521 in this path, but could be as high as 1944 to match the IEEE 802.2 transmit buffer size in the OS/2 Communications Manager configuration. This value does not need to match the MAXDATA value in the NCP gen, because that value applies to the OS/2 SDLC connection. If the transmit buffer size is not equal to the maximum I-field length, session establishment negotiates to the lower level.

To automatically start Communications Manager, add the command `START CM` to the `STARTUP.CMD` file.

Unless you change the defaults, the OS/2 SNA gateway will automatically start when Communications Manager is started.



---

## Section 4. IBM Peer-to-Peer Networking Paths

The following paths are included in this section:

- "Path 17: OS/2 Extended Edition Over Token Ring LAN" on page 188
- "Path 18: AS/400 Host Over Token Ring LAN" on page 202
- "Path 19: OS/2 Networking Services/2 with AS/400 Network Node (Token Ring)" on page 214

---

## Path 17: OS/2 Extended Edition Over Token Ring LAN

### Path Description

This configuration utilizes the APPC function of the SNA•ps product running on an Apple Macintosh that is connected to an IBM PS/2 running IBM OS/2 Extended Edition 1.3 with Communications Manager through an IBM Token-Ring (IEEE 802.5) local area network.

The configuration is shown in Figure 133 on page 189. The PS/2 is attached to the Token Ring using a 16/4 Mbps Token-Ring interface card. An Apple Token Ring 4/16 NB Card was used in the Macintosh for Token Ring LAN attachment.

This configuration verified the capability of providing an APPC connection between the Macintosh and the PS/2.

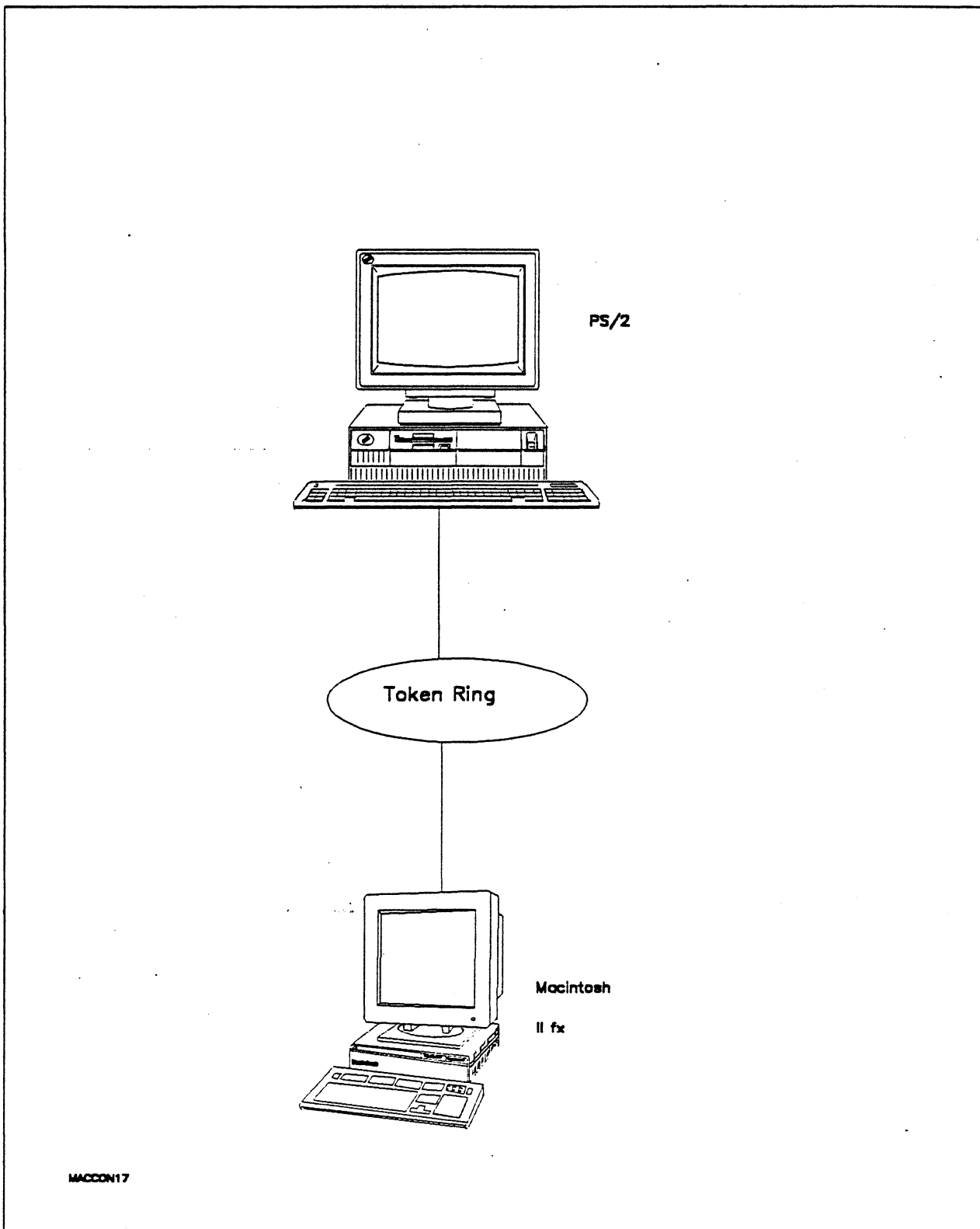

Figure 133. Path 17 Configuration - OS/2 Extended Edition Over Token Ring LAN

## Hardware and Software

The following section describes the hardware and software that was used for this path.

### PS/2

- OS/2 Extended Edition V1.30.1 CSD WR05016
- SAA Networking Services/2 V1.0
- Total System Memory - 10M
- IBM Memory Expansion Adapter
- IBM Token-Ring Network 16/4 Adapter/A
- ESDI Fixed Disk Controller

### Token Ring

- 16 Mbps

### Macintosh IIx

- System Software 7.0
- SNA•ps Gateway/64 V1.1 (beta)
- SNA•ps APPC APDA kit
- Apple Token Ring 4/16 NB Card with MCP memory expansion kit (1MB total).
- Total memory - 4M
- Hard disk - 80M

## Configuration Details and Operating Procedures

**OS/2 Extended Edition and Communications Manager:** It is assumed that OS/2 Extended Edition with Communications Manager has been previously installed.

1. Start Communications Manager. The last screen previously used in Communications Manager appears. If this screen is not the Communications Manager Main Menu, hit ESC until that panel is shown.
2. To configure Communications Manager, select "Advanced" from the action bar, select option 4 (Configuration.), enter a configuration file name (for this example PATH17 was used) and hit the ENTER key. Various profiles that can be configured are presented.
3. Select option 1 (Workstation profiles) and hit the ENTER key. Configure with the values shown in the following screens.

```

Workstation Profile (1 of 2)
Comment . . . . . :
  Macintosh to PS/2
Machine type - model . . . . . : 8580-121
IBM plant of manufacture-
  Machine sequence number . . . . . : 23-9003875
Translation table file name . . . . . :
Error log file name . . . . . :
  ERROR.DAT
Error log size . . . . . : 16 K
Error log overflow option . . . . . : Wrap
Message log file name . . . . . :
  MESSAGE.DAT
Message log size . . . . . : 500 messages
Message log overflow option . . . . . : Wrap
Display message pop-ups . . . . . : Yes
Enable auto-start options . . . . . : Yes

```

```

Workstation Profile (2 of 2)
Load these services:
SNA/APPC . . . . . : Yes
SRPI . . . . . : No
X.25 . . . . . : No
ACDI . . . . . : No

Auto-start these emulators:
3270 terminal emulation (DFT) . . . . . : No
3270 terminal emulation (Non-DFT) . . . . . : No
ASCII terminal emulation . . . . . : No
5250 Work Station Feature . . . . . : No

Display this screen first . . . . . :
  Communications Manager main menu
Display this session first . . . . . :

```

Hit ENTER to save the profile information.

4. Select option 4 (SNA feature profiles) and hit the ENTER key. Another panel containing a list of SNA-related profiles is presented. Select the "SNA base profile..." option and configure with the values shown in the following screen.

```

                SNA Base Profile
Physical unit (PU) name . . . . . : PS0S2109
Network name. . . . . : USIBMT0
Node ID (in hex). . . . . : 30266
Auto-activate APPC attach manager . . . . . : Yes

```

Hit ENTER to save the profile information.

- 5. Select the "Data Link Control (DLC) profiles..." option, select "IBM Token-Ring Network..." option, select Adapter 0 and Create and then configure with the values shown in the following screen.

```

                IBM Token-Ring Network DLC Adapter Profile
Adapter number . . . . . : 0
Load DLC . . . . . : Yes
Maximum number of link stations. . . . . : 4
Percent of incoming calls. . . . . : 0%
Free unused link . . . . . : No
Congestion tolerance . . . . . : 80%
Maximum RU size. . . . . : 2048 bytes
Send window count. . . . . : 2
Receive window count . . . . . : 2
C&SM LAN ID. . . . . : PS0S2109
Send alert for beaconing . . . . . : No

```

Hit ENTER to save the profile information.

- 6. Select the "APPC logical unit (LU) profiles..." option, the Create option, enter a Profile name of FILEREQ and configure with the values shown in the following screen.

```

                Local APPC Logical Unit Profile
LU alias . . . . . : FILEREQ
Comment. . . . . :
    For APPC to MAC
LU Name. . . . . : PS2APPC
Default LU . . . . . : No
LU local address (NAU address) . . . . . : 00
LU session limit . . . . . : 255
Maximum number of
transaction programs . . . . . : 0

```

Hit ENTER to save the profile information.

- 7. Select the "APPC partner logical unit profiles..." option, the Create option, enter a Profile name of FILESVR and configure with the values shown in the following screen.



```

Partner LU Profile
Partner LU (PLU) alias . . . . . : FILESVR
Comment. . . . . :
  For APPC to Macintosh
Fully qualified PLU name . . . . . : .APPLAPP
PLU uninterpreted name . . . . . :
LU alias . . . . . : FILEREQ
DLC type . . . . . :
  IBM Token-Ring Network
Adapter/directory entry. . . . . : 0
Destination address (in hex) . . . . . : 1000E0017D1D
PLU session limit. . . . . : 8 sessions
Maximum mapped conversation
  logical record length. . . . . : 32767 bytes
LU-LU-session security . . . . . : No
Conversation security. . . . . : No
Conversation security verified . . . . . : No
Permanent connection . . . . . : No
Solicit SSCP session . . . . . : No

Mode Name                Initial Session Limit
-----                -
MODE1                    LU62ISL

```

Hit ENTER to save the profile information.

8. Select the "APPC transmission service mode profiles..." option, the Create option, enter a Profile name of MODE1 and configure with the values shown in the following screen.

```

Transmission Service Mode Profile
Mode name. . . . . : MODE1

Comment. . . . . :
  For APPC to Macintosh

Minimum RU size. . . . . : 256
Maximum RU size. . . . . : 2048

Receive pacing limit . . . . . : 8

Session limit. . . . . : 8

```

Hit ENTER to save the profile information.

9. Select the "APPC initial session limit profiles..." option, the Create option, enter a Profile name of LU62ISL and configure with the values shown in the following screen.

```

Initial Session Limit Profile
Initial session limit profile. . . . . : LU62ISL

Comment. . . . . :
  For APPC to Macintosh

Minimum number of
contention winners source. . . . . : 2

Minimum number of
contention winners target. . . . . : 2

Number of automatically
activated sessions . . . . . : 2
    
```

Hit ENTER to save the profile information.

10. Select the "APPC remotely attachable transaction program (TP) profiles..." option, the Create option, enter a Profile name of PS2TP and configure with the values shown in the following screen.

```

Remotely Attachable Transaction Program Profile
TP profile name. . . . . : PS2TP
Comment. . . . . :
  For APPC to Macintosh
Service TP . . . . . : No
Service TP first character . . . . . :
TP name. . . . . :
  FILEMSVR
TP filespec. . . . . :
  C:\CMLIB\FILECSVR.EXE
Sync level . . . . . : Either
Conversation type. . . . . : Either
Conversation security. . . . . : No
TP operation . . . . . :
  Non-queued - attach started
Queued allocates timeout . . . . . : 480
TP receive timeout . . . . . : 480
Max attach queue depth . . . . . : 5
TP start-up parameters . . . . . :

Program type . . . . . :
  Full screen (separate screen group)
    
```

Hit ENTER to save the profile information.

11. All the necessary SNA feature profiles have now been defined. Hit the ESC key to get back to the Communication Configuration Menu.
12. Select the "LAN feature profiles" option. Select the following from the LAN Profile Configuration panel:

```

LAN Profile Configuration
Adapter number . . . . . 0

Interface. . . . . IEEE 802.2...
    
```

13. Select "IBM Token-Ring Network 16/4 Adapter /A" from the Specify LAN Adapter Type panel and use the following values to configure the IEEE 802.2 Token-Ring Profile.

```

IEEE 802.2 Token-Ring Profile (1 of 2)
Adapter number and version . . . . . : 0 - 16/4 /A
Load LAN support . . . . . : Yes
Adapter shared RAM address . . . . . :
Use universally
  administered address . . . . . : Yes
Adapter address. . . . . :
Maximum number SAPs. . . . . : 5
Maximum link stations. . . . . : 12
Maximum number group SAPs. . . . . : 0
Maximum members per group SAP. . . . . : 0
Maximum number of users. . . . . : 4
Transmit buffer size . . . . . : 2072 bytes
Number of transmit buffers . . . . . : 2
Receive buffer size. . . . . : 96 bytes
Minimum receive buffers. . . . . : 49

```

```

IEEE 802.2 Token-Ring Profile (2 of 2)
Adapter number and version . . . . . : 0 - 16/4 /A

Adapter "Open" options
  Wrap interface . . . . . : No
  Contender. . . . . : No
  Override Token release default . . . . . : No
Group 1 response timer (T1). . . . . : 015 x 40 ms.
Group 1 acknowledgement timer (T2) . . . . . : 003 x 40 ms.
Group 1 inactivity timer (Ti). . . . . : 255 x 40 ms.
Group 2 response timer (T1). . . . . : 025 x 40 ms.
Group 2 acknowledgement timer (T2) . . . . . : 010 x 40 ms.
Group 2 inactivity timer (Ti). . . . . : 255 x 40 ms.
Number of queue elements . . . . . : 800
Number of Global Descriptor
  Table selectors. . . . . : 30

```

Hit ENTER to save the profile information.

Communications Manager profiles have now been configured.

**Note:** After configuring the necessary profiles, the following must be done:

1. Use the Verify option of Communications Manager to check the configuration for potential errors. Use the Message option to check for error messages if the verify fails. The configuration file must pass verification before it can be used.
2. From the Communications Manager Main Menu, select option 4 ("Specify new configuration file name default") to specify the new configuration file (PATH17) that will be used the next time Communications Manager is started.
3. Exit Communications Manager (Exit, then select option 2 Exit Immediate, then select Yes).
4. Restart Communications Manager, which causes it to use the new configuration file that was created.

### Macintosh

1. Start the SNA•ps Config program by double clicking the application icon. The SNA•ps Config resources window appears.
2. In the SNA•ps Config resources window, click the New button below the Lines box. A dialog box appears (refer to Figure 134 on page 197) in which the type of card being configured can be selected. Because Token Ring is the default for card type and is the desired DLC type connection to the PS/2, click OK.
3. The dialog box for a Token Ring line appears (refer to Figure 135 on page 197). For this path, change the Maximum I-Field Length to 2057, then click OK.
4. In the Lines box in the SNA•ps Config resources window, select *LINE01*, which is the name of the Token Ring line that was created in step 3, then click the New button under Partners. The Token Ring Partner dialog box appears. In the Link Address field, enter the adapter address of the PS/2 Token Ring adapter card. (See "Observations and Hints" on page 201 for help.) In the Partner XID field, enter 05D 30266, of which the first three characters are always sent by PS/2s during exchange identification and the last five characters correspond to the Node ID in the PS/2 SNA Base Profile. In the Gateway XID field, enter 00A 00000. There is no corresponding field for this in the PS/2's configuration. (Refer to Figure 136 on page 198.) Click OK.
5. In the Partners box in the SNA•ps Config resources window, select *HOST01*, which is the name of the Partner that was created in step 4, then click the New button below the Local 6.2 LUs box in the APPC Resources category. A dialog box appears in which you can create a local 6.2 LU. (Refer to Figure 137 on page 198.) Enter APPLAPPC in the Name and Network LU Name fields. This name corresponds to the network identifier of the fully qualified PLU name in the PS/2's Partner LU profile (refer to 7 on page 192). Enter USIBMTO in the Network Qualifier field. The Network Qualifier corresponds to the Network Name in the PS/2 SNA Base profile (refer to 4 on page 191). Click OK.
6. Select the Local LU APPLAPPC, then click the New button below the TPs box. A dialog box appears in which you can create an entry for an associated transaction program. (Refer to Figure 138 on page 199.) Enter \* in the Name field, then click OK.
7. Select the Local LU APPLAPPC, then click the New button below the Remote 6.2 LUs box. A dialog box appears in which you can create a remote 6.2 LU. (Refer to Figure 139 on page 199.) Enter PS2APPC in the Name and Network LU Name fields. The Network LU Name corresponds to the LU name in OS/2's local APPC logical unit profile (refer to 6 on page 192). Enter USIBMTO in the Network Qualifier field. This corresponds to the network name in OS/2's SNA Base Profile (refer to 4 on page 191). Click OK.
8. Select the remote LU PS2APPC, then click the New button below the Modes box. A dialog box appears in which you can create an APPC mode. The mode contains parameters that are used in establishing initial session limits and parameters that can be negotiated in the BIND. (Refer to Figure 140 on page 200.) Enter MODE1 in the Name field. This corresponds to the Mode name in the PS/2's Transmission Service Mode Profile (refer to 8 on page 193). Change the other values as indicated in Figure 140 on page 200, then click OK.
9. Choose Save As from the File menu. Save this file as *path17*.
10. Start the SNA•ps Admin program by double clicking the application icon. The Network Gateway Status window appears. In the Network Gateway Status window, select the Token Ring gateway that you want to configure. Choose Select Configuration from the Gateway menu. Select *path17*, then click on the Select button to assign *path17* to the Token Ring gateway.
11. To start the gateway, in the Network Gateway Status window, select the Token Ring gateway with *path17* specified as the configuration. Choose Start Gateway from the Gateway menu. Click Start to confirm that you want this gateway started. When the gateway has been started, the Status column of the Network Gateway Status window contains "Started."

12. Select this gateway and choose Show Gateway from the Gateway menu. The resource window is displayed. (Refer to Figure 141 on page 200.) This shows active sessions between the PS/2 and Macintosh IIfx.

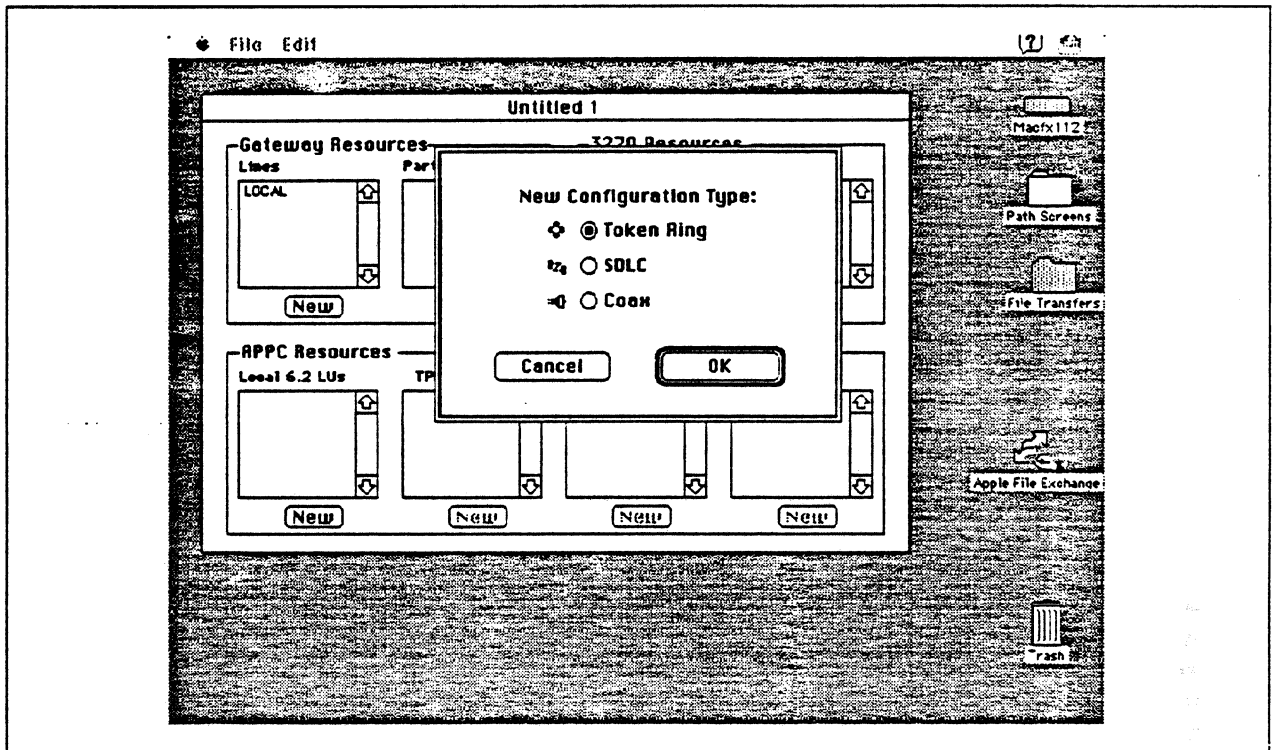

Figure 134. DLC Type Selection for Upstream Connection

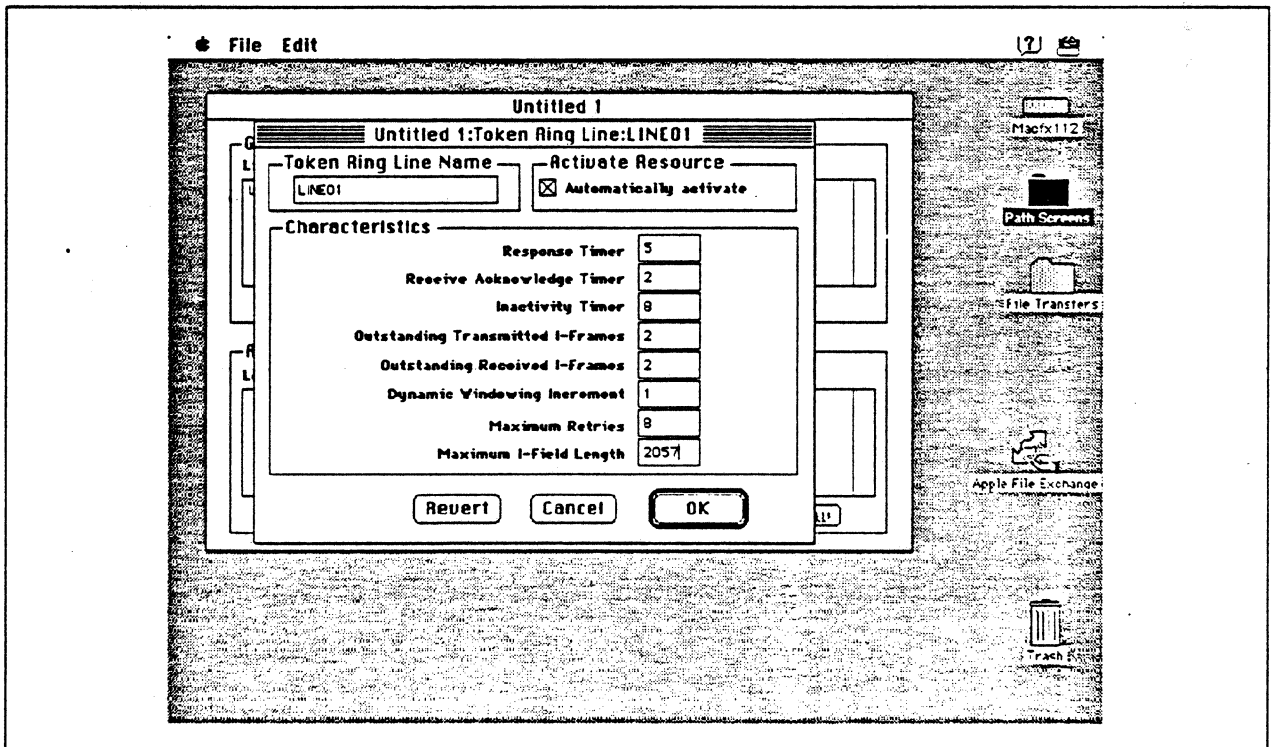

Figure 135. Token Ring Line Configuration Parameters

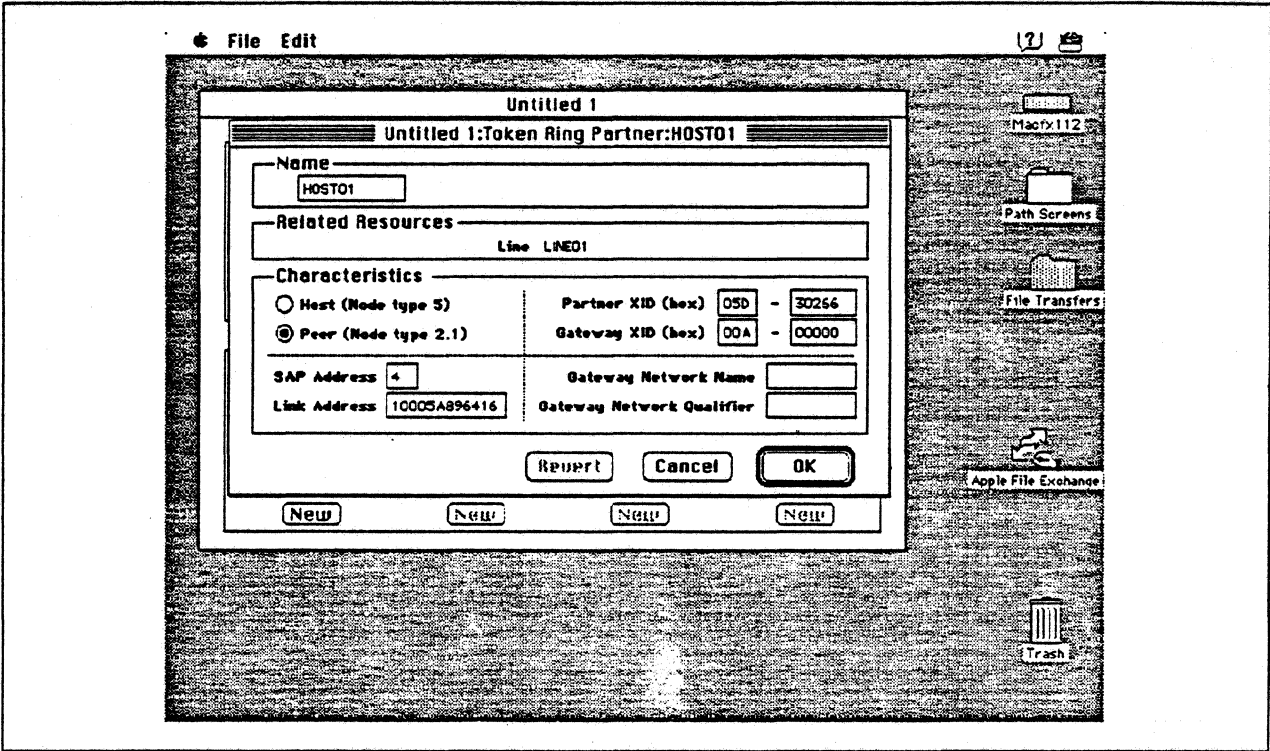

Figure 136. Token Ring Partner Configuration Parameters

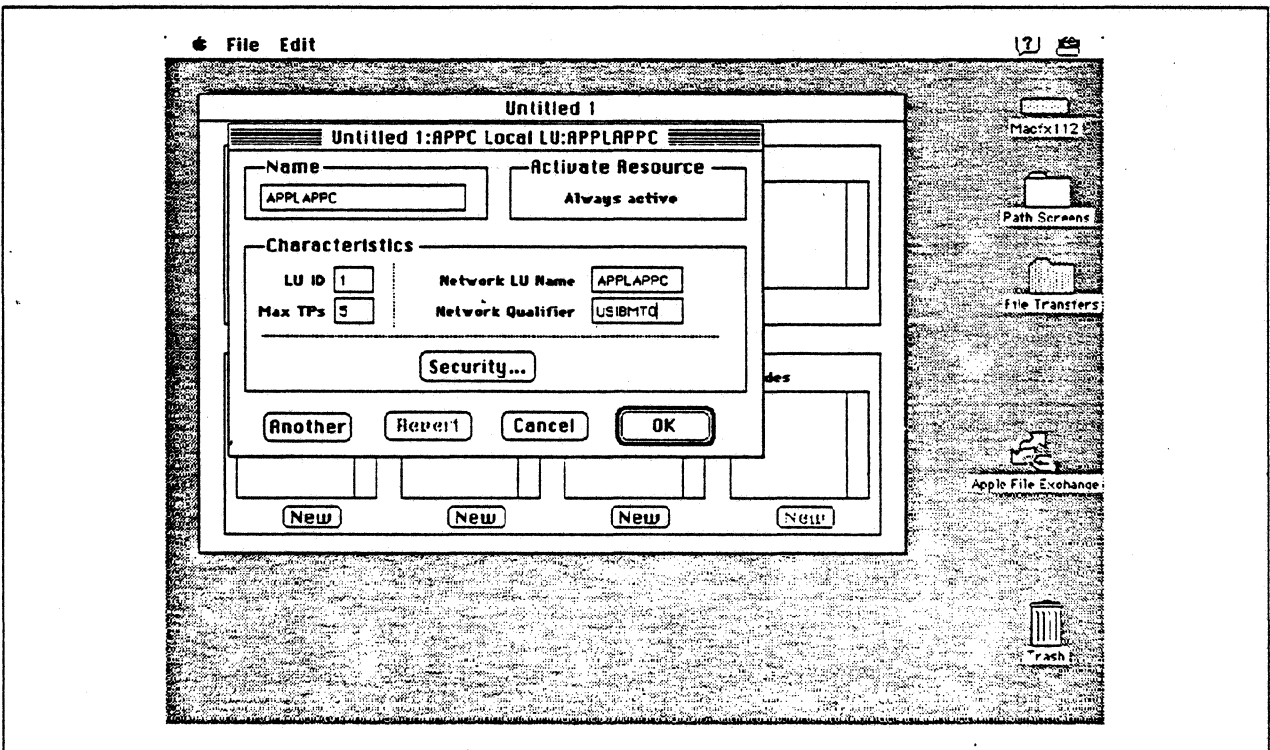

Figure 137. Configuring an APPC Local LU

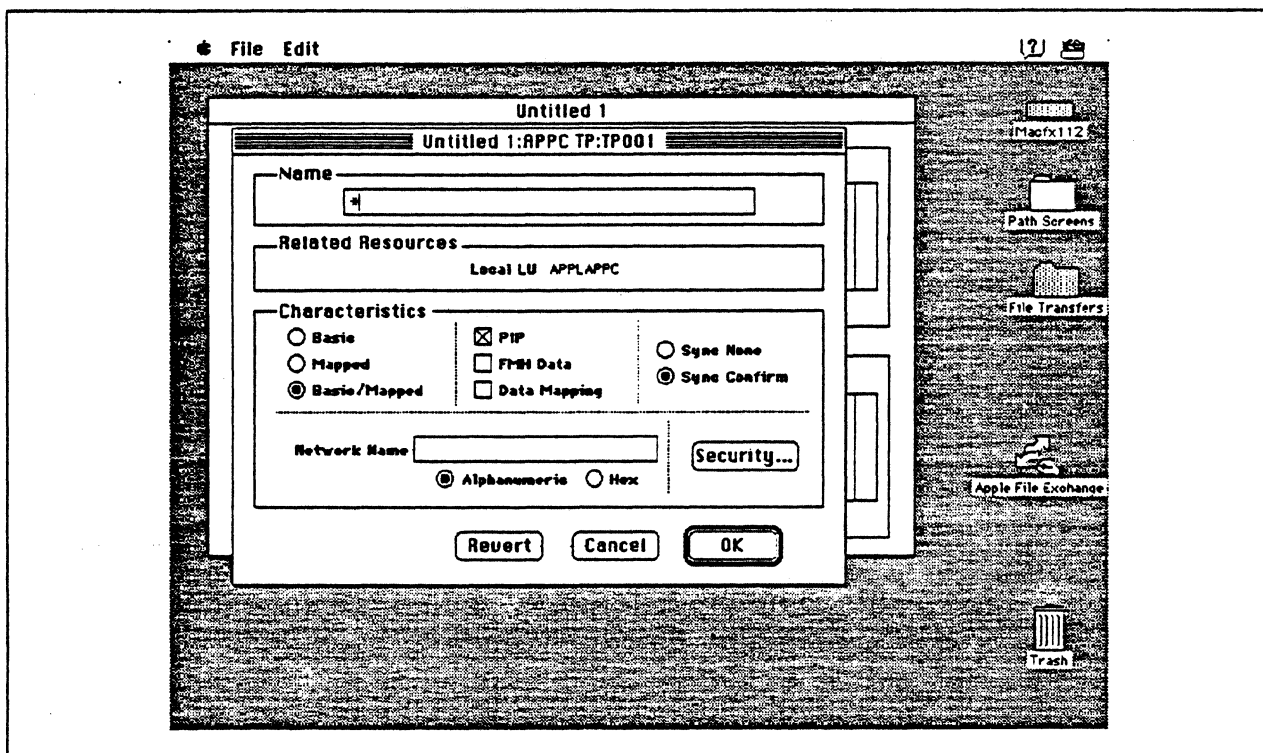

Figure 138. Configuring an APPC Transaction Program

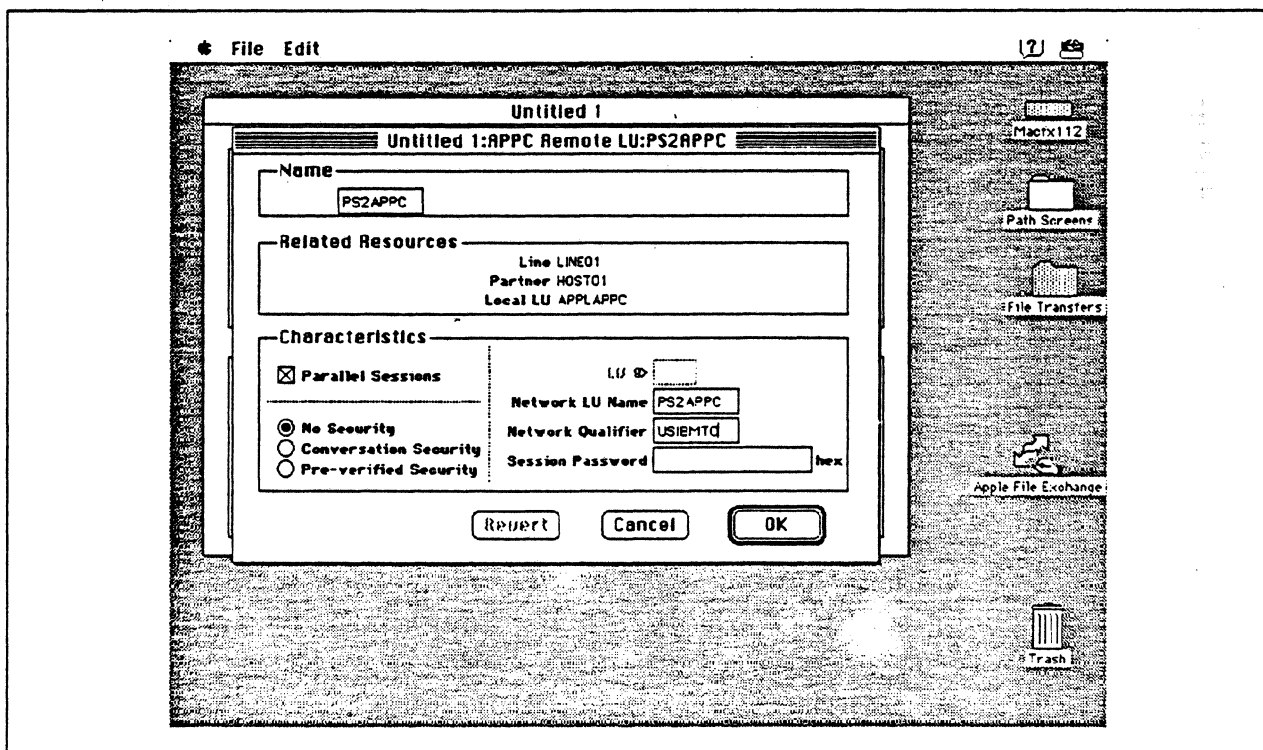

Figure 139. Configuring an APPC Remote LU

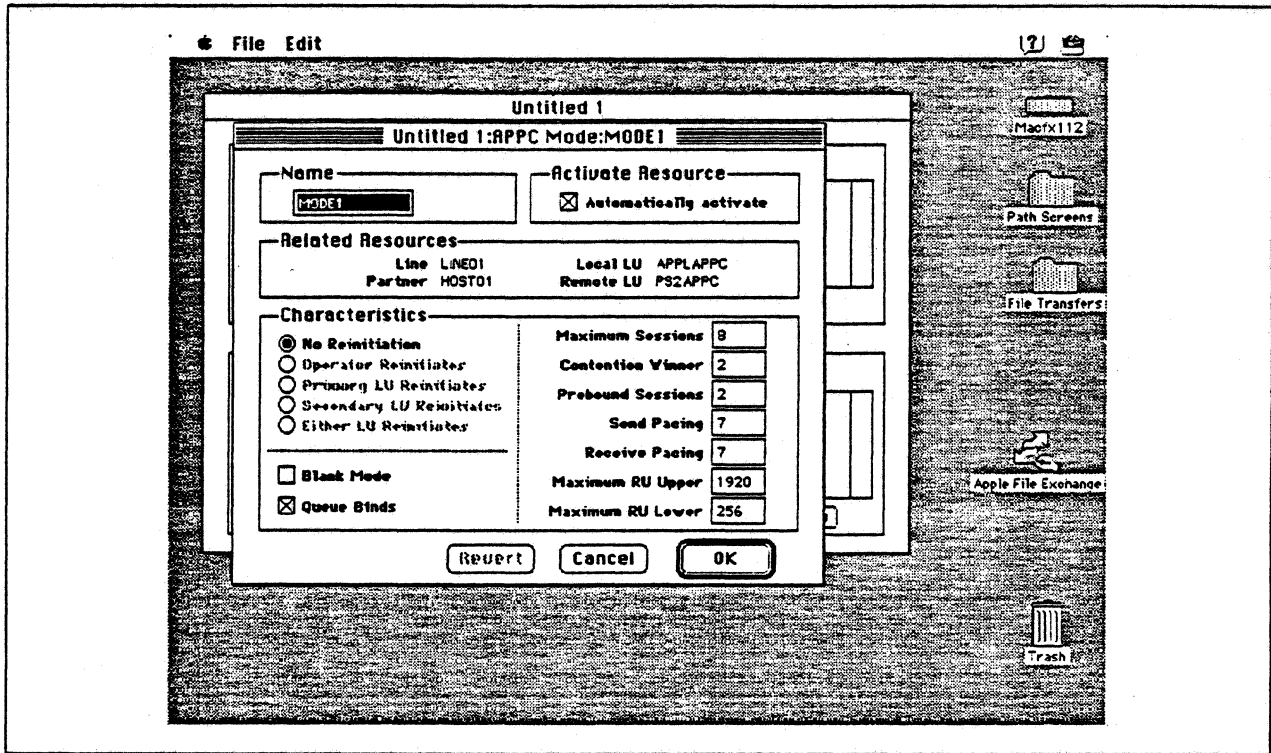

Figure 140. Configuring an APPC Mode

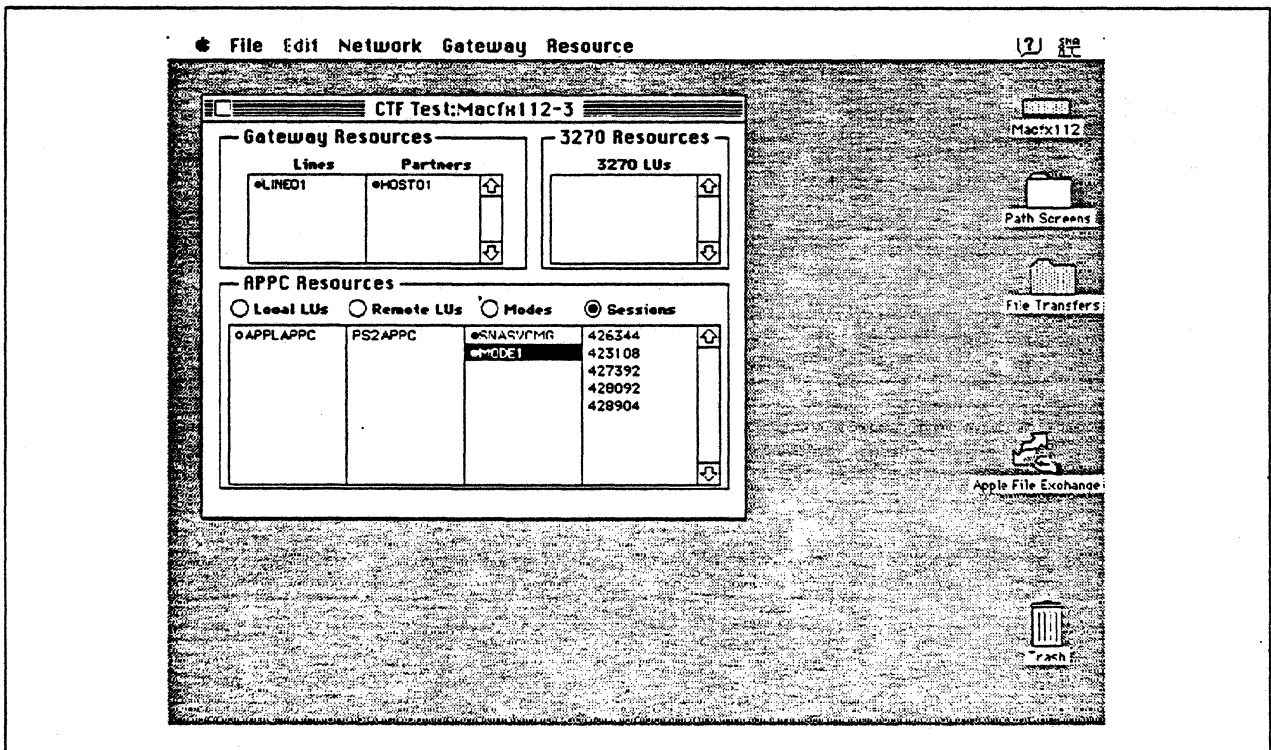

Figure 141. SNA\*ps Admin Network Status Window Showing Active APPC Sessions



## Observations and Hints

In the PS/2 configuration, the destination address 1000E0017D1D in the Partner LU Profile corresponds to the Token Ring address of the Apple Token Ring 4/16 NB Card.

To find the adapter address of the PS/2's Token Ring adapter, in an OS/2 window with C:\CMLIB as the working directory, issue the command type acs1an.log. The adapter address is displayed as the node address.

If the transmit buffer size (refer to step 13 on page 194) is not equal to the maximum l-field length (refer to Figure 135 on page 197), session establishment negotiates to the lower level.

Sample APPC programs available as part of the OS/2 Extended Edition 1.3 product were used on the PS/2. File transfers were performed in both directions.

---

## Path 18: AS/400 Host Over Token Ring LAN

### Path Description

This configuration utilizes the APPC capability of the SNA•ps product running on an Apple Macintosh that is connected to an IBM AS/400 through an IBM Token-Ring (IEEE 802.5) local area network.

The configuration is shown in Figure 142 on page 203. The AS/400 is attached to the token ring using a 16/4 Mbps token-ring interface card. An Apple Token Ring 4/16 NB Card was used in the Macintosh for Token Ring LAN attachment.

This configuration verified the capability of providing an APPC connection between the Macintosh and the AS/400.

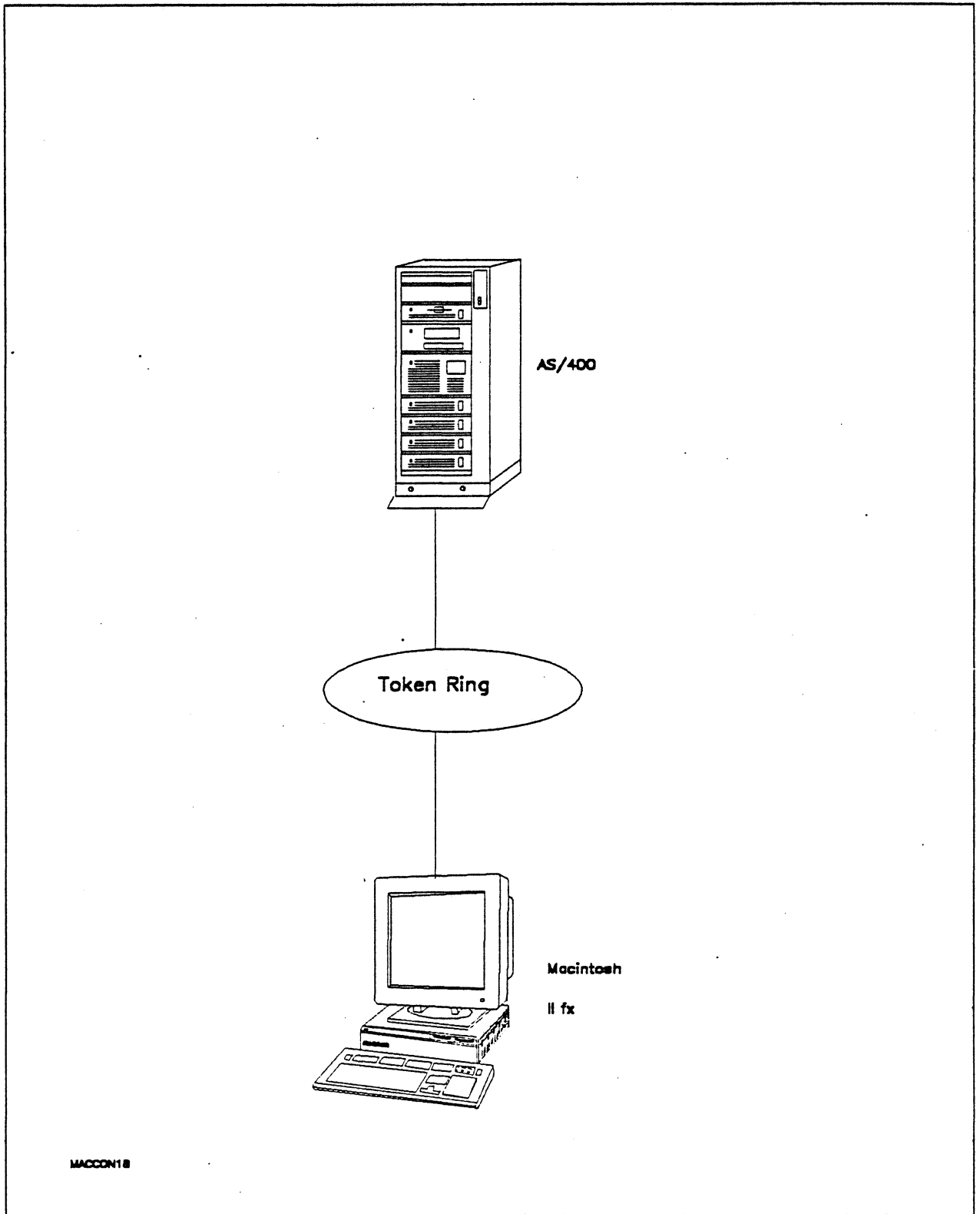

Figure 142. Path 18 Configuration - AS/400 Host Over Token Ring LAN

## Hardware and Software

The following section describes the hardware and software that was used for this path.

### AS/400

- 9406 system
- OS/400 Version 2 Release 1

### Token Ring

- 16 Mbps

### Macintosh IIfx

- System Software 7.0
- SNA•ps Gateway/64 V1.1 (beta)
- SNA•ps APPC APDA kit
- Apple Token Ring 4/16 NB Card with MCP memory expansion kit (1MB total)
- Total memory - 4M
- Hard disk - 80M

## Configuration Details and Operating Procedures

**AS/400:** For communications between a workstation and an AS/400 via a Token-Ring using APPC, the AS/400 controller and device descriptions do not have to be explicitly created. Only the Token-Ring line description must be explicitly created. At the time the workstation attempts to contact the AS/400, the necessary controller and device description are dynamically created by the AS/400 and implicitly varied on. For this path we let the AS/400 dynamically create the controller and device description.

The following list contains the objects (Line Description; Controller Description and Device Descriptions) used for this path.

### Line Description - LAN

```

Line description . . . . . : TRNLIN031
Option . . . . . : *BASIC
Category of line . . . . . : *TRLAN

Resource name . . . . . : LIN031
Online at IPL . . . . . : *NO
Vary on wait . . . . . : *NOWAIT
Maximum controllers . . . . . : 50
Line speed . . . . . : 16M
Maximum frame size . . . . . : 2057
TRLAN manager logging level. . . . : *MIN
  Current logging level. . . . . : *MIN
TRLAN manager mode . . . . . : *OBSERVING
Log configuration changes . . . . . : *NOLOG
Token-ring inform of beacon . . . . : *YES
Local adapter address . . . . . : 400040300000
Exchange identifier . . . . . : 05640300
Early token release. . . . . : *NO
Error threshold level . . . . . : *OFF
Text . . . . . : Connection to Token-Ring

```

Line description . . . . . : TRNLIN031  
 Option . . . . . : \*SSAP  
 Category of line . . . . . : \*TRLAN

SSAP	Maximum Frame	Type	SSAP	Maximum Frame	Type
----	-----	---	----	-----	---
04	*MAXFRAME	*SNA	14	*MAXFRAME	*SNA
08	*MAXFRAME	*SNA	18	*MAXFRAME	*SNA
0C	*MAXFRAME	*SNA	1C	*MAXFRAME	*SNA
10	*MAXFRAME	*SNA	20	*MAXFRAME	*SNA

Line description . . . . . : TRNLIN031  
 Option . . . . . : \*APPN  
 Category of line . . . . . : \*TRLAN

Link speed . . . . . : 4M      \*\* see Observations and Hints \*\*  
 Cost/connect time . . . . . : 0  
 Cost/byte . . . . . : 0  
 Security for line . . . . . : \*NONSECURE  
 Propagation delay . . . . . : \*LAN  
 User-defined 1 . . . . . : 128  
 User-defined 2 . . . . . : 128  
 User-defined 3 . . . . . : 128  
 Autocreate controller . . . . . : \*YES  
 Autodelete controller . . . . . : \*NONE

Line description . . . . . : TRNLIN031  
 Option . . . . . : \*TMRRTY  
 Category of line . . . . . : \*TRLAN

Recovery limits:  
 Count limit . . . . . : 2  
 Time interval . . . . . : 5

#### Controller Description - APPC

Controller description . . . . . : APPL04  
 Option . . . . . : \*BASIC  
 Category of controller . . . . . : \*APPC  
 Link type . . . . . : \*LAN  
 Online at IPL . . . . . : \*NO  
 Character code . . . . . : \*EBCDIC  
 Maximum frame size . . . . . : 16393  
 Remote network identifier . . . . . : USIBMT0  
 Remote control point . . . . . : APPL04  
 Initial connection . . . . . : \*DIAL  
 Switched disconnect . . . . . : \*YES  
 Data link role . . . . . : \*NEG  
 LAN remote adapter address . . . . . : 1000E0017D1D  
 LAN DSAP . . . . . : 04  
 LAN SSAP . . . . . : 08  
 Text . . . . . : AUTOMATICALLY CREATED BY QLUS

Controller description . . . . . : APPL04  
 Option . . . . . : \*SWTLINLST  
 Category of controller . . . . . : \*APPC  
 Switched lines . . . . . : TRNLIN031

Controller description . . . . . : APPL04  
 Option . . . . . : \*DEV  
 Category of controller . . . . . : \*APPC  
 Attached Devices . . . . . : APPLE04

Path 18

```
Controller description . . . . . : APPL04
Option . . . . . : *APPN
Category of controller . . . . . : *APPC
  APPN-capable . . . . . : *YES
  APPN CP session support . . . . . : *YES
  APPN node type . . . . . : *CALC
  APPN transmission grp number . . . . . : *CALC
  APPN minimum switched status . . . . . : *VRYONPND
  Model controller description . . . . . : *NO
  Control owner . . . . . : *SYS

Controller description . . . . . : APPL04
Option . . . . . : *TMRRTY
Category of controller . . . . . : *APPC
  Disconnect timer . . . . . : 170
  LAN frame retry . . . . . : *CALC
  LAN connection retry . . . . . : *CALC
  LAN response timer . . . . . : *CALC
  LAN connection timer . . . . . : *CALC
  LAN acknowledgement timer . . . . . : *CALC
  LAN inactivity timer . . . . . : *CALC
  LAN acknowledgement frequency . . . . . : *CALC
  LAN max outstanding frames . . . . . : *CALC
  LAN access priority . . . . . : *CALC
  LAN window step . . . . . : *NONE
Recovery limits:
  Count limit . . . . . : 2
  Time interval . . . . . : 5
```

Device Description - APPC

```
Device description . . . . . : APPLE04
Option . . . . . : *BASIC
Category of device . . . . . : *APPC
  Remote location . . . . . : APPLE04
  Online at IPL . . . . . : *NO
  Local location . . . . . : CON403
  Remote network identifier . . . . . : *NETATR
  Attached controller . . . . . : APPL04
  Message queue . . . . . : QSYS0PR
  Library . . . . . : *LIBL
  Local location address . . . . . : 00
  APPN-capable . . . . . : *YES
Single session:
  Single session capable . . . . . : *NO
  Text . . . . . : AUTOMATICALLY CREATED BY QLUS

Device description . . . . . : APPLE04
Option . . . . . : *MODE
Category of device . . . . . : *APPC
  Mode . . . . . : *NETATR
```

The following list contains the network attribute values used for this path. (Use the DSPNETA command to display the values.)

**Network Attributes**

```

Current system name . . . . . : CON403
  Pending system name . . . . . : (blank)
Local network ID . . . . . : USIBMT0
Local control point name . . . . . : CON403
Default local location . . . . . : CON403
Default mode . . . . . : BLANK
APPN node type . . . . . : *NETNODE
Maximum number of intermediate sessions . . . . . : 200
Route addition resistance . . . . . : 128
Server network ID/control point name . . . . . : *LCLNETID *ANY
Alert status . . . . . : *ON
Alert primary focal point . . . . . : *NO
Alert default focal point . . . . . : *NO
Alert logging status . . . . . : *ALL
Alert controller description . . . . . : *NONE
Message queue . . . . . : QSYSOPR
  Library . . . . . : QSYS
Output queue . . . . . : QPRINT
  Library . . . . . : QGPL
Job action . . . . . : *FILE
Maximum hop count . . . . . : 16
DDM request access . . . . . : *OBJAUT
PC Support request access . . . . . : *OBJAUT
Default ISDN network type . . . . . :
Default ISDN connection list . . . . . : QDCCNNLANY

```

The following list contains the values for the mode description used for this path. (Use the CRTMODD command to create this mode description and the WRKMODD command to display the values.)

**Mode Description for LU62 mode**

```

Mode description name . . . . . : LU62
Class-of-service . . . . . : #CONNECT
Maximum number of sessions . . . . . : 8
Maximum conversations . . . . . : 8
Locally controlled sessions . . . . . : 4
Pre-established sessions . . . . . : 4
Inbound pacing value . . . . . : 7
Outbound pacing value . . . . . : 7
Max length of request unit . . . . . : *CALC
Text . . . . . : Macintosh to AS/400 APPC

```

**Class-of-Service Description for AS/400:** Use the COS description #CONNECT, contained in the QSYS library, which is supplied by IBM as part of the OS/400 software.

**Macintosh**

1. Start the SNA•ps Config program by double clicking the application icon. The SNA•ps Config resources window appears.
2. In the SNA•ps Config resources window, click the New button below the Lines box. A dialog box appears (refer to Figure 143 on page 209) in which the type of card to configure can be selected. Because Token Ring is the default for card type and is the desired DLC type connection to the AS/400, click OK.
3. The dialog box for a Token Ring line appears (refer to Figure 144 on page 209). For this path, change the Maximum I-Field Length to 2057, then click OK.

4. In the Lines box in the SNA•ps Config resources window, select *LINE01*, which is the name of the Token Ring line that was created in step 3, then click the New button under Partners. The Token Ring Partner dialog box appears. Click on the Peer button. Enter the Local Adapter Address specified on the AS/400's Token Ring Line description (TRNLIN031). In the Partner XID field, enter the Exchange Identifier specified on the AS/400's Token Ring Line description (TRNLIN031). In the Gateway XID field, enter any value. The SNA•ps Config program requires some value in this field, but the AS/400 does not care what it is (see "Observations and Hints" on page 213). In the Gateway Network Name, enter the remote control point name. In the Gateway Network Qualifier, enter the remote network identifier. (Reference the screen shown in Figure 145 on page 210.) Click OK.
5. In the Partners box in the \*SNA•ps Config resources window, select *HOST01*, which is the name of the Partner that was created in step 4, then click the New button below the Local 6.2 LUs box in the APPC Resources category. A dialog box appears in which to create a local 6.2 LU. (Refer to Figure 146 on page 210.) Enter *APPLE04* in the Name field and the Network LU Name field. The network LU name corresponds to the remote location in the AS/400's device description. Enter *USIBMTO* in the Network Qualifier field. The network qualifier corresponds to the remote network identifier in the AS/400's controller description. Click OK.
6. Select the local LU *APPLE04*, then click the New button below the TPs box. A dialog box appears in which to create an entry for an associated transaction program. (Refer to Figure 147 on page 211.) Enter \* in the Name field, then click OK.
7. Select the local LU *APPLE04*, then click the New button below the Remote 6.2 LUs box. A dialog box appears in which to create a remote 6.2 LU. (Refer to Figure 148 on page 211.) Enter *CON403* in the Name and Network LU Name fields. This corresponds to the local location in the AS/400's device description. Enter *USIBMTO* in the Network Qualifier field. The network qualifier corresponds to the local network ID specified in the AS/400's network attributes. Click OK.
8. Select the Remote LU *CON403*, then click the New button below the Modes box. A dialog box appears in which to create an APPC mode. The mode contains parameters that are used in establishing initial session limits and also parameters that can be negotiated in the BIND. Enter *LU62* in the name field. This corresponds to the *LU62* mode description name created on the AS/400 (refer to page 207). Change the other values as indicated in Figure 149 on page 212, then click OK.
9. Choose Save As from the File menu. Save this file as *path18*.
10. Start the SNA•ps Admin program by double clicking the application icon. The Network Gateway Status window appears. In the Network Gateway Status window, select the Token Ring gateway to be configured. Choose Select Configuration from the Gateway menu. Select *path18*, then click on the Select button to assign *path18* to the Token Ring gateway.
11. To start the gateway, in the Network Gateway Status window, select the Token Ring gateway with *path18* specified as the configuration. Choose Start Gateway from the Gateway menu, then click Start to confirm to start this gateway. When the gateway has been started, the Status column of the Network Gateway Status window contains "Started."
12. Select this gateway, then choose Show Gateway from the gateway menu. The resource window is displayed. Figure 150 on page 212 shows the active sessions between the AS/400 and the Macintosh IIfx.



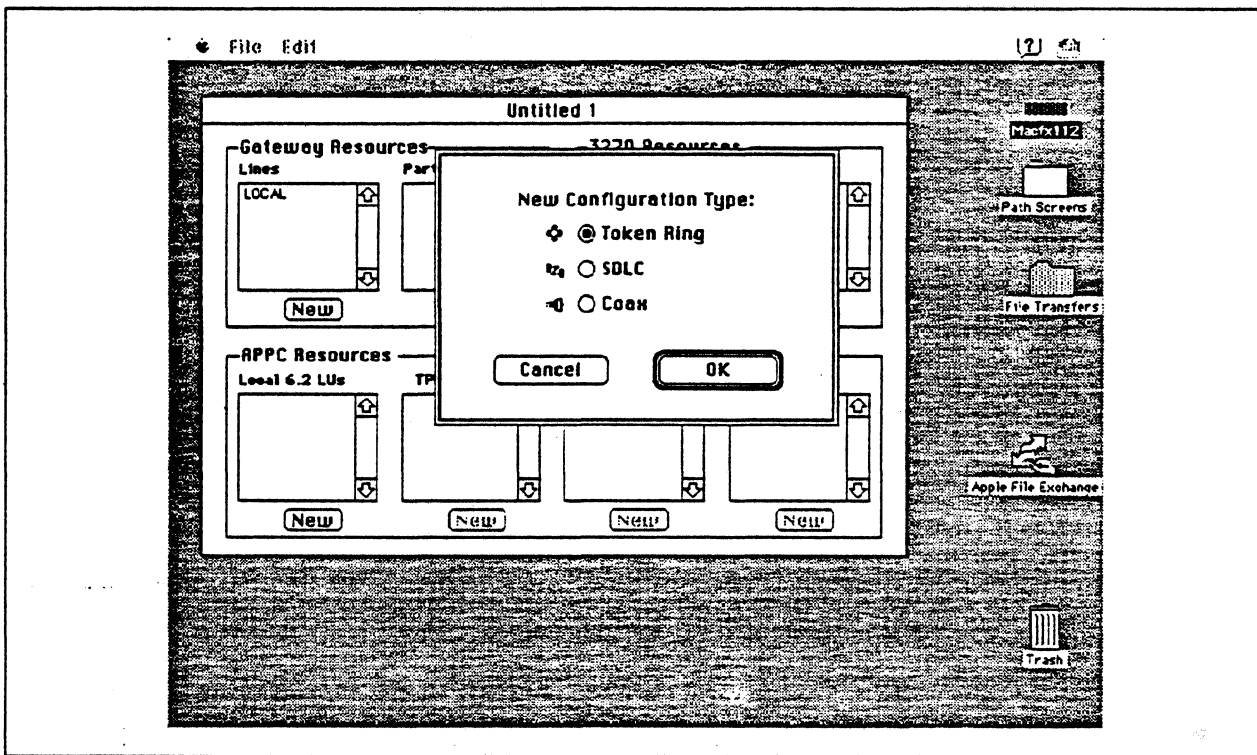

Figure 143. DLC Type Selection for Upstream Connection

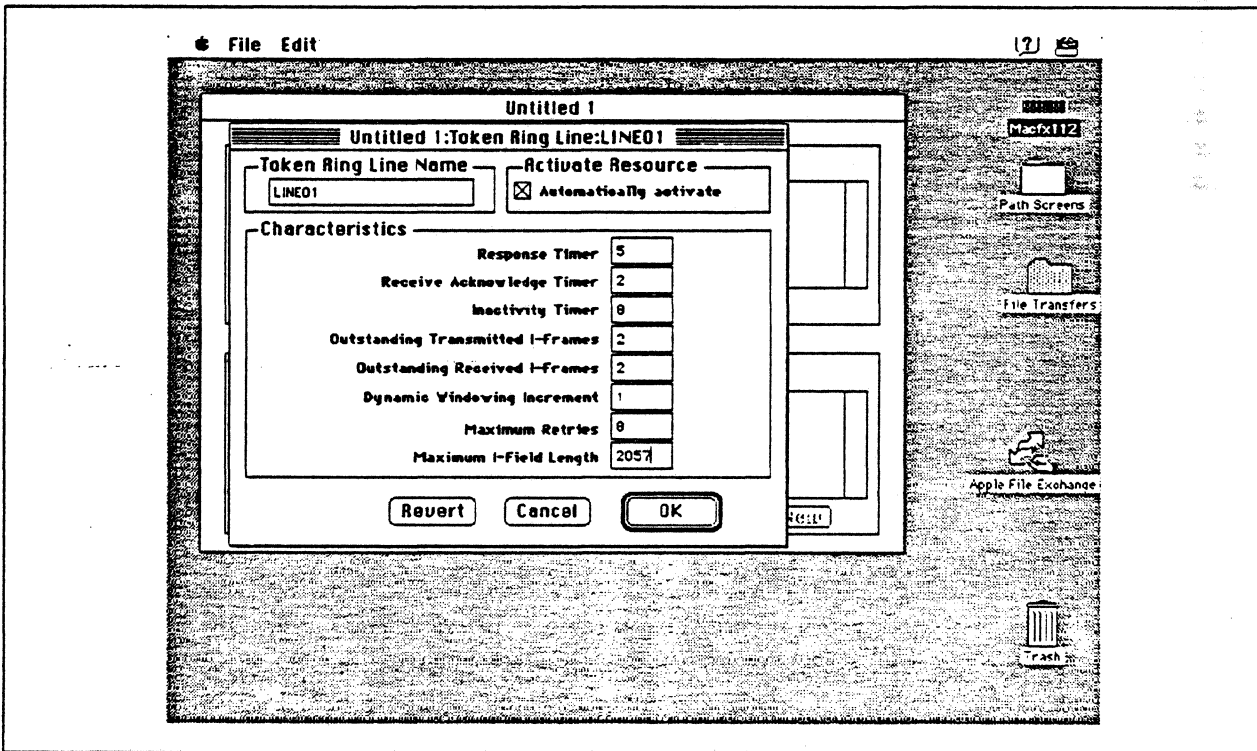

Figure 144. Token Ring Line Configuration Parameters

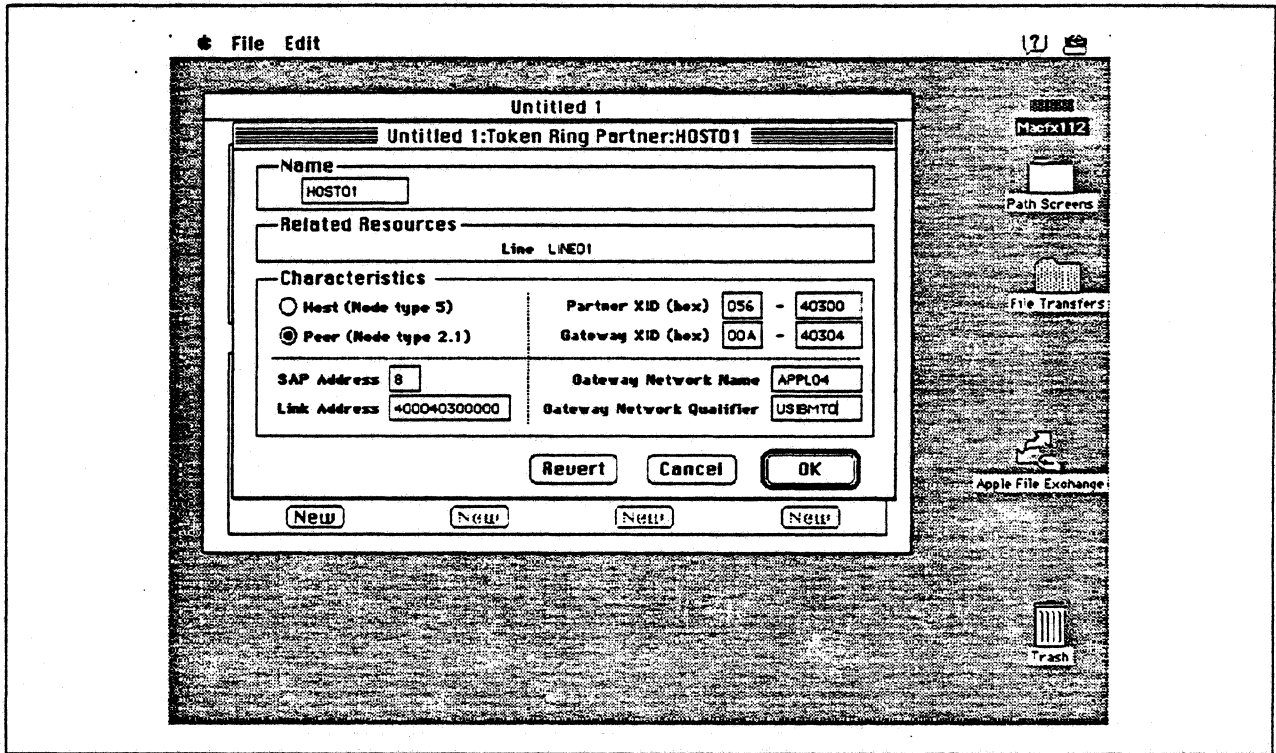

Figure 145. Token Ring Partner Configuration Parameters

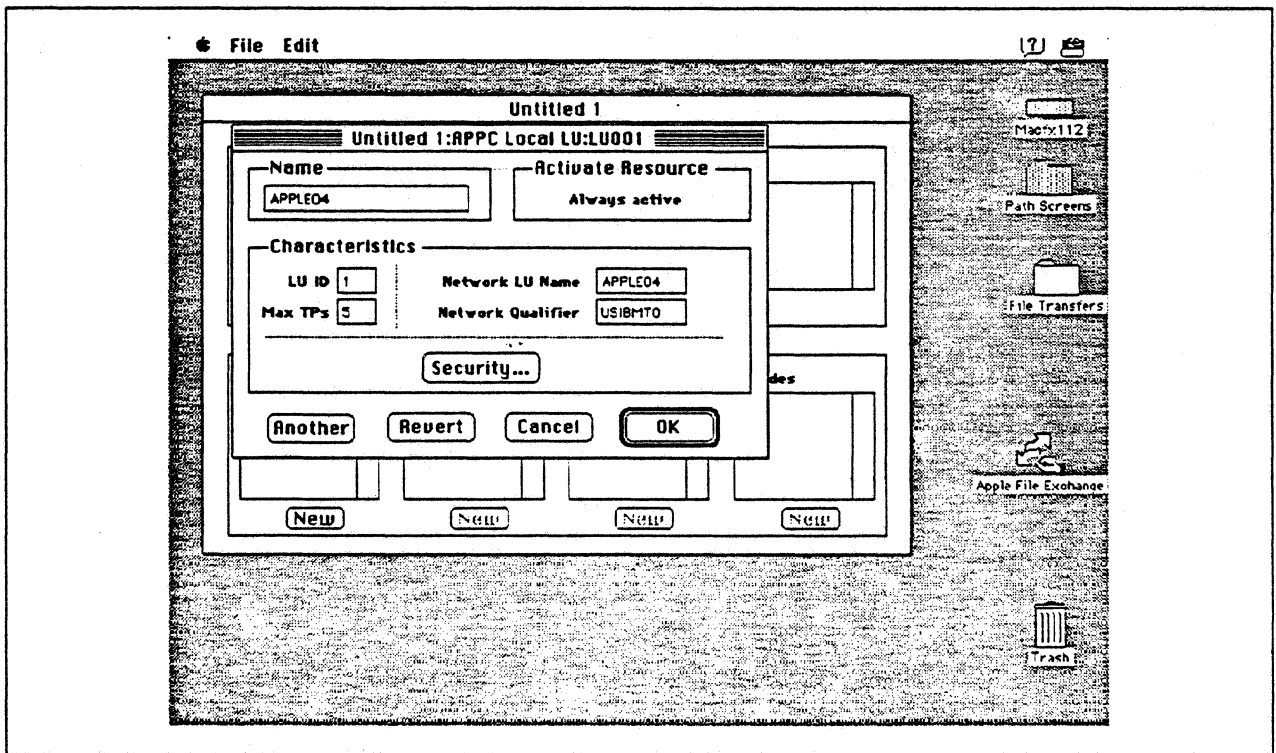

Figure 146. Configuring an APPC Local LU

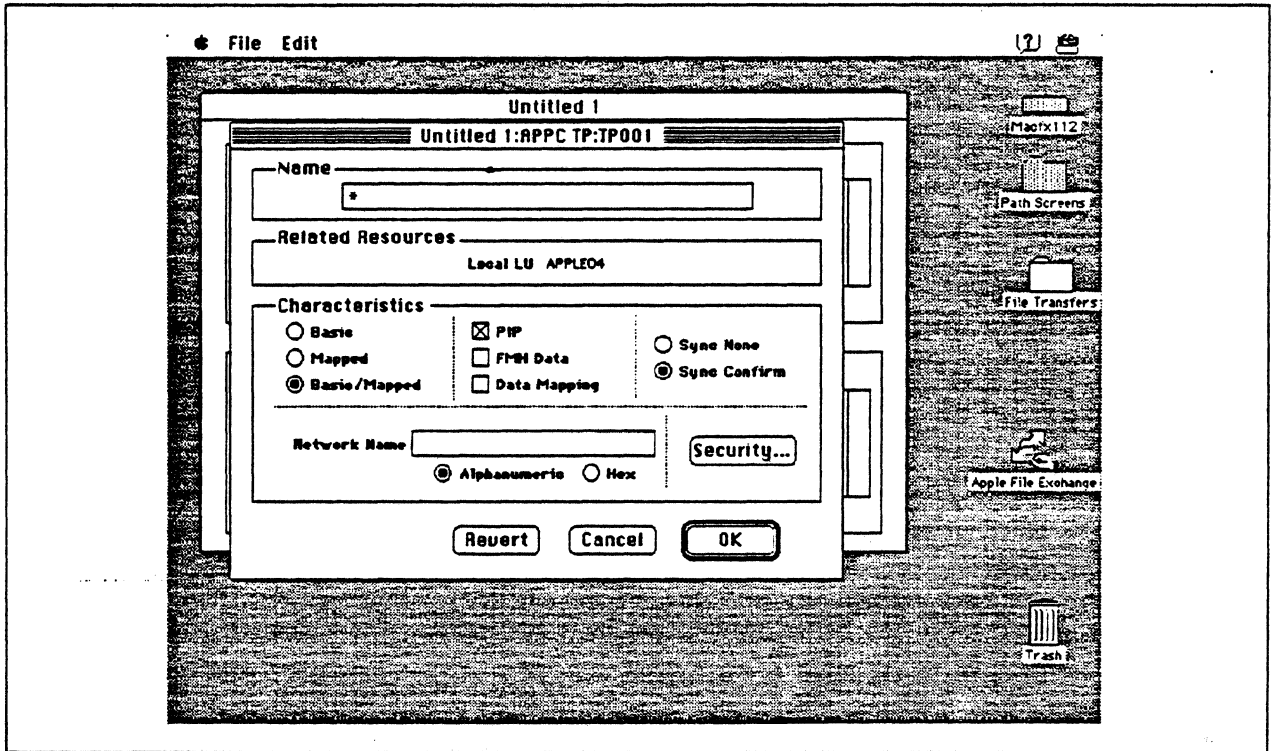

Figure 147. Configuring an APPC Transaction Program

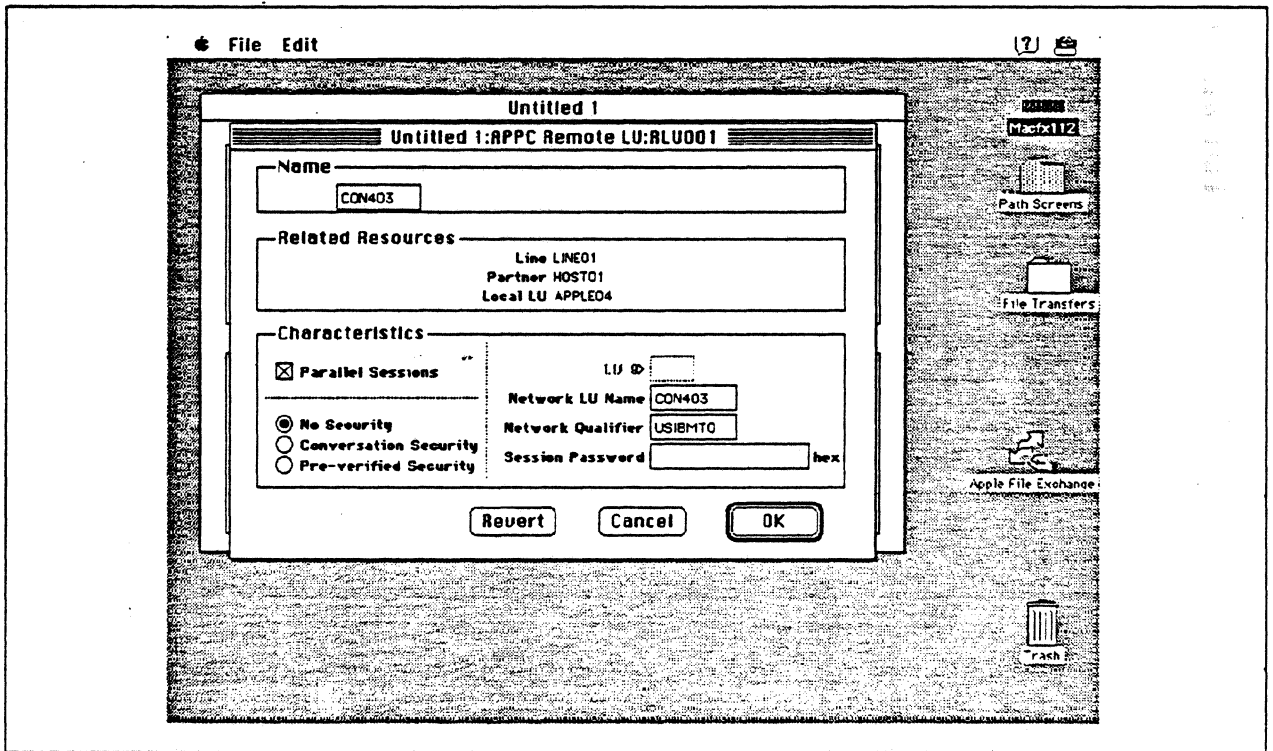

Figure 148. Configuring an APPC Remote LU

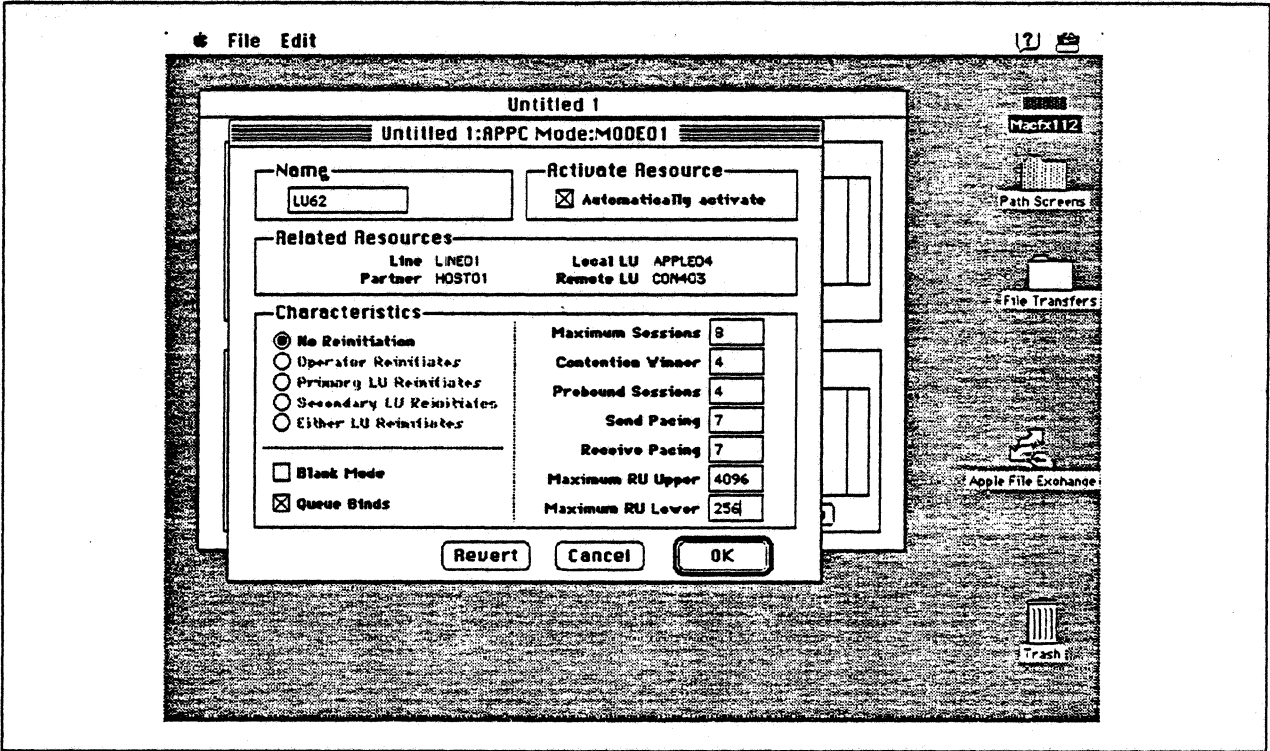

Figure 149. Configuring an APPC Mode

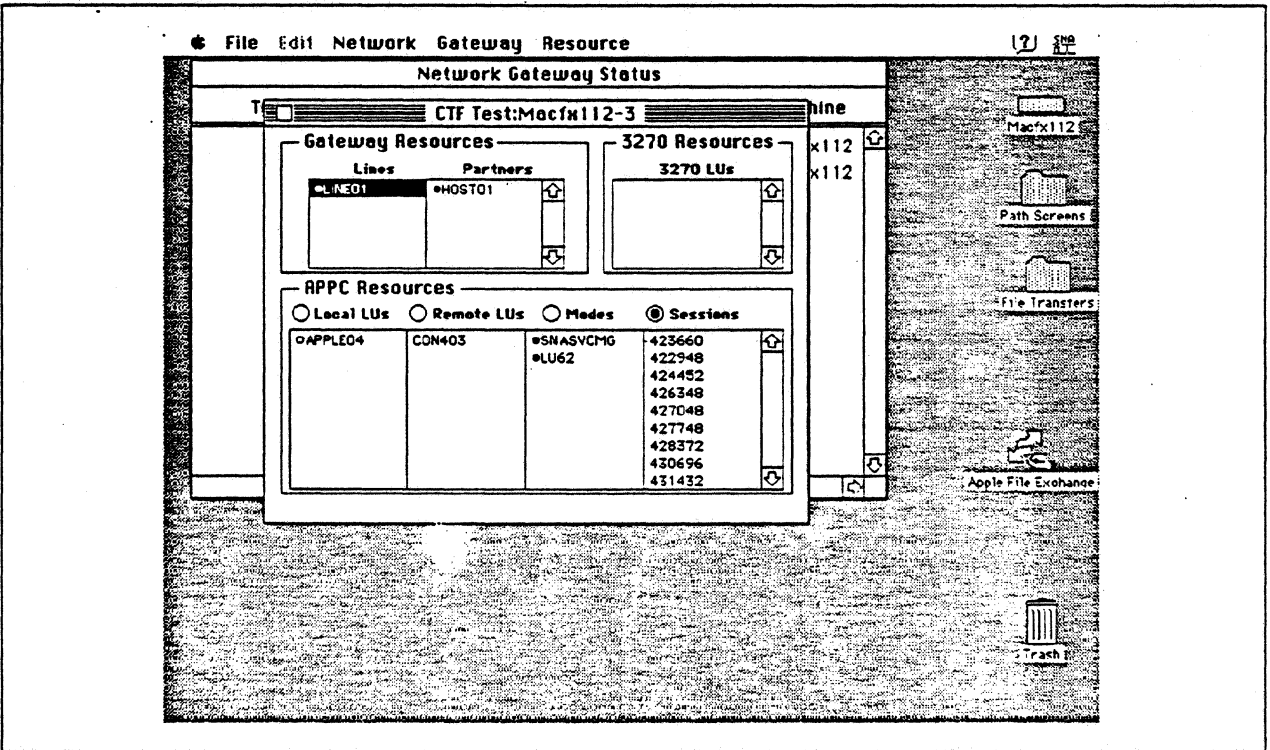

Figure 150. SNA\*ps Admin Network Status Window Showing Active APPC Sessions

## Observations and Hints

In the AS/400 configuration, the LAN remote adapter address 1000E0017D1D corresponds to the Token Ring address of the Apple Token Ring 4/16 NB Card.

APPC programs allowing file transfers in both directions were exercised.

When the AS/400 Token-Ring line is varied on, the line should go to the VARIED ON state which indicates that the AS/400 Token-Ring adapter has been successfully inserted on the ring.

The SNA•ps Config program requires that a value be entered in the Gateway ID field (refer to Figure 145 on page 210), but there are situations where this value is not checked by the AS/400 during XID exchange. In this path the AS/400 controller description was auto-configured. When auto-configured, the Gateway ID (referred to as exchange identifier in AS/400 literature) from the Macintosh is ignored and not included in the created controller description. Therefore, in this path, any Gateway ID value may be specified when configuring the Macintosh. However, if you explicitly create an AS/400 controller description and specify an exchange identifier (EXCHID parameter), then the exchange identifier is used to verify the XID coming from the Macintosh. In that case, for the controller to be successfully contacted, the Gateway ID would have to match the value used on the controller description EXCHID parameter.

In the AS/400 line description there is both a line speed parameter and a link speed parameter. It is the line speed parameter that determines the actual rate at which the token-Ring adapter will run. The link speed parameter is used only for lines that are attached to APPC or host controller descriptions that specify APPN(\*YES). This parameter is used to define line characteristics for use by APPN in class-of-service processing; it does not necessarily represent the actual line speed. The value selected for this parameter and the class of service selected for a session determine route selection through an APPN network. If you are using APPN but do not plan to tailor the route selection process, use the default values.

---

## Path 19: OS/2 Networking Services/2 with AS/400 Network Node (Token Ring)

### Path Description

This configuration utilizes the APPC capability of the SNA•ps product running on an Apple Macintosh connected through an IBM AS/400 on a Token Ring (IEEE 802.5) local area network to an IBM PS/2 with OS/2 Extended Edition 1.3 and Network Services/2 via another Token Ring local area network.

The configuration is shown in Figure 151 on page 215. The AS/400 is attached to the Token Rings using 16/4 Mbps Token Ring interface cards. An Apple Token Ring 4/16 NB Card is used in the Macintosh for LAN attachment. The PS/2 is attached to the Token Ring using a 16/4 Mbps Token-Ring Adapter/A.

This configuration verified an APPC connection between the Macintosh (as a LEN node) and the PS/2 (as an EN) with the AS/400 acting as a network node.

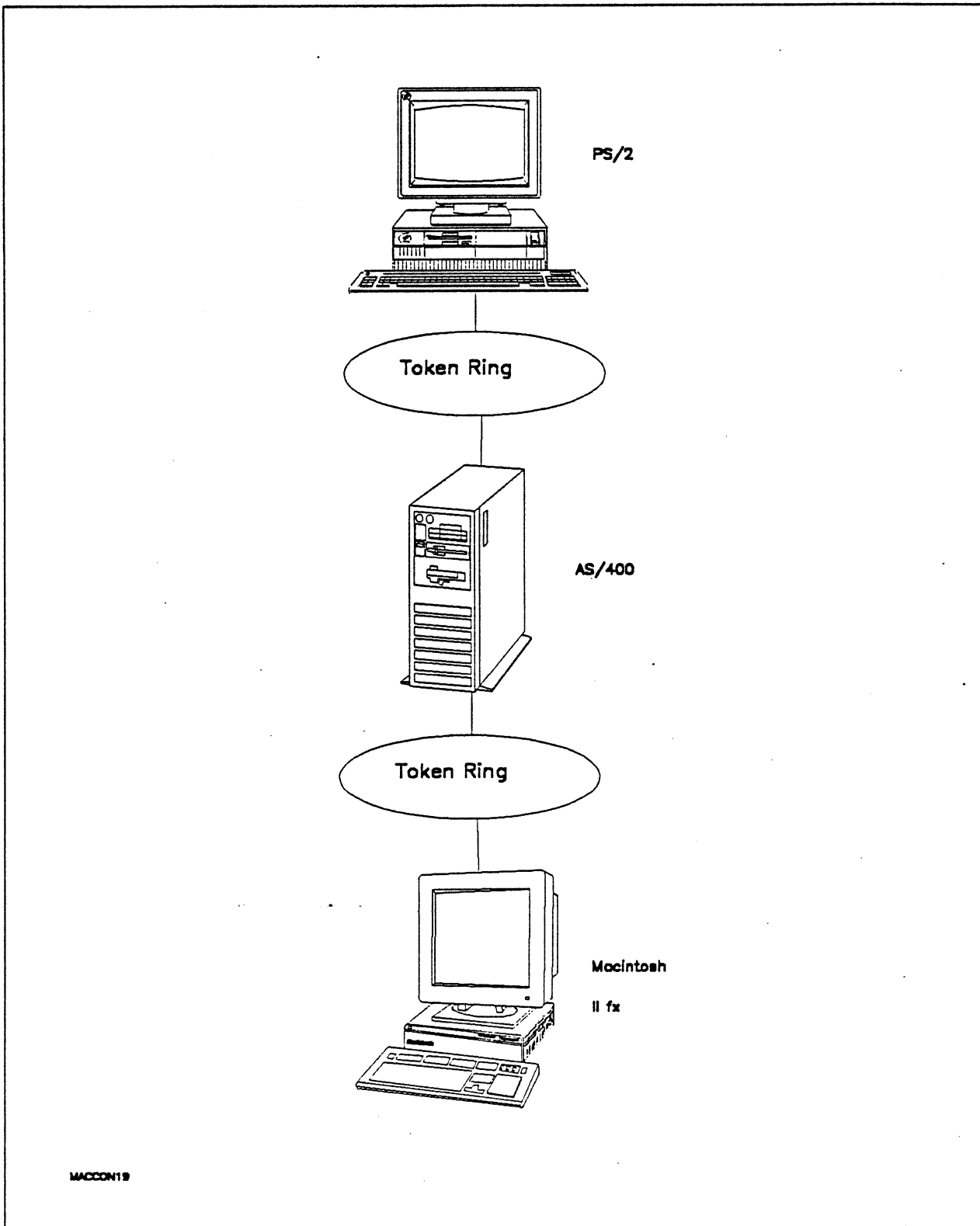

Figure 151. Path 19 Configuration - OS/2 Networking Services/2 with AS/400 Network Node (Token Ring)

## Hardware and Software

The following section describes the hardware and software that was used for this path.

### PS/2

- OS/2 Extended Edition V1.30.1 CSD WR05016
- SAA Networking Services/2 Version 1.0
- Total System Memory - 10M
- IBM Memory Expansion Adapter
- IBM Token-Ring Network 16/4 Adapter/A
- ESDI Fixed Disk Controller

### Token Rings

- 16 Mbps

### AS/400

- 9406 system
- 16/4 Token-Ring adapter cards (2) feature #2626
- OS/400 Version 2 Release 1

### Macintosh IIx

- System Software 7.0
- SNA•ps Gateway/64 V1.1 (beta)
- Apple Token Ring 4/16 NB Card
- Total memory - 4M
- Hard disk - 80M



## Configuration Details and Operating Procedures

### OS/2 Extended Edition and Communications Manager

**OS/2 CONFIG.SYS file:** The OS/2 CONFIG.SYS file used on this PS/2 is shown below. Notice that there are additional entries placed in CONFIG.SYS when NS/2 is installed. These entries allow NS/2 APPN/APPC functions to be implicitly used by Communications Manager.

```

PROTSHELL=C:\OS2\PMShell.EXE C:\OS2\OS2.INI C:\OS2\OS2SYS.INI C:\OS2\CMD.EXE
SET COMSPEC=C:\OS2\CMD.EXE
LIBPATH=C:\CMLIB\APPN\DLL;C:\OS2\DLL;C:\MUGLIB\DLL;C:\CMLIB\DLL;
C:\IBMLAN\NETLIB;C:\;
SET PATH=C:\CMLIB\APPN;C:\OS2;C:\MUGLIB;C:\CMLIB;C:\IBMLAN\NETPROG;
C:\OS2\SYSTEM;C:\OS2\INSTALL;C:\;
SET DPATH=C:\CMLIB\APPN;C:\OS2;C:\MUGLIB\DLL;C:\CMLIB;C:\IBMLAN\NETPROG;
C:\OS2\SYSTEM;C:\OS2\INSTALL;C:\;
SET PROMPT=$i {$p}
SET HELP=C:\CMLIB\APPN;C:\OS2\HELP;
BUFFERS=60
IOPL=YES
DISKCACHE=64
MAXWAIT=3
MEMMAN=SWAP,MOVE,SWAPDOS
PROTECTONLY=NO
SWAPPATH=C:\OS2\SYSTEM 512
THREADS=255
COUNTRY=001,C:\OS2\SYSTEM\COUNTRY.SYS
DEVINFO=SCR,BGA,C:\OS2\VIOTBL.DCP
DEVICE=C:\CMLIB\RQCSDD.SYS
SET VIDEO_DEVICES=VIO_IBM8514A
SET VIO_IBM8514A=DEVICE(BVHVGA,BVH8514A)
DEVICE=C:\OS2\POINTDD.SYS
DEVICE=C:\OS2\IBMMOU02.SYS
DEVICE=C:\OS2\MOUSE.SYS TYPE=IBMMOU$
DEVICE=C:\OS2\PMDD.SYS
SET KEYS=0N
SET BOOKSHELF=C:\OS2\BOOK;
SHELL=C:\OS2\COMMAND.COM /P
BREAK=OFF
FCBS=16,8
RMSIZE=640
DEVICE=C:\OS2\EGA.SYS
DEVICE=C:\OS2\DOS.SYS
DEVINFO=KBD,US,C:\OS2\KEYBOARD.DCP
CODEPAGE=437,850
DEVICE=C:\CMLIB\LANDD.SYS
DEVICE=C:\CMLIB\APPN\ACSLDLAN.SYS
DEVICE=C:\CMLIB\TRNETDD.SYS CFG=C:\CMLIB\PATH19.CFG
RUN=C:\CMLIB\ACSTRSYS.EXE
DEVICE=C:\CMLIB\ASYNCDDB.SYS
DEVICE=C:\CMLIB\NETBDD.SYS CFG=C:\CMLIB\PATH19.CFG
DEVICE=C:\IBMLAN\NETPROG\RDRHELP.SYS
IFS=C:\IBMLAN\NETPROG\NETWKSTA.SYS /I:C:\IBMLAN
DEVICE=C:\CMLIB\APPN\CMKFMDD.SYS

```

**OS/2 Extended Edition Communications Manager:** It is assumed that OS/2 Extended Edition with Communications Manager has been previously installed. First, configure the Communications Manager as specified in the SAA Networking Services/2 Installation and Network Administrator's Guide (SC52-1110)

chapter 7 and Appendix G. This creates a Communications Manager configuration file which has the basic APPC support included. As mentioned in the above reference, many of the Communications Manager configuration profiles are not used once NS/2 is installed, but one must have a verified Communications Manager configuration file which includes APPC support as a starting point to use NS/2.

In addition some Communications Manager profiles must be configured precisely since NS/2 relies on them to be properly configured. The procedure for configuring these profiles is shown below.

1. Start Communications Manager. The last screen previously used in Communications Manager appears. If this screen is not the Communications Manager Main Menu, hit ESC until that panel is shown.
2. To configure Communications Manager, select "Advanced" from the action bar, select option 4 (Configuration..), enter a configuration file name (for this example PATH19 was used) and hit the ENTER key. You will then be presented with various profiles which may be configured.
3. Select option 1 (Workstation profile) and hit the ENTER key. Configure with the values shown in the following screens.

```

Workstation Profile (1 of 2)
Comment . . . . . :
  Mac to PS/2 thru AS/400
Machine type - model . . . . . : 8580-121
IBM plant of manufacture-
  Machine sequence number . . . . . : 23-9003875
Translation table file name . . . . . :
Error log file name . . . . . :
  ERROR.DAT
Error log size . . . . . : 16 K
Error log overflow option . . . . . : Wrap
Message log file name . . . . . :
  MESSAGE.DAT
Message log size . . . . . : 500 messages
Message log overflow option . . . . . : Wrap
Display message pop-ups . . . . . : Yes
Enable auto-start options . . . . . : Yes
    
```

```

Workstation Profile (2 of 2)
Load these services:
SNA/APPC . . . . . : Yes
SRPI . . . . . : No
X.25 . . . . . : No
ACDI . . . . . : No

Auto-start these emulators:
3270 terminal emulation (DFT) . . . . . : No
3270 terminal emulation (Non-DFT) . . . . . : No
ASCII terminal emulation . . . . . : No
5250 Work Station Feature . . . . . : No

Display this screen first . . . . . :
  Communications Manager main menu
Display this session first . . . . . :
    
```

Hit ENTER to save the profile information.

4. Select option 4 (SNA feature profiles) and hit the ENTER key. You will be presented with another panel containing a list of SNA-related profiles.

5. Select the "Data Link Control (DLC) profiles..." option, select "IBM Token-Ring Network..." option, select Adapter 0 and Create and then configure with the values shown in the following screen.

```

IBM Token-Ring Network DLC Adapter Profile
Adapter number . . . . . : 0
Load DLC . . . . . : Yes
Maximum number of link stations. . . . . : 4
Percent of incoming calls. . . . . : 0%
Free unused link . . . . . : No
Congestion tolerance . . . . . : 80%
Maximum RU size. . . . . : 2048 bytes
Send window count. . . . . : 2
Receive window count . . . . . : 2
C&SM LAN ID. . . . . : PS0S2110
Send alert for beaconing . . . . . : No
    
```

Hit ENTER to save the profile information.

6. The necessary SNA feature profiles have now been defined. Hit the ESC key to get back to the Communication Configuration Menu.
7. Select the "LAN feature profiles" option. Select the following from the LAN Profile Configuration panel:

```

LAN Profile Configuration
Adapter number . . . . . 0
Interface. . . . . IEEE 802.2...
    
```

8. Select "IBM Token-Ring Network 16/4 Adapter /A" from the Specify LAN Adapter Type panel and use the following values to configure the IEEE 802.2 Token-Ring Profile.

```

IEEE 802.2 Token-Ring Profile (1 of 2)
Adapter number and version . . . . . : 0 - 16/4 /A
Load LAN support . . . . . : Yes
Adapter shared RAM address . . . . . :
Use universally
  administered address . . . . . : Yes
Adapter address. . . . . :
Maximum number SAPs. . . . . : 5
Maximum link stations. . . . . : 10
Maximum number group SAPs. . . . . : 0
Maximum members per group SAP. . . . . : 0
Maximum number of users. . . . . : 4
Transmit buffer size . . . . . : 4464 bytes
Number of transmit buffers . . . . . : 2
Receive buffer size. . . . . : 96 bytes
Minimum receive buffers. . . . . : 103
    
```

```

IEEE 802.2 Token-Ring Profile (2 of 2)
Adapter number and version . . . . . : 0 - 16/4 /A

Adapter "Open" options
Wrap interface . . . . . : No
Contender. . . . . : No
Override token release default . . . . . : No
Group 1 response timer (T1). . . . . : 015 x 40 ms.
Group 1 acknowledgement timer (T2) . . . . . : 003 x 40 ms.
Group 1 inactivity timer (Ti). . . . . : 255 x 40 ms.
Group 2 response timer (T1). . . . . : 025 x 40 ms.
Group 2 acknowledgement timer (T2) . . . . . : 010 x 40 ms.
Group 2 inactivity timer (Ti). . . . . : 255 x 40 ms.
Number of queue elements . . . . . : 800
Number of Global Descriptor
Table selectors. . . . . : 30

```

Hit ENTER to save the profile information.

The profiles required for Communications Manager have now been configured.

**Note:** After configuring the necessary profiles, do the following:

1. Use the Verify option of Communications Manager to check the configuration for potential errors. Use the Message option to check for error messages if the verify fails. The configuration file must pass verification before it can be used.
2. From the Communications Manager Main Menu, select option 4 ("Specify new configuration file name default") to specify the new configuration file (PATH19) that will be used the next time Communications Manager is started.
3. Exit Communications Manager (Exit, then select option 2 Exit Immediate, then select Yes).

**Note:** NS/2 must be installed after OS/2 Extended Edition 1.3 has been installed. After NS/2 has been installed and configured, Communications Manager must be restarted as described above. See the next section on Network Services/2 for more information.

**Network Services/2:** Network Services/2 is an IBM product which replaces the APPC function contained in the OS/2 Extended Edition Communications Manager. NS/2 also provides APPN support that is not included with OS/2 Extended Edition Communications Manager. NS/2 can only be installed after OS/2 Extended Edition is installed. Part of the NS/2 installation includes disabling the normal Communications Manager DLLs (dynamic link libraries) and replacing them with the NS/2 DLLs. In this way when APPC/APPN functions are requested through Communications Manager, the NS/2 code is accessed and actually provides the functions.

NS/2 was installed and configured using the advanced configuration panels. The resulting configuration file (PATH19.NDF) is shown below.

```

DEFINE_LOCAL_CP FQ_CP_NAME(USIBMT0.PS0S2110 )
                CP_ALIAS(PS0S2110)
                NAU_ADDRESS(INDEPENDENT_LU)
                NODE_TYPE(EN)
                NODE_ID(X'30267')
                HOST_FP_SUPPORT(NO);

DEFINE_LOGICAL_LINK LINK_NAME(LINK0001)
                   ADJACENT_NODE_TYPE(NN)
                   PREFERRED_NN_SERVER(YES)
                   DLC_NAME(IBMTRNET)
                   ADAPTER_NUMBER(0)
                   DESTINATION_ADDRESS(X'400040300041')
                   CP_CP_SESSION_SUPPORT(YES)
                   ACTIVATE_AT_STARTUP(YES)
                   LIMITED_RESOURCE(NO)
                   LINK_STATION_ROLE(USE_ADAPTER_DEFINITION)
                   SOLICIT_SSCP_SESSION(NO)
                   EFFECTIVE_CAPACITY(USE_ADAPTER_DEFINITION)
                   COST_PER_CONNECT_TIME(USE_ADAPTER_DEFINITION)
                   COST_PER_BYTE(USE_ADAPTER_DEFINITION)
                   SECURITY(USE_ADAPTER_DEFINITION)
                   PROPAGATION_DELAY(USE_ADAPTER_DEFINITION)
                   USER_DEFINED_1(USE_ADAPTER_DEFINITION)
                   USER_DEFINED_2(USE_ADAPTER_DEFINITION)
                   USER_DEFINED_3(USE_ADAPTER_DEFINITION);

DEFINE_LOCAL_LU LU_NAME(PS2110 )
                LU_ALIAS(FILESVR )
                NAU_ADDRESS(INDEPENDENT_LU);

DEFINE_PARTNER_LU FQ_PARTNER_LU_NAME(USIBMT0.MAC01 )
                 PARTNER_LU_ALIAS(FILEREQ)
                 MAX_MC_LL_SEND_SIZE(32767)
                 CONV_SECURITY_VERIFICATION(NO)
                 PARALLEL_SESSION_SUPPORT(YES);

DEFINE_MODE MODE_NAME(MODE1 )
            COS_NAME(#CONNECT)
            DEFAULT_RU_SIZE(NO)
            MAX_RU_SIZE_UPPER_BOUND(4096)
            RECEIVE_PACING_WINDOW(8)
            MAX_NEGOTIABLE_SESSION_LIMIT(32767)
            PLU_MODE_SESSION_LIMIT(8)
            MIN_CONWINNERS_SOURCE(4);

DEFINE_TP TP_NAME(FILEMSVR)
          FILESPEC(C:\CMLIB\APPN\SAMPLES\FILE\OS2SAMP\FILECSVR.EXE)
          CONVERSATION_TYPE(EITHER)
          CONV_SECURITY_RQD(NO)
          SYNC_LEVEL(EITHER)
          TP_OPERATION(NONQUEUED_AM_STARTED)
          PROGRAM_TYPE(BACKGROUND)
          RECEIVE_ALLOCATE_TIMEOUT(120);

START_ATTACH_MANAGER;

```

**AS/400:** For workstation communication through an AS/400 via a Token Ring using APPC the AS/400 controller description and any associated device description does not have to be explicitly created. At the time the workstation attempts to contact the AS/400, the necessary controller/device descriptions are dynamically created and implicitly varied on. For this path the AS/400 dynamically creates the controller description for the Macintosh and the controller and device descriptions for the PS/2. Note that since the Macintosh functions as a LEN node, only a controller description is created. Since the PS/2 functions as an EN node, both a controller and device description are dynamically created.

The line description must be explicitly created. The values used for the line description are shown below.

**Line Description - LAN (TRNLIN041)**

```

Line description . . . . . : TRNLIN041
Option . . . . . : *BASIC
Category of line . . . . . : *TRLAN

Resource name . . . . . : LIN041
Online at IPL . . . . . : *NO
Vary on wait . . . . . : *NOWAIT
Maximum controllers . . . . . : 50
Line speed . . . . . : 16M
Maximum frame size . . . . . : 2057
TRLAN manager logging level. . . . : *MIN
  Current logging level. . . . . : *MIN
TRLAN manager mode . . . . . : *OBSERVING
Log configuration changes . . . . . : *NOLOG
Token-ring inform of beacon . . . . : *YES
Local adapter address . . . . . : 400040300041
Exchange identifier . . . . . : 05615366
Early token release. . . . . : *NO
Error threshold level . . . . . : *OFF
Text . . . . . : Connection to Token-Ring
  
```

```

Line description . . . . . : TRNLIN041
Option . . . . . : *SSAP
Category of line . . . . . : *TRLAN
  
```

SSAP	Maximum Frame	Type	SSAP	Maximum Frame	Type
04	*MAXFRAME	*SNA	14	*MAXFRAME	*SNA
08	*MAXFRAME	*SNA	18	*MAXFRAME	*SNA
0C	*MAXFRAME	*SNA	1C	*MAXFRAME	*SNA
10	*MAXFRAME	*SNA	20	*MAXFRAME	*SNA

```

Line description . . . . . : TRNLIN041
Option . . . . . : *APPN
Category of line . . . . . : *TRLAN

Link speed . . . . . : 4M    ** see Observations and Hints **
Cost/connect time . . . . . : 0
Cost/byte . . . . . : 0
Security for line . . . . . : *NONSECURE
Propagation delay . . . . . : *LAN
User-defined 1 . . . . . : 128
User-defined 2 . . . . . : 128
User-defined 3 . . . . . : 128
Autocreate controller . . . . . : *YES
Autodelete controller . . . . . : *NONE
  
```

```

Line description . . . . . : TRNLIN041
Option . . . . . : *TMRRTY
Category of line . . . . . : *TRLAN

```

## Recovery limits:

```

Count limit . . . . . : 2
Time interval . . . . . : 5

```

The dynamically created controller for the PS/2 resulted in the description shown below.

**Controller Description - APPC (PS0S2110)**

```

Controller description . . . . . : PS0S2110
Option . . . . . : *BASIC
Category of controller . . . . . : *APPC
  Link type . . . . . : *LAN
  Online at IPL . . . . . : *NO
  Character code . . . . . : *EBCDIC
  Maximum frame size . . . . . : 16393
  Remote network identifier . . . . . : USIBMT0
  Remote control point . . . . . : PS0S2110
  Initial connection . . . . . : *DIAL
  Switched disconnect . . . . . : *YES
  Data link role . . . . . : *NEG
  LAN remote adapter address . . . . . : 10005AAD36C5
  LAN DSAP . . . . . : 04
  LAN SSAP . . . . . : 04
  Text . . . . . : Automatically created by QLUS

Controller description . . . . . : PS0S2110
Option . . . . . : *SWTLINLST
Category of controller . . . . . : *APPC
  Switched lines . . . . . : TRNLIN041

Controller description . . . . . : PS0S2110
Option . . . . . : *DEV
Category of controller . . . . . : *APPC
  Attached Devices . . . . . : PS0S211000

Controller description . . . . . : PS0S2110
Option . . . . . : *APPN
Category of controller . . . . . : *APPC
  APPN-capable . . . . . : *YES
  APPN CP session support . . . . . : *YES
  APPN node type . . . . . : *CALC
  APPN transmission grp number . . . . . : *CALC
  APPN minimum switched status . . . . . : *VRYONPND
  Model controller description . . . . . : *NO
  Control owner . . . . . : *SYS

```

Path 19

```
Controller description . . . . . : PSOS2110
Option . . . . . : *TMRRTY
Category of controller . . . . . : *APPC
  Disconnect timer . . . . . : 170
  LAN frame retry . . . . . : 10
  LAN connection retry . . . . . : 10
  LAN response timer . . . . . : 10
  LAN connection timer . . . . . : 70
  LAN acknowledgement timer . . . . . : 1
  LAN inactivity timer . . . . . : 100
  LAN acknowledgement frequency . . . : 1
  LAN max outstanding frames . . . . . : 2
  LAN access priority . . . . . : 0
  LAN window step . . . . . : *NONE
Recovery limits:
  Count limit . . . . . : 2
  Time interval . . . . . : 5
```

The dynamically created device for the PS/2 resulted in the description shown below.

**Device Description - APPC (PSOS211000)**

```
Device description . . . . . : PSOS211000
Option . . . . . : *BASIC
Category of device . . . . . : *APPC
  Remote location . . . . . : PSOS2110
  Online at IPL . . . . . : *NO
  Local location . . . . . : CON403
  Remote network identifier . . . . . : *NETATR
  Attached controller . . . . . : PSOS2110
  Message queue . . . . . : QSYSOPR
  Library . . . . . : *LIBL
  Local location address . . . . . : 00
  APPN-capable . . . . . : *YES
Single session:
  Single session capable . . . . . : *NO
Text . . . . . : Automatically created by QLUS

Device description . . . . . : PSOS211000
Option . . . . . : *MODE
Category of device . . . . . : *APPC
  Mode . . . . . : *NETATR
```

The following line description must be explicitly created. The values used for the line description are shown below.



Line Description - LAN (TRNLIN031)

```

Line description . . . . . : TRNLIN031
Option . . . . . : *BASIC
Category of line . . . . . : *TRLAN

Resource name . . . . . : LIN031
Online at IPL . . . . . : *NO
Vary on wait . . . . . : *NOWAIT
Maximum controllers . . . . . : 50
Line speed . . . . . : 16M
Maximum frame size . . . . . : 2057
TRLAN manager logging level . . . . . : *MIN
  Current logging level . . . . . : *MIN
TRLAN manager mode . . . . . : *OBSERVING
Log configuration changes . . . . . : *NOLOG
Token-ring inform of beacon . . . . . : *YES
Local adapter address . . . . . : 400040300000
Exchange identifier . . . . . : 05640300
Early token release . . . . . : *NO
Error threshold level . . . . . : *OFF
Text . . . . . : Connection to Token-Ring
  
```

```

Line description . . . . . : TRNLIN031
Option . . . . . : *SSAP
Category of line . . . . . : *TRLAN
  
```

SSAP	Maximum Frame	Type	SSAP	Maximum Frame	Type
04	*MAXFRAME	*SNA	14	*MAXFRAME	*SNA
08	*MAXFRAME	*SNA	18	*MAXFRAME	*SNA
0C	*MAXFRAME	*SNA	1C	*MAXFRAME	*SNA
10	*MAXFRAME	*SNA	20	*MAXFRAME	*SNA

```

Line description . . . . . : TRNLIN031
Option . . . . . : *APPN
Category of line . . . . . : *TRLAN

Link speed . . . . . : 4M      ** see Observations and Hints **
Cost/connect time . . . . . : 0
Cost/byte . . . . . : 0
Security for line . . . . . : *NONSECURE
Propagation delay . . . . . : *LAN
User-defined 1 . . . . . : 128
User-defined 2 . . . . . : 128
User-defined 3 . . . . . : 128
Autocreate controller . . . . . : *YES
Autodelete controller . . . . . : *NONE
  
```

```

Line description . . . . . : TRNLIN031
Option . . . . . : *TMRRTY
Category of line . . . . . : *TRLAN
  
```

```

Recovery limits:
  Count limit . . . . . : 2
  Time interval . . . . . : 5
  
```

The dynamically created controller for the Macintosh resulted in the description shown below.

## Controller Description - APPC (MACFX112)

```

Controller description . . . . . : MACFX112
Option . . . . . : *BASIC
Category of controller . . . . . : *APPC
  Link type . . . . . : *LAN
  Online at IPL . . . . . : *NO
  Character code . . . . . : *EBCDIC
  Maximum frame size . . . . . : 16393
  Remote network identifier . . . . . : USIBMT0
  Remote control point . . . . . : MACFX112
  Exchange identifier . . . . . : 00A00000
  Initial connection . . . . . : *DIAL
  Switched disconnect . . . . . : *YES
  Data link role . . . . . : *NEG
  LAN remote adapter address . . . . . : 1000E0017D1D
  LAN DSAP . . . . . : 04
  LAN SSAP . . . . . : 04
  Text . . . . . : Automatically created by QLUS

Controller description . . . . . : MACFX112
Option . . . . . : *SWTLINLST
Category of controller . . . . . : *APPC
  Switched lines . . . . . : TRNLIN031

Controller description . . . . . : MACFX112
Option . . . . . : *DEV
Category of controller . . . . . : *APPC
  Attached Devices . . . . . : No devices attached

Controller description . . . . . : MACFX112
Option . . . . . : *APPN
Category of controller . . . . . : *APPC
  APPN-capable . . . . . : *YES
  APPN CP session support . . . . . : *YES
  APPN node type . . . . . : *CALC
  APPN transmission grp number . . . . . : *CALC
  APPN minimum switched status . . . . . : *VRYONPND
  Model controller description . . . . . : *NO
  Control owner . . . . . : *SYS

Controller description . . . . . : MACFX112
Option . . . . . : *TMRRTY
Category of controller . . . . . : *APPC
  Disconnect timer . . . . . : 170
  LAN frame retry . . . . . : 10
  LAN connection retry . . . . . : 10
  LAN response timer . . . . . : 10
  LAN connection timer . . . . . : 70
  LAN acknowledgement timer . . . . . : 1
  LAN inactivity timer . . . . . : 100
  LAN acknowledgement frequency . . . . . : 1
  LAN max outstanding frames . . . . . : 2
  LAN access priority . . . . . : 0
  LAN window step . . . . . : *NONE
  Recovery limits:
    Count limit . . . . . : 2
    Time interval . . . . . : 5

```

The following list contains the network attribute values used for this path. (Use the DSPNETA command to display the values.)

**Network Attributes**

```

Current system name . . . . . : CON403
  Pending system name . . . . . : (blank)
Local network ID . . . . . : USIBMT0
Local control point name . . . . . : CON403
Default local location . . . . . : CON403
Default mode . . . . . : BLANK
APPN node type . . . . . : *NETNODE
Maximum number of intermediate sessions . . . . . : 200
Route addition resistance . . . . . : 128
Server network ID/control point name . . . . . : *LCLNETID *ANY
Alert status . . . . . : *ON
Alert primary focal point . . . . . : *NO
Alert default focal point . . . . . : *NO
Alert logging status . . . . . : *ALL
Alert controller description . . . . . : *NONE
Message queue . . . . . : QSYSOPR
  Library . . . . . : QSYS
Output queue . . . . . : QPRINT
  Library . . . . . : QGPL
Job action . . . . . : *FILE
Maximum hop count . . . . . : 16
DDM request access . . . . . : *OBJAUT
PC Support request access . . . . . : *OBJAUT
Default ISDN network type . . . . . :
Default ISDN connection list . . . . . : QDCCNNLANY
  
```

**Configuration List for APPN Remote Routing:** The following information shows the way the APPN remote routing configuration list must be set up. To configure this list use the WRKCFGL command, select F6 to create a configuration list of QAPPNRMT of type \*APPNRMT. If the system already has this created, use option 2 to change the list to include the entries listed below.

**QAPPNRMT Configuration List**

Remote Location	Remote Network ID	Remote Local Location	Remote Control Point	Control Point Net ID	Sec. Loc	Sgl. Ses.	# of Conv.	Lcl Pt.	Pre-est. Ses.
MAC01	USIBMT0	CON403	MACFX112	USIBMT0	*NO	*NO	10	*NO	*NO

Since LEN nodes must be explicitly defined in the remote configuration list, an entry exists for the Macintosh. No entry is required for the PS/2 since it functions as an EN node.

**Mode Description for ASI400:** The following list contains the values for the mode description used for this path. This mode description was created using the CRTMODD command.

**Mode Description for MODE1 mode**

```

Mode description name . . . . . : MODE1
Class-of-service . . . . . : #CONNECT
Maximum number of sessions . . . . : 10
Maximum conversations . . . . . : 10
Locally controlled sessions. . . . : 5
Pre-established sessions . . . . . : 0
Inbound pacing value . . . . . : 7
Outbound pacing value . . . . . : 7
Max length of request unit . . . . : *CALC
Text . . . . . : for PS/2 to Mac thru AS/400
    
```

**Class-of-Service Description for AS/400:** Use the #CONNECT COS description, which is contained in the QSYS library that is supplied by IBM as part of the OS/400 software.

**Macintosh**

1. Start the SNA•ps Config program by double clicking the application icon. The SNA•ps Config resources window appears.
2. In the SNA•ps Config resources window, click the New button below the Lines box. A dialog box appears (refer to Figure 152 on page 229) in which the type of card to configure can be selected. Because Token Ring is the default for card type and is the desired\_DLC type connection to the AS400, click OK.
3. The dialog box for a Token Ring line appears (refer to Figure 153 on page 230). For this path, change the Maximum I-Field Length to 2057, then click OK.
4. In the Lines box, select the name of the Token Ring line that was created in step 3, then click the New button under Partners. The Token Ring Partner dialog box appears. Click on the Peer. In the Link Address field, enter the Local Adapter Address specified on the AS/400's Token Ring Line description (TRNLIN031). In the Partner XID field, enter the Exchange Identifier specified on the AS/400's Line description (TRNLIN031). In the Gateway XID field, enter any value here. The SNA•ps Config program requires a value in this field, but the AS/400 does not care what is used (see "Observations and Hints" on page 233). In the Gateway Network Name, enter the remote control point name. In the Gateway Network Qualifier, enter the remote network identifier. (Refer to Figure 154 on page 230.) Click OK.
5. In the Partners box, select the name of the Partner (HOST01) that was created in step 4, then click the New button below the Local 6.2 LUs box in the APPC Resources category. A dialog box appears in which to create a local 6.2 LU (refer to Figure 155 on page 231). In the Name and Network LU Name fields, enter MAC01. Enter USIBMTO in the Network Qualifier field. The network qualifier and network LU name correspond, respectively, to the remote location and remote network ID specified in an entry in the AS/400's APPN Remote Configuration list. Also, the network qualifier with network LU name corresponds to the fully qualified partner LU name (FQ\_PARTNER\_LU\_NAME) in the NS/2 DEFINE\_PARTNER\_LU verb in the PATH19.NDF file. Click OK.
6. Select the local LU MAC01, then click the New button below the TPs box. A dialog box appears in which to create an entry for an associated transaction program (refer to Figure 156 on page 231). Enter \* in the Name field, then click OK.
7. Select the local LU MAC01, then click the New button below the Remote 6.2 LUs box. A dialog box appears in which to create a remote 6.2 LU (refer to Figure 157 on page 232). In the Name and Network LU Name fields, enter PS2110. Enter USIBMTO in the Network Qualifier field. The Network LU Name corresponds to the LU name (LU\_NAME) in the NS/2 DEFINE\_LOCAL\_LU verb in the PATH19.NDF file. Click OK.

8. Select the remote LU PS2110, then click the New button below the Modes box. A dialog box appears in which to create an APPC mode. The mode contains parameters that are used in establishing initial session limits and also parameters that can be negotiated in the BIND. Enter MODE1 in the Name field. This corresponds to the parameters used with the NS/2 DEFINE\_MODE verb in the PATH19.NDF file. Change the other values as indicated in Figure 158 on page 232, then click OK.
9. Choose Save As from the File menu. Save this file as *path19*.
10. Start the SNA•ps Admin program by double clicking the application icon. The Network Gateway Status window appears. In the Network Gateway Status window, select the Token Ring gateway to be configured. Choose Select Configuration from the Gateway menu. Select *path19*, then click on the Select button to assign *path19* to the Token Ring gateway.
11. To start the gateway, in the Network Gateway Status window, select the Token Ring gateway with *path19* specified as the configuration. Choose Start Gateway from the Gateway menu. Click Start to confirm the start of the gateway. When the gateway has been started, the Status column of the Network Gateway Status window contains "Started."
12. Select this gateway, then choose Show Gateway from the Gateway menu. The resource window is displayed. This shows active sessions between the PS/2 and Macintosh IIfx through the AS/400.

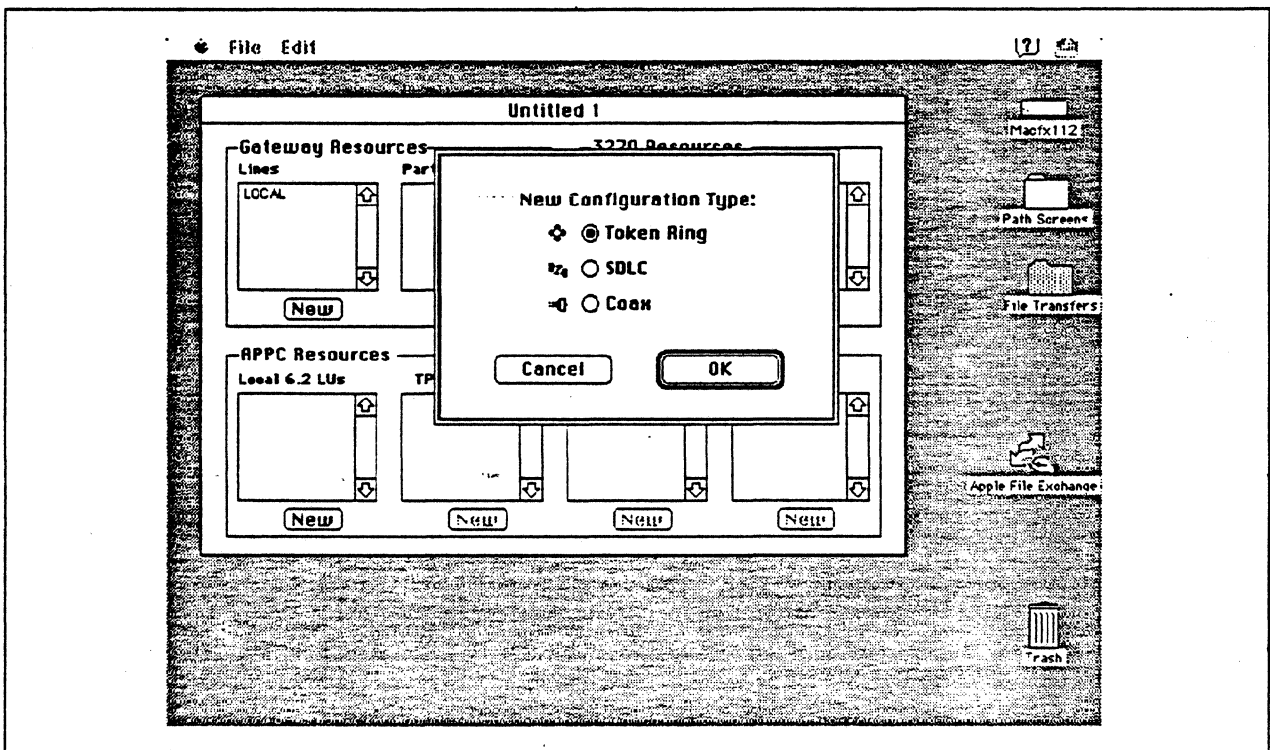

Figure 152. DLC Type Selection for Upstream Connection

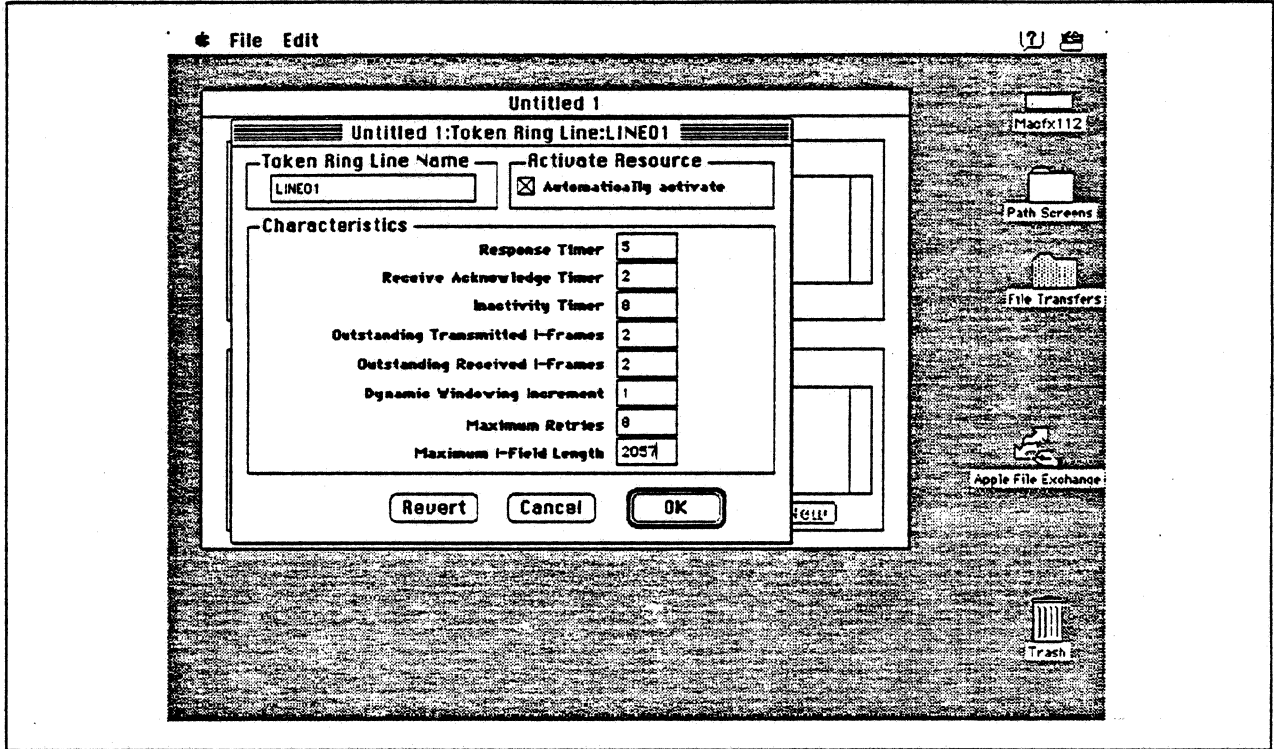

Figure 153. Token Ring Line Configuration Parameters

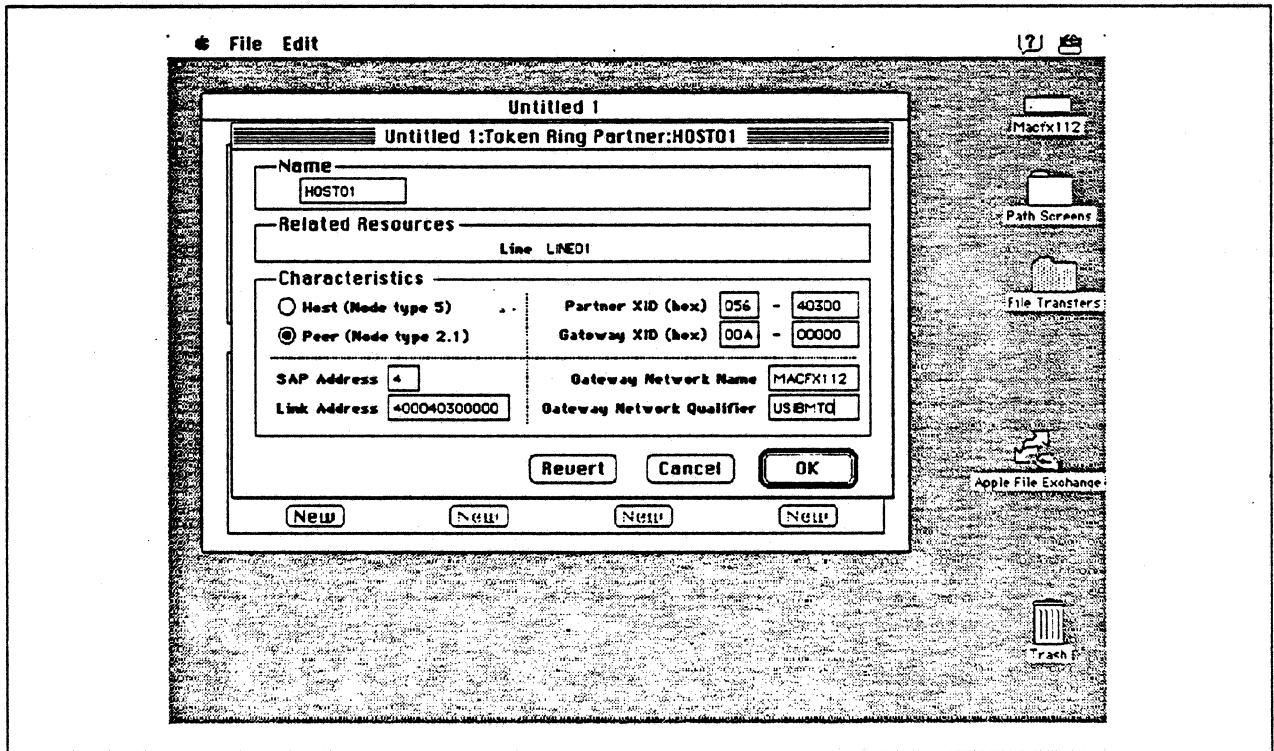

Figure 154. Token Ring Partner Configuration Parameters

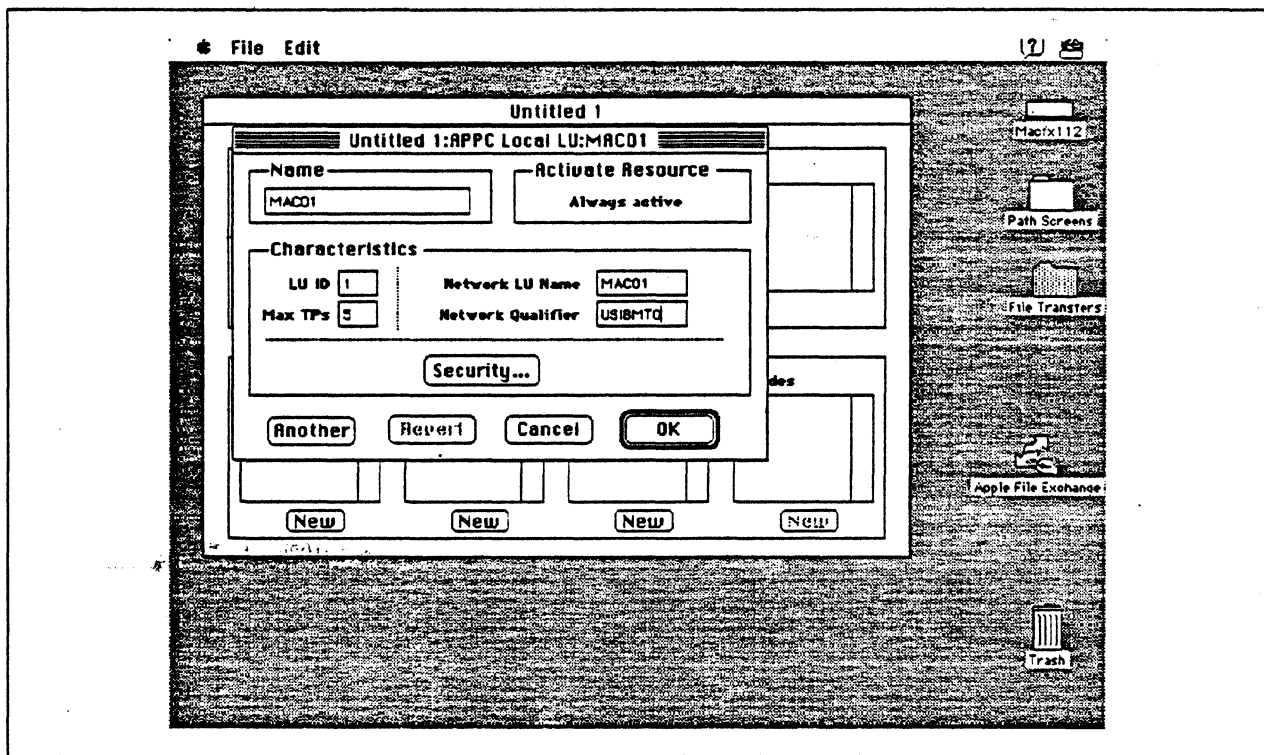

Figure 155. Configuring an APPC Local LU

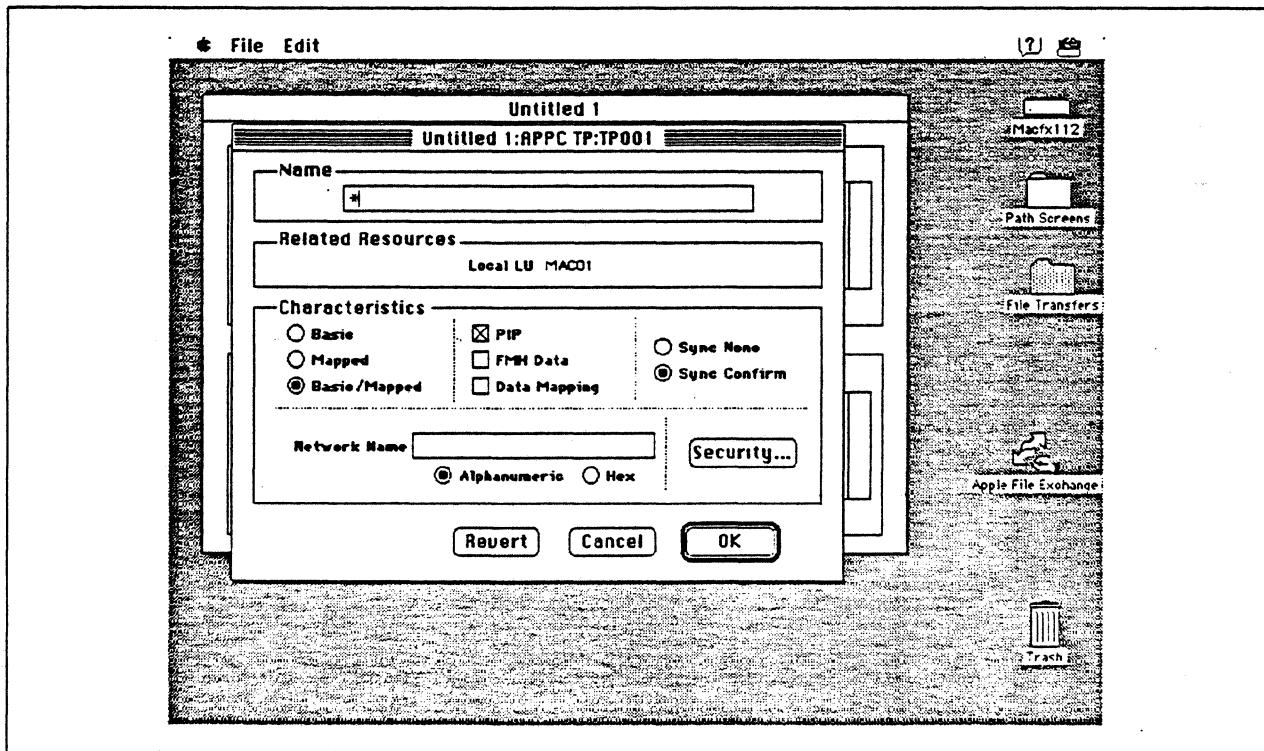

Figure 156. Configuring an APPC Transaction Program

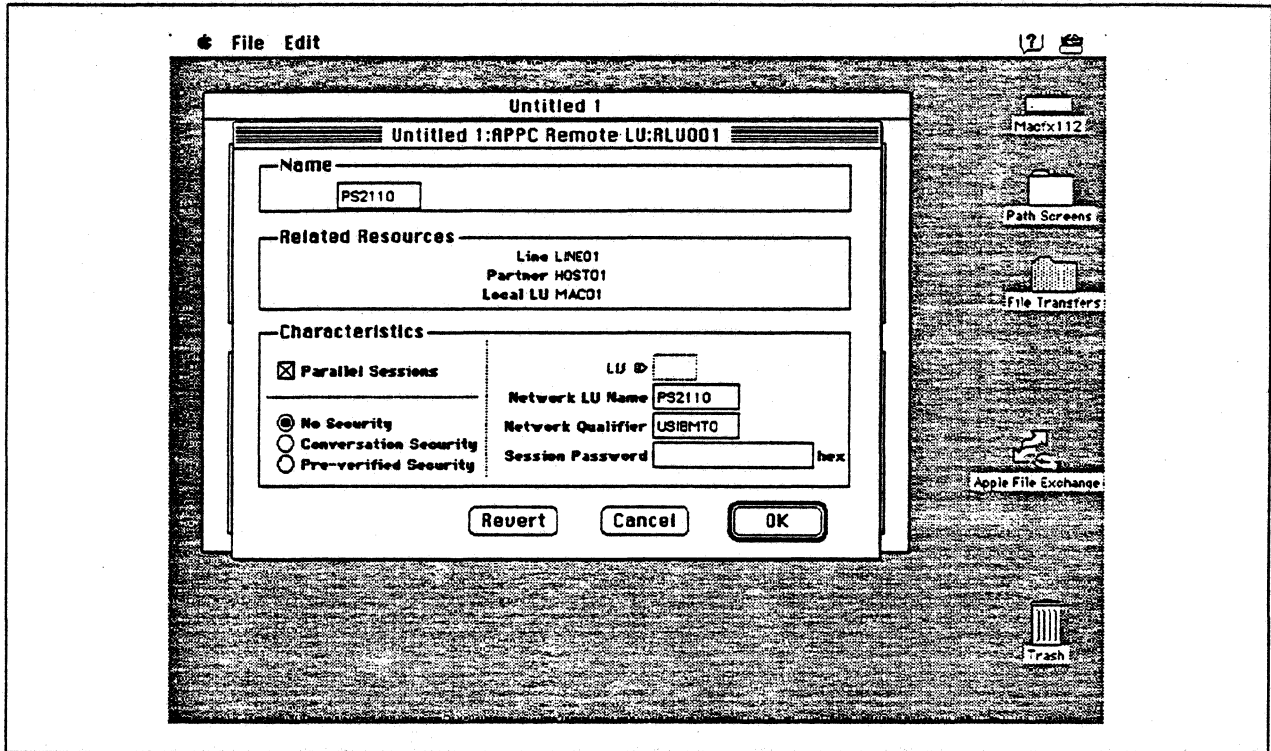

Figure 157. Configuring an APPC Remote LU

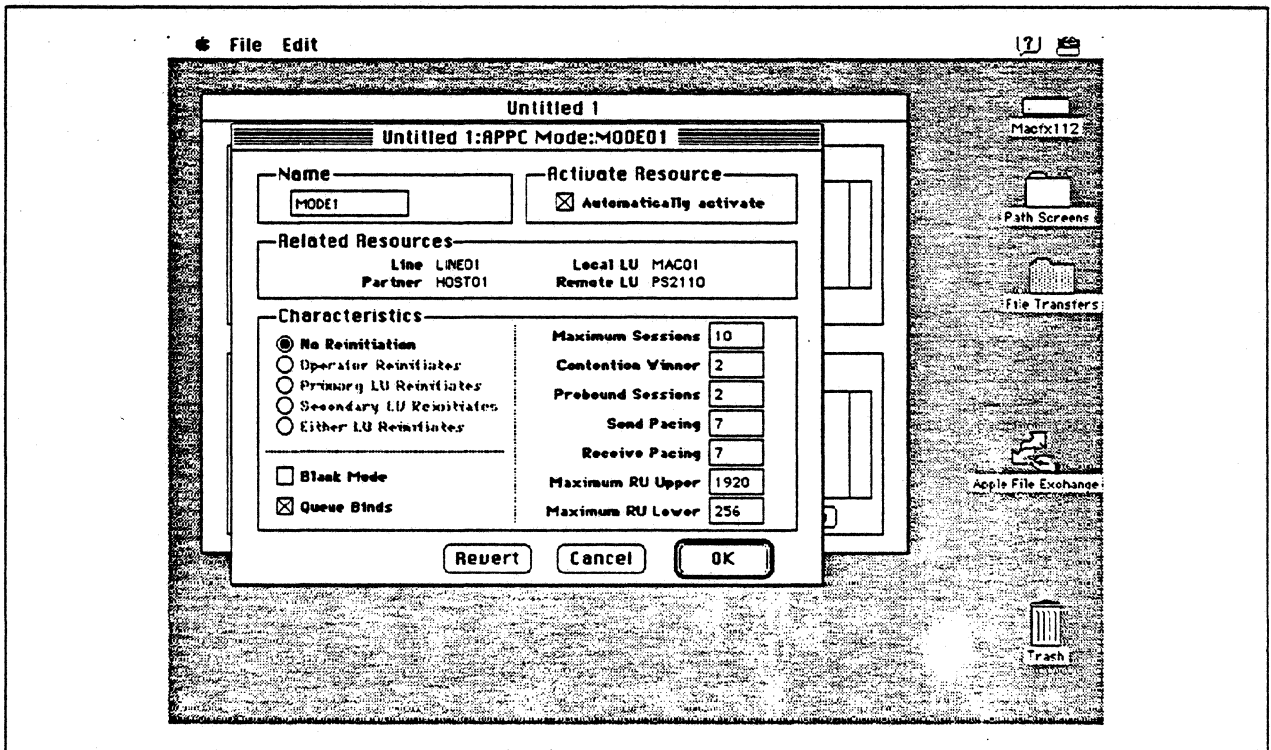

Figure 158. Configuring an APPC Mode



## Observations and Hints

In the AS/400 configuration, the LAN remote adapter address 100E0017CBC corresponds to the Token Ring address of the Apple Token Ring 4/16 NB Card.

If the transmit buffer size (refer to step 8 on page 219) is not equal to the maximum l-field length (refer to Figure 153 on page 230), session establishment negotiates to the lower level.

APPC file transfers were performed for this path using sample APPC applications provided with the SNA•ps APPC APDA kit and OS/2 Communications Manager. Note that the sample programs provided with NS/2 were not used because the TP name hardcoded in the FILECSVR program in the NS/2 samples is "FileServer". The TP name used by the Macintosh sample programs and the OS/2 Communications Manager sample programs is "FILEMSVR". It is mandatory that both ends of the connection use the same TP name. In the case of the OS/2 FILECSVR program it does a RECEIVE\_ALLOCATE using a hardcoded TP name of FILEMSVR which can successfully accept an Allocate from the Macintosh using a TP name of FILEMSVR.

When a VARY ON is issued to the AS/400 Token-Ring line descriptions (TRNLIN031 and TRNLIN041), the lines should go to the VARIED ON state, which indicates that the AS/400 Token-Ring adapters have been successfully inserted on the ring.

The SNA•ps Config program requires that a value be entered in the Gateway ID field (refer to Figure 154 on page 230), but there are situations where this value is not checked by the AS/400 during XID exchange. In this path the AS/400 controller description was auto-configured. When auto-configured, the Gateway ID (referred to as exchange identifier in AS/400 literature) from the Macintosh is ignored and not included in the created controller description. Therefore, in this path, any Gateway ID value may be specified when configuring the Macintosh. However, if you explicitly create an AS/400 controller description and specify an exchange identifier (EXCHID parameter), then the exchange identifier is used to verify the XID coming from the Macintosh. In that case, for the controller to be successfully contacted, the Gateway ID would have to match the value used on the controller description EXCHID parameter.

In the AS/400 line description there is both a line speed parameter and a link speed parameter. It is the line speed parameter that determines the actual rate at which the token-Ring adapter will run. The link speed parameter is used only for lines that are attached to APPC or host controller descriptions that specify APPN(\*YES). This parameter is used to define line characteristics for use by APPN in class-of-service processing; it does not necessarily represent the actual line speed. The value selected for this parameter and the class of service selected for a session determine route selection through an APPN network. If you are using APPN but do not plan to tailor the route selection process, use the default values.



---

## Appendix A. Apple Products Datasheets

This appendix contains some of the datasheets that are available from Apple Computer for products that are used in these configurations. For additional information on Apple products, contact your Apple representative.

The contents of this appendix is reprinted by permission of Apple Computer Inc.

This appendix contains the following datasheets:

- SNA•ps 3270 on page 236
- SNA•ps Gateway on page 240
- Apple Token Ring 4/16 NB Card on page 244
- Apple TokenTalk NB Card on page 246
- Apple EtherTalk NB Card on page 250
- Apple Ethernet LC Card on page 254
- Apple Serial NB Card on page 258
- Apple Coax/Twinax Card on page 260
- System Software 7.0 on page 262
- Apple Internet Router on page 268
- Macintosh IIfx on page 272
- Macintosh IIfx on page 278

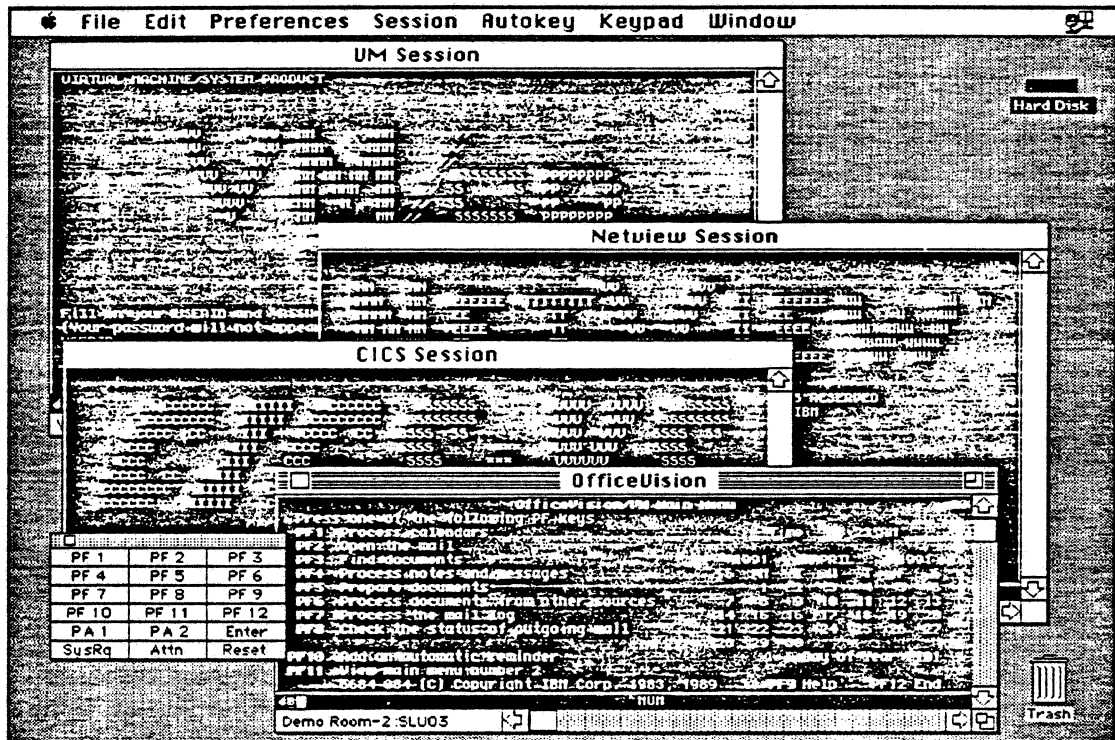

## Overview

SNA • ps™ 3270 (Systems Network Architecture protocols and services) is a full-function 3270 display terminal emulation program that enables Apple® Macintosh® personal computers to communicate with IBM mainframes. This application provides both Control Unit Terminal (CUT) and Distributed Function Terminal (DFT) emulation of IBM 3270 Information Display Systems.

The SNA • ps 3270 application software works with the Apple Coax/Twinax Card, Apple

TokenTalk® NB Card, or Apple Serial NB Card installed in any Macintosh II system and supports up to 5 direct or AppleTalk®-distributed 3270 sessions. In an AppleTalk network with an SNA • ps Gateway installed, SNA • ps 3270 users can access host services from any Macintosh, including the Macintosh Plus, Macintosh Classic®, Macintosh SE and SE/30, Macintosh LC, Macintosh Portable, and any Macintosh II system. In addition, users can access multiple gateways for concurrent access to multiple hosts.

File transfer is supported for text, binary, and Macintosh document transfers using the IBM IND\$FILE host software in the MVS/TSO, VM/CMS, and CICS environments. Copy and paste functions between the Macintosh and mainframe applications are supported using the Clipboard. These facilities allow you to transfer data easily between the mainframe and a local application on the Macintosh desktop.

## Features

## Benefits

---

<ul style="list-style-type: none"><li>• 3270 terminal emulation for models 2, 3, 4, and 5</li></ul>	<ul style="list-style-type: none"><li>• Enables Macintosh users to access 3270-based applications.</li></ul>
<ul style="list-style-type: none"><li>• Extended attribute support</li></ul>	<ul style="list-style-type: none"><li>• Provides display support for base and extended attributes and status line symbols.</li></ul>
<ul style="list-style-type: none"><li>• File transfer compatible with the IBM IND\$FILE standard</li></ul>	<ul style="list-style-type: none"><li>• Allows users to move files between Macintosh and IBM System/370 hosts running MVS/TSO, VM/CMS, or CICS.</li></ul>
<ul style="list-style-type: none"><li>• NetView network management</li></ul>	<ul style="list-style-type: none"><li>• Reports error conditions based on standard NetView alerts.</li></ul>
<ul style="list-style-type: none"><li>• On-line help</li></ul>	<ul style="list-style-type: none"><li>• Provides convenient help in configuring and running SNA * ps 3270.</li></ul>
<ul style="list-style-type: none"><li>• Keyboard remapping</li></ul>	<ul style="list-style-type: none"><li>• Allows users to create any layout of 3270 control keys on the attached Macintosh keyboard.</li></ul>
<ul style="list-style-type: none"><li>• Configurable on-screen keypads</li></ul>	<ul style="list-style-type: none"><li>• Eliminates the need for the user to memorize the keyboard map.</li></ul>
<ul style="list-style-type: none"><li>• Keystroke record and playback</li></ul>	<ul style="list-style-type: none"><li>• Allows definition of a string of frequently used keystrokes for automated host access.</li></ul>
<ul style="list-style-type: none"><li>• Support for all Macintosh platforms—compact, portable, and modular</li></ul>	<ul style="list-style-type: none"><li>• Provides a single, Apple-labeled 3270 emulation product for all Macintosh personal computers.</li></ul>
<ul style="list-style-type: none"><li>• SNA/DFT sessions distributed over AppleTalk</li></ul>	<ul style="list-style-type: none"><li>• Allows SNA access for Macintosh systems connected to AppleTalk networks.</li></ul>
<ul style="list-style-type: none"><li>• MultiFinder® compatibility</li></ul>	<ul style="list-style-type: none"><li>• Enables background file transfers while running other Macintosh applications.</li></ul>

---

**Product Details****3270 Terminal Emulation**

SNA<sup>®</sup>ps supports the following terminal types:

- 3178/3278 models 1, 2, 3, 4, 5, and C3
- 3278/3279 models 2, 3, 4
- 5/S2A, S2B, S3A, and S3B
- 3180 model 1
- 3191/3192 Display Station models A, B, C, D, E, F, and L

**3270 Display Terminal Functions**

SNA<sup>®</sup>ps 3270 supports base and extended attributes, extended color support, and OIA status line symbols.

**MultiFinder Compatibility**

SNA<sup>®</sup>ps 3270 stays active in the background under MultiFinder, enabling file transfers to continue while you work with other 3270 sessions or local Macintosh applications.

**AppleTalk Gateway**

SNA<sup>®</sup>ps 3270 runs as a client to an SNA<sup>®</sup>ps Gateway on the user's computer or on another computer connected to the AppleTalk network or internet-work.

**Special Features**

SNA<sup>®</sup>ps 3270 includes on-line help, keyboard remapping of 3270 control keys, on-screen keypads for easy access to frequently used 3270 keys, and keystroke recording and play-back for automating operations such as file transfers and electronic mail retrieval.

---

**Related Products****Software**

- SNA<sup>®</sup>ps Gateway/8  
Order No. M1037LL/A
- SNA<sup>®</sup>ps Gateway/32  
Order No. M1038LL/A
- SNA<sup>®</sup>ps Gateway/64  
Order No. M1039LL/A

**Hardware**

- Apple Coax/Twinax Card  
Order No. M0261
  - Apple TokenTalk NB Card  
Order No. M0237
  - Apple Serial NB Card  
Order No. M0264
  - Macintosh Coprocessor Platform™ Memory Expansion Kit  
Order No. M0145LL/A
- 

**Product Support**

Ninety days of free software support is included from Apple's Technical Coordinator Answerline. After the initial 90-day period, annual support contracts are available for a fee.



# SNA•ps 3270

---

**System Requirements**

To use SNA•ps 3270 for CUT or S-session DFT, you need:

- A Macintosh II system
- An Apple Coax/Twinax Card, Apple TokenTalk NB Card, or Apple Serial NB Card
- Macintosh system software version 6.0.5 or later

To use SNA•ps 3270 as a client to an SNA•ps Gateway, you need:

- SNA•ps 3270 or SNA•ps 3270 GC
- A Macintosh Plus or later Macintosh system as the client computer
- A Macintosh II system running the SNA•ps Gateway software on your AppleTalk network
- Macintosh system software version 6.0.5 or later

On the IBM host, you must have the following IBM file transfer software:

- 5665-311 (3270-PC File Transfer Program for MVS)
- 5664-281 (3270-PC File Transfer Program for VM/SP)
- 5798-DQH (CICS/VS 3270-PC File Transfer Program)

---

**Ordering Information**

**SNA•ps 3270**  
Order No. M0499LL/A  
For connecting to IBM mainframes directly or through an SNA•ps Gateway

With your order, you receive:

- SNA•ps 3270 application software
- SNA•ps 3270 Manager for configuration
- A version of the SNA•ps Gateway that supports up to 5 3270 sessions on the Apple Coax/Twinax Card, Apple TokenTalk NB Card, or Apple Serial NB Card

- Device drivers for the Apple Coax/Twinax Card in CUT or NLCA (Non-SNA Local Channel Attached) environments
- SNA•ps system files
- *SNA•ps 3270 User's Guide*
- Registration card for 90 days of free telephone support from Apple's Technical Coordinator Answerline

---

**SNA•ps 3270 GC**  
Order No. M1220LL/A  
For connecting to IBM mainframes through an SNA•ps Gateway

With your order, you receive:

- SNA•ps 3270 application software
- SNA•ps system files
- *SNA•ps 3270 User's Guide*
- Registration card for 90 days of free telephone support from Apple's Technical Coordinator Answerline

---

**Apple Computer, Inc.**

20525 Mariani Avenue  
Cupertino, CA 95014  
(408) 996-1010  
TLX: 171-576

© 1991 Apple Computer, Inc. Apple, the Apple logo, AppleTalk, Macintosh, MultiFinder, and TokenTalk are registered trademarks of Apple Computer, Inc. Macintosh Coprocessor Platform and SNA•ps are trademarks of Apple Computer, Inc. Classic is a registered trademark licensed to Apple Computer, Inc. IBM and NetView are registered trademarks, and OfficeVision is a trademark, of International Business Machines Corporation. June, 1991. Product specifications subject to change without notice. Printed in U.S.A.  
M05111A

# SNA • ps Gateway

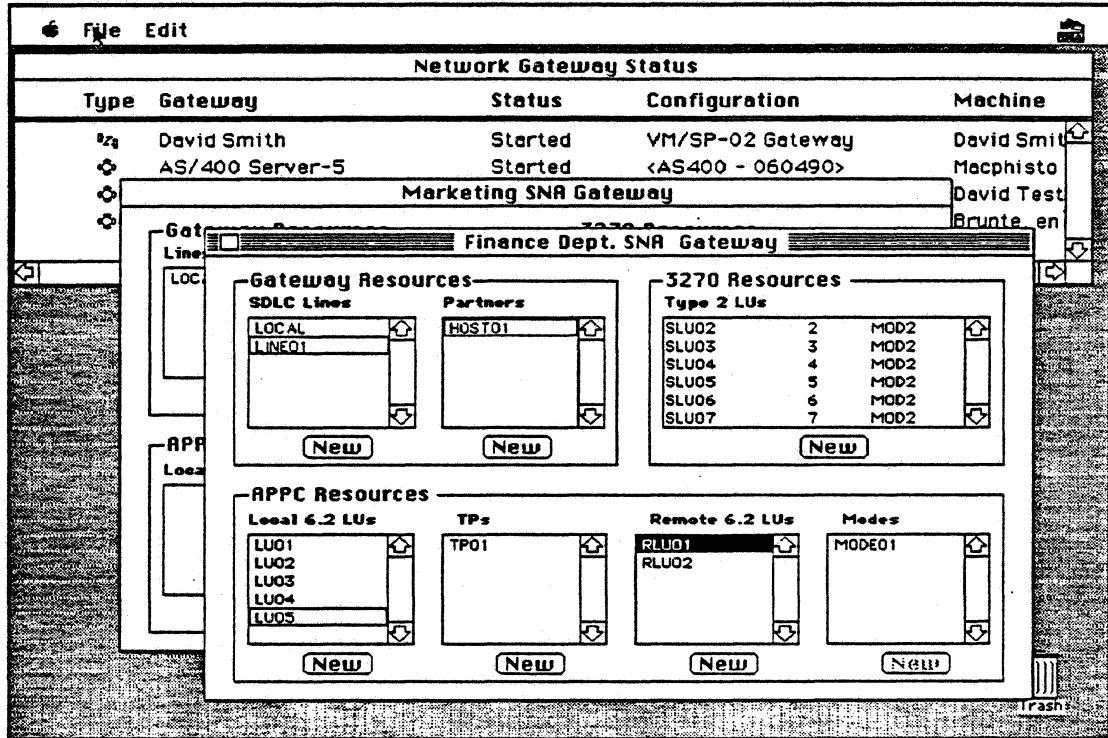

## Overview

The SNA • ps™ Gateway, Apple's implementation of Systems Network Architecture protocols and services, is an integrated 3270, Advanced Program-to-Program Communications (APPC), and Advanced Peer-to-Peer Networking (APPN) gateway. The SNA • ps Gateway can be configured as a personal gateway for direct SNA connectivity or as an AppleTalk® network gateway to enable any Apple® Macintosh® personal computer to communicate with IBM systems running the VM, MVS, OS/400, and OS/2 operating systems.

The SNA • ps Gateway is a comprehensive solution for SNA access, featuring flexibility and high performance. Flexibility for users and system administrators is offered through support for multiple expandable interface cards, tunable performance parameters, and combined 3270 and APPC configurations. These features provide access to existing 3270 terminal-based applications and provide the user with Macintosh user interfaces to host applications, databases, and OfficeVision services while furnishing a simple

migration path to emerging distributed applications based on APPC and APPN.

The SNA • ps Gateway is designed for high performance, offering parallel sessions and independent LU support, and is implemented on an intelligent NuBus™ card. This design frees the main Macintosh processor to run other LAN applications that provide file, mail, and database services. The gateway can also be upgraded to support new features and future releases without hardware changes or complex and time-consuming upgrade and installation procedures.



## *Features*

## *Benefits*

---

<ul style="list-style-type: none"><li>• Implementation of IBM SNA LU 2, LU 6.2, and NT 2.1 protocols</li></ul>	<ul style="list-style-type: none"><li>• Provides compatibility with IBM 3270, APPC, and APPN Low Entry Networking (LEN) SNA standards.</li></ul>
<ul style="list-style-type: none"><li>• Integrated SNA access</li></ul>	<ul style="list-style-type: none"><li>• Enables the installation of a single software/hardware product for access to any IBM SNA-based system—VM, MVS, OS/400, or OS/2.</li></ul>
<ul style="list-style-type: none"><li>• SAA compliant</li></ul>	<ul style="list-style-type: none"><li>• Ensures interoperability with current and future IBM environments and applications.</li></ul>
<ul style="list-style-type: none"><li>• AppleTalk Gateway</li></ul>	<ul style="list-style-type: none"><li>• Enables AppleTalk network users to access host resources with minimal additional hardware.</li></ul>
<ul style="list-style-type: none"><li>• 3270 and APPC support</li></ul>	<ul style="list-style-type: none"><li>• Provides convenient migration and coexistence between existing 3270 applications and new APPC cooperative and distributed applications.</li></ul>
<ul style="list-style-type: none"><li>• Tunable performance parameters</li></ul>	<ul style="list-style-type: none"><li>• Allows the gateway to be optimized based on application, environment, and user requirements.</li></ul>
<ul style="list-style-type: none"><li>• Hardware independence</li></ul>	<ul style="list-style-type: none"><li>• Provides the flexibility to choose among standard SNA connections—Token Ring, SDLC, or coax/DFT.</li></ul>
<ul style="list-style-type: none"><li>• NetView alert support</li></ul>	<ul style="list-style-type: none"><li>• Allows client applications or system administrators to send/filter alerts to NetView.</li></ul>

---

**Product Details****SNA Protocols**

The SNA<sup>®</sup>ps Gateway protocols are a complete implementation of IBM LU 2, LU 6.2, and NT 2.1.

**AppleTalk Gateway**

In AppleTalk network environments, the SNA<sup>®</sup>ps Gateway serves as a network resource for Macintosh applications such as SNA<sup>®</sup>ps 3270 or third-party SNA<sup>®</sup>ps-compatible applications.

**Server Administration**

These Macintosh applications, which can be run on the Macintosh containing the SNA<sup>®</sup>ps Gateway or on a Macintosh connected to the Gateway via AppleTalk, are used to initialize and manage local and remote SNA<sup>®</sup>ps Gateways: SNA<sup>®</sup>ps 3270 Manager allows SNA<sup>®</sup>ps Gateway configuration where only 3270 terminal emulation is needed for a single connection to a single host.

SNA<sup>®</sup>ps Config allows SNA<sup>®</sup>ps Gateway configuration for more complex environments that may involve multiple lines, multiple hosts, and APPC connections. SNA<sup>®</sup>ps Admin provides a complete set of management features for SNA<sup>®</sup>ps Gateways running any configuration created by SNA<sup>®</sup>ps 3270 Manager or SNA<sup>®</sup>ps Config.

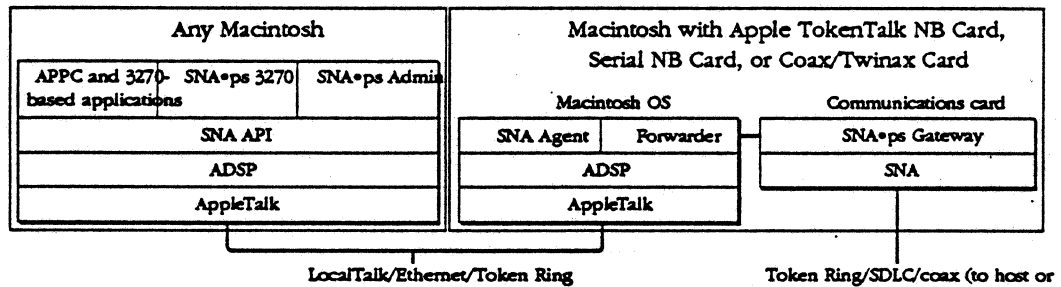
**SNA<sup>®</sup>ps architecture**

---

**Related Products**

- Apple Coax/Twinax Card  
Order No. M0261
- Apple TokenTalk NB Card  
Order No. M0237
- Apple Serial NB Card  
Order No. M0264
- Macintosh Coprocessor  
Platform™ Memory Expansion Kit  
Order No. M0145LL/A

**Programming Tools**

- Contact APDA<sup>®</sup> (Apple Programmer's and Developer's Association) for 3270 and APPC programming interfaces, documentation, and sample programs:

**APDA**

Apple Computer, Inc.  
20525 Mariani Avenue,  
M/S 33-G  
Cupertino, CA 95014-6299 U.S.A.  
800-282-2732 (United States)  
800-637-0029 (Canada)  
408-562-3910 (International)  
AppleLink<sup>®</sup> address: APDA

---

**Product Support**

Ninety days of free software support is included from Apple's Technical Coordinator Answerline. After the initial 90-day period, annual support contracts are available for a fee.



# SNA•ps Gateway

## System Requirements

To use the SNA•ps Gateway, you need:

- A Macintosh II system with a minimum of 1 MB of RAM (Additional RAM on the Macintosh

- II logic board will not affect gateway performance.)
- System software version 6.0.5 or later

- An Apple Coax/Twinax Card, Apple TokenTalk NB Card, or Apple Serial NB Card

## Ordering Information

### Gateway Software

• The SNA•ps Gateway is available in three versions depending on the desired number of SNA sessions:

#### SNA•ps Gateway/8

- Order No. M1037LL/A
- Provides support for up to 8 3270 or APPC sessions.
  - Runs on the Apple TokenTalk NB and Apple Serial NB Card with support for up to 8 3270 or APPC sessions.
  - Runs on the Apple Coax/Twinax Card but is limited to 5 3270 sessions.

#### SNA•ps Gateway/32

- Order No. M1038LL/A
- Provides support for up to 32 3270 or APPC sessions.
  - Runs on the Apple Serial NB Card with support for up to 18 sessions. Requires the Macintosh Coprocessor Platform Memory Expansion Kit on the Apple Serial NB Card to support 19 to 32 sessions.
  - Runs on the Apple TokenTalk NB Card with support for up to 8 3270 and APPC sessions.
  - Runs on the Apple Coax/Twinax Card with support for up to 5 3270 sessions.

### SNA•ps Gateway/64

- Order No. M1039LL/A
- Provides support for up to 64 3270 or APPC sessions.
  - Runs on the Apple Serial NB Card with support for up to 18 sessions. Requires the Macintosh Coprocessor Platform Memory Expansion Kit on the Apple Serial NB Card to support 19 to 64 sessions.
  - Runs on the Apple TokenTalk NB Card with support for up to 8 3270 and APPC sessions.
  - Runs on the Apple Coax/Twinax Card with support for up to 5 3270 sessions.

Each of the above packages includes:

- SNA•ps Gateway software
- SNA•ps Admin and Config programs
- SNA•ps system files
- SNA•ps Administrator's Guide
- Registration card for 90 days of free telephone support from Apple's Technical Coordinator Answerline

### Client Software

• To use the gateway for host access, you need an application that supports the SNA•ps Gateway's 3270 or APPC interfaces. SNA•ps 3270, Apple's 3270 terminal emulation application, is available separately for the Macintosh Plus and later systems.

#### SNA•ps 3270

- Order No. M0499LL/A
- For connecting to IBM mainframes directly or through an SNA•ps Gateway
  - Includes a 5-session DFT gateway and CUT and NLCA drivers

#### SNA•ps 3270 GC

- Order No. M1220LL/A
- For connecting to IBM mainframes through an SNA•ps Gateway
  - Includes only the SNA•ps 3270 application software for access to an SNA•ps Gateway

Apple Computer, Inc.

20525 Mariani Avenue  
Cupertino, CA 95014  
(408) 996-1010  
TLX: 171-576

© 1991 Apple Computer, Inc. Apple, the Apple logo, AppleLink, AppleTalk, LocalTalk, Macintosh, and TokenTalk are registered trademarks of Apple Computer, Inc. A/RCS/E, Macintosh Coprocessor Platform, and SNA•ps are trademarks of Apple Computer, Inc. Classic is a registered trademark licensed to Apple Computer, Inc. IBM and NetView are registered trademarks, and OfficeVision, OS/2, and OS/400 are trademarks, of International Business Machines Corporation. NuBus is a trademark of Texas Instruments. June, 1991. Product specifications subject to change without notice. Printed in U.S.A. M1038LL/A

## Apple Token Ring 4/16 NB Card

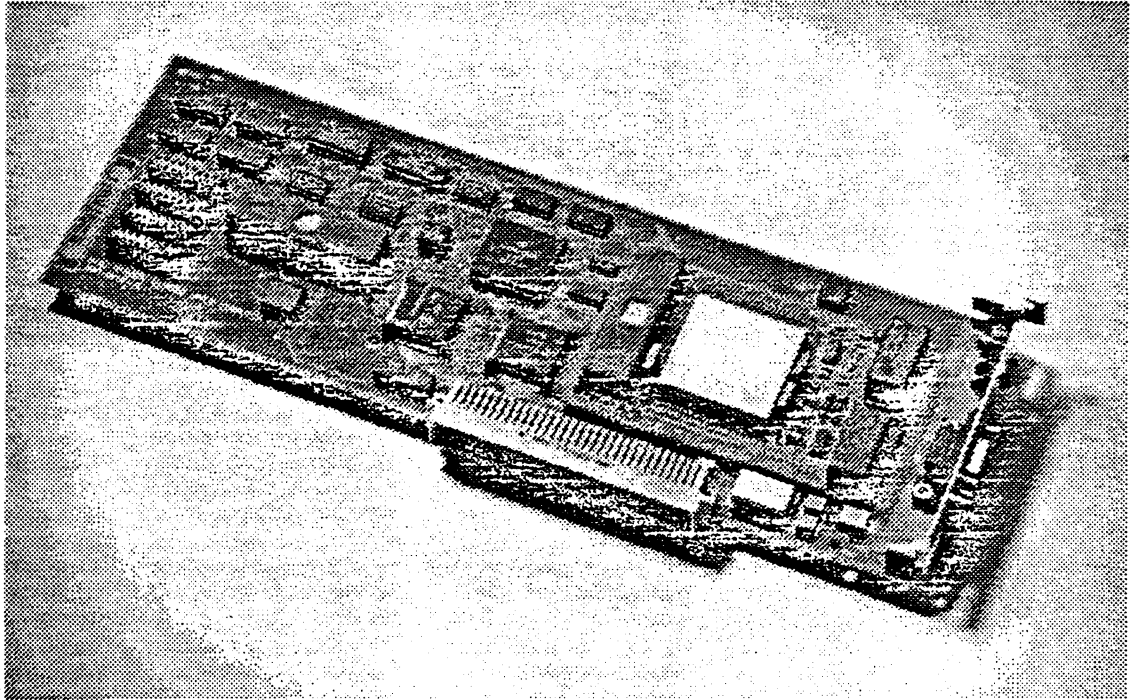

The Apple Token Ring 4/16 NB Card is a bus master network interface card that allows Macintosh computers with NuBus™ expansion slots to connect to Token Ring networks that operate at either 4 or 16 megabits per second (Mbps). The card is based on the Macintosh Coprocessor Platform, and includes its own Motorola 68000 microprocessor, 512K of RAM, and A/ROSE, a real-time, multitasking operating system that runs on the card. The card operates independently of the main Macintosh processor, executing multiple networking protocols or network application

programs concurrently. This maximizes both system and network performance.

The Token Ring 4/16 NB Card uses the IBM Token Ring chip set, ensuring compatibility and interoperability with all IBM Token Ring networks that operate at 4 or 16 Mbps. The card also supports a variety of software environments, including AppleTalk, 3270, and APPC. This flexibility provides users connected to Token Ring networks with access to both local area network (LAN) and mainframe-based services.

- Apple Token Ring 4/16 NB Card**
- > Connection to IEEE 802.5 and 802.2 industry-standard Token Ring networks
  - > Software-switchable 4 and 16 Mbps speeds
  - > IBM Token Ring chip set; DB-9 connector formatting to IBM-type cabling
  - > Includes TokenTalk software
  - > Password-protected speed selection, timer settings, and locally administered address
- All Macintosh Coprocessor Platform Cards**
- > Multiprocessor, bus master architecture
  - > Motorola 68000 microprocessor
  - > 512K RAM, expandable to 2.5 MB RAM
  - > Apple Real-time Multitasking Operating System Environment (A/ROSE)

# Apple Token Ring 4/16 NB Card

## Technical Specifications

### Hardware

- > Chip set: IBM Token Ring
- > Connector: DB-9 connector for attaching to IBM Type 1 cabling. External adapters for Type 3 cabling are available from other vendors
- > Processor: Motorola 68000 running at 10 Mhz
- > Bus interface: NuBus bus master
- > Memory: 512K of RAM, expandable to 2.5 megabytes
- > Power requirements: 1.5 amps at 5 volts  
Certification: FCC Class A; VDE
- > Expansion memory: When increasing memory on the card, the following specifications must be met.  
Type: Dynamic RAM  
Size: 256K x 4 (for expanding to 1 MB) or 1 MB x 4 (for expanding to 2.5 MB)  
Configuration: 4 bits wide  
Package: ZIP  
Speed: 120 ns or faster  
To expand the Token Ring 4/16 NB Card memory to 1 MB, order the Macintosh Coprocessor Platform Memory Expansion Kit (see details below under "Ordering Information and Related Products"). Or, obtain the following parts:  
Mitsubishi part M5M44C256L-12  
Hitachi part HM514256ZP-12

To expand the Token Ring 4/16 NB Card memory to 2.5 MB, obtain the following parts:  
Toshiba part TC514400z-10  
Texas Instruments part TMS44400-12SD

### Software

- > Application interface: AppleTalk, Apple 3270 API, APPC verb interface
- > LLC implementation: Type 1 and Type 2
- > Routing: Supports IBM source routing

### Software - Configurable Card Settings

- > Transmission speed: 4 or 16 megabits per second
- > Token Ring address: burned-in or locally administered address
- > Timers: Response (T1), Acknowledge (T2), and Inactivity (T3)
- > Card settings can be password-protected

### Token Ring Cabling Specifications

- Shielded twisted-pair (IBM Type 1 cabling)
- > Maximum distance from multistation access unit (MAU) to device (lobe length) = 300 meters
  - > Maximum distance between two MAUs (trunk length) = 200 meters
  - > Maximum devices per ring = 260
- Unshielded twisted-pair (IBM Type 3 cabling)
- > Maximum distance from MAU to device (lobe length) = 100 meters
  - > Maximum distance between two MAUs (trunk length) = 120 meters
  - > Maximum devices per ring = 72

## Ordering Information and Related Products

Apple Token Ring 4/16 NB Card  
Order No. M0415LL/A

### With your order, you'll receive:

- > Apple Token Ring 4/16 NB Card
- > TokenTalk software installer disk
- > *Apple Token Ring 4/16 NB Card User's Guide*

### Related Products

For 3270 terminal emulation and/or APPC services, order:  
Apple SNA \*ps Gateway version 1.1 or later.  
SNA \*ps requires at least 1 megabyte of RAM on the card.

To increase memory, order:  
Macintosh Coprocessor Platform Memory Expansion Kit. Order No. M0145LL/A

You can also use products from other vendors to increase the memory on the card. See details under "Hardware" above.

Apple Computer, Inc.  
20525 Mariani Avenue  
Cupertino, CA 95014  
(408) 996-1010  
TLX 171-576

© 1991 Apple Computer, Inc. Apple, the Apple logo, AppleTalk, and Macintosh are trademarks of Apple Computer, Inc., registered in the United States and other countries. Hitachi is a registered trademark of Hitachi, Ltd. IBM is a registered trademark of International Business Machines Corp. Mitsubishi is a registered trademark of Mitsubishi Electric Corp. Motorola is a registered trademark of Motorola Corp. NuBus is a trademark, and Texas Instruments is a registered trademark, of Texas Instruments, Inc. Toshiba is a registered trademark of Toshiba, Inc. Mention of non-Apple products is for informational purposes, and constitutes neither an endorsement nor a recommendation. Apple assumes no responsibility with regard to the selection, performance, or use of these products. Product specifications are subject to change without notice. Printed in U.S.A.  
L0104LL/A

## Apple TokenTalk NB Card

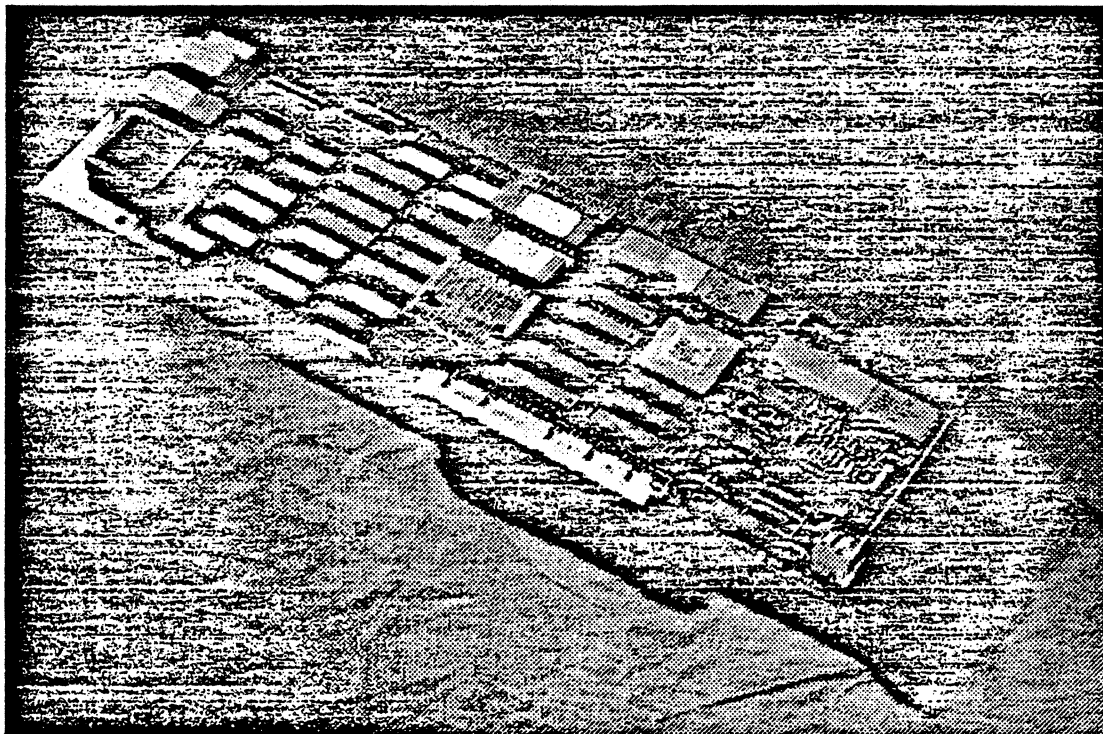

### Overview

The Apple® TokenTalk™ NB Card is an expansion card that allows personal computers in the Macintosh II family of systems to connect to IBM and IBM-compatible Token-Ring networks. Because the card supports a variety of network environments, including AppleTalk®, 3270, APPC, and SMB, users can access local area network (LAN) and mainframe-based services connected to the Token-Ring.

The Apple TokenTalk NB Card is an intelligent NuBus™ interface card that has its own 68000 microprocessor, memory, and multi-tasking operating system. Operating independently of the main

Macintosh II processor, the card supports the concurrent execution of multiple networking protocols with minimal access to the Macintosh II processor and operating system. It incorporates the industry-standard Texas Instruments TMS 380 chip set for all Token-Ring access functions. And because all the communications processing is done on the card, your Macintosh II is free to run other Macintosh applications.

The Apple TokenTalk NB Card is compatible with the IEEE 802.5 Media Access Control (MAC) standard for Token-Ring networks, as well as the IEEE 802.2 Logical Link Control (LLC) standard for

higher-level software access to 802.5 facilities. The card transmits and receives data at 4 megabits per second, and interoperates with other IEEE 802-compatible Token-Ring interface cards at the physical and data link layers.

## *Features*

## *Benefits*

---

- Connection to IEEE 802.5 and 802.2 industry-standard Token-Ring networks

- Provides Macintosh access to network-based applications, services, and data.
- Supports the IBM cabling system.

---

- Support for AppleTalk protocols and services

- Allows access to network-based services via a single cabling system.
- Provides access to AppleTalk services at 4 megabits per second.

---

- Texas Instruments' TMS 390 Token Ring chip set

- Ensures compatibility with the IEEE and IBM Token-Ring standards.

---

- Based on the Macintosh Coprocessor Platform™

- Handles all communications processing for the Macintosh II.
- Allows concurrent execution of multiple networking protocols.

---

- Support for Apple and third-party network services

- Enables the user to choose from a range of network environments.

# TokenTalk Software and SMB File Transfer Utility (included with Apple TokenTalk NB Card)

## TokenTalk Software

Apple's TokenTalk software, which is compatible with AppleTalk Phase 2, brings the advantages of the AppleTalk network system to standard Token-Ring networks. Personal computers in the Macintosh II family of systems can be connected to virtually any size Token-Ring network or internetwork while retaining access to all AppleTalk-based resources, such as Apple LaserWriter® printers and AppleShare® file and print servers.

As part of the AppleTalk network system,

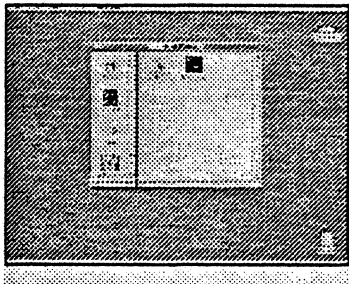

TokenTalk is completely transparent to the Macintosh user. After the user installs TokenTalk via a simple Macintosh program, AppleTalk services appear as they would on any AppleTalk network. Through the Control Panel desk accessory, the user can easily establish a link to the TokenTalk network. The Chooser desk accessory is then used to select AppleTalk network services.

The TokenTalk software provides the extended features of AppleTalk Phase 2.

AppleTalk Phase 2 permits users to build single networks of more than 64,000 Macintosh personal computers, and internetworks of more than 16 million Macintosh computers. And the TokenTalk software delivers AppleTalk network services concurrently with other Token-Ring services, such as MacDFT™ or MacAPPC™.

Using network routers, such as the AppleTalk Internet Router, TokenTalk also allows easy user access to services on LocalTalk™ and EtherTalk™ networks.

### Features

- Support for AppleTalk Phase 2 protocols running over 802.5 Token-Ring networks
- Integration into the Macintosh desktop environment
- Support for source-routing bridges
- User-installable

### Benefits

- Brings AppleTalk services to Macintosh users in Token-Ring environments.
- Provides consistency in network installation, connection, and access.
- Allows TokenTalk users to leverage their investment in IBM Token-Ring bridges.
- Installs quickly and easily.

## SMB File Transfer Utility

The SMB File Transfer Utility software allows users of Macintosh and IBM-compatible personal computers to exchange files to share information in their workgroups. Apple

Macintosh II systems attached to a Token-Ring network can access information on IBM PC LAN Program SMB (Server Message Block) file servers. Users can mount SMB volumes and transfer files between their Macintosh II systems

and the mounted volumes. The SMB File Transfer Utility uses the Apple File Exchange application (included) to transfer and translate files between Macintosh and MS-DOS formats.

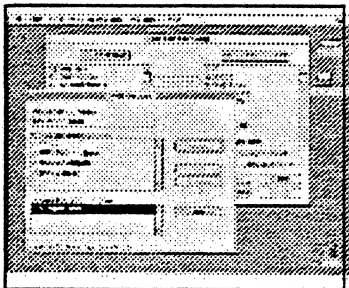

### Features

- SMB protocols
- The Apple File Exchange application
- A desk accessory for accessing files on the SMB server

### Benefits

- Allows Macintosh computers to access IBM PC LAN Program SMB file servers.
- Runs concurrently with TokenTalk software and other TokenRing services
- Makes it easier to share data between difference operating environments.
- Allows files to be translated into an application-specific format
- Allows easy mounting and dismounting of SMB server volumes.





# Apple TokenTalk NB Card

## System Requirements

To use the Apple TokenTalk NB Card, you'll need:

- A personal computer in the Macintosh II family of systems
- One or more of the following applications:
  - TokenTalk software (AppleTalk

services over Token-Ring)

- SMB File Transfer Utility software (file transfer to and from SMB servers)
- MacDFT software (3270 emulation over Token-Ring)
- MacAPPC software (APPC

support over Token-Ring)

TokenTalk software and SMB File Transfer Utility software are included with the Apple TokenTalk NB Card. MacDFT software and MacAPPC software are available separately from Apple.

## Technical Specifications

### Connectors

- DB-9 connector for attaching to the IBM cabling system
- External adapter (available from other suppliers) for use with Type 3 cabling

### Interface

- NuBus; plugs into any Macintosh II computer

### Processor

- Motorola 68000 running at 10 megahertz

### Memory

- 512K of RAM

### Application Interface

- AppleTalk, Apple 3270 API, APPC

### Power dissipation

- 15 watts

### Transmit/Receive data rate

- 4-megabit-per-second on-board transceiver

## Ordering Information

Apple TokenTalk NB Card

Order No. M0237

With your order, you'll receive:

- Apple TokenTalk NB Card
- User Confidence Test disk
- TokenTalk Installer disk
- *TokenTalk User's Guide*
- SMB File Transfer Utility disk
- *SMB File Transfer Utility Software User's Guide*

Other platforms supported by the Apple TokenTalk NB Card  
To run five-session 3270 emulation on the Apple TokenTalk NB Card, you'll need to order the MacDFT software. To run MacAPPC over TokenRing, you'll need the MacAPPC software.

Please refer to the following product sheets for descriptions of features and ordering information about these Apple products:

- Apple Coax/Twinax Card (M0063LL/A)

- MacDFT (M0064LL/A)
- MacAPPC (M0238LL/A)

Apple Computer, Inc.

20525 Mariani Avenue  
Cupertino, CA 95014  
(408) 996-1010  
TLX: 171-576

© 1989 Apple Computer, Inc. Apple, the Apple logo, AppleShare, AppleTalk, LaserWriter, and Macintosh are registered trademarks of Apple Computer, Inc. EtherTalk, LocalTalk, MacAPPC, MacDFT, Macintosh Coprocessor Platform, and TokenTalk are trademarks of Apple Computer, Inc. IBM is a registered trademark of International Business Machines Corporation. Motorola is a registered trademark of Motorola Corporation. MS-DOS is a registered trademark of Microsoft Corporation. NuBus is a trademark of Texas Instruments.  
June 1989. Product specifications are subject to change without notice.  
Printed in U.S.A. M0062LL/A

## Apple Ethernet NB Card

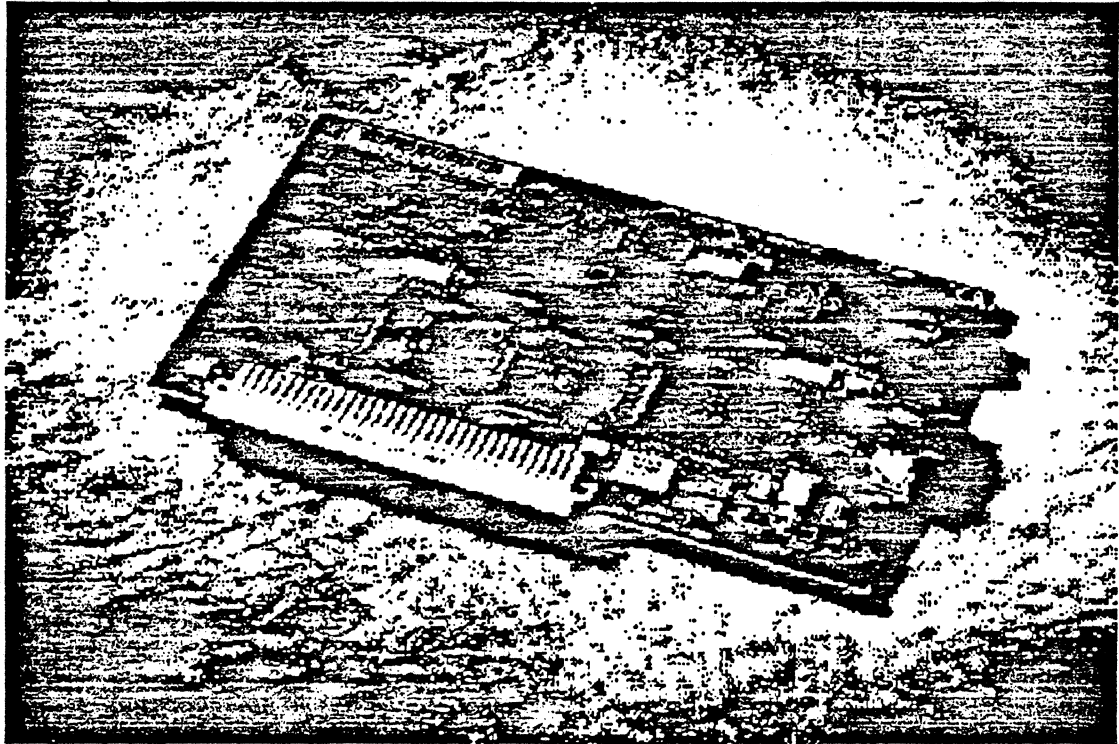

### Overview

The Apple® Ethernet NB Card is a bus master network interface card that provides connectivity to IEEE 802.3 Ethernet networks for the Macintosh® II family of personal computers.

The Ethernet NB Card has its own 68000 microprocessor, memory, and real-time multi-tasking operating system. Operating independently of the main Macintosh processor, the card supports the concurrent execu-

tion of multiple networking protocols while maximizing both system and network performance.

The Ethernet NB Card includes an Apple Ethernet port. With the addition of the appropriate Apple Ethernet Cable System media adapter, which plugs into the port, Ethernet NB Card users can connect to any standard Ethernet cabling environment: thin coax, thick coax, and unshielded

twisted-pair. Because all Apple Ethernet Cable System components are IEEE 802.3 compliant, they can interoperate in multi-vendor environments.

This easy-to-install card lets you use a variety of networking protocols with a Macintosh computer, including AppleTalk®, TCP/IP, and DECnet™.

## Features

## Benefits

- |  |  |
|--|--|
| <ul style="list-style-type: none"> <li>• Compliance with IEEE 802.3 standards</li> </ul>   | <ul style="list-style-type: none"> <li>• Allows the Macintosh II family of computers to connect to industry-standard Ethernet networks and interoperate in multivendor Ethernet environments.</li> </ul>   |
| <ul style="list-style-type: none"> <li>• Apple Ethernet Cable System compatibility</li> </ul>  | <ul style="list-style-type: none"> <li>• Can be used in any standard Ethernet cable environment with the appropriate Apple Ethernet media adapter.</li> </ul>  |
| <ul style="list-style-type: none"> <li>• Includes EtherTalk® software</li> </ul>   | <ul style="list-style-type: none"> <li>• Provides AppleTalk network system users with transparent access to network services.</li> </ul>   |
| <ul style="list-style-type: none"> <li>• A/UX® local area networking support</li> </ul>  | <ul style="list-style-type: none"> <li>• When used with the A/UX operating system from Apple, provides a complete solution for connecting to local area network environments based on the UNIX® operating system, including TCP/IP and the Network File System (NFS).</li> </ul> |
| <ul style="list-style-type: none"> <li>• Based on the Macintosh Coprocessor Platform™</li> <li>• Multiprocessor, bus master architecture</li> <li>• MC68000 microprocessor</li> <li>• 512K RAM, expandable to 2.5MB</li> </ul> | <ul style="list-style-type: none"> <li>• Handles all communications processing for the Macintosh II family of computers. Allows concurrent execution of multiple networking protocols. Optimizes system and network performance.</li> </ul>                                      |

### Product Details

The Apple Ethernet NB Card provides physical and link level access to data communications networks meeting IEEE 802.3 and 802.2 Logical Link Control (LLC)

type 1 standards. Several networking protocols can be used with the Ethernet NB Card. The following table outlines configura-

tions provided by Apple.

<i>Protocol</i>	<i>Operating System</i>	<i>Product</i>	<i>Ordering Information</i>
AppleTalk	Macintosh	EtherTalk® software	Included with Ethernet NB Card
AppleTalk	A/UX	EtherTalk for A/UX software	Included with A/UX version 2.0 and later
TCP/IP	Macintosh	MacTCP® software	Available through Apple Software Licensing
TCP/IP and NFS	A/UX	B-NET software	Included with A/UX version 2.0

**System Requirements**

In addition to the Apple Ethernet NB Card and accompanying software, the following are required to connect one of the Macintosh II family of personal computers to an Ethernet network.

- One available NuBus™ slot in the computer. Or, with the Macintosh IIfx, a NuBus Adapter Card. Macintosh system software version 6.0.4 or later; or

A/UX system software version 2.0 or later.

- If you are using AppleTalk network services, the network must use AppleTalk Phase 2 protocols.
- An Apple Ethernet Cable System media adapter. Each of the Apple Ethernet Cable System media adapters is described below.

**Apple Ethernet Thin Coax Transceiver (Order No. M0329LL/A)**

The Apple Ethernet Thin Coax Transceiver provides "plug-and-play" networking in a high-performance Ethernet environment. The Ethernet NB Card, the Apple Ethernet Thin Coax Transceiver, and the 2-meter

segment of thin coaxial cable included with the Transceiver are all that you need to connect your Macintosh NB computer to an Ethernet network. No terminators or other Ethernet hardware is required.

The Apple Ethernet Self-Terminating Cable—5 Meter (Order No. M0833LL/A) and Apple

Ethernet Self-Terminating Cable—13-Meter Plenum (Order No. M0436LL/A), or other RG 58 A/U thin coaxial cable, can be used to connect devices that are more than 2 meters apart.

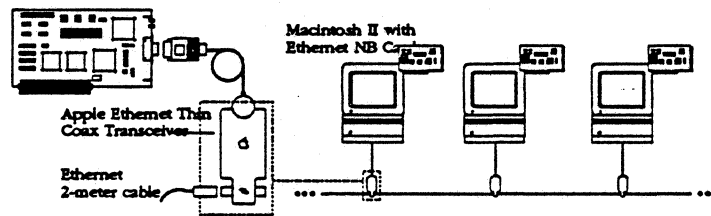

**Apple Ethernet Twisted-Pair Transceiver\* (Order No. M0437LL/A) Order No. M0417LL/The Apple Ethernet Twisted-Pair Transceiver**

is used to connect the Ethernet NB Card to an Ethernet network using unshielded twisted-pair cable. To use Ethernet with unshielded twisted-pair media, you need an

IEEE 802.3 10BASE-T-compatible hub, sold

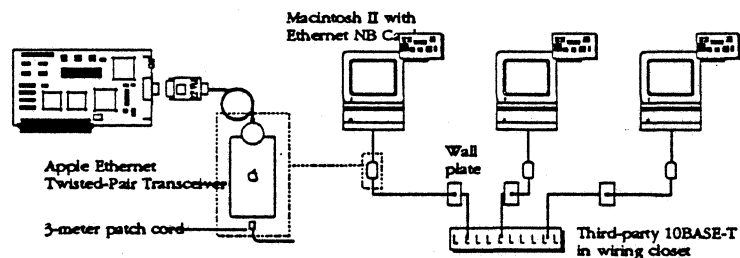

\* See back page for FCC certification information.



# Apple Ethernet NB Card

## System Requirements (cont)

Apple Ethernet AUI Adapter  
(Order No. M0432LL/A)  
The Apple Ethernet AUI Adapter

provides the Ethernet NB Card with a standard IEEE 802.3 Attachment Unit Interface (AUI). The AUI can be used to connect

the Ethernet NB Card to an external transceiver.

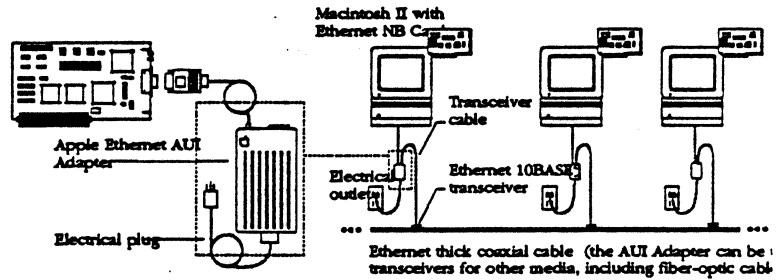

## Technical Specifications

- **Connector:** Apple Ethernet
- **Transmit/Receive data rate:** 10-megabits-per-second maximum data rate
- **Processor:** Motorola Corporation 68000 running at 10 megahertz

- **RAM:** 512K standard, expandable to 1MB with Apple Order No. M0145LL/A, or 2.5 MB with third-party memory expansion modules
- **Environmental requirements:** Operating temperature: 50° to 104° F (10° to 40° C); Humidity:

- 20% to 95% non-condensing at a temperature range of 25° to 40° C
- **Ethernet controller:** National Semiconductor DP83932 (SONIC)

## Ordering Information

### Apple Ethernet NB Card

The Apple Ethernet Twisted-Pair Transceiver is used to connect the Ethernet NB Card to an Ethernet network using separately from third-party vendors.

With your order you receive:

- Apple Ethernet NB Card
- EtherTalk Installer disk
- Ethernet NB Card User's Guide
- Limited warranty statement

\* This device has not been approved by the Federal Communications Commission. This device is not, and may not be offered for sale or lease, or sold or leased until approval of the FCC has been obtained.

Apple Computer, Inc.

20525 Mariani Avenue  
Cupertino, CA 95014  
(408) 996-1010  
TLX: 171-576

© 1991 Apple Computer, Inc. Apple, the Apple logo, AppleTalk, MUX, EtherTalk, Macintosh, and MacTCP are registered trademarks of Apple Computer, Inc. Macintosh Coprocessor Platform is a trademark of Apple Computer, Inc. SONIC is a trademark of National Semiconductor Corporation. DBCnet is a trademark of Digital Equipment Corporation. NUBus is a trademark of Texas Instruments. UNIX is a trademark of AT&T. Product specifications are subject to change without notice. Printed in U.S.A. M072LLA

## *Apple Ethernet LC Card*

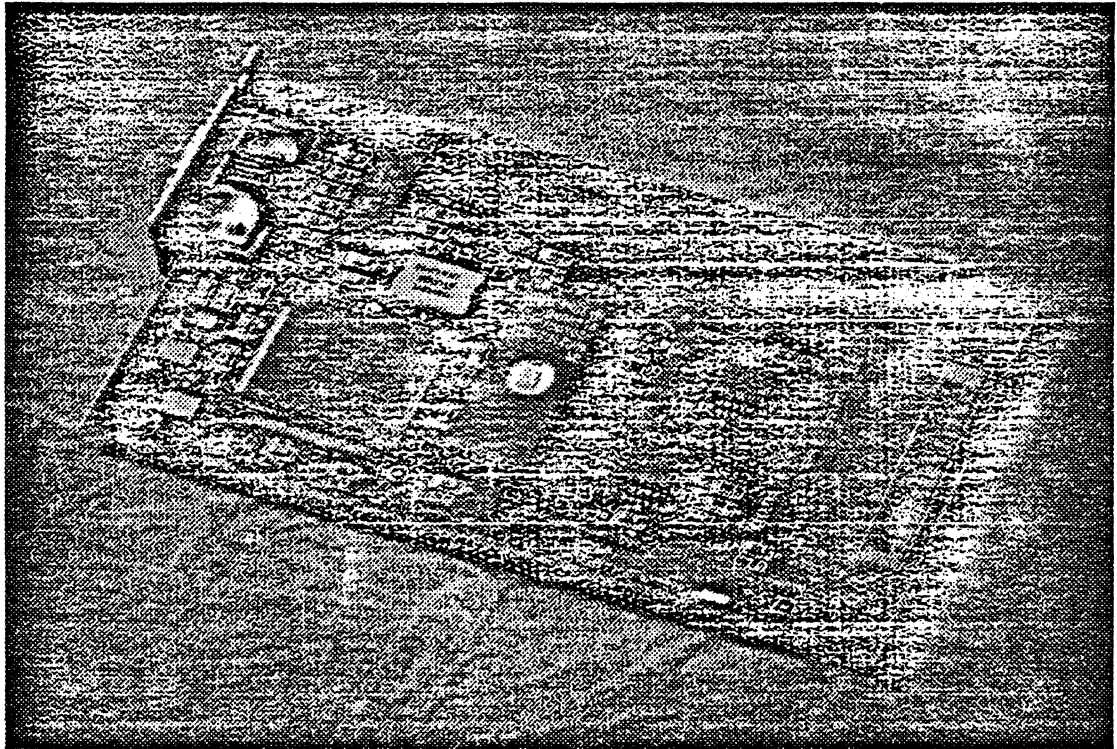

### *Overview*

The Apple® Ethernet LC Card is an affordable, high-performance network interface card for the Macintosh® LC personal computer.

The Apple Ethernet LC Card and the Apple Ethernet Thin Coax Transceiver provide a high-performance (10 megabits per second) network option that is

easier to install and configure than traditional Ethernet systems. The Ethernet LC Card, Apple Ethernet Thin Coax Transceiver, and 2-meter thin coaxial cable (included with the Transceiver) are all you need to connect Macintosh LC computers together on an Ethernet network. Because the Apple Ethernet Thin Coax Transceiver is self-terminat-

ing, no terminators or other Ethernet equipment is required.

In addition to the Apple Ethernet Thin Coax Transceiver, Apple Ethernet media adapters are available to integrate the Ethernet LC Card into twisted-pair and thick coaxial cable Ethernet environments.

# Apple Ethernet LC Card

---

## System Requirements

In addition to the Apple Ethernet LC Card and accompanying software, the following are required to connect a Macintosh LC personal computer to an Ethernet network.

- ▶ The Macintosh Operating System.
- ▶ If you are using AppleTalk network services, the network must use AppleTalk Phase 2 protocols.

- ▶ An Apple Ethernet Cable System external transceiver or AUI adapter. Each of the available Apple Ethernet media adapters is described in this data sheet.

---

## Product Details

The Apple Ethernet LC Card provides physical and link level access to data communications

networks meeting IEEE 802.3 and 802.2 Logical Link Control (LLC) type 1 standards.

---

## Technical Specifications

- ▶ *Connector:* Apple Ethernet
- ▶ *Transmit/Receive data rate:* 10-megabits-per-second maximum data rate
- ▶ *Power dissipation:* < 4 watts

- ▶ *Environmental requirements:* Operating temperature: 50° to 104° F (10° to 40° C); Humidity: 20% to 95% non-condensing at a temperature range of 25° to 40° C

- ▶ *Ethernet controller:* National Semiconductor DP83932 (SONIC)

---

## Ordering Information

Apple Ethernet LC Card

Order No. M0443LL/A

With your order you receive:

- ▶ Apple Ethernet LC Card
- ▶ *EtherTalk* Installer disk
- ▶ *Ethernet LC User's Guide*
- ▶ Limited warranty statement

\* This device has not been approved by the Federal Communications Commission. This device is not, and may not be offered for sale or lease, or sold or leased until approval of the FCC has been obtained.

---

Apple Computer, Inc.

20525 Mariani Avenue  
Cupertino, CA 95014  
(408) 996-1010  
TLX: 171-576

\* 1991 Apple Computer, Inc. Apple, the Apple logo, AppleTalk, EtherTalk, and Macintosh are registered trademarks of Apple Computer, Inc. SONIC is a trademark of National Semiconductor Corporation. Product specifications are subject to change without notice. Printed in U.S.A. M10711LL/A

## Features

## Benefits

- ▶ Apple Ethernet Cable System compatibility
- ▶ Includes EtherTalk® software
- ▶ Compliance with IEEE 802.3 standards
- ▶ Provides "plug-and-play" networking for the Macintosh LC computer. Allows the Macintosh LC computer to connect to any Ethernet cabling environment.
- ▶ Provides AppleTalk® network system users with a higher-performance connection to network services.
- ▶ Allows Macintosh LC computers to connect to industry-standard Ethernet networks and interoperate in multivendor Ethernet environments.

### System Requirements

#### Apple Ethernet Thin Coax Transceiver (Order No. M0329LL/A)

The Apple Ethernet Thin Coax Transceiver provides "plug-and-play" networking in a high-performance Ethernet environment. The Ethernet LC Card,

the Apple Ethernet Thin Coax Transceiver, and the 2-meter segment of thin coaxial cable included with the Transceiver are all that you need to connect a Macintosh LC computer to an Ethernet network. No terminators or other Ethernet hardware is required.

The Apple Ethernet Self-Terminating Cable—5 Meter (Order No. M0833LL/A) and Apple Ethernet Self-Terminating Cable—13-Meter Plenum (Order No. M0436LL/A), or other RG 58 A/U thin coaxial cable, can be used to connect devices that are more than 2 meters apart.

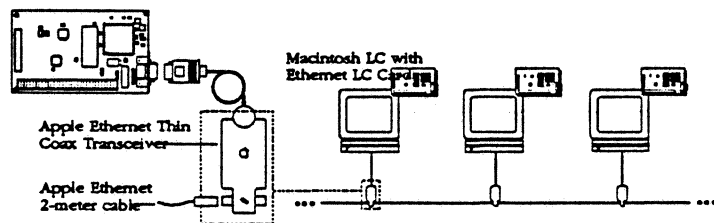



**System Requirements**

**Apple Ethernet Twisted-Pair Transceiver\* (Order No. M0437LL/A)**

The Apple Ethernet Twisted-Pair Transceiver is used to connect the Ethernet LC Card to an Ethernet network using unshielded twisted-pair cable.

To use Ethernet with unshielded twisted-pair media, you need an IEEE 802.3 10BASE-T-compatible hub, sold separately from third-party vendors.

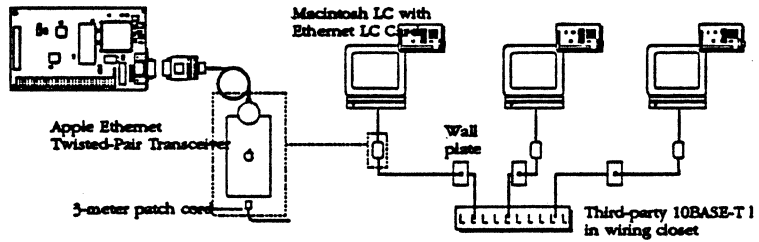

**Apple Ethernet AUI Adapter (Order No. M0432LL/A)**

The Apple Ethernet AUI Adapter provides the Ethernet LC Card with a standard IEEE 802.3 Attachment Unit Interface

(AUI). The AUI can be used to connect the Ethernet LC Card to an external transceiver.

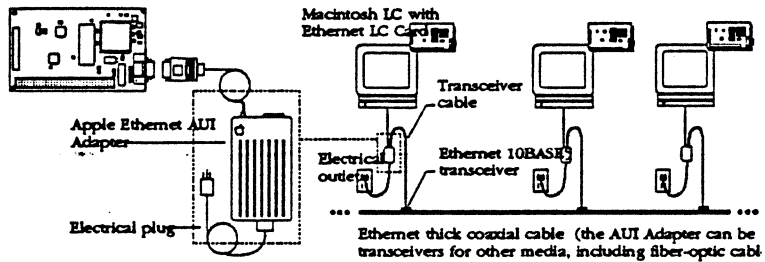

\* See back page for FCC certification information.

## Apple Serial NB Card

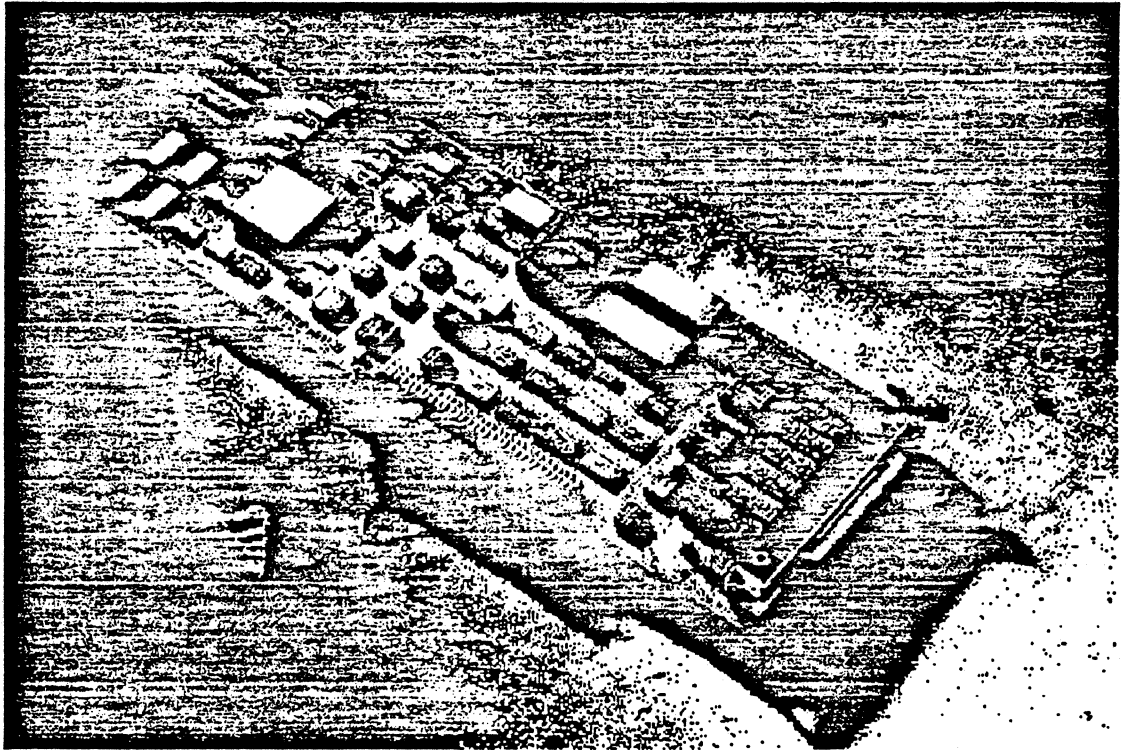

### Overview

The Apple® Serial NB Card is an expansion card that allows personal computers in the Macintosh® II family of systems to connect to remote systems via a variety of industry-standard serial communications protocols. The card includes four serial ports that support RS-232, RS-422, X.21, or V.35 communications.

An intelligent NuBus™ card, the Apple Serial NB has its own 68000 microprocessor, memory, and multitasking operating system.

Operating independently of the main Macintosh II processor, the Serial NB Card supports the execution of communications protocols with minimal access to the Macintosh II processor and operating system. And because all of the communications processing is done on the card, Macintosh applications can run more effectively under MultiFinder®.

When used with Apple's MacAPPC™ or MacDFT® software, the Serial NB Card provides a complete SDLC solution, at the

physical and data-link layers, for connectivity in the IBM Systems Network Architecture (SNA) environment.

MacX25™ software, running on the Serial NB Card, provides packet assembler/disassembler (PAD) services, and X.25 packet-level services to application programs.



# Apple Serial NB Card

Features and Benefits	Features	Benefits	
	<ul style="list-style-type: none"> <li>Based on the Macintosh Coprocessor Platform™</li> </ul>	<ul style="list-style-type: none"> <li>Handles all communications processing for the Macintosh II.</li> </ul>	
	<ul style="list-style-type: none"> <li>Four serial ports, two of which can be configured for high-speed communications.</li> </ul>	<ul style="list-style-type: none"> <li>Can be configured for use as RS-232, RS-422, X.21, or V.35 communications ports.</li> </ul>	
System Requirements	To use the Apple Serial NB Card, you'll need:	<ul style="list-style-type: none"> <li>A personal computer in the Macintosh II family of systems.</li> <li>Macintosh system software version 6.03 (or later)</li> </ul>	
Technical Specifications	<b>Connector</b> <ul style="list-style-type: none"> <li>DB-62 connector—for multiple-port connectivity (cable available separately from Apple Computer)</li> </ul> <b>Interface</b> <ul style="list-style-type: none"> <li>NuBus—plugs into any computer in the Macintosh II family</li> </ul>	<b>Processor</b> <ul style="list-style-type: none"> <li>Motorola 68000 running at 10 megahertz</li> </ul> <b>Memory</b> <ul style="list-style-type: none"> <li>512K of RAM, expandable to 1 megabyte</li> </ul>	<b>Power Dissipation</b> <ul style="list-style-type: none"> <li>10 watts</li> </ul> <b>Transmit/Receive data rates</b> <ul style="list-style-type: none"> <li>19.2 kilobits per second</li> <li>64 kilobits per second using the specified DMA-backed ports</li> </ul>
Ordering Information	<b>Apple Serial NB Card</b> Order No. M0264	With your order, you'll receive: <ul style="list-style-type: none"> <li>Apple Serial NB Card</li> <li>Installation Guide</li> </ul>	<ul style="list-style-type: none"> <li>Limited warranty statement</li> </ul>
	<b>MacAPPC (available separately from Apple Computer)</b> Order No. M0698	With your order, you'll receive: <ul style="list-style-type: none"> <li>Four 800K disks with MacAPPC code and sample applications</li> </ul>	<ul style="list-style-type: none"> <li>Documentation on MacAPPC</li> </ul>
	<b>MCP memory expansion kit</b> Order No. M0145LL/A	With your order, you'll receive: <ul style="list-style-type: none"> <li>Four 256K x 4 twenty-pin ZIP DRAMs to be installed by dealer</li> </ul>	
	<b>MacX25</b> Order No. M0711	With your order, you'll receive: <ul style="list-style-type: none"> <li>Four 800K disks with MacX25 server and user code</li> </ul>	<ul style="list-style-type: none"> <li>MacX25 Administrator's Guide</li> <li>MacX25 User's Guide</li> </ul>
	<b>MacDFT 1.1</b> Order No. M0695	With your order, you'll receive: <ul style="list-style-type: none"> <li>One 800K disk with MacDFT software</li> </ul>	<ul style="list-style-type: none"> <li>MacDFT 1.1 User's Guide</li> </ul>
	<b>Apple RS232 Cable</b> M0128LL/A	With your order, you'll receive: <ul style="list-style-type: none"> <li>One RS-232 cable with four connectors</li> </ul>	

Apple Computer, Inc.

20525 Mariani Avenue  
Cupertino, CA 95014  
(408) 996-1010  
TLX: 171-576

© 1990 Apple Computer, Inc. Apple, the Apple logo, MacDFT, Macintosh, and MultiFinder are registered trademarks of Apple Computer, Inc. MacAPPC, Macintosh Coprocessor Platform and MacX25 are trademarks of Apple Computer, Inc. IBM and SNA are registered trademarks of International Business Machines Corporation. Motorola is a registered trademark of Motorola Corporation. NuBus is a trademark of Texas Instruments.  
May 1990. Product specifications are subject to change without notice.  
Printed in U.S.A. M0297LL/B

## Apple Coax/Twinax Card

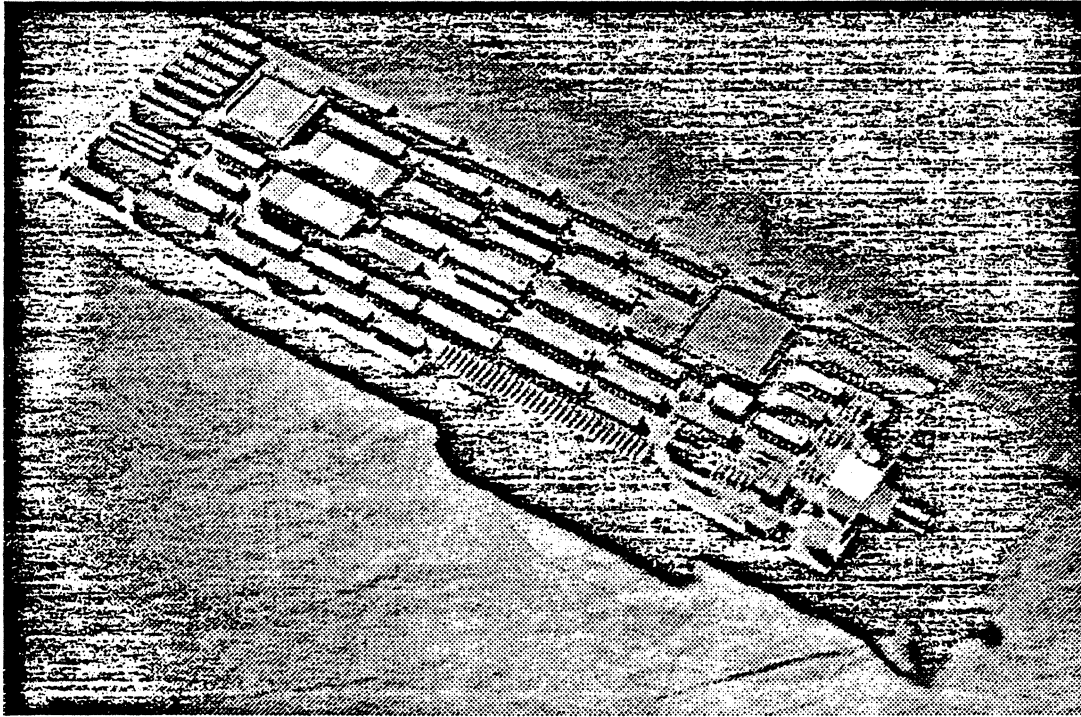

### Overview

The Apple® Coax/Twinax Card is an expansion card that allows personal computers in the Macintosh® II family of systems to connect to an IBM SNA (Systems Network Architecture) network as 3270 Information Display Systems, via industry-standard coax cabling. The card allows users to access mainframe-based 3270 applications in the same manner as they would from a terminal, while enjoying all of the benefits of Macintosh technology for their local applications. The Apple Coax/Twinax Card also has a twinax connector for third-party 5250 terminal emulation support.

This intelligent NuBus™ interface card has its own 68000 microprocessor, memory, and multitasking operating system. Operating independently of the main Macintosh II processor, the Apple Coax/Twinax Card supports the execution of communications protocols with minimal access to the Macintosh II processor and operating system. And because all of the communications processing is done on the card, Macintosh applications can run more effectively under MultiFinder.®

The MacDFT® application software works with the Apple Coax/Twinax Card to allow single-session Control Unit Terminal (CUT) emulation or up to five-session Distributed Function Terminal (DFT) 3270 emulation. Files can be transferred to or from mainframes running VM/CMS or MVS/TSO using the IBM IND\$FILE package.

The Apple 3270 API, a high-level application programming interface, gives application developers a consistent platform for developing customized 3270 applications.



# Apple Coax/Twinax Card

<b>Features and Benefits</b>	<b>Features</b>	<b>Benefits</b>	
	<ul style="list-style-type: none"> <li>• Connection to SNA networks</li> </ul>	<ul style="list-style-type: none"> <li>• Allows access to applications and data on IBM mainframes.</li> </ul>	
	<ul style="list-style-type: none"> <li>• Based on the Macintosh Coprocessor Platform™</li> </ul>	<ul style="list-style-type: none"> <li>• Handles all SNA communications processing for the Macintosh II.</li> </ul>	
	<ul style="list-style-type: none"> <li>• 512K of RAM, expandable to 1 megabyte</li> </ul>	<ul style="list-style-type: none"> <li>• Provides support for multiple protocols.</li> </ul>	
<b>System Requirements</b>	To use the Apple Coax/Twinax Card, you'll need:	<ul style="list-style-type: none"> <li>• A personal computer in the Macintosh II family of systems</li> <li>• Macintosh system software version 6.0.3 or later</li> </ul>	<ul style="list-style-type: none"> <li>• MacDFT application software or compatible third-party software</li> </ul>
<b>Technical Specifications</b>	<b>Connector</b>	<b>Processor</b>	<b>Application programming interface</b>
	<ul style="list-style-type: none"> <li>• BNC (coax) and 15-pin D-style (twinax)</li> </ul>	<ul style="list-style-type: none"> <li>• Motorola 68000 running at 10 megahertz</li> </ul>	<ul style="list-style-type: none"> <li>• Apple 3270 API</li> </ul>
	<b>Interface</b>	<b>Memory</b>	<b>Coax support</b>
	<ul style="list-style-type: none"> <li>• NuBus; plugs into any Macintosh II computer</li> </ul>	<ul style="list-style-type: none"> <li>• 512K of RAM, expandable to 1 megabyte</li> </ul>	<ul style="list-style-type: none"> <li>• Category A</li> </ul>
			<b>Power dissipation</b>
			<ul style="list-style-type: none"> <li>• 10 watts</li> </ul>
<b>Ordering Information</b>	<b>Apple Coax/Twinax Card</b>	Order No. M0261	With your order, you'll receive: <ul style="list-style-type: none"> <li>• Apple Coax/Twinax Card</li> <li>• <i>MacDFT User's Guide</i></li> <li>• Limited warranty statement</li> </ul>
	<b>MacDFT Software</b>	Order No. M0695 Please refer to the MacDFT data sheet (M0064LL/A) for features and product details.	With your order, you'll receive: <ul style="list-style-type: none"> <li>• MacDFT Software</li> <li>• <i>MacDFT User's Guide</i></li> <li>• Limited warranty statement</li> </ul>

Apple Computer, Inc.

20525 Mariani Avenue  
Cupertino, CA 95014  
(408) 996-1010  
TLX: 171-576

©1990 Apple Computer, Inc. Apple, the Apple logo, MacDFT, Macintosh, and MultiFinder are registered trademarks of Apple Computer, Inc. Macintosh Coprocessor Platform is a trademark of Apple Computer, Inc. IBM and SNA are registered trademarks, and MVS and VM are trademarks, of International Business Machines Corporation. Motorola is a registered trademark of Motorola Corporation. NuBus is a trademark of Texas Instruments.  
May 1990. Product specifications are subject to change without notice. Printed in U.S.A.  
M0064LL/B

# Macintosh System Software Version 7.0

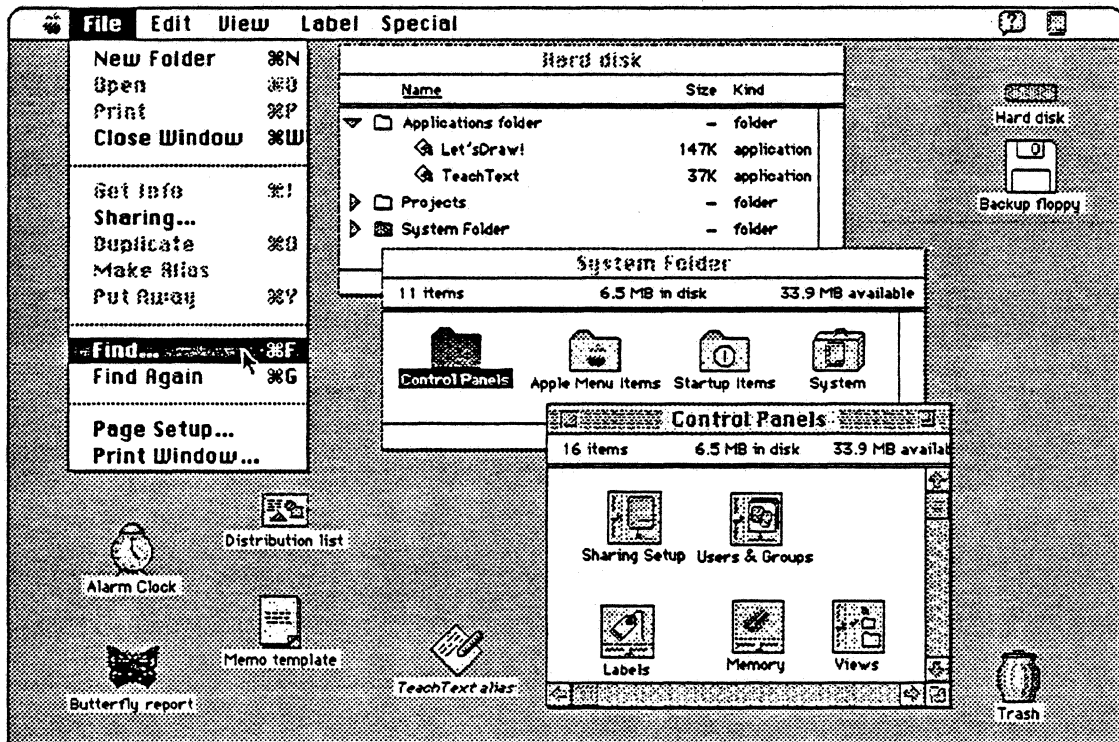

## Overview

Macintosh® System Software Version 7.0, the new Macintosh standard for personal computing, brings dynamic new capabilities and greater ease of operation to everyone who uses an Apple® Macintosh personal computer. System 7 offers immediate advantages to users of any Macintosh with 2 megabytes of memory and a hard disk drive, and it paves the way for a new generation of powerful application software.

You'll find that System 7 builds on the basic capabilities that distinguish the Macintosh from other personal computers. System 7 strengthens the computer's familiar, commonsense way of working that gives you direct, intuitive access to the computer's resources.

Because many of System 7's new features work with current Macintosh applications, you can take advantage of them right away. TrueType® fonts, for example, give you sharp-looking text in all your current applications—

on screen and on your printer. A new version of the Finder® gives you easier and faster access to your folders and documents. Multitasking, now standard to the Macintosh experience, allows you to work with several programs at the same time and even continue working while the computer performs other tasks. And System 7's virtual memory capability allows you to open more applications simultaneously without having to buy additional RAM.

System 7 also provides easier network access with built-in Macintosh file sharing. You can easily share files and folders with other Macintosh users on the same network without having to dedicate a Macintosh for use as a file server. And the innovative Balloon Help™ feature makes it easy to learn as you work; you can interactively find out about Macintosh features simply by pointing at something on the screen. And since developers are building Balloon Help into new versions of their

Macintosh applications, you can easily learn about and take better advantage of your software.

New versions of Macintosh applications will allow you to take advantage of other new System 7 capabilities such as Publish and Subscribe and Data Access. Publish and Subscribe helps you keep information up-to-date by providing an automatic link between documents—between a spreadsheet and a report, for example. Changes in one document are automatically reflected in the other, even over a network. And Data Access provides better access to remote host databases.

Macintosh users can easily upgrade to System 7, retaining their investment in both their applications and their Macintosh expertise. Upgrade kits are available for both individuals and groups of Macintosh users, and each upgrade kit includes toll-free phone support. Other support programs are also available.

## Features

## Benefits

### Features available with current Macintosh applications

- |  |   |
|--|---|
| <ul style="list-style-type: none"><li>• Compatibility with current Macintosh applications and utilities</li></ul>  | <ul style="list-style-type: none"><li>• Lets you run most Macintosh software.</li><li>• Preserves and enhances your investment in software, hardware, information, and training.</li></ul>  |
| <ul style="list-style-type: none"><li>• Multitasking</li></ul>   | <ul style="list-style-type: none"><li>• Lets you use two or more applications at the same time and switch among them easily.</li><li>• Allows you to continue working on other tasks while printing a document, copying or transferring files, sorting databases, re-calculating spreadsheets, etc.</li></ul>   |
| <ul style="list-style-type: none"><li>• Cut, Copy, and Paste</li></ul>   | <ul style="list-style-type: none"><li>• Allows you to move information back and forth between all Macintosh applications with ease.</li><li>• Allows you to use the most appropriate application for your work.</li></ul>   |
| <ul style="list-style-type: none"><li>• Virtual memory*</li></ul>  | <ul style="list-style-type: none"><li>• Allows you to open more applications without adding RAM.</li></ul>  |
| <ul style="list-style-type: none"><li>• 32-bit addressing**</li></ul>  | <ul style="list-style-type: none"><li>• Lets you use more than 8 megabytes of RAM on certain models of Macintosh.</li><li>• Makes it possible for you to work with very large applications, complex graphic documents, and data-intensive applications.</li></ul>   |
| <ul style="list-style-type: none"><li>• Finder, including:<ul style="list-style-type: none"><li>—Find command</li><li>—Customizable Apple menu</li><li>—Alias capability</li></ul></li></ul> | <ul style="list-style-type: none"><li>• Quickly locates files on your hard disk.</li><li>• Lets you search for files by name, size, kind, date, and other criteria.</li><li>• Lets you add your own programs and documents to the Apple menu for quick, one-click access.</li><li>• Allows you to file an application or a document in more than one place on your hard disk.</li><li>• Allows you to access your hard disk when working at another Macintosh computer on the same network.</li></ul> |
| <ul style="list-style-type: none"><li>• TrueType outline fonts</li></ul>   | <ul style="list-style-type: none"><li>• Lets you work with multiple sizes of precision fonts on the screen.</li><li>• Helps you produce professional-quality documents on any printer.</li><li>• Allows you to install fonts simply by dragging their icons into the System Folder.</li></ul>   |
| <ul style="list-style-type: none"><li>• Balloon Help</li></ul>   | <ul style="list-style-type: none"><li>• Provides "learn as you work" help. You simply point to something on the screen; balloons appear to identify and describe the feature.</li><li>• Allows you to get help while you work, without stopping what you're doing.</li></ul>  |

\* Virtual memory is supported by Macintosh computers with a 68030 microprocessor and Macintosh II computers with both a 68020 microprocessor and a 68051 Paged Memory Management Unit (PMMU).

\*\* 32-bit addressing is available on the following Macintosh models: Macintosh LC, Macintosh IIfx, Macintosh IIfx, and Macintosh IIfx.

## Features

## Benefits

- Macintosh file sharing

- Allows workgroups to share folders and files without the expense of a dedicated server.
- Permits you to use the network to retrieve files from your office when working in another location.
- Lets you share files with System 6 Macintosh computers and, with third-party products, with MS-DOS, or Windows-based computers.

---

### Features available with new versions of Macintosh applications

- Publish and Subscribe

- Allows you to automatically update information by creating links between documents—a spreadsheet and a report, for example—so that changes made in one document are automatically reflected in the other.
- Streamlines the revision process.
- Lets you work with the most current information.
- Makes it easier for people to work together, because Macintosh users can update documents across the network.

- 
- Data Access capability

- Provides built-in access to remote host databases.
- Allows you to extract data from remote mainframes using one familiar Macintosh interface.

- 
- 32-bit QuickDraw™ graphics

- Produces screen images of true photographic quality by enabling color systems to display up to 16 million colors simultaneously.
- Allows the creation of highly detailed renderings, simulations, and animation sequences.

- 
- Sound input

- Allows you to add voice comments to voice-capable word processing, spreadsheet, presentation, and other documents.

---

### Upgrade Kit features

- "Before You Install" disk

- Prepares you for System 7 by introducing new features and checking your system for compatibility.
- Provides a printed compatibility report of your system.

- 
- Installer

- Allows convenient, one-click installation of system software, even across a network.
- Saves time when upgrading many computers.

- 
- Networking Basics Tour

- Makes it easy to understand and use the networking features of System 7.



## Product Specifications and Details

### Upgrade products

Two kits are available for Macintosh users who want to upgrade to System 7. The System 7 Personal Upgrade Kit is for individuals who want to upgrade a single Macintosh to System 7. The System 7 Group Upgrade Kit is designed for users who want to

upgrade a group of Macintosh computers to System 7. Both upgrade kits include the "Before You Install" disk, which simplifies installation and checks for application compatibility with System 7.

The Group Upgrade Kit contains special materials and tools to help

you move a group or entire installation of Macintosh computers to System 7. The kit includes the *System 7 Group Upgrade Guide*, which has upgrade strategies and information; a CD-ROM disc containing version 7.0 software, which allows System 7 to be installed across the network; and

administrator tools.

To help customers with questions about System 7, each upgrade kit includes direct, toll-free telephone upgrade support. Other support programs are also available.

### New Features at a Glance

When opening and saving documents, it's easier to choose among items on the Macintosh desktop.

New features of Finder windows, such as keyboard navigation and outline views of folders, make it easier to select icons.

The Startup Items folder lets you launch items at startup simply by placing them in the folder.

The Balloon Help facility gives you information as you work.

The Application menu makes it easy to switch among several open programs.

You can assign labels to icons.

Macintosh file sharing lets you share folders on a hard disk with other users on the network without a dedicated file server.

Control panels let you set options in your system.

The Find command quickly locates files and brings them to the desktop.

Automatic document updating is available with new Macintosh applications.

You can open desk accessories by double-clicking their icons.

Items in the System Folder are organized into intelligent folders. New system tools are automatically placed in the correct location.

You can create custom icons.

Stationery pads let you easily create documents with common elements.

Aliases give you access to documents and applications from two or more locations in the system.

The Apple Menu Items folder lets you add documents or applications to the Apple menu by dragging icons into the folder.

Virtual memory lets most Macintosh users expand system memory with hard disk space.

Fonts and sounds are easier to install and remove; simply drag their icons into or out of the System file.

The Trash isn't emptied until you choose the Empty Trash command.

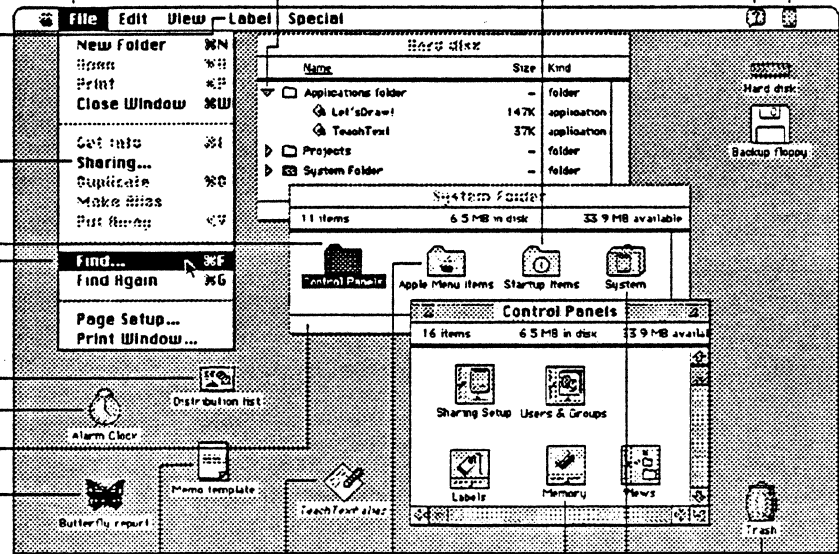

### Built-in fonts

Two types of fonts are supplied with System 7: TrueType fonts and bitmapped fonts. TrueType fonts include: Times®, (plain, bold, italic, and bold italic), Helvetica®, (plain and bold), Symbol, Courier (plain and bold), Chicago, New York, Monaco, and Geneva.

### Print drivers

ImageWriter®, Driver, LaserWriter®, Driver, Personal LaserWriter LS Driver, Personal LaserWriter SC Driver, ImageWriter LQ Driver, Apple StyleWriter®, Driver, AppleTalk®, ImageWriter Driver, and AppleTalk ImageWriter LQ Driver are included with System 7.

### Networking capabilities

**AppleTalk network system**

- Media supported: LocalTalk®, Ethernet (EtherTalk®), or TokenRing (TokenTalk®)
- Maximum number of nodes per network: Over 16 million with AppleTalk Phase II networking

**Macintosh file sharing**

- Maximum number of shared

folders per machine: 10, with an unlimited number of enclosed folders

- Maximum number of guest users connected: 10, with up to 50 identified in the Users & Groups file
- User Management: Built-in; specify user names, passwords, group membership, access privileges (open, read, modify)

## Product Specifications and Details

### Memory capabilities

- Accessible memory with 24-bit addressing: Up to 8 MB of physical memory; up to 14 MB with virtual memory
- Accessible memory with 32-bit addressing: Up to 1 gigabyte of physical memory; up to 1 gigabyte of virtual memory (maximum installable memory in Macintosh IIx and IIfx is 128 MB)

### Performance characteristics

- Application compatibility**
- Compatible with most Macintosh System 6 applications
- Processor compatibility**
- Compatible with 68000, 68020, and 68030 microprocessors, 68851 Paged Memory Management Unit (PMMU), and 68881 and 68882 floating-point units (FPUs)
- Memory (RAM)**
- Required: Minimum 2 MB of RAM

- Used: 1 to 125 MB, depending on CPU configuration
- Disk use**
- Space consumed: Approximately 2.5 to 4 MB, depending on configuration
  - Formats supported: 400K, 800K, 1.4 MB Macintosh disks; read/write 720K and 1.44 MB MS-DOS or OS/2 disks.
  - File name format: Up to 31 characters with mixed case, spaces, and symbols

- Maximum file and volume size: 4 gigabytes
  - Maximum number of files per volume: 65,536
  - Maximum number of volumes open at once: Unlimited\*
  - Maximum number of tasks supported: Unlimited\*
- Sound**
- Play from disk and input to disk
  - Maximum number of channels of sound simultaneously: 4
- \* Limited only by available system memory

### The Finder

The Finder displays all of the pull-down menus and icons needed to manage files, folders, disks, and applications in the Macintosh and over a network. Some of the capabilities in the System 7 Finder include:

Apple menu	Choose Control Panels, desk accessories, and other user-selected items. Monitor memory usage.
File menu	Locate files by name, date, size, label, or kind. Open applications, documents, and folders. Print documents and directories. Share folders with other users. Make an alias for an application, document, or folder. File information for an application or document; adjust memory usage of an application; turn a document into stationery.
Edit menu	Cut, Copy, and Paste information.
Views menu	View the contents of a Finder window by icon, name, size, kind, date, or label. View an outline of the contents of a folder.
Labels menu	Assign labels or colors to icons.
Special menu	Clean up windows and desktop. Sort by icon, name, size, kind, date, or label. Erase the contents of floppy disks and hard disks. Restart and shut down the computer.
Help menu	Display information about items on the screen.
Application menu	Switch among open applications. Hide and show programs.
Trash container	Discard files and folders.
<b>Desk accessories</b>	
Chooser	Select among printers, file servers, and other network resources.
Key Caps	Display characters of different fonts.
Alarm Clock	Clock/calendar with alarm
Calculator	Four-function calculator
Puzzle	Classic 15-tile game
Note Pad	Eight pages of "scratch paper" for text
Scrapbook	Storage for frequently used graphics and text
Battery	Battery charge indicator on Macintosh Portable**

### Control Panels

Macintosh control panels make it possible to change many of the standard settings for the Macintosh. Special control panels are supplied with some Macintosh models. The standard set of System 7 control panels includes:

General controls	Set desktop pattern and color, time, date, and volume.
Startup Device	Select the disk drive to be used for startup.
Mouse	Set mouse speed and responsiveness.
Keyboard	Set keyboard repeat rate and layout for international use.
Monitors	Choose the number of colors/grays to display. Specify positions of multiple monitors.
Brightness	Set screen brightness.**
Color	Select highlight and window color.
Memory	Increase system memory by using hard disk space, set the disk cache, and turn on 32-bit addressing on supporting Macintosh models.
Labels	Customize labels in the Finder.
Views	Customize icons and information in Finder windows.
Sharing Setup	Identify the Macintosh to the network, start file sharing, and turn on program linking.
Network	Specify network cabling system to use (LocalTalk, EtherTalk, or TokenTalk).**
Users & Groups	Administer names and passwords of users with whom files and folders will be shared.
File Sharing Monitor	Monitor file sharing activity.
Sound	Specify system alert sound and, on some models, input sounds.
Map	Set physical location and time zone.
Easy Access	Keyboard operation for physically impaired users
CloseView	Screen magnifier for visually impaired users
Portable	Special settings for the Macintosh Portable**
International	Specify time, date, currency format, and script system.
<b>Utilities</b>	
Apple File Exchange	Convert files from other operating systems such as MS-DOS.
Disk First Aid*	Disk diagnostics and repair
LaserWriter	Download one or more fonts to an Apple LaserWriter printer.
Font Utility	Simple text editor
Teach Text	Simple text editor
Apple HD SC Setup	Apple SCSI hard disk initialization

\*\* Available with certain Macintosh models



# Macintosh System Software Version 7.0

## System Requirements

To use Macintosh System Software Version 7.0, you'll need the following:

- A Macintosh Plus, Classic<sup>™</sup>, SE, SE/30, Portable, LC, II, Ix, IIfx, IId, IId, or IIfx personal computer with at least 2 megabytes of RAM and a hard disk
  - A Macintosh 128K, 512K, or 512K-enhanced personal computer with a Macintosh Plus Logic Board Upgrade, at least 2 megabytes of RAM, and a hard disk
- Notes: Those who are using the built-in video capabilities of a Macintosh IIfx or Macintosh IIfx may need to add RAM when upgrading to System 7.

## Ordering Information

**System 7 Personal Upgrade Kit\***  
Order No. M8221LL/A

- With your order, you'll receive:
  - Macintosh System Software Version 7.0 (eight 800K disks)
  - "Before You Install" with Compatibility Checker (one disk)
  - HyperCard, version 2.1 (two disks)
  - Complete setup, learning, and reference documentation
  - 90 days of toll-free upgrade assistance
  - Limited warranty statement

**System 7 Group Upgrade Kit\***  
Order No. M8221LL/A  
With your order, you'll receive:

- System 7 Group Upgrade Guide
- System 7 CD-ROM disc with:
  - Macintosh System Software Version 7.0
  - System 7 disk images
  - Macintosh Electronic Reference
  - "Before You Install"
  - Compatibility Checker
  - Networking Basics Tour
  - HyperCard version 2.1
- Floppy disks of all System 7 software (11 disks)
- Complete setup, learning, and reference documentation
- Licensing agreement and registration card
- 180 days of toll-free upgrade assistance
- Limited warranty statement

\*Macintosh System Software Version 7.0 is also delivered free of charge to subscribers to the Macintosh System Software Update Program.

## System 7 Upgrade Assistance

To make your transition to System 7 as smooth as possible, Apple offers two direct upgrade support services for customers in the U.S.A.:

**System 7 Upgrade Answerline**  
This direct telephone service helps customers plan their upgrade (including hardware requirements, compatibility, and backup strategies); install System 7; and troubleshoot any problems that might surface during the upgrade process.

Purchasers of the System 7 Personal Upgrade Kit receive 90 days of toll-free upgrade assistance, and purchasers of the System 7 Group Upgrade Kit receive 180 days of toll-free upgrade assistance. Customers who have questions about upgrading to System 7 but have not purchased an upgrade kit can contact the Upgrade Answerline by calling 1-800-535-APPL at the cost of \$2 per minute.

**Automated Q&A System**  
This automated, computer-based system allows callers to listen to recorded answers to the most frequently asked questions about installing and using System 7. It is available 24 hours a day, 7 days a week. Purchasers of the System 7 Personal Upgrade Kit receive 90 days of toll-free access; purchasers of the System 7 Group Upgrade Kit receive 180 days of toll-free access; and customers who do not purchase an upgrade kit can call (408) 571-7700 to access the automated Q&A System; they pay only the cost of the telephone call.

## Apple Computer, Inc.

20525 Mariani Avenue  
Cupertino, CA 95014  
(408) 996-1010  
TLX 171576

© 1991 Apple Computer, Inc. Apple, the Apple logo, AppleLink, HyperCard, ImageWriter, LaserWriter, LocalTalk, Macintosh, SystemWriter, and TokenTalk are registered trademarks of Apple Computer, Inc. Balloon Help, Disk First Aid, Finder, QuickDraw, and TrueType are trademarks of Apple Computer, Inc. Classic is a registered trademark, licensed to Apple Computer, Inc. Hercules and Times are registered trademarks of Linotype Corporation; MS-DOS is a registered trademark of Microsoft Corporation. OS/2 is a trademark of International Business Machines Corporation. Macintosh of non-Apple products is for informational purposes and constitutes neither an endorsement nor a recommendation. Apple assumes no responsibility with regard to the selection, performance, or use of these products.  
April 1991. Product specifications are subject to change without notice. Printed in U.S.A.  
1000611A

# AppleTalk Internet Router

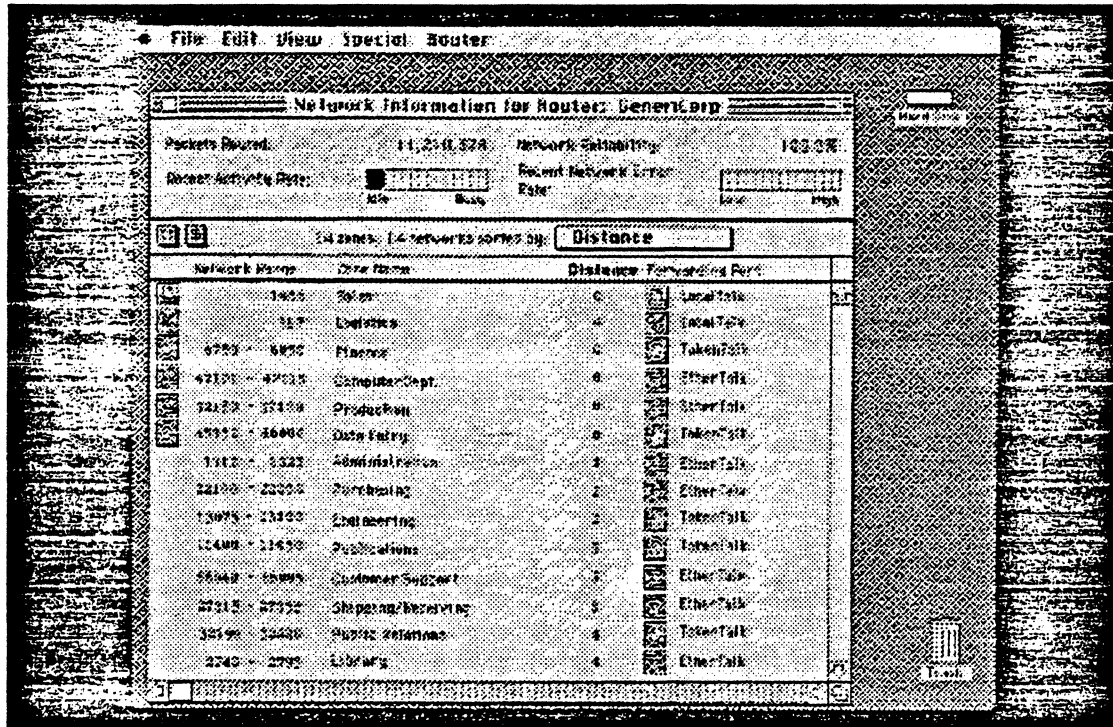

## Overview

The AppleTalk® Internet Router lets you increase the size and improve the performance and manageability of your AppleTalk network system. It allows AppleTalk networks such as LocalTalk™, EtherTalk™, and TokenTalk™ to be interconnected to form an internet. The router moves data from one network to another transparently so that the internet functions like a single network. This means that users can share files and printers across the

internet, as well as send and receive mail, in the same way that they access these resources on a single network.

A key component of the AppleTalk network system, the AppleTalk Internet Router offers room to grow for even the largest networking installations. Features such as extended addressing and improved zone-based-access to internet resources let network professionals build for the future.

As with other Apple® Macintosh® products, the AppleTalk Internet Router is easy to use. Even a network novice can have it running in minutes and begin to make use of its powerful features.

## Features

## Benefits

- 
- |   |   |
|---|---|
| • Background routing capability                         | • Allows the Macintosh running the router software to run other services in the foreground.   |
| • Up to eight network ports per router                  | • Allows interconnection of up to eight networks per Macintosh, enabling flexible network topologies and optimum use of the Macintosh serving as a router.                          |
| • Up to 1,024 networks per internet                     | • Provides room for growth for even the largest network systems.  |
| • Extended network addressing of up to 16 million nodes | • Supports large network systems that use data link bridges for local and wide area networking.   |
| • Zone naming on a per-node basis                       | • Streamlines the use of the Chooser in large networks.   |
| • Network independent                                   | • Supports LocalTalk, EtherTalk, and TokenTalk.<br>• Lets you choose the best network for each environment and then connect multiple networks to form an integrated network system. |
| • Monitoring of router traffic and errors               | • Provides an effective internetwork management tool.   |
| • Easy setup and operation                              | • Lets even novice network users benefit from this powerful software.   |
| • Dynamic internet route maintenance                    | • Requires no additional administration after setup.  |
| • Isolation of local traffic                            | • Increases internet performance by keeping local traffic at the local network level—isolating it from the internet.  |
| • Redundant topologies                                  | • Allows AppleTalk internets to use alternate routes automatically in the event of a failure in the primary route.  |
| • Report facility                                       | • Allows router statistics and routing tables to be printed and logged for network management purposes.   |

## Product Details

### Support of Large Networks

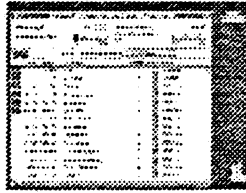

The AppleTalk Internet Router lets users build large internets that span a company or campus. An AppleTalk internet can support as many as 16 million devices (nodes). These can be distributed over as many as 1,024 interconnected networks, or can be allocated to one large network such as those that use data link bridges to interconnect local area networks.

### Easy Setup

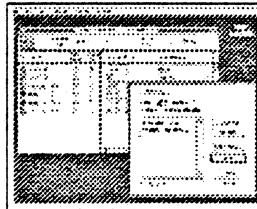

The AppleTalk Internet Router identifies all network connections installed on the Macintosh serving as the router. You simply enter a network number range for each network you want to interconnect. Zone names can be defined to streamline directory services on large internets. The rest is automatic, because the AppleTalk Internet Router dynamically communicates with other AppleTalk routers to build a table of the entire internet. Users can then view and access resources throughout the internet.

### Improved Internet Reliability

The AppleTalk Internet Router can be used to improve internet reliability. Most network problems remain isolated to a single network. By using a redundant route topology, internet traffic can be rerouted in case of a failure in a particular network.

### Flexibility

The router lets network planners fine-tune their AppleTalk systems by isolating local traffic from internet traffic, and by providing a choice of topology and network performance to accommodate the most demanding network environments.

### The Router Environment

AppleTalk Internet Router software runs in the background on a Macintosh computer, allowing the router to share the same Macintosh as the Apple-Share® File and Print Servers, as well as third-party mail servers. The router uses between 120K and 160K of system memory, depending on the number of networks in the internet.

### Media Independence

The AppleTalk Internet Router can interconnect all types of AppleTalk networks, including LocalTalk, EtherTalk, and TokenTalk, to offer the greatest flexibility in choice of media and topology. The AppleTalk Internet Router can be used to provide transparent access to the LaserWriter® and ImageWriter® II printers from EtherTalk and TokenTalk networks.

### Direct Routing

The improved routing protocol of AppleTalk Phase 2 sends data directly to the router along the shortest path to the destination, increasing internet performance.

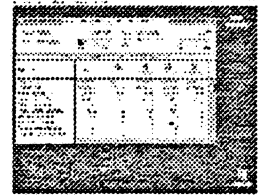

### Monitoring and Control

Through the router desk accessory, you can display various windows that let you monitor activity and network statistics on the router, view an active routing table of the entire internet, change the router setup information, or print the contents of the setup and administrative displays.

### Zone Multicast

Zone Multicast, provided on EtherTalk and TokenTalk networks, allows a message to be sent to all members of a particular zone without disturbing other nodes on the network. Zone Multicast improves network performance by reducing traffic overhead caused by broadcasts.

### Upgrade Path

AppleTalk internets can include AppleTalk Internet Routers as well as third-party routers that meet the AppleTalk Phase 2 specification. An upgrade utility is included with the AppleTalk Internet Router so that it can communicate with older routers during the upgrade process. Also, during the upgrade to AppleTalk Phase 2, the AppleTalk Internet Router allows nodes using older versions of EtherTalk to communicate with nodes using EtherTalk Version 2.0. These features allow an incremental upgrade path to AppleTalk Phase 2 where needed.



## AppleTalk Internet Router

---

<b>System Requirements</b>	To use the AppleTalk Internet Router, you'll need: <ul style="list-style-type: none"><li>• A Macintosh Plus, SE, SE/30, II, IIX, or IICX personal computer</li></ul>	<ul style="list-style-type: none"><li>• Macintosh System Software Version 6.0.3 or later</li></ul>	<ul style="list-style-type: none"><li>• All necessary network interface cards, cabling, and software for each network connection</li></ul>
<b>Ordering Information</b>	<b>AppleTalk Internet Router</b>	Order No. M0705	With your order, you'll receive: <ul style="list-style-type: none"><li>• AppleTalk Internet Router software</li><li>• Macintosh System Software 6.0.3</li><li>• <i>AppleTalk Internet Router Administrator's Guide</i></li></ul>

---

Apple Computer, Inc.

20525 Mariani Avenue  
Cupertino, CA 95014  
(408) 996-1010  
TLX: 171-576

© 1989 Apple Computer, Inc. Apple, the Apple logo, AppleShare, AppleTalk, ImageWriter, LaserWriter, and Macintosh are registered trademarks of Apple Computer, Inc. EtherTalk, LocalTalk, and TokenTalk are trademarks of Apple Computer, Inc.  
June 1989. Product specifications are subject to change without notice.  
Printed in U.S.A. M0069LLA

## Macintosh IIx

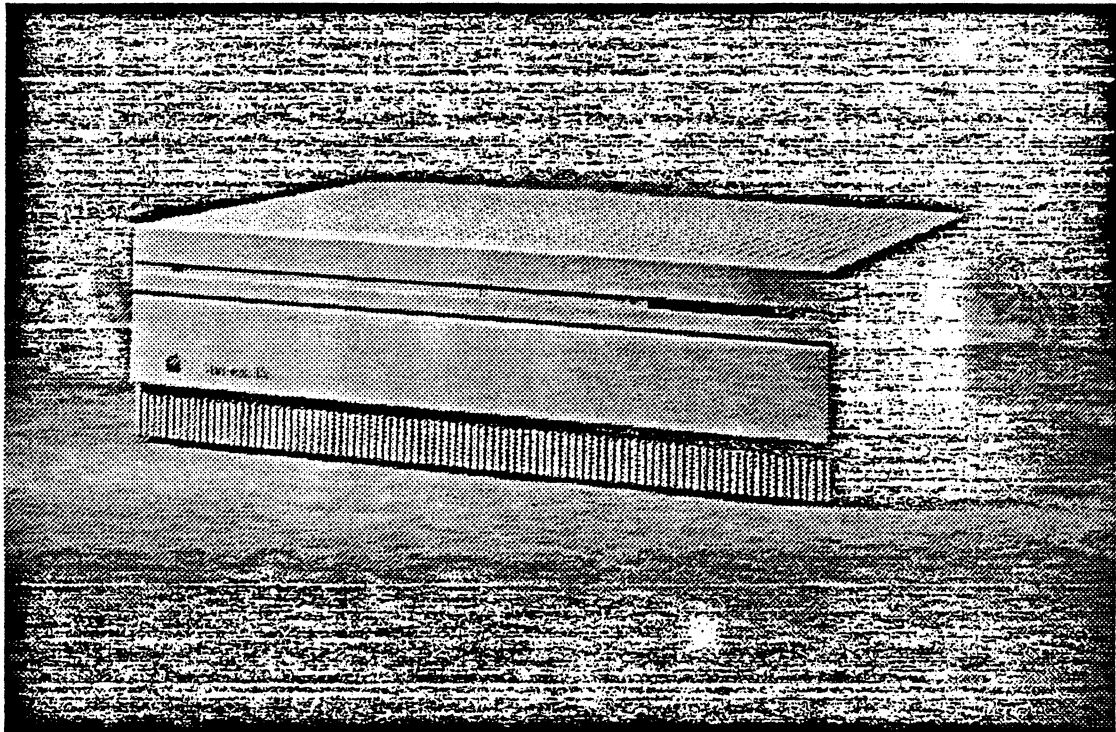

### Overview

The Apple® Macintosh® IIx is an extremely high-speed and elegantly engineered personal computer that has been designed for people who need the ultimate in Macintosh responsiveness as well as new Macintosh capabilities.

To provide maximum Macintosh performance and responsiveness, the Macintosh IIx incorporates a high-speed, 40-megahertz 68030 microprocessor, a 32K Static RAM Cache memory subsystem, and a 68882 floating-point coprocessor for high-speed processing of complex mathematical functions.

The Macintosh IIx also incorporates, for the first time, dedicated I/O (input/output) processors. These custom-designed ASICs (application-specific integrated circuits) boost system efficiency by managing low-level I/O tasks—for the Apple Desktop Bus™, floppy disk drives, and serial ports—that were previously carried out by the 68030 processor. In addition, the

Macintosh IIx contains a dedicated SCSI/DMA (Small Computer System Interface/Direct Memory Access) controller that improves SCSI performance.

Users who need maximum system expandability will especially appreciate the versatility of the Macintosh IIx. First, system memory can be expanded from 4 to 8 megabytes for high-performance applications that demand superior system responsiveness.

Second, the Macintosh IIx includes six NuBus™ expansion slots that can accommodate a wide range of Apple and third-party expansion cards, such as additional network interface and graphics cards. A new Processor Direct Slot (PDS) provides a direct interface for third-party hardware options. And six external interface ports accommodate peripherals such as hard disks and printers, LocalTalk™ network connections, and Apple Desktop Bus devices.

For floppy disk storage, the Macintosh IIx uses the 1.4-megabyte Apple SuperDrive™ disk drive, which allows users to read from and write to 3.5-inch Macintosh floppy disks as well as 3.5-inch disks used in a variety of other personal computers. The Macintosh IIx can also be configured with up to 160 megabytes of internal hard disk storage, and it will accommodate a second SuperDrive.

Best of all, the Macintosh IIx is a Macintosh, which means that it still offers all of the benefits of earlier Macintosh systems: access to more than 3,000 of the most powerful, graphics-based applications available; ease of learning and ease of use through a consistent, graphics-based interface; choice without confusion in hardware and software; the convenience of “plug and play” compatibility; and the assurance that all Macintosh components will work together smoothly.



## Features

## Benefits

- 
- |   |   |
|---|---|
| <ul style="list-style-type: none"><li>• 4 megabytes of on-board RAM, expandable to 8 megabytes</li></ul>  | <ul style="list-style-type: none"><li>• Provides a simple growth path for users as they need additional memory.</li><li>• Allows multiple applications to be opened concurrently under the MultiFinder® operating system.</li><li>• Provides memory space for manipulation of large amounts of data, such as large spreadsheets, complex CAD drawings, scanned images, and sound files.</li></ul> |
| <ul style="list-style-type: none"><li>• Optional parity support</li></ul>   | <ul style="list-style-type: none"><li>• Provides detection of DRAM (dynamic RAM) parity errors for increased data integrity.</li></ul>  |
| <ul style="list-style-type: none"><li>• 512K of ROM on a SIMM (Single In-Line Memory Module), including:<ul style="list-style-type: none"><li>—32-bit addressing</li><li>—Hierarchical File System</li><li>—32-bit Color QuickDraw™</li></ul></li></ul> | <ul style="list-style-type: none"><li>• Enables future 32-bit versions of the Macintosh operating system to address up to 4 gigabytes of memory.</li><li>• Organizes document storage and allows easy access to files.</li><li>• Provides a consistent user interface throughout the Macintosh family and enables color systems to display up to 16 million colors simultaneously.</li></ul>      |
| <ul style="list-style-type: none"><li>• Macintosh user interface, including mouse, icons, windows, and pull-down menus</li></ul>  | <ul style="list-style-type: none"><li>• Makes most applications intuitive and easy to learn.</li><li>• Reduces training and support costs.</li><li>• Provides a consistent user interface across applications.</li></ul>  |
| <ul style="list-style-type: none"><li>• MultiFinder operating system</li></ul>  | <ul style="list-style-type: none"><li>• Allows multiple applications to be opened concurrently.</li><li>• Lets users easily cut and paste information between applications.</li><li>• Allows background tasks to be run while users interact with applications in the foreground.</li></ul>   |
| <ul style="list-style-type: none"><li>• Software compatibility</li></ul>  | <ul style="list-style-type: none"><li>• Lets users run virtually all Macintosh software.</li></ul>  |
| <ul style="list-style-type: none"><li>• Variable-speed fan controller</li></ul>   | <ul style="list-style-type: none"><li>• Provides quiet system operation.</li></ul>  |
-

## Features

## Benefits

- 
- |  |   |
|--|---|
| <ul style="list-style-type: none"><li>• Full 32-bit 68030 microprocessor, running at 40 megahertz</li><li>—Built-in Paged Memory Management Unit (PMMU)</li></ul>  | <ul style="list-style-type: none"><li>• Offers increased levels of performance and system responsiveness over other Macintosh II systems.</li><li>• Supports multitasking operating systems such as A/UX®, Apple's implementation of the AT&amp;T UNIX® operating system.</li></ul>   |
| <ul style="list-style-type: none"><li>• 68882 floating-point math coprocessor, running at 40 megahertz</li></ul>   | <ul style="list-style-type: none"><li>• Provides fast processing of complex mathematical functions while complying with IEEE 80-bit floating-point standards.</li></ul>   |
| <ul style="list-style-type: none"><li>• Built-in zero-wait-state 32K Static RAM Cache</li></ul>  | <ul style="list-style-type: none"><li>• Accelerates system performance.</li></ul>   |
| <ul style="list-style-type: none"><li>• Two dedicated I/O processors</li></ul>   | <ul style="list-style-type: none"><li>• Improves system efficiency by handling low-level tasks previously carried out by the 68030 microprocessor and associated with the floppy disk drive(s), Apple Desktop Bus, and serial ports.</li></ul>  |
| <ul style="list-style-type: none"><li>• SCSI/DMA controller</li></ul>  | <ul style="list-style-type: none"><li>• Increases performance of the SCSI bus.</li></ul>  |
| <ul style="list-style-type: none"><li>• Built-in Processor Direct Slot (PDS)</li></ul>   | <ul style="list-style-type: none"><li>• Provides a fast, 32-bit direct interface to the system bus for high-speed, third-party option cards.</li></ul>  |
| <ul style="list-style-type: none"><li>• SuperDrive floppy disk drive</li></ul>   | <ul style="list-style-type: none"><li>• Provides 75 percent more storage capacity than 800K disk drives.</li><li>• Allows convenient transfer of data files between Macintosh, OS/2, MS-DOS, and Apple II systems on the same 3.5-inch disk, using the Apple File Exchange utility.</li></ul>   |
| <ul style="list-style-type: none"><li>• Support for up to 160 megabytes of internal hard disk storage</li></ul>  | <ul style="list-style-type: none"><li>• Accommodates either a 5.25-inch half-height hard disk drive or a 3.5-inch hard disk drive in several capacities.</li></ul>  |
| <ul style="list-style-type: none"><li>• Six NuBus expansion slots</li></ul>  | <ul style="list-style-type: none"><li>• Makes it easy to create custom configurations to meet specific needs. (Cards are self-configuring—they require no DIP switches, and can be placed in any slot.)</li></ul>   |
| <ul style="list-style-type: none"><li>• Six built-in ports:<ul style="list-style-type: none"><li>—Two serial ports</li><li>—Two Apple Desktop Bus ports</li><li>—One SCSI port</li><li>—One sound port</li></ul></li></ul> | <ul style="list-style-type: none"><li>• Provides support for popular peripherals without using NuBus expansion slots.</li><li>• Provides access to LocalTalk networks, which allow users to connect Macintosh IIx systems to other computers and to LaserWriter® printers through the AppleTalk® network system.</li><li>• Supplies high-quality, four-voice digital sound that is compatible with all applications that use Macintosh sound.</li></ul> |
-

---

**Product Details****68030 Processor**

- Full 32-bit 68030 microprocessor runs at 40 megahertz.
- The 32-bit address bus provides up to 4 gigabytes of data space.
- 256-byte, on-chip address and instruction caches provide high levels of performance.
- Built-in PMMU supports virtual, shared, and protected memory in operating systems that have been designed for it.
- Burst mode RAM access enables groups of instructions and data to be read in fewer clock cycles than are required in normal access mode.

**68882 Math Coprocessor**

- The 32-bit 68882 math coprocessor runs at 40 megahertz and accelerates the execution of complex math functions, including trigonometric and logarithmic series.

**Optional Parity Support**

- Parity DRAM and a parity controller can be built into the Macintosh IIx system as an option.

**ROM**

- A 512K ROM SIMM socket on the logic board provides an easy upgrade path to future versions of ROM SIMMs.

**Static RAM Cache**

- A built-in zero-wait-state 32K Static RAM Cache provides high

levels of zero-wait-state CPU performance.

**RAM**

- RAM in the Macintosh IIx can be increased to 8 megabytes. The Macintosh IIx uses 80-nanosecond RAM.
- As denser, 4-megabit and 16-megabit RAM chips become available, RAM can be increased to 32 and 128 megabytes, respectively.

**Input/Output Processors**

- Two dedicated I/O processors manage low-level I/O tasks for the serial ports, floppy disk drive(s), and Apple Desktop Bus, providing higher levels of overall system performance.

**NuBus Expansion Slots**

- NuBus provides a multiplexed 32-bit address bus and data bus on a single 96-pin connector.
  - NuBus is self-configuring. Cards can be plugged into any slot and the system will automatically identify and configure each card, without DIP switches or jumper wires.
  - The NuBus architecture supports data transfer rates of up to 37.5 megabytes per second.
- SCSI (Small Computer System Interface)
- SCSI is a high-performance interface bus used to connect hard disks and other SCSI-based

devices, such as the AppleCD SC<sup>®</sup> CD-ROM drive and the Apple Scanner, to the Macintosh IIx. Up to seven SCSI peripherals, including an internal hard disk, can be connected.

- The Macintosh IIx SCSI subsystem is managed by a dedicated SCSI/DMA controller, which increases system efficiency.
- The SCSI I/O subsystem can provide data transfer rates in excess of 3 megabytes per second.

**Network Support**

- The Macintosh IIx provides full ROM support for all AppleTalk protocols, and includes built-in serial ports for LocalTalk network connections.

**Operating System Support**

- Macintosh system software includes:
  - System Tools Version 6.0.5 or greater (the Macintosh operating system)
  - Printer disk (printer drivers for all Apple printers)
  - Utilities disks (include utilities such as the Apple File Exchange, HD SC Setup, CloseView, Disk First Aid<sup>™</sup>, and Font/DA Mover)
- HyperCard<sup>®</sup> Version 1.2.5 (or greater) is included.
- A/UX Version 2.0 (optional) is compatible with the Macintosh IIx.

---

**Technical Specifications****Processor**

- 68030, 32-bit architecture
- 40-megahertz clock speed
- Burst mode RAM access
- Two 256-byte, built-in instruction and data caches (Harvard architecture)

**Coprocessor**

- 68882 floating-point coprocessor (IEEE standard—80 bits precision)
- 40-megahertz clock speed

**Static RAM Cache**

- Built-in zero-wait-state 32K Static RAM Cache memory architecture

**DRAM**

- 80-nanosecond, fast-page mode, 64-pin SIMMs
- 1-megabit DRAM package
- 4- or 8-megabyte memory configurations

**Optional Parity Support**

- Installation of parity generating chip and parity DRAM (9-chip

SIMM) provides parity error detection

**Memory Subsystem**

- Supports overlapping reads from Cache/ROM and writes to DRAM

**Input/Output Processor (IOP) Chips**

- Two IOP chips are standard cell implementations of a 2-megahertz 6502. The IOP chips manage the floppy disk drive(s) (SWIM chip), the Apple Desktop Bus, and the serial ports (SCC chip).

**Technical Specifications  
(continued)**

**SCSI/DMA Controller**

- Standard cell implementation of 53C80 SCSI chip and DMA control logic. The SCSI/DMA chip manages the SCSI bus.

**Interfaces**

- Six internal NuBus slots support full 32-bit address and data buses
- Processor Direct Slot (PDS) provides high-speed, 32-bit access to the system bus
- Two mini-8 serial (RS-232/RS-422) ports
- Two Apple Desktop Bus ports allow daisy-chaining of multiple peripheral devices
- SCSI interface uses a 50-pin internal connector and a DB-25 connector for the first external device; all subsequent SCSI-based peripherals use standard SCSI-to-

**SCSI interface cables**

- Stereo sound jack
- Mouse
- Mechanical tracking: Optical shaft encoding at  $3.9 \pm 0.39$  pulses per millimeter ( $100 \pm 10$  pulses per inch) of travel

**Sound Generator**

- Apple's custom digital sound chip provides 8-bit stereo sampling at 44.1 kilohertz, and includes four-voice wave-table synthesis—capable of driving stereo headphones or other stereo equipment through the sound jack

**Electrical Requirements**

- Line voltage: 100 to 240 volts AC, automatically configured
- Frequency: 48 to 62 hertz,

**single phase**

- Maximum power: 230 watts, not including monitor power

**Size and Weight**

**Main unit**

- Height: 5.5 in. (14.0 cm)
- Width: 18.7 in. (47.4 cm)
- Depth: 14.4 in. (36.5 cm)
- Weight: 24 lb. (10.9 kg)\*

**Mouse:**

- Height: 1.1 in. (2.8 cm)
- Width: 2.1 in. (5.3 cm)
- Depth: 3.8 in. (9.7 cm)
- Weight: 6 oz. (.17 kg)

\*Weight will be greater with internal hard disk drive.

**Ordering Information**

**Macintosh IIx CPU**

Order No.  
M5510LL/A

- With your order, you'll receive:
- Macintosh IIx personal computer with 4 megabytes of RAM and a built-in 1.4-megabyte SuperDrive
  - Mouse
  - Documentation set
  - System software and HyperCard software
  - Training disks
  - Limited warranty statement

**Macintosh IIx 4/80 CPU**

Order No.  
M5515LL/A

- With your order, you'll receive:
- Macintosh IIx personal computer with 4 megabytes of RAM, a built-in 1.4-megabyte SuperDrive, and an 80-megabyte internal hard disk drive
  - Mouse
  - Documentation set
  - System software and HyperCard software
  - Training disks
  - Limited warranty statement



# Macintosh IIx

## Ordering Information (continued)

**Macintosh IIx 4/160 CPU**

Order No.  
M5520LL/A

- With your order, you'll receive:
- Macintosh IIx personal computer with 4 megabytes of RAM, a built-in 1.4-megabyte SuperDrive, and a 160-megabyte internal hard disk drive
  - Mouse
  - Documentation set
  - System software and HyperCard software
  - Training disks
  - Limited warranty statement

**Macintosh IIx 4/80 CPU with A/UX**

Order No.  
M5523LL/A

- With your order, you'll receive:
- Macintosh IIx personal computer with 4 megabytes of RAM, a built-in 1.4-megabyte SuperDrive, and an 80-megabyte internal hard disk drive containing A/UX
  - Mouse
  - Documentation set
  - System software and HyperCard software
  - Training disks
  - Limited warranty statement

**Macintosh IIx 4/80 CPU with Parity Support**

Order No.  
M5524LL/A

- With your order, you'll receive:
- Macintosh IIx personal computer with 4 megabytes of parity error detection RAM, a built-in 1.4-megabyte SuperDrive, and an 80-megabyte internal hard disk drive
  - Mouse
  - Documentation set
  - System software and HyperCard software
  - Training disks
  - Limited warranty statement

**Macintosh IIx 4MB Memory Expansion Kit\***

Order No.  
M0376LL/A

- With your order, you'll receive:
- 4-megabyte DRAM upgrade

**Macintosh IIx 4MB Parity Memory Expansion Kit\***

Order No.  
M0377LL/A

- With your order, you'll receive:
- 4-megabyte parity DRAM upgrade

\* Dealer installation required.

Apple Computer, Inc.

20525 Mariani Avenue  
Cupertino, CA 95014  
(408) 996-1010  
TLX: 171-576

© 1990 Apple Computer, Inc. Apple, the Apple logo, AppleCD SC, AppleTalk, A/UX, HyperCard, LaserWriter, Macintosh, and MultiFinder are registered trademarks of Apple Computer, Inc. Apple Desktop Bus, Disk First Aid, LocalTalk, QuickDraw, and SuperDrive are trademarks of Apple Computer, Inc. MS-DOS is a registered trademark of Microsoft Corporation. NuBus is a trademark of Texas Instruments. OS/2 is a trademark of International Business Machines Corporation. LINUX is a registered trademark of AT&T. March 1990. Product specifications are subject to change without notice. Printed in U.S.A. M055LL/A

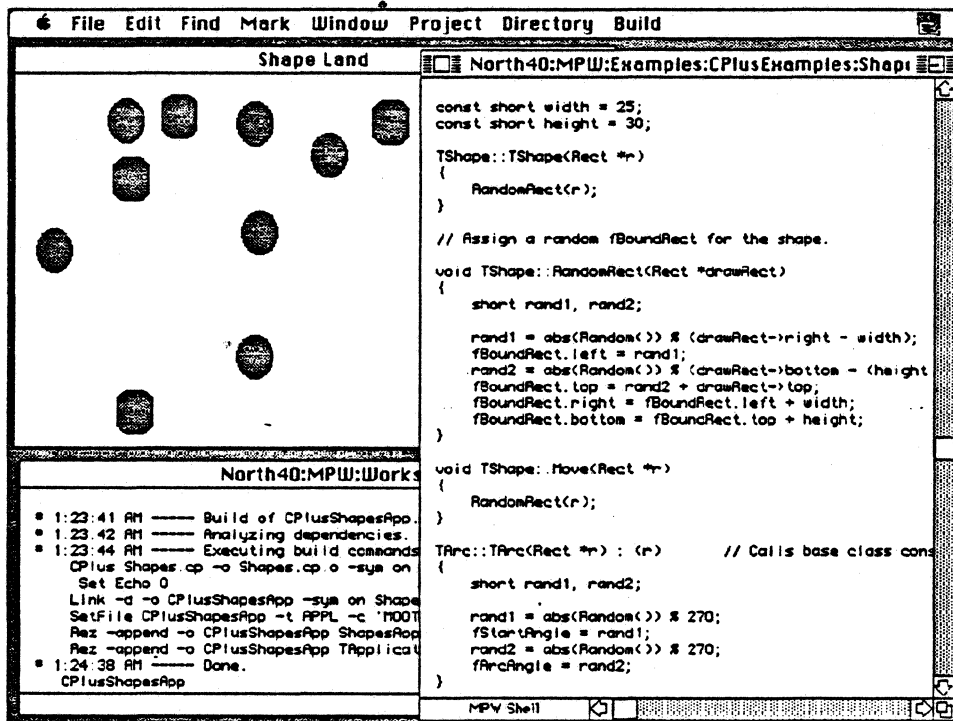

## Overview

The Macintosh® IIfx personal computer offers high performance and enhanced functionality in a system with the same small footprint and flexible design as the Macintosh IIx. People who require high-speed program execution for large spreadsheets, databases, and graphically intensive applications will appreciate the performance delivered by the Macintosh IIfx.

A 25-megahertz 68030 microprocessor makes the most significant contribution to the dramatic performance improvement offered by the Macintosh IIfx. Increasing the clock speed of the 68030 enables the system to perform up to 45 percent faster

than the Macintosh IIcx and Macintosh IIx computers. To speed the processing of complex mathematical functions, a 68882 math coprocessor comes standard with the Macintosh IIfx.

By installing an optional cache memory card, users can improve system performance by as much as 50 percent for many applications.

The Macintosh IIfx also comes with built-in video capability that enables the system to display up to 256 colors or shades of gray simultaneously on a variety of Apple® color and gray-scale monitors.

The Macintosh IIfx includes three internal NuBus™ expansion

slots, space for a 3.5-inch internal hard disk drive, seven standard external ports to accommodate peripherals, and the capability of expanding RAM to up to 8 megabytes. The Macintosh IIfx uses the 1.4-megabyte Apple SuperDrive™, which allows it to read from and write to 3.5-inch Macintosh floppy disks, as well as the 3.5-inch disks used by many other personal computers.

The Macintosh IIfx is compatible with virtually all Macintosh applications and comes standard with Apple's MultiFinder® operating system and HyperCard®, a tool for custom software solutions.

## Features

## Benefits

- 
- |  |  |
|--|--|
| <ul style="list-style-type: none"><li>• Full 32-bit 68030 microprocessor, running at 25 megahertz</li><li>—Built-in Paged Memory Management Unit (PMMU)</li><li>—Burst-mode RAM access capability</li></ul>  | <ul style="list-style-type: none"><li>• Offers superior processing speed, power, and performance.</li><li>• Supports multitasking operating systems (such as Apple's A/UX<sup>®</sup>) that require memory management capabilities in order to run.<ul style="list-style-type: none"><li>• Allows instructions and data to be read in fewer clock cycles than in the normal access mode, improving overall system performance.</li></ul></li></ul> |
| .....  |  |
| <ul style="list-style-type: none"><li>• 68882 floating-point math coprocessor</li></ul>  | <ul style="list-style-type: none"><li>• Provides fast processing of complex mathematical functions.</li></ul>  |
| .....  |  |
| <ul style="list-style-type: none"><li>• Cache connector</li></ul>  | <ul style="list-style-type: none"><li>• With the installation of a high-speed cache card, you can increase the overall performance of many applications by as much as 50 percent.</li></ul>  |
| .....  |  |
| <ul style="list-style-type: none"><li>• Built-in video support for the following Apple monitors:<ul style="list-style-type: none"><li>—13-inch AppleColor™ High-Resolution RGB Monitor with up to 256 colors or shades of gray</li><li>—Macintosh 12" Monochrome Display with up to 256 shades of gray simultaneously</li><li>—15-inch Apple Macintosh Portrait Display with up to 16 shades of gray</li></ul></li></ul> | <ul style="list-style-type: none"><li>• Provides the flexibility to choose among three of Apple's most popular monitors.</li><li>• Makes it easier to set up the system.</li><li>• Enhances system expandability by freeing up the NuBus slot usually occupied by the video card.</li><li>• Reduces system cost by eliminating the cost of a video card.</li></ul>   |
| .....  |  |
| <ul style="list-style-type: none"><li>• Three NuBus expansion slots</li></ul>  | <ul style="list-style-type: none"><li>• Lets you configure your system to meet specific needs.</li><li>• Makes it easy to add a variety of cards. (Cards are self-configuring—they require no DIP switches, and can be placed in any slot.)</li></ul>  |
| .....  |  |
| <ul style="list-style-type: none"><li>• Unique industrial design</li><li>—Small footprint</li><li>—Locking power switch</li></ul>  | <ul style="list-style-type: none"><li>• Can be used in either a horizontal or a vertical orientation.</li><li>• Takes up very little desktop space.</li><li>• Allows the system to restart automatically in the event of a power failure.</li></ul>  |
| .....  |  |
| <ul style="list-style-type: none"><li>• Apple SuperDrive</li></ul>   | <ul style="list-style-type: none"><li>• Provides 75 percent more storage capacity than 800K disk drives.</li><li>• Allows you to transfer data files conveniently between Macintosh, OS/2, MS-DOS, and Apple II systems on the same 3.5-inch disk, using the Apple File Exchange utility.</li></ul>  |
| .....  |  |
| <ul style="list-style-type: none"><li>• Internal hard disk storage</li></ul>   | <ul style="list-style-type: none"><li>• Accommodates a 3.5-inch hard disk drive (several capacities are available).</li></ul>  |

## Features

## Benefits

- 
- |   |  |
|---|--|
| <ul style="list-style-type: none"><li>• Eight built-in ports:<ul style="list-style-type: none"><li>—Two serial ports</li><li>—Two Apple Desktop Bus™ ports</li><li>—One SCSI port</li><li>—One DB-19 serial port (for an external floppy disk drive)</li><li>—One DB-15 video port (for built-in video support)</li><li>—One sound port</li></ul></li></ul> | <ul style="list-style-type: none"><li>• Allows you to tailor your system to your needs with popular peripherals without using expansion slots.</li><li>• Provides access to LocalTalk® networks, allowing you to connect your Macintosh IIci to other computers and to LaserWriter® printers through the AppleTalk® network system.</li><li>• Provides connection for Apple Desktop Bus devices such as a keyboard, mouse, trackball, or graphics tablet.</li><li>• Supports up to seven SCSI peripherals.</li><li>• Provides connection to built-in video.</li><li>• Supplies high-quality stereo sound to the stereo jack.</li></ul> |
| <hr/> <ul style="list-style-type: none"><li>• 4 megabytes of on-board RAM, expandable to 32 megabytes</li></ul>   | <ul style="list-style-type: none"><li>• Provides the flexibility to grow as you need additional memory.</li><li>• Enables you to open multiple applications concurrently under MultiFinder.</li></ul>  |
| <hr/> <ul style="list-style-type: none"><li>• Optional parity support</li></ul>   | <ul style="list-style-type: none"><li>• With installation of optional parity RAM, provides memory-checking capability.</li></ul>   |
| <hr/> <ul style="list-style-type: none"><li>• 512K of ROM, including:<ul style="list-style-type: none"><li>—32-bit addressing</li><li>—Hierarchical File System</li><li>—32-Bit QuickDraw™</li></ul></li></ul>  | <ul style="list-style-type: none"><li>• Enables future 32-bit versions of the Macintosh Operating System to address up to 4 gigabytes of memory.</li><li>• Organizes document storage and allows easy access to files.</li><li>• Provides a consistent user interface throughout the Macintosh family and enables color systems to display up to 16 million colors simultaneously.</li></ul>   |
| <hr/> <ul style="list-style-type: none"><li>• Macintosh user interface, including mouse, icons, windows, and pull-down menus</li></ul>  | <ul style="list-style-type: none"><li>• Makes most applications intuitive and easy to learn, reducing training and support costs.</li><li>• Provides a consistent user interface across applications.</li></ul>  |
| <hr/> <ul style="list-style-type: none"><li>• MultiFinder operating system</li></ul>  | <ul style="list-style-type: none"><li>• Allows multiple applications to be opened concurrently.</li><li>• Lets you integrate information from multiple applications easily by cutting and pasting between them.</li><li>• Allows you to continue working with applications while performing certain tasks in the background.</li></ul>   |
| <hr/> <ul style="list-style-type: none"><li>• Software compatibility</li></ul>  | <ul style="list-style-type: none"><li>• Allows you to run virtually all Macintosh software, including applications designed to take advantage of floating-point coprocessors.</li></ul>  |
| <hr/> <ul style="list-style-type: none"><li>• Apple Sound Chip</li></ul>  | <ul style="list-style-type: none"><li>• Provides high-quality, four-voice digital sound.</li><li>• Is compatible with all applications that use Macintosh sound.</li></ul>   |



## Product Details

### 68030 microprocessor

- The 32-bit 68030 microprocessor runs at 25 megahertz.
- The 32-bit address bus provides a total addressable space of 4 gigabytes.
- Separate instruction and data caches provide significantly faster processing.
- Built-in PMMU supports virtual, shared, and protected memory in operating systems that have been designed for it.
- Burst-mode RAM access enables groups of instructions or data to be read in fewer clock cycles than are required in normal access mode.

### Built-in video

- The built-in video capabilities of the Macintosh IIci are made possible through the addition of three components to the logic board: the RBV (RAM-Based Video) chip, which functions as the video controller; a digital-to-analog converter (DAC); and a DB-15 external connector. The screen image is stored in a screen buffer located in main memory.

### Optional parity support

- When ordering the Macintosh IIci, users can request a parity system. The system will be configured with a parity controller and parity RAM.

### ROM

- The Macintosh IIci comes standard with 512K of ROM. In addition, a ROM SIMM socket located on the logic board will facilitate the installation of future versions of ROM as they become available.

### RAM

- The Macintosh IIci can be upgraded incrementally to 32 megabytes of RAM.
- To support the 25-megahertz 68030 microprocessor, the Macintosh IIci utilizes very high speed (80-nanosecond) RAM. Users can increase system memory capacity with Macintosh IIci Memory Expansion Kits.

### NuBus expansion slots

- NuBus provides a multiplexed 32-bit address bus and data bus on a single 96-pin connector.
- NuBus is self-configuring: Cards can be plugged into any slot and the system will automatically identify and configure each card, without DIP switches or jumper wires.
- The NuBus architecture supports data transfer rates of up to 37.5 megabytes per second.

### SCSI

- SCSI (Small Computer System Interface) is a high-performance interface for connecting the Macintosh IIci to hard disks and other peripherals, such as the LaserWriter IIsc, Apple Scanner, AppleCD SC® CD-ROM drive, and other devices. Up to seven SCSI peripherals (including an internal hard disk) can be connected.
- SCSI provides data transfer rates of up to 1 megabyte per second.

### Network support

- The Macintosh IIci provides full ROM support for all AppleTalk protocols, and has serial ports for LocalTalk network connections.

### Operating system software

- Macintosh system software includes:
  - System software version 6.0.5 or later (the Macintosh Operating System) —Printer disk (printer drivers for all Apple printers)
  - System Additions disks (include utilities such as the Apple File Exchange, HD SC Setup, CloseView, Disk First Aid™ and Font/DA Mover)
  - HyperCard version 1.2.3 or later is included.
  - A/UX version 1.1.1 or later is compatible with the Macintosh IIci.

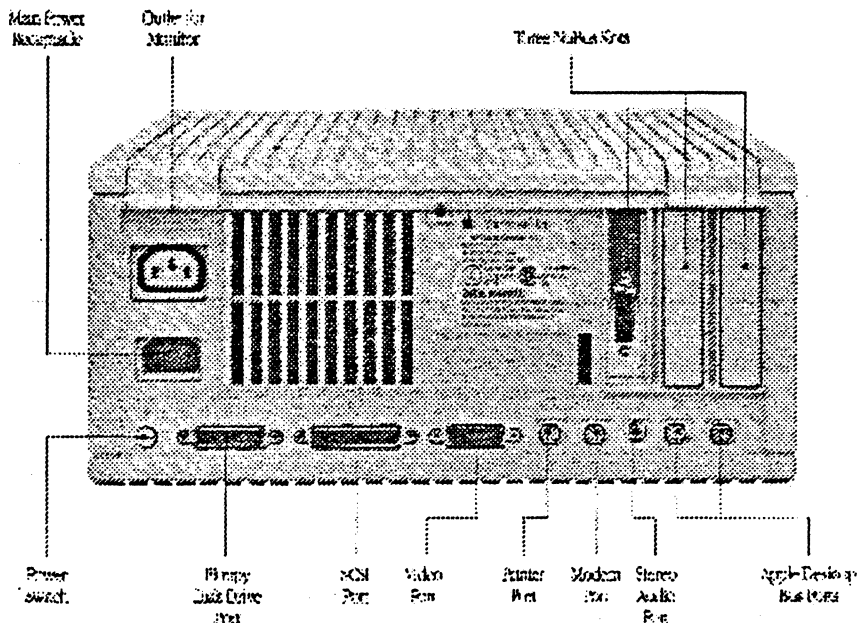

## Technical Specifications

### Processor

- 68030; 32-bit internal Harvard architecture
- 25-megahertz clock speed
- Burst-mode RAM access
- 256-byte instruction and data caches

### Coprocessor

- 68882 floating-point coprocessor (IEEE standard—80 bits precision)

### Cache connector

- 120-pin memory cache connector (for connection of optional high-speed memory cache card)

### Built-in video support

- Supports 640- by 480-pixel screens (such as the Macintosh 12" Monochrome Display and the 13-inch AppleColor High-Resolution RGB Monitor) at up to 256 colors or shades of gray (up to 8 bits per pixel).
- Supports 640- by 870-pixel screens (such as the 15-inch Apple Macintosh Portrait Display) at up to 16 shades of gray.

### Optional parity support

- Installation of parity generating chip and parity RAM converts the system to a parity system

### Interfaces

- Three NuBus internal slots support full 32-bit address and data buses.
- Two mini-8 serial (RS-232/RS-422) ports
- Two Apple Desktop Bus ports allow daisy-chaining of multiple peripheral devices.
- SCSI interface: one 50-pin internal connector and one DB-25 external connector
- One DB-19 serial port for connecting external floppy disk drives
- One DB-15 video port for built-in video
- Stereo sound jack

### Mouse

- Mechanical tracking; optical shaft encoding at  $3.9 \pm 0.39$  pulses per mm ( $100 \pm 10$  pulses per in.) of travel

### Sound generator

- Apple's custom digital sound chip provides 8-bit stereo sampling at 44.1 kilohertz, and includes four-voice wave-table synthesis—capable of driving stereo headphones or other stereo equipment through the sound jack

### Electrical requirements

- Line voltage: 100 to 240 volts AC, automatically configured
- Frequency: 50 to 60 hertz, single phase
- Maximum power: 90 watts, not including monitor power

### Size and weight

#### Main unit

- Height: 5.5 in. (14.0 cm)
- Width: 11.9 in. (30.2 cm)
- Depth: 14.4 in. (36.5 cm)
- Weight: 14 lb. (6.4 kg) with internal hard disk drive

#### Mouse

- Height: 1.1 in. (2.8 cm)
- Width: 2.1 in. (5.3 cm)
- Depth: 3.8 in. (9.7 cm)
- Weight: 6 oz (.17 kg)

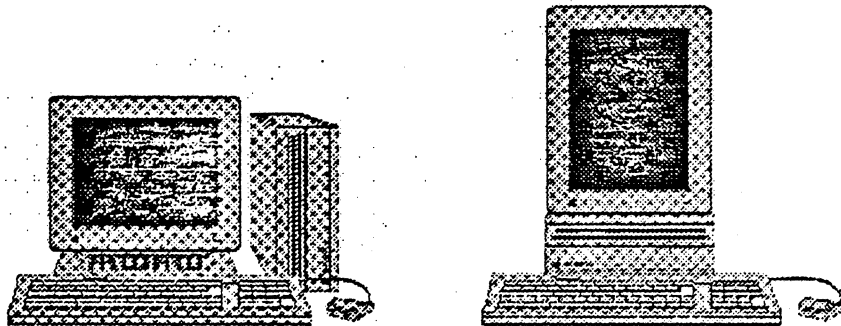

*The versatile design of the Macintosh IIcx allows it to be used in either vertical or horizontal orientation*



## Macintosh IIci

---

### Ordering Information

**Macintosh IIci CPU**  
Order No. M5737LL/A

With your order, you'll receive:

- Macintosh IIci personal computer with 4 megabytes of RAM and a built-in 1.4 megabyte Apple SuperDrive floppy disk drive

- Mouse
- Complete setup, learning, and reference documentation
- System software and HyperCard software
- Training disk
- Limited warranty statement

---

**Macintosh IIci 4/80 CPU**  
Order No. M5740LL/A

With your order, you'll receive:

- Macintosh IIci personal computer with 4 megabytes of RAM, a built-in 1.4 megabyte Apple SuperDrive floppy disk drive, and internal 80-megabyte hard disk drive

- Mouse
- Complete setup, learning, and reference documentation
- System software and HyperCard software
- Training disk
- Limited warranty statement

---

**Macintosh IIci 4/80 CPU with Parity Support**  
Order No. M5745LL/A

With your order, you'll receive:

- Macintosh IIci personal computer with parity error-checking hardware, 4 megabytes of parity RAM, a built-in 1.4-megabyte Apple SuperDrive floppy disk drive, and internal 80 megabyte hard disk drive

- Mouse
- Complete setup, learning, and reference documentation
- System software and HyperCard software
- Training disk
- Limited warranty statement

---

**Macintosh IIci 4/80 CPU with A/UX**  
Order No. M5750LL/A

With your order, you'll receive:

- Macintosh IIci personal computer with 4 megabytes of RAM, a built-in 1.4 megabyte Apple SuperDrive floppy disk drive, and internal 80-megabyte hard disk drive with A/UX installed

- Mouse
- Complete setup, learning, and reference documentation
- System software and HyperCard software
- Training disk
- Limited warranty statement

---

Apple Computer, Inc.

20525 Mariani Avenue  
Cupertino, CA 95014  
(408) 996-1010  
TLX: 171-576

©1990 Apple Computer, Inc. Apple, the Apple logo, AppleCD SC, AppleTalk, A/UX, HyperCard, LaserWriter, LocalTalk, Macintosh, and MultiFinder are registered trademarks of Apple Computer, Inc. AppleColor, Apple Desktop Bus, Disk Plus Aid, QuickDraw, and SuperDrive are trademarks of Apple Computer, Inc. MS-DOS is a registered trademark of Microsoft Corporation. NuBus is a trademark of Texas Instruments. OS/2 is a trademark of International Business Machines Corporation. Monitor and keyboard sold separately.  
October 1990. Product specifications are subject to change without notice. Printed in U.S.A.  
M5738LL/C



---

## Appendix B. VTAM Logon Mode Table Definitions

This appendix contains logon mode table entries that were used in the paths that are described in this document.

---

### Logon Mode Table Entries for LUs

```
*****
*          LOGMODE TABLE ENTRY FOR REMOTE SNA 3270 DEVICES      @P022655*
*          WITH EXTENDED DATA STREAMS (3278 OR 3279).          *
*          SCREEN SIZE IS 24 X 80.                               @R498801*
*****
SNX32702 MODEENT LOGMODE=SNX32702,FMPROF=X'03',TSPROF=X'03',    *
                PRIPROT=X'B1',SECPROT=X'90',COMPROT=X'3080',    *
                RUSIZES=X'87F8',                                *
                PSERVIC=X'028000000000185000007E00'
*
*
*****
*          LOGMODE TABLE ENTRY FOR REMOTE SNA 3270 DEVICES      *
*          WITH EXTENDED DATA STREAMS (MOD3).                  *
*          PRIMARY SCREEN 24 X 80 (1920)                        *
*          ALTERNATE SCREEN 32 X 80 (2560)                      @Z89842*
*****
SNX32703 MODEENT LOGMODE=SNX32703,FMPROF=X'03',TSPROF=X'03',    *
                PRIPROT=X'B1',SECPROT=X'90',COMPROT=X'3080',    *
                RUSIZES=X'87F8',                                *
                PSERVIC=X'028000000000185020507F00'
*
*
*****
*          LOGMODE TABLE ENTRY FOR REMOTE SNA 3270 DEVICES      *
*          WITH EXTENDED DATA STREAMS (MOD4).                  *
*          PRIMARY SCREEN 24 X 80 (1920)                        *
*          ALTERNATE SCREEN 43 X 80 (3440)                      @Z96936*
*****
SNX32704 MODEENT LOGMODE=SNX32704,FMPROF=X'03',TSPROF=X'03',    *
                PRIPROT=X'B1',SECPROT=X'90',COMPROT=X'3080',    *
                RUSIZES=X'87F8',                                *
                PSERVIC=X'02800000000018502B507F00'
*
*
*****
*          LOGMODE TABLE ENTRY FOR REMOTE SNA 3270 DEVICES      *
*          WITH EXTENDED DATA STREAMS (MOD5).                  *
*          PRIMARY SCREEN 24 X 80 (1920)                        *
*          ALTERNATE SCREEN 27 X 132 (3564)                     @Z96936*
*****
SNX32705 MODEENT LOGMODE=SNX32705,FMPROF=X'03',TSPROF=X'03',    *
                PRIPROT=X'B1',SECPROT=X'90',COMPROT=X'3080',    *
                RUSIZES=X'87F8',                                *
                PSERVIC=X'02800000000018501B847F00'
```

---

### Logon Mode Table Entry for Printer on VM

```
RSCSPRT3 MODEENT LOGMODE=RSCSPRT3,FMPROF=X'03',TSPROF=X'03',      X
                  PRIPROT=X'B1',SECPROT=X'20',COMPROT=X'3080',      X
                  SSNDPAC=X'00',SRCVPAC=X'00',RUSIZES=X'C7C7',      X
                  PSNDPAC=X'80',PSERVIC=X'0380000000185018507F0000'
```

---

### Logon Mode Table Entry for Printer on MVS

```
SCS      MODEENT LOGMODE=SCS,FMPROF=X'03',TSPROF=X'03',PRIPROT=X'B1', *
                  SECPROT=X'90',COMPROT=X'3080',RUSIZES=X'87C6',      *
                  PSERVIC=X'01000000E100000000000000',              *
                  PSNDPAC=X'01',SRCVPAC=X'01'
```

## Appendix C. NCP Gen Listing

This appendix contains the generation listing for the NCP that was used in these configurations.

```

OPTIONS NEWDEFN=(YES,ECHO)
LSSMVS PCCU CUADDR=321,          3745 CONTROL UNIT ADDRESS      X
          AUTODMP=NO,          PROMPT BEFORE DUMPING NCP      X
          AUTOIPL=YES,         NO PROMPT BEFORE RELOADING NCP X
          DUMPDS=VTAMDUMP,     DUMP FILE VTAM DDNAME         X
          CDUMPDS=CSPDUMP,     DUMP FILE VTAM DDNAME         X
          MDUMPDS=MOSSDUMP,    DUMP FILE VTAM DDNAME         X
          MAXDATA=4096,        MAX DATA SIZE                 X
          SUBAREA=1,          LSSMVS VTAM SUBAREA           X
          OWNER=HOSTMVS,      RESOURCE OWNER                 X
          GWCTL=ONLY,         FOR GWNCP                      X
          NETID=USIBMTO,      FOR GWNCP                      X
          INITEST=NO          NO 3745 INITIAL TEST          X

          TITLE 'NCP FOR PRODUCTION'
*****
*          BUILD MACRO SPECIFICATIONS          *
*****
NCPBUILD BUILD MAXSUBA=63,      MUST BE SAME AS IN VTAM STR DEF X
          VERSION=V5R3,        NCP VERSION FOR 3745          X
          NETID=USIBMTO,       NETWORK ID REQ.                X
          HSBPOOL=80,          FOR GWNCP                      X
          LOADLIB=NCPLoad,     GIVES ERROR BUT REQUIRED FOR VTAM X
          TYP SYS=MVS,         OS USED FOR STAGE 2            X
          TYP GEN=NCP,         NCP ONLY                      X
          BFRS=128,           NCP BUFFER SIZE (DEFAULT)     X
          UCHAN=NO,           X                               X
          MAXSSCP=2,          TWO HOSTS CAN ACTIVATE THIS NCP X
          NUMHSAS=2,          3 HOSTS CAN COMMUNICATE CONCURRENTLY X
          ERASE=NO,           DO NOT ERASE BUFFERS (DEFAULT) X
          DIALTO=60,          WAIT 1 MIN FOR ANSWER          X
          DSABLT0=3.0,        USED WHEN DEACTIVATING LINK    X
          ENABLT0=180,        LARGE ENOUGH FOR DIAL OR LEASED X
          MODEL=3745,         X                               X
          NEWNAME=NCP30,      EEW 5                          X
          OLT=YES,           ONLINE TEST AVAILABLE(DEFAULT) X
          SLOWDOWN=12,        SLOWDOWN AT 12% BUFS AVAIL    X
          SUBAREA=30,         SUBAREA ADDRESS = 30          X
          BRANCH=100,         BRANCH TRACE TABLE           X
          LTRACE=2,           LINE TRACE TABLE             X
          ADSESS=50,          X                               X
          AUXADDR=50,         X                               X
          NAMTAB=50,          X                               X
          USGTIER=5,          X                               X
          X25.SNAP=YES,       |                               x
          X25.USGTIER=5,     |                               x
          X25.IDNUMH=0,      |                               x
          X25.MCHCNT=2,     | NPSI                          x
          X25.PREFIX=Z,      |                               x
          X25.MAXPIU=64K,    |                               x
          TRACE=NO           ADDRESS-TRACE ENTRIES

```

# NCP Gen Listing

```

*****
*       SYSCNTRL OPTIONS REQUIRED BY VTAM       *
*****
NCPSYSC SYSCNTRL OPTIONS=(MODE,STORDSP,          X
                    RCNTRL,RCOND,RECMD,RIMM,ENDCALL, X
                    BHSASSC)
*   GWNAU NEEDED FOR GWNCP
    GWNAU NUMADDR=100
*****
*   HOST MACRO SPECIFICATIONS OS VTAM         *
*   UNITSZ TIMES MAXBFRTU MINUS BFRPAD EQUALS MAX MESSAGE SIZE *
*   FOR INBOUND MESSAGES                       *
*****
HOSTMVS HOST  INBFRS=40,          # OF BUFFERS          X
                MAXBFRTU=41,      # OF BUFFERS          X
                UNITSZ=384,        THREE BUFFERS HOLD BATCH PIU X
                BFRPAD=0,
                STATMOD=YES,      X
                SUBAREA=1          SUBAREA OF LSSMVS VTAM
                PATH DESTSA=(1,29,28,45,46), X
                ER0=(1,1),ER1=(1,1),VR0=0,VR1=1
* NO CSB MACROS
    LUDRPOOL NUMTYP1=20,NUMTYP2=100,NUMILU=100
*****
***      APPLE TO IBM PATHS                    ***
*****
GR30APP GROUP CLOCKNG=EXT,DIAL=NO,              +
                LNCTL=SDLC,MAXDATA=521,         +
                MAXOUT=7,PASSLIM=3,PAUSE=0.2,   +
                PUTYPE=2,REPLYTO=2,SERVLIM=2,   +
                TYPE=NCP
*
*****
*   SDLC DEFINITION FOR PATH 02
*****
T03014L LINE  ADDRESS=(014),ANS=CONT,DUPLEX=FULL,NRZI=YES
*
    SERVICE ORDER=(T03014P1)
*
T03014P1 PU   ADDR=C1,                          C
                PACING=0,                        C
                VPACING=0,                       C
                IRETRY=YES,                      C
                MAXDATA=265,                     C
                SSCPFM=USSSCS,                  C
                DISCNT=NO,                       C
                PUTYPE=2,                        C
                MAXOUT=7,                        C
                MODETAB=ISTINCLM,               C
                DLOGMOD=SNX32702,                C
                USSTAB=TPOUSS
T0301402 LU   LOCADDR=2,DLOGMOD=SNX32702        * 3278 MODEL 2 *
T0301403 LU   LOCADDR=3,DLOGMOD=SNX32703        * 3278 MODEL 3 *
T0301404 LU   LOCADDR=4,DLOGMOD=SNX32704        * 3278 MODEL 4 *
T0301405 LU   LOCADDR=5,DLOGMOD=SNX32705        * 3278 MODEL 5 *
T0301406 LU   LOCADDR=6,DLOGMOD=SCS            * 3287 SCS PRINTER *

```



\*\*\*\*\*

\* SDLC DEFINITION FOR PATHS 10, 11, & 16

\*\*\*\*\*

T03015L LINE ADDRESS=(015),ANS=CONT,DUPLEX=FULL,NRZI=YES

\*

SERVICE ORDER=(T03015P1)

\*

T03015P1 PU	ADDR=C1,	C
	PACING=0,	C
	VPACING=0,	C
	IRETRY=YES,	C
	MAXDATA=521,	C
	SSCPFM=USSSCS,	C
	DISCNT=NO,	C
	PUTYPE=2,	C
	MAXOUT=7,	C
	MODETAB=ISTINCLM,	C
	DLOGMOD=SNX32702,	C
	USSTAB=TPOUSS	

T0301502 LU	LOCADDR=2,DLOGMOD=SNX32702	* 3278 MODEL 2 *
T0301503 LU	LOCADDR=3,DLOGMOD=SNX32703	* 3278 MODEL 3 *
T0301504 LU	LOCADDR=4,DLOGMOD=SNX32704	* 3278 MODEL 4 *
T0301505 LU	LOCADDR=5,DLOGMOD=SNX32705	* 3278 MODEL 5 *
T0301506 LU	LOCADDR=6,DLOGMOD=SCS	* 3287 SCS PRINTER *
T0301507 LU	LOCADDR=7,DLOGMOD=SNX32702	* 3278 MODEL 2 *
T0301508 LU	LOCADDR=8,DLOGMOD=SNX32702	* 3278 MODEL 2 *
T0301509 LU	LOCADDR=9,DLOGMOD=SNX32702	* 3278 MODEL 2 *
T0301510 LU	LOCADDR=10,DLOGMOD=SNX32702	* 3278 MODEL 2 *
T0301511 LU	LOCADDR=11,DLOGMOD=SNX32702	* 3278 MODEL 2 *
T0301512 LU	LOCADDR=12,DLOGMOD=SNX32702	* 3278 MODEL 2 *
T0301513 LU	LOCADDR=13,DLOGMOD=SNX32702	* 3278 MODEL 2 *
T0301514 LU	LOCADDR=14,DLOGMOD=SNX32702	* 3278 MODEL 2 *
T0301515 LU	LOCADDR=15,DLOGMOD=SNX32702	* 3278 MODEL 2 *
T0301516 LU	LOCADDR=16,DLOGMOD=SNX32702	* 3278 MODEL 2 *
T0301517 LU	LOCADDR=17,DLOGMOD=SNX32702	* 3278 MODEL 2 *
T0301518 LU	LOCADDR=18,DLOGMOD=SNX32702	* 3278 MODEL 2 *
T0301519 LU	LOCADDR=19,DLOGMOD=SNX32702	* 3278 MODEL 2 *
T0301520 LU	LOCADDR=20,DLOGMOD=SNX32702	* 3278 MODEL 2 *
T0301521 LU	LOCADDR=21,DLOGMOD=SNX32702	* 3278 MODEL 2 *
T0301522 LU	LOCADDR=22,DLOGMOD=SNX32702	* 3278 MODEL 2 *
T0301523 LU	LOCADDR=23,DLOGMOD=SNX32702	* 3278 MODEL 2 *
T0301524 LU	LOCADDR=24,DLOGMOD=SNX32702	* 3278 MODEL 2 *
T0301525 LU	LOCADDR=25,DLOGMOD=SNX32702	* 3278 MODEL 2 *
T0301526 LU	LOCADDR=26,DLOGMOD=SNX32702	* 3278 MODEL 2 *
T0301527 LU	LOCADDR=27,DLOGMOD=SNX32702	* 3278 MODEL 2 *
T0301528 LU	LOCADDR=28,DLOGMOD=SNX32702	* 3278 MODEL 2 *
T0301529 LU	LOCADDR=29,DLOGMOD=SNX32702	* 3278 MODEL 2 *
T0301530 LU	LOCADDR=30,DLOGMOD=SNX32702	* 3278 MODEL 2 *
T0301531 LU	LOCADDR=31,DLOGMOD=SNX32702	* 3278 MODEL 2 *
T0301532 LU	LOCADDR=32,DLOGMOD=SNX32702	* 3278 MODEL 2 *
T0301533 LU	LOCADDR=33,DLOGMOD=SNX32702	* 3278 MODEL 2 *
T0301534 LU	LOCADDR=34,DLOGMOD=SNX32702	* 3278 MODEL 2 *
T0301535 LU	LOCADDR=35,DLOGMOD=SNX32702	* 3278 MODEL 2 *
T0301536 LU	LOCADDR=36,DLOGMOD=SNX32702	* 3278 MODEL 2 *
T0301537 LU	LOCADDR=37,DLOGMOD=SNX32702	* 3278 MODEL 2 *
T0301538 LU	LOCADDR=38,DLOGMOD=SNX32702	* 3278 MODEL 2 *
T0301539 LU	LOCADDR=39,DLOGMOD=SNX32702	* 3278 MODEL 2 *
T0301540 LU	LOCADDR=40,DLOGMOD=SNX32702	* 3278 MODEL 2 *
T0301541 LU	LOCADDR=41,DLOGMOD=SNX32702	* 3278 MODEL 2 *

**NCP Gen Listing**

```

T0301542 LU   LOCADDR=42,DLOGMOD=SNX32702   * 3278 MODEL 2 *
T0301543 LU   LOCADDR=43,DLOGMOD=SNX32702   * 3278 MODEL 2 *
T0301544 LU   LOCADDR=44,DLOGMOD=SNX32702   * 3278 MODEL 2 *
T0301545 LU   LOCADDR=45,DLOGMOD=SNX32702   * 3278 MODEL 2 *
T0301546 LU   LOCADDR=46,DLOGMOD=SNX32702   * 3278 MODEL 2 *
T0301547 LU   LOCADDR=47,DLOGMOD=SNX32702   * 3278 MODEL 2 *
T0301548 LU   LOCADDR=48,DLOGMOD=SNX32702   * 3278 MODEL 2 *
T0301549 LU   LOCADDR=49,DLOGMOD=SNX32702   * 3278 MODEL 2 *
T0301550 LU   LOCADDR=50,DLOGMOD=SNX32702   * 3278 MODEL 2 *
T0301551 LU   LOCADDR=51,DLOGMOD=SNX32702   * 3278 MODEL 2 *
T0301552 LU   LOCADDR=52,DLOGMOD=SNX32702   * 3278 MODEL 2 *
T0301553 LU   LOCADDR=53,DLOGMOD=SNX32702   * 3278 MODEL 2 *
T0301554 LU   LOCADDR=54,DLOGMOD=SNX32702   * 3278 MODEL 2 *
T0301555 LU   LOCADDR=55,DLOGMOD=SNX32702   * 3278 MODEL 2 *
T0301556 LU   LOCADDR=56,DLOGMOD=SNX32702   * 3278 MODEL 2 *
T0301557 LU   LOCADDR=57,DLOGMOD=SNX32702   * 3278 MODEL 2 *
T0301558 LU   LOCADDR=58,DLOGMOD=SNX32702   * 3278 MODEL 2 *
T0301559 LU   LOCADDR=59,DLOGMOD=SNX32702   * 3278 MODEL 2 *
T0301560 LU   LOCADDR=60,DLOGMOD=SNX32702   * 3278 MODEL 2 *
T0301561 LU   LOCADDR=61,DLOGMOD=SNX32702   * 3278 MODEL 2 *
T0301562 LU   LOCADDR=62,DLOGMOD=SNX32702   * 3278 MODEL 2 *
T0301563 LU   LOCADDR=63,DLOGMOD=SNX32702   * 3278 MODEL 2 *
T0301564 LU   LOCADDR=64,DLOGMOD=SNX32702   * 3278 MODEL 2 *
T0301565 LU   LOCADDR=65,DLOGMOD=SNX32702   * 3278 MODEL 2 *

```

\*\*\*\*\*

\* SDLC DEFINITION FOR PATH 14

\*\*\*\*\*

```

*
T03009L LINE ADDRESS=(009),ANS=CONT,DUPLEX=FULL,NRZI=YES
*

```

```

    SERVICE ORDER=(T03009P1,T03009P2)
*

```

\* 3174 GATEWAY PU DEFINITION

```

*
T03009P1 PU   ADDR=C1,                               C
              PACING=0,                             C
              VPACING=0,                             C
              IRETRY=YES,                            C
              MAXDATA=521,                           C
              SSCPFM=USSSCS,                         C
              DISCNT=NO,                             C
              PUTYPE=2,                               C
              MAXOUT=7,                              C
              MODETAB=ISTINCLM,                      C
              DLOGMOD=SNX32702,                      C
              USSTAB=TPOUSS

```

```

T0300912 LU   LOCADDR=2,DLOGMOD=SNX32702   * 3278 MODEL 2 *
T0300913 LU   LOCADDR=3,DLOGMOD=SNX32702   * 3278 MODEL 2 *
T0300914 LU   LOCADDR=4,DLOGMOD=SNX32702   * 3278 MODEL 2 *
T0300915 LU   LOCADDR=5,DLOGMOD=SNX32702   * 3278 MODEL 2 *
T0300916 LU   LOCADDR=6,DLOGMOD=SCS        * 3287 SCS PRINTER *
*

```

\* APPLE PU DEFINITION

```

*
T03009P2 PU   ADDR=C2,                               C
              PACING=0,                             C
              VPACING=0,                             C
              IRETRY=YES,                            C
              MAXDATA=521,                           C

```

```

SSCPFM=USSSCS,
DISCNT=NO,
PUTYPE=2,
MAXOUT=7,
MODETAB=ISTINCLM,
DLOGMOD=SNX32702,
USSTAB=TPOUSS
T0300922 LU LOCADDR=2,DLOGMOD=SNX32702 * 3278 MODEL 2 *
T0300923 LU LOCADDR=3,DLOGMOD=SNX32703 * 3278 MODEL 3 *
T0300924 LU LOCADDR=4,DLOGMOD=SNX32704 * 3278 MODEL 4 *
T0300925 LU LOCADDR=5,DLOGMOD=SNX32705 * 3278 MODEL 5 *
T0300926 LU LOCADDR=6,DLOGMOD=SCS * 3287 SCS PRINTER *

```

C  
C  
C  
C  
C

\*\*\*\*\*  
\*\*\*\*\*

\*\*\* TOKEN RING CONNECTIONS

\*\*\*\*\*

\* AA211 RING DEFINITIONS (PHYSICAL)

```

T030T1PG GROUP ECLTYPE=(PHYSICAL,ANY)
T030T1PL LINE ADDRESS=(1088,FULL),LOCADD=400037301088,PORTADD=1, X
RCVBUFC=4095,MAXTSL=2044,ADAPTER=TIC2,TRSPEED=16

```

```

T030T1PU PU
T030T1LU LU ISTATUS=ACTIVE

```

\* BUILDING RING DEFINITIONS (PHYSICAL)

```

T030T2PG GROUP ECLTYPE=(PHYSICAL,ANY)
T030T2PL LINE ADDRESS=(1089,FULL),LOCADD=400037451001,PORTADD=2, X
RCVBUFC=4095,MAXTSL=692,ADAPTER=TIC2,TRSPEED=4

```

```

T030T2PU PU
T030T2LU LU ISTATUS=ACTIVE

```

\* AA211 RING DEFINITIONS (LOGICAL)

```

T030T1G1 GROUP ECLTYPE=(LOGICAL,PERIPHERAL),PHYPORT=1

```

```

T030T1L1 LINE CALL=INOUT
T030T1P1 PU
T030T1L2 LINE CALL=INOUT
T030T1P2 PU
T030T1L3 LINE CALL=INOUT
T030T1P3 PU
T030T1L4 LINE CALL=INOUT
T030T1P4 PU
T030T1L5 LINE CALL=INOUT
T030T1P5 PU
T030T1L6 LINE CALL=INOUT
T030T1P6 PU
T030T1L7 LINE CALL=INOUT
T030T1P7 PU
T030T1L8 LINE CALL=INOUT
T030T1P8 PU
T030T1L9 LINE CALL=INOUT
T030T1P9 PU
T030T1LA LINE CALL=INOUT
T030T1PA PU

```

\*\*

\* PERIPHERALS (LOGICAL) - SITE RING DEFINITIONS

\*

```

T030T2G1 GROUP ECLTYPE=(LOGICAL,PERIPHERAL),PHYPORT=2
T030T2L1 LINE CALL=INOUT
T030T2P1 PU
T030T2L2 LINE CALL=INOUT
T030T2P2 PU

```

## NCP Gen Listing

```
T030T2L3 LINE CALL=INOUT
T030T2P3 PU
T030T2L4 LINE CALL=INOUT
T030T2P4 PU
T030T2L5 LINE CALL=INOUT
T030T2P5 PU
T030T2L6 LINE CALL=INOUT
T030T2P6 PU
T030T2L7 LINE CALL=INOUT
T030T2P7 PU
T030T2L8 LINE CALL=INOUT
T030T2P8 PU
T030T2L9 LINE CALL=INOUT
T030T2P9 PU
T030T2LA LINE CALL=INOUT
T030T2PA PU
```

\*\*\*\*\*

```
*** CHANNEL ADAPTERS
```

\*\*\*\*\*

```
GR30CA GROUP LNCTL=CA
```

```
**
```

```
T030CA0L LINE CA=TYPE6,ADDRESS=(8), X
          NCPCA=ACTIVE
```

```
T030CA0P PU PUTYPE=5,NETID=USIBMT0
```

```
**
```

```
GENEND
END
```

---

## Bibliography

---

### VTAM V3R3 Publications

The following paragraphs describe part of the VTAM V3R3 library. For additional information on the VTAM V3R3 library, contact your IBM representative.

#### *VTAM Network Implementation Guide* (SC31-6404)

This manual contains information about how to install VTAM, how to define a network to VTAM, how to test your network definitions, and how to tune VTAM. Use this manual in conjunction with the *VTAM Resource Definition Reference*.

#### *VTAM Resource Definition Reference* (SC31-6412)

This manual contains the VTAM definition statements and start options. It also has information on the operands of NCP definition statements that affect VTAM. To assist VM users, this manual contains an appendix describing VSCS start options. Use this manual in conjunction with the *VTAM Network Implementation Guide*.

#### *VTAM Customization* (LY43-0046)

This manual enables a system programmer to customize VTAM. It discusses VTAM, VSCS, and TSO/VTAM installation exit routines, the replaceable constants module, and the communication network management (CNM) routing table.

#### *VTAM Operation* (SC31-6408)

This manual enables a system programmer to prepare a "run book" for a VTAM network. This manual also serves as a reference manual to programmers and operators requiring detailed information about specific operator commands.

#### *VTAM Messages and Codes* (SC31-6405)

This manual contains, in alphanumerical order, all messages and codes issued by VTAM. These messages include VTAM messages for network operators, TSO/VTAM messages for network operators, TSO/VTAM messages for terminal users, USS messages for terminal users, and VSCS messages. This manual can be inserted into the operating system messages manual, if desired, or used as a stand-alone manual.

#### *VTAM Programming* (SC31-6409)

This manual describes how to use VTAM macroinstructions to send data to and receive data from (1) a terminal in either the same or a different domain, or (2) another application program in either the same or

a different domain. Also included is a dictionary of VTAM macroinstructions.

#### *VTAM Programming for LU 6.2* (SC31-6410)

This manual describes the VTAM LU 6.2 programming interface for host application programs. This manual applies to programs that use only LU 6.2 sessions or that use LU 6.2 sessions along with other session types. (Only LU 6.2 sessions are covered in this manual.)

#### *VTAM Diagnosis* (LY43-0042)

This manual assists system programmers in identifying a VTAM problem, classifying it, and collecting information about the problem in preparation for calling the IBM Support Center. The information collected includes traces, dumps, and other problem documentation.

#### *VTAM Reference Summary* (LY43-0047)

This manual is designed as a quick reference for system programmers. This manual contains selected reference information that includes VTAM and VSCS commands, VTAM definition statements, VTAM start options, VTAM macroinstructions, and VTAM and VSCS trace formats.

#### *Planning and Reference for NetView, NCP, and VTAM* (SC31-6811)

This manual describes how to plan for NetView V2R1, NCP V5R3, SSP V3R5, and VTAM V3R3. It explains the functions available with NetView, NCP, and VTAM, the advantages of using them in different situations, and how to plan for the functions readers want to use. The reference part of the manual contains cross-product or cross-task reference information, which may or may not be related to planning. The manual also contains NCP storage estimates.

---

### NCP V5R4 Publications

The following paragraphs describe part of the NCP V5R4 library. For additional information on the NCP V5R4 library, contact your IBM representative.

#### *NCP, SSP, and EP Generation and Loading Guide* (SC30-3348)

This manual contains information on generating and loading NCP and EP (in the PEP environment) using SSP.

#### *NCP, SSP, and EP Resource Definition Guide* (SC30-3447)

This manual describes the physical and operational characteristics of NCP and EP (in the PEP environment) using SSP. It also describes the definition statements and keywords associated with those characteristics.

*NCP, SSP, and EP Resource Definition Reference*  
(SC30-3448)

This manual contains detailed descriptions of the definition statements and keywords used to define NCP and EP (in the PEP environment) using SSP.

*NCP Customization Guide* (LY30-5606)

This manual is designed to help system analysts, system programmers, and system engineers modify NCP.

*NCP Customization Reference* (LY30-5607)

This manual supplements *NCP Customization Guide*. It describes the resources and macroinstructions provided by IBM for customizing NCP.

*SSP Customization* (LY43-0021)

This manual is designed to help system analysts, system programmers, and system engineers modify SSP.

*NCP, SSP, and EP Messages and Codes* (SC30-3169)

This manual is a reference manual of abend codes issued by NCP and EP in the PEP environment, and messages issued by the system support programs associated with the NCP. It is intended to help people who operate, maintain, generate, or load an NCP. This edition includes all of the messages and codes for NCP, SSP, and EP.

*NCP, SSP, and EP Diagnosis Guide* (LY30-5591)

This manual is designed to help customers and IBM program support representatives isolate and define problems in NCP and EP (in the PEP environment) using SSP. The primary purpose of the manual is to help the user interact with the IBM Support Center to resolve a problem. In addition, it includes detailed descriptions of how to use the programming tools available with NCP and SSP.

*NCP and EP Reference* (LY30-5605)

This manual contains reference material describing the internal organization and function of NCP and EP in the PEP environment. It provides information for customization and diagnosis.

---

## NetView 2.2 Publications

The following paragraphs describe part of the NetView V2R2 library. For additional information on the NCP V5R4 library, contact your IBM representative.

*Learning about NetView Graphic Monitor Facility*  
(SK2T-6005)

This is an interactive OS/2-based training package (3.5-inch diskettes) that teaches operators how to use the NetView Graphic Monitor Facility to identify network problems. This training package uses graphics and interactive product simulations in a series of lessons that teach the basics of operation.

*Learning about NetView Operation* (SK2T-1995)

This is an interactive DOS-based operator training package (3.5-inch diskettes) that teaches SNA and basic network management concepts to new and inexperienced NetView operators. This training package uses VGA graphics, animation, and interactive NetView product simulations in a series of lessons to teach the basics of NetView operation.

*NetView Administration Reference* (SC31-6044) This manual is for system programmers and network operators who need a complete understanding of the NetView resource definition statements. This manual lists each statement in alphabetical order, giving its purpose and location.

*NetView Application Programming Guide* (SC31-6098)

This manual explains how to write programs that send NMVT or CP-MSU formatted alerts to NetView, send data buffers to other application programs, and receive data buffers from other application programs.

*NetView at a Glance* (GC31-6123)

This manual provides an overview of the NetView program. This manual describes how NetView provides comprehensive system and network management for a wide variety of network environments, including SNA networks, non-SNA networks, local area networks, and voice networks. This manual also describes NetView's major features, components, and automation capabilities.

*NetView Automation Planning* (SC31-6101)

This manual describes an approach for automating the operation of your systems and networks. It includes information you should know before beginning to automate, discusses creating a plan to outline schedules and goals, and explains basic design guidelines for automation.

*NetView Automation Implementation* (LY43-0008)

This manual describes how to complete an automation project that you have planned using *NetView Automation Planning*. It discusses issuing automatic responses to messages and alerts, performing routine operator tasks with command procedures, and other ways of automating system and network management. Reference material describes the NetView automation table, along with other facilities for routing and automation.

*NetView Bridge Implementation* (SC31-6033)

This manual explains how to plan for and implement the NetView Bridge function after NetView is installed. NetView Bridge is a set of application program interfaces (APIs) that allow NetView to interact with various types of databases. The step-by-step instructions tell you how to set up and customize the NetView Bridge function for your environment. In addition, this manual assists you in linking to databases that are external to NetView.

*NetView Customization Guide* (SC31-6048)

This manual is designed for system programmers and others who want to customize the NetView program to reflect their network's needs or operating procedures. This manual focuses on the different application programming interfaces that can be customized and explains how to modify NetView help panels and problem determination panels.

*NetView Customization: Using Assembler* (SC31-6090)

This manual describes the ways system programmers can tailor the NetView program to satisfy unique requirements or operating procedures. It discusses the uses and advantages of user-written programs (installation exit routines, command processors, and subtasks). It also provides instructions in designing, writing, and installing user-written programs in assembler.

*NetView Customization: Using PL/I and C* (SC31-6089)

This manual describes the ways system programmers can tailor the NetView program to satisfy unique requirements or operating procedures. It discusses the uses and advantages of user-written programs (installation exit routines, command processors, and subtasks). It also provides instructions in designing, writing, and installing user-written programs in PL/I and C.

*NetView Customization: Writing Command Lists* (SC31-6050)

This manual explains how to simplify network operator tasks by using command lists. It provides step-by-step instructions for writing simple and advanced command lists.

*NetView Graphic Monitor Facility Operation* (SC31-6099)

This manual explains how to use the NetView Graphic Monitor Facility to monitor networks, as well as how to customize the graphic representations of your network. This manual complements the information in *Learning about NetView Graphic Monitor Facility* (3.5-inch diskettes) by giving more background information and details on the functions available to users.

*NetView Installation and Administration Guide* (MVS: SC31-6051) (VM: SC31-6006)

These manuals help system programmers install and prepare the NetView program for operation. They are arranged in a simplified, step-by-step style and are meant to be used in conjunction with the sample network documented in *NetView Samples* (MVS: SC31-6047) (VM: SC31-6007).

*NetView Library Supplement* (VM and VSE: SD35-0236)

This manual includes technical changes occurring after the initial availability of NetView V2R2 for MVS.

*NetView Messages* (SC31-6097)

This manual lists the messages issued by NetView and the NetView Graphic Monitor Facility. It explains briefly what each message means, what the system action is, what the response should be, and what the related commands are, if any.

*NetView Operation* (SC31-6053)

This manual provides system programmers and experienced network operators a comprehensive explanation of network management using the NetView program. Topics include detailed command explanation and panel flows, as well as information on how the various components interact with each other. This manual contains the printed version of the online command help. It is intended to be used whenever NetView online help is not available and not as a replacement for the online information.

*NetView Problem Determination and Diagnosis* (LY43-0005)

This manual aids system programmers in identifying a NetView problem, classifying it, and describing it to an IBM Support Center.

*NetView Resource Alerts Reference* (SC31-6055)

This manual lists the messages sent by NetView-supported hardware and software resources. It helps system programmers analyze the messages into their component parts: action codes, event types, message text, and qualifiers. The manual is a

reference for those who need more information than online help provides.

*NetView Samples* (MVS: SC31-6047) and (VM: SC31-6007)

These manuals contain sample NetView, NCP, and VTAM definitions that network planners and system programmers can review when preparing for and installing NetView.

---

## AS/400 Publications

The following paragraphs describe part of the AS/400 library. For additional information on the AS/400 library, contact your IBM representative.

*System Introduction* (GC41-9766)

This manual provides information on the features and capabilities of the AS/400 system. It familiarizes the user with characteristics of the system and the various licensed programs used on the AS/400 system.

*Publications Guide* (GC41-9678)

This manual identifies and describes the printed and online information in the AS/400 library, as well as other publications about the AS/400 system. It also provides information about which publications are available with the product and describes how to order additional manuals.

*Network Planning Guide* (GC41-9861)

This manual provides information about planning for a communications network. It is intended to assist the user in identifying which communications application programs may be of use in the creation of a communications network.

*Communications: Operating System/400 Communications Configuration Reference* (SC41-0001)

This manual provides information on how to configure the communications functions available with the OS/400 licensed program, including detailed descriptions of network interface, line, controller, device, mode, and class-of-service descriptions; configuration lists; and connection lists.

*Communications: Remote Work Station Guide* (SC41-0002)

This manual provides information on how to set up and use remote workstation support, such as display

station passthrough, distributed host command facility, and 3270 remote attachment.

*Communications: Local Area Network Guide* (SC41-0004)

This manual provides information for using the AS/400 system in an Ethernet or token-ring network.

*Communications: Management Guide* (SC41-0024)

This manual provides information on how to start, stop, verify, and test communications; handle communications errors; and work with communications status.

*Operator's Guide* (SC41-8082)

This manual provides information about how to use the system unit control panel and console; send and receive messages; respond to error messages; start and stop the system; and do such system tasks as working with jobs, printing, security, backup and recovery, messages, tapes and diskettes, online education, program temporary fixes (PTFs), and problems. Also included are sections on setting up the AS/400 system and keeping it running smoothly.

*Device Configuration Guide* (SC41-8106)

This manual provides information on how to do an initial hardware configuration and how to change that configuration. It also contains conceptual information about device configuration and planning information for device configuration on the 9406, 9404, and 9402 system units. It also contains information on automatic configuration, how to do local configuration, including configuring ASCII devices. Information about local, twinaxial, ASCII workstation controllers, modems, and the devices that attach to these local workstation controllers is also included as well as forms for local workstation attachment diagrams.

*Communications: Advanced Program-to-Program Communications Programmer's Guide* (SC41-8189)

This manual provides information about the APPC support provided by the AS/400 system. It is a guide for developing application programs that use APPC and for defining the communications environment for APPC communications.

*Communications and Systems Management Guide (Alerts and Distributed Systems Node Executive)* (SC41-9661)

This manual provides information for configuring the AS/400 system to use change management support (distributed systems node executive) and problem management support (alerts).



---

## **OS/2 Extended Edition V1.3 Publications**

The following paragraphs describe part of the OS/2 Extended Edition library. For additional information on the OS/2 Extended Edition library, contact your IBM representative.

*IBM Operating System/2 Extended Edition Version 1.3 Commands Reference* (01F0290, S01F-0290)

This manual provides information about the base operating system commands, Communications Manager commands, Database Manager commands, batch file commands, and CONFIG.SYS commands.

*IBM Operating System/2 Extended Edition Version 1.3 System Administrator's Guide for Communications* (01F0302)

This manual provides the system administrator with information and worksheets needed to install and configure Communications Manager. There is information about the hardware and software supported by Communications Manager, along with memory and disk storage requirements. This manual also provides a detailed explanation of configuration services and information on the keyboard definition utility and sub-system management.

*IBM Operating System/2 Extended Edition Version 1.3 System Administrator's Guide for Communications* (01F0295, S01F-0295)

This manual describes how to develop programs that use the IBM OS/2 Version 1.3 advanced program-to-program communications (APPC) interface. It also contains CICS sample programs.

The following three publications are provided with the OS/2 program package (and are also available as a documentation only set, *IBM Operating System/2 Extended Edition Version 1.3 End User Publications* (01F0289, S01F-0289-00)).

*IBM Operating System/2 Extended Edition Version 1.3 Getting Started*

This manual contains an introduction to the OS/2 program and provides the steps and basic information needed to install or remove the OS/2 program. In addition, there are sections that will help you become familiar with the OS/2 program. These include instructions on how to log on to your workstation, view the online overview, and navigate through the Presentation Manager\* and full-screen interfaces.

*IBM Operating System/2 Extended Edition Version 1.3 User's Guide, Volume 1: Base Operating System*

This manual provides information for you to accomplish the basic tasks provided by the Base Operating System component of the OS/2 program.

*IBM Operating System/2 Extended Edition Version 1.3 User's Guide, Volume 2: Communications Manager and LAN Requester*

This manual provides information for you to accomplish the basic tasks provided by Communications Manager and IBM OS/2 Extended Edition Version 1.3 Local Area Network Requester components of the OS/2 program

*IBM OS/2 LAN Server Commands Reference* (33F9431, S33F-9431-00)

This manual provides a printed copy of the OS/2 LAN Server user and network administrator commands.

*IBM OS/2 LAN Server Version 1.3 Getting Started* (33F9430, S33F-9430-00)

This manual assists the network administrator in planning for a local area network (LAN) and installing the server program.

*IBM OS/2 LAN Server Version 1.3 User's Guide* (33F9427, S33F-9427-00)

This manual provides information for OS/2 LAN support for the user. Step-by-step procedures for full-screen interface and user tasks are included.

*IBM OS/2 LAN Server Version 1.3 Network Administrator's Guide* (33F9428, S33F-9428-00) provides information for OS/2 LAN support for the network administrator. Step-by-step procedures for the full-screen interface and network administrator tasks are included.

---

## **Networking Services/2 Version 1.0 Publications**

The following paragraphs describe part of the Networking Services/2 library. For additional information on the Networking Services/2 library, contact your IBM representative.

*Networking Services/2 Installation and Network Administrator's Guide* (SC52-1110)

This manual describes the procedures and operator uses to install Networking Services/2 and to configure the Networking System/2 environment.

*Networking Services/2 System Management Programming Reference* (SC52-1111)

This manual describes the functions pertaining to Networking Services/2 configuration and management,

and the programming interface used to invoke the configuration and management functions.

*Networking Services/2 APPC Programming Reference (SC52-1112)*

This manual describes the functions of APPC available with Networking Services/2, and the programming interface used to invoke APPC functions.

*Networking Services/2 Problem Determination Guide (SC52-1113)*

This manual describes problem determination procedures you can use to identify and solve system and communications problems related to the Networking Services/2 environment.

---

## Apple Publications

The following paragraphs describe some applicable Apple documents. Contact your Apple representative for information on other available documentation.

*Learning Macintosh (030-3933-A)*

This manual describes the basic features of a Macintosh computer, for example, how to use a mouse and what to do with icons. It also describes basic tasks like preparing disks for use, using windows to look at the contents of a disk, creating and revising documents, using file folders and printing documents.

*SNA\*ps 3270 User's Guide (030-1713-A)*

This manual contains an overview of SNA\*ps 3270, tells you how to install SNA\*ps 3270, and gives basic information on using the product.

*SNA\*ps 3287 User's Guide (available 1Q92)*

This manual describes how to configure and operate 3287 printer emulation with the SNA\*ps Gateway product.

*Macintosh Reference (030-3934-A)*

This manual explains the standard Macintosh operations, starting up the system, managing disks and disk drives, and other Macintosh features.

*Macintosh Networking Reference (030-3936-A)*

This manual describes how to activate AppleShare, how to create users and groups in an AppleShare networking environment, and how to monitor the network.

*Network Products Installer (030-3916-A)*

This document tells you how to use the *Network Products Installer* disk, which you must use to install the following network software products onto Macintosh IIci or Macintosh IIx computers: AppleTalk Internet Router, EtherTalk, SMB File Transfer Utility, and TokenTalk.

*SNA\*ps Administrator's Guide (600-2115-A)*

This manual describes how to install, configure and operate the SNA\*ps Gateway product.

*Apple Internet Router Administrator's Guide*

This manual is provided with the Apple Internet Router.

*Apple Serial NB Card Installation Guide (030-1550-A)*

This manual describes how to install the Apple Serial NB Card in your Macintosh II computer.

*Apple TokenTalk NB User's Guide (030-3381-A)*

This manual describes how to install the hardware and software required to connect your Macintosh II computer to a TokenTalk network. It also provides information on using the network connection to access AppleTalk services and devices across a TokenTalk network.

*Apple EtherTalk NB User's Guide (030-2216-A)*

This manual describes how to install the hardware and software required to connect your Macintosh II computer to an EtherTalk network. It also provides information on using the network connection to access AppleTalk services and devices across an EtherTalk network.

*LocalTalk Cable System Owner's Guide (030-0043)*

This manual describes the components of the LocalTalk cable system and how to use them to connect Macintosh computers and Apple printers.

*IBM/Apple Enterprising Networking Guide For SNA Products*  
(Z325-6027-0)

Please complete the following survey and return it, so we may improve possible future documents. Rate each question on a scale of 1 to 5 (1 means "not useful" and 5 means "extremely useful").

How useful was this document in helping you support combined Apple-IBM environments ?

1 2 3 4 5

How useful were the screen reproductions ?

1 2 3 4 5

How useful were the Path Configuration Diagrams ?

1 2 3 4 5

How helpful were the Operating Procedures ?

1 2 3 4 5

How helpful were the Configuration Details ?

1 2 3 4 5

Please describe any errors you encountered.

Please add any additional comments.

Be sure to print your name and address below if you would like a reply. If we have questions about your comment, may we call you? If so, please include your phone number.

Please Return To:

International Business Machines Corporation  
Multivendor Networking Facility  
Department B17  
P.O. Box 12195  
Research Triangle Park, North Carolina 27709-9990

