

This Newsletter No. GN34-0447
Date October 13, 1978
Base Publication No. GA34-0031-1
File No. S1-13
Previous Newsletters None

IBM Series/1
Attachment Features
Description

© IBM Corp. 1978

This Technical Newsletter provides replacement pages for the subject publication. Pages to be inserted and/or removed are:

3-1 through 3-6
3-9 through 3-12

A technical change to the text or to an illustration is indicated by a vertical line to the left of the change.

Summary of Amendments

This technical newsletter supports an engineering change that adds a buffer to the TTY attachment feature card.

Note. Please file this cover letter at the back of the manual to provide a record of changes.



Chapter 3. Teletypewriter Adapter Feature

This chapter provides a functional description of and machine-language programming information for the Teletypewriter Adapter User Attachment Feature card (referred to as the teletypewriter adapter in the remainder of this chapter). Also included is information on operational characteristics including (1) data transmission and (2) transmit and receive operations. This material can be found at the end of this chapter.

Functional Description

The teletypewriter adapter is an input/output device attachment. This attachment was designed primarily to attach a teletypewriter I/O device such as a Teletype* Model ASR33, ASR35, or KSR33. However, the adapter may be used to attach other devices that satisfy the interface requirements. Some of the commercially available devices that can be attached to this feature include:

- Printer - keyboards
- Keyboard - display units
- Keyboard - display - printer units
- Printers
- Tape cassettes
- Tape units
- Card readers
- Badge readers
- Plotters

Note. The interrupt mask time of the program support system that is used may preclude operation at the bit rate required by any of the above devices. Unbuffered devices whose input is from the keyboard are generally much less affected by the interrupt mask time of the program support system. See *IBM Series/1 User's Attachment Manual*, GA34-0033, Chapter 4, for details.

One of the following bit-transfer rates can be selected:

<i>Bits per second</i>	
50	300
75	600
100	1200
110	2400
150	4800
200	9600

Note. The interrupt mask time of the program support system may preclude operation at bit rates higher than 110 bps.

The bit-transfer rate that the teletypewriter adapter can accept is selectable at installation time by a field-installable connector (jumper) on the attachment logic card. The jumper can be changed if a different I/O device is attached that operates at another bit-transfer rate.

Attachment options between the teletypewriter adapter and the attached device are also selectable at installation time by field-installable jumpers on the attachment logic card. These jumpers can be changed to accommodate a different I/O device if desired. Four input options—isolated and non-isolated contact sense, TTL, and EIA—and three output options—solid state switch/TTL, current driver, and EIA—are available.

Also, three outputs—solid state switch/TTL for write control, solid state switch/TTL for read control, and EIA data terminal ready—are available to the user. Write control and read control are controlled by modifier bit 7 in the Write and Read commands. (See "Write" command and "Read" command in this chapter.) The EIA data terminal ready output is active when power is applied to the teletypewriter adapter.

The teletypewriter adapter supports full duplex operation. Data can be concurrently transmitted and received between the teletypewriter adapter and the attached device. Any of the 256 hex data codes can be transmitted or received.

The teletypewriter adapter does not *transmit* break characters. *Received* break characters will appear to the program support system as a series of all zero characters followed by one unpredictable character.

*Trademark of Teletype Corporation

Programming Information

Initial Program Load (IPL)

The teletypewriter adapter can perform initial program load (IPL) as either the primary or alternate IPL source. During installation, this option is selected by a field-installable connector (jumper) on the attachment logic card. If Primary is selected on the attachment card and the IPL Source switch on the console is in the Primary position, the teletypewriter adapter is selected to perform the IPL when the Load key is pressed. If the connector is installed in the Alternate position, the IPL Source switch on the console must be in the Alternate position for the teletypewriter adapter to perform IPL.

The IPL record length is 256 bytes and starts loading into main storage at location zero. When IPL is completed, control is turned over to the instruction at main-storage location zero on interrupt level zero.

Operate I/O Instruction

Communication between the processor and the device attached to the teletypewriter adapter is initiated by the processor. All teletypewriter adapter functions (control, write, and read) must be initiated with Operate I/O instructions stored in the processor.

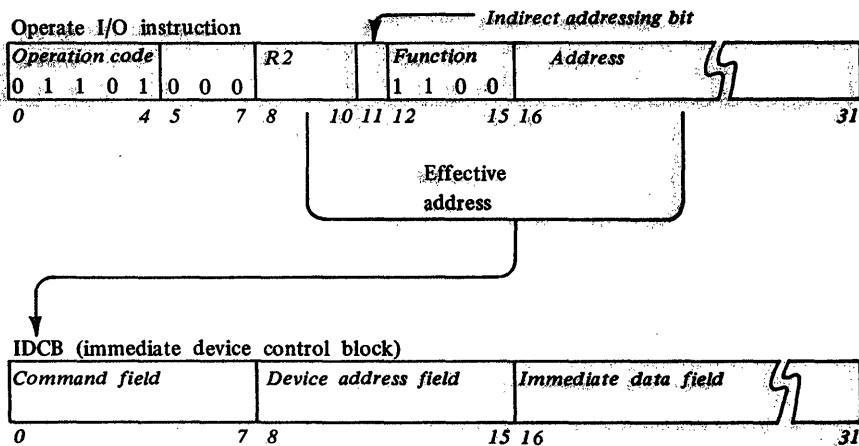

The address field (bits 16–31) and the contents of the register specified in the R2 field (bits 8–10) of the Operate I/O instruction generate an effective address that points to a main-storage location containing an immediate device control block (IDCB). IDCBS are doubleword blocks of storage reserved by programs for storage of device-directed commands.

If bit 11 of the instruction (the indirect addressing bit) is a 1, the effective address address points to a main storage location containing the *address* of the IDCB.

Addressing

The attached device is addressed by the 8-bit address field in the IDCB (bits 8–15).

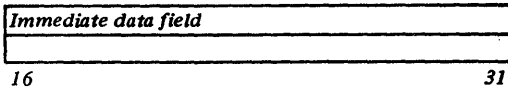
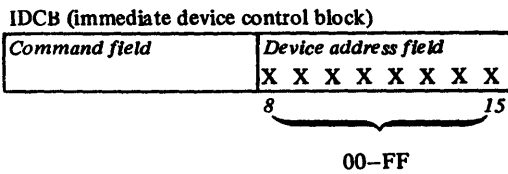

Field-installable jumpers on the teletypewriter adapter attachment card provide the capability of selecting any one of 256 addresses (00–FF hex) for the attached device.

Commands

The teletypewriter adapter performs two types of receive operations. An understanding of these two types is necessary before discussing commands and condition codes.

- Nonnal receive operation.
 This receive operation results in posting an attention interrupt. No data characters are lost.
- Overrun receive operation.
 This receive operation results in posting an exception (overrun) interrupt. A second character is received and the leading edge of its first stop bit time is detected before the first character is read by the program. The second character is lost. The first character is in the receive buffer register and can be read by executing an Operate I/O instruction with a Read command in the IDCB.

As shown below, IDCB command-field bits 0–7 define the various control and read functions issued to the teletypewriter adapter by the processor. The specific commands are described in the following sections.

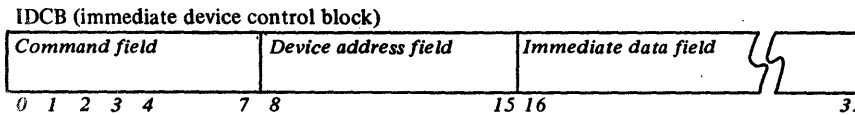

Chan	R/W	Function	Modifier	Hex	Specific command
0	1	10 Control	0000	60	Prepare
0	1	10 Control	1111	6F	Reset device
0	1	10 Control	1110	6E	Reset to diagnostic wrap
0	1	01 Write	000X	50,51	Write
0	0	01 Read	000X	10,11	Read
0	0	10 Read status	0000	20	Read ID

Write bit 7 = 0 Write control interface line is disabled
 1 Write control interface line is enabled

Read bit 7 = 0 Read control interface line is disabled
 1 Read control interface line is enabled

The condition codes referred to in the following I/O command descriptions are listed in the "Condition Codes Reported for an Operate I/O Instruction" section of this chapter.

Prepare

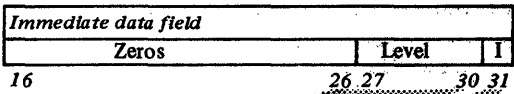
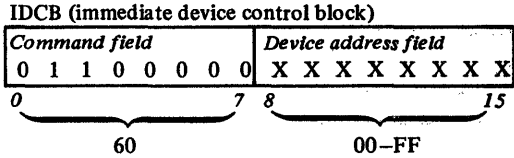

Bits	Level	Bit
27-30		31
0000	0	0 = interrupts not allowed
0001	1	
0010	2	1 = interrupts allowed
0011	3	

The Prepare command loads the interrupt level and I bit into the teletypewriter adapter prepare register. The I bit (bit 31) determines if the teletypewriter adapter can report an I/O interrupt. If the I bit equals 0, I/O interrupts are not reported. If the I bit equals 1, I/O interrupts are reported. The interrupt level (bits 27-30) is the level on which the teletypewriter adapter reports I/O interrupts. Level 0 is the highest-priority level; level 3 is the lowest. The teletypewriter adapter does not report condition code 1 (busy) to this command. If condition code 5 (interface data check) is reported, the command was not successfully executed.

Device Reset

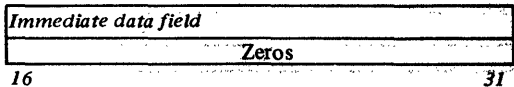
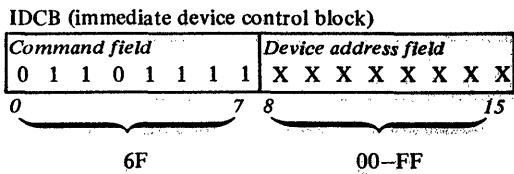

The Device Reset command resets all registers except the prepare-field register and the transmit-data register. The write- and read-control interface lines are disabled. Pending interrupts and condition codes are reset. The teletypewriter adapter does not report condition codes 1 (busy) and 5 (interface data check) to this command.

Reset-to-Diagnostic-Wrap

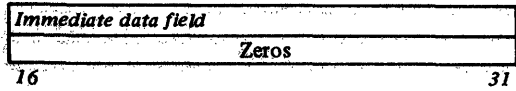
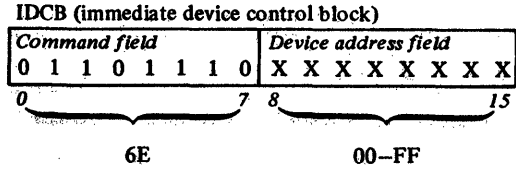

The Reset-to-Diagnostic-Wrap command places the teletypewriter adapter in the diagnostic-wrap state by (1) resetting pending interrupts, condition codes, and all registers in the teletypewriter adapter except the prepare register, and (2) disabling the read- and write-control interface lines.

In the diagnostic-wrap state, commands can be issued to the teletypewriter adapter for testing purposes. A device may or may not be attached to the teletypewriter adapter during testing. If a Write command is issued, data is sent to the teletypewriter adapter transmit-data register and, if attached, to the device. At the completion of the transmit operation, a device-end interrupt is reported. The data is also sent to the teletypewriter adapter receive-data register, and at the completion of the receive operation an attention interrupt is reported. For checking purposes, the teletypewriter adapter can be forced into an overrun condition by not reading the receive-data register after the attention interrupt is accepted, and then issuing another Write command. The teletypewriter adapter does not report condition codes 1 (busy) and 5 (interface data check) to this command.

The diagnostic-wrap state is exited by issuing a Reset Device or Halt I/O command, a system reset, or a power-on reset.

Write

IDCB (immediate device control block)

Command field								Device address field							
0	1	0	1	0	0	0	X	X	X	X	X	X	X	X	X
0								8							
50								00-FF							
51															

Immediate data field															
Zeros												Data byte			
16															
23												24			
31															

Bit 7 = 0 Write control interface line is disabled

Bit 7 = 1 Write control interface line is enabled

The Write command loads bits 24–31 of the IDCB into the teletypewriter adapter transmit-data register. The teletypewriter adapter then transfers the byte serially by bit to the attached device. If command-field bit 7=0, the write-control interface line is disabled (open). If command-field bit 7=1, the write-control interface line is enabled (closed). A device-end interrupt is reported at the completion of the data transfer. If the teletypewriter adapter is in a write-busy or interrupt-pending state, condition code 1 (busy) is reported and the command is not executed. If condition code 5 (interface data check) is reported, the command was not successfully executed.

Halt I/O

The teletypewriter adapter responds to the channel-directed Halt I/O command by resetting all registers (except the prepare-field register), pending interrupts, and pending condition codes (see "Status After Resets" in this chapter).

Read

IDCB (immediate device control block)

Command field								Device address field							
0	0	0	1	0	0	0	X	X	X	X	X	X	X	X	X
0								8							
10								00-FF							
11															

Immediate data field															
Zeros															
16															
31															

Bit 7 = 0 Read control interface line is disabled

Bit 7 = 1 Read control interface line is enabled

The Read command loads the byte contained in the teletypewriter adapter receive-buffer register into bits 24–31 of the IDCB. If command-field bit 7=0, the read-control interface line is disabled. If command-field bit 7=1, the read-control interface line is enabled. No interrupts result from the execution of this command. If the teletypewriter adapter is in a read-busy or interrupt-pending state, condition code 1 (busy) is reported and the command is not executed. If condition code 5 (interface data check) is reported, the command is not executed. Note that the byte in the receive-buffer register is not changed as a direct result of a Read command. The data in the receive-buffer register is changed only by a normal receive operation.

Read ID

IDCB (immediate device control block)

Command field								Device address field							
0	0	1	0	0	0	0	0	X	X	X	X	X	X	X	X
0								8							
20								00-FF							

Immediate data field															
Zeros															
16															
31															

The Read ID (identification) command loads the device-ID byte into bits 24–31 of the IDCB. The device ID for the teletypewriter adapter is 10 hex. The device-identification word contains a unique identification code and physical information about the device, and can be used to determine the devices that are attached to the system. The teletypewriter adapter does not report condition code 1 (busy) to this command. If condition code 5 (interface data check) is reported, the command was not successfully executed.

Status Information

Condition codes containing the status of the I/O operation are reported to the processor. These codes are explained in the following sections.

Condition Codes Reported for an Operate I/O Instruction

The following condition codes are reported during an Operate I/O instruction.

Condition code	Meaning
0	<i>Device not attached</i> —reported if the teletypewriter adapter is addressed, but is not installed on the system.
1	<i>Busy</i> —reported by the teletypewriter adapter under the following conditions: <ol style="list-style-type: none">1. To a Write command—the teletypewriter adapter is executing a transmit operation to the attached device or has a device-end interrupt pending (write busy or interrupt pending).2. To a Read command—the teletypewriter adapter is executing a normal receive operation or has an attention or exception interrupt pending (read busy or interrupt pending). The teletypewriter adapter is not busy to a Read command by reason of executing an overrun receive operation. Busy is reported to any command outside of the defined command set for the teletypewriter adapter if the teletypewriter adapter is in the write-busy, read-busy, or interrupt-pending states. Since the teletypewriter adapter supports full duplex operation (simultaneous read and write), it can be write busy and read busy, write busy and interrupt pending, or read busy and interrupt pending at the same time.
2	<i>Not reported</i>
3	<i>Command reject</i> —reported if the command issued is outside the defined command set for the teletypewriter adapter.
4	<i>Not reported</i>
5	<i>Interface data check</i> —reported if a parity error occurs on the data bus during data transfer.
6	<i>Not reported</i>
7	<i>Satisfactory</i> —reported when a command is accepted.

I/O Interrupt

The teletypewriter adapter initiates an I/O interrupt when the Prepare command sets the I bit in the prepare register to 1, and the following interrupts occur:

- Attention—a normal receive operation has been completed
- Exception—an overrun receive operation has been completed
- Device end—a transmit operation has been completed

Attention, exception, and device-end interrupts can be pending at the same time. If an exception interrupt and a device-end interrupt are pending at the same time, the exception interrupt takes precedence at interrupt-reporting time. The reporting and acceptance of the exception interrupt does not reset a pending device-end interrupt. The interrupt is defined by the condition code reported during interrupt acceptance. The teletypewriter adapter does not utilize the interrupt information byte (IIB) of the interrupt-ID word. The IIB is always presented as zeros.

Condition Codes Reported for an I/O Interrupt

The following condition codes are reported during an I/O interrupt.

Condition code	Meaning
0	<i>Not reported</i>
1	<i>Not reported</i>
2	<i>Exception</i> —reported when the teletypewriter adapter has completed at least one overrun receive operation. A device-end interrupt may be pending, but exception interrupt takes precedence in reporting.
3	<i>Device end</i> —reported at completion of the execution of a Write command or completion of an IPL operation. No exception interrupt is pending at interrupt-reporting time.
4	<i>Attention</i> —reported when the teletypewriter adapter has completed a normal receive operation.
5	<i>Not reported</i>
6	<i>Attention and exception</i> —reported when the teletypewriter adapter has completed a normal receive operation and has completed at least one overrun receive operation.
7	<i>Attention and device end</i> —reported after executing either a Write command or an IPL operation, and the teletypewriter adapter has completed a normal receive operation.

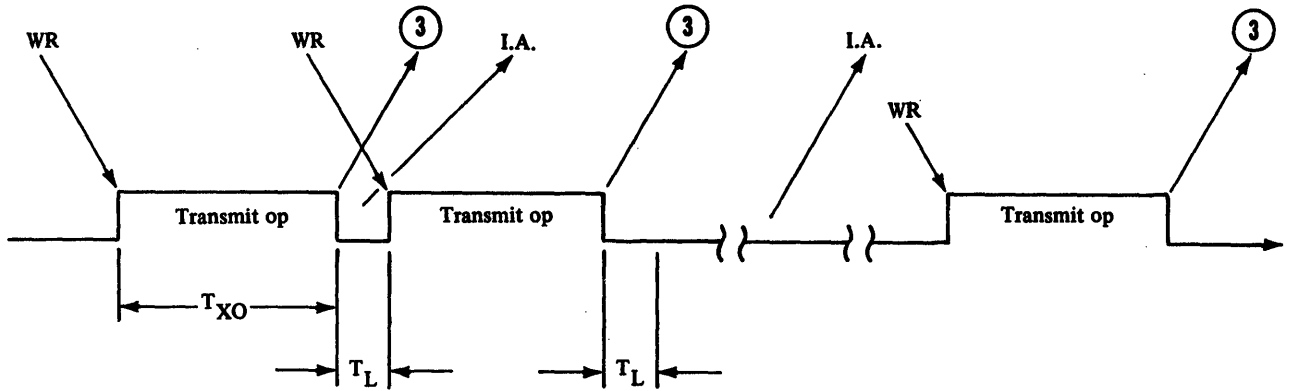

Key:

- ③ = Post device end interrupt (condition code 3)
- I.A. = Interrupt accept
- WR = Write command accepted

Baud rate	T_{XO} (milliseconds)	T_L (milliseconds)
9600	.936	.208
4800	1.87	.416
2400	3.74	.832
1200	7.49	1.66
600	14.98	3.33
300	29.96	6.66
200	44.94	10.0
150	59.9	13.3
110	81.9	18.2
100	89.88	20.0
75	119.08	26.6
50	179.76	40.0

T_{XO} and T_L are $\pm 0.1\%$

Figure 3-2. Transmit operation timing diagram

Receive Operations

Figure 3-3 depicts timing for receive operations. A circle with a 2, 4, or 6 denotes an interrupt with appropriate condition code. I.A. (&R) denotes interrupt accept (and read) by the processor. RCV OP denotes the envelope of a receive operation.

Timings are depicted at device rated operation. T_{RO} is the time of a receive operation from initiation by the device to the posting of an interrupt. It is 9 bit times at the selected frequency. At 9600 bps, $T_{RO} = .936$ ms; at 110 bps, $T_{RO} = 81.9$ ms.

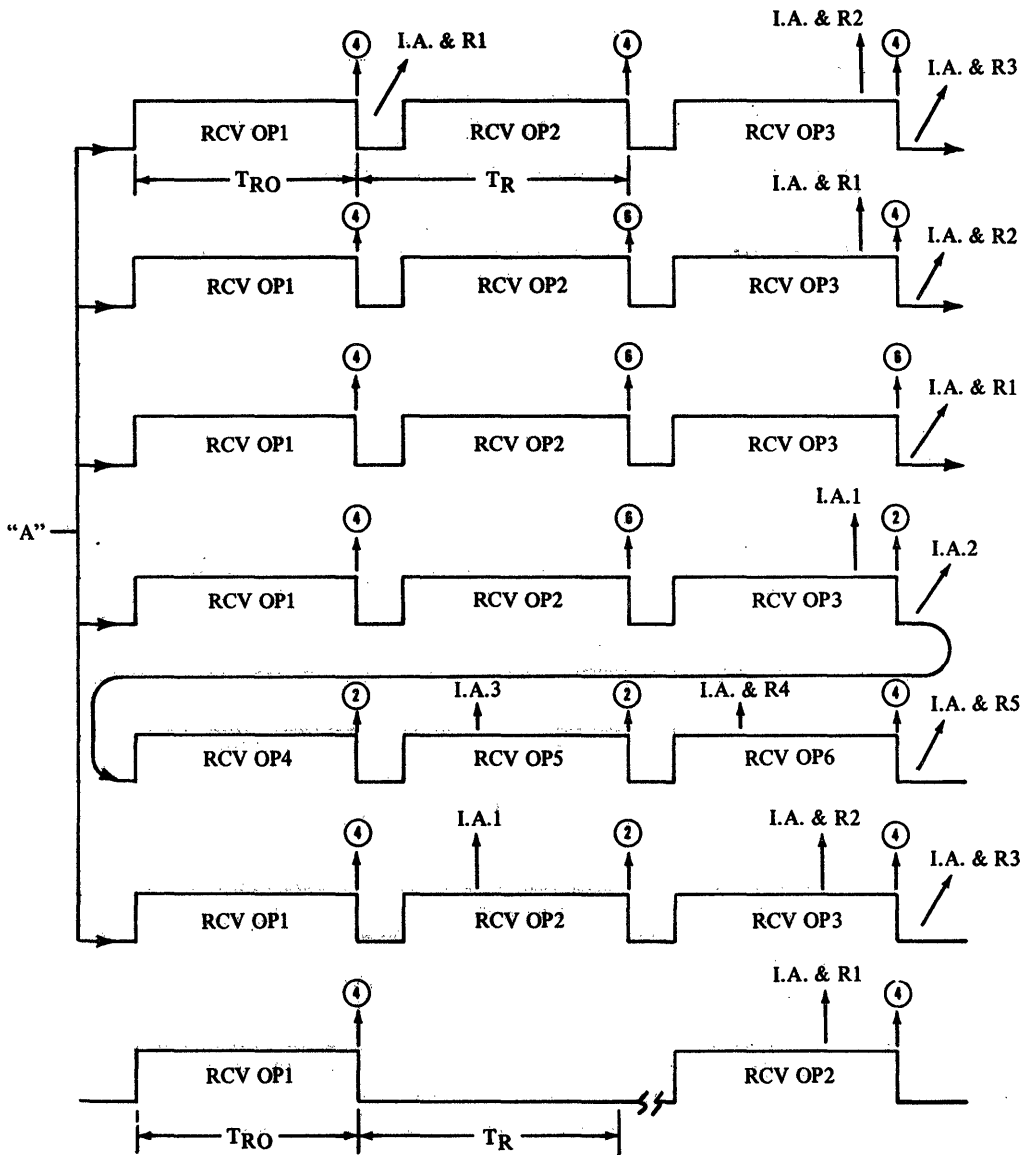

Key:
 "A" = Entry point on right side of diagram
 (2)(4)(8) = Interrupt with circled condition code
 I.A. = Interrupt accept
 I.A. & R = Interrupt accept and execute read command

Baud rate	T_{RO} (milliseconds)	T_R (milliseconds) for 1 stop bit	T_R (milliseconds) for 2 stop bit
9600	.936	1.01	1.12
4800	1.87	2.05	2.26
2400	3.74	4.14	4.55
1200	7.49	8.30	9.14
600	14.98	16.6	18.3
300	29.96	33.3	36.6
200	44.94	49.9	54.9
150	59.9	66.6	73.3
110	81.9	90.8	99.9
100	89.9	99.9	109.9
75	119.1	133.3	146.6
50	179.8	199.9	219.9

T_{RO} and T_R are $\pm 0.1\%$

Figure 3-3. State and timing diagram for possible receive operations

On receive operations, an attention interrupt is posted at the leading edge of the first stop bit time for that character. The interrupt accept and read (I.A.&R) must be done before the leading edge of the first stop bit time of the *next* character to prevent overrun. T_R is equal to the maximum permissible time the processor can delay in performing an interrupt accept and read after an attention interrupt is posted. T_R is equal to the number of stop bits sent, plus one (start bit), plus the number of data bits sent, all multiplied by one bit time. Note that by programming the device for 2 stop bits, T_R (the amount of time the program has to handle the attention interrupt) may be increased by approximately 10%.

Assuming one stop bit and eight data bits, at 9600 bps $T_R = 1.01$ ms; at 110 bps $T_R = 90.8$ ms. Figure 3-3 is a state and timing diagram of possible receive sequences.

The basic sequences on Figure 3-3 start from point A with a normal receive operation, ending in an attention interrupt being posted. The top line depicts interrupt acceptance and reading of the receive buffer register within time T_R . I.A.&R1 reads the character received in RCV OP 1, I.A.&R2 reads the character received in RCV OP 2 and I.A.&R3 reads the character received in RCV OP 3.

The second line depicts delay in interrupt accept and read beyond T_R . In this case, the character received in RCV OP 2 was lost and the data read by I.A.&R1 was the character received in RCV OP 1.

The third line depicts a delay of greater than $2 T_R$ in taking an I.A.&R for RCV OP 3. In this case, the characters received in RCV OPS 2 and 3 were lost, and the data from RCV OP 1 was read by I.A.&R1.

The fourth, fifth, and sixth lines depict what will occur if the read is omitted from the interrupt accept. The fourth and fifth lines depict what will occur if an interrupt accept without read is taken after a condition code 6 (attention and exception) is posted. Note that the characters resulting from RCV OPS 2, 3, 4, and 5 were lost, and that the character read by I.A.&R4 was the character received in RCV OP 1.

The sixth line depicts what will occur if an interrupt accept without read is taken after a condition code 4 (attention) is taken. Note that the character resulting from RCV OP 2 was lost. I.A.&R2 read the character resulting from RCV OP 1.

If T_R has been exceeded, no overrun will occur *unless* the first stop bit time of another character is detected by the attachment before the I.A.&R occurs to clear the interrupt and read the first character. The seventh line is an example of this. Even though I.A.&R1 did not occur until after T_R , no overrun occurred since the first character was read by I.A.&R1 before the leading edge of stop bit time of the next character.

Programming Considerations For Maximum Transmission-Receive Rates

The following list provides some examples of how to obtain maximum transmission rates.

- **Transmit interrupt servicing.**
At the beginning of the first stop bit, the teletypewriter adapter sends an interrupt request to the processor to signal the completion of the current character transmission. This interrupt must be serviced and another transmit operation initiated by the end of the second stop-bit time if maximum transmission rate is to be maintained.
- **Receive interrupt servicing.**
At the beginning of the first stop bit time, the attachment transfers the received character from the receive SERDES to the receive buffer register; it also sends an interrupt request to the processor to signal that a character has been received. This character must be read by the program before stop bit time of the *next* character to prevent an overrun from occurring. The amount of time the software has to read a character is one full *character* time including start bit and stop bit(s).
- **Device stop bits.**
Devices that are designed to receive either one or two stop bits may be attached to the teletypewriter adapter card. If the device is designed for only one stop bit, the second stop bit appears to be a one-bit-time separation between character frames. Therefore, if a device is programmable for either one or two stop bits, it should be programmed for only one stop bit. This programming will increase the receive data rate of the teletypewriter adapter by approximately 9 percent.
- **Device data rates.**
If a device is programmable for several different data rates that can be supported by the teletypewriter adapter, the device should be programmed for the highest data-transfer rate that results in reliable operation in the environment in which the system is placed.
- **Duplex operation.**
The teletypewriter adapter is a full duplex attachment. It can transmit and receive data simultaneously. Therefore, devices attached to the teletypewriter adapter should be configured for full duplex operation.



GN34-0447-00

