

GA27-3094-3
File No. S370-09

Systems

**Operating Procedures Guide:
IBM 3774 and 3775
Communication Terminals**

IBM

GA27-3094-3
File No. S370-09

Systems

**Operating Procedures Guide:
IBM 3774 and 3775
Communication Terminals**

IBM

Preface

This Operating Procedures Guide is directed to operators of the IBM 3774 and 3775 Communication Terminals (non-programmable models), and to personnel writing job application procedures for these terminals.

Because the IBM 3774 and 3775 terminals are used in many applications, detailed procedures for processing each job cannot be presented here. This guide describes the purpose and use of the terminal's controls as they apply to all jobs. You can use this manual in preparing a detailed operator procedure for a specific job in your application.

Users of this manual who need more information about the functions and features of the terminals should refer to the *3770 System Components* manual; this manual and other publications that may be useful to you are listed under "Related Publications" in the front of this manual.

The information in this manual is organized as follows:

- Chapter 1 is an introduction to the 3774 and 3775 Communication Terminals.
- Chapter 2 contains the 3774 and 3775 operating procedures, and includes exercises for becoming familiar with operation of the terminals.
- Chapter 3 contains procedures for resuming operation following a machine halt or error interruption, and gives guidelines for determining when to request service.
- Chapter 4 through 11 contain procedures for making the various input and output devices ready for operation, and for correcting problems such as card jams.
- Appendix A provides reference information for emulating IBM 2770 Data Communication System workstation functions.
- Appendix B contains procedures for running communication tests.
- Appendix C is a summary of the 3774 and 3775 keyboard keys, lights, and switches.

Fourth Edition (May, 1976)

This is a major revision of, and obsoletes, GA27-3094-2. Changes or additions to the text and illustrations are indicated by a vertical line to the left of the change.

Changes are periodically made to the information herein; any such changes will be reported in subsequent revisions or Technical Newsletters. Before using this publication in connection with the operation of IBM systems or equipment, refer to the latest *System/370 Bibliography* (Order No. GC20-0001) and associated Technical Newsletters for the edition that is applicable and current.

Requests for copies of IBM publications should be made to your IBM representative or to the IBM branch office serving your locality.

This manual has been prepared by the IBM System Communications Division, Publication Center, Department E01, P.O. Box 12195, Research Triangle Park, North Carolina 27709. A form for reader's comments is provided at the back of this publication. If the form has been removed, comments may be sent to the above address. Comments become the property of IBM.

Related Publications

- *IBM 3770 Data Communication System—System Components*, GA27-3097
- *IBM 3774 and 3775 Communication Terminals Reference Summary*, GA27-3095
- *General Information—Binary Synchronous Communications*, GA27-3004
- *Synchronous Data Link Control General Information*, GA27-3093
- *IBM Remote Multiplexers and Communications Terminals Installation Manual—Physical Planning*, GA27-3006
- *Printer Forms Layout Sheets*, GX20-1816
- *Forms Design Considerations—System Printers*, GA24-3488
- *IBM System/370 Bibliography*, GC20-0001
- *Planning and Installation of a Data Communication System Using IBM Line Adapters*, GA24-3435
- *IBM Data Processing Glossary*, GC20-1699
- *IBM 3872 Modem User's Guide*, GA27-3058
- *IBM 3874 Modem User's Guide*, GA33-0002
- *IBM 4872 Modem Model 1*, GA36-0001
- *IBM 4872 Modem Models 2 and 3*, GA36-0004

Summary of Amendments

Second Edition (January, 1975)

The operating procedures were changed to include how to define and start a job that uses the Record Format Control feature. Error codes for the Record Format Control feature were added to the numeric position readout (NPR) codes in Chapter 3. Appendix C provided a summary listing of the terminal's switches, keys, and lights.

Third Edition (October, 1975)

This edition incorporated TNL GN27-3167 and added information about operation using Synchronous Data Link Control (SDLC). Corrections, additions, and clarification were made throughout the manual.

Fourth Edition (May, 1976)

This edition incorporates corrections and editorial changes throughout the manual, and includes additional information about operation using SDLC.

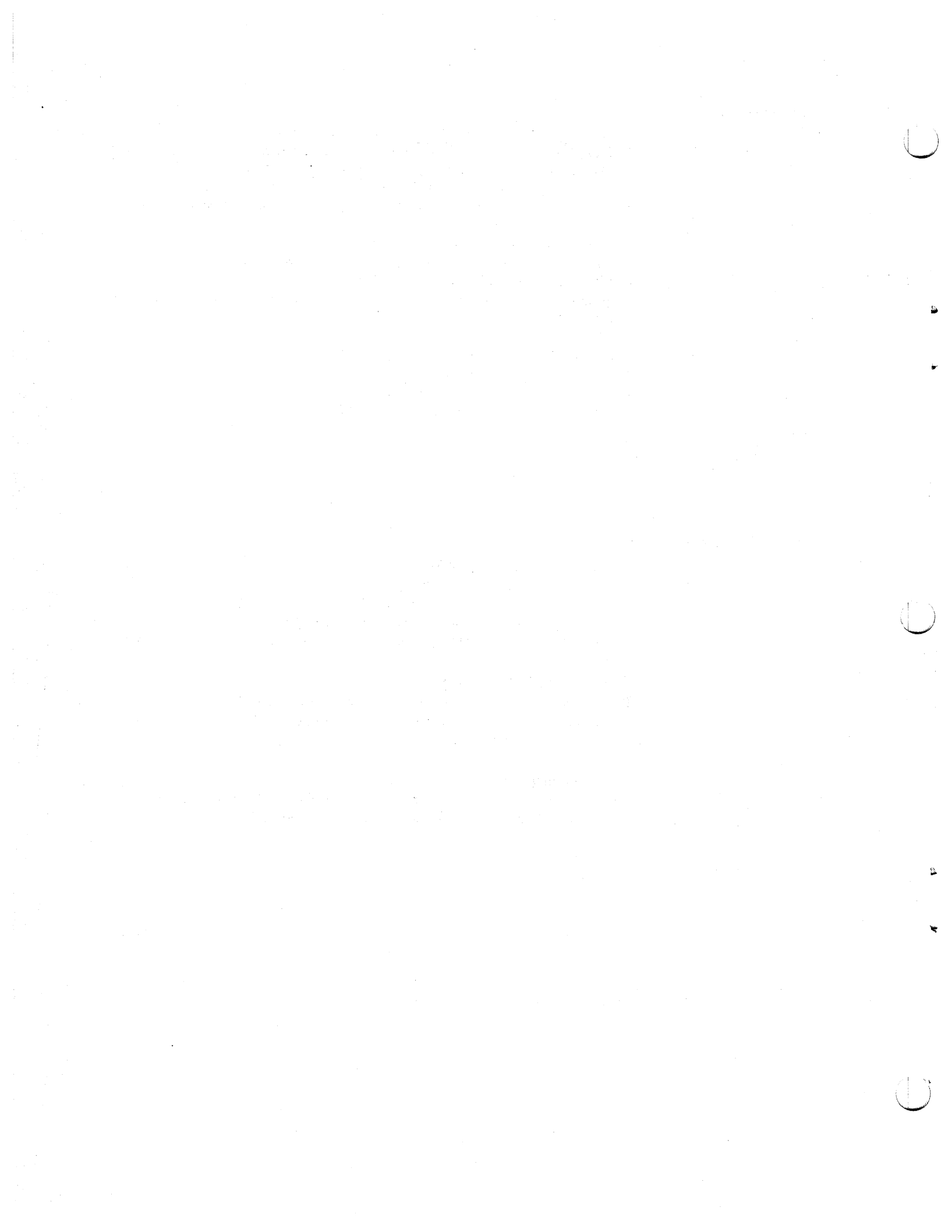

Contents

Chapter 1. Introduction	1-1
The Basic Terminal Components	1-3
The Controller	1-3
The Console Printer	1-3
Serial Console Printer (for the IBM 3774 Communication Terminal)	1-3
Line Console Printer (for the IBM 3775 Communication Terminal)	1-3
The Keyboard and Operator Panel	1-4
The Diskette Storage Device	1-4
The Auxiliary Operator Panel	1-5
Chapter 2. Operating Procedures	2-1
Overview of IBM 3774 and IBM 3775 Communication Terminal Operation	2-1
Operation Exercises	2-2
Exercise Number 1: A Keyboard-to-Diskette-Storage Device Job	2-2
Exercise Number 2: A Diskette-Storage-Device-Console Printer Job	2-3
Power On/Off Procedures	2-4
Power On	2-4
Power Off	2-4
Remote Power Off	2-4
Forms Control	2-5
Entering an Operator Defined Job From the Keyboard	2-6
To Define a Job From the Keyboard	2-6
Entering an Operator Defined Job From the Card Reader	2-12
Writing Operator Defined Jobs to the Diskette Storage Device	2-18
Entering Operator Defined Jobs From the Diskette Storage Device	2-18
Starting a Job Using BSC	2-19
Communication Line Jobs—BSC	2-23
Starting a Job Using SDLC	2-25
Communication Line Jobs—SDLC	2-28
Terminating a Communication Line Job	2-29
Transmit Request to the CPU	2-29
Keyboard-to-Line Jobs	2-29
Switched Communication (Dial) Network Procedures	2-30
Initiating a Call	2-30
Answering a Call	2-30
Automatic Answer	2-31
Example No. 1: Starting a System Defined Disk to Line Job	2-32
Example No. 2: Starting an Operator Defined Disk to Line Job	2-32
Ending a Job	2-32
Ending Keyboard to Output Device Jobs	2-33
Ending Card Reader to Output Device Jobs	2-33
Ending Diskette Storage Device to Output Device Jobs	2-33
Stopping a Job Before Normal Job End	2-34
Using the Operator Panel Indicators	2-36
Input and Output Device Indicators	2-36
CPU SELECT Indicator	2-36
PRINT INHIBIT Indicator	2-36
OPRN CHECK (Operation Check) Indicator	2-36
SYSTEM CHECK Indicator	2-37
ON LINE Indicator	2-37
STANDBY Indicator	2-37
PROCEED Indicator	2-37
UPPER CASE Indicator	2-37
Using the Operator Panel Switches	2-38
HOLD PRINT Switch	2-38
INTRP (Interrupt) Switch	2-38
When the Interrupt Switch Is Off	2-38
When the Interrupt Switch Is On	2-39
Interrupt Feature System Considerations	2-39
EXTEND/ALARM Switch	2-40
Using the EXTEND/ALARM Switch With Keyboard Jobs	2-40
Using the EXTEND/ALARM Switch With Jobs Other Than Keyboard Jobs	2-40

INTRO

PROC'D

ERP

3774 PTR

3775 PTR

DISK

2502

3501

3521

ID

3784

2770 EM

TESTS

SUMM

AUTO Switch	2-40
Using the AUTO Switch With Keyboard Jobs	2-40
Using the AUTO Switch With Diskette to Console Printer Jobs	2-41
Using the AUTO Switch With Keyboard to Card Punch Jobs	2-41
DISK Switch	2-41
UPDATE/MONITOR Switch	2-41
Using the UPDATE/MONITOR Switch With Keyboard To Diskette Jobs	2-42
Using the UPDATE/MONITOR Switch With Jobs Other Than Keyboard Jobs	2-42
Using the CODE Key	2-44
CODE Key Functions	2-44
Extended CODE Key Functions	2-50
Using the Keyboard Buffer Edit Keys	2-52
Using the Keyboard Buffer Edit Keys: Exercise No. 1	2-52
Using the Keyboard Buffer Edit Keys: Exercise No. 2	2-54
Using the Keyboard Buffer Edit Keys: Exercise No. 3	2-54
Description of Buffer Edit Keys	2-55
BUFFR RTN (Buffer Return) Key	2-55
BUFFR LINE RETURN Key	2-55
BUFFR BKSP (Buffer Backspace) Key	2-55
PRINT BUFFR Key	2-55
PRINT Line Key	2-55
PRINT CHAR Key	2-55
RESET Key	2-55
CNCL (Cancel) Key	2-55
Description of Control Keys Used During Keyboard Entry	2-56
PRINT VIEW Key	2-56
RESET Key	2-56
FORM FEED Key	2-56
VERT TAB (Vertical Tab) Key	2-56
INDEX Key	2-56
Diskette Storage Device Jobs	2-57
Diskette Labels	2-57
Diskette Records	2-58
Active and Inactive Data Set Status	2-59
Multivolume Data Sets	2-59
Defective Diskette Sectors	2-60
Entering Keyboard Data on Disk	2-60
Updating a Diskette Record	2-61
Updating a Diskette Record During a Keyboard-to-Diskette Job	2-62
Operation With Two Diskette Storage Devices	2-62
Diskette Interchangeability	2-63
Chapter 3. Error Recovery and Problem Identification	3-1
Overview of Error Recovery and Problem Identification Procedures	3-1
Restarting a Job Following an Error	3-1
Requesting Maintenance on the Terminal	3-1
Printing the Error Log	3-2
Using the Trouble Report Form	3-2
Numeric Position Readout (NPR) Codes	3-3
Diskette Data Recovery Procedures	3-17
Section 1: General Data Recovery Procedure	3-17
Section 2: Diskette Failure During Read Operation	3-18
Section 3: Diskette Failures During Write Operation	3-18
Problem Identification Procedures	3-19
Error Recovery Procedure	3-19
How to Perform Communication Tests	3-20
To Perform Test 0 (Terminal Communication Test)	3-20
To Perform Test 2 (Modem Wrap Test)	3-20
To Perform Test 3 (Modem Transmit Test)	3-21
To Perform Test 4 (Modem Receive Test)	3-23

Chapter 4. 3774 Console Printer	4-1
Make Ready Procedure	4-1
General Operating Information	4-2
Installing and Aligning Printer Forms	4-3
Loading Cut Forms in the Printer	4-3
Loading Margin-Punched Forms Using the Forms Tractor	4-6
Loading Single-Part Continuous Paper-Friction Feed	4-8
Using the Pressure Feed Bail	4-10
Aligning Forms to the First Print Line	4-12
Setting the Print Position Indicator	4-12
Installing or Removing the Forms Tractor	4-12
To Install the Forms Tractor	4-12
To Remove the Forms Tractor	4-12
Changing the Ribbon	4-13
Removing and Installing the Platen	4-14
Removing the Platen	4-14
Installing the Platen	4-15
Chapter 5. 3775 Console Printer	5-1
Make Ready Procedure	5-1
General Forms Handling Information	5-1
Installing and Aligning Printer Forms	5-2
Loading Forms in the Printer	5-2
Aligning Forms to the First Print Line	5-3
Replacing the Ribbon	5-6
Removing the Ribbon	5-6
Installing the Ribbon	5-6
Replacing the Print Belt	5-9
Removing the Print Belt	5-9
Installing the Print Belt	5-10
Chapter 6. Diskette Storage Device	6-1
Make Ready Procedure	6-1
Diskette Handling	6-4
Chapter 7. IBM 2502 Card Reader	7-1
Make Ready Procedure	7-1
To Unload the Stacker	7-2
To Unload the Stacker (Before Full)	7-2
To Unload a Full Stacker	7-2
To Reload the Hopper	7-3
To Reload the Hopper (Before Empty)	7-3
To Reload an Empty Hopper	7-3
To Set Up for Short Cards—51 or 66 Column	7-4
To Remove a Card Jam	7-6
Jam at the Cornering Station or the Read Station	7-6
Jam Between the Read Station and the Stacker	7-6
Chapter 8. IBM 3501 Card Reader	8-1
Make Ready Procedure	8-1
Operating Procedures	8-3
Reloading the Hopper or Unloading the Stacker	8-3
Removing a Card Jam	8-3
Chapter 9. IBM 3521 Card Punch	9-1
Make Ready Procedure	9-1
Operating Procedures	9-3
Reloading the Hopper or Emptying the Stacker	9-3
Emptying the Chip Box	9-3
Removing Card Jams	9-4
Replacing the Inkroll	9-6
Cleaning the Typedrum	9-7
Using the Status Indicators	9-7

INTRO

PROC'D

ERP

3774 PTR

3775 PTR

DISK

2502

3501

3521

ID

3784

2770 EM

TESTS

SUMM

Chapter 10. Operator ID (Identification) Card Reader	10-1
Reading an Identification Card	10-1
 Chapter 11. IBM 3784 Line Printer	11-1
IBM 3784 Line Printer Operating Procedures	11-1
Make Ready Procedure	11-1
Operator Panel Switches and Indicators	11-1
Installing and Aligning Printer Forms	11-4
Replacing the Ribbon	11-7
Replacing the Print Belt	11-10
 Appendix A. Emulating IBM 2770 Workstation Jobs	A-1
Introduction	A-1
Defining and Starting an IBM 2770 Workstation Job	A-2
Defining an IBM 2770 Workstation Job	A-2
Starting an IBM 2770 Workstation Job	A-2
OS/VS1 RES Operator Notes	A-3
OS/VS2 (JES2) Notes	A-4
IMS/VS Operator Notes	A-6
 Appendix B. Test Procedures	B-1
Communication Test Procedures	B-1
Step 1: Run Test 0 (Terminal Communication Test)	B-1
Step 2: Run Test 2 (Modem Wrap Test)	B-2
Step 3: Run Test 3 (Modem Transmit Test)	B-3
Step 4: Run Test 4 (Modem Receive Test)	B-4
Error Count During Normal Transmission Charts	B-4
Modem Transmit Equalization	B-5
Modem Receive Equalization	B-5
Using the Communication Test Adapter Cable	B-6
Binary Synchronous Communications Online Test	B-8
To Enter Online Test Mode	B-8
Requesting Online Test 01 on a Switched or Non-Switched Point-to-Point Communication Network	B-8
Requesting Online Test 14 on a Switched or Non-Switched Point-to-Point Communication Line	B-9
Requesting Online Test on a Multipoint Communication Network	B-9
SDLC Communications Online Echo Test	B-10
 Appendix C. Summary of Operator Controls	C-1
Auxiliary Operator Panel Controls	C-1
Operator Panel Switches	C-2
Operator Panel Keys	C-3
Operator Panel Lights	C-6
Index	X-1

List of Illustrations

1-1.	IBM 3774 Communication Terminal	1-1
1-2.	IBM 3775 Communication Terminal	1-2
1-3.	IBM 3774 and 3775 Data Path	1-2
1-4.	Keyboard and Operator Panel	1-4
1-5.	Auxiliary Operator Panel	1-5
2-1.	Example of a Keyboard-to-Diskette Job Defined From the Keyboard	2-11
2-2.	Card Format for an Operator Defined Job	2-13
2-3.	Example of Card Format for Operator Defined Jobs	2-17
2-4.	Using the CODE Key	2-44
2-5.	Buffer Edit Keys	2-52
3-1.	Trouble Report Form	3-2
3-2.	Typical Modem Connector, Telephone Equipment Connector, and Modem Power Plug	3-19
3-3.	Modem Panel Showing Meter and Transmit Equalizer Control	3-22
3-4.	Modem Panel Showing Equalizer Controls	3-25
4-1.	Operator Controls	4-1
4-2.	Opening the Printer Cover	4-4
4-3.	The Forms Tractor Unit	4-5
4-4.	Installing Cut Forms	4-5
4-5.	Paper Routing Using the Forms Tractor	4-6
4-6.	Installing Margin-Punched Forms	4-7
4-7.	Paper Path for Friction Feeding	4-10
4-8.	Using the Pressure Feed Bail	4-11
4-9.	Installing the Forms Tractor Unit	4-13
4-10.	Ribbon Path	4-14
4-11.	Removing and Installing the Platen	4-16
5-1.	Printer Locations	5-1
5-2.	Opening the Printer Cover	5-2
5-3.	Print Unit Open/Close	5-4
5-4.	Opening Upper Forms Guide	5-4
5-5.	Inserting Forms	5-5
5-6.	Placing Forms on Tractor Pins	5-5
5-7.	Raising Ribbon Guides	5-6
5-8.	Ribbon Cassette Removal	5-7
5-9.	Installing the Ribbon	5-7
5-10.	Releasing Print Belt Tension	5-9
5-11.	Removing Print Belt	5-9
5-12.	Installing the Print Belt	5-10
6-1.	Opening the Diskette Device Door	6-1
6-2.	Removing/Inserting a Diskette	6-2
6-3.	Closing the Diskette Device Door	6-3
7-1.	2502 Make Ready Procedure	7-1
7-2.	2502 Short Card Setup Procedure	7-5
7-3.	2502 Card Jam Removal	7-7
8-1.	3501 Make Ready Procedure	8-1
8-2.	Removing a Card Jam	8-3
8-3.	Closing the Read Head Cover	8-4
9-1.	3521 Make Ready Procedure	9-1
9-2.	Emptying the Chip Box	9-3
9-3.	Removing a Card Jam at the Hopper	9-4
9-4.	Removing a Card Jam in the Card Path Area	9-5
9-5.	Replacing the Ink Roll	9-6
10-1.	ID (Identification) Card Reader	10-1
11-1.	IBM 3784 Line Printer	11-2
11-2.	Opening the Printer Cover	11-4
11-3.	Print Unit Open/Close	11-5
11-4.	Opening Upper Forms Guide	11-5
11-5.	Inserting Forms	11-6
11-6.	Placing Forms on Tractor Pins	11-7
11-7.	Raising Ribbon Guides	11-8
11-8.	Ribbon Cassette Removal/Installation	11-8
11-9.	Installing the Ribbon	11-9
11-10.	Releasing Print Belt Tension	11-10
11-11.	Removing Print Belt	11-11
11-12.	Installing the Print Belt	11-12
B-1.	Test Adapter Cable	B-6

INTRO

PROC'D

ERP

3774 PTR

3775 PTR

DISK

2502

3501

3521

ID

3784

2770 EV

TESTS

SUMM

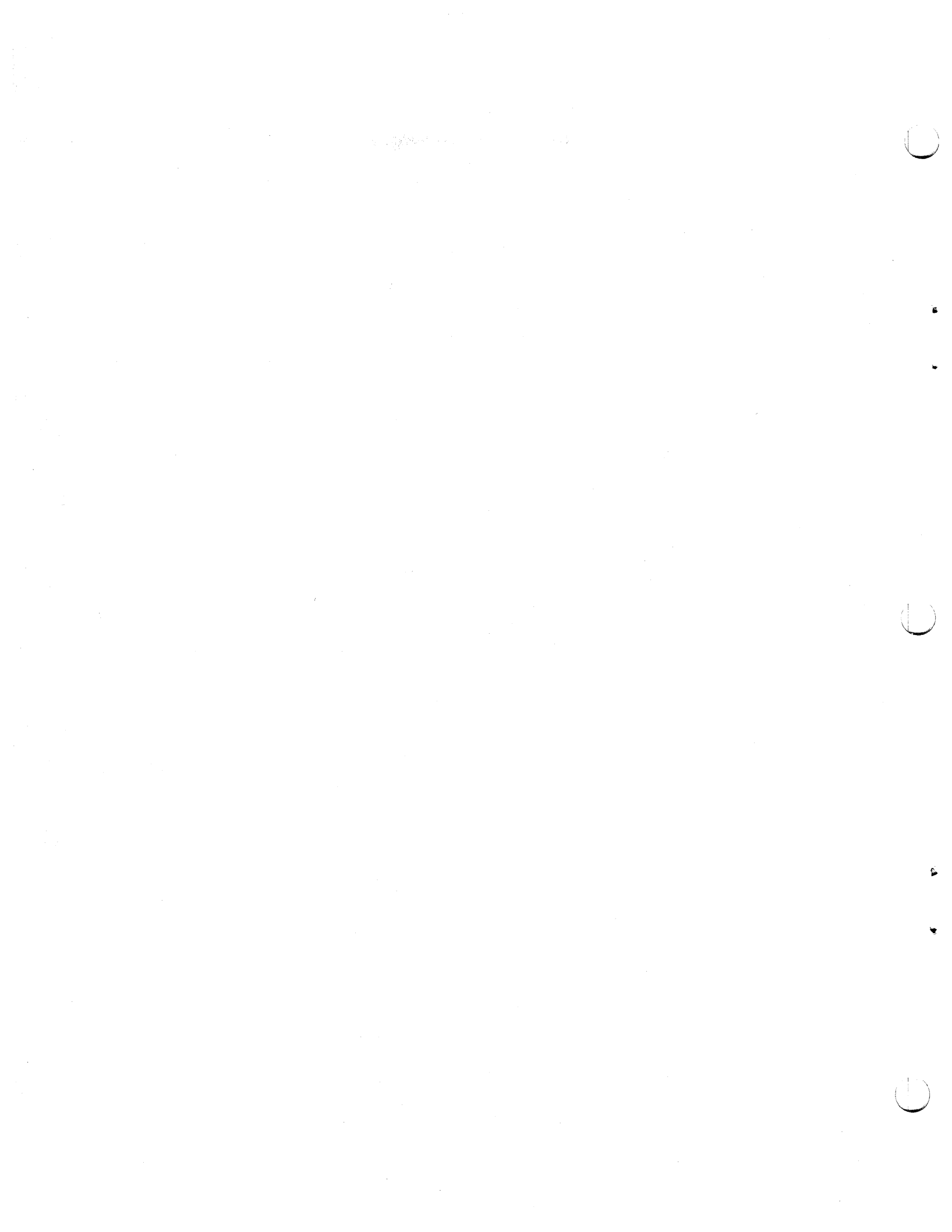

Chapter 1. Introduction

Figure 1-1 illustrates a typical IBM 3774 Communication Terminal, and Figure 1-2 illustrates a typical IBM 3775 Communication Terminal. Additional input and output devices (such as a card reader or a card punch) are added when required by the application. The input and output device chapters that follow (starting with Chapter 4) describe the operating procedures for these devices.

Figure 1-3, IBM 3774 and 3775 Data Path, illustrates the path of data when running a job on the terminal. A job is a unit of work on the terminal; for example, transferring punched card data from a card reader to the terminal's console printer. The "Overview of IBM 3774 and 3775 Communication Terminal Operation" section that starts Chapter 2 summarizes the steps in running a job on the terminal: (1) Power on, (2) Define the job's input and output device combination and features, (3) Start the job, and (4) End the job.

The basic components section that follows summarizes the function of the components in a typical terminal configuration. Use the *System Components* manual for a more detailed description of the terminal's functions and capabilities.

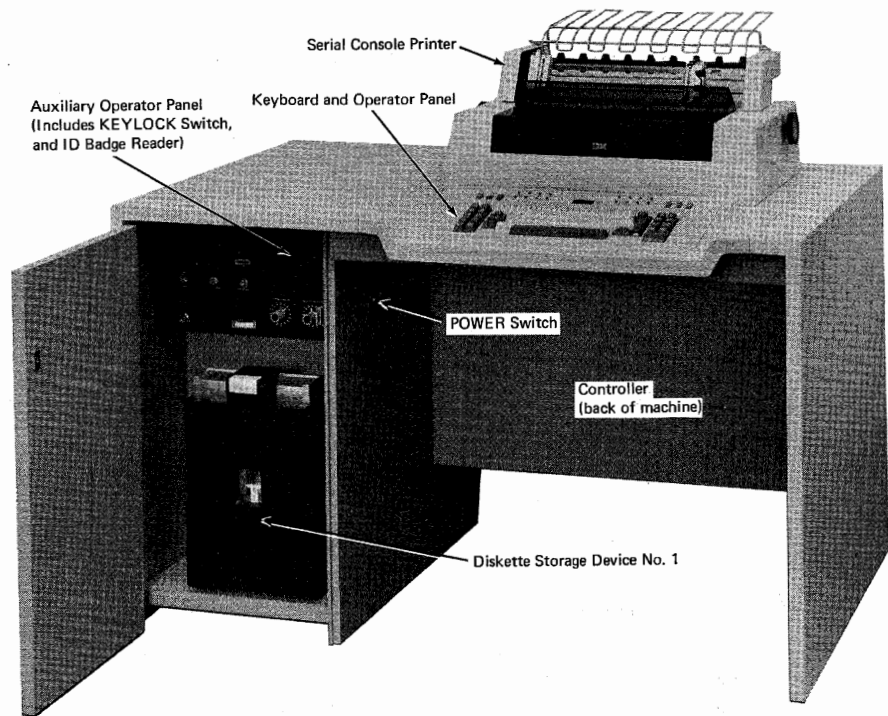

Figure 1-1. IBM 3774 Communication Terminal

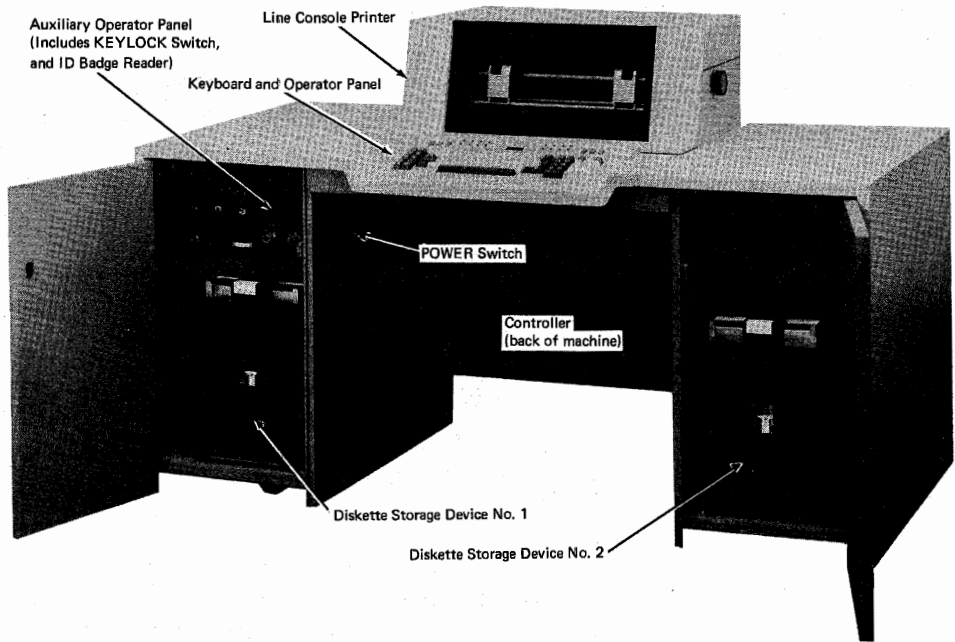
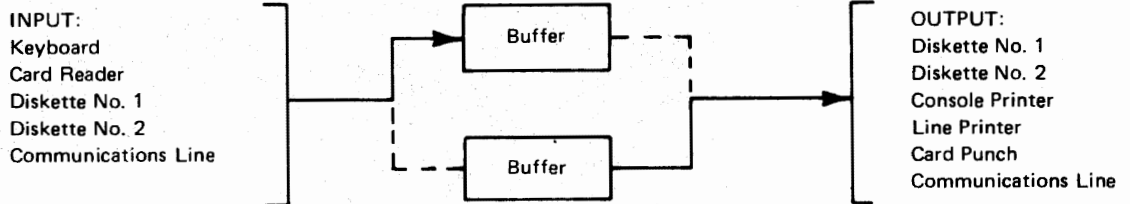

Figure 1-2. IBM 3775 Communication Terminal

1. You select the job's input and output device combination when you define and start a job as described in chapter 2.
2. Data from the job's input device transfers to the controller.
3. Temporary data storage areas (buffers) in the controller store the data for transfer to the job's output device.
4. First buffer fills, second empties



5. Second buffer fills, first empties

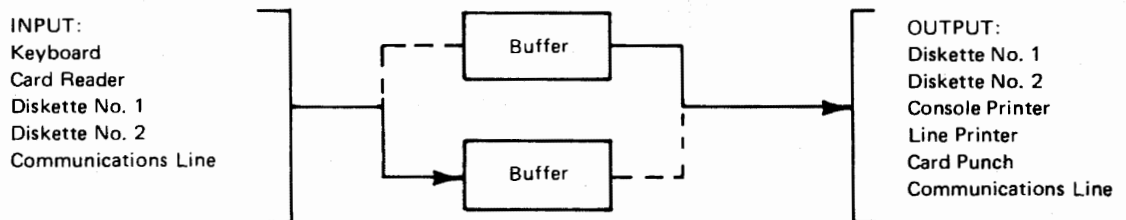

Figure 1-3. IBM 3774 and 3775 Data Path

The Basic Terminal Components

The Controller

- The controller controls the transfer of information between the system's input and output devices.
- You select the input and output devices for a specific job when you define or start a job.
- Two temporary storage areas (buffers) in the controller store information transmitted from the input device, and transfer the information to the output device.
- The buffers alternate in use between input and output. At any one time, one buffer is dedicated to input and the other to output. When the input buffer fills and the output buffer empties, they exchange functions. This arrangement allows the overlap of input and output operations. For example, when entering keyboard information for transfer to the Diskette Storage Device, you need not wait for the information to be written on the diskette to continue; keying continues into the second buffer while the previously entered information is being written on the diskette.
- When you turn the operator panel EXTEND/ALARM switch on, the buffer operation changes to a single (larger) buffer. When using a single buffer for keyboard entry, you enter data in the buffer and the data transfers to the output device when the buffer fills. Keying to the buffer continues when data transfer to the output device completes.
- Functional tests automatically check controller functions each time you turn the terminal's power on. You check that these tests ran correctly when you perform the power on procedure that is described in Chapter 2.

The Console Printer

Two types of console printers are available: a serial console printer (for the IBM 3774 Communication Terminal), or a line console printer (for the IBM 3775 Communication Terminal).

Serial Console Printer (for the IBM 3774 Communication Terminal)

- The serial console printer prints serially by character by selectively pushing print wires forward to contact an inked ribbon and the paper as the print mechanism moves across the print line. The printer is bidirectional; prints as the print head moves in either the left-to-right or the right-to-left motion across the page.
- The print head moves to the right after printing each character entered from the keyboard (to allow the viewing of the character) when the PRINT VIEW key is pressed. The PRINT VIEW key is described in the Using the Keyboard Buffer Edit Keys section in Chapter 2.
- The print position indicator shown in Chapter 4 indicates the next position to be printed.

Note: The printer's print position indicator is functional only when the terminal is in Print View mode, and is functional for print positions 1 through 124; this is described in more detail in the description of the PRINT VIEW key (see "Using the Keyboard Buffer Edit Keys") in Chapter 2.

- Margins, horizontal and vertical tab stops, and forms length are electronically controlled. You define these tab settings when you perform one of the procedures described in the "Entering Operator Defined Jobs" sections in Chapter 2.

Line Console Printer (for the IBM 3775 Communication Terminal)

- Prints a line at a time when printing information from the controller buffer.
- The printable characters are on a continuously rotating print belt. As the print belt rotates, a comparison is made between the character in front of each print hammer and the character that is to be printed in that print position. The print position hammer fires, forcing the paper and ribbon against the character on the print belt, when the character is in the correct position to print.

- When you pause during keyboard entry, or at the end of the print line, the printer platen automatically lowers to make the line you are printing visible. The platen rises automatically when printing continues.
- The print position indicator shown in Chapter 5 indicates the next position to be printed.
- Margins, horizontal and vertical tab stops, and forms length are electronically controlled. You define these tab settings when you perform one of the procedures described in the "Entering Operator Defined Jobs" sections in Chapter 2.

The Keyboard and Operator Panel

- The keyboard has character keys, a space bar, and other typewriter-like control keys. The arrangement of these keys is similar to that on a typewriter keyboard.
- Keys for controlling system operation are located on either side of the keyboard; switches for controlling system operation are located above the keyboard.
- Lights located above the keyboard indicate system status and error conditions.
- The numeric position readout (NPR) indicators display a three digit number that indicates either the current record number when running a Diskette Storage Device job, or error conditions. When the operator panel OPRN CHECK or SYSTEM CHECK indicator is on, the number in the NPR indicates a special system status or error condition; the condition for each message-type NPR display is listed in the "Error Recovery and Problem Identification" section.

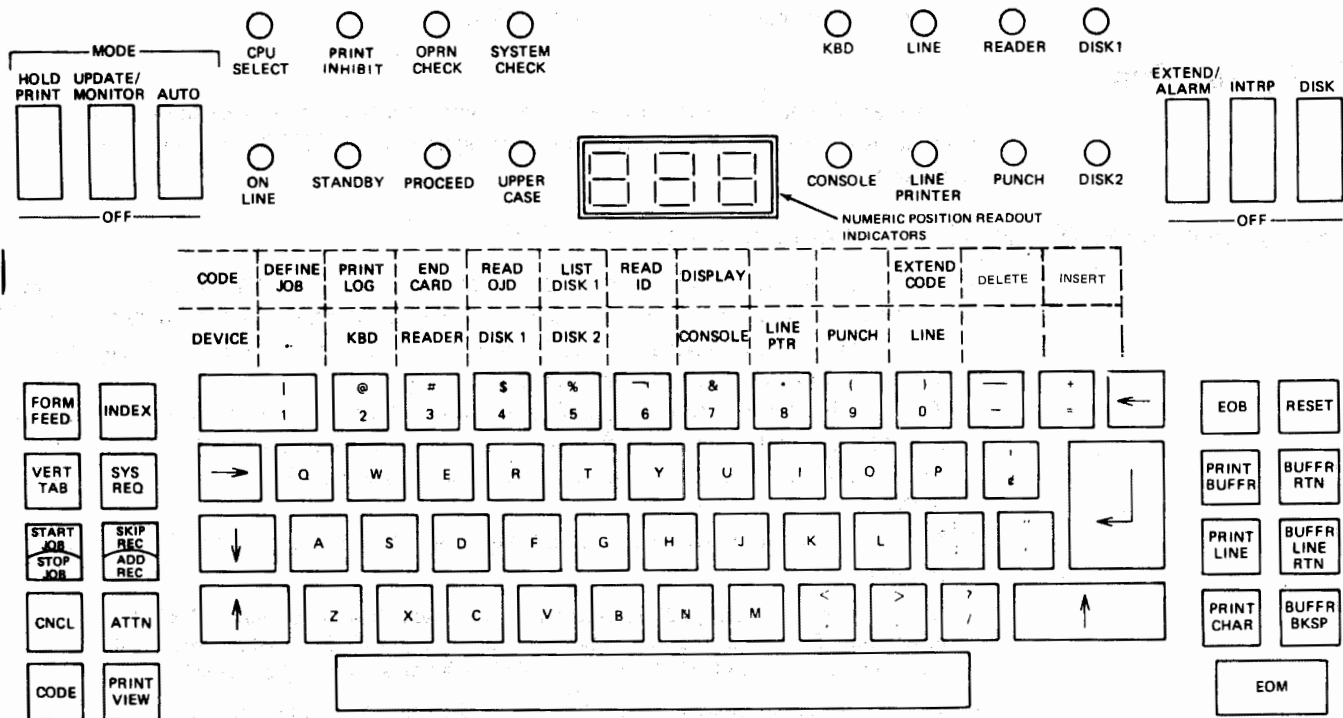

This figure shows the EBCDIC keyboard arrangement for use in the U.S. and Canada.

Figure 1-4. Keyboard and Operator Panel

The Diskette Storage Device

- Information is recorded on a small operator-changeable diskette.
- The Diskette Storage Device records information from any of the system's input devices, and information from the communications line.
- Information from system input devices can be stored on the diskette, and later transmitted to a central processor.

- Up to five operator defined jobs can be stored on the diskette, and read into the controller when needed. These jobs are described in the "Entering Operator Defined Jobs" sections in Chapter 2.
- The information on the diskette is divided into records. Each record is identified by a record number (1 through 948); this number is used later to recall a record for updating, correction, or as a starting point for transmission to an output device or the communications line. During a Diskette Storage Device job, the record number displays in the operator panel readout indicators.
- The "Diskette Storage Device" chapter provides more information on using the Diskette Storage Device, and provides information on handling the diskette.

The Auxiliary Operator Panel

- The auxiliary operator panel has controls for adjusting the terminal's modem for best performance with the communication facility.

Note: A modem is a device that links the terminal to the communication facility used in communicating with a central processor. A modem modulates and demodulates signals transmitted over communication facilities.

- The panel has a key-operated lock used to prevent unauthorized use of the system and has a SYSTEM RESET key used to reset all controller functions.

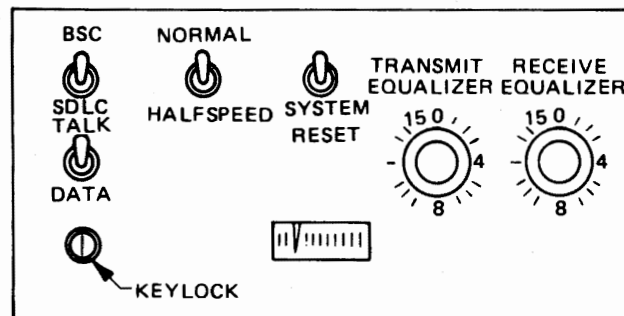
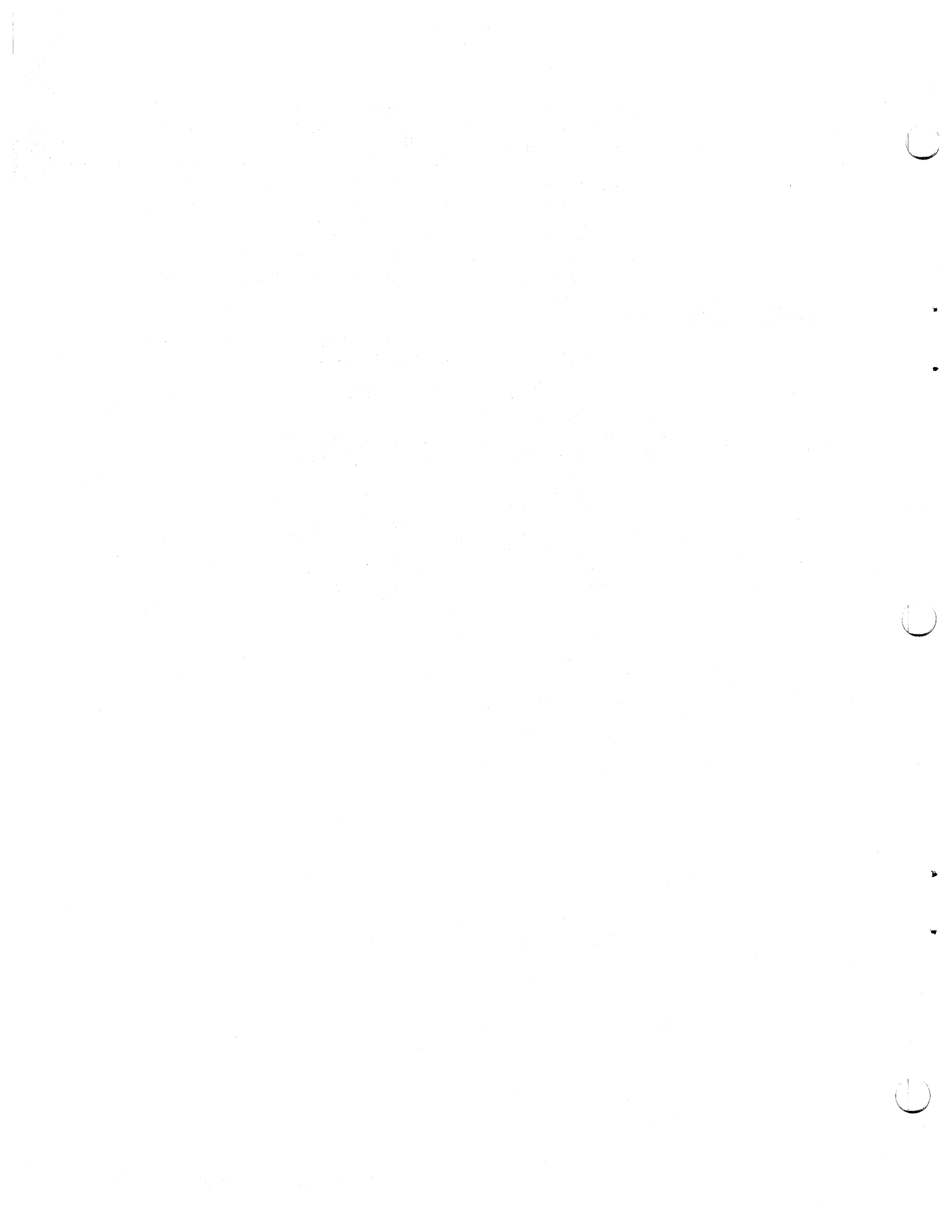

Figure 1-5. Auxiliary Operator Panel



Chapter 2. Operating Procedures

Overview of IBM 3774 and 3775 Communication Terminal Operation

PROC'D

- 1 **TURN POWER ON:** The controller runs functional tests.
Define a job when the tests complete.
- 2 **DEFINE THE JOB:** There are two ways to define a job:

Operator Defined Jobs

Use the keyboard, card reader or Diskette Storage Device to:

Define the job's identification number; the terminal stores up to five job definitions.

Define the job's input device and output device combination.

Define features used in the job.

Define a data set name for diskette jobs.

Define the printer forms format.

System Defined Jobs

When you start a job, use the keyboard to select one of the input and output device combinations already defined by the terminal; the terminal defines the other job parameters.

- 3 **START THE JOB:** Use the operator panel switches to select terminal functions. Use the CODE key to select additional terminal functions, and to select options required in using the communication line.

Select one of the *OPERATOR DEFINED* jobs, or select a *SYSTEM DEFINED* job.

Use the diskette data set name and starting record number already defined, or override by entering a new name and starting record number.

- 4 **STOP THE JOB:** The terminal is ready for starting the next job.

Operation Exercises

If you are not already familiar with the operation of the terminal, do the keyboard-to-Diskette-Storage-Device and the Diskette-Storage-Device-to-console-printer jobs that follow to become familiar with the terminal's operation.

Exercise Number 1: A Keyboard-to-Diskette-Storage-Device Job

- 1 If it is not already off, turn the terminal's POWER switch to the off position.
- 2 Turn these operator panel switches off:

HOLD PRINT
UPDATE/MONITOR
AUTO
EXTEND/ALARM
INTRP (Interrupt)
DISK

- 3 If it is not already unlocked, set the security keylock to the UNLOCKED position; the keylock is located on the auxiliary operator panel if this feature is installed on your terminal. Proceed to Step 4 if the keylock is not on the auxiliary operator panel.
- 4 Set the terminal's POWER switch to the on position.

Note: The terminal runs tests and control functions; during this time a series of numbers display in the operator panel readout indicators. When the tests and control functions end, the readout indicators are blank, and the PROCEED indicator turns on, the terminal is in local mode.

- 5 Install a diskette in the Diskette Storage Device. Use the Make Ready Procedure in Chapter 6 if you do not know how to install the diskette. Use a diskette that does not contain data required for another job; the diskette used in this procedure will be erased.
- 6 Select the "Create Diskette" function:

- A. Hold the CODE key down and enter a numeric "0" from the keyboard;
- B. Release the CODE key;
- C. Enter a numeric "2" from the keyboard.

Note: The number "2" displays in the readout indicators; this number indicates that the "Create Diskette" function is selected, and will be performed when you press the EOM key (Step 7). "Create Diskette" erases the diskette and creates it as an IBM 3774 or IBM 3775 diskette.

- 7 Press the EOM key.
Wait for the PROCEED indicator to come on before continuing. When the PROCEED indicator comes on, the "Create Diskette" function has completed, and the terminal is in local mode.

- 8 Start a keyboard-to-Diskette Storage Device job as follows:

- A. Press the START JOB key.
- B. Enter these characters from the keyboard to select the input and output device combination (keyboard and Diskette Storage Device):

S24

- C. Press the EOM key.

- D. A keyboard to Diskette Storage Device (system defined) job starts, and these operator panel indicators turn on:

PROCEED
KBD (Keyboard)
DISK 1

001 (The diskette record number displays in the readout indicators)

- 9 Enter this line (or a similar test data line) from the keyboard, and press the Return key at the end of the line.

This is a test line for transfer to the Diskette Storage Device.

Note: As you enter the line, the characters print on the console printer and enter the controller buffer. If you notice an error as you are entering from the keyboard, you can use the keyboard buffer edit keys to correct the error; operator exercises in how to use these keys are included in the "Using the Keyboard Buffer Edit Keys" section in this chapter.

- 10 Press the EOM key.
- 11 The test line you entered transfers from the controller buffer to the Diskette Storage Device. Diskette record number 002 displays in the readout indicators.

Note: Since the job started is a system defined job (and the keyboard is the job's input device), the terminal assigns a data set name of SK00 to the test line. You could continue entering data from the keyboard, and the data would transfer to the Diskette Storage Device each time you pressed the EOM key. For the purposes of this exercise, stop the job as described in Step 12.

- 12 Hold the CODE key down and press the START JOB key.

Note: The job stops, and the terminal goes to local mode; the PROCEED indicator turns on, all other operator panel indicators are off.

- 13 Now that a test line is written on the diskette (under data set name SK00), do "Exercise Number 2: A Diskette-Storage-Device-To-Console-Printer Job" to transfer the test line from the diskette to the console printer.

Exercise Number 2: A Diskette-Storage-Device-to-Console-Printer Job

After completing "Exercise Number 1: A Keyboard to Diskette Storage Device Job", perform this job.

- 1 Start a Diskette Storage Device to console printer job as follows:
 - A. Press the START JOB key.
 - B. Enter these characters from the keyboard to select the input and output device combination (Diskette Storage Device and console printer):
S47
 - C. Press the EOM key.
 - D. A Diskette-Storage-Device-to-console-printer (system defined) job starts, and these operator panel indicators turn on:
DISK 1
CONSOLE (Console Printer)
001 (The Diskette record number displays in the readout indicators)
- 2 The test line you entered in exercise one transfers from the Diskette Storage Device and prints on the console printer.
- 3 If your machine has only one Diskette Storage Device, the job ends automatically, and the terminal goes to local mode; the PROCEED indicator turns on, all other operator panel indicators are off. If your machine has two Diskette Storage Devices, the second one is automatically selected after the first diskette is read.

Power On/Off Procedures

Power On

Use this procedure before you turn the terminal's power on:

- 1 Turn the operator panel MODE switches off.
- 2 If it is not already unlocked, set the security keylock to the UNLOCK position; if the security keylock function is installed on the terminal, the switch is located on the auxiliary operator panel.

Note: No operations involving the terminal's keyboard can be performed when the security keylock is locked.

- 3 Set the BSC/SDLC switch to the proper position.
- 4 If a 2502 or 3521 (or both) is attached, turn the 3782 power switch(es) off.
- 5 Set the POWER switch to the on position.
 - The terminal runs functional tests and performs control diskette functions; numbers that indicate the status of the tests display in the readout indicators; do not press any keyboard keys (or operator panel switches) during the time.
 - The readout indicators are blank when the tests end successfully.
 - The terminal is ready for keyboard to printer operation (local mode) when the numeric position readout (NPR) indicators are blank and the operator panel PROCEED indicator turns on. The printer forms control is set as described under "Forms Control" in this chapter.

Note: The numeric position readout (NPR) displays "888" when the diagnostic tests end if you did not turn all operator panel MODE switches off (or set the security keylock to UNLOCKED) before turning power on. If this happens, turn the operator panel MODE switches off, and set the security keylock to UNLOCKED; the readout indicators should then be blank.

- 6 Turn the 3782 power switch(es) on.

Power Off

Perform this procedure before turning the terminal's power off:

- 1 Print the error log:
 - A. Hold the CODE key down, and enter a numeric "2" from the keyboard.
 - B. The error log prints on the console printer. If the error log does not print, press the SYSTEM RESET switch and repeat step A.
 - C. Save the error log printout. Service personnel use this log in determining the cause of machine failures. The time and date should be written on the printout.
- 2 Turn the 3782 power switch(es) off.
- 3 Before you turn power off, turn the operator panel HOLD PRINT switch on to return the serial console printer's print head to the home position.
- 4 Turn the POWER switch to the off position.

Remote Power Off

When transmission to the terminal ends, the central processor can send a message to the terminal that causes the terminal's power to turn off; the terminal's POWER switch goes to the off position. To turn power on again following a remote-power-off sequence, follow the power-on procedure previously described.

Forms Control

After you initially turn power on and the terminal has run the functional tests, the terminal is in local mode. With the terminal in this condition, you can load forms into the printer and simply key data to the printer; you can press **SYS REQ** to start a keyboard-to-communication line job; or if you turn the **INTRP** switch on, the central processor can select the terminal and start a communication line-to-printer job. In any of these cases, the terminal sets the forms control as follows:

- The left margin is set to 1.
- The maximum print position and the right margin are set to 132.
- No horizontal tab stops are set.
- No vertical tab stops are set.
- Forms length is set at 66 lines.
- The last printed line on the form is set at 61.

The forms control just described is also selected if you start a system-defined job. See the job start procedures in this chapter. To select a different forms control format than above, you must start an operator-defined job. Once you start an operator-defined job, the forms control defined in this job remains in effect throughout the job and for any following jobs, until you select an operator-defined or system-defined job having a different forms control format.

When a communication line job ends, and the central processor starts transmitting to the terminal, or if you press **SYS REQ** or start a system-defined job to continue transmitting from the terminal, the forms control format selected is the same as that for the original (operator or system defined) job that you started. On the 3774 with an attached 3784 printer, if a job using the 3784 printer is interrupted by the CPU (**INTRP** switch on), the forms control defined for the 3784 printer is also in effect for the console printer.

When a job using the printer ends, the forms do not space beyond the last printed line. For the next job started by the operator, printing begins at the left margin on this same line if you do not manually reposition the forms. To continue printing on the next line of the same form, you can press the **Return** (↵) key to space the forms one line, or press the **FORM FEED** key to begin printing on the next form.

PROC'D

Entering an Operator Defined Job From the Keyboard

Define mode is a mode of operation where a job's:

- A. Identification is defined; it is assigned a job number;
- B. Input and output device combination is defined;
- C. Features are defined;
- D. Diskette data set name is defined;
- E. Printer forms format is defined.

Before you start defining a job, check that the console printer has an adequate supply of forms, and that the forms are spaced beyond the last line that was printed on the form. After starting, do not open the printer cover, turn the **HOLD PRINT** switch on, or do any other action that interrupts defining the job; once started you should finish defining the job before performing some other operating procedure, to avoid having to re-define the entire job or a part of the job.

When in define mode, instructions (prompts) print on the console printer that identify the job parameter you will enter next in response to the prompt. The prompt repeats and the operator attention speaker sounds when the terminal detects an invalid response; when this happens, enter the valid response and continue the job definition.

If you notice an error when entering a job parameter (before you press the EOM key), you can use the **BUFR BACKSPACE** key to correct the error; this key is described in the "Using the Keyboard Buffer Edit Keys" section.

To Define a Job From the Keyboard:

- 1 If a job is running, allow the job to end, or stop the job as described in the "Ending a Job" section.
- 2 If not already in local mode, enter local mode by holding the **CODE** key down and pressing the **START JOB** key.

Note: When in local mode, the **PROCEED** indicator is on, and the **CPU SELECT** indicator may be on. All other operator panel indicators are off.

- 3 Enter define mode by holding the **CODE** key down and entering a numeric "1" from the keyboard.
- 4 When "ID = " prints on the console printer, enter the job identification number (1 through 5).

Note: The terminal stores up to five job definitions, each one is identified by a number (1 through 5). You will use this identification number later when you want to start this job.

- 5 Press the **EOM** key.

Note: You can stop before completely defining a job by holding the **CODE** key down and pressing the **START JOB** key. However, a job that is not completely defined will be invalid if you try to use it at job start time; a job definition should be stopped only when a higher priority task requires it, and the job must be re-defined.

If you stop after defining the printer's horizontal and vertical tab stops (or stop before defining them and they were previously defined), the terminal retains the tab stop definitions; when you define the job again, you need not re-enter the tab stops.

- 6 When "DEV = " prints on the console printer, enter one of these numbers to define the job's input and output device combination:

- 04 = Communications Line to Diskette No. 1
- 07 = Communications Line to Console Printer
- 08 = Communications Line to IBM 3784 Line Printer
- 09 = Communications Line to Card Punch

- 20 = Keyboard to Communication Line
- 24 = Keyboard to Diskette No. 1
- 25 = Keyboard to Diskette No. 2
- 27 = Keyboard to Console Printer*
- 28 = Keyboard to 3784 Printer
- 29 = Keyboard to Card Punch**
- 30 = Card Reader to Communication Line
- 34 = Card Reader to Diskette No. 1
- 35 = Card Reader to Diskette No. 2
- 37 = Card Reader to Console Printer
- 38 = Card Reader to IBM 3784 Line Printer
- 39 = Card Reader to Card Punch
- 40 = Diskette No. 1 to Communication Line
- 45 = Diskette No. 1 to Diskette No. 2
- 47 = Diskette No. 1 to Console Printer
- 48 = Diskette No. 1 to IBM 3784 Line Printer
- 49 = Diskette No. 1 to Card Punch
- 50 = Diskette No. 2 to Communication Line
- 57 = Diskette No. 2 to Console Printer
- 58 = Diskette No. 2 to IBM 3784 Line Printer
- 59 = Diskette No. 2 to Card Punch

Record Format Control Jobs:

For Record Format jobs, the alternate input and/or output device(s) must be specified, if used. If alternate input is not used, keyboard input must be specified. If alternate output is not used, console printer output must be specified.

- 24f = Keyboard to Diskette 1
- 25f = Keyboard to Diskette 2
- 27f = Keyboard to Console Printer
- 29f = Keyboard to Card Punch
- 34f = Card Reader to Diskette 1
- 35f = Card Reader to Diskette 2
- 37f = Card Reader to Console Printer
- 39f = Card Reader to Card Punch
- 44f = Diskette 1 to Diskette 1
- 45f = Diskette 1 to Diskette 2
- 47f = Diskette 1 to Console Printer
- 49f = Diskette 1 to Card Punch
- 57f = Diskette 2 to Console Printer
- 59f = Diskette 2 to Card Punch

Notes:

*Keyboard to Console Printer (27) is intended for typewriter-like jobs; printer tabs can be defined, but data does not enter the controller buffer; buffer edit functions cannot be performed.

**For IBM 3775 terminal keyboard-to-card punch jobs, the printer's left margin sets at print position 1 and the maximum print position sets at position 80; operator definitions for these print positions are ignored.

7 Enter the character(s) listed here if the feature is required in this job; otherwise, go on to the next step:

T = Transparent Mode*

C = Compress Option*

I = Inhibit Interpret Print (IBM 3521 Card Punch); will not interpret when used as a reader or as a punch.

D = Delete Data Sets After Read

(Deletes all data sets after reading, except the operator-defined-jobs data set)

Z = IBM 3521 Card Punch Readback Checking not used (inhibited)

*You can specify either the Compress option or the Transparent Mode option (not both) on any one job definition. The card reader must be the job's input device when you specify the Compress option. For a diskette-to-line job, you can specify only the transparent mode option. For Record Format Control jobs, do not specify Compress or Transparent Mode.

8 Press the EOM key.

9 When "DSN=" prints (for Diskette Storage Device jobs only) on the console printer, *either*:

A. Enter a data set name.

- A data set name has four characters; the first two characters must be alphabetic characters; the last two characters must be numeric characters.
- When you enter (define) a data set name, the terminal:
 - Transmits only the data set defined when the diskette is the job's input device.
 - Uses the defined data set name when the diskette is the job's output device.
- For Record Format Control jobs, the data set name is the name of the Record Format Control program data set.

B. Press the EOM key (Step 10) to bypass entering a data set name. If you bypass entering a data set name, the terminal:

Transmits all active data sets when the diskette is the job's input device.

The "DSN=" prompt repeats when the diskette is the job's output device; a data set name must be assigned. A data set name must also be specified for all record format control jobs, including diskette input jobs.

10 Press the EOM key.

11 When "SHF=" prints on the console printer, *either*:

A. Bypass the defining of the printer's horizontal tab stops as stated in the following procedure, OR

B. Define the printer's horizontal tab stops as described in the procedure that follows.

TO BYPASS DEFINING THE HORIZONTAL TAB STOPS:

Use either of these methods to bypass defining the horizontal tab stops:

- Press the EOM key, and horizontal tab stops are not defined; when this job is running:
 - The printer spaces one space each time a horizontal tab is received.
 - The left margin is defined at print position one.
 - The right margin is defined at print position 132.
- Enter an "=" character from the keyboard and press the EOM key; the horizontal tab stops will be as defined when this job number was previously defined; if you enter the "=" character and tab stops were not previously defined, the terminal's speaker sounds and the "SHF" prompt (Step 11) repeats.
 - Do not enter an "=" character if a prompting instruction has been repeated after an invalid entry has been made.

TO DEFINE THE HORIZONTAL TAB STOPS:

Note: For 3774 terminals only, the operator panel's readout indicators (NPR) display the console printer's print position during the time that horizontal tab stops are being defined; the NPR number can be used instead of the console printer's print position indicator when defining horizontal tab stops. The 3774 printer's print position indicator is not functional after print position 125. To set tabs after position 125, use the NPR number for reference.

- A. If the printer's print position indicator is at the print position of the left margin stop, enter the character "X"; if not, press the space bar repeatedly until you come to the position of the left margin stop and enter the character "X".
- B. Press the keyboard space bar repeatedly until you come to print position of a horizontal tab stop.
- C. Enter the character "X".
- D. Continue steps B and C until all horizontal tab stops are entered.

Note: You can bypass the next two steps, set right margin and print position (E and F), by pressing the EOM key (step 12); if you bypass these steps, the terminal defines the right margin and maximum print position at 132.

- E. Press the keyboard space bar repeatedly until you come to the right margin stop, and enter the character "R"; if the right margin stop and the maximum print position are the same, enter the character "B" instead of "R".
- F. Press the space bar repeatedly until you come to the maximum print position, and enter the character "M"; if the maximum print position and the right margin stop are the same, the "B" character you entered in step E already completed this entry.

12 Press the EOM key.

13 When "SVF=" prints on the console printer, *either*:

- A. Bypass the defining of the printer's vertical tab stops as stated in the following procedure, OR
- B. Define the printer's vertical tab stops as described in the procedure that follows.

TO BYPASS DEFINING THE VERTICAL TAB STOPS:

Use either of these methods to bypass defining the vertical tab stops:

- Press the EOM key, and vertical tab stops are not defined; when this job is running:

The printer spaces one line each time a vertical tab is received.

The print lines per form is defined as 61 lines.

The forms length is defined as 66 lines.

- Enter an "=" character from the keyboard and press the EOM key; the vertical tab stops will be as defined when this job number was previously defined; if you enter the "=" character and the tab stops were not previously defined, the terminal's speaker sounds and "SVF" prompt (Step 13) repeats.

Do not enter an "=" character if a prompting instruction has been repeated after an invalid entry has been made.

PROC'D

TO DEFINE THE VERTICAL TAB STOPS USING BSC:

Note: During the vertical tab stop definition (using BSC only) it is permissible not to enter tab stop numbers in ascending numerical sequence; however, out-of-sequence vertical tab stops will be skipped over (ignored) when successive VT (vertical tab) characters are used to cause skipping. For example, if the tab stops were assigned in the sequence 1, 3, 2, 4, 5, successive VT characters would cause skips to tab stops 1, 3, 4, and 5. Tab stop 2 would be ignored.

- A. Press the Return key repeatedly until you come to the line number of a vertical tab stop.

For example: If the first tab stop is to be entered at line 5 of the form, you would press the Return key 4 times to space the printer to the fifth print line.

- B. Enter the number(s) of the tab stop(s) for this line; separate the numbers with a comma (,) if you enter more than one tab stop number for the same line.

For example, to define tab stops seven, eight, and nine for a line you would enter: 7, 8, 9.

Note: The vertical tab stop numbers are equivalent to the channel numbers used by the IBM 2770 Data Communication System's "Vertical Format Control" feature. The IBM 2770 uses a 12 channel carriage tape; holes punched in the tape define the print line and channel number of an IBM 2770 tab stop.

- C. Continue steps A and B until all (up to twelve) vertical tab stops are entered.

Note: Once you use a number for a vertical tab stop, do not use it for lines that follow; if you do, the terminal defines the tab stop number at the line it was last entered (previous entries for the number are ignored).

- D. Press the Return key repeatedly until you come to the last print line of the form, and enter the character "L"; or if the last print line number is the same as the end of form line number, enter the character "B".

- E. Press the Return key repeatedly until you come to the end of the form, and enter the character "F"; or if the end of form is the same as the last print line number, the "B" character you entered in step D already completed this entry.

Note: The maximum form length is 127 lines.

TO DEFINE THE VERTICAL TAB STOPS USING SDLC:

- A. Press the Return key repeatedly until you come to the line at which a vertical tab stop is to be set.

- B. Enter an "X" character.

- C. Repeat Steps A and B until all (up to 12) vertical tab stops are set.

- D. Press the Return key repeatedly until you come to the last line to be printed on the form, and enter an "L". If the last printed line and the end of form line are the same, enter a "B". (If you enter a "B", go to Step 14.)

Note: The maximum form length is 127 lines.

- E. Press the Return key repeatedly until you come to the end of the form, and enter an "F".

- 14** Press the EOM key.

- 15** When "ID =" prints, *either*:

- A. Start defining another job (step 4), OR

- B. Exit from define mode by holding the CODE key down and pressing the START JOB key.

EXAMPLE:

- 1 Enter local mode by holding the CODE key down and pressing the START JOB key. The PROCEED indicator turns on; all other indicators are off.
- 2 Enter define mode by holding the CODE key down and entering the number "1" from the keyboard.
- 3 "ID =" prints on the console printer; identify the job number by:
 - A. Entering a numeric "1" (the job's identification number) from the keyboard;
 - B. Pressing the EOM key.
- 4 "DEV =" prints on the console printer; define the job's input and output device combination by:
 - A. Entering the number "24" from the keyboard; this defines a Keyboard-to-Diskette No. 1 job;
 - B. Pressing the EOM key.
- 5 "DSN =" prints on the console printer. Enter the data set name "SKOO" from the keyboard.
- 6 "SHF =" prints on the console printer; bypass defining the printer's horizontal tab stops by pressing the EOM key.

Note: When the job starts, the printer will space one space each time it receives a horizontal tab.
- 7 "SVF =" prints on the console printer; bypass defining the printers vertical tab stops by pressing the EOM key.

Note: When the job starts, the printer will space one line each time it receives a vertical tab.
- 8 "ID =" prints on the console printer; hold the CODE key down and press the START JOB key to exit from define mode.

Figure 2-1. Example of a Keyboard-to-Diskette Job Defined From the Keyboard

Entering an Operator Defined Job From the Card Reader

TO DEFINE A JOB FROM THE CARD READER:

- 1 Turn the operator panel DISK switch off.
- 2 Place the card reader in a ready condition, and load the job definition card(s).

Note: When using the IBM 2502 Card Reader, turn the reader's EOF (end-of-file) switch on. When using the IBM 3501 Card Reader (or the IBM 3521 Card Punch as a reader), place an end-of-file (/EOF) card after the last job definition card in the hopper.

- 3 Hold the CODE key down and press the numeric "4" key.
 - The job definition card(s) read.
 - The numeric position readout is blank, and the PROCEED indicator turns on when the job definition reads successfully.
 - The numeric position readout displays "232" if the terminal detects an invalid job identification number, or all of the card columns required are not punched. When this happens, correct the card and re-enter the job definition. Do not use a job definition that has been detected as invalid.

Note: Not all fields are checked, but must be punched as described in Figure 2-2.

- Figure 2-2, Card Format for an Operator Defined Job, illustrates the card format required for a job definition.
- Figure 2-3, Example of Card Format for Operator Defined Jobs, provides an example of the card format. All fields must be punched as indicated. The terminal checks the job ID number only.
- You can define from one to five jobs from the card reader at one time; once defined, they are available for selection when you perform the Starting a Job procedure.

Note: Read a maximum of six cards (five job definition cards plus one IBM 3501 or 3521 end-of-file card); do not add additional cards in the hopper until the job definition cards are read.

**CARD
COLUMN**

JOB DEFINITION INFORMATION PUNCHED

- 01 Punch the job's identification number (1 through 5). You will use this number to start this job. This entry must be punched.
- 02 03 Punch one of these numbers in columns 2 and 3 to define the job's input device and output device. This entry must be punched.

- 04 = Communication Line to Diskette No. 1
- 07 = Communication Line to Console Printer
- 08 = Communication Line to IBM 3784 Line Printer
- 09 = Communication Line to Card Punch

- 20 = Keyboard to Communication Line
- 24 = Keyboard to Diskette No. 1
- 25 = Keyboard to Diskette No. 2
- 27 = Keyboard to Console Printer*
- 28 = Keyboard to 3784 Printer
- 29 = Keyboard to Card Punch**

- 30 = Card Reader to Communication Line
- 34 = Card Reader to Diskette No. 1
- 35 = Card Reader to Diskette No. 2
- 37 = Card Reader to Console Printer
- 38 = Card Reader to IBM 3784 Line Printer
- 39 = Card Reader to Card Punch

- 40 = Diskette No. 1 to Communication Line
- 45 = Diskette No. 1 to Diskette No. 2
- 47 = Diskette No. 1 to Console Printer
- 48 = Diskette No. 1 to IBM 3784 Line Printer
- 49 = Diskette No. 1 to Card Punch

- 50 = Diskette No. 2 to Communication Line
- 57 = Diskette No. 2 to Console Printer
- 58 = Diskette No. 2 to IBM 3784 Line Printer
- 59 = Diskette No. 2 to Card Punch

Notes:

*Keyboard to Console Printer (27) is intended for typewriter-like jobs; printer tabs can be defined, but data does not enter the controller buffer; buffer edit functions cannot be performed.

**Keyboard to Card Punch (29) jobs: When using the IBM 3775 terminal, define the printer's left margin at print position 1, and the maximum print position at print position 80.

- 04 Punch the character listed here to select the feature(s) listed; punch a numeric "0" in this column if none of the features are required.

CHAR. PUNCHED	NO		COMPRESS**	TRANSPARENT MODE**
	INTERPRET* IBM 3521 CD READER	INTERPRET* IBM 3521 CD PUNCH		
2	X	X		
4			X	
6	X	X	X	
8				X
A	X	X		X

*Will interpret print when used as a reader.

Will not interpret print when used as a punch.

**Compress and Transparent Mode may not be specified for Record Format Control jobs.

Figure 2-2. Card Format for an Operator Defined Job (Part 1 of 5)

CARD
COLUMN

JOB SETUP INFORMATION PUNCHED

05 Punch the character listed here to select the feature(s) listed; punch a numeric "0" if none of the features are required.

CHAR. PUNCHED	INHIBIT 3521 READ-BACK CHECKING	RECORD FORMAT CONTROL
4	X	
8		X
C	X	X

06 Punch a numeric 4 in this column to select the "Transmit all active disk data sets" function; punch a numeric "0" in this column if the function is not required.

07 Punch a numeric 4 in this column to select the Delete all Data Sets after Transmission function; punch a numeric "0" in this column if the function is not required.

08 11 Punch a four-character disk data set name; punch a numeric "0" in this column if the function is not required.

- The data set name has four characters.
- The first two characters must be alphabetic characters.
- The last two characters must be numeric characters.
- For Record Format Control jobs, the data set name is the name of the Record Format Control program data set.

12 13 Punch the printer's maximum print position, in hexadecimal*. This entry must be punched, and must not be greater than 132.

14 15 Punch the printer's right margin print position, in hexadecimal*; the right margin must be greater in value than the left margin. This entry must be punched, and must not be greater than 132.

16 49 Punch the print position of the left margin stop and the horizontal tab stops as shown in the "Horizontal Tab Definitions in Card Columns 16 through 49" chart that follows; these card columns must be punched—see the note below. Note that you punch the binary value of the tab stop print position in the card column indicated on the chart. The first print position defined is the left margin stop. The remaining positions defined are the tab stops.

Punch the character "F" in card columns 16 through 49 if you are not using horizontal tab stops in the job application.

If tab stops are used, punch a zero (0) in the card columns that do not contain a tab stop.

50 51 Punch the printer's form length, in hexadecimal*; the maximum form length is 127 lines. This entry must be punched.

52 53 Punch the printer forms last print line, in hexadecimal*; last print line must be no greater in value than the form length. This entry must be punched.

54 77 Punch the line number of the printer's vertical tab stops (up to twelve), in hexadecimal*. Vertical tab stops should be entered in ascending numerical sequence. Out-of-sequence vertical tab stops will be ignored if successive VT characters are used to cause skipping.

Punch a numeric "0" in card columns 54 through 77 if you are not using vertical tab stops in the job application.

78 80 Leave these columns blank.

*Use the "Decimal to Hexadecimal Conversion Chart" that follows.

Figure 2-2. Card Format for an Operator Defined Job (Part 2 of 5)

DECIMAL TO HEXADECIMAL CONVERSION CHART

PROC'D

FIRST HEXA-DECIMAL DIGITS	SECOND HEXADECIMAL DIGIT															
	0	1	2	3	4	5	6	7	8	9	A	B	C	D	E	F
0	0000	0001	0002	0003	0004	0005	0006	0007	0008	0009	0010	0011	0012	0013	0014	0015
1	0016	0017	0018	0019	0020	0021	0022	0023	0024	0025	0026	0027	0028	0029	0030	0031
2	0032	0033	0034	0035	0036	0037	0038	0039	0040	0041	0042	0043	0044	0045	0046	0047
3	0048	0049	0050	0051	0052	0053	0054	0055	0056	0057	0058	0059	0060	0061	0062	0063
4	0064	0065	0066	0067	0068	0069	0070	0071	0072	0073	0074	0075	0076	0077	0078	0079
5	0080	0081	0082	0083	0084	0085	0086	0087	0088	0089	0090	0091	0092	0093	0094	0095
6	0096	0097	0098	0099	0100	0101	0102	0103	0104	0105	0106	0107	0108	0109	0110	0111
7	0112	0113	0114	0115	0116	0117	0118	0119	0120	0121	0122	0123	0124	0125	0126	0127
8	0128	0129	0130	0131	0132	0133	0134	0135	0136	0137	0138	0139	0140	0141	0142	0143
9	0144	0145	0146	0147	0148	0149	0150	0151	0152	0153	0154	0155	0156	0157	0158	0159
A	0160	0161	0162	0163	0164	0165	0166	0167	0168	0169	0170	0171	0172	0173	0174	0175
B	0176	0177	0178	0179	0180	0181	0182	0183	0184	0185	0186	0187	0188	0189	0190	0191
C	0192	0193	0194	0195	0196	0197	0198	0199	0200	0201	0202	0203	0204	0205	0206	0207
D	0208	0209	0210	0211	0212	0213	0214	0215	0216	0217	0218	0219	0220	0221	0222	0223
E	0224	0225	0226	0227	0228	0229	0230	0231	0232	0233	0234	0235	0236	0237	0238	0239
F	0240	0241	0242	0243	0244	0245	0246	0247	0248	0249	0250	0251	0252	0253	0254	0255

Example: Card Columns 14 and 15 (Right Margin Print Position)

To define the printer's right margin at print position 120:

1. Find the decimal number "0120" in the body of the chart.
2. Read across the chart to the left to find the first hexadecimal digit (7). You would punch a number "7" in card column 14.
3. Read up from the "0120" to find the second hexadecimal digit (8). You would punch a number "8" in card column 15.

Figure 2-2. Card Format for an Operator Defined Job (Part 3 of 5)

HORIZONTAL TAB DEFINITIONS IN CARD COLUMNS 16 THROUGH 49											
PRINT POSITION	{0000	0000	0111	1111	1112	2222	2222	2333	3333		
	{1234	5678	9012	3456	7890	1234	5678	9012	3456		
BINARY VALUE	8421	8421	8421	8421	8421	8421	8421	8421	8421		
CARD COLUMN	16	17	18	19	20	21	22	23	24		
PRINT POSITION	{3334	4444	4444	4555	5555	5556	6666	6666	6777		
	{7890	1234	5678	9012	3456	7890	1234	5678	9012		
BINARY VALUE	8421	8421	8421	8421	8421	8421	8421	8421	8421		
CARD COLUMN	25	26	27	28	29	30	31	32	33		
PRINT POSITION	{0000	0000	0000	0000	0000	0000	0001	1111	1111		
	{7777	7778	8888	8888	8999	9999	9990	0000	0000		
	{3456	7890	1234	5678	9012	3456	7890	1234	5678		
BINARY VALUE	8421	8421	8421	8421	8421	8421	8421	8421	8421		
CARD COLUMN	34	35	36	37	38	39	40	41	42		
PRINT POSITION	{1111	1111	1111	1111	1111	1111	1111				
	{0111	1111	1112	2222	2222	2333	3333				
	{9012	3456	7890	1234	5678	9012	3456				
BINARY VALUE	8421	8421	8421	8421	8421	8421	8421				
CARD COLUMN	43	44	45	46	47	48	49				

Figure 2-2. Card Format for an Operator Defined Job (Part 4 of 5)

HORIZONTAL TAB DEFINITIONS IN CARD COLUMNS 16 THROUGH 49 (CONT.)

Note: When more than one tab setting is required for print positions assigned to one of the card columns, add the binary values as follows, and punch the character indicated here in the card:

BINARY VALUES	CHARACTER PUNCHED
1	1
2	2
1+2	3
4	4
4+1	5
4+2	6
4+2+1	7
8	8
8+1	9
8+2	A
8+2+1	B
8+4	C
8+4+1	D
8+4+2	E
8+4+2+1	F

FOR EXAMPLE:

To define horizontal tab stops in print positions 8, 16, 78, and 80:

- Position 8 is the only tab stop for card column 17, you would punch a 1 in column 17.
- Position 16 is the only tab stop for card column 19, you would punch a 1 in column 19.
- Positions 78 and 80 are both in card column 35, you would punch a 5 in column 35; the binary values of 4 (for print position 78) and 1 (for print position 80) are equal to 5.

Figure 2-2. Card Format for an Operator Defined Job (Part 5 of 5)

Writing Operator Defined Jobs to the Diskette Storage Device

Once the operator defined jobs are entered in the controller, you can use this procedure to store the job definitions on a diskette.

TO WRITE OPERATOR DEFINED JOBS TO THE DISKETTE STORAGE DEVICE:

- 1 Place the diskette in the Diskette Storage Device, close the diskette door, and wait about 10 seconds for the device to come to a ready condition.
- 2 Hold the CODE key down and press the numeric "0" key; then, release the CODE key.
- 3 Enter the number "3" from the keyboard.
The number "3" displays in the numeric position readout.
- 4 Press the EOM key.
The operator job definitions (up to 5) write from the controller to the diskette.

Entering Operator Defined Jobs from the Diskette Storage Device

Once the operator defined jobs are written on a Diskette, you can use this procedure to enter the job definitions in the controller.

TO ENTER OPERATOR DEFINED JOBS FROM THE DISKETTE STORAGE DEVICE:

- 1 Turn the operator panel DISK switch on.
- 2 Place the diskette in the Diskette Storage Device, close the diskette door, and wait about 10 seconds for the device to come to a ready condition.
- 3 Hold the CODE key down, and press the numeric "4" key.
 - The job definitions read from the Diskette Storage Device to the controller.
 - You can select any of these (up to five) operator job definitions when you perform the "Starting a Job" procedure.

Starting a Job Using BSC

Use this procedure to start a job once it is defined as described in the "Operator Defined Jobs" section; and use this procedure to select and start one of the system defined jobs.

PROC'D

Two examples of the procedure for starting a job follow this procedure.

- 1 If a job is running, allow the job to end, or stop the job as described in the "Ending a Job" section.
- 2 If not already in local mode, enter local mode by holding the CODE key down and pressing the START JOB key.

Note: When in local mode, the PROCEED indicator is on, and the CPU SELECT indicator may be on. All other operator panel indicators are off.

- 3 Place the input and output devices used in this job in a ready condition; use the "Make Ready Procedure" that is the first section in the chapter that describes the device:

3774 Console Printer . . . Chapter 4
3775 Console Printer . . . Chapter 5
Diskette Storage Device . . . Chapter 6
IBM 2502 Card Reader . . . Chapter 7
IBM 3501 Card Reader . . . Chapter 8
IBM 3521 Card Punch . . . Chapter 9
IBM 3784 Line Printer . . . Chapter 11

Note: If starting a printer job that requires installing different length forms, press the FORM FEED key before installing the forms to set the terminal's controller at the first print line of a form. When the new forms are installed, position them to the first print line.

If starting a job that uses the same form length as the previous job, you may want to space the printer forms one line by pressing the Return key, or space the forms to the first print line of a new form by pressing the FORM FEED key. If there is printing on the current line, you must press the Return or the FORM FEED key.

- 4 Set the operator panel switches as follows:

Note: A more detailed description of the use of each of these switches is included under "Using the Operator Panel Switches" in this chapter.

HOLD PRINT	ON:	Always off when starting a job; after a job starts, turn on to temporarily stop the printer while adjusting forms or some other operator action; should be turned off as soon as possible to allow the job to continue.
	OFF:	To continue printing.
UPDATE/MONITOR	ON:	When the job's output device is not the console printer, and you want a printed copy (monitor print) of data that transfers to the output device; must be on before the job starts to get monitor printing during the job. Monitor printing cannot be done during a diskette-to-diskette job.
	ON:	Used after a keyboard to diskette job starts to update diskette records.
	OFF:	Monitor printing or diskette record update not required.
AUTO	ON:	For keyboard jobs, to automatically transfer data to the output device when the buffer fills; can be turned on after the job starts.
	ON:	For diskette to console printer jobs, to temporarily stop the job after the first record prints. Turn the AUTO switch back off to continue the job.
	ON:	For keyboard to card punch jobs, to automatically punch a card each time you press the keyboard Return key; can be turned on after the job starts.
	OFF:	For the other job applications.
EXTEND/ALARM	ON:	For keyboard to diskette or communication line jobs to extend buffer size; be turned on before the job starts.
	ON:	For jobs other than keyboard, the audible alarm sounds for conditions that require operator attention; can be turned on after the job starts.
	OFF:	For the other job applications, and for Record Format Control jobs.

INTRP (Interrupt)	ON:	Allows central processor interrupt of active jobs that do not define the communication line as an input or output device.
	OFF:	Central processor interrupt not allowed.
DISK	ON:	All data from the central processor (communication line) transfers to the Diskette Storage Device, except Data containing a "DC1" (X'11') which transfers to the console printer.
	OFF:	Input data from the central processor (communication line) transfers to the output device defined by the job, to the device selected by the central processor, or (when device selection is not used) to the console printer.
NORMAL/ HALF SPEED	NORMAL:	The terminal's modem operates at its rated speed.
	HALF SPEED:	The terminal's modem operates at half its rated speed.

Note: After changing the switch's setting, hold the CODE key down and press the CNCL (Cancel) key; then, release the CODE key.

5 Set any of the following modes of operation by holding the CODE key down and entering one of these characters:

Note: The "Using the CODE key" section in this chapter provides more detail on the use of the following functions.

- I Selects Inquiry mode.
- X Selects Ignore ETX/EOT.
- U Selects Monocase.
- D De-selects the above functions (I, X, and U).
- A Selects automatic disconnect. (CODE/Q for Belgian keyboard)
- M Selects manual disconnect.
- S Selects SNBU (switched network backup), and terminates leased line operation.
- R Terminates SNBU, and selects leased line operation.
- J Selects RJE.
- L Selects 6 lines per inch for 3775 console printer jobs. The terminal is in 6 lines per inch after power on.
- K Selects 8 lines per inch for 3775 console printer jobs.

Note: The terminal must be in *local mode* to select (or de-select) these functions; the terminal is in local mode at this point in the start job procedure. When in local mode, the PROCEED indicator is on. All other operator panel indicators are off.

Once these functions are selected, they need not be reselected at each job start time unless the terminal's power was turned off. At power on time the terminal automatically selects the CODE functions D, A, L, and R listed above.

After selecting SNBU (CODE and "S"), hold the CODE key down and press the CNCL (Cancel) key to complete termination of leased line operation.

6A For *OPERATOR DEFINED* jobs, press the START JOB key, and enter the job number (1 through 5).

6B For *SYSTEM DEFINED* jobs, press the START JOB key and enter the three characters listed here to select the job's input and output device combination:

Note: To start a keyboard-to-communication line job (with the system-defined job parameters listed below), press the SYS REQ key; you need not press START JOB and enter characters as listed below.

- S04 = Communication Line to Diskette No. 1
- S07 = Communication Line to Console Printer
- S08 = Communication Line to IBM 3784 Line Printer
- S09 = Communication Line to Card Punch
- S20 = Keyboard to Communication Line
- S24 = Keyboard to Diskette No. 1
- S29 = Keyboard to Card Punch
- S30 = Card Reader to Communication Line
- S34 = Card Reader to Diskette No. 1
- S37 = Card Reader to Console Printer
- S38 = Card Reader to IBM 3784 Line Printer
- S39 = Card Reader to Card Punch
- S40 = Diskette No. 1 to Communication Line
- S45 = Diskette No. 1 to Diskette No. 2
- S47 = Diskette No. 1 to Console Printer
- S48 = Diskette No. 1 to IBM 3784 Line Printer
- S49 = Diskette No. 1 to Card Punch
- S50 = Diskette No. 2 to Communication Line

Note: For *SYSTEM DEFINED* jobs, the terminal always defines the job parameters listed here:

- Print lines per form = 61 lines.
- Form length = 66 lines.
- Left margin = print position number one.
- Right margin = print position 132, with the exception of the card punch jobs described in the "Card Punch Jobs Note" at the end of this list.
- Printer spaces one space each time a horizontal tab is received.
- Printer spaces one line each time a vertical tab is received.
- Transparent mode not selected.
- Compress option not selected.
- Interpret print is selected when the IBM 3521 is used as a punch.
- Interpret print is not selected when the IBM 3521 is used as a reader.
- Delete data sets after transmission not selected.
- IBM 3521 Card Punch Readback checking is active.

Card Punch Jobs: For IBM 3775 terminal keyboard-to-card punch jobs, or jobs that monitor print card punch data, the left margin sets at print position 1, and the right margin sets at print position 80.

7A For *OPERATOR DEFINED* jobs, use the data set name already defined, or override by entering a new data set name.

- A data set name has four characters.
- The first two characters must be alphabetic characters.
- The last two characters must be numeric characters.

Note: When data sets are received during communications line jobs, and the Ignore ETX/EOT function is not defined, the last two (numeric) characters increment as each new data set is received (SL00, SL01, SL02, ---).

- 7B** For *SYSTEM DEFINED* jobs: (1) If the diskette is the output device, enter a data set name, or the system will assign a data set name as follows:

Data Set

Name	Type of System Defined Job Selected
SK00	Any job with the keyboard as the job's input device.
SC00	Any job with the card reader as the job's input device.
SL00	Any job with the communication line as the job's input device.

(2) If the diskette is the input device, all active data sets will be read. If this is the case, omit Step 8.

- 8** For diskette jobs, enter the record number of the first diskette record to be read, or omit this step, and the terminal starts reading at the first diskette record.

Note: If all active data sets are to be read, the record number will be ignored.

- 9** Press the EOM key to start the job; or, if you want to change the start job entry, press the RESET key, and re-enter (starting at Step 7A).
- If you defined an off-line job, the job starts now.
 - If you defined a communication line job (on-line) and the terminal is connected to a non-switched network, or to a switched network and the connection has already been established, (the STANDBY light is on), the job starts now and the STANDBY light turns off.
- 10** Go to "Communication Line Jobs—BSC" for additional procedures and considerations for communication (on-line) jobs.

Communication Line Jobs—BSC

Use this procedure to enter data for transmission to the central processor:

- 1 Start an input device to communication line job as described under "Starting a Job Using BSC."
 - If using a switched communication network modem select either the manual or the automatic disconnect functions, that are part of the "Starting a Job" procedure.
 - When the job starts, the operator panel STANDBY indicator turns on; the STANDBY indicator remains on until transmission to the central processor begins.
- 2 If using a switched communication network modem, establish a communication link with the central processor as described in the "Switched Communication Network Procedures" section.
- 3 For either switched or leased communication networks, the operator panel ON LINE indicator turns on, when a communication link with the central processor is established; it is normal operation for the ON LINE indicator to blink (turn on and off) during transmission to the central processor.
- 4 For jobs other than keyboard jobs, the input device starts automatically when the communication link is established.
- 5 For keyboard jobs: When the operator panel PROCEED indicator turns on, enter the data to be transmitted from the keyboard.
 - The console printer prints the keyboard data as it enters the controller buffer; use the buffer edit keys described in the "Using the Keyboard Buffer Edit Keys" section to make any changes or corrections that are required.
 - After data is entered from the keyboard, you can press EOB or EOM to transmit the data to the central processor.
 - If you press EOB to transmit the data, you can then resume keyboard entry, and data continues printing on the same line and in the next print position.
 - If you press EOM to transmit the data, the keyboard-to-line job ends (the PROCEED light turns off). You can then start the job again, or press SYS REQ to start it. When you do this and resume keying (or if the central processor starts sending data), printing begins at the left margin on this same line unless you reposition the forms. To space the forms to another line, press CODE/INDEX to prevent an LF character from being included in the data, or press Return (↵) or INDEX to include the LF character. To move to the beginning of a new form, you can press FORM FEED, and an FF character enters the buffer, or press CODE/FORM FEED and a character does not enter the buffer.

PROC'D

- 6** If the processor starts transmitting, or if you press the SYS REQ (System Request) key to continue transmitting from the keyboard, the terminal automatically starts a keyboard-to-line job with job parameters in one of the following lists, depending upon whether you originally started an *Operator Defined* or a *System Defined* job.

A. If the job you started was a *SYSTEM DEFINED* job:

Print lines per form = 61 lines.
Form length = 66 lines.
Left margin = print position number one.
Right margin = print position number 132.
Printer spaces one space each time a horizontal tab is received.
Printer spaces one line each time a vertical tab is received.
Transparent mode not selected.
Compress option not selected.
Interpret Print (IBM 3521 Card Punch) is selected.
Delete data sets after transmission not selected.
IBM 3521 Card Punch Readback checking is active.
Disk data set name = SL00

B. If the job you started was an *OPERATOR DEFINED* job:

These job parameters remain as you defined them:

Print lines per form
Form length
Left margin
Right margin
Horizontal and Vertical tab stops

The terminal defines these additional job parameters:

Transparent mode not selected.
Compress option not selected.
Interpret print (IBM 3521 Card Punch) is selected.
Delete data sets after transmission not selected.
IBM 3521 Card Punch Readback checking is active.
Disk data set name = SL00

Note: The printer forms format (such as tabs stops, and forms width and length) that were defined when the job was started remain as defined until the job is stopped.

- 7** To stop the communications line job, hold the CODE key down, and press the START JOB key; the STANDBY indicator turns off when the job stops, and the terminal goes to local mode. When in local mode the PROCEED indicator is on, and the CPU SELECT indicator may be on. All other operator panel indicators are off.

Note: If using a switched communication line (and the manual disconnect function is specified), the ON LINE indicator remains on; another communication line job can be started without re-establishing a data link with the central processor.

- 8** To terminate a switched communication network data link, hold the CODE key down and press the CANCEL key; terminate after you stop the job (step 7) and the STANDBY indicator turns off.

To prepare the terminal for receiving from the central processor, start a communication line-to-output device job as described in the "Starting a Job" section. Note also that the terminal can receive from the processor when the INTRP (Interrupt) switch is on; this is also described in the "Starting a Job" section.

Starting a Job Using SDLC

A job can be started using this procedure any time the terminal's device lights are off, and the following indicators on:

PROCEED	The terminal is in local mode, and any online or offline job can be started (the CPU SELECT light may also be on; if so, an online job should be started).
STANDBY PROCEED	An online job (session) has completed, and the terminal is in standby mode. An online job only can be started. You can press CODE/START JOB to turn the STANDBY light off and the terminal returns to local mode and you can start an offline job.
ON LINE STANDBY PROCEED	The terminal is in communicate mode, and the CPU is either waiting to transmit data to the terminal, or waiting for the terminal to transmit data (the CPU has not terminated the session). You can start only an online job.

After power on, the terminal should be in local mode with the PROCEED light on and all other lights off (on machines connected to a non-switched network, the CPU SELECT light may also be on).

When the terminal is in any of the conditions listed above, an online keyboard-to-communication line job can be started using the following procedure, or using the SYS REQ key.

- 1 Place the input and output devices to be used by the job in a ready condition (refer to Chapters 4 through 9 for the make-ready procedures for the devices).

Note: If starting a printer job that uses the same forms as the previous job, you can space the forms one line by pressing the Return (↵) key, or space them to the beginning of the next form by pressing the FORM FEED key. If there is printing on the current line, you must do this or overprinting will occur.

If starting a printer job that uses different forms, press the FORM FEED key before installing new forms to set the line counter to the first print line. Install the new forms and manually position them to the first print line.

- 2 Set the following switches:

HOLD PRINT	Turn Off
UPDATE/MONITOR	Turn on if you want monitor printing; can be turned on or off at any time. Can be turned on later for Diskette Update operation.
AUTO	Can be on or off at this point; can be turned on or off after the job starts to select Auto mode.
EXTEND/ALARM	Turn on now if you want extended buffer size for keyboard-to-diskette or keyboard-to-line jobs. Can be turned on or off at any time to enable or disable audible alarm.
INTRP	Turn on to allow the CPU to interrupt an offline job; turn off to prevent CPU interrupt of an offline job.
DISK	Turn on if you want CPU data intended for an attached card punch or 3784 printer to be written onto a diskette. Turn Off if you want CPU data intended for an attached card punch or 3784 printer to be directed to that device.

NORMAL/
HALF SPEED

Set to NORMAL and the terminal's modem operates at its rated speed. Set to HALF SPEED and the terminal's modem operates at half its rated speed.

If you change the switch setting, hold the CODE key down and press CNCL.

BSC/SDLC

Must be set to SDLC. If not, turn power off, change the switch setting, and turn power back on (see "Power On/Off Procedures").

Note: See Appendix C for additional information about these switches.

- 3** If the terminal is in local mode, set any of the following modes by holding the CODE key down and entering the character listed:

X	Set Ignore ETX/EOT
U	Select Monocase
D	Deselect X, and U, above
A	Select Automatic Disconnect (CODE/Q for Belgian keyboard)
M	Select Manual Disconnect
S	Select switched network operation (SNBU)
R	Select non-switched network operation (SNBU)
K	Select line spacing 8 lines per inch (3775 Only)
L	Select line spacing 6 lines per inch (3775 Only)
Z	Select Unattended mode (CODE/W for Belgian; CODE/Y for Austrian/German keyboard)

Note: These functions can be selected only when the terminal is in local mode. The functions D, A, R, and L are selected at power on or when SYSTEM RESET is operated. Refer to "CODE Key Functions" for information about these functions.

- 4A** If you want to use the SYS REQ key to start a keyboard-to-line job, bypass the remainder of this procedure and go to "Communication Line Jobs—SDLC".
- 4B** To select an *OPERATOR-DEFINED* job, press the START JOB key and enter the job identification number 1 through 5.
- 4C** To select a *SYSTEM-DEFINED* job, press the START JOB key and enter one of the three-character combinations shown below:

S04	Communication Line to Diskette 1
S07	Communication Line to Console Printer
S08	Communication Line to 3784 Printer
S09	Communication Line to Card Punch
S20	Keyboard to Communication Line
S24	Keyboard to Diskette 1
S29	Keyboard to Card Punch
S30	Card Reader to Communication Line
S34	Card Reader to Diskette 1
S37	Card Reader to Console Printer
S38	Card Reader to 3784 Printer
S39	Card Reader to Card Punch
S40	Diskette 1 to Communication Line
S45	Diskette 1 to Diskette 2
S47	Diskette 1 to Console Printer
S48	Diskette 1 to 3784 Printer
S49	Diskette 1 to Card Punch
S50	Diskette 2 to Communication Line

Note: For a system-defined job, the following parameters are selected, but the forms format can be overridden by a set forms control message from the CPU:

Print lines per form = 61 lines.
Forms length = 66 lines.
Left margin is set at print position 1.
Right margin is set at print position 132.*
Printer spaces one space when a horizontal tab is received.
Printer spaces one line when a vertical tab is received.
Transparent mode is not selected.
Compress option is not selected.
Interpret print is selected when the 3521 is used as a punch.
Interpret print is not selected when the 3521 is used as a reader.
Delete data sets after transmit is not selected.
3521 readback check is active.

* For keyboard to card punch jobs, or jobs that monitor print card data, the right margin is set at position 80.

- 5A** For an *OPERATOR-DEFINED* job, you can override the data set name already defined by entering a new data set name consisting of four characters; the first two alphabetic and the last two numeric. Bypass this step if you want to use the defined name.
- 5B** For a *SYSTEM-DEFINED* job using the diskette as the output device, you can enter a four character data set name (the first two alphabetic and the last two numeric), or a data set name will be assigned as follows:
- SK00 - For a Keyboard-to-Diskette job.
 - SC00 - For a Card Reader-to-Diskette job.
 - SL00 - For a Communication Line-to-Diskette job.
- 6** For diskette input jobs, enter the record number of the first diskette record to be read, or omit this entry and reading begins with the first record of the data set.
- 7** Press the RESET key if you want to return to Step 5 to change an entry, or press EOM to start the job.

Note: If you selected an offline job, the job starts now. If you selected a communication line job and the terminal is connected to a non-switched network, or to a switched network and the connection to the CPU has already been established (the STANDBY light is on), the job starts now.

- 8** Go to "Communication Line Jobs—SDLC" for additional considerations and procedures for communication line jobs.

Communication Line Jobs—SDLC

- 1 If using a switched communication network, establish a communication link with the CPU, as described under “Switched Communication (Dial) Network Procedures” in this chapter.

If you started a job using the **START JOB** key (Step 6 of the job start procedure), the job starts when the communication link is established and the **EOM** key is pressed. For either switched or non-switched networks, the **ON LINE** light may or may not turn on (the light is turned on by a command from the CPU to place the terminal in a session with the CPU).

- 2
 - A. If a **SYS REQ** (System Request) key operation is required or allowed by the CPU, press the **SYS REQ** key. This starts a keyboard-to-line job and the **KBD** and **LINE** lights turn on.
 - B. Deselect Auto mode (turn the **AUTO** switch off).
 - C. Key in a logon message of up to 512 characters. The content of this message is dependent upon the requirements of the CPU application program.
 - D. Press the **EOM** key to transmit the message, or the message is transmitted automatically if both buffers are filled (512 characters are entered). The message is routed to the **SSCP** (System Services Control Point) in the host CPU.
- 3 Further operation of the terminal is dependent upon the CPU application program. At this point the terminal may still be in local mode, or may now have the **ON LINE** light on indicating that the terminal is now in session with the CPU. The CPU can also request that some other device be made ready, or that some other job be set up by the operator.
 - Several exchanges of data can occur between the terminal and the CPU, but unless the CPU places the terminal in session, the **ON LINE** light will not turn on.
 - If the CPU places the terminal in session, the **ON LINE** light turns on, and the CPU can start transmitting to the terminal, or may require that the terminal transmit. Several different jobs can execute during the session.
 - When the CPU has no more jobs for the terminal, it may leave the terminal in session with the **ON LINE**, **PROCEED** and **STANDBY** lights on. When the terminal is in this state, there are four ways that a communication line job can be started (an offline job cannot be started):
 1. You can start a job using the job start procedure,
 2. You can start a job using the **SYS REQ** key (keyboard-to-line to **SSCP** only),
 3. You can start a keyboard-to-line (to CPU application program) job simply by keying in data, or
 4. The CPU can start the job.
 - After the CPU turns the **ON LINE** light off, the **STANDBY** and **PROCEED** lights are on. You can press **CODE/START JOB** to turn the **STANDBY** light off, and then start an offline or online job using the job start procedure or using a **SYS REQ** key operation.
- 4 When a communication line job ends, and the CPU starts a communication line-to-printer job, it may send new horizontal and vertical forms definition to the terminal. If the CPU does not send new forms definition, the format remains as it was defined for the previous system- or operator-defined job (see “Starting a Job Using SDLC” for the system-defined job parameters). For other types of jobs, the following are selected:
 - Transparent mode is not selected.
 - Compress is not selected.
 - Delete data sets after transmit is not selected.
 - Interpret print (3521) is selected.
 - 3521 readback checking is active.

- 5 If using a switched network and automatic disconnect is specified, the line is disconnected about 20 seconds after the ON LINE light turns off.

Terminating a Communication Line Job

You can terminate a communication line job at any time during a session by pressing the CNCL (Cancel) key. When you do, any data received or transmitted should be discarded, since it is incomplete. This is not a normal job end and should not normally be done.

You can request that the CPU terminate a session by pressing CODE/START JOB. The CPU may or may not honor this request immediately. When the CPU honors the request, it sends a command to turn the terminal's ON LINE light off and terminates the session.

Transmit Request to the CPU

When the terminal is receiving data from the CPU, you can press the ATTN (Attention) key to request that the CPU stop transmitting, and allow the terminal to transmit to the CPU. The action taken by the CPU on receiving this request, however, is dependent upon the CPU program. It may allow the request, or may ignore it completely.

Keyboard-to-Line Jobs

For keyboard-to-line jobs, the PROCEED, ON LINE, KBD, and LINE lights turn on and indicate that data entry can be accepted. When the terminal is in this state, and Auto mode is *not* selected, keyboard data entered into the buffer is transmitted when the EOB or EOM key is pressed, or is transmitted automatically when the buffer becomes full (256 characters have been entered).

When Auto mode *is* selected (AUTO switch on), the buffer is transmitted when the Return (↵) key is pressed to end a line. Thus, with Auto mode selected, buffer length never exceeds 132 characters.

The console printer prints the keyboard-entered data as it enters the controller buffer, provided that the CPU has not sent a Print Inhibit command. This command turns on the PRINT INHIBIT light, and printing of any keyboard-entered data is prevented. The light remains on and printing is prevented until the CPU sends a command to turn the light off and allow printing.

Switched Communication (Dial) Network Procedures

Use one of these procedures to establish a switched communication (dial) network link with a central processor: (1) initiating a call, (2) answering a call, or (3) automatic answer.

Initiating a Call

Use this procedure to dial and establish a switched communication link with a central processor.

Note: For most efficient use of the communication link, the job should be started prior to dialing, and all input and output devices should be in a ready condition. The party that initiates the call transmits first.

- 1 Set the modem's TALK/DATA switch (or the equivalent) to the TALK position.
- 2 Lift the telephone handset off-hook and dial the telephone number of the central processor.
- 3 Omit this step if the central processor is equipped with the automatic answer feature. The central processor operator will answer the call, verify that his machine is ready for the data transaction, and set the modem to data mode.
- 4 You will hear the central processor modem's answer tone. The answer tone's duration is approximately three seconds; the central processor is ready to receive when the answer tone stops.
- 5 Set the modem's TALK/DATA switch (or the equivalent) to the DATA position, when the answer tone from the central processor stops.
- 6 Place the telephone handset back on-hook. The communication link with the central processor is established.
- 7 To terminate the call:
 - A. Stop the job after all data transfer completes: Hold the CODE key down and press the START JOB key.
 - B. Disconnect the communication link: if manual disconnect was specified, hold the CODE key down and press the CNCL key; or, when the automatic disconnect function is defined (see "Using the CODE Key"), the communication link automatically disconnects after a 45-second timeout.

Answering a Call

Use this procedure to respond to an incoming telephone call and establish a switched communication link with a central processor. This procedure is not required when the automatic answer feature is installed; refer to the "Automatic Answer" section for a description of the functions provided by this special feature.

Note: For most efficient use of the communication link, the job should be started prior to answering the telephone call, and all input and output devices should be in a ready condition. The party that initiates the call transmits first.

- 1 The telephone rings.
- 2 Set the modem's TALK/DATA switch (or the equivalent) to the TALK position, and lift the telephone handset off-hook.
- 3 Verify, through voice communication with the central processor operator, that the system is ready for the data transaction.
- 4 Set the modem's TALK/DATA switch (or the equivalent) to the DATA position.
- 5 The modem transmits answer tone to the modem at the central processor.
- 6 Place the telephone handset back on-hook. The central processor operator establishes the communication link by setting the modem to data mode.

7 To terminate the call:

- A. Stop the job after all data transfer completes: hold the CODE key down and press the START JOB key.
- B. Disconnect the communication link: hold the CODE key down and press the CNCL key.

PROC'D

Automatic Answer

Automatic answer is a feature that enables the system to respond to incoming switched communications network telephone calls automatically. The series of functions automatically performed when the call occurs is:

1. The modem presents a ring indication to the controller when the call occurs.
2. The controller presents a data terminal ready indication to the modem if the call is to be automatically answered.
3. The modem transmits answer tone to the central processor for approximately three seconds. The communication link is established when the central processor goes to data mode.

Note: The terminal will not automatically answer a call until either a communication line job is started, or the operator panel's INTRP (Interrupt) switch is turned on.

Example No. 1: Starting a System Defined Disk to Line Job

This example is for starting a system defined Diskette Storage Device to communication line job with these parameters: (1) Monitor printing is required; (2) The switched communications manual disconnect function is required; (3) The diskette data set name "AA00" must be assigned; and (4) The diskette must start reading at record number 12.

- 1 Turn the UPDATE/MONITOR switch on to select monitor printing.
- 2 Hold the CODE key down and enter the character "M" from the keyboard to select the switched communications network manual disconnect function.
- 3 Press the START JOB key.
- 4 Enter these characters from the keyboard to select the diskette 1-to-communication line system defined job:

S40AA0012

where:

S = A system defined job.

40 = Selects a diskette number 1 to communication line job.

AA00 = The data set name.

12 = The first diskette record read.

Note: When the record number is less than 3 digits, it is not necessary to enter leading zeros. That is, for record number 8, you would enter the number "8"; not "008".

- 5 Press the EOM key to start the job.

Example No. 2: Starting an Operator Defined Disk to Line Job

This example is for starting an operator defined Diskette Storage Device to communication line job with these parameters: (1) Monitor printing is required; (2) The switched communications manual disconnect function is required; (3) The diskette data set name "AA00" must be assigned; and (4) The diskette must start reading at record number 12.

Assume that operator defined job number one defined a Diskette Storage Device to communication line job. The data set name defined was "AA00".

- 1 Turn the UPDATE/MONITOR switch on to select monitor printing.
- 2 Hold the CODE key down and enter the character "M" from the keyboard to select the switched communications network manual disconnect function.
- 3 Press the START JOB key.
- 4 Enter these characters from the keyboard to select the diskette 1-to-communications line operator-defined job:

112

where:

1 = Operator defined job number 1.

12 = The first diskette record read.

Note that since a data set name was not entered prior to the "12", the data set name will be as defined in job number 1 ("AA00").

- 5 Press the EOM key to start the job.

Ending a Job

All jobs, except those that define the keyboard as the input device, end automatically as described in the following sections.

When a job ends, the console printer does not automatically space or line feed after printing the last character in the job; when the next job starts, the printer resumes printing at this point in the form. If you wish printing for the next job to begin on a new line, press the Return key when the current job ends. If the job that ends is a keyboard job, and the printer's print position is beyond 132, you must press the Return key when the job ends.

Ending Keyboard to Output Device Jobs

For keyboard jobs, other than communication line jobs, stop the job (after the last keyboard data is entered in the controller buffer) as follows:

- 1 Press the EOB or EOM key to transfer the keyboard data from the controller buffer to the job's output device.
- 2 Stop the job (hold the CODE key down and press the START JOB key); the terminal goes to local mode; the PROCEED indicator is on, and the CPU SELECT indicator may be on. All other operator panel indicators are off.

For keyboard-to-communication line jobs, use the "Communication Line Jobs" procedure in this chapter; for these jobs, the application may require stopping the job after the first keyboard data is sent, after several keyboard messages are sent, or after receiving data from the central processor in response to data sent from the keyboard.

Ending Card Reader to Output Device Jobs

Card reader jobs end automatically when the terminal's controller detects an end-of-file condition.

End-of-file occurs:

For IBM 2502 Card Reader jobs, when the last card in the hopper reads, and the reader's EOF (End-of-File) switch is on;

For IBM 3501 Card Reader jobs (or jobs using the IBM 3521 as a reader), when the end-of-file card reads; the end-of-file card is the job's last card, and these five characters are punched in the first five columns of the card (the remainder of the card is blank):

`/*EOF`

The terminal automatically goes to local mode when the job ends; the PROCEED indicator is on, and the CPU SELECT indicator may be on. All other operator panel indicators are off.

Data may be lost if you stop a job (hold the CODE key down and press the START JOB key) before it ends as described above. The "Stopping a Job Before Normal Job End" section describes some ways (by job type) to avoid losing data when stopping a job before it ends.

Ending Diskette Storage Device to Output Device Jobs

Diskette Storage Device jobs end automatically when the last record in a diskette data set (or from all active data sets) reads to the controller buffer and transfers to the job's output device; one data set reads when a data set name is defined (either when defining or starting a job); all active data sets read when a data set name is not defined.

When the last record reads, and the data set is continued on another diskette (multi-volume data set), the terminal either:

- A. Automatically starts reading the next diskette (when a second Diskette Storage Device is installed on the terminal), OR
- B. Displays code 300 (end-of-volume) in the readout indicators. The job continues when you install the next diskette (volume), and then hold the CODE key down and press the RESET key.

The terminal automatically goes to local mode when the job ends; the PROCEED indicator is on, and the CPU SELECT indicator may be on. All other operator panel indicators are off.

Data may be lost if you stop a job (hold the CODE key down and press the START JOB key) before it ends as described above. The "Stopping a Job Before Normal Job End" section describes some ways (by job type) to avoid losing data when stopping a job before it ends.

Stopping a Job Before Normal Job End

If you stop a job (hold the CODE key down and press the START JOB key) before normal job end (described in the previous sections) these output devices terminate as follows:

- Card Punch:** Finishes punching the card it was punching; additional card punch data may be in the controller buffer, but it is not punched.
- Printer:** A partial line may be printed; additional printer data may be in the controller buffer, but it is not printed. To avoid partially printing a line before stopping a job, turn the terminal's HOLD PRINT switch on; the terminal finishes printing the line it was printing.
- Diskette:** Finishes writing the record it was receiving from the controller buffer; performing a List Diskette Status function (see "Using the CODE Key") will indicate the number of records written on the diskette.

Using SDLC, a communication line job can be stopped by pressing the CNCL (Cancel) key. Any data received during the job is incomplete and should be discarded. A request that the CPU terminate a session is sent when the CODE/START JOB keys are pressed. This request may or may not be honored immediately by the CPU. When it is honored, the CPU will send a command to the terminal to turn the ON LINE light off, and terminates the session.

Following are procedures (by job input device) for avoiding the loss of data.

- Card Reader Jobs:**
 - 1 Press the reader's STOP key.
 - 2 Remove all cards from the hopper.
 - 3 Press the reader's NPRO (Non Process Runout) key, and place the cards that feed on the bottom of the deck that you removed from the hopper.
 - 4A For IBM 2502 Card Reader jobs, place a temporary last card in the hopper (it can be the bottom card of the deck you removed in Step 3), and turn the reader's EOF (end-of-file) switch on.
 - 4B For IBM 3501 Card Reader Jobs, place an end-of-file (/ * EOF) card in the hopper.
 - 5 Press the reader's START key; the end-of-file condition reads, and the job ends normally. To continue later, place the cards (you removed from the hopper in Step 3) back in the hopper, and start the job again.
- Diskette to Printer Jobs:**
 - 1 Note the number in the operator panel readout indicators; this is the diskette record number that is now printing, or the record number that will print next.
 - 2 For the console printer, turn the AUTO switch on; printing stops when the diskette record finishes printing.
 - 3 Stop the job (hold the CODE key down and press the START JOB key). To continue later, start the job and specify a starting diskette record number that is one less than the number you noted in Step 1. One record of data may be repeated.



Diskette to

Card Punch Jobs:

- 1** Note the number in the operator panel readout indicators; this is the diskette record number that is now being punched.
- 2** Stop the job (hold the CODE key down and press the START JOB key); the terminal goes to local mode (PROCEED is on, all other indicators are off).
- 3** To continue later, start the job and specify the starting diskette record number that is one less than the number you noted in Step 1. When you start, the first card(s) punched may be repeats of the last card(s) punched when you stopped the job (Step 2); discard any duplicate cards.

Diskette 1 to

Diskette 2 Jobs:

- 1** Stop the job (hold the CODE key down and press the START JOB key).
- 2** Perform a List Diskette Status as described in the "Using the CODE Key" section; the status of the diskette installed in Diskette Storage Device 1 prints; save this printout for comparison to a List Diskette Status you will do later.
- 3** Remove the diskette from Diskette Storage Device 1, and save it as you will re-install it later.
- 4** Remove the diskette from Diskette Storage Device 2, and install it in Diskette Storage Device 1.
- 5** Perform a List Diskette Status (again); the status of the diskette that was installed in the Diskette Storage Device 2 prints; compare this printout to the first diskette status printout you got in Step 2:
 - A. The "HDR1" lines of both printouts will be the same until you come to the HDR1 line for the data set name that was transmitting when you stopped the job.
 - B. The number of records in the first printout (status of the diskette that was in Diskette Storage Device 1) will be greater than the number of records in the second printout (status of the diskette that was installed in Diskette Storage Device 2).

For example, if you stopped the job when data set name CC00 was transmitting and CC00 contained 50 records, the first printout would list the data set record count as 50 records; the second printout would list the data set as having some number less than 50 (if 25 records transferred when you stopped the job, the printout would list 25 records).
- 6** When starting the job again, specify the data set name that was transmitting when you stopped the job; and specify a starting record number that is one greater than the number of records listed in the status printout for the diskette that was installed in Diskette Storage Device 2.

Note: If the last data set record does not contain any significant characters (a "nul" record), it will not be copied to diskette 2.

Using the Operator Panel Indicators

This section describes the use of the operator panel indicators in determining the terminal's status when a job is running.

Input and Output Device Indicators

There is a device indicator for each input or output device that can be attached to the terminal:

- KBD (Keyboard)
- LINE (Communications Line)
- READER (Card Reader)
- DISK 1 (Diskette Storage Device Number 1)
- CONSOLE (Console Printer)
- LINE PTR (Line Printer)
- PUNCH (Card Punch)
- DISK 2 (Diskette Storage Device Number 2)

The device indicator turns on when:

1. A job is running and the device is defined as the job's input or output device.
2. A CODE key function is selected that uses the device.
3. A device error occurs. When an error occurs on a device:
 - A. The indicator for the device associated with the error remains on, and the other input or output device indicators turn off.
 - B. The OPRN (Operation) CHECK or SYSTEM CHECK indicator turns on.
 - C. An error code displays in the numeric position readout (NPR) indicators. The error codes and error recovery procedures are listed in the "Numeric Position Readout Codes" section.

CPU SELECT Indicator

This indicator turns on when the central processor selects an input or output device that is not available for operation with the communication line; it is not available for use either because the INTRP switch is on and the device is being used in the current job, or because the INTRP switch is off and the communication line job has not been started. Also, this indicator turns on if the central processor selects a device that is not installed on the terminal.

The operator action required when this indicator turns on is described in the Interrupt switch description in this section.

PRINT INHIBIT Indicator

This indicator is not used when operating with BSC. When using SDLC, the indicator is turned on and off by signals from the CPU. When the light is on, keyboard-entered data in the buffer cannot be printed or accessed, except to transmit the data.

OPRN CHECK (Operation Check) Indicator

This indicator turns on when an input or output device needs some operator attention (such as a printer out-of-forms, card reader hopper empty, or diskette full condition), or when trying to re-establish the communication line link after an error. An error code displays in the numeric position readout (NPR) indicators. The error codes and error recovery procedures are listed in the "Numeric Position Readout Codes" section.

The operator panel speaker sounds when an operation check occurs; if installed, the audible alarm sounds for jobs other than keyboard jobs when the EXTEND/ALARM switch is on. In most cases, error indicators clear and the job's input and output device combination indicators restore when the error condition is corrected. For a diskette full or an all diskette labels used condition, you must hold the CODE key down and press the RESET key to restart after another diskette is installed.

SYSTEM CHECK Indicator

This indicator turns on when a controller error or an input or output device error occurs. An error code displays in the numeric position readout (NPR) indicators. The error codes and error recovery procedures are listed in the "Numeric Position Readout Codes" section.

The operator panel speaker sounds when a system check occurs; if installed, the audible alarm sounds for jobs other than keyboard jobs when the EXTEND/ALARM switch is on. When SYSTEM CHECK turns on, the job has been stopped; the indicator turns off, and the terminal goes to local mode, when you hold the CODE key down and press the RESET key.

ON LINE Indicator

Using BSC: This indicator turns on when the communication line is defined as a job's input or output device, and a communication link is established with the central processor. The ON LINE indicator remains on until the communication link with the processor is broken; it is normal operation for the indicator to blink during data transmission.

Using SDLC: This indicator is turned on and off by signals from the CPU. When the light is on, the terminal is in a session with the CPU, as described in Chapter 2, "Communication Line Jobs—SDLC".

STANDBY Indicator

Using BSC: This indicator turns on when a job starts that defines the communication line as the job's input or output device. The STANDBY indicator turns off when data transmission with the central processor begins; it remains off until the job's transmission ends; you can start another job that defines the communication line as the job's input or output device when the STANDBY indicator turns on again.

Using SDLC: This indicator is on when the terminal is in communicate mode and there is no line job active. When the STANDBY indicator is on, you can start another job that defines the communication line as the job's input or output device.

PROCEED Indicator

This indicator turns on when data entry from the keyboard is permitted, either in local mode or when a job that defines the keyboard as the input device starts.

UPPER CASE Indicator

This indicator turns on when keyboard data is being entered in upper case (the upper shift key was pressed). When the indicator is off, keyboard data enters in lower case (down shift).

Using the Operator Panel Switches

Hold Print Switch

Turn this switch on when loading or adjusting forms is required on the console printer.

When the switch is on:

- The serial console printer stops printing, and the print head moves to the left margin to allow forms loading; code 260 displays in the readout indicators to alert the operator that the job is held up.
- The line console printer stops printing, and releases forms clamps to allow forms adjustment or forms loading.
- On SDLC machines, the HOLD PRINT switch can be turned on to prevent the terminal from sending 'intervention required' signals to the CPU. If the switch is turned on before the timer expires during an intervention required condition, the timer is disabled until the switch is turned off. The switch is active for any output device that is being used.

Operator Notes:

1. Turning the HOLD PRINT on during any job using the printer holds up the entire job; it could cause a communication line job timeout to occur. Therefore, the switch should be turned on only when necessary.
2. The operator panel speaker sounds if you try to enter any keyboard characters while the HOLD PRINT switch is on.
3. Do not turn the HOLD PRINT switch on when you are defining a job; if you do, you may have to repeat all or part of the job parameter you were entering when you turned the HOLD PRINT switch on.

INTRP (Interrupt) Switch

Turn the INTRP (Interrupt) switch on to allow the central processor to automatically interrupt a job you are running; for example, a card reader to printer job would be interrupted if data for the Diskette Storage Device was received from the central processor.

First, consider the operating procedure when the INTRP switch is off, and a selection sequence is received from the central processor. Following this is a description of the operating procedure when the INTRP switch is on, and a selection sequence is received from the central processor.

When the Interrupt Switch Is Off

When the INTRP (Interrupt) switch is off, and the central processor selects a system output device:

- The CPU SELECT light turns on.
- The operator has these options:
 1. Ignore the central processor's request, and continue the current job; hold the CODE key down and press the RESET key to turn off the operator panel indicators.
 2. Stop the current job, and start a communication line job to accept the central processor's selection sequence.

Note: If the CPU SELECT indicator turns on again, you most probably started a job that does not specify the input or output device being selected by the central processor. After checking that you started the correct job, contact the processor operator to determine if a device that is not installed on your terminal is being selected.

3. Turn the INTRP (Interrupt) switch on; the current job will be automatically interrupted when the next selection sequence is received; exceptions to this are described in the "Interrupt Feature System Considerations" section.

When the Interrupt Switch Is On

When the INTRP (Interrupt) switch is on, a select sequence received from the central processor automatically interrupts the job you are running; exceptions to this are described in the "Interrupt Feature System Considerations" section. When the interrupt occurs:

- The system automatically stores the job parameters that are necessary to restart the job that is interrupted.
- The keyboard locks, and the PROCEED indicator turns off.
- The ON LINE indicator turns on, and the on line job proceeds.
- When the on line job completes:
 1. The ON LINE indicator turns off.
 2. The PROCEED indicator turns on if the job that was interrupted was a keyboard job.
 3. The system automatically continues the job that was interrupted.

Interrupt Feature System Considerations

Not all jobs can be automatically interrupted, and the selection of the systems output device for online jobs is controlled by the user's program at the central processor. Use this list of system considerations for the interrupt feature to determine if use of the INTRP switch is applicable to your specific job.

- When the central processor selects the printer or card punch that is being used in the current job, the current job is not automatically interrupted; the operator procedure is the same as described in "When the Interrupt Switch is Off", with two exceptions:
 1. An interrupt to a keyboard to printer job that selects the printer will be accepted.
 2. When using a switched (or point-to-point leased) communication line and the current job is not interrupted, there will be a pause while the terminal's controller determines that the selected device is being used and the job cannot be interrupted. Following this, the current job continues.

Note: If the current job is a card reader to diskette job, the controller's interrupt pause (during the current job) may cause less than the maximum possible number of cards to be written on one of the diskette records; no data is lost.

- The current job is not interrupted if any of its input or output devices are in a not ready condition.
- When the central processor does not select the printer, the Diskette Storage Device is selected if the DISK switch is on.
- CODE key functions are not automatically interrupted, with the exception of the Display and the Ripple Print functions.

Note: Turn the INTRP (Interrupt) switch off before selecting either the Display or the Ripple Print functions.

When the interrupt job printing finishes, and the current job resumes, printing continues at the point on the print line where the interrupt job stopped printing. Therefore, if the interrupt job does not transmit some forms control character before ending, the current job's printing resumes on the same line as the last line of the interrupt job.

- Jobs where the keyboard is defined as the input device are interrupted; however, keyboard data already in the controller buffer is erased and must be re-entered.

PROC'D

Extend/Alarm Switch

This switch is a dual function switch. When used with keyboard to Diskette Storage Device or keyboard to communications line jobs, the switch is used to select the terminal's extend buffer size function. When used with jobs other than jobs where the keyboard is the job's input device, the switch is used to select the terminal's audible alarm function.

Using the EXTEND/ALARM Switch With Keyboard Jobs

With the EXTEND/ALARM switch on before the job starts, keyboard data enters a single (512-byte) controller buffer until the buffer fills, or until you press the EOM or EOB key. Buffer data transfers to the Diskette Storage Device or the communications line (in blocks of 256 characters) when you enter the EOB or EOM character; you can resume entering keyboard data in the buffer when the transfer completes. If you enter 256 or fewer characters, only one block is sent over the communication line. Two blocks (records), however, will be sent to the diskette.

When the Record Format Control feature is used, the data enters a larger (2048-byte) buffer. The Record Format Control's insert and delete (CODE = and CODE -) capabilities can be used; the insert and delete functions are described in the "Using the CODE Key" section in this chapter.

Using the EXTEND/ALARM Switch With Jobs Other Than Keyboard Jobs

When running jobs other than jobs that define the keyboard as the job's input device, turn the EXTEND/ALARM switch on to select the terminal's audible alarm function; the switch can be turned on or off at any time during the job. With the EXTEND/ALARM switch on, the audible alarm sounds for conditions that require operator attention, such as a printer out-of-forms condition, or system error conditions. Press the RESET key to turn the alarm off.

Auto Switch

The function of the AUTO switch varies with the type of job that is running. The AUTO switch must be turned off before starting a Record Format job, and must remain off during the job. A description of the use of the AUTO switch for the different job definitions follows.

Using the AUTO Switch With Keyboard Jobs

For keyboard-to-diskette operation, if the AUTO switch is off, keyboard-entered data is written onto the diskette when the EOB or EOM key is pressed. When the AUTO switch is on, the data is written onto the diskette automatically when the buffer becomes full. A partially filled buffer can be transmitted by pressing the EOB or EOM key.

For SDLC operation, if the AUTO switch is off, keyboard-entered data is transmitted when the EOB or EOM key is pressed, or when the buffer becomes full. If the AUTO switch is on, data is transmitted when the Return (↵) key is pressed to end a line (line length cannot exceed 132 characters).

For BSC operation, the AUTO switch has no effect.

The function of the AUTO switch, as it is used when the UPDATE/MONITOR switch is on, is described in the "UPDATE/MONITOR Switch" section.

Using the AUTO Switch With Diskette to Console Printer Jobs

When the AUTO switch is on at the start of (or during) a diskette to console printer job, the current record prints, the job pauses, and code 260 displays in the readout indicators. The job continues when the AUTO switch is turned off. This function can be used to print operator instructions when starting a job, or to finish printing the current diskette record (the record number displays in the readout indicators).

PROC'D

Using the AUTO Switch With Keyboard to Card Punch Jobs

When the AUTO switch is on during a keyboard-to-card punch job, the punch will punch a card each time you press the keyboard's Return key. The switch can be turned on at any time during the job. The Return key is not a valid entry if Auto mode was entered with a buffer full condition (code 999 displayed in NPR).

If you press the BUFFR LINE RTN (Buffer Line Return) key after a card punches, a duplicate of the data punched in the last card is moved into the controller buffer; if you then press the Return key, a duplicate of the last card punches. Note that more than one card will punch if more than one card is contained in the line of buffer data, and the cards are separated by an end-of-card character; the end-of-card character is entered as described in the "Using the CODE Key" section in this chapter.

You may edit data using the buffer edit function before punching the card. To print the duplicated data, press the BUFFR RTN or the BUFFR LINE RTN key, and then press the PRINT LINE or the PRINT BUFFR key.

Note: To duplicate and punch cards with no console printing or forms movement, use the EOM key instead of the Return key.

Disk Switch

When this switch is on, all data from the central processor (with the exception of data that contains a device selection character that selects the console printer) is written to the Diskette Storage Device. Data set names start with "SL00" (or the data set name defined at job start time) and the number increments for each additional data set.

Note: If the central processor transmits data with a selection character that is for a device not installed on the terminal, and the DISK switch is on, the data writes to the diskette; this function allows application programs written for IBM 2770 to write to the IBM 3774 or IBM 3775.

If an operator message is written to the console printer while data is being transmitted to the diskette, note that console messages are not stored on the diskette. Therefore, if console messages that require some specific operator action are intermixed with data transmitted to the diskette, the operator may not be able to take the action specified in the console message to recreate the data written to the diskette.

The DISK switch is also used when reading operator defined jobs from the Diskette Storage Device to the controller, as described in the "Operator Defined Jobs" section.

Update/Monitor Switch

This switch is a dual function switch. When used with keyboard to Diskette Storage Device jobs, the switch is used in updating diskette records. When used with jobs other than jobs using the keyboard as the job's input device, the switch is used to select monitor printing.

For jobs that monitor print card punch data, the left margin sets at print position 1, and the right margin sets at print position 80.

Using the UPDATE/MONITOR Switch With Keyboard to Diskette Jobs

After starting a keyboard to diskette job (or at any time during a keyboard to diskette job), turn the UPDATE/MONITOR switch on to selectively recall previously recorded records on the Diskette Storage Device. To recall a Diskette Storage Device record:

- 1 Turn the UPDATE/MONITOR switch on.
- 2 Enter the number of the diskette record you want to update; the record number is up to 3 digits in length.

Note: You can press the RESET key, and enter another record number if you want to change the record number you first enter.

- 3 Press the EOM key.
 - The Diskette Storage Device record transfers to the controller buffer for printing, editing, or deletion. The record number displays in the readout indicators.

Note: If the record number you enter is greater than the number of records in the data set, the readout indicators will be zero. The correct record number must be entered.
 - Turn the AUTO switch on if you want to recall successive buffer records without entering the buffer number; the next successive record transfers to the controller buffer each time you press the EOB or the EOM key.
 - Once you have used the AUTO switch, and want to return to specifying each record rather than using the AUTO switch function:
 - A. Press the EOB or EOM key to transfer the current record to the diskette.
 - B. Turn the AUTO switch off.
 - C. Continue this procedure at Step 2.
 - If the AUTO switch is off, you will have to enter the record number to call in another record after you press the EOB or EOM key.
- 4 Press the EOM key, and the updated record transfers to the diskette.
- 5 Turn the UPDATE/MONITOR switch off when you complete the update operation, and the terminal returns to the record number the job was at when the update was started.

Using the UPDATE/MONITOR Switch With Jobs Other Than Keyboard Jobs

When running jobs other than those that define the keyboard as the job's input device, and a printed copy (monitor print) of data sent to the job's output device is desired, turn the UPDATE/MONITOR switch on before you start the job. For example, when sending data from the card reader to the card punch, the console printer would monitor print the data punched if the UPDATE/MONITOR switch was turned on before the job started. Printer forms must be properly inserted before the job is started.

Monitor printing cannot be done during a diskette-to-diskette job, or (on the 3774) when the job's output device is the 3784 Printer.

Note that the console printer automatically prints keyboard data on jobs where the keyboard is specified as the job's input device; you need not use the UPDATE/MONITOR switch.

For a job application where the terminal alternates in transmitting to and receiving from the central processor, and monitor printing of received data only is required, turn the UPDATE/MONITOR switch on after the transmit job starts; monitor printing will then begin when the processor starts transmitting to the terminal.

Also, if you turn the UPDATE/MONITOR switch on after starting a job, and the job is interrupted by the central processor, monitor printing will occur when the processor starts transmitting.

When monitor printing data to the card punch, a hyphen (-) character prints instead of control characters or characters that are not printable; for IBM 3775 terminals only, the printer's left margin sets at print position 1, and the maximum print position sets at 80.

PROC

Using the Code Key

Figure 2-4 illustrates the use of the CODE key in selecting functions.

- 1 Hold the CODE key down, and press one of the following keyboard keys listed in the "Code Key Function Chart" to select one of the functions listed; release the CODE key after pressing the keyboard key listed in the chart.
- 2 These labels indicate the function selected when the keyboard key below the label is pressed. Additional functions are listed in the "Code Key Function Chart".

Notes: *CODE Key Functions* (functions that do not begin with the number "0") execute immediately.

Extended CODE Key Functions (functions that begin with the number "0") do not execute immediately; the functions number displays in the readout indicators to allow the operator to verify that the correct function was selected. The function executes when you press the EOM key; the function cancels if you press the RESET key instead of the EOM key.

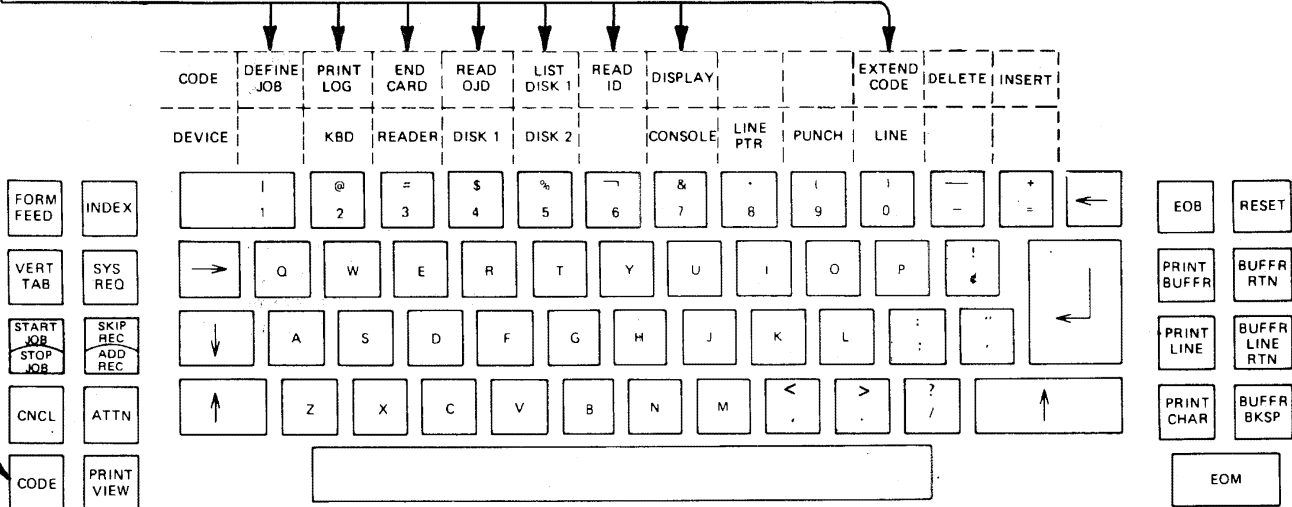

This figure shows the EBCDIC keyboard arrangement for use in the U.S. and Canada.

Figure 2-4. Using the Code Key

Code Key Functions

FUNCTION	SELECTION*	DESCRIPTION
Select Define Mode	CODE/1	Selects define mode for operator defined job setup(s). Use the "Entering an Operator Defined Job from the Keyboard" section in chapter 2 to enter a job definition.
Print Error Log	CODE/2	Prints the terminal's error log that is used by service personnel in determining the cause of errors.
End Card	CODE/3	Inserts an IRS (end-of-card) character in the buffer. An IRS (end-of-card) character formats the buffer data for output to a card punch.
Read Operator Job Definition	CODE/4	Reads the operator defined job definitions from diskette (if the DISK switch is on), or cards (if the DISK switch is off), to the controller.

* With the keyboard in lowercase shift, hold the CODE key down and enter the character shown.

FUNCTION	SELECTION*	DESCRIPTION																																																			
Display Devices and Modes	CODE/7	<p>To display a job's input and output device combination, and modes of operation.</p> <ol style="list-style-type: none"> 1 Turn the INTRP (Interrupt) switch off. 2 Hold the CODE key down and enter a numeric "7". 3 Enter the job number (1 through 5) whose input and output device combination you want to display. <ul style="list-style-type: none"> • The input and output device combination number displays in the readout indicators. • The input device number displays in the left readout position; the output device number displays in the right readout position. <p>Note: The input and output devices are listed on a decal directly above the keyboard numeric keys; find the device on the decal, and the number on the keyboard numeric key directly below the device name is the number that displays in the readout indicators.</p> 4 Enter a numeric "0" from the keyboard. <ul style="list-style-type: none"> • "Operation Mode" numbers display in the readout indicators. • Use the following charts of the left and right (NPR) display to determine what modes are defined at the current time. The center readout indicator is blank. <p>Note: The modes that display are the modes defined in the terminal at the current time; these modes are defined for all jobs (operator defined and system defined), as well as the job number you entered above (Step 3).</p> <table border="1" data-bbox="527 744 1177 1032"> <thead> <tr> <th>LEFT NPR</th> <th>MONOCASE SELECTED</th> <th>IGNORE ETX/EOT SELECTED</th> <th>INQUIRY MODE SELECTED</th> </tr> </thead> <tbody> <tr><td>0</td><td>NO</td><td>NO</td><td>NO</td></tr> <tr><td>1</td><td>NO</td><td>NO</td><td>YES</td></tr> <tr><td>2</td><td>NO</td><td>YES</td><td>NO</td></tr> <tr><td>3</td><td>NO</td><td>YES</td><td>YES</td></tr> <tr><td>4</td><td>YES</td><td>NO</td><td>NO</td></tr> <tr><td>5</td><td>YES</td><td>NO</td><td>YES</td></tr> <tr><td>6</td><td>YES</td><td>YES</td><td>NO</td></tr> <tr><td>7</td><td>YES</td><td>YES</td><td>YES</td></tr> </tbody> </table> <table border="1" data-bbox="527 1053 966 1266"> <thead> <tr> <th>RIGHT NPR</th> <th>MANUAL DISCONNECT SELECTED</th> <th>SNBU SELECTED</th> </tr> </thead> <tbody> <tr><td>0</td><td>NO</td><td>NO</td></tr> <tr><td>1</td><td>NO</td><td>YES</td></tr> <tr><td>2</td><td>YES</td><td>NO</td></tr> <tr><td>3</td><td>YES</td><td>YES</td></tr> </tbody> </table> 5 Hold the CODE key down and press START JOB, or press RESET to end the display. 	LEFT NPR	MONOCASE SELECTED	IGNORE ETX/EOT SELECTED	INQUIRY MODE SELECTED	0	NO	NO	NO	1	NO	NO	YES	2	NO	YES	NO	3	NO	YES	YES	4	YES	NO	NO	5	YES	NO	YES	6	YES	YES	NO	7	YES	YES	YES	RIGHT NPR	MANUAL DISCONNECT SELECTED	SNBU SELECTED	0	NO	NO	1	NO	YES	2	YES	NO	3	YES	YES
LEFT NPR	MONOCASE SELECTED	IGNORE ETX/EOT SELECTED	INQUIRY MODE SELECTED																																																		
0	NO	NO	NO																																																		
1	NO	NO	YES																																																		
2	NO	YES	NO																																																		
3	NO	YES	YES																																																		
4	YES	NO	NO																																																		
5	YES	NO	YES																																																		
6	YES	YES	NO																																																		
7	YES	YES	YES																																																		
RIGHT NPR	MANUAL DISCONNECT SELECTED	SNBU SELECTED																																																			
0	NO	NO																																																			
1	NO	YES																																																			
2	YES	NO																																																			
3	YES	YES																																																			

* With the keyboard in lowercase shift, hold the CODE key down and enter the character shown.

FUNCTION	SELECTION*	DESCRIPTION									
Select Inquiry Mode (BSC ONLY)**	CODE/i	Selects the Inquiry Mode function (using BSC only).									
Select Ignore ETX/EOT**	CODE/x	Selects the ignore ETX/EOT (message and control characters) function. Note: This function is used on jobs where communication line data is written to diskette; when the function is selected, communication line data writes to the diskette in one continuous data set. When the function is not selected, the data set name changes each time the message control character ETX or EOT is received. For example, if the job's starting data set name were SL00, the name would change to SL01 after receiving an ETX or EOT character. Caution: If a data set with the same name already exists on the diskette, the communication line data will be linked to the existing data.									
Select Monocase**	CODE/u	Causes all keyboard alphabetic characters (A through Z) to enter the controller buffer in upper case.									
Deselect Functions i,x, and u**	CODE/d	De-selects the above CODE key functions (I, X, and U). Note: Since these functions are automatically de-selected when you turn power on, you need to use this function only to de-select functions selected after power on.									
Select Automatic Disconnect**	CODE/a (CODE/q for Belgian keyboard)	Selects the switched communication network automatic disconnect feature. Automatic disconnect is selected at power on time.									
Select Manual Disconnect**	CODE/m	Selects the switched communication network manual disconnect feature. When selected, manual disconnect overrides the automatic disconnect at job end.									
Select SNBU**	CODE/s	Selects Switched Communication Network Backup (SNBU) operation, and terminates leased communications network operation.									
Terminate SNBU**	CODE/r	Terminates Switched Communication Network Backup (SNBU) operation, and selects leased communication network operation. Note: Since this function automatically selects when you turn power on, you need to select it only after the "CODE key and S" function has been selected. When leased line operation is selected, there is a delay of approximately 50 seconds until the terminal terminates SNBU and is operational on the leased line.									
Select RJE	CODE/j	On the 3774 using BSC (the BSC/SDLC switch is in the BSC position), this function reverses the component selection for the console printer and the 3784 printer, as follows: <table border="1" style="margin-left: auto; margin-right: auto;"> <thead> <tr> <th><u>Selection Character</u></th> <th><u>Normal Operation</u></th> <th><u>CODE/J Function Selected</u></th> </tr> </thead> <tbody> <tr> <td>DC1 ('11')</td> <td>Selects Console Printer</td> <td>Selects 3784 Printer</td> </tr> <tr> <td>) ('5D')</td> <td>Selects 3784 Printer</td> <td>Selects Console Printer</td> </tr> </tbody> </table> Once this function is selected, it remains in effect until the SYSTEM RESET switch is operated or until power is turned off.	<u>Selection Character</u>	<u>Normal Operation</u>	<u>CODE/J Function Selected</u>	DC1 ('11')	Selects Console Printer	Selects 3784 Printer) ('5D')	Selects 3784 Printer	Selects Console Printer
<u>Selection Character</u>	<u>Normal Operation</u>	<u>CODE/J Function Selected</u>									
DC1 ('11')	Selects Console Printer	Selects 3784 Printer									
) ('5D')	Selects 3784 Printer	Selects Console Printer									
Select 8 Lines/Inch**	CODE/k	Selects 8 lines per inch for the 3775 terminal's console printer.									
Select 6 Lines/Inch**	CODE/l	Selects 6 lines per inch for the 3775 terminal's console printer. Line spacing of 6 lines per inch is set at power on.									

*With the keyboard in lower case shift, hold the CODE key down and enter the character shown.

**These functions can be selected only when the terminal is in local mode (the PROCEED indicator is on, and the CPU SELECT indicator may be on; all other indicators are off).

FUNCTION	SELECTION**	DESCRIPTION
Select Insert Function	CODE/= (For certain World Trade countries use the key directly below the INSERT label)	<p>Insert character can be selected only on terminals that have the extended (2048-byte) buffer; up to 256 characters can be inserted. The insert function cannot be used in Update Mode.</p> <p>To insert characters during a keyboard job (with the EXTEND/ALARM switch on):</p> <ol style="list-style-type: none"> 1. Use the buffer edit keys to position the buffer edit point where the characters are to be inserted. Refer to the "Using the Keyboard Buffer Edit Keys" section in this chapter. 2. Hold the CODE key down and enter an "=" character; then, release the CODE key. "530" displays in the NPR. 3. Enter the data to be inserted and press the EOM key; or if data is not to be inserted, press the RESET key. The terminal exits from insert mode when either EOM or RESET is pressed.
Select Delete Function	CODE/- (For certain World Trade countries, use the key directly below the DELETE label)	<p>Characters, lines, or the remainder of the buffer can be deleted. Delete can be selected only on terminals that have the extended (2048-byte) buffer. The delete function cannot be used in Update Mode.</p> <p>To perform the delete function during a keyboard job (with the EXTEND/ALARM switch on):</p> <ol style="list-style-type: none"> 1. Use the buffer edit keys to position the buffer edit point where the delete function starts. (Refer to the "Using the Keyboard Buffer Edit Keys" section in this chapter.) 2. Hold the CODE key down and enter a "-" character from the keyboard; then, release the CODE key. "531" displays in the NPR. Either characters, lines, or the remainder of the buffer can be deleted; select the function desired from the following list: <ul style="list-style-type: none"> <i>Characters:</i> Press the PRINT CHAR key for each character to be deleted; the print position advances each time you press the key. <i>Lines:</i> Press the PRINT LINE key for each line to be deleted; the print position advances each time you press the key. <i>Remainder of Buffer:</i> Press the PRINT BUFFER key, and the remainder of the buffer is deleted; the print position advances to the end of the buffer. 3. Press the EOM key, and the delete function executes. To cancel the delete function, press the RESET key; delete will not execute. <p>Note: Buffer edit can be performed after pressing the EOM or RESET key; do not attempt buffer edit during entry of the insert or delete function.</p>
Set Unattended Mode** (SDLC only)	CODE/z (Code/w for Belgium CODE/Y for Austria/Germany)	<p>This sequence can be used when unattended terminal operation is desired. In this mode, an error response is sent to the CPU immediately if a recoverable device error occurs (for example, card reader out of cards). (This error response is normally sent after a three-minute timeout.)</p>

*With the keyboard in lowercase shift, hold the CODE key down and enter the character shown.

**These functions can be selected only when the terminal is in local mode (the PROCEED indicator is on, and the CPU SELECT indicator may be on; all other indicators are off).

FUNCTION	SELECTION*	DESCRIPTION
Disconnect	CODE/CNCL	Disconnects the communication link.
Form Feed	CODE/FORM FEED**	Moves the console printer paper to the start of the next form without inserting a character in the buffer.
Index	CODE/INDEX**	Moves the console printer paper one line without inserting a character in the buffer.
Reset Indicators	CODE/RESET	<p><i>Resets indicators:</i> OPRN (Operation) CHECK, SYSTEM CHECK, CPU SELECT, readout indicators (NPR), and any input or output device indicator that is indicating an error.</p> <p>Note: The "Using the Operator Panel Indicators" section describes the above indicators; and Chapter 3 describes the use of the readout indicators in recovering from errors. Following is a summary of the CODE-key-and-RESET-key function when either the SYSTEM CHECK, the OPRN CHECK, or the CPU SELECT indicators are on:</p> <p>SYSTEM CHECK on: The job has stopped; using the CODE-key-and-RESET-key function returns the terminal to local mode.</p> <p>OPRN CHECK on: A. The job stopped due to an input or output device not ready condition, or transmission retries when using the communication line. Using the CODE-key-and-RESET-key function turns off the indicators, but does not clear the error condition; use the error recovery procedures in chapter 3 to correct the error and continue the job. Buffer edit functions can be performed after using the CODE-and-RESET key. B. The job stopped due to an end-of-diskette when writing to, or reading from, a diskette; or the job stopped due to an all label full condition on the diskette. Using the CODE-key-and-RESET-key function indicates to the terminal that another diskette has been installed, and the job continues; these conditions are included in the error recovery procedures in Chapter 3.</p> <p>CPU SELECT on: The CODE-key-and-RESET-key function resets the indicator.</p>
Stop Job	CODE/START JOB	Stops the current job. During a communication line job using SDLC, Stop Job sends a request to terminate the session to the CPU (refer to "Stopping a Job Before Normal Job End").

PROC'D

* Hold the CODE key down and press the control key shown. These functions (except for CODE/RESET and CODE/START JOB) can only be selected when the terminal is in local mode. In local mode, the PROCEED indicator is on and the CPU SELECT indicator may be on; all other indicators are off.

**The keyboard must be in lowercase shift to select these functions.

Extended Code Key Functions

- 1 With the keyboard in lowercase shift, hold the CODE key down and press the numeric "0" key to select extended CODE key functions. Release the CODE key after entering the "0".
 - 2 The character(s) you enter after the "0" selects the extended CODE key function. These functions, and the characters entered to select them are listed on the "Extended Code Key Function Chart" that follows.
 - 3 The characters entered to select the function display in the NPR indicators. Check these indicators to verify that the correct function was selected.
- Note:** The function cancels (does not execute) if you press the RESET key instead of the EOM key.
- 4 The function executes when you press the EOM key.
 - 5 If the function selected is invalid, the number entered remains in the NPR. It can be cleared by pressing CODE/RESET.

For example, to select the "Clear Disk Number 1" function:

1. Hold the CODE key down, and press the numeric "0" key; then, release the CODE key.
2. Enter a numeric "1" character from the keyboard.
3. The number "1" displays in the numeric position readout indicators.
4. Press the EOM key, and the "Clear Disk Number 1" function executes.

FUNCTION	SELECTION*	DESCRIPTION
Clear Diskette 1	CODE/01	Deletes all data sets on disk number one, with the exception of job definitions.
Create Diskette 1	CODE/02	Deletes all data sets and job definitions on diskette number one. Creates diskette one as an IBM 3770 diskette.
Create Diskette 1 Exchange	CODE/021 (Upper or lower case i)	Deletes all data sets and job definitions on diskette number one. Creates the diskette as a 3770 exchange diskette; the number "21" displays in the readout indicators before the EOM key is pressed.
Write Operator Defined Jobs	CODE/03	Writes a data set of up to 5 operator defined jobs to diskette #1.
Change Diskette Data Set Name or Status	CODE/04	<p>NAME CHANGE:</p> <p>After entering the "04" and pressing the EOM key, wait for the PROCEED indicator to turn on, and:</p> <p>A. Type in two data set names, separated by a slash (/) character; the first name is the name now on the diskette, the second name is the new data set name. For example, to change data set name AA00 to BB00, you would type:</p> <p style="padding-left: 40px;">AA00/BB00</p> <p>B. Press the EOM key and the data set name changes.</p> <p>STATUS CHANGE:</p> <p>After entering the "04" and pressing the EOM key, wait for the PROCEED indicator to turn on, and:</p> <p>A. Type in the data set name.</p> <p>B. Type in the character listed here to select the data set's status:</p> <p style="padding-left: 40px;">A The data set is active. I The data set is inactive. C The data set is multivolume (continued on another diskette). L The data set is the last of a multivolume data set. S The data set is a single (not multivolume) data set.</p> <p>For example, to change data set BB00 to inactive, you would type:</p> <p style="padding-left: 40px;">BB00i</p> <p>C. Press the EOM key and the data set status changes.</p>

*With the keyboard in lowercase shift, hold the CODE key down and enter a numeric 0; release the CODE key and enter the second digit.

Using the Keyboard Buffer Edit Keys

The location of the keyboard buffer edit keys is shown in Figure 2-5. Use these keys to update or correct data in the controller buffer. These keys can be used only when running a job that defines the keyboard as the job's input device.

If you do not already know how to use the buffer edit keys to correct or update data in the buffer, do the three "Using the Keyboard Buffer Edit Keys" exercises that follow. Following the three exercises is a summary description of the function of each of the buffer edit keys.

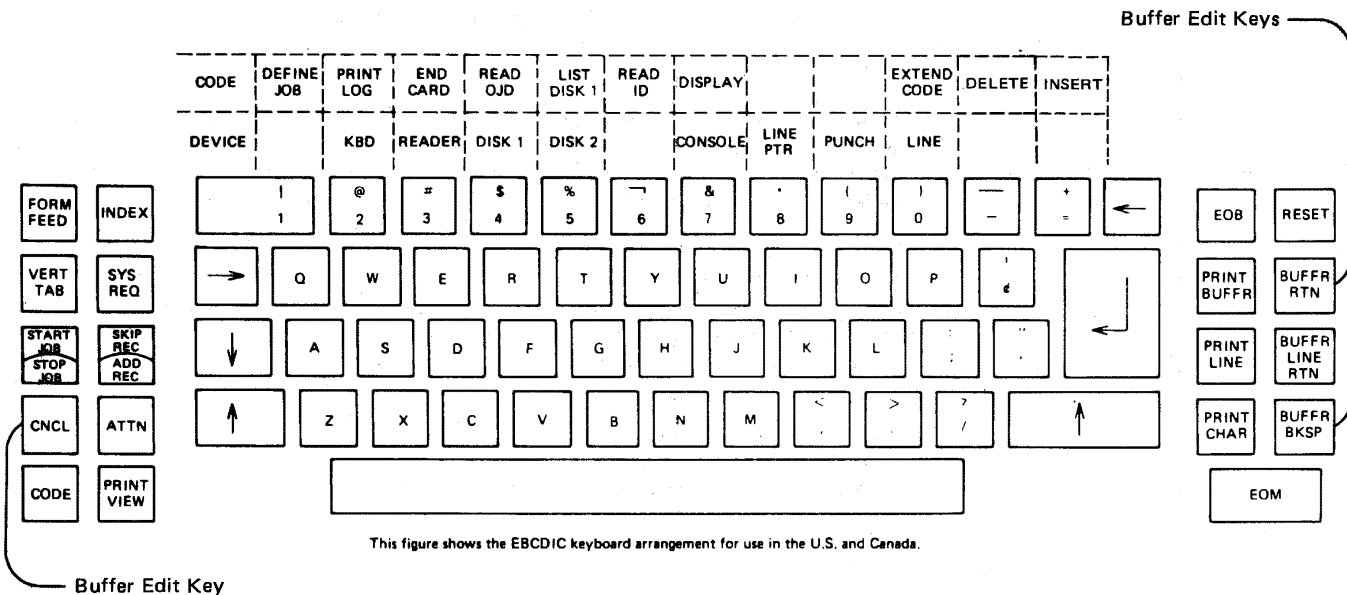

Figure 2-5. Buffer Edit Keys

Using the Keyboard Buffer Edit Keys: Exercise No. 1

- 1 If the terminal is not in local mode, review the "Ending a Job" description to determine that you are not interrupting an active job; then, enter local mode by holding the CODE key down and pressing the START JOB key.

Note: When in local mode, the PROCEED indicator is on, and the CPU SELECT indicator may be on. All other operator panel indicators are off.

- 2 Start this system defined keyboard to Diskette Storage Device job:

- A. Press the START JOB key.
- B. Enter these characters from the keyboard:

S24

- C. Press the EOM key.

The job starts and these operator panel indicators turn on:

PROCEED
KBD (Keyboard)
DISK 1

3 Enter these three lines from the keyboard as they appear here; note that you enter an error in line 2 and line 3 (you will use the edit keys to correct them), and note that you press the Return key at the end of each line:

LINE 1: I will use the buffer edit keys to correct this line.

LINE 2: I wilt use the buffer edit keys to correct this line.

LINE 3: I will use teh buffer edit keys to correct this line.

4 The three lines you entered are in the buffer and the buffer is ready to receive the next character; that is, the buffer is at the next position after the new line character that follows the "." in line 3. We will call the position of the buffer the "buffer edit point" in order to explain the use of the edit keys.

5 Press the BUFFR RTN (Buffer Return) key.

The buffer edit point moves to the first character in the buffer (the "L" in line 1).

6 Press the PRINT BUFFR key and the contents of the buffer (from the buffer edit point to the end of the buffer) prints as follows:

LINE 1: I will use the buffer edit keys to correct this line.

LINE 2: I wilt use the buffer edit keys to correct this line.

LINE 3: I will use teh buffer edit keys to correct this line.

Note: The buffer edit point is again at the next position after the new line character that follows the "." in line 3.

7 Correct the "teh" error in line 3 as follows:

A. Press the BUFFR LINE RTN (Buffer Line Return) key. The buffer edit point moves to the first character in line 3 ("L").

B. Use the PRINT CHAR (Print Character) key to print the contents of line 3, up to the "teh" error; a character prints, and the buffer edit point moves one character each time you press the key. When you are at the error, the line is printed as follows:

LINE 3: I will use t

C. Enter the characters "h" and "e" to correct the error; the buffer edit point moves, and the characters print as you enter them. Line 3 appears as follows on the console printer:

LINE 3: I will use the

Note: The buffer edit point is at the "space" character after the word "the".

D. Press the PRINT LINE key and the remainder of line 3 prints (from the buffer edit point to the end of the line) as follows:

LINE 3: I will use the buffer edit keys to correct this line.

Note: The buffer edit point is now one character position beyond the end of line 3.

8 Correct the "wilt" error in line 2 as follows:

A. Press the BUFFR LINE RTN key.

The buffer edit point moves to the first character in line 3 ("L").

B. Press the BUFFR LINE RTN key (again).

The buffer edit point moves to the first character in line 2 ("L").

C. Use the PRINT CHAR key to print the contents of line 2, up to the "wilt" error; a character prints, and the buffer edit point moves one character each time you press the key. When you are at the error, the line is printed as follows:

LINE 2: I wil

- D. Enter the character "1" to correct the error; the buffer edit point moves, and the character prints as you enter it. Line 2 appears as follows on the console printer:

LINE 2: I will

Note: The buffer edit point is at the "space" character after the word "will"

- 9 Print the contents of the buffer again to make sure that the errors are corrected:
- A. Hold the CODE key down and press the INDEX key; this spaces the printer form one line without entering a character in the buffer.
 - B. Press the BUFR RTN (Buffer Return) key.
The buffer edit point moves to the first character in the buffer (the "L" in line 1).
 - C. Press the PRINT BUFR key and the contents of the buffer (from the buffer edit point to the end of the buffer) prints as follows:
LINE 1: I will use the buffer edit keys to correct this line.
LINE 2: I will use the buffer edit keys to correct this line.
LINE 3: I will use the buffer edit keys to correct this line.
- 10 Press the CNCL (Cancel) key to erase the buffer (the buffer edit point moves to the first buffer character position), and *either*:
- A. Do the next buffer edit exercise, starting at step 2, OR
 - B. Stop the job by holding the CODE key down and pressing the START JOB key.

Using the Keyboard Buffer Edit Keys: Exercise No. 2

- 1 Start a system defined keyboard to Diskette Storage Device job as described in steps 1 and 2 of exercise number 1 (above).
- 2 Enter this line from the keyboard:
I will enter an error on this ward
Note: The buffer edit point is one character position beyond the error "ward".
- 3 Press the BUFR BKSP (Buffer Backspace) three times to position the buffer edit point at the "a" character that is in error.
- 4 Enter the characters "o", "r", and "d" to correct the error.
- 5 Hold the CODE key down and press the INDEX key; this spaces the printer form one line without entering a character in the buffer.
- 6 Press the BUFR LINE RTN key to position the buffer edit point at the beginning of the line.
- 7 Press the PRINT LINE key, and the corrected line prints as follows:
I will enter an error on this word
- 8 Press the CNCL (Cancel) key to erase the buffer, and either:
A. Do the next buffer edit exercise, starting at step 2, OR
B. End the job by holding the CODE key down and pressing the START JOB key.

Using the Keyboard Buffer Edit Keys: Exercise No. 3

- 1 Start a system defined keyboard to Diskette Storage Device job as described in steps 1 and 2 of exercise number 1 (above).
- 2 Misspell the word "buffer" in this sentence as you enter it as follows:
I will use the bufer edit keys to correct this line.
- 3 Hold the CODE key down and press the INDEX key; this spaces the printer form one line without entering a character in the buffer.
- 4 Press the BUFR LINE RTN (Buffer Line Return) key to position the buffer edit point at the start of the line.

- 5 Use the PRINT CHAR key to print the contents of the line up to error point; the line prints as follows:

I will use the buf

- 6 Continue entering the remainder of the line as follows:

I will use the buffer edit keys to correct this line.

Note: Since the correction to the word "buffer" added a character, the remainder of the line (after the error) had to be re-entered.

- 7 Stop the job by holding the CODE key down and pressing the START JOB key.

Description of Buffer Edit Keys

BUFFR RTN (Buffer Return) Key

Press this key to reset to the beginning of the buffer; the operator speaker sounds if already at the beginning of the buffer.

BUFFR LINE RETURN Key

Press this key to backspace the buffer to the previous new line or record separator character; the buffer backspaces to the beginning of the buffer when no new line or record separator character is found.

BUFFR BKSP (Buffer Backspace) Key

Press this key to backspace the buffer one position. You cannot backspace over a control character; if you press the key to backspace, and a control character is detected, the operator attention speaker sounds, and the backspace will not occur.

PRINT BUFFR Key

Press this key to print the contents of the buffer from the current position of the buffer to the end of the buffer.

PRINT LINE Key

Press this key to print buffer data from the current position of the buffer to the next new line or record separator character. Or when there is no new line or record separator character, data from the current position of the buffer to the end of the buffer prints.

If an escape sequence such as "ESC A" (skip to the first line of a form) is included in the data, the escape function executes, and any lines remaining in the buffer will print.

PRINT CHAR Key

Press this key to print the character at the current position of the buffer; the buffer increments to the next character position after printing. If a control character (such as line feed, or new line) is stored in the current position of the buffer, the control function executes.

An escape character (ESC) will print as a hyphen (-) character; the character following the ESC character prints; the escape function (such as "ESC A", skip to the first print line) does not execute.

RESET Key

Press this key to reset to the first buffer position available for storing data; that is, immediately after the last character stored in the buffer.

CNCL (Cancel) Key

Press this key to erase the buffer contents; that is, clear the buffer and reset to the first buffer position.

Description of Control Keys Used During Keyboard Entry

These control keys, used during keyboard entry, are often used with the buffer edit keys; therefore, they are summarized here.

PRINT VIEW Key

This key is used with the serial console printer only. When you press the PRINT VIEW key, the print head moves to the right and the last character printed can be seen; after the print head moves beyond print position 125, the PRINT VIEW key is inactive.

The terminal enters Print View mode when you press the PRINT VIEW key twice in succession, or once immediately after a horizontal tab, a backspace, 3 character spaces, or the BUFFR RTN or BUFFR LINE RTN key is pressed. When in Print View mode, the print head automatically moves to the right to allow viewing of the print line when there is a pause during keyboard entry.

To allow viewing of the print line during buffer edit operations, the terminal automatically displays the next print position when the buffer edit keys listed below are pressed:

- The BUFFR RETURN key is pressed.
- The BUFFR LINE RTN key is pressed.
- The BUFFR BKSP key is pressed.
- The BKSP key is pressed.
- The PRINT CHAR key is pressed.

The terminal exits from Print View mode when:

- The PRINT VIEW key is pressed.
- The PRINT LINE key is pressed.
- The PRINT BUFFR key is pressed.
- The SYS REQ key is pressed.
- CODE/START JOB keys are pressed.

RESET Key

- Resets the buffer edit position as described in the "Using the Keyboard Buffer Edit Keys" section above.
- Turns off the audible alarm.
- When pressed before the EOM key, cancels the entry when:
 - Starting a job.
 - Entering extended CODE key functions.
 - Entering a record number when updating diskette records.

FORM FEED Key

Causes the printer to space to the first print line of a form, and enters the form feed character in the controller buffer; hold the CODE key down while pressing FORM FEED, and the character does not enter the buffer.

VERT TAB (Vertical Tab) Key

Causes the printer to space to a form's next vertical tab stop line.

INDEX Key

Causes the printer to space one line, and enters the index character in the controller buffer; hold the CODE key down while pressing INDEX and the character does not enter the buffer.

Diskette Storage Device Jobs

This section provides operating procedures and considerations for jobs that define the Diskette Storage Device as the job's input or output device; a more technical description of the features and functions of the device is included in the *System Components* manual.

PROC'D

Diskette Labels

Labels written on the diskette identify the diskette's data sets. Labels contain a data set name, extent of the data set (the diskette space the data set uses), data set status, multivolume indicator, and other fields used by the terminal.

The data set name is either:

- A. Defined by the operator by entering an operator defined job;
- B. Entered by the operator when the job starts;
- C. Defined by the terminal when the job starts.

A maximum of 18 labels (data set names) can be written on one diskette. A data set label is written only if data has been entered into the data set. If a data set closes (either by a job ending, or by an automatic job interrupt by the central processor), and another data set writes on the diskette, another label is used when a job starts that uses the data set that was closed; for example:

1. Start this keyboard-to-diskette job that uses data set name AA01:
 - A. Press the START JOB key.
 - B. Enter these characters from the keyboard:
S24AA01
 - C. Press the EOM key.

The terminal starts the job; the data set name is AA01.
2. Enter at least one record into the data set.
3. Stop the job (hold the CODE key down and press the START JOB key). The job ends, and data set name AA01 closes.
4. Start this card reader-to-diskette job that uses data set name BB01:
 - A. Press the START JOB key.
 - B. Enter these characters from the keyboard:
S34BB01
 - C. Press the EOM key.

The terminal starts the job; the data set name is BB01.
5. Read at least one card to the data set.
6. Stop the job (hold the CODE key down and press the START JOB key). The job ends and data set name BB01 closes.
7. Start the keyboard-to-diskette job (Step 1) again; and again, use data set name AA01:
 - A. Press the START JOB key.
 - B. Enter these characters from the keyboard:
S24AA01
 - C. Press the EOM key, and enter at least one record into the data set.

The terminal starts the job; data set name AA01 opens; this data set name (that closed when you stopped the job in Step 2) now occupies two data set labels; that is, the data set is on two segments on the diskette. When a job starts that transmits this data set, the terminal collects all the data set segments and transmits them as if they were one continuous data set.

The terminal identifies these segments by using a two digit segment (label) number immediately after the four character data set name, and adds another character to indicate the data set is continued. Thus, the two labels for data set AA01, used in this example, are:

AA0101C and AA0102

Note: The diskette's data set labels and other status information print on the console printer when you initiate a "List Disk Status" function (Hold the CODE key down and enter the number 5 from the keyboard); this list function is described in more detail in the "Using the CODE Key" section in this chapter.

When a diskette has several data sets, with several labels (segments), the maximum number (18) of labels may be used. When this happens, new data sets cannot be added to the diskette; and new data cannot be added to any data set, with the exception of the last data set on the diskette; however, the data sets can be updated. Either code 305 or 317 displays in the operator panel readout indicators when the maximum number of labels are written on a diskette.

When a diskette is full (even though all labels are not used), no data may be added, but any data set may be updated. Either error code 299 or 311 displays in the operator panel readout indicators when a diskette becomes full.

For communication line jobs when "Ignore ETX/EOT" is not defined, a line data set (for example SL00) is closed when ETX is received from the processor; as transmission from the processor continues, the data set name increments (for example to SL01). If a diskette fills, the same data set name is added to the next diskette inserted. If the name already exists on the inserted diskette, the name is incremented. To reopen an existing data set, Ignore ETX/EOT must be specified before the data set name is specified.

For each new communication line-to-diskette job, the data set name reverts to SL00. If this name does not exist on the diskette in diskette device 1, and there is space on the diskette, the name SL00 is used. If the name already exists on the diskette, the name is incremented until a new name is generated. If there is no space on the diskette in diskette device 1, the data set is written on the diskette in device 2, using a name that did not previously exist on either of the two diskettes.

Diskette Records

Diskette records, when not full, are always padded to the right with NULs. Records are written in the following manner:

- 3770 mode diskettes, using either BSC or SDLC, have a record size of 256 bytes and are written in two nonsequential sectors (every third physical sector). A BSC 3770 mode diskette can contain up to 948 data records. An SDLC 3770 mode diskette can contain a maximum of 947 data records, due to the 'FM Header' which is always the first record written on the diskette. The FM Header contains information used by the terminal when the data set is transmitted to the central processor.
- 3770 basic exchange diskettes written using BSC have a record size of 128 bytes, and records are written two at a time in sequential sectors. These diskettes can accommodate up to 948 data records.
- 3770 basic exchange diskettes written using SDLC may have data sets with record sizes from 1 to 128 bytes, and are written sequentially one sector at a time. These diskettes can contain up to 1898 records.

Active and Inactive Data Set Status

The terminal tests the active or inactive status of a diskette data set to determine if it can be transmitted to the job's output device. The intent of this status test is to prevent (at the operator's option) a data set from being copied or sent over the communication line. Data sets are automatically marked active (and can be copied or transmitted), with the exception of jobs where the central processor interrupts (auto interrupt or reverse interrupt) a job and transmits to the Diskette Storage Device; these are marked inactive (and cannot be copied or transmitted) to prevent them from being inadvertently sent back to the central processor or copied.

Use extended CODE key function 4 to change the status of a data set; this function is described in the "Using the CODE Key" section in this chapter.

Multivolume Data Sets

A diskette can become full before a data set is completely written to it. When this happens, the data set is closed and the status is marked with a "c" to indicate that the data set continues on another diskette. If the terminal has two Diskette Storage Devices the terminal automatically begins writing on the second diskette, or displays error code 285 in the readout indicators if the second diskette is not ready. If diskette data is continued onto three or more volumes, place the third volume on diskette device 1, and when NPR code 311 displays indicating that diskette 2 is full, press CODE/RESET to continue using device 1. If diskette device 1 is not ready, NPR code 347 displays. Alternating use of devices 1 and 2 continues in this manner until the last volume is written. For best performance, the full volume should be replaced while the alternate diskette is being written. For keyboard-to-diskette jobs, the terminal does not automatically skip to the second diskette when the first diskette is full, but indicates which diskette has filled and waits for another diskette to be installed.

- A. Remove the full diskette, and install a new diskette.
- B. Hold the CODE key down and press the RESET key, and the job continues.

Note: When a data set continues from a previous volume, the data set's status is marked with a character "L" at stop job time to indicate the diskette's data set is the last of a multivolume data set.

At job start time, when the data set to be read is continued, NPR code 301 (diskette 1) or 313 (diskette 2) displays to alert the operator that it is a continued data set. If the data set is to be processed, press CODE/RESET to continue the job. If it is not to be processed, stop the job by pressing CODE/START JOB.

When reading a data set that is continued on another diskette and the end of volume is reached, the terminal automatically tries to read the next volume from diskette device 2 if it is installed and ready, or displays NPR code 285 if device 2 is not ready. If data is continued onto three or more volumes, the third volume must be placed on device 1, and when NPR code 312 displays indicating end of volume, press CODE/RESET to continue reading from device 1. If device 1 is not ready, NPR code 347 displays. If the data is not found on device 1, NPR code 297 displays. The process repeats for additional volumes. If the volume on diskette device 2 is not replaced after it is read, the same volume will be read again when device 2 is reselected. For best performance, the volumes should be replaced after they are read, while the opposite diskette is being read. If a second Diskette Storage Device is not installed on the terminal, code 300 displays in the readout indicators, and the operator:

- A. Installs the next diskette in the volume.
- B. Holds the CODE key down and presses the RESET key.

Note: The operator can stop the job (hold the CODE key down and press the START JOB key) instead of reading the next diskette in the volume. Further, the multivolume status indicator can be changed by using the extended CODE key function 4 as described in the "Using the CODE Key" section in this chapter.

If you do not specify a data set name in the job definition or when starting a job (read all active data sets), there will be no indication that a data set is continued. In this case, the terminal will read whatever diskettes are ready and then end the job. NPR codes 285, 297, 301, 309, 312, or 313 will not occur.

Defective Diskette Sectors

A sector is a section on the diskette where information is stored. Occasionally, defective sectors are found when trying to write information to the diskette. When this happens, the terminal automatically skips two sectors (to bypass the defective sector), and writes the information in the next (good) sector. As a record number is associated with the sectors that were skipped, the record number for the data written after skipping sectors is one greater than the previously written record.

In Update mode, code 307 displays in the readout indicators when requesting the record number of a defective diskette sector. When this happens request the next higher record number, and continue the job. When a diskette with defective sectors is copied to another diskette, the receiving diskette does not skip sectors unless a defective sector on the receiving diskette is detected; therefore, the number of records may change when copying from one diskette to another. If you perform a list diskette status function as described in the "Using the CODE Key" section, before and after you copy a diskette, you can determine if defective sectors were detected; the number of records in the data set changes.

Entering Keyboard Data on Disk

Use this procedure to enter data on a new diskette, add a data set to a diskette, or add data to an existing data set:

CAUTION:

Check the label on the diskette envelope to be sure you are using the correct diskette. You could inadvertently erase data and job definitions on the wrong diskette.

- 1 Create the diskette, if necessary. Omit this step if adding a data set to an existing diskette data set.
 - A. Install the diskette in Diskette Storage Device number 1.
 - B. Hold the CODE key down and enter a "0"; then, release the CODE key and enter either a "2" or "2I" from the keyboard:
- 2 Creates a 3770 diskette; the number "2" displays in the readout indicators.
2I Creates an exchange (3770) diskette; the number "2I" displays in the readout indicators.



- C. Press the EOM key.
 - D. If your job requires entering to diskette number 2, remove the diskette and install it in Diskette Storage Device number 2.
- 2 Start a Diskette Storage Device job as described in the "Starting a Job" section.
 - Select the keyboard as the job's input device.
 - Select the Diskette Storage Device as the job's output device.
 - 3 Wait for the PROCEED indicator to turn on before you continue.
 - 4 Enter the data from the keyboard.
 - The operator panel readout indicators (NPR) display the diskette record number (1 to 948) that you are entering in the controller buffer. This record transfers to the diskette when: (1) You press the EOM or the EOB key, or (2) the controller buffer fills and the operator panel AUTO switch is on. If an error number, or other NPR code displays in the NPR, the record number will not reappear until the current record is written.
 - With the AUTO switch off, the NPR displays "999" when the controller buffer fills, and you have not pressed the EOM or EOB key; any character keyed after the "999" displays will not enter the buffer; enter these characters in the next buffer after you press the EOM or EOB key.
 - When entering lengthy data sets, you should occasionally end and restart the job. Doing this gives you check points for restarting a job if a power loss occurs. Your check point for restarting a job after a power loss will be the last job end you entered.
 - 5 Stop the job (hold the CODE key down and press the START JOB key) when all the job's records are transferred, or when part of the records are transferred and a checkpoint for restarting the job is desired.

Updating a Diskette Record

Use this procedure to update (change) a record on a diskette:

CAUTION

Check the label on the diskette envelope to be sure you are using the correct diskette. You could inadvertently erase data on the wrong diskette.

- 1 Install the diskette in the Diskette Storage Device.
- 2 Start a keyboard to Diskette Storage Device job as described in the "Starting a Job" section.
 - Select the keyboard as the job's input device.
 - Select the Diskette Storage Device as the job's output device.

Note: Record updating can be performed at any time during a keyboard-to-diskette job, as described in the "Updating Diskette Records During a Keyboard-to-Diskette Job" section that follows.
- 3 Wait until the PROCEED indicator turns on before proceeding to Step 4.
- 4 Turn the UPDATE/MONITOR switch on.
- 5 Enter the record number of the diskette record you wish to update.
- 6 Press the EOM key.
 - The diskette record transfers to the controller buffer.
 - The record number displays in the readout indicators.
 - Use the keyboard buffer edit keys (described in the Keyboard Buffer Edit Keys section) to change the data as desired.

Note: You may press the RESET key instead of the EOM key, and return to Step 5 if you entered the wrong record number.

- 7 Press the EOM key.
 - The updated record transfers back to the diskette.
 - Enter another record number if you need to update more than one diskette record, and repeat Steps 5 and 6.

Note: With the AUTO switch on, the next diskette record (in sequence) transfers to the controller buffer when you press the EOM key in Step 6. The numeric position readout indicators display the diskette record number.

To exit from auto mode, but continue updating, turn the AUTO switch off after the record you last updated transfers to the diskette; then continue at Step 5 of this procedure.

- 8 To exit from update mode, turn the UPDATE/MONITOR switch off.
- 9 To stop the job, after exiting from update mode, hold the CODE key down and press the START JOB key.

Updating a Diskette Record During a Keyboard-to-Diskette Job

At any time during a keyboard-to-diskette job, you can update previously entered records of a data set as follows:

- 1 Press the EOM key to write the record you are currently entering to the diskette; if you do not press the EOM key, the data currently in the buffer erases when the UPDATE/MONITOR switch is turned on (Step 2).

Note: The number of the record you would next write to the diskette displays in the readout indicators.

- 2 Turn the UPDATE/MONITOR switch on.
- 3 Repeat Steps 5, 6, and 7 of the "Updating a Diskette Record" procedure described above; do this for as many records as you want to update.
- 4 When you want to exit from update mode:
 - A. Turn the UPDATE/MONITOR switch off.
 - B. The number of the record you will next write to the diskette displays in the readout indicators; you may continue the keyboard-to-diskette job.

Operation With Two Diskette Storage Devices

On terminals having two Diskette Storage Devices, the following will occur:

- When writing on diskette 1, and it becomes full, writing will automatically continue onto diskette 2 (except for keyboard-to-diskette jobs).
- When reading all active data sets, diskette 2 will be automatically read after diskette 1.

Listed below are some of the operations that can be performed on terminals with two Diskette Storage Devices:

- All active data sets can be copied from diskette to diskette; inactive (bypass) data sets are not copied. Data sets can be deleted by copying active data sets onto diskette 2 and then clearing diskette 1.
- Data sets of the same name can be "pooled". If a data set of the same name exists on both diskette 1 and diskette 2, data from the data set on diskette 1 is added to the same data set on diskette 2.
- All segments of a data set can be collected and written as a data set with just one label. When a data set with more than one label is copied to another diskette, the result is a single continuous data set with one label.
- The second diskette can be used as an extension of the first. This is described under "Multivolume Data Sets" in this section.
- A non-3770 diskette can be transmitted from diskette 2 to the central processor, and response data written (received) onto diskette 1. The original diskette 2 data is not altered.

Diskette Interchangeability

See the publication *IBM 3770 Data Communication System—System Components, GA27-3097*, for additional details on diskette interchangeability. The following must be observed:

- Non-3770 diskettes cannot be written on by the 3770 in BSC mode.
- Non-3770 diskettes can be read by the 3774 or 3775 if they adhere to the rules for basic exchange format, and the record length does not exceed 128 characters.
- ASCII or EBCDIC compatibility must be maintained.
- A data set written in BSC mode can be read later in SDLC mode, but BSC space compression sequences are ignored.
- A data set written in SDLC mode (non-exchange) cannot be read later in BSC mode.

PROC'D

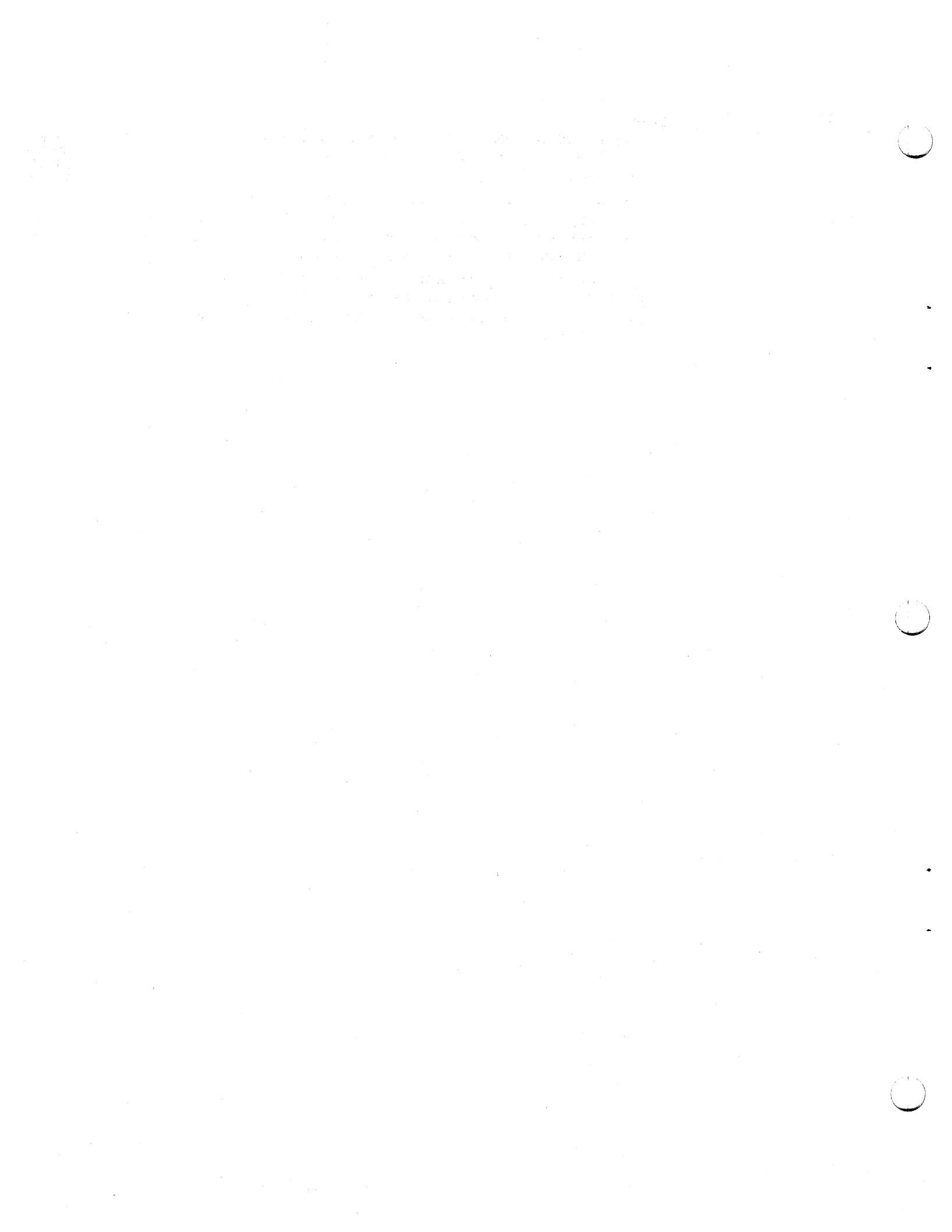

Chapter 3. Error Recovery and Problem Identification

Overview of Error Recovery and Problem Identification Procedures

Error recovery and problem identification procedures assist in recovering from an error condition that interrupted system operation, or assist in determining when system maintenance is required.

The objectives of the error recovery and problem identification procedures are:

- To identify the cause of the error status.
- To correct the error condition and restart system operation.
- To keep a log (record) of error interrupts to assist maintenance personnel in trouble diagnosis.

Restarting a Job Following an Error

Use this procedure to restart system operation following an error stop:

- 1 Observe the operator panel indicators that are on.
 - Either the SYSTEM CHECK or the OPRN (Operational) CHECK indicator will be on. If SYSTEM CHECK is on, the job is ended.
 - If an input or output device error occurred, the operator panel indicator for the device in error remains on, the other input and output indicators turn off.
 - The number displayed in the readout indicators (NPR) identifies the error type. These numbers and the error recovery procedure for the error are listed in the "Numeric Position Readout (NPR) Codes" section.
- 2 Scan the list of codes in the "Numeric Position Readout (NPR) Codes" section, and perform the error recovery procedure listed with the code number.

Note: Return to Step 3 of this procedure if the recovery procedure is unsuccessful.
- 3 If errors continue after performing the procedure listed for the NPR number, and the procedure does not state that the Problem Identification Tests are to be run, request maintenance on the terminal as described in the "Requesting Maintenance on the Terminal" section that follows.

Requesting Maintenance on the Terminal

When you request maintenance on the terminal, always:

- A Record the error conditions on the Trouble Report Form.
- B Print the Error Log as described in the "Printing the Error Log" procedure that follows.
- C Save the copies of the Trouble Report Form and the error log printout; maintenance personnel need this information to analyze and repair the cause of the error condition.

Also save any input or output device media, such as cards or printer forms, that will provide an example of the error condition.

Printing the Error Log

To print and use the error log:

- 1 Hold the CODE key down, and press the numeric "2" key.
- 2 The error log prints. If the error log does not print, press the SYSTEM RESET switch and repeat Step 1.
- 3 Save the error log printout; maintenance personnel use this log in determining the cause of machine failures, the time and date should be written on the printout.
- 4 This part of the error log printout is for the operator's information:

The last five (three-digit) numbers of the printout is a list of the readout indicator numbers (NPR codes) for the last five errors that occurred on the terminal. The first number in the list identifies the last error that occurred on the terminal; the last number in the list identifies the fifth-to-last error that occurred on the terminal.

Using the Trouble Report Form

Use the report form (Figure 3-1) to record information on the status of the system when an error interruption occurs. Maintenance personnel need this system status information to analyze and repair the cause of system failures. Several copies of the trouble report form are included at the back of this manual.

- 1 Circle the operator panel indicators and switches that are on before performing any error recovery procedures:

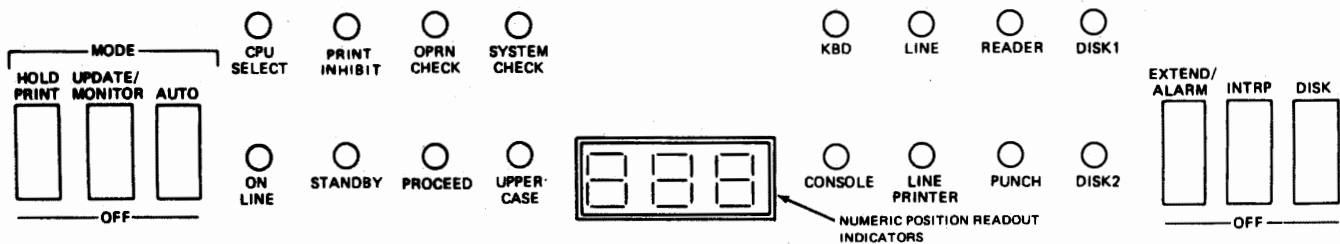

- 2 ----- Enter the number that is displayed in the readout (NPR) indicators.
- 3 Circle the position of these auxiliary operator panel switches:
TALK-DATA BSC-SDLC NORMAL-HALF SPEED
- 4 Circle the input and output devices selected in this job setup:
KEYBOARD CARD READER DISK 1 DISK 2 CONSOLE PRINTER
3784 PRINTER CARD PUNCH COMMUNICATIONS LINE
- 5 Circle the features selected in this job setup:
TRANSPARENT MODE COMPRESS DELETE DATA SETS
MONOCASE MANUAL DISCONNECT INQUIRY MODE
IGNORE ETX/EOT SNBU
- 6 Print the error log: (A) Hold the CODE key down, and press the numeric "2" key, and (B) the error log prints. If the error log does not print, press the SYSTEM RESET key and repeat step A.
- 7 Comments (additional information or results of "Problem Identification Tests"):

Figure 3-1. Trouble Report Form

Numeric Position Readout (NPR) Codes

When an error occurs and the OPRN CHECK (Operational Check) or SYSTEM CHECK indicator is on:

- If the audible alarm sounds, press the RESET key to turn it off.
- Scan this list of readout (NPR) codes to locate the code number displayed in the readout.
- Perform the recovery procedure provided with the code number.

Note: Some of the codes are listed more than once. In these cases, use the recovery procedure that applies to the job you are running. For example, code 250 applies to either the Serial or the Line console printer. When code 250 occurs you would select the procedure for the Serial Printer (if using an IBM 3774 Terminal), or the procedure for the Line Printer (if using an IBM 3775 Terminal).

If an NPR code number that is not listed here appears, a machine malfunction probably occurred and you should request machine maintenance, as described under "Requesting Maintenance on the Terminal".

For communication line jobs where the error causes the job to end, the error code remains in the NPR until CODE and RESET are pressed, or until the terminal accepts another device selection from the central processor.

Caution: When you hold the CODE key down and press the RESET key, the code displayed in the NPR clears, but the error condition remains. When this happens, the terminal appears to be in an undetermined state if you attempt an operation without first correcting the cause of the error. For example, on 3774 terminals, code 260 displays when the HOLD PRINT switch is on. If CODE and RESET were pressed without turning the HOLD PRINT switch off, the code 260 display would clear, but with the HOLD PRINT switch still on, the terminal's speaker sounds when operation from the terminal's keyboard is attempted.

If the terminal appears to be in an undetermined state, check that:

- The operator panel switches are in the correct position.
- The console printer has not reached its maximum print position; if it has, press the Return key to return to the left margin.
- The input and output devices are in a ready condition; that is, check for out-of-card or end-of-forms conditions.

NPR NO.	DESCRIPTION	OPERATOR ACTION
--2	Timer failure (the first two readout indicator positions are blank).	This error may occur when running communication tests. A. If the error occurred when running test 0, request maintenance on the terminal. B. If the error occurred when running test 2, refer to the "Problem Identification Procedures" section of this chapter for the operator action to be taken. Note: All terminals can run communication test 0; but not all terminals have modems attached that are capable of running test 2. This is described in more detail in the "Problem Identification Procedures" section in this chapter.
000	During Update mode in diskette jobs, an incorrect record number was specified; the number is greater than the number of records on the diskette.	The error occurred when updating (a keyboard-to-Diskette Storage Device job). Enter another record number and press the EOM key.
000	When power is turned on and the "000" display remains, it indicates an error occurred during functional tests.	Turn power off and back on again; request maintenance on the terminal if the error continues.
001 002 003	Power on test display. These numbers normally do not display long enough to be seen by the operator.	If the display remains for an extended time, turn power off and back on again. Request maintenance on the terminal if the error continues.

NPR NO.	DESCRIPTION	OPERATOR ACTION
004	Power on test display.	This display normally remains for a few seconds during power on. If the display remains for an extended time, turn power off and back on again. Request maintenance on the terminal if the error continues.
005	Power on test display.	This number normally does not display long enough to be seen by the operator. If the display remains for an extended time, turn power off and back on again (refer to "Power On/Off Procedures" in Chapter 2). Request maintenance on the terminal if the error continues.
006	Power on test display.	This display remains for a few seconds during power on. If the display remains for an extended time, turn power off and back on again. Request maintenance on the terminal if the error continues.
1-- 2-- 3-- 4-- 5-- 6-- 7--	Power On Test Error Display (the last two readout positions are blank). One of these numbers displays if a checking error occurs during power on.	Turn power off and back on. If the error continues, request machine maintenance.
200	BEL character received (3775 only).	1. Press CODE/RESET to continue without changing forms, or 2. Turn the HOLD PRINT switch on and install forms in the printer. The NPR clears when the printer cover is closed.
206	Diskette 1, the data set name to be written already exists on the diskette, and this is a basic exchange diskette. To write this data set, it would have to be segmented, and this is not possible on a basic exchange diskette.	Use another (unique) data set name, recreate the diskette, or replace the diskette, and restart the job.
207	Diskette 1, FM header incompatibility. An attempt was made to write either an exchange data set on a 3770 mode diskette or a non-exchange data set on an exchange mode diskette from the line using SDLC, or an attempt was made to mix compressed and non-compressed data in the same data set.	Replace the diskette, or create this diskette as an exchange or non-exchange diskette, as required, and restart the job; or don't attempt to mix compressed and non-compressed data.
208	Diskette 1, incompatibility error. <i>Using BSC:</i> An attempt was made to read or write a data set having a "T" in the Exchange Type Indicator (refer to List Diskette CODE key function in Chapter 2). <i>Using SDLC:</i> An attempt was made to write into a data set having an "E" or "Blank" in the Exchange Type Indicator (refer to List Diskette CODE key function in Chapter 2).	Replace the diskette, or do a Create Diskette CODE key function (if data on the diskette is no longer needed), and restart the job.
210	Diskette compare error when writing updated record to the controller.	No control record is written over the data; read the buffer again and verify that the data is correct.
211	Diskette 1, invalid record number specified at job start time. The record number specified is greater than the data size.	Hold the CODE key down and press the RESET key to return to local mode. Use the List Diskette Status CODE key function (see "Using the Code Key" in Chapter 2) to determine the number of records in the data set.
212	Diskette 1, physical record length is not equal to 128 characters per sector. This diskette can not be processed by a 3770.	Replace the diskette.
213	Diskette No. 1, diskette block length is 512 bytes.	The same as error code 225.
215	Diskette 1, incompatibility error. <i>Using BSC:</i> Data cannot be written onto this diskette either from the line, or during off-line operation. <i>Using SDLC:</i> Data can be written onto this diskette only from the line.	Replace the diskette, and restart the job.

NPR NO.	DESCRIPTION	OPERATOR ACTION
216	Diskette No. 1, relocated sector condition detected.	The same as error code 228.
218	Diskette 2, the data set name to be written already exists on the diskette, and this is a basic exchange diskette. To write this data set, it would have to be segmented, and this is not possible on a basic exchange diskette.	Use another (unique) data set name, recreate the diskette, or replace the diskette, and restart the job.
219	Diskette 2, FM header incompatibility. An attempt was made to write either an exchange data set on a 3770 mode diskette or a non-exchange data set on an exchange mode diskette from the line using SDLC, or an attempt was made to mix compressed and non-compressed data in the same data set.	Replace the diskette, or create this diskette as an exchange or non-exchange diskette, as required, and restart the job; or don't try to mix compressed and non-compressed data.
220	Diskette 2, incompatibility error. See code 208 for description.	Same as code 208.
222	Control diskette and checking operation during power on sequence.	Request machine maintenance if this number displays for longer than approximately two minutes during power on.
223	Diskette No. 2, invalid record number specified at job start time.	The same as error code 211.
224	Diskette 2, the diskette Physical Record Length is not equal to 128 characters per sector. This diskette cannot be processed by a 3770.	Replace the diskette.
225	Diskette No. 2, block length is 512 bytes.	Perform a "List Diskette" CODE key function to verify that the block length is 512 bytes. The terminal cannot process the 512 block length; if a 3776 terminal is available, the diskette can be used (in 512 block length mode).
227	Diskette 2, incompatibility error. See code 215 for description.	Replace the diskette and restart the job.
228	Diskette No. 2, re-located sector condition detected while reading a non-3770 diskette.	Continue reading by holding the CODE key down and pressing RESET; or end the job by holding the CODE key down and pressing the START JOB key.
229	3784 printer, not operational	<ol style="list-style-type: none"> 1. Check that the printer is in a ready condition; refer to the make ready procedure in Chapter 11. 2. If the printer is still not ready, press the 3784's MACH RESET switch; the PRT READY (Print Ready) indicator should turn on. 3. If the PRT READY indicator comes on, notify the operator at the central processor, and discard the data received on this job; then restart the job. Request maintenance if the problem occurs when you restart the job.
230	3784 printer, parity error at the 3784.	The same as error code 229.
231	3784 printer, parity error at the 3774.	The same as error code 229.
232	Invalid job definition read from card reader.	The job identification number must be a number 1 through 5, as specified in the "Entering an Operator Defined Job From the Card Reader" section in Chapter 2, and all 77 of the job definition card columns must be punched. Correct the card and re-enter the job definition for this and any following cards.
233	Enter ID (Identification).	Insert an identification badge in the ID Reader; the procedure for doing this is illustrated in Chapter 10, Operator ID Reader.
234	Defective control diskette sector read after power on.	Request machine maintenance.
235	Identification badge reader, read error.	<ol style="list-style-type: none"> 1. Hold the CODE key down and press the RESET key to reset the error. 2. Read the identification card again, using the CODE key 6 function described in the "Using the CODE key" section.



NPR NO.	DESCRIPTION	OPERATOR ACTION
236	Keyboard, parity error. The controller inserts a hyphen character into the controller buffer in place of the character in error.	Backspace (using the BUFFR BKSP key) to the error character, and enter the correct character; press the RESET key to resume keying after the last character entered in the buffer.
237	Serial printer (3774), parity error.	This error occurs only after turning the terminal's power on, or after operating the SYSTEM RESET switch. The terminal automatically retries when the error occurs; if successful, the 237 error display in the readout indicators clears (the indicators are blank). Request maintenance on the terminal if the 237 error display remains in the readout indicators.
242	3501 Card Reader emitter pulse error.	<ol style="list-style-type: none"> 1. Locate the card read when the error occurred. If a card is under the read head, it is the failing card; otherwise, the top card in the stacker is the failing card. 2. Place the card located in Step 1 in the hopper at the bottom of the card deck. 3. Press the START key.
243	3501 Card Reader overrun.	Same as code 242.
243	2502 Card Reader overrun.	<ol style="list-style-type: none"> 1. Remove cards from the hopper. 2. Open the reader cover and check for a card jam. Normally there is one card at the pre-read station. 3. Remove the top card from the stacker and check it for torn webbing, out of specification punching, or other damage. Replace if necessary. 4. Press the 2502 NPRO key. 5. Place any cards found in Step 2, the card from Step 3, and any card ejected in Step 4 in proper sequence at the bottom of the deck taken from the hopper. 6. Place card deck in hopper and press the START key.
244	3501 Card Reader invalid punch.	<ol style="list-style-type: none"> 1. Locate the card read when the error occurred. If a card is under the read head, it is the failing card; otherwise, the top card in the stacker is the failing card. 2. Correct the card if any column has more than one punch in card rows 1 through 7. 3. Place the card located in Step 1 (or the corrected card) at the bottom of the card deck and replace the card deck in the hopper. 4. Press the START key.
244	2502 card reader, validity check.	<ol style="list-style-type: none"> 1. Remove the cards from the hopper. 2. Press the NPRO key. 3. Remove the top two cards from the stacker, and place them on the bottom of the deck removed from the hopper. 4. Check the bottom card of the hopper deck for an invalid card code (more than one punch in rows one through seven in any card column). Correct any errors. 5. Place the cards back in the hopper. 6. Press the START key.
245	2502 card reader, read check.	The same as error code 243.
246	3501 card reader, feed check.	The same as error code 243.
246	2502 Card Reader feed check.	<ol style="list-style-type: none"> 1. Remove the cards from the hopper, check for a damaged card, and replace if necessary. 2. Open the reader cover, check for and remove any card jam, and replace any damaged cards. 3. Press the NPRO key. 4. Place cards from Steps 1, 2, and 3 in proper sequence at bottom of card deck, and place card deck back in the hopper. 5. Press the START key.
247	2502 card reader, misregistration	First, check the position of the 2502 OMR switch; this error occurs if attempting to read punched cards in OMR mode. Second, perform the operator action listed for 2502 error code 243.
248	2502 card reader, card late.	The same as error code 243.

ERP

NPR NO.	DESCRIPTION	OPERATOR ACTION
249	3501 Card Reader all holes punched, or trailing edge error.	<ol style="list-style-type: none"> 1. Locate the card read when the error occurred. If a card is under the read head, it is the failing card; otherwise the top card in the stacker is the failing card. 2. Correct the card if one or more of the card columns has all holes punched. 3. Place the card back in the hopper and press the START key.
249	2502 card reader, trailing edge error.	The same as error code 243.
250	Serial printer (3774), emitter timing.	Clear the error by holding the CODE key down and pressing the RESET key; printing continues with the printer attempting to reprint the character in error. Request maintenance on the terminal if the error continues.
250	Line printer (3775), sync check.	Clear the error by holding the CODE key down and pressing the RESET key; then, restart the job. Request maintenance on the terminal if the error continues.
250	3784 printer, sync check.	The same as error code 229.
251	Serial printer (3774), carrier motion.	The same as error code 250.
251	Line Printer (3775) Belt Error.	Check to see if belt is a 48-character belt: if it is, remove it from the printer (a 48-character belt cannot be used on the 3775). If it is not a 48-character belt, clear the error by pressing CODE and RESET, and restart the job. Request machine maintenance if the error continues.
251	3784 printer, belt error.	<ol style="list-style-type: none"> 1. Visually check for and correct: a printer cover open, a paper jam, the throat open, or the printer being out of forms. The job will continue without loss of data if the HOLD PRINT switch had been turned on before the operator opened the printer cover. Turn the HOLD PRINT switch off to continue printing. If an error occurs with the HOLD PRINT switch on, data will be lost. 2. A possible hardware error condition exists if none of the conditions checked in Step 1 exist. Notify the operator at the central processor, and discard the data received on this job; then, restart the job. Request maintenance if the problem occurs when you restart the job.
252	Line printer (3775), thermal check.	A thermal check automatically shuts down the printer. Request machine maintenance.
252	3784 printer, thermal check.	The same as error code 229.
253	Serial (3774) printer, line feed error.	The same as error code 322.
253	3784 printer, paper jam/throat open.	The same as error code 251.
253	Line printer (3775) Paper Jam or throat open.	Same as code 251 for the 3784 printer.
254	Serial printer (3774), hammer fire error.	Hold the CODE key down and press the RESET key; then, restart the job. Request maintenance on the terminal if the error continues.
254	Line printer, hammer fire error.	A hammer fire error automatically shuts down the printer. Request machine maintenance.
254	3784 printer, hammer fire check.	A hammer fire error automatically shuts down the printer. Request machine maintenance.
255	Machine check.	Hold the CODE key down and press the RESET key; then, restart the job. Request maintenance on the terminal if the error continues.
256	Machine check.	Hold the CODE key down and press the RESET key; then, restart the job. Request maintenance on the terminal if the error continues.
257	Machine check.	Hold the CODE key down and press the RESET key; then, restart the job. Request maintenance on the terminal if the error continues.
258	Machine check.	Hold the CODE key down and press the RESET key; then, restart the job. Request maintenance on the terminal if the error continues.

NPR NO.	DESCRIPTION	OPERATOR ACTION
259	Machine check.	Hold the CODE key down and press the RESET key; then, restart the job. Request maintenance on the terminal if the error continues.
260	Either the HOLD PRINT or AUTO switch is on (or the UPDATE/MONITOR switch is off), stopping printing on the console printer.	Set the above operator panel switches as required for the job. (Refer to the "Starting a Job" section in Chapter 2); when the switches are set correctly, the error automatically clears and printing continues.
285	Diskette No. 2 not ready.	Same as code 347 with OPRN CHECK or SYSTEM CHECK.
286	Diskette No. 2 CRC error. This is either a diskette or a machine failure.	Refer to "Diskette Data Recovery Procedures" to recover data on the diskette.
287	Diskette No. 2 AM (address mark)/overrun error. This is either a diskette or a machine failure.	Refer to "Diskette Data Recovery Procedures" to recover data on the diskette.
288	Diskette No. 2 no record found. See error code 350 for description and recovery.	Refer to "Diskette Data Recovery Procedures".
289	Diskette No. 2 diskette buffer error. See error code 351 for description and recovery.	Refer to "Diskette Data Recovery Procedures".
290	Diskette No. 2 diskette buffer parity error. This is a machine error during a read or a write operation.	Refer to "Diskette Data Recovery Procedures" for information about possible continuation of the job using a different diskette device, or request machine maintenance.
291	Diskette No. 2 diskette buffer timeout. This is a machine error during a read or a write operation.	Same as code 290.
292	Online: Incomplete transmission; the terminal's job was ended prematurely by the central processor, and the terminal has returned to standby mode.	Restart the job, or the CPU may restart the job. This is not a normal job end; the recovered data at the terminal will be available, but may be incomplete.
293	Online (BSC Only): Buffer overrun; the terminal's buffer capacity was exceeded.	Notify the operator at the CPU. Received data at the terminal will be incomplete. It is recommended that the operator discard data received on this job.
294	Online (BSC Only): Mixed blocks, a mixture of transparent and nontransparent data blocks.	Discard the data received on the job: Notify the operator at the CPU.
295	Online (BSC Only): Transparency check; the terminal is transmitting; a data link control character is included in the message text and the terminal is not in transparent mode.	Notify the operator at the CPU to discard the data received on this job. The terminal operator should correct the data and restart the job.
296	Diskette No. 1. The diskette cannot be processed by the 3770. (It does not have a VOL1 or HDR1 label.)	If the diskette no longer contains valid data from another system, it can be made usable on the 3770 via the Create Diskette CODE key function. Stop the job, do the Create Diskette Procedure as described in Chapter 2 under "Using the CODE Key", and restart the job.
297	Diskette No. 1, data set not present.	<ol style="list-style-type: none"> 1. Determine that the correct diskette for this job is installed. 2. Perform a "List Diskette Status" operation to list all data sets on the Diskette. 3. Place the proper diskette in device 1 and restart the job.
298	Diskette No. 1 inactive data set. This data set was purposely tagged inactive.	If you wish, the status can be changed to active by using the Change Status CODE key function, if this is a 3770 diskette.
299	<p>Diskette No. 1, diskette full. The end of the data set has been reached and is marked continued.</p> <p>Note: If it is not desired to keep this data set marked continued (for unattended considerations) use the Change Status CODE key function to change the status.</p>	<p>Either:</p> <ol style="list-style-type: none"> A. Insert another diskette.* Hold the CODE key down and press RESET to continue the job. B. End the job (hold the CODE key down and press the appropriate START JOB key). <p>*Caution: For line source jobs, the replacement diskette must not be a full diskette, or the data set name will be incremented causing loss of data set integrity.</p>

NPR NO.	DESCRIPTION	OPERATOR ACTION
300	Diskette No. 1 end of volume/read. This condition occurs when the end of a continued data set is reached.	<ol style="list-style-type: none"> 1. Insert the diskette containing the next sequential volume and press CODE and RESET to continue the job, or 2. End the job by pressing CODE and START job.
301	Diskette No. 1 multivolume data set (the data set is contained on more than one diskette). This indication occurs at Start Job time to alert the operator to install the diskettes in the proper sequence. The code also occurs when the machine is expecting a multivolume data set, but the present diskette is marked as a single volume.	When ready to continue, hold the CODE key down and press RESET and the job continues; or you can end the job by holding the CODE key down and pressing START JOB.
302	Diskette 1 is either a non-3770 diskette, or one created as an exchange diskette using SDLC. The 3776 cannot write BSC data sets on this diskette.	Install a 3770-created diskette, or if data on this diskette is no longer needed, create this diskette as described in Chapter 2 under "Using the CODE Key".
303	Diskette No. 1, ASCII/EBCDIC compatibility error. An ASCII diskette is mounted on an EBCDIC machine, or an EBCDIC diskette is mounted on an ASCII machine.	Install the correct diskette, or create this diskette as described in the "Using the CODE Key" section.
304	Diskette No. 1, invalid entry during Change Status CODE key function. The code also occurs if you try to read or write job definitions using a non-3770 or 3770 SDLC exchange mode diskette (job definition is not written on these diskettes).	<p>During Change Status:</p> <ol style="list-style-type: none"> 1. Check the second data set name entered when changing the name. The first two characters must be alphabetic and the second two numeric. If used, the status character (the last character) must be either an "A" or an "I", or the multivolume character must be "C" for a continued, "L" for last of a multivolume, or "S" for single (not multivolume) data set. 2. Hold the CODE key down and press RESET to reset the error. 3. Repeat the Change Status CODE key function. <p>During job definition read or write, replace the diskette with a 3770 mode or 3770 BSC exchange diskette.</p>
305	Diskette No. 1, all data set labels full. No data sets can be added to the diskette, but data sets can be updated. Ignore the NPR code when it occurs during diskette update.	<p>Once the data set labels are used, no more data sets can be added to the diskette; this is described in more detail in the "Diskette Storage Device Jobs" section of Chapter 2. To continue the job, install another diskette, and hold the CODE key down and press the RESET key.</p> <p>Note: To make any changes desired to any data set, start a keyboard-to-diskette job for that data set and use the update function; update is described in the "Diskette Storage Device Jobs" section in Chapter 2.</p>
306	Diskette No. 1 has tracks with no Address Marks. This code can also occur if the diskette door is opened while the diskette is in operation.	If the diskette door was opened, close it and restart the job; otherwise, no more attempts should be made to write on the diskette. If this was a write operation, data written up to this point can be read. If it was a read operation, additional data on this data set may be retrieved as described in this chapter under "Diskette Data Recovery Procedures". Further Diskette data in a different data set can also be retrieved.
307	Defective sector detected during UPDATE mode. The record number keyed during a keyboard to diskette (update) job is located in an unused (defective) sector of the diskette.	Enter another record number, and continue the job. There is no data written on the defective sector; this is described in more detail in the "Diskette Storage Device Jobs" section of Chapter 2. If the job aborted during update, data may be lost. Otherwise, data should be contained in the next sequential buffer.
308	Diskette No. 2 cannot be processed by a 3770. (It does not have a VOL1 or HDR1 label).	Same as code 296.
309	Diskette No. 2 data set not present.	<ol style="list-style-type: none"> 1. Remove the diskette from device 2 and place it on device 1. 2. Perform a List Diskette Status operation to determine if this is the correct diskette for the job. 3. When the correct diskette is found, place it in diskette device 2. 4. Restart the job.

NPR NO.	DESCRIPTION	OPERATOR ACTION
310	Diskette No. 2 inactive data set. This data set was purposely tagged inactive.	Same as code 298.
311	Diskette No. 2, diskette full. The end of the data set has been reached, and the data set is marked continued.	Same as code 299.
312	Diskette No. 2 end of volume/read. This condition occurs when the end of a continued data set is reached.	Same as code 300.
313	Diskette 2 is, or should be, a multivolume data set. At job start time, this code displays if diskette 2 is marked as a multivolume data set. If the code occurs after reading a multivolume data set from diskette 1, then diskette 2 does not contain a continuation of the data set (it is not marked 'continued' or 'last') read from diskette 1.	If the code occurred at job start time, press CODE/RESET and the job continues. If the code occurred after diskette 1 was read, replace diskette 2 with the proper diskette and press CODE/RESET to continue.
314	Diskette 2 is either a non-3770 diskette, or one created as an exchange diskette using SDLC. The 3776 cannot write BSC data sets on this diskette.	Same as code 302.
315	Diskette No. 2, ASCII/EBCDIC compatibility error. An ASCII diskette is installed on an EBCDIC machine, or an EBCDIC diskette is installed on an ASCII machine.	Install the correct diskette, or create this diskette as described in Chapter 2 under "Using the CODE Key".
316	The diskette does not conform to 3770 diskette exchange format.	Check the diskette label using the List Disk Status CODE key function to be sure that the correct diskette is installed. Check the blocksize, special requirements indicator, etc.
317	Diskette No. 2 all data set labels full. See NPR code 305 for description.	Same as code 305.
318	Diskette No. 2 has tracks with no Address Marks. This code may also display if the diskette door is opened while the diskette is in operation.	Same as code 306.
319	Diskette No. 1 or 2, data set is write protected. A 3770 diskette is installed, but the requested data set cannot be reopened because the write protect indicator was set by another system. The 3770 cannot set nor clear the write protect indicator.	Check that the correct diskette is installed.
320	3501 card reader, hopper check.	<ol style="list-style-type: none"> 1. Determine that cards were loaded in the hopper. 2. Check for and repair damaged cards. 3. Reload the hopper. 4. Press the START key to continue the read operation.
320	3521 card punch, not ready. Note: The NPR is not cleared until the 3521 begins punching.	<ol style="list-style-type: none"> 1. If hopper is empty, load it with cards and go to Step 3. 2. Remove cards from hopper, check for damaged card, replace if necessary, and return cards to hopper. 3. Press START key.
320	2502 card reader, attention condition (not ready).	<ol style="list-style-type: none"> 1. Ensure that 2502/3782 power is on. 2. Empty the stacker if it is full. 3. Reload the hopper if it is empty. 4. Open the top cover and check that the post read station cover is closed. Close the top cover. 5. Press the START key.

NPR NO.	DESCRIPTION	OPERATOR ACTION
321	2502 Card Reader OMR (Optical Mark Read) check. A card with an OMR error is offset from the other cards in the stacker.	<ol style="list-style-type: none"> 1. Remove any offset cards from the stacker and inspect for marks that are too light and for smudged or incomplete erasures of OMR marks. Correct any errors. 2. Press the NPRO key. 3. Open the top cover and determine if the OMR lamp is on when the Mode switch is in the MARK or MARK-PUNCH position. Request machine maintenance if the lamp is not on. 4. Place corrected cards in the hopper. 5. Press the START key, unless the EOF switch is on, in which case it is necessary to restart the job.
322	Serial printer (3774), power not ready.	This error indicates that a momentary drop in the printer's line voltage occurred. The job continues when power restores; request machine maintenance if the error continues.
322	Line printer (3775), cover open.	<ol style="list-style-type: none"> 1. Visually check for and correct: a printer cover open, a paper jam, the throat open, or the printer being out of forms. The job will continue without loss of data if the HOLDPRINT switch had been turned on before the operator opened the printer cover. Turn the HOLD PRINT switch off to continue printing. 2. A possible hardware error condition exists if none of the conditions checked for in Step 1 exists. Notify the operator at the central processor, discard the data received on this job, and restart the job. Request machine maintenance if the problem occurs when you restart the job.
322	3784 printer, cover open.	The same as error code 251.
323	Serial (3774) and Line (3775) printer, end of forms.	<p>You can continue printing on the form that remains in the printer (approximately 8 inches) one line at a time by using this procedure (for each line):</p> <p>Note: Print quality at the bottom 8 inches of paper may be reduced because the paper is not firmly held.</p> <ol style="list-style-type: none"> 1. Wait until the line finishes printing and hold the CODE key down and press the RESET key. A line prints, and the error code displays again. 2. Repeat Step 1 if you need to print additional lines. 3. A. If using the line printer (3775), turn the HOLD PRINT switch on and install forms in the printer. B. If using the serial printer (3774): <ol style="list-style-type: none"> (1) Turn the HOLD PRINT switch on. (2) Hold the CODE key down and press the RESET key. (3) Install forms in the printer. 4. To continue after loading forms, turn the HOLD PRINT switch off.
323	3784 printer, end of forms.	The same as error code 251.
324	Machine check.	Operator Action: Restart the job; request machine maintenance if the error continues.
325	Machine check.	Restart the job; request machine maintenance if the error continues.
326	Machine check.	Restart the job; request machine maintenance if the error continues. If this error occurs immediately after power on, turn the terminal's power off and back on, and restart; request machine maintenance if the error continues.
327	Machine check, overrun.	Notify the operator at the central processor, discard data received or transmitted on this job. The terminal returns to standby mode; the terminal operator or the central processor can restart the job. If using a switched communications network, redial the connection before starting the job again. Request machine maintenance if the problem occurs when you restart the job.
328	Machine check, underrun.	The same as error code 327.
329	Machine check, invalid B-Status.	The same as error code 327.

NPR NO.	DESCRIPTION	OPERATOR ACTION
330	Machine check, timeout write.	<p>Notify the operator at the central processor, discard data received or transmitted on this job. The terminal returns to standby mode; the terminal operator or the central processor can restart the job.</p> <p>If the error continues, refer to the Problem Identification section, and run "Test 0: Terminal Communications Test" only; if test 0 fails, request maintenance on the terminal; if test 0 does not fail, request maintenance on the modem.</p>
331	Machine check, timeout read (BSC Only).	The same as error code 327.
331	SDLC read timeout. The machine has been receiving in sync for more than 25 seconds without receiving flag characters.	Notify the central processor operator and restart the job. Request machine maintenance if the error continues.
332	Online: transmit line check; possible communications line problem, fifteen negative responses to data block checking were received (BSC), or 20 write retries were attempted (SDLC).	Use the "Problem Identification Procedures" in this chapter.
333	Online, receive line check, possible communication line problem.	The same as error code 332.
334	Online: Bid timeout/invalid (BSC Only); the communication link was not available for transmitting after 15 bid attempts.	The same as error code 332.
334	SDLC idle timeout. There has been no line activity for 20 seconds. Using a switched line and auto answer, the line is disconnected.	Notify the central processor operator. The job continues when line activity resumes, if the terminal is not connected to a switched line.
335	Online (BSC Only): Data response—timeout/invalid; possible communication line problem, no response to the checking sequence for a transmitted data block, or failure of the central processor to continue sending data.	The same as error code 332.
335	SDLC primary abort. The central processor has terminated the job.	Notify the central processor operator. The job may be resumed by the central processor.
335	Online: No response or invalid response to terminal-transmitted data block, or the terminal failed to receive further data from the central processor.	Use the "Problem Identification Procedures" in this chapter.
336	Online (BSC Only): Record check; possible communication line problem, a count of 15 wrong acknowledgments to data block checking was received.	The same as error code 332.
337	Online (BSC Only): Error recovery timeout. About three minutes has elapsed since an attention condition (such as printer out of forms) was detected, and the attention condition was not corrected.	Make the affected device ready and restart the job. Either the terminal operator or the central processor can restart the job.
338	Online: Data communications equipment interruption occurred: possible modem or communication line problem.	<p>If error occurs when dialing, redial the connection; a job restart is not required, the job starts when the connection is established.</p> <p>If the error occurs when a job is running, notify the central processor operator and restart the job; request maintenance on the modem if the error continues.</p>
339	3521 card punch, print (sync check) error.	<p>Operator Action for Offline Jobs:</p> <p>For punch jobs:</p> <ol style="list-style-type: none"> 1. Press the NPRO key (blank card should be ejected to the stacker). 2. Remove the top two cards from the stacker; place the blank card back in the hopper and discard the punched card. 3. Press the START key.

NPR NO.	DESCRIPTION	OPERATOR ACTION
339 (Cont.)		<p>For reader jobs:</p> <ol style="list-style-type: none"> 1. Remove top card from the stacker. 2. Press the NPRO key. 3. Take card from Step 1 and any card(s) from Step 2 and return to hopper in proper sequence. 4. Press the START key. <p>Operator Action for Online Jobs:</p> <p>For an online job, printing stops for the remainder of the job but the punching or reading continues normally. If printing accuracy is not important to the job, the card in error and the remaining unprinted cards can be printed later in offline mode.</p> <ol style="list-style-type: none"> 1. Press the RESET key. 2. Start the next job.
340	3521 card punch, transport sync check.	<p>Operator Action for Punch Operation:</p> <ol style="list-style-type: none"> 1. Remove the top card from the stacker and discard it. 2. Press the NPRO key and remove the blank card from the stacker. 3. Press the START key. <p>Operator Action for Read Operation:</p> <ol style="list-style-type: none"> 1. Remove the top card from the stacker. 2. Press the NPRO key. 3. Take card from Step 1 and any card(s) from Step 2 and return to hopper in proper sequence. 4. Press the START key.
341	3521 card punch, eject/increment check.	The same as error code 340.
342	3521 card punch (with read feature), read sensor error.	The same as error code 340.
343	3521 card punch, feed check.	<ol style="list-style-type: none"> 1. Remove the cards from the hopper. 2. Check for a card jam in the hopper or the transport area. 3. Repair or replace any damaged cards if reading; discard any damaged cards if punching. 4. Press the NPRO key. 5. Press the START key.
344	3521 card punch, punch error.	<ol style="list-style-type: none"> 1. Remove the top card from the stacker and discard it. 2. Press the NPRO key and remove the blank card from the stacker. 3. Press the START key to punch a new card to replace the one in error.
345	3521 card punch, overrun or interrupt check.	The same as error code 340.
346	3521 card punch, invalid read character.	<ol style="list-style-type: none"> 1. Remove the top card from the stacker, and inspect for an invalid card code (more than one hole punched in any column in rows one through seven). 2. Press the NPRO key and remove the card that ejects to the stacker. 3. Place the corrected card inspected in Step 1 on the bottom of the hopper and place the card from Step 2 in the hopper in sequence.
347 All Lights On	The control diskette (in back of the machine) is not ready (early shipped machines).	Check that the diskette door is latched closed. If it is, request machine maintenance.
347 OPRN CHECK Light On	Diskette No. 1 not ready at Job Start.	<ol style="list-style-type: none"> 1. Determine that a diskette is installed and the Diskette Device cover is latched closed. When correctly installed, the diskette label is at the top facing the front. 2. The DISK 1 light turns off when the diskette is installed, the Diskette Device cover is latched closed, and the diskette is turning at the proper speed. <p>Note: If a diskette operation starts before the diskette is turning at the proper speed, error code 347 automatically clears when the diskette is at the proper speed (about 10 seconds is required).</p>

NPR NO.	DESCRIPTION	OPERATOR ACTION
347 SYSTEM CHECK Light On	Diskette No. 1 not ready, job in progress. The job is terminated.	The diskette door must not be opened after the job is started, except to install another volume when so indicated by codes 299/311, 300/312, 301/313, or 305/317. If a diskette write operation was in progress, all data written to this data set is lost because the data set label could not be written. Refer to "Diskette Data Recovery Procedures" for additional information. Check that the Diskette Device door is latched closed; if it is, request machine maintenance.
348	Diskette No. 1 CRC error. This is either a diskette or a machine failure.	Refer to "Diskette Data Recovery Procedures".
349	Diskette No. 1 AM (Address Mark)/overrun error. This is either a diskette or a machine failure.	Refer to "Diskette Data Recovery Procedures".
350	Diskette No. 1 no record found. The required diskette sector cannot be located, due to a diskette or a machine failure. If using a non-3770 diskette the sequence number in the volume label may be incorrect; if so, the diskette cannot be processed on a 3770 nor can the Diskette Create function be performed.	Refer to "Diskette Data Recovery Procedures".
351	Diskette No. 1 buffer compare error. This is either a diskette or a machine failure that occurred on a write operation. Data written onto the diskette and read back does not compare to that contained in the diskette buffer.	Refer to "Diskette Data Recovery Procedures".
352	Diskette No. 1 buffer parity error. This is a machine error during a read or write operation.	Refer to "Diskette Data Recovery Procedures" for information about possible continuation of the job using a different diskette device, or request machine maintenance.
353	Diskette No. 1 buffer timeout error. This is a machine error during a read or a write operation.	Same as code 352.
354	Reader or punch power off occurred (READER or PUNCH operator panel indicator identifies which device).	<ol style="list-style-type: none"> 1. Hold the CODE key down and press the START JOB key. 2. For 2502 Card Reader or 3521 Card Punch, turn the power switch on if it is off. 3. For 3501 Card Reader or 3521 Card Punch, plug in the power cord (at the back) if it is not plugged. 4. If Step 2 or Step 3 corrects the problem, press CODE/RESET and restart the job. 5. If performing Steps 2 or 3 does not correct the problem, request machine maintenance. <p>Note: For IBM 3521 Card Punch jobs, allow several seconds after power on to allow the 3521's read head to warm up before starting the job.</p>
500	Record Format Control, ADD REC invalid at this time.	Enter the valid keyboard data required at this point in the job.
501	Record Format Control, keyboard data entered is not numeric.	Re-enter the field; enter numeric characters.
502	Record Format Control, incorrect self-check digit entered.	Verify that the last digit in the field you just entered is the proper self-check digit; then reenter the entire field.
510	Record Format Control, odd number of characters in record format specification.	Restart the job. Contact the system programmer if the error continues. Save any output device media, such as printer forms or cards; these will help in determining the cause of the error.



NPR NO.	DESCRIPTION	OPERATOR ACTION
511	Record Format Control, diskette data set name error.	The same as error code 510. A. The data set name's first two characters must be alphabetic; the last two characters must be numeric. B. For Diskette No. 1 to Diskette No. 1 Record Format jobs, the input and output data set names cannot be the same. C. For Record Format jobs other than Diskette No. 1 to Diskette No. 1, check that the data set name was entered correctly.
512	Record Format Control, the first record format descriptor is not a CFD (Control Field Descriptor).	The same as error code 510.
513	Record Format Control, the next CFD specified as match or mismatch action; no further CFDs exist with the record format specification.	Notify the system programmer of this problem; save any of the job's output device media, such as printer forms or cards; these will help in determining the cause of the error.
514	Record Format Control, horizontal tab setting not defined.	Check that the correct operator-defined job was selected when the job was started; and check that the horizontal tab stops were defined correctly.
515	Record Format Control, displacement plus length of alternate input field is greater than the input record length.	The same as error code 513.
516	Record Format Control, field length for decimal insert is greater than 255.	The same as error code 513.
517	Record Format Control, the alternate input field is not numeric.	The same as error code 513.
518	Record Format Control, characters in the record format specification are not hexadecimal; each character must be either "0" through "9" or "A" through "F".	The same as error code 510.
519	Record Format Control, this CFD (Control Field Descriptor) and copy is specified for mismatch action; no alternate input device is specified for this job.	The same as error code 513.
520	Record Format Control; alternate input field requested for CFD (Control Field Descriptor) or FD (Field Descriptor); no alternate input device is defined for this job.	The same as error code 513.
521	Record Format Control, alternate output field requested for FD (Field Descriptor); no alternate output device is defined for this job.	The same as error code 513.
522	Record Format Control, Diskette No. (input+0 to Diskette No. 1 (output+0 job); the input data set is multivolume.	The same as error code 510.
523	Record Format Control, Diskette No. 1 (input+0 to Diskette No. 1 (output+0 job); the diskette is full.	The same as error code 513.
524	Record Format Control, input buffer length is not an even multiple of specified logical input record length for the job.	The same as error code 513.
554	Remote power off, 3784 printer failure.	The same as error code 555.

NPR NO.	DESCRIPTION	OPERATOR ACTION
555	Remote power off sequence failure.	<p>This error code indicates an error occurred when a remote power off sequence was received from the central processor.</p> <p>A. If your terminal does not have the remote power off feature, press the SYSTEM RESET key and continue operation; notify the operator at the central processor that the error occurred.</p> <p>B. If your terminal has the remote power off feature, press the SYSTEM RESET key and continue operation; request maintenance on the terminal if the error continues.</p>
775	SDLC terminal in error recovery. You have tried to start a job different from the one currently in error recovery.	Restart the job on which the error occurred.
776	The terminal has been placed in transmit mode by receiving a change direction while in brackets, and you have tried to start a receive job.	Start a transmit job.
777	Invalid Job Definition, device not on terminal or entry invalid.	Hold the CODE key down and press the RESET key, and redefine the job; or, if the error occurred at job start time, restart the job.
801	No clear to send (Communication Test problem).	<p>A. If error occurred when running test 0, request maintenance on the terminal.</p> <p>B. If error occurred when running test 2, refer to the "Problem Identification Procedures" section of this chapter for the operator action to be taken.</p> <p>Note: All terminals can run communication test 0; not all terminals have modems attached that are capable of running test 2. This is described in more detail in the "Problem Identification Procedures" section.</p>
802	Transmit clock problem (Communication Test problem).	The same as error code 801.
803	Failure to recognize any receive data (Communication Test problem).	The same as error code 801.
806	Communication Driver (Communication Test problem).	The same as error code 801.
807	Receiving data before any data is transmitted (Communication Test problem).	The same as error code 801.
808	First character data compare error (Communication Test problem).	The same as error code 801.
809	Random data compare error (Communication Test problem).	The same as error code 801.
810	Communication Driver (Communication Test problem).	The same as error code 801.
811	Communication Driver (Communication Test problem).	The same as error code 801.
812	Communication Driver (Communication Test problem).	The same as error code 801.
813	Communication Driver (Communication Test problem).	The same as error code 801.
814	Communication Driver (Communication Test problem).	The same as error code 801.
815	Communication Driver (Communication Test problem).	The same as error code 801.
838	DSR and/or CTS glitching (Communication Test problem).	The same as error code 801.
840	Power on test error display.	If any number in this range remains on after power-on or after SYSTEM RESET, request machine maintenance.

NPR NO.	DESCRIPTION	OPERATOR ACTION
841	Power on test error display.	The same as error code 840.
842	Power on test error display.	The same as error code 840.
843	Power on test error display.	The same as error code 840.
844	Power on test error display.	The same as error code 840.
845	Power on test error display.	The same as error code 840.
846	Power on test error display.	The same as error code 840.
861	Power on test error display.	The same as error code 840.
869	Power on test error display.	The same as error code 840.
870	Power on test error display.	The same as error code 840.
871	Power on test error display.	The same as error code 840.
872	Power on test display	This display normally remains on during initialization after power on. If the display remains on for more than three minutes, turn power off, and back on again. Request machine maintenance on the terminal if the error occurs.
888	Power on or System Reset Test Error, or keyboard operation attempted when security keylock is locked.	If one of the MODE switches was on when you turned power on (or pressed SYSTEM RESET), turn it off. If the auxiliary operator panel keylock was locked when attempting to use the keyboard, set the keylock to the UNLOCKED position; then, hold the CODE key down and press the RESET key to continue the job.
998	Insert function buffer full. The maximum number of characters (256) have been entered when performing the insert character function described in the "Using the CODE Key" section in Chapter 2.	Either: A. Press the EOM key to insert the characters in the terminal's buffer; or B. Press the RESET key to cancel the insert function.
999	Buffer full condition.	Press the EOM key to transfer the buffer data to the job's output device; or, you can use the buffer edit keys to change the data as described in the "Using the Keyboard Buffer Edit Keys" section.

Diskette Data Recovery Procedures

This section supplements the information in the "Numeric Position Readout (NPR) Code" section; it provides additional information for those codes that identify a diskette error.

Section 1: General Data Recovery Procedure

- A. Verify that the proper diskette is being used and retry the job to see if the failure continues.
- B. If problems still occur, do the following procedure:
 1. Replace the current diskette with a new one (spare).
 2. Perform a Create Diskette (CODE 0 and 2) function.
 3. Start a keyboard to diskette job. Enter data, then end the job.
 4. Start a diskette to console printer job. End the job.

If all functions appear satisfactory, you may have a problem with the original diskette on which the error occurred. If errors occur in the exercise above, a hardware failure may be causing the error and the operator should request machine maintenance.
- C. For diskette errors, continue to Section 2 if reading, or Section 3 if writing. In general, if diskette errors are encountered, an effort should be made to discontinue use of the diskette for future data sets and to copy existing data sets to a new volume if facilities are available. You should refer to operating procedures for the other device for details on re-creation of a new diskette.

Section 2: Diskette Failure During Read Operation

- A. If the error occurs before the first buffer (record) is read, the problem is likely on track 0. Retry the operation. If this is unsuccessful, all data on the diskette is probably lost since the desired data set label cannot be read. Depending upon which sector(s) is bad, other labels on track 0 could possibly be read and hence the data retrieved.
- B. If data has already been read from the diskette when the error occurs, only those buffers (records) that are not readable, and buffers beyond those that are not readable, need be lost. Determine the last buffer that is readable by watching the buffer number in the NPRs.
- C. Restart the job and request that reading start at a buffer (record) number after the failing buffer. The data in the failing record will have to be recreated.

Section 3: Diskette Failures During Write Operation

- A. If records have been written on the diskette (the NPR indicators increment as each record is written), a data set label was opened or re-opened; therefore, track 0 is probably not defective. If no records have been written, restart the job using another diskette.
- B. When a diskette error occurs, whether a machine or diskette failure, the terminal's controller attempts to close out the data set being written; for example, the label on track 0 of the diskette is updated to show the last buffer (record) successfully written.
- C. The job may be restarted using another diskette.
- D. When a buffer compare error occurs, a diskette surface defect is assumed. The normal procedure is to write control records on the bad sector pair and then write the data on the next available sector pair, all of which happens without operator knowledge. If a control record cannot be detected after it has been written, the job stops and code "351" displays; when this happens, the buffer of data (record) is not written on the diskette. If in Update Mode and a compare error occurs when rewriting a particular buffer, the job stops (and code "351" displays) without attempting to write any control records since subsequent sectors already contain data. In this case, re-reading the buffer should result in a CRC check if the surface is indeed defective; if it can be read successfully, a machine write failure is indicated. When reading, control records are automatically skipped so continuity of data is maintained.
- E. Terminals with a second Diskette Storage Device have further data recovery capability as follows:
 - 1. Multiple volumes may be continued from diskette 1 to diskette 2, eliminating problems mentioned above.
 - 2. A data set containing a defective area can be copied to the point of failure. Then, the data at the failure point can be re-created and added to the new volume. The new volume can then be complete by copying the data from the first good record after the defective area to the end of the volume. The "Starting a Job" section in Chapter 2 describes how to start reading at a specific diskette record number.

Problem Identification Procedures

The following error recovery and problem identification procedures are designed to assist you in recovering from an online error stop condition, and to assist you in determining which service organization to contact if error recovery is not successful. These procedures are to be performed *only* when one of the following online error codes is displayed in the NPR: 332, 333, 334, 335, or 336.

Error Recovery Procedure

- 1 Hold the CODE key down, and press the START JOB key.

Note: The error code number in the console NPR display will go out, and the console display will then be blank.

- 2 Hold the CODE key down, and press the CNCL key.

Note: The telephone equipment will be disconnected, on a dialed call.

- 3 Check all exposed telephone equipment connectors, modem connector, and the modem power plug (as shown in Figure 3-2), for loose connections. Tighten any loose connection. Do *not* unplug the terminal power plug.

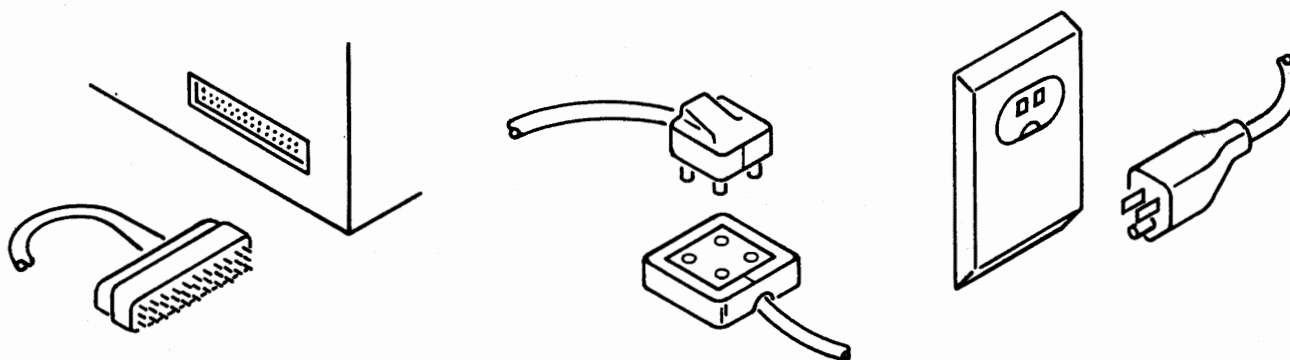

Figure 3-2. Typical Modem Connector, Telephone Equipment Connector, and Modem Power Plug

- 4 Restart the job.

Note 1: Notify the host operator that the job is being restarted. Discard any data already received, since it will be repeated.

Note 2: The telephone must be redialed by the originator of the call after the job has been restarted on a dialed line.

If there is no error after restarting the job, further testing is not required. Return to normal operation.

If the online error condition recurs, go to Step 5.

- 5 Fill out a Trouble Report Form. There are extra copies of the Trouble Report Form following Appendix B of this manual.
- 6 Hold the CODE key down, and press the START JOB key.
- 7 Hold the CODE key down, and press the CNCL key.
- 8 Hold the CODE key down, and enter a numeric **2**.

Note: The error log is printed out. When the printing stops, continue with Step 9.

- 9 Record the time and the date on the error log; attach the log to the Trouble Report Form and save both for service personnel.

Go to the "To Perform Test 0" section that follows.

How to Perform Communications Tests

To Perform Test 0 (Terminal Communication Test)

- 1 Hold the CODE key down, and enter a numeric .
 - 2 Release the CODE key and then enter a numeric .
- A "6" appears in the NPR.
- 3 Press the EOM key.

appears momentarily (about 2-12 seconds) in the NPR.

If the display then changes to , skip to Step 7.

If the display changes to any number from to continue on to Step 4.

- 4 Write the number that appears in the display, under the "Comments" section on the Trouble Report Form. Also write "Test 0" in the "Comments" section.
- 5 Hold the CODE key down, and press the START JOB key.
- 6 Call for service on the terminal.

Do not go to Step 7; no further tests are required. The terminal may be used for a job which does not require online operation.

- 7 Follow the instruction that has been checked.

If the modem is not an IBM Modem:

Refer to the modem or data set manual and make the recommended tests, if any.

If the tests indicate that there is a modem or data set problem, call the appropriate service organization for modem or data set service.

If no modem or data set tests are available, or if the tests indicate that there is no modem or data set problem, inform the host operator that there is an online problem. Tell the operator that local tests indicate no problem with the terminal. You should turn the problem over to the host operator for resolution, then start a job that does not require online operation.

If the modem is an IBM modem or a non-IBM modem with wrap test capability:

Continue on to Test 2.

To Perform Test 2 (Modem Wrap Test)

Note: If you are testing the Switched Network Backup feature, you must first activate the alternate switched network by holding down the CODE key while pressing the key. All tests that follow will then be performed on the Switched Network Backup modem or communication line.

- 1 Enter a numeric from the keyboard.

appears momentarily (about 2-12 seconds) in the NPR.

If the display changes to , skip to Step 5.

If the display changes to any number from to , go to Step 2.

- 2 Write the number that appears in the display, under the "Comments" section on the Trouble Report Form. Also write "Test 2" in the "Comments" section.
- 3 Hold the CODE key down, and press the START JOB key.
- 4 Follow the instruction that has been checked.

If the terminal has an integrated modem

- Call for service on the terminal.

Do not go to Step 5; no further tests are required. The terminal may be used for jobs that do not require online operation.

If the terminal has an external modem

- Call the modem supplier for modem service.

Do not go to Step 5; no further tests are required. The terminal may be used for jobs that do not require online operation.

- 5 Follow the instruction that has been checked.

If there is no modem transmit and receive test capability at the host:

- Inform the host operator that there is an online problem. Tell him that local tests indicate no problem with the terminal and modem. You should then turn the problem over to the host operator for resolution.

Do not go to the next test; no further tests are required. The terminal may be used for a job which does not require online operation.

If the host has modem transmit and receive test capability:

- Continue on to Test 3.

To Perform Test 3 (Modem Transmit Test)

- 1 Inform the host operator that there is an online problem and that local tests indicate no problem with the terminal or modem.

Note: If your terminal communicates with the host over a dial network, it is recommended that a different telephone be used for voice communication with the host operator.

- 2 Request the host operator to run host local communications tests and inform you of the results.

If these tests fail, the problem must be resolved at the host. Ask the host operator to inform you when maintenance has been completed there, so that you can resume online operation. *Do not* go to Step 3.

If host local communications tests run successfully, go to Step 3.

- 3 Tell the host operator that you want to run the modem transmit and receive tests. Ask the host operator to run the Modem Receive Test (Test 4) while you run the Modem Transmit Test (Test 3) for a 3-minute test period.

Note 1: If your terminal communicates with the host over a dial network, the connection between the terminal and the host modem must be redialed to run the test.

Note 2: If your terminal is on a multipoint network, all traffic must be stopped before this test is run.

- 4 Enter a numeric "3" from the keyboard to start the Modem Transmit Test (Test 3).

Note: If you change between TALK and DATA modes on external data sets or modems before this test is completed, you must restart the test by keying a numeric **3** again.

If the test is running properly, the STANDBY indicator will come on shortly (within 15 seconds) after the numeric "3" has been keyed. Go to Step 7 if the STANDBY indicator is on.

If the STANDBY or ONLINE indicators do not come on, or if a number from **8 0 1** to **8 3 8** appears in the NPR, go to Step 5.

- 5** Write the number that appears in the display, under the "Comments" section on the Trouble Report Form. Also write "Test 3" in the "Comments" section, and go to Step 6.
- 6** Follow the instruction that has been checked.

If the terminal has an integrated modem

Call for service on the terminal.

Do not go to Step 7; no further tests are required. The terminal may be used for jobs that do not require online operation.

If the terminal has an external modem

Call for modem service.

Do not go to Step 7; no further tests are required. The terminal may be used for jobs that do not require online operation.

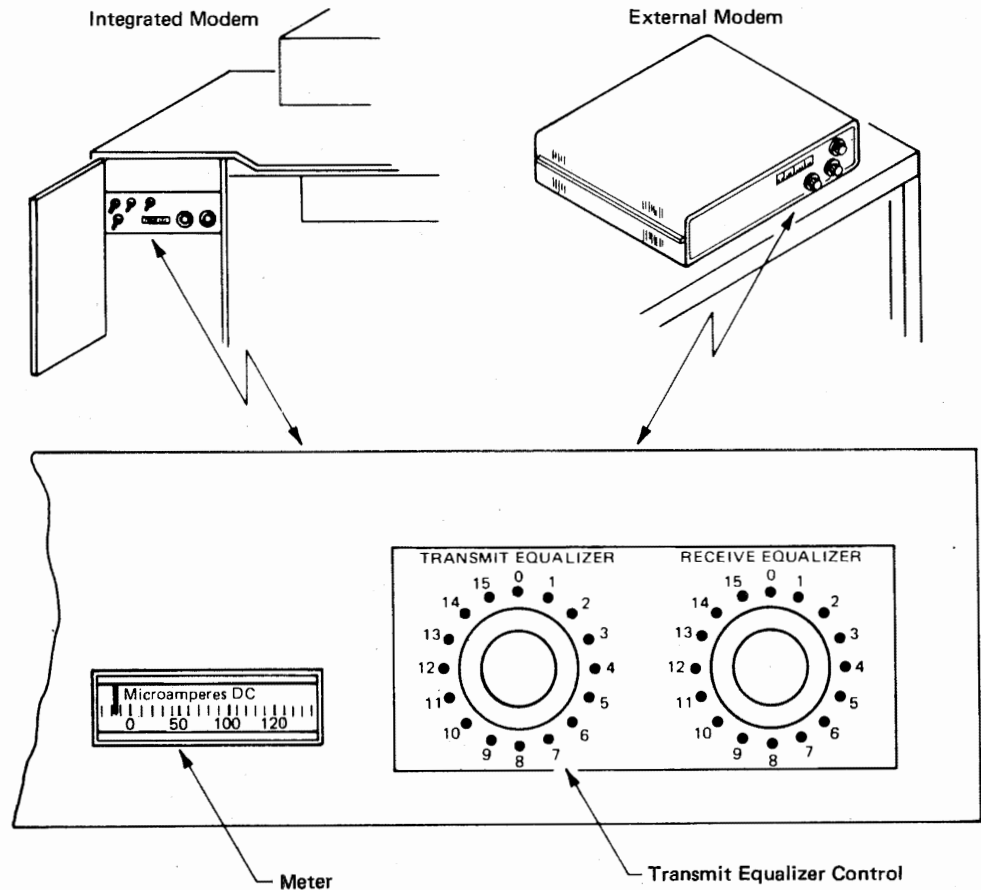

Figure 3-3. Modem panel, Showing Meter and Transmit Equalizer Control

- 7 Ask the host operator if too many errors are being received at the host.

If the host is *not* receiving too many errors, go to Step 11.

If the host is receiving too many errors, look at the modem panel (Figure 3-3) to see if it has a meter and a TRANSMIT EQUALIZER.

If the modem panel does *not* have a meter, go to Step 12.

If the modem panel has a TRANSMIT EQUALIZER, go to Step 8; otherwise, go to Step 9.

- 8 Request the host operator to perform receive equalization. The host operator should instruct you to try various TRANSMIT EQUALIZER settings until the lowest meter reading is achieved at the *host* meter. Skip to Step 10.
- 9 Request the host operator to adjust the host receive equalizer to obtain the lowest meter reading *at the host*. Go to Step 10.
- 10 Determine from the host operator if too many errors are still being received.

If the host operator says the error level is acceptable, go to Step 11.

If the host operator is still receiving too many errors, skip to Step 12.

- 11 Request the host operator to discontinue the Modem Receive Test (Test 4) and to start the Modem Transmit Test (Test 3). Proceed to "To Perform Test 4 (Modem Received Test)".
- 12 Ask the host operator to discontinue testing. Have the host operator call the common carrier for service.
- 13 Hold the CODE key down, and press the START JOB key.

The terminal may be used for jobs that do not require online operation.

To Perform Test 4 (Modem Receive Test)

- 1 Enter a numeric from the keyboard.

If the PROCEED indicator is *on*, the host has started Test 3. Skip to Step 6.

If the PROCEED indicator is *not on* go to Step 2.

- 2 Check with the host operator to find out if Test 3 is running.

If the host is running Test 3 and the PROCEED indicator now comes on, skip to Step 6.

If the host is running Test 3 but the PROCEED indicator is *not on*, go to Step 3.

- 3 If the terminal communication line is *not* of the dial type, go to Step 5.

If the terminal communication line is of the dial type, pick up the receiver and press the button for talk, and listen for a signal (a high-pitched tone or a hissing sound).

If a signal is heard, go to Step 4.

If a signal is *not* heard, go to Step 5.

- 4** Follow the instruction that has been checked.

If the terminal has an integrated modem

Call for service on the terminal.

Do not go to Step 5; no further tests are required. The terminal may be used for jobs that do not require online operation.

If the terminal has an external modem

Call for modem service.

Do not go to Step 5; no further tests are required. The terminal may be used for jobs that do not require online operation.

- 5** Ask the host operator to call the common carrier for service and state that terminal tests indicate a problem in transmitting from the host to the terminal.

Do not go to Step 6; no further testing is required. The terminal may be used for jobs that do not require online operation.

- 6** Start a 3-minute receive error test period by entering a numeric 4 . (This resets the error count to zero before starting the 3-minute test.)
- 7** Three minutes after entering the 4 , compare the error count shown in the NPR, with the benchmark error count.

benchmark error count

If the current error count exceeds the benchmark error count by 10 or more, go to Step 8. If not, skip to Step 10.

- 8** Look at the modem panel (see Figure 3-4) to see if it has a RECEIVE EQUALIZER.

If your modem panel has a RECEIVE EQUALIZER, go to Step 9; otherwise, skip to Step 12.

- 9** As you turn the RECEIVE EQUALIZER knob clockwise to each setting, watch the meter to get the lowest meter reading. (See Figure 3-4.)

After the RECEIVE EQUALIZER knob has been set for the lowest meter reading, enter a numeric 4 again, to make another 3-minute error count test.

If the new error count no longer exceeds the benchmark error count by 10 or more, skip to Step 11.

If the new error count still exceeds the benchmark error count by 10 or more, skip to Step 12.

- 10** Discontinue testing, and write under "Comments", on the Trouble Report Form, that the communications tests do not show any failures.

Call for service on the terminal.

You may start a job which does not require online operation.

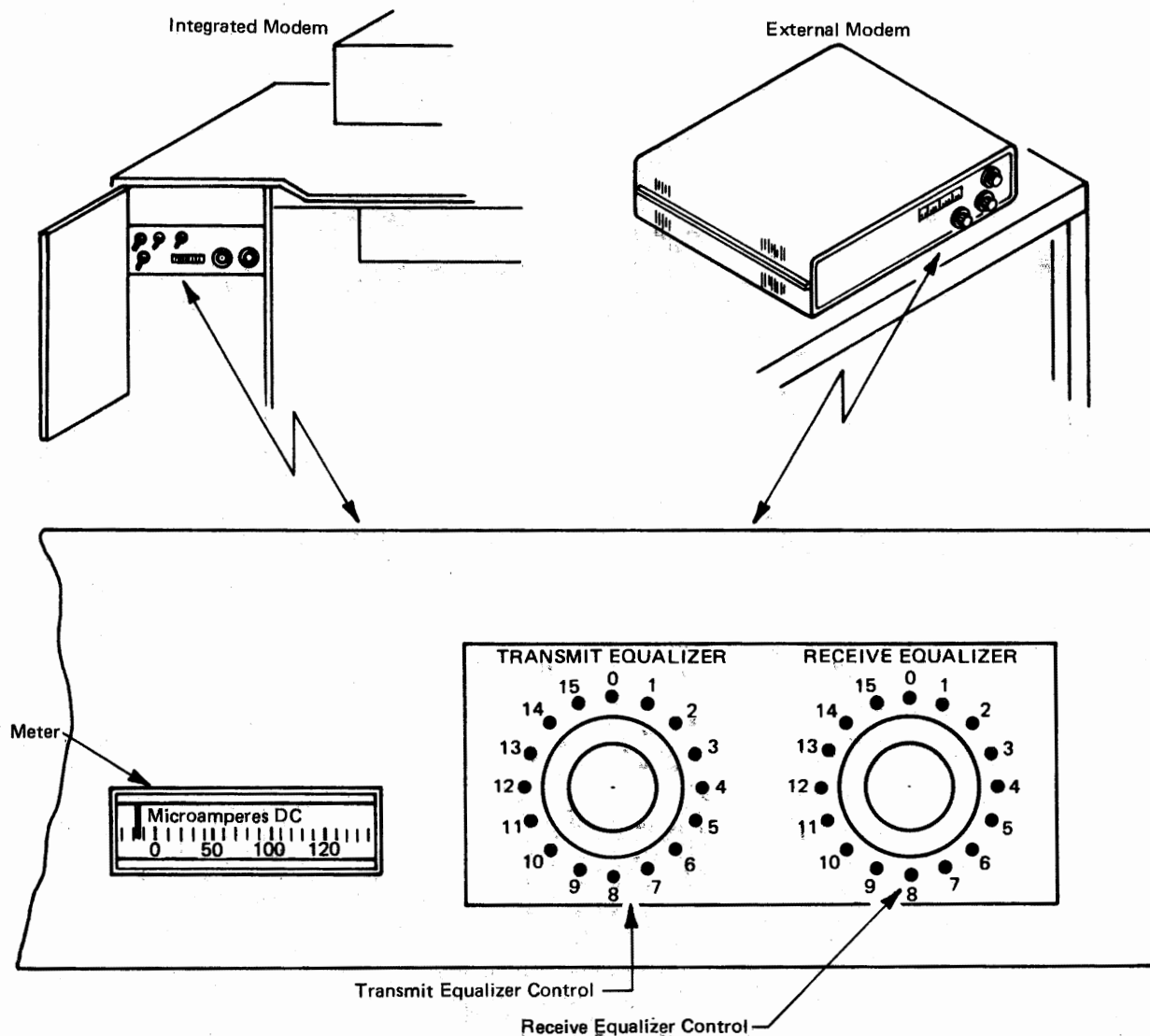

Figure 3-4. Modem Panel Showing Equalizer Controls

- 11 Discontinue testing, and restart the online job you were running when the error stop condition occurred.

If the online error recurs, write under "Comments" on the Trouble Report Form that the error recurred during Step 11 of Test 4.

Call for service on the terminal. Do *not* go to Step 12.

- 12 The terminal may be used for jobs which do not require online operation. Ask the host operator to discontinue testing. Have the host operator call the common carrier for service.
- 13 Hold the CODE key down, and press the START JOB key.
- 14 Hold the CODE key down, and press the CANCEL key.

The terminal may be used for jobs that do not require online operation.



Chapter 4. 3774 Console Printer

Make-Ready Procedure

Use the procedures in this chapter to place the printer in a ready condition for operation with the terminal. The printer is not in a ready condition unless:

- A. Forms are installed as described in the “Installing and Aligning Printer Forms” section.

Note: When using margin-punched forms, be sure that the printer’s paper release lever is forward (toward the front of the printer) before you start a job: With the forms release lever forward, the printer senses an end of forms condition; it does not when the lever is not forward.

- B. The printer ribbon is installed as described in the “Replacing the Ribbon” section.

Figure 4-1 illustrates the printer controls used in the operation of the printer.

3774
PTR

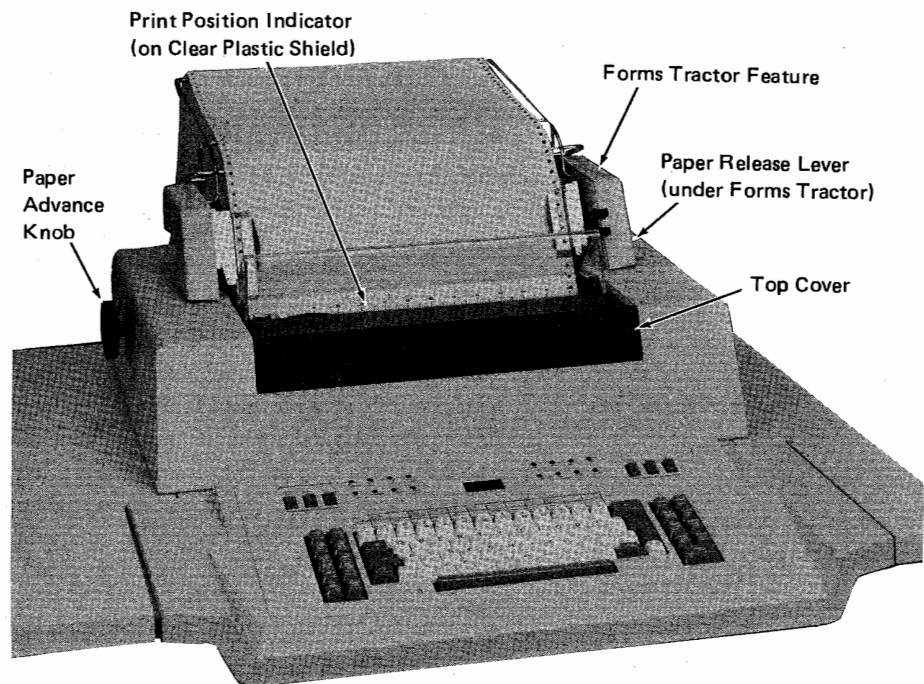

Figure 4-1. Operator Controls (Part 1 of 2)

General Operating Information

The following recommendations and procedures should be observed to ensure proper forms feeding.

CAUTION

Do not allow printing to occur beyond the edge of the paper or in the pin-feed holes, or the print wires may be damaged.

- The Forms Stand accessory is recommended to facilitate feeding and stacking of fan-fold forms.
- Paper should not be stored in low humidity areas. Under low humidity conditions, a static electrical charge can build up on the paper, causing poor paper feeding and stacking.
- Paper should always be removed from the box before use (do not cut off the top of the box, and feed from the box).
- At least one foot (31 cm) clearance should be maintained between the Forms Stand and a wall or other obstruction.
- Ensure that there is clearance between the Forms Stand (if present) and the back of the machine so that forms do not bind.
- The paper supply should be parallel with the back of the machine, and in line with the pins of the Forms Tractor (if used). Jams can occur if the paper supply is not positioned properly.
- **At least three sheets of paper should be on the stacking surface prior to operation. Ensure that paper does not fall onto the supply stack.**
- The right rear paper guide block (if present) should be positioned to within 1/4 inch (6mm) from the edge of the paper, unless maximum width paper is being used.
- When loading paper, make sure that the left edge of the paper is to the left of the forms sensing lever located behind the cutout on the left side of the platen.
- When using the Forms Tractor:
 - a. The pressure roll release lever must be in the forward position (rollers released).
 - b. The paper bail rollers, if present, must be placed in the rear position (position "C" in Figure 4-8).
 - c. The forms tractors should be adjusted so that the tractor pins are centered in the pin feed holes. If the tractors are adjusted too close together, wrinkling of the paper will occur, causing poor print quality, noisy operation, and possible jams. If adjusted too far apart, the holes may tear out, or paper may ride up on the pins.
 - d. Paper should be routed as shown in Figure 4-5. Ensure that the Forms Tractor is fully seated on the printer.

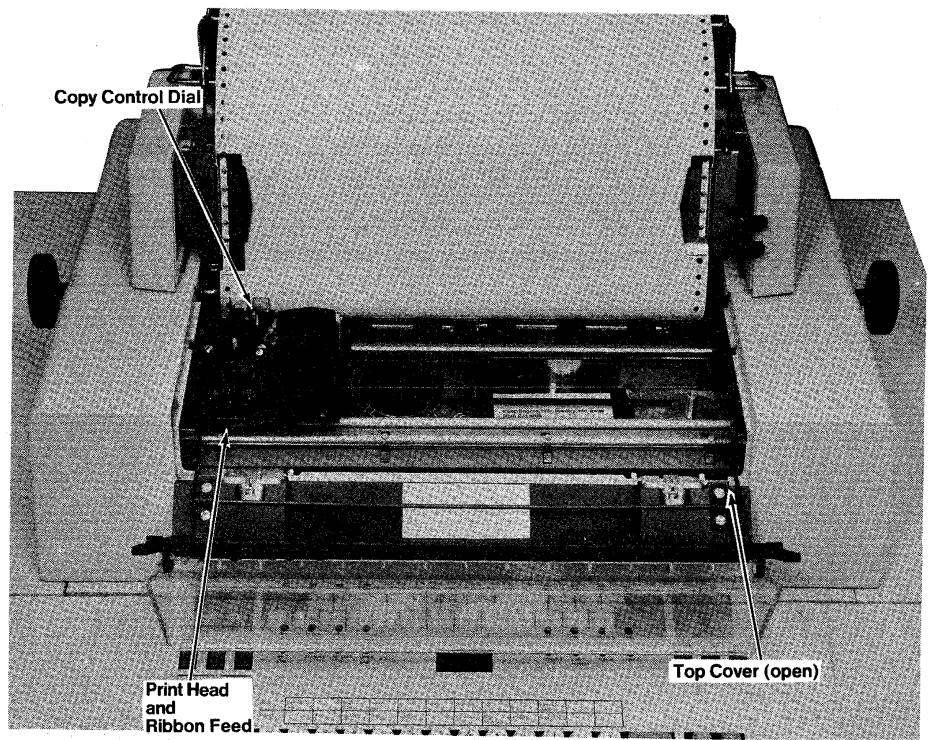

Figure 4-1. Operator Controls (Part 2 of 2)

Installing and Aligning Printer Forms

Loading Cut Forms in the Printer

Use this procedure to load cut forms* in the printer:

- 1 Turn the terminal's operator panel HOLD PRINT switch on to return the print head to the forms loading position (the extreme left side).

Note: You should turn the HOLD PRINT switch on to return the print head to the forms loading position when the printer will not be used for an extended period of time. Remember to turn the HOLD PRINT switch OFF after the print head is at the forms loading position.
- 2 Open the printer cover (Figure 4-2) as follows:
 - A. Slide the clear plastic cover forward.
 - B. Pivot the cover assembly forward (toward the front of the terminal).
- 3 If the forms tractor unit is installed, remove it as described under "Installing or Removing the Forms Tractor".
- 4 Move the paper release lever to the back as shown in Figure 4-4.
- 5 Align the left form guide (Figure 4-4) to the left edge of the platen, and place the bail assembly in position "B" (Figure 4-8).
- 6 Insert the cut forms as in a standard typewriter; align the forms against the left form guide, and push the form into the slot behind the platen until it stops.

* Such as paper that is not margin punched for use with the forms feed tractor.

- 7 Maintain pressure on the form with one hand, and turn the paper advance knob with the other hand until the first print line on the form is under the line on the print head paper guide.
- 8 Place the ball in position "A" (Figure 4-8).
- 9 Close the printer cover.
- 10 Turn the terminal's operator panel HOLD PRINT switch off.
- 11 Adjust the copy control dial (shown in Figure 4-1) for best printing with the forms you are using; set the dial to satisfy these requirements:
 - Legible printing on the last copy.
 - No ribbon-smudging on the first copy.

Notes:

- (a) Caution: when printing, do not print off the edge of the forms.
- (b) If the last copy is not legible, turn the copy control dial toward "0", one step at a time, until the last copy is legible.
- (c) If the ribbon smudges the first copy, rotate the copy control dial toward "8", one step at a time until the smudging stops.

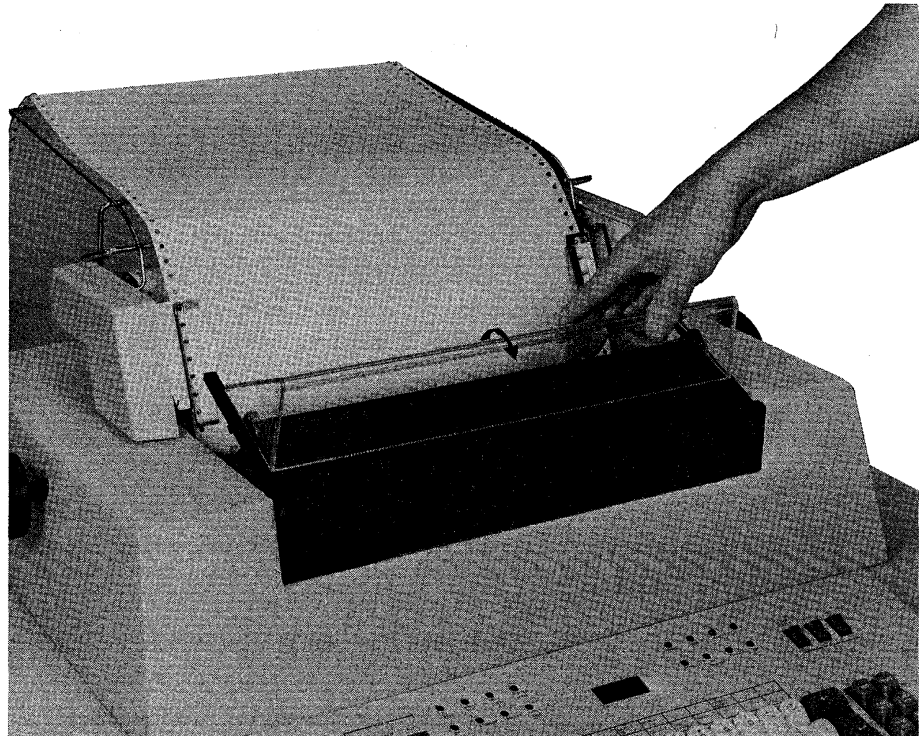
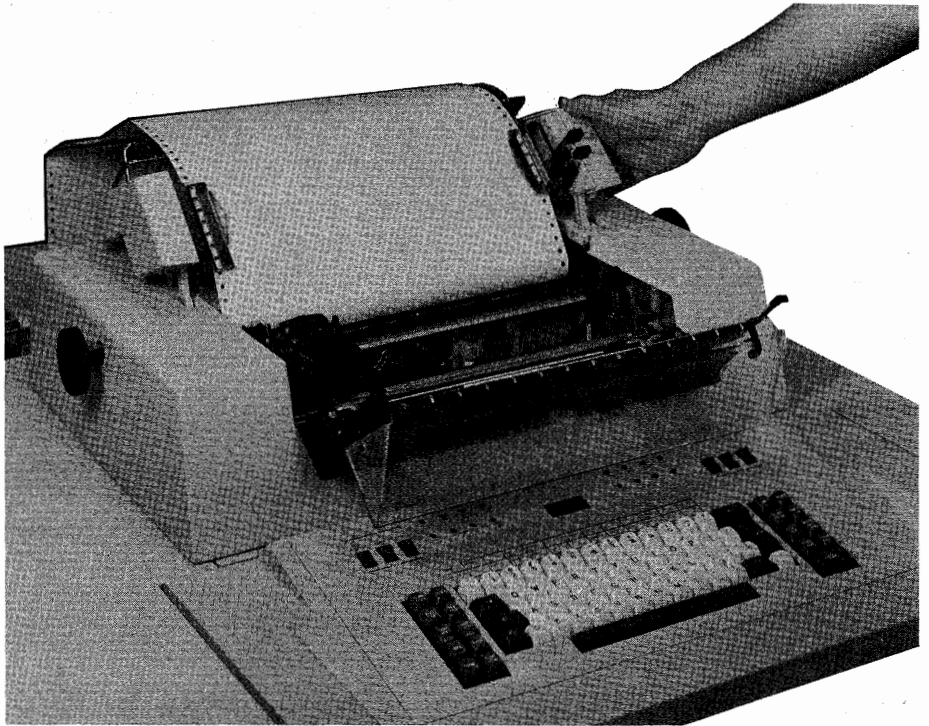

Figure 4-2. Opening the Printer Cover



3774
PTR

Figure 4-3. The Forms Tractor Unit

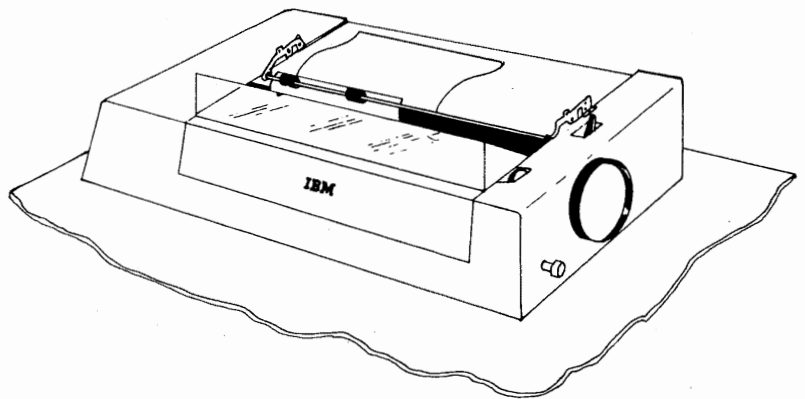
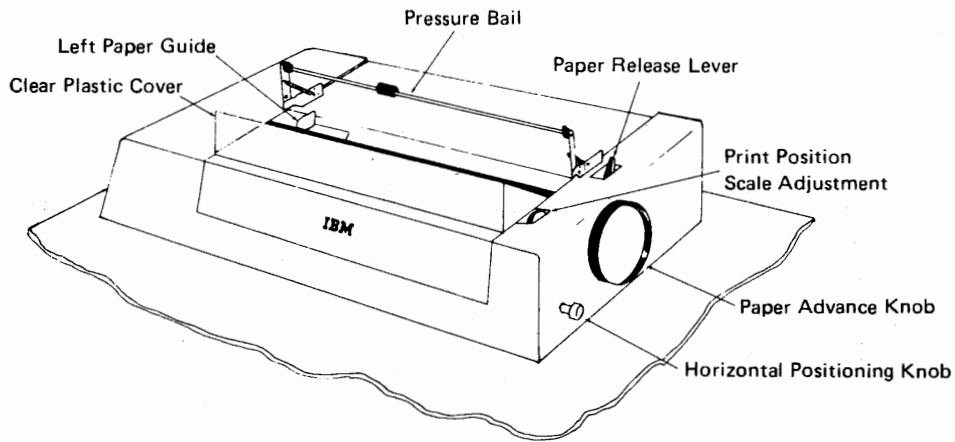
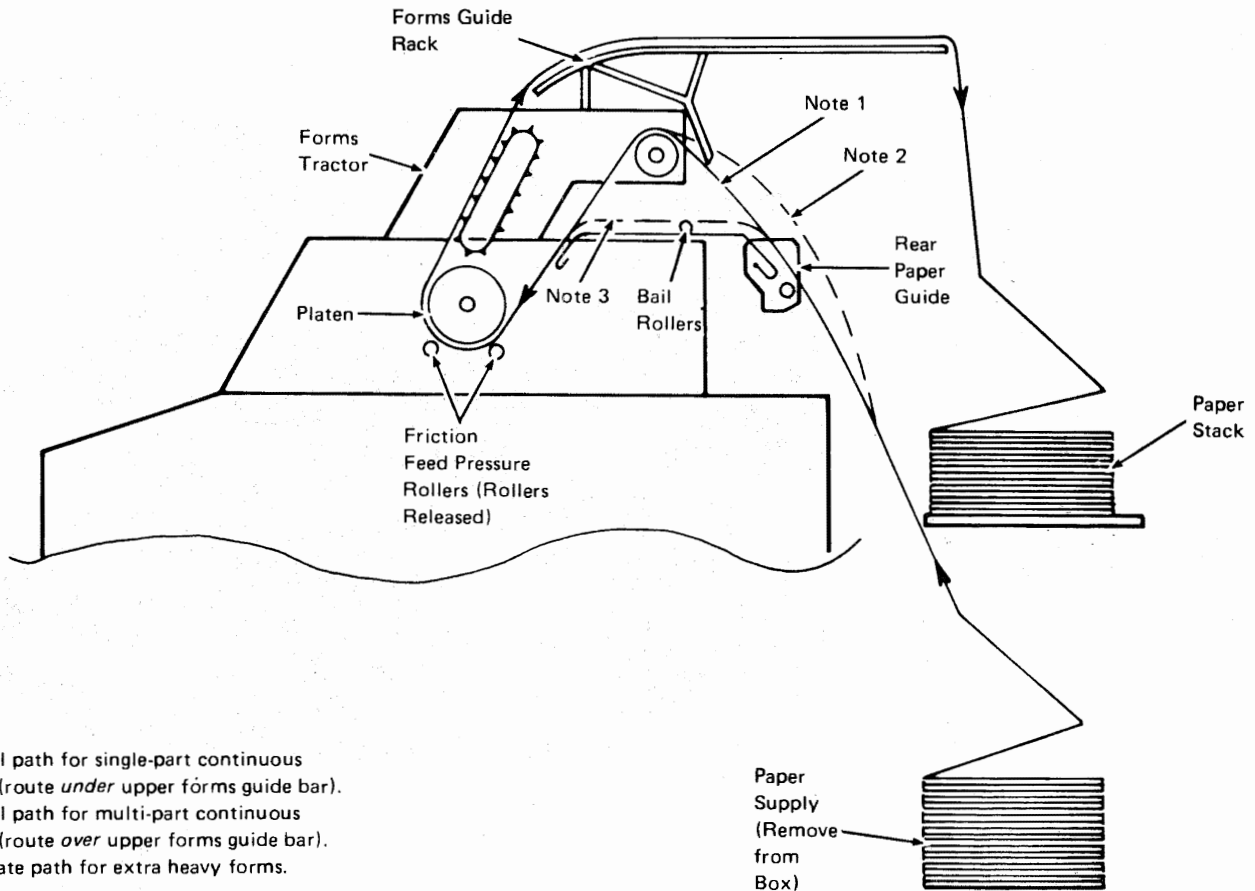

Figure 4-4. Installing Cut Forms



Notes:

1. Normal path for single-part continuous forms (route *under* upper forms guide bar).
2. Normal path for multi-part continuous forms (route *over* upper forms guide bar).
3. Alternate path for extra heavy forms.

Figure 4-5. Paper Routing Using the Forms Tractor

Loading Margin-Punched Forms Using the Forms Tractor

Use this procedure to install margin-punched forms* in the printer:

Note: If you notice that an out-of-forms condition will occur before a printing job completes, you can turn the terminal's operator panel HOLD PRINT switch on to stop the job while you load forms; turn the HOLD PRINT switch OFF after you load the forms.

- 1 Turn the terminal's operator panel HOLD PRINT switch on to return the print head to the forms loading position (the extreme left side).

Note: You should turn the HOLD PRINT switch on to return the print head to the forms loading position when the printer will not be used for an extended period of time. Remember to turn the HOLD PRINT switch OFF after the print head is at the forms loading position.
- 2 Open the printer cover as shown in Figure 4-2.
- 3 If you are converting from cut forms to margin-punched forms, move the left forms guide (shown in Figure 4-4) to the extreme left.
- 4 Pivot the forms guide rack (Figure 4-5) up and forward to a vertical position, if necessary.
- 5 Move the paper release lever (Figure 4-6) to the back.
- 6 Place the forms in position behind the printer.
- 7 Thread the paper as shown in Figure 4-5. Align the forms against the left (when facing the front of the printer) form guide when threading the paper.
- 8 Turn the paper advance knob to move the forms around the platen until a few inches of forms come out at the front of the platen.
- 9 Open the cover over the pins on each form tractor shown in Figure 4-6.

*Margin-punched forms, forms with feed holes punched in the left and right margins for use with a forms tractor.



Figure 4-6. Installing Margin-Punched Forms (Part 1 of 2)

- 10 Pull the paper release lever forward to allow the forms to be moved freely, and to activate the end-of-forms switch; the lever remains forward while feeding paper with the tractor.
Note: Keep the forms toward the left form guide to keep the forms in contact with the forms sensing pin; if contact with the sensing pin is lost, remove the forms and insert again.
- 11 Pull the forms up and place the left margin holes over the tractor pins; close the left tractor cover.
- 12 If you are using a new size form, squeeze the two knobs on the right tractor and slide the tractor to align the pins with the right margin holes.
- 13 Place the right margin holes over the right tractor pins, and close the right tractor cover.
- 14 Pivot the forms guide rack back to the horizontal position.

- 15 Turn the forms advance knob to align the forms to the first line to be printed. If you turn the forms advance knob backward, pull slack forms out the back of the printer to keep the forms from buckling at the print head.

Note: Use the "Aligning Forms to the First Print Line" procedure that follows for more precise alignment of the forms.

- 16 Turn the terminal's operator panel HOLD PRINT switch off.

- 17 Close the printer cover.

- 18 When you start printing:

- a. Check that the forms stack properly. For best stacking, the forms fold should be in the same direction as the original fold.
- b. Check the print alignment. Use the "Aligning Forms to the First Print Line" procedure that follows for more precise alignment of the forms.
- c. Adjust the copy control dial (shown in Figure 4-1) for best printing with the forms you are using; set the dial to satisfy these requirements:
 - Legible printing on the last copy.
 - No ribbon-smudging on the first copy.

Notes:

1. If the last copy is not legible, turn the copy control dial toward "0", one step at a time, until the last copy is legible.
2. If the ribbon smudges the first copy, rotate the copy control dial toward "8", one step at a time until the smudging stops.

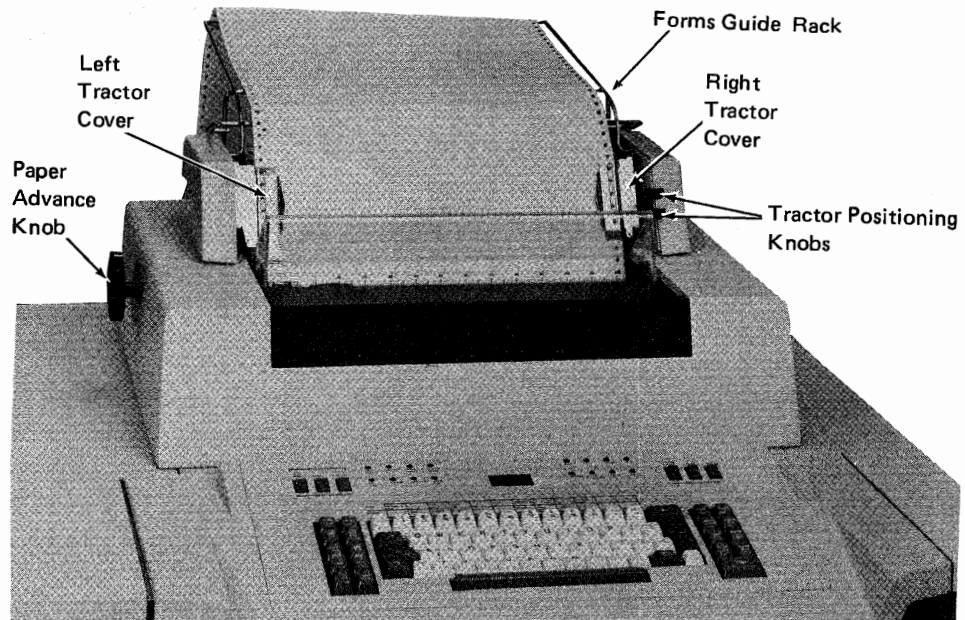

Figure 4-6. Installing Margin-Punched Forms (Part 2 of 2)

Loading Single-Part Continuous Paper – Friction Feed

Use this procedure to load single-part fan-fold continuous forms in the printer when the forms tractor is not used:

Note: If you notice that an out-of-forms condition will occur before a printing job completes, you can turn the terminal's operator panel HOLD PRINT switch on to stop the job while you load forms; turn the HOLD PRINT switch OFF after you load the forms.

- 1 Turn the terminal's operator panel HOLD PRINT switch on to return the print head to the forms loading position when the printer will not be used for an extended period of time. Remember to turn the HOLD PRINT switch OFF after the print head is at the forms loading position.

- 2 Bring the print position indicator (a clear plastic shield) forward.
- 3 If the forms tractor unit is installed, remove it as described under "Installing or Removing the Forms Tractor".
- 4 Grasp both right and left hand bail links and rotate the pressure feed bail forward into position "B" shown in Figure 4-8, part 2.
- 5 Move the paper release lever to the back.
- 6 Move the left forms guide (the sliding metal piece, Figure 4-4) so that is aligned (approximately) with the left end of the platen.
- 7 Move the right rear guide (shown in Figure 4-7) to the extreme right (when viewed from the front of the terminal). Then, thread the paper under the drag shaft (Figure 4-7) with the side to be printed facing the front of the terminal.
- 8 With the paper against the fixed left rear guide (Figure 4-7), slide the right guide along until it is close to (1/4 to 3/8 inch) the edge of the paper.
- 9 Place the paper in position behind the platen, and insert the paper as in a standard typewriter with the forms near the left front form guide; push it into the slot behind the platen until it stops.

Note: Keep the paper near the left form guide while inserting to keep the paper in contact with the forms sensing lever; if contact with the sensing lever is lost, remove the paper and insert again.

- 10 Maintain pressure on the paper with one hand, and turn the paper advance knob with the other hand until a few inches of the paper comes out the front of the platen area.
- 11 Pull the paper release lever forward.
- 12 Lay the front edge of the paper down on top of the printer behind the platen and align the edges keeping it firm against the platen and in line with the rear guides.
- 13 Push the paper release lever toward the back of the printer.
- 14 Slide the pressure bail rollers so they are approximately 2 inches in from each side of the paper.
- 15 Rotate the pressure bail down on top of the paper (Figure 4-8, position "A") keeping the paper taut against the platen.
- 16 Adjust the copy control dial to "0".
- 17 Advance the paper to the first line to be printed. Check for proper alignment of the paper with the rear guides.
- 18 Turn the terminal's operator panel HOLD PRINT switch off.
- 19 Close the printer cover.
- 20 When you start printing:
 - a. Check to make sure that the paper stacks properly on the forms stand/stacker (if installed).
 - b. Check the print alignment.
 - c. Adjust the copy control dial as required for best printing with the paper you are using and check for any ribbon smudging. If smudging occurs, rotate the copy control one step at a time toward position "8".
 - d. Periodic manual intervention is necessary to adjust for paper skew.

3774
PTR

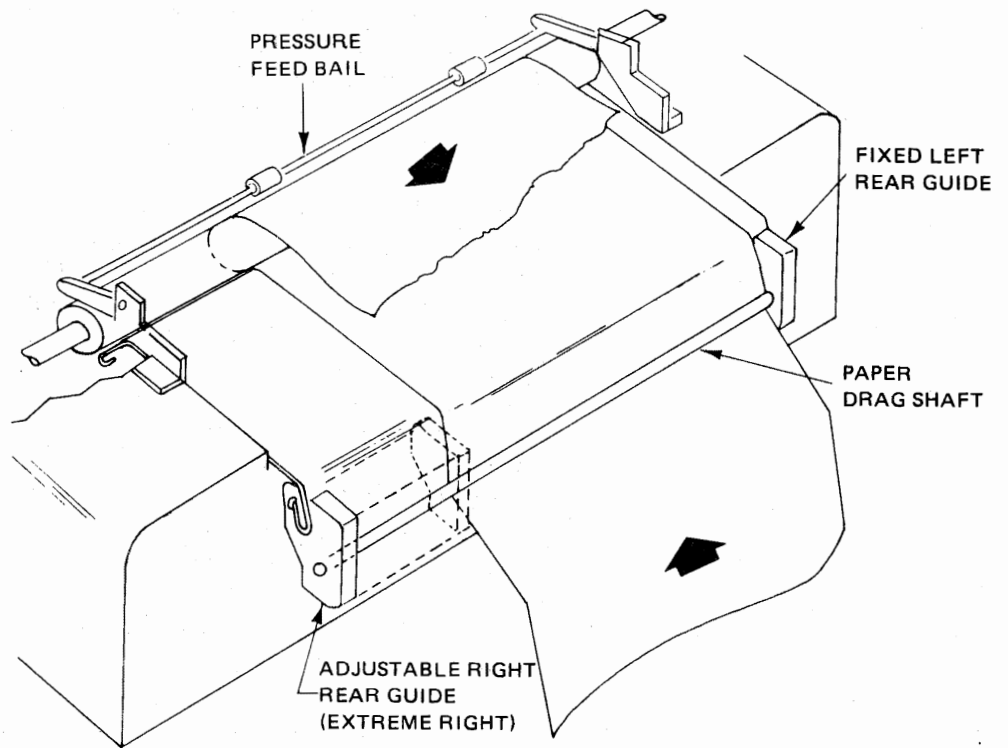
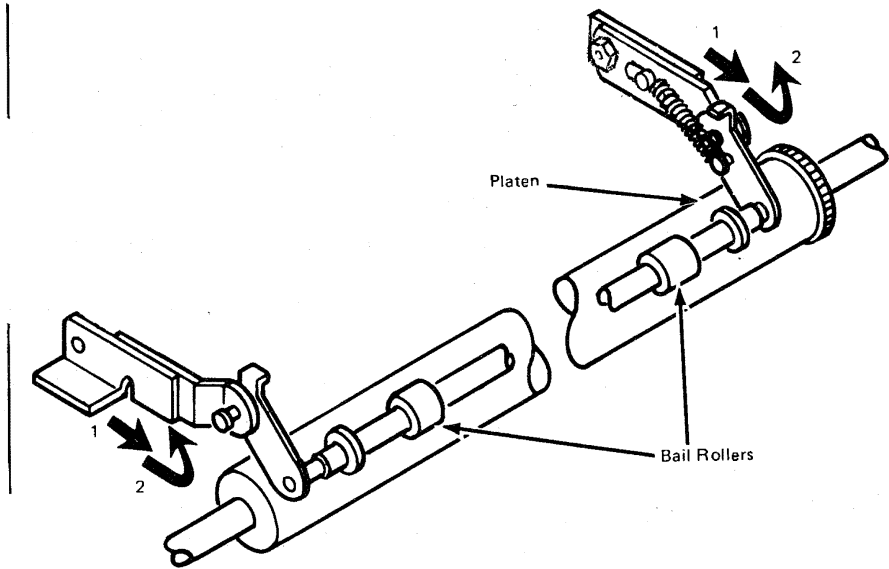

Figure 4-7. Paper Path for Friction Feeding

Using the Pressure Feed Bail

- A. For pressure feeding of paper, the bail must be in position shown with the paper held between the bail rollers and the platen. The lower pressure rolls are also against the paper.
- B. To insert or adjust paper, move the clear plastic shield forward. Then lift the paper bail until it stops in the upright position (position "B" in Figure 4-8, part 2). Release the lower rolls by moving the paper release lever to the forward position.
- C. To move the bail completely out of the way so the pin feed assembly can be used, the bail must first be raised up to position "B" in Figure 4-8, part 2. Then, *using both hands*, pull the righthand and lefthand links *forward* and rotate upward and backwards to position "C" as shown in Figure 4-8, part 2.



3774
PTR

Figure 4-8. Using the Pressure Feed Bail (Part 1 of 2)

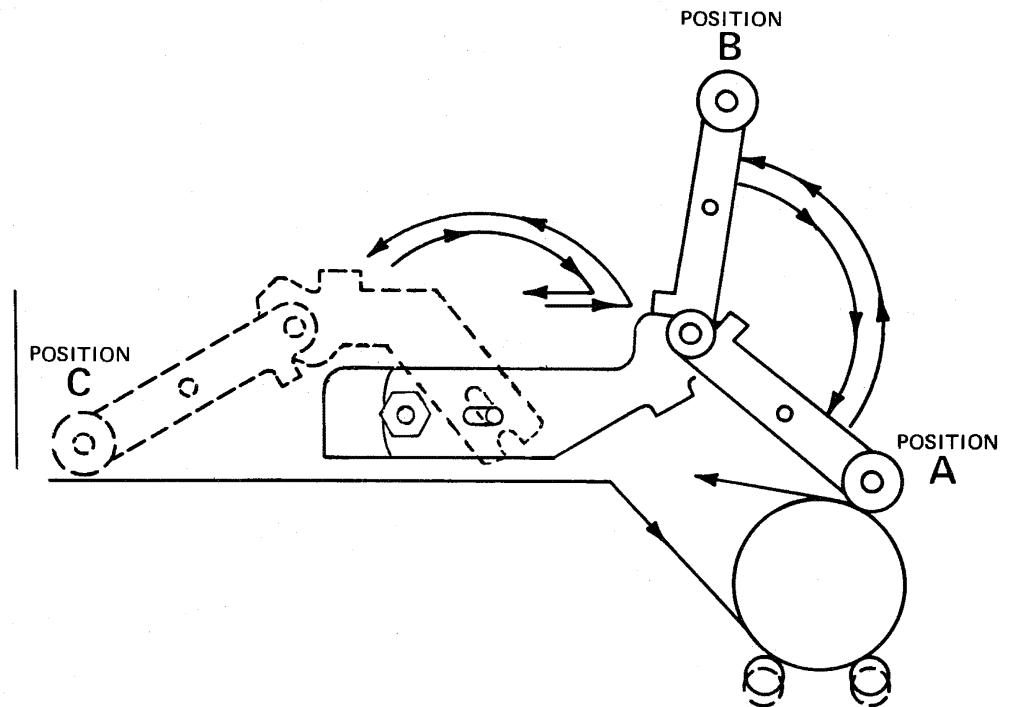

Figure 4-8. Using the Pressure Feed Bail (Part 2 of 2)

Aligning Forms to the First Print Line

Use this procedure when you need precise alignment of the print head to the forms first print line, such as when using preprinted forms.

- 1 Align the form's first print line to the print head as accurately as you can when loading the forms.
- 2 While the terminal is printing:
 - a. Turn the paper advance knob (shown in Figure 4-6) to adjust the vertical position of the print line.
 - b. Turn the horizontal fine adjustment knob (shown in Figure 4-6) to adjust the horizontal position of the print line.
- 3 If using a Forms Feed Tractor, additional adjustment for the first print position can be made by squeezing the two knobs on the left tractor and sliding to the left or right.

Setting the Print Position Indicator

When in print view mode (see PRINT VIEW key description in Appendix C), the red vertical line on the print head shield aligns with a number on the print position indicator scale (printed on the clear plastic cover). The red vertical line indicates the print position where the next character will be printed. Perform the following procedure to align the red vertical line to the print position indicator.

- 1 Start a keyboard-to-console printer job as described in the "Starting a Job" section in Chapter 2.
- 2 Press the PRINT VIEW key to place the terminal in print view mode.
- 3 Press the Return key to place the printer at the first print position.
- 4 Turn the knurled knob (print position scale adjustment located on the right side of the printer as shown in Figure 4-4) to align the red vertical line to the job's first print position.

Installing or Removing the Forms Tractor

Use these procedures to install or remove the forms tractor unit shown in Figure 4-9.

To Install the Forms Tractor

- 1 Place the bail assembly in position "C" (Figure 4-8).
- 2 Set the forms tractor unit on top of the printer as shown in Figure 4-9.
- 3 Press down on both ends near the back of the tractor unit until the rear arms snap over the retaining pins.
- 4 Press down on both ends near the front of the tractor unit until the front arms snap over the platen shaft.

To Remove the Forms Tractor

To remove the forms tractor unit, pull up on the rear sides of the unit and pivot it forward until the rear arms snap from the retaining pins and lift the unit up.

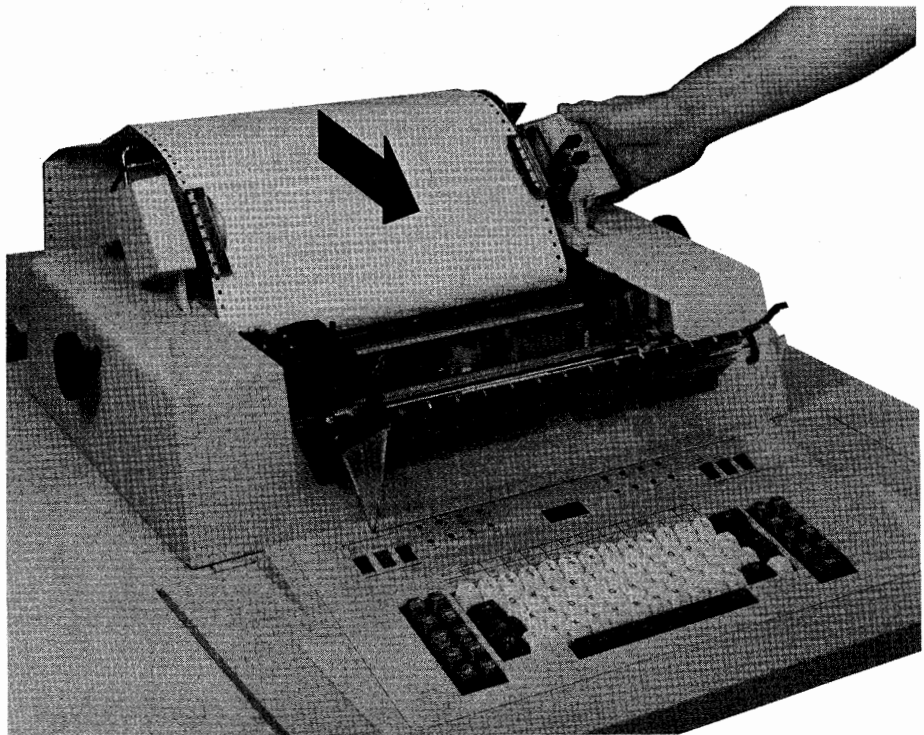

3774
PTR

Figure 4-9. Installing the Forms Tractor Unit

Changing the Ribbon

Use this procedure to change the printer's ribbon.

- 1 Turn the HOLD PRINT switch on to return the print head to the extreme left; then turn the switch off.
- 2 Turn the terminal's power switch off.
- 3 Open the printer cover as shown in Figure 4-2.
- 4 Manually position the print mechanism to about the middle of the printer.
- 5 Open the ribbon feed rolls by rotating the ribbon release lever (Figure 4-10) so that it points to the right.
- 6 Put on the gloves supplied with the new ribbon.
- 7 Open the ribbon box cover. Note the drawing on the ribbon box cover that shows how to install the ribbon.
- 8 Remove the old ribbon from the guides and from the print head. Lay the ribbon loop on top of the old ribbon in the ribbon box, and remove the ribbon and discard it.
- 9 Eject the new ribbon from its holder into the ribbon box and discard the ribbon holder.
- 10 Hold the ribbon coil lightly with one hand, and with the other hand pull about 10 inches (254 mm) of ribbon from the coil and lay it in a loop across the print head.
- 11 Thread the side of the loop nearest the platen between the feed rolls, and around the guidepost, as shown in Figure 4-10.
- 12 Close the feed rolls by turning the ribbon release lever so that it points toward you.
- 13 Thread the ribbon between the print head and the platen, and be sure that the ribbon is behind the ribbon shield.
- 14 Thread the part of the loop nearest you through the slot in the ribbon box.

- 15 Thread the ribbon through the ribbon guides as shown.
- 16 Put a half-turn twist in the ribbon, and slide the ribbon (bottom edge first) into the horizontal ribbon guides.
- 17 Rotate the ribbon feed knob to remove the slack from the ribbon. Continue turning the knob and check that the ribbon feeds properly.
- 18 Close the ribbon box cover.
- 19 Close the printer cover.

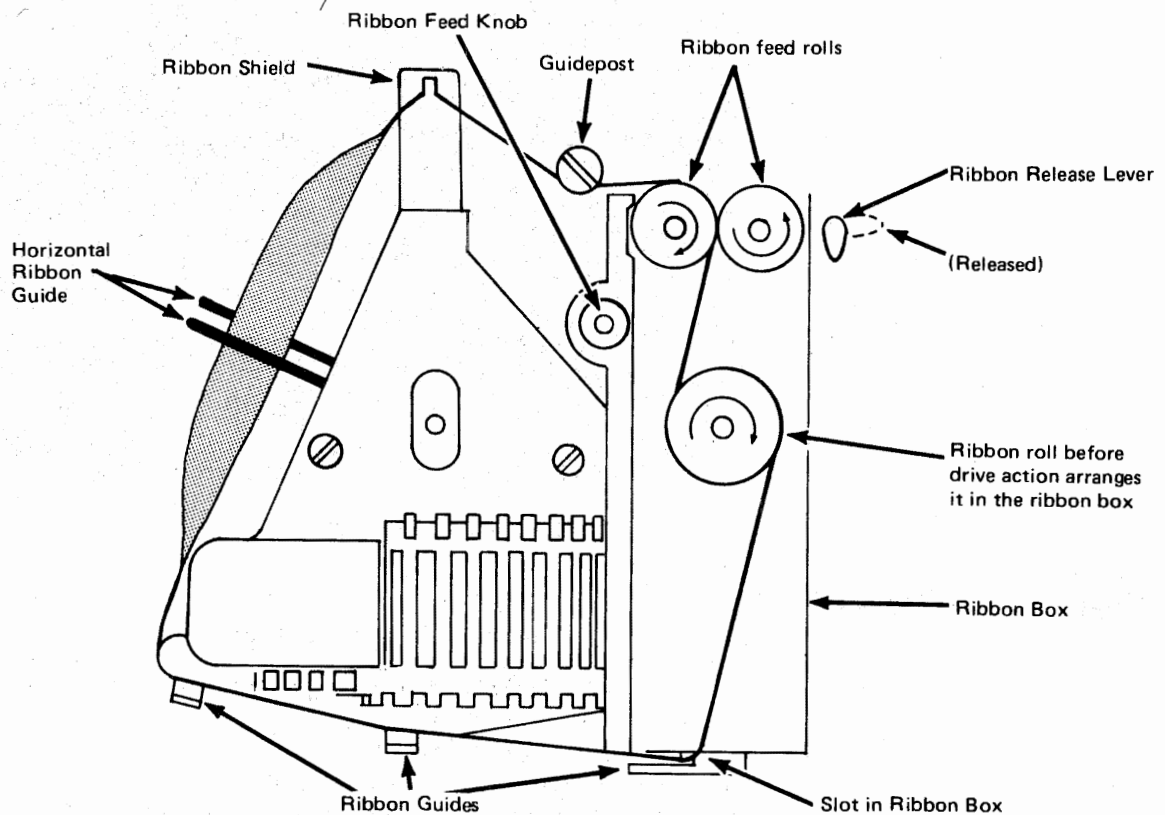

Figure 4-10. Ribbon Path

Removing and Installing the Platen

Removing the Platen

Use this procedure to remove the platen.

- 1 Space the print head to the center of the platen by entering either horizontal tab or space characters from the keyboard.
- 2 Turn the terminal's power switch off.
- 3 If the forms tractor unit is installed, remove it. Position the bail assembly in position "C" (Figure 4-8).
- 4 Open the printer cover as shown in Figure 4-2; then, open the platen extension covers shown in Figure 4-11.
- 5 Press down on both platen release levers shown in Figure 4-11.
- 6 Lift the platen from the printer; use the "Installing the Platen" procedure that follows to put the platen back in the printer.

Note: When you clean the platen, apply the platen cleaner sparingly with a soft cloth; cleaners are available from stationery suppliers.

Installing the Platen

Use this procedure to install the platen.

- 1 The print head should be at the center of the platen, as it was when you removed the platen.
- 2 Hold the platen with the gear to your right.
- 3 Place the groove of the platen in the right platen latch.
- 4 Press down on both platen knobs. The platen snaps into place; then, close the platen extension covers.
- 5 Close the printer cover, and put the forms tractor in position.

3774
PTR

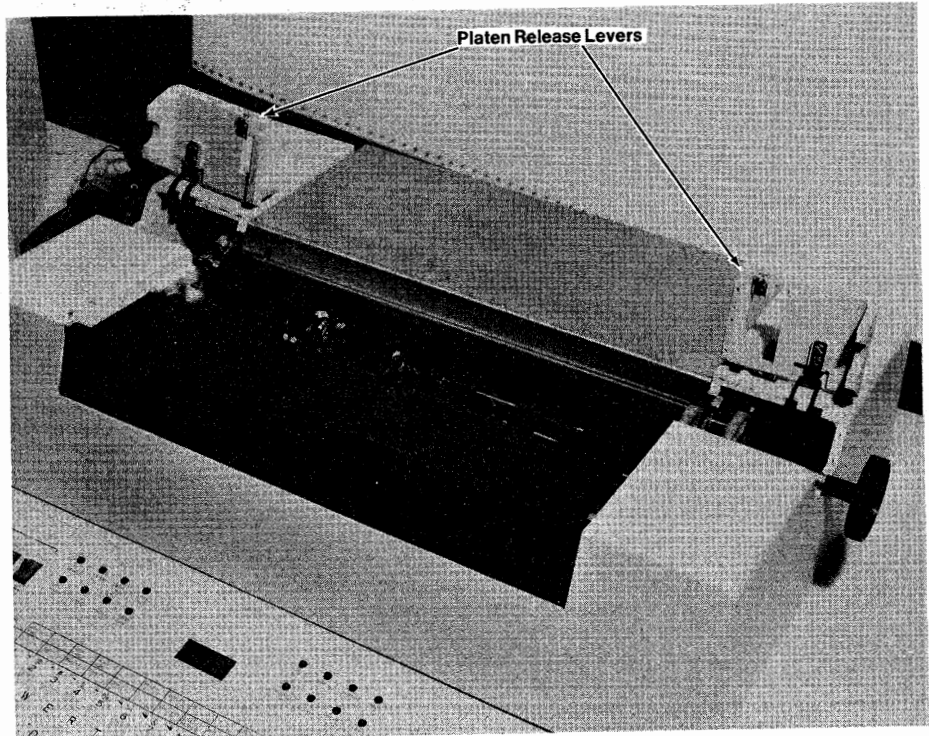

Figure 4-11. Removing and Installing the Platen



Chapter 5. 3775 Console Printer

Make Ready Procedure

Use the procedures in this chapter to place the printer in a ready condition for operation with the terminal. The printer is not in a ready condition unless:

- Forms are installed as described in the “Installing and Aligning Printer Forms” section.

Note: Always turn the terminal's HOLD PRINT switch on before opening the printer cover, or attempting to install or align printer forms. Remember to turn the switch off before starting a job.

- The printer ribbon is installed as described in the “Replacing the Ribbon” section.
- The printer print belt is installed as described in the “Changing the Print Belt” section.

Figure 5-1 illustrates the printer controls used in the operation of the printer.

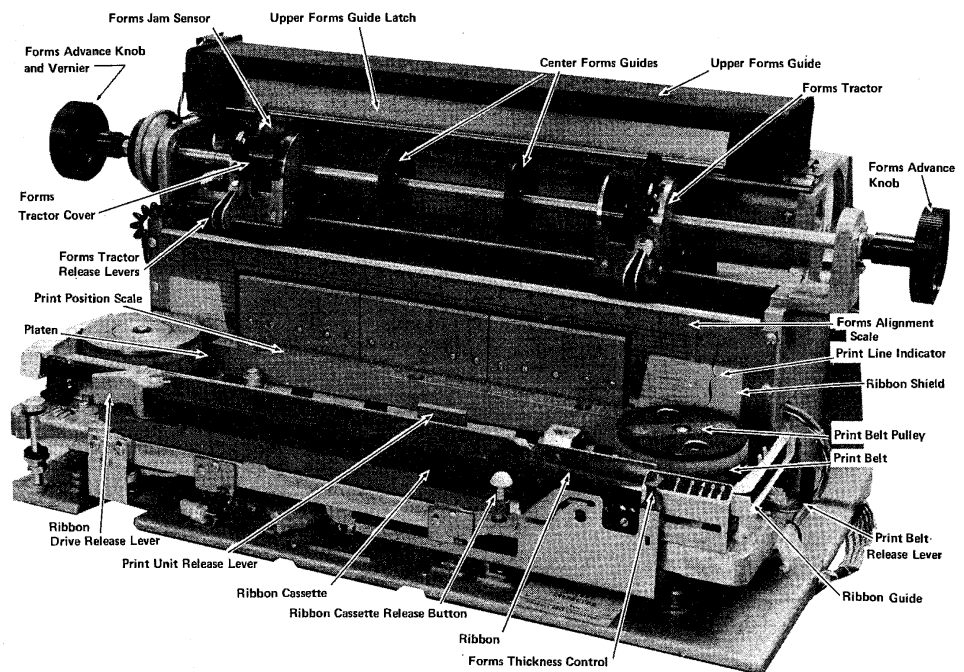

Figure 5-1. Printer Locations

General Forms Handling Information

- The Forms Stand accessory is recommended to facilitate feeding and stacking of fan-fold forms.
- Paper should not be stored in low humidity areas. Under low humidity conditions, a static electrical charge can build up on the paper, causing poor paper feeding and stacking.
- Paper should always be removed from the box before use (do not cut off the top of the box, and feed from the box).
- At least one foot clearance should be maintained between the Forms Stand and a wall or other obstruction.
- Ensure that there is a clearance between the Forms Stand, if used, and the back of the machine so that forms do not bind.
- The paper supply should be parallel with the back of the machine, and in line with the pins of the forms tractors. Jams can occur if the paper supply is not properly positioned.
- At least three sheets of paper should be on the stacking surface prior to unattended operation. Ensure that the paper does not fall onto the supply stack.

- Do not allow printing to occur beyond the edges of the paper or in the pin feed holes.
- The forms tractors should be adjusted so that the pins are centered in the pin feed holes. If the tractors are adjusted too close together, wrinkling of the paper will occur, causing poor print quality, noisy operation, and possible jams. If adjusted too far apart, the holes may tear out or paper may ride up off the pins.

Installing and Aligning Printer Forms

Loading Forms in the Printer



Figure 5-2. Opening the Printer Cover (Part 1 of 2)

Use this procedure to load forms in the printer.

Note: Always turn the terminal's HOLD PRINT switch on before opening the printer cover, or attempting to install or align printer forms. Remember to turn the switch off before starting a job.

- 1 Open the printer cover as shown in Figure 5-2.
- 2 Open the print unit as shown in Figure 5-3.
- 3 Open the tractor covers, and the upper forms guide, as shown in Figure 5-4.
- 4 Slide the rear forms guides apart and feed the forms squarely into the forms chute as shown in Figure 5-5.
 - Be sure that the forms pass under the end-of-forms (EOF) switch.
 - Pull approximately nine inches (230 mm) of forms out of the front of the printer and lay it over the print unit.
- 5 Squeeze the tractor release levers (Figure 5-6) and move each tractor to accommodate the forms width.
- 6 Start the forms into the upper forms guide and place the form-feed holes on the tractor pins.
 - Be sure that the forms are square on the tractors.
 - Close the tractor covers, the upper forms guide, and the print unit.
- 7 Turn the forms advance knob and verify that the forms feed correctly.
- 8 Align the forms to the first print line as described in the "Aligning Forms to the First Print Line" section that follows.

Keystroke Feedback Adjustment: Turn clockwise to increase the sound of the feedback from the keyboard. Feedback is the sound heard when a keyboard key is pressed.

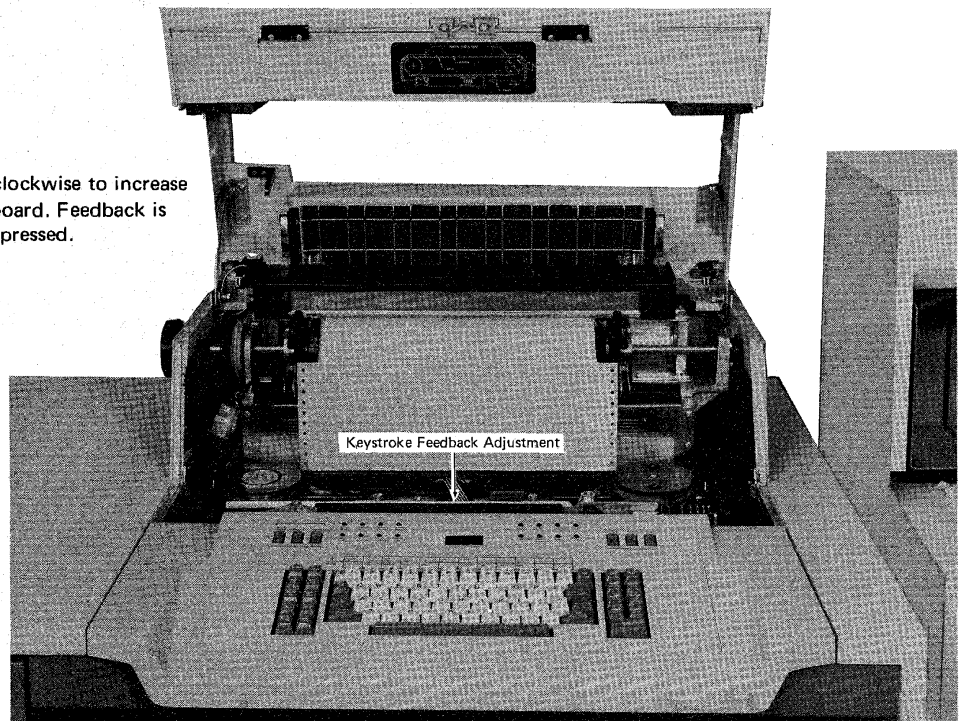

3775
PTR

Figure 5-2. Opening the Printer Cover (Part 2 of 2)

Aligning Forms to the First Print Line

- 1 Check the forms tension; the tractor pins should keep the forms taut, but should not hold the forms so taut that the form's feed holes tear when printing. Refer to Figure 5-6 if you need to move the tractor pins for more or less tension on the form.
- 2 Set the forms thickness control (Figure 5-1) to the number of parts in the form being used.
- 3 Align the form to the printer's print position indicator. Refer to Figure 5-6 if you need to move the tractor pins to align the form to the print position indicator.
- 4 Position the form in the forms chute so that the form is aligned to the same position on both the rear form alignment scale, shown in Figure 5-5 and the front form alignment scale, shown in Figure 5-1. Refer to Figure 5-6 if you need to move the tractor pins to align the forms.
- 5 Use the forms advance knob, shown in Figure 5-1, to advance the forms to one line above the first print line indicator (also shown on Figure 5-1).

Note: The recommended location of the first print line is a minimum of one-half inch (12,7 mm) below the forms perforation.

- 6 Push the forms advance knob in to engage the vernier adjustment, and advance the forms to align to the first print line.
 - Align the form perforation to the number on the print line indicator that corresponds to the first print line on the form.
 - If you advance the paper too far, turn the forms advance knob backward while you pull the forms out of the chute to remove slack. You will have to re-align the forms after backing forms to below the first print line.

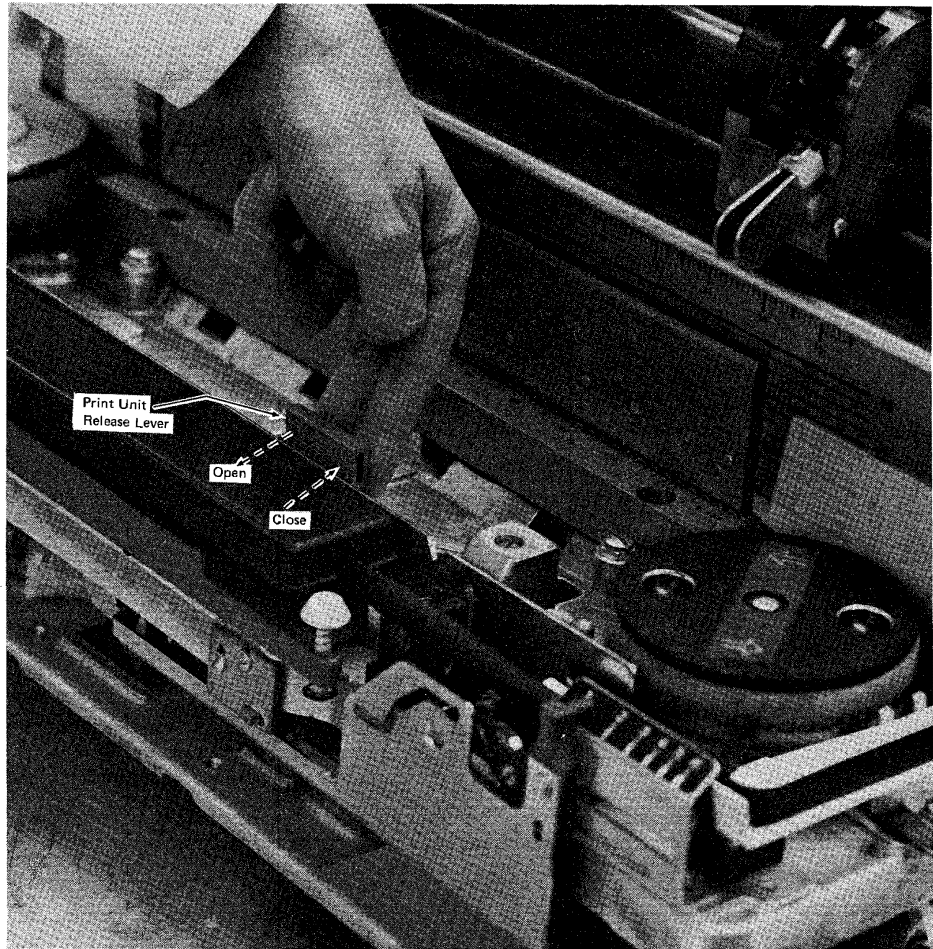

Figure 5-3. Print Unit Open/Close

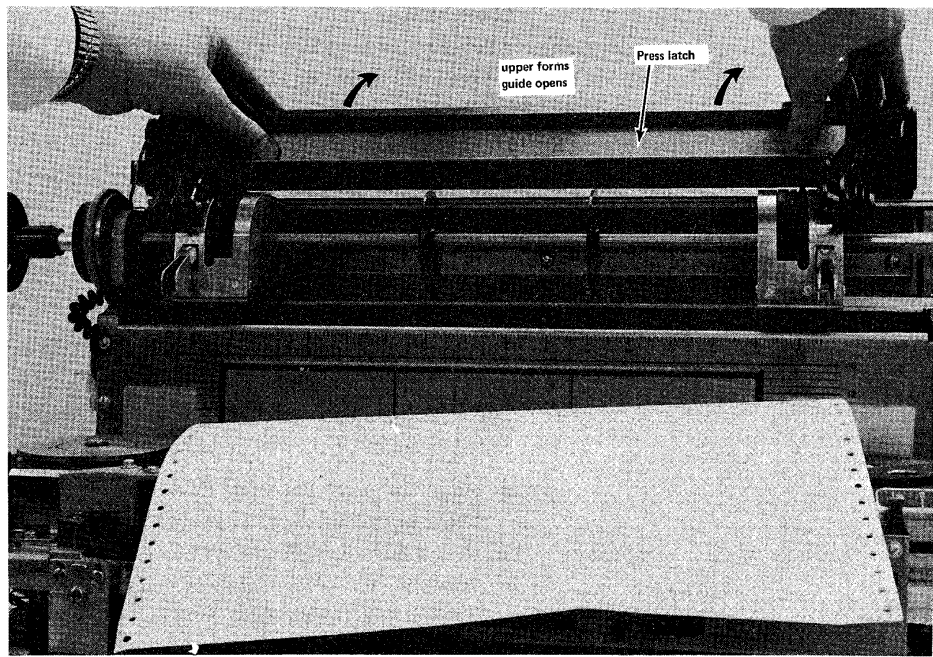
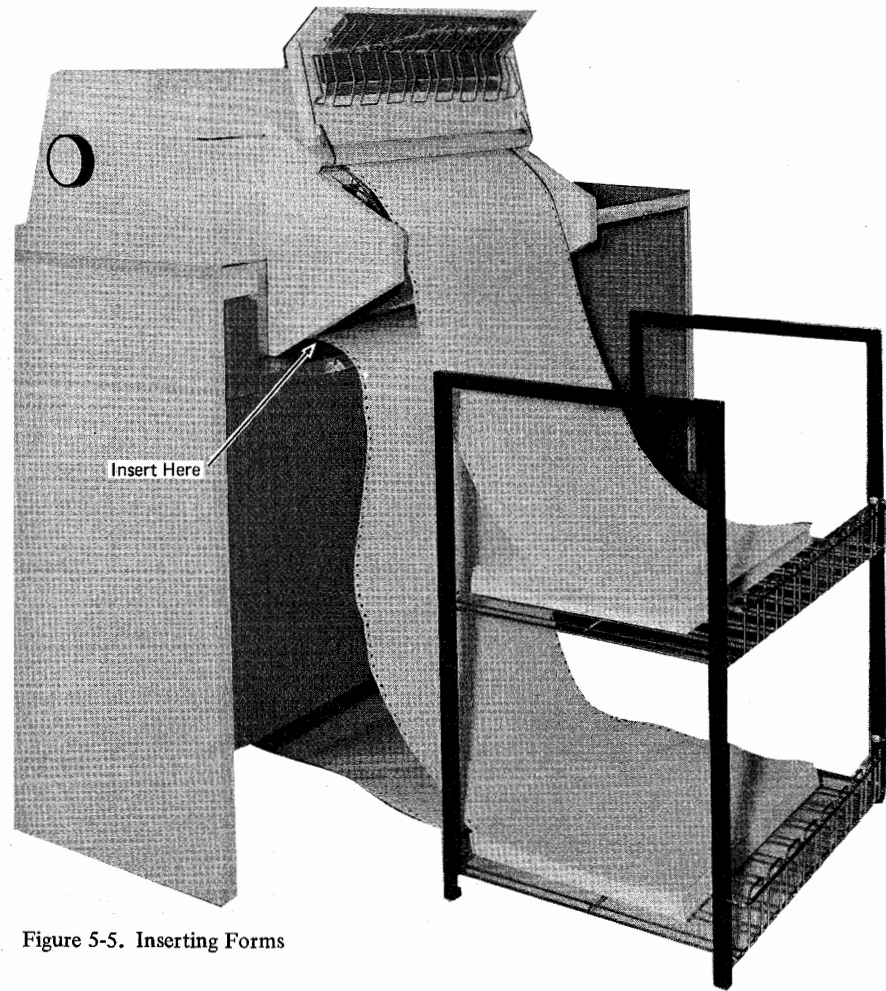

Figure 5-4. Opening Upper Forms Guide



3775
PTR

Figure 5-5. Inserting Forms

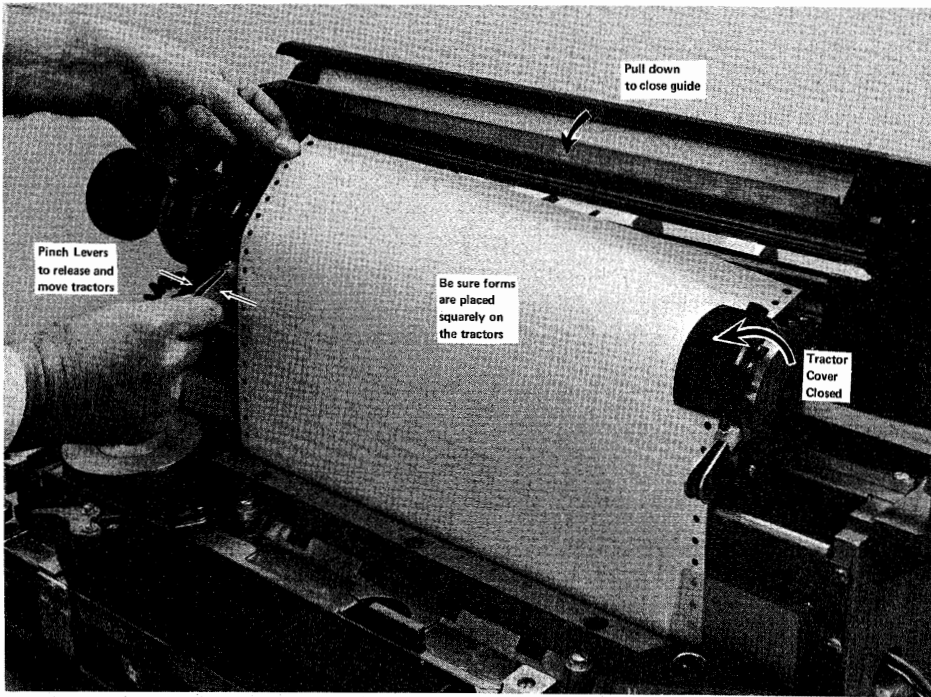

Figure 5-6. Placing Forms on Tractor Pins

Replacing the Ribbon

Removing the Ribbon

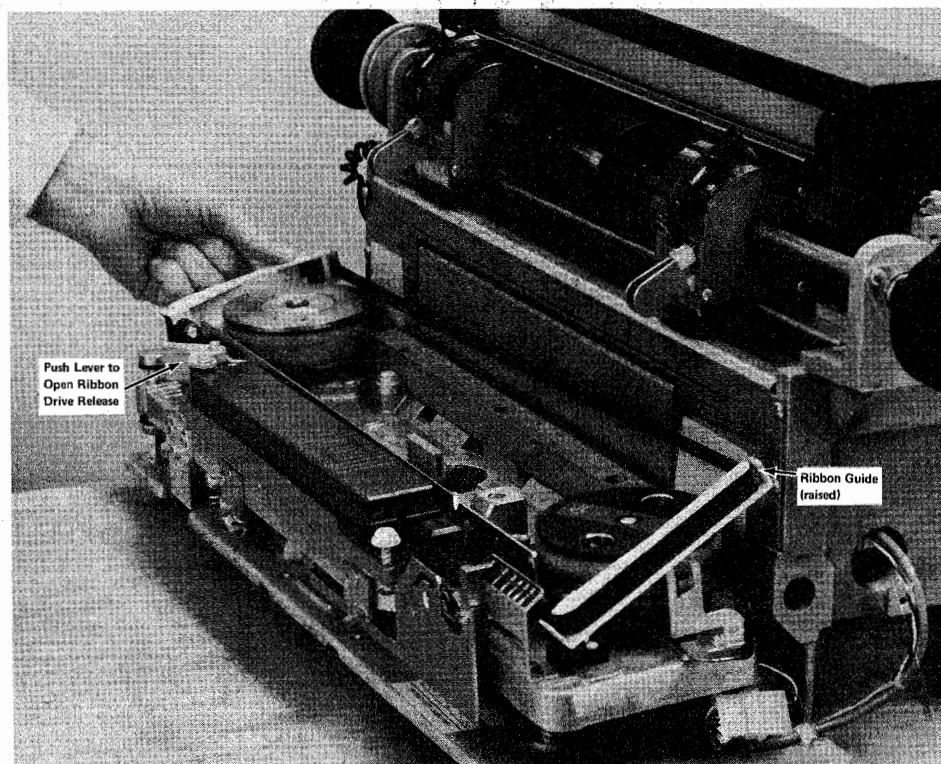

Figure 5-7. Raising Ribbon Guides

Use this procedure to remove the ribbon.

- 1 Open the printer cover as shown in Figure 5-2.
- 2 Open the print unit as shown in Figure 5-3.
- 3 Remove the forms.
- 4 Raise both ribbon guides as shown in Figure 5-7.
- 5 Open the ribbon drive release lever as shown in Figure 5-7.
- 6 Press the ribbon cassette release button down, and slide the ribbon cassette to the right until it is free, as shown in Figure 5-8.
- 7 Remove the ribbon from the ribbon guides shown in Figure 5-8.
- 8 Lift the ribbon cassette out of the printer.
- 9 Install the replacement ribbon cassette as described in the "Installing the Ribbon" section that follows.

Installing the Ribbon

Use this procedure to install a printer ribbon.

- 1 Open the printer cover as shown in Figure 5-2.
- 2 If you are replacing the printer ribbon, follow the "Removing the Ribbon" procedure above to remove the old printer ribbon.
- 3 Open the ribbon drive release lever shown in Figure 5-7.
- 4 Lay the cassette on the printer so that the left end (the end that has a curved surface that fits the feed roll) is approximately one inch (25,4 mm) from the ribbon drive rolls. The right end of the cassette will cover the ribbon cassette release button.

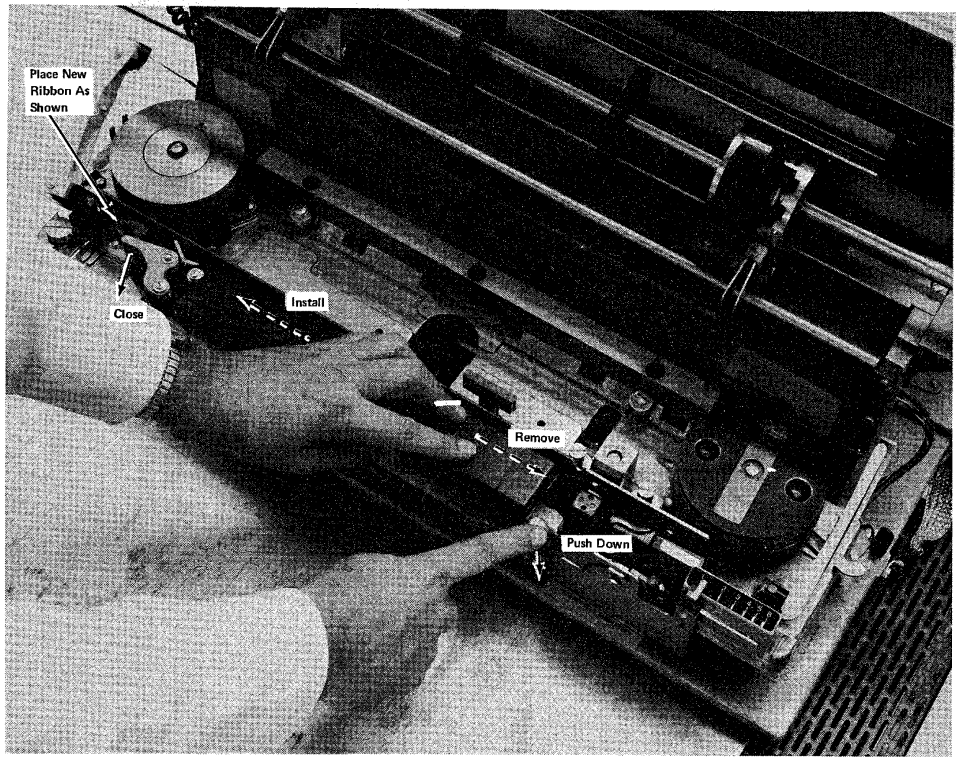

3775
PTR

Figure 5-8. Ribbon Cassette Removal/Installation

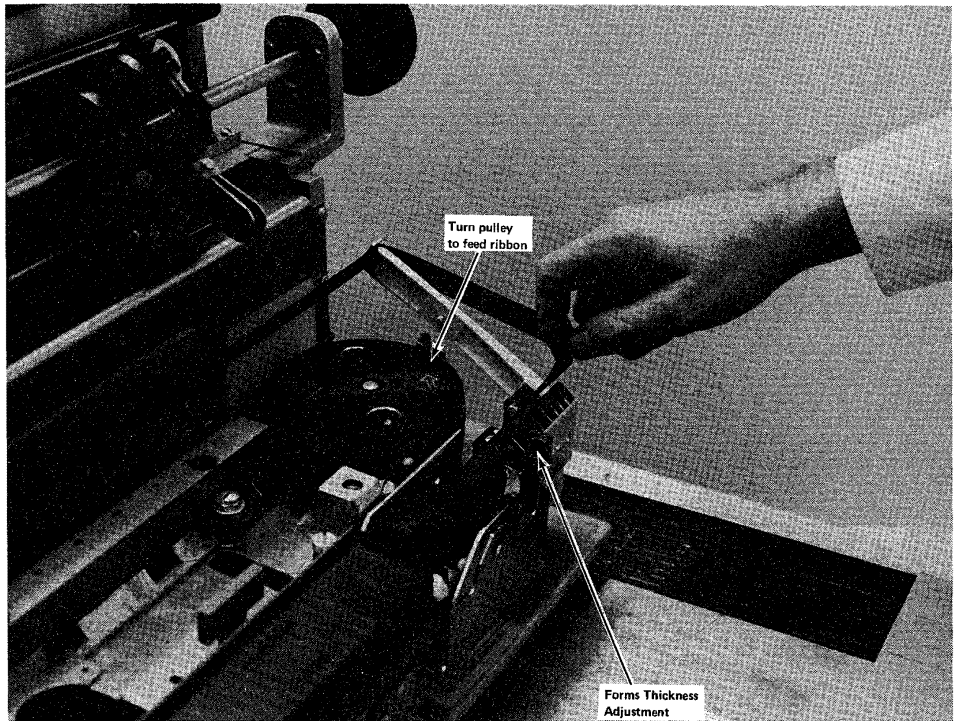

Figure 5-9. Installing the Ribbon

- 5 Pull approximately six inches of ribbon out of the left end of the cassette, place the ribbon in between the ribbon drive rollers, press down on the cassette, and slide the cassette to the left until it latches in place as shown in Figure 5-8.
- 6 Use the ribbon feed diagram on the printer as a guide; feed the ribbon from the left end of the cassette, through the release lever, and around the left guide.
- 7 Close the ribbon drive release lever shown in Figure 5-8.
- 8 Take up any extra ribbon slack by turning the print belt pulley shown in Figure 5-9.
- 9 Lower the ribbon guides shown in Figure 5-7.
- 10 Turn the print belt pulley again to feed the ribbon down between the print belt and the ribbon shield. Continue turning the print belt pulley, and verify that the ribbon feeds correctly.
- 11 Close the print unit shown in Figure 5-3.
- 12 Close the printer cover.

Replacing the Print Belt

Removing the Print Belt

Use this procedure to remove the print belt:



Figure 5-10. Releasing Print Belt Tension

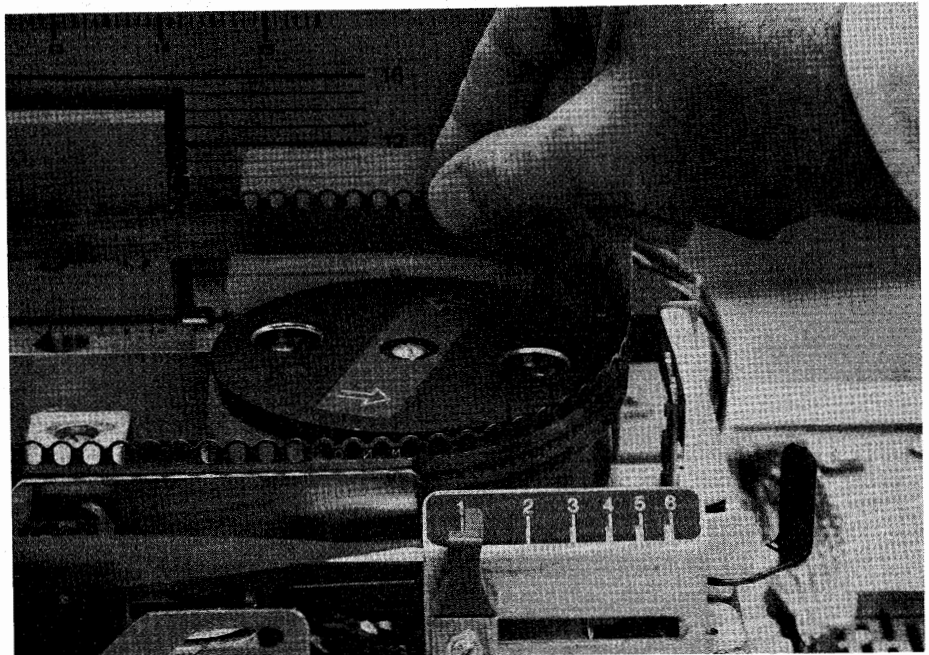

Figure 5-11. Removing Print Belt

- 1 Open the printer cover as shown in Figure 5-2.
- 2 Pull the print belt release lever forward to loosen belt tension as shown in Figure 5-10.
- 3 Lift the print belt off the pulleys, and store the belt in a safe location.
- 4 Follow the "Installing the Print Belt" procedure that follows when replacing the print belt.

Installing the Print Belt



Figure 5-12. Installing the Print Belt

Use this procedure to install the print belt:

- 1 If a print belt is on the printer, follow the "Removing the Print Belt" procedure above to remove the belt.
- 2 Raise both ribbon guides as shown in Figure 5-7.
- 3 Hold the print belt with the type up, and carefully place the belt around the pulleys and in back of the belt guard as shown in Figure 5-12.

Note: Do not place the belt all the way to the bottom of the pulley.

- 4 Move the print belt release lever to the rear to tighten the belt on the pulleys as shown in Figure 5-10.
- 5 Turn the print belt pulley counterclockwise, and observe the print belt as it moves on the pulleys as shown in Figure 5-12.

Note: If the belt does not move down on the pulleys, there is interference below the belt or the belt is positioned incorrectly; to correct this, remove the belt, check the belt path for interference, and install the belt again.

- 6 Lower the ribbon guides as shown in Figure 5-7.
- 7 Turn the print belt pulley and check that the print belt and ribbon turn correctly.
- 8 Close the print unit as shown in Figure 5-3.
- 9 Close the printer cover.

3775
PTR



Chapter 6. Diskette Storage Device

Make Ready Procedure

Use this procedure to install a diskette and place the Diskette Storage Device in a ready condition for transmitting data to, or receiving data from, the controller.

- 1 Open the front cover of the controller.
- 2 Press down on the latch and pull back on the front of the door to open the Diskette Storage Device (Figure 6-1).
- 3 Remove the old diskette if one is installed (Figure 6-2).
- 4 Install the new diskette (Figure 6-2).
- 5 Close the Diskette Storage Device door (Figure 6-3).

Note: The Diskette Storage Device is ready for system operation in approximately ten seconds.

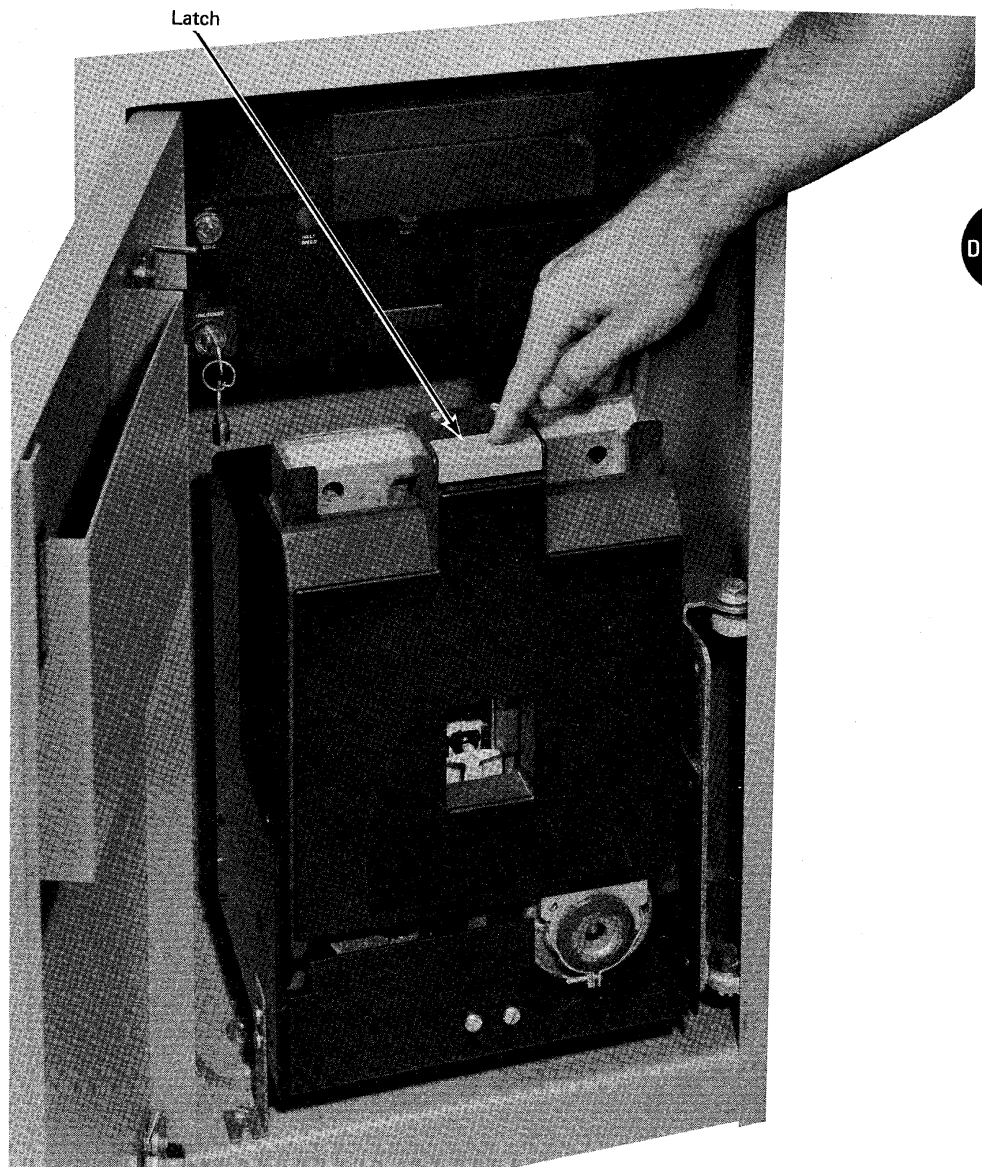

Figure 6-1. Opening the Diskette Device Door

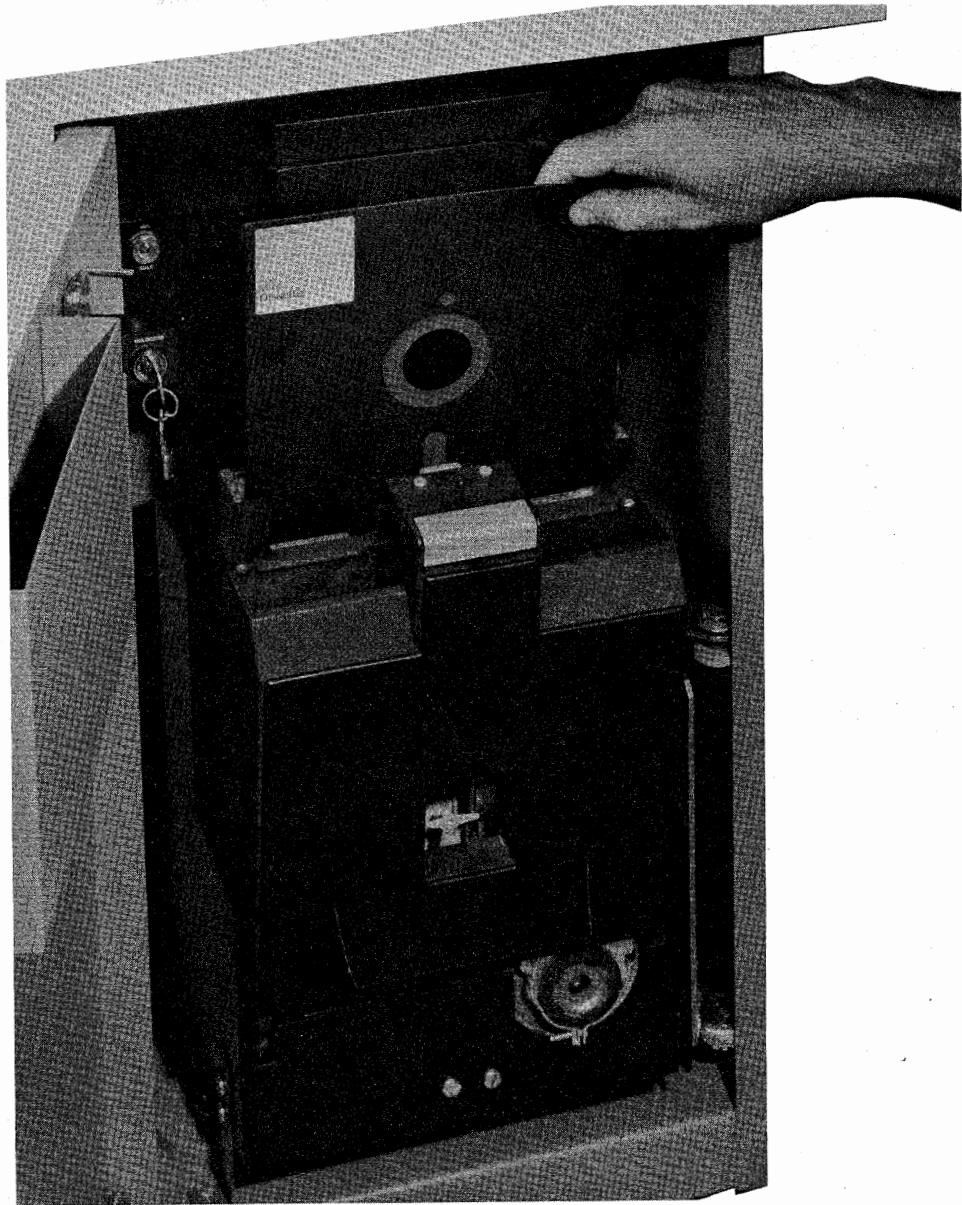
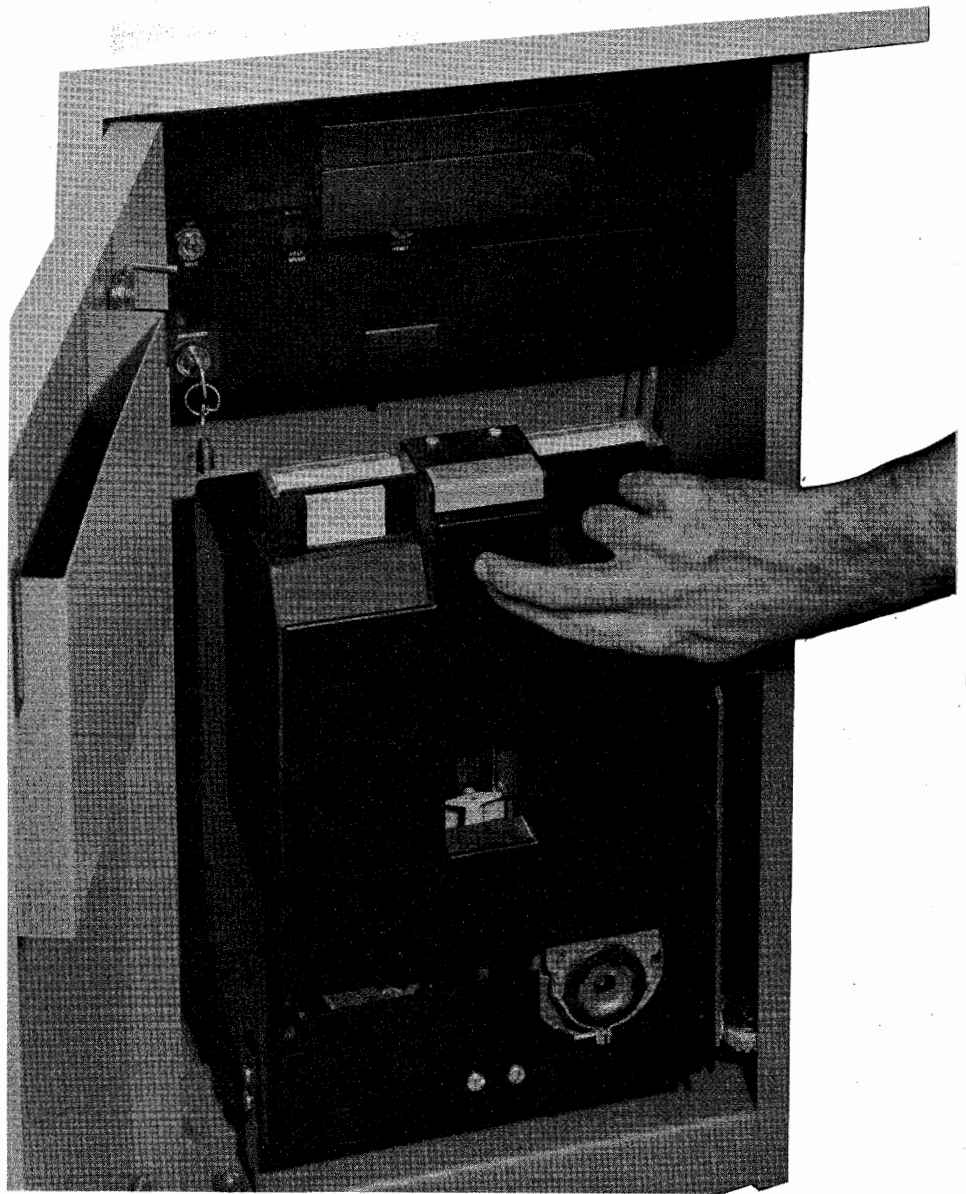

Figure 6-2. Removing/Inserting a Diskette



DISK

Figure 6-3. Closing the Diskette Device Door

Diskette Handling

Diskettes used with the Diskette Storage Device consist of a small flexible disk about 8 inches (203 mm) in diameter enclosed in a holder. The diskette itself is made of material similar to computer magnetic tape, and, like magnetic tape, requires special care in handling. Diskettes that are physically damaged (creased, torn, or warped), or contaminated with foreign material (dust, fingerprints, etc.), will cause read/write errors and possible damage to the Diskette Storage Device.

The following precautions are necessary to prevent damage and contamination of the diskette surface:

- Return the diskette to its envelope after removing the diskette from the Diskette Storage Device.
- Do not write on the diskette, except in the area indicated, or use paper clips on it.
- Do not touch or attempt to clean the diskette surface.
- Keep diskettes away from magnetic fields.
- Do not expose diskettes to excessive heat or sunlight.
- Do not stack objects on top of diskettes.

The *System Components* manual provides information on diskette storage and shipping.

Chapter 7. IBM 2502 Card Reader

Make Ready Procedure

The objective of the make ready procedure is to place the 2502 in a ready condition for reading the job's card input. Refer to Figure 7-1 for the location of the 2502 controls used in this procedure.

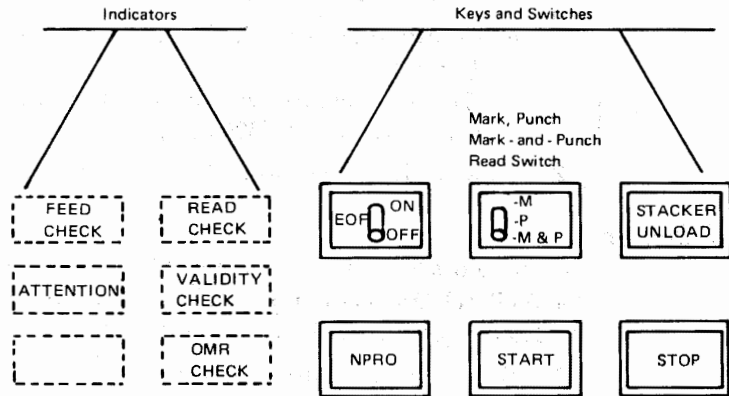
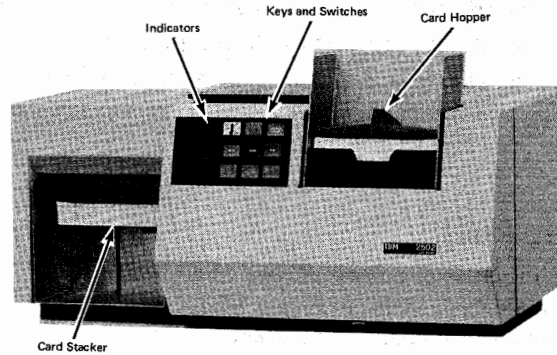

Figure 7-1. 2502 Make Ready Procedure

To place the 2502 in a ready condition:

- 1 Remove all cards from the hopper.
- 2 Turn the system power on, if it is not already on; then turn the 3782 power switch on. The reader's ATTENTION indicator turns on.
- 3 To clear out any cards that may be in the reader:
 - A. Remove all cards from the hopper;
 - B. If a job is not already started, start a card reader job;
 - C. Press the NPRO (Non Process Run Out) key.
- 4 Load the cards to be read in the hopper.
 - Place the cards in the hopper face down, and with the bottom (9-hole) edge of the card towards the machine.
 - Place the card weight on top of and in the same direction as the cards.
- 5 If you have placed the last batch of cards for this job in the hopper, set the EOF (end-of-file) switch to the ON position; if not, set the EOF switch to the OFF position.

Note: If the hopper empties and the EOF switch is off, at least one card must be placed in the hopper, the EOF switch turned on, and the START key pressed for EOF to be recognized.

6 Set the OMR (optical mark read) switch to the desired position:

- Position "M" to read marked data.
- Position "P" to read punched data.
- Position "M-P" to read both marked and punched data.

Note: The *System Components* manual describes the card format for reading both marked and punched data.

7 If already in a job, press the reader's START key. If starting a new job, pressing the START key is not necessary; the reader starts automatically when the job starts.

- The ATTENTION indicator turns off.
- The reader is in a ready condition, and reads under control of the system controller.

To Unload the Stacker

To Unload the Stacker (Before Full)

Use this procedure when you note that the stacker will become full before all cards in the batch are read. Refer to Figure 7-1 for the location of the 2502 controls used in this procedure. To unload the stacker:

- 1 Press the STACKER UNLOAD key.
 - The card reader stops reading cards to allow time for removing the cards from the stacker.
 - The reader automatically starts reading cards in approximately 30 seconds (150 cpm) or 15 seconds (300 cpm).
- 2 Press the START key to continue the read operation.

To Unload a Full Stacker

Use this procedure when you note that the stacker is full, and the reader is stopped with the ATTENTION indicator on. Refer to Figure 7-1 for the location of the 2502 controls used in this procedure. To unload the stacker:

- 1 Remove the cards from the stacker.
 - The ATTENTION indicator turns off.
- 2 Press the START key to continue the read operation.

To Reload the Hopper

To Reload the Hopper (Before Empty)

Use this procedure when you note that the hopper will become empty before all cards in the batch are read. Refer to Figure 7-1 for the location of the 2502 controls used in this procedure. To reload the hopper:

- 1 Press the STACKER UNLOAD key.
 - The reader stops reading cards to allow time for reloading the hopper.
 - The reader automatically starts reading cards in approximately 30 seconds.
- 2 Remove the card weight.
- 3 Load cards to be read in the hopper.
 - Place the cards in the hopper face down, and with the bottom (9-hole) edge of the card towards the machine.
 - Place the card weight on top of and in the same direction as the cards.
- 4 If you have placed the last batch of cards for this job in the hopper, set the EOF (end-of-file) switch to the ON position; if not, set the EOF switch to the OFF position.
- 5 Press the START key to continue the read operation.

To Reload an Empty Hopper

Use this procedure when you note that the hopper is empty, and the reader is stopped with the ATTENTION indicator on. Refer to Figure 7-1 for the location of the 2502 controls used in this procedure. To reload the hopper:

- 1 Remove the card weight.
- 2 Load cards to be read in the hopper.
 - Place the cards in the hopper face down, and with the bottom (9-hole) edge of the card towards the machine.
 - Place the card weight on top of and in the same direction as the cards.
- 3 If you have placed the last batch of cards for this job in the hopper, set the EOF (end-of-file) switch to the ON position; if not, set the EOF switch to the OFF position.
- 4 Press the START key to continue the read operation.

To Set Up for Short Cards—51 or 66 Column

Perform this procedure to set up for reading 51 or 66 column cards. Refer to Figure 7-2 for the location of the parts and controls included in this procedure. To set up for 51 or 66 column cards:

- 1 Insert spacer(s) in the hopper.
 - Insert a spacer on each side of the hopper for 51-column cards.
 - Insert a spacer only on the left side (standing in front of machine) for 66-column cards.
- 2 Raise the top cover.
- 3 Move the stacker-stop assembly to the short-document position.
 - Push down on the left (standing in front of the machine) end of the assembly and slide it to the right until you feel a definite stopping action.

Note: To restore the stacker to the 80-column card position, push down on the right end of the stacker-stop assembly and slide it to the left.
- 4 Set the stacker-spring lever at its short (51/66) document setting.
- 5 Load the hopper with the short column cards.
 - Place the cards in the hopper face down, and with the bottom (9-hole) edge of the card towards the machine.
 - Place the card weight on top of and in the same direction as the cards.
- 6 If you have placed the last batch of cards for this job in the hopper, set the EOF (end-of-file) switch to the ON position; if not, set the EOF switch to the OFF position.
- 7 Press the START key.
 - The reader will feed one card.
 - The reader is in a ready condition, and reads under control of the system controller.

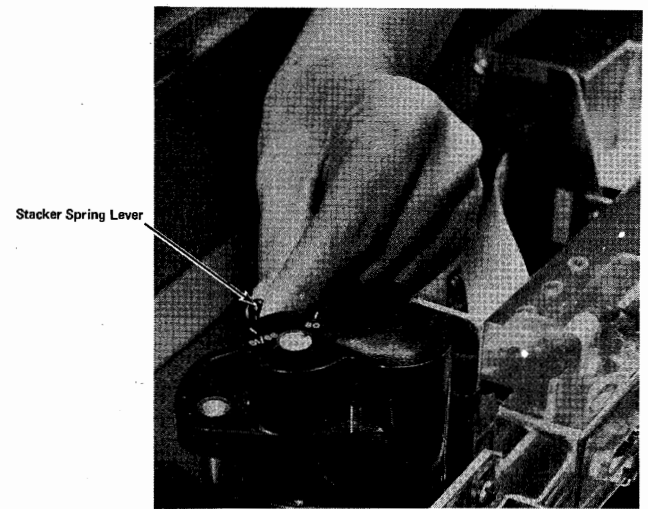
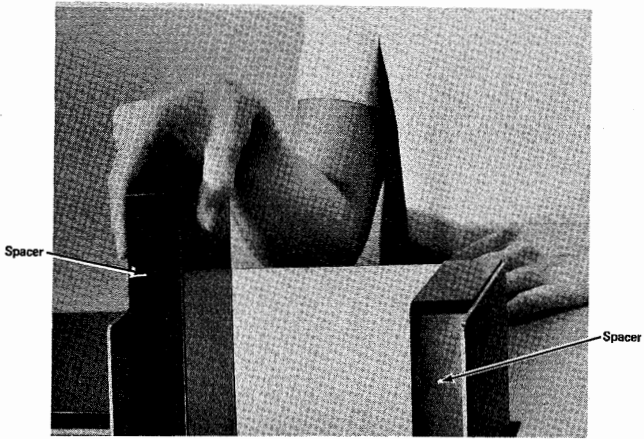

2502

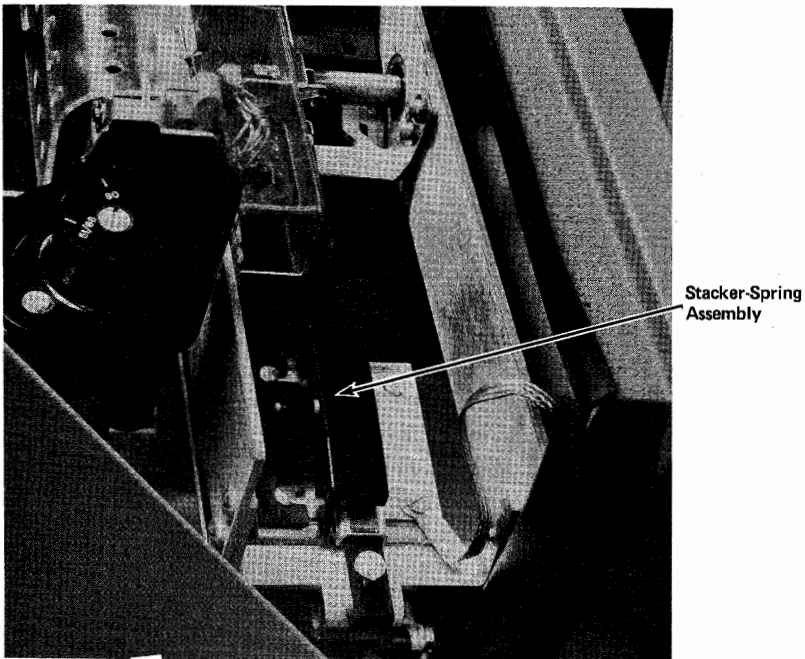

Figure 7-2. 2502 Short Card Setup Procedure

To Remove a Card Jam

Use this procedure to remove a card jam at either the cornering or read stations, or a card jam between the read station and the stacker. Refer to Figure 7-3 for the location of the 2502 controls used in this procedure.

Jam at the Cornering Station or the Read Station

- 1 Raise the top cover.
- 2 Push back (towards the front of the machine) on the latch and raise the read head upper card guide.
- 3 Remove the jammed card(s).
- 4 Lower the read head upper card guide back to the horizontal position and relatch.

Jam Between the Read Station and the Stacker

- 1 Raise the top cover.
- 2 Pull up on the upper card guide assembly.
- 3 Remove the jammed card(s).
- 4 Lower the upper card guide to the horizontal position.

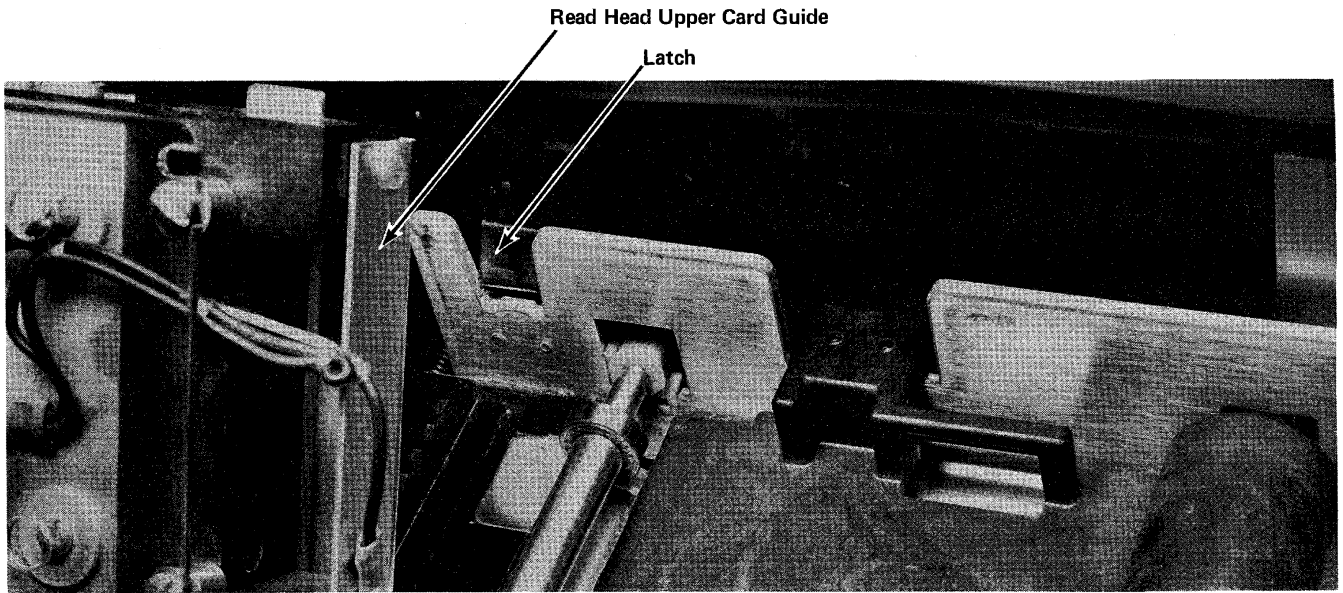

2502

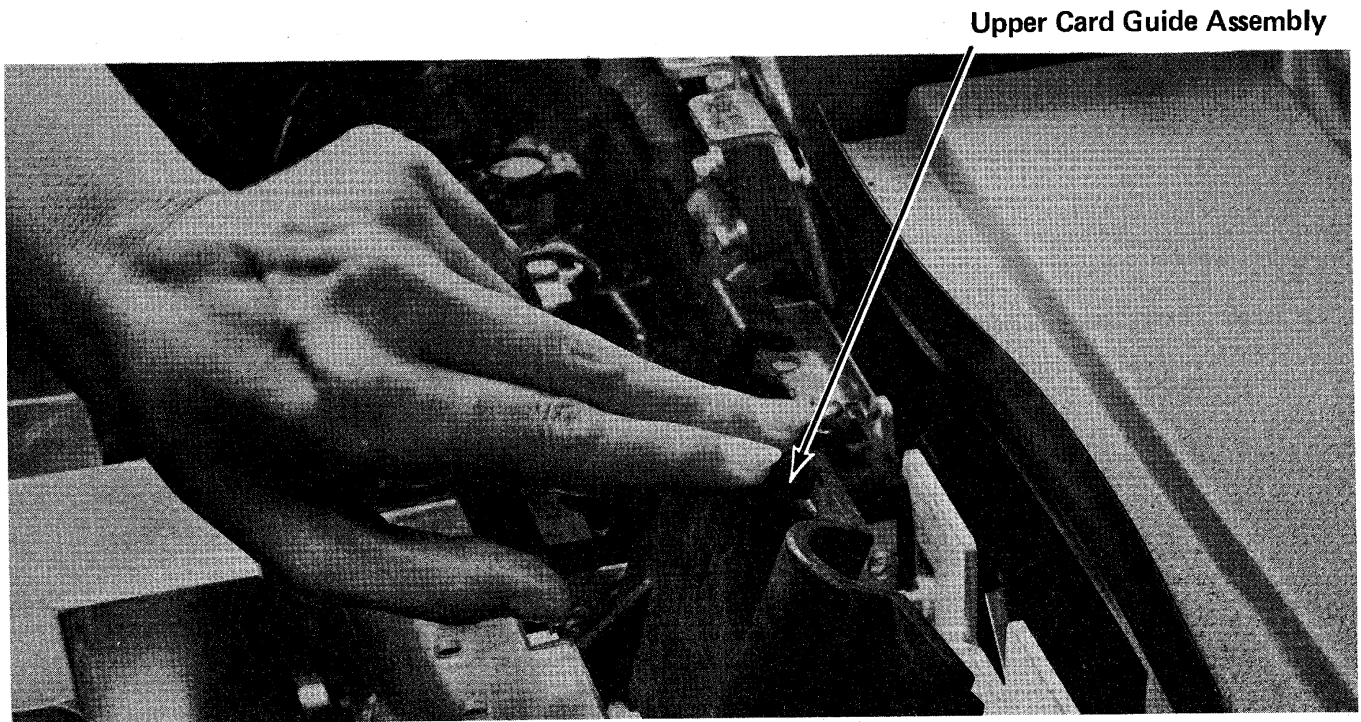

Figure 7-3. 2502 Card Jam Removal



Chapter 8. IBM 3501 Card Reader

Make Ready Procedure

The objective of the make ready procedure is to place the reader in a ready condition for reading the job's card input. Refer to Figure 8-1 for the location of the reader controls used in this procedure.

- 1 Remove all cards from the hopper.
- 2 Turn the terminal's POWER switch on, if it is not already on.
- 3 Load the cards to be read in the hopper.
 - Place the cards in the hopper face down, with the 9-edge towards the rear of the reader and column 1 to your left, as is indicated on the reader hopper.
 - Place the card weight on top of the cards.
- 4 If already in a job, press the GREEN (START) key; if starting a new job, pressing the START key is not necessary.
 - Both 3501 lights (status indicators) turn on when a job starts that defines the card reader as the job's input device.
 - The reader is in a ready condition, and reads under control of the system controller.

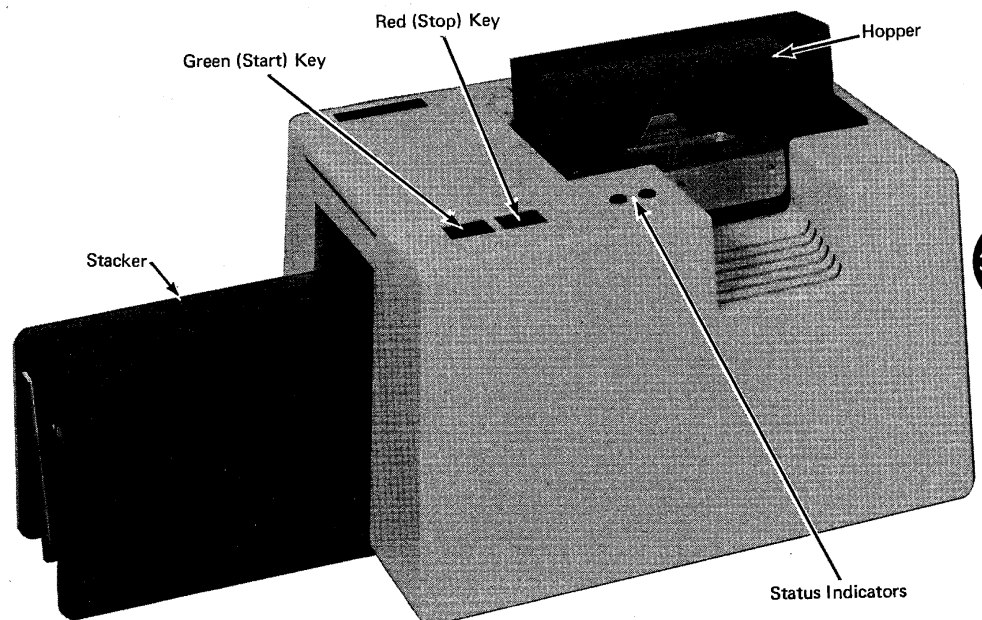

Figure 8-1. 3501 Make Ready Procedure (Part 1 of 2)

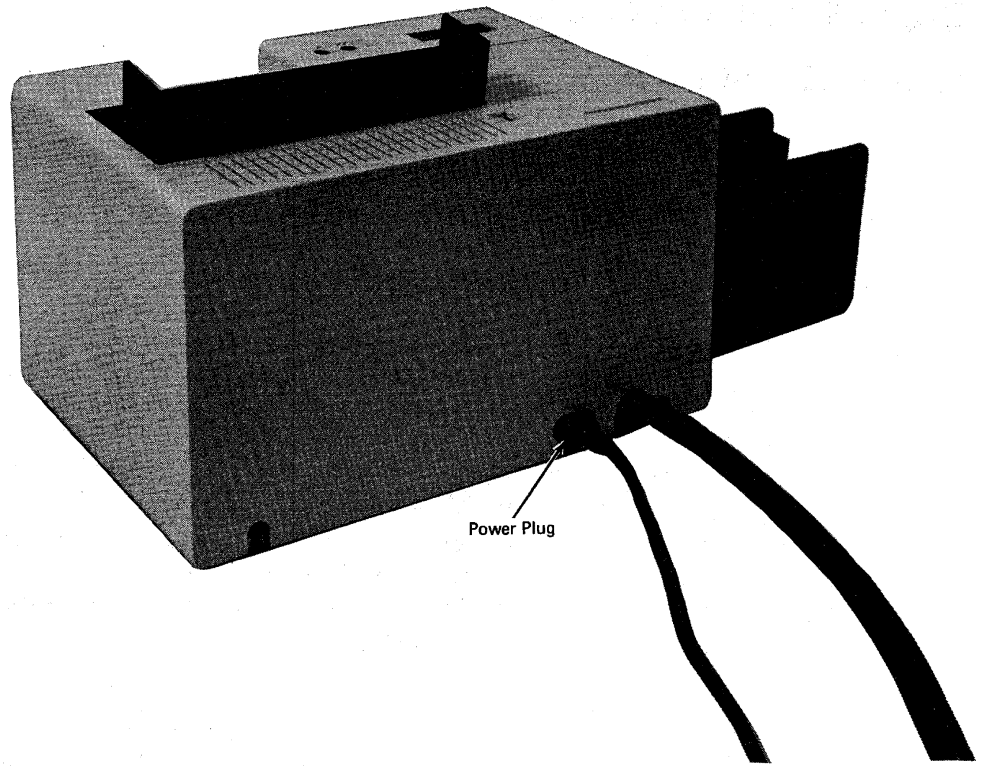

Figure 8-1. 3501 Make Ready Procedure (Part 2 of 2)

Operating Procedures

Reloading the Hopper or Unloading the Stacker

Use this procedure to either add cards to the reader hopper, or remove cards from the stacker. Refer to Figure 8-1 for the location of the reader controls used in this procedure.

- 1 Press the reader RED (STOP) key.
 - The reader stops after it reads the card in process.
- 2 Add the cards required to the hopper, and unload the stacker if required.
- 3 Press the reader GREEN (START) key.
 - Both 3501 lights (status indicators) turn on when a job starts that defines the card reader as the job's input device.
 - The reader is in a ready condition, and reads under control of the system controller.

Removing a Card Jam

CAUTION

As you do not turn the terminal's power off when removing a card jam, you can avoid unexpected starting of the reader by disconnecting the reader's power plug at the rear of the reader. Be sure to reconnect the plug after you have removed the card jam.

- 1 Press the RED (STOP) key.
- 2 Remove the cards from the hopper.
- 3 Open the top cover as shown in Figure 8-2.

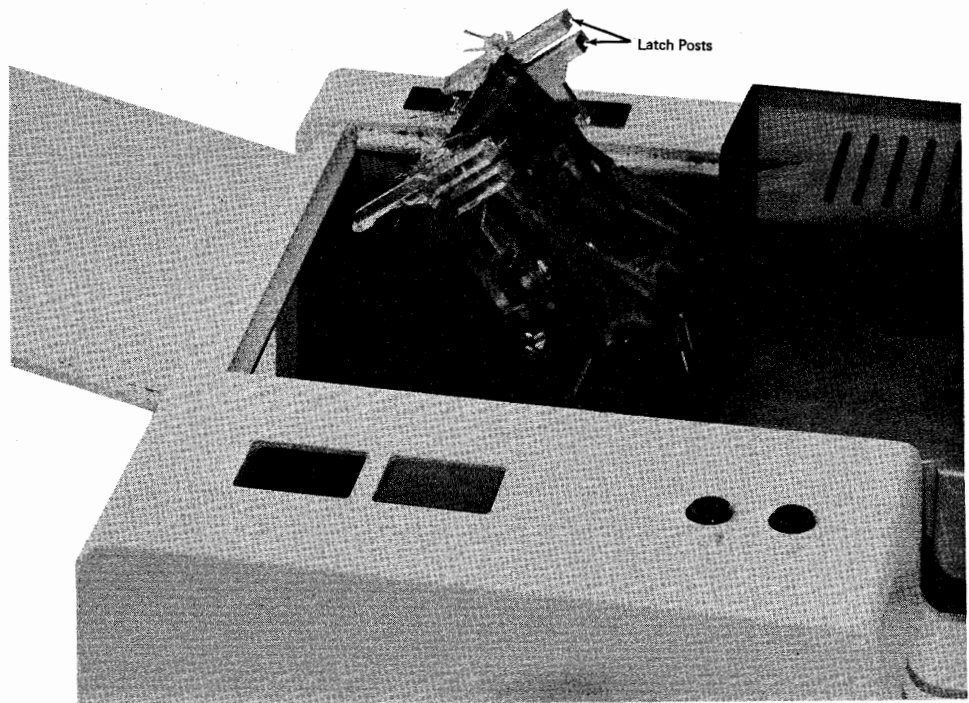

Figure 8-2. Removing a Card Jam

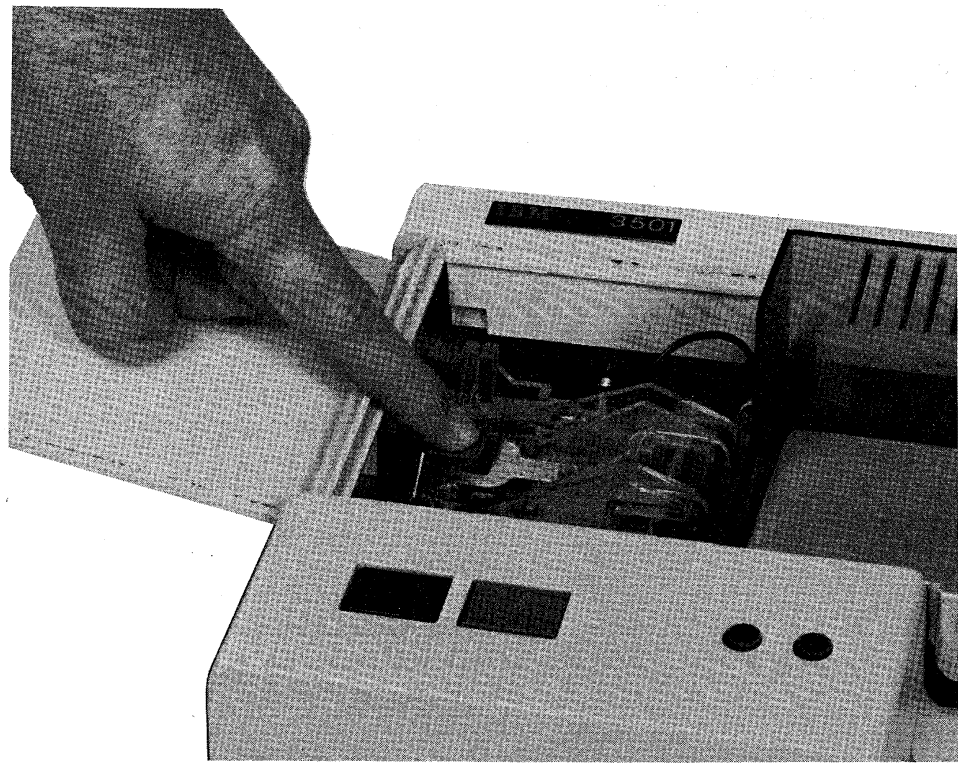

Figure 8-3. Closing the Read Head Cover

- 4** Rotate the read head card cover open (up and to the right) by squeezing the top of the latch posts together, as shown in Figure 8-2.
 - The card transport area is open for removal of the card jam.
 - Be careful not to snag the card on the read head star wheels when removing the jam.
- 5** Close the read head card cover by pressing firmly on the cover as shown in Figure 8-3. Check to be sure that both lock post latches lock in place.
- 6** Close the top cover.
- 7** If disconnected, plug in the power plug at the back of the reader.
- 8** Make the reader ready, as described in the "Make Ready Procedure".

Chapter 9. IBM 3521 Card Punch

Make Ready Procedure

The objective of the make ready procedure is to place the punch in a ready condition for punching the job's card output. Refer to Figure 9-1 for the location of the punch controls used in this procedure.

Caution: Be sure that the front cover is closed before making the punch ready. The punch motor will run with the front cover open.

- 1 Remove all cards from the hopper.
- 2 Turn the terminal's power on, if it is not already on.
- 3 Turn the 3521's POWER switch on if it is not already on; the switch is located on the front of the IBM 3782 Card Attachment Unit.

Note: When the read feature is installed, there is a time delay of approximately 45 seconds before the 3521 becomes ready after power is turned on. If you try to start a job during this time delay period, "354" displays in the NPR and the job must be restarted.

- 4 If performing an error recovery procedure, press the BLUE (Non-Process Run Out) key; if starting a new job, pressing the BLUE key is not necessary.

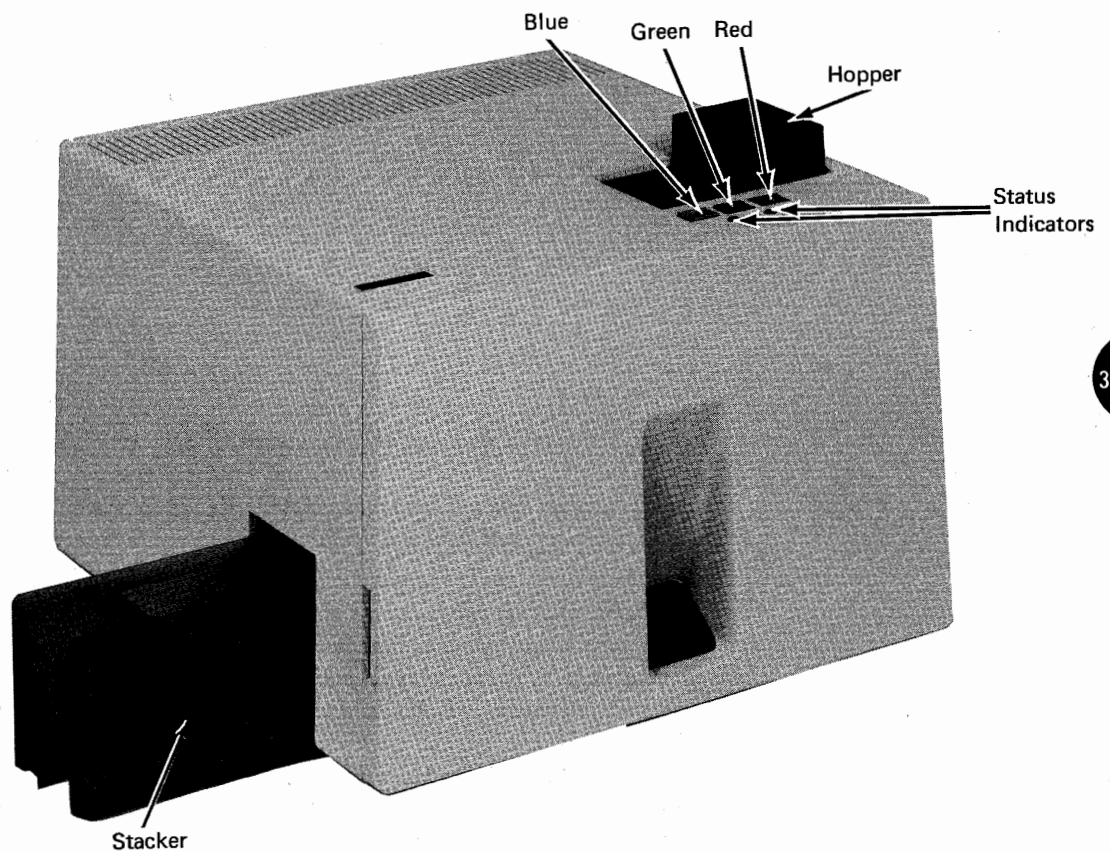

Figure 9-1. 3521 Make Ready Procedure (Part 1 of 2)

- 5 Move the hopper slide to the left, and place cards against the hopper slide and the bottom of the hopper (column 1 end down, 9-edge to the rear). Allow the slide and cards to move to the right into position for feeding. Ensure that the first card does not fall partially through the feed throat.

Multiple card decks for successive card read jobs can be placed in the hopper, with an /*EOF card followed by a blank card at the end of each deck.

Note: Cards must be fanned and joggled before loading in the hopper. Bent or warped cards must be straightened.

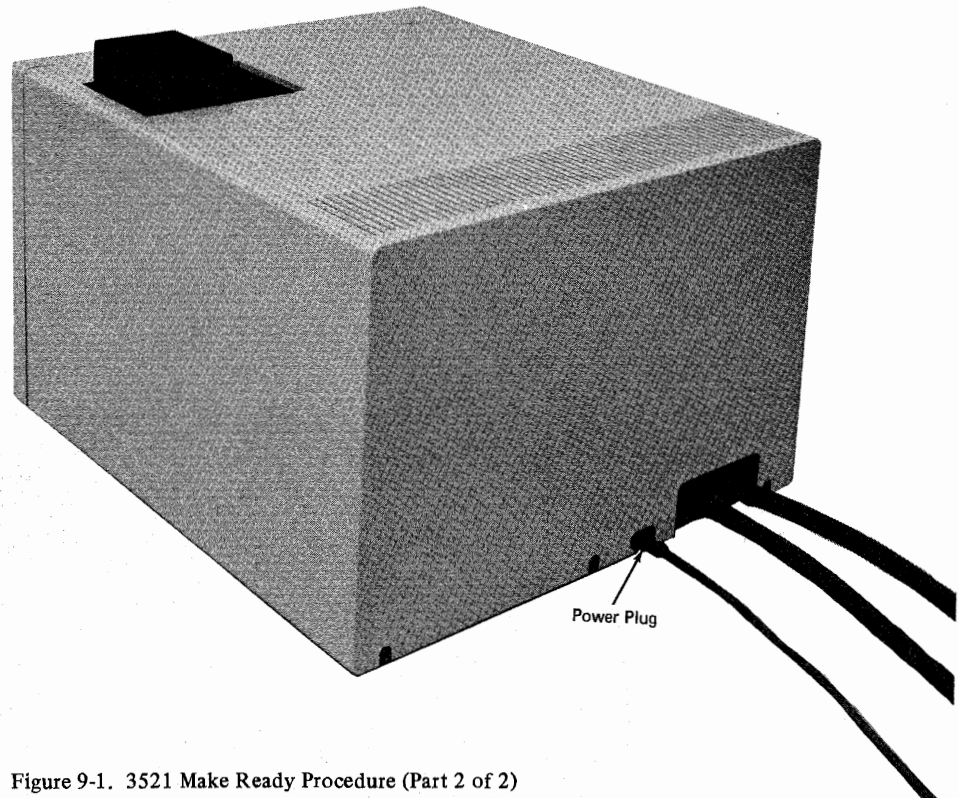

Figure 9-1. 3521 Make Ready Procedure (Part 2 of 2)

- 6 If already in a job, press the 3521's GREEN (START) key. If starting a new job, pressing the START key is not necessary; the reader starts automatically when the job starts.
 - Both 3521 lights (status indicators) turn on when a job starts that defines the 3521 as the job's input or output device (reader or punch).
 - The 3521 is in a ready condition, and reads or punches under control of the terminal's controller.

POWER NOTE: If the 3521's motor does not start, check that the power switch located on the front of the IBM 3782 Card Attachment Unit is turned on; and check that the power plug at the rear of the 3521 is connected.

Operating Procedures

Reloading the Hopper or Emptying the Stacker

Use this procedure to either add cards to the hopper, or remove cards from the stacker. Refer to Figure 9-1 for the location of the punch controls used in this procedure.

- 1 Press the RED (STOP) key.
- 2 Add cards to the hopper. (See Step 5 of "Make Ready Procedure")

Note: Cards must be fanned and joggled before loading in the hopper. Bent or warped cards must be straightened.

- 3 Remove the cards from the stacker.
- 4 Press the GREEN (START) key.
 - Both 3521 lights (status indicators) turn on when a job starts that defines the 3521 as the job's input or output device.
 - The 3521 is in a ready condition, and reads or punches under control of the terminal's controller.

Emptying the Chip Box

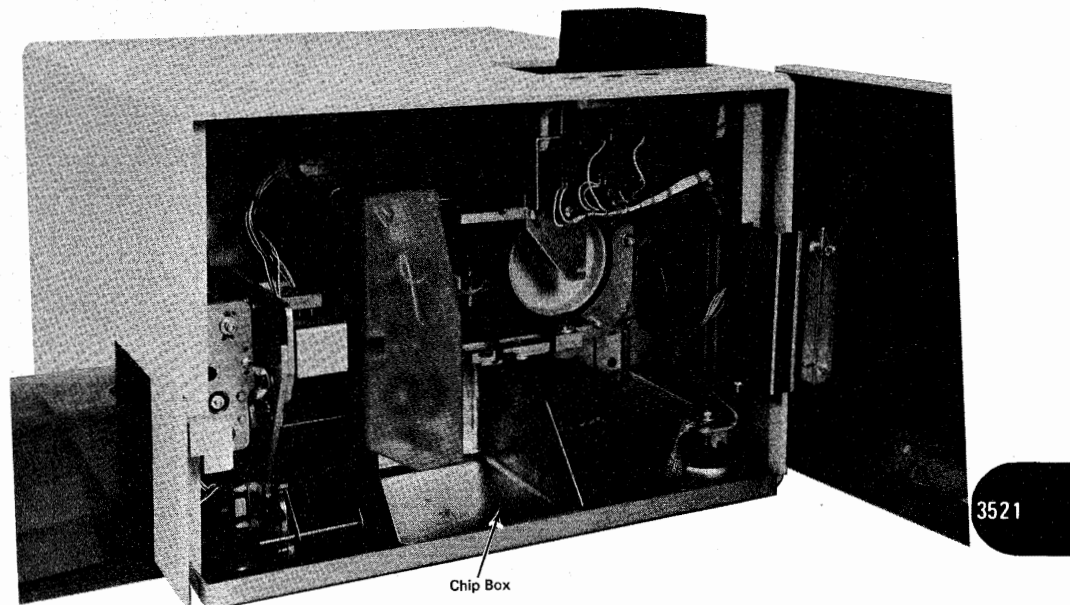

Figure 9-2. Emptying the Chip Box

The chip box window in the front cover of the punch indicates when the chip box is full. As card chad builds up it can be seen through the chip box window. Empty the chip box before it overfills and card chad spills into the base of the punch.

Caution: If card chad does spill into the base of the machine, be sure you turn the machine power off (at the 3782 Card Attachment Unit) before using a vacuum cleaner to remove the chad.

To empty the chip box:

- 1 Press the RED (STOP) key.
- 2 Turn the card punch power off.
- 3 Open the front cover (door) as indicated in Figure 9-2.

- 4 Remove the chip box (Figure 9-2).
- 5 Replace the chip box after it is emptied.
- 6 Close the front cover.
- 7 Make the card punch ready as described in the "Make Ready Procedure".

Removing Card Jams

The most probable cause of a card jam is card damage at the column 1 end of the card; the card is bent or nicked and will not pass through the punch. Most card jams can be removed easily; however, trying to use the NPRO (non process run out) key to try to run a damaged card through the punch, or forcing a card out of the punch can complicate the correction of an otherwise simple card jam.

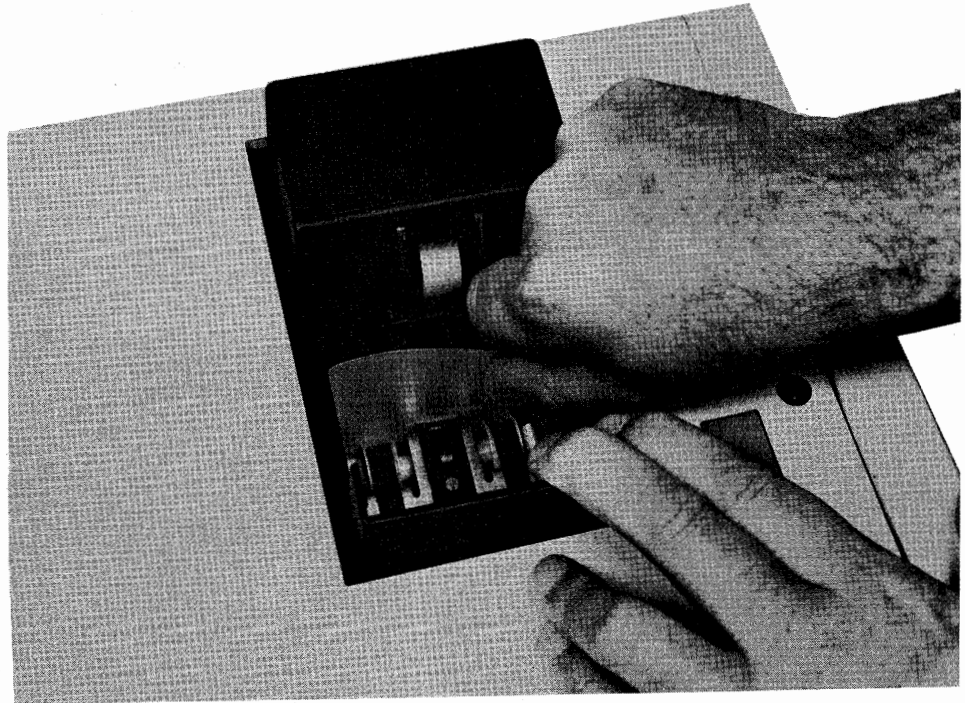

Figure 9-3. Removing a Card Jam at the Hopper

To remove a card jam:

CAUTION

As you do not turn the terminal or card punch power off when removing a card jam, you can avoid unexpected starting of the punch by disconnecting the punch's power plug at the rear of the punch; this plug is shown in Figure 9-1. Be sure to reconnect the plug after the card jam is removed.

- 1 Press the RED (STOP) key.
- 2 If the card jam is at the hopper, remove the card as shown in Figure 9-3.
- 3 Open the front cover as shown in Figure 9-1.
- 4 To gain access to the card path area, loosen the wingscrew located at the top of the punch's printing unit (see Figure 9-4,) and pivot the top half of the printing unit open.
- 5 Open the registration station cover shown in Figure 9-4. Hold the cover out of the way as shown in Figure 9-4.

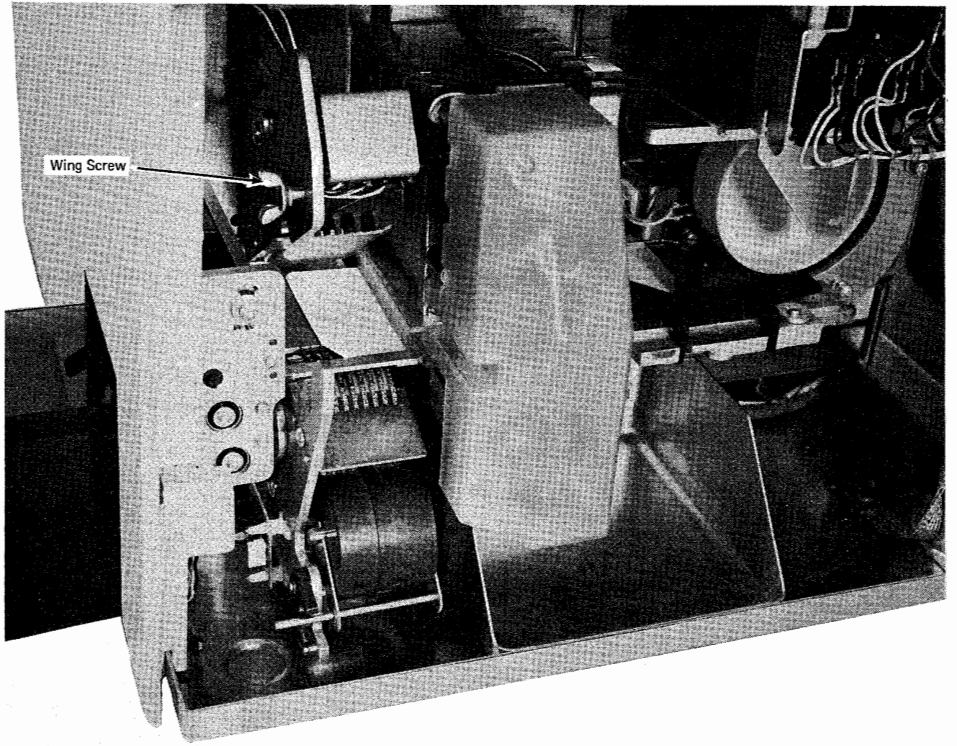

Figure 9-4. Removing a Card Jam in the Card Path Area (Part 1 of 2)

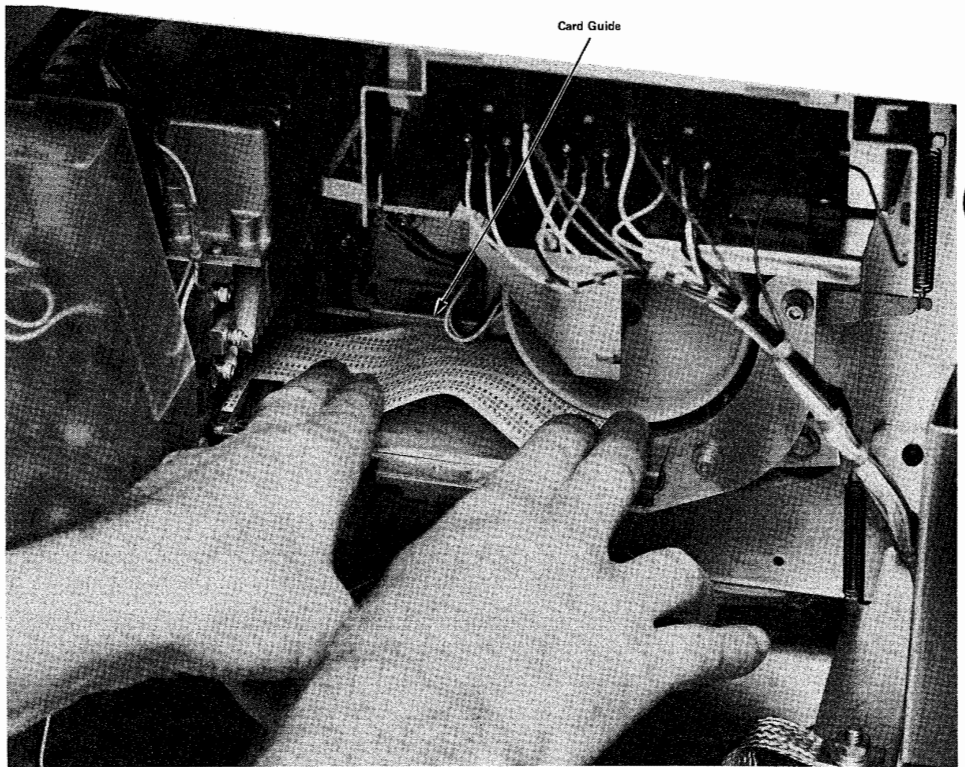

Figure 9-4. Removing a Card Jam in the Card Path Area (Part 2 of 2)

3521

- Carefully pry the card up and buckle it from both ends as shown in Figure 9-4.

Note: The column 80 end of the card (under the large wheel) will have some drag, due to the spring-loaded pressure roll.

At the column 1 end, pull the card from the punch in a straight line to avoid cutting the card on the card guide. As the card clears the guide, take it out of the punch in the direction shown in Figure 9-4.

- Close the registration station cover.
- Pivot the top half of the printing unit closed, hold it down against the stop, and tighten the wingscrew.
- Close the front cover.
- If disconnected, plug in the power plug at the back of the punch.
- Make the punch ready as described in the "Make Ready Procedure".

Replacing the Inkroll

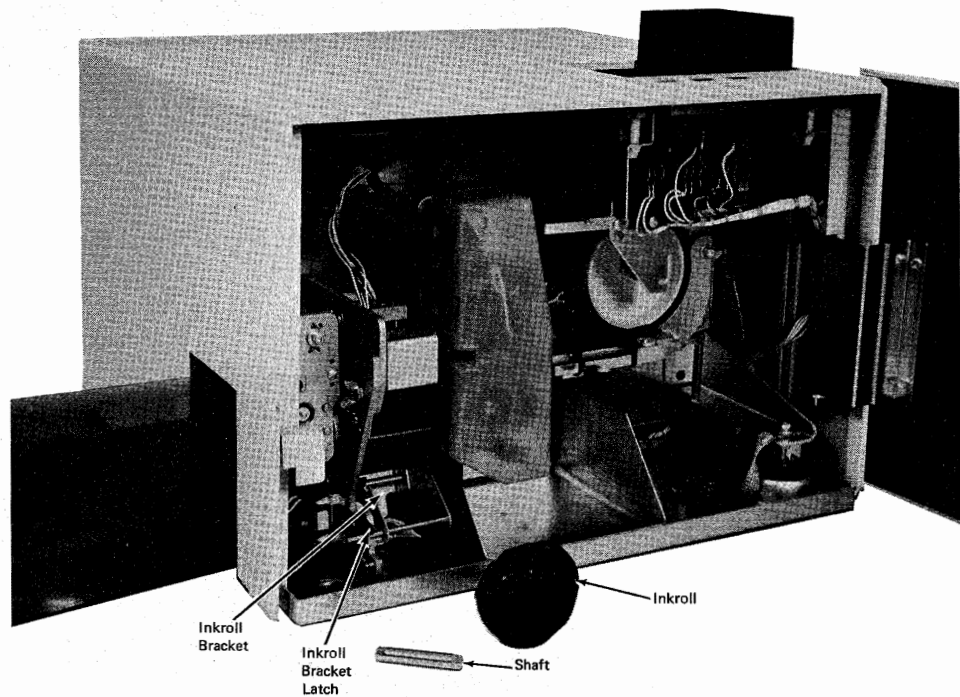

Figure 9-5. Replacing the Inkroll

To replace the inkroll:

- Press the RED (STOP) key.
- Open the front cover as shown in Figure 9-2.
- Disengage the inkroll from the typedrum by pressing down on the inkroll bracket (Figure 9-5) until the latch snaps into place.
- Remove the old inkroll cartridge and shaft from the bracket.
- Remove the shaft from the old inkroll cartridge.
- Insert the shaft in the new inkroll cartridge.
- Insert the new inkroll cartridge and shaft into the inkroll bracket so that the shaft ends are in the bracket slots.

- 8 Engage the inkroll with the typedrum by pushing down on the inkroll bracket latch.

Note: You need not engage the inkroll with the typedrum if the 3521 will be run for long periods without printing (the interpret feature is not used). If you leave the inkroll disengaged, it will increase the life of the inkroll, and will reduce the dust and ink buildup on the typedrum.

Cleaning the Typedrum

As the 3521 runs, ink and card dust accumulate on the typedrum. If not removed, this ink and dust buildup will affect the legibility of the printed characters. Cleaning the typedrum more frequently is better than waiting until the character faces on the drum become clogged and cause a problem. For most applications, cleaning the typedrum monthly is adequate.

To clean the typedrum:

- 1 Remove the inkroll as described in the "Replacing the Inkroll" procedure.
- 2 Install the brush cartridge exactly as if it were a new inkroll. Use the "Replacing the Inkroll" procedure.
- 3
 - A. Close the front cover.
 - B. Start a job that defines the 3521 as the job's output device; for example, a keyboard to punch job.
 - C. Press the BLUE (Non Process Run Out) key about ten times; about ten non-process-run-out cycles should clean the typedrum; press the BLUE key ten more times if the typedrum is not clean.
- 4 Use the "Replacing the Inkroll" procedure to install the inkroll that was removed in Step 1.

Using the Status Indicators

The 3521's status indicators together with the indicators on the terminal's operator panel provide an indication of the 3521's status at any given point in running a job. When both of the 3521's status indicators are on, the 3521 is in a ready status, and is selected as the terminal's input or output device.

When either of the status indicators is off (indicating a not-ready or error condition), first check the terminal's operator panel indicators to determine the cause of the problem and the procedure for correcting the problem. When an error involving the 3521 occurs:

- The terminal's operator panel PUNCH indicator will be on if the 3521 is used as a punch.
- The terminal's operator panel READER indicator will be on if the 3521 is used as a reader.
- All other input and output device indicators on the operator panel will be off.
- Either the OPRN (Operational) CHECK or the SYSTEM CHECK indicators will be on.
- A number displays in the operator panel's readout indicators that indicates the type of error. Chapter 3 lists these error numbers together with the procedure for determining the cause of and for correcting the error.

A summary of the error types displayed when either of the indicators is off follows. Use the method described above for correcting error conditions.

3521

LEFT INDICATOR OFF: Generally indicates a problem occurred after the card reached the registration station, such as punch check, read check, sync check, or card jam after registration.

RIGHT INDICATOR OFF: Generally indicates a problem occurred before the card reached the registration station, such as hopper check (hopper empty), or card jam while feeding the card.

Chapter 10. Operator ID (Identification) Card Reader

Reading an Identification Card

Hold the CODE key down and enter a numeric 6 from the keyboard; release the CODE key. When the operator panel readout indicator (NPR) displays number "233", insert the identification badge in the reader at the right side and slide the badge through the reader from right to left; slide the badge through the reader at a steady rate.

Note: The badge's magnetic stripe faces down, and toward the back of the terminal.

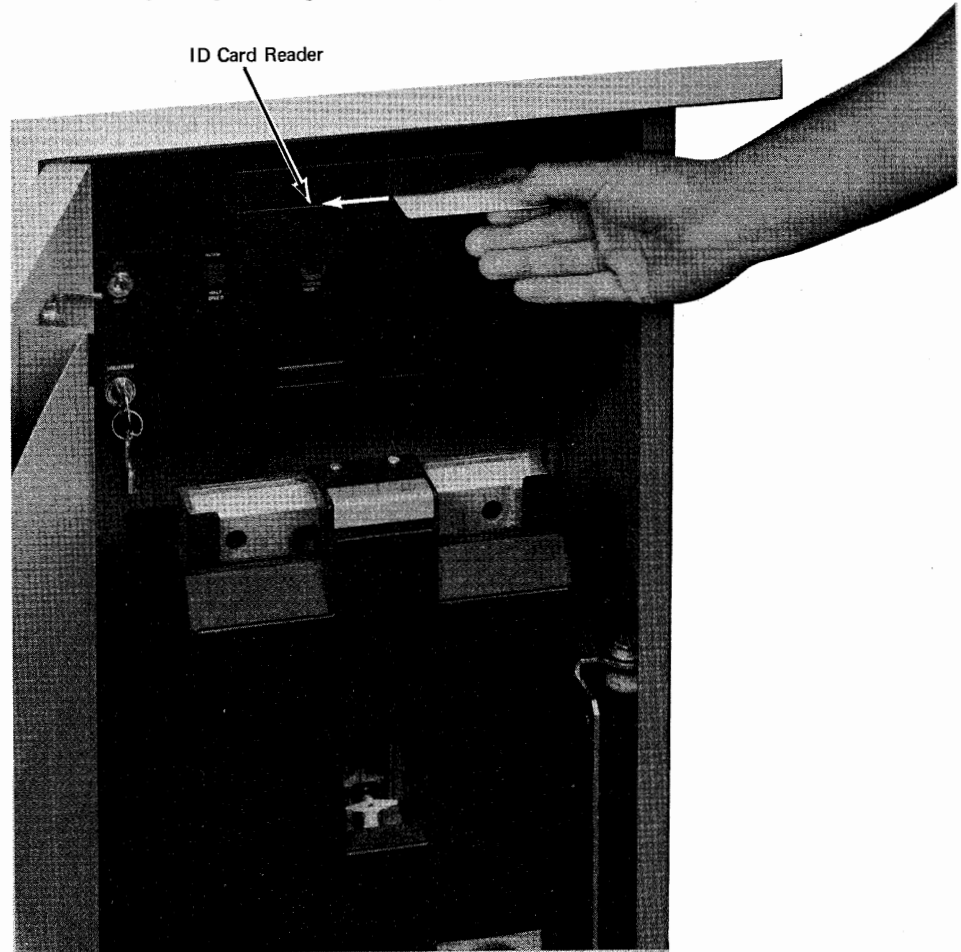
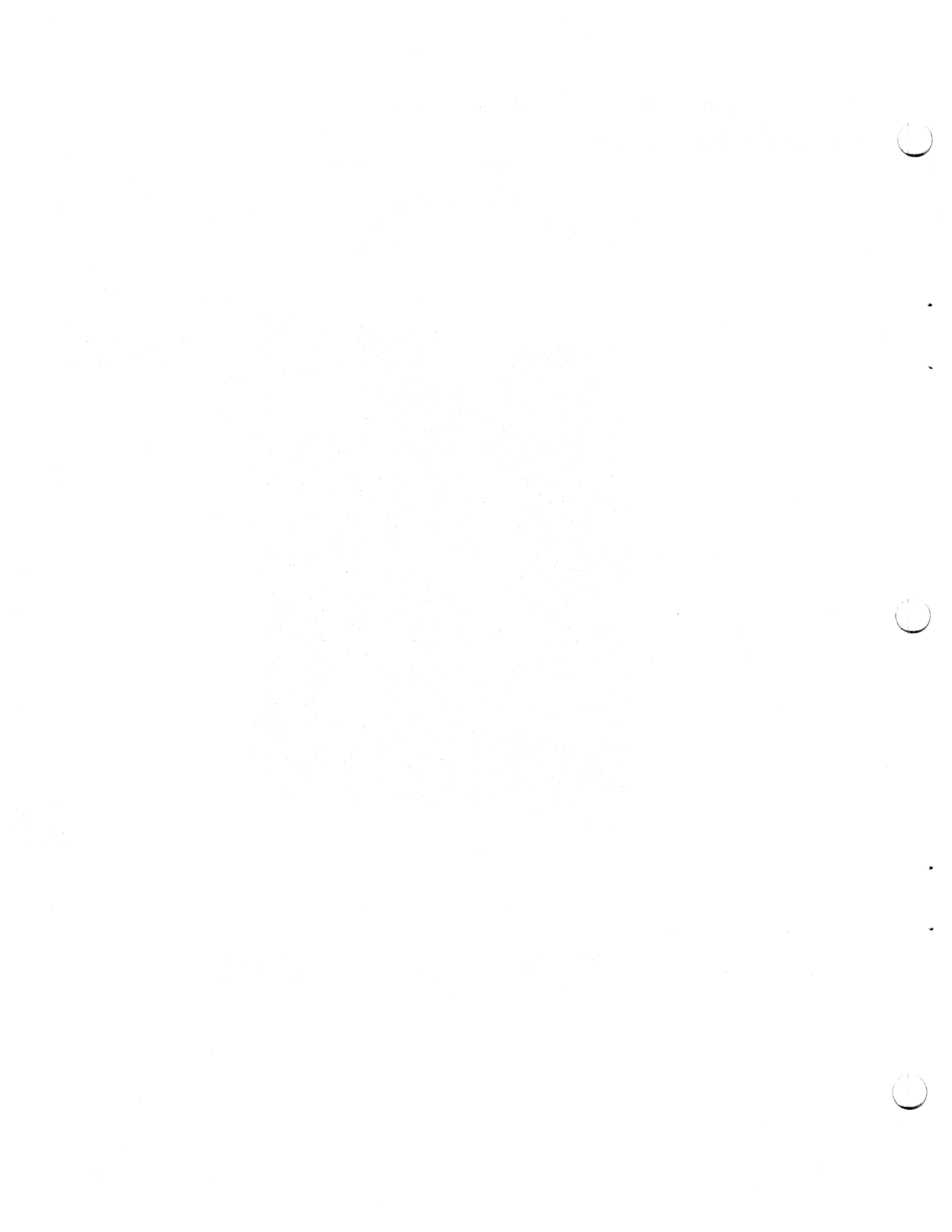

Figure 10-1. ID (Identification) Card Reader

If the operator attention speaker sounds after reading the badge, insufficient space remains in the buffer for reading the badge. Use the BUFFER BKSP key to back up until at least 41 spaces remain and read the card again.



Chapter 11. IBM 3784 Line Printer

IBM 3784 Line Printer Operating Procedures

The normal procedure for using the 3784 Printer with the 3774 terminal is as follows:

- 1 Insert paper in the 3784 as described in the "Installing and Aligning Printer Forms" section; forms can be installed with or without turning the printer's power on.
 - 2 Turn the 3774 power on.
 - 3 Turn all 3784 operator panel switches off.
 - 4 Turn the 3784's power on; the power switch is located on the front of the printer.
 - 5 When the 3784's PRT READY indicator comes on, the printer is ready for operation with the 3774 terminal. If the PRT READY indicator does not come on within two minutes, check through the items in the Make Ready Procedure that follows; determine that all items are correct.
- If any of the operator panel switches (other than the 6/8 LPI switch) are on after power on or system reset, the MACH CHECK light turns on and an "8" displays in the NPR. Turn the switches off to clear the error.
 - If the 3784 NPR displays a continuous 0, 1, 2, 4, 5, or 6 after power on, there is a machine failure. Request maintenance on the machine.

Make Ready Procedure

Use the procedures in this chapter to place the printer (shown in Figure 11-1) in a ready condition for operation with the terminal. The printer is in a ready condition when:

- Forms are installed as described in the "Installing and Aligning Printer Forms" section.

Note: Always turn the 3784's HOLD PRINT switch on before opening the printer cover, or attempting to install or align printer forms. Remember to turn the switch off before starting a job.

- The printer ribbon is installed as described in the "Replacing the Ribbon" section.
- The printer print belt is installed as described in the "Changing the Print Belt" section.
- The 3784's PTR READY indicator is on. You should align printer forms and execute a forms feed before starting a 3784 printer job.

Note: The printer's margins, tabs, and other forms definitions are defined when the 3774 terminal's job is defined and started as described in Chapter 2.

Operator Panel Switches and Indicators

MACH RESET (Machine Reset) Switch

Operating this switch resets the 3784. The functional tests that run when 3784 power is turned on also run when the MACH RESET switch is operated.

8 LPI/6 LPI Switch

The position of this switch determines whether the 3784 prints 6 or 8 lines per inch. The HOLD PRINT switch must be turned on before changing the switch setting, or the new setting will not be recognized. Turn the HOLD PRINT switch off to resume operation.

FORM FEED Switch

When the HOLD PRINT switch is on and the FORM FEED switch is operated, the printer forms skip to the first print line of a new form, as determined by the active job definition. The switch is inoperative if HOLD PRINT is off. Turn off the HOLD PRINT switch to resume operation.

HOLD PRINT Switch

Turning this switch on suspends printing on the 3784, and can cause a timeout to occur if doing a communication line job. When the switch is turned off, printing resumes. When the 3784 is at an end-of-forms condition, one line at a time can be printed by turning the HOLD PRINT switch on and off.

The HOLD PRINT switch is also used in conjunction with other operator panel switches, as is described in this section.

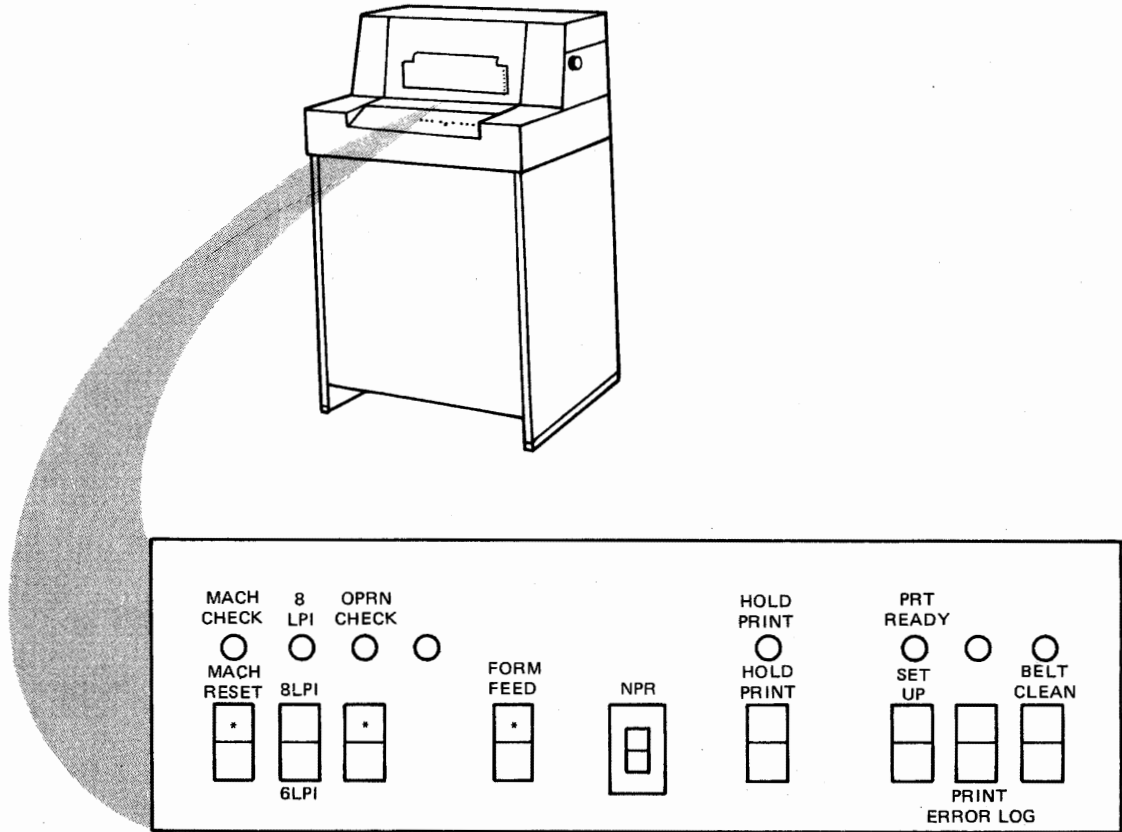

Figure 11-1. IBM 3784 Line Printer

SET UP Switch

This operation can be used to determine the horizontal and vertical forms positioning. When the HOLD PRINT switch is on and the SET UP switch is operated, the 3784 prints the character "X" across the print line from the left to the right margin. The 3784 NPR displays "1" during this operation. Turn the SET UP switch off after the line prints, and turn off the HOLD PRINT switch.

The SET UP switch is not functional when a 3784 printer job is active. If turned on during a job, a "9" displays in the NPR.

PRINT ERROR LOG Switch

When the HOLD PRINT switch is on and the PRINT ERROR LOG switch is operated, the 3784 error log prints. Service personnel use the error log to determine the cause of errors. The 3784 NPR displays "4" during the error log print. Turn off the PRINT ERROR LOG switch and the HOLD PRINT switch when printing is complete.

The PRINT ERROR LOG switch is not functional when a 3784 printer job is active. If turned on during a job, a "9" displays in the NPR.

BELT CLEAN Switch

When the HOLD PRINT switch is on and the BELT CLEAN switch is operated, the 3784 prints a ripple pattern of all characters on the print belt. Printing continues until the switch is turned off. The BELT CLEAN switch is not functional when a 3784 printer job is active. If turned on during a job, a "9" displays in the NPR.

To clean the print belt:

- 1 Turn the HOLD PRINT switch on.
- 2 Remove the printer ribbon.
- 3 Place type cleaning paper (IBM part number 451529, or the equivalent) in the printer.
- 4 Turn the BELT CLEAN switch on to print the ripple pattern. The 3784 NPR displays "2" during the ripple print.
- 5 When the belt is clean, turn the BELT CLEAN switch off to stop the ripple pattern.
- 6 Remove the type cleaning paper, and replace the printer ribbon.
- 7 Turn the HOLD PRINT switch off.

MACH CHECK (Machine Check) Indicator

When this indicator turns on, it indicates that the job has stopped because of a 3784 printer error such as a thermal failure. When this indicator turns on, a number that identifies the error displays in the 3774 terminal's operator panel NPR. The procedure for recovering from the error is listed with the NPR number in Chapter 3.

OPRN CHECK (Operation Check) Indicator

When this indicator turns on, it indicates that the job has stopped because of a 3784 printer error that requires operator intervention, such as an out-of-forms condition. When this indicator turns on, a number that identifies the error displays in the 3774 terminal's operator panel NPR. The procedure for recovering from the error is listed with the NPR number in Chapter 3.

HOLD PRT (Hold Print) Indicator

This indicator turns on when the HOLD PRINT switch is on.

PRT READY (Print Ready) Indicator

When this indicator is on, the 3784 is ready to receive and print data from the 3774 terminal's controller.

8 LPI (Lines Per Inch) Indicator

When this indicator is on, the 3784 prints 8 lines per inch. When the indicator is off, the 3784 prints 6 lines per inch.

NPR (Numeric Position Readout) Indicator

A "1" displayed in the NPR indicates an error in the attachment to the terminal.

A "3" displayed in the NPR indicates a 3784 printer failure.

An "8" displayed with the MACH CHECK light on indicates that a switch (other than the 6/8 LPI switch) is on after power on or system reset.

A "9" displayed indicates that a switch was turned on during an active 3784 job.

Use the error recovery procedures in Chapter 3 when an error occurs.

Unlabeled 3784 Indicators and Switches

Switches and indicators that are not labeled are used in the maintenance of the printer.

Installing and Aligning Printer Forms

Loading Forms in the Printer

Use this procedure to load forms in the printer.

Note: Always turn the terminal's HOLD PRINT switch on before opening the printer cover, or attempting to install or align printer forms. Remember to turn the switch off before starting a job.

- 1 Open the printer cover as shown in Figure 11-2. Press the latch to unlatch the cover, and lift the cover.
- 2 Open the print unit as shown in Figure 11-3.
- 3 Open the tractor covers, and the upper forms guide as shown in Figure 11-4.
- 4 Slide the rear forms guide apart and feed the forms squarely into the forms chute as shown in Figure 11-5.
 - Ensure that there is sufficient clearance between the 3784 and the Forms Stand so that there is no drag on the forms.
 - Be sure that the forms pass under the end-of-forms (EOF) switch.
 - Pull approximately nine inches (230 mm) of forms out of the front of the printer and lay it over the print unit.
- 5 Squeeze the tractor release levers, shown in Figure 11-6, and move each tractor to accommodate the forms width.

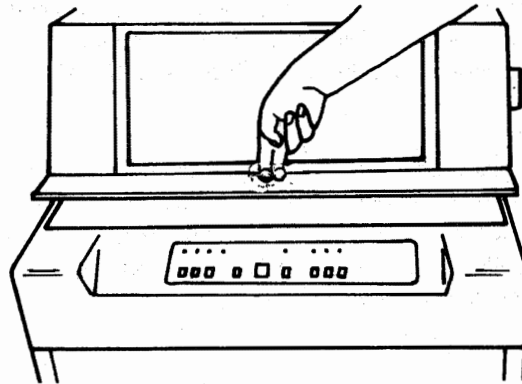

Figure 11-2. Opening the Printer Cover

- 6 Start the forms into the upper forms guide and place the form-feed holes on the tractor pins.
 - Be sure that the forms are square on the tractors.
 - Close the tractor covers, the upper forms guide, and the print unit.
- 7 Turn the forms advance knob and verify that the forms feed correctly.
- 8 Align the forms to the first print line as described in the "Aligning Forms to the First Print Line" section that follows.

Aligning Forms to the First Print Line

- 1 Check the forms tension. The tractor pins should keep the forms taut, but should not hold the forms so taut that the form's feed holes tear when printing. Refer to Figure 11-6 if you need to move the tractor pins for more or less tension on the forms.
- 2 Set the forms thickness control (Figure 11-9) to the number of parts in the form being used.
- 3 Align the form to the printer's print position indicator. Refer to Figure 11-6 if you need to move the tractor pins to align the form to the print position indicator.

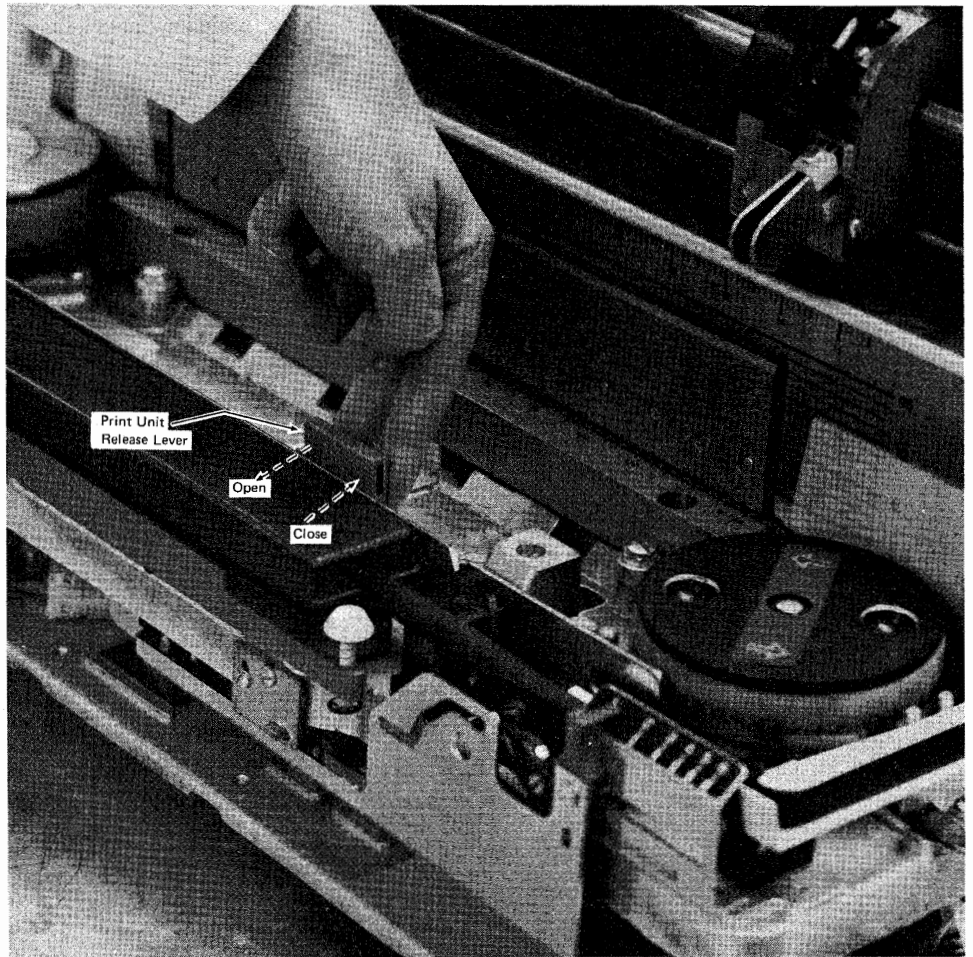

Figure 11-3. Print Unit Open/Close

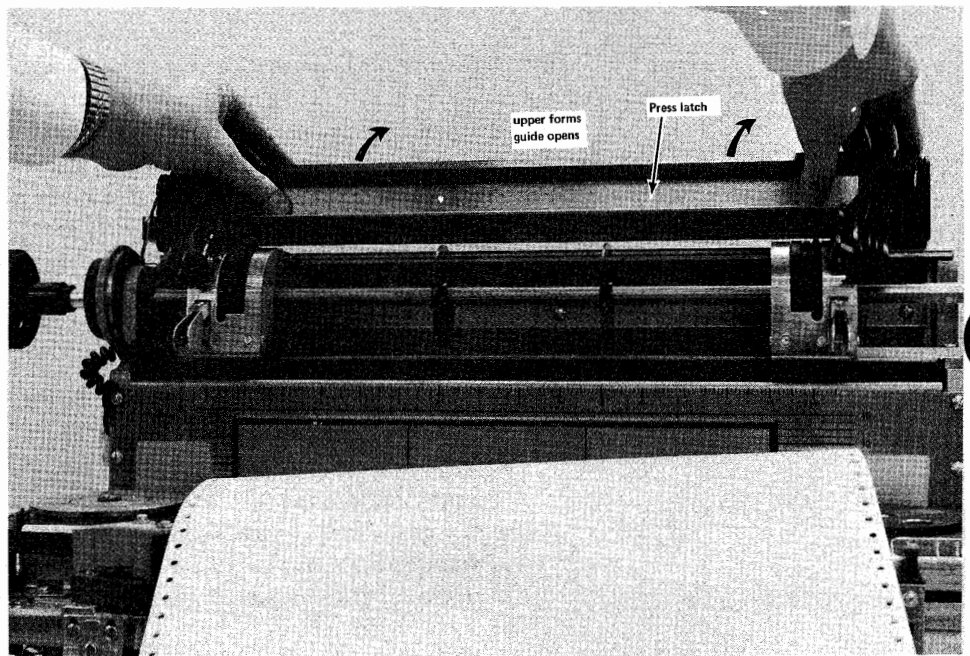

Figure 11-4. Opening Upper Forms Guide

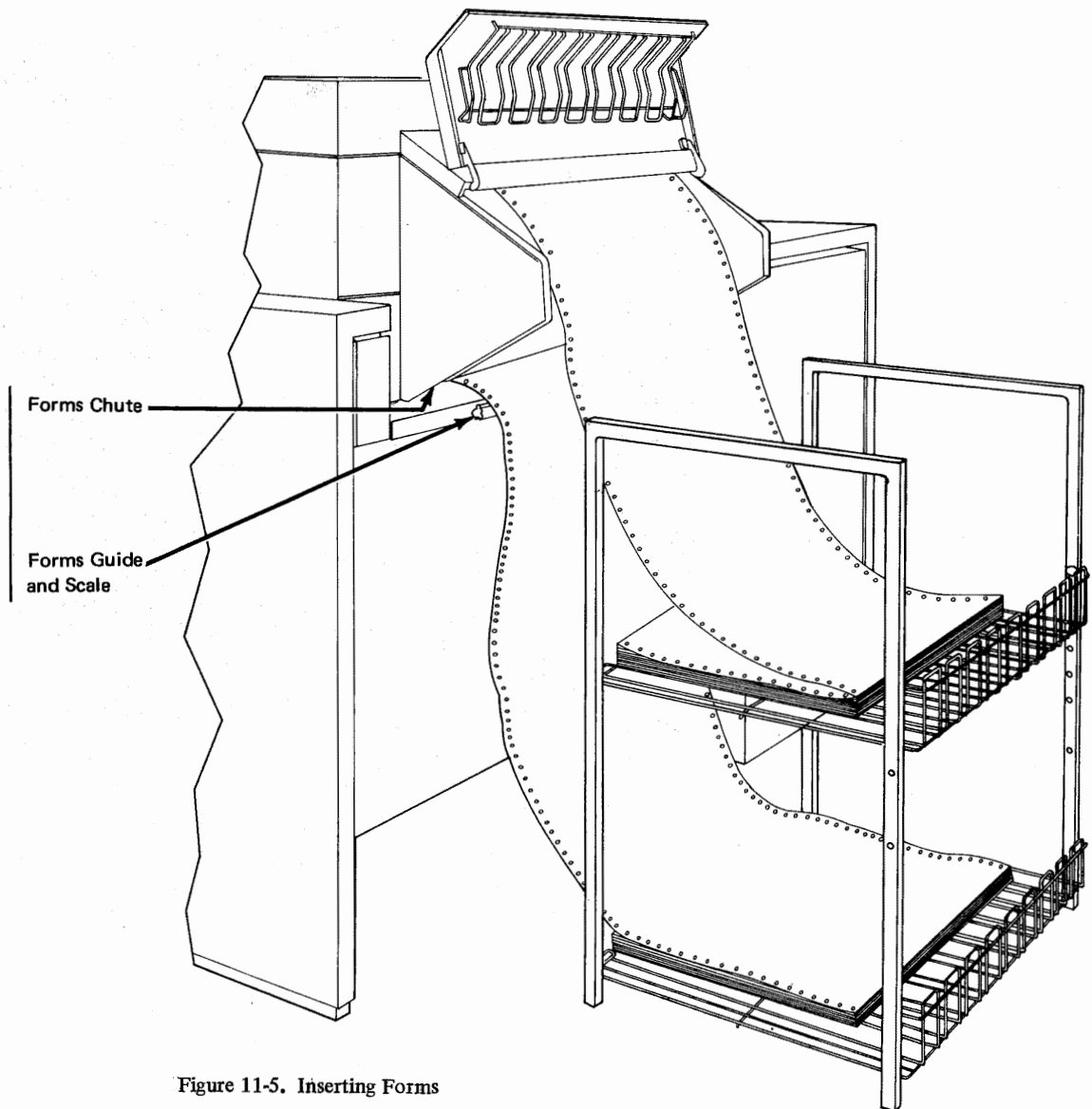

Figure 11-5. Inserting Forms

- 4 Position the form in the forms chute so that the form is aligned to the same position on both the rear form alignment scale (Figure 11-5) and the front form alignment scale. Refer to Figure 11-6 if you need to move the tractor pins to align the forms.
- 5 Use the forms advance knob to advance the forms to one line above the first print line on the print line indicator.

Note: The recommended location of the first print line is a minimum of one-half inch (12.7 mm) below the forms perforation.
- 6 Push the forms advance knob in to engage the vernier adjustment, and advance the forms to align to the first print line.
 - Align the form perforation to the number on the print line indicator that corresponds to the first line on the form.
 - If you advance the paper too far, turn the form advance knob backward while you pull the forms out of the chute to get slack out. You will have to re-align the forms after backing forms to below the first print line.

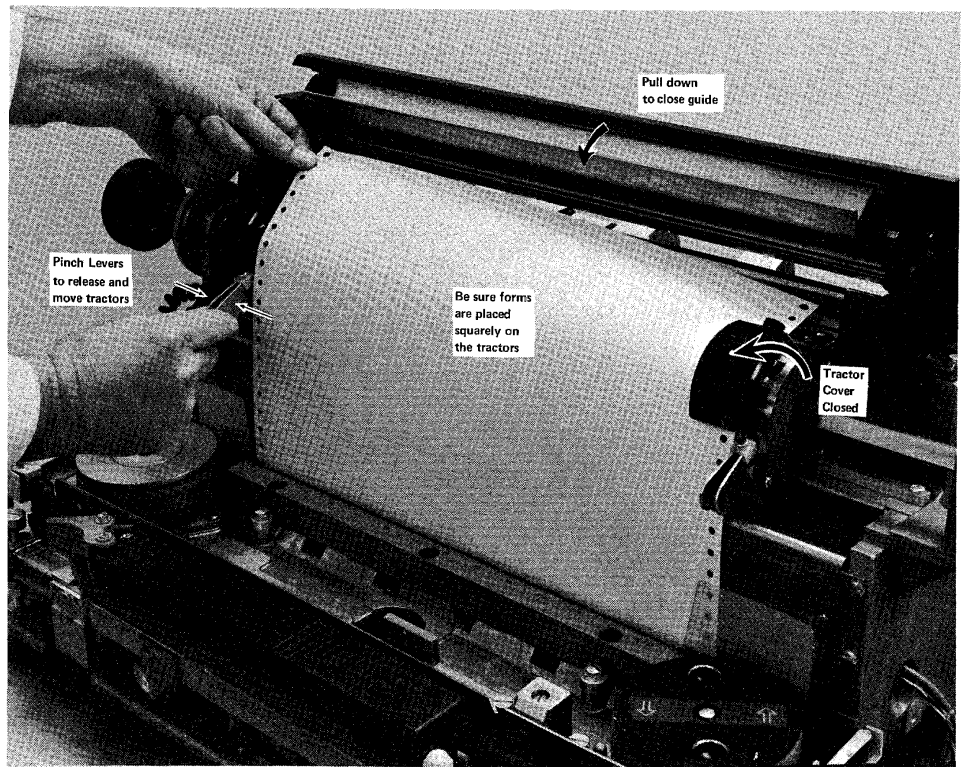

Figure 11-6. Placing Forms on Tractor Pins

Replacing the Ribbon

Removing the Ribbon

Use this procedure to remove the ribbon.

- 1 Open the printer cover as shown in Figure 11-2.
- 2 Open the print unit as shown in Figure 11-3.
- 3 Remove the forms.
- 4 Raise both ribbon guides as shown in Figure 11-7.
- 5 Open the ribbon drive release lever as shown in Figure 11-7.
- 6 Press the ribbon cassette release button down, and slide the ribbon cassette to the right until it is free, as shown in Figure 11-8.
- 7 Remove the ribbon from the ribbon guides shown in Figure 11-8.
- 8 Lift the ribbon cassette out of the printer.
- 9 Install the replacement ribbon cassette as described in the "Installing the Ribbon" section that follows.

Installing the Ribbon

Use this procedure to install a printer ribbon.

- 1 Open the printer cover as shown in Figure 11-2.
- 2 If you are replacing the printer ribbon, follow the "Removing the Ribbon" procedure above to remove the old printer ribbon.
- 3 Open the ribbon drive release lever shown in Figure 11-7.
- 4 Lay the cassette on the printer so that the left end (the end that has a curved surface that fits the feed roll) is approximately one inch (25.4 mm) from the ribbon drive rolls. The right end of the cassette will cover the ribbon cassette release button.

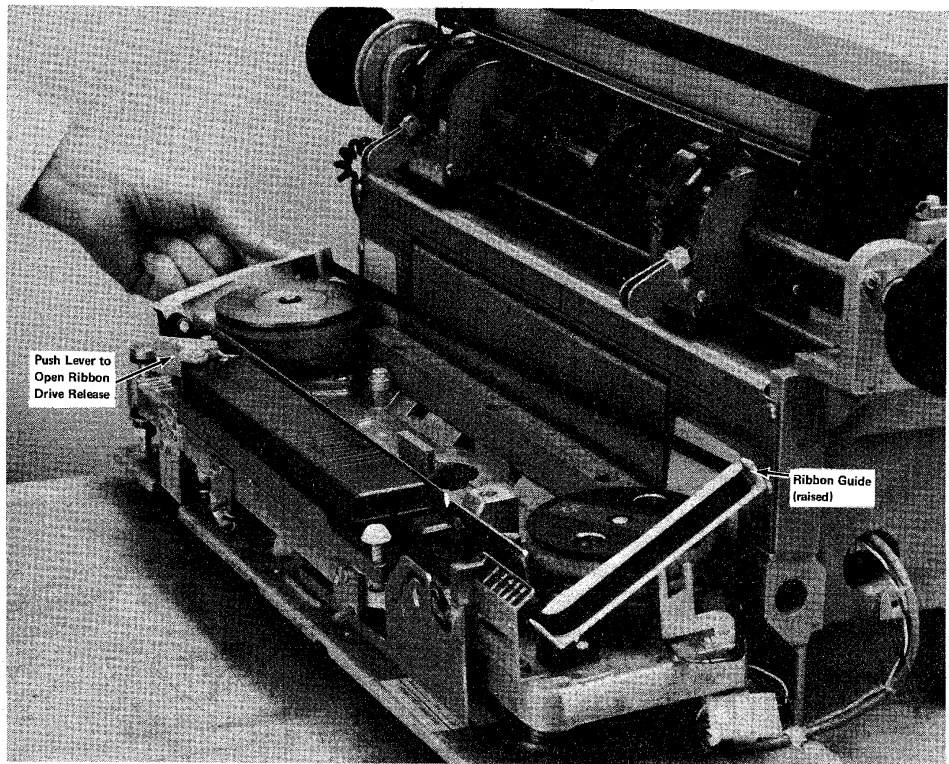

Figure 11-7. Raising Ribbon Guides

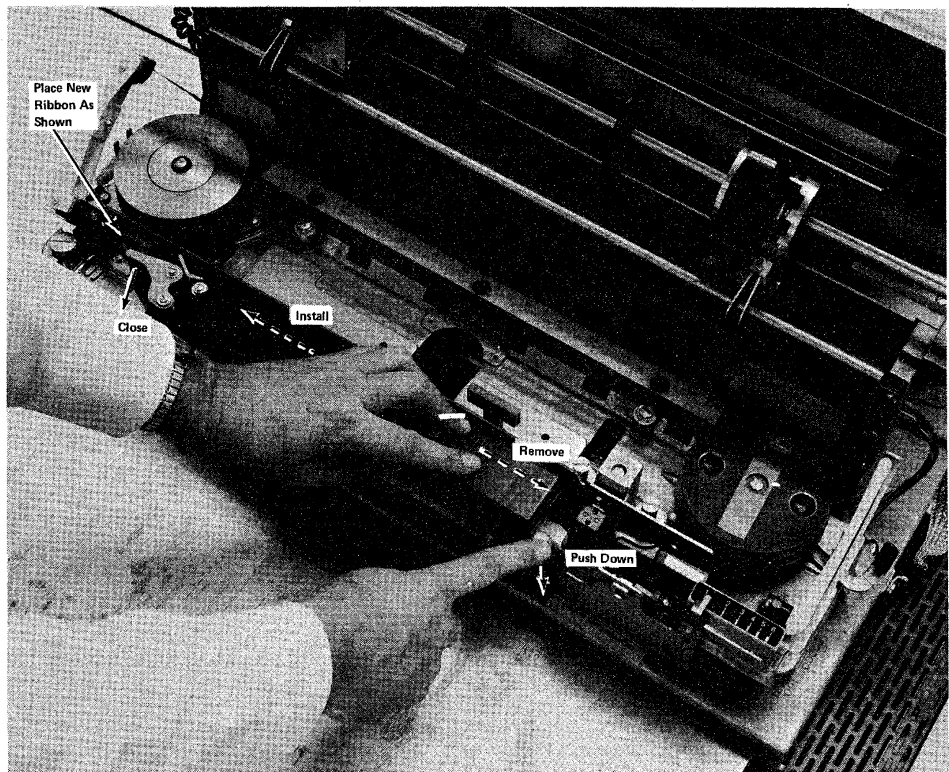

Figure 11-8. Ribbon Cassette Removal/Installation

- 5 Pull approximately six inches of ribbon out of the left end of the cassette, place the ribbon in between the ribbon drive rollers, press down on the cassette, and slide the cassette to the left until it latches in place as shown in Figure 11-8.
- 6 Use the ribbon feed diagram on the printer as a guide; feed the ribbon from the left end of the cassette, through the release lever, and around the left guide.
- 7 Close the ribbon drive release lever shown in Figure 11-8.
- 8 Take up any extra ribbon slack by turning the print belt pulley shown in Figure 11-9.
- 9 Lower the ribbon guides shown in Figure 11-7.
- 10 Turn the print belt pulley again to feed the ribbon down between the print belt and the ribbon shield. Continue turning the print belt pulley, and verify that the ribbon feeds correctly.
- 11 Close the print unit shown in Figure 11-3.
- 12 Close the printer cover.

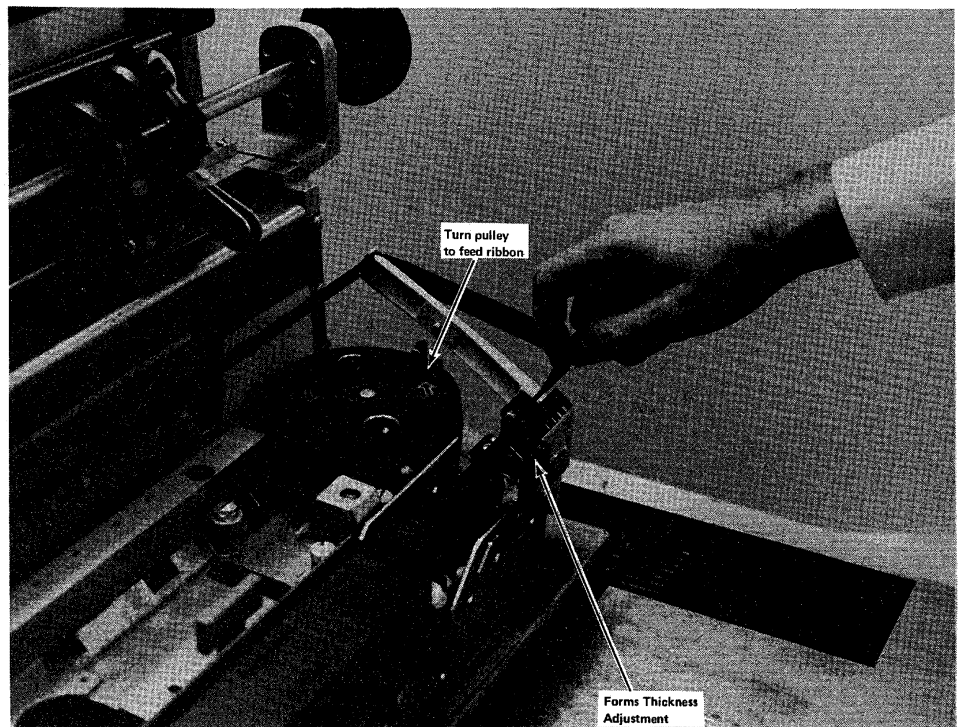

Figure 11-9. Installing the Ribbon

Replacing the Print Belt

Removing the Print Belt

Use this procedure to remove the print belt:

- 1 Open the printer cover as shown in Figure 11-2.
- 2 Pull the print belt release lever forward to loosen belt tension as shown in Figure 11-10.
- 3 Lift the print belt off the pulleys, and store the belt in a safe location.
- 4 Follow the "Installing the Print Belt" procedure that follows when replacing the print belt.

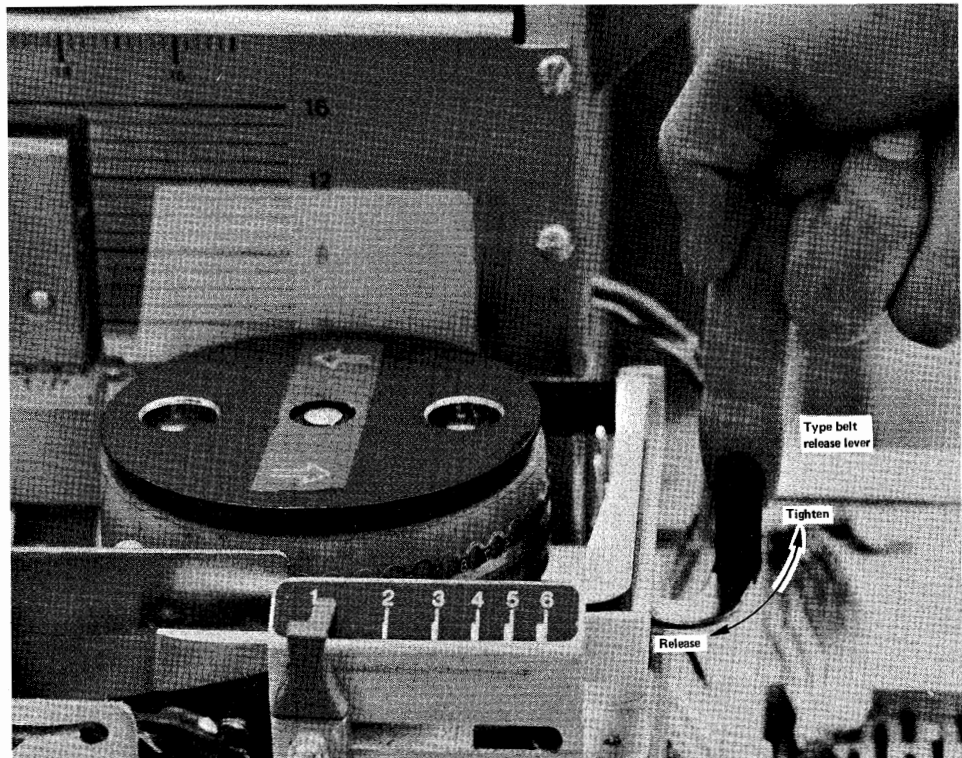

Figure 11-10. Releasing Print Belt Tension

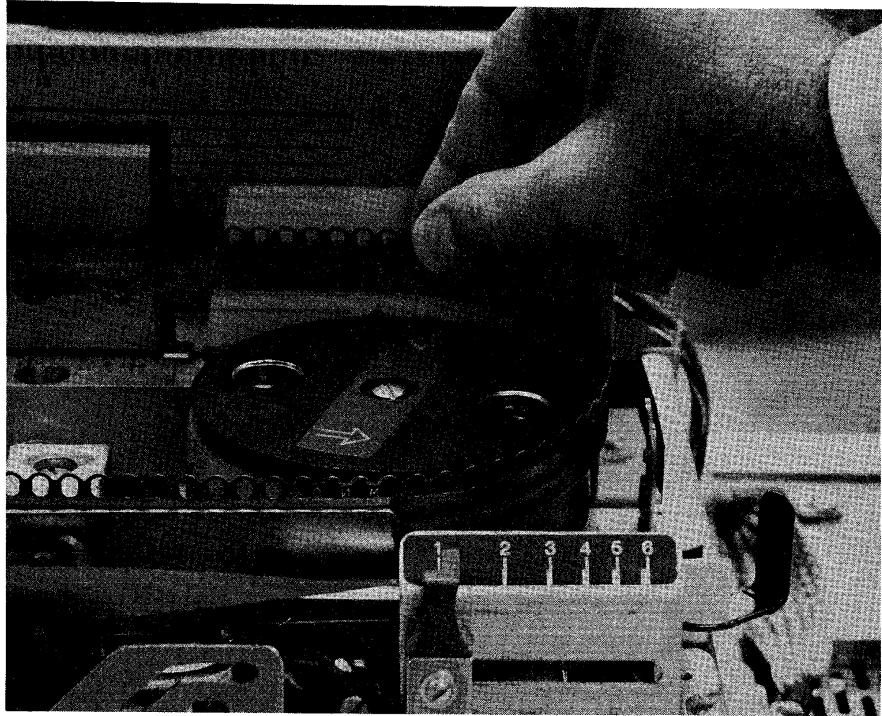

Figure 11-11. Removing Print Belt

Installing the Print Belt

Use this procedure to install the print belt:

- 1 If a print belt is on the printer, follow the "Removing the Print Belt" procedure above to remove the belt.
- 2 Raise both ribbon guides as shown in Figure 11-7.
- 3 Hold the print belt with the type up, and carefully place the belt around the pulleys and in back of the belt guard as shown in Figure 11-12.

Note: Do not place the belt all the way to the bottom of the pulley.

- 4 Move the print belt release lever to the rear to tighten the belt on the pulleys as shown in Figure 11-10.
- 5 Turn the print belt pulley counterclockwise, and observe the print belt as it moves on the pulleys as shown in Figure 11-12.

Note: If the belt does not move down on the pulleys, there is interference below the belt or the belt is positioned incorrectly; to correct this, remove the belt, check the belt path for interference, and install the belt again.

- 6 Lower the ribbon guides as shown in Figure 11-7.
- 7 Turn the print belt pulley and check that the print belt and ribbon turn correctly.
- 8 Close the print unit as shown in Figure 11-3.
- 9 Close the printer cover.



Figure 11-12. Installing the Print Belt

Appendix A. Emulating IBM 2770 Workstation Jobs

Introduction

This section provides reference information for users of the IBM 3774 and IBM 3775 that are using the terminal to emulate these workstation functions of the IBM 2770 Data Communication System:

- OS/VS1 RES 2770 Workstation Jobs
- OS/VS2 (JES2) 2770 Workstation Jobs
- IMS/VS 2770 Workstation Jobs

The “Defining and Starting an IBM 2770 Workstation Job” section lists those input and output device combinations and features that are available on both the IBM 2770 and the IBM 3774 and IBM 3775 terminals. The “Entering Operator Defined Jobs from the Keyboard” section, and the “Starting a Job” sections (in Chapter 2), describe how to define and start jobs using these devices and features.

The “Operator Notes” section includes reference information on emulating IBM 2770 workstation functions when operating with one of the programs that are listed above. If you are not already familiar with this reference information, read it before defining or starting an IBM 2770 workstation job.

Defining and Starting an IBM 2770 Workstation Job

Defining an IBM 2770 Workstation Job

The following input and output device combinations and features are available on both the IBM 3774 and IBM 3775, and on the IBM 2770 terminals; define these when entering an operator defined job from the keyboard, and the "DEV =" instruction prints on the console printer (refer to Step 6 of the "Entering Operator Defined Jobs from the Keyboard" procedure Chapter 2):

07 = Communication Line to Console Printer
08 = Communication Line to IBM 3784 Line Printer
09 = Communication Line to Card Punch

20 = Keyboard to Communication Line
29 = Keyboard to Card Punch

30 = Card Reader to Communication Line
37 = Card Reader to Console Printer
38 = Card Reader to IBM 3784 Line Printer
39 = Card Reader to Card Punch

T = Transparent Mode*

C = Compress Option*

I = Interpret Print (IBM 3521 Card Punch) not selected

Z = IBM 3521 Card Punch Read-back Checking not used (inhibited)

* You can specify either the Compress option or the Transparent Mode option (not both) on any one job definition. The card reader must be the job's input device when you specify the Compress option.

Starting an IBM 2770 Workstation Job

In addition to the operator defined input/output device combinations and features that can be defined (as previously described in the "Defining an IBM 2770 Workstation Job" section), these system defined jobs can be selected when starting a job:

S07 = Communication Line to Console Printer
S08 = Communication Line to IBM 3784 Line Printer
S09 = Communication Line to Card Punch

S20 = Keyboard to Communication Line
S29 = Keyboard to Card Punch

S30 = Card Reader to Communication Line
S37 = Card Reader to Console Printer
S38 = Card Reader to IBM 3784 Line Printer
S39 = Card Reader to Card Punch

Select the above jobs when starting a job as described under "Starting a Job" in chapter 2. The 2502 attached to the 3770 operates differently from the 2502 attached to the 2770 (refer to Chapter 7).

OS/VS1 RES Operator Notes

- OS/VS1 RES REFERENCE:** Refer to the *OS/VS1 RES Workstation User's Guide*, GC28-6879, for a description of the program's operating characteristics and operator commands.
- BUFFER SIZE:** The IBM 3774 and 3775 transmits and receives in blocks of 256 characters.
- DISK SWITCH USE:** When the DISK switch is on, WTOR (Write to Operator and Reply) messages write to the Diskette Storage Device, unless the message contains a DC1 (X'11') character to select the console printer.
- For messages that do not contain a DC1 character, you can request that the central processor operator issue a display/request command to display all outstanding WTORs for your terminal, and enter the replies through the processor's console.
- BSC/SDLC SWITCH:** The auxiliary operator panel BSC/SDLC switch must be in the BSC position.
- UPDATE/MONITOR SWITCH:** Do not turn the UPDATE/MONITOR switch on to select monitor printing.
- ERROR RECOVERY:** Use the error recovery and problem identification procedures in Chapter 3 to restart operation following an error.

OS/VS2 (JES2) Operator Notes

OS/VS2 (JES2)
REFERENCE:

Refer to the Operator's Library: OS/VS Reference (JES2), GC38-0210 for a description of the program's operating characteristics and operator commands.

BUFFER SIZE:

The IBM 3774 and 3775 transmits and receives in blocks of 256 characters.

DISK SWITCH USE:

When the DISK switch is on, WTOR (Write to Operator and Reply) messages write to the Diskette Storage Device, unless the message contains a DC1 (X'11') character to select the console printer.

For messages that do not contain a DC1 character, you can request that the central processor operator issue a display/request command to display all outstanding WTORS for your terminal, and enter the replies through the processor's console.

BSC/SDLC SWITCH:

The auxiliary operator panel BSC/SDLC switch must be in the BSC position.

STANDARD JOB CYCLE:

1. Sign on (establishment of communications).
2. Transmit the job to the processor; start a keyboard to communications line (or a card reader to communications line) job.
3. The job executes.
4. The processor transmits the job's printed (or punched) output to the terminal.

TRANSMIT JOB NOTES:

Select the Monocase function when you start the job if you are transmitting from the keyboard and want all alphabetic characters (A through Z) to transmit in upper case.

To simulate card reader input when using the keyboard, enter an end-of-card character (IRS) by holding the CODE key down and entering a numeric "3" from the keyboard. When entering card formatted data from the keyboard, the terminal's controller buffer stores (and transmits) the equivalent of 3 cards.

JES2 SYSTEM COMMANDS:

Press the EOM key to terminate each line of console input to JES2.

ERROR RECOVERY NOTES:

Use the error recovery and problem identification procedures in Chapter 3 to restart operation following an error.

When job restart is required while transmitting, the job that is partially read into the terminal must be reread from the beginning. When this happens, the terminal operator requests the processor operator to issue the appropriate JES2 command, or to delete the partially read job. The terminal operator restarts the job (from the beginning).

When job restart is required while receiving, the job that was partially transmitted to the terminal must be retransmitted from the beginning. When this happens, the terminal operator requests the processor operator to issue the appropriate JES2 command to retransmit the job that was partially transmitted.

IMS/VS Operator Notes

IMS/VS REFERENCE:	Refer to <i>IMS/VS Telecommunication Device Support Operator's Reference Manual</i> , SH20-9028, for a description of the program's operating characteristics and operator commands.
BUFFER SIZE:	The IBM 3774 and 3775 transmits and receives in blocks of 256 characters.
BSC/SDLC SWITCH:	The auxiliary operator panel BSC/SDLC switch must be in the BSC position.
WHEN DEFINING A JOB:	Do not select transparent mode.
WHEN STARTING A JOB:	Place all input and output devices used in the job in a ready condition, even though only one input and one output device is defined at job start time.
STATUS MESSAGES:	<p>Select the Inquiry Mode function.</p> <p>Two terminal-oriented status messages are transmitted by IMS/VS. One message deals with the amount of information discarded by IMS/VS when a logical input error occurs, and the other message deals with component status when an input/output error occurs.</p> <p>These messages are generated and sent to the terminal operator if the terminal's printer is in a ready status. If the printer is not ready, the terminal is stopped and marked inoperable without generating the status message to the terminal.</p>
ERROR RECOVERY:	Use the error recovery and problem identification procedures in Chapter 3 to restart the terminal's operation following error interruptions.

Appendix B. Test Procedures

Communication Test Procedures

This series of tests assists in identifying which maintenance organization to contact when you experience communication problems: the terminal, the modem attached to the terminal, the common-carrier, or the modem at the central processor.

When a problem occurs during an on-line job (a job that defines the communication line as the job's input or output device), start performing the four steps of the communication tests:

- Step 1: Run Test 0 (Terminal Communication Test)
- Step 2: Run Test 2 (Modem Wrap Test)
- Step 3: Run Test 3 (Modem Transmit Test)
- Step 4: Run Test 4 (Modem Receive Test)

Stop testing at the point where a test indicates a problem, and contact the maintenance organization indicated by the test results.

Step one provides instructions for entering communication test mode by selecting one of the terminal's CODE key functions; test 0 runs automatically when the terminal enters communication test mode; the remaining tests are selected by entering a number from the keyboard. As the tests run, numbers display in the operator panel's numeric position readout (NPR) indicators; these numbers identify either the status of the test that is running, or an error condition detected during the test. The location of the readout (NPR) indicators is illustrated in the "Keyboard and Operator Panel" section of Chapter 1.

Step 1: Run Test 0 (Terminal Communication Test)

Follow these steps to enter communication test mode and run test 0:

- 1** If a job is running, allow the job to end, or stop the job as described under "Ending a Job" in Chapter 2.
- 2** If the terminal is not in local mode, enter local mode:
 - A. Hold the CODE key down and press the START JOB key.
 - B. The terminal enters local mode. When in local mode, the PROCEED indicator is on, all other operator panel indicators are off.
 - C. If the terminal did not enter local mode, press the SYSTEM RESET switch and repeat step A.
- 3** Set the auxiliary operator panel NORMAL/HALF SPEED switch to the NORMAL position; or, go on to the next step in this procedure if the switch is not installed on your terminal.
- 4** Enter communication test mode:
 - A. Hold the CODE key down and enter the number "0" from the keyboard.
 - B. Release the CODE key.
 - C. Enter the number "6" from the keyboard.

Note: The number "6" displays in the readout indicators; this indicates that you have selected the communication test mode function. The terminal will enter communication test mode when you press the EOM key (step D).

- D.** Press the EOM key to enter communication test mode, and run test 0 (terminal communication test).
- 5** Test 0 (terminal communication test) runs automatically. The operator panel readout indicator (NPR) displays one of these indications of the status of the test.
 - A. NPR = 01: The test is running; has not completed.
 - B. NPR = 00: The test ended without error; no problem was detected in the terminal communication test.

- C. NPR displays an 800-series number, and the operator panel SYSTEM CHECK indicator turns on: An error was detected during the test; these 800-series numbers (for example 801 = a clear to send error) identify the error; these numbers are listed in the "Numeric Position Readout (NPR) Codes" section of Chapter 3.
- 6 If an error was detected during the test:
 - A. Record the 800-series number on the "Trouble Report Form" for the information of maintenance personnel.
 - B. Request maintenance on the terminal, as described in the "Requesting Maintenance on the Terminal" section at the front of chapter 3.
 - C. Stop testing: Exit from communication test mode by holding the CODE key down and pressing the JOB key.
- 7 If the test ended without error, you have identified that the problem is not in the terminal's controller (including the communication driver); either:
 - A. Repeat test 0 by entering the number "0" from the keyboard; OR
 - B. Go to "Step 2: Run Test 2 (Modem Wrap Test)".

Note: If testing the Switched Network Backup (SNBU) feature, select SNBU by holding the CODE key down and entering the character "S" from the keyboard.

Step 2: Run Test 2 (Modem Wrap Test)

Before you can run test 2, you need to know if the modem used with your terminal is capable of running test 2.

This question should have been answered for you before you attempted to run these tests. If the following question was marked "NO", do not attempt to run test 2. If the following question was marked "YES", run test 2 to determine if there is a problem in the terminal's modem:

This terminal's modem can run test 2 (Modem Wrap Test): _____ YES. _____ NO.

- 1 If you have not already done so, perform "Step 1: Run Test 0 (Terminal Communication Test)"; test 0 must run without error before running test 2.
- 2 After test 0 ends (without error), enter the number "2" from the keyboard to start test 2 (Modem Wrap Test).
- 3 Test 2 (Modem Wrap Test) runs. The operator panel readout indicators (NPR) displays one of these indications of the status of the test.
 - A. NPR = 01: The test is running; has not completed.
 - B. NPR = 00: The test ended without error; no problem was detected in the modem wrap test.
 - C. NPR displays an 800-series number, and the operator panel SYSTEM CHECK indicator turns on: An error was detected during the test; these 800-series numbers (for example 801 = a clear to send error) identify the error; these numbers are listed in the "Numeric Position Readout (NPR) Codes" section of Chapter 3.
- 4 If an error was detected during the test:
 - A. Check that the modem's cables (power cord, cable from the terminal to the modem, and cable from the modem to the communication line jack) are plugged in; run the communication tests again after re-connecting any plugs that were not plugged in; go on to the next step (B) if the plugs were connected.
 - B. Record the 800-series number on the "Trouble Report Form" for the information of maintenance personnel.
 - C. Request maintenance on the modem. If using an IBM modem, request maintenance as described in the "Requesting Maintenance on the Terminal" section at the front of Chapter 3.
 - D. Stop testing: Exit from communication test mode by holding the CODE key down and pressing the START JOB key.

- 5 If the test ended without error, you have identified that the problem is not in the terminal's controller (test 0 ran without error), or in the terminal's modem (test 2 ran without error); either:
 - A. Repeat test 0 by entering the number "0" from the keyboard;
 - B. Repeat test 2 by entering the number "2" from the keyboard; OR
 - C. Go to "Step 3: Run Test 3 (Modem Transmit Test)".

Step 3: Run Test 3 (Modem Transmit Test)

- 1 If you have not already done so:
 - A. Perform "Step 1: Run Test 0 (Terminal Communication Test)": test 0 must run without error;
 - B. Perform "Step 2: Run Test 2 (Modem Wrap Test)": test 2 must run without error.
- 2 Contact the operator at the central processor; request that the following two tests (or the equivalent to these tests) be run at the central processor; and request that the central processor operator request maintenance to correct any errors noted during these tests:

Test 0 (Terminal Communication Test)

Test 2 (Modem Wrap Test)

Note: If test 0 and test 2 ran without error at both the terminal and the central processor, you have identified that both the terminal and the central processor can transmit and receive in a local test circuit. The next step is to determine that both can transmit and receive using the communication line (common-carrier facility).

- 3 If the central processor operator noted an error when running test 0 or test 2, stop testing: Exit from communication test mode by holding the CODE key down and pressing the JOB key; resume the job when the central processor operator notifies you that the problem has been corrected.
- 4 Contact the operator at the central processor; inform the operator that you will run test 3 (Modem Transmit Test); request that the processor operator run test 4 (Modem Receive Test), and record the error count while the test runs.
- 5 Start test 3 (Modem Transmit Test) by entering a numeric "3" from the keyboard. The operator panel STANDBY indicator turns on when the test starts.
- 6 If using a switched communication (dial) network, dial the central processor's modem and establish the communication link. The "Switched Communications (Dial) Network Procedures" section in chapter 2 describes how to do this.
- 7 Contact the operator at the processor to obtain the test results; one of these conditions could occur:
 - A. The processor did not receive the test transmission; if this happens:
 - (1) When using a switched communication line, re-dial the connection and run the test again.
 - (2) When using a leased communication line, request that the common-carrier company test the communication facilities, and correct any problems.
 - B. The processor received the test transmission, but the error count was excessive when compared to the "Error Count During Normal Transmission" chart that follows; if this happens:
 - (1) If using a switched communication line, re-dial the connection and try the test again.
 - (2) If using a leased communication line, and the terminal's auxiliary operator panel has a TRANSMIT EQUALIZER control knob, or the terminal's modem is an IBM 3872 Modem, check the equalization as described in the "Modem Transmit Equalization" section in this chapter; then, return to this point in the test procedure. If performing transmit equalization does not correct the problem, request that the common-carrier company test the communication facilities and correct any problems.

- (3) If using a leased line and the terminal's auxiliary operator panel does not have a TRANSMIT EQUALIZER control, request that the common-carrier company test the communication facilities and correct any problems.
- 8 If no problems were noted when running test 3, you have identified that the terminal can transmit to the central processor. The next step "Step 4: Run Test 4 (Modem Receive Test)", is to identify that the terminal can receive from the central processor.

Step 4: Run Test 4 (Modem Receive Test)

- 1 Since you just finished "Step 3: Run Test 3 (Modem Transmit Test)", the terminal is now running test 3, and remains in communication test mode.
- 2 Contact the operator at the central processor; request that the processor operator run test 3 (Modem Transmit Test); inform the operator that you will run test 4 (Modem Receive Test), and check the error count for the test message received.
- 3 Start test 4 by entering a numeric "4" from the keyboard.
- 4 The operator panel PROCEED indicator turns on when the test starts; this indicates that you are receiving a signal from the processor's modem.
- 5 When test 4 starts, a count of the number of errors received displays in the operator panel readout indicators. Compare this error count to the "Error Count During Normal Transmission" Chart that follows.

Note: You can reset the error count, and start counting the errors again, by entering a numeric "4" from the keyboard (this restarts test 4). Do this to re-check the number of errors received for any given period of time.

- 6 One of these problems can occur when the test starts:
 - A. The terminal did not receive the test transmission; if this happens:
 - (1) When using a switched communication line, re-dial the connection and try the test again.
 - (2) When using a leased communication line, request that the common-carrier company test the communication facilities and correct any problems.
 - B. The terminal received the test transmission, but the error count was excessive when compared to the "Error Count During Normal Transmission" chart that follows; if this happens:
 - (1) If using a switched communication line, re-dial the connection and try the test again.
 - (2) If using a leased communication line, and the terminal's auxiliary operator panel has a RECEIVE EQUALIZER control knob, or the terminal's modem is an IBM 3872 Modem, check the equalization as described in the "Modem Receive Equalization" section in this chapter; then, return to this point in the test procedure. If performing receive equalization does not correct the problem, request that the common-carrier company test the communication facilities and correct any problems.
 - (3) If using a leased line and the terminal's auxiliary operator panel does not have a RECEIVE EQUALIZER control, request that the common-carrier company test the communication facilities and correct any problems.

Error Count During Normal Transmission Charts

These charts provide space for recording both the auxiliary operator panel meter readings and switch settings (used during modem equalizing), and the error counts noted when running communication tests.

These readings are recorded during normal, satisfactory operation with the central processor; use these charts as a reference to identify abnormally high, troublesome readings noted when equalizing the terminal's modem or checking an error count when running communication test 3 (Modem Transmit Test), or test 4 (Modem Receive Test).

REFERENCE CHART FOR TEST 3 (MODEM TRANSMIT TEST):

Meter Reading = _____ Date = _____
Test 4 Error Count = _____, for _____ minutes running. (approximately
3 minutes)
TRANSMIT EQUALIZER Switch Position = _____

Note: The test 4 error count is taken at the central processor.

REFERENCE CHART FOR TEST 4 (MODEM RECEIVE TEST):

Meter Reading = _____ Date = _____
Test 4 Error Count = _____, for _____ minutes running.
(approximately 3 minutes)
RECEIVE EQUALIZER Switch Position = _____

Modem Transmit Equalization

Use this procedure to adjust the modem's transmit signal for best performance with the communication line and the processor's modem.

If the auxiliary operator panel on your terminal does not have the TRANSMIT EQUALIZER switch, do not use this procedure; use the equalization procedure provided with the modem that is attached to your terminal.

- 1 If you have not already done so, enter communication test mode and run test 0 as described in the "Step 1: Run Test 0 (Terminal Communication Test)" section; do not exit from communication test mode when test 0 ends.
 - 2 After test 0 ends (without error), enter the number "2" from the keyboard to run test 2 (Modem Wrap Test); do not exit from communication test mode when test 2 ends.
 - 3 After test 2 ends (without error), contact the central processor operator; request that the processor operator:
 - A. Run test 0 and test 2 (or the equivalent to these tests); the tests must run without error.
 - B. After test 2 ends, start test 4 (Modem Receive Test).
 - 4 Inform the processor operator that you will run test 3 (Modem Transmit Test), and will adjust your modem's transmit signal for a best (minimum) meter reading on his modem's signal quality meter.
 - 5 Start test 3 (Modem Transmit Test) by entering the number "3" from the keyboard.
- Note: The operator panel STANDBY indicator turns on when the test starts.
- 6 Set the auxiliary operator panel TRANSMIT EQUALIZER switch to the different settings (from 0 through 15). Ask the processor operator to inform you at what point his modem's signal quality meter reading is at the minimum reading; leave the TRANSMIT EQUALIZER switch at this setting.
 - 7 Notify the central processor operator when you have completed equalizing; to exit from communication test mode, hold the CODE key down and press the START JOB key.

Modem Receive Equalization

Use this procedure to adjust the modem for best performance with the signal received on the communication line.

If the auxiliary operator panel on your terminal does not have the RECEIVE EQUALIZER switch, do not use this procedure; use the equalization procedure provided with the modem that is attached to your terminal.

- 1 If you have not already done so, enter communication test mode and run test 0 as described in the "Step 1: Run Test 0 (Terminal Communication Test)" section; do not exit from communication test mode when test 0 ends.

TESTS

- 2 After test 0 ends (without error), enter the number "2" from the keyboard to run test 2 (Modem Wrap Test); do not exit from communication test mode when test 2 ends.
- 3 After test 2 ends (without error), contact the central processor operator; request that the processor operator:
 - A. Run test 0 and test 2 (or the equivalent to these tests); the tests must run without error.
 - B. After test 2 ends, request that the processor operator start test 3 (Modem Transmit Test).
- 4 Start test 4 (Modem Receive Test) by entering the number "4" from the keyboard.
- 5 The operator panel PROCEED and ON LINE indicators turn on when the test starts; this indicates that you are receiving a signal from the processor's modem.
- 6 Set the auxiliary operator panel RECEIVE EQUALIZER switch to the different settings (from 0 through 15) until you note the point where the signal quality meter is at a minimum reading; leave the RECEIVE EQUALIZER switch at this setting.
- 7 Notify the central processor operator when you have completed equalizing; to exit from communication test mode, hold the CODE key down and press the START JOB key.

Using the Communication Test Adapter Cable

If your terminal has an attached modem with the test adapter cable shown in Figure B-1, use this procedure to check the terminal's communication driver, and check the cable to the terminal's modem.

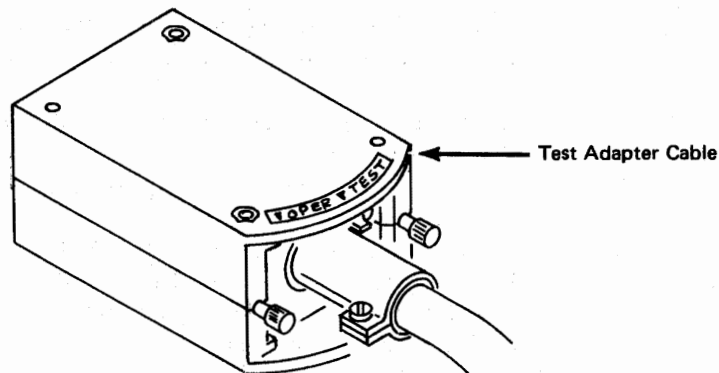

Figure B-1. Test Adapter Cable

- 1 If a job is running, allow the job to end, or stop the job as described in the "Ending a Job" section in Chapter 2.
- 2 If the terminal is not in local mode, enter local mode:
 - A. Hold the CODE key down and press the START JOB key.
 - B. The terminal enters local mode. When in local mode, the PROCEED indicator is on and the CPU SELECT indicator may be on. All other operator panel indicators are off.
 - C. If the terminal did not enter local mode, press the SYSTEM RESET switch and repeat Step A.
- 3 Enter communication test mode:
 - A. Hold the CODE key down and enter the number "0" from the keyboard.
 - B. Release the CODE key.
 - C. Enter the number "6" from the keyboard.

Note: The number "6" displays in the readout indicators; this indicates that you have selected the communication test mode function. The terminal will enter communication test mode when you press the EOM key (step D).

- D. Press the EOM key to enter communication test mode, and run test 0 (terminal communication test).
- 4 Test 0 (terminal communication test) runs automatically. The operator panel readout indicator (NPR) displays one of these indications of the status of the test:
- A. NPR = 01: The test is running; has not completed.
 - B. NPR = 00: The test ended without error; no problem was detected in the terminal communication test.
 - C. NPR displays an 800-series number, and the operator panel SYSTEM CHECK indicator turns on: An error was detected during the test; these 800-series numbers (for example 801 = a clear to send error) identify the error; these numbers are listed in the "Numeric Position Readout (NPR) Codes" section of Chapter 3.
- 5 If an error was detected during the test:
- A. Record the 800-series number on the "Trouble Report Form" for the information of maintenance personnel.
 - B. Request maintenance on the terminal, as described in the "Requesting Maintenance on the Terminal" section at the front of Chapter 3.
 - C. Stop testing: Exit from communication test mode by holding the CODE key down and pressing the START JOB key.
- 6 If the test ended without error, you have identified that the problem is not in the terminal's controller (including the communication driver); either:
- A. Repeat test 0 by entering the number "0" from the keyboard;
OR
 - B. Go to Step 7.
- 7 Place the test adapter cable's switch (shown in Figure B-1) to the TEST position.
- 8 Enter the number "2" from the keyboard to start test 2 (Modem Wrap Test).
- 9 Test 2 (Modem Wrap Test) runs, and the ON LINE indicator turns on. The operator panel readout indicators (NPR) displays one of these indications of the status of the test.
- A. NPR = 01: The test is running; has not completed.
 - B. NPR = 00: The test ended without error; no problem was detected in the modem wrap test.
 - C. NPR displays an 800-series number, and the operator panel SYSTEM CHECK indicator turns on: An error was detected during the test; these 800-series numbers (for example 801 = a clear to send error) identify the error; these numbers are listed in the "Numeric Position Readout (NPR) Codes" section of Chapter 3.
 - D. If an 802 error (transmit clock problem) was detected, transmit timing is not being received from the modem. Request maintenance on the modem.
 - E. If an 800-series error other than 802 was detected, or if the ON LINE indicator did not remain on during test 2, record the error code number and trouble symptom on the Trouble Report Form for the information of maintenance personnel. Request maintenance on the terminal as described in the "Requesting maintenance on the Terminal" section at the front of Chapter 3.
 - F. If the test ended without error, you have identified that the problem is not in the terminal. In this case, return the test adapter cable's switch to the OPER (Operate) position. If the communication problem still occurs, request maintenance on the attached modem.

Binary Synchronous Communications Online Test

Online test provides a means for transmitting test messages to and from the central processor. The online test program that resides in the central processor controls the tests. You initiate tests by entering online test mode and transmitting a request for test to the central processor.

This section includes procedures for entering online test mode, and for requesting either online test "01" or "14". The following chart describes tests "01" and "14". As not all users have the online test capability described in this manual, you should contact the operator at the central processor to determine if you can use these online test procedures, or if procedures for using other tests are available.

Note: RFT = Request for Test.

EBCDIC = Extended Binary Coded Decimal Interchange Code.

TEST NO.	DESCRIPTION
01	The processor transmits the text message received in the RFT the number of times requested in the RFT. The maximum length text message is 256 characters, including the RFT message.
14	EBCDIC Message: The processor transmits a 36 character message (A through Z, and 0 through 9) the number of times requested by the RFT.

To Enter Online Test Mode

- 1 Hold the CODE key down, and enter a numeric "0" from the keyboard; then, release the CODE key.
- 2 Enter a numeric "5" from the keyboard; the number "5" displays in the readout (NPR) indicators.
- 3 Press the EOM key.
 - The terminal enters online test mode.
 - The terminal is ready for the request for test (RFT) message.
- 4 If using a switched communication (dial) network, dial the number of the central processor's modem and establish the communication link. The "Switched Communication (Dial) Network Procedures" section in Chapter 2 describes how to do this.

Requesting Online Test 01 on a Switched or Non-switched Point-to-Point Communication Network

- 1 Enter online test mode as described in "To Enter Online Test Mode".
- 2 Enter this request for test (RFT) message from the keyboard:

`%01YY0 SPACE DC TEXT`

where: YY = the number of times test 01 runs.

SPACE = a space character.

DC = the device control number for the device that receives the test message:

1 = console printer

2 = card punch

3 = Diskette Storage Device

4 = line printer

TEXT = the test message you enter from the keyboard.

(Used with test 01 only)

- 3 Press the EOM key to start the test.

Note: Error code 295 displays in the readout indicators if the RFT is entered incorrectly; if this happens, hold the CODE key down and press the START JOB key to exit from online test mode. Enter online test and enter the RFT message again.

- 4 Hold the CODE key down and press the START JOB key to exit from online test mode.

Requesting Online Test 14 on a Switched or Non-switched Point-to-Point Communication Line

- 1 Enter online test mode as described in "To Enter Online Test Mode".
- 2 Enter this request for test (RFT) message from the keyboard:

`%14YY1DC SPACE`

where: 14 = the test number.

YY = the number of times the test runs.

DC = the device control number for the device that receives the test message:

1 = console printer

2 = card punch

3 = Diskette Storage Device

4 = line printer

SPACE = a space character.

- 3 Press the EOM key to start the test.

Note: Error code 295 displays in the readout indicators if the RFT is entered incorrectly; if this happens, hold the CODE key down and press the START JOB key to exit from online test mode. Enter online test and enter the RFT message again.

- 4 Press the RESET key to exit from online test mode.

Requesting Online Test on a Multipoint Communication Network

- 1 Enter online test mode as described in "To Enter Online Test Mode".
- 2 Enter this request for test (RFT) message from the keyboard:

`%XXYY3AADC SPACE TEXT`

where: XX = the test number (either test 01 or test 14).

YY = the number of times the test runs.

AA = the two-character address of the terminal.

DC = the device control number for the device that receives the test message.

1 = console printer

2 = card punch

3 = Diskette Storage Device

4 = line printer

SPACE = a space character.

TEXT = the test message you enter from the keyboard. (Used with test 01 only)

- 3 Press the EOM key to start the test.

Note: Error code 295 displays in the readout indicators if the RFT is entered incorrectly; if this happens, hold the CODE key down and press the START JOB key to exit from online test mode. Enter online test and enter the RFT message again.

- 4 Hold the CODE key down and press the START JOB key to exit from online test mode.

SDLC Communications Online Echo Test

The online Echo test is a means for transmitting test messages to and from the central processor. The online test program that resides in the central processor controls the test. You initiate the test by entering a logon message to the central processor to request testing.

The terminal must be in SDLC mode and the central processor must be operational before the Echo Test can be initiated.

To Initiate Echo Test:

Do you wish to start the test from your terminal?

Y N

Do you wish to start the test from another terminal?

Y N

Have host CE start T3700SNA.
Go to line (e) of Example 1 – Echo Test.

Enter logon applid (istoltep).
Then respond DEV/3700SNA/ /.
Where DEV = Symbolic name of the test terminal.
Go to line (e) of Example 1 – Echo Test.

Note: If a BIND failure message is received;
Respond to ENTER DEV/TEST/OPT with DEV (X'030321903040')/3700SNA/ /.

Example 1 – Echo Test (Under TOLTEP)

Press SYS REQ key

Logon applid (istoltep)

F1021 ISTOLTEP REL. 2.0 INITIALIZATION IN PROGRESS

F1071 OPTIONS ARE NTL, NEL, NPP, FE, NMI, EP, CP, PR, NTR, NAP

F105D ENTER DEV/TEST/OPT/

*/T3700sna//

F1581 S T3700SNA UNIT 00CF RT2LU1

901 ENTER YYDATA, PROMPT, OR END

4 test data

test data

test data

test data

test data

901 ENTER YYDATA, PROMPT, OR END

end

905 END OF ECHO TESTING

F1581 T3700SNA UNIT 00CF RTS2LU1

F1071 OPTIONS ARE NTL, NEL, NPP, FE, NMI, EP, CP, PR, NTR, NAP

F105D ENTER DEV/TEST/OPT/

CNCL key

(a)

(b)

(b)

(b)

(c)

(d)

(e)

(f)

(g)

(g)

(g)

(g)

(h)

(i)

(j)

(b)

(b)

(b)

(k)

Description

The meaning of each line is as follows:

- (a) The logon to TOLTEP (Teleprocessing Online Test Executive Program).
- (b) Standard OLT messages.

Note: Printing will stop after the first line unless the system operator approves the use of the terminal.

- (c) An asterisk in the device field designates that the test device is the one that is now communicating (logged on).

The test field contains the test number for Echo (3700SNA).

No options were modified.

- (d) Standard OLT message.

The symbolic name of the test device is given here (RTS2LU1).

- (e) Echo is requesting TEST DATA, PROMPT or END.
- (f) A response of '4 test data' requests that the data be repeated four times.
- (g) The data is being Echoed.
- (h) Echo requests ECHO DATA, PROMPT or END.
- (i) A request of end of testing has been entered.
- (j) Ending message of Echo (no errors).
- (k) This will cancel TOLTEP and the terminal can be logged off.

Note: Refer to the publication *DOS/VS and OS/VS TOLTEP for VTAM*, GC 28-0663, for additional information and detailed test procedures.

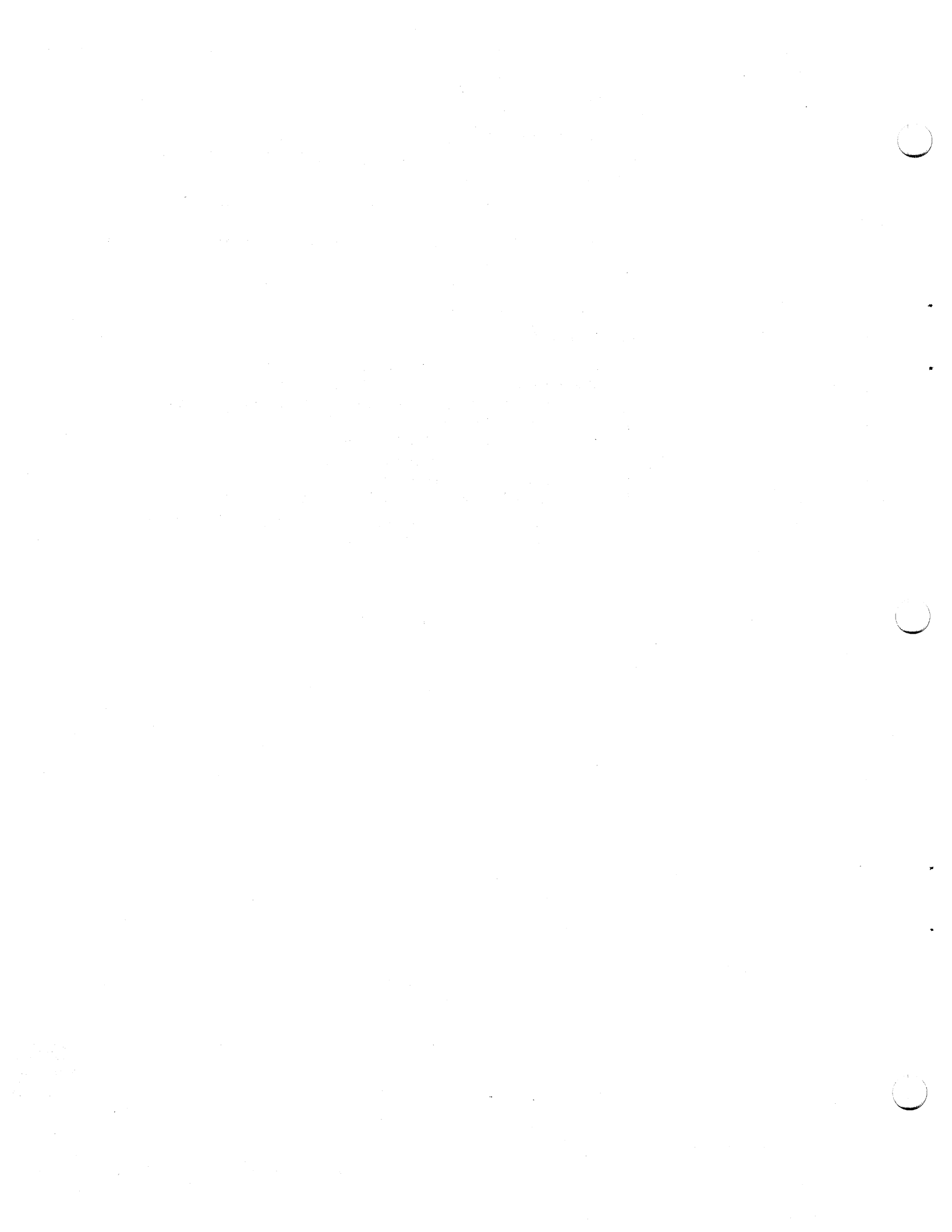

Appendix C: Summary of Operator Controls

Auxiliary Operator Panel Controls

Power On/Off Switch

This switch controls ac power to the terminal. When power is turned on, the bring-up diagnostics run and the terminal is left in local mode with the **PROCEED** indicator on. Any other indicator being on signals either a failure in the terminal's electronic components, that one of the Mode switches is on, or that the Keylock is off. The "Power On" procedure in Chapter 2 describes how to determine the terminal's status when turning power on.

BSC/SDLC Switch

This switch is present on machines using the SDLC/BSC Switch Control Communication feature. Before turning power on, the switch must be placed in the BSC position to communicate using BSC procedures, or in the SDLC position to communicate using SDLC procedures. If the switch setting must be changed after power on, the terminal power must be turned off, the setting changed, and power turned back on (see "Power On/Off Procedures").

NORMAL/HALF-SPEED Switch

This switch is present on machines using the 2400 BPS Integrated Modem, and is present on all World Trade machines. Using the 2400 BPS Integrated Modem, transmission is at 2400 BPS with the switch in the NORMAL position, or at 1200 BPS with the switch in the HALF-SPEED position. On World Trade machines using either an Integrated Modem or an external DCE, line speed with the switch in the NORMAL position is at the modem's maximum rated speed. With the switch in the HALF-SPEED position, line speed is half of the modem's maximum rated speed, if the modem used has this capability.

To change the switch's setting:

- A. If a job is running enter Local mode by ending the job as described under "Ending a Job" in Chapter 2;
- B. Set the switch to the desired position;
- C. Hold the CODE key down and press the CNCL (Cancel) key; then, release the CODE key.

TALK/DATA Switch

This switch is present on machines using the 2400 BPS Integrated Modem, Switched Caducee Network. It must be set to TALK for voice communication, or to DATA for data communication.

SYSTEM RESET Switch

This switch causes the terminal to interrupt any operation in progress and leaves the terminal in the same power-on state as described under "POWER ON/OFF Switch". Operator defined jobs will not be deleted.

Keylock

This is the key-operated switch for the Keylock feature. The switch must be in the UNLOCKED position to perform keyboard operations.

Signal Quality Meter

This meter is present on machines using the 2400 BPS Integrated Modem, Point-to-Point or Multipoint Tributary (see "Communication Test Procedures" in Appendix B).

Transmit and Receive Equalizer Controls

These rotary controls are present on machines using the 2400 BPS Integrated Modem, Multipoint Tributary. The Receive Equalizer control alone is present on machine using the 2400 BPS Integrated Modem, Point-to-Point (see "Communication Test Procedures" in Appendix B).

Operator Panel Switches

HOLD PRINT

Turning this switch on suspends printing on the console printer so that forms may be inserted or adjusted. When the switch is turned off, printing resumes.

On SDLC machines, the HOLD PRINT switch can be turned on to prevent the terminal from sending 'intervention required' signals to the CPU. If the switch is turned on before the timer expires during an intervention required condition, the timer is disabled until the switch is turned off. The switch is active for any output device that is being used.

INTRP (Interrupt)

When this switch is on during offline mode operation, the central processor can interrupt the offline job and transmit data to the 3774 or 3775 terminal. The terminal will disable the keyboard, stop the offline job, receive data from the central processor, and automatically return to the offline job after receiving EOT from the central processor (see "Using the Operator Panel Switches" in Chapter 2).

DISK

Using BSC: This switch forces all data received from the central processor to be written on an attached Diskette Storage Device, regardless of any other component selection (except the console printer) received from the central processor. Data can be routed to the intended output in offline operation by using a system-defined or operator-defined job.

Using SDLC: This switch forces all data received from the central processor to be written on an attached diskette storage device, regardless of any other component selection specified in the FM Header, except for the console printer. If no FM Header is received, the data is sent to the console printer regardless of the setting of the DISK switch.

EXTEND/ALARM

This switch selects the single 512-byte buffer for keyboard-to-line or keyboard-to-Diskette buffer edit operation. If the Record Format feature is installed, the 2048-byte variable length buffer function is activated.

For any job not involving the keyboard, this switch being on causes the Audible Alarm, if installed, to sound for any device-error or not-ready condition.

AUTO

This switch controls the output of data from the controller's buffer. With the AUTO switch OFF, the EOB or EOM key must be pressed to write the buffer contents to an attached Diskette Storage Device (offline mode). If the switch is on, data is automatically written when the buffer becomes full (256 characters have been entered), or less than 256 characters can be read out by pressing the EOB or EOM key. Using BSC, the switch has no effect during keyboard-to-line operation. Using SDLC, with the AUTO switch off, keyboard-entered data is transmitted when the EOB or EOM key is pressed or when the buffer becomes full. With the AUTO switch on, the buffer is transmitted when the Return (↵) key is pressed.

During keyboard-to-card punch operation, the AUTO switch being on causes a card to punch when the Return key is pressed, or causes the previous card to be duplicated when the BUFFER LINE RTN key and Return key are pressed.

During diskette-to-printer operation, the AUTO switch being on causes printing to halt after the current record of the data set is printed.

UPDATE/MONITOR

This switch turned on during a keyboard-to-diskette job places the terminal in a mode that allows the operator to recall records from the diskette. Setting the switch on and entering a diskette record number reads the record into the controller's buffer. The record can then be printed, edited, or corrected. One 256-byte record at a time can be recalled, regardless of the setting of the EXTEND/ALARM switch.

After editing, the record can be read out of the controller's buffer and written back on the diskette by pressing the EOM or EOB key. If the AUTO switch is on, the next sequential diskette record automatically reads into the controller's buffer after the previous record is written to the diskette. If the AUTO switch is OFF, the next record can be recalled by entering the record number of the next desired record, or Update mode can be ended by turning the UPDATE/MONITOR switch OFF.

For jobs other than keyboard-to-diskette, the switch is used to cause monitor printing on the console printer.

Operator Panel Keys

The keyboard should be in lowercase shift when using the following keys. Some keys are not operative in uppercase shift.

INDEX

This key causes the forms to feed one line, and stores an LF character in the controller's buffer. The next character entered will print in the next sequential print position. Pressing the CODE key in conjunction with this key causes an index function without storing a character in the buffer. The INDEX key is inactive on machines using the USASCII code.

FORM FEED

This key causes the forms to advance to the first printing line on the next form, and stores an FF character in the controller's buffer. Pressing the CODE key in conjunction with this key causes a form feed function without storing a character in the buffer.

START/STOP JOB

Pressing this key followed by a job number selects one of the system or operator-defined jobs and execution begins. Pressing the key in conjunction with the CODE key stops the job, and the terminal returns to Local mode.

VERT TAB

Pressing this key causes the printer forms to advance to the next predefined vertical tab stop, and stores a VT character in the buffer. If no vertical tab stops are defined, pressing this key causes a printer line feed.

SYS REQ (System Request)

This key can be used to initiate a system-defined keyboard-to-line job if the STANDBY light is on after a previous online job.

SKIP/ADD REC (Skip or Add Record)

This key is active when the Record Format feature is in use. In this mode of operation, pressing this key causes a record to be skipped. Pressed in conjunction with the CODE key, it allows a record to be keyed in from the keyboard.

CNCL (Cancel)

Using BSC, pressing this key clears the buffer of all data. Using SDLC, pressing this key causes a communication line job to be terminated. Any data received during the job is incomplete and should be discarded.

ATTN (Attention)

This key is active only when using SDLC, and when receiving from the CPU or when the terminal is in standby mode. The key is inoperative at any other time. When the key is pressed, a signal is sent to the CPU requesting that the CPU allow the terminal to transmit. The action taken by the CPU is dependent upon the CPU program, and it may allow the terminal to transmit, or it may ignore the signal.

CODE

This key is used in conjunction with certain numeric or alphabetic keyboard keys to select functions such as:

- Define Job
- Print Error Log
- Communication Facilities Testing
- Stop Job
- End Card
- Display Input/Output Devices for Job (in NPR)
- Create Diskette (Delete all data including job definition)
- Change Data Set Status (Active or Inactive or Multivolume)
- Change Data Set Name
- Write Job Definition on Diskette
- Read Job Definition from Diskette or Cards
- List Diskette Data Sets
- Clear Diskette (Delete all data except job definition)
- Read Operator ID Card
- Set or Reset Switched Network Backup (SNBU)
- Print All characters to Clean Print Belt (3775 Console Printer)
- Set Monocase. This may be set to allow all uppercase and numeric key entry, without use of the Shift keys.
- Set Manual or Auto Disconnect. This may be specified at any time. *Manual* may be specified to keep the line from disconnecting when the on-line job ends.
- Select Inquiry Mode Operation
- Set Ignore ETX/EOT. This may be specified any time the machine is in Local mode, and causes all data to be written as a continuous data set regardless of whether ETX or EOT is received.
- Reset Ignore ETX/EOT, Inquiry Mode, and Monocase Operation.
- Select 8 line per inch console printing.
- Reset 8 line per inch, set 6 line per inch console printing.
- Select 3784 for console output.

Keys used in conjunction with the CODE and EXTEND CODE keys to select these functions are described in the "Using the CODE Key" section of Chapter 2.

PRINT VIEW

This key is active on the 3774 only. When the key is pressed during key entry, the print mechanism moves to the right so that the last printed character can be seen. The print mechanism is automatically repositioned for printing when the next character is struck.

Pressing the key twice in succession causes the print mechanism to move aside, permitting viewing after each data key is pressed. The "Using the Keyboard Buffer Edit Keys" section of Chapter 2 provides more detail in the use of this key.

EOB (End of Block)

Pressing the key causes the controller buffer's contents to be transmitted (online mode), or to be written to the diskette device, if attached (offline mode).

For keyboard-to-line jobs, the buffer is transmitted with an indication to the CPU that this is not the last buffer to be transmitted for this job.

RESET

Pressing this key resets the Audible Alarm. Pressing this key after a buffer edit operation restores the buffer pointer to the first buffer position past the end of data in the buffer. Pressing CODE and RESET resets the SYSTEM CHECK or OPRN CHECK indicator, resets the NPR, and turns the device indicator off.

PRINT BUFFR (Print Buffer)

Pressing the key causes data to be printed, beginning at the current buffer position, through the end of data contained in the buffer.

BUFFR RTN (Buffer Return)

Pressing this key restores the buffer pointer to the beginning of the buffer. Data is not destroyed and can be printed out or corrected.

PRINT LINE

Pressing this key causes a line (or remainder of a line) to print, beginning at the current buffer position, through the next NL or IRS character, or to the end of data contained in the buffer.

BUFFR LINE RTN (Buffer Line Return)

Pressing this key restores the buffer pointer to the beginning of the current line, or to the beginning of the buffer if only one line has been entered. During keyboard-to-card punch operation, pressing this key causes a card to be duplicated if the AUTO switch is on.

PRINT CHAR (Print Character)

Pressing this key causes a character from the current buffer position to print in the printer's current print position. Holding the key down causes typamatic operation (continuous printing) until the key is released.

BUFFR BKSP (Buffer Backspace)

Pressing this key causes the buffer pointer to back up one position (one character space). Data is not destroyed when backspaced over, and can be printed out or corrected. The BUFFR BKSP key cannot be used to backspace into the previous line of data (as defined by the character ending the previous line), or to backspace over other control characters (such as HT, VT, and IRS) contained in the buffer.

EOM (End of Message)

Pressing this key causes data in the buffer to be transmitted (online mode), or to be written to an attached device (offline mode).

For keyboard-to-line jobs the buffer is transmitted with an indication to the CPU that this is the last buffer to be transmitted for this job.

Operator Panel Lights

Device Indicators

An indicator is provided for each I/O device. The device indicators indicate the active devices for the selected job, not-ready conditions, and device errors. Certain device errors cause the device to lose its ready condition, and its associated light turns on and the Operator Attention Speaker sounds to inform the operator that the device needs attention.

Numeric Position Readout (NPR)

This is a three-digit numeric display that provides different indications depending on the operation being performed. If the Diskette Storage feature is installed, record numbers associated with the diskette records are indicated here. Message code numbers providing operator guidance and indicating system status and error conditions are displayed in the NPR. These code numbers, in conjunction with other operator panel indicators being on, are related to operating procedures described in the "Numeric Position Readout Codes" section in Chapter 3.

ON LINE

This light is on whenever "Line" is specified as an I/O device by the job definition and the data link connection has been established. The light remains on until the data link connection is broken. The light blinks during actual transmission.

STANDBY

This light turns on when a job involving the communication line is started. The light remains on until transmission begins, and then turns off. It is off until the job ends, and then turns on. Another online job can be started after the light turns on again.

CPU SELECT

This light indicates that the terminal has rejected a line bid, an MPLC polling sequence, or an MPLC selection sequence from the central processor because the terminal is not ready to operate in line mode.

OPRN CHECK (Operation Check)

This light turns on and the Operator Attention Speaker sounds when the operator has performed an incorrect procedure, or when some I/O device needs attention. A device light will also be on if an I/O device needs attention. A message code number will be displayed in the NPR. This number corresponds to an explanation or procedure, as described in the "Numeric Position Readout Codes" section in Chapter 3.

PRINT INHIBIT

Using SDLC, this indicator is turned on and off by signals from the CPU. When the light is on, keyboard data entered into the buffer cannot be printed or accessed any other way by the operator; data can only be transmitted to the CPU. The indicator is not used with BSC.

SYSTEM CHECK

This light turns on and the Operator Attention Speaker sounds when certain machine errors occur. A message code number will be displayed in the NPR indicating the cause of the error. If an I/O device caused the error, the appropriate device indicator will also be on.

PROCEED

Data entry from the keyboard is permitted when this light is on.

UPPER CASE

This light turns on when the keyboard is in uppercase shift (Upper Shift key has been pressed).

A

active and inactive data sets, diskette 2-59
 aligning forms
 3774 console printer 4-3
 3775 console printer 5-2
 3784 printer 11-4
 all active data sets, how to transmit 2-8
 answering a call, communication line jobs 2-30
 audible alarm 2-19, 2-25
 AUTO switch, setting when starting a job 2-19, 2-25
 automatic answer, communication line jobs 2-31
 auxiliary operator panel, location 1-5

B

badge reader (identification) 10-1
 basic exchange diskettes 2-58
 BELT CLEAN switch (3784) 11-1
 binary synchronous communication online test B-7
 BSC online test B-7
 buffer, explanation 1-2
 buffer edit
 description of keys 2-55
 location of keys 2-52
 operator exercises 2-52
 BUFR BKSP key 2-55
 BUFR LINE RTN key 2-55
 BUFR RTN key 2-55

C

card format
 for job definitions 2-12
 for operator defined jobs, example 2-17
 card jam
 2502 card reader 7-6
 3521 card punch 9-4
 card reader
 end-of-file for defining a job 2-12
 how to use to define a job 2-12
 ID (identification) 10-1
 jobs 2-7, 2-21, 2-26, 2-33
 change name or status of diskette, CODE key function 2-50
 changing the ribbon
 3774 printer 4-9
 3775 printer 5-6
 3784 printer 11-7
 chart
 binary value to character punched in card 2-16
 communication test reference B-4
 decimal to hexadecimal 2-15
 error count during normal transmission B-4
 checking, readback (3521 Card Punch) 2-8, 2-14, 2-21, 2-24, 2-27, 2-28
 chip box, 3521 card punch 9-3
 cleaning print belt, CODE key function 2-51
 cleaning print belt, 3784 11-1
 cleaning the typedrum, 3521 card punch 9-7
 clear diskette function, CODE key function 2-50
 CNCL key 2-55
 CODE key
 change name or status of diskette 2-50
 cleaning print belt 2-51
 clear diskette function 2-50
 communication test mode 2-51
 create diskette function 2-50

CODE key (continued)

define mode 2-44
 disconnect switched communications link 2-49
 display devices and modes 2-46
 end card 2-44
 list diskette status 2-45
 print error log 2-44
 print SDLC link test 2-51
 read
 identification 2-45
 operator job definitions 2-44
 reset check indicators 2-49
 ripple print 2-51
 select
 forms feed function 2-49
 ignore ETX/EOT 2-47
 index function 2-49
 inquiry mode 2-47
 manual disconnect 2-47
 monocase 2-47
 SNBU (switched network backup) 2-47
 terminate SNBU (switched network backup) 2-47
 write operator defined jobs to diskette 2-50
 codes, NPR 3-3
 communication line jobs 2-23, 2-28
 answering a call 2-30
 automatic answer 2-31
 BSC 2-23
 initiating a call 2-30
 SDLC 2-28
 starting and ending 2-19
 communication test
 CODE key function 2-51
 how to enter B-1
 introduction to B-1
 compress option, how to select 2-6, 2-13
 console printer 1-3
 for IBM 3774 1-3
 for IBM 3775 1-3
 line (3775)
 aligning forms 5-2
 first print line alignment 5-3
 HOLD PRINT switch use 5-2
 installing forms 5-2
 make ready procedure 5-1
 opening the cover 5-2
 print belt replacing 5-9
 print unit opening and closing 5-2
 replacing the print belt 5-9
 replacing the ribbon 5-6
 upper forms guide, opening/closing 5-4
 serial (3774)
 aligning forms 4-12
 changing the ribbon 4-13
 end-of-forms sensing 4-1
 forms tractor unit 4-12
 loading cut forms 4-3
 loading margin punched forms 4-6
 make ready procedure 4-1
 platen, removing and installing 4-14
 ribbon changing 4-13
 contents, diskette labels 2-45
 controller functions 1-3
 controls
 3774 console printer 4-1
 3775 console printer 5-1
 3784 printer 11-1

- conversion chart
 - binary value to character punched in card 2-16
 - decimal to hexadecimal 2-15
- correcting
 - error conditions 3-1
 - keyboard entries 2-52
- create diskette function, CODE key function 2-50
- cut forms, installing 3774 console printer 4-3

D

- data path 1-2
- data set labels, how to list 2-45
- data set name
 - for system defined jobs 2-22, 2-27
 - how to
 - define 2-8, 2-21, 2-27
 - transmit all active 2-8
 - transmit only one data set 2-8
 - overriding when starting job 2-21, 2-27
- data sets, delete after transmission 2-8, 2-14
- decimal to hexadecimal conversion chart 2-15
- defective sectors, diskette 2-60
- define mode
 - CODE key function 2-44
 - how to enter 2-6
 - introduction 2-6
- defining a job
 - card format from card reader 2-12
 - checks before doing 2-6
 - correcting errors 2-6
 - from diskette 2-18
 - from keyboard 2-6
 - from the card reader 2-12
 - from the keyboard, example 2-11
 - introduction to 2-6
 - operator exercise 2-2
 - overview 2-1
 - procedure from keyboard 2-6
 - selecting job's features 2-7, 2-13, 2-20, 2-26
 - stopping before completed 2-6
 - writing job definitions to diskette 2-18
 - 2770 workstation jobs A-2
- delete data sets after transmission, selecting 2-8
- delete (CODE key function) 2-48
- determination tests, problem 3-18
- DEV=, prompt instruction in define mode 2-6
- dialing a connection, communication line jobs 2-30
- disconnect switched communications link, CODE key function 2-49
- DISK switch
 - description 2-41
 - setting when starting a job 2-20, 2-25
- DISK 1 indicator, description 2-36
- DISK 2, indicator, description 2-36
- Diskette Storage Device
 - active and inactive data sets 2-59
 - all active datasets, how to transmit 2-8
 - change name or status 2-50
 - clear diskette function 2-50
 - create diskette function 2-50
 - data recovery 3-17
 - data set labels, to list 2-45
 - data set name
 - how to define 2-8, 2-21, 2-27
 - how to transmit all active 2-8
 - how to transmit only one 2-8
 - defective sectors 2-60
 - delete data sets after transmission 2-8, 2-14
 - diskette handling 6-4
 - diskette interchangeability 2-63
 - entering keyboard data 2-60
 - general data recovery 3-17

- Diskette Storage Device (*continued*)
 - jobs 2-57
 - labels 2-57
 - list diskette labels 2-45
 - location 1-4
 - make ready procedure 6-1
 - multivolume data sets 2-59
 - records 2-58
 - transmitting all active data sets 2-8
 - updating records 2-61
 - updating records during keyboard jobs 2-62
 - write operator defined jobs to diskette 2-18
 - display devices and modes, CODE key function 2-46
 - displays, errors 3-3
 - DSN=, prompt instruction in define mode 2-8

E

- edit buffer, using keyboard for 2-52
- eight lines/inch 2-47, 11-1
- emptying
 - the chip box, 3521 card punch 9-3
 - the hopper, 2502 card reader 7-3
 - the stacker, 3521 card punch 9-3
- emulating 2770 workstation jobs A-1
- end card, CODE key function 2-44
- end of forms condition, 3774 console printer 4-1
- ending a job
 - before normal job end 2-34
 - card reader jobs 2-33
 - diskette jobs 2-33
 - keyboard jobs 2-33
 - SDLC line job 2-25
- end-of-file, card reader defined jobs 2-12
- end-of-forms switch, 3774 console printer 4-7
- entering binary synchronous communication online test B-7
- entering keyboard data, diskette 2-60
- equalization
 - modem receive B-5
 - modem transmit B-4
- error count during normal transmission charts B-4
- error log
 - how to print 3-2
 - how to use 3-2
 - operator's information 3-2
 - printing prior to power off 2-4
 - use 3-1
 - 3784 11-2
- error recovery procedures 3-1
- errors, NPR list 3-3
- exchange diskettes 2-58
- EXTEND/ALARM switch
 - description C-2
 - setting when starting a job 2-19, 2-25
- extended CODE key functions 2-50

F

- features, selected during define mode 2-7
- first print line alignment
 - 3775 console printer 5-3
 - 3784 printer 11-4
- form, trouble report 3-2
- FORM FEED key 2-56
- forms
 - control 2-5
 - installing 3774 console printer 4-3
 - installing 3775 console printer 5-2
 - installing, 3784 11-4
 - margin punched, 3774 console printer 4-6
- forms alignment
 - console printer
 - 3774 4-12
 - 3775 5-2
 - 3784 11-4

forms feed function, CODE key function 2-49
FORM FEED switch (3784) 11-1
forms tractor unit, 3774 4-4
 removing, 3774 console printer 4-12
full stacker, 2502 card reader 7-2

G
general printer operating information 4-1, 5-1, 11-1

H
HOLD PRINT switch
 description C-2
 setting when starting a job 2-19, 2-25
 use at power off time 2-4
 use with 3774 console printer 4-3
 use with 3775 console printer 5-2
 use with 3784 printer 11-3
hopper empty, 2502 card reader 7-3
horizontal tab stops
 entered from card reader 2-14
 printer, how to define 2-9

I
ID=, prompt instruction in define mode 2-6
identification card reader 10-1
identification tests, problem 3-18
ignore ETX/EOT
 CODE key function 2-47
 selecting 2-20, 2-26
ims/vs 2770 workstation jobs A-1
inactive data sets 2-59
index function, CODE key function 2-49
INDEX key C-3
indicator
 descriptions
 input and output device C-5
 operator panel C-5
indicators and switches
 operator panel C-1
 2502 card reader 7-1
 3501 card reader 8-1
 3521 card punch 9-1
 3784 printer 11-1
initiating a call, communication line jobs 2-30
inkroll, 3521 card punch 9-6
input and output device combinations
 operator defined jobs 2-6
 system defined jobs 2-21, 2-26
inquiry mode
 CODE key function 2-47
 selecting 2-21, 2-26
insert (CODE key function) 2-48
installing a diskette 6-1
installing forms,
 3774 printer 4-6, 4-8
 3774 printer cut forms 4-3
 3775 printer continuous forms 5-2
 3784 printer 11-4
interpret print selection (3521 Card Punch) 2-6
INTRP switch
 description C-2
 setting when starting a job 2-21, 2-25
interrupt feature system considerations 2-38

J
job
 definitions, number stored 2-6
 restart, following an error 3-1
jobs, diskette 2-57

K
KBD indicator, description 2-36
keyboard
 introduction to 1-4
 to communication line jobs 2-23, 2-28
 to console printer jobs, function 2-7
 to diskette jobs 2-60
keylock, location 1-5

L
labels, diskette 2-57
last SDLC address received 2-51
last SDLC command received 2-51
left margin
 printer, how to define 2-9
 printer following power on 2-4
LINE indicator, description 2-36
LINE PTR indicator, description 2-35
list diskette labels and status, CODE key function 2-45
list of errors, NPR 3-3
local mode
 entering
 before defining job 2-6
 before running communication tests B-1
 before starting a job 2-19, 2-25
following power on 2-4

M
MACH CHECK light (3784) 11-3
maintenance, how to request 3-1
make ready procedure
 Diskette Storage Device 6-1
 2502 card reader 7-1
 3501 card reader 8-1
 3521 card punch 9-1
 3774 console printer 4-1
 3775 console printer 5-1
 3784 printer 11-1
manual disconnect
 CODE key function 2-47
 selecting 2-20, 2-26
margin punched forms, 3774 console printer 4-6
maximum print position, how to define 2-9
mode
 binary synchronous communication online test B-7
 communication test B-1
 define 2-6
 local 2-4
modem
 receive equalization B-5
 receive test (test 4) B-4
 transmit equalization B-5
 transmit test (test 3) B-3
 wrap test (test 2) B-2
modes
 selected at power on time 2-20, 2-26
 setting when starting a job 2-20, 2-26
monitor print 2-19, 2-25
monocase
 Code key function 2-47
 selecting 2-20, 2-25
multipart forms, 3774 console printer 4-6
multivolume data sets, diskette 2-59

N
normal transmission error count charts B-4
NORMAL/HALF SPEED switch B-1
NPR
 (numeric position readout) location 1-4
 display when defining a job from card reader 2-12

NPR (continued)

- displays during communication tests B-1
- list 3-3
- use in correcting errors 3-1
- use in identifying errors 3-1
- 3784 printer 11-3
- numbers, NPR display 3-3, 11-3

O

- OMR (optical mark read), 2502 card reader 7-1
- ON LINE indicator, description C-6
- online test, binary synchronous communication B-7
- opening cover, 3774 console printer 4-4
- opening the cover, 3775 console printer 5-2
- operation, general printer 4-2, 5-1, 11-1
- operator defined jobs
 - example for starting 2-32
 - exercise in performing 2-2
 - how to start 2-19, 2-25
 - overview 2-1
 - using job number when starting 2-21, 2-26
- operator exercises
 - buffer edit 2-52
 - defining and starting a job 2-2, 2-3
- operator panel, introduction to 1-4
- OPRN CHECK indicator
 - 3774/3775 C-6
 - 3784 11-3
- os/vs1 res 2770 workstation jobs A-1
- os/vs2 jes2 2770 workstation jobs A-1
- out of forms, 3774 console printer 4-1

P

- paper path
 - 3774 forms tractor 4-6
 - 3774 friction feeding 4-10
- paper release lever, 3774 console printer 4-1
- platen, remove and install, 3774 console printer 4-14
- power off, procedure 2-4
- power on
 - functional tests 2-4
 - procedure 2-4
- print, interpret (3521 Card Punch) 2-7
- print belt replacing
 - 3775 5-10
 - 3784 11-10
- PRINT BUFFR key 2-55
- PRINT CHAR key 2-55
- print error log,
 - CODE key function 2-44
 - 3784 11-2
- PRINT INHIBIT indicator C-6
- PRINT LINE key 2-55
- print unit opening and closing
 - 3775 5-2
 - 3784 11-4
- PRINT VIEW key C-4
- print SDLC link test 2-51
- printer forms considerations, before starting a job 2-19, 2-25
- printing the error log 3-2
- problem identification tests 3-18
- procedure
 - communication tests B-1
 - modem receive equalization B-5
 - modem transmit equalization B-4
 - problem identification 3-18
- PROCEED indicator, description 2-36, C-6
- prompting instructions, when defining a job 2-6
- PRT READY indicator (3784) 11-3
- PUNCH indicator, description 2-36

R

- read
 - ID (identification)
 - CODE key function 2-45
 - how to read card 10-1
 - operator job definitions, CODE key function 2-44
 - readback checking (3521 Card Punch) 2-8
 - READER indicator, description 2-36
 - receive equalization, modem B-5
 - RECEIVE EQUALIZER control B-5
 - receive test; modem B-4
 - record format jobs 2-7
 - records, diskette 2-58
 - reference chart
 - for modem receive test (test 4) B-4
 - for modem transmit test (test 3) B-4
 - reloading the hopper
 - 3501 card reader 8-3
 - 3521 card punch 9-3
 - remote power off, function 2-4
 - removing a card jam
 - 2502 card reader 7-6
 - 3501 card reader 8-3
 - 3521 card punch 9-4
 - replacing
 - the inkroll, 3521 card punch 9-6
 - the print belt, 3775 console printer 5-9
 - the ribbon
 - 3774 console printer 4-13
 - 3775 console printer 5-6
 - 3784 printer 11-7
 - report form, trouble 3-2
 - request for test, RFT (BSC online) B-7
 - requesting maintenance 3-1
 - reset check indicators, CODE key function 2-49
 - RESET key 2-49, 2-55, C-5
 - restarting following an error 3-1
 - RFT, request for test (BSC online) B-7
 - ribbon changing
 - 3774 4-13
 - 3775 5-6
 - 3784 11-7
 - ribbon path, 3774 4-14
 - right margin stop, printer how to define 2-9
 - ripple print,
 - CODE key function 2-51
 - 3784 11-1
 - rje select 2-47
 - running communication tests B-1

S

- SDLC jobs 2-25
- SDLC print link test 2-51
- security keylock
 - function 2-4
 - location 1-5
- serial printer 4-1
- service, how to request 3-1
- SETUP switch (3784) 11-2
- set unattended mode 2-26, 2-48
- SHF=, prompt instruction in define mode 2-8
- short card jobs, 2502 card reader 7-4
- six lines/inch 2-47, 11-1
- SNBU (switched network backup)
 - CODE key function 2-47
 - selecting 2-20, 2-26
- STANDBY indicator, description 2-25, 2-37
- starting a job
 - communication line (BSC) 2-23
 - communication line (SDLC) 2-28
 - how to 2-19, 2-25

starting a job *(continued)*
 operator exercise 2-2
 overview 2-1
 starting a system defined job
 example 2-32
 how to 2-19, 2-25
 overview 2-1
 starting an operator defined job
 example 2-32
 how to 2-19, 2-25
 overview 2-1
 starting diskette record, when starting a job 2-22, 2-27
 starting 2770 workstation jobs A-2
 SVF=, prompt instruction in define mode 2-9
 switched network procedures 2-30
 switches, operator panel settings when starting a job 2-19, 2-25
 switches and indicators
 operator panel 2-36, C-2
 2502 card reader 7-1
 3501 card reader 8-1
 3521 card punch 9-1
 3784 printer 11-1
 SYS REQ key 2-23, 2-28, C-3
 SYSTEM CHECK indicator, description 2-37, C-6
 system defined job parameters
 for communication line jobs 2-24, 2-28
 when starting a job 2-21, 2-27
 system defined jobs
 example for starting 2-32
 how to start 2-19, 2-25
 overview 2-1
 selecting input/output device combination 2-21, 2-26
 SYSTEM RESET switch, location 1-5

T

tab stops
 how to define 2-9, 2-10, 2-14
 printer following power on 2-4
 terminal communication test (test 0) B-1
 terminal operation, overview 2-1
 terminate SNBU (switched network backup),
 CODE key function 2-47
 terminating a call, communication line jobs 2-30
 test
 binary synchronous communication online test B-7
 echo, SDLC B-10
 messages, request for test (BSC online) B-8
 power on functional 2-4
 procedures, introduction to communication tests B-1
 SDLC B-10
 0, terminal communication test B-1
 2, modem wrap test B-2
 3, modem transmit test B-3
 4, modem receive test B-4
 TRANSMIT EQUALIZER control B-4
 transmit request 2-29
 transmit test, modem B-3
 transmitting all active data sets 2-8
 transparent mode, how to select 2-7
 trouble report form 3-2
 type belt replacing, 3775 console printer 5-9
 type belt replacing, 3784 11-10
 typedrum, 3521 card punch 9-7

U

unattended mode, SDLC 2-26, 2-48
 unloading the stacker
 2502 card reader 7-2
 3501 card reader 8-3
 UPDATE/MONITOR switch
 description 2-41
 setting when starting a job 2-19, 2-25

updating records
 diskette 2-61
 during keyboard to diskette jobs 2-62
 UPPER CASE indicator, description 2-37
 upper forms guide, opening/closing, 3775 line printer 5-4
 using the error log 3-2

V

VERT TAB key 2-56
 vertical tab stops, printer how to define 2-10

W

workstation job notes (2770 emulation) A-3
 wrap test, modem B-2
 write operator defined jobs to diskette, CODE key
 function 2-50
 writing job definitions to diskette 2-18

2

2502 card reader
 card jam removal 7-6
 emptying the hopper 7-3
 end-of-file 2-33
 full stacker 7-2
 hopper empty 7-3
 indicators and switches 7-1
 make ready procedure 7-1
 OMR (optical mark read) 7-1
 removing a card jam 7-6
 short card jobs 7-4
 switches and indicators 7-1
 unloading the stacker 7-2
 51 column cards 7-4
 66 column cards 7-4
 2770 workstation job emulation A-1

3

3501 card reader
 end-of-file 2-33
 indicators and switches 8-1
 make ready procedure 8-1
 reloading the hopper 8-3
 removing a card jam 8-3
 switches and indicators 8-1
 unloading the stacker 8-3
 3521 card punch
 card jam 9-4
 chip box 9-3
 cleaning the typedrum 9-7
 emptying the chip box 9-3
 emptying the stacker 9-3
 end-of-file 2-33
 indicators and switches 9-1
 inkroll 9-6
 interpret print 2-7, 2-21, 2-27
 make ready procedure 9-1
 reloading the hopper 9-3
 removing a card jam 9-4
 replacing the inkroll 9-6
 switches and indicators 9-1
 typedrum 9-7
 3774 Communication Terminal 1-1
 3774 printer 4-1
 3775 Communication Terminal 1-1
 3775 printer 5-1
 3784 Line Printer
 aligning forms 11-4
 indicators
 HOLD PRT 11-3
 MACH CHECK 11-3

3784 Line Printer (continued)

NPR 11-3
OPRN CHECK 11-3
PRT READY 11-3
unlabeled indicators 11-3
8 LPI 11-3
installing forms 11-4
make ready procedure 11-1
opening the cover 11-4
print belt replacing 11-10
print unit opening and closing 11-4
replacing the ribbon 11-7
switches
BELT CLEAN 11-1
FORM FEED 11-1
HOLD PRINT 11-1
MACH RESET 11-1
PRINT ERROR LOG 11-2

3784 Line Printer (continued)

SETUP 11-2
unlabeled switches 11-3
8 LPI/6LPI 11-1
type belt replacing 11-10

5
51 column cards, 2502 card reader 7-4

6
6 lines/inch 2-47, 11-1
66 column cards, 2502 card reader 7-4

8
8 lines/inch 2-47, 11-1

Trouble Report Form

1 Circle the operator panel indicators and switches that are on before performing any error recovery procedures:

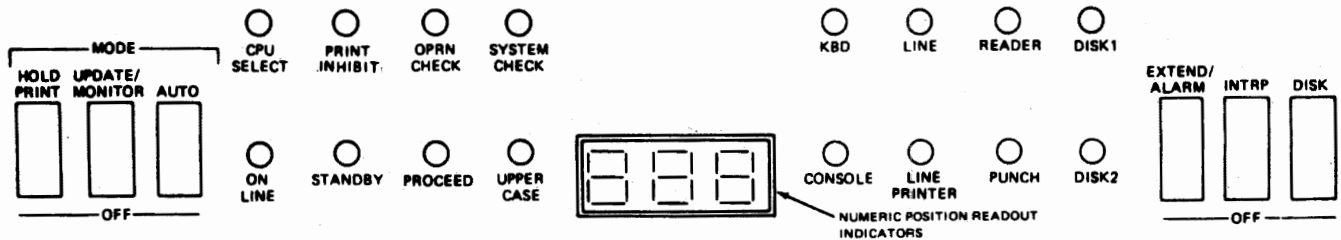

2 ----- Enter the number that is displayed in the readout (NPR) indicators.

3 Circle the position of these auxiliary operator panel switches:

TALK-DATA BSC-SDLC NORMAL-HALF SPEED

4 Circle the input and output devices selected in this job setup:

KEYBOARD CARD READER DISK 1 CONSOLE PRINTER
 3784 PRINTER CARD PUNCH DISK 2 COMMUNICATIONS LINE

5 Circle the features selected in this job setup:

TRANSPARENT MODE COMPRESS DELETE DATA SETS
 MONOCASE MANUAL DISCONNECT INQUIRY MODE
 IGNORE ETX/EOT SNBU

6 Print the error log: (A) Hold the CODE key down, and press the numeric "2" key, and (B) the error log prints. If the error log does not print, press the SYSTEM RESET key and repeat step A.

7 Comments (additional information or results of "Problem Identification Tests"):

Operating Procedures Guide:
IBM 3774 and 3775 Communication Terminals

**READER'S
COMMENT
FORM**

Order No. GA27-3094-3

Your comments, accompanied by answers to the following questions, help us produce better publications for your use. Each reply is carefully reviewed by the persons responsible for writing and publishing this material. Comments and suggestions become property of IBM.

Please direct *any requests for copies of publications or for assistance in using your IBM System or equipment*, to your IBM representative or to the IBM sales office serving your locality.

- Did this publication meet your needs?
- What is your occupation?
- How did you use this publication?

COMMENTS

We would appreciate your comments: please give specific page and line references when appropriate. Additional comments may be made on the other side of this form.

Cut or Fold Along This Line

If you would like a reply, complete the following (Please Print):

Your Name _____

Company Name _____

Department _____

Street Address _____

City _____ State _____ Zip Code _____

Thank you for your cooperation. No postage stamp is necessary if mailed in the U.S.A. (Elsewhere, an IBM office or representative will be happy to forward your comments.)

ADDITIONAL COMMENTS:

Cut or Fold Along Line

Operating Procedures Guide: IBM 3774 and 3775 Communication Terminals (File No. S370-09 Printed in U.S.A. Order No. GA27-3094-3

Fold

Fold

First Class
Permit 40
Armonk
New York

Business Reply Mail
No postage stamp necessary if mailed in the U.S.A.

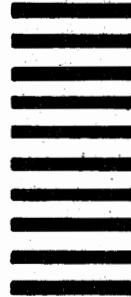

Postage will be paid by:

International Business Machines Corporation
Dept. E01
P.O. Box 12195
Research Triangle Park
North Carolina 27709

Fold

Fold



International Business Machines Corporation
Data Processing Division
1133 Westchester Avenue, White Plains, New York 10604
(U.S.A. only)

IBM World Trade Corporation
821 United Nations Plaza, New York, New York 10017
(International)



International Business Machines Corporation
Data Processing Division
1133 Westchester Avenue, White Plains, New York 10604
(U.S.A. only)

IBM World Trade Corporation
821 United Nations Plaza, New York, New York 10017
(International)