

GA27-3051-4
File No. S360/S370-09

Systems

**Introduction to the
IBM 3704 and 3705
Communications Controllers**



Systems

**Introduction to the
IBM 3704 and 3705
Communications Controllers**



Fifth Edition (September 1978)

This is a major revision of, and makes obsolete, GA27-3051-3. This edition contains several additions and changes as indicated on the Summary of Amendments page. Changes are periodically made to the information herein; before using this publication in connection with the operation of IBM systems, consult the latest IBM System/370 Bibliography (GC20-0001) and associated Technical Newsletters, for the editions that are applicable and current.

It is possible that this material may contain reference to, or information about, IBM products (machines and programs), programming or services which are not announced in your country. Such references or information must not be construed to mean that IBM intends to announce such IBM products, programming or services in your country.

Publications are not stocked at the address given below; requests for copies of IBM publications should be made to your IBM representative or to the IBM branch office serving your locality.

This manual has been written by the IBM System Communications Division, Publications Development, Department E02, P.O. Box 12195, Research Triangle Park, North Carolina 27709. A reader's comment form is provided at the back of this publication. If the form has been removed, comments may be sent to the above address. IBM may use or distribute any of the information you supply in any way it believes appropriate without incurring any obligation whatever. You may, of course, continue to use the information you supply.

Preface

The IBM 3704 and 3705 Communications Controllers are compatible, programmed transmission control units designed to assume many data communication control functions formerly assigned to a data communication access method. The 3704 and the 3705 are controlled by programs in the controller.

This publication contains introductory information on the hardware components of the controllers and on the programs provided to support them. Any user or potential user of a 3704 or 3705—including management, programmers, operators, and maintenance personnel—should be familiar with the contents of this manual. The only prerequisite for this manual is an understanding of basic data communication operations.

The manual is divided into six chapters:

- General Concepts—This chapter gives an overview of the place of 3704 and 3705 communications controllers in the data communication environment. It describes primarily the advantages that the controllers offer to the data communication installation.
- Communications Controller Hardware Concepts—This chapter describes the functions of the 3704 and 3705 hardware components and features. It also indicates which features can be combined and, in general, the type of support each feature provides.
- Network Control Program Concepts—This chapter summarizes the services (both standard and optional) provided by the non-licensed version of the network control program (NCP/VS).
- Emulation Program Concepts—This chapter summarizes the functions of the emulation program for the IBM 2701 Data Adapter Unit and the IBM 2702 and IBM 2703 Transmission Controls.
- Partitioned Emulation Programming Extension—This chapter explains how a network control program with the partitioned emulation programming (PEP) extension can concurrently perform network control functions for certain communication lines and emulation functions for others.
- The System Support Programs—This chapter covers the control-program generation procedure, the controller assembler, and the utilities. Primary emphasis is on the structure and use of the macro language for generating the control program.

The appendixes contain information on (1) the devices supported by the controllers in the network control mode, (2) the types of stations supported by the controllers in emulation mode, (3) the capabilities of the line-attachment hardware for the controllers, (4) the publications relating to the 3704 and 3705 controllers, and (5) configuration charts for storage layout, channel adapters, and communication scanners.

In this manual, the term *controller* is used when the discussion applies to both the 3704 and the 3705. A *data communication subsystem*, as referred to in this publication, includes remote stations, modems (data sets), communication lines, and the communications controller. The *data communication network* consists of either: (1) one or more stations and the communication lines that connect them to the controller and host or (2) in Systems Network Architecture (SNA) terms, the combination of two or more single-host networks into one large multiple-host network. The term *station* refers to the data communication equipment at the remote end of a communication line.

The term *network* has at least two meanings. A *public network* is a network established and operated by common carriers or telecommunication Administrations for the specific purpose of providing circuit-switched, packet-switched, or nonswitched-circuit services to the public. A *user application network* is a configuration of data processing products, such as processors, controllers, and terminals, established and operated by users for the purpose of data processing or information exchange, which may use transport services offered by common carriers or telecommunication Administrations.

Network, as used in this publication, refers to a user application network.

A station may include one or several data communication units. A *data communication unit* is a single piece of equipment that communicates with a computer from a remote location over a communication line. It can be a terminal, a terminal component, a control unit, or another computer.

As used throughout this publication, the term *communication line*, or simply *line*, refers to the path over which information is transmitted from one point in a data communication network to another. The path may in actuality be any communication facility of the communications common carrier, such as wire or radio; or it may be a combination of facilities.

Licensed and non-licensed versions of the network control program are available for IBM communications controllers.

Licensed versions of the network control program are IBM program products that offer advanced communications function (ACF) for 3705-I and 3705-II controllers. Licensed network control programs are referred to in this publication as ACF/NCP/VS. For more information about ACF/NCP/VS, refer to *Introduction to Advanced Communications Function*, GC30-3033 and *ACF/NCP/VS (Network Control Program and System Support Programs) General Information*, GC30-3058.

Non-licensed versions of the network control program are available for both the 3704 and 3705 controllers, however, they do not have the advanced communications function. In this publication, non-licensed versions of the network control program are referred to as NCP/VS.

Related Publications

These publications about the IBM 3704 and 3705 are available:

IBM 3704 and 3705 Communications Controllers:

Principles of Operation (GC30-3004)

Emulation Program Generation and Utilities Guide and Reference Manual
(GC30-3002)

Emulation Program Storage and Performance Reference Manual (GC30-3005)

Assembler Language (GC30-3003)

Emulation Program, Program Logic Manual (SY30-3001)
(For 3705 with Type 1 Channel Adapter)

Emulation Program Logic Manual (For 3705 with Type 4 Channel Adapter),
SY30-3031

Network Control Program/VS Generation and Utilities Guide and Reference Manual (GC30-3007)

IBM 3704 and 3705 Control Program Generation & Utilities Guide & Reference Manual (GC30-3008)

Introduction to Advanced Communication Function, GC30-3033

ACF/NCP/VS (Network Control Program and System Support Programs) General Information (GC30-3058)

Network Control Program, Program Logic Manual (SY30-3003)

Network Control Program/VS, Program Logic Manual (SY30-3007)

IBM 3704 and 3705 Control Program Generation and Utilities Guide and Reference Manual (GC30-3000)

Storage Estimates and Performance Planning for the IBM 3704 and 3705 Communications Controllers Network Control Program (GC30-3006)

IBM 3704 and 3705 Program Reference Handbook (GY30-3012)

Network Control Program/TCAM Network User's Guide (GC30-3009)

Guide to Using the IBM 3704 Communications Controller Control Panel (GA27-3086)

Guide to Using the IBM 3705 Communications Controller Control Panel (GA27-3087)

IBM 3704 Operator Reference Summary (GA27-3091)

IBM 3705 Operator Reference Summary (GA27-3092)

IBM System/360 Installation Manual—Physical Planning (GC22-6820)

IBM System/370 Installation Manual—Physical Planning (GC22-7004)

Appendix D summarizes the contents of each of these manuals. Ask your IBM representative about the current availability of publications about the 3704 and 3705 communications controllers.

BLANK

Contents

Chapter 1: General Concepts	1-1
Network Configuration with the Communications Controllers	1-2
Program Support for the Controllers	1-3
NCP/VS	1-4
ACF/NCP/VS	1-4
Emulation Program	1-5
Partitioned Emulation Programming Extension	1-6
System Support Programs	1-6
A Compatible Family	1-6
The Controllers Are Flexible	1-7
The Controllers Are Modular in Design	1-9
The Controllers Offer High Availability	1-9
The Controllers Conserve Processing Unit Resources	1-10
The Controllers Use a Single Subchannel Address	1-10
The Design of the Controllers Increases Reliability and Reduces Overhead	1-11
The Controllers Provide Many Error Recovery and Diagnostic Facilities	1-11
Chapter 2: Communications Controller Hardware Concepts	2-1
The 3704 Hardware	2-1
The Central Control Unit	2-1
The Control Panel	2-2
3704 Storage	2-2
The 3704 Channel Adapter (Local 3704 Only)	2-2
Remote Program Loader (Remote 3704 Only)	2-2
Communication Scanners	2-3
Line Interface Bases	2-4
Extended Environment Feature (Remote 3704 Only)	2-4
The 3705 Hardware	2-4
3705-I Hardware	2-4
3705-II Hardware	2-4
The Central Control Unit	2-5
The Control Panel	2-5
3705-I Core Storage	2-6
3705-II Monolithic Storage	2-6
Cycle Utilization Counter	2-6
High-Speed Local Attachment	2-6
Channel Adapters	2-6
Remote Program Loader	2-9
Communication Scanners	2-9
Attachment Bases	2-10
Line Interface Bases	2-11
Extended Environment Feature (Remote 3705 Only)	2-11
Internal Air Circulation Features (Remote 3705-I Only)	2-11
Chapter 3: Network Control Program Concepts	3-1
Functions of the Network Control Program	3-5
Standard Functions	3-5
Communication Control	3-5
Error Recording and Diagnostics	3-6
Optional Functions	3-6
Block Handling Functions	3-6
Error Recovery and Diagnostics	3-6
Miscellaneous Options	3-7
Dynamic Control Functions	3-8
Chapter 4: Emulation Program Concepts	4-1
Multiple Subchannel Support	4-2
Chapter 5: Partitioned Emulation Programming Extension Concepts	5-1
Advantage of the PEP Extension	5-1
Channel Attachment	5-2
Control Sequences, Data Transfers, and Functions	5-2
Communication Lines and Stations Supported	5-2

Chapter 6: The System Support Programs	6-1
Control Program Generation	6-1
The Control Program Generation Language	6-2
System Macros	6-2
Configuration Macros	6-2
Block Handling Macros	6-3
Generation Delimiter Macro	6-4
Coding the Generation Language	6-4
General Logic Flow of the Control Program Generation Procedure	6-4
Stage One.	6-6
Intervention Between Stages of Control Program Generation	6-7
Stage Two	6-7
Generating Multiple Control Programs	6-7
The Controller Assembler	6-7
The Instruction Set	6-8
Macro Capability of the Assembler	6-8
The Assembler Instructions	6-8
Uses of the Assembler	6-8
The Utilities	6-8
The Loader	6-9
How the Loader Operates	6-9
The Dump Program	6-9
How the Dump Program Operates.	6-10
Loading and Dumping a Remote Controller	6-10
Loading	6-10
Dumping	6-11
Appendix A: Types of Stations Supported by the IBM 3704 and 3705 Communications Controllers in Network Control Mode	A-1
Appendix B: Types of Stations Supported by the IBM 3704 and 3705 Communications Controllers in Emulation Mode	B-1
Appendix C: 3704 and 3705 Line Interface Bases and Line Sets	C-1
Clocking Requirements for Line Interface Bases and Line Sets	C-8
Appendix D: Publications Relating to the IBM 3704 and 3705	D-1
Appendix E: 3705-I and 3705-II Hardware Configurations and Model Information	E-1
List of Abbreviations	Abbr-1
Glossary	Gloss-1
Index	X-1

Figures

	IBM 3704 Communications Controller	xii
	IBM 3705 Communications Controller	xii
1-1.	Centralization of Function in the IBM Communications Controllers	1-1
1-2.	Data Communication Network with a Single Communications Controllers	1-2
1-3.	Data Communication Network with Two IBM 3705-II Communications Controllers Connected by Local/Remote Communication Link	1-3
1-4.	A Multi-System Data Communication Network	1-5
1-5.	System Data Flow	1-8
2-1.	Summary of Differences between 3704 and 3705 Controllers	2-1
2-2.	Communication Line and Storage Capacities of the 3704 (by Model)	2-2
2-3.	Maximum Hardware Configuration of the 3704	2-3
3-1.	Data Flow between Host Processor and Station through a Local Controller	3-2
3-2.	Data Flow between Host Processor and Station through a Local and a Remote Controller	3-3
3-3.	Logical Data Flow between the Access Method and Stations via Local and Remote Controllers	3-4
6-1.	Format of the Input Stream for Network Control Program Generation	6-5
6-2.	Example of the Control Program Generation Procedure under OS	6-5
6-3.	Example of the Emulation Program Generation Procedure under DOS/VS	6-6

Summary of Changes for GA27-3051-3

The fourth edition contained the following changes.

Program Product Version of the Network Control Program

The program product version of the network control program, which supports systems network architecture (SNA) networking, were described in Chapter 8 of this edition. The outstanding feature of this version is its support of interconnection of two or more single-host networks to share resources and reduce costs.

3705-II Hardware Enhancements

Also included in Chapter 8 of this edition were descriptions of the following enhancements of the 3705-II hardware:

- Type 4 channel adapter improvements
- 3705-II remote capability
- Duplex wideband line sets

Manual Changes

TNL GN27-3165 were incorporated into this revision. That TNL contained information about the 3705-II and four new features.

Other minor clarifications and corrections appeared in this edition.

Summary of Changes for GA27-3051-4

The fifth edition contains the following changes.

Additions

Models J, K, and L have been added to the 3705-II product line, and descriptions of each model are included in Chapter 2. These models include (1) a 900 nanosecond cycle time, (2) maximum storage capacity of 512K bytes, and (3) a cycle utilization counter.

Also incorporated into Chapter 2 of this edition is a description of the High Speed Local Attachment Feature.

Line Sets 1W and 1Z for use with the High-Speed Local Attachment Feature are also described in Appendix C.

Appendix E

Charts showing storage capacity, half-duplex line capacity, and module configuration for all 3705 models appear in a new appendix—Appendix E. Also shown in chart form are the permissible configurations of channel adapters and communication scanners for the 3705.

Deletions

Enhancement feature descriptions have been incorporated into Chapter 2 of this edition from Chapter 7 of previous editions.

Information about the IBM program product, ACF/NCP/VS, has been removed from this edition and incorporated into *ACF/NCP/VS (Network Control Program and System Support Programs) General Information (GC30-3058)*. The description of 3705-II hardware extensions has been incorporated into Chapter 2 of this edition from Chapter 8 of the previous edition.

Reorganization of Chapter 2

Information in Chapter 2 of this edition is reorganized because of additions, deletions, and changes to material in previous editions of this manual.

Rearrangement of Chapters

Chapters in this edition present 3704/3705 information in the following sequence.

1. General concepts
2. 3704/3705 hardware descriptions
3. Network control program description
4. Emulation program description
5. Partitioned emulation programming description
6. System support programs

Terminology Changes

The term *teleprocessing* has been replaced by *data communication* when referring to communication networks or subsystems.

The term *CPU* has been replaced by *processing unit* or *host processor*.

Other minor clarifications and corrections appear in this edition.

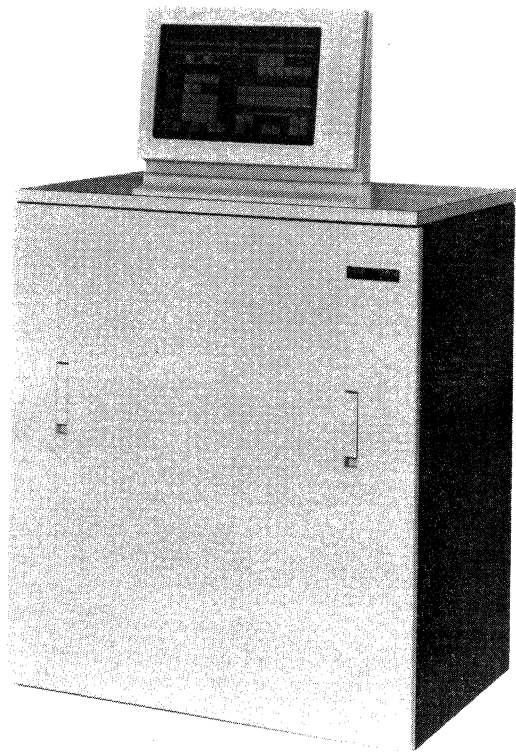

IBM 3704 Communications Controller

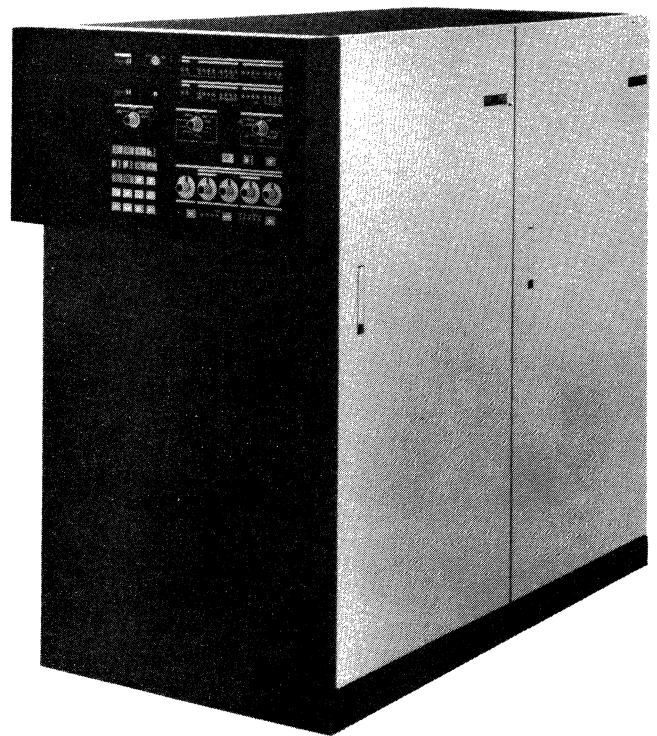

IBM 3705 Communications Controller with Two Frames

Chapter 1: General Concepts

The IBM 3704 and 3705 Communications Controllers are compatible, programmed transmission control units designed to assume many of the line-control and processing functions for a data communication subsystem. In many installations, primary control of the communication network is concentrated in the host processor, with an access method controlling the flow of data to and from the stations in the network. Sending and receiving data over the communication lines is a function of the transmission control unit, operating in response to commands from the access method. In addition to performing the usual functions of transmission control units, the IBM 3704 and 3705 Communications Controllers take over many of the functions of an access method. In this way, the controllers remove much of the control of the data communication subsystem from the host processor. Figure 1-1 illustrates this centralization of function.

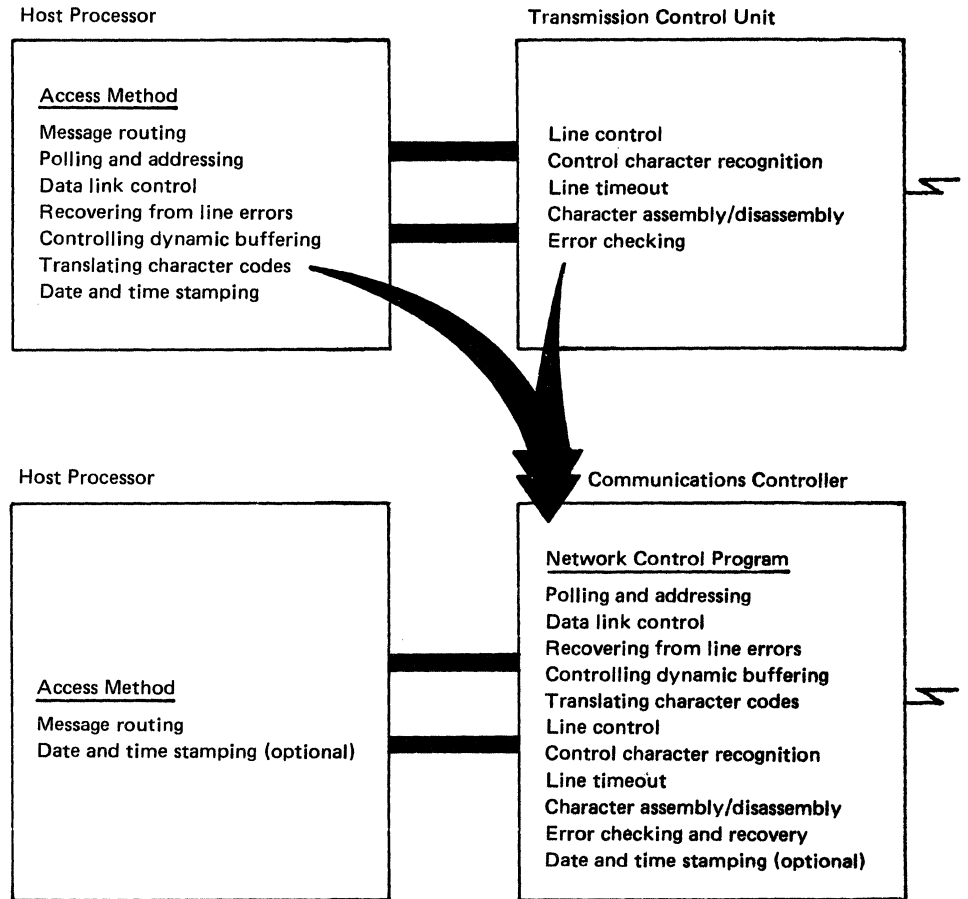

Figure 1-1. Centralization of Function in the IBM Communications Controllers

Network Configuration with the Communications Controllers

The 3704 and 3705 controllers, though dissimilar in appearance, serve the same purpose in a data communication network. With appropriate programming, the controllers operate as network concentrators. The controllers collect data from terminals and send it at high speed to a host processor. A 3705 with the remote support feature can also operate as a remote network concentrator. The essential difference between the two controllers is the size of the networks they can accommodate. Figure 2-1 in Chapter 2 summarizes the differences between the controllers in number of communication lines, maximum line speeds, and storage capacity available. (As used throughout this publication, the term *communication* line, or simply line, refers to the path over which information is transmitted from one point in a communication network to another. The path may actually be any communication facility of the communication common carrier, such as wire or radio; or it may be a combination of facilities.)

The control program in the communications controller communicates with an access method in the host processor to which the controller is connected.

A controller may be attached directly to a host processor channel via a channel adapter, or it may be located many miles distant from the host processor. Figure 1-2 shows a data communication network in which all stations are directly connected to a single controller attached to a host processor channel. Figure 1-3 shows a network in which the stations more distant from the host processor are connected to a separate controller. In the latter arrangement, the controller attached to the host processor channel is called the *local controller*, and the distant controller is called the *remote controller*. Using remote controllers in a communication network allows the controller to be placed nearer the stations it serves, thus reducing the aggregate length of the communication lines. This reduction in line mileage can significantly lessen line charges—a major portion of network cost—even though two controllers and a relatively expensive communication line between them are required.

A remote controller must be linked to a local controller by a duplex or half-duplex communication line. This line, called the *local/remote communication link*, carries all the message traffic exchanged between the host processor and stations connected to the remote controller. (In this publication, the term *duplex communication line* means a line having two independent data paths over which data can be transmitted simultaneously in both directions; a *half-duplex communication line* is one having a single data path over which data can be transmitted in either direction, but not simultaneously. A duplex communication line may operate in half-duplex mode.)

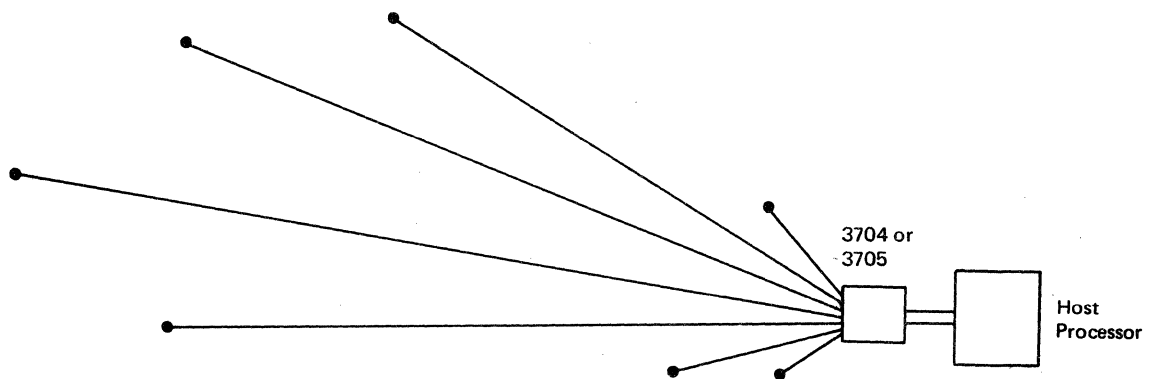

Figure 1-2. Data Communication Network with a Single Communications Controller

If a communication link between a local and remote controller fails, the controllers may be connected via the switched communication network (with half-duplex data transfer) provided that they have the required hardware and program options.

Although Figure 1-3 shows only one remote controller, multiple remote controllers may be connected to the same local controller, each by a separate local/remote communication link. (A remote controller cannot be connected to more than one local controller.)

The 3705-I and the 3705-II are designed for attachment to an IBM System/360 byte-multiplexer channel or to an IBM System/370 selector, block-multiplexer, or byte-multiplexer channel. The 3705-II, as shown in Figure 1-3, can also be used for communication over a duplex or half-duplex local/remote communication link with a local, channel-attached 3705-I or 3705-II. The 3704 is designed for either local or remote attachment to a System/360 or System/370 byte-multiplexer channel.

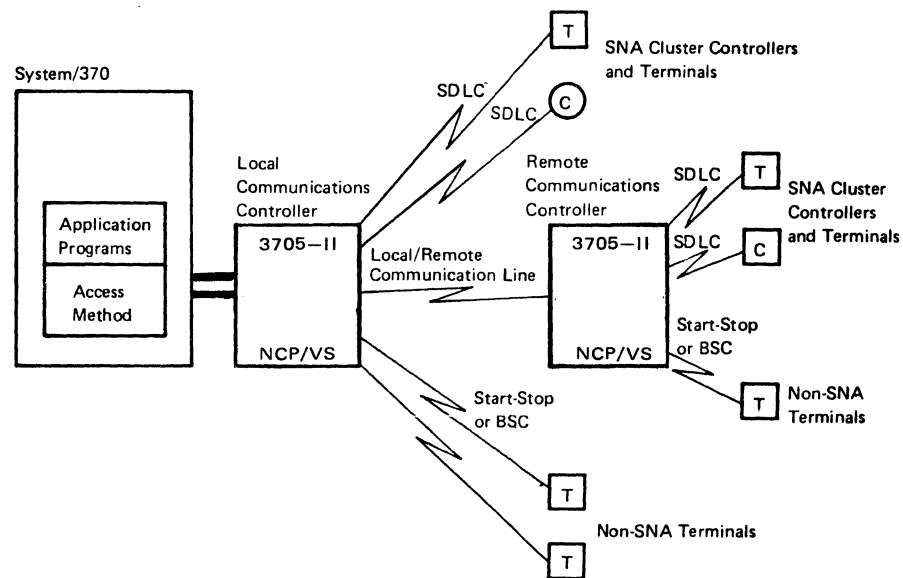

Figure 1-3. Data Communication Network with Two IBM 3705-II Communications Controllers Connected by Local/Remote Communication Line

Program Support for the Controllers

The network control program (NCP), which is loaded into a 3704 or 3705, provides the communications controller with the flexibility to meet the demands of an expanding data communications network. The 3704 or 3705 executes the NCP, under control of an access method stored in the host processor, and relieves the processor of much of the responsibility for network management.

NCP/VS

A non-licensed version of the network control program, known as network control program/virtual storage (NCP/VS), is provided for both the IBM 3704 and IBM 3705. NCP/VS is described in Chapter 3 of this publication.

The combination of the access method, communications controllers, terminals, and interconnecting communication lines shown in Figure 1-3 are referred to collectively as a single-domain network, or domain. In this example, the communications controllers are loaded with the NCP/VS version of the network control program.

ACF/NCP/VS

A licensed version of the network control program, known as advanced communications function for the network control program/virtual storage (ACF/NCP/VS), is available for the 3705 only. This IBM program product works with an access method in the host processor to provide advanced communications function networking, in accordance with the concepts of systems network architecture (SNA). The use of ACF/NCP/VS depends upon (1) the 3705 hardware configuration, and (2) the access method in the host processor (for example, ACF/TCAM/VS or ACF/VTAM/VS). For a more thorough description of ACF/NCP/VS, refer to *ACF/NCP/VS (Network Control Program and System Support Programs) General Information (GC30-3058)*. Consult your IBM representative for information on access methods that operate with ACF/NCP/VS.

The networking capabilities of ACF/NCP/VS are particularly appropriate for users who wish to interconnect several locations to share resources and reduce communication costs. Formerly, a network included only a single host computer and a variety of communications controller, cluster, and terminal nodes. Combining the ACF/NCP/VS program product with the 3705, systems network architecture (SNA), and access methods such as ACF/TCAM/VS or ACF/VTAM/VS, provides a flexible approach to the design of single-system and multi-system data communication networks. See Figure 1-4.

This combination of IBM products offers:

- Continuous growth potential from small to large single-system networks, and from single system networks to a multi-system network
- A choice of access methods: such as ACF/TCAM/VS or ACF/VTAM/VS
- Compatibility with existing application programs that use the current levels of TCAM and VTAM
- Coexistence with other access methods
- Increased access to information and host processing
- Extended sharing of resources across domains
- Elimination of redundant application programs in two or more domains
- Application program transparency of the location of a terminal involved in cross-domain communication
- Continuation of cross-domain operations following some failures in the network
- Possible decrease in communication line costs by utilizing cross-domain resources
- Backup capability for critical applications or devices

Figure 1-4 shows a simple multi-system data communication network. In the context of the large network, the original networks are treated as domains, each managed by a system services control point (SSCP). For a thorough description of networking, refer to *An Introduction to Advanced Communications Function, GC30-3033*.

Emulation Program

IBM provides an emulation program (EP) to run in controllers attached to a host processor channel. This program emulates most functional operations of the IBM 2701 Data Adapter Unit, the IBM 2702 Transmission Control, and the IBM 2703 Transmission Control, and allows many programs written for operation with the 2701, 2702, and 2703 to operate with the controllers without modification.

The emulation program can communicate with access methods running in a System/360 or System/370. Chapter 4 describes the emulation program in more detail.

The *NCP Generation and Utilities* and *EP Generation and Utilities* manuals provide information on defining network control programs and emulation programs, and on using the support programs. See Appendix D for descriptions of these manuals.

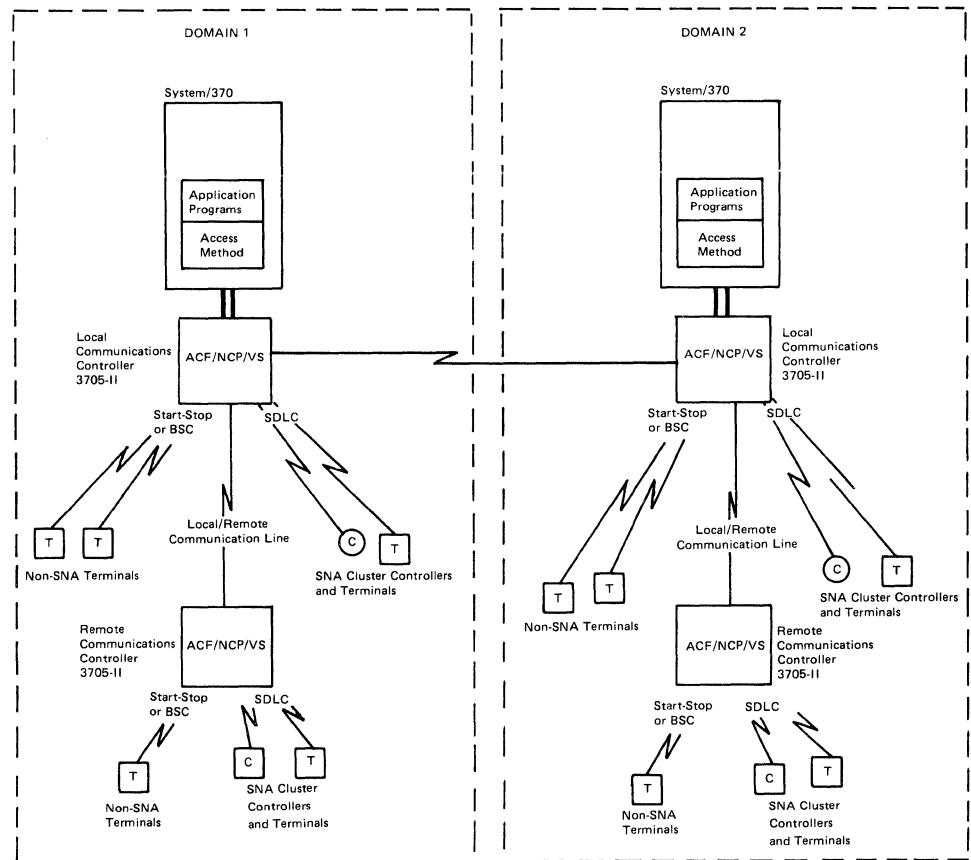

Figure 1-4. A Multi-System Data Communication Network

Partitioned Emulation Programming Extension

A feature of both the licensed and non-licensed versions of the NCP is called the partitioned emulation programming (PEP) extension. The PEP extension allows the program to operate some communication lines in network control mode while operating others in emulation mode. An NCP with the PEP extension can be executed only in a local controller. The program communicates with one or more access methods in the System/370 host processor. Chapter 5 contains additional information about the partitioned emulation programming extension.

System Support Programs

In addition to the network control and emulation programs, IBM system support programs are available. These programs, which are executed in the processing unit, generate control programs, load them into controller storage, and dump controller storage. Chapter 6 specifies the operating systems under which the support programs run and describes their functions. For information about system support programs used with ACF/NCP/VS, refer to *ACF/NCP/VS (Network Control Program and System Support Programs) General Information (GC30-3058)*.

A Compatible Family

The various models of the 3704 and the 3705 make up a compatible family of communications controllers that provides a data communication entry for every type of installation, from the completely new user to the large user with an existing network. The controllers offer a path for conversion from existing systems and for continuing data communication growth.

The 3704 is designed primarily for installations that do not require more than 32 communication lines. The emulation program eases the transition from an IBM 2701 and 2702 to the 3704.

The 3705 is designed for large and small installations. The controller offers the user a convenient means of increasing the size of a network. The emulation program and both the NCP/VS and ACF/NCP/VS with PEP allow conversion from the 2701, 2702, and 2703 to the 3705.

Figure 2-1 in Chapter 2 summarizes the differences between the 3704 and 3705 controllers in number of communication lines, maximum line speeds, and storage capacity available.

Transition from a 3704 to a 3705 is eased by the compatibility of the IBM-supplied programming support for the two machines. The NCP/VS for either the 3704 or the 3705 can be generated from the same library of network control program modules; only one library of emulation program modules is required for both machines. The NCP/VS generated for the 3704 could be executed by a 3705 with the same configuration of communication lines and adapter hardware, provided the amount of storage installed is adequate. Conversely, an NCP/VS generated for the 3705 could be executed by a 3704, if both are equipped with the same types of scanners and channel adapters, and both have sufficient storage. The support programs for the NCP/VS and emulation programs are identical for the 3704 and the 3705. Likewise, an access method that communicates with the 3704 will communicate with an identically configured 3705.

The ACF/NCP/VS program is not available for IBM 3704 Communications Controllers.

The Controllers Are Flexible

Flexibility is one of the principal advantages of the 3704 and 3705 controllers. Both the hardware and network control programs are designed to allow a high degree of flexibility in configuring the data communication subsystem to meet the particular requirements of most installations.

The 3704 and 3705 can communicate with many types of network stations and terminals using both synchronous and asynchronous line-control disciplines at various line speeds. For information on line speeds and line sets, refer to Chapter 2 and Appendix C. For a list of stations supported, refer to Appendixes A and B. The network control programs recognize and translate a variety of transmission codes, including ASCII, EBCDIC, EBCD, BCD, and Correspondence Code.

Hardware Flexibility

A maximum of 32 asynchronous communication lines for half-duplex operation can be attached to the 3704. A maximum of 352 lines for half-duplex operation can be attached to the largest model of the 3705. These limits include any local/remote communication links. Each duplex local/remote communication link decreases by two and each half-duplex local/remote communication link decreases by one the number of communication lines available for communicating with stations in the network in half-duplex mode. The actual number of communication lines that the controllers can support depends upon performance factors and the combination of features chosen.

In addition, the line-attachment hardware provided for the controllers allows many different types of communication lines to be attached through a single line scanner. Lines are available in pairs (and in some cases, singly). This characteristic allows considerable latitude in the number of line types that can be attached to the controllers. This is especially advantageous when an installation requires a few lines of several different types. In many cases, such a network requires only a minimum of line-attachment hardware.

The 3705 hardware offers additional flexibility in the choice of channel adapters and line scanners (called *communication scanners* in the controllers). Depending upon the anticipated throughput and type of system attachment desired, you can choose between four types of channel adapters and four types of communication scanners. Three types of communication scanners and three types of channel adapters offer high throughput and performance capabilities. The other type of each one, which costs less but can handle less throughput, is suitable for use with smaller networks. The 3704 is available with two types of communications scanners and offers only the low-throughput channel adapter.

Programming Flexibility

Further contributing to the flexibility of the 3704 and 3705 controllers are the network control programs, which you can adapt to the requirements of your installation. The network control program functions include a wide range of facilities to control the data communication subsystem. In addition, a number of optional functions can be performed by the network control program or by the access method, or, in some cases, omitted entirely.

In performing its functions, the control program interacts with the communication scanners and the channel adapters to control the flow of data through the data communication subsystem. Figure 1-5 illustrates the data flow to and from the terminal and the host processor through the various parts of the controller.

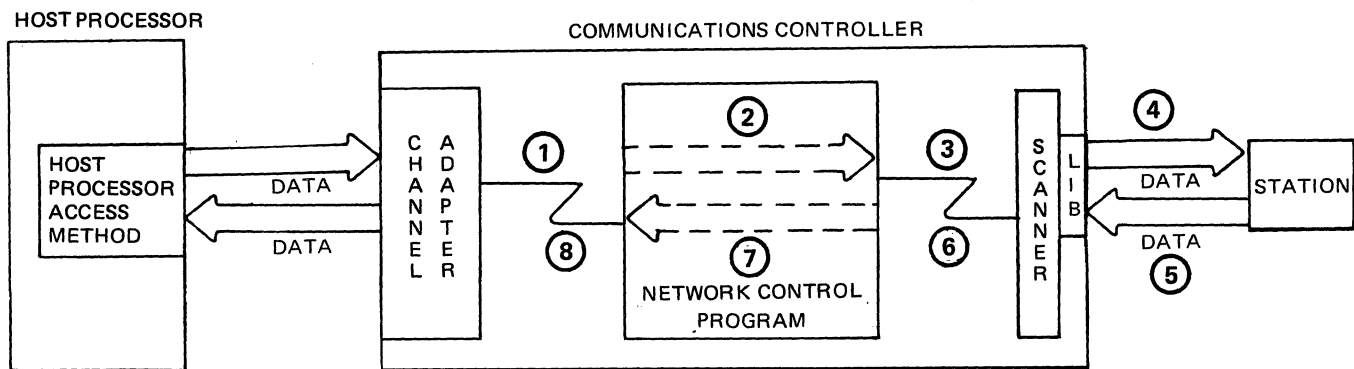

- | | |
|---|--|
| ① Channel adapter notifies NCP as data arrives. | ⑤ Station sends data to the controller. |
| ② NCP processes data, prepares it for station. | ⑥ Communication scanner notifies NCP as data arrives. |
| ③ NCP activates communication scanner when data is ready to be sent to station. | ⑦ NCP processes data, prepares it for host processor. |
| ④ Data is transmitted across communication line to station. | ⑧ NCP activates channel adapter when data is ready to be sent to host processor. |

Figure 1-5. System Data Flow

You describe the network control program that meets the requirements of your installation by using a high-level macro language. This language gives you control over many of the operating characteristics of the data communication subsystem. You control some characteristics by specifying particular values for certain network control program parameters or specific functions to be included in or excluded from the program. You control other characteristics indirectly, depending on the network and the options you specify. For example, you need not specify the order in which communication lines are scanned for service requests. The scanning scheme is determined internally by the network control program generation procedure using a combination of factors that you specify in describing the network.

Since the scanning mechanism is program-controlled, the controller's scanning hardware need not be rewired for every change in network configuration. When new communication lines are added to the network, any modifications to the scanning scheme are made automatically when the network control program is regenerated to include the new lines.

This characteristic also permits the generation of several different network control programs to handle different subsets of communication lines, all attached to the same controller. The program currently resident in the controller determines which lines are scanned and in which order, depending upon the parameters specified when that program was generated.

Flexibility in the network control program is increased by the ability to change certain network characteristics dynamically, that is, during execution of the program. The access method can issue special commands to the program to make changes such as activating and deactivating communication lines. This allows you to modify the data communications subsystem as the demands of the network change.

A principal advantage of a network control program with the partitioned emulation programming (PEP) extension is the ability to operate the same communication line alternately in network control mode and emulation mode. Changes from one mode to the other are made during program execution, by command from the access method. Alternate operation requires that the stations connected to the line be supported in both network control mode and emulation mode. (Appendixes A and B list the types of stations supported in each mode.) In addition, you must specify, during program generation, that the line is to be operable in either mode.

The Controllers Are Modular In Design

Much of the flexibility of the controllers comes from the modular design of the hardware and the network control program. Such modularity allows the controllers to grow easily to meet the needs of an expanding data communication subsystem.

Both the 3704 and the 3705 offer storage in increments that can be ordered according to the needs of the particular installation. They also offer a wide range of choices in line-attachment hardware.

The controller is available in models—four for the 3704 and sixty-four for the 3705—that allow expansion of the data communication network. The various models of the 3705 also offer options in the number of channel adapters and communication scanners you can order, in addition to the amount of storage and line-attachment hardware.

Also, the network control program is designed in modules that are selected according to the requirements of the network. Since no data communication subsystem requires all the facilities of the network control program, you can specify through the program generation language only those facilities that your particular installation needs. The generation procedure automatically selects the appropriate modules to perform those functions.

The Controllers Offer High Availability

Many characteristics of the controller hardware and the network control program work together to ensure that availability of the controller to perform its normal data communication functions is high.

For example, the network control program provides error recovery procedures (ERPs) that can recover from many intermittent hardware or transmission errors. In most cases, the controller remains available to the rest of the network while the ERPs are being executed.

Some hardware options also increase the availability of the controllers. For example, three types of channel adapters have a two-channel switch feature that allows each of them to be attached to two host processor channels at once. If one channel fails, the channel adapter can be manually switched to the second channel. (This feature does not provide for simultaneous operation over both channels.)

An option that further increases availability in the larger models of the 3705 is their ability, when executing a network control program, to support four channel adapters. This feature allows physical attachment to four different host processors. If one host processor or channel adapter fails, the network control program can be switched to another channel adapter either by command from the host access method or by reloading the NCP using an alternate channel adapter.

One type of channel adapter allows the 3705 to be attached to both processing units of a tightly-coupled multiprocessor through one channel adapter. The 3705 appears as the same I/O unit to each processing unit and can be accessed alternately by each processing unit in exactly the same manner. This facility allows the access methods for the 3705 (ACF/TCAM/VS or ACF/VTAM/VS, for example) to run in either processing unit with the path from the 3705 being transparent to the access method. This type of channel adapter can also provide an alternate path when attached to a uniprocessor.

For attachment of the communication lines, the 3705 can have up to four communication scanners. If one of the scanners fails, only those communication lines attached to it are affected; under most circumstances, the rest of the network can continue to operate as usual.

The Controllers Conserve Processing Unit Resources

The controllers, when executing a network control program, can take over many functions that were previously performed by the data communications access method. In doing so, they free resources in the host processor to handle more local processing jobs. The advantages to the host processor increase as the size of the communications network increases.

Most of the advantages to the host processor come from the removal of line-control and buffering functions from the access method to the controller. Much of the line-control information previously maintained by the access method in control blocks is now maintained by the network control program. In addition, the controller buffers data as it arrives from the stations and sends it to the host processor in blocks. Consequently, the access method can allocate buffers after an entire block has arrived from a station, and empty buffer space in host storage is no longer tied up while data is being transmitted over the communication lines. Buffer requirements for the access method are therefore reduced, especially when input from the network is high.

The network control program can also take over some of the processing functions, such as date-and-time insertion, previously assigned to the access method. Including these functions in the network control program saves the host processor both the time and the main storage required by the processing programs.

The Controllers Use a Single Subchannel Address

A local controller, when executing a network control program, occupies a single control-unit position on the channel and requires only a single subchannel address to communicate with the host processor. (The emulation program requires a separate subchannel address on a byte-multiplexer channel for each communication line in the network.) Therefore, if the controller is operating under control of NCP/VS or ACF/NCP/VS, many subchannel addresses are still available for the attachment of other peripheral I/O equipment, and the channel facilities can be better utilized.

Also because of this characteristic, the 3705 with the network control program can be attached to a System/370 selector or block multiplexer channel, regardless of the number of communication lines in the network. This capability is advantageous to a data communication subsystem with high-speed communication lines and high throughput requirements.

The Design of the Controllers Increases Reliability and Reduces Overhead

The controllers are designed so that data are transferred between remote stations and the host processor with maximum reliability and efficiency. The controllers have four interrupt levels, performing those functions that are most critical at the highest priority level. Correspondingly, the network control program has five program levels, the first four paralleling the hardware interrupt levels, the fifth performing the functions that are not critically time-dependent.

As an example of the type of priorities established by the interrupt scheme, the first interrupt level (both hardware and program) handles those situations that require immediate attention—hardware and program checks and requests for IPL (initial program load), among others. If these conditions are not resolved immediately, normal operation of the controller is impossible. Therefore, they receive highest priority.

The most critical of the normal data communication functions are handled at the second interrupt level. These are the servicing of the communication lines and the handling of data as it arrives and leaves. The controller hardware and the control program interact very closely at this level to ensure data integrity.

The controllers have four groups of eight general registers. One group is associated with each of the three lower program levels, and the fourth is shared by the first two program levels. This feature eliminates much of the overhead involved in saving and restoring register contents when passing control from one level to another. Therefore, the controllers can devote more time to the network-control functions.

Three types of channel adapters use *cycle steal* to transfer data. Cycle steal allows the channel adapter to transfer data to or from storage without interfering with the logic of the control program. Program execution is simply suspended for the length of one machine cycle, during which the data is transferred. Thus the overhead involved in regular program interrupts is eliminated.

The Controllers Provide Many Error Recovery and Diagnostic Facilities

The network control program has a number of error recovery procedures and diagnostic facilities to enhance the reliability and serviceability of the controllers.

Some error recovery procedures (ERPs) are executed automatically by the network control program when a transmission error occurs. If these procedures fail to recover from the error, the program can perform other ERPs. In some cases, the program can notify the access method of the error and allow the access method to try to solve the problem.

The network control program also collects statistics on errors that occur for each line and sends these statistics to the host processor when a given count is reached.

Other diagnostic aids are also available for the controllers. Online terminal tests can be executed for the stations in the data communication network. In addition, a diagnostic wrap facility enables the controller to test the communication line attachment hardware to determine whether problems are in the controller hardware or in the communication lines.

BLANK

Chapter 2: Communications Controller Hardware Concepts

This chapter describes segments of hardware that make up the IBM 3704 and 3705 controllers. Figure 2-1 summarizes the differences between the two machines. Specific differences between the models of the 3705 are shown in Appendix E.

The 3704 Hardware

The 3704 consists of a single module that contains the central control unit; the control panel; storage ranging from 16K (16,384) bytes to 64K (65,536) bytes in 16K increments; a communication scanner; the line-attachment hardware necessary to connect as many as 32 communication lines for half-duplex operation; and a channel adapter for attachment to an IBM System/360 channel or System/370 channel. Figure 2-3 illustrates the maximum configuration of the 3704. A brief description of the function of each segment of hardware follows.

The Central Control Unit

The central control unit contains the circuits and data-flow paths needed to execute the 3704 instructions and to control 3704 storage and the attached adapters. It also includes a storage-protection mechanism. The central control unit operates under the control of the program resident in the 3704.

	<u>3704</u>	<u>3705</u>
Maximum number of lines for half-duplex operation	32	352
Maximum local to local line speed in bits per second (without modems attached)	2400	57,600
Maximum communication line speed in bits per second (with modems attached)	50,000	230,400
Number of communication scanner types available	2	4
Maximum number of communication scanners installable	1	4
Number of channel adapter types available	1	4
Maximum number of channel adapters installable	1	4
Range of storage capacity	16K-64K	16K-512K
Size of storage increments	16K	32K (Models A-H) 64K (Models J-L)

Figure 2-1. Summary of Differences between 3704 and 3705 Controllers

The Control Panel

The 3704 control panel contains the switches and indicators necessary to control certain 3704 functions manually. Some of the functions provided by the control panel are the ability to store and display information in 3704 storage and registers; the control and indication of power; indications of controller status; operator/controller communication controls; and diagnostic controls. Like the 3705, the unit protection lock switch and remote power off features are available for remote 3704 controllers.

3704 Storage

Storage in the 3704 is available in 16K increments up to 64K bytes. The base machine includes 16K bytes of storage. To install storage above 16K, an expansion feature is required.

The amount of storage in the 3704 is designated by 3704 models. Figure 2-2 shows the model names and amount of storage in each.

Model	Maximum Number of Half-Duplex Lines	Amount of Storage (Bytes)
A1	32	16K
A2	32	32K
A3	32	48K
A4	32	64K

Figure 2-2. Communication Line and Storage Capacities of the 3704 (by Model)

The 3704 Channel Adapter (Local 3704 Only)

The 3704 provides a single channel adapter, the type 1 channel adapter, for attachment to an IBM System/360 or System/370 byte-multiplexer channel. This channel adapter operates the same as the type 1 channel adapter for the 3705.

The channel adapter can have the two-channel switch feature, which allows the 3704 to be attached to two channels. (The channels can be attached to the same host processor or two different host processors.) However, only one of the channels can be enabled for operation at a time. The channel to be enabled is selected by means of a manual switch on the 3704 control panel.

Remote Program Loader (Remote 3704 Only)

A 3704 used as a remote controller requires a remote program loader instead of a channel adapter. The remote program loader makes it possible to load a network control program (NCP/VS) from the host processor, via the local controller and the local/remote communication link. The remote program loader includes a small auxiliary storage device and a read-only storage unit. The auxiliary storage device contains loading, dumping, and diagnostic routines.

A 3704 equipped with a remote program loader cannot have a channel adapter.

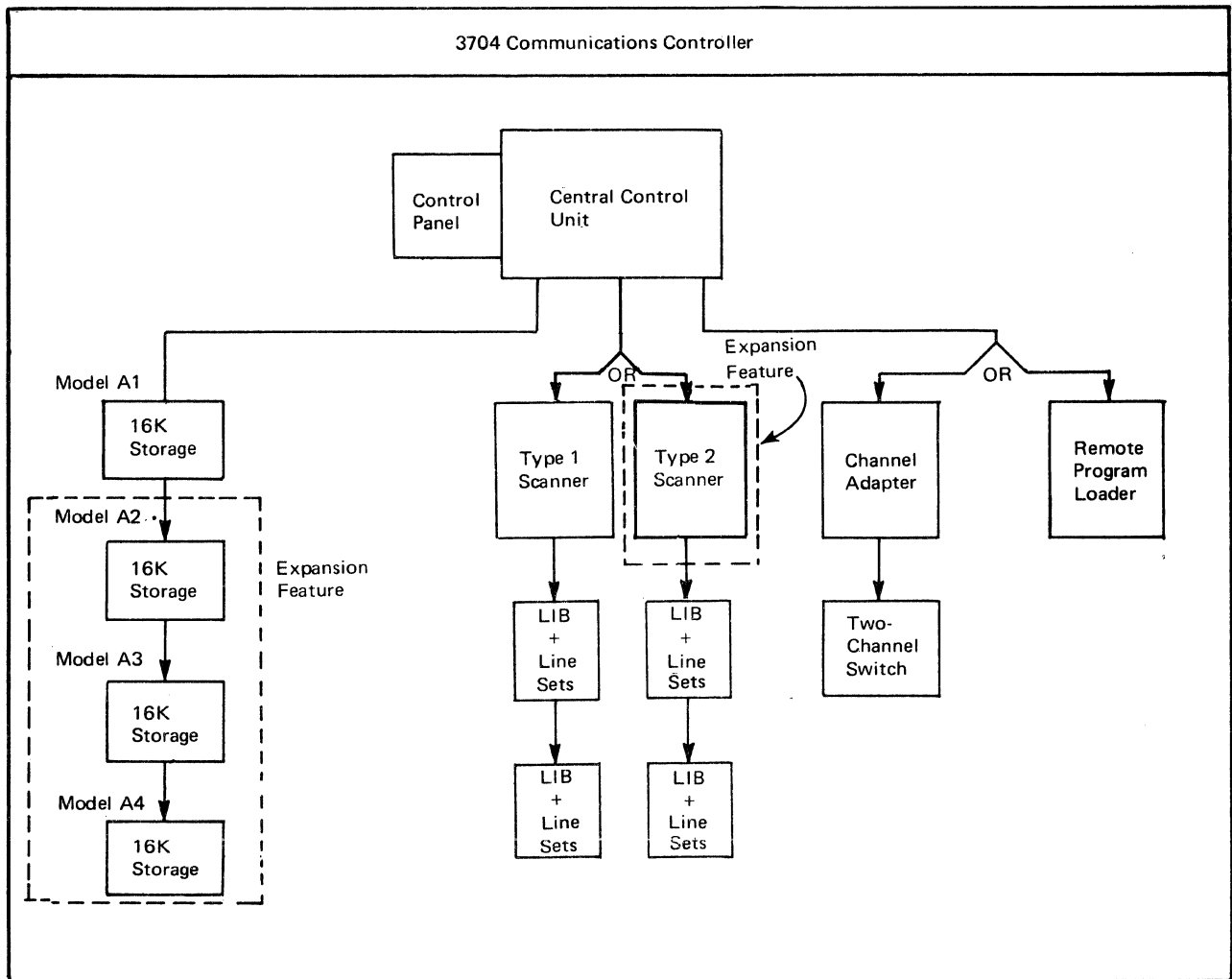

Figure 2-3. Maximum Hardware Configuration of the 3704

Communication Scanners

The 3704 can be equipped with either a type 1 or a type 2 communication scanner.

The type 1 scanner interrupts the control program for each bit that arrives or leaves over a communication line. The program assembles and disassembles characters.

The type 2 scanner interrupts the program only when an entire character has been received from or transmitted onto the communication line. The scanner hardware assembles and disassembles characters.

For either scanner, the actual limit on the number of communication lines that can be attached depends upon the speeds required; the higher the maximum speeds, the smaller the number of lines the scanner can handle.

Communication scanners service local/remote communication links as well as communication lines to remote stations. The scanner servicing a local/remote communication link may be either type 1 or type 2.

Line Interface Bases

Communication lines are attached to the 3704 through line interface bases (LIBs). One or two LIBs can be installed in the 3704. Depending upon the type of line termination, as many as 16 communication lines can be attached through one LIB.

Communication lines are attached to LIBs through line sets. A single line set may provide the interface for one or two communication lines depending upon the type of interface. The types of LIBs and line sets available for the 3704 are described in Appendix C, "3704 and 3705 Line Interface Bases and Line Sets". The characteristics of the interface between the line sets and common-carrier facilities are described in the *Original Equipment Manufacturers' Information* publication (GA27-3053).

Extended Environment Feature (Remote 3704 Only)

A 3704 equipped with the remote program loader may have the extended environment feature, which allows the controller to operate in a location without air conditioning. The minimum ambient temperature is 10° C (50° F); the maximum is 38° C (100° F). Without the extended environment feature, the allowable temperature range is 15.5° C (60° F) to 32.2° C (90° F).

The 3705 Hardware

The IBM 3705 consists of up to four frames and is available in 64 models, based on the number of frames, amount of storage, and physical line-attachment capability. Each model is designated by a letter and a number, such as J1. Refer to Appendix E for information and charts showing the hardware configurations available for models of both the 3705-I and the 3705-II.

3705-I Hardware

The 3705-I is available in 20 models and can consist of up to four frames, as shown in Appendix E. In all of the models, the first frame contains a central control unit with a cycle time of 1.2 microseconds and at least 16K bytes of core storage. The first frame of a 3705-I can contain an additional 32K bytes of storage (the maximum storage capacity of frame 1 is 48K bytes). In addition, the first frame contains provisions for mounting a channel adapter or a remote program loader, a communication scanner, and LIBs and line sets.

The second frame of a 3705-I can contain, in increments of 32K bytes, a maximum of 64K bytes of core storage (see Appendix E). The second frame also has provisions for mounting a channel adapter, a communication scanner, and LIBs and line sets.

The third and fourth frames of a 3705-I contain provisions for mounting a communication scanner and LIBs and line sets. In addition, each frame can contain, in 32K byte increments, a maximum of 64K bytes of core storage. Channel adapters cannot be installed in either the third or the fourth frame of a 3705-I.

3705-II Hardware

The 3705-II is available in 44 models and can consist of up to four frames, as shown in Appendix E. In all of the models, the first frame contains a central control unit with a cycle time of either 1.0 microsecond (Models E–H) or 900 nanoseconds (Models J–L). In addition, the first frame of all models contains a control panel, at least 32K bytes of monolithic storage, and provisions for mounting channel adapters, LIBs and line sets, a communications scanner, and a remote program loader. Maximum storage capacity of the first frame is 256K bytes.

The second frame of a 3705-II has provisions for mounting channel adapters, a communication scanner, and LIBs and line sets. In addition, the second frame of Models J–L can contain, in increments of 64K bytes, up to 256K bytes of monolithic storage (see Appendix E).

The third and fourth frame of a 3705-II have provisions for mounting a communication scanner (one per frame) and additional LIBs and line sets. Channel adapters and monolithic storage cannot be installed in either the third or the fourth frame of a 3705-II.

Unless noted otherwise, the following hardware items are available for both the 3705-I and 3705-II and can be field installed.

- Monolithic storage
- 900 nanosecond cycle time (see Notes 1 and 2)
- Cycle utilization counter on 3705-II, Models J, K, or L (see Notes 1 and 2)
- High speed local attachment, 14,400 or 57,600 bps
- Type 1 channel adapter with two-channel switch
- Type 2 channel adapter with two-channel switch
- Type 3 channel adapter
- Type 4 channel adapter with two-channel switch
- Type 1 communication scanner (see Note 3)
- Type 2 communication scanner
- Type 3 communication scanner
- Type 3HS communication scanner, 230,400 bps (see Note 2)
- Remote program loader
- LIB Types 1–12 and available line sets (described in Appendix C)

Notes:

1. This hardware item is available on an RPQ basis for the 3705-II, Models E–H.
2. This hardware item cannot be installed on a 3705-I.
3. This hardware item cannot be installed on a 3705-II.

Models of the 3705 can be upgraded to larger models at the user's installation.

Appendix E contains configuration charts of the 3705 hardware. A brief description of the functions of each segment of the hardware follows.

The Central Control Unit

The central control unit contains the circuits and data-flow paths needed to execute the 3705 instructions and to control 3705 storage and the attached adapters. It also includes a storage-protection mechanism. The central control unit operates under the control of the 3705 control program.

The Control Panel

The 3705 control panel contains the switches and indicators necessary to control certain 3705 functions manually. Some of the functions provided by the control panel are the ability to store and display information in 3705 storage and registers; the control and indication of power; indications of controller status; operator/controller communication controls; and diagnostic controls. The 3704 and 3705 *Control Panel Guides* explain how to use the control panel.

A remote 3705 will, in many installations, operate largely unattended. Two useful features are available for a remote 3705: unit protection and remote power off.

The unit protection feature is a lock switch that allows all control panel switches (except Power On/Off) to be disabled. This prevents unauthorized or inadvertent use of the panel to modify the control program being executed.

The remote power off feature allows power to be turned off by command from the host processor (via the local controller). This eliminates the need to have someone present to turn power off manually at the end of the day's operations. Power must be turned on manually, however, at the remote controller's panel.

3705 Storage

3705 Core Storage

Core storage in the 3705-I, Models A-D, ranges from 16K bytes (16,384) to 240K bytes (245,760) in 32K increments. The storage capacity increases as the model number increases, as shown in Appendix E.

3705 Monolithic Storage

One 32K byte unit of monolithic storage is always installed in the first frame of a 3705-II. As the models increase in size, additional 32K byte units of monolithic storage are installed in the first frame. A maximum of eight 32K units of storage (256,000 bytes) can reside in the first frame. The first frame of a 3705-II Model J, K, or L, always contains 256K bytes of storage, and the second frame contains at least 64K bytes of storage. Three additional 64K byte units of storage are available for the second frame of Models J-L (maximum capacity of the second frame is 256,000 bytes). Therefore, the storage in a 3705-II ranges from 32K bytes to 512K bytes, as shown in Appendix E. Monolithic storage cannot be installed in the third or fourth frame of a 3705-II.

Cycle Utilization Counter

The cycle utilization counter is a standard feature only for 3705-II, Models J-L (see Note). This counter, operating under a release of ACF/NCP/VS (an IBM program product), allows a user to measure 3705 utilization by counting the machine cycles used for cycle steal operations, instruction execution, and maintenance operations. The cycle utilization counter (a 15-bit binary counter) advances by one each time the 3705 completes eight machine cycles.

Note: The cycle utilization counter is available on an RPQ basis for Models E-H of a 3705-II.

High-Speed Local Attachment

The high-speed local attachment is a special feature of the 3705-II. It includes a 1W and 1Z line set (see Appendix C for line set descriptions), internal clock rates of either 57,600 Hz or 14,400 Hz, and a cable. The high-speed local attachment allows communication (without modems) over a half-duplex or a full-duplex line connecting either two 3705s or a 3705 and a batch-oriented terminal. For example, two 3705s can communicate at a line speed of 57,600 bps or 14,400 bps, or a 3705 can communicate with a terminal at a line speed of 14,400 bps or 57,600 bps.

Channel Adapters

Channel adapters are used to attach the 3705 controller to a host processor channel. The channel adapter interacts with the control program in the controller to transfer data across an I/O channel to and from the host processor.

Four types of channel adapters are available for the 3705 communications controller.

Type 1 Channel Adapter

The type 1 channel adapter handles a relatively low volume of throughput and requires intervention from the 3705 control program for each data transfer burst. It is, however, adequate for many small networks and costs less than the type 2, type 3, or type 4 channel adapters. The type 1 channel adapter can only be installed in the first frame of a 3705. Refer to Appendix E.

The type 1 channel adapter can have a two-channel switch. The characteristics of the two-channel switch are described later in this chapter.

The type 1 channel adapter provides attachment to an IBM System/360 or System/370 byte-multiplexer channel.

Type 2 Channel Adapter

The type 2 channel adapter operates under control of the network control program only. All data transfers between a type 2 channel adapter and storage in the 3705 are in cycle steal mode. The type 2 channel adapter requires less intervention from the 3705 control program than the type 1 channel adapter.

The type 2 channel adapter provides attachment to an IBM System/370 selector, byte-multiplexer, or block-multiplexer channel.

The type 2 channel adapter provides attachment to an IBM System/370 selector, byte-multiplexer, or block-multiplexer channel and can have a two-channel switch if it is the only type 2 channel adapter in frame 1 or frame 2 of a 3705. The characteristics of the two-channel switch are described later in this chapter.

Type 3 Channel Adapter

The type 3 channel adapter operates under control of the network control program only. The type 3 channel adapter provides the same capabilities as the type 2 channel adapter. In addition, the type 3 channel adapter can be attached to two host processor channels. These two channel interfaces can be simultaneously enabled, and alternate (though not simultaneous) operation over the two interfaces is permitted. When a channel I/O operation over one channel interface is being executed, an I/O initiation attempt by the second channel (attached through the type 3 channel adapter's second interface) causes a Busy status to be presented over that interface. Having given a Busy status, the adapter generates an asynchronous Device End when the I/O operation causing the Busy state has been completed on the opposite channel interface.

The type 3 channel adapter can be enabled to either interface or to both at the same time. Enabling and disabling of the channel interfaces are controlled by manual switches located on the 3705 control panel. A pair of enable/disable switches exists for each type 3 channel adapter (one for each channel interface).

Type 4 Channel Adapter

A type 4 channel adapter has three modes of operation.

In its reset state, a type 4 channel adapter is functionally equivalent to a type 1 channel adapter. This allows control programs written for the type 1 channel adapter to be used with the type 4 channel adapter.

In extended buffer mode, the type 4 channel adapter can transfer a maximum of 32 bytes of data across the channel during each data transfer burst. The emulation program user can choose, through an EP generation option, the number of bytes of data the EP is to pass to the channel adapter each time the appropriate level 3 channel adapter interrupt occurs. In this case, the user has a choice of 4, 8, 16, or 32 bytes. The non-licensed IBM program (NCP/VS) has no generation option to control the amount of data passed to the channel adapter; it always transfers four bytes.

In cycle steal mode, a type 4 channel adapter handles a larger volume of throughput and requires less intervention from the 3705 EP or NCP control program than a type 1 channel adapter or a type 4 channel adapter in extended buffer mode.

Appendix E summarizes the permissible combinations of the type 4 channel adapter with other channel adapters and scanners.

A type 4 channel adapter can have a two-channel switch when it is the only adapter in frame 1 or frame 2 of a 3705. The characteristics of the two-channel switch are described later in this chapter.

The type 4 channel adapter provides attachment to a selector, byte-multiplexer, or block-multiplexer channel of a System/370, or to a byte-multiplexer channel of a System/360.

With any type of channel adapter, a 3705 executing the network control program appears as a single control unit on the channel and uses a single subchannel address. The emulation program requires multiple subchannel addresses and can be used only with a type 1 or a type 4 channel adapter.

Network Control Program Support for the Channel Adapters

The non-licensed IBM network control program (NCP/VS) can be used with either a type 1, type 2, type 3, or type 4 channel adapter. However, NCP/VS can contain the code for only one type of channel support at a time: type 1 support (for either the type 1 or type 4 channel adapter) or type 2 support (for either the type 2 or type 3 channel adapter). Therefore, if the 3705 is equipped with either a type 1 or type 4 channel adapter and either a type 2 or type 3 channel adapter, the nonsupported channel adapter should be disabled when the 3705 is operating in network control mode.

Emulation Program Support for the Channel Adapters

The emulation program can operate only with a type 1 or type 4 channel adapter. Therefore, when a 3705 is equipped with either a type 1 or type 4 channel adapter and either a type 2 or type 3 channel adapter is operating with the stand-alone version of the emulation program, the type 2 or type 3 channel adapter should be disabled.

Partitioned Emulation Support for the Channel Adapters

A network control program with the PEP extension can contain the code to support a type 1 or type 4 channel adapter and a type 2 or type 3 channel adapter. (Operation in emulation mode is possible only with the type 1 or type 4 channel adapters.) If the 3705 is equipped with a type 1 or a type 4 channel adapter and a type 2 or type 3 channel adapter, the type 1 or type 4 adapter handles data interchanges for communication lines in emulation mode, and the type 2 or type 3 adapter handles data interchanges for those in network control mode.

The Two-Channel Switch Feature

The type 1, type 2, and type 4 channel adapters can have a two-channel switch. With this feature, the 3705 can be attached to two channels through one channel adapter. (The channels can be attached to the same processing unit or to two different processing units.) However, only one of the channels can be enabled for operation at a time. The channel to be enabled is selected by means of a manual switch on the 3705 control panel.

If two channel adapters are installed and both have a two-channel switch, the 3705 can be attached to four channels (and, consequently, to as many as four host processors).

The two-channel switch feature for the type 1, type 2, and type 4 channel adapters should not be confused with the enable/disable switches for the type 3 channel adapter.

Remote Program Loader

The remote program loader must reside in frame 1 of a remote 3705 controller. In a 3705-I, the remote program loader occupies space normally reserved for a channel adapter. The remote program loader makes it possible to load a network control program from the host processor via the local controller and the local/remote communication link. The remote program loader includes a small auxiliary storage device and a read-only storage unit. The auxiliary storage device contains loading, dumping, and diagnostic routines.

The remote program loader must reside in frame 1 of a remote 3705 controller and it occupies space normally reserved for a channel adapter. The remote program loader makes it possible to load a network control program from the host processor via the local controller and the local/remote communication link. The remote program loader includes a small auxiliary storage device and a read-only storage unit. The auxiliary storage device contains loading, dumping, and diagnostic routines.

The remote program loader feature can exist on the 3705-II with either type 1, type 2, type 3, or type 4 channel adapters or without any channel adapter. A maximum of three channel adapters may coexist on a 3705-II with the remote program loader. However, if there are three channel adapters, they must all be type 4s.

The remote program loader feature cannot coexist with a channel adapter on the 3705-I.

Communication Scanners

The communication scanners provide the connection between the communication-line attachment hardware (line interface bases) and the central control unit. The primary function of the scanners is to monitor the communication lines for service requests.

Communication scanners service communication lines between local and remote controllers, as well as lines between local controllers and remote stations. The scanner servicing a communication line between remote and local controllers may be either a type 1, type 2, type 3, or type 3 HS. Consult your IBM representative for information about the transmission codes that can be used with each type of communication scanner.

Type 1 Scanner

The type 1 scanner interrupts the 3705 control program for each bit that arrives or leaves over a communication line. The program assembles and disassembles characters. Only one type 1 scanner can be installed in the 3705.

A 3705 with the type 1 scanner installed, cannot contain any of the other types of communication scanners.

Type 2 Scanner

The type 2 scanner hardware assembles and disassembles characters. It interrupts the control program only when an entire character has arrived on or left from a line.

Type 2 scanners can be mixed with other scanners and channel adapters in the combinations shown in Appendix E. Type 3 scanners cannot be installed with a type 1 scanner.

Type 3 Scanner

The type 3 scanner provides for the attachment of BSC communication lines that operate with either the EBCDIC or the ASCII transmission code (in transparent or nontransparent mode) or for the attachment of SDLC communication lines. In the 3705-I, Models B, C, and D, one type 3 scanner can be installed in the second, third, and fourth frames; with a maximum of three in a Model D; in these models, a type 2 scanner must be installed in

the first frame. A type 3 scanner is not allowed in the first frame of a 3705-I. In a 3705-II, a type 3 scanner can be installed in each of the four frames of a Model H or L.

Type 3 scanners can be mixed with other scanners and channel adapters in the combinations shown in Appendix E. Type 3 scanners cannot be installed with a type 1 scanner or a type 1 channel adapter.

When installed in the first frame of the 3705-II, the type 3 scanner can have up to 48 half-duplex, synchronous communication lines physically attached: when installed in the second, third, or fourth frame of either a 3705-I or a 3705-II, it can have up to 64 half-duplex, synchronous lines attached. The actual number of lines that can operate successfully with the type 3 scanner depends upon many factors, including: line speed, whether the lines are capable of half-duplex or duplex data transmission, and which control program is handling the lines.

The type 3 scanner can operate with the following line interface bases (LIBs): LIB Type 1, LIB Type 8, LIB Type 9, and LIB Type 10. Only the line sets that support synchronous line controls can be used with the type 3 scanner. See Appendix C for a description of the LIBs and line sets.

The type 3 scanner can operate with either the network control program or the emulation program. The scanner interrupts the 3705 control program after receiving or sending an entire buffer of data rather than after each bit or byte. The length of the data to be transferred is provided dynamically by the control program. For the network control program, the maximum buffer length is 248 bytes; for the emulation program, the buffer length may be 4, 8, 16, 32, 64, 96, 160, 192, or 224 bytes.

An added capability of the type 3 scanner is code translation via hardware for BSC lines operating in network control mode. The scanner translates from ASCII to EBCDIC when receiving from the line and from EBCDIC to ASCII when transmitting to the line.

Type 3HS Scanner

The type 3HS scanner allows a 3705-II to operate in BSC or SDLC mode at line speeds up to 230,400 bps. The scanner addresses only two line interfaces, and it operates with a 1GA and 1TA line set on a type 1 LIB.

In the 3705-II, a single type 3HS scanner can be installed in each of the four possible frames. Therefore, a 3705-II, Model H or L, can contain four of the type 3HS scanners.

Although type 3HS scanners cannot be combined with a type 1 scanner or a type 1 channel adapter, it can be mixed with other scanners and channel adapters in the combinations shown in Appendix E.

Attachment Bases

An attachment base is a required feature for support of the 3705 adapters. Two types of attachment bases are available: the type 1 attachment base and the type 2 attachment base.

The type 1 attachment base provides common controls to the central control unit for both the type 1 scanner and the type 1 channel adapter. The type 2 attachment base provides common controls to the central control unit and line addressing controls for the type 2, type 3, and type 3HS scanners.

One or both of the attachment bases are required, depending on the type of scanner and channel adapters installed in the 3705. The requirements are as follows:

<u>Hardware Installed</u>	<u>Attachment Base Required</u>
Type 1 Scanner with Type 1 CA	Type 1 Attachment Base
Type 2 Scanner with Type 1 CA	Type 1 and Type 2 Attachment Base
Type 2, or Type 3, or Type 3HS Scanners with Type 2, Type 3, or Type 4 CAs	Type 2 Attachment Base

Line Interface Bases

Communication lines are attached to the 3705 through line interface bases (LIBs). Several LIB types are available to handle requirements for different types of line terminations. Depending upon the type of line termination, as many as 16 communication lines can be attached through one LIB.

Communication lines are attached to LIBs through line sets. A single line set may provide the interface for one or two communication lines depending upon the type of interface. The types of LIBs and the line sets that can be installed in them are described in Appendix C, "3704 and 3705 Line Interface Bases and Line Sets". The characteristics of the interface between the line sets and common-carrier facilities are described in the *Original Equipment Manufacturers' Information* publication (GA27-3053).

Extended Environment Feature (Remote 3705 Only)

A 3705 equipped with the remote program loader may have the extended environment feature, which allows the controller to operate in a location without air conditioning. The minimum ambient temperature is 10° C (50° F); the maximum is 38° C (100° F). Without the extended environment feature, the allowable temperature range is 15.5° C (60° F) to 32.2° C (90° F).

Internal Air Circulation Features (Remote 3705-I Only)

A remote 3705-I, if equipped with the extended environment feature, also requires the internal air circulation feature for each storage block in the controller. The internal air circulation features provide improved air cooling of the controller storage. A separate internal air circulation feature is required for each storage block in the controller. A 3705-I having 80K bytes of storage, for example, requires three internal air circulation features: one for the first 16K storage block and one for each of the two 32K blocks.

BLANK

Chapter 3: Network Control Program Concepts

The network control program (NCP) resides in the communications controller to control the transfer of data between the stations in a data communication network and the host processor. At least 48K bytes of storage are required to run the NCP/VS program; therefore, 3705 Model A2, B2, C2, D2, or higher, or 3704 Model A3 or A4 must be installed.

The primary functions of the network control program are related to the transmitting and receiving of data. In addition, for start-stop and binary synchronous (BSC) stations, the program can optionally process the data passing through the controller, either by means of IBM-supplied processing programs or by user-coded programs.

The network control program includes routines to attempt error recovery, to record error statistics, and to perform diagnostic tests. These routines enable the program to recover from many transmission errors without user intervention. When irrecoverable errors occur, these routines aid in finding the source and correcting the error.

The network control program performs the preceding functions whether it is executed by a local controller or by a remote controller. The NCPs in the local and remote controllers are called respectively the *local* NCP and the *remote* NCP. Each program performs the message control function for its respective controller.

The network control program interacts with the communication scanners and the channel adapters to control the flow of data through the data communication subsystem. Interaction with the adapters occurs through interrupt mechanisms. Figure 3-1 illustrates data flow between a station and a processing unit through a single controller attached to a host processor channel. Figure 3-2 shows the data flow through a local and a remote controller.

The network control program communicates with the access method in the host processor to control the logical flow of data. The interface between the two programs is a field of control information. Each block of data passing between the controller and the host processor is preceded by control information that identifies the data. Control information can also be sent alone by the access method to request operations from the network control program. Conversely, the program can send control information to the access method to signal completion of an operation or to report the status of an element of the data communication network. Message data may or may not follow the control information. Figure 3-3 shows how the network control program and the access method communicate with each other. The attached data is optional, depending on the operation. The local program inspects the control information field of each block received from the access method. By doing so, it determines which controller is to transmit the block to the receiving station. (In the control information field the access method must specify both the receiving station and the controller to which that station is connected.)

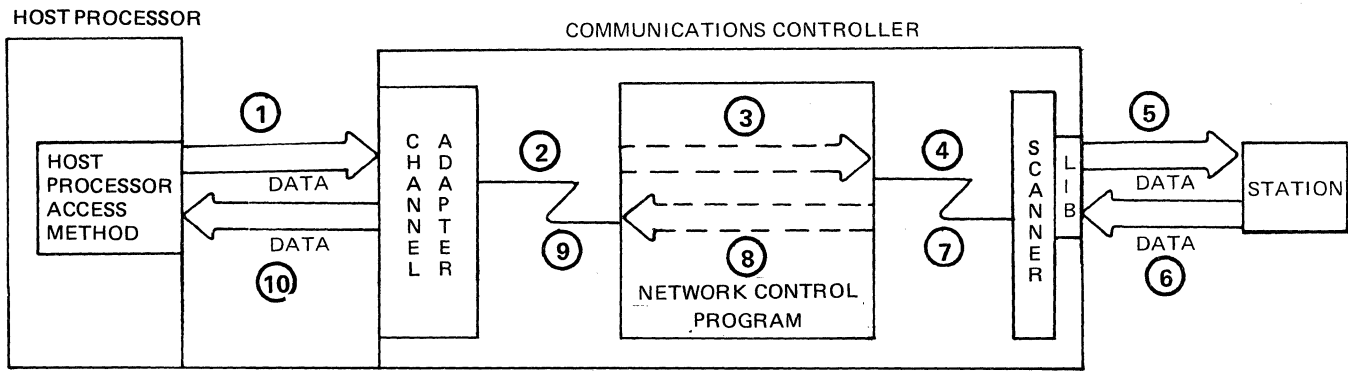

KEY

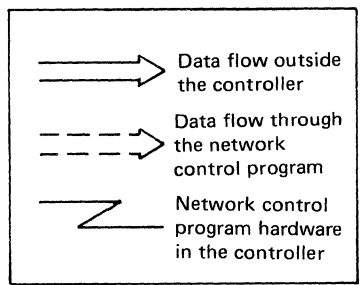

Host Processor to Station

Station to Host Processor

- | | |
|---|--|
| <ul style="list-style-type: none"> ① Host processor sends data to the controller. ② Channel adapter notifies network control program as data arrives. ③ Network control program processes data, prepares it for station. ④ Network control program activates communication scanner when data is ready to be sent to station. ⑤ Data is transmitted across communication line to station. | <ul style="list-style-type: none"> ⑥ Station sends data to the controller. ⑦ Communication scanner notifies network control program as data arrives. ⑧ Network control program processes data, prepares it for host processor. ⑨ Network control program activates channel adapter when data is ready to be sent to host processor. ⑩ Channel transfers data to host processor. |
|---|--|

Figure 3-1. Data Flow between a Host Processor and a Station through a Local Controller

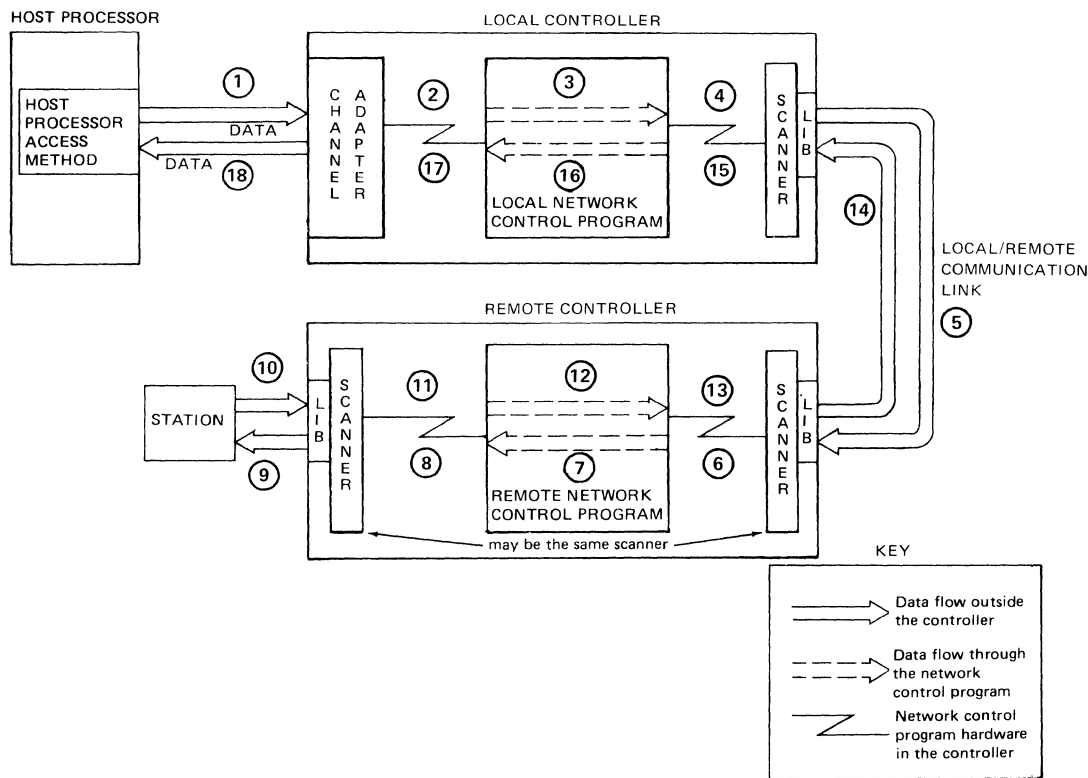

Host Processor to Station

- ① Host processor sends data to local controller.
- ② Channel adapter notifies network control program as data arrives.
- ③ Local network control program determines that destination of data is a station connected to the remote controller.
- ④ Local network control program activates communication scanner when data is ready to be sent to remote controller.
- ⑤ Data is transmitted over local/remote communication link to remote controller.
- ⑥ Communication scanner notifies remote network control program as data arrives.
- ⑦ Remote network control program processes data, prepares it for station.
- ⑧ Remote network control program activates communication scanner when data is ready to be sent to station.
- ⑨ Data is transmitted over communication line to station.

Station to Host Processor

- ⑩ Station sends data to remote controller.
- ⑪ Communication scanner notifies remote network program as data arrives.
- ⑫ Remote network control program processes data, prepares it for host processor.
- ⑬ Remote network control program activates communication scanner when data is ready to be sent to local controller.
- ⑭ Data is transmitted over local/remote communication link to local controller.
- ⑮ Communication scanner notifies local network control program as data arrives.
- ⑯ Local network control program prepares data for host processor.
- ⑰ Local network control program activates channel adapter when data is ready to be sent to host processor.
- ⑱ Channel transfers data to host processor.

Figure 3-2. Data Flow between a Host Processor and Station through a Local and Remote Controller

The format of the control information field varies according to the type of station to which the message is directed. If the station uses binary synchronous or start-stop communications, the network control program (NCP) retains the entire control information field and transmits only the message data to the station. If the station communicates via synchronous data link control (SDLC), the NCP retains a portion of the control information and transmits the remainder with the message data to the station. Likewise, SDLC stations, when transmitting to the communications controller, prefix the message data with a field of control information; the NCP adds to the control information before returning the block to the host processor.

If the receiving station is connected to a remote controller, the local network control program simply forwards the entire block—control information and data—to the remote controller. The remote NCP then forwards the message data (or message data and abbreviated control information) to the station as described above. (In order for a remote controller to communicate with SDLC stations, NCP/VS or ACF/NCP/VS must be running.)

Figure 3-3 shows how the NCP uses BSC and SDLC control information fields to route messages through a remote controller.

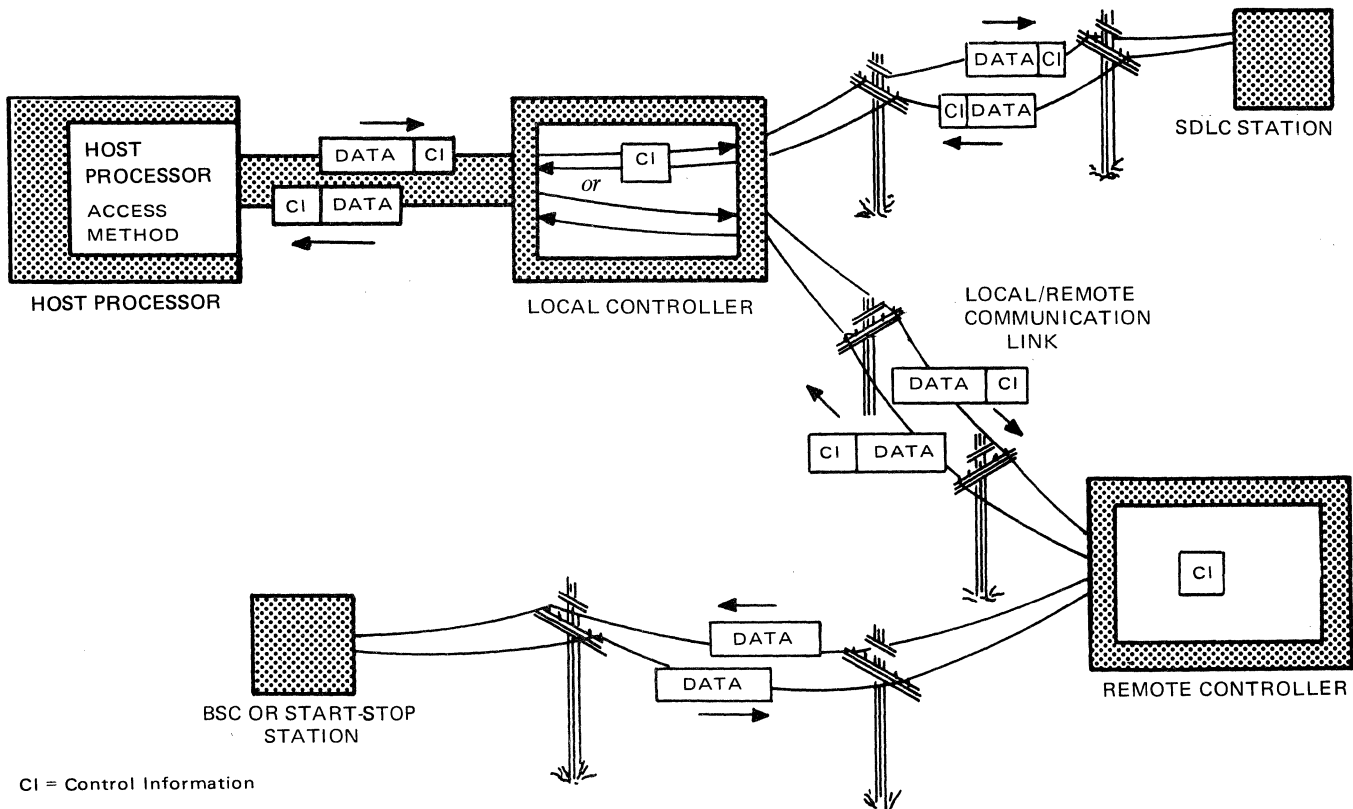

Figure 3-3. Logical Data Flow between the Access Method and Stations via Local and Remote Controllers

Functions of the Network Control Program

The network control program performs a wide range of functions for the data communication subsystem. Certain functions are standard for any network control program; others are optional, selected as part of the program generation procedure. The *NCP Generation and Utilities* manuals describe the purpose of each function and explain how to code program generation statements to include the function. (See Appendix D for a description of these publications.)

Standard Functions

Standard functions of the 3704 and 3705 with the network control program include those that any transmission control unit performs, such as control character recognition, communication-line time-out control, error checking, and character assembly and disassembly. In the controllers, these functions are performed for the most part by the network control program rather than by hardware. In addition to these functions, the following are standard features of the network control program.

Communication Control

The network control program takes over most of the control of the communication lines from the host processor access method. The standard communication control functions are:

- Polling and addressing of data communication units on multipoint communication lines.
- Dialing and answering stations over the switched communication network.
- Character, bit, or buffer service. The network control program is interrupted whenever a character, bit, or buffer arrives over a communication line. The type of scanner installed determines whether the interrupt occurs for each character, each bit, or each buffer. If the interrupt occurs for a character or bit, the program moves the character or bit into a buffer.
- Control Character Insertion and Deletion. The network control program inserts control characters at the beginning and end of each block of data when transmitting to a station and deletes them when receiving from a station.
- Determining to which remote controller (if any) a block is to be sent.
- Controlling message traffic between local and remote controllers. This includes transmitting program load modules to remote controllers and passing storage dump data from remote controllers to the access method.
- Character Code Translation (BSC and start-stop lines only). As data arrives from a station, the network control program automatically translates it from transmission code into EBCDIC. Likewise, EBCDIC data is translated automatically into transmission code before being transmitted to a station.
- Dynamic Buffering. The network control program allocates buffers from controller storage as it receives data from a station or from the host processor. When it accumulates an entire block of data (regardless of whether the last buffer is filled), it transfers the data to the host processor.
- Speed selection. Speed selection allows the network control program (either NCP/VS or ACF/NCP/VS) to change the transmission rate on a line equipped with IBM 3872 or 3875 modems. A command from the access method specifies whether the normal (high) rate or (low) rate is desired. (A communication line whose performance has become too degraded for satisfactory transmission at the normal rate can often transmit satisfactorily at the lower rate.)

Error Recording and Diagnostics

The network control program maintains several types of error records and provides display capabilities for diagnostic purposes. These include:

- **Hardware- and Program-Check Recording.** The program keeps a record of hardware and program checks, transferring the information to the host processor whenever possible. If transfer is impossible (for example, if the channel adapter fails), the program displays the type of check on the control panel.
- **Permanent Line Error Recording.** If normal error recovery procedures fail to recover from a transmission error (including local/remote communication link errors), the network control program transfers a record containing information about the error to the host processor.
- **Statistics Recording.** The program maintains for each teleprocessing unit a count of the number of I/O operations and the number of temporary errors that occur for that unit.
- **Dynamic Panel Display.** This permits the operator to display storage areas, register contents, or control information on the control panel.

The type 3 communication scanner can be used with both the NCP/VS and the ACF/NCP/VS, however, the NCP/VS cannot be used for intermediate block checking (ITB mode) while in transparent text on BSC lines attached through a type 3 scanner. Also, the use of a 3705 as a tributary station attached to a multipoint BSC line through a type 3 scanner is not allowed by either NCP/VS or ACF/NCP/VS.

Optional Functions

Many of the network control program functions are optional; they may be performed instead by the host access method, or they may be omitted entirely. You select the options that meet your needs when you generate the program. Some options are automatically included in the program unless you specify that they are to be omitted. Others are omitted unless you specify that they are to be included. The following functions are optional.

Block Handling Functions

For binary synchronous and start-stop communications, the network control program can process blocks of data from either the station or the host processor via optional programs called *block handling routines*. These routines are not available for data going to or coming from an SDLC station. You can select the following block handling functions:

- Date and/or time insertion
- Correction of text incorrectly entered from a station

Additional block handling functions are possible through routines that you write and assemble with the controller assembler. These routines are included in the program by coding a generation macro provided for that purpose.

Block processing is described in more detail in the section, "Block Handling Macros", in Chapter 6 of this publication.

Error Recovery and Diagnostics

- **Critical Situation Notification (BSC and start-stop stations only).** The network control program can notify stations when the host processor, channel, or local/remote communication link fails. You define the message to be sent to stations when a critical situation arises.

- **Address Trace.** The operator can request through the 3704 or 3705 control panel that the network control program record the contents of four variables (storage areas and/or registers) when a certain address in controller storage is accessed. This provides a dynamic trace facility for diagnostic purposes.
- **Line Trace.** The operator can request through the host access method that the network control program record the data characters and certain control information as the data is transferred between the scanner and the network control program in the 3705. Up to eight lines of both transmitted and received data is recorded and sent to the host processor. The number of lines that can be traced depends upon the line speeds and the load on the 3705.
- **On line Terminal Tests.** On line terminal testing (OLTT) facilities are available through the controllers. The network control program provides support for the OLTT functions by executing test routines constructed by an OLTT program in the host processor.
- **Online Line Testing.** Online line testing (OLLT) capabilities are available for SDLC communication lines. The NCP executes test routines constructed by a test executive program in the host processor.
- **Pause-Retry.** When a transmission error occurs, the network control program tries to retransmit the data after an interval that you specify. You also specify the maximum number of retries for each station. This function is included for all stations unless you specify that no retries are to be made.
- **Switched Network Backup.** For certain types of BSC and start-stop stations, you can specify an alternate path for communication over the switched communication network to be used if the primary point-to-point communication line encounters an error from which normal error recovery procedures fail to recover.
- **Manual Switched Network Backup.** This facility, an extension of the switched network backup facility mentioned above, allows the console operator to call a station upon being informed that the regular nonswitched communication line to the station has failed. He enters a console message identifying the station to be contacted, and receives in response the identification of the switched backup line. Placing the call and transmission of data then occur as described below for manual dial operation. Data transmission continues over the backup line until the console operator re-establishes the regular nonswitched line connection. Manual switched network backup is for use when automatic switched network backup is not available.
- **Alternate Switched Operation for Local/Remote Communication Links.** For each remote controller connected to the local controller by a point-to-point communication link, NCP/VS or ACF/NCP/VS may change to a half-duplex link in the switched communication network if the regular local/remote communication link fails. (A separate switched alternate communication link is required for each remote controller.) The throughput capacity of the half-duplex communication link may be less than that of a regular duplex local/remote communication link operating at the same speed.

Miscellaneous Options

- **Channel Delay Feature.** This option allows you to specify an interval, in increments of 100 milliseconds, to be observed before the network control program presents Attention status to the channel. If a time delay is specified, data arriving from the stations is stored in the network control program buffer pool until the interval elapses. Then all the stored data can be transferred across the channel with only one interrupt to the host processor, thus decreasing host processor overhead. If no time delay is specified, each block of data is transferred as soon as it is processed by the network control program, requiring more frequent interrupts to the host processor. If the network control program receives enough data to fill all the allotted buffer space in the host processor before the specified interval elapses, it presents Attention to the channel immediately.

- Binary Synchronous Identification Verification. This feature is available for certain BSC stations that communicate over the switched communication network. You provide a list of valid IDs for communication lines on which ID verification is to be used. The NCP compares the ID received against those in the list and allows the station to connect if a match is found. If no match is found, the NCP can pass the information to the access method in the host processor, or it can break the connection, at your option. The ID verification feature provides the option of keeping some IDs in the controller (for example, those of the more active stations) and some in the host processor (those of the less active stations). Or ID verification can be done entirely by the host access method.
- Multiple Terminal Access (MTA). This option, available for certain low-speed, start-stop terminals, allows the controller to communicate with dissimilar types of terminals over the same switched communication line. When a terminal calls the controller over the MTA line, the MTA option identifies the type of terminal and the transmission code used. The following terminal types are supported by this option:

IBM 1050 Data Communication System
 IBM 2740 Communication Terminal (Basic)
 IBM 2740 Communications Terminal (Transmit Control)
 IBM 2740 Communications Terminal (Transmit Control with Checking)
 IBM 2740 Communications Terminal (Checking)
 IBM 2741 Communications Terminal
 Terminals using CPT-TWX (models 33 and 35) code (at line speeds of
 110 bps, 134 bps, or 300 bps)

The terminal types, code combinations, and communication lines to be used for multiple terminal access are specified as parameters in the program generation language.

- Manual Dial Operation. This is for use when automatic calling is not available. Upon receiving a command to contact a station, the network control program, via the access method, sends the console operator a message instructing him to make the call. After the operator establishes the call, he places the communication line in data mode. The program can then communicate with the station.
- Carriage Return Delay. This option, available for certain start-stop terminals, causes the network control program to pause momentarily before starting a write operation that immediately follows a read operation from the terminal. This prevents random printing during the return motion of the terminal's printing mechanism by allowing time for the printing mechanism to return to the left margin.
- Monitor Mode. When this option is selected for a communication line, the network control program monitors the line during input and output operations and between commands for an Attention signal sent by the terminal or a disconnect condition, the NCP notifies the host access method.

Dynamic Control Functions

The network control program recognizes commands from the host access method to dynamically change certain parameters of the data communication subsystem. Some of the dynamic control functions are standard; others are included in or excluded from the program by specifying them at program generation time. The dynamic control functions include:

- Activation and deactivation of communication lines. Commands from the access method request the program to activate or deactivate one or more communication lines attached to the controller.
- Requesting the status of a communication line.

- Replacing ID characters and polling and addressing characters for BSC and start-stop data communication units.
- Changing the order in which data communication units on a multipoint BSC or start-stop communication line are polled and addressed.
- Changing the number of consecutive times data communication units on a multipoint BSC or start-stop communication line can respond negatively to polling before the line is rescheduled for other operations.
- Altering the sequence of network control program commands for a particular data communication unit.
- Changing the block handling routines for data associated with a BSC or start-stop data communication unit.
- Setting the time and date in the controller.
- Changing the maximum number of data transmissions between the host processor and a data communication unit on a multipoint BSC or start-stop line before the network control program tries to service other units on the line.
- Turning off the power at a remote controller by command from the access method.

BLANK

Chapter 4: Emulation Program Concepts

The emulation program (EP) allows a local 3704 or 3705 to operate as an IBM 2701 Data Adapter Unit, an IBM 2702 Transmission Control, an IBM 2703 Transmission Control, or any combination of the three. The emulation program allows many programs written for support of the 2701, 2702, and 2703 to operate with the communications controller with no modification. They include IBM Type I access methods that support the 2701, 2702, and 2703, as well as IBM Type II and Type III programs and user-written programs that interface with the 2701, 2702, and 2703 in a manner equivalent to IBM Type I access method programs. Programs that involve timing dependencies and support of certain special and custom features may have to be changed.

The emulation program requires that a type 1 or type 4 channel adapter be installed in the controller for attachment to a System/360 or System/370 byte-multiplexer channel. All models of the 3704 and the 3705 have enough storage to accommodate small emulation program configurations, but larger configurations require more than the minimum amount of storage.

The emulation program in conjunction with the type 1 or type 4 CA permits the use of the same control sequences and data transfers as do the 2701, 2702, and 2703. It also provides most of the standard functions of these control units. Not supported are the parallel data adapter, synchronous data adapter type 1, the programmable two-processor switch, two-channel attachment, six-bit transcode, selector channel attachment, direct attachment of the IBM 1032 Digital Time Unit, and the IBM 2712 Remote Multiplexer attachment features.

In addition to the standard 2701-2702-2703 functions, the emulation program also supports certain RPQs (requests for price quotation) for these control units.

In emulation mode, a 3705 containing a single type 1 or type 4 channel adapter can attach up to 255 communication lines for half-duplex operation at speeds from 45.5 bps to 50,000 bps. A 3705 containing two type 4 channel adapters can attach up to 352 communication lines if each adapter is connected to a separate host processor channel. The 3704 can attach up to 32 communication lines at speeds from 45.5 bps to 50,000 bps. The actual number of lines that can be attached depends upon the specific configuration of the data communication subsystem. Each line attached to the controller in emulation mode requires a nonshared subchannel address on the byte-multiplexer channel.

The emulation program allows operations with a type 3 communications scanner (attached to BSC lines only). In addition, the EP allows the use of transparent ASCII code on BSC lines attached to a type 3 scanner. Previously this feature was available only as a PRPQ (Programming Request for Price Quotation). The EP does not allow operation of a 3705 as a tributary station on a multipoint BSC line attached through a type 3 scanner.

The emulation program operates with access methods under the virtual operating systems--DOS/VS, OS/VS1, and OS/VS2--under OS/MFT and OS/MVT systems. Type 4 CA support may necessitate changing certain access method parameters, such as I/O buffer size, to handle timing changes resulting from changes in channel transfer widths.

The equivalent of EP support is provided for communication lines operating in emulation mode under a PEP system when the NCP portion is NCP/VS or ACF/NCP/VS.

Multiple Subchannel Support

An optional capability provided by the emulation program allows two type 4 channel adapters to be attached to the same or different host processors. This capability is called *multiple subchannel line access* (MSLA). As part of this support, the EP can switch control of communication lines from one access method to another, either within the same host processor or between different host processors. This capability is accomplished by assigning multiple subchannel addresses on the same or different channels to a single communication line during EP generation. Thus two access methods have access to the same communication line over separate subchannels.

The use of multiple subchannels for one communication line provides the following advantages to the user:

- Load balancing—The user can switch communication lines from one host processor to the other during busy periods to balance the load on the processors.
- Configuration backup—The user can switch control of a group of lines assigned to one host processor to the other host processor if the host processor, access method, or channel fails.
- Communication line sharing—Two access methods in the same or different host processors can share communication lines (for example, for two different applications). The sharing is alternate, not concurrent.

In this mode of operation, the first access method to try to use a shared line gets control of the line and keeps control until it (the same access method) releases the line by disabling it. Once the line is free, the other access method (or the same one) can assume control of the line. If the second access method tries to gain control of the line while it is being used by the first, the attempt is rejected, and the operator must intervene to retry the operation when the line is free.

Under certain circumstances, the emulation program allows the operator to switch control of a line, using the 3705 control panel, even though the controlling access method has not released the line.

Two type 4 channel adapters can also be used with a PEP system. The lines operating in EP mode, under control of either the NCP/VS or the ACF/NCP/VS, can use the multiple subchannel support. Under NCP/VS, only one of the two type 4 CAs can have an NCP subchannel. With ACF/NCP/VS, both of the type 4 CAs can have an NCP subchannel.

Appendix B lists the terminals, control units, and computers supported by the 3704 and the 3705 over communication lines in emulation mode, when the controller is executing an emulation program or a network control program with the partitioned emulation programming (PEP) extension.

The *Emulation Program Generation and Utilities* manual explains how to code program generation statements to generate an emulation program suited to the needs of your installation. (See Appendix D for a description of this publication.)

Chapter 5: Partitioned Emulation Programming Extension Concepts

The network control program (NCP/VS or ACF/NCP/VS), is capable of operating communication lines in emulation mode as well as in network control mode. This capability is available only for NCPs running in local controllers.

The partitioned emulation programming (PEP) extension of the network control program (either NCP/VS or ACF/NCP/VS) allows the communications controller to operate as an IBM 2701, 2702, or 2703 transmission control unit (or any combination of the three) for certain lines, while performing network control functions for others. (The controller must be attached to the System/370 by a type 1 or type 4 channel adapter, by a type 1 or type 4 and a type 2 or type 3 channel adapter, or by multiple (up to four) type 4 channel adapters.)

During program generation you specify each communication line as being operable in network control mode, or in emulation mode, or both. If you specify operation in either mode, the line always operates in that mode. But if you specify operation in both modes, you can change the line from one mode to the other upon command from the host processor. Program generation language parameters specify the mode in which the line is to be placed initially when the network control program is loaded.

The partitioned emulation programming (PEP) extension allows many programs written for support of the IBM 2701, 2702, and 2703 to operate with the controller without modification. These programs include IBM Type I access methods that support the 2701, 2702, and 2703 as well as IBM Type II and III programs and user-written programs that interface with these units in a manner equivalent to Type I access method programs. Programs that involve timing dependencies and support of certain special and custom features may have to be changed.

Advantage of the PEP Extension

The principal advantage of the PEP extension is that it allows concurrent operation of existing application or access method programs, designed to communicate with a 2701, 2702, or 2703, and new (or converted) application programs designed to communicate with NCP/VS or ACF/NCP/VS.

With concurrent operation, you need not convert all existing application or access method programs before realizing the benefits of operating communication lines in network control mode rather than in emulation mode. You may convert programs gradually, over any desired period. As conversion of each program is completed, you may change the communication lines used by that program from emulation mode to network control mode. Spreading the conversion process over an extended period allows each program to be more thoroughly tested than if all programs had to be converted at once. However, the sooner you convert all programs, the sooner you will realize the full benefits of operating all lines in network control mode.

You may wish to defer conversion of any existing application programs until new application programs, designed for use with the network control program, are completed. This may be advantageous when installation of the controller coincides with the development of new applications for the data communication subsystem. You can then concentrate on developing the new application programs.

Channel Attachment

A network control program with the PEP extension requires a type 1 or a type 4 channel adapter in the communications controller for attachment to a System/370 byte-multiplexer channel.

If the controller has a type 1 or a type 4 adapter, the channel appears to the access method as a number of separate subchannels, one for each communication line that is to operate in emulation mode, a single subchannel for all lines that are to operate in network control mode.

Data interchanges on the emulation subchannels have priority over data interchanges on the network control subchannel. The throughput of communication lines in network control mode is affected by such factors as (1) the amount of message traffic in the data communication network, and (2) the relative proportion of lines in emulation mode and network control mode.

If the controller is a 3705 equipped with a type 2 or a type 3 channel adapter as well as a type 1 or a type 4 channel adapter, the type 1 or type 4 adapter handles only data interchanges for lines in emulation mode, and the other adapter handles all data interchanges for lines in network control mode.

When two channel adapters are used with the network control program (either NCP/VS or ACF/NCP/VS), they can be attached to two separate host processors. (This capability is referred to as two-host PEP.) The lines operating in NCP mode are controlled by VTAM, TCAM, or EXTAM in one host processor over a type 2, type 3, or type 4 channel adapter. The lines operating in EP mode are controlled by an access method in the second host processor over a type 1 or a type 4 channel adapter.

Each communication line to be operated in emulation mode must occupy one of a sequence of contiguous subchannel addresses, all of which are reserved for the controller. Not all lines represented by addresses in the sequence need operate in emulation mode. However, the emulation subchannel corresponding to a line is active only when that line is operating in emulation mode.

Control Sequences, Data Transfers, and Functions

A network control program with PEP, in conjunction with either the type 1 or type 4 channel adapter, permits the use of the same control sequences and data transfers as do the IBM 2701, 2702, and 2703. It also provides most of the standard functions of these units. Not supported are the parallel data adapter, synchronous data adapter type 1, the programmable two-processor switch, two-channel attachment, six-bit transcode, selector channel attachment, direct attachment of the IBM 1032 Digital Time Unit, and the IBM 2712 Remote Multiplexer attachment.

Communication Lines and Stations Supported

A 3705 that is to execute a network control program with PEP can attach up to 352 communication lines for half-duplex operation. Of these, up to 255 can be in emulation mode because of a host processor subchannel limitation.

A 3704 that is to execute a network control program with PEP can attach up to 32 communication lines for half-duplex operation at speeds from 45.5 to 50,000 bps.

The actual maximum number of communication lines the program can use depends upon the specific configuration of the data communication subsystem and upon the relative proportion of lines operating in network control mode and emulation mode.

A network control program with PEP can communicate in network control mode with the types of stations listed in Appendix A, and in emulation mode with those listed in Appendix B.

BLANK

Chapter 6: The System Support Programs

The IBM-supplied system support programs for the network control program (NCP/VS) and the emulation program (EP) are available to help you install and use your communications controller. There are four system support programs: (1) a procedure for generating the control program, (2) an assembler, (3) a loader, and (4) a dump program. The loader and the dump program are utility programs. Each remote controller has a small auxiliary storage device containing load and dump routines. These routines are not part of the system support programs described below, which apply only to local controllers. Loading and dumping of a remote controller are described at the end of the chapter. For information on ACF/NCP/VS system support programs, refer to *ACF/NCP/VS (Network Control Program and System Support Programs) General Information* (CG30-3058).

The system support programs for the network control program will run under (1) OS (Operating System) in an IBM System/370, (2) OS/VS (Operating System/Virtual Storage) in a System/370, and (3) DOS/VS (Disk Operating System/Virtual Storage) in a System/370.

Support programs for the emulation program will run under (1) OS in a System/360 or System/370, (2) OS/VS in a System/370, (3) DOS/VS in a System/370.

Consult your IBM representative to determine the availability of the system support programs under each of the operating systems referred to above.

The generation procedure and the assembler are executed entirely in the host processor. (This need not be the host processor for the controller.) Each of the utilities is divided into two portions, one of which runs in the host processor and the other in the controller. Use of the system support programs is described in the *Control Program Generation and Utilities* and *EP Generation and Utilities* manuals. See Appendix D for a description of these publications.

Control Program Generation

You create the control program that meets the requirements of your data communication subsystem by means of a control-program generation procedure. To help you generate the control program, IBM supplies (1) a generation language by which you specify network configuration and program options, and (2) a library of macro definitions from which the source statements are expanded.

The generation procedure is similar for both network control programs and emulation programs, although there are minor differences in the OS, OS/VS, and DOS/VS procedures. The generation languages for both control programs are also similar. However, more macros and operands are provided for defining a network control program than for an emulation program because of the greater number of network control options available. The following sections describe the generation language, some coding conventions, and how the generation procedure works. Some topics are addressed only for the network control program because they are not applicable to the emulation program. Generation procedures for the network control program and emulation program are covered in detail in separate publications, which are described in Appendix D.

The Control Program Generation Language

The control program generation language provides a high-level means for generating the control program for the 3704 or the 3705. The language is designed to minimize the programming effort for even the most complex configuration of lines and stations.

The generation language is made up of macro instructions that fall into four categories according to the type of parameters they define. The types of macros are (1) system macros, (2) configuration macros, (3) block handling (BH) macros, and (4) a generation delimiter macro.

System Macros

The system macros provide information pertaining to controller hardware features, certain control program options, and program generation information such as data set names. The system macros specify, for example:

- The amount of storage installed in the controller.
- The size of buffers used for communications in network control mode.
- The type of channel adapter installed (for the 3705 and the network control program only).
- Optional dynamic control functions to be included in the network control program.
- The identifier of the controller.
- Whether the network control program is to operate in a local or a remote controller.

Configuration Macros

The configuration macros provide the information necessary to construct the tables needed by the control program to control the flow of data between the controller and remote stations or other controllers, and between a local controller and the host processor.

One group of these macros defines the characteristics of the elements in the data communication network—line groups, communication lines (including local/remote communication links), clusters, terminals (or controllers), and components. You code a macro for each element in the network. The macros must be arranged in a specific order to associate a particular communication line with a particular line group, a particular terminal with a particular communication line, etc. The hierarchy from the highest level to the lowest level is: line group, line, cluster, terminal, component. For example, you would arrange the macros defining a line group with two lines, two terminals on each line, and two components on each terminal as follows:

```
Group definition
  Line definition
    Terminal definition
      Component definition
      Component definition
    Terminal definition
      Component definition
      Component definition
  Line definition
    Terminal definition
      Component definition
      Component definition
    Terminal definition
      Component definition
      Component definition
```

To define a local/remote communication link to which three controllers are attached, you would code:

```
Group definition
  Line definition
    Controller definition
    Controller definition
    Controller definition
```

Each macro is associated with the last higher-level macro that precedes it. This type of structure simplifies coding by allowing you to specify characteristics that are the same for all levels of a hierarchy only on the highest level. For example, if a characteristic pertains to all terminals on a multipoint communication line, you code that characteristic only on the macro that defines the line.

The rest of the configuration macros provide the following types of information:

- Information needed for data transfer between the host access method and the network control program; for example, average block size and buffer-unit size in the host processor (not applicable for emulation mode data transfer).
- Information describing the communication scanner(s) attached to the controller.
- Definition of the remaining control tables necessary to control the network; for example, lists of valid identification sequences for binary synchronous stations that call in over the switched communication network (not applicable for lines in emulation mode).

These configuration macros, unlike those that define the elements in the data communication network, can appear in any order in relationship to each other in the control program generation input stream.

Block Handling Macros

The block handling (BH) macros apply only to messages transmitted over binary synchronous and start-stop communication lines in network control mode. They describe optional processing that the network control program can perform on a block of data before transferring the block to a station or to the host processor.

Some BH macros define *block handling routines* (BHRs) that perform specific processing functions. The BHRs specified by these macros perform the following types of processing:

- Inserting the date and/or time of day into blocks of data.
- Correction of text incorrectly entered from a station. The macro defines the character to be recognized by the BHR as a backspace character. The BHR deletes these characters from the text and overlays the characters preceding the backspace characters with the text that follows.

Example:

```
Input from terminal: CHARACTER bks bks ER
After processing by BHR: CHARACTER
```

Using the controller assembler, you can write additional block handling routines to process blocks in other ways. A BH macro allows you to include these routines in the network control program at the time the program is generated.

In a network control program with the PEP extension, block-handling routines may be associated only with communication lines in network control mode. No block processing is performed for lines in emulation mode. In addition, block handling routines are not available for synchronous data link control (SDLC) lines in NCP/VS.

The remaining BH macros provide for the grouping of block handling routines into block handlers and sets of block handlers. A *block handler* consists of one or more block handling routines defined by the individual BH macros. Many block handlers can be defined for a single network control program configuration. Special BH macros delimit the beginning and end of each block handler and provide a symbolic name for it. When multiple block handlers are defined, one must be completed before the next is defined.

Up to three block handlers are grouped into a *block handler (BH) set*, defined by another BH macro. Each block handler in a BH set can be executed at one of three points in time, as follows:

1. After a command has been received from the host access method for a communication unit but before it has been determined that the communication line is available.
2. After a command has been received from the host access method for a communication unit but only after the communication line is available.
3. When an input operation on a communication line ends.

Each BH set may be associated with one or more data communication units. You can associate a BH set with a TP unit when generating a network control program by coding the name of the BH set as an operand of the configuration macro that defines the unit.

Generation Delimiter Macro

The generation delimiter macro ends the control program generation input stream.

Coding the Generation Language

The generation language is designed to make coding as easy as possible. All the operands of the individual macros are keywords, so the programmer does not have to be concerned with the sequence in which he codes the operands. However, the relative order of the macros in the input stream is to some extent fixed.

Figure 6-1 illustrates the format of the input stream for a typical network control program generation. For communication lines in emulation mode, there are no non-positional configuration macros or block-handling macros.

General Logic Flow of the Control Program Generation Procedure

When you have coded the generation macros that describe the network connected to the controller, you generate the control program using the control program generation procedure. The generation procedure is a two-stage process (for OS and OS/VS) or a three-stage process (for DOS/VS) that runs as a series of jobs in a host processor. Figure 6-2 illustrates the procedure for program generation under OS. Figure 6-3 illustrates the procedure for emulation program generation under DOS/VS. (Similar procedures are followed for program generation under OS/VS and DOS/VS.)

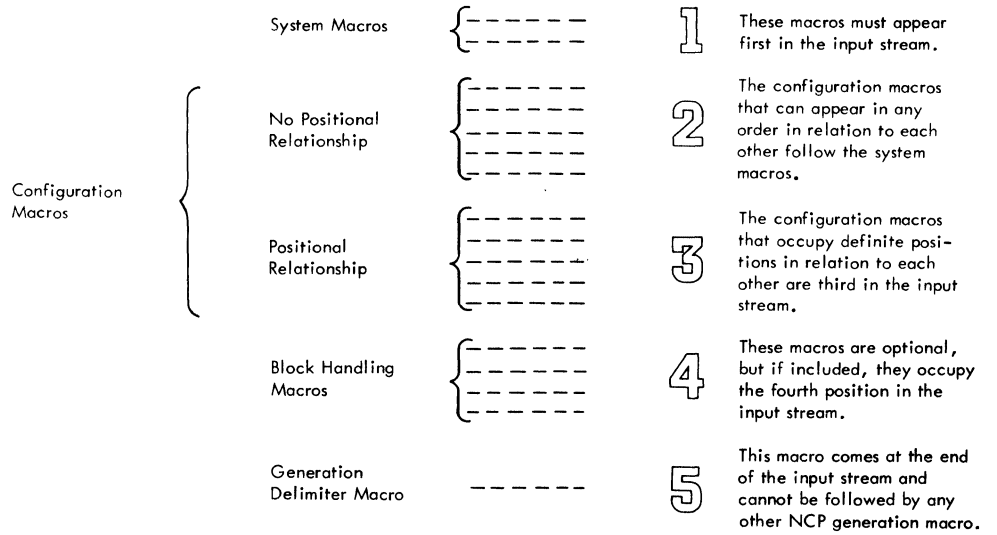

Figure 6-1. Format of the Input Stream for Network Control Program Generation

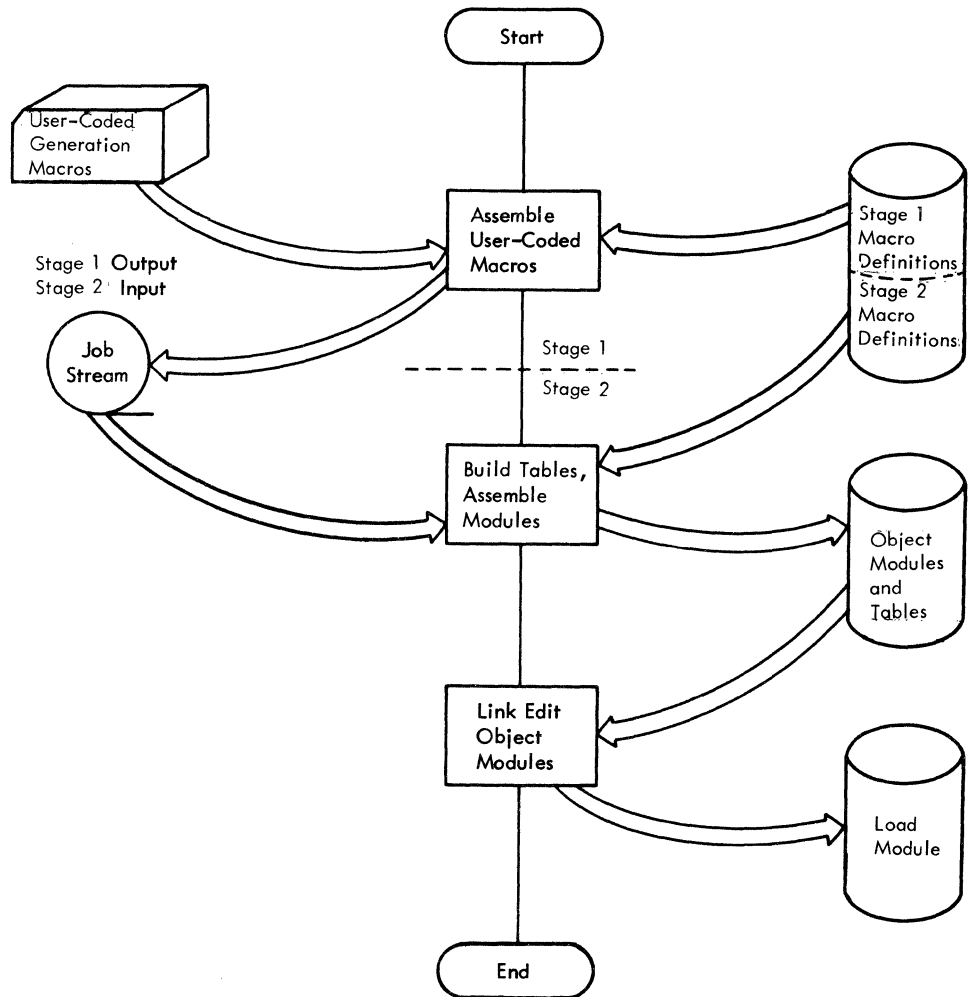

Figure 6-2. Example of the Control Program Generation Procedure under OS

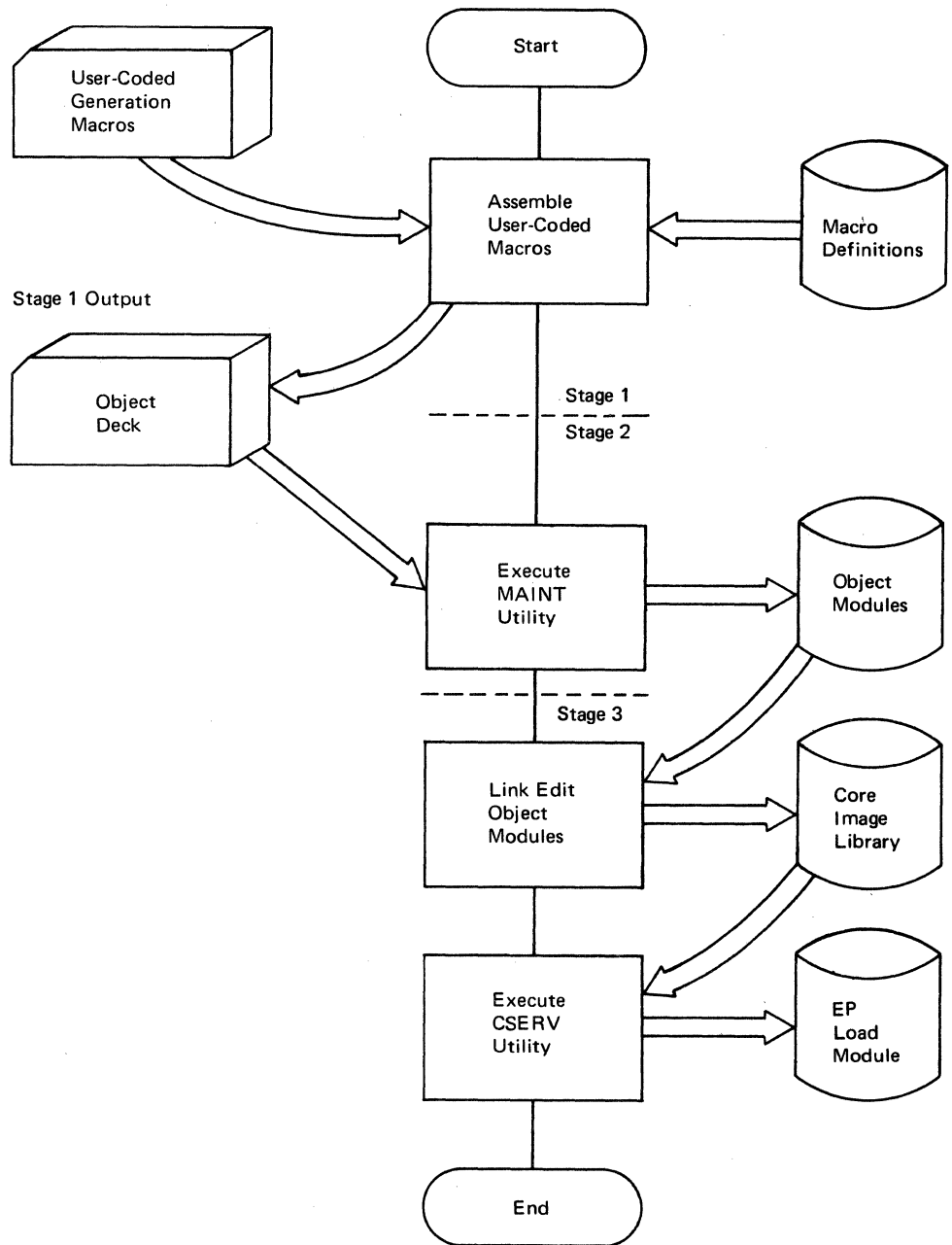

Figure 6-3. Example of the Emulation Program Generation Procedure under DOS/VS

Stage One

In the first stage of the generation procedure, the macros you have coded are assembled by the controller assembler. If generating under OS or OS/VS, you may use an OS or OS/VS assembler, instead of the controller assembler, for stage one assembly. Generation under DOS/VS requires the controller assembler. For OS, OS/VS, and DOS/VS output from the assembly is a job stream containing the data and control statements necessary to create the desired control program. The job stream is a sequential data set that can be directed to cards, tape, or a direct access storage unit.

Intervention Between Stages of Control Program Generation

Intervention is required between stages of the generation procedure. If there are errors in the source statements entered as input to stage one, you receive a diagnostic message for each statement that contains an error. For severe errors, the source statements must be resubmitted until these errors are corrected.

Stage Two

If there are no severe assembly errors, you initiate the second stage of the generation procedure. The second stage creates the control program that will support the data communication subsystem and perform the processing functions that you have specified.

For OS and OS/VS, the job stream from stage one contains the data necessary to select the appropriate program modules and build the proper tables. Using the information you coded in the generation macros, stage two first builds the tables, then assembles (using the controller assembler) the modules that are dependent on the network you define. Then the OS or OS/VS linkage editor is executed to combine the appropriate modules into the control program load module. Finally, the load module is stored on a direct access storage unit.

For DOS/VS, stage two of the generation procedure assembles the control tables and the program modules that are dependent on the network you define and creates job control statements and linkage-editor statements for stage three. Stage three catalogs the tables and modules assembled in stage two and link edits them into a control program load module. The CSERV utility must then be executed to move the load module to a direct-access data set from which the loader utility may obtain it.

Generating Multiple Control Programs

You can generate as many network control program or emulation program load modules for a controller as you wish. Each program requires a separate generation, and each must have a different symbolic name in order that the loader can identify the load module to be transferred into the controller.

Multiple load modules are useful for installations that have several distinct applications for the data communication subsystem. For example, if your installation uses only start-stop communication lines during the day and only binary synchronous lines at night, separate control programs for the separate configurations could reduce the amount of storage required for the controller and make the program operation more efficient.

The Controller Assembler

The controller assembler is available to assemble programs written in controller assembler language. In its external structure, it is very similar to the OS assembler. The *Assembler Language* manual explains how to use the controller assembler. See Appendix D for a description of this manual.

The assembler operates on three kinds of instructions; (1) machine instructions (written in controller assembler language notation); (2) macro instructions; and (3) assembler instructions. The assembler translates the machine instructions and the macro instructions into executable object code. The assembler instructions direct the assembler to perform certain operations during the assembly process, but they are not converted into executable code. These three types of instructions are similar to the types of instructions processed by the OS assembler.

The Instruction Set

The instruction set for the controllers consists of 51 machine instructions. The instructions are represented to the assembler by mnemonic operation codes, usually followed by one or more operands. Most of the machine instructions are register-oriented. That is, they represent operations involving two registers, a register and immediate data, or a register and a storage area.

The assembler converts the machine instructions into two or four bytes of object code, depending on the length assigned to the particular instruction.

The *3704 and 3705 Principles of Operation* manual explains each of the machine instructions and gives the assembler language statement that corresponds to each.

Macro Capability of the Assembler

The macro language for the controllers is an extension of the controller assembler language. It provides a convenient method of generating a desired sequence of assembler language statements many times in one or more programs. Macro definitions can be coded in line in assembler-language programs or stored in a host library and called in when needed by means of a macro instruction coded in the program.

The Assembler Instructions

Instructions to the controller assembler are written as assembler pseudo operation codes, with or without operands. These instructions perform such functions as delimiting the beginning and end of sections of code, defining data areas, controlling the format of listings, and specifying base registers.

Uses of the Assembler

The uses of the controller assembler include: (1) preassembling user-written block handling routines, and (2) assembling the control program generation macros and application-dependent modules during the control program generation procedure.

The assembler enables you to add to the IBM-supplied network control program modules block handling routines (BHRs) that are unique to your applications (for start-stop and binary synchronous communication lines). Using the controller assembler language, you code BHRs to process the data in message blocks going to or coming from a station. Then you use the assembler to create object modules that are stored in the same library with the IBM-supplied network control program object modules. At program generation time, if you have coded the appropriate macros, the BHRs you have written are link-edited together with the IBM modules to form the network control program load module.

The Utilities

The loader and the dump programs help you start operation of the control program and locate errors. Both are utility programs, controlled by the appropriate job control statements and control cards.

These programs are used only for loading and dumping a local communications controller. A remote controller is loaded and dumped by interaction between the access method in the host processor and utility routines in the remote controller, as described later in this chapter.

The Loader

The loader has two loading functions: (1) it transfers a diagnostic routine, the *initial test* routine, into the controller, and (2) it transfers the control program from host secondary storage into the controller.

The loading of the initial test routine occurs before the control program is loaded into the controller. This routine tests the hardware for conditions that could possibly result in failure of the controller after operation begins. If the initial test routine discovers any exceptional conditions, it causes a hard stop of the controller and cancels transfer of the control program across the channel. Indicators on the control panel are set to aid in isolating the problem.

Whenever the loader is invoked, the initial test routine is executed automatically. However, you can suppress execution of initial test by means of a utility control card entered as input to the loader.

The loader is invoked to load the control program in the following two instances:

- At start-up time. The loader is started by job control statements entered into the job stream by the operator.
- When the controller fails because of some error condition. The operator starts the loader in this case, too.

This does not mean, however, that IPL (initial program load) of the controller is always performed by the loader. TCAM, for example, has an optional loading facility that can automatically load the network control program at start-up time or reload it if the controller fails. Thus, operator intervention is not required if this option is selected for TCAM.

How the Loader Operates

The part of the loader that resides in the host processor handles all external input and output requirements of the loading process. This portion reads the control program load module from secondary storage and issues a Write command for each block of code to be transferred across the channel into the controller.

The portion of the loader that resides in the controller initializes the controller to prepare it for the data written from the host processor. It then communicates with the host portion, accepting blocks of code from the channel and positioning them appropriately in controller storage.

The Dump Program

The dump program dumps the contents of controller storage to help you isolate and correct problems when error conditions arise. You have three options when requesting a dump:

- You can specify the limits of the storage area to be printed out from the dump. Otherwise, you receive a printout of the complete dump (except for a small area at the beginning of storage).
- You can request a formatted dump of the network control program. In this case, the dump program isolates and labels certain control blocks, printing them at the beginning of the dump. (Formatting applies only to control blocks associated with communication lines in network control mode.)
- You can request that the mnemonic operation codes for all machine instructions be interleaved with the instructions in the dump (NCP/VS only).

Both formatted and unformatted dumps contain a hexadecimal representation of controller storage. In addition, all dumps include the contents of the general registers and the EBCDIC representation of all letters and numbers in the dump.

Note that after any dump (whether it be a complete storage dump or a dump of only a portion of storage), the control program must be reloaded before operation can be resumed.

How the Dump Programs Operate

The dump programs for OS and OS/VS have two job steps. The first step, which requires code in both the host processor and the controller, dumps the entire contents of controller storage and the contents of the general registers to a data set on host disk storage.

The first step then automatically invokes the second step, which runs entirely in the host processor. Step two first analyzes the utility control cards, on which you have specified the options desired for this dump (storage limits, formatting, etc.). You may request a printout of as many different areas of the dump as you wish by including a control card for each area. Then step two formats the dump when appropriate, reads the requested contents from the disk data set, translates them into printable hexadecimal characters, and when requested, interleaves the mnemonics with the instructions. Finally, it writes the requested portion(s) of the dump to an output data set to be printed out.

The host access method can also perform the functions of step one of the dump program. In this case, step two is not invoked automatically; you must initiate it as an independent job in order to print out the dump.

The DOS/VS dump program consists of only one job step and uses no intermediate disk data set. It is, however, functionally the same as the OS/VS dump. Both programs provide optional formatting of control blocks associated with communication lines in network control mode.

After a dump, the controller is idle and must be reloaded before it can operate again.

Loading and Dumping a Remote Controller

A remote controller can be loaded or dumped only when the local controller to which it is connected is executing a network control program (NCP/VS or AFC/NCP/VS).

Loading

The access method can be notified in two ways that loading of a remote controller is required: (1) The operator at the host console can enter a command requesting loading, or (2) the remote controller can send a request for IPL in response to an attempt by the access method to initiate communication with it. The remote controller requests IPL after (1) its power is turned on, (2) the remote network control program abends, (3) the operator at the remote controller presses the Load switch, or (4) the utility program in the remote controller encounters an error during loading or dumping.

The access method initiates loading by sending a Load command to the remote controller. Utility routines in the remote controller (loaded from the auxiliary storage device under one of the four conditions described above) accept load module data

blocks from the access method. After all load module blocks have been transferred to the remote controller, the utility routines wait until the access method next attempts to initiate communication with the remote controller before transferring control to the newly loaded network control program.

After a power-on sequence and usually after the Load switch is pressed, the remote controller executes diagnostic routines that test the controller hardware. When these routines are not run, it may be appropriate for the access method to obtain a storage dump before the loading process begins. To do so, the access method sends a Dump command instead of a Load command. After the dumping action is completed, the access method can send a Load command.

Dumping

A command entered at an operator console informs the access method that dumping is required. Alternatively, a dump may be initiated by a request for IPL from the remote controller; under certain circumstances the access method may determine that the controller should be dumped before it is loaded. (For example, if the remote network control program abends, the access method may request a dump before reloading.) In either case, the access method sends a Dump command to the remote controller to initiate the dumping action.

It is the responsibility of the access method to format the storage dump as needed and cause it to be printed at the host processor.

BLANK

Appendix A: Types of Stations Supported by the IBM 3704 and 3705 Communications Controllers in Network Control Mode

The IBM 3704 and 3705 Communications Controllers, whether local or remote, can communicate in network control mode with stations of the following types. Consult your IBM representative for the specific requirements for support of each of these stations.

Start-Stop Terminals

IBM 1050 Data Communication System
IBM 2740 Communications Terminal, Models 1 and 2
IBM 2741 Communications Terminal
IBM Communicating Magnetic Card Selectric® Typewriter

Binary Synchronous Terminals

IBM 2770 Data Communications System
IBM 2780 Data Transmission Terminal (no support for Transcode)
IBM 2972 General Banking Terminal System, Models 8 and 11
IBM 3270 Information Display System
IBM 3735 Programmable Buffered Terminal
IBM 3740 Data Entry Terminal
IBM 3780 Data Communication Terminal

Synchronous Data Link Control Clusters and Terminals

IBM 3270 Information Display System
IBM 3600 Finance Communication System
IBM 3614 Consumer Transaction Facility
IBM 3650 Retail Store System
IBM 3660 Supermarket System
IBM 3767 Communication Terminal
IBM 3770 Data Communication System
IBM 3790 Communication System

Transmission Control Units

IBM 2701 Data Adapter Unit (with Synchronous Data Adapter Type II)^{1,2}

IBM 2703 Transmission Control (with Synchronous Terminal Control)^{1,2}

IBM 2715 Transmission Control, Model 2¹

IBM 3704 Communications Controller³

IBM 3705 Communications Controller³

Computers (BSC support only, except for System/7)

IBM System/3

IBM System/7 (supported as an IBM 2740 Communications Terminal, Model 1, with the Record Check feature, or as a System 3)

IBM System/360, Model 20 (with Binary Synchronous Communications Adapter)

IBM System/360, Model 25 (with Integrated Communications Attachment with Synchronous Data Adapter II)

IBM System/370, Model 125 (with Integrated Communications Attachment with Synchronous Data Adapter II)

IBM System/370, Model 135 (with Integrated Communications Attachment with Synchronous Data Adapter II)

IBM 1130 Computing System (with Synchronous Communications Adapter)

IBM 1800 Data Acquisition and Control System (via IBM 1826 Data Adapter Unit with Communication Adapter)

The controllers also communicate in network control mode with the following:

- A. World Trade teleprinters that use CCITT No. 2 or No. 5 code on nonswitched point-to-point communication lines.
- B. Terminals using the following line control disciplines: AT & T 83B3 or WU 115A start-stop code, over point-to-point or multipoint non-switched telegraph lines; CPT-TWX (33/35) start-stop code over the switched communication network.

Attachment of non-IBM equipment is under the provisions of the IBM Multiple Supplier Systems Policy.

¹ BSC support only.

² Supported only when attached locally to an IBM System/360 or System/370.

³ A *local* controller can communicate in network control mode with (1) one or more other local 3704 or 3705 controllers, via a binary synchronous communication line, and (2) one or more remote 3704 or 3705 controllers via a duplex or half-duplex SDLC data transmission channel.

A *remote* controller (1) *must* communicate in network control mode with a local controller via a duplex or half-duplex SDLC data transmission channel and (2) *may* communicate in network control mode with one or more local 3704 or 3705 controllers via binary synchronous communication line.

Appendix B: Types of Stations Supported by the IBM 3704 and 3705 Communications Controllers in Emulation Mode

The IBM 3704 and 3705 Communications Controllers, when attached to a host processor channel, can communicate in emulation mode with stations of the following types. Consult your IBM representative for the specific requirements for support of each of these stations.

Start-Stop Terminals

IBM 1030 Data Collection System
IBM 1050 Data Communication System
IBM 1060 Data Communication System
IBM 2260 Display Station (via IBM 2848 Display Control)
IBM 2265 Display Station (via IBM 2845 Display Control)
IBM 2740 Communications Terminal, Models 1 and 2
IBM 2741 Communications Terminal
IBM 2760 Optical Image Unit (via the IBM 2740 Communications Terminal, Model 1)
IBM 3767 Communication Terminal

Binary Synchronous Terminals

IBM 2770 Data Communications System
IBM 2780 Data Transmission Terminal (no support for Transcode)
IBM 2970 Models 5 and 8 Banking Terminals (not available in the United States and Canada)
IBM 2972 General Banking Terminal System, Models 8 and 11
IBM 3270 Information Display System
IBM 3650 Retail Store System
IBM 3660 Supermarket System
IBM 3670 Brokerage Communication System (supported only in the United States and Canada)
IBM 3735 Programmable Buffered Terminal
IBM 3740 Data Entry Terminal
IBM 3770 Data Communication System
IBM 3780 Data Communication Terminal

Transmission Control Units

IBM 2701 Data Adapter Unit (with Synchronous Data Adapter Type II)^{1,2}
IBM 2703 Transmission Control (with Synchronous Terminal Control)^{1,2}
IBM 2715 Transmission Control, Model 2¹
IBM 3704 Communications Controller³
IBM 3705 Communications Controller³

¹ BSC support only.

² Supported only when attached locally to an IBM System/360 or System/370.

³ A local controller can communicate in emulation mode with one or more other channel-attached 3704 or 3705 controllers via a binary synchronous communication line.

Computers (BSC support only except for System/7)

IBM System/3

IBM System/7 (supported as an IBM 2740 Communications Terminal, Model 1, with the Record Check feature; also supported as a BSC station)

IBM System/360, Model 20 (with Binary Synchronous Communications Adapter)

IBM System/360, Model 25 (with Integrated Communications Attachment with Synchronous Data Adapter II)

IBM System/370, Model 125 (with Integrated Communications Attachment with Synchronous Data Adapter II)

IBM System/370, Model 135 (with Integrated Communications Attachment with Synchronous Data Adapter II)

IBM 1130 Computing System (with Synchronous Communications Adapter)

IBM 1800 Data Acquisition and Control System (via IBM 1826 Data Adapter Unit with Communication Adapter)

IBM 3750 Switching System (not available in the United States and Canada)

The controllers also communicate in emulation mode with the following:

- A. World Trade teleprinters that use CCITT No. 2 or No. 5 code on nonswitched point-to-point, nonswitched multipoint, or switched network communication lines.
- B. Terminals using the following line control disciplines: AT & T 83B3 or WU 115A start-stop code, point-to-point or multipoint nonswitched telegraph lines; CPT-TWX (33/35) start-stop code over the switched communication network.

Attachment of non-IBM equipment is under the provisions of the IBM Multiple Supplier Systems Policy.

Appendix C: 3704 and 3705 Line Interface Bases and Line Sets

Line interface bases (LIB) and their associated line sets provide for the attachment of communication lines to the IBM 3704 and 3705 Communications Controllers. Several different types of LIBs and line sets are available, as listed below.

Note 1: Prior to July 1, 1979, IBM data circuit terminating equipment (modems) must attach to the U.S. Public Switched Network through (1) data couplers registered with the FCC (Federal Communications Commission), or (2) non-registered data couplers provided by the telephone company and other suppliers (such grandfathered data couplers can remain installed for the full term of the installation - refer to Part 68 of *Rules and Regulations of the FCC*). Installations occurring on or after July 1, 1979, may only use data couplers registered with the FCC to connect IBM modems to U.S. Public Switched Network. The data coupler isolates D.C. voltages, limits the power transmitted to the U.S. Public Switched Network and protects the U.S. Public Switched Network from external voltage surges. IBM does not provide data couplers.

IBM modems are only compatible with FCC registered data couplers that are equivalents of the telephone company provided U.S.O.C. (Universal Service Order Code) types CBS and/or CDT.

Note 2: The maximum number of line sets attachable to the 3704 or the 3705 depends upon the speed (data rate) of the lines, the type of channel adapters and communication scanners installed, and the mode of operation (network control mode or emulation mode). Discuss your requirements with your IBM representative to determine permissible combinations of the LIBs and line sets listed.

LIB Type 1: The LIB Type 1 provides for attachment of the following line sets. Line sets 1A, 1B, 1C, 1D, 1E, 1F, 1G, 1GA, 1H, 1J, 1K, 1N, 1R, 1S, 1T, 1TA, 1U, 1W, and 1Z may be attached to a LIB Type 1 in a 3705. In a 3704, line sets 1A, 1B, 1C, 1D, 1E, 1F, 1H, 1L, 1M, 1P, 1Q, 1X, and 1Y may be attached to LIB Type 1 or A1; line sets 1G, 1J, and 1K may be attached only to a LIB Type A1.

1. Line Set 1A (Low-Speed External Modem)—This line set provides for the attachment of two start-stop communication lines at speeds up to 1200 bps, each line having an EIA RS-232C/CCITT V.24 interface for attachment to an external modem. The IBM modems with which this line set can operate include the following:
IBM 2711 Line Adapters
IBM 3976 Models 1, 2, and 3 (not available in the United States and Canada)
IBM 3977 Model 2 (not available in the United States and Canada)
IBM 5979 L01/L02 (not available in the United States and Canada)
2. Line Set 1B (Low Speed Duplex External Modem)—This line set provides for the attachment of one start-stop duplex communication line that has an EIA RS-232C/CCITT V.24 interface, at speeds up to 1200 bps. This line set combines two communication-line ports into a true duplex data port. This line set cannot be used for a duplex line connecting a local and a remote communications controllers.
3. Line Set 1C (Low Speed Local Attachment)—This line set provides for the local attachment of two IBM start-stop terminals at speeds up to 1200 bps via IBM-provided cables. Modems are not required. Total cable length may not exceed 200 feet.
4. Line Set 1D (Medium Speed External Modem)—This line set provides for the attachment of two start-stop or synchronous communication lines at speeds up to 9600 bps, each of which has an EIA RS-232C/CCITT V.24 interface for

attachment to an external modem. The IBM modems with which this line set can operate include those mentioned under Line Set 1A, as well as the following:

IBM 3872 (2400/1200 bps)

IBM 3874 (4800 bps)

IBM 3875 (7200/3600 bps)

IBM 3978-12 (2400 bps) (not available in the United States and Canada)

IBM 3978-14 (4800 bps) (not available in the United States and Canada)

IBM 4872 (4800 bps)

5. Line Set 1E (Autocall Adapter)—This line set has two interfaces for attachment of two external automatic calling units. These automatic calling units may be associated with any switched-network communication lines attached through Line Sets 1A, 1D, or 1G.
6. Line Set 1F (Medium Speed Local Attachment)—This line set provides for the local attachment of two IBM synchronous terminals at speeds up to 2400 bps via IBM-provided cables. Modems are not required. Total cable length may not exceed 100 feet. The attached terminal must provide its own clocking.
7. Line Set 1G (High Speed External Modem) —This line set provides for the attachment of one synchronous communication line for operation at speeds up to 50,000 bps. It has a digital interface for attachment to a switched or leased wideband external modem. The IBM modems with which this line set can operate include the following:
IBM 3978-1 (20.4/40.8K bps) (not available in the United States and Canada)
This line set can be attached only to a LIB Type 1 in a 3705 and only to a LIB Type A1 in a 3704.
8. Line Set 1GA (High Speed External Modem) —This line set provides for the attachment of one synchronous communication line for operation at speeds up to 230,400 bps. It has a digital interface for attachment to a switched or nonswitched wideband external modem.
This line set can be attached only to a LIB Type 1 in a 3705-II. An IBM Type 3HS Communication Scanner is required to operate the 1GA line set at line speeds above 57,600 bps, and no more than two line sets may be attached to a scanner that is conditioned for external clocking.
9. Line Set 1H (Medium Speed Duplex External Modem)—This line set provides for the attachment of one duplex nonswitched communication line at speeds up to 9600 bps; the line set has an EIA RS-232C/CCITT V.24 interface for attachment to an external modem. The IBM modems with which this line set can operate include those mentioned under line set 1D.
10. Line Set 1J (External Mil Std 188C Modem)—This line set provides for the attachment of one start-stop or synchronous communication line at speeds up to 50,000 bps via an external modem having an interface that conforms to the requirements of Mil Std 188C (Section 7.2.1). This line set, available only in the United States and Canada, can be attached only to a LIB Type 1 in a 3705 and only to a LIB Type A1 in a 3704.
11. Line Set 1K (External CCITT V.35 Modem)—This line set provides for the attachment of one point-to-point synchronous communication line at speeds up to 57,600 bps via an external modem or 1W line set having an interface that conforms to the requirements of CCITT V.35. This line set, not available in the United States and Canada, can be attached only to a LIB Type 1 in a 3705 and only to a LIB Type A1 in a 3704.

Modem Attachment Base (2400 bps)—This attachment base provides for the attachment of up to two line sets 1L and 1M in any combination. The attachment base and line sets are available only for the 3704 with a LIB Type 1 or A1. Line sets 1L and 1M are equivalent to line sets 5A and 5B on the IBM 3705.

Note: This attachment base cannot be installed in conjunction with the remote program loader, the modem attachment base with auto-answer, the duplex data attachment base, or line set 1Q.

12. Line Set 1L (2400 bps Leased Point-to-Point Integrated Modem)—This line set provides for the attachment of one synchronous communication line at a speed of 1200 or 2400 bps. The line set includes a 2400 bps integrated modem with receive equalization, suitable for communication with similarly equipped IBM modems over nonswitched 3002 channels with C1, or equivalent, conditioning. No external modem is required.
13. Line Set 1M (2400 bps Multipoint Control Leased Line Integrated Modem)—This line set provides for the attachment of one synchronous line at a speed of 1200 or 2400 bps. The line set includes an IBM 2400 bps integrated modem with no equalization, suitable for communication with similar IBM multipoint tributary modems equipped with both transmit and receive equalization over nonswitched 3002 communication channels with C1, or equivalent, conditioning. No external modem is required.
14. Line Set 1N (External CCITT X.21 Interface)—This line set provides for the attachment of two half-duplex nonswitched synchronous lines or one full-duplex nonswitched synchronous line at speeds of 2400, 4800, 9600, or 48,000 bps. The 1N line set can operate with either a type 2 or type 3 communication scanner.

Modem Attachment Base with Auto-Answer (2400 bps)—This attachment base provides for the attachment of up to two line sets 1P. The attachment base and line set are available only for the 3704 with a LIB Type 1 or A1 and only in the United States and Canada. Line set 1P is equivalent to line set 6A on the IBM 3705.

Note: This attachment base cannot be installed in conjunction with the model attachment base, the duplex data attachment base, or line set 1Q.

15. Line Set 1P (2400 bps Switched Network Integrated Modem)—This line set provides for the attachment of one synchronous communication line at a speed of 1200 or 2400 bps. The line set includes a 2400/1200 bps integrated modem equipped with auto-answer, suitable for communication over a switched data communication network with a similarly equipped modem. No external modem or autocal unit is required.
16. Line Set 1Q (2400 bps Switched Network Integrated Modem with Auto-Answer and Automatic Call Originate)—This line set provides for the attachment of one synchronous communication line at a speed of 1200 or 2400 bps. The line set includes a 2400 bps integrated modem equipped with the auto-answer and automatic call originate (ACO) features. It is suitable for the automatic dialing of a remote station, the automatic answering of an incoming call, and communications over the switched communication network with a similar IBM modem, which must be equipped with the auto-answer feature. No external modem or autocal unit is required.

Line set 1Q is available only for the 3704 with a LIB Type 1 or A1 and only in the United States and Canada. Line set 1Q is equivalent to LIB Type 7 on the IBM 3705.

Only one line set 1Q can be installed per 3704.

Note: Line set 1Q cannot be installed in conjunction with the modem attachment base, the modem attachment base with auto-answer, or the duplex data attachment base.

17. Line Set 1R (External CCITT X.21 Interface)—This line set provides for the attachment of one full-duplex switched synchronous line at speeds of 2400, 4800, 9600, or 48,000 bps. The 1R line set operates with a type 2 communication scanner only.
18. Line Set 1S (High Speed Half-duplex, CCITT V.35 Interface)—This line set provides for the attachment of one CCITT V.35 type interface to be used on a switched or nonswitched communication facility or a 3705 with a 1W line set at up to 57,600 bps. This line set is available only in the United States and Canada. It may only be attached to a LIB Type 1 in a 3705-I or 3705-II; no more than eight may be attached to the LIB.
19. Line Set 1T (High Speed Duplex External Modem)—This line set provides for the attachment of one duplex synchronous line that has a digital interface for attachment to an external modem for up to 50,000 bps switched or nonswitched wideband facilities. The control program must condition this line interface for external clock control. This line set can only be attached to a LIB Type 1 in a 3705-I or 3705-II; no more than four may be attached to the LIB.
20. Line Set 1TA (High Speed Duplex External Modem)—This line set provides for the attachment of one duplex synchronous line that has a digital interface for attachment to an external modem for up to 230,400 bps switched or nonswitched wideband facilities. The control program must condition this line interface for external clock control. This line set can only be attached to a LIB Type 1 in a 3705-II. An IBM 3705 Communication Scanner Type 3HS is required to operate the 1TA line set at line speeds above 57,600 bps, and no more than one line set may be attached to a scanner that is conditioned for external clocking.
21. Line Set 1U (High Speed Duplex, CCITT V.35 Interface)—This line set provides for the attachment of one duplex line that has a CCITT V.35 interface for attachment to an external modem for up to 57,600 bps switched or non-switched communications facilities or directly attached to a 3705 with a 1Z line set. The control program must condition this line interface for external clock control. This line set can only be attached to a LIB Type 1 in a 3705-I or 3705-II; no more than four may be attached to the LIB.
22. Line Set 1W (High Speed Local Attachment)—This line set provides for the local attachment of one half-duplex line operating at speeds up to 57,600 bps (business machine clock - Feature Code 4651 - is required). The 1W line set has a CCITT V.35 interface that allows attachment to another CCITT V.35 interface in a terminal or a 3705 containing a 1K or a 1S line set.
23. Line Set 1Z (High Speed Local Attachment)—This line set provides for the local attachment of one full duplex line operating at a speed of 57,600 bps (refer to the 1W line set description in this section). The 1Z line set has a CCITT V.35 interface that allows attachment to another CCITT V.35 interface in another terminal or 3705 containing a 1U line set.

Duplex Data Attachment Base—This attachment base provides for the attachment of up to two line sets 1X and 1Y in any combination. The attachment base and line sets are available only for the 3704 with a LIB Type 1 or A1. Line sets 1X and 1Y are equivalent to line sets 11A and 11B on the IBM 3705.

Note: The duplex data attachment base cannot be installed in conjunction with the remote program loader, the modem attachment base, the modem attachment base with auto-answer, or line set 1Q.

24. Line Set 1X (2400 bps Point-to-Point Leased Line Duplex Data Integrated Modem)—This line set provides for the attachment of one synchronous duplex leased communication line at 1200 or 2400 bps. This line set includes one 2400 bps integrated duplex data modem with receive equalization, suitable for communication over leased 3002 channels with C1, or equivalent, conditioning. No external modem is required.

25. Line Set 1Y (2400 bps Multipoint Control Duplex Data Integrated Modem)—This line set provides for the attachment of one synchronous duplex non-switched communication line at 1200 or 2400 bps. This line set includes one 2400 bps integrated duplex data modem with no equalization, suitable for communication over nonswitched 3002 channels with C1, or equivalent, conditioning. No external modem is required.

LIB Type A1: The LIB Type A1, available only for the 3704 with a type 2 communication scanner, provides for the attachment of all type 1 line sets except 1GA and 1TA. The attachment bases required for attachment of line sets 1L, 1M, 1P, 1X, and 1Y are also available for LIB Type A1.

LIB Type 2: The LIB Type 2 provides for the attachment of the following line set.

1. Line Set 2A (Telegraph Single Current)—This line set provides for the attachment of two single-current telegraph communication lines that can operate at line speeds up to 200 bps. Each line can be wired for 20 ma, 40 ma, or 62.5 ma single current termination.

LIB Type 3: The LIB Type 3 provides for the attachment of the following line sets.

1. Line Set 3A (Limited Distance Type 1 [2-wire] Line Adapter)—This line set provides for the attachment of two start-stop communication lines at speeds up to 134.5 bps. The line set includes two IBM Limited Distance Type 1 (2-wire) line adapters (for up to 4.75 wire miles). No external modems are required.
2. Line Set 3B (Limited Distance Type 1 [4-wire] Line Adapter)—This line set provides for attachment of two start-stop communication lines at speeds up to 134.5 bps. This line set includes two IBM Limited Distance Type 1 (4-wire) line adapters (for up to 4.75 wire miles). No external modems are required.

LIB Type 4: The LIB Type 4 provides for the attachment of the following line sets.

1. Line Set 4A (Limited Distance Type 2 [2-wire] Line Adapter)—This line set provides for the attachment of two start-stop communication lines at speeds up to 600 bps. The line set includes two IBM Limited Distance Type 2 (2-wire) line adapters (for up to 8.25 wire miles). No external modems are required.
2. Line Set 4B (Leased Line [2-wire] Line Adapter)—This line set provides for the attachment of two start-stop communication lines at speeds up to 600 bps. The line set includes two IBM Leased Line (2-wire) line adapters. No external modems are required.
3. Line Set 4C (Leased Line (4-wire) Line Adapter)—This line set provides for the attachment of two start-stop communication lines at speeds up to 600 bps. This line set includes two IBM Leased Line (4-wire) line adapters. No external modems are required.

LIB Type 5: The LIB Type 5, available for the 3705 only, provides for the attachment of the following line sets.

1. Line Set 5A (2400/1200 bps Point-to-Point Leased Line Integrated Modem)—This line set provides for the attachment of one synchronous communication line at a speed of 1200 or 2400 bps. The line set includes a 2400/1200 bps integrated modem with receive equalization suitable for communication with a similarly equipped IBM modem over a leased 3002 channel with C1, or equivalent, conditioning. No external modem is required.

2. **Line Set 5B (2400/1200 bps Multipoint Control Leased Line Integrated Modem)**—This line set provides for the attachment of one synchronous communication line at a speed of 1200 or 2400 bps. The line set includes a 2400/1200 bps integrated modem with no equalization, suitable for communication with a similar IBM multipoint tributary modem equipped with both transmit and receive equalization over a leased 3002 channel with C1, or equivalent, conditioning. No external modem is required.

LIB Type 6: The LIB Type 6, available for the 3705 only, provides for the attachment of the following line set. This LIB is available only in the United States and Canada.

1. **Line Set 6A (2400/1200 bps Switched Network Integrated Modem)**—This line set provides for the attachment of one synchronous communication line at a speed of 1200 or 2400 bps. The line set includes a 2400/1200 bps integrated modem equipped with auto-answer and suitable for communication over the switched communication network with an IBM modem similarly equipped. No external modem or autocal unit is required.

LIB Type 7: (2400 bps Switched Network Integrated Modem with Automatic Call Originate). The LIB Type 7 provides the LIB and line set functions for the attachment, to the 3705 only, of one synchronous communication line at a speed of 1200 or 2400 bps. The line interface hardware includes a 2400 bps modem equipped with the auto-answer and automatic call originate (ACO) functions. This modem is suitable for the automatic dialing of a remote station, the automatic answering of an incoming call, and communication over the switched communication network with a similar IBM modem, which must be equipped with the auto-answer feature. No external modem or autocal unit is required. LIB Type 7 is available only in the United States and Canada.

LIB Type 8: The LIB Type 8 provides for the attachment of the following line sets.

In the 3704 only, a modem attachment base (1200 bps) is required for the attachment of line sets 8A and 8B (up to two in any combination).

1. **Line Set 8A (1200 bps Leased Integrated Modem)**—For the 3705, this line set provides for the attachment of two synchronous communication lines at speeds up to 1200 bps in the United States. In countries outside the United States, it provides for the attachment of two start-stop lines at a speed of 600 bps or two synchronous lines at speeds of 600 bps or 1200 bps. For the 3704, line set 8A provides for the attachment of one synchronous non-switched line at speeds up to 1200 bps in the United States. In countries outside the United States, it provides for the attachment of one start-stop line at a speed of 600 bps or one synchronous line at a speed of 1200 bps. This line set includes one (for the 3704) or two (for the 3705) 1200 bps integrated modems suitable for communication over a nonswitched, voice-grade channel with similar IBM modems. No external modems are required.

2. Line Set 8B (1200 bps Switched Network Integrated Modem)—For the 3705 this line set provides for the attachment of two synchronous communication lines at speeds up to 1200 bps. For the 3704, line set 8B provides for the attachment of one half-duplex synchronous line at speeds up to 1200 bps. The line set includes one (for the 3704) or two (for the 3705) 1200 bps integrated modems equipped with auto-answer and suitable for communication over the switched communication network with similar IBM modems. No external modems are required. This line set is available only in the United States and Canada.
3. Line Set 8C (1200 bps Leased Line Integrated Modem with Break)—This line set, available only for the 3704, provides for the attachment of one half-duplex start-stop or synchronous nonswitched communication line at speeds up to 1200 bps. The line set includes one IBM 1200 bps integrated modem with break, suitable for communication over a nonswitched voice-grade channel with a similar IBM modem. The break capability is supported for start-stop operation up to 300 bps. No external modems are required.
4. Line Set 8D (1200 bps Switched Network Integrated Modem with Break)—This line set, available only for the 3704, provides for the attachment of one half-duplex start-stop or synchronous switched communication line at speeds up to 1200 bps. The line set includes one 1200 bps integrated modem with break and auto-answer capability, suitable for communication over the switched communication network with similar IBM modems. The break capability is supported for start-stop operation up to 300 bps. No external modems are required.

LIB Type 9: For the 3705, the LIB Type 9 provides for the attachment of the following line set. For the 3704, LIB Type 9 includes the line set hardware. LIB Type 9 is available only in the United States and Canada.

1. Line Set 9A (1200 bps Switched Network Integrated Modem with Automatic Call Originate)—This line set provides for the attachment of one synchronous communication line at speeds up to 1200 bps. The line set includes one 1200 bps integrated modem equipped with the auto-answer and automatic call originate (ACO) functions. It is suitable for the automatic dialing of a remote station, the automatic answering of an incoming call, and communication over the switched communication network with a similar IBM modem (which must be equipped with the auto-answer feature and may be equipped with the ACO feature). No external modems or auto call units are required.

LIB Type 10: The LIB Type 10 provides for the attachment of the following line set.

1. Line Set 10A (1200 bps Leased Duplex Integrated Modem)—This line set provides for the attachment of one synchronous duplex nonswitched communication line at speeds up to 1200 bps. The line set includes one 1200 bps integrated modem. No external modem is required.

LIB Type 11: The LIB Type 11, available for the 3705 only, provides for the attachment of the following line sets.

1. Line Set 11A (2400 bps Point-to-Point Leased Line Duplex Data Integrated Modem)—This line set provides for the attachment of one synchronous duplex nonswitched communication line at a speed of 1200 or 2400 bps. The line set includes one 2400 bps integrated duplex data modem with receive equalization, suitable for communication over leased 3002 channels with C1, or equivalent, conditioning. No external modem is required.

2. Line Set 11B (2400/1200 bps Multipoint Control Integrated Modem)—This line set provides for the attachment of one synchronous duplex nonswitched communication line at 1200 or 2400 bps. The line set includes one 2400/1200 bps integrated duplex data modem with no equalization for multipoint master operation. It is suitable for communication over nonswitched 3002 channels with C1, or equivalent, conditioning. No external modem is required.

LIB Type 12: The LIB Type 12, available only for the 3705, provides for the attachment of the following line sets.

1. Line Set 12A (1200 bps Leased Line Integrated Modem with Break)—This line set provides for the attachment of two half-duplex start-stop or synchronous leased communication lines at speeds up to 1200 bps. This line set includes two 1200 bps integrated modems with break, suitable for communication over non-switched, voice-grade channels with similar IBM modems. The break capability is supported for start-stop operation up to 300 bps. No external modems are required.
2. Line Set 12B (1200 bps Switched Network Integrated Modem with Break)—This line set provides for the attachment of two half-duplex start-stop or synchronous switched communication lines at speeds up to 1200 bps. The line set includes two 1200 bps integrated modems with break and auto-answer capability, suitable for communication over the switched communication network with a similar IBM modem. The break capability is supported for start-stop operation up to 300 bps. No external modems are required.

Clocking Requirements for Line Interface Bases and Line Sets

The following list indicates whether a communications controller line set (or line interface base, when no line sets are required) uses business machine clocking or modem clocking. In general (but not always), business machine clocking is used for speeds of 2400 bps or less, and modem clocking is used for speeds greater than 2400 bps.

<i>Line Set or LIB</i>	<i>Type of Clocking</i>	<i>Line Set or LIB</i>	<i>Type of Clocking</i>
1A	Business machine	1X	Modem
1B	Business machine	1Y	Modem
1C	Business machine	1Z	Business machine**
1D	Business machine* or modem	2A	Business machine
1E	No clocking required for auto-call interface	3A	Business machine
1F	Business machine	3B	Business machine
1G	Modem	4A	Business machine
1GA	Modem	4B	Business machine
1H	Business machine* or modem	4C	Business machine
1J	Business machine* or modem	5A	Modem
1K	Modem	5B	Modem
1L	Modem	6A	Modem
1M	Modem	7 (LIB)	Modem
1N	DCE	8A	Business machine
1P	Modem	8B	Business machine
1Q	Modem	8C	Business machine
1R	DCE	8D	Business machine
1S	Modem	9 (LIB)	Business machine
1T	Modem	9A	Business machine
1TA	Modem	10A	Business machine
1U	Modem	11A	Modem
1W	Business machine**	11B	Modem
		12A	Business machine
		12B	Business machine

*Business machine clocking may be used for these line sets at speeds of 2400 bps or lower.
 **Consult your IBM representative for information

Appendix D: Publications Relating to the IBM 3704 and 3705

The chart below indicates the types of manuals that apply to each of six general functions that the 3704 or 3705 user may perform. The following pages contain synopses of the contents of all the publications currently available for the controllers. They are arranged in alphabetical order by category of manual (for example, program generation manuals, program logic manuals, and storage and performance manuals).

<i>Learning</i>	<i>Planning</i>	<i>Coding</i>	<i>Installing/ Generating</i>	<i>Operating</i>	<i>Maintaining</i>
Introduction	Preinstallation Guide and Installation Record Physical Planning Program Generation Storage and Performance	Assembler Language Principles of Operation User's Guide (UBHRs)* Handbook Program Logic Manual (NCP macros)**	Program Generation Storage and Performance User's Guide (fine tuning)*	Operator Reference Card Control Panel Guide Program Generation (utilities)	Program Logic Manual** Handbook FETMM** Principles of Operation Control Panel Guide User's Guide (debug)*

*Network Control Program only.

**These manuals must be purchased.

Assembler Language

IBM 3704 and 3705 Communications Controller Assembler Language (GC30-3003)

The contents of this manual include:

- Basic assembler language concepts, such as coding conventions, terms, and expressions.
- A description of the communications controller machine instructions.
- A description of the function of the communications controller assembler instructions and how to code them.
- A description of the communications controller macro language and how to write a macro definition.

Control Panel Guides

Guide to Using the IBM 3704 Communications Controller Control Panel (GA27-3086)

Guide to Using the IBM 3705 Communications Controller Control Panel (GA27-3087)

The contents of these manuals include:

- A general description of the capabilities of the control panel.
- Step-by-step operating procedures that are program-independent.
- Step-by-step operating procedures for use with the emulation program.
- Step-by-step operating procedures for use with the network control program.

- A glossary of the panel controls that summarizes their functions and provides a cross-reference to the applicable procedures.
- A diagram of the control panel.
- A list of register addresses to be used in certain panel procedures.
- A description of the check and status lights on the panel.
- Emulation program and network control program control block layouts required to interpret certain panel displays.

FE Theory and Maintenance Manuals (FETMMs)

IBM 3704 Communications Controller Theory–Maintenance (SY27-0115)

The contents of this manual include:

- The control panel procedures and the control panel tests to direct the IBM Customer Engineer (CE) to a failing functional unit and to a failing field replaceable unit within the functional unit.
- The tests performed by the ROS bootstrap program and a description of the control panel procedures for use while diagnosing errors detected by the ROS bootstrap program.
- A description of the relationship between the central control unit and the adapters.
- A description of how the functional units of the 3704 work so that the CE can verify that the suspected card indicated by the diagnostics is actually causing the failure. The functional units described are:
 - Central control unit
 - Channel adapters
 - Communication scanners
 - Line interface bases and line sets
 - Power supply
 - Storage
 - Remote program loader.

IBM 3705 Communications Controller Theory–Maintenance (SY27-0107)

Volume one contains:

- A maintenance philosophy section which points the IBM Customer Engineer (CE) to the correct part of the manual for locating a failure.
- The control panel procedures and the control panel tests to direct the CE to a failing unit.
- The tests performed by the ROS bootstrap program.
- A description of the central control unit and the storage to help a CE verify a problem.

Volume two contains a description of how the channel adapters and communication scanners work to help an IBM Customer Engineer verify problems.

Volume three contains a description of how the line interface bases, line sets, and power supply work to aid in detecting failures.

Handbook

IBM 3704 and 3705 Program Reference Handbook (GY30-3012)

The contents of this manual include:

- Diagrams showing various relationships between data areas for both the network control program (NCP) and the emulation program (EP).
- Layouts of all NCP and EP data areas with field and bit definitions.
- NCP commands and modifiers.
- Responses returned to the host by the NCP.
- EP command codes.
- 3704 and 3705 instruction set showing the mnemonic code and the bit pattern for each instruction.
- External register functions.
- Description and layout of the interface control word (ICW).
- NCP abend codes.
- Line character code charts.
- Examples of polling and addressing.
- Miscellaneous Data Recorder record formats.

Introduction

Introduction to the IBM 3704 and 3705 Communications Controllers (GA27-3051)

The contents of this manual include:

- A discussion of the advantages of the communications controllers, which introduces some general concepts.
- A general discussion of the 3704 and 3705 hardware units and their functions.
- A general discussion of the functions and use of the system support programs, including the program generation language and procedures, the assembler, and the loader and dump utility programs.
- A discussion of the concepts and functions of the network control program.
- A discussion of the concepts and functions of the emulation program.
- A discussion of the concepts and functions of the partitioned emulation programming extension to the network control program.
- Lists of the types of stations supported by the controllers in network control mode and emulation mode.
- A summary of the line interface bases and line sets available for the controllers.
- A summary of publications relating to the communications controllers.

Operator Reference Cards

IBM 3704 Operator Reference Summary (GA27-3091)

IBM 3705 Operator Reference Summary (GA27-3092)

These reference cards contain basic operating and error recovery procedures for the 3704 and 3705 operator. All procedures described are program-independent.

Physical Planning Manuals

IBM System/360 Installation Manual—Physical Planning (GC22-6820)

IBM System/370 Installation Manual—Physical Planning (GC22-7004)

IBM Remote Multiplexers and Communications Terminals Installation Manual—Physical Planning (GA27-3006)

These manuals contain physical specifications, electrical and environmental requirements, and cabling requirements for the IBM 3704 and 3705 Communications Controllers.

Preinstallation Guide/Installation Record

Teleprocessing Preinstallation Guide for IBM 3704 and 3705 Communications Controllers (GC30-3020)

This publication lists the equipment characteristics of the data communication network and communications controller that the user must specify when coding an emulation program or network control program. The publication consists of a series of tables, one for each type of station supported by the program and one for each type of line set with which the controller can be equipped. Each table gives the appropriate values to code for the station or line set represented. For some characteristics several values are listed, the appropriate choice depending on how the user's station is equipped (for instance, which transmission code it employs) or in which of alternate modes he wishes the station or line to operate. In these cases, accompanying notes suggest where the user may learn the values appropriate for his installation.

Teleprocessing Installation Record for IBM 3704 and 3705 Communications Controllers (GC30-3021)

This publication provides the user with a convenient means for recording the details of his 3704- or 3705-based data communication configuration—existing or planned—that he must know before coding an emulation program or network control program. As furnished, the publication consists of a series of formatted charts, each of which has appropriately labeled spaces representing the information items pertinent to a particular type of communication line (such as a multipoint communication line) and the stations associated with that line. A chart is also provided for recording the hardware units installed in the communications controller, along with related information such as line interface and subchannel addresses used.

From the package of charts provided, the user selects the number and types appropriate to his data communication configuration. Upon filling in the information indicated and assembling the charts into a binder, he has a convenient record of his configuration that gives much of the information needed to code a program appropriate to his installation. (The charts also contain spaces for related information not needed in coding the program, for example, common-carrier circuit numbers.)

Principles of Operation

IBM 3704 and 3705 Communications Controllers Principles of Operation (GC30-3004)

The contents of this manual include:

- A general description of the 3704 and 3705 communications controllers and their functional hardware units.
- A description of the registers, interrupt scheme, and program levels.
- A description of the basic storage addressing procedure and the format for addressing the individual communication lines.
- A description of the 3704 and 3705 machine instructions with their formats and condition codes.
- Descriptions of the operation and programming requirements of the central control unit, the communication scanners, and the channel adapters.
- External register functions.
- Input/Output instruction bit definitions.
- A summary of Input/Output instructions.

Program Generation Manuals

IBM 3704 and 3705 Control Program/VS Generation and Utilities Guide and Reference Manual (GC30-3008)

This manual contains information on NCP/VS. The contents include:

- The data communication characteristics that the analyst or programmer must consider when defining the network control program.
- Detailed descriptions of the macro instructions that define a network control program and how to code them.
- How to create a network control program load module by executing the program generation procedure once the generation macros have been coded.
- How to use the independent loader and dump utility programs.
- Diagnostic messages produced by the program generation procedure and the utility programs.
- Coding examples for switched network dial sets and multiple terminal access operation.
- Sign-on procedures for operators of multiple terminal access stations.

ACF/NCP/VS (Network Control Program and System Support Programs) General Information (GC30-3058)

This manual contains information on ACF/NCP/VS, a licensed IBM program product. The contents include:

- Introduction to Networks and ACF/NCP/VS
- ACF/NCP/VS in a Single-Domain Network
- ACF/NCP/VS in a Multiple-Domain Network
- ACF/System Support Programs
- ACF/NCP/VS Release 2
- Migration Considerations
- Preinstallation Planning
- Communications Terminals and Systems Supported by ACF/NCP/VS
- Publications Relating to ACF/NCP/VS
- ACF/NCP/VS in a Remote Communications Controller
- Emulation Mode Support

IBM 3704 and 3705 Communications Controllers Emulation Program Generation and Utilities Guide and Reference Manual (GC30-3002)

The contents of this manual include:

- Detailed descriptions of the macro instructions that define an emulation program and how to code them.
- How to create an emulation program load module by executing the generation procedure once the generation macros have been coded.
- How to use the independent loader and dump utility programs.
- Coding example for emulation program generation.
- Storage requirements for the loader and dump programs and for emulation program generation.
- Diagnostic messages produced by the program generation procedure and the utility programs.

This manual covers both OS and DOS/VS considerations where differences exist.

Program Logic Manuals (PLMs)

IBM 3704 and 3705 Communications Controllers Network Control Program/VS Program Logic Manual (SY30-3013).

This manual contains information on NCP/VS programming logic. The contents include:

- A summary of command processing in the network control program (NCP), including data flow and control flow.
- The physical organization of the NCP.
- A description of the functional units of the NCP including:
 - Initialization, initiation, and termination.
 - Channel adapter management.
 - Level 1 processing.
 - Interval timer routines.
 - Serviceability aids.
 - Multiple terminal access facility.
 - Block handler support.
 - Tasks in the NCP.
 - System supervisor.
- A verbal description of the major data areas in the NCP.
- Method of Operation diagrams describing in detail the following NCP functions and relating them to the NCP code:
 - Initialization.
 - Channel adapter management.
 - Processing requests from the host.
 - Processing machine and program checks.
 - Serviceability aids.
 - Block handling functions.
 - Termination.
- A detailed description of the NCP system supervisor, relating its functions to the macros used to request those functions.
- A cross-reference table listing all NCP CSECTs with their entry points, functions, exits, and method of operation diagrams that refer to them.
- Formats of the NCP macro instructions.
- A generalized layout of the NCP modules in controller storage.
- The standard labels used to refer to external registers.
- A chart of register usable by CSECT.
- A cross-reference chart listing pertinent information about each of the Control commands.
- A summary of online terminal testing and a detailed description of each online test interpretive command.
- A chart showing the sequence in which level 5 subtasks are executed to process each type of request from the host.
- Charts showing the line operations performed by the NCP for each type of I/O command.
- Diagrams showing save area formats.
- Information about the status and sense indications presented to the host by the NCP via the channel adapter.

The contents of this manual include:

- A description of the physical and logical organization of the emulation program (EP).
- A description of the EP data areas, including control areas, tables, and queues.
- A description of the functions of the EP, divided according to the functions of the interface control program (ICP) and the line control program (LCP).
- Method of Operation diagrams describing in detail the following EP functions and relating them to the EP code:
 - Level 3 interrupt handling.
 - Level 2 interrupt handling.
 - Queue management.
 - Level 1 error detection.
 - Panel display request processing.
- A directory listing the EP routines with their function and other pertinent cross-reference information.
- A description of diagnostic aids, including:
 - Error detection.
 - Error recovery.
 - Error isolation tools.
 - A summary of general register usage in the EP.
- Summaries of status and sense information presented to the host processor.
- A chart showing the relationship between EP generation macros and the routines they cause to be included in the EP.

Storage Estimate Manuals

Storage Estimates and Performance Planning for the IBM 3704 and 3705 Communications Controllers Network Control Program (GC30-3006)

The contents of this manual include:

- How to estimate storage requirements for a given configuration of the network control program, including:
 - Basic code requirements.
 - Storage requirements for optional system functions.
 - Storage requirements for support of particular communication line and station types.
 - Storage requirements for control blocks that vary according to configuration.
 - Storage requirements for user-generated code.
 - Storage requirements for buffers.
 - Storage requirements for the PEP extension.
- How to select options that may improve the performance of the network control program, including:
 - Channel adapter options.
 - Internal NCP options, such as network slowdown threshold values, sub-blocking options, and block-handling routines.

Storage Estimates for the IBM 3704 and 3705 Communications Controllers Emulation Program (GC30-3005)

The contents of this manual include how to estimate storage requirements for a given configuration of the emulation program, including:

- Storage requirements for support of various hardware options and terminals.
- Storage requirements for support of various transmission codes.
- Storage requirements for serviceability aids.
- Storage requirements for control blocks and tables that vary according to configuration.

User's Guide

Network Control Program/TCAM Network User's Guide (GC30-3009)

The contents of this manual include:

- A description of how TCAM and the network control program (NCP) communicate, including the use of the BTU and a summary of channel operations.
- A description of how the NCP operates the communications controller.
- A description of how the NCP and TCAM work together to control the communication network.
- A summary of aids for diagnosing the NCP/TCAM network.
- A sample UBHR program.
- A summary of the NCP and TCAM generation macro instructions.
- A summary of TCAM commands for the NCP.
- An example of an NCP storage dump.

Appendix E: 3705-I and 3705-II Hardware Configurations and Model Information

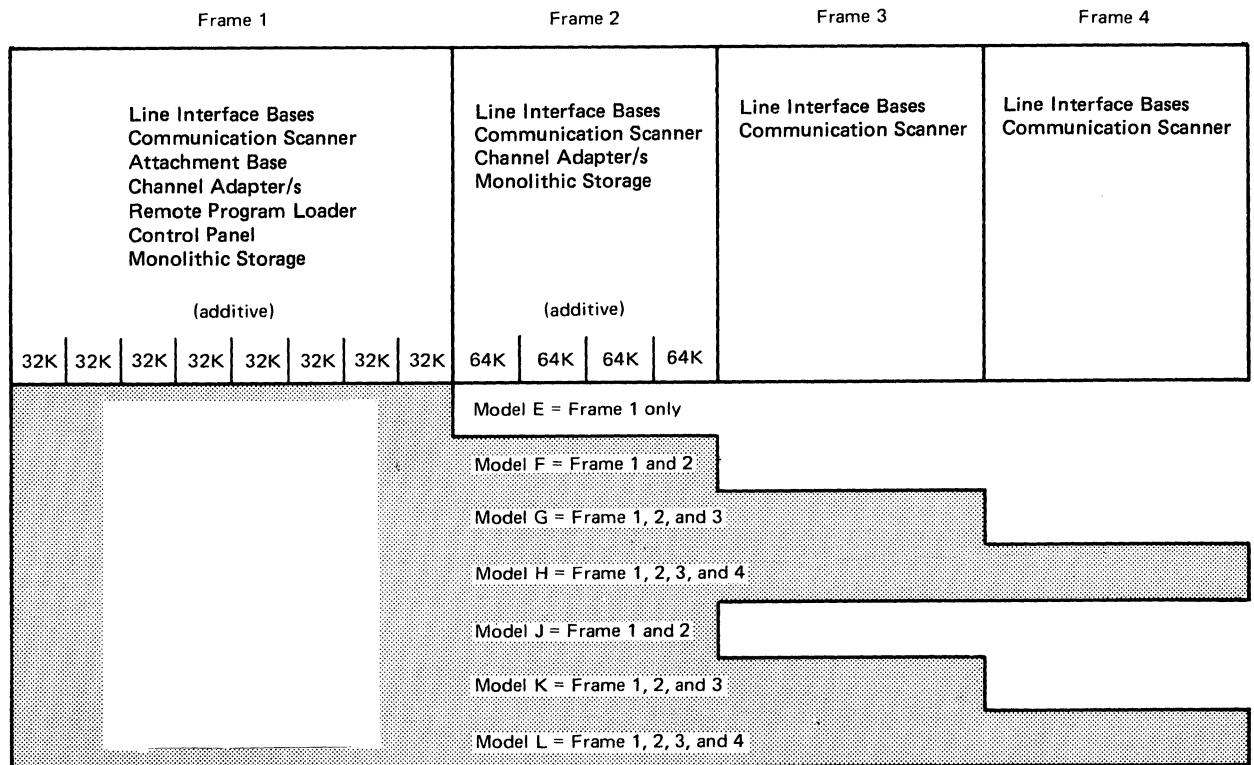
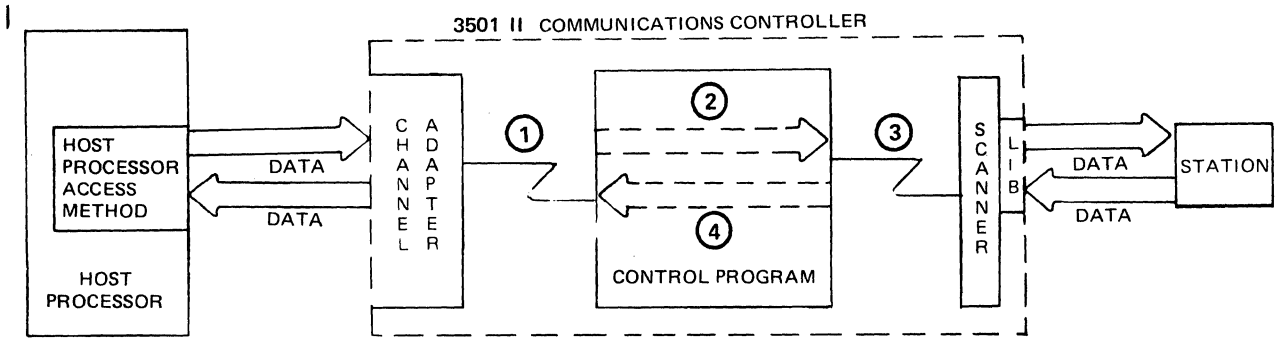

E1 - L4

E1, F1, G1, H1	32K
E2, F2, G2, H2	64K
E3, F3, G3, H3	96K
E4, F4, G4, H4	128K
E5, F5, G5, H5	160K
E6, F6, G6, H6	192K
E7, F7, G7, H7	224K
E8, F8, G8, H8	256K
J1, K1, L1	320K
J2, K2, L2	384K
J3, K3, L3	448K
J4, K4, L4	512K

Maximum number of half-duplex lines per model

Model E	= 64
Models F and J	= 160
Models G and K	= 256
Models H and L	= 352

Channel Adapter and Communication Scanner Combinations for the 3705-II (Part 1 of 2)

Channel Adapter Type and Quantity				Communication Scanner Type and Quantity		3705-II Model #
1	2	3	4	2	3/3HS *	
1				1		E
				2		F
				3		G
				4		H
1				1		E and J
				2		F and J
				3		G and K
				4		H and L
2				1		F and J
				2		F and J
				3		G and K
				4		H and L
1				1		E and J
				2		F and J
				3		G and K
				4		H and L
2				1		F and J
				2		F and J
				3		G and K
				4		H and L
1				1 1		F and J
				1 2		G and K
				1 3		H and L
				2 1		G and K
				2 2		H and L
				3 1		H and L
2				1 1		F and J
				1 2		G and K
				1 3		H and L
				2 1		G and K
				2 2		H and L
				3 1		H and L
1				1		E and J
				2		F and J
				3		G and K
				4		H and L
2				1		F and J
				2		F and J
				3		G and K
				4		H and L
1				1		E and J
				2		F and J
				3		G and K
				4		H and L
2				1		F and J
				2		F and J
				3		G and K
				4		H and L
1				1		E and J
				2		F and J
				3		G and K
				4		H and L
2				1		F and J
				2		F and J
				3		G and K
				4		H and L
1				1 1		F and J
				1 2		G and K
				1 3		H and L
				2 1		G and K
				2 2		H and L
				3 1		H and L

(Note 5)

Channel Adapter Type and Quantity				Communication Scanner Type and Quantity		3705-II Model #
1	2	3	4	2	3/3HS *	
	2			1 1		F and J
				1 2		G and K
				1 3		H and L
				2 1		G and K
				2 2		H and L
				3 1		H and L
	1			1		E and J
				2		F and J
				3		G and K
				4		H and L
	2			1		E, F, and J
				2		F and J
				3		G and K
				4		H and L
	3			1		F and J
				2		F and J
				3		G and K
				4		H and L
	4			1		F and J
				2		F and J
				3		G and K
				4		H and L
	1			1		E and J
				2		F and J
				3		G and K
				4		H and L
	2			1		E, F, and J
				2		F and J
				3		G and K
				4		H and L
	3			1		F and J
				2		F and J
				3		G and K
				4		H and L
	4			1		F and J
				2		F and J
				3		G and K
				4		H and L
	1			1 1		F and J
				1 2		G and K
				1 3		H and L
				2 1		G and K
				2 2		H and L
				3 1		H and L
	2			1 1		F and J
				1 2		G and K
				1 3		H and L
				2 1		G and K
				2 2		H and L
				3 1		H and L

(Note 4)

(Note 2)

(Note 4)

(Note 2)

Channel Adapter and Communication Scanner Combinations for the 3705-II (Part 2 of 2)

Channel Adapter Type and Quantity				Communication Scanner Type and Quantity		3705-II Model #
1	2	3	4	2	3/3HS *	
		3		1 1 1 2 1 3 2 1 2 2 3 1		F and J G and K H and L G and K H and L H and L
		4		1 1 1 2 1 3 2 1 2 2 3 1		F and J G and K H and L G and K H and L H and L
1	1			1 2 3 4		F F G H
1	1			1 2 3 4		F F G H
1	1			1 2 3 4		F and J F and J G and K H and L
1	1			1 2 3 4		F and J F and J G and K H and L

(Note 4)

(Notes 1 and 5)

(Note 5)

Channel Adapter Type and Quantity				Communication Scanner Type and Quantity		3705-II Model #
1	2	3	4	2	3/3HS *	
1	1			1 1 1 2 1 3 2 1 2 2 3 1		F and J G and K H and L G and K H and L H and L
1	1			1 2 3 4		E, F, and J F and J G and K H and L
1	1			1 2 3 4		E, F, and J F and J G and K H and L
1	1			1 1 1 2 1 3 2 1 2 2 3 1		F and J G and K H and L G and K H and L H and L
1	1			1 2 3 4		F and J F and J G and K H-L
1	1			1 2 3 4		F and J F and J G and K H and L
1	1			1 1 1 2 1 3 2 1 2 2 3 1		F and J G and K H and L G and K H and L H and L

(Notes 1 and 3)

(Notes 1 and 3)

(Notes 1 and 3)

(Notes 1 and 3)

(Notes 1 and 3)

(Notes 1 and 3)

* For allowable configurations and attachment capability of Type 3HS Communication Scanners, contact your IBM Marketing Representative.

Any model of 3705-II may contain a remote program loader (RPL) in addition to channel adapters shown except as indicated by note 4. (The RPL is always located in the first frame of the 3705-II.)

Note 1: Communication over both CAs can occur only when the control program is performing emulation subchannel operations over the Type 1 or 4 CA and native subchannel operations over the other CA.

Note 2: Communication over both Type 4 CAs can occur when the control program performs (1) native subchannel operations over both CAs or (2) native subchannel operations over one CA and emulation subchannel operations over both CAs.

Note 3: The Type 4 CA must be installed in the base module when the controller contains a Type 4 and a Type 2 CA or a Type 4 and a Type 3 CA.

Note 4: Remote program loader (RPL) for this configuration (four channel adapters) not available.

Note 5: Type 1 CAs cannot be installed on 3705-II, Models J, K, and L.

Channel Adapter Locations on a 3705-II

1st CA Type	2nd CA Type	3rd CA Type	4th CA Type	Frame Location			
				1st CA	2nd CA	3rd CA	4th CA
1	—	—	—	Frame 1	—	—	—
1	2	—	—	Frame 1	Frame 2	—	—
1	3	—	—	Frame 1	Frame 2	—	—
2	—	—	—	Frame 1	—	—	—
2	2	—	—	Frame 1	Frame 2	—	—
2	3	—	—	Frame 1	Frame 2	—	—
3	—	—	—	Frame 1	—	—	—
3	2	—	—	Frame 1	Frame 2	—	—
3	3	—	—	Frame 1	Frame 2	—	—
4	—	—	—	Frame 1	—	—	—
4	2	—	—	Frame 1	Frame 1	—	—
4	2	—	—	Frame 1	Frame 2	—	—
4	3	—	—	Frame 1	Frame 2	—	—
4	4	—	—	Frame 1	Frame 1	—	—
4	4	—	—	Frame 1	Frame 2	—	—
4	4	4	—	Frame 1	Frame 1	Frame 2	—
4	4	4	—	Frame 1	Frame 2	Frame 2	—
4	4	4	4	Frame 1	Frame 2	Frame 2	Frame 2

Limitations

1. For the 3705-II, if two channel adapters are in the same frame, then no two-channel switch feature is allowed.
2. If two channel adapters are in the first frame of 3705-II, at least one of the adapters must be a Type 4 CA.
3. For the 3705-II, the Remote Program Load feature can co-exist with a channel adapter in frame 1.
4. No channel adapters are allowed in the third or fourth frame of a 3705-II.

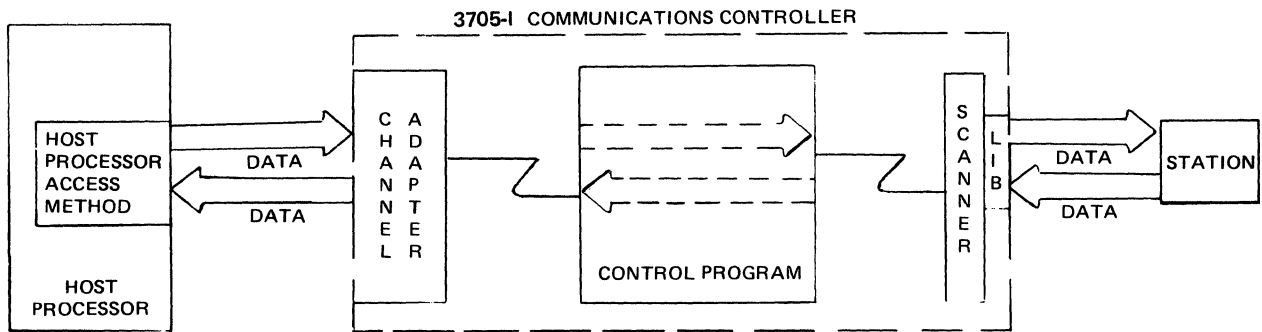

	Frame 1		Frame 2		Frame 3		Frame 4	
	Line Interface Bases Communication Scanner Attachment Base Channel adapter Remote Program Loader Control Panel		Line Interface Bases Communication Scanner Channel adapter		Line Interface Bases Communication Scanner		Line Interface Bases Communication Scanner	
	Core Storage	(additive)	(additive)		(additive)		(additive)	
	16K	32K	32K	32K	32K	32K	32K	32K
Model A	1	2						
Model B	1	2	3	4				
Model C	1	2	3	4	5	6		
Model D	1	2	3	4	5	6	7	8
Storage Capacity	16K	48K	80K	112K	144K	176K	208K	240K

Maximum number of half-duplex
 lines per model

- Model A = 64
- Model B = 160
- Model C = 256
- Model D = 352

Channel Adapter and Communication Scanner Combinations for the 3705-I (Part 1 of 2)

Channel Adapter Type and Quantity				Communication Scanner Type and Quantity			3705-I Model #			
1	2	3	4	1	2	3	A	B	C	D
1				1			*	x	x	x
1				1			*	x	x	x
				2			*	x	x	
				3				*	x	
				4					*	
1				1			*	x	x	x
				2			*	x	x	
				3				*	x	
				4					*	
2				1			*	x	x	
				2			*	x	x	
				3				*	x	
				4					*	
1				1 1			*	x	x	
				1 2			*	x		
				1 3				*		
				2 1			*	x		
				2 2				*		
				3 1					*	
2				1 1			*	x	x	
				1 2			*	x	x	
				1 3				*		
				2 1			*	x		
				2 2				*		
				3 1					*	
1				1			*	x	x	x
				2			*	x	x	
				3				*	x	
				4					*	
2				1			*	x	x	
				2			*	x	x	
				3				*	x	
				4					*	

(note 6)

(note 6)

Channel Adapter Type and Quantity				Communication Scanner Type and Quantity			3705-I Model #			
1	2	3	4	1	2	3	A	B	C	D
1				1 1			*	x	x	
				1 2				*	x	
				1 3				*		
				2 1			*	x		
				2 2				*		
				3 1					*	
2				1 1			*	x	x	
				1 2			*	x	x	
				1 3				*		
				2 1			*	x		
				2 2				*		
				3 1					*	
1				1			*	x	x	x
				2			*	x	x	
				3				*	x	
				4					*	
2				1			*	x	x	
				2			*	x	x	
				3				*	x	
				4					*	
1				1 1			*	x	x	
				1 2			*	x	x	
				1 3				*		
				2 1			*	x		
				2 2				*		
				3 1					*	
2				1 1			*	x	x	
				1 2			*	x	x	
				1 3				*		
				2 1			*	x		
				2 2				*		
				3 1					*	

(note 6)

(note 6)

(note 6)

(notes 3 and 6)

Channel Adapter and Communication Scanner Combinations for the 3705-I (Part 2 of 2)

Channel Adapter Type and Quantity				Communication Scanner Type and Quantity			3705-I Model #			
1	2	3	4	1	2	3	A	B	C	D
1	1			1			*	x	x	
1	1			1			*	x	x	
				2			*	x	x	
				3				*	x	
				4					*	
1	1			1			*	x	x	
1	1			1			*	x	x	
				2				*	x	
				3					*	x
				4						*
1	1			1			*	x	x	
				2			*	x	x	
				3				*	x	
				4					*	
1	1			1	1		*	x	x	
				1	2			*	x	
				1	3				*	
				2	1			*	x	
				2	2				*	
				3	1				*	

(note 1)

(note 1)

(note 6)

Channel Adapter Type and Quantity				Communication Scanner Type and Quantity			3705-I Model #			
1	2	3	4	1	2	3	A	B	C	D
1	1			1			*	x	x	
				2			*	x	x	
				3				*	x	
				4					*	
1	1			1	1		*	x	x	
				1	2			*	x	
				1	3				*	
				2	1			*	x	
				2	2				*	
				3	1				*	
1	1			1			*	x	x	
				2			*	x	x	
				3				*	x	
				4					*	
1	1			1	1		*	x	x	
				1	2			*	x	
				1	3				*	
				2	1			*	x	
				2	2				*	
				3	1				*	

(note 4)

(notes 1, 4, and 6)

(notes 1 and 4)

(notes 1, 4, and 6)

#A 3705-I can contain a remote program loader (RPL) if it does not contain any channel adapters. See Note 5.

* Indicates, for a 3705-I, the smallest model of 3705 required to accommodate the number of channel adapters and communication scanners shown at left.

x Indicates other models of 3705-I that can accommodate the number of channel adapters and communication scanners shown at left; the larger model so indicated may be required if the storage size required exceeds the capacity of the model indicated by *.

Note 1: Communication over both CAs can occur only when the control program is performing emulation subchannel operations over the Type 1 or 4 CA and native subchannel operations over the other CA.

Note 2: A 3705-I cannot contain only Type 3 Scanners; it can contain Type 3 Scanners in each expansion module if the base module contains a Type 2 Scanner.

Note 3: Communication over both Type 4 CAs can occur when the control program performs (1) native subchannel operations over both CAs or (2) native subchannel operations over one CA and emulation subchannel operations over both CAs.

Note 4: The Type 4 CA must be installed in the base module when the controller contains a Type 4 and a Type 2 CA or a Type 4 and a Type 3 CA.

Note 5: The RPL in a 3705-I can co-reside with any combination of Type 1 or Type 2 communication scanners but not with a Type 3 scanner or any channel adapter.

Note 6: The Type 2 Scanner must be in frame 1.

Channel Adapter Locations on a 3705-I

1st CA Type	2nd CA Type	Frame Location	
		1st CA	2nd CA
1	—	Frame 1	—
1	2	Frame 1	Frame 2
1	3	Frame 1	Frame 2
2	—	Frame 1	—
2	2	Frame 1	Frame 2
2	3	Frame 1	Frame 2
3	—	Frame 1	—
3	2	Frame 1	Frame 2
3	3	Frame 1	Frame 2
4	—	Frame 1	—
4	2	Frame 1	Frame 2
4	3	Frame 1	Frame 2
4	4	Frame 1	Frame 2

Limitations

1. The first frame of a 3705-I can contain one Channel Adapter Type 1, 2, 3, or 4CA.
2. The second frame of a 3705-I can contain one Channel Adapter Type 2, 3, or 4 CA.
3. No channel adapters are allowed in the third or fourth frame of a 3705-I.
4. No channel adapters are allowed in a 3705-I with a Remote Program Load Feature.

List of Abbreviations

ACF	Avanced Communication Function
ACO	Automatic Call Originate
ASCII	American National Standard Code for information interchange
AT&T	American Telephone and Telegraph Company
BCD	Binary Coded Decimal
BH macro	block handling marcro
BH set	block handler set
BHR	block handling routine
bksp	backspace
bps	bits per second
BSC	binary synchronous communications
°C	degree Celsius
CA	channel adapter
CCITT	Comite Consultatif International Telegraphique et Telephonique (Consultative Committee on International Telegraphy and Telephony)
DOS	Disk Operating System
DOS/VS	Disk Operating System/Virtual Storage
EBCD	Extended Binary Coded Decimal
EBCDIC	Extended Binary Coded Decimal Interchange Code
EIA	Electronic Industries Association
EP	Emulation Program
ERP	error recovery procedure
°F	degree Fahrenheit
FDX	(Full) Duplex
Hz	hertz
ID	identification
I/O	input/output
IPL	initial program load
K	thousand (1,024, when referring to bytes of storage)
LIB	line interface base
LU	Logical Unit
ma	milliampere
MTA	Multiple Terminal Access
NCP	Network Control Program
OLLT	online line test
OLTT	online terminal test
OS	Operating System
OS/VS	Operating System/Virtual Storage
PEP	Partitioned Emulation Programming
PU	Physical Unit
RPQ	Request for Price Quotation
SDLC	synchronous data link control
SNA	Systems Network Architecture
SSCP	System Services Control Point
TCAM	Telecommunications Access Method
TCU	Transmission Control Unit
TWX	Teletypewriter Exchange
VS	Virtual Storage
VTAM	Virtual Telecommunications Access Method
WU	Western Union

Asterisked (*) definitions are reproduced with permission from the American National Dictionary for Information Processing, copyright 1977 by the Computer and Business Equipment Manufacturers Association, copies of which may be purchased from the American National Standard Institute, 1430 Broadway, New York, N.Y. 10018.

Access method. A data management technique for transferring data between main storage and input/output units.

Addressing. The means whereby the originator or control unit selects the teleprocessing unit to which it is going to send a message.

Alternate local/remote communication link. A switched, point-to-point communication line used as an alternate path between a local controller and a remote controller when the regular local/remote communication link has failed.

Attachment base. A 3705 hardware feature that provides the controls to the central control unit for the 3705 adapters.

Bit service. The process of character assembly or disassembly.

Block handler (BH). A group of block handling routines that are executed sequentially to process a block of data at a specified point in its path through the network control program.

Block handler (BH) set. A group of block handlers. A BH set may be associated with one or more teleprocessing units.

Block handling macro (BH macro). One of the control program generation macros that describe optional block processing functions to be included in the network control program.

Block handling routine (BHR). A routine that performs a single processing function for a block of data passing through the network control program. A typical BHR function is inserting the date and time of day in the block.

Buffer. An area of storage that is temporarily reserved for use in an input/output operation, into which data is read or from which data is written.

Central control unit. The controller hardware unit that contains the circuits and data flow paths needed to execute the instruction set and to control controller storage and the attached adapters.

Channel adapter (CA). A controller hardware unit that provides attachment of the controller to a System/360 or System/370 channel.

Channel-attached controller. Equivalent to *local controller*.

Character assembly. The process by which bits are put together to form characters as the bits arrive on a communication line. In the controllers, character assembly is performed either by the control program or by the communication scanner, depending on the type of scanner installed.

Character code. A system of representing digits, letters, special symbols, or control functions by assigning a particular bit pattern to each character. All characters represented in the same character code have the same number of bits.

Character disassembly. The process by which characters are broken down into bits for transmission over a communication line. In the controllers, character disassembly is performed either by the control program or by the communication scanner, depending on the type of scanner installed.

Character service. The process by which a character is moved to a buffer from the storage area where it was assembled.

Checkpoint/restart. A facility that records the status of the teleprocessing network at designated intervals or following certain events. Following system failure, the system can be restarted and continue without loss of messages.

Clock. A device that generates periodic signals used for synchronization.

Cluster. A station that consists of a control unit and the terminals attached to it.

Communication line. The means of connecting one location to another for the purpose of transmitting and receiving data. In this publication, the term refers to any communication facility of the communications common carrier, whether it is actually a wire or some other means of communication, such as radio or satellite.

Communication scanner. A controller hardware unit that provides the connection between line interface bases and the central control unit. The communication scanner monitors the communication lines for service requests.

Communication unit. A unit of data communications equipment linked to the controller via a communication line and identified as a cluster, terminal, or component at the time the control program is generated.

Component. An independently addressable part of a station that performs either an input or an output function but not both.

Configuration macro. One of the control program generation macros that provide information necessary to construct the tables needed by the control program to control the flow of data between the controller and stations and between the controller and the host processor.

Control program generation language. The set of macro instructions and associated operands by which the user defines for the controller the network configuration and operating parameters of the teleprocessing subsystem.

Control program generation procedure. A two-stage process that creates a control-program load module based on parameters specified by the user through the control program generation language.

Cycle steal. The process by which a type 2, a type 3, or a type 4 channel adapter acquires machine cycles from the 3705 control program for data transfer.

***Data circuit-terminating equipment (DCE).** The functional unit of a data station that establishes, maintains, and releases a connection and provides those functions necessary for any code or signal conversion between the data terminal equipment and the data transmission line.

***Data communication.** The transmission and reception of data.

Data communication network. The stations that are controlled by a single access method (or, in controllers, by a single control program), and the communication lines by which they are linked to the communication control unit.

Data communication subsystem. The part of a data processing system devoted to the transfer of data across communication lines. The subsystem consists of the stations, modems (data sets), communication lines, and the communication control unit.

***Duplex.** In communications, pertaining to a simultaneous two-way independent transmission in both directions. Contrast with *half duplex*. Synonymous with *full duplex*.

Duplex communication line. A communication line having two independent data paths over which data can be transmitted in both directions simultaneously. (Also called *full-duplex communication line*.) Contrast with *half-duplex communication line*.

Dynamic. Occurring at the time a program is executed.

Dynamic buffering. Allocating storage as it is needed for incoming data during program execution.

Dynamic control function. One of the network control program functions initiated by a Control command from the host access method.

Element. A part of the teleprocessing network defined by a control program generation macro. Possible elements are line groups, communication lines, clusters, terminals, and components.

Emulation Program (EP). A control program that allows a local 3704 or 3705 to operate functionally as an IBM 2701 Data Adapter Unit, an IBM 2702 Transmission Control, an IBM 2703 Transmission Control, or any combination of the three.

Error recovery procedure (ERP). A program that automatically attempts to correct a transmission error.

Formatted dump. A dump in which certain network control program control blocks are isolated and identified.

Full-duplex communication line. Equivalent to *duplex communication line*.

Generation delimiter macro. The macro that marks the end of the control program generation input stream.

***Half-duplex.** In communications, pertaining to an alternate, one way at a time, independent transmission. Contrast with *duplex*.

Half-duplex communication line. A communication line having a single data path over which data can be transmitted in either direction, but not simultaneously. Contrast with *duplex communication line*.

Hard stop. Immediate termination of controller operation without the execution of orderly closedown procedures.

Hardware check. A failure in a hardware unit that halts operation.

Host processor. In a TCAM or VTAM data communication system, the processing unit in which TCAM or VTAM resides. Devices attached by channels to the host processor are said to be local devices. Remote devices must be attached to the host processor via a local communications controller.

Initial test routine. A diagnostic program executed in the controller before the control program is loaded. The initial test routine tests the controller hardware for conditions that might cause failure after operation begins.

Interrupt. A break in the normal sequence of instruction execution. It causes an automatic transfer to a preset storage location where appropriate action is taken.

Invite. A network control program teleprocessing command that starts a session with a teleprocessing device by allowing the device to send data to the host processor.

Line. Equivalent to *communication line*.

Line adapter. An IBM modem that is a feature of a particular product. Some communications controller line sets include line adapters; others require external modems. See also *modem*.

Line control character. A special character that controls transmission of data over a communication line. For example, line control characters are used to start or end a transmission, to cause transmission-error checking to be performed, and to indicate whether a station has data to send or is ready to receive data.

Line group. A group of communication lines by which stations supported by the same line-control discipline are connected to the controller.

*American National Standard Definition

Line interface base (LIB). A controller hardware unit that provides for the attachment of communication lines to the controller.

Line scanner. See *communication scanner*.

Line set. A controller hardware unit through which one or two lines are attached to line interface base.

Load module. A program in a format suitable for loading into storage for execution.

Local controller. A channel-attached communications controller, which may be connected by a communication line to one or more distant controllers called remote controllers. All transmissions over the local/remote communication link are initiated and controlled by the local controller.

Local network control program. A network control program, version 5, executed in a local controller and able to communicate with a network control program in a remote controller.

Local/remote communication link. A duplex or half-duplex communication line linking a local controller and a remote controller, over which message data flows between the access method (via the local controller) and the remote controller. A local/remote communication link is also used for loading a network control program, into a remote controller and for transferring to the host processor the contents of remotecontroller storage (dumping). All transmission over the local/remote communication link is controlled by the local network control program. See also *alternate local/remote communication link*.

***Modem.** (MODulator-DEModulator) A device that modulates and demodulates signals transmitted over communication facilities. See also *line adapter*.

Multiprocessor. A computer employing two or more processing units under integrated control. A tightly-coupled multiprocessor is a computer employing two or more processing units that are controlled by the same operating system and share all of main storage and most of auxiliary storage.

NCP. See *Network Control Program*.

Network. In data processing, a user application network. See also *public network*.

Network Control Program (NCP). A control program for the controllers, generated by the user from a library of IBM-supplied modules.

Parameter. A variable that is given a constant value for a specific purpose or process.

Partitioned Emulation Programming (PEP). A feature of the network control program (except version 1) that allows a local 3704 or 3705 to operate as an IBM 2701, 2702, 2703 control unit (or any combination of the three) for certain communication lines, while performing network control functions for other lines in the teleprocessing network.

Pause-retry. A network control program option that allows the user to specify how many times the program should try to retransmit data after a transmission error occurs, and how long the program should wait between successive attempts.

Polling. A technique by which each of the teleprocessing units sharing a communication line is periodically interrogated to determine whether it has data to send.

Primary controller. Equivalent to *local controller*.

Primary network control program. Equivalent to *local network control program*.

Program check. An error in a program that suspends execution of the program.

Program product. A licensed program that performs a function for the user and usually interacts with and relies upon system control programming or some other IBM-provided control program.

Public network. A network established and operated by common carriers or telecommunication Administrations for the specific purpose of providing circuit-switched, packet-switched, or nonswitched-circuit services to the public. Contrast with *user application network*.

***Record.** A collection of related items of data treated as a unit.

Remote controller. A 3704 or 3705 that communicates with a local controller over a local/remote communication link.

Remote network control program. A network control program, version 5, that is executed in a remote controller.

Remote Program Loader. A feature that includes a read-only storage unit and a small auxiliary storage device installed in a remote controller to allow the controller to be loaded and dumped over the local/remote communication link.

Resource. Any facility of a computing system or operating system required by a job or task, including main storage, input/output units, processing time, etc.

Secondary controller. Equivalent to *remote controller*.

Secondary network control program. Equivalent to *remote network control program*.

Station. A point in a teleprocessing network at which data can either enter or leave.

Subchannel. The CPU channel facility required for sustaining a single I/O operation.

Subsystem. A secondary or subordinate system, usually capable of operating independently of, or asynchronously with a controlling system.

Switched Network Backup. An optional facility of the network control program that allows the user to specify for certain types of stations a switched line to be used as an alternate path if the primary line becomes unavailable due to an irrecoverable error.

*American National Standard Definition

Symmetrical I/O unit. A unit that is attached to two processors, appears as the same I/O unit to each processor, and can be accessed in the same manner by each processor.

Synchronous Data Link Control (SDLC). A discipline for the management of synchronous, transparent, serial-by-bit information transfer over a communication channel. Transmission exchanges may be duplex or half-duplex over switched or dedicated communication lines. The communication channel configuration may be point-to-point, multipoint, or loop. SDLC includes comprehensive detection and recovery procedures for transmission errors introduced by the communication channel.

System macro. One of the control program generation macros that provide information pertaining to the entire controller.

Terminal. A teleprocessing unit capable of sending and receiving information over a communication line.

Tightly-coupled multiprocessor. See *multiprocessor*.

Transmission code. A character code for sending information over communication lines.

Transmission Control Unit (TCU). An input/output control unit that addresses messages to and receives messages from a number of remote stations.

Trunk line. Equivalent to *local/remote communication link*.

Two-channel switch. A hardware feature that allows the controller to be attached to two host processor channels through a single type 1, type 2, or type 4, channel adapter.

Uniprocessor. A computer employing one processing unit.

User application network. A configuration of data processing products, such as processors, controllers, and terminals, established and operated by users for the purpose of data processing or information exchange, which may use services offered by common carriers or telecommunication Administrations. Contrast with *public network*.

- abbreviations, list of Abbr-1
- access method
 - (*see also* TCAM)
 - automatic load capability 6-9
 - communication with NCP 3-1, 3-4
 - definition of Glos-1
 - functions taken over by the NCP 1-1, 3-5
 - interface with NCP 3-1, 3-4
 - support for the EP 4-1
 - support for the NCP 1-4
 - used to control the network 1-1
 - used to execute step one of dump 6-10
 - used to recover from errors 1-11
- adapters
 - (*see also* channel adapter, communication scanner)
 - interaction with NCP 3-1
 - 3704, description of 2-1
 - 3705-1
 - attachment bases required 2-10
 - combinations of E-6, E-7
 - description of 2-4
 - 3705-11
 - combinations of E-2, E-3
 - description of 2-4
- address trace 3-7
- addressing
 - definition of Glos-1
 - on multipoint lines 3-5
- addressing characters, replacing 3-9
- addressing order, changing 3-9
- advanced communications function 1-4
- alternate path retry (*see* switched network backup)
- alternate switched local/remote communication link 1-3, 3-7
 - definition of Glos-1
- ASCII (USASCII) 1-7
 - translated by type 3 scanner 2-10
 - transparency with EP 4-1
- assembler, controller
 - function of 6-7
 - instruction types for 6-7, 6-8
 - macro capability of 6-8
 - use in control program generation 6-6, 6-7
 - used to assemble user BHRs 6-8
- assembler, DOS/VS
- assembler instructions, for the controller 6-8
- assembler, OS
 - in control program generation 6-6
 - similarity of controller assembler to 6-7
- assembly (*see* character assembly)
- attachment bases
 - definition of Abbr-1
 - description of 2-10
 - for modems C-3, C-4
- attachment, high-speed local 2-6
 - requirements for 2-10
- attention status 3-7
- automatic IPL 6-9
- auxiliary storage (*see* secondary storage)
- availability of the controllers 1-9

- backspace editing 6-3
- BCD 1-7
- binary synchronous station (*see* BSC station)

- bit service
 - by type 1 communication scanner 2-3, 2-9
 - definition of Glos-1
 - interrupt for 3-5
- block, specifying size for host processor 6-3
- block handler
 - defining with NCP generation macros 6-3
 - definition of Glos-1
 - delimiters 6-4
 - execution points 6-4
- block handler (BH) set
 - associating with data communication devices 6-4
 - defining with NCP generation macros 6-4
 - definition of Glos-1
 - number of block handlers in 6-4
- block handling (BH) macros
 - definition of Glos-1
 - position in input stream 6-5
 - purpose of 6-3
 - to define block handler sets 6-4
 - to include user-written BHRs 6-3
 - to specify block handling routines 6-3
- block handling routine (BHR)
 - changing association of 3-9
 - definition of Glos-1
 - description of 6-3, 6-4
 - specifying for NCP generation 6-3
 - user-written 6-3
- block-multiplexer channel
 - attachment of type 2 and type 3 channel adapters to 2-7
 - for attachment of 3705 to host processor 1-3
- BSC station
 - ID verification for 3-7
 - types supported by controllers
 - in emulation mode B-1, B-2
 - in network control mode A-1, A-2
- buffer service, interrupt for 3-5
- buffering
 - dynamic 3-5
 - in the controllers 1-10
- buffers
 - allocation of in access method 1-10
 - definition of Glos-1
 - specifying size of
 - in host processor 6-3
 - in NCP 6-2
 - storage requirements in host processor 1-10
- byte-multiplexer channel
 - attachment of type 1 channel adapter to 2-6, 2-7
 - attachment of type 2 and type 3 channel adapters to 2-7
 - for attachment of 3704 to host processor 1-3
 - for attachment of 3705 to host processor 1-3
 - required for the EP 4-1

- carriage return delay 3-8
- central control unit
 - attachment base connection to (3705) 2-10
 - definition of Glos-1
 - description of
 - for 3704 2-1
 - for 3705 2-4
- channel
 - attachment to type 1 channel adapter 2-6
 - attachment to type 2 channel adapter 2-7
 - attachment to type 3 channel adapter 2-7

- channel (*continued*)
 - attachment to type 4 channel adapter 2-8
 - for attachment of 3704 to host processor 1-3
 - for attachment of 3705 to host processor 1-3
 - switching
 - by command 1-9
 - by manual switch 1-9, 2-8
 - time delay on 3-7
 - channel adapter
 - definition of Glos-1
 - description of
 - 3704 2-2
 - 3705 2-6, 2-7
 - interaction with NCP 3-1
 - NCP support for 2-8
 - PEP support for 2-8
 - specifying type 6-2
 - switching
 - by command 1-9
 - by manual switch 1-9, 2-8
 - two-channel switch feature 2-2, 2-8
(*see also* two-channel switch)
 - type 1
 - description of 2-2, 2-6
 - with the EP 2-8, 4-1
 - type 2
 - channel delay feature on 3-7
 - description of 2-7
 - switching 2-8
 - use of cycle steal in 1-11, 2-7
 - type 3
 - description of 2-7
 - type 4
 - description of 2-7
 - 3704, description of 2-1
 - 3705
 - attachment bases required 2-10
 - attachment to channel 1-3, 2-6
 - choice of types 1-7, 2-6
 - combination with communication scanners E-2, E-6
 - combinations of E-2, E-6
 - description of 2-6, 2-7
 - specifying type 6-2
 - channel delay feature 3-7
 - character assembly
 - definition of Glos-1
 - with type 1 communication scanner 2-3, 2-9
 - with type 2 communication scanner 2-3, 2-9
 - character code
 - definition of Glos-1
 - translation of 3-5
 - character disassembly
 - definition of Glos-1
 - with type 1 communication scanner 2-3, 2-9
 - with type 2 communication scanner 2-3, 2-9
 - character service
 - definition of Glos-1
 - interrupt for 3-5
 - checks
 - hardware
 - priority of 1-11
 - recording of 3-6
 - program
 - priority of 1-11
 - recording of 3-6
 - clocking, requirements by line set C-8
 - cluster
 - defining characteristics of 6-2
 - definition of Glos-1
 - position in network hierarchy 6-2
 - code (*see* character code, transmission code)
 - communication control functions (NCP) 3-5
 - communication line
 - activation and deactivation of 3-8
 - alternate as backup 3-7
 - alternate switched for local/remote communication 1-3, 3-7
 - attachment hardware, testing 1-11
(*see also* line interface base, line set)
 - combinations of 1-7
 - defining characteristics of 6-2
 - definition of Glos-1
 - dial (*see* switched communication line)
 - local/remote link (*see* local/remote communication link)
 - maximum attachable to type 3 scanner 2-9, 2-10
 - maximum attachable to 3704 2-1
 - maximum attachable to 3705 2-1, E-1
 - maximum number supported in emulation mode 4-1
 - multiple subchannel support for 4-2
 - multipoint (*see* multipoint communication line)
 - position of in network hierarchy 6-2
 - recording status of 3-7
 - restriction on number of 1-7
 - switched (*see* switched communication line)
 - switching to alternate host processor 4-2
 - time-out control 3-5
- communication link, (*see* local/remote communication link)
 - communication scanner
 - choice of types 1-7, 2-9
 - definition of Glos-1
 - describing through control program generation 6-3
 - interaction with NCP 3-1
 - type 1
 - bit service 2-9
 - character assembly and disassembly 2-9
 - restriction on installation in 3705 2-9
 - type 2
 - character assembly and disassembly 2-9
 - type 3
 - combination with channel adapters E-2, E-6
 - description of 2-9, 2-10
 - LIBs supported by 2-11
 - restriction for 3705 2-9
 - type 3HS
 - combination with channel adapters E-2
 - description of 2-9, 2-10
 - LIBs supported by 2-11
 - restriction for 3705 2-10
 - 3704, description of 2-3
 - 3705
 - attachment bases required 2-10
 - combination with channel adapters E-2, E-6
 - description of 2-9
 - function of 2-9
 - restriction on combination 2-10
- compatibility of controllers 1-6
 - component
 - (*see also* data communication unit under teleprocessing)
 - defining characteristics of 6-2
 - definition of Glos-1
 - position in network hierarchy 6-2
 - computers
 - types supported
 - in emulation mode B-2
 - in network control mode A-2
 - configuration
 - maximum
 - of 3704 2-3
 - 3704 hardware 2-1
 - 3705-1 hardware 2-4
 - 3705-11 hardware 2-4
 - configuration macros
 - definition of Glos-1
 - description of 6-2
 - nonpositional
 - position in input stream 6-5
 - types of parameters 6-3
 - positional
 - association with higher level 6-3
 - example of hierarchy 6-2, 6-3
 - position in input stream 6-5
 - specifying characteristics at highest level 6-3

- to associate BH set with data communication device 6-4
- to define tables 6-3
- to define data communication network 6-2
- control blocks
 - (see also tables)
 - for line-control information 1-10
 - isolated for formatted dump 6-9
- control character (see line-control character)
- control functions (see dynamic control functions)
- control information in data blocks 3-1
 - handling by NCP 3-1, 3-4
- control panel
 - description of
 - for 3704 2-2
 - for 3705 2-5
 - for diagnostics after hard stop 6-9
 - for dynamic displays 3-6
 - to display errors 3-6
 - to display storage areas 3-6
 - to display variables for address trace 3-6
 - to request address trace 3-7
- control program generation language 6-1
 - (see also control program generation macros)
 - coding convention input stream format 6-4, 6-5
 - definition of Glos-1
 - ease of programming 6-1, 6-2
 - used to select functions 1-8
- control program generation macros 6-2
 - (see also block handling macros, configuration macros, generation delimiter macro, control program generation language, system macros)
 - arrangement in input stream 6-5
 - assembly of 6-6
 - operands of 6-4
 - types of 6-2
- control program generation procedure 6-4
 - host processor requirements for 6-1
 - definition of Glos-1
 - format of input stream for 6-5
 - general logic flow of
 - example of, under DOS/VS 6-6
 - example of, under OS 6-5
 - intervention between stages 6-7
 - stage one 6-6
 - stage three (DOS/VS) 6-7
 - stage two 6-7
 - macros (see control program generation macros)
- control program load module (see load module, control program)
- conversion of access method or application programs 5-1
- Correspondence Code 1-7
- counter, cycle utilization 2-6
- critical situation notification 3-6
- cycle steal
 - definition of Glos-1
 - function of 1-11
 - type 4 CA 2-7
- cycle utilization counter 2-6
- data flow
 - between host processor and station 3-1
 - between local and remote controller 3-2, 3-3
 - control of 3-1
 - logical 3-1, 3-4
- data set (see modern)
- date, setting 3-9
- date/time insertion 6-3
- device (see data communication unit under teleprocessing)
- diagnostic wrap facility 1-11
- diagnostics
 - address trace 3-7
 - initial test routine 6-9
 - messages in control program generation procedure 6-7
 - online line tests 3-7
 - online terminal tests 3-7
 - to increase reliability and serviceability 1-11
 - dial lines (see switched lines)
 - differences between 3704 and 3705, summary of 2-1
 - direct access storage
 - for dump data set 6-10
 - for control program generation job stream 6-6
 - for control program load module 6-7
 - disassembly (see character disassembly)
 - displays
 - dynamic, on control panel 3-6
 - storage 3-6
 - domain, definition 1-4
 - DOS/VS
 - program generation under 6-6, 6-7
 - support for EP system support programs 6-1
 - dump
 - contents of 6-9
 - formatted
 - definition of Glos-2
 - requesting 6-9
 - dump program
 - for DOS/VS 6-10
 - for OS 6-10
 - functions of 6-9, 6-10
 - operation of 6-10
 - options
 - displaying mnemonic operation codes 6-10
 - requesting formatted dump 6-9
 - specifying storage limits 6-9
 - dumping
 - of local controller 6-9, 6-10
 - of remote controller 6-11
 - duplex communication line, definition of Glos-2
 - duplex data attachment base C-4
 - dynamic buffering
 - definition of Glos-2
 - function of 3-5
 - dynamic control functions
 - definition of Glos-2
 - including in NCP 6-2
 - EBCD 1-7
 - EBCDIC
 - as transmission code 1-7
 - translated by type 3 scanner 2-10
 - translation to transmission code 3-5
 - used in dump 6-10
 - editing of data by NCP 6-3
 - elements
 - defining characteristics of 6-2
 - definition of Glos-2
 - hierarchy of 6-2, 6-3
 - emulation mode, stations supported in B-1
 - emulation, partitioned (see partitioned emulation programming extension)
 - emulation program (EP)
 - ASCII transparency support 4-1
 - channel requirements 4-1
 - concepts 4-1
 - definition of Glos-2
 - generation procedure
 - under DOS/VS 6-4, 6-6
 - under OS 6-4, 6-5
 - multiple subchannel support 4-2
 - storage requirement 4-1
 - support for type 3 scanner 4-1
 - support for type 4 channel adapter 4-1

- emulation program (EP) *(continued)*
 - support programs for 4-1
 - transmission control unit functions not supported 4-1
- error checking 3-6
- error records
 - for hardware and program checks 3-6
 - for permanent line errors 3-6
 - transferring to host processor 3-6
- error recovery procedures
 - alternate path retry *(see switched network backup)*
 - definition of Glos-2
 - pause-retry 3-7
 - to correct transmission errors 1-11
 - to increase availability 1-10
- errors
 - in coding control program generation language
 - correction of 6-7
 - notification of 6-7
 - transmission, retries of 3-7
- extended environment feature 2-4, 2-11

- FET (Field Effect Transistor) storage
 - (see monolithic storage)*
- flexibility of the controllers 1-7
- formatted dump
 - contents of 6-9
 - definition of Glos-2
 - requesting 6-9
- full-duplex line *(see duplex communication line)*

- general registers
 - groups of 1-11
 - represented in dump 6-10
- generation delimiter macro
 - definition of Glos-2
 - function of 6-4
 - position in input stream 6-5

- half-duplex communication line, definition of Glos-2
- hard stop
 - caused by initial test routine 6-9
 - definition of Glos-2
- hardware, 3704
 - (see also individual hardware segments)*
 - configuration 2-3
 - description of 2-1
 - flexibility of 1-7
 - interrupt levels 1-11
 - modularity of 1-9
- hardware, 3705
 - (see also individual hardware segments)*
 - communication line attachment hardware, testing of 1-11
 - configuration E-1
 - description of 2-4
 - flexibility of 1-7
 - interrupt levels 1-11
 - models E-1
 - modularity of 1-9
- hardware checks
 - definition of Glos-2
 - error records for 3-5
 - priority of 1-11
 - high speed local attachment 2-6
- host access method *(see access method)*
- host processor
 - advantages of controllers to 1-10
 - connection to two with EP 4-2
 - connection to two with PEP 5-2
 - definition of Glos-2
- IBM System/360
 - attachment of controllers to 1-3
 - support for EP 1-5
 - support for system support programs 6-1
- IBM System/370
 - attachment of controllers to 1-3
 - support for EP 1-5
 - support for NCP 1-4, 1-6
 - support for system support programs 6-1
- IBM 2701 Data Adapter Unit
 - emulation of 4-1
- IBM 2702 Transmission Control
 - emulation of 4-1
- IBM 2703 Transmission Control
 - emulation of 4-1
- ID characters replacing 3-9
- ID verification
 - defining lists for 6-3
 - function of 3-8
- initial test routine
 - automatic execution of 6-9
 - definition of Glos-2
 - function of 6-9
 - loading of 6-9
 - suppression of 6-9
- input stream for NCP generation, format 6-5
- instruction set for the controller 6-7, 6-8
- instructions
 - assembler 6-7, 6-8
 - machine 6-7, 6-8
 - macro
 - for control program generation 6-1
 - for controller assembler 6-7, 6-8
 - operated on by controller assembler 6-7, 6-8
- interface
 - EP/access method 4-1
 - NCP/access method 3-1
- interrupt
 - by type 1 communication scanner 2-3, 2-9
 - by type 2 communication scanner 2-3, 2-9
 - by type 3 communication scanner 2-10
 - definition of Glos-2
 - for bit service 3-5
 - for buffer service 3-5
 - for character service 3-5
- interrupt levels 1-11
- IPL (initial program load)
 - after a dump 6-10
 - after a failure of the controller 6-9
 - at start-up time 6-9
 - by TCAM 6-9
 - of a remote controller 6-10
 - priority of 1-11

- job stream, created in control program generation 6-6

- LIB Type 1 C-1
- LIB Type A1 C-5
- LIB Type 2 C-5
- LIB Type 3 C-5
- LIB Type 4 C-5
- LIB Type 5 C-5
- LIB Type 6 C-6
- LIB Type 7 C-6
- LIB Type 8 C-6
- LIB Type 9 C-7
- LIB Type 10 C-7
- LIB Type 11 C-7
- LIB Type 12 C-8
- line *(see communication line)*

- line adapter, definition of Glos-2
- line attachment hardware, testing 1-11
(see also line interface base, line set)
- line-control character
 - definition of Glos-2
 - deletion 3-5
 - insertion 3-5
 - recognition 3-5
- line-control disciplines 1-7
- line-control information in NCP 1-10
- line errors
 - correction of 1-9, 1-11
 - recording of 1-11, 3-6
- line group
 - defining characteristics of 6-2
 - definition of Glos-2
 - position in network hierarchy 6-2
 - switching to alternate host processor with EP 4-2
- line interface base (LIB)
 - (see also LIB Type 1; LIB Type 2; etc.)
 - definition of Glos-2
 - line sets attached to 2-4, 2-11
(see also line set)
 - maximum in 3704 2-4
 - maximum in 3705 2-11
 - maximum number of lines attachable 2-4, 2-11
 - types of, description 2-11, C-1
- line scanner (see communication scanner)
- line set
 - clocking requirements C-8
 - definition of Glos-2
 - number of lines per 2-4, 2-11
 - types of, description C-1
- Line Set 1 A C-1
- Line Set 1 B C-1
- Line Set 1 C C-1
- Line Set 1 D C-1
- Line Set 1 E C-2
- Line Set 1 F C-2
- Line Set 1 G C-2
- Line Set 1 GA C-2
- Line Set 1 H C-2
- Line Set 1 J C-2
- Line Set 1 K C-2
- Line Set 1 L C-3
- Line Set 1 M C-3
- Line Set 1 N C-3
- Line Set 1 P C-3
- Line Set 1 Q C-3
- Line Set 1 R C-4
- Line Set 1 S C-4
- Line Set 1 T C-4
- Line Set 1 TA C-4
- Line Set 1 U C-4
- Line Set 1 W C-4
- Line Set 1 X C-4
- Line Set 1 Y C-4
- Line Set 1 Z C-5
- Line Set 2A C-5
- Line Set 3A C-5
- Line Set 3B C-5
- Line Set 4A C-5
- Line Set 4 B C-5
- Line Set 4C C-5
- Line Set 5A C-5
- Line Set 5B C-6
- Line Set 6A C-6
- Line Set 8A C-6
- Line Set 8B C-7
- Line Set 8C C-7
- Line Set 8D C-7
- Line Set 9A C-7
- Line Set 10A C-7
- Line Set 11 A C-7
- Line Set 11 B C-8
- Line Set 12A C-8
- Line Set 12 B C-8
- line time-out control 3-5
- linkage editor, use in generation procedure 6-5, 6-7
- load module, control program
 - creation of 6-4
 - definition of Glos-3
 - generating more than one
 - example 6-7
 - reasons for 6-7
 - loading of
 - into local controller 6-9
 - into remote controller 6-10
 - storing 6-7
- loader
 - functions 6-9
 - operation of
 - controller portion 6-9
 - host portion 6-9
 - when invoked 6-9
- loading
 - (see also IPL)
 - of local controller 6-9
 - of remote controller 6-10
- local attachment, high-speed 2-6
- local controller
 - attachment to remote controller 1-2, 1-3
 - definition of Glos-3
- local network control program definition of Glos-2
- local/remote communication link
 - alternate switched 1-3, 3-7
 - communication scanners used with 2-4, 2-9
 - defining during control program generation 6-3
 - definition of Glos-2
 - used to connect controllers 1-2, 1-3
- machine instructions, for the controllers 6-8
- macro language, for the controllers 6-8
- macros, control program generation (see control program generation macros)
- main storage (see storage)
- manual dial operation 3-8
- manual switched network backup 3-7
- manuals, 3704 and 3705 D-1
- message
 - diagnostic
 - in control program generation procedure 6-7
 - sent when critical situation occurs 3-6
- mnemonic operations codes
 - displaying in dump 6-9
 - to represent machine instructions 6-8
- models
 - of 3704 2-2
 - of 3705 2-4, E-1
- modern
 - attachment base C-3
 - clocking requirements C-8
 - definition of Glos-3
 - dual-speed 3-5
- modularity
 - of the controller hardware 1-9
 - of the network control program 1-9
- monitor mode 3-8
- monolithic storage 2-4, 2-6
- multiple subchannel support with EP 4-2
- multiple terminal access (MTA) 3-8
- multiplexer (see transmission control unit)
- multipoint lines
 - addressing on 3-5
 - polling on 3-5
- multiprocessor
 - attachment to 1-9
 - definition of Glos-3

- NCP (*see* network control program)
- negative response limit, changing 3-9
- network (*see* data communication network)
- network control mode, stations supported in A-1, A-2
- network control program, virtual storage (NCP/VS)
 - carriage return delay function 3-8
 - changing characteristics dynamically 1-8, 3-8
 - channel delay feature 3-7
 - communication with access method 3-1, 3-4
 - concepts 3-1
 - control of characteristics by control program generation language 1-8
 - controlling traffic between local and remote controllers 3-3, 3-4
 - definition of Glos-3
 - diagnostic facilities 1-11
 - dynamic buffering 3-5
 - error recovery facilities 1-11
 - functions 3-5
 - dynamic control 3-8
 - option 3-6, 3-8
 - standard 3-5
 - generating more than one 6-7
 - generation of 1-8
 - ID verification feature 3-8
 - interaction with adapters 3-1
 - load module (*see* load module, control program)
 - loading of
 - into local controller 6-9
 - into remote controller 6-10
 - manual dial function 3-8
 - model required 3-1
 - modularity of 1-9
 - monitor mode 3-8
 - multiple terminal access feature 3-8
 - pause-retry function 3-7
 - program levels 1-11
 - speed selection function 3-5
 - storage requirement 3-1
 - summary of functions 3-1
 - switched network backup function 3-7
 - NCP/VS 1-4, 3-1
 - ACF/NCP/VS 1-4
- networking 1-4
 - illustration 1-6
- nonpositional configuration macros (*see* configuration macros, nonpositional)

- object code, creation of by controller assembler 6-8
- online line testing 1-11, 3-7
- online terminal test (OLTT)
 - NCP support for 3-7
 - program in host processor 3-7
 - requests for 3-7
- optional NCP functions 3-6, 6-3
 - block processing
 - description of 6-3
 - specifying for control program generation 6-3
 - error recovery and diagnostics 3-6
 - miscellaneous options 3-7, 3-8
 - selecting 3-6
- OS (Operating System)
 - assemblers 6-6
 - linkage editor 6-5, 6-7
 - support for system support programs 6-1

- panel display, dynamic 3-6
- parameter, definition of Glos-3
- partial dump 6-9

- partitioned emulation programming (PEP)
 - extension 1-6, 5-1
 - advantages of 5-1
 - channel requirements for 5-2
 - concepts 5-1
 - connection to two host processors 5-2
 - definition of Glos-3
 - functions 6-1
 - generating 6-1
 - stations supported by A-1, B-1
 - two type-4 channel adapters with 5-2
- pause-retry
 - definition Glos-3
 - description of 3-7
- permanent line error recording 3-6
- polling
 - definition of Glos-3
 - negative response to 3-9
 - on multipoint lines 3-5
- polling characters, replacing 3-9
- polling order, changing 3-9
- positional configuration macros (*see* configuration macros, positional)
- priority, interrupt 1-11
- program checks
 - definition of Glos-3
 - error records for 3-6
 - priority of 1-11
- program generation 6-1
- program levels 1-11
- programming flexibility 1-7
- public network
 - definition of Glos-3
- publications, 3704 and 3705 D-1

- record, definition of Glos-3
- reference manuals, 3704 and 3705 D-1
- registers
 - dynamic display of 3-6
 - groups of 1-11
 - represented in controller instruction set 6-8
 - represented in dump 6-10
- remote controller
 - access method communication with 3-4
 - advantages of 1-2
 - communication with local controller 3-4
 - connection to local controller 1-2, 1-3
 - data flow through 3-3, 3-4
 - definition of Glos-3
 - dumping 6-11
 - extended environment feature 2-4, 2-11
 - loading 6-10
 - purpose of 1-2, 1-3
 - remote power off feature 2-2, 2-6
 - remote program loader required 2-2, 2-9
- remote network control program
 - communication with access method 3-4
 - definition of Glos-3
- remote power off feature 2-2, 2-6
- remote program loader 2-2, 2-9
 - definition of Glos-3
- remote station (*see* station)
- resource, definition of Glos-3
- RPQ features of 2701, 2702, 2703 supported by EP 4-1

- scanner (*see* communication scanner)
- scanning scheme
 - changing of 1-8
 - determination of through control program generation 1-8
- SDLC stations supported A-1

- secondary storage
 - for control program generation job stream 6-5, 6-6
 - for control program load module 6-7
 - for dump 6-10
- selector channel
 - attachment of channel adapters to 2-7
 - for attachment of 3705 to host processor 1-3
- speed selection 3-5
- stage one of control program generation 6-6
- stage three of control program generation (DOS/VS) 6-7
- stage two of control program generation 6-7
- standard NCP functions 3-5
 - communication control functions 3-5
 - error recording and diagnostics 3-6
- start-stop stations
 - multiple terminal access for 3-8
 - types supported by controllers
 - in emulation mode B-1
 - in network control mode A-1
- station
 - definition of Glos-3, iii
 - notification of in critical situation 3-6
 - types supported
 - in emulation mode B-1, B-2
 - in network control mode A-1, A-2
- statistics
 - count of I/O operations 3-6
 - error
 - kept by NCP 1-11, 3-6
 - record of temporary errors 3-6
- status
 - attention 3-7
 - requesting 3-9
- storage, controller
 - dumping
 - of local controller 6-9, 6-10
 - of secondary controller 6-10
 - dynamic display of 3-6
 - increments available in 3704 2-2
 - increments available in 3705-I 2-4, E-5
 - increments available in 3705-II 2-5, E-1
 - monolithic in 3705-II 2-6
 - representation of in dump 6-10
 - requirement for the EP 4-1
 - requirement for the NCP/VS 3-1
 - specifying limits of for dump 6-9
 - specifying amount of 6-2
- storage, main (*see* main storage)
- storage-protection mechanism 2-1, 2-5
- storage, secondary (*see* secondary storage)
- subchannel
 - address
 - requirement for EP 4-1
 - requirement for NCP 1-10
 - definition of Glos-3
 - NCP restriction with two type 4 CAs 4-2
 - support of more than one per line with EP 4-2
- subsystem, (*see* data communication subsystem under teleprocessing)
- summary of differences between 3704 and 3705 2-1
- support programs (*see* system support programs)
- switched communication lines
 - answering on 3-5
 - as alternate path 3-7
 - attachment of multiple terminal types to 3-8
 - dialing on 3-5
 - ID verification for 3-8
- switched network backup
 - definition of Glos-3
 - description of 3-7
 - manual 3-7
- symmetrical I/O unit Glos-3
- synchronous data link control (SDLC) Glos-3
- system macros
 - definition of Glos-4
 - position in input stream 6-5
 - types of parameters on 6-2
- system services control point 1-5
- system support programs
 - components of 1-6, 6-1
 - concepts 6-1
 - DOS/VS support for 6-1
 - OS support for 6-1
 - OS/VS support for 6-1
 - purpose of 6-1
- System/360 (*see* IBM System/360)
- System/370 (*see* IBM System/370)
- tables
 - built during control program generation 6-7
 - defining through control program generation 6-3
- TCAM (Telecommunications Access Method)
 - loading facility 6-9
 - SNA networks 1-4
 - support for the NCP 1-4
- teleprocessing
 - access method (*see* access method)
 - definition of data communication Glos-2
 - data communication network
 - defining through control program generation 6-1
 - definition of Glos-2, iii
 - example of hierarchy in 6-2, 6-3
 - data communication subsystem
 - data flow through 3-1
 - definition of Glos-1, iii
 - dynamic modification of 1-8, 3-8
 - roll of the controller in 1-1
 - data communication unit
 - associating block handler sets with 3-9, 6-4
 - definition of Glos-2, iv
 - types of supported in emulation mode B-1, B-2
 - types supported in network control mode A-1, A-2
- temperature range, for remote controllers 2-4, 2-11
- terminal
 - (*see also* station? data communication unit)
 - defining characteristics of 6-2
 - definition of Glos-4
 - position in network hierarchy 6-2
 - types supported
 - in emulation mode B-1, B-2
 - in network control mode A-1, A-2
- terminal component (*see* component)
- text correction
 - defining backspace character 6-3
 - example 6-3
 - function of 6-3
- throughput, as a factor in choosing adapters 1-7
- time, setting 3-9
- time/date insertion 6-3
- trace, address 3-7
- translation
 - of character codes 3-5
 - of dump into hexadecimal 6-10
- transmission code
 - (*see also* ASCII, EBCDIC)
 - definition of Glos-4
 - supported by NCP 1-7
 - supported by type 3 scanner 2-9
 - translation by type 3 scanner 2-10
 - translation into EBCDIC by NCP 3-5

transmission control unit
 definition of Glos-4
 functions not supported by EP 4-1
 RPQ features supported by EP 4-1
 traditional function of 1-1, 3-5
 type supported
 in emulation mode B-1, B-2
 in network control mode A-1, A-2

transmission error
 correction of 1-10, 1-11
 recording of 1-11, 3-6
 retries of 3-7

trunk line (*see* local/remote communication link)

two-channel switch
 definition of Glos-4
 description of 2-8
 for attachment to several host processors 2-8
 restriction 2-8
 to increase availability 1-9

two-host PEP 5-2

type 1 channel adapter (*see* channel adapter, type 1)

type 1 communication scanner (*see* communication scanner, type 1)

type 2 channel adapter (*see* channel adapter, type 2)

type 2 communication scanner (*see* communication scanner, type 2)

type 3 channel adapter (*see* channel adapter, type 3)

type 3 communication scanner (*see* communication scanner, type 3)

type 3HS communication scanner
 (*see* communication scanner, type 3)

type 4 channel adapter (*see* channel adapter, type 4)

uniprocessor
 definition of Glos-4
 type 3 CA attachment to 2-7

unit protection feature 2-1, 2-5

upgrading a controller to larger model 2-5

USASCII (*see* ASCII)

user application network
 definition of Glos-3

utilities
 (*see also* loader dump)
 description of 6-8
 execution of 6-1

utility control card
 for dump 6-9, 6-10
 for loader 6-9

utilization counter, cycle 2-6

Introduction to the
IBM 3704 and 3705
Communications Controllers

**READER'S
COMMENT
FORM**

Order No. GA27-3051-4

This form may be used to communicate your views about this publication. They will be sent to the author's department for whatever review and action, if any, is deemed appropriate. Comments may be written in your own language; use of English is not required.

IBM may use or distribute any of the information you supply in any way it believes appropriate without incurring any obligation whatever. You may, of course, continue to use the information you supply.

Note: *Copies of IBM publications are not stocked at the location to which this form is addressed. Please direct any requests for copies of publications, or for assistance in using your IBM system, to your IBM representative or to the IBM branch office serving your locality.*

Possible topics for comment are:

Clarity Accuracy Completeness Organization Coding Retrieval Legibility

Cut or Fold Along This Line

If you would like a reply, complete the following (Please Print):

Your Name _____ Date _____

Company Name _____

Department _____

Street Address _____

City _____ State _____ Zip Code _____

Thank you for your cooperation. No postage stamp is necessary if mailed in the U.S.A. (Elsewhere, an IBM office or representative will be happy to forward your comments.)

Cut or Fold Along Line

ADDITIONAL COMMENTS:

Please Do Not Staple

Fold and tape

Fold and tape

First Class
Permit 40
Armonk
New York

Business Reply Mail

No postage stamp necessary if mailed in the U.S.A.

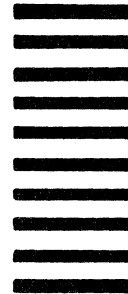

Postage will be paid by:

International Business Machines Corporation
Dept. E02
P.O. Box 12195
Research Triangle Park
North Carolina 27709

Fold and tape

Fold and tape



International Business Machines Corporation
Data Processing Division
1133 Westchester Avenue, White Plains, N.Y. 10604

IBM World Trade Americas/Far East Corporation
Town of Mount Pleasant, Route 9, North Tarrytown, N.Y., U.S.A. 10591

IBM World Trade Europe/Middle East/Africa Corporation
360 Hamilton Avenue, White Plains, N.Y., U.S.A. 10601



This Newsletter No. GN27-3252
Date July 5, 1979

Base Publication No. GA27-3051-4
File No. S360/S370-09

Previous Newsletters None

Introduction to the IBM 3704 and 3705 Communications Controllers

© IBM Corp. 1972, 1973, 1974, 1976, 1978

This Technical Newsletter provides replacement pages for the subject publication. Pages to be inserted and/or removed are:

iii - vi	C-1 through C-8
1-7 through 1-10	E-1 through E-6
2-1, 2-2	Glossary-3, Glossary-4
2-5 through 2-12	X-1, X-2
3-1, 3-2	X-5 through X-8
3-9, 3-10	

A Technical change to the text or to an illustration is indicated by a vertical line to the left of the change.

Summary of Changes

This Technical Newsletter contains information on the Type 3 HS Communication Scanner for 3705-II

Note: Please file this cover letter at the back of the manual to provide a record of the changes.





Technical Newsletter

This Newsletter No. GN27-3277

Date 21 Jan 1980

Base Publication No. GA27-3051-4

File No. S360/S370-09

Previous Newsletters GN27-3252

Introduction to the IBM 3704 and 3705 Communications Controllers

© IBM Corp. 1972, 1973, 1974, 1976, 1978

This Technical Newsletter provides replacement pages for the subject publication. Pages to be inserted and/or removed are:

Title page through iv	Glossary 3 and 4
C-1 through C-8	X-5, X-6
Glossary 1 and 2	

A technical change to the text or to an illustration is indicated by a vertical line to the left of the change.

Summary of Changes

This Technical Newsletter contains information on Line Sets 1N (nonswitched) and 1R (switched), which attach to the External CCITT X.21 Interface.

Note: Please file this cover letter at the back of the manual to provide a record of the changes.

111
22



International Business Machines Corporation
Data Processing Division
1133 Westchester Avenue, White Plains, N.Y. 10604

IBM World Trade Americas/Far East Corporation
Town of Mount Pleasant, Route 9, North Tarrytown, N.Y., U.S.A. 10591

IBM World Trade Europe/Middle East/Africa Corporation
360 Hamilton Avenue, White Plains, N.Y., U.S.A. 10601