

VOLUME 008 MACHINE 3705- -0015984 MODEL E08 SYSTEM 0004XBW MODE

BOX SHIP 82/12/30

LOGIC TYPE -0- SYSTEMS DIAGRAMS

PAGE NUM	SH	TITLE	PART NUM	EC NUM	FEATURE B/M OR B/MS
VB020		LOGIC L.I.B. TYPE 1	0001785512	309540	.W. 0005997507
VB021		LOGIC L.I.B. TYPE 1	0001785513	309540	.W. 0005997507
VB022		LOGIC L.I.B. TYPE 1	0001785514	311286	.W. 0005997507
VB023		LOGIC L.I.B. TYPE 1	0001785515	311286	.W. 0005997507
VB024		LOGIC L.I.B. TYPE 1	0001785516	309520	.W. 0005997507
VB025		LOGIC L.I.B. TYPE 1	0001785517	309520	.W. 0005997507
VB026		LOGIC L.I.B. TYPE 1	0001785518	309540	.W. 0005997507
VB027		LOGIC L.I.B. TYPE 1	0001785519	309540	.W. 0005997507
VB028		LOGIC L.I.B. TYPE 1	0001785520	309520	.W. 0005997507
VB029		LOGIC L.I.B. TYPE 1	0001785521	309540	.W. 0005997507
VB030		LOGIC L.I.B. TYPE 1	0001785522	309520	.W. 0005997507
VB060		LOGIC L.I.B. TYPE 1	0001785523	322670	.W. 0005997507
VB061		LOGIC L.I.B. TYPE 1	0001785524	322670	.W. 0005997507
VB062		LOGIC L.I.B. TYPE 1	0001785525	322670	.W. 0005997507
VB063		LOGIC L.I.B. TYPE 1	0001785526	322670	.W. 0005997507
VB064		LOGIC L.I.B. TYPE 1	0001785527	322670	.W. 0005997507
VB065		LOGIC L.I.B. TYPE 1	0001785528	322670	.W. 0005997507
VB066		LOGIC L.I.B. TYPE 1	0001785529	322670	.W. 0005997507
VB067		LOGIC L.I.B. TYPE 1	0001785530	322670	.W. 0005997507
VB069		LOGIC L.I.B. TYPE 1	0001785531	322670	.W. 0005997507
VB070		LOGIC L.I.B. TYPE 1	0001785532	322670	.W. 0005997507
VB071		LOGIC L.I.B. TYPE 1	0001785533	322670	.W. 0005997507
VB072		LOGIC L.I.B. TYPE 1	0001785534	322670	.W. 0005997507
VB073		LOGIC L.I.B. TYPE 1	0001785535	322670	.W. 0005997507
VB074		LOGIC L.I.B. TYPE 1	0001785536	322670	.W. 0005997507
VB075		LOGIC L.I.B. TYPE 1	0001785537	322670	.W. 0005997507
VB080		LOGIC L.I.B. TYPE 1	0001785538	309520	.W. 0005997507
VB081		LOGIC L.I.B. TYPE 1	0001785539	309520	.W. 0005997507
VB082		LOGIC L.I.B. TYPE 1	0001785540	309540	.W. 0005997507
VB083		LOGIC L.I.B. TYPE 1	0001785541	309520	.W. 0005997507
VB084		LOGIC L.I.B. TYPE 1	0001785542	309520	.W. 0005997507
VB085		LOGIC L.I.B. TYPE 1	0001785543	309520	.W. 0005997507
VB086		LOGIC L.I.B. TYPE 1	0001785544	309520	.W. 0005997507
VB087		LOGIC L.I.B. TYPE 1	0001785545	309520	.W. 0005997507
VB088		LOGIC L.I.B. TYPE 1	0001785546	309520	.W. 0005997507
VB089		LOGIC L.I.B. TYPE 1	0001785547	309520	.W. 0005997507
VB100		LOGIC L.I.B. TYPE 1	0001785548	309520	.W. 0005997507
VB101		LOGIC L.I.B. TYPE 1	0001785549	309520	.W. 0005997507
VB102		LOGIC L.I.B. TYPE 1	0001785550	309540	.W. 0005997507
VB103		LOGIC L.I.B. TYPE 1	0001785551	309540	.W. 0005997507
VB104		LOGIC L.I.B. TYPE 1	0001785552	309520	.W. 0005997507
VB105		LOGIC L.I.B. TYPE 1	0001785553	309520	.W. 0005997507

VOLUME 008 MACHINE 3705- -0015984 MODEL E08 SYSTEM 0004XBW MODE

BOX SHIP 82/12/30

LOGIC TYPE -0- SYSTEMS DIAGRAMS

PAGE NUM	SH	TITLE	PART NUM	EC NUM	FEATURE B/M OR B/MS
VB106		LOGIC L.I.B. TYPE 1	0001785554	309520	.W. 0005997507
VB107		LOGIC L.I.B. TYPE 1	0001785555	309520	.W. 0005997507
VB108		LOGIC L.I.B. TYPE 1	0001785556	309520	.W. 0005997507
VB109		LOGIC L.I.B. TYPE 1	0001785557	309520	.W. 0005997507
VB110		LOGIC L.I.B. TYPE 1	0001785558	309520	.W. 0005997507
VB121		LOGIC L.I.B. TYPE 1	0001785980	309543	.W. 0005997507
VB122		LOGIC L.I.B. TYPE 1	0001785981	309543	.W. 0005997507
VB123		LOGIC L.I.B. TYPE 1	0001785982	309543	.W. 0005997507
VB124		LOGIC L.I.B. TYPE 1	0001785983	309543	.W. 0005997507
VB125		LOGIC L.I.B. TYPE 1	0001785984	309953	.W. 0005997507
VB126		LOGIC L.I.B. TYPE 1	0001785985	309953	.W. 0005997507
VB127		LOGIC L.I.B. TYPE 1	0001785986	309543	.W. 0005997507
VB128		LOGIC L.I.B. TYPE 1	0001785987	309953	.W. 0005997507
VB129		LOGIC L.I.B. TYPE 1	0001785988	309543	.W. 0005997507
VB130		LOGIC L.I.B. TYPE 1	0001785989	309953	.W. 0005997507
VB140		LOGIC L.I.B. TYPE 1	0001856430	309546	.W. 0005997507
VB141		LOGIC L.I.B. TYPE 1	0001856431	309546	.W. 0005997507
VB142		LOGIC L.I.B. TYPE 1	0001856432	309546	.W. 0005997507
VB143		LOGIC L.I.B. TYPE 1	0001856433	311266	.W. 0005997507
VB144		LOGIC L.I.B. TYPE 1	0001856434	309546	.W. 0005997507
VB146		LOGIC L.I.B. TYPE 1	0001856435	309546	.W. 0005997507
VB147		LOGIC L.I.B. TYPE 1	0001856436	309546	.W. 0005997507
VB148		LOGIC L.I.B. TYPE 1	0001856437	309546	.W. 0005997507
VB150		LOGIC L.I.B. TYPE 1	0001749539	318570	.W. 0005997507
VB151		LOGIC L.I.B. TYPE 1	0001749540	318570	.W. 0005997507
VB152		LOGIC L.I.B. TYPE 1	0001749541	318570	.W. 0005997507
VB153		LOGIC L.I.B. TYPE 1	0001749542	318570	.W. 0005997507
VB154		LOGIC L.I.B. TYPE 1	0001749543	318570	.W. 0005997507
VB156		LOGIC L.I.B. TYPE 1	0001749544	318570	.W. 0005997507
VB157		LOGIC L.I.B. TYPE 1	0001749545	318570	.W. 0005997507
VB158		LOGIC L.I.B. TYPE 1	0001749546	318570	.W. 0005997507
VB160		LOGIC L.I.B. TYPE 1	0008549001	321391	.W. 0005997507
VB161		LOGIC L.I.B. TYPE 1	0008549002	321391	.W. 0005997507
VB162		LOGIC L.I.B. TYPE 1	0008549003	321391	.W. 0005997507
VB163		LOGIC L.I.B. TYPE 1	0008549004	321391	.W. 0005997507
VB164		LOGIC L.I.B. TYPE 1	0008549005	321391	.W. 0005997507
VB165		LOGIC L.I.B. TYPE 1	0008549006	321391	.W. 0005997507
VB166		LOGIC L.I.B. TYPE 1	0008549007	321391	.W. 0005997507
VB167		LOGIC L.I.B. TYPE 1	0008549008	321391	.W. 0005997507
VB168		LOGIC L.I.B. TYPE 1	0008549009	321391	.W. 0005997507
VB169		LOGIC L.I.B. TYPE 1	0008549010	321391	.W. 0005997507
VB170		LOGIC L.I.B. TYPE 1	0008549011	321391	.W. 0005997507

VOLUME 008 MACHINE 3705- -0015984 MODEL E08 SYSTEM 0004XBW MODE BOX SHIP 82/12/30

LOGIC TYPE -0- SYSTEMS DIAGRAMS

PAGE NUM	SH	TITLE	PART NUM	EC NUM	FEATURE B/M OR B/MS
VB200		LOGIC L.I.B. TYPE 1	0001754230	321371	.W. 0005997507
VB201		LOGIC L.I.B. TYPE 1	0001754231	321371	.W. 0005997507
VB210		LOGIC L.I.B. TYPE 1	0001754232	321371	.W. 0005997507
VB211		LOGIC L.I.B. TYPE 1	0001754233	321371	.W. 0005997507
VB220		LOGIC L.I.B TYPE 1	0001754234	344292	.W. 0005997507
VB221		LOGIC L.I.B TYPE 1	0001754235	344292	.W. 0005997507
VB222		LOGIC L.I.B TYPE 1	0001754236	344292	.W. 0005997507
VB223		LOGIC L.I.B. TYPE 1	0001754237	344292	.W. 0005997507
VB224		LOGIC L.I.B. TYPE 1	0001754238	321371	.W. 0005997507
VB225		LOGIC L.I.B. TYPE 1	0001754239	321371	.W. 0005997507
VB226		LOGIC L.I.B. TYPE 1	0001754240	316650	.W. 0005997507
VB227		LOGIC L.I.B. TYPE 1	0001754241	316650	.W. 0005997507

TOTAL PART NUMBERS THIS VOLUME 96

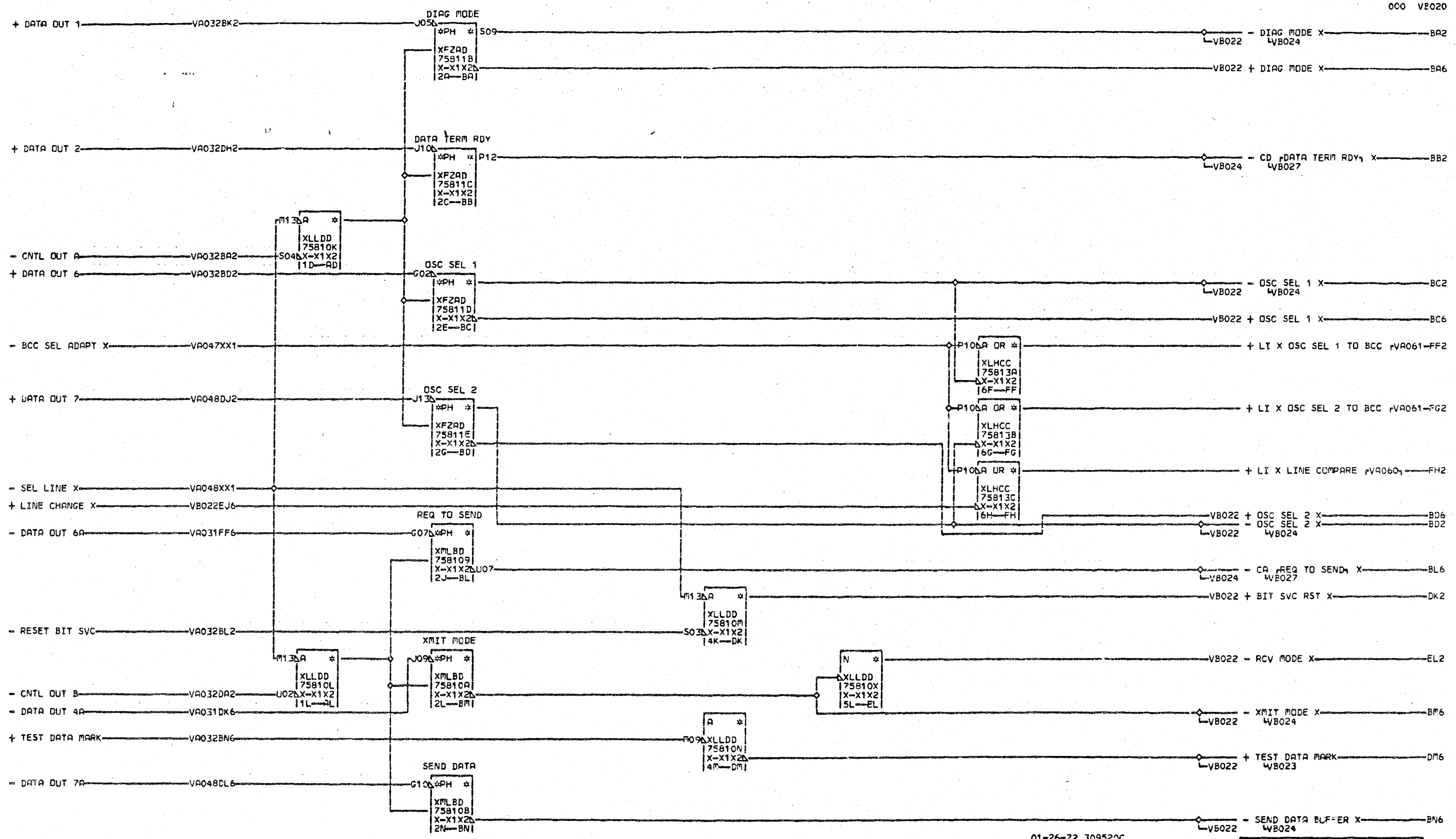

01-26-72 309520C
03-10-72 309540

STAR#	STOP	LINE	PAIR
DATE	04-06-72	MACH#	27RNB
LOG	253	FRAME	01
		P.No	1785512
IBM CORP.	SDD	BLX.	FJ

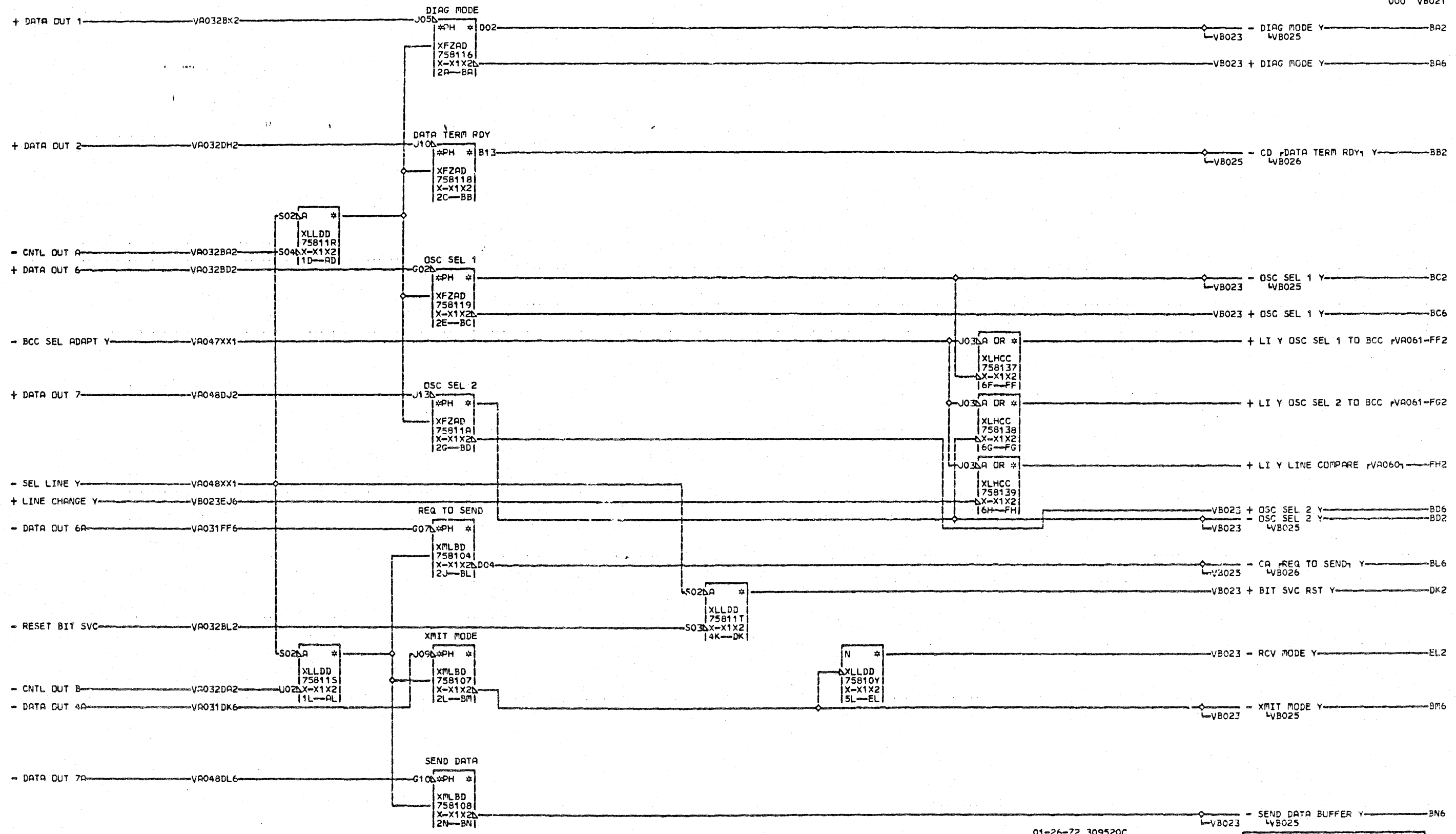

01-26-72 309520C
03-10-72 309540

START	STOP	LINE PAIR
DATE	04-06-72	ARCH. 27KNB
LOG	255	FRAME 01
		P.N. 1785513
IBM CORP.	SDD BLK.	FJ

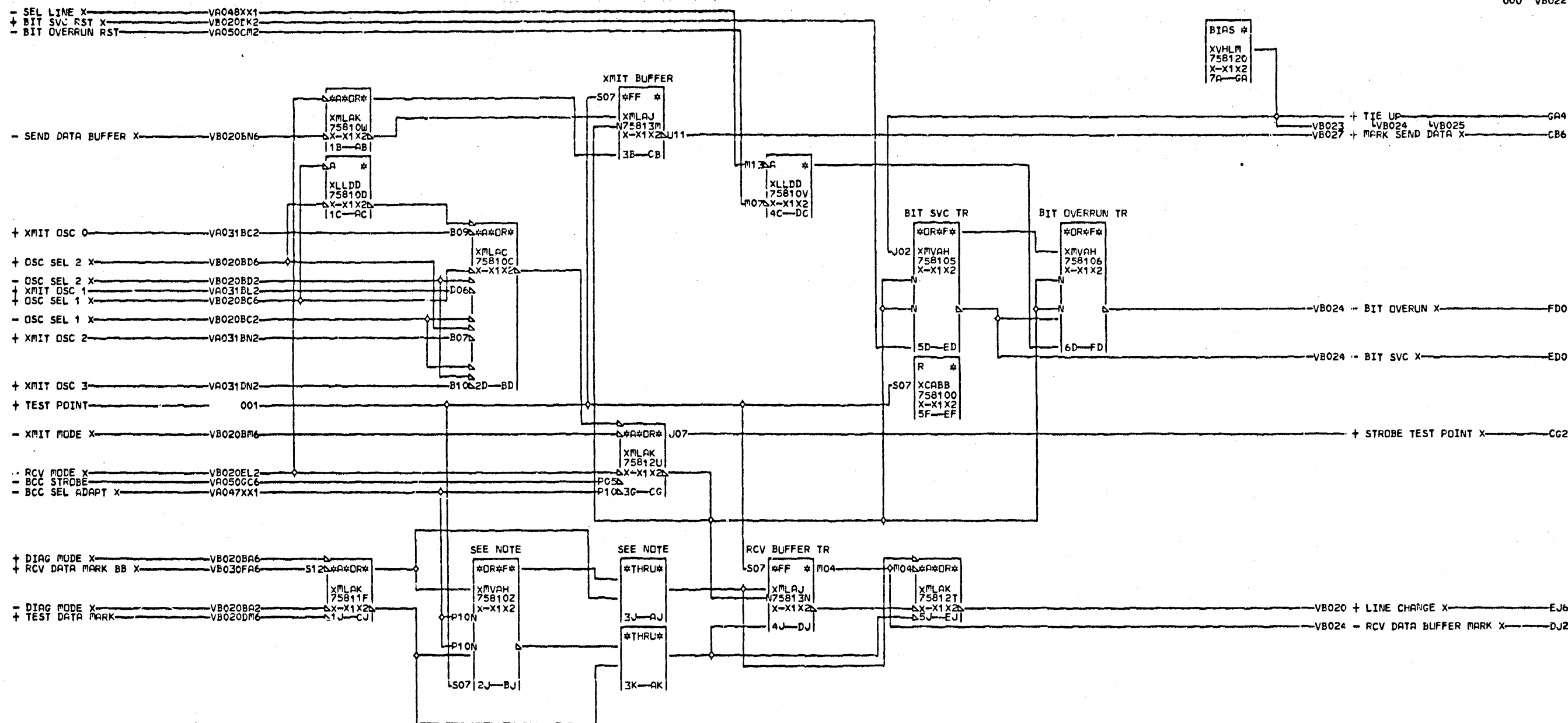

NOTE
 CARD PN 8211458 INSTALLED
 BLOCK BJ NOT PRESENT
 THRU BLOCKS BOTTOM INPUT TO
 OUTPUT CONNECTED TOP OPEN
 CARD PN 8238677 INSTALLED
 BLOCK BJ PRESENT
 THRU BLOCKS TOP INPUT TO
 OUTPUT CONNECTED BOTTOM OPEN

01-26-72 309520C
 03-10-72 309540
 11-11-74 311286

START STOP LINE PAIR	
DATE	11-22-74 MACH. 27RNB
LOG	400 FRAME 01
	P.N. 1785514
IBM CDRP.	SDD BLK. GB

VB022
 000

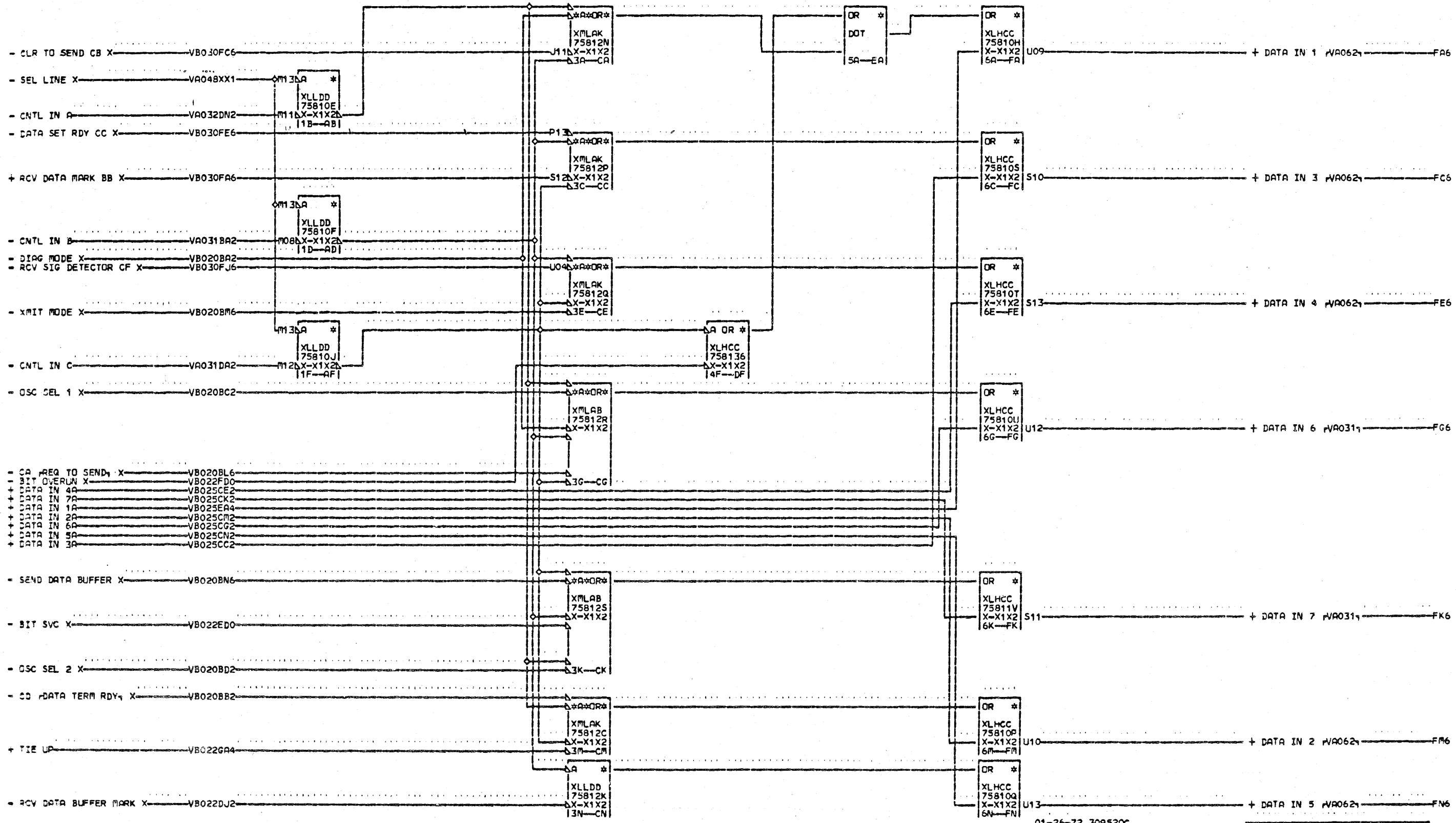

01-26-72 309520C

START STOP LINE PAIR			
DATE	01-26-72	MACH#	27RNB
LOG	600	FRAME	01
		PeNo	1785516
IBM CORP.	SDD BLK.		FP

1
3
2
4
000

V
B
0
2
4
000

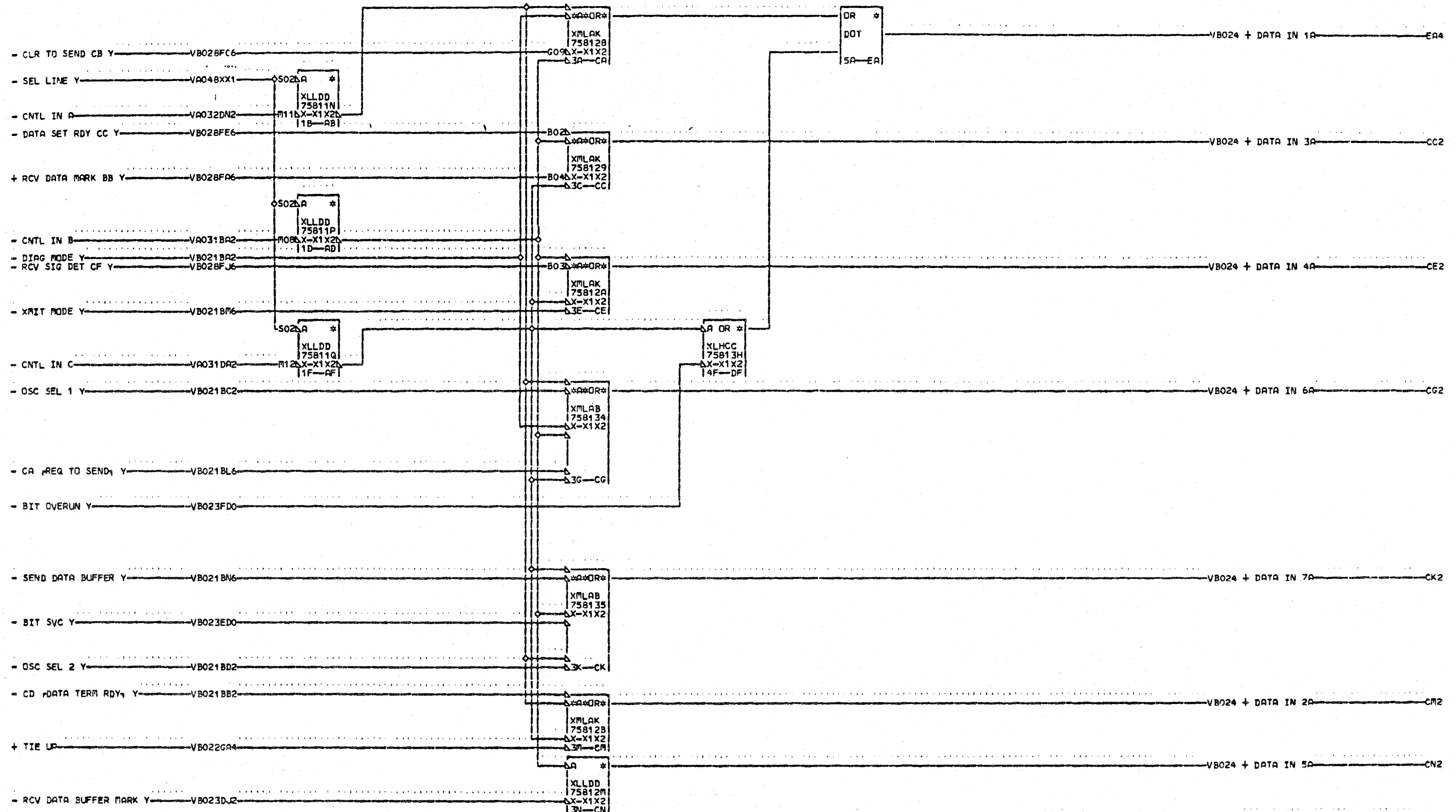

01-26-72 309520C

START STOP LINE PAIR			
DATE	01-26-72	FRAC#	27RNB
LDG	600	FRAME	01
		P.N.	1785517
IBM CORP.	5DD	BLK.	EB

VB025
000

UNOBY
000

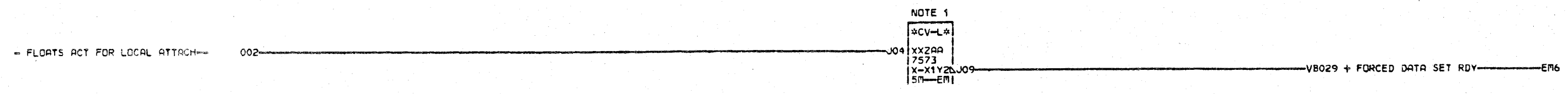
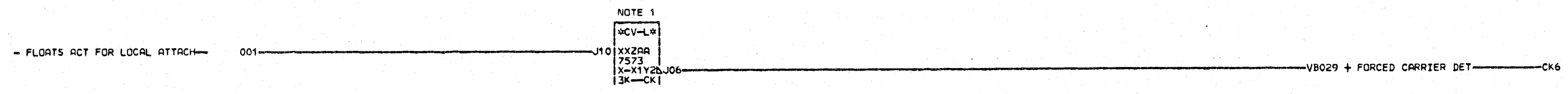
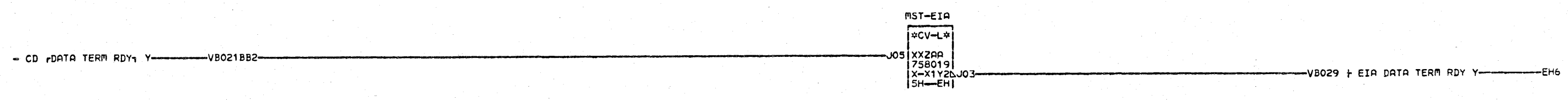
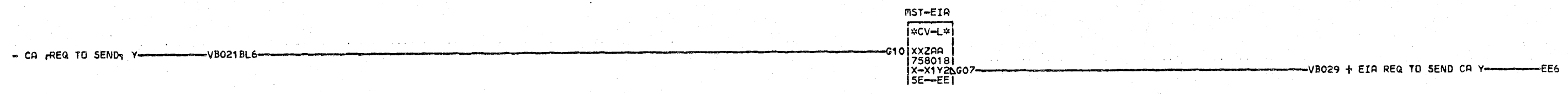
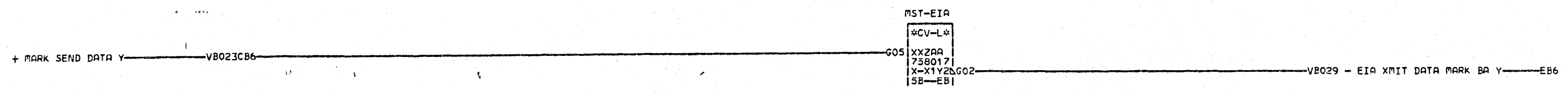

* NOTE 1 FOR LINE SET TYPE 1C
 * START STOP LOCAL CARD
 * 8211450 IS USED INSTEAD
 * OF 8218947
 V
 B
 0
 2
 6
 000

01-26-72 309520C
 03-10-72 309540

START STOP		V
LINE PAIR EIA DRIVERS		B
DATE	04-06-72 MACH. 27RNB	0
LDG	255 FRAME	2
	PaNo 1785518	6
IBM CCRP.	SDD BLK.	000
	EN	

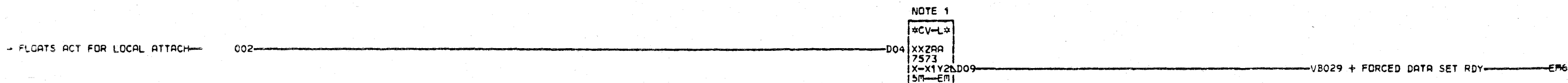
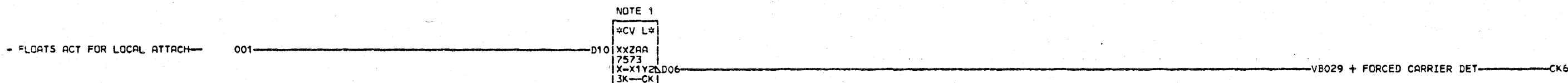
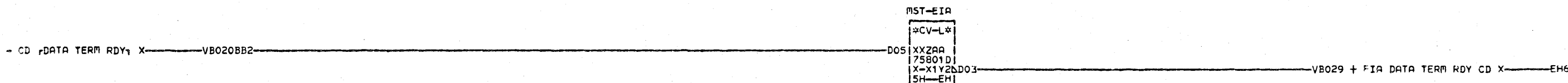
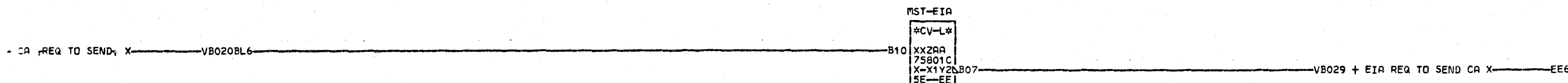
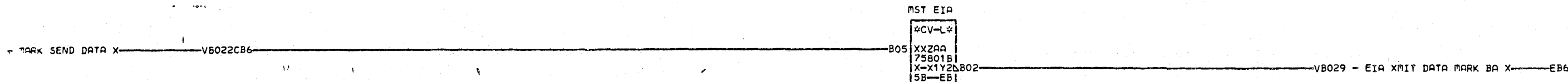

* NOTE 1 FOR LINE SET TYPE 1C
 * START STOP LOCAL CARD
 * 8211450 IS USED INSTEAD
 * OF 8218947

01-26-72 309520C
 03-15-72 309540

START STOP			
LINE PAIR EIA DRIVERS			
DATE	04-06-72	MACH.	27RNB
LOG	023	FRATE	01
P.N.		1785319	
IBM CORP.	SDD BLK.	EN	000

7

000

7

000

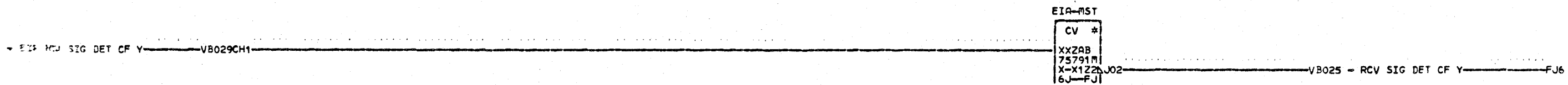
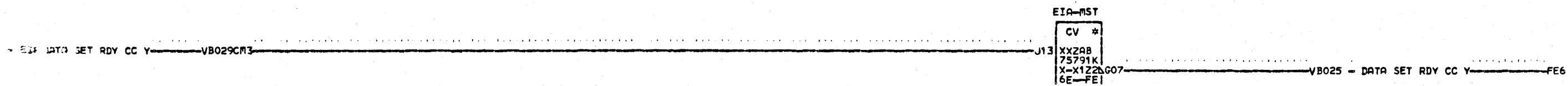
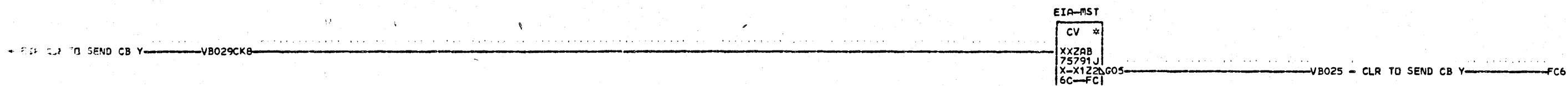
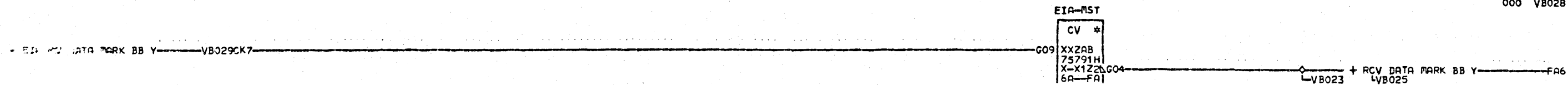

01-26-72 309520C

START STOP EIA TERMINATOR

DATE 01-26-72 MACH. 27RNB

LOG 600 FRAME 01

PaNs 1785520

IBM CORP. SDD BLK. FN

VB028
000

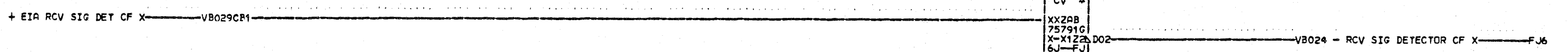
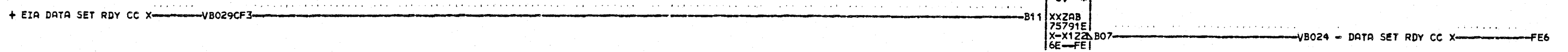
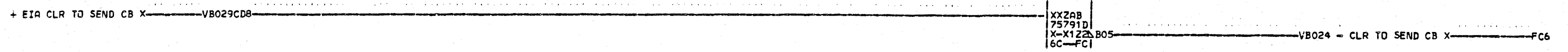
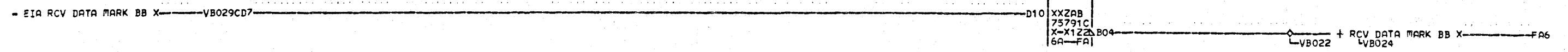

01-26-72 309520C

VB030
000

START STOP EIA TERMINATOR			
DATE	01-26-72	MACH	27RNB
LOG	600	FRAME	01
		P.N.	1785522
IBM CORP.	SDD	BLK.	FK

VB030
000

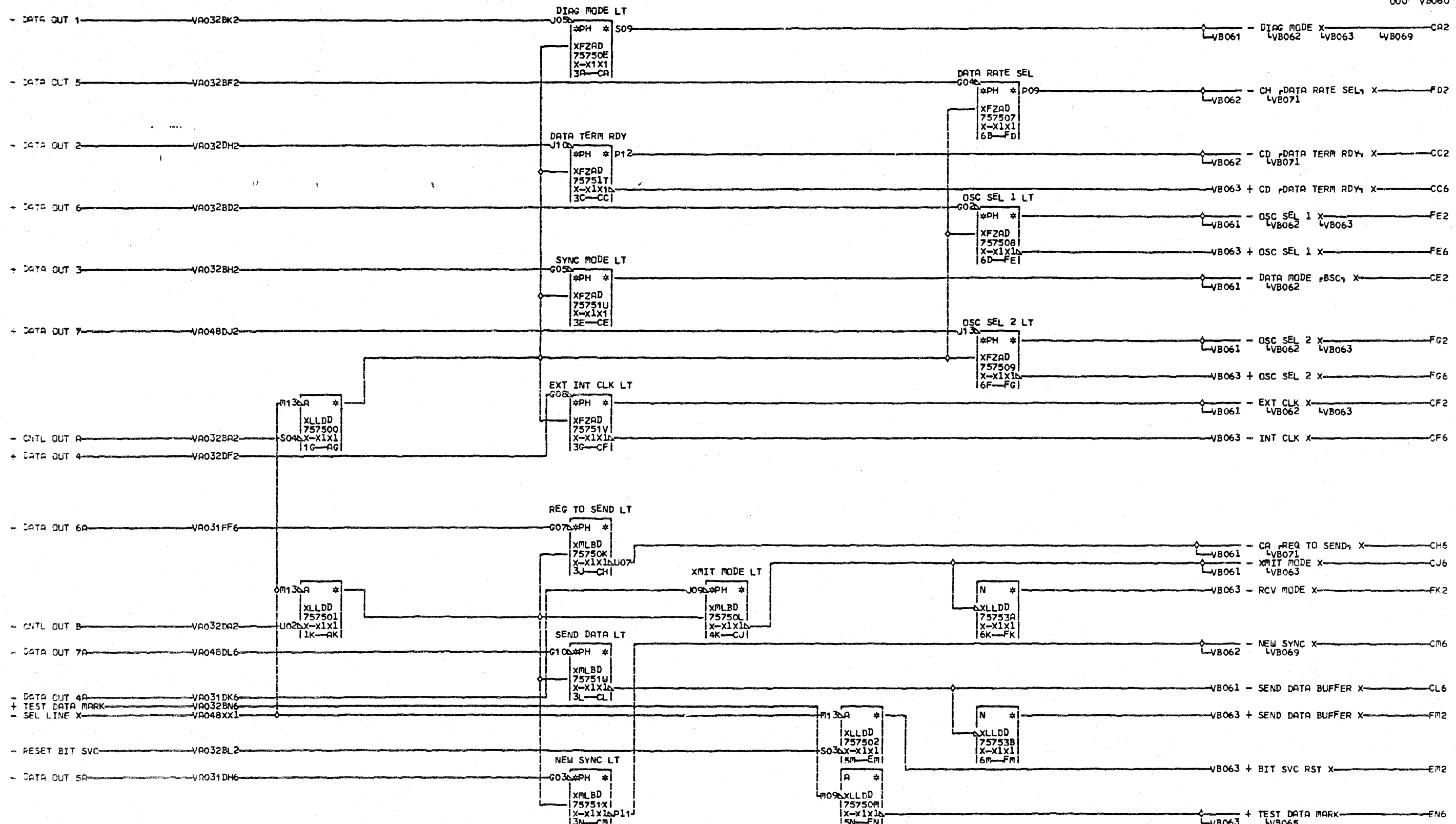

NOTE SYNC MODE EXT INT CLK
NEW SYNC AND DATA RATE SEL
CIRCUITS ARE NOT USED IN START
STOP OPERATION.

01-26-72 309520C
09-17-80 322670

EIA SYNCHRONOUS START	STOP	V
DATE 09-22-80	LINE PAIR MACH. 27RNB	0
LOG 748	FRAME 01	6
	P.N. 1785523	0
IBM CDDP.	SPD BLK.	000

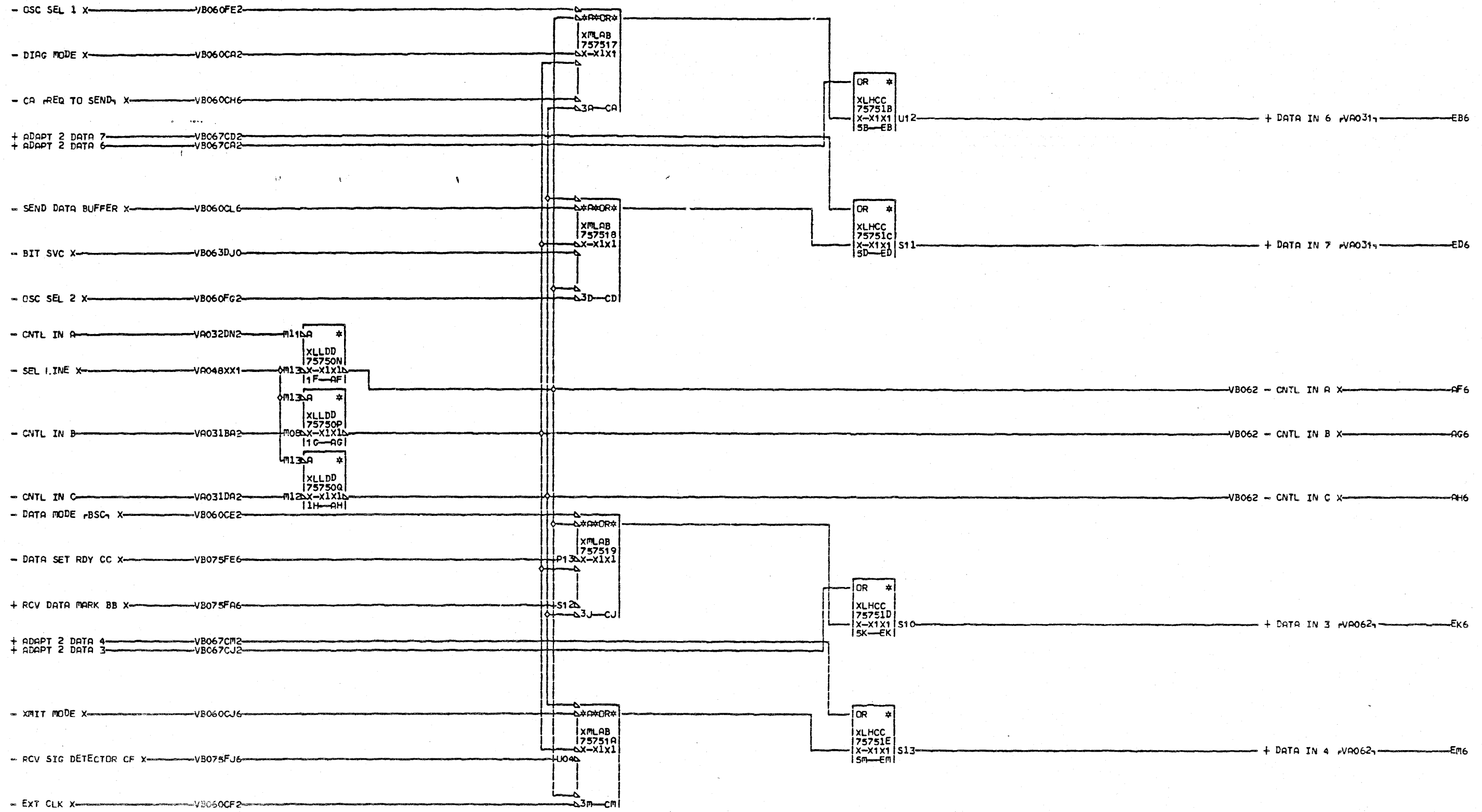

VB061
000

01-26-72 309520C
09-17-80 322670

ETA SYNCHRONOUS START STOP			
LINE PAIR			
DATE	09-22-80	MACH.	27RMB
LOG	748	FRAME	01
		P.N.	1785524
IBM CORP.	SDD BLK.	EN	

VB061
000

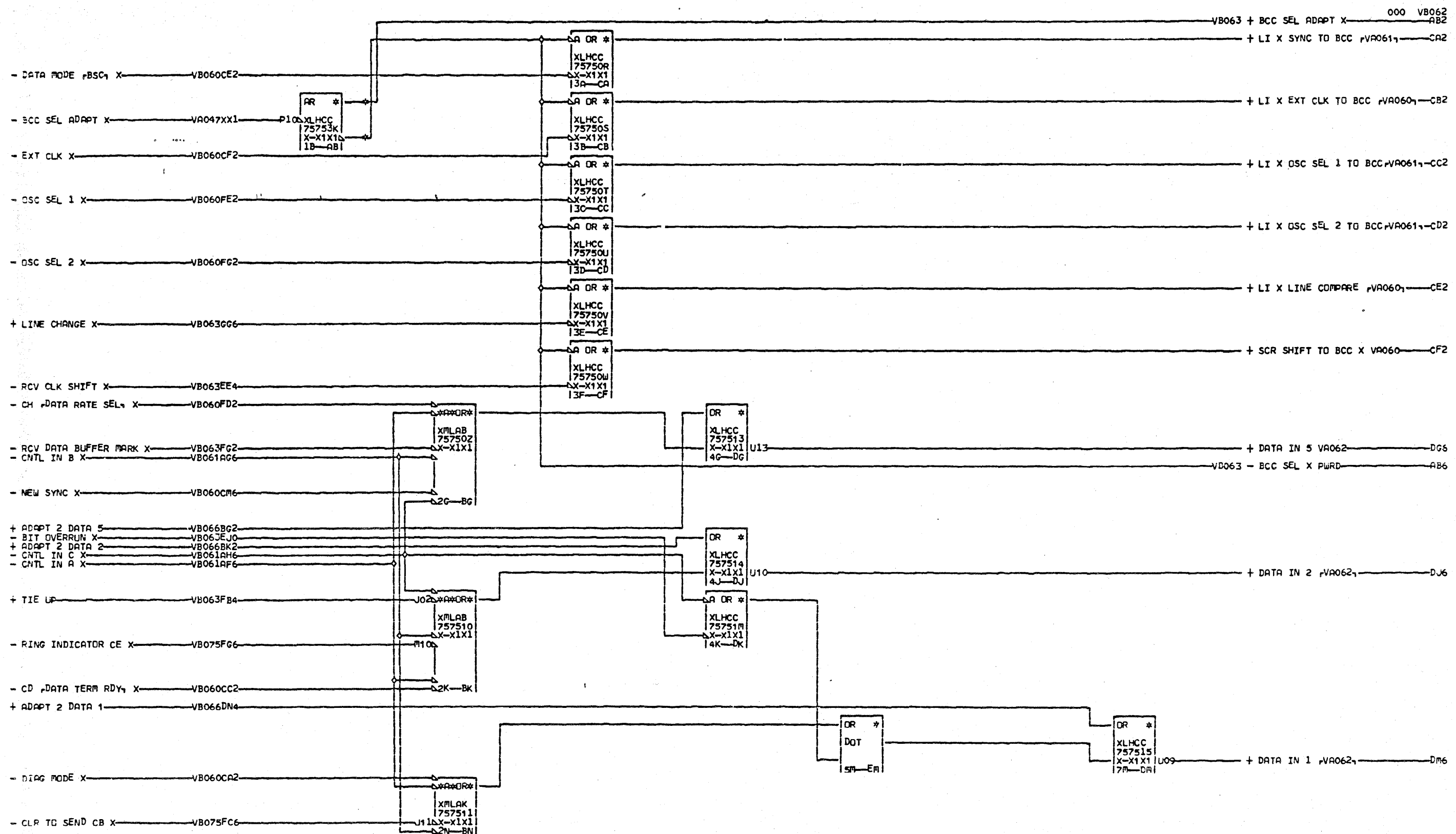

V
B
0
6
2
000

NET	PTN	VFR	BK	ITNF1	ITNE2	LINE3	LINE4	LINE5	01-26-72	3095200
AB2			BC	R	*	XCA	BB	75753E	X-X1X1	03-10-72 309540
AB6			AC	R	*	XCA	BB	75753A	X-X1X1	05-26-75 312925
										09-17-80 322670

EIA SYNCHRONOUS START STOP
LINE PAIR
DATE 09-22-80 FRAM# 27RNB
LOG 748 FRAME 01
P.N. 1785525
IBM CORP. SDN BLK. GM

V
B
0
6
2
000

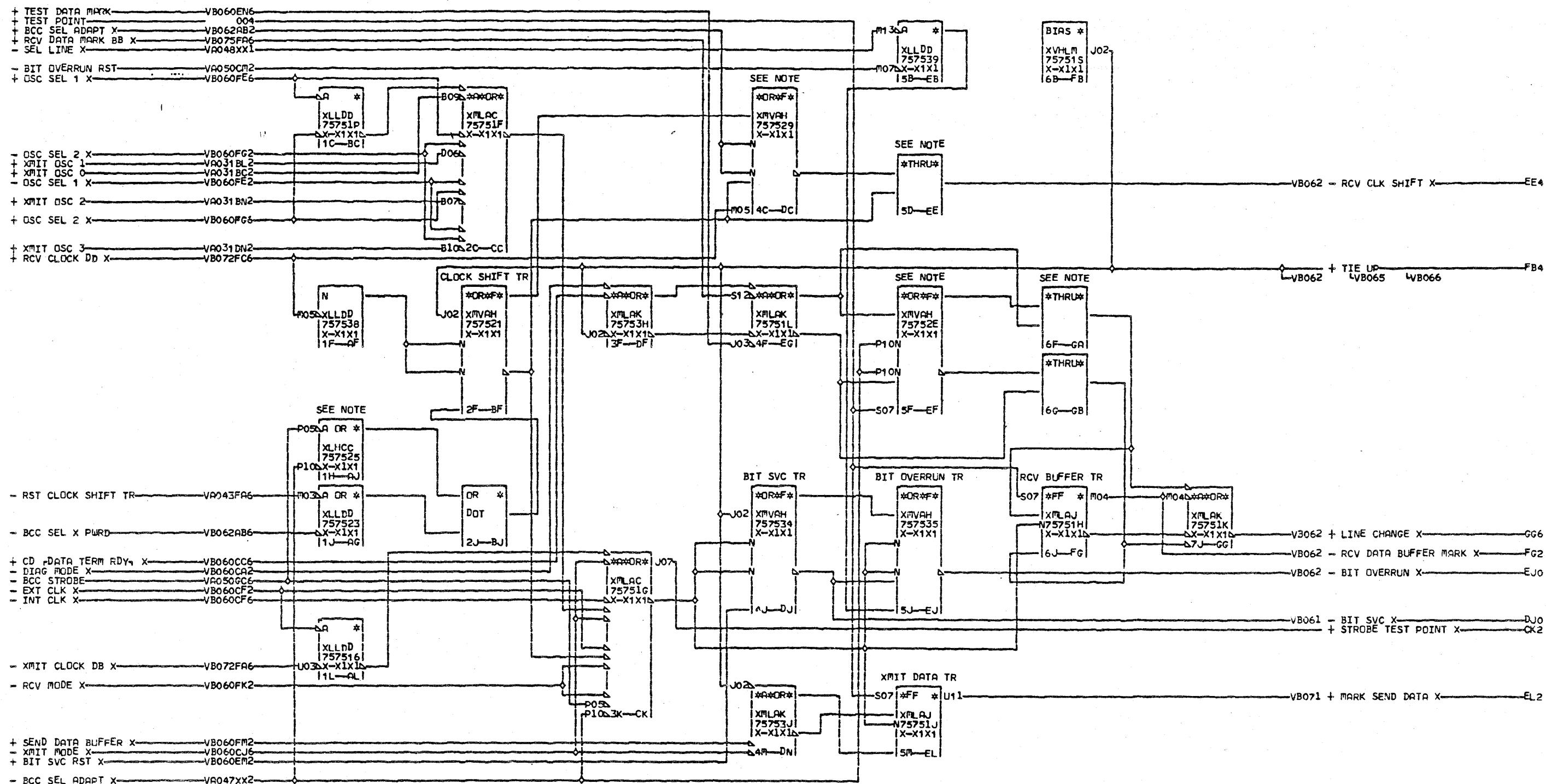

CARD PN 821452 INSTALLED
 BLKS AJ DC EF NOT PRESENT
 V THRU BLKS BOTTOM INPUT CONN
 B CARD PN 8250115 BLKS AJ DC NOT
 0 PRESENT, THRU BLKS GA GB TOP
 6 INPUT CONN EE BOTTOM CONN
 3 CARD PN 8250112 INSTALLED
 ALL BLKS PRESENT
 000ALL THRU BLKS TOP INPUT CONN

NET	PIN	VER	BK	LINE1	LINE2	LINE3	LINE4	LINE5	
004	S07	AH	R	*		XCABB	757531	X-X1X1	01-26-72 309520C 03-10-72 309540 11-11-74 311286 05-26-75 312925 09-17-80 322670

EIA SYNCHRONOUS START STOP			
LINE PAIR			
DATE	FRAMES	STOP	
09-22-80	748	27FNB	01
LOG	748	FRAME	01
		PaN	1785526
IBM CORP.	SDD BLK.		CH

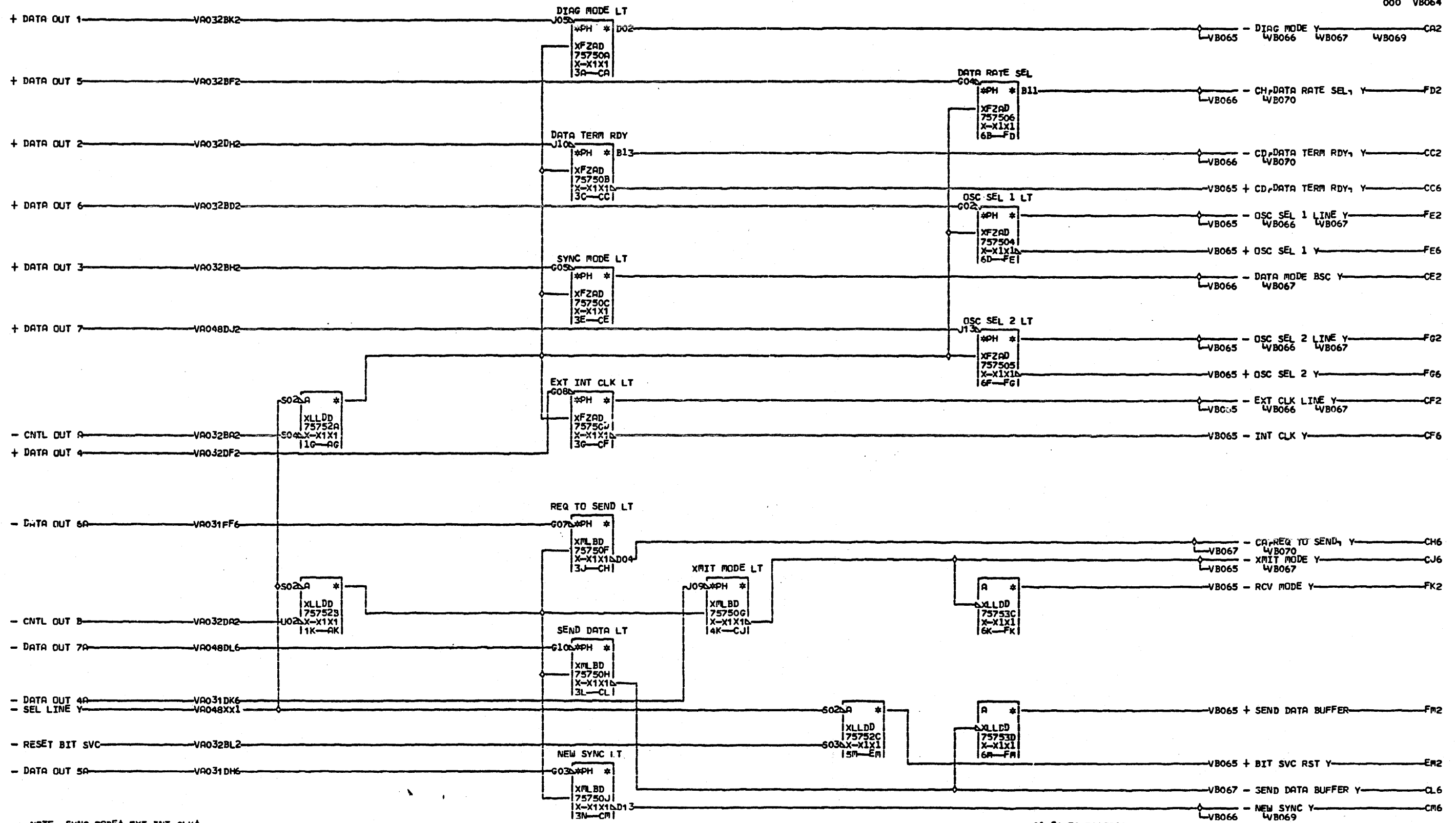

NOTE SYNC MODE EXT INT CLK
 NEW SYNC AND DATA RATE SEL
 V CIRCUITS ARE NOT USED IN START
 B STOP OPERATION.
 0
 6
 4
 000

01-26-72 309520C
 09-17-80 322670

EIA SYNCHRONOUS	START	STOP	V
DATE	09-22-80	MACH. 27RNB	B
LOG	748	FRAME 01	6
		P.N. 1785527	4
IBM CORP.	SDD BLK.	GL	000

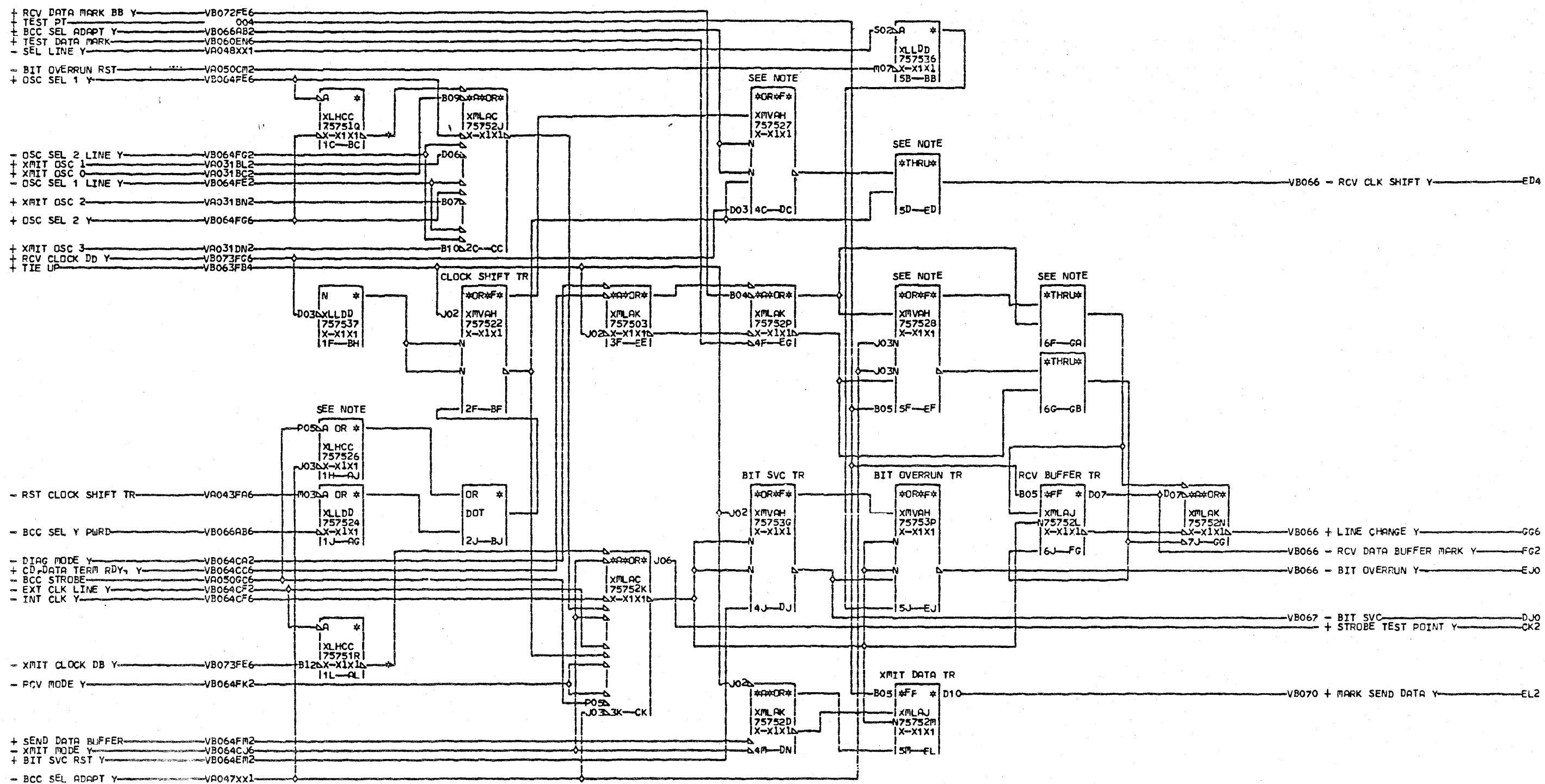

NOTE
SEE NOTE PAGE VB063
V
B
0
6
5
000

MFT	PIN	VER	BK	LINE1	LINE2	LINE3	LINE4	LINE5	01-26-72	309520C	
004	B05		AN	R	*		XCABB	757530	X-X1X1	03-10-72	309540
AL6			AN	R	*		XCABB	757532	X-X1X1	11-11-74	311286
BC6			BAR	*			XCABB	757533	X-X1X1	05-26-75	312925
										09-17-80	322670

EIA SYNCHRONOUS START STOP
LINE PAIR
DATE 09-22-80 MACH. 27RNB
LOG 748 FRAME 01
P.N. 1785528
IBM CORP. SED BLK. GH 000

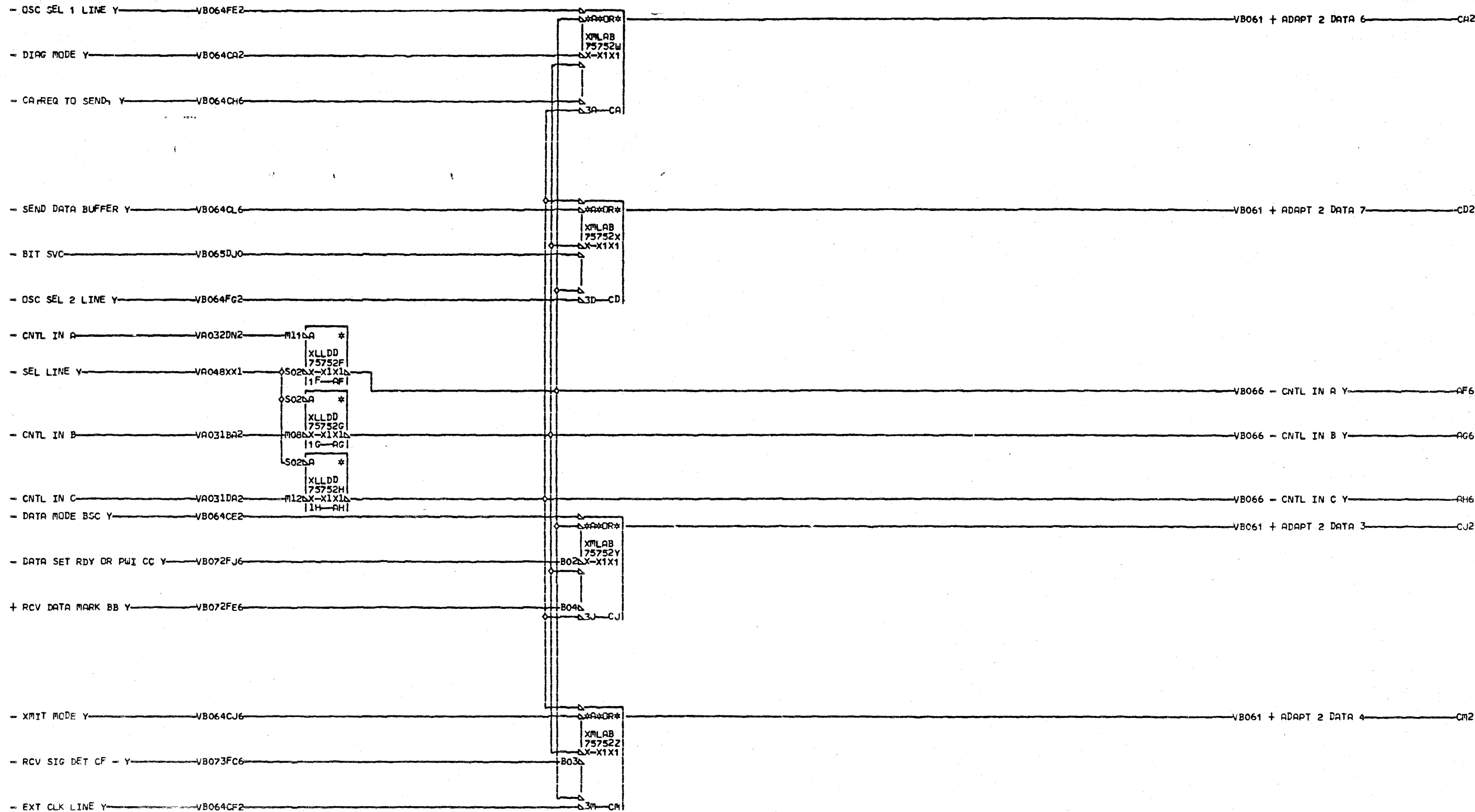

01-26-72 309520C
09-17-80 322670

EIA SYNCHRONOUS START STOP			
LINE PAIR			
DATE	09-22-80	FRAM	27RNB
LOG	748	FRAME	01
		P.N.	1785530
IRM CORR.	SDD BLK.		CN

V
B
0
6
7

000

V
B
0
6
7

000

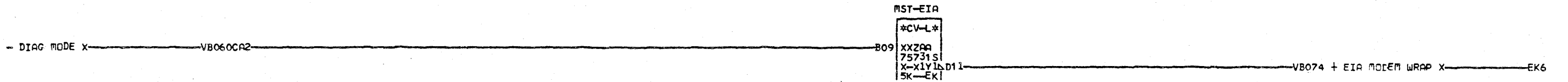
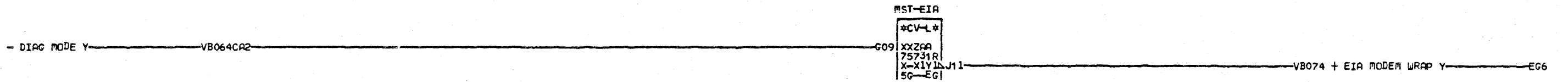
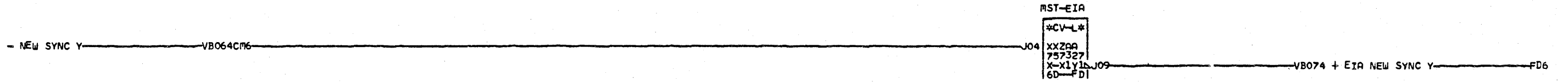
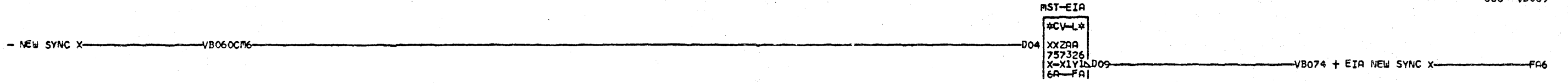

NOTE THESE CIRCUITS ARE NOT USED IN START STOP OPERATION.

VB069
000

01-26-72 309520C
09-17-80 322670

FIA SYNCHRONOUS START STOP			
LINE PAIR EIA DRIVERS			
DATE	09-22-80	MACH.	27RNB
LCG	748	FRAME	01
		P.No.	1785531
IBM CORP.	SDD BLK.	FF	000

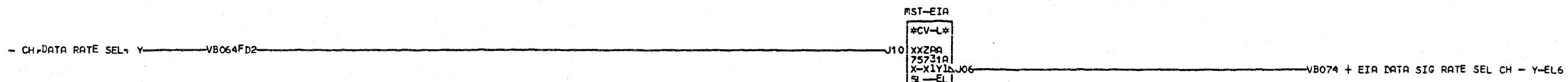
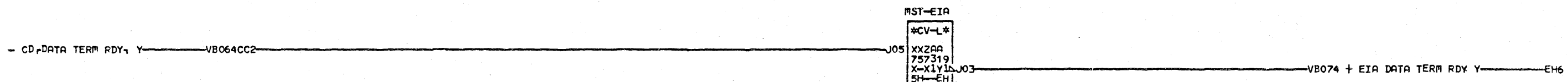
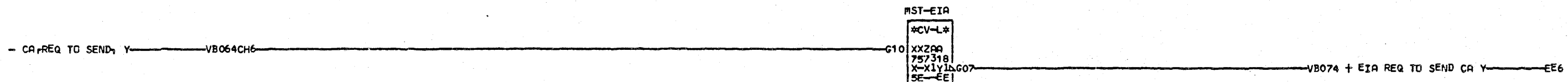
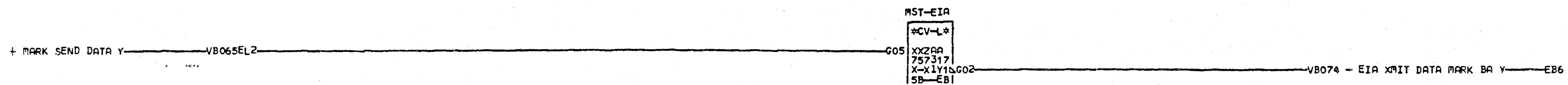

NOTE THE DATA RATE SEL
CIRCUIT IS NOT USED IN START
STOP OPERATION.

V
B
0
7
0
000

01-26-72 309520C
09-17-80 322670

EIA SYNCHRONOUS START STOP			
LINE PAIR EIA DRIVERS			
DATE	09-22-80	MACH.	27RNB
LOG	748	FRAME	01
		P.N.	1785532
IBM CORP.	SDD BLK.		EN

V
B
0
7
0
000

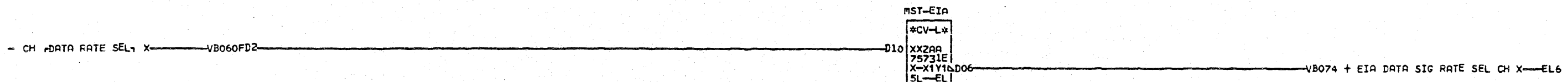
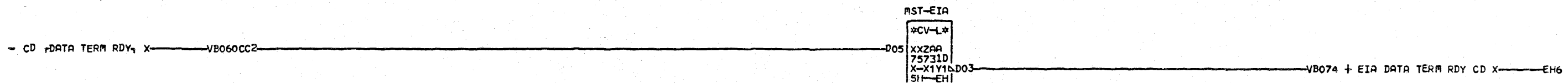
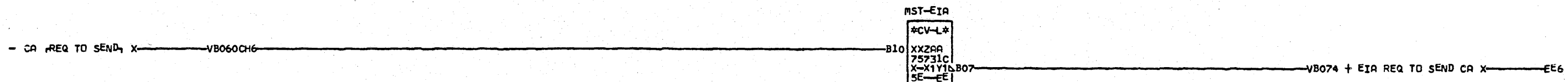
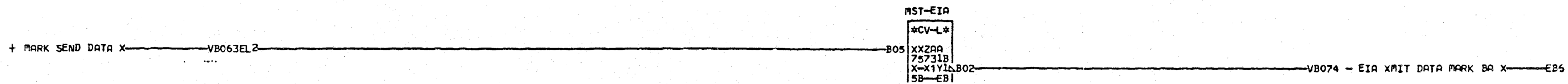

NOTE THE DATA RATE SEL
 CIRCUIT IS NOT USED IN START
 STOP OPERATION.

V
 B
 0
 7
 1
 000

01-26-72 309520C
 09-17-80 322670

EIA SYNCHRONOUS START STOP				V
LINE PAIR EIA DRIVERS				B
DATE	09-22-80	PACH.	27RNB	0
LCG	748	FRAME	01	7
		P.N.	1785533	1
IR ⁹ CCRP.	SDD BLK.		EN	000

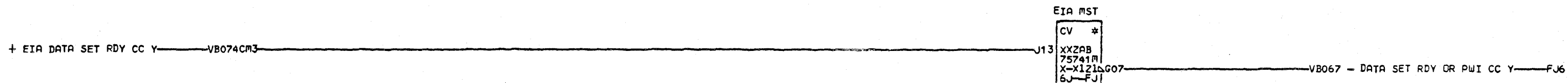
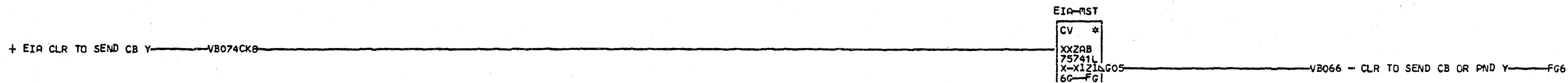
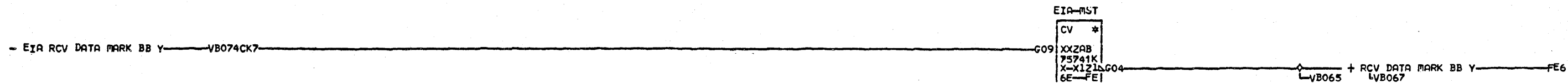
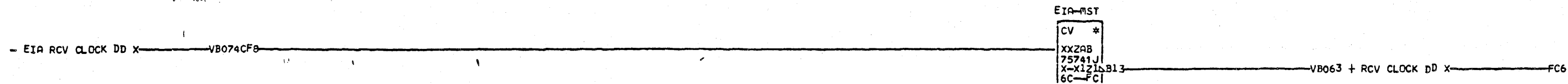
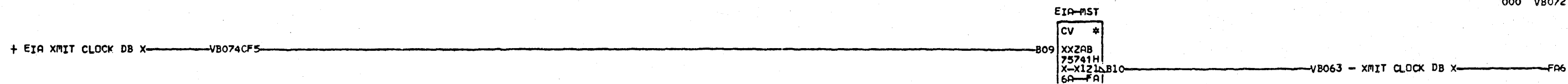

NOTE EIA XMIT AND RCV CLOCK
CIRCUITS ARE NOT USED IN START
STOP OPERATION.

VB
0
7
2

000

01-26-72 309520C
09-17-80 322670

EIA SYNCHRONOUS START STOP	
LINE PR TERMINATOR	
DATE	09-22-80 MACH. 27RNB
LDG	748 FRAME 01
P.N. 1785534	
IBM CORP.	SDD BLK. GN

VB
0
7
2

000

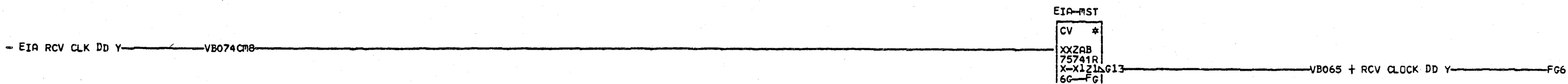
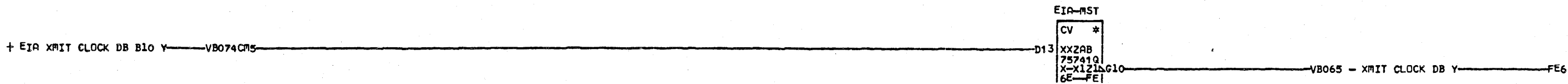
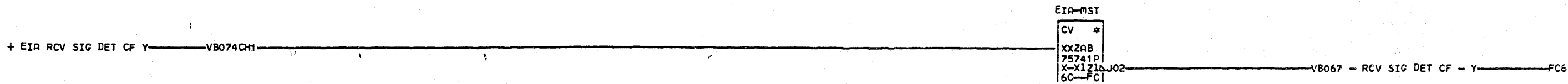
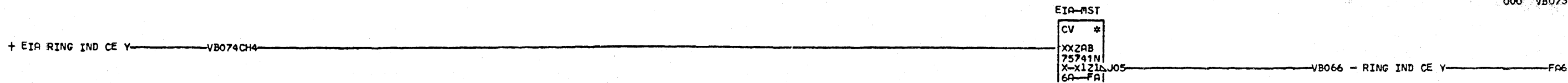

NOTE EIA RING IND & EIA XMIT
AND RCV CLOCK CIRCUITS ARE NOT
USED IN START STOP OPERATION.

VB073
000

01-26-72 309520C
09-17-80 322670

FIA SYNCHRONOUS START STOP			
LINE PR TERMINATOR			
DATE	09-22-80	MACH.	27RNB
LOG	748	FRAME	01
		P.N.	1785535
IBM CORP.	SDD BLK.	FK	

VB073
000

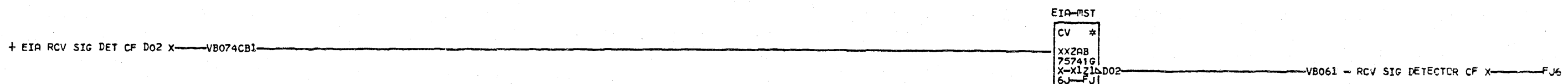
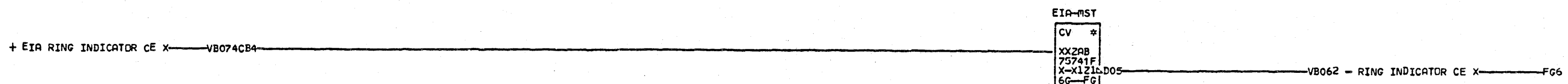
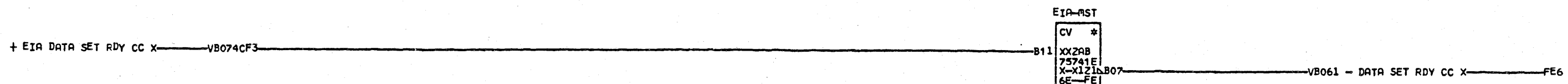
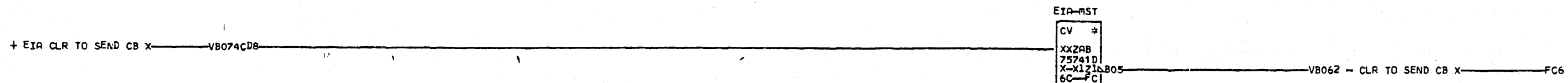
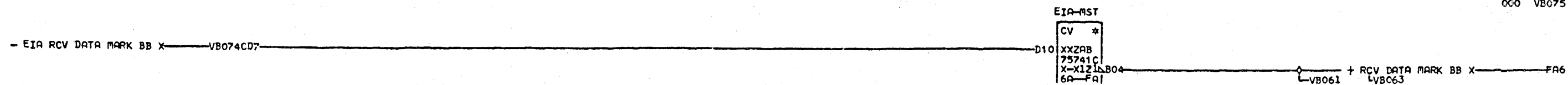

NOTE EIA RING INDICATOR
CIRCUIT IS NOT USED IN START
STOP OPERATION.

VB075
000

01-26-72 309520C
09-17-80 322670

EIA SYNCHRONOUS START STOP			
LINE PR TERMINATOR			
DATE	09-22-80	MACH.	27RNB
LOG	748	FRAME	01
P.N.		1785537	
IBM CORP.	SDD BLK.	FK	

V
B
0
7
5
000

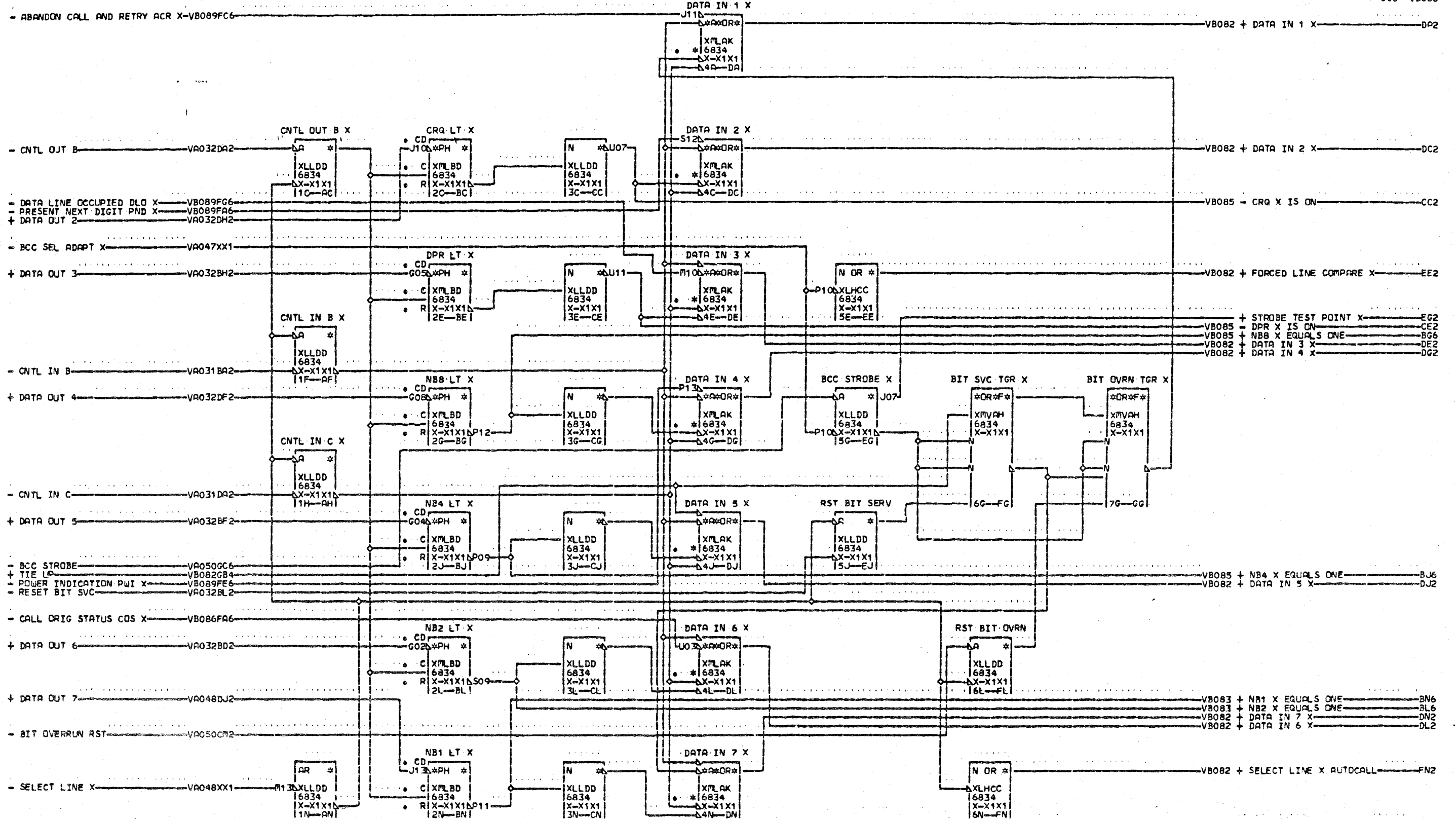

VB080
000

01-26-72 309520C

AUTO CALL			
LINE DATA			
DATE	01-25-72	FRAC#	27RNB
LOG	600	FRAME	01
		P.No.	1785538
IBM CORP.	5DD	BLK.	GH

VB080
000

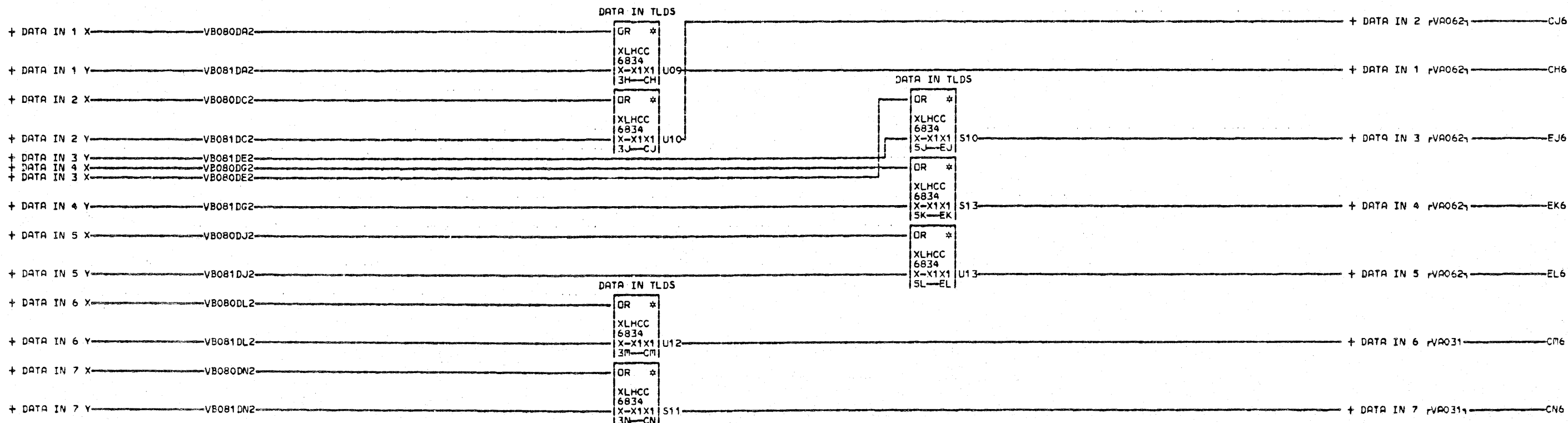
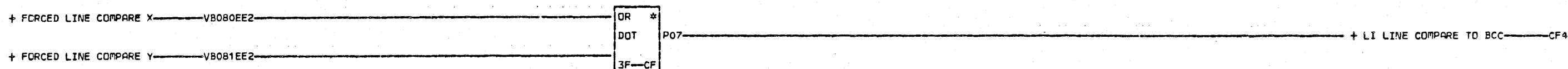
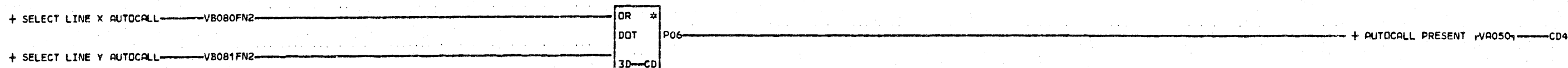
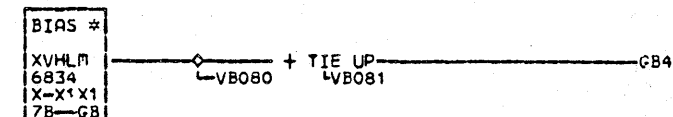

01-26-72 309520C
03-29-72 309540

AUTO CALL			
LINE PAIR			
DATE	04-06-72	PACH.	27RNB
LOG	201	FRAME	01
		P.No.	1785540
IBM CORP.	SDD	BLK.	GC

VB082

000

VB082

000

+ NB1 X EQUALS ONE - VB080BN6

MST-EIA

CV-L
XXZAA
757326
X-X1Y1ND09
6A-FAI

D04

-VB088 - DIGIT SIGNAL NB1 X- FA6

+ NB1 Y EQUALS ONE - VB081BN6

MST-EIA

CV-L
XXZAA
757327
X-X1Y1ND09
6D-FDI

J04

-VB088 - DIGIT SIGNAL NB1 Y- FD6

+ NB2 Y EQUALS ONE - VB081BL6

MST-EIA

CV-L
XXZAA
75731R
X-X1Y1ND11
5G-EGI

G09

-VB088 - DIGIT SIGNAL NB2 Y- EG6

+ NB2 X EQUALS ONE - VB080BL6

MST-EIA

CV-L
XXZAA
75731S
X-X1Y1ND11
5K-EKI

B09

-VB088 - DIGIT SIGNAL NB2 X- EK6

01-26-72 309520C

VB083
000

AUTO CALL			
LINE PAIR EIA DRIVERS			
DATE	01-26-72	MACH#	27RNB
LOG	600	FRAME	01
		PeNo	1785541
IBM CORP.		SDD BLK#	FF

VB083
000

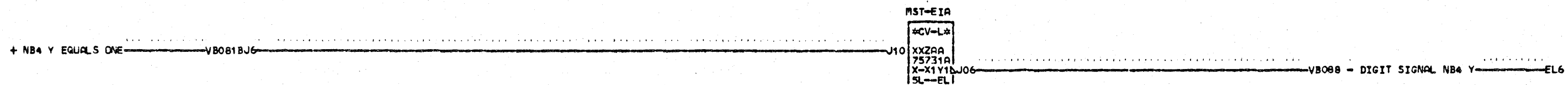
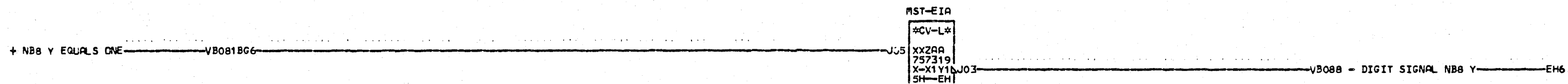
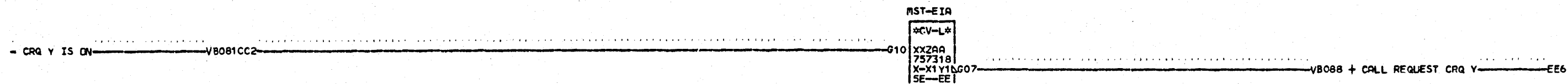
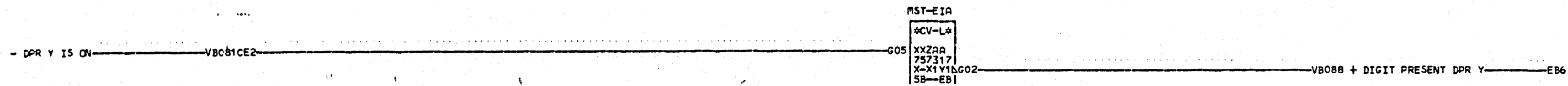

01-26-72 309520C

ABOBY
000

AUTO CALL			
LINE PAIR ZIA DRIVERS			
DATE	01-26-72	FRAC#	27RNB
LOG	600	FRAME	01
P#No		1785542	
IBM CORP.	SDD	BLK.	EN

VB
08
4
000

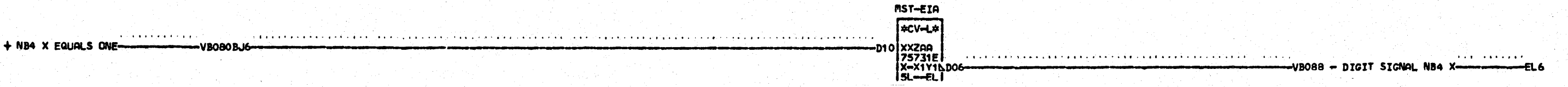
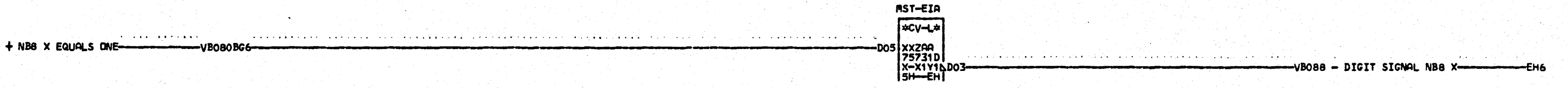
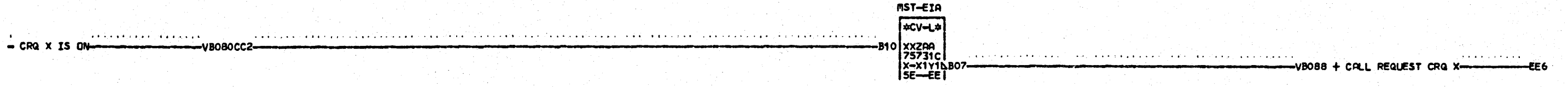
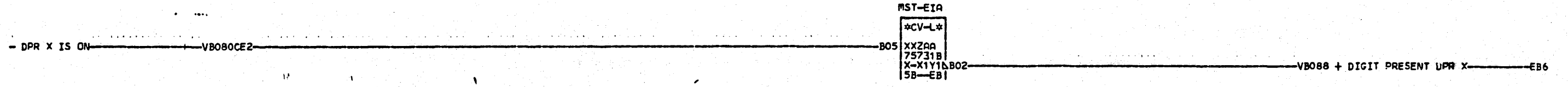

000

01-26-72 309520C

AUTO CALL			
LINE PAIR EIA DRIVERS			
DATE	01-26-72	MACH	27RNB
LOG	600	FRAME	01
		P.No.	1785543
IBM CORP.	SDD	BLK.	EN

V
B
0
8
5
000

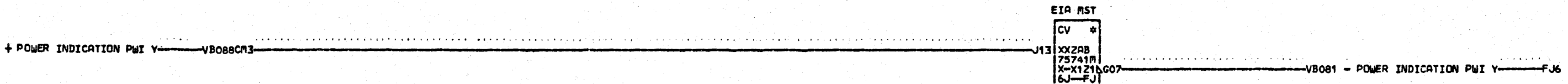
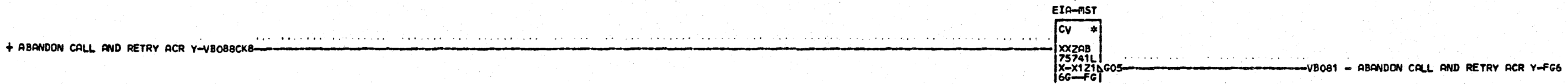
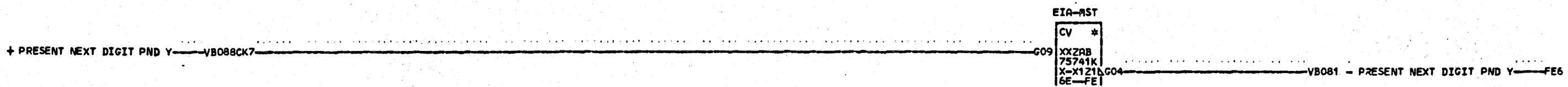
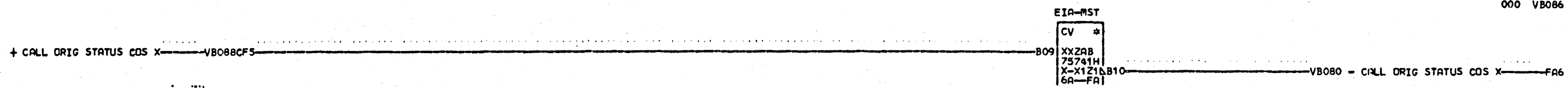

01-26-72 309520C

VB086
000

AUTO CALL EIA TERMINATOR CARD			
DATE	01-26-72	RACH.	27RNB
LOG	600	FRAME	01
		P.No.	1785544
IBM CORP.	SDD	BLK.	GN

VB086
000

000 VB087

+ DATA LINE OCCUPIED DLO Y-----VB088CH4

EIA-RST

CV *
XXZAB
75741N
X-X1Z1LJ05
6A-FAI

-----VB081 - DATA LINE OCCUPIED DLO Y-----FA6

+ CALL ORIG STATUS COS Y-----VB088CM5

EIA-RST

CV *
XXZAB
75741Q
X-X1Z1LG10
6E-FEI

-----VB081 - CALL ORIG STATUS COS Y-----FE6

01-26-72 309520C

VB087
000

AUTO CALL EIA		
TERMINATOR CARD		
DATE	01-26-72	MACH. 27RNB
LOG	600 FRAME	01
	P.N. 1785545	
IBM CORP.	SDD BLK.	FKI

VB087
000

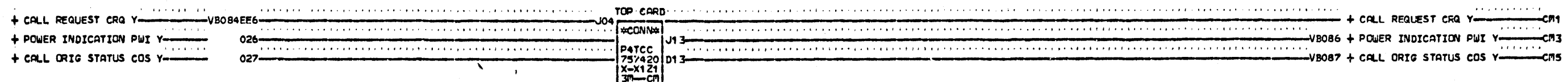
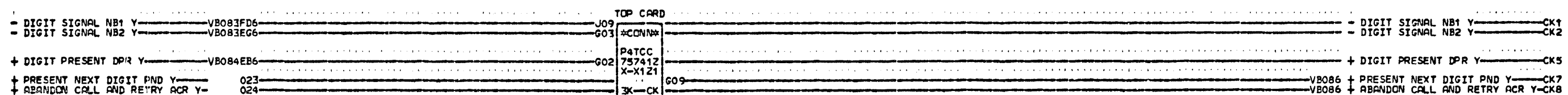
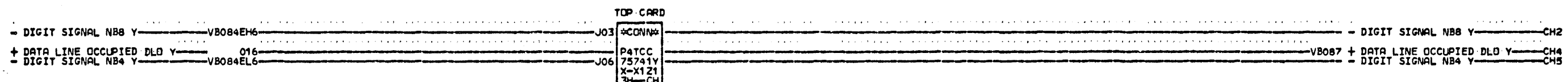
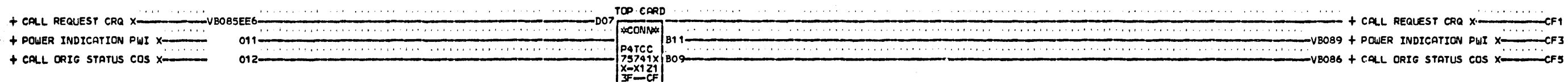
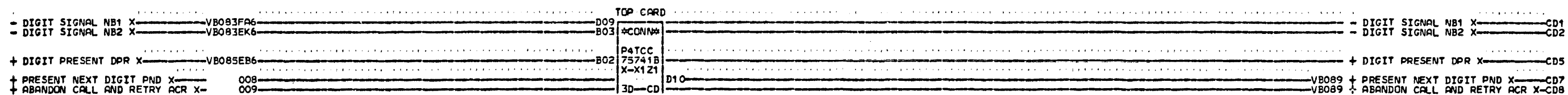
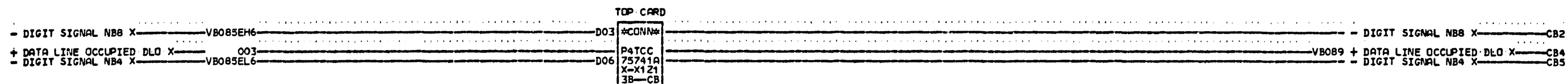

01-26-72 309520C

AUTO CALL EIA TERMINATOR CARD		V
DATE	01-26-72 MACH# 27RNB	B
LOG	600 FRAME	01
		8
		8
	P#N# 1785546	000
IBM CORP.	SDD BLK.	D11

VB088
000

+ PRESENT NEXT DIGIT PND X—VB088CD7.....D10

EIA-MST
CV *
XXZAB
75741C
X-X1Z1B04
6A—FA

VB080 - PRESENT NEXT DIGIT PND X—FA6

+ ABANDON CALL AND RETRY ACR X—VB088CD8.....B05

EIA-MST
CV *
XXZAB
75741D
X-X1Z1B05
6C—FC

VB080 - ABANDON CALL AND RETRY ACR X—FC6

+ POWER INDICATION PMI X—VB088CF3.....B11

EIA-MST
CV *
XXZAB
75741E
X-X1Z1B07
6E—FE

VB080 - POWER INDICATION PMI X—FE6

+ DATA LINE OCCUPIED DLO X—VB088CB4.....D05

EIA-MST
CV *
XXZAB
75741F
X-X1Z1D05
6G—FG

VB080 - DATA LINE OCCUPIED DLO X—FG6

01-26-72 309520C

VB089
000

AUTO CALL EIA TERMINATOR CARD			
DATE	01-26-72	RACH#	27RNB
LOG	600	FRAME	01
		P.N.	1785547
IBM CORP.	SDD	BLK.	FK

VB089
000

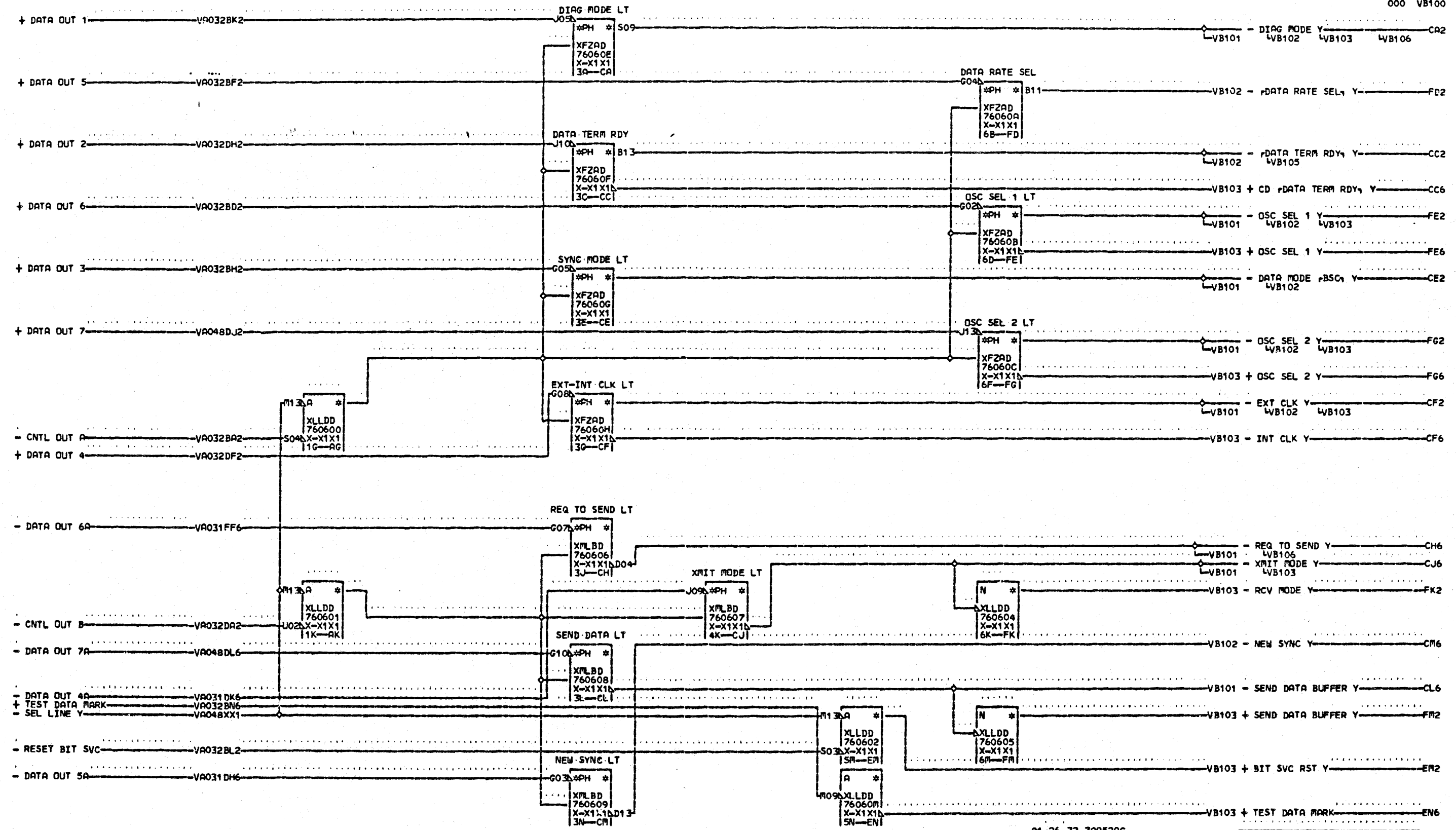

01-26-72 309520C

DIGITAL LINE			
DATE	01-26-72	MACH.	27RNB
LOG	600	FRAME	01
		P.N.	1785548
IBM CORP.	SDD BLK.		GL

VB100
000

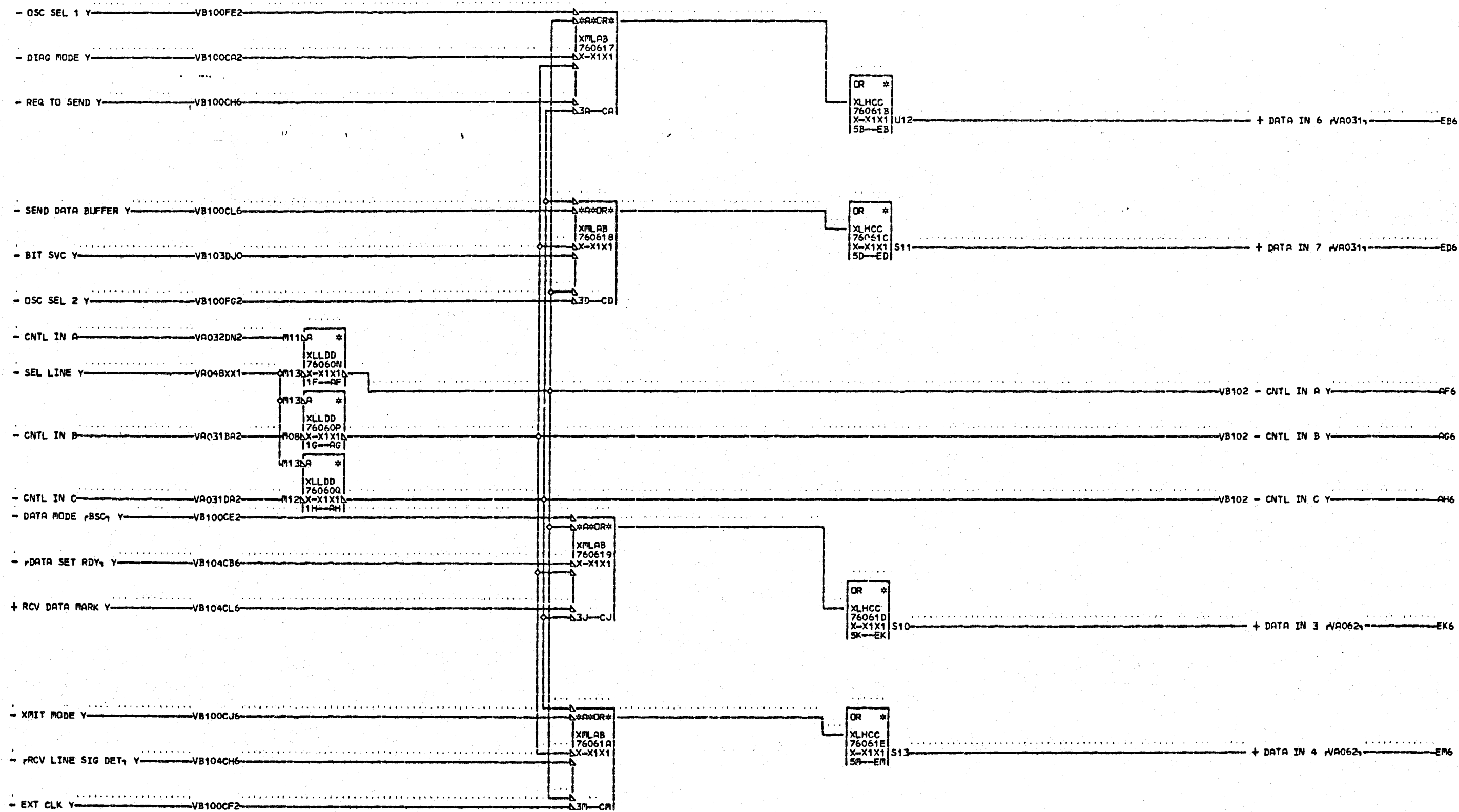

01-26-72 309520C

VB101
000

DIGITAL LINE			
DATE	01-26-72	RACH	27RNB
LOG	600	FRAME	01
		PaNo	1785549
IBM CORP.	SDD	BLK	EN

VB101
000

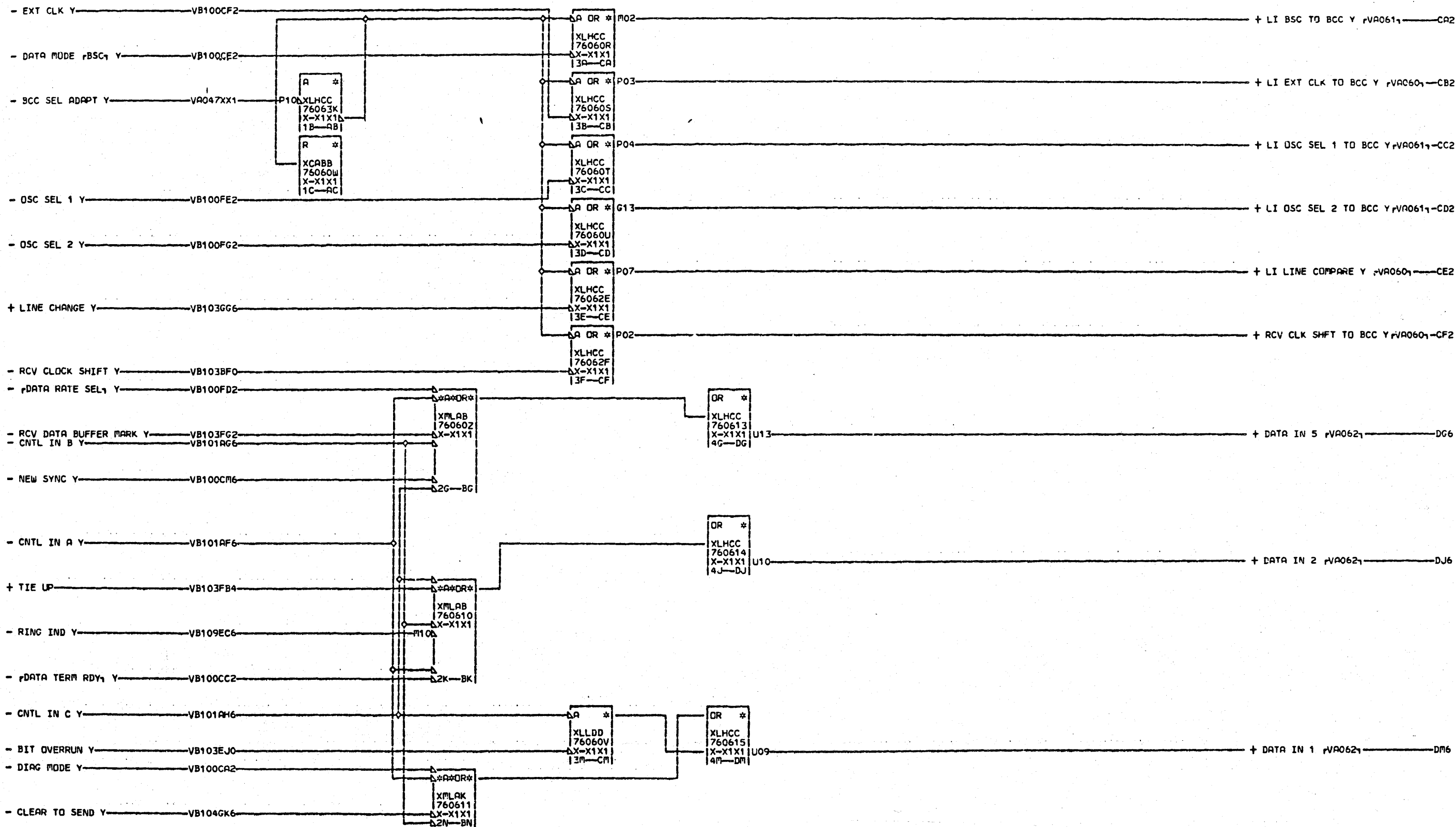

V
B
1
0
2
000

01-26-72 309520C
03-10-72 309540

DIGITAL LINE			
DATE	04-06-72	MACH.	27RNB
LOG	255	FRAME	01
		PaN.	1785550
IBM CORP.	SDD BLK.		DN

V
B
1
0
2
000

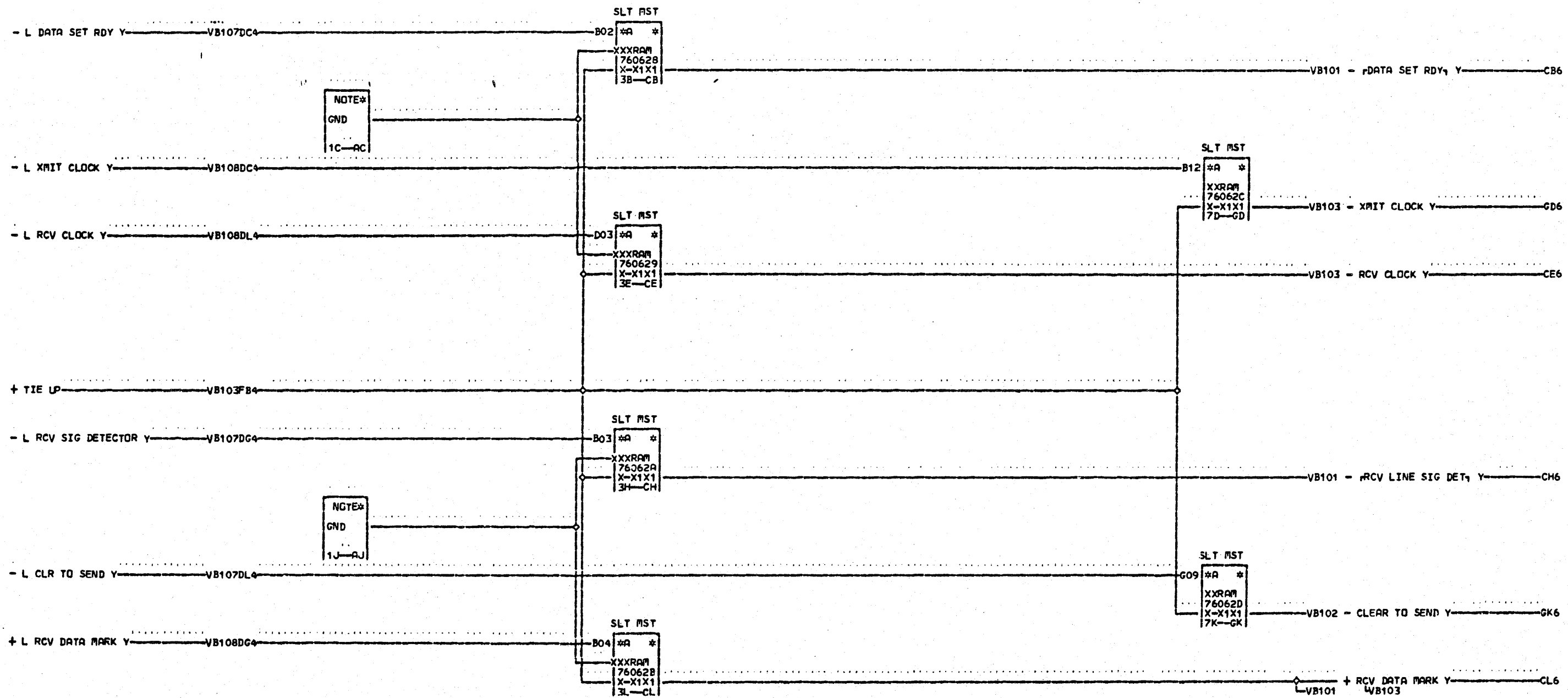

01-26-72 309520C

VB104
000

DIGITAL LINE			
DATE	01-26-72	PACH	27RNB
LOG	600	FRAME	01
		PoNo	1785552
IBM CORP.	SDD	BLK	6L

VB104
000

- DATA TERM RDY Y VB100CC2

MST-EIA
 CV-L
 XXZAA
 757611
 X-X1Y1 J03
 5B-EB

J05

VB110 + EIA DATA TERM RDY Y EB6

VB105
000

01-26-72 309520C

DIGITAL DRIVERS			
DATE	01-26-72	RACH.	27RNB
LOG	600	FRAME	01
		P.No.	1785553
IBM CORP.	SDD	BLK.	FF

VB105
000

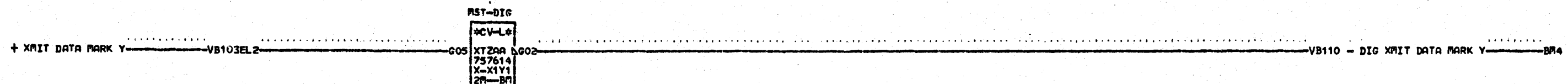
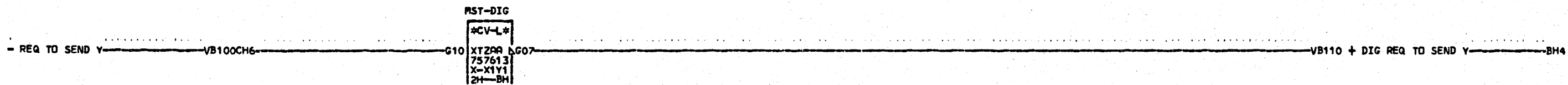
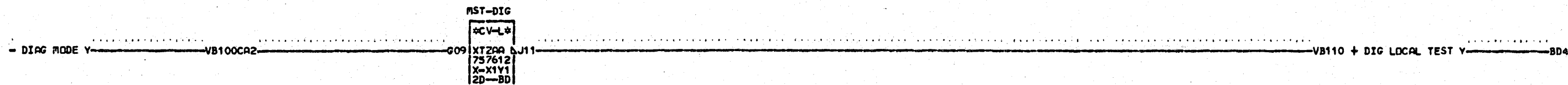

01-26-72 309520C

VB106
000

DIGITAL DRIVERS			
DATE	01-26-72	MACH.	27RNB
LOG	600	FRAME	01
		P.No.	1785554
IBM CORP.	SDD BLK.	FR	

VB106
000

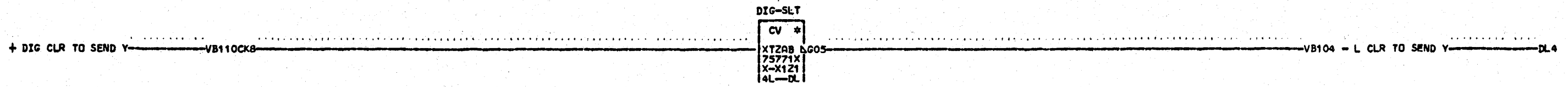
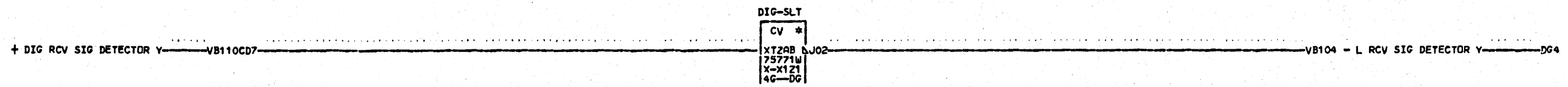
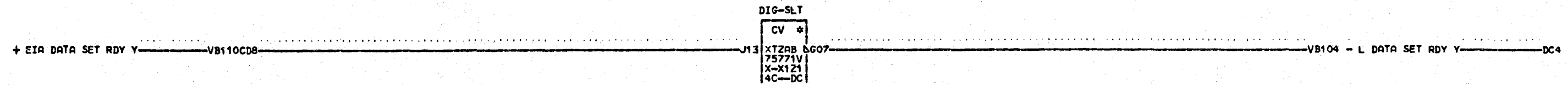

01-26-72 309520C

000

DIGITAL TERMINATOR CARD			
DATE	01-26-72	MACH#	27RNB
LOG	600	FRAME	01
		P#N#	1785555
IBA CORP.	SDD	BLK.	0L

V
B
1
0
7
000

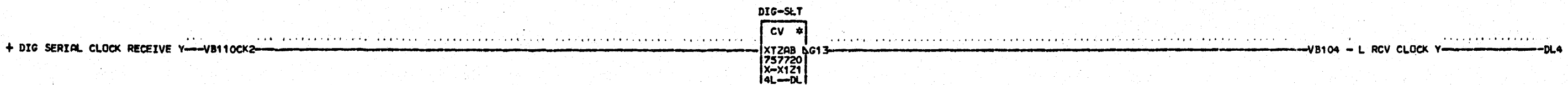
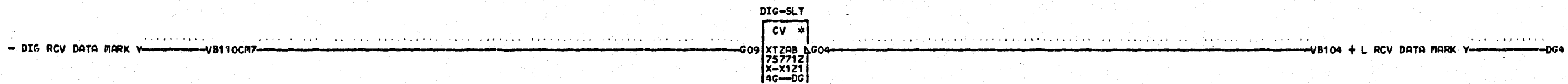
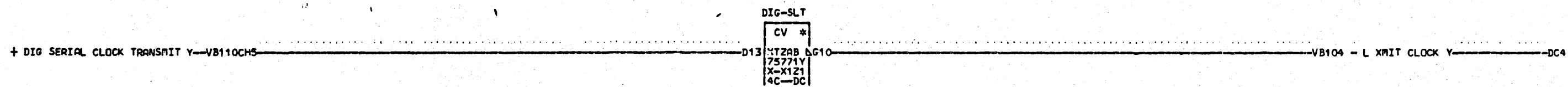

01-26-72 309520C

VB108
000

DIGITAL TERMINATOR CARD			
DATE	01-26-72	FRAC#	27RNB
LOG	600	FRAME	01
		PoNo	1785556
IBM CORP.	SDD	BLK.	GL

VB108
000

+ EIA RING IND Y - VB110CB1

EIA-MST

CV *
XXZAB
75771N
X-X1Z1D05
5C-EC1

- VB102 - RING IND Y - EC6

01-26-72 309520C

VB109
000

DIGITAL TERMINATORS			
DATE	01-26-72	MACH.	27RNB
LOG	600	FRAME	01
		PaN.	1785557
IBM CORP.	SDD	BLK.	FJ

VB109
000

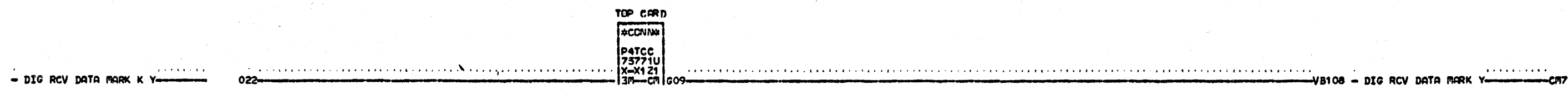
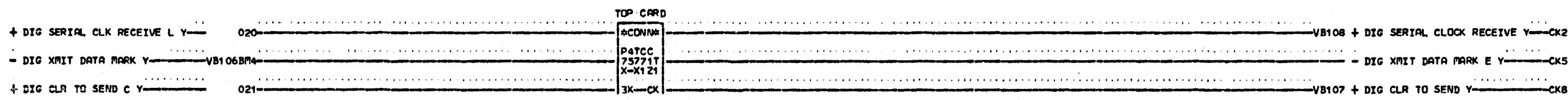
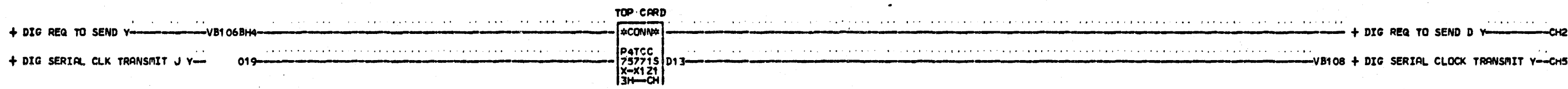
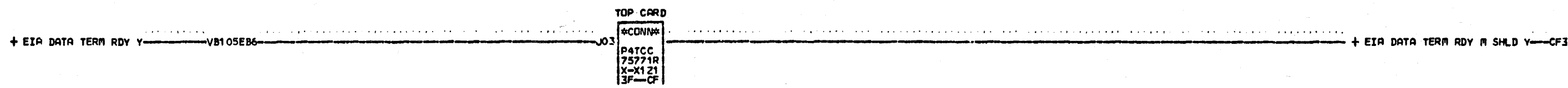
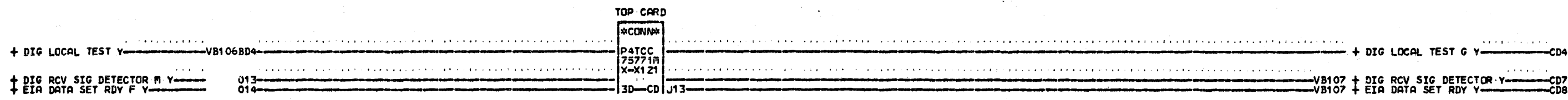
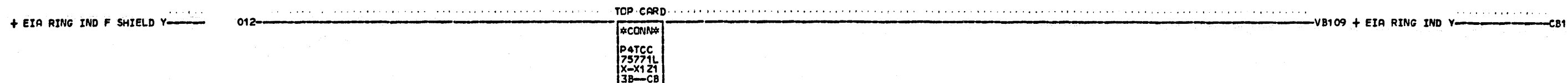

01-26-72 309520C

VB110
000

DIGITAL TERMINATOR CARD			
DATE	01-26-72	MACH.	27RNB
LDG	600	FRAME	01
		PaNo	178-5558
IBA CORP.	SDD BLK.		EL

VB110
000

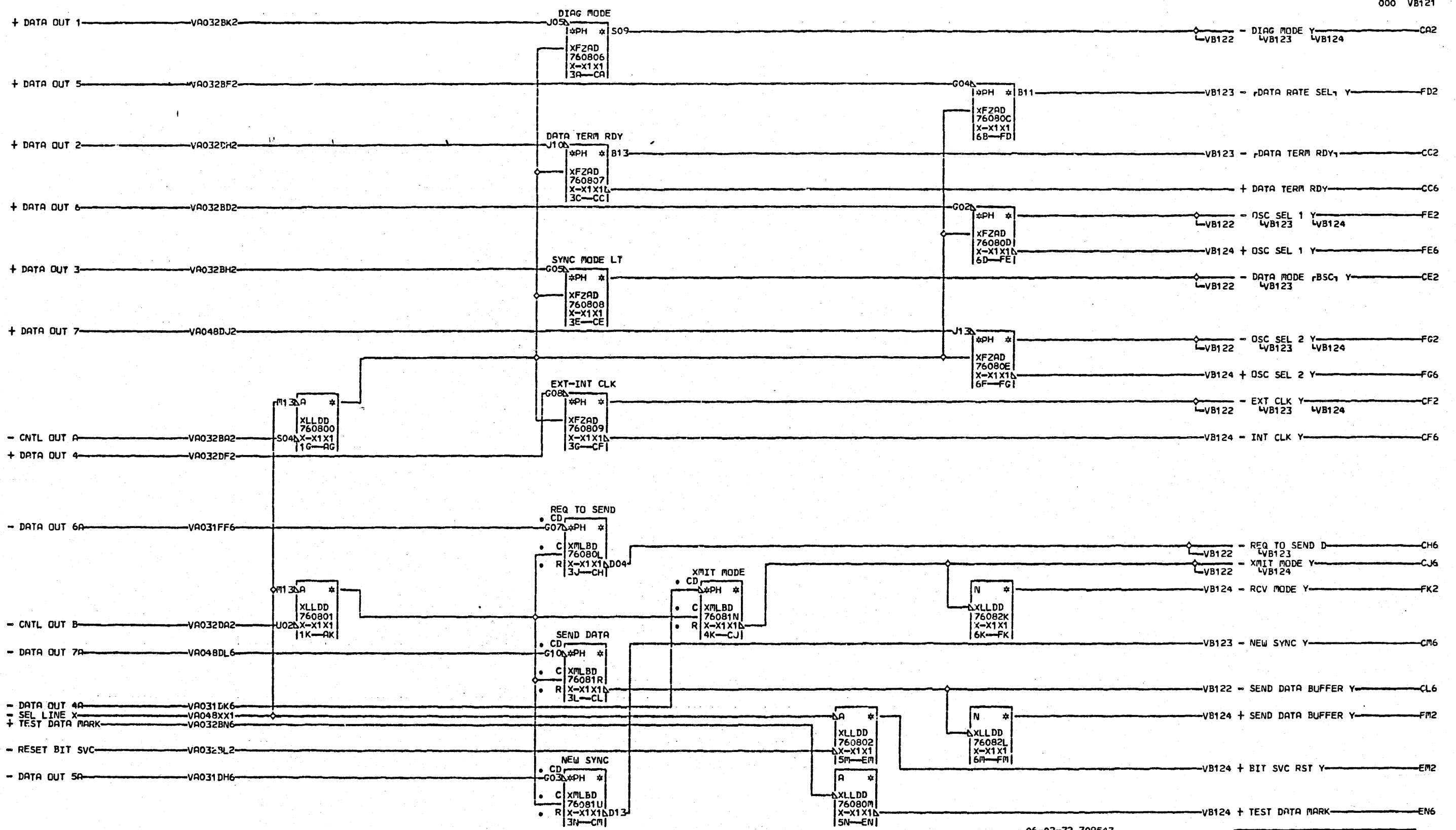

06-02-72 309543

VB
1
2
1
000

MIL 188 C			
DATE	06-02-72	MACH.	27RNB
LOG	143	FRAME	01
		PoN.	1785980
IBM CORP.	SDD	BLK.	GL

VB
1
2
1
000

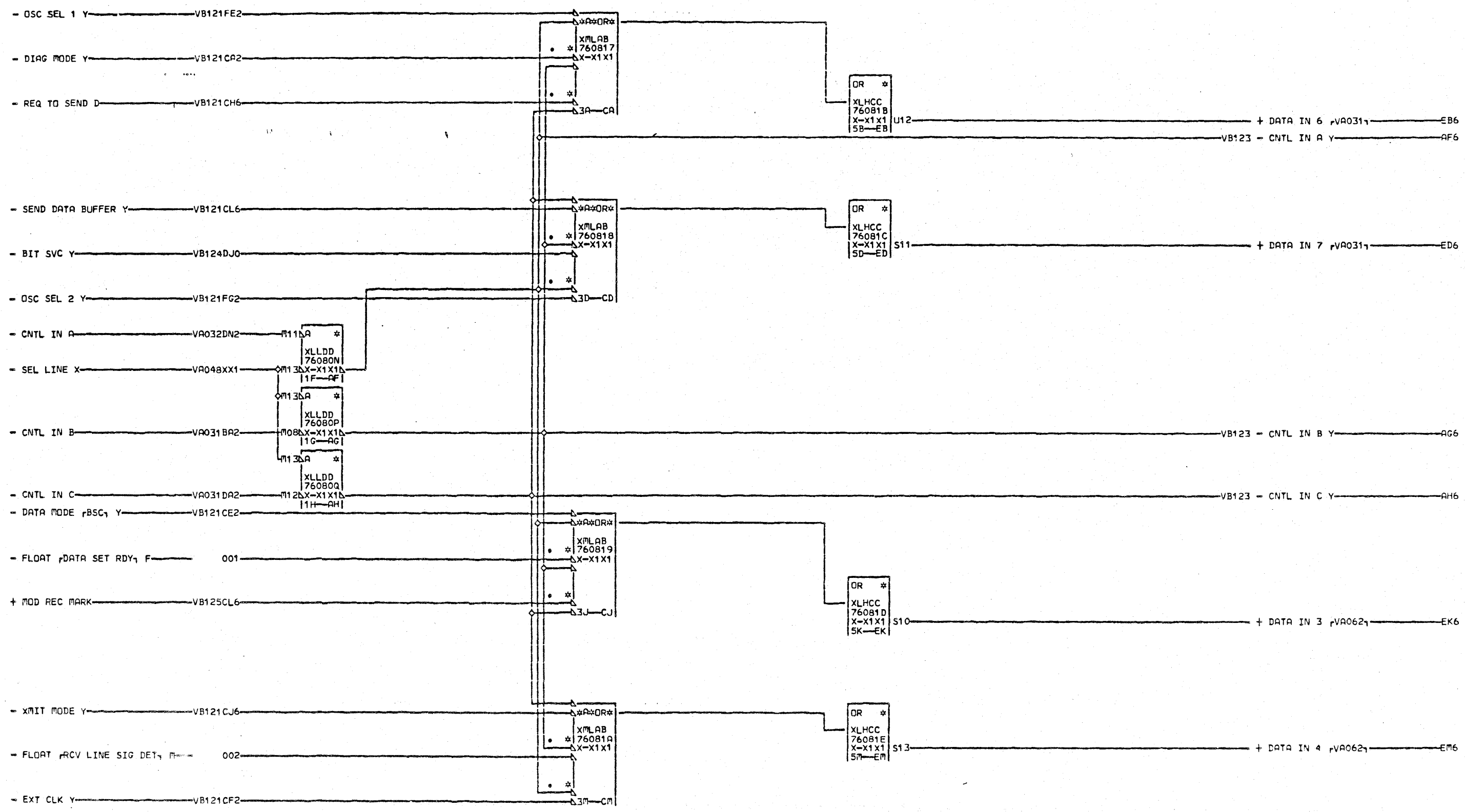

06-02-72 309543

VB
1
2
2
000

MIL 188 C			
DATE	06-02-72	MACH.	27RN3
LOG	143	FRAME	01
		P.N.	1785981
IB7 CORP.	SDD BLK.	EN	

VB
1
2
2
000

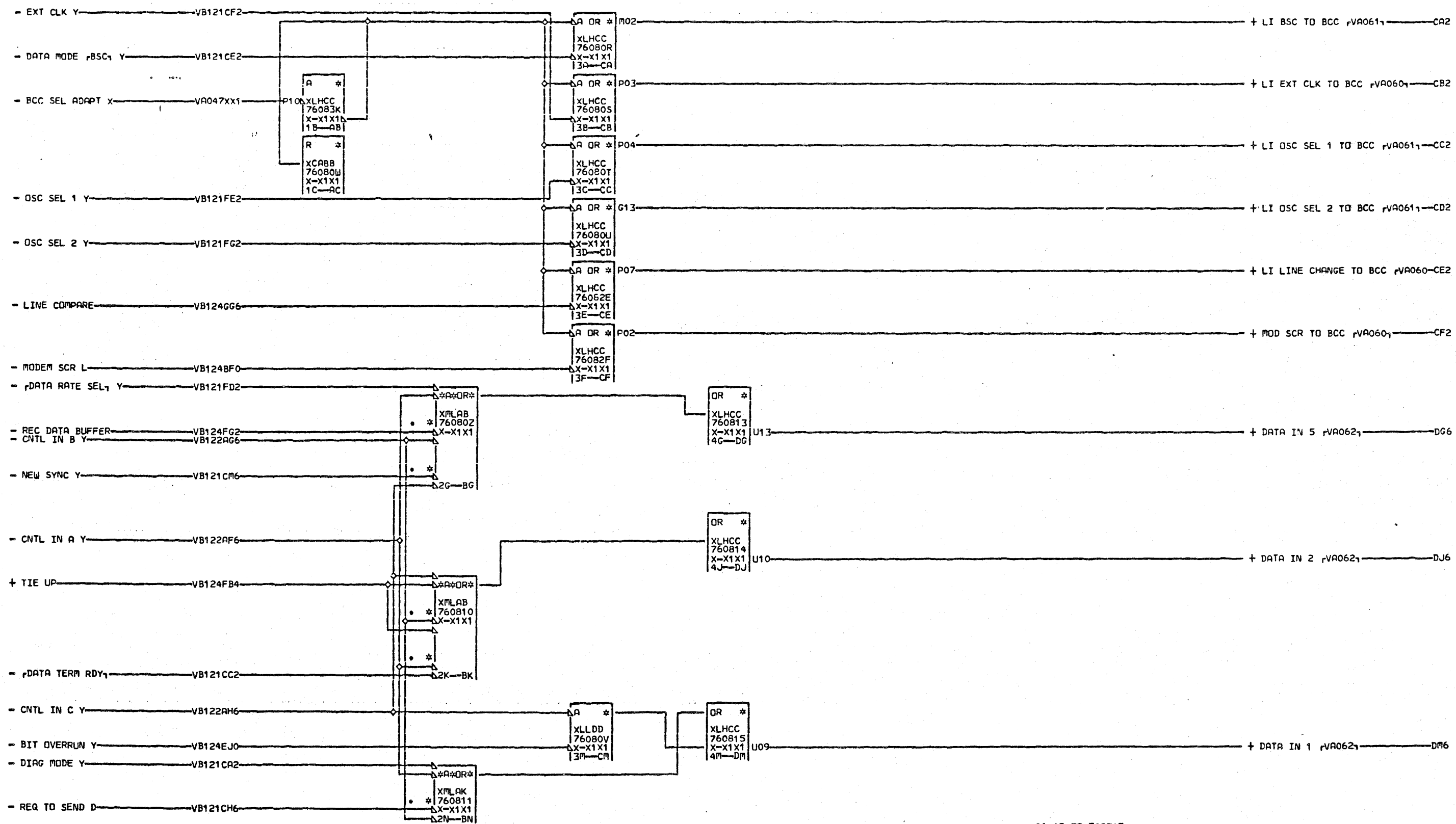

06-02-72 309543

V
B
1
2
3
000

MIL 188 C			
DATE	06-02-72	MACH.	27RNB
LOG	143	FRAME	01
		P.N.	1785982
IBM CORP.	SDD	BLK.	DN

V
B
1
2
3
000

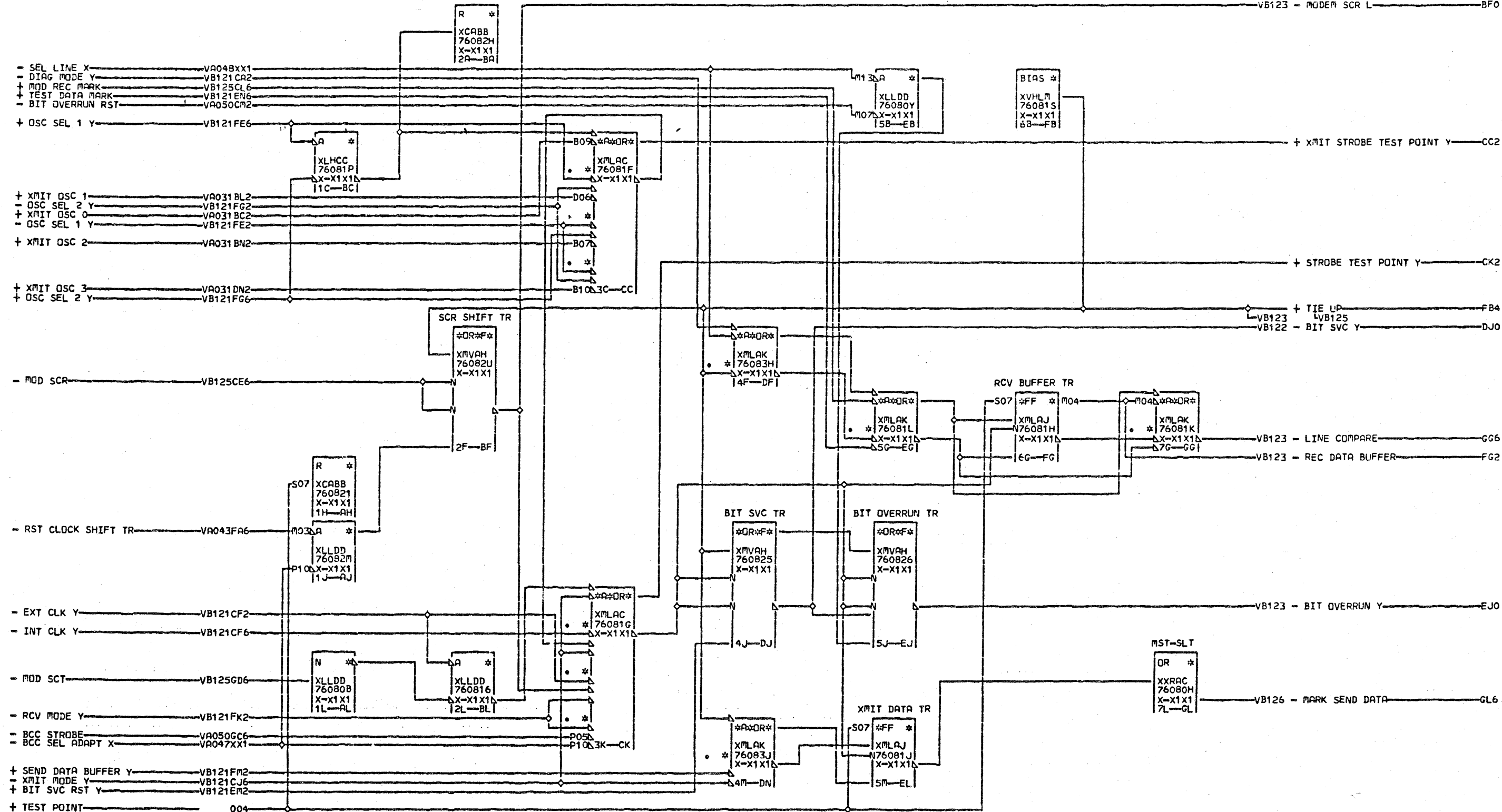

06-02-72 309543

V
B
1
2
4
000

MIL 188 C			
DATE	06-02-72	MACH.	27RNB
LOG	143	FRAME	01
		P.N.	1785983
IBM CORP.	SDD	BLK.	GA

V
B
1
2
4
000

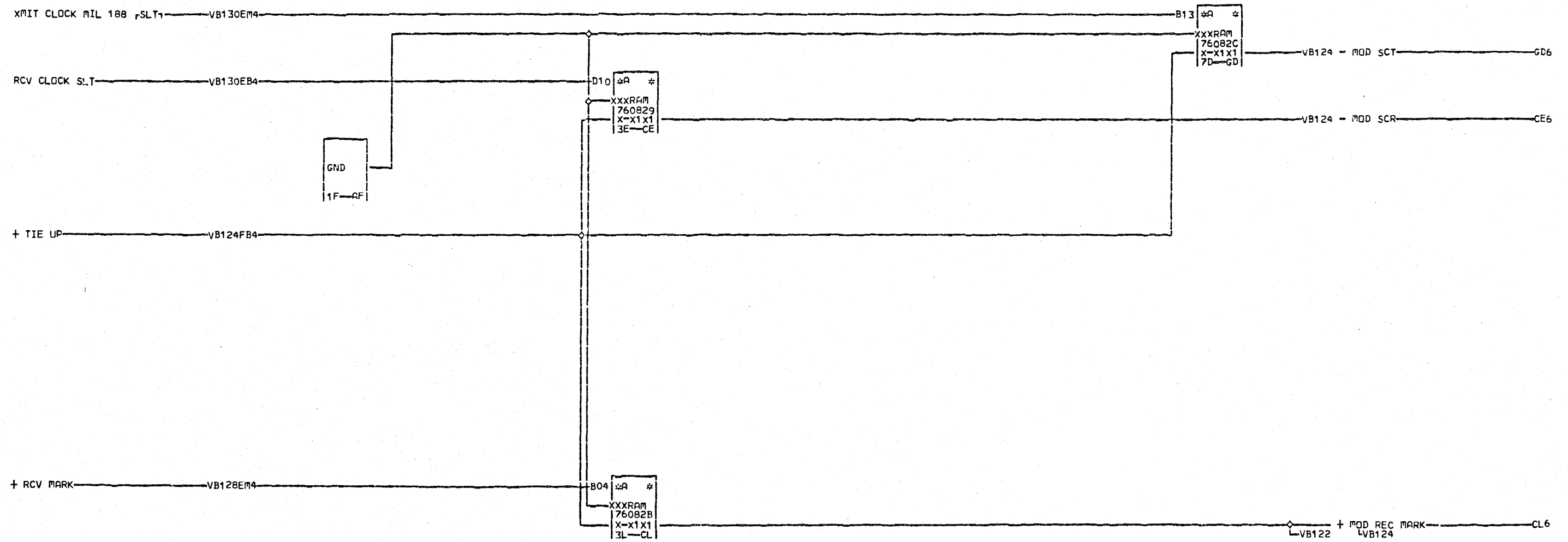

VB
1
2
5
000

06-02-72 309543
11-07-72 309953

MIL 188 C			
DATE	11-07-72	MACH.	27RNB
LOG	919	FRAME	01
		P.N.	1785984
IBM CORP.	SDD BLK.		GP

VB
1
2
5
000

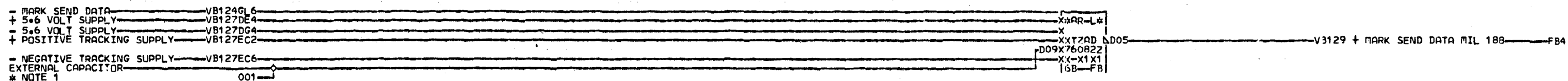

NOTE 1
SEE PAGE VA007 NOTE 6
FOR INFORMATION

06-02-72 309543
11-07-72 309953

MIL 188 C DRIVER			
DATE	11-07-72	MACH.	27RNB
LOG	919	FRAME	01
		P.N.	1785985
IBM CORP.	SDD BLK.		GH

VB
1
2
6
000

VB
1
2
6
000

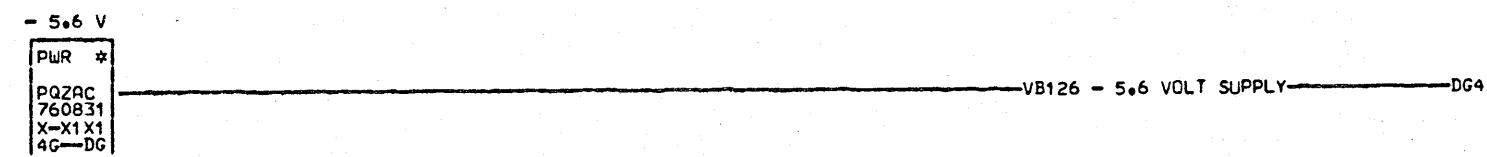
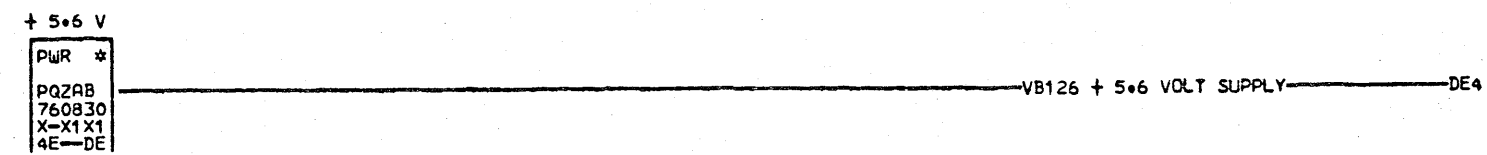
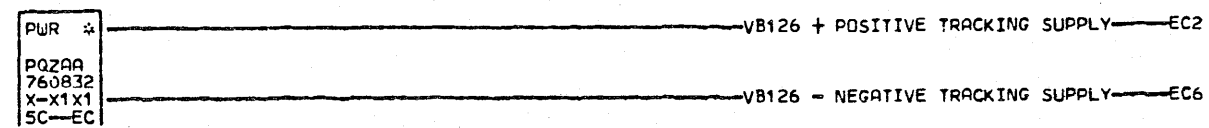

06-02-72 309543

VB127
000

MIL 188 C ZENER SUPPLY			
DATE	06-02-72	MACH.	27RNB
LOG	143	FRAME	01
		P.N.	1785986
IBM CORP.	SDD	BLK.	GL

VB
1
2
7
000

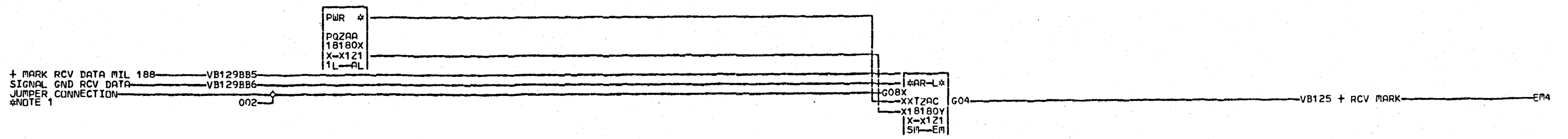

NOTE 1 JUMPER TO
 SIGNAL GND FOR LOW
 INPUT IMPEDANCE, G08 TO J11.

V
 B
 1
 2
 8

000

06-02-72 309543
 11-07-72 309953

MIL 188 C TERMINATOR		V B 1 2 8
RCV DATA		
DATE	11-07-72 MACH. 27RNB	000
LOG	919 FRAME 01	
	P.N. 1785987	
IBM CORP.	SDD BLK.	GP

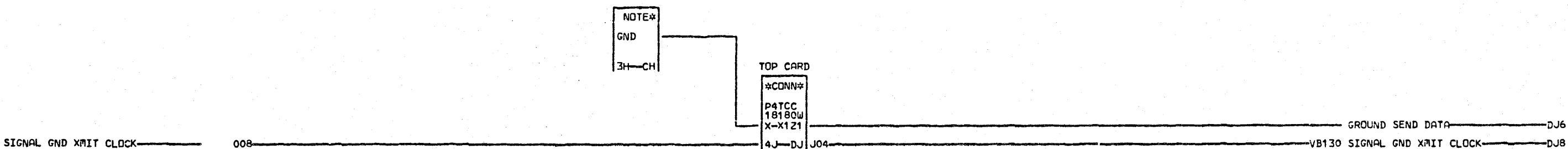
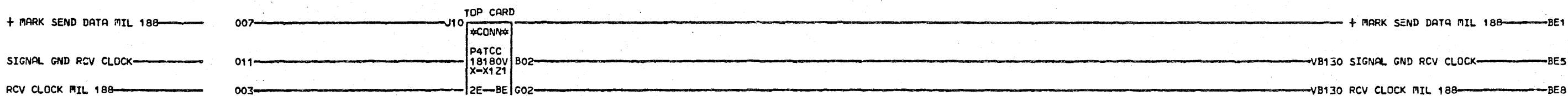
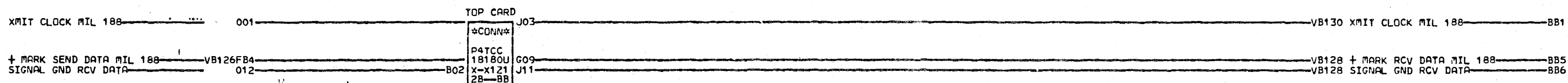

VB129
000

06-02-72 309543

MIL 188 C TOP CARD CONNECTOR			
DATE	06-02-72 MACH. 27RNB		VB129
LQG	143	FRAME 01	9
		P.N. 1785988	000
IBM CORP.	SDD BLK.	FK	

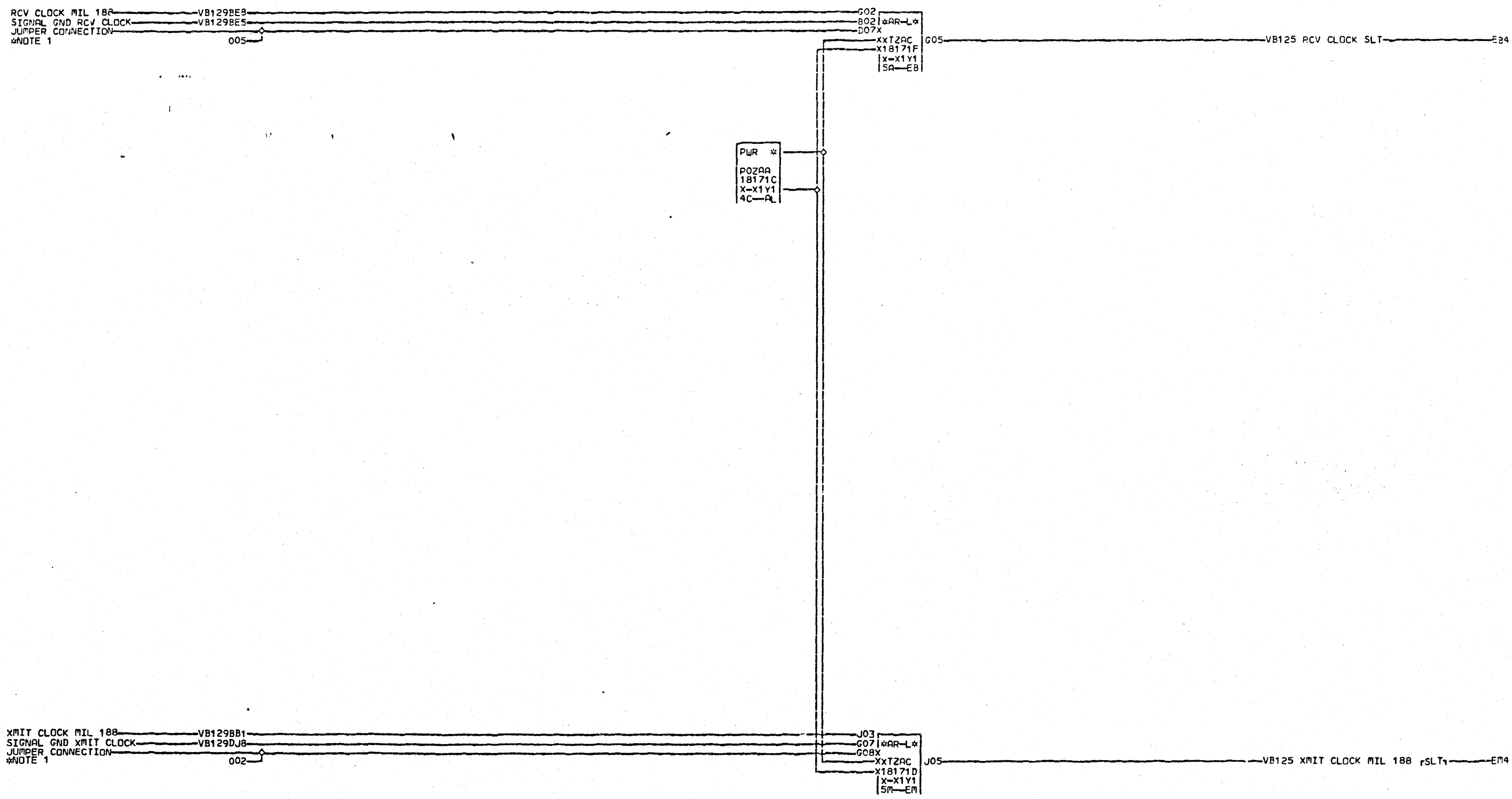

NOTE 1 JUMPER TO
SIGNAL GND FOR LOW
V INPUT IMPEDANCE
B G08 TO G07 FOR XMIT CK
1 D07 TO B02 FOR RCV CK
3
0
000

06-02-72 309543
11-07-72 309953

MIL 188 C TERMINATOR			
XMIT CLOCK			
DATE	11-07-72	MACH.	27RNB
LOG	919	FRAME	01
		P.N.	1785989
IBM CORP.	SDD	BLK.	GP

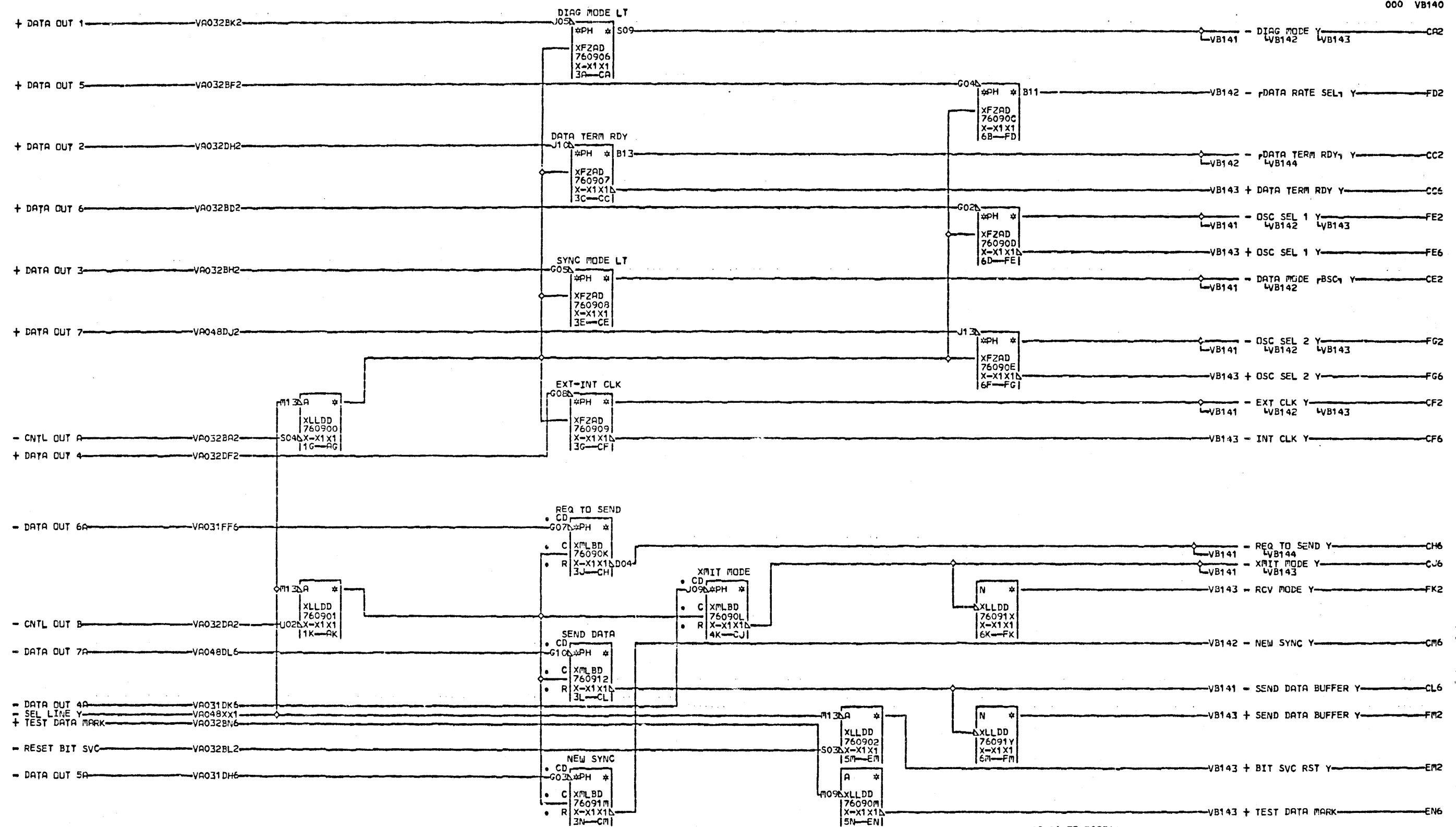

08-24-72 309546

V
B
1
4
0
000

V 35 INTERFACE		
DATE	08-29-72	MACH. 27RNB
LOG	083	FRAME 01
		P.N. 1856430
IBM CORP.	SDD BLK.	GL

V
B
1
4
0
000

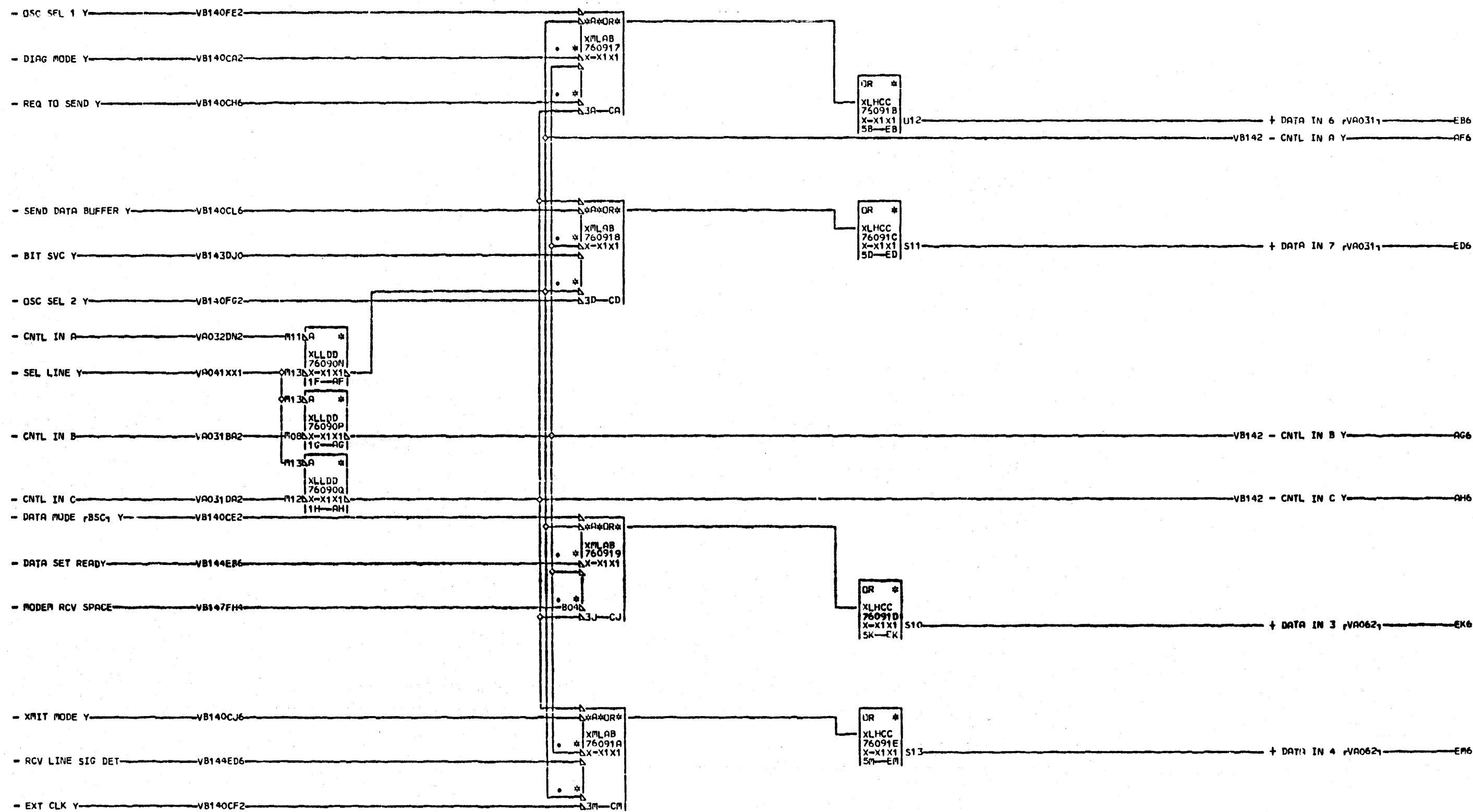

08-24-72 309546

V
B
1
4
1
000

V35 INTERFACE			
DATE	08-29-72	MACH.	27RNB
LOG	083	FRAME	01
		P.N.	1856431
IBM CORP.	SDD BLK.		EN

V
B
1
4
1
000

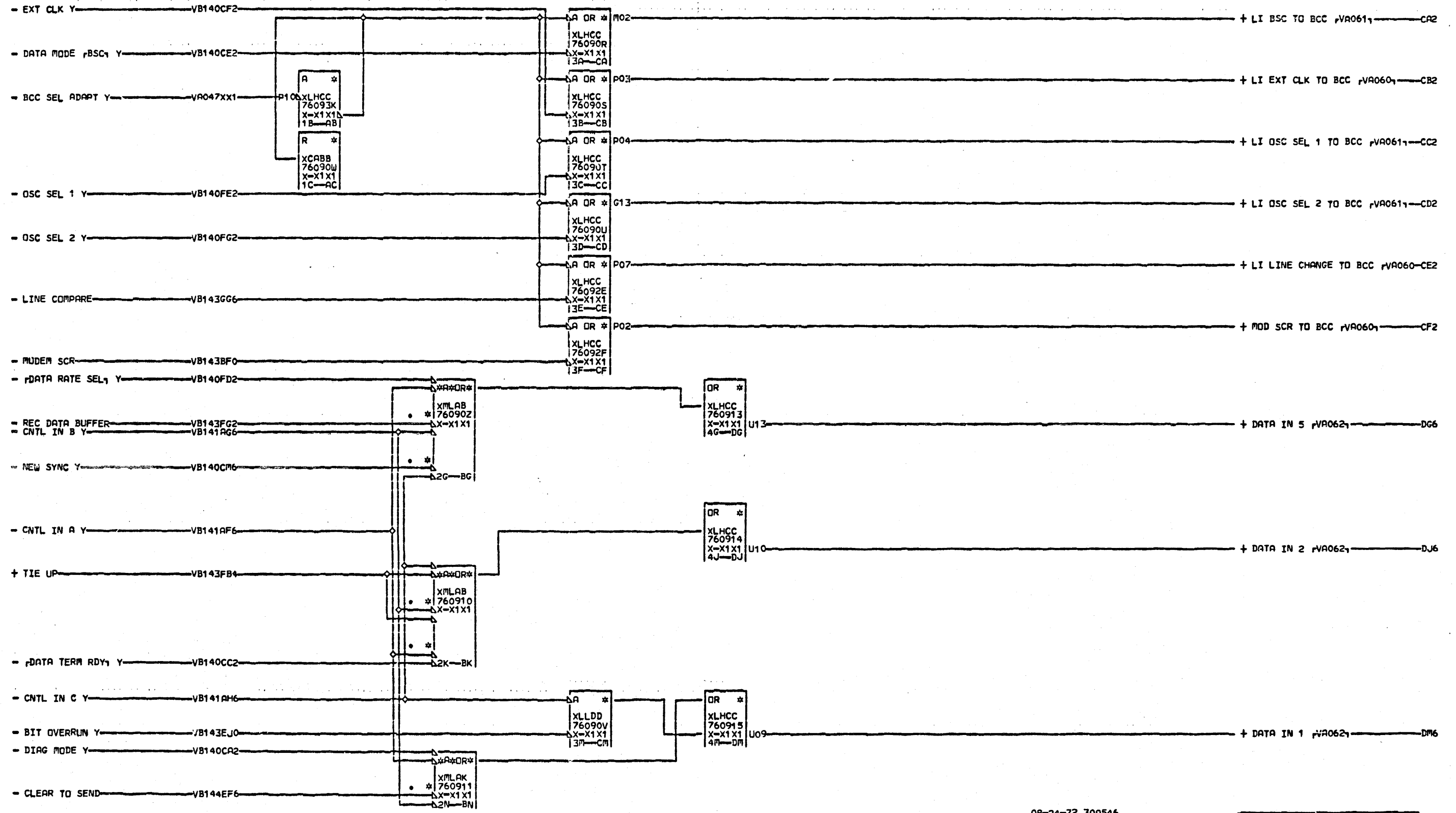

V
B
1
4
2
000

08-24-72 309546

V35 INTERFACE			
DATE	08-29-72	MACH.	27RNB
LOG	083	FRAME	01
		P.N.	1856432
IBM CORP.	SDD	BLK.	DN

V
B
1
4
2
000

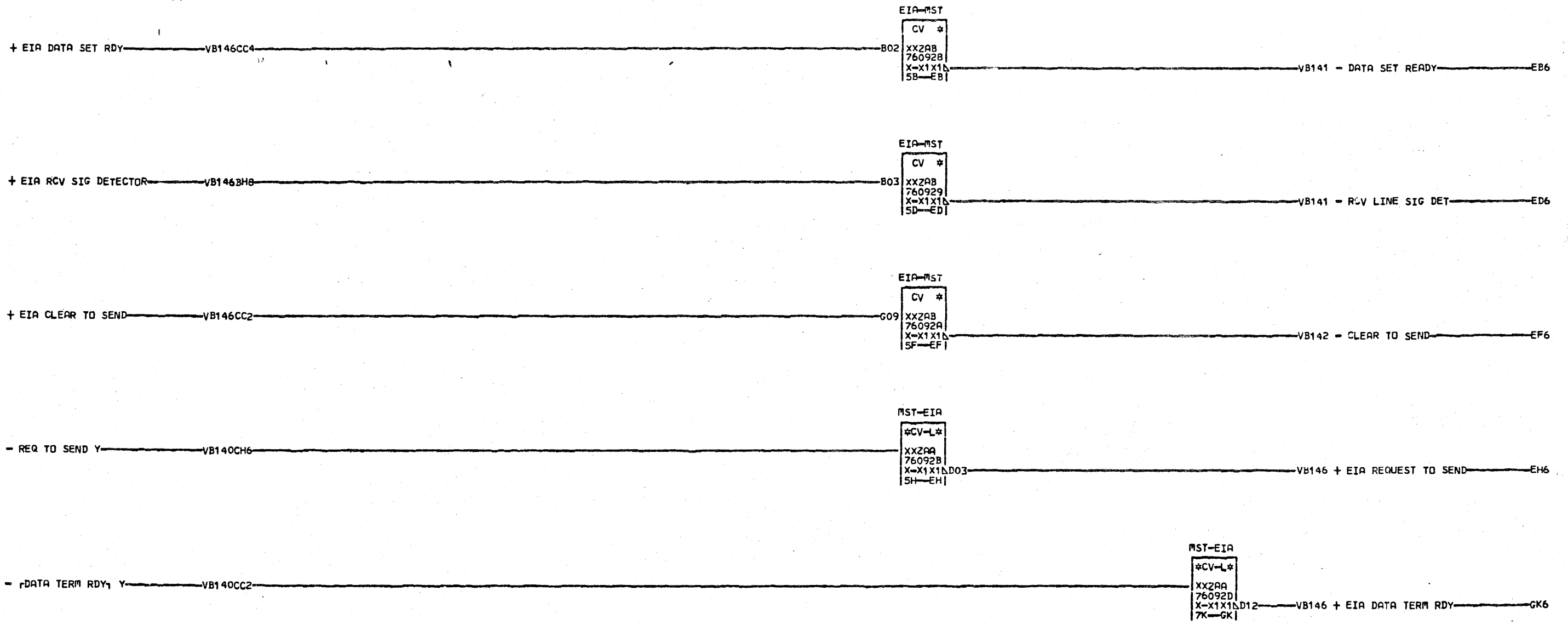

08-24-72 309546

VB144
000

V35 INTERFACE EIA CIRCUITS			
DATE	08-29-72	MACH.	27RNB
LOG	083	FRAME	01
		P.No.	1856434
IBM CORP.	SDD	BLK.	GP

VB144
000

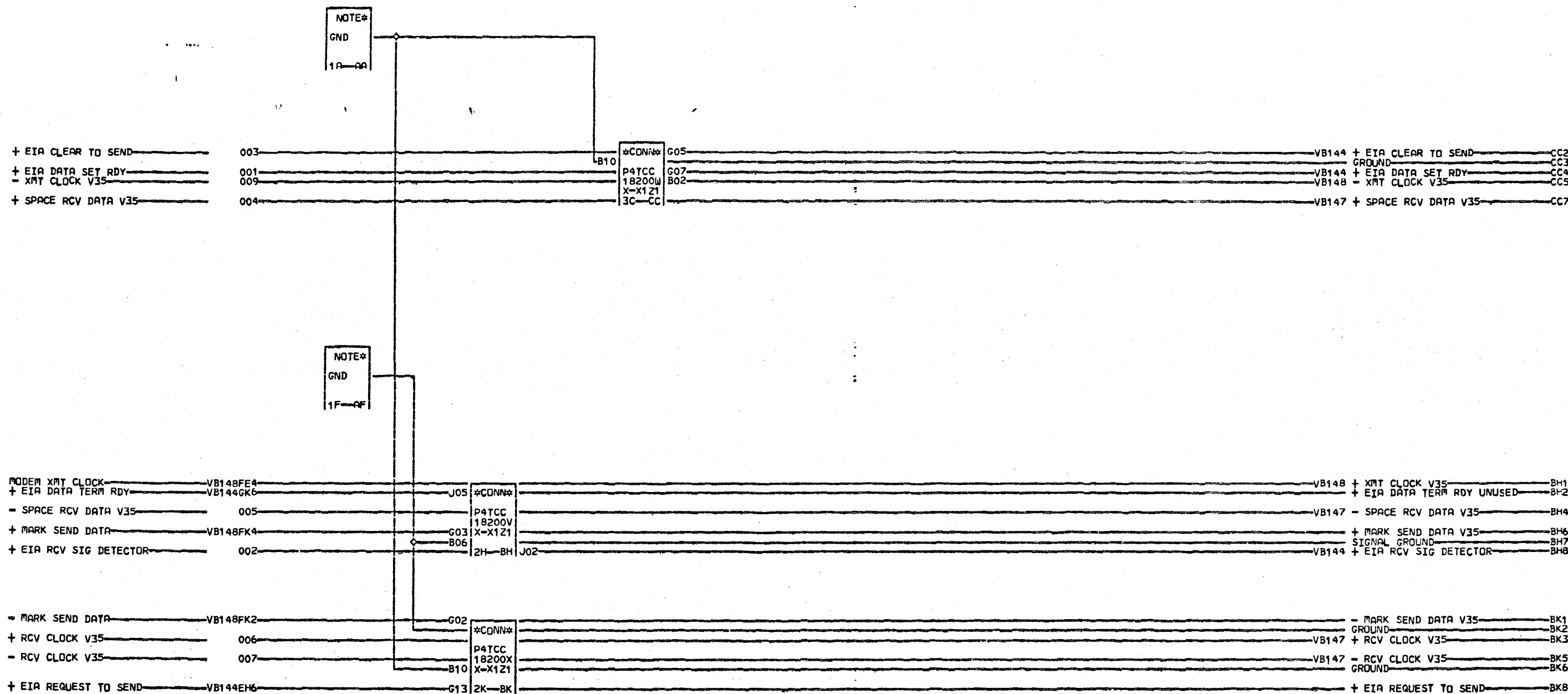

V35 TOP CARD CONNECTOR			
DATE	08-29-72	MACH.	27RNB
LOG	130	FRAME	01
		P.No.	1856435
IBM CORP.	SDD	BLK.	GP

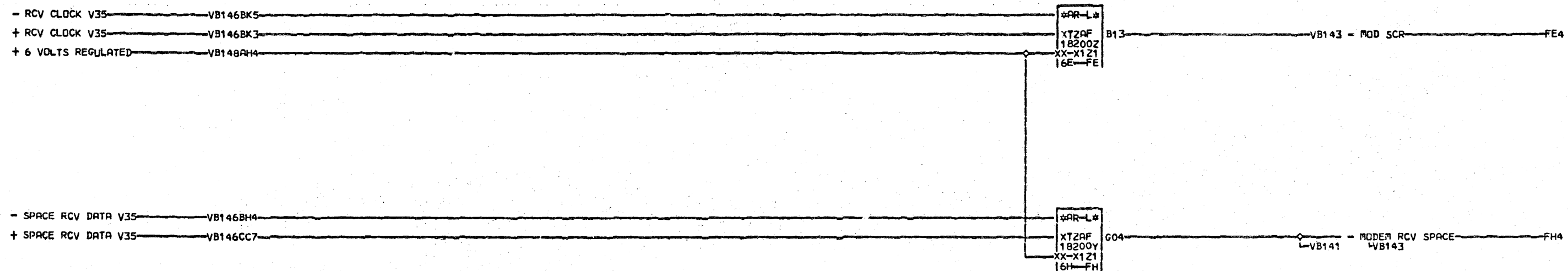

08-24-72 309546

VB147
000

V35 TERMINATOR RCV CLOCK			
DATE	08-29-72	MACH.	27RNB
LOG	083	FRAME	01
		P.N.	1856436
IBM CORP.	SDD	BLK.	GP

VB147
000

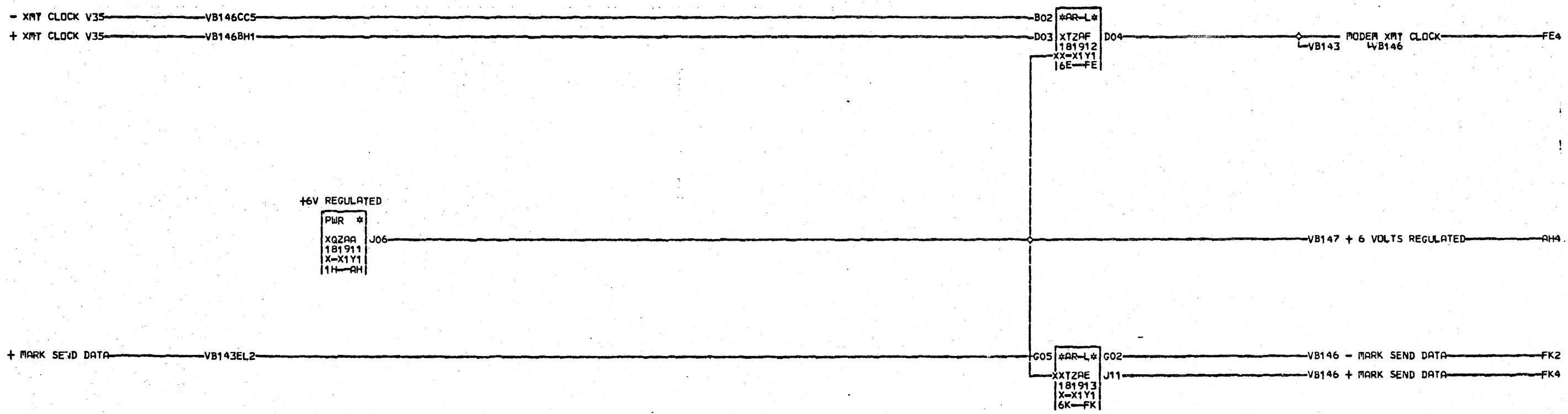

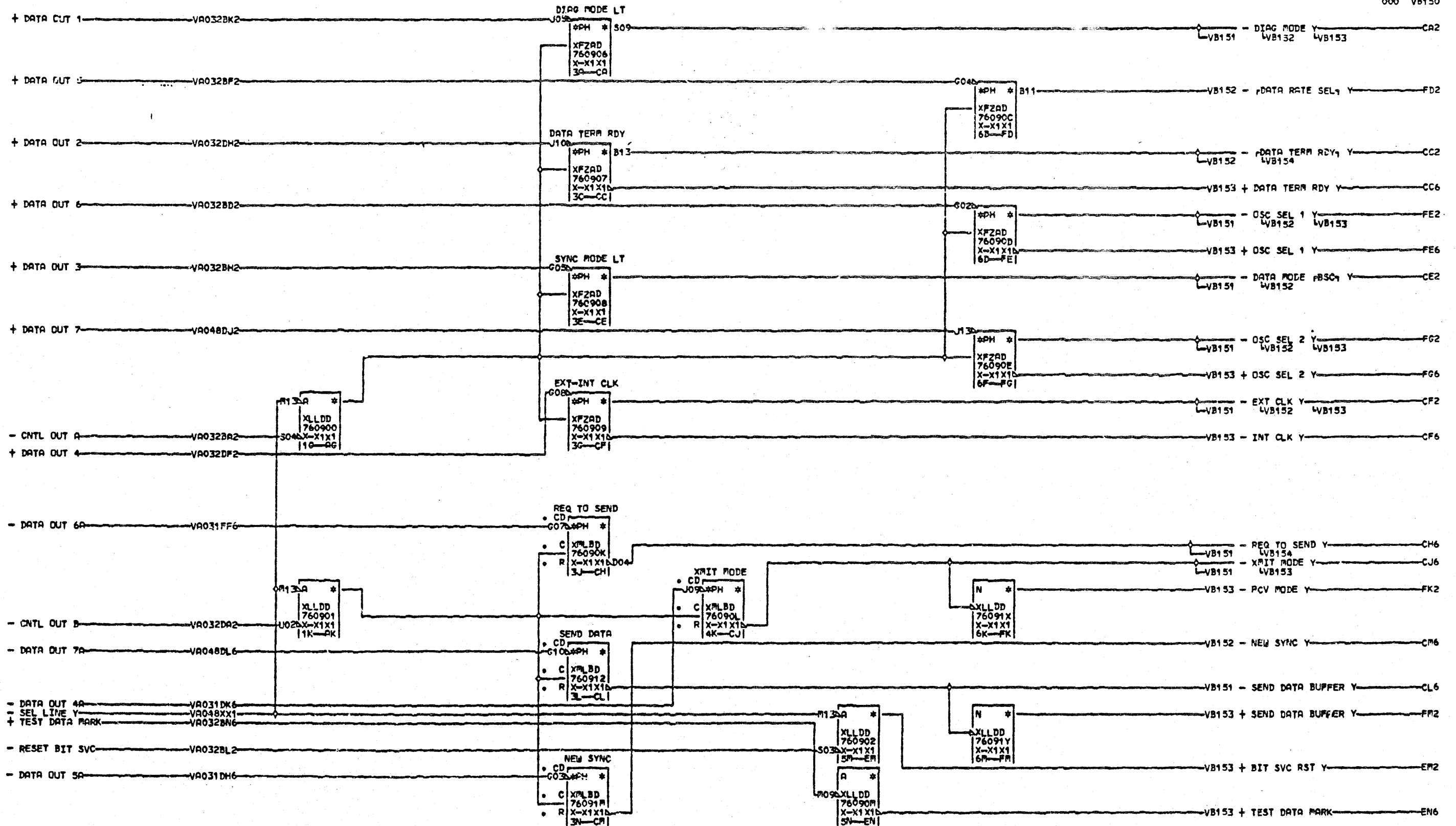

05-23-78 318570

V 35 INTERFACE			
DATE	08-10-78	MACH.	27RNB
LOG	713	FRAME	01
		PaN.	1749539
IBM CORP.	SDD BLK.		SA

VB150
000

VB150
000

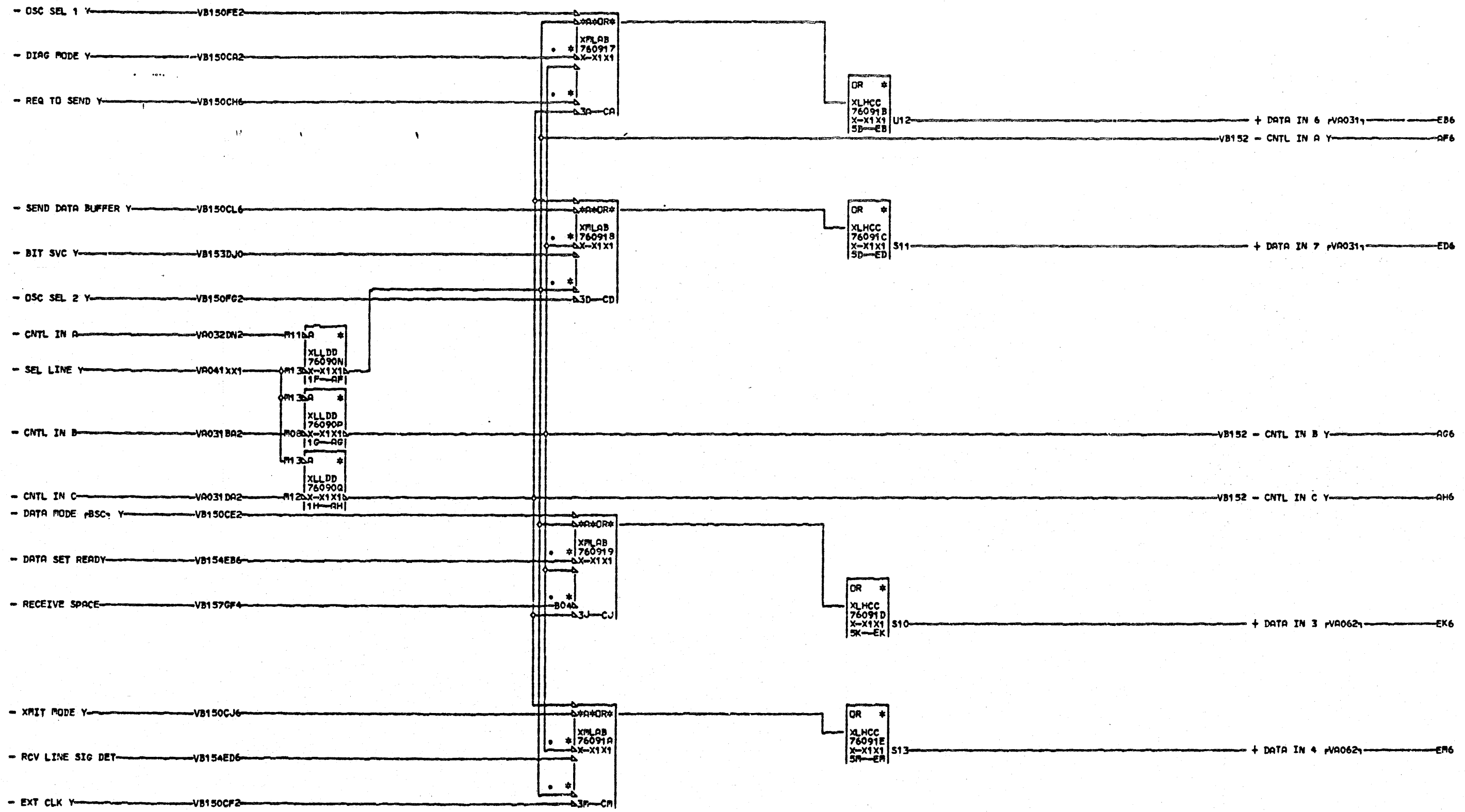

05-23-78 318570

V
B
1
5
1
000

V35 INTERFACE			
DATE	08-10-78	PACH.	27RNB
LOG	713	FRAME	01
		P.No.	1749540
IBM CORP.	SDD	BLK.	SA

V
B
1
5
1
000

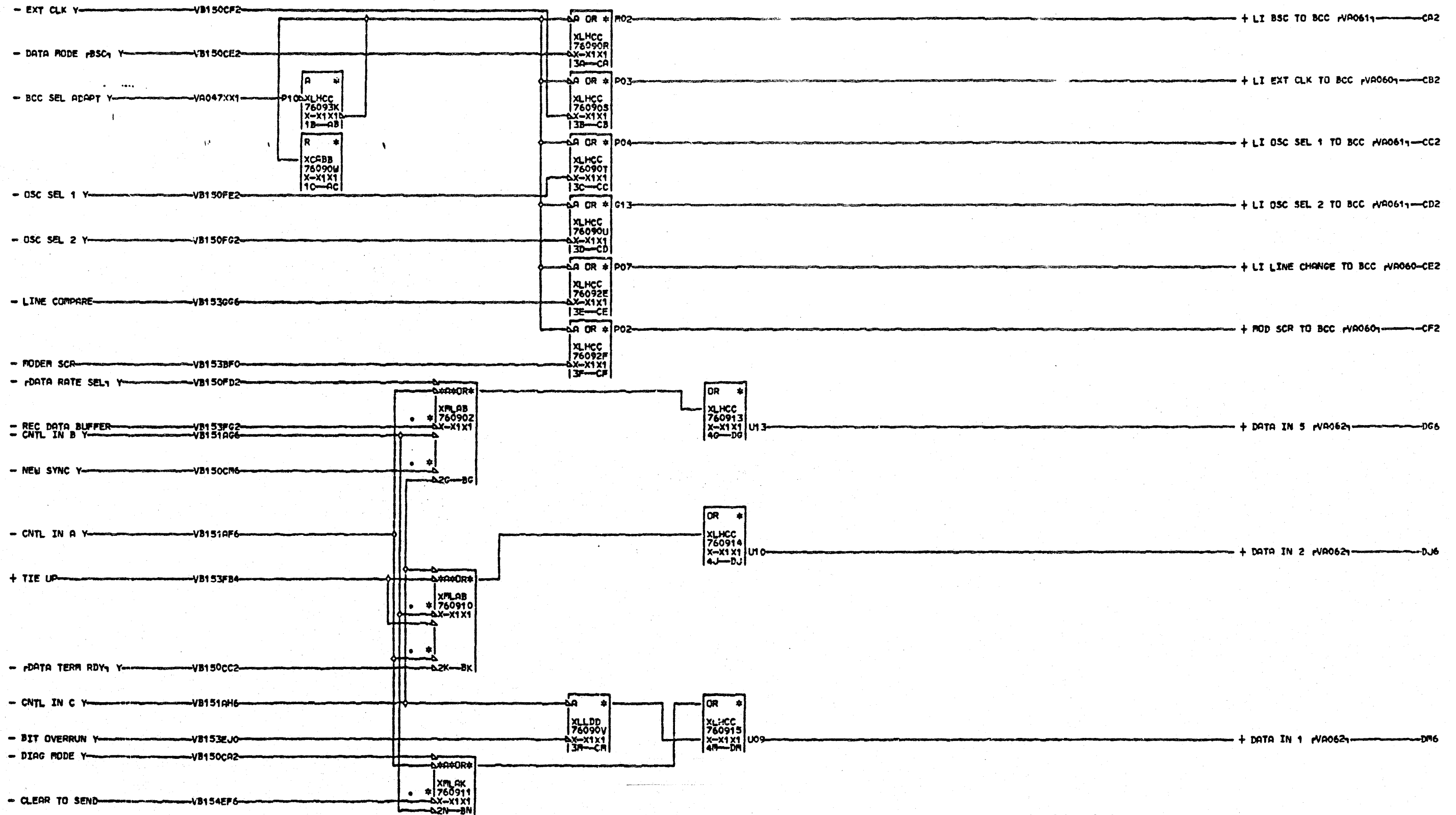

V
B
1
5
2
000

05-23-78 318570

V35 INTERFACE			
DATE	08-10-78	FRAC.	27RNB
LOG	713	FRAME	01
		P.N.	1749541
IBM CORP.	SDD	BLK.	SA

V
B
1
5
2
000

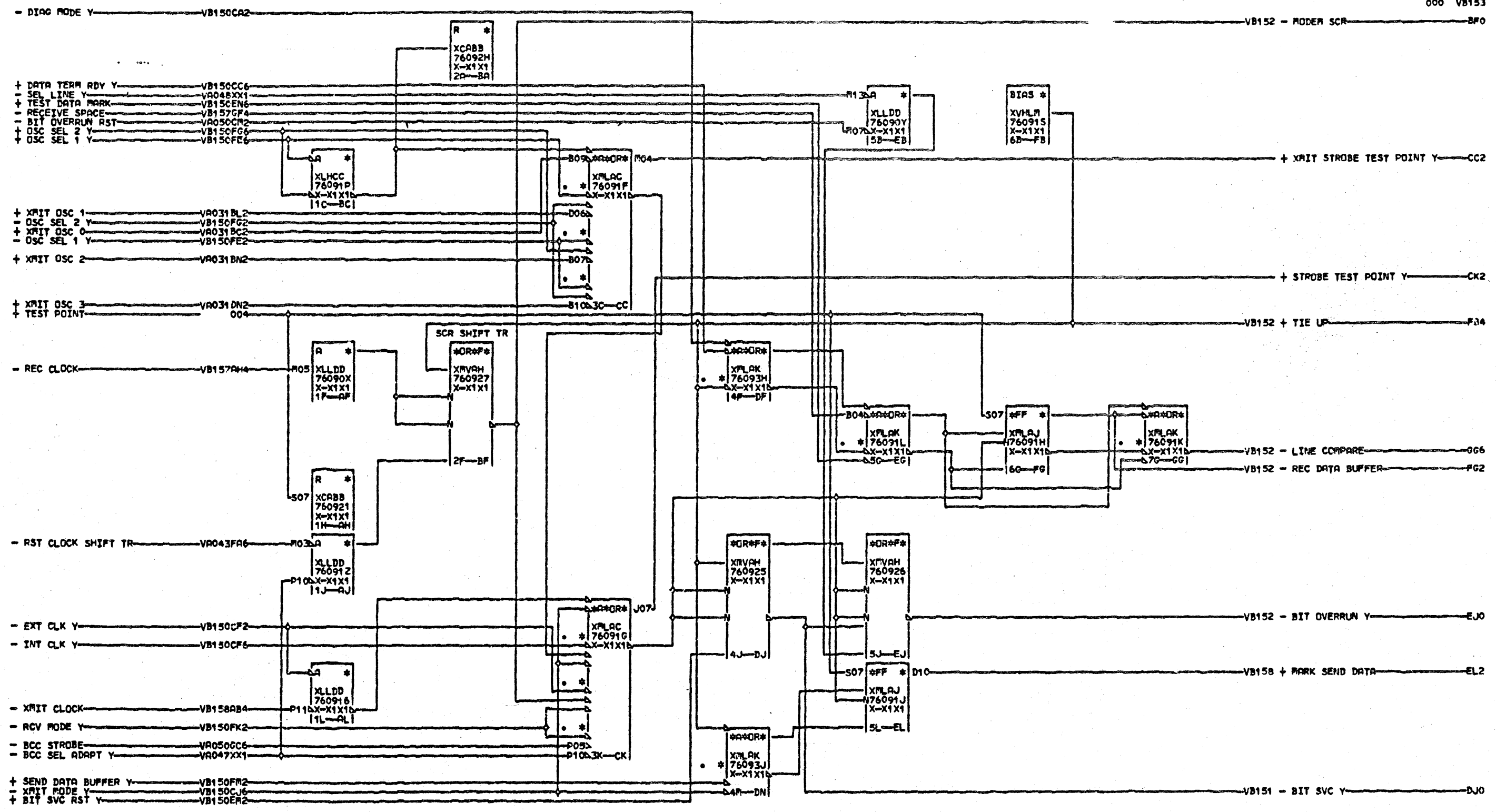

05-23-78 318570

000

V35 INTERFACE		
DATE	08-10-78	MACH. 27RNB
LOG	713	FRAME 01
		P.N. 1749542
IBM CORP.	SDD BLK.	SA

000

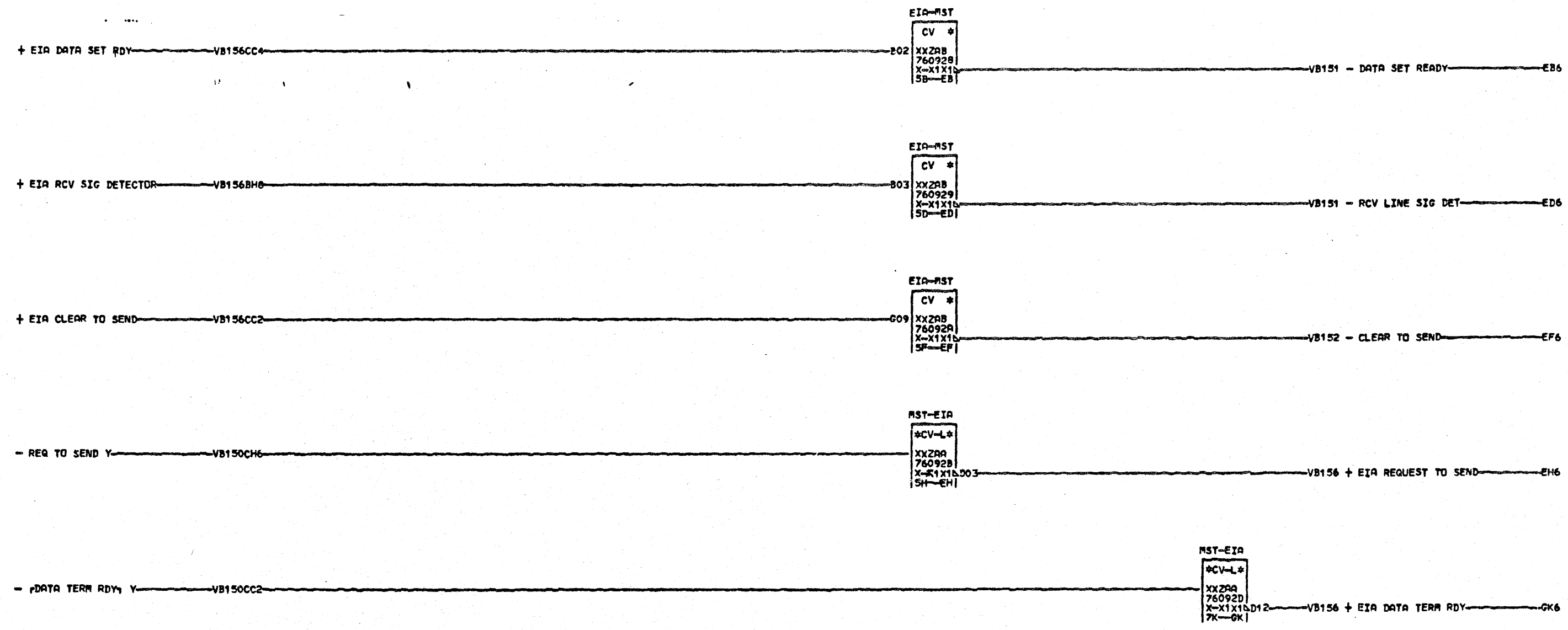

05-23-78 318570

VB154
000

V35 INTERFACE EIA CIRCUITS			
DATE	08-10-78	PACH.	27RNB
LOG	713	FRAME	01
		P.N.	1749543
IBM CORP.	SDD	BLK.	SA

VB154
000

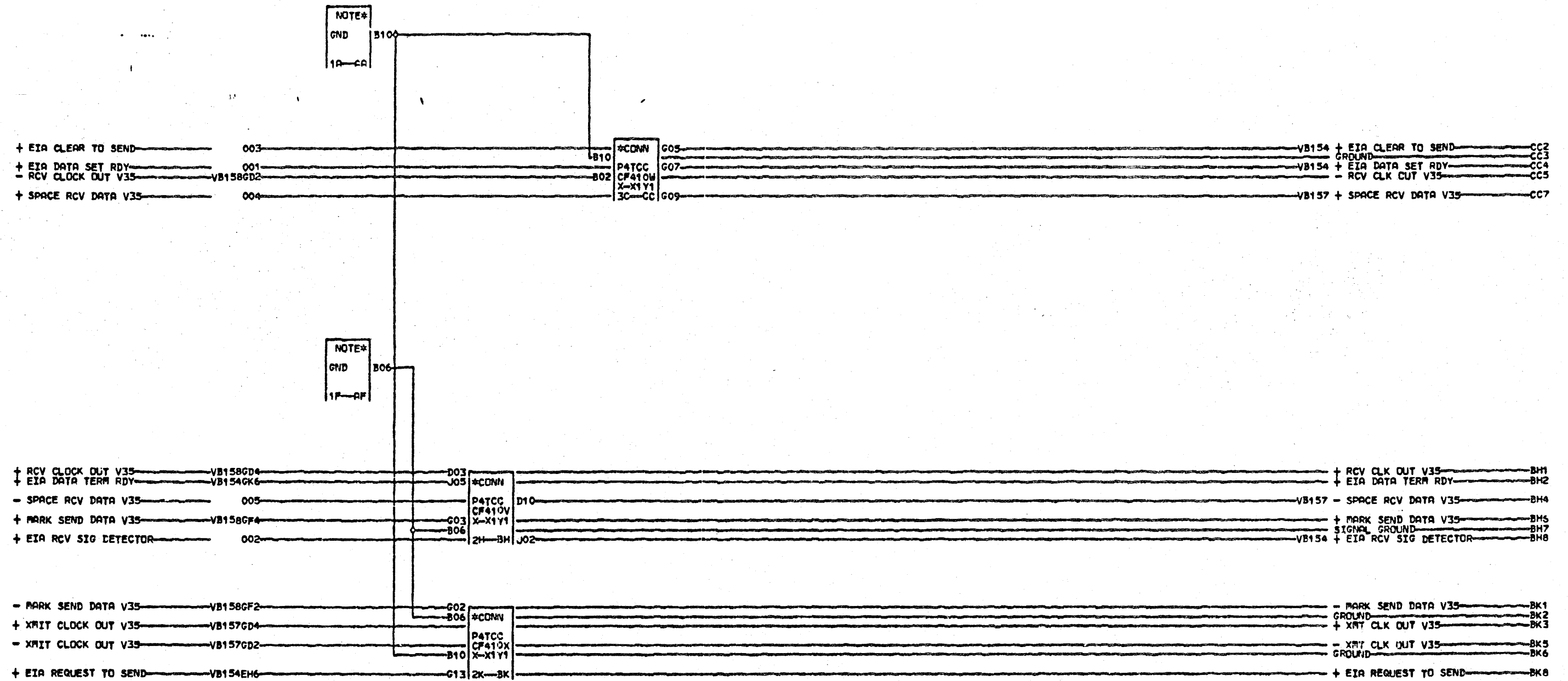

05-23-78 318570

VB156
000

V35 TOP CARD CONNECTOR			
DATE	08-10-78	FRM#	27RNB
LOG	713	FRM#	01
		PN#	1749544
IBM CORP.	SDD	BLK#	SA

VB156
000

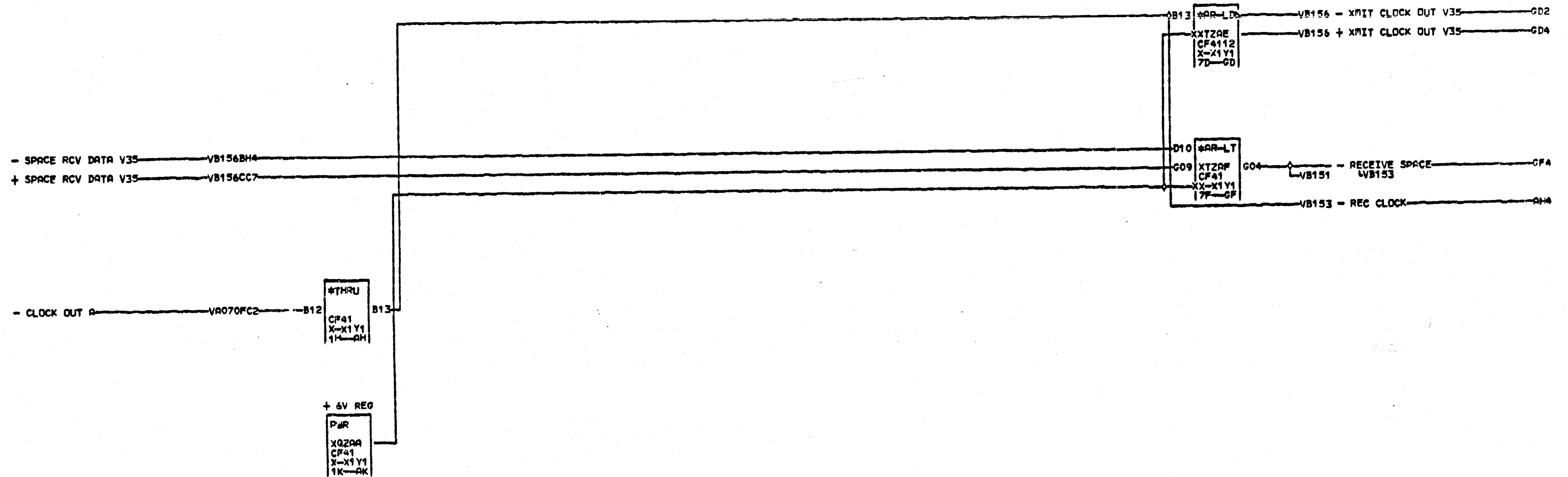

06-05-78 318570

V35 DRIVER FOR XMIT			
CLOCK OUT			
DATE	08-10-78	FRAC.	27RN3
LOG	731	FRAME	01
		P.N.	1749545
IBM CORP.	SCD BLK.	SA	

VB157

VB157
000

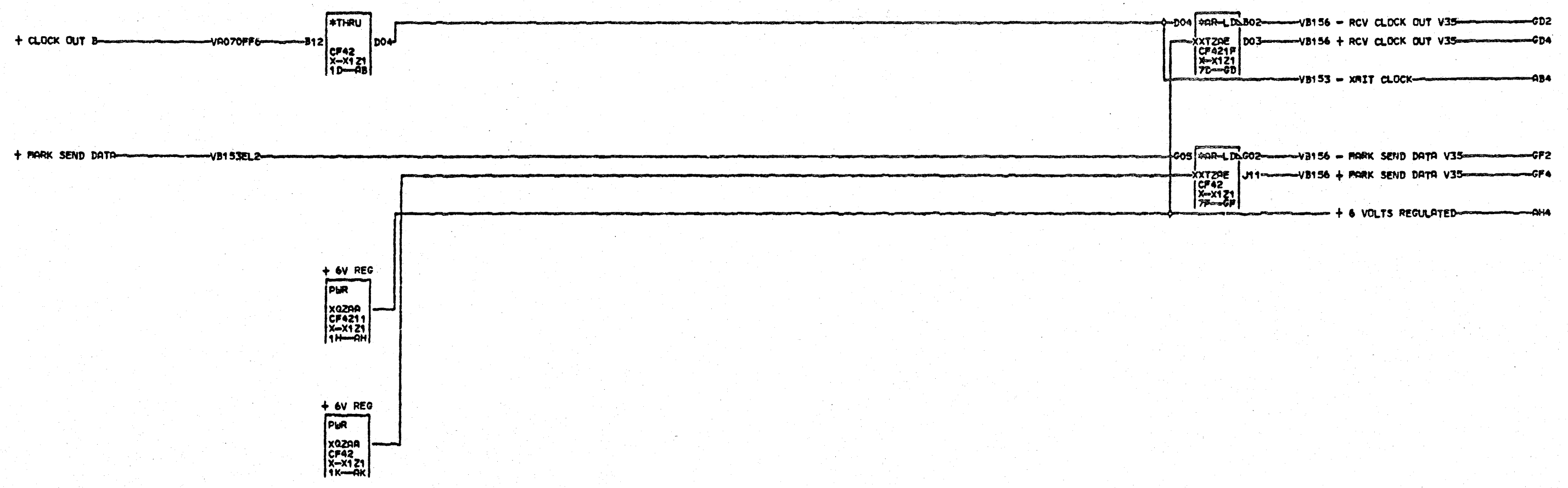

06-05-78 318570

VB158
000

V35 DRIVER			
RCV CLOCK OUT			
DATE	08-10-78	FRAC#	27RNB
LOG	731	FRAME	01
		P.N.	1749546
IBM CORP.	SCD BLK.	SA	

VB158
000

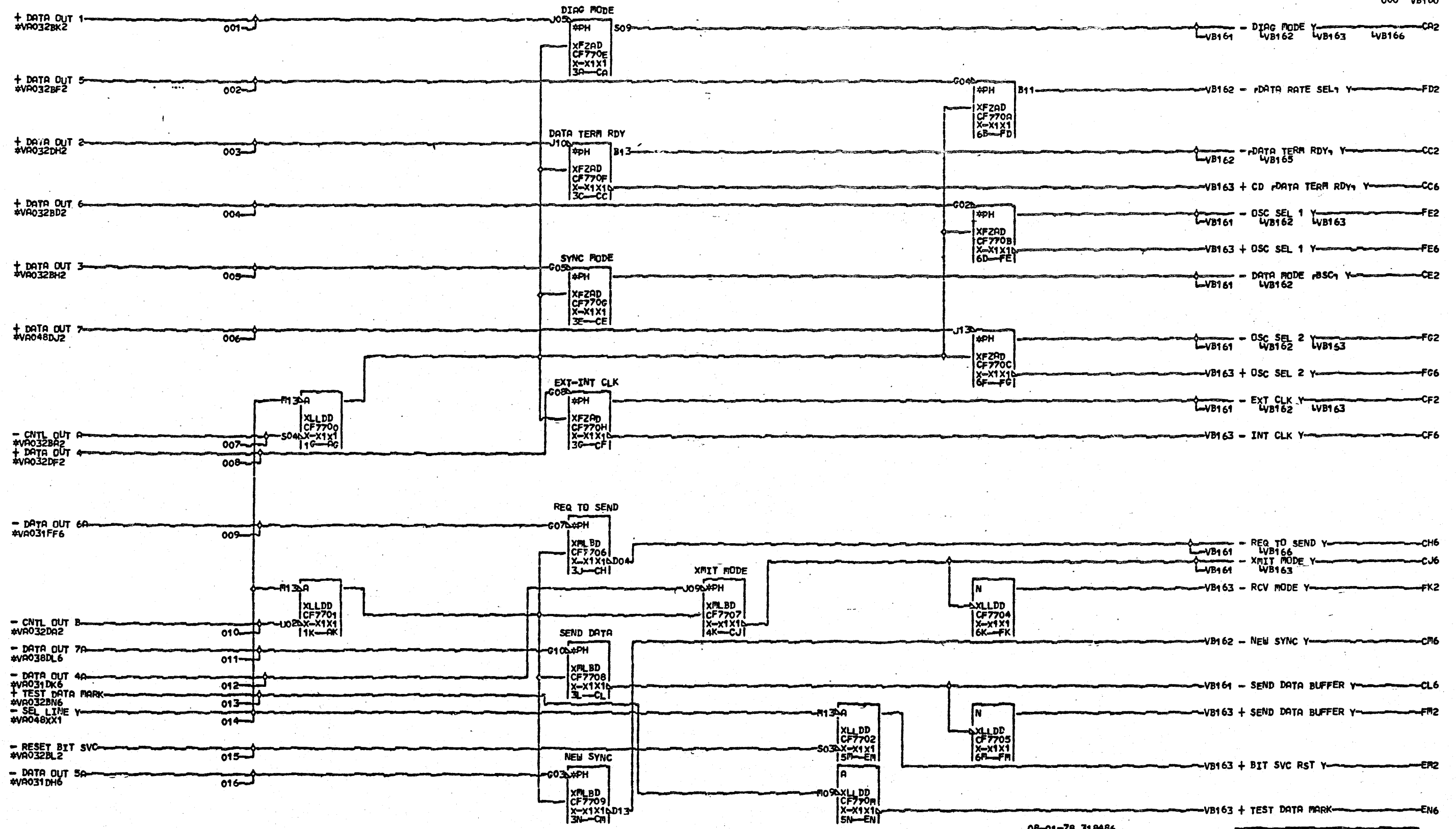

08-01-78 318486
05-16-79 321391

HIGH SPEED LINE			
DATE	05-17-79	MACH.	27RNB
LOG	387	FRAME	0X
		P.N.	8549001
IBM CORP.	SDD BLK.		GL

V
B
1
6
0
000

V
B
1
6
0
000

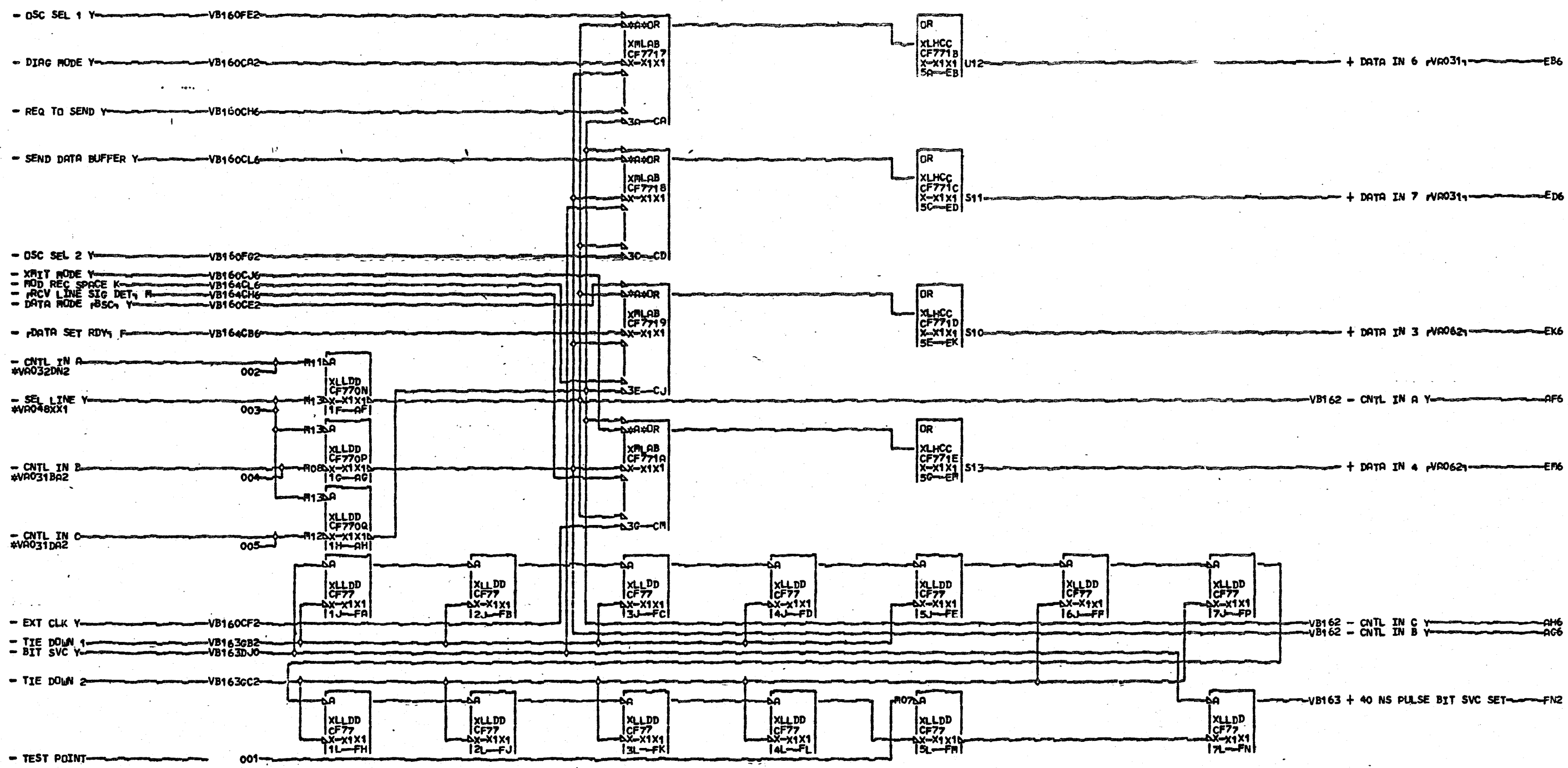

VB161
000

08-01-78 318486
05-16-79 321391

HIGH SPEED LINE		
DATE	05-17-79	PACH- 27RNB
LOG	387	FRAME OX
		- P.N. 8549002
IBM CORP.	SDD BLK.	Fq

18708

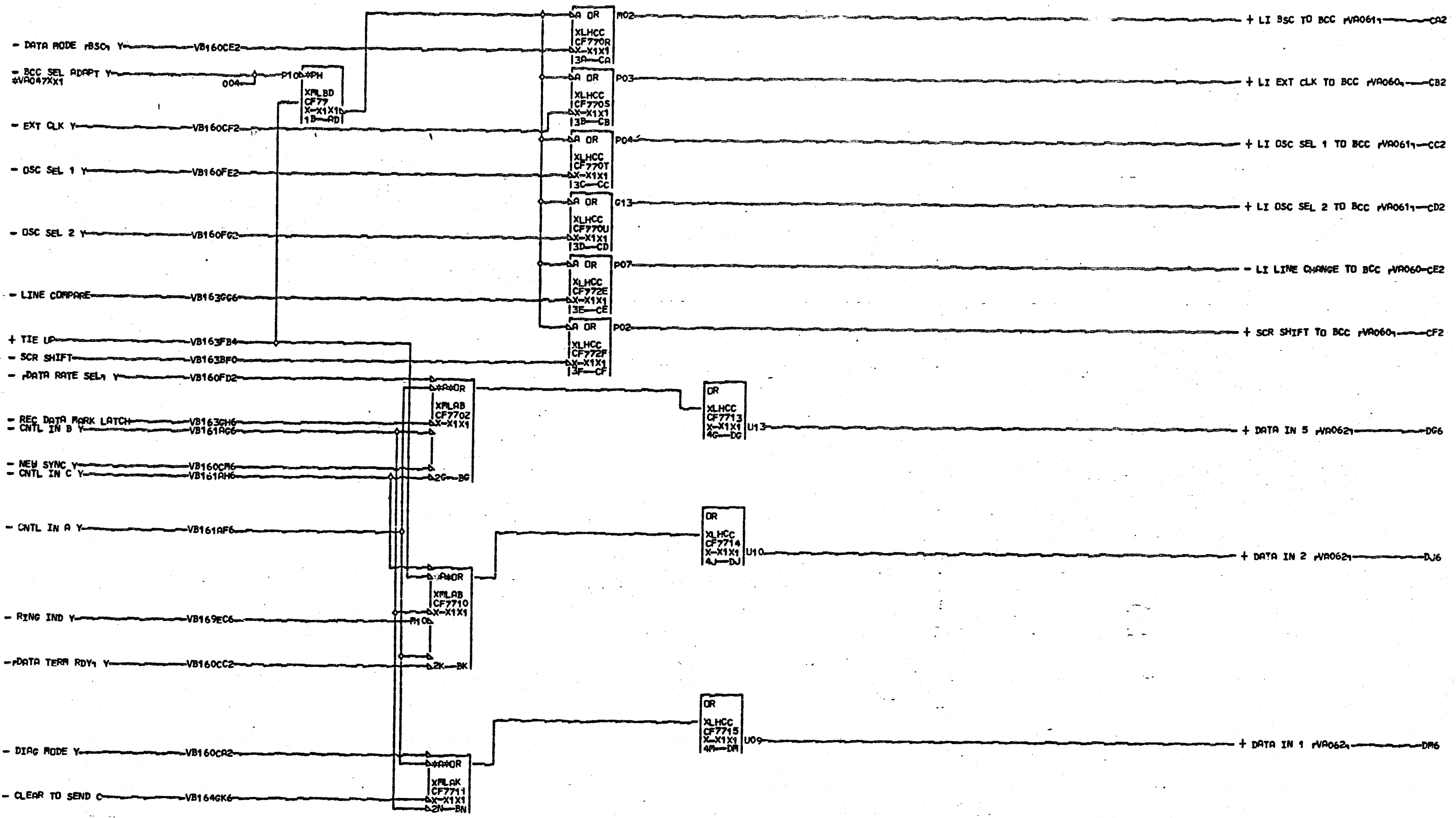

VB162
000

08-01-78 318486
05-16-79 321391

HIGH SPEED LINE			
DATE	05-17-79	FRAM	27RNB
LOG	387	FRAME	OX
		- P.N.	8549003
IBM CORP.	SDD	BLK.	DN

88.08

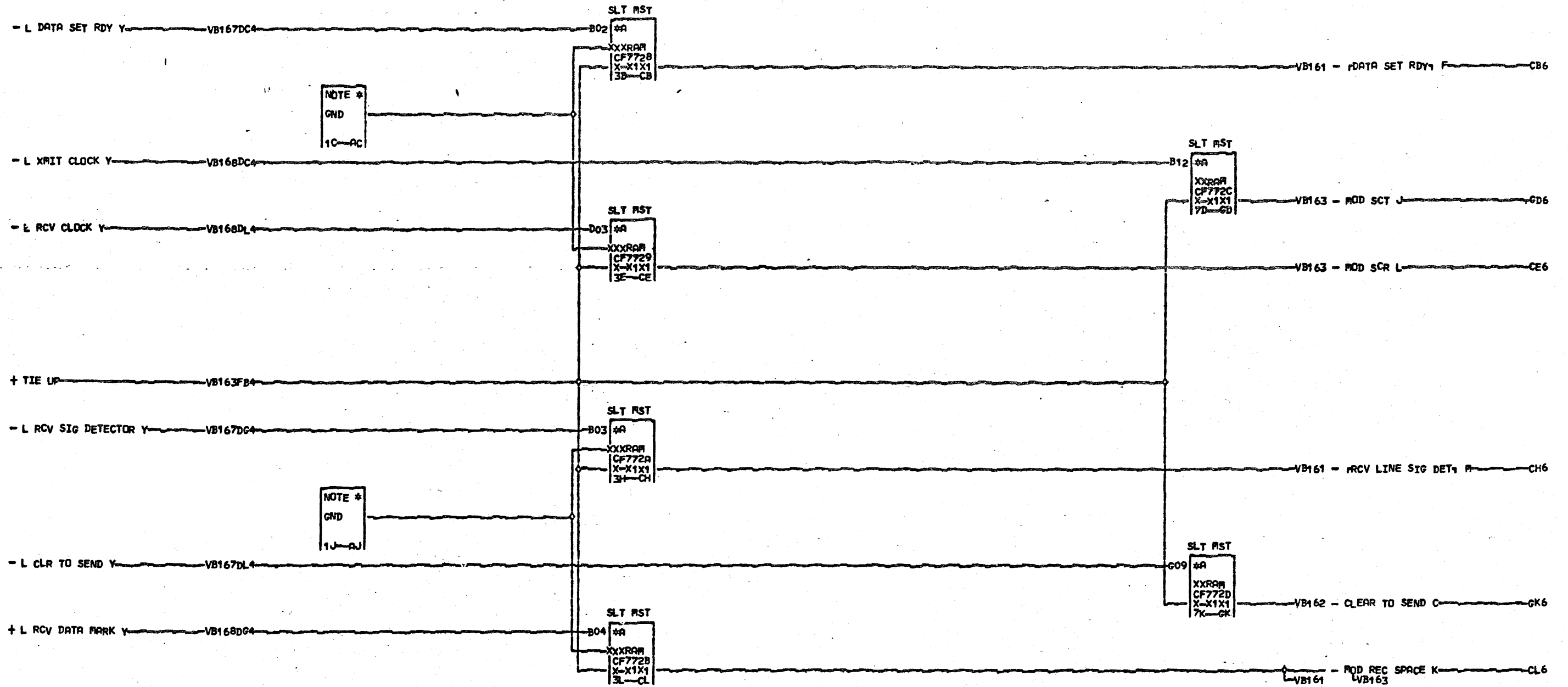

VB164
000

08-01-78 318486
05-16-79 321391

HIGH SPEED LINE			
DATE	05-17-79	MACH.	27RNB
LOG	387	FRAME	0X
		P.N.	8549005
IBM CORP.	SDD	BLK.	GL

VB164
000

DATA TERM RDY Y VB160CC2

RST-EIA
 #CV-L#
 XXZAA
 757611
 X-X1Y1J03
 5B-EB1

VB170 + EIA DATA TERM RDY Y EB6

VB165
000

08-01-78 318486
05-16-79 321391

DIGITAL DRIVERS			
DATE	05-17-79	RACH.	27RNB
LOG	387	FRAP	01
		- P.No.	8549006
IBM CORP.	SDD	BLK.	FF

VB165
000

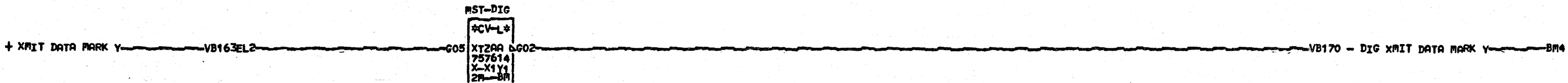
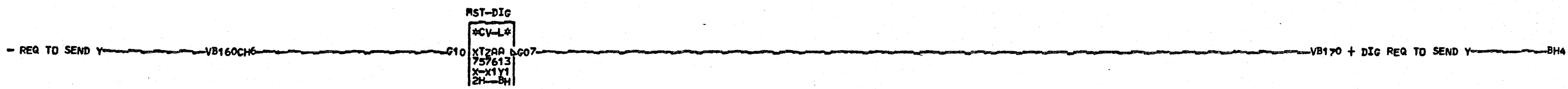
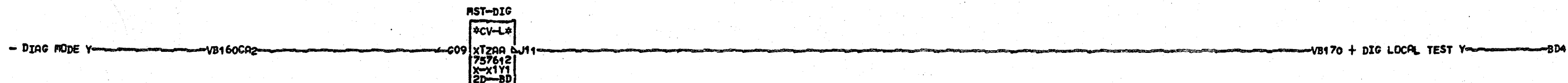

08-01-78 318486
05-16-79 321391

DIGITAL DRIVERS		
DATE	05-17-79 MACH. 27RNB	
LOG	387 FRAME	01
	- P.N. 8549007	
IBM CORP.	SDD BLK.	FR

V
B
1
6
6
000

V
B
1
6
6
000

+ EIA DATA SET RDY Y-----VB170CD8-----J13 DIG-SLT CV * XTZAB 6G07-----VB164 - L DATA SET RDY Y-----DC4
 75771V
 X-X121
 4C-DC

+ DIG RCV SIG DETECTOR Y-----VB170CD7-----J02 DIG-SLT CV * XTZAB 6J02-----VB164 - L RCV SIG DETECTOR Y-----DC4
 75771W
 X-X121
 4C-DG

+ DIG CLR TO SEND Y-----VB170CK8-----J05 DIG-SLT CV * XTZAB 6G05-----VB164 - L CLR TO SEND Y-----DL4
 75771X
 X-X121
 4L-DL

08-01-78 318486
05-16-79 321391

DIGITAL TERMINATOR CARD			
DATE	05-17-79	MACH.	27RNB
LOG	387	FRAME	01
		P.No.	8549008
IBM CORP.	SDD BLK.		GL

000

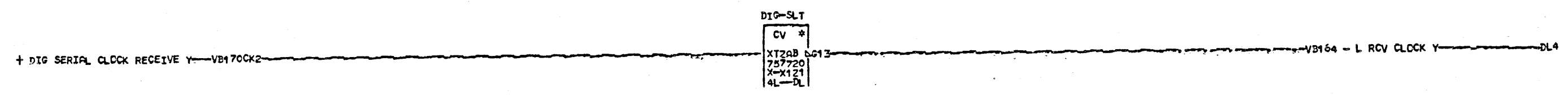
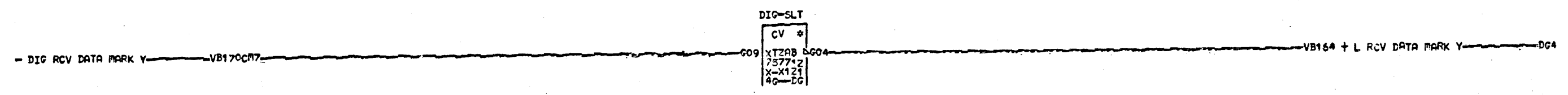
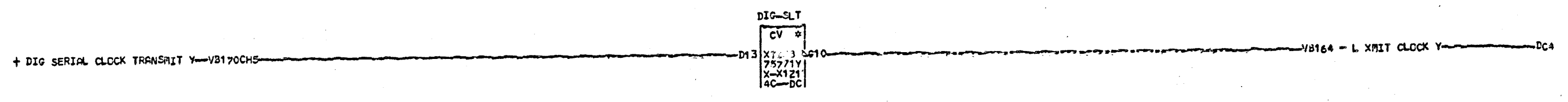

08-01-73 318435
05-16-79 321391

DIGITAL TERMINATOR CARD			
DATE	05-17-79	MACH.	27RNB
LCG	387	FRAME	01
		P.N.	8540009
IBM CCRP.	SDD BLK.		GL

V
B
1
6
8
000

16.08

+ EIA RING IND Y VB170CB1

EIA-RST

CV *

XXZAB

75771N

X-X1Z1bD05

5C-EC

VB162 - RING IND Y EC6

000

08-01-78 318486
05-16-79 321391

DIGITAL TERMINATORS			
DATE	05-17-79	MACH.	27RNB
LDC	387	FRAME	01
		- P.N.	8549010
IBM CORP.	SDD	BLK.	FJ

VB169
000

06.08

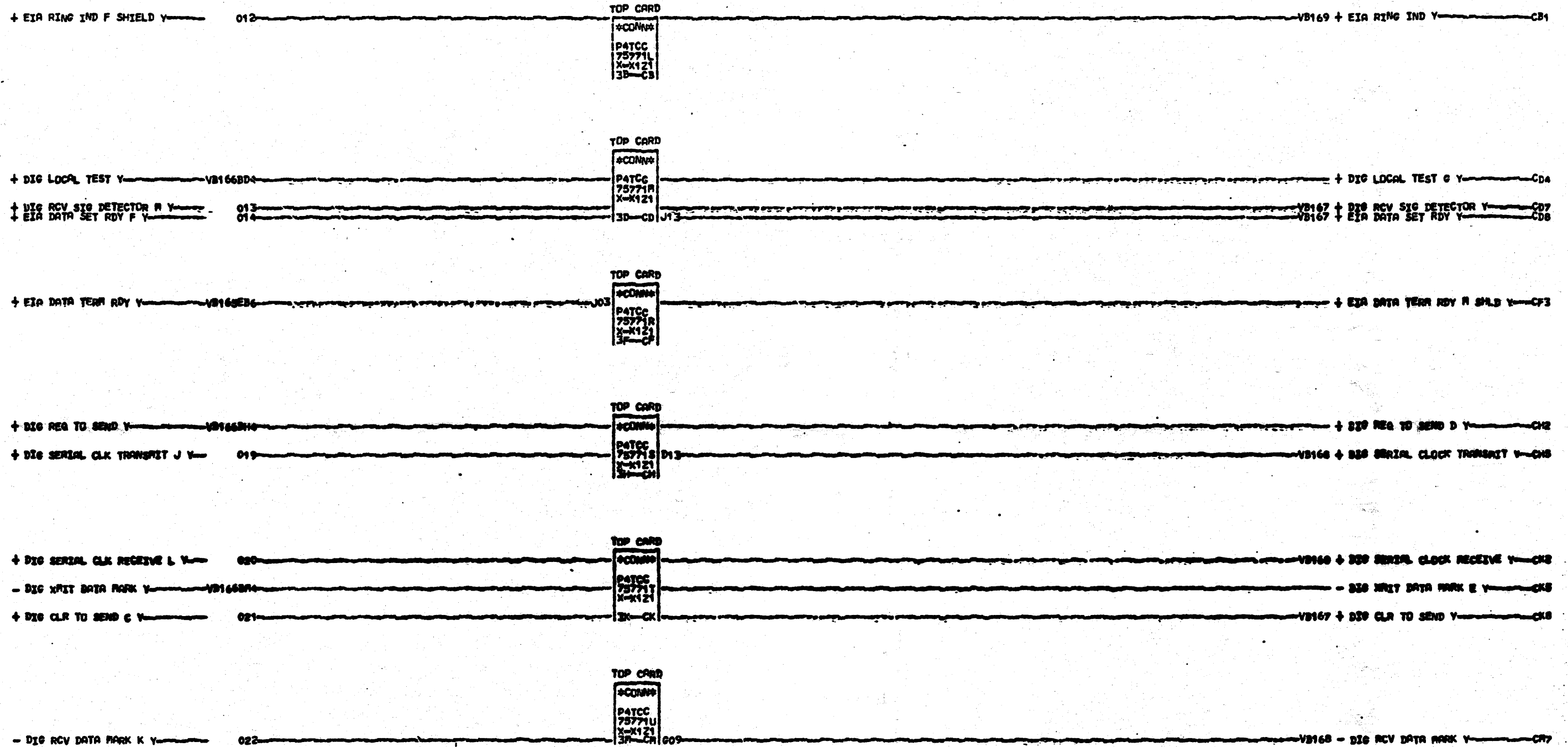

08-01-78 318486
65-10-75 321391

DIGITAL TERMINATOR CARD			
DATE	05-17-79	FRAC#	27RNB
LOG	387	FRAC#	01
		P.N.	8549011
IBM CORP.	SDD B.L.K.		EL

V
B
1
7
0
000

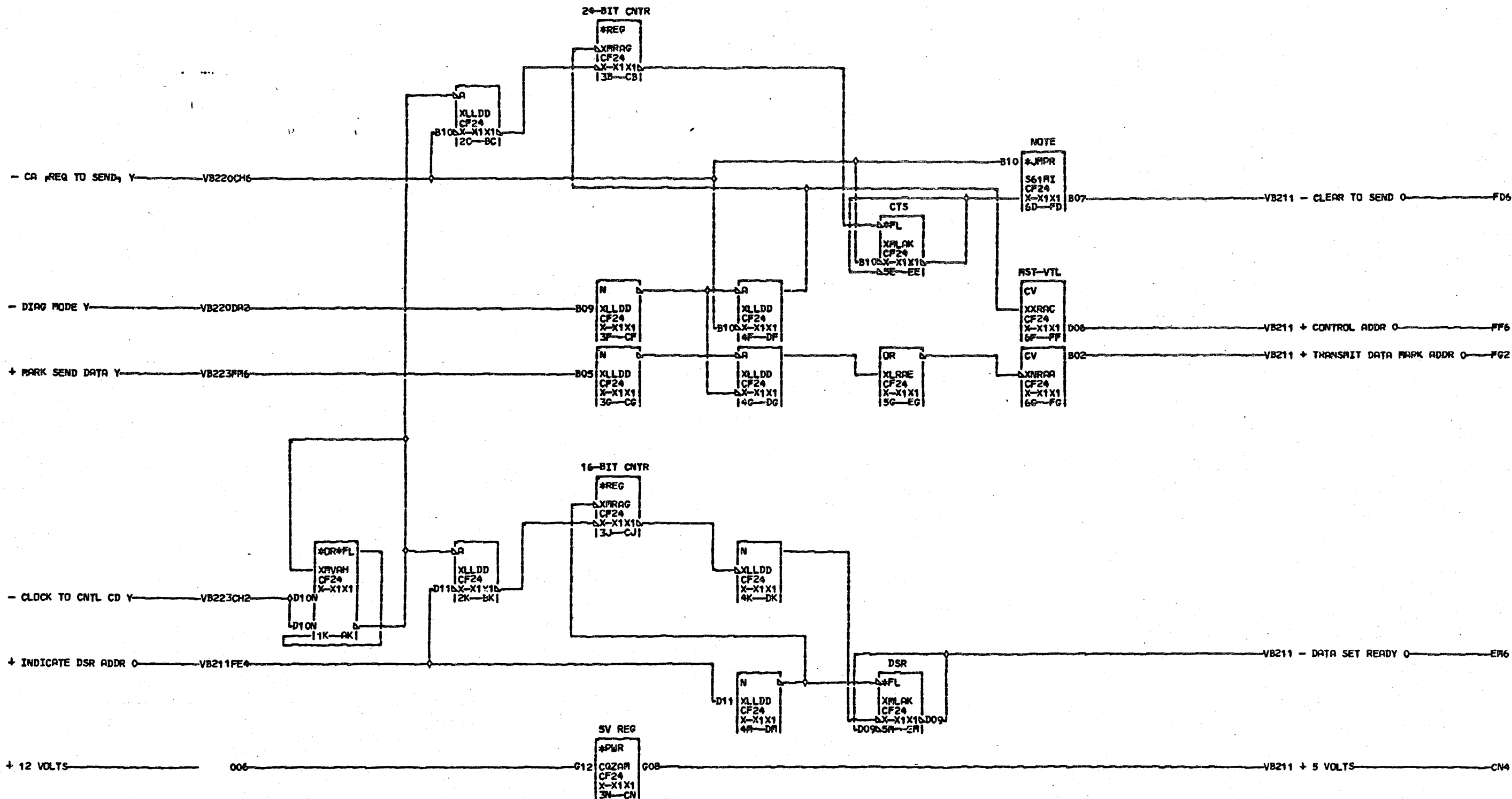

NOTE CARD JUMPER FOR CLEAR TO SEND DELAY. SEE PAGE VA017
 V B SEE VA000 FOR CARD LOCATIONS.
 2
 0
 0
 000

07-25-78 316650
 01-18-79 321251
 03-19-79 321371

X.21 CONTROL ADDRESS 0			V B 2 0 0 000
DATE	01-23-80	MACH. 27RNB	
LOG	867	FRAME 01	
	P.N.	1754230	
IBM CORP.	BLK.	FH	

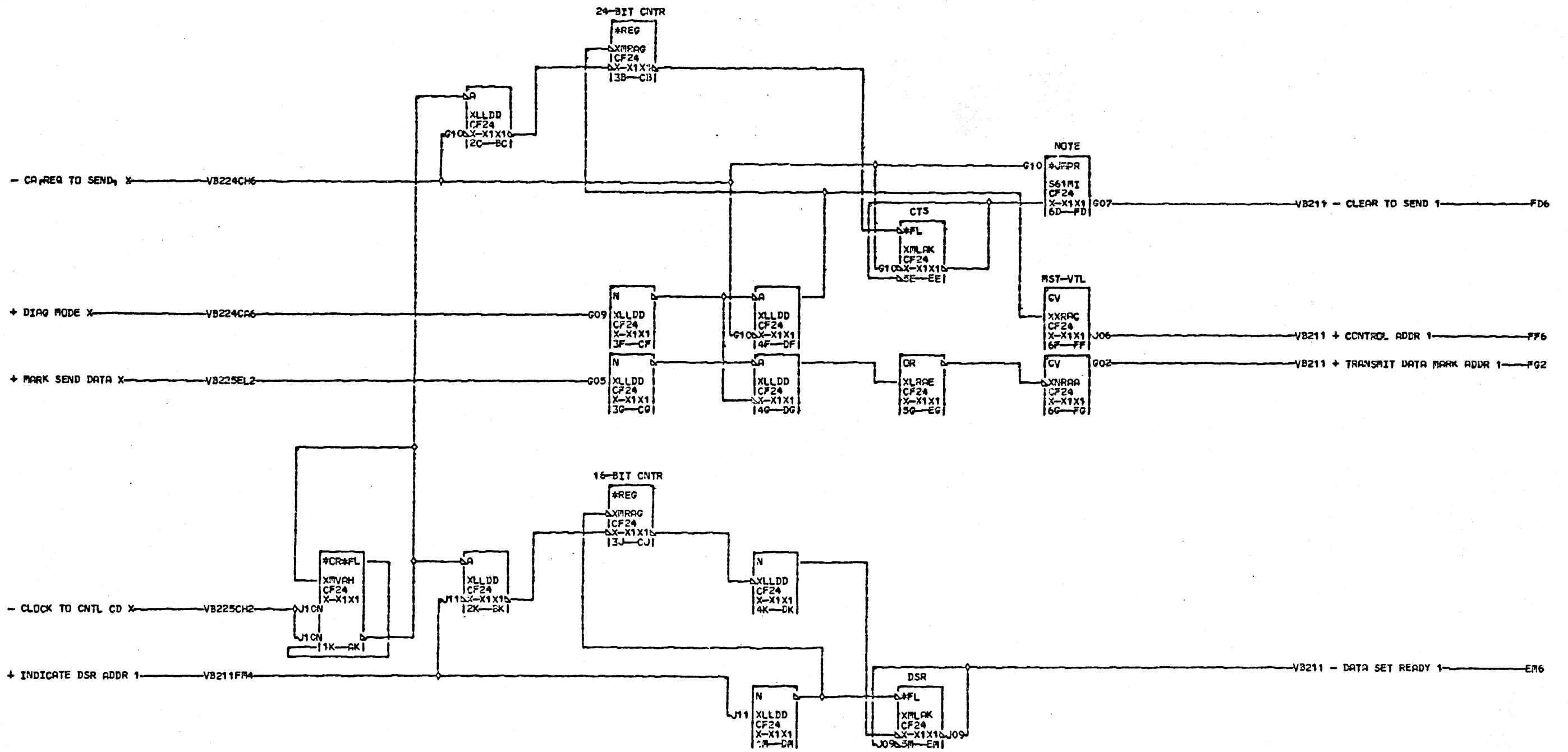

NOTE: CARD JUMPER FOR CLEAR TO SEND DELAY. SEE PAGE VA017

07-10-78 316650
 01-18-79 321251
 03-19-79 321371

X.21 CONTROL ADDRESS 1		
DATE	01-23-80 MACH. 27RNB	
LOG	867 FRAME	01
	P.N. 1754231	
IBM CORP.	BLK.	FH

000

000

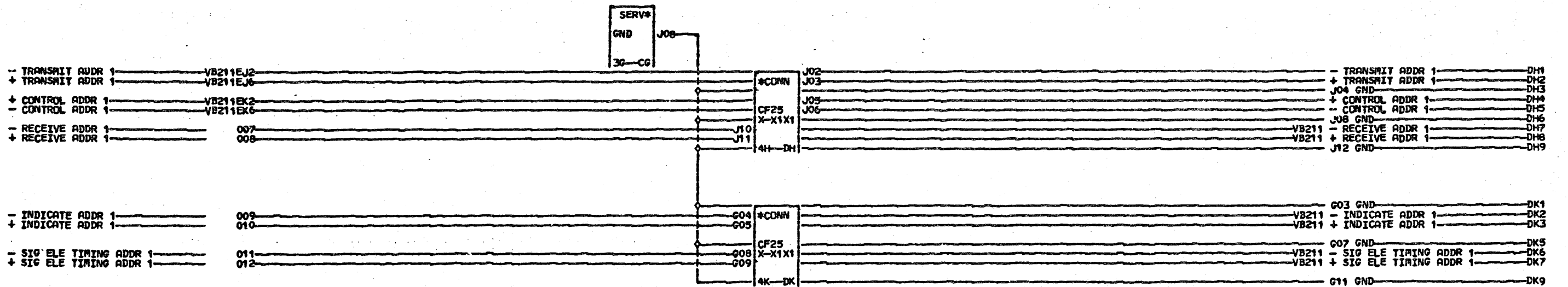
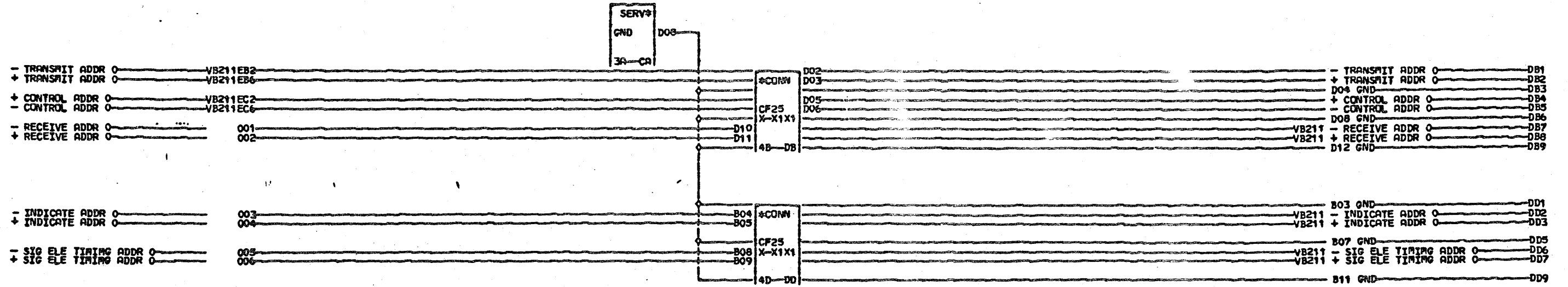

VB210
000

07-10-78 316650
03-19-79 321371

X-21			
TOP CARD CONNECTORS			
DATE	01-23-80	RACH.	27RNB
LOG	867	FRAME	01
		P.N.	1754232
IBA CORP.	BLK.		DL

VB210
000

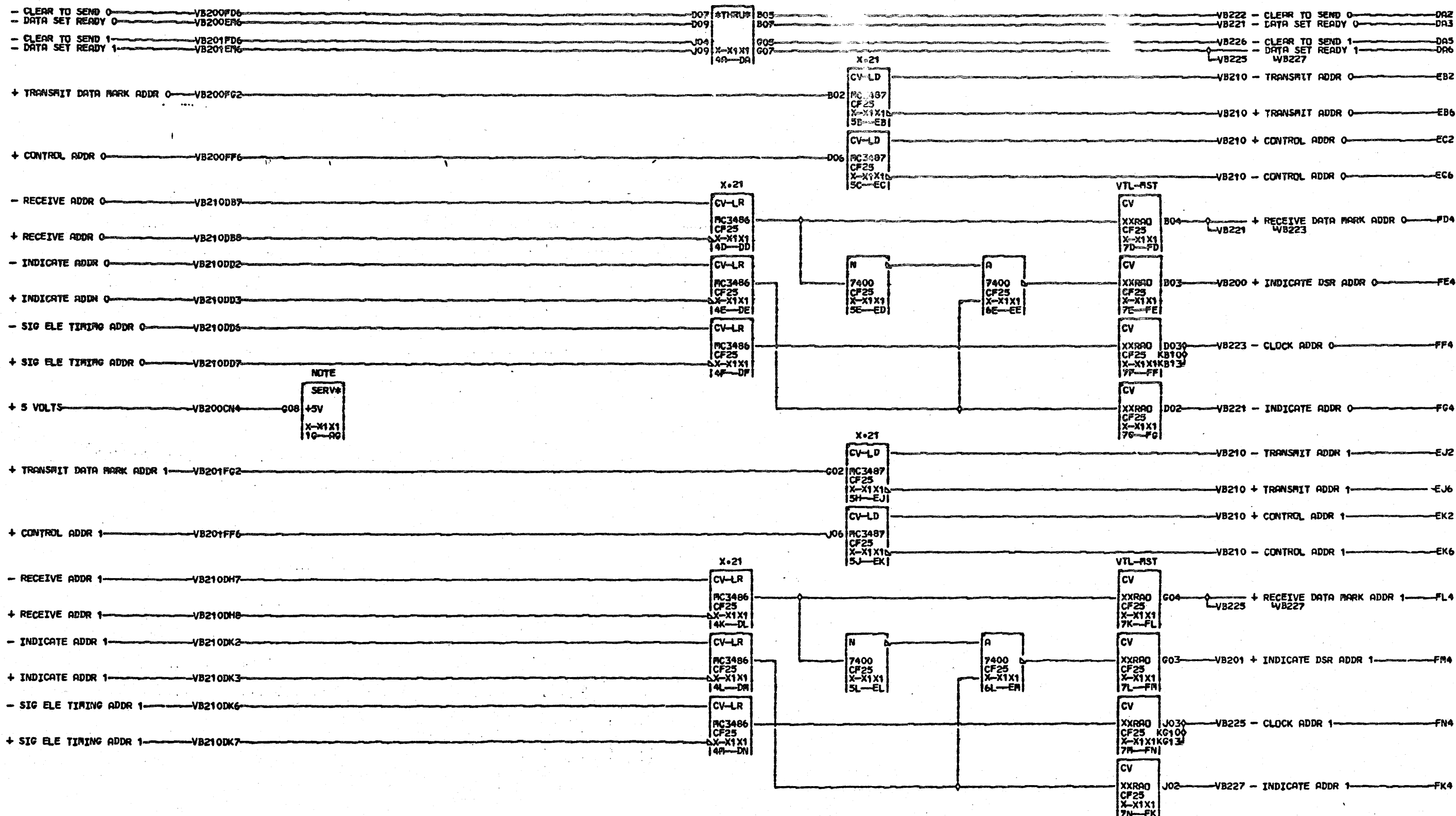

NOTE
SERV4
+5V
X-X1X1
1G-A0

NOTE BOARD JUMPER REQUIRED FOR 5 VOLTS. SEE PAGE VA017

07-25-78 316650
01-18-79 321251
03-19-79 321371

X-21			
DRIVERS AND RECEIVERS			
DATE	01-23-80	MACH.	27RNB
LOG	867	FRAME	01
		P.N.	1754233
IBM CORP.	BLK.		FP

000

000

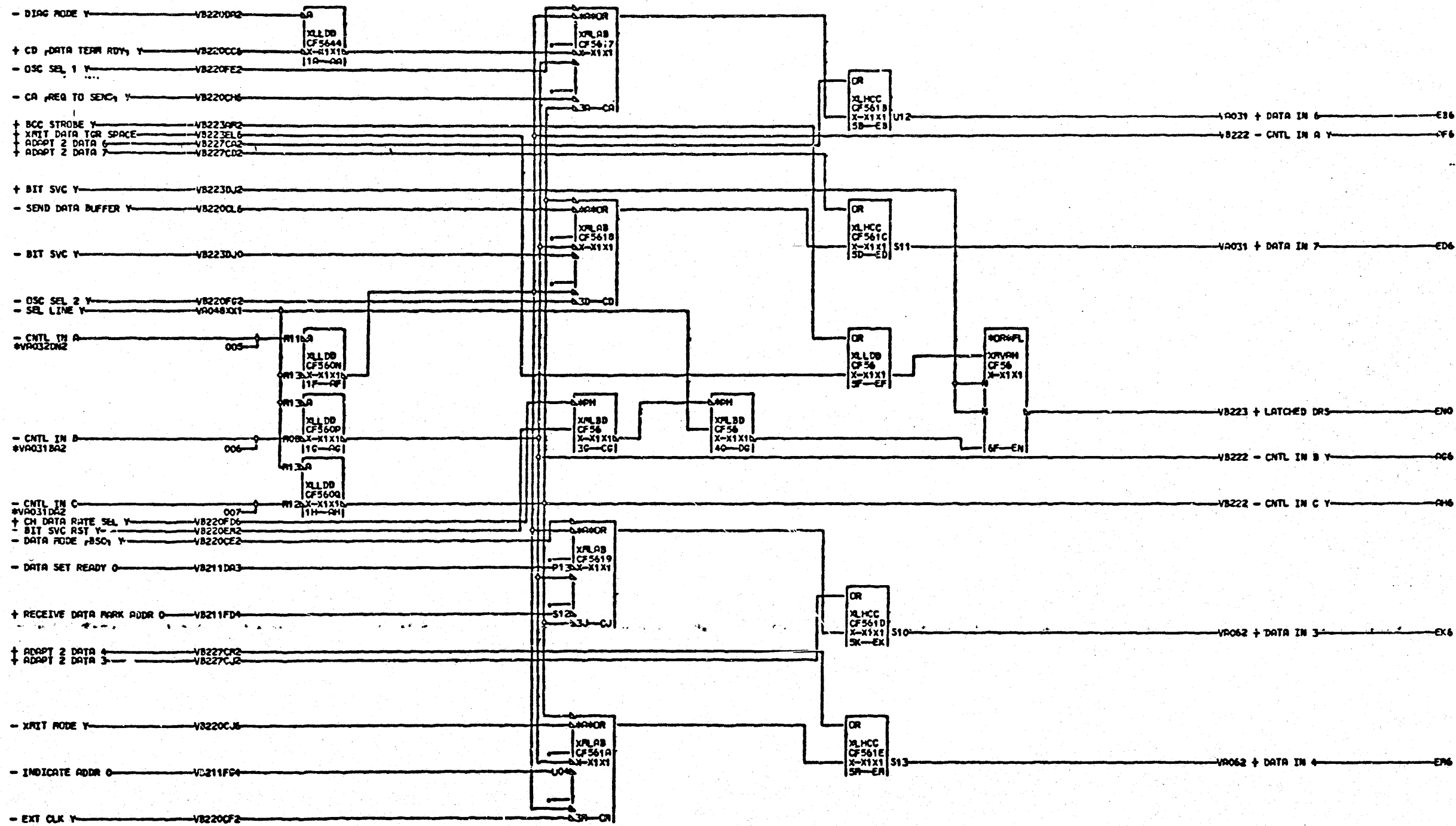

000

07-10-78 316650
10-07-80 344292

MEDIUM SPEED - HIGH SPEED			
X21 LINE PAIR			
DATE 10-15-80 PACH. 27RHS			
LOG	786	FRAME	01
P.No. 1754215			
IBM CORP.	SCD SLK.	EP	000

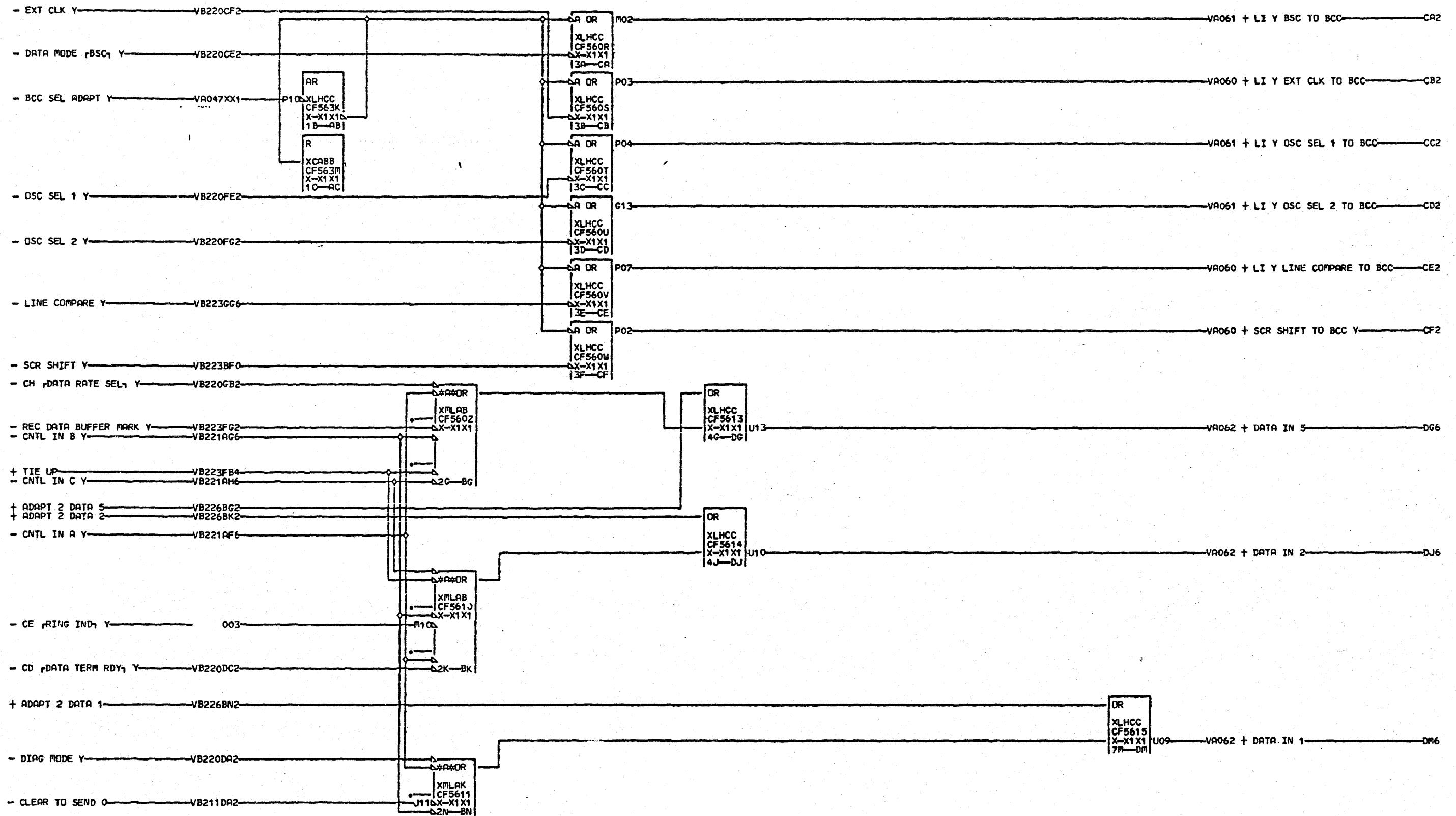

07-25-78 316650
10-07-80 344292

MEDIUM SPEED - HIGH SPEED			
X21 LINE PAIR			
DATE	10-15-80	PACH.	27RNB
LOG	786	FRAME	01
		P.No	1754236
IBM CCRP.	SCD	BLK.	GN

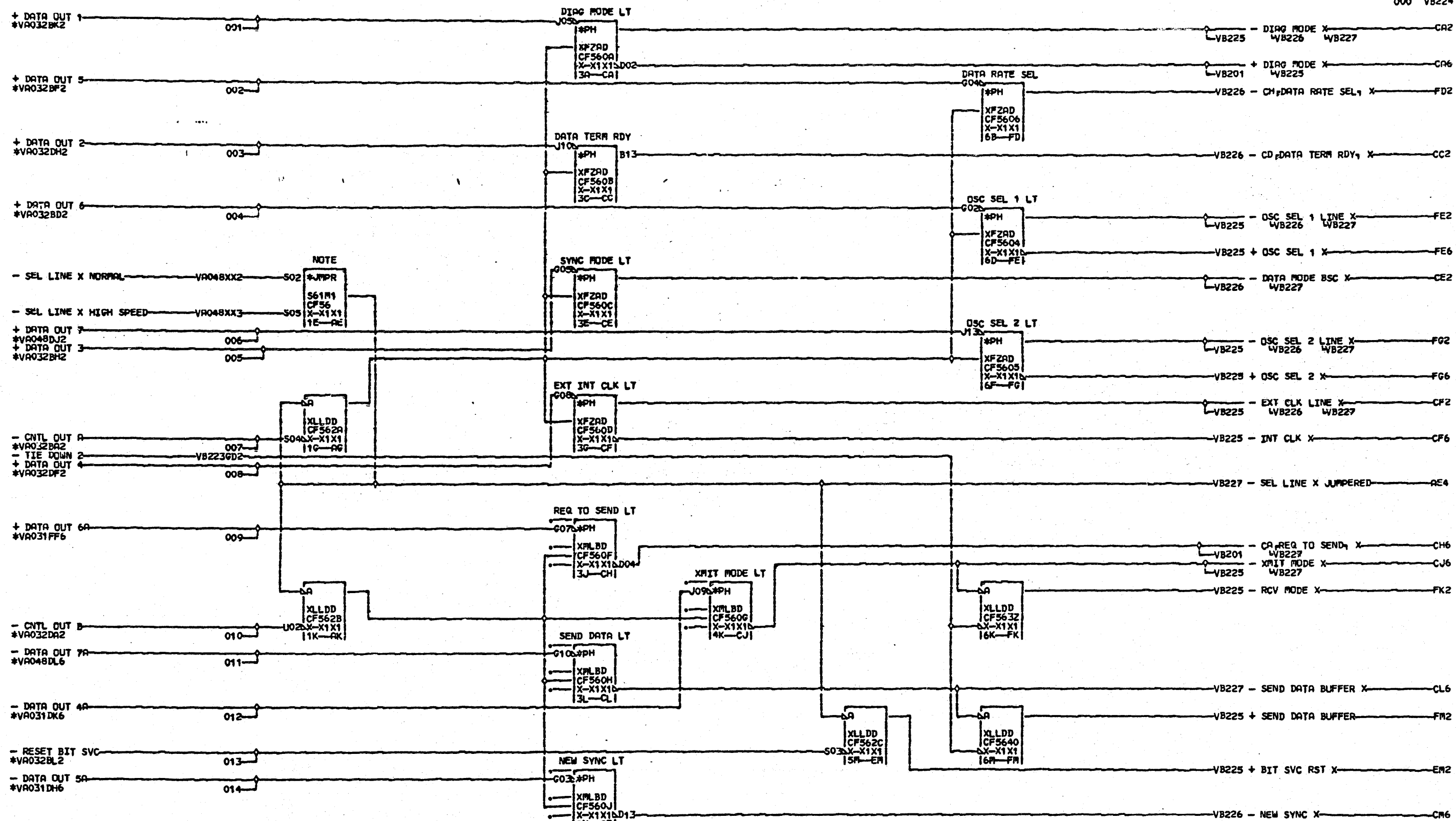

NOTE BOARD JUMPER REQUIRED FOR HIGH SPEED ADDRESS SELECTION. SEE PAGES VA000 B AND VA017.

2
2
4
000

07-10-78 316650
03-19-79 321371

MEDIUM SPEED - HIGH SPEED		V
X21 LINE PAIR		B
DATE	01-23-80	2
LOG	867 FRAME	2
	P.N. 1754238	4
IBM CORP.	SCD BLK.	000
		GL

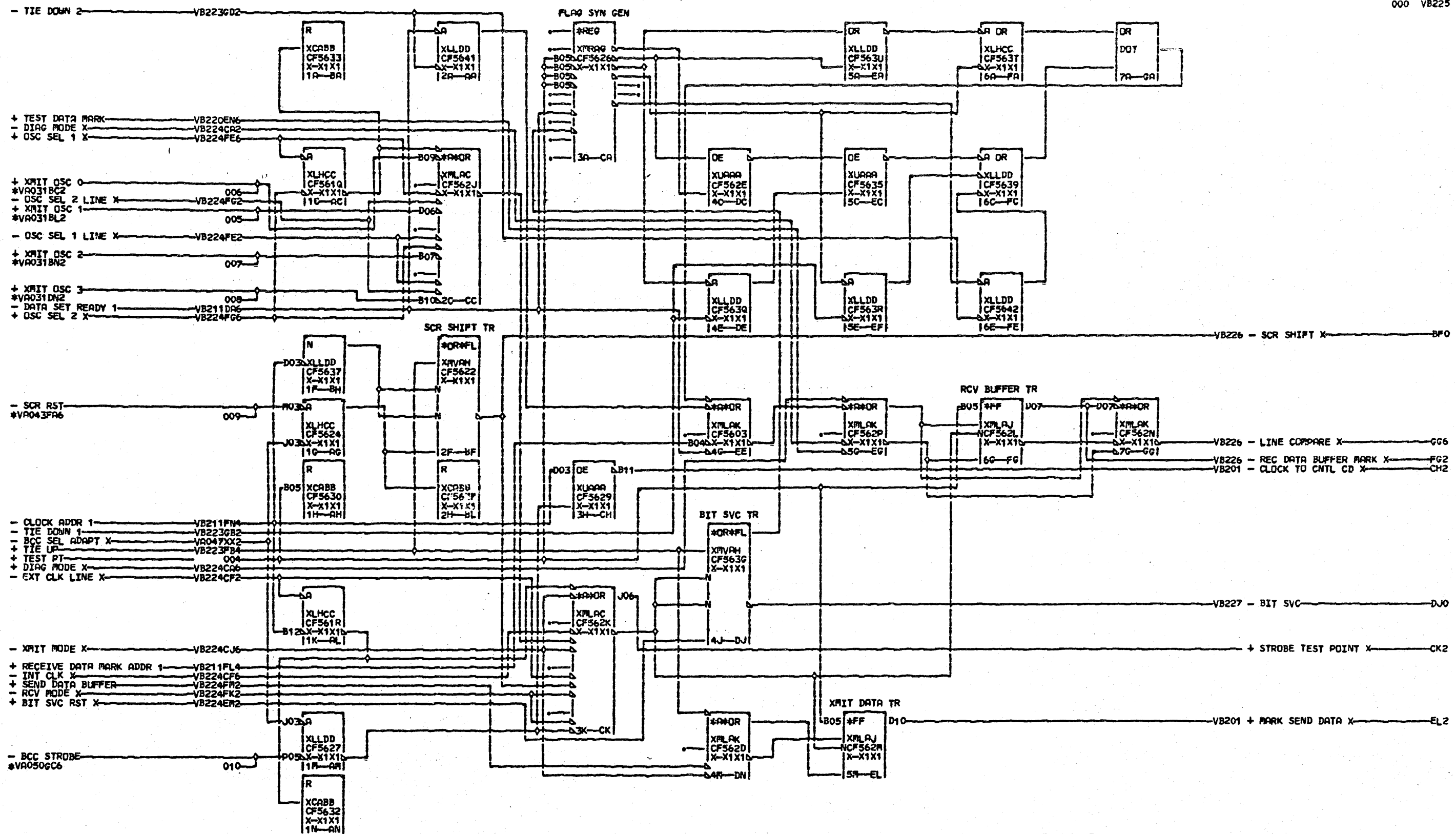

000

07-10-78 316650
 01-18-79 321251
 03-19-79 321371

MEDIUM SPEED - HIGH SPEED		
X21 LINE PAIR		
DATE	01-23-80	MACH. 27RNB
LOG	867	FRAME 01
P.N. 1754239		000
IBM CORP. SCD BLK.		GH

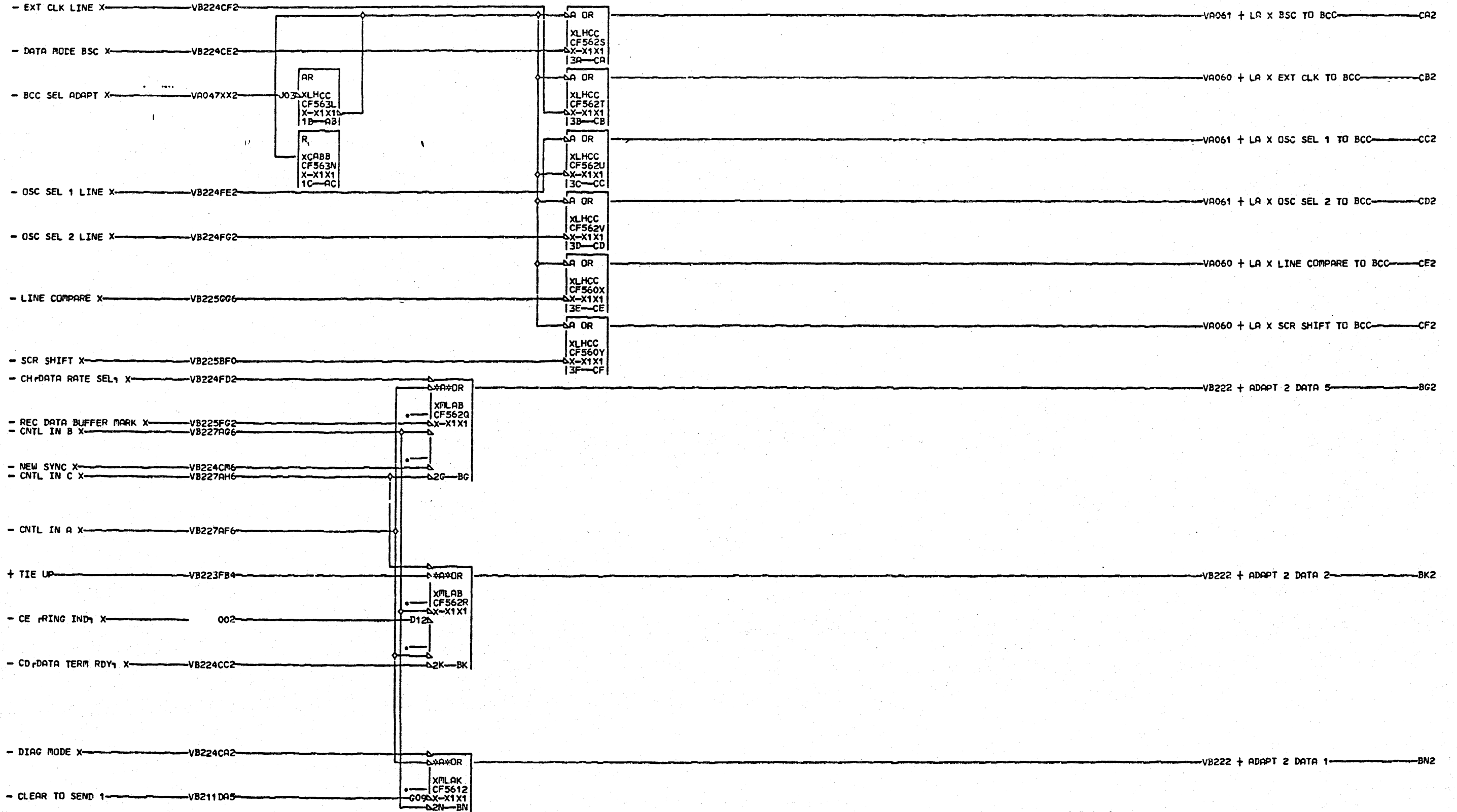

07-10-78 316650

MEDIUM SPEED - HIGH SPEED		
X21 LINE PAIR		
DATE	08-31-78	MACH. 27RNB
LOG	844A FRAME	01
	P.N.	1754240
IBM CORP.	SCD BLK.	DP

V
B
2
2
6
000

V
B
2
2
6
000

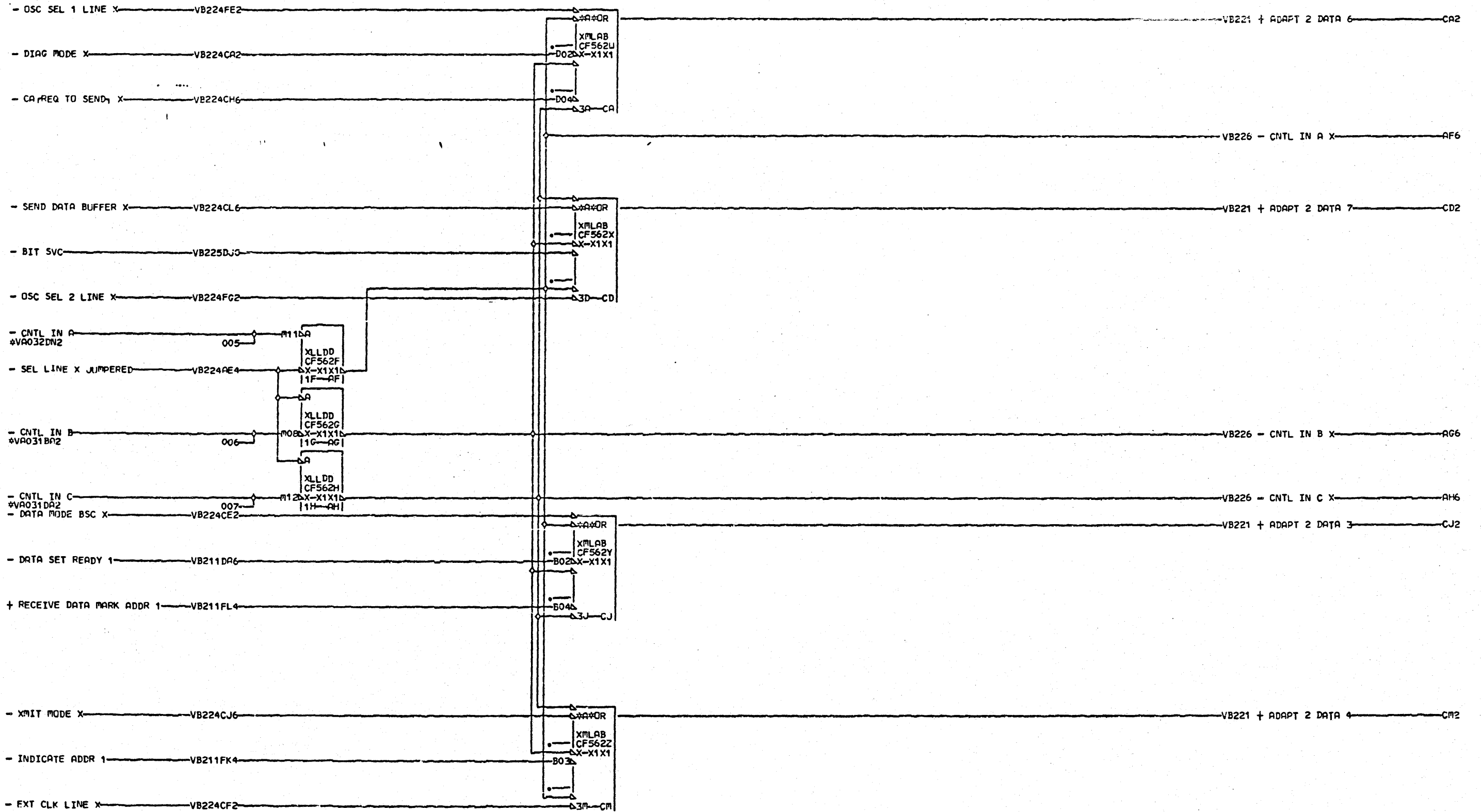

07-25-78 316650

V
B
N
N
V
000

MEDIUM-SPEED - HIGH-SPEED			
X21 LINE PAIR			
DATE	C9-31-78	MACH.	27RNB
LOG	873	FRAME	01
		P.N.	1754241
IBM CORP.	SCD BLK.	CN	

V
B
N
N
V
000