

GA27-2827-13
File No. S360/S370/S3/4300/8100-09

Systems

**IBM 3270
Information Display System**

**3274 Control Unit
Planning, Setup, and
Customizing Guide**

Configuration Support Levels A,B,C,T

Validation Number 10

Models 1, 21, 31, and 51C

IBM

GA27-2827-13
File No. S360/S370/S3/4300/8100-09

Systems

**IBM 3270
Information Display System**

**3274 Control Unit
Planning, Setup, and
Customizing Guide**

Configuration Support Levels A,B,C,T

Validation Number 10

Models 1, 21, 31, and 51C

IBM

Federal Communications Commission (FCC) Statement

Warning: This equipment generates, uses, and can radiate radio frequency energy and if not installed and used in accordance with the instruction manual, may cause interference to radio communications. It has been tested and found to comply with the limits for a Class A computing device pursuant to Subpart J of Part 15 of FCC Rules, which are designed to provide reasonable protection against such interference when operated in a commercial environment. Operation of this equipment in a residential area is likely to cause interference in which case the user at his own expense will be required to take whatever measures may be required to correct the interference.

IBM Statement

This warning is also applicable to all attaching units produced for use in the U.S.A. that have been manufactured after December 31, 1980. A notice of compliance has been affixed within the customer access area of all affected units.

CAUTION

This product is equipped with a UL-listed and CSA-certified plug for the user's safety. It is to be used in conjunction with a properly grounded receptacle to prevent electrical shock.

Fourteenth Edition (May 1984)

This major revision obsoletes GA27-2827-12.

This publication is for planning only. Changes are made periodically to the information herein; before using this publication in connection with the operation of IBM systems or equipment, consult your IBM sales representative or the latest *IBM System/360 Bibliography*, GC20-0360, or the *IBM System/370 and 4300 Processors Bibliography*, GC20-0001, for the editions that are applicable and current.

References in this publication to IBM products, programs, or services do not imply that IBM intends to make these available in all countries in which IBM operates. Any reference to an IBM program product in this publication is not intended to state or imply that only IBM's program product may be used. Any functionally equivalent program may be used instead.

Publications are not stocked at the address given below; requests for IBM publications should be made to your IBM representative or to the IBM branch office serving your locality.

A form for readers' comments is provided at the back of this publication. If the form has been removed, comments may be addressed to IBM Corporation, Department 52Q, Neighborhood Road, Kingston, N.Y., U.S.A. 12401. IBM may use or distribute whatever information you supply in any way it believes appropriate without incurring any obligation to you.

Preface

This guide is written for customer personnel who are responsible for planning the installation of the IBM 3274 Control Unit.

Organization of Manual

This guide has 7 chapters and 13 appendixes:

- Chapter 1, "Planning Your Installation," provides site planning information for your 3274 installation.
- Chapter 2, "Introduction to Customizing," describes the customizing operation and how and by whom the 3274 customizing procedure is performed.
- Chapter 3, "Preparing to Customize," describes the sequence numbers used in the 3274 customizing procedure. These sequence numbers are associated with functions and features of the 3274 and guide you through the customizing procedure. They are grouped by 3274 model number.
- Chapter 4, "Initial Customizing Procedure," describes how to perform the initial customizing of the 3274.
- Chapter 5, "Modification Procedure," describes how to modify a 3274 configuration without performing the entire customizing procedure.
- Chapter 6, "Backup Diskette Generation Procedures," describes how to generate a backup (duplicate) system or load diskette. You can use this procedure to create a duplicate of your system or load diskette.
- Chapter 7, "Update-Diskette Installation Procedures," describes how to install an update-diskette package on your customized 3274.
- Appendix A, "Planning Checklist," provides a suggested checklist to help you plan your installation.
- Appendix B, "3274 Device Cables," provides cable attachment information, and also channel attachment information for the 3274 Models 1A, 1B, 1D, 21A, 21B, 21D, 31A, and 31D.

- Appendix C, "Printer Authorization Matrix," describes the printer authorization matrix and how to define it. You will need to refer to this appendix if you wish to use this function.
- Appendix D, "Subsystem Verification Procedure," describes a procedure for verifying the 3274 subsystem after initial microcode load (IML) is performed.
- Appendix E, "Color Convergence Procedure," describes a procedure for converging the color patterns on the 3279 Color Display Station during customizing.
- Appendix F, "3274 Communication Cables," provides cabling information for Models 1C, 21C, 31C, and 51C and shows adapters for modem connections.
- Appendix G, "Planning for 3274 Model 31C Modem Address Switch Settings," tells you how to set the Modem Address switches if you have a 3274 Model 31C with an integrated modem.
- Appendix H, "Planning for 3274 Model 51C Switch Settings," tells you how to set the Transmit Level, Line Speed, or Modem Address switches if you have a 3274 Model 51C.
- Appendix I, "3274 Control Storage Requirements," explains how to determine control storage requirements for each model of the 3274.
- Appendix J, "Multiple Interactive Screen Definition—Sequence Number 171," explains how to identify multiple interactive screens using sequence number 171.
- Appendix K, "Response Time Monitor Customizing Information," provides background information and the sequence number 128 description needed to install the response time monitor (RTM) function.
- Appendix L, "Alert Function Customizing Information (Sequence Number 220)," provides the background information needed to install the alert function.
- Appendix M, "Keyboard Layouts for Sequence Numbers 131 through 135 and 166," contains the keyboard diagrams referred to in Chapter 3 for these sequence numbers.

Following the appendixes are a list of abbreviations used in this manual and an index.

Related Publications

For detailed information about the functions and features of the above 3270 Information Display System units, see the latest editions of:

- *An Introduction to the IBM 3270 Information Display System*, GA27-2739, which describes the 3270 hardware units and capabilities, lists programming support, and suggests typical applications
- *IBM 3270 Information Display System: 3274 Control Unit Description and Programmer's Guide*, GA23-0061, which provides system level information regarding the functional and programming characteristics of the 3274 Control Unit and attached terminals
- *IBM 3270 Information Display System: Installation Manual—Physical Planning*, GA27-2787, which provides physical planning information for the 3270 units, including floor planning, electrical and environmental requirements, cabling, and machine specifications and descriptions
- *IBM 3270 Information Display System: Character Set Reference*, GA27-2837, which provides all the keyboard layouts and input/output interface codes available with the 3270 Information Display System both in the United States and in World Trade countries
- *IBM 3270 Personal Computer: Introduction and Preinstallation and Planning*, GA23-0179, which provides information for evaluating and planning the use of the IBM 3270 Personal Computer with the IBM 3274 Control Unit
- *IBM 3290 Information Panel Description and Reference*, GA23-0021, which provides introductory and programming information
- *IBM 3270 Information Display System: IBM 3299 Terminal Multiplexer Product Information*, G520-4216, which provides information on how the 3299 can be used to reduce the amount of cabling in a 3270 Information Display System installation.

See the *IBM 3270 Information Display System Library User's Guide*, GA23-0058, for a complete list of 3270 manuals.

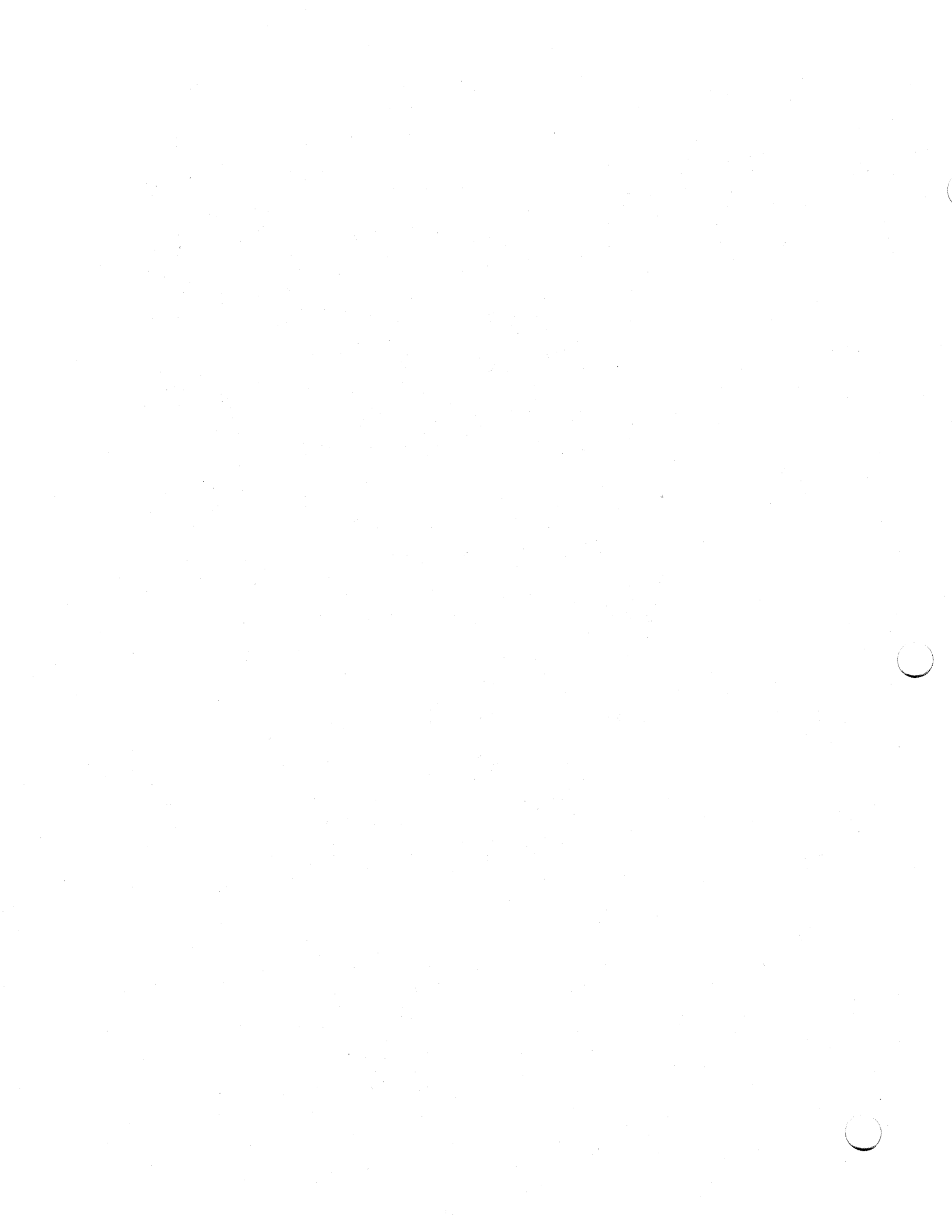

Contents

Chapter 1. Planning Your Installation	1-1
Introduction	1-1
System Planning	1-3
Site Preparation	1-3
Communication Services (3274 Models 1C, 21C, 31C, and 51C)	1-4
Local Channel Attachment (3274 Models 1A, 1B, 1D, 21A, 21B, 21D, 31A, and 31D)	1-4
Programming Support	1-6
Response Time	1-6
Configuration Support	1-7
IBM 3270 Personal Computer Compatibility with the 3274	1-9
3290 Compatibility with the Host	1-9
Predelivery Planning	1-10
Installing Your 3274 Subsystem	1-12
Before Equipment Arrives	1-13
After Equipment Arrives	1-14
Replacing a 3271 or a 3272 with a 3274	1-19
Problem Determination Procedures	1-20
Relocation/Removal	1-20
Progress Review	1-20
IBM Americas/Far East and IBM Europe/Middle East/Africa	1-21
Supplemental Information	1-21
Safety	1-21
Security	1-21
Personnel Training	1-22
Voice Communication between Terminal Operators and Host System Operators	1-22
Chapter 2. Introduction to Customizing	2-1
Subsystem Verification	2-2
3274 Model 31C and 51C Switch Settings	2-3
Preparation for Customizing	2-3
Chapter 3. Preparing to Customize	3-1
3274 Models 1A, 21A, and 31A	3-3
001: Keyboard Validation	3-3
011: Patch Request	3-3
021: Printer Authorization Matrix	3-3
022: Printer Authorization Matrix Definition	3-4
031: Number of RPQ Diskettes Required	3-4
032: Request RPQ Parameter List (Configuration Support C and T Only)	3-4

- 111: Number of Category B Terminals (Configuration Support A, B, and C Only) 3-4
- 112: Number of Category A Terminals 3-5
- 113: Extended Function Store 3-7
- 114: IBM 3270 Personal Computer Attachment (Configuration Support C Only) 3-7
- 121: Keyboard Language/Character Set I/O Interface Code 3-8
- 127: Response Time Monitor (RTM) Definition (Configuration Support C Only) 3-9
- 128: RTM Boundaries and Interface Specification (Configuration Support C Only) 3-9
- 131: Typewriter Keyboard 3-10
- 132: Data Entry Keyboard 3-10
- 133: Data Entry Keypunch Layout Keyboard 3-10
- 134: APL Keyboard 3-10
- 135: Text Keyboard 3-10
- 139: 3290 Keypad Selection (Configuration Support T Only) 3-11
- 141: Magnetic Character Set 3-11
- 143: Host-Loadable Printer Authorization Matrix 3-11
- 145: 3289 Print Control 3-11
- 147: Local-Copy Function 3-12
- 151: 3274 Model Designation 3-12
- 161: Color Convergence 3-12
- 162: Structured Field and Attribute Processing (SFAP) (Configuration Support C Only) 3-12
- 163: Extended Character Set Adapter (Configuration Support C Only) 3-13
- 164: Programmed Symbols (PS) (Configuration Support C Only) 3-13
- 165: Decompression (Configuration Support C Only) 3-13
- 166: Attribute Select Keyboard (Configuration Support C Only) 3-14
- 170: Distributed Function Terminals (Configuration Support T Only) 3-14
- 171: Multiple Interactive Screens (Configuration Support T Only) 3-15
- 173: 3290 Options (Configuration Support T Only) 3-15
- 175: 3290 Password (Configuration Support T Only) 3-17
- 176: BSC Enhanced Communication Option (Configuration Support T Only) 3-17
- 201: SNA Local Channel Control Unit Address 3-17
- 211: SCS Support 3-17
- 213: Between Bracket Printer Sharing 3-17
- 215: Physical Unit Identification (PUID) 3-17
- 220: Alert Function (SNA Only) (Configuration Support C) 3-18
- 301 through 362 3-18
- 900: Entry Acceptance 3-18
- 999: Specification Panel 3-18
- 3274 Models 1B, 1D, 21B, 21D, and 31D 3-19
- 001: Keyboard Validation 3-19
- 011: Patch Request 3-19
- 021: Printer Authorization Matrix 3-19
- 022: Printer Authorization Matrix Definition 3-20
- 031: Number of RPQ Diskettes Required 3-20
- 032: Request RPQ Parameter List (Configuration Support C and T Only) 3-20

111: Number of Category B Terminals (Configuration Support A, B, and C Only)	3-20
112: Number of Category A Terminals	3-21
113: Extended Function Store	3-23
114: IBM 3270 Personal Computer Attachment (Configuration Support C Only)	3-23
121: Keyboard Language/Character Set I/O Interface Code	3-24
127: Response Time Monitor (RTM) Definition (Configuration Support C Only)	3-25
128: RTM Boundaries and Interface Specification (Configuration Support C Only)	3-25
131: Typewriter Keyboard	3-25
132: Data Entry Keyboard	3-26
133: Data Entry Keypunch Layout Keyboard	3-26
134: APL Keyboard (Models 1D, 21D, and 31D Only)	3-26
135: Text Keyboard (Models 1D, 21D, and 31D Only)	3-26
139: 3290 Keypad Selection (Configuration Support T Only)	3-26
141: Magnetic Character Set	3-27
143: Host-Loadable Printer Authorization Matrix	3-27
145: 3289 Print Control	3-27
147: Local-Copy Function	3-27
151: 3274 Model Designation	3-28
161: Color Convergence	3-28
162: Structured Field and Attribute Processing (SFAP) (Configuration Support C Only; Models 1D and 31D Only)	3-28
163: Extended Character Set Adapter (Configuration Support C Only; Models 1D and 31D Only)	3-29
164: Programmed Symbols (PS) (Configuration Support C Only; Models 1D and 31D Only)	3-29
165: Decompression (Configuration Support C Only; Models 1D and 31D Only)	3-29
166: Attribute Select Keyboard (Configuration Support C Only; Models 1D and 31D Only)	3-30
170: Distributed Function Terminals (Configuration Support T Only)	3-30
171: Multiple Interactive Screens (Configuration Support T Only)	3-31
173: 3290 Options (Configuration Support T Only)	3-31
175: 3290 Password (Configuration Support T Only)	3-33
176: BSC Enhanced Communication Option (Configuration Support T Only)	3-33
201 through 362	3-33
900: Entry Acceptance	3-34
999: Specification Panel	3-34
3274 Models 1C, 21C, 31C, and 51C	3-35
001: Keyboard Validation	3-37
011: Patch Request	3-37
021: Printer Authorization Matrix	3-37
022: Printer Authorization Matrix Definition	3-37
031: Number of RPQ Diskettes Required	3-38
032: Request RPQ Parameter List (Configuration Support C and T Only)	3-38
111: Number of Category B Terminals (Configuration Support A, B, and C Only)	3-38
112: Number of Category A Terminals	3-39

- 113: Extended Function Store 3-41
- 114: IBM 3270 Personal Computer Attachment (Configuration Support C Only) 3-42
- 121: Keyboard Language/Character Set I/O Interface Code 3-42
- 127: Response Time Monitor (RTM) Definition (Configuration Support C Only) 3-42
- 128: RTM Boundaries and Interface Specification (Configuration Support C Only) 3-44
- 131: Typewriter Keyboard 3-44
- 132: Data Entry Keyboard 3-44
- 133: Data Entry Keypunch Layout Keyboard 3-45
- 134: APL Keyboard 3-45
- 135: Text Keyboard 3-45
- 139: 3290 Keypad Selection (Configuration Support T Only) 3-45
- 141: Magnetic Character Set 3-46
- 143: Host-Loadable Printer Authorization Matrix 3-46
- 145: 3289 Print Control 3-46
- 147: Local-Copy Function 3-46
- 151: 3274 Model Designation 3-47
- 161: Color Convergence 3-47
- 162: Structured Field and Attribute Processing (SFAP) (Configuration Support C Only) 3-47
- 163: Extended Character Set Adapter (Configuration Support C Only) 3-47
- 164: Programmed Symbols (PS) (Configuration Support C Only) 3-48
- 165: Decompression (Configuration Support C Only) 3-48
- 166: Attribute Select Keyboard (Configuration Support C Only) 3-49
- 170: Distributed Function Terminals (Configuration Support T Only) 3-49
- 171: Multiple Interactive Screens (Configuration Support T Only) 3-50
- 173: 3290 Options (Configuration Support T Only) 3-50
- 175: 3290 Password (Configuration Support T Only) 3-52
- 176: BSC Enhanced Communication Option (Configuration Support T Only) 3-52
- 201: SNA Local Channel Control Unit Address 3-53
- 211: SCS Support (SDLC Only) 3-53
- 213: Between Bracket Printer Sharing (SDLC Only) 3-53
- 215: Physical Unit Identification (PUID) (SDLC Only) 3-53
- 220: Alert Function (SNA Only) (Configuration Support C) 3-54
- 301: Control Unit Number (BSC Only) 3-54
- 302: SDLC Control Unit Address 3-54
- 305: BSC Printer Polling 3-55
- 310: Modem Connection 3-55
- 311: Modem Wrap (External Modems Only) 3-56
- 313: NRZI (SDLC Only) or NRZ Encoding 3-56
- 313: Internal or External Clocking (BSC Only) 3-56
- 314: Multipoint or Point-to-Point Network 3-57
- 317: Switched Network Backup (SNBU) 3-57
- 318: Normal or Half-Speed Transmission 3-57
- 321: EBCDIC or ASCII Character Set 3-58
- 331: BSC or SDLC Protocol 3-58
- 342: Request-to-Send (RTS) Control (2-Wire or 4-Wire) 3-58
- 343: Communication Interface Options 3-59

345: Answer Tone (Configuration Support C and T Only; World Trade External Switched Network Modems Only)	3-59
347: High-Speed Data Rate (Configuration Support C Only; Loop Attachment Only; Model 51C Only)	3-59
351: HPCA (SDLC Only) or CCA Adapter	3-60
352: Encrypt/Decrypt (SDLC Only) (Configuration Support A, B, and C Only)	3-60
360: X.21 Switched Retry (Configuration Support C; Model 51C Only) (SDLC Only)	3-60
361: X.21 Switched Retry Timing (Configuration Support C; Model 51C Only) (SDLC Only)	3-60
362: X.21 Switched Options (Configuration Support C; Model 51C Only) (SDLC Only)	3-60
900: Entry Acceptance	3-61
999: Specification Panel	3-61

Chapter 4. Initial Customizing Procedure 4-1

Chapter 5. Modification Procedure 5-1

Chapter 6. Backup Diskette Generation Procedures 6-1

Backup System Diskette 6-1

Backup Load Diskette 6-2

Chapter 7. Update-Diskette Installation Procedures 7-1

RPQ Update-Diskette Installation 7-1

Language Update-Diskette Installation 7-1

Update-Diskette Installation Procedure for Configuration Support A, B, or C 7-3

Update-Diskette Installation Procedures for Configuration Support T Procedure for Updating with New Feature and New System Diskettes 7-5

Procedure for Updating with a New Load Diskette Only 7-7

Appendix A. Planning Checklist A-1

Appendix B. 3274 Device Cables B-1

Instructions for Completing the 3274 Device Cable Attachment Form B-2

Appendix C. Printer Authorization Matrix C-1

Description C-1

Printer Modes C-1

Printer Class Structure C-2

Source Device Lists C-3

Matrix Structure C-3

Defining the Printer Authorization Matrix during Customizing C-5

Appendix D. Subsystem Verification Procedure D-1

Appendix E. Color Convergence Procedure E-1

Operator Instructions E-1

Convergence Procedure E-1

Error Conditions E-2

Appendix F. 3274 Communication Cables F-1

Appendix G. Planning for 3274 Model 31C Modem Address Switch Settings G-1

Modem Address Switches (Integrated Modems Only) G-1

Instructions for Setting 3274 Model 31C Modem Address Switches G-3

Appendix H. Planning for 3274 Model 51C Switch Settings H-1

Transmit Level Switches (1200 BPS Integrated Modem, U.S. and Canada Only) H-1

Instructions for Setting 3274 Model 51C Transmit Level Switches (U.S. and Canada Only) H-3

Loop Data Speed Switches (Loop Adapter Feature Only) H-5

Instructions for Setting 3274 Model 51C Loop Data Speed Switches H-6

Modem Address Switches (Integrated Modems with Speeds Greater Than 1200 BPS Only) H-8

Instructions for Setting 3274 Model 51C Modem Address Switches H-9

Appendix I. 3274 Control Storage Requirements I-1

Models 1A, 1C, 1D, and 51C I-1

Models 21A, 21C, 21D, 31A, 31C, and 31D I-2

Appendix J. Multiple Interactive Screen Definition — Sequence Number 171 J-1

Appendix K. Response Time Monitor (RTM) Customizing Information K-1

RTM Requirements K-1

Host Interface K-1

RTM Description K-2

Sequence Number 127 K-2

Sequence Number 128 K-3

Appendix L. Alert Function Customizing Information (Sequence Number 220) L-1

Operator-Generated Alert Message L-1

Appendix M. Keyboard Layouts for Sequence Numbers 131 through 135 and 166 M-1

List of Abbreviations X-1

Index X-3

Figures

- 2-1. Configuration Information Needed 2-4
- 3-1. 3274 Model 1A, 21A, and 31A Category A and B Terminal Quantity Relationships 3-6
- 3-2. 3274 Model 1A, 21A, and 31A Keyboard Language and Character Set I/O Interface Code 3-8
- 3-3. 3274 Model 1B, 1D, 21B, 21D, and 31D Category A and B Terminal Quantity Relationships 3-22
- 3-4. 3274 Model 1B, 1D, 21B, 21D, and 31D Keyboard Language and Character Set I/O Interface Code 3-24
- 3-5. Default Values 3-36
- 3-6. 3274 Model 1C, 21C, 31C, and 51C Category A and B Terminal Quantity Relationships 3-40
- 3-7. 3274 Model 1C, 21C, 31C, and 51C Keyboard Language and Character Set I/O Interface Code 3-43
- 3-8. BSC Polling Address/Control Unit Number Conversion Chart 3-55
- 4-1. Valid Key Positions during Customizing 4-9
- 4-2. Valid Key Positions during Customizing When Japanese Katakana and Japanese English Keyboards Are Used 4-10
- 4-3. Inserting a Diskette into the 3274 Control Unit (during Customizing) 4-11
- 4-4. Operator Codes during Customizing Only 4-13
- 4-5. Steady 8 4 2 1 Indicator Codes during Customizing Only 4-15
- 4-6. Flashing 8 4 2 1 Indicator Codes during Customizing Only 4-16
- 4-7. 8 4 2 1 Indicator Codes during IML That May Result from an Incorrect Customizing Procedure 4-17
- 5-1. Valid Key Positions during the Modification Procedure 5-9
- 5-2. Valid Key Positions during the Modification Procedure When Japanese Katakana and Japanese English Keyboards Are Used 5-10
- 5-3. Inserting a Diskette into the 3274 Control Unit (during Modification) 5-11
- 5-4. Operator Codes during Modification Procedure Only 5-13
- 5-5. Steady 8 4 2 1 Indicator Codes during the Modification Procedure Only 5-15
- 5-6. Flashing 8 4 2 1 Indicator Codes during the Modification Procedure Only 5-16
- 5-7. 8 4 2 1 Indicator Codes during IML That May Result from an Incorrect Modification Procedure 5-17
- 6-1. Valid Key Positions during Backup Diskette Generation 6-9
- 6-2. Valid Key Positions during Backup Diskette Generation When Japanese Katakana and Japanese English Keyboards Are Used 6-10
- 6-3. Inserting a Diskette into the 3274 Control Unit (during Backup Diskette Generation) 6-11
- 6-4. Operator Codes during Backup Diskette Generation Only 6-13

- 6-5. Steady 8 4 2 1 Indicator Codes during Backup Diskette Generation Only 6-15
- 6-6. Flashing 8 4 2 1 Indicator Codes during Backup Diskette Generation Only 6-16
- 6-7. 8 4 2 1 Indicator Codes during IML That May Result from an Incorrect Backup Diskette Generation 6-17
- 7-1. Steady 8 4 2 1 Indicator Error Codes during Update Diskette Procedure 7-7
- 7-2. Flashing 8 4 2 1 Indicator Error Codes during Update Diskette Procedure 7-8
- C-1. Example of a Printer Authorization Matrix C-4
- C-2. Example of a Completed Printer Authorization Matrix Form C-6
- C-3. Example of a Printer Authorization Matrix Worksheet (Models 1A, 1B, 1C, 1D, 21A, 21B, 21C, 21D, 31A, 31C, and 31D) C-7
- C-4. Sample Printer Authorization Matrix Worksheet (Models 1A, 1B, 1C, 1D, 21A, 21B, 21C, 21D, 31A, 31C, and 31D) C-8
- C-5. Sample Printer Authorization Matrix Worksheet (Model 51C) C-9
- E-1. Examples of Unconverged and Converged Display Screens E-3
- G-1. Conversion of BSC Control Unit Address and SDLC Control Unit Address to Binary-Equivalent Modem Address Switch Settings on 3274 Model 31C G-2
- G-2. Example of 3274 Model 31C Modem Address Switch Settings G-2
- H-1. 3274 Model 51C Transmit Level Switches H-2
- H-2. Loop Data Speed Switch Settings H-5
- H-3. Conversion of BSC Control Unit Address and SDLC Control Unit Address to Binary-Equivalent Modem Address Switch Settings on 3274 Model 51C H-8
- H-4. Example of 3274 Model 51C Modem Address Switch Settings H-8
- I-1. 3274 Model 1A Control Storage Requirements I-3
- I-2. 3274 Model 1C/SNA Control Storage Requirements I-4
- I-3. 3274 Model 1C/BSC Control Storage Requirements I-6
- I-4. 3274 Model 1D Control Storage Requirements I-8
- I-5. 3274 Model 51C/SNA Control Storage Requirements I-10
- I-6. 3274 Model 51C/BSC Control Storage Requirements I-12
- I-7. 3274 Models 1A, 1C, and 1D Extended Function Store Features I-13
- I-8. 3274 Model 51C Extended Function Store Features I-13
- I-9. 3274 Model 21A Control Storage Requirements I-14
- I-10. 3274 Model 21C/SNA Control Storage Requirements I-15
- I-11. 3274 Model 21C/BSC Control Storage Requirements I-16
- I-12. 3274 Model 21D Control Storage Requirements I-17
- I-13. 3274 Model 31A Control Storage Requirements I-18
- I-14. 3274 Model 31C/SNA Control Storage Requirements I-19
- J-1. Example of MIS Configuration J-2
- J-2. Possible Multiple-Screen Formats J-2
- J-3. Possible Multiple-Screen Configurations J-4
- J-4. Example of How the 3274 Views MIS Addressing J-5
- J-5. Example of How the Host Views MIS Addressing in SNA Protocol J-6
- K-1. Counters and Boundaries K-5
- M-1. Example of Typewriter Keyboard M-2
- M-2. Example of Data Entry Keyboard M-2
- M-3. Example of Data Entry Keypunch Keyboard M-3
- M-4. Example of APL Keyboard M-3
- M-5. Example of Text Keyboard M-4

- M-6. Example of an Attribute Select Typewriter Keyboard M-4
- M-7. Example of an Attribute Select Typewriter/APL Keyboard M-5
- M-8. Example of a Typewriter Overlay Keyboard M-6

Summary of Changes

Fourteenth Edition (May 1984)

- Customizing information has been added for the 4250 printer. See sequence numbers 162, 163, and 211.
- The IBM 3270 Personal Computer in distributed function terminal (DFT) mode has been added to the list of DFTs in Chapter 1.
- A copy of the *IBM 3274 Configuration Data Card (Configuration Support: A, B, C, T)*, GA23-0046, has been added at the end of Chapter 4.
- Chapter 7 has been added to provide the “Update-Diskette Installation Procedures” (engineering changes) for maintenance enhancements.
- Appendix J has been revised to apply to all DFTs.
- Appendix M has been added to provide more information for customizing sequence numbers 131 through 135 and 166.
- An Index has been added.
- Editorial and technical corrections have been made throughout the publication.

Thirteenth Edition (September 1983)

1. Customizing information has been added for the Response Time Monitor (RTM) and alert functions:
 - Appendix K. Response Time Monitor Customizing Information
 - Appendix L. Alert Customizing Information
2. The following sequence numbers have been added:
 - 127 - RTM Definitions
 - 128 - RTM Boundaries and Interface
 - 220 - Alert

3. Support for three new languages:

French AZERTY (105)
Swiss French
Swiss German

4. Editorial and technical corrections have been made throughout the publication.

5. As noted in the preface, the phrase “distributed function terminal(s)” appears in this edition. See Preface for identification of terminals in this category.

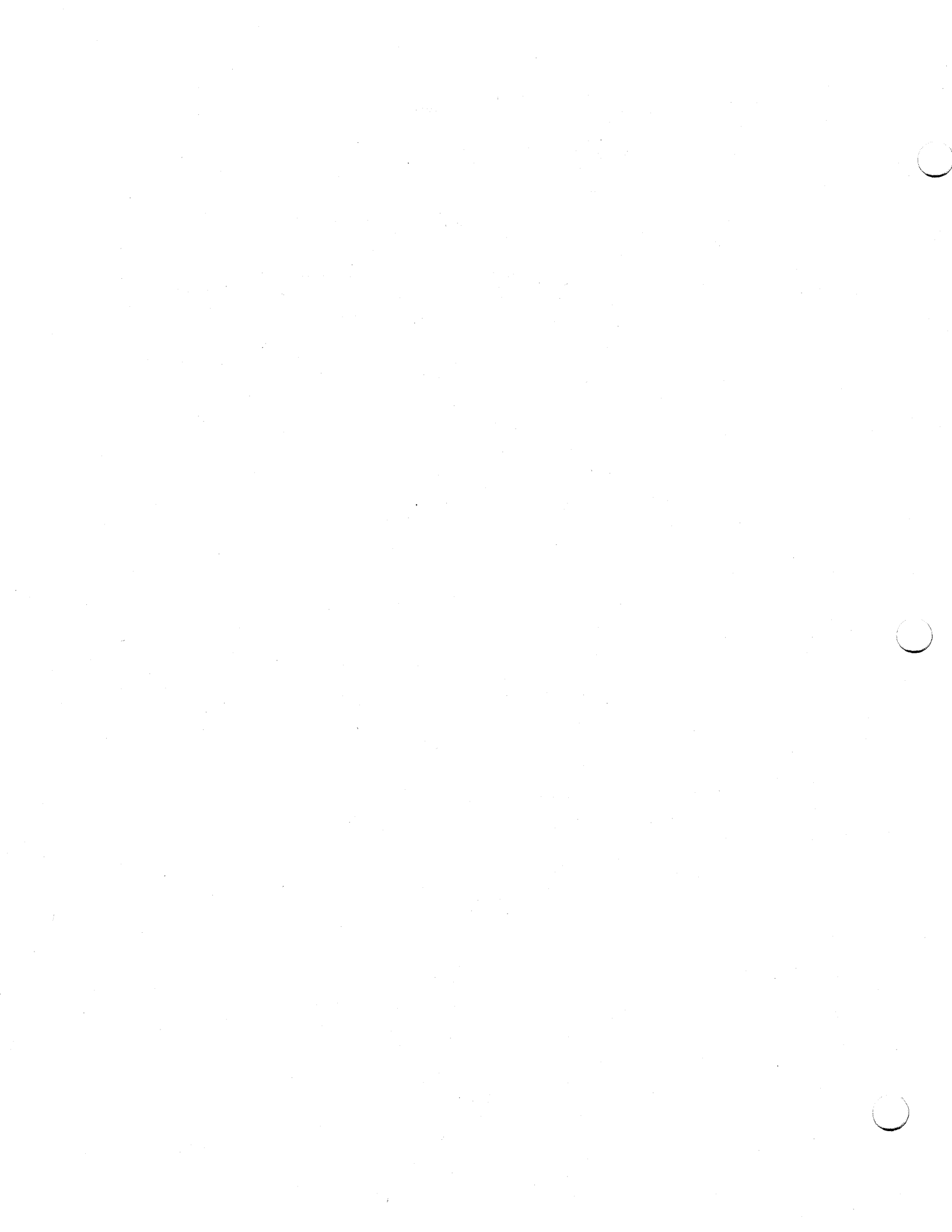

Chapter 1. Planning Your Installation

Introduction

This guide will help you plan the installation of the IBM 3274 Control Unit Models 1A, 1B, 1C, 1D, 21A, 21B, 21C, 21D, 31A, 31C, 31D, and 51C. These models may be divided into two groups: those that are locally attached via a channel to the host and those that are remotely attached through communication facilities to the host.

Local-channel-attached models are:

- 1A, 21A, and 31A
- 1B and 21B
- 1D, 21D, and 31D.

Remotely attached models are:

- 1C, 21C, 31C, and 51C.

Terminals that can attach to the 3274 Control Unit are divided into two categories, A and B.

Category A terminals are:

- IBM 3178 Display Station Models C1, C2, and C3
- IBM 3179 Color Display Station in 3279-emulation mode
- IBM 3180 Display Station in 3278-emulation mode
- IBM 3230 Printer Model 2
- IBM 3262 Line Printer Models 3 and 13
- IBM 3268 Printer Model 2
- IBM 3270 Personal Computer in DFT mode
- IBM 3278 Display Station Models 1 through 5

- IBM 3278 Display Station Models 1 through 5 with the IBM 3270 Personal Computer Attachment
- IBM 3279 Color Display Station, All Models except 2C
- IBM 3287 Printer Models 1C and 2C
- IBM 3287 Printer Models 1 and 2 with 3274/3276 Attachment (Feature 8331)
- IBM 3289 Line Printer Models 1 and 2
- IBM 3290 Information Panel (Only with 3274 Models 31A, 31C, 31D, and 51C)
- IBM 4250 Printer Model 1 (Only with 3274 Models 31A and 31D)
- IBM 5210 Printer Models G01 and G02
- IBM 6580 Displaywriter System

Category B terminals are:

- IBM Personal Computer XT/370
- IBM 3277 Display Station Models 1 and 2
- IBM 3284 Printer Models 1 and 2
- IBM 3286 Printer Models 1 and 2
- IBM 3287 Printer Models 1 and 2 with 3271/3272 Attachment (Feature 8330)
- IBM 3288 Line Printer Model 2

All models of the 3274, as well as the terminals that connect to it, are delivered with unpacking instructions attached to an outside surface of the shipping carton. In addition to the unpacking instructions, the 3274 Models 1C, 21C, 31C, and 51C, and all terminals, have setup instructions inside the shipping carton. The unpacking instructions and the setup instructions are step-by-step procedures that describe the unpacking and setup tasks for the unit. Once the 3274 is set up, it must be customized for your unique configuration. Instructions on what you must plan for and how to customize your 3274 are given in Chapter 2 of this manual.

Note: The term *distributed function terminal (DFT)* is used in this publication. Current terminals in this category are:

- IBM 3270 Personal Computer
- IBM 3290 Information Panel.

System Planning

The following tasks should be planned so that they can be accomplished in a timely manner:

- Site preparation for the 3274 subsystem
- Communication facilities preparation for remote attachment of the 3274 Control Unit
- Host system channel preparation for local attachment of the 3274 Control Unit
- Programming support preparation
- 3274 predelivery planning activities.

It may be useful to assign a person in your organization the responsibility of ensuring that all these tasks are planned. The Planning Checklist in Appendix A of this guide contains the events, in a suggested sequence, that should be planned in order to install a locally attached model, and/or to set up a remotely attached model, of the 3274 for the first time; it therefore contains more detail than is required for adding to or replacing an existing subsystem. In either case, each event should be carefully considered so that installation and/or setup is problem-free.

Site Preparation

The specifications for the physical requirements of all the attached terminals are given in *IBM 3270 Information Display System: Installation Manual—Physical Planning, GA27-2787*.

This guide will help you provide compatibility between these units and the following:

- Work-space considerations
- Electrical requirements
- Cable requirements and installation
- Power cord plug requirements
- Environmental requirements.

Communication Services (3274 Models 1C, 21C, 31C, and 51C)

Arrangements need to be made for the installation of the communication facilities between the remotely attached models of the 3274 and the host communication unit/adaptor. There must be compatibility between the 3274, the modems, the communication line, and the communication unit/adaptor; for example, line speed, duplex or half-duplex facilities, and nonreturn to zero (NRZ) or nonreturn to zero inverted (NRZI).

Compatibility among these components is a major consideration. To reduce delays caused by incompatibility, it is recommended that you request assistance from your communication representative and from your IBM representative to determine whether the 3274, modems, communication line, and communication unit/adaptor are compatible. In addition, schedules should be established to ensure that the modems, communication line, and communication unit/adaptor are installed and tested before delivery of the 3274 and the attached units.

Local Channel Attachment (3274 Models 1A, 1B, 1D, 21A, 21B, 21D, 31A, and 31D)

A plan needs to be established for required changes to your host system selector, multiplexer, or block multiplexer channel configuration. Considerations should include device priorities, device data rates, device addresses, I/O interface cable lengths, and changes to the sequence and control (power sequencing and emergency power off) cables.

The Channel Attachment Information Form in Appendix B should be completed before the 3274 is delivered. This information will be required by the IBM service representative at the time of installation. The following information will assist you in completing the form. For further information, see the *IBM System/370 Installation Manual—Physical Planning*, GC22-7004. These models may be attached to a byte multiplexer, block multiplexer, or selector channel. In most cases, the choice of channel attachment depends on system considerations such as channel utilization rather than 3274 operation.

Selector or Block Multiplexer Channel (Non-Byte Mode Operation)

If you choose to attach these models to a block multiplexer or selector channel, the following options should be selected:

- Select the 100-kb data rate (for the A models only).
- Select burst mode for the A models. No selection is required for the B and D models.
- Select the priority that will produce the greatest channel efficiency with other attached devices. Factory wiring of high priority is recommended.

The 3274 Models A, B, and D are designed to operate with disconnect command chaining (DCC). Depending on the processor being used, maximum channel utilization can be gained by proper specification of the unit control word (UCW) in the host. Consult your IBM systems engineer to find out whether a shared or nonshared UCW should be specified. Also, see the latest version of the *IBM System/370 Input/Output Configurator*, GA22-7002.

Byte Multiplexer Channel (Byte Mode Operation)

If you choose to attach these models to a byte multiplexer channel, the following selections should be made:

- Select the correct mode as follows:
 - Select byte mode for the A models.
 - Select burst mode for the B and D models only if the 3274 is the only device on the channel. In all other cases, select byte mode.
- Select a priority that is below all overrunnable devices on the channel. This can be accomplished by channel cabling between devices and/or the channel priority options.
- On the A models, select the data rate that will produce maximum channel utilization with other devices attached to the same channel. There is no data rate selection option on the B and D models.

When choosing a control unit address for the A models of the 3274, you may use any one of the 256 possible addresses.

The B and D models are very similar to the 3272. The hexadecimal (hex) address of the control unit must be a multiple of hex 10 (hex 00, hex 10, hex 20, etc.). If more than 16 devices are attached, the control unit address must be a multiple of hex 20 (hex 00, hex 20, hex 40, etc.).

The B and D models also require an address range. Calculate the number of contiguous addresses as follows:

$$8 \times \text{Number of Type A Terminal Adapters} + \\ 4 \times \text{Number of Type B Terminal Adapters}$$

For example, a control unit address of hex 20 with two Type A Terminal Adapters and three Type B Terminal Adapters would be $16 + 12 = 28$. Therefore, 28 is the number of contiguous addresses. The 3274 B and D models will then respond to addresses hex 20 through hex 3B.

Programming Support

It is important to plan for proper programming support at the host system.

The 3274 clusters can be added to most 3270 display/printer systems with minimal impact on the existing programs. In certain cases, however, host system definition (SYSGEN) parameters will have to be changed to accommodate attachment of a 3274 cluster. Information on programming requirements is given in *IBM 3270 Information Display System: 3274 Control Unit Description and Programmer's Guide*, GA23-0061.

In addition, it is recommended that for 3274 clusters you enhance your system availability and serviceability by installing the online test executive program (OLTEP) at the host system. Contact your IBM representative for information about OLTEP.

For IBM 3270 Personal Computers attached to the 3274, the file transfer program can be used to send and receive files between a personal computer session and a host virtual machine/conversational monitor system (VM/CMS) VM/SP 2.1 or time sharing option (TSO) session. Before either program can be used, the IBM host-supported file transfer program, 5664-281 for VM/CMS or 5665-311 for TSO, must be installed at the host site.

Response Time

The response time (performance/throughput) of the terminals (displays and printers) attached to a 3274 can be significantly affected by many factors. Some of these factors are:

- Inbound and outbound message lengths
- Frequency and content of message (tabbing, modified data tags (MDTs), selects, and so on)
- Type of channel and size of processing unit
- Protocol (systems network architecture [SNA] or non-SNA; binary synchronous communication [BSC] or Synchronous Data Link Control [SDLC])
- Cluster size, network content, and line speed
- Printer speed and type (with or without intelligence, matrix or line printing, LU1, LU2, or LU3 mode, and with or without color option)
- Screen size and features (Programmed Symbols [PS], color, and so on)
- The associated system control and application programs.

To help you to determine response time during the early planning stages of your 3274 display/printer subsystem, it is recommended that you contact your IBM sales representative. He has the tools and facilities to evaluate your 3274 subsystem response time.

Configuration Support

Multiple levels of diskettes (configuration-support levels) are available for the 3274 Control Units discussed in this guide. These levels allow selection of the diskettes (feature, system, and load) that will satisfy your requirements.

To update your 3270 system with additional functions, you may have to change your configuration-support level. Consult your IBM representative for specific functions included in each configuration-support level.

When new function is added to a configuration support, IBM sends its customers, at their request, an update-diskette package. The *Update-Diskette Installation Procedures* (engineering changes) for maintenance enhancements are in Chapter 7.

Note: An engineering change for a particular configuration support can be applied only to a control unit that is customized for the same configuration support.

Configuration Support A

Configuration Support A is shipped unless Configuration Support B, C, or T is specified. It is the base level of 3274 support, including base color on attached terminals, plus support for solicitation of summary maintenance statistics from a 3274 Model 1A, 21A, 31A, 1C/SNA, 21C/SNA, 31C/SNA, and 51C/SNA through the use of Network Problem Determination Application (NPDA).

Configuration Support B (Not Available for Models 1B and 21B)

Configuration Support B provides support for all 3270 functions included in Configuration Support A, plus the ability to attach 3278 Display Station Model 5's, and support for the following functions:

- Pacing of inbound message traffic (Models 1A, 21A, 31A, 1C/SNA, 21C/SNA, 31C/SNA, and 51C/SNA)
- Automatic session recovery in both single- and multidomain networks (1C/SNA, 21C/SNA, 31C/SNA, and 51C/SNA)
- Host notification of changes in the power on/off status at attached terminals (Models 1A, 21A, 31A, 1C/SNA, 21C/SNA, 31C/SNA, and 51C/SNA).

Configuration Support C (Not Available for Models 1B, 21A, 21B, 21C, and 21D)

Configuration Support C provides support for all 3270 functions included in Configuration Support B plus support for the following additional functions:

- Structured Field and Attribute Processing (SFAP) (extended binary-coded decimal interchange code [EBCDIC] only)
- Programmed Symbols (PS) on attached terminals
- Extended Color on attached terminals
- Extended Highlighting on attached terminals
- Decompression of PS load data
- BSC text blocking
- Response time monitor (RTM)
- Alert function
- BSC transparency
- Switched network operation (SNA/SDLC and Model 51C only)
- Integrated modems (Models 31C and 51C only)
- Loop attachment (SNA/SDLC and Model 51C only)
- IBM 3270 Personal Computer Attachment
- IBM 4250 Model 1.

Configuration Support T (Not Available for Models 1B, 21A, 21B, 21C, and 21D)

Configuration Support T provides support for the 3290 Information Panel in addition to the other 3270 functions and terminals *except*:

- Category B terminals
- 3279 Extended Color models
- Structured Field and Attribute Processing (SFAP)
- Programmed Symbols (PS)
- Loop Adapter
- X.21 Adapter
- Encrypt/Decrypt

- Entry Assist
- 4250 Printer Attachment
- Alert function
- Response time monitor (RTM).

Encrypt/Decrypt Feature (3274 Models 1C, 21C, 31C, and 51C)

It is the customer's responsibility to install a copy of the secondary logical unit (LU) key (the terminal master key) in the 3274 Control Unit equipped with Encrypt/Decrypt (feature 3680). This should be done by someone in a position of trust, such as a security officer. Once the terminal master key has been installed in the 3274, the 3274 generates a verification pattern based on the terminal master key. A master-key verification procedure can be performed by any operator without compromising the security of the Encrypt/Decrypt feature. A mercury battery, IBM Part 1743456, is installed in the 3274 to sustain the terminal master key when the 3274 power is off. Replacing this battery, or its equivalent, is also a customer responsibility. Procedures to install and verify the terminal master key, and to replace the mercury battery, are described in *IBM 3270 Information Display System 3274 Operator's Reference and 3274/3270 Problem Determination Guide*, GA27-2850.

Refer also to *IBM Cryptographic Subsystem Concepts and Facilities*, GA22-9063, for background information, and to *IBM 3270 Information Display System: 3274 Control Unit Description and Programmer's Guide*, GA23-0061, for programming information.

IBM 3270 Personal Computer Compatibility with the 3274

If any IBM 3270 Personal Computers are included in the subsystem, obtain a copy of the Information Worksheet that is used for customizing the IBM Personal Computer system diskette. Make sure that the information on this worksheet agrees with the responses given to the sequence numbers during 3274 customizing. Refer to *IBM 3270 Personal Computer Introduction and Preinstallation Planning*, GA23-0179, for more information.

3290 Compatibility with the Host

If any 3290 Information Panels are included in the subsystem, check whether setup level 3 changes are required to make the 3290s compatible with their definition at the host. If so, after customizing is completed and an initial microcode load (IML) of the system has been performed, it may be necessary to set the control unit offline before switching on the 3290. Otherwise, errors may occur when the host tries to communicate with the 3290.

Predelivery Planning

The local channel-attached models of the 3274 are installed by an IBM service representative. The remotely attached models, on the other hand, are set up by your personnel. To prevent delays and help ensure a smoother installation/setup, it is recommended that a designated person in your organization:

1. Compile the installation-dependent information described in this section.
2. Distribute the installation-dependent information to the appropriate personnel or to the IBM service representative.
3. Coordinate the activities of your personnel and/or the IBM service representative.

Local Channel Cables

The I/O interface and power sequencing cables between a 3274 and a local channel will be installed and connected by IBM. However, these cables must be ordered by cable order unless you are replacing a 3272 with a 3274, in which case, the same cables can be used.

Communication Cable

The communication cable that connects the remotely attached 3274 to the modem or channel service unit is delivered with the 3274. This cable is connected to the 3274 by the setup personnel. Instructions for connecting the communication cable to the 3274 are provided by the 3274 Setup Instructions delivered with these models. Connection to the modem or channel service unit is described in Appendix F.

System Grounding for a Remotely Attached 3274

Frame ground (EIA RS232 or CCITT V.28 pin 1) and signal ground (EIA RS232 or CCITT V.28 pin 7) should be connected together at one point only. This can be either in the 3274 or in the modem or channel service unit. It is recommended that, if possible, this connection be made in the modem or channel service unit.

In Europe/Middle East/Africa countries, the majority of modems do not have this connection made. For this reason, connection has been made within the remotely attached 3274 models at the plant of manufacture.

Note: If you are replacing a 3271 or 3275 with a 3274 Model 1C, 21C, 31C, or 51C, the modem should already have signal ground and frame ground connected together. However, this should be verified with your communication supplier.

Fan-Out Feature: This feature permits two or more control units to be connected to a single modem. If the modem has this capability, it is imperative that the signal ground and frame ground wires be connected together in the modem.

3274 Device Cables

The device cables are the coaxial cables that connect the 3274 to its attached display stations and printers either directly or via the IBM 3299 Terminal Multiplexer. These cables should be procured and installed before the delivery of the 3274 and of the units that will be attached to the 3274. Your personnel (or contractor) will connect these cables to the 3274 and to the attached terminals.

Note: If you are replacing a 3271 or a 3272 with a 3274, you can use the existing device cables between the 3271/3272 and the attached units. However, the 3271 or 3272 device cables must be connected/disconnected by an IBM service representative, because the 3271 and 3272 and the attached units do not have customer access areas. It is recommended that, before the IBM service representative disconnects these cables, you have the cables marked as described below.

To reduce delays associated with connecting these cables to the 3274, it is recommended that each cable be marked at both ends to identify:

- The 3274 connector panel type (Category A panels or Category B panels) and the 3274 port (0 to 31) to which it is to be connected
- The unit type of the terminal to be attached.

For additional information concerning device cables, refer to *IBM 3270 Information Display System: Installation Manual—Physical Planning*, GA27-2787.

IBM 3299 Terminal Multiplexer

The IBM 3299 Terminal Multiplexer provides improved flexibility in the installation of a 3270 Information Display System by reducing the amount of coaxial cabling required in an installation.

IBM 3270 Information Display System terminals are usually connected to the 3274 Control Unit by coaxial cables. In some installations, available space for these cables runs out as the number of terminals installed grows. The 3299 attaches up to eight terminals. A single cable is used between the 3299 and the 3274 Control Unit, thus saving significant amounts of coaxial cable.

The 3299 will be of interest primarily to customers installing newly acquired 3270 systems, expanding existing systems, or relocating large numbers of 3270 terminals. The 3299 will normally be installed at about the same time that coaxial cabling is installed.

For details about the 3299, see *IBM 3270 Information Display System: IBM 3299 Terminal Multiplexer Product Information*, G520-4216.

Device Cable Attachment Forms

A 3274 Device Cable Attachment Form is provided in Appendix B of this guide to help simplify marking and connecting the cables. Instructions for completing all portions of the form except Network Addresses and for using the form are also included in Appendix B. A form should be completed for each 3274 cluster you order. Copies of the completed form should be given to the personnel who will install and mark the cables and to the personnel who will connect the cables to the 3274. In addition, a copy of the form should be stored in the pocket inside the 3274 customer access door for future reference.

Network Address Labels

Hexadecimal address labels (IBM Part 1743290) are delivered with the 3274. (They will be found, together with an *IBM 3274 Control Unit Problem Report Form*, GX23-0203, and *IBM 3274 Configuration Data Card (Configuration Support: A, B, C, T)*, GA23-0046, in the pocket inside the 3274 customer access door. On the Model 51C they are in the diskette storage area on the front of the machine.) After each terminal is set up, the label that specifies the terminal's network address should be attached to the address label holder on the terminal (if present).

It is recommended that a designated person in your organization (1) obtain the network addresses from the system programmer, (2) enter the addresses in the Network Address column of the 3274 Device Cable Attachment Form in Appendix B, and (3) distribute the address information to the person who will attach the address labels.

For information concerning SNA network addresses, refer to *Systems Network Architecture General Information: Network Addresses*, GA27-3102; for information concerning BSC network addresses, refer to *IBM 3270 Information Display System: 3274 Control Unit Description and Programmer's Guide*, GA23-0061.

Installing Your 3274 Subsystem

When your subsystem arrives and you are ready to install the equipment, you will need some information that is packaged with the various components (unpacking instructions, setup instructions, and problem determination information) and some that will be extracted from this manual (customizing forms, subsystem verification procedure, color convergence procedure for the 3279, Printer Authorization Matrix Form, and Model 31C or 51C switch setting instructions). Some of the forms in this manual require that you fill in information that is unique to your installation. It is recommended that you perform your installation in the following sequence.

Before Equipment Arrives

1 Prepare the physical location.

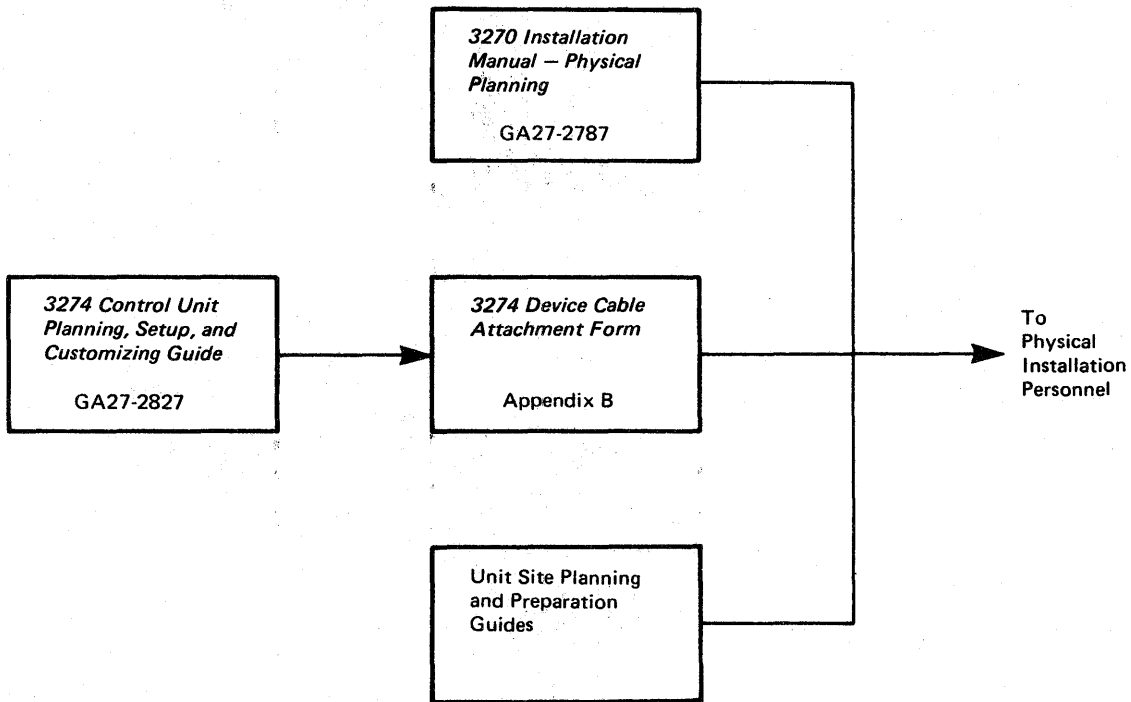

2 Prepare installation-unique information.

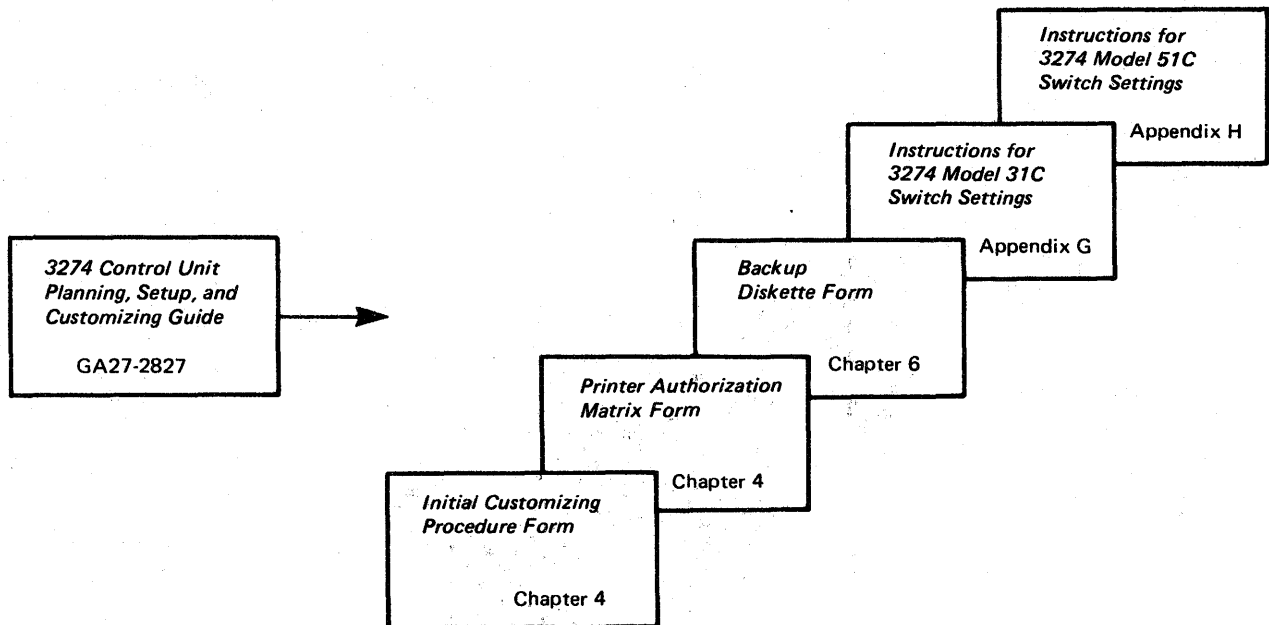

After Equipment Arrives

Note: Each unit has a Problem Determination Guide packaged with it. If a problem arises while you are setting up a particular component, consult the guide for that component before calling IBM.

3 Unpack and set up the display terminals.

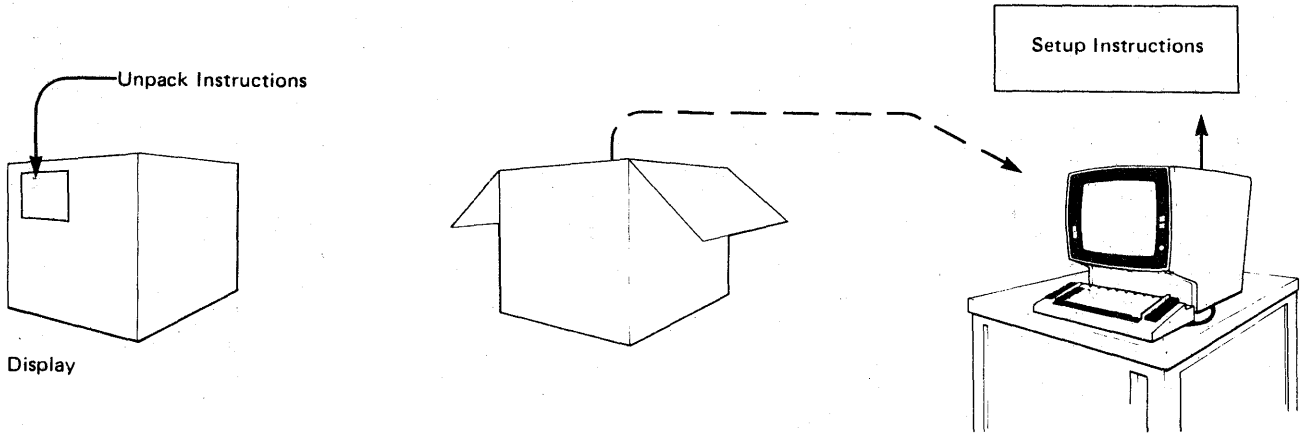

4 Unpack and set up the printers.

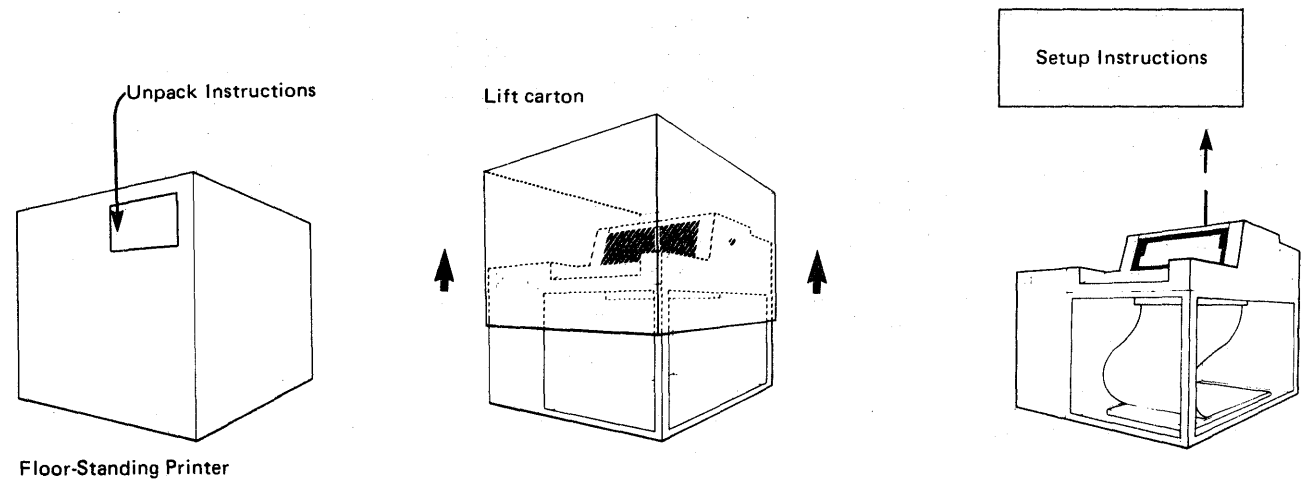
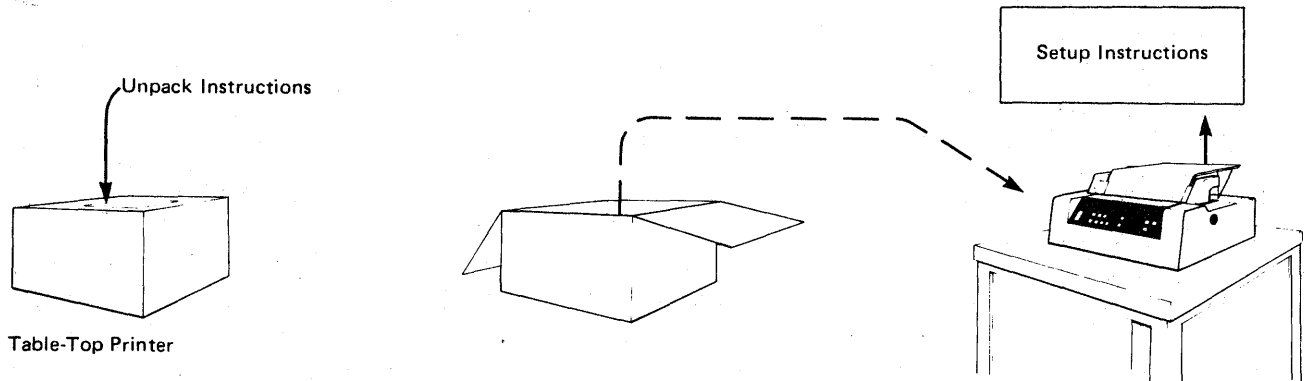

5 Unpack and set up the 3274 Control Unit.

Note: Because special skills and tools are needed to set up A, B, and D models, call your IBM service representative after your personnel have unpacked and placed the unit. Your personnel should continue at step 06 when the IBM service representative completes the setup.

3274 Control Unit
All Models except 51C

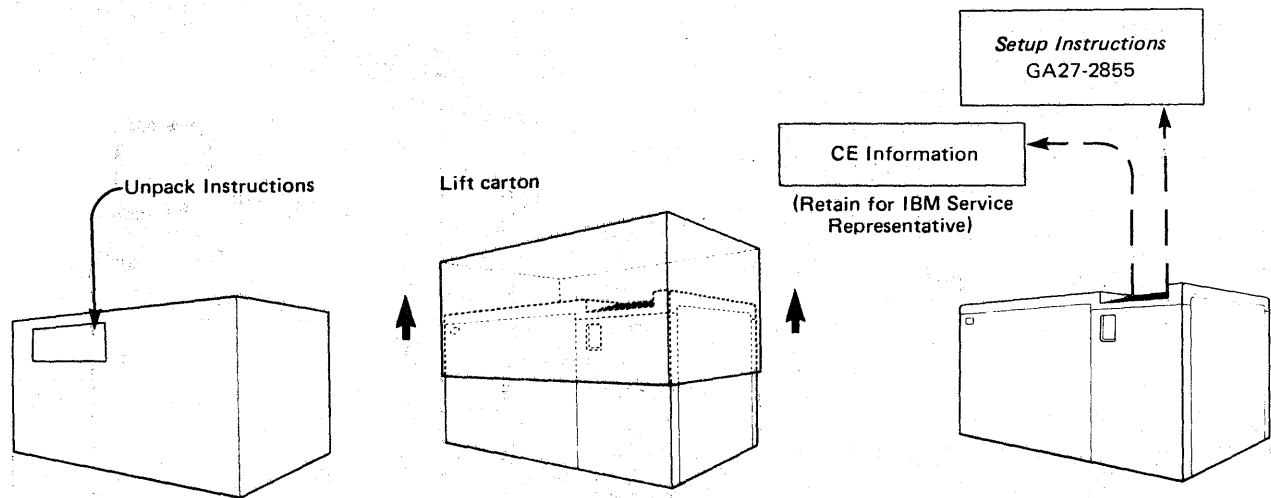

3274 Control Unit
Model 51C

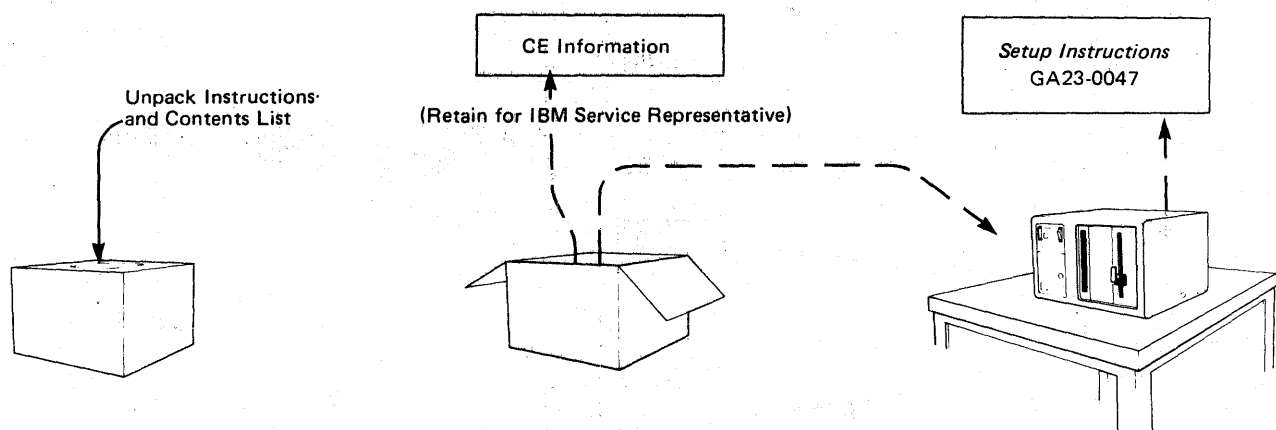

6 Connect the terminals.

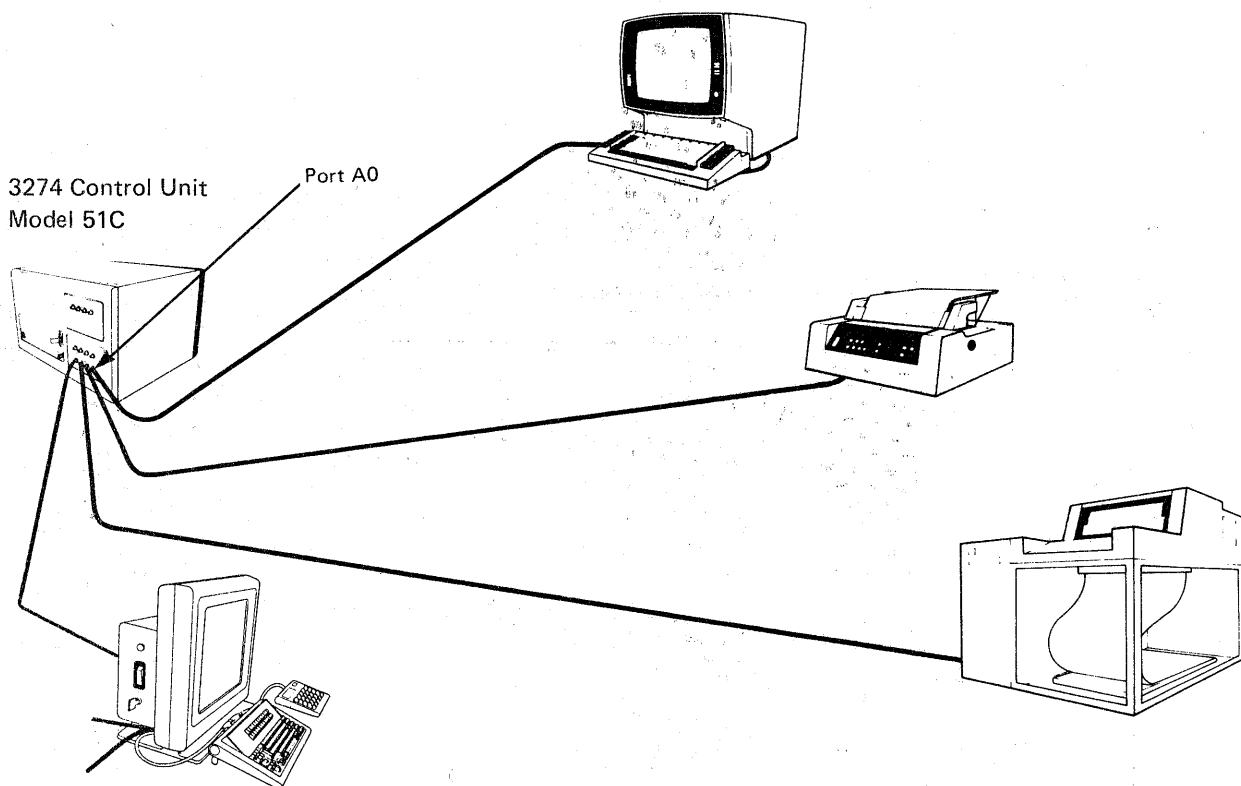
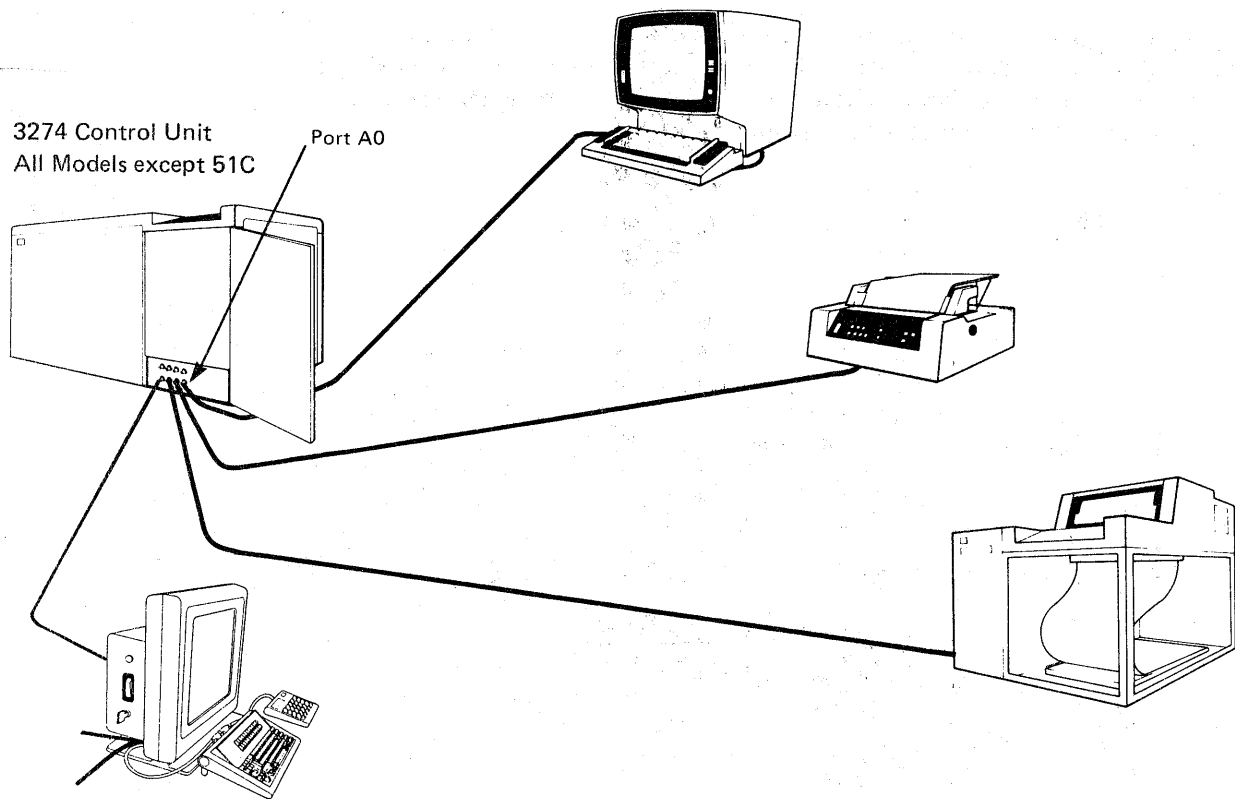

7 Supply customizing information.

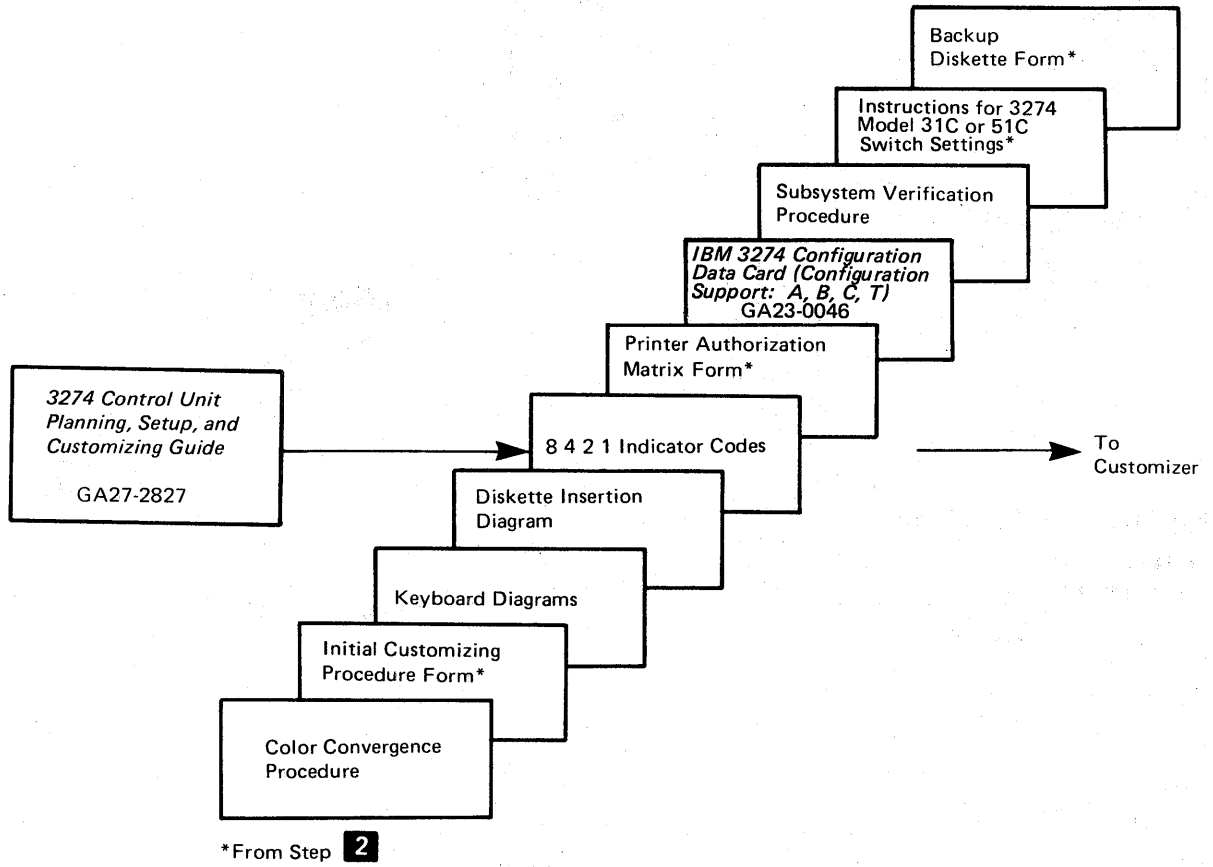

8 Verify the validation numbers.

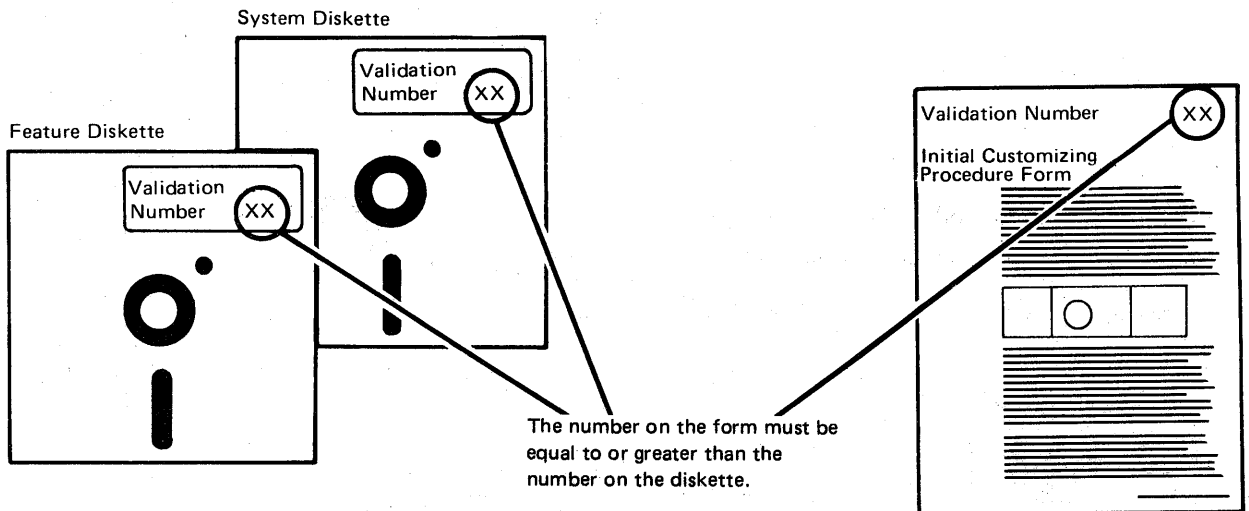

9 Customize the 3274 Control Unit.

3274 Control Unit
All Models except 51C

3274 Control Unit
Model 51C

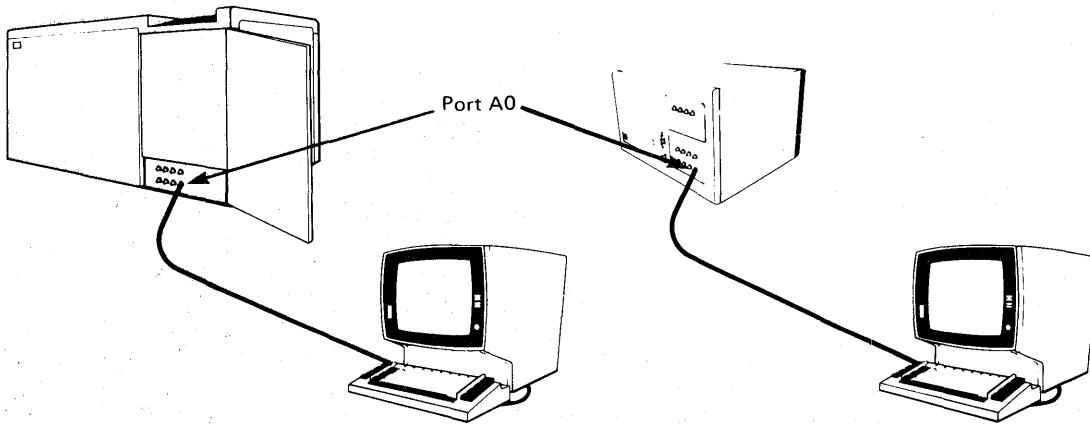

10 Press the IML pushbutton on the control panel.

3274 Control Unit
All Models except 51C

3274 Control Unit
Model 51C

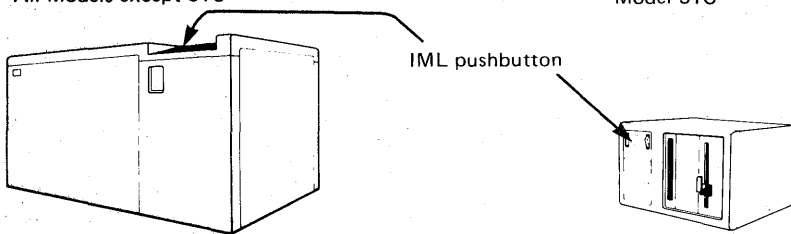

11 Perform subsystem verification.

Note: Go to Appendix D in this manual.

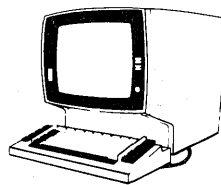

12 Set the 3274 Model 31C or 51C switches.

Note: Go to Appendixes G and H in this manual.

3274 Control Unit
Model 31C

3274 Control Unit
Model 51C

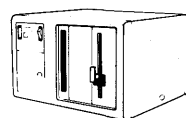
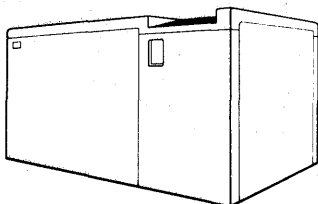

Replacing a 3271 or a 3272 with a 3274

When a 3272 is replaced by a local channel-attached model of the 3274, the existing 3272 local channel attachment and device cables (coaxial cables between the 3272 and its attached units) can be used with the 3274. However, if the existing 3277/3284/3286/3288 units are to be attached to the 3274, the device addresses of these units have to be changed. For information concerning device addresses for the 3274 cluster, refer to *IBM 3270 Information Display System: 3274 Control Unit Description and Programmer's Guide*, GA23-0061.

The 250V watertight plug used on the 3272 is not compatible with the 3274 waterproof plug. Therefore, when a 3272 is replaced by a 3274, the power receptacle must be changed prior to installation of the 3274. See *IBM 3270 Information Display System: Installation Manual—Physical Planning*, GA27-2787, for the type required.

When a 3271 is replaced by a remotely attached model of the 3274, the existing 3271 device cables and modem can be used with the 3274. However, the device addresses of the existing 3277/3284/3286/3288 units and the communication cable that connects the 3271 to its modem cannot be used with the 3274. A new communication cable is delivered with the 3274.

If the existing 3271 or 3272 device cables are to be used with the 3274, it is recommended that the cables be marked as described under "3274 Device Cables."

Notes:

1. *The 3277 keyboards and operator ID card readers can be used only with the 3277 Display Station.*
2. *The 3274, when operating in BSC mode, functions as a 3271 Control Unit, but is not compatible with the 3275 Display Station.*

When a 3271 or a 3272 is replaced by a 3274, the following should be considered:

- The 3274 can control up to sixteen 3277s/3284s/3286s/3288s. Therefore, more than one 3274 is required to replace a 3271 or 3272 that has more than 16 of these units attached.
- The 3274 needs a 3178, 3179, 3180, 3278, or 3279 attached to port A0.

Note: All the 3271 or 3272 device cables must be connected/disconnected by an IBM service representative, because the 3271 or 3272 and the attached units do not have customer access areas.

Problem Determination Procedures

The problem determination procedures will help you perform problem determination with minimal reliance on the host system. These procedures use tests contained in the terminals. See *IBM 3270 Information Display System Library User's Guide*, GA23-0058, for a list of problem determination manuals.

The procedures enable you to determine whether a problem is being caused by a cluster unit, a system unit or function outside the 3274 cluster, or an operator error. You will also be able to determine whether:

- Operation in a degraded mode is possible
- Useful work can be done until the problem is corrected
- The repair action can be scheduled for deferred maintenance.

If you require the help of an IBM service representative, the error message and error condition information should be recorded on a problem report form for the failing unit before the service representative is called. This information will help the service representative resolve the problem as soon as possible.

Relocation/Removal

To ensure proper handling and/or shipping of the 3274 and the attached terminals when the units are removed or relocated to a different room, building, or mailing address, it is recommended that you call your local IBM branch office. Your IBM representative will supply you with the necessary information and can order the required materials.

Note: The help of an IBM service representative is required to relocate a local channel-attached 3274.

Progress Review

To ensure a smooth installation and/or setup of the 3274 and attached terminals, it is recommended that approximately two months before delivery of the units you and the IBM representative review (1) the progress (or the schedule associated with the changes) at the host system site, (2) the communication network and modems, (3) the physical changes needed at the cluster site, and (4) the progress of the predelivery planning tasks. At the same time, you and your IBM representative can review the cluster configuration to determine whether the feature mix is adequate.

It is also recommended that about two weeks before delivery of the units a designated person in your organization and the setup personnel review the setup instructions with your IBM representative.

IBM Americas/Far East and IBM Europe/Middle East/Africa

The predelivery/setup responsibilities and procedures for the 3274 Models 1C, 21C, 31C, and 51C, and for attached display stations and printers, are the same for U.S. installation and for installation in countries served by IBM Americas/Far East and IBM Europe/Middle East/Africa.

If you need IBM publications in languages other than English, ask your IBM representative. The IBM representative can provide information concerning the availability of translated IBM publications.

Supplemental Information

Safety

The 3270 units are listed by the Underwriters' Laboratory. Exposed hazardous voltages are not present at the designated customer access areas of the units.

DANGER

Your personnel should be warned not to go beyond the customer access areas, because there are hazardous voltages within the areas designated for trained personnel only.

Electrical grounding of the 3274 and of all the attached units is essential for safety. Be sure that all the facility power receptacles are properly grounded and will accept a grounding type plug (3-prong or equivalent). If you have any questions about the grounding of power receptacles, contact an electrician. For information about power cord plugs, power receptacles, and other safety considerations, refer to *IBM 3270 Information Display System: Installation Manual—Physical Planning*, GA27-2787.

Security

If the 3274 and the attached units have access to proprietary records or personnel records, it is recommended that you implement appropriate safeguards for the security of the information and the units. In addition to safeguards that you may develop, accessories such as the Magnetic Hand Scanner and the Magnetic Slot Reader may be available for attachment to your display stations. Also available with the remotely attached models of the 3274 is an Encrypt/Decrypt feature that enhances data security in an SNA-communication environment.

Personnel Training

If you intend to provide formal training for your operators, you may wish to use the operator's guides and problem determination guides that are available for your units. See *IBM 3270 Information Display System Library User's Guide*, GA23-0058, for a list of the manuals appropriate to your installation.

Voice Communication between Terminal Operators and Host System Operators

It is recommended that a telephone be available at each location to allow the 3274 cluster operators to talk with the host system operators. This will assist the operators in performing the problem determination procedures as well as the daily work.

Chapter 2. Introduction to Customizing

Once installation of your 3274 Control Unit is completed as shown in the appropriate "Setup Instructions" and the device cables are connected, you are ready to configure your system of displays and printers. The 3274 Control Unit permits you, the user, to specify the configuration under which your 3274 operates; that is, you customize your 3274 subsystem. The configuration information is stored on a diskette mounted inside the 3274 and enables the 3274 to control all the terminals attached to it. This diskette, delivered with the 3274, also contains microcode to direct control unit functions and perform diagnostic routines to test the 3274 prior to operation. But before this diskette can function in your system, you must customize it by writing your configuration information on it.

Briefly, you perform customizing by typing in the system parameters at a 3178, 3179, 3180, 3278, or a 3279 attached to port A0 of the 3274. If a 3179 is used, it must be operating in 3279-emulation mode. If a 3180 is used, it must be operating in 3278-emulation mode. As a result of this procedure, a unique configuration table is written on the diskette. If 3290 Information Panels are being used with the 3274, the configuration table is written onto a *load* diskette. If no 3290s are being used, the configuration table is written onto a *system* diskette. In daily operations, the operator inserts this customized diskette in the 3274 and presses the on/off switch to the on position, or, if this switch is already on, presses the IML pushbutton. This action causes the 3274 to execute the diagnostic routines stored on the diskette. Upon successful completion of these tests, the 3274 is loaded with the configuration data that was stored on the diskette by the customizing procedure. System operation can now begin.

There are various occasions when it will be necessary to customize your system or load diskette(s):

- When you initially customize your diskette (as described above).
- When you wish to duplicate your diskette. (This new diskette is referred to as a *backup* diskette.)
- When you wish to generate a second diskette to be used for a different purpose; for example, you may choose to have one diskette to operate in BSC mode and another to operate in SDLC/SNA mode.
- When you need to recustomize your diskette because you have changed your configuration. This includes adding or removing features such as Encrypt/Decrypt or terminal adapters.

Customizing a 3274 Control Unit usually involves a planner and someone responsible for the actual customizing operation. The planner identifies and compiles the configuration information needed for each 3274 and gives it to the person responsible for customizing the 3274. This person is prompted by a series of sequence numbers that are displayed in the form of three digits. The responses to these sequence numbers are usually entries of 1 to 8 alphanumeric characters. The display station used for this operation must be attached to port A0 of the 3274. The display station should also be near the 3274 during customizing because certain indicators must be observed on the 3274. (If you are using a 3279 Color Display Station, a color convergence procedure may have to be performed before customizing. The color convergence procedure is described in Appendix E.)

In general, the person who customizes the system or load diskette uses a *language* diskette and a *feature* diskette in conjunction with the customizing procedure. The language diskette is used to customize the system or load diskette for languages other than English (U.S.), Canadian (Bilingual), Canadian French (all are EBCDIC), and American National Standard Code for Information Interchange (ASCII) (U.S.). (ASCII is available in the U.S. only.) The feature diskette is used to customize the system or load diskette for all other cluster parameters. The detailed customizing procedures explain when to insert the required diskettes and direct the person customizing the 3274 to enter the configuration information into the 3274 through a display station attached to port A0 of the 3274.

To simplify the customizing task, it is recommended that the planner compile the configuration information and supply it to the person responsible for performing the customizing procedure. Included in Chapter 3 are descriptions of the parameters to be entered and instructions for completing the Initial Customizing Procedure Form (Chapter 4). A form should be completed for each 3274 ordered before delivery of the unit. In addition, configuration information should be copied on the *IBM 3274 Configuration Data Card*, GA23-0046, (shipped with the 3274) and stored in the 3274. (A pocket on the inside of the 3274 customer access door is a convenient place to store this card. On the Model 51C, this card is stored in the diskette storage area on the front of the machine.)

Subsystem Verification

After customizing is completed, all devices are attached to the 3274, and an initial microcode load (IML) of the subsystem has been performed, it should be verified that the control unit can reach all attached devices. This can be done by means of the "Subsystem Verification Procedure" in Appendix D. This procedure allows the operator to:

- Verify the number of type A and B devices configured
- Determine whether a device is powered on or off
- Determine whether a device has been disabled as a result of a device error.

This procedure should be given to the person responsible for performing the customizing procedure.

3274 Model 31C and 51C Switch Settings

It may be necessary to set various switches on the 3274 Models 31C and 51C prior to operation. Information needed to set these switches is given in Appendix G for Model 31C and in Appendix H for Model 51C. Instructions for the person who will do the customizing are included in these appendixes.

Preparation for Customizing

To prepare for customizing, it is recommended that the planner:

1. Use Chapter 3 as a guide to determine what configuration information is needed for each 3274 model. Figure 2-1 and the sequence number descriptions identify the information sources.
2. Using Figure 2-1 as a guide and the sequence number descriptions in Chapter 3, compile the needed information for each 3274 and fill in the Initial Customizing Procedure Form in Chapter 4.

Note: An operator experienced in customizing may want to use the *IBM 3274 Configuration Data Card (Configuration Support: A, B, C, T)*, GA23-0046, instead of the Initial Customizing Procedure Form to customize the 3274. A copy of this card is included at the end of Chapter 4.

The sequence number descriptions in Chapter 3 are grouped as follows:

3274 Models 1A, 21A, and 31A

3274 Models 1B, 1D, 21B, 21D, and 31D

3274 Models 1C, 21C, 31C, and 51C

3. Identify each diskette. A label in the upper right corner of the diskette identifies the diskette type by name, IBM part number, and validation number. The IBM part numbers (listed according to Configuration Support A, B, C, or T) are:

	A	B	C	T
Feature diskette	5718400	5675100	5675102	6062688
System diskette	5718420	5675101	5675103	6062689
Language diskette	5718440	5718440	5862415	6870779
Load diskette	—	—	—	6062856

In addition, you may wish to write a unique designation of your own on the label; for example, you could specifically identify it as to configuration and 3274 Control Unit in which it is to be customized and used.

Sequence Number	Function	3274 ¹					Notes	Response Definition
		1A, 21A, 31A	1B, 21B	1C, 21C, 31C	51C	1D, 21D, 31D		
001	Keyboard validation	X	X	X	X	X	1	—
011	Patch request	X	X	X	X	X	1	—
021	Printer authorization matrix	X	X	X	X	X	2	0=No 1=Yes
022	Printer authorization matrix specification	X	X	X	X	X	1	See Chapter 3.
031	Number of RPO diskettes required	X	X	X	X	X	3	0=Not required 1=One diskette required 2=Two diskettes required 3=Three diskettes required
032	Request RPO parameter list	X	X	X	X	X	4	0=No 1=Yes
111	Number of Category B terminals (Configuration Support A, B, and C only)	X	X	X	X	X	—	See Chapter 3.
112	Number of Category A terminals	X	X	X	—	X	—	See Chapter 3.
113	Extended function store	X	—	X	X	X	3	See Chapter 3.
114	IBM 3270 Personal Computer Attachment	X	—	X	X	X	5	0=No 1=Yes
121	Keyboard language/character set I/O interface code	X	X	X	X	X	3	See Chapter 3.
127	Response Time Monitor (RTM) definition	X	—	X	X	—	3	See Chapter 3.
128	RTM boundaries and interface specification	X	—	X	X	—	3	See Chapter 3.
131	Typewriter keyboard	X	X	X	X	X	3	0=No 1=Yes
132	Data entry keyboard	X	X	X	X	X	3	0=No 1=Yes
133	Data entry keypunch layout keyboard	X	X	X	X	X	3	0=No 1=Yes
134	APL keyboard	X	—	X	X	X	3	0=No 1=Yes
135	Text keyboard	X	—	X	X	X	3	0=No 1=Yes
139	Keypad selection (Configuration Support T only)	X	X	X	X	X		See Chapter 3.
141	Magnetic character set	X	X	X	X	X	3	A=No B=Numeric (3277-compatible) C=Alphanumeric (auto entry for nondisplay data) D=Alphanumeric (auto entry for all data)
143	Host-loadable printer authorization matrix	X	X	X	X	X	2	0=No 1=Yes
145	3289 print control	X	X	X	X	X	2	0=No 1=Yes
147	Local-copy function	—	—	X	X	X	2,6	0=No 1=Yes
151	3274 Model designation	X	X	X	X	X	3	1,2,3,4, A,B,C,D,E
161	Color convergence	X	X	X	X	X	3	0=No 1=Yes
162	Structured field and attribute processing (SFAP)	X	—	X	X	X	5	0=No 1=Yes
163	Extended character set adapter	X	—	X	X	X	5	See Chapter 3.
164	Programmed Symbols (PS)	X	—	X	X	X	5	0=No 1=Yes
165	Decompression	X	—	X	X	X	5	0=No 1=Yes
166	Attribute Select keyboard	X	—	X	X	X	5	A=None B=Without numeric lock C=With numeric lock
170	Distributed function terminals	X	—	X	X	X	—	0=No 1=Yes, with and without load diskette 2=Yes, without load diskette
171	Multiple interactive screens	X	—	X	X	X	—	See Chapter 3.
173	3290 options	X	—	X	X	X	—	See Chapter 3.
175	3290 password	X	—	X	X	X	—	See Chapter 3.
176	BSC enhanced communication option	—	—	X	X	—	—	0=No 1=Yes
201	SNA local channel control unit address	X	—	—	—	—	2	See Chapter 3.

Figure 2-1 (Part 1 of 2). Configuration Information Needed

Sequence Number	Function	3274 ¹					Notes	Response Definition
		1A, 21A, 31A	1B, 21B	1C, 21C, 31C	51C	1D, 21D, 31D		
211	SCS support (SDLC only)	X	—	X	X	—	3	0=No 1=Yes
213	Between bracket printer sharing (SDLC only)	X	—	X	X	—	2	0=No 1=Yes
215	Physical unit identification (PUID) (SDLC only)	X	—	X	X	—	2	See Chapter 3.
220	Alert Function (SNA only)	X	—	X	X	—	5	See Chapter 3.
301	Control unit number (BSC only)	—	—	X	X	—	2	See Chapter 3.
302	SDLC control unit address	—	—	X	X	—	2	See Chapter 3.
305	BSC printer polling	—	—	X	X	—	6	0=No 1=Yes
310	Modem connection	—	—	X	X	—	3	See Chapter 3.
311	Modem wrap (external modems only)	—	—	X	X	—	3	0=Not possible 1=Possible
313	NRZI (SDLC only) or NRZ encoding	—	—	X	X	—	3,7	0=NRZ 1=NRZI
313	Internal or external clocking (BSC only)	—	—	X	X	—	6	0=External 1=Internal
314	Multipoint or point-to-point network	—	—	X	X	—	3,7	0=Multipoint 1=Point-to-Point
317	Switched network backup (SNBL)	—	—	X	X	—	3,7	See Chapter 3.
318	Normal or half-speed transmission	—	—	X	X	—	3,7	0=Normal 1=Half
321	ASCII or EBCDIC character set	—	—	X	X	—	3,7	0=EBCDIC 1=ASCII
331	BSC or SDLC protocol	—	—	X	X	—	3,7	0=BSC 1=SDLC
342	Request-to-send (RTS) control (2-wire or 4-wire)	—	—	X	X	—	3,7	See Chapter 3.
343	Communications interface options	—	—	X	X	—	3,7	See Chapter 3.
345	Answer tone (Configuration Support C and T only; World Trade external switched network modems only)	—	—	—	X	—	—	0=Transmit Answer Tone Required 1=Transmit Answer Tone Not Required
347	High-speed data rate (Configuration Support C and Loop Attachment only)	—	—	—	X	—	—	0=Data rate less than 38.4K 1=Data rate 38.4
351	HPCA (SDLC only) or CCA adapter	—	—	X	X	—	3,7	0=CCA 1=HPCA
352	Encrypt/Decrypt (SDLC only) (Configuration Support A, B, and C only)	—	—	X	X	—	3	0=No 1=Yes
360	X.21 Switched retry (Configuration Support C and SDLC only)	—	—	—	X	—	—	00=X.21 Switched not used XX=Number of retries Minimum 00
361	X.21 Switched retry timing (Configuration Support C and SDLC only)	—	—	—	X	—	—	00=X.21 Switched not used XX=Number of seconds between retries, must be from 01 to 20.
362	X.21 Switched option (Configuration Support C and SDLC only)	—	—	—	X	—	—	See Chapter 3.
900	Entry acceptance	X	X	X	X	X	1	—
901	Printer authorization matrix acceptance	X	X	X	X	X	1	—
904	Response Time Monitor Acceptance	X	X	X	X	X	—	See Appendix K.
999	Specification panel	X	X	X	X	X	1	—

¹ An X in the model column indicates needed information; a dash indicates not applicable.

Notes:

1. Information is already identified on the Initial Customizing Procedure Form.
2. Obtain information from the system programmer.
3. Obtain information from equipment orders placed with IBM, with the common carrier, and (if necessary) with the modem manufacturer.
4. An RPQ parameter list is required by certain RPQs. Specific information is supplied with the RPQ.
5. Does not apply to Models 1B, 21A, 21B, 21C, and 21D.
6. Models 1C, 21C, 31C, and 51C BSC only.
7. This parameter must be compatible with the host-system communication controller and/or the modem.

Figure 2-1 (Part 2 of 2). Configuration Information Needed

4. Enter the following information on the Initial Customizing Procedure Form in Chapter 4:
 - a. The type of keyboard (typewriter or data entry) to be used by the operator during customizing.

Note: If using a 76- or 88-key Japanese English or Japanese Katakana keyboard, specify the number of keys and keyboard type.
 - b. In step 1, the identification of each diskette to be used.
 - c. In step 7, the response to sequence number 031. This is the number (0, 1, 2, or 3) of RPQ diskettes to be used. If your response to sequence number 031 is not 0, you will have to enter a response to sequence number 032. See "032 (Request RPQ Parameter List)" in Chapter 3.
 - d. In step 8, the responses to be keyed in by the operator, using as a guide the information in Chapter 3 that applies to the model to be customized. Use that portion of the step that applies to your configuration.
5. Fill out the Printer Authorization Matrix Form at the end of Chapter 4 if the printer authorization matrix is to be defined, or if changes are to be made to the existing matrix.
6. Give the following to the operator who will customize the 3274:
 - a. A copy of the Color Convergence Procedure (Appendix E) (if required)
 - b. The completed Initial Customizing Procedure Form (this is a multipage form)
 - c. A copy of the *IBM 3274 Configuration Data Card (Configuration Support: A, B, C, T)*, GA23-0046
 - d. The completed sequence number 128 Procedures Form (if applicable).
 - e. A copy of the appropriate keyboard layout showing valid keys for the keyboard the operator will be using (Figures 4-1 and 4-2, in Chapter 4)
 - f. The completed Printer Authorization Matrix Form (if required)
 - g. The 3274 Diskette Insertion Procedure that applies to the 3274 being customized (Figure 4-3)
 - h. A copy of the "Operator Codes" chart (Figure 4-4, in Chapter 4)
 - i. Copies of the "8 4 2 1 Indicator Codes" charts (Figures 4-5 through 4-7, in Chapter 4)

- j. Feature and system diskettes
- k. Language diskette (if applicable)
- l. Load diskette (if applicable)
- m. RPQ diskette(s) (if applicable)
- n. RPQ parameter list instructions (if applicable)
- o. A copy of the Subsystem Verification Procedure (Appendix D)
- p. Instructions for setting Model 31C switches (if applicable, Appendix G) or Model 51C switches (if applicable, Appendix H)
- q. Sequence number 128 procedures for installing the RTM function (Appendix K).

It may be convenient for the planner at the central or host-system location to prepare the Initial Customizing Procedure Forms for several 3274s at other locations and to forward the forms to each location.

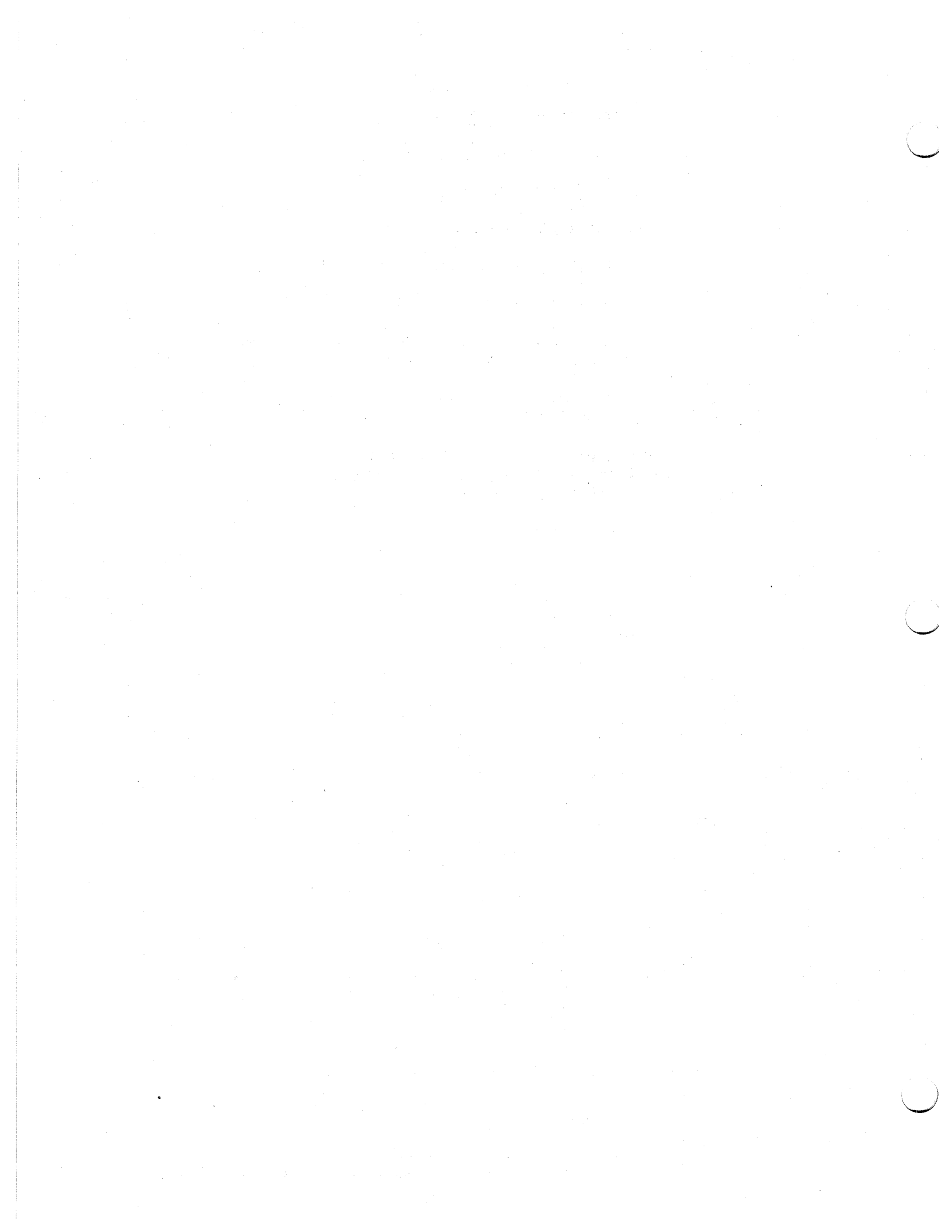

Chapter 3. Preparing to Customize

This chapter supplies the information the planner needs to fill in the Initial Customizing Procedure Form in Chapter 4. The sequence numbers for customizing the 3274 Control Unit are grouped by model under three headings:

1. 3274 Models 1A, 21A, and 31A
2. 3274 Models 1B, 1D, 21B, 21D, and 31D
3. 3274 Models 1C, 21C, 31C, and 51C.

Select the heading that includes the model to be customized, and write the replies in step 8 of the Initial Customizing Procedure Form in Chapter 4. The sequence numbers are listed here and on the form, from left to right, top to bottom, in numeric order; however, they may not be displayed on the display station screen in numeric order. Although all sequence numbers are listed in each group of models, only those required for the model being customized are explained. All other sequence numbers instruct the planner to insert a zero response on the Initial Customizing Procedure Form. This is necessary because all sequence numbers will be displayed after the responses are typed in. The sequence numbers that are not applicable to the model being customized will be filled in with the default values. See the section for your 3274 model for the default values.



3274 Models 1A, 21A, and 31A

Use the following sequence numbers and instructions in conjunction with the Initial Customizing Procedure Form in Chapter 4 to customize 3274 Models 1A, 21A, and 31A.

001: Keyboard Validation

The response required for this sequence number is '1234567890ABCDEF' followed by a space and the validation number that is printed on the front cover of this book and on the first page of the Initial Customizing Procedure Form. The first part of the response verifies that the keyboard being used for customizing is operating properly. The last two digits (the validation number) are used to check that the level of this customizing guide is equal to or greater than the level of the feature and system diskettes.

Note: If a data entry keypunch layout keyboard is used, the New Line key is pressed when ENTER is specified. Also, the PF10 key is pressed when RESET is required; the PF8 key is pressed when New Line is required. See Figures 4-1 and 4-2 (in Chapter 4) for valid key positions and for the differences just noted. Be sure to specify the keyboard type on the Initial Customizing Procedure Form.

011: Patch Request

The response required for this sequence number is already entered on the form in step 5. The IBM service representative may use this sequence number to make a diskette patch request.

021: Printer Authorization Matrix

Enter a 0 in step 6 on the Initial Customizing Procedure Form if any of the following conditions applies:

- The printer authorization matrix is to be entered only by a host application program (a 1 must be specified in sequence number 143).
- All printers are to be used in system mode, and local copy operations are not desired.
- No printers are to be attached to the system.

Enter a 1 if a matrix is to be defined, thereby causing sequence number 022 to be displayed. Regardless of the response to sequence number 143, the matrix specified in sequence number 022 will remain in effect each time the 3274 is IMLed.

022: Printer Authorization Matrix Definition

The printer authorization matrix is defined in sequence number 022. See Appendix C for detailed information on responding to sequence number 022.

Fill in the appropriate spaces on the Printer Authorization Matrix Form with a definition for each printer in your configuration, and attach it to the Initial Customizing Procedure Form. The definitions may be entered in any sequence. Also, definitions do not have to be entered successively; for example, you may enter definitions in groups 1, 2, and 3 of the form, skip groups 4 and 5, and continue at group 6.

Once a printer authorization matrix has been defined, sequence number 021 is no longer displayed when a customized 3274 Control Unit is being updated. Instead, the defined matrix is displayed. If the entire matrix is deleted, sequence number 021 is again displayed during each updating procedure until a new matrix is defined. Any time the initial customizing procedure is performed, the sequence number 021 is displayed and the printer authorization matrix must be redefined if it is still required.

031: Number of RPQ Diskettes Required

Enter the number of RPQ diskettes required (0, 1, 2, or 3) in step 7 of the Initial Customizing Procedure Form.

032: Request RPQ Parameter List (Configuration Support C and T Only)

Enter a 1 if you require the RPQ parameter list; enter a 0 if not. If you enter a 1 here, sequence number 033 (RPQ Parameters) is displayed, with spaces for parameter information. If you enter a 0, sequence number 033 is not displayed.

Note: An RPQ parameter list is required by certain RPQs. Specific information about this list, sequence number 033 format, and implementation is supplied with the RPQ.

111: Number of Category B Terminals (Configuration Support A, B, and C Only)

Enter a 2-digit number (00 to 16) specifying the number of Category B terminals that it is possible to attach to your 3274. (The actual number you have attached at any given time may be smaller than this number.) See sequence number 112 for a description of category types.

Notes:

1. A 2-digit number must be entered. If necessary, use a leading zero; for example, to specify 8, enter 08.
2. Specify the number of Category B terminals in multiples of 4 (maximum of 16).

112: Number of Category A Terminals

Enter a 2-digit number (08 to 32) specifying the number of Category A terminals that it is possible to attach to your 3274. (The actual number you have attached at any given time may be smaller than this number.) See Note 1.

Notes:

1. *If any distributed function terminals are to be configured with multiple interactive screens, it is recommended that you specify the actual number of Category A devices attached, rather than in multiples of 8. (See Note 4.)*
2. *A 2-digit number must be entered. If necessary, use a leading zero; for example, to specify 8, enter 08.*
3. *Category A terminals:*

*3178 Models C1, C2, and C3
 3179 in 3279-emulation mode
 3180 Model 1 in 3278-emulation mode
 3230 Model 2
 3262 Models 3 and 13
 3268 Model 2
 IBM 3270 Personal Computer in DFT mode
 3278 Models 1, 2, 3, 4, and 5
 3278 Models 1–5 with IBM 3270 Personal Computer Attachment
 3279 All Models except 2C
 3287 Models 1 and 2 with 3274/3276 Attachment (feature 8331)
 3287 Models 1C and 2C
 3289 Models 1 and 2
 3290 Information Panel
 4250 Model 1
 5210 Models G01 and G02
 6580 Displaywriter System*

Category B terminals:

*IBM Personal Computer XT/370
 3277 Models 1 and 2
 3284 Models 1 and 2
 3286 Models 1 and 2
 3287 Models 1 and 2 with 3271/3272 Attachment (feature 8330)
 3288 Model 2*

4. *Specify the number of Category A terminals in multiples of 8 (maximum of 32) and the number of Category B terminals in multiples of 4 (maximum of 16), unless the sum of the two categories exceeds 32. See Note 1.*

If the sum of the two categories exceeds 32:

- For Category B terminals, specify the actual number of Category B terminals (sequence number 111).
- For Category A terminals, specify the difference between 32 and the number of Category B terminals (sequence number 111).

Example: 13 Category B terminals and 17 Category A terminals would be specified as 13 and 19, respectively. Figure 3-1 shows the relationship and the ways to specify the various Category A and B terminal quantities. Note that, when Category A terminal adapters are added or removed, the host-recognized address of port B0 changes.

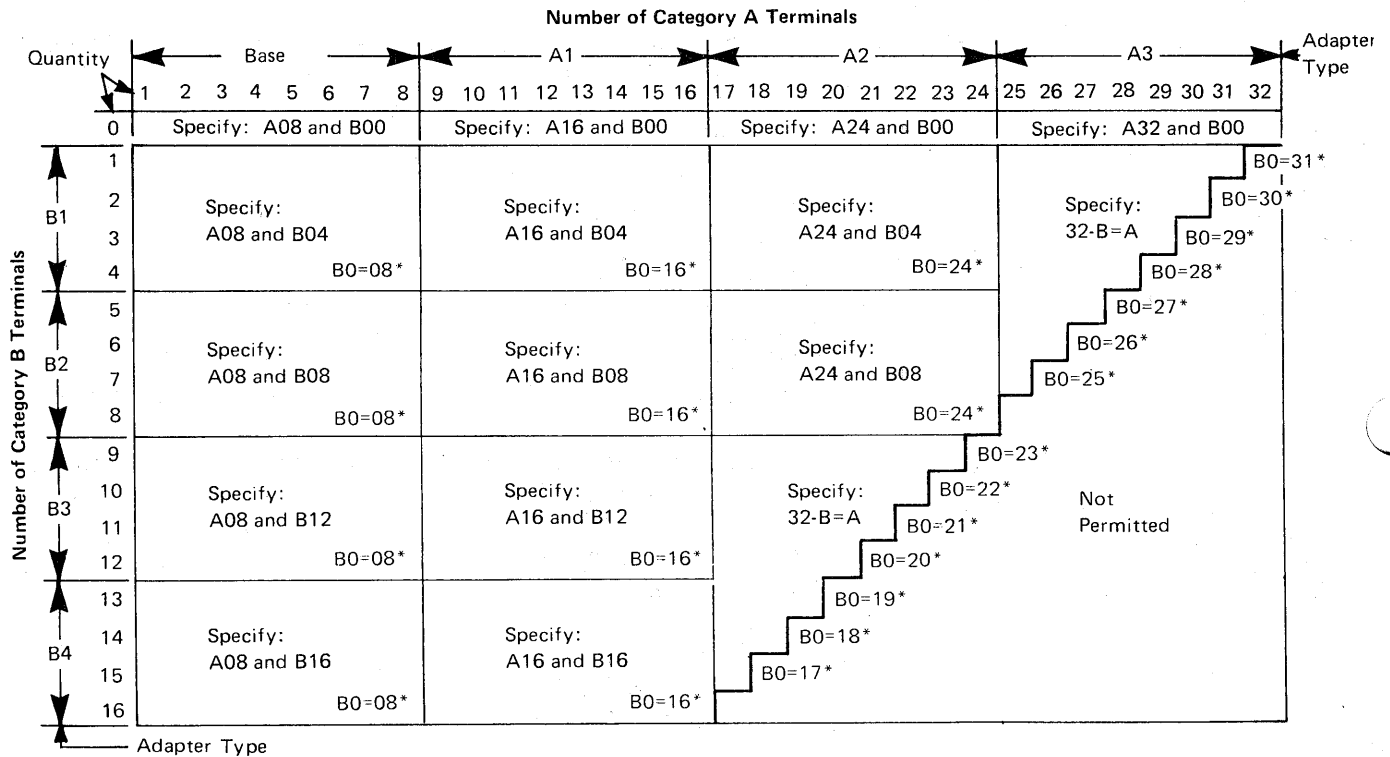

*The host-recognized port addresses are sequential, with the first Category A port (port A0) always being address 0 (with the exception of SNA, which is always 02). The first Category B port (port B0) is always the next sequential address after the last Category A port.

Figure 3-1. 3274 Model 1A, 21A, and 31A Category A and B Terminal Quantity Relationships

113: Extended Function Store

Model 1A: Enter one of the following to specify whether any, and which, Extended Function Store feature is installed:

- 0000^{1, 2} = No Extended Function Store feature is installed.
- 3622^{1, 2} = Extended Function Store type C1 (feature 3622) is installed.
- 5000² = Extended Function Store types C1 (feature 3622) and C3 (feature 3625) are installed.
- 5100² = Extended Function Store type C2 (feature 3623) is installed.
- 7000^{1, 2} = Extended Function Store types C1 (feature 3622) and D1 (feature 3627) are installed.
- 7800^{1, 2} = Extended Function Store types C1 (feature 3622) and D2 (feature 3628) are installed.
- 9000² = Extended Function Store types C1 (feature 3622), C3 (feature 3625), and D1 (feature 3627) are installed.
- 9100² = Extended Function Store types C2 (feature 3623) and D1 (feature 3627) are installed.
- 9800 = Extended Function Store types C1 (feature 3622), C3 (feature 3625), and D2 (feature 3628) are installed.
- 9900 = Extended Function Store types C2 (feature 3623) and D2 (feature 3628) are installed.

Model 21A: Enter A000.^{1, 2}

Model 31A: Enter D000.

¹ Not valid for Configuration Support C.

² Not valid for Configuration Support T.

114: IBM 3270 Personal Computer Attachment (Configuration Support C Only)

Enter a 1 if an IBM 3270 Personal Computer Attachment will be attached to a display station connected to your 3274 and you intend to transfer data between the IBM 3270 Personal Computer Attachment and the host; enter a 0 if not.

Note: If you answer 114 with a 1, you must answer sequence numbers 147 (Local-Copy Function) and 162 (Structured Field and Attribute Processing) with a 1.

121: Keyboard Language/Character Set I/O Interface Code

Enter a 2-digit number (01 and 03 to 32) from Figure 3-2 specifying the keyboard language and character set I/O interface code being used. A 2-digit number must be entered. If necessary, use a leading zero; for example, to specify 7, enter 07.

Sequence Number 121 Response	Keyboard Language	Character Set I/O Interface Code
01	English (U.S.)	English (U.S.)
03	Austrian/German	Austrian/German
04	Belgian	Belgian
05	Brazilian	Brazilian
06 ¹	Canadian (French)	Canadian (French)
07	Danish	Danish/Norwegian
08 ^{2,3}	Danish	Danish/Norwegian (Alternate)
09 ³	Finnish	Finnish/Swedish
10 ^{2,3}	Finnish	Finnish/Swedish (Alternate)
11	French (QWERTY)	French
12 ³	French (AZERTY)	French
13 ^{2,3}	Austrian/German	Austrian/German (Alternate)
14	International	International
15	Italian	Italian
16	Japanese (English)	Japanese (English)
17	Japanese (Katakana)	Japanese (Katakana)
18 ³	Portuguese (not allowed with Configuration Support C)	Portuguese (Alternate)
19	Spanish	Spanish
20 ^{2,3}	Spanish	Spanish (Alternate)
21	Spanish-speaking	Spanish-speaking
22	English (U.K.)	English (U.K.)
23	Norwegian	Danish/Norwegian
24	Swedish	Finnish/Swedish
25	EBCDIC (WT)	English (U.S.)
26 ^{2,3}	Norwegian	Danish/Norwegian (Alternate)
27 ^{2,3}	Swedish	Finnish/Swedish (Alternate)
28	Portuguese	Portuguese
29 ¹	Canadian (Bilingual)	Canadian (Bilingual)
30 ⁴	French AZERTY (105-character)	French AZERTY (105-character)
31 ⁴	Swiss German	Swiss German/Swiss French
32 ⁴	Swiss French	Swiss German/Swiss French

¹ Canadian (Bilingual) is supported by Configuration Support T only. Canadian (French) is supported by Configuration Support A, B, and C only.

² Structured Field and Attribute Processing (SFAP) (Sequence Number 162) is not supported with these languages.

³ Not supported by Configuration Support T.

⁴ Configuration Support C and T only.

Notes:

- Keyboard layouts and character set I/O interface code information are given in *IBM 3270 Information Display System: Character Set Reference, GA27-2837*.
- An alternate character set I/O Interface code should be selected only when compatibility with the 3271/3272/3275 data base is required. To facilitate later migration, all systems should be upgraded to the latest support 3270 level.

Figure 3-2. 3274 Model 1A, 21A, and 31A Keyboard Language and Character Set I/O Interface Code

127: Response Time Monitor (RTM) Definition (Configuration Support C Only)

A two-digit response is required. Both digits must be either zero or a nonzero value as follows:

First Digit:

- 0 – RTM support not wanted.
- 1 – RTM without host support. The RTM log and Last Transaction Time Indicator are displayed and reset on port 0* only.
- 2 – RTM without host support. The RTM log and Last Transaction Time Indicator are displayed and reset on all ports.*
- 3 – RTM with host support. The RTM log and Last Transaction Time Indicator are not displayable on any local port.*
- 4 – RTM with host support. The RTM log and Last Transaction Time Indicator are displayable on port 0* only.
- 5 – RTM with host support. The RTM log and Last Transaction Time Indicator are displayable on all ports.*

* All terminals can display the Last Transaction Time Indicator, but only non-distributed function terminals can display the RTM log.

Second Digit:

- 0 – RTM support not wanted.
- 1 – End response time measurement when the first character is displayed on screen.
- 2 – End response time measurement when the keyboard again becomes usable.
- 3 – End response time measurement when a Change Direction (CD) or End Bracket (EB) indication is received. (A CD in conjunction with a Read command will not stop the timer.)

Response time measurement starts with recognition by the control unit of an inbound AID request, for example, by pressing the ENTER key. The second digit responses define the end of the measurement.

Nonzero responses to sequence number 127 cause sequence number 128, RTM Boundaries and Interface Specification, to be displayed later in the customization sequence.

See Appendix K in this publication for more details concerning RTM.

128: RTM Boundaries and Interface Specification (Configuration Support C Only)

This sequence number (a panel) is displayed after the specification panel is accepted *and* only if the response to sequence number 127 is nonzero. See Appendix K for details.

131: Typewriter Keyboard

For an example of this keyboard type, see Figure M-1 in Appendix M.

Enter a 0 if there are no 3178-C2s *and* none of the 3278s or 3279s have a typewriter keyboard (feature 2715, 2717, 4621, 4627, 4640, or 4651); enter a 1 if any do.

132: Data Entry Keyboard

For an example of this keyboard type, see Figure M-2 in Appendix M.

Enter a 0 if there are no 3178-C1s *and* none of the 3278s or 3279s have a data entry keyboard (feature 2716 or 4622); enter a 1 if any do.

133: Data Entry Keypunch Layout Keyboard

For an example of this keyboard type, see Figure M-3 in Appendix M.

Enter a 0 if none of the attached 3278s or 3279s have a data entry keypunch layout keyboard (feature 4623); enter a 1 if any do.

134: APL Keyboard

For an example of this keyboard type, see Figure M-4 in Appendix M.

Enter a 0 if none of the attached 3278s or 3279s have an APL keyboard (feature 4626 or 4652); enter a 1 if any do.

Note: For Configuration Support A and B only, enter a 1 if an APL keyboard is not attached to any 3278 or 3279 but you wish to display or print APL characters.

135: Text Keyboard

For an example of this keyboard type, see Figure M-5 in Appendix M.

Enter a 0 if none of the attached 3278s or 3279s have a text keyboard (feature 4629); enter a 1 if any do.

Note: For Configuration Support A and B only, enter a 1 if a text keyboard is not attached to any 3278 or 3279 but you wish to display or print text characters.

139: 3290 Keypad Selection (Configuration Support T Only)

Enter one of the following to specify the type of keypad you will be using on your 3290:

- 0 = No keypad or the default keypad (National Language Numeric Keypad)
- 1 = 24-key numeric keypad
- 2 = 25-key numeric keypad (, on key 4)
- 3 = 25-key numeric keypad (. on key 4)
- 4-6 = Reserved
- 7 = Program Function Keypad

Enter a 0 if you have no 3290 Information Panels.

Note: If a nonzero response is specified for this sequence number, a 1 must be specified for sequence number 170.

141: Magnetic Character Set

Enter one of the following to specify the magnetic character set installed:

- A = None
- B = Numeric (3277-compatible)
- C = Alphanumeric (auto entry for secure data)
- D = Alphanumeric (auto entry for all data)

143: Host-Loadable Printer Authorization Matrix

Enter a 1 if a printer authorization matrix is to be loaded from the host; enter a 0 if it is not.

This matrix is defined by a user-written application program. When run, a host-loaded matrix overrides any other printer authorization matrix. (See also sequence number 021.)

145: 3289 Print Control

Enter a 1 if a 3289 Line Printer with the text print belt (feature 9496) is attached. Enter a 0 if no 3289 Line Printer is attached or if a 3289 without the text print belt is attached.

147: Local-Copy Function

Enter a 1 for this sequence number in step 8 on the Initial Customizing Procedure Form. This function is not selectable; it is automatically included in your configuration.

Distributed Function Terminal: If you are using the local-copy function on a distributed function terminal such as the IBM 3270 Personal Computer or the 3290, you must specify a printer authorization matrix (see Appendix C).

IBM 3270 Personal Computer Attachment: If an IBM 3270 Personal Computer Attachment is configured (sequence number 114=1), you *must* respond to 147 with a 1.

151: 3274 Model Designation

Enter an A to specify a 3274 Model 1A. Enter a 1 to specify a Model 21A or 31A.

161: Color Convergence

Enter a 0 if either of the following applies:

- In U.S. and Canada only, all the 3279 Color Display Stations attached have model numbers ending in -1, for example, S2A-1.
- No 3279 Color Display Stations are attached.

Enter a 1 if any other 3279 Color Display Stations are attached.

162: Structured Field and Attribute Processing (SFAP) (Configuration Support C Only)

Enter a 1 if APL, SFAP, the LU Type 1 SNA character string (SCS) (3287 Printer with feature 9661), or a 4250 Model 1 Printer is used; enter a 0 if not.

If an IBM 3270 Personal Computer Attachment is configured (sequence number 114=1), you must respond to 162 with a 1.

SFAP is necessary if you are using the extended character set (Write Structured Field command or the Set Attribute, Start Field Extended, or Modify Field orders). (See 163 following.) LU Type 1 SCS supports extended color, extended highlighting (underscore), and Programmed Symbols on LU Type 1 printers with feature 9661.

If you respond 1 to this sequence number, you *must not* respond 08, 10, 13, 20, 26, or 27 to sequence number 121.

If you enter a 0, sequence numbers 163–166 will not be asked.

163: Extended Character Set Adapter (Configuration Support C Only)

This is the number of terminals (displays and printers) that process the APL/Text functions and extended color, Programmed Symbols, and extended highlighting. Count one for each:

- 3179 in 3279-emulation mode
- 3180 Model 1 in 3278-emulation mode
- 3230 Model 2
- 3262 Models 3 and 13
- 3268 Model 2
- 3278 with Extended Character Set Adapter (feature 3610)
- 3279 Models 2B, 3B, S2B, and S3G
- 3279 Models 02X and 03X with Extended Function Store (feature 3850)
- 3287 with Extended Character Set Adapter (feature 3610)
- 4250 Model 1

A 2-digit number must be entered. If necessary, use a leading zero; for example, to specify 8, enter 08.

Notes:

1. *This number must not exceed the number of Category A terminals specified in sequence number 112.*
2. *If an IBM 3270 Personal Computer Attachment is configured (sequence number 114=1), each attachment must be considered a count unless the associated display has been counted as a display with the Extended Character Set Adapter (feature 3610) installed.*

164: Programmed Symbols (PS) (Configuration Support C Only)

Enter a 1 if any attached terminals have a Programmed Symbols (PS) feature (5781, 5782, or 5783) installed; enter a 0 if not.

165: Decompression (Configuration Support C Only)

Enter a 1 if you want to send compressed PS data; otherwise, enter a 0. (This sequence number is not asked if a 0 was specified for sequence number 164 [Programmed Symbols].)

Note: Decompressing data on a locally attached 3274 could cause performance degradation.

166: Attribute Select Keyboard (Configuration Support C Only)

Note: This sequence number will not be asked unless you specified a 1 for sequence number 131 (typewriter keyboard) or 134 (APL keyboard).

For examples of the attribute select keyboards, see Figures M-6 through M-8 in Appendix M.

Enter one of the following to specify whether an attribute select typewriter keyboard (feature 4651), an attribute select typewriter/APL keyboard (feature 4652), or a typewriter overlay keyboard (feature 4640) is being used:

- A = None of these keyboards is being used.
- B = One or more of these keyboards are being used, but you do not wish to use the numeric lock function on *any* of them.
- C = One or more of these keyboards are being used, and you wish to use the numeric lock function on *all* of them.

170: Distributed Function Terminals (Configuration Support T Only)

- 0 = No distributed function terminals are attached.
- 1 = Distributed function terminals that require a load diskette will be attached, *or* a combination of distributed function terminals that require a load diskette and those that do not require a load diskette will be attached.
- 2 = Only distributed function terminals that *do not* require a load diskette will be attached.

Notes:

1. *If your response is 0, sequence numbers 171 through 176 are not displayed.*
2. *If your response is 2, respond to sequence numbers 139, 173, and 175 with 0's.*

171: Multiple Interactive Screens (Configuration Support T Only)

A 2-digit number must be entered for each of the following; if you are not using multiple interactive screens, enter 10 zeros:

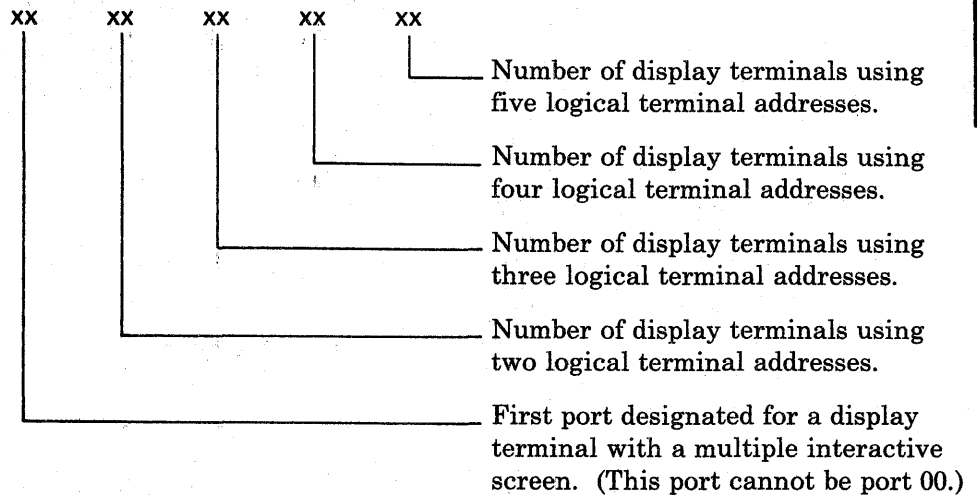

See Appendix J for a detailed description of multiple interactive screens.

173: 3290 Options (Configuration Support T Only)

Each of the eight bits in this response must be specified either as 0 or as 1. A 0 disables the particular option, and a 1 enables it. Enter all 0's if you do not have a 3290 Information Panel.

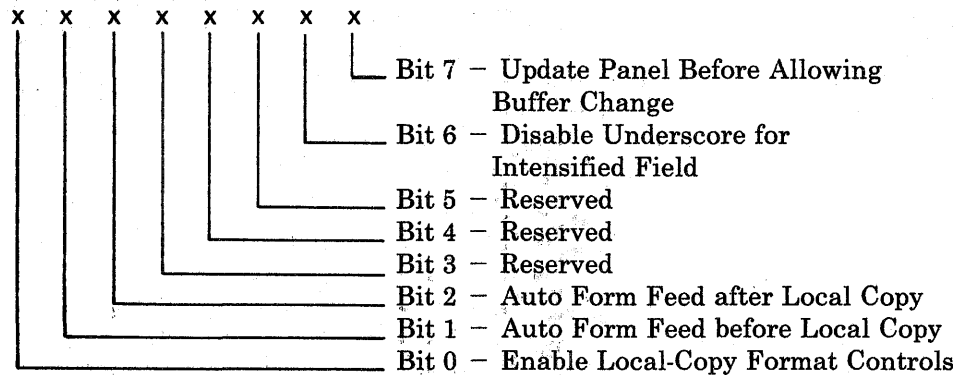

Bit 0 - Enable Local-Copy Format Controls.

The 3290 generates an SCS data stream to perform a local-copy operation to a printer. If the printer does not have Save/Restore Format capability and the printer is operated in shared mode, that is, a local-copy operation is permitted between brackets of an LU-1 session, there is a possibility that the format controls established by the host program will be destroyed by the local-copy operation. Proper use of this bit will help alleviate the contention situation for establishing format controls. When the printer supports

Save/Restore Format, this option has no effect; the 3290 will send format controls.

When bit 0 is set to 0, the 3290 will not send format controls to a printer that lacks Save/Restore Format capability. The 0 setting is the default and is applicable to those operating environments where the host program does not reestablish format controls with each Begin Bracket. Note that the format of the local-copy output depends on the format controls established by the operator or host program.

When bit 0 is set to 1, the 3290 will send format controls to the printer, even though the printer lacks Save/Restore Format capability. This enables the local-copy output to duplicate, as closely as possible, the character image being copied. The 1 setting is applicable to those operating environments where the printer is not shared or the host program reestablishes format controls with each Begin Bracket.

Bit 1 – Automatic Form Feed before Local Copy.

Specify bit 1 as a 0 (zero) if you do not want to generate an automatic form feed before a local-copy operation is performed.

Specify bit 1 as a 1 if you want to generate an automatic form feed before a local-copy operation is performed.

Bit 2 – Automatic Form Feed after Local Copy.

Specify bit 2 as a 0 (zero) if you do not want to generate an automatic form feed after a local-copy operation is performed.

Specify bit 2 as a 1 if you want to generate an automatic form feed after a local-copy operation is performed.

Bits 3–5 – Reserved. Specify 0.

Bit 6 – Disable Underscore for Intensified Fields.

When bit 6 is set to 0, the 3290 *will* underscore all fields carrying the field intensify attribute.

When bit 6 is set to 1, the 3290 *will not* underscore fields carrying the field intensify attribute.

Bit 7 – Update Panel Before Allowing Buffer Change.

When bit 7 is set to 0, the 3290 will suspend panel updating to process a host transmission. Under high-data-rate conditions, messages sent by the host and placed in the display buffer may get overlaid with new data before being displayed on the panel.

When bit 7 is set to 1, all display buffer contents must be displayed on the panel before new data can be placed in the display buffer. It is recommended that bit 7 be set to 1 when 3290s are being used as system consoles or other applications where potentially high message rates are possible and the user is required to visually interpret all data sent by the host.

175: 3290 Password (Configuration Support T Only)

Enter the 6-digit password to allow permanent changes to the 3290 logical terminal definition table using setup level 3.

176: BSC Enhanced Communication Option (Configuration Support T Only)

Enter 0. Not applicable to A models.

201: SNA Local Channel Control Unit Address

Enter the 2-character hexadecimal control unit address; this information can be obtained from the system programmer at the host system location. The host system recognizes this address as the input/output (I/O) address.

211: SCS Support

Enter a 1 if the LU Type 1 SNA character string (SCS) (3287 Printer with feature 9660, 3230 Printer, 3262 Line Printer, 3268 Printer, 3289 Line Printer, or 4250 Model 1 Printer) is used; enter a 0 if not.

213: Between Bracket Printer Sharing

Enter a 0 if Between Bracket Printer Sharing is not allowed; enter a 1 if it is.

215: Physical Unit Identification (PUID)

The physical unit identification (PUID) is a 5-character code that identifies the control unit to the host in response to an SDLC XID command.

If the PUID is not used, enter 00000 for this sequence number in step 8 on the Initial Customizing Procedure Form.

If the PUID is used, each control unit in a network should be assigned a unique PUID. The PUID must be obtained from the system programmer and entered as the response to this sequence number in step 8 on the Initial Customizing Procedure Form.

220: Alert Function (SNA Only) (Configuration Support C)

Enter a 0, 1, 2, or 3 as follows:

- 0 - No alert function wanted.
- 1 - Alert function without operator-generated alert message capability.
- 2 - Alert function with operator-generated alert message capability from port 0 only.*
- 3 - Alert function with operator-generated alert message capability from all ports.*

* Operator-generated alert messages cannot be issued from a 3277 or a distributed function terminal.

301 through 362

For sequence numbers 301 through 362, fill in the appropriate boxes in step 8 of the Initial Customizing Procedure Form with the following entries:

- 301 Enter 00.
- 302 Enter 00.
- 305 - 352 Enter 0 in each box.
- 360 Enter 00 (Configuration Support C only).
- 361 Enter 00 (Configuration Support C only).
- 362 Enter 00000000 (Configuration Support C only).

900: Entry Acceptance

Sequence number 900, which appears as part of the sequence number 999 display, prompts the operator to enter a 1 if, after the entries are verified, all the responses are entered correctly. If incorrect responses are detected by the 3274, the 1 is automatically changed back to a 0 by the 3274, an operator code is displayed for the incorrect information, and incorrect entries are intensified.

999: Specification Panel

Sequence number 999 displays all the responses entered during the customizing operation, permitting the operator to review the entries and to make any corrections needed. The Initial Customizing Procedure Form instructs the operator how to reply to this sequence number.

3274 Models 1B, 1D, 21B, 21D, and 31D

Use the following sequence numbers and instructions in conjunction with the Initial Customizing Procedure Form in Chapter 4 to customize 3274 Models 1B, 1D, 21B, 21D, and 31D.

001: Keyboard Validation

The response required for this sequence number is '1234567890ABCDEF' followed by a space and the validation number that is printed on the front cover of this book and on the first page of the Initial Customizing Procedure Form. The first part of the response verifies that the keyboard being used for customizing is operating properly. The last two digits (the validation number) are used to check that the level of this customizing guide is equal to or greater than the level of the feature and system diskettes.

Note: If a data entry keypunch layout keyboard is used, the New Line key is pressed when ENTER is specified. Also, the PF10 key is pressed when RESET is required; the PF8 key is pressed when New Line is required. See Figures 4-1 and 4-2 (in Chapter 4) for valid key positions and for the differences just noted. Be sure to specify the keyboard type on the Initial Customizing Procedure Form.

011: Patch Request

The response required for this sequence number is already entered on the form in step 5. The service representative may use this sequence number to make a diskette patch request.

021: Printer Authorization Matrix

Enter a 0 in step 6 on the Initial Customizing Procedure Form if any of the following conditions applies:

- The printer authorization matrix is to be entered only by a host application program (a 1 must be specified in sequence number 143).
- All printers are to be used in system mode, and local-copy operations are not desired.
- No printers are to be attached to the system.

Enter a 1 if a matrix is to be defined, thereby causing sequence number 022 to be displayed. This matrix will be established for each 3274 IML, regardless of the response to sequence number 143.

022: Printer Authorization Matrix Definition

The printer authorization matrix is defined in sequence number 022. See Appendix C for detailed information on responding to sequence number 022.

Fill in the appropriate spaces on the Printer Authorization Matrix Form with a definition for each printer in your configuration, and attach it to the Initial Customizing Procedure Form. The definitions may be entered in any sequence. Also, definitions do not have to be entered successively; for example, you may enter definitions in groups 1, 2, and 3 of the form, skip groups 4 and 5, and continue at group 6.

Once a printer authorization matrix has been defined, sequence number 021 is no longer displayed when a customized 3274 Control Unit is being updated. Instead, the defined matrix is displayed. If the entire matrix is deleted, sequence number 021 is again displayed during each updating procedure until a new matrix is defined. Any time the initial customizing procedure is performed, the sequence number 021 is displayed and the printer authorization matrix must be redefined if it is still required.

031: Number of RPQ Diskettes Required

Enter the number of RPQ diskettes required (0, 1, 2, or 3) in step 7 on the Initial Customizing Procedure Form.

032: Request RPQ Parameter List (Configuration Support C and T Only)

Enter a 1 if you require the RPQ parameter list; enter a 0 if not. If you enter a 1 here, sequence number 033 (RPQ Parameters) is displayed, with spaces for parameter information. If you enter a 0, sequence number 033 is not displayed.

Note: An RPQ parameter list is required by certain RPQs. Specific information about this list, sequence number 033 format, and implementation is supplied with the RPQ.

111: Number of Category B Terminals (Configuration Support A, B, and C Only)

Enter a 2-digit number (00 to 16) specifying the number of Category B terminals that it is possible to attach to your 3274. (The actual number you have attached at any given time may be smaller than this number.) See sequence number 112 for a description of category types.

Notes:

1. Specify the number of Category B terminals in multiples of 4 (maximum of 16).
2. A 2-digit number must be entered. If necessary, use a leading zero; for example, to specify 4, enter 04.

3. *The 3274 Models 1B, 1D, 21B, 21D, and 31D are multiaddress units wired during installation for a limited address range. If this limited address range and the specified number of Category A and B terminals do not match, the 3274 will not be able to complete a normal startup sequence.*

112: Number of Category A Terminals

Enter a 2-digit number (08 to 32) specifying the number of Category A terminals that it is possible to attach to your 3274. (The actual number you have attached at any given time may be smaller than this number.) See Note 1.

Notes:

1. *If any distributed function terminals are to be configured with multiple interactive screens, it is recommended that you specify the actual number of Category A devices attached, rather than multiples of 8. (See Note 4.)*
2. *A 2-digit number must be entered. If necessary, use a leading zero; for example, to specify 8, enter 08.*
3. *Category A terminals:*

*3178 Models C1, C2, and C3
3179 in 3279-emulation mode
3180 Model 1 in 3278-emulation mode
3230 Model 2
3262 Models 3 and 13
3268 Model 2
IBM 3270 Personal Computer in DFT mode
3278 Models 1, 2, 3, 4, and 5
3278 Models 1–5 with IBM 3270 Personal Computer Attachment
3279 All Models except 2C
3287 Models 1 and 2 with 3274/3276 Attachment (feature 8331)
3287 Models 1C and 2C
3289 Models 1 and 2
3290 Information Panel
4250 Model 1
5210 Models G01 and G02
6580 Displaywriter System*

Category B terminals:

*IBM Personal Computer XT/370
3277 Models 1 and 2
3284 Models 1 and 2
3286 Models 1 and 2
3287 Models 1 and 2 with 3271/3272 Attachment (feature 8330)
3288 Model 2*

- Specify the number of Category A terminals in multiples of 8 (maximum of 32) and the number of Category B terminals in multiples of 4 (maximum of 16), unless the sum of the two categories exceeds 32. (See Note 1.)

If the sum of the two categories exceeds 32:

- For Category B terminals, specify the actual number of Category B terminals (sequence number 111).
- For Category A terminals, specify the difference between 32 and the number of Category B terminals (sequence number 111).

Example: 13 Category B terminals and 17 Category A terminals would be specified as 13 and 19, respectively. Figure 3-3 shows the relationship and the ways to specify the various Category A and B terminal quantities. Note that, when Category A terminal adapters are added or removed, the host-recognized address of port B0 changes.

- The 3274 Models 1B and 21B are multiaddress units wired during installation for a limited address range. If this limited address range and the specified number of Category A and B terminals do not match, the 3274 will not be able to complete a normal startup sequence.

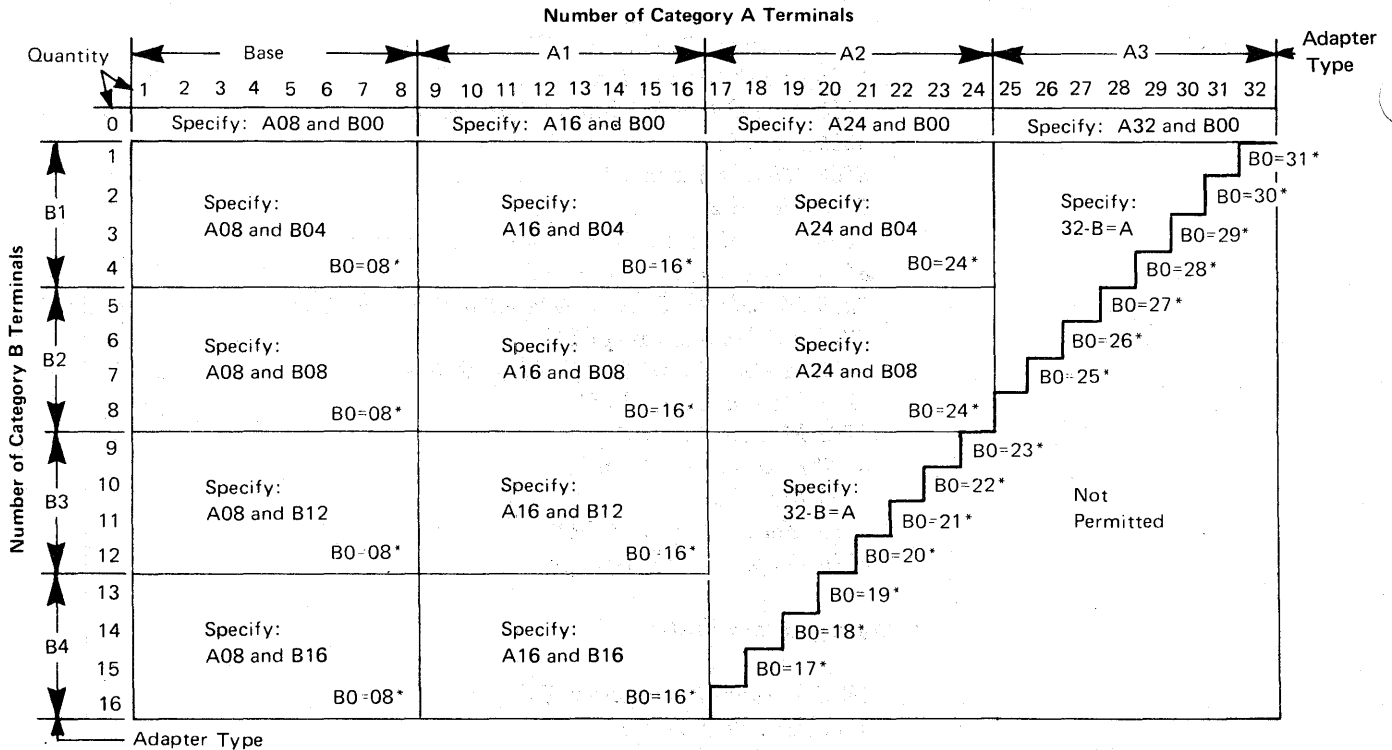

*The host-recognized port addresses are sequential, with the first Category A port (port A0) always being address 0 (with the exception of SNA, which is always 02). The first Category B port (port B0) is always the next sequential address after the last Category A port.

Figure 3-3. 3274 Model 1B, 1D, 21B, 21D, and 31D Category A and B Terminal Quantity Relationships

113: Extended Function Store

Model 1B: Enter 0000.

Model 1D: Enter one of the following to specify whether any, and which, Extended Function Store feature is installed:

- 0000^{1,2} = No Extended Function Store feature is installed.
- 3622^{1,2} = Extended Function Store type C1 (feature 3622) is installed.
- 5000² = Extended Function Store types C1 (feature 3622) and C3 (feature 3625) are installed.
- 5100² = Extended Function Store type C2 (feature 3623) is installed.
- 7000^{1,2} = Extended Function Store types C1 (feature 3622) and D1 (feature 3627) are installed.
- 7800^{1,2} = Extended Function Store types C1 (feature 3622) and D2 (feature 3628) are installed.
- 9000² = Extended Function Store types C1 (feature 3622), C3 (feature 3625), and D1 (feature 3627) are installed.
- 9100² = Extended Function Store types C2 (feature 3623) and D1 (feature 3627) are installed.
- 9800 = Extended Function Store types C1 (feature 3622), C3 (feature 3625), and D2 (feature 3628) are installed.
- 9900 = Extended Function Store types C2 (feature 3623) and D2 (feature 3628) are installed.

Models 21B and 21D: Enter A000.^{1,2}

Model 31D: Enter D000.

¹ Not valid for Configuration Support C.

² Not valid for Configuration Support T.

114: IBM 3270 Personal Computer Attachment (Configuration Support C Only)

Enter a 1 if an IBM 3270 Personal Computer Attachment will be attached to a display station connected to your 3274 and you intend to transfer data between the IBM 3270 Personal Computer Attachment and the host; enter a 0 if not.

Note: If you answer 114 with a 1, you must answer sequence numbers 147 (Local-Copy Function) and 162 (Structured Field and Attribute Processing) with a 1.

121: Keyboard Language/Character Set I/O Interface Code

Enter a 2-digit number (01 and 03 to 32) from Figure 3-4 specifying the keyboard language and character set I/O interface code being used. A 2-digit number must be entered. If necessary, use a leading zero; for example, to specify 7, enter 07.

Sequence Number 121 Response	Keyboard Language	Character Set I/O Interface Code
01	English (U.S.)	English (U.S.)
03	Austrian/German	Austrian/German
04	Belgian	Belgian
05	Brazilian	Brazilian
06 ¹	Canadian (French)	Canadian (French)
07	Danish	Danish/Norwegian
08 ^{2,3}	Danish	Danish/Norwegian (Alternate)
09 ³	Finnish	Finnish/Swedish
10 ^{2,3}	Finnish	Finnish/Swedish (Alternate)
11	French (QWERTY)	French
12 ³	French (AZERTY)	French
13 ^{2,3}	Austrian/German	Austrian/German (Alternate)
14	International	International
15	Italian	Italian
16	Japanese (English)	Japanese (English)
17	Japanese (Katakana)	Japanese (Katakana)
18 ³	Portuguese (not allowed with Configuration Support C)	Portuguese (Alternate)
19	Spanish	Spanish
20 ^{2,3}	Spanish	Spanish (Alternate)
21	Spanish-speaking	Spanish-speaking
22	English (U.K.)	English (U.K.)
23	Norwegian	Danish/Norwegian
24	Swedish	Finnish/Swedish
25	EBCDIC (WT)	English (U.S.)
26 ^{2,3}	Norwegian	Danish/Norwegian (Alternate)
27 ^{2,3}	Swedish	Finnish/Swedish (Alternate)
28	Portuguese	Portuguese
29 ¹	Canadian (Bilingual)	Canadian (Bilingual)
30 ⁴	French AZERTY (105-character)	French AZERTY (105-character)
31 ⁴	Swiss German	Swiss German/Swiss French
32 ⁴	Swiss French	Swiss German/Swiss French

¹ Canadian (Bilingual) is supported by Configuration Support T only. Canadian (French) is supported by Configuration Support A, B, and C only.

² Structured Field and Attribute Processing (SFAP) (Sequence Number 162) is not supported with these languages.

³ Not supported by Configuration Support T.

⁴ Configuration Support C and T only.

Notes:

1. Keyboard layouts and character set I/O interface code information are given in *IBM 3270 Information Display System: Character Set Reference, GA27-2837*.

2. An alternate character set I/O Interface code should be selected only when compatibility with the 3271/3272/3275 data base is required. To facilitate later migration, all systems should be upgraded to the latest support 3270 level.

Figure 3-4. 3274 Model 1B, 1D, 21B, 21D, and 31D Keyboard Language and Character Set I/O Interface Code

127: Response Time Monitor (RTM) Definition (Configuration Support C Only)

A two-digit response is required. Both digits must be either zero or a nonzero value as follows:

First Digit:

- 0 – RTM support not wanted.
- 1 – RTM without host support. The RTM log and Last Transaction Time Indicator are displayed and reset on port 0* only.
- 2 – RTM without host support. The RTM log and Last Transaction Time Indicator are displayed and reset on all ports.*

* All terminals can display the Last Transaction Time Indicator, but only non-distributed function terminals can display the RTM log.

Second Digit:

- 0 – RTM support not wanted.
- 1 – End response time measurement when the first character is displayed on screen.
- 2 – End response time measurement when the keyboard again becomes usable.

Response time measurement starts with recognition by the control unit of an inbound AID request, for example, by pressing the ENTER key. The second digit responses define the end of the measurement.

Nonzero responses to sequence number 127 cause sequence number 128, RTM Boundaries and Interface Specification, to be displayed later in the customization sequence.

See Appendix K in this publication for more details concerning RTM.

128: RTM Boundaries and Interface Specification (Configuration Support C Only)

This sequence number (a panel) is displayed after the specification panel is accepted, *and* only if the response to sequence number 127 is nonzero. See Appendix K.

131: Typewriter Keyboard

For an example of this keyboard type, see Figure M-1 in Appendix M.

Enter a 0 if there are no 3178-C2s *and* none of the 3278s or 3279s have a typewriter keyboard (feature 2715, 2717, 4621, 4627, 4640, or 4651); enter a 1 if any do.

132: Data Entry Keyboard

For an example of this keyboard type, see Figure M-2 in Appendix M.

Enter a 0 if there are no 3178-C1s *and* none of the 3278s or 3279s have a data entry keyboard (feature 2716 or 4622); enter a 1 if any do.

133: Data Entry Keypunch Layout Keyboard

For an example of this keyboard type, see Figure M-3 in Appendix M.

Enter a 0 if none of the attached 3278s or 3279s have a data entry keypunch layout keyboard (feature 4623); enter a 1 if any do.

134: APL Keyboard (Models 1D, 21D, and 31D Only)

For an example of this keyboard type, see Figure M-4 in Appendix M.

Enter a 0 if none of the attached 3278s or 3279s have an APL keyboard (feature 4626 or 4652); enter a 1 if any do.

Note: For Configuration Support A and B only, enter a 1 if an APL keyboard is not attached to any 3278 or 3279 but you wish to display or print APL characters.

135: Text Keyboard (Models 1D, 21D, and 31D Only)

For an example of this keyboard type, see Figure M-5 in Appendix M.

Enter a 0 if none of the attached 3278s or 3279s have a text keyboard (feature 4629); enter a 1 if any do.

Note: For Configuration Support A and B only, enter a 1 if a text keyboard is not attached to any 3278 or 3279 but you wish to display or print text characters.

139: 3290 Keypad Selection (Configuration Support T Only)

Enter one of the following to specify the type of keypad you will be using on your 3290:

- 0 = No keypad or the default keypad (National Language Numeric Keypad)
- 1 = 24-key numeric keypad
- 2 = 25-key numeric keypad (, on key 4)
- 3 = 25-key numeric keypad (. on key 4)
- 4-6 = Reserved
- 7 = Program Function Keypad

Enter a 0 if you have no 3290 Information Panels.

Note: If a nonzero response is specified for this sequence number, a 1 must be specified for sequence number 170.

141: Magnetic Character Set

Enter one of the following to specify the magnetic character set installed:

A = None

B = Numeric (3277-compatible)

C = Alphanumeric (auto entry for secure data)

D = Alphanumeric (auto entry for all data)

143: Host-Loadable Printer Authorization Matrix

Enter a 1 if a printer authorization matrix is to be loaded from the host; enter a 0 if it is not.

This matrix is defined by a user-written application program. When run, a host-loaded matrix overrides any other printer authorization matrix. (See also sequence number 021.)

145: 3289 Print Control

Enter a 1 if a 3289 Line Printer with the text print belt (feature 9496) is attached. Enter a 0 if no 3289 Line Printer is attached or if a 3289 without the text print belt is attached.

147: Local-Copy Function

Models 1B and 21B: Enter a 1 for this sequence number in step 8 on the Initial Customizing Procedure Form. This function is not selectable on the Models 1B and 21B; it is automatically included in your configuration.

Models 1D, 21D, and 31D: Enter a 1 if the local-copy function is being used; enter a 0 if it is not.

Distributed Function Terminal: If you want to use the local-copy function on a distributed function terminal, enter a 1 and specify a printer authorization matrix (see Appendix C).

Notes:

1. *If a 0 is entered, local copy by means of the Print key is nullified.*
2. *If an IBM 3270 Personal Computer Attachment is configured (sequence number 114=1), you must respond to 147 with a 1.*

151: 3274 Model Designation

Enter one of the following to specify the 3274 model:

B = Model 1B¹

D = Model 1D

2 = Model 21B¹

4 = Models 21D and 31D

¹ Not valid for Configuration Support C or T.

161: Color Convergence

Enter a 0 if either of the following applies:

- In U.S. and Canada only, **all** the 3279 Color Display Stations attached have model numbers ending in -1, for example, S2A-1.
- No 3279 Color Display Stations are attached.

Enter a 1 if any other 3279 Color Display Stations are attached.

162: Structured Field and Attribute Processing (SFAP) (Configuration Support C Only; Models 1D and 31D Only)

Enter a 1 if APL, SFAP, or a 4250 Model 1 Printer is being used; enter a 0 if not.

If an IBM 3270 Personal Computer Attachment is configured (sequence number 114 = 1), you must respond to 162 with a 1.

SFAP is necessary if you are using the extended character set (Write Structured Field command or the Set Attribute, Start Field Extended, or Modify Field orders). (See 163 following.)

If you respond 1 to this sequence number, you *must not* respond 08, 10, 13, 20, 26, or 27 to sequence number 121.

If you enter a 0, sequence numbers 163 – 166 will not be asked.

163: Extended Character Set Adapter (Configuration Support C Only; Models 1D and 31D Only)

This is the number of terminals (displays and printers) that process the APL/Text functions and extended color, Programmed Symbols, and extended highlighting. Count one for each:

- 3179 in 3279-emulation mode
- 3180 Model 1 in 3278-emulation mode
- 3230 Model 2
- 3262 Models 3 and 13
- 3268 Model 2
- 3278 with Extended Character Set Adapter (feature 3610)
- 3279 Models 2B, 3B, S2B, and S3G
- 3279 Models 02X and 03X with Extended Function Store (feature 3850)
- 3287 with Extended Character Set Adapter (feature 3610)
- 4250 Model 1

A 2-digit number must be entered. If necessary, use a leading zero; for example, to specify 8, enter 08.

Notes:

1. *This number must not exceed the number of Category A terminals specified in sequence number 112.*
2. *If an IBM 3270 Personal Computer Attachment is configured (sequence number 114=1), each attachment must be considered a count unless the associated display has been counted as a display with the Extended Character Set Adapter (feature 3610) installed.*

164: Programmed Symbols (PS) (Configuration Support C Only; Models 1D and 31D Only)

Enter a 1 if any attached terminals have a Programmed Symbols (PS) feature (5781, 5782, or 5783) installed; enter a 0 if not.

165: Decompression (Configuration Support C Only; Models 1D and 31D Only)

Enter a 1 if you want to send compressed PS data; otherwise, enter a 0. (This sequence number is not asked if a 0 was specified for sequence number 164 [Programmed Symbols].)

Note: Decompressing data on a locally attached 3274 could cause performance degradation.

166: Attribute Select Keyboard (Configuration Support C Only; Models 1D and 31D Only)

Note: This sequence number will not be asked unless you specified a 1 for sequence number 131 (typewriter keyboard) or 134 (APL keyboard).

For examples of the attribute select keyboards, see Figures M-6 through M-8 in Appendix M.

Enter one of the following to specify whether an attribute select typewriter keyboard (feature 4651), an attribute select typewriter/APL keyboard (feature 4652), or a typewriter overlay keyboard (feature 4640) is being used:

- A = None of these keyboards is being used.
- B = One or more of these keyboards are being used, but you do not wish to use the numeric lock function on *any* of them.
- C = One or more of these keyboards are being used, and you wish to use the numeric lock function on *all* of them.

170: Distributed Function Terminals (Configuration Support T Only)

- 0 = No distributed function terminals are attached.
- 1 = Distributed function terminals that require a load diskette will be attached, *or* a combination of distributed function terminals that require a load diskette and those that do not require a load diskette will be attached.
- 2 = Only distributed function terminals that *do not* require a load diskette will be attached.

Notes:

1. *If your response is 0, sequence numbers 171 through 176 are not displayed.*
2. *If your response is 2, respond to sequence numbers 139, 173, and 175 with 0's.*

171: Multiple Interactive Screens (Configuration Support T Only)

A 2-digit number must be entered for each of the following; if you are not using multiple interactive screens, enter 10 zeros:

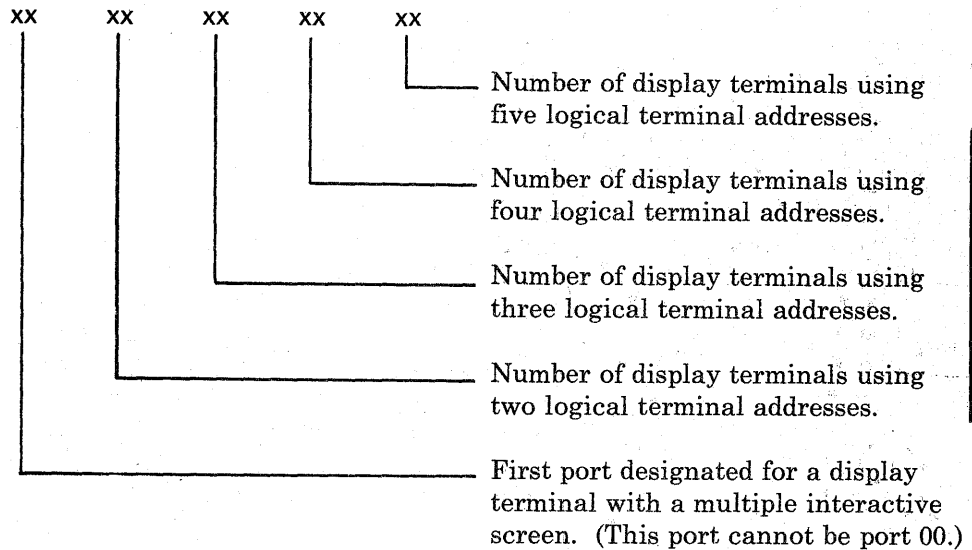

See Appendix J for a detailed description of multiple interactive screens.

173: 3290 Options (Configuration Support T Only)

Each of the eight bits in this response must be specified either as 0 or as 1. A 0 disables the particular option, and a 1 enables it. Enter all 0's if you do not have a 3290 Information Panel.

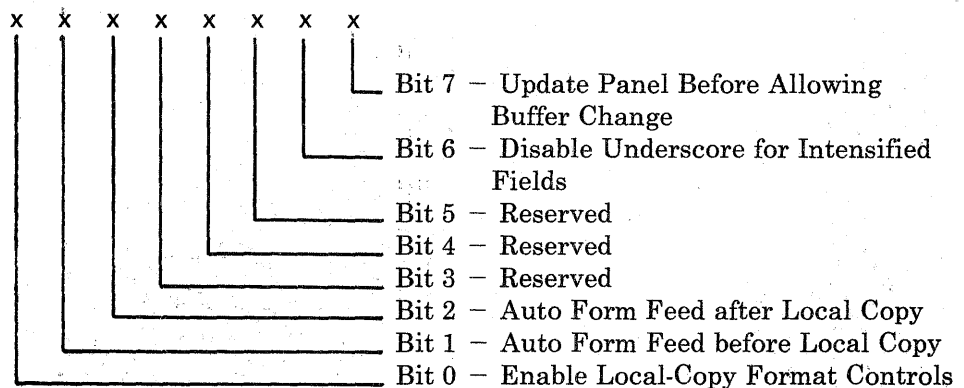

Bit 0 - Enable Local-Copy Format Controls.

The 3290 generates an SCS data stream to perform a local-copy operation to a printer. If the printer does not have Save/Restore Format capability and the printer is operated in shared mode, that is, a local-copy operation is permitted between brackets of an LU-1 session, there is a possibility that the format controls established by the host program will be destroyed by the local-copy operation. Proper use of this bit will help alleviate the contention situation

for establishing format controls. When the printer supports Save/Restore Format, this option has no effect; the 3290 will send format controls.

When bit 0 is set to 0, the 3290 will not send format controls to a printer that lacks Save/Restore Format capability. The 0 setting is the default and is applicable to those operating environments where the host program does not reestablish format controls with each Begin Bracket. Note that the format of the local-copy output depends on the format controls established by the operator or host program.

When bit 0 is set to 1, the 3290 will send format controls to the printer, even though the printer lacks Save/Restore Format capability. This enables the local-copy output to duplicate, as closely as possible, the character image being copied from the distributed function terminal. The 1 setting is applicable to those operating environments where the printer is not shared or the host program reestablishes format controls with each Begin Bracket.

Bit 1 – Automatic Form Feed before Local Copy.

Specify bit 1 as a 0 (zero) if you do not want to generate an automatic form feed before a local-copy operation is performed.

Specify bit 1 as a 1 if you want to generate an automatic form feed before a local-copy operation is performed.

Bit 2 – Automatic Form Feed after Local Copy.

Specify bit 2 as a 0 (zero) if you do not want to generate an automatic form feed after a local-copy operation is performed.

Specify bit 2 as a 1 if you want to generate an automatic form feed after a local-copy operation is performed.

Bits 3–5 – Reserved. Specify 0.

Bit 6 – Disable Underscore for Intensified Fields.

When bit 6 is set to 0, the 3290 *will* underscore all fields carrying the field intensify attribute.

When bit 6 is set to 1, the 3290 *will not* underscore fields carrying the field intensify attribute.

Bit 7 – Update Panel Before Allowing Buffer Change.

When bit 7 is set to 0, the 3290 will suspend panel updating to process a host transmission. Under high-data-rate conditions, messages sent by the host and placed in the display buffer may get overlaid with new data before being displayed on the panel.

When bit 7 is set to 1, all display buffer contents must be displayed on the panel before new data can be placed in the display buffer. It is recommended that bit 7 be set to 1 when 3290s are being used as system consoles or other applications when potentially high message rates are possible and the user is required to visually interpret all data sent by the host.

175: 3290 Password (Configuration Support T Only)

Enter the 6-digit password to allow permanent changes to the 3290 definition table using setup level 3.

176: BSC Enhanced Communication Option (Configuration Support T Only)

Enter 0. Not applicable to B and D models.

201 through 362

For sequence numbers 201 through 352, fill in the appropriate boxes in step 8 of the Initial Customizing Procedure Form with the following entries:

- | | |
|-----------|--|
| 201 | Enter 00. |
| 211 | Enter 0. |
| 213 | Enter 0. |
| 215 | Enter 00000. |
| 301 | Enter 00. |
| 302 | Enter 00. |
| 305 – 352 | Enter 0 in each box. |
| 360 | Enter 00 (Configuration Support C only). |
| 361 | Enter 00 (Configuration Support C only). |
| 362 | Enter 00000000 (Configuration Support C only). |

900: Entry Acceptance

Sequence number 900, which appears as part of the sequence number 999 display, prompts the operator to enter a 1 if, after the entries are verified, all the responses are entered correctly. If incorrect responses are detected by the 3274, the 1 is automatically changed back to a 0 by the 3274, an operator code is displayed for the incorrect information, and incorrect entries are intensified.

999: Specification Panel

Sequence number 999 displays all the responses entered during the customizing operation, permitting the operator to review the entries and to make any corrections needed. The Initial Customizing Procedure Form instructs the operator how to reply to this sequence number.

3274 Models 1C, 21C, 31C, and 51C

When a Model 1C, 21C, 31C, or 51C is being customized, some sequence numbers are not asked. The responses to those sequence numbers are filled in internally by the 3274 and displayed for the operator during the verification step of the initial customizing procedure (Initial Customizing Procedure Form, step 9). Many of these defaulted responses are determined by the response given to sequence number 343 (Communication Interface Options). Figure 3-5 shows those default values. Figure 3-5 does not list all the sequence numbers that may be necessary to customize a 3274 Model C. Use the remainder of this chapter to determine the proper responses to sequence numbers that are not listed in the figure.

Find your response to sequence number 343 at the top of the chart (Figure 3-5). The default values are given in the shaded blocks in the column for that response. The sequence numbers are listed in the left column of the chart. Use the values in the shaded blocks as the responses to the sequence numbers in step 8 of the Initial Customizing Procedure Form. Blank blocks indicate that you should use the sequence number explanations in the remainder of this chapter to decide on the proper response.

Other sequence numbers are conditionally defaulted. Those default values and conditions are as follows:

Sequence Number	Default Value	Condition
112	08	If 151 = E
121	02	If 321 = 1
131	1	If 321 = 1
132	0	If 321 = 1
133	0	If 321 = 1 or 121 = 17
134	0	If 321 = 1
135	0	If 321 = 1 or 121 ≠ 01
143	0	If 147 = 0
147	1	If 331 = 1
162	0	If 321 = 1
163	00	If 321 = 1 or 162 = 0
164	0	If 321 = 1 or 162 = 0
165	0	If 321 = 1 or 162 = 0 or 164 = 0
166	A	If 321 = 1 or 162 = 0
211	0	If 331 = 0
213	0	If 331 = 0
215	00000	If 331 = 0

You may eliminate many of the sequence numbers for your configuration by using the preceding information to fill in the default values in step 8 on the Initial Customizing Procedure Form. After filling in the default values, you can fill in unanswered sequence numbers by using the explanations in the remainder of this chapter.

Use the following descriptions in conjunction with the Initial Customizing Procedure Form in Chapter 4 to customize a 3274 Model 1C, 21C, 31C, or 51C.

Response to Sequence Number 343

C Models

Sequence Number	0	1	2	3*	4	5	6	7	8	9	A*	B
111*											00	
112											08	
301			00	00	00		00	00			00	
302												
305			0	0	0		0	0			0	
310	0	0	0	0		0	0	0	0	0	0	0
311		0	0	0		0	0	0	0	0	0	0
313			0	0		1	1	1	1	1	0	
314		0	0	0	0		0	0			0	
317		0	0	0	0	0	0	0			0	0
318		0	0	0	0	0	0	0	0	0	0	0
321			0	0								
331			1	1	1		1	1			1	
342		0	0	0	0		0	0			0	1
345	1	1	1	0		1	1	1	1	1	1	1
347*	0	0	0	0	0	0	0	0	0	0		0
351				1		0	0	0	0	0	1	
352*											0	
360*	00	00	00		00	00	00	00	00	00	00	00
361*	00	00	00		00	00	00	00	00	00	00	00
362*	00000000				00000000							

*Not applicable to Configuration Support T.

Figure 3-5. Default Values

001: Keyboard Validation

The response required for this sequence number is '1234567890ABCDEF' followed by a space and the validation number that is printed on the front cover of this book and on the first page of the Initial Customizing Procedure Form. The first part of the response verifies that the keyboard being used for customizing is operating properly. The last two digits (the validation number) are used to check that the level of this customizing guide is equal to or greater than the level of the feature and system diskettes.

Note: If a data entry keypunch layout keyboard is used, the New Line key is pressed when ENTER is specified. Also, the PF10 key is pressed when RESET is required; the PF8 key is pressed when New Line is required. See Figures 4-1 and 4-2 (in Chapter 4) for valid key positions and for the differences just noted. Be sure to specify the keyboard type on the Initial Customizing Procedure Form.

011: Patch Request

The response required for this sequence number is already entered on the form in step 5. The service representative may use this sequence number to make a diskette patch request.

021: Printer Authorization Matrix

Enter a 0 in step 6 on the Initial Customizing Procedure Form if any of the following conditions applies:

- The printer authorization matrix is to be entered only by a host application program (a 1 must be specified in sequence number 143).
- All printers are to be used in system mode, and local-copy operations are not desired.
- No printers are to be attached to the system.

Enter a 1 if a matrix is to be defined, thereby causing sequence number 022 to be displayed. This matrix will be established for each 3274 IML, regardless of the response to sequence number 143.

022: Printer Authorization Matrix Definition

The printer authorization matrix is defined in sequence number 022. See Appendix C for detailed information on responses to sequence number 022.

Fill in the appropriate spaces on the Printer Authorization Matrix Form with a definition for each printer in your configuration, and attach it to the Initial Customizing Procedure Form. The definitions may be entered in any sequence. Also, definitions do not have to be entered successively; for example, you may enter definitions in groups 1, 2, and 3 of the form, skip groups 4 and 5, and continue at group 6.

Once a printer authorization matrix has been defined, sequence number 021 is no longer displayed when a customized 3274 Control Unit is being updated. Instead, the defined matrix is displayed. If the entire matrix is deleted, sequence number 021 is again displayed during each updating procedure until a new matrix is defined. Any time the initial customizing procedure is performed, the sequence number 021 is displayed and the printer authorization matrix must be redefined if it is still required.

031: Number of RPQ Diskettes Required

Enter the number of RPQ diskettes required (0, 1, 2, or 3) in step 7 on the Initial Customizing Procedure Form.

032: Request RPQ Parameter List (Configuration Support C and T Only)

Enter a 1 if you require the RPQ parameter list; enter a 0 if not. If you enter a 1 here, sequence number 033 (RPQ Parameters) is displayed, with spaces for parameter information. If you enter a 0, sequence number 033 is not displayed.

Note: An RPQ parameter list is required by certain RPQs. Specific information about this list, sequence number 033 format, and implementation is supplied with the RPQ.

111: Number of Category B Terminals (Configuration Support A, B, and C Only)

Models 1C, 21C, and 31C: Enter a 2-digit number (00 to 16) specifying the number of Category B terminals that it is possible to attach to your 3274. (The actual number you have attached at any given time may be smaller than this number.)

Model 51C: If category B terminals are to be used, enter 04 in response to this sequence number in step 8 on the Initial Customizing Procedure Form.

Note: A Model 51C with the Loop Adapter (feature 4850) does not allow Category B terminals to be attached.

See sequence number 112 for a description of category types.

Notes:

1. A 2-digit number must be entered. If necessary, use a leading zero; for example, to specify 4, enter 04.
2. Specify the number of Category B terminals in multiples of 4 (maximum of 16).

112: Number of Category A Terminals

Models 1C, 21C, and 31C: Enter a 2-digit number (08 to 32) specifying the number of Category A terminals that it is possible to attach to your 3274. (The actual number you have attached at any given time may be smaller than this number.) See Note 1.

Notes:

1. *If any distributed function terminals are to be configured for multiple interactive screens, it is recommended that you specify the actual number of Category A devices to be attached, rather than multiples of 8. (See Note 4.)*
2. *A 2-digit number must be entered. If necessary, use a leading zero; for example, to specify 8, enter 08.*
3. *Category A terminals:*

*3178 Models C1, C2, and C3
3179 in 3279-emulation mode
3180 Model 1 in 3278-emulation mode
3230 Model 2
3262 Models 3 and 13
3268 Model 2
IBM 3270 Personal Computer in DFT mode
3278 Models 1, 2, 3, 4, and 5
3278 Models 1–5 with IBM 3270 Personal Computer Attachment
3279 Models 2A, 2B, 3A, and 3B
3287 Models 1 and 2 with 3274/3276 Attachment (feature 8331)
3287 Models 1C and 2C
3289 Models 1 and 2
3290 Information Panel
5210 Models G01 and G02
6580 Displaywriter System*

Category B terminals:

*IBM Personal Computer XT/370
3277 Models 1 and 2
3284 Models 1 and 2
3286 Models 1 and 2
3287 Models 1 and 2 with 3271/3272 Attachment (feature 8330)
3288 Model 2*

4. *Specify the number of Category A terminals in multiples of 8 (maximum of 32) and the number of Category B terminals in multiples of 4 (maximum of 16), unless the sum of the two categories exceeds 32. See Note 1.*

If the sum of the two categories exceeds 32:

- For Category B terminals, specify the actual number of Category B terminals (sequence number 111).
- For Category A terminals, specify the difference between 32 and the number of Category B terminals (sequence number 111).

Example: 13 Category B terminals and 17 Category A terminals would be specified as 13 and 19, respectively. Figure 3-6 shows the relationship and the ways to specify the various Category A and B terminal quantities. Note that, when Category A terminal adapters are added or removed, the host-recognized address of port B0 changes.

Model 51C: Enter a 08 in step 8 on the Initial Customizing Procedure Form. Although not asked for the Model 51C, the sequence number is shown on the verification frame with 08 filled in.

Quantity	Number of Category A Terminals																																Adapter Type																
	Base								A1								A2								A3																								
	1	2	3	4	5	6	7	8	9	10	11	12	13	14	15	16	17	18	19	20	21	22	23	24	25	26	27	28	29	30	31	32																	
0	Specify: A08 and B00								Specify: A16 and B00								Specify: A24 and B00								Specify: A32 and B00																								
1	Note: The 51C is limited to eight A devices and four B devices. Specify: A08 and B04 B0=08*								Specify: A16 and B04								Specify: A24 and B04								Specify: 32-B=A								B0=31*																
2																									B0=16*								B0=24*								B0=28*								B0=30*
3																									B0=16*								B0=24*								B0=28*								B0=29*
4																									B0=16*								B0=24*								B0=28*								B0=27*
5	Specify: A08 and B08								Specify: A16 and B08								Specify: A24 and B08								Specify: 32-B=A								B0=26*																
6	Specify: A08 and B08								Specify: A16 and B08								Specify: A24 and B08								Specify: 32-B=A								B0=25*																
7	Specify: A08 and B08								Specify: A16 and B08								Specify: A24 and B08								Specify: 32-B=A								B0=25*																
8	Specify: A08 and B08								Specify: A16 and B08								Specify: A24 and B08								Specify: 32-B=A								B0=25*																
9	Specify: A08 and B12								Specify: A16 and B12								Specify: 32-B=A								Specify: 32-B=A								Not Permitted																
10	Specify: A08 and B12								Specify: A16 and B12								Specify: 32-B=A								Specify: 32-B=A								Not Permitted																
11	Specify: A08 and B12								Specify: A16 and B12								Specify: 32-B=A								Specify: 32-B=A								Not Permitted																
12	Specify: A08 and B12								Specify: A16 and B12								Specify: 32-B=A								Specify: 32-B=A								Not Permitted																
13	Specify: A08 and B12								Specify: A16 and B12								Specify: 32-B=A								Specify: 32-B=A								Not Permitted																
14	Specify: A08 and B16								Specify: A16 and B16								Specify: 32-B=A								Specify: 32-B=A								Not Permitted																
15	Specify: A08 and B16								Specify: A16 and B16								Specify: 32-B=A								Specify: 32-B=A								Not Permitted																
16	Specify: A08 and B16								Specify: A16 and B16								Specify: 32-B=A								Specify: 32-B=A								Not Permitted																

*The host-recognized port addresses are sequential, with the first Category A port (port A0) always being address 0 (with the exception of SNA, which is always 02). The first Category B port (port B0) is always the next sequential address after the last Category A port.

Figure 3-6. 3274 Model 1C, 21C, 31C, and 51C Category A and B Terminal Quantity Relationships

113: Extended Function Store

Model 1C: Enter one of the following to specify whether any, and which, Extended Function Store feature is installed:

- 0000^{1,2} = No Extended Function Store feature is installed.
- 3622^{1,2} = Extended Function Store type C1 (feature 3622) is installed.
- 5000² = Extended Function Store types C1 (feature 3622) and C3 (feature 3625) are installed.
- 5100² = Extended Function Store type C2 (feature 3623) is installed.
- 7000^{1,2} = Extended Function Store types C1 (feature 3622) and D1 (feature 3627) are installed.
- 7800^{1,2} = Extended Function Store types C1 (feature 3622) and D2 (feature 3628) are installed.
- 9000² = Extended Function Store types C1 (feature 3622), C3 (feature 3625), and D1 (feature 3627) are installed.
- 9100² = Extended Function Store types C2 (feature 3623) and D1 (feature 3627) are installed.
- 9800 = Extended Function Store types C1 (feature 3622), C3 (feature 3625), and D2 (feature 3628) are installed.
- 9900 = Extended Function Store types C2 (feature 3623) and D2 (feature 3628) are installed.

Model 21C: Enter A000.^{1,2}

Model 31C: Enter D000.

Model 51C: Enter one of the following to specify whether any, and which, Extended Function Store feature is installed:

- A000^{1,2} = No extended function store feature is installed.
- B000² = Extended Function Store type D1 (feature 3630) is installed.
- C000 = Extended Function Store types D1 (feature 3630) and D3 (feature 3631) are installed.
- D000 = Extended Function Store type D2 (feature 3632) is installed, or Extended Function Store type D4 (feature 1800) is installed.

¹ Not valid for Configuration Support C.

² Not valid for Configuration Support T.

114: IBM 3270 Personal Computer Attachment (Configuration Support C Only)

Enter a 1 if an IBM 3270 Personal Computer Attachment will be attached to a display station connected to your 3274 and you intend to transfer data between the IBM 3270 Personal Computer Attachment and the host; enter a 0 if not.

Note: If you answer 114 with a 1, you must answer sequence numbers 147 (Local-Copy Function) and 162 (Structured Field and Attribute Processing) with a 1.

121: Keyboard Language/Character Set I/O Interface Code

Enter a 2-digit number (01 to 32) from Figure 3-7 specifying the keyboard language and character set I/O interface code being used. A 2-digit number must be entered. If necessary, use a leading zero; for example, to specify 7, enter 07.

127: Response Time Monitor (RTM) Definition (Configuration Support C Only)

A two-digit response is required. Both digits must be either zero or a nonzero value as follows:

First Digit:

- 0 - RTM support not wanted.
- 1 - RTM without host support. The RTM log and Last Transaction Time Indicator are displayed and reset on port 0* only.
- 2 - RTM without host support. The RTM log and Last Transaction Time Indicator are displayed and reset on all ports.*
- 3 - RTM with host support. The RTM log and Last Transaction Time Indicator are not displayable or resettable on any local port.*
- 4 - RTM with host support. The RTM log and Last Transaction Time Indicator are displayable on port 0* only.
- 5 - RTM with host support. The RTM log and Last Transaction Time Indicator are displayable on all ports.*

* All terminals can display the Last Transaction Time Indicator, but only non-distributed function terminals can display the RTM log.

Note: Responses 3, 4, and 5 are applicable to SDLC networks only.

Sequence Number 121 Response	Keyboard Language	Character Set I/O Interface Code
01	English (U.S.)	English (U.S.)
03	Austrian/German	Austrian/German
04	Belgian	Belgian
05	Brazilian	Brazilian
06 ¹	Canadian (French)	Canadian (French)
07	Danish	Danish/Norwegian
08 ^{2,3}	Danish	Danish/Norwegian (Alternate)
09 ³	Finnish	Finnish/Swedish
10 ^{2,3}	Finnish	Finnish/Swedish (Alternate)
11	French (QWERTY)	French
12 ³	French (AZERTY)	French
13 ^{2,3}	Austrian/German	Austrian/German (Alternate)
14	International	International
15	Italian	Italian
16	Japanese (English)	Japanese (English)
17	Japanese (Katakana)	Japanese (Katakana)
18 ³	Portuguese (not allowed with Configuration Support C)	Portuguese (Alternate)
19	Spanish	Spanish
20 ^{2,3}	Spanish	Spanish (Alternate)
21	Spanish-speaking	Spanish-speaking
22	English (U.K.)	English (U.K.)
23	Norwegian	Danish/Norwegian
24	Swedish	Finnish/Swedish
25	EBCDIC (WT)	English (U.S.)
26 ^{2,3}	Norwegian	Danish/Norwegian (Alternate)
27 ^{2,3}	Swedish	Finnish/Swedish (Alternate)
28	Portuguese	Portuguese
29 ¹	Canadian (Bilingual)	Canadian (Bilingual)
30 ⁴	French AZERTY (105-character)	French AZERTY (105-character)
31 ⁴	Swiss German	Swiss German/Swiss French
32 ⁴	Swiss French	Swiss German/Swiss French

¹ Canadian (Bilingual) is supported by Configuration Support T only. Canadian (French) is supported by Configuration Support A, B, and C only.

² Structured Field and Attribute Processing (SFAP) (Sequence Number 162) is not supported with these languages.

³ Not supported by Configuration Support T.

⁴ Configuration Support C and T only.

Notes:

- Keyboard layouts and character set I/O interface code information are given in *IBM 3270 Information Display System: Character Set Reference, GA27-2837*.
- An alternate character set I/O Interface code should be selected only when compatibility with the 3271/3272/3275 data base is required. To facilitate later migration, all systems should be upgraded to the latest support 3270 level.

Figure 3-7. 3274 Model 1C, 21C, 31C, and 51C Keyboard Language and Character Set I/O Interface Code

Second Digit:

- 0 – RTM support not wanted.
- 1 – End response time measurement when the first character is displayed on screen.
- 2 – End response time measurement when the keyboard again becomes usable.
- 3 – End response time measurement when a Change Direction (CD) or End Bracket (EB) indication is received. (A CD in conjunction with a Read command will not stop the timer.)

Note: Response 3 is applicable to SDLC networks only.

Response time measurement starts with recognition by the control unit of an inbound AID request, for example, by pressing the ENTER key. The second digit responses define the end of the measurement.

Nonzero responses to sequence number 127 cause sequence number 128, RTM Boundaries and Interface Specification, to be displayed later in the customization sequence.

See Appendix K in this publication for more details concerning RTM.

128: RTM Boundaries and Interface Specification (Configuration Support C Only)

This sequence number (a panel) is displayed after the specification panel is accepted *and* only if the response to sequence number 127 is nonzero. See Appendix K.

131: Typewriter Keyboard

For an example of this keyboard type, see Figure M-1 in Appendix M.

Enter a 0 if there are no 3178-C2s *and* none of the 3278s or 3279s have a typewriter keyboard (feature 2715, 2717, 4621, 4624, 4627, 4628, 4640, or 4651); enter a 1 if any do.

132: Data Entry Keyboard

For an example of this keyboard type, see Figure M-2 in Appendix M.

Enter a 0 if there are no 3178-C1s *and* none of the 3278s or 3279s have a data entry keyboard (feature 2716 or 4622); enter a 1 if any do.

133: Data Entry Keypunch Layout Keyboard

For an example of this keyboard type, see Figure M-3 in Appendix M.

Enter a 0 if none of the attached 3278s or 3279s have a data entry keypunch layout keyboard (feature 4623); enter a 1 if any do.

134: APL Keyboard

For an example of this keyboard type, see Figure M-4 in Appendix M.

Enter a 0 if none of the attached 3278s or 3279s have an APL keyboard (feature 4626 or 4652); enter a 1 if any do.

Note: For Configuration Support A and B only, enter a 1 if an APL keyboard is not attached to any 3278 or 3279 but you wish to display or print APL characters.

135: Text Keyboard

For an example of this keyboard type, see Figure M-5 in Appendix M.

Enter a 0 if none of the attached 3278s or 3279s have a text keyboard (feature 4629); enter a 1 if any do.

Note: For Configuration Support A and B only, enter a 1 if a text keyboard is not attached to any 3278 or 3279 but you wish to display or print text characters.

139: 3290 Keypad Selection (Configuration Support T Only)

Enter one of the following to specify the type of keypad you will be using on your 3290:

- 0 = No keypad or the default keypad (National Language Numeric Keypad)
- 1 = 24-key numeric keypad
- 2 = 25-key numeric keypad (, on key 4)
- 3 = 25-key numeric keypad (. on key 4)
- 4-6 = Reserved
- 7 = Program Function Keypad

Enter a 0 if you have no 3290 Information Panels.

Note: If a nonzero response is specified for this sequence number, a 1 must be specified for sequence number 170.

141: Magnetic Character Set

Enter one of the following to specify the magnetic character set installed:

A = None

B = Numeric (3277-compatible)

C = Alphanumeric (auto entry for secure data)

D = Alphanumeric (auto entry for all data)

143: Host-Loadable Printer Authorization Matrix

Enter a 0 if a printer authorization matrix is not to be loaded from the host; enter a 1 if it is.

This matrix is defined by a user-written application program. When run, a host-loaded matrix overrides any other printer authorization matrix. (See also sequence number 021.)

145: 3289 Print Control

Enter a 1 if a 3289 Line Printer with the text print belt (feature 9496) is attached. Enter a 0 if no 3289 Line Printer is attached or if a 3289 without the text print belt is attached.

147: Local-Copy Function

BSC: Enter a 1 if the local-copy function Print key is being used; enter a 0 if it is not.

Distributed Function Terminal: If you want to use the local-copy function on a distributed function terminal, enter a 1 and specify a printer authorization matrix (see Appendix C).

Note: If a 0 is entered, local copy by means of the Print key and the host Copy command are nullified.

If an IBM 3270 Personal Computer Attachment is configured (sequence number 114=1), you *must* respond to 147 with a 1.

SDLC: Enter a 1 for this sequence number in step 8 on the Initial Customizing Procedure Form. This function is not selectable for SDLC and is automatically included in your configuration.

151: 3274 Model Designation

Enter one of the following to specify the 3274 model:

C = Model 1C

E = Model 51C

3 = Models 21C and 31C

161: Color Convergence

Enter a 0 if either of the following applies:

- In U.S. and Canada only, all the 3279 Color Display Stations attached have model numbers ending in -1, for example, S2A-1.
- No 3279 Color Display Stations are attached.

Enter a 1 if any other 3279 Color Display Stations are attached.

162: Structured Field and Attribute Processing (SFAP) (Configuration Support C Only)

Enter a 1 if APL, SFAP, or the LU Type 1 SNA character string (SCS) (3287 Printer with feature 9661) is used; enter a 0 if not.

If an IBM 3270 Personal Computer Attachment is configured (sequence number 114=1), you must respond to 162 with a 1.

SFAP is necessary if you are using the extended character set (Write Structured Field command or the Set Attribute, Start Field Extended, or Modify Field orders). (See 163 following.) LU Type 1 SCS supports extended color, extended highlighting (underscore), and Programmed Symbols on LU Type 1 printers with feature 9661.

If you respond 1 to this sequence number, you *must not* respond 08, 10, 13, 20, 26, or 27 to sequence number 121.

If you enter a 0, sequence numbers 163–166 will not be asked.

163: Extended Character Set Adapter (Configuration Support C Only)

This is the number of terminals (displays and printers) that process the APL/Text functions and extended color, Programmed Symbols, and extended highlighting. Count one for each:

- 3179 in 3279-emulation mode
- 3180 Model 1 in 3278-emulation mode
- 3230 Model 2

- 3262 Models 3 and 13
- 3268 Model 2
- 3278 with Extended Character Set Adapter (feature 3610)
- 3279 Models 2B, 3B, S2B, and S3G
- 3279 Models 02X and 03X with Extended Function Store (feature 3850)
- 3287 with Extended Character Set Adapter (feature 3610)

A 2-digit number must be entered. If necessary, use a leading zero; for example, to specify 8, enter 08.

Notes:

1. *This number must not exceed the number of Category A terminals specified in sequence number 112.*
2. *If an IBM 3270 Personal Computer Attachment is configured (sequence number 114= 1), each attachment must be considered a count unless the associated display has been counted as a display with the Extended Character Set Adapter (feature 3610) installed.*
3. *If you respond 1 to this sequence number, you must not respond 08, 10, 13, 20, 26, or 27 to sequence number 121.*

164: Programmed Symbols (PS) (Configuration Support C Only)

Enter a 1 if any attached terminals have a Programmed Symbols (PS) feature (5781, 5782, or 5783) installed; enter a 0 if not.

165: Decompression (Configuration Support C Only)

Enter a 1 if you want to send compressed PS data; otherwise, enter a 0. (This sequence number is not asked if a 0 was specified for sequence number 164 [Programmed Symbols].)

Note: Decompressing data on a locally attached 3274 could cause performance degradation.

166: Attribute Select Keyboard (Configuration Support C Only)

Note: This sequence number will not be asked unless you specified a 1 for sequence number 131 (typewriter keyboard) or 134 (APL keyboard).

For examples of the attribute select keyboards, see Figures M-6 through M-8 in Appendix M.

Enter one of the following to specify whether an attribute select typewriter keyboard (feature 4651), an attribute select typewriter/APL keyboard (feature 4652), or a typewriter overlay keyboard (feature 4640) is being used:

- A = None of these keyboards is being used.
- B = One or more of these keyboards are being used, but you do not wish to use the numeric lock function on *any* of them.
- C = One or more of these keyboards are being used, and you wish to use the numeric lock function on *all* of them.

170: Distributed Function Terminals (Configuration Support T Only)

- 0 = No distributed function terminals are attached.
- 1 = Distributed function terminals that require a load diskette will be attached, *or* a combination of distributed function terminals that require a load diskette and those that do not require a load diskette will be attached.
- 2 = Only distributed function terminals that *do not* require a load diskette will be attached.

Notes:

1. *If your response is 0, sequence numbers 171 through 176 are not displayed.*
2. *If your response is 2, respond to sequence numbers 139, 173, and 175 with 0's.*

171: Multiple Interactive Screens (Configuration Support T Only)

A 2-digit number must be entered for each of the following; if you are not using multiple interactive screens, enter 10 zeros:

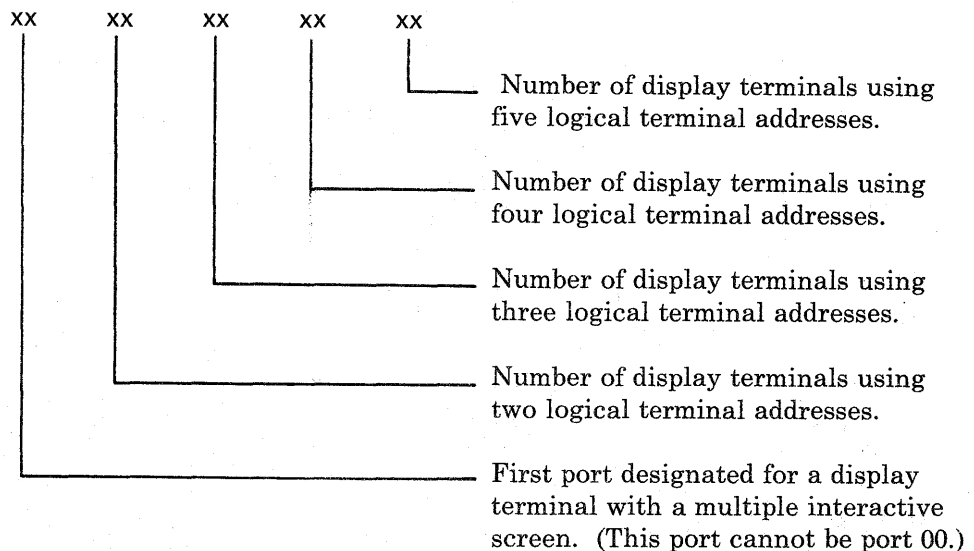

See Appendix J for a detailed description of multiple interactive screens.

173: 3290 Options (Configuration Support T Only)

Each of the eight bits in this response must be specified either as 0 or as 1. A 0 disables the particular option, and a 1 enables it. Enter all 0's if you do not have a 3290 Information Panel.

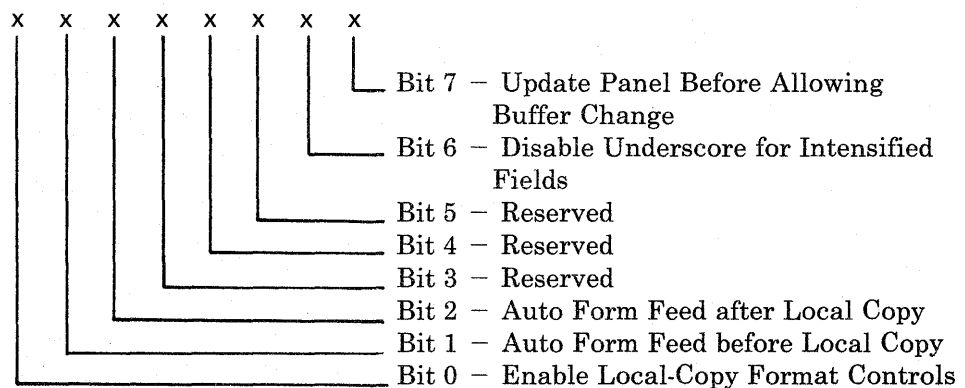

Bit 0 - Enable Local-Copy Format Controls.

The 3290 generates an SCS data stream to perform a local-copy operation to a printer. If the printer does not have Save/Restore Format capability and the printer is operated in shared mode, that is, a local-copy operation is permitted between brackets of an LU-1 session, there is a possibility that the format controls established by the host program will be destroyed by the local-copy operation. Proper use of this bit will help alleviate the contention situation

for establishing format controls. When the printer supports Save/Restore Format, this option has no effect; the distributed function terminal will send format controls.

When bit 0 is set to 0, the 3290 will not send format controls to a printer that lacks Save/Restore Format capability. The 0 setting is the default and is applicable to those operating environments where the host program does not reestablish format controls with each Begin Bracket. Note that the format of the local-copy output depends on the format controls established by the operator or host program.

When bit 0 is set to 1, the 3290 will send format controls to the printer, even though the printer lacks Save/Restore Format capability. This enables the local-copy output to duplicate, as closely as possible, the character image being copied. The 1 setting is applicable to those operating environments where the printer is not shared or the host program reestablishes format controls with each Begin Bracket.

Bit 1 – Automatic Form Feed before Local Copy.

Specify bit 1 as a 0 (zero) if you do not want to generate an automatic form feed before a local-copy operation is performed.

Specify bit 1 as a 1 if you want to generate an automatic form feed before a local-copy operation is performed.

Bit 2 – Automatic Form Feed after Local Copy.

Specify bit 2 as a 0 (zero) if you do not want to generate an automatic form feed after a local-copy operation is performed.

Specify bit 2 as a 1 if you want to generate an automatic form feed after a local-copy operation is performed.

Bits 3–5 – Reserved. Specify 0.

Bit 6 – Disable Underscore for Intensified Fields.

When bit 6 is set to 0, the 3290 *will* underscore all fields carrying the field intensify attribute.

When bit 6 is set to 1, the 3290 *will not* underscore fields carrying the field intensify attribute.

Bit 7 – Update Panel Before Allowing Buffer Change.

When bit 7 is set to 0, the 3290 will suspend panel updating to process a host transmission. Under high-data-rate conditions, messages sent by the host and placed in the display buffer may get overlaid with new data before being displayed on the panel.

When bit 7 is set to 1, all display buffer contents must be displayed on the panel before new data can be placed in the display buffer. It is recommended that bit 7 be set to 1 when 3290s are being used as system consoles or other applications where potentially high message rates are possible and the user is required to visually interpret all data sent by the host.

175: 3290 Password (Configuration Support T Only)

Enter the 6-digit password to allow permanent changes to the 3290 definition table using setup level 3.

176: BSC Enhanced Communication Option (Configuration Support T Only)

Specify a 1 if all the following conditions exist:

- You have distributed function terminals attached
- Your system is capable of handling enhanced BSC protocols in response to outbound transmissions of Write Acknowledgments (BSC WACK)
- You use any of the following IBM program products, which support BSC WACK:
 - ACF/NCP Version 1, Release 2 and higher
(CICS/VS and IMS/VS using VTAM or TCAM and ACF/NCP are supported.)
 - ACF/VTAM Version 2, Release 1 and higher (4321/4331 Communication Adapter)*
 - ACF/VTAME
 - CICS/VS Version 1, Release 6 and higher using BTAM
 - VM/370 SP Release 3 and higher

* Terminals attached through 370X Communication Controllers are supported in the ACF/NCP releases indicated above.

Specify a 0 if any of the following conditions exists:

- You do not have distributed function terminals attached
- Your system is not capable of handling BSC WACK
- Your system has IMS/VS using BTAM
- Your system has TCAM or ACF/TCAM using 370X EP.

You must ensure that the program products being used are at compatible levels and support the required display functions.

201: SNA Local Channel Control Unit Address

Enter 00 for this sequence number in step 8 on the Initial Customizing Procedure Form.

211: SCS Support (SDLC Only)

Enter a 1 if the LU Type 1 SNA character string (SCS) (3287 Printer with feature 9660, 3230 Printer, 3262 Line Printer, 3268 Printer, or 3289 Line Printer) is used; enter a 0 if not.

213: Between Bracket Printer Sharing (SDLC Only)

Enter a 0 if Between Bracket Printer Sharing is not allowed; enter a 1 if it is.

215: Physical Unit Identification (PUID) (SDLC Only)

The physical unit identification (PUID) is a 5-character code that identifies the control unit to the host in response to an SDLC XID command. It is required if the 3274 is to be used on a switched data link.

If the PUID is not used, enter 00000 for this sequence number in step 8 on the Initial Customizing Procedure Form.

If the PUID is used, each control unit in a network should be assigned a unique PUID. The PUID must be obtained from the system programmer and entered as the response to this sequence number in step 8 on the Initial Customizing Procedure Form.

220: Alert Function (SNA Only) (Configuration Support C)

Enter a 0, 1, 2, or 3 as follows:

- 0 – No alert function wanted.
- 1 – Alert function without operator-generated alert message capability.
- 2 – Alert function with operator-generated alert message capability from port 0 only.*
- 3 – Alert function with operator-generated alert message capability from all ports.*

* Operator-generated alert messages cannot be issued from a 3277 or a distributed function terminal.

301: Control Unit Number (BSC Only)

Enter the 2-digit decimal control unit number. Obtain the polling address (in hexadecimal) for this control unit from the system programmer at the host system site. Use Figure 3-8 to convert this address to the decimal control unit number.

Notes:

1. *Because it is standard practice to send the address twice, the system programmer may give you a "double address," for example, 4040. You would use only the first two digits, that is, 40.*
2. *If your 3274 has an integrated modem feature (5640, 5740, 5840, or 5842) installed, see Appendix G for proper setting of the Modem Address switches.*

302: SDLC Control Unit Address

Enter the 2-character hexadecimal SDLC control unit address; this information can be obtained from the system programmer at the host system location. The host system, if using NCP, specifies this address in the 3704/3705 PU macro. For loop operation, this address must match the loop adapter station address.

Note: If your 3274 has an integrated modem feature (5640, 5740, 5840, or 5842) installed, see Appendix G for proper setting of the Modem Address switches.

BSC Hexadecimal Polling Address		Control Unit Number (Sequence Number 301 Response)
EBCDIC	ASCII	
40	20	00
C1	41	01
C2	42	02
C3	43	03
C4	44	04
C5	45	05
C6	46	06
C7	47	07
C8	48	08
C9	49	09
4A	5B	10
4B	2E	11
4C	3C	12
4D	28	13
4E	2B	14
4F	21	15
50	26	16
D1	4A	17
D2	4B	18
D3	4C	19
D4	4D	20
D5	4E	21
D6	4F	22
D7	50	23
D8	51	24
D9	52	25
5A	5D	26
5B	24	27
5C	2A	28
5D	29	29
5E	3B	30
5F	5E	31

Example: If the EBCDIC hexadecimal BSC polling address is 4E, the value to be entered is 14. If the ASCII hexadecimal BSC polling address is 4E, the value to be entered is 21.

Figure 3-8. BSC Polling Address/Control Unit Number Conversion Chart

305: BSC Printer Polling

Reply with a 1 if the host uses specific polling and printers are not defined in the host polling list. Reply with a 0 if the host uses general polling.

310: Modem Connection

Enter a 1 if the 3274 is connected via the CCITT 108.1 Interface operating in connect-data-set-to-line (CDSTL) mode.

Enter a 0 if the 3274 is:

- Operating on a nonswitched line.
- Operating on a switched line in the U.S. or in Canada.

- Operating in Data Terminal Ready/Data Set Ready (DTR/DSR) mode in countries other than Canada.
- Connected via the CCITT V.35 Interface.

311: Modem Wrap (External Modems Only)

Enter a 1 if the modem is capable of a DTE-initiated automatic wrap test; enter a 0 if not. (In this case, the DTE is the 3274 Control Unit. The wrap test is initiated by the Test [DTE] control signal option via pin 18 from the 3274 Control Unit.)

If an IBM 3863, 3864, 3865, 3872, 3874, or 3875 modem is used, enter a 1 if the Test (DTE) control signal option was activated at the time of modem installation.

Wrap Feature: Determine whether the modem permits data to be wrapped under control of the 3274 Control Unit or whether the modem has a switch to control the wrap function. If the modem has the wrap capability and wrapping can be controlled from the 3274 Control Unit, it is recommended that this method be used.

If you are unable to determine that your modem has the wrap option activated, enter a 0. However, note that this may require you to recustomize at a later date if you determine later that the modem does have the wrap option activated and you wish to use the wrap capability.

313: NRZI (SDLC Only) or NRZ Encoding

Enter a 1 if nonreturn to zero inverted (NRZI) encoding is used; enter a 0 if nonreturn to zero (NRZ) encoding is used. (This parameter must be compatible with the host system communication controller and/or the modem.)

313: Internal or External Clocking (BSC Only)

Enter a 1 if feature 6301 is installed; enter a 0 if it is *not*.

Note: For external modems operating at 1200 bps with 3274 feature 6301 (business machine clock) installed, you must enter 1.

314: Multipoint or Point-to-Point Network

Enter a 0 if the 3274 is part of a multipoint network; enter a 1 if it is part of a point-to-point network.¹

Note: If the 3274 is attached to an IBM 3865 Modem Model 2, or if the 3274 has integrated modem feature 5842 installed, you *must* enter a 0.

317: Switched Network Backup (SNBU)

If your modem does not have SNBU capability, if you do not wish to use SNBU, or if you are using the CCITT V.35 Interface feature (1550), enter a 0 in response to this sequence number.

2-Wire SNBU:

If your modem has SNBU capability and you wish to use this capability, you should customize a second diskette, using the modification procedure in Chapter 5. When customizing the second diskette, enter 1 in response to this sequence number¹ if your modem is a 3872, 3874, 3875, or a 1200-bps integrated modem; enter a 0 in all other cases.

4-Wire SNBU:

If the 3274 is attached to an IBM 3863, 3864, or 3865 Modem with the 4-wire SNBU feature, enter a 0.

Note: A switched network attachment to some original equipment manufacturer (OEM) equipment requires the use of a protective device. This might have to be ordered from an OEM communication equipment supplier and installed separately.

318: Normal or Half-Speed Transmission

Enter a 0 if the modem does not have half-speed transmission capability, if full-speed transmission capability is desired, or if you are using the CCITT V.35 Interface feature (1550). Enter a 1 if half-speed transmission operation is desired.

If the modem has half-speed transmission capability, determine whether this capability can be controlled externally by the 3274 or by a switch on the modem. If the capability can be controlled by a switch on the modem, it is recommended that a 0 be entered and that the switch be used.¹

Note: To have the capability to operate in either full-speed or half-speed mode, two system diskettes may be generated (as described in Chapter 6), one for full-speed operation and one for half-speed operation. To switch modes, select the other system diskette and perform IML procedures. Ensure that diskettes are appropriately labeled.

¹ This parameter must be compatible with the host system communication controller and/or the modem.

321: EBCDIC or ASCII Character Set

Enter a 0 if the EBCDIC character set is used; enter a 1 if the ASCII character set is used (available in the U.S. only).

331: BSC or SDLC Protocol

Enter a 0 if the BSC protocol is used; enter a 1 if the SDLC protocol is used. (This parameter must be compatible with the host system communication controller.)

342: Request-to-Send (RTS) Control (2-Wire or 4-Wire)

SDLC:

2-wire: Enter a 0.
4-wire: Enter a 1.

Notes:

1. *If you are using the CCITT V.35 Interface feature (1550), enter a 1.*
2. *Entering a 1 here and also in response to sequence number 314 will provide a permanent RTS.*
3. *If you enter a 0 in response to this sequence number, you must also enter a 0 in response to sequence number 314.*

BSC:

2-wire: Enter a 0.
4-wire: If your host modems use the NEW SYNC feature, enter a 0. If you desire RTS from selection to end of transmission (EOT), enter a 1. (Be aware that entering a 1 may cause communication errors if your host modems use the NEW SYNC feature. If in doubt, enter a 0.)

Notes:

1. *If you are using the CCITT V.35 Interface feature (1550), enter a 1.*
2. *If you enter a 0 in response to this sequence number, you must also enter a 0 in response to sequence number 314.*

343: Communication Interface Options

Choose the communication interface you are using from the Interface and Feature Number columns, and enter the corresponding Response to this sequence number.

Interface	Feature Number	Response
CCITT V.35 Interface	1550	0
External Modem Interface (Nonswitched)	3701	0
Digital Data Service (DDS) Adapter	5650, 5651	1
X.21 Nonswitched	5655	2
X.21 Switched	5656 ¹	3
External Modem Interface (Switched)	3701 ²	4
1200-bps Integrated Modem (Nonswitched)	5500 ²	5
1200-bps Integrated Modem (Switched) with Auto Answer	5501 ²	6
1200-bps Integrated Modem (Switched) with Manual Answer	5502 ²	7
1200-bps Integrated Modem with SNBU and Manual Answer	5507 ²	8
1200-bps Integrated Modem with SNBU and Auto Answer	5508 ²	9
Loop attachment	4850 ¹	A
Integrated modem with speeds greater than 1200 bps	5640, 5740, ² 5840, 5842	B

¹ Applies to Configuration Support C only.

² Applies to Configuration Support C and T only.

345: Answer Tone (Configuration Support C and T Only; World Trade External Switched Network Modems Only)

Enter a 0 if your external switched network modem requires the 3274 transmit answer tone; otherwise, enter a 1.

347: High-Speed Data Rate (Configuration Support C Only; Loop Attachment Only; Model 51C Only)

Enter a 0 if your loop attachment data rate is less than 38.4 kb. Enter a 1 if it is 38.4 kb. This answer is dependent on the Loop Speed selected. (See Appendix H for additional information.) If you respond 1 to this sequence number, you must respond 1 to sequence numbers 331 and 351.

351: HPCA (SDLC Only) or CCA Adapter

Enter a 0 if the CCA Adapter feature (6301 or 6302) is installed; enter a 1 if the HPCA Adapter feature (6303) is installed.

352: Encrypt/Decrypt (SDLC Only) (Configuration Support A, B, and C Only)

Enter a 0 if the Encrypt/Decrypt feature (3680) is not installed; enter a 1 if it is.

360: X.21 Switched Retry (Configuration Support C; Model 51C Only) (SDLC Only)

Enter 00 if you are not using the X.21 Switched feature. If you are using this feature, enter the number of times that an incoming or outgoing call will be retried after the initial attempt is unsuccessful. Enter 00 if retry will not be used.

Note: A 2-digit number must be entered. If necessary, use a leading zero; for example, to specify 3, enter 03.

361: X.21 Switched Retry Timing (Configuration Support C; Model 51C Only) (SDLC Only)

Enter 00 if you are not using the X.21 Switched feature. If you are using this feature, enter the number of seconds between the retries specified in sequence number 360. This can be from 01 to 20 seconds. Enter 00 if retry will not be used.

Note: A 2-digit number must be entered. If necessary, use a leading zero; for example, to specify 3, enter 03.

362: X.21 Switched Options (Configuration Support C; Model 51C Only) (SDLC Only)

Enter 00000000 if you are not using the X.21 Switched feature. If you are using this feature, the response to this sequence number defines what X.21 options can be used on the terminals attached to all Category A ports except port A0. The conditions for port A0 are described following the diagram below. Each of the 8 digits in this response must be specified either as 1, meaning "yes," or 0, meaning "no."

Each digit allows or disallows one of the following:

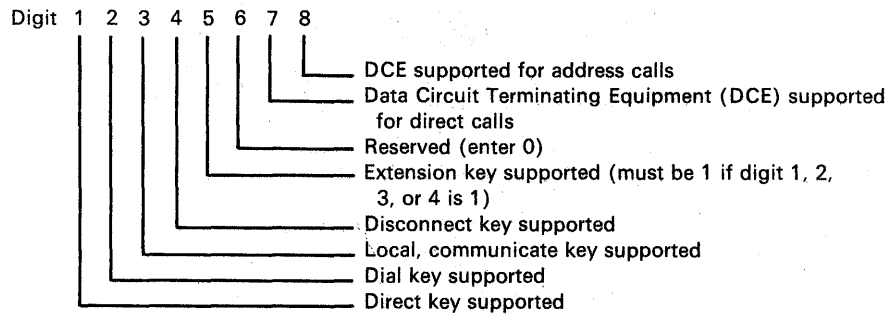

Note: If the X.21 Switched feature is being used, either digit 7 or digit 8 must be specified as 1, depending on which DCE support is used.

Port A0 access to the X.21 options is determined as follows: With the exception of the Direct and Dial keys (digits 1 and 2), port A0 always has access to all the X.21 options. Access to Direct and to Dial is dependent on the status of the DCE for direct calls (digit 7) and address calls (digit 8). If direct calls are supported (digit 7 specified as 1), the Direct key is supported on port A0. If address calls are supported (digit 8 specified as 1), the Dial key is supported on port A0. If both digits 7 and 8 are specified as 1, both the Direct and Dial keys are supported on port A0.

Example: 00011001 indicates that the Disconnect key (digit 4 specified as 1) and the Extension key (digit 5 specified as 1) can be used on all Category A terminals attached to the 3274. All Category A terminals support the DCE for address calls (digit 8 specified as 1). Since the Extension key allows access to all other X.21 keys, it must be specified if the other keys are to be used. Regardless of the response to this sequence number, the terminal attached to port A0 always has access to all the X.21 options.

900: Entry Acceptance

Sequence number 900, which appears as part of the sequence number 999 display, prompts the operator to enter a 1 if, after the entries are verified, all the responses are entered correctly. If the 3274 detects incorrect responses, it automatically changes the 1 back to a 0, an operator code is displayed for the incorrect information, and incorrect entries are intensified.

999: Specification Panel

Sequence number 999 displays all the responses entered during the customizing operation, permitting the operator to review the entries and to make any corrections needed. The Initial Customizing Procedure Form instructs the operator how to reply to this sequence number.

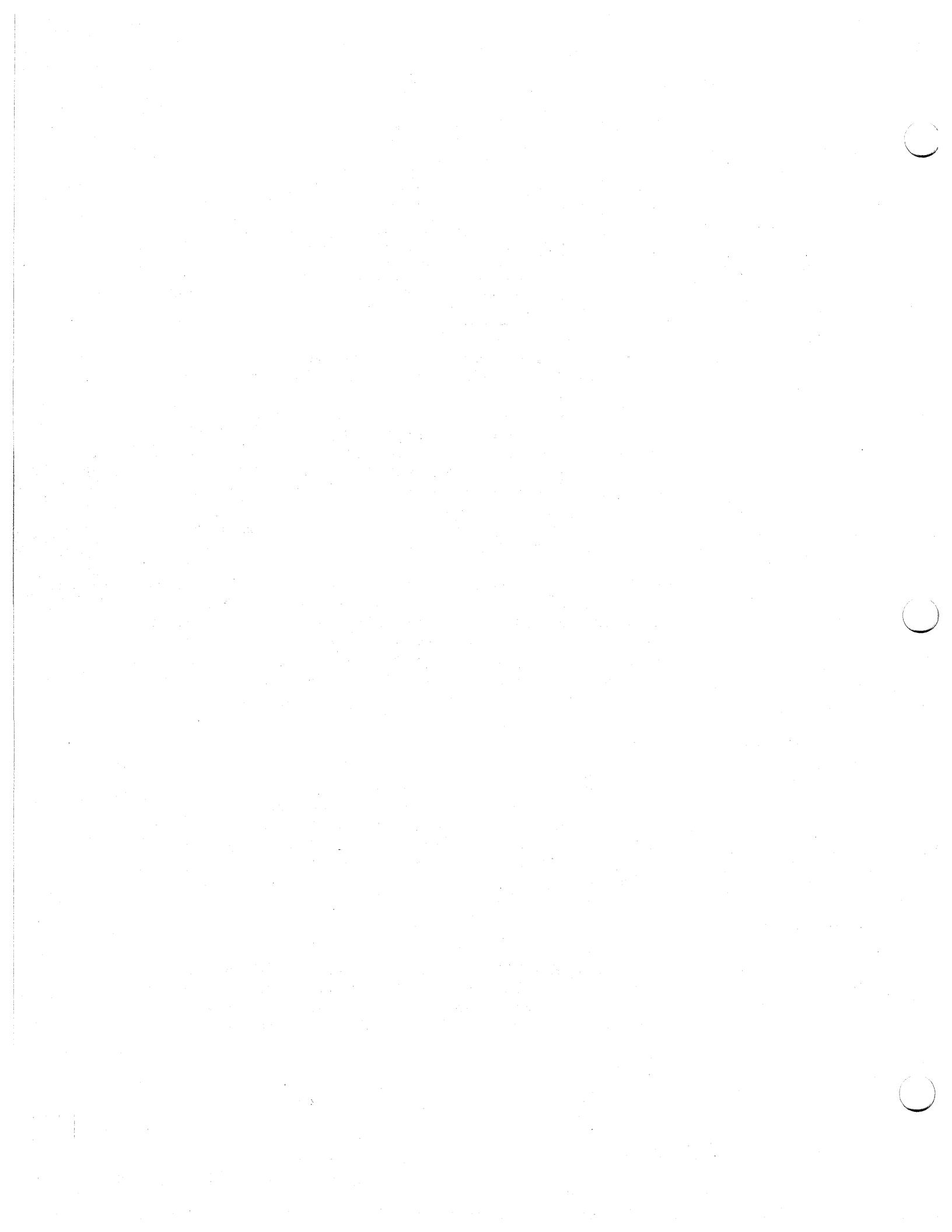

Chapter 4. Initial Customizing Procedure

This chapter contains a recommended Initial Customizing Procedure Form. This form should be used the first time the 3274 Control Unit is customized. Once the 3274 is successfully customized, if changes are required or desired, the Modification Procedure Form might be useful. See Chapter 5 for specifics.

The information on the Initial Customizing Procedure Form should be copied onto the *IBM 3274 Configuration Data Card (Configuration Support: A, B, C, T)*, GA23-0046, supplied with the 3274. A copy of this card is included at the end of this chapter. The card should be stored, for future reference, in the diskette storage area of the 3274.

The planner should enter the following information on the Initial Customizing Procedure Form:

1. The type of keyboard (typewriter or data entry) to be used by the operator.

Note: If using a 76- or 88-key Japanese English or Japanese Katakana keyboard, specify the number of keys and the keyboard type.

2. In step 1, the identification of each diskette to be used.
3. In step 7, the response to sequence number 031 (number of RPQ diskettes to be used). If you have no RPQ diskettes, the response is 0. If your response to sequence number 031 is not 0, you may have to enter a response to sequence number 032. See "032 (Request RPQ Parameter List)" in Chapter 3.
4. In step 8, the responses to be entered by the operator, using as a guide the section in Chapter 3 that applies to the model being customized. Fill in the boxes that apply to your configuration support.

In addition to the Initial Customizing Procedure Form, this chapter contains:

- Keyboard diagrams showing the valid key positions for customizing (Figures 4-1 and 4-2).
- A diagram showing how to insert a diskette properly into the 3274 Control Unit (Figure 4-3).

- A chart giving the meanings of, and recommended actions for, the operator codes that may appear on the display station during the customizing procedure (Figure 4-4).
- Charts giving the meanings of, and recommended actions for, the 8 4 2 1 indicator codes that appear on the 3274 control panel during the customizing procedure (Figures 4-5 and 4-6).
- A chart giving the meanings of, and recommended actions for, the 8 4 2 1 indicator codes that could appear on the 3274 control panel during IML because of improper customizing (Figure 4-7).
- A Printer Authorization Matrix Form to be used with sequence number 022 in Chapter 3.
- A copy of the *IBM 3274 Configuration Data Card (Configuration Support: A, B, C, T)*, GA23-0046.

All the information listed herein and the completed Initial Customizing Procedure Form should be given to the operator who is to perform the customizing procedure at the display station.

Initial Customizing Procedure Form

Validation Number 10

Review this entire form before starting the customizing procedure. Display station operating procedures are described in the *Operator's Guide* for the display station to be used in customizing.

This procedure configures the 3274 Control Unit. *If you do not get the expected result in any step, start over at step 1. If you still do not get the expected result, report the problem.*

There are four indicators, labeled 8 4 2 1, on the 3274 control panel. The meanings of the 8 4 2 1 indicator codes are shown in Figures 4-5 and 4-6. If an error occurs during this procedure, the 8 4 2 1 indicator code may help you locate the cause. Within this form, an on indicator is called a 1, an off indicator a 0 (zero). Example: 8 4 2 1

* * o * = 1101

3274 Control Panel

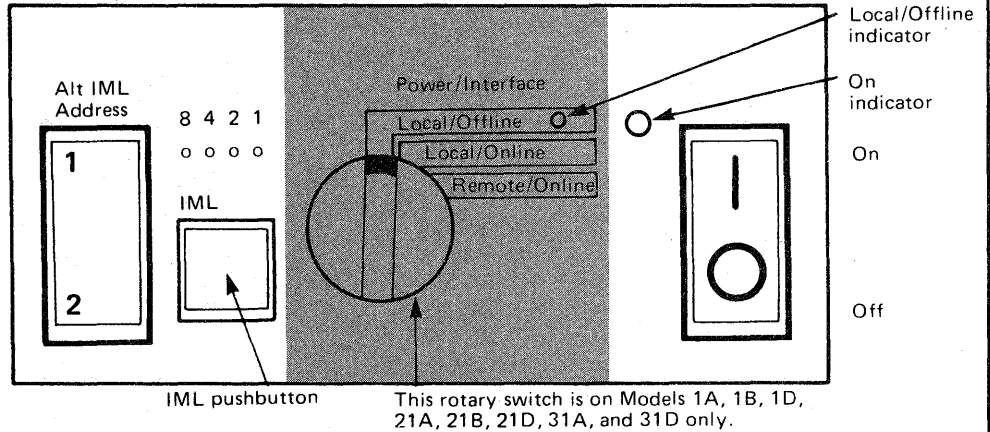

Type of keyboard to be used:

- Typewriter
- Data Entry Keypunch
- Data Entry
- Japanese Katakana Typewriter
- Japanese Katakana Data Entry
- Japanese English Typewriter

During customizing, only certain keys are active. Turn to Figures 4-1 and 4-2, following this form, to see which keys on your keyboard can be used for customizing.

1. Obtain the:

- Feature diskette _____
 - System diskette _____
 - Language diskette (if applicable) _____
 - Load diskette (if applicable) _____
 - RPQ diskette(s) (if applicable) 1. _____
 - 2. _____
 - 3. _____
- } These diskettes were delivered with the 3274.

2. Ensure that the 3274 Control Unit and the display station have power switched on. The display station must have a keyboard and must be attached to port A0 of the 3274.

Note: When customizing a 3274 Model 1A, 1B, 1D, 21A, 21B, 21D, 31A, or 31D, do not set the on/off switch to the off position unless the rotary switch on the control panel is in the Local/Offline position and the Local/Offline indicator is on. The Power/Interface switch must be in the Local/Offline position and the Local/Offline indicator must be on.

3. Insert the *feature* diskette (Figure 4-3), and press the IML pushbutton momentarily. Within 1 minute, the 8 4 2 1 indicator code should be 0001. If you are using a 3279 Color Display Station, refer to Appendix E for the convergence procedure.
4. Look for a 3-digit sequence number in the upper left corner of the screen. The first one is 001. Beneath the sequence number are Xs, which you replace by typing in the response to sequence number 001 (below). If the response you enter is acceptable, a new sequence number will be displayed. If the response is unacceptable, a 2-digit operator code will be displayed in the upper center portion of the screen. See Figure 4-4 for the meaning of this code.

If you are using a 3179 display station, it must be operating in 3279-emulation mode. If you are using a 3180 display station, it must be operating in 3278-emulation mode. If your 3179 or 3180 is not in emulation mode (that is, if it is in native mode), the number 212 will appear in the operator information area of the display screen when the first keystroke is attempted and customizing cannot proceed.

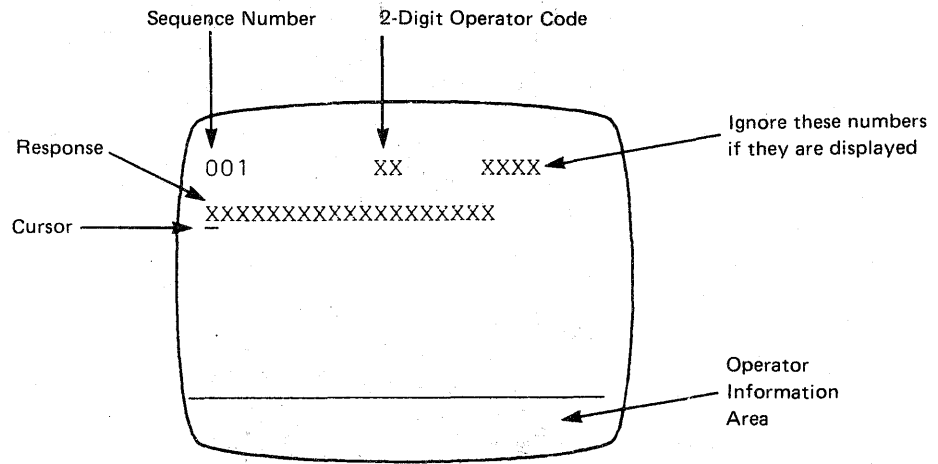

Note: If a 76- or 88-key Japanese English or Japanese Katakana keyboard is used, press the key circled in Figure 4-2 before proceeding. The keyboard will be locked for about 10 seconds. When the keyboard unlocks, continue.

- Type in the following characters in response to sequence number 001:
1234567890ABCDEF
- Press the spacebar once.
- Type in the 2-digit validation number that is printed on the first page of this form.
- Press ENTER.

Note: Use only the cursor move keys or tab key to reposition the cursor.

5. Type in a 0 (zero) in response to sequence number 011. Press ENTER.
6. If you have *not* been given a Printer Authorization Matrix Form, type in a 0 in response to sequence number 021 and press ENTER. If you have been given the Printer Authorization Matrix Form, type in a 1 and press ENTER; then follow the instructions on the form.

7. Type in the number of RPO diskettes _____ being used in response to
(0-3)

sequence number 031. Press ENTER.

Note: If you respond to sequence number 031 with a 1, 2, or 3, sequence number 032 may be displayed. If you have been given specific RPO parameter instructions, follow those instructions. If not, type in a 0 in response to 032 and press ENTER.

8. Look for new sequence numbers. They may not be in numeric order; nor will all be displayed. Type in the responses that were recorded on the following sequence number layouts. (Note that the numbers are listed from left to right, top to bottom, to match a display to be shown later in step 9.) Press ENTER after typing in each response. If an error occurs after you enter a response, a 2-digit operator code will be displayed in the top center of the display screen. Figure 4-4 may help you to find the cause of the error.

Configuration Support A and B (Read left to right.)

Note: Use leading zeros to have 1-digit response fill a 2-digit box.

111 - <input type="text"/>	112 - <input type="text"/>	113 - <input type="text"/>	
121 - <input type="text"/>	131 - <input type="text"/>	132 - <input type="text"/>	133 - <input type="text"/>
134 - <input type="text"/>	135 - <input type="text"/>		
141 - <input type="text"/>	143 - <input type="text"/>	145 - <input type="text"/>	147 - <input type="text"/>
151 - <input type="text"/>			161 - <input type="text"/>
201 - <input type="text"/>	211 - <input type="text"/>	213 - <input type="text"/>	215 - <input type="text"/>
301 - <input type="text"/>	302 - <input type="text"/>	305 - <input type="text"/>	310 - <input type="text"/>
311 - <input type="text"/>	313 - <input type="text"/>	314 - <input type="text"/>	317 - <input type="text"/>
318 - <input type="text"/>	321 - <input type="text"/>	331 - <input type="text"/>	342 - <input type="text"/>
343 - <input type="text"/>	351 - <input type="text"/>	352 - <input type="text"/>	900 - 0

Configuration Support C (Read left to right.)

Note: Use leading zeros to have 1-digit response fill a 2-digit box.

111 - <input type="text"/>	112 - <input type="text"/>	113 - <input type="text"/>	114 - <input type="text"/>	121 - <input type="text"/>	127 - <input type="text"/>
131 - <input type="text"/>	132 - <input type="text"/>	133 - <input type="text"/>	134 - <input type="text"/>	135 - <input type="text"/>	
141 - <input type="text"/>	143 - <input type="text"/>	145 - <input type="text"/>	147 - <input type="text"/>		
151 - <input type="text"/>					
161 - <input type="text"/>	162 - <input type="text"/>	163 - <input type="text"/>	164 - <input type="text"/>	165 - <input type="text"/>	166 - <input type="text"/>
201 - <input type="text"/>	211 - <input type="text"/>	213 - <input type="text"/>	215 - <input type="text"/>		220 - <input type="text"/>
301 - <input type="text"/>	302 - <input type="text"/>	305 - <input type="text"/>	310 - <input type="text"/>	311 - <input type="text"/>	313 - <input type="text"/>
314 - <input type="text"/>	317 - <input type="text"/>	318 - <input type="text"/>	321 - <input type="text"/>	331 - <input type="text"/>	342 - <input type="text"/>
343 - <input type="text"/>	345 - <input type="text"/>	347 - <input type="text"/>	351 - <input type="text"/>	352 - <input type="text"/>	
360 - <input type="text"/>	361 - <input type="text"/>	362 - <input type="text"/>			900 - 0

Configuration Support T (Read left to right.)

Note: Use leading zeros to have 1-digit response fill a 2-digit box.

112 - <input type="text"/>	113 - <input type="text"/>	121 - <input type="text"/>			
131 - <input type="text"/>	132 - <input type="text"/>	133 - <input type="text"/>	134 - <input type="text"/>	135 - <input type="text"/>	139 - <input type="text"/>
141 - <input type="text"/>	143 - <input type="text"/>	145 - <input type="text"/>	147 - <input type="text"/>		
151 - <input type="text"/>	161 - <input type="text"/>				
170 - <input type="text"/>	171 - <input type="text"/>	<input type="text"/>	<input type="text"/>	<input type="text"/>	173 - <input type="text"/>
175 - <input type="text"/>		176 - <input type="text"/>			
201 - <input type="text"/>	211 - <input type="text"/>	213 - <input type="text"/>	215 - <input type="text"/>		
301 - <input type="text"/>	302 - <input type="text"/>	305 - <input type="text"/>	310 - <input type="text"/>	311 - <input type="text"/>	313 - <input type="text"/>
314 - <input type="text"/>	317 - <input type="text"/>	318 - <input type="text"/>	321 - <input type="text"/>	331 - <input type="text"/>	342 - <input type="text"/>
343 - <input type="text"/>	345 - <input type="text"/>	351 - <input type="text"/>			
					900 - 0

9. After the last response is entered, sequence number 999 is displayed with the responses entered during step 8. Verify the entries with the layout in step 8. You may change entries by moving the cursor to the entry to be changed and entering the new response. Do not try to change the sequence number itself.
10. When all the entries are correct, move the cursor to the zero after sequence number 900, change it to a 1, and press ENTER. If any entry is unacceptable, the entry to sequence number 900 is changed back to 0 (zero) and the unacceptable response is intensified. (With the 3179 and the 3279, intensified characters are white and red instead of blue and green.) The 2-digit operator code in the upper center portion of the screen refers to the greatest sequence number with its response intensified. (Figure 4-4 gives the meaning of these codes.) Repeat step 9 and this step. If there are still unacceptable entries, report the problem.
If all the entries are acceptable, the screen will be cleared and:
 - a. If the response to sequence number 127 was nonzero, sequence number 128 (a panel) will be displayed. Enter the responses given for sequence number 128 on the procedure sheet attached to this form. When the responses are accepted, go to step 11.
 - b. If the response to sequence number 127 was zero, the screen remains cleared. Go to step 11.

11. Within 2 minutes, the 8 4 2 1 indicator code on the 3274 Control Unit should be flashing one of the following:

1100 — Replace the feature diskette with the *RPO* diskette. *Do not press the IML pushbutton.* (If you do press the IML pushbutton, go back to step 3.) After the RPO diskette is inserted, the code will change to 0111 within 30 seconds. If additional RPO diskettes are required or if you inserted a diskette that is not an RPO diskette, the indicator code will again flash 1100. Repeat the procedure for each additional RPO diskette. *At no time should you press the IML pushbutton.* When the RPO diskette procedure is completed, the indicator code should be flashing 1110. Reinsert the *feature* diskette. *Do not press the IML pushbutton.* Within 2 minutes, the 8 4 2 1 indicator code will flash 1011 or 1101. Perform the functions indicated.

1101 — Replace the feature diskette with the *language* diskette. *Do not press the IML pushbutton.* (If you do press the IML pushbutton, go back to step 3.) Within 30 seconds, the indicator code will change to 0111 and then to flashing 1011 within 1 minute. When the indicator code is flashing 1011, replace the language diskette with the *system* diskette. *Do not press the IML pushbutton.* Within 1 minute, the 8 4 2 1 indicator code will change to a steady 1000. Within 15 minutes the 8 4 2 1 indicator code will change to one of the following.

Note: If errors occur during this 15-minute period, a flashing 8 4 2 1 indicator code will appear. See Figures 4-5 and 4-6.

0011 — Replace the system diskette with the *load* diskette. *Do not press the IML pushbutton.* (If you do press the IML pushbutton, go back to step 3.) Within 5 minutes, the 8 4 2 1 indicator code will change to 1111, indicating that customizing is completed.

1111 — Customizing is completed. Go to step 12.

1011 — Replace the feature diskette with the *system* diskette. *Do not press the IML pushbutton.* (If you do press the IML pushbutton, go back to step 3.) Within 1 minute, the 8 4 2 1 indicator code will change to a steady 1000. Within 15 minutes, the 8 4 2 1 indicator code will change to one of the following.

Note: If errors occur during this 15-minute period, a flashing 8 4 2 1 indicator code will appear. See Figures 4-5 and 4-6.

0011 — Replace the system diskette with the *load* diskette. *Do not press the IML pushbutton.* (If you do press the IML pushbutton, go back to step 3.) Within 5 minutes, the 8 4 2 1 indicator code will change to 1111, indicating that customizing is completed.

1111 — Customizing is completed. Go to step 12.

12. Be sure that the 3274 is attached to the appropriate communication facility.

Note: If you used a load diskette in this procedure, that load diskette should be used for step 13. Otherwise, the system diskette should be used.

13. Press the IML pushbutton. During the IML operation, errors may occur because of improper customizing. The 8 4 2 1 indicator codes caused by these errors are shown in Figure 4-7.

If, after the IML operation is initiated, the **X**  symbol appears for more than 1 minute with no communication reminders in the display station's operator information area, contact your host system operator to ensure that the 3274 Control Unit is being polled.

14. If it has not already been done, copy the configuration information from this form onto the *IBM 3274 Configuration Data Card (Configuration Support: A, B, C, T)*, GA23-0046, supplied with the 3274 Control Unit. Store the card, for future reference, in the pocket on the inside of the 3274 operator access door on Models 1, 21, and 31, or in the diskette storage area on the front of the Model 51C.
15. If a Subsystem Verification Procedure has been given to you, perform that procedure.
16. If you have been given instructions for setting 3274 Model 31C or 51C switches, follow those instructions.

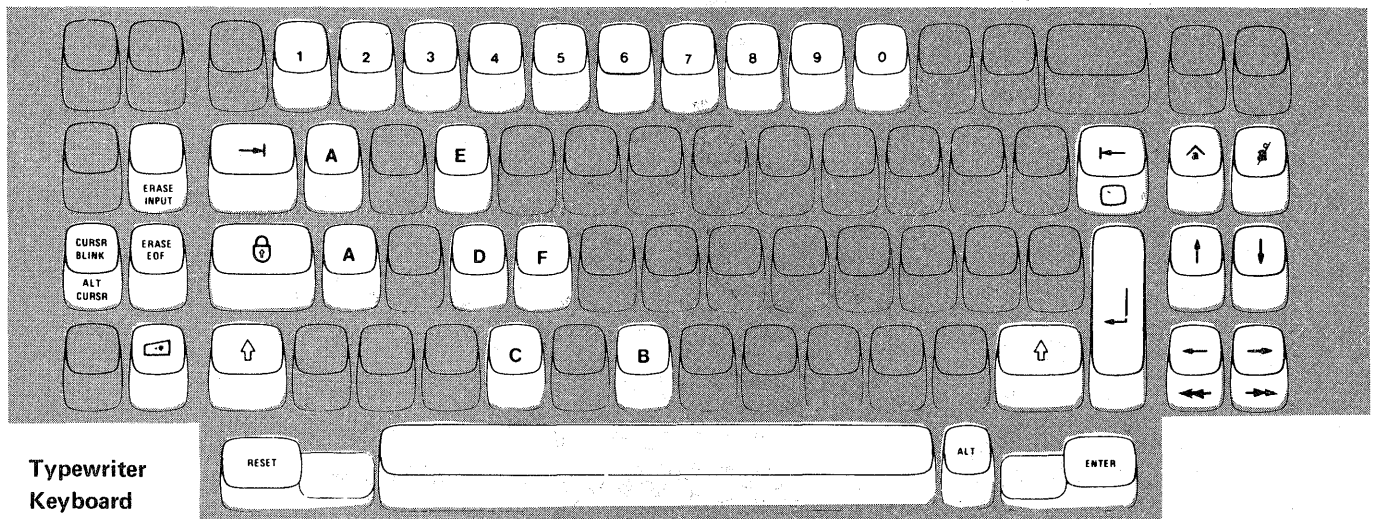

Typewriter Keyboard

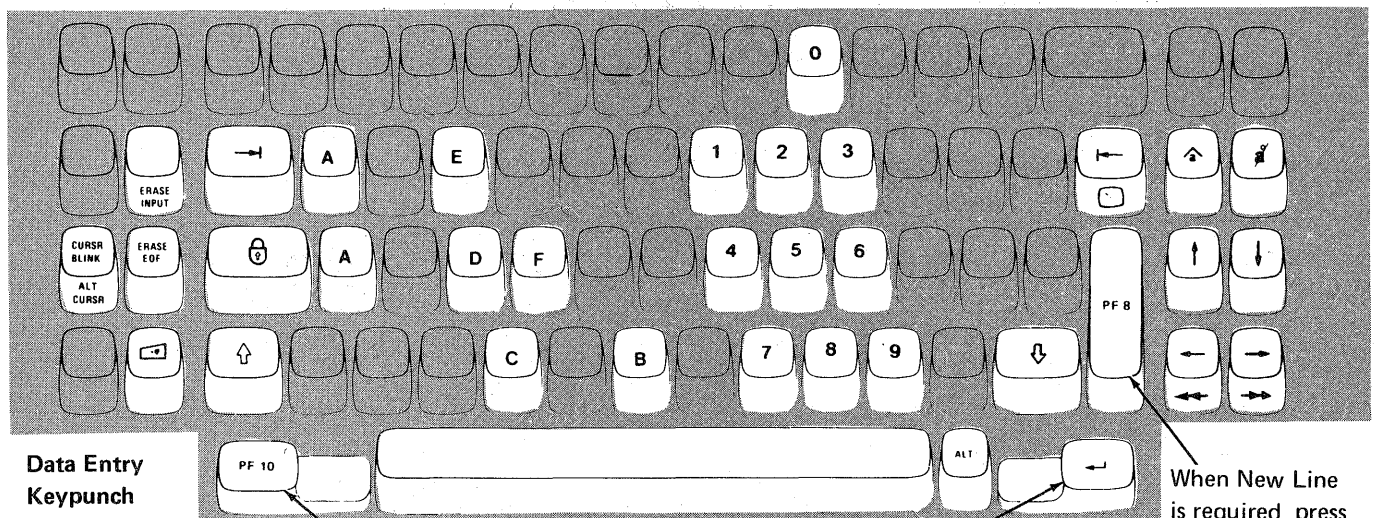

Data Entry Keypunch Keyboard

When ENTER is specified, press the New Line key.
When RESET is required, press the PF 10 key.

When New Line is required, press the PF8 key.

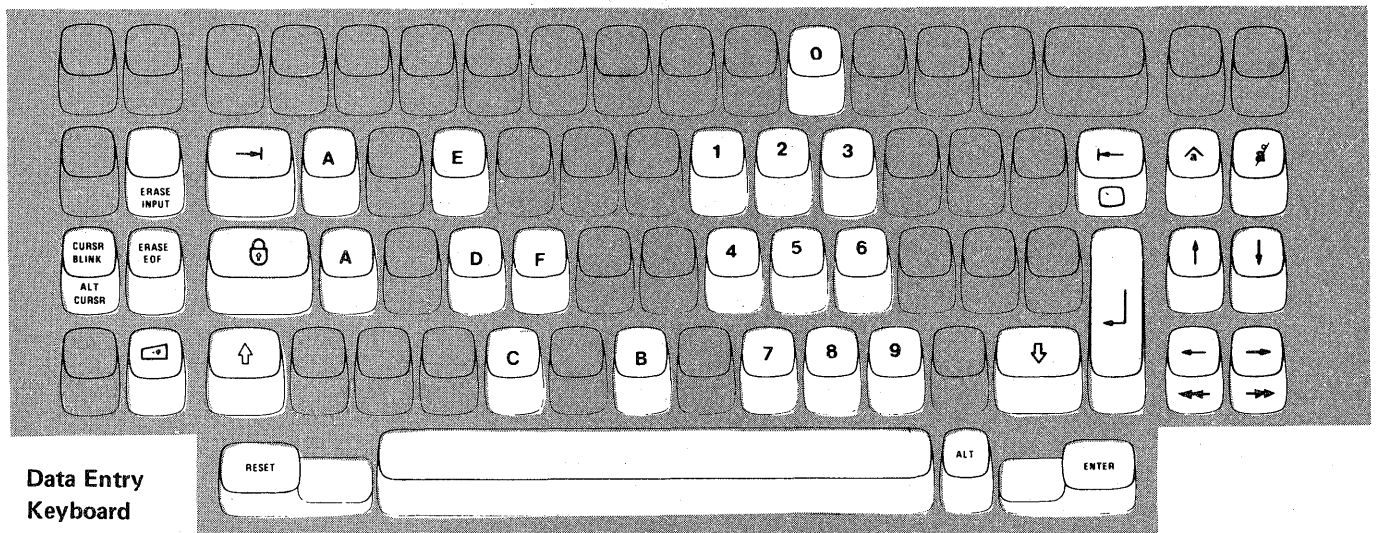

Data Entry Keyboard

Note: During customizing, only certain key positions are valid. Only those key positions shown above are to be used.

Figure 4-1. Valid Key Positions during Customizing

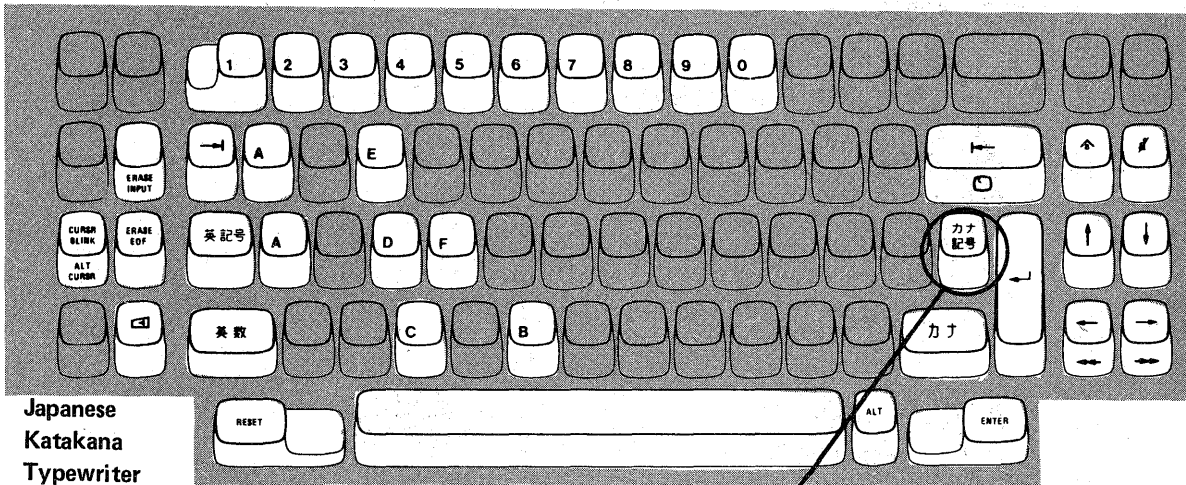

Japanese
Katakana
Typewriter
Keyboard

Press this key when sequence number 001 appears in the upper left corner of the screen.

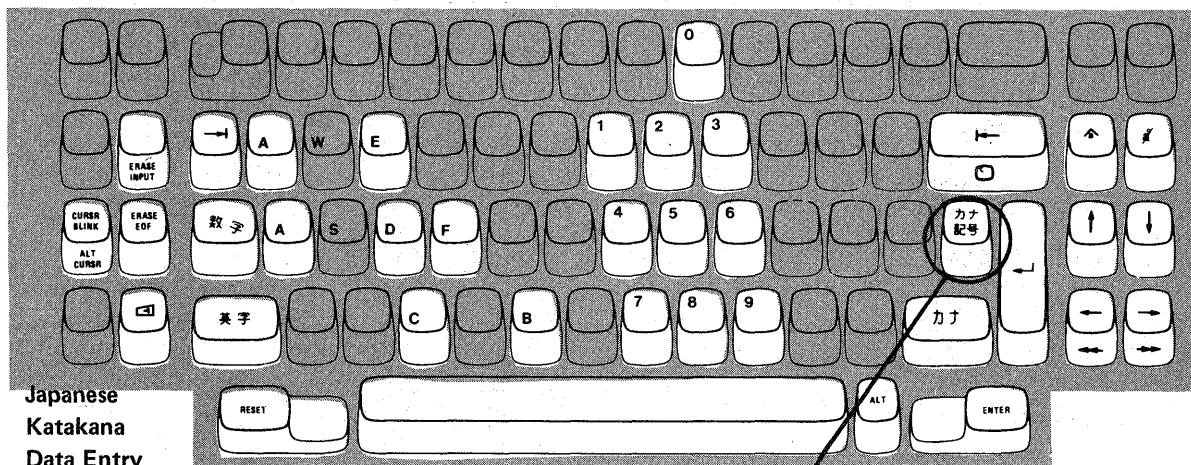

Japanese
Katakana
Data Entry
Keyboard

Press this key when sequence number 001 appears in the upper left corner of the screen.

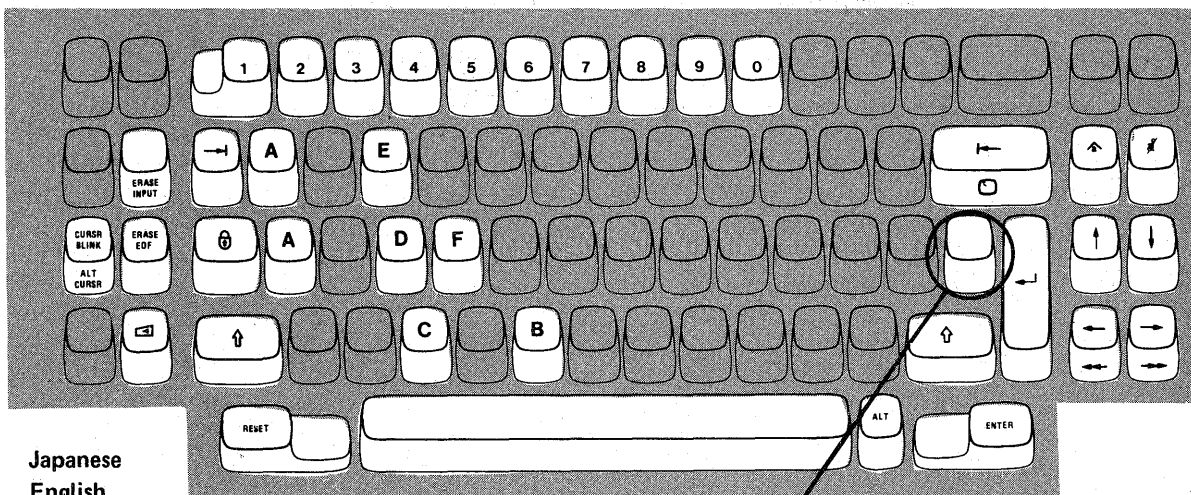

Japanese
English
Typewriter
Keyboard

Press this key when sequence number 001 appears in the upper left corner of the screen.

Note: These diagrams show the valid keys for both the 76- and 88-key keyboards. The PF keys on the right side of the 88-key keyboards are not valid during this procedure and therefore not shown.

Figure 4-2. Valid Key Positions during Customizing When Japanese Katakana and Japanese English Keyboards Are Used

3274 Diskette Insertion Procedure (All Models except 51C)

1. Open the customer access door, and locate the diskette reader enclosure.

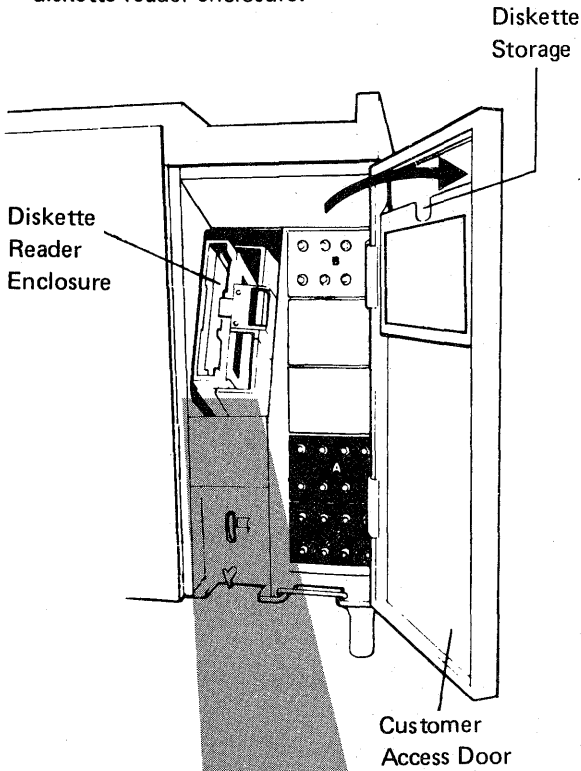

2. Open the diskette reader enclosure door by pressing the latch to the right.

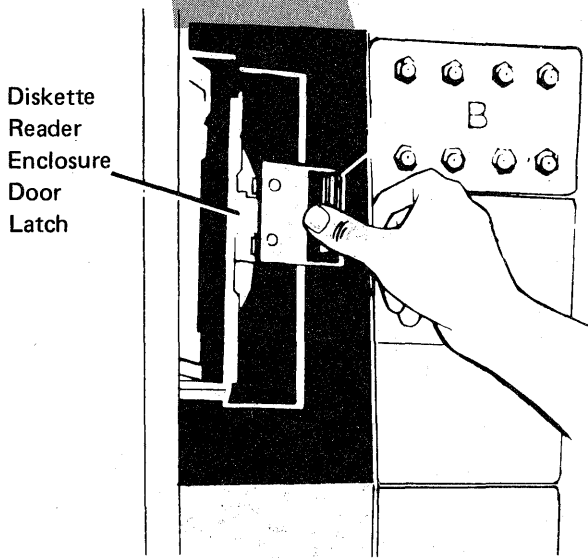

3. Remove the diskette to be used with the 3274 from its gray protective envelope, and insert it squarely into the enclosure. Note that the diskette label position is to the right.

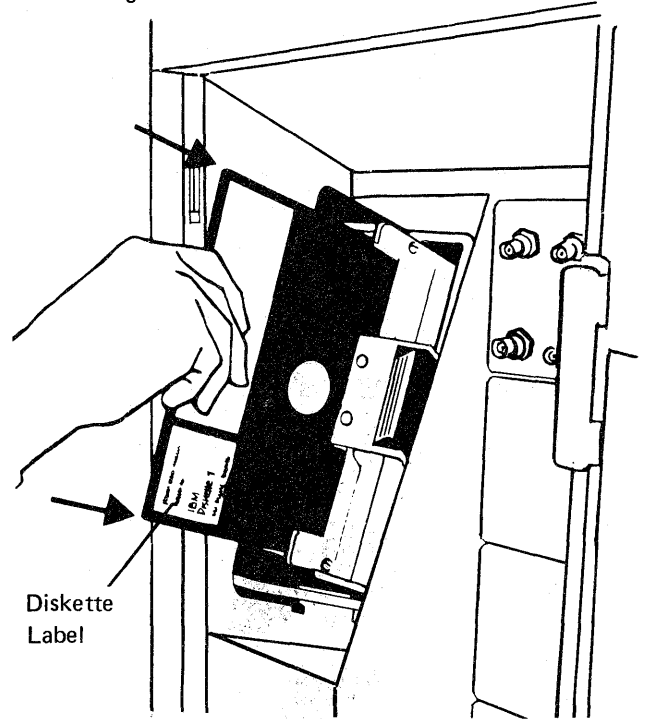

4. Close the diskette reader enclosure door by pushing the door to the left until it latches (clicks).

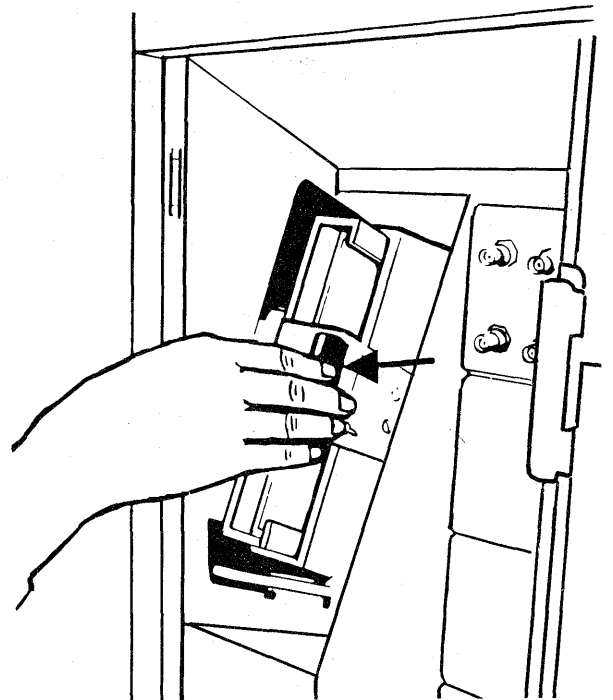
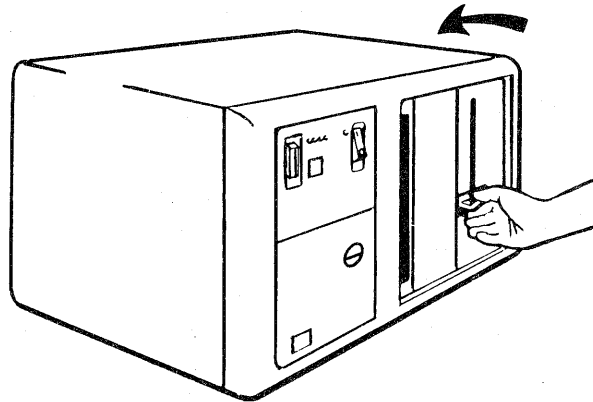

Figure 4-3 (Part 1 of 2). Inserting a Diskette into the 3274 Control Unit (during Customizing)

3274 Diskette Insertion Procedure (Model 51C)

1. Open the diskette reader by turning the lever counterclockwise to the vertical position.



2. Remove the diskette to be used with the 3274 from its gray protective envelope, and insert it squarely into the enclosure. Note that the diskette label position is on your left.

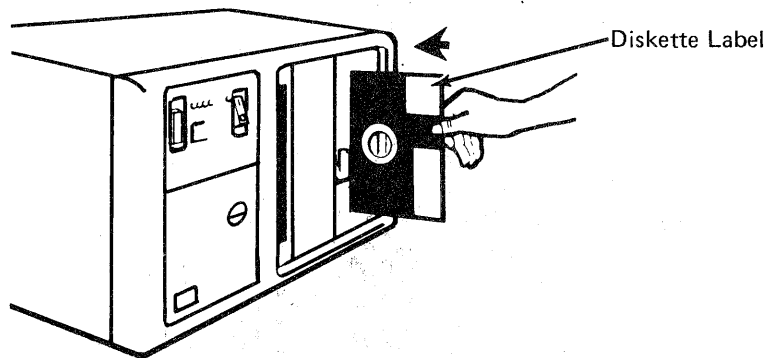

3. Close the diskette reader by turning the lever to the horizontal position.

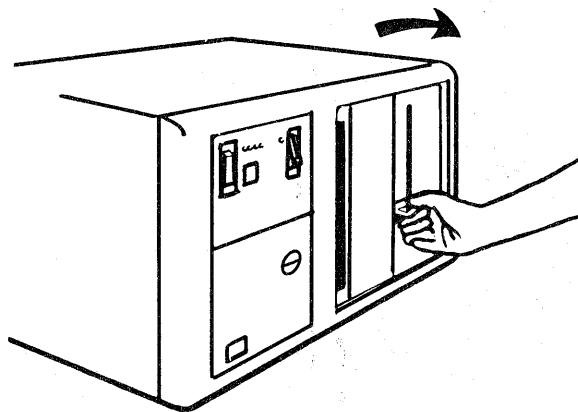

Figure 4-3 (Part 2 of 2). Inserting a Diskette into the 3274 Control Unit (during Customizing)

Code ¹	Meaning	Action
01	One or more of the first 10 characters are incorrect.	Enter the correct response.
02	One or more of the 11th to 17th characters, including the space, are incorrect.	Enter the correct response.
03	1. One of the last two characters you entered in response to sequence number 001 is incorrect, or, 2. The diskette release level is not the same as the documentation level.	1. Enter the correct response. 2. Restart after matching diskette and documentation levels.
11	You entered an invalid response (too many characters, value too high or too low, wrong character, etc.).	Enter the correct response.
12	You entered a character other than A, B, C, D, E, 1, 2, 3, or 4 in response to sequence number 151 (3274 Model Designation).	Enter the correct response.
13	Your response has too few characters.	Enter the correct response.
14	1. The numeric total of the responses you entered for sequence numbers 111 (Number of Category B Terminals) and 112 (Number of Category A Terminals) is greater than 32 (Models 1, 21, and 31) or 12 (Model 51C). 2. Your response to sequence number 163 (Extended Character Set Adapter) is greater than your response to sequence number 112 (Number of Category A Terminals).	1. Enter the correct responses. 2. Change your response to sequence number 163 to the same value as, or a value less than, your response to sequence number 112.
21	You made an unacceptable change during the modify sequence (number 999).	Recheck the entries, and correct them.
22	You specified something in your configuration that is not compatible with the character set you specified in sequence number 321. If you specified the EBCDIC character set (321=0), sequence number 121 must not be "02." If you specified the ASCII character set (321=1): Sequence number 121 must be "02" Sequence number 131 must be "1" Sequence numbers 132, 133, 134, and 135 must be "0" Sequence numbers 162, 163, 164, and 165 must be "0" Sequence number 166 must be "A"	Verify and enter the correct response(s).
23	One or more of your responses are not compatible with the response to sequence number 331 (BSC or SDLC Protocol).	Verify and enter the correct responses.
24	1. All your responses to sequence numbers 131 through 135 (keyboard types) are 0's (at least one must be 1), or 2. Your response to sequence number 113 (Extended Function Store) was something other than 0000 or A000. Your response indicates that the Extended Function Store feature is installed in your 3274 when, in fact, the feature is not installed.	1. Verify and enter the correct responses. 2. Verify and enter the correct response.
25	1. If this response is to sequence number 133 (Data Entry Keypunch Layout Keyboard), you specified the Katakana language (121=17) and a Data Entry Keypunch Layout Keyboard (133=1). The Data Entry Keypunch Layout Keyboard cannot be specified with the Katakana language. 2. If this response is to sequence number 131, the response to sequence number 121 cannot be 17, 31, or 32. If this response is to sequence number 133, 134, or 135, the response to sequence number 121 cannot be 31 or 32. 3. If this response is to sequence number 113 (Extended Function Store), the 3274 has less storage than indicated in your response to sequence number 113. 4. You specified a language other than 01 (U.S. English) to sequence number 121 and Text (135=1). Text cannot be specified with languages other than U.S. English.	1. Verify and enter the correct response. 2. Verify and enter the correct response. 3. Report the problem. 4. Verify and enter the correct response.
26	You do not have enough storage to support all the features you have selected.	Report the problem and verify that the storage specified in response to sequence number 113 is correct. (The storage requirements for the features you have selected may have to be recalculated using the storage-requirement tables in Appendix I.)

¹ If any entry is unacceptable, the entry for sequence number 900 is changed back to 0 (zero) and the unacceptable value is intensified.

Figure 4-4 (Part 1 of 2). Operator Codes during Customizing Only

Code ¹	Meaning	Action
27	<ol style="list-style-type: none"> You specified languages 18 or 29 and they are not allowed with your configuration support. You specified SFAP (162=1) and a language that is not allowed with SFAP (121=02, 08, 10, 13, 20, 26, or 27). You specified a language that is not allowed with a 3290 Information Panel (121=02, 06, 08, 09, 10, 12, 13, 20, 26, or 27). 	<ol style="list-style-type: none"> Specify Portuguese (127=28). Language 29 not allowed with Configuration Support C. Verify and enter the correct responses. Verify and enter the correct response.
28	<p>Your responses to sequence numbers 113 (Extended Function Store) and 151 (3274 Model Designation) are incompatible.</p> <p>You have specified RTM (sequence number 127) with a 3274 Model 1 A, -C, -D (sequence number 151). This is not allowed.</p>	Verify and enter the correct response.
29	You specified an Attribute Select keyboard (166=B or C), but you did not specify a Typewriter keyboard (131=1) or an APL keyboard (132=1).	Either change 166 to "A" or change 131 and/or 134 to "1".
30	<ol style="list-style-type: none"> You have specified a starting address for Multiple Interactive Screens (sequence number 171), but you have not specified logical terminal addresses. You have specified logical terminal addresses for Multiple Interactive Screens (sequence number 171), but you have not specified a starting address. 	Review instructions for defining Multiple Interactive Screens (Appendix J) and enter the correct response.
31	You have specified an invalid starting address for Multiple Interactive Screens (sequence number 171).	Specify a starting address that is not port A0, but is low enough to allow for your required number of terminals.
32	Your response to either sequence number 112 or 171 is incorrect. You have specified more logical terminals than your system will allow.	Review Appendix B, remembering that if using BSC or a 3274 Model D, you cannot specify more than 32 terminal addresses. If using SDLC or 3274 Model A, you cannot specify more than 128 terminal addresses.
33	Zero has been specified in sequence number 170, but you specified a nonzero response to sequence number 171, 173, 175, or 176.	Either specify 1 to sequence number 170, or zeros to sequence numbers 171, 173, 175, and 176.
36	You have specified a nonzero response for sequence number 139, but a zero response for sequence number 170. 170 must be 1 for 139 to be nonzero.	Verify responses to sequence numbers 139 and 170, then enter the correct response(s).
60	Both response fields for sequence number 127 must be either zero or non-zero.	Enter a zero or non-zero response in both fields.
61	You do not have host support and your first digit response to sequence number 127 was a 3, 4, or 5, or your second digit was a 3. This is not allowed.	Enter an acceptable response.
62	An invalid time boundary is specified in sequence number 128. The maximum time allowed is 27:18.3. The seconds field must not exceed 59.	Enter time values in the permitted range.
63	Field B1 in sequence number 128 cannot be specified as 00:00.0.	Specify at least 00:00.1 in field B1.
64	Entries for fields B1 through B4 in sequence number 128 are not in ascending order.	Enter boundary values in ascending order.
65	A time boundary value of 00:00.0 is embedded between two non-zero values in sequence number 128. This is not allowed.	Enter an appropriate non-zero value.
66	A non-zero boundary value follows a maximum boundary value (27:18.3) in sequence number 128. Only a zero boundary value (00:00.0) can follow the maximum.	Correct your boundary value sequence.
99	Your entries are acceptable, but the entry for sequence number 900, 901, or 904 has not been changed to a 1.	Change the entry to a 1.

¹ If any entry is unacceptable, the entry for sequence number 900 is changed back to 0 (zero) and the unacceptable value is intensified. All codes except 99.

Figure 4-4 (Part 2 of 2). Operator Codes during Customizing Only

Steady Code	Diskette Mounted	Meaning	Action
0001	Feature	Customizing being performed	None.
0010	Any (indication lasts for 3 minutes or more)	Diskette improperly inserted or an internal 3274 error	Insert diskette properly and retry.
0011	Feature	Customizing being performed	None.
0100	Feature	Patch, printer authorization matrix, or RPQ being performed	None.
0101	Feature	Configuration being performed	None.
0110	Feature	Modification being performed	None.
0111	Feature, language, or RPQ	Normal 3274 operation	None.
1000	System or load (customizing in process)	Normal 3274 operation	None.
1001	Any	Internal 3274 error	Retry. If the error recurs, follow your local procedure for problem recovery.
1010	Any	Internal 3274 error	Retry. If the error recurs, follow your local procedure for problem recovery.
1101	Any (customizing procedure in progress)	<ol style="list-style-type: none"> 1. IML pushbutton pressed while diskette is being changed, or 2. A bad or uncustomized system or load diskette is being used 	<ol style="list-style-type: none"> 1. Recustomize. Do not press the IML pushbutton unless instructed to do so. 2. Insert a good customized system or load diskette.
1111	System or load (IML not performed)	Customizing is completed	IML can be performed.

Figure 4-5. Steady 8 4 2 1 Indicator Codes during Customizing Only

Flashing Code ¹	Diskette Mounted	Meaning	Action
0000 0011	System	Load diskette request	Insert load diskette.
0000 0101	Any	System or load diskette request	Insert system or load diskette.
0000 1010	System	A diskette read error occurred.	Retry. If the error recurs, follow your local procedure for problem recovery.
	Load	A diskette read error occurred.	Try to perform Load Diskette Backup Procedure. If this fails, recustomize using the feature and system diskettes.
0000 1011	Any	System diskette request	Insert system diskette.
0000 1100	Any	RPO diskette request	Insert RPO diskette.
0000 1101	Any	Language diskette request	Insert language diskette.
0000 1110	Any	Feature diskette request	Insert feature diskette.
0100 0010	System or load	Configuration on system or load diskette being used for update-diskette procedure is not compatible with this 3274	Use a system or load diskette with a compatible configuration.
1000 0001	System or load	Uncustomized system or load diskette being used during update procedure	Use customized system or load diskette.
1001 0110	Any	Wrong-level diskette being used	Use correct-level diskette.
1111 0001	Feature	On/Off switch or TEST key pressed instead of ENTER	Retry. If the error recurs, follow your local procedure for problem recovery.
	System	Internal 3274 error	Follow your local procedure for problem recovery.
1111 0010	Feature	3278 Model 2 or higher is not attached to port A0.	Attach 3278 Model 2, its equivalent, or higher to port A0. Retry customizing.
1111 0011	Feature	Insufficient storage in 3274	Follow your local procedure for problem recovery.
1111 0100	System	Internal 3274 error	Retry. If the error recurs, follow your local procedure for problem recovery.
1111 0101	System	Internal 3274 error	Retry. If the error recurs, follow your local procedure for problem recovery.
	Feature	On/Off switch or TEST key pressed instead of ENTER	
1111 0110	RPO	Incompatible RPOs	Follow your local procedure for problem recovery.
	Feature	Internal 3274 error	
1111 0111	System	Internal 3274 error	Follow your local procedure for problem recovery.
1111 1000	System	Internal 3274 error	Follow your local procedure for problem recovery.
1111 1001	System, feature, language, or RPO	Internal 3274 error	Follow your local procedure for problem recovery.
1111 1010	System	Internal 3274 error	Follow your local procedure for problem recovery.
1111 1011	System	Internal 3274 error	Follow your local procedure for problem recovery.
1111 1100	Any	Diskette drive error or a bad diskette	Retry. If the error recurs, follow your local procedure for problem recovery.
1111 1101	System, feature, language, or load	Diskette drive error or a bad diskette	Retry. If the error recurs, follow your local procedure for problem recovery.
1111 1110	System, feature, language, or RPO	Internal 3274 error	Retry. If the error recurs, follow your local procedure for problem recovery.

¹ These codes will flash alternately as shown, for example, 0000, 1011, 0000, 1011.

Figure 4-6. Flashing 8 4 2 1 Indicator Codes during Customizing Only

Steady Code	Flashing Code ¹	Diskette Mounted	Meaning	Action
—	0101 0000 ²	System or load	Internal 3274 error or wrong response to sequence number 113 during customizing procedure	Check response to sequence number 113, and retry. If the error recurs, follow your local procedure for problem recovery.
—	0110 0000 ²	System or load	Internal 3274 error or wrong response to sequence number 111, 112, 151, or 351 during customizing procedure	Check response to sequence number 111, 112, 151, or 351, and retry. If the error recurs, follow your local procedure for problem recovery.
—	0110 0001 ³	System or load	Address range set in control unit does not include highest logical device address assigned during customization ⁴	Check responses to sequence numbers 111, 112, 116, 117, and 118. If correct have IBM CE check address range setting in control unit.
—	0111 0000 ²	System or load	1. Internal 3274 error, or 2. Wrong response to sequence number 311 or 343, or 3. The 3274 is not connected to the communication facility	1 and 2. Check responses to sequence numbers 311 and 343, and retry. 3. Connect the 3274 to the communication facility. If the error recurs, follow your local procedure for problem recovery.
—	1000 0000	System or load	Internal 3274 error or wrong response to sequence number 111 during customizing procedure	Check response to sequence number 111, and retry. If the error recurs, follow your local procedure for problem recovery.
—	1001 0000	System or load	Internal 3274 error or wrong response to sequence number 352 during customizing procedure	Check response to sequence number 352, and retry. If the error recurs, follow your local procedure for problem recovery.
—	1001 1010	System or load	Internal 3274 error or wrong response to sequence number 151 during customizing	Check response to sequence number 151 and retry. If the error recurs, follow your local procedure for problem recovery.
—	1001 1110	System or load	Insufficient storage	Follow your local procedure for problem recovery.
—	1011 0000	System or load	Internal 3274 error or wrong response to sequence number 127 during customizing procedure	Check response to sequence number 127, and retry. If the error recurs, follow your local procedure for problem recovery.
1101	—	System or load	Uncustomized system diskette	Insert customized system diskette.
1110	—	System or load	Insufficient storage	Check response to sequence number 113, and retry. If the error recurs, follow your local procedure for problem recovery.

¹ These codes will flash alternately as shown, for example, 0101, 0000, 0101, 0000, and so on.

² These codes may blink for 5 seconds, followed by a different steady code for 3 seconds.

³ Models 1D, 21D, and 31D only. These codes will alternate continuously as follows: left code blinks for 5 seconds, then right code is on steady for 3 seconds.

⁴ When the 3290 Information Panel is attached to 3274D units and the Multiple Interactive Screen function is being used, the address range set in the control unit must include the highest logical device address assigned, not the highest physical device address.

Note: These indicators may be caused by something other than incorrect customizing. Further aids can be found in the *IBM 3270 Information Display System: 3274 Control Unit Problem Determination Guide, GA27-2850*.

Figure 4-7. 8 4 2 1 Indicator Codes during IML That May Result from an Incorrect Customizing Procedure

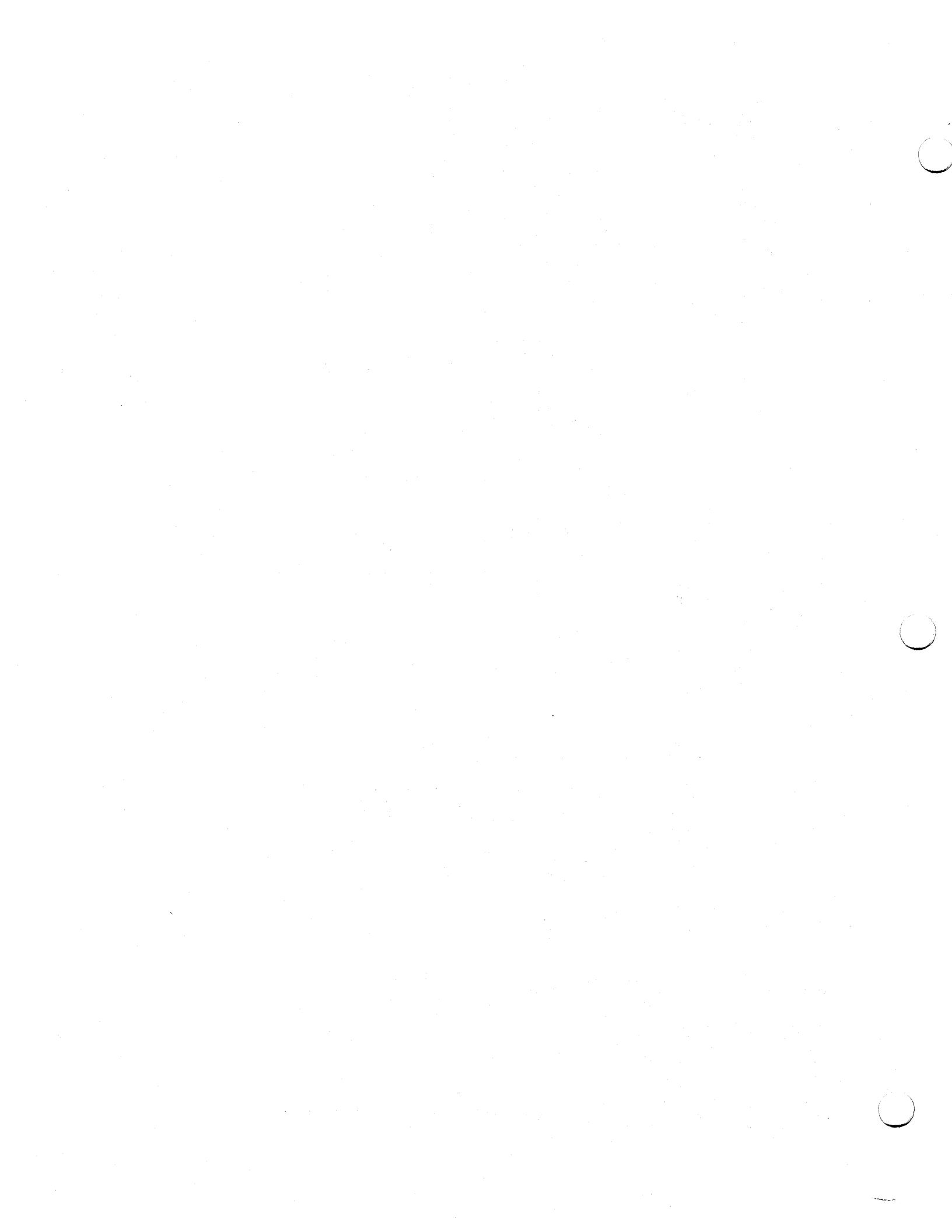

Printer Authorization Matrix Form

In response to sequence number 022, enter the characters (below) supplied by the planner in the appropriate groups on your display screen. If a group already is displayed as AA M XXXX YYYY YYYY, your entry will overwrite these characters. When you have completed all your entries, move the cursor to the zero after sequence number 901 at the bottom of the screen, change it to a 1, and press ENTER. Any entry that is not valid will be intensified at this time and the 1 you entered will change back to a 0 (zero). Correct the invalid entry, and return to 901. Again, change the zero to a 1, and press ENTER. When all entries are valid, the printer authorization matrix display will be replaced by the next customizing sequence number. (If, at any time during this procedure, you wish to cancel any entries you have just made, change the 0 (zero) after the 901 to A and press ENTER.) Return to your original instructions.

To delete an entry, move the cursor (with cursor-move keys or tab key) to the leftmost position of the entry (the Printer Port Address) and press the spacebar twice. The entire matrix, or as many entries as desired, can be deleted in this manner. After all changes have been made, press ENTER. All deleted entries will be displayed as AA M XXXX YYYY YYYY. When the matrix is satisfactorily defined, move the cursor to the zero after sequence number 901, change it to a 1, and press ENTER.

	Printer Port Address		Printer Mode	Printer Class Assignment				Source Device List							
	A	A	M	X	X	X	X	Y	Y	Y	Y	Y	Y	Y	Y
1)	-	-	-	-	-	-	-	-	-	-	-	-	-	-	-
2)	-	-	-	-	-	-	-	-	-	-	-	-	-	-	-
3)	-	-	-	-	-	-	-	-	-	-	-	-	-	-	-
4)	-	-	-	-	-	-	-	-	-	-	-	-	-	-	-
5)	-	-	-	-	-	-	-	-	-	-	-	-	-	-	-
6)	-	-	-	-	-	-	-	-	-	-	-	-	-	-	-
7)	-	-	-	-	-	-	-	-	-	-	-	-	-	-	-
8)	-	-	-	-	-	-	-	-	-	-	-	-	-	-	-
9)	-	-	-	-	-	-	-	-	-	-	-	-	-	-	-
10)	-	-	-	-	-	-	-	-	-	-	-	-	-	-	-
11)	-	-	-	-	-	-	-	-	-	-	-	-	-	-	-
12)	-	-	-	-	-	-	-	-	-	-	-	-	-	-	-
13)	-	-	-	-	-	-	-	-	-	-	-	-	-	-	-
14)	-	-	-	-	-	-	-	-	-	-	-	-	-	-	-
15)	-	-	-	-	-	-	-	-	-	-	-	-	-	-	-
16)	-	-	-	-	-	-	-	-	-	-	-	-	-	-	-

	Printer Port Address		Printer Mode	Printer Class Assignment				Source Device List							
	A	A	M	X	X	X	X	Y	Y	Y	Y	Y	Y	Y	Y
17)	-	-	-	-	-	-	-	-	-	-	-	-	-	-	-
18)	-	-	-	-	-	-	-	-	-	-	-	-	-	-	-
19)	-	-	-	-	-	-	-	-	-	-	-	-	-	-	-
20)	-	-	-	-	-	-	-	-	-	-	-	-	-	-	-
21)	-	-	-	-	-	-	-	-	-	-	-	-	-	-	-
22)	-	-	-	-	-	-	-	-	-	-	-	-	-	-	-
23)	-	-	-	-	-	-	-	-	-	-	-	-	-	-	-
24)	-	-	-	-	-	-	-	-	-	-	-	-	-	-	-
25)	-	-	-	-	-	-	-	-	-	-	-	-	-	-	-
26)	-	-	-	-	-	-	-	-	-	-	-	-	-	-	-
27)	-	-	-	-	-	-	-	-	-	-	-	-	-	-	-
28)	-	-	-	-	-	-	-	-	-	-	-	-	-	-	-
29)	-	-	-	-	-	-	-	-	-	-	-	-	-	-	-
30)	-	-	-	-	-	-	-	-	-	-	-	-	-	-	-
31)	-	-	-	-	-	-	-	-	-	-	-	-	-	-	-

Configuration Data Card (Configuration Support: A, B, C, T)

Number	Meaning
001	Keyboard Validation
011	Patch Request
021	Printer Authorization Matrix
022	(See reverse side)
031	Number of RPQ diskettes
032	Request RPQ Parameter List
111	Number of Category B Terminals
112	Number of Category A Terminals
113	Extended Function Store
114	Personal Computer Attachment
121	Keyboard Language
127	RTM Definition
128	RTM Boundaries and Interface
131	Typewriter Keyboard
132	Data Entry Keyboard
133	Data Entry Keypunch Keyboard
134	APL Keyboard
135	Text Keyboard
141	Magnetic Character Set
143	Host-Load Printer Authorization Matrix
145	3289 Text Print Control
147	Local-Copy Function
151	3274 Model Designation
161	Color Convergence
162	Structured Field and Attribute Processing (SFAP)
163	Extended Character Set Adapter
164	PS Terminals
165	Decompression
166	Attribute Select Keyboard
170	Distributed Function Terminals
171	Multiple Interactive Screens
173	3290 Options
175	Password
176	BSC Enhanced Communication Option
201	Control Unit Address
211	SCS Support
213	Between Bracket Printer Sharing
215	Physical Unit ID
220	Alert
301	BSC Control Unit Number
302	SDLC Control Unit Address

Number	Meaning
305	BSC Printer Polling
310	Modem Connection
311	Modem Wrap
313	NRZI/NRZ – Internal/External Clocking
314	Multipoint/Point to Point
317	Switched Network Backup
318	Normal/Half Speed
321	EBCDIC/ASCII
331	BSC/SDLC
342	RTS Control
343	Communication Interface
345	Answer Tone
347	High-Speed Data Rate
351	HPCA/CCA
352	Encrypt/Decrypt
360	X.21 Switched Retry
361	X.21 Switched Retry Timing
362	X.21 Switched Options

CE Data		
201	Local Channel CU Address	_____
	Master Terminal Operator Phone	_____
	Host CPU	_____
	Application Program	_____
	Remote TP Line	
	Logical Line No.	BSC _____ SDLC _____
	Logical LU ID	_____
	Line Speed	_____
	Host	_____
	Application	_____
	Diskette No.	_____

Chapter 5. Modification Procedure

The Modification Procedure Form is used to modify an existing 3274 configuration without performing the entire customizing procedure. The recommended form contained in this chapter should be used only after the 3274 Control Unit has been initially customized with the Initial Customizing Procedure Form in Chapter 4.

Note: Changes to any of the following sequence numbers will cause extensive configuration changes. It is recommended that the initial customizing procedure in Chapter 4 be used to change these sequence numbers and that the proper planning be performed before the changes are made.

151 – Model Designation

162 – Structured Field and Attribute Processing

201 – Control Unit Address¹

301 – Control Unit Number¹

302 – SDLC Control Unit Address¹

331 – BSC or SDLC Protocol

343 – Communication Interface Options

Be sure that the changes are recorded on the *IBM 3274 Configuration Data Card (Configuration Support: A, B, C, T)*, GA23-0046, stored in the diskette storage area of the 3274.

Note: An operator experienced in customization may want to use the Configuration Data Card instead of the Modification Procedure Form to modify the 3274 configuration.

¹ The modification procedure should not be used to change a 0 response to sequence number 201, 301, or 302.

The planner should enter the following information on the Modification Procedure Form:

1. The type of keyboard (typewriter or data entry) to be used by the operator.

Note: If using a 76- or 88-key Japanese English or Japanese Katakana keyboard, specify the number of keys and keyboard type.

2. In step 1, the identification of each diskette to be used.
3. In step 7, the response to sequence number 031 (number of RPQ diskettes to be used). If your response to sequence number 031 is not 0, you may have to enter a response to sequence number 032. See "032 (Request RPQ Parameter List)" in Chapter 3.

In addition to the Modification Procedure Form, this chapter contains:

- Keyboard diagrams showing the valid key positions for modification (Figures 5-1 and 5-2).
- A diagram showing how to insert diskettes into the 3274 Control Unit (Figure 5-3).
- A chart giving the meanings of, and recommended actions for, the operator codes that may appear on the display station during the modification procedure (Figure 5-4).
- Charts giving the meanings of, and recommended actions for, the 8 4 2 1 indicator codes that appear on the 3274 control panel during modification (Figures 5-5 and 5-6).
- A chart giving the meanings of, and recommended actions for, the 8 4 2 1 indicator codes that could appear on the 3274 control panel during IML as a result of improper modification (Figure 5-7).
- A Printer Authorization Matrix Form to be used with sequence number 022 (Printer Authorization Matrix Specification).

All the information above and the completed Modification Procedure Form should be given to the operator who is to perform the modification procedure.

Review this entire form before starting the procedure. Display station operating procedures are described in the *Operator's Guide* for the display station to be used in customizing.

This procedure modifies an existing 3274 Control Unit configuration. *If you do not get the expected result in any step, start over at step 1. If you still do not get the expected result, report the problem.*

You can negate the modification procedure at any time *before step 11* by inserting the customized system or load diskette and pressing the IML pushbutton. This will return your system to its last customized level.

There are four indicators, labeled 8 4 2 1, on the 3274 control panel. The meanings of the 8 4 2 1 indicator codes are shown in Figures 5-5 and 5-6. If an error occurs during this procedure, the 8 4 2 1 indicator code may help you locate the cause. Within this form, an on indicator is called a 1, an off indicator a 0 (zero). Example: 8 4 2 1
* * 0 * = 1101

3274 Control Panel

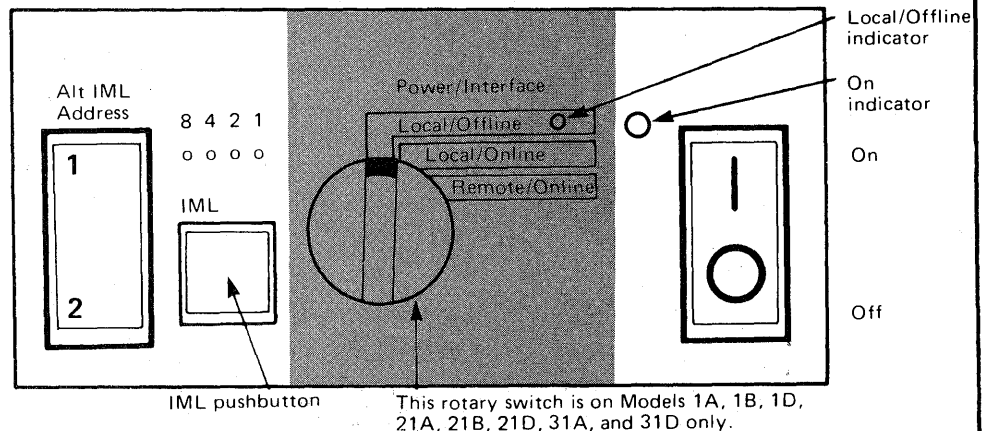

Type of keyboard to be used:

- | | |
|--|---|
| <input type="checkbox"/> Typewriter | <input type="checkbox"/> Japanese Katakana Typewriter |
| <input type="checkbox"/> Data Entry Keypunch | <input type="checkbox"/> Japanese Katakana Data Entry |
| <input type="checkbox"/> Data Entry | <input type="checkbox"/> Japanese English Typewriter |

During customizing, only certain keys are active. Turn to Figures 5-1 and 5-2, following this form, to see which keys on your keyboard can be used for customizing.

1. Obtain the:

- Feature diskette _____
 - Customized system, or customized load, diskette _____
 - Language diskette (if applicable) _____
 - RPQ diskette(s) (if applicable) _____
1. _____
2. _____
3. _____

2. Ensure that the 3274 Control Unit and the display station have power switched on. The display station must have a keyboard and must be attached to port A0 of the 3274.

Note: When customizing a 3274 Model 1A, 1B, 1D, 21A, 21B, 21D, 31A, or 31D, do not set the on/off switch to the off position unless the rotary switch on the control panel is in the Local/Offline position and the Local/Offline indicator is on. The Power/Interface rotary switch must be in the Local/Offline position and the Local/Offline indicator must be on.

3. Insert the *feature* diskette (see Figure 5-3) and, holding the Alt IML Address switch in position 1, press and release the IML pushbutton; then release the Alt IML Address switch. Within 2 minutes, the 8 4 2 1 indicator code will be flashing:

1011 if you are customizing Configuration Support A, B, or C

0101 if you are customizing Configuration Support T.

4. If you have a customized load diskette, insert the customized load diskette; otherwise, insert the customized system diskette.

Within 1 minute, the 8 4 2 1 indicator code will be a flashing 1110.

5. Insert the *feature* diskette again. Within 1 minute, the 8 4 2 1 indicator code will be a steady 0001. If you are using the 3279, refer to Appendix E for the convergence procedure.

6. Look for a 3-digit sequence number in the upper left corner of the screen. The first one is 001. Beneath the sequence number are Xs, which you replace by typing in the response to sequence number 001 (below). If the response you enter is acceptable, a new sequence number will be displayed. If the response is unacceptable, a 2-digit operator code will be displayed in the upper center portion of the screen. See Figure 5-4 for the meaning of this code.

If you are using a 3179 display station, it must be operating in 3279-emulation mode. If you are using a 3180 display station, it must be operating in 3278-emulation mode. If your 3179 or 3180 is not in emulation mode (that is, if it is in native mode), the number 212 appears in the operator information area of the display screen when the first key-stroke is attempted and customizing cannot proceed.

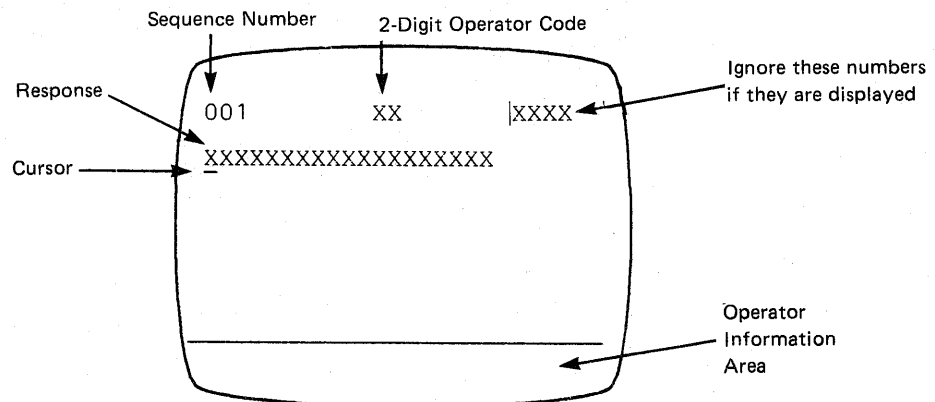

Note: If a 76- or 88-key Japanese English or Japanese Katakana keyboard is used, press the key circled in Figure 5-2 before proceeding. The keyboard will be locked for about 10 seconds. When the keyboard unlocks, continue.

- Type in the following characters in response to sequence number 001:
1234567890ABCDEF
- Press the spacebar once.
- Type in the 2-digit validation number that is printed on the first page of this form.
- Press ENTER.

Note: Use only the cursor move keys or tab key to reposition the cursor during this procedure.

7. Type in a 0 (zero) in response to sequence number 011. Press ENTER.

8. At this time, either sequence number 021 is displayed (meaning that no printer authorization matrix has been defined) or the defined matrix is displayed.

If sequence number 021 is displayed and if you have not been given a Printer Authorization Matrix Form, type in a 0 (zero) and press ENTER. If you have been given the Printer Authorization Matrix Form, type in a 1 and press ENTER; then follow the instructions on the form.

If the printer authorization matrix is displayed and you are to make changes to the matrix, make the changes. Move the cursor to the entry for 901 (located at the bottom of the screen), change it to a 1, and press ENTER. If you have no changes, simply move the cursor to the entry for 901, change it to a 1, and press ENTER.

9. Type in the number of RPQ diskettes _____ being used in response to sequence number 031. Press ENTER. ⁽⁰⁻³⁾

Note: If you respond to sequence number 031 with a 1, 2, or 3, sequence number 032 may be displayed. If you have been given specific RPQ parameter instructions, follow those instructions. If not, type in a 0 in response to 032 and press ENTER.

10. The entire set of sequence numbers should now be displayed on the display screen. Change the responses to the sequence numbers as required. After all changes have been made, move the cursor to the entry for sequence number 900, change it to a 1, and press ENTER. If all the entries are acceptable, the screen will be cleared and:

- a. If the response to sequence number 127 was nonzero, sequence number 128 (a panel) will be displayed. Enter the responses given for sequence number 128 on the procedure sheet attached to this form. When the responses are accepted, go to step 11.
- b. If the response to sequence number 127 was zero, the screen remains cleared. Go to step 11.

If any entry is unacceptable, the entry for sequence number 900 is changed back to a 0 (zero) and the unacceptable response is intensified. The operator code in the upper center portion of the display refers to the greatest sequence number with its response intensified. (With the 3179 or the 3279, intensified characters are white and red instead of blue and green.) The meanings of the operator codes are shown in Figure 5-4.

Check all responses that were changed, and correct any errors. Again, move the cursor to the entry for 900, change it to a 1, and press ENTER. If errors recur, report the problem.

11. Within 2 minutes, the 8 4 2 1 indicator code on the 3274 Control Unit should be flashing one of the following:

1100 — Replace the feature diskette with the *RPQ* diskette. *Do not press the IML pushbutton.* If you do press the IML pushbutton, go back to step 3.) After the RPQ diskette is inserted, the code will change to 0111 within 30 seconds. If additional RPQ diskettes are required or if you inserted a diskette that is not an RPQ diskette, the indicator code will again flash 1100. Repeat the procedure for each additional RPQ diskette. *At no time should you press the IML pushbutton.* When the RPQ diskette procedure is completed, the indicator code should be flashing 1110. Reinsert the *feature* diskette. *Do not press the IML pushbutton.* Within 2 minutes, the 8 4 2 1 indicator code will flash 1011 or 1101. Perform the functions indicated.

1101 — Replace the feature diskette inserted with the *language* diskette. *Do not press the IML pushbutton.* (If you do press the IML pushbutton, go back to step 3.) Within 30 seconds, the indicator code will change to 0111 and then to flashing 1011 within 1 minute. When the indicator code is flashing 1011, replace the language diskette with the *system* diskette. *Do not press the IML pushbutton.* Within 1 minute, the 8 4 2 1 indicator code will change to a steady 1000. Within 15 minutes, the 8 4 2 1 indicator code will change to one of the following.

Note: If errors occur during this 15-minute period, a flashing 8 4 2 1 indicator code will appear. Figures 5-5 and 5-6 may help you locate the cause.

0011 — Replace the system diskette with the *load* diskette. *Do not press the IML pushbutton.* (If you do press the IML pushbutton, go back to step 3.) Within 5 minutes, the 8 4 2 1 indicator code will change to 1111 (all lights are on) indicating that modification is successfully completed.

1111 — Modification is successfully completed.

1011 — Replace the feature diskette with the *system* diskette. *Do not press the IML pushbutton.* (If you do press the IML pushbutton, go back to step 3.) Within 1 minute, the 8 4 2 1 indicator code will change to a steady 1000. Within 15 minutes, the 8 4 2 1 indicator code will change to one of the following.

Note: If errors occur during this 15-minute period, a flashing 8 4 2 1 indicator code will appear. Figures 5-5 and 5-6 may help you locate the cause.

0011 — Replace the system diskette with the *load* diskette. *Do not press the IML pushbutton.* (If you do press the IML pushbutton, go back to step 3.) Within 5 minutes, the 8 4 2 1 indicator code will change to 1111 (all lights are on), indicating that modification is successfully completed.

1111 — Modification is successfully completed.

If it has not already been done, record the changes made during this procedure onto the *IBM 3274 Configuration Data Card (Configuration Support A, B, C, T)*, GA23-0046, stored in the pocket inside the 3274 customer access door on Models 1, 21, and 31 or in the diskette storage area on the front of the Model 51C.

Be sure the 3274 is attached to the appropriate communication facility. An IML of the 3274 may be initiated. During IML, errors may occur because of improper modification. The 8 4 2 1 indicator codes caused by these errors are shown in Figure 5-7.



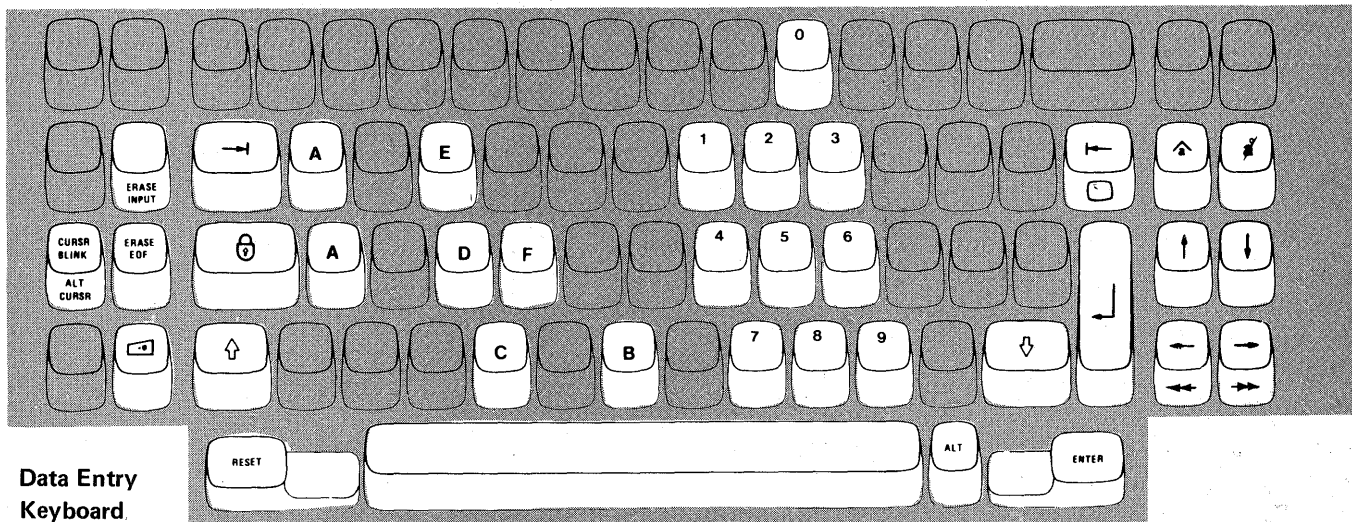
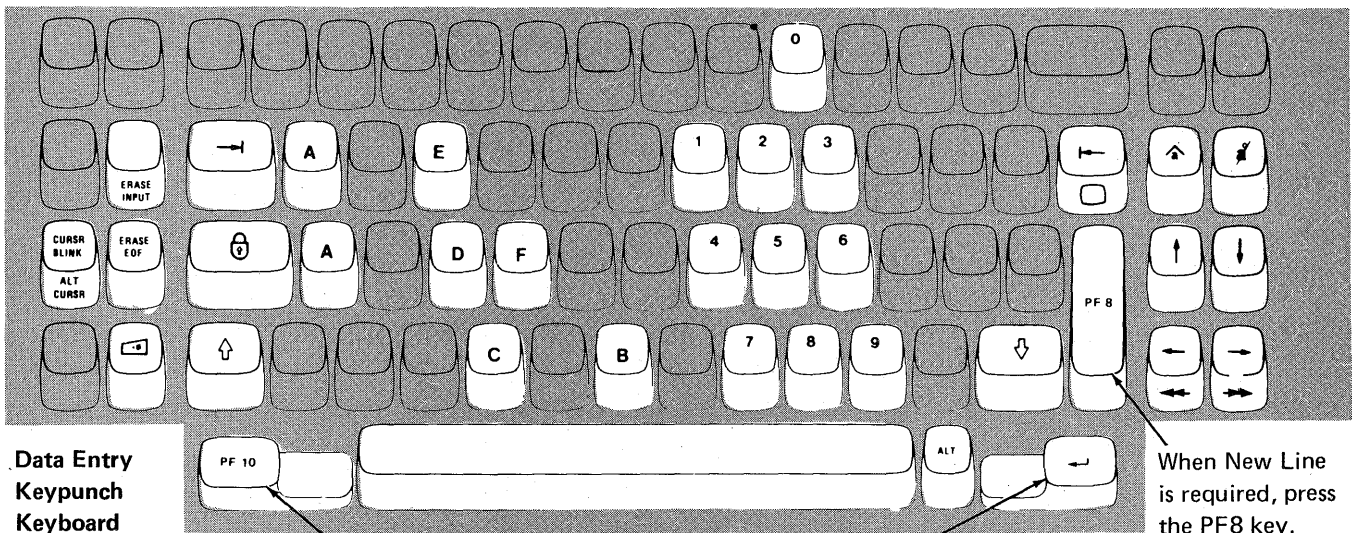
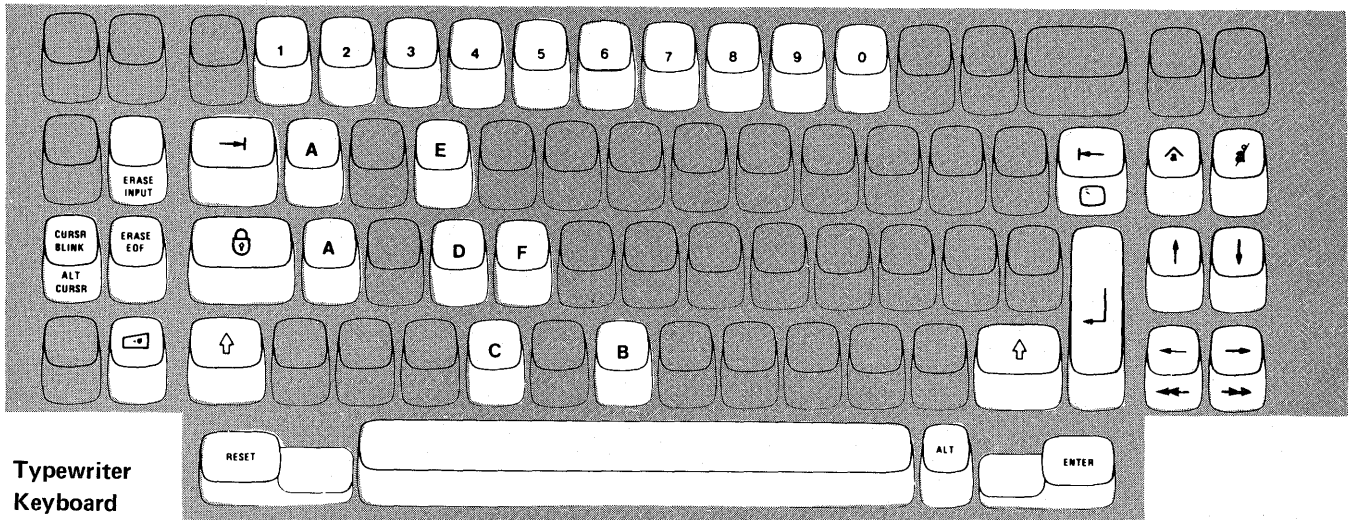

Note: During the modification procedure, only certain key positions are valid. Only those key positions shown above are to be used.

Figure 5-1. Valid Key Positions during the Modification Procedure

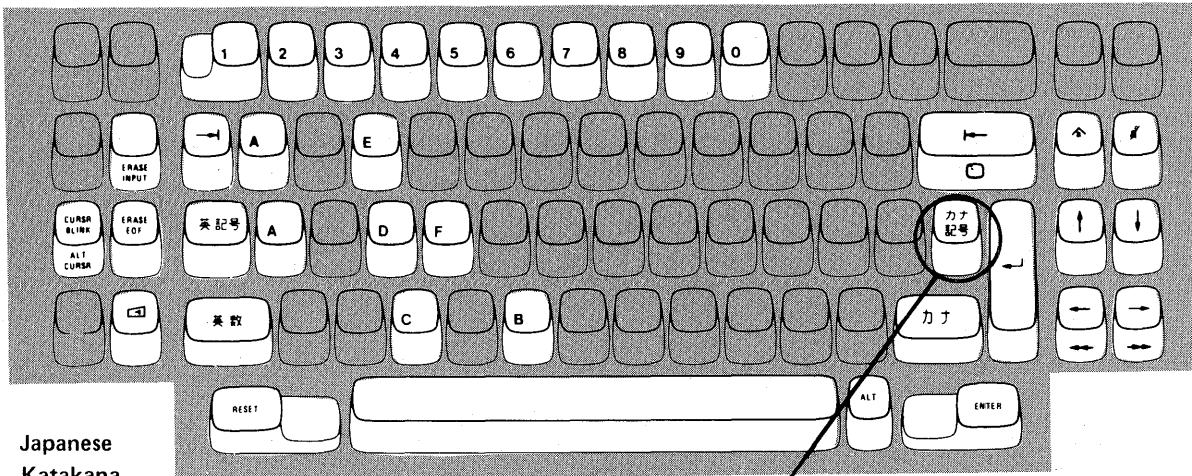

Japanese
Katakana
Typewriter
Keyboard

Press this key when sequence number 001 appears in the upper left corner of the screen.

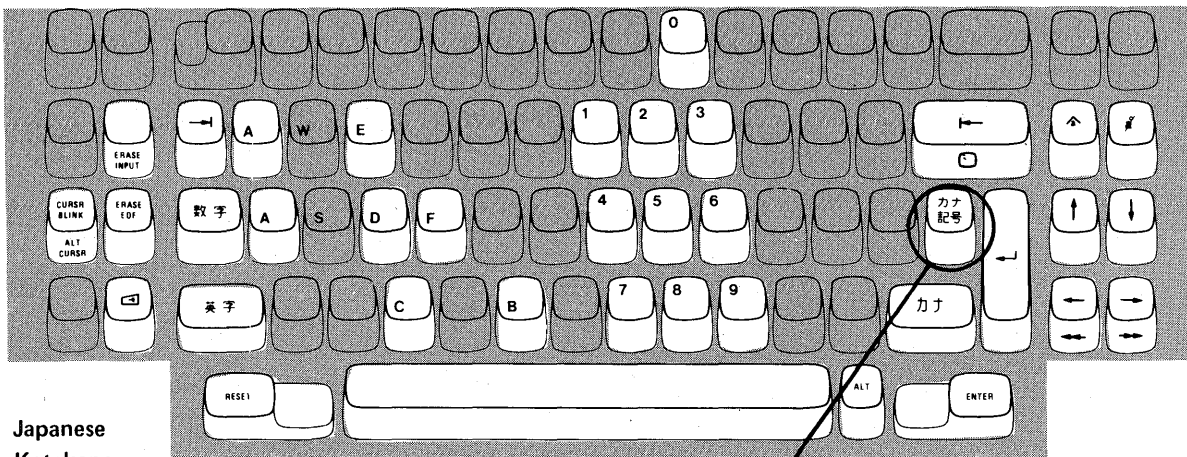

Japanese
Katakana
Data Entry
Keyboard

Press this key when sequence number 001 appears in the upper left corner of the screen.

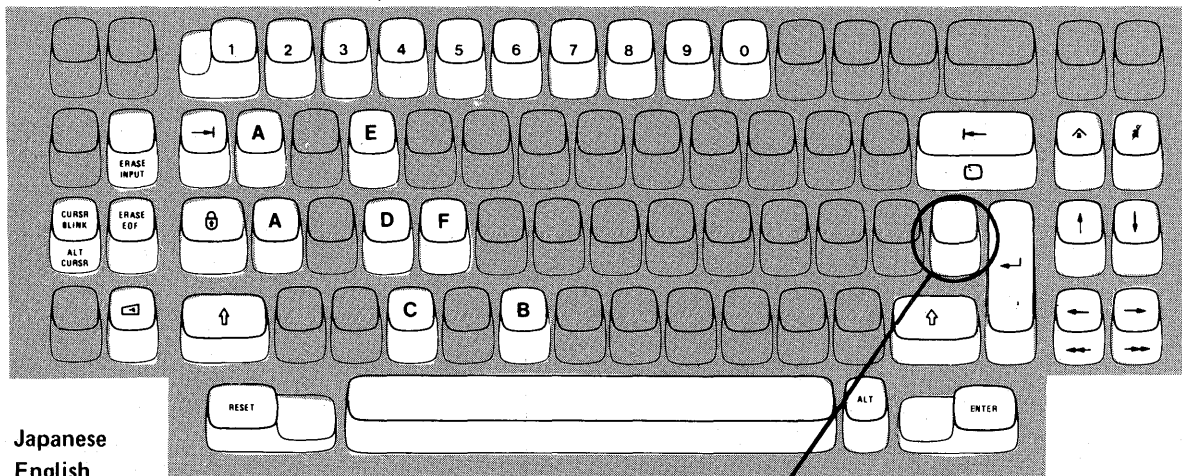

Japanese
English
Typewriter
Keyboard

Press this key when sequence number 001 appears in the upper left corner of the screen.

Note: These diagrams show the valid keys for both the 76- and 88-key keyboards. The PF keys located on the right side of the 88-key keyboards are not valid during this procedure and therefore not shown.

Figure 5-2. Valid Key Positions during the Modification Procedure When Japanese Katakana and Japanese English Keyboards Are Used

3274 Diskette Insertion Procedure (All Models except 51C)

1. Open the customer access door, and locate the diskette reader enclosure.

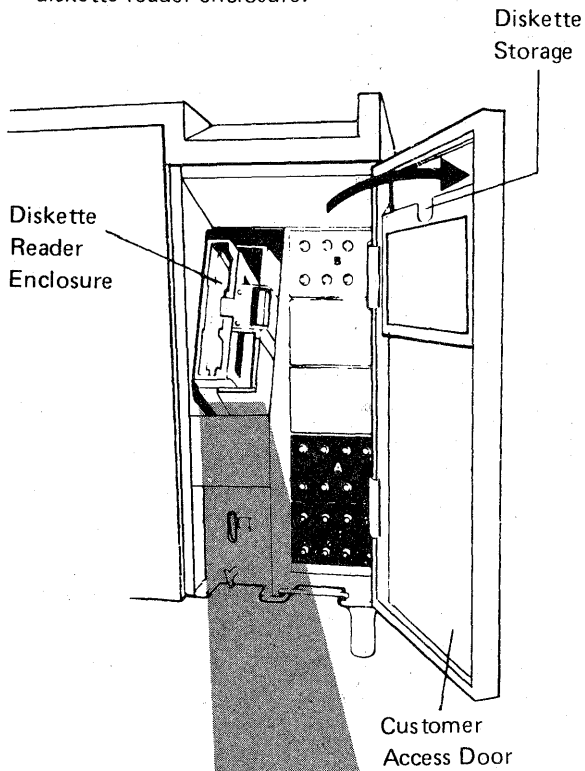

3. Remove the diskette to be used with the 3274 from its gray protective envelope, and insert it squarely into the enclosure. Note that the diskette label position is to the right.

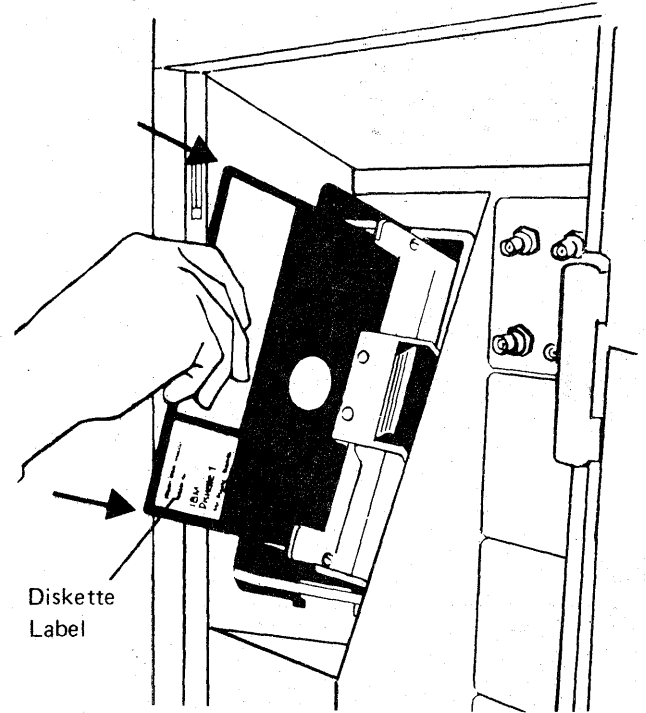

2. Open the diskette reader enclosure door by pressing the latch to the right.

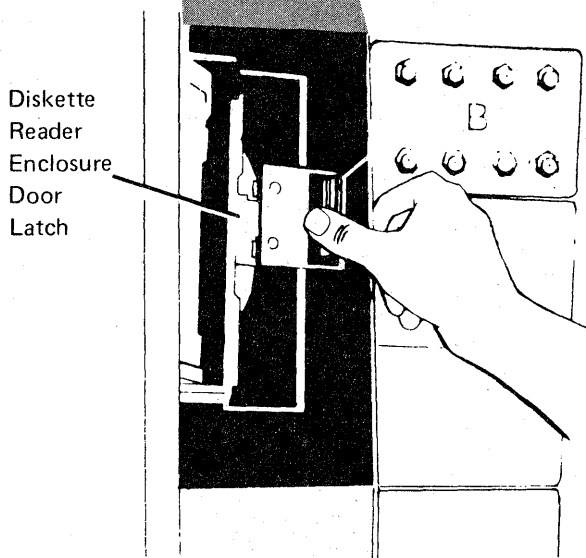

4. Close the diskette reader enclosure door by pushing the door to the left until it latches (clicks).

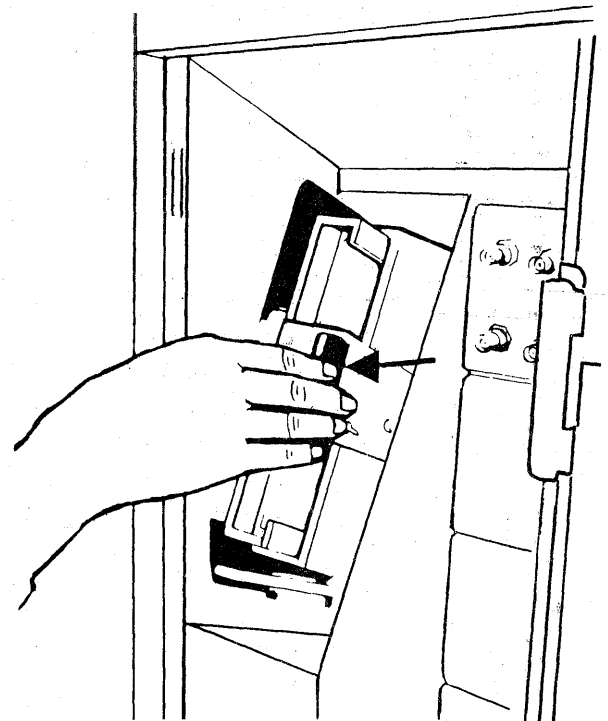
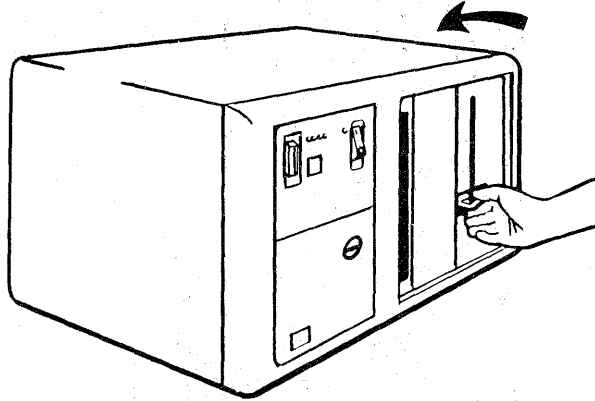

Figure 5-3 (Part 1 of 2). Inserting a Diskette into the 3274 Control Unit (during Modification)

3274 Diskette Insertion Procedure (Model 51C)

1. Open the diskette reader by turning the operator lever to the vertical position.



2. Remove the diskette to be used with the 3274 from its gray protective envelope, and insert it squarely into the enclosure. Note that the diskette label position is on your left.

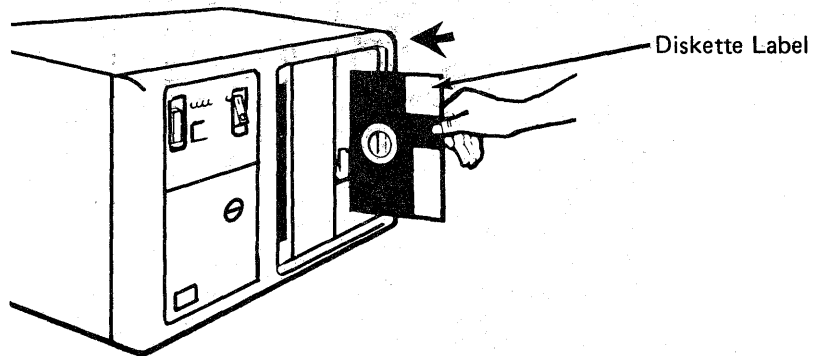

3. Close the diskette reader by turning the operator lever to the horizontal position.

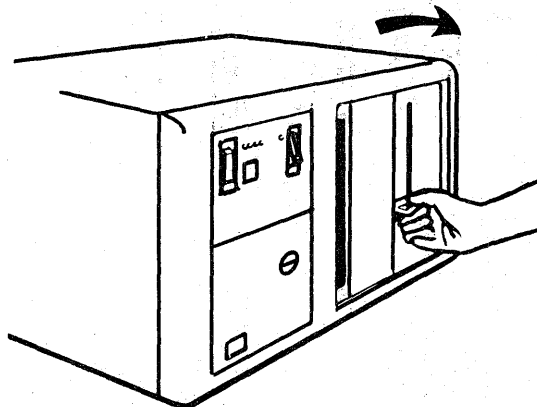

Figure 5-3 (Part 2 of 2). Inserting a Diskette into the 3274 Control Unit (during Modification)

Code ¹	Meaning	Action
01	One or more of the first 10 characters are incorrect.	Enter the correct response.
02	One or more of the 11th to 17th characters, including the space, are incorrect.	Enter the correct response.
03	1. One of the last two characters you entered in response to sequence number 001 is incorrect, or, 2. The diskette release level is not the same as the documentation level.	1. Enter the correct response. 2. Restart after matching diskette and documentation levels.
11	You entered an invalid response (too many characters, value too high or too low, wrong character, etc.).	Enter the correct response.
12	You entered a character other than A, B, C, D, E, 1, 2, 3, or 4 in response to sequence number 151 (3274 Model Designation).	Enter the correct response.
13	Your response has too few characters.	Enter the correct response.
14	1. The numeric total of the responses you entered for sequence numbers 111 (Number of Category B Terminals) and 112 (Number of Category A Terminals) is greater than 32 (Models 1, 21, and 31) or 12 (Model 51C). 2. Your response to sequence number 163 (Extended Character Set Adapter) is greater than your response to sequence number 112 (Number of Category A Terminals).	1. Enter the correct responses. 2. Change your response to sequence number 163 to the same value as, or a value less than, your response to sequence number 112.
21	You made an unacceptable change during the modify sequence (number 999).	Recheck the entries, and correct them.
22	You specified something in your configuration that is not compatible with the character set you specified in sequence number 321. If you specified the EBCDIC character set (321=0), sequence number 121 must not be "02." If you specified the ASCII character set (321=1): Sequence number 121 must be "02" Sequence number 131 must be "1" Sequence numbers 132, 133, 134, and 135 must be "0" Sequence numbers 162, 163, 164, and 165 must be "0" Sequence number 166 must be "A"	Verify and enter the correct response(s).
23	One or more of your responses are not compatible with the response to sequence number 331 (BSC or SDLC Protocol).	Verify and enter the correct responses.
24	1. All your responses to sequence numbers 131 through 135 (keyboard types) are 0's (at least one must be 1), or 2. Your response to sequence number 113 (Extended Function Store) was something other than 0000 or A000. Your response indicates that the Extended Function Store feature is installed in your 3274 when, in fact, the feature is not installed.	1. Verify and enter the correct responses. 2. Verify and enter the correct response.
25	1. If this response is to sequence number 133 (Data Entry Keypunch Layout Keyboard), you specified the Katakana language (121=17) and a Data Entry Keypunch Layout Keyboard (133=1). The Data Entry Keypunch Layout Keyboard cannot be specified with the Katakana language. 2. If this response is to sequence number 131, the response to sequence number 121 cannot be 17, 31, or 32. If this response is to sequence number 133, 134, or 135, the response to sequence number 121 cannot be 31 or 32. 3. If this response is to sequence number 113 (Extended Function Store), the 3274 has less storage than indicated in your response to sequence number 113. 4. You specified a language other than 01 (U.S. English) to sequence number 121 and Text (135=1). Text cannot be specified with languages other than U.S. English.	1. Verify and enter the correct response. 2. Verify and enter the correct response. 3. Report the problem. 4. Verify and enter the correct response.
26	You do not have enough storage to support all the features you have selected.	Report the problem and verify that the storage specified in response to sequence number 113 is correct. (The storage requirements for the features you have selected may have to be recalculated using the storage-requirement tables in Appendix I.)

¹ If any entry is unacceptable, the entry for sequence number 900 is changed back to 0 (zero) and the unacceptable value is intensified.

Figure 5-4 (Part 1 of 2). Operator Codes during Modification Procedure Only

Code ¹	Meaning	Action
27	<ol style="list-style-type: none"> You specified languages 18 or 29 and they are not allowed with your configuration support. You specified SFAP (162=1) and a language that is not allowed with SFAP (121=02, 08, 10, 13, 20, 26, or 27). You specified a language that is not allowed with a 3290 Information Panel (121=02, 06, 08, 09, 10, 12, 13, 20, 26, or 27). 	<ol style="list-style-type: none"> Specify Portuguese (127=28). Language 29 not allowed with Configuration Support C. Verify and enter the correct responses. Verify and enter the correct response.
28	<p>Your responses to sequence numbers 113 (Extended Function Store) and 151 (3274 Model Designation) are incompatible.</p> <p>You have specified RTM (sequence number 127) with a 3274 Model 1 A, -C, -D (sequence number 151). This is not allowed.</p>	Verify and enter the correct response.
29	You specified an Attribute Select keyboard (166=B or C), but you did not specify a Typewriter keyboard (131=1) or an APL keyboard (132=1).	Either change 166 to "A" or change 131 and/or 134 to "1".
30	<ol style="list-style-type: none"> You have specified a starting address for Multiple Interactive Screens (sequence number 171), but you have not specified logical terminal addresses. You have specified logical terminal addresses for Multiple Interactive Screens (sequence number 171), but you have not specified a starting address. 	Review instructions for defining Multiple Interactive Screens (Appendix J) and enter the correct response.
31	You have specified an invalid starting address for Multiple Interactive Screens (sequence number 171).	Specify a starting address that is not port A0, but is low enough to allow for your required number of terminals.
32	Your response to either sequence number 112 or 171 is incorrect. You have specified more logical terminals than your system will allow.	Review Appendix B, remembering that if using BSC or a 3274 Model D, you cannot specify more than 32 terminal addresses. If using SDLC or 3274 Model A, you cannot specify more than 128 terminal addresses.
33	Zero has been specified in sequence number 170, but you specified a nonzero response to sequence number 171, 173, 175, or 176.	Either specify 1 to sequence number 170, or zeros to sequence numbers 171, 173, 175, and 176.
36	You have specified a nonzero response for sequence number 139, but a zero response for sequence number 170. 170 must be 1 for 139 to be nonzero.	Verify responses to sequence numbers 139 and 170, then enter the correct response(s).
60	Both response fields for sequence number 127 must be either zero or non-zero.	Enter a zero or non-zero response in both fields.
61	You do not have host support and your first digit response to sequence number 127 was a 3, 4, or 5, or your second digit was a 3. This is not allowed.	Enter an acceptable response.
62	An invalid time boundary is specified in sequence number 128. The maximum time allowed is 27:18.3. The seconds field must not exceed 59.	Enter time values in the permitted range.
63	Field B1 in sequence number 128 cannot be specified as 00:00.0.	Specify at least 00:00.1 in field B1.
64	Entries for fields B1 through B4 in sequence number 128 are not in ascending order.	Enter boundary values in ascending order.
65	A time boundary value of 00:00.0 is embedded between two non-zero values in sequence number 128. This is not allowed.	Enter an appropriate non-zero value.
66	A non-zero boundary value follows a maximum boundary value (27:18.3) in sequence number 128. Only a zero boundary value (00:00.0) can follow the maximum.	Correct your boundary value sequence.
99	Your entries are acceptable, but the entry for sequence number 900, 901, or 904 has not been changed to a 1.	Change the entry to a 1.

¹ If any entry is unacceptable, the entry for sequence number 900 is changed back to 0 (zero) and the unacceptable value is intensified. All codes except 99.

Figure 5-4 (Part 2 of 2). Operator Codes during Modification Procedure Only

Steady Code	Diskette Mounted	Meaning	Action
0001	Feature	Customizing being performed	None.
0010	Any (indication lasts for 3 minutes or more)	Diskette improperly inserted or an internal 3274 error	Insert diskette properly and retry.
0011	Feature	Customizing being performed	None.
0100	Feature	Patch, printer authorization matrix, or RPQ being performed	None.
0101	Feature	Configuration being performed	None.
0110	Feature	Modification being performed	None.
0111	Feature, language, or RPQ	Normal 3274 operation	None.
1000	System or load (customizing in process)	Normal 3274 operation	None.
1001	Any	Internal 3274 error	Retry. If the error recurs, follow your local procedure for problem recovery.
1010	Any	Internal 3274 error	Retry. If the error recurs, follow your local procedure for problem recovery.
1101	Any (customizing procedure in progress)	<ol style="list-style-type: none"> 1. IML pushbutton pressed while diskette is being changed, or 2. A bad or uncustomized system or load diskette is being used 	<ol style="list-style-type: none"> 1. Recustomize. Do not press the IML pushbutton unless instructed to do so. 2. Insert a good customized system or load diskette.
1111	System or load (IML not performed)	Customizing is completed	IML can be performed.

Figure 5-5. Steady 8 4 2 1 Indicator Codes during the Modification Procedure Only

Flashing Code ¹	Diskette Mounted	Meaning	Action
0000 0011	System	Load diskette request	Insert load diskette.
0000 0101	Any	System or load diskette request	Insert system or load diskette.
0000 1010	System	A diskette read error occurred.	Retry. If the error recurs, follow your local procedure for problem recovery.
	Load	A diskette read error occurred.	Try to perform Load Diskette Backup Procedure. If this fails, recustomize using the feature and system diskettes.
0000 1011	Any	System diskette request	Insert system diskette.
0000 1100	Any	RPQ diskette request	Insert RPQ diskette.
0000 1101	Any	Language diskette request	Insert language diskette.
0000 1110	Any	Feature diskette request	Insert feature diskette.
0100 0010	System or load	Configuration on system or load diskette being used for update-diskette procedure is not compatible with this 3274	Use a system or load diskette with a compatible configuration.
1000 0001	System or load	Uncustomized system or load diskette being used during update procedure	Use customized system or load diskette.
1001 0110	Any	Wrong-level diskette being used	Use correct-level diskette.
1111 0001	Feature	On/Off switch or TEST key pressed instead of ENTER	Retry. If the error recurs, follow your local procedure for problem recovery.
	System	Internal 3274 error	Follow your local procedure for problem recovery.
1111 0010	Feature	3278 Model 2 or higher is not attached to port A0.	Attach 3278 Model 2, its equivalent, or higher to port A0. Retry customizing.
1111 0011	Feature	Insufficient storage in 3274	Follow your local procedure for problem recovery.
1111 0100	System	Internal 3274 error	Retry. If the error recurs, follow your local procedure for problem recovery.
1111 0101	System	Internal 3274 error	Retry. If the error recurs, follow your local procedure for problem recovery.
	Feature	On/Off switch or TEST key pressed instead of ENTER	
1111 0110	RPQ	Incompatible RPQs	Follow your local procedure for problem recovery.
	Feature	Internal 3274 error	
1111 0111	System	Internal 3274 error	Follow your local procedure for problem recovery.
1111 1000	System	Internal 3274 error	Follow your local procedure for problem recovery.
1111 1001	System, feature, language, or RPQ	Internal 3274 error	Follow your local procedure for problem recovery.
1111 1010	System	Internal 3274 error	Follow your local procedure for problem recovery.
1111 1011	System	Internal 3274 error	Follow your local procedure for problem recovery.
1111 1100	Any	Diskette drive error or a bad diskette	Retry. If the error recurs, follow your local procedure for problem recovery.
1111 1101	System, feature, language, or load	Diskette drive error or a bad diskette	Retry. If the error recurs, follow your local procedure for problem recovery.
1111 1110	System, feature, language, or RPQ	Internal 3274 error	Retry. If the error recurs, follow your local procedure for problem recovery.

¹ These codes will flash alternately as shown, for example, 0000, 1011, 0000, 1011.

Figure 5-6. Flashing 8 4 2 1 Indicator Codes during the Modification Procedure Only

Steady Code	Flashing Code ¹	Diskette Mounted	Meaning	Action
—	0101 0000 ²	System or load	Internal 3274 error or wrong response to sequence number 113 during customizing procedure	Check response to sequence number 113, and retry. If the error recurs, follow your local procedure for problem recovery.
—	0110 0000 ²	System or load	Internal 3274 error or wrong response to sequence number 111, 112, 151, or 351 during customizing procedure	Check response to sequence number 111, 112, 151, or 351, and retry. If the error recurs, follow your local procedure for problem recovery.
—	0110 0001 ³	System or load	Address range set in control unit does not include highest logical device address assigned during customization ⁴	Check responses to sequence numbers 111, 112, 116, 117, and 118. If correct have IBM CE check address range setting in control unit.
—	0111 0000 ²	System or load	1. Internal 3274 error, or 2. Wrong response to sequence number 311 or 343, or 3. The 3274 is not connected to the communication facility	1 and 2. Check responses to sequence numbers 311 and 343, and retry. 3. Connect the 3274 to the communication facility. If the error recurs, follow your local procedure for problem recovery.
—	1000 0000	System or load	Internal 3274 error or wrong response to sequence number 111 during customizing procedure	Check response to sequence number 111, and retry. If the error recurs, follow your local procedure for problem recovery.
—	1001 0000	System or load	Internal 3274 error or wrong response to sequence number 352 during customizing procedure	Check response to sequence number 352, and retry. If the error recurs, follow your local procedure for problem recovery.
—	1001 1010	System or load	Internal 3274 error or wrong response to sequence number 151 during customizing	Check response to sequence number 151 and retry. If the error recurs, follow your local procedure for problem recovery.
—	1001 1110	System or load	Insufficient storage	Follow your local procedure for problem recovery.
—	1011 0000	System or load	Internal 3274 error or wrong response to sequence number 127 during customizing procedure	Check response to sequence number 127, and retry. If the error recurs, follow your local procedure for problem recovery.
1101	—	System or load	Uncustomized system diskette	Insert customized system diskette.
1110	—	System or load	Insufficient storage	Check response to sequence number 113, and retry. If the error recurs, follow your local procedure for problem recovery.

¹These codes will flash alternately as shown, for example, 0101, 0000, 0101, 0000, and so on.

²These codes may blink for 5 seconds, followed by a different steady code for 3 seconds.

³Models 1D, 21D, and 31D only. These codes will alternate continuously as follows: left code blinks for 5 seconds, then right code is on steady for 3 seconds.

⁴When the 3290 Information Panel is attached to 3274D units and the Multiple Interactive Screen function is being used, the address range set in the control unit must include the highest logical device address assigned, not the highest physical device address.

Note: These indicators may be caused by something other than incorrect customizing. Further aids can be found in the *IBM 3270 Information Display System: 3274 Control Unit Problem Determination Guide*, GA27-2850.

Figure 5-7. 8 4 2 1 Indicator Codes during IML That May Result from an Incorrect Modification Procedure

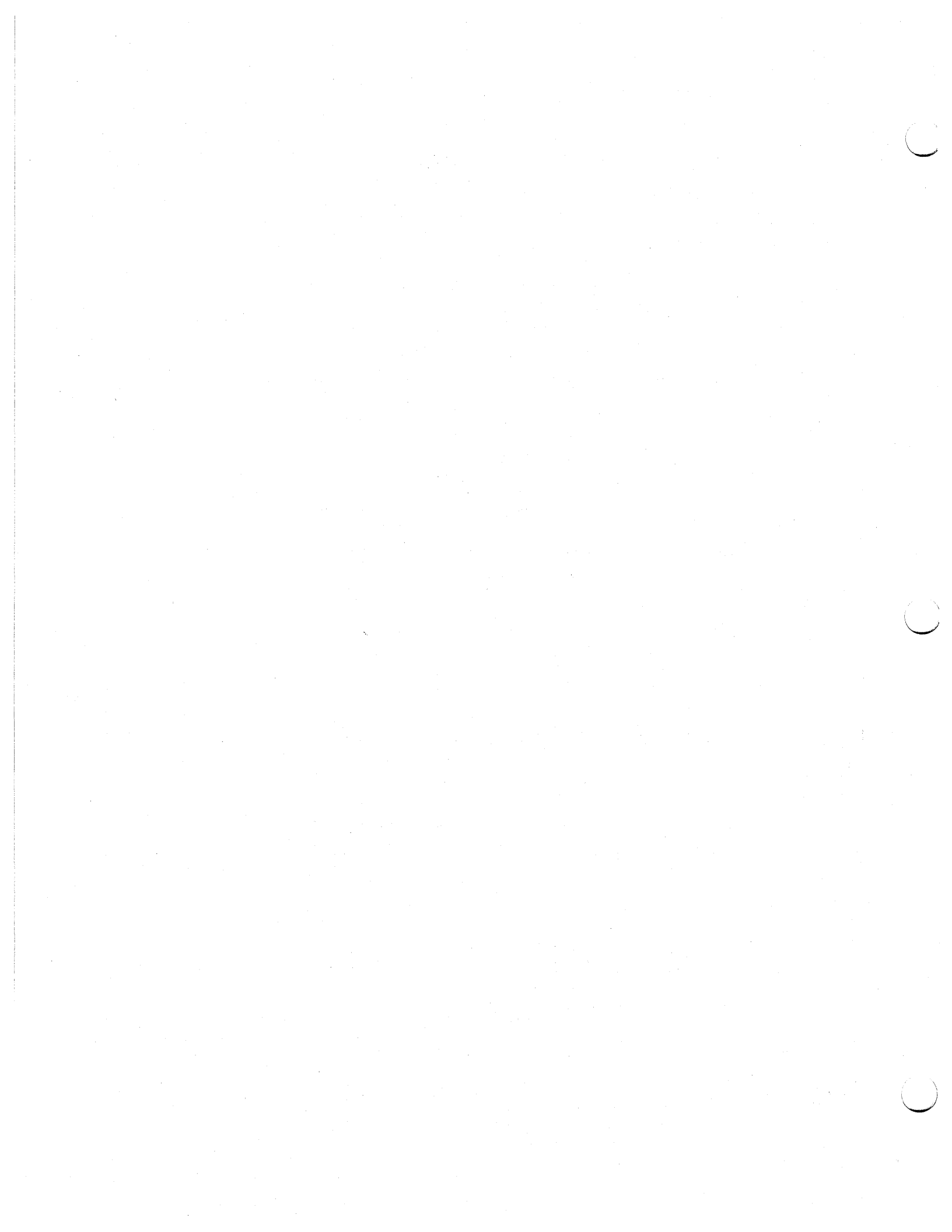

Printer Authorization Matrix Form

In response to sequence number 022, enter the characters (below) supplied by the planner in the appropriate groups on your display screen. If a group already is displayed as AA M XXXX YYYYY YYYYY, your entry will overwrite these characters. When you have completed all your entries, move the cursor to the zero after sequence number 901 at the bottom of the screen, change it to a 1, and press ENTER. Any entry that is not valid will be intensified at this time and the 1 you entered will change back to a 0 (zero). Correct the invalid entry, and return to 901. Again, change the zero to a 1, and press ENTER. When all entries are valid, the printer authorization matrix display will be replaced by the next customizing sequence number. (If, at any time during this procedure, you wish to cancel any entries you have just made, change the 0 (zero) after the 901 to A and press ENTER.) Return to your original instructions.

To delete an entry, move the cursor (with cursor-move keys or tab key) to the leftmost position of the entry (the Printer Port Address) and press the spacebar twice. The entire matrix, or as many entries as desired, can be deleted in this manner. After all changes have been made, press ENTER. All deleted entries will be displayed as AA M XXXX YYYYY YYYYY. When the matrix is satisfactorily defined, move the cursor to the zero after sequence number 901, change it to a 1, and press ENTER.

	Printer Port Address		Printer Mode	Printer Class Assignment				Source Device List								
	A	A	M	X	X	X	X	Y	Y	Y	Y	Y	Y	Y	Y	Y
1)	-	-	-	-	-	-	-	-	-	-	-	-	-	-	-	-
2)	-	-	-	-	-	-	-	-	-	-	-	-	-	-	-	-
3)	-	-	-	-	-	-	-	-	-	-	-	-	-	-	-	-
4)	-	-	-	-	-	-	-	-	-	-	-	-	-	-	-	-
5)	-	-	-	-	-	-	-	-	-	-	-	-	-	-	-	-
6)	-	-	-	-	-	-	-	-	-	-	-	-	-	-	-	-
7)	-	-	-	-	-	-	-	-	-	-	-	-	-	-	-	-
8)	-	-	-	-	-	-	-	-	-	-	-	-	-	-	-	-
9)	-	-	-	-	-	-	-	-	-	-	-	-	-	-	-	-
10)	-	-	-	-	-	-	-	-	-	-	-	-	-	-	-	-
11)	-	-	-	-	-	-	-	-	-	-	-	-	-	-	-	-
12)	-	-	-	-	-	-	-	-	-	-	-	-	-	-	-	-
13)	-	-	-	-	-	-	-	-	-	-	-	-	-	-	-	-
14)	-	-	-	-	-	-	-	-	-	-	-	-	-	-	-	-
15)	-	-	-	-	-	-	-	-	-	-	-	-	-	-	-	-
16)	-	-	-	-	-	-	-	-	-	-	-	-	-	-	-	-

	Printer Port Address		Printer Mode	Printer Class Assignment				Source Device List							
	A	A	M	X	X	X	X	Y	Y	Y	Y	Y	Y	Y	Y
17)	-	-	-	-	-	-	-	-	-	-	-	-	-	-	-
18)	-	-	-	-	-	-	-	-	-	-	-	-	-	-	-
19)	-	-	-	-	-	-	-	-	-	-	-	-	-	-	-
20)	-	-	-	-	-	-	-	-	-	-	-	-	-	-	-
21)	-	-	-	-	-	-	-	-	-	-	-	-	-	-	-
22)	-	-	-	-	-	-	-	-	-	-	-	-	-	-	-
23)	-	-	-	-	-	-	-	-	-	-	-	-	-	-	-
24)	-	-	-	-	-	-	-	-	-	-	-	-	-	-	-
25)	-	-	-	-	-	-	-	-	-	-	-	-	-	-	-
26)	-	-	-	-	-	-	-	-	-	-	-	-	-	-	-
27)	-	-	-	-	-	-	-	-	-	-	-	-	-	-	-
28)	-	-	-	-	-	-	-	-	-	-	-	-	-	-	-
29)	-	-	-	-	-	-	-	-	-	-	-	-	-	-	-
30)	-	-	-	-	-	-	-	-	-	-	-	-	-	-	-
31)	-	-	-	-	-	-	-	-	-	-	-	-	-	-	-

Chapter 6. Backup Diskette Generation Procedures

Each 3274 Control Unit is shipped with two uncustomized system diskettes. If you are using 3290s, you also received two uncustomized load diskettes. You customize one system diskette (or load diskette, if using 3290) using the initial customizing procedure in Chapter 4, and use this customized diskette to IML your 3274. The second system or load diskette may be used as a duplicate or backup. You generate a backup diskette by performing one of the two procedures recommended in this chapter:

- The Backup System Diskette Generation Procedure for system diskettes. A display station is required. Any IBM display station except an IBM 3270 Personal Computer in DFT mode, a 3277, or a 3290 can be used.
- The Backup Load Diskette Generation Procedure for load diskettes (Configuration Support T only). No display station is required.

Backup System Diskette

The planner should enter the following information on the Backup System Diskette Form:

1. The type of keyboard (typewriter or data entry) to be used by the operator.
Note: If using a 76- or 88-key Japanese English or Japanese Katakana keyboard, specify the number of keys and keyboard type.
2. In step 1, the identification of each diskette to be used.
3. In step 7, the response to sequence number 031 (number of RPQ diskettes to be used). If your response to sequence number 031 is not 0, you may have to enter a response to sequence number 032. See "032 (Request RPQ Parameter List)" in Chapter 3.

The completed Backup System Diskette Form and the following information should be given to the operator who is to perform this backup system diskette generation:

- Keyboard diagrams showing the valid key positions for backup diskette generation (Figures 6-1 and 6-2).
- A diagram showing how to insert diskettes into the 3274 Control Unit (Figure 6-3).

- A chart giving the meanings of, and recommended actions for, the operator codes that may appear on the display station during backup diskette generation (Figure 6-4).
- Charts giving the meanings of, and recommended actions for, the 8 4 2 1 indicator codes that appear on the 3274 control panel during the backup diskette generation (Figures 6-5 and 6-6).
- A chart giving the meanings of, and recommended actions for, the 8 4 2 1 indicator codes that could appear on the 3274 control panel during IML as a result of improper backup diskette generation (Figure 6-7).

Backup Load Diskette

The planner should enter the identification of each diskette in step 1 of the Backup Load Diskette Form. This form and the following information should be given to the operator who is to perform this backup load generation at the 3274 Control Unit:

- A diagram showing how to insert diskettes into the 3274 Control Unit (Figure 6-3).
- Charts giving the meanings of, and recommended actions for, the 8 4 2 1 indicator codes that appear on the 3274 control panel during the backup diskette generation (Figures 6-5 and 6-6).
- A chart giving the meanings of, and recommended actions for, the 8 4 2 1 indicator codes that could appear on the 3274 control panel during IML as a result of improper backup diskette generation (Figure 6-7).

Review this entire form before starting the procedure to create a backup system diskette. Display station operating procedures are described in the *Operator's Guide* for the display station to be used in customizing.

This procedure duplicates the existing system diskette. *If you do not get the expected result in any step, start over at step 1. If you still do not get the expected result, report the problem.*

There are four indicators, labeled 8 4 2 1, on the 3274 control panel. The meanings of the 8 4 2 1 indicator codes are shown in Figures 6-5 and 6-6. If an error occurs during this procedure, the 8 4 2 1 indicator code may help you locate the cause. Within this form, an on indicator is called a 1, an off indicator a 0 (zero). Example: 8 4 2 1

* * 0 * = 1101

3274 Control Panel

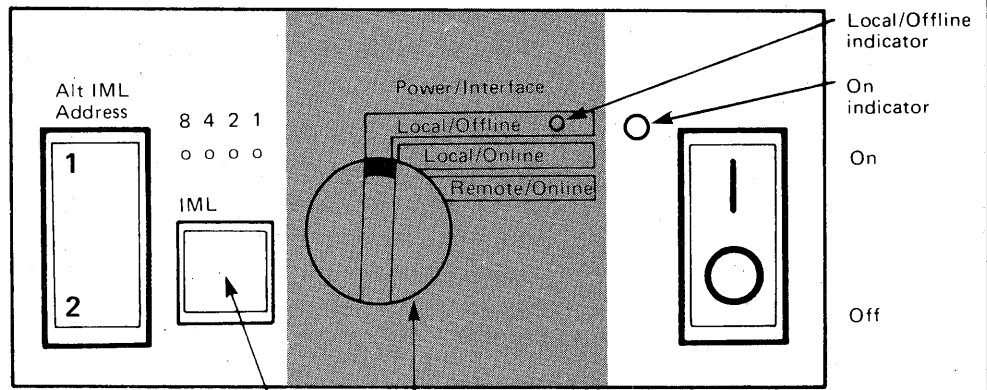

IML pushbutton

This rotary switch is on Models 1A, 1B, 1D, 21A, 21B, 21D, 31A, and 31D only.

Type of keyboard to be used:

- | | |
|--|---|
| <input type="checkbox"/> Typewriter | <input type="checkbox"/> Japanese Katakana Typewriter |
| <input type="checkbox"/> Data Entry Keypunch | <input type="checkbox"/> Japanese Katakana Data Entry |
| <input type="checkbox"/> Data Entry | <input type="checkbox"/> Japanese English Typewriter |

During customizing, only certain keys are active. Turn to Figures 6-1 and 6-2, following this form, to see which keys on your keyboard can be used for customizing.

1. Obtain the:

- Feature diskette _____
- Customized system diskette (diskette to be duplicated) _____
- Backup system diskette (diskette to be customized) _____
- Language diskette (if applicable) _____
- RPQ diskette(s) (if applicable) 1. _____
- 2. _____
- 3. _____

2. Ensure that the 3274 Control Unit and the display station have power switched on. The display station must have a keyboard and must be attached to port A0 of the 3274.

Note: When customizing a 3274 Model 1A, 1B, 1D, 21A, 21B, 21D, 31A, or 31D, do not set the on/off switch to the Off position unless the rotary switch on the control panel is in the Local/Offline position and the Local/Offline indicator is lit. The Power/Interface switch must be in the Local/Offline position and the Local/Offline indicator must be on.

3. Insert the *feature* diskette (see Figure 6-3) and, holding the Alt IML Address switch in position 1, press and release the IML pushbutton; then release the Alt IML Address switch. Within 2 minutes, the 8 4 2 1 indicator code will be flashing:
1011 if you are customizing Configuration Support A, B, or C
0101 if you are customizing Configuration Support T.
4. Insert the *customized system* diskette. Within 1 minute, the 8 4 2 1 indicator code will be a flashing 1110.
5. Insert the *feature* diskette again. Within 1 minute, the 8 4 2 1 indicator code will be a steady 0001. If you are using a 3279, refer to Appendix E for the convergence procedure.
6. Look for a 3-digit sequence number in the upper left corner of the screen. The first one is 001. Beneath the sequence number are Xs, which you replace by typing in the response to sequence number 001 (below). If the response you enter is acceptable, a new sequence number will be displayed. If the response is unacceptable, a 2-digit operator code will be displayed in the upper center portion of the screen. See Figure 6-4 for the meaning of this code.

If you are using a 3179 display station, it must be operating in 3279-emulation mode. If you are using a 3180 display station, it must be operating in 3278-emulation mode. If your 3179 or 3180 is not in emulation mode (that is, if it is in native mode), the number 212 appears in the operator information area of the display screen when the first keystroke is attempted and customizing cannot proceed.

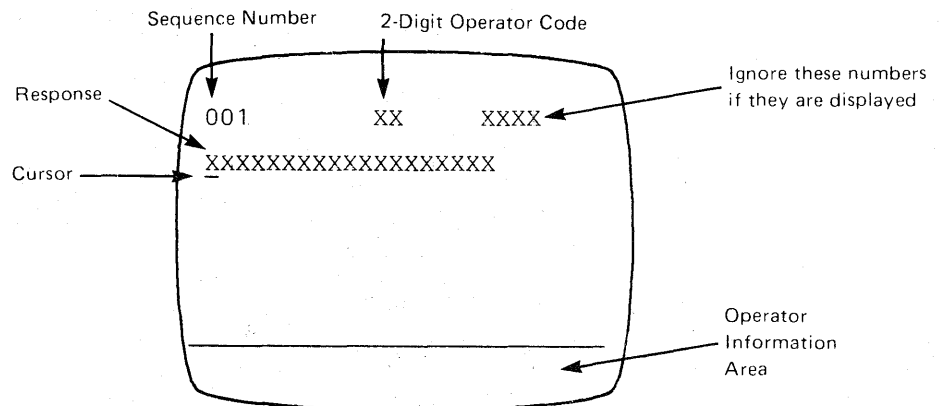

Note: If a 76- or 88-key Japanese English or Japanese Katakana keyboard is used, press the key circled in Figure 6-2 before proceeding. The keyboard will be locked for about 10 seconds. When the keyboard unlocks, continue.

- Type in the following characters in response to sequence number 001:
1234567890ABCDEF
- Press the spacebar once.
- Type in the 2-digit validation number that is printed on the first page of this form.
- Press ENTER.

Note: Use only the cursor move keys or tab key to reposition the cursor during this procedure.

7. Type in a 0 (zero) in response to sequence number 011. Press ENTER.

8. At this time, either sequence number 021 is displayed (meaning that no printer authorization matrix has been defined) or the defined matrix is displayed.

If sequence number 021 is displayed, type in a 0 (zero). Press ENTER. If the matrix is displayed, move the cursor to the zero after sequence number 901 and change it to a 1. Press ENTER.

9. Type in the number of RPQ diskettes _____ being used in response to sequence number 031. Press ENTER.
(0-3)

Note: If you respond to sequence number 031 with a 1, 2, or 3, sequence number 032 may be displayed. If you have been given specific RPQ parameter instructions, follow those instructions. If not, type in a 0 in response to 032 and press ENTER.

10. The entire set of sequence numbers should now be displayed on the screen. Move the cursor to the zero after sequence number 900, and change it to a 1. Press ENTER.

If all the entries are acceptable, the screen will be cleared and:

- a. If the response to sequence number 127 was nonzero, sequence number 128 (a panel) will be displayed. Enter the responses given for sequence number 128 on the procedure sheet attached to this form. When the responses are accepted, go to step 11.
- b. If the response to sequence number 127 was zero, the screen remains cleared. Go to step 11.

11. Within 2 minutes, the 8 4 2 1 indicator code on the 3274 Control Unit should be flashing one of the following:

1100 — Replace the feature diskette with the *RPQ* diskette. *Do not press the IML pushbutton.* (If you do press the IML pushbutton, go back to step 3.) After the RPQ diskette is inserted, the code will change to 0111 within 30 seconds. If additional RPQ diskettes are required or if you inserted a diskette that is not an RPQ diskette, the indicator code will again flash 1100. Repeat the procedure for each additional RPQ diskette. *At no time should you press the IML pushbutton.* When the RPQ diskette procedure is completed, the indicator code should be flashing 1110. Reinsert the *feature* diskette. *Do not press the IML pushbutton.* Within 2 minutes, the 8 4 2 1 indicator code will flash 1011 or 1101.

1011 – Replace the feature diskette with the *backup system* diskette. *Do not press the IML pushbutton.* (If you do, go back to step 3.) Within 1 minute, the indicator code will change to a 1000 and remain this way for approximately 15 minutes. Then, the indicator code will change to 1111 (all lights are on), indicating backup system diskette generation is successfully completed. If errors occur during this 15-minute period, a flashing 8 4 2 1 indicator code appears. Figures 6-5 and 6-6 may help you locate the cause.

1101 – Replace the feature diskette with the *language* diskette. *Do not press the IML pushbutton.* (If you do press the IML pushbutton, go back to step 3.) Within 30 seconds, the indicator code will change to 0111 and then to flashing 1011 within 1 minute. When the indicator code is flashing 1011, replace the language diskette with the *backup system* diskette. *Do not press the IML pushbutton.* Within 1 minute, the indicator code will change to a 1000 and remain this way for approximately 15 minutes. Then, the indicator code will change to 1111 (all the lights are on), indicating backup system diskette generation is successfully completed. If errors occur during this 15-minute period, a flashing 8 4 2 1 indicator code will appear. Figures 6-5 and 6-6 may help you locate the cause.

The newly created *backup system* diskette may now be used as well as the existing *customized* system diskette. Be sure the 3274 is attached to the appropriate communication facility. The backup system diskette may now be used to initiate an IML of the 3274. During IML, errors may occur because of improper backup diskette creation. Figure 6-7 shows the 8 4 2 1 indicator codes caused by these errors.

Review this entire form before starting the procedure to create a backup load diskette. Unit operating procedures are described in the *IBM 3274 Operator's Reference and Problem Determination Guide, GA27-2850*.

This procedure duplicates the existing load diskette. *If you do not get the expected result in any step, start over at step 1. If you still do not get the expected result, report the problem.*

There are four indicators, labeled 8 4 2 1, on the 3274 control panel. The meanings of the 8 4 2 1 indicator codes are shown in Figures 6-5 and 6-6. If an error occurs during this procedure, the 8 4 2 1 indicator code may help you locate the cause. Within this form, an on indicator is called a 1, an off indicator a 0 (zero). Example: 8 4 2 1

* * o * = 1101

3274 Control Panel

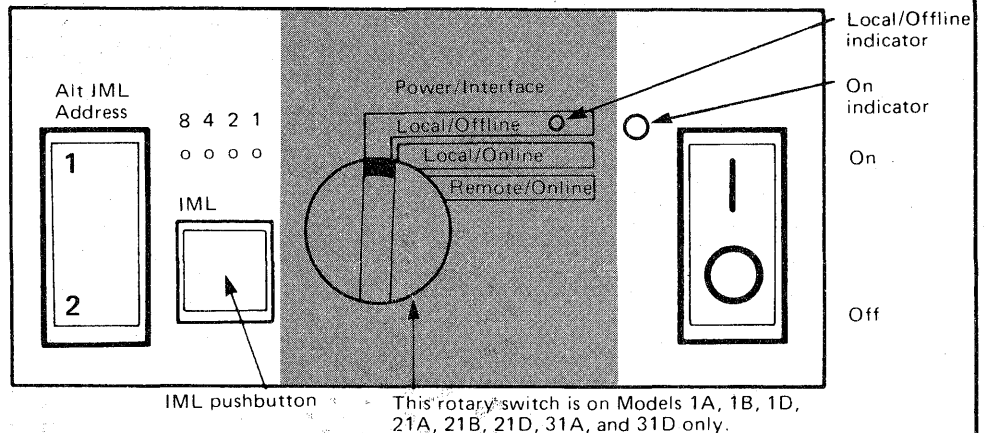

1. Obtain:

- System diskette used to initially customize the load diskette (diskette to be duplicated)
- Backup load diskette (diskette to be customized)

2. Ensure that the 3274 Control Unit has power switched on.

Note: *When customizing a 3274 Model A, B, or D, do not set the on/off switch to the off position unless the rotary switch on the control panel is in the Local/Offline position and the Local/Offline indicator is lit. The Power/Interface switch must be in the Local/Offline position and the Local/Offline indicator must be on.*

3. Insert the *system* diskette (see Figure 6-3) and, holding the Alt IML Address switch in position 1, press and release the IML pushbutton; then release the Alt IML Address switch. Within 1 minute, the 8 4 2 1 indicator code will be flashing 0011.
4. Insert the *load* diskette. *Do not press the IML pushbutton.* Within 1 minute, the indicator code will change to a 1000 and remain this way for approximately 15 minutes. Then the indicator code will change to a solid 1111, indicating backup load diskette generation is successfully completed. If errors occur during this 15-minute period, a flashing 8 4 2 1 indicator code will appear. Figures 6-5 and 6-6 may help you locate the cause.

The newly created backup load diskette may now be used as well as the existing customized load diskette.

Be sure the 3274 is attached to the appropriate communication facility. The backup load diskette may now be used to initiate an IML of the 3274 Control Unit. During IML, errors may occur because of improper backup diskette creation. The 8 4 2 1 indicator codes caused by these errors are shown in Figure 6-7.

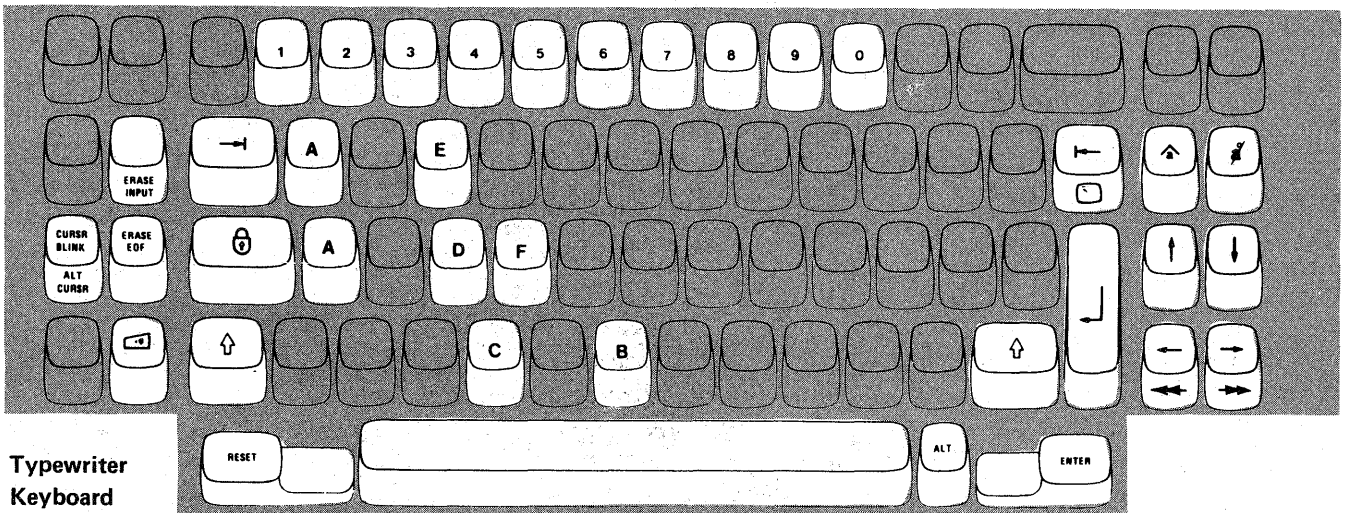

Typewriter Keyboard

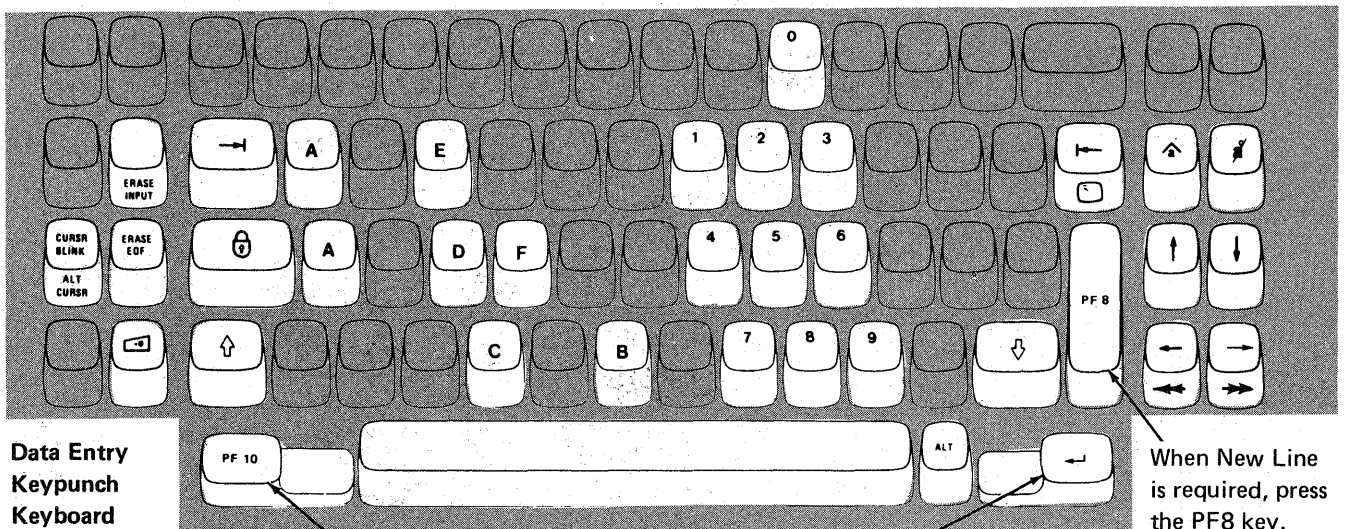

Data Entry Keypunch Keyboard

When ENTER is specified, press the New Line key.
When RESET is required, press the PF10 key.

When New Line is required, press the PF8 key.

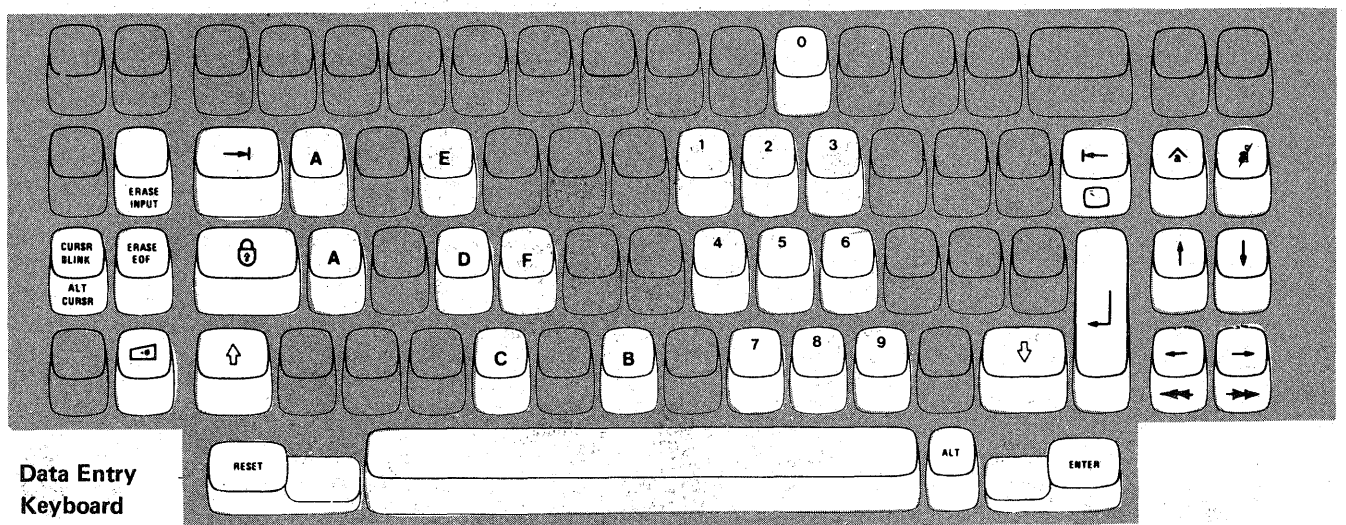

Data Entry Keyboard

Note: During backup diskette generation, only certain key positions are valid. Only those key positions shown above are to be used.

Figure 6-1. Valid Key Positions during Backup Diskette Generation

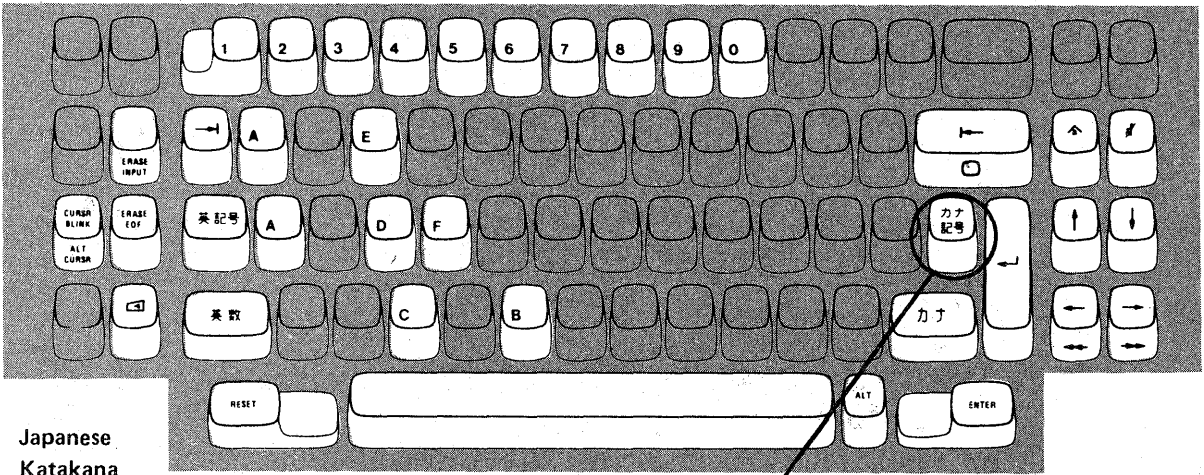

Japanese
Katakana
Typewriter
Keyboard

Press this key when sequence number 001 appears in the upper left corner of the screen.

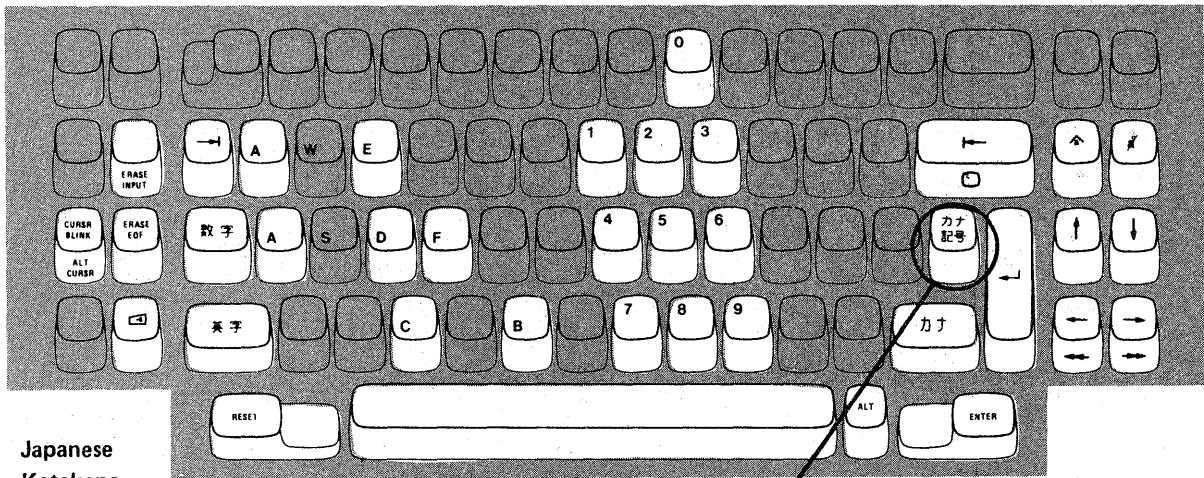

Japanese
Katakana
Data Entry
Keyboard

Press this key when sequence number 001 appears in the upper left corner of the screen.

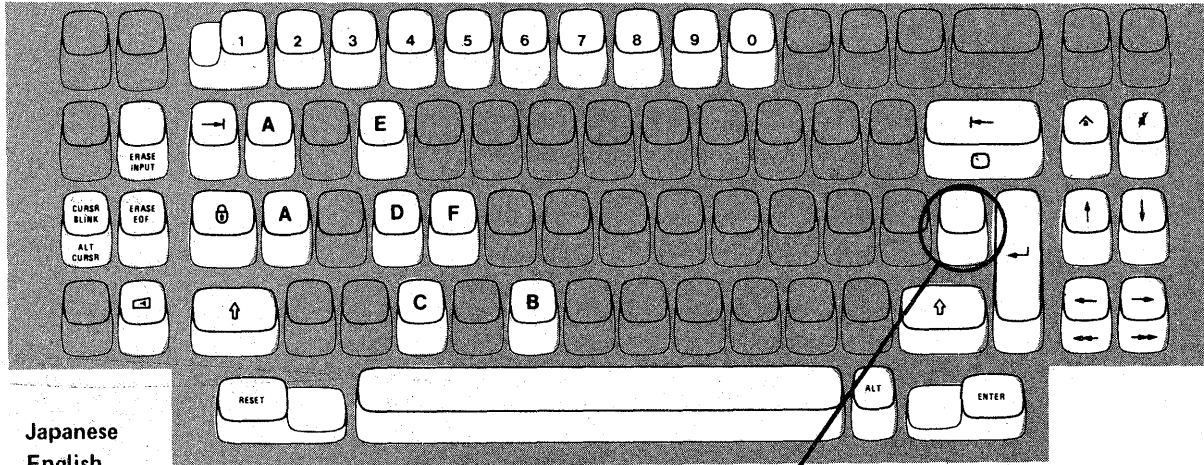

Japanese
English
Typewriter
Keyboard

Press this key when sequence number 001 appears in the upper left corner of the screen.

Note: These diagrams show the valid keys for both the 76- and 88-key keyboards. The PF keys located on the right side of the 88-key keyboards are not valid during this procedure and therefore not shown.

Figure 6-2. Valid Key Positions during Backup Diskette Generation When Japanese Katakana and Japanese English Keyboards Are Used

3274 Diskette Insertion Procedure (All Models except 51C)

1. Open the customer access door, and locate the diskette reader enclosure.

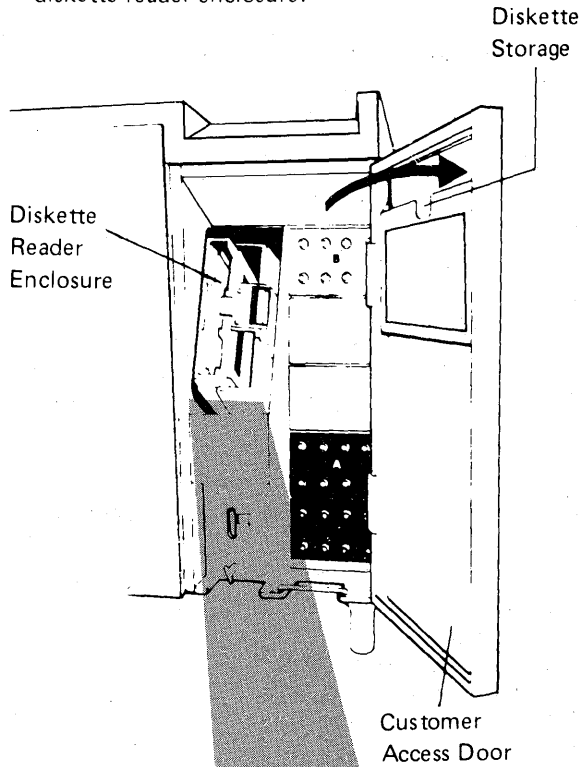

3. Remove the diskette to be used with the 3274 from its gray protective envelope, and insert it squarely into the enclosure. Note that the diskette label position is to the right.

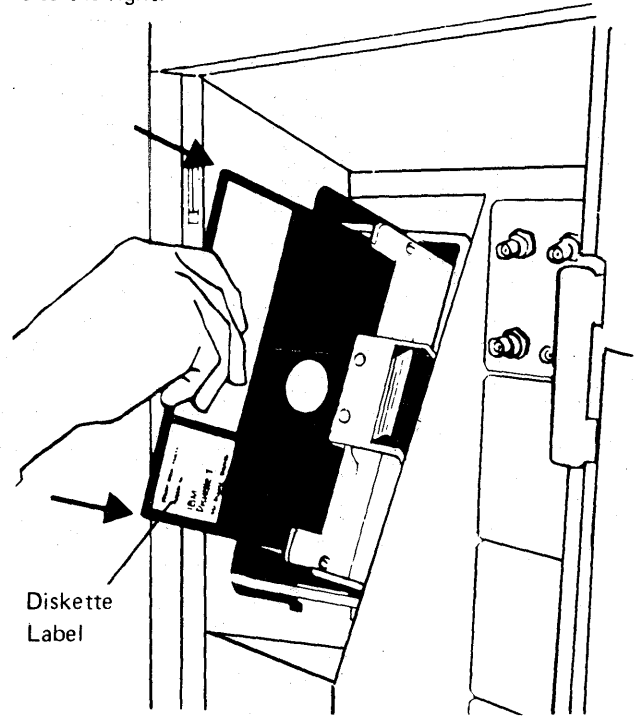

2. Open the diskette reader enclosure door by pressing the latch to the right.

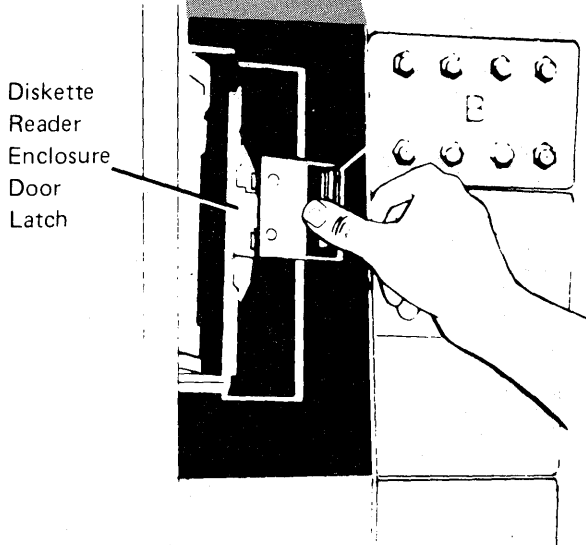

4. Close the diskette reader enclosure door by pushing the door to the left until it latches (clicks).

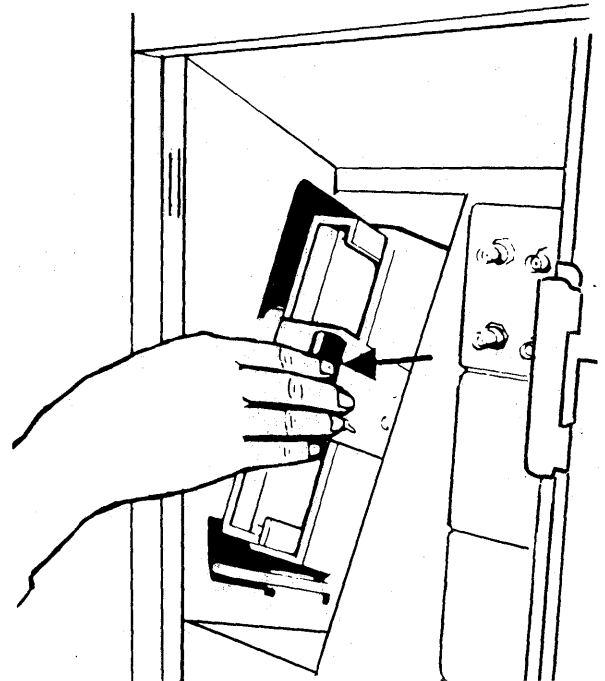
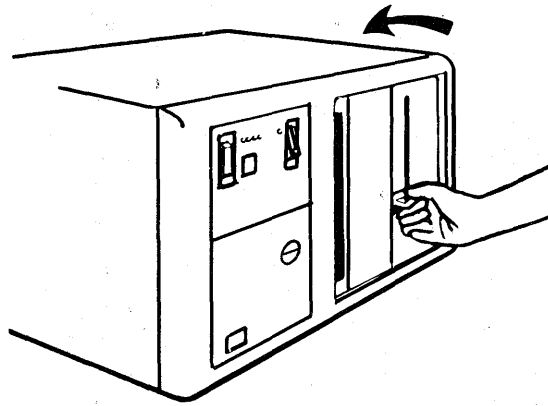

Figure 6-3 (Part 1 of 2). Inserting a Diskette into the 3274 Control Unit (during Backup Diskette Generation)

3274 Diskette Insertion Procedure (Model 51C)

1. Open the diskette reader by turning the operator lever to the vertical position.



2. Remove the diskette to be used with the 3274 from its gray protective envelope, and insert it squarely into the enclosure. Note that the diskette label position is on your left.

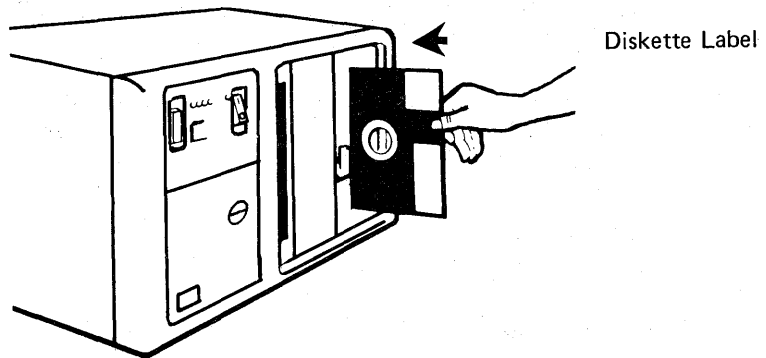

3. Close the diskette reader by turning the operator lever to the horizontal position.

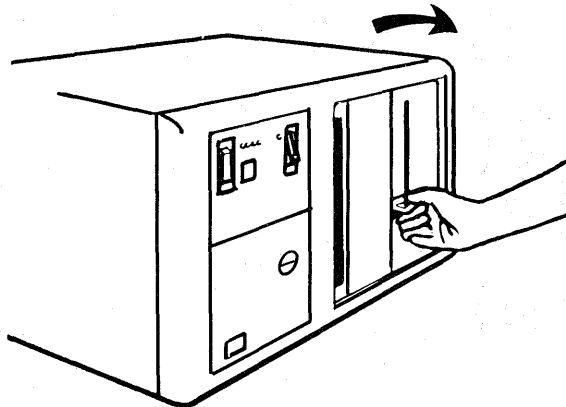

Figure 6-3 (Part 2 of 2). Inserting a Diskette into the 3274 Control Unit (during Backup Diskette Generation)

Code ¹	Meaning	Action
01	One or more of the first 10 characters are incorrect.	Enter the correct response.
02	One or more of the 11th to 17th characters, including the space, are incorrect.	Enter the correct response.
03	1. One of the last two characters you entered in response to sequence number 001 is incorrect, or, 2. The diskette release level is not the same as the documentation level.	1. Enter the correct response. 2. Restart after matching diskette and documentation levels.
11	You entered an invalid response (too many characters, value too high or too low, wrong character, etc.).	Enter the correct response.
12	You entered a character other than A, B, C, D, E, 1, 2, 3, or 4 in response to sequence number 151 (3274 Model Designation).	Enter the correct response.
13	Your response has too few characters.	Enter the correct response.
14	1. The numeric total of the responses you entered for sequence numbers 111 (Number of Category B Terminals) and 112 (Number of Category A Terminals) is greater than 32 (Models 1, 21, and 31) or 12 (Model 51C). 2. Your response to sequence number 163 (Extended Character Set Adapter) is greater than your response to sequence number 112 (Number of Category A Terminals).	1. Enter the correct responses. 2. Change your response to sequence number 163 to the same value as, or a value less than, your response to sequence number 112.
21	You made an unacceptable change during the modify sequence (number 999).	Recheck the entries, and correct them.
22	You specified something in your configuration that is not compatible with the character set you specified in sequence number 321. If you specified the EBCDIC character set (321=0), sequence number 121 must not be "02." If you specified the ASCII character set (321=1): Sequence number 121 must be "02" Sequence number 131 must be "1" Sequence numbers 132, 133, 134, and 135 must be "0" Sequence numbers 162, 163, 164, and 165 must be "0" Sequence number 166 must be "A"	Verify and enter the correct response(s).
23	One or more of your responses are not compatible with the response to sequence number 331 (BSC or SDLC Protocol).	Verify and enter the correct responses.
24	1. All your responses to sequence numbers 131 through 135 (keyboard types) are 0's (at least one must be 1), or 2. Your response to sequence number 113 (Extended Function Store) was something other than 0000 or A000. Your response indicates that the Extended Function Store feature is installed in your 3274 when, in fact, the feature is not installed.	1. Verify and enter the correct responses. 2. Verify and enter the correct response.
25	1. If this response is to sequence number 133 (Data Entry Keypunch Layout Keyboard), you specified the Katakana language (121=17) and a Data Entry Keypunch Layout Keyboard (133=1). The Data Entry Keypunch Layout Keyboard cannot be specified with the Katakana language. 2. If this response is to sequence number 131, the response to sequence number 121 cannot be 17, 31, or 32. If this response is to sequence number 133, 134, or 135, the response to sequence number 121 cannot be 31 or 32. 3. If this response is to sequence number 113 (Extended Function Store), the 3274 has less storage than indicated in your response to sequence number 113. 4. You specified a language other than 01 (U.S. English) to sequence number 121 and Text (135=1). Text cannot be specified with languages other than U.S. English.	1. Verify and enter the correct response. 2. Verify and enter the correct response. 3. Report the problem. 4. Verify and enter the correct response.
26	You do not have enough storage to support all the features you have selected.	Report the problem and verify that the storage specified in response to sequence number 113 is correct. (The storage requirements for the features you have selected may have to be recalculated using the storage-requirement tables in Appendix I.)

¹ If any entry is unacceptable, the entry for sequence number 900 is changed back to 0 (zero) and the unacceptable value is intensified.

Figure 6-4 (Part 1 of 2). Operator Codes during Backup Diskette Generation Only

Code ¹	Meaning	Action
27	<ol style="list-style-type: none"> You specified languages 18 or 29 and they are not allowed with your configuration support. You specified SFAP (162=1) and a language that is not allowed with SFAP (121=02, 08, 10, 13, 20, 26, or 27). You specified a language that is not allowed with a 3290 Information Panel (121=02, 06, 08, 09, 10, 12, 13, 20, 26, or 27). 	<ol style="list-style-type: none"> Specify Portuguese (127=28). Language 29 not allowed with Configuration Support C. Verify and enter the correct responses. Verify and enter the correct response.
28	<p>Your responses to sequence numbers 113 (Extended Function Store) and 151 (3274 Model Designation) are incompatible.</p> <p>You have specified RTM (sequence number 127) with a 3274 Model 1 A, -C, -D (sequence number 151). This is not allowed.</p>	Verify and enter the correct response.
29	You specified an Attribute Select keyboard (166=B or C), but you did not specify a Typewriter keyboard (131=1) or an APL keyboard (132=1).	Either change 166 to "A" or change 131 and/or 134 to "1".
30	<ol style="list-style-type: none"> You have specified a starting address for Multiple Interactive Screens (sequence number 171), but you have not specified logical terminal addresses. You have specified logical terminal addresses for Multiple Interactive Screens (sequence number 171), but you have not specified a starting address. 	Review instructions for defining Multiple Interactive Screens (Appendix J) and enter the correct response.
31	You have specified an invalid starting address for Multiple Interactive Screens (sequence number 171).	Specify a starting address that is not port A0, but is low enough to allow for your required number of terminals.
32	Your response to either sequence number 112 or 171 is incorrect. You have specified more logical terminals than your system will allow.	Review Appendix B, remembering that if using BSC or a 3274 Model D, you cannot specify more than 32 terminal addresses. If using SDLC or 3274 Model A, you cannot specify more than 128 terminal addresses.
33	Zero has been specified in sequence number 170, but you specified a nonzero response to sequence number 171, 173, 175, or 176.	Either specify 1 to sequence number 170, or zeros to sequence numbers 171, 173, 175, and 176.
36	You have specified a nonzero response for sequence number 139, but a zero response for sequence number 170. 170 must be 1 for 139 to be nonzero.	Verify responses to sequence numbers 139 and 170, then enter the correct response(s).
60	Both response fields for sequence number 127 must be either zero or non-zero.	Enter a zero or non-zero response in both fields.
61	You do not have host support and your first digit response to sequence number 127 was a 3, 4, or 5, or your second digit was a 3. This is not allowed.	Enter an acceptable response.
62	An invalid time boundary is specified in sequence number 128. The maximum time allowed is 27:18.3. The seconds field must not exceed 59.	Enter time values in the permitted range.
63	Field B1 in sequence number 128 cannot be specified as 00:00.0.	Specify at least 00:00.1 in field B1.
64	Entries for fields B1 through B4 in sequence number 128 are not in ascending order.	Enter boundary values in ascending order.
65	A time boundary value of 00:00.0 is embedded between two non-zero values in sequence number 128. This is not allowed.	Enter an appropriate non-zero value.
66	A non-zero boundary value follows a maximum boundary value (27:18.3) in sequence number 128. Only a zero boundary value (00:00.0) can follow the maximum.	Correct your boundary value sequence.
99	Your entries are acceptable, but the entry for sequence number 900, 901, or 904 has not been changed to a 1.	Change the entry to a 1.

¹If any entry is unacceptable, the entry for sequence number 900 is changed back to 0 (zero) and the unacceptable value is intensified. All codes except 99.

Figure 6-4 (Part 2 of 2). Operator Codes during Backup Diskette Generation Only

Steady Code	Diskette Mounted	Meaning	Action
0001	Feature	Customizing being performed	None.
0010	Any (indication lasts for 3 minutes or more)	Diskette improperly inserted or an internal 3274 error	Insert diskette properly and retry.
0011	Feature	Customizing being performed	None.
0100	Feature	Patch, printer authorization matrix, or RPQ being performed	None.
0101	Feature	Configuration being performed	None.
0110	Feature	Modification being performed	None.
0111	Feature, language, or RPQ	Normal 3274 operation	None.
1000	System or load (customizing in process)	Normal 3274 operation	None.
1001	Any	Internal 3274 error	Retry. If the error recurs, follow your local procedure for problem recovery.
1010	Any	Internal 3274 error	Retry. If the error recurs, follow your local procedure for problem recovery.
1101	Any (customizing procedure in progress)	<ol style="list-style-type: none"> 1. IML pushbutton pressed while diskette is being changed, or 2. A bad or uncustomized system or load diskette is being used 	<ol style="list-style-type: none"> 1. Recustomize. Do not press the IML pushbutton unless instructed to do so. 2. Insert a good customized system or load diskette.
1111	System or load (IML not performed)	Customizing is completed	IML can be performed.

Figure 6-5. Steady 8 4 2 1 Indicator Codes during Backup Diskette Generation Only

Flashing Code ¹	Diskette Mounted	Meaning	Action
0000 0011	System	Load diskette request	Insert load diskette.
0000 0101	Any	System or load diskette request	Insert system or load diskette.
0000 1010	System	A diskette read error occurred.	Retry. If the error recurs, follow your local procedure for problem recovery.
	Load	A diskette read error occurred.	Try to perform Load Diskette Backup Procedure. If this fails, recustomize using the feature and system diskettes.
0000 1011	Any	System diskette request	Insert system diskette.
0000 1100	Any	RPQ diskette request	Insert RPQ diskette.
0000 1101	Any	Language diskette request	Insert language diskette.
0000 1110	Any	Feature diskette request	Insert feature diskette.
0100 0010	System or load	Configuration on system or load diskette being used for update-diskette procedure is not compatible with this 3274	Use a system diskette or load with a compatible configuration.
1000 0001	System or load	Uncustomized system or load diskette being used during update procedure	Use customized system or load diskette.
1001 0110	Any	Wrong-level diskette being used	Use correct-level diskette.
1111 0001	Feature	On/Off switch or TEST key pressed instead of ENTER	Retry. If the error recurs, follow your local procedure for problem recovery.
	System	Internal 3274 error	Follow your local procedure for problem recovery.
1111 0010	Feature	3278 Model 2 or higher is not attached to port A0.	Attach 3278 Model 2, its equivalent, or higher to port A0. Retry customizing.
1111 0011	Feature	Insufficient storage in 3274	Follow your local procedure for problem recovery.
1111 0100	System	Internal 3274 error	Retry. If the error recurs, follow your local procedure for problem recovery.
1111 0101	System	Internal 3274 error	Retry. If the error recurs, follow your local procedure for problem recovery.
	Feature	On/Off switch or TEST key pressed instead of ENTER	
1111 0110	RPQ	Incompatible RPQs	Follow your local procedure for problem recovery.
	Feature	Internal 3274 error	
1111 0111	System	Internal 3274 error	Follow your local procedure for problem recovery.
1111 1000	System	Internal 3274 error	Follow your local procedure for problem recovery.
1111 1001	System, feature, language, or RPQ	Internal 3274 error	Follow your local procedure for problem recovery.
1111 1010	System	Internal 3274 error	Follow your local procedure for problem recovery.
1111 1011	System	Internal 3274 error	Follow your local procedure for problem recovery.
1111 1100	Any	Diskette drive error or a bad diskette	Retry. If the error recurs, follow your local procedure for problem recovery.
1111 1101	System, feature, language, or load	Diskette drive error or a bad diskette	Retry. If the error recurs, follow your local procedure for problem recovery.
1111 1110	System, feature, language, or RPQ	Internal 3274 error	Retry. If the error recurs, follow your local procedure for problem recovery.

¹ These codes will flash alternately as shown, for example, 0000, 1011, 0000, 1011.

Figure 6-6. Flashing 8 4 2 1 Indicator Codes during Backup Diskette Generation Only

Steady Code	Flashing Code ¹	Diskette Mounted	Meaning	Action
—	0101 0000 ²	System or load	Internal 3274 error or wrong response to sequence number 113 during customizing procedure	Check response to sequence number 113, and retry. If the error recurs, follow your local procedure for problem recovery.
—	0110 0000 ²	System or load	Internal 3274 error or wrong response to sequence number 111, 112, 151, or 351 during customizing procedure	Check response to sequence number 111, 112, 151, or 351, and retry. If the error recurs, follow your local procedure for problem recovery.
—	0110 0001 ³	System or load	Address range set in control unit does not include highest logical device address assigned during customization ⁴	Check responses to sequence numbers 111, 112, 116, 117, and 118. If correct have IBM CE check address range setting in control unit.
—	0111 0000 ²	System or load	1. Internal 3274 error, or 2. Wrong response to sequence number 311 or 343, or 3. The 3274 is not connected to the communication facility	1 and 2. Check responses to sequence numbers 311 and 343, and retry. 3. Connect the 3274 to the communication facility. If the error recurs, follow your local procedure for problem recovery.
—	1000 0000	System or load	Internal 3274 error or wrong response to sequence number 111 during customizing procedure	Check response to sequence number 111, and retry. If the error recurs, follow your local procedure for problem recovery.
—	1001 0000	System or load	Internal 3274 error or wrong response to sequence number 352 during customizing procedure	Check response to sequence number 352, and retry. If the error recurs, follow your local procedure for problem recovery.
—	1001 1010	System or load	Internal 3274 error or wrong response to sequence number 151 during customizing	Check response to sequence number 151 and retry. If the error recurs, follow your local procedure for problem recovery.
—	1001 1110	System or load	Insufficient storage	Follow your local procedure for problem recovery.
—	1011 0000	System or load	Internal 3274 error or wrong response to sequence number 127 during customizing procedure	Check response to sequence number 127, and retry. If the error recurs, follow your local procedure for problem recovery.
1101	—	System or load	Uncustomized system diskette	Insert customized system diskette.
1110	—	System or load	Insufficient storage	Check response to sequence number 113, and retry. If the error recurs, follow your local procedure for problem recovery.

¹ These codes will flash alternately as shown, for example, 0101, 0000, 0101, 0000, and so on.

² These codes may blink for 5 seconds, followed by a different steady code for 3 seconds.

³ Models 1D, 21D, and 31D only. These codes will alternate continuously as follows: left code blinks for 5 seconds, then right code is on steady for 3 seconds.

⁴ When the 3290 Information Panel is attached to 3274D units and the Multiple Interactive Screen function is being used, the address range set in the control unit must include the highest logical device address assigned, not the highest physical device address.

Note: These indicators may be caused by something other than incorrect customizing. Further aids can be found in the *IBM 3270 Information Display System: 3274 Control Unit Problem Determination Guide*, GA27-2850.

Figure 6-7. 8 4 2 1 Indicator Codes during IML That May Result from an Incorrect Backup Diskette Generation



Chapter 7. Update-Diskette Installation Procedures

If you have requested and received an update-diskette package from IBM, follow the procedures in this chapter to update your customized IBM 3274 Control Units.

The update-diskette package is for use only on previously customized 3274 Control Units and should not be used prior to initial customizing. It is recommended that each update-diskette package be installed on your 3274 Control Units as soon as possible after the package is received.

RPQ Update-Diskette Installation

If your 3274 has not been customized, and you have received a new RPQ diskette, follow the Initial Customizing Procedure in Chapter 4.

If your 3274 has been customized, and you have received only a new RPQ diskette (no new feature, system, or load diskettes), use the Modification Procedure in Chapter 5 to install the new RPQ diskette.

If your update-diskette package includes new feature, system, or load diskettes in addition to a new RPQ diskette, use the appropriate procedure in this chapter for your configuration support to install the update-diskette package.

Language Update-Diskette Installation

Note: Do not install the new language diskette unless the release level number on the new language diskette is greater than or equal to the release level number on your current (old) language diskette.

If your 3274 has not been customized, and you have received a new language diskette, follow the Initial Customizing Procedure in Chapter 4.

If your 3274 has been customized, and you have received only a new language diskette (no new feature, system, or load diskettes), use the Modification Procedure in Chapter 5 to install the new language diskette.

If your update-diskette package includes new feature, system, or load diskettes in addition to a new language diskette, use the appropriate procedure in this chapter for your configuration support to install the update-diskette package.

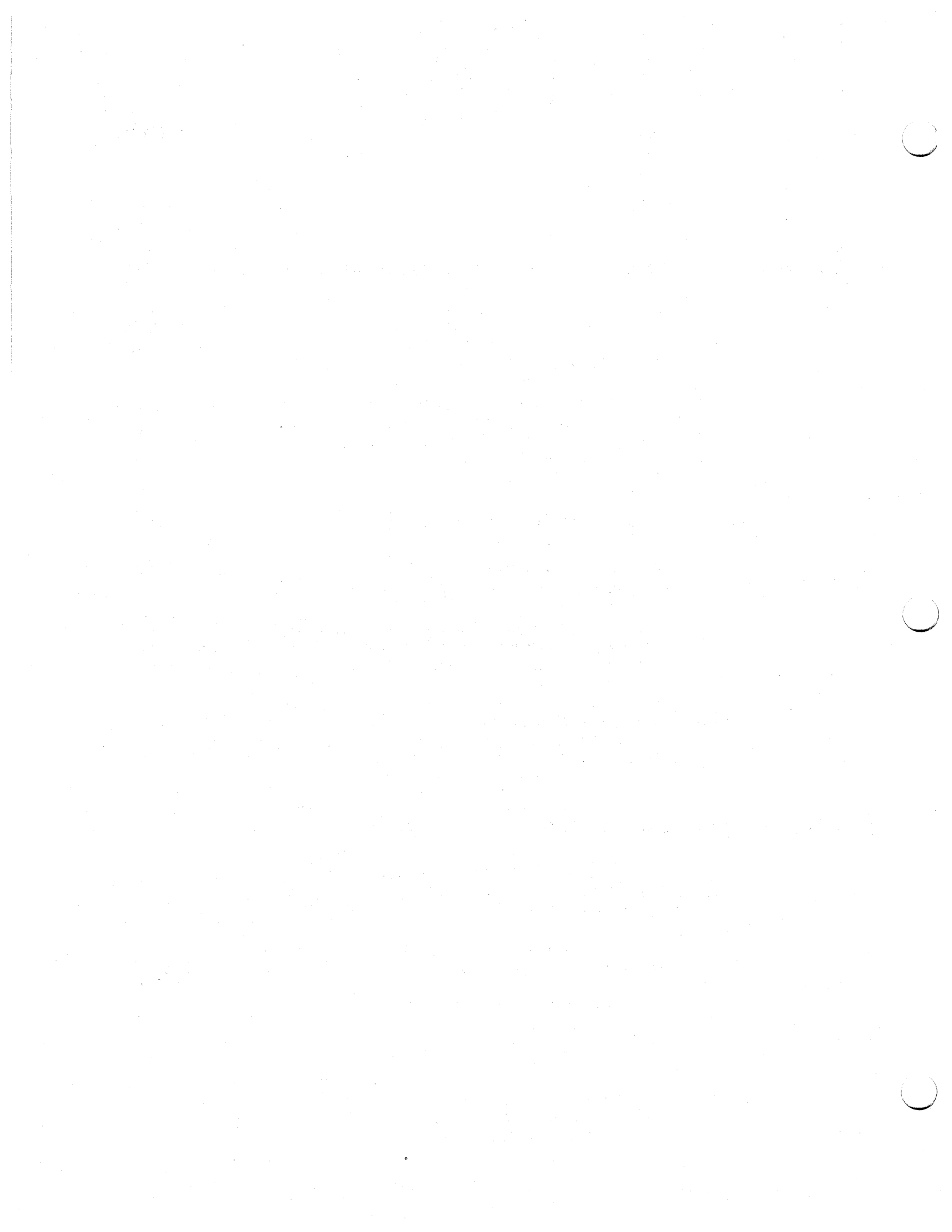

Update-Diskette Installation Procedure for Configuration Support A, B, or C

This procedure uses the update-diskette package and current diskettes to incorporate maintenance enhancements into 3274 Control Units that have been previously customized with Configuration Support A, B, or C. Contact the person responsible for customizing your 3274 before you perform this procedure. It should take you less than 1 hour to complete this procedure.

Note: If you encounter any difficulty during this procedure, follow your local procedure for problem recovery.

1. Obtain the following:
 - a. Current system diskette (primary or backup), language diskette (if applicable), and RPQ diskette(s) (if applicable)
 - b. New system diskette
 - c. New feature diskette
 - d. All RPQ diskettes, if any, included in the update package. If a diskette is included for a new RPQ, place it with the other RPQ diskettes. If a new RPQ diskette is provided for an existing RPQ, substitute it for the current RPQ diskette.

Note: Do not install this update unless (1) the configuration support (A, B, or C) on the new system diskette is exactly the same as that shown on your current system diskette, *and* (2) the release number on the new system diskette is higher than the release number on your current system diskette.

2. Ensure that the 3274 has power on.

Note: On locally attached 3274s, the rotary switch on the operator panel must be in the Local/Offline position and the Local/Offline indicator must be lit.

3. Insert the new feature diskette.
4. While holding the Alt IML Address switch in position 2, press and release the IML pushbutton; then release the Alt IML Address switch. Within 2 minutes, the 8 4 2 1 indicators will display a flashing 1011 code.
5. Replace the new feature diskette with the current system diskette. *Do not press the IML pushbutton.* (If you do press the IML pushbutton, go back to step 3.) In approximately 20 seconds, the 8 4 2 1 indicators will display a flashing 1110 code.
6. Replace the current system diskette with the new feature diskette.
7. The following 8 4 2 1 indicator codes define the subsequent actions to be taken. After a diskette is inserted, wait approximately 2 minutes for the machine to complete its operation before interpreting the new status of the 8 4 2 1 indicators.

8 4 2 1 Indicator Codes

Steady Display	Flashing Display	Action/Comments
	0000 - 1011	Insert the new system diskette.
	0000 - 1100	Insert the RPQ diskette. (If multiple RPQs are to be processed, repeat this step as required.)
	0000 - 1101	Insert the language diskette.
	0000 - 1110	Insert the new feature diskette.
	0100 - 0010	The configuration support (A, B, or C) of the new system diskette is not compatible with this 3274. Terminate this procedure, and follow your local procedure for problem recovery.
	1000 - 0001	The current system diskette is not customized. Use the proper customized diskette, and retry from step 3. If retry is not successful, follow your local procedure for problem recovery.
	1001 - 0110	Wrong system diskette. Insert the system diskette normally used in daily operation, and retry from step 3. If retry is not successful, follow your local procedure for problem recovery.
0010		The diskette was improperly inserted or an internal 3274 error occurred. Retry from step 3 with the diskette inserted properly. If retry is not successful, follow your local procedure for problem recovery.
1010		This diskette may be faulty. Retry from step 3 with the backup diskette, if available. If retry is not successful, follow your local procedure for problem recovery.
1111		The update procedure is completed, and normal startup (IML) can be performed.

Note: Indicator codes other than those shown above indicate a possible malfunction. Retry the operation once, starting with step 3. If the same error recurs, refer to Figures 7-1 and 7-2 for the meaning of the indicator code and for the action to take. If progress cannot be made, record the 8 4 2 1 indicator code and follow your local procedure for problem recovery.

8. If a new backup system diskette is desired, repeat the procedure from step 3, using the new backup system diskette in place of the new system diskette.
9. After the update procedure is completed, follow your local procedure for disposing of all excess diskettes.

Update-Diskette Installation Procedures for Configuration Support T

The following procedures describe how to update Configuration Support T customized IBM 3274 Control Units using:

- New feature and system diskettes (no load diskette)
- New feature and system diskettes and new load diskette
- New feature and system diskettes and current load diskette
- New load diskette and current system diskette.

The procedures incorporate maintenance enhancements into a 3274 Control Unit that has been previously customized to operate under Configuration Support T. You should contact the person responsible for customizing your 3274 before you perform either of these procedures.

If an error occurs during a procedure, either a steady or a flashing error code will be displayed by the 8 4 2 1 indicators. Figures 7-1 and 7-2 contain the meaning of these error codes and the corrective action you should take.

Procedure for Updating with New Feature and New System Diskettes

Note: You may use this procedure with no load diskette, with a current load diskette, or with a new load diskette. For updating the 3274 Control Unit with *only* a new load diskette, use the **Procedure for Updating with a New Load Diskette Only**, the last procedure in this chapter.

Do not install this update unless (1) your 3274 is customized with Configuration Support T, and (2) the release number on the new diskettes is higher than the release number on your current diskettes.

1. Obtain the following:

- Current system diskette (primary or backup), load diskette (primary or backup, if applicable), language diskette (if applicable), and RPQ diskette(s) (if applicable)
- New system diskette
- New feature diskette
- New language diskette (if applicable)
- New load diskette (if applicable)
- All RPQ diskettes (if any) included in the update package. If a diskette is included for a new RPQ, place it with the other RPQ diskettes. If a new RPQ diskette is provided for an existing RPQ, substitute it for the current RPQ diskette.

2. Ensure that the 3274 Control Unit has power on.

Note: On locally attached 3274 Control Units, the rotary switch on the operator panel must be in the Local/Offline position and the Local/Offline indicator must be lit.

3. Insert the new feature diskette.
4. While holding the Alt IML Address switch in position 2, press and release the IML pushbutton and then release the Alt IML Address switch. Within 2 minutes, the 8 4 2 1 indicators will display a flashing 0101 code.
5. Replace the feature diskette with the current system diskette (or the current load diskette, if applicable). *Do not press the IML pushbutton.* (If you do press the IML pushbutton, go back to step 3.) In approximately 20 seconds, the 8 4 2 1 indicators will display a flashing 1110 code.
6. Replace the system diskette (or load diskette) with the new feature diskette.
7. The following 8 4 2 1 indicator codes define the next actions to take. After a diskette is inserted, wait approximately 2 minutes for the machine to complete its operation before reading the 8 4 2 1 indicators and taking the next action.

8 4 2 1 Indicator Codes

Steady Display	Flashing Display	Action/Comments
	0000 - 0011	Insert the load diskette, current or new as applicable.
	0000 - 1011	Insert the new system diskette.
	0000 - 1100	Insert the RPQ diskette. (If you have more than one RPQ diskette to be processed, repeat this step as required.)
	0000 - 1101	Insert the language diskette, current or new as applicable.
	0000 - 1110	Insert the new feature diskette.
1111		The update procedure is completed, and you may perform normal startup (IML).

Note: If a load diskette is used in your 3274 installation, then it should be used for all subsequent IMLing of the 3274 and you should not use the system diskette.

Procedure for Updating with a New Load Diskette Only

1. Obtain the following:
 - Current system diskette (used to initially customize the current load diskette)
 - New load diskette.
2. Ensure that the 3274 Control Unit has power on. On locally attached 3274s, the rotary switch on the operator panel must be in the Local/Offline position and the Local/Offline indicator must be lit.
3. Insert the current system diskette.
4. While holding the Alt IML Address switch in position 1, press and release the IML pushbutton and then release the Alt IML Address switch. Within 1 minute, the 8 4 2 1 indicators will display a flashing 0011 code.
5. Replace the current system diskette with the new load diskette. *Do not press the IML pushbutton.* (If you do press the IML pushbutton, go back to step 3.)
6. Within 5 minutes, the 8 4 2 1 indicators will display a solid 1111 code, indicating that the update procedure has been successfully completed.
7. If desired, repeat the procedure to generate a backup load diskette.

Note: For all subsequent IMLing of the 3274 Control Unit, you should use the new load diskette, not the system diskette.

Steady Code	Meaning	Action
0010	The diskette is improperly inserted or an internal 3274 error occurred.	Insert the diskette properly and retry.
1001	An internal 3274 error occurred.	Retry. If the error recurs, follow your local procedure for problem recovery.
1010	An internal 3274 error occurred.	Retry. If the error recurs, follow your local procedure for problem recovery.
1101	Either the IML pushbutton was pressed at the wrong time or an uncustomized or bad diskette is being used.	Contact the person responsible for customizing the 3274 to ensure that the proper diskette is being used and then perform the procedure again, pressing the IML pushbutton only when told to do so.

Figure 7-1. Steady 8 4 2 1 Indicator Error Codes during Update Diskette Procedure

Flashing Code	Meaning	Action
0000-1010	A diskette read error occurred.	Retry. If the error recurs, follow your local procedure for problem recovery.
0100-0010	The configuration support of the system diskette or load diskette is not compatible with this 3274.	Terminate this procedure and follow your local procedure for problem recovery.
1000-0001	The system diskette or load diskette is not customized.	Use the proper customized diskette and retry from step 3. If the retry is not successful, follow your local procedure for problem recovery.
1001-0110	Wrong diskette (system, feature, RPQ, or language diskette).	Insert the correct diskette.
1111-0001	Either the On/Off switch or TEST key was pressed instead of the ENTER key or an internal 3274 error occurred.	Retry. If the error recurs, follow your local procedure for problem recovery.
1111-0010	A 3278 Model 2, its equivalent, or higher must be attached to port A0.	After attaching the proper model, retry the procedure.
1111-0011	Insufficient storage in 3274.	Follow your local procedure for problem recovery.
1111-0100	An internal 3274 error occurred.	Retry. If the error recurs, follow your local procedure for problem recovery.
1111-0101	Either the On/Off switch or TEST key was pressed instead of the ENTER key or an internal 3274 error occurred.	Retry. If the error recurs, follow your local procedure for problem recovery.
1111-0111	An internal 3274 error occurred.	Follow your local procedure for problem recovery.
1111-1000	An internal 3274 error occurred.	Follow your local procedure for problem recovery.
1111-1001	An internal 3274 error occurred.	Follow your local procedure for problem recovery.
1111-1010	An internal 3274 error occurred.	Follow your local procedure for problem recovery.
1111-1011	An internal 3274 error occurred.	Follow your local procedure for problem recovery.
1111-1100	Either a diskette drive error occurred or a bad diskette is being used.	Retry. If the error recurs, follow your local procedure for problem recovery.
1111-1101	Either a diskette drive error occurred or a bad diskette is being used.	Retry. If the error recurs, follow your local procedure for problem recovery.
1111-1110	An internal 3274 error occurred.	Retry. If the error recurs, follow your local procedure for problem recovery.

Figure 7-2. Flashing 8 4 2 1 Indicator Error Codes during Update Diskette Procedure

Appendix A. Planning Checklist

This planning checklist is provided as a sample plan; the plan may have to be modified to accommodate your unique 3270 configuration.

Weeks Before Delivery	Schedule Date	Responsibility		✓	Event
		Customer	IBM		
16	_____	X			Designate a person in your organization who will be responsible for all phases of the 3270 installation.
		X	X		Review this planning guide with the person designated above.
		X			Decide who will install (1) the device cables between the 3274 and the attached terminals and (2) the power receptacles, wiring, etc. (your maintenance personnel or a contractor).
		X	X		Determine the schedule dates with the IBM representative. Fill in the dates on this form and give a copy to the IBM representative.
		X			Identify and schedule data communication needs. Identify the source for communication line (contact telephone company). Order modems as required.
14	_____	X			Lay out the floor plan. Show locations of control units, terminals, and modems.
		X			Order supplies (refer to "Supplies" list).
		X	X		Review the overall installation plan with IBM representative.
		X			Place order for device cables (coaxial cables between 3274 and attached terminals) from IBM or a contractor, or order the materials to make the cables yourself. Refer to <i>Installation and Assembly of Coaxial Cable and Accessories</i> , GA27-2805.
12	_____	X			Determine whether changes are required to the existing programs (system control program, network control program, program products, and application programs). (Refer to <i>IBM 3274 Control Unit Description and Programmer's Guide</i> , GA23-0061). If so, schedule the required changes.
		X			Determine whether changes are required to the existing data processing units (host system computer and transmission control units). If so, schedule the required changes.

Weeks Before Delivery	Schedule Date	Responsibility		✓	Event
		Customer	IBM		
		X			Arrange for the installation of (1) the device cables between the 3274 and the attached terminals and (2) the power receptacles, wiring, etc.
		X			Define a training program for employees.
		X			Order the required terminal manuals.
10	_____	X			Review the progress of the data communication plan. Identify and resolve any schedule conflicts.
9	_____	X	X		Review the 3270 configuration to make sure the configuration meets your requirements. Make any necessary changes to your order.
8	_____	X	X		Review the installation plan to define any exposure to schedule.
		X	X		Confirm the arrival of package containing cables.
		X			Start installing and labeling cables and power receptacles.
6	_____	X			Start employee training.
			X		IBM representative checks progress of site preparation.
4	_____	X			Receive supplies (magnetic stripe cards, forms, etc.).
		X			Complete the installation of cables and power receptacles.
2	_____	X			Complete the checkout of the cables and power: continuity and polarity tests of cables, power receptacles, and safety considerations.
		X			Complete the required changes to the existing programs and data processing units.
		X			Complete the site preparation.
		X			Install communication facilities (telephone line and modems).
		X			Make sure all the necessary information is available for the setup personnel (switch settings, configuration information, customizing form, etc.).
		X			Review setup instructions with the setup personnel.

Weeks Before Delivery	Schedule Date	Responsibility		✓	Event
		Customer	IBM		
Arrival of Units	_____	X			Move the terminals to locations. Unpack per unpacking instructions.
		X			Read the setup instructions.
		X			Complete the setup of 3274 C models and attached terminals, using the setup instructions included in the shipping cartons.
			X		Install 3274 A, B, and D models.
		X			Complete the 3274 customizing.

MEMORANDUM FOR THE RECORD

Subject: [Illegible]

[Illegible text]

[Illegible text]

[Illegible text]

[Illegible text]

[Illegible text]

[Illegible text]

Appendix B. 3274 Device Cables

In order to assign the device cables to the correct 3274 ports, you should be aware of the following:

- Two categories of terminals can be attached to the 3274: Category A and Category B. Category A units must be attached to a 3274 Type A Terminal Adapter; Category B units, to a 3274 Type B Terminal Adapter.
- Type A Terminal Adapters and Type B Terminal Adapters can be ordered in various combinations to provide a maximum cluster of (a) 32 Category A units or (b) 32 Category A and Category B units, of which a maximum of 16 can be Category B units on all models except the Model 51C. The 3274 Model 51C can have a maximum of 8 Category A units and 4 Category B units.
- Depending upon the configuration of the 3274 and its attached units, a maximum of five device cable connector panels can be installed on the 3274 (see 3274 Device Cable Attachment Form). Each panel used to attach Category A units contains eight ports for attachment of device cables; each panel used to attach Category B units contains either four or eight active ports. Therefore, on all models except the Model 51C, a maximum of 40 ports can be present. However, only 32 of the possible 40 ports can be used.
- There are two types of 3274 device cable connector panels:
 - Black panels, labeled *A*, which are used to attach device cables from units that attach to a Type A Terminal Adapter.
 - White panels, labeled *B*, which are used to attach device cables from units that attach to a Type B Terminal Adapter.

The lowermost panel on all models, except the Model 51C, and the second and third lower panels, if present, are *always* black, are labeled *A*, have ports numbered 0 through 23 (A0 – A23), and are used to attach only Category A units.

- On all models except the Model 51C, the fourth panel from the bottom (if present) has a dual function. It can be used to attach either Category A units or Category B units. This panel can be used for one or the other category of machines, *but not both categories*. When this panel is used to attach Category A units, the panel is black, is labeled *A*, and has ports numbered 24 through 31 (A24 – A31); when this panel is

used to attach Category B units, the panel is white, is labeled *B*, and has ports numbered 8 through 15 (B8 – B15).

- On all models except the Model 51C, the fifth (uppermost, if present) panel is *always* white, is labeled *B*, has ports numbered 0 through 7 (B0 – B7), and is used to attach only Category B units.
- Port A0 must always be assigned to a 3178, 3179, 3180, 3278, or 3279 with a keyboard.

Instructions for Completing the 3274 Device Cable Attachment Form

1. Determine how many terminals are in each of the following two categories:

Category A – 3178, 3179, 3180, 3230, 3262, 3268, IBM 3270 Personal Computer, 3278, 3279, 3287 with a 3274 Attachment feature, 3289, 3290, 4250, and 5210.

Category B – 3277, 3284, 3286, 3287 with a 3271/3272 Attachment feature, and 3288.

2. Assign a 3178, 3179, 3180, 3278, or 3279 with a keyboard to port A0, and fill in the unit location (office/column number) and telephone number columns of the table. It is recommended that this display station be as close as possible to the 3274, because it will be used for 3274 customizing and problem determination.
3. Assign the remaining Category A units to the ports numbered A1 through A31 sequentially (bottom of table to top). Fill in the table with the required information for each unit. If any of the ports numbered A24 through A31 (A11 for 51C) are used, cross out the B port number(s) to the right of the A port number(s) used.
4. If there are no Category B units in the configuration, go to step 6.
5. Assign the Category B units to the ports numbered B0 through B15 (B07 for 51C), starting at port B0 and progressing sequentially (top of table to bottom). Fill in the required information in the table for each unit. If any of the ports numbered B8 through B15 are used, cross out the A port number(s) to the left of the B port number(s) used.
6. Cross out all unused port entries in the table.
7. Write the 3274 location information (office/column number) above the table.

It is recommended that copies of the completed form be given to the personnel who will install and mark the cables and to the personnel who will connect the cables to the 3274. In addition, a copy of the form should be stored in the pocket inside the 3274 customer access door.

3274 Device Cable Attachment Procedure

Note: If you have a Model 51C, go directly to Step 3.

- 1 DO** Open the customer access door.
- 2 DO** Unlatch the device cable retention clamp by lifting up on the left side of the clamp and rotating it toward the front of the 3274.

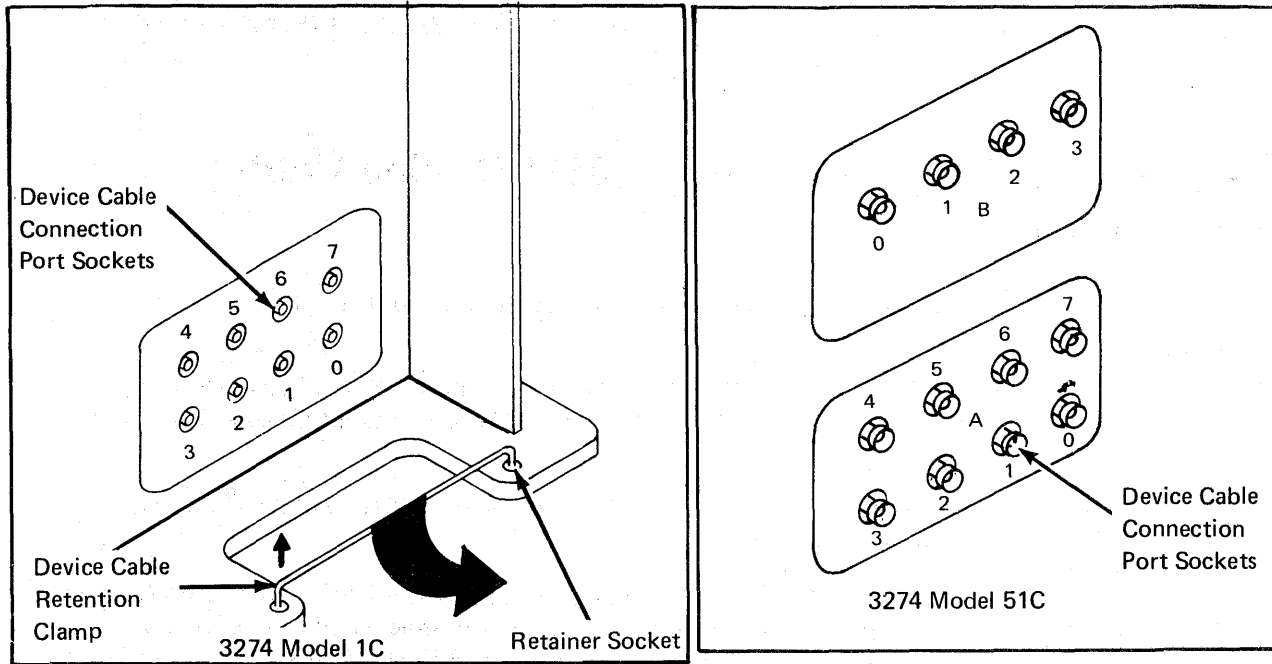

- 3 DO** Use the 3274 Device Cable Attachment Form on the back of this page to connect the device cables to their corresponding ports on the device cable panel(s).
- DO** Use a push-and-twist clockwise motion to connect and lock the device cables to the port sockets.

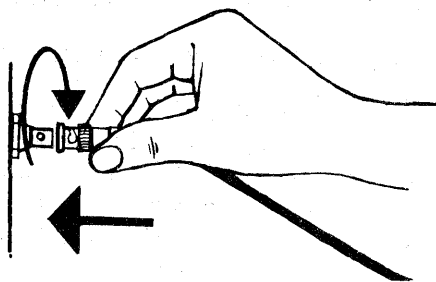

Caution: Do not connect or disconnect device cables during an electrical storm.

- 4 DO** Rotate the device cable retention clamp toward the rear of the 3274 (clockwise), and latch the clamp in place by inserting the loose end firmly in the retainer socket. Be sure all the device cables are behind the retention clamp.
- 5 DO** Close the customer access door.

3274 Device Cable Attachment Form (Models 1A, 1B, 1C, 1D, 21A, 21B, 21C, 21D, 31A, 31C, and 31D)

DO Use this form to connect the device cables to the 3274 ports.

1. Connect the device cables identified for the A panel and port numbers (A0, A1, A2, and so on) to the corresponding ports on the black connector panels. Connect the cables in numeric order from the bottom of the table to the top.
2. Connect the device cables identified for the B panel and port numbers (B0, B1, B2, and so on) to the corresponding ports on the white connector panels. Connect the cables, starting with the largest (used) port number in the B portion of the table, in reverse numeric order (B15, B14, B13, and so on) from the bottom of the table to the top. Use the chart on the back of this sheet to fill in information.

3274 Panel and Port Number	Network Address	Cable Identification	Terminal Type	Terminal Location	Telephone Nearest the Terminal
B0					
B1					
B2					
B3					
B4					
B5					
B6					
B7					
A31 or B8					
A30 or B9					
A29 or B10					
A28 or B11					
A27 or B12					
A26 or B13					
A25 or B14					
A24 or B15					
A23					
A22					
A21					
A20					
A19					
A18					
A17					
A16					
A15					
A14					
A13					
A12					
A11					
A10					
A9					
A8					
A7					
A6					
A5					
A4					
A3					
A2					
A1					
A0			3278 or equivalent		

SAMPLE

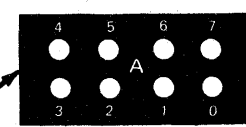
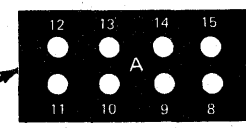
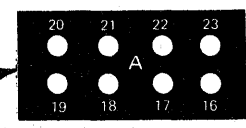
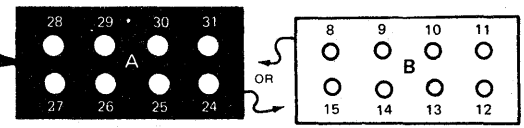
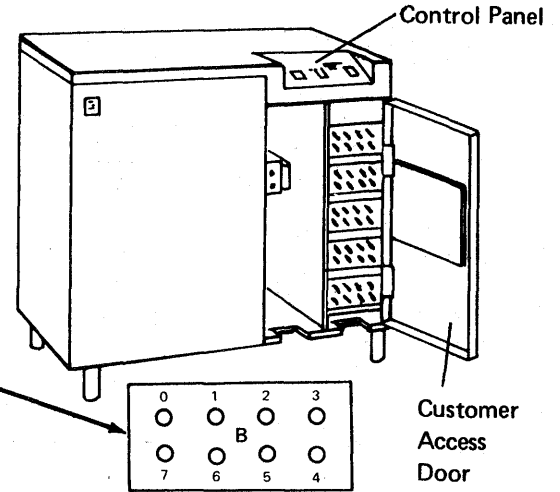

Note: Maximum of 32 terminals

3274 Panel and Port Number	Network Address	Cable Identification	Terminal Type	Terminal Location	Telephone Nearest the Terminal
B0 B1 B2 B3					
B4 B5 B6 B7					
A31 or B8 A30 or B9 A29 or B10 A28 or B11					
A27 or B12 A26 or B13 A25 or B14 A24 or B15					
A23 A22 A21 A20					
A19 A18 A17 A16					
A15 A14 A13 A12					
A11 A10 A9 A8					
A7 A6 A5 A4					
A3 A2 A1 A0			3278 or equiva- lent		

Note: Maximum of 32 terminals

3274 Device Cable Attachment Form (Model 51C)

DO Use this form to connect the device cables to the 3274 ports.

1. Connect the device cables identified for the A panel and port numbers (A0, A1, A2, and so on) to the corresponding ports on the connector panels. Connect the cables in numeric order from the bottom of the table to the top.
2. Connect the device cables identified for the B panel and port numbers (B0, B1, B2, and so on) to the corresponding ports on the connector panels. Connect the cables, starting with the largest (used) port number in the B portion of the table.

3274 Panel and Port Number	Network Address	Cable Identification	Terminal Type	Terminal Location	Telephone Nearest the Terminal
B0 B1 B2 B3					
A7 A6 A5 A4					
A3 A2 A1 A0			3278 or equivalent		

Note: Maximum of 12 terminals

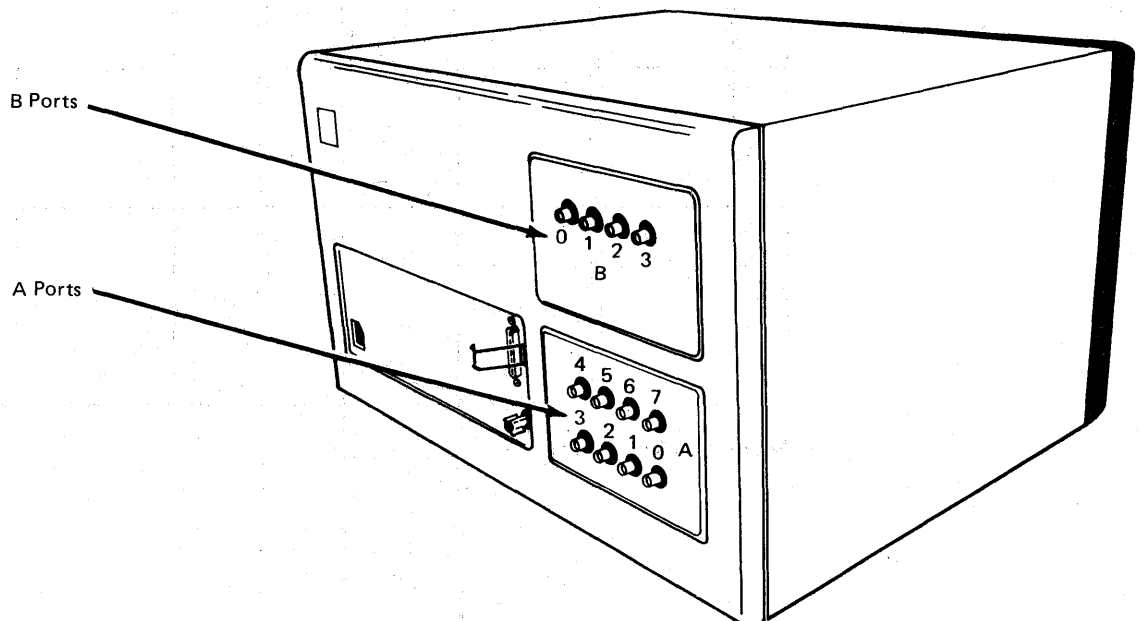

Handwritten text, mostly illegible due to extreme fading and blurring. Some faint words like "The" and "and" are visible.

Channel Attachment Information Form (3274 Models 1A, 1B, 1D, 21A, 21B, 21D, 31A, and 31D)

This form should be completed before delivery of your 3274 (Models 1A, 1B, 1D, 21A, 21B, 21D, 31A, and 31D). The IBM service representative will require the information to connect your 3274 properly to the local channel.

Control unit address (in hexadecimal) _____

Number of contiguous addresses needed
(Models B and D only) _____

Type of channel (byte multiplexer, block multiplexer, or selector) _____

Mode (byte or burst) _____

High or low-channel priority _____

Channel data rate
(Models 1A, 21A, and 31A only) 100-kilobyte _____

See *IBM 3270 Information* 20-kilobyte _____

Display System: 3274 Control Unit Description and Programmer's Guide, GA23-0061.

Ensure that the correct power receptacle is available.

... ..
... ..
... ..

... ..
... ..
... ..

... ..
... ..
... ..

... ..
... ..
... ..

... ..
... ..
... ..

... ..
... ..
... ..

... ..
... ..
... ..

Appendix C. Printer Authorization Matrix

Description

The 3274 printer authorization matrix is required for local-copy operations. Local copy between Category A terminals can be either host-initiated or Print-key-initiated; local copy between Category B terminals must be host-initiated. Local-copy operations cannot be performed between Category A and Category B terminals.

The printer authorization matrix is used to:

- Establish printer mode. A printer may be reserved for the exclusive use of either the host or the local-copy function. A third mode allows a sharing between these two functions.
- Assign print *classes*. A print *class* is a way of grouping printers for use by local copy. A local-copy request directed to a class is then serviced by one of the printers assigned to that group.
- Define source device lists. The source device list specifies which displays may use any given printer for local copy. Note that all displays for a printer must be attached to the same adapter type as the printer. For example, a Category A printer can have only Category A displays in its source device list.

If a printer authorization matrix is not loaded, the default condition for the control unit and its terminals is that all printers are in system mode, and local-copy operations are not possible except with the BSC Copy command.

Printer Modes

A printer may be in one of three modes, specified in the printer authorization matrix as *local*, *system*, or *shared* mode. Each printer on the 3274 defaults to system mode until a matrix is loaded. Printers that are specified as being in shared or local mode then become available for local copy use.

Local Mode

A printer in local mode may be used for local-copy functions regardless of host attachment or communication protocol. This means that displays within the cluster may contend for the use of printers but the host may not. The printer is not available for direct print operations from the host.

A local-copy operation involves the transfer of data from the display buffer to the printer buffer and the subsequent printing of that data. A local copy may be initiated by an operator using the Print key on a display station attached to a 3274 or by the host when the display is operating in SNA/SDLC.

System Mode

A printer in system mode is entirely under host (system) control. This is the default mode each printer assumes when no matrix has been defined. The printer cannot be used for operator-initiated local-copy requests; nor is it available for host-initiated copy operations when using SNA/SDLC. However, when operating with BSC discipline, the printer may honor a BSC Copy command when it is in system mode. The BSC Copy command, directed to the *to* device, specifies the *from* device as a command parameter and does not use the printer authorization matrix.

Shared Mode

In shared mode, both host-directed printing operations and local-copy operations are permitted on the same printer. When in system mode, the printer is protected from local copies; in local mode, the printer is protected from host-initiated operations. In shared mode, however, the subsystem does not guarantee this kind of integrity. When using a printer in shared mode, the user must assume responsibility for the integrity of his printed data by "installation rules" and proper programming practices.

In SNA/SDLC, a printer designated as being in shared mode in the printer authorization matrix may be used for local copy under the following conditions:

- When the printer is not in session with a primary logical unit (PLU) in the host
- When Between Bracket Printer Sharing (sequence number 213) has been specified in the customizing procedure and the printer is not in bracket state with the PLU in the host

Printer Class Structure

The printer authorization matrix permits the assignment of a printer to a class. By the selection of a class containing multiple printers, improved copy throughput can be obtained. The definition of a class of printers is made by the customer and may be based on type, character subset, type of forms mounted, location, and so forth. For example, in a particular installation class, "72" may have been defined as referring to all printers

with yellow paper. Thus, an operator may select an authorized printer on the basis of this characteristic rather than by address.

The printer authorization matrix allows a maximum of 16 printer classes to be defined in each subsystem. A display operator may select a printer by class by using the IDENT key (Alt key pressed) and typing in a number ranging from 70 through 85 corresponding with one of 16 classes. In any configuration, a single printer may be in one class, several, or none. Several printers may be members of a single class.

Source Device Lists

Each printer may be restricted as to which displays it may accept local copies from. Any given printer may be permitted to process copies from some, all, or none of the displays on the control unit. When a local copy is directed to a print class, the printer selected will be one that is authorized to accept copies from the requesting display. Not all printers assigned to a particular class may be authorized for the same subset of display terminals.

Matrix Structure

The 3274 printer authorization matrix defines how display stations (source devices) can use printers (destination devices) attached to the same control unit for the purpose of accepting a local-copy request.

The printer authorization matrix is structured as a two-dimensional array, with each printer in the cluster represented by a printer port address with the following format:

Printer Port Address	Mode	Class	Source Device List
----------------------	------	-------	--------------------

Printer port address is the first field of the descriptor. A decimal address from 01 to 31 for all models except Model 51C (01 to 07 for Model 51C) allows all printers to be attached to any port on the control unit, except port 0. Addresses are sequential by adapter.

Mode defines the printer to be in system, local, or shared mode, where:

0 = System

1 = Local

2 = Shared

Class permits the grouping of printers into classes. This field is bit-coded, one bit for every 16 classes, so that a single printer may be in more than one class. Valid classes are designated 70 through 85 inclusive. Coding a 1 under the appropriate class permits the printer to accept copies from display stations selected by that class.

Source Device List is a bit-coded field that specifies which displays (D) are authorized and configured to use the printer (P) associated with this device descriptor. Each bit position is associated with a port number on the cluster. Coding a 1 under a given display station port address permits the printer to service copy requests from that display station.

Consider an example in which ports 0 through 11 of a 3274 Control Unit have terminals attached as follows:

```

Port Number      0  1  2  3  4  5  6  7  8  9 10 11
Terminal         D  D  P  P  D  D  P  P  D  D  D  D
  
```

The printer authorization matrix describing this configuration is shown in Figure C-1. In this example, the display at port 0 may copy only to the printer on port 2. This printer is not addressable by class (class = all zeros).

Printer		Source Device List																					
Attached to Port with Address	Mode	Class																					
		70	71	72	73	-	-	85	Port No. 0	1	2	3	4	5	6	7	8	9	10	11	...	31	
		Terminal:																					
02	Local (1)	0	0	0	0	-	-	0		1	0	X	X	0	0	X	X	0	0	0	0		0
03	Shared (2)	0	1	0	0	-	-	0		0	1	X	X	1	0	X	X	0	0	0	0		0
06	Local (1)	0	1	0	0	-	-	0		0	1	X	X	1	0	X	X	1	1	0	0		0
07	System (0)	0	0	0	0	-	-	0		0	0	X	X	0	0	X	X	0	0	0	0		0

X = Reserved, set to 0 D = Display P = Printer

Figure C-1. Example of a Printer Authorization Matrix

The displays on ports 1 and 4 may copy to either the printer on port 3 or the printer on port 6; the displays on ports 8 and 9 may copy only to the printer on port 6. The printer on port 3 may also be used by the host. If selected by address, the addressed printer is logically connected to the display for local-copy operations. If selected by class, all printers in the class are logically connected to the display for local-copy operations. In a class environment, printers in the class are selected by the control unit on a most-available basis.

The display at port 5 is not authorized to use a printer as a local-copy device. Also, the printer at port 7 is in system mode and therefore reserved for exclusive use by the system. It is not available to any displays for local-copy operations, even if these displays are authorized in the source device list.

It is important to note that source devices are associated with destination devices, not with classes. Thus, several printers may be defined to be in class 75, but a particular display may be authorized only for some subset, or even none, of the printers in that class. When class identification is displayed in the operator information area of the display, copying is performed only to authorized printers in that class.

Defining the Printer Authorization Matrix during Customizing

Figure C-2 shows how the printer authorization matrix is filled out to define the matrix shown in Figure C-1. In Sequence A, the port addresses are shown in numeric sequence; however, this is not a requirement. The entries may be entered as shown in Sequence B, that is, in no particular sequence and not in consecutive groups. The following description refers only to Sequence A. The example of a worksheet in Figure C-3 shows how the numeric entries of Figure C-2 are derived. To fill out the worksheet for the printer attached to port with address 02 (Figure C-1), AA = 02. This printer is to operate in local mode, so $m = 1$. These numbers will later be transferred to the Printer Authorization Matrix Form. Figure C-4 shows a sample printer authorization matrix worksheet for 3274 Models 1, 21, and 31. Figure C-5 shows a sample printer authorization matrix worksheet for a Model 51C. Note that when specifying a printer authorization matrix for a Model 51C, although 31 possible entries are displayed, only seven can be specified.

The X and Y entries are completed in two steps. In step 1, the binary values of X and Y are entered on the worksheet for the class and the source device list, respectively. In step 2, the binary values are converted to hexadecimal notation. The hexadecimal notations are later transferred to the Printer Authorization Matrix Form.

To continue with Figure C-1, no class (70 through 85) is defined for the printer attached to port 02, so XXXX = hex 0000. The source device list in Figure C-1 indicates (by a 1) that the display terminal attached to port 0 can copy to this printer. Therefore, a 1 is entered in the 0 column of the first Y (Figure C-3). No other displays can copy to this printer, so 0's (zeros) are entered in all remaining columns under the Ys. The binary 1000 under the first Y on the worksheet is converted to hex 8. Because all other X and Y entries are binary 0's, all remaining hex entries are 0's.

Printer Authorization Matrix Form

In response to sequence number 022, enter the characters (below) supplied by the planner in the appropriate groups on your display screen. If a group already is displayed as AA M XXXX YYYY YYYY, your entry will overwrite these characters. When you have completed all your entries, move the cursor to the zero after sequence number 901 at the bottom of the screen, change it to a 1, and press ENTER. Any entry that is not valid will be intensified at this time and the 1 you entered will change back to a 0 (zero). Correct the invalid entry, and return to 901. Again, change the zero to a 1, and press ENTER. When all entries are valid, the printer authorization matrix display will be replaced by the next customizing sequence number. (If, at any time during this procedure, you wish to cancel any entries you have just made, change the 0 (zero) after the 901 to A and press ENTER.) Return to your original instructions.

To delete an entry, move the cursor (with cursor-move keys or tab key) to the leftmost position of the entry (the Printer Port Address) and press the spacebar twice. The entire matrix, or as many entries as desired, can be deleted in this manner. After all changes have been made, press ENTER. All deleted entries will be displayed as AA M XXXX YYYY YYYY. When the matrix is satisfactorily defined, move the cursor to the zero after sequence number 901, change it to a 1, and press ENTER.

	Printer Port Address	Printer Mode	Printer Class Assignment	Source Device List	
	A A	M	X X X X	Y Y Y Y Y Y Y Y	
Sequence A	1) 0 2	1	0 0 0 0	8 0 0 0 0 0 0 0	
	2) 0 3	2	4 0 0 0	4 8 0 0 0 0 0 0	
	3) 0 6	1	4 0 0 0	4 8 C 0 0 0 0 0 0	
	4) 0 7	0	0 0 0 0	0 0 0 0 0 0 0 0	
5)	- -	-	- - - -	- - - - - - - -	
6)	- -	-	- - - -	- - - - - - - -	
7)	- -	-	- - - -	- - - - - - - -	
Sequence B	8) 0 3	2	4 0 0 0	4 8 0 0 0 0 0 0	
	9)	- -	- - - -	- - - - - - - -	
	10) 0 6	1	4 0 0 0	4 8 C 0 0 0 0 0 0	
	11)	- -	- - - -	- - - - - - - -	
	12)	- -	-	- - - -	- - - - - - - -
	13) 0 7	0	0 0 0 0	0 0 0 0 0 0 0 0	
	14) 0 2	1	0 0 0 0	8 0 0 0 0 0 0 0	
	15)	- -	-	- - - -	- - - - - - - -
16)	- -	-	- - - -	- - - - - - - -	

Figure C-2. Example of a Completed Printer Authorization Matrix Form

Printer Port Address	Mode	Class				Source Device List							
		X	X	X	X	Y	Y	Y	Y	Y	Y	Y	Y
Class Number		70 71 72 73	74 75 76 77	78 79 80 81	82 83 84 85	0 1 2 3	4 5 6 7	8 9 10 11	12 13 14 15	16 17 18 19	20 21 22 23	24 25 26 27	28 29 30 31
02	1	0 0000	0 0000	0 0000	0 0000	8 1000	0 0000	0 0000	0 0000	0 0000	0 0000	0 0000	0 0000
03	2	4 0100	0 0000	0 0000	0 0000	4 0100	8 1000	0 0000	0 0000	0 0000	0 0000	0 0000	0 0000
06	1	4 0100	0 0000	0 0000	0 0000	4 0100	8 1000	C 1100	0 0000	0 0000	0 0000	0 0000	0 0000
07	0	0 0000	0 0000	0 0000	0 0000	0 0000	0 0000	0 0000	0 0000	0 0000	0 0000	0 0000	0 0000
--	--	--	--	--	--	--	--	--	--	--	--	--	--

Port Number
Hexadecimal Notation
Binary Value

Figure C-3. Example of a Printer Authorization Matrix Worksheet (Models 1A, 1B, 1C, 1D, 21A, 21B, 21C, 21D, 31A, 31C, and 31D)

Printer Port Address	Mode	Class				Source Device List											
		X 70 71 72 73	X 74 75 76 77	X 78 79 80 81	X 82 83 84 85	Y 0 1 2 3	Y 4 5 6 7	Y 8 9 10 11	Y 12 13 14 15	Y 16 17 18 19	Y 20 21 22 23	Y 24 25 26 27	Y 28 29 30 31				
A A	M																
--	-	-	-	-	-	-	-	-	-	-	-	-	-	-			
--	-	-	-	-	-	-	-	-	-	-	-	-	-	-			
--	-	-	-	-	-	-	-	-	-	-	-	-	-	-			
--	-	-	-	-	-	-	-	-	-	-	-	-	-	-			
--	-	-	-	-	-	-	-	-	-	-	-	-	-	-			
--	-	-	-	-	-	-	-	-	-	-	-	-	-	-			
--	-	-	-	-	-	-	-	-	-	-	-	-	-	-			
--	-	-	-	-	-	-	-	-	-	-	-	-	-	-			
--	-	-	-	-	-	-	-	-	-	-	-	-	-	-			

Enter this row on the Printer Authorization Matrix Form

Figure C-4. Sample Printer Authorization Matrix Worksheet (Models 1A, 1B, 1C, 1D, 21A, 21B, 21C, 21D, 31A, 31C, and 31D)

Printer Port Address	Mode	Class				Source Device List	
		X 70 71 72 73	X 74 75 76 77	X 78 79 80 81	X 82 83 84 85	Y 0 1 2 3	Y 4 5 6 7
A A	M						
--	--	--	--	--	--	--	--
--	--	--	--	--	--	--	--
--	--	--	--	--	--	--	--
--	--	--	--	--	--	--	--
--	--	--	--	--	--	--	--
--	--	--	--	--	--	--	--
--	--	--	--	--	--	--	--
--	--	--	--	--	--	--	--
--	--	--	--	--	--	--	--

Enter this row on the Printer Authorization Matrix Form

Figure C-5. Sample Printer Authorization Matrix Worksheet (Model 51C)



1948

...

...

...

...

...

...



Appendix D. Subsystem Verification Procedure

The procedure in this appendix is intended as a means of verifying that the 3274 Control Unit can communicate with all its attached terminals (display stations and printers). It should be given to, and performed by, the person responsible for customizing the 3274.

This procedure can be performed only after the 3274 Control Unit has been successfully customized and an IML performed. Its purpose is to verify that the 3274 can communicate with all its attached terminals.

1. Ensure that all attached terminals and the 3274 are powered on.
2. Press the IML pushbutton. Various 8 4 2 1 patterns will appear. When IML is completed, all 8 4 2 1 indicators will be off.
3. While holding the ALT key down on the display station keyboard, press and release the TEST key and then release the ALT key.

The word TEST will appear on the bottom left of the display screen.

4. Enter /3, and press ENTER.

The first two lines of your display screen should resemble those shown in the diagram below. The actual format may vary, depending on how you replied to sequence numbers 111 and 112 in the customizing procedure.

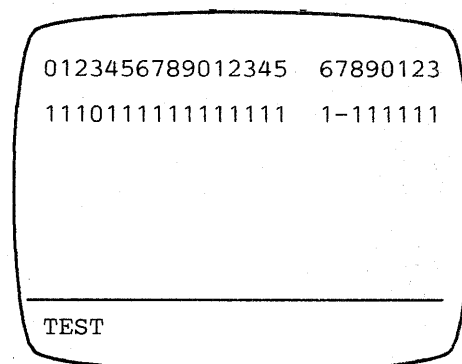

The first line represents the terminals configured for your 3274. Starting from the left, the 0 through 9 represent the Category A terminals attached to ports A0 through A9 on the 3274. The next characters (0 through 5) represent the Category A terminals attached to ports A10 through A15. The blank indicates that there are no more Category A terminals. (The actual number of Category A terminals shown will equal your response to sequence number 112.) The

remaining characters on the first line (6 through 3) represent the Category B terminals attached to ports B0 through B7 on the 3274. (The actual number of Category B terminals shown will equal your response to sequence number 111.)

The second line represents the status of each terminal on line 1. A 1 indicates that the terminal is powered on and communicating with the 3274. A 0 indicates that the port represented is not communicating with a terminal; this is the case with the terminal attached to port A3 in the diagram. This could be caused by the following:

- The terminal connected to that port is powered off.
- No terminal is connected to that port.
- A problem exists within the terminal connected to that port.

When a 0 status is indicated, you should:

- Verify that a terminal is connected to the port. Do this by checking the port connectors on the 3274 (as shown in the following diagram) to see whether a wire is connected to the port.

3274 Models 1, 21, and 31

3274 Model 51C

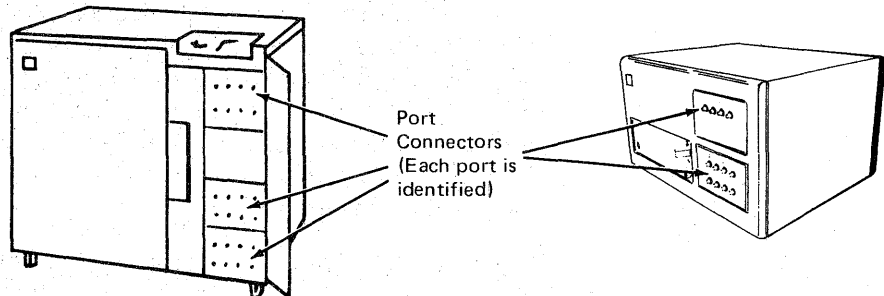

- If a coaxial cable is not connected, the 0 is not a problem indication.
- If a coaxial cable is connected, the terminal is either powered off, not connected to the other end of the coaxial cable, or not working properly. Follow your local procedures to correct the problem.

A — indicates that the 3274 was communicating with the terminal, but no longer is, because of a problem within the terminal. Follow your local procedures to correct the problem.

Any other lines should be ignored. They contain information used by the IBM service representative for problem diagnosis.

5. To end this procedure: While holding ALT key down on the display station keyboard, press and release TEST; then release ALT.

The word TEST will disappear from the bottom left of the display screen, and the screen will be cleared. If you are using a 3274 Model 31C or 51C and have been given instructions for setting the Model 31C or 51C switches, follow those instructions. Otherwise, proceed with your usual work.

Appendix E. Color Convergence Procedure

The procedure in this appendix describes how to adjust the color convergence on a 3279 Color Display Station during 3274 customizing. It should be given to the person responsible for customizing the 3274.

Note: In the U.S.A. and in Canada, if you are using a 3279 whose model number ends in -1 (for example, S2A-1), this color convergence procedure cannot be performed.

Operator Instructions

When a 3274 is customized with a 3279 Color Display Station, a pattern similar to those shown in Figure E-1 will appear on the display screen after step 3 of the Initial Customizing Procedure Form is performed. The pattern allows you to adjust the convergence of the 3279 if needed. (*Convergence* means superimposing one set of lines on another so that only one set of lines is visible.) Allow a 10-minute warm-up period after the 3279 is switched on before deciding whether convergence is needed.

Figure E-1 shows examples of unconverged and converged display screens. An unconverged pattern will be multicolor; a converged pattern will appear as white lines. Take care when converging your 3279, because improper convergence will make it difficult to tell the colors of characters on the outer edges of the display screen.

Convergence Procedure

Note: If your 3279 is properly converged, hold down the ALT key, press and release the TEST key, and return to step 4 of the Initial Customizing Procedure Form. If your 3279 is not properly converged, perform the following procedure.

1. Be sure that the center switch to the right of the display screen is in the lower (● ●) position.
2. Press the spacebar. A pattern will appear in the center of the display screen.
3. Use the cursor movement keys (<- , -> , | , and |) to move one set of lines until they converge with the other (color becomes yellow). The movement of the lines is very slight and may not be perceptible at first.

4. Press the spacebar again. A different color pattern will appear in the center of the screen.
5. Use the cursor movement keys to converge this pattern (color becomes pink).
6. Press the R key. The pattern from step 2 will again appear in the center of the screen. Reconverge this pattern if necessary.
7. Press the spacebar twice. The pattern will appear on a different location of the display screen.
8. Use the cursor movement keys to converge the pattern.
9. Press the spacebar again. A different color pattern will appear in the same location.
10. Use the cursor movement keys to converge the pattern.
11. Press the R key. The pattern from step 6 will again appear on the display screen. Reconverge this pattern if necessary.
12. Repeat steps 7 through 11 (12 times) until all patterns appear on the display screen at one time (as shown in Figure E-1).
13. When all patterns are on the display screen at the same time, check to see that they are all converged properly. If any are not, repeat this procedure, starting at step 2.
14. When all patterns are converged properly, hold down the ALT key, press and release the TEST key, and return to step 4 of the Initial Customizing Procedure Form.

Error Conditions

The following error indications may appear in the operator information area during the convergence procedure:

<i>Indicator</i>	<i>Symptom</i>	<i>Action</i>
228	Unable to converge pattern fully.	Change the battery.
229	Area of display screen above operator information area is all green.	Report the problem.

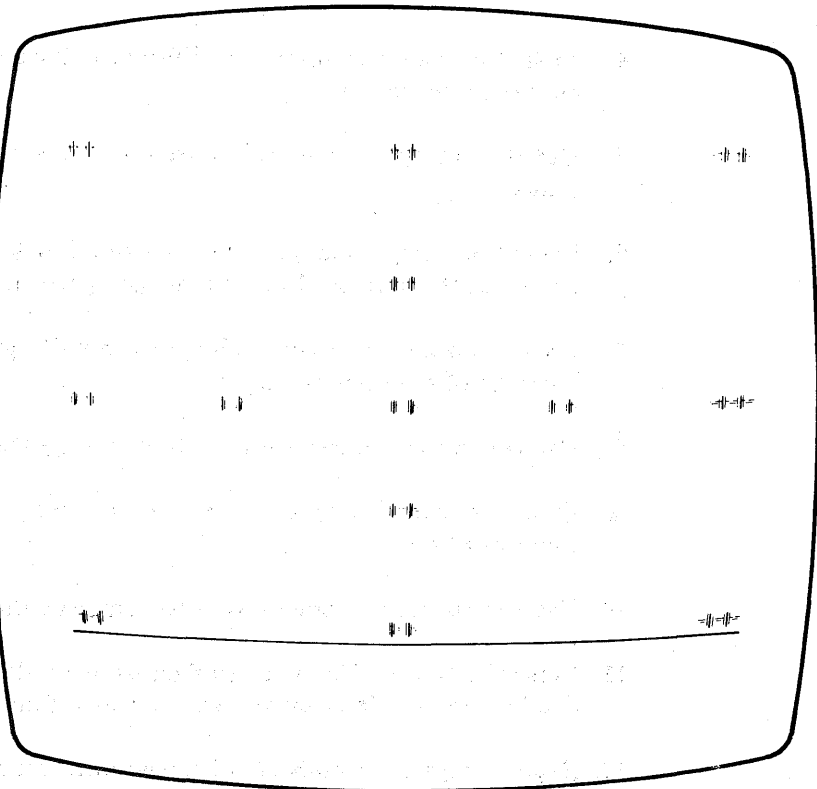

Unconverged

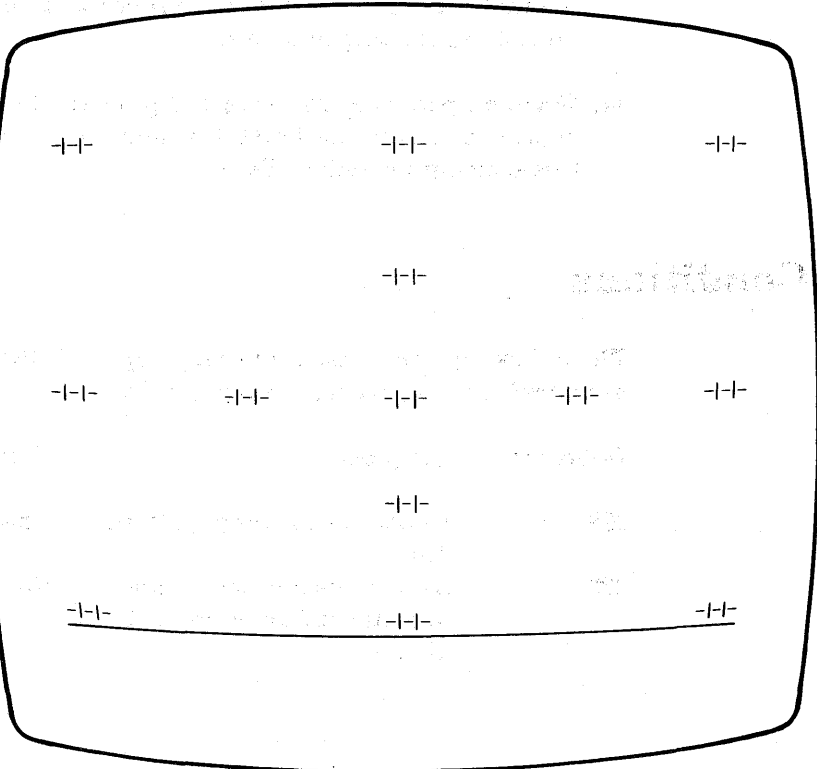

Converged

Figure E-1. Examples of Unconverged and Converged Display Screens

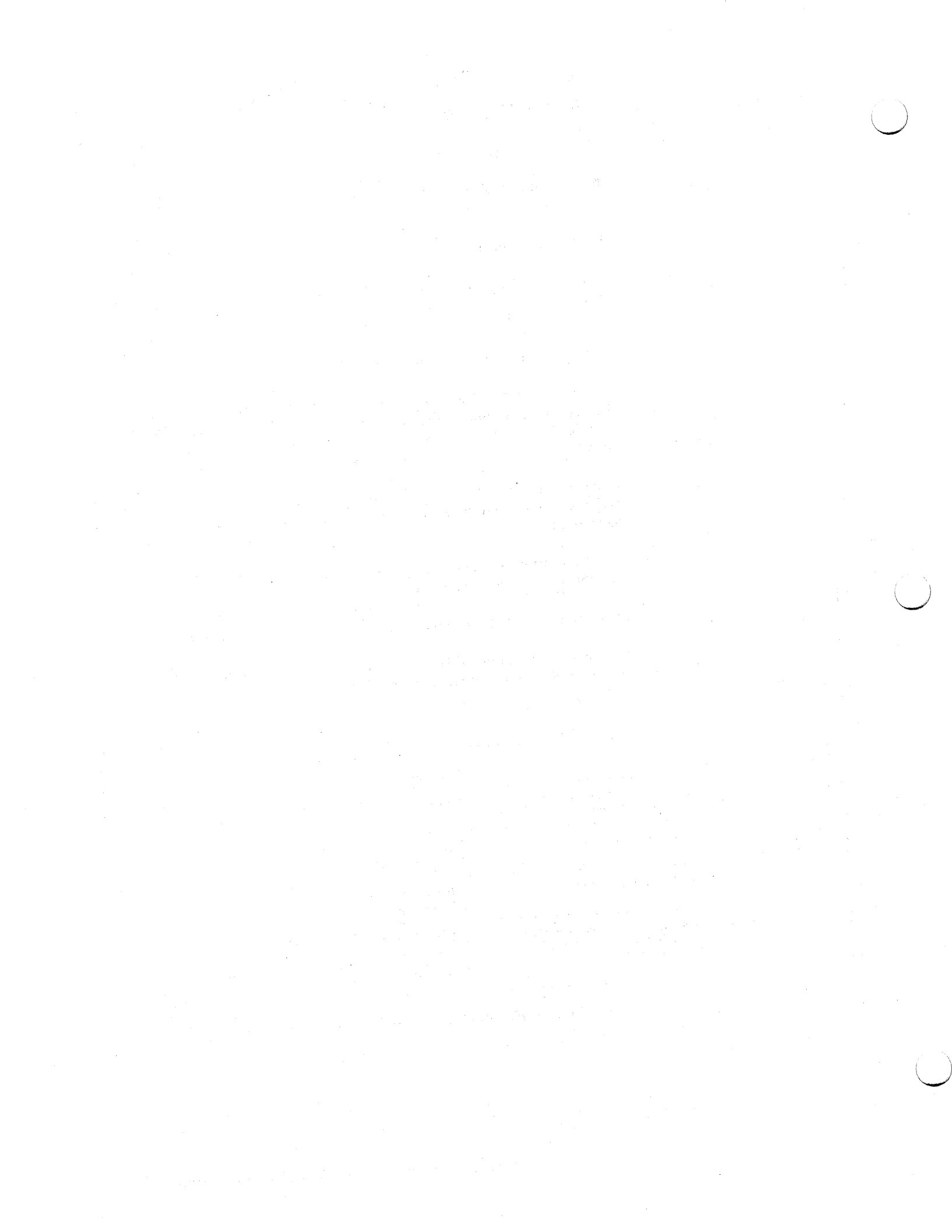

Appendix F. 3274 Communication Cables

This appendix shows the various communication cable configurations and adapters for the 3274 Control Unit. It is organized as follows:

- External Modem Cables
- Loop Adapter Cable
- X.21 Cable
- Digital Data Service Adapter Cable
- Integrated Modem Cables
- CCITT V.35 Interface Cable

External Modem Cables

3274 Model 51C with an External Modem Attached to a Switched Line or Models 1C, 21C, 31C, and 51C Attached to a Nonswitched Line (All Countries except United Kingdom Datel Modem)

You have received either a single or a dual (two cable sections joined by a connector) communication cable with your 3274. Follow the instructions that apply to the cable you received.

Single Cable

3274 Models 1C, 21C, and 31C

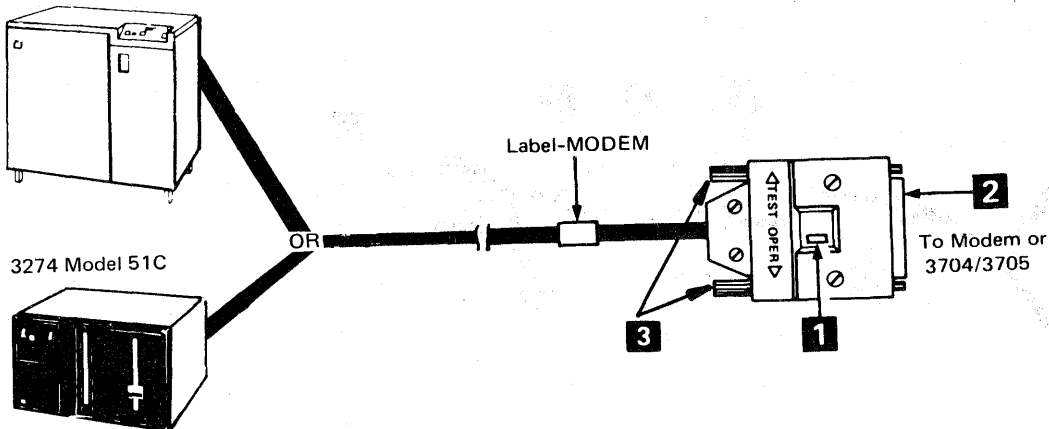

- Set the TEST/OPER switch **1** to the OPER position. If you are in Japan, read the note on this page first; then continue with "Thumbscrew Replacement Instructions."
- Connect the cable plug **2** to the modem or to the 3704/3705 Line Set 1F Interface Cable connector (for direct attachment to a 3704/3705). Tighten the thumbscrews **3** of the cable plug securely with your fingers.

Note (If you are in Japan): *The black thumbscrews on the communication cable shipped to you are made with metric threads and are attachable to NTT modems or their equivalents. If your modem is an IBM 3872 or 3874, or any other modem using an English-unit connector, the black thumbscrews must be replaced with the gold thumbscrews (made with English threads) provided in the customer envelope.*

Thumbscrew Replacement Instructions:

- Remove the black thumbscrews **A** by pulling them in the direction of the arrows. (Do not be afraid to apply necessary force)

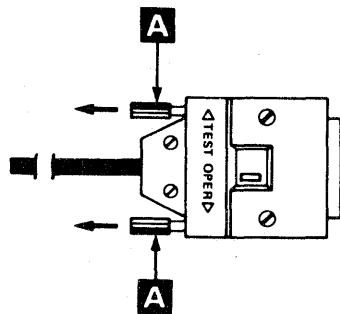

- Insert the gold thumbscrews provided in the customer envelope by pushing them in the reverse direction of the arrows until the end of each thumbscrew appears outside the hood.

Note: You should keep the removed thumbscrews in the customer envelope for later use; the modem may be changed or the terminal may be relocated.

Dual Cable

3274 Models 1C, 21C, and 31C

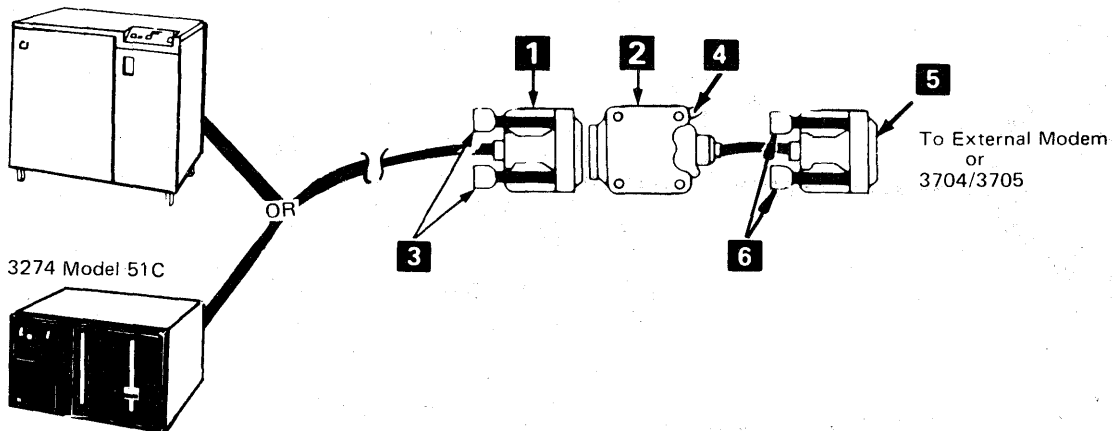

- Connect the cable plug **1** on the long section of the communication cable to the socket **2** on the short section of the communication cable. Tighten the thumbscrews **3** of the cable plug **1** securely with your fingers.
- Set the TEST/OPER switch **4** to OPER.
- Connect the cable plug **5** to the modem or to the 3704/3705 Line Set 1F Interface Cable Connector (for direct attachment to a 3704/3705). Tighten the thumbscrews **6** of the cable plug **5** securely with your fingers.

3274 Model 51C with an External Modem Attached to a Switched Line or Models 1C, 21C, 31C, and 51C Attached to a Nonswitched Line with a United Kingdom Datel Modem

You have received either a Version 1 or Version 2 communication cable with your 3274. Follow the instructions that apply to the version you received.

Version 1 Cable

- Connect the cable plug **1** attached to the long communication cable to the socket **2** of the 0.4-meter (15-in.) communication cable. Tighten the thumbscrews **5** of the cable plug **1** securely with your fingers.
- Set the TEST/OPER switch **3** to OPER.
- Connect the cable plug **4** on the other end of the 0.4-meter (15-in.) cable to the modem.

3274 Models 1C, 21C, and 31C

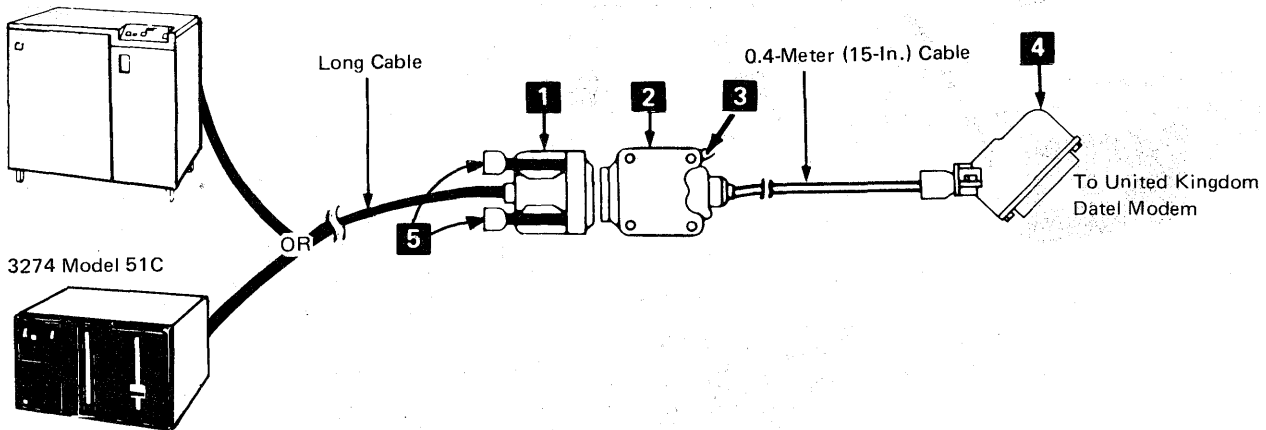

Version 2 Cable

- Connect the cable plug **1** attached to the long communication cable labeled MODEM to the socket **2** of the 0.4-meter (15-in.) communication cable. Tighten the thumbscrews **5** of the cable plug **1** securely with your fingers.
- Set the TEST/OPER switch **3** to the OPER position.
- Connect the cable plug **4** on the other end of the 0.4-meter (15-in.) cable to the modem.

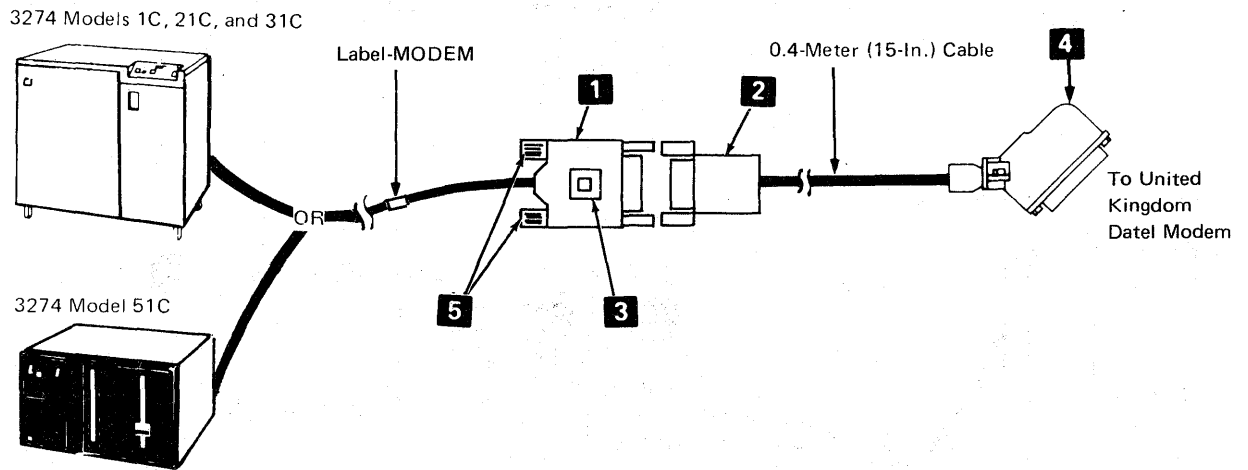

Loop Adapter Cable

3274 Model 51C with a Loop Adapter Attached to a Loop (All Countries)

The 3274 Model 51C communication cable that attaches to the loop is called the *Loop Station Connector (LSC) cable*.

- Plug the LSC cable connector **3** into the LSC receptacle **2** from the loop. Push the connector until it snaps into the receptacle.

Note: To disconnect the LSC cable from its receptacle, press the locking button **1** on the LSC connector as far as it will go and pull the connector from the receptacle.

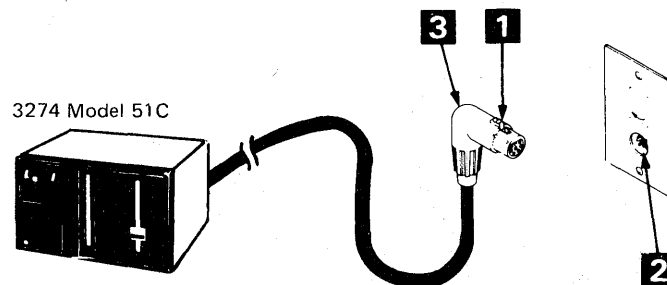

X.21 Cable

3274 Model 51C with X.21 Attached to a Switched or Nonswitched Line or Models 1C, 21C, and 31C with X.21 Attached to a Nonswitched Line

- Set the TEST/OPER switch **1** to the OPER position.
- Connect the cable plug **2** on the long section of the communication cable to the socket **3** on the short section of the communication cable. Tighten the thumb-screws **4** of the cable socket **3** securely with your fingers.
- Connect the cable plug **5** to the modem. Tighten the thumbscrews **6** of the cable plug **5** securely with your fingers.

3274 Models 1C, 21C, and 31C

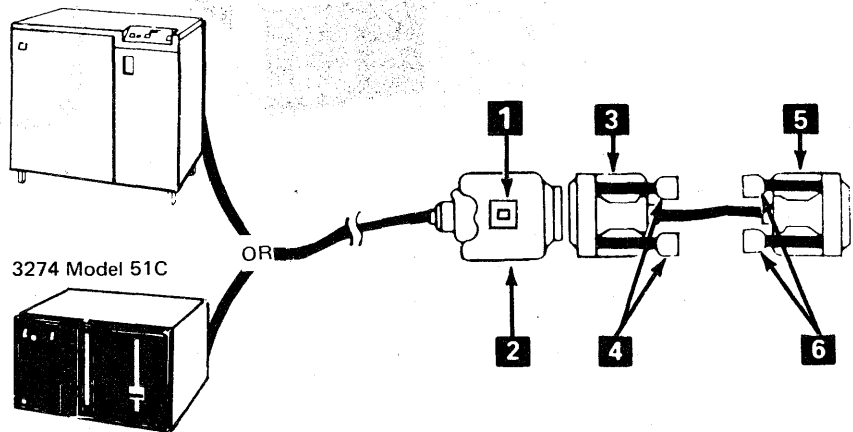

Digital Data Service Adapter Cable

3274 Models 1C, 21C, 31C, and 51C with Digital Data Service (DDS) Adapter Attached to AT&T Channel Service Unit (U. S. Only)

- Set the TEST/OPER switch **1** to the OPER position.
- Connect the cable plug **2** on the end of the cable labeled CSU to the channel service unit. Tighten the thumbscrews **3** of the cable plug securely with your fingers.

3274 Models 1C, 21C, and 31C

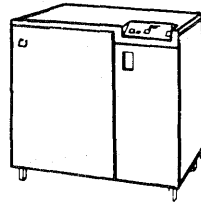

3274 Model 51C

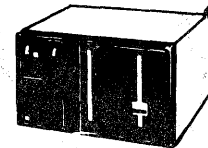

OR

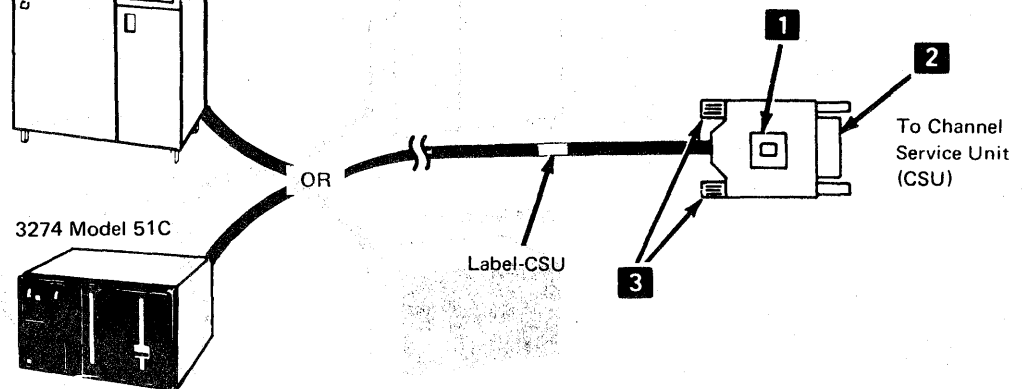

Integrated Modem Cables

3274 Models 31C and 51C with an Integrated Modem Attached to a Nonswitched Line (U.S. and Canada Only)

- Plug the four-prong plug attached to the communication cable marked **NONSWITCHED** into the four-pin receptacle connected to the nonswitched line.

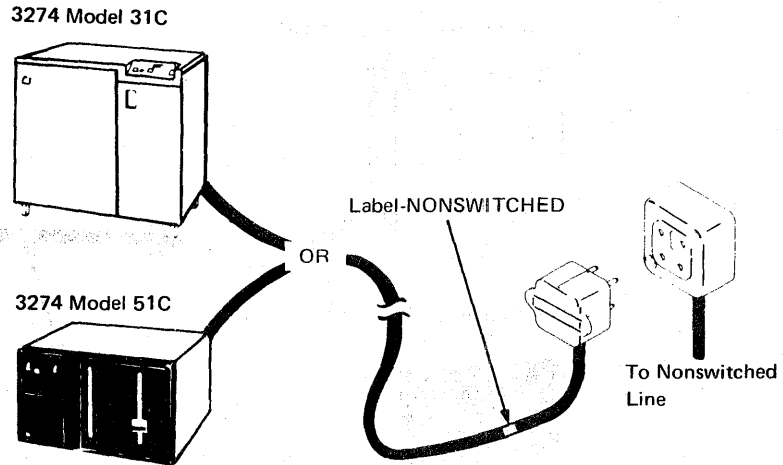

**3274 Models 31C and 51C with an Integrated Modem
Attached to a Nonswitched Line (Japan Only)**

You will receive the following parts in the customer envelope when the 3274 is delivered to your site.

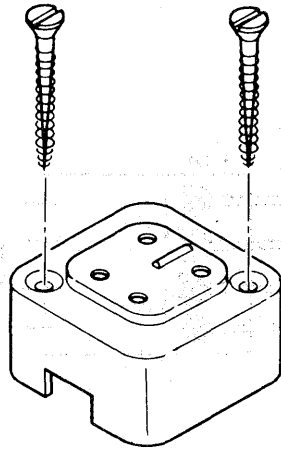

1 Four-Pin Receptacle
(with two screws)

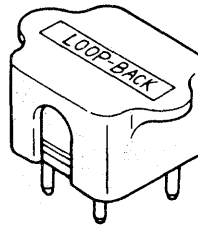

2 LOOP-BACK Plug

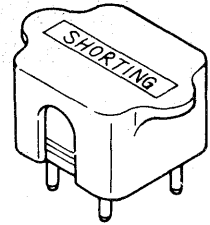

3 SHORTING Plug

- Keep the LOOP-BACK plug **2** and SHORTING plug **3** in a convenient place for future use. (When required, the NTT may ask you to use them for testing the communication lines or associated equipment.)

The four-pin receptacle **1** is for the 3274 Models 31C and 51C communication cable connection and should be connected to the NTT nonswitched line through the NTT-provided device, PD-1A, according to the following instructions:

- Connect one end of a pair cable to the R and GN terminals of the four-pin receptacle **1**. Connect the opposite end to the DS terminals of the PD-1A.
- Connect one end of another pair cable to the Y and BK terminals of the four-pin receptacle **1** and the opposite end to the DR terminals of the PD-1A.

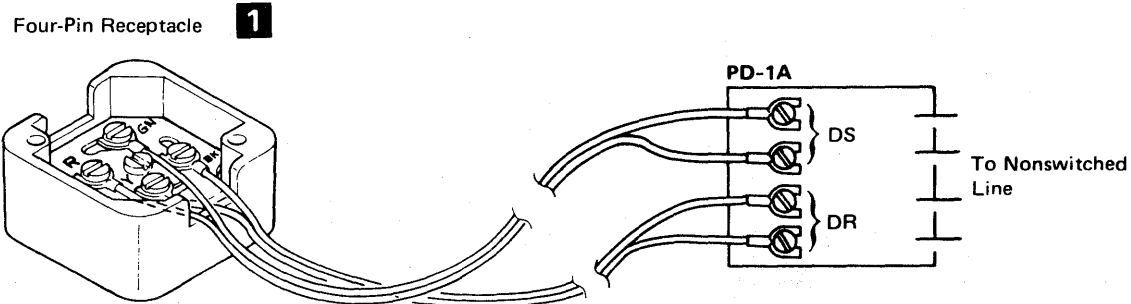

- Attach the four-pin receptacle **2**, using the two screws supplied, to a place that is convenient to connect the communication cable from the 3274.
- Plug the four-prong plug **3** attached to the communication cable marked NON-SWITCHED into the four-pin receptacle connected to the nonswitched line.

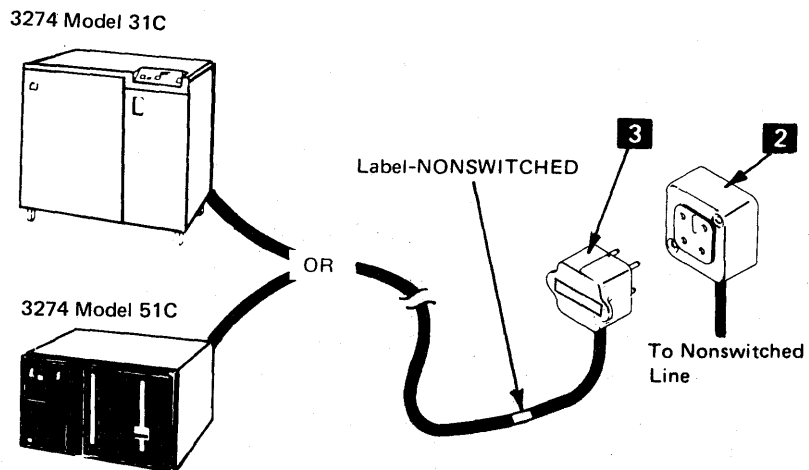

**3274 Model 51C with a 1200-BPS Integrated Modem
Attached to a Switched Line with Manual Answer
(U. S. and Canada Only)**

- Plug the four-prong plug attached to the communication cable marked SWITCHED into the four-pin receptacle connected to the data coupler.

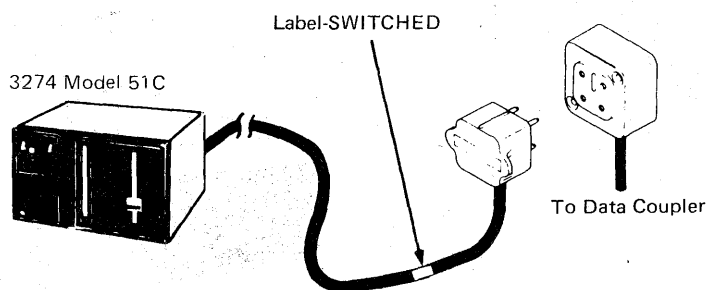

3274 Model 51C with a 1200-BPS Integrated Modem Attached to a Nonswitched Line with Switched Network Backup (SNBU) and Manual Answer (U. S. and Canada Only)

- Plug the four-prong plug attached to the communication cable marked **NONSWITCHED** into the four-pin receptacle connected to the nonswitched line.
- Plug the four-prong plug attached to the communication cable marked **SWITCHED** into the four-pin receptacle connected to the data coupler.

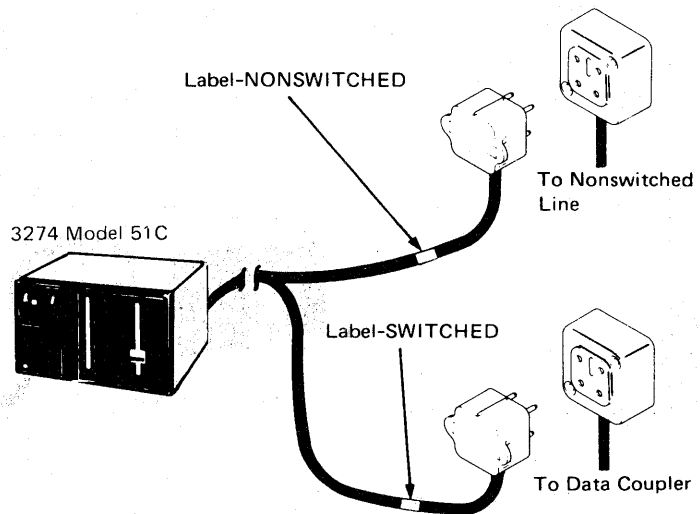

Note: *It is recommended that:*

- *The four-pin receptacle from the data coupler (Type CBS or CDT, or FCC-certified equivalent) be labeled SWITCHED LINE.*
- *The four-pin receptacle from the nonswitched line be labeled NONSWITCHED LINE.*

**3274 Model 51C with a 1200-BPS Integrated Modem
Attached to a Switched Line with Auto-Answer
(U. S. and Canada Only)**

Attach the communication cable's color-coded wires to the data coupler as shown in the following table and diagram.

Coupler Terminal	Wire Color
DR	Black
DT	White
RI	Violet
OH	Blue
CCT	Brown
DA	Yellow
SG	Gray
SH	Red

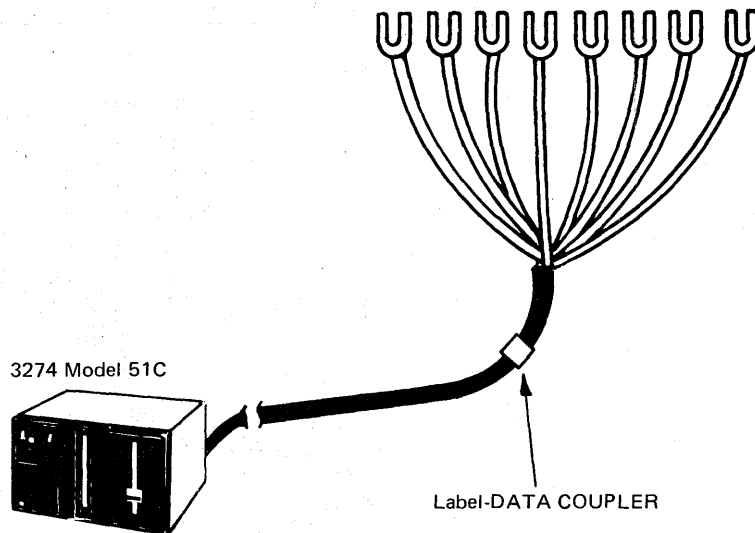
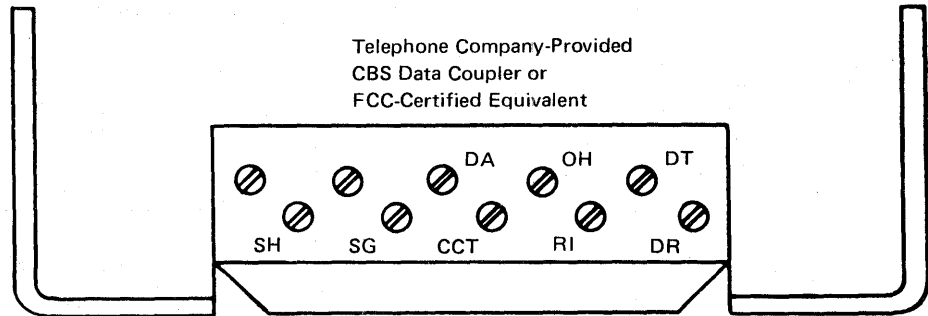

3274 Model 51C with a 1200-BPS Integrated Modem Attached to a Nonswitched Line with Switched Network Backup (SNBU) and Auto-Answer (U. S. and Canada Only)

- Plug the four-prong plug attached to the communication cable marked NON-SWITCHED into the four-pin receptacle connected to the nonswitched line.
- Attach the communication cable's color-coded wires to the data coupler, as shown in the following table and diagram.

Coupler Terminal	Wire Color
DR	Black
DT	White
RI	Violet
OH	Blue
CCT	Brown
DA	Yellow
SG	Gray
SH	Red

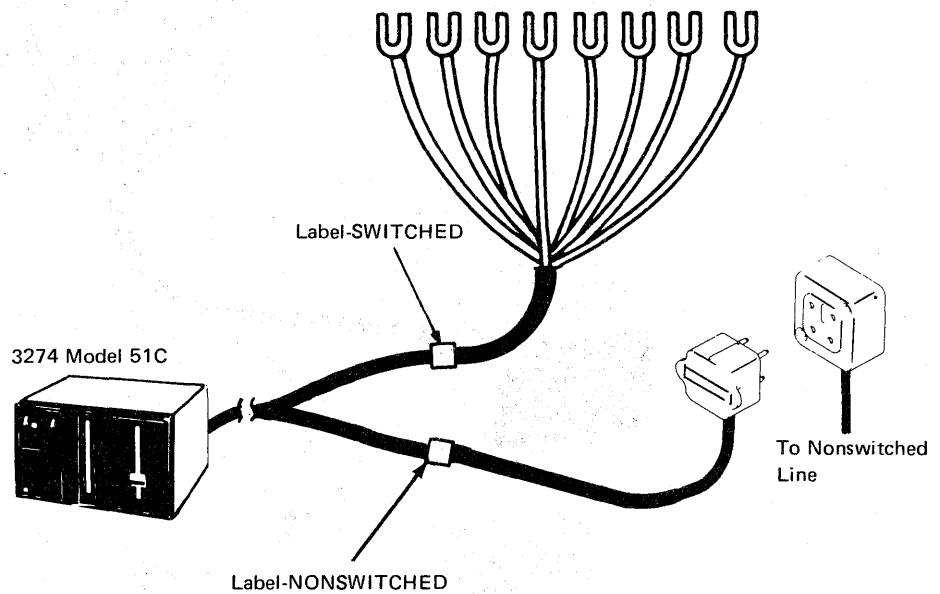
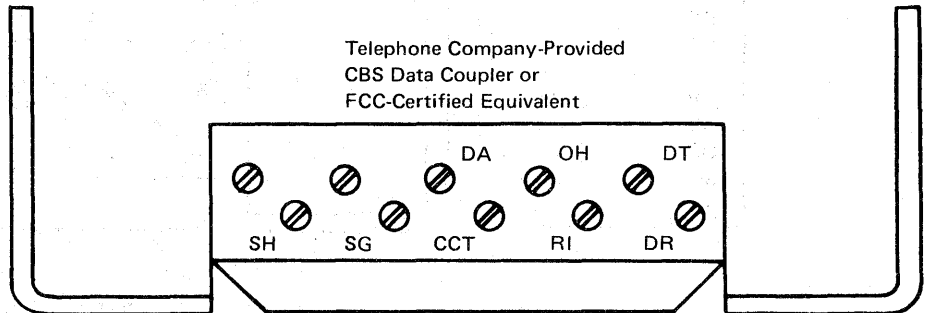

**3274 Model 51C with a 1200-BPS Integrated Modem
Attached to a Nonswitched Line with Switched Network
Backup (SNBU) and Auto-Answer (Countries Other Than
the U. S. and Canada That Do Not Use Communication
Cable Adapters)**

- Connect the Transmit Pair (White and Red) wires of the cable labeled NONSWITCHED—A communication cable to the communication facility termination as follows:
 - White wire to -XMIT terminal
 - Red wire to +XMIT terminal
- Connect the Receive Pair (Black and Yellow) wires of the cable labeled NONSWITCHED—A communication cable to the communication facility termination as follows:
 - Black wire to +REC terminal
 - Yellow wire to -REC terminal
- Connect the Switched Lines (White and Red) wires of the cable labeled SWITCHED—B communication cable to the Telephone Line terminals of the PTT connection block. Either wire may be connected to either terminal.
- Connect the Telephone Set (Black and Yellow) wires of the cable labeled SWITCHED—B communication cable to the Telephone Set terminals of the PTT connection block. Either wire may be connected to either terminal.

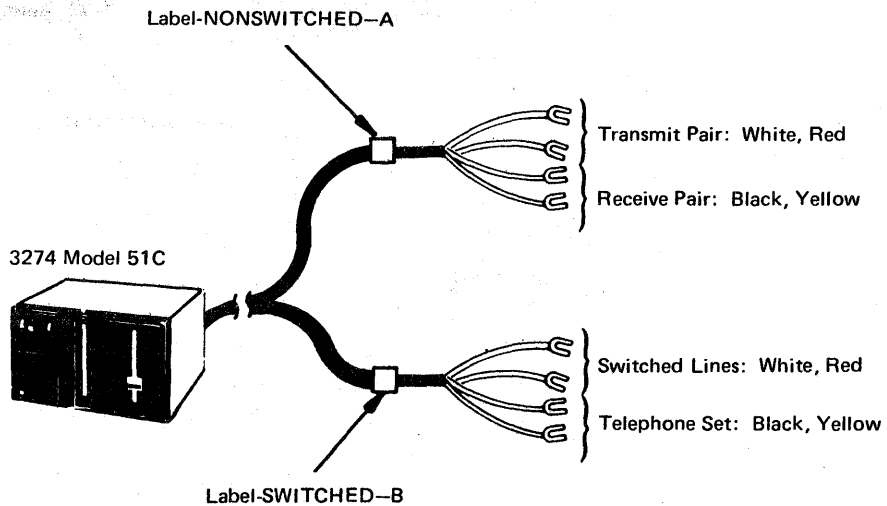

**3274 Model 51C with a 1200-BPS Integrated Modem
Attached to a Switched Line with Auto-Answer (Countries
Other Than the U. S. and Canada That Do Not Use
Communication Cable Adapters)**

Note: The communication cable labeled NONSWITCHED-A is not used in this configuration.

- Connect the Switched Lines (White and Red) wires of the section of the communication cable labeled SWITCHED-B to the Telephone Line terminals of the PTT connection block. Either wire may be connected to either terminal.
- Connect the Telephone Set (Black and Yellow) wires of the section of the communication cable labeled SWITCHED-B to the Telephone Set terminals of the PTT connection block. Either wire may be connected to either terminal.

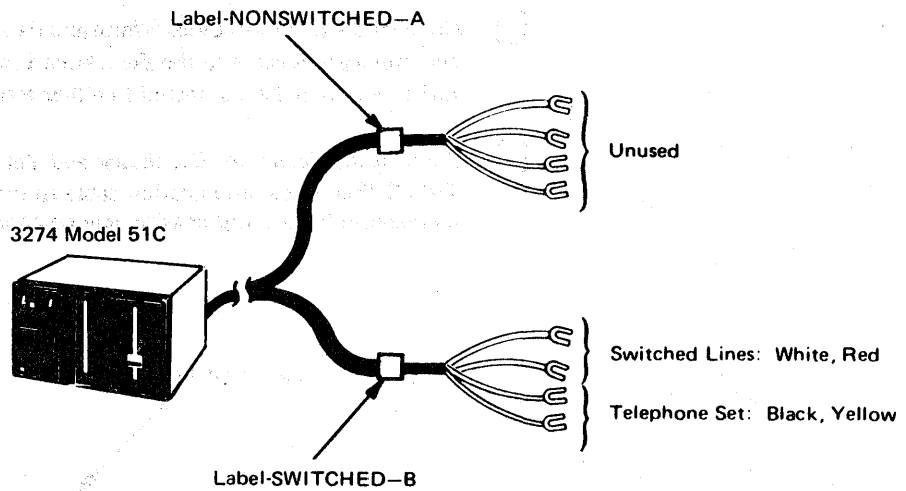

**3274 Model 51C with a 1200-BPS Integrated Modem
Attached to a Switched Line with Auto-Answer (Countries
Other Than the U. S. and Canada That Use Communication
Cable Adapters)**

- Plug the four-prong plug attached to the communication cable marked SWITCHED into the four-pin receptacle connected to the data coupler.

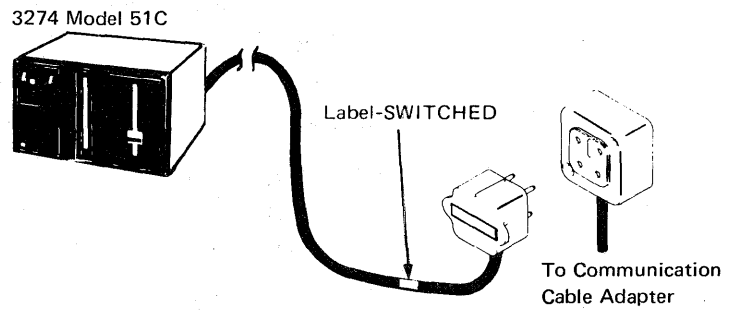

**3274 Models 31C and 51C with an Integrated Modem Attached
to a Switched or Nonswitched Line (Countries Other Than the U. S.
and Canada That Do Not Use Communication Cable Adapters)**

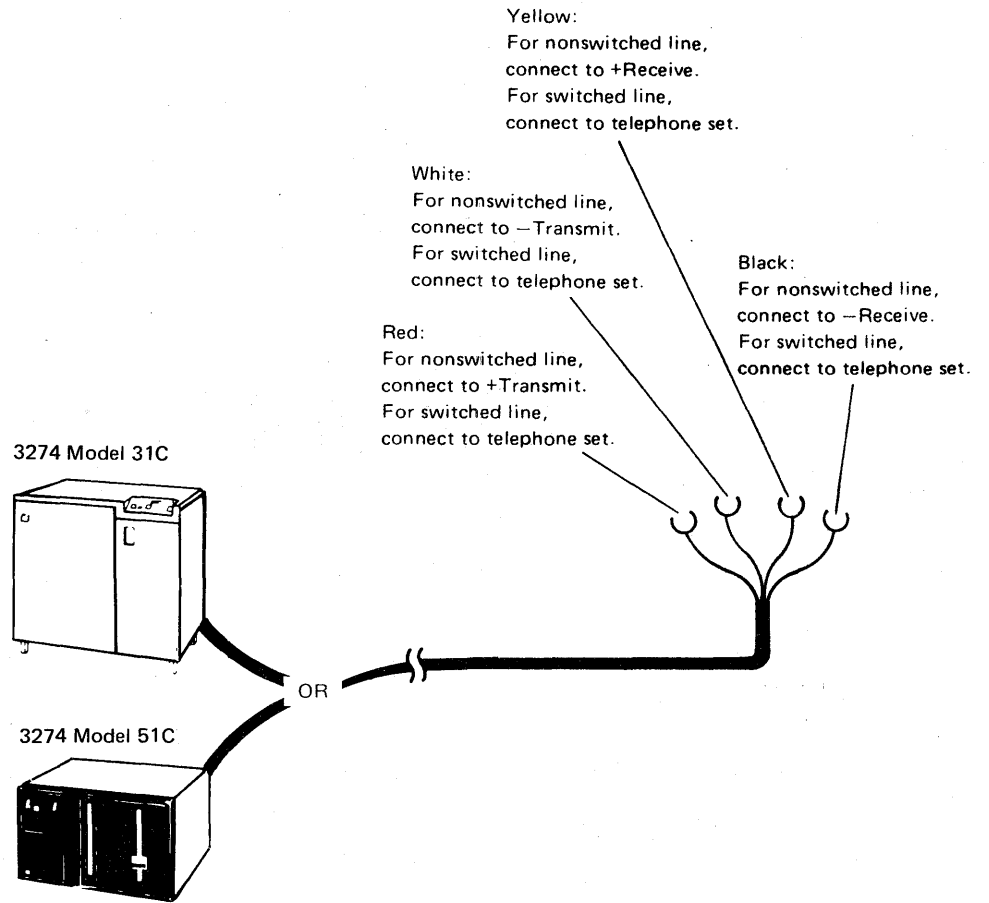

**3274 Models 31C and 51C with a 1200-BPS Integrated
Modem Attached to a Switched Line or Any Integrated
Modem Attached to a Nonswitched Line (France Only)**

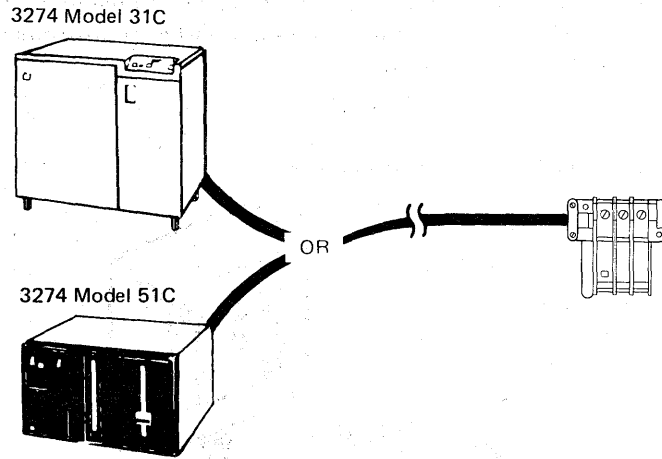

Communication Cable Adapters for Countries Other Than the U. S. and Canada

These adapters are for use with integrated modems in countries other than the U. S. and Canada. The adapter is installed by inserting the four-prong plug of the communication cable from the 3274 into the four-pin receptacle on the adapter. The other end of the adapter is attached to the communications line.

Finland Switched Line Adapter

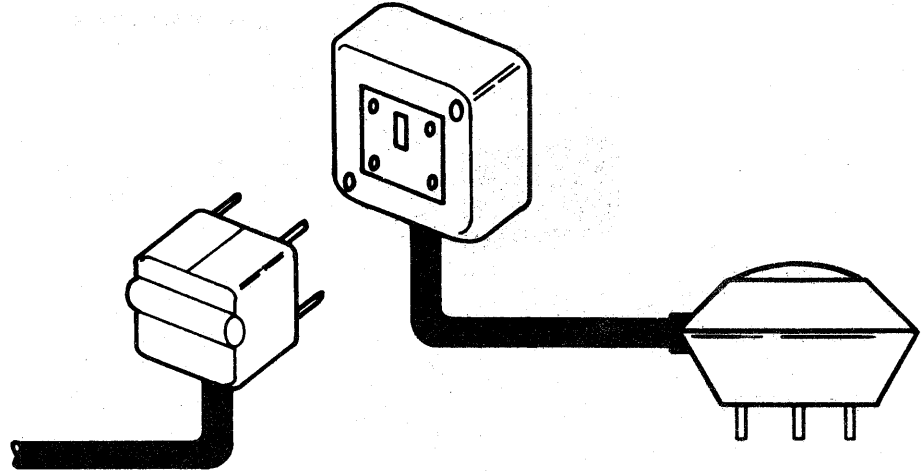

Finland Nonswitched Line Adapter

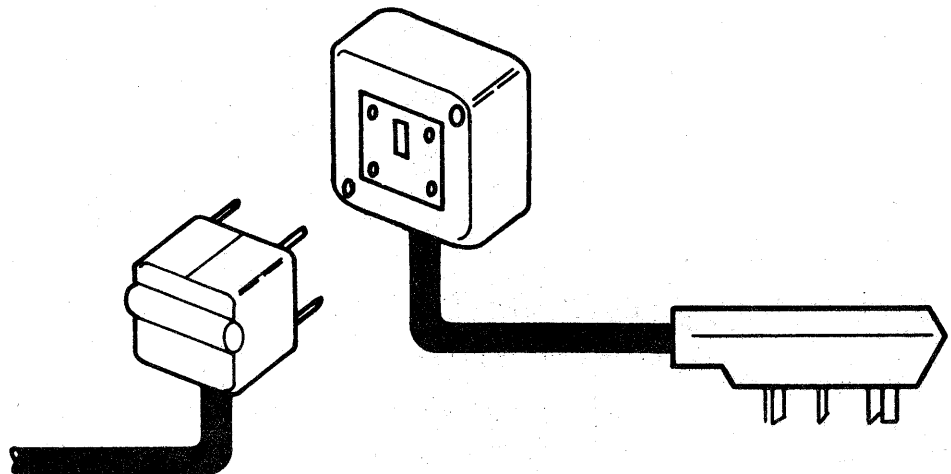

Austria and Israel Switched and Nonswitched Line Adapter and Belgium, Netherlands, and Switzerland Nonswitched Line Adapter

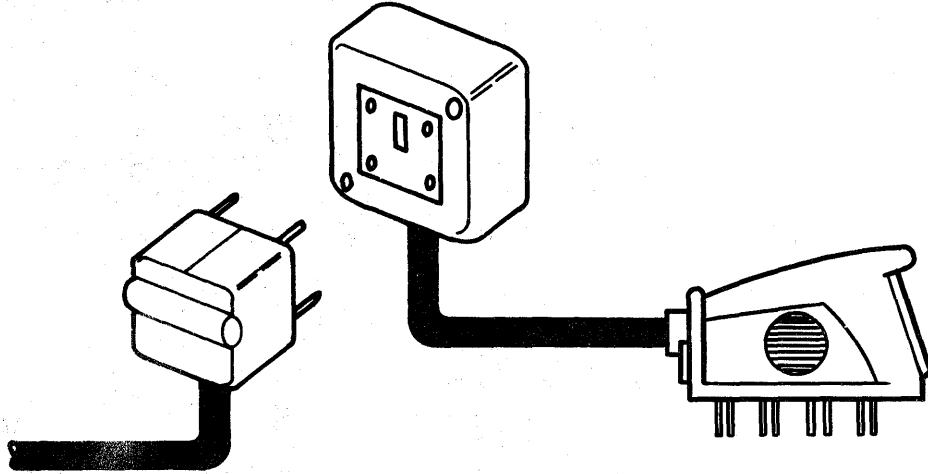

Netherlands Switched Line Adapter

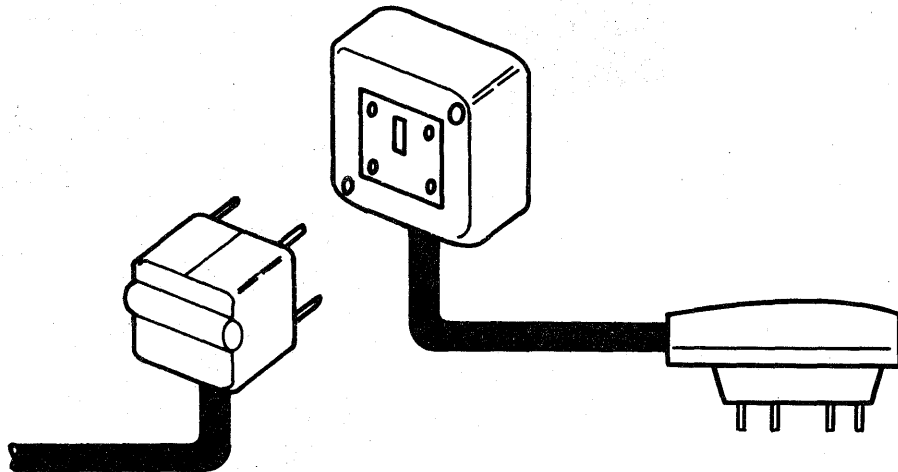

CCITT V.35 Interface Cable

3274 Models 1C, 21C, 31C, and 51C Attached to a CCITT V.35 Interface

You have received a dual (two cable sections joined by a connector) communication cable with your 3274.

Follow these instructions:

Set the TEST/OPER switch **1** to the OPER position. Connect the cable plug **2** to the modem or to the 3704/3705 Line Set 1W Interface Cable connector (for direct attachment to a 3704/3705). Tighten the thumbscrews **3** of the cable plug securely with your fingers.

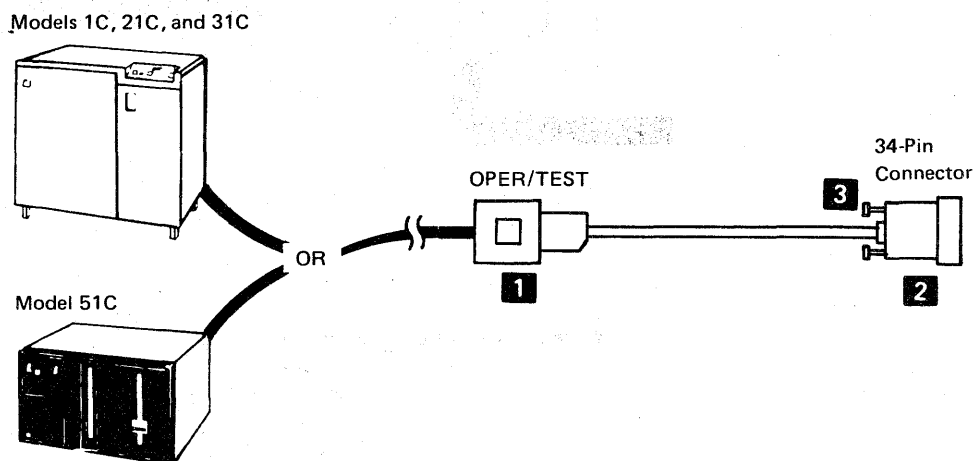



Appendix G. Planning for 3274 Model 31C Modem Address Switch Settings

Modem Address Switches (Integrated Modems Only)

The Modem Address switches are installed only on a 3274 Model 31C that has an integrated modem feature (#5640, 5740, 5840, or 5842) installed. These switches are located behind a door on the control panel. These switches must be set to the binary equivalent of either your BSC control unit address (this is the hexadecimal polling address you obtained from the system programmer for your response to sequence number 301) or your SDLC control unit address (this is your response to sequence number 302). Failure to set the Modem Address switches properly will result in valid data operations of the 3274 but inability to execute the link problem determination aid (LPDA) function of the integrated modem.

Use Figure G-1 to convert your sequence number response to its binary equivalent. For example, if your response to sequence number 301 is 21, the eight Modem Address switches should be set as shown in Figure G-2.

Enter the Modem Address switch settings in step 2 of the instructions following Figure G-2. Give the completed instructions to the person who will customize the 3274.

Numeric Value	Modem Address Switch Settings			
0	Off	Off	Off	Off
1	Off	Off	Off	On
2	Off	Off	On	Off
3	Off	Off	On	On
4	Off	On	Off	Off
5	Off	On	Off	On
6	Off	On	On	Off
7	Off	On	On	On
8	On	Off	Off	Off
9	On	Off	Off	On
A	On	Off	On	Off
B	On	Off	On	On
C	On	On	Off	Off
D	On	On	Off	On
E	On	On	On	Off
F	On	On	On	On

Figure G-1. Conversion of BSC Control Unit Address and SDLC Control Unit Address to Binary-Equivalent Modem Address Switch Settings on 3274 Model 31C

Response to Sequence Number 301	2				1			
	1	2	3	4	5	6	7	8
Switch Number								
Switch Setting	Off	Off	On	Off	Off	Off	Off	On

Figure G-2. Example of 3274 Model 31C Modem Address Switch Settings

Instructions for Setting 3274 Model 31C Modem Address Switches

1. Open the customer access area door on the control panel. Insert your finger into the recessed area to the left of the door. Pull the edge of the door toward you, and swing it to the right.

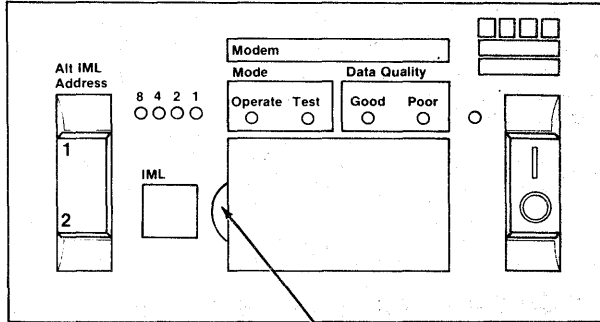

Insert finger in recess, and pull door to open.

2. Set the Modem Address switches on or off as indicated in the boxes below. Press the top of the switch for on; press the bottom of the switch for off.

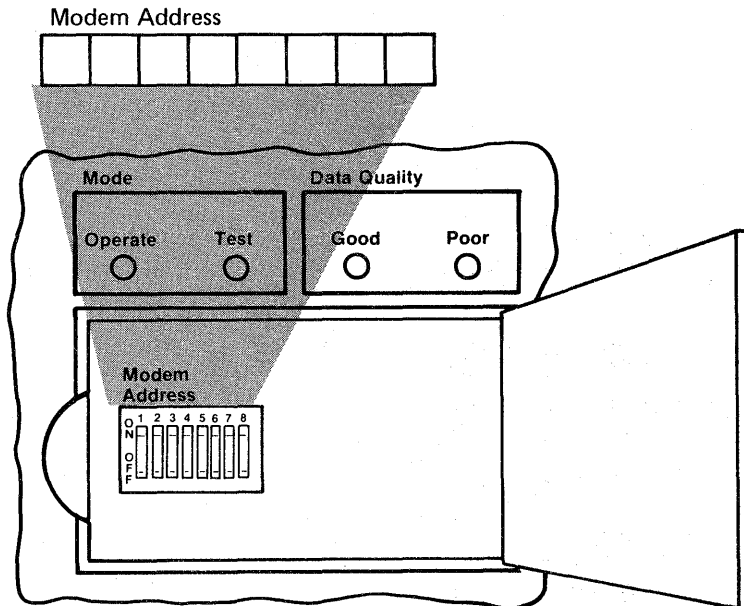

3. Close the customer access area door.

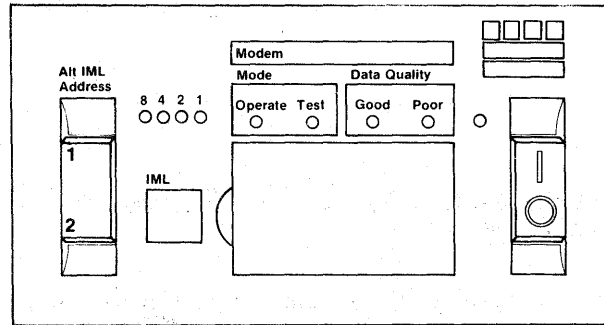

4. Your 3274 is now ready for use.

Appendix H. Planning for 3274 Model 51C Switch Settings

Of the many switches that may be installed on a Model 51C operator panel, three switch groups require some planning: Transmit Level switches, Loop Data Speed switches, and Modem Address switches. The Transmit Level switches control the signal level between the Model 51C and the host. The Loop Data Speed switches control the data rate of the loop. The Modem Address switches determine the address that the host will use to communicate with the Model 51C.

Only one of these switch groups will be on your Model 51C. Transmit Level switches are installed on a Model 51C that attaches to a 1200-bps switched network (U.S. only). Loop Data Speed switches are installed on a Model 51C that attaches to an 8100 Information System or a 4331 Processor loop. Modem Address switches are installed on a Model 51C with a greater-than-1200-bps integrated modem that attaches to a nonswitched network.

The following descriptions tell you how to determine whether your Model 51C has any of these switches, how to determine the proper switch settings, and what information to pass on to the person who will customize your Model 51C.

Transmit Level Switches (1200 BPS Integrated Modem, U.S. and Canada Only)

The Transmit Level switches are installed only on a 3274 Model 51C Control Unit that has an integrated modem feature (#5501, 5502, 5507, or 5508) that attaches to a switched network. These switches are used to match the Model 51C transmit level to the data coupler (type CDT, CBS, or FCC-certified equivalent) that is attached to the termination of the communication line. Consult the data coupler manufacturer's representative to determine the proper dBm¹ level for the data coupler. Use Figure H-1 to determine the correct setting of the Transmit Level switches for the dBm level obtained from the manufacturer's representative; then enter this information in the instructions following the figure. Give the completed instructions to the person who will customize your Model 51C.

¹ Same as decibel (dB), but comparison is to an absolute value of power, 1 milliwatt.

dBm Level	Transmit Level Switches			
	-1dB	-2dB	-4dB	-8dB
0	OFF	OFF	OFF	OFF
-1	ON	OFF	OFF	OFF
-2	OFF	ON	OFF	OFF
-3	ON	ON	OFF	OFF
-4	OFF	OFF	ON	OFF
-5	ON	OFF	ON	OFF
-6	OFF	ON	ON	OFF
-7	ON	ON	ON	OFF
-8	OFF	OFF	OFF	ON
-9	ON	OFF	OFF	ON
-10	OFF	ON	OFF	ON
-11	ON	ON	OFF	ON
-12	OFF	OFF	ON	ON
-13	ON	OFF	ON	ON
-14	OFF	ON	ON	ON
-15	ON	ON	ON	ON

Figure H-1. 3274 Model 51C Transmit Level Switches

Instructions for Setting 3274 Model 51C Transmit Level Switches (U.S. and Canada Only)

1. Open the customer access area door on the bottom left of the Model 51C. To unlatch the door, turn the slotted screw head counterclockwise with a coin.

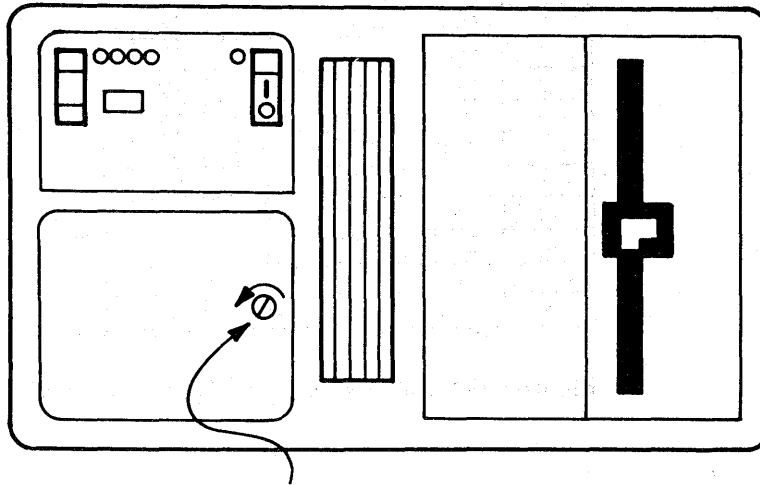

Slotted Screw Head
(Turn counterclockwise to open)

2. Set the Transmit Level switches on or off as indicated in the boxes below. Push the switch up for on and down for off.

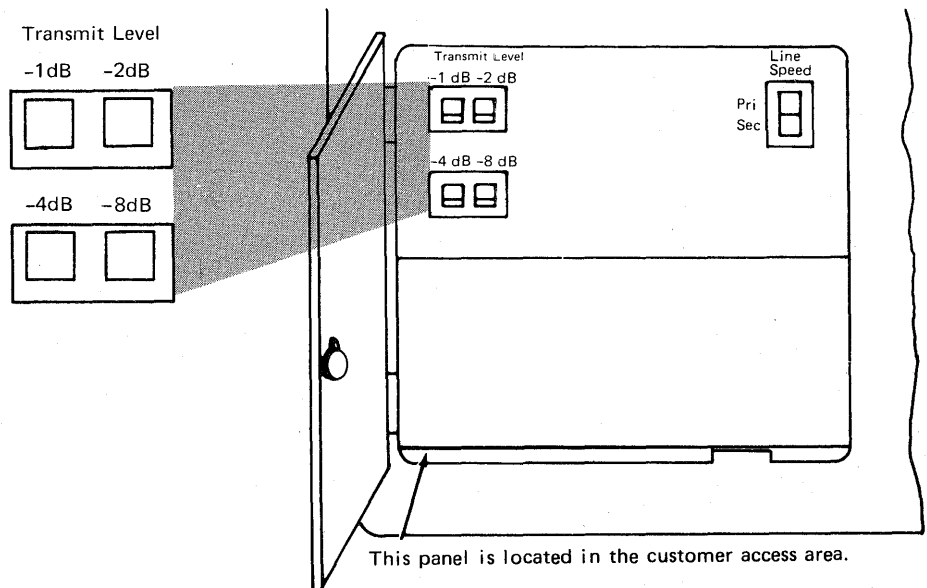

3. Close the customer access area door. Secure the latch by turning the slotted screw head clockwise with a coin.

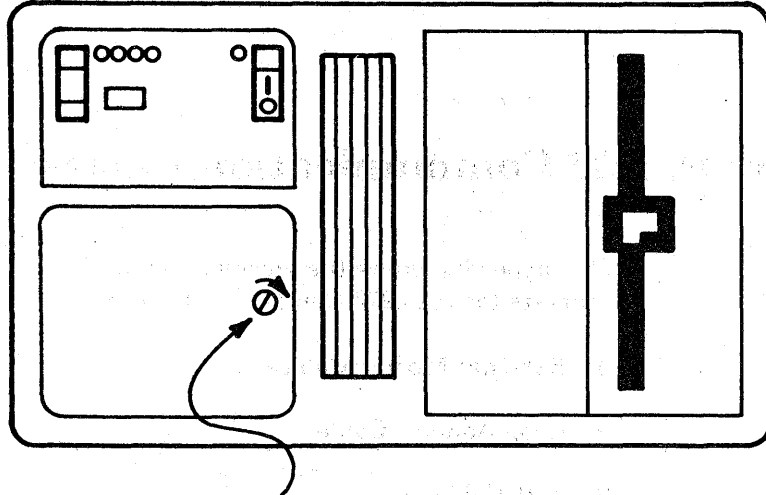

Slotted Screw Head (Turn clockwise to secure)

4. Your 3274 is now ready for use.

Loop Data Speed Switches (Loop Adapter Feature Only)

The Loop Data Speed switches are installed only on 3274 Model 51C Control Units that have the Loop Adapter feature (#4850) to attach to a 4331 Processor or to an 8100 Information System loop. These switches are used to select the primary and secondary loop data speeds. If the loop operates at a carrier speed of 9600 bps, the operator can switch the loop data speed by using the Pri/Sec switch on the Model 51C operator panel. [If the loop operates at a carrier speed of 38,400 bps, the Sec (Secondary) position of the Pri/Sec switch should not be used.]

To determine the Loop Data Speed settings, first select the table in Figure H-2 for the loop carrier speed, either 9600 bps or 38,400 bps. Using this table, find the primary and secondary loop data speeds that your system is going to use. The switch settings are shown to the left of the loop data speeds you select. Fill in the switch settings on the instructions following Figure H-2. Give the completed instructions to the person who will customize your Model 51C.

For a loop carrier speed of 9600 bps, use the following table:

Loop Data Speed Switch Setting			Line Speed (bps)	
1	2	3	Pri	Sec
Off	Off	Off	9600	4800
Off	Off	On	9600	2400
Off	On	Off	4800	2400
On	Off	Off	2400	1200

For a loop carrier speed of 38,400 bps (direct-attached loop only), use the following table:

Loop Data Speed Switch Setting			Line Speed (bps)	
1	2	3	Pri	Sec
Off	Off	Off	38,400	*
On	Off	Off	9600	*

*Do not use.

Figure H-2. Loop Data Speed Switch Settings. (See sequence number 347 for additional information on changing loop speed selection.)

Instructions for Setting 3274 Model 51C Loop Data Speed Switches

1. Open the customer access area door on the bottom left of the Model 51C. To unlatch the door, turn the slotted screw head counterclockwise with a coin.

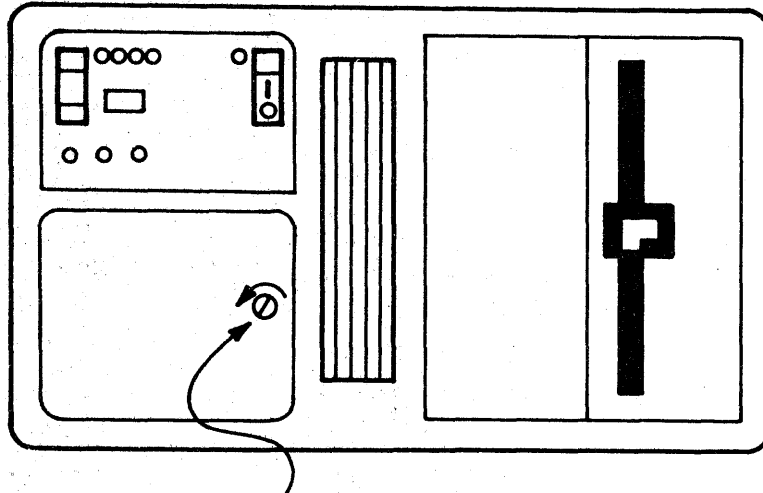

Slotted Screw Head
(Turn counterclockwise to open)

2. Set the Loop Data Speed switches on or off as indicated in the boxes below. Push the switch up for on and down for off.

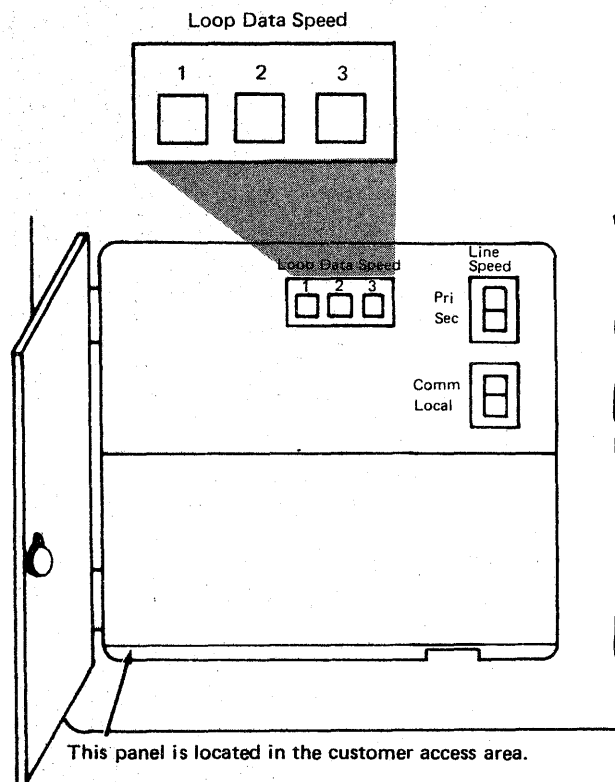

3. Close the customer access area door. Secure the latch by turning the slotted screw head clockwise with a coin.

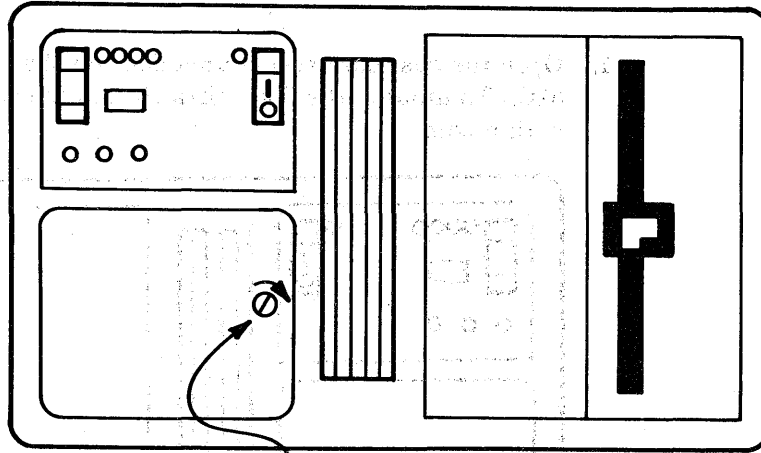

Slotted Screw Head (Turn clockwise to secure)

4. Your 3274 is now ready for use.

Modem Address Switches (Integrated Modems with Speeds Greater Than 1200 BPS Only)

The Modem Address switches are installed only on a 3274 Model 51C that has an integrated modem feature (#5640, 5740, 5840, or 5842) installed. These switches are located behind a door on the control panel. These switches must be set to the binary equivalent of either your BSC control unit address (this is the hexadecimal polling address you obtained from the system programmer for your response to sequence number 301) or your SDLC control unit address (this is your response to sequence number 302). Failure to set the Modem Address switches properly will result in valid data operations of the 3274 but inability to execute the link problem determination aid (LPDA) function of the integrated modem.

Use Figure H-3 to convert your sequence number response to its binary equivalent. For example, if your response to sequence number 301 is 21, the eight Modem Address switches should be set as shown in Figure H-4.

Enter the Modem Address switch settings in Step 2 of the instructions following Figure H-4. Give the completed instructions to the person who will customize the 3274.

Numeric Value	Modem Address Switch Settings			
0	Off	Off	Off	Off
1	Off	Off	Off	On
2	Off	Off	On	Off
3	Off	Off	On	On
4	Off	On	Off	Off
5	Off	On	Off	On
6	Off	On	On	Off
7	Off	On	On	On
8	On	Off	Off	Off
9	On	Off	Off	On
A	On	Off	On	Off
B	On	Off	On	On
C	On	On	Off	Off
D	On	On	Off	On
E	On	On	On	Off
F	On	On	On	On

Figure H-3. Conversion of BSC Control Unit Address and SDLC Control Unit Address to Binary-Equivalent Modem Address Switch Settings on 3274 Model 51C

Response to Sequence Number 301	2				1			
Switch Number	1	2	3	4	5	6	7	8
Switch Setting	Off	Off	On	Off	Off	Off	Off	On

Figure H-4. Example of 3274 Model 51C Modem Address Switch Settings

Instructions for Setting 3274 Model 51C Modem Address Switches

1. Open the customer access area door on the bottom left of the Model 51C. To unlatch the door, turn the slotted screw head counterclockwise with a coin.

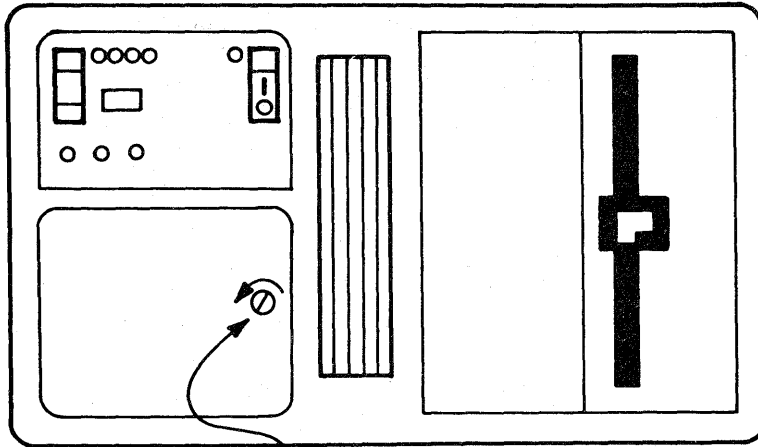

Slotted Screw Head
(Turn counterclockwise to open)

2. Set the Modem Address switches on or off as indicated in the boxes below. Press the top of the switch for on; press the bottom of the switch for off.

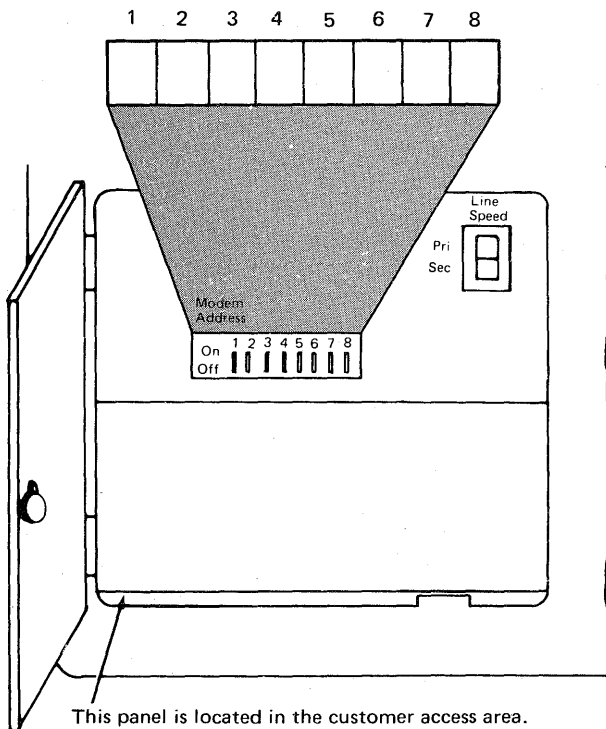

3. Close the customer access area door. Secure the latch by turning the slotted screw head clockwise with a coin.

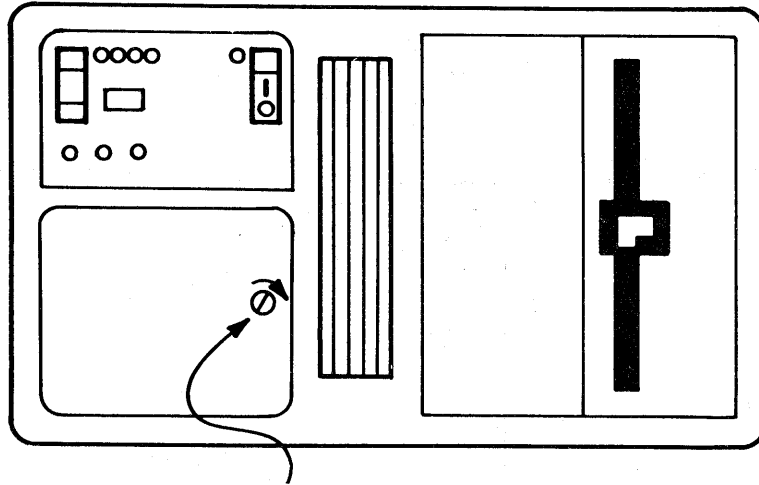

Slotted Screw Head (Turn clockwise to secure)

4. Your 3274 is now ready for use.

Appendix I. 3274 Control Storage Requirements

The following paragraphs describe how to determine the control storage requirements for the selected model of the 3274 Control Unit.

Models 1A, 1C, 1D, and 51C

After having selected the configuration support and the desired special features for your 3274, you will have to determine the control storage required. Because some combinations of functions and features exceed the basic storage capacity of the control unit you have chosen, you may have to order Extended Function Store features to provide adequate control storage. Still other combinations may exceed the maximum control storage possible with all Extended Function Store features. Such combinations are invalid configurations. In these situations, you must forfeit feature(s) in order to reduce the control storage requirements to an amount not exceeding the maximum control storage possible.

Do the following procedural steps to determine which, if any, Extended Function Store features must be ordered for the model you have selected:

1. Select the Configuration Support option that contains the functions you want.
2. Refer to the appropriate figure of control storage requirements, and select the features and functions you want.
 - a. Use Figure I-1 for a 3274 Model 1A.
 - b. Use Figure I-2 for a 3274 Model 1C using SNA protocol.
 - c. Use Figure I-3 for a 3274 Model 1C using BSC protocol.
 - d. Use Figure I-4 for a 3274 Model 1D.
 - e. Use Figure I-5 for a 3274 Model 51C using SNA protocol.
 - f. Use Figure I-6 for a 3274 Model 51C using BSC protocol.
3. Determine the total Type C and total Type D storage required for the features and functions you selected in step 2.
4. Add the Type C and Type D totals to determine the total control storage required. If this total is less than or equal to 65,536, no Extended Function Store features are required and you can stop here. If the total is greater than 65,536, continue with step 5.
5. For Model 1A, 1C, or 1D, see Figure I-7. If you chose Configuration Support A or B, begin at Line 1 and work down. If you chose Configuration Support C, begin at Line 4 and work down. Stop at the first line that satisfies the control storage requirements you determined

in steps 3 and 4. This line tells you the Extended Function Store features that your 3274 Model 1A, 1C, or 1D requires.

For Model 51C, see Figure I-8. Begin at the top and work down. Stop at the first line that satisfies the control storage requirements you determined in steps 3 and 4. This line tells you the Extended Function Store features that your 3274 Model 51C requires.

Models 21A, 21C, 21D, 31A, 31C, and 31D

After having selected the Configuration Support option and the desired special features, you will have to determine the control storage required. Some combinations of functions and features will exceed the basic control-storage capacity of the Model 21 control unit you have chosen. If the sum of the control storage requirements exceeds 65,536, a Model 21 control unit cannot be used and a Model 31 control unit is required. Note the special considerations for Models 31A and 31C/SNA in step 5 below.

Do the following procedural steps to determine the control storage requirements for the functions and features you have selected:

1. Determine which Configuration Support option contains the functions you want.
2. Refer to the appropriate figure of control storage requirements, and select the features and functions you want.
 - a. Use Figure I-9 for a 3274 Model 21A.
 - b. Use Figure I-10 for a 3274 Model 21C using SNA protocol.
 - c. Use Figure I-11 for a 3274 Model 21C using BSC protocol.
 - d. Use Figure I-12 for a 3274 Model 21D.
3. Determine the total storage requirements for the features and functions you selected in step 2.
4. If the total storage requirements calculated in step 3 are equal to or less than 65,536, the Model 21 can be used. If the storage requirements exceed 65,536, however, the Model 21 Control Unit cannot be used and a Model 31 Control Unit is required. If you determine that a Model 31A or a Model 31C/SNA is required, do step 5.
5. If you chose Configuration Support C (#9112) and either Model 31A or 31C/SNA, you must ensure that the combination of functions and features you select forms a valid configuration by doing the following:
 - a. Refer to the appropriate figure of control storage requirements, and select the features and functions you want.
 - 1) Use Figure I-13 for a 3274 Model 31A.
 - 2) Use Figure I-14 for a 3274 Model 31C/SNA.
 - b. Determine the total storage requirements for the features and functions you selected in step a.
 - c. If the total storage requirements calculated in step b exceed 71,680, you must forfeit one or more features so that the total storage requirements do not exceed 71,680.

3274 Model 1A	Type C	Type D
Model 1A Base (including Copy) (Choose one)		
● Configuration Support A (#9110)	41,200	13,600
● Configuration Support B (#9111)	45,072	14,484
● Configuration Support C (#9112)	50,030	17,940
Category A terminals (Choose one) ²		
● 1 to 8 terminals (included in base)	0	0
● 1 to 16 terminals	0	2,048
● 1 to 24 terminals	0	4,096
● 1 to 32 terminals	0	6,144
Keyboards on Category A terminals (Select all that apply, choosing at least one) ⁴		
● Typewriter (3278/3279-#4621, 4624, 4627, 4628, 4640, 4651)	0	786 ¹
● Data Entry (3278/3279-#4622)	0	786 ¹
● Data Entry Keypunch Layout (3278/3279-#4623)	0	786 ¹
● Text (3278/3279-#4629)	0	1,560
● APL (3278/3279-#4626, 4652)	0	1,560
Canadian French Keyboards (any)	500	150
● Typewriter (3278/3279-#4621, 4624, 4627, 4628, 4640, 4651)	0	1,042 ¹
● Data Entry (3278/3279-#4622)	0	1,042 ¹
● Data Entry Keypunch Layout (3278/3279-#4623)	0	1,042 ¹
● APL (3278/3279-#4626, 4652)	0	1,816
Japanese Katakana Keyboards		
● Typewriter (3278/3279-#2715, 2717, 2719, 2708)	0	1,304
● Data Entry (3278/3279-#2716)	0	1,304
● APL (3278/3279-#2718, 2721)	0	2,072
IBM 3270 Personal Computer Attachment	3,200	300
Category B terminals (Choose one) ^{2,3}		
● 1 to 4 terminals	4,900	5,624
● 1 to 8 terminals	4,900	6,648
● 1 to 12 terminals	4,900	7,672
● 1 to 16 terminals	4,900	8,696
APL/Text Control Function (Choose one)		
● Configuration Support A or B	1,700	1,200
● Configuration Support C	0	0
3289 Text Print Control	0	512
Host-Loadable Printer Authorization Matrix	500	0
Between Bracket Printer Sharing	800	100
SCS Printer Support (3287-#9660, 9661) ⁵ (3230, 3262, 3268, and 3289-basic function)	1,600	100
Magnetic Reader Control (3278/3279-#4999) (Choose one)		
● 3275/3277-Compatible 10-Character Set	600	60
● Numeric and Alphanumeric Character Sets	1,630	316
3279 Color Convergence	4,296 ⁶	1,198 ⁶
The following are available with Configuration Support C only		
Structured Field and Attribute Processing (SFAP) ⁵	4,950	950
Programmed Symbols (PS)	2,700	190
Decompression of PS Load Data	900	0
Extended Attribute Terminals (add 256 for each terminal): 3278/3287 with #3610; 3279-2B, 3B, S2B, and S3G; 3279-02X and 03X with #3850.	0	#x256
Alert	2,544	4,224

¹ Configuration Support A consideration only: If all three keyboard types (Typewriter, Data Entry, and Data Entry Keypunch Layout) are required on display stations attached to the 3274, add 1000 to the Type D storage requirements in addition to that listed.

² If the total type D requirement for Category A and Category B terminals exceeds 10,744, use 10,744.

³ No customizing option or additional control storage is required to support the 3275/3277-compatible character set for the Operator Identification Card Reader (4600) on 3277 Display Stations (Category B terminals) attached to a 3274.

⁴ Add the indicated amount for each keyboard type to be used.

⁵ The SFAP function is also required when the SCS Support for SFAP feature (#9661) is to be used on the 3287 Printer Model 1, 1C, 2, or 2C. This function does not support ASCII or the 1970 Alternate Character Set codes for Austria/Germany, Denmark/Norway, Finland/Sweden, and Spain.

⁶ U.S.A. and Canada only. If all the 3279s attached to the controller have model numbers ending in -1 (for example, S2A-1), this amount of control storage is not required.

Figure I-1. 3274 Model 1A Control Storage Requirements

3274 Model 1C/SNA	Type C	Type D
Model 1C/SNA (including Copy) (Choose one) EBCDIC		
● Configuration Support A (#9110)	41,030	13,700
● Configuration Support B (#9111)	46,102	15,096
● Configuration Support C (#9112)	50,580	17,940
ASCII		
● Configuration Support A (#9110)	41,446	14,100
● Configuration Support B (#9111)	46,518	15,496
● Configuration Support C (#9112)	51,700	18,090
Category A terminals (Choose one) ²		
● 1 to 8 terminals (included in base)	0	0
● 1 to 16 terminals	0	2,048
● 1 to 24 terminals	0	4,096
● 1 to 32 terminals	0	6,144
Keyboards on Category A terminals (Select all that apply, choosing at least one) ⁴		
● Typewriter (3278/3279-#4621, 4624, 4627, 4628, 4640, 4651)	0	786 ¹
● Data Entry (3278/3279-#4622)	0	786 ¹
● Data Entry Keypunch Layout (3278/3279-#4623)	0	786 ¹
● Text (3278/3279-#4629)	0	1,560
● APL (3278/3279-#4626, 4652)	0	1,560
Canadian French Keyboards (any)	450	150
● Typewriter (3278/3279-#4621, 4624, 4627, 4628, 4640, 4651)	0	1,042 ¹
● Data Entry (3278/3279-#4622)	0	1,042 ¹
● Data Entry Keypunch Layout (3278/3279-#4623)	0	1,042 ¹
● APL (3278/3279-#4626, 4652)	0	1,816
Japanese Katakana Keyboards		
● Typewriter (3278/3279-#2715, 2717, 2719, 2708)	0	1,304
● Data Entry (3278/3279-#2716)	0	1,304
● APL (3278/3279-#2718, 2721)	0	2,072
IBM 3270 Personal Computer Attachment	3,200	300
Category B terminals (Choose one) ^{2,3}		
● 1 to 4 terminals	4,900	5,624
● 1 to 8 terminals	4,900	6,648
● 1 to 12 terminals	4,900	7,672
● 1 to 16 terminals	4,900	8,696
APL/Text Control Function (Choose one)		
● Configuration Support A or B	1,700	1,200
● Configuration Support C	0	0
3289 Text Printer Control	0	512
High Performance Communications Adapter (#6303)		
● Configuration Support A or B	600	-500
● Configuration Support C	600	+400
Host-Loadable Printer Authorization Matrix	500	0
Between Bracket Printer Sharing	800	100
SCS Printer Support ⁵ (3287-#9660,9661) (3230, 3262, 3268, and 3289-basic feature)	1,600	100

Figure I-2 (Part 1 of 2). 3274 Model 1C/SNA Control Storage Requirements

3274 Model 1C/SNA	Type C	Type D
Magnetic Reader Control (3278/3279-#4999) (Choose one) <ul style="list-style-type: none"> ● 3275/3277-Compatible 10-Character Set ● Numeric and Alphanumeric Character Sets 	600 1,630	60 316
Encrypt/Decrypt (#3680)	3,200	2,000
3279 Color Convergence	4,296 ⁶	1,198 ⁶
The following are available with Configuration Support C only		
Structured Field and Attribute Processing (SFAP) ⁵	4,950	950
Programmed Symbols (PS)	2,700	190
Decompression of PS Load Data	900	0
Extended Attribute Terminals (add 256 for each terminal): 3278/3287 with #3610; 3279-2B, 3B, S2B, and S3G; 3279-02X and 03X with #3850.	0	#x256
Alert	2,544	4,224

¹ Configuration Support A consideration only: If all three keyboard types (Typewriter, Data Entry, and Data Entry Keypunch Layout) are required on display stations attached to the 3274, add 1000 to the Type D storage requirements in addition to that listed.

² If the total Type D requirement for Category A and Category B terminals exceeds 10,744, use 10,744.

³ No customizing option or additional control storage is required to support the 3275/3277-compatible character set for the Operator Identification Card Reader (4600) on 3277 Display Stations (Category B terminals) attached to a 3274.

⁴ Add the indicated amount for each keyboard type to be used.

⁵ The SFAP function is also required when the SCS Support for SFAP feature (#9661) is to be used on the 3287 Printer Model 1, 1C, 2, or 2C. This function does not support ASCII or the 1970 Alternate Character Set codes for Austria/Germany, Denmark/Norway, Finland/Sweden, and Spain.

⁶ U.S.A. and Canada only. If all the 3279s attached to the controller have model numbers ending in -1 (for example, S2A-1), this amount of control storage is not required.

Figure I-2 (Part 2 of 2). 3274 Model 1C/SNA Control Storage Requirements

3274 Model 1C/BSC	Type C	Type D
Model 1C/BSC (Choose one)		
EBCDIC		
● Configuration Support A (#9110)	38,000	13,800
● Configuration Support B (#9111)	41,872	14,684
● Configuration Support C (#9112)	47,150	22,200
ASCII		
● Configuration Support A (#9110)	38,000	14,500
● Configuration Support B (#9111)	41,872	15,384
● Configuration Support C (#9112)	48,650	22,900
Category A terminals (Choose one) ²		
● 1 to 8 terminals (included in base)	0	0
● 1 to 16 terminals	0	2,048
● 1 to 24 terminals	0	4,096
● 1 to 32 terminals	0	6,144
Keyboards on Category A terminals (Select all that apply, choosing at least one) ⁴		
● Typewriter (3278/3279-#4621, 4624, 4627, 4628, 4640, 4651)	0	786 ¹
● Data Entry (3278/3279-#4622)	0	786 ¹
● Data Entry Keypunch Layout (3278/3279-#4623)	0	786 ¹
● Text (3278/3279-#4629)	0	1,560
● APL (3278/3279-#4626, 4652)	0	1,560
Canadian French Keyboards (any)	500	150
● Typewriter (3278/3279-#4621, 4624, 4627, 4628, 4640, 4651)	0	1,042 ¹
● Data Entry (3278/3279-#4622)	0	1,042 ¹
● Data Entry Keypunch Layout (3278/3279-#4623)	0	1,042 ¹
● APL (3278/3279-#4626, 4652)	0	1,816
Japanese Katakana Keyboards		
● Typewriter (3278/3279-#2715, 2717, 2719, 2708)	0	1,304
● Data Entry (3278/3279-#2716)	0	1,304
● APL (3278/3279-#2718, 2721)	0	2,072
IBM 3270 Personal Computer Attachment	3,200	300
Category B terminals (Choose one) ^{2,3}		
● 1 to 4 terminals	4,700	1,724
● 1 to 8 terminals	4,700	2,748
● 1 to 12 terminals	4,700	3,772
● 1 to 16 terminals	4,700	4,796
APL/Text Control Function (Choose one)		
● Configuration Support A or B	2,200	4,700
● Configuration Support C	0	0
3289 Text Printer Control	0	512
Host-Loadable Printer Authorization Matrix	550	0
Copy (Print Key Function)	2,700	0

Figure I-3 (Part 1 of 2). 3274 Model 1C/BSC Control Storage Requirements

3274 Model 1C/BSC	Type C	Type D
Magnetic Reader Control (3278/3279-#4999) (Choose one)		
● 3275/3277-Compatible 10-Character Set	600	60
● Numeric and Alphanumeric Character Sets	1,630	316
3279 Color Convergence	4,296 ⁶	1,198 ⁶
The following are available with Configuration Support C only		
Structured Field and Attribute Processing (SFAP) ⁵	4,950	950
Programmed Symbols (PS)	2,700	9,610
Decompression of PS Load Data	900	0
Extended Attribute Terminals (add 256 for each terminal): 3278/3287 with #3610; 3279-2B, 3B, S2B, and S3G; 3279-02X and 03X with #3850.	0	#x256

¹ Configuration Support A consideration only: If all three keyboard types (Typewriter, Data Entry, and Data Entry Keypunch Layout) are required on display stations attached to the 3274, add 1000 to the Type D storage requirements in addition to that listed.

² If the total Type D requirement for Category A and Category B terminals exceeds 6844, use 6844.

³ No customizing option or additional control storage is required to support the 3275/3277-compatible character set for the Operator Identification Card Reader (4600) on 3277 Display Stations (Category B terminals) attached to a 3274.

⁴ Add the indicated amount for each keyboard type to be used.

⁵ This function does not support ASCII or the 1970 Alternate Character Set codes for Austria/Germany, Denmark/Norway, Finland/Sweden, and Spain.

⁶ U.S.A. and Canada only. If all the 3279s attached to the controller have model numbers ending in -1 (for example, S2A-1), this amount of control storage is not required.

Figure I-3 (Part 2 of 2). 3274 Model 1C/BSC Control Storage Requirements

3274 Model 1D	Type C	Type D
Model 1D (including copy) (Choose one) <ul style="list-style-type: none"> ● Configuration Support A (#9110) ● Configuration Support B (#9111) ● Configuration Support C (#9112) 	34,500 38,372 39,720	17,000 17,884 24,900
Category A terminals (Choose one) ² <ul style="list-style-type: none"> ● 1 to 8 terminals (included in base) ● 1 to 16 terminals ● 1 to 24 terminals ● 1 to 32 terminals 	0 0 0 0	0 2,048 4,096 6,144
Keyboards on Category A terminals (Select all that apply, choosing at least one) ⁴ <ul style="list-style-type: none"> ● Typewriter (3278/3279-#4621, 4624, 4627, 4628, 4640, 4651) ● Data Entry (3278/3279-#4622) ● Data Entry Keypunch Layout (3278/3279-#4623) ● Text (3278/3279-#4629) ● APL (3278/3279-#4626, 4652) Canadian French Keyboards (any) <ul style="list-style-type: none"> ● Typewriter (3278/3279-#4621, 4624, 4627, 4628, 4640, 4651) ● Data Entry (3278/3279-#4622) ● Data Entry Keypunch Layout (3278/3279-#4623) ● APL (3278/3279-#4626, 4652) Japanese Katakana Keyboards <ul style="list-style-type: none"> ● Typewriter (3278/3279-#2715, 2717, 2719, 2708) ● Data Entry (3278/3279-#2716) ● APL (3278/3279-#2718, 2721) 	0 0 0 0 0 500 0 0 0 0 0 0 0 0 0	786 ¹ 786 ¹ 786 ¹ 1,560 1,560 150 1,042 ¹ 1,042 ¹ 1,816 1,304 1,304 2,072
IBM 3270 Personal Computer Attachment	3,200	300
Category B terminals (Choose one) ^{2,3} <ul style="list-style-type: none"> ● 1 to 4 terminals ● 1 to 8 terminals ● 1 to 12 terminals ● 1 to 16 terminals 	4,300 4,300 4,300 4,300	3,724 4,748 5,772 6,796
APL/Text Control Function (Choose one) <ul style="list-style-type: none"> ● Configuration Support A or B ● Configuration Support C 	1,700 0	4,600 0
Copy (Print Key Function)	2,700	0
3289 Text Print Control	0	512
Host-Loadable Printer Authorization Matrix	550	0
Magnetic Reader Control (3278/3279-#4999) (Choose one) <ul style="list-style-type: none"> ● 3275/3277-Compatible 10-Character Set ● Numeric and Alphanumeric Character Sets 	600 1,120	60 316

Figure I-4 (Part 1 of 2). 3274 Model 1D Control Storage Requirements

3274 Model 1D	Type C	Type D
3279 Color Convergence	4,296 ⁶	1,198 ⁶
The following are available with Configuration Support C only		
Structured Field and Attribute Processing (SFAP) ⁵	4,950	950
Programmed Symbols (PS)	2,700	190
Decompression of PS Load Data	900	0
Extended Attribute Terminals (add 256 for each terminal): 3278/3287 with #3610; 3279-2B, 3B, S2B, and S3G; 3279-02X and 03X with #3850.	0	#x256

¹ Configuration Support A consideration only: If all three keyboard types (Typewriter, Data Entry, and Data Entry Keypunch Layout) are required on display stations attached to the 3274, add 1000 to the Type D storage requirements in addition to that listed.

² If the total Type D requirement for Category A and Category B terminals exceeds 8844, use 8844.

³ No customizing option or additional control storage is required to support the 3275/3277-compatible character set for the Operator Identification Card Reader (4600) on 3277 Display Stations (Category B terminals) attached to a 3274.

⁴ Add the indicated amount for each keyboard type to be used.

⁵ This function does not support ASCII or the 1970 Alternate Character Set codes for Austria/Germany, Denmark/Norway, Finland/Sweden, and Spain.

⁶ U.S.A. and Canada only. If all the 3279s attached to the controller have model numbers ending in -1 (for example, S2A-1), this amount of control storage is not required.

Figure I-4 (Part 2 of 2). 3274 Model 1D Control Storage Requirements

3274 Model 51C/SNA	Type C	Type D
Model 51C/SNA (including copy) (Choose one)		
EBCDIC		
● Configuration Support A (#9110)	41,030	13,700
● Configuration Support B (#9111)	46,102	15,096
● Configuration Support C (#9112)	50,580	17,940
ASCII		
● Configuration Support A (#9110)	41,446	14,100
● Configuration Support B (#9111)	46,518	15,496
● Configuration Support C (#9112)	51,700	18,090
Keyboards on Category A terminals (Select all that apply, choosing at least one) ³		
● Typewriter (3278/3279-#4621, 4624, 4627, 4628, 4640, 4651)	0	786 ¹
● Data Entry (3278/3279-#4622)	0	786 ¹
● Data Entry Keypunch Layout (3278/3279-#4623)	0	786 ¹
● Text (3278/3279-#4629)	0	1,560
● APL (3278/3279-#4626, 4652)	0	1,560
Canadian French Keyboards (any)	450	150
● Typewriter (3278/3279-#4621, 4624, 4627, 4628, 4640, 4651)	0	1,042 ¹
● Data Entry (3278/3279-#4622)	0	1,042 ¹
● Data Entry Keypunch Layout (3278/3279-#4623)	0	1,042 ¹
● APL (3278/3279-#4626, 4652)	0	1,816
Japanese Katakana Keyboards		
● Typewriter (3278/3279-#2715, 2717, 2719, 2708)	0	1,304
● Data Entry (3278/3279-#2716)	0	1,304
● APL (3278/3279-#2718, 2721)	0	2,072
IBM 3270 Personal Computer Attachment	3,200	300
Category B terminals ²	4,900	5,624
APL/Text Control Function (Choose one)		
● Configuration Support A or B	1,700	1,200
● Configuration Support C	0	0
3289 Text Print Control	0	512
High Performance Communications Adapter (#6303)		
● Configuration Support A or B	600	-500
● Configuration Support C	600	+400
Host-Loadable Printer Authorization Matrix	500	0
Between Bracket Printer Sharing	800	100
SCS Printer Support ⁴ (3287-#9660, 9661) (3230, 3262, 3268, and 3289-basic feature)	1,600	100
Magnetic Reader Control (3278/3279-#4999) (Choose one)		
● 3275/3277-Compatible 10-Character Set	600	60
● Numeric and Alphanumeric Character Sets	1,630	316
Encrypt/Decrypt (#3680)	3,200	2,000

Figure I-5 (Part 1 of 2). 3274 Model 51C/SNA Control Storage Requirements

3274 Model 51C/SNA	Type C	Type D
3279 Color Convergence	4,296 ⁵	1,198 ⁵
The following are available with Configuration Support C only		
Structured Field and Attribute Processing (SFAP) (EBCDIC only)	4,950	950
Programmed Symbols (PS)	2,700	190
Decompression of PS Load Data	900	0
Extended Attribute Terminals (add 256 for each terminal) (3278/3287-#3610/3279 Model 2B or 3B)	0	#x256
Loop Attachment (EBCDIC only)	3,200	850
X.21 Switched Network Operation	6,500	2,100
Alert	2,544	4,224
RTM	4,488	1,862

¹ Configuration Support A consideration only: If all three keyboard types (Typewriter, Data Entry, and Data Entry Keypunch Layout) are required on display stations attached to the 3274, add 1000 to the Type D storage requirements in addition to that listed.

² No customizing option or additional control storage is required to support the 3275/3277-compatible character set for the Operator Identification Card Reader (4600) on 3277 Display Stations (Category B terminals) attached to a 3271.

³ Add the indicated amount for each keyboard type to be used.

⁴ The SFAP function is also required when the SCS Support for SFAP feature (#9661) is to be used on the 3287 Printer Model 1, 1C, 2, or 2C.

⁵ U.S.A. and Canada only. If all the 3279s attached to the controller have model numbers ending in -1 (for example, S2A-1), this amount of control storage is not required.

Figure I-5 (Part 2 of 2). 3274 Model 51C/SNA Control Storage Requirements

3274 Model 51C/BSC	Type C	Type D
Model 51C (Choose one)		
EBCDIC		
● Configuration Support A (#9110)	38,000	13,800
● Configuration Support B (#9111)	41,872	14,684
● Configuration Support C (#9112)	47,150	22,200
ASCII		
● Configuration Support A (#9110)	38,000	14,500
● Configuration Support B (#9111)	41,872	15,384
● Configuration Support C (#9112)	48,650	22,900
Keyboards on Category A terminals (Select all that apply, choosing at least one) ³		
● Typewriter (3278/3279-#4621, 4624, 4627, 4628, 4640, 4651)	0	786 ¹
● Data Entry (3278/3279-#4622)	0	786 ¹
● Data Entry Keypunch Layout (3278/3279-#4623)	0	786 ¹
● Text (3278/3279-#4629)	0	1,560
● APL (3278/3279-#4626, 4652)	0	1,560
Canadian French Keyboards (any)	450	150
● Typewriter (3278/3279-#4621, 4624, 4627, 4628, 4640, 4651)	0	1,042 ¹
● Data Entry (3278/3279-#4622)	0	1,042 ¹
● Data Entry Keypunch Layout (3278/3279-#4623)	0	1,042 ¹
● APL (3278/3279-#4626, 4652)	0	1,816
Japanese Katakana Keyboards		
● Typewriter (3278/3279-#2715, 2717, 2719, 2708)	0	1,304
● Data Entry (3278/3279-#2716)	0	1,304
● APL (3278/3279-#2718, 2721)	0	2,072
IBM 3270 Personal Computer Attachment	3,200	300
Category B terminals ²	4,700	1,724
APL/Text Control Function (Choose one)		
● Configuration Support A or B	2,200	4,700
● Configuration Support C	0	0
3289 Text Print Control	0	512
Host-Loadable Printer Authorization Matrix	550	0
Copy (Print Key Function)	2,700	0
Magnetic Reader Control (3278/3279-#4999) (Choose one)		
● 3275/3277-Compatible 10-Character Set	600	60
● Numeric and Alphanumeric Character Sets	1,630	316
3279 Color Convergence	4,296 ⁴	1,198 ⁴
The following are available with Configuration Support C only		
Structured Field and Attribute Processing (SFAP) (EBCDIC only)	4,950	950
Programmed Symbols (PS)	2,700	9,610
Decompression of PS Load Data	900	0
Extended Attribute Terminals (add 256 for each terminal): 3278/3287 with #3610; 3279-2B, 3B, S2B, and S2G; 3279-02X and 03X with #3850.	0	#x256
Response Time Monitor	2,016	1,488

¹ Configuration Support A consideration only: If all three keyboard types (Typewriter, Data Entry, and Data Entry Keypunch Layout) are required on display stations attached to the 3274, add 1000 to the Type D storage requirements in addition to that listed.

² No customizing option or additional control storage is required to support the 3275/3277-compatible character set for the Operator Identification Card Reader (4600) on 3277 Display Stations (Category B terminals) attached to a 3274.

³ Add the indicated amount for each keyboard type to be used.

⁴ U.S.A. and Canada only. If all the 3279s attached to the controller have model numbers ending in -1 (for example, S2A-1), this amount of control storage is not required.

Line	Factors	Storage Size	Feature Codes
1	Type C + Type D	≤ 65,536	None
2	Type C + Type D and Type C and Type D	> 65,536 ≤ 49,152 ≤ 32,768	1801 and 3622
3	Type C + Type D and Type C and Type D	> 65,536 ≤ 49,152 ≤ 49,152	1801, 3622, and 3627
4	Type C + Type D and Type C and Type D	> 65,536 ≤ 65,536 ≤ 32,768	1801, 3622, and 3625, or 1801 and 3623
5	Type C + Type D and Type C and Type D	> 65,536 ≤ 65,536 ≤ 49,152	1801, 3622, 3625, and 3627, or 1801, 3623, and 3627
6	Type C + Type D and Type C and Type D	> 65,536 ≤ 65,536 > 49,152	1801, 3622, 3625, and 3628, or 1801, 3623, and 3628
7	Type C and Type C and Type D	> 65,536 ≤ 71,680 Any	1801, 3622, 3625, and 3628, or 1801, 3623, and 3628
8	Type C	> 71,680	Invalid Configuration

Figure I-7. 3274 Models 1A, 1C, and 1D Extended Function Store Features

Factors	Storage Size	Feature Codes
Type C + Type D	≤ 65,536	None
Type C + Type D and Type C and Type D	> 65,536 ≤ 65,536 ≤ 32,768	1802 and 3630
Type C + Type D and Type C and Type D	> 65,536 ≤ 65,536 > 32,768	1800 (or 1802 and 3632), (or 1802, 3630, and 3631 – Field Upgrade Only)
Type C and Type C and Type D	> 65,536 ≤ 71,680 Any	1800 (or 1802 and 3632), (or 1802, 3630, and 3631 – Field Upgrade Only)
Type C	> 71,680	Invalid Configuration

Figure I-8. 3274 Model 51C Extended Function Store Features

3274 Model 21A	Storage Requirements
Model 21A (including Copy) (Choose one) ● Configuration Support A (#9110) ● Configuration Support B (#9111)	54,800 59,556
Category A terminals (Choose one) ● 1 to 8 terminals (included in base) ● 1 to 16 terminals ● 1 to 24 terminals ● 1 to 32 terminals	0 2,048 4,096 6,144
Keyboards on Category A terminals (Select all that apply, choosing at least one) ² ● Typewriter (3278/3279-#4621, 4627) ● Data Entry (3278/3279-#4622) ● Data Entry Keypunch Layout (3278/3279-#4623) ● Text (3278/3279-#4629) ● APL (3278/3279-#4626) Canadian French Keyboards (any) ● Typewriter (3278/3279-#4621, 4624, 4627, 4628) ● Data Entry (3278/3279-#4622) ● Data Entry Keypunch Layout (3278/3279-#4623) ● APL (3278/3279-#4626) Japanese Katakana Keyboards ● Typewriter (3278/3279-#2715, 2717) ● Data Entry (3278/3279-#2716) ● APL (3278/3279-#2718)	786 ¹ 786 ¹ 786 ¹ 1,560 1,560 650 1,042 ¹ 1,042 ¹ 1,042 ¹ 1,816 1,304 1,304 2,072
IBM 3270 Personal Computer Attachment	3,500
APL/Text Control Function	2,900
3289 Text Print Control	512
Host-Loadable Printer Authorization Matrix	500
Between Bracket Printer Sharing	900
SCS Printer Support (3287-#9660) (3230, 3262, 3268, and 3289-basic function)	1,700
Magnetic Reader Control (3278/3279-#4999) (Choose one) ● 3275/3277-Compatible 10-Character Set ● Numeric and Alphanumeric Character Sets	660 1,946
3279 Color Convergence	5,494 ³

¹ Configuration Support A consideration only: If all three keyboard types (Typewriter, Data Entry, and Data Entry Keypunch Layout) are required on display stations attached to the 3274, add 1000 to the storage requirements in addition to that listed.

² Add the indicated amount for each keyboard type to be used.

³ U.S.A. and Canada only. If all the 3279s attached to the controller have model numbers ending in -1 (for example, S2A-1), this amount of control storage is not required.

Figure I-9. 3274 Model 21A Control Storage Requirements

3274 Model 21C/SNA	Storage Requirements
Model 21C/SNA (including Copy) (Choose one) EBCDIC	
● Configuration Support A (#9110)	54,730
● Configuration Support B (#9111)	61,198
ASCII	
● Configuration Support A (#9110)	55,546
● Configuration Support B (#9111)	62,014
Category A Terminals (Choose one)	
● 1 to 8 terminals (included in base)	0
● 1 to 16 terminals	2,048
● 1 to 24 terminals	4,096
● 1 to 32 terminals	6,144
Keyboards on Category A terminals (Select all that apply, choosing at least one) ²	
● Typewriter (3278/3279-#4621, 4624, 4627, 4628)	786 ¹
● Data Entry (3278/3279-#4622)	786 ¹
● Data Entry Keypunch Layout (3278/3279-#4623)	786 ¹
● Text (3278/3279-#4629)	1,560
● APL (3278/3279-#4626)	1,560
Canadian French Keyboards (any)	600
● Typewriter (3278/3279-#4621, 4624, 4627, 4628)	1,042 ¹
● Data Entry (3278/3279-#4622)	1,042 ¹
● Data Entry Keypunch Layout (3278/3279-#4623)	1,042 ¹
● APL (3278/3279-#4626)	1,816
Japanese Katakana Keyboards	
● Typewriter (3278/3279-#2715, 2717)	1,304
● Data Entry (3278/3279-#2716)	1,304
● APL (3278/3279-#2718, 2721)	2,072
IBM 3270 Personal Computer Attachment	3,500
APL/Text Control Function	2,900
3289 Text Print Control	512
High Performance Communications Adapter (#6303)	100
Host-Loadable Printer Authorization Matrix	500
Between Bracket Printer Sharing	900
SCS Printer Support (3287-#9660) (3230, 3262, 3268, and 3289-basic feature)	1,700
Magnetic Reader Control (3278/3279-#4999) (Choose one)	
● 3275/3277-Compatible 10-Character Set	660
● Numeric and Alphanumeric Character Sets	1,946
Encrypt/Decrypt (#3680)	5,200
3279 Color Convergence	5,494 ³

¹ Configuration Support A consideration only: If all three keyboard types (Typewriter, Data Entry, and Data Entry Keypunch Layout) are required on display stations attached to the 3274, add 1000 to the storage requirements in addition to that listed.

² Add the indicated amount for each keyboard type to be used.

³ U.S.A. and Canada only. If all the 3279s attached to the controller have model numbers ending in -1 (for example, S2A-1), this amount of control storage is not required.

Figure I-10. 3274 Model 21C/SNA Control Storage Requirements

3274 Model 21C/BSC	Storage Requirements
Model 21C/BSC (Choose one) EBCDIC <ul style="list-style-type: none"> ● Configuration Support A (#9110) ● Configuration Support B (#9111) ASCII <ul style="list-style-type: none"> ● Configuration Support A (#9110) ● Configuration Support B (#9111) 	51,800 56,556 52,500 57,256
Category A Terminals (Choose one) ³ <ul style="list-style-type: none"> ● 1 to 8 terminals (included in base) ● 1 to 16 terminals ● 1 to 24 terminals ● 1 to 32 terminals 	0 2,048 4,096 6,144
Keyboards on Category A terminals (Select all that apply, choosing at least one) ⁴ <ul style="list-style-type: none"> ● Typewriter (3278/3279-#4621, 4624, 4627, 4628) ● Data Entry (3278/3279-#4622) ● Data Entry Keypunch Layout (3278/3279-#4623) ● Text (3278/3279-#4629) ● APL (3278/3279-#4626) Canadian French Keyboards (any) <ul style="list-style-type: none"> ● Typewriter (3278/3279-#4621, 4624, 4627, 4628) ● Data Entry (3278/3279-#4622) ● Data Entry Keypunch Layout (3278/3279-#4623) ● APL (3278/3279-#4626) Japanese Katakana Keyboards <ul style="list-style-type: none"> ● Typewriter (3278/3279-#2715, 2717) ● Data Entry (3278/3279-#2716) ● APL (3278/3279-#2718) 	786 ¹ 786 ¹ 786 ¹ 1,560 1,560 650 1,042 ¹ 1,042 ¹ 1,042 ¹ 1,816 1,304 1,304 2,072
IBM 3270 Personal Computer Attachment	3,500
Category B terminals (Choose one) ^{2,3} <ul style="list-style-type: none"> ● 1 to 4 terminals ● 1 to 8 terminals ● 1 to 12 terminals ● 1 to 16 terminals 	6,424 7,448 8,472 9,496
APL/Text Control Function	6,900
3289 Text Print Control	512
Host-Loadable Printer Authorization Matrix	550
Copy (Print Key Function)	2,700
Magnetic Reader Control (3278/3279-#4999) (Choose one) <ul style="list-style-type: none"> ● 3275/3277-Compatible 10-Character Set ● Numeric and Alphanumeric Character Sets 	660 1,436
3279 Color Convergence	5,494 ⁵

¹ Configuration Support A consideration only: If all three keyboards (Typewriter, Data Entry, and Data Entry Keypunch Layout) are required on display stations attached to the 3274, add 1000 to the storage requirements in addition to that listed.

² No customizing option or additional control storage is required to support the 3275/3277-compatible character set for the Operator Identification Card Reader (4600) on 3277 Display Stations (Category B terminals) attached to a 3274.

³ If the total requirement for Category A and Category B terminals exceeds 11,544, use 11,544.

⁴ Add the indicated amount for each keyboard type to be used.

⁵ U.S.A. and Canada only. If all the 3279s attached to the controller have model numbers ending in -1 (for example, S2A-1), this amount of control storage is not required.

Figure I-11. 3274 Model 21C/BSC Control Storage Requirements

3274 Model 21D	Storage Requirements
Model 21D (Choose one) <ul style="list-style-type: none"> ● Configuration Support A (#9110) ● Configuration Support B (#9111) 	51,500 56,256
Category A Terminals (Choose one) ³ <ul style="list-style-type: none"> ● 1 to 8 terminals (included in base) ● 1 to 16 terminals ● 1 to 24 terminals ● 1 to 32 terminals 	0 2,048 4,096 6,144
Keyboards on Category A terminals (Select all that apply, choosing at least one) ⁴ <ul style="list-style-type: none"> ● Typewriter (3278/3279 - #4621, 4627) ● Data Entry (3278/3279-#4622) ● Data Entry Keypunch Layout (3278/3279-#4623) ● Text (3278/3279-#4629) ● APL (3278/3279-#4626) Canadian French Keyboards (any) <ul style="list-style-type: none"> ● Typewriter (3278/3279-#4621, 4624, 4627, 4628) ● Data Entry (3278/3279-#4622) ● Data Entry Keypunch Layout (3278/3279-#4623) ● APL (3278/3279-#4626) Japanese Katakana Keyboards <ul style="list-style-type: none"> ● Typewriter (3278/3279-#2715, 2717) ● Data Entry (3278/3279-#2716) ● APL (3278/3279-#2718) 	786 ¹ 786 ¹ 786 ¹ 1,560 1,560 600 1,042 ¹ 1,042 ¹ 1,042 ¹ 1,816 1,304 1,304 2,072
IBM 3270 Personal Computer Attachment	3,500
Category B terminals (Choose one) ^{2,3} <ul style="list-style-type: none"> ● 1 to 4 terminals ● 1 to 8 terminals ● 1 to 12 terminals ● 1 to 16 terminals 	8,024 9,048 10,072 11,096
APL/Text Control Function	6,300
Copy (Print Key Function)	2,700
3289 Text Print Control	512
Host-Loadable Printer Authorization Matrix	550
Magnetic Reader Control (3278/3279-#4999) (Choose one) <ul style="list-style-type: none"> ● 3275/3277-Compatible 10-Character Set ● Numeric and Alphanumeric Character Sets 	660 1,436
3279 Color Convergence	5,494 ⁵

¹ Configuration Support A consideration only: If all three keyboard types (Typewriter, Data Entry, and Data Entry Keypunch Layout) are required on display stations attached to the 3274, add 1000 to the storage requirements in addition to that listed.

² No customizing option or additional control storage is required to support the 3275/3277-compatible character set for the Operator Identification Card Reader (4600) on 3277 Display Stations (Category B terminals) attached to a 3274.

³ If the total requirement for Category A and Category B terminals exceeds 13,144, use 13,144.

⁴ Add the indicated amount for each keyboard type to be used.

⁵ U.S.A. and Canada only. If all the 3279s attached to the controller have model numbers ending in -1 (for example, S2A-1), this amount of control storage is not required.

Figure I-12. 3274 Model 21D Control Storage Requirements

3274 Model 31A	Storage Requirements
Configuration Support C	50,030
IBM 3270 Personal Computer Attachment	3,500
Category B terminals	4,900
Host-Loadable Printer Authorization Matrix	500
Between Bracket Printer Sharing	800
SCS Printer Support (3287 - #9660, 9661) ¹ (3230, 3262, 3268, and 3289-basic feature)	1,600
Magnetic Reader Control (3278/3279 - #4999) (Choose one)	
● 3275/3277-Compatible 10-Character Set	600
● Numeric and Alphanumeric Character Sets	1,630
3279 Color Convergence	4,296 ³
Structured Field and Attribute Processing (SFAP) ²	4,950
Programmed Symbols (PS)	2,700
Decompression of PS Load Data	900
Canadian French Keyboards (any)	500
Alert	2,544
RTM	4,488

¹The SFAP function is also required when the SCS Support for SFAP feature (#9661) is to be used on the 3287 Printer Model 1, 1C, 2, or 2C.

²This function does not support ASCII or the 1970 Alternate Character Set codes for Austria/Germany, Denmark/Norway, Finland/Sweden, and Spain.

³U.S.A. and Canada only. If all the 3279s attached to the controller have model numbers ending in -1 (for example, S2A-1), this amount of control storage is not required.

Figure I-13. 3274 Model 31A Control Storage Requirements

3274 Model 31C/SNA	Storage Requirements
Configuration Support C	50,580
IBM 3270 Personal Computer Attachment	3,500
Category B terminals	4,900
Host-Loadable Printer Authorization Matrix	500
Between Bracket Printer Sharing	800
SCS Printer Support (3287 - #9660, 9661) ¹ (3230, 3262, 3268 and 3289-basic feature)	1,600
Magnetic Reader Control (3278/3279 - #4999) (Choose one) ● 3275/3277-Compatible 10-Character Set ● Numeric and Alphanumeric Character Sets	600 1,630
3279 Color Convergence	4,296 ³
Structured Field and Attribute Processing (SFAP) ² (EBCDIC only)	4,950
Programmed Symbols (PS)	2,700
Decompression	900
High Performance Communications Adapter (#6303)	600
Encrypt/Decrypt (#3680)	3,200
Canadian French Keyboards (any)	450
X.21 Switched Network Operation	6,500
Alert	2,544
RTM	4,488

¹The SFAP function is also required when the SCS Support for SFAP feature (#9661) is to be used on the 3287 Printer Model 1, 1C, 2, or 2C.

²This function does not support ASCII or the 1970 Alternate Character Set codes for Austria/Germany, Denmark/Norway, Finland/Sweden, and Spain.

³U.S.A. and Canada only. If all the 3279s attached to the controller have model numbers ending in -1 (for example, S2A-1), this amount of control storage is not required.

Figure I-14. 3274 Model 31C/SNA Control Storage Requirements

Appendix J. Multiple Interactive Screen Definition — Sequence Number 171

Sequence number 171 allows you to define the Multiple Interactive Screen (MIS) configuration you will be using with your distributed function terminals (DFTs). You can specify none, two, three, four, or five terminal addresses. When defining MIS, you must also define the port address on which the first MIS display station is connected. This cannot be port 0. All remaining display stations that will use MIS *must* be connected to the next sequential ports following the one specified as the first MIS port. Similarly, the MIS designations will be assigned, within the 3274, in ascending sequential order. As shown in the example in Figure J-1, two 3278 Display Stations are attached to ports 00 and 01, respectively. The first MIS DFT is attached to port 02, and the remaining three DFTs are attached consecutively to ports 03, 04, and 05. Your response to sequence number 171, then, would be 02 01 02 01 00, where:

- 02 = Port to which the first MIS DFT is attached to the 3274.
- 01 = One 2-screen MIS DFT is attached to port 02.
- 02 = Two 3-screen MIS DFTs are attached to ports 03 and 04, respectively.
- 01 = One 4-screen MIS DFT is attached to port 05.
- 00 = No 5-screen MIS DFTs are attached to the 3274.

When you are using MIS, sequence numbers 112 and 170 must be compatible with sequence number 171. It is recommended that the response to sequence number 112 (Number of Category A devices) be the exact number of physical devices attached to the 3274. (Category B devices are not allowed with Configuration Support T; therefore, sequence number 111 is not displayed.) In the above example, you have two 3278 Display Stations attached to ports 00 and 01, respectively, and four DFTs attached to ports 02, 03, 04, and 05, respectively. This gives you a total of six Category A devices. Your response to sequence number 112, therefore, is 6.

Your response to sequence number 170 must be 1, indicating that you do have DFTs attached. If you respond 0 to sequence number 170, DFTs will not operate on the 3274.

It is possible to address up to five different applications with MIS. Physically, it is only possible to display these applications in a one-, two-, or four-panel screen format, as is shown in Figure J-2.

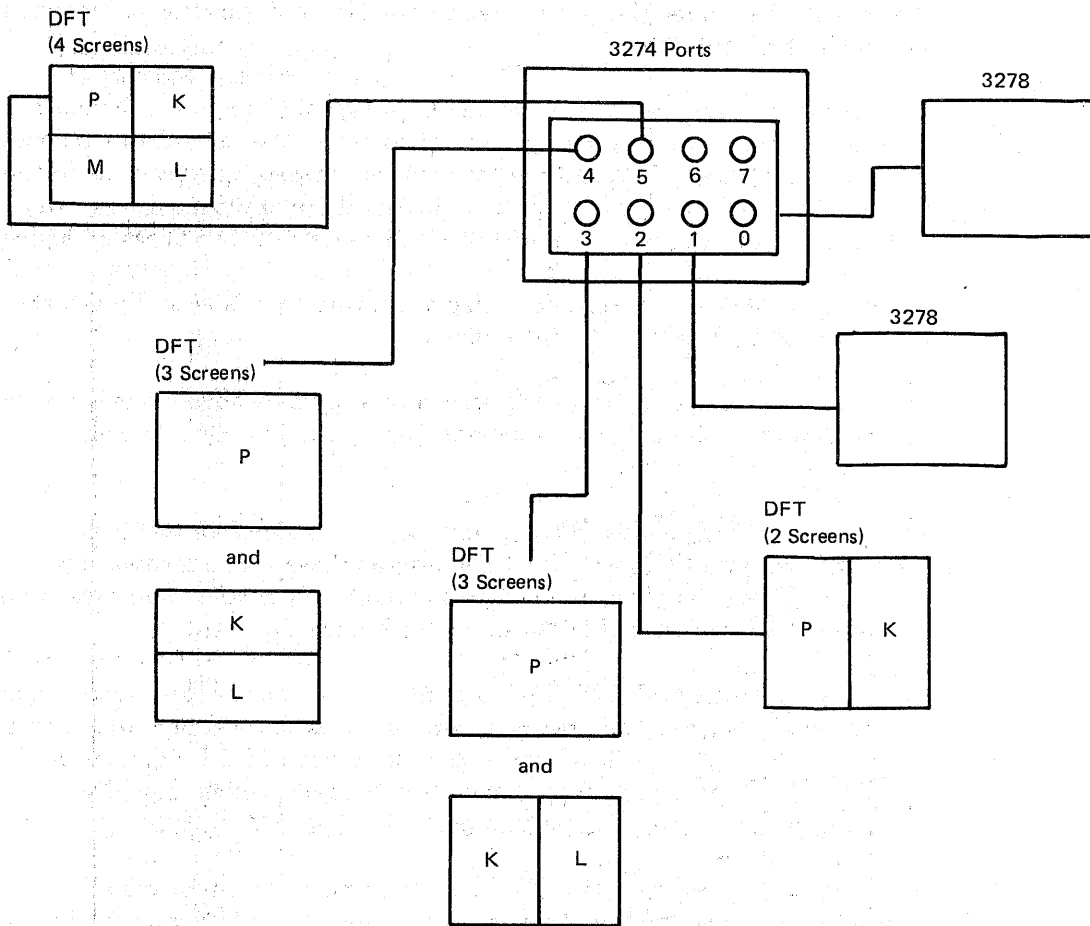

Figure J-1. Example of MIS Configuration

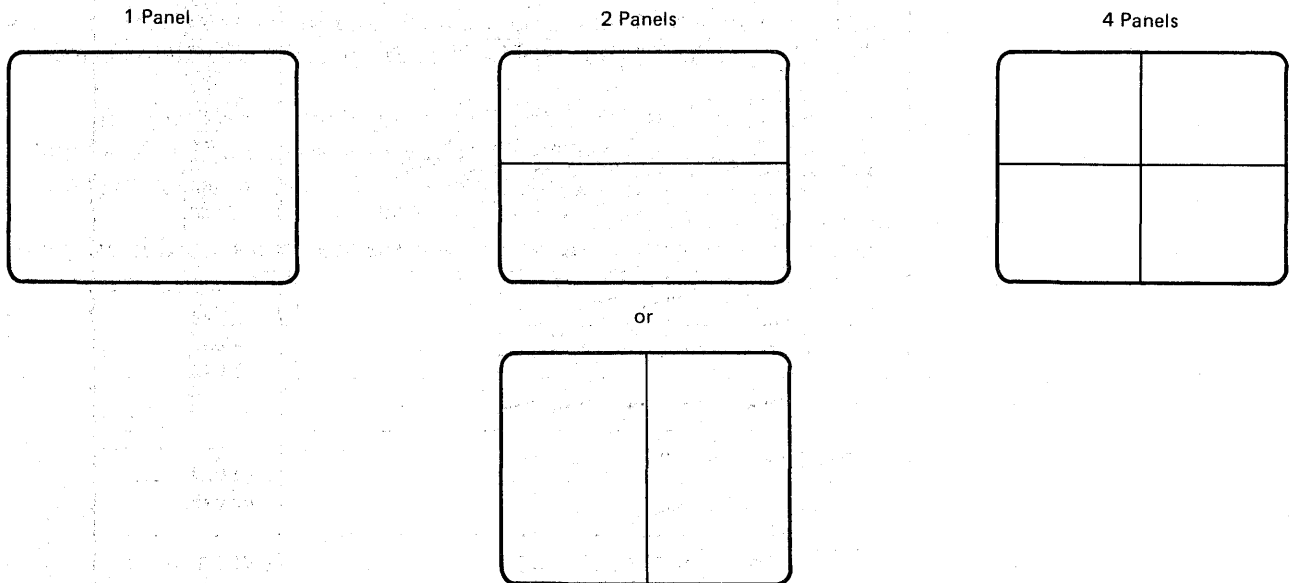

Figure J-2. Possible Multiple-Screen Formats

These one-, two-, or four-panel screen formats are combined, as is shown in Figure J-3, to produce the two through five MIS configurations allowed in sequence number 171.

Your response to sequence number 112 (Number of Category A devices) defines the number of physical devices attached to the 3274. Your response to sequence number 171 (Multiple Interactive Screens), however, as in the example in Figure J-1, implies that, logically, there are more devices than you specified in sequence number 112. MIS deals with two types of devices:

1. *Primary* device — the physical display station that is actually attached to the 3274 ports, as explained above.
2. *Secondary* device — shares the screen of a primary device but is treated internally by the 3274 as a separate display station with its own address.

The secondary device must have a port address assigned to it if it is to communicate with the host. The 3274 assigns these port addresses by beginning where the physical devices leave off. Figure J-4 is an extension of the example in Figure J-1. As shown in Figure J-4:

- The two-screen MIS DFT has its primary device physically attached and addressed through port 02. Because port 05 is the last port to which a physical device (in this example, the four-screen MIS DFT) is attached, the two-screen display station has its secondary device logically attached and addressed through port 06.
- The first three-screen MIS DFT has its primary device physically attached and addressed through port 03 and its two secondary devices logically attached and addressed through ports 07 and 08, respectively.
- The second three-screen MIS DFT has its primary device physically attached and addressed through port 04 and its two secondary devices logically attached and addressed through ports 09 and 10, respectively.
- The four-screen MIS DFT has its primary device physically attached and addressed through port 05 and its three secondary devices logically attached and addressed through ports 11, 12, and 13, respectively.

Figure J-5 shows how the host would address the devices in this example when an SNA protocol is used.

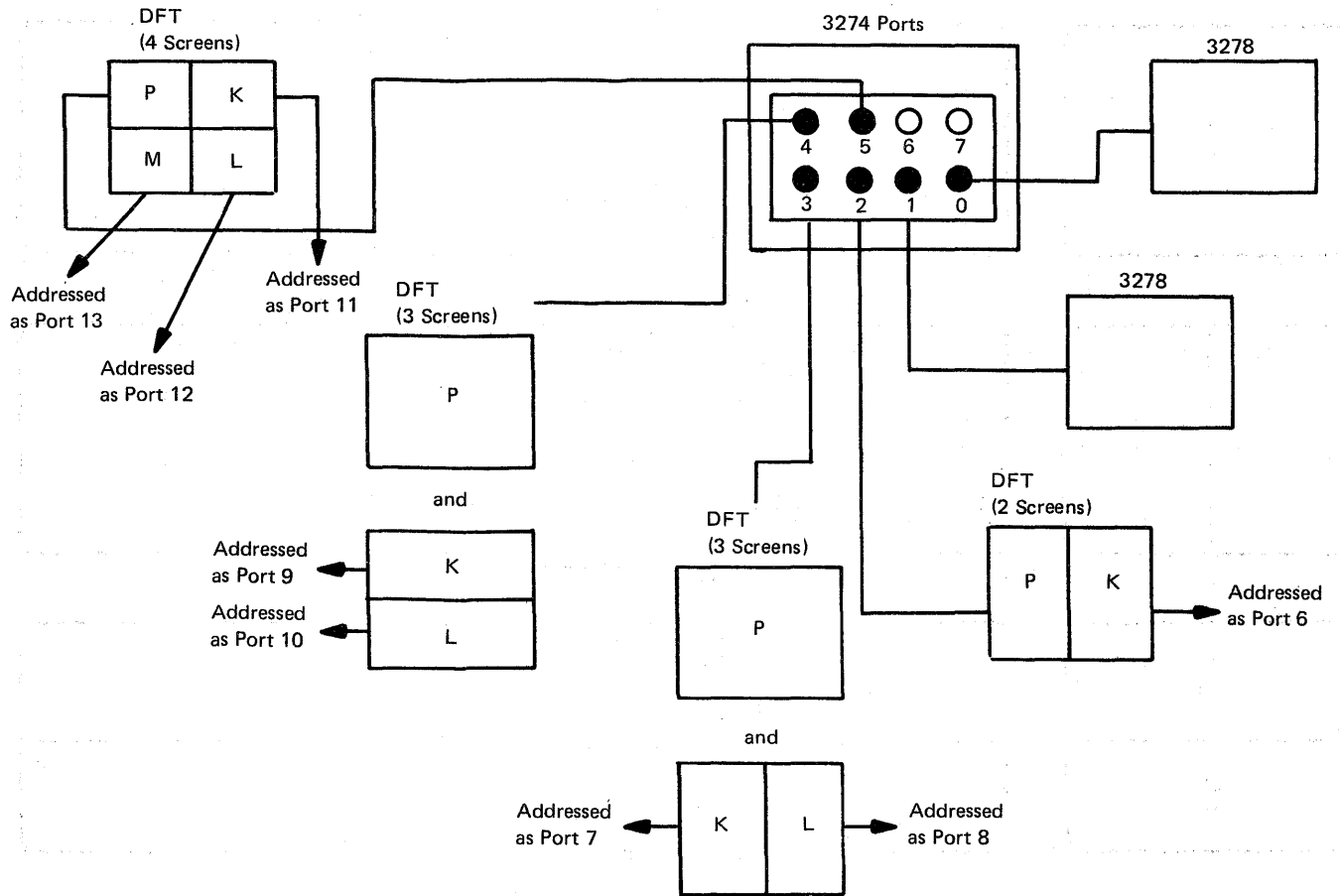

- Primary Terminal address
(physical device attached)
- Secondary Terminal address
(no physical device attached)

Note: The SNA protocol is allowed a total of 128 primary and secondary terminal addresses. Non-SNA protocols are allowed a total of 32 primary and secondary terminal addresses.

Figure J-4. Example of How the 3274 Views MIS Addressing

Host View

3274 View

		Host Terminal Control Table			
Physically Attached Devices	{	LU1	LU	LOCADDR=2,	DLOGMOD=T3278M2
		LU2	LU	LOCADDR=3,	DLOGMOD=T3278M2
		² LU3	LU	LOCADDR=4,	DLOGMOD=Txxxx
		² LU4	LU	LOCADDR=5,	DLOGMOD=Txxxx
		³ LU5	LU	LOCADDR=6,	DLOGMOD=Txxxx
		⁴ LU6	LU	LOCADDR=7,	DLOGMOD=Txxxx
DFT Secondary Terminal Addresses	{	¹ LU7	LU	LOCADDR=8,	DLOGMOD=T3278Mx
		² LU8	LU	LOCADDR=9,	DLOGMOD=T3278Mx
		² LU9	LU	LOCADDR=10,	DLOGMOD=T3278Mx
		³ LU10	LU	LOCADDR=11,	DLOGMOD=T3278Mx
		³ LU11	LU	LOCADDR=12,	DLOGMOD=T3278Mx
		⁴ LU12	LU	LOCADDR=13,	DLOGMOD=T3278Mx
		⁴ LU13	LU	LOCADDR=14,	DLOGMOD=T3278Mx
		⁴ LU14	LU	LOCADDR=15,	DLOGMOD=T3278Mx

¹	Two-Screen
²	Three-Screen
³	Three-Screen
⁴	Four-Screen

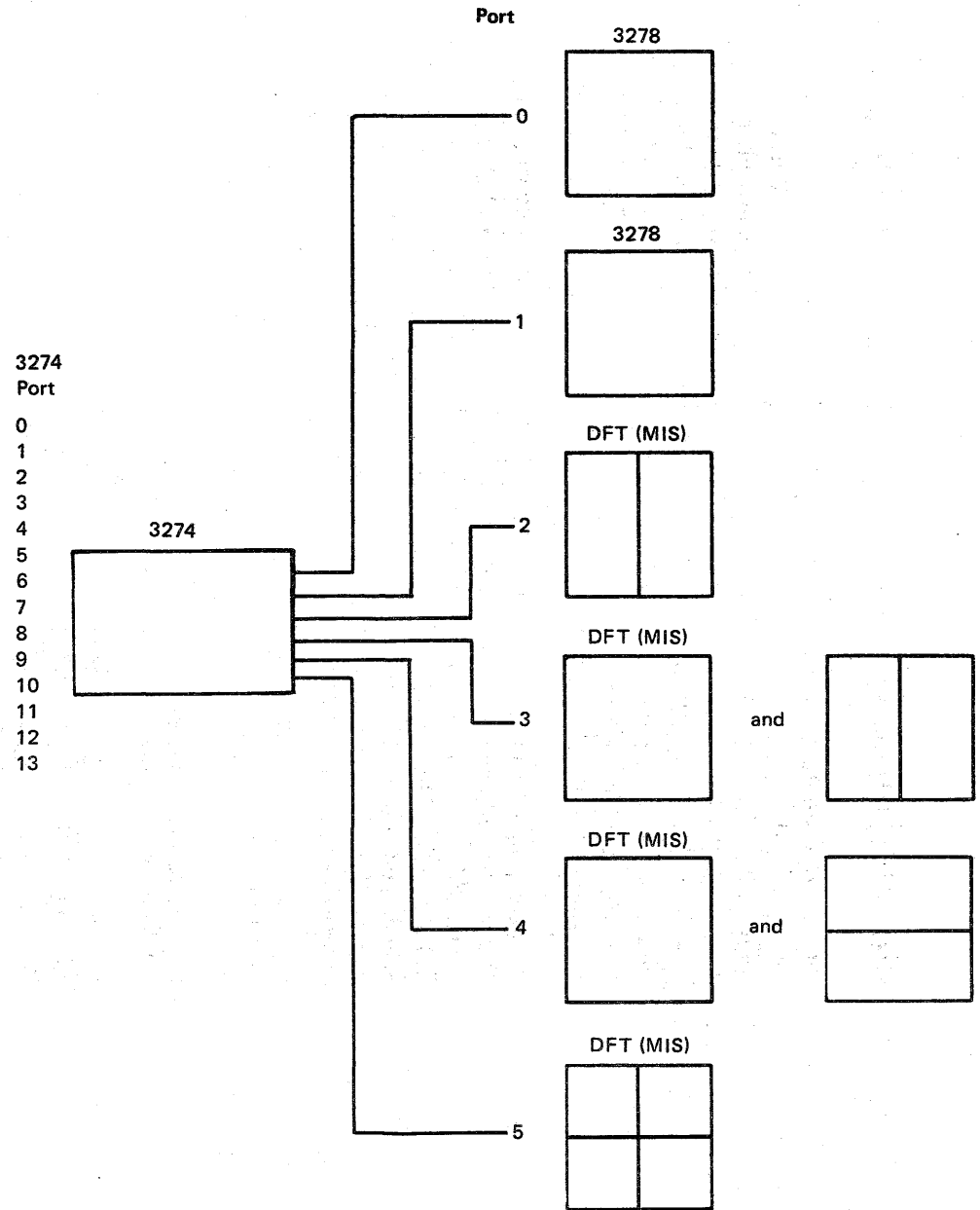

Figure J-5. Example of How the Host Views MIS Addressing in SNA Protocol

Appendix K. Response Time Monitor (RTM) Customizing Information

This appendix provides the background information needed to answer the customizing questions for the RTM function (sequence numbers 127 and 128). It also provides descriptions of sequence numbers 127 and 128.

Further description of the RTM function is contained in the *3274 Control Unit Description and Programmer's Guide*, GA23-0061.

RTM Requirements

The RTM function is available on 3274 Models 31A, 31C, 31D, and 51C. Configuration Support C is required.

An RTM timer card (special feature 6101) must be installed in the control unit.

Display devices for which response times can be measured are the 6850 Displaywriter, the IBM 3270 Personal Computer, and the 3178, 3179, 3180, 3277, 3278, and 3279 display stations. Distributed function terminals such as the 3290 Information Panel are also supported through a special interface.

Host Interface

The RTM function has a host interface for SNA communications. Although IBM does not provide host support programming at this time, it is IBM's intent to provide host programming support for the IBM 3274 Response Time Monitor function. When introduced, the support will be an offering that will run on the IBM System/370, 4300, 303X, and 308X products. It will collect response time data from the 3274 in SNA mode and will display that information to network operations personnel. Further information on the availability of this package will be provided at a later date.

No host programming is required to use the 3274 RTM function for 3270 subsystem display of response times.

For BSC and non-SNA local channels, no host interface is provided in RTM, and response time display is available only at the 3274 subsystem.

RTM Description

When the RTM function is customized (sequence numbers 127 and 128) you are specifying where the RTM data will be displayed (127), what will be timed (127), the status for the host interface (128), and the boundary values used in measuring the response times (128).

Sequence Number 127

The first digit response to sequence number 127 determines where data will be displayed.

Possible responses are:

- RTM is not configured.
- RTM is configured with *no* host support (SNA and non-SNA). On port 0 only, the operator is authorized to: (1) display RTM log information in Test mode and (2) display the Last Transaction Time indicator. The authorized operator may also reset the RTM data via the A4/4 test.
- RTM is configured with *no* host support (SNA and non-SNA). On all ports, the operator is authorized to: (1) display RTM log information in Test mode and (2) display the Last Transaction Time indicator. All operators may reset the RTM data via the A4/4 test.
- RTM is configured *with* host support (SNA only). No subsystem display of RTM log information or Last Transaction Time indicator is authorized.
- RTM is configured *with* host support (SNA only). On port 0 only, the operator is authorized to: (1) display RTM log information in Test mode and (2) display the Last Transaction Time indicator.
- RTM is configured *with* host support (SNA only). On all ports, the operator is authorized to: (1) display RTM log information in Test mode and (2) display the Last Transaction Time indicator.

Note: Authorization to display RTM log information given by the latter three responses may be altered by the host at any time. These responses are applicable to SNA networks only.

What Will Be Timed

The second digit of the response to sequence number 127 determines what will be measured.

Response time is measured from recognition of the inbound AID request in the 3274 until the end of the transaction. The end-of-transaction parameter is defined for all devices when the 3274 is customized. When the 3274 is attached via an SNA protocol, response time is measured on the LU-LU flow only; none is measured for the SSCP-LU session.

The end-of-transaction parameter may be defined as one of the following:

- **FIRST CHARACTER:** The measurement is terminated when the first character of the next outbound message is written to the device. Note that this character can be (1) an EAU, E/W, E/WA command, (2) an EUA or SBA order, (3) a Load PS or Erase Reset function, (4) reset MDT, or (5) actual data for the device buffer. Note also that a Write with no data terminates the RTM measurement.
- **KEYBOARD USABLE:** The measurement is terminated when the next outbound operation (other than READ) to that device contains a WCC or EAU command and the operation has been processed by the 3274. The operator is then able to use the keyboard.
- **CD/EB:** This definition is only valid in an SNA environment. The measurement is terminated upon receipt of a Change Direction (CD) or End Bracket (EB) which puts the device into Send or Contention state, respectively. This is usually equivalent to a "time-to-last-character."

Notes:

1. *EB and CD received in an exception response request or in a definite response causes measurement to be terminated on LIC (last in chain).*
2. *CD in conjunction with a Read does not stop the timer.*

Sequence Number 128

When sequence number 127 is answered with a nonzero response, sequence number 128 (a panel) is displayed. One of two versions of the panel (Example A or Example B following) will be displayed depending on the first digit response to sequence number 127. The panel provides fields for specifying the time boundaries for the RTM counters (Example A) or a flag field for setting host interface status and fields for setting the time boundaries (Example B).

Example A

128	X...X
B1 - 00 : 01 . 0	
B2 - 00 : 02 . 0	
B3 - 00 : 05 . 0	
B4 - 00 : 10 . 0	
	904 - 0

Example B

128

X...X

F1 - 00000000

B1 - 00 : 01 . 0

B2 - 00 : 02 . 0

B3 - 00 : 05 . 0

B4 - 00 : 10 . 0

904 - 0

The panel of Example B is not displayed unless the first digit response to sequence number 127 was a 3, 4, or 5.

The initial values shown in the F1 and B1 through B4 fields are the default values for those fields and will be present when the panel is first displayed.

The cursor is initially positioned as shown in each example.

Sequence number 128 fields and responses are as follows:

X...X is the model number field. This field is *not* defined during customization but will show the control unit address, model number, and, if appropriate, the communication mode being used (SDLC or BSC). The BSC or SDLC address is picked up from sequence number 301 or 302, as appropriate.

F1 is the host interface status field. If displayed an eight digit response is required. Valid digits are 0 and 1 and carry the following meaning:

A 0 turns off the function associated with the digit position

A 1 turns on the function associated with the digit position

Function and digit position are related as follows:

XXXXXXXX

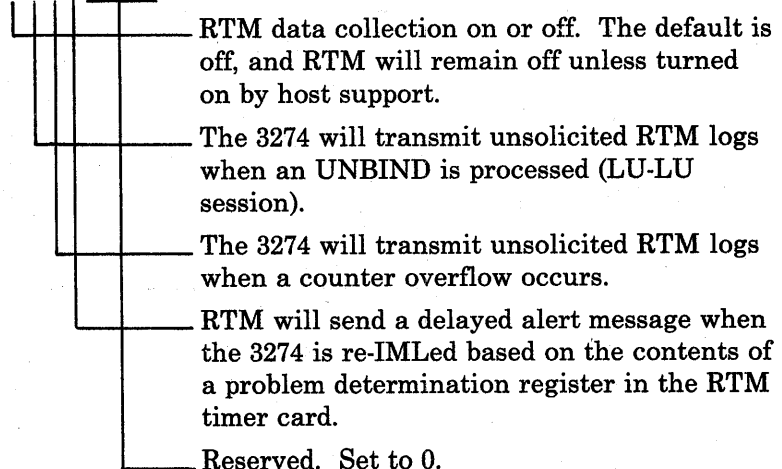

B1 - B4 are the fields used to specify the maximum time (the boundary) associated with each RTM counter. (See Boundary Values following.) Specification is in minutes, seconds, and tenths of seconds; for example 11 : 35 . 3, is 11 minutes, 35 and 3 tenths seconds.

The rules for specifying boundaries are:

- From one to four boundaries may be specified.
- The maximum allowable boundary is 27 : 18 . 3
- The seconds field may not exceed 59 seconds.
- A zero entry (00 : 00 . 0) for field B1 is not allowed.
- Entries (B1 to B4) must ascend in value; any entries after the maximum value *must* be zero.
- A zero entry may not be embedded between two nonzero entries.

904 is the acceptance field. Change the zero to a one when you have completed your RTM specification.

Boundary Values (Sequence Number 128)

When the RTM feature support is customized in the 3274, a series of five counters (Figure K-1) is allocated for each configured device or logical terminal representing intervals of time into which the various response times are mapped. During the customizing process, up to four counters may be set up by specifying the maximum times, or boundaries, associated with each. If a response time is less than or equal to a particular boundary, the counter associated with that boundary is incremented at the end of the transaction. If not, the next boundary value is checked. If the response time does not fit within any of the boundaries, then it is mapped into the fifth, or overflow, counter. Should any one of the four boundaries be specified as the maximum, the counter associated with that boundary becomes the overflow counter and subsequent counters are ignored. By specifying boundary values properly, a customer is able to obtain a distribution of his network responses for each logical terminal.

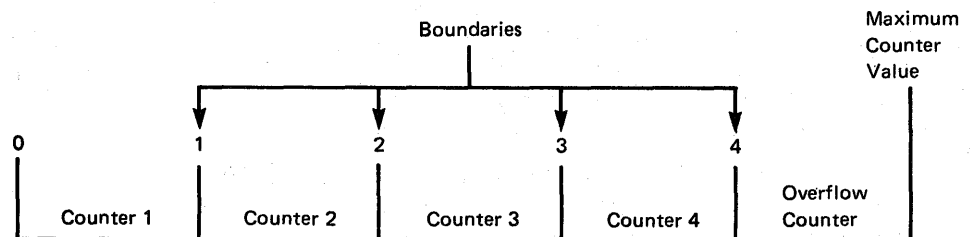

Figure K-1. Counters and Boundaries

Boundaries must be specified in order of increasing magnitude. The maximum boundary value is 27 minutes, 18.3 seconds. The maximum counter value is 65,535. The counter will not wraparound when this value is reached. If any of the boundaries is set to the maximum boundary value,

the counter associated with it becomes the overflow counter. Customizing default boundaries are 1, 2, 5, and 10 seconds.

The total response time is also kept for each logical terminal. Each time a counter (including the overflow counter) is incremented, the corresponding transaction time is added to a total-time register for that device. By dividing this total time by the total number of transactions, the average response time may be calculated. This average response time is available only through the host application; it cannot be displayed on a device attached to the 3274.

Boundary Value Examples (Sequence Number 128)

The following examples illustrate a correct boundary specification and some of the incorrect specifications for which the operator error code is displayed at the top center of the sequence number 128 panel.

1. A correct specification.

```
B1 - 00 : 02 . 1
B2 - 00 : 03 . 2
B3 - 00 : 05 . 5
B4 - 00 : 07 . 7
```

The first counter will be incremented for each response time of 2.1 seconds or less.

The second counter will be incremented for each response time exceeding 2.1 seconds but less than or equal to 3.2 seconds.

The third counter will be incremented for each response time exceeding 3.2 seconds but less than or equal to 5.5 seconds.

The fourth counter will be incremented for each response time exceeding 5.5 seconds but less than or equal to 7.7 seconds.

The fifth counter (the overflow counter, no boundary specified) will be incremented for each response time exceeding 7.7 seconds.

2. Boundary values not in ascending order.

```
B1 - 00 : 02 . 0
B2 - 00 : 05 . 7
B3 - 00 : 04 . 5
B4 - 00 : 06 . 8
```

Operator error code 64 is displayed.

3. A zero entry for field B1 is not allowed.

```
B1 - 00 : 00 . 0
B2 - 00 : 00 . 1
B3 - 00 : 00 . 2
B4 - 00 : 00 . 3
```

Operator error code 63 is displayed.

Sequence Number 128 Procedures

The customization planner will have entered a checkmark by the procedure to be followed.

- Default values. Change the 0 after 904 to a 1 and press ENTER.
- Procedure A. No host communication. Enter the values shown below in the B fields.

128

B1 - _ _ : _ _ . _
B2 - _ _ : _ _ . _
B3 - _ _ : _ _ . _
B4 - _ _ : _ _ . _

After entering the values shown, change the 0 after 904 to a 1 and press ENTER. If the entries are acceptable, the screen clears. If the entries are not acceptable, the incorrect entries are highlighted and an operator code is displayed at top center of the panel. See Figure 4-4.

- Procedure B. Host Communication. Enter the values shown below in the F1 and B fields.

128

F1 - _ _ _ _ _ _ _ _
B1 - _ _ : _ _ . _
B2 - _ _ : _ _ . _
B3 - _ _ : _ _ . _
B4 - _ _ : _ _ . _

After entering the values shown, change the 0 after 904 to a 1 and press ENTER. If the entries are acceptable, the screen clears. If the entries are not acceptable, the incorrect entries are highlighted and an operator code is displayed at top center of the panel. See Figure 4-4.



Appendix L. Alert Function Customizing Information (Sequence Number 220)

Alert is an SNA-only function and requires Configuration Support Level C on 3274 Models 1A, 31A, 1C, 31C, and 51C.

The SSCP-PU session is used to send alert data to the host. The alert information flows through the Network Communication Control Facility (NCCF) to the Network Problem Determination Application (NPDA) program. NPDA maintains a data base of alert information based on filters currently in effect for devices throughout the network and allows users to perform problem determination and failure isolation.

The 3274 will attempt to send alert data for all errors that have not affected the integrity of the host adapter, the 3274 processor, control storage, or the control program itself. The 3274 sends alert data based on the NNN error codes generated by the 3274 control unit and attached devices, and the NPDA determines which alert data has significance.

NPDA Version 3, Release 1, is required at the host for use of the alert function.

Operator-Generated Alert Message

Among the possible responses to customizing question 220 are those indicating that operator-generated alert message capability is wanted. An operator-generated alert message is a skeleton message, called up by an operator and filled in with installation-specified information. To properly process an operator-generated alert message, the Network Problem Determination Application at the host must have been set up to receive the message. See the *3274 Description and Programmer's Guide* for the details of sending an operator-generated alert message.

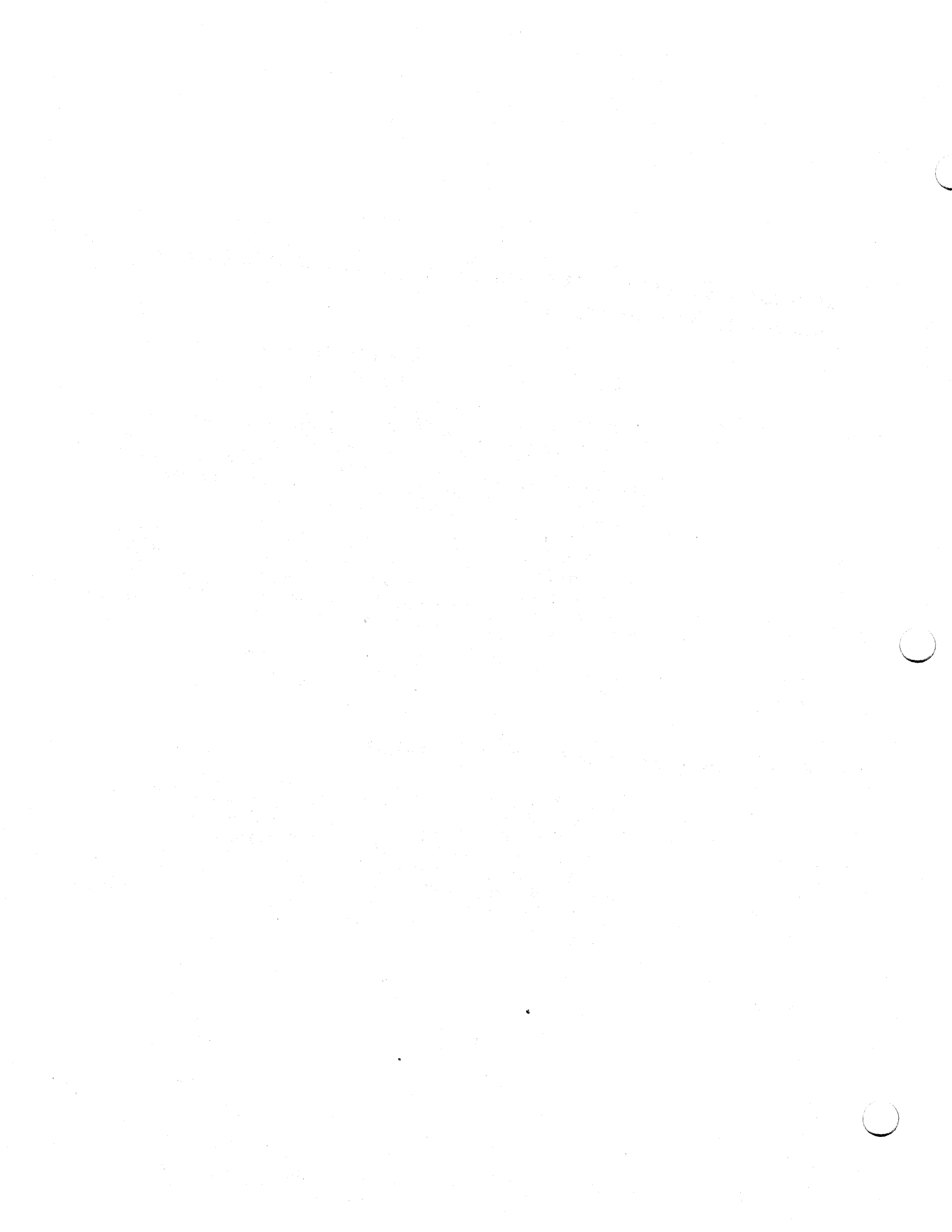

Appendix M. Keyboard Layouts for Sequence Numbers 131 through 135 and 166

Sequence numbers 131 through 135 and 166 refer to keyboard types that are available on the 3278s and 3279s. Figures M-1 through M-8 show the U.S. English keyboard layouts for the 3278s and 3279s. For a complete description of all 3270 keyboard layouts, refer to the *IBM 3270 Information Display System: Character Set Reference*, GA27-2837.

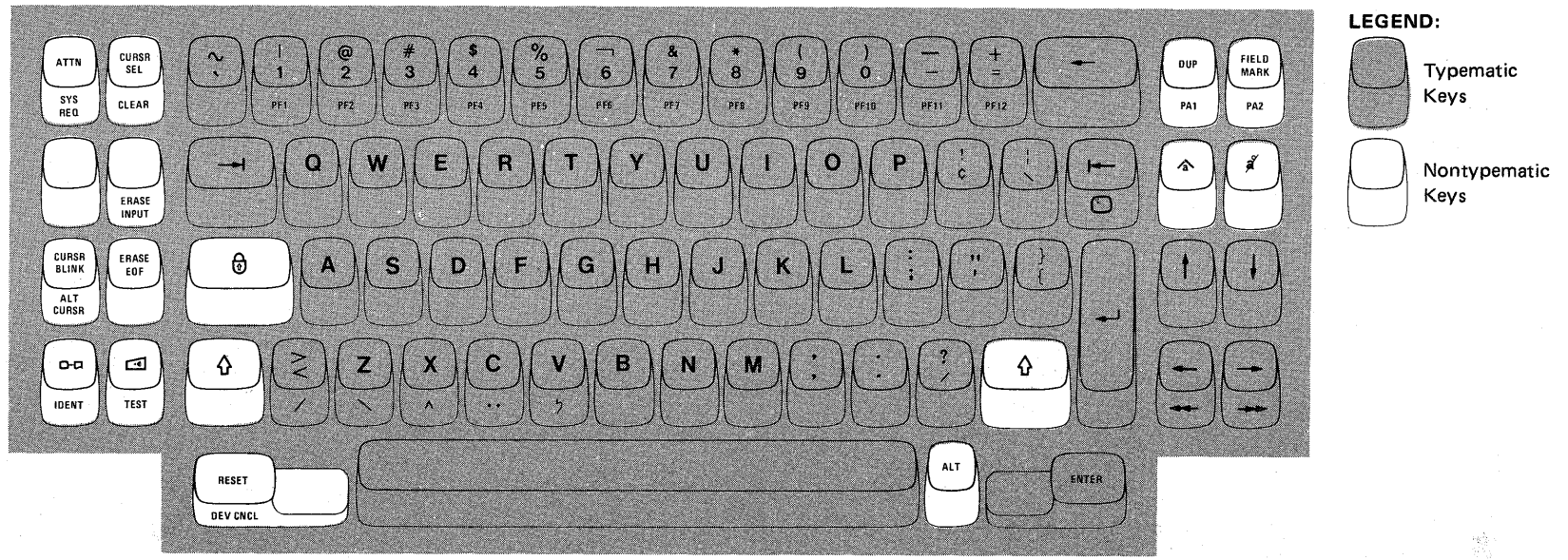

Figure M-1. Example of Typewriter Keyboard

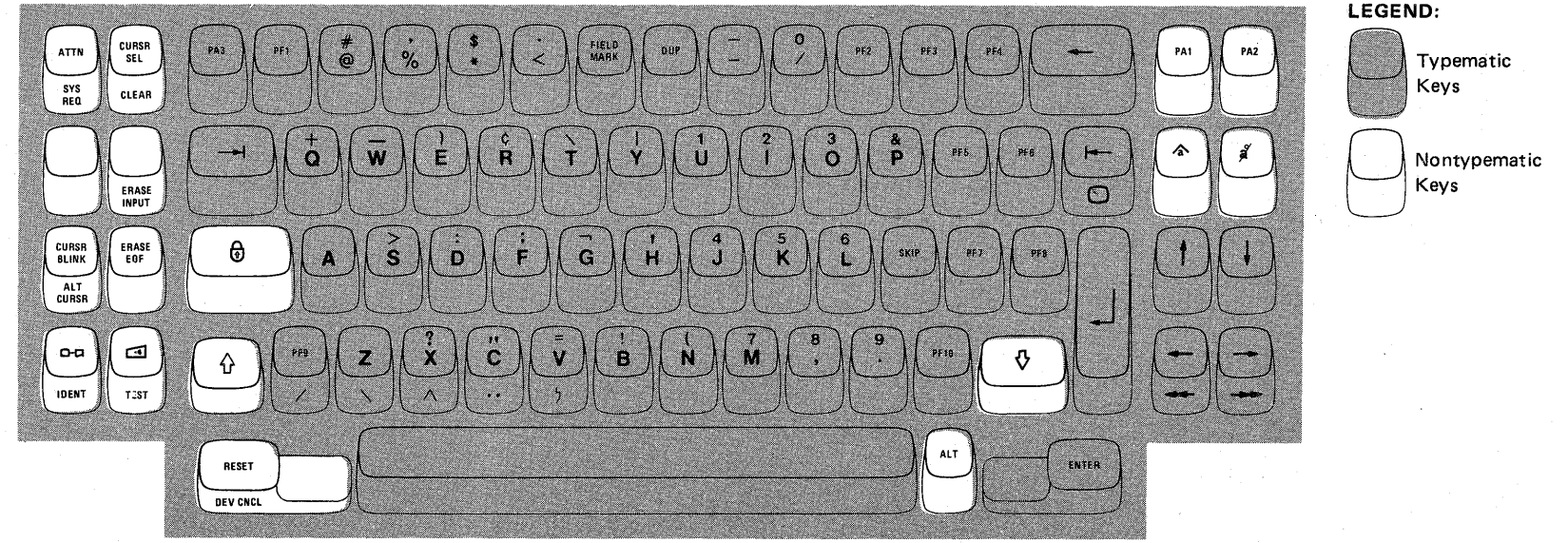

Figure M-2. Example of Data Entry Keyboard

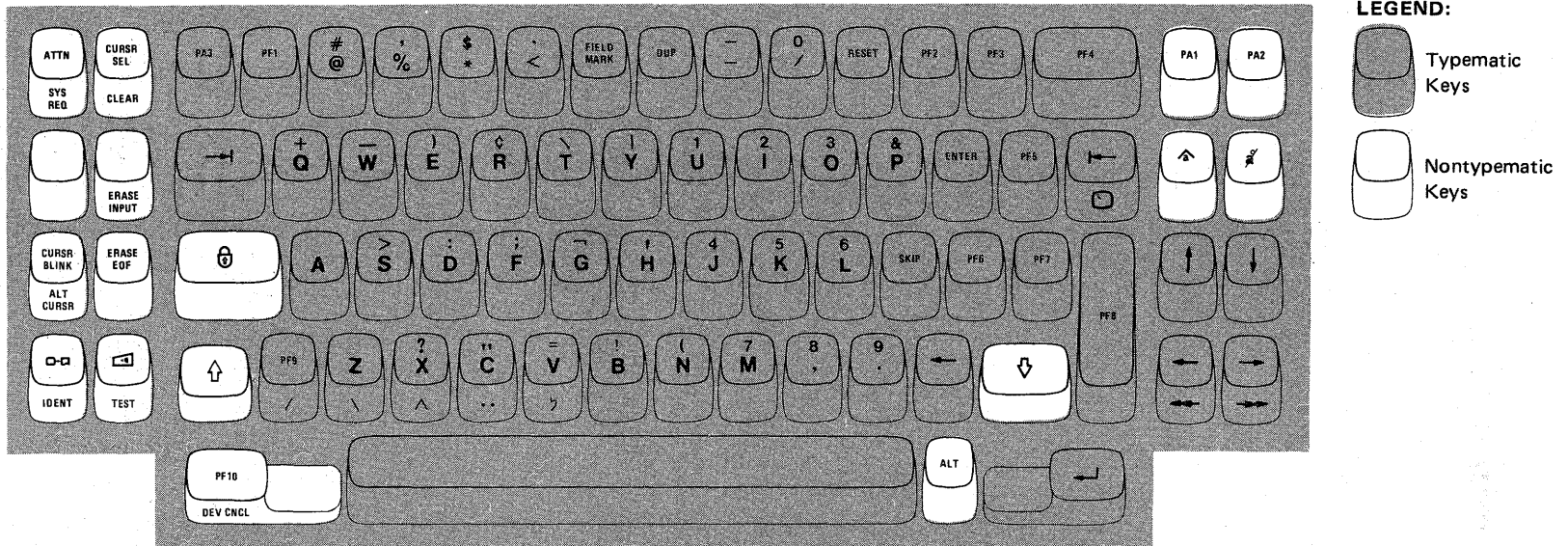

Figure M-3. Example of Data Entry Keypunch Keyboard

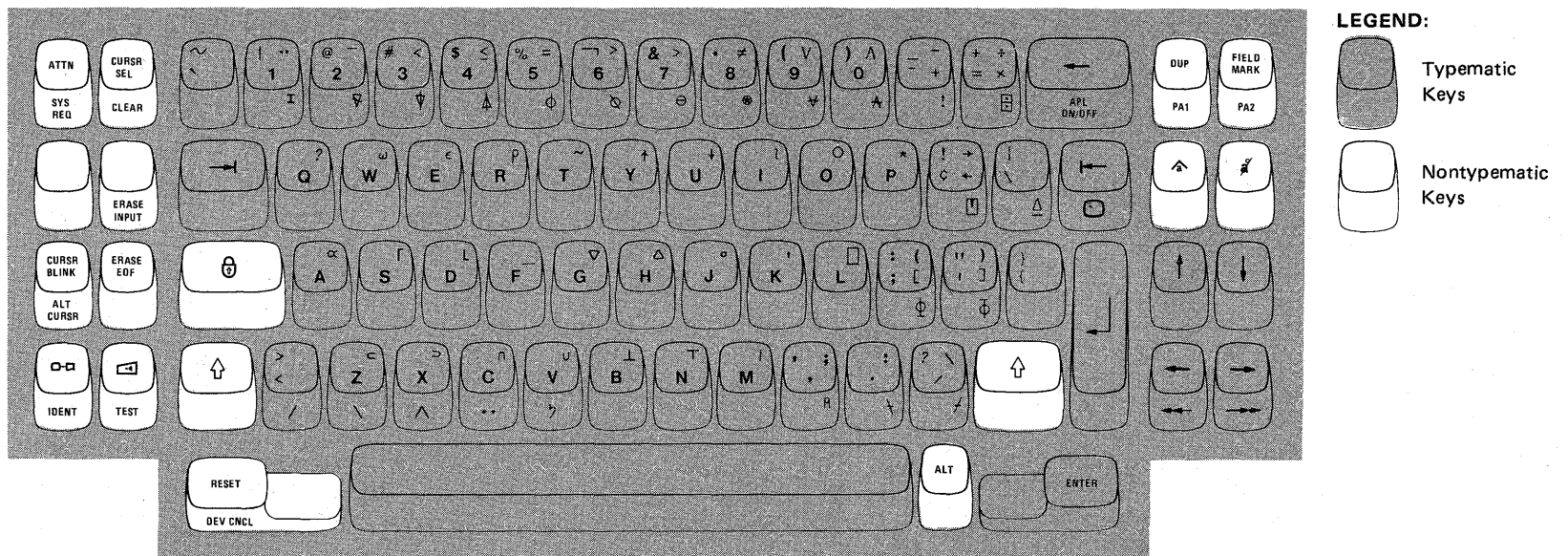

Figure M-4. Example of APL Keyboard

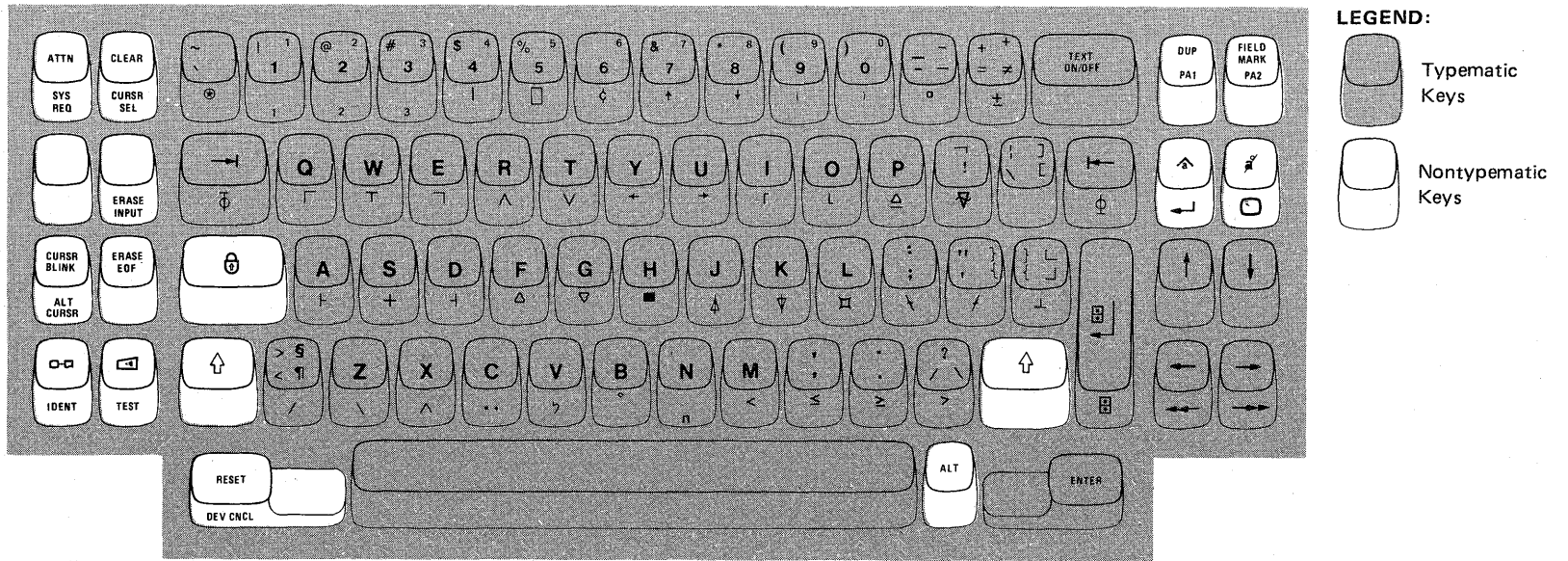

Figure M-5. Example of Text Keyboard

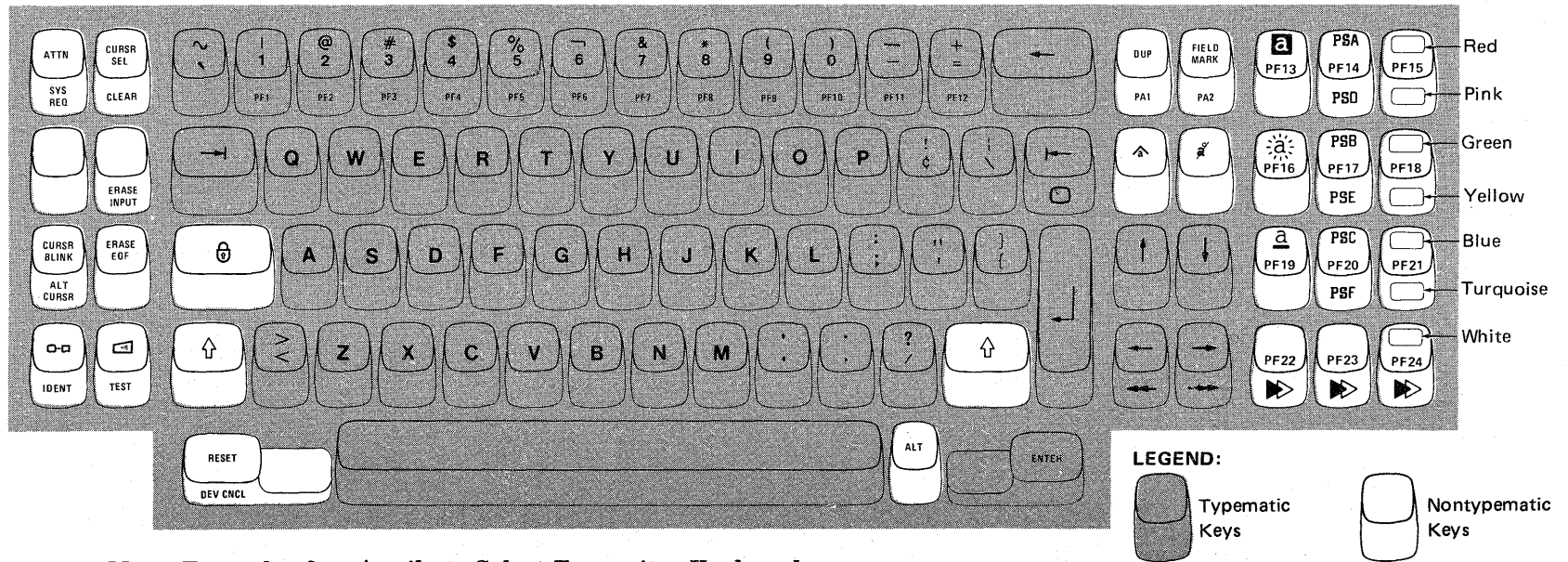
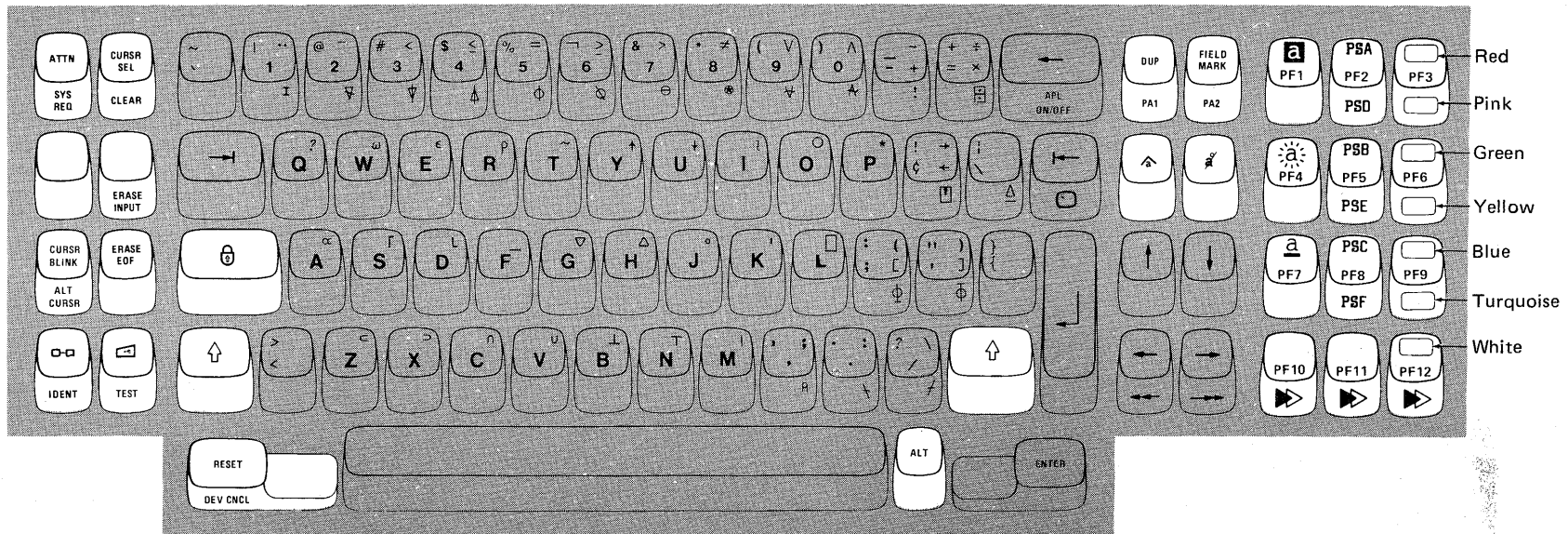
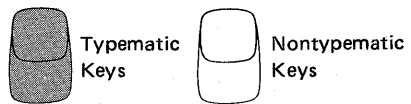

Figure M-6. Example of an Attribute Select Typewriter Keyboard



LEGEND:



Note: On 87-key and 88-key APL keyboards, program function keys are assigned PF1 through PF12 rather than PF13 through 24.

Figure M-7. Example of an Attribute Select Typewriter/APL Keyboard

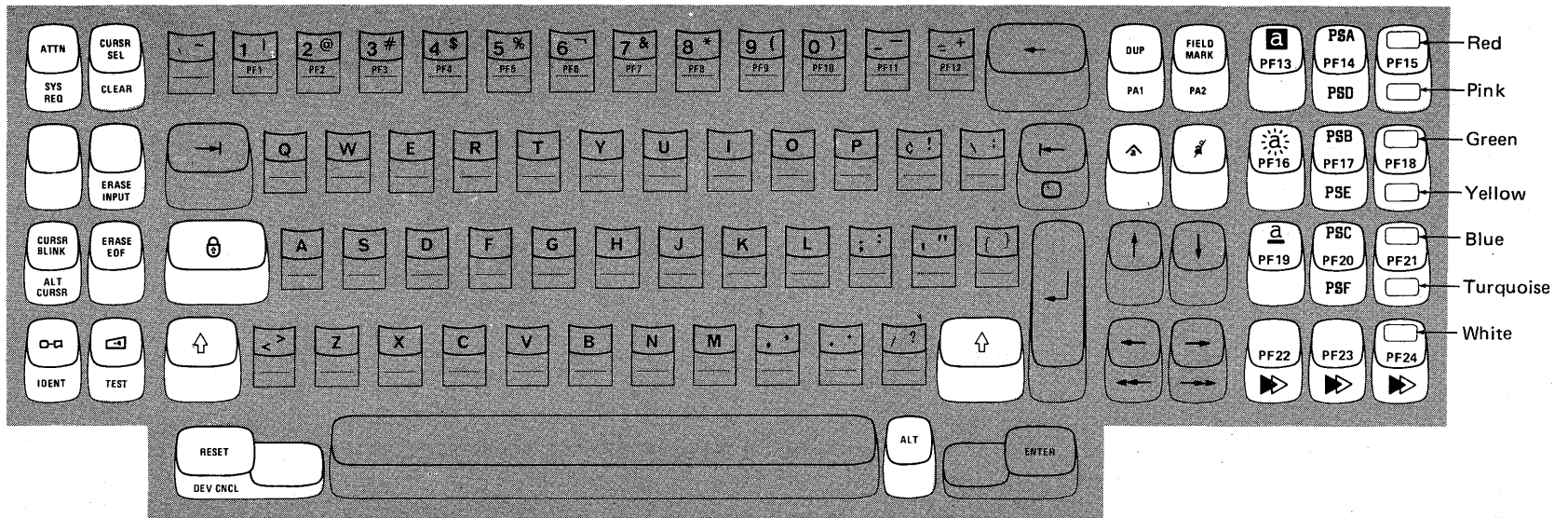

LEGEND:

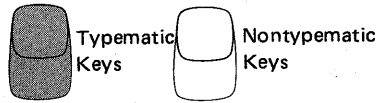
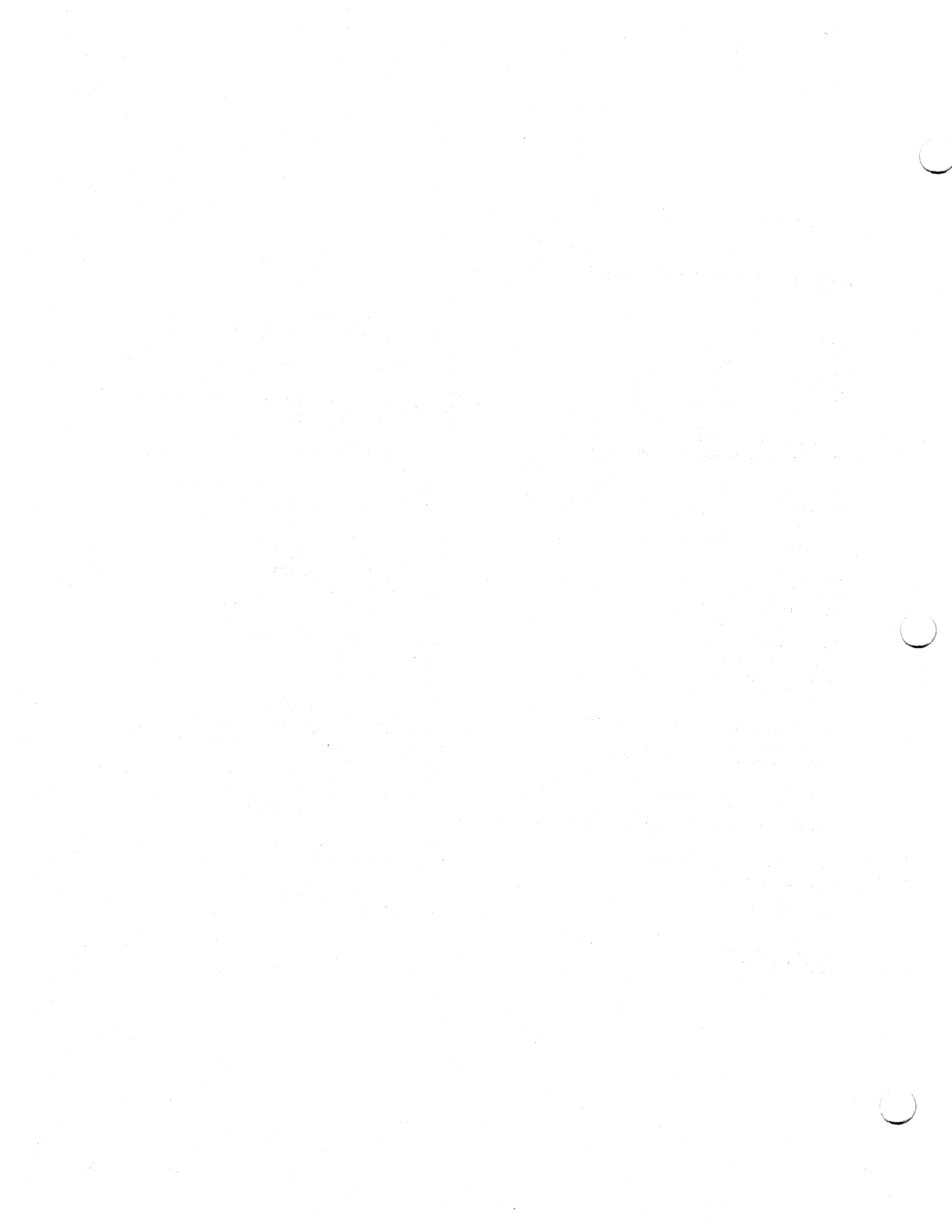

Figure M-8. Example of a Typewriter Overlay Keyboard

List of Abbreviations

- A/FE.** Americas/Far East.
Alt. Alternate.
APL. A programming language.
ASCII. American National Standard Code for Information Interchange.
- BPS.** Bits per second.
BSC. Binary synchronous communication.
- CCA.** Common communication adapter.
CCITT. Consultative Committee on International Telephone and Telegraph.
CDSTL. Connect data set to line.
- dB.** Decibel.
DCC. Disconnect command chaining.
DCE. Data-Circuit-Terminating Equipment.
DDS. Digital Data Service.
DFT. Distributed function terminal.
DSR. Data set ready.
DTE. Data terminal equipment.
DTR. Data terminal ready.
- EBCDIC.** Extended binary-coded decimal interchange code.
EIA. Electronic Industries Association.
- FCC.** Federal Communications Commission.
- HPCA.** High-Performance Communications Adapter.
- IML.** Initial microcode load.
I/O. Input/output.
- kb.** Kilobyte.
- LPDA.** Link problem determination aid.
LU. Logical unit.
- MDT.** Modified data tag.
MIS. Multiple Interactive Screen.
- NCCF.** Network Communication Control Facility.
NCP. Network Control Program.
NPDA. Network Problem Determination Application.
NRZ. Nonreturn to zero.
NRZI. Nonreturn to zero inverted.
NTT. Nippon Telegraph and Telephone.
- OEM.** Original equipment manufacturer.
OLTEP. Online test executive program.
- PF.** Program function.
PLU. Primary logical unit.
PS. Programmed Symbols.
PU. Physical unit.
PUID. Physical unit identification.
- RPQ.** Request for price quotation.
RTM. Response Time Monitor
RTS. Request to send.
- SCS.** SNA character string.
SDLC. Synchronous data link control.
SFAP. Structured Field and Attribute Processing.
SNA. Systems network architecture.
SNBU. Switched network backup.
SSCP. System services control point.
SYSGEN. System generation.
- UCW.** Unit control word.
U.S. United States.
- WCC.** Write control character.
WT. World Trade.



Index

A

abbreviations, list of X-1
alert
 customizing L-1
 SNA only (220) 3-56
APL keyboard (134) 3-10, 3-28, 3-47, M-3
attribute select keyboard (166) 3-14, 3-32, 3-51, M-4

B

backup diskette generation
 definition 2-1, 6-1
 load diskette 6-2
 system diskette 6-1
between bracket printer sharing (213) 3-17, 3-55
boundary values K-5
BSC
 enhanced communications (176) 3-54
 printer polling (305) 3-57
 protocol (331) 3-60

C

cables
 attachment forms 1-12
 communications 1-10, F-1
 device 1-11, B-1
 local channel 1-10
category A terminals 1-1, 3-5, 3-23, 3-41
category B terminals 1-2, 3-4, 3-22, 3-40
CCA adapter (351) 3-62
channel
 attachment form B-9
 block multiplexer 1-4
 byte multiplexer 1-5
 selector 1-4
checklist A-1
clocking (313) 3-58
cluster 1-6
codes
 operator codes 4-13, 5-12, 6-13
 8 4 2 1 indicators 4-15, 5-17, 6-15, 7-4
color convergence 2-2, 3-12, 3-30, 3-49, E-1
communications cables 1-10, F-1
communications interface (343) 3-61
compressed data (see decompression)
configuration data card 2-2, 2-3, 4-21

configuration support

A 1-7
B 1-7
C 1-8
T 1-8

control storage requirements I-1
control unit address (201) 3-17
control unit number (301) 3-56

D

data entry keyboard (132) 3-10, 3-26, 3-44
data entry keypunch layout keyboard (133) 3-10, 3-26, 3-45
decompression (165) 3-13, 3-48
device cables B-1
disconnect command chaining (DCC) 1-5
diskette insertion procedure 4-11, 4-12
diskettes
 backup 2-1, 6-1
 backup load 6-2, 6-7
 backup system 6-1, 6-6
 load 2-1
 part numbers 2-3
 system 2-1, 4-3, 4-7
distributed function terminals
 (170) 3-14, 3-30, 3-49
 definition 1-2
duplex 1-4

E

encrypt/decrypt (352) 3-18, 3-33, 3-60
entry acceptance (900) 3-18, 3-34, 3-61
extended character set (163) 3-13, 3-47
extended function store (113) 3-7, 3-23, 3-41

F

fan-out feature 1-10
forms
 backup load diskette generation 6-7
 backup system diskette generation 6-3
 initial customizing procedure 4-3
 modification procedure 5-1
 printer authorization matrix C-6 to C-9
 RTM boundaries and interface K-1
 3274 device cable attachment form B-6, B-7

G

grounding 3274 1-10

H

half-speed transmission (318) 3-18, 3-33, 3-57
 high-speed data rate (347) 3-18, 3-33, 3-59
 host-directed printing C-2
 HPCA adapter (351) 3-18, 3-33, 3-60

I

IBM Americas/Far East 1-21
 IBM Europe/Middle East/Africa 1-21
 IBM 3270 Personal Computer 1-1, 1-9,
 (170) 3-14, 3-30, 3-49
 IBM 3270 Personal Computer Attachment (114) 3-7,
 3-23, 3-42
 IBM 3290 Information Panel 1-2, 1-8, 1-9
 IML pushbutton 1-18
 indicator codes (see codes)
 Initial Customizing Procedure Form 2-6, 4-3
 installing 3274 subsystem 1-12

K

key positions, valid 4-9, 5-2, 6-9
 keyboard language (121) 3-8, 3-24, 3-42
 keyboard validation (001) 3-3, 3-19, 3-37
 keyboards
 A models 3-10
 B and D models 3-25, 3-26
 C models 3-44, 3-45
 keypad selection (139) 3-11, 3-26

L

language, keyboards 3-8, 3-24, 3-42
 load diskette
 backup generation 6-1
 definition 2-1
 local channel attachment 1-4
 local-copy function (147) 3-12, 3-27, 3-46
 loop data speed switches H-5
 setting H-5

M

magnetic character set (141) 3-11, 3-27, 3-46
 modem address switches
 Model 31C G-1
 Model 51C H-1
 modem connection (310) 3-18, 3-33, 3-55
 modem wrap (311) 3-18, 3-33, 3-56
 modes, printer C-1
 Modification Procedure Form 5-3
 multiple interactive screen
 (171) 3-15, 3-31, 3-50
 feature J-1
 multipoint network (314) 3-18, 3-33, 3-57

N

network
 multipoint 3-18, 3-33, 3-57
 point-to-point 3-18, 3-33, 3-57
 network address labels 1-12
 Network Problem Determination Application
 (NPDA) 1-7
 nonreturn to zero (NRZ) 1-4
 nonreturn to zero inverted (NRZI) 1-4
 number of RPQ diskettes required (031) 3-4,
 3-20, 3-38

O

operator codes (see codes)

P

patch request (011) 3-3, 3-19, 3-37
 Personal Computer, IBM 3270 1-1
 compatibility with host 1-9
 personnel training 1-22
 physical unit identification (215) 3-17,
 3-33, 3-53
 planning 1-3, 1-10
 planning checklist A-1
 point-to-point network (314) 3-18, 3-33, 3-57
 preparation, site 1-3
 printer authorization matrix (021) 3-3, 3-19, 3-37
 acceptance C-3
 definition (022) 3-4, 3-20, 3-37
 description C-1
 matrix structure C-3
 printer class structure C-2

- printer modes C-1
 - source device lists C-1, C-3
 - form 2-6, C-6
 - initial customizing 4-4
 - modification 5-5
- printer modes
 - local C-2
 - shared C-2
 - system C-2
- printer port address C-3
- printing, host-directed C-2
- problem determination 1-20
- procedures
 - backup load diskette generation 6-2
 - backup system diskette generation 6-1
 - color convergence E-1
 - initial customizing 4-1
 - modification 5-1
 - problem determination 1-20
 - subsystem verification D-1
 - update-diskette installation 1-6, 7-1
- programmed symbols (164) 3-13, 3-29, 3-48
- programming support 1-6

R

- relocation/removal 1-20
- remotely attached models 1-10, 1-19
- replacing models 1-19
- request RPQ parameter list (032) 3-4, 3-20, 3-38
- request-to-send (RTS) control (342) 3-18, 3-33, 3-48
- response time 1-6
- Response Time Monitor (RTM)
 - boundary and interface specification (128) 3-9, 3-25, 3-44
 - boundary values K-5
 - customizing K-2
 - definition (127) 3-9, 3-25, 3-42
 - description K-2
 - form K-7
 - requirements K-1
- RPQ diskettes required (031) 3-4, 3-20, 3-38
- RTM (see Response Time Monitor)

S

- safety 1-21
- SCS support (211) 3-17
- SDLC control unit address (317) 3-57
- SDLC/SNA mode 1-6, 1-8
- security 1-9, 1-21
- sequence numbers 2-3 to 2-5, 3-1
- SFAP 1-8
- site preparation 1-3

- SNA local channel control unit address (201) 3-17, 3-33, 3-53
- source device lists C-4
- specification panel (999) 3-18, 3-34, 3-61
- structured field (162) 3-12, 3-28, 3-47
- subsystem verification
 - introduction to 1-18, 2-2
 - procedure D-1
- switch settings
 - loop data speed H-5
 - modem address G-1, H-1
 - planning H-1
 - transmit level H-3
- switched network backup (SNBU) (317) 3-18, 3-33, 3-53
- system diskette
 - backup generation 6-3
 - definition 2-1
- systems network architecture (SNA) 1-6

T

- tables
 - loop data speed switch settings H-5
 - modem address switch settings G-1, H-1
 - transmit level switches H-3
- terminal multiplexer, 3299 1-11
- text keyboard (135) 3-10, 3-26, 3-45
- transmit level switches H-3
- typewriter keyboard (131) 3-10, 3-25, 3-44

U

- unit control word (UCW) 1-5
- update-diskette installation procedure 1-7, 7-1
- updating configuration support 1-7

V

- valid key positions 4-9, 5-2, 6-9
- verification, subsystem D-1

X

- X.21 adapter 1-8
- X.21 switched options (362) 3-60
- X.21 switched retry (360) 3-60
- X.21 switched retry timing (361) 3-60

3

3178 Display Station 1-1, 2-1
3179 Color Display Station 1-1, 2-1
3180 Display Station 1-1, 2-1
3230 Printer 1-1
3262 Line Printer 1-1
3268 Printer 1-1
3270 Personal Computer 1-1, 1-9
3270 Personal Computer Attachment (114) 3-7,
3-23, 3-42
3271 replacing 1-19
3272 replacing 1-19
3274 communication cables F-1 - F-23
3274 control storage requirements I-1
3274 Control Unit F-1
3274 device cable attachment form 1-12, B-6, B-7
3274 device cable attachment procedure B-3
3274 device cables B-1
3274 model designation (151) 3-12, 3-28, 3-47
3274 Models 1A, 21A, 31A 3-3
3274 Models 1B, 1D, 2B, 21D, and 31D 3-19
3274 Models 1C, 21C, 31C, and 51C 3-35
3277 Display Station 1-2
3278 Display Station 1-1, 2-1
3279 Color Display Station 1-2, 1-8, 2-1
3284 Printer 1-2
3286 Printer 1-2
3287 Printer 1-2
3288 Line Printer 1-2
3289 Line Printer 1-2
3289 print control (145) 3-11, 3-27, 3-46
3290 Information Panel 1-2, 1-9
3290 keypad selection (139) 3-11, 3-26, 3-45
3290 options (173) 3-15, 3-31, 3-50
3290 password (175) 3-17, 3-33, 3-52
3299 Terminal Multiplexer 1-11

4

4250 Printer 1-2, 1-8

5

5210 Printer 1-2

6

6580 Displaywriter 1-2

8

8 4 2 1 indicator codes (see codes)

IBM 3270 Information Display System
3274 Control Unit Planning,
Setup, and Customizing Guide

READER'S
COMMENT
FORM

Order No. GA27-2827-13

This manual is part of a library that serves as a reference source for systems analysts, programmers, and operators of IBM systems. You may use this form to communicate your comments about this publication, its organization, or subject matter, with the understanding that IBM may use or distribute whatever information you supply in any way it believes appropriate without incurring any obligation to you. Your comments will be sent to the author's department for whatever review and action, if any, are deemed appropriate.

Note: Copies of IBM publications are not stocked at the location to which this form is addressed. Please direct any requests for copies of publications, or for assistance in using your IBM system, to your IBM representative or to the IBM branch office serving your locality.

How did you use this publication?

- As an Introduction As a text (student)
 As a reference manual As a text (instructor)
 For another purpose (explain) _____

Is there anything you especially like or dislike about the organization, presentation, or writing in this manual? Helpful comments include general usefulness of the book; possible additions, deletions, and clarifications; specific errors and omissions.

Page Number:

Comment:

NOTE: STAPLES CAN CAUSE PROBLEMS WITH AUTOMATIC MAIL SORTING EQUIPMENT.
PLEASE USE PRESSURE SENSITIVE OR OTHER GUMMED TAPE TO SEAL THIS FORM.

What is your occupation? _____

Newsletter number of latest Technical Newsletter (if any) concerning this publication: _____

If you wish a reply, give your name and address: _____

IBM branch office serving you _____

Thank you for your cooperation. No postage stamp necessary if mailed in the U.S.A. (Elsewhere, an IBM office or representative will be happy to forward your comments or you may mail directly to the address in the Edition Notice on the back of the title page.)

Reader's Comment Form

Fold and Tape

Please Do Not Staple

Fold and Tape



NO POSTAGE
NECESSARY
IF MAILED
IN THE
UNITED STATES

BUSINESS REPLY MAIL
FIRST CLASS PERMIT NO. 40 ARMONK, N.Y.

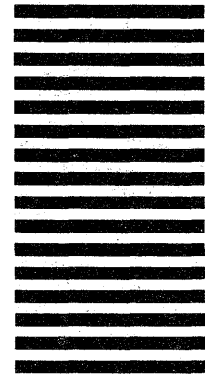

POSTAGE WILL BE PAID BY ADDRESSEE:

International Business Machines Corporation
Department 52Q
Neighborhood Road
Kingston, New York 12401

Fold and Tape

Please Do Not Staple

Fold and Tape





PRINTED IN U.S.A.

GA27-2827-13