

GA23-0061-0
File No. S360/S370/S3/4300/8100-09

(Revised by TNLS,
GN31-1318 -1135)

Systems

**IBM 3270
Information Display System**

**3274 Control Unit
Description and
Programmer's Guide**

The IBM logo, consisting of the letters 'IBM' in a bold, sans-serif font, where each letter is formed by a series of horizontal bars of varying lengths.

Warning: This equipment generates, uses, and can radiate radio frequency energy and if not installed and used in accordance with the instructions manual, may cause interference to radio communications. It has been tested and found to comply with the limits for a Class A computing device pursuant to Subpart J of Part 15 of FCC Rules, which are designed to provide reasonable protection against such interference when operated in a commercial environment. Operation of this equipment in a residential area is likely to cause

interference in which case the user at his own expense will be required to take whatever measures may be required to correct the interference.

This warning is also applicable to all attaching units produced for use in the USA that have been manufactured after December 31, 1980. A notice of compliance has been affixed within the customer access area of all affected units.

First Edition (November 1980)

Changes are periodically made to the information herein; before using this publication in connection with the operation of the IBM 3270 Information Display System, consult the latest *IBM System/360 Bibliography, GA22-6822*, or *IBM System/370 and 4300 Processors Bibliography, GC20-0001*, for the editions that are applicable and current.

It is possible that this material may contain reference to, or information about, IBM products (machines and programs), programming, or services that are not announced in your country. Such references or information must not be construed to mean that IBM intends to announce such IBM products, programming, or services in your country.

Publications are not stocked at the address given below; requests for IBM publications should be made to your IBM representative or to the IBM branch office serving your locality.

A form for readers' comments is provided at the back of this publication. If the form has been removed, address comments to IBM Corporation, Department 52Q, Neighborhood Road, Kingston, N.Y. 12401. IBM may use or distribute any of the information you supply in any way it believes appropriate without incurring any obligation whatever. You may, of course, continue to use the information you supply.

Preface

This publication provides system level reference material related to the functional and programming characteristics of the IBM 3274 Control Unit and attached terminals.

The following 3270 display system machines are referred to in this publication:

IBM 3274 Control Unit Models 1A, 1B, 1C, 1D, 21A, 21B, 21C, 21D, 31A, 31C, 31D, and 51C

IBM 3277 Display Station Models 1 and 2

IBM 3278 Display Station Models 1, 2, 3, 4, and 5

IBM 3279 Color Display Station Models 2A, 2B, 3A, and 3B

IBM 3230 Printer Model 2

IBM 3262 Printer Models 3 and 13

IBM 3268 Printer Model 2

IBM 3287 Printer Models 1, 1C, 2, and 2C

IBM 3289 Line Printer Models 1 and 2

IBM 3284 Printer Models 1 and 2

IBM 3286 Printer Models 1 and 2

IBM 3288 Line Printer Model 2

The full complement of IBM 3270 Information Display System machines is identified in the introductory publication *An Introduction to the IBM 3270 Information Display System*, Form No. GA27-2739.

Other publications containing 3274-related information such as site preparation or customizing are identified at the end of this preface. Publications dealing directly with the referenced terminals that attach to the 3274, and other aspects of the 3270 Information Display System, are identified in the Library User's Guide (see end of Preface).

Organization of This Publication

The first two chapters deal with the 3274 models, host attachments, the 3274 interpretation and execution of the commands and orders contained in the 3270 data stream, and the characteristics of the previously referenced 3270 system terminals when attached to the 3274 Control Unit.

The next three chapters address the functioning of the 3274 and attached devices when locally attached to the host system (A, B, and D units), when remotely attached to the host system using BSC (bisynchronous communication protocol) for communication (C units and 51C), or remotely attached (C units and 51C) to the host system using SNA/SDLC protocols for communication.

The final chapters provide programming examples of the 3270 data stream including use of programmed symbols, color capabilities, and highlighting of fields on the display screen. Suggestions for handling terminal operator input and development routines for encoding and decoding messages from the displays are also discussed.

Appendixes are provided that deal with the following topics:

- 3274 Error Status Indicator Code Interpretation
- Operator Area Information Symbols (3278, 3279)
- Keys and Keyboards
- APL/Text Feature
- Katakana Feature
- Encrypt/Decrypt Feature
- RECFMS Formats
- Selector Light Pen and Magnetic Stripe Reading Device
- Buffer Address I/O Interface Codes
- X.21 Switched Network Adapter Feature
- Symbol Definition Bit String Compression

- Indicators and Controls (3277, 3284, 3286, 3288)
- Compression of Symbol Definition Bit Strings
- Glossary

Related Publications

The following publications supplement the information contained in this publication:

IBM 3270 Information Display System

3274 Control Unit Planning, Setup, and Customizing Guide, GA27-2827

3274 Control Unit Operator's Guide, GA23-0023

The *3270 Information Display System Reference Summary, GX20-1878*, contains summary listings of the status and sense codes, error codes, and other reference data discussed in this publication.

Publications describing the printers and displays attaching to the 3274, the 3270 data stream, the use of color, highlighting, and programmed symbols, operating and problem determination procedures, and programming information, are listed in *IBM 3270 Information Display System, Library User's Guide, GA23-0058*.

Information concerning the Multiuse Communications Loop, used to attach 3270 devices to 8100 Information Systems, is contained in:

IBM 8100 Information System: Communications, Loop, and Display/Printer Attachment Description, GA27-2883

IBM Multiuse Communications Loop Planning Guide, GA23-0038

IBM Multiuse Communications Loop Installation Guide, GA23-0039

The two Multiuse Communication Loop publications cited above and the following IBM 4300 Processor publications provide information concerning attachment of the 3274-51C to the 4331 Processor via the 4331 Loop Adapter:

IBM 4300 Processors Summary and Input/Output and Data Communications Configurator, GA33-1523

IBM 4331 Processor Functional Characteristics and Processor Complex Configurator, GA33-1526

3270 equipment attached to the 4331 Processor via the loop adapter appears to the 4331 as though it were locally channel-attached.

Contents

Chapter 1. Control Units and Data Stream 1-1

Display System Components	1-1
Data Flow	1-3
Interface Codes	1-4
SNA Interface Codes	1-4
BSC Interface Codes	1-4.1
Device Addressing	1-11
Data Stream	1-12
3270 Data Stream Function	1-12
Commands/Structured Fields	1-12
Orders	1-14
Attributes	1-15
Write Commands	1-15
12/14-Bit Addressing	1-15
Write Command	1-16
Erase/Write Command	1-19
Erase/Write Alternate Command	1-19
Write, Erase/Write, and Erase/Write Alternate Commands (LU Type 3)	1-23
Write Structured Field (WSF) Command, Function Management Header 1 (FMH1), and Structured Field Functions	1-25
WSF Command	1-25
Function Management Header 1 (FMH1)	1-26
Structured Field Functions	1-26
SCS Data Structured Field (SCS Data)	1-31
Read Partition (Query) Structured Field	1-32
Orders and Attributes	1-33
Orders	1-33
Start Field (SF) Order	1-33
Set Buffer Address (SBA) Order	1-33
Insert Cursor (IC) Order	1-35
Program Tab (PT) Order	1-35
Repeat to Address (RA) Order	1-36
Erase Unprotected to Address (EUA) Order	1-37
Structured Field and Attribute Processing Orders	1-37
Read Commands	1-40
Read Buffer Command	1-41
Read Modified Command	1-43
Read Modified Operation	1-43
Short Read	1-45
Test Request Read	1-45
Read Modified All Command	1-46
Query Reply Structured Field	1-46
Query Reply (Color) Structured Field	1-47
Query Reply (Extended Highlighting) Structured Field	1-48
Query Reply (Usable Area) Structured Field	1-48
Query Reply (Reply Mode) Structured Field	1-50
Query Reply (Symbol Sets) Structured Field	1-50
Inbound Transmissions	1-52
Inbound Operation Device Characteristic (INOP)	1-52.1
Read States	1-53
Host Acknowledgments	1-55
Processing of Read Commands	1-55
Processing of Read Partition-Query Structured Fields	1-58
Control Commands	1-59
Copy Command	1-59
Structured Field and Attribute Processing Considerations for Copy	1-63
Select Command (3274 B Units)	1-63

Select Read Modified (RM) Command (3274 D Units)	1-64
Select Read Buffer (RB) Command (3274 D Units)	1-64
Select Read Modified from Position (RMP) Command (3274 D Units)	1-64
Select Read Buffer from Position (RBP) Command (3274 D Units)	1-65
Select WRT Command (3274 D Units)	1-65
Erase All Unprotected Command	1-65
No Operation Command (3274 B and D Units)	1-66
Sense Command (3274 B and D Units)	1-66
Sense ID Command (3274 B and D Units)	1-66
Miscellaneous Operations	1-67
Test Request Function	1-67
Use of BSC Line Discipline	1-67
Text Transmission	1-67
Screen Update Protected Message Responses	1-68
Error Handling	1-68
Character Sets	1-69
Use of SNA Protocol	1-69
Non-SNA Local Control Unit Differences	1-70
Operation Checks	1-70
Buffer Updates	1-70
Security Keylock	1-70

Chapter 2. Terminals 2-1

Display Stations	2-1
Display Images	2-1
Display Fields	2-5
Attributes	2-6
Field Attributes	2-6
Field Attribute Character	2-7
Base Color Mode	2-7
Extended Attributes	2-9
Extended Highlighting (Attribute Type X'41')	2-10
Extended Color (Attribute Type X'42')	2-10
Symbol Set (Attribute Type X'43')	2-11
Programmed Symbols	2-12
Single-Plane Symbol Sets	2-14
Triple-Plane Symbol Sets	2-14
Secondary Colors	2-15
Defining a Triple-Plane Symbol	2-15
Reverse Video and Triple-Plane Symbols	2-17
Unit and Model-Dependent Differences (Displays)	2-18
Keyboard Types	2-18
Keyboard Program Function Keys	2-18
Display Screen Size	2-18
Key Operation	2-18
Insert Mode	2-18
Typamatic Keys	2-18
Numeric Shift Key	2-19
Screen Update	2-19
Display of New Line (NL), End of Message (EM), and Forms Feed (FF) Orders	2-19
Display of Duplicate (DUP) and Field Mark (FM) Characters	2-19
Operator Indicators and Symbols	2-19
Uppercase and Lowercase Character Display	2-19
Security Keylock	2-20
Printers	2-20
Print Line Formatting	2-21

Printer Orders (3270 Data Stream Mode) 2-21	ENQ (Enquiry) 4-8
New Line (NL) and End of Message (EM) (All Printers) 2-23	WACK (Wait before Transmit) 4-8
Forms Feed (FF) (3230, 3262, 3268, 3287, 3288, and 3289) 2-23	RVI (Reverse Interrupt) 4-9
Suppress Index (SI) (3288) 2-23	STX (Start of Text) 4-9
Carriage Return (CR) (3230, 3262, 3268, 3287, and 3289 Printers) 2-24	SOH (Start of Heading) 4-9
Printer Operations (3270 Data Stream Mode) 2-24	ETB (End of Transmission Block) 4-9
Page Length Control/VFC Operations 2-25	ETX (End of Text) 4-9
SCS Operations 2-26	EOT (End of Transmission) 4-10
SCS Control Codes 2-27	ITB (End of Intermediate Transmission Block) 4-10
Program Attention (PA) and Cancel Print Switches 2-31	ESC (Escape) 4-10
Print Format Control 2-32	TTD (Temporary Text Delay) 4-10
Local Copy Function 2-32	Operational Sequences (Nonswitched Line) 4-10
3274 Printer Authorization Matrix 2-33	Remote Chaining of 3270 Commands 4-11
3274 Local Copy Operation 2-43	General and Specific Poll Sequences 4-11
Host-Initiated Local Copy Using SNA/SDLC 2-47	Selection Addressing Sequence 4-17
Local Copy Performed without SNA Protocol 2-49	Write-Type and Control-Type Command Sequences 4-17
Mono/Dual Case Control 2-50	Read-Type Command Sequences 4-21
Format Control during Shared Printer Operations 2-50	Status and Sense (S/S) Bytes 4-21
Error Conditions 2-52	Error Recovery Procedures 4-27
Unit and Model-Dependent Differences (Printers) 2-53	Supplementary Procedures 4-29
Buffer Size 2-53	EOT to a Text Block 4-30
Uppercase and Lowercase Printouts 2-53	Errors Detected During a Specific or General Poll Sequence 4-30
New Line (NL) and End of Message (EM) Orders 2-54	RVI to Selection Addressing Sequence 4-30
New Line (NL) at Maximum Print Position plus One Character 2-54	Chapter 5. SNA/SDLC Communication 5-1
Duplicate (DUP) and Field Mark (FM) Character 2-54	Transmission Formats 5-1
Split Vertical Bar () Character 2-54	Session Components 5-2
Chapter 3. Local Operations (3274 B and D Units) 3-1	SNA Sessions 5-2
Non-SNA Local Operations 3-1	SSCP-PU Session 5-3
Interface Operations 3-1	SSCP-Secondary LU Session 5-3
Selection 3-3	LU-LU Session 5-3
Command Initiation 3-3	Initiating an LU-LU Session 5-3
Chaining 3-5	Terminating an LU-LU Session 5-5
Status 3-5	Transmission Header 5-6
Initial Status 3-7	EFI=1 5-6
Ending Status 3-9	EFI=0 5-6
Asynchronous Status 3-9	SNA Commands 5-7
Error-Recovery Procedures 3-13	Commands Supported 5-7
3274 B and D Unit Device-Detected Errors 3-13	Command Description 5-8
Referenced Error-Recovery Procedures 3-13	Activate Physical Unit (ACTPU) 5-8
Channel-Detected Errors 3-14	Deactivate Physical Unit (DACTPU) 5-8
Chapter 4. Remote Operations—BSC 4-1	Activate Logical Unit (ACTLU) 5-8
Introduction 4-1	Deactivate Logical Unit (DACTLU) 5-9
Code Structures 4-1	Notify 5-9
Channel Program Concepts 4-1	Bind 5-10
Text Blocking 4-1	Unbind 5-13
Related Publications 4-2	Clear 5-14
Multipoint (Nonswitched Line) Data Link Control 4-2	Start Data Traffic (SDT) 5-14
3274 Modes of Operation 4-2	Cancel 5-14
Control Mode 4-3	Chase 5-15
Text Mode 4-3	Bid 5-15
Transparent-Monitor Mode 4-3	Signal 5-16
Transparent Mode 4-3	LU Status (LUSTAT) 5-16
Redundancy Checking 4-6	Ready to Receive (RTR) 5-16
Data-Link Control Characters 4-6	REQMS 5-16
Pad 4-7	RECFMS 5-17
SYN (Synchronous Idle) 4-7	Shutdown 5-17
DLE (Data Link Escape) 4-7	Shutdown Complete 5-17
ACK 0 (Even Acknowledge) 4-7	FM Data 5-17
ACK 1 (Odd Acknowledge) 4-8	Pacing 5-20
NAK (Negative Acknowledgment) 4-8	LU Type 1 5-21
	LU Types 2 and 3 5-21
	SNA Responses 5-22
	Summary of SNA Commands 5-22
	Sample SNA Command Sequences 5-22

Session Processing States	5-29	Write-Read Sequence	5-57
Data Traffic (Reset/Active) State	5-29	CCW-Error Recovery Procedures	5-58
Contention (CONT) State	5-29	Remote Operations-SDLC	5-60
Send (SEND) State	5-30	SDLC Transmission Frames	5-60
Receive (RCV) State	5-31	Response Modes	5-60
ERP1 State	5-31	Control Field	5-61
Bracket States	5-32	Supervisory Commands	5-61
Between Bracket (BETB) State	5-32	Nonsequenced Commands and Responses	5-62
Pending Begin Bracket (PEND.BB) State	5-32	Terminal Identification and Addressing	5-63
In Bracket (INB) State	5-33	Terminal ID	5-63
3274 Bracket State Errors	5-33	SDLC Station Address	5-63
RU Lengths	5-33	Information (I) Frame	5-63
Outbound to the 3274	5-33	Sequence Error Recovery Procedures	5-64
Inbound from the 3274	5-34	Abort Function	5-64
Segmenting Description	5-34	Timeout Controls	5-64
Segmenting Outbound	5-34	SNA Reference Data	5-65
Segmenting Inbound	5-35	Bind Default	5-65
3274 Errors	5-35	Bind Check	5-65
Data Link	5-35	SNA Sense Codes	5-67
LU-LU Session Error Reporting	5-36	Logical Unit Status (LUSTAT)	5-72
Sessions	5-36	Error Recovery Procedures	5-75
Setting the Screen Size	5-38	Chapter 6. Screen Design	6-1
Operation in SSCP-SLU Session	5-38	Introduction	6-1
SSCP-SLU Contention Operation	5-38	Field Concept	6-1
Nonerror Operation	5-39	What Attributes May Be Assigned to a Field	6-2
Error Operation	5-39	Protection	6-2
Outbound Message Handling	5-39	Color	6-3
Inbound Message Handling	5-40	Extended Highlighting	6-3
System Logon (3277 Attached to 3274)	5-40	Character Content	6-3
System Logon (3278 or 3279 Attached to 3274)	5-41	Visibility and Detectability	6-4
System Logoff (3277 Attached to 3274)	5-41	Transmission	6-5
System Logoff (3278 or 3279 Attached to 3274)	5-41	Attribute Processing	6-6
SNA Printer Control	5-42	Example of Field Definition	6-8
Local Operations (3274 A Units)	5-43	Planning the Panel	6-12
Interface Operations	5-44	Using the Panel Layout Sheet	6-12
Selection	5-44	An Example of Laying Out a Panel	6-13
Command Initiation	5-44	Adding Orders to the Panel Layout Sheets	6-15
Chaining	5-45	Coding the Panel	6-23
Commands	5-45	Using the Repeat to Address Order	6-35
Write Command	5-46	Using the Write Control Character (WCC)	6-35
Read Command	5-46	An Example of a Sequence of Panels	6-37
No Operation Command	5-46	Analyzing Input Data	6-42
Sense Command	5-47	The Operator's Response	6-42
Control Command	5-47	Attention Identifier (AID)	6-43
Write Break Command	5-48	Input Data	6-43
Write Start 0 Command	5-48	SBA Codes	6-43
Read Start 0 Command	5-49	Program Attention (PA) Keys	6-44
Write Start 1 Command	5-49	Program Function (PF) Keys	6-44
Read Start 1 Command	5-49	Selector Pen and Cursor Select Input and Output	6-45
Restart Reset Command	5-49	Selector Field Format	6-45
Sense ID Command	5-49	Designator Characters	6-46
Test I/O Command	5-49	The Relationship of One Data Stream to Another	6-47
Status and Sense Definitions	5-50	Modifying Existing Panels	6-48
Description	5-50	Using Erase Unprotected to Address (EUA)	6-51
Initial Status	5-50	Using Erase All Unprotected (EAU) Command	6-52
Ending Status	5-52	Repetitive Output	6-54
Asynchronous Status	5-52	Using the Program Tab (PT)	6-54
Error Recovery Procedures	5-54	Defining a Character	6-57
3274-A-Unit-Detected Errors	5-54	Using Structured Fields	6-58
Referenced Error Recovery Procedures	5-54	Load Programmed Symbols	6-58
Channel-Detected Errors	5-55	Triple Planes	6-64
Typical CCW Sequences	5-55		
Read CCW Sequence	5-56		
Write CCW Sequence	5-56		

Chapter 7. Screen Management 7-1

- Decoding and Generating Data Streams 7-2
 - Decoding Read Modified Input Data Stream 7-2
 - Nonselector Pen or Noncursor Select Data Streams 7-3
 - Immediate Selector Pen or Cursor Select Data Stream 7-7
 - Mixed Read Modified Input Data Streams 7-9
- Building Output Data Streams 7-9
- Static Data Streams 7-9
- Semidynamic Output Streams 7-12
- Dynamic Output Streams 7-12
- Large Screen Size 7-14
- 3274 Copy Function 7-14

Appendix A. 3274 Error Status Indicator Code Interpretation A-1
 Supplement A A-17

Appendix B. Operator Information Area Symbols (3278, 3279) B-1

Appendix C. Keys and Keyboards C-1

- Keyboard Operations C-1
 - Cursor C-1
 - Keyboards C-2
 - Key Functions C-2
 - Automatic Skip C-3
 - Character-Oriented Keys C-3
 - Field-Oriented Keys C-4
 - ERASE EOF (Erase to End of Field) Key C-5
 - ERASE INPUT Key C-5
 - INS (Insert) MODE Key (3277) a, (Insert Mode) Key (3278 or 3279) C-5
 - DEL (Delete) Key (3277), Delete Key (3278 or 3279) C-6
 - RESET Key C-6
 - DUP (Duplicate) Key C-7
 - FM (Field Mark) Key C-7
 - Program Attention Keys C-8
 - SHIFT Key 3277, 3278, or 3279 C-9
 - LOCK Key 3277, 3278, or 3279 C-9
 - NUM Key 3277, 3278, or 3279 C-10
 - NUM LOCK Key 3277, 3278, or 3279 C-10
 - ALPHA Key 3277, 3278, or 3279 C-10
 - CURSR SEL (Cursor Select) Key C-10
 - ATTN (Attention) Key C-11
 - CURSR (Cursor) BLINK Key C-11
 - ALT CURSR (Alternate Cursor) Key C-11
 - TEST Key C-11
 - Click Key C-12
 - Print Key C-12
 - IDENT Key C-12
 - Dead Keys, Canadian-French Keyboards C-13
 - Dead-Key Operations with Programmed Symbols C-14
 - Attribute-Select Keys C-14
 - Extended Highlighting C-16
 - Symbol Set C-16
 - Extended Color C-17
 - Numeric Lock Feature Operation C-17
 - Keyboard Disabled (INPUT INHIBITED Indicator Is On) C-18

Appendix D. APL/Text Feature D-1

- APL/Text and Test Print Data Streams D-2
- 3274 APL/Text and Text Print Customizing Options D-2

- 3278-1, -2, -3, -4 and -5 or 3279-2B and -3B APL/Text D-2
- APL Keyboards D-9
 - 87- and 88-Key Typewriter/APL Keyboards D-9
 - 88-Key Katakana Typewriter/APL Keyboard D-10
 - APL Keyboard World Trade Considerations D-10
 - 87-Key Typewriter/Text Keyboard D-11
- 3287-1 and -2 with APL/Text D-12
- 3289-1 and -2 with Text Print D-12
- BSC Copy Command D-13
- Local Copy D-13

Appendix E. Katakana Feature E-1

- Interface Codes E-1
- Keyboard Shift Operations E-1
- LATIN SHIFT and KANA SHIFT Keys-3277 E-1
- Katakana Shift Keys-3278 and 3279 E-4

Appendix F. Encrypt/Decrypt Feature F-1

- Encrypt/Decrypt Products F-1
 - IBM Programmed Cryptographic Facility Program Product F-1
 - ACF/VTAM Encrypt/Decrypt Feature F-1
 - 3274/3276 Encrypt/Decrypt Feature F-1
- Establishing Cryptographic Sessions F-2
 - Bind Command Processing F-3
 - Installing the Secondary LU Key in the 3274 F-4
 - Terminal Master Key Verification for the 3274 F-4

Appendix G. Request Formatted Maintenance Statistics (REFMS) Formats G-1

- REQMS Request Type 1-Link Test Statistics G-1
- REQMS Request Type 2-Summary Counters G-1
- REQMS Request Type 3-Communication Adapter Data Error Counts G-2
- REQMS Request Type 5-3274 Configuration Information G-3

Appendix H. Selector-Light-Pen and Magnetic-Stripe Reading Device Operations H-1

- Selector-Light-Pen Operations H-1
 - Selector-Light-Pen Field Format H-2
 - Designator Characters H-2
- Magnetic-Stripe Reading Devices H-4
 - Magnetic Slot Reader and Magnetic Hand Scanner H-7
 - Numeric and Alphameric Character Sets H-8
 - Capacities H-12
 - Magnetic-Stripe Format H-12
 - Operational Differences because of Screen Format in SNA Mode (LU-LU Session) or Non-SNA Mode H-14
 - MSR/MHS Validity Tests H-18
 - SSCP-LU Session H-19
 - MSR/MHS Operator Indicators and Alarm H-20
 - Test Cards H-21
 - Operator Identification Card Reader and Magnetic Slot Reader H-22
 - 3277-Compatible Numeric Character Set H-23
 - Magnetic-Stripe Format (OICR/MSR) H-23
 - Operational Differences because of Screen Format H-24
 - Error Conditions (OICR/MSR) H-26
 - OICR/MSR Validity Tests H-26
 - MSR Operator Indicators and Alarm H-29

Appendix I. X.21 Switched Network Adapter Feature (3274 Model 51C) I-1

- 3274-51C X.21 Functions I-1
- X.21 Inquiry Facility I-2

X.21 Keys and Indicators I-2
 The Keys I-2
 The Indicators I-3
 X.21 Operations I-3
 Extension Mode I-3
 Ready State I-4
 Dial In State I-4
 Outgoing Call in Process State I-6
 Ready-for-Data and Data Transfer States I-6
 Disconnection-in-Process State I-7
 Incoming Call State I-7
 Controlled-Not-Ready State I-7
 Call Progress Signals I-8
 Call Progress Signal Handling I-8
 Registration/Cancellation Facility I-9
 Error Conditions I-9
 Inquiry Facility I-9

Appendix J. Buffer Address I/O Interface Codes J-1

Appendix K. Compression of Symbol Definition Bit Strings K-1
 Character Cell Division K-1
 The Compression Process K-2
 The Comparison Rules and Header Bits K-2
 Creating the Compressed Bit String K-4
 Examples of the Compression Algorithm in Use K-5
 Example of Algorithm Using Comparison Rule 1 K-5
 Example of Algorithm Using Comparison Rule 2 K-6
 Example of Algorithm Using Comparison Rule 3 K-7

Appendix L. Indicators and Controls (3277, 3284, 3286, 3288) L-1

Appendix M. Abbreviations M-1

Appendix N. Glossary N-1

Index X-1

Figures

- 1-1. 3274 Host and Device Combinations 1-2
- 1-2. (Deleted)
- 1-3. United States EBCDIC I/O Interface Code for 3274 Control Units with 3277, 3284, 3286, 3287 (with 3271/3272 Attachment Feature), and 3288 Terminals Attached 1-5
- 1-4. United States EBCDIC I/O Interface Code for 3274 Units and Attached 3262, 3278, 3279, 3287 (with 3274/3276 Attachment Feature), and 3289 Terminals 1-6
- 1-5. Matrix for Hyphenation and Negative Responses, 3274 Control Unit 1-7
- 1-6. United States ASCII I/O Interface Code for 3274 C Units and 51C with 3277, 3284, 3286, 3287 (with 3271/3272 Attachment Feature), and 3288 Terminals Attached 1-8
- 1-7. United States ASCII I/O Interface Code for 3274 Units and Attached 3278, 3279, 3287 (with 3274/3276 Attachment Feature), and 3289 Terminals 1-9
- 1-8. Control Character I/O Codes 1-10
- 1-9. Example of 3274 Control Unit Address Assignments 1-11
- 1-10. Command Codes 1-13
- 1-11. Write Control Character (WCC) 1-17
- 1-12. Reset Matrix 1-18
- 1-13. LU Type 2 Screen Size Bind Format 1-21
- 1-14. LU Type 3 Buffer Size Bind Format 1-24
- 1-15. Buffer Control Orders and Order Codes 1-34
- 1-16. Attribute Defaults 1-40
- 1-17. Attention ID (AID) Configurations 1-42
- 1-18. Read State Transitions 1-54
- 1-19. Copy Control Character (CCC) 1-60
- 1-20. Buffer Transfers for 3274 C Unit and 51C Copy Command Operation 1-62
- 1-21. Sense Bit Description—3274 B and D Units 1-67
- 2-1. Buffer Location and Display Screen Character Position Relationships 2-2
- 2-2. Buffer Addressing Layouts for 480-, 960-, 1920-, 2560-, 3440-, and 3564-Character Terminals (2 Parts) 2-3
- 2-3. Example of Formatted Display 2-5
- 2-4. Extended Attributes—A Conceptual View 2-6
- 2-5. Field Attribute Character Bit Assignment 2-8
- 2-6. Colors Derived from Field Attributes 2-8
- 2-7. Size of Character Position 2-13
- 2-8. Conceptual View of Programmed Symbols Set 2-13
- 2-9. Color Combinations 2-15
- 2-10. A Triple-Plane Symbol 2-16
- 2-11. Reverse Video Highlighting of Triple-Plane Symbols 2-17
- 2-12. Relationship between Buffer Data and Printed Data 2-22
- 3-1. Locally Attached 3270 Display System Using 3274 A, B, and D Units 3-2
- 3-2. 3274 B and D Unit Device Addressing, 16 or Fewer Devices per Control Unit 3-3
- 3-3. 3274 B and D Unit Device Addressing, 17 or More Devices per Control Unit 3-4
- 3-4. Status Byte Bit Assignments for 3274 B and D Units 3-6
- 3-5. Initial Status and Sense Conditions for 3274 B and D Units 3-8
- 3-6. Ending Status and Sense Conditions for 3274 B and D Units 3-10
- 3-7. Asynchronous Status and Sense Conditions for 3274 B and D Units 3-11
- 4-1. General Poll and Specific Poll, Sequence/Response Diagram (2 Parts) 4-12
- 4-2. Remote Control Unit and Device Addressing 4-15
- 4-3. 3274 Message Response to Polling or Read Modified Command 4-16
- 4-4. Selection Addressing, Sequence/Response Diagram (2 Parts) 4-18
- 4-5. Write-Type and Control-Type Commands, Sequence/Response Diagram (2 Parts) 4-20
- 4-6. Read-Type Command, Sequence/Response Diagram (2 Parts) 4-22
- 4-7. Remote Status and Sense Byte Definitions—BSC 4-24
- 4-8. Remote Error Status and Sense Responses—BSC (2 Parts) 4-25
- 4-9. Remote 3274 BSC Status and Sense Conditions 4-28
- 5-1. Establishing a Session with a 3274 5-4
- 5-2. Device Addressing for SNA Terminals 5-7
- 5-3. SNA Commands Supported by the 3274 5-8
- 5-4. Bind Command Session Parameters (3 Parts) 5-11
- 5-5. Summary of SNA Commands Received 5-23
- 5-6. Summary of SNA Commands Sent 5-23
- 5-7. Bracket/Chain-LU Type 2 Initiated (without Contention) 5-24
- 5-8. Bracket/Chain-Host Initiated (without Contention) 5-24
- 5-9. Bracket/Chain-Host/SLU Contention 5-25
- 5-10. Signal from Host 5-26
- 5-11. Shutdown/Shutdown Complete 5-27
- 5-12. Cancel, SLU Type 2 Sending 5-28
- 5-13. RTR-LU Type 1 or LU Type 3 Send 5-28
- 5-14. State Diagram for Session Ownership of Device 5-37
- 5-15. 3274 Logical Subsystem 5-42
- 5-16. 3274 A Unit Local Command Codes 5-45
- 5-17. Status Bit Assignments for 3274 A Units 5-50
- 5-18. Sense Bit Assignments for 3274 A Units 5-51
- 5-19. Initial Status and Sense Conditions for 3274 A Units 5-52
- 5-20. Ending Status and Sense Conditions for 3274 A Units (2 Parts) 5-53
- 5-21. Asynchronous Status and Sense Conditions for 3274 A Units 5-55
- 5-22. Bind Parameter Checking 5-66
- 5-23. Summary Table of LUSTATS 5-73
- 6-1. Example of Four Fields and Attribute Bytes 6-2
- 6-2. Results of Keyboard and Field Combinations 6-4
- 6-3. Model for Field Attributes and Extended Field Attributes, A Conceptual View 6-7
- 6-4. Relationship of Character and Extended Field Attributes 6-7
- 6-5. Character Attribute Override 6-8
- 6-6. Example of Attribute Specification 6-9
- 6-7. Block-Diagramming a Sequence of Panels 6-12
- 6-8. Sign-On Panel as Written Out on Layout Sheet 6-13
- 6-9. Panel Layout, Including Attribute and Cursor Positions 6-14
- 6-10. Laying Out Field Attributes 6-16
- 6-11. Text Items on Panel Layout Sheet 6-17
- 6-12. Attributes 6-18
- 6-13. Attribute Default Values 6-18
- 6-14. Completed Order and Attribute Information, No SFAP Capability 6-19
- 6-15. Completed Order and Attribute Information for Extended Field and Character Attribute Capability 6-20
- 6-16. Completed Orders and Attribute Information for an Extended Color Display 6-21

- 6-17. Buffer Control Orders and Order Codes 6-22
- 6-18. Sign-On Procedure Panel with Buffer Addresses 6-25
- 6-19. Attribute Combinations in Hexadecimal 6-26
- 6-20. Assembler Language Statements for Sign-On Panel 6-34
- 6-21. An Example of the RA Order 6-36
- 6-22. WCC Hexadecimal Codes 6-37
- 6-23. Panel 1 of an Accounts Receivable Application 6-38
- 6-24. Panel 2, Showing the Results of a Search on a Customer Name 6-39
- 6-25. Panel 3, Showing the Customer's Open Invoices 6-39
- 6-26. Panel 4, Showing Use of the Calculator 6-41
- 6-27. Panel 5, Showing Selection of Invoices after Using the Calculator 6-41
- 6-28. Panel 6, Showing New Balance after Posting 6-42
- 6-29. Sign-On Panel with Operator's Input 6-42
- 6-30. Input Data Sequence 6-43
- 6-31. Definition of Field for Selector Pen Operation 6-45
- 6-32. Sample Panel for Selector Pen or Cursor Select Detection 6-46
- 6-33. Modifying an Existing Panel, Basic Panel 6-49
- 6-34. Existing Panel with Error Message 6-49
- 6-35. Panel Layout Changes for Error Message (Keyed to Text) 6-50
- 6-36. Error Message Panel with Serial Number Field Erased 6-51
- 6-37. Example of EUA Use 6-52
- 6-38. Sign-On Panel with Three Erased Fields 6-53
- 6-39. Erasing Multiple Fields with EUA 6-53
- 6-40. Example of Data Entry Panel 6-55
- 6-41. Data Entry Panel with Entered Data 6-55
- 6-42. Employee Data Panel 6-56
- 6-43. Panel Defined with Program Tab 6-57
- 6-44. Character Definition for a 9x16 Display Matrix 6-59
- 6-45. Character Definition for a 10x8 Printer Matrix 6-60
- 6-46. Structured Fields 6-60
- 6-47. Structured Field Data Stream to Load a Box "A" for a 9x16 Display Matrix 6-61
- 6-48. Structured Field Data Stream to Load a Box "A" for a 10x8 Printer Matrix 6-61
- 6-49. Programmed Symbol Sets 6-63
- 6-50. Character Definition of a Multicolor Symbol 6-64
- 7-1. Relationship of Screen Management to Telecommunications Management and Application Program 7-1
- 7-2. Table of Requirements 7-5
- 7-3. Example of Selector Pen Panel 7-8
- 7-4. Sample Mapping Table 7-8
- A-1. Indicator Code-Log Area Correlation A-18
- C-1. Attribute Select Keys C-15
- D-1. Diagram of APL/Text Devices D-1
- D-2. APL/Text Feature, 1-Byte I/O Interface Codes (3274/3278/3279/3287) D-3
- D-3. APL/Text Feature, 2-Byte I/O Interface Codes (3274/3278/3279/3287) D-4
- D-4. National Use Differences I/O Interface Code (3274/3278/3279/3287) D-5
- D-5. Katakana/APL 1-Byte I/O Interface Codes (3274/3278/3279/3287) D-6
- D-6. Katakana/APL 2-Byte I/O Interface Codes (3274/3278/3279/3287) D-7
- D-7. 3289 Text Print Feature I/O Interface Codes D-8
- D-8. 87-Key Typewriter/APL Keyboard D-9
- D-9. 88-Key Katakana Typewriter/APL Keyboard D-10
- D-10. 87-Key Typewriter/Text Keyboard D-11
- E-1. Japanese Katakana EBCDIC I/O Interface Code for 3274 Control Units with 3277, 3284, 3286, 3287 (with 3271/3272 Attachment Feature), and 3288 Terminals Attached E-2
- E-2. Japanese Katakana EBCDIC I/O Interface Code for 3274 Control Units with 3262, 3278, 3279, 3287 (with 3274/3276 Attachment Feature), and 3289 Terminals Attached E-3
- H-1. Selector Light Pen H-1
- H-2. Sample Display Screen for Selector-Light Pen Operations H-4
- H-3. Attachment of Magnetic Reading Devices to 3270 System Units H-5
- H-4. Magnetic Slot Reader (3278 and 3279 Attachments) H-5
- H-5. Magnetic Hand Scanner (3278 and 3279 Attachments) H-6
- H-6. Operator Identification Card Reader (3277 Attachment) H-7
- H-7. Numeric Character Set Used with Magnetic Slot Reader and Magnetic Hand Scanner Attached to a 3278 or 3279 Display Station That Is Connected to a 3274 Control Unit H-9
- H-8. Alphameric Character Set Used with Magnetic Slot Reader and Magnetic Hand Scanner Attached to a 3278 or 3279 Display Station That Is Connected to a 3274 Control Unit (2 Parts) H-16
- H-9. Magnetic-Stripe Capacities when Using the Numeric and Alphameric Character Sets H-13
- H-10. Magnetic-Stripe Format (MSR and MHS Using Numeric and Alphameric Character Sets) H-13
- H-11. Operation of the Display with an Unformatted Screen (MSR or MHS Using Numeric or Alphameric Character Set H-15
- H-12. Operation of the Display with a Formatted Screen (MSR or MHS Using Numeric or Alphameric Character Set), Example 1 H-16
- H-13. Operation of the Display with a Formatted Screen (MSR or MHS Using Numeric or Alphameric Character Set), Example 2 H-17
- H-14. 3277-Compatible Numeric Character Set Used with Operator Identification Card Reader and Magnetic Slot Reader H-22
- H-15. Magnetic-Stripe Format (OICR and MSR Using 3277-Compatible Numeric Character Set) H-24
- H-16. Operation of the Display with an Unformatted Screen (OICR or MSR Using 3277-Compatible Numeric Character Set) H-25
- H-17. Operation of the Display with a Formatted Screen (OICR or MSR Using 3277-Compatible Numeric Set), Example 1 H-27
- H-18. Operation of the Display with a Formatted Screen (OICR or MSR Using 3277-Compatible Numeric Set), Example 2 H-28
- I-1. Control Unit/Terminal Responses in Dial-In State I-6
- K-1. Type 1 Data Format-An Example Dot Pattern Encoded K-3
- K-2. Example of Compression Algorithm Using Comparison Rule 1 K-5
- K-3. Example of Compression Algorithm Using Comparison Rule 2 K-6
- K-4. Example of Compression Algorithm Using Comparison Rule 3 K-7
- L-1. Indicators and Controls for Terminals 3277, 3284, 3286, and 3288 L-1

Chapter 1. Control Units and Data Stream

The 3274 Control Unit (Model 1A, 1B, 1C, 1D, 21A, 21B, 21C, 21D, 31A, 31C, 31D or 51C) is one of the basic components of the 3270 Information Display System, a family of products that can be tailored to meet the needs of a wide range of display applications.

The 3270 system offers the user a wide selection of components and configurations. Also available are a large variety of features which improve performance, provide additional operational capability, and permit expansion of the display system. (The features are described in *IBM 3270 Information Display System: Configurator*, GA27-2849.)

Models of the 3274 can be selected to form 3270 system configurations attachable to System/360, System/370, System/3, 4300 Processor, and 8100 Information System configurations as host systems. (See *An Introduction to the IBM 3270 Information Display System*, GA27-2739, for possible system combinations.)

The 3274 Control Unit can attach locally or remotely to a host system. 3274 units employ binary synchronous communication (BSC) or synchronous data link control (SDLC) transmission disciplines in remote operations.

Figure 1-1 provides an overview.

Note: *The 3274 Models 1, 21, and 31 bearing like letter designations (e.g., 1C, 21C, 31C) support the same terminals, terminal configurations, and functions. The Model 21 units have less control storage capability than the Model 1 and 31 machines and do not support some of the available terminal features or feature combinations.*

Throughout this publication, references to 3274 "A units," "B units," "C units," and "D units" are used as convenient abbreviations for all model numbers suffixed by the same letter (for example, 3274 Models 1A, 21A, and 31A = A units). The 3274 Model 51C is referred to as 51C.

Display System Components

The 3270 Information Display System has three basic components: a control unit, a display station, and a printer.

The control unit provides for the 3270 system's attachment to a data processing system and directs the operation of attached display stations and printers.

The display station provides image display of data transmitted from the host system. A display station with an attached keyboard enables the user to enter, modify, or delete data on the display, and to cause the revised data to be returned to the host system for storage or additional processing.

The printer provides printed copy of data displayed at a display station or transmitted from the host system.

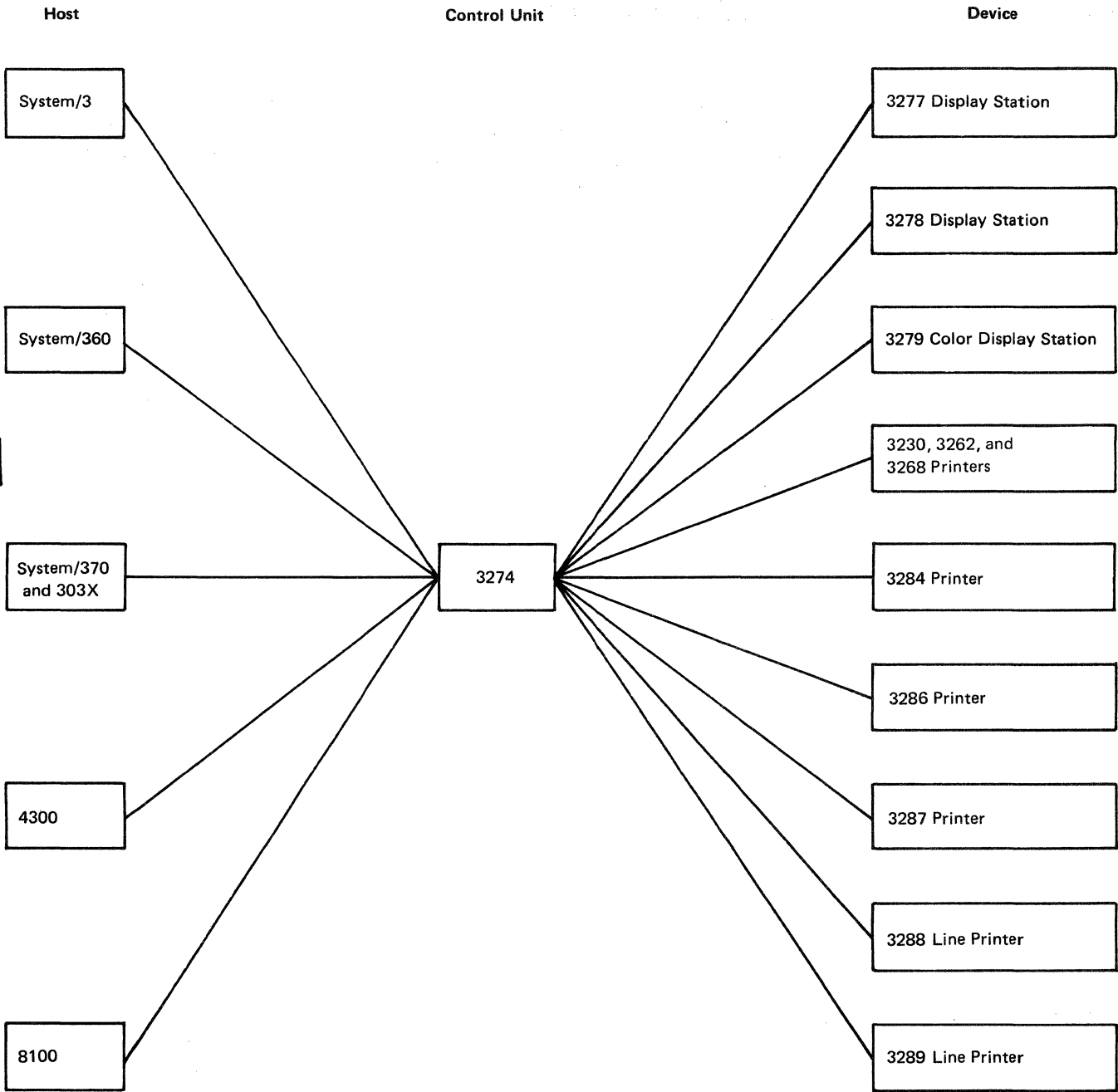

Figure 1-1. 3274 Host and Device Combinations

When not executing a command operation, the control units continually perform an internal poll of all attached devices. Internal polling is performed to determine the current device status and whether the device has an I/O pending condition.

The current status of each device indicates to the control unit whether the device is available, ready, or busy. This information is recorded in the associated device adapter in the control unit.

Additionally, when the host program addresses a specific device, the control unit stops the sequential polling and polls the addressed device to obtain its latest status. If conditions permit, the control unit communicates solely with

that device until the operation is completed. At that time, sequential polling is resumed.

Data Flow

The 3274 Control Unit models can operate in local or remote configurations:

- The 3274 A units operate as channel-attached local units using SNA protocols (see Chapter 5).
- The 3274 B and D units operate as channel-attached local units using the host processor channel program (see Chapter 3).
- The 3274 C units and 51C operate as remote units using SNA/SDLC or BSC disciplines (see Chapters 4 and 5).

In the SNA/SDLC environment, attached 3278s or 3279s function as LU type 2. The data stream RU for a write-type command, for example, consists of the command code, buffer orders, and display data.

The 3230, 3262, 3268, 3287, or 3289 attached to a 3274, or the 3288 attached to a 3274, can also function in BSC or SNA/SDLC protocol. When operating in SNA/SDLC, the 3230, 3262, 3268, 3287, and 3289 function as LU type 3. When SCS is installed in the 3230, 3262, 3268, 3287, or 3289, the printer functions as an LU type 1. The 3230, 3262, 3268, 3287, and 3289 can also operate as local copy devices; that is, data may be sent to a printer(s) from a display station attached to the same 3274, which functions in either BSC or SNA/SDLC disciplines.

The instantaneous rate at which data is transferred between main storage of the data processing system and a device attached to the 3270 system depends on the information-transfer capability of the channel, whether data or command codes are transferred, and whether a local or remote 3270 system is attached.

In a local configuration, the control unit provides information to, and accepts information from, the channel at an instantaneous byte rate established by the channel or control unit, whichever is the slower. For the 3274 B and D units, the instantaneous data transfer rate for write operations is a maximum of 650,000 bytes per second and for read operations is a maximum of 400,000 bytes per second. With the 3274 A units (SNA operation), the maximum data transfer rate is 100,000 bytes per second; however, if 3277s are attached, continuous overrun conditions may exist. To remove these conditions, the maximum data transfer rate reduces to 20,000 bytes per second without significantly degrading subsystem performance.

When a remotely attached 3270 system is in operation, the rate at which data is transferred between the data processing system's main storage and the control unit depends on the type of transmission control unit and on the modems and communication facilities used. The 3270 system accepts data from, and provides it to, the transmission control unit/communication facility at the byte rate established by the transmission control unit/communication facility.

All command operations that direct movement of data to and from the 3270 system result in transfer of data between the control unit and a device buffer.

When commands are not being performed, the control unit and the device buffer interact asynchronously, and the last image displayed by a previous command is continuously regenerated at a visible rate.

Interface Codes

Data, commands, and orders transmitted between the control unit and the host system are in the form of interface codes. Two different codes are used in the United States: extended binary-coded decimal interchange code (EBCDIC) and American National Standard Code for Information Interchange (ASCII). The EBCDIC codes are also used in the World Trade countries (ASCII is available only in the U.S.); refer to *IBM 3270 Information Display System: Character Set Reference*, GA27-2837, for details.

Figures 1-3 and 1-4 show the United States EBCDIC interface codes for several control unit/device combinations. Figure 1-5 indicates the actions taken by the 3274 Control Unit in response to various interface code points. Figures 1-6 and 1-7 show the United States ASCII codes. Figure 1-8 shows the control character codes. Refer to Appendix E for the Katakana codes.

ASCII uses 7 of a byte's 8 bits for information, allowing addressing of 128 code points per byte. The high-order ASCII bit is always zero. EBCDIC uses all 8 bits for information, allowing addressing of 256 code points per byte.

EBCDIC and ASCII explicitly define an information interchange code (ICC) and implicitly specify unique character sets. See the *Character Set Reference* manual.

SNA Interface Codes

With SDLC, the 3274 Control Unit operates with EBCDIC or an alternate, which is usually ASCII.

The alternate code is selectable as a feature during customizing. The 3274 Physical Unit (PU) cannot support multiple alternate codes concurrently. The Alternate Code feature:

- Defines the available alternate ICC.
- Defines the character set for all associated LU2 terminals.
- Allows only typewriter keyboards.
- Should not be used with an LU using the SNA Character Set (SCS).

The characteristics of LU-LU sessions are established by the SNA Bind RU. The Bind indicates which, if any, alternate code will be allowed for the ICC. The LUs must agree on an alternate code before one can be used.

The Request Header Code Select Indicator (RH CSI) indicates the alternate or EBCDIC ICC for the FMD RU. All host-bound FMD RUs will use alternate code when permitted by the bind and will have their RH CSIs set.

The alternate code character set is supported only for typewriter keyboards. The differences between the EBCDIC and ASCII keyboard layouts are noted below; four keys are involved, and the coding points associated with each are in parentheses:

Key Shift	Keypop Symbol	
	EBCDIC	ASCII
Up	Bar (X'4F')	Exclamation point (X'21')
Up	<i>Not</i> sign (X'5F')	Circumflex (X'5E')
Up	Exclamation point (X'5A')	Right bracket (X'5D')
Down	Cent sign (X'4A')	Left bracket (X'5B')

Code structures pertain only to the data portion of information in an SDLC data stream. All but the SNA LU-LU function management data request unit (FMD RU) is considered bit-significant control information and is not subject to graphic representation.

| *BSC Interface Codes*

| The BSC interface codes are described under “Redundancy Checking” and “Data-Link Control Characters,” in Chapter 4.

Hex 1 Bits 4567	00				01				10				11				Bits 0,1
	00	01	10	11	00	01	10	11	00	01	10	11	00	01	10	11	2,3
	0	1	2	3	4	5	6	7	8	9	A	B	C	D	E	F	Hex 0
0000	0	NUL			SP	&										0	
0001	1		SBA			/		a	j				A	J		1	
0010	2		EUA					b	k	s			B	K	S	2	
0011	3		IC					c	l	t			C	L	T	3	
0100	4							d	m	u			D	M	U	4	
0101	5	PT	NL					e	n	v			E	N	V	5	
0110	6							f	o	w			F	O	W	6	
0111	7							g	p	x			G	P	X	7	
1000	8							h	q	y			H	Q	Y	8	
1001	9		EM					i	r	z			I	R	Z	9	
1010	A				ç	ı	ı										
1011	B				.	\$.	#									
1100	C	FF	DUP	RA	<	*	%	@									
1101	D		SF		()	_	'									
1110	E		FM		+	.	>	~									
1111	F			SUB		⌋	>	"									

Notes:

1. Character code assignments other than those shown within all outlined areas of this chart are undefined. If an undefined character code is programmed, the character that will be displayed or printed is not specified. The character displayed by the 3277 for a given undefined character code may be different for other devices. IBM reserves the right to change at any time the character displayed for an undefined character code.
2. Lowercase alphabetic characters (shown within the dotted outlined area) are displayed or printed as uppercase characters, unless the terminal has dual-case capability.
3. NL, EM, FF, DUP, and FM control characters are displayed or printed as 5 9 < * and ; characters, respectively, except by printers under format control, in which case NL and EM do not result in the printing of a character, and by printers successfully executing FF, in which case < is not printed.
4. Bits 0 and 1 are assigned for the following characters: AID, attribute, write control (WCC), copy control (CCC), CU and device address, buffer address, sense, and status. Bits 0 and 1 are assigned so that each character can be represented by a graphic character within the solid outlined areas of the chart. See Figure 1-8.
5. This table also applies for Belgian, French, and Italian mono-case I/O interface codes and graphics.
6. The ' character (hex 6A) is not displayed and is printed by the 3287 and 3288 only.
7. The SUB control character (hex 3F) is not supported for terminals attached to 3274 Control Units.
8. For BSC data-link control characters, see Chapter 4.

Figure 1-3. United States EBCDIC I/O Interface Code for 3274 Control Units with 3277, 3284, 3286, 3287 (with 3271/3272 Attachment Feature), and 3288 Terminals Attached

		00				01				10				11				Bits 0,1
Hex 1		00	01	10	11	00	01	10	11	00	01	10	11	00	01	10	11	Bits 2,3
Bits 4567	Hex 0	0	1	2	3	4	5	6	7	8	9	A	B	C	D	E	F	Hex 0
0000	0	NUL				SP	&	-						()	\	0	
0001	1		SBA					/		a	j	~		A	J		1	
0010	2		EUA							b	k	s		B	K	S	2	
0011	3		IC							c	l	t		C	L	T	3	
0100	4									d	m	u		D	M	U	4	
0101	5	PT	NL							e	n	v		E	N	V	5	
0110	6									f	o	w		F	O	W	6	
0111	7									g	p	x		G	P	X	7	
1000	8	GE		SA						h	q	y		H	Q	Y	8	
1001	9		EM	SFE						i	r	z		I	R	Z	9	
1010	A					¡	!		:									
1011	B					.	\$,	#									
1100	C	FF	DUP	MF	RA	<	*	%	@									
1101	D	CR	SF			()	_	'									
1110	E		FM			+	;	>	=									
1111	F				SUB		^	?	"								EO	

Notes:

- Character code assignments other than those shown within all outlined areas of this chart are undefined. If an undefined character code is programmed, the character that will be displayed or printed is a hyphen (-); hex code 60 will be returned on a subsequent read operation. For control units with Configuration Support C installed, undefined control codes from X'00' to X'3F' cause a negative response (SNA) or an Op Chk (BSC). IBM reserves the right to change at any time the character displayed or printed and the I/O interface code returned for an undefined character code. See Figure 1-5.
- CR, NL, EM, and FF control characters are displayed and printed as blank characters. The DUP and FM control characters are displayed as ¤ and ¤, respectively, and are displayed and printed as * and ; when operating in mono-case mode.
- Bits 0 and 1 are assigned for the following characters: AID, attribute, write control (WCC), copy control (CCC), CU and device address, buffer address, sense, and status. Bits 0 and 1 are assigned so that each character can be represented by a graphic character within the solid outlined areas of the chart. See Figure 1-8.
- For BSC data-link control characters, see Chapter 4. For the SCS control codes associated with the SNA Character String feature on 3262, 3287 (with the 3274/3276 Attachment feature), and 3289 printers, see Chapter 2.
- When operating in mono-case mode, the lowercase alphabetic characters are displayed or printed as uppercase characters.
- When 3277, 3284, 3286, 3287 (with the 3271/3272 Attachment feature), and 3288 terminals are attached to a 3274 Control Unit, the codes of characters: ` ~ { } and \ will be accepted and returned, but they will generally be displayed or printed as different graphics for the various language specify features.
When the CR control character is directed to one of these terminals, CR will be displayed or printed as > (on mono-case terminals), and no CR function will be executed; hex code 0D will be returned on a subsequent read operation.

Figure 1-4. United States EBCDIC I/O Interface Code for 3274 Units and Attached 3262, 3278, 3279, 3287 (with 3274/3276 Attachment Feature), and 3289 Terminals

Controller With	Display or Printer	
	Without ECSA ¹	With ECSA ¹
Configuration Support A and B; codepoints <i>not</i> preceded by X'08'	All unsupported control codepoints or unsupported graphic codepoints are replaced with hyphen codepoints in the data buffer.	
Configuration Support B; codepoints X'nn' preceded by X'08'	X'08nn' is replaced by a single hyphen codepoint in the data buffer.	For X'nn' equal to all control codepoints and unsupported APL codepoints, X'08nn' is replaced by a hyphen codepoint in the data buffer.
Configuration Support C; codepoints <i>not</i> preceded by X'08'	For 3278, 3287, 3289 devices: (1) a hyphen codepoint replaces codepoints CE, CF, DD, DE, DF, ED, EE, EF, and FE in the data buffer, (2) a negative response is given to control codepoints in the range X'00' to X'3F' and X'FF' except for codepoints 00, 05, 08, 0C, 0D, 11, 12, 13, 15, 19, 1C, 1D, 1E, and 3C, and (3) graphic codepoints X'40' to 'FE', except as noted above, are stored in the data buffer and returned in subsequent read operations. For the 3277 device: (1) Unsupported graphic codepoints in the range X'40' to X'FE' are replaced with a hyphen codepoint in the data buffer, and (2) a negative response is given as described above for the 3278.	A negative response is given to unsupported control codepoints in the range X'00' to X'3F'. All codepoints in the range X'40' to X'FE' plus X'3F' and X'FF' are stored in the data buffer and returned in subsequent read operations.
Configuration Support C; codepoints X'nn' preceded by X'08'	For X'nn' equal to X'00' through X'3F' or X'FF', a negative response is returned.	
	For X'nn' equal to X'40' through X'FE', X'08nn' is replaced by a single hyphen codepoint in the data buffer.	For X'nn' equal to all unsupported APL codepoints, X'08nn' is replaced by a single hyphen codepoint in the data buffer.

¹ Extended character set adapter

Figure 1-5. Matrix for Hyphenation and Negative Responses – 3274 Control Unit

		Hex 1							
		000	001	010	011	100	101	110	111
		0	1	2	3	4	5	6	7
Bits 4321	Hex 0	← Bits 7, 6, 5							
0000	0	NUL		SP	@	P			p
0001	1		SBA		1	A	Q	a	q
0010	2		EUA	"	2	B	R	b	r
0011	3		IC	#	3	C	S	c	s
0100	4		RA	\$	4	D	T	d	t
0101	5			%	5	E	U	e	u
0110	6			&	6	F	V	f	v
0111	7			'	7	G	W	g	w
1000	8			(8	H	X	h	x
1001	9	PT	EM)	9	I	Y	i	y
1010	A	NL	SUB	*		J	Z	j	z
1011	B			+		K	[k	
1100	C	FF	DUP			L	\	l	
1101	D		SF	-		M]	m	
1110	E		FM	>		N	^	n	
1111	F			?		O	_	o	

Notes:

1. Character code assignments other than those shown within all outlined areas of this chart are undefined. If an undefined character code is programmed, the character that will be displayed or printed and the I/O interface code returned on a subsequent read operation are not specified. The character displayed or printed by these terminals for a given undefined character code may be different for other terminals. IBM reserves the right to change at any time the character displayed or printed and the I/O interface code returned for an undefined character code.
2. Lowercase alphabetic characters (shown within the dotted outlined area) are converted to uppercase by the display station or printer and displayed or printed as uppercase characters.
3. NL, EM, FF, DUP, and FM control characters are displayed or printed as 5 9 < * and ; characters, respectively, except by printers under format control, in which case NL and EM do not result in the printing of a character, and by printers successfully executing FF, in which case < is not printed.
4. AID, attribute, write control (WCC), copy control (CCC), CU and device address, buffer address, sense, and status characters are assigned as specified in Figure 1-8 so that each character can be represented by a graphic character within the solid outlined portion of this chart.
5. ASCII A option displays and prints | and 7 for interface codes 21 and 5E (hex), respectively. ASCII B option displays and prints ! and ^ for codes 21 and 5E (hex), respectively.
6. The SUB control character (hex 1A) is not supported for terminals attached to 3274 Control Units.
7. For BSC data-link control characters, see Chapter 4.

Figure 1-6. United States ASCII I/O Interface Code for 3274 C Units and 51C with 3277, 3284, 3286, 3287 (with 3271/3272 Attachment Feature), and 3288 Terminals Attached

		Hex 1							
		000	001	010	011	100	101	110	111
		0	1	2	3	4	5	6	7
Bits 4321	Hex 0								
0000	0	NUL		SP	0	@	P	·	p
0001	1		SBA	!	1	A	Q	a	q
0010	2		EUA	"	2	B	R	b	r
0011	3		IC	#	3	C	S	c	s
0100	4		RA	\$	4	D	T	d	t
0101	5			%	5	E	U	e	u
0110	6			&	6	F	V	f	v
0111	7			'	7	G	W	g	w
1000	8			(8	H	X	h	x
1001	9	PT	EM)	9	I	Y	i	y
1010	A	NL		*	:	J	Z	j	z
1011	B			+	;	K	[k	}
1100	C	FF	DUP	'	<	L	\	l	
1101	D	CR	SF	-	=	M]	m	}
1110	E		FM	.	>	N	^	n	~
1111	F			/	?	O	_	o	

Notes:

1. Character code assignments other than those shown within all outlined areas of this chart are undefined. If an undefined character code is programmed, the character that will be displayed or printed is a hyphen (-); code 2D will be returned on a subsequent read operation. IBM reserves the right to change at any time the character displayed or printed and the I/O interface code returned for an undefined character code.
2. CR, NL, EM, and FF control characters are displayed and printed as blank characters. The DUP and FM control characters are displayed as * and ; respectively, and are displayed and printed as * and ; when operating in mono-case mode.
3. AID, attribute, write control (WCC), copy control (CCC), CU and device address, buffer address, sense, and status characters are assigned as specified in Figure 1-8 so that each character can be represented by a graphic character within the solid outlined portion of this chart.
4. For BSC data-link control characters, see Chapter 4.
5. When operating in mono-case mode, the lowercase alphabetic characters are displayed or printed as uppercase characters.
6. When 3277, 3284, 3286, 3287 (with the 3271/3272 Attachment feature), and 3288 terminals are attached to a 3274 Control Unit, the characters | ' ~ { } and \ are displayed or printed as \ ' - () and \ respectively; codes 7C, 60, 7E, 7B, 7D, and 5C will be returned on a subsequent read operation. When the CR control character is directed to one of these terminals, CR will be displayed or printed as > (on mono-case terminals), and no CR function will be executed; code 0D will be returned on a subsequent read operation.

Figure 1-7. United States ASCII I/O Interface Code for 3274 Units and Attached 3278, 3279, 3287 (with 3274/3276 Attachment Feature), and 3289 Terminals

Bits 2-7	Graphic	EBCDIC	ASCII
00 0000	SP	40	20
00 0001	A	C1	41
00 0010	B	C2	42
00 0011	C	C3	43
00 0100	D	C4	44
00 0101	E	C5	45
00 0110	F	C6	46
00 0111	G	C7	47
00 1000	H	C8	48
00 1001	I	C9	49
00 1010	{	4A	-
	[-	5B
00 1011		4B	2E
00 1100	<	4C	3C
00 1101	(4D	28
00 1110	+	4E	2B
00 1111	{	4F	-
	!	-	21
01 0000	&	50	26
01 0001	J	D1	4A
01 0010	K	D2	4B
01 0011	L	D3	4C
01 0100	M	D4	4D
01 0101	N	D5	4E
01 0110	O	D6	4F
01 0111	P	D7	50
01 1000	Q	D8	51
01 1001	R	D9	52
01 1010	{	5A	-
]	-	5D
01 1011	\$	5B	24
01 1100	*	5C	2A
01 1101)	5D	29
01 1110	;	5E	3B
01 1111	{	5F	-
	^	-	5E

Bits 2-7	Graphic	EBCDIC	ASCII
10 0000	-	60	2D
10 0001	/	61	2F
10 0010	S	E2	53
10 0011	T	E3	54
10 0100	U	E4	55
10 0101	V	E5	56
10 0110	W	E6	57
10 0111	X	E7	58
10 1000	Y	E8	59
10 1001	Z	E9	5A
10 1010	{	(EBCDIC)	6A
10 1011	,		6B
10 1100	%	6C	25
10 1101	-	6D	5F
10 1110	>	6E	3E
10 1111	?	6F	3F
11 0000	0	F0	30
11 0001	1	F1	31
11 0010	2	F2	32
11 0011	3	F3	33
11 0100	4	F4	34
11 0101	5	F5	35
11 0110	6	F6	36
11 0111	7	F7	37
11 1000	8	F8	38
11 1001	9	F9	39
11 1010	:	7A	3A
11 1011	#	7B	23
11 1100	@	7C	40
11 1101	'	7D	27
11 1110	=	7E	3D
11 1111	"	7F	22

Note: The characters above are used as attribute, AID, write control (WCC), copy control (CCC), CU and device address, and buffer address. They are also used as status and sense except when operating in BSC. When any of these characters is transmitted to the program, the CU assigns the appropriate EBCDIC code. If transmission is in ASCII, the CU translates the EBCDIC code to ASCII code prior to transmission.

To use this table to determine the hex code transmitted for an address or control character, first determine the values of bits 2-7. Select this bit configuration from the "Bits 2-7" column. The hex code that will be transmitted (either in EBCDIC or in ASCII) is to the right of the bit configuration.

Use this table also to determine equivalent EBCDIC and ASCII hex codes and their associated graphic characters. See Figure 1-6, Note 5, for ASCII A and B graphic character difference for ASCII codes 21 and 5E (hex).

Graphic characters for the United States I/O interface codes are shown. Graphic characters might differ for particular World Trade I/O interface codes. Refer to IBM 3270 Information Display System: Character Set Reference, GA27-2837, for possible graphic differences when these codes are used.

Figure 1-8. Control Character I/O Codes

Device Addressing

Addresses for devices on 3274 control units are based on the port to which they are attached. The port sockets are numbered, and device adapters are attached in accordance with requirements detailed in *IBM 3270 Information Display System: 3274 Control Unit Planning, Setup, and Customizing Guide*, GA27-2827. The 32 addresses available for each 3274 (12 for Model 51C) are assigned sequentially to the ports, beginning at the bottom adapter; if no device is attached to a port, the address for that port is reserved even though unused. All category A ports are attached at the bottom of the control unit and receive sequential addresses, starting with 00 in non-SNA and 02 in SNA systems. Type B ports are attached above the A ports and are assigned sequential addresses, starting after the last type A port address. Type A addresses are reserved in blocks of 8 (each type A adapter has 8 ports on it); type B addresses are reserved in blocks of 4.

Figure 1-9 illustrates 3274 Control Unit address assignments.

Port Number	Type of Device Attached	Address	
		SNA	Non-SNA
A0	A	02	00
A1	A	03	01
A2	A	04	02
A3	A	05	03
A4	None	06	04
A5	None	07	05
A6	None	08	06
A7	None	09	07
A8	A	10	08
A9	A	11	09
A10	A	12	10
A11	A	13	11
A12	A	14	12
A13	A	15	13
A14	None	16	14
A15	A	17	15
B0	B	18	16
B1	B	19	17
B2	None	20	18
B3	None	21	19
B4	B	22	20
B5	B	23	21
B6	None	24	22
B7	None	25	23

Note: *Regardless of the type of host attachment, the 3274 Printer Authorization Matrix requires all port addresses of each type to be based on a 0 origin.*

Figure 1-9. Example of 3274 Control Unit Address Assignments

Data Stream

The 3270 data stream consists of application data, commands/structured field functions, and orders which are transmitted between the control unit and the host system. Control information, which governs the movement of the data stream, is also transmitted.

Data transfer commands are issued to initiate such operations as the total or partial writing, reading, and erasing of data in a selected terminal character buffer. Control commands initiate control unit and/or terminal operations not involved with data transfer (except for status information). Structured field functions (data transfer or control) are used for such operations as loading a programmed symbol set and querying a terminal as to its characteristics; for example, character buffer capacity. Orders can be included in write data streams either alone or intermixed with display and print data.

Two types of orders are available - buffer control orders and printer format orders. Buffer control orders are interpreted and executed as they are received by the control unit, and are used to position, define, modify, assign attributes on a field and character basis, and format data being written to a display character buffer; to erase selected unprotected data in the buffer; and to reposition the cursor. Printer formatting orders are initially stored in the printer character buffer as data and are interpreted and executed by the printer logic when encountered in the print operation.

The balance of this chapter consists of 3270 data stream description.

3270 Data Stream Function

The 3270 data stream - outbound - can consist of commands, structured fields, write control characters (WCC) if appropriate, orders, character data, and the parameters needed by a control command. Inbound data streams (read operations) consist of orders and character data or requested sense and control information.

The command or structured field type-code defines the operation to be performed.

Commands/Structured Fields

The operations which may be specified include:

- Write to the character buffer
- Erase and then Write to the character buffer
- Erase and then Write to the Alternate size character buffer
- Read the entire character buffer
- Read only the Modified data from the character buffer (some exceptions)
- Read All the Modified data from the character buffer (no exceptions)
- Erase All the Unprotected data from the character buffer
- Copy the content of character buffer A to character buffer B. (3274 C units, 51C BSC only.)
- Select a terminal and initiate terminal character buffer to control unit buffer transfer of all data, modified data only, or data from position in preparation

- for a Read Buffer, Read Modified or a Write operation (3274 B and D units).
- Perform No functional Operation, retrieve pending status (3274 B and D units).
- Sense further definition of the Unit Check condition (3274 B and D units).
- Sense the Control Unit Identification (3274 B and D units).

When the Structured Field and Attribute Processing Option is installed in the control unit, the following structured field functions are available:

- 3270 DS; a structured field function used to combine 3270 write-type commands and the COPY command (BSC) with other structured field functions in a single transmission to devices supporting structured field and attribute processing.
- Write Structured Field (WSF); a write-type command indicating that structured fields follow.
- Load Programmed Symbols (LPS); a structured field function used to load symbol definition data into loadable terminal storage.
- Set Reply Mode (SRM); a structured field function used to define the format of inbound data streams generated by Read command operations.
- Read Partition-Query; a structured field function used to query a terminal as to its characteristics.
- Query Reply; a structured field function containing the terminal characteristics requested by Read Partition-Query.
- SCS Data; a structured field function used to transmit an SCS data stream to a printer in an LU Type 1 session when other structured fields are also in the transmission.

Command codes, including the WSF command, are shown in Figure 1-10.

Command	3274 B and D Units	3274 A and C Units and 51C		Graphic
	EBCDIC Hex	EBCDIC Hex	ASCII Hex	
Copy ¹	NA	F7	37	7
Erase All Unprotected	0F	6F	3F	?
Erase/Write	05	F5	35	5
Erase/Write Alternate	0D	7E	3D	=
Read Buffer	02	F2	32	2
Read Modified	06	F6	36	6
Read Modified All	NA	6E	3E	:
Write	01	F1	31	1
No Operation	03	NA	NA	NA
Select ²	0B	NA	NA	NA
Select RM ³	0B	NA	NA	NA
Select RB ³	1B	NA	NA	NA
Select RMP ³	2B	NA	NA	NA
Select RBP ³	3B	NA	NA	NA
Select WRT ³	4B	NA	NA	NA
Sense	04	NA	NA	NA
Sense ID	E4	NA	NA	NA
Write Structured Field ³	11	NA	NA	NA
Write Structured Field	NA	F3	NA	NA

¹ Applicable to 3274 C units (BSC) and 51C (BSC) only.

² Applicable to 3274 B units

³ Applicable to 3274 D units

Figure 1-10. Command Codes

Orders

The outbound data stream can contain orders directing the formatting of a display terminal buffer or the formatting of a printer operation. For a discussion of the printer formatting orders (NL, EM, FF, SI, and CR), refer to Chapter 3.

Orders that can be included in the 3270 data stream are described below:

The Set Buffer Address (SBA) order is followed by two address characters, and sets a pointer called the *current buffer address* (CBA). Subsequent data characters will be stored in the character buffer in a sequential fashion beginning at the CBA. As each character is stored, the CBA is updated to point to the next character location in the character buffer.

The Start Field (SF) order indicates that the next character in the data stream is to be interpreted as a field attribute character. It will therefore be stored in the character buffer in a unique fashion so that the hardware will interpret it as a field attribute and not as a data character.

The Insert Cursor (IC) order causes the cursor to be displayed at the screen location associated with CBA.

The Program Tab (PT) order will cause the CBA to be set to the first data character position in the next unprotected field in the buffer. Under certain circumstances it will also cause nulls to be inserted into the character buffer from this new CBA to the end of the field.

The Repeat to Address (RA) order is followed by 2 character buffer address bytes and a character to be repeated. That character will be replicated through the character buffer up to, but not including, the specified buffer address.

The Erase Unprotected to Address (EUA) order is followed by 2 character buffer address bytes and causes nulls to be inserted in all unprotected buffer locations starting at the CBA and up to, but not including, the specified stop address.

When the Structured Field and Attribute Processing option is installed in the control unit, the following orders are available for use with appropriately configured terminals:

The Start Field Extended (SFE) order is followed by a 1-byte count indicating the number of attribute type and value *pairs* which follows. The specified number of attribute type and value pairs follows the count.

The Modify Field (MF) order allows specified extended field attributes to be modified without having to respecify all the attributes in the field. The structure of the Modify Field order is identical to that of the Start Field Extended order, having a 1-byte *count* field followed by the specified number of attribute type and value pairs.

The Set Attribute (SA) order provides the ability to associate attributes with individual characters rather than with fields. In this case, only a *single* attribute type and value pair follows the order, and the count field is absent. Once a character attribute has been established using this order, it applies to all subsequent characters in the transmission, until a new character attribute value *of the same type* is established with another Set Attribute order. Character attribute values are reset to their defaults at the beginning of each transmission. The character attributes specified with Set Attribute orders override the same attribute type settings specified with the SFE or MF orders applying to the fields in which the characters are stored.

Attributes

Four attribute types can be specified in the orders included in the 3270 data stream: field, color, extended highlighting, and symbol set. All four can be assigned to fields and three of the four can be assigned to individual characters.

The color, extended highlighting, and symbol set attribute types may be applied to characters as well as fields. Values accompany the attribute type designation, specifying, for instance, red for the color attribute, or protected, numeric for the field attribute. Refer to Chapter 2 for a discussion of attributes.

Write Commands

Two write-type commands, Write and Erase/Write, are used to load, format, and selectively erase device buffer data. These commands can also initiate certain device operations such as starting the printer, resetting the keyboard, and sounding the audible alarm. Write and erase/write operations are identical except that Erase/Write causes complete erasure of the device buffer before the write operation is started. Thus, Erase/Write is used to load the buffer with completely new data, whereas Write can be used to modify existing buffer data.

A third write-type command, Erase/Write Alternate, performs the erase/write function for 3278 and 3279 displays and 3287 and 3289 printers. It is also used to switch the display or printer into large screen or expanded print capacity mode. The Erase/Write Alternate command is valid when sent to the 3274.

12/14-Bit Addressing

Twelve- or 14-bit buffer addressing is allowed in an outbound data stream. (Inbound data streams always use 12-bit addressing.) Definition of 12- or 14-bit buffer addressing is as follows:

Bits 0 and 1 of the first address byte following an SBA, RA, or EUA order are considered flag bits and have the following significance:

= 00 — 14-bit binary address follows

= 01 — 12-bit coded address follows

= 10 — Reserved

= 11 — 12-bit coded address follows

When the flag bits are 00, the next 14 bits (the remainder of the current byte (6 bits) and 8 bits of the next byte) are considered a buffer address in binary form. No address translation is necessary. Receipt of a buffer address beginning with the flag bits 10 will cause a negative response (X'1005') or an Op Chk when the 3274 has configuration support C installed.

Write Command

The bytes received by the 3274 for Write command operation consist of a command code, a write control character (WCC), and orders and/or data. Remotely attached 3274 control units also receive appropriate data link control framing. The sequence of bytes is as follows:

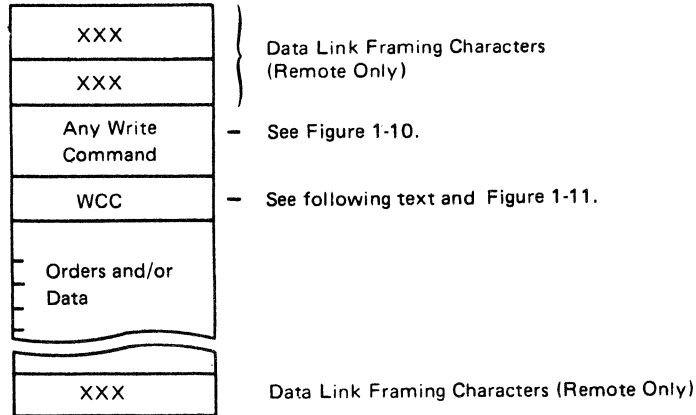

The minimum data stream following a Write command is a 1-byte WCC. This is ensured because the byte count field of the write channel control word (CCW) must be set to a minimum of 1 when attached to the 3274 Model 1B or 1D, or else the command code is not sent. The minimum Write command data stream to a remote 3270 consists of framing characters (for example, in BSC, STX, ESC, and ETX) and the command code. To be meaningful, a WCC byte should follow the command code; if the BSC data link control character ETX follows the command code, an all-zero default WCC byte is generated by the control unit, and command execution is ended normally. An order or display/print data byte that immediately follows the command code is interpreted as a WCC by the control unit.

The WCC byte format is as follows:

.	Reset Bit	Printout Format	Start Print	Sound Alarm	Keyboard Restore	Reset MDT Bits
0	1	2	3	4	5	6

*Determined by the configuration of bits 2 through 7. See Figure 1-11.

Figure 1-11 describes the function of each WCC bit. When the WCC specifies an operation that does not apply to the selected device (for example, if the Sound Alarm bit is set and the selected device does not have the Audible Alarm feature), the specified operation is ignored. When the WCC byte is followed by order or display/print data bytes, only the Reset MDT Bits function, if specified, is performed before the write operation; any other WCC function is deferred until all data is written and all orders are performed.

Orders and buffer data can follow the WCC character. (Orders are described later in this chapter, following the “Write Commands” description.) Buffer data can be written into any specified location of the buffer without erasing or modifying data in the other buffer locations. Data characters are stored in successive buffer locations until an order is encountered in the data stream which alters the buffer address, or until all the data has been entered. During the write operation, the buffer address is advanced one location as each character is stored.

The buffer location where data entry starts depends upon the following considerations:

1. The starting location may be specified by an SBA order that follows the WCC. (This order is described later in this chapter under “Orders.”)
2. The starting location will be the buffer address containing the cursor if the Write command is not chained or if it is chained from a Copy, Select, Erase All Unprotected, No Operation, or Sense command.
3. The starting location will be the current buffer address if the Write command is chained from a Read or another Write command.

The formatting and placement of write data and the modification of existing buffer data are described under “Orders.”

Bit	Explanation
0	Determined by the contents of bits 2 through 7 as shown in Figure 1-8.
1	WCC reset bit. When set to 1, resets the functions denoted in Figure 1-12.
2,3	Define the printout format, as follows: = 00 – The NL, EM, and CR ¹ orders in the data stream determine print line length. Provides a 132-print position line when the orders are not present. = 01 – Specifies 40-character print line. = 10 – Specifies 64-character print line. = 11 – Specifies 80-character print line.
4	Start Printer bit. When set to 1, initiates a printout operation at completion of the write operation.
5	The Sound Alarm bit. When set to 1, sounds the audible alarm at the selected device at the end of the operation if that device has an audible alarm.
6	The Keyboard Restore bit. When set to 1, restores operation of the keyboard by resetting the INPUT INHIBITED indicator on 3277 displays, and the System Lock or Wait symbol on 3278, or 3279 displays. It also resets the AID byte at the termination of the I/O command.
7	Reset MDT bits. When set to 1, all MDT bits in the selected devices' existing buffer data are reset before any data is written or orders are executed.

¹ The CR order is applicable to the 3262, 3287 and 3289 printers only.

Figure 1-11. Write Control Character (WCC)

Keyboard Actions or Data Stream States	Reply Mode	Color, Extended Highlighting, PS		INOP	Programmed Symbols		Base Color Override Bit
		Selection	Indicator		Symbol-Set ID	Content	
Clear key (SSCP)	R	R	1	R	NC	NC	R
Clear key (unowned)	R	R	1	R	NC	NC	R
Clear key (LULU)	R	R	1	R	NC	NC	R
System request key SSCP (unowned)	R	R	1	R	NC	NC	R
System request key SSCP (LULU)	R	R	1	R	NC	NC	R
System request key unowned (SSCP)	R	R	1	R	NC	NC	R
Receipt of RU (SSCP)	R	R	1	R	NC	NC	R
System request key LULU (SSCP)	R	R	1	R	NC	NC	R
TEST key "ENTER"	2	R	1	R	NC	NC	R
TEST key "EXIT"	R	R	1	R	NC	NC	R
WCC Reset in EW/EWA	R	R	1	R	NC	NC	R
Power on	R	R	R	R	R	R	R
SNA Clear (LULU)	NC	NC	NC	NC	NC	NC	NC
SNA ACTLU (SSCP-owned)	NC	NC	NC	NC	NC	NC	NC
SNA DACTLU	NC	NC	NC	NC	NC	NC	NC
SNA ACTLU (unowned)	NC	NC	NC	NC	NC	NC	NC
UNBIND	NC	NC	NC	NC	NC	NC	NC
BIND	R	R	R	R	NC	NC	R
Set Reply Mode	3	NC	1	NC	NC	NC	4
SA, SFE, MF	NC	NC	NC	NC	NC	NC	5
082B (external viewpoint)	R	R	R	R	NC	NC	R
CD/EB WRITE acknowledgment	NC	NC	NC	R	NC	NC	NC

R = Reset (to default value) NC = No change

Notes:

1. Display exactly those attribute selection indicators that are honored as a result of the Reply mode.
2. Allow all attribute key selections during test.
3. Inbound Reply mode changed to the mode described in the structured field.
4. If the Reply mode indicates color as an acceptable operator selection, then the color-override bit is set.
5. If SA, SFE, or MF reference color, then the color-override bit is set.

Figure 1-12. Reset Matrix

Programming Notes:

1. *If the commands are being chained, the Write or Erase/Write command with the Start Print WCC bit set must be the last command in the chain. If not:*
 - a. *Local control units abort the Write or Erase/Write command that specifies Start Print.*
 - b. *Remote control units perform the print operation and abort the next command.*
2. *The Printout Format bits are honored only if the Start Print bit is set in the same WCC.*
3. *In remote operations, if a Write command that includes data is chained from a previous Write command, an SBA order should immediately follow the WCC to define the starting location at which data entry is to start; this permits recovery in case of an error condition that requires retransmission of that data.*

Programming Restriction: *A Write command should not be chained from an Erase All Unprotected command. If it is, the operation is undefined.*

Erase/Write Command

Execution of the Erase/Write command performs two operations: an erase operation and a write operation. The erase operation clears the entire device buffer to nulls, positions the cursor to character location 0, and resets the buffer address to 0.

Erase/Write then performs the write and WCC operations in the same manner as a Write command. If no WCC is sent, the Erase/Write command will not erase the buffer.

An Erase/Write command can also return a display or printer to the default screen size or character print capacity (as next described under "Erase/Write Alternate Command").

Erase/Write Alternate Command

The 3278 and 3279 displays and 3287 and 3289 printers with a capacity of 960 characters can function as 480-character devices; 1920-, 2560-, 3440-, and 3564-character (3278 Model 5, 3287, and 3289 attached to 3274 A, C, and D units only) displays and printers can function as 1920-character devices. Thus, application programs written for 3277 displays and for 3284, 3286, and 3288 printers can be used without modification of screen or print format for 3278 or 3279 displays and for 3287 and 3289 printers.

For the 3274 B, C, or D units, a unique instruction is required from the application program to enable a display or printer to function at greater than 480- or 1920-default-character capacity. The Erase/Write Alternate command is used to switch a 3278 or 3279 display screen size or a 3287 or 3289 print capacity to the alternate size indicated by the display model number or specified for the printer as follows:

3278 Model	3279 Model	3287 and 3289 Model	Default Character Capacity	Alternate Character Capacity
1	—	1, 2	480	960
2	2A, 2B	1, 2	1920	1920
3	3A, 3B	1, 2	1920	2560
4	—	1, 2	1920	3440
5	—	1, 2	1920	3564

The Erase/Write Alternate command also operates as an Erase/Write command. Once the display or printer is placed in alternate mode, operation continues in alternate mode until the operator presses the CLEAR, SYS REQ (SNA only), or TEST key or until an Erase/Write command is received, the SNA session is unbound, power fails at the control unit, display, or printer, or, in locally attached 3270 systems, a system reset sequence occurs. Only these conditions return the display or printer to the default-value screen-size or character print capacity. For the 3274 B, C, or D units, the Erase/Write Alternate and Erase/Write commands are used to switch a display screen size, or a print capacity to alternate size, or vice versa, according to Bind parameter definition.

When in emulation mode, and with the display not in an LU-LU session, the operator may set the display to its maximum size by pressing the CLEAR key.

A 3278 or 3279 display operating as an LU type 2 requires the format shown in Figure 1-13 as part of the bind operation.

Byte 24 determines the screen size for both the base and the extended LU type 2. Only 480- and 1920-character displays are supported in the base LU type 2, which corresponds to the 3277 Models 1 and 2. The Bind format must specify the extended LU type 2 for larger screen sizes. The base LU type 2 screen size is in effect during the entire session when coded in byte 24. Bytes 20 through 23 are ignored in this case. The 3277s attached to the 3274 are always in base LU type 2 Bind format. Any I/O device that has base LU type 2 Bind format can accept an Erase/Write Alternate command, but it is executed as an Erase/Write command.

Byte	Bit	Model	Content	Description
20	0-7	1	X'01' - X'0C'	Default number of rows 1-12
		2	X'01' - X'18'	1-24
		3	X'01' - X'20'	1-32
		4	X'01' - X'2B'	1-43
		5	X'01' - X'1B'	1-27
21	0-7	1	X'28'	Default number of columns 40
		1-5	X'50'	80
		5	X'84'	132
22	0-7	1	X'01' - X'0C'	Alternate number of rows 1-12
		2	X'01' - X'18'	1-24
		3	X'01' - X'20'	1-32
		4	X'01' - X'2B'	1-43
		5	X'01' - X'1B'	1-27
23	0-7	1	X'28'	Alternate number of columns 40
		1-5	X'50'	80
		5	X'84'	132
24	0-7	0	Reserved	Session screen size reserved
		1-5	b'000 0000'	Base default (12 x 40 or 24 x 80)
		1	b'000 0001'	Base Model 1 default (12 x 40)
		2-5	b'000 0010'	Base Model 2 default (24 x 80)
		1-5	b'111 1110'	Extended default (size specified in bytes 20 and 21)
		1-5	b'111 1111'	Extended alternate (size specified in bytes 22 and 23)
<p>Note: Row values outside these ranges and column values other than those listed cause the Bind to be rejected with X'0821'.</p>				

Figure 1-13. LU Type 2 Screen Size Bind Format

When bits 1 through 7 of byte 24 are coded b'0000000', the device assumes the 3277 default size defined for that model display. Buffer wrap occurs as if the device were physically a 3277 Model 1 or 2 display. If an Erase/Write Alternate command is received while bound, it is processed as a normal Erase/Write command. No state change occurs within the display. Default screen sizes are as follows:

3278 Model	3279 Model	Default Screen Size Assumed with Byte 24 = b'0000000'
1	—	480 (12 x 40)
2	2A, 2B	1920 (24 x 80)
3	3A, 3B	1920 (24 x 80)
4	—	1920 (24 x 80)
5	—	1920 (24 x 80)

Only a Model 1 display can be bound as b'0000001', a base LU type 2 with a 12 x 40 character screen. This coding of the Bind image is rejected with X'0821' on Models 2, 3, 4, and 5.

A Model 2, 3, 4, and 5 display can be bound as b'0000010', a Base LU type 2 with a 24 x 80 character screen. This Bind format, if used for a Model 1 display, causes the Bind to be rejected with X'0821'.

When operating with a screen size of 480 characters, sequential buffer addresses map to the 12 x 40 screen format in row major order. When operating in other screen sizes, sequential buffer addresses map to the defined screen format in row major order.

Byte 24 must be coded X'7E' or X'7F' to use displays in large-screen mode (2560, 3440, and 3564 characters) during the LU-LU session.

When bits 1 through 7 of byte 24 are coded X'7E', the screen size of the device is defined in bytes 20 and 21 of the Bind image, and bytes 22 and 23 are ignored. The device operates with the defined screen size during the entire session. An Erase/Write Alternate command is accepted by the device but is interpreted as an Erase/Write command. No state change occurs, and the screen size remains as defined in bytes 20 and 21 of the Bind image. Valid codings of bytes 20 and 21 are as follows:

		Model 1	Model 2	Model 3	Model 4	Model 5
Byte 20	Hex	≤ X'0C'	≤ X'18'	≤ X'20'	≤ X'2B'	≤ X'1B'
	Row	≤ 12	≤ 24	≤ 32	≤ 43	≤ 27
Byte 21	Hex	X'28' X'50'	X'50'	X'50'	X'50'	X'50' X'84'
	Col	40 80	80	80	80	80 132

If the Bind specifies an invalid number of columns, or if the number of rows is greater than the maximum row specified (above) for each model, the Bind will be rejected. Buffer wrap will occur at the end of the row specified in byte 20.

When bits 1 through 7 of byte 24 are coded b'0111111', a dynamic switch can be made during the session between a default screen size and an alternate screen size. When byte 24 is coded in this way, bytes 20 through 23 define the default and alternate screen sizes.

Valid codings of these bytes are as follows:

		Model 1	Model 2	Model 3	Model 4	Model 5
Bytes 20 and 22	Hex	≤ X'0C'	≤ X'18'	≤ X'20'	≤ X'2B'	≤ X'1B'
	Row	≤ 12	≤ 24	≤ 32	≤ 43	≤ 27
Bytes 21 and 23	Hex	X'28' X'50'	X'50'	X'50'	X'50'	X'50' X'84'
	Col	40 80	80	80	80	80 132

The Bind is rejected if an invalid number of columns is coded in the Bind image or if the number of rows is greater than the maximum row value shown for each model (above). When in alternate-size mode, the display will wrap at the end of the row specified in byte 22 of the Bind image. When in default-size mode, the screen will wrap at the end of the row specified in byte 20 of the Bind image.

Once the Bind has taken place, the display is cleared and set to the default screen size and format. Request/Response Units (RUs) that contain SBA, RA, or EUA orders with addresses out of the range of the default screen size are rejected with -RSP (1005) (address out of range) response. Data will wrap at the default screen boundary whether input by the operator or from the outbound data stream, and wrapping will occur at the default screen boundary as defined for all other 3270 operations (for example, Erase All Unprotected, Read Buffer).

The Erase/Write Alternate command dynamically switches the display to the specified alternate screen size. Note that, on a Model 2 display, the Erase/Write Alternate command performs no meaningful function.

If bound to dynamically switch, the device assumes the characteristics of a display with the alternate screen size, upon receipt of an Erase/Write Alternate command. RUs that contain SBA, RA, or EUA orders that have addresses out of the range of the valid alternate screen size are rejected with -RSP (1005) (address out of range).

Write, Erase/Write, and Erase/Write Alternate Commands (LU Type 3)

Both 3287 and 3289 printers can operate as LU type 3, and extended LU type 3. Commands and orders used by LU type 2 are applicable to LU type 3 and extended LU type 3 except for the read-type commands: Read Buffer, Read Modified, and Read Modified All. Read-type commands are rejected with -RSP (1003) (invalid command code).

LU type 3 operations are directed by write-type commands. As specified in the Bind, printers that function as base LU type 3 operate as 480- or 1920-character devices, and printers that function as extended LU type 3 operate with alternate buffer sizes of 960, 1920, 2560, 3440, or 3564 characters, or the full physical buffer. The alternate size is established by an Erase/Write Alternate command, and the default size is established by an Erase/Write command. Loss of power at the printer or the control unit or unbinding the session returns the printer to the default buffer size.

The WCC for LU type 3 and extended LU type 3 is shown in Figure 1-11. The function of bits 2, 3 (Printout Format), 5 (Sound Alarm), and 7 (Reset MDT bits) is the same as for LU type 2. When bit 4 (Start Print) is set to 1, the printer buffer content is printed after completion of the data transfer. Otherwise, printing does not occur after completion of the data transfer.

Buffered printers that operate as LU type 3 employ the format shown in Figure 1-14 as part of the Bind operation.

Byte	Bit	Content	Description
19	0-7	Reserved	
20	0-7	X'0C' X'18' X'1B' X'20' X'2B'	Default number of rows 12 24 27 32 43
21	0-7	X'28' X'50' X'84'	Default number of columns 40 80 132
22	0-7	X'0C' X'18' X'1B' X'20' X'2B'	Alternate number of rows 12 24 27 32 43
23	0-7	X'50' X'84'	Alternate number of columns 80 132
24	0 1-7	Reserved Session Buffer Size b'0000000' b'0000001' b'0000010' b'1111110' b'1111111'	 Extended LU3 uses all available buffer space. No size is specified. Base LU3, 12 x 40 Base LU3, 24 x 80 Extended LU3 static buffer size is defined in bytes 20, 21. Extended LU, alternate sizes are indicated in bytes 22, 23.
All other values are reserved and cause the Bind to be rejected with X'0821'.			

Figure 1-14. LU Type 3 Buffer Size Bind Format

Byte 24 establishes the buffer size for both base and extended LU type 3 operations. The base LU type 3 operation supports a 480- or 1920-character buffer only, using the Erase/Write command. To use larger printer buffer sizes, the Bind must specify Extended LU type 3 operation.

The Erase/Write Alternate command is accepted in base LU type 3, but it is processed as an Erase/Write command. No state change occurs. All 3287s and 3289s can be bound with b'0000001' or b'0000010'.

When bits 1 through 7 of byte 24 are coded b'0000000', the entire print buffer can be used, regardless of size. Buffer wrap occurs at the end of the physical buffer. An Erase/Write Alternate command is processed as a normal Erase/Write command. No state change occurs.

When coded b'1111110', byte 24 indicates extended LU type 3 operation with the buffer size coded in bytes 20 and 21. Buffer size switching is not allowed. Bytes 22 and 23 are ignored. When an Erase/Write Alternate command is encountered in the data stream, it is interpreted as a normal Erase/Write command.

When byte 24 is coded b'1111111', bytes 22 and 23 are inspected to determine the maximum alternate buffer size to be used during the session; for example, a Bind for 32 rows of 80 characters each permits the use of programs written for 960-, 1920-, and 2560-character buffer sizes. (If programs written for 132-character columns are used, byte 22 must be interpreted differently.) This assumes that programs do not depend upon buffer address wrap during write operations.

If the printer cannot support the required buffer size, the Bind is rejected with a -RSP (0821) response parameter error. A 3287 with a basic 2K buffer cannot, for example, accept an LU 3 Bind specifying a 2560-character buffer. The 3274 supports any column count within the constraints of the above row/column product. The row/column product determines the print buffer wrap point. Print control is managed by the WCC and not by the Bind parameter values.

Write Structured Field (WSF) Command, Function Management Header 1 (FMH1), and Structured Field Functions

For 3270 systems in the SNA/SDLC environment (LU Types 2 and 3 sessions), the BSC environment, and locally attached systems, the WSF command and its associated structured field functions provide the mechanism for:

- Combining eligible 3270 commands and structured field functions in a single transmission to terminals supporting SFAP (3270DS structured field).
- Loading symbol definition data into a specified terminal storage (Load Programmed Symbols structured field).
- Querying a terminal as to its characteristics (Read Partition—Query structured field).
- Specifying the type of inbound transmission wanted, and allowing/disallowing operator selection of color, extended highlighting, and symbol-set characteristics for keyed-in data (Set Reply Mode structured field).

For LU type 1 sessions, a Function Management Header Type 1 (FMH1) and structured field functions (Load Programmed Symbols, Read Partition - Query, SCS Data) provide the mechanism for support of the Structured Field and Attribute Processing (SFAP) option in an SCS data stream.

WSF Command

The WSF command must be the first item in any structured-field transmission. The length field of the first structured field follows immediately.

Command chaining involving the WSF command is not allowed, except after a Select Write (WRT) command.

In processing a structured-field transmission, the 3274, except for the Read Partition - Query structured field, does not check for multiple transmissions of a specific structured-field type. When the same type of structured field appears more than once in the transmission, the last occurrence of the field sets the values used.

A WSF transmission does not change printer allocations.

If a WSF transmission is sent to a controller and device not configured or featured for structured-field and attribute processing, an Op Chk or negative response (X'1003') is returned.

Function Management Header 1 (FMH1)

To direct a structured field data stream to a printer in LU type 1 session, an FMH1 is used, rather than the WSF command, to indicate the beginning of a structured field data stream. The format header indicator in the Bind command (byte 6, bit 1) must specify function management header included. The FMH1 format accepted by the 3274 is X'0601000B6000'. A data stream, with a properly specified Bind command (byte 6 bit 1 set to 1) and an FMH1 in the format just described, directed to a printer equipped for SFAP support, will be accepted by the 3274. For other printers, the Bind with byte 6 bit 1 set 1 will be rejected with sense code X'0821'.

A data stream containing a Bind with byte 6 bit 1 set to 0 and an FMH1 is rejected with sense code X'400F'.

Structured Field Functions

Structured fields, whether outbound or inbound, have the following general format: length—type—parameters and data.

The length-field value includes the 2 bytes of the length field. A length-field value of zero causes the structured field to be treated as the last structured field in the transmission.

The type field identifies the purpose of the structured field, and the parameters and data that follow are variable, depending on the structured-field type.

3270DS Structured Field. The 3270DS structured field is used to transmit Write, Erase/Write, Erase/Write Alternate, Erase All Unprotected, or BSC Copy commands as part of a 3270 structured field data stream containing other structured field functions (e.g., the LPS structured field).

The 3274 Control Unit Models 1 and 31A, C, and D and 51C support the 3270DS structured field when Configuration Support C is installed.

Each 3270DS structured field encountered in the data stream is processed to completion before operations are started on a succeeding structured field.

A format description and explanatory notes for the 3270DS structured field follow:

Byte	Bit	Content	Meaning
0, 1	—	X'nnnn'	Length of structured field
2	—	X'40'	3270DS identifier
3 ₁	—	X'00'	Mandatory; checked. Any other value is rejected with SNA sense code X'1005' or non-SNA op-check.

Byte	Bit	Content	Meaning
4 ¹	—	—	3270 command codes. Byte 4 values are checked. Any value other than those shown results in rejection with SNA sense code X'1003' or non-SNA op-check. Error checking for the 3270 command specified is the same as for the command when not enclosed in a structured field.
	—	X'F1' X'F5' X'7E' X'6F' X'F7'	Write Erase/Write ² Erase/Write Alternate ² Erase All Unprotected Copy (BSC) ³
5	—	X'nn'	Byte 5 contains the Write Control Character (WCC) ⁴ for the Write command (X'F1', X'F5', X'7E'), or the Copy Control Character (CCC) for the BSC Copy command (X'F7').
6, 7	—	X'nn'	The "From" address for the BSC Copy command; or the start of 3270 data stream order and data associated with the Write commands.
7-n	—	X'nn...'	Orders and data continued (Write commands)

¹ If bytes 3 and 4 are missing, an SNA sense code of X'1005' or a non-SNA op-check is returned.

² If no WCC is defined, no erasing or resetting occurs.

³ See page 1-26.2

⁴ See page 1-26.2

The BSC Copy command must meet the following requirements to be valid in a 3270DS structured field. An op-check will be returned if they are not met.

- The communications must be BSC.
- The 3270DS structured field carrying the BSC Copy command must be the last structured field in the transmission.

The same rules apply to the BSC Copy command in the 3270DS structured field as cited for the command when used in a nonstructured field 3270 data stream.

If the 3270DS structured field carrying the BSC Copy command is sent to an SNA configured controller, SNA sense code X'1003' is returned.

When a data stream contains multiple 3270DS structured fields, and thereby multiple WCCs, the WCC functions will be executed as defined below.

RESET	Executed in each structured field as it is encountered.
START PRINT	Executed at the end of the transmission, after the write operation has been completed. Only the last structured field in the transmission may have a WCC that specifies Start Print. If the Start Print bit is set in any of the other structured fields, the WSF will be rejected with SNA sense code X'1001' (RU Data error) or non-SNA op-check.
SOUND ALARM	Executed for each structured field at the end of the operation specified for the structured field.
KEYBOARD RESTORE	Examined for each structured field and noted if set to restore. The keyboard will be unlocked if the WCC byte in one of the 3270DS structured fields was set to unlock. The keyboard will not be unlocked until the end of transmission is processed.
RESET MDT	Executed for each structured field containing a Write command, prior to writing any data or executing any orders in the data stream. The bit is ignored on an Erase/Write or Erase/Write Alternate command.

Load Programmed Symbols (LPS) Structured Field. The LPS structured field is used to load symbol definition data into loadable terminal storage. (The *Color and Programmed Symbols* publication, GA33-3056, describes Programmed Symbols capability, applications, and programming support.)

Terminals configured to support Programmed Symbols can have up to six loadable storages (IDs of X'02' to X'07', correlating to the attribute selection keys PS-A to PS-F).

To accommodate multiple colors within a single-character location, some of the loadable terminal storages are provided with three primary color planes. Storage X'05' on the 3287 Models 1C and 2C and storages X'04', X'05', and X'07' (PS-C, PS-D, and PS-F) on the 3279 Models 2A and 3A are triple-plane storages.

The storage ID and a unique symbol-set ID [Coded Graphic Local Identifier (CGLI)] are specified in the LPS structured field, and the controller logic keeps track of the association. When the symbol set ID shows up in SA, SFE, or MF orders as a Programmed Symbols attribute value, the symbol set is accessed in the specified storage.

A Programmed Symbol set contains up to 190 symbol definitions and a space code point (X'40'). Code points X'41' to X'FE' correlate to the 190 possible symbols. Note that not all code points can be invoked from a keyboard, only those permitted by the keyboard/language combination installed.

The skip suppression facility (specified in byte 3, bit 2) provides for suppression of the vertical spacing between character cells. If specified, skip suppression is applied any time the symbol set ID appears as an attribute value, effective with the next row of cells. Suppression is by row; that is, the symbol set ID of the symbol set specifying suppression must appear as an attribute value in each row if skip suppression is wanted. Specification of another symbol set with skip suppression off, or default to the base character set, normally stops skip suppression with the next row. However, when the base character set is selected by default and the change occurs when the field attribute and extended field attribute are associated with the first character position in a row, skip suppression will not turn off until the next line plus one.

Note: *Skip suppression is available only on the 3278 Model 2 and the 3279 Model 2B.*

The LPS structured field has a basic and extended form, as follows.

Byte	Bit	Content	Meaning
0, 1	—	X'nnnn'	Length of structured field, including extensions if present.
2	—	X'06'	LPS structured field identifier.
3	∅	b'∅'	Basic LPS format. No extensions present.
		b'1'	LPS format extensions present.
	1	b'∅'	Do not clear the specified terminal storage (byte 6) prior to loading. This enables symbol definitions to be added to an existing set.
		b'1'	Clear the specified terminal storage (byte 6) before loading the symbol definitions in this structured field. The entire storage is cleared of any existing symbol definitions. If this PS set is part of a triple-plane set, only the plane(s) indicated in byte 12 (extension) is(are) cleared.
	2	b'∅'	Skip suppression off. Normal row spacing (vertical) in effect.
		b'1'	Skip suppression on. The next row will be positioned adjacent to the current row, with no spacing (vertical) between rows.
3		b'∅'	Must be b'0'. Other values are rejected with negative response (X'1003') or Op Chk.

Byte	Bit	Content	Meaning
4—7	X'1'		<p>The symbol definition data in this LPS is display type 1; each symbol definition specifies the dot pattern to be displayed in a 9-dot-wide-by-16-dot-deep block matrix. The definition consists of 18 bytes of data, the first two bytes defining a 16-bit vertical slice of the matrix (left side) and the following 16 bytes representing sixteen 8-bit horizontal slices (top to bottom) of the matrix.</p> <p>Definitions for the 9 x 16 block matrix are always assumed. When the display uses only a 9 x 12 block matrix, the last four bits of the 16-bit vertical slice and the last four 8-bit slices are ignored.</p>
	X'2'		<p>Display type 2. Display type 2 is the Display type 1 definitions in compressed form. See Appendix K for compression discussion.</p>
	X'5'		<p>The symbol definition data in this LPS is printer type 5. Each symbol definition specifies the dot pattern to be displayed in a 10-dot-wide-by-8-dot-deep block matrix. The definition consists of 10 bytes of data, each representing an 8-bit vertical slice of the matrix. Bit 1 of byte 1 represents the upper-left dot in the matrix. Byte 10 represents the right-hand side of the matrix.</p>
	X'6'		<p>Printer type 6. Printer type 6 is the printer type 5 definitions in compressed form. The 3274 Control Unit, with Configuration Support C, will decompress the data for LU type 3 devices. See Appendix K for compression discussion.</p> <p>Values other than X'1', X'2', X'5', or X'6' in bits 4-7 are not accepted. A negative response (X'1003') or Op Chk results.</p>
4	—	X'nn'	<p>Programmed Symbol set identifier; valid values are X'40' to X'EF'. The controller associates this ID with the terminal storage ID specified in byte 6. This ID is used in SFE, MF, and SA orders as a Programmed Symbol attribute value. An X'FF' in this byte causes the control unit to mark the storage specified in byte 6 as "free" and effectively blocks any further reference to the symbol set. Invalid values cause a negative response (X'1003') or Op Chk.</p>
5	—	X'nn'	<p>X'nn' is an EBCDIC I/O interface code point in the range X'41' to X'FE. Invalid code points cause a negative response (X'1005') or Op Chk.</p>

Byte	Bit	Content	Meaning
			The code point correlates with a symbol-definition data slot in the Loadable terminal storage, and the symbol definitions are loaded into slots correlated with contiguous EBCDIC code points, starting with the slot pointed to by X'nn'. Loading continues until (1) a positive response indicates that loading ended on a matrix boundary or (2) a negative response indicates that loading did not end on a matrix boundary, that code point X'FE' has been overrun, or that algorithm conditions for decompression were not met.
6	—	X'nn'	Loadable terminal storage ID in the range X'02' to X'07'. These values equate with the PS attribute selection keys PS-A through PS-F, respectively. Invalid IDs or a valid ID not loaded causes a negative response (X'084C') or Op Chk.
7	—	X'nn'	Length specification for extended form, including this length parameter itself. If X'nn' is X'00' or a value greater than X'06', a negative response (X'1005') or Op Chk is returned. Bytes 7 through 12 compose the LPS extension, and the parameters may be progressively included by specifying the appropriate length. Omitted parameters are equated to X'00', and the effect is the same as receiving a byte containing X'00'.
8	∅	b'∅'	All dots available for display or printing.
		b'1'	Fewer than all dots may be displayed or printed.
	1	b'0'	For a local copy operation, the ID of this symbol set (byte 4) is compared with symbol-set IDs in the printer. If there is a match, the copy is performed using the corresponding symbol set in the printer. If there is no match, the characters of the interface code in the printer's read-only storage are used.
		b'1'	Symbol set IDs are not compared. Characters from the interface code in the printer's read-only storage are used.
	2	b'0'	This symbol set is keyboard-selectable. The PS key corresponding to the storage specified in byte 6 is enabled.
		b'1'	This symbol set is not keyboard-selectable; it is intended for output only. The PS selection key cannot be enabled while this storage and the specified symbol set (byte 4) are associated.
3-7		b'00000'	If bits 3-7 are not zero, a negative response (X'1003') or Op Chk is returned.

Byte	Bit	Content	Meaning
9, 10	—	X'nn'	Bytes 9 and 10 are the horizontal (9) and vertical (10) dot specification for the block matrix size of symbols in the set. If specified, byte 9 must be X'0A' for printers and X'09' for displays, and byte 10 must be X'08' for printers and X'10' for displays. These values are assumed if bytes 9 and 10 are not specified or are set to zero. A negative response (X'1005') or an Op Chk is returned for values other than the above.
11	—	X'00'	If not X'00', a negative response (X'1003') or Op Chk is returned.
12	0—4	b'00000'	Must be 0. Other values cause a negative response (X'1003') or Op Chk.
	5—7	b'000'	When loading triple-plane terminal storages, b'000' causes the symbol definitions for each code point to be loaded in all three planes.
		b'001'	Load the symbol definitions in the blue plane.
		b'010'	Load the symbol definitions in the red plane.
		b'100'	Load the symbol definitions in the green plane.
			Any other values in bits 5-7 cause a negative response (X'084C') or Op Chk.

Set Reply Mode (SRM) Structured Field. The SRM structured field defines the format of inbound data streams generated in response to Read commands and specifies the character attributes (Color, Extended Highlighting, Programmed Symbols) that the operator may select for keyed data. Three inbound data stream formats can be set by the SRM structured field: field mode, extended field mode, and character mode. Character mode also controls operator selection of character attributes.

SF, SBA orders, field attributes, characters, and the graphic escape code (X'08') may be included in inbound field mode transmissions.

SFE, SBA orders, field attributes, extended field attributes, characters, and the graphic escape code (X'08') may be included in inbound extended field mode transmissions.

SFE, SBA, SA orders, field attributes, extended field attributes, character attributes, and the graphic escape code (X'08') may be included in inbound character mode transmissions.

The graphic escape code (X'08') is returned with a character (all modes) when the Programmed Symbols character attribute value indicates that the APL/Text storage contains the definition of the character.

The SRM structured field consists of a length specification, an identifier, a reply mode specification, and, if character mode is specified, attribute type specifications. Length is a minimum of 5 bytes. Byte and bit content and meaning are as follows:

Byte	Bit	Content	Meaning
0, 1	—	X'0000' or X'0005' to X'nnnn'	Length of structure.
2	—	X'09'	Set Reply Mode identifier.
3	—	X'00'	Reserved, must be zero. Other values result in negative response (X'1005') or Op Chk.
4	—	X'00' X'01' X'02'	Field mode. Extended Field mode. Character mode. Other Values result in negative response (X'1003') or Op Chk.
5—7	—	X'nn' or X'nnnn' or X'nnnnnn'	Attribute list for character mode. Bytes 5-7 are effective only if X'02' was specified in byte 4. Any, or all, of the character attribute types - Color, Extended Highlighting, Programmed Symbols - may be listed. Values are: X'41' - Extended Highlighting X'42' - Color X'43' - Programmed Symbols Other values result in negative response (X'1003') or Op Chk.

SCS Data Structured Field (SCS Data)

The SCS Data structured field allows an SCS printer data stream to be included in the same chain of RUs as the other structured fields (Read Partition-Query, Load Programmed Symbols) that can be directed to a printer in an LU type 1 session.

The SCS print stream must be sent via SCS Data if any of the other structured fields are included in the transmission.

The syntax is:

Byte	Content	Meaning
0, 1	X'nnnn'	Length of structured field. If X'0000', indicates last or only structured field in transmission.
2	X'41'	SCS Data identifier.
3	X'00'	Mandatory. Any other value results in rejection and sense code X'1005' is returned.
4—n	data	The SCS printer data stream.

Read Partition (Query) Structured Field

The Read Partition (Query) structured field provides the mechanism for a host application program to inquire as to the color, highlighting, usable area, reply modes, and symbol-set characteristics of a terminal and to receive a reply. This field is valid only in outbound data streams and must be the only or last structured field in a Write Structured Field (WSF) transmission. The format of the Read Partition structured field is as follows:

Byte	Bit	Content	Meaning
0—1	—	X'0000' or X'0005'	Length field
2	—	X'01'	Structured field type
3	—	X'FF'	Mandatory
4	—	X'02'	Identifies this structured field as a query

If bytes 3 and 4 do not exist or bytes exist after byte 4, an Op Chk or sense code X'1005' is returned. If byte 3 does not contain X'FF' or byte 4 does not contain X'02', an Op Chk or sense code X'1003' is returned. If the SNA outbound chain does not contain a change direction indicator (CD) or *does* contain an end bracket indicator (EB), the chain is rejected with negative response X'0829'.

The response by the controller to the query is the transmission of a series of structured fields that describe the characteristics of the addressed terminal. Response is immediate when SDLC/SNA protocols are being used; response is given when the terminal is polled if BSC protocol is being used, and, in the case of the 3274 D units, when a Read Modified CCW is received.

When Read Partition—Query is received by a 3274 D unit as the last structured field in a WSF transmission, the 3274 control unit returns a status of DE and terminates the operation. The Time indicator in the Operator Information Area is turned on, and the keyboard is locked to prevent operator interference with the query reply. The keyboard is unlocked upon receipt of a Write type command with the keyboard restore bit set.

If Read Partition—Query is not the last structured field in the WSF transmission, or, if there is an error in the WSF data, a 3274 D unit terminates the operation with status of DE, UC and sets the operation check bit in the sense byte.

Following acceptance of the Read Partition—Query structured field, a 3274 D unit generates an asynchronous status of attention, requesting the host to issue a Read Modified command to obtain the query reply.

Orders and Attributes

Orders

Orders can be included in Write, Erase/Write, or Erase/Write Alternate command data streams, either alone or intermixed with display or print data. Two types of orders are available: printout format orders and buffer control orders. Printout format orders are initially stored in the buffer as data and are subsequently executed only during a print operation (see Chapter 2).

The following paragraphs describe buffer control orders, which are executed as they are received in the write data stream by the 3274; these orders are not stored in the buffer. Six buffer control orders (see Figure 1-15) are provided to position, define, and format data being written into the buffer, to erase selected unprotected data in the buffer, and to reposition the cursor; three buffer control orders are provided for managing the Color, Extended Highlighting, and Programmed Symbols attributes for fields and characters when the SFAP option is installed. Refer to "Structured Field and Attribute Processing Orders" discussed later in this section.

Start Field (SF) Order

This order notifies the control unit that the next byte in the write data stream is an attribute character. (The attribute character is described in Figure 2-5.) The control unit then stores the next byte (the attribute character) at the current buffer address. As the attribute character is stored, the control unit sets a control bit at that address; this bit identifies the byte as an attribute character during subsequent program or device operations with the buffer data.

When received by control units and terminals supporting the extended field attributes, the SF order causes the default value (X'00') for the Color, Extended Highlighting, and Programmed Symbols attribute types to be set in the extended field attribute buffer.

Note: *The byte immediately following the SF order in the data stream is always stored as an attribute character, even when the byte is intended as an order or an alphanumeric data character.*

During execution of a Read Buffer command, the control unit automatically inserts SF order codes in the read data stream immediately before each attribute character. This permits identification of the attribute characters by the program and also permits correct storage of attribute characters in the buffer if the read data is used for subsequent write operations.

Set Buffer Address (SBA) Order

This 3-byte order specifies a new buffer address from which write operations are to start or continue. Set Buffer Address orders can be used to write data into various areas of the buffer. An SBA order can also precede another order in the data stream to specify the starting address for a PT, RA, or EUA order; to specify the address at which an attribute byte is to be stored by an SF, or SFE order or modified by an MF order; or to specify the address at which the cursor is to be repositioned by an IC order.

Order Sequence	Byte 1 (Order Code)		Byte 2	Byte 3	Byte 4
	EBCDIC (Hex)	ASCII (Hex)			
Start Field (SF)	1D	1D	Attribute Character ¹		
Set Buffer Address (SBA)	11	11	1st Address Byte ³	2nd Address Byte ³	
Insert Cursor (IC)	13	13			
Program Tab (PT)	05	09			
Repeat to Address (RA)	3C	14	1st Address Byte ³	2nd Address Byte ²	Character to Be Repeated
Erase Unprotected to Address (EUA)	12	12	1st Address Byte ³	2nd Address Byte ²	

Notes:

1. Figure 2-5 shows attribute byte.
2. Appendix J lists the 2-byte code for each possible address. To be a valid address:
 - a. If the default size is used in BSC mode, the maximum buffer addresses are:

3277-1, 3278-1: 479
3277-2; 3278-2, -3, -4, -5; 3279-2, -3: 1919
 - b. If the alternate size is used in BSC mode, the maximum buffer addresses are specified by the device model number:

Model 1: 959
Model 2: 1919
Model 3: 2559
Model 4: 3439
Model 5: 3563
 - c. If the SNA/SDLC mode is used, the maximum default size and alternate size are the display size minus 1. The display size is defined in the Bind parameter.

Figure 1-15. Buffer Control Orders and Order Codes

If the SBA order specifies an invalid address (for example, greater than 479 for a 3277 Model 1 or 1919 for a 3277 Model 2), the write operation is terminated at this point.

When a Read Modified command is executed and an attribute character (initially sent to the device by writing an SF order) is detected with the MDT bit set, the CU inserts, in place of the attribute, an SBA code followed by the 2-byte buffer address of the first character in the modified field (attribute address + 1). This permits identification by the control unit of fields that are modified. When a Read Modified command is executed in a remote unit, this 3-byte sequence is always sent in the same text block. Remote units do not split this sequence between two successive blocks.

Insert Cursor (IC) Order

This order repositions the cursor to the location specified by the current buffer address. Execution of this order does not change the current buffer address. For example, if IC is issued when the current buffer address is 160 and the cursor is at location 80, the cursor is moved from location 80 and inserted at location 160. The current buffer address at the end of this operation would remain 160.

Program Tab (PT) Order

The PT order advances the current buffer address to the address of the first character position of the next unprotected field. If the PT is issued when the current buffer address is the location of an attribute byte of an unprotected field, the buffer address advances to the next location of that field (one location). In addition, if the PT order in the write data stream does not follow a control command, order, or order sequence such as WCC, IC, or RA (3-character sequence), nulls are inserted in the buffer from the current buffer address to the end of the field, regardless of the value of bit 2 (protected/unprotected) of the attribute character for the field. Whenever a character position is set to null by the PT order, the default value (X'00') for the Color, Extended Highlighting, and Programmed Symbols attribute types is set in the character attribute buffer. When the PT order follows a control command, order, or order sequence, the buffer content is not modified for that field.

The PT order stops its search at the last location in the buffer. If an attribute character for an unprotected field is not found by this point, the buffer address is set to location 0. (If the PT order finds an attribute character for an unprotected field in the last buffer location, the buffer address is also set to zero.)

To continue the search for an unprotected field, a second PT order must be issued immediately following the first one. Since the current buffer address was reset to 0 by the first PT order, the second PT order begins its search at buffer location 0. If the previous PT order was still inserting nulls in each character location when it terminated at the last buffer location, the new PT order will continue to insert nulls from buffer location 0 to the end of the current field.

Repeat to Address (RA) Order

The RA order stores a specified alphanumeric or null character in all buffer locations, starting at the current buffer address and ending at (but not including) the specified stop address. This stop address and the character to be repeated are identified by the three bytes immediately following the RA order in the write data stream, as follows:

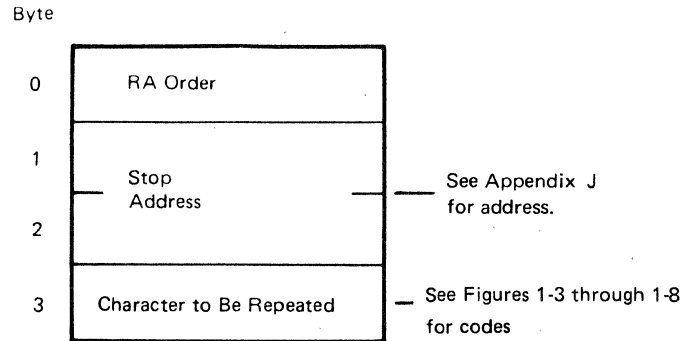

The third character following the RA order is always interpreted as the character that will be repeated. If an invalid stop address is specified, the write operation is terminated at this point without storing the character, and error status is generated. When Color, Extended Highlighting, or Programmed Symbols attributes are specified for the character, the attribute values are entered into the character attribute buffer as each repeated character is written in the data buffer.

When the stop address is lower than the current buffer address, the RA operation wraps from the bottom row of the buffer to the top row. When the stop address equals the current address, the specified character is stored in all buffer locations.

Attribute characters will be overwritten by the RA order if they occur before the RA order stop address.

Erase Unprotected to Address (EUA) Order

The EUA order inserts nulls in all unprotected buffer character locations, starting at the current buffer address and ending at, but not including, the specified stop address. This stop address is specified by 2 address bytes which immediately follow the EUA order in the write data stream. If an invalid address is specified, the write operation is terminated at this point and error status is generated. Whenever a character position is set to null by the EUA order, the default value (X'00') for the Color, Extended Highlighting, and Programmed Symbols attribute types is set in the character attribute buffer.

When the stop address is lower than the current buffer address, the EUA operation wraps from the bottom row of the buffer to the top row. When the stop address equals the current address, all unprotected character locations in the buffer are erased.

Attribute characters are not affected by the EUA order.

Structured Field and Attribute Processing Orders

Three orders—Start Field Extended (SFE), Modify Field (MF), and Set Attribute (SA)—are used to manage the Color, Extended Highlighting, and Programmed Symbols attributes for fields and individual characters. (Field attributes—protection, display, character type, etc.—can also be controlled by SFE and MF.) The SFE and MF orders are used to define and alter attributes as they apply to whole fields; the SA order sets the Color, Extended Highlighting, and Programmed Symbols attributes as they apply to individual characters. All three orders make use of a “type value” pair (2 bytes) to define the type of attribute (field, Color, Extended Highlighting, Programmed Symbols) and the setting. (Attribute types and values are discussed later on.) These orders can be included in Write, Erase/Write, or Erase/Write Alternate command data streams, alone or intermixed with display and print data.

Start Field Extended (SFE) Order. The Start Field Extended (SFE) order (hex code 29) is used to define the start of a field and to assign field, Color, Extended Highlighting, and Programmed Symbols attributes to the field.

The format of the order is “X’29’—number of type/value pairs-type-value-type-value . . . type-value.” The first byte after the order specifies the number of type/value pairs following; *type* is any of the 4 attribute types that can be specified; and *value* is the setting for the type.

Any permissible attribute type not specifically defined in the order has its value set to binary zeros. When specified more than once in the SFE order, the *last occurrence* of an attribute type and value determines the setting. If the number of type/value pairs is specified as zero, all attribute types are set to their default values.

Attribute values that are unknown or cannot be maintained and returned inbound are rejected with an Op Chk in non-SNA protocol, or, for Color and Extended Highlighting in SNA protocol, a negative response of X’1003’, or, for Programmed Symbols, X’0863’.

This order causes a field attribute byte to be generated at the current buffer position.

Modify Field (MF) Order. The Modify Field (MF) order (hex code 2C) is used to selectively change field, Color, Extended Highlighting, and Programmed Symbols attributes at the current buffer address. The current buffer address must be that of a field attribute byte; otherwise, the order is rejected with an Op Chk in non-SNA protocol, or a negative response of X’1005’ for SNA protocol. Only the attribute types specified in the order are changed.

The format of the order is “X’2C’—number of type/value pairs-type-value-type-value . . . type-value.” The first byte after the order specifies the number of type/value pairs following; *type* is one of the four attribute types specifiable in the MF order; and *value* is the setting for the type. (See “Attribute Types and Values.”)

At the completion of order processing, the current buffer address is incremented by 1.

If the number of type/value pairs is specified as zero, no change is made to any of the attributes and the current buffer address is incremented by 1. However, the current buffer address must still be that of a field attribute.

When specified more than once in an MF order, the *last occurrence* of an attribute type and value determines the setting.

Attribute values that are unknown or cannot be maintained and returned inbound are rejected with an Op Chk in non-SNA protocol, or, for Color and Extended Highlighting in SNA protocol, a negative response of X'1003', or, for Programmed Symbols, X'0863'.

Set Attribute (SA) Order. The Set Attribute (SA) order (hex code 28) is used to change the Color, Extended Highlighting, or Programmed Symbols attributes applicable to the character at the current buffer address, or to set these attribute types to their default value. Attributes set for the character at the current buffer address are applied to the current and subsequent characters until another SA order is encountered or the attributes are reset by a write type command or power-on-reset. Color, Extended Highlighting, and Programmed Symbols attributes set at the character level override the same attributes set at the field level.

The format of the order is "X'28'-type-value" (3 bytes). *Type* is one of the four attribute types specifiable in the SA order, and *value* is the setting for the type. (See "Attribute Types and Values.") If more than one attribute type is to be changed, more than one SA order can precede the character in the data stream.

An Erase/Write or Erase/Write Alternate command resets the data buffer to nulls and each attribute associated with the nulled characters to its default value.

An SA order is generated and inserted in the inbound data stream only when the *attribute value* of an attribute type that has been specified in the Set Reply Mode structured field changes. The assumption is made that the Color, Extended Highlighting, and Programmed Symbols attribute types are all set to their default values at the beginning of the inbound transmission. The first SA order generated will be for the first attribute not equal to its default value. (See "Set Reply Mode Structured Field" in the discussion of the Write Structured Field command.)

Attribute values that are unknown or cannot be maintained and returned inbound are rejected with an Op Chk in non-SNA protocol, or, for Color and Extended Highlighting in SNA protocol, a negative response of X'1003', or, for Programmed Symbols in SNA protocol, a negative response of X'0863'.

Attribute Types and Values. The following attribute types and values are used in the Start Field Extended, Modify Field, and Set Attribute orders. Type codes other than those given here are rejected with an Op Chk (non-SNA) or a negative response of X'1003' (SNA).

Attribute Type	Code	SFE, MF Orders	Order
Character Attribute reset	X'00'	—	x
Field Attribute	X'C0'	x	—
Extended Highlighting	X'41'	x	x
Color	X'42'	x	x
Programmed Symbols	X'43'	x	x

The x indicates that the type code is valid when used in the order.

Valid attribute values for each code are as follows:

Type Code	Values	Result
X'00'	X'00'	This is the only valid setting for this attribute type. This type/value pair is used only with the SA order. All character attributes specifiable in SA order are set to default value.
X'C0'		The codes appearing here are determined by the field attributes desired. See Figure 2-5 for a breakdown of the field attribute byte.
X'41'	X'00' X'F1' X'F2' X'F4'	Default. See Figure 1-16. Blink Reverse video Underscore
X'42'	X'00' X'F1' X'F2' X'F3' X'F4' X'F5' X'F6' X'F7'	Default. See Figure 1-16. Blue Red Pink Green Turquoise Yellow White for 3279, black for 3287, multicolor for triple plane symbol
X'43'	X'00' X'40' X'EF' X'F1'	Default. See Figure 1-16. Valid range for symbol-set IDs assigned in the Load Programmed Symbols structured field. Symbol-set ID for the APL/Text symbol set in terminal storage ID X'01'. This is the only non-loadable symbol set supported, and this attribute value may only be used in the SA order. If X'F1' is received in an SFE or MF order, an Op Chk or negative response of X'1005' is returned.

Attribute Defaults: Default conditions for the attribute types field (Color, Extended Highlighting, and Programmed Symbols) are described in Figure 1-16.

The Color, Extended Highlighting, and Programmed Symbol set attributes always assume the default condition when code X'00'. Character attributes assume the field setting (if defined); otherwise, the character attributes are as noted above for field attribute default.

Attribute Type	Default Condition		
	Field Attribute	Character Attribute	
		Screen	
		Formatted	Unformatted
Field	Unprotected, A/N, display, non-detectable, MDT bit off	Not applicable	Not applicable
Color	3279 ¹ 3278 – green 3287 – black ²	Inherit field color	3279 ¹ – green 3278 – green 3287 – black ²
Extended Highlighting	None	Inherit field highlight	None
Programmed Symbols	Nonloadable character set in read-only storage.	Inherit field specified Programmed Symbol	Nonloadable character set in read-only storage.

¹ If the base color switch is set to color and the data stream contains any attribute type-color (X'42') specification, or the Set Reply Mode (SRM) function has set character mode with color as the reply mode, then the base color switch setting is overridden, and the field default display color is green (white if the field is intensified). (See the reset matrix in Figure 1-12 for the actions that cancel the override of the base color switch.)

² If feature 9136 is installed – green

Figure 1-16. Attribute Defaults

Read Commands

Three read-type commands are executed by the 3274. Read Buffer, Read Modified, and Read Modified All. Read Buffer causes the entire buffer contents of the addressed terminal to be read into main storage. The operation initiated by Read Modified is determined by display station operator actions. The information read during execution of Read Modified or Read Modified All could consist of fields of data modified by keyboard operations, data entered by magnetic reading devices, buffer addresses, or data of selector light-pen or CURSR SEL fields, or the code of a Program Function or Program Access key.

In remote BSC configurations, reading is normally accomplished by a General or Specific Poll sequence. In local configurations, an operator action that requires program interaction causes an attention interruption; the program would respond to this attention interruption with a read command. In remote, the 3274 cannot generate attention interruption. Instead, the host program should issue poll sequences periodically. Upon receipt of a poll sequence, the 3274 BSC control unit initiates one of three operations:

1. If status and sense information is pending, this information is sent to the TCU.
2. If an operator action has occurred that requires reading by the program, and status and sense information is not pending, a control-unit-generated Read Modified command operation is performed.

3. If no operator action has occurred and status and sense information is not pending, the control unit sends End of Transmission (EOT) to the TCU, terminating the operation.

Programming Note: *Unsolicited read commands are not recommended because the information read by these commands may be incomplete.*

During a read-buffer or read-modified operation, when BSC line discipline is used, a SUB character (3F in EBCDIC, 1A in ASCII) is sent in place of any byte that has bad parity. Also, a Data Check sense condition is recorded. Normal transmission of the read data then continues until the usual ending point. At that time, the operation ends as follows: (1) in local, Unit Check is sent in the ending status byte; (2) in remote, the transmission is terminated with ENQ in place of ETX or ETB.

Read Buffer Command

Execution of the Read Buffer command causes all data in the addressed device buffer, from the buffer location at which reading starts through the last buffer location, to be transferred to main storage. This command is provided primarily for diagnostic purposes. The transfer of data begins:

1. From buffer address 0 if the Read Buffer command is unchained. Certain 3270 emulators also begin data transfer from buffer address 0 if the Read Buffer command is chained from a Sense, Select, No Operation, or Copy command.
2. From the current buffer address if the Read Buffer command is chained. Certain 3270 emulators only begin data transfer from the current buffer address if the Read Buffer command is chained from a Write, Erase/Write, Read Modified, or another Read Buffer command. Regardless of where the transfer of data begins, data transfer from the buffer will terminate when the last character location in the buffer has been transferred, or before the last character location has been transferred as follows: (1) in local configurations, when the channel byte count reaches 0 (in this case, the buffer address after termination is undefined); or (2) in remote configurations, when the last character of a text block has been transferred (described in Chapters 4 and 5).

The transferred data stream begins with a 3-character read heading consisting of the AID character followed by a 2-character cursor address. The contents of all buffer locations are transferred, including nulls. Start Field or Start Field Extended (SF, SFE) orders are inserted by the control unit to identify the beginning of each field.

The possible cursor address byte configurations are shown in Appendix J. The possible Attention Identification (AID) byte configurations are shown in Figure 1-17. An AID configuration other than 60 or E8 is set when the operator at the selected display station has performed an operation that requires program intervention. These operations are (1) pressing a Program Function or Program Access key, (2) reading a magnetic stripe, or (3) detecting on an attention field with the selector light pen or CURSR SEL key. The attribute character is shown in Figure 2-5.

AID	Hex Character (EBCDIC)	Hex Character (ASCII)	Graphic Character	Read Modified Command Operation	Resultant Transfer to CPU
No AID generated (Display or Display Station)	60	2D	—	Rd Mod (Unsolicited Read or Read Modified from Host)	If performing a remote polling operation, no read operation occurs; otherwise field addresses and text in the modified fields are transferred.
No AID generated (Printer)	E8	59	Y	Rd Mod	
ENTER key and & (Selector-Light-Pen Attention)	7D	27	'	Rd Mod	AID code and cursor address, followed by an SBA order, attribute address +1, and text for each modified field. Nulls are suppressed.
PF 1 key	F1	31	1	Rd Mod	
PF 2 key	F2	32	2	Rd Mod	
PF 3 key	F3	33	3	Rd Mod	
PF 4 key	F4	34	4	Rd Mod	
PF 5 key	F5	35	5	Rd Mod	
PF 6 key	F6	36	6	Rd Mod	
PF 7 key	F7	37	7	Rd Mod	
PF 8 key	F8	38	8	Rd Mod	
PF 9 key	F9	39	9	Rd Mod	
PF 10 key	7A	3A	:	Rd Mod	
PF 11 key	7B	23	#	Rd Mod	
PF 12 key	7C	40	@	Rd Mod	
PF 13 key	C1	41	A	Rd Mod	
PF 14 key	C2	42	B	Rd Mod	
PF 15 key	C3	43	C	Rd Mod	
PF 16 key	C4	44	D	Rd Mod	
PF 17 key	C5	45	E	Rd Mod	
PF 18 key	C6	46	F	Rd Mod	
PF 19 key	C7	47	G	Rd Mod	
PF 20 key	C8	48	H	Rd Mod	
PF 21 key	C9	49	I	Rd Mod	
PF 22 key	4A	5B	¢	Rd Mod	
PF 23 key	4B	2E	•	Rd Mod	
PF 24 key	4C	3C	<	Rd Mod	
Operator Identification Card Reader	E6	57	W	Rd Mod	
Magnetic Slot Reader and Magnetic Hand Scanner	E7	58	X	Rd Mod	
Selector-Light-Pen Attention space null	7E	3D	=	Rd Mod	AID code, cursor address, and field addresses only; no data.
PA 1 key	6C	25	%	Short Rd	AID code only.
PA 2 (CNCL) key	6E	3E	>	Short Rd	
PA 3 key	6B	2C	,	Short Rd	
CLEAR key	6D	5F	—	Short Rd	
TEST REQ and SYS REQ keys	F0	30	0	Tst Req Rd	A test request message. AID transferred on Read Buffer only.

Note: Graphic characters for the United States I/O interface codes are shown. If a World Trade country I/O interface code is used, refer to IBM 3270 Information Display System: Character Set Reference, GA27-2837, for possible graphic character differences.

Figure 1-17. Attention ID (AID) Configurations

Read Modified Command

Read Modified initiates one of three operations, as determined by operator actions at the display station: (1) Read Modified, (2) Short Read, or (3) Test or System Request Read. Figure 1-17 lists the operator actions and the resulting Read Modified command operation initiated by each action. Read Modified commands normally are not used for remote configurations since polling initiates a control-unit-generated read-modified operation if AID is generated and if status is not pending.

A major feature of Read Modified command operations is null suppression. The device buffer is cleared to all nulls when the operator turns power on or presses the CLEAR key, or when the erase portion of an Erase/Write command is executed at the selected device. Also, selected portions of a buffer can be cleared to nulls by the Erase All Unprotected command and certain orders. During Read Modified command operations, null codes are not sent.

Read Modified Operation

During a Read Modified command, if an AID other than selector-light-pen attention, the CURSR SEL key, a PA key, or the CLEAR key is generated, all fields that have been modified by a keyboard, the selector light pen, the CURSR SEL key, or the reading of a magnetic stripe are transferred to the program. All nulls are suppressed during data transfer and thus are not included in the read data stream. As a field is modified by the operator, the modified data tag (MDT) bit is set in the attribute byte for that field. Then, when a read-modified operation is performed, successive attribute bytes are examined for a set MDT bit. When the bit is found, the data in the associated field is read (with nulls suppressed) before the next attribute byte is examined.

The first 3 bytes of the read data stream are always the AID code (Figure 1-17) and the 2-byte cursor address; these bytes are called the "read heading."

Following the read heading is the alphameric data of each modified field. The data for each field is preceded in the data stream by a Set Buffer Address (SBA) order code followed by the 2-byte buffer address of the first character position in that field (the attribute address + 1). Thus, the read data stream when data has been modified is as follows:

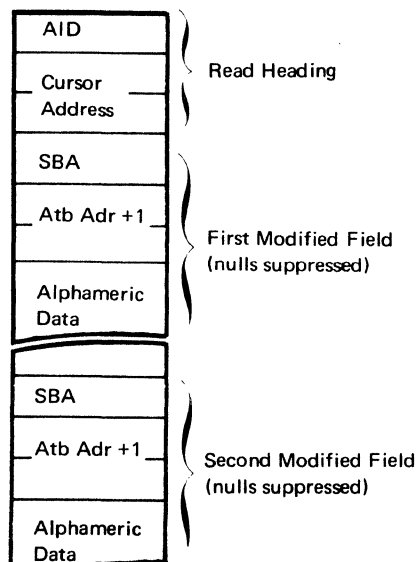

If a space or null selector-light-pen attention AID is generated, at a 3277 display, fields are not transferred to main storage during the read-modified operation. Instead, when a set MDT bit is found (indicating selector-light-pen and/or keyboard activity), only the Read Heading, the SBA order code, and the attribute address + 1 are transferred.

Note that if fields are modified by the keyboard but completion of the modification is signaled by a selector-light-pen-attention operation on other than ampersand character-designator fields, a resulting read-modified operation will read only the address of the modified fields, not the modified data. A Read Modified command can be used to obtain both the address of, and the data in, each field that has the MDT bit set to 1.

The buffer location at which the search begins for attribute bytes that define modified fields is a function of command chaining. This location is:

1. Buffer address 0 if the Read Modified command is unchained or is chained from a Copy, Select, Sense, or No Operation command.
2. The current address if the Read Modified command is chained from a Write, Erase/Write, Read Modified, Read Modified All, or Read Buffer command.

The search for modified-field attribute bytes ends when the last buffer location is checked.

The transfer of read data is terminated as follows:

1. If the last modified field is wrapped from the last buffer (for example, 479 or 1919) to the first location, the operation is terminated after all data in the field is transferred (nulls are suppressed). The buffer address at the end of the operation is the address of the next attribute byte in the buffer. For example, if a modified field extends from address 1900 (the attribute byte) to address 79 (wrapped field), the data from address 1901 through 79 is transferred (nulls are suppressed); in this case, the read operation is terminated with the buffer address set to 80 (the attribute byte of the next field).
2. If the buffer does not contain a wrapped modified field, and if the channel byte count has not reached zero (local operation only), the modified data stream is terminated when the last modified field is transferred; at the end of the operation, the buffer address is set to 0.
3. During 3274 B and D unit operations, if the channel byte count reaches zero before all modified data is transferred, read operations are terminated and the remaining modified data is not transferred. The buffer address after termination is undefined.

If the buffer is formatted (contains fields) but none of the fields have been modified, the read data stream consists of the 3-byte read heading only.

If the buffer is unformatted (contains no fields), the read data stream consists of the 3-byte read heading followed by all alphameric data in the buffer (nulls are suppressed), even when part or all of the data has not been modified. Since an unformatted buffer contains no attribute bytes, no SBA codes with associated addresses or address characters are included in the data stream, and the modification of data cannot be determined. Data transfer starts at address 0, regardless of command chaining, and continues to the end of the buffer. At the end of the operation, the buffer address is set to 0. This read operation can also be terminated by the channel byte count reaching zero before all data is read; in this case, the buffer address after termination is undefined.

Short Read

The Read Modified command causes a short read operation if the CLEAR, CNCL, or a PA key has been pressed at the selected device. During the Short Read operation, only an AID byte is transferred to main storage. This AID byte identifies the key that was pressed.

Test Request Read

This description applies only to units not using SNA protocol. The Read Modified command causes a Test Request Read operation if the TEST REQ (3277) or SYS REQ (3278 and 3279) key has been pressed at the selected device. The Test Request Read data stream sent to main storage is as follows:

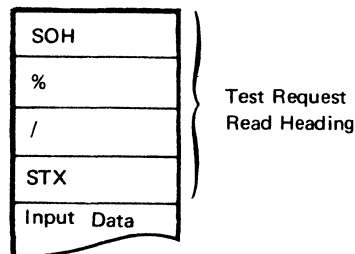

The Test Request Read heading is generated by the control unit. The remainder of the data stream is the same as described previously for read-modified operations, excluding the 3-byte read heading (AID and cursor address). If the buffer is unformatted, all alphameric data in the buffer is included in the data stream (nulls are suppressed), starting at address 0. If the buffer is formatted, each attribute byte is examined for a set MDT bit. Each time a set MDT bit is found, the alphameric data in the field associated with that bit is sent to main storage (nulls are suppressed); if no MDT bits are set, the read data stream consists of the Test Request Read heading only. The buffer location at which the search for MDT bits begins and the transfer of data ends is the same as described for read-modified operations.

Test Request Read function usage is determined by the access method. Normally, the operator would (1) clear the display, (2) enter test request data in a predefined format, and then (3) press the TEST REQ or SYS REQ key.

Read Modified All Command

The Read Modified All command is used with the 3274 A and C units and 51C operating in SNA/SDLC protocol. This command operates like a Read Modified command except that both addresses and data from all modified fields are sent to the host, regardless of the AID byte generated. The Read Modified All command is not generated by the control unit in response to a poll sequence. It must be sent by the host.

Query Reply Structured Field

The response by the control unit to the Read Partition—Query function is the transmission of a series of structured fields indicating the field and character attributes, the screen or page size and characteristics, the symbol sets, and the reply modes available on the addressed terminal. Five structured fields are transmitted, each defining a characteristic: color, highlighting, usable area, reply modes, and symbol sets. Since each structured field contains its own unique identification *the order in which the fields are transmitted is not important*. An example follows. After the example the individual structured fields are discussed.

The data stream sent in response to a Read Partition Query structured field for a control unit with a device having an EAB is:

Hex	Function
X'88' or X'0601008B6000'	AID (X'0601008B6000' is the Function Management Header Type 1 (FMH1) required to transmit the Query Reply structured field inbound from a printer in an LU type 1 session.)
X'00168186Z008 (16 Z bytes)'	Color
X'000F818704 (8 Z bytes)'	Highlighting
X'00178181Z100 (17 Z bytes)'	Usable Area
X'00078188000102'	Reply Mode
X'00008185B000 (7 Z bytes)'	Character Sets
X'03'	Number of bytes in descriptor
X'000000'	ROS 0
X'0100F1' (if present)	ROS 1 (ROS=Read-only storage)
X'02ZZtt' (if present)	RWS 2-PSA (RWS=Read/Write storage)
X'03ZZtt' (if present)	RWS 3-PSB
X'04ZZtt' (if present)	RWS 4-PSC
X'05ZZtt' (if present)	RWS 5-PSD
X'06ZZtt' (if present)	RWS 6-PSE
X'07ZZtt' (if present)	RWS 7-PSF

Where *Z* is a variable of the structured field that depends upon the device that is attached to the control unit.

tt is the symbol set ID for sets that have been host loaded. It is returned as X'FF' if the set is not loaded.

If a device has ECSA and ROS or RWS is not present in a ROS or RWS location, the descriptor for that location is not returned.

A Query Reply inbound data stream consists of AID byte X'88', or the FMH1 noted above, defining what follows as an inbound structured field data stream, followed by the structured fields. Each structured field is of the general format: length—type—data.

Note: Query Reply is the only structured field transmission sent inbound from a printer in LU type 1 or type 3 session.

Query Reply (Color) Structured Field

This Query Reply structured field indicates the color attribute values recognized by the addressed terminal and returned in an inbound data stream. Eight pairs of bytes, one pair for each of the possible color attribute values, are returned to the host. The first byte of a pair contains the color attribute value accepted; the second byte contains the same value if that color is supported by the terminal, or the default color attribute value (X'00') if it is not. There is one exception: the second byte of the pair defining the default color attribute for the terminal indicates the default color that will be supported.

The format of the Query Reply (Color) structured field is as follows:

Byte	Bit	Content	Meaning
0, 1	—	X'0016'	Length
2	—	X'81'	Query Reply structured field ID
3	—	X'86'	Identifies this query reply as color
4	0	b'0'	Reserved
	1	b'0'	Printer only; black ribbon not loaded
		b'1'	Printer only; black ribbon loaded
	2—7	b'000000'	Reserved
5	—	X'08'	Number of color pairs
6—21			(Terminal-dependent; see following)

Byte	1st Byte		2nd Byte		Full Color
	Possible Attribute Value	3230, 3262, 3268, 3278	3287-1,-2	3287-1C,-2C	
6, 7	X'00'	X'F4'	X'F7'	X'F7'	X'F4'
8, 9	X'F1'	X'00'	X'00'	X'F1'	X'F1'
10, 11	X'F2'	X'00'	X'00'	X'F2'	X'F2'
12, 13	X'F3'	X'00'	X'00'	X'00'	X'F3'
14, 15	X'F4'	X'00'	X'00'	X'F4'	X'F4'
16, 17	X'F5'	X'00'	X'00'	X'00'	X'F5'
18, 19	X'F6'	X'00'	X'00'	X'00'	X'F6'
20, 21	X'F7'	X'00'	X'00'	X'F7'	X'F7'

As an example, the following Query Reply (Color) structured field might be transmitted for a 3287 Model 1C and 2C printer:

X'00168186000800F7F1F1F2F2F300F4F4F500F600F7F7'

Query Reply (Extended Highlighting) Structured Field

This Query Reply structured field indicates the highlighting attribute values recognized by the addressed terminal and returned in an inbound data stream. Four pairs of bytes, one pair for each of the possible highlighting attribute values, are returned to the host. The first byte of a pair contains the highlighting attribute value accepted; the second byte contains the same value if that highlighting attribute is supported by the terminal or the default highlighting attribute value (X'00') if it is not. There is one exception: the second byte of the pair defining the default highlighting attribute support indicates the default highlighting that will be supported.

The format of the Query Reply (Extended Highlighting) structured field is as follows:

Byte	Content	Meaning
0, 1	X'0000' or X'000D'	Length of structure
2	X'81'	Query reply identifier
3	X'87'	Identifies this query reply as highlighting
4	X'04'	Number of highlighting pairs
5—12	(Terminal-dependent; see following. Note: <i>Possible highlighting attribute values are X'00'—default, X'F0'—normal, X'F1'—blink, X'F2'—reverse video, X'F4'—underscore</i>)	

Byte	Possible Attribute Value	1st Byte	2nd Byte
		3278	3230, 3262, 3268, 3287-1,-2,-1C,-2C 3279
5, 6	X'00'	X'F0'	X'F0'
7, 8	X'F1'	X'F1'	X'00'
9, 10	X'F2'	X'F2'	X'00'
11, 12	X'F4'	X'F4'	X'F4'

Query Reply (Usable Area) Structured Field

This Query Reply structured field indicates the size and characteristics of the screen or page of the addressed terminal. Screen or page size is expressed as width of usable area in characters (columns or print positions) and depth of usable area in characters (rows or print lines). [For a printer, the values returned correspond to the maximum print position (MPP) and maximum print line supported by the hardware, *not to the current settings if operator-specifiable.*]

The default size of the dot matrix block within which a character is presented is also defined.

The format of the Query Reply (Usable Area) structured field is as follows:

Byte	Bit	Content	Meaning		
0, 1	—	X'0017'	Length of this structure		
2	—	X'81'	Query reply identifier		
3	—	X'81'	Identifies this query reply as "usable area".		
4	0, 1	b'00'	Reserved		
		2	b'0'	3270DS structured field supported	
			b'1'	3270DS structured field not supported	
	3	b'0'	Not a hard-copy device		
		b'1'	A hard-copy device		
	4—7	b'0001'	14-bit addressing allowed		
	4—7	b'1111'	If reply is from a device operating in LU type 1 mode.		
5	—	X'00'	Reserved		
6, 7	—	—	Width of usable area in characters (dot matrix blocks)		
		X'50'	3278-2,-3,-4		
		X'50'	3279-2,-3		
		X'84'	3230, 3262, 3268, 3278-5, 3287		
8, 9	—	—	Depth of usable area in characters (dot matrix blocks)		
		X'18'	3278-2		
		X'20'	3278-3		
		X'2B'	3278-4		
		X'1B'	3278-5		
		X'18'	3279-2		
		X'20'	3279-3		
		X'66'	3287		
		X'7F'	3230, 3262, 3268		
		10	—	X'00'	Unit of measure is the inch for distance between dots given for X and Y directions in bytes 11—14 and 15—18.
		11—14	—	—	Dot spacing in the X (horizontal) direction, expressed as a fraction; 2-byte numerator/2-byte denominator; and measured in the units defined in byte 10.
X'00000000'	3262				
X'00020089'	3278-2,-3,-4				
X'00010071'	3278-5				
X'000A02E5'	3279-2,-3				
X'00010064'	3268				
X'000100A0'	3230				
X'00010064'	3287				
15—18	—	—	Dot spacing in the Y (vertical) direction, expressed as a fraction; 2-byte numerator/2-byte denominator; and measured in the units defined in byte 10.		
		X'00000000'	3262		
		X'0002008C'	3278-2,-3,-4,-5		
		X'0002006F'	3279-2,-3		
		X'00010040'	3268		
		X'000100A0'	3230		
		X'00020085'	3287		

Byte	Bit	Content	Meaning
19	—	—	Default width of dot matrix block, in dots
		X'00'	3262
		X'09'	3278-2,-3,-4,-5
		X'09'	3279-2,-3
		X'0A'	3268, 3287
20	—	X'0C'	3230
		—	Default depth of dot matrix block, in dots
		X'00'	3262
		X'10'	3278-2,-3
		X'0C'	3278-4,-5
		X'0C'	3279-2,-3
21, 22	—	—	Character buffer size, in bytes. Buffer size is not reported for devices operating in LU type 1 mode.
		X'0780'	3278-2 (1920)
		X'0A00'	3278-3 (2560)
		X'0D70'	3278-4 (3440)
		X'0DEC'	3278-5 (3564)
		X'0780'	3279-2 (1920)
		X'0A00'	3279-3 (2560)
		X'/nnnn'	3230, 3262, 3268, 3287—Dependent on installed buffer size (2K or 4K). Equivalent to display sizes except when byte 24 of an LU type 3 Bind command is set to X'00'. Wrap points for the physical buffer are then given as follows:
			2K buffer — X'07B0' (1968) 4K buffer — X'0EB0' (3760) with PS feature installed 4K buffer — X'0FB0' (4016) no PS feature

Query Reply (Reply Mode) Structured Field

This Query Reply structured field indicates the form of inbound data stream that the addressed terminal supports.

The format is as follows:

Byte	Bit	Content	Meaning
0, 1	—	X'0007'	Length
2	—	X'81'	Query reply identifier
3	—	X'88'	Identifies this Query reply as "reply mode".
4	—	X'00'	Indicates that the terminal supports Field Mode inbound data streams.
5	—	X'01'	Indicates that the terminal supports Extended Field Mode data streams.
6	—	X'02'	Indicates that the terminal supports Character Mode data streams.

Query Reply (Symbol Sets) Structured Field

This Query Reply structured field indicates the number and kind of symbol sets (both user-defined and IBM-defined Programmed Symbol sets present in the terminal. The terminal storage ID is given as well as an indication of whether it is associated with a symbol set. The structured field consists of a 12-byte base and up to eight 3-byte storage descriptors, one for each storage area present in the terminal.

The format of the Query Reply (Symbol Sets) structured field is as follows:

Byte	Bit	Content	Meaning
0, 1	—	X'nnnn'	Length—includes any 3-byte symbol set descriptors present
2	—	X'81'	Query reply identifier
3	—	X'85'	Identifies this query reply as "symbol sets".
4	0	b'1'	Graphic escape supported
		b'0'	Graphic escape not supported
		b'0'	Reserved
		b'0'	Load Programmed Symbols structured field <i>not</i> supported
		b'1'	Load Programmed Symbols structured field supported
		b'0'	Load Programmed Symbols structured field extension <i>not</i> supported
		b'1'	Load Programmed Symbols structured field extension supported
		b'0'	Reserved
5	—	b'000'	Reserved
		X'00'	Reserved
6	—	—	Default dot matrix block width
		X'00'	3262
		X'0A'	3268, 3287
		X'0C'	3230
		—	Default dot matrix block width
		X'09'	Display
		X'00'	3262
		X'08'	3268, 3287
7	—	X'12'	3230
		X'10'	Display
		X'40000000'	Display supports load PS data format type 1. (Will be X'60000000' if the 3274 has been customized to support decompression.)
		X'04000000'	Printer supports load PS data format type 5. (Will be X'06000000' if the 3274 has been customized to support decompression.)
8—11	—	X'03'	Length of each symbol-set descriptor which follows.

Descriptors (One or more descriptors follow byte 12; a descriptor defines one terminal storage and symbol-set characteristics.)

0	—		Terminal storage identification: X'00' to X'07'
		X'00'	Read-only storage containing I/O interface code symbol set.
		X'01'	Read-only storage containing APL/Text symbol set if feature present
		X'02'	Host loadable terminal storages for Programmed Symbol sets. These storages are specified in the load PS structured field.
		to X'07'	
1	0	b'0'	Read-only storage
		b'1'	Loadable terminal storage
	1	b'0'	Single-plane storage
		b'1'	Triple-plane storage
	2	b'0'	Symbols are accessed using a 1-byte code.
	3	b'0'	Comparison of the symbol set ID of the symbol set loaded in this storage with the symbol set ID(s) of sets loaded in the printer is allowed (copy operations).
		b'1'	Comparison is not allowed.

Byte	Bit	Content	Meaning
	4—7	b'0000'	Reserved
2		X'nn'	Symbol set ID. The ID is currently associated with the terminal storage ID contained in byte 0. Value range is X'40' through X'EF' for valid symbol ID. A value of X'FF' indicates that the storage is not associated with any symbol set.

Inbound Transmissions

Inbound transmissions result from an operator “enter” action, a host-initiated (unsolicited) read request, or a host retry of an inbound transmission.

An operator “enter” action is one that causes an attention identifier (AID) to be transmitted inbound. The host program responds with a read request. The host program must acknowledge the inbound transmission before a new inbound operation can be performed. (See “Host Acknowledgments” following.)

A host-initiated read operation is an inbound transmission not caused by an operator “enter” action. No host acknowledgment is required before a new inbound transmission can occur.

Host retry is a retransmission of the last unacknowledged inbound transmission from the device. The host must acknowledge reception of an inbound transmission before a “new” inbound transmission can take place. A host retry transmission does not cause read state transitions (read states are discussed following) and is not considered a “new” inbound transmission requiring host acknowledgment. Host retry occurs until a host acknowledgment takes place.

The type of inbound transmission is either a Query Reply structured field (the response to the Read Partition-Query structured field discussed earlier in this

chapter), or data from the device buffer (for example, modified fields of the display image). An inbound operation device characteristic (INOP), set by the controller, defines the type.

Inbound Operation Device Characteristic (INOP)

The device characteristic INOP determines the operation to be performed when data is transmitted inbound on a retry transmission in SNA, BSC, or Local Attachment environments, or when the device is in a data pending state in a Local Attachment environment.

INOP is set by any of the following:

- An operator “enter” action sets INOP to Read Modified.
- Reception of a Read Partition-Query structured field sets INOP to Query.
- Host acknowledgment of an inbound transmission sets INOP to Read Modified.

INOP and the seven read states discussed next are used in the description of read command processing later in this chapter.

Read States

While powered on, a device is in one of seven states with respect to read operations. The three primary states are: Normal, Data Pending, and Retry. The data pending and retry states have three substates: Enter, Read, and Stacked Enter. The events that cause transitions between the states are shown in Figure 2-18, Parts A and B.

Normal Read State. A device is in Normal read state when powered on, or prior to initiation of a new read operation, or after use of the Reset key in certain instances (see Figure 1-18).

When in Normal read state, an operator “enter” action or the reception of a Read Partition-Query structured field causes the device to prepare to generate the inbound data stream and to go into a Data Pending state if in a BSC or Local Attachment environment, or to transmit the data and go into a Retry state if in a SNA environment.

In all environments, a host-initiated read operation causes the data to be transmitted with no state transitions occurring. The device remains in Normal read state.

Data Pending States. There are three data pending states:

- Data Pending Enter: the device state after an operator “enter” action occurred.
- Data Pending Read: the device state after reception of a Read-Partition-Query structured field.
- Data Pending Stacked Enter: the device state after a Read Partition-Query structured field was received while the device was in Data Pending Enter read state or Retry Enter read state (the enter data is stacked).

A Poll (BSC) or a read command (Local Attachment) received while the device is in a data pending state causes the data to be transmitted and the device to be placed in the corresponding Retry state. (See Figure 1-18, Part B.)

In an SNA environment, the data pending states do not occur. An “enter” action or reception of a Read Partition-Query structured field causes the data to be transmitted directly and the device to be placed in Retry state. (See Figure 1-18, Part A.)

Retry States. There are three retry states:

- Retry Enter: the device state after “enter” data was transmitted to the host.
- Retry Read: the device state after Query Reply data was transmitted to the host.
- Retry Stacked Enter: the device state after “enter” data was stacked (non-SNA environment only) and the Query Reply data has been transmitted to the host.

While in a retry state, the last inbound transmission can be retried by means of a Read Modified command.

A host acknowledgment causes the device to revert from a retry state to the normal read state, or, in the case of Retry Stacked Enter, to the Data Pending Stacked Enter read state.

Figure 1-18 shows the read states and the events that affect them.

With reference to Figure 1-18, the indicators displayed in the Operator Information Area of a display are as follows:

State	Indicator
①	No indicator or System Lock indicator
②	Time indicator (BSC) or System Lock indicator (Local Attachment)
③	Time indicator
④	Time indicator
⑤	System Lock (BSC and Local Attachment) Time indicator (SNA)
⑥	Time indicator
⑦	Time indicator

Events \ Read States	Normal	Retry	
	①	Enter⑤	Read⑥
"Enter" Action	⑤	R	R
Read Command	①	⑤	⑥
Read Partition-Query	⑥	R	⑥
Host Acknowledgment	—	①	①

Part A. SNA Environment – Read State Transitions

Events \ Read States	Normal	Data Pending			Retry		
	①	Enter②	Read③	Stacked Enter④	Enter⑤	Read⑥	Stacked Enter⑦
"Enter" Action	②	R	R	R	R	R	R
Read Command (BSC)	①	①	①	①	⑤	⑥	⑦
Read Command Local Attachment	①	⑤	⑥	⑦	⑤	⑥	⑦
Read Partition-Query	③	④	—	—	④	③	④
Poll (BSC)	—	⑤	⑥	⑦	—	—	—
Host Acknowledgment	—	①	①	②	①	①	②
Reset Key	—	①	—	—	①	—	—

Part B. BSC and Local Attachment (Non-SNA) Environment – Read State Transitions

Key: ① = Next state entered. Same state indicated means no transition.
 R = Reject, no state transition.
 — = No action, no state transition.

Figure 1-18. Read State Transitions

Host Acknowledgments

After inbound transmissions resulting from operator “enter” actions, or after transmission of the reply to a Read Partition-Query, the transmission must be acknowledged before a new inbound operation can be performed.

For inbound transmissions generated by operator “enter” actions, the following are host acknowledgments:

- An outbound transmission containing a Write, Erase/Write, or Erase/Write Alternate command followed by a WCC with the keyboard restore bit set to 1, or an Erase All Unprotected command.
- In a BSC or Local Attachment (non-SNA) environment, any write transmission when the device is in Data Pending Enter read state.
- In a BSC environment, a Copy command.
- In an SNA environment, any outbound transmission that, after processing, leaves the SLU in Send state or Contention state. These transmissions include null RUs carrying a CD or EB indicator.

For inbound Query Reply transmissions, the acknowledgment is:

- Any valid outbound data stream transmission other than a read command. For purposes of Query Reply acknowledgment, write commands without a write control character (WCC) are considered an acknowledgment. The reception of a Write Structured Field command is also an acknowledgment.

Host acknowledgment resets INOP to Read Modified.

Processing of Read Commands

Read commands (Read Modified, Read Modified All, Read Buffer) are processed as follows.

SNA Environment

1. If any of the following conditions pertains, the read command is rejected:
 - a. The SLU is not in SNA Receive (RCV) or Contention (CONT) state.
 - b. The chain that contains the RU does not specify CD.
 - c. The chain that contains the RU specifies EB.

Otherwise, step 2 or 3 is performed.

2. If the device is in Normal read state, then data is transmitted inbound as defined by:
 - a. The command
 - b. The AID (Read Modified command only)
 - c. The reply Mode (see “Set Reply Mode” earlier in this chapter)

The device remains in the Normal read state if the read operation was host-initiated. The device is placed in Retry state if the transmission was generated by an "enter" action or reception of a Read Partition-Query structured field.

3. If the device is in a Retry state, then a "retry" is performed as follows:
 - a. If the command is Read Modified and INOP specifies Query, then the appropriate query replies are transmitted.
 - b. If the command is Read Modified and INOP specifies Read Modified, then data is transmitted as specified by:
 - (1) The Read Modified command
 - (2) The AID
 - (3) The reply mode
 - c. If the command is Read Modified All or Read Buffer, then data is transmitted as defined by:
 - (1) The command
 - (2) The reply mode

The device remains in the retry state until a host acknowledgment causes a transition to the Normal read state.

BSC or Local Attachment Environment

1. If the device is in Normal read state in a BSC or Local Attachment environment, then:
 - a. Data is transmitted inbound as defined by:
 - (1) The command (Read Modified, Read Buffer)
 - (2) The AID (Read Modified command only)
 - (3) The reply mode

The device remains in Normal read state.

2. If the device is in a Data Pending state in a BSC environment, then data is transmitted as defined by:
 - a. The command
 - b. The AID (Read Modified command only)
 - c. The reply mode

The device is placed in Normal read state.

3. If the device is in a Data Pending state in a Local Attachment environment, then:
 - a. If the command is Read Modified and INOP specifies Query, the appropriate query replies are transmitted.
 - b. If the command is Read Modified and INOP specifies Read Modified, then data is transmitted as defined by:
 - (1) The Read Modified command
 - (2) The AID
 - (3) The reply mode
 - c. If the command is Read Buffer, then data is transmitted as defined by:
 - (1) The command
 - (2) The reply mode

For items a, b, and c, the device is placed in the corresponding Retry state (Enter, Read, Stacked Enter).

4. If the device is in a Retry state in a BSC or Local Attachment environment, then a “retry” is performed as follows:
 - a. If the command is Read Modified and INOP specifies Query, then the appropriate query replies are transmitted inbound.
 - b. If the command is Read Modified and INOP specifies Read Modified, then data is transmitted as defined by:
 - (1) The Read Modified command
 - (2) The AID
 - (3) The reply mode
 - c. If the command is Read Buffer, then data is transmitted as defined by:
 - (1) The command
 - (2) The reply mode

For items a, b, and c, the device remains in the retry state.

Processing of Read Partition-Query Structured Fields

Read Partition-Query and the Query Reply are processed as follows.

SNA Environment

1. If any of the following conditions pertains, the Read Partition (Query) is rejected.
 - a. The SLU is in a Retry state.
 - b. The SLU is not in SNA RCV or CONT state.
 - c. The Read Partition is not the last structured field in the RU chain.
 - d. The chain containing the RU does not specify CD or specifies EB.
 - e. Byte 3 of the query is not X'FF'.

Otherwise, steps 2 through 6 are performed.

2. The Time indicator is displayed.
3. INOP is set to Query.
4. The data is transmitted inbound.
5. The SLU is placed in RCV state.
6. The SLU is placed in Retry Read state.

BSC or Local Attachment Environment

1. If the device is in Normal Read state, then:
 - a. The Time indicator is displayed.
 - b. INOP is set to Query.
 - c. For BSC:
 - (1) The device prepares to generate the required inbound data stream.
 - (2) The device is placed in Data Pending Read state.
 - (3) A later Poll causes the data to be transmitted and the device to be placed in Retry Read state.
 - d. For Local Attachment (non-SNA):
 - (1) A channel attention occurs.
 - (2) The device is placed in Data Pending Read state.
 - (3) A later read command causes the data to be transmitted and the device to be placed in Retry Read state.

2. If the device is in Data Pending Enter state or Retry Enter state, then:
 - a. The outstanding enter data is stacked.
 - b. The X-Clock condition remains in effect.
 - c. INOP is set to Query.
 - d. For BSC:
 - (1) The device prepares to generate the required inbound data stream.
 - (2) The device is placed in Data Pending Stacked Enter state.
 - (3) A later Poll causes the Query Reply data to be transmitted inbound and the device to be placed in Retry Stacked Enter state.
 - e. For Local Attachment (non-SNA):
 - (1) A channel attention occurs.
 - (2) The device is placed in Data Pending Stacked Enter state.
 - (3) A later read modified command causes the data to be transmitted and the device to be placed in Retry Stacked Enter.

Control Commands

Control commands initiate certain control unit and/or device operations not involved with the transfer of data (other than status). Four control-type commands are executed by the 3274: Copy, Select, Erase All Unprotected, and No Operation. Not all control commands are valid for all models. The applicable control units are identified within the description of each control command.

Copy Command

The 3274 C units and 51C support the Copy command when operating with BSC protocol. These units do not support the Copy command when operating with SNA/SDLC protocol; however, a local copy function is provided (see Chapter 2).

Copy is used to transfer buffer data from one device to another device attached to the same control unit. The selected device is the "to" device, the one to which buffer data will be transferred. The "from" device, the source of the buffer data to be copied, is identified in the second of two bytes that follow the Copy command code; the first byte, called the copy control character (CCC), identifies the type of data to be copied. The CCC can also, at the "to" device, start print operations, specify the printout format for those operations, and, when the device is a display station, sound the audible alarm.

The Copy data stream is as follows:

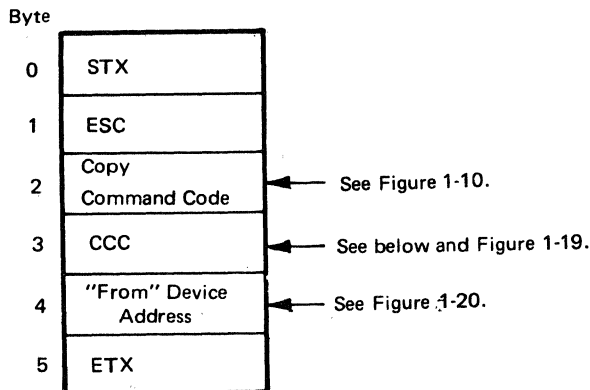

The CCC-byte format is as follows:

0	1	Printout Format	Start Print	Sound Alarm	Type of Data to Be Copied		
0	1	2	3	4	5	6	7

*Determined by the configuration of bits 2 through 7. See Figure 1-8.

Figure 1-19 describes the function of each CCC bit. A CCC and address byte must always follow the command code; if they do not, the control unit aborts the command and generates error status.

Bit	Explanation
0,1	Determined by the contents of bits 2 through 7 as shown in Figure 1-8.
2,3	Define the printout format as follows: = 00 – The NL, EM, and CR ¹ orders in the data stream determine print line length. Provides a 132-print position line when the orders are not present. = 01 – Specifies a 40-character print line. = 10 – Specifies a 64-character print line. = 11 – Specifies an 80-character print line.
4	The Start Print bit. When set to 1, initiates a printout operation at the "to" device after buffer transfers are completed.
5	The Sound Alarm bit. When set to 1, sounds the audible alarm at the "to" device after buffer transfers are completed if that device has an audible alarm.
6,7	Define the type of data to be copied as follows: = 00 – Only attribute characters are copied. = 01 – Attribute characters and unprotected alphameric fields (including nulls) are copied. Nulls are transferred for the alphameric characters not copied from the protected fields. = 10 – All attribute characters and protected alphameric fields (including nulls) are copied. Nulls are transferred for the alphameric characters not copied from the unprotected fields. = 11 – The entire contents of the storage buffer (including nulls) are copied.

¹ The CR order is applicable to the 3262, 3287 (3274 Attachment) and 3289 Printers only.

Figure 1-19. Copy Control Character (CCC)

Copy command operations are similar to Write command operations. After the control unit, for example, accepts the Copy data stream, it initiates the transfer of all bytes from the “from” device buffer to the control unit buffer. Upon completion of this transfer, the control unit inserts nulls in all character locations that do *not* contain the type of data specified by CCC bits 6 and 7. The updated control unit buffer contents are then transferred to the selected (“to”) device. At the completion of Copy command operations, the cursor is in the same character location at the “to” device as it was at the “from” device at the start of operations.

The “from” device buffer can be “locked” (made incapable of being copied) by writing a protected/alphanumeric attribute byte (bit 2=1 and 3=0) in address 0 (with BSC only).

The Copy command can specify as the “from” device the same device that is selected (the “to” device). This procedure provides a means of programming selective device buffer “erase” operations as specified by CCC bits 6 and 7. In this case, the device buffer contents are transferred to the control unit, nulls are inserted as determined by the CCC, and the resulting buffer contents are transferred back to the same device buffer.

When the buffer size of the “from” device is smaller than, or equal in size to, the buffer size of the “to” device, screen size switching occurs as listed in Figure 1-20. Invalid transfers are also indicated. The buffer of the “to” device is, in effect, cleared before the copy is performed. The same rules apply for copy-operation transfers to printer buffers.

Programming Notes:

1. *Copy should not be chained from a Write, Erase/Write Alternate, Erase/Write Unprotected, or Erase All Unprotected command, since it will copy the data as modified by the Write or Erase command.*
2. *If the CCC Start Print bit is set and commands are being chained, Copy should be the last command of the chain. If not, the control unit aborts the subsequent command.*
3. *Copy can be executed from a smaller buffer size to a larger buffer size, but an attempt to copy from a larger to a smaller buffer size will cause an Operation Check.*
4. *An Operation Check will occur if copying from an APL device in APL mode to a device that does not have the APL feature installed.*

When the “to” device is a 3288 equipped with the Text Print feature, a restricted character set applies, as shown in Figure D-10. A printout of a display station buffer containing the remaining characters of the 3288 120-character set, not included in the 3288 restricted character set, may be obtained by sending the contents of the display buffer to the host system. When the host receives data from a 3277 to be printed on a 3288, it translates the character codes received into codes that are applicable to the 3288 before transmission to the printer.

To	3277-1	3277-2	3278-1	3278-1	3278-2	3278-2	3278-3	3278-4	3278-4	3278-5	3278-5
	480	1920	960	480	3279	3279	1920	3440	1920	3564	1920
From											
3277-1											
480	o	●	v	o	●	●	●	●	●	●	●
3277-2											
1920	-	o	-	-	o	v	o	v	o	v	o
3278-1											
960	-	●	o	A	●	●	●	●	●	●	●
3278-1											
480	o	●	v	o	●	●	●	●	●	●	●
3278-2, 3279											
1920	-	o	-	-	o	v	o	v	o	v	o
3278-2, 3279											
2560	-	-	-	-	-	o	A	●	A ¹	●	A ²
3278-3											
1920	-	o	-	-	o	v	o	v	o	v	o
3278-4											
3440	-	-	-	-	-	-	-	o	A	●	A ³
3278-4											
1920	-	o	-	-	o	v	o	v	o	v	o
3278-5											
3564	-	-	-	-	-	-	-	-	-	o	A
3278-5											
1920	-	o	-	-	o	v	o	v	o	v	o

Legend:

- o Transfer allowed, no change in screen state required.
- Transfer not allowed, Operation Check returned to host.
- Transfer allowed, no change in screen state (appearance on "from" and "to" device may differ).
- A Transfer allowed, screen state changes to alternate size.
- v Transfer allowed, screen state changes to default size.

Notes:

- ¹The 3440 screen does not have a 2560 mode; therefore, the screen size is set to 3440.
- ²The 3564 screen does not have a 2560 mode; therefore, the screen size is set to 3564. The format is changed from 80 to 132 columns.
- ³The 3564 screen does not have a 3440 mode; therefore, the screen size is set to 3564. The format is changed from 80 to 132 columns.

Figure 1-20. Buffer Transfers for 3274 C Unit and 51C Copy Command Operation

Structured Field and Attribute Processing Considerations for Copy

If the Copy command references a “from” device that has *not* received the SFE, SA, or MF orders or the GE control code (X‘08’) since the last buffer clear (for example, EW, EWA commands), a copy action takes place. If the “from” device does have the extended functions in use, the Copy command is rejected with OC and US status (indicating a locked buffer) unless all of the following conditions are met:

1. The “from” device is a display.
2. The destination device is a printer.
3. The source device does not have a protected alphanumeric attribute in the first position.
4. The Copy Control Character has bits 4 (Start Print), 6, and 7 (Copy Entire Buffer) set to 1.

If these conditions are met, an attempt is made to produce a local copy. (See also the “Local Copy Function” in Chapter 2.)

Select Command (3274 B Units)

Select is an immediate command. The 3274 D units treat the Select command as a Select RM command (both the Select command and the Select RM command use the X‘0B’ command code). The Select command is invalid for all other 3274 control units. The 3274 B units execute a Select command by performing a device-to-control-unit buffer transfer. If not preceded by a Select command, this same buffer-transfer operation is performed as part of an initial (unchained) Write, Read Modified, or Read Buffer command.

The advantages of Select command usage are realized when a 3274 B unit is attached to a block multiplexer channel or to a byte multiplexer channel operating in forced Burst mode for the complete data transfer. Upon receipt of Select, the control unit sends Channel End as initial status to the channel. This frees a block multiplexer channel to perform other operations. Upon successful completion of the buffer transfer, the control unit sends Device End status asynchronously to the channel. Upon receipt of this status by the channel, a chain operation to the desired command (Write, Read Modified, or Read Buffer) must be initiated for effective use of the Select command. Note that device-to-control-unit buffer transfer time is not part of the execution time for this command.

At the conclusion of the command following the Select command, the control unit again issues Device End status. At this point, the channel may chain to another command of the same type or it may disconnect. If a chaining operation is performed, another Select command is unnecessary since the addressed device buffer contents are already in the 3274 B unit buffer.

Thus, the Select command is used to separate the device-to-control-unit buffer transfer operation portion of a Write, Read Modified, or Read Buffer command from the actual execution of the command. By doing so, the channel can use the buffer transfer time for other operations.

Select Read Modified (RM) Command (3274 D Units)

Select RM is an immediate command. It is used in place of the Select command (used by the 3274 B units) when a read-modified operation is to be executed.

The Select RM command causes a different operation in the 3274 D units than that caused by the Select command for the 3274 B units. The 3274 B units execute a Select command by performing a device-to-control-unit buffer transfer. If not preceded by a Select command, this same buffer-transfer operation is performed as part of an initial (unchained) Write, Read Modified, or Read Buffer command.

The 3274 D units execute a Select RM command by preparing for a read-modified operation; that is, the terminal buffer is searched for any modified fields, and the input data stream is built. This could result in an AID only (Short Read), test-request-read, or a read-modified data stream. If the command following the Select RM command (chained) is a Write command, the input data is not used. The write data stream is received by the 3274 D units and processed to the terminal. If the Write command is a WCC, SBA xx only, and then chained to a Read Buffer or a Read Modified command, the input data stream that had been prepared is not used, and the appropriate data stream is prepared upon receipt of the Read Buffer or Read Modified command. If the command following the Select RM is Read Buffer, the input data is not used, a read-buffer operation is performed, and the data is sent to the host.

The Select RM command is used to separate the device-to-3274-D-unit read-modified preparation from the channel operation to decrease channel use by the 3274 D units.

Note: *The successful use of the Prepare to Send select commands on the 3274 D units requires that appropriate code be included in the access methods of the host operating system. Host operating system "sysgen" manuals indicate the operating system sysgen macros that are a prerequisite.*

Select Read Buffer (RB) Command (3274 D Units)

Select RB is an immediate command. It replaces the Select command used by the 3274 B units when a read-buffer operation is to be executed.

The 3274 D units execute a Select RB command by preparing for a read-buffer operation; that is, a device-to-control-unit buffer transfer is performed and a read-buffer data stream is built. When the data stream is completed, Device End is sent to the host. If the command chained to the select RB command is not a Read Buffer, the command will not be accepted, and CE, DE, UC, OC will be sent to the host.

Select Read Modified from Position (RMP) Command (3274 D Units)

Select RMP is an immediate command. A Select RMP command is executed by recording the read-modified condition and returning Device End.

The commands following the Select RMP command should be a chained Write command followed by a chained Read Modified command. [The Write Command contains only four bytes (WCC, SBA xx) to set the buffer address.] If the sequence is other than as described, the command will not be accepted, and CE, DE, UC, OC will be sent to the host.

Upon receipt of the Write command, the 3274 D units will perform the read modified from position preparation, and return Device End to the host when the data stream is completed. The RM command is then executed.

Select Read Buffer from Position (RBP) Command (3274 D Units)

Select RBP is an immediate command. A Select RBP command is executed by recording the read-buffer condition and returning Device End.

The commands following the Select RBP command should be a chained Write command followed by a chained Read Buffer command. [The Write command contains only four bytes (WCC, SBA xx) to set the buffer address.] If the sequence is other than as described, the command will not be accepted, and CE, DE, UC, OC will be sent to the host.

Upon receipt of the Write command, the 3274 D units will perform the read buffer from position preparation, and return Device End to the host when the data stream is completed. The Read Buffer command is then executed.

Select WRT Command (3274 D Units)

Select WRT is an immediate command. A Select WRT command is executed by returning Device End to the host. If the chained command following the Select WRT is not a Write or Write Structured Field (WSF) command, CE, DE, UC, OC will be sent to the host.

Erase All Unprotected Command

This command performs five functions at the addressed device:

1. Clears all unprotected buffer character locations to nulls.
2. Resets to 0 the MDT bit for each unprotected field.
3. Unlocks the keyboard when either the System Lock or the Wait symbol is displayed on the 3278 or 3279. The Erase All Unprotected command always unlocks the keyboard attached to the 3277.
4. Resets the AID byte.
5. Repositions the cursor to the first character location in the first unprotected field of the buffer. If no unprotected fields exist, the cursor is positioned to buffer location 0.

In local configurations, Erase All Unprotected is an immediate type command. Upon acceptance of this command, the 3274 B or D units go "busy" and send Channel End initial status to the channel. Upon successful completion of this command, the control unit sends Device End status asynchronously to the channel and then goes "not busy."

Programming Restriction: *Erase All Unprotected should not be chained to a Write, Erase/Write, Erase/Write Alternate, Copy, or another Erase All Unprotected command. If it is, the resulting operation is not defined.*

No Operation Command (3274 B and D Units)

The No Operation command performs no function operation in the control unit, but may be used to retrieve pending status. No Operation is an immediate command; therefore, Channel End and Device End normally will be presented as initial status unless pending status or a busy condition exists.

Sense Command (3274 B and D Units)

The Sense command should be issued in response to Unit Check status for further definition of the Unit Check condition. The control unit responds to a Sense command by sending 1 byte of sense data to the channel and resets the sense register when the Device End (DE) for the command is accepted by the channel.

All other commands to the same address, except a No Operation or a Test I/O "command" (command code of X'00'), reset the sense register immediately when the command is issued. Sense commands issued to an address other than the one for which sense data is pending are responded to with a Busy and Status Modifier (B, SM) initial status indication, and the sense register is not reset. Sense should be issued following receipt of Unit Check status to ensure that valid sense information is retrieved.

The sense byte configuration is as follows:

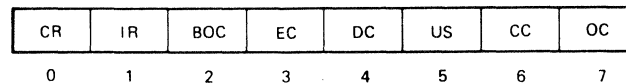

Figure 1-21 summarizes the significance of each sense bit. The various sense and status bit combinations are described in Figures 4-5, 4-6, and 4-7.

Sense ID Command (3274 B and D Units)

The Sense ID command requests data transfer to the host. Four bytes of data are sent as follows:

3274 B and D Units

Byte 0	FF	FF
Bytes 1, 2	3274	3274
Byte 3	1B	1D

Sense ID is honored when the 3274 B or D units are in one of the following states:

- Power on
- IML completed
- Online
- Not busy
- No outstanding status to be presented

Bit	Name	Significance
0	Command Reject (CR)	Set if the 3274 B or D units have received an invalid command; the valid commands are listed in Figure 1-10.
1	Intervention Required (IR)	Set if a command, other than Sense, was addressed to a device that is unavailable or is in the "not ready" condition.
2	Bus Out Check (BOC)	Set if the B or D units have detected bad parity on any command or data byte received from the channel.
3	Equipment Check (EC)	Set if: (1) the 3274 B or D units have asynchronously detected a parity check on data received from a device in response to an internal poll for attention status (the internal poll is tried twice before EC is set), (2) a printer error occurs. If this is a device-detected condition, Unit Specify is also set.
4	Data Check (DC)	Set if: (1) the 3274 B or D units or a device have detected bad parity on data transferred internally or between the control unit and a device during command operations, (2) a 3277, 3278, or 3279 has detected a cursor check, or (3) a device has detected a buffer check. If this is a device-detected condition, Unit Specify is also set.
5	Unit Specify (US)	Set if the sense bits resulted from a device-detected error.
6	Control Check (CC)	Set when the 3274 B or D units have detected a timeout condition. (The addressed device fails to perform a specified operation or respond within a specified period of time.)
7	Operation Check (OC)	Set when the 3274 B or D units have received a valid command or order that they cannot execute, as follows: <ol style="list-style-type: none"> 1. SBA, RA, or EUA order specifies an invalid buffer address. 2. Write data stream ends before all required bytes of SBA, RA, EUA, or SF order sequence are received. 3. Write, Erase/Write, or Erase/Write Alternate with Start Print bit set in WCC is chained to the next command; the print operation is suppressed. 4. The 3274 B units received a Write type command with the WCC equal to X'88'. 5. The 3274 D units received a command chained to a Select RB, Select RBP, Select RMP, or Select WRT command other than was expected; or the byte count of a Write command after RBP or RMP was not equal to 4.

Figure 1-21. Sense Bit Description—3274 B and D Units

Miscellaneous Operations

Test Request Function

The Test Request function is available for all 3270 systems. The Test Request message sent to the host (SOH%/STX) is invoked from the keyboard. The TEST REQ key is used on keyboards attached to the 3277s, and the SYS REQ key is used on keyboards attached to 3278 and 3279 displays. Systems using 3274s must operate in Compatibility mode to perform the Test Request function. The TEST key provided on 3278 and 3279 displays is used to invoke internal 3274 tests.

Use of BSC Line Discipline

Text Transmission

Buffer Transfers. The 3274 sends a positive response before transfer of the device buffer to the control unit. If an error occurs, the 3274 provides a positive response to the selection sequence and indicates the error with Data Check and Unit Specify status.

Partial Message Transfer. The 3274 allows parts of messages to be transmitted to the host before all data is moved from the 3278 or 3279 to the control unit. If a terminating condition prevents completion of data transfer from the 3278 or 3279 to the control unit after inbound link transmission has started, the control unit sends STX SUB ENQ. The control unit responds to specific polling with Device Check (DC) and Unit Specify (US). A selection sequence with a write-type command is accepted. A selection sequence with a read-type command is rejected with DC and US.

Limited Conversational Text Mode. The 3274 can operate in Limited Conversational Text mode. If the host transmits a text block following receipt of a text transmission that ends in ETB, the 3274 initiates a timeout and sends ENQ.

Screen Update Protected Message

If a protected message is sent to a 3278 display, the first message byte sent must be the protected attribute.

To ensure data security when nondisplayable data is sent to a 3278 display, a nondisplay attribute byte must be sent before new nondisplayable data is sent. When a screen image is being partially changed, care must be taken not to overwrite a nondisplay attribute in the current image. In general, the Erase/Write command is recommended if the current image contains a protected message.

Responses

RVI. The 3274 initiates a timeout if RVI is received in response to RVI.

Responses While Performing Concurrent Terminal Tests. While performing concurrent terminal tests, the 3274 responds to the host with EOT if messages are received, with RVI if a selection sequence is received, and with IR (Intervention Required) in reply to a Specific Poll. No response is sent by the control unit to a General Poll. While individual device tests are performed, the device remains in a busy state for a relatively long period of time.

Error Handling

Unrecoverable Errors. If a nonretryable error occurs in a 3278 or 3279 buffer, or if an error is detected in a transfer of data from the 3274 to the 3278 or 3279, the buffer is cleared, and the host is informed of the error by Device Check and Unit Specify status but is not informed of the clear operation.

Responses to Invalid Sequences. The sequence "SOH, ESC, Write command, WCC, STX ETX" is valid.

If the host selects the 3274 and issues a Read Modified command, the control unit transmits a single block of text ending with ETX and expects to receive an acknowledgment from the host (under BSC rules governing Limited Conversational mode). If the host makes an error by beginning a new command sequence starting with STX, then the control unit replies with ENQ.

Character Sets

Character sets that provide 94 characters (excluding space and null) are designed for various languages. They are available for the 3278 and 3279 displays and for 3262, 3287 and 3289 printers. Character sets available for the 3277 display and for the 3284, 3286, and 3288 printers contain 88 characters (excluding space and null). Unique character sets used in World Trade countries are available for the 3278, 3279, 3287, and 3289 units.

Units that employ the 96-character character set can display or print either mono-case or dual-case alphabetic characters.

The split vertical bar ($\left| \right|$) character, hex 6A, was available only for the 3288. Character code 6A is now available as the ($\left| \right|$) character on 3278, 3279, 3287, and 3289 units installed in the United States, and as a series of unique characters selected for use in World Trade character sets.

When the 3277 display is attached to the 3274, six character codes are provided which are also valid for the 3278 or 3279 display when attached to the 3274, but the characters displayed are different. A comparison of the displayed U.S. EBCDIC characters is as follows:

Code	C0	D0	E0	6A	A1	79
3277	()			-	'
3278/ 3279	{	,	}	\		~

Refer to *IBM 3270 Information Display System: Character Set Reference*, GA27-2837, for a detailed comparison of character sets in all languages supported by the 3270 system.

Care must be exercised when communicating between 3277, 3278, and 3279 displays attached to a 3274. For example, if information is entered at a 3278 or 3279 within brackets such as {AA} and transferred to the 3277 where it is modified and then returned to the 3278 or 3279 as {BBB}, the 3277 operator must use the Insert Mode function instead of direct keying to modify the information. Otherwise, the reply will be displayed on the 3278 or 3279 as {BBB}.

Use of SNA Protocol

The 3274 functions as FID type 2 using SNA protocol.

Non-SNA Local Control Unit Differences

Operation Checks

The 3274 D units do not Op Check a WCC = X'88' during a Write command.
The 3274 B units do Op Check a WCC = X'88'.

The 3274 B units report certain operation-check conditions as *ending status*.
The 3274 D units do not execute the data stream as it is received from the channel and, therefore, report these conditions as *asynchronous status*.

Buffer Updates

The 3274 B units bring the device buffer into the control unit, update it, and return it to the device; the 3274 D units update the device buffer directly. If a Bus Out Check (BOC) or Operation Check (OC) is detected, the 3274 B units do not update the device buffer. The 3274 D units may change part of the device buffer prior to detecting the BOC or OC.

Because the 3274 D units have updated a portion of the device buffer, a Write command can be retried only if new fields have not been created in the buffer portion which has been cleared by a Program Tab or Erase Unprotected to Address Order. This applies only to BOC since OC is a nonrecoverable program error.

Security Keylock

The 3274 sends Device End only when the key is turned from the locked to the unlocked position if the host attempted to select the terminal while it was locked.

Chapter 2. Terminals

This chapter describes the function of the display stations and printers that can attach to the 3274 Control Units. For more detailed information on display images, refer to Chapter 6, Screen Design. Refer to the "Operator Guides" publications for the displays and printers for more device specific information. Indicators and controls for the 3277 Display Station and the 3284, 3286, and 3288 printers are described in Appendix L.

Display Stations

Display Images

Display stations for the 3270 system are buffered displays. Data displayed on the screen is stored in coded form in a display buffer; the buffer contains as many locations as there are character positions on the screen. The data may be loaded from the host system by the application program or from a keyboard attached to the display station. Figure 2-1 illustrates the concept of a buffered display.

The display image contains a fixed number of horizontal rows, with a fixed number of character positions in each row. Depending upon the capacity of the screen, the number of rows and characters is as follows:

480-character display	12 rows of 40 characters
960-character display	12 rows of 80 characters
1920-character display	24 rows of 80 characters
2560-character display	32 rows of 80 characters
3440-character display	43 rows of 80 characters
3564-character display	27 rows of 132 characters

There is a fixed relationship between each location in the display buffer and each character position on the display screen. Buffer addresses start from 0, for the character position at the left of the top row, and proceed sequentially along the rows and down the screen to the character position at the right of the bottom row (for example, an image with 960 character positions has buffer addresses from 0 to 959). Figure 2-2 shows the addresses of the first and last character positions in each row, depending upon the available screen capacity.

Each location in the buffer contains 1 byte of storage; codes loaded into the buffer are 2-digit hexadecimal codes. Write commands are used to load the display buffer locations with the code needed to display the required data on the display screen (see Chapter 1). Defined codes that are displayed as alphameric characters are shown in Figures 1-3 through 1-7.

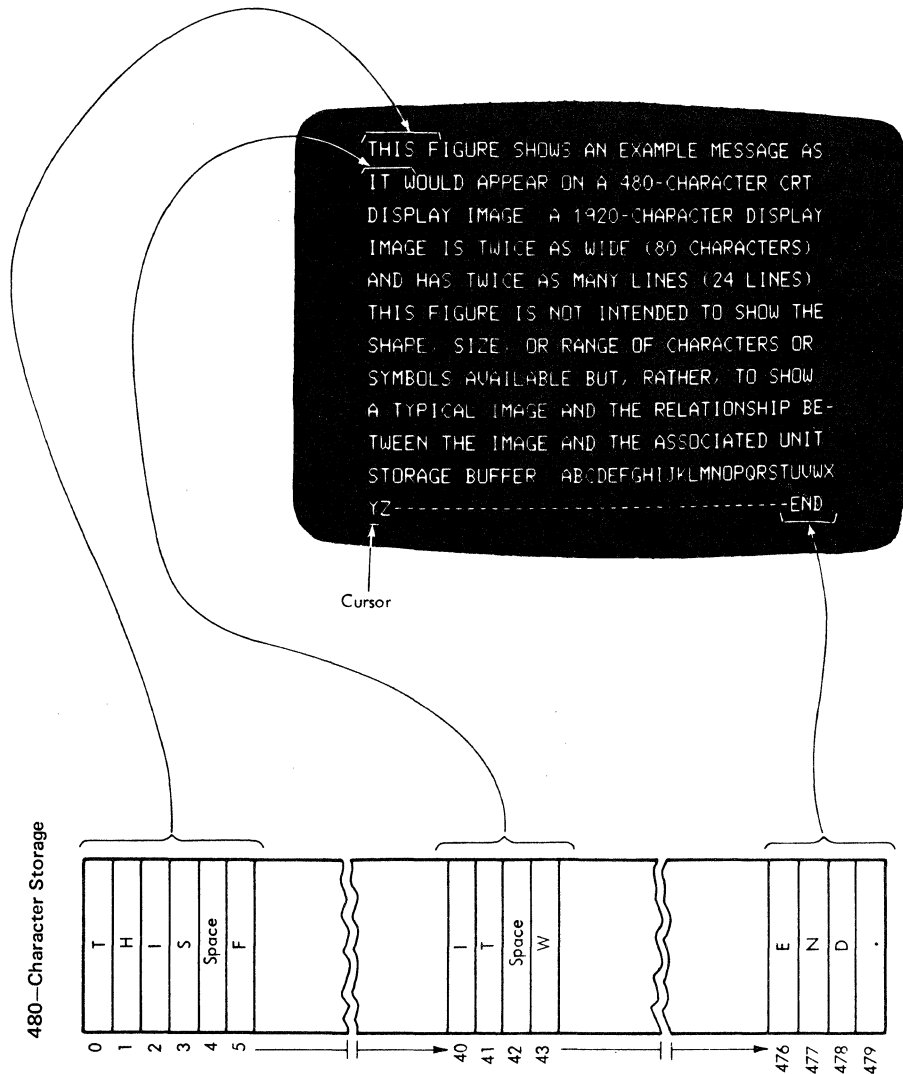
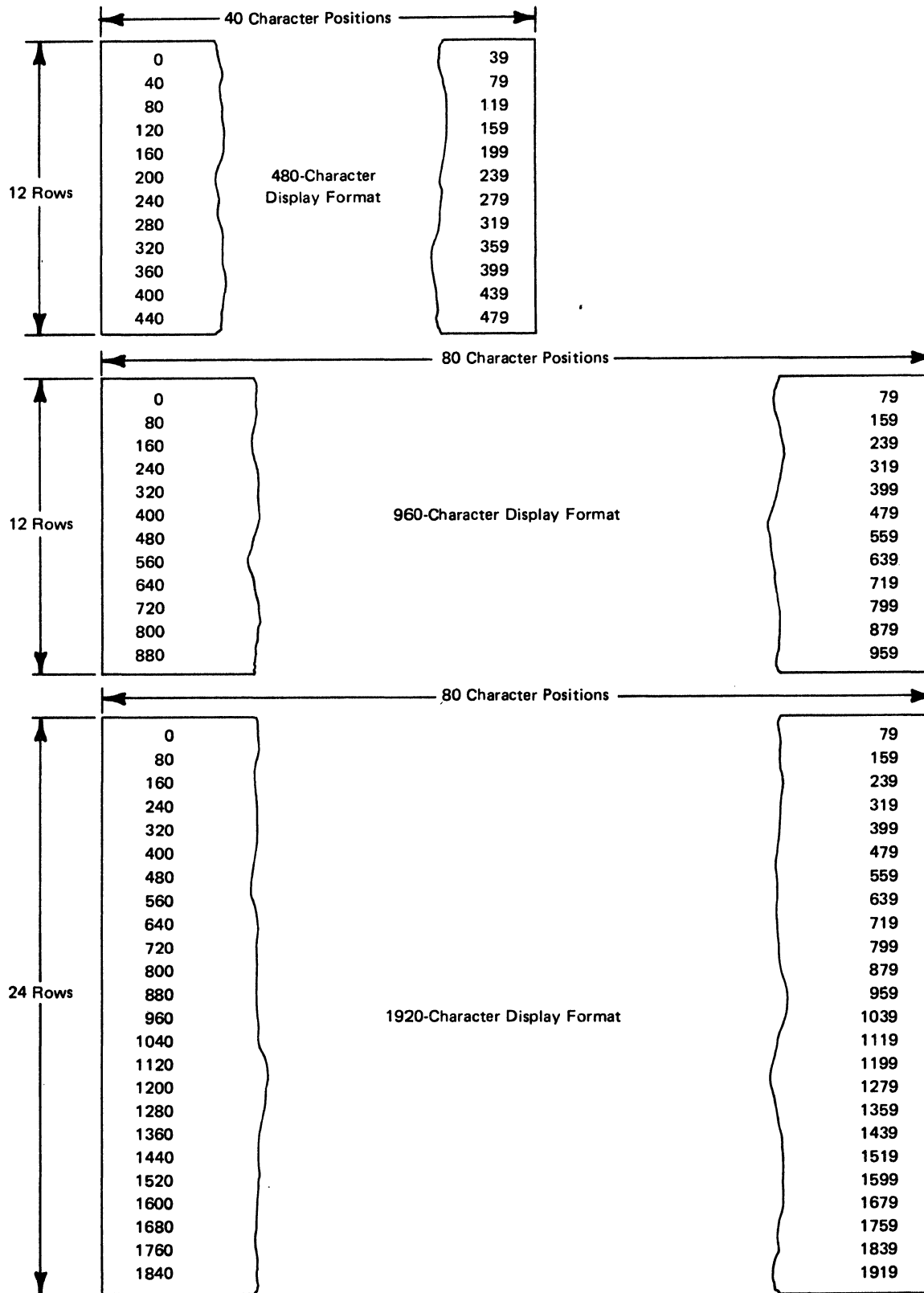

Figure 2-1. Buffer Location and Display Screen Character Position Relationships

Display images may be formatted or unformatted:

- **Formatted Display** A formatted display is one that has separate fields defined by the program. The first character position in each field contains a control character that defines the characteristics of the field. See "Field Attributes," later in this chapter, for a description of the control character.
- **Unformatted Display** An unformatted display is one that has no defined fields. An operator may input data into any position on the screen; to access the data, the program must issue a read command for the entire display buffer.



Note: See Appendix B for hexadecimal equivalents.

Figure 2-2 (Part 1 of 2). Buffer Addressing Layouts for 480-, 960-, 1920-, 2560-, 3440-, and 3564-Character Terminals

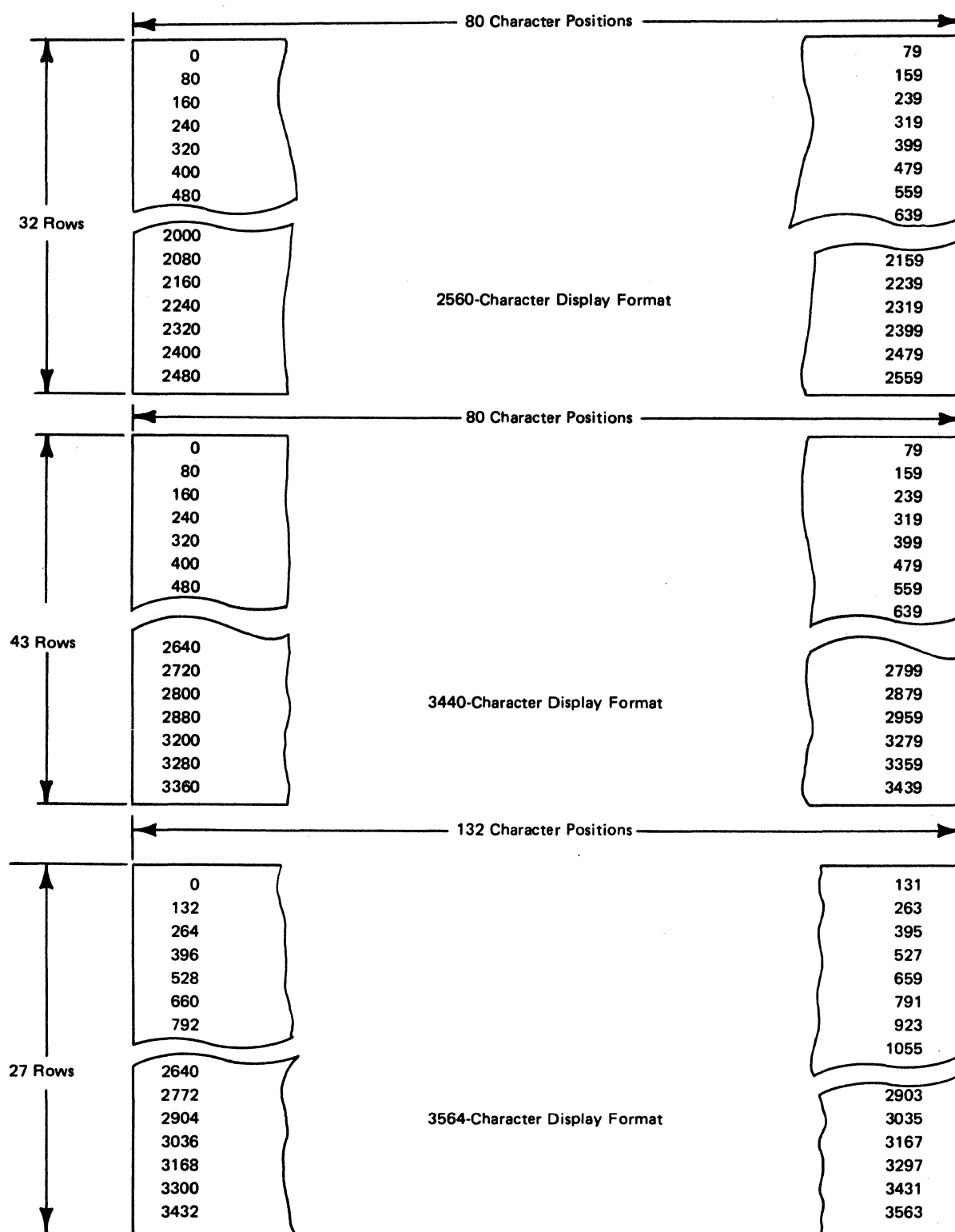

Figure 2-2 (Part 2 of 2). Buffer Addressing Layouts for 480-, 960-, 1920-, 2560-, 3440-, and 3564-Character Terminals

Display Fields

A formatted display contains display fields defined by the program. These fields consist of blocks of character positions bounded by control characters. The control character at the start of a field is set by the program to determine the characteristics of the field; this character contains the field attributes. (For details, see "Attributes," later in this chapter.) Fields containing character positions on more than one row "wrap" from the last character position on one row to the first character position on the next row. A field may wrap the screen; if the first character position on the screen does not contain a control character, the last field on the screen wraps from the last character position to the first. (Some field-oriented operations are terminated early if the field wraps the screen; this effect is noted in the descriptions of the specific operations.)

Display fields simplify operations both for the operator and for the programmer. Headings can be displayed to prompt the operator as to the data that should be entered, and the program can identify fields that contain entered data without reading the entire display buffer. When data is being entered into a formatted display, the presence of a control character acts as a tab stop; pressing the tab key advances the cursor from its current position to the first character position in the next unprotected field. (An unprotected field is one that accepts data input from the keyboard.)

The example in Figure 2-3 illustrates the versatility of formatted displays. In this example, the solid characters represent the displayed form of characters stored in the buffer. The dotted squares represent the character positions corresponding to control characters at the start of each field. The dotted characters represent fields of data that are stored in the buffer, but that have been defined by the operator as nondisplayable; that is, not to be displayed to the operator.

To define the start of a field, the program may issue a Write command transferring a Set Buffer Address (SBA) order and a Start Field (SF) order to the display; the specified buffer address is selected, and the control character specified by the SF order is loaded into the addressed location. Only the start of a field is defined; starting a field ends the previous field at the character position prior to the new control character.

```
□NAME :□ JOHN B DOE
□SALARY □ 1 2 5 2 3
□JOB TITLE :□ WRITER
□PHONE # :□ 383-7628
```

Figure 2-3. Example of Formatted Display

Attributes

All display stations for the 3270 system may be programmed with formatted fields. The control character at the start of each field contains the field attributes. Attributes contained in this character apply to all the data contained in the field; for example, the attribute character for the field containing PHONE # in Figure 2-3 might define the field as protected to ensure that the operator does not enter data into that field, and the field containing 383-7628 might be defined as unprotected to allow the data to be changed.

Display stations that support the Structured Field and Attribute Processing option, such as the 3279 Models 2B and 3B, are capable of handling extended attributes. The extended attributes increase the number of characteristics that can be defined. Extended attributes may be applied to a field and to individual characters within the field. Extended attributes may also be applied to individual characters in an unformatted display.

Extended attributes do not occupy positions in the display buffer. Conceptually, three additional buffers are provided for the extended attributes. Each buffer has the same number of locations and the same address map as the display buffer. Figure 2-4 shows the concept of four parallel buffers.

Field Attributes

The field-attribute character occupies the first character position of each display field in a formatted display; the corresponding character position on the display screen is always blank. This 8-bit attribute character is loaded by a Start Field or Start Field Extended (attribute type X'CO') order to (1) define the start of a field and (2) assign characteristics to the field. Bit positions in the character are significant to the display; the value assigned to each bit or group of bits controls whether a specific attribute is applied.

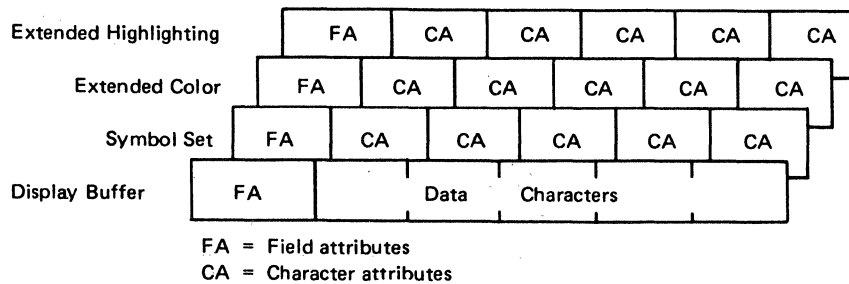

Figure 2-4. Extended Attributes – A Conceptual View

Field Attribute Character

Figure 2-5 shows the significance of bits in the field-attribute character. Characteristics set by the field-attribute character are:

- **Protected/Unprotected:** An operator cannot enter data into or modify the content of a protected field. Input fields that require data from the operator must be unprotected.
- **Alphameric/Numeric:** In an unprotected input field, alphameric/numeric defines the type of data that an operator can enter into the field. This attribute has special meaning for protected fields, data entry keyboards, and the Numeric Lock feature.
- **Nondisplay/Display/Intensified:** Data contained in the field is either not displayed, displayed at normal intensity, or displayed at high intensity. The 3279 does not support two levels of intensity; if no extended attribute is defined, nonintensified fields and intensified fields are displayed in different colors. (The actual colors are determined by the position of the Base Color switch and the value of the Protected/Unprotected attribute.)

Programming Note: Refer to Appendix H for the use of intensified field attributes when formatting selector-light-pen-detectable fields.

- **Detectable/Nondetectable:** Displayed data in a detectable field can be detected by the selector light pen. (The detectable field must contain a designator character as described under “Selector-Light-Pen Operations” in Appendix H.)

Field attributes are protected against input from the keyboard; however, bit 7 (Modified Data Tag) is set to 1 when the operator enters data into the field defined by the attributes. Attribute characters are not protected against operation of the CLEAR key; pressing the CLEAR key erases all locations in the display buffer.

Base Color Mode

The 3279 uses the field attributes for the additional purpose of controlling color.

Models 2A and 3A of the 3279 always decode the field attributes to assign a color to each display field. If the operator sets the Base Color switch to base color (oooo), then the fields are colored in one of four colors—red, blue, green, or white—depending upon the protect and intensify bits. If the operator sets the Base Color switch to monochrome (oo), all data is displayed in green except for intensified fields; intensified data is displayed in white. The particular attributes examined are the protect and intensify attributes. Figure 2-6 shows how the value of these attributes determines the color of characters displayed in a field.

Attribute character bit assignments are summarized as follows:

X	X	U/P	A/N	D/SPD	Reserved	MDT	
0	1	2	3	4	5	6	7
EBCDIC Bit	Field Description						
0, 1	- Value determined by contents of bits 2–7. See Figure 1-8 for hexadecimal values.						
2	- 0 = Unprotected - 1 = Protected						
3	- 0 = Alphameric - 1 = Numeric (causes automatic upshift of data entry keyboard)						
Note: Bits 2 and 3 equal to 11 causes an automatic skip. See text.							
4, 5	- 00 = Display/not selector-light-pen detectable. - 01 = Display/selector-light-pen detectable. - 10 = Intensified display/selector-light-pen detectable. - 11 = Nondisplay, nonprint, nondetectable.						
6	- Reserved.						
7	- Modified Data Tag (MDT); identifies modified fields during Read Modified command operations. - 0 = Field has not been modified. - 1 = Field has been modified by the operator. Can also be set by program in data stream.						

Figure 2-5. Field Attribute Character Bit Assignment

Field Attribute	Attribute Bit				Base Color Switch	
	2	3	4	5	oo	oooo
Unprotected, normal intensity	0	X	0	X	Green	Green
Unprotected, intensified	0	X	1	0	White	Red
Protected, normal intensity	1	X	0	X	Green	Blue
Protected, intensified	1	X	1	0	White	White

Figure 2-6. Colors Derived from Field Attributes

Models 2B and 3B support extended color. When extended color is used, the Base Color switch is disabled. However, if extended colors are not used by the application program, these models display base color or monochrome mode in the same way as Models 2A and 3A. See “Extended Color Attributes” later in this chapter for more information.

Note: *The integrity of the unprotected/protected attribute is preserved; the operator can enter data only into an unprotected field.*

Extended Attributes

Additional characteristics may be assigned to display fields and to individual character positions within the fields when the display station supports the 3270 Structured Field and Attribute Processing option. The extensions to the field attributes are:

- Extended Highlighting (blink, reverse video, underscore)
- Color (blue, red, pink, green, turquoise, yellow, white)
- Programmed Symbols (the character code in the display buffer is used to address a Programmed Symbol set)

Note: *Extended attributes are ignored if “nondisplay” is set in the field attribute.*

When a character is displayed in a formatted field, the character attributes corresponding to the display buffer location are examined to determine the extended attributes of the character. If any of the character attributes contain X'00', that particular attribute is “inherited” from the extended field attribute.

The application program may assign character attributes to an unformatted display. Because there are no extended field attributes, however, the defaults for Extended Highlighting and Programmed Symbol set are *none* and *base character set*. Setting the extended color character attribute to X'00' in an unformatted display causes the color to default to green.

Extended field attributes are protected against input from the keyboard. Input data from the keyboard is always assigned character attributes of X'00' if the operator does not select specific attributes. Enabling operator selection is a function of the reply mode set by a Write Structured Field command.

The orders used by the program to load or change extended attributes are Start Field Extended, Modify Field, and Set Attribute. Orders and commands are described in Chapter 1.

Extended Highlighting (Attribute Type X'41')

Extended Highlighting offers three ways in which a character or a field can be highlighted: blink, reverse video, underscore. The valid codes for Extended Highlighting are:

- X'00' — Select default (see Note 1)
- X'F1' — Blink
- X'F2' — Reverse video (see Note 2)
- X'F4' — Underscore

Notes:

1. *Default depends upon whether the display is formatted or unformatted:*
 - a. *Formatted: X'00' in the character attribute causes that attribute to be inherited from the extended field attribute. X'00' in both the character attribute and the extended field attribute causes display without highlighting.*
 - b. *Unformatted: X'00' in the character attribute causes display without highlighting.*
2. *Refer to "Triple-Plane Symbol Sets" later in this chapter for the effect of reverse video on symbols defined with more than one color in a single-character position.*
3. *If the operator selects "cursor blink" or "reverse cursor," the cursor attribute interacts with the Extended Highlighting attribute (see "Cursor" in Appendix C).*

Extended Color (Attribute Type X'42')

Extended Color is available only on 3279 Models 2B and 3B attached to a 3274 Control Unit equipped for structured field and attribute processing. For compatibility of programming between color and monochrome, this attribute may be sent to a similarly attached 3278 Model 1, 2, 3, 4, or 5 when the 3278 is equipped with the Extended Character Set Adapter feature.

Extended Color offers seven colors that can be defined for individual characters within a field or for complete fields. The valid codes for the Extended Color attribute are:

- X'00' — Select default (see Note 1)
- X'F1' — Blue
- X'F2' — Red
- X'F3' — Pink
- X'F4' — Green
- X'F5' — Turquoise
- X'F6' — Yellow
- X'F7' — Neutral—white (see Note 2)

Notes:

1. *Default for an unformatted display is always green.*

On a formatted display, a character attribute of X'00' causes a default to the extended field attribute. When the extended field attribute also contains X'00', the display of base colors by 3279 Models 2B and 3B is suppressed if attribute type X'42' (Extended Color attribute) is used in the data stream following:

- a. *Erase/Write or Erase/Write Alternate command.*
- b. *Set Reply Mode structured field function.*

When the display of base colors is suppressed, default is white for data in an intensified field and green for all other data. (See Chapter 1 for details of commands and orders.)

Base color is reenabled by either (1) an Erase/Write or Erase/Write Alternate command with bit 1 of the WCC set to 1 or (2) the operator's pressing the Clear Sys Req, or TEST key. Colors displayed when base color is enabled depend upon the field attributes and on the setting of the Base Color switch. (See "Base Color Mode," earlier in this chapter.)

2. *X'F7' as a character attribute or "inherited" from the extended field attribute causes the character to be displayed white except when a triple-plane symbol set is used. (See "Triple-Plane Symbol Set," later in this chapter.)*

Symbol Set (Attribute Type X'43')

The Programmed Symbols features PS-2 and PS-4 use the character code from the display buffer as an address to access a symbol set. (For details, see "Programmed Symbol Sets," later in this chapter.) Symbol sets are selected by the symbol set attribute. Valid codes for this attribute are:

- X'00' — Select default (see Note 1)
- X'40' — Range of valid identities for symbol sets (see Note 2)
through
X'EE'
- X'F1' — Select APL/Text character set (see Note 3)

Notes:

1. *Default depends upon whether the display is formatted or unformatted:*
 - a. *Formatted: X'00' in the character attribute causes that attribute to be inherited from the extended field attribute. X'00' in both the character attribute and the extended field attribute selects the base character set.*
 - b. *Unformatted: X'00' in the character attribute selects the base character set.*

2. *The identity assigned to a symbol set is determined by the programmer; it is a valid identity only when the symbols have been loaded.*
3. *X'F1' can not be used in the extended field attribute. This value is supported only if the APL/Text character set is present. If used it is rejected.*

Programmed Symbols

A Programmed Symbol (PS) is a special character or graphic component that is loaded by the application program into a symbol set in the device. Each symbol set contains 190 symbol locations; each location contains a pattern of binary bits equivalent to the dot pattern contained in each character position on the display screen. To define a symbol, the application program sets only those bits in a location that relates to the active dots needed to display the symbol.

Symbol sets are either single-plane or triple-plane. Triple-plane sets are not available on monochrome displays. The advantage of a triple-plane set is that it allows more than one color to be used in a single character position. The following symbol sets are available at each PS address:

PS Address	3278 Models 2, 3, and 4	3279 Models 2B and 3B
A	Single plane	Single plane
B	Single plane	Single plane
C	Single plane	Triple plane
D	Single plane	Triple plane
E	Single plane	Single plane
F	Single plane	Triple plane

Characters displayed are a pattern of active dots. Each character position on the screen is addressed by the display as a matrix of dots. Characters of the base character set are defined within the display station as a pattern of active dots in this matrix. The number of dots in the matrix and the size of the matrix vary between display stations. Figure 2-7 illustrates the character position as defined for the 3279 Models 2B and 3B and lists the parameters used by the 3278 Models 2, 3, and 4.

When displaying a character from the base character set, the display station reads an EBCDIC code from the display buffer. This EBCDIC code is used to address the base character set, and the addressed location contains the pattern of points needed to display the character. However, if the character attributes define or "inherit" a symbol set, then the character code addresses a location in the symbol set.

Take, for example, an application that displays a histogram. This application would require a symbol set containing "fill" patterns. Location X'81' in the symbol set might then contain a cross hatch fill pattern. In this example, X'81' in two locations in the display buffer might fetch two different patterns of active dots; from the base character set, X'81' would fetch character *a*, and from the symbol set, X'81' would fetch the cross-hatch pattern. Figure 2-8 illustrates this example; the figure assumes that symbol set Y has been loaded.

```

* * * * *
* * * * *
* * * * *
* * * * *
* * * * *
* * * * *
* * * * *
* * * * *
* * * * *
* * * * *
* * * * *
* * * * *
* * * * *
* * * * *
* * * * *
* * * * *

```

	3278-2, -3	3278-4	3279	3290
Width, dots	9	9	9	9
Height, dots	16	12	12	12
Spacing between dots:				
Vertical	0.38 mm (0.015 inch)	0.38 mm (0.015 inch)	0.46 mm (0.018 inch)	
Horizontal	0.37 mm (0.0145 inch)	0.37 mm (0.0145 inch)	0.34 mm (0.0135 inch)	

Figure 2-7. Size of Character Position

```

Display Buffer  | X'81' | X'81' |
Symbol Set    | base | Y |

```

Base Character Set	Symbol Set Y
-----	X--X--X--
-----	-X--X--X--
-----	--X--X--X--
-----	X--X--X--
-XXXX--	-X--X--X--
-----X--	--X--X--X--
-XXXXX--	X--X--X--
-X-----X--	-X--X--X--
-XXXXX--	--X--X--X--
-----X--	X--X--X--
-----	-X--X--X--
-----	--X--X--X--

Figure 2-8. Conceptual View of Programmed Symbols Set

Symbol sets are loaded by the program issuing a Write Structured Field command. Data sent to the display by the Write Structured Field command includes (1) the number of the set being loaded, (2) the 1-character identity assigned to the set, (3) a starting address for the load, and (4) the data that defines the required symbol or set of symbols. Valid addresses for location in each symbol set range from X'41' through X'FE'. Loading of a set starts at the location specified in the Write Structured Field command and progresses sequentially until all data has been transferred to the set. For details, refer to "WSF Command, FMH1, and Structured Fields" in Chapter 1.

Single-Plane Symbol Sets

A single-plane symbol set has no inherent color characteristic and is available for both monochrome and color displays. On color displays, symbols from a single-plane set are displayed in the color defined in the character attribute or the extended field attribute. If the extended color attribute is X'00' in both the character attribute and the extended field attribute, the symbol is displayed in the default color (white for data or symbols in an intensified field and green for all other data and symbols).

Triple-Plane Symbol Sets

In certain applications, it may be necessary to display more than one color within a single character position. For example, the Programmed Symbols feature may be used to display three lines: one red, one blue, and one yellow. These lines may cross at certain points, and the area of the crossing point is significantly smaller than the area of a single character position. If multiple colors could not be displayed within a character position, the point of intersection might appear as follows:

```

- - - - - - - - - - - - - - - r
- - - - - - - - - - - - - - - r
- - - - - - - - - - - - - - - r
b b b b b b b b b r r r r r r r r r b b b b b b b b b
- - - - - - - - - - - - - - - r - - - - - - - - - - -
- - - - - - - - - - - - - - - r - - - - - - - - - - -
- - - - - - - - - - - - - - - r - - - - - - - - - - -
y y y y y y y y y r r r r r r r r r y y y y y y y y y
- - - - - - - - - - - - - - - r - - - - - - - - - - -
- - - - - - - - - - - - - - - r - - - - - - - - - - -
```

Legend:
r = red
b = blue
y = yellow
- = blank

The Programmed Symbols feature overcomes this difficulty by allowing the user to define symbols that contain more than one color; these symbols are stored in a triple-plane symbol set. Triple-plane symbol sets contain a separate plane for each primary color: red, blue, and green. Corresponding locations in each plane may be loaded with a different pattern of active bits. Addressing a location in a triple-plane symbol set fetches the bit patterns from each plane at that location; the three patterns form the symbol displayed. The symbol is displayed in the character position related to the display buffer location that contains the code used to address the symbol set.

If the extended color attribute is X'F7' when a triple-plane set is addressed for a symbol, the pattern from each plane is displayed in the primary color for the plane, that is, red, blue, or green. To obtain pink, yellow, turquoise, and white, the same dot is made active in more than one plane. The combinations of the primary colors are described below under "Secondary Colors."

If a color is defined in the character attribute or inherited from the extended field attribute, all three patterns are displayed in the defined color. If no extended color attribute is defined, the default is white for symbols in intensified fields and green for symbols in all other fields.

Triple-plane sets may be used as single-plane sets. If the program loads a triple-plane set without defining it as such, the same symbol is loaded into each plane. Loading a triple-plane set as a single-plane set causes the symbol to take on the color characteristics of a singleplane set.

Secondary Colors

Secondary colors are obtained by mixing red, blue, and green. The secondary colors are pink, yellow, turquoise, and white. When a pattern of bits from a triple-plane symbol set is displayed with the extended color attribute of X'F7', if the same bit is active in more than one plane, the active primary colors combine to produce secondary colors. See Figure 2-9 for the combinations of primary colors.

Defining a Triple-Plane Symbol

A typical example of a symbol that requires a triple plane occurs where the application program displays a graph with lines in different colors. At the point where two or more lines cross, each line needs to hold its color in the same character position as another line. The application programmer should also be aware of color mixing that might occur at the point common to several lines.

Primary Colors			
Red	Blue	Green	Video
No	No	No	No display
No	No	Yes	Green
No	Yes	No	Blue
No	Yes	Yes	Turquoise
Yes	No	No	Red
Yes	No	Yes	Yellow
Yes	Yes	No	Pink
Yes	Yes	Yes	White

Figure 2-9. Color Combinations

Take, for example, the instance where two horizontal lines, one blue and one yellow, are cut by a red vertical line. The active dots at the character position might appear as shown in Figure 2-10.

Note: *If the triple-plane example shown in Figure 2-10 were displayed with any color attribute other than X'F7' (neutral), the three planes would be displayed in one character position using the defined color; an attribute of X'00' for a triple-plane set always defaults to white for symbols in an intensified field and to green for symbols in all other fields. For example, if the symbol previously described is displayed with a color attribute of X'F5' (turquoise), the symbol would be displayed as:*

```

- - - - t - - - -
- - - - t - - - -
- - - - t - - - -
t t t t t t t t t
- - - - t - - - -
- - - - t - - - -
- - - - t - - - -
t t t t t t t t t
- - - - t - - - -
- - - - t - - - -
- - - - t - - - -

```

Legend: t = turquoise

```

----- r -----
----- r -----
----- r -----
b b b b r b b b b
----- r -----
----- r -----
----- r -----
y y y y r y y y y
----- r -----
----- r -----
----- r -----

```

Legend: b = active blue bit
 g = active green bit
 r = active red bit
 y = yellow (red = green)

Note: *The symbol extends to the edges of the character position, thus allowing the lines to continue without interruption into the adjacent character positions.*

Red Plane	Blue Plane	Green Plane
----- r -----	-----	-----
----- r -----	-----	-----
----- r -----	-----	-----
----- r -----	b b b b - b b b b	-----
----- r -----	-----	-----
----- r -----	-----	-----
----- r -----	-----	-----
----- r -----	-----	-----
r r r r r r r r r	-----	g g g g - g g g g
----- r -----	-----	-----
----- r -----	-----	-----
----- r -----	-----	-----

Figure 2-10. A Triple-Plane Symbol

Reverse Video and Triple-Plane Symbols

When reverse video is the Extended Highlighting attribute for a triple-plane symbol, the inactive primary colors for each point are made active and the active primary colors are made inactive. Figure 2-11 shows the effect of reversing the primary colors.

For example, specifying reverse video for the triple-plane symbol used in this chapter has the following result:

<u>Normal Video</u>	<u>Reverse Video</u>
-- -- r -- --	w w w w t w w w w
-- -- r -- --	w w w w t w w w w
-- -- r -- --	w w w w t w w w w
b b b b r b b b b	y y y y t y y y y
-- -- r -- --	w w w w t w w w w
-- -- r -- --	w w w w t w w w w
-- -- r -- --	w w w w t w w w w
-- -- r -- --	w w w w t w w w w
y y y y r y y y y	b b b b t b b b b
-- -- r -- --	w w w w t w w w w
-- -- r -- --	w w w w t w w w w
-- -- r -- --	w w w w t w w w w

Legend: b = blue
 g = green
 r = red
 t = turquoise
 w = white
 y = yellow

Primary Colors			Normal Video	Reverse Video
Red	Blue	Green		
No	No	No	No display	White
No	No	Yes	Green	Pink
No	Yes	No	Blue	Yellow
No	Yes	Yes	Turquoise	Red
Yes	No	No	Red	Turquoise
Yes	No	Yes	Yellow	Blue
Yes	Yes	No	Pink	Green
Yes	Yes	Yes	White	No display

Figure 2-11. Reverse Video Highlighting of Triple-Plane Symbols

Unit and Model-Dependent Differences (Displays)

This section describes model-dependent differences that affect display and keyboard operations.

Keyboard Types

Typewriter and data entry type keyboards can be attached to 3277, 3278, and 3279 displays. The operator console keyboard can be attached to 3277 displays only.

Keyboard Program Function Keys

Typewriter and operator console keyboards attached to the 3277 have a maximum of 12 program-function (PF) keys. The data entry and data entry (keypunch-layout) keyboards attached to the 3277 displays have five PF keys. A maximum of 24 PF keys are available on the typewriter keyboard attached to the 3278 and 3279 displays; and 10 PF keys are provided on the data entry and data entry keypunch-layout keyboards used with the 3278 and 3279 units.

Display Screen Size

The 3277 has model-dependent screen sizes of 480 or 1920 characters. The 3278 and 3279 displays have model-dependent screen sizes of 960, 1920, 2560, 3440, or 3564 characters. In addition, 960-character displays can function as 480-character displays, and 2560- 3440-, and 3564-character units can function as 1920-character displays.

Programs written for one screen size can be used without change on other screen sizes that have the same width (that is, 40 or 80 characters) and a greater number of lines, provided that (1) a protected field-attribute character follows the last position on the screen that contains data and (2) the program does not depend on data wrap.

Key Operation

Insert Mode

On keyboards attached to the 3277 displays, the RESET key is used to return the keyboard to normal operation after an insert-mode (INS MODE) operation. To return a keyboard attached to the 3278 or 3279 display to normal operation, any key that causes I/O communication can be used.

Typamatic Keys

This cursor move and space keys are typamatic on the keyboards attached to the 3277 displays. On keyboards attached to 3274 displays, alphameric keys (in addition to the cursor move and space keys) are typamatic.

Numeric Shift Key

When the Numeric Shift key on a data entry keyboard attached to the 3277 display is used with a key that does not have an upper shift symbol (@, #, D), a blank character is inserted in the buffer. When the same operation is performed using the Numeric Shift key on a data entry keyboard attached to the 3278 or 3279 display, a no-shift character is placed in the buffer.

Screen Update

On 3277 displays, the entire image is removed from the screen when the screen content is changed. This action causes a blank screen (referred to as "blink") prior to display of a new image. When the content of a 3278 or 3279 is changed, the entire image is not removed. Display stations attached to a 3274 using SNA/SDLC protocol update the display image in character blocks of up to 256 bytes. As the screen on a display attached to a BSC 3274 is updated, if a communication line or program error is detected during execution of a Write command, the update operation is stopped and the previous image is restored. If the error persists, successive retry operations will be noted at the display station.

Display of New Line (NL), End of Message (EM), and Form Feed (FF) Orders

The NL, EM, and FF order codes are displayed as 5, 9, and < respectively on a 3277, but are not displayed on 3278 and 3279 units.

Display of Duplicate (DUP) and Field Mark (FM) Characters

The DUP and FM characters are displayed as * and ; on 3277 displays, and on 3278 and 3279 displays when the Dual Case/Mono Case switch is in the Mono Case position. On 3278 and 3279 displays, the same symbols appear with an overscore added (*, ;), when the Dual Case/Mono Case switch is in the Dual Case position or always appear with an overscore when the displays have the Extended Character Set Adapter installed and are attached to a 3274 with Configuration Support C installed.

Operator Indicators and Symbols

The 3277 has three operator indicator lights, located on the right side of the display tube. The 3278 Models 2, 3, 4, and 5 and 3279 units can display up to 80 Operator Information Area symbols across the bottom row of the display image; the 3278 Model 1 units can display up to 64 Operator Information Area symbols.

Uppercase and Lowercase Character Display

The 3277 displays uppercase alphabetic characters. The 3278 and 3279 units display lowercase character codes received from the host unless the Dual Case/Mono Case switch is placed in the Mono Case position, which results in an uppercase character display.

Lowercase codes are transmitted between the host and the 3278 or 3279 display.

Security Keylock

The Security Keylock is a security-enhancement special feature that provides a key-controlled lock for 3277, 3278, and 3279 displays. When the key is in the "off" position or is removed from the display station, the message buffer is "locked," which prevents entry, modification, and display of data. The display station is unavailable to programmed read or write operations and to operator inputs such as keyboard entry, card reader entry, and selector-light-pen operations.

Programmed attempts to access display stations that have the key turned off or removed from the lock result in responses being returned to the CPU by the control unit. Responses are device- and operation-dependent, as summarized in the following table:

Device Attachment	Operation	Response
3274 B and D Units	All	UC, IR Status and Sense
3274 C Units and 51C (BSC)	Specific Poll	IR Status and Sense
	General Poll	EOT
	Selection Addressing Sequence	RVI
3274 A and C Units and 51C (SNA/SDLC)	Normal Flow	IR (Negative Response 0802) Requests

Printers

Printers for the 3270 Information Display System provide a printed copy of information that is displayed at a display station or of information written from the host program. Printed data appears in the same alphameric characters and symbols that appear on a display, and printouts can be formatted the same way a display is formatted. Cursor information is ignored by the printer.

The following printers are available for attachment to the 3274 control units:

- The IBM 3230 Printer Model 2, an electromatrix printer supporting 3270 Data Stream and SNA Character String (SCS) modes of controlling printer formatting.
- The 3262 Models 3 and 13, a line printer supporting 3270 Data Stream and SNA Character String (SCS) modes of controlling printer formatting.
- The IBM 3268 Printer Model 2 matrix printer supporting 3270 Data Stream and SNA Character String (SCS) modes of controlling printer formatting.
- The 3284 Models 1 and 2, a matrix printer supporting the 3270 Data Stream mode of controlling printer formatting.
- The 3286 Models 1 and 2, a matrix printer supporting the 3270 Data Stream mode of controlling printer formatting.

- The 3287 Models 1, 2, 1C, and 2C, a matrix printer supporting 3270 Data Stream and SNA Character String (SCS) modes of controlling printer formatting; the C models are capable of supporting the Color, Extended Highlighting, and Programmed Symbols functions of the Structured Field and Attribute Processing customization option of the 3274 control units. Extended Highlighting and Programmed Symbols are supported on Models 1 and 2.
- The 3288 Models 1 and 2, a line printer supporting the 3270 Data Stream mode of controlling printer formatting.
- The 3289 Models 1 and 2, a line printer supporting the 3270 Data Stream and SNA Character String (SCS) modes of controlling printer formatting.

The relationship between the printer buffer and a printout is shown in Figure 2-12.

Full descriptions of the 3230, 3262, 3268, 3287, and 3289 printers are contained in the following publications:

IBM 3230 Printer Model 2 Product Description, GA24-3759

IBM 3262 Line Printer Models 3 and 13 Component Description, GA24-3741

IBM 3268 Printer Model 2 Description, GA27-3268

IBM 3287 Printer Models 1 and 2 Component Description, GA27-3153

IBM 3287 Printer Models 1C and 2C Component Description, GA27-3229

IBM 3289 Line Printer Component Description, GA27-3176

Print Line Formatting

Printout operations are specified by a Write command or a Copy command (3274 C units and 51C, using BSC only) addressed to the printer. The print line format in which the data is to be printed from the buffer can be specified as part of the command in one of three printer formats. These formats define the print line length: 40, 64, or 80 character positions per line. If a format is not specified, the print line length is determined by platen length on 3284 and 3286 printers, while the print line length is 132 character positions on the 3262, 3287, 3288, and 3289 printers. Print line length (maximum presentation line—MPL) can be set to values less than 132 character positions by the operator on the 3230, 3262, 3268, 3287, and 3289 printers.

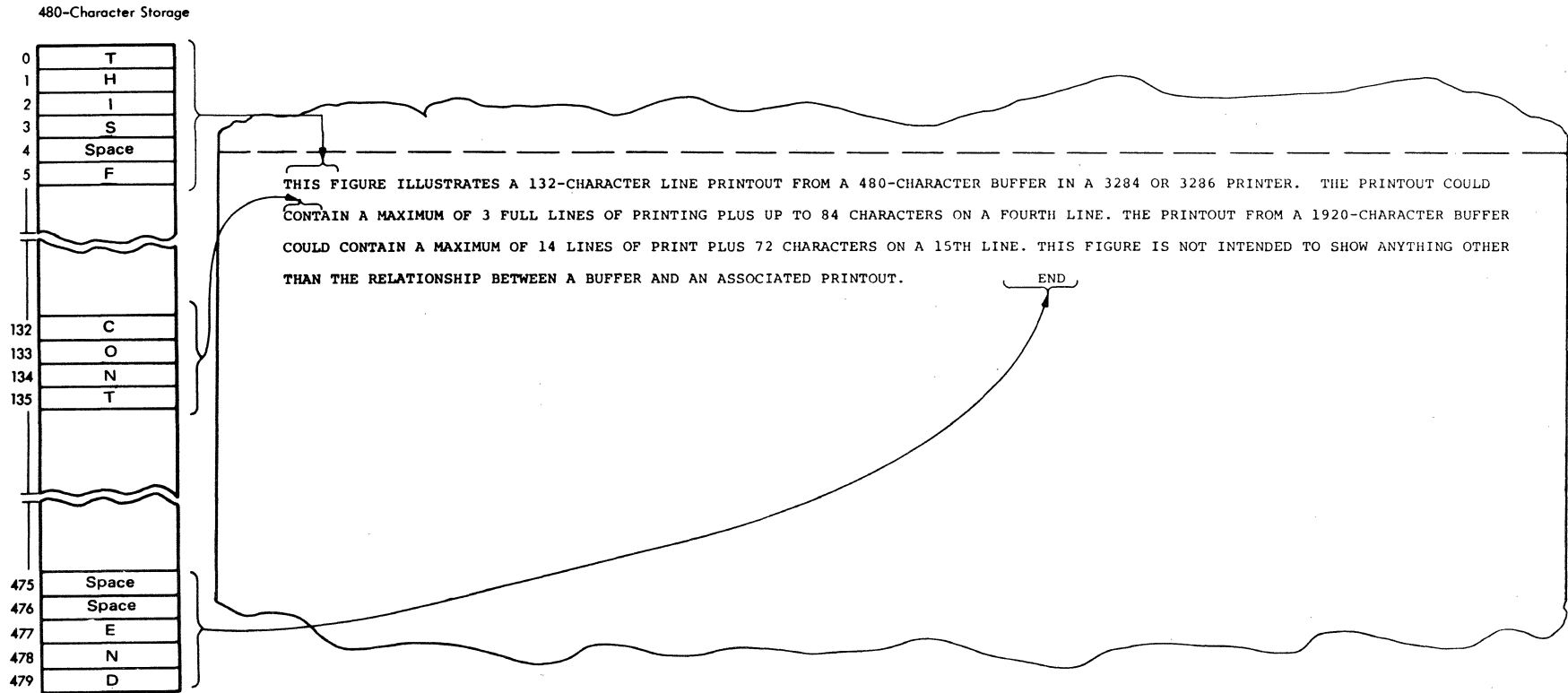

Figure 2-12. Relationship between Buffer Data and Printed Data

When the 3278 or 3279 Print key is used to initiate a printout, or when the 3274 SNA host copy operation, described later under “Local Copy Function,” is executed, the print line length will be the same as that of the source display. Print line length formats are specified below:

Operation	Command	Addressed Terminal	Format Specification
Host Write (except SCS)		Write	Printer WCC bits 2 and 3
BSC Host Copy	Copy	Printer	CCC bits 2 and 3
SNA Host Copy	Write	Display	Same as display
PRINT key	NA	NA	Same as display

Printer Orders (3270 Data Stream Mode)

Printer orders are transferred as part of the data stream from the application program and stored in the buffer as data.

Programming Note: *Devices without the Extended Character Set Adapter (ECSA) feature support 182 characters in the base character set; devices with the ECSA feature support 191 characters in the base character set. If characters from the 191-character set that are not supported by the 182-character set are directed to a device without the ECSA feature, then that device may interpret certain of these unsupported characters as control codes.*

Some PS symbols may contain code points that coincide with those of control functions. If these symbols are directed to a device without the PS feature, that device will interpret these symbols as control codes.

New Line (NL) and End of Message (EM) (All Printers)

The NL order is executed only when encountered during an unformatted printout; that is, a printout that does not have a line-length format specified. When an NL order is encountered in the buffer, the printer performs an NL function. If no NL order is encountered before the printer reaches the end of a line (as determined by the maximum print position), the printer automatically performs an NL function and continues printing. If an NL order is encountered at one character position past the maximum print position, the 3230, 3268, 3284, 3286, 3287, and 3288 printers will perform two NL functions; the 3262 and 3289 printers will perform one NL function.

The NL order is not executed when located in a nondisplay/nonprint field; it is treated as an alphanumeric character and printed as a space. In addition, the NL order is not executed when encountered during formatted printout. Instead, it is printed by the 3284, 3286, 3287, and 3288 printers as the graphic “5,” and by the 3230, 3262, 3268, 3287, and 3289 printers as a space character.

The EM order is executed only when encountered during an unformatted printout. The EM order is not executed when located in a nondisplay/nonprint field; it is treated as an alphanumeric character and printed as a space. In addition, the EM order is not executed when encountered during a formatted printout. Instead, it is printed by the 3284, 3286, 3287, and 3288 printers as the graphic “9,” and by the 3230, 3262, 3268, 3287, and 3289 printers as a space character.

Forms Feed (FF) (3230, 3262, 3268, 3287, 3288, and 3289)

Valid Forms Feed (FF) orders are executed by the 3230, 3262, 3268, 3287, 3288, and 3289 printers during either formatted or unformatted printouts. (The FF order is described under "Page Length Control/VFC Operations.") When a valid FF order is encountered in the first print position of a line, the print form indexes to a predetermined print line on the next form.

Suppress Index (SI) (3288)

The 3288 printer, when equipped with the Text Print special feature, honors the Suppress Index (SI) order code. The SI order causes printing of two or more lines of data at the same paper position. The SI order is transferred as part of the data stream from the application program and is stored in the printer buffer as data.

When the SI order is detected during a write or erase/write printout operation, the print line containing the SI order is printed over the line just printed. There is no limit to the number of sequential print lines that contain the SI order or to the number of SI order codes contained in the buffer. The SI order code prints as a space.

When line-length format is not specified, the SI order defines the print line length just as the NL order establishes print line length. The SI order must be placed after the last character in an unformatted line; the maximum number of characters is 131, with the SI order in the 132 position (refer to "Print Line Formatting"). If the VFC specify feature is installed on the printer, an FF order can follow an SI order (refer to "Page Length Control/VFC Operations").

During a formatted printout (40, 64, or 80 character positions per line), the application program can place the SI order in any character position of the print line. However, greater program flexibility is usually obtained by placing the SI order in a normally blank position of the overstrike line.

When the SI order is placed in the first print line of a message, the last print line of the preceding message is not overprinted. In this case, the SI order functions as an NL order.

Carriage Return (CR) (3230, 3262, 3268, 3287, and 3289 Printers)

When the Carriage Return (CR) order code is found in the data stream, the next print position will be the leftmost character position on the current print line. CR orders are not executed when they occur in nonprint fields and when the printout is formatted (printer format bits in the WCC indicate a line length). In both cases, the CR order is printed as a space character.

Printer Operations (3270 Data Stream Mode)

When the WCC Start Print bit is set to 1, the printout starts after the control-unit-to-printer-buffer transfer is completed.

During a formatted print operation, data characters in the printer buffer are scanned one line at a time before they are printed. A line feed is executed after each line is printed. If a line contains only space characters (one or more), line feed is performed to cause a blank line in the printout. When null characters, attribute characters, or alphanumeric characters in nonprint fields are encountered, they are treated as follows:

- If embedded in a print line, they are printed as spaces.
- If they constitute an entire line, they are ignored and the line feed is not performed; as a result, a blank line does not appear in the printout, and the data is compressed vertically one line.

During an unformatted operation, buffer data printout begins at buffer location 0 and continues until the last position of the buffer is printed or until a valid EM character is encountered. Each print line is left-justified. At the end of each printout, a final line feed is executed so that the printer is ready to start the next printout. When the print-terminating EM order appears in the first print position of the print line, a final line feed is not executed because the printer is already positioned at the left margin for the next printout.

Page Length Control/VFC Operations

The ability to index forms vertically under program control to a predetermined print line is provided by the Page Length Control function for the 3262 and 3287 printers, by the Vertical Forms Control (VFC) specify feature for the 3288, and as part of the basic 3289 functional capability. Special inks and preprinted forms containing index marks are not required to make this feature operational.

When a valid Forms Feed (FF) order is encountered in the buffer during a printout, the form skips to a predetermined line. Printing begins on the predetermined line; the first print position (the buffer location containing the FF character) is printed as a space character. Printing and skipping continue until the printout is terminated. The printer is “busy” while printing and skipping.

There is no limit on the number of FF orders that can be included in the printer buffer or on the frequency of their occurrence. However, for an FF order to be considered valid and thus initiate skipping, FF characters must be placed in buffer locations corresponding to the first position of a print line in a field designated either print or nonprint. This can be accomplished by placing the FF character (1) in the first character after the WCC in a write, erase/write, or erase/write alternate data stream to the printer or (2) after a valid NL or CR order.

When an FF character is placed in the first character position of any print line (for example, in character position 41 in a buffer with a printout format of 40 characters per line specified, or in character position 133 in a buffer for an unformatted printout), the form skips to line 1, position 2.

An FF order in any other position (than the above) in the printer buffer is considered invalid; the skip operation is not executed, and the FF character prints as a “<” character on the 3288 or as a space character on the 3262, 3287, or 3289, except when the FF order is located in a nonprint field. The “<” character prints during either formatted or unformatted printouts. When an FF order is sent to a 3288 that does not have the VFC feature installed, or if the skip operation is not executed, the FF character is printed as a “<” character. A valid FF order prints as a space character.

During a print operation, if a valid FF order is encountered when the form is located at the predetermined skip stop line (the first print line of each form) of a 3288, the skip operation will be executed, and a blank form will result. The 3262, 3287, and 3289 will not skip a blank form.

Programming Note: *Placing the FF order at the end of a print buffer is not recommended. When a valid FF order is placed at the end of a print buffer and is followed by an EM order, the 3262, 3287, 3288, and the 3289 printers will stop printing and skip to line 2 of the next form.*

Before beginning Page Length Control/VFC operations, forms must be loaded in the printer and aligned to the print line where skipping should stop and printing begin. If the forms are not aligned properly while initially being loaded, all forms will be misaligned. The 3287 and 3288 Page Length Control/VFC circuitry synchronizes with the skip stop line on the form as the cover is closed and the printer goes from not ready to ready. If the cover must be raised or if a not-ready condition occurs, the form must be checked to ensure that the skip stop line is in the proper position before reclosing the cover.

The two Selector Switches must be set to the number corresponding to the total number of print lines from one skip stop to the next for each Page Length Control/VFC application. There can be up to 99 lines between successive skip stop lines. When uniform length forms are used, the setting for the switches is computed by multiplying the forms length in inches by the lines-perinch setting, either 6 lines per inch for the 3288, or 6 or 8 lines per inch for the 3262, 3287, and 3289 printers. (For example, when 11-inch forms are installed on the 3288, the switches should be set at 66.)

Programming Notes:

- 1. If an NL order and an FF order appear on the last line of a 3288 printout and VFC is installed, FF is suppressed and the printer will not skip a full form. If this condition occurs on a 3262, 3287, or 3289 printer, subsequent printing will begin on a new form.*
- 2. The Page Length Control function on the 3287 printer is synchronized when power is applied or when the FF switch is pressed.*

SCS Operations

The SCS control codes provide printed page format control. They also can set modes of operation, define data to be used in a unique way, and allow communication between a terminal operator and an application program.

The SCS data stream consists of a sequential string of control and data characters and can be preceded with a Write command and Write Control character, or, for printers supporting the Structured Field and Attribute Processing option, the FMH-1 header and SCS DATA structured field described in Chapter 1.

SCS Control Codes

SCS control codes are honored by the 3262, 3287, and 3289 printers when operating as LU type 1 attached to the 3274. These printers, using SCS support, can perform a variety of page-editing functions. The SCS control codes follow:

Code	EBCDIC (Hex)	Name
BS	16	Back Space
BEL	2F	Bell Function
CR	0D	Carriage Return
ENP	14	Enable Presentation
FF	0C	Forms Feed
GE	08	Graphic Escape
HT	05	Horizontal Tab
INP	24	Inhibit Presentation
IRS	1E	Interchange-Record Separator
LF	25	Line Feed
NL	15	New Line
SA	28	Set Attribute
SHF	2BC1	Set Horizontal Format
SLD	2BC6	Set Line Density
SVF	2BC2	Set Vertical Format
TRN	35	Transparent
VCS	04XX	Vertical Channel Select
VT	0B	Vertical Tab

Note: *To ensure format integrity, any change in print format should be followed by the appropriate synchronizing event (CR, NL, FF, etc.).*

The SCS control codes are defined as follows:

Back Space (BS): a format control that moves the print position horizontally one position to the left. If the print position is at column 1, the function is inoperative. Left margin settings are ignored.

Carriage Return (CR): a format control that moves the print position horizontally to the left margin on the same line. If the print position is already at the left margin, the function is inoperative.

Enable Presentation (ENP): a formatting control character used to enable the printing of keyboard input data on the presentation space. This code performs no function on the LU type 1 device, but it is accepted without error response and without affecting format.

Form Feed (FF): a format control that moves the print position to the top and left margin of the next form. If the maximum presentation line (MPL) value has not been set and there is no default value, the MPL defaults to 1, and the print position moves to the left margin of the next line.

Horizontal Tab (HT): a format control that moves the print position horizontally to the next tab stop setting. Horizontal tab stop values are set by using the Set Horizontal Format (SHF) function. If there are no horizontal tab stops set to the right of the current print position, the horizontal tab function results in a space.

Programming Note: *Horizontal tab placed after the MPP will cause a space in the first print position on the next line.*

Inhibit Presentation (INP): a format control character used to inhibit the printing of keyboard input data. This code performs no function on the LU type 1 device, but it is accepted without error response and without affecting format.

Interrecord Separator (IRS): a separator character, normally used on the LU-SSCP session. If received on an LU-LU session, the IRS defaults to a New Line (NL) function.

Line Feed (LF): a format control that moves the print position vertically down to the next line.

New Line (NL): a format control that moves the print position to the left margin and vertically down to the next line. NL is functionally equivalent to CR followed by LF.

Set Horizontal Format (SHF): a data-defining control used to set the horizontal format controls. These include left and right margins and horizontal tab stops. A 1-byte binary count follows the SHF code that indicates the number of bytes to the end of the SHF string, including the count byte. The first 3 bytes following the count byte define the maximum presentation position (MPP), the left margin (LM), and the right margin (RM), respectively. Tab stop settings follow the right margin position. All values are expressed as 1-byte binary numbers.

The minimum SHF sequence is 1-byte long, which sets the horizontal format controls to their default conditions. The SHF sequence is:

(SHF)(cnt)(MPP)(LM)(RM)(T1)(T2)...(Tn)

This value is used to define a line length less than, or equal to, the maximum print position. The MPP default value is the maximum print position (132) or the value set up by the printer operator (3262 and 3289).

Programming Note: *If the MPP is set to a value greater than the physical page width, data may be lost (for example, printing on the platen or print head jams at the right margin).*

LM specifies the column value of the leftmost print position. The LM also serves as the first horizontal tab stop. Valid LM values are less than, or equal to, the MPP. The LM default value is 1.

RM is not used in printing operations.

T1...Tn are horizontal tab stop settings. The tab stops do not have to be in order. Valid tab stop values are equal to or less than MPP.

Set Line Density (SLD): specifies the distance to be moved for single-line vertical spacing, as in LF or NL. A 2-byte parameter follows the SLD control code. The first byte, a count field, can be either X'01' or X'02'. A count field of X'01' with no parameter byte will set default print density. The sequence can also be '1BC60200', which will set default value to 6 lines per inch. The second byte specifies the distance in standard typographic points (one point = 1/72 inch). For example, a value of 12 points indicates 6 lines per inch. LPI/Point Values are as follows:

LPI	3 ¹	4 ¹	6	8
Point Values	24 ¹	18 ¹	12	9

¹3289 only

Programming Note: *If the SLD is changed without a corresponding change in the MPL (and vice versa), printing may occur on the form fold.*

When the logical unit controlling a 3287 or 3289 receives an LU type 1 Bind, the 3287 or 3289 will default to a line density of 6 lines per inch.

Density values not implemented are rejected with a negative response of X'1005', parameter error. Line densities defined for the 3287 and 3289 printers are as follows:

LPI	6	8	4 ¹	3 ¹
SLD	12	9	18 ¹	24 ¹

¹3289 only

Set Line Density (SLD) - 3262: SLD sets the number of print lines per inch by specifying the distance to be moved for single-line vertical spacing, as in LF or NL. This function changes values that were previously set during printer initialization or by pressing the CHANGE LPI key on the operator's panel.

A 2-byte parameter follows the SLD control code. The first byte, a count field, may be either X'01' or X'02'. The second byte is a line density parameter (lpi) which specifies the distance to be moved for single-line vertical spacing. This value may be X'18' (for 3 lpi), X'12' (for 4 lpi), X'0C' (for 6 lpi), or X'09' (for 8 lpi).

A count field or X'01' with no following line density parameter byte sets the default print line density to the current operator panel setting (either 6 or 8 lpi). A count field of X'11' (host system default) also sets line density to 6 lpi.

The following examples show how to use the SLD function:

2BC60218 = 3 lpi

2BC60212 = 4 lpi

2BC60209 = 8 lpi

2BC6020C = 6 lpi

2BC601 = default to op panel setting

If no SLD value is specified, the printer uses the operator-selected value.

Set Vertical Format (SVF): sets vertical format controls, including the maximum presentation line (MPL), top margin (TM), bottom margin (BM), and vertical tab stops. A 1-byte count field follows the SVF character to indicate the number of bytes, including the count byte, in the SVF string.

The first three values following the count in an SVF string are the maximum presentation line, the top margin, and the bottom margin, in that order. A zero for any of these values results in the function assuming the default value. Vertical tab stop values follow the bottom margin. All values are expressed as 1-byte binary numbers.

The SVF sequence is:

(SVF)(cnt)(MPL)(TM)(BM)(T1)...(Tn)

MPL defines the page depth. All values between 0 and 102 (3287) and 0 and 127 (3289) are valid. A page depth defined by the SVF takes precedence over the device default value. The MPL default value for the 3287 is 1; the MPL default value for the 3289 is 1 or the contents of the Selector switch. If the Selector switch is set to 00 and power is turned on, the MPL defaults to 1; if the Selector switch is set to 00 and the Reset switch is pressed, the MPL remains unchanged.

Programming Note: *If the MPL is set to a value greater than the physical page length, printing may occur on the form fold.*

TM specifies the line value used as the top representation line on the page. The top margin is also the first vertical tab stop. Valid TMs are equal to, or less than, MPL. The default TM value is 1.

Programming Note: *After the TM is initialized, the TM should not be changed because a TM change requires operator intervention to align the physical page. The printer cannot detect physical line 1; therefore, it is assumed the operator has aligned physical line 1 to the printer's logical line 1. If a printer must be used in an intermixed SCS/non-SCS environment, the operator should always set the physical page line 1 at the first line to be printed and that the TM always be set to a value of 1.*

BM specifies the line value that, if exceeded, causes an automatic skip to a new page. BM must be greater than, or equal to, TM, and less than, or equal to, the MPL. The default BM value is the MPL value.

Transparent (TRN): a data-definition character which provides for the transmission of data in transparent mode. A 1-byte binary value follows the TRN code which specifies the number of bytes of transparent data to follow. The length does not include the length byte. Transparent data is user-defined and is not scanned for SCS control. Valid graphics are printed. Invalid graphics are printed as hyphens (-).

Vertical Channel Select (VCS): is a device control code that allows selection of one of 12 vertical channels to control vertical format. The first character of the code is the select code, followed by a function value which selects the appropriate channel. When necessary, printers default the VCS code to an LF function. The 3287 always executes LF. The 3262 or 3289 skips to the channel, as specified by VCS.

Vertical Tab (VT): a format control that moves the print position vertically down to the next vertical tab stop setting. Vertical tab stops are set by using the Set Vertical Format (SVF) function. If there are no vertical tab stops below the current print position, the VT function results in an LF function.

Graphic Escape (GE): a character selection code that immediately precedes a codepoint and is used to indicate that the character to be displayed or printed is to be selected from the character set stored in ROS 1. (The base character set for the machine is stored in ROS 0.)

Set Attribute (SA): an attribute defining code used to associate the color, extended highlighting, and programmed symbols attribute types with a character or string of characters. The SA code can also reset the attributes defined for a character or string of characters to those of the field in which the character(s) appear. (See Chapter 1.)

Program Attention (PA) and Cancel Print Switches

The PA1/PA2 and Cancel Print switches are provided when SCS is installed on 3262, 3287, and 3289 printers (SCS is always installed on the 3289) attached to the 3274 via the type A adapter. These switches allow the operator to communicate with the host system in SCS mode, and are used with the Hold Print/Enable Print switch. Operator- or host-initiated operations can be performed.

Cancel Print. The Cancel Print switch causes the printer to terminate the current print operation. Portions of a chain that have not been passed to the printer are purged by the control unit.

Cancel print is meaningful when the printer is printing SCS data or waiting for the next data in a chaining operation. If the Cancel Print switch is pressed and the printer is not processing SCS print data, an invalid switch operation is indicated at the printer. The control unit is not made aware of this condition.

PA1/PA2. The PA1/PA2 switch causes an attention to be sent to the control unit. The status indicator on the printer will indicate acceptance of the code, and printing is resumed if it was in progress prior to the PA switch sequence. The two-digit code is then cleared from the status indicator.

The operator may then initiate another PA switch selection if the previous selection is overwritten. PA switch information is not stacked within the subsystem.

The control unit of an SCS printer transmits the PA switch codes to the PLU as FM data, as follows (note that there is a blank between APAK and the PA switch code digits):

PA Switch	Text String Transmitted
1	APAK 01

If the printer is not in SCS mode (for example, performing a local copy operation), an invalid switch operation is indicated, and no PA switch sequence can be initiated.

Print Format Control

The format of the printed data is determined by the following parameters:

- Maximum Presentation Position (MPP)
- Maximum Presentation Line (MPL)
- Lines per Inch (LPI)
- Single/Doublespace
- Mono/Dual Case

The 3262 and 3289 allow the operator to change the machine default values of these parameters. They can be set by the host or control unit in SCS and non-SCS print modes. See the 3289 or 3262 Component Description manuals for detail.

When the 3287 is operating in SCS mode, the operator can change the machine default of only Single/Doublespace. The default values are MPP = 132, MPL = 1, LPI = 6, and Mono/Dual Case = Dual.

Local Copy Function

In addition to processing the BSC Copy command in remote control units (3274 C units and 51C BSC), the 3274 units provide a local copy function which allows direct data transfer from a display station to a printer(s) attached to the same control unit. The local copy function is directed by the 3274 *printer authorization matrix*. The printer authorization matrix must be loaded into the control unit.

The local copy function can be operator- or host-initiated. For operator-initiated copy, the Print key on a keyboard attached to a 3278 or 3279 may be used by the operator to initiate a local copy request. The local copy request is serviced by a printer selected under control of the print-control matrix.

In SNA models (3274 A and C units or 51C (SDLC)), host-initiated local copy requests are initiated by issuing a write-type command with the WCC Print Bit set to 1. Printer selection and servicing of the local copy request proceed in much the same way as for operator-initiated local copy requests.

Do not attempt to copy graphics dependent on more than one character position for their presentation. If the graphic data cannot be accessed by a single code point, the printout will be inaccurate because of the differing block matrix sizes and dot densities between display and printer. Also, attempting to copy to a printer not featured for Programmed Symbol operation, or not containing a matching symbol set (with the one in the display station), results in default to the I/O interface character set installed in the printer.

3274 Printer Authorization Matrix

The 3274 printer authorization matrix resides on the system diskette and is either sent from the host per operator request or specified during 3274 customizing. The matrix defines the operating characteristics of the printers attached to the control unit. (For details on specifying the matrix from a terminal, refer to the *IBM 3270 Information Display System: 3274 Control Unit Planning, Setup, and Customizing Guide, GA27-2827.*) In this regard, the matrix serves a three-fold purpose:

1. Establish Printer Mode. A printer may be reserved for exclusive use of either the host or the local copy function. A third mode allows a sharing between these two functions.
2. Assign Print "Classes." A print "class" is a way of grouping printers for use by local copy. A local copy request directed to a "class" is then serviced by one of the printers assigned to that group.
3. Define Source Device Lists. The source device list specifies which displays may use any given printer for local copy. Note that all displays for a printer must be attached to the same adapter type as the printer. For example, a category A printer can have only category A displays in its source device list.

Printer Modes. A printer may be in one of three modes, specified in the printer authorization matrix as local, system, or shared mode. Each printer on the 3274 is defaulted to system mode until a matrix is loaded. Printers that are specified as being in shared or local mode then become available for local copy use.

Local Mode. A printer in local mode may be used for local copy functions regardless of host attachment or communication protocol. This means that displays within the cluster may contend for use of printers but the host may not. The printer is not available for direct print operations from the host.

A local copy operation involves the transfer of data from the display buffer to the printer buffer and the subsequent printing of that data. A local copy may be initiated by an operator using the Print key on a 3278 or a 3279 attached to a 3274 or by the host when the display is operating in SNA/SDLC. (The Start Print bit in the WCC of a Write command to the source display initiates the host copy operation.)

The response to a Copy command or a direct print request(s) from the host to a printer when in local mode is Intervention Required (IR). Also, a printer in local mode cannot validly be specified as a "from" BSC device in a Copy command. An I/O operation addressed to a printer in local mode when attached to a 3274-1B or -1D results in Control Check (CC). Subsequent operations cause Intervention Required. The control unit sends Device End (DE) when the printer is returned to either shared or system mode.

In SNA/SDLC, an LU type 1 or 3 bind request to a printer is rejected with a negative response of X'0801' (printer not assigned) when the printer has been put into local mode.

System Mode. A printer in system mode is entirely under host (system) control. This is the default mode each printer assumes when no matrix has been loaded. The printer cannot be used for operator-initiated local copy requests. The printer is likewise not available for host-initiated copy operations when using SNA/SDLC. However, when operating with BSC discipline, the printer may honor a BSC Copy command when it is in system mode. The BSC Copy command, directed to the "to" device, specifies the "from" device as a command parameter and does not use the printer authorization matrix. Host-directed printing is described under "3274 Local Copy Operation."

Shared Mode. In shared mode, both host-directed printing operations and local copy operations are permitted on the same printer. When in system mode, the printer is protected from local copies; in local mode, the printer is protected from host-initiated operations. However, when in shared mode, the subsystem does not guarantee this type of integrity. The user must assume the responsibility for integrity of his printed data by "installation rules" and proper programming practices when using a printer in shared mode. In BSC, an operator-initiated local copy operation to a printer in shared mode is not executed if the printer has status pending from a previous host-directed print operation. General or Specific polling will clear the printer status and free the printer for local copy usage.

In SNA/SDLC, a printer in shared mode attached to a 3274 configured for session sharing may be used for local copy only when it is not in session with a PLU in the host. A printer attached to a 3274 configured for between-bracket printer sharing, may be used for local copy when not in brackets with the PLU.

Printer Class Structure. The printer authorization matrix provides the ability to assign a printer to a class. The definition of a class of printers is made by the customer, and may be based on type, character subset, type of forms mounted, location, etc. For example, in a particular installation class, "72" may have been defined as referring to all printers with yellow paper. Thus, an operator may select an authorized printer on the basis of these characteristics rather than by address. When multiple printers are assigned to a class, improved copy throughput can be obtained.

The printer authorization matrix allows a maximum of 16 printer classes to be defined in each subsystem. A display operator may select a printer by class by using the IDENT key (ALT key depressed) and keying in a number ranging from 70 through 85 corresponding with one of the 16 classes. With this type of operation, the control unit selects an authorized printer in the class to service the copy. In any configuration, a single printer may be in one or several classes, or not in a class. Several printers may be members of a single class.

Source Device Lists. Each printer may be restricted as to which displays it may accept local copies from. Note that the control unit restricts local copy operations to devices on the same adapter (type A or type B). Any given printer may be permitted to process copies from some, all, or none of the displays on the same adapter. Even if configured in the source device list, local copy from a type B display to a type A printer (and vice versa) is not allowed.

When a local copy is directed to a print class, the printer selected will be one that is attached to the same adapter and that is authorized to accept copies from the requesting display. Not all printers assigned to a particular class may be authorized for the same subset of display terminals.

Matrix Structure. The 3274 printer authorization matrix defines how display stations (source devices) may use printers (destination devices) attached to the same control unit for the purpose of printing a local copy request.

The printer authorization matrix is structured as a two-dimensional array with each device in the cluster represented by a destination device descriptor with the following format:

Printer Port Address	Mode	Class	Source Device List
----------------------	------	-------	--------------------

Printer Port Address is the first field of the descriptor. A decimal address from 01 to 31 for the 3274 allows printers to be attached to any port on the control unit, except port 0. Addresses are sequential by adapter.

Mode defines the printer to be in local, system, or shared mode.

Class is the third field of the descriptor, and provides the ability to group printers into classes. This field is bit-coded, one bit for each of 16 classes, so that a single printer may be in more than one class. Valid classes are designated 70 through 85 inclusive. Coding a 1 under the appropriate class allows the printer to accept copies from displays selecting that class, provided it is authorized by the source device list.

Source Device List is a bit-coded field that specifies which displays (D) are authorized and configured to use the printer (P) associated with this device descriptor. Each bit position is associated with a port number on the cluster. Coding a 1 under a given display port address allows the printer to service copies from that display.

Note: *The class and source device list must be changed from binary representation to hexadecimal for entry during customizing.*

Consider an example in which ports 0 through 9 of a 3274 have terminals attached as follows:

```

Port Number  0 1 2 3 4 5 6 7 8 9
Terminal     D D P P D D P P D D
  
```

With the following matrix:

Printer			
Attached to Port with Address	Mode	Class 70 71 72 73...	Source Device List
			Port No: 0 1 2 3 4 5 6 7 8 9 Terminal: D D P P D D P P D D
02	Local	0 0 0 0 ...	1 0 X X 0 0 X X 0 0 ...
03	Shared	0 1 0 0 ...	0 1 X X 1 0 X X 0 0 ...
06	Local	0 1 0 0 ...	0 1 X X 1 0 X X 1 1 ...
07	System	0 0 0 0 ...	0 0 X X 0 0 X X 0 0 ...

X = Reserved, set to 0.

In this example, the display at port 0 may copy only to the printer on port 2. This printer is not addressable by class (class = all zeros). The displays on ports 1 and 4 are authorized to use either the printer on port 3 or the printer on port 6, while the displays on ports 8 and 9 are authorized to use only the latter. The printer on port 3 may also be used by the host. If selected by address, the addressed printer is logically connected to the display for local copy operations. If addressed by class, all printers in the class are logically connected to the display for local copy operations. In a class environment, printers in the class are selected on a most-available basis.

The display at port 5 is not authorized to use a printer as a local copy device. Also, the printer at port 7 is in system mode and therefore reserved for exclusive use by the system. It is not available to any displays for local copy operations, even if there is an authorized display in the source device list.

It is important to note that source devices are associated with destination devices, not with classes. Thus several printers may be defined to be in class 75, but a particular display may only be authorized for some subset, or even for none of the printers in that class. When class identification is displayed in the indicator row of the display, copying is performed only to authorized printers in that class.

Note: *When defining the printer authorization matrix, it is desirable to match the capabilities of the destination printers with those of the source display, especially the capabilities for APL/Text handling and support of the Extended Highlighting, Color, and Programmed Symbols functions. If the print buffer is at least as large as the display buffer, a copy request will be honored, but, if the other capabilities do not match, a degradation of the printout may result, depending upon the contents of the display buffer when the copy request is honored.*

Loading the Matrix. The 3274 printer authorization matrix is required to perform local copy operations between category A terminals. Local copy operations are not permitted between category B terminals attached to a 3274. However, host-initiated copy may be performed by presetting a PF key on the category B terminal. If no matrix is loaded, the default condition for the cluster is that all printers are in System mode, and local copy operations are not possible except with the BSC Copy command. The matrix is loaded by one of the following procedures:

- The matrix may be defined during the customizing process. If so, the matrix is automatically loaded whenever IML is performed on the system diskette. See the *IBM 3270 Information Display System: 3274 Control Unit Planning, Setup, and Customizing Guide, GA272827*.
- The operator initiates loading of a printer authorization matrix as follows:
 1. The display operator initiates a transaction with a host program responsible for defining, managing, and loading the printer authorization matrix. This transaction may, through appropriate interaction with the operator, define a new printer authorization matrix, retrieve a previously defined matrix from host storage, or redefine an existing matrix.
 2. The host program then transmits the matrix data to the display attached to port 0 as normal application data in a data stream, causing it to be stored in the display buffer as normal character data.
 3. The operator holds down ALT and presses the Erase to End of Field key (EOF), causing the buffer to be scanned one row at a time from top to bottom. As each row is processed, the configuration data is stored in internal form in the control unit.

If the control unit is a 3274-51C with the X.21 Switched Network Adapter feature installed, buffer scanning is initiated by using the ALT key, the X.21 extension key, and the Host Load Matrix key as follows:

1. Simultaneously pressing the ALT and X.21 extension key
2. Then pressing the Host Load Matrix key

During the loading process, the Time symbol is displayed in the Operator Information Area and the keyboard is locked. If the load is successful, the Time symbol is turned off and the keyboard unlocks. The cursor appears in column 1 of the row containing the end-of-matrix attribute sequence. The operator can then return to normal activity. Local printing can take place according to the authorization established in the matrix. When the load process is completed, configuration data cannot be retrieved from the control unit for presentation back to the operator or the host.

If the loading process is unsuccessful, the Program Check symbol is displayed and the keyboard remains locked. The cursor appears in column 1 of the row containing the error. The operator can reset the keyboard and resume operation. Only those device descriptors that have been processed take effect. Recovery procedures are the responsibility of the application program. It is a host program responsibility to ensure that correct matrix data is loaded. If invalid data is loaded, unexpected results may occur when the matrix is used by the subsystem. Loading of the matrix will terminate abnormally only when there is a Program Check. A display must be operating in 80-column format to

properly load a matrix. If a matrix load is attempted, and the display is in 40-column mode, a Program Check will occur.

Screen Format. When the operator initiates the load operation from the keyboard, the printer authorization matrix must appear in the buffer as shown below:

- Rows 1,2 — Reserved
- 3 — Header
- 44N — Destination Device Descriptors
- N+1 — Trailer

The first two lines of the display are reserved for the host program to display descriptive information to the display operator. These positions are not scanned during the load process.

Header. There must be a sequential string of four attribute characters, beginning at the first character position on the third row of the display, as follows:

Hex		Graphic	Definition
EBCDIC	ASCII		
60	2D	—	Protected
C1	41	A	Unprotected, MDT = 1
D4	4D	M	Unprotected, Numeric, Detectable
60	2D	—	Protected

This 4-byte sequence uniquely identifies the buffer data that follows as print authorization data. If the sequence does not appear exactly as shown, a Program Check occurs and the loading process is terminated. The remainder of the third row is not scanned.

Device Descriptors. Subsequent rows of the display contain the destination device descriptors. One descriptor is contained in a row. The format of each descriptor is as follows:

Col 1	Cols 2, 3	Col 4	Cols 5-20	Cols 21-52
Protected Attribute - 1 byte	Address of Printer - 2 bytes	Printer Mode - 1 byte	Print Class - 16 bytes	Source Device List - 32 bytes

The protected attribute, b'010 0000', defines the next 51 bytes as a destination device descriptor. If it does not appear in the first column of the row, a Program Check occurs and the loading process is terminated at this point.

The 2 bytes immediately following the attribute character provide the character-coded decimal address of the printer being described. For example, the printer at port 03 is identified by the character data "03," X'F0F3'. Addresses are validated at the time the matrix is loaded to ensure that addresses are within the range of the number of devices configured on the control unit. A Program Check is indicated if an invalid device address is specified.

Printer mode is expressed as follows, as a 1-character field:

Mode	Hex		
	EBCDIC	ASCII	Graphic
Local	D3	4C	L
System	E2	53	S
Shared	D1	4A	J

Any other coding of this byte results in the printer being defined to be in system mode. There is no validation of this byte during loading of the matrix. If there is a conflict between the mode definition and the coding of the source device list, the mode byte takes precedence.

The next 16 characters define the printer classes that are applicable to the device. By appropriate coding of this field, a device can be defined for multiple classes. Each character in this field is defined to be a character-coded digit, representing one entry in the class field of the device descriptor:

Display Column:	5	6	7	8	9	10	11	12	13	14	15	16	17	18	19	20
Class:	70	71	72	73	74	75	76	77	78	79	80	81	82	83	84	85

The character 1, X'F1', in one of these character positions defines the device being described as a member of the class associated with the corresponding position in the class field of the device descriptor. The character 0, X'F0', or any other character in this position, means that the device is not in the associated class.

The source device list is a 32-byte field. Source devices authorized for printers are character-coded. The character "1," X'F1', in any character location, specifies the associated device as an authorized source device for the destination device being defined. The character 0, X'F0', or any other value in this location, indicates that the associated device is not a valid source device:

Display Column:	21	22	23	24	25	26	27	28	29	30	31	32	.	.	.	52
Device Address:	00	01	02	03	04	05	06	07	08	09	10	11	.	.	.	31

Each descriptor takes 52 bytes, including the attribute byte; thus, each row contains 52 bytes of significant information. Other data on the row is not scanned during the load process. The first descriptor begins at row 4 column 2, the second at row 5 column 1, etc.

Trailer. The end of the matrix is signaled by the following sequence of four attribute bytes, beginning in the first column of the row following the last valid destination device descriptor:

Hex	EBCDIC	ASCII	Graphic	Definition
60		2D		Protected
C5		45	E	Unprotected, MDT = 1, Detectable
D5		4E	N	Unprotected, Numeric, MDT = 1, Detectable
C4		44	D	Unprotected, Detectable

Scanning of the buffer terminates at this point; the configuration data and each device descriptor are stored in the control unit. If a descriptor has been previously loaded for a particular destination device, it is replaced by the one being loaded. An existing descriptor, not replaced, is in effect for local copy operations. There is no global reset other than power off on the control unit. Only a Program Check causes termination of the load process prior to completion. If the configuration data is not valid, for example, if a display is selected as a destination device, there is no notification of this condition to either the operator or the application program. However, when a local copy operation is attempted, it will not be performed.

Programming Note: *If a printer authorization matrix is constructed using multiple Write commands, the WCC bit setting must not specify reset MDT bit 7 = 1.*

Mode Transitions. When a new printer authorization matrix is loaded into the 3274, unsatisfied print requests may still be queued. These print requests may have been made using destination device descriptors which were modified by the loading process. When new device descriptors are loaded into the subsystem, outstanding print requests are satisfied (if possible) based on the new configuration matrix. If the print requests cannot be satisfied, they are purged from the queue.

If a destination device changes from local to system mode, a bind to the printer LU is allowed, and any local copy requests queued for the printer are purged from the queue. When initiated by an operator using the Print key, the Busy symbol on the requesting display changes to Operator Unauthorized. When initiated by the host using the Start Print bit in the WCC, a negative response of X'0801', printer not available, is sent to the PLU. Any printing actually in process is completed. If a device changes from system to local mode, subsequent transmissions to the SLU are responded to with X'0801', printer not available. If the printer is not in session, the transition to local mode is immediate. When changed from shared to system mode, the transition is immediate if the printer is in session with a host PLU. If the printer LU is not in session when the change is made, a session may be bound to the printer LU. However, any outstanding print requests are purged from the print queue. When initiated by the operator with the Print key, the Busy symbol is replaced with the Operator Unauthorized symbol. (Refer to Appendix B for symbol descriptions.) When initiated by the host with the Start Print bit in the WCC, a negative response of X'0801' is generated to the host request. When changing from local to shared mode, and from system to shared mode, the transition is immediate.

3274 Printer Status Symbols. The following conditions determine which printer status symbols appear in the Operator Information Area when the printer authorization matrix is loaded from the host:

1. After the matrix is updated, the Printer Assignment symbol is checked on each display station. If the current assignment symbol is still valid, i.e., the printer or printer class is authorized for use by the display operator, the symbol is not changed. If the assignment is not valid, but the display operator is authorized to use other printers, the Printer Assignment symbol is changed to What Printer symbol. If there are no printers in the system authorized for use by the display station, the Printer Assignment symbol does not appear.

2. If the Printer Assignment symbol is not displayed when the matrix is loaded, and there are printers authorized for the display station, the Printer Assignment symbol then appears. The nn value is assigned as the first (lowest address) printer authorized for the display station. If there are no authorized printers for the display station, the symbol will not appear.
3. The priority of the printer status symbols, from lowest to highest, is as follows:
 - a. No display
 - b. □□?? What Printer
 - c. □□nn Printer Assignment
 - d. □□__ Assign Printer
 - e. □■nn Printer Printing
 - f. □→nn Printer Failure

Thus, if Printer Assignment or Printer Failure is displayed while the matrix is loaded, the symbol will not change until the condition causing the current indication is cleared, as for example, when the printing operation is completed. The new printer status symbol is then displayed.

4. Writing the What Printer symbol to a display, or removing the Printer Assignment symbol, will terminate the print ID sequence if the operator has been entering a print ID during the load process. The cursor will be visible, and there will be no inhibit conditions.
5. If operator-initiated print requests are queued and a new matrix is loaded, the symbols will change (as previously described). If there is no change in assignment, the queued requests will be processed normally. However, if the Printer Assignment symbol is not displayed or is changed to the What Printer symbol by the load process, the Operator Unauthorized symbol is displayed, the print request is removed from the queue, and the keyboard is locked. Pressing the RESET key will unlock the keyboard. If the queued request was host-initiated, the keyboard remains locked, the Time symbol is displayed, the request is removed from the queue, and a negative response of X'0801', printer not assigned, is sent to the PLU.
6. If the Print key is pressed while the What Printer symbol is displayed or while no Printer Assignment symbol is displayed, the Operator Unauthorized symbol will be displayed and the keyboard will be locked. RESET will unlock the keyboard.
7. If the IDENT key is pressed while the What Printer symbol is displayed, the Printer Assignment symbol will appear. The first (lowest number) print class of the first (lowest address) printer authorized for use by the display is indicated by nn.
8. If the IDENT key is pressed while no Printer Assignment symbol is displayed, the Operator Unauthorized symbol is displayed and the keyboard is locked. RESET will unlock the keyboard.
9. If power is removed from a display station after the matrix is loaded, and there are printers authorized for use by the display station, the Printer Assignment symbol will be displayed as described previously in condition 2.

Changes that can occur to the printer status symbols are summarized as follows:

If the Current Printer Status Symbol is:	And the New Matrix Specifies:	Then the New Symbol Is:
<p>□-□nn □-■nn □-■nn</p>	nn is still authorized.	□-□nn
<p>□-□nn □-■nn □-■nn</p>	nn is no longer authorized, but there are authorized printers for the display station.	□-□??
<p>□-□nn □-■nn □-■nn</p>	nn is no longer authorized, and there are no authorized printers for the display station.	blank
□-□??	An authorized printer exists for this display station.	□-□??
blank	Authorized printers exist for the display station.	□-□nn
□-□?? or blank	No authorized printers exist for the display station.	blank

Print and IDENT key operations are summarized as follows:

If the Current Printer Status Symbol Is:	And the Following Key Is Operated:	Then:
□-□?? or blank	Print	Operator Unauthorized is displayed, and the keyboard is locked.
□-□??	IDENT	The control unit will make assignment and display □-□nn.
blank	IDENT	Operator Unauthorized is displayed, and the keyboard is locked.
□-□nn	Print	Print request is processed as described under "Operator-Initiated Copy."
□-□nn	IDENT	□-□ is displayed and print ID mode is entered.

3274 Local Copy Operation

The operator initiates a local copy function using the Print key on the keyboard of a 3278 or a 3279 attached to a 3274, or, in SNA/SDLC, the PLU initiates a local copy operation by sending a write-type command to the display, with the Start Print bit turned on in the WCC. The host-initiated local copy function may be initiated with the BSC Copy command directed to the “to” device (as described under “Copy Command” in Chapter 1).

The responses to local print requests are discussed in the following paragraphs. These responses depend upon the availability of printers within a selected print class. When a selected print class contains two or more printers, and no printers are immediately available, the system response to the print request is based on the most available printer(s) in the selected print class. Categories of unavailability, in order from most to least available, are:

1. Busy executing a display printout for another SLU.
2. An Intervention Required condition exists.
3. Allocated as LU1 or LU3, in session with a PLU.
4. A permanent error situation.

Printer Selection. With the exception of the BSC Copy command, the printer authorization matrix is used to direct local copy data from a display to an associated printer (as described previously).

Consider the following example of printer selection:

Printer		Source Device List												
Attached to Port with Address	Mode	Class				Port								
		70	71	72	73...	0	1	2 3 4 5 6 7						
		Terminal: D D P P D D P D												
02	Lo	0	1	0	0	...	1	1	X	X	0	0	X	0
03	Lo	0	0	1	0	...	1	1	X	X	0	0	X	0
06	Lo	0	0	1	0	...	0	0	X	X	1	1	X	0

The displays at ports 0 and 1 can copy to the printer at ports 2 and 3. The displays at ports 4 and 5 can copy only to the printer at port 6, and the display at port 7 cannot copy to any printer.

The class connections are shown in the Operator Information Area of each display. In this example, the indicators are:

Displays at ports 0 and 1—71

Displays at ports 4 and 5—72

No connection is shown in the Operator Information Area of display 7.

If the printer at port 2 is not a member of class 71 or any other class, the symbols on the display at ports 0 and 1 show the destination address 02, even though these displays are also authorized for using the printer at port 3 with membership in class 72. In other words, a display is always connected to the authorized printer at the port with the lowest address. The display symbol shows the class number (lowest) if the printer has membership in one or more classes, or the destination address if the printer is not a member of any class.

When a display is connected to a class, as shown on its symbol, the most available printer with lowest destination address is selected if there is more than one most-available printer with membership in that class.

When the display symbol shows a printer port address, only one printer is connected. The print request is executed on that printer when it is, or becomes, available. The display terminal operator may connect to another authorized printer by using the IDENT key.

If an application program requires a certain printer for copy output, the application program may begin a session by prompting the operator to select a certain printer class by transmitting a message, such as:

“Select Print Class 79”

The operator can then make the appropriate selection.

Local print data from a display station is always directed to an authorized printer in the “connected” printer class whether the copy is initiated by the operator or by the PLU. With the IDENT key on a 3278 or a 3279 attached to a 3274, the display operator may alter this defined connection from the display keyboard. A new print class may be selected by pressing the IDENT key and keying in a two-digit identification number (ID) between 70 and 85. The class selected by the operator then appears in the Operator Information Area of the display. The print class ID, keyed in using the IDENT key, selects a valid print class by comparisons with the class fields in the authorized device descriptors of the printer authorization matrix. At least one destination device in the class must have the source display in its source list for the class ID to be valid because copy operations are performed only on printers that have the source display in their source device list. The display operator may also select an authorized printer by pressing IDENT and keying in the port address of the desired printer.

If the specified print ID is not authorized, that is, the matrix does not permit the display to copy to the selected device or members of a selected class, then the Input Inhibited Operator Unauthorized symbol is displayed. If the selected print ID is not in the matrix, the Input Inhibited What Number symbol is displayed. In both cases, the print ID routine is exited, and the keyboard is locked. The operator may press RESET and retry the print ID sequence. The display connection indicator reflects the connection prior to the initiation of the print ID sequence. If the selected print class or printer is authorized and valid for this display, the connection indicator changes to indicate the new connection, and print ID mode is exited.

When in print ID mode, the following rules apply:

1. The RESET key and other keys that cause a reset operate normally and cause the print ID mode to be terminated.
2. The ATTN key, DEV CNCL key, security keylock, and unsolicited host write operate normally; however, a 3274 print ID mode is terminated.
3. Other keys that normally function during a keyboard inhibit condition function while in print ID mode without causing an exit.
4. All other keys that are not honored during a keyboard inhibit condition cause the Input Inhibited What symbol to be displayed and print ID mode to be terminated.
5. The unlock condition of the IDENT key is governed by the same rules as a normal data key.

Operator-Initiated Copy. With the printer authorization matrix loaded in the 3274, the operator may initiate a local copy operation by pressing the Print key on the display keyboard. The Print key is active in an SNA environment under the following conditions:

1. No session has been established (prior to receipt of ACTLU, or after receipt of DACTLU).
2. Session owner is "Unowned."
3. The terminal is in Test mode, and the keyboard is unlocked.
4. Session owner is the SSCP, and the keyboard is unlocked.
5. Session owner is the PLU, the keyboard is unlocked, and the SLU is not in receive state.

The Print key is active in a BSC environment whenever the Time symbol is not displayed.

If the specified print class or printer address is valid but the printer or all printers in the print class are busy doing local copy operations for other displays, the Input Inhibited Printer Busy (short term) symbol is displayed. If the printer or all printers in the class are busy because they are "in brackets" (SNA) or "have status pending" (BSC) with a host application, which is only possible when the printer is in shared mode, the Printer Very Busy (long term) symbol is displayed. In either case, the request is then queued, and the keyboard is locked until the copy can be performed or the operator cancels the print request. Note that the Printer Busy (short term) symbol is displayed if the operator presses Print while the Printer Printing symbol is being displayed, even if other printers in the assigned print class are available. The operator can wait until a printer becomes available to perform the copy function. The RESET key has no effect while a print request is on the queue; however, the operator can cancel the local copy request by pressing the DEV CNCL key (while the request is on the queue). This turns off the Input Inhibited symbol, unlocks the keyboard, and dequeues the print request. The operator is then free to perform another task.

If the print class or printer address is valid but the printer or all printers in the selected class are not functional, then the Input Inhibited Printer Not Working symbol is displayed and the keyboard is locked. The operator must depress the DEV CNCL key to continue. This action turns off the Input Inhibited symbol and unlocks the keyboard. The print request is not queued. The operator may then choose an alternate action. When the Printer Not Working symbol has been turned on as a result of an operator-initiated copy request, this symbol, and an associated Printer Failure symbol, if displayed, will be turned off by receipt of any outbound FM data request.

If the operator attempts to print again, and the selected print class is still not operational, the Input Inhibited Printer Not Working symbol reappears. Some operator action, for example, loading paper in the printer, may be required to clear a not-functional condition. If no valid print class or printer is defined for this display (no connection indicator) and the Print key is depressed, the Input Inhibited Operator Unauthorized symbol is displayed and the keyboard is locked. The indicators remain on until the operator presses the RESET key.

When a valid printer is selected, and the display-to-printer buffer transfers begins, the display keyboard is locked and the Printer Busy symbol remains displayed. This symbol remains on and the keyboard remains locked until the buffer transfer is completed successfully. When this occurs, the keyboard unlocks, and the Printer Printing symbol replaces the connection symbol during the print operation. The Printer Printing symbol always indicates the actual device address of the selected printer. Once the actual printing operation is complete, the Printer Printing symbol is replaced by the original printer assignment symbol.

If the printer stops during a local copy operation (out of paper, paper jam, etc; a data check on the printer does not fall in this category), the Printer Malfunction symbol replaces the Printer Printing symbol and the print is terminated. The keyboard locks and the Printer Not Working symbol is also displayed, calling the operator's attention to the failure. The Printer Failure symbol always specifies the failing printer, not the print class. In this state, the DEV CNCL key will remove both of the symbols from the display.

Operator-Unauthorized Condition. If the display cannot perform the copy operation because the most-available printer does not have a large enough buffer, the operator will be alerted by an inhibit condition with the Operator Unauthorized symbol. This may occur, for example, when the operator attempts to copy to a 1920-character buffer printer from a 3440-character display.

The Operator Unauthorized symbol is also displayed if the indicated selection turns out to be a display rather than a printer. This may occur when an invalid device descriptor gets loaded in the matrix.

Host Interference with Operator Copy (SNA). Once the display operator has initiated a local copy operation, any outbound FM data request will be rejected with a busy indication, X'082D', during the time that the operator request is queued or the buffer is being transferred, and an outbound FM data request is received for display. Once the buffer transfer has been completed, the display is free to receive outbound FM data requests. If a negative response has been sent because of this condition, an LUSTAT of X'0001D000' will be sent at the completion of the buffer transfer to notify the host that the busy condition no

longer exists. FM data may be written into the display buffer as soon as the buffer transfer is complete.

If the host is in session with the printer, the local copy operation will not change the selected size of the printer buffer as set by the host session.

Host-Initiated Local Copy using SNA/SDLC

The host application program may initiate a local copy function in an SNA environment by sending to the display station a write-type command with the Start Print bit in the WCC turned on. (The copy function under SNA ignores WCC bits 2 and 3.) The control unit performs the local copy function as required, using the print class or printer assigned to the display and displayed in the Operator Information Area. When a write-type command is sent to the display with the Start Print bit on, the display first interprets the orders and data in the write data stream and updates the display buffer. During this time, the Input Inhibited Time symbol is displayed. Once the buffer write is completed, the control unit attempts to use the printer(s) it assigned to the display. The Time symbol remains on while the copy operation takes place. Once the buffer transfer is completed, the Printer Printing symbol replaces the Printer Assignment symbol. The Printer Printing symbol always shows the specific terminal address of the printer actually doing the print operation.

The keyboard remains locked, regardless of keyboard Restore, until the print operation is completed. When the print operation is completed, the keyboard unlocks according to the keyboard Restore in the WCC. The Time symbol is removed, and the Assignment symbol replaces the Printer Printing symbol.

To perform the host-initiated local copy described above, the host program must send a write-type command with the Start Print bit turned on in the WCC as an RQD chain or an RQE, CD, 1EB chain. Otherwise, the synchronization may be lost or the request rejected with response X'0843'.

Printer Busy Condition. If, after performing the display buffer update operation, the control unit finds that the connected printer or all printers in the selected print class are busy with other local copy operations, the print request will be queued; the Time symbol remains on; the Printer Busy symbol is not displayed. The DEV CNCL key will not function on queued host-initiated requests.

On a 3274 configured for between bracket printer sharing, if the selected printer or all printers in the selected class are found to be "in" brackets with the PLU, the copy operation is refused. After the write operation is complete, the control unit will respond negatively to the print request with X'0807', printer busy. When between bracket printer sharing, the 3274 will not hold the printer if a release condition occurs after the 0807 or 082E response and before the LUSTAT is sent.

Once a print request has been refused with "printer busy," the SLU sends an LUSTAT of '0001B000' to the PLU when a printer becomes available. (Only one LUSTAT is returned per SLU, regardless of the number of times the PLU may have requested a local print operation.)

The PLU may choose not to wait for the LUSTAT but to continue with other display work. Even though the SLU is taken out of the ERP.1 state by the PLU, it is still bound to send in the LUSTAT at the first opportunity when the printer becomes available.

The 3274 will not hold the printer after sending an '0001B000' LUSTAT when configured for between session printer sharing. If between bracket printer sharing is selected, the 3274 will broadcast LUSTATs for all displays it can service. The printer is then held until each of those displays has provided a release by one of the following:

- Receiving an FM data request. If start print is specified, it is processed prior to releasing the printer.
- Display powers off or a permanent error is detected on the display.
- Clear, Unbind, DACTLU, or ACTLU is received.
- DACTPU/ACTPU is received.

Printer Not Assigned Condition. If a printer is not assigned to the SLU at the time it is selected, the control unit responds to the write type command with negative response (0801) "printer not assigned."

On a 3274 configured for between session printer sharing, if the selected printer or all printers in the selected class are busy because they are "in" session with a host application, the print request is refused. After the write operation is completed, the control unit will respond negatively to the print request with X'0801', printer not assigned.

"Printer not assigned" will also be sent to the PLU when a copy request is made, and the selected printer cannot perform the copy because of a feature mismatch between the display device and the printer.

In all cases mentioned above, once the negative response has been sent to the host, the 3274 enters the ERP.1 state.

Printer Not Functional Condition. If the most-available printer is not functional at the time the printer is selected, the Printer Not Working symbol replaces the Time symbol. The Write command is responded to with negative response (083E) intervention required or negative response (082F) permanent printer error. The display LU goes into the ERP.1 state as defined for printer busy. When intervention-required is returned, recovery may require operator action, e.g., loading forms. When the intervention-required condition has been cleared, the control unit will generate an LUSTAT 0001B000 to the PLU in session with the display. After receiving the LUSTAT, the PLU may reinitiate the copy request by sending a Write command with the Start Print bit in the WCC and with no data.

If the operator operates the DEV CNCL key while the Printer Not Working symbol is being displayed, the Printer Not Working symbol is replaced by the Time symbol.

If the PLU transmits any FM data request to the display and the Printer Not Working symbol has not been cleared, the FM data request will remove the Printer Not Working symbol and, if displayed, an associated Printer Failure symbol, and may take the SLU out of the ERP.1 state.

No LUSTAT is required when 082F (permanent error) is sent as a response to the Write command.

If the printer malfunctions during the print operation, both the Printer Not Working and the Printer Failure symbols are displayed. The print operation terminates, and the Write command is responded to with negative response (082E) or negative response (082F). The keyboard remains locked and the system waits for some recovery action as defined above. If another device is available in the same printer class, the 3274 may generate the LUSTAT immediately.

Note that any FM data requests from the PLU will clear a Printer Not Working symbol. This requires careful planning by an installation in the use of host- and operator-initiated printing.

Local Copy Performed without SNA Protocol

In a BSC environment, host-initiated local copy is initiated through use of the Copy command (remote only). The description of operator indicators under "Host-Initiated Local Copy using SNA/SDLC" does not apply to the Copy command. Operator-initiated copy in a non-SNA subsystem is the same as defined under "Operator-Initiated Copy."

When a printer or class of printers is in shared mode, the contention between host and local copy use of the printers is resolved according to the following procedure:

1. If, during processing of an operator-initiated copy operation, the host sends a selection addressing sequence to the printer, the control unit will respond with an RVI and set Intervention Required. When the local copy queue no longer exists and the printer becomes available, Device End (DE) is sent in response to a poll (remote) or as asynchronous sense/status (local) to signal that the printer is available.
2. To provide security in systems that operate in a non-SNA environment, the printer buffer is cleared after successful operator-initiated local copy operations are completed. A read buffer or read modified operation will not return the contents of a printer buffer just used in a local copy operation by another display operator.
3. A host program may use several messages to load a buffer with data to be printed or for temporary data storage. Once the program initiates loading of the buffer, operator-initiated local copy operations cannot be performed until print operation is completed, or until there is a permanent error. An operator-initiated print request via the Print key during this period is queued, and the Device Very Busy symbol is displayed. The host system should issue an Erase/Write command with the Start Print bit "on" to release the printer for local print operations.
4. The host application program can use the printer when there are no operator-initiated local copy requests outstanding. If it is required that the host have sole ownership of the printer for data integrity or performance considerations, the printer should be designated as a system mode printer in the printer authorization matrix.
5. If the printer authorization matrix is changed during normal operation, the transitions are made as described under "Mode Transitions."

6. If a host transmission to the display is received while an operator-initiated copy request is queued, the host transmission will be accepted and written to the display. No change will be made to the status of the operator-initiated copy. If the copy is queued and buffer transfer has not taken place, the new screen will be copied. If buffer transfer has started before arrival of the host transmission to the display, the transfer will be completed before writing to the display. In this case, the old screen will be copied.
7. Each time the local copy queue is completed, a Device End will be transmitted to the CPU by the 3274, thereby signaling that the printer is available. The printer buffer is set to the default size after each copy queue is completed.

Mono/Dual Case Control

When power is applied, the 3262 and the 3289 are automatically activated to print the dual-case character set; the 3287 is activated to print mono case.

In dual-case operation, the alphabetic character codes sent by the host determine whether uppercase or lowercase characters are printed, provided that the print belt has the dual-case character set. In mono-case operation, the lowercase alphabetic character codes print equivalent uppercase characters.

The Change Case switch can be pressed to change the print case on the 3262, 3287, and 3289. However, when operating with LU1 printers in SNA, the data character codes and the print belt character set determine whether mono- or dual-case characters are printed, regardless of the Change Case switch setting.

In a BSC environment, when using the Copy command to transfer data from a display to a printer, the setting of the Change Case switch on the "from" display determines mono or dual case in the "to" printer. When the Copy command transfers data from a display or a printer to a display, the Change Case switch on the "to" display determines whether mono or dual case is displayed.

Format Control during Shared Printer Operations

When shared printers respond to uncoordinated print requests, control of the horizontal and vertical print position format is governed by the operating mode(s) and the format selected.

- | In BSC or 3274 B or D unit printer operations, sharing occurs on a buffer load basis, between local copy requests and host-initiated printer output, by means of write-type or Copy commands. When using SNA protocol, local copy requests for display buffer data originating from an LU2 session may share a printer with either LU3 or LU1 host output. Sharing of LU2 and LU3 devices is comparable to BSC or 3274 B or D unit operation.
- | In BSC, 3274 B or D unit, and in SNA LU2 printer operations when performing local copy, the entire buffer content, including nulls, attribute, and buffer control characters of a "from" display or a "from" printer (non-SNA only), can be transferred to a printer buffer.

During formatted print operations, the data is scanned a line at a time. If a line contains one or more data characters (including Space, NL, EM, and CR) in a display/print field, the line is printed and a line feed is performed. To produce a blank line, at least one Space character must be present.

A valid FF character is executed regardless of the attribute of the field, except for the 3262 and 3289-1 and -2. These printers do not execute or print any characters in a nonprint field, including the FF character. If the FF character is invalid, it is not executed and prints as a blank in a field that is not defined as nondisplay/nonprint.

If a line contains only nulls, attribute characters, or alphanumeric characters (including Space, NL, EM, FF, or CR) in a nonprint/nondisplay field, no line is printed and no line feed is performed. A screen facsimile can be obtained only by inserting at least one space character in the blank lines.

In BSC, 3274 B or D unit, and SNA LU3 printer operations when directly printing from the host, the identical procedure is followed as described above once data has been loaded in the buffer and the print operation is started. Thus, when a print operation is completed, a line feed will have been automatically performed after printing of the last line (blank or not). Therefore, the next buffer load of data, regardless of the source, starts printing on the next line, ignores the previous horizontal position, and is contiguous with the previous output except for blank lines as provided in either or both buffer data.

A valid FF control character in the data at either the beginning or end of a form (one or more buffer loads) ensures synchronization of the forms with the data. Interleaving of a local copy operation within a host output print operation using VFC will usually cause local copy to be printed on part of a completed form or cause at least one form to be misprinted. This may best be avoided by configuring the printer in system mode, thus excluding its use for local copy.

In BSC, and 3274 B or D unit unformatted print operations, the completed print operation terminates at a new line position. Thus, the next print operation is also contiguous with the previous output except for possible blank lines as specified in the data. (SNA LU type 1 devices do not perform unformatted printouts.)

When operating as an SNA LU type 1 device, an automatic LF, NL, etc., is not sent at the end of a bracket or a session. Therefore, the print position may be one position to the right of the last printed character. The first printed line resulting from a local copy operation performed with an LU2 device is printed on the line that is currently available. Overprinting may occur if the first line is not specified as a blank line. When the local copy operation is completed, the LU1 session resumes with a new bracket at the horizontal print established by the preceding LU1 bracket.

Error Conditions

Four error conditions may be encountered at the printers. In each of the following cases, when an error is detected, the program is notified.

Not Ready. A printer is defined as not ready when it is out of paper, its cover is open, or it is mechanically disabled (unable to advance to its proper position). When a 3284 or 3286 printer mechanism experiences a "printer hang" condition (see Glossary) during a printout, the printer will stay busy with an Equipment Check (EC) present. For 15 seconds, the mechanism will automatically attempt to recover. If the recovery attempt is successful, the printer will return to the ready condition. If the recovery attempt is not successful after 15 seconds, the printer will become not ready, as indicated by Intervention Required (IR) status.

A 3262 displays an error code in the status indicator. The operator may be able to clear the error condition and continue printing.

If a printer (not the 3289) is not ready at the start of a printout, or if it becomes not ready during a printout operation, the print operation terminates. Error status is sent to the channel once when the condition occurs during a printout and, then, again each time a printout is initiated.

When the 3287 detects other than parity errors, the Check indicator lights, and the associated error code is displayed in the two-digit Status indicator. The operator may be able to correct the error and continue operation.

Character Generator or Sync Check Errors. The characters printed are a function of the character generator or character belt installed. When an incorrectly formed character is printed during a printout (not the 3287 or 3289), no attempt is made to substitute or alter the character. When the printout operation is completed, a new line function is executed and an X is printed (feature-dependent). A sync check error occurs when a character belt hammer is out of sync.

Parity Error. If a parity error is detected on a character about to be printed, the graphic X (3284, 3286, 3288) or an error graphic (*prx10T,L*) (3287) is printed in place of the character with incorrect parity. The buffer continues printing until all printable characters have been printed. The printer prints a graphic X. The isolated X character (specify feature on the 3287 and 3288) serves to indicate the detection of the parity error.

An $\text{\textcircled{X}}$ (an X overprinted with an O) prints in place of an incorrect character on a 3262. An $\text{\textcircled{X}}$ also prints in the left margin of the next line.

Command-Chaining. In local operations, if any command is chained to a command that initiates a print operation, an error condition occurs: no printout is performed, the command is aborted, and the system channel is notified of the error. In remote operations, if command chaining is attempted, error status is sent to the system channel but the printout is completed.

Unit and Model-Dependent Differences (Printers)

Following are the model-dependent differences between printer units that affect printer operations. (Refer also to the 3262, 3287, and 3289 Component Description publications.)

Buffer Size

The buffer size of the 3284, 3286, and 3288 is model-dependent. Model 1 units contain 480 characters, and Model 2 units contain 1920 characters.

The basic 3287 (all models) contains a 2K-character buffer, which can be expanded to 4K characters. The 3289 (all models) contains a 4K-character buffer. However, the number of characters that can be effectively accessed corresponds to the buffer size specified for the printer.

The 3287 and 3289 buffer size is specified as 960, 1920, 2560, 3440, or 3564 bytes. Additional space remaining in the buffer is available for SCS operation, if required. The 3262 has 8K bytes of buffer storage.

During an erase/write operation to a 3284, 3286, or 3288, the full 480- or 1920-character buffer is erased. When an Erase/Write command is sent to the 3287 or 3289, the buffer is erased up to the specified default size (480 or 1920 characters). The Set Buffer Address (SBA) order, when sent to the 3274, is valid if the address specified is less than the effective buffer size.

A data or attribute wrap operation to buffer position zero occurs when data characters are addressed beyond the effective end of the buffer. The last effective position in the buffer is the default buffer size when operating in SNA/SDLC protocol.

Uppercase and Lowercase Printouts

The 3284, 3286, and 3288 print uppercase alphabetic characters unless the Extended Character Set feature is installed (which provides additional characters, including lowercase).

Printouts in either uppercase or lowercase characters may be obtained from the 3287 and 3289 printers, depending upon the setting of the 3287 and 3289 Change Case switch, and the command or print operation in process. During execution of an Erase/Write or Erase/Write Alternate command, the printer switch setting determines the character case, and the previous request is erased. During a Copy command or local print operation, the character case is determined by the setting of the Mono/Dual switch on the "from" display.

Note: *For 3289, the 94-character belt is the only belt that has lowercase characters. On the 3262, only the 96-character band (US EBCDIC) has lowercase characters.*

While performing a Write command or buffer reprint operation, the previous print case request is honored. Change Case switch settings are ineffective during transmission of the SCS data stream to a 3262, 3287, or 3289 (SCS is always dual case). The proper character code points must be used to ensure that the correct printout occurs.

New Line (NL) and End of Message (EM) Orders

NL and EM orders are printed as 5 and 9 respectively on 3284, 3286, and 3288 printers and are printed as space characters on 3262, 3287, and 3289 printers when attached to 3274 control units.

New Line (NL) at Maximum Print Position plus One Character

When the 3289 printer encounters an NL character one character position past the line length (maximum print position), it performs a single new-line function. The 3284, 3286, 3287, and 3288 printers perform two new-line functions.

Duplicate (DUP) and Field Mark (FM) Character

DUP and FM characters are printed as ; and * respectively on 3284, 3286, 3287, 3288, and 3289 printers.

Split Vertical Bar (|) Character

The Split Vertical Bar (|) character, hex 6A, is available on the 3262 (96-character set band), 3287, 3288, and 3289 printers (and also 3278 and 3279 displays).

Chapter 3. Local Operations (3274 B and D Units)

The 3274 non-SNA locally attached control units are the 3274 Models 1B, 1D, 21B, 21D, and 31D. (The 3274 Models 1A, 21A, and 31A operate with SNA protocol and are discussed in Chapter 5.)

Non-SNA Local Operations

The 3274 B and D units can attach to a selector channel, to a byte multiplexer channel, or to a block multiplexer channel, each through the I/O interface (Figure 3-1). When attached to a byte multiplexer channel, operations can be in forced-burst mode or in single-byte-multiplex mode. The channel, in turn, is attached to main storage and to the central processing unit (CPU).

Note: *In the following text, the term "control unit" refers to the 3274 B and D units unless otherwise indicated.*

The channel program controls all control unit operations by transmitting information across the I/O interface. This information consists of: (1) an address byte, which selects one control unit and one device (display or printer) attached to the control unit; (2) command bytes, which specify the type of operation to be performed by the control unit for that device; (3) data bytes, which either are stored in the control unit buffer for ultimate use by the selected device as display or printout data or are decoded as orders and used by the control unit for formatting the buffer; and (4) various control signals. Status bytes, which are automatically generated by the control unit, inform the channel program (1) of the general condition of the control unit and selected device at various stages of command operations and (2) of unique conditions of the control unit and any attached device when command operations are not in progress.

Interface Operations

Local interface operations are summarized in the following paragraphs and are described in detail in the *IBM System/370 Principles of Operations* manual, GA22-7000. The CPU program initiates control unit operations with a Start I/O instruction. This instruction identifies the I/O control unit and device (in this case, the control unit and a display or printer) and causes the channel to fetch a channel address word (CAW) from a fixed location in main storage. The CAW designates the storage protection key and the location in main storage from which the channel subsequently fetches the first channel command word (CCW). The CCW specifies the command to be executed and the number and address, in main storage, of any bytes to be transmitted.

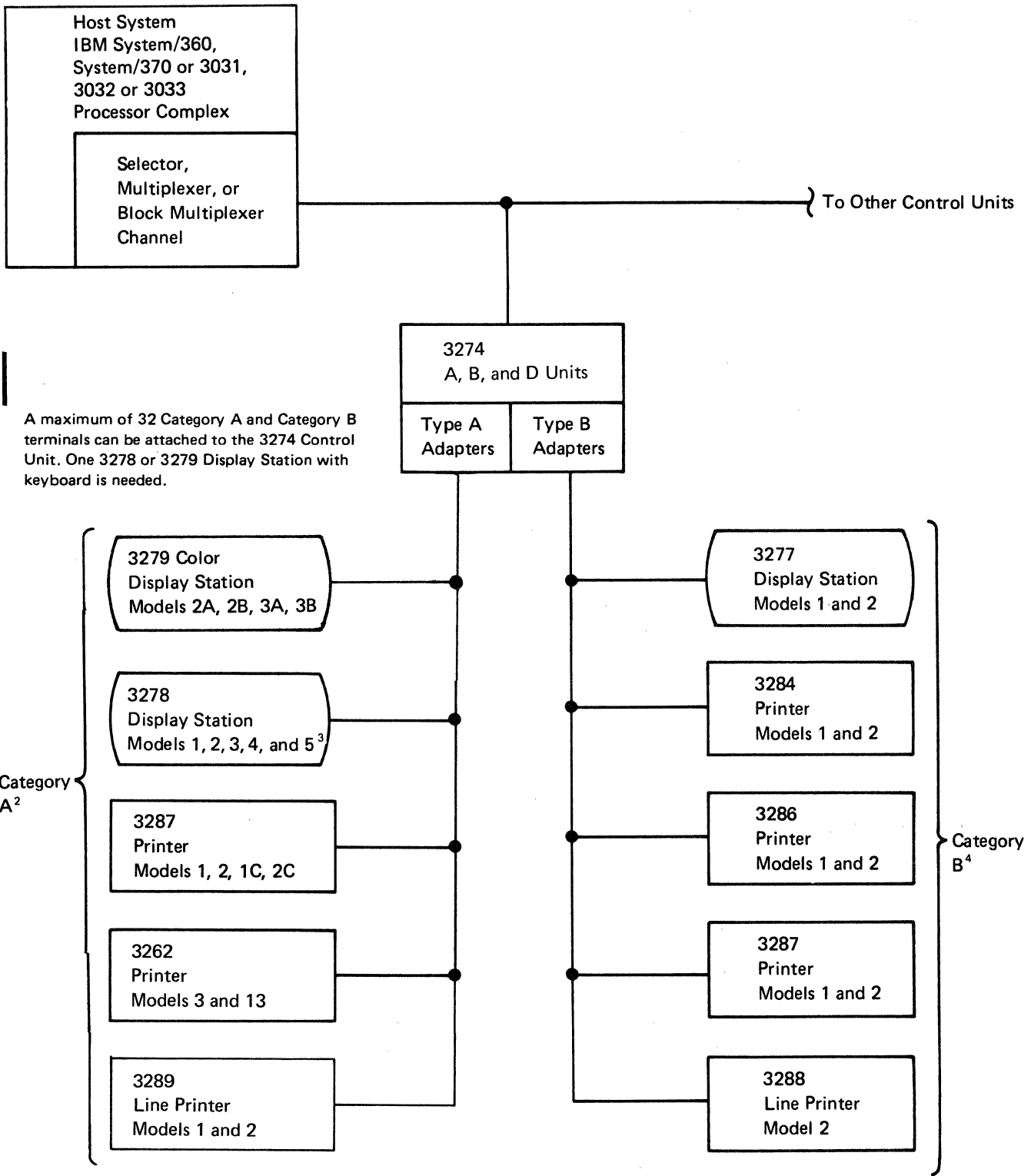

A maximum of 32 Category A and Category B terminals can be attached to the 3274 Control Unit. One 3278 or 3279 Display Station with keyboard is needed.

¹ 3274 A units operate in SNA mode and do not attach to a System/360 (see Chapter 5).
3274 B and D units operate in 3272 compatibility mode.
² Up to 32 Category A display stations and printers can be attached to any one control unit. A 3278 or 3279 with keyboard is needed.
³ A 3278 Model 5 cannot be attached to a 3274 B unit.
⁴ Up to 16 Category B display stations and printers can be attached to one control unit.

Figure 3-1. Locally Attached 3270 Display System Using 3274 A, B and D Units

Selection

The channel attempts to select the control unit and an attached device by sending a unique address byte to the control unit (and to all other control units attached to the same channel or subchannel). When a control unit has 16 or fewer devices attached, the first four bits of the address byte specify the control unit address and the last four bits of the address byte specify the device address (Figure 3-2). Up to 32 devices can attach to control units that have even-numbered addresses; these addresses are coded as shown in Figure 3-3. Note that no more than 16 devices can be attached to a control unit that has an odd-numbered address. Device address must always be assigned sequentially, starting with address 0. However, no priority is given to particular device address.

When a control unit recognizes both addresses, it logically connects to the channel and responds to the selection by returning the address byte to the channel.

Command Initiation

Command operations by the control unit start when the control unit and a device are successfully selected. When a command is to be executed by the control unit (not by the channel alone), the channel sends the command code (CCW bits 0 7) to the control unit.

Control Unit No.	8-bit Local Address Byte		Device No.	4 5 6 7 (XXXX)
	Control Unit	Device		
	0 1 2 3	4 5 6 7		
0	0000	XXXX	0	0000
1	0001	XXXX	1	0001
2	0010	XXXX	2	0010
3	0011	XXXX	3	0011
4	0100	XXXX	4	0100
5	0101	XXXX	5	0101
6	0110	XXXX	6	0110
7	0111	XXXX	7	0111
8	1000	XXXX	8	1000
9	1001	XXXX	9	1001
10	1010	XXXX	10	1010
11	1011	XXXX	11	1011
12	1100	XXXX	12	1100
13	1101	XXXX	13	1101
14	1110	XXXX	14	1110
15	1111	XXXX	15	1111

Figure 3-2. 3274 B and D Unit Device Addressing, 16 or Fewer Devices per Control Unit

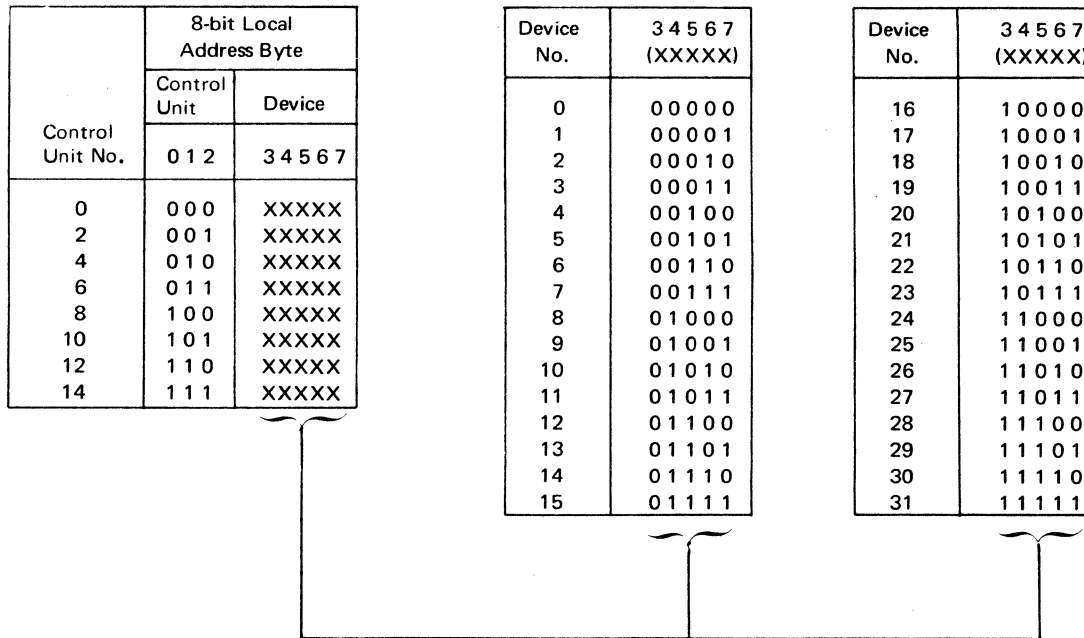

Note: Control Unit Nos. 1, 3, 5, 7, 9, 11, 13, and 15 cannot be assigned when attached devices are assigned Device No. 16 or greater.

Figure 3-3. 3274 B and D Unit Device Addressing, 17 or More Devices per Control Unit

When execution of the command involves a transfer of data (such as Write or Read Modified), the control unit responds to the command with a status byte (called "initial" status) indicating whether it can execute the command. If the command can be executed, the channel is set up to respond automatically to service requests from the control unit, and the control unit assumes further control of the operation. Command operation can be terminated by the control unit or when the channel byte count reaches 0. At this time, the control unit sends the channel a second status byte (called "ending" status) which indicates whether the command operation was successfully performed.

When the function of the 3270 command does not involve the transfer of data (such as EAU), it is called an "immediate" command. The resulting control unit operation depends on the particular command, as follows. If the command is No Operation, ending status and initial status are combined to indicate to the channel that the control unit has completed execution of the command. If the command is Select or Erase All Unprotected, which initiates certain control unit and device operations, the initial status from the control unit is such that block and byte multiplexer channels are released to perform other operations (selector channels remain logically connected to the control unit). When command execution is completed by the control unit and selected device (and regains selection if attached to a block or byte multiplexer channel), the control unit sends ending status to the channel, indicating whether the command was successfully performed.

Chaining

When the channel has completed the operations specified by a CCW, it can continue the activity initiated by the Start I/O by fetching a new CCW, thereby starting execution of another command. The fetching of this new CCW is called "command chaining," and the CCWs belonging to such a sequence are said to be chained. All CCWs in a chain apply to the control unit and device specified by the Start I/O instruction.

Either of two types of chaining can be specified by the current CCW (bits 32 and 33): data chaining or command chaining. During data chaining (current CCW bit 32=1), the new CCW fetched by the channel defines a new main storage area (data address) for the current command. During command chaining (current CCW bit 33=1), the new CCW specifies a new command and a data address for that new command.

Thus, when command chaining is used, the control unit is selected following the Start I/O instruction when the channel receives the first CCW in the chain that involves operations with the control unit. The control unit is dedicated to one CCW string until final Channel End time or until operations are abnormally terminated. Programming restrictions that must be observed when command chaining is used are described in Chapter 1.

Status

The control unit generates a status byte to inform the channel of certain control unit and device conditions. This status byte can be generated synchronously (while the control unit is selected and performing a command operation with the channel) or asynchronously (while the control unit is not selected).

Synchronous status is passed to the channel as both both "initial" and "ending" status to a command. Initial status reflects the condition of the selected device and/or control unit upon receipt of a command, and indicates to the channel whether the command can be executed. Ending status reflects the condition of the control unit and selected device after all channel/3270 interface operations of a nonimmediate command are completed. Asynchronous status reflects (1) ending status for an immediate command other than No Operation, (2) a second ending status for a Write, Erase/ Write, Erase/Write Alternate command, indicating that the control-unit-to-device buffer transfer is completed, or (3) an equipment condition or operator action not associated with command execution (an attention).

Figure 3-4 describes each bit of the status byte. Status is reset by the control unit once it has been accepted by the channel.

Bit	Name	Condition
0	Attention (A)	Indicates a request for services from a 3277, 3278, or 3279. Set by certain keyboard, selector-light-pen, or card-reader activity at the 3277, 3278, or 3279. Program should respond by issuing a Read Modified command (chained from a Select command if block or byte multiplexer channel) to the 3277, 3278 or 3279 requesting attention. Attention bit is also set with Unit Check bit as result of asynchronously detected equipment malfunction; in this case, program should respond by issuing a Sense command.
1	Status Modifier (SM)	Is set, with Busy bit, in initial status byte to indicate that there is pending status for a device other than the one selected.
2	Control Unit End (CUE)	Is set following a busy condition, after pending status is cleared or when control unit is no longer busy, to indicate that control unit is now not busy and is free to accept a new command.
3	Busy (B)	Is set alone in initial status byte when addressed device is busy because it is performing a print operation or an Erase All Unprotected command. Set with SM when addressed control unit is busy. When the channel addresses a device other than the one that is busy and control unit is not busy, addressed device becomes selected and the command is honored. Busy bit is also set with pending status if addressed device has such status; if pending status is for a device other than the one addressed, Status Modifier bit is also set.
4	Channel End (CE)	Indicates channel data transfer operations are completed. Is set alone (1) in initial status for Select or Erase All Unprotected command, or (2) as ending status for Write, Erase/Write, or Erase/Write Alternate command; in all cases, Device End status is sent asynchronously when device operations (command execution or control-unit-to-device-buffer transfer) are completed. Is set with Device End, to indicate that control unit and device operations (except printing) are completed (1) in initial status for No Operation command, (2) in ending status for Read Buffer, Read Modified, or Sense command, or (3) asynchronously if only Channel End status was pending and the device operation is completed before the channel accepts status. Is set with Device End and Unit Exception in initial status for Read or Write command if addressed device is busy executing another command.
5	Device End (DE)	Indicates that control unit and device have completed all command operations and are free to execute another command. Is set (1) in initial status for No Operation command, (2) in ending status for Read Buffer, Read Modified, or Sense command, and (3) in asynchronous status for Write, Erase/Write, Erase/Write Alternate, Select, or Erase All Unprotected command.
6	Unit Check (UC)	Is set when an irregular program or equipment condition is detected by control unit or the device. Program should always respond to Unit Check status by issuing a Sense command for further definition of condition.
7	Unit Exception (UE)	Is set in ending status (synchronous or asynchronous) when control unit has attempted to execute a command but has found, after initial status was returned, that addressed device was busy.

Figure 3-4. Status Byte Bit Assignments for 3274 B and D Units

Figures 3-5, 3-6, and 3-7 list the initial, ending, and asynchronous status and sense bit combinations, respectively. The abbreviations used in these figures are as follows:

Status Bits

- **B - Busy**

CE - Channel End

DE - Device End

SM - Status Modifier

UE - Unit Exception

UC - Unit Check
- **Sense Bits**

BOC - Bus Out Check

CC - Control Check

CR - Command Reject

DC - Data Check

EC - Equipment Check

IR - Intervention Required

OC - Operation Check

US - Unit Specify

Initial Status

Initial status is generated by the control unit in response to initial selection, by the channel, of the control unit and an attached device. During the initial selection sequence, the status byte is sent to the channel after the control unit receives a command.

Figure 3-5 shows the possible initial status bit configurations. An all-zero status byte is sent when a nonimmediate command is accepted for execution by the control unit; it is also sent in response to Test I/O if other status is not pending. The Unit Check bit is set if the command is not accepted by the control unit because of a program or equipment error.

Initial status to immediate commands is as follows. For No Operation, Channel End and Device End are both set to indicate completion of the command. For Select and Erase All Unprotected, which do not involve data transfer between the channel and the control unit, Channel End is set. This frees a block or byte multiplexer channel for other operations while the command is being executed. When command execution is completed, ending status is presented asynchronously.

If a Start I/O Fast Release (SIOF) is executed by the channel, then unchained initial status becomes ending status. (See *System/370 Principles of Operation*, GA22-7000.)

When status is pending (a previous status byte is awaiting transfer to the channel), the pending status byte, with the Busy bit set, is sent to the channel in response to any command (not to a Test I/O instruction), and that command is not accepted by the control unit. For Test I/O, the pending status byte is presented without the Busy bit set. If the pending status is for a device other than the one selected during the initial command sequence, only Busy, Status Modifier (B, SM) is presented to the channel and the pending status is retained at the control unit.

Status ¹ (Hex)	Sense (Hex)	Display	Printer	Error Recovery Procedure	Condition
All Zeros (00)		X	X		Normal status for any command other than No Operation, Select, or Erase All Unprotected.
CE (08)		X	X		Normal status for a Select or Erase All Unprotected command.
CE, DE (0C)		X	X		Normal status for a No Operation command.
UC (02)	BOC (20)	X	X	1	A parity check was detected on the command byte.
UC (02)	IR (40)	X	X	2	A command other than Sense was addressed to a device that the control unit has recorded as "unavailable" or "not ready".
UC (02)	CR (80)	X	X	3	An invalid command was issued to control unit.
B (10)		X	X		Response to a command addressed to a device which is being serviced by the control unit or which is completing a previously issued command.
B, SM (50)		X	X		Response to a command addressed to a device other than device whose status is pending or device being serviced by the control unit.

¹ If an SIOF is executed by the channel, unchained initial status becomes ending status.

Figure 3-5. Initial Status and Sense Conditions for 3274 B and D Units

Ending Status

When the control unit completes channel operations for a nonimmediate command, it sends an ending status byte to the channel, freeing the channel for other operations. This status byte always relates to the command operation that has been executed. The normal ending status byte for a Read Buffer, Read Modified, or Sense command will have only the Channel End and Device End bits set, indicating that the command has been executed. Normal ending status for a Write, Erase/Write, or Erase/Write Alternate command is Channel End alone. When the control-unit-to-device buffer transfer is completed, ending the command operation, Device End status is sent to the channel as asynchronous status. Any error condition associated with the operation just executed will cause additional status bits to be set. Figure 3-6 shows the possible ending status bit configurations. Ending status causes an I/O interruption unless chaining is specified.

When the control unit has pending status, it attempts to gain selection of the channel asynchronously to pass this status. It is passed to the channel either when selection is accomplished or as initial status for the next command (with the Busy bit set), whichever occurs first.

Asynchronous Status

Asynchronous status reflects: (1) the ending status of an "immediate" command other than No Operation; (2) the second ending status for a Write, Erase/Write, or Erase/Write Alternate command, indicating that all command-initiated operations are completed; (3) an action by the device operator that requires program intervention (attention status); or (4) a control unit or attached device equipment malfunction. Figure 3-7 shows the possible asynchronous status bit configurations.

When an asynchronous status condition occurs, the control unit attempts to gain selection by the channel (this is a hardware function), and passes this status to the channel when selection is accomplished. This status is called "pending" status until selection is accomplished. If the channel issues a command before retrieving this pending status, the pending status is returned, with the Busy bit set, in place of initial status for the command; in this case, the command is not executed, unless it is a Test I/O instruction.

When an asynchronous condition occurs at a device while the control unit is performing command operations with another device, the asynchronous status remains pending until the control unit completes the current command operation, returns ending status to the channel, and becomes not busy. The control unit then retrieves the pending status from the device and attempts to present it to the channel in the same manner as other asynchronous statuses.

Some other conditions of multiple status that can occur are not covered here. These conditions can be caused by multiple error conditions occurring simultaneously.

Status (Hex)	Sense (Hex)	Display	Printer	Error Recovery Procedure	Condition
CE ¹ (08)		X	X		Sent at end of data stream on Write, Erase/Write, or Erase/Write Alternate command.
CE, DE ^{1,2} (0C)		X	X		Sent at end of data stream on a Read Buffer, Read Modified, or Sense command or when channel byte count goes to zero on a Read Modified or Read Buffer command.
CE, DE, UC ² (0E)	BOC (20)	X	X	10	The control unit detected a parity error on a character in data stream of a Write, Erase/Write, or Erase/Write Alternate command. ³
CE, DE, UC ^{1,2} (0E)	DC, US (0C)	X	X	1	Addressed device detected a parity or cursor check during a Write, Read Buffer, or Read Modified command. Also, the control unit may disable the device because of error. (UC, IR is reported on the retry since the device requires a Power On Reset to be reenabled.)
CE, DE, UC ^{1,2} (0E)	DC (08)	X	X	1	The control unit detected a cursor or parity check during receipt of data stream on a Write, Erase/Write Alternate, or Erase/Write command.
CE, DE, UC ^{1,2} (0E)	DC (08)	X	X	10	The control unit detected a cursor or parity check during transmission of data stream on a Read Buffer or Read Modified command.
CE, DE, UC ^{1,2} (0E)	CC (02)	X	X	10	Addressed device failed to respond in a specified period of time to an Erase/Write, or Erase/Write alternate command, or an unchained Read Buffer, Read Modified or Write command, or the device security key was in the off position. When attached to a 3274 B unit, the addressed device was found to be in test mode or assigned as a local copy device. (UC, IR will be reported on a subsequent operation.
CE, DE, UC ² (0E)	OC (01)	X	X	3	The 3274 B unit received an invalid buffer address in data stream of a Write, Erase/Write, or Erase/Write Alternate command, or data stream ended before providing all characters required for an SBA, RA, SF, or EUA order on a Write, Erase/Write, or Erase/Write Alternate command. Also, when receiving a write type command with a WCC = X'88'.
					3274 D Units Only: An incorrect Select command chain sequence was received.
CE, DE, UE ^{1,2} (0D)		X	X	9	The control unit attempted to perform a Read Buffer, Read Modified, Write, Erase/Write, or Erase/Write Alternate command but found, after returning initial status, that the addressed device was "busy".

¹ Occurs if a Start IO Fast Release (SIOF) is executed by the channel for Select, Erase All Unprotected, or No Operation.

² If this status is stacked by the channel, CUE could be generated and combined with it before the stacked status is accepted by the channel.

³ A 3274 D unit updates the device buffer as it processes the data stream. A 3274 B unit does not change the device buffer until after the total data stream has been processed.

Figure 3-6. Ending Status and Sense Conditions for 3274 B and D Units

Status ¹ (Hex)	Sense (Hex)	Display	Printer	Error Recovery Procedure	Condition
A (80)		X			An attention-generating action (e.g., program access key has been depressed) was performed by the operator.
DE (04)		X	X		The control unit-to-device buffer transfer is completed on a Write, Erase/Write, or Erase/Write Alternate command which did not start a printer. The device becomes "not busy" after completing an Erase All Unprotected command or the printer becomes "not busy" after completing a printout. The device-to-control unit buffer transfer is completed on a Select command. A device changes from "not available" to "available" or from "not ready" to "ready". A device becomes "not busy" after having previously sent Unit Exception when the control unit attempted to execute a command with the device when it was "busy".
A, UC (82)	DC, US (0C)	X	X	1	An idle device detected a parity check or cursor check in its buffer, or an idle device on a 3274 has been disabled because of control-unit-detected errors. (UC, IR may be reported on the next retry since the device requires a Power On Reset.)
A, DE, UC (86)	IR (40)		X	6	The addressed printer became Not Ready (out of paper or cover open) before completion of a print operation.
DE, UC (06)	IR (40)		X	6	A command attempting to start a printer found it Not Ready.
A, DE, UC (86)	IR, EC, US (54)		X	6	A printer became mechanically disabled during a printout and an automatic recovery was not successful, the printer CARRIAGE MOTOR POWER switch was off, or the switch fuse was blown.
DE, UC (06)	IR, EC, US (54)		X	6	A command attempted to start a print operation, but the printer CARRIAGE MOTOR POWER switch is turned off.
A, DE, UC (86)	EC, US (14)		X	7	A printer character generator or sync check error occurred or the printer became mechanically disabled during printout, but restored itself.
DE, UC (06)	DC (08)	X	X	10	During a Select, Erase/Write, or Erase/Write Alternate command the control unit (1) detected a parity or cursor error, or (2) detected a parity check on data received from the addressed device in response to an internal poll during a command.

Figure 3-7 (Part 1 of 2). Asynchronous Status and Sense Conditions for 3274 B and D Units

Status ¹ (Hex)	Sense (Hex)	Display	Printer	Error Recovery Procedure	Condition
DE, UC (06)	DC (08)	X	X	1	During a Write command, the control unit (1) detected a parity or cursor error, or (2) detected a parity check on data received from the addressed device in response to an internal poll during a command.
DE, UC (06)	DC, US (0C)	X	X	1	The addressed device detected a parity or cursor check while executing a Select, Write, Erase/Write, Erase/Write Alternate, or Erase All Unprotected command. Also, the control unit may disable the device because of error. (UC, IR is reported on the retry since the device requires a Power On Reset to be reenabled.)
DE, UC (06)	OC (01) ²	X	X	3	A Write, Erase/Write, or Erase/Write Alternate command, containing a WCC with a Start Print bit, is chained to a subsequent command. The 3274 D unit received an invalid buffer address in data stream of Write-type command, or data stream ended before providing all characters required for an SBA, RA, SF, or EUA order on a Write-type command. A portion of the device buffer may have been changed. ³ The 3274 D unit received an incorrect Select command chain sequence.
DE, UC (06)	CC (02)	X	X	10	The addressed device failed to respond in a specified period of time to a Select, Write, Erase/Write, Erase/Write Alternate, or Erase All Unprotected command, a display was in test mode, the device's security key was in the off position, or a printer was assigned as a local copy device. (UC, IR will be reported on a subsequent operation.)
DE, UE (05)		X		9	The control unit attempted to perform a Select or Erase All Unprotected command, but found, after returning initial status, that the addressed device was busy.
CUE (20)		X	X		The control unit had been addressed while busy, but is now not busy and is free to accept a new command.

¹ If this asynchronous status is stacked by the channel, an asynchronous CUE could be generated and combined with it before the stacked status is accepted by the channel.

² The 3274 B units set OC upon receipt of a WCC = X'88'; the 3274 D units do not set OC upon receipt of a WCC = X'88'.

³ A 3274 D unit updates the device buffer as it processes the data stream. A 3274 B unit does not change the device buffer until the total data stream has been processed.

Figure 3-7 (Part 2 of 2). Asynchronous Status and Sense Conditions for 3274 B and D Units

Error-Recovery Procedures

|3274 B and D Unit Device-Detected Errors

Error conditions detected by the control unit or by an attached device are indicated to the program by Unit Check status. The program must respond to this status by using a Sense command for further definition of the condition. If a Sense command is not performed and the sense conditions still exist, the control unit will not honor any other interrupts from the devices. Subsequent recovery operations are then determined by the combined configurations of Unit Check status bits and associated sense bits.

Referenced Error-Recovery Procedures

The recovery procedures referenced in the Error Recovery Procedure column of Figures 3-5, 3-6, and 3-7 are as follows:

1. Reconstruct the entire buffer image and retry the failing chain of commands. The sequence of commands used to reconstruct this image should start with an Erase/Write command (or Erase/Write Alternate on a 3274). If, after two retries, the problem is not corrected, follow procedure 4.
2. The error indicates the device is "unavailable." Request and wait for operator intervention to "ready" the device; then, upon receipt of DE status, retry the chain of commands.
3. A nonrecoverable program error has occurred. Examine the data stream to locate the problem.
4. Request maintenance for the device that is giving trouble. After the repair, reconstruct the buffer image, starting with an Erase/Write command (or Erase/Write Alternate).
5. Record the error for future reference, and continue with the program. This error occurred while the control unit was "idle" and is not indicative of a data error.
6. The error indicates the printer is out of paper, has the cover open, or has a disabled print mechanism. Request operator intervention to "ready" the printer; then, upon receipt of DE status, retry the print operation by issuing a Write command with the proper WCC and no data stream. (There is no data error; the data is still intact in the device buffer and can be reused.) If this procedure is unsuccessful, follow procedure 1.
7. The error occurred during a printout and indicates either a character generator or sync check error or a disabled print mechanism. There is no buffer data error. The proper error recovery procedure is application-dependent since the user may or may not want a new printout. Because the buffer contents are still good, procedure 6 may be followed.
8. A data error occurred at the device during a printout. This indicates a data error at the device; procedure 1 should be followed.
9. A device is busy, but the control unit was not informed of this in time to respond with Busy status in the initial-status byte. A DE status will be generated asynchronously when the device becomes not busy. After the DE is received, retry the chain of commands that was being executed when the Unit Exception (UE) status was received.

10. Retry the failing chain of commands. If, after two retries, the problem is not corrected, follow procedure 1. A Write command to a 3274 D unit can be retried if new fields have not been created in the buffer portion which has been cleared by a Program Tab or Erase Unprotected to Address order.

Channel-Detected Errors

Errors detected by the channel are indicated to the program by the channel status byte in the channel status word (CSW). If the channel status byte indicates a Channel Control Check, an Interface Control Check, or a Channel Data Check, the recommended error-recovery procedure is to retry the chain of commands. If the problem is not corrected after three retries, request maintenance for the channel that is giving trouble.

Programming Note: *System/370 Models 155 and 158 may also present a machine check interrupt prior to the CSW store. When an IBM operating system is used, this machine check interrupt (HIR) is not seen by the I/O Supervisor (IOS) or by the device-dependent error-recovery procedures.*

Chapter 4. Remote Operations—BSC

Introduction

When using Binary Synchronous Communications (BSC) operating mode, the 3274 C units and 51C can communicate with the host program via an IBM 2701, 2703, 3704, 3705, or an equivalent Integrated Communications Adapter (hereafter called "TCU") and with appropriate data sets as specified for the control unit. (Hereafter the term "3274" is used to encompass the 3274 C units and 51C in BSC mode.)

The 3274 uses BSC procedures over duplex or half-duplex facilities (nonswitched or privately owned); these communications use the Multipoint Data Link mode of operation only.

Code Structures

Each 3274 can operate with one or two code structures: EBCDIC (Extended Binary-Coded Decimal Interchange Code) or ASCII (American National Standard Code for Information Interchange). The choice of code depends on the application. However, for system compatibility, the same code must be chosen for all units on a particular communications line.

Channel Program Concepts

In remote configurations, the TCU becomes the intermediary between the 3274 and the channel program. As such, the TCU, not the 3274, executes channel commands and initiates I/O interrupts. At the start of each I/O operation involving the TCU, the Start I/O instruction addresses the TCU and a communications line attached to that TCU; it does not address an individual remote control unit on that line. Subsequent CCWs in the channel program initiate TCU operations; they specify TCU commands, not 3274 commands.

Selection of a 3274 and all subsequent command operations are specified by character sequences in TCU Write CCW data streams. Write CCW data to the TCU communications line selected by Start I/O can contain: (1) address bytes to select a control unit on that line; (2) the code of a command (such as Erase/Write or Write) to initiate a control unit operation; or (3) orders and/or display/print data for the control unit buffer. In addition, this write data will contain the appropriate data-link control characters. Thus, all characters sent by the TCU to a 3274, with the exception of SYN, pad, and BCC characters, originate from the data stream of a Write CCW addressed to the TCU.

Programming Note: *All Write commands should be set for CCW chaining to a Read command when a response is expected. (This prevents a loss of data received by the TCU in response to Write command operations.) An exception to this requirement is when the Write command is used to issue EOT to the 3274.*

Text Blocking

The 3274 performs inbound text blocking. Each block of data can contain a maximum of 256 text characters. Of that total, each block contains the STX and ETB (or ETX) data-link control characters. Two address bytes (CU poll

address and device address) precede the read heading in the first block only and are included in the 256-character total. The last block of a message is terminated with ETX, which is also included in the 256-character total.

Programming Note: *If the automatic polling facility (Auto Poll) is used by the TCU, the Auto Poll index byte will add 1 byte to the text block created by the 3274.*

Block check characters (BCC) are transmitted as the last characters of a data stream. (Refer to "Redundancy Checking" described later in this chapter.) BCC is not counted as text because it follows the ETX and ETB data link characters. Upon successful comparison of the received BCC with the accumulated BCC, the program should respond with ACK to read the next block of text; each subsequent block is preceded by STX to initiate BCC accumulation by the TCU.

Text blocking does not disjoin the three-byte SBA order sequence (SBA code and two-byte field address) generated during execution of a Read Modified command. Therefore, the last characters of a block ending with an SBA sequence would be ... SBA, Address, Address, ETB (or ETX).

Related Publications

Readers who are unfamiliar with the binary synchronous method of communications should review the following publications, as applicable:

- *General Information—Binary Synchronous Communications*, GA27-3004
- *IBM 2701 Data Adapter Unit Component Description*, GA22-6864 (especially the section that describes the Synchronous Data Adapter—Type II)
- *IBM 2703 Transmission Control Components Description*, A27-2703 (especially the section on BSC capabilities)
- *Introduction to the IBM 3704 and 3705 Communications Controller*, GA27-3051

Multipoint (Nonswitched Line) Data Link Control

Each 3274 can operate on a nonswitched communications line with multiple stations. Time-sharing of the line is accomplished by interleaving transmissions between the TCU and all units on the line. A 3274 operates multidropped on the same line with other properly featured units, such as other 3270 units, IBM 2770s, and IBM 2780s.

The TCU is the *control station* of the multipoint, centralized network. All units attached by communications lines to the TCU are called *tributary stations*. The control station is the focal point of the network and maintains, under program control, an orderly flow of network traffic by initiating all data transfers. The control station is either the transmitter or receiver of every communication.

3274 Modes of Operation

In the multipoint environment, the 3274 is always in one of four modes of operation: control mode, text mode, transparent-monitor mode, or transparent mode.

Control Mode

The 3274 enters control mode whenever it transmits or receives a valid EOT sequence. While in control mode, the unselected 3274 monitors the communications line for the following:

1. A valid selection or poll addressing sequence, by which the 3274 will become selected for entry into text mode.
2. A DLE-STX sequence, placing the 3274 in transparent-monitor mode.

Text Mode

Once a 3274 is successfully selected, it enters text mode. In text mode, the 3274 is either a master station or a slave station, as is the TCU. This status depends on the operation being performed. The station that is transmitting a message is called the *master station*; the station that is receiving and acknowledging the message is called the *slave station*.

The 3274 becomes the master station (and the TCU the slave station) once it sends STX to the TCU while executing a Read command or a poll operation. As the master station, it can (1) transmit text messages and (2) transmit ENQ to request a reply or retransmission from the TCU. After transmission of the message is completed, the 3274 returns to control mode.

The 3274 becomes the slave station (and the TCU the master station) when executing a write-type command. As a slave station, it responds appropriately to master-station (TCU) transmissions.

Transparent-Monitor Mode

Transparent-monitor mode is provided with EBCDIC 3274s only. It permits the transmission of data in any of the 256 possible EBCDIC bit patterns between the TCU and another unit on the same communications line with the 3274. This data may be independent of the selected transmission code (EBCDIC). Examples of such format-independent data are packed-decimal data, programs (both source and object), core images, and other binary data. Thus, link control characters within this data will not inadvertently initiate a 3274 operation.

When an EBCDIC 3274 decodes a DLE STX sequence while in control mode, it enters transparent-monitor mode. While in this mode, the 3274 disregards *all* data configurations that may appear on the communications line except for (1) a transparent text sync sequence (DLE SYN) or (2) a transparent text-terminating sequence (DLE ITB, DLE ETX, DLE ETB, or DLE ENQ). The 3274 leaves transparent-monitor mode and returns to control mode (1) if a transparent text sync sequence is not received within any 3-second period or (2) if a transparent text-terminating sequence is decoded.

Transparent Mode

The 3274 provides transparent-mode transmission support (inbound and outbound) for the displays and printers that use the Extended Highlighting, Color, or Programmed Symbols function. Any data link control characters transmitted while the control unit is in transparent mode must be preceded by a

DLE to be recognized as control functions. The following control functions are used:

- DLE STX—Initiates transparent mode for the following text.
- DLE ETB—Terminates a block of transparent text, returns the link to normal mode, and calls for a reply.
- DLE ETX—Terminates the transparent text, returns the link to normal mode, and calls for a reply.
- DLE SYN—Used to maintain synchronization, or as a time-fill sequence for transparent mode.
- DLE ENQ—Indicates “disregard this block of transparent data” and returns the link to normal mode.
- DLE DLE—Used to transmit DLE as data when a bit pattern equivalent to DLE appears in the transparent text. One DLE is disregarded; the other is treated as data.
- DLE ITB—Terminates an intermediate block of transparent text, returns the data link to normal mode, and does not call for a reply. The BCC character follows DLE ITB.

The boundaries of transparent data are determined by the DLE STX and by the DLE ITB, DLE ETB, or DLE ETX control functions, which initiate and terminate the transparent mode of operation. The controller and the displays or printers that support the Extended Highlighting, Color, and Programmed Symbols functions can accept data in transparent mode at any time; acceptance is not related to the use of the Extended Highlighting, Color, or Programmed Symbols functions.

For outbound transparent text transmissions:

- Order splitting is permitted with a DLE ETB, meaning that the next block is a continuation of the text.
- DLE ETX processing is the same as in nontransparent mode; each block must start with a command sequence.
- On a teleprocessing line error, after a return of NAK by the 3274, either a retransmission of the block or an EOT is expected from the sender.
- When a program error is found in the data, or a device error occurs during the processing of a block, the 3274 returns an EOT.
- NAK is returned by the 3274 when a transmission has DLE ETX or DLE ETB missing.

Note: *Block size is to be limited to 3,000 bytes in a Write Structured Field (WSF) transmission containing the LPS structured field.*

Inbound Transparent Transmissions: The 3274 C units and 51C transmit inbound data in transparent mode only if:

- The inbound reply mode is extended field.
- The inbound reply mode is character.
- The inbound data stream includes structured fields.

Transparent Text Blocking (Outbound): The following example illustrates the sequence expected during outbound blocking.

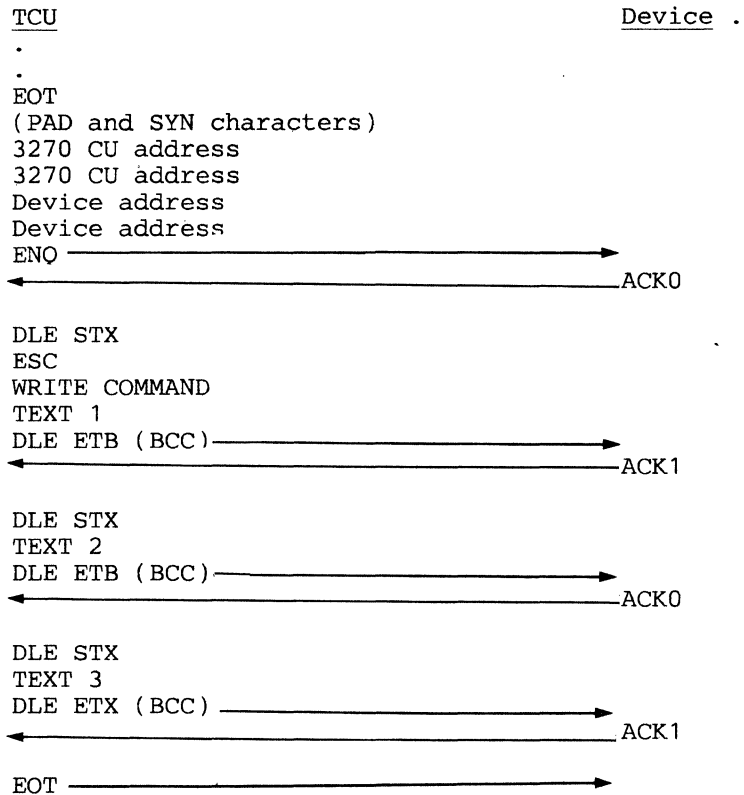

Order sequences may be split in the blocking process. For example, one block may end with:

```
SBA
DLE ETB (BCC)
```

and the next block continue with:

```
DLE STX
ADDRESS
ADDRESS
```

Outside of transparent mode, ETB is treated as an ETX function. If the transmission for TEXT 2 in the example had omitted the DLE prefix, ETB would have been treated as ETX and the transmission acknowledged, but the transmission for TEXT 3—not beginning with a command—would have been treated as an error.

If the outbound blocked transmission contains a read command, the ETB is treated as ETX. The read data stream is transmitted.

If a text block other than the first in the transmission contains a command, the second command sequence (ESC, CMMD) is treated as data. The device is in transparent mode, expecting a text block, and is not checking for a command sequence in the incoming transmission.

When a text block is expected, and another BSC control sequence, such as RVI or WACK, is received, the device ignores it. The effect is a timeout at the TCU.

Redundancy Checking

A redundancy check is performed on the following communications line data:

1. 3274 command-sequence characters (including the write data of a Write, Erase/Write, or Erase/Write Alternate command).
2. Data transmitted to the TCU in response to a read-type command or to a polling sequence.

A block check character (BCC) is accumulated for each block of data at both the TCU and the 3274. If EBCDIC code is used, a 2-byte BCC is generated (cyclic redundancy check accumulation); if ASCII code is used, a 1-byte BCC is generated (longitudinal redundancy check accumulation).

BCC accumulation is initiated by, but does not include, the first STX or SOH framing character. All characters following this STX or SOH, up to and including the end-of-block character (ETB or ETX), are part of the accumulation. Following the ETB or ETX character, the transmitting unit transmits its BCC character(s). The receiving unit then compares this character(s) with the BCC it has accumulated. If the redundancy accumulations are different, a transmission error has occurred.

When the 3274 is the receiving unit and detects a BCC error, it responds to the transmission by sending NAK to the TCU. When the TCU is the receiving unit, it will set Unit Check in the ending status for the TCU command being executed when the BCC error was detected; also, it will set Data Check in the sense byte.

Note: *BCC characters are removed from the data stream when received for comparison by the TCU or by the 3274; they are not stored in main storage or in the 3274 buffer.*

In both EBCDIC and ASCII, transmission formats (data link controls) are rigidly screened so that communication is orderly and accurate. Improper transmissions are ignored or rejected to avoid the acceptance of faulty messages. Received or transmitted data blocks are counted odd-even-odd-even, etc., by both the transmitter and receiver (by means of ACK 0's and ACK 1's), and their counts must agree at each block-check point.

Data-Link Control Characters

Two types of characters are transmitted between the TCU and the 3274: CU data-link control characters and 3274 message data. Data-link control characters are used for such purposes as message framing, acknowledgment that received message data was valid or invalid, and identification of the start- or end-of-text transmission. Data-link control characters are used (singly or in sequences) by the TCU (under program control) and by the 3274 to establish and control all data link operations in an orderly fashion. The 3274 message data consists of all address, command, order, and display/print characters sent to the 3274 and of all buffer data, AID bytes, and status/sense bytes read from the 3274. Data-link control characters are described individually in the

following paragraphs and are described with 3274 message data later in this chapter (under “Operational Sequences”).

The data-link control characters, with their EBCDIC or ASCII codes, are as follows:

<u>Data-Link</u> <u>Control Character</u>	<u>EBCDIC (Hex)</u>	<u>ASCII (Hex)</u>
ACK 0 (2 bytes)	1070	1030
ACK 1 (2 bytes)	1061	1031
DLE	10	10
ENQ	2D	05
EOT	37	04
ESC	27	1B
ETB	26	17
ETX	03	03
ITB	1F	1F
NAK	3D	15
RVI (2 bytes)	107C	103C
SOH	01	01
STX	02	02
SYN	32	16
TTD	022D	0205
WACK	106B	103B

All control characters transmitted by the TCU (except pad and SYN) are issued by the channel program as part of a TCU Write CCW data stream. All control characters transmitted to the TCU are generated by the control unit; a Read command to the TCU is used to store these characters (except pad and SYN) into main storage for subsequent analysis by the access method.

Pad

Pad characters, leading and trailing, are generated by TCU or 3274 hardware to ensure complete transmission or reception of the first and last significant character of each transmission.

SYN (Synchronous Idle)

Two consecutive SYN characters are generated by TCU or 3274 hardware to establish character synchronization. The TCU can also embed SYN characters in text for time-fill to maintain synchronization; the 3274 discards these SYN characters (does not store them in the buffer).

DLE (Data Link Escape)

DLE is always the first byte in the following 2-byte control characters: ACK 0, ACK 1, WACK, and RVI. DLE is also used as the first character in several 2-character sequences that are used in transparent-monitor mode (described earlier in this chapter under “Transparent Monitor Mode”).

ACK 0 (Even Acknowledge)

ACK 0 is a 2-byte character, as follows:

- EBCDIC: 1070 (hex)
- ASCII: 1030 (hex)

ACK 0 is transmitted by the 3274 after a successful selection addressing (not poll) sequence to indicate to the TCU that the 3274 is ready to accept transmission. ACK 0 is also transmitted by the 3274 or by the TCU upon receipt and validation of an even-numbered (second, fourth, etc.) text block.

ACK 1 (Odd Acknowledge)

ACK 1 is a 2-byte character, as follows:

- EBCDIC: 1061 (hex)
- ASCII: 1031 (hex)

ACK 1 is transmitted by the 3274 or TCU upon receipt and validation of an odd-numbered (first, third, etc.) text block.

NAK (Negative Acknowledgment)

NAK is transmitted by the 3274 in response to a TCU text transmission that (1) terminates with ENQ, (2) has ENQ embedded in text, (3) has invalid BCC, (4) contains a TTD sequence (STX ENQ), or (5) has ETX missing.

When NAK is received by the 3274 in response to a text transmission, the 3274 retransmits the last block of text.

Programming Note *The TCU should be programmed to respond with NAK to an ENQ (that ends a text block) from the 3274; this NAK causes the 3274 to send EOT and retain the status for error recovery.*

ENQ (Enquiry)

The 3274 transmits ENQ (1) to request a reply from the TCU following a 3-second timeout, (2) to request retransmission of the previous reply from the TCU, or (3) as the last character of a text message in which a data check was detected by the 3274. (See "Programming Note" above.)

When the 3274 receives ENQ in response to a transmission, the last 3274 transmission to the TCU is repeated. The 3274 responds with NAK when ENQ is received (1) as the last character of a TCU-aborted text transmission, (2) embedded in text, or (3) as part of a TTD sequence (STX ENQ).

To be addressed successfully, the 3274 must receive ENQ as the last character of a polling or selection addressing sequence.

WACK (Wait before Transmit)

WACK is a 2-byte character, as follows:

- EBCDIC: 106B (hex)
- ASCII: 103B (hex)

WACK is generated by the 3274 (1) in response to a selection addressing (not poll) sequence when a printer or a 3277 attached to the 3274 is busy, and (2) in response to a Write or Copy command text transmission when the Start Printer bit is set in the WCC or CCC. The 3274 responds with ENQ to a WACK from the TCU.

RVI (Reverse Interrupt)

RVI is a 2-byte character as follows:

- EBCDIC: 107C (hex)
- ASCII: 103C (hex)

RVI is generated by the 3274 in response to an attempted selection (not poll) by the TCU when the 3274 has a status and sense message to be transmitted. Whenever the 3274 accepts RVI from the TCU, the 3274 responds with EOT and resets all pending status and sense information. The 3274 accepts RVI in place of ACK 0 or ACK 1 and then only when they would have been valid. If RVI is received at the 3274 in response to RVI, a timeout occurs at the 3274.

STX (Start of Text)

The 3274 receives STX as the first character of a command or TTD sequence. The STX causes the 3274 to clear its BCC and start accumulating a new BCC (STX is not included in the accumulation). Subsequent STX (and SOH) characters are included in the BCC accumulation. STX is transmitted by the 3274 to the TCU as the first character of a read-data text block except in a status or test-request message; this STX causes the TCU to start accumulating a new BCC (STX is not included in the accumulation).

The first character in status and test-request messages is SOH, with STX following two header characters. With a message of this type, the TCU starts BCC accumulation upon receipt of the first SOH; the subsequent STX character is included in the BCC accumulation.

SOH (Start of Heading)

The 3274 generates SOH in a 3-character heading sequence that identifies the accompanying data as a status message (SOH, %, R, STX, ---) or as a test-request message (SOH, %, /, STX, data ---). The TCU starts BCC accumulation upon receipt of SOH (SOH is not included in the accumulation).

ETB (End of Transmission Block)

During a message transfer operation, ETB informs the receiving unit that BCC follows. The 3274 treats ETB as though it were ETX by checking BCC and then generating the appropriate response; the 3274 does not accept conventionally blocked outbound text.

ETX (End of Text)

During a message transfer operation, ETX informs the receiving unit that BCC follows. The 3274 transmits ETX at the end of the last (or only) block of a text message. Then, upon successful comparison of the received BCC with the accumulated BCC, the program should respond with ACK to the 3274. If the BCC comparison is unsuccessful, the TCU interrupts the program (Channel End, Device End, and Unit Check status, with Data Check set in the sense byte); the program should respond with NAK to the 3274. Receipt of ETX by the 3274 initiates a BCC comparison, causes a line turnaround, and causes generation of an appropriate response to the TCU.

EOT (End of Transmission)

EOT is transmitted by the 3274 (1) when the 3274 is a slave station and is unable to perform an operation requested by the TCU; (2) when the 3274 is a master station, as normal termination of a read operation; (3) when the 3274 has completed General Poll operations with each attached device; or (4) as an answer to RVI sent by the TCU. Line synchronization is dropped, and the 3274 is returned to control mode. Note that the program can also issue EOT to the 3274 in order to drop line synchronization and return the 3274 to control mode. EOT does not reset status and sense in the 3274; therefore, it should not be sent as a response to a status message.

Following receipt of a valid selection addressing sequence, if an error occurs during buffer transfer, the 3274 will provide a positive response to the selection sequence and internally set DC and US status. EOT is sent in response to the following 3270 command or poll.

ITB (End of Intermediate Transmission Block)

The 3274 does not accept conventionally blocked text. However, to coexist on a BSC multipoint line on which ITB may be used, the 3274 includes the ITB and associated BCC in its own BCC accumulation but then removes them from the data stream so that they are not stored in the buffer. The 3274 does not perform a BCC comparison at that time, but continues the receive operations until ETB or ETX is decoded.

ESC (Escape)

ESC must precede the command code in each command-sequence data stream transmitted to the 3274, as follows: STX, ESC, CMD, ---. The 3274 does not generate ESC.

TTD (Temporary Text Delay)

TTD is a two-character sequence: STX ENQ. The 3274 responds to TTD by transmitting NAK to the TCU. The 3274 does not generate TTD. TTD may also be used by the master station to terminate an operation (that is, initiate a forward abort). The 3274 (slave station) will always respond with a NAK, expecting the master station to transmit EOT. In this case, the slave station interprets this sequence as a controlled forward abort rather than an end of transmission.

Operational Sequences (Nonswitched Line)

The following paragraphs describe the various data and control sequences that can be performed with the 3274 operating on a nonswitched line. These sequences are divided into four categories:

1. Specific and General Poll
2. Selection addressing
3. Write and control type commands
4. Read-type commands

The description of each category is associated with a Sequence/Response Diagram, which shows (1) all 3274 responses to program-generated transmissions by the TCU and (2) normal program-handling of 3274 transmissions. These diagrams show the I/O supervisor/access method as examining each 3274 response to determine which operation to initiate next; however, for specific applications, additional use of command chaining in the channel programs may be desirable.

A selection addressing sequence selects a 3274 and an attached device for subsequent command operations. Polling sequences are selection sequences used specifically to obtain pending status at a device. Either a Specific Poll sequence requesting status from a particular device or a General Poll sequence sent to all devices may be executed.

Remote Chaining of 3270 Commands

For remote operations, 3270 command codes are included in the data stream of a Write CCW to the TCU. Remote chaining of 3270 commands is defined as the transmission of more than one command sequence to a 3274 following a single selection addressing or poll sequence. This chaining normally is accomplished with separate Write CCWs in the channel program. For example, the channel program could (1) write selection addressing sequence and read the response for evaluation by the I/O supervisor/access method, (2) write a 3270 Write command and text block and read the 3274 response for evaluation, and then (3) write a 3270 Write command followed by a second text block and read the 3274 response for evaluation.

The program may chain 3270 commands following a selection addressing sequence provided that the BSC rules governing limited conversational mode are observed. (Refer to *General Information Binary Synchronous Communications*, GA27-3004.) The 3274 permits any valid command to be chained following a poll sequence; however, Read Buffer or Read Modified should not be chained because the BSC rules for limited conversational mode (a maximum of two consecutive data transfers without an intervening ACK) will be violated.

Any 3270 command (except Erase All Unprotected) may be chained from a Write, Erase/Write, Erase/Write Alternate, or Copy command. However, if the Write, Erase/Write, Erase/Write Alternate, or Copy command has started a print operation, the 3274 will abort the subsequent chained command (the print operation is completed normally).

General and Specific Poll Sequences

When a General or Specific Poll sequence is issued (Figure 4-1), one of three possible results occurs:

1. If status and sense information is pending with or without an AID present, a status and sense message is generated.
2. If status and sense information is not pending and an AID is present, a Read Modified command is executed.
3. If there is no status or sense information or *no* AID pending, an EOT response is generated.

Figure 4-9 lists the conditions under which status and sense messages are transmitted.

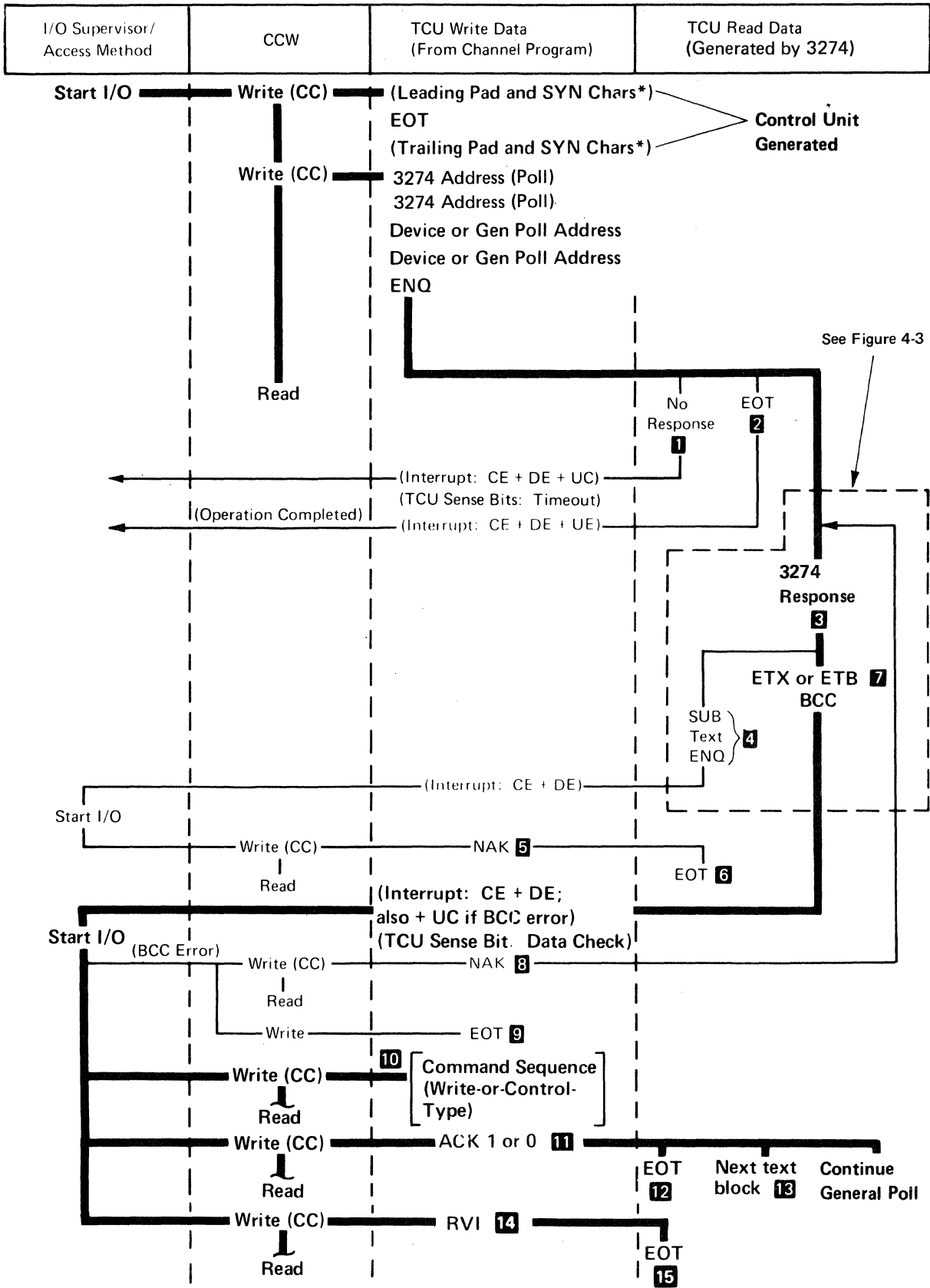

Figure 4-1 (Part 1 of 2). General Poll and Specific Poll, Sequence/Response Diagram

Notes:

- 1** The 3274 will fail to respond to the addressing or polling sequence, causing a TCU timeout, for any of the following reasons:
 - The 3274 is “unavailable” (has power off, is “offline”, or is not attached).
 - Any character in the polling sequence is invalid.
 - The characters in the polling sequence are out of order.
 - The polling sequence is incomplete (less than seven characters).
 - The 3274 address is incorrect in the write data stream.
 - The addressed 3274 was left selected from the previous transmission.
- 2** There is no I/O pending nor pending status. For General Poll, the CU sends EOT only after polling all devices.
- 3** The device response is a function of the kind of device and its status. Types of responses include: Text, Status, and Test Request messages. (Refer to Figure 4-3.)

For General Poll, the search for a response starts at some random device address and continues sequentially (as long as ACKs are received in response to text transmissions) until all devices are given the opportunity to respond.
- 4** Upon detection of an internal parity check or a cursor check, the 3274 (1) substitutes the SUB character for the character in error, (2) records Data Check status, and (3) transmits an ENQ in place of ETX (or ETB) and BCC at the end of the text block. The General Poll process is stopped.
- 5** Mandatory program response to a text block terminated in ENQ.
- 6** Terminates the operation. The nature of the error (parity or cursor check) does not warrant a retry. This response indicates that status and sense information is stored. The status retrieval information included in Figure 4-6, Note 2, applies.
- 7** ETB is used to frame each block of a blocked text message, except the last block. ETX is used to frame the last block of a blocked text message.
- 8** BCC error has been detected. The program issues NAK to cause the 3274 to repeat its last transmission.
- 9** Response issued by the program to terminate the operation if the TCU is unsuccessful in receiving a valid BCC following “n” attempts by the 3274 to transmit the message. This response does not cause the 3274 to reset its sense/status information. Therefore, the same status message will be transmitted if a Specific Poll is immediately issued to the same device.
- 10** This transmission must be a write or control-type command sequence (described in Figure 4-5). A read-type command would violate BSC standards on limited conversational mode.

For General Poll, this transmission stops the polling operation. The General Poll must be reinitiated to ensure receipt of all pending device messages.
- 11** Positive acknowledgment. The text block has been successfully received by the TCU. The program issues ACK 1 in response to the first and all odd-numbered text blocks and issues ACK 0 in response to the second and all even-numbered text blocks.
- 12** Normal termination of a Specific or General Poll
- 13** The second and all succeeding text blocks are framed as the first except they do not include the 3274/device address sequence.
- 14** RVI to terminate polling sequence.
- 15** Termination of polling sequence on receipt of RVI.

LEGEND:

(CC) = Chain Command (CC) Flag in CCW is set to 1.

(Interrupt) = TCU-generated interrupt (CE = Channel End, DE = Device End, UE = Unit Exception, UC = Unit Check).

*Only the critical framing characters (sync pattern and pad) are shown. All other framing characters are also hardware-generated as required. See SL *General Information - Binary Synchronous Communications*, GA27-3004, for a complete description.

Figure 4-1 (Part 2 of 2). General Poll and Specific Poll, Sequence/Response Diagram

Control unit and device address bytes transmitted for the General and Specific Poll sequences are as follows:

1. General Poll Address byte sequence:
3274 Poll Address
3274 Poll Address (See Figure 4-2.)
7F (EBCDIC) or 22 (ASCII) } Used in place of the two
7F (EBCDIC) or 22 (ASCII) } device-address bytes.

2. Specific Poll address byte sequence:
3274 Poll Address }
3274 Poll Address } (See Figure 4-2.)
Device Address }
Device Address }

The selected 3274 remains selected at the completion of a poll operation so that the program can issue a Write, Erase/Write, Erase/ Write Alternate, Copy, or EAU command without reselecting the 3274 and the device; command operations will be with (1) the device that was selected by Specific Poll or (2) the device from which a response was last received during the General Poll operation. Selection is dropped when the 3274 transmits EOT; the 3274 transmits EOT when the 3274 has no pending status or messages, or after it receives NAK from the TCU in response to a message that ends with ENQ.

Specific Poll addresses the 3274 and one device to determine if status and sense information or a manually entered message is awaiting transfer to the TCU. The pending status and sense information or message is transferred automatically by the 3274 upon receipt of the Specific Poll addressing sequence.

When a General Poll addresses the 3274, each attached device is examined in the order in which the ENTER key was pressed. If a message is present, it is transferred to the TCU. Each message is accompanied by the address of the device from which it originated.

Upon completion of this transfer, an ACK response from the program causes the 3274 to continue the General Poll operation, either by transferring another block of a text message or by examining other attached devices for pending messages. The program could issue a command rather than ACK to the device from which the message was just received only after inbound blocks that end with ETX. The 3274 will ignore any commands that are sent in response to a block of data that ends with ETB. Once the 3274 has examined all attached devices and has successfully transferred all pending messages, it generates EOT and returns to control mode. If the program wishes to terminate the General Poll, an RVI may be issued to the 3274, forcing an EOT response. A command issued rather than the ACK (after blocks that end with ETX) will also terminate the General Poll.

Figure 4-3 shows the message formats. Note that a device address is not provided in the heading of a Test Request message. An address must be manually entered by the operator as part of the text; this is because the operator may specify the address of another device for test operations with the program.

The status and sense bits are described later in this chapter under "Status and Sense (S/S) Bytes."

Column 1				
Use this column for:				
<ul style="list-style-type: none"> ● Device Selection, ● Specific Poll, ● General Poll, and ● Fixed Return Addresses 				
CU or Device Number	EBCDIC I/O Char.	EBCDIC Hex (Note 1)	ASCII I/O Char.	ASCII Hex
0	SP	40	SP	20
1	A	C1	A	41
2	B	C2	B	42
3	C	C3	C	43
4	D	C4	D	44
5	E	C5	E	45
6	F	C6	F	46
7	G	C7	G	47
8	H	C8	H	48
9	I	C9	I	49
10	¢	4A	[5B
11	.	4B	.	2E
12	<	4C	<	3C
13	(4D	(28
14	+	4E	+	2B
15	or !	4F	!	21
16	&	50	&	26
17	J	D1	J	4A
18	K	D2	K	4B
19	L	D3	L	4C
20	M	D4	M	4D
21	N	D5	N	4E
22	O	D6	O	4F
23	P	D7	P	50
24	Q	D8	Q	51
25	R	D9	R	52
26	!	5A]	5D
27	\$	5B	\$	24
28	*	5C	*	2A
29)	5D)	29
30	:	5E	:	3B
31	∩ or ^	5F	^	5E

Column 2				
Use this column for:				
<ul style="list-style-type: none"> ● 3274 Selection Addresses ● Test Requests 				
CU Number	EBCDIC I/O Char.	EBCDIC Hex (Note 1)	ASCII I/O Char.	ASCII Hex
0	-	60	-	2D
1	/	61	/	2F
2	S	E2	S	53
3	T	E3	T	54
4	U	E4	U	55
5	V	E5	V	56
6	W	E6	W	57
7	X	E7	X	58
8	Y	E8	Y	59
9	Z	E9	Z	5A
10		6A		7C
11	,	6B	,	2C
12	%	6C	%	25
13	-	6D	-	5F
14	>	6E	>	3E
15	?	6F	?	3F
16	0	F0	0	30
17	1	F1	1	31
18	2	F2	2	32
19	3	F3	3	33
20	4	F4	4	34
21	5	F5	5	35
22	6	F6	6	36
23	7	F7	7	37
24	8	F8	8	38
25	9	F9	9	39
26	:	7A	:	3A
27	#	7B	#	23
28	@	7C	@	40
29	'	7D	'	27
30	=	7E	=	3D
31	" (Note 2)	7F	"	22

Examples:

3274 Addressing			
General Poll CU5	CU Address	EBCDIC	ASCII
		{ C5	45
Device Address	{ 7F	22	
	{ 7F	22	
Specific Poll Device 4 on CU5	CU Address	{ C5	45
		{ C5	45
Device Address	{ C4	44	
	{ C4	44	
Select Device 4 on CU5	CU Address	{ E5	56
		{ E5	56
Device Address	{ C4	44	
	{ C4	44	

Notes:

1. Graphic characters for the United States I/O interface codes are shown. Graphic characters for EBCDIC 4A, 5A, 5B, 7B, 7C, and 7F might differ for particular World Trade I/O interface codes. Refer to *IBM 3270 Information Display System: Character Set Reference*, GA27-2837, for possible graphic differences when these codes are used.
2. I/O character address ("") is used as the device address to specify a General Poll operation.

Figure 4-2. Remote Control Unit and Device Addressing

(Note: This figure is referenced in Figures 4-1 and 4-6.)

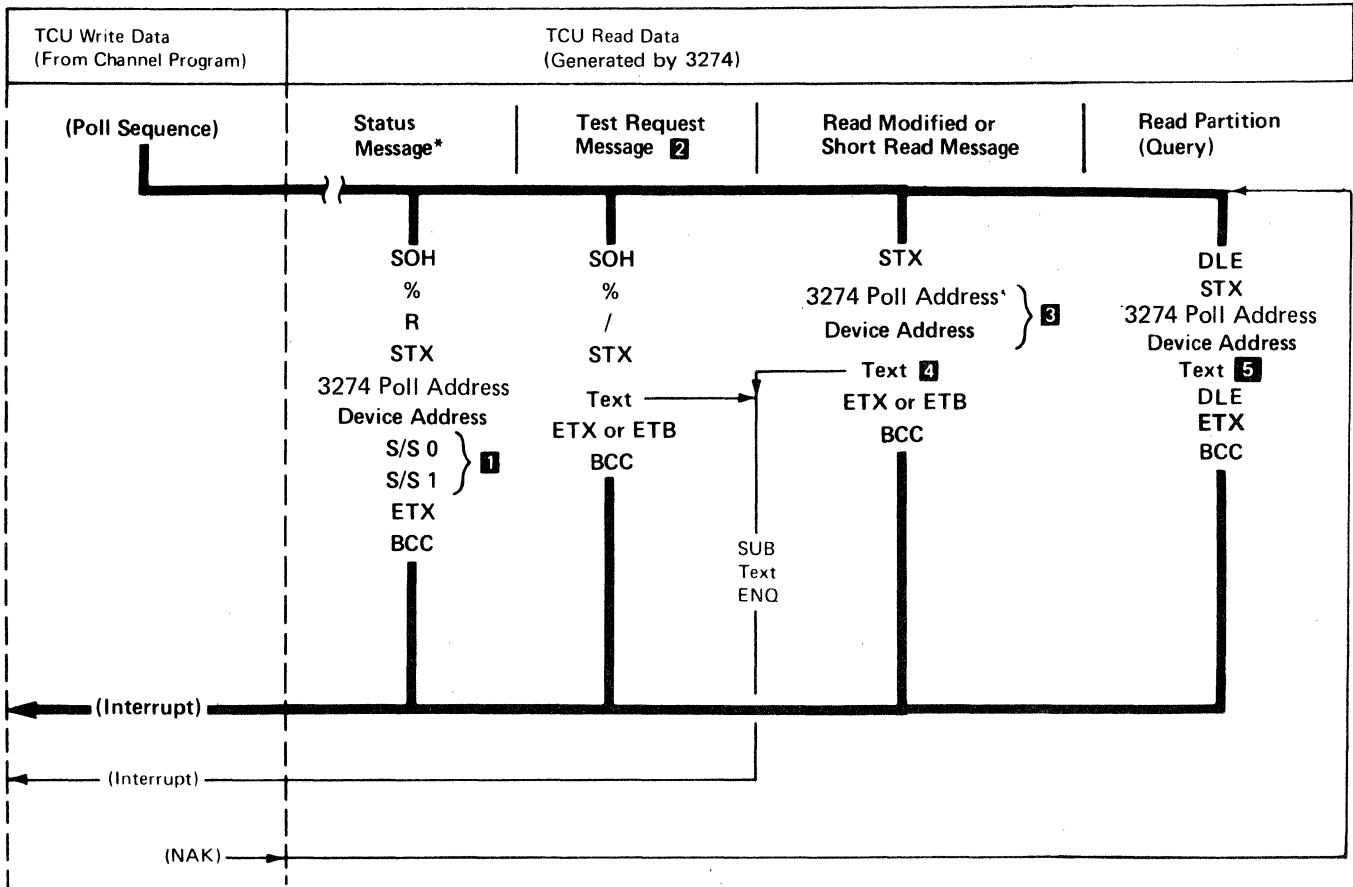

*Response to General Poll or Specific Poll only (not program-generated Read Modified command)

Notes:

- 1 A status message response is issued to a General or Specific Poll if (1) the 3274 has pending status (General Poll ignores Device Busy and device "unavailable" and, if the 3274 continues polling of next device), or (2) if error status develops during execution of the poll. Status and sense bit assignments are described in Figure 4-7.
- 2 A Test Request Message response is issued to a General or Specific Poll if a TEST REQ key is pressed at the keyboard of a polled 3277, or if a SYS REQ key is pressed at a 3278 or 3279 attached to a 3274.
- 3 This address is included only in the first block of a blocked text message.
- 4 The text portion of this message is the result of either a Read Modified or Short Read operation by the 3274. Figure 4-5 lists each operator action and the resulting read operation that will be performed.
- 5 The text portion of this message is the result of a Read Partition (Query) structured field function.

LEGEND:

(Interrupt) = TCU-generated interrupt.

Figure 4-3. 3274 Message Response to Polling or Read Modified Command

Selection Addressing Sequence

The selection addressing sequence (Figure 4-4) specifies a 3274 and an attached device in preparation for write-, control-, or read-type command sequences. It is similar in format to a Specific Poll sequence in that a 3274 address is sent, followed by a device address, but different I/O characters and hex codes are used to represent the 3274 address bytes. Column 1 in Figure 4-2 lists the characters and hex codes used to complete the selection addressing sequence. Comparative examples of 3274 and device address codes for General Poll, Specific Poll, and selection addressing sequences are shown at the bottom of Figure 4-2.

For the 3274, the selection addressing sequence performs a function similar to a local Select command in that it causes a device-to-control unit buffer transfer. The 3274 provides a positive response to a selection sequence before transfer of a device buffer to the 3274. If an error occurs during buffer transfer, following receipt of a valid selection addressing sequence, a positive response to the selection sequence is provided by the 3274, and DC and US status are internally set. EOT is sent in response to the following command.

Write-Type and Control-Type Command Sequences

The program initiates a Write, Erase/Write, Erase/Write Alternate, Copy, or EAU operation (Figure 4-5) by first writing a command and, except for EAU, a data sequence to the selected 3274 and then reading the response. All write-type commands and Copy commands must be followed by a minimum of one data byte (the WCC or CCC byte). If the program reads a positive response (ACK) from the 3274, it can terminate the operation or continue with another command. The program can write blocks of text to the 3274 by initiating, after receipt of each ACK, a Write command sequence for each block to be written.

Write data is blocked to devices attached to a 3274 as follows: Each time the 3274 receives a selection addressing sequence, it begins to transfer the device buffer contents to the control unit buffer. As the Write command data is received by the control unit, updating occurs, and the result is asynchronously transferred to the buffer of the addressed device. The device buffer contents not affected by the write data stream remain unaltered in the device buffer. If the transmission of a block of data to the control unit is successful (ACK reply), a device-to-control-unit-buffer transfer is begun. If the transmission of a block of write data to the control unit is unsuccessful (e.g., NAK reply), the buffer contents previously stored in the control unit buffer are immediately transferred to the device buffer before another Write command is received. These contents include any previous text blocks that were written successfully. Thus, the 3274 can receive retransmission of the block that was unsuccessfully received.

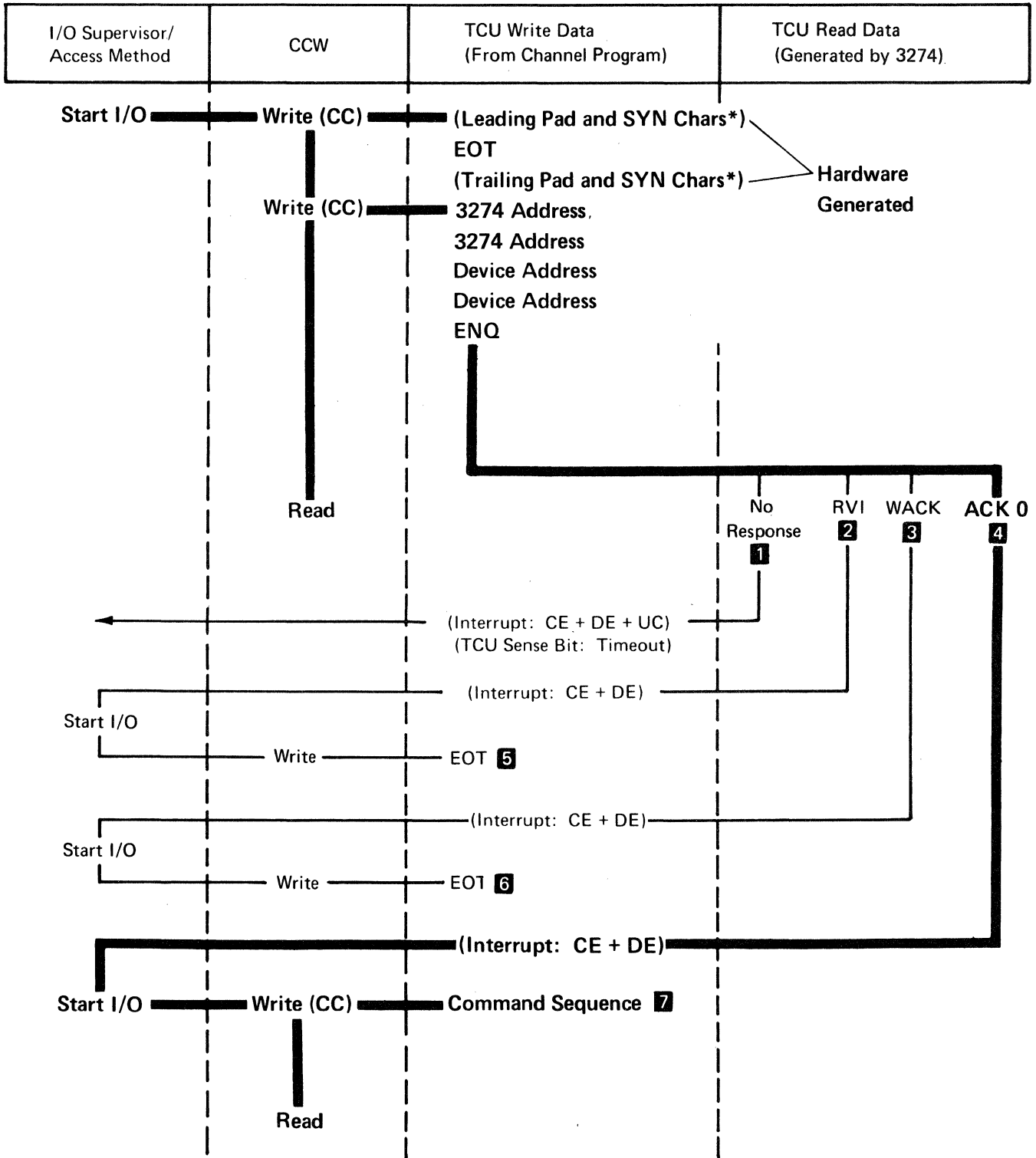

*Only the critical framing characters (sync pattern and pad) are shown. All other framing characters are also hardware-generated as required. See *SL General Information – Binary Synchronous Communications, GA27-3004*, for a complete description.

Figure 4-4 (Part 1 of 2). Selection Addressing, Sequence/Response Diagram

Notes:

- 1** The 3274 will fail to respond to the addressing or polling sequence causing a TCU timeout, for any of the following reasons:
 - The 3274 is “unavailable” (has power off, is “offline”, or is not attached).
 - Any character in the polling sequence is invalid.
 - The characters in the polling sequence are out of order.
 - The polling sequence is incomplete (less than seven characters).
 - The 3274 address is incorrect in the write data stream.
 - The addressed 3274 was left selected from the previous transmission.
- 2** 3274: The addressed device has pending status (excluding Device Busy or Device End).
- 3** The addressed 3274 is busy. No S/S information is stored. An RVI response takes precedence over a WACK response.
- 4** The address has been successfully received, no status is pending.
- 5** Termination of attempted addressing sequence: Availability of valid status and sense information cannot be ensured unless a Specific Poll is issued to the responding device as the next addressing sequence issued to this 3274.
- 6** Termination of attempted addressing sequence.
- 7** Refer to Figure 4-5 or 4-6 for the desired command sequence.

LEGEND:

(CC) = Chain Command (CC) Flag in CCW is set to 1.

(Interrupt) = TCU-Generated interrupt (CE = Channel End, DE = Device End, and UC = Unit Check)

Figure 4-4 (Part 2 of 2). Selection Addressing, Sequence/Response Diagram

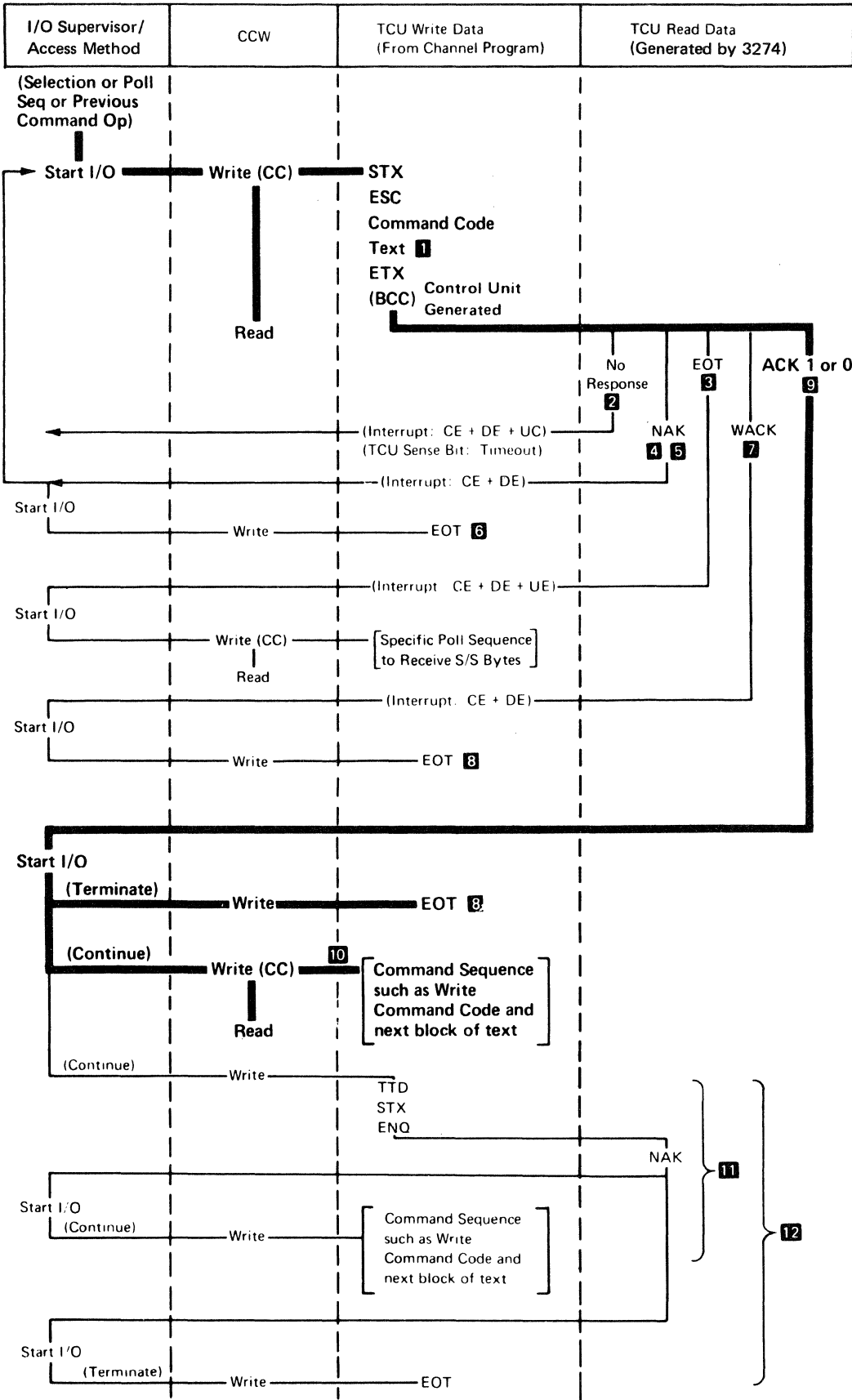

Figure 4-5 (Part 1 of 2). Write-Type and Control-Type Commands, Sequence/Response Diagram

Notes:

- 1** No text is transmitted on an EAU command transmission.
- 2** Command transmission was not successfully received because of invalid framing (STX missing). Causes a timeout at TCU.
- 3** The 3274 is unable to perform the operation indicated in the command transmission because of a busy/unavailable/not ready device.
- 4** If a transmission problem causes both a 3274 detected check condition and a BCC error, the BCC error takes precedence over all other check conditions, and a NAK is transmitted to the TCU.
- 5** BCC error or missing ETX has been detected. The NAK response requests the program to repeat its last transmission.
- 6** Response issued by the program to terminate the operation if the 3274 is unsuccessful in receiving a valid BCC following "n" attempts by the program to transmit the message.
- 7** If the Start Printer bit is set in the WCC or CCC, a WACK response indicates that the text transmission was successfully received but that the printer is now busy and an additional chained command cannot be accepted.
- 8** Normal termination of the operation by the program.
- 9** Command execution has been successfully completed.
- 10** Repeat the operation shown in this figure or in Figure 4-6 for the next command sequence.
- 11** Example of a Temporary Text Delay (TTD) sequence.
- 12** Example of terminating an operation using TTD (a forward abort sequence).

LEGEND:

(CC) = Chain Command (CC) Flag in CCW is set to 1.

(Interrupt) = TCU-generated interruption (CE = Channel End, DE = Device End, UE = Unit Exception, UC = Unit Check).

Figure 4-5 (Part 2 of 2). Write-Type and Control-Type Commands, Sequence/Response Diagram

Read-Type Command Sequences

Programming Note: *Read Buffer is used primarily for diagnostic purposes, and Poll (General and Specific) is normally used in place of Read Modified for remote read operations.*

The program initiates a read operation (Figure 4-6) by first writing a command sequence to the selected 3274 and then reading the response. If the 3274 responds with text followed by ETB, and if BCC comparison at the TCU is successful, the program should write ACK to retrieve the next block. This should continue until an error is detected or until a text block is followed by ETX. After ETX is received, the program should write ACK to the 3274 and then read the EOT reply. The three types of Read Modified message responses are shown in Figure 4-3.

The 3274 will retransmit text up to 15 times when NAK or an incorrect ACK is received or when ENQ is received in response to a conversational text reply to a Read command. The 3274 supports limited-conversational-text mode. If the host transmits a text block following receipt of a text transmission which ends in ETB, a timeout occurs at the 3274 and ENQ is sent to the host.

Status and Sense (S/S)Bytes

All remote status and sense conditions are combined into 2 bytes. These 2 bytes are always sent in a status message. In EBCDIC code, the bits are transmitted as indicated in Figure 4-7. If the sense bytes are transmitted in ASCII code, the EBCDIC code defined below is translated to ASCII before transmission.

Status and sense conditions are recorded by the 3274 for each device. These conditions may include busy or ready status or detected errors. Figure 4-8 shows how these status and sense conditions are interpreted for each error response transmitted by the 3274 in response to a poll sequence from the TCU.

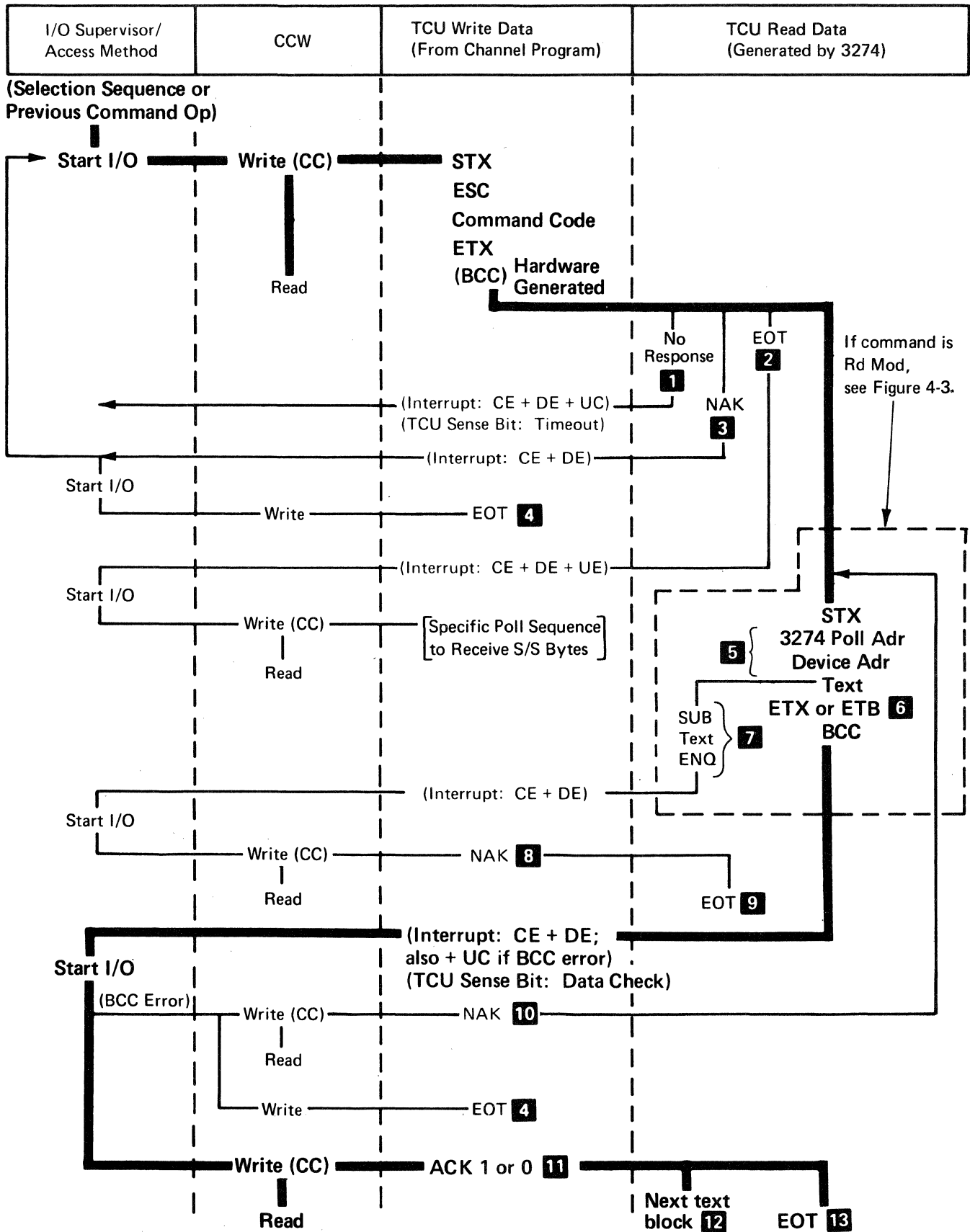

Figure 4-6 (Part 1 of 2). Read-Type Command, Sequence/Response Diagram

Notes:

- 1** Command transmission was not successfully received because of invalid framing (STX missing). Causes timeout at TCU.
- 2** The 3274 is unable to perform the operation indicated in the command transmission because of a busy/unavailable/not ready device or a 3274 detected check condition (receipt of an illegal command/order sequence, failure to decode a valid command, or an I/O interface "overrun"). The EOT response to a command transmission indicates that status information is stored in the 3274. To ensure retrieval of valid status, a Specific Poll must be issued to the device-responding EOT as the next addressing sequence issued to this 3274.
- 3** If a transmission problem causes both a 3274-detected check condition and a BCC error, the BCC error takes precedence over all other check conditions, and a NAK is transmitted to the TCU.
- 4** Response issued by the program to terminate the operation if the 3274 is unsuccessful in receiving a valid BCC following "n" attempts by the program to transmit the message.
- 5** This address sequence is included only in the first block of a blocked text message.
- 6** ETB is used to frame each block of a blocked text message, except for the last block. ETC is used to frame the last block of a blocked text message.
- 7** Upon detection of an internal parity check, the 3274 automatically substitutes the SUB character for the character in error. If a parity or cursor check is detected, ENQ is transmitted in place of ETX (or ETB) and BCC at the end of the text block and appropriate status and sense information is stored. This is also used by the 3274 if, after transmitting the first block, the transmission cannot be completed due to power being off at the terminal.
- 8** Mandatory program response to a text block terminated in ENQ.
- 9** Response to terminate the operation. The nature of the error (parity or cursor check) does not warrant a retry. This response indicates that appropriate status and sense information is stored. The status retrieval information included in Note 2 applies.
- 10** BCC error has been detected. The program issues NAK to cause the 3274 to repeat its last transmission.
- 11** Positive acknowledgment. The text block has been successfully received by the TCU. The program issues ACK 1 in response to the first and all odd-numbered text blocks and issues ACK 0 in response to the second and all even-numbered text blocks. This response to a text block terminated in ETX turns on the device SYSTEM AVAILABLE indicator.
- 12** The second and all succeeding text blocks are framed as the first except that they do not include the 3274/device address sequence.
- 13** Normal termination of the operation following transmission of the last text block.

LEGEND:

(CC) = Chain Command (CC) Flag in CCW is set to 1.

(Interrupt) = TCU-generated interrupt (CE = Channel End, DE = Device End, UE = Unit Exception, UC = Unit Check)

Figure 4-6 (Part 2 of 2). Read-Type Command, Sequence/Response Diagram

Bit No.	Bit Definition
	S/S Byte 0:
0	Dependent upon setting of bits 2-7.
1	Always a 1.
2	Reserved.
3	Reserved.
4	<p>Device Busy (DB) – This bit indicates that the addressed device (except the 3278 or 3279) is busy executing an operation or that a busy detection was previously made by a command or Specific Poll. The device is busy when it is executing an Erase All Unprotected command or a print operation, accepting data from the operator identification card reader, or performing various keyboard operations (ERASE INPUT, Backtab, and CLEAR).</p> <p>This bit is set with Operation Check when a Copy command is received which specifies a “busy” device with its “from” address.</p> <p>This bit is set with Unit Specify when a command is addressed to a busy device. This can occur by chaining a command to a Write, Erase/Write, Erase/Write Alternate, or Copy command which started a printer or by chaining a command to a Specific Poll addressed to a busy device.</p> <p>Note: DB is not returned for the 3278 or 3279 when executing an Erase All Unprotected command, accepting data from the MSR or MHS, or performing ERASE INPUT, Backtab, or CLEAR keyboard operations.</p>
5	<p>Unit Specify (US) – This bit is set if any S/S bit is set as a result of a device-detected error or if a command is addressed to a busy device.</p>
6	<p>Device End (DE) – This bit indicates that the addressed device has changed from unavailable to available and not ready to ready, or busy to not busy. This bit is included during a Specific or General Poll but is not considered pending status by a selection-addressing sequence.</p> <p>If a selection-addressing sequence detects that the addressed device has pending status and also detects one of the above status changes that warrants a Device End, then the Device End bit is set and preserved along with the other pending status, and an RVI response is made.</p>
7	Reserved.
	S/S Byte 1:
0	Dependent upon setting of bits 2-7.
1	Always a 1.
2	Command Reject (CR) – This bit is set upon receipt of an invalid 3270 command.
3	<p>Intervention Required (IR) – This bit is set if:</p> <ul style="list-style-type: none"> ● A Copy command contains a “from” address in its data stream which specifies an unavailable device. ● A command attempted to start a printer but found it not ready. The printout is suppressed. ● The 3274 receives a selection-addressing sequence or a Specific Poll sequence for a device which is unavailable or which became not ready during a printout. A General Poll sequence does not respond to the unavailable/not ready indication and proceeds to determine the state of the next device. ● The 3274 receives a command for a device which has been logged as unavailable or not ready.
4	Equipment Check (EC) – This bit indicates a printer character generator or sync check error occurred, the printer became mechanically disabled, or a 3274 detected bad parity from the device.
5	Data Check (DC) – This bit indicates a 3274 operation to a device was unsuccessful (i.e., the device was disabled with DC returned to the host; IR will be returned on subsequent retry by the host).
6	Reserved.
7	<p>Operation Check (OC) – This bit, when set alone, indicates one of the following:</p> <ul style="list-style-type: none"> ● Receipt of an illegal buffer address or of an incomplete order sequence on a Write, Erase/Write, or Erase/Write Alternate command. ● The device did not receive a CCC or a “from” address on a Copy command. ● Receipt of an invalid command sequence. (ESC is not received in the second data character position of the sequence.) ● The internal buffering capability is exceeded on a 3274. <p>This bit is set with Unit Specify to indicate that the “from” address on a Copy command specified a device with a “locked” buffer (the device data is secure).</p>

Figure 4-7. Remote Status and Sense Byte Definitions – BSC

Device Response	Command	S/S Explanation
RVI	Selection	<p>Outstanding Status – Pending information from a previous operation with the same device. (If the addressed device is busy, WACK is sent to the TCU instead of RVI, and no S/S bit is set.) Note: A selection-addressing sequence does not recognize a Device End as pending status. If there is no other pending status, it resets this bit and proceeds with the selection. If the addressed device has other pending status, Device End remains set with it, and the RVI response is made as usual.</p> <p>IR – The addressed device is unavailable.</p> <p>DE, EC, US – A character generator or syn check error has occurred, or the printer was mechanically disabled but the condition has been corrected. DE, EC, US is not sent by the 3287 or 3289.</p> <p>DE, IR – The addressed printer is out of paper, its power has been turned off, or its cover is open.</p> <p>DE, IR, EC, US – The addressed printer is mechanically disabled and cannot recover.</p> <p>DE, DC, US – A parity error is detected at the printer.</p> <p>DC, US – A parity check or cursor check is detected by the addressed device on the data it is sending to the control unit. For a 3274, an operation to a terminal was unsuccessful. The terminal was disabled and DC US returned to the host. On subsequent retry by the host, IR will be returned to the host.</p>
EOT	Read Commands	<p>CR – Invalid 3274 command is received.</p> <p>OC – Invalid command sequence (ESC is not in the second data character position), or data follows the command in the data stream received at the device.</p> <p>DB, US – The addressed device is busy. The command was chained to a Write, Erase/Write, Erase/Write Alternate, or Copy command which started a print, or it was chained to a Specific Poll.</p> <p>IR – A command is addressed to an unavailable device.</p> <p>DC – The 3274 is unable to complete a Read command operation after the first block has been sent to the host, because either there was an error in the terminal or the terminal was powered off after the first block was sent. A SUB character and an ENQ character are placed in the buffer. When the TCU responds NAK, the 3274 responds EOT.</p> <p>DC, US – A parity check or cursor check is detected by the addressed device on the data it is sending to the control unit. An operation to a terminal was unsuccessful. The terminal was disabled and DC US returned to the host. On subsequent retry by the host, IR will be returned to the host.</p>
EOT	Write Commands	<p>CR – An Invalid or illegal 3274 command is received.</p> <p>OC – An invalid command sequence (ESC is not in the second data position), an illegal buffer address or an incomplete order sequence is received, or a data byte was sent to the device during the Write command before the operation required by the previous data byte was completed.</p> <p>DC, US – The device detects a parity or cursor check on its buffer during the command operation. For a 3274, an operation to a terminal was unsuccessful. The terminal was disabled and DC US returned to the host. On subsequent retry by the host, IR will be returned to the host.</p> <p>DB, US – The addressed device is busy. The message is accepted but not stored in the 3274 buffer. The command is aborted.</p>
EOT	Copy Command	<p>DB, OC – The “from” device is busy. (The device is busy executing an operation, a printout, reading data from the operator identification card reader, or performing a keyboard operation.) The Copy command is aborted.</p> <p>IR, OC – The “from” device is not available.</p> <p>OC, US – The “from” device has a locked buffer.</p> <p>OC – The data stream contains other than 2 bytes (the CCC and the “from” address). The command is aborted.</p> <p>OC – The “from” device buffer is larger than the “to” device buffer.</p> <p>OC – The buffer of the “from” device (has APL/Text feature) contains APL/Text characters (entered since an Erase/Write or Erase/Write Alternate command or a CLEAR key operation) and the “to” device does not have the APL/Text feature.</p>

Figure 4-8 (Part 1 of 2). Remote Error Status and Sense Responses – BSC

Device Response	Command	S/S Explanation
EOT	Copy Command (cont)	DC, OC, US – Set when “from” device detects an internal parity or cursor check. For a 3274, an operation to a terminal was unsuccessful. The terminal was disabled and DC US returned to the host. On subsequent retry by the host, IR will be returned to the host. DB, US – The addressed “to” device is busy. DB, US, OC, DE – The addressed device becomes not busy before a Specific Poll is issued to retrieve the DB, US, OC status (described above).
EOT	Write, Erase/Write, Erase/Write Alternate, Copy Commands	IR – Addressed device is not available, or addressed printer is not ready.
EOT	Erase All Unprotected Command	OC – One or more data bytes followed the command (buffer overrun).
	Specific and General Poll	DE, IR, EC, US – An unrecoverable mechanical failure is detected at the printer. DE, EC, US – A character generator or sync check error or a mechanical failure is detected at a 3284/3286/3288 printer but then recovered from. DC, US – A parity check or cursor check is detected by the addressed device on the data it is sending to the control unit. For a 3274, an operation to a terminal was unsuccessful. The terminal was disabled and DC US returned to the host. On subsequent retry by the host, IR will be returned to the host. DC – The 3274 is unable to complete a Read command operation after the first block has been sent to the host, because either there was an error in the terminal or the terminal was powered off after the first block was sent. A SUB character and an ENQ character are placed in the buffer. When the TCU responds NAK, the 3274 responds EOT. DE – The poll finds a device (1), previously recorded as busy, now not busy or, (2), previously recorded as unavailable <i>or</i> not ready, now available <i>and</i> ready. IR, DE – The poll finds a device, previously recorded as ready, available, and busy, now not ready and not busy, or the printer went not ready during a printout. DC, US, DE – A parity error is detected at printer.
	Specific Poll	DB – The addressed device is busy.
NAK	Read and Write Commands	NAK is transmitted by the 3274, when it detects a block check character (BCC) error on the TCU transmission. A BCC error has priority over all other detectable error conditions. If, for example, a BCC error and a parity error are detected during the same command transmission, the parity error condition is reset, and a NAK response is set by the 3274.

Figure 4-8 (Part 2 of 2). Remote Error Status and Sense Responses – BSC

Error Recovery Procedures

Errors detected at the 3274 are indicated to the system processor by the following responses: RVI, NAK, EOT, or sense/status information. The meaning of the responses depends upon their sequences, as defined in Figures 4-1 and 4-3 through 4-6.

When errors occur in the 3278 or 3279, the error condition is reported once to a General Poll. The 3274 allows parts of messages to be transmitted to the host before all data is transferred from the 3278 or 3279 to the 3274. If a terminating condition prevents completion of data transfer from the 3278 or 3279 to the 3274 after inbound link transmission has started, the 3274 sends STX.....SUB ENQ. The 3274 responds to a Specific Poll with DC status. Following a selection addressing sequence, a write-type command is accepted but a read-type command is rejected and DC status is returned by the 3274.

When the host selects the 3274 and issues a Read Modified command, the 3274 transmits a single block of text followed by ETX. If the host makes an error by starting a new command sequence with STX, the 3274 responds with ENQ. If more than one text block is transmitted to the host, with ACK received from the host after each ETB, the host may respond to ETX on the last block, with a new command sequence beginning with STX, ESC.

Figure 4-9 lists the various error combinations of sense/status bits (with the exception of Device Busy (DB), which is not an error) and the recommended error recovery procedure for each combination. Supplementary procedures are also recommended. Although there are 256 possible combinations of status and sense bits, only a portion of this total is normally used. Combinations other than those listed may occur. For example, an unpredictable catastrophic hardware failure could induce an undefined combination of status and sense bits. Errors that occur at the "from" device during a Copy command are identified by an Operation Check (OC) sense bit in addition to the sense bit representing the detected error.

The error-recovery procedures recommended in Figure 4-9 are as follows:

1. Execute a new address selection addressing sequence and retransmit the message, starting with the command sequence that was being executed when the error occurred. If, after two retries, the operation is not successful, this should be considered as a nonrecoverable error. Follow supplementary procedure B after two retries.
2. Reconstruct the entire device buffer, if possible, and retry the failing chain of commands (within the BSC sequence of operations). The sequence of commands used to reconstruct the buffer should start with an Erase/Write or Erase/Write Alternate command. If the information in the screen buffer is such that it cannot, or need not, be reconstructed, the operation may still be retried. If an unrecoverable 3278 or 3279 buffer error is detected, the entire buffer is cleared and the host system is informed of the error by receiving DC, US status but is not informed of the clear operation. If, after three retries, the operation is not successful, this should be considered as a nonrecoverable error. Follow supplementary procedure A.

Sense/ Status Bits	Detected during 3274 Operation						Transmitted in Response to:		Error Recovery Procedure
	Hex		Selection Addressing Sequence	Specific Poll Sequence	General Poll Sequence	A 3270 Command	Specific Poll	General Poll	3274
	EBCDIC	ASCII							
CR	40 60	20 2D				D, P	D, P		6
OC	40 C1	20 41				D, P	D, P		6
OC, US	C4 C1	44 41				D, P	D, P		13
IR	40 50	20 26	D, P	D, P		D, P	D, P		4
IR, OC	40 D1	20 4A				D, P	D, P		5
DC	40 C4	20 44	D, P	D, P	D, P	D, P	D, P	D, P	1
DC, US	C4 C4	44 44	D, P	D, P	D, P	D, P	D, P	D, P	2
DC, OC, US	C4 C5	44 45				D, P	D, P		3
DC, US, DE	C6 C4	46 44		P	P		P	P	8
IR, DE	C2 50	42 26		P	P		P	P	4
EC, US, DE	C6 C8	46 48		P	P		P	P	7**
IR, EC, US, DE	C6 D8	46 51		P	P		P	P	7
DB	C8 40	48 20	D, P	D, P			D, P		9
DB, US*	4C 40	3C 20				D, P	D, P		10
OC, DB*	C8 C1	48 41				D, P	D, P		11
DE	C2 40	42 20		D, P	D, P		D, P	D, P	None

Note: The attached device errors that are detected asynchronously do not cause a sense bit to set until the device is polled for status during a selection-addressing, Specific Poll, or General Poll sequence. Those error S/S bit combinations that contain DE were detected during a printout.

*The DB, US, and OC S/S bits will be combined if a Copy command is addressed to a busy "to" device and the command also specifies the "from" device the same as the "to" device.

**Occurs only if 3284, 3286, 3288 printers are attached.

LEGEND:

D — Display (3277, 3278, 3279)
P — Printer

Figure 4-9. Remote 3274 BSC Status and Sense Conditions

Programming Note A cursor check in the 3284 is indistinguishable from a second selection to a 3277 with a cursor check. A selection addressing sequence or poll sequence to another device on the same control unit should be attempted before flagging the control unit as inoperative. A successful sequence indicates that the CU is probably satisfactory, and the device requires manual intervention to reset it (for example, a 3277 with a nonrecoverable data check). An unsuccessful sequence indicates that the CU may be at fault and requires manual intervention to reset it.

- The error occurred during execution of a Copy command. Execute procedure 2, except that it is the buffer of the "from" device specified by the Copy command that should be reconstructed. After three retries, follow supplementary procedure B.
- The error indicates that the printer is out of paper, has its cover open, or has a disabled print mechanism; or it indicates that the device is unavailable. Request (or wait for) either the display or system operator to ready the device. Then, retry the printout by issuing a Write command with the proper WCC and no data stream. (There is no data error, and the data is still intact in the device buffer and can be reused.) Or, follow procedure 2.
- The error indicates that the "from" device specified by a Copy command is unavailable. Note that the device address associated with the error status and sense information does not indicate the device that actually required

“readying.” The device that requires the corrective action is the device specified by the “from” address in the Copy command. When the device is determined and made “ready,” follow procedure 1.

6. The operation should be tried up to six times. Continued failure implies an application programming problem, which can be detected by analyzing the failing write data stream.
7. The error occurred during a printout operation and indicates either a character-generator error or a disabled print mechanism. There is no data error. The proper error recovery procedure is application-dependent since the user may or may not want a new printout. If a new printout is required, follow procedure 4.
8. A data error occurred in the device buffer during a printout, and procedure 2 should be followed.
9. A Specific Poll detected that the addressed device is busy. Periodically issue a Specific Poll to pick up the Device End sense/status bit sent by the device when it becomes not-ready (unless this status change is detected on a selection addressing sequence).
10. Indicates that a command was erroneously addressed to a busy device. Periodically issue a General or Specific Poll to pick up the Device End sense/status bit sent by the device when it becomes not busy. Then follow procedure 1.
11. Indicates that, in attempting to execute a Copy command, the “from” device was found to be busy. Follow procedure 1 when the “from” device becomes not busy. Note that the device address associated with the status and sense message is the address of the “to” device and not that of the busy “from” device. The “from” device will transmit Device End via a Specific or General Poll when it becomes not busy.
12. An attempt was made to execute a Copy command, but access to the “from” device data was not authorized. The device address associated with the error sense/status bits is that of the copy “to” device.

Supplementary Procedures

- A. Request maintenance for the device that is giving trouble. After repair, reconstruct the screen buffer image. The sequence of commands used to reconstruct this image should start with an Erase/Write command. Retry the failing chain of commands according to the procedure that referred you to this supplementary procedure.
- B. The “from” device specified by the Copy command in the failing chain of commands (CCWs) is malfunctioning. The “from” device should be determined from the data-stream information, and maintenance should be requested for the device. After the repair, reconstruct the buffer image. The sequence of commands used to reconstruct this image should start with an Erase/Write command. Retry the failing chain of commands according to the procedure that referred you to this supplementary procedure.
- C. Same as procedure 1, except a new selection addressing sequence is not performed, and this message is transmitted as part of the present device selection.
- D. Same as procedure 1, except retransmit the entire failing chain of commands.

EOT to a Text Block

The recommended recovery procedure depends upon the type of detected error. A Specific Poll must be issued immediately following the EOT to obtain the error sense/status information. Then the recovery procedures referenced in Figure 4-9 should be executed.

Errors Detected During a Specific or General Poll Sequence

Any errors that result from execution of the poll sequence itself are contained in Figure 4-9, and those recovery procedures apply. The detected error bits are transmitted to the TCU in a Status Message during the poll sequence.

RVI to Selection Addressing Sequence

A Specific Poll must be issued immediately following the RVI to a selection addressing sequence to obtain the error sense/status information. Then the recovery procedures defined in Figure 4-9 should be followed.

Chapter 5. SNA/SDLC Communication

This chapter provides information to aid the system analyst and the system programmer in establishing the host-to-3274 communication, using Systems Network Architecture (SNA) protocols. A knowledge of the Network Control Program (NCP) and IBM access methods is assumed. The IBM access methods supporting SNA are VTAM, TCAM, and EXTM.

Additional information on SNA can be found in the *Systems Network Architecture Format and Protocol Reference Manual: Architecture Logic*, SC30-3112. Information to assist the host programmer in planning the use of SNA commands and access method macros can be found in the following publications:

VTAM:

ACF/VTAM Programming, SC27-0449

ACF/VTAM General Information, GC27-0608

TCAM:

TCAM Concepts and Application OS/VS, GC30-2049

TCAM Programmer's Guide OS/VS1, GC30-2054

TCAM Programmer's Guide OS/VS2, GC30-0241

EXTM Option of CICS/DOS/VS:

EXTM Version 1.0 General Information, GH20-1597

EXTM Version 2.0/3.0 General Information, GH20-1702

3790 Communication System:

Introduction to the IBM 3790 Communication System, GA27-2807

Network Control Program:

IBM 3704 and 3705 Communications Controller Network Control Program/VS Generation and Activities Guide and Reference Manual, GC30-3008

Transmission Formats

The host program and the 3274 communicate using half-duplex, flip-flop, send-receive protocols. When the host program or the 3274 is transmitting data, it assumes the role of the sending Logical Unit (LU). The LU to which the transmission is directed is the receiving LU. An LU is the logical entity that communicates on behalf of an end user (such as a terminal or application program). The term *outbound* refers to transmissions from the host to the 3274. The term *inbound* refers to transmissions from the 3274 to the host.

The portions of a transmission between the host and the 3274 that are discussed in this chapter are:

Request/Response Header (RH). This header describes the type of message being transmitted and contains indicators that control SNA protocols.

Request/Response Unit (RU). This contains the data or commands that flow in the transmission. (Note that occasional reference is made to a Null RU, that is, an RU that contains no data.)

Transmission Header (TH). This header contains format identification, mapping fields, and an expedited flow indicator.

The 3274 can communicate with the host system by means of a teleprocessing network that uses the synchronous data link control (SDLC) transmission format. The 3274 may also communicate using channel attachment to a host system. A description of SDLC transmission format is found in *IBM Synchronous Data Link Control General Information, GA27-3093*.

Session Components

Within SNA, communication takes place between LUs. For 3274 operation, the host always contains the Primary Logical Unit (PLU), and the 3274 contains the Secondary Logical Unit (SLU). The 3274 can have from 1 to 32 SLUs (addresses 2 through 33).

A set of logical connections, called *sessions*, is required to control the exchange of data and control information between the host program and a 3274 SLU. At the host system, the access method provides the System Services Control Point (SSCP) function for all sessions that are established with the 3274. The SSCP maintains information that allows a PLU to establish and maintain an LU-LU session with a specific 3274 LU.

SNA Sessions

The sessions that must exist between the host system and the 3274, for an access method application program and the 3274 to exchange information, are as follows:

SSCP-PU (access method—3274 Physical Unit (PU))

SSCP-PLU (access method—host program)

SSCP-SLU (access method—3274 SLU)

PLU-SLU (host program—3274 SLU) (referred to as LU-LU)

The following topics discuss the sessions individually and identify how they are established and terminated. The SNA commands that establish and terminate the sessions are identified. SNA commands are discussed in detail under “SNA Commands.”

SSCP-PU Session

Before establishing the SSCP-PU (access method—3274 control unit) session, the physical transmission or channel connection to the host must be established. In locally attached systems, the Online/Offline switch must be placed in the Online position before communication can be established between the 3274 Model 1A and the host.

The SSCP-PU session must be established before establishing the SSCP-SLU or LU-LU sessions. When the access method network operator activates a specific 3274, the access method issues the Activate Physical Unit (ACTPU) command to the control unit. A predefined start procedure for the access method may also request the activation of specific 3274 control units. The SSCP-PU session is the first session established between the host system and the 3274.

The SSCP-PU session is terminated when the access method network operator deactivates the 3274. When all SSCP-LU sessions for the control unit have been terminated, the access method issues the Deactivate Physical Unit (DACTPU) command. When the 3274 returns a positive response to the DACTPU command, the SSCP-PU session is terminated.

In locally attached systems, the Online/Offline switch may be placed in the Offline position when the host communication function is terminated.

SSCP-Secondary LU Session

When the SSCP-PU session is established, an activate command may be issued to the access method to establish the SSCP-SLU session. The access method will issue an Activate Logical Unit (ACTLU) for the appropriate SLU or SLUs in the 3274. The SSCP-SLU session must be established before establishing the LU-LU session.

The SSCP-SLU session is terminated when the access method sends a Deactivate Logical Unit (DACTLU) command to the specified SLU. When the control unit returns a positive response to the DACTLU command, the SSCP-SLU session is terminated.

LU-LU Session

Initiating an LU-LU Session

Three types of LU-LU sessions are supported by the 3274. Further description of these sessions is provided later in this section. The LU-LU session types are:

- Type 1 — The device attached to the 3274 SLU is a printer, and the data stream is the SNA character string (SCS).
- Type 2 — The device attached to the 3274 SLU is a keyboard/display, and the data stream is in the 3270 data stream compatibility (DSC) mode format.
- Type 3 — The device attached to the 3274 SLU is a printer, and the data stream is in the 3270 DSC mode format.

The SNA Bind command is used to differentiate these types of sessions.

The command flow sequence required to establish a session is summarized in Figure 5-1. The command flow nomenclature is generalized, and access method specific macro names are not used. The example assumes that no sessions are active between the host and the 3274. The access method sends the ACTPU command to establish the SSCP-PU session **1**. ACTLU commands **2** are then sent to establish SSCP-PLU and SSCP-SLU sessions. The SSCP-PLU session can be established by the host application any time prior to logon. The network is now ready for LU-LU sessions to be established.

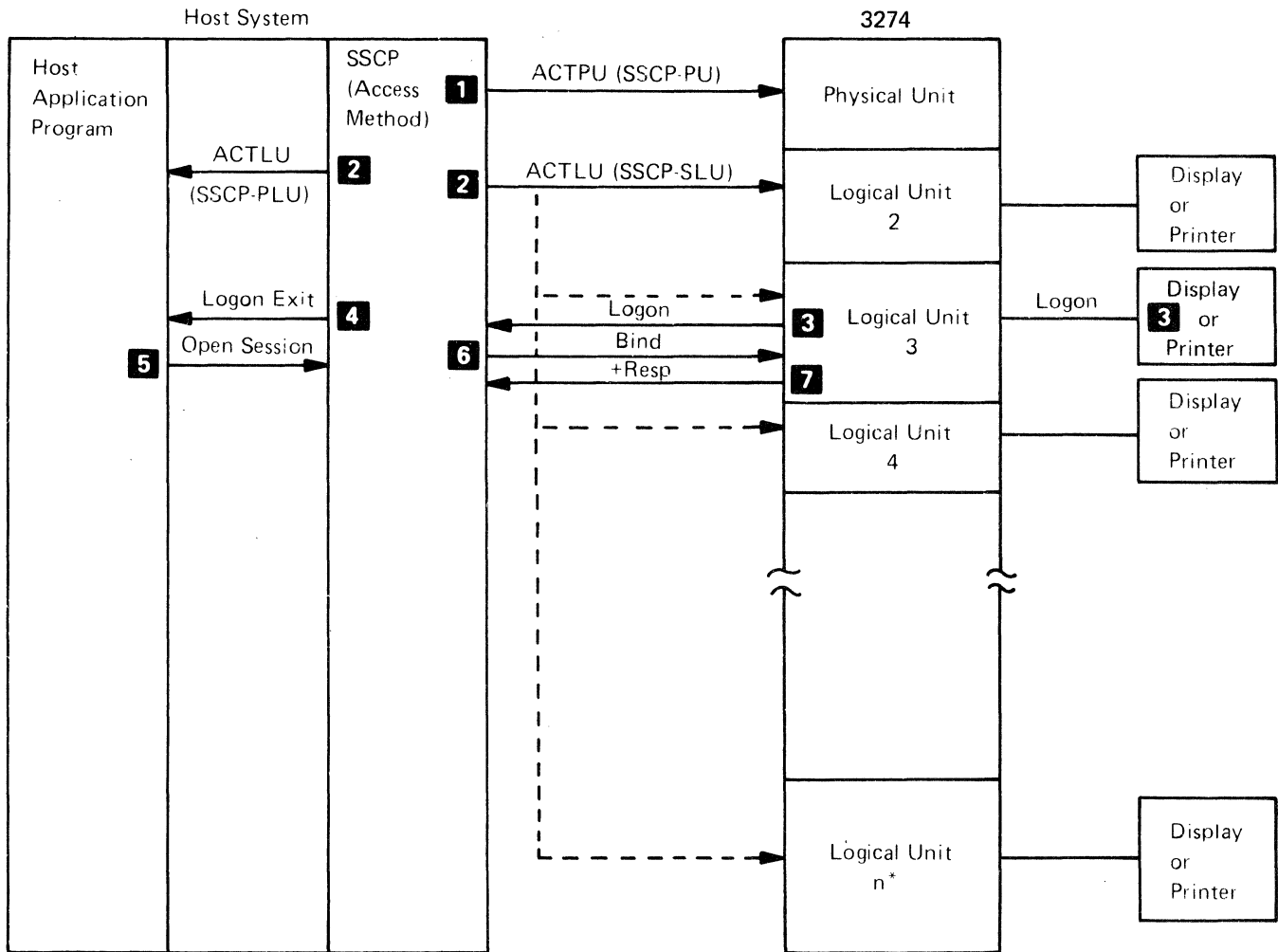

*The highest LU number for a 3274 is 33. (Note that LU1 is reserved.)

Figure 5-1. Establishing a Session with a 3274

An LU-LU session is started by the host application program when it issues the Bind request. The LU-LU session may be initiated by the host application program (for example, acquiring the terminal or by a simulated logon) or by the display terminal operator **3** (a character-coded logon). If a character coded logon is received by the access method, the access method translates the logon request and schedules a logon exit **4** for the PLU. After the PLU receives control at the logon exit, or when the PLU acquires a terminal, the PLU passes an open session request to the access method **5** which results in an SNA Bind **6** being passed to the SLU. The 3274 LU examines the session parameters of the Bind and, if they are acceptable, allows the session to be established by sending a positive response **7** to the Bind command. If the session parameters are not acceptable, the 3274 LU rejects the Bind command by returning a negative response, indicating that the session parameters are invalid (sense code X'0821'). Also, if power is not on at the device, a negative sense code X'080A' or X'0845' is returned to the Bind. Bind is discussed later in this chapter.

After the Bind command has been accepted with a positive response, the host program can issue the Start Data Traffic command to allow data traffic to flow for the session.

The manner in which an LU-LU session may be initiated depends on the type of session being started. A type 1 or type 3 session must be initiated by the PLU. A type 2 session may be initiated by either the PLU or SLU.

Terminating an LU-LU Session

The PLU can terminate an LU-LU session by requesting that the SSCP close the session. The SSCP then sends the Unbind command to the secondary LU, and the LU-LU session is terminated.

Type 2 sessions can also be terminated by the display operator in either of two ways. The first method is to notify the PLU (where supported), on the LU-LU session, that termination is desired; the PLU then terminates the session. In the second method, the display operator changes from an LU-LU session to an SSCP-SLU session by using the System Request key (SYS REQ) and enters a logoff message. The SSCP then passes the logoff request to the PLU, if the logoff message is conditional, or issues the Unbind for the PLU if the logoff message is unconditional.

A PLU may close the session in an orderly fashion by issuing a Shutdown command. When the host program issues the Shutdown command, the 3274 returns the Shutdown Complete command after completing any outstanding operation and entering the between bracket state. Note that the PLU must close a bracket with end bracket before the Shutdown command is effective.

Transmission Header

The 3274 terminals support FID2 transmission headers (TH). The transmission header consists of 6 bytes:

TH0:	FID (Bits 0—3)	Format Identification
	MPF (Bits 4—5)	Mapping Field
	RES (Bit 6)	Reserved
	EFI (Bit 7)	Expedited Flow Indicator
TH1:	RES (Bits 0—7)	Reserved
TH2:	DAF' (Bits 0—7)	Destination Address Field (See Figure 5-2 and "Device Addressing" in Chapter 1)
TH3:	OAF' (Bits 0—7)	Origin Address Field
TH4,5:		Sequence Number on Normal, ID Number on expedited flow requests and responses

The 3274 handles transmission headers received on outbound requests as follows:

1. All reserved parameters are ignored on requests.
2. MPF—The 3274 supports outbound segmenting for FM data.
3. EFI—The expedited flow indicator identifies normal (0) or expedited (1) flow requests.

EFI=1

The 3274 supports the following requests as outbound expedited flow requests:

RU Category	Request
SC	ACTPU, DACTPU, ACTLU, DACTLU, BIND, UNBIND, CLEAR, SDT
NC	Not supported
DFC	SIGNAL, SHUTDOWN
FMD	Not supported

When the 3274 receives any requests listed above with correct categories and EFI=1, they will be passed through for further processing.

EFI=0

The 3274 supports the following requests as outbound normal flow requests:

RU Category	Normal Request
SC	Not supported
NC	Not supported
DFC	Cancel, Bid, Chase, RTR
FMD on PLU-SLU	Any request
FMD on SSCP-SLU	Any in SCS format
FMD on SSCP-SPU	REQMS

When the 3274 receives any of the requests listed above associated with the correct categories and EFI=0, they will be passed through for further processing.

Device Number	Device Address Field							
	Bits: 0	1	2	3	4	5	6	7
PU	0	0	0	0	0	0	0	0
**	0	0	0	0	0	0	0	1
0	0	0	0	0	0	0	1	0
1	0	0	0	0	0	0	1	1
2	0	0	0	0	0	1	0	0
3	0	0	0	0	0	1	0	1
4	0	0	0	0	0	1	1	0
5	0	0	0	0	0	1	1	1
6	0	0	0	0	1	0	0	0
7	0	0	0	0	1	0	0	1
8	0	0	0	0	1	0	1	0
9	0	0	0	0	1	0	1	1
10	0	0	0	0	1	1	0	0
11	0	0	0	0	1	1	0	1
12	0	0	0	0	1	1	1	0
13	0	0	0	0	1	1	1	1
14	0	0	0	1	0	0	0	0
15	0	0	0	1	0	0	0	1
16	0	0	0	1	0	0	1	0
17	0	0	0	1	0	0	1	1
18	0	0	0	1	0	1	0	0
19	0	0	0	1	0	1	0	1
20	0	0	0	1	0	1	1	0
21	0	0	0	1	0	1	1	1
22	0	0	0	1	1	0	0	0
23	0	0	0	1	1	0	0	1
24	0	0	0	1	1	0	1	0
25	0	0	0	1	1	0	1	1
26	0	0	0	1	1	1	0	0
27	0	0	0	1	1	1	0	1
28	0	0	0	1	1	1	1	0
29	0	0	0	1	1	1	1	1
30	0	0	1	0	0	0	0	0
31	0	0	1	0	0	0	0	1

**Address reserved.

Figure 5-2. Device Addressing for SNA Terminals

SNA Commands

SNA commands define a set of controls to establish and terminate sessions, and to assist in the management of host-to-3274 data flow and sessions.

Three types of SNA commands are discussed in the following topics:

- Session Control (SC) commands—These commands establish and terminate sessions in the network.
- Data Flow Control (DFC) commands—These commands control the flow of data in an LU-LU session.
- Function Management Data (FMD) command—This command is used to transfer data in the LU-LU session.

Commands Supported

The SNA commands supported by the 3274 are listed in Figure 5-3.

SNA Command							
Name	Type	SSCP	PU	SSCP	SLU	PLU	SLU
		→	←	→	←	→	←
ACTPU	SC	X					
DACTPU	SC	X					
ACTLU	SC			X			
DACTLU	SC			X			
Bind	SC					X	
Unbind	SC					X	
SDT	SC					X	
Clear	SC					X	
Cancel	DFC					X	X
Chase	DFC					X	
LUSTAT	DFC						X
SHUTD	DFC					X	
SHUTC	DFC						X
RTR	DFC						X ¹
Bid	DFC					X	X ¹
Signal	DFC					X	X ²
Data	FMD					X	
REQMS	FMD	X					
RECFMS	FMD		X				
Notify	FMD				X		

¹ Only SLU types 1 and 3 (3274 configured for between-bracket printer sharing).

² Only SLU types 1 and 2.

Figure 5-3. SNA Commands Supported by the 3274

Command Description

Activate Physical Unit (ACTPU)

The ACTPU command is sent by the access method to establish the SSCP-PU session with a 3274 control unit. The SSCP-PU session is established when the 3274 returns a positive response to the ACTPU command.

The ACTPU command can be transmitted when the SSCP-SLU and LU-LU sessions are active; for example, when an NCP restart procedure occurs. When the 3274 receives the ACTPU command, all active sessions are terminated immediately (unless ACTPU ERP is specified). The 3274 returns a positive response to the ACTPU command, and the SSCP-PU session is reestablished.

Deactivate Physical Unit (DACTPU)

When the 3274 receives the DACTPU command, all LU-LU and SSCP-SLU sessions and the SSCP-PU session are terminated. If a command other than ACTPU is received after a positive response has been returned for the DACTPU command, the 3274 returns a negative response with sense data indicating PU not active (sense code X'8008').

Activate Logical Unit (ACTLU)

The ACTLU command is sent by the access method to establish the SSCP-SLU session with each 3274 control unit LU. The SSCP-SLU session is established when the 3274 returns a positive response to the ACTLU command. The

SSCP-PU session must be established prior to the receipt of ACTLU to allow the 3274 to return a positive response to this command. If the 3274 receives a command other than ACTPU, ACTLU, DACTPU, or DACTLU before the SSCP-LU session is established, a negative response is returned with sense data indicating LU not active (sense code X'8009'). Note that the SLU is in the 3274 and that the session can be activated without a display or printer being powered on or attached.

When an SSCP-SLU session has been previously established and the 3274 receives an ACTLU command for that LU, any active session between that LU and a host program is terminated (unless ACTPU specifies ERP). The 3274 returns a positive response to the ACTLU command, and the SSCP-LU session is reestablished.

Deactivate Logical Unit (DACTLU)

Receipt of this command terminates the SSCP-SLU session. If an LU-LU session is established when the DACTLU command is received, the session is terminated. When the 3274 receives a command other than DACTPU, ACTPU, or ACTLU after a positive response has been returned for the DACTLU command, a negative response is returned with sense data indicating SLU not active (sense code X'8009').

Notify

The 3274 supports the Notify command, when it flows from the secondary LU in the 3274 to the SSCP, for purposes of advising the SSCP of power on or off conditions at the device. The Notify command uses the same protocols and state changes, including keyboard control if device ownership is SSCP-SLU, as the character-coded requests. An inbound Notify may be sent while the device screen is in the unowned state; it does not cause a transition to the SSCP-SLU owned state.

The request is sent as follows:

TH0:	X'2C'	(Secondary-->Primary, normal)
TH1:	X'00'	
DAF':	X'00'	
OAF':	Address of LU sending Notify	
SNF:	X'0000'	
RH0:	X'0B'	(Request FMD, formatted, OC)
RH1:	X'80'	(DR1)
RH2:	X'00'	
RU0:	X'81'	Network Services
RU1:	X'06'	Session Service
RU2:	X'20'	Notify
RU3:	X'0C'	Vector key
RU4:	X'06'	Length
RU5:	b'0000 00x1'	
RU6—7:	X'0000'	LU—LU session limit
RU8—9:	X'0000'	LU—LU session count
RU10:	X'00'	Reserved

X = 0 Secondary LU is not enabled, power off.

X = 1 Secondary LU is enabled, power on.

The vector X'0C' is contained in the ACTLU positive response to notify the SSCP of device power on or off status at ACTLU time. While the SSCP—SLU session exists (that is, the ACTLU sequence has been processed, but a following DACTLU sequence has not, and an LU—LU session is not bound), any detected power on or off change by the device causes Notify to be sent to the SSCP. While an LU—LU session is bound, power on or off change notification is sent to the PLU by negative response and LUSTAT as already implemented. However, when an Unbind is received, the SLU checks the device power on or off status. If the status is power off, a Notify is sent to the SSCP at that time. Also, if an Unbind is generated by the 3274, a NOTIFY is sent to the SSCP.

The 3274 will also support a negative response of X'0845' to a BIND because of device power off. X'0845' will be the sense code in operation following IML for the control unit.

The 3274 will use the Positive/Negative response to Notify to determine whether the host can support queued initiates. If Notify receives a negative response, the 3274 will assume the SSCP does not support Notify and will set the sense code to X'080A' for a negative response to Bind for all LUs in the control unit. The negative response X'080A' will remain in effect until the control unit is powered off or re-IMLed or until a new ACTPU is received. Following the ACTPU for any of these conditions, the default response code of X'0845' is in effect.

For unformatted data flow on the SSCP—SLU session, a negative response from the SSCP will leave the SLU in receive state. This will cause a hang condition if a negative response (Notify) leaves the SLU in receive state. Therefore, the SLU will return to contention state irrespective of the value of the response.

Bind

This command is sent by the access method to request an LU-LU session between an application program and a 3274 SLU. The 3274 returns a positive response to establish the LU-LU session. When the session cannot be established, the 3274 returns a negative response with sense data that describes the reason the session was rejected.

The 3274 examines session parameters that are received with the Bind command. The values required depend on the type of session established. Figure 5-4 provides a detailed description of the session parameters that are sent with the Bind command.

When the SSCP-SLU session is established and the 3274 receives a command that flows in the LU-LU session other than the Bind, a negative response is returned with sense data indicating no session established (sense code X'8005').

If the device attached does not have power on or is physically detached from the 3274 cable port, a negative response is returned with sense data indicating power off (sense code X'080A').

When a LU-LU session exists, that is, one Bind has been accepted, and the 3274 receives a subsequent Bind command for the LU, a negative response is returned with sense data indicating session already exists (sense code X'0815') if the Bind sender address is the same as the session already found. A negative response indicating function active (sense code X'0805') is returned if the Bind sender address differs from the session already found.

Byte	Hex Value	Bit Setting	Meaning
0	31		Identifies this RU as a Bind command.
1	01		Bind type and format. The only Bind type supported is Hex 01.
2	03		Function management (FM) profile. Specifies that the data flow control commands and the request/response protocols that are to be used for this session conform to FM Profile 3.
3	03		Transmission services (TS) profile. Specifies that the 3274 conforms to TS Profile 3; that is, pacing and sequence numbers are used with normal flow transmission and that data traffic is controlled by the Clear and Start Data Traffic commands.
4			Primary LU Protocols.
		X	Chaining use: 0 The PLU can send only single-element chains. 1 The PLU can send single- or multiple-element chains.
		. X	Request mode selection: 0 Immediate request mode is used. Only one definite response can be outstanding at a time. That response must be received before the PLU can send another RU.
		. . XX	Chaining responses: 01 The PLU can only request exception-only responses. 10 The PLU can only request definite responses. 11 The PLU can request definite or exception-only responses.
	 00 . .	Reserved.
	 X .	Compression indicator: 0 Must be 0.
	 X	Send End Bracket Indicator (EB): 1 The PLU can send the EB.
5			Secondary LU Protocols.
		X	Chaining Use: 0 The 3274 can send only single-element chains. 1 The 3274 can send single- or multiple-element chains. Note: 0 or 1 for LU type 1 or 3. 1 for LU type 2.
		. X	Request mode selection: 0 Immediate request mode is used. The 3274 can issue a request for a single definite response. No further transmissions are sent until the 3274 receives the requested response.
		. . XX	Chaining responses: 01 The 3274 can only request exception-only responses. 10 The 3274 can only request definite responses. 11 The 3274 can request either definite or exception-only responses.
	 00 . .	Reserved.

Figure 5-4 (Part 1 of 3). Bind Command Session Parameters

Byte	Hex Value	Bit Setting	Meaning
6	X.	Compression indicator: 0 The 3274 cannot send compressed data.
	X	Send End Bracket indicator (EB): 0 The 3274 cannot send the EB.
			Common Protocols.
		0... ..	Reserved.
		.X... ..	Function management (FM) header usage: 0 The PLU and the 3274 cannot exchange FM headers. 1 The PLU and the 3274 can exchange FM headers.
		..X.	Brackets usage: 1 Bracketed session is used. Both the PLU and the 3274 must use bracket protocols.
		...X	Bracket termination protocol: 1 Bracket termination rule 1 is used (refer to "Bracket Protocol" for a description of bracket termination rule 1).
	 X...	Alternate Code selection: 0 Both the PLU and the 3274 must use EBCDIC. 1 Both the host program and the 3274 can use an alternate code. An example of an alternate code is ASCII.
	000	Reserved.
		7	
XX.	Normal Flow Send/Receive mode (selection): 10 This session uses half-duplex, flip-flop (HDX FF) transmissions. Refer to "Session Processing States."		
..X.	Recovery responsibility: 0 The PLU is responsible for error recovery.		
...X	Brackets first speaker: 0 The 3274 is always the first speaker.		
.... 000.	Reserved.		
.... .X	Contention resolution: 0 Contention (simultaneous transmissions from the host program and the 3274) is resolved in favor of the 3274.		
8	00xx xxxx		Secondary-to-primary LU pacing count. If set to zeros, pacing is not used.
9	00xx xxxx		The primary-to-secondary pacing value defines the number of RUs that may be received by the 3274 before a pacing response must be returned to indicate readiness for another block of RUs. If set to zeros, pacing is not used. See "Pacing" for recommendations of pacing values.
10	XX		Maximum RU size sent by the secondary LU. This value represents the largest RU that can be sent by the 3274. It is expressed as a mantissa (8 through F) and an exponent value of 2 by which the mantissa is multiplied. For example, when the mantissa is specified as 8 and the exponent of 2 is 5 (hex 85), the RU size represented is 256 bytes. Examples of mantissa and exponent values used by the 3274 are shown below with the RU size they represent: 85=256 86=512 C6=768 87=1024 A7=1280 C7=1536 E7=1792 88=2048

Figure 5-4 (Part 2 of 3). Bind Command Session Parameters

<u>Byte</u>	<u>Hex Value</u>	<u>Bit Setting</u>	<u>Meaning</u>
			See "RU Lengths Supported" for detailed information about values supported by the 3274.
11	XX		Maximum RU size sent by the primary LU. This value represents the largest RU that can be sent by the PLU and is specified in the same format as for the secondary LU (byte 10). See "RU Lengths Supported" for detailed information about values supported by the 3274.
12, 13			Ignored by 3274.
For SLU Type 1:			
14	01		Type 1 print function using SCS data stream.
15-16	00		Reserved.
17	 X	If set to b'1' the Read Partition-Query and Query Reply structured fields are supported by the secondary logical unit. Not checked by 3274, but will be accepted.
18	E1		Sent but not checked by the 3274 for LU type 1.
19	00		Reserved.
20-24			Not supported for LU type 1.
For SLU Types 2 and 3:			
14	02		Type 2 3270 data stream compatibility mode.
14	03		Type 3 3270 print function using 3270 data stream.
15	80	X.	If set to b'1' the Read Partition-Query and Query Reply structured fields are supported by the secondary logical unit. Not checked by 3274, but will be accepted.
16-19	00		Reserved.
20-24	XX		Refer to Figure 1-13 for LU type 2. Refer to Figure 1-14 for LU type 3.
For all SLU Types:			
25+			Reserved.

Figure 5-4 (Part 3 of 3). Bind Command Session Parameters

Session parameters included in the Bind command RU define the protocols that govern the session. Figure 5-4 describes the contents of a Bind command RU that are supported by the 3274 and explains how the session parameters are used. A generalized setting for the access method logmode table is listed under "Bind Default" later in this chapter. Also listed (under "Bind Check") are the checks that the 3274 makes when the Bind command is received. Specific customer optimization or device features may require changes for each installation.

Also listed later in this chapter (under "Logical Unit Status") are the checks made by the 3274 for each logical unit type. Failure to properly specify the required session parameters results in rejection of the Bind command by the control unit because the session parameters are invalid (sense code X'0821').

Unbind

Receipt of this command directs the 3274 to terminate the LU-LU session between a host program and a 3274 SLU. The LU-LU session is terminated when the 3274 returns a positive response to the Unbind command.

Clear

Receipt of the Clear command causes the 3274 to enforce the data-traffic-reset state upon the LU-LU session. Clear also causes the 3274 to initialize all inbound and outbound transmission buffers. When data-traffic-reset state is activated for an LU-LU session, only the following commands are valid for that session: Clear, Unbind, and Start Data Traffic (SDT).

Start Data Traffic (SDT)

This command allows data traffic to flow during an LU-LU session. The SDT command must be issued after a Bind command has established the LU-LU session. It is also sent after Clear to complete a session resynchronization sequence with the 3274. SDT is valid only when the data-traffic-reset state is active for an LU-LU session.

To complete a session resynchronization sequence, the host program must request transmission of the SDT command from the access method.

Cancel

When received, normal SNA use of this command directs the receiver to discard all elements of the chained transmission being received. However, the 3274 processes data RUs to the display or printer as they are received without waiting until end-of-chain. Therefore, the Cancel command serves to provide a proper termination for an otherwise incomplete chain. A Cancel command received between chains only affects the 3274 state controlled by the change direction (CD) and end bracket (EB) bit settings carried in the RH with the Cancel command. Processing of a chained transmission is terminated when the Cancel command is received. EB or CD may be sent with the command.

When a chained transmission is in progress and the 3274 returns a negative response to an element of that chain, the PLU should terminate that chained transmission and issue the Cancel command if the last chain element has not already been sent to the 3274.

When sent by the 3274 type 2 SLU, the Cancel command directs the PLU to stop processing a chained transmission and to discard all elements of the chain that are currently being received. The Cancel command is substituted for the end of the chain if a 3278 or 3279 failure or operator action prevents transfer of all data from the display to the 3274.

When the PLU returns a negative response for an element of a chain, the following will happen:

- *For a 3274 when inbound pacing is not used*, the entire chain will be transmitted before the PLU response is examined. Cancel will not be sent.
- *For a 3274 when inbound pacing is used*, the negative response from the PLU will be examined only if the 3274 must look for a pacing response. If the negative response is examined, the 3274 will send Cancel and will not transmit the remaining elements in the chain. If the negative response is not examined, the entire chain will be transmitted and Cancel will not be sent.

In either case, the PLU should discard all elements of a chained transmission after sending a negative response.

Chase

Chase is used to confirm that all preceding requests have passed through the network and have been processed. When this command is received, the 3274 returns a positive response to the PLU, indicating all previous chains have been processed.

The PLU should complete or cancel the current chained transmission before issuing the Chase command. When a chained transmission is sent with exception-only responses requested, the Chase command can be used to verify that all responses for that chain have been received. The EB or CD indicators can be issued with the Chase command.

Bid

The Bid command is sent by the PLU to a 3274 SLU to request permission to begin a bracket. The use of Bid avoids long chains of data using transmission time and then being discarded because the SLU won bracket contention. If the Bid is accepted by the SLU, a positive response is returned and the SLU goes to begin-bracket-pending state and waits for the request containing BB.

A 3274 SLU that is configured for between-bracket printer sharing can reject a Bid command by winning bracket contention for the following reasons:

1. LU Type 2

- The 3274 is already in Bracket (INB), and a PLU protocol error exists. The sense code returned is X'0813'.
- The operator has initiated an inbound data stream carrying Begin Bracket (BB). The sense code returned is X'0813'.
- An operator has started to enter data on the screen but has not initiated an inbound data stream. The sense code returned is X'081B'.

2. LU Type 1 or 3

- The SLU is already INB, and a host program protocol error exists. The sense code is X'0813'.
- A printer attached to the 3274 is busy doing a local copy operation. The sense code returned is X'0814'. The 3274 will send the Ready to Receive (RTR) command to the host program when the printer becomes not-busy and a BB can be accepted by the secondary LU. This applies to the 3274 only when configured for between-bracket printer sharing.

Signal

The PLU can send the Signal command to the 3274 SLU to request the Change Direction (CD) indicator. The SLU will complete any chained transmissions in progress and send the CD to the PLU. A request with CD but no data (a Null-RU) will be sent if the SLU is in send state but has not started transmitting. If the SLU is already in receive state, BETB, or ERP1 state (see "Session States"), the Signal is positively responded to but no SLU action is taken.

The 3274 will send the Signal command (X'00010000') when the terminal operator presses the keyboard ATTN key or, for an LU type 1, either of the printer PA switches. The command is expedited and has no effect on SLU states. Once Signal has been sent by an SLU, pressing the ATTN or PA keys will not cause a second Signal until the 3274 has received a response to the first Signal.

LU Status (LUSTAT)

The 3274 SLU sends the LUSTAT command to notify the PLU that a processing error has been detected or that a change in the operational status of a device has occurred. A 4-byte status code is sent by the 3274 SLU to describe the error condition or the device status change.

For LUSTAT codes and conditions that determine which LUSTAT is sent, refer to "Logical Unit Status" later in this chapter.

Ready to Receive (RTR)

A 3274 type 1 or 3 SLU sends this command to indicate when a previously rejected bracket (with sense code X'0814') can be initiated by the host program. The RTR command is allowed only when the session is ready to receive a new bracket. This applies to the 3274 only when configured for between-bracket printer sharing.

When the RTR command is sent and a positive response is received from the host program, the printer LU enters begin-bracket-pending state and expects the host program to begin a bracket.

REQMS

The Request Maintenance Statistics (REQMS) command is sent by the SSCP to a 3274 when the Network Determination Aid Processor (NDAP) requests PU performance statistics. Four types of requests can be made:

- Type 1 Link Test Statistics
- Type 2 Summary Counters
- Type 3 Communication Adapter Data Error Counts
- Type 5 3274 Configuration Information

The state of the RESET/NO-RESET indicator in the REQMS request determines whether the log area where the transmitted maintenance statistics are stored is cleared.

An REQMS request that cannot be executed by the 3274 is rejected with a negative response; an accepted REQMS request receives a positive response and the requested statistics (formatted as RECFMS) as an inbound message.

RECFMS

Record Formatted Maintenance Statistics (RECFMS) is sent by the 3274 to the SSCP in response to an REQMS command (the 3274 will not send unsolicited RECFMS requests to the host). The RECFMS maintenance statistics are recorded at the host by the Network Communications Control Facility (NCCF).

When the 3274 accepts an REQMS request, it transmits the maintenance statistics requested. If the REQMS specified "RESET," the error log area referenced by the REQMS is reset by the 3274 after the RECFMS is transmitted, otherwise, the error log area is not reset.

For descriptions of the RECFMS responses, refer to Appendix G.

Shutdown

The PLU sends the Shutdown command. Receipt of this command directs the 3274 SLU to prepare for a session termination sequence. The 3274 returns a positive response to the PLU, but data-transfer sequences are not inhibited.

The Shutdown command causes the session to enter shutdown-complete-pending state. The pending state is maintained until the SLU completes normal flow processing and goes between bracket (BETB). The SLU then sends the Shutdown Complete command to the PLU.

Shutdown Complete

This command is sent by the 3274 after the Shutdown command has been received from the host program and an End Bracket has caused the SLU to go to BETB state.

When the Shutdown Complete command is sent to the PLU, the session enters shutdown state. When shutdown state is active, no data transmissions can be sent to the PLU; the PLU, however, may continue to send data to the 3274.

The PLU may either terminate the session using Unbind when the Shutdown Complete command is received from the 3274, or use Shutdown as a means of quiescing traffic. Exit from Shutdown Complete requires a Clear and SDT if the command is used as a quiesce function.

FM Data

This command is used to transfer data in the LU-LU or SSCP-LU session. It may only be sent in LU-LU session when data traffic is allowed (SDT has been issued and received a positive response).

When communicating with a 3274 SLU, the following FM data protocols are used:

Bracket: Bracket Protocol is used to delimit a series of related inbound and outbound FM data request units (RUs); for example, all the RUs required to complete a transaction.

Chaining: Chaining logically connects one or more RUs from a single LU; for example, all RUs required to complete a display image.

Change Direction: Change direction informs the receiving LU that the sending LU has completed transmission and expects the next transmission to be from the receiving LU; for example, the PLU has transmitted a complete form image and expects the next transmission to be from the display operator when the blank fields in the form image are filled in.

Bracket Protocol. The 3274 provides a bracket protocol to delimit a series of related inbound and outbound requests. A bracket may consist of one input and one output, many sets of inputs and outputs, or a series of requests flowing in a single direction. The Begin Bracket (BB) and End Bracket (EB) indicators are used to delimit a bracket. References are made to bracket states (BETB and INB); these states are described under "Bracket States."

A bracket is initiated when the Begin Bracket indicator (BB) is accepted by the primary or secondary LU. The bracket is usually ended when the End Bracket indicator (EB) is received by the secondary LU. The specific conditions that end a bracket are defined by SNA bracket termination rule 1 (see below). Two commands, Bid and Ready to Receive (RTR), are implemented to further define the initiation of a bracketed session. These commands are described under "SNA Commands."

The following protocols apply for 3274 bracket processing.

For sessions with type 2 SLUs, the SLU may begin a bracket any time the session is between brackets. The PLU may request permission to begin a bracket using Bid. If the SLU returns a positive response, the PLU may begin a bracket. If the SLU returns a negative response, the PLU must wait for the next BB from the SLU.

For type 1 and 3 sessions, the PLU may begin a bracket any time the session is between brackets (the only time the SLU will begin a bracket is when the operator presses the PA key). The PLU may start a bracket by sending a transmission that contains BB or by sending Bid, waiting for a positive response, and then sending a transmission that contains BB.

The PLU may attempt to initiate a bracket by simply sending a transmission with BB. If a contention situation exists (the SLU begins a bracket before receiving BB from the PLU), the SLU returns a negative response to the PLU's transmission and then discards all portions of the chain from the PLU. The SLU assumes that its transmission will be accepted by the PLU.

If a Bid or BB from the PLU is rejected, the 3274 will do the following:

- For a session with a type 2 SLU, the SLU sends BB when it next has data to send. The PLU may return its data when it receives Change Direction (CD).
- For a type 1 or 3 session with a 3274 configured for between-session printer sharing, the SLU will not reject the PLU's Bid or BB unless a protocol error is detected. The PLU should restart the transaction.

- For a type 1 or 3 session with a 3274 configured for between-bracket printer sharing, the SLU will only reject the PLU's Bid or BB if the printer is performing a local print function or when a protocol error is detected. When the local print is completed, the SLU will send RTR.

The host program can end a bracket. The 3274 cannot end a bracket. Bracket protocol establishes the following restrictions on beginning and ending brackets:

1. BB and EB cannot be sent with response RUs.
2. The EB cannot be sent with the Bid or RTR command. All other normal flow DFC commands can end the bracket.
3. All outbound chains that begin a bracket but do not carry EB must be sent with definite response requested.

The 3274 supports bracket termination rule 1 as follows:

1. When EB is received and the last element of a chain requires definite response, the 3274 will enter between-bracket state (BETB) from in-bracket state (INB) after +RSP to the chain or stay INB after -RSP.
2. When EB is received and the last element of a chain requires exception response, the 3274 will enter BETB from INB immediately.

The 3274 ignores the BB bit on all outbound requests except FM data, and ignores EB on all outbound requests except FM data and DFC commands Cancel and Chase.

Chaining Protocol Definition. A data chain is a complete unit of data that originates at a single LU. Data RU chaining provides a method of logically defining a complete unit of data regardless of whether the data is transmitted as a single RU or as a series of consecutive RUs. Each RU is associated with only one chain. An individual RU may be the beginning, middle, ending, or only (both beginning and ending) RU in the chain; the chaining indicators, Begin Chain (BC) and End Chain (EC), are contained in the request header. The following are definitions of each type of RU in a chain:

First in Chain (FIC)	—	Identifies an RU that begins a chained transmission (RH=BC $\bar{\wedge}$ EC).
Middle in Chain (MIC)	—	Is transmitted with all RUs following the BC transmission, with the exception of the last RU in that chain (RH= $\bar{\wedge}$ BC $\bar{\wedge}$ EC).
Last in Chain (LIC)	—	Identifies the RU that completes a chained transmission (RH=EC $\bar{\wedge}$ BC).
Only in Chain (OIC)	—	Both the BC and EC indicators are included to indicate a transmission that consists of a single RU. That RU is termed a single-element chain (RH=BCEC).

A chain is correct if the RUs consist of:

1. FIC, LIC; or
2. FIC, MIC,..., LIC; or
3. OIC.

Any other sequence of chaining indicators will cause a chaining error.

Chaining Operations. When the 3274 receives a chain with chaining indicators in an improper sequence (for example, FIC, MIC, FIC), a negative response, with sense data indicating a chaining error (sense code X'2002'), is returned to the host program. The 3274 purges the chain, ignoring subsequent elements of that chain until a data RU with the LIC or a Cancel command is received. Receipt of an OIC data RU terminates the purging of a chain; the OIC message is also purged. Sending RUs having chaining indicators in the sequence FIC, MIC, OIC is a violation of chaining protocol. In this case, when the 3274 receives the OIC transmission, the chaining error is detected, the OIC transmission is purged, purging of chain elements is stopped, and a negative response is sent for the OIC transmission. The 3274 is now ready to normally process the next chain.

Change Direction. The 3274 uses a half-duplex, flip-flop (HDX-FF) mode to transfer normal flow data. Only one of the two LUs in the session may send at a given time. The flip-flop protocol demands that, when one LU is sending, the other must be prepared to receive. Therefore, the two states of send and receive (RCV) exist on each end of the session.

A bit in the request header, called the Change Direction (CD) indicator, is used to keep the two end-point LUs in synchronization. Each time an LU accepts this CD in a request, it means it is that LU's turn to send. Each time an LU sends the CD in a request, that LU must then be prepared to receive. The 3274 always sends CD with LIC or OIC in an FMD RH. Exceptions may occur following negative responses. See "ERP1" state.

Pacing

Inbound and Outbound pacing is supported by the 3274. Pacing is used as a tuning parameter for the system. Usage comments are included here; however, control is under the user's discretion at NCP or equivalent definition time.

The pacing count (N) determines the number of normal flow request RUs that can flow before a pacing response is required to allow the next group of N RUs to continue. A special response designated as Isolated Pacing Response (IPR) is used to return the pacing response if a response to the outbound request is not required at the time the pacing response is required. The 3274 will indicate readiness with a pacing response as soon as printer buffers become available after receiving the pacing request. Thus, the number of normal flow RUs allowed in the network due to pacing is up to $2N-1$. RUs may vary in length as specified in the Bind parameter.

LU Type 1

For the 3274, device dependencies exist because the printer is slower than the displays. Care must be exercised in the use of pacing and/or definite response protocol so that waiting RUs and/or chains are not stacked in the 3274 link buffers.

Within a chain, the 3274 transfers RUs from the link buffer pool to the printer buffer as they are received. The pacing parameter is then used to ensure that there is adequate printer buffer space so that the link buffer pool does not fill and restrict data flow to the keyboard displays or other printers.

During the transmission of multiple chains, interaction occurs between pacing and the type of response requested. When a definite response is requested, a response for a chain must be received by the PLU before it can send the next chain. When exception response is requested, the PLU may send any number of consecutive chains without waiting for a response. Therefore, a definite response enforces a type of pacing.

When OIC RUs are used that are less than, or equal to, 256 bytes, it is redundant to specify both pacing and definite response; unnecessary network traffic will occur if both are specified. The 3274 will not accept a pacing count of zero. When chains with multiple RUs are used, pacing is necessary even though definite response is requested.

During the transmission of multiple chains, the 3274 uses printer buffers as an extension of the link buffer pool. Pacing is based on the total buffer capacity.

If the 3274 SLU type 1 receives more normal flow requests than it is guaranteed by using the outbound pacing mechanism, and the printer buffer does not have enough space left to store the outbound data, a RSP using sense code X'0801' will be returned. The 3274 will respond to the chain in process of being printed and clear any remaining unprocessed chains from the printer, including the chain causing the error. A chain SNF error is likely to occur if additional chains are sent prior to a CLEAR for the 3274.

LU Types 2 and 3

For LU type 2, the 3274 will generally operate faster than the link, and pacing is not required for the controllers.

For LU type 3, the definite response required when the WCC Start Print bit is set is an effective alternative to pacing.

In telecommunication networks where RUs are processed through more than one communication controller (for example, a 3704 and a 3790 or two 3705s), outbound pacing may be required for type 2 and 3 LUs to prevent data traffic congestion in these controllers.

Inbound pacing is supported by the 3274. Usage in a tree-structured network may not be required. Usage in large telecommunication networks may require inbound pacing to prevent congestion at communication controllers in the network.

SNA Responses

The RH contains indicators that describe the type of response given: Definite Response 1 (DR1) or Definite Response 2 (DR2). The RH also contains an Exception Response (EX) indication that is used when describing the response protocol. Definite response protocol (DR1 \neg EX or DR2 \neg EX) specifies that a response, either positive or negative, must be given. Exception response protocol (DR1 EX or DR2 EX) specifies that only a negative response may, or need be, returned.

The only definite response type requested by the 3274 is Definite Response 1 (DR1). The response protocol requested by the 3274 (definite response and/or exception response) is defined in the Bind.

The 3274 will respond to message from the host with any requested response type (DR1, DR2, or both). The 3274 supports definite response or exception response protocols.

No distinction is made (within this chapter) between the specific response types. The term "positive response" indicates successful receipt of a command or data RU. The term "negative response" indicates that the receiving LU detected an error, which is reported to the sending LU.

Summary of SNA Commands

Figure 5-5 summarizes the validity of SNA commands received by the 3274 relative to the sessions (SSCP-PU, SSCP-LU, and LU-LU) to two LU-LU session processing states (data traffic reset and in brackets). Figure 5-6 shows the same for SNA commands sent by the 3274.

Sample SNA Command Sequences

Figures 5-7 through 5-13 illustrate the use of SNA commands. Responses to commands are not shown unless the response is a necessary part of the example.

SNA Command Received	SSCP-PU Session Active	SSCP-LU Session Active	LU-LU Session Active	LU-LU Session Processing States			
				Data Traffic Reset		In Bracket	
				On	Off	On	Off
ACTLU	R	E	T				
ACTPU	E	T	T				
DACTLU	R	T	T				
DACTPU	R,T	T	T				
Bind			E, I	X			X
Unbind			R, T				
Cancel			R		R		
Chase			R			R	
Clear			R	X			X
SDT			R	R	X		
Signal			R		R		
Shutdown			R		R		
FM Data			R		R	R	
REQMS	R						

Legend:

- R – Required state for this command to be valid.
- I – Command invalid if in this processing state.
- E – Command establishes this session.
- T – Command terminates this session.
- X – Command sets the processing state to the indicated status.

Figure 5-5. Summary of SNA Commands Received

SNA Command Sent	SSCP-PU Session Active	SSCP-LU Session Active	LU-LU Session Active	LU-LU Session Processing States			
				Data Traffic Reset		In Bracket	
				On	Off	On	Off
LUSTAT			R		R		
Signal			R		R		
Cancel			R		R	R	
Ready to REC			R		R		R
Shutdown Complete			R		R		R
FM Data			R		R	R	
RECFMS	R		R				
Notify		R					

Legend:

- R – Required state for this command to be valid.

Figure 5-6. Summary of SNA Commands Sent

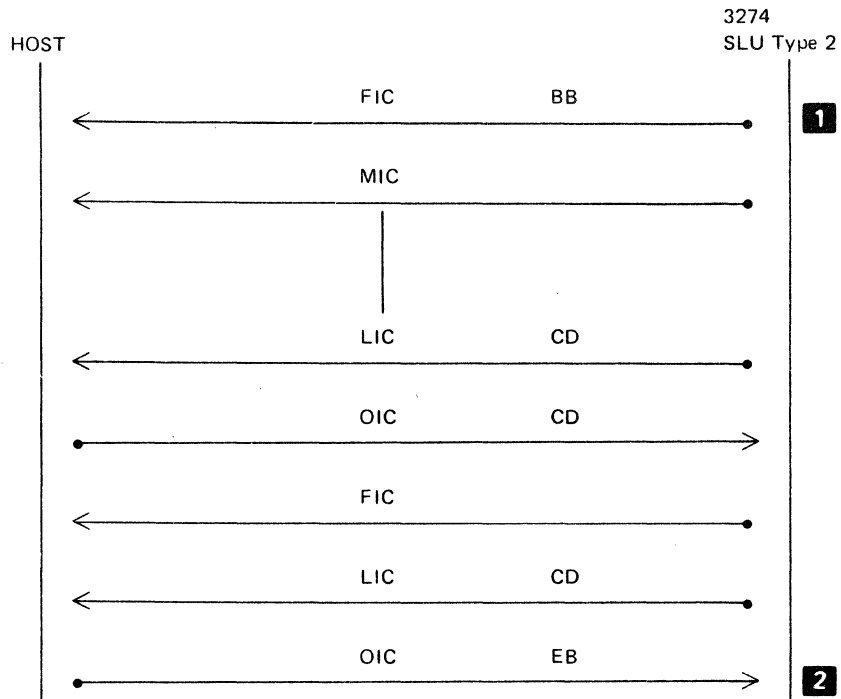

- 1** Initial conditions: Session established and both ends in contention-between-bracket state. SLU type 2 initiates a bracket and sends a chain as a result, for example, of Enter key depression.
- 2** After the required exchange of chains is completed, the host ends the 'unit of work' by sending EB (an LU type 2 cannot send EB). The EB chain may contain data: for example, a write to the screen; or it may be a Null RU chain, that is, only RHs.

Figure 5-7. Bracket/Chain -- LU Type 2 Initiated (without Contention)

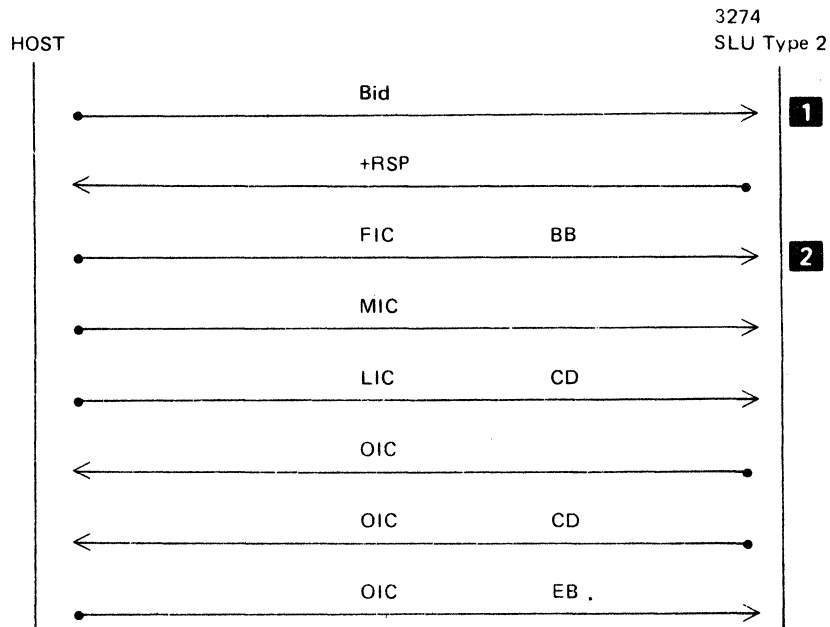

- 1** Initial conditions: Session established and both ends in contention between bracket state. Host sends Bid to indicate intention to begin a bracket.
- 2** The +RSP was SLU type 2, go ahead to the host. The host initiated the 'unit of work' with BB. **Note:** The host has the option of going directly to **2**, that is, skipping the Bid. However, there is a possibility of Bid rejection (Figure 5-9), which would result in resending the data associated with **2**.

Figure 5-8. Bracket/Chain -- Host Initiated (without Contention)

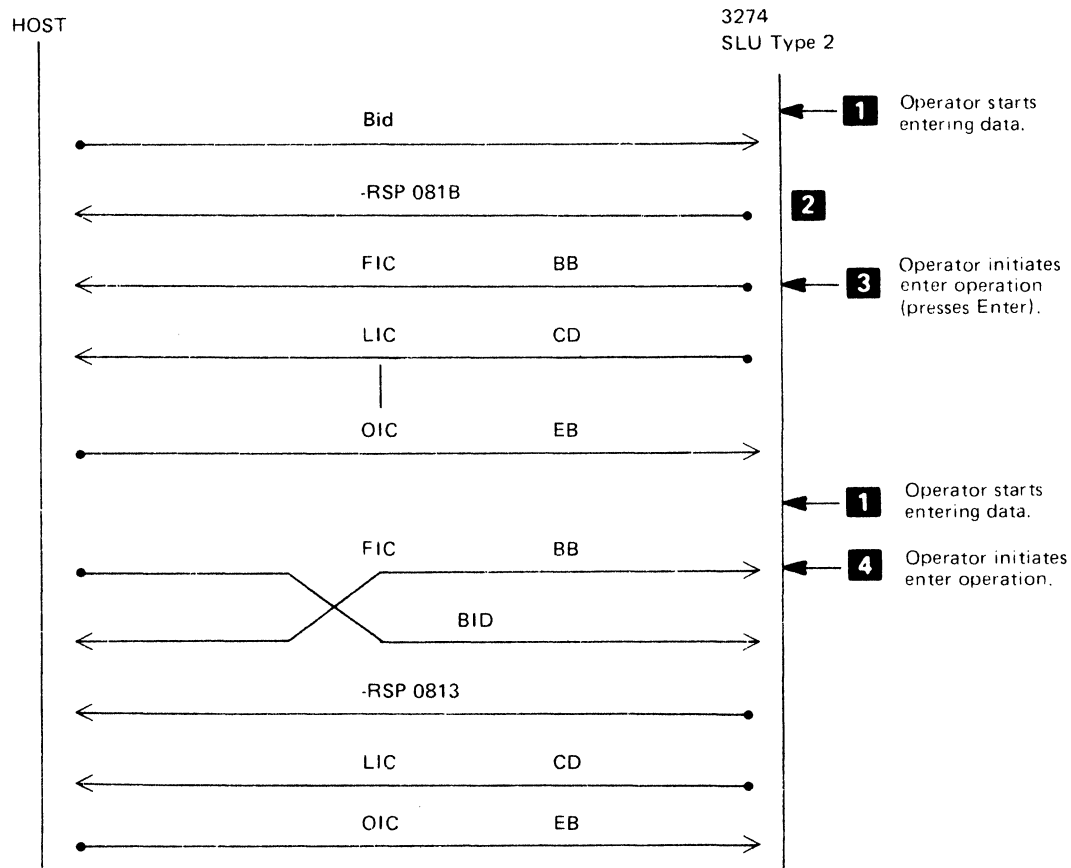

- 1** Initial conditions: Session established and both ends are in between-bracket state. The first operator keystroke puts the type 2 SLU in the send (but not transmitting) state. The type 2 SLU remains in BETB state.
- 2** The type 2 SLU will reject a Bid (or BB) with 081B. Receiver in transmit mode.
- 3** The operator initiates an enter operation; for example, he presses the ENTER key. The type 2 SLU begins a bracket and transmits the operator-entered data.
- 4** When the operator presses the ENTER key, type 2 SLU goes to in-bracket (INB) state. Type 2 SLU begins a bracket and starts sending data. The host end has sent a Bid (or BB) before the type 2 SLU first chain element was received. The type 2 SLU rejects the Bid (or BB) with 0813. The sense code differs from **2** because the bracket check is made before the HDX state check. In **2**, the bracket check was good.

Figure 5-9. Bracket/Chain – Host/SLU Contention

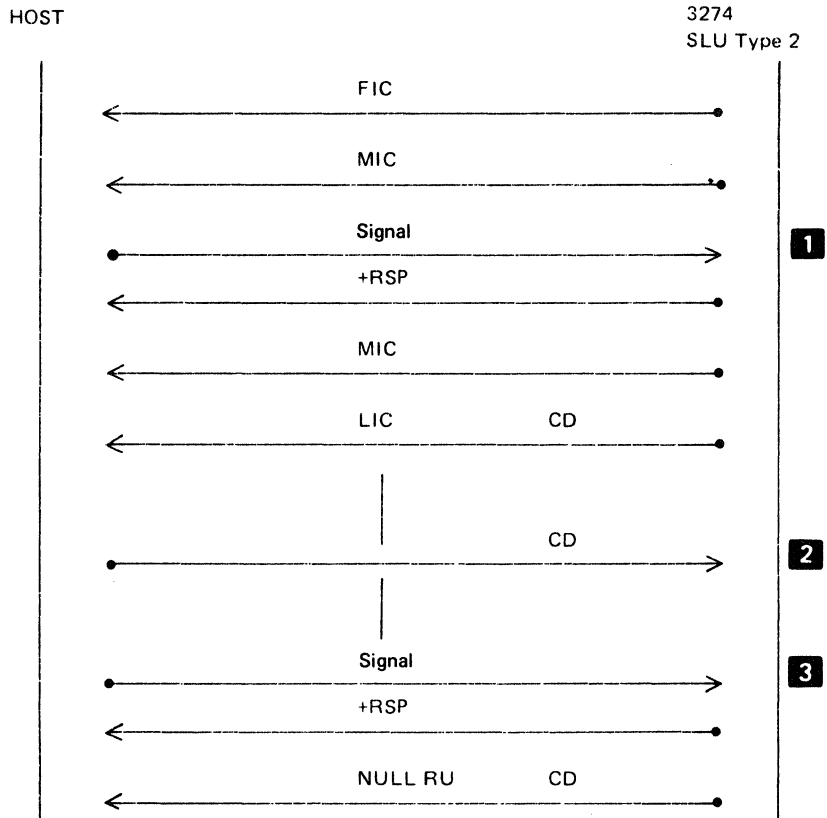

- 1** The SLU type 2 receives Signal while sending. The +RSP is returned to acknowledge receipt of Signal. The Signal is effectively treated as a NO-OP, and the SLU completes sending of the chain. The SLU type 2 always sends CD with the end of a data chain.
- 2** CD allows the SLU to send. The operator starts keying in data.
- 3** Before the operator initiates sending of data, for example, presses the ENTER key, the host sends Signal. The SLU sends +RSP to Signal, locks the keyboard, and sends CD.

Figure 5-10. Signal from Host

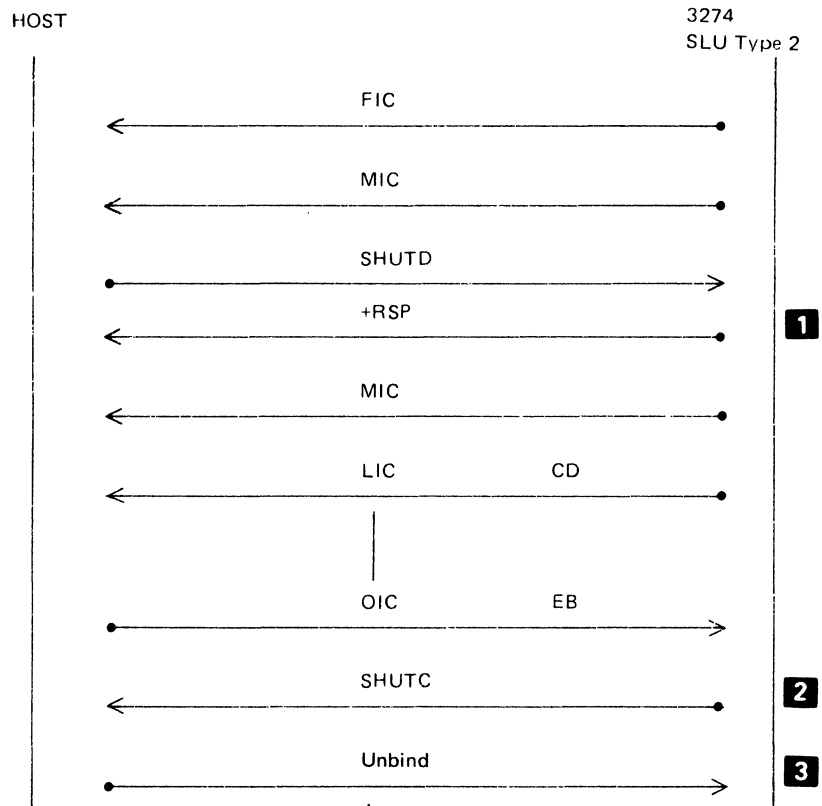

- 1** The SLU type 2 is alerted that the host wants to shut down. However, a synchronizing EB must be received before effecting shutdown.
- 2** The SLU goes into shutdown; that is, inbound normal flow (including Signal) is inhibited.
- 3** The host terminates the session. (*Note: The host could clear the condition and continue by sending Clear, SDT instead of terminating the session.*)

Figure 5-11. Shutdown/Shutdown Complete

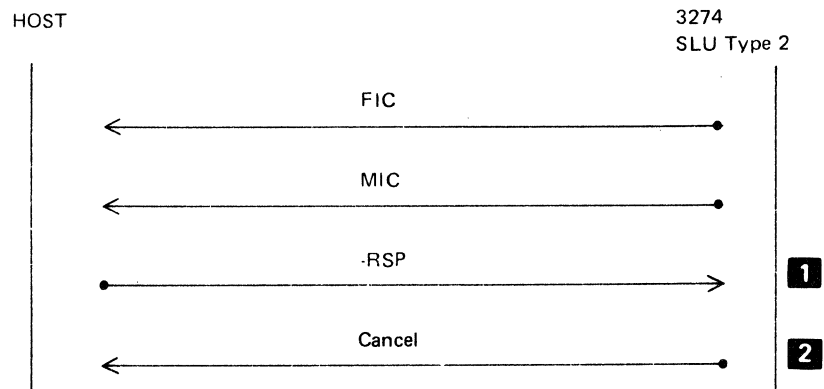

- 1** The type 2 SLU receives -RSP to a chain element. **Note:** *Normally, the 3274 will not examine any response until the entire chain has been sent and will therefore not send Cancel as the result of receiving a -RSP. However, when inbound pacing is in effect, responses are examined when the SLU must receive a pacing response before continuing transmission. A -RSP will then be detected and cause Cancel to be sent.*
- 2** The type 2 SLU sends Cancel to direct the host to discard the chain elements already received. The SLU goes to receive state, waiting for host recovery action.

Figure 5-12. Cancel, SLU Type 2 Sending

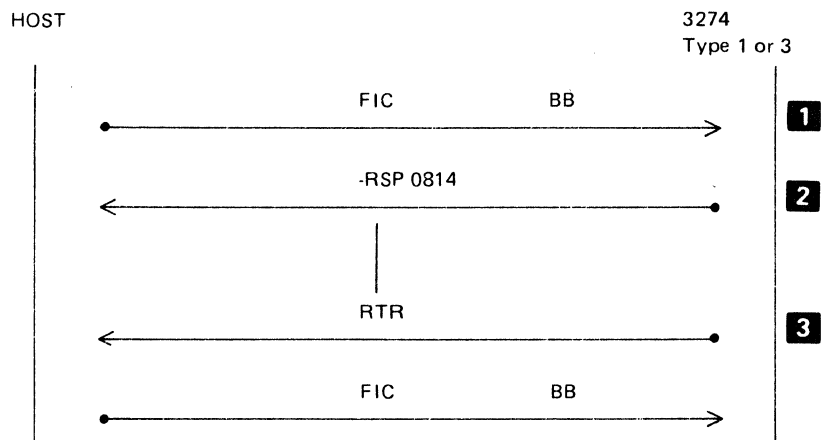

- 1** The printer associated with the SLU type 1 or 3 is not available because a local copy is being done. Consequently, the SLU type 1 or 3 cannot honor the host BB (or Bid).
- 2** The SLU type 1 or 3 rejects BB (or Bid) with -RSP X'0814' (Bracket Reject, RTR to follow).
- 3** The printer becomes available, and SLU type 1 or 3 send RTR to indicate to the host that a bracket may be started.

Figure 5-13. RTR – LU Type 1 or LU Type 3 Send

Session Processing States

The 3274 controls the processing of SNA commands, responses, and user data transmissions with a set of session states. Some of these states are defined by SNA and others are unique 3274 definitions that cause SNA state transitions. When the 3274 receives the Clear or Bind command, all 3274 session states are reset.

This section describes the processing states used by the 3274. When several states relate to a common processing function such as bracket or chain processing, they are described under a common heading. The remaining processing states are described individually.

Data Traffic (Reset/Active) State

Reset of all SNA LU-LU states in the 3274 is assured by entering data-traffic-reset state. This state is entered when a Bind or Clear command is received from the PLU. When data-traffic-reset state is turned off by SDT, the state is referred to as data traffic active.

When in data-traffic-reset state for any LU-LU session, the 3274 SLU cannot transmit data or commands to the host program. The host can send only session-recovery and session-termination commands when in this state. The 3274 accepts only data RUs for an LU-LU session during data-traffic-active state.

When in data-traffic-reset state and a data RU or a command other than SDT or Unbind is received from the host program, the 3274 returns a negative response with system sense data indicating that data traffic is inactive (sense code X'2005'). No other state, except contention, can exist when the SLU is in data-traffic-reset state.

Contention (CONT) State

The contention state on the LU-LU session exists only between brackets. In this state, the LU resources are not allocated. All associated I/O devices are enabled and the SLU can accept data from either the terminal or the host, whichever occurs first. The first arrival triggers a change to send or receive state.

For the SSCP-SLU session, contention state exists between the successful completion of all chains.

Send (SEND) State

The send state is common to both contention and HDX FF modes of operation.

In send state, the 3274 LU resources are allocated for inbound (to the primary) operations. Internally, there are two subdivisions of the send state. These are referred to as send --.xmit (send-not-transmit) and send-xmit (send-transmit). Send --.xmit exists while the control unit is entering data from a keyboard, MSR, or selector light pen into the device buffers. The state is entered from contention by the first keystroke capable of changing data on the display, or by initial input from the type 2 SLU MSR or selector light pen or the type 1 SLU PA key. The state is maintained until exited to send-xmit by an action causing the data to be sent inbound, generally the ENTER key. The transition from send --.xmit to send-xmit also causes the transition to in-bracket (INB) state when leaving contention. The transition always causes the keyboard to be locked and the Input Inhibit (3277, 3278, and 3279) and Wait (3278, 3279) indicators to be turned on. When in-bracket, send --.xmit is entered from receive state or ERP1 state after successfully processing an outbound chain carrying CD but not EB.

The type 2 SLU keyboard does not automatically unlock when the send state is entered from either receive state or ERP1 state. The keyboard is unlocked only if:

- A previous WCC specified keyboard restore, or
- The SLU is in send state and the terminal operator presses the RESET key.

After going from contention to send --.xmit state, any normal outbound requests received on that session will be discarded and a negative response "Receiver in Transmit Mode" with sense code X'081B' will be sent. Once INB, any normal outbound requests received on that session (FMD with BB or Bid) while in send state will be discarded and a negative response 'Bracket Bid Reject' with sense code X'0813' will be sent. Neither of these responses causes any state change in the 3274 or 3276 SLU. If INB and in send state, a request received that does not carry BB will be rejected by the 3274 with sense code X'2004'.

During send-xmit state, the data is being transferred from the device buffer to the PLU. Except for a possible LUSTAT, all normal flow chains on the LU-LU session will carry the CD. The transition out of send-xmit depends upon the response type carried with the inbound request. If a definite response is requested, the transition from send-xmit to receive takes place after the response to the inbound request is returned to the 3274. If an exception response is requested, the transition from send to receive takes place as soon as the end-of-chain has been successfully transferred to the transmission link.

The SSCP-SLU session operates in definite-response mode only. Therefore, the transition is from send-xmit to contention upon the receipt of a positive response, or send-xmit to receive if a negative response is returned.

Receive (RCV) State

The receive state is common to both contention and HDX-FF modes of operation. In this state, the 3274 LU resources are allocated for outbound (from the PLU) operations.

When RCV state is active, inbound normal flow requests cannot be sent. Responses, as requested, and control commands of the expedited flow can be sent inbound.

Input devices may be activated by a WCC character that specifies Keyboard Restore. However, an attempt to send data to the PLU by an operator, by using the selector light pen or MSR, or by pressing the ENTER, PA, or CURSR SEL key will not be allowed.

Normal flow traffic from the PLU is passed to the device when it is in receive state. This is allowed to halt local device operations by causing the keyboard to be locked and the Input Inhibited and Wait indicators to be turned on. A request with a WCC containing the Keyboard Restore bit set to zero is treated as a NO-OP for the keyboard states; that is, if the keyboard was unlocked before the write, it will remain unlocked after a successful write. If the keyboard was locked before the write, it will remain locked after the write.

For the LU-LU session, receive state is entered from contention state if an outbound normal flow message is accepted for processing. It is entered from send-xmit after receiving a response from an inbound request carrying CD and definite response, or after successfully transferring the chain to the data link when the request carries CD and exception response. For the SSCP-LU session, receive state is entered from contention if an outbound normal flow message is accepted for processing. It is entered from send-xmit if a negative response is received for an inbound request.

For the LU-LU session, receive state is changed to send --.xmit after successfully processing a last-of-chain carrying the CD. Receive state is changed to contention state after successfully processing and responding to a chain carrying EB, or after receiving a chain carrying EB which carries exception response requested. Receive state is changed to ERP1 state if any negative response except X'0813', X'0814', or X'081B' is returned to the outbound request.

For the SSCP-SLU session, receive state is changed to contention after returning the response to the outbound request.

ERP1 State

ERP1 is a special state created to allow for error recovery protocols. The PLU is always responsible for error recovery; therefore, the SLU state structure generally is awaiting an outbound request to correct the error condition. However, there are times when the SLU must first recover and notify the PLU of its recovery by use of LUSTAT command before the PLU can take action. Thus, the SLU ERP1 state allows a form of contention mode within brackets. This state has the characteristic of being able to receive any request, but only sending LUSTATs.

When an LUSTAT flows inbound, the SLU remains in ERP1 state. This allows successive LUSTATs to flow without requiring the general exchange of CD between each LUSTAT. LUSTAT does not request change direction when sent while in ERP1 state.

ERP1 state is entered by an SLU after responding with any negative response except X'0813', X'0814', and X'081B'. If the negative response does not change the state to betweenbrackets (BETB), the transition to ERP1 takes place at end-of-chain.

ERP1 state is changed by accepting an outbound chain carrying CD. Following processing of the CD bit, the transition is made to Send state.

When in ERP1 state, the keyboard is locked, except for the SYS REQ, ATTN, and TEST REQ keys.

Bracket States

The 3274 has three major states associated with bracket protocols: between bracket (BETB), in bracket (INB), and pending begin bracket (PEND.BB). These states are used to ensure synchronization of traffic between the PLU and the SLU. Transitions between these states are controlled by the BB and EB bits and by the Bid command.

Between Bracket (BETB) State

BETB state exists when the PLU and SLU are in contention to begin a bracket. This is the state entered after the SDT command is accepted. When the Bid or BB is accepted from the PLU or sent by the SLU, BETB state ends. If the host program cancels the chain containing the Begin Bracket, or if the SLU sends negative response for the chain containing the Bid or BB, the 3274 returns to BETB state. BETB state is normally assumed when an EB has been processed successfully.

When a chain carrying both BB and EB is being processed, BETB state is not changed.

The 3274 sets BB on the first RU transmitted when the control unit enters INB from BETB.

BETB is terminated and INB is entered when the first (or only) element of a chain with BB bit on is ready to be transmitted; that is, an ENTER, PA, PF, or other attention key is pressed.

Pending Begin Bracket (PEND.BB) State

In the PEND.BB state, the 3274 is waiting for a bracket to be begun by the host system. The 3274 has either returned a positive response to a Bid command or has received a positive response to a Ready to Receive command. When the host program attempts to begin a bracket and the 3274 is in PEND.BB state, the 3274 will not reject the bracket with sense code X'0813' or X'0814'.

In Bracket (INB) State

INB state is entered when the 3274 receives a BB without the EB or when the 3274 begins a bracket. INB state is maintained by the 3274 until the positive definite response to the EB chain is returned to the host or until the 3274 receives the last element of the EB chain when exception response is requested.

3274 Bracket State Errors

Error codes generated for bracket error conditions are as follows. The bracket state conditions remain unchanged after sending the error code.

State \ Command	Chase & EB	Chase & ~EB	Bid	Cancel & EB	Cancel & ~EB	FMD & BB	FMD & ~BB
BETB	2003	—	—	2003	—	—	2003
INB	—	—	0813	—	—	0813	—
PEND.BB	2003	—	—	2003	—	—	2003

RU Lengths

Outbound to the 3274

The maximum RU length that a PLU is permitted to send is defined in byte 11 of Bind. The 3274 accepts a maximum RU size within the following constraints. Note that where multiple constraints apply, the maximum RU size is limited to the smallest size calculated by applying each constraint.

For 3274 channel attachment: The maximum RU size received must be less than or equal to 1536 bytes. Byte 11 of Bind (PLU max send size) is not checked. A negative response with sense code X'1002' (RU length error) will occur if the PLU transmits an FM data RU greater than 1536 bytes.

For a type 1 SLU in a 3274: The following formula applies:

$$MRU \leq \left(\frac{BUFF - 336}{PC} \right) - 11$$

where:

MRU is the smallest multiple of 256, more than or equal to the maximum RU size specified in byte 11 of the Bind.

PC is the pacing count specified in byte 9 of the Bind.

BUFF is the device buffer size.

A Bind reject with sense code X'0821' will occur if the Bind specifications do not meet these limits.

For type 2 and 3 SLUs in a teleprocessing-attached 3274: There are no 3274 restrictions.

Inbound from the 3274

The 3274 accepts only a 'Multiple Element Chains' Bind for inbound operation. The maximum RU size can be controlled by the PLU through byte 10 of the Bind request. For the 3274, the RU size transmitted inbound is limited by the lesser of two values: the value in byte 10 or 1024. If the value of byte 10 is greater than the 3274 capabilities, the Bind will be accepted, but the actual RU size will be limited to device capabilities.

The minimum value that may be specified by byte 10 of the Bind request is 64 bytes for the 3274. If lesser values are specified, the Bind will be rejected with a negative response, sense code X'0821'.

Segmenting Description

RUs sent to network terminals are often larger than acceptable for optimum transfer of data by the link connecting the terminal to the network. Therefore, a Basic Information Unit (BIU) consisting of RH and RU may be divided into smaller elements, called *segments*, that are transmitted over the link. The 3274 supports inbound and outbound segmenting on the LU-LU session except when attached to a local channel.

The segment elements are defined as follows. The First in Segment (FIS) element is equated to Begin-BIU, not End-BIU. The Last in Segment (LIS) element equates to End-BIU, not Begin BIU. The Middle in Segment (MIS) equates to not Begin-BIU, not End-BIU. An Only in Segment (OIS) contains the entire BIU.

Sequencing of segments is in the correct order if the sequence consists of:

1. FIS, LIS
2. FIS, MIS,..., LIS
3. OIS

Segmenting Outbound

Errors due to improper sequencing of the segment elements will cause the 3274 to enter normal disconnect mode. This action does not permit sending a negative response to the PLU. The 3274 will also deactivate the Physical Unit and all Logical Units and turn on the Communication Check indicator on all 3278s and 3279s. See Appendix B.

The 3274 passes segment elements through for processing and immediate display or printing when the terminal is attached using a Terminal Adapter Type A (for example, a 3278). The segments are collected and processed in the 3274 on an RU basis when the terminal is attached using a Terminal Adapter Type B (for example, a 3277).

The maximum size for segment elements (the NCP MAX DATA SIZE parameter) delivered to the 3274 must not exceed 256 bytes of data plus 6 Transmission Header (TH) bytes and 3 Request/Response Header (RH) bytes for the FIS or OIS. The maximum size for MIS or LIS must not exceed 256

bytes of data plus 6 bytes of TH. If the segment elements exceed 256 bytes, a 3274 featured with the high-performance communications adapter will reject the segment element by not incrementing the link count and discarding the frame information. Continuous rejection of a segment element that is too long is expected to cause a retry failure in the communication controller, and results in a station inoperative disconnect by that node. A 3274 featured with the common communications adapter will return a Command Reject for this condition.

The Communication Check indicator showing buffer overflow is turned on for all operational 3278 or 3279 displays connected to the 3274 when the control unit detects buffer overflow.

When the 3274 is connected to NCP, it is recommended that the NCP buffer size be set for one of the following byte sizes:

Optimum: 64, 128, or 256 bytes.

Second Choice: 84, 124, 248, or 252 bytes.

Segmenting Inbound

Segmenting inbound is supported by the 3274 on the LU-LU session under the following conditions:

1. When maximum RU size is specified as 256 or less and accepted at Bind time, no segmenting is used by the 3274.
2. When maximum RU size is specified as greater than 256, the RUs are segmented into segment elements containing 256 data bytes each for FIS or MIS, provided sufficient data is transmitted to cause segmenting.

Note: *For the 3274 A units, inbound segmenting is determined by Bind, byte 10, and buffer size established at connection time.*

When the Bind maximum RU size is greater than 256 bytes, considerations other than maximum RU size and amount of data to be transmitted may determine the actual RU length (\leq Max RU size) that is sent. The 3274 will never send an RU having more than 1024 bytes.

Programming Note: *The 3274 may interleave a response between the inbound segment element of an RU.*

3274 Errors

Data Link

For data link control, action is as discussed in *IBM Synchronous Data Link Control General Information*, GA27-3093. Unique action is that the Set Normal Response Mode command causes the 3274 to reset from an Activated Physical Unit to a Deactivated Physical Unit. All sessions must be restarted by the sequence starting with ACTPU.

A segmenting error will not be reported by an SNA negative response, but will cause the 3274 to go to normal-disconnect mode and do an internal DACTPU.

LU-LU Session Error Reporting

A protocol has been established for the reporting of transmission and processing errors during sessions. When the host program or the 3274 SLU is the receiving LU, errors are reported by turning a negative response to the sending LU, with descriptive sense data included.

The format of the 4-byte sense data RU, sent with a negative response, is as follows:

0	1	2 and 3
System Major Code	Sense Modifier	User Sense

Byte 0 of the sense data RU is bit-encoded to reflect one of six transmission error categories, as follows:

Byte 0 in Hex	Major Code
'80'	Path Error
'40'	RH Error
'20'	State Error
'10'	Request Error
'08'	Request Reject
'00'	User-Defined Error

Byte 1 of the sense data RU is a binary modifier that further defines the error condition. The modifier encoding is unique to each major code.

Bytes 2 and 3 are zeros for all negative responses sent by the 3274. The section "SNA Sense Codes" later in this chapter defines the modifier encoding for each major code of system sense data that is issued by the 3274.

Note that the 3274 will not examine the sense data in a negative response from the host. All negative responses on the LU-LU session cause the 3274 to enter RCV state and await further action by the host.

Sessions

Three sessions exist for the 3274 when operating with SNA protocols. These sessions are: SSCP-PU, SSCP-SLU, and LU-LU (PLU-SLU). The three sessions can exist simultaneously. The SSCP-SLU and LU-LU sessions may wish to use the display simultaneously.

An interactive protocol is used with the 3274, in which, at any given time, only one of the sessions is defined as the device (display screen, keyboard, and data buffer) owner. During ownership, any attempts by the nonowner session to send FM data is rejected.

The state diagram (Figure 5-14) shows the transfer of device ownership between the SSCP-SLU and the LU-LU session. Prior to ACTLU, or following DACTLU, no session can own a device. Local operations initiated by the TEST key are not defined as sessions.

Device ownership is indicated to the operator by symbols in column 3 of the Operator Information Area. (Refer to Appendix B for a detailed explanation of Operator Information Area symbols.) Prior to ACTLU or following DACTLU, this column is blank. ACTLU causes the Unowned symbol to appear.

After ACTLU is received, the SYS REQ key (or equivalent 3277 function) may be used by the operator to control which session owns the device. When the LU-LU session is not bound and the Unowned symbol appears in column 3, the SYS REQ key, or an RU from the SSCP, transfers device ownership to the SSCP-SLU session. At this time the System Operator symbol appears in column 3. The operator can then communicate with the SSCP.

If the attached device is a printer or a display without a keyboard, an FM data request to the SLU from the SSCP while in the unowned state will be rejected with category not supported sense code X'1007'.

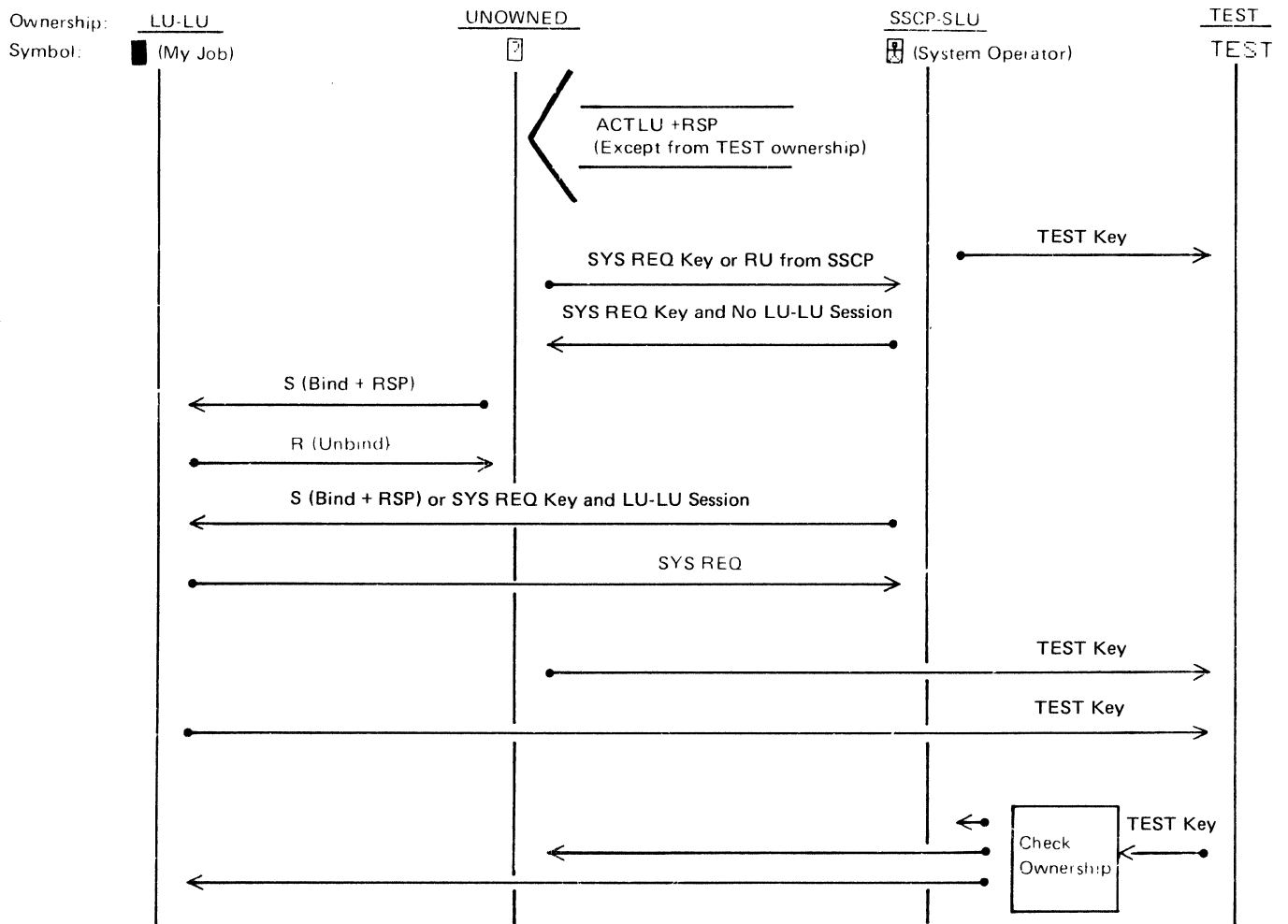

Figure 5-14. State Diagram for Session Ownership of Device

When a Bind command is received and positively responded to, ownership is transferred immediately from the SSCP-SLU session, or the unowned state, to the LU-LU session, and the My Job symbol appears in column 3. Note that Bind commands may be PLU-initiated without operator logon.

The SYS REQ key is also used to transfer ownership from the LU-LU session to the SSCP-SLU session. This transfer of ownership interrupts communications taking place during the LU-LU session without waiting for completion of outbound chains. Inbound chains will complete unless a test is made for a pacing response. As long as the LU-LU session remains bound, another depression of the SYS REQ key will cause ownership transfer back to the LU-LU session. Note that if the LU-LU session is not bound, the SYS REQ key will cause ownership transfer to the unowned state.

Pressing the TEST key causes the device to go into or leave the test ownership state. This state removes the device from the SLU and makes it unavailable to either the SSCP or PLU. If the PLU sends an FM request, the SLU sends RSP X'082D'. If the SSCP sends an FM request, the SLU sends RSP X'081B'. These responses assume that all other requirements for an active session have been met. When leaving the test state, a check is made for SSCP or PLU device ownership. Return will be to the session whose ownership is indicated by the check or to the unowned state if neither the PLU nor SSCP is the owner.

Setting the Screen Size

When ownership changes, the screen size may change. When changing from the unowned state to SSCP-SLU ownership, the screen size is set to the maximum physical size. When the screen enters the unowned or test state, the initial screen size is the size set by the previous owner; pressing the CLEAR key will set the screen to the maximum physical size. Operation and control of the screen size when the owner is the LU-LU session is discussed under "Erase/Write Alternate command" in Chapter 1.

Pressing the SYS REQ key causes the screen to be cleared. The screen also is cleared by the transfer of ownership from unowned to SSCP-owned when this state transfer is caused by an outbound RU from the SSCP.

Operation in SSCP-SLU Session

The following paragraphs describe the operational characteristics of the 3274 when exchanging display data on the SSCP-SLU session.

SSCP-SLU Contention Operation

The 3274 supports FM profile 0. Immediate control and immediate response are followed, and all requests are treated as definite requests.

HDX-contention is implemented, and a normal flow request must be processed and acknowledged by a response before an opposite-direction normal flow request can be accepted or processed.

The 3274 SLU is in contention state whenever SSCP-SLU session ownership mode is entered by use of the SYS.REQ key.

Nonerror Operation

For nonerror operation, the receipt of a positive response, or transmission of the response, initiates the transition to contention state. The transition from contention to receive state is initiated by the recognition of an outbound request. The transition from contention to send-not-xmit is made when the first data key pressed is accepted. [Refer to "Send (SEND) State."] The transition to send-xmit is made when the ENTER key is accepted.

The keyboard is controlled by state conditions. It is unlocked when in contention or send-not-xmit, and locked when in receive or send-xmit. The operative keys that are locked or unlocked are the same as for the LU-LU session.

Error Operation

When a normal flow request has been transmitted inbound and a negative response is received, the SLU goes into receive state and waits for an outbound request from the SSCP.

When the 3274 SLU detects a temporary or permanent error condition while in send or contention state, the SLU goes into contention state. The SSCP is not notified of the error.

When a normal flow request is received but cannot be accepted because of error or a not-available condition, the SLU goes into contention state following the negative response.

Outbound Message Handling

The SSCP may send messages to a display when the SSCP-SLU session owns the display. The messages are byte strings consisting of SCS control codes and SSCP-supported graphic codes. There is an outbound limit of 256 bytes of data. The only valid SCS control codes are NL and, when the APL/Text feature is installed, the Graphic Escape character. NULL, IFS, and IRS are treated as graphics and displayed as blank, *, and ; respectively. Any other binary combination in the SCS data stream will be treated as if it is a graphic. The characters appearing on the screen for code points other than supported graphics are unpredictable.

Each message from the SSCP is displayed at the current cursor address. When the 3274 receives an NL control code in the SSCP message, it will insert nulls in the character positions remaining in the display line being written and position the cursor at the leftmost position of the next line. Characters following the NL code are displayed beginning at the new cursor position. The message wraps to the top of the screen if the last line on the screen is written and additional characters remain in the message.

After displaying the data in the received chain, the 3274 places the cursor in the position next to the last character if NL does not follow. If the message is ended by NL, the remainder of the line is set to nulls, and the cursor appears in the first character position of the next line. This cursor position address is called the initial cursor address and is stored to identify the starting position of the operator's display input data.

Inbound Message Handling

When the System Operator symbol is displayed, an operator can enter the message bound for the SSCP from the character position occupied by the cursor.

After entering a message, the operator must press the ENTER key to initiate transmission of the inbound message to the SSCP. Pressing other PA keys has no effect, except for the CLEAR key. Data transmission does not occur. If other PA or PF keys are depressed, Input Inhibited and Minus Function symbols are turned on. Pressing the CLEAR key causes the display screen to be cleared, and the initial cursor address is reset. The ERASE INPUT and ERASE EOF keys operate as defined under "Key Functions" in Appendix C.

Chains sent on the SSCP-SLU session are OIC, and have a maximum RU length of 256 bytes. The 3274 will send the data (excluding nulls) contained in the first 256 screen character positions including and following the cursor address, or to the end of screen, whichever occurs first.

System Logon (3277 Attached to 3274)

The 3277 does not have the session ownership symbols that are present on the 3278. Therefore, when an operator starts to use a 3277 which might have been used previously and left in an unknown session ownership, the following sequence of operations may be necessary to determine session ownership:

1. Check the display screen to see if messages exist which indicate that the terminal is already in an LU-LU session and that, therefore, system logon is not required.
2. If logon is required, press the TEST REQ key and then the CLEAR key. The SYSTEM AVAILABLE light should turn on (if it was off), and the INPUT INHIBITED light should be off. If the SYSTEM AVAILABLE light does not turn on, repeat the TEST REQ key, CLEAR key sequence. If the SYSTEM AVAILABLE light still does not turn on, the terminal is not connected to the system.

Key in the character-coded logon request and press the ENTER key. The SYSTEM AVAILABLE light will turn off.

Wait for the SYSTEM AVAILABLE light to turn back on. This indicates that the 3274 has received a positive response to the inbound message.

3. Acceptance of the Bind command does not cause a change in the SYSTEM AVAILABLE light, and therefore a message should be sent from the PLU to notify the operator that the LU-LU session has been established.

System Logon (3278 or 3279 Attached to 3274)

By means of the logon sequences, the terminal operator requests that a session be established with a PLU. The logon sequence is as follows:

1. The terminal operator checks the symbol displayed in column 3 of the Operator Information Area. If the My Job symbol is displayed, the terminal is already connected to a PLU, and system logon is not required.
2.
 - a. If the Unowned symbol is displayed, the terminal operator presses the SYS REQ key to enter the SSCP-SLU owned session and then keys in a character-coded logon request in a syntax defined by the installation. The operator presses the ENTER key, and the logon message is sent to SSCP.
 - b. If the System Operator symbol is displayed, the display station is already owned by the SSCP-SLU session. In this case, the operator performs step 2a, except the SYS REQ key is not pressed.
3. SSCP receives the logon request and sends a positive response (X SYSTEM disappears).
4. SSCP may send a message, such as a prompting or error message, if necessary. When the 3274 receives this message, it sends a +RSP if accepted for display, or RSP X'081B' if device ownership has been transferred to the LU-LU session.
5. A successful logon causes the My Job symbol to appear. An error message leaves the System Operator symbol displayed; the operator may retry, starting with step 2b.

Note: *An SSCP-SLU message confirming LOGON should not be used since this may arrive after the Bind command and confuse the operator by displaying the Message Received symbol.*

System Logoff (3277 Attached to 3274)

This system logoff sequence is similar to that described below for the 3278 except that the two-key sequence of TEST REQ key followed by the CLEAR key is used in place of the SYS REQ key.

System Logoff (3278 or 3279 Attached to 3274)

By performing the logoff sequence, the terminal operator requests the SSCP to terminate a session with the PLU. The logoff sequence is as follows:

1. The terminal operator presses the SYS REQ key to enter the SSCP-SLU owned session and keys in a character-coded logoff request in a syntax defined by the installation. When the operator presses the ENTER key, the logoff message is sent to SSCP.
2. SSCP receives the logoff request and sends a DR response.
3. SSCP may send a message. When the 3274 receives the message, it sends a +RSP if accepted for display, or RSP X'081B' if device ownership has been transferred.

SNA Printer Control

The following paragraphs describe the structure of the SNA session and the SNA control for printer operations. Details and constraints of subsystem operation are described under "3274 Local Copy Function" in Chapter 2.

Figure 5-15 shows a typical example of a logical subsystem and the point at which contention for the printer occurs.

Printers attached to the 3274 can be configured to operate in one of the three following modes:

1. **System Mode**—The printer is logically coupled with a type 1 or 3 SLU as the principal device; the SLU is in direct session with the PLU. The SLU type is selected at the time the session is bound (the Bind command) and remains the same throughout the session. In this mode, the printer cannot be used for local copy functions.

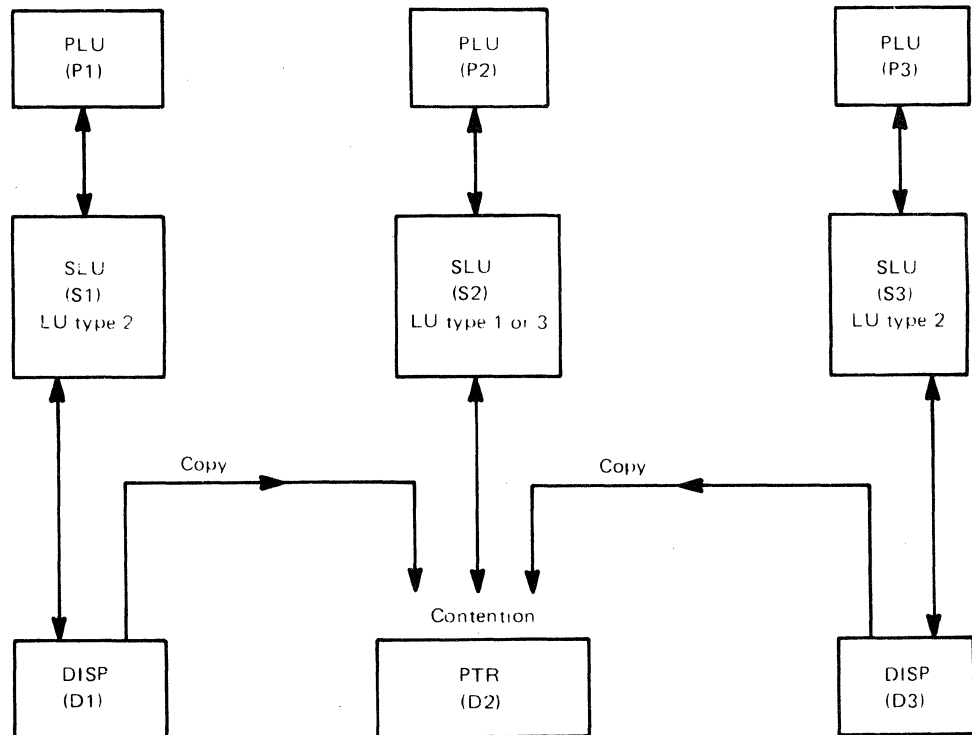

P1,P2,P3 : PLUs at the host.

S1,S3 : SLUs in the 3274 operating as LU type 2.

S2 : SLU in the 3274 operating as LU type 1 or LU type 3.

D1,D3 : Display device controlled by S1 and S3, respectively.

D2 : Printer device controlled by S2 or copied to from D1 or D3

Figure 5-15. 3274 Logical Subsystem

2. Local Mode—The printer may be used by one or more type 2 SLUs as a subsidiary device for local copy functions. A copy request may be initiated by the SLU's PLU (WCC with Start Print=1) or by the operator using the Print key. In this mode, the printer cannot be used by a type 1 or 3 SLU; a Bind request for the SLU associated with the printer will be rejected with sense code X'0801'.
3. Shared Mode—Both the SLU type 2 and the SLU type 1 or 3 may compete for use of the printer. The printer is used by the SLU type 1 or 3 as a principal device and by the SLU type 2 as a subsidiary device. Depending upon proper customizing, sharing may be done between brackets or between sessions.

Between-Bracket Printer Sharing: When in shared mode, printer contention is allowed to occur between brackets. When the printer's SLU enters BETB state (or if a session does not exist), the printer is available for either a local copy from an SLU type 2 or an SLU type 1 or 3 bracket, whichever occurs first. If a local copy function is being performed for either a single SLU type 2 or a queue of SLU type 2 requests, a BB request for the type 1 or 3 SLU will be rejected with sense code X'0814' (Bracket Reject, RTR to Follow). When all local copies are completed, the type 1 or 3 SLU acquires the printer and sends RTR to the PLU. If the type 1 or 3 SLU is in-bracket, the printer is not available for local copy functions. (See the description of the copy function for details.)

Between Session Sharing: When in shared mode, the 3274 allows a printer to be used for local copy only when the printer is not being used in an SLU type 1 or 3 session. If a printer is being used for local copy and a Bind is received to initiate a type 1 or 3 session, the 3274 allows the local copy in progress to complete and then sends a positive response to the PLU. All queued local copy requests will either be processed by an alternate printer or rejected with sense code X'0801' (No Printer Configured). This type of sharing biases the printer availability in favor of the type 1 or 3 SLU session.

Local Operations (3274 A Units)

The 3274 A units are 3790-compatible using data stream compatibility (DSC) mode of operation. They attach to a System/370 using a selector, multiplexer, or block multiplexer channel via the standard I/O interface. When attached to a byte multiplexer channel, operation will be in 2-byte multiplex mode.

The channel program controls all 3274 A unit operations by transmitting information across the I/O interface. This information consists of: (1) an address byte, which selects one control unit, (2) a command byte, which specifies the type of operation to be performed, (3) a link header, (4) SNA data, and (5) various control signals. Status bytes, which are automatically generated, inform the channel of the general and unique conditions of the 3274 A units when command operations are not in progress.

Interface Operations

Local interface operations for the 3274 A units are summarized in the following paragraphs and are described in detail in the *IBM System/370 Principles of Operations* manual, Form GA22-7000, and the *IBM System/360 and System/370 I/O Interface Channel to Control Unit Original Equipment Manufacturers' Information* manual, Form GA22-6974. The CPU program initiates operations with a Start I/O instruction. This instruction identifies the I/O control unit and causes the channel to fetch a channel address word (CAW) from a fixed location in main storage. The CAW designates the storage protection key and the location in main storage from which the channel subsequently fetches the first channel command word (CCW). The CCW specifies the command to be executed and number and address, in main storage, of any bytes to be transmitted.

Any one of 256 terminal addresses (0-255) may be assigned.

Selection

The channel attempts to select a 3274 A unit by placing a unique address byte on the channel or subchannel. When the addressed 3274 A unit recognizes its address, it logically connects to the channel and responds to the selection by returning the address to the channel. 3274 A units are single-address control units and device addressing is accomplished via SNA protocol.

Command Initiation

Command operations start when a 3274 A unit is successfully selected. When a command is to be executed by the control unit (not by the channel alone), the channel sends the command code (CCW bits 0—7) to the 3274 A unit.

When execution of the command involves a transfer of data (such as write or read operation), the 3274 A unit responds to the command with a status byte called "initial" status, which indicates when it can execute the command. If the command can be executed, the channel responds automatically to service requests from the control unit, and the control unit assumes further control of the operation. Command operation can be terminated by the control unit or by the channel when the channel byte count reaches zero. At this time, the control unit sends the channel a second status byte, called "ending" status, which indicates whether the command operation was successfully performed.

Chaining

When the channel has completed the operations specified by a CCW, it can continue the activity initiated by the Start I/O by fetching a new CCW, thereby starting execution of another command. Fetching of this new CCW is called "command chaining," and the CCWs which belong to such a sequence are said to be chained. All CCWs in a chain apply to the control unit specified by the Start I/O instruction. Multiple devices may be specified through SNA protocol.

Either of two types of chaining can be specified by the current CCW (bits 32 and 33): data chaining or command chaining. During data chaining (current CCW bit 32=1), the new CCW fetched by the channel defines a new main storage area, the data address, for the current command. Data chaining is transparent to the control unit. During command chaining (current CCW bit 33=1), the new CCW specifies a new command and a data address for that new command.

The control unit is totally dedicated to one CCW string until final Channel End time or until operations are abnormally terminated.

Commands

The commands and orders discussed in Chapter 1 are contained in the SNA data stream. The commands listed in Figure 5-16 are the command codes (CCW bits 0—7) the channel sends to the control unit.

Command	Code
Write	01
Read	02
No Operation (NOP)	03
Sense	04
Control	05
Write Break	09
Write Start 0	31
Read Start 0	32
Write Start 1	51
Read Start 1	52
Restart Reset	93
Sense ID	E4
Test I/O	00

Figure 5-16. 3274 A Unit Local Command Codes

Write Command

The Write command requests data transfer from the host. A minimum of 4 bytes, called the *Link Header*, must be transmitted in the following specific format:

- Link Header consisting of:
 - Data Count Field (2 bytes)
 - Bytes 0 and 1 must contain the total byte count of the record which is being transferred.
 - Byte 2 is reserved.
 - Byte 3 contains the Function code. A value of X'00' is used for normal data transfer.
- SNA Data
 - TH (FID2), RH, and RU

Read Command

The Read command requests data transfer to the host. The format of the data is:

- Link Header* consisting of:
 - Data Count Field (2 bytes)
 - Reserved (1 byte)
 - Function code (1 byte). A value of X'00' is used for normal data transfer.
 - Pad Characters (n bytes)

*The size of the Link Header is determined by the Connect. (Refer to "Control Command" below.)
- SNA Data
 - TH (FID2), RH, and RU

No Operation Command

The No Operation command does not transfer data. Ending status to this command does not reflect any change within the control unit. Normal System/370 usage inserts No Operation (NOP) in a CCW string for possible later dynamic program modification, or as a standalone command for checking availability of the channel path to the control unit. Additionally, the NOP command may be used as the ending command in the Read CCW, Write CCW, and the Write-Read CCW sequences.

Sense Command

The Sense command is normally issued after Unit Check status has been presented to the host, and requests 2 bytes of sense data. The sense bits are predictable and meaningful only after presentation of Unit Check status. The sense bits are retained for reading until a command other than Sense, Test I/O, or NOP is accepted.

Control Command

The Control command provides two functions to the 3274 A units: Connect and Disconnect.

Connect Function. The Host Physical Unit Services issues a Control command (05) to send initialization parameters to the 3274 A units.

The data stream consists of the following 10 bytes:

Byte	0	1	2	3	4	5	6	7	8	9
Content	Length		Res	Func Code	Numbers of Host Buffers		Size of Host Buffers		S to P Link-Header Size	

Length = X'000A'	—	Total number of bytes (including length)
Reserved = X'00'	—	Not used
Function Code = X'01'	—	Connect function code
Number of Host Buffers	—	The number of buffers contained in each host Read channel program. Used to determine the maximum number of Basic Transmission Units (BTUs) that may be sent to the host with CCW string.
Size of Host Buffers	—	The total number of bytes that may be sent with each Read CCW (i.e., buffer). The total length is the sum of the Path Information Unit and Secondary to Primary (S-to-P) Link Header, including pad characters.
Secondary-to-Primary Link Header Size	—	Specifies the total length of the S-to-P Link Header. This length consists of the 4-byte fixed portion of the Link Header plus 'n' pad characters. All S to P PIUs are preceded by 4+n bytes.

The 3274 A unit determines that these parameters are acceptable when the size of the host buffer is large enough to accommodate the Link Header (LH), the Pad, the Transmission Header (TH), the Request Header (RH), and at least 64 bytes of data (RU), and the host buffer is an even number of bytes.

Rejection of the Connect function code will be a status of DE, UC to the next command received by the control unit. The sense byte will contain NI (not initialized). Sense Command Reject (CR) may also be set according to the type of command received.

Receipt of a connect function code while already connected will result in the control unit disconnecting and then reconnecting using the new initialization parameters.

Disconnect Function. The Host Physical Unit Services issues a Control command (05) that sends a Disconnect function. The NI sense bit will be set.

The contents of the 4-byte* data stream are:

Byte	0	1	2	3
Content	Length		Reserved	Function Code

Length = X'0004' — Total number of bytes

Reserved = X'00' — Not used

Function Code = X'02' — Disconnect function code

*The data stream can be larger than 4 bytes but only 4 bytes are used and the rest are ignored. The number of bytes sent must agree with the length in the data count field.

Write Break Command

This command must be used as the last Write command in all Write CCW sequences. If only one write CCW is to be issued, it must be the Write Break command. This command includes all the functions shown for the Write command.

Write Start 0 Command

All SNA data from the host is sent by a Write CCW sequence. A Write Start command initializes the sequence. No data is transferred for this command. It attempts to set the Write Start indicator which is used as a reference for data sent from the host.

All data from the host in a chained command CCW string is under the envelope of a preceding Write Start 0 command. The data is considered valid (i.e., no need for retransmission) when the control unit receives a Write Start 1 command. "New" data is transmitted only when the Write Start 1 command is accepted by the control unit.

Note that "new" data is transmitted when a Restart Reset immediately precedes a Write Start 0. The Write Start command attempts to change the Write Start indicator state. The indicator is not changed if the command is not accepted, or Unit Exception (UE) is part of the ending status.

Read Start 0 Command

All SNA data is received by the host via a Read CCW sequence, which is initialized by a Read Start command. This sequence will be considered fully complete by the 3274 A unit upon receipt of a subsequent alternate Read Start command. "New" data is transmitted when a Restart Reset command immediately precedes a Read Start 0 command. No data is transferred for this command.

Write Start 1 Command

This command is similar to the Write Start 0 command. It attempts to change the Write Start indicator from the alternate setting of the Write Start 0 command. In other respects, the two commands are the same. Note that "old" data is retransmitted when a Restart Reset command immediately precedes a Write Start 1 command.

Read Start 1 Command

This command complements the Read Start 0 command. Previous ("old") data is retransmitted when this command follows a Restart Reset command.

Restart Reset Command

Data is not transferred with this command. Restart Reset is used to reset the Read Start and Write Start indicators to logical zero. Previously transmitted data is subject to retry if the Restart Reset command is followed by a Read Start 1 command or a Write Start 1 command (improper usage may result in duplicate or lost data). Ending status does not reflect the inability to transfer data to or from the control unit.

Sense ID Command

This command requests data transfer to the host. Four bytes of data are sent as follows:

Byte 0—FF, Byte 1,2—3274, Byte 3—1A

The Sense ID command is honored when the 3274 A unit is in one of the following states:

- Power On
- IML Completed
- On Line
- Not Busy
- No outstanding status to be presented

Test I/O Command

This command transfers no data. It is never coded in a CCW. It originates from a Test I/O instruction or from channel hardware not under program control. A Test I/O command will clear outstanding status in the 3274 A unit.

Status and Sense Definitions

Description

The 3274 A units generate a status byte to inform the channel of certain control unit conditions. This status byte can be generated synchronously (when the control unit is selected and performing a command operation with the channel) or asynchronously (while the control unit is not selected). Figure 5-17 describes status bits. Figure 5-18 describes the sense bits.

Initial Status

Initial status is generated by the 3274 A units in response to the initial selection and command sequence. The status byte is sent to the channel after the 3274 A unit receives the command.

Figure 5-19 shows the possible initial status bit configurations. An all-zero status byte is sent when a command is accepted for execution by the control unit.

Bit	Name	Condition
0	Attention (A)	Indicates an inbound message has been readied for transmission to the host. The host should respond by issuing a Read CCW sequence.
1	Status Modifier (SM)	Indicates to the host that the control unit is ready to receive data from the host or set in response to Write Break command, as a request for a Read. Also set with Busy (see below) when control unit is busy.
2	Control Unit End (CUE)	Is set following a busy condition, after pending status is cleared or when control unit is no longer busy, to indicate that the control unit is now not busy and is free to accept a new command.
3	Busy (B)	Is set in initial status byte with the Status Modifier (SM) when the addressed control unit is busy. The control unit uses this sequence when it cannot respond to the normal channel initiated selection sequence. See CUE above for the reset of the busy state.
4	Channel End (CE)	Indicates channel data transfer operations are completed. No error unless Unit Check (UC) is included.
5	Device End (DE)	Indicates that the control unit is ready to receive a new command.
6	Unit Check (UC)	Is set when an invalid program or equipment condition is detected by the control unit or the device. The program should always respond to Unit Check status by issuing a Sense command for further definition of condition.
7	Unit Exception (UE)	Indicates that no data is available for a successive (following) read.

Figure 5-17. Status Bit Assignments for 3274 A Units

Bit	Name	Condition
0	(CR) Command Reject	Set if the 3274 A unit has received an invalid command. It is also set if the Not Initialized bit is set and a Restart Reset, Read Start 0/1, Write Start 0/1, Read, Write or Write Break command is received.
1	Intervention Required (IR)	Not used.
2	(BOC) Bus Out Check	Set if the 3274 A unit has detected bad parity on any command or data byte received from the channel.
3	(EC) Equipment Check	Set in response to any command if a control unit parity check has occurred, or if a control unit I/O error has been detected during a Control, Read, Write, or Write Break command.
4	(DC) Data Check	Set in response to a Control, Write or Write Break command along with Data Length Check (DLC) (refer to DLC) or to a Read command if the byte count specified in the host's Read command was not large enough to transfer all data associated with the control unit's buffer.
6	(NI) Not Initialized	Set when the 3274 A unit has not been initialized via an acceptable Connect function via a Control command.
8	(DLC) Data Length Check	Set in response to a Control, Write, or Write Break command if fewer than 4 bytes have not been transferred as the data count field or the count in the data count field does not equal the total byte count received.
12	(PCM) Parity Check Modifier	See Figure 5-20, Ending Status and Sense Conditions.
13	(PC1) Parity Check 1	See Figure 5-20, Ending Status and Sense Conditions.
14	(PC2) Parity Check 2	See Figure 5-20, Ending Status and Sense Conditions.
15	(MC) Machine Check	Set with Equipment Check to indicate that an internal 3274 A unit error occurred.

Note: Sense bits 5, 7, 10, and 11 are not used.

Figure 5-18. Sense Bit Assignments for 3274 A Units

Status ¹	Sense	ERP ²	Condition
All Zeros			Normal status for all commands.
B,SM			Response to a command when the control unit cannot respond to a normal channel-initiated selection sequence.
B,'x'			Pending status

¹ If a Start I/O Fast Release (SIOF) is executed by the channel, unchained initial status becomes ending status.

² Refer to "Referenced Error Recovery Procedures."

Figure 5-19. Initial Status and Sense Conditions for 3274 A Units

Ending Status

When the control unit completes channel operations for a command, it sends an ending status byte to the channel, freeing the channel for other operations. This status byte always relates to the command operation that has been executed. The normal ending status byte for a read-type command or sense-type command will have only the Channel End and Device End bits set, indicating that the command has been executed. Normal ending status for a write-type command is Channel End alone. When the control unit-to-device buffer transfer is completed, ending the command operation, Device End status is sent to the channel as asynchronous status. Any error condition associated with the operation just executed will cause additional status bits to be set. Figure 5-20 shows the possible ending status bit configurations. Ending status causes an I/O interruption unless command chaining is specified.

When the control unit has pending status, it attempts to gain selection of the channel asynchronously to pass this status. It is passed to the channel either when selection is accomplished or as initial status of a Start I/O (with the Busy bit set), whichever occurs first.

Asynchronous Status

Asynchronous status reflects: (1) the second ending status for a Control, Read, Write and Write Break command, indicating that all command-initiated operations are completed; (2) a request for the host to initiate a Read CCW sequence; (3) that the control unit now has buffers available for a Write CCW sequence; or (4) whether the control unit is initialized or not initialized. Figure 5-21 shows the possible asynchronous status conditions.

When an asynchronous status condition occurs, the control unit attempts to gain selection by the channel, and passes this status to the channel when selection is accomplished. This status is called "pending" status until selection is accomplished. If the channel issues a command before retrieving this pending status, the pending status is returned, with the Busy bit set, in place of initial status for the command; in this case, the command is not executed.

There are other conditions of multiple status that can occur which are not covered here. These conditions can be caused by multiple error conditions occurring simultaneously.

Status ¹ (hex)	Sense (hex)	ERP ²	Condition
CE (08)			Sent at end of data stream on a Control, Write, Read or Write Break command.
CE,DE ¹ (0C)			Sent at end of data stream on all valid commands except Control, Write, Read and Write Break.
CE,DE,UE ¹ (0D)			Sent in response to: <ol style="list-style-type: none"> 1. A Control Write, Write Break, or Write Start 0/1 command because of insufficient buffer space at the time of the request. The command and its associated data transfer (if any) are rejected. 2. Read command if there is no new data available at this time for a subsequent Read in this CCW sequence. All available data has been transferred to the host. 3. Read Start 0/1 command if there is no data available for transfer to the host in response to this request.
CE,DE,UE,A ¹ (8D)			Sent in response to: <ol style="list-style-type: none"> 1. A Control, Write, Write Break, or Write Start 0/1 command because of insufficient buffer space at the time of the request. The command and its associated data transfer, if any, are rejected. In addition, a Read CCW sequence is requested. 2. Read Start 0/1 command as a warning. Its purpose is to notify the host that an unsolicited Read CCW sequence was issued. The command was rejected. However, data is available for transmission to the host. 3. Read command in which all data for a block has been transmitted to the host; therefore, a new Read CCW sequence is requested. Note that a new Read CCW sequence is necessary to release the buffers for re-use.
CE,DE,UC (0E)	CR,N1 (8200)	2	Sent in response to a Restart Reset, Read Start 0/1, Write Start 0/1, Read, Write, or Write Break command if the control unit is not initialized.
CE,DE,UC (0E)	CR (8000)	1	An invalid command was issued to the control unit.
CE,DE,UC (0E)	BOC,PC2 (2002)	1	The control unit detected a parity error at command time or on data transfer from the host.
CE,DE,UC (0E)	BOC,PC1,PC2 (2006)	1	The control unit detected a channel parity error during a Write command.

Figure 5-20 (Part 1 of 2). Ending Status and Sense Conditions for 3274 A Units

Status ¹ (hex)	Sense (hex)	ERP ²	Condition
CE,DE,UC (0E)	EC,PC1 (1004)	1	Detection of a control unit parity error during a Write command.
CE,DE,UC (0E)	EC,PC1,PCM (100C)	1	Detection of a control unit parity error during a Read command.
CE,DE,UC (0E)	EC,PC2 (1002)	1	Detection of a channel parity error during a Read command.
CE,DE,UC (0E)	EC,MC (1001)	1	Detection of an internal error during a Write or Read command.
CE,DE,UC (0E)	DC (0800)	1	The byte count specified in the host's Read command was not large enough to transfer all data associated with the control unit buffer.
CE,DE,UC (0E)	DC,DLC (0880)	1	Set in response to a Control, Write, or Write Break command if a minimum of four bytes have not been transferred or if the count in the data-count field did not equal the total byte count received.

¹ If this status is stacked by the channel, CUE could be generated and combined with it before the stacked status is accepted by the channel.

² See "Referenced Error Recovery Procedures."

Figure 5-20 (Part 2 of 2). Ending Status and Sense Conditions for 3274 A Units

Error Recovery Procedures

3274-A-Unit-Detected Errors

Error conditions detected by the 3274 A units are indicated to the program by Unit Check status. The program must respond to this status by using a Sense command for further definition of the condition.

Device-detected errors are reported via SNA. See "SNA Sense Codes" at the end of this chapter.

Referenced Error Recovery Procedures

The recovery procedures in the Error Recovery Procedure (ERP) column of Figures 5-19, 5-20, and 5-21 are as follows:

1. Issue a message containing the address of the channel and unit, the CSW, the sense data, and the CCW executed. If the first CCW of the chain is a valid Start command, begin retry from that point. If the failure is continuous, notify the operator.
2. Issue an initializing control command.

Status ¹	Sense	ERP ²	Condition
A			The control unit requests the host to initiate a Read CCW sequence.
DE			The control unit is ready to communicate with the host. In the case of a Control, Read, Write, or Write Break command, this is normal ending status. For Control, Write, or Write Break, all data associated with the command has been transferred; transfer was terminated by the channel. For Read, all data available for this command has been transferred. However, more data is available for a subsequent Read. A NOP command at the end of a Read CCW sequence is a special case. If this is seen by the host, it indicates incompatibility between the host and the 3274 A unit. The number of Read CCWs in the host is less than the number expected by the 3274 A unit as a result of the connect function.
DE,SM			The status is presented only in response to the Write Break command. This status should not be seen by the host program. The channel will utilize this status to skip a CCW. (See Write CCW sequence.)
DE,SM,A			Indicates that the control unit requires a Read CCW sequence.
DE,UC	NI	2	The control unit has successfully enabled the interface to the host and the not initialized bit is on.

¹ If this status is stacked by the channel, CUE could be generated and combined with it before the stacked status is accepted by the channel.

² See "Referenced Error Recovery Procedures."

Figure 5-21. Asynchronous Status and Sense Conditions for 3274 A Units

Channel-Detected Errors

Errors detected by the channel are indicated to the program by the channel status byte in the CSW. If the channel status byte indicates a Channel Control Check, an Interface Control Check, or a Channel Data Check, the recommended error recovery procedure is to retry the chain of commands. If the channel status byte indicates a Channel Program Check, a Protection Check, or an Incorrect Length (should not occur), the recommended error recovery procedure is to terminate the task. A program error has probably occurred.

Typical CCW Sequences

The following CCW sequence is recommended for support of the 3274 A Units.

Read CCW Sequence

The commands used in the Read CCW sequence are Read Start 0/1, Read, and NOP. All Read CCW sequences must start with a Read Start 0/1 command and are initiated only on the request of 3274 A units.

An example of a possible Read CCW sequence follows:

Read Start 0	CC
Read	CC,SLI
Read	CC,SLI
Read	CC,SLI
Read	CC,SLI
NOP	

Note: *The number of Read CCWs should equal the number of buffers specified in the Connect function.*

The NOP as shown above is recommended. The control unit will signal CE,DE as ending status to the NOP. Normally, the data should be depleted before the NOP command is reached. Ending status to the last Read CCW used will be CE,DE,UE(A).

Whenever the host issues the next Read CCW sequence, it must start with the alternate Read Start command, which in this case would be Read Start 1. However, if the sequence is restarted with its original Read Start command, in this case Read Start 0, the control unit interprets this to mean that an error has occurred and presents the data again.

Write CCW Sequence

When the host has been notified that the control unit has buffers available, it may at any time issue a Write CCW sequence.

The commands used in Write CCW sequences are Write Start 0/1, Write, Write Break, and NOP.

Every Write CCW sequence must start with a Write Start 0/1 command. Command chaining into a Write Start command should only be from a NOP or Restart Reset command. The last write command should be a Write Break command, which in turn should be followed by two NOP commands or by an NOP and a Read CCW sequence.

An example of a possible Write CCW sequence follows:

Write Start 0	CC
Write	CC,SLI
Write	CC,SLI
Write	CC,SLI
Write Break	CC,SLI
NOP	
NOP	

Two NOP commands are necessary at the end of this CCW chain because the ending sequence will depend upon the availability of data for transmission to the host. If no data is to be transmitted, DE is signaled to the Write Break command. As a result, the channel command chains into the first NOP command. However, if data is to be transmitted, the ending status signaled to the Write Break command will be DE, SM. The channel will then skip the first NOP command and command chain to the second NOP command, thereby ending the CCW sequence. If this skip to the second NOP command occurs, the host must remember that a Read CCW sequence is "owed" to the control unit, and that the unit will not request the Read with an asynchronous attention interrupt. However, it will respond with DE, SM to all Write Break commands until all data has been correctly transmitted.

Note: *If the host issues a Write CCW sequence starting with the original Write Start command, in this example -Write Start 0, the control unit interprets this to mean that an error has occurred and starts taking in the data, discarding it, and counting the Write commands received until the count matches its saved CCW counter. Any data subsequently received will then be treated as new data.*

Write-Read Sequence

This sequence is used for reducing host activity and clearing buffers in the control unit as rapidly as possible. It consists of the previous two sequences combined. It is a Write CCW sequence which at the option of the control unit may continue into a Read CCW sequence if data is available for transmission to the host. The method used is to signal SM with the DE for the Write Break command. The SM causes the channel to skip the NOP CCW and to continue into the Read CCW sequence.

If there is no data available to transmit to the host, the SM will not be signaled in the ending status. The channel will then command chain from the Write Break command into the NOP command, thereby ending the CCW sequence.

An example of a possible Write-Read CCW sequence follows:

Write Start 0	CC
Write	CC,SLI
Write	CC,SLI
Write	CC,SLI
Write Break	CC,SLI
NOP	
Read Start 0	CC
Read	CC,SLI
Read	CC,SLI
Read	CC,SLI
Read	CC,SLI
Read	CC,SLI
NOP	

Notes:

1. *The number of Read CCWs should equal the number of buffers specified in the Connect function.*
2. *If due to error the CCW chain is broken in the section containing the Write CCWs, then the entire CCW chain must be re-sent by the host. If an error occurs in the read portion of the CCWs, only the Read CCW sequence should be re-sent.*

CCW—Error Recovery Procedures

The error recovery procedures have been outlined in preceding paragraphs. The following paragraphs describe those procedures. Commands involved are those shown in the Write, Read, and Write-Read CCW sequences. The actual retry must be from the first CCW in the write or read sequence, which must be a Write Start or a Read Start command or may be reinitialized by a Restart Reset command.

After a 3274 A unit has received the Control command containing a valid Connect function, it expects the first host Write CCW sequence to begin with a Write Start 0, and the first host Read CCW sequence to begin with a Read Start 0. Upon receipt of a new Write Start or Read Start command, the control unit complements its appropriate switch, which remembers which Write or Read Start command is due next. In error situations, the CCW sequences reissued by the host must not be changed, and retry must be from the appropriate Read or Write Start command or from a Restart Reset command.

In error-free operation, Read CCW sequences should not be issued by the host unless solicited by Attention, or by Status Modifier in response to the Write Break command.

When an error occurs in the data transfer, recovery is controlled by proper use of the following five commands, as appropriate, in a Read or Write CCW sequence:

- Read Start 0
- Read Start 1
- Write Start 0
- Write Start 1
- Restart Reset

Read Start 0/1 Commands. One of these commands initializes the Read CCW sequence. It reads old or new data. To read new data, Attention or Status Modifier must have been presented or the Read Start command will end with CE,DE,UE. The normal ending status is CE,DE, which allows the Read Start to be command-chained to a Read command(s).

Reissuing a Read CCW sequence without changing the Read Start command will result in rereading previously transmitted data, whether or not an error occurred. The read operation need not have been solicited by the control unit.

The expected Read Start indicator in the control unit is changed only if the response to the Read Start command was CE,DE and if the Read Start command received was the expected one. Thus, the host should change its Read Start CCW only after successful completion of its Read CCW sequence. Successful completion is signaled by DE,UE to one of the Read CCWs.

Write Start 0/1 Commands. One of these commands initializes the Write CCW sequence. It indicates whether the host is transmitting old or new data. The normal ending status is CE,DE, which allows the Write Start command to be command-chained to a Write or Write Break command. The ending status of CE,DE,UE indicates a buffer depletion condition (no buffers available to receive the data from the host). The host must stop sending data and await a buffer available signal (DE,SM).

When the host receives the Buffer Available signal, it may resume data transmission, starting with the CCW that was rejected with the UE status. However, the CCW chain may be handled as if an error has occurred and the host may resend the complete Write CCW sequence starting with the unmodified Write Start command initially used. Whenever the host does start a Write CCW sequence with the same Write Start command as previously used, the control unit will then discard the data from a number of Write commands until the count of discarded records equals its previous count of the number of records accepted. Subsequent data will then be treated as new data.

The expected Write Start indicator in the control unit is changed only if the response to the Write Start command was CE,DE, and if the Write Start command received was the expected one. Thus, the host should change its write start indicator only after completion is signaled with DE or DE,SM as ending status to the Write Break command.

Restart Reset Command. This command may be used to resynchronize channel transfers after any host failure, provided the control unit has not been re-IMLed. This command sets the indicators to expect Write Start 0 and Read Start 0 as the next starting CCW for transmitting new data. Thus, Write Start 1 and Read Start 1 may be used to retry the last transmitted records. The host may then continue normal transmission by using the Write Start 0 and Read Start 0 commands for all new transmissions.

If Read Start 0 is used first, then any old data is destroyed, and only new data, if available, may be read. If Read Start 1 is used first, then the last data transmitted to the host is to be retried. Therefore, any portion of data already processed by the host should be skipped after a reread, and any portion of data not processed before the error is lost if Read Start 0 is used first.

To continue write data transfers after a Restart Reset command is issued, the host may use either Write Start command. If Write Start 1 is used, the last Write CCW sequence as its associated data should be used. Then any record which was successfully processed under the last accepted Write Start command will be skipped by the control unit. If Write Start 0 is used first, then the accepted record count in the control unit is reset and all records now sent by the host will be processed as new data.

The host must be aware of these possibilities and use the proper Read Start and Write Start command to avoid lost or duplicate data.

Remote Operations—SDLC

SDLC Transmission Frames

SDLC transmission frames are composed of a series of 8-bit binary-coded bytes which contain addressing, data, control, and checking information.

Transmission between the controller and the 3274 takes place according to a predefined frame format which consists of the following sequence of bytes:

Flag (F) Sequence—1 byte

Secondary Station Address (A)—1 byte

Control (C) Field—1 byte

Information (I) Field—up to 256 bytes of message data, preceded by header information

Frame Check Sequence (FCS)—2 bytes

Flag (F) Sequence—1 byte

Bit synchronization preceding transmission of an initial flag and following a line turnaround is achieved by transmission of 16 zero bits after the Clear to Send signal is turned on and the NRZI encoder (when used) is enabled.

When sending or receiving over an SDLC link, these units operate in modulo-8 mode—that is, up to seven frames at a time.

For a detailed description of the SDLC frame format, refer to *IBM Synchronous Data Link Control General Information*, GA27-3093. Support of the frame sequence, flag byte, address byte, and frame check sequence bytes conforms to the referenced document.

Response Modes

The 3274 functions in two link operating modes: normal response mode (NRM) and normal disconnect mode (NDM). In NRM, the 3274 can initiate transmission only as a result of receiving a frame from the communications controller which contains the P bit set to 1. Single or multiple frames may be sent. The last frame (or a single frame) transmitted by the 3274 in response to a command received with the P bit set to 1 must have the F bit set to 1. When the 3274 has completed a transmission, a new transmission cannot be initiated until a subsequent frame is received from the communications controller which contains the P bit set to 1. A response transmission initiated by the 3274, which requires acknowledgment from the communications controller, is repeated each time the communications controller polls until the acknowledgment is received. There is no limit to the number of transmissions. Responses that require acknowledgment from the communications controller are I frames, FRMR, and RR when transmitted with the F bit set to 0, to report clearing of a busy condition.

When in NDM, the 3274 cannot accept or transmit I or supervisory (S) frames. Nonsequenced responses are not transmitted unless the 3274 is solicited to reply. Invalid or nonimplemented commands received in NDM cause the 3274 to transmit a DM response at the next response opportunity. DM can be retransmitted until an SNRM or DISC command is received. Command reject conditions are not present in NDM.

The following paragraphs describe the 3274 support of the control and information fields.

Control Field

The control field designates the frames as supervisory (S), nonsequenced (NS), or information (I).

Supervisory Commands

The 3274 supports only the supervisory commands Receive Ready (RR) and Receive Not Ready (RNR).

The C-field formats are as follows:

RR	<table border="1"><tr><td>Nr</td><td>P/F</td><td>00</td><td>01</td></tr></table>	Nr	P/F	00	01
Nr	P/F	00	01		
	012 3 45 67				
RNR	<table border="1"><tr><td>Nr</td><td>P/F</td><td>01</td><td>01</td></tr></table>	Nr	P/F	01	01
Nr	P/F	01	01		
	012 3 45 67				

The 3274 will transmit RNR when it cannot accept further data from the link.

When the reported RNR condition is cleared, the control unit will transmit an I frame or RR with the F bit on after a frame with the P bit on is received.

If the 3274 has received an RNR, an I frame will not be transmitted until an RR or I frame with the poll bit on is received.

The transmission or receipt of an NS frame does not indicate the RNR condition has cleared.

Nonsequenced Commands and Responses

The following nonsequenced commands and responses are supported by the 3274:

Command/Response	C-Field	Hex Code
Set Normal Response Mode (SNRM) Command	1 0 0 P 0 0 1 1 0 1 2 3 4 5 6 7	93
Disconnect (DISC) Command	0 1 0 P 0 0 1 1 0 1 2 3 4 5 6 7	53
Unnumbered Acknowledgment (UA) Response	0 1 1 F 0 0 1 1 0 1 2 3 4 5 6 7	73
Disconnect Mode (DM) Response	0 0 0 F 1 1 1 1 0 1 2 3 4 5 6 7	1F
Frame Reject (FRMR) Response	1 0 0 F 0 1 1 1 0 1 2 3 4 5 6 7	97
Test Command/Response	1 1 1 P/F 0 0 1 1 0 1 2 3 4 5 6 7	F3
Exchange Station ID Command/Response	1 0 1 P/F 1 1 1 1 0 1 2 3 4 5 6 7	BF

The SNRM command sets the 3274 in NRM. Receipt of SNRM causes the 3274 to deactivate the physical unit if it is in active state. The On-Line and Ownership symbols are turned off.

The DISC command sets the 3274 in NDM.

The UA response is sent by the 3274 to acknowledge receipt and acceptance of the SNRM and DISC commands.

The Test command is used to initiate one round-trip transmission of test data both in NRM and NDM. The 3274 will return the Test response without data if buffering is not available to hold the complete test data, or with data if buffering is available.

The Disconnect Mode (DM) response is sent by the 3274 in normal disconnect mode (NDM) to request on-line status. DM is sent in response to any command except Test and XID. DM is sent in response to the SNRM command when the 3274 cannot enter NRM.

The FRMR response is implemented by the 3274 as described in GA27-3093. The FRMR will be sent in response to any poll until an SNRM or DISC is received to reset the control unit.

The XID command and response contains additional data beyond the C byte. The 3274 responds to the XID command in NRM or NDM, except when an FRMR condition exists, in which case the FRMR response takes precedence over XID. The additional data of the XID response consists of 48 bits (except for the Multi-Use Communications Loop that has a variable length XID), defined as follows:

Bits	Meaning
0—3	ID format B'0000'
4—7	PU type B'0010'
8—15	Self-description X'00'
16—27	X'017'
28—47	Terminal ID

Bits 28—47 are a unique terminal ID.

Terminal Identification and Addressing

Terminal ID

The 3274 has a unique, 5-character identification, that is selected at customization time.

SDLC Station Address

The SDLC station address is a 1-byte address that must be selected by the customer at setup time.

For details, refer to *IBM 3270 Information Display System Planning and Setup Guide*, GA27-2827. An SDLC station address of either X'00' or X'FF' should not be assigned.

Information (I) Frame

The information frame is used to transmit message data. When transmitted, the I frame contains a maximum of 256 bytes of RU message data preceded by 6 bytes of transmission header (TH) and, optionally, three bytes of request/response header (RH). For further information, refer to "Segmenting Description" in this chapter.

Sequence Error Recovery Procedures

A sequence error occurs when the 3274 receives an I frame with an incorrect Ns sequence count and valid FCS bytes. The 3274 does not accept the I frame that caused the sequence error and rejects all following I frames until an I frame is received which contains the correct Ns value, at which time the sequence error condition is reset.

The 3274 transmits I frames in the sequence indicated by the last Nr count received, which may include retransmission of previously transmitted I frames that have not been acknowledged.

All I frames are transmitted in contiguous sequence according to the Ns value within the constraints of the modulo count.

Abort Function

The abort function is used by the communications controller or by the 3274 when a frame being transmitted is to be discarded. The abort function is performed by transmitting eight contiguous 1 bits without zero insertion at the earliest possible time following recognition of an abort situation. No FCS is transmitted. When, for example, the 3274 receives seven contiguous 1 bits, it discards the aborted frame. The 3274 employs the abort function when an equipment malfunction occurs that causes an erroneous transmission.

Timeout Controls

When the 3274 is attached point to point or multipoint and does not recognize any valid outbound frame for 20 to 25 seconds, a nonproductive timeout occurs. The timeout causes the 3274 to set the Communication Check symbol on all attached 3278s. The timer is reset to zero every time the 3274 detects a valid outbound frame. The Communication Check symbol is turned off when a valid frame is received by the station.

If a condition of no line activity is detected by the 3274 for 20 to 25 seconds, the Communication Check symbol is set on all attached 3278s. The indicator will be turned off when a valid frame is received.

SNA Reference Data

Bind Default

The following is suggested as a setting for the access method logmode table for LU type 1:

Byte	Binary Bits	Byte	Binary Bits
	0123 4567		0123 4567
0	0011 0001	9	0000 0001
1	0000 0001	10	1000 0101
2	0000 0011	11	1000 0111
3	0000 0011	12,13	0000 0000
4	1011 0001	14	0000 0001
5	1001 0000	15—17	0000 0000
6	0011 0000	18	1110 0001
7	1000 0000	19—26	0000 0000
8	0000 0000		

The suggested settings for LU type 2 are the same as for LU type 1 except for:

Byte	Binary Bits
—	0123 4567
9	0000 0000
10	1000 0111
14	0000 0010
18	0000 0000
24	0000 0001 Model 1
24	0000 0010 Model 2

The suggested settings for LU type 3 are the same as for LU type 1 except for:

Byte	Binary Bits
—	0123 4567
9	0000 0000
14	0000 0011
18	0000 0000

Bind Check

The Bind parameters sent to the 3274 will be checked as shown in Figure 5-22.

Byte	Bit	LU Type 1		LU Type 2		LU Type 3	
		Check	Reject if	Check	Reject if	Check	Reject if
1	0-3	C	¬ X'0'	C	¬ X'0'	C	¬ X'0'
2, 3	4-7	C	¬ X'1'	C	¬ X'1'	C	¬ X'1'
		C	¬ X'03'	C	¬ X'03'	C	¬ X'03'
4	0	NC		NC		NC	
	1	C	B'1'	C	B'1'	C	B'1'
	2, 3	C	B'00'	C	B'00'	C	B'00'
							B'01'
5	4,5	NC		NC		NC	
	6	C	B'1'	C	B'1'	C	B'1'
	7	C	B'0'	C	B'0'	C	B'0'
	0	NC		C	B'0'	NC	
6	1	NC		NC		NC	
	2, 3	C save	B'00'	C save	B'00'	C save	B'00'
	4-7	NC		NC		NC	
7	0	NC		NC		NC	
	1	C	B'1'	C	B'1'	C	B'1'
	2	C	B'0'	C	B'0'	C	B'0'
	3	C	B'0'	C	B'0'	C	B'0'
	4	C	**	C	**	C	**
5-7	NC		NC		NC		
8	0,1	C	¬ B'10'	C	¬ B'10'	C	¬ B'10'
	2	C	B'1'	C	B'1'	C	B'1'
	3	C	B'1'	C	B'1'	C	B'1'
	4-7	NC		NC		NC	
9	0,1	NC		NC		NC	
10	2-7	C	X'00'	NC		NC	
	0-7	C		C		NC	
11		C		NC		NC	
12,13		NC		NC		NC	
14		C	¬ correct device	C	¬ correct device	C	¬ correct device
15-19		NC		NC		NC	
20-23		NC		C*		C*	
24		NC		C save		C save Device Dep	
25		NC		NC		NC	
26†		C	¬ X'00'	C	¬ X'00'	C	¬ X'00'

(27-35 All bytes ignored)

Notes:

† Bytes 26-35 are reserved for the Encrypt/Decrypt feature.

* If byte 24 bits 4-7 has X'E' or X'F', these bytes are checked.

** Feature dependent.

C - Check

NC - No check

B - Bit

¬ - Logical Not

Figure 5-22. Bind Parameter Checking

SNA Sense Codes

Each major error code has modifiers for further description in sense byte 1. The modifier codes supported and the controller or terminal condition causing the negative response to be returned are described below.

Sense Byte 1 Description

Path Error X'80'

X'04'—Unrecognized DAF'

Controller does not have a terminal adapter for the DAF address.

X'05'—NO SESSION

- A Bind has not been received or accepted.
- A request other than Bind is sent to an SLU which has already accepted a Bind, and the OAF' is not X'00' or the OAF in the accepted Bind.

X'08'—PU NOT Active

The 3274 has not received or accepted an ACTPU, or a control condition caused an internally generated DACTPU.

X'09'—LU NOT Active

The 3274 has not received or accepted an ACTLU, or a control condition caused an internally generated DACTLU.

X'0F'—Invalid Address Combination

A request was addressed to the PU (DAF'=X'00'), and the OAF was not SSCP (OAF'=X'00').

RH Error X'40'

X'06'—Exception Response Not Allowed

LIC carried exception response when Bind specified definite response.

X'07'—Definite Response Not Allowed

LIC carried definite response when Bind specified exception response or LIC carried definite response.

X'0A'—No-Response Not Allowed

A chain element did not have DR1, DR2, or the exception bit set to 1.

X'0F'—Format Indicator Not Allowed

An FM request received by the 3274 indicated formatted header included.

State Error X'20'

X'01'—Sequence Number Error

The sequence number of the normal flow request did not match the number expected.

X'02'—Chaining Error

Chain elements were out of protocol sequence.

X'03'—Bracket State Error

A bracket state error occurred.

X'04'—Direction Error

A normal flow without begin bracket was received while the 3274 was in send state.

X'05'—Data Traffic Reset

An FM or DFC request was received before an SDT was received or accepted.

X'09'—Session control protocol violation (Encrypt/Decrypt feature)

An FM request was received prior to a valid CRV.

Request Error X'10'

X'02'—RU Length Error

Message length > 1536 bytes (3274-1A only). RU size exceeds Bind specification (LUT1 only).

X'03'—Function Not Supported

- Unsupported Session Control Request
- Unsupported Data Flow Control Request
- Signal-Code is not X'00010000'
- Network Control Request
- FM Data Stream
- Invalid Command
 - Data Following a Read, RM, RMA, or EAU command
 - For LU type 3, any Read, RM, or RMA command
- Unsupported FM Data, SSCP --> SPU

X'05'—Parameter Error

Invalid address following SBA, RA, or EUA order (SBA, RA, or EUA order without parameters), or SCS parameter error.

X'07'—Category Not Supported

- An FMD request from the SSCP was directed to a printer.
- An unsupported network service message received.
- An unsupported FM Data command received.

Request Reject X'08'

X'01'—Resource Not Available

- LU type 2, a printer is not allowed by the authorization matrix.
- For LU type 1 or 3, Bind reject because printer is authorized for local mode only.
- For LU type 1, outbound pacing algorithm is overrun.

X'02'— Intervention Required (on principal device).

- For LU type 2, security keylock is turned off.
- For LU type 1 or 3, printer condition such as end of form, paper jam, printer cover up, or hold time out.

X'05'—Session Limit Exceeded

A Bind was received whose OAF' differs from the PLU already bound.

X'07'—Subsidiary Device Temporarily Not Available

For LU type 2, a printer to be copied to is in bracket on an LU type 1 or 3 session, or an operator has depressed DEV CNCL key.

X'0A'—Permission Rejected

Display or printer power is off. The SSCP will not be notified when the device powers on.

X'0C'—Procedure Not Supported

An unsupported REQMS type request was received.

X'11'—Break

Sent on LU type 1 when the operator depresses the printer Hold Print Key followed by Cancel key, if a chain has not completed printing.

X'13'—Bracket Bid Reject—(No RTR)

- Returned by LU types 1 and 2 to a BID or BID with Begin Bracket if the display has won contention and started a bracket.
- Returned by all LU types when a BID or Begin Bracket was received and INB state already exists. This may be a protocol error.

X'14'—Bracket Bid Reject—(RTR to follow).

For LU type 1 or 3, the printer is busy doing local copy from a display. RTR will be returned when the printer becomes not busy with local copy.

X'15'—Function Active

- Bind reject if the same OAF' already has an accepted Bind to the SLU.
- REQMS request is in process.

X'1B'—Receiver in Transmit Mode

- The SLU is between bracket, but a data key has been depressed.
- An FM message was received from the SSCP while the display was owned by the PLU-SLU session or is in test mode.
- An SSCP FM message is rejected if local copy is taking place while the SSCP-SLU session owns the display.

X'1C'—Request Not Executable

The 3274 has a nonrecoverable error.

X'21'—Invalid Session Parameters

Bind parameters do not match the 3274 Bind checks.

X'29'—Change Direction Required

A 3270 read-type command was received without a Change Direction or with an End Bracket.

X'2A'—Presentation Space Altered, Request Executed

An LU type 2 3277 attached to a 3274 has a reset keyboard, and tried to enter while in receive state.

X'2B'—Presentation Space Integrity Lost

- A temporary error has occurred; for example, parity check in device.
- An operator has cleared the display by switching to SSCP-SLU session or test mode and returned to PLU-SLU session.

X'2D'—SLU Busy

- LU type 2 display is owned by SSCP-SLU session or test mode.
- LU type 2 display is busy doing an operator-initiated local copy.
- LU type 2 3277 attached to 3274 is busy with a Back Tab.

X'2E'—Intervention Required at Subsidiary Device

For LU type 2, a printer being copied to from a host-initiated print has intervention-required type error. Refer X'0802'. Printer power off or not attached to the controller is included in this category.

X'2F'—Request Not Executable Because of LU Subsidiary Device.

For LU type 2, a printer being copied to has a nonrecoverable error.

X'31'—LU Component Disconnected

This response is returned if the device attached to the 3274 cannot be contacted by a device poll. This is due to device power off, cable detached from the controller port, or connecting cable broken.

X'43'—Required Function Manager Synchronization Not Supplied

For LU type 2 or 3 chains having the print bit on, must be definite response or exception response chain must carry CD.

X'45'—Permission Rejected

Display or printer power is off. The SSCP will be notified when the device powers on.

X'4A'—Presentation Space Altered, Request Not Executed

Refer to X'2A'.

X'4C'—Resource Not Configured

X'63'—Symbol Set Not Loaded

X'71'—Read State Error

Logical Unit Status (LUSTAT)

LUSTAT provides a means for the SLU to report exception conditions or status when the SLU is not in receive state (a negative response is used when the SLU is in receive state). The following are the CD settings that accompany LUSTAT and the state changes, if any, that occur:

SLU State When LUSTAT Sent	CD Setting	State Change
BETB	CD may be set	None
ERP1	CD not set	None
Send	CD set for principal device	to Receive
	CD not set for subsidiary device	None

Inbound LUSTATs are sent with exception response by the 3274.

Programming Note: *An LUSTAT showing power off sent while in send state carries CD. An LUSTAT that shows power on cannot be sent until the PLU causes an SLU state change to (S, *R).*

The following status codes will be used by the 3274 to send information to the PLU, on the PLU-SLU session:

Value	Explanation
X'0001Z000'*	Device now available; presentation space not destroyed.
X'00020000'	Device has received CD, but has no input mechanism.
X'081C2000'*	Component Failure; Permanent Error.
X'082B0000'	Device available; presentation space integrity lost.
X'08310000'	Principal device is powered off or disconnected.
X'0801Z000'*	Printer has been removed from configured status.

*Where Z specifies whether the status refers to the principal or subsidiary device. (Refer to "SNA Printer Control" for a description of principal and subsidiary devices.) The value of Z is defined as follows:

LU type 1 Principal (printer)	Z = 0
LU type 2 Principal (display)	Z = D
LU type 2 Subsidiary (printer)	Z = B
LU type 3 Principal (printer)	Z = 0

The priority of these status codes, in low to high order, is assigned as:

X'0002', X'0001', X'082B', X'0831', X'0801', X'081C'

The 3274 will send the highest level of priority status when an opportunity allows its transmission.

Definition: (S, *R) = Send state, ERP1 state, or BETB state.

The upper section of Figure 5-23 shows the LUSTAT codes that are returned to clear the negative response condition listed in the left column. The lower section lists the LUSTAT codes that are used to report an SLU error condition instead of a negative response. The X's show the sessions that use the code points.

LUSTAT Returned				
Negative Response Code	LU Type			
	T1	T2	T3	SSCP
0802	00010000	0001D000	00010000	NA
	082B0000	082B0000	082B0000	
	081C0000	081CD000	081C0000	
	08310000	08310000	08310000	
0807	NA	0001B000	NA	NA
		0801B000		
		081CB000		
		081CD000		
082D	NA	0001D000	NA	NA
		082B0000		
		081CD000		
082E	NA	0001B000	NA	NA
		0801B000		
		081CB000		
		081CD000		
0831	082B0000	082B0000	082B0000	NA
	081C0000	081CD000	081C0000	NA

Sent By			
LUSTAT	LU Type		
	T1	T2	T3
SEND			
BETB			
ERP.1			
00020000	X	X	X
081C0000	X		X
081CB000		X	
081CD000		X	
082B0000	X	X	X
08310000	X	X	X
0801B000		X	

Figure 5-23. Summary Table of LUSTATs

LUSTAT is used as follows:

For all LU types, when the 3274 has sent -RSP with X'0802' or X'082E' and this condition is reset, LUSTAT with X'0001P000' will be sent, where the value P is X'0' for LU type 1 or 3, X'D' for LU type 2 principal (display), and X'B' for LU type 2 subsidiary device (printer).

If the presentation integrity is lost while an X'0802' condition exists, LUSTAT with X'082B0000' will be sent instead of X'0001P000' when the X'0802' condition is reset.

For LU type 2, when the 3274 SLU has sent -RSP with secondary component not available (X'0807') and this condition is reset, LUSTAT with X'0001B000' will be sent.

For all LU types supported by the 3274, the LUSTAT X'0002'0000' will be sent to the PLU when the 3274 accepts a normal flow request carrying CD, but no input components (keyboard, light pen, MSR, etc.) are attached to the device.

For all LU types, LUSTAT with X'082B0000' will be sent to the PLU when the 3274 SLU detects presentation integrity lost (for example, regeneration buffer parity error), and is in (S, *R) state for the 3274.

For LU type 2, when the 3274 has sent -RSP (Device Busy) (X'082D') to a PLU request because of session ownership change from PLU to SSCP or TEST, LUSTAT with X'082B0000' will be sent to the PLU when returning to PLU-SLU session.

For LU type 2, when the -RSP (Device Busy) X'082D) has been returned from the 3274 for a Back Tab busy condition, the LUSTAT X'0001D000' component now available to the PLU will be sent when the busy condition clears.

For LU type 2, when the 3274 has sent -RSP (Device Busy) (X'082D') to a PLU because the SLU is busy executing a local copy, the 3274 sends LUSTAT X'0001D000' component now available to the PLU when the busy condition clears.

For all LU types, if a principal device is powered off or unplugged from the controller port and a session exists which is in (S, *R) state, LUSTAT X'08310000' will be sent to the PLU.

For all LU types, when a principal device has sent -RSP or LUSTAT X'0831000' and then power is restored, LUSTAT with X'082B0000' will be sent to the PLU.

For all LU types, if the 3274 finds a permanent error in the principal device and is in (S, *R) state, LUSTAT with X'081CP000' will be sent to the PLU. The value of P is the same as previously defined.

For LU type 2, if the 3274 finds a permanent error in the subsidiary device and is in (S, *R) state, the worsening of the previous condition will not be reported. Instead, LUSTAT X'0001B000' will be sent, and the next outbound request will be rejected with the proper sense code.

For LU type 2, if the 3274 finds the subsidiary device has been configured from local or shared mode to system mode, LUSTAT X'0001B000' will be sent if an LUSTAT is owed. The next outbound request will be rejected with the proper sense code.

Error Recovery Procedures

The following sense codes are returned by a negative response or an LUSTAT. Suggested recovery procedures are indicated for each error code and must be evaluated for the needs of each user.

Negative Response Codes:

Error Code	Recovery Procedures Notes
Path errors X'80xx'	1
RH errors X'40xx'	2
State errors X'20xx'	2,3
Request errors X'10xx'	2,21
Request Reject: X'08xx'	

Hex 'xx' LU Type 1 LU Type 2 LU Type 3

Hex 'xx'	LU Type 1	LU Type 2	LU Type 3	
01	5	5 or 6	5	
02	8	7	8	
05	4	4	4	
07	NA	7	NA	
0A	4	4	4	
11	9	NA	NA	
13	10,11	10,11	10,11	
14	12	NA	12	
15	4	4	4	
1B	NA	13	NA	See Recovery Note(s) indicated.
1C	3,4	3,4	3,4	
21	1	1	1	
29	3,4	3,4	3,4	
2A	NA	14	NA	
2B	16	16	16	
2D	NA	7	NA	
2E	NA	7	NA	
2F	NA	17	NA	
31	7	7,18	7	
43	NA	7,19	7,19	
45	1	1	1	

LUSTAT Sense Codes:

Hex Code	Recovery Procedure Notes
0001 0000	9a
0001 B000	9a
0001 D000	9a
0002 0000	21
082B 0000	16
081C 0000	3
081C B000	17
081C D000	3
0831 0000	7,18,20
0801 B000	6,17

Recovery Notes:

1. No recovery action can be taken until the 'xx' condition reported is corrected.
2. Unbind and correct program code.
3. Retry the operation up to three times by sending Clear, SDT, and starting traffic at a program check-point restart. Terminate the operation if the retries are not successful.
4. No recovery; look for an alternate terminal or terminate the operation.
5. Unbind, and look for an alternate terminal or terminate the operation.
6. Read the display, and save for later printout.
7. Wait for LUSTAT; recovery based on LUSTAT code.
8. Wait for LUSTAT; retransmit chain.
9. User options:
 - a. Resend chain.
 - b. Send next chain.
 - c. Send query to printer operator for PA key response.
10. Check the input queue for inbound data with BB and CD.
11. Protocol error occurred. Retry without BID or BB.
12. Wait for RTR to begin bracket.
13.
 - a. Check the input queue, and wait for data.
 - b. Send SIGNAL to get CD.
14. Retry with CD and not EB.

15. User options:
 - a. Send Null or comment RU with CD to give control to operator.
 - b. Send Read Modified command with CD to obtain display AIDS and modified data.
 - c. Reformat display from check-point restart.
16. Reformat display or printer from check-point restart.
17. Retry the operation up to three times by use of Write command and WCC with Start Print bit set to 1. An alternate printer may become available.
18. Unbind to force user identification by entering new logon.
19. Retry with correct bit settings.
20. When received, the user must be sure the secondary logical unit is in ERP1 or send state, to allow sending the LUSTAT which indicates a power-on condition.
21. Program dependent:
 - a. If input is required from terminal, unbind and select an alternate terminal.
 - b. If input is not required, data output may continue. CD should be suppressed.

Chapter 6. Screen Design

Introduction

To use whatever you have created for display or printing, your information must be communicated to a 3270 device by means of the 3270 data stream, which is made up of structured fields, commands, control characters, orders, attributes, and data.

Structured fields provide another format for sending information to a display or printer.

Commands control such things as whether you write to or read from a display and whether the screen is erased before new data is written.

Control characters are used with certain commands to perform such functions as sounding the audible alarm, formatting the printer, and restoring or enabling the keyboard.

Orders are instructions written to the 3270 to tell the display unit how to format your panel.

Attributes determine the characteristics of the fields and characters within a field.

Data is the information you are displaying or printing.

The 3270 data stream is based upon the presence of a mapped character buffer in the device. There is a fixed one-to-one relationship between each character storage location in the buffer and each character position on the display. For instance, consider a display, for which the display screen is composed of 12 rows of 40 columns each. Row 1 maps to the first 40 character storage positions in the character buffer, row 2 maps to the second 40 character storage positions, and so on. This sequence is the same whether the display is 12 rows and 40 columns or up to 27 rows of 132 columns.

When an Erase/Write command is transmitted to the device, the character buffer is first cleared to nulls (X'00') and subsequent text is written into the character buffer sequentially. The format of the data stream is as follows:

Write Command	WCC	Orders and Text
------------------	-----	-----------------

Field Concept

People dealing with information see it as a collection of individual elements. For example, what we know about John Smith's employment may be a collection of individual elements: his name, serial number, location, and date of hire. The size of the element is the amount of data required to convey useful information. You do not think of J and O and H and N as useful individually, but collectively, as the name JOHN. You do not think of JOHNSMITH963981BOSTON070262 as being useful collectively, but see the

elements individually: name: JOHN SMITH, serial number: 963981, location: BOSTON, date of hire: 07/02/62.

Each data element has its own characteristics. In this example, the serial number is six numeric digits and varies from employee to employee. The word *NAME* is 4 characters, is alphabetic, is all uppercase, and does not change. When people record these elements of data on paper, they take on such additional characteristics as position (where on the sheet of paper the item is written), color (what ink or medium is used), size of the letters, and writing style.

In the past, when information was handled by a data processing device, it was generally handled as an artificial entity called a record. The contents and characteristics of a record were primarily determined by device requirements, and little or no attention was given to the individual information elements. Data processing users had to adjust their thought pattern to conform to the machine requirements.

The IBM 3270 Information Display System recognizes that people deal with individual units of information. The system, which is designed to conform to human needs and requirements, and enables you to deal with data by individual elements or *fields*, each with its own characteristics.

You may describe data to the 3270 on a field or character basis and specify the characteristics or *attributes* of each individual field or character. The 3270 then provides program and data control based on your individual field and character definitions.

What Attributes May Be Assigned to a Field

Besides length, which is controlled by the position of field attributes, you may specify the following additional characteristics with the attributes.

Protection

A field is either protected or unprotected. When it is protected, the operator cannot enter or modify data in any location within that field.

In an unprotected field, the operator can enter characters or can delete or modify characters that are already there. Headings, labels, titles, and formats are commonly specified as protected. Any field in which the 3270 operator should enter or modify data must be specified as unprotected.

In Figure 6-1, *NAME:* would most likely be specified as protected. JOHN B DOE would be specified as protected if it was written by the application program and is to remain unchanged. If JOHN B DOE is to be entered or modified by the operator, the attribute 2 must specify unprotected.

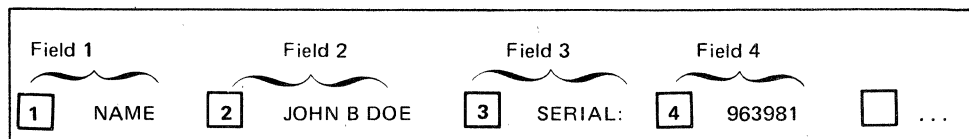

Figure 6-1. Example of Four Fields and Attribute Bytes

Color

If the device has the capability of displaying or printing in color, then the fields or individual characters may be defined in four or seven colors, depending on whether the device has base-color or extended-color capability.

- Base Color - Terminals with base color can display or print fields in one of four colors, depending on the definition of the field by the field-intensify/field-protection bits in the field attribute character. Base color can be produced on color displays using existing 3270 programs.
- Extended Color - Terminals with extended color capability can display or print fields or characters in one of seven colors or characters in multicolors. The colors available in extended color are white, red, blue, green, pink, yellow, and turquoise. Extended colors for color displays and printers are defined as follows:

Color Displayed on 3279	Color Printed on 3287 Models 1C and 2C
-------------------------	--

White	Black or green
Red	Red
Blue	Blue
Green	Green or black
Pink	Black
Yellow	Black
Turquoise	Black

Note: The printing of black or green, as shown, depends upon the Base Color (black or green) specify feature selected.

Extended Highlighting

If the display has the capability of interpreting the extended field and character attributes, then Extended Highlighting attributes (blink, reverse video, and underscore) can be applied to entire fields or to individual characters. In Figure 6-1, the unprotected fields could be underscored to highlight them as operator input areas.

For printers with the ability to interpret these extended attributes, only the underscore attribute can be applied to whole fields or to individual characters.

Character Content

A field is either alphameric, numeric, or user-defined symbols. An operator can enter alphameric, numeric, special characters, or user-defined symbols in an alphameric field.

The numeric attribute is more complex; it depends upon whether the numeric Lock feature is present and which keyboard is attached to the display. Figure 6-2 shows what characters may be entered with various combinations of keyboards and field types.

Keyboard Type	Keyboard Numeric Lock	Shift Key Pressed	Field Type	Protected	Resulting Characters		
					In Buffer	Displayed On Screen	Read Into Storage
Typewriter	No	No	Alpha or Numeric	No	Lowercase	Uppercase	Lowercase
Typewriter	No	Yes	Alpha or Numeric	No	Uppercase	Uppercase	Uppercase
Typewriter	Yes	No	Alpha	No	Lowercase	Uppercase	Lowercase
Typewriter	Yes	Yes	Alpha	No	Uppercase	Uppercase	Uppercase
Typewriter	Yes	No	Numeric	No	Can only enter 0–9, period, and minus sign; any other characters lock keyboard.		
Typewriter	Yes	Yes	Numeric	No	Can only press dup key; any other action locks keyboard (3277). Shift key overrides on 3278 and 3279. See Numeric Lock discussion in Appendix C.		
Data Entry	No	—	Alpha	No	Alpha keys produce uppercase alpha characters. Numeric shift key produces numeric characters. Alpha shift key has no effect.		
Data Entry	No	—	Numeric	No	Numeric shift key has no effect. Alpha shift key overrides numeric specification and allows alpha character entry.		
Data Entry	Yes	—	Alpha	No	Alpha keys produce uppercase alpha characters. Numeric shift allows numeric character entry. Alpha shift key has no effect.		
Data Entry	Yes	—	Numeric	No	Can only enter 0–9, period, dup, and minus sign. Any other characters lock all keys except for RESET key. Numeric shift key allows numeric character entry. Alpha shift key allows alpha character entry.		

Figure 6-2. Results of Keyboard and Field Combinations

Visibility and Detectability

A field is either displayable or nondisplayable. When it is displayable and contains characters, those characters are visible to the operator. When it is nondisplayable, any characters within that field are not visible to the operator. The nondisplayable attribute is useful for entering classified or security information at a display unit that is in public view.

To maintain security, make sure that programs:

- Send a nondisplay attribute byte prior to sending the intended new nondisplayable data to preclude its momentary appearance on the screen.
- Do not overwrite a field attribute of nondisplay for the currently displayed image when partially changing field formats.

All characters within a displayable field can be displayed at regular brightness, at a high intensity, in color, with Extended Highlighting (blink, reverse video, or underscore), so that they stand out among regular display fields. Blink, reverse video, underscore, color, or high intensity can be used to call attention to error conditions or to emphasize protected fields or format fields. When used on a color display, high intensity causes the field or character to be displayed in white. However, if the color property is defined, it will override the high-intensity property.

High intensity on a monochrome display results in the field or character so defined to be displayed at a brighter level than those defined as regular intensity.

Throughout this document, in discussions on highlighting fields for better operator recognition and performance, remember that, if the device has the capability of interpreting the structured fields and attribute processing functions, then color, reverse video, blink, or underscore may be used to highlight fields or characters for display. Color and/or underscore can be used to highlight printer output. On 3278 displays, only Extended Highlighting and high intensity can be used. Normal intensity or underscore may be used for all input fields, so the terminal operator can tell at a glance which fields require operator action.

You should not specify unprotected fields as high intensity since such fields may become selector-pen-detectable (if this feature is installed) if the operator enters a question mark, ampersand, or blank as the first input character. Fields are specified as either detectable or nondetectable. When a field is detectable, it can be used for selector-pen operations. A nondetectable field location cannot be detected by the selector-pen or cursor select. It is good practice to designate all detectable fields as protected to prevent the operator from changing the content of the sensitive field.

Transmission

The fields that have been entered or modified by the operator are sent to the application program by a Read Modified operation. The 3270 keeps track of such modifications and uses that information to select data to send to the application program. If you wish to pass a field into the computer regardless of modification, you may assign the "modified" or "modified data tag" (MDT) property. However, you should note that the operator can change the MDT property unless you also assign the protected property.

You can decide which combination of attributes you want within the limitations specified. Certain attribute combinations produce additional characteristics. For example, the numeric (limiting keyboard use) and protected (eliminating keyboard use) attributes seem contradictory, but, when specified together, automatically skip the cursor past the field.

You should also be aware that the application program is not limited by attributes. The application program can, for example, place alphabetic information in a field defined as numeric, or protected, or both. The operator does not have such liberty.

If you do not specify any combination of attributes, a field is assumed to have the following attributes:

- Alphameric
- Unprotected
- Displayable (at regular brightness)
- Nondetectable by the selector pen or cursor select
- Not modified
- Color - If used as a character attribute, it defaults to the defined extended field attribute. If used as an extended field attribute, it defaults to the color defined in the Query Reply structured field.
- Nonloadable character set (the character set shipped with the device).
- Extended Highlighting - If used as a character attribute, it defaults to the defined extended field attribute. If used as an extended field attribute, it defaults to the defined extended highlighting defined in the Query Reply structured field.

The field attribute in the 3270 data stream uses a single nondisplayed and protected character position on the screen and serves as a visual separation between successive fields.

Attribute Processing

The model for attribute processing is shown in Figure 6-3. Each device has a character buffer and an attribute buffer (for extended field and character attributes). For each character in the character buffer, there is an associated position in the attribute buffer. Where a position in the character buffer is occupied by a field attribute, the corresponding position in the attribute buffer is interpreted by the hardware as an extended field attribute. Where it is a graphic or control character, the associated position in the attribute buffer is interpreted as a character attribute. The extended field and character attributes do not occupy a position in the character buffer, but instead are in a related position in the attribute buffer. The extended field and character attributes do not occupy a position on the display surface nor do they print.

If an extended field attribute, such as underscore is used, then the relationship between character and field attributes is as shown in Figure 6-4. Remember that the position in the attribute buffer associated with a field attribute character is interpreted as an extended field attribute, and those positions associated with the graphic characters are interpreted as character attributes.

When the character attributes associated with characters in a field are not defined (X'00'), the characters are displayed with the attributes specified for the field. As seen in Figure 6-5, when the character attributes are defined (not X'00'), then the characters are displayed with the attributes specified for the character, overriding the field attributes specified.

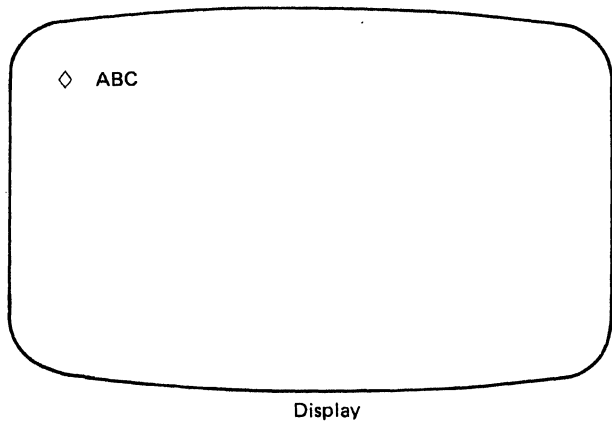

FA = Field Attribute
 CA = Character Attribute
 EFA = Extended Field Attribute

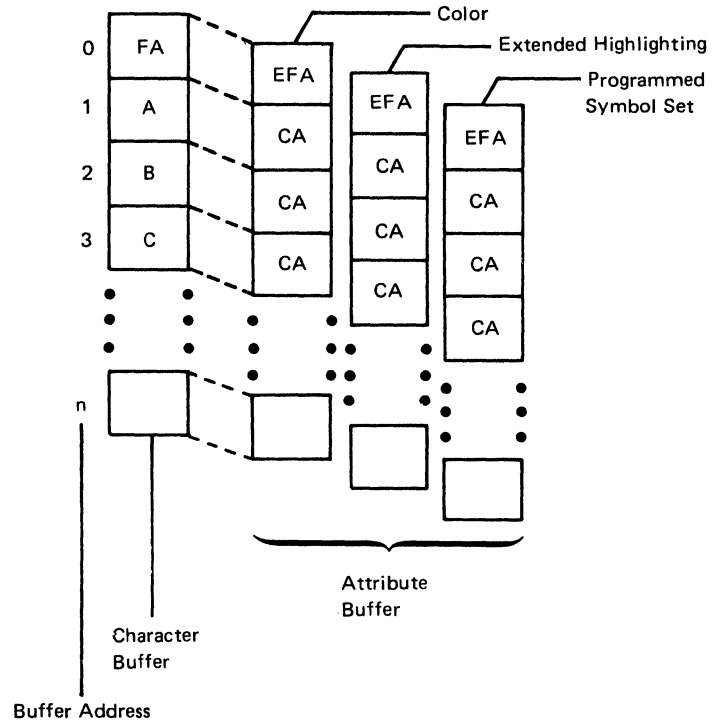

Figure 6-3. Model for Field Attributes and Extended Field Attributes, A Conceptual View

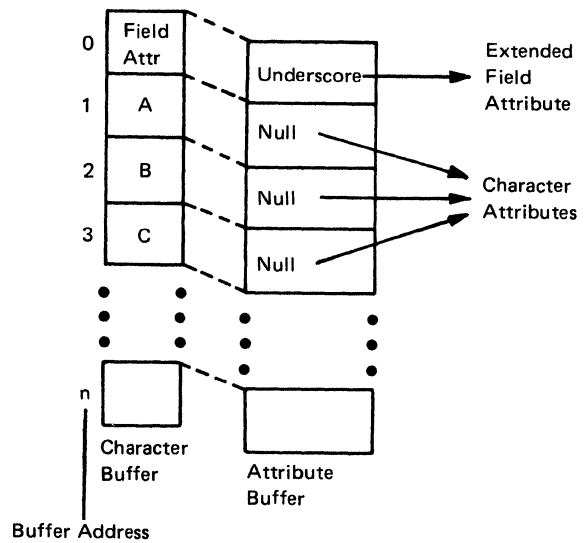
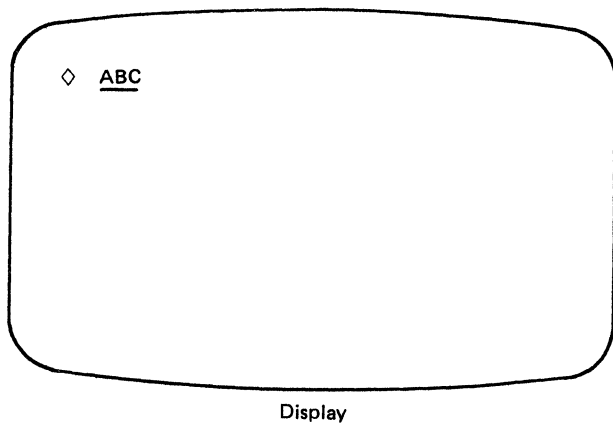
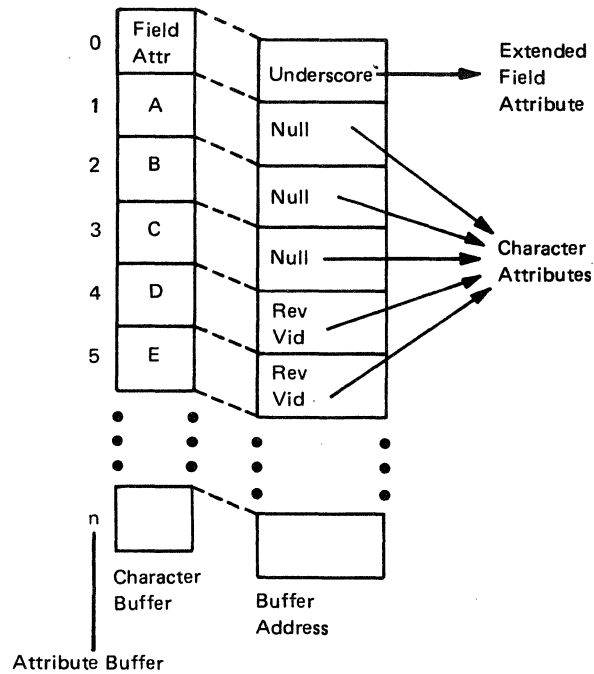
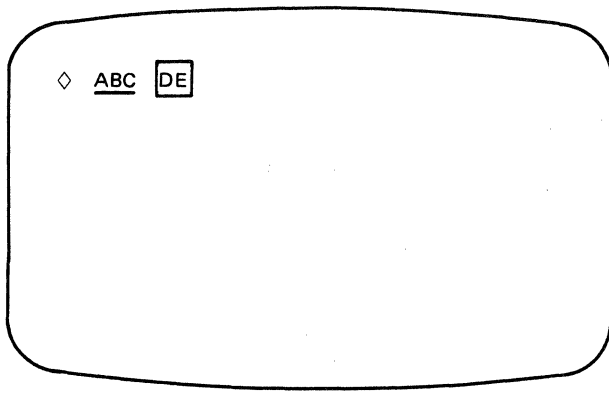

Figure 6-4. Relationship of Character and Extended Field Attributes



□ — Indicates reverse video

Figure 6-5. Character Attribute Override

Example of Field Definition

A typical sign-on procedure illustrates how you might define fields. Figure 6-6 illustrates a simple procedure in which the application program requests the operator to provide his name, location, and serial number.

Field 1: SIGN-ON PROCEDURE:

This field is a heading which the operator should not be able to alter. It is unnecessary for the words SIGN-ON PROCEDURE to be returned to the computer when the ENTER key is pressed. This field should be protected, alphameric, displayed at normal intensity, not detectable by the selector pen or cursor select, and not modified. All default attributes can be assumed, except that you must specify this field as protected.

Field 2: PLEASE ENTER ... INFORMATION

You should specify this field as protected. Remember that the characteristics of a field are determined by the field attribute at the beginning of the field. Field 1 and Field 2 have identical attributes and are adjacent to each other. You may choose to define them separately and use two field attributes, or you may choose to omit the field attribute at the beginning of Field 2. In the latter case the two headings combine to become a single field of greater length.

```

◇ SIGN-ON PROCEDURE

◇ PLEASE ENTER YOUR SIGN-ON INFORMATION

◇ NAME: ◇ _           ◇ LOCATION: ◇

◇ SERIAL NUMBER: ◇   ◇

◇ PASSWORD: ◇       ◇

◇ WHEN ALL INFORMATION IS COMPLETE
  PLEASE PRESS THE "ENTER" KEY

```

Figure 6-6. Example of Attribute Specification

Field 3: NAME:

This field should be protected, alphameric, not modified, and not detectable by the selector pen. The heading could be displayed at high intensity. Specify the protected and high-intensity attributes (the two deviations from the default attributes).

Field 4: The Area Following NAME:

The null area following NAME: is an input area for the operator and must therefore be unprotected. The display marks this field as modified if anything is entered into it, so you should not specify the modified attribute. The default attributes (alphameric, unprotected, displayable at normal intensity, not detectable by the selector pen or cursor select, and not modified) apply. Use a default attribute at the beginning of this field.

The maximum number of characters the operator can enter is determined by the length of this field. The length is equivalent to the number of nulls, or available positions on the screen, between the field attribute for Field 4 and the field attribute for Field 5.

Field 5: LOCATION:

The field attribute for this field is the same as that specified for Field 3; protected and high intensity should be specified. This field attribute prevents the operator from keying a name longer than the maximum length desired. If the name is shorter than the maximum field size, the operator presses the TAB key when the name is complete. The TAB automatically skips the cursor past protected fields, such as this one, and stops at the first character position in which data can be entered (the next unprotected field). In this example, the cursor would be positioned for entry of location. If the operator attempts to key too many characters (a name greater than 17 characters in the example), the cursor is positioned under this attribute for the 18th character. The next keystroke attempts to destroy this field attribute but fails to do so because field attributes are protected. The keyboard is inhibited, the clicker shuts off, and the "input inhibited" indicator is turned on. The operator's attention is assured since this condition requires pressing the RESET key to continue.

If the field attribute for this field were omitted, the word **LOCATION:** would become part of Field 4 and would be normal intensity and unprotected. This is undesirable since the operator could continue entering name information beyond the desired maximum length and could modify the heading information by entering data in the screen locations occupied by **LOCATION:**.

Field 6: The Area Following LOCATION:

This field is for operator input and therefore must be unprotected. The rest of the default attribute values apply and so a default attribute may be used. You need specify only that a field is to begin following **LOCATION:** This field ends with the field attribute at the beginning of Field 7, which determines the length of the field.

Field 7: SERIAL NUMBER:

This field, like **NAME:** and **LOCATION:**, should be specified as protected and high intensity. This also limits the location field length to 5 characters. Note that if field 6, the input field for location, were defined as always being a 5-character code, Field 7, **SERIAL NUMBER:**, could be defined as auto-skip to save the operator from having to press **TAB** after filling in the location code.

Field 8: The Area Following SERIAL NUMBER:

The null area following **SERIAL NUMBER:** is an input area for the operator and must be unprotected. It should also be specified as numeric so that if the operator tries to enter alphabetic data in the field (and the keyboard has the Numeric Lock feature), the keyboard inhibits entry of the incorrect character, the keyboard clicker shuts off, and the **DO NOT ENTER (X)** indicator appears to notify the operator of the error. The improper character does not appear on the screen, and the correct digit may be entered after the operator presses the **RESET** key.

The serial number in the example always contains a fixed number of digits and is the last field entered. The maximum length of the field is determined by the location of the field attribute for the next field. But the next field in the example is too far away (**PASSWORD**).

By placing an additional field attribute following input Field 8, the operator cannot enter a serial number that is too long.

Field 9: The Area Between the Additional Attribute Described in Field 8 and PASSWORD:

By definition, the additional field attribute you used to delimit the serial number field begins a new field. The protected attribute alone is sufficient for this field, and this attribute limits length for the serial number field. Normally, however, protected (output) fields that follow fixed-length input fields should be defined as protected and numeric. The protected and numeric field attribute defines a field as auto-skip. Auto-skip automatically positions the cursor at the location following the field attribute for the next unprotected field, which is the next place you want to key data. This technique saves keystrokes for the operator.

When the operator keys the last character of the preceding fixed-length field, the cursor normally enters the next field, which may be protected. But since the next field is auto-skip, the cursor skips this intervening protected field, and automatically positions itself for entry of the next field, without an extra keystroke.

Field 10: PASSWORD:

This would be exactly like the serial number field, protected and intensified.

Field 11: The Input Field for PASSWORD:

This, like the input field for serial number, should be unprotected and numeric. But, one additional characteristic should be added, that of non-display. This allows the operator to input his or her password without anyone in the area being able to read it since it will not be visible on the display surface, thereby allowing for security. Again you would place an additional field attribute following input Field 11 to ensure that the number entered would be of proper length.

This additional length check is used here because this is the last field to be entered. If you had another field to enter after PASSWORD:, it might be more advantageous to omit this length check, as explained in Field 9.

Field 12: The Area Between the Additional Attribute Described in Field 11 and WHEN ... COMPLETE.

This field should be protected since it is not an operator input area. The rest of the default values apply.

Field 13: WHEN ALL ... KEY.

This field is a heading which the operator should not be allowed to change. It need not be high intensity and thus it may be defined as protected only. Field 13 does not automatically terminate when the last screen position is reached. The field definition continues from the bottom right screen position to the upper left screen position until the next field attribute is reached. This is called "wraparound." Keep this in mind, particularly if you define the last field on a screen as unprotected!

Since items 13 and 1 are adjacent to each other (by wraparound) and all have the same attributes, they may be combined into a single field by the omission of field attributes before WHEN and SIGN-ON. The result is a single protected field beginning after the input area for password, wrapping around the screen, and terminating either at PLEASE or at NAME if Fields 1 and 2 have been previously combined.

Combining fields in the above manner may be convenient but may cause confusion and error if you change the screen layout later. It is a better practice to specify separate fields in all cases.

The panel is completely formatted when the fields are positioned, the field attributes are all defined, and the cursor is placed. You must now begin the transition from the visual image, or human-oriented panel, to the detailed data necessary for the 3270 to implement your panel design.

Planning the Panel

You can think of a panel as a single display screen image created by your program. After an application program has been defined, the information that will be passed between the program and the terminal operator must be defined. This information can be thought of as output panels and input responses to panels. Usually, you will be able to approximate the sequence of the panels needed. The exact sequence of output panels often depends on the input responses to them.

Assuming you have a good understanding of the type of application program (such as data entry, order entry, or inquiry) and the kind of information that must be exchanged and processed (such as customer name, invoices, and check amounts), you can consider which panels come first. Suppose the first panel required is a sign-on panel, as shown in Figure 6-7. After sign-on, the next panel might allow the terminal operator to choose one of several different applications or procedures that he would use. But what if the name or word entered was not an authorized sign-on? Another panel might tell the terminal operator about this and ask him to reenter a sign-on name. Figure 6-7 illustrates a technique, sometimes called "block diagramming," that may help in laying out a sequence of panels.

Using the Panel Layout Sheet

After block-diagramming the panels in the application or procedure, you are ready to decide on the exact contents of each panel: the fields that will be in the panel, what attributes each field will have, and what words will be displayed in the panel. This can be done on graph paper. The *IBM 3270 Information Display System Layout Sheet*, GX27-2951 or GX27-0014, is useful for layout.

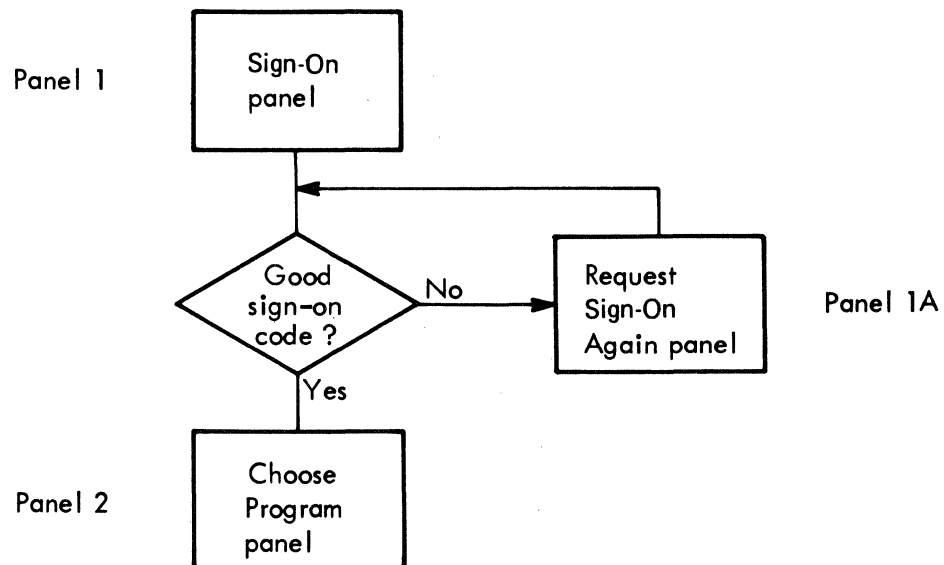



Figure 6-7. Block-Diagramming a Sequence of Panels

One of these sheets can be used for each panel. After laying out a sequence of panels, you have a collection of panel layout sheets. Using the information on these sheets and the block diagram showing the relationship between panels, the program can be written to send the panels to a terminal and handle an operator's response to them.

An Example of Laying Out a Panel

To lay out a panel, consider the sign-on panel shown in Figure 6-6. You might jot down on a piece of paper the information required for the panel, or you might write it directly on the panel layout sheet. Figure 6-8 shows what the panel part of the layout sheet might look like after you put the text you wanted for your sign-on panel on the layout sheet. A 1920-character display is shown here.



**3270 Information Display System
Layout Sheet**

Panel ID _____ Subject _____

Job No. _____ Sheet _____ of _____

Originated by _____ Date _____

		COLUMN																																																											
		1-10	11-20	21-30	31-40	41-50	51-60	61-70	71-80																																																				
		1	2	3	4	5	6	7	8	9	0	1	2	3	4	5	6	7	8	9	0	1	2	3	4	5	6	7	8	9	0	1	2	3	4	5	6	7	8	9	0	1	2	3	4	5	6	7	8	9	0	1	2	3	4	5	6	7	8	9	0
ROW	01																																																												
	02	SIGN-ON PROCEDURE																																																											
	03																																																												
	04	PLEASE ENTER YOUR SIGN-ON INFORMATION																																																											
	05																																																												
	06																																																												
	07																																																												
	08																																																												
	09	NAME:										LOCATION:																																																	
	10																																																												
	11																																																												
	12																																																												
	13	SERIAL NUMBER:																																																											
	14																																																												
	15																																																												
	16	PASSWORD:																																																											
	17																																																												
	18																																																												
	19	WHEN ALL INFORMATION IS COMPLETE																																																											
	20																																																												
	21	PLEASE PRESS THE "ENTER" KEY																																																											
	22																																																												

Figure 6-8. Sign-On Panel as Written Out on Layout Sheet

For example, you might want the fields **NAME:**, **LOCATION:**, and **SERIAL NUMBER:** to have high intensity to focus the operator's attention on them, because these fields indicate where the operator enters information. You might want to protect the fields other than the operator input fields so that the operator could not erase them; the operator input fields following **NAME:**, **LOCATION:**, **SERIAL NUMBER:**, and **PASSWORD:** should be unprotected so the operator can type in information. The operator input field following **SERIAL NUMBER:** and **PASSWORD:** can be numeric to allow some work station editing; the operator would not be allowed to accidentally enter an alphabetic character. Field length can be defined by beginning a new field where you want the previous field to end (in some cases, this new field serves only to give a length attribute to a previous field).

Having decided on these attributes, you can use the columns on the back of the layout sheet to record the locations and attributes of the fields you have created. Your recording in these columns might appear as in Figure 6-10.

The use of these columns depends on whether the panel designer also codes the panels or only designs them. The information now on the layout sheet can be used to write a line of code that, when sent to the display, displays your panel with its specified field characteristics.

Adding Orders to the Panel Layout Sheets

The back of the panel layout sheet is used for writing the panel orders. The headings indicate what the columns should contain.

The first six columns, as shown in Figure 6-11, identify items in the text, their addresses, and the orders required to format them. The column headings are explained below:

- **Item:** Refers to any part of the panel that requires one or more orders to the control unit to format it. There are 14 items in the sign-on panel:
 1. **SIGN-ON PROCEDURE**
 2. **PLEASE ENTER YOUR SIGN-ON INFORMATION**
 3. **NAME:**
 4. Input field
 5. **LOCATION:**
 6. Input field
 7. **SERIAL NUMBER:**
 8. Input field
 9. Field to limit size of serial number input
 10. **PASSWORD**
 11. Input field
 12. Field to limit the size of the password field
 13. **WHEN ALL INFORMATION IS COMPLETE**
 14. **PLEASE PRESS THE ENTER KEY**

Item	Display Printer		Buffer Address		Orders	Prot	No.
	Row	Col	Dec	Hex			
1	2	30			SBA SF ATT		
2	4	20			SBA SF ATT		
3	9	10			SBA SF ATT		
4	9	16			SF ATT IC		
5	9	41			SBA SF ATT		
6	9	51			SF ATT		
	9	80			SBA SF ATT		
7	13	10			SBA SF ATT		
8	13	25			SF ATT		
9	13	32			SBA SF ATT		
10	16	10			SBA SF ATT		
11	16	20			SF ATT		
12	16	27			SBA SF ATT		
13	19	15			SBA SF ATT		
14	21	16			SBA		

Figure 6-10. Laying Out Field Attributes

Item	Display Printer		Buffer Address		Orders
	Row	Col	Dec	Hex	

Figure 6-11. Text Items on Panel Layout Sheet

Since each field requires an SF or SFE order, there are always at least as many items as fields. There are more items than fields when, for example, the SBA order is used to space over unused positions within a single large field, as in Item 14.

- Row, Col: Contain the starting location (row, column) address of each item.
- Dec, Hex: Are for a different addressing format which you do not need if you use the row, column addressing format. Therefore, you may use these columns for any notes to yourself or leave them blank.
- Orders: Contains the orders (described in Chapter 1) you are writing, such as SBA, SF, SFE, and so forth.

As shown in Figure 6-12, the columns under the heading Attribute provide the field or character attributes that can be defined. The programmer checks the appropriate columns of the attributes he is changing from the default values. The meaning of abbreviations used in Figure 6-12 follows:

- Prot: Protected
- No.: Numeric
- High Int: High intensity
- Sel Det: Selector-pen-detectable or cursor selectable
- Non-Disp Prt: Not displayed not printed at printer
- MDT On: Modified data tag on
- Yel: Yellow
- Turq: Turquoise
- Rev Vid: Reverse video
- PS Set: Programmed symbol set
- PSA through PSF: Programmed symbol set A through Programmed symbol set F (they correspond to Read/Write storage buffers 02 through 07)

You are now ready to add the required orders to the panel layout form. This may require that you rewrite the back of the form if it was originally prepared without regard to orders or if insufficient space was allowed. The completed layout sheet containing all the orders are shown in the following figures:

- Figure 6-14 lists the orders for a display with no structured field and attribute processing capabilities; that is, it only has field attribute processing capabilities.

Item	Display Printer		Buffer Address		Orders	Prot	No.	High Int	Sel Det	Non-Disp Prt	MDT On
	Row	Col	Dec	Hex							
1	2	30			SBA SF ATT ✓						
2	4	20			SBA SF ATT ✓						
3	9	10			SBA SF ATT ✓			✓			
4	9	16			SF ATT IC						
5	9	41			SBA SF ATT ✓			✓			
6	9	51			SF ATT						
	9	80			SBA SF ATT						
7	13	10			SBA SF ATT ✓			✓			
8	13	25			SF ATT		✓				
9	13	32			SBA SF ATT ✓		✓				
10	16	10			SBA SF ATT ✓			✓			
11	16	20			SF ATT ✓					✓	
12	16	27			SBA SF ATT ✓						
13	19	15			SBA SF ATT ✓						
14	21	16			SBA						

Figure 6-14. Completed Order and Attribute Information, No SFAP Capability

Order Sequence Order	Byte 1 (Order Code)		Byte 2	Byte 3	Byte 4	Byte n	Byte n+1
	EBCDIC Hex	ASCII Hex					
Start Field (SF)	1D	1D	Attribute				
Set Buffer Address (SBA)	11	11	Address	Address			
Insert Cursor (IC)	13	13					
Program Tab (PT)	05	09					
Repeat To Address (RA)	3C	14	Address	Address	Char. ¹		
Erase Unprotected to Address (FUA)	12	12	Address	Address			
Set Attribute (SA)	28	NA	Attr type	Attr value			
Start Field Extended (SFE)	29	NA	Number of pairs	Attr type 1	Attr value 1	Attr type n	Attr value n
Modify Field (MF)	2C	NA	Number of pairs	Attr type 1	Attr value 1	Attr type n	Attr value n

¹ When graphic escape is used in the RA order, the fourth byte will be the graphic escape character and the fifth byte will be the character to be repeated.

Figure 6-17. Buffer Control Orders and Order Codes

Coding the Panel

To write a panel in assembler language so that it can be part of the application program, you must transfer the panel's text and orders to the appropriate programming coding sheet or any other form you find suitable.

On the coding sheet (and in your program), a panel is represented by a series of programming statements, each with a name to which your program can refer. In the following example, SIGNPANL is the name of the sign-on panel. When the application program wants to send the sign-on panel to a display unit, it issues an Erase/Write or Erase/Write Alternate command and designates SIGNPANL as the panel for display.

The display orders must be written in the programming statements using the hexadecimal codes listed in Figure 6-17. Thus, SF is represented by 1D, SBA by 11, IC by 13, SFE by 29, SA by 28, and so on. In the following discussion, three statements are shown per item, identified by (1), (2), and (3) and are to be interpreted as follows:

- (1) = for a display using field attributes.
- (2) = for a display with the capability to interpret extended field and field attributes.
- (3) = for a display with extended color capability.

Each part of each order must be written in hexadecimal, including the attribute byte that follows the SF order and the buffer address that follows the SBA order.

Item 1. SIGN-ON PROCEDURE.

Begin coding the first item on the panel layout sheet: the title, SIGN-ON PROCEDURE. Start with the orders for the panel text which must precede the text itself so that the control unit knows what to do with the text. To write this title, you must tell the control unit:

- Where the title is displayed on the panel. The SBA order will be used to set the buffer address location to row 2 (R2) and column 30 (C30).
- That this location is the start of a field. The Start Field (SF) order tells the control unit that the location contains a field attribute and not a text character. The field attribute defines the properties of this field up to the next field attribute encountered. In this case, the field is protected. The remaining properties of the field are default attributes and do not have to be defined. For displays with extended field and character attributes, Extended Highlighting and Color properties will be defined as indicated in Figures 6-15 and 6-16.

The first order for the title is the SBA order. Figure 6-17 shows that the SBA hexadecimal code is 11, so this code is used in the program statement. Figure 6-17 also shows that the SBA order must be accompanied by 2 bytes of address information. This address is also in hexadecimal.

Now refer to Appendix J for the address row 2 (R2) and column 30 (C30) that must follow the SBA order. The EBCDIC address is C16D and it follows the SBA code in the programming statement. This address should also be recorded on the layout sheet in the Buffer Address Hex column for future reference. If you prefer, you may look up all of the addresses and record them in a similar manner before writing the programming statements. See Figure 6-18 for an example.

The next order for the title is the SF order, which is followed by the field attribute. Attribute definitions are shown in Figure 6-19. The SF code (1D), and the attribute code (60), are read from Figure 6-17 and 6-19 respectively and added to the programming statement. The data stream would be coded as follows:

(1)	SBA (11)	Address (C1)	Address (6D)	Order (1D)	Attribute (60)	S	I	G	N	-	O	N
-----	-------------	-----------------	-----------------	---------------	-------------------	---	---	---	---	---	---	---

P	R	O	C	E	D	U	R	E
---	---	---	---	---	---	---	---	---

(2)	SBA (11)	Address (C1)	Address (6D)	Order (SFE) (29)	No. of Attribute Pairs (01)	A/T (FA) (C0)	A/V (60)
-----	-------------	-----------------	-----------------	------------------------	-----------------------------------	---------------------	-------------

S	I	G	N	-	O	N	P	R	O	C	E	D	U	R	E
---	---	---	---	---	---	---	---	---	---	---	---	---	---	---	---

(3)	SBA (11)	Address (C1)	Address (6D)	Order (SFE) (29)	No. of Attribute Pairs (02)	A/T (FA) (C0)	A/V (60)
-----	-------------	-----------------	-----------------	------------------------	-----------------------------------	---------------------	-------------

A/T (Color) (42)	A/V (Red) (F2)	S	I	G	N	-	O	N	P	R	O	C	E	D	U	R	E
------------------------	----------------------	---	---	---	---	---	---	---	---	---	---	---	---	---	---	---	---

Note: The meanings for the abbreviations used in these and the following data stream format examples are:

- SBA = Set Buffer Address
- Addr = Address
- Attr = Attribute
- A/T = Attribute type
- A/V = Attribute value
- # Pairs = Number of attribute type/value pairs
- Prot = protected
- HI = High intensity
- Ex Hi = Extended Highlighting
- SF = Start Field
- SFE = Start Field Extended
- FA = Field Attribute
- IC = Insert cursor

Each item contained in the block is one byte of the data in the program.

Item	Display Printer		Buffer Address		Orders
	Row	Col	Dec	Hex	
1	2	30		C16D	SBA SF ATT
2	4	20		C4C3	SBA SF ATT
3	9	10		4AC9	SBA SF ATT
4	9	16		4A4F	SF ATT IC
5	9	41		4AEB	SBA SF ATT
6	9	51			SF ATT
	9	80		4B4F	SBA SF ATT
7	13	10		4FC9	SBA SF ATT
8	13	25			SF ATT
9	13	32		4F5F	SBA SF ATT
10	16	10		D2F9	SBA SF ATT
11	16	20			SF ATT
12	16	27		D34A	SBA SF ATT
13	19	15		D66E	SBA SF ATT
14	21	16		D94F	SBA

Figure 6-18. Sign-on Procedure Panel with Buffer Addresses

Field Attribute Bit Definitions

ATTRIBUTE						Hex
Prot	A/N	MDT ON	High Intens	Sel Det	Non Disp PRT	
U		Y		Y		40
U						C1
U		Y		Y		C4
U		Y		Y		C5
U		Y	H	Y		C8
U			H	Y		C9
U		Y	-	-	Y	4C
U		Y	-	-	Y	4D
U	N	Y				50
U	N					D1
U	N			Y		D4
U	N	Y		Y		D5
U	N	Y	H	Y		D8
U	N	Y	H	Y		D9
U	N		-	-	Y	5C
U	N	Y	-	-	Y	5D
P		Y				60
P						61
P				Y		E4
P		Y		Y		E5
P		Y	H	Y		E8
P		Y	H	Y		E9
P			-	-	Y	6C
P		Y	-	-	Y	6D
P	S	Y				F0
P	S					F1
P	S			Y		F4
P	S	Y		Y		F5
P	S	Y	H	Y		F8
P	S	Y	H	Y		F9
P	S		-	-	Y	7C
P	S	Y	-	-	Y	7D

S = Skip Y = Yes
 U = Unprotected H = High
 P = Protected N = Numeric

Extended Field Attribute Types and Values

Type Code	Setting	Result
X'00'	X'00'	This is the only valid setting for this attribute type. This type/value pair is used only with the SA order. All character attributes specifiable in SA order are set to default value.
X'C0'		The codes appearing here are determined by the field attributes desired.
X'41'	X'00' X'F1' X'F2' X'F4'	Default. Blink Reverse video Underscore
X'42'	X'00' X'F1' X'F2' X'F3' X'F4' X'F5' X'F6' X'F7'	Default. Blue Red Pink Green Turquoise Yellow White for 3279, black for 3287
X'43'	X'00' X'40' X'EF' X'F1'	Default. Valid range for symbol-set IDs assigned in the Load Programmed Symbols structured field. Symbol-set ID for the APL/Text symbol set in terminal storage ID X'01'. This is the only nonloadable symbol set supported, and this attribute value may only be used in the SA order. IF X'F1' is received in an SFE or MF order, an Op Chk or negative response of X'1005' is returned.

Figure 6-19. Attribute Combinations in Hexadecimal

Item 2. PLEASE ENTER YOUR SIGN-ON INFORMATION

To write this information, the control unit must know only where the text is located. Therefore, you must use an SBA instruction followed by the address for R4, C20. This is also the beginning of a protected field, so you should include an SF order and a protected attribute.

The code for this field, except for the address, is identical to the code for field 1 SIGN-ON PROCEDURE and will not be repeated here.

Item 3. NAME:

As with Item 2, the location where the text is to be displayed must be identified. Write an SBA order followed by the EBCDIC buffer address X'hex 4AC9'. This is the beginning of a protected, high-intensity field. For a color display, it would be protected and yellow. The data stream would be coded as follows:

(1)	SBA	Address	Address	Order	Attribute	N	A	M	E	:
	(11)	(4A)	(C9)	(SF) (1D)	(E8)					

(2)	SBA	Address	Address	Order	No. of	A/T	A/V	N	A	M	E	:
	(11)	(4A)	(C9)	(SFE) (29)	Pairs (01)	(FA) (C0)	(E8)					

(3)	SBA	Address	Address	Order	No. of	A/T	A/V	A/T	Color
	(11)	(4A)	(C9)	(SFE) (29)	Pairs (02)	(FA) (C0)	(E8)	(42)	

A/V	N	A	M	E	:
Yellow					
(F6)					

Item 4. Input Field for Operator's Name.

Since this item immediately follows Item 3, the control unit already knows the correct address. Therefore, there is no reason to issue an SBA order. Item 4 is the start of a new field, however, so you must issue an SF order to instruct the display to expect a field attribute next. The field attribute defines the input field as unprotected (U), alphameric (A), normal intensity, not detectable by selector pen, and no MDT on. Because these are the default attributes, you do not have to check anything in the attribute definition columns. However, for the terminals that interpret extended field and character attributes, the underscore property will be added.

The cursor should follow the field attribute to indicate where the operator should begin to enter information. The Insert Cursor (IC) order displays the cursor at this current buffer address. After the display has stored the field

attribute in location R9, C16, the new current address is R9, C17; this is the place where the cursor appears on the panel.

To code an input field that contains no text, such as the input field for NAME:, write just one programming statement that contains the orders for that field. The "hex" values are:

- (1) X'1D4013'
- (2) X'2902C04041F413'
- (3) X'2902C04041F413'

The data stream would be coded as follows:

(1)

Order SF (1D)	Attribute (40)	Order IC (13)
---------------------	-------------------	---------------------

(2)

Order SFE (29)	#Pairs (02)	A/T FA (C0)	A/V (40)	A/T EX HI (41)	A/V (F4)	Order IC (13)
----------------------	----------------	-------------------	-------------	----------------------	-------------	---------------------

(3)

Order SFE (29)	#Pairs (02)	A/T FA (C0)	A/V (40)	A/T EX HI (41)	A/V (F4)	Order IC (13)
----------------------	----------------	-------------------	-------------	----------------------	-------------	---------------------

Item 5. LOCATION

The control unit must have two orders for this item which (1) give the starting buffer address (SBA) of the field as R9, C41, and (2) indicate that it is the start of a new field (SF) or (SFE), that it is protected, has high intensity, and for a color display is yellow. The "hex" values are:

- (1) X'114AE81DE8'
- (2) X'114AE82901C0E8'
- (3) X'114AE82902C0E842F6'

The data stream would be coded as follows:

(1)	Order SBA (11)	Addr (4A)	Addr (E8)	Order SF (1D)	Attr (E8)	L	O	C	A	T	I	O	N	:
-----	----------------------	--------------	--------------	---------------------	--------------	---	---	---	---	---	---	---	---	---

(2)	Order SBA (11)	Addr (4A)	Addr (E8)	Order SFE (29)	# Pairs (01)	A/T FA (C0)	A/V (E8)
-----	----------------------	--------------	--------------	----------------------	-----------------	-------------------	-------------

L	O	C	A	T	I	O	N	:
---	---	---	---	---	---	---	---	---

(3)	Order SBA (11)	Addr (4A)	Addr (E8)	Order SFE (29)	# Pairs (02)	A/T (C0)	A/V (E8)	A/T (42)	A/V (F6)
-----	----------------------	--------------	--------------	----------------------	-----------------	-------------	-------------	-------------	-------------

L	O	C	A	T	I	O	N	:
---	---	---	---	---	---	---	---	---

Note: The previous examples show how the text follows in the data stream to be coded. Hereafter only the word "Text" will be used rather than the actual words.

Item 6. Input Field for Operator's Location Code

This item immediately follows the text of the last item so there is no need to set the buffer address. Write only the SF order to indicate the start of a new unprotected field, and use default attributes.

For the extended field attribute terminals, the Extended Highlighting property of underscore will be used. Therefore, the following precaution should be taken. If the field is not terminated by an additional SBA order at location column 80, the underscore property would wrap the line and continue until the next SF or SFE order is encountered. Since only the field for operator input should be underscored, terminate the field at the proper location using the proper orders. The "hex" values are:

- (1) X'1D40114B4F1D60'
- (2) X'2902C04041F4114B4F2901C060'
- (3) X'2902C04041F4114B4F2901C060'

The data stream would be coded as follows:

(1)	Order SF (1D)	Attr (40)	Order SBA (11)	Addr (4B)	Addr (4F)	Order SF (1D)	Addr (60)
-----	---------------------	--------------	----------------------	--------------	--------------	---------------------	--------------

(2)	Order SFE (29)	# Pairs (02)	A/T FA (C0)	A/V (40)	A/T Ex Hi (41)	A/V (F4)	Order SBA (11)	Addr (4B)	Addr (4F)
-----	----------------------	-----------------	-------------------	-------------	----------------------	-------------	----------------------	--------------	--------------

Order SFE (29)	# Pairs FA (01)	A/T (C0)	A/V (60)
----------------------	-----------------------	-------------	-------------

(3)	Order SFE (29)	# Pairs (02)	A/T FA (C0)	A/V (40)	A/T Ex Hi (41)	A/V (F4)	Order SBA (11)	Addr (4B)	Addr (4F)
-----	----------------------	-----------------	-------------------	-------------	----------------------	-------------	----------------------	--------------	--------------

Order SFE (29)	# Pairs FA (01)	A/T (C0)	A/V (60)
----------------------	-----------------------	-------------	-------------

Note that, with the SFE order, if the field attributes are all defaults as in the case above of (C0,40), only the extended field attributes need be coded. The X'C040' need not be coded since these defaults will be assumed by the display.

Item 7. SERIAL NUMBER

This field requires an SBA order to location R13, C10 and an SF or SFE order to begin a new field. The attributes are specified the same as that for Item 5 except the color will now be pink. The "hex" values are:

- (1) X'114FC91DE8, text "SERIAL NUMBER:"
- (2) X'114FC92901C0E8, text "SERIAL NUMBER:"
- (3) X'114FC92902C0E842F3, text "SERIAL NUMBER:"

The data stream would be coded as follows:

(1)	Order SBA (11)	Addr (4F)	Addr (C9)	Order SF (1D)	Attr (E8)	Text
-----	----------------------	--------------	--------------	---------------------	--------------	------

(2)	Order SBA (11)	Addr (4F)	Addr (C9)	Order SFE (29)	# Pairs (01)	A/T FA (C0)	A/V (E8)	Text
-----	----------------------	--------------	--------------	----------------------	-----------------	-------------------	-------------	------

(3)	Order SBA (11)	Addr (4F)	Addr (C9)	Order SFE (29)	# Pairs (02)	A/T FA (C0)	A/V (E8)	A/T Color (42)
-----	----------------------	--------------	--------------	----------------------	-----------------	-------------------	-------------	----------------------

A/V (F3)	Text
-------------	------

Item 8. Input Field for Serial Number.

Because the field attribute for this input field immediately follows the last character of the previous field, an SBA is not required. The attribute is numeric; for the terminals that can interpret extended field and character attributes, it will also have the Extended Highlighting property of blink. The "hex" values are:

- (1) X'1D50'
- (2) X'2902C05041F1'
- (3) X'2902C05041F1'

The data stream would be coded as follows:

(1)	Order SF (1D)	Attribute (50)
-----	---------------------	-------------------

(2)	Order SFE (29)	# Pairs (02)	A/T FA (C0)	A/V (50)	A/T Ex Hi (41)	A/V (F1)
-----	----------------------	-----------------	-------------------	-------------	----------------------	-------------

(3)	Order SFE (29)	# Pairs (02)	A/T FA (C0)	A/V (50)	A/T Ex Hi (41)	A/V (F1)
-----	----------------------	-----------------	-------------------	-------------	----------------------	-------------

Item 9. An Extra Field Created to Limit the Size of the Serial Number Input Field

This field follows the input field and is protected and numeric. This field is an auto skip field which will place the cursor at the next location for operator input, the password input field. An SBA is required for location R13, C32, for proper placement of the attribute. The "hex" values are:

- (1) X'114F5F1DF0'
- (2) X'114F5F2901C0F0'
- (3) X'114F5F2901C060'

The data stream would be coded as follows:

(1)

Order SBA (11)	Addr (4F)	Addr (5F)	Order SF (1D)	Attribute (F0)
----------------------	--------------	--------------	---------------------	-------------------

(2)

Order SBA (11)	Addr (4F)	Addr (5F)	Order SFE (29)	# Pairs (01)	A/T FA (C0)	A/V (F0)
----------------------	--------------	--------------	----------------------	-----------------	-------------------	-------------

- (3) Same as (2).

Note: *The previous format examples are representative of all those for the sign-on panel fields. The following item explanations will not show formats unless there are differences.*

Item 10. PASSWORD

The control unit must have two orders for this item: an SBA order that gives the starting address of R16, C10 and an SF or SFE order to indicate that it is the start of a new field. The field attribute defines a protected and intensified field. The "hex" values are:

- (1) X'11D2F91DE8'
- (2) X'11D2F92901C0E8'
- (3) X'11D2F92901C0E8'

Item 11. Input Field for Password

Because the field attribute for this input field immediately follows the last character of the previous field, an SBA order is not required. The attribute is numeric and nondisplayable. The "hex" values are:

- (1) X'1D5C'
- (2) X'2901C05C'
- (3) same as (2).

Item 12. Extra Field

This is another extra field created to limit the size of the password, identical to the field to limit the size of the serial number. This follows an input field and is protected only. An SBA is required for location R16, C27, for proper placement of the field attribute byte. The "hex" values are:

- (1) X'11D34A1D60'
- (2) X'11D34A2901C060'
- (3) same as (2).

Item 13. "WHEN ALL INFORMATION IS COMPLETE"

The control unit must have two orders for this item: an SBA order that gives the starting address of R19, C16 and an SF or SFE order to indicate that it is the start of a new field. The field attribute defines a protected field, and the rest of the field attributes take the default value. For the color display, the color turquoise is an added property. The "hex" values are:

- (1) X'11D66E1D60'
- (2) X'11D66E2901C060'
- (3) X'11D66E2902C06042F5'

Following each of the above statements in the program would be the text "WHEN ALL INFORMATION IS COMPLETE."

Item 14. "PLEASE PRESS THE 'ENTER' KEY."

All of the words from "WHEN ALL" through "KEY" could have been treated as a single item, but the proper amount of blank spaces would have to be sent between "COMPLETE" and "PLEASE" to position "PLEASE" properly at R21, C16. It is easier and less chance for error to use the three characters required for the SBA order and its associated address, breaking the field into two items, to position "PLEASE" at R21, C16. The "hex" values are the same for (1), (2), and (3): X'11D94F' followed by the text "PLEASE PRESS THE 'ENTER' KEY."

Each item from the panel layout sheet is coded in this fashion. Figure 6-20 shows the assembler language code required to display the sign-on panel for a display with no SFAP capability and for an extended color display. Except for one control character, it consists entirely of the panel text, preceded by the display orders for that text.

The SIGN-ON panel is now complete and can be sent to the display unit by the application program.

SIGNPANL (NO EXTENDED ATTRIBUTES)

JOHN DOE

11/11/80

1 1

```
SIGNPANL DC X\F5' ERASE/WRITE
DC X\C7' WCC
DC X\11C16E1D60' SBA R2C31 ATT P
DC C\SIGN-ON PROCEDURE'
DC X\11C4C41D60' SBA R4C21 ATT P
DC C\PLEASE ENTER YOUR SIGN-ON INFORMATION'
DC X\114A4A1DE8' SBA R9C11 ATT P HI-INT
DC C\NAME:'
DC X\1D4013' ATT U CURSOR
DC X\114AE91DE8' SBA R9C42 ATT P HI-INT
DC C\LOCATION:' ATT U
DC X\1D40'
DC X\114F4A1DE8' SBA R13C11 ATT P HI-INT.
DC C\SERIAL NUMBER:'
DC X\1D50' ATT U NUM
DC X\114FSF1D60' SBA R13C32 ATT P
DC X\11D27A1DE8' SBA R16C11 ATT P HI-INT
DC C\PASSWORD:'
DC X\1D5C' ATT U NUM NON-DISPLAY
DC X\11D34A1D60' SBA R16C27 ATT P
DC X\11D66F1D60' SBA R19C16 ATT P
DC C\WHEN ALL INFORMATION IS COMPLETE'
DC X\11D94F' SBA R21C16
DC C\PLEASE PRESS THE "ENTER" KEY'
```

SIGNPANL (7 COLOR DISPLAY)

JOHN DOE

11/11/80

1 1

```
SIGNPANL DC X\F5' ERASE/WRITE
DC X\C7' WCC
DC X\11C16E2902C06042F2' SBA R2C31 ATT P RED
DC C\SIGN-ON PROCEDURE'
DC X\11C4C42902C06042F2' SBA R4C21 ATT P RED
DC C\PLEASE ENTER YOUR SIGN-ON INFORMATION'
DC X\114A4A2902C0E842F6' SBA R9C11 ATT P YELLOW
DC C\NAME:'
DC X\2902C04041F413' ATT U CRSOR UND-SCORE
DC X\114AE92902C0E842F6' SBA R9C42 ATT P YELLOW
DC C\LOCATION:'
DC X\2902C04041F4' ATT U UNDERSCORE
DC X\114B4F1DF0' SBA R9C80 ATT P NUM
DC X\114F4A2902C0E842F3' SBA R13C11 ATT P PINK
DC C\SERIAL NUMBER:'
DC X\2902C05041F1' ATT U NUMERIC BLINK
DC X\114F5F2901C060' SBA R13C32 ATT P
DC X\11D27A2901C0E8' SBA R16C11 ATT P HI-INT.
DC C\PASSWORD:'
DC X\2901C05C' ATT NON-DISP. NUM U
DC X\11D34A2901C060' SBA R16C27 ATT P
DC X\11D66F2902C06042F5' SBA R19C16 ATT P TORQUOISE
DC C\WHEN ALL INFORMATION IS COMPLETE'
DC X\11D94F' SBA R21C16
DC C\PLEASE PRESS THE "ENTRY" KEY'
```

Figure 6-20. Assembler Language Statements for Sign-On Panel

Using the Repeat to Address Order

The Repeat to Address (RA) order stores a specified alphanumeric or null character in buffer locations, starting at the current buffer address and ending at (but not including) the specified stop address. The specified stop address then becomes the current buffer address.

RA is 3C in hexadecimal. RA can repeat null characters and can erase selected parts of the screen. You may also use it to repeat any other character. To put a row of asterisks under the last title in the sign-on panel, after the DC statement for "PLEASE PRESS THE ENTER KEY," you specify an SBA for R22, C1. The RA order should repeat the asterisk character to location R1, C1 (the address after the last *). This is noted on the layout form as shown in Figure 6-21.

The order in the example is coded as:

```
DC X'3C4040'  
DC C'*'
```

If you want to delete a field already on the screen, repeat the "null" character.

Using the Write Control Character (WCC)

The control unit to which the display unit is attached uses the orders to format the panel. One control character for the control unit must be included following the write commands for every panel you write: the Write Control Character (WCC). However, no WCC is required between a Write Structured Field command and a structured field. The WCC is a hexadecimal code that provides control information for the control unit and defines printer information for printing panels. The other information in the WCC specifies:

- Whether to sound the audible alarm. The audible alarm is an optional display unit and printer feature that sounds a tone at the display unit upon program request. You can request this function by selecting the appropriate WCC hexadecimal code. If this feature is not installed on a display unit, the request is ignored.
- Whether to restore the keyboard at the end of your panel operation. If this option is requested, the keyboard, which locks when the operator completes a panel operation, is automatically unlocked when the program has finished processing the operator's input. Keyboard restoration means the operator does not have to press the RESET key.

You might not want to unlock the keyboard after each panel is displayed. For example, if you plan to write out another panel before you want to accept input, locking the keyboard prevents the operator from entering data before it is needed. Also, after writing an incorrect panel, you may want to force the operator to press the RESET key to make sure you have gained his attention.

- Whether to reset the modified data tag (MDT). If this option is specified, the field attributes of all modified fields are reset. This function resets all input fields to their original (unmodified) status when an operation is completed so they are ready for the next operation.

Each panel written to a display unit or printer must begin with the WCC to identify whether these functions are requested.

The hexadecimal code for each possible WCC combination is shown in Figure 6-22. See the *IBM 3270 Data Stream Programmer's Reference manual*, GA23-0059 for more information on the WCC.

Item	Display Printer		Buffer Address		Orders
	Row	Col	Dec	Hex	
1	2	30		C16D	SBA SF ATT
2	4	20		C4C3	SBA SF ATT
3	9	10		4AC9	SBA SF ATT
4	9	16		4A4F	SF ATT IC
5	9	41		4AEB	SBA SF ATT
6	9	51			SF ATT
	9	80		4B4F	SBA SF ATT
7	13	10		4FC9	SBA SF ATT
8	13	25			SF ATT
9	13	32		4F5F	SBA SF ATT
10	16	10		D2F9	SBA SF ATT
11	16	20			SF ATT
12	16	27		D34A	SBA SF ATT
13	19	15		D66E	SBA SF ATT
14	21	16		D94F	SBA
15	23	01		5B6A	RA *

Figure 6-21. An Example of the RA Order

WCCs for the Display

Start Printer	Sound Audible Alarm	Restore Keyboard	Reset MDTs	Code This Hex Value
No	Yes	Yes	Yes	C7
No	Yes	Yes	No	C6
No	Yes	No	Yes	C5
No	Yes	No	No	C4
No	No	Yes	Yes	C3
No	No	Yes	No	C2
No	No	No	Yes	C1
No	No	No	No	40

WCCs for the Printer

Start Printer	Sound Audible Alarm	Restore Keyboard	Reset MDTs	Code This Hex Value If You Want			
				NL and EM Codes Honored	40-Char. Line	64-Char. Line	80-Char. Line
Yes	Yes	Yes	Yes	4F	5F	6F	7F
Yes	Yes	Yes	No	4E	5E	6E	7E
Yes	Yes	No	Yes	4D	5D	6D	7D
Yes	Yes	No	No	4C	5C	6C	7C
Yes	No	Yes	Yes	4B	5B	6B	7B
Yes	No	Yes	No	4A	5A	6A	7A
Yes	No	No	Yes	C9	D9	E9	F9
Yes	No	No	No	C8	D8	E8	F8

Figure 6-22. WCC Hexadecimal Codes

An Example of a Sequence of Panels

Assume you are given the assignment of designing the panels for an accounts receivable application. You are to create the panels that will allow a terminal operator to post a customer payment against his unpaid invoices. The terminal operator will be sitting at a 3270 work station, removing checks and invoice copies from envelopes. If the invoice copies are returned with the check, the terminal operator will for each invoice enter the customer number, payment, and invoice number. If the invoice copies are not returned, the terminal operator will have to find the customer number based on the customer name and then decide which open invoices to apply the payment against. It will be helpful if the operator has some way of adding various open invoices to find a combination that totals the payment.

The 1920-character panels that follow show one possible solution. The first panel in the application is shown in Figure 6-23. If the invoice copies come with the check, the terminal operator can enter the customer number, amount, and invoice number, and press the ENTER key.

This posts the payment against the specified invoice. The terminal operator can then post the next payment and so forth; as long as the customer number and invoice number are known, only Panel 1 is displayed.

If, however, no invoice is returned and the customer number is not known, the customer name can be entered. The name need not be the complete name of the company; it can be the first name of the company. In our example, the check says only CAPITOL so that is what the operator enters. When the name has been entered, the terminal operator presses the ENTER key. The customer number is missing, so Panel 2 is displayed.

Panel 2, shown in Figure 6-24, shows all customers and customer numbers phonetically similar to the name entered in response to Panel 1. Item numbers in Panel 2 allow the terminal operator to select one by using the corresponding Program Function (PF) key (see "Program Function Keys" later in this chapter).

As a result of terminal operator response to Panel 2, Panel 3 (shown in Figure 6-25) displays all open invoices for the identified customer. The terminal operator can now use the selector pen or cursor select to specify the open invoices to which the payment applies. He does this by touching the selector pen to the question mark adjacent to each desired invoice number or by positioning the cursor in the invoice number field and processing the cursor select keys; selection is verified immediately by the question mark changing to a > character. To post the payment against the selected invoice numbers, the operator can select APPLY. If, however, the operator cannot easily tell the invoices to which the payment is applied, he can select CALC instead of APPLY.

Selecting CALC displays Panel 4 (Figure 6-26); this is the same as Panel 3 except that ACCOUNTS RECEIVABLE, which was high intensity in Panel 3, is now normal intensity in Panel 4. A new line with CALCULATOR in high intensity indicates the screen mode and explains the functions of the PF keys. The terminal operator can now use the lower right quadrant of the screen as a *scratch pad* to figure out a combination of open invoices that will total the payment check. This use of one part of the screen for a separate function is sometimes called a *split-screen capability*.

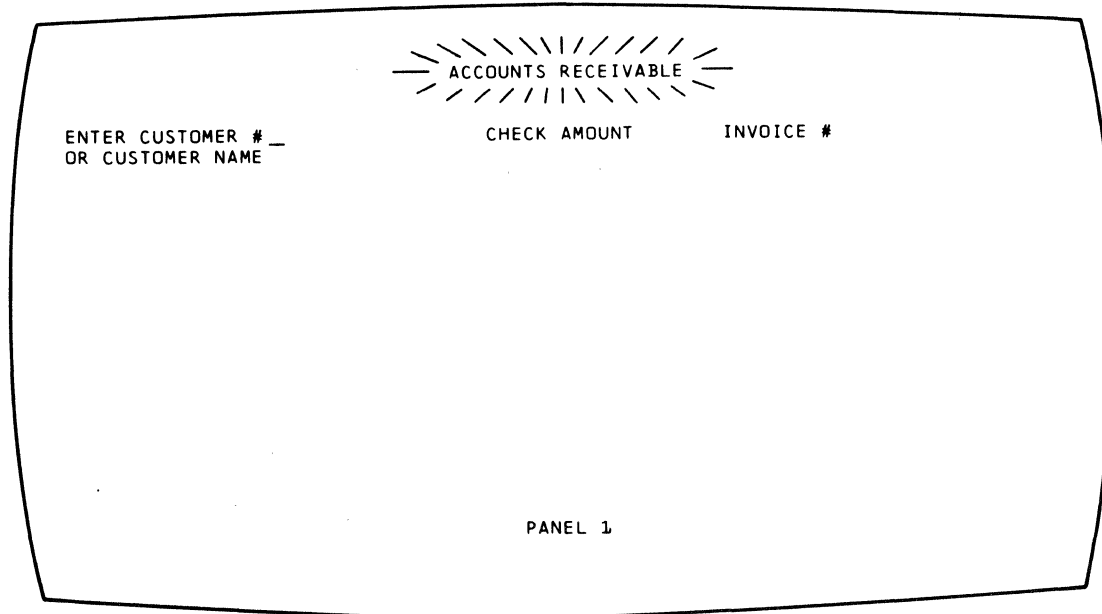

Figure 6-23. Panel 1 of an Accounts Receivable Application

ITEM	CUST #	NAME/ADDRESS	ITEM	CUST #	NAME/ADDRESS
1	0010341	CAPITAL AVIATION 711 HILLSBOROUGH ST. RALEIGH, N.C. 27611	5	0052693	CAPITOL ELECTRIC 56 STATE ST. MONTPELIER, VT. 05602
2	0028472	CAPITOL BAKERIES 1800 MAIN ST. COLUMBIA, S.C. 29201	6	0084362	CAPITOL FEATHER CO. 899 LOGAN ST. DENVER, COLO. 80217
3	0034020	CAPITOL COLA CORP 1439 PEACHTREE ST. NE ATLANTA, GA. 30309	7	0048729	CAPITAL GLASS CO. 121 STATE ST. ALBANY, N.Y. 12201
4	0041938	CAPITAL DRUG CO. 201 NORTH 9TH ST. RICHMOND, VA. 23219	8	0038492	CAPITOL HOLDING CO. 1609 SHOAL CREEK B AUSTIN, TEXAS 78701

PANEL 2

Figure 6-24. Panel 2, Showing the Results of a Search on a Customer Name

ACCOUNTS RECEIVABLE

CUST #	NAME	INVOICE #	DATE	(D)	GROSS	NET
0028472	CAPITOL BAKERIES	? A984632	11/01/71		\$182.50	\$182.50
		? B000312	12/05/71		\$778.00	\$778.00
CHK AMT	\$4,000.00	? B000418	12/07/71		\$98.50	\$98.50
TOT DUE	\$5,358.40	? B000964	12/11/71		\$1,250.00	\$1,250.00
		? B001200	12/21/71		\$682.40	\$682.40
		? B001439	12/25/71		\$395.00	\$395.00
		? B001800	01/11/72	*	\$1,029.75	\$1,009.15
		? B002015	01/15/72	*	\$982.50	\$962.85

MANUAL APPLY
CALC NEXT

PANEL 3

Figure 6-25. Panel 3, Showing the Customer's Open Invoices

The calculator could be programmed a number of different ways. It could, as our example illustrates, show in one column in the CALCULATOR quadrant all invoice numbers selected (shown with > in Figure 6-26) prior to selecting CALC and in another column show any balance remaining from the check amount after subtracting the selected invoice numbers. In Figure 6-26, Panel 4 is shown as it would appear if the terminal operator had first selected four invoice numbers and then selected CALC. In this example, the selected invoices equal the check amount so .00 is shown as the balance after subtracting the selected invoices.

Panel 4 shows that the CALCULATOR could also allow the operator to key in amounts and to add or subtract them from the check amount (pressing PF1 in our example adds keyed-in amounts; PF2 subtracts one keyed-in amount from another). To start over at any point, the operator can press PF3 to clear the calculator quadrant. In our example, the selected invoices equal the check amount, so they can now be posted. But first the terminal operator must leave the CALCULATOR routine by pressing PF4 (RETURN). This displays Panel 5, shown in Figure 6-27.

Panel 5 is the same as Panel 4 except that, with the operator having signaled completion of the CALCULATOR, the word now appears in normal intensity and ACCOUNTS RECEIVABLE once again appears in high intensity. The terminal operator can now, using the selector pen or cursor select, select the invoices against which to apply the payment and then select APPLY to post the payment.

Panel 6 (in Figure 6-28) shows the ACCOUNTS RECEIVABLE file for the customer after posting the payment, with the new balance and the total amount applied. To continue to the next customer, the operator selects NEXT and returns to Panel 1.

Not all the 3270's possibilities are shown in these six panels, and not all users will have the selector pen or cursor select; this example was designed to show only what panels are and how the 3270 can be used.

Note that, in the above example, the terminal operator does not see as many panels as the programmer must create; not all panels necessarily appear to the operator in any given application. What the programmer regards as separate panels may appear to the terminal operator as one changing panel.

In the above example, a number of additional panels or variations to the panels shown would be required. For example, if the terminal operator presses an invalid PF key, a variation of the panel would be required to send a message to the operator over the panel presently at his display. In programming panels that are variations of one main panel, it may be useful to assign panel designations (for example, Panel 4A, 4B, and so forth) for variations of Panel 4.

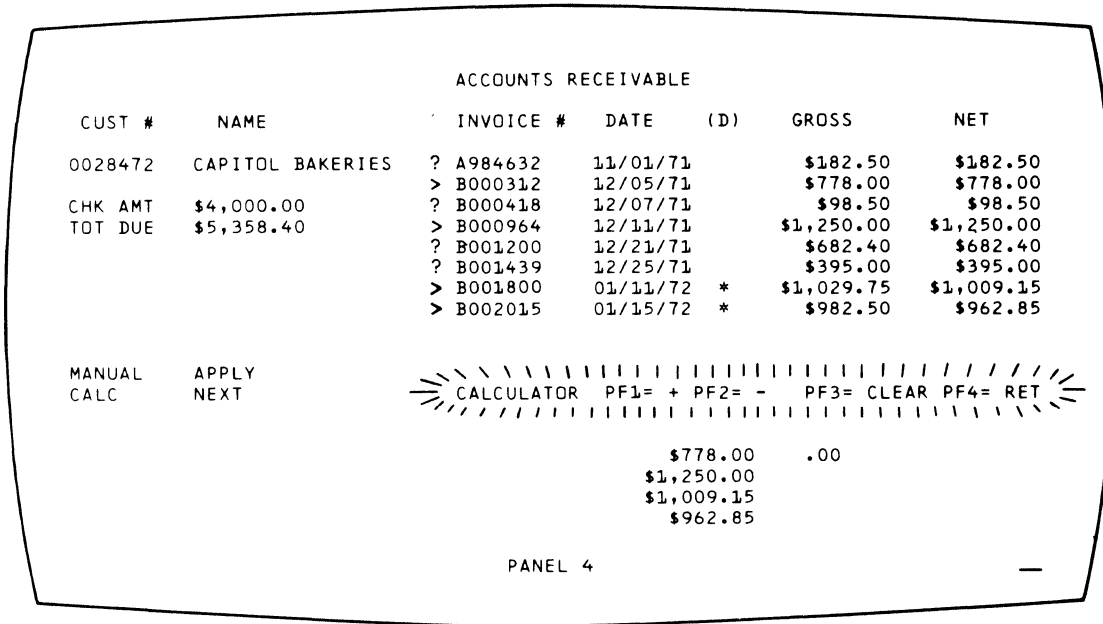

Figure 6-26. Panel 4, Showing Use of the Calculator

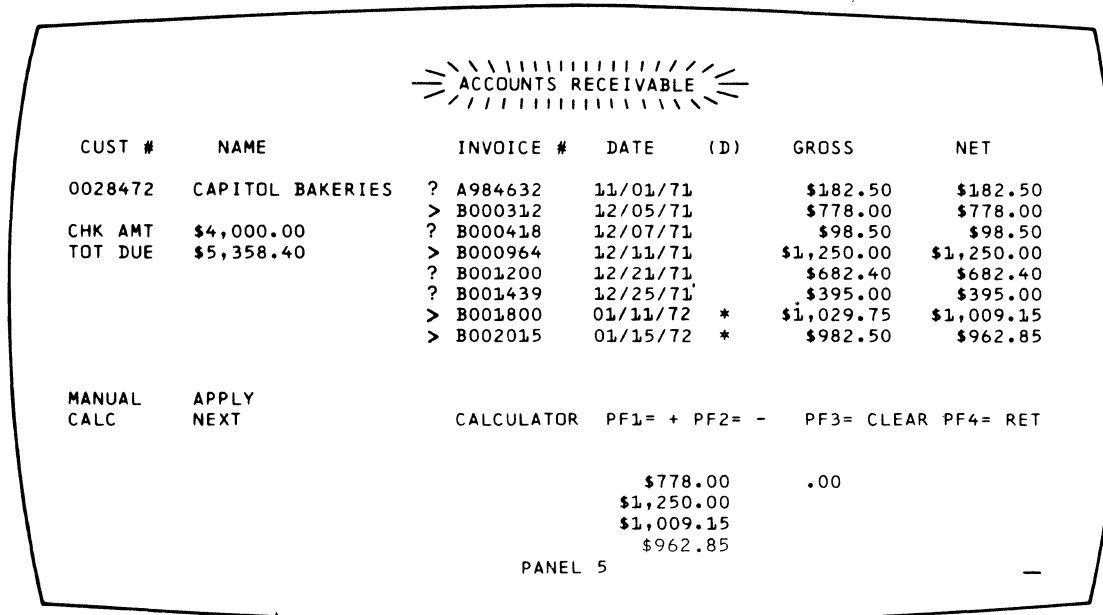

Figure 6-27. Panel 5, Showing Selection of Invoices after Using the Calculator

ACCOUNTS RECEIVABLE						
CUST #	NAME	INVOICE #	DATE	(D)	GROSS	NET
0028472	CAPITOL BAKERIES	? A984632	11/01/71		\$182.50	\$182.50
CHK AMT	\$4,000.00	? B000418	12/07/71		\$98.50	\$98.50
TOT DUE	\$5,358.40	? B001200	12/21/71		\$682.40	\$682.40
NEW BAL	\$1,358.40	? B001439	12/25/71		\$395.00	\$395.00
SEL INV	\$4,000.00					
MANUAL CALC	APPLY NEXT					

PANEL 6

Figure 6-28. Panel 6, Showing New Balance after Posting

Analyzing Input Data

The Operator's Response

When a sign-on panel is displayed, the operator responds by entering name, location, and serial number as shown in Figure 6-29. As the operator keys this information, the entered data characters are stored in the display unit's buffer and are displayed as part of the panel. Data that is entered in a nondisplayable field is stored in the buffer, but does not appear on the panel.

When the operator finishes entering the requested data, he indicates the end of this operation by pressing the ENTER key, which causes an automatic Read Modified command execution and sends the following information to your program:

- An attention code to identify that the ENTER key was pressed.
- The address of the cursor's location.

SIGN-ON PROCEDURE	
PLEASE ENTER YOUR SIGN-ON INFORMATION	
NAME: JOHN SMITH	LOCATION: BOSTN
SERIAL NUMBER: 963981	
WHEN ALL INFORMATION IS COMPLETE YOU MAY PRESS THE ENTER KEY	

Figure 6-29. Sign-On Panel with Operator's Input

- The start buffer address code to identify the next 2 characters as addresses.
- The starting addresses of every modified field, followed by the data in the modified fields.

Figure 6-30 shows this sequence of input data, which is explained below.

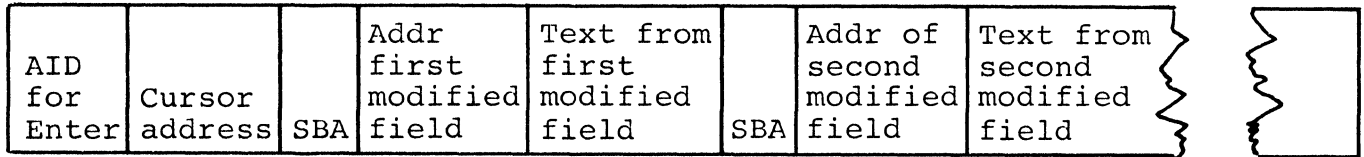

Figure 6-30. Input Data Sequence

Attention Identifier (AID)

The Attention Identifier (AID) is a hexadecimal code. By identifying this code, your program can determine in which of several possible ways the operator contacted the program and determine what request is being made. For example, pressing the ENTER key requests “Please enter this data.”

For a Read Modified, the AID code is followed by the cursor address, which is the hexadecimal code for the row and column location of the cursor when the operator contacted your program.

Input Data

All the modified fields from the panel follow the AID code and the cursor address. A modified field is any field whose field attribute has the MDT on. A modified field can be one that was modified by the operator or one that was defined by you in your program with the MDT on in its field attribute.

When any character location in an input field is modified by the operator, the MDT in the field attribute for that field is automatically turned on. An input field is not necessarily a modified field. If the operator made no entry in the SERIAL field, for example, only his name, location, and the date would be sent as modified fields to your program.

The display unit sends all the data in a modified field except nulls. When an operator finishes an operation, the display unit reads through the buffer for every field attribute whose code indicates its MDT is on. Each time one is found, the display unit provides an SBA code and the starting address (the field attribute’s address plus one) of the modified field. The SBA code identifies to your program that an address follows. It is the same X’11’ code that you coded in your panel to identify the starting locations of the panel’s text.

SBA Codes

SBA codes identify the incoming data by cross-referencing it to the correct input field.

For the sign-on panel, your program knows that row 6, column 8 (X’C34F’) is the start of the name input field. When it receives the first SBA code (X’11’), it checks the address that follows to see if it is (X’C34F’). If it is, your program knows the text that follows it (until the next SBA code) is the operator’s name and can process the input accordingly.

The first part of the input from the sign-on panel is as follows:

7D	C4	C6	11	C3	4F	J	O	H	N	S	M	I	T	H	...
----	----	----	----	----	----	---	---	---	---	---	---	---	---	---	-----

The hexadecimal codes are:

- 7D: The AID code for the ENTER key
- C4C6: The cursor address R7, C23. The cursor is at the next character location after the entered serial number.
- 11: The SBA order code which tells the program that the next 2 characters are addresses. (See Figure 6-17.)
- C34F: The location (R6, C8) where the following text is located on the panel.
- JOHN SMITH ...: The first modified field containing the operator's name.

Program Attention (PA) Keys

Each 3270 keyboard has at least one program attention (PA) key that the operator can use to request program attention without sending any input data.

The AID codes for the PA keys are shown under a separate heading in Figure 1-17, because they are not followed by input data even though there may be modified fields on the panel when a PA key is pressed. All four short read codes consist of just the AID code.

Your program should use these keys for operator requests for immediate action such as trouble alerts or requests for termination. For example, the assignment of several PA keys might be:

- PA1: Terminate current application
- PA2: Return to starting (master) panel
- PA3: Explain system message

Program Function (PF) Keys

Program function (PF) keys are a keyboard feature. Your program defines the function that each key requests when it is pressed by the operator.

There is a separate AID code for each PF key so that your program can quickly identify which key was pressed and consequently which function was requested. When a PF key is pressed, all modified fields on the panel and their addresses are sent with the AID code and cursor address, the same as the ENTER key. For this reason, a PF key can be a valuable time-saving device for the operator. For example, the assignment of several PF keys might be:

- PF1: Return to previous panel
- PF2: Clear (without using data) and repeat current panel
- PF3: Set up next panel

- PF4: Page forward
- PF5: Page backward
- PF6: Return to page 1

Selector Pen and Cursor Select Input and Output

Positioning data for selector pen (optional feature) or cursor select (basic feature on the 3278 and 3279) use and setting the attribute characters are the same as for any other type of data, but the select function has additional data-stream requirements.

Selector Field Format

A field for selector pen operations must be defined as shown in Figure 6-31. The cursor select does not require the three-part character that must precede the selector pen field, although it can be present. Also, the cursor selection can be on any character in the field.

The field attribute, the designator character (described in the next section), and displayed alphameric characters must be on the same line. If the field is longer than one line, only those characters on the same line as the field attribute can be detected by the selector.

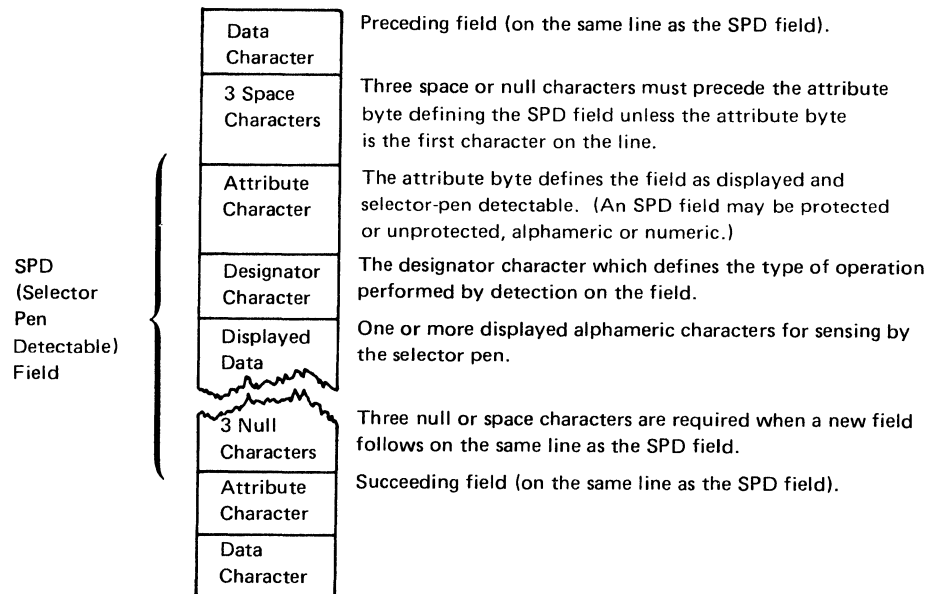

Figure 6-31. Definition of Field for Selector Pen Operation

Designator Characters

Designator characters define three types of selector fields: selection and two types of attention. Each type of field performs a different operation.

The selection field is defined by a question mark (?) designator character. When the selector pen detects a selection field, the MDT bit in the field attribute for that field is set in the display buffer. Also, the designator character is automatically changed on the screen to a greater-than (>) sign to provide a visible indication to the operator that the detection was successful. If a mistake was made and the operator again detects on that same field, the > reverts to a ? and the MDT is reset. The first type of attention field is defined by a space or null designator character. Probing an attention field or selecting it with the cursor is similar to using an ENTER key. The input information is released to be read by the application program when it is ready to do so. The second type of attention field is the ampersand (&) with the 3274. Probing this field causes the program to issue a Read Modified command and obtain both the address and data of each field.

Figure 6-32 shows a sample selector pen panel that illustrates some of the special input and output data stream considerations.

For output, an Erase/Write creates the panel. In the WCC, you enable input and optionally reset the MDTs. Next you specify an SBA sequence to get you to R1, C7, followed by an SF or SFE with a protected attribute.

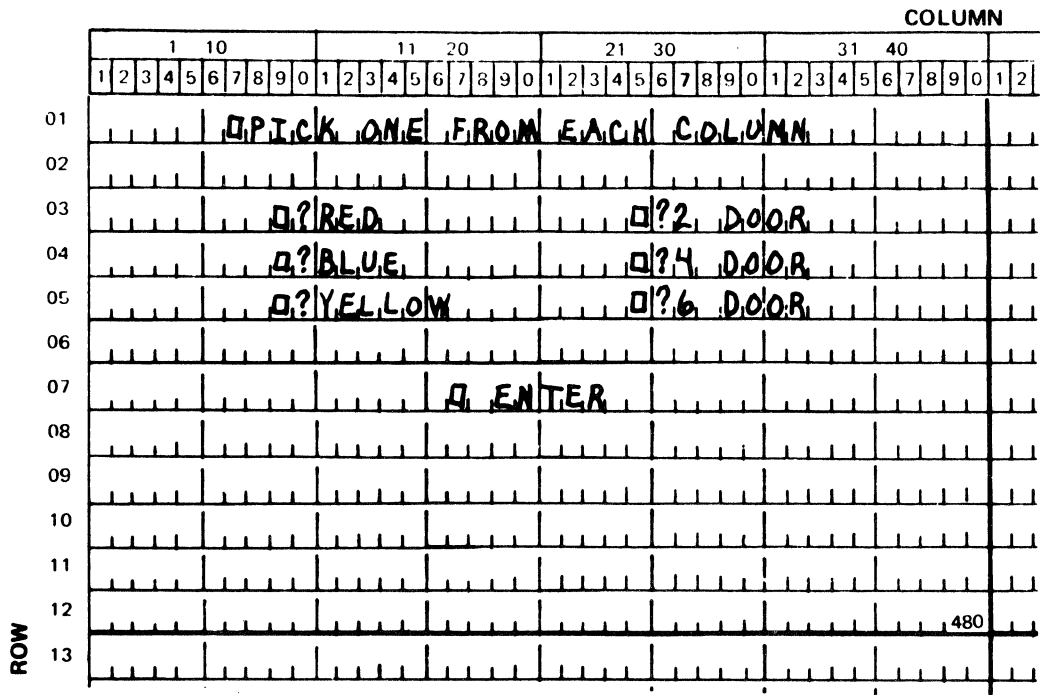

Figure 6-32. Sample Panel for Selector Pen or Cursor Select Detection

This should be followed by the heading "PICK ... COLUMN" and another SBA to R3, C9. Then specify an SF order, followed by a protected (detectable fields may be protected) and detectable attribute. Next you need the designator "?" followed by "RED":

C	O	L	U	M	N	S B A	R3	C9	S F	P +	?	R	E	D
---	---	---	---	---	---	-------------	----	----	--------	--------	---	---	---	---

An SBA after "RED" to R3, C25, provides more than the three required null characters and positions the SF or SFE field attribute, and designator for "2 DOOR." This type of sequence is repeated for the remaining fields to location R7, C28. The designator here must be a null or a blank so that probing or selecting by the cursor causes the "ENTER" field to release the selection to the application program.

As the operator uses the selector pen or cursor select, the program correlates the address of each selector-pen-detectable field with the data associated with it.

To combine selector-pen or cursor-select-detectable input with keyboard or cursor select input, use the keyboard to release the data to the application program by pressing the ENTER key or a PF key. Use of the selector pen or cursor select to release the data, such as by selecting "ENTER" in our example, transmits only the addresses of the fields in which the MDT was set unless you are using a 3274 control unit, in which case the address and data are transmitted.

In the example, if you pick RED and 4 DOOR, the symbolic input would appear as follows:

Pen A I D	Cursor ADDR	S B A	R3	C10	S B A	R4	C26
--------------------	----------------	-------------	----	-----	-------------	----	-----

Shortening transmissions by eliminating unnecessary data requires some caution. If you design a panel requiring both pen selection and keyboard entry, do not put an attention designator (space or null) on the panel. An attention designator after keyboard entry transmits only the address of the keyboard input field and causes the loss of its contents. Not having an attention designator on the panel assures you that an ENTER or PF key will be used, and the modified field contents will be transmitted (and the words "RED" and "4 DOOR" in the example).

The Relationship of One Data Stream to Another

The examples used so far have assumed that you started with a blank screen and that you built the entire panel into your data stream with Erase or Write commands. This approach may lead to tedious work and lengthy data streams, which you can avoid if the panel you wish to display differs only slightly from the one that is presently displayed. The following discussion deals with modification of existing data streams.

Modifying Existing Panels

Suppose the displayed panel is the sign-on panel in the previous sections. If the operator keys an invalid serial number, you may wish to notify him of his error and request reentry of the serial number field only. You could create a new error message panel, write it to the display, require that the operator acknowledge its receipt, create a special serial number entry panel, write it, and finally read the corrected serial number. A better way might be to use the existing sign-on panel.

After the operator has keyed the data and it has been read into the computer, the screen appears as shown in Figure 6-33. You would like the screen to look like Figure 6-34. Most of the information you want displayed is already there. An Erase/Write or Erase/Write Alternate command would clear the screen and require writing a data stream containing all the information for the new panel. You could use a Write command which modifies existing data in the 3270's buffer.

To change the panel in Figure 6-33 to look like Figure 6-34:

1. Position the cursor at R7, C17.
2. Replace the message beginning at R10, C5 with the error message.
3. Change the attribute at R10, C4 to high intensity for the error message.

To make these changes, the right side of your panel layout for the error panel might (in abbreviated form) look like Figure 6-35:

- Item 1. Repositions the cursor to R7, C17.
- Item 2. Changes the attribute at R10, C4 to protected and high intensity.

Note: If the designer of the sign-on panel had combined the original field at this location with the previous field, with the field "SIGN-ON PROCEDURE," and with the following field by omitting the attributes at R10, C4; R2, C11; and R4, C2, the result would be undesirable. The attribute placed at R10, C4 would begin a new field. This would not affect the preceding field but, by wraparound, would cause "SIGN-ON PROCEDURE" and "PLEASE ... INFORMATION" to be high intensity even though they were neither intended to be so, nor were they rewritten. For this reason you should adhere closely to the "Field Concept" and not combine fields unless necessary for efficiency; if you must combine fields, be very careful to avoid undesired results.

- Item 3. Repositions the data flow to correctly place the second line of the error message. 3 characters are used instead of 6 null characters.
- Item 4. Repositions the data flow for the third line of the error message.

ROW	COLUMN																																							
	1 - 10										11 - 20										21 - 30										31 - 40									
	1	2	3	4	5	6	7	8	9	0	1	2	3	4	5	6	7	8	9	0	1	2	3	4	5	6	7	8	9	0	1	2	3	4	5	6	7	8	9	0
01																																								
02																																								
03																																								
04																																								
05																																								
06																																								
07																																								
08																																								
09																																								
10																																								
11																																								
12																																							480	
13																																								

Figure 6-33. Modifying an Existing Panel, Basic Panel

ROW	COLUMN																																							
	1 - 10										11 - 20										21 - 30										31 - 40									
	1	2	3	4	5	6	7	8	9	0	1	2	3	4	5	6	7	8	9	0	1	2	3	4	5	6	7	8	9	0	1	2	3	4	5	6	7	8	9	0
01																																								
02																																								
03																																								
04																																								
05																																								
06																																								
07																																								
08																																								
09																																								
10																																								
11																																								
12																																							480	
13																																								

Figure 6-34. Existing Panel with Error Message

Item	Display Printer		Buffer Address		Orders	Prot	No.	High Int	Sel Det	Non-Disp Prt	MDT On	
	Row	Col	Dec	Hex								
1	07	17			SBA							
					IC							
2	10	04			SBA							
					SF							
			"LINE 1 OF ERROR MESSAGE"									
3	11	05			SBA							
			"LINE 2 OF ERROR MESSAGE"									
4	12	05			SBA							
			"LINE 3 OF ERROR MESSAGE"									

Figure 6-35. Panel Layout Changes for Error Message (Keyed to Text)

Since there are two different types of Write commands for the 3274, you must tell the I/O portion of your program which type to use for the data stream. You may want to indicate the type you want in a comment in the data stream. It is suggested that you establish some convention for indicating command selection by discussing it at your installation with the people responsible for the I/O portion of the program.

In Figure 6-33, assume that the operator now keys "9" and presses the ENTER key. The "9" corrects the original entry error and the serial number field now reads "963981." What goes into the application program? The prior discussion of input data streams shows the basic format, but which fields can you expect? You know that the serial number input field will be received in its entirety, since keying the "9" caused the display to turn on the MDT for this field, and any field which has been modified is transmitted in its entirety (except nulls).

The input field MDTs for NAME, LOCATION, and SERIAL NUMBER were all turned on by the data entered into those fields in the sign-on panel. While an Erase/Write or Erase/Write Alternate resets all MDTs, a Write does not; therefore, if you do not reset them, all three input fields are returned to the application program. Because not all of them have changed, all three should not return to the application program. You may specify in the WCC that all MDTs in the device are reset "off" or "not modified" (you should do so here).

You may also want to sound the audible alarm, if you have one, with the error panel. A WCC to reset the keyboard, reset all MDTs, and sound the alarm is defined as DC X'C7' (see Figure 6-22). You can now use the Write command to change the sign-on panel into the error message panel.

Caution: As you have seen, the Write command allows you to modify an existing screen image while retaining all or a portion of the information already displayed. With the Write command, you can treat the 3270 as a typewriter-type terminal and write your panel line by line or field by field. Using multiple Write commands to create a panel, while technically possible, may create problems.

The operator might start keying data into the panel before you have finished writing it all to the screen. You can prevent this problem by not enabling the keyboard until the last Write in the series.

Using successive Write commands to accomplish what one Write command can do is an inefficient use of the communication line on remote 3270s and unnecessary I/O overhead on local 3270s.

Wherever possible, use a single Write command to avoid the inconveniences noted above.

Using Erase Unprotected to Address (EUA)

The error panel shown in Figure 6-34 displayed the erroneous serial number. All the operator had to do was to key over the incorrect digits. This may sometimes be confusing. You might instead want to erase only the serial number input field as shown in Figure 6-36.

Begin again with the desired WCC. Place the cursor at R7, C17 with an SBA to R7, C17, followed by an IC order. To erase what was entered in the serial number input field, use the EUA order, (watch the sequence of these letters so you do not confuse them with EAU, which is discussed next). EUA inserts nulls (erases all unprotected positions) from the current buffer address up to, but not including, the specified stop address. It will also set any character attributes of the nulled characters to X'00'.

The specified stop address then becomes the current buffer address. The format of the order is similar to an SBA; the code for the order itself (X'12' for EUA) is immediately followed by a row and column address.

		COLUMN																																																	
		1 - 10										11 - 20										21 - 30										31 - 40																			
		1	2	3	4	5	6	7	8	9	0	1	2	3	4	5	6	7	8	9	0	1	2	3	4	5	6	7	8	9	0	1	2	3	4	5	6	7	8	9	0	1	2	3	4	5	6	7	8	9	0
01																																																			
02																																																			
03																																																			
04																																																			
05																																																			
06																																																			
07																																																			
08																																																			
09																																																			
10																																																			
11																																																			
12																																																			
13																																																			

Figure 6-36. Error Message Panel with Serial Number Field Erased

At the first position to be erased (a result of prior operation), you should include an EUA order. For a terminating address, you may use R7, C23 (the first position after the last to be erased). There is a better stop address, however. Since EUA erases only unprotected fields, and since the field beginning at R7, C23 is protected, it can be included in the range covered by the EUA. If R10, C4 is used as the stop address, nothing additional is erased, but you can then write the next attribute without using an SBA, saving three characters of transmission (see Figure 6-37). The current buffer address is the stop address. Any data or SF order that follows go into the buffer at this address.

EUA erases all unprotected fields within its range and can erase multiple fields. Suppose you wanted all three input fields erased on the error panel, as shown in Figure 6-38. First place the cursor at R7, C17, then "back up" with an SBA to R6, C8 (the name input field) before issuing the EUA to R10, C4 (see Figure 6-39).

You could have started at R6, C8 with an SBA to R6, C8, followed by the EUA to R10, C4. However, sometime later in the data stream you would have had to "back up," probably with an SBA to insert the cursor.

Using Erase All Unprotected (EAU) Command

In the preceding example, you wanted to erase all unprotected data, reposition the cursor, and add some new titles to the sign-on panel to make it an error panel. The EAU command:

- Clears all unprotected character locations and associated character attributes to nulls.
- Resets MDTs in all unprotected fields.
- Unlocks the keyboard.
- Resets the AID.
- Repositions the cursor to the first character of the first unprotected field.

Item	Display Printer		Buffer Address		Orders	Prot	No.	High Int	Sel Det	Non-Disp Prt	MDT On
	Row	Col	Dec	Hex							
1	07	17			SBA						
					IC						
	10	04			EUA						
2					SF ATT	✓		✓			
					"LINE 1 OF ERROR MESSAGE"						
					.						
					.						
					.						

Figure 6-37. Example of EUA Use

ROW	COLUMN																																							
	1 10										11 20										21 30										31 40									
	1	2	3	4	5	6	7	8	9	0	1	2	3	4	5	6	7	8	9	0	1	2	3	4	5	6	7	8	9	0	1	2	3	4	5	6	7	8	9	0
01																																								
02																																								
03																																								
04																																								
05																																								
06																																								
07																																								
08																																								
09																																								
10																																								
11																																								
12																																								
13																																							480	

Figure 6-38. Sign-On Panel with Three Erased Fields

Item	Display Printer		Buffer Address		Orders	Prot	No.	High Int	Sel Det	Non-Disp Prt	MDT On
	Row	Col	Dec	Hex							
01	07	17			SBA						
					IC						
	06	08			SBA						
	10	04			EVA						
					SF	ATT	✓		✓		
					.						
					.						
					.						

Figure 6-39. Erasing Multiple Fields with EVA

This command appears to do what you want (it even does what the WCC would have done), but it does not write any data to the screen. You could issue an EAU command before the Write command. Then you would just write the new titles in their proper positions. You have then issued two commands to create one panel. What, then, is EAU for? It logically resets the panel for repetitive input using the same panel. Do not use EAU to change panels.

Data Entry Example: You can use the EAU command to change a sign-on panel slightly and make it a data entry panel. Then the operator just keys in NAME, LOCATION, and SERIAL NUMBER for the first employee. If an error is made, an error panel is shown. If there is no error, you may want to clear the input, reset the MDTs, unlock the keyboard, and reposition the cursor. The data entry panel might appear as shown in Figure 6-40.

The operator keys JOHN SMITH, presses TAB, keys BOSTN, presses TAB, keys 963981, and presses ENTER (Figure 6-41). You simply send the 3270 an EAU command to unlock the keyboard. The operator then sees the same panel as in Figure 6-40 and may now key data for the next employee. You have used your knowledge of what is already displayed to arrive at the next panel or to re-create the present panel.

Repetitive Output

In the data entry example, you used one panel repetitively for input of employee information. You can reverse the requirement and design an employee data screen. For this example, assume the application is inquiry with "browsing" capability. Assume also that the operator has previously used another panel to request the information for employee number 963981. The display might appear as shown in Figure 6-42.

At the bottom of the panel, the operator is instructed to use the PA1 key to see the next employee page, probably number 963982. The PA2 key is assigned to page backwards. Remember, PA keys are assigned by the program. Program attention keys cause a short transmission; they do not even transmit the contents of changed fields. For an inquiry and browsing application, there should be no input. The PA key assures there is no input even if the operator changes one of the unprotected fields, so its use is preferred to the ENTER or PF keys.

Using the Program Tab (PT)

The input fields in the previous examples are output fields in this example. You could designate them as protected, but if you did, you could not use another 3270 function called Program Tab. The Program Tab (PT) order advances the current buffer address to the address of the first character location of the next unprotected field. When the PT order immediately follows an alphameric or null character (not another order) in the WRITE data stream (other than the character specified by the Repeat to Address order, which is discussed earlier), it also inserts nulls in all the character positions from the current buffer address to the end of the current field. The PT order can be used to page through the employee data file.

		COLUMN																																							
		1 10										11 20										21 30										31 40									
		1	2	3	4	5	6	7	8	9	0	1	2	3	4	5	6	7	8	9	0	1	2	3	4	5	6	7	8	9	0	1	2	3	4	5	6	7	8	9	0
ROW																																									
01																																									
02		EMPLOYEE DATA ENTRY																																							
03																																									
04		PLEASE ENTER YOUR EMPLOYEE INFORMATION																																							
05																																									
06		NAME: A																				LOCATION: A																			
07		SERIAL NUMBER: K																																							
08																																									
09																																									
10		WHEN ALL INFORMATION IS COMPLETE																																							
11		YOU MAY PRESS THE ENTER KEY																																							
12																																								480	
13																																									

Figure 6-40. Example of Data Entry Panel

		COLUMN																																							
		1 10										11 20										21 30										31 40									
		1	2	3	4	5	6	7	8	9	0	1	2	3	4	5	6	7	8	9	0	1	2	3	4	5	6	7	8	9	0	1	2	3	4	5	6	7	8	9	0
ROW																																									
01																																									
02		EMPLOYEE DATA ENTRY																																							
03																																									
04		PLEASE ENTER YOUR EMPLOYEE INFORMATION																																							
05																																									
06		NAME: A JOHN SMITH																				LOCATION: A BOSTON																			
07		SERIAL NUMBER: A 963980																																							
08																																									
09																																									
10		WHEN ALL INFORMATION IS COMPLETE																																							
11		YOU MAY PRESS THE ENTER KEY																																							
12																																								480	
13																																									

Figure 6-41. Data Entry Panel with Entered Data

ROW	COLUMN																																							
	1 10										11 20										21 30										31 40									
	1	2	3	4	5	6	7	8	9	0	1	2	3	4	5	6	7	8	9	0	1	2	3	4	5	6	7	8	9	0	1	2	3	4	5	6	7	8	9	0
01																																								
02																																								
03																																								
04																																								
05																																								
06																																								
07																																								
08																																								
09																																								
10																																								
11																																								
12																																								
13																																								

Figure 6-42. Employee Data Panel

When ready to view the information for the next employee, press the PA1 key. Since you want to modify only the present panel, not erase it or blank the unprotected fields, you request a WRITE command with a WCC to unlock the keyboard. Because you are not sure of the present buffer address, you might begin with an SBA order to R6, C8 followed by the next employee name from the disk file - JOE AMES. Because this name contains fewer characters than JOHN SMITH, the screen would look like this if you did not clear the remainder of the field:

03																																						
04																																						
05																																						
06																																						
07																																						
08																																						

You must also place the location code at location R6, C36. You could use blanks after the name and an SBA sequence, or EUA with its associated address. Use PT instead. Insert a PT order after the "S" in "AMES". The single PT order clears the remainder of the unprotected name field to nulls and positions for the location code. PT should also follow the location code to position for the serial number. The data stream might look like this:

W	S																																					
C	B	R6	C36	J	C	E	A	M	E	S	P	K	N	G	S	T	T	9	3	9	8	2																
C	A																																					

The screen would appear as shown in Figure 6-43.

		COLUMN																																									
		1 - 10										11 - 20										21 - 30										31 - 40											
		1	2	3	4	5	6	7	8	9	0	1	2	3	4	5	6	7	8	9	0	1	2	3	4	5	6	7	8	9	0	1	2	3	4	5	6	7	8	9	0	1	2
ROW	01																																										
02												EMPLOYEE DATA																															
03																																											
04	THIS INFORMATION IS CONFIDENTIAL																																										
05																																											
06	NAME: JOE AMES										LOCATION: KINGST																																
07	SERIAL NUMBER: 09639820																																										
08																																											
09																																											
10	TO SEE THE NEXT EMPLOYEE PAGE PA1																																										
11	TO RETURN TO THE PREVIOUS PAGE PA2																																										
12																																									480		
13																																											

Figure 6-43. Panel Defined with Program Tab

Defining a Character

All 3270 terminals have a nonloadable character set installed in the device. A second nonloadable character set is present if the machine has the APL/TEXT capability. Application programs use the characters or symbols in these sets as they are; they cannot alter or add to them.

Along with the nonloadable character sets found in the 3270, the 3270 data stream allows for the storage and accessing of up to six character sets by using the Programmed Symbols feature. These character sets are user-defined and can be altered whenever required. Each character set can have up to 190 graphic symbols. They are loaded under program control and may be used by the display operator by accessing the appropriate code points. The user may use the full character cell to design a character or symbol, allowing for a high degree of flexibility in the choice of graphic symbols, which can be used for the display and printing of diagrams, curves, graphs and special fonts, such as bold face and mathematical symbols, in addition to other special symbols.

On the 3278 and 3279 display stations, each character is represented by a pattern of dots selected from a character cell. The 3278 Models 2 and 3 have character cells of 9 dots horizontally by 16 dots vertically, while the 3278 Model 4 and all 3279 models have character cells of 9 dots horizontally and 12 dots vertically. On the 3287 printers, each character is represented by a pattern of dots selected from a character cell of 10 dots horizontally by 8 dots vertically. Characters are normally represented by predefined patterns accessed by codes in the data stream, sent to the terminal, which represent code points for selecting the character from the character set.

To define a character, the byte value for the character cell must be put into the data stream by the use of bytes M-N of the Load Programmed Symbols structured field. A 10 x 8 character cell is composed of 80 dots and a 9 x 16 character cell is composed of 144 dots. By slicing the character cell into bytes, 8 dots to a byte, characters can be formed. If each dot is a bit, then turning it on (1) allows this dot to display or print, as the case may be. By considering the slices as bit strings, turning each dot on (1) or off (0) gives a hex representation which determines what is printed or displayed. Consider the example of the box "A" in Figure 6-44. Figure 6-44 shows the slicing of the character cell and its bit string hexadecimal representation for a display 9 x 16 character cell. Figure 6-45 shows the same for a 10 x 8 printer character cell.

Using Structured Fields

As pointed out earlier, the 3270 data stream is a formatted data stream. To provide additional controls and transmit various data types other than character, it was necessary to define a new data structure in the data stream. This is termed "structured fields."

In the 3270 data stream, structured fields are introduced with the Write Structured Field (WSF) command. This command does not contain explicit control information as the other 3270 commands do. It simply means, "Here is data in a structured field format."

Following the WSF command, all data in the transmission must be in structured field format. A structured field transmission has the form shown in Figure 6-46.

The structured field syntax permits variable-length data and controls to be encoded in such a way that a device that is processing the data stream sequentially can decompose a sequence of fields into its component fields without having to scan every byte. Each structured field contains a 2-byte-length field. This indicates the length of the field (including the length bytes), in effect, pointing to the next structured field in the transmission. Next follows a 1-byte type field, and then parameters and data in the format defined by the type code. If the value specified in the length field is zero, this structured field is treated as the last structured field in the transmission. The type field in the structured field identifies the purpose of the field.

Load Programmed Symbols

The Load Programmed Symbols (Load PS) structured field is one type of structured field defined as an outbound control function. It is used to load character definition data into the device. This structured field causes characters and symbols to be loaded into contiguous addressable slots in the read/write storage buffers. If no data is transmitted with this structured field, the operation is executed as specified in the parameters field of the structured field and no data is loaded. This allows the characteristics of the character set to be changed without altering the contents of the character set.

As an example of structured field usage, consider the loading of the box "A" from Figures 6-44 and 6-45 into a Programmed Symbol buffer area. Figures 6-47 and 6-48 show the structured field for loading this symbol into the device.

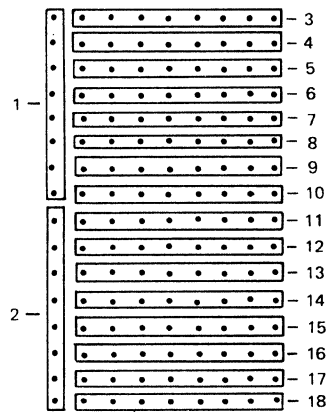
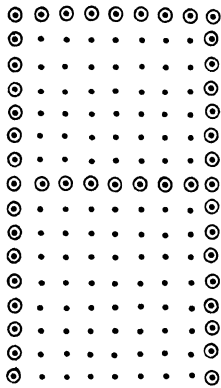

1. 11111111 = X'FF'
2. 11111111 = X'FF'
3. 11111111 = X'FF'
4. 00000001 = X'01'
5. 00000001 = X'01'
6. 00000001 = X'01'
7. 00000001 = X'01'
8. 00000001 = X'01'
9. 00000001 = X'01'
10. 11111111 = X'FF'
11. 00000001 = X'01'
12. 00000001 = X'01'
13. 00000001 = X'01'
14. 00000001 = X'01'
15. 00000001 = X'01'
16. 00000001 = X'01'
17. 00000001 = X'01'
18. 00000001 = X'01'

Figure 6-44. Character Definition for a 9 x 16 Display Matrix

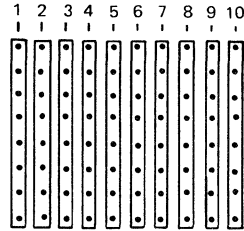
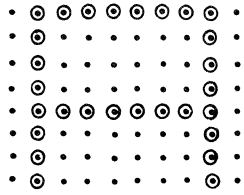

1. 00000000 = X'00'
2. 11111111 = X'FF'
3. 10001000 = X'88'
4. 10001000 = X'88'
5. 10001000 = X'88'
6. 10001000 = X'88'
7. 10001000 = X'88'
8. 10001000 = X'88'
9. 11111111 = X'FF'
10. 00000000 = X'00'

Figure 6-45. Character Definition for a 10 x 8 Printer Matrix

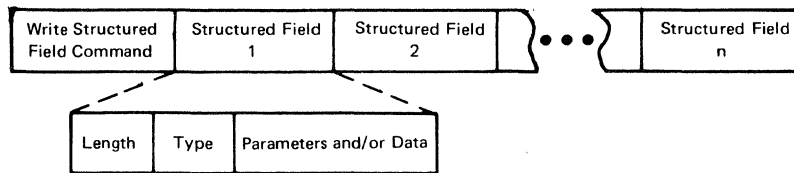
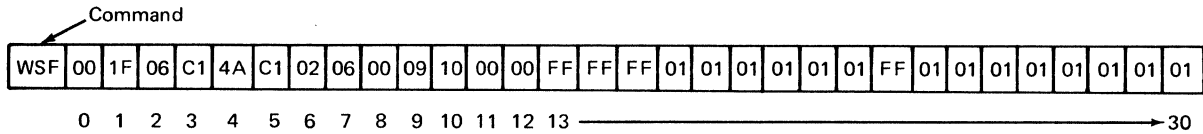
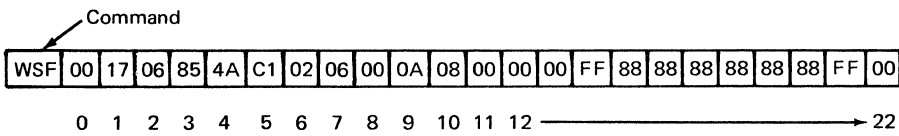

Figure 6-46. Structured Fields



Byte	Content	Meaning
Command	WSF	Write Structured Field command.
0	00	Length
1	1F	
2	06	Load P's type of structured field.
3	C1	Extended form; clear PS storage, skip suppression off, Type 1 data format.
4	4A	LCID of character set.
5	C1	Beginning code point for the character set.
6	02	Use PS storage buffer number 2.
7	06	There are 6 bytes to the extended form.
8	00	All points available, no LCID compare and the PS set is keyboard selectable.
9	09	Number of X-units in the character cell (9).
10	10	Number of Y-units in the character cell (16).
11	00	Reserved, must be zero.
12	00	It is a single plane symbol.
13 – 30		These bytes define the box "A" in Figure 6-44.

Figure 6-47. Structured Field Data Stream to Load a Box 'A' for a 9x16 Display Matrix



Byte	Content	Meaning
Command	WSF	Write Structured Field command
0	00	Length
1	17	
2	06	Load P's structured field type
3	85	Extended form; do not clear PS storage, Type 5 data format (loading from left to right)
4	4A	LCID of character set
5	C1	Beginning code point for the character set
6	02	Use P's storage buffer number 2.
7	06	There are 6 bytes to the extended form.
8	00	All points are available, no LCID compare, the PS set is keyboard selectable.
9	0A	Number of X-Units in the character cell (10).
10	08	Number of Y-units in the character cell (8).
11	00	Reserved, must be zero.
12 – 22		These bytes define the box "A" in Figure 6-45.

Figure 6-48. Structured Field Data Stream to Load a Box 'A' for a 10x8 Printer Matrix

Now suppose we wanted to use the 3270 data stream to display the box "A" after the Load PS structured field loaded it into the device. How is this done? It can be accessed by using the attribute type, character set, and the attribute value which is the LCID for the character set containing the "A."

The LCID is assigned to the character set in the Load PS structured field. This LCID is used in the extended attributes when one wants to access the character sets loaded in the device. The Load PS structured field also gave the starting code point for the character set. With this information, the character set can be accessed by the application program or by the operator. We can access the box "A" by using the above information. In the program we would write a DC statement as follows:

```
DC X'114040290241F1434A'  
DC X'C1'
```

This is:

11	an SBA order
40	row 1
40	column 1
29	an SFE order
02	2 attribute type-value pairs
41	attribute type of extended highlighting
F1	attribute value of blink
43	attribute type of character set
4A	the local character set ID (LCID) of the character set
C1	the code point for the "A"

Figure 6-49 portrays the above process. If we had both nonloadable and loadable character sets in our device, what would be displayed when our data stream was interpreted? Well, if our data stream contained the LCID for the nonloadable character set, what would be displayed would be from the nonloadable character set, PS0 here. If the LCID was from our loadable character set (4A), what would be displayed for the codepoint (C1) would be from character set 4A. If no character set was defined in the 3270 data stream, then what would be displayed would be from the default character set, a nonloadable character set installed and shipped with the device. In this example, let our loadable character set 4A be equal to Programmed Symbol set B (PSB), Read/Write Storage 03.

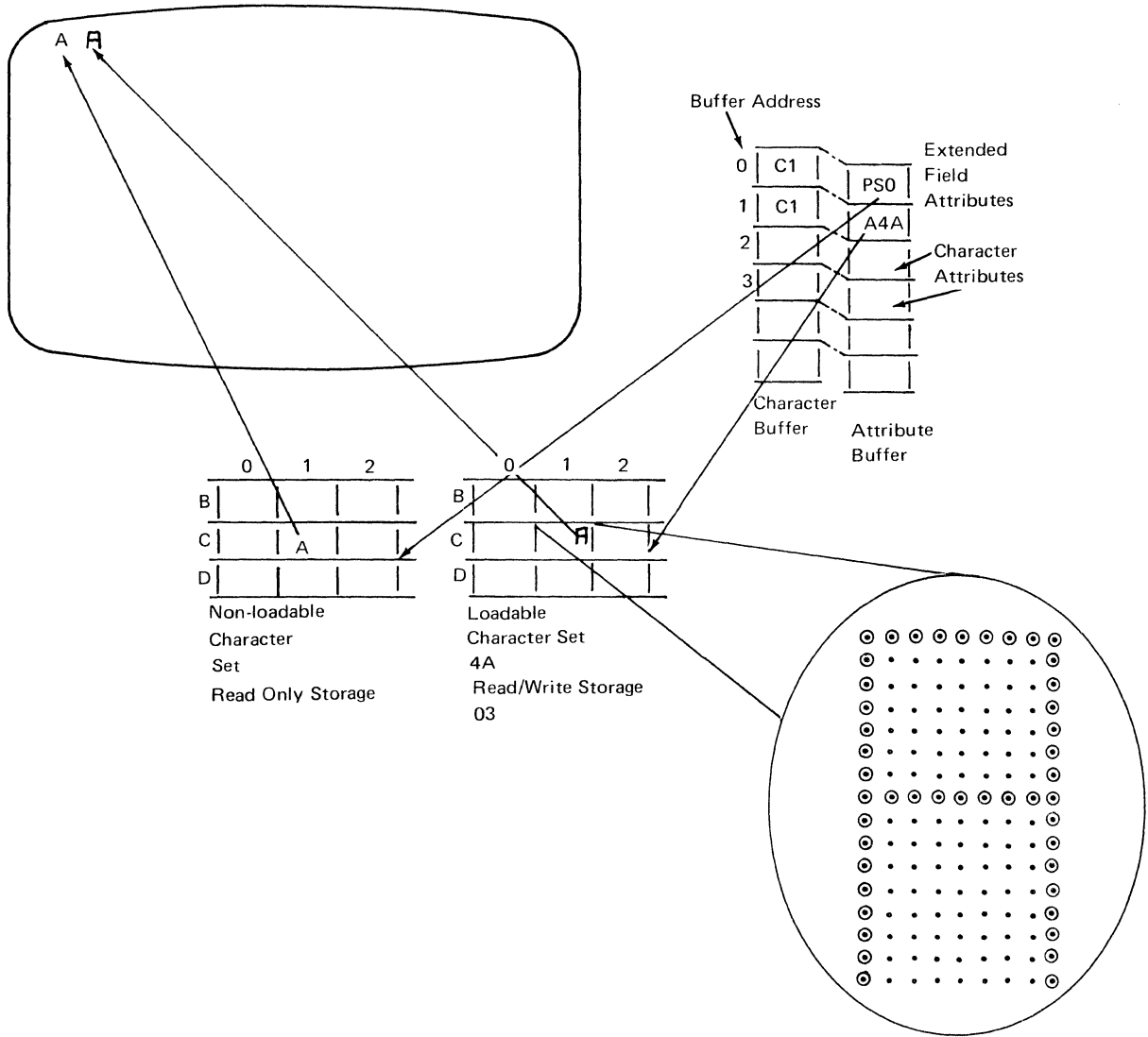
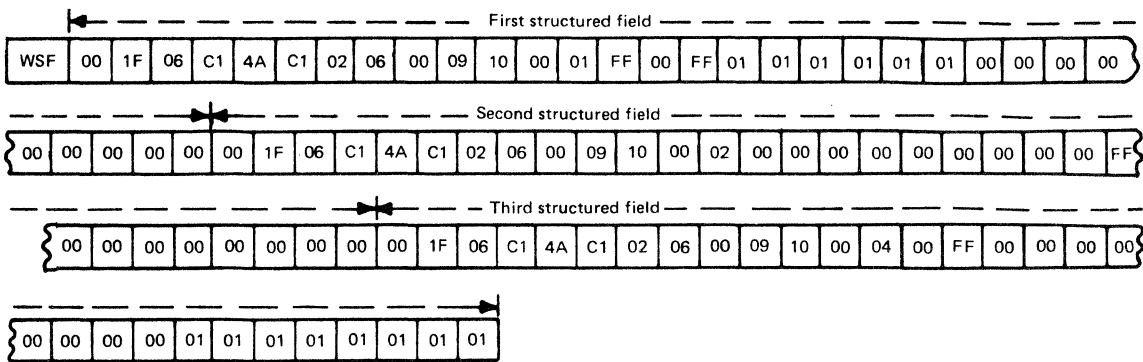

Figure 6-49. Programmed Symbol Sets

Triple Planes

There may be a need, in certain circumstances, to be able to display or print in more than one color within a single character position. A Programmed Symbols set enables the user to define symbols in more than one color. This is called a triple-plane set. A triple-plane Programmed Symbols set occupies three times the normal amount of storage for each defined character, arranged in three planes, each representing one of the three primary colors: red, blue, and green. By defining only a portion of the total symbol in each color plane, the user can obtain a whole symbol in more than one color. When multicolored symbols are required, the appropriate patterns must be defined in the three primary colors, loaded using the Load PS structured field, and referenced for use with a X'F7' color attribute type.

Consider again the box "A" example. To load this symbol in three colors, the structured field of Figure 6-50 would be used and, if referenced properly for display or printing, the symbol would print or display as indicated.



This data stream would result in the character's being displayed as shown below.

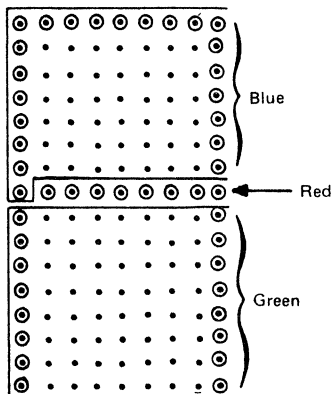

Figure 6-50. Character Definition of a Multicolor Symbol

A multicolored symbol could appear in various ways when displayed or printed:

- If a symbol defined in a triple-plane set is displayed or printed with the color attribute X'F7', the pattern defined in each color plan is presented in that color. When part of a whole symbol appears in more than one color plane, the colors combine as follows:

Plane in Which Dot Is Defined	Color of Dot	
	3279	3287 Printer
Red	Red	Red
Blue	Blue	Blue
Green	Green	Green
Red and blue	Pink	Black
Red and green	Yellow	Black
Blue and green	Turquoise	Black
All three	White	Black

- If a symbol defined in a triple-plane set is displayed or printed with an explicit color attribute other than X'F7' (for example, red), the whole symbol as defined by combining all three planes is displayed in the specified color (red).
- If a symbol defined in a triple-plane set is displayed or printed without any color attribute, the whole symbol appears in monochrome in the same way as any character.

Unless the user loads the three planes in a triple-plane symbol set separately, the system loads the same pattern into all three planes. Thereafter, the triple-plane set behaves (for any character that has the same pattern in all three planes) exactly as if it were a single-plane set. Consequently, a triple-plan set can always be used as if it were a single-plane set.

Chapter 7. Screen Management

A screen management program module is a set of subroutines physically separate from application programs and from the telecommunications management program module of an online 3270 system. Figure 7-1 illustrates this relationship.

Support functions in a screen management program may reduce the amount of detail work required by the application programs, and effectively use the features of the 3270. The separation of screen management from the other programs also allows screen management to be modified with little or no impact on application programs or on the telecommunications management programs.

Screen management might include:

- Decoding input data streams.
- Dynamic building of output data streams.
- Generating multiple I/O requests to the Line Control Module based upon a single request from an application program (that is, WRITE then READ).
- Automatic paging; the application program passes multiple pages to screen management, which asks the line control module to write a particular page to a display, depending on the display operator's request.
- Automatic copying (providing a hard copy of a display image).

The BSC COPY function supports data movement between any types of device attached to the same control unit: display to display, display to printer, printer to display, and printer to printer. To prevent copying information from an unauthorized device, the control unit provides a program-controlled copy-lock for devices attached to it. If the first position of a device buffer contains a field attribute character with the protected option, the control unit rejects any attempt to copy from that device.

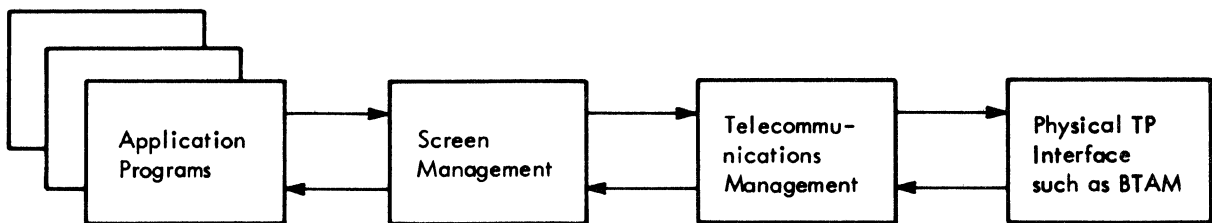

Figure 7-1. Relationship of Screen Management to Telecommunications Management and Application Program

Decoding and Generating Data Streams

The data streams sent between application programs and the 3270 contain unique orders that request particular operations by the 3270 displays and printers. Generalized subroutines can be written to assist the application programmer's interface with the 3270 system, and an interface can be built to simplify online programs.

This chapter discusses several approaches to developing a screen management module whose functions can be used by the application programmer to prepare output data streams and to decode input data streams. The approaches demonstrate how some 3270 device-dependent considerations can be removed from the application programmer's responsibility. The different techniques for 3270 input or output data stream manipulation can be used in various combinations to suit the needs of the installation.

This discussion assumes that the device management routines (line control) make the local and remote 3270 transparent to the application program. Therefore, discussion of data streams in this chapter ignores all header data in the input stream up to and including the AID character and all header data in the output stream up to but not including the Write Control Character (WCC).

Decoding Read Modified Input Data Stream

A Read Modified command for a display station with a formatted screen (a screen with at least one attribute character defined) produces a data stream consisting of the data from each field whose modified data tag has been turned on (either by program control or by data entered in the field). Each transmitted data field is preceded by the 3270 buffer address where that data is located on the display. The order of the fields transmitted from the screen is from left to right for each line, starting at the top of the screen and ending at the bottom of the screen. All null characters in a transmitted field are stripped out by the control unit during transmission.

The data stream, ignoring the header information up to and including the AID character, appears as:

S	A	A		S	A	A	
B	1	2	DATA	B	1	2	. . .
A				A			

If the data entered in a field is of variable length or if a field can be skipped by the terminal operator, the data from a particular field on a given panel can appear in a different location within the data stream for each set of operator input. A Read Modified command produces a variable-length data stream of fixed-length fields and variable-length fields concatenated together.

Each 2-character screen address in the data stream is immediately preceded by a Set Buffer Address (SBA) order. The detection of each SBA order in the data stream identifies the next two characters in the stream as a 3270 screen address and also indicates the end of the preceding data field. The System/360 and System/370 Translate and Test instruction (TRT) can be used to scan the data stream and to stop at each main storage address containing an SBA order.

If the detected main storage address of the current SBA order is known, the following calculations can be performed for a given data stream:

```
SBA( 1 ), ADD( 1A ), ADD( 1B ), DATA FIELD( 1 ),
SBA( 2 ), ADD( 2A ), ADD( 2B ), DATA FIELD( 2 ),
SBA( 3 ),
```

The numbers in parentheses are used as subscripts to provide unique identification:

- The length of data field(1) = [Address of SBA(2) - Address of SBA (1)] -3.
- The 2-character 3270 screen address of data field(1) can be found at the address of SBA(1) +1.
- The length of data field(2) = [Address of SBA(3) - Address of SBA (2)] -3.
- The 2-character screen address of data field(2) can be found at the address of SBA(2) +1.

The 2-character 3270 screen address as it appears in the input stream does not provide a direct decimal or binary numeric value that can be used to calculate the relative position in the 3270 buffer from which the data was read.

However, you can use the following routine to convert the 3270 address as it appears in the input data stream to a binary value which directly indicates the position (relative to zero) of the data in the 3270 buffer.

Assume that R3 contains the address of SBA(1) and that R4 and R5 are work registers. R5 will contain the result at the end of the routine.

```
ADDCNVRT EQU *
SR R4, R4      CLEAR WORK REG
SR R5, R5      CLEAR WORK REG
IC R4, 0(R3)   GET FIRST ADDRESS CHAR (ADD ( 1A ))
N R4, = F'63'  TURN OFF ALL BITS EXCEPT LAST SIX
IC R5, 1(R3)   GET SECOND ADDRESS CHAR (ADD ( 1B ))
N R5, = F'63'  TURN OFF ALL BITS EXCEPT LAST SIX
SLL R4, 6      SHIFT FIRST ADDRESS SIX BITS
                TO THE LEFT
AR R5, R4      ADD THE RESULTS TOGETHER
```

By using the above technique, several approaches may be developed to a general purpose subroutine that decodes the variable field length data stream for the application program, and returns the data in a more easily processed format.

Nonselector Pen or Noncursor Select Data Streams

Display Buffer Image Technique: By using the Read Buffer command, you can use the display buffer image technique to return to the application program a main storage buffer area the same size as the display buffer (480, 960, 1920, 2560, 3440, 3564). The data read from the display is placed in the same relative position in the main storage buffer as it occupied in the display buffer, with all other positions in the returned buffer cleared to spaces.

For this technique, use the TRT instruction and the 3270 address conversion routine. You must know the relative locations in the display buffer where data can be entered by the operator, so that the decoded buffer can be processed

when returned by the mapping subroutine. The completed layout sheet for the panel in which the operator enters data will give you the required addresses relative to the respective buffers.

Using the image technique, all data received from the 3270 is left-justified in its respective fields. This has no effect on fixed-length fields, variable-length alphanumeric fields (which are normally left-justified), or omitted input fields. However, you must be aware of variable-length numeric fields where the operator can omit leading zeros.

Although the image technique requires little main storage for the mapping subroutine, main storage can be wasted if the routine returns a complete buffer with little data. To help overcome this problem, the decoding routine can pass back to the application program, a field at the beginning of the buffer. The field indicates the total length of the buffer, which allows the decoding routine to use a buffer area just large enough to accommodate the relative address of the last data field read.

Mapping from a Table of Requirements: This mapping technique requires a table assembly for each unique input panel that the mapping subroutine decodes for the application program. The table provides information to the subroutine so that the input data stream in one main storage buffer can be decoded a field at a time and moved to a specified relative offset in another main storage buffer (the target buffer) according to the directions assembled in the table. The preassembled table could be used to specify the following information to the mapping subroutines:

1. The 3270 buffer address preceding each field, which could be read from a particular panel. This is the buffer address as it appears in the data stream which corresponds to the first data position in a field, not to the buffer location of the field attribute byte that defines the field. Any data fields in the 3270 input stream that do not have a matching buffer address in the table would be ignored by the typical mapping routine using the table approach.
2. An offset relative to zero that provides the starting position of each field in the target buffer. This information allows the application programmer to order the fields in the target buffer in a sequence that may or may not agree with the field sequence in the transmitted data stream.
3. A value that indicates the maximum length of each field in the target buffer. This information allows the mapping routine to truncate data stream fields that are too long for the target fields. The maximum field length value is also required if the mapping routine supports right-justification of fields during mapping.
4. A flag byte consisting of bit switches that could indicate:
 - Whether left justification with low-order blank padding is requested.
 - Whether right justification with high-order zero fill is requested.
 - Whether the field should be translated to ensure uppercase characters only.
 - Any additional functions the installation wishes to implement in the mapping routine.

Figure 7-2 shows some typical logical contents of the table. The order of the elements within each table entry is optional.

Assume that you map the following input data stream in hexadecimal using the sample table in Figure 7-2:

1140D4F1F2F31140E8818283848511C1C6E385A7A3

The following target buffer, also in hexadecimal, would be returned to the application program:

C1C2C3C4C54040404040F0F0F1F2F3E385A7A34040

This approach to mapping makes the application program's input processing routine device-independent.

Instead of the mapping table, you could write a macro instruction to prepare the table; the macro would convert written requests into the proper machine language constants.

A typical format for a macro instruction to build the sample table shown in Figure 7-2 might be:

```
MAP      NAME=TABLE,MODEL=2
MAP      ADD=( 1,21),OFFSET=11,MAXL=5,JUST=RIGHT
MAP      ADD=( 1,41),OFFSET=1,MAXL=10,JUST=LEFT,TRAN=YES
MAP      ADD=( 1,71),OFFSET=16,MAXL=6,JUST=LEFT
```

Note: The *ADD* parameter specifies the 3270 buffer in row and column notation relative to one. For example, buffer position zero equals row 1, column 1. The offset values are expressed relative to one. The macro instruction can have default options; for example, if *JUST=RIGHT* is not specified, *JUST=LEFT* can be assumed.

TABLE	DS OH	
ENTRY 1	DC X'40D4'	ACTUAL 3270 ADDRESS FOR POS 20
	DC H'10'	RELATIVE OFFSET IN TARGET BUFFER
	DC HL1'5'	MAX FIELD LENGTH OF TARGET FIELD
	DC X'80'	RIGHT JUSTIFY, NO TRANSLATE FLAG
ENTRY 2	DC X'40E8'	ACTUAL 3270 ADDRESS FOR POS 40
	DC H'0'	RELATIVE OFFSET IN TARGET BUFFER
	DC HL1'10'	MAX FIELD LENGTH OF TARGET FIELD
	DC X'40'	LEFT JUSTIFY, TRANSLATE FLAG
ENTRY 3	DC X'C1C6'	ACTUAL 3270 ADDRESS FOR POS 70
	DC H'15'	RELATIVE OFFSET IN TARGET BUFFER
	DC HL1'6'	MAX FIELD LENGTH OF TARGET FIELD
	DC X'00'	LEFT JUSTIFY, NO TRANSLATE FLAG
ENDOLIST	DC X'FF'	END OF LIST INDICATOR

Note: 3270 buffer addresses in the table are shown relative to buffer location zero; relative offsets in the target buffer are shown relative to zero.

Figure 7-2. Table of Requirements

The following example shows the logic flow for a table-driven input mapping technique:

1. Find the 3270 buffer address of a data field to be processed in the input data stream, using the TRT instruction.
2. Determine the length of the data field in the data stream using the techniques previously discussed.
3. Search the table of requirements, using the 3270 buffer address found in step 1 as a search argument to find a matching entry.
4. Add the offset value from the entry found in the table to the starting address of the main storage map buffer, to produce the main storage address of the start of the receiving field.
5. If the length of the data field determined in step 2 is greater than the maximum field length value in the entry found in the table, go to step 10.
6. Check the flag byte in the entry found in the table. If left justification is requested, go to step 10. Otherwise proceed to step 7 for right justification.
7. Move zoned decimal zeros to the receiving field, using the field starting address determined in step 4. Use the maximum field length value in the entry found in the table as the length for the move.
8. Develop a new main storage address for the start of the receiving field to accommodate the request for right justification. The right-justified starting address for the receiving field equals (the field starting address determined in step 4 + maximum field length value in the entry found in the table) - length of the data field in the data stream found in step 2.
9. Move the data field from the data stream to the main storage address developed in step 8, using the length of the data in the data stream determined in step 2. Return to the start of this routine to find the next data field in the data stream.
10. Move blanks to the receiving field, using the starting address of the field as determined in step 4. Use the maximum field length value in the entry found in the table as the length for the move.
11. Move the data field from the data stream to the receiving field, using the field address determined in step 4. Use the length of the data in the data stream (determined in step 2) as the length for the move.
12. Check the flag byte in the entry found in the table to determine if uppercase translation is requested. If it is not requested, return to the start of this routine to find the next data field in the data stream.
13. Translate the data in the receiving field to uppercase, then return to the start of this routine to find the next data field in the data stream. The translation can be done in two ways:
 - Use the TRANSLATE instruction with the translation table built to convert lowercase alphabetic characters to uppercase.
 - Use the OR instruction to place blanks in the field. This will change the DUP and FM characters. The FM appears as a semicolon (;) on the screen, but appears in the data stream as X'1E'. It will be converted to a true ; (X'5E'). The DUP appears as an asterisk (*) on

the screen, but appears in the data stream as X'1C'. It will be converted to a true * (X'5C').

Immediate Selector Pen or Cursor Select Data Stream

When a Read Modified command is executed for a display station as a result of an immediate detection by the selector pen or cursor select, the resulting data stream consists of address strings that identify which fields on the screen have the modified data tag set; the 3274 Control Unit also transmits the modified data if the proper designator character is used.

The data stream, ignoring the header information up to and including the AID character, appears as:

S	A	A	S	A	A	
B	1	2	B	1	2	. . .
A			A			

If the operator keys into a field and an immediate selector field is selected, the keyed data is not transmitted. However, if keyed data is entered by the operator, delayed selector fields are selected, and the ENTER key or a PF key is pressed; then the address and data for all fields, whether selected or keyed, are included in the data stream.

You can use a subroutine to free the application program from determining which fields were selected on a panel. A table can be built that consists of the 3270 buffer addresses, giving the location of each selectable field on a panel. The mapping routine can then compare the addresses in the table, and return to the application program a list of indicators that identify the selected fields.

The list of indicators can be returned to the application program. A string of one-position fields can be used, and each position can indicate with a unique character that a field was selected. The first position in the returned list can be marked if a field in the data stream has the same address as the first element in the address table; the second position in the returned list can be marked if a field in the data stream has the same address as the second element in the address table. The application program can then determine which relative positions in the list have been marked to determine which fields have been selected by the operator.

Because the input from a display using selector pen or cursor select detection is a series of fixed-length addresses, the mapping routine can analyze the input stream and decode it.

For example, using the selector panel illustration in Figure 7-3, assume that the operator has selected the delayed-detectable fields located at row 5, column 10 and row 3, column 26 and the immediate-detectable field located at row 7, column 18. The input data stream transmitted in hexadecimal from the display would be:

11C1E911C2E911C4C1

Using the sample table in Figure 7-4, the mapping routine returns a list in hexadecimal to the application program:

406F40406F406F

ROW	COLUMN																																							
	1 - 10										11 - 20										21 - 30										31 - 40									
	1	2	3	4	5	6	7	8	9	0	1	2	3	4	5	6	7	8	9	0	1	2	3	4	5	6	7	8	9	0	1	2	3	4	5	6	7	8	9	0
01																																								
02																																								
03																																								
04																																								
05																																								
06																																								
07																																								
08																																								
09																																								
10																																								
11																																								
12																																								
13																																								

Figure 7-3. Example of Selector Pen Panel

SELTABLE	EQU *	FOR MODEL 1 DISPLAY
DC	X'C1D9'	ROW 3 COL 10
DC	X'C1E9'	ROW 3 COL 26
DC	X'C2C1'	ROW 4 COL 10
DC	X'C2D1'	ROW 4 COL 26
DC	X'C2E9'	ROW 5 COL 10
DC	X'C2F9'	ROW 5 COL 26
DC	X'C4C1'	ROW 7 COL 18
DC	X'FF'	TABLE STOP INDICATOR

Note: The 3270 addresses used in the above table correspond to the buffer position of the Selector Pen designator character in a field, not to the location of the field attribute character which defines the field.

Figure 7-4. Sample Mapping Table

This list indicates that the 2nd, 5th, and 7th fields were selected. Note that the addresses of the selected fields appear in the datastream in the same sequence that the fields appear in the display buffer. When a selector pen panel is designed by columns, the address of the field selected from the first column may not occur before the address of the field selected from the second column in the input data stream.

You can write a macro instruction similar to the one used to build the table in Figure 7-2 to build the selector pen table:

```
MAP      NAME=SELTABLE,MODEL=1
MAP      ADD=( 3,10 )
MAP      ADD=( 3,26 )
MAP      ADD=( 4,10 )
. . .
```

Mixed Read Modified Input Data Streams

When some keyed input and some delayed selector pen or cursor select detection occur in a panel during the same input operation from a display, you can use the table-driven mapping technique for nonselector-pen or cursor select panels. Specify the table elements so that all delayed selector fields have a maximum length of one character. The mapping routine places the first character from the appropriate data stream field into the target field. The first character in a delayed selector field that has been selected is always a (>); that is, X'6E'. The application program can examine the target buffer for that character in the proper target field to determine whether the field has been selected.

Building Output Data Streams

The 3270 requires specific bit patterns for order sequences, control characters, and buffer addressing. The data streams can be prepared in several different ways. A data stream to build a static panel (a panel which will always be displayed in exactly the same manner) can be assembled in an application program as a set of data constants. A semidynamic panel, which may occasionally be modified or added to, can have the static portion assembled in the application program and have the program dynamically modify or add to the data stream. A data stream for a dynamic panel (a panel with a high degree of change) must be created or assembled as a unit at execution. This section discusses how to reduce the considerations of device-dependency required to support static, semidynamic, and dynamic output data streams.

Static Data Streams

You can write macro instructions to simplify the preparation of static data streams for the 3270. One approach is to write a set of macro instructions in which each macro instruction prepares a single order sequence. Another approach is to write one macro instruction that can prepare all types of order sequences, but prepares only one sequence for each execution of the macro instruction in a program.

A sample macro instruction of the first type might be:

```
$MOD MODEL = 1, 2, 3, 4, 5
```

This macro instruction sets a global value so that the specified model number is used until another \$MOD macro instruction is encountered. The model number is required to correctly calculate 3270 buffer addresses. The buffer address X'C2D5' represents column 4, row 30, for a Model 1 display, and column 2, row 70, for a Model 2 display.

The following are also examples of the first type of macro instruction:

\$SBA (1,10) generates the SBA order sequence X'1140C9'

\$SF (PROT,NUM,SKIP,MDT,HI,DET,NONDISP) generates an SF order (X'1D') followed by the appropriate attribute character defined by the options selected in parentheses. Notice that if PROT is not specified, unprotected is assumed; if numeric is not specified, alphameric is assumed.

\$RA (1,10,'*') generates the RA order sequence X'3C40C95C'.

\$EUA (1,10) generates an EUA order sequence X'1240C9'.

\$WCC (RESET,RESTORE,ALARM,PRINT,40CHAR,64CHAR,80CHAR,NLEM) generates the proper WCC, depending on the options selected in parentheses.

\$CCC (PRINT,40CHAR,64CHAR,80CHAR,ALARM,ATT,UNPROT,PROT,ALL) generates the proper copy control character (CCC), depending on the options selected in parentheses. (The CCC identifies the type of data to be copied.)

\$IC generates X'13'

\$KBD KEYBOARD - APL or Text Used with the Data Analysis feature to identify the keyboard providing 3277-2 display input.

\$SI generates the Suppress Index character, valid for the 3288-2 or 3289 printer. Other printers receive | (the or bar) in place of the Suppress Index character.

After you have defined the macro instruction, the data stream required to build the sign-on panel shown in Figure 6-8 could be created as follows:

```

SIGN-ON  $MOD      MODEL=1
          $WCC      ( RESET,RESTORE )
          $SBA      ( 2,11 )
          $SF        ( PROT )
          DC         C'SIGN-ON PROCEDURE'
          $SBA      ( 4,2 )
          $SF        ( PROT )
          DC         C'PLEASE ENTER YOUR SIGN-ON INFORMATION'
          $SBA      ( 6,1 )
          $SF        ( PROT,HI )
          DC         C'NAME: '
          $SF
          $IC
          $SBA      ( 6,25 )
          $SF        ( PROT,HI )
          DC         C'LOCATION: '
          $SF
          $SBA      ( 7,1 )
          $SF        ( PROT,HI )
          DC         C'SERIAL NUMBER: '
          $SF        ( NUM )
          $SBA      ( 7,23 )
          $SF        ( PROT )
          $SBA      ( 10,4 )
          $SF        ( PROT )
          DC         C'WHEN ALL ... ENTER KEY'

```

You could also write the second type of instruction, a single 3270 data stream macro instruction, which might have the format:

			1
<symbol>	\$MAC	op-type , (attributes) , (row,column) <,character> ,MODEL=	2
			3
			4

symbol

specifies a symbol that refers to the data stream.

op-type

specifies the type of screen control operation to generate. Valid values are: SF, SBA, IC, RA, EUA, WCC, and CCC.

(row,column)

specifies the row (1 to 43) and column (1 to 132) where the operation starts or ends (depending on the op-type). This parameter is required for op-types SBA, RA, and EUA.

(attributes)

indicates attributes or control bits for SF, WCC, and CCC.

Some valid values for SF are: PROT, SKIP, NUM, MDT, HI, DET, NONDISP.

Some valid values for WCC are: RESET, RESTORE, ALARM, PRINT, 40CHAR, 64CHAR, 80CHAR, NLEM.

Some valid values for CCC are: PRINT, 40CHAR, 64CHAR, 80CHAR, ALARM, ATT, UNPROT, PROT, ALL.

character

specifies the character used in the RA function.

MODEL=

indicates the model of 3270. This model number is used to calculate the buffer address. This parameter is specified only once in the first macro instruction of a data stream series or whenever the data stream to be generated is for a different model than the preceding series. Model numbers 3 and 4 can be specified only for the 3278 Display Station.

After you have defined the macro instruction, the data stream required to create the sign-on panel shown in Figure 6-8 could be as follows:

```

SIGN-ON  $MAC    WCC,(RESET,RESTORE),MODEL=1
          $MAC    SBA,(2,11)
          $MAC    SF,(PROT)
          DC      C'SIGN-ON PROCEDURE'
          $MAC    SBA,(4,2)
          $MAC    SF,(PROT)
          DC      C'PLEASE ENTER YOUR SIGN-ON INFORMATION'
          $MAC    SBA,(6,1)
          $MAC    SF,(PROT,HI)
          DC      C'NAME:'
          $MAC    SF
          $MAC    IC
          $MAC    SBA,(6,25)
          $MAC    SF,(PROT,HI)
          DC      C'LOCATION:'
          $MAC    SF
          $MAC    SBA,(7,1)
          $MAC    SF,(PROT,HI)
          DC      C'SERIAL NUMBER:'
          $MAC    SF,(NUM)
          $MAC    SBA,(7,23)
          $MAC    SF(PROT)
          $MAC    SBA,(10,4)
          $MAC    SF,(PROT)
          DC      C'WHEN ALL ... ENTER KEY'

```

These two types of macro instructions can generate either a total static data stream or static sections of data streams that can be dynamically assembled at execution by the application program.

Semidynamic Output Streams

A semidynamic panel requires some dynamic modification. Perhaps an error message must be written to a particular part of the panel and the cursor must be moved to the input field in which an error was detected during editing. The application program can concatenate preassembled static data stream segments into the program, such as field error messages. The same macro instructions that build static data streams can build partial static streams. As the input from a panel is edited, the standard error message for each field can be assembled in the output buffer, thus allowing multiple brief messages to be sent to the display in one operation.

You may have to change one or two attribute characters from high intensity to low intensity and erase the unprotected fields on a display. For example, an error message segment may have changed a field to high intensity to call the operator's attention to the field; the operator has recognized the error and

reentered the correct information. The display must now be made ready for the next input on the panel. Concatenate the order stream segments to change the attribute characters and use the Erase Unprotected to Address (EUA) order to restore the panel; do not transmit all the data and orders to completely refresh the panel.

Dynamic Output Streams

It may become physically impossible to hold in main storage all possible output data and order stream combinations that could occur during execution of an application. To eliminate the need for storage, you can incorporate a subroutine into screen management to accept parameters from an application program, to decode the parameters and to create the data stream. You can also write for the application program a macro instruction that builds a parameter list in line from entries you specify in the macro instruction, and then branches to the screen management routine to build the required orders and data in the buffer area.

The macro instruction could appear as follows:

```
$BUILD ADD=ADDFIELD,ATT=( R3 ),DATA=( R4 ),LEN=( R5 )
```

The ADDFIELD contains the 3270 buffer address in either row-column format, binary offset, or 3270 address form. R3 contains the address of the attribute byte, R4 contains the address of the data to be entered in the field, and R5 contains the length of the data. The attribute character parameter is optional.

The subroutine could convert row and column buffer addresses relative to one to decimal offsets relative to zero with the following formula:

```
Model 1 Buffer:      ((R-1)X40)+(C-1)
Models 2, 3, 4 Buffer: ((R-1)X80)+(C-1)
```

If the row and column buffer addresses relative to one are in two single-byte areas in binary, the conversion to binary offsets relative to zero can be coded as follows:

```
SR      R3,R3
IC      R3,COLUMN
BCTR    R3,0
SR      R4,R4
IC      R4,ROW
BCTR    R4,0
MH      R4,=H'40' USE VALUE OF 80 FOR MODEL 2
AR      R4,R3  RESULT IN R4
```

The following subroutine converts a binary halfword that represents the offset relative to zero of a position in a 3270 buffer to an equivalent 2-character 3270 address. R3 is a work register, and R4 points to the binary halfword to be converted. The converted result is found at ANSWER.

```

LH      R3,0(R4)
STC     R3,ANSWER+1
SRL     R3,6
STC     R3,ANSWER
NI      ANSWER+1,X'3F'
TR      ANSWER(2),TAB
.
.
.
ANSWER DC      X'0000'
TAB     DC      X'40C1C2C3C4C5C6C7C8C9A4B'
        DC      X'4C4D4E4F50D1D2D3D4D5D6D7'
        DC      X'D8D95A5B5C5D5E5F6061E2E3'
        DC      X'E4E5E6E7E8E96A6B6C6D6E6F'
        DC      X'F0F1F2F3F4F5F6F7F8F97A'
        DC      X'7B7C7D7E7F'

```

Large Screen Size

Application programs written for systems that use 480- or 1920-character screen size will run on large screen displays. Terminals with large screen capacity (960, 2560, 3440, and 3564 characters) will automatically default to smaller screen size unless the large screen size has been specified explicitly by the application program. The Erase Write Alternate command is used to switch a display into large screen mode.

Since buffer address wrapping is screen size dependent, application programs should not depend on buffer wrap during write operations. Also, field attributes must be appropriately placed to delimit the end of the screen image.

3274 Copy Function

The 3274 Control Units operating in BSC mode can only process the Copy command. However, the 3274 can also handle the local copy function as follows:

1. Local copy can be initiated by using the Print key and the print authorization matrix. A local copy involves the transfer of data directly from the display buffer to the printer buffer and its subsequent printing.
2. The host can initiate a copy via the print authorization matrix by setting the start-print bit in the WCC of a write command.

Refer to "Local Copy Function" in Chapter 2.









Appendix A. 3274 Error Status Indicator Code Interpretation

This appendix lists the 3274 error codes, possible causes for the error status indication, the handling of each error by the machine, and suggested recovery techniques. Supplement A, which follows the listing, details a procedure for obtaining additional information from the DCB log area.

The following notes apply to the listing.













1. The three-digit numbers listed in the "Error Code" column are logged and are displayed only if the associated check (Chk) indicator is displayed.
2. The four-digit numbers listed in the "Indicator" column are displayed in the 8 4 2 1 indicators on the 3274.
3. Inhibit conditions shown in the Indicator column are reset by the 3278 or 3279 RESET key.
4. The communication reminder indicators used with the 500 series error codes are extinguished when the communication link again becomes functional.

Error Code	Indicator	Probable Cause	Effect	Recovery
2%% (Feature)	— Mach Chk (X 2 2%%)	a. Keyboard type is not supported. b. Operation was attempted on inoperative or unsupported terminal feature.	Display error indication on affected 3278 or 3279. a. Unpredictable keyboard operations. b. Feature cannot be used. The remainder of the terminal is unaffected.	Verify that the customizing procedure specified the proper keyboard/feature support. Press RESET key to restore keyboard.
202 (Type A Terminal)	— Mach Chk (X 2 202)	Internal terminal error.	Affected terminal is disabled. Set sense: Non-SNA: DC/US SNA: 081C	At the affected terminal, switch the Normal/Test switch from Normal to Test and back again (or switch power off, then on).
203 (Feature)	— Mach Chk (X 2 203)	Terminal feature circuitry failure.	Display error indication on affected 3278 or 3279.	Press RESET key and retry the operation.
204 (Type A Terminal)	— Mach Chk (X 2 204)	Terminal buffer parity error.	Display error indication on affected 3278 or 3279. a. CU clears the terminal buffer and sets sense: Non-SNA: DC/US SNA: 082B b. If internal recovery is unsuccessful, terminal is disabled. Set sense: Non-SNA: DC/US SNA: 081C	a. Host recovery. b. If CU recovery is unsuccessful, switch Normal/Test switch from Normal to Test and back again (or switch power off, then on).
205 (Feature)	— Mach Chk (X 2 205)	An operation was attempted on an inoperative or unsupported terminal feature.	Display error indication on affected 3278 or 3279. Feature cannot be used; remainder of the terminal is not affected.	Press RESET key and retry the operation. (Verify that the customizing procedure specified the failing feature.)
206 (Feature)	— Mach Chk (X 2 206)	Feature did not initialize properly.	Display error indication on affected 3278 or 3279. All terminal features are disabled. Basic terminal functions remain operative.	Press RESET key and continue.
207 (Type A Terminal)	— Mach Chk (X 2 207)	The terminal failed to respond to the CU.	Display error indication on affected 3278 or 3279. Affected terminal is disabled. Set sense: Non-SNA: DC/US SNA: 081C	At the affected terminal, switch the Normal/Test switch from Normal to Test and back again (or switch power off, then on).
208 (Type A Terminal)	— Mach Chk (X 2 208)	Invalid terminal response to CU.	Display error indication on affected 3278 or 3279.	Press RESET key and retry the operation.
209 (Type A Adapter) (Type A Terminal)	— Mach Chk (X 2 209)	CU-to-terminal communication failure.	Display error indication on affected 3278 or 3279. Affected terminal is disabled. Set sense: Non-SNA: DC/US SNA: 081C	At the affected terminal, switch the Normal/Test switch from Normal to Test and back again (or switch power off, then on). Check co-ax connection for looseness.

Error Code	Indicator	Probable Cause	Effect	Recovery
210 (Type A Terminal) (Feature)	— Mach Chk (X  210)	Keyboard type is not supported.	Display error indication on affected 3278 or 3279. Unpredictable keyboard operations.	Verify that the customizing procedure specified that this keyboard type was attached to the subsystem.
211 (Type A Terminal)	— Mach Chk (X  211)	Invalid terminal response to CU.	Display error indication on affected 3278 or 3279. Keyboard is locked if affected terminal is a display.	Press RESET key and retry the operation.
212 (Type A Terminal) (Keyboard)	— Mach Chk (X  212)	An invalid keystroke code was received from this display.	Display error indication on affected 3278 or 3279. Keyboard is locked.	
222 (Type A Terminal) (Feature)	— Mach Chk (X  222)	Selector-light-pen error.	Display error indication on affected 3278 or 3279. Keyboard is locked.	Press RESET key and retry the operation. If no keyboard, retry the operation.
223 (Feature)	— Mach Chk (X  223)	ECSA adapter buffer parity error.	Display error indication on affected 3278 or 3279. a. CU clears the terminal buffer and sets sense: Non-SNA: DC/US SNA: 082B b. If internal recovery is unsuccessful, the terminal is disabled; set sense: Non-SNA: DC/US SNA: 081C	a. Host Recovery. Press RESET key to continue. b. If CU recovery is unsuccessful, switch the Normal/Test switch from Normal to Test and back again (or switch power off, then on).
224 (Type A Terminal) (Feature)	— Mach Chk (X  224)	MSR or MHS error.	Display error indication on affected 3278 or 3279. Keyboard is locked.	Press RESET key and retry the operation. If no keyboard, retry the operation.
225 (Feature)	— Mach Chk (X  225)	ECSA adapter error.	Display error indication on affected 3278 or 3279. a. Keyboard is locked. If not recoverable; b. Display disabled. Set sense: Non-SNA: DC/US SNA: 081C	a. Press RESET key and retry the operation. b. At the affected terminal, switch the Normal/Test switch from Normal to Test and back again (or switch power off, then on).
226, 227 (Feature)	— Mach Chk (X  226, 227)	Transmission error communicating with ECS feature.	Display error indication on affected 3278 or 3279. Affected terminal is disabled. Set sense: Non-SNA: DC/US SNA: 081C	At the affected terminal, switch the Normal/Test switch from Normal to Test and back again (or switch power off, then on).
228 (3279)	— Mach Chk (X  228)	a. If the keyboard can be reset, the battery has failed. b. If the keyboard cannot be reset, the color convergence hardware has failed.	Display error indication on affected 3279. a. Keyboard is locked. (Terminal can be used if keyboard is reset.) b. Terminal is disabled. Set sense: Non-SNA: DC/US SNA: 081C	a. Replace the battery. (Refer to 3279 Problem Determination Guide for replacement procedure.) b. At the affected terminal, switch the Normal/Test switch from Normal to Test and back again (or switch power off, then on).

Error Code	Indicator	Probable Cause	Effect	Recovery
229 (3279)	— Mach Chk	The color convergence hardware storage failed during: a. A power-on sequence. b. Test 7 execution.	Display error indication on affected 3279. a. The terminal is not enabled. b. The keyboard is inhibited.	At the affected terminal, switch the Normal/Test switch from Normal to Test and back again (or switch power off, then on).
231 (Type A Terminal) (Printer)	— —	An unrecoverable printer error has occurred.	The affected printer is disabled. Set sense: Non-SNA: EC/IR/US SNA: 081C	See the printer Problem Determination Guide.
234 (Type A Terminal)	— Mach Chk (X 234)	The ECS adapter does not have the required ROS.	Display error indication on affected 3278 or 3279. Terminal is not enabled.	Required ROS must be installed.
270, 271, 273 (Type B Adapter)	1010 —	An unrecoverable terminal error has occurred.	All Type B terminals are disabled; Type A terminals are not affected.	Re-IML; perform host recovery if required.
272 (Type B Adapter)	1010 —	Terminal request was not serviced by the CU.	Set sense: Non-SNA: DC/US SNA: 082B	Host recovery.
274 (Type B Terminal)	— —	A terminal busy condition does not clear.	Affected terminal is disabled. Set sense: Non-SNA: DC/US SNA: 081C	At the affected terminal, switch power off, then on.
275 (Type B Printer)	— —	The affected printer indicates equipment check and not ready condition.	Set sense: Non-SNA: EC/IR/US SNA: 081C	Operator recovery; follow locally established procedures.
276 (Type B Printer)	— —	The affected printer indicates equipment check. (Character generator error or sync check.)	Set sense: Non-SNA: EC/US SNA: 082B	Host recovery.
277 (Type B Terminal)	— —	A terminal buffer parity error has occurred.	Set sense: Non-SNA: DC/US SNA: 082B If internal recovery is unsuccessful, terminal is Non-SNA: DC/US SNA: 081C	Host recovery. If host recovery is unsuccessful, switch power off, then on.
278 (Type B Adapter) (Type B Terminal)	— —	A CU-to-terminal communication problem.	Affected terminal is disabled if second attempt by CU is unsuccessful, and sense is set: Non-SNA: DC/US SNA: 081C	At the affected terminal, switch power off, then on.
279 (Type B Terminal)	— —	Internal terminal error.	Affected terminal is disabled. Set sense: Non-SNA: DC/US SNA: 081C	

Error Code	Indicator	Probable Cause	Effect	Recovery
292, 294, 295 296, 298, 299 (Type A Adapter)	Mach Chk (X 29 292, 294, 295, 296, 298,299)	Adapter failure. Terminal status may have been lost.	Display error indication on all 3278s/3279s.	Press RESET key and retry the operation.
293 (Type A Adapter)	Mach Chk (X 29 293)	The CU has received input from a terminal port that is not in the configuration table.		Press RESET key and retry the operation. (Verify that the number of Type A terminals attached agrees with the number specified during the customizing procedure.)
297 (Type A Adapter)	Mach Chk (X 29 297)	Adapter failure or unisolated terminal failure.		Press RESET key and retry the operation.
310, 311 (C Units-BSC)	1001 Mach Chk (X 31 310, 311)	A host communication adapter failure has occurred.	Display error indication on all 3278s/3279s. Host communication is disabled.	Re-IML; perform host recovery if required.
320, 321 (C Units-SDLC) (Model 51C-SDLC)	1001 Mach Chk (X 32 320, 321)			
326 (Model 51C; X.21 switched)	1001 Mach Chk (X 32 326)	A host adapter failure has occurred.	Host communication is disabled.	Re-IML; perform host recovery if required.
330, 331 (C Units-SDLC) (Model 51C-SDLC)	1001 Mach Chk (X 33 330, 331)	A host communication adapter failure has occurred.	Display error indication on all 3278s/3279s. Host communication is disabled.	Re-IML; perform host recovery if required.
332, 333 (Model 51C; Multiuse Com- munication Loop)	1001 Mach Chk (X 33 332, 333)	A host adapter failure has occurred: 332 = HPCA wrap failure 333 = LSA wrap failure	Display error indication on all affected 3278s/3279s. Host communication is disabled.	Re-IML; perform host recovery if required.
334 (Model 51C; Multiuse Com- munication Loop)	1001 Mach Chk (X 33 334)	Three SHUTOFF commands have been received from the host; or an LSC hardware failure has occurred.	Same as 332, 333.	Same as 332, 333.
335, 336 (Model 51C; Multiuse Com- munication Loop)	1001 Mach Chk (X 33 335, 336)	A host adapter failure has occurred: 335 = LSA failure 336 = LSC wrap failure	Same as 332, 333.	Same as 332, 333.
340, 341, 342 (A Units)	1001 Mach Chk (X 34 340, 341, 342)	A host communication adapter failure has occurred.	Host communication is disabled.	Re-IML; perform host recovery if required.
350, 351, 352 353, 357 (B Units)	1001 Mach Chk (X 35 350, 351, 352, 353, 357)			

Error Code	Indicator	Probable Cause	Effect	Recovery
354 (B Units)	1001 Mach Chk (X  354)	The number of terminals specified during customizing exceeds the number specified in the adapter address jumpers.	Display error indication on all 3278s/3279s. Host communication is disabled.	Verify that the number of terminals specified during customizing does not exceed the number of addresses jumpered on the adapter.
355 (B Units)	Mach Chk (X  355)	A host communication adapter failure has occurred.	Display error indication on the selected 3278/3279. Set sense: DC	Host recovery. Press RESET key to restore keyboard.
356 (B Units)	Mach Chk (X  356)			
360, 361, 363 (D Units)	1001 Mach Chk (X  360, 361, 363)		Host communication is disabled. Set sense: DC	Re-IML; perform host recovery if required.
362, 364 (D Units)	Mach Chk (X  362, 364)	A CU failure occurred during an I/O operation.	Display error indication on the selected 3278/3279. Set sense: DC	Host recovery. Press RESET key to restore keyboard.
381 (All 3274 Models)	0010 Mach Chk (X  381)	CU logic error.	Display error indication on all 3278s/3279s. Host communication is disabled.	Re-IML; perform host recovery if required.
390 (All 3274 Models)	0001 or 0011-0111 Mach Chk (X  390)	A storage parity error has occurred.		
391 (All 3274 Models)	0010 or 1101 Mach Chk (X  391)	CU logic failure.		
392, 393, 394, 395 (Model 52C Kanji)	0111 Mach Chk (X  392, 393, 394, 395)	Kanji font card 1(392), 2(393), 3(394), or 4(395) contains unusable character font.		
397 (Encrypt/ Decrypt)	1110 Mach Chk (X  397)	An unrecoverable Encrypt/Decrypt I/O error has occurred. The adapter is disabled.	Display error indication at the affected 3278/3279. Set sense: 0848	Note: <i>Non-cryptographic sessions may still be run. Press RESET key and use local logon/logoff procedures.</i>
398 (Encrypt/ Decrypt)	— Mach Chk (X  398)	A master key parity error has been received and recovery attempts were unsuccessful.		Refer to Master Key Entry and Verification Procedure in the <i>Operator's Guide</i> . If Master Key Verification fails, replace battery and enter master key. Note: <i>Non-cryptographic sessions may still be run. Press RESET key and use local logon/logoff procedures.</i>
399 (Encrypt/ Decrypt)	— Mach Chk (X  399)	An unrecoverable Encrypt/Decrypt failure has occurred and recovery attempts were unsuccessful. The adapter is disabled.		Note: <i>Non-cryptographic sessions may still be run. Press RESET key and use local logon/logoff procedures.</i>

Error Code	Indicator	Probable Cause	Effect	Recovery
401 (All 3274 Models)	— Prog Chk (X PROG 401)	a. Invalid command received. b. SFE, MF, SA with invalid alias.	Display error indication on affected 3278/3279. Set sense: a. Non-SNA: CR/OP SNA: 1003 b. SNA: 0863	Press RESET key to reset the program check indicator and retry the operation. Call host-support programmer if the problem persists, since it is probably a data stream error.
402 (A, C, and D Units and 51C)	— Prog Chk (X PROG 402)	Invalid (out of range) address was received following an SBA, RA, or EUA order. MF order addressed nonfield attribute location.	Display error indication on affected 3278/3279. Set sense: a. Non-SNA: CR/OP SNA: 1005 b. SNA: 0863	
403 (A, C, and D Units and 51C)	— Prog Chk (X PROG 403)	Data stream containing: a. Data following a Rd, Rd Mod, or EAU command was received, or b. Invalid parameter following an SFE, MF, or SA order. c. A GE or RA order was received with invalid parameters.	Display error indication on affected 3278/3279. Set sense: Non-SNA: OC SNA: 1003	
404 (A, C, and D Units and 51C)	— Prog Chk (X PROG 404)	Data stream ended before all required bytes on an SBA, RA, EUA, SF, SFE, MF, or SA order were received.	Display error indication on affected 3278/3279. Set sense: Non-SNA: OC SNA: 1005	
405 (C Units-BSC) (Model 51C-BSC)	— Prog Chk (X PROG 405)	Invalid Copy command was received.	Display error indication on affected 3278/3279. Set sense: OC	
406 (C Units-BSC) (Model 51C-BSC) (D Units)	— Prog Chk (X PROG 406)	Invalid command sequence received.		
407 (B Units)	— Prog Chk (X PROG 407)	Valid command or order received that cannot be executed because: a. SBA, RA, or EUA order specifies an invalid address, or b. Write data stream ends before all required bytes of SBA, RA, EUA, or SF order sequence are received, or c. Write, E/W, EWA with Start Print bit set in WCC is chained to the next command; the print operation is suppressed.		
408 (C Units-BSC) (Model 51C-BSC)	— Prog Chk (X PROG 408)	Line buffer overflow.		

Error Code	Indicator	Probable Cause	Effect	Recovery
410 (A Units)	— Prog Chk (X PROG 410)	RU greater than 1,536 bytes received.	Display error indication on affected 3278/3279. Set sense: 1002	Press RESET key to reset the program check indicator and retry the operation. Call host- support programmer if the problem persists, since it is probably a data stream error.
411 (SNA)	— Prog Chk (X PROG 411)	LU1 RU received with greater length than in Bind specification.		
412 (SNA)	— Prog Chk (X PROG 412)	LU1 RU received with less length than in Bind specification.		
413 (SNA)	— Prog Chk (X PROG 413)	The attempted function is not supported.	Display error indication on affected 3278/3279. Set sense: 1003	
414 (Encrypt/ Decrypt)	— Prog Chk (X PROG 414)	A bad pool count or a non-module-8 RU has been received during a crypto session.		
420 (SNA)	— Prog Chk (X PROG 420)	LIC carried exception response when Bind specified definite response.	Display error indication on affected 3278/3279. Set sense: 4006	
421 (SNA)	— Prog Chk (X PROG 421)	LIC carried definite response when Bind specified exception response.	Display error indication on affected 3278/3279. Set sense: 4007	
422 (SNA)	— Prog Chk (X PROG 422)	No Response is not allowed.	Display error indication on affected 3278/3279. Set sense: 400A	
423 (SNA)	— Prog Chk (X PROG 423)	Format indicator (FI) bit is not allowed.	Display error indication on affected 3278/3279. Set sense: 400F	
430 (SNA)	— Prog Chk (X PROG 430)	Sequence number error.	Display error indication on affected 3278/3279. Set sense: 2001	
431 (SNA)	— Prog Chk (X PROG 431)	Chaining error.	Display error indication on affected 3278/3279. Set sense: 2002	
432 (SNA)	— Prog Chk (X PROG 432)	Bracket error.	Display error indication on affected 3278/3279. Set sense: 2003	
433 (SNA)	— Prog Chk (X PROG 433)	Data Traffic Reset.	Display error indication on affected 3278/3279. Set sense: 2005	
434 (SNA)	— Prog Chk (X PROG 434)	Direction error.	Display error indication on affected 3278/3279. Set sense: 2004	
439 (Encrypt/ Decrypt)	— Prog Chk (X PROG 439)	FM data received prior to a valid CRV.	Display error indication on affected 3278/3279. Set sense: 1001	

Error Code	Indicator	Probable Cause	Effect	Recovery
440 (SNA)	— —	Session Limit exceeded.	Log error number for affected terminal. Set sense: 0805	Press RESET key to reset the program check indicator and retry the operation. Call host-support programmer if the problem persists, since it is probably a data stream error.
441 (SNA)	— —	Bracket Bid Reject (No RTR).	Log error number for affected terminal. Set sense: 0813	
441 (SNA)	— —	Receiver in Transmit Mode.	Log error number for the affected terminal. Set sense: 081B	
442 (SNA)	— Prog Chk (X PROG 442)	Request not executable.	Display error indication on affected 3278/3279. Set sense: 081C	
443 (SNA)	— Prog Chk (X PROG 443)	Change Direction required.	Display error indication on affected 3278/3279. Set sense: 0829	
444 (SNA)	— —	Session already Bound.	Log error number for affected terminal. Set sense: 0815	
445 (SNA)	— Prog Chk (X PROG 445)	ACTLU not equal to GOLP or Erp.	Display error indication on affected 3278/3279. Set sense: 0821	
450–458 (SNA)	— Prog Chk (X PROG 450–468)	Bind Reject; Bind parameters do not match Bind checks: a. 450 = Profile error b. 451 = Primary protocol error c. 452 = Secondary protocol error d. 453 = Common protocol error e. 454 = Screen Size specification error f. 455 = LU profile error g. 456 = LU1 error h. 457 = Bind Spec for crypto was specified when feature not present or a CRV was received in CRV invalid state. i. 458 = Crypto master key mismatch between the host and the controller. See <i>Planning and Setup Guide</i> .	Display error indication on affected 3278/3279. Set sense: 0821	
460	— Prog Chk (X PROG 460)	Control Unit detected and Invalid printer authorization matrix.	Display error indication on the 3278/3279 on port 0.	

Error Code	Indicator	Probable Cause	Effect	Recovery
462	— Prog Chk (X PROG 462)	Printer detected an error in LU1 data stream.	Sense set by printer.	Host Recovery.
468 (SNA)	— —	Printer detected error in LU1 data stream.	Log error number for affected printer. Sense set by printer: 1003 — function not supported 1005 — currently supported in base code 084C — Illegal PS selection 0863 — Illegal alias selection 1008 — Invalid FMH	Call host-support programmer if problem persists, since it is probably a data stream error.
470 (Extended Data Stream)	— Prog Chk (X PROG 470)	Unsupported code point <X'40' decoded, or X'3F' or X'FF' sent to non-ECSA device.	Display error indication on affected 3278/3279. Set sense: Non-SNA: OC SNA : 1003	Press RESET key to reset the program check indicator and retry the operation. Call host-support programmer if the problem persists, since it is probably a data stream error.
471 (Extended Data Stream)	— Prog Chk (X PROG 471)	Extended data stream function cannot be executed: a. Unsupported structured field type b. Device without ECSA feature c. Invalid load format addressed to terminal PS storage d. Invalid mode in Set Reply mode e. Invalid operation in Read Partition (not Query) f. Symbol set ID out of valid range g. Invalid X or Y value for Load PS structured field h. Section ID not supported (byte 11 not equal to 0) i. Invalid length structured field j. Invalid partition ID k. Invalid EBCDIC code point l. Invalid reserved bits received in the data stream m. (BSC only) Buffer overflow; more than 3K bytes of uncompressed PS data received	Display error indication on affected 3278/3279. Set sense: Non-SNA: OC SNA : For a, b, c d, e, f, h, l, m; 1003 For g, i, j, k; 1005	
472 (Extended Data Stream)	— Prog Chk (X PROG 472)	Improper command sequence from host caused a read structured field state error.	Display error indication on affected 3278 or 3279. Set sense: Non SNA: OC SNA : 0871	

Error Code	Indicator	Probable Cause	Effect	Recovery
473 (Extended Data Stream) *	— Prog Chk (X PROG 473)	a. ECSA adapter present, but a terminal storage was addressed that was not physically present. b. A color plane operation was attempted to terminal storage with no color plane. c. The color plane operation was invalid. d. Specified terminal storage ID outside supported range.	Display error indication on affected 3278/3279. Set sense: Non-SNA: OC SNA : 084C	Press RESET key to reset the program check indicator and retry the operation. Call host-support programmer if the problem persists, since it is probably a data stream error.
474 (Extended Data Stream)	— Prog Chk (X PROG 474)	No extended DCB customized for this device.	The device cannot be used for execution of extended data stream functions. Display error indication on affected 3278/3279. Set sense: Non-SNA: OC SNA : 1003	Log on to an application that does not require extended function, or perform the customizing process for the extended DCB for this device and re-IML.
475 (Extended Data Stream)	Prog Chk (X PROG 475)	WCC had START PRINT bit set, but not last structured field.	Display error indication on affected 3278/3279. Set sense: Non-SNA: OC SNA : 1001	Press RESET key to reset the program check indicator and retry the operation. Call host-support programmer if the problem persists, since it is probably a data stream error.
498 (SNA)	— Prog Chk (X PROG 498)	Negative response received.	Display error indication on affected 3278/3279.	Press RESET key to reset the program check indicator and retry the operation. Call host-support programmer if the problem persists.
499 (SNA)	— Prog Chk (X PROG 499)	Exception request.		
501 (C Units and 51C)	— Comm Chk (X Z501)	Data Set Ready (DSR) signal from modem has dropped.	Display error indication on all 3278s/3279s. Host communication is inhibited.	Check modem. Press RESET key and retry the operation.
501 (A, B, and D Units)	— Comm Chk (X Z 501)	Manual OFFLINE switch in the OFFLINE position.		At the control unit, place switch the ONLINE position.
501 (Model 51C; Multiuse Comm Loop)	— Comm Chk (X Z 501)	Local/Comm switch set to Local.	Host communication is inhibited.	At the CU, switch the Local/Comm switch to Comm.
502 (C Units-SDLC) (Model 51C-SDLC)	— Comm Chk (X Z 502)	Clear to Send (CTS) signal from the modem is missing.		Check modem. Press RESET key and retry the operation.
503 (B and D Units)	— Comm Chk (X Z 503)	A selective reset sequence was received.		Press RESET key and retry the operation.

*See Supplement A at end of list.

Error Code	Indicator	Probable Cause	Effect	Recovery
504 (C Units-SDLC) (Model 51C-SDLC)	— Comm Chk (X †Z 504)	The CU is disconnected from the line: a. IML b. DISC from network c. CU detected errors d. Operator action	Display error indication on all affected 3278s/3279s. The station is closed and disconnected.	A new connection is required.
505 (C Units-SDLC) (Model 51C-SDLC)	— Comm Chk (X †Z 505)	Initial state of CU on a Disconnect command was received.		Host recovery (an SNRM command is required). Press RESET key and retry the operation.
505 (A Units)	— Comm Chk (X †Z 505)	Initial state of CU; a Disconnect command or a System Reset was received.		Host recovery (a connect sequence is required). Press RESET key and retry the operation.
505 (B and D Units)	— Comm Chk (X †Z 505)	System Reset was received.	Display error indication on all 3278s/3279s.	Host recovery (the first I/O operation other than TIO or Sense, will clear the Communication Reminder). Press RESET key and retry the operation.
505 (Model 51C; Multiuse Comm Loop)	— Comm Chk (X †Z 505)	Initial state of control unit; a DISC command has been received, or beaconing has been completed.	Display error indication on all 3278s/3279s. Host communication is inhibited.	Host recovery (an SNRM command is required). Press RESET key and retry the operation.
507 (Model 51C; Multiuse Comm Loop)	— Comm Chk (X †Z 507)	No RLSD for a 4-second period.	Display error indication on all 3278s/3279s. The station is closed, and wrap tests are performed. If the wrap tests are successful, beaconing is initiated, and †Z 515 is broadcast.	Host recovery. If †Z 507 remains in the communication reminder area, check for a X 3nn keyboard inhibit and refer to that error description.
508 (Model 51C; Multiuse Comm Loop)	— Comm Chk (X †Z 508)	A CNFG command was received that specified Set Monitor mode.	Display error indication on all 3278s/3279s. Monitor mode is entered.	A CNFG command that specifies CLEAR or RESET is received from the host.
509 (Model 51C; Multiuse Comm Loop)	— Comm Chk (X †Z 509)	A CNFG command was received that specified Suppress Loop Carrier mode.	Display error indication on all 3278s/3279s. The controller suppresses the carrier after responding to the CNFG command.	
510 (SNA)	— Comm Chk (X †Z 510)	The PU is not active.		Host recovery (ACTPU is required).
511 (A Units)	— Comm Chk (X †Z 511)	Disconnect command was received when PU was active.		Host recovery (Connect is required).
512 (A Units)	— Comm Chk (X †Z 512)	Connect command was received when PU was already connected.		Host recovery (ACTPU is required).
514 (A Units)	— Comm Chk (X †Z 514)	Connect error caused by: a. Odd-number buffer length was specified, or b. Insufficient length buffer was specified.		Host recovery (Valid Connect is required). See "Connect Function," under "Control Command," in Chapter 5.

Error Code	Indicator	Probable Cause	Effect	Recovery
515 (Model 51C; Multiuse Comm Loop)	— Comm Chk (X †Z 515)	During the monitoring of "RLSD", a "no RLSD" condition was detected and wrap tests were run successfully.	Beacon is entered, and RLSD is sampled.	Receipt of more than 50% RLSD samples will cause the station to stop beaconing. SNRM is required (see 505).
518 (C Units-SDLC) (Model 51C-SDLC)	— Comm Chk (X †Z 518)	A segment was received with improper sequencing the TH MPF bits.	Display error indication on all 3278s/3279s; all PUs and LUs are deactivated.	Host recovery (SNRM is required).
519 (C Units-SDLC) (Model 51C-SDLC)	— Comm Chk (X †Z 519)	A message was received that is larger than the CU buffer.	CCA: SDLC Command Reject response is sent to the host. HPCA: NR/NS mismatch.	Host recovery. (Check NCP Sysgen parameters if the condition persists.)
520 (C Units-SDLC) (Model 51C-SDLC)	— Comm Chk (X †Z 520)	Non-productive timeout caused by: a. A valid frame not received in the past 20-25 seconds, or b. The communication line is hung at space or a valid data character.	Display error indication on 3278s/3279s. Host communication is inhibited.	Verify the operational status of the communication network. Reset by receipt of a valid frame or a frame containing a poll.
521 (C Units-SDLC) (Model 51C-SDLC)	— Comm Chk (X †Z 521)	No Flag characters on the line in the past 20-25 seconds. On a switched network, three successive occurrences of an idle timeout will cause the station to disconnect.		
522 (Model 51C; Multiuse Comm Loop)	— Comm Chk (X †Z 522)	The controller's Read Control Block overflowed. The line may be hung at a space or valid data character.	Display error indication on all 3278s/3279s. Host communication is inhibited.	Verify the operational status of the communication network. Reset by receipt of a valid frame or a frame containing a poll.
525 (C Units-SDLC) (Model 51C-SDLC)	— Comm Chk (X †Z 525)	A connection problem exists on the communications link that prevents establishing or reestablishing host communication. (Set by receipt of 20 Write retries, 20 ROLs, 20 CRs, 20 XIDs, or 20 HSAs.)		Verify the operational status of the communication network.
525 (Model 51C; Multiuse Comm Loop)	— Comm Chk (X †Z 525)	A connection problem exists on the communications link that prevents establishing or reestablishing host communication. (Set by receipt of 20 Write retries, 20 ROLs, 20 CRs, 20 XIDs, or 20 NSAs.)	Display error indication on all 3278s/3279s. Host communication is inhibited. The station is closed, and wrap tests are performed. If the wrap tests fail, X † 332, 333, or 336 is broadcast.	Verify the operational status of the network. If there were wrap-test failures, an IML is required. If the wrap tests were successful, an SNRM is required.
527 (Model 51C; Multiuse Comm Loop)	— Comm Chk (X †X 527)	Write timeout caused by clocking problem or missing CTS.		Verify the operational status of the network; re-IML.

Error Code	Indicator	Probable Cause	Effect	Recovery
528 (C Units-SDLC) (Model 51C-SDLC)	— Comm Chk (X †Z 528)	Command Reject caused by: a. Detection of an NR sequence error, or b. Receipt of a command that has no data field defined, or c. Receipt of an invalid command.	Display error indication on all 3278s/3279s. All PUs and LUs are deactivated.	Host recovery (SNRM required). Verify proper 370X parameters if condition persists.
529 (C Units-SDLC) (Model 51C-SDLC)	— Comm Chk (X †Z 529)	Abnormal response from the modem.	Display error indication on all 3278s/3279s. Host communication is inhibited. All PUs and LUs are deactivated.	Check modem; host recovery SNRM required).
530 (C Units and 51C)	— Comm Chk (X †Z 530)	Write timeout caused by: a. Modem clocking missing, or b. CTS has dropped.	Display error indication on all 3278s/3279s. Host communication is inhibited. In SDLC, all PUs and LUs are deactivated.	Check modem; host recovery. (In SDLC, SNRM is required.)
531 (C Units-BSC) (Model 51C-BSC)	— Comm Chk (X †Z 531)	CU has sent a NAK response because: a. A BCC error was detected, or b. Three seconds elapsed during a read operation without receipt of SYN, ETX, or ETB, or c. A forward abort (ENQ in text) was received, or d. A Temporary Text Delay sequence (STX ENQ) was received.	Display error indication on the affected 3278s/3279s. The affected terminal buffer is restored to its state before the error occurred.	Host recovery. (Host should retransmit the last transmission.) Also resets Communication Reminder symbol.
532 (C Units-BSC) (Model 51C-BSC)	— Comm Chk (X †Z 532)	Approximately 20 seconds have elapsed without the detection of SYN characters on the line.	Display error indication on all 3278s/3279s. Host communication is inhibited.	Verify the operational status of the communication network. Host recovery. (A valid Poll or selection-addressing sequence is required.) Also resets Communication Reminder symbol.
533 (C Units-BSC) (Model 51-C BSC)	— Comm Chk (X †Z 533)	The CU did not receive ETX or ETB with the last block of text transmitted by the host. The host has sent ENQ to the CU.	Display error indication on the affected 3278/3279. The affected terminal buffer is restored to its state before the error occurred. The CU will transmit its last ACK (1/0).	Host recovery. (Host should retransmit the last transmission sent that preceded ENQ.) Also resets Communication Reminder symbol.

Error Code	Indicator	Probable Cause	Effect	Recovery
534 (C Units-BSC) (Model 51C-BSC)	— Comm Chk (X †Z 534)	a. The CU did not receive a response to its last block sent, and has sent ENQ 15 times. b. The CU has acknowledged a selecting sequence or Text block, and has waited 45 seconds without detecting synchronization (PAD and SYNs)	Display error indication on the affected 3278/3279. Host communication is inhibited.	Host recovery. (A valid Poll or selection-addressing is required.) Also resets Communication Reminder symbol.
535 (C Units-BSC) (Model 51C-BSC)	— Comm Chk (X †Z 535)	The CU received 15 consecutive NAKs to its last transmission.	Display error indication on the affected 3278/3279. Host communication is inhibited. The CU transmits EOT and enters control mode.	
536 (C Units-BSC) (Model 51C-BSC)	— Comm Chk (X †Z 536)	The CU received 15 consecutive ACK0s instead of ACK1s, or vice versa.		
540 (A Units)	— —	A Restart Reset, Read Start, Write Start, Read, Write, or Write Break command was received while the CU was not initialized.	Set sense: 8200*	Host recovery. (A Connect command is required.)
541 (A Units)	— —	An invalid command was received.	Set sense: 8000*	Host recovery; verify host sysgen for proper device-type.
543 (A Units)	— —	A channel parity error occurred during selection.	Set sense: 2002*	Host recovery.
544 (A Units)	— —	A channel parity error occurred during a host write operation.	Set sense: 2006*	
545 (A Units)	— —	A CU parity error occurred during a host write operation.	Set sense: 1002*	
546 (A Units)	0001 or 0011-0111 —	A CU parity error occurred during a host read operation.	Set sense: 1006*	
547 (A Units)	1001 —	A channel parity error occurred during a host read operation.	Set sense: 1002*	
548 (A Units)	1001 or 1011 —	A CU error occurred during an I/O operation.	Set sense: 1001*	
549 (A Units)	— —	The byte count specified in the host's Read command was insufficient to transfer all associated data from the CU buffer.	Set sense: 0800*	

Error Code	Indicator	Probable Cause	Effect	Recovery
550 (A Units)	— —	The count in the link header did not equal the byte count received.	Set sense: 0880*	Host recovery.
551 (B and D Units)	— Comm Chk (X +Z 551)	CU detected bad parity on any command or data byte received.	Display error indication on affected 3278/3279. Set sense: BOX (20)*	
555 (X.21 switched)	— Comm Chk (X +Z 555)	Format error on a network CPS or line ID.	Display error indication on all affected 3278/3279s.	Press Comm key.
556 (X.21 switched)	— Comm Chk (X +Z 551)	X.21 network timeout has been detected.		
557 (X.21 switched)	— Comm Chk (X +Z 557)	Network not ready.	Keyboard inhibited until network becomes ready.	If error persists, network recovery may be indicated.
558 (X.21 switched)	— Comm Chk (X +Z 558)	Lost data.	CPS will not be displayed.	Press Comm key.
559 (X.21 switched)	— Comm Chk (X +Z 559)	DCE cleared; the network or host has disabled communications.	3274 will go to a Call Ready state.	Host or operator initiates a call.
560 (X.21 switched)	— Comm Chk (X +Z 560)	Not +/Bel received while monitoring for incoming call, or Proceed to Select not received while dialing.		
561 (X.21 switched)	— Comm Chk (X +Z 561)	A CLR Timeout detected during a "clearing sequence."	3274 will monitor the network, waiting for a Network Ready state.	If error persists, network recovery may be required.
562 (X.21 switched)	— Comm Chk (X +Z 562)	Compare error. A signal mismatch on the 3274s driver/receiver.	Display error indicator on all affected 3278/3279s.	Press Comm key.
565 (X.21 switched)	— Comm Chk (X +Z 565)	Invalid operation caused by unknown network failure.		
599 (X.21 switched)	— Comm Chk (X +Z 599)	Local mode. An operator depressed the local key on an attached 3278/3279.	3274 is offline to the the network.	Press Comm key to return to Call Ready state.

Note: Sense conditions marked with an asterisk (*) in the Effect column are transmitted by the 3274 A unit in response to a sense command. They should not be confused with SNA sense.

Supplement A

Complementing the PROG 4nn indicator codes, bytes X'170'—X'174' of the extended DCB are used as a log area for additional information. The extended DCB is created during customization for devices supporting Structured Field and Attribute Processing (SFAP).

Bytes X'170', X'171' contain the displacement in hex to the byte in the Write Structured Field that was found to be in error. (The WSF command = byte 1.) Bytes X'172', X'173' contain the displacement into the particular structured field (SF) where the error was detected. Byte X'174' contains the SF type of the SF that contained the error.

Figure A-1 correlates the 4nn numbers, the values found in bytes X'172—174', the SNA sense code, and a description of the error. OP check is the sense set for local attachment (non-SNA) and BSC in all cases.

Bytes X'170—174' may be displayed in the following manner. Enter Test Mode by pressing the Alt and Test keys. Select the DCB in question by typing in AA/6; AA is the coax port number in question (00-31). (If the device being used for the test is the port in question, /6 will suffice.) Press the Enter key. The display should now contain:

Line 1 AA/6 (Same as input)

Line 2 00

Line 3 XXXX XXXX XXXX XXXX XXXX XXXX XXXX XXXX

Line 4 XXXX XXXX XXXX XXXX XXXX XXXX XXXX XXXX

Line 5 XXXX XXXX XXXX XXXX XXXX XXXX XXXX XXXX

Line 6 XXXX XXXX XXXX XXXX XXXX XXXX XXXX XXXX

Where: 00 = The displacement from the start of the control block (in hex, the low-order digit is dropped) of the portion of the control block currently being displayed.

XXXX = Hex representation of the portion of the control block currently being displayed

Press the PA1 or Enter key five times. Line 2 should change to 04, 08, 0C, 10, and then 14. The low-order digit being dropped, the values are really X'40', X'80', X'C0', X'100', and X'140'. X'170'—'174' are the first 5 bytes on line 6.

Note: Values exceeding X'0C' on line 2 appear only if an extended DCB (for this device) is present.

4nn	Bytes X'172-174'	Sense	Error Description (See Note)
471	0003 XX XX = any value but 01, 06, or 09	1003	Unsupported SF type
471	----	1003	WSF command sent to a device without an ECSA feature
471	0004 06	1003	Invalid load format addressed to terminal PS storage
471	000A 06	1005	Invalid horizontal (X) value for LPS SF
	000B 06	1005	Invalid vertical (Y) value for LPS SF
471	000C 06	1003	Byte 11 is not equal to 0 in LPS SF
471	0001 XX XX = 01, 06, or 09	1005	Invalid length SF
471	0004 09	1005	Byte 3 not 0 in SRM SF
471	0005 09	1003	Invalid Mode in SRM SF
471	0005 01	1003	Byte 4 is not X'02' in Read Partition-Query SF
471	0005 06	1003	Symbol set ID out of legal range
471	0006 06	1005	Invalid EBCDIC code point
471	000D 06	1003	Bits 0-4 of Byte 12 in LPS SF not 0
471	0009 06	1003	Bits 3-7 of byte 8 in LPS not 0
471	0002 06	Op Chk	(BSC only) Greater than 3K of uncompressed LPS data received
471	0004 01	1003	Byte 3 not X'FF' in Read Partition-Query SF
473	0007 06	084C	ECSA present but addressed RWS in device not physically present
473	000D 06	084C	Color plane invalid

Note: As part of overall SFAP problem determination, the usage of the following functions should be kept in mind. If the device in question does not have an extended DCB (not enough allocated during customization), the DCB display procedure (described above) inhibits the keyboard with the minus function indicator on the fourth pressing of the PA1 or Enter Key. If the device does not have an ECSA feature, Test 8 (Enter test mode, type in /8, press Enter) inhibits the keyboard with a wrong number indicator. This is also true if SFAP is not configured. If SFAP is not configured, the above nnn numbers do not appear.

Figure A-1. Indicator Code – Log Area Correlation

Appendix B. Operator Information Area Symbols (3278, 3279)

Readiness and System Connection Symbols (Locations 1 through 7)

Symbol	Name	Explanation
Ⓜ	3274 Ready	The appropriate ready symbol is displayed in location 1 of the Operator Information Area when the 3274 to which the display is attached is ready (functional), and the display is ready.
<u>A</u> <u>B</u>	Online A Online B	<p>The Online <i>A</i> and Online <i>B</i> symbols govern transactions with the host system. Certain keyboard functions and the meaning of some Operator Information Area symbols differ depending upon which set of rules is applicable.</p> <p><i>Online A.</i> The control unit is connected to the system under <i>A</i> rules. The <i>A</i> symbol appears in remote systems using BSC protocol, and in locally attached non-SNA systems. It is turned on by receipt of the following commands: Write, Erase/Write, Erase All Unprotected, Copy, Read Modified, and Read Buffer.</p> <p>The <i>A</i> symbol is turned off when:</p> <ol style="list-style-type: none"> 1. An operator action causes host communication. 2. The display station is turned off. 3. The Normal/Test switch is placed in Test, or the TEST key is pressed to place the 3274 in test mode. <p><i>Online B.</i> The control unit is connected to the system under <i>B</i> rules. The <i>B</i> symbol appears in systems that use SNA protocol. It is turned on by completion of an ACTPU/ACTLU command sequence, and is turned off by execution of DACTPU or DACTLU, including an internal DACTPU sequence, and when the Normal/Test switch is placed in Test or the TEST key is pressed.</p>

Symbol	Name	Explanation
■	My Job	The display station is connected to the operator's application program. This symbol is displayed in position 3. It appears in systems that use BSC or SNA protocol, or in locally attached non-SNA systems. In systems using BSC or locally attached non-SNA systems, it is turned on with the <i>A</i> symbol, and is turned off when power is removed, and when the Normal/Test switch is placed in Test. When using SNA protocol, it is turned on when the operator's application session owns the screen.
☒	System Operator	This symbol is used with SNA protocol and indicates that the system operator (SSCP Control Program) session owns the display screen. Except for the ENTER key, the Program Attention keys are not functional when this symbol is displayed.
☒	Unowned	The display station is connected to the system (using SNA only), but not to the operator's application program or to the system operator (control program). The SYS REQ key is used if LOGON is required. This symbol is displayed in position 3.
TEST	Test	The display station is in test mode. Test mode is initiated or terminated by pressing the TEST key while holding the ALT key. TEST is displayed in locations 3 through 6. Test procedures are described in the <i>IBM 3270 Information Display System: 3278 Display Station Problem Determination Guide, GA27-2639</i> , and the <i>IBM 3270 Information Display System: 3279 Display Station Problem Determination Guide, GA33-3051</i> .

Symbol	Name	Explanation
N	In-Use Indicator (3274-51C; X.21 Switched Network Adapter feature)	Data transfer is taking place between the control unit and the host system. The In-Use indicator is displayed on all attached 3278 and 3279s when the control unit has entered the X.21 data transfer state. The X.21 disconnect key (▶ DISC) is the only key honored in the data transfer state. Pressing the ▶ DISC key disconnects the line and causes the Disconnection-in-Process indicator to be displayed, followed by the Call Ready indicator when the process is complete.

Do Not Enter (Input Inhibited), Locations 9 through 17: All these symbols contain an “X” in position 9 (do not enter), combined with other symbols in positions 11 through 17, which define why input is disabled. The keyboard does not lock mechanically, but a change in state of the keyboard clicker (on to off, or off to on) indicates that the keyboard is disabled.

The following keys are not disabled: RESET, SYS REQ, ATTN, TEST, DEV CNCL, shift keys, ALT CURSR, CURSR BLINK, and Click keys.

Also, during an unsolicited write or during buffer transfer while executing a BSC Copy command, a limited number of keystrokes will be accepted for processing, and input is not disabled. The 3274 will queue up to four keystrokes, and, if the queue capacity is not exceeded, will process the input normally when the host restores the keyboard. If the capacity of the queue is exceeded, all queued keystrokes will be discarded and the What symbol is displayed.

RESET will remove the input disabled condition and restore the keyboard except when the following symbols are displayed: Time, Printer Busy, Printer Very Busy, Printer Not Working, and Security Key.

For a 3278 or 3279 display without a keyboard, a selector-light-pen or MSR operation will remove the same input disabled conditions as the RESET key. A selector-light-pen or MSR operation will not cause a reset on a 3278 or 3279 display that has a keyboard attached.

Symbol	Name	Explanation
X Ⓞ	Time	<p>Time is required for the system to perform a function. This symbol is displayed due to:</p> <ol style="list-style-type: none"> 1. Line protocol requirements. 2. A keyboard that has been locked by the host; for example, during a host-initiated print operation. 3. Internal processing constraints of the control unit, such as loading of the printer authorization matrix from a 3278 or 3279 Display Station into a 3274. <p>When operating with SNA protocol, the keyboard will be restored and the Time symbol is removed by a WCC which contains the keyboard restore bit set to 1.</p> <p>If a "Change Direction" was also received, the 3274 will enter send state. However, if a CD was not received, the session will remain in receive state when the WCC contains the Keyboard Restore bit set to 1.</p> <p>In this state, all keys can be used except the Program Attention and Print keys. Use of a Program Attention key will result in display of the Minus Function symbol. If a WCC which contains a Keyboard Restore bit set is not received, display of the Time symbol is determined by whether the CD has been received, as follows:</p> <ol style="list-style-type: none"> 1. If CD has not been received, the session will remain in receive state and the Time symbol remains displayed with keyboard locked. 2. If CD has been received, the 3274 will enter send state; and, if the keyboard was unlocked prior to receipt of the command, the Time symbol is removed and the keyboard is restored. Otherwise, the Time symbol is replaced by the System Lock symbol.



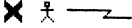

Symbol	Name	Explanation
		If End Bracket is received, the Time symbol is removed, the session enters contention state, and the keyboard is restored regardless of the WCC setting.
		When using BSC protocol or locally attached non-SNA systems, the keyboard will be unlocked, and the Time symbol removed, if the WCC keyboard restore bit is on, or if the keyboard had been unlocked prior to receipt of the command. Otherwise, Time will be replaced by the System Lock symbol.
X SYSTEM	System Lock	The program has disabled the keyboard following an entry. The operator may receive a message and then press Reset to restore the keyboard. In systems that use SNA protocol, the System Lock symbol appears when the application program has replied to the last message sent by the operator and is requesting the operator to send the next message. At this time, however, the host has not unlocked the keyboard. (The Keyboard Restore bit is not set in any WCC that follows the last message from the operator.)
		When the System Lock symbol appears in BSC systems, or in locally attached non-SNA systems, the host is notified of the last AID generated.
X 	nnn Machine Check	The display station is not working properly. The symbol is accompanied by three digits, nnn, (3278 or 3279 attached to 3274), which define the probable cause of the problem. Recovery procedures depend upon the type of error.
		Refer to Appendix A for a description of the machine check codes. Machine check symbols are almost always reset by the operator using the RESET, SYS REQ (SNA only), or TEST keys. If the 3278 or 3279 does not have a keyboard, a selector lightpen, an MSR, or an MHS can be used to reset the Machine Check symbol.

Symbol	Name	Explanation
✕  _nnn	Communication Check	An attempt was made to cause host communication or to use the MSR, MHS, or selector light pen that causes host communication, and a communication link error was detected while the Communications Reminder is displayed. Data cannot be sent. The RESET, TEST, or SYS REQ (SNA) key should be pressed. This symbol is accompanied by up to three digits, nnn (3278 or 3279 attached to 3274), which define the probable cause of the problem. (The Communication Reminder symbol is displayed as long as the condition exists.) Refer to Appendix A for a description of the communication-check codes.
✕  _	Operator Communication Check (3274-51C.X.21 Switched Network Adapter Feature)	The operator has requested an X.21 function that is currently prohibited. See Appendix I.
✕ PROGNnn	Program Check	A programming error was detected in the data received by the control unit. RESET should be pressed, and the operation should be retried. This symbol is accompanied by up to three digits, nnn, (3278 or 3279 attached to 3274), which define the probable cause of the problem. Refer to Appendix A for a description of the program-check codes.
✕ ?+	What?	The last input was not accepted. The What symbol appears when: <ol style="list-style-type: none"> 1. Keystrokes are being queued during unsolicited write or buffer transfer, and the capacity of the queue is exceeded. (The queue is not processed in this case.) 2. ATTN or SYS REQ was pressed while inbound processing was queued for the device. 3. ATTN, SYS REQ, or TEST was pressed during a Time condition which was caused by internal processing constraints of the 3274. 4. The operator continued to key while the Time, Printer Busy, or Printer Not Working symbol was displayed.

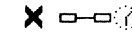
Symbol	Name	Explanation
		<ol style="list-style-type: none"> 5. Two conflicting operations have been attempted “simultaneously” with one operation not serviced. (For example, CLEAR and selector light pen.) 6. A dead key operation has been aborted, and a standalone accent created at the cursor location. 7. Print ID mode has been aborted. The RESET key restores the keyboard. <p>This indicator is also displayed under additional indicators for X.21 switched feature operation (refer to Appendix I).</p> <p>Because of uncertainty about what was accepted, the operator should check the contents of the screen before repeating the operation. In addition:</p> <ol style="list-style-type: none"> 1. If ALT or a shift key was used, press the key again and then press RESET and retry the operation. 2. When retrying SYS REQ or ATTN, repeated use of these keys may be necessary if inbound processing is queued.
✕	-f Minus Function	<p>A currently unavailable function was requested. RESET should be pressed to restore the keyboard. Conditions that cause a Minus Function are:</p> <ol style="list-style-type: none"> 1. Use of an ATTN, PF, or PA key while in SSCP session or in the “unowned state,” or prior to ACTLU. Also use of the Enter key in the “unowned state” or prior to ACTLU. 2. Use of SYS REQ prior to receipt of ACTLU in SNA. 3. Any of the following actions in receive state with the keyboard unlocked: Print and all AID generating keys. 4. Use of ATTN while operating with remote systems that use BSC or local non-SNA systems. 5. Use of SYS REQ, ATTN, and any PA or PF key that is not specified for test mode.

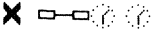
Symbol	Name	Explanation
<p>6. When invoking concurrent test 0, the control terminal is not the test terminal, and the latter is either in session (SNA) or has the Time indicator on in systems that use BSC or in local non-SNA systems.</p> <p>7. When using the IDENT key during a printing operation.</p> <p>8. MSR/MHS in "receive state" or in "unowned state."</p> <p>9. MSR in SSCP-LU session with 3277-compatible 10-character set.</p>	<p>The security key is turned off and no operator input.</p>	<p>✕ -f ✕ Minus Function Operator Unauthorized</p>
<p>This symbol means that the display operator has tried to change the Programmed Symbols, Color, or Extended Highlighting attributes when disallowed by the host program. The keyboard is locked as a result. Pressing the Reset key restores the keyboard.</p> <p>The indicator is also displayed when a Programmed Symbols terminal storage is referenced (PS-A—PS-F attribute keys) but the storage has no symbol set currently associated with it, or the symbol set is marked not keyboard-selectable.</p>	<p>The security key is turned off and no operator input can be accepted. When the key is turned on, this symbol disappears, but any other pre-existing do-not-enter condition may then be displayed.</p> <p>RESET does not remove the Security Key symbol. The Shift, ALT CURSR, CURSR BLINK, and Click keys, and associated symbols, and all other noninput disabled symbols will function when the Security Key symbol is displayed. The Security Key has priority over other input disabled symbols except when machine checks prevent communication between the control unit and the terminal.</p>	<p>✕  Security Key</p>

Symbol	Name	Explanation
	Printer Not Working	<p>The printer assigned to the display station is not functioning, and no other printers in the class are available. If this symbol appears after the Print key was pressed, and if the Printer Failure symbol is not displayed, the printer assigned to the display (or the most available printer in the class) is not functional. The print request is cancelled, and the DEV CNCL key should be pressed to restore the keyboard. (RESET has no effect.) Restoration of the printer will not automatically remove the Printer Not Working symbol. If the Printer Failure symbol is displayed in the printer status area, the printer stopped during the last print operation. If the print operation was initiated by the Print key, DEV CNCL should be pressed to restore the keyboard. The display terminal indicator may precede a comparable indicator on the printer by as much as 2 minutes.</p> <p>The Printer Not Working symbol may also appear for a host-initiated print operation. Operators are not instructed to use DEV CNCL, but, if used, the the Printer Not Working symbol is replaced with the Time symbol, and the host must continue the operation. Subsequent receipt of outbound FM data will remove the Printer Not Working symbol.</p>
	Printer Busy	<p>The printer assigned to the display station is busy. The operator may either wait for the printer to become available or press the DEV CNCL key. For print requests initiated by the Print key, DEV CNCL will cancel the request, remove the Device Busy symbol, and restore the keyboard.</p> <p>For host-initiated requests, DEV CNCL will cause Device Busy to be replaced by the Wait symbol, and a negative response will be sent to the host. If the Print key was used, it may be possible to select another printer.</p>

Symbol	Name	Explanation
	Printer Very Busy	<p>This symbol applies only to operator-initiated requests via the Print key and means the same as Printer Busy except that more time than usual is anticipated before the print request is accepted. It is displayed when the requested printer is allocated to the host as follows:</p> <ol style="list-style-type: none"> 1. If  B is displayed, the printer is currently "in bracket" with a host PLU. 2. If  A is displayed, a host Write, Erase/Write, or Copy command has been addressed to the printer, and the print operation has not yet been started by the host (via a command with the Start Print bit on in the WCC).
	Operator Unauthorized	<p>This symbol means that the operator has requested a printer for which the terminal or attached device is not authorized. RESET should be pressed to restore the keyboard.</p> <p>This symbol appears when:</p> <ol style="list-style-type: none"> 1. The Print key is pressed while the Printer Assignment columns of the Operator Information Area show no printer assignment or show question marks. 2. The IDENT key is pressed on a 3278 or 3279 attached to a 3274 when there is no printer assignment. 3. During a print ID sequence, the operator enters a number which is in the printer authorization matrix, but is not authorized for the display. 4. During a local print operation initiated by the Print key, the "printer" assigned is really a display. This can occur if an invalid device description is loaded into the printer authorization matrix. 5. The print buffer is unable to store the contents of a display buffer (for example, when the display buffer is too large) during an operator-initiated local copy operation.

Symbol	Name	Explanation
✘ ←↵→	Go Elsewhere	<p>An action has been attempted which is invalid for the display screen location. RESET should be pressed, and either the cursor should be moved or some other action taken.</p> <p>The Go Elsewhere symbol appears when:</p> <ol style="list-style-type: none"> 1. An attempt has been made to enter, insert, erase, or delete a character when the cursor is in a protected field or at an attribute location. 2. An attempt has been made to use the CURSR SEL key while the cursor is not in a cursor select or selector-light-pen field. 3. An attempt has been made to enter MSR/MHS data outside the operator input area during an SSCP-LU session when the 3274 is configured for the numeric and alphameric character sets.
✘ ↵>	More Than	<p>This symbol means that the operator has attempted to enter too much information into a field. RESET should be pressed to restore the keyboard, and the operation should be retried and the entry corrected.</p>
✘ ↵NUM	Numeric	<p>This symbol appears when the Numeric Lock feature is installed. A non-numeric entry was made at a display screen location reserved for numeric information. RESET should be pressed to restore the keyboard, and the operation should be retried.</p>
✘ ↵#?	What Number	<p>The operator has entered a number which is unacceptable at the display screen location. This message appears when a selected print ID is not numeric or is not in the matrix, or an incorrect entry is made in test mode. (Refer to description of IDENT key in Appendix C for further information.) RESET should be pressed to restore the keyboard and to make the correct entry.</p>



Symbol	Name	Explanation
✕ 𐄀	Questionable Card	The operator tried to read an inappropriate magnetic stripe card. RESET should be pressed and the correct MSR card should be used. If a keyboard is not available, repeat the operation using a valid MSR card. This symbol will also appear if the End of Inquiry (EOI) character is present on the magnetic card. Cards with EOI are applicable to the operator identification card reader for the 3277 only.
✕ 𐄁 + ? ✕ 𐄂 + ? ✕ 𐄃 + ? ✕ 𐄄 + ? ✕ 𐄅 + ? ✕ 𐄆 →	Accent Plus What	<p>These messages indicate that an invalid dead key/character key combination was entered (Canadian French keyboard only). RESET should be pressed to restore the keyboard, and a valid dead key/character key combination should be entered. Valid combinations are as follows:</p> <pre> ' a A e E u U ' e E ^ a A e E i î o Ô u U " e E i î u U § § § </pre> <p>For further information, refer to "Dead Keys, Canadian French Keyboards" in Appendix C.</p>
✕ -S	Minus Symbol	The symbol keyed is not available. The RESET key should be pressed to restore the keyboard.

Reminders (Locations 21 through 27)

→z_nnn	Communication Reminder	<p>The communication link connecting the control unit to the system is producing errors. Refer to Appendix A for a description of the error codes.</p> <p>The Communication Reminder appears when:</p> <ol style="list-style-type: none"> 1. The control unit detects a permanent error condition in the connection to the host. (Attempts to retry have ceased.) In this case, the reminder symbol is sent to all terminals attached to the control unit.
--------	------------------------	---

Symbol	Name	Explanation
		2. In BSC mode, a line error is detected which results in the original contents of the screen being restored and a request for retransmission made to the host. In this case, the reminder symbol is sent only to the affected terminal.
—	Call Ready ¹	<p>The 3274 is in X.21 Ready state.² This indicator appears when the terminal is powered on and whenever the control unit is in Ready state.² Dial operations or an incoming call are accepted.</p> <p>The ▶ DIAL, ▶ DIRECT, ▶ LOCAL, TEST, and Other² keys are accepted.</p> <p>The ▶ DISC and ▶ COMM keys are ignored.</p> <p>Keys that produce an AID signal are rejected with display of the minus function indicator (X-f).</p>
—_Nnn	Call Ready ¹ with Call Progress Signal	<p>A call has been placed but the connection has not been completed for the reason indicated by nn. (See Appendix I for nn code interpretation.)</p> <p>Keys, except ▶ DISC and ▶ COMM, are treated as for Call Ready.</p> <p>The ▶ DISC and ▶ COMM keys are accepted and clear the call progress code. The control unit returns to Ready state².</p>
—_#?	Dial-In ¹	<p>This indicator is displayed at the terminal originating the call when the ▶ DIAL key is pressed. The control unit is waiting for the operator to key in the dial digits.</p> <p>—_## is displayed at other terminals connected to the same control unit as the originating terminal.</p>

Symbol	Name	Explanation
→ —	Outgoing Call ¹ in Process	<p>At the originating terminal: The ▶ DIAL, ▶ DIRECT, ▶ LOCAL, ▶ DISC, TEST, and Other² keys are accepted; the AID keys CLEAR and ENTER are accepted (all others are rejected with minus function (X-f) displayed), and the COMM key is ignored.</p> <p>At other terminals: The ▶ DISC, TEST, and Other² keys are accepted; the ▶ DIAL, ▶ DIRECT, and ▶ LOCAL keys are rejected with the operator communication check indicator (X*-) displayed.</p> <p>The ▶ COMM key is ignored, and AID keys are rejected with the minus function indicator (X-f) displayed.</p> <p>This indicator is displayed when the operator presses the ENTER key after keying in the dial digits. If no dial digits have been entered, the ENTER key is rejected and the What Number? indicator (X*#?) and Call Ready¹ indicator (—) are displayed.</p> <p>The ▶ DISC, TEST, and Other² keys are accepted.</p> <p>The ▶ DIRECT, ▶ DIAL, and ▶ LOCAL keys are rejected with the Operator Communication check indicator (X*—) displayed.</p> <p>The ▶ COMM key is ignored, and AID keys are rejected with the minus function indicator (X-f) displayed.</p>
→ —Nnn	Outgoing Call ¹ in Process with Call Progress Signal	<p>The outgoing call is in process and connection is not being made for the reason indicated by nn. (See Appendix I for nn code interpretation.) If the connection cannot be made, the control unit returns to ready state² and the Call Ready with Call Progress Signal indicator is displayed.</p>

Symbol	Name	Explanation
		<p>The ▶ DISC, TEST, and Other² keys are accepted; the ▶ DIRECT, ▶ DIAL, and ▶ LOCAL keys are rejected with the Operator Communication Check indicator (X*~z) displayed.</p> <p>The ▶ COMM key is ignored, and AID keys are rejected with the minus function indicator (X-f) displayed.</p>
	Incoming Call ¹ in Process	<p>This indicator appears when the control unit has been addressed by the network and is processing an incoming call. When the connection is completed, the Incoming Call in Process indicator is turned off and the In-use indicator (N) is displayed.</p> <p>The ▶ DISC, TEST, and Other² keys are accepted; the ▶ DIRECT, ▶ DIAL, and ▶ LOCAL keys are rejected with the Operator Communication check indicator (X*~z) displayed; the ▶ COMM key is ignored, and the AID keys are rejected with the minus function (X-f) indicator displayed.</p>
	Disconnect in Process ¹	<p>This indicator is displayed when the ▶ DISC key is pressed or a disconnect command or timeout condition causes the connection to be broken.</p> <p>The TEST and Other² keys are accepted; the ▶ DIRECT, ▶ DIAL, and ▶ LOCAL keys are rejected with the Operator Communication check indicator displayed; the ▶ DISC and ▶ COMM keys are ignored, and the AID keys are rejected with the minus function (X-f) indicator displayed.</p>
	Local ¹	<p>This indicator is displayed when the ▶ LOCAL key is pressed. The control unit is offline to the network, in the X.21 Controlled-Not-Ready state.²</p> <p>Incoming and outgoing calls are inhibited.</p> <p>Pressing the ▶ COMM key restores the control unit to ready state.²</p>

Symbol	Name	Explanation
		The ▶ COMM, TEST, and Other keys are accepted; the ▶ LOCAL key is ignored; and the ▶ DIRECT, ▶ DIAL, and ▶ DISC keys are rejected with the Operator Communication Check indicator (X† z-) displayed.
		The AID keys are rejected with the minus function indicator (X-f) displayed.

The following notes apply to the indicators discussed in the Communication Reminder area:

Notes:

1. 3274-51C with the X.21 Switched Network Adapter feature.
2. See Appendix I for definitions of X.21 states and Other keys, and details concerning the X.21 feature.

Programmed Symbols (Locations 31 through 34)

The symbol set indicators, locations 31 through 33, show the symbol set that will be addressed for a displayable character or symbol in response to the next character entered at the keyboard. A supplementary indicator in location 34 is present if the application program allows the operator to select a PS character attribute for character positions in the current field.

S0	Base character set	The base character set is addressed for a displayable character when the operator presses a character key.
PSA through PSF	Symbol set A through symbol set F	The EBCDIC code for characters entered at the keyboard will be used to address the indicated symbol set for a displayable character.

Supplementary Indicator:

None		The operator is not allowed to select a symbol set.
†		The current character set or symbol set was selected by the operator.
▶		The current character set or symbol set is determined by the extended field attribute; either (1) operator selection is allowed, but no selection has been made, or (2) the operator has selected field inherit.

Symbol	Name	Explanation
--------	------	-------------

Shifts and Modes (Locations 32 through 41):

Note: *Display stations that support the Extended Data Stream feature use locations 36 through 44 for Shifts and Modes and the insert-mode symbol transfers to location 52.*

NUM	Numeric	The Numeric Lock feature is installed and the keyboard is in numeric shift, which allows use of the 0 through 9 keys, and the decimal sign, minus (-), and DUP keys only. (The comma replaces the decimal sign in certain World Trade languages.)
↑	Upshift	The keyboard is in upshift.
^	Insert	The keyboard is in insert mode. A character may be inserted at the cursor location. Characters beyond the cursor position move to make room for the inserted character.
APL		The keyboard is in APL mode.
TEST		The keyboard is in TEXT mode.
▶	X.21 Extension Mode Entered	<p>This indicator is displayed when the X.21 extension key is pressed to enable use of the X.21 modifier keys.</p> <p>All keyboard status indicators such as KANA, APL, TEXT, UPSHIFT, etc., are reset.</p> <p>When in extension mode:</p> <ol style="list-style-type: none"> 1. The RESET key operates normally but does not reset extension mode. 2. The ALT key is ignored. 3. If any key other than the X.21 modifier keys, the ALT key, or the RESET key is pressed, the Retry indicator is displayed and extension mode is reset. 4. Pressing the extension key will reset extension mode.

Symbol	Name	Explanation
--------	------	-------------

Extended Highlighting (Locations 46 and 47)

The Extended Highlighting indicators in locations 46 and 47 show how the next character entered at the keyboard will be highlighted on the display screen; any symbol in location 46 confirms that the operator is allowed to select an extended highlighting character attribute for character positions in the current field.

None		The operator is not allowed to select extended highlighting.
a	Normal	Normal condition. No extended highlighting in effect.
a	Reverse Video	Character highlighting by reversing the light intensity between the character and its background.
a	Blink	Character highlighting by blinking on and off at regular intervals.
a	Underscore	Character highlighting by underscore.

Supplementary Indicator

⌘		The current extended highlighting attribute was selected by the operator.
▶		The current extended highlighting is determined by the extended field attribute; either (1) operator selection is allowed, but no selection has been made, or (2) the operator has selected field inherit.

Extended Color (Locations 49 and 50)

The color indicators in locations 49 and 50 show the color that will be used to display the next character entered at the keyboard; any indication in location 49 confirms that the operator is allowed to select an extended color character attribute for character positions in the current field.

None		The operator is not allowed to select extended color.
■	Extended color	The color of the symbol is the color used to display the next character at the keyboard.
0	Default	The color is green or white by default.

Supplementary Indicator

⌘		The current extended color attribute was selected by the operator.
---	--	--

Symbol	Name	Explanation
▶		The current extended color is determined by the extended field attribute; either (1) operator selection is allowed, but no selection has been made, or (2) the operator has selected field inherit.

Printer Status (Locations 60 through 64)

□-□nn	Printer Assignment	The display station is authorized to use printer address number nn. Individual printers may be assigned address numbers 1 through 31 when attached to the 3274. Valid print classes are designated 70 through 85 for the 3274.
□-□??	What Printer	The printer IDENT has changed. Pressing the IDENT key causes display of a new printer assignment.
□-■nn	Printer Printing	The printer identified by nn is printing information from the display station.
□-□nn	Printer Failure	The printer identified by nn has stopped while printing information from the display station. This symbol will remain on until: <ol style="list-style-type: none"> 1. The condition is cleared following operator intervention. 2. The operator uses DEV CNCL following a printer-not-functional condition. 3. Receipt of outbound FM data.
□-□_ _	Assign Printer	When the operator changes the assigned printer using the IDENT key, the two numbers appear in the assignment columns replacing the underlines.
	(nothing displayed)	If a display is attached to a 3274 (☒ displayed in location 1), printing cannot take place. The operator may be able to assign a printer using the IDENT key.

Appendix C. Keys and Keyboards

Keyboard Operations

Keyboards, which may be attached to a 3270 display, enable the operator to change, edit, or create character displays except within fields defined by attribute characters as protected from keyboard operations by the program. As messages are being composed or modified by keyboard operations, the changes are inserted in the buffer and then displayed. When the operator completes an operation and presses the ENTER or an AID generating key, an I/O pending interruption occurs.

Cursor

A special symbol, called a *cursor*, is displayed on the display screen to indicate where the next character entered from the keyboard will be stored. The cursor on the 3277 displays appears as an underscore beneath a character. On 3278 and 3279 displays, the cursor may appear as an underscore, as a blinking underscore, or as a rectangular or blinking rectangular symbol imposed over a character. The character within the rectangular cursor remains visible. The operator may change the cursor from an underscore to a rectangular symbol, or vice versa, by pressing the Alternate Cursor (ALT CURSR) key. The same operator may cause either type cursor to blink by using the Cursor Blink (CURSR BLINK) key. When the cursor is displayed under one character in a line of characters, that character can be changed or deleted by keyboard action. Also, if the cursor is displayed under (or within) a position without a display character, a character can be inserted in that position by keyboard action.

One, and only one, cursor must always be in the display buffer. A cursor check occurs when the display station circuitry detects no cursor or more than one cursor in the buffer. When the display is turned on, the cursor is automatically generated and displayed in the first location on the screen. The cursor can be repositioned by the keyboard operator and also by the program. The cursor is not affected by field attributes or by the Security Keylock special feature; it is displayed even when positioned in a nondisplayed/nonprint field and when the Security Keylock special feature (if installed) is turned off.

On the 3278 and 3279, the normal cursor is an underscore and the alternative cursor is a reverse image of the character in the character position containing the cursor. Cursor blink and reverse cursor interact with the Extended Highlighting attributes. The combinations are as follows:

	Extended Highlighting Attribute		
	Reverse	Blink	Underscore
Normal cursor	Reverse character, normal cursor	Character blink, normal cursor	No underscore, normal cursor
Normal cursor with blink	Reverse character, cursor blink	Character blink, and cursor blink	Underscore alternating with normal cursor
Reverse cursor	Normal character cursor displayed as line of dots	Solid character alternating with reverse character	Reverse character with normal underscore

Keyboards

Six types of keyboards are available: typewriter, data entry, data entry keypunch layout, operator console, APL, and text keyboards. All keyboards have special symbol keys and control keys for entering data. The type of keyboard determines the characters and symbols that can be transmitted from the system for the display image.

Variations between keyboards include 66-key and 78-key versions for the 3277 and 75-key and 87-key versions for the 3278 and 3279. The 66-key/75-key keyboards provide all the basic operator keys. The 78-key/87-key keyboards provide expanded operator-to-program message flexibility with 12 additional keys that may be defined to fit the requirements of the application program. Refer to *3270 Information Display System: Character Set Reference*, GA27-2837, for key layouts and nomenclature.

Typewriter and APL 87-key and 88-key keyboards are available with extended function for the 12 program function keys on the right-hand side of the keyboard. The added functions are by operator selection of the extended attributes (Extended Highlighting, Programmed Symbol set, and Color). The 87-key and 88-key typewriter keyboard with attribute selection is also available as an overlay keyboard; the 48 character keys in the typewriter section of the keyboard have narrow keytops, and blank overlays are available for the user to mark up special characters or symbols assigned to these keys when using Programmed Symbols. Overlay keyboards are available only for displays with the PS feature.

Key Functions

Alphabetic characters on typewriter or operator console keyboards attached to 3270 displays can be entered into the display buffer in either uppercase or lowercase code, depending upon the position of the Shift key. Alphabetic characters in the buffer (uppercase or lowercase codes) are displayed as uppercase characters on 3277 displays. On 3278 and 3279 displays, they are displayed as all uppercase or uppercase and lowercase characters, as determined by the setting of the Dual Case/Mono Case switch. The shift keys on the

Katakana keyboards operate differently from the keys described here; refer to Appendix E for details.

Keyboard entry of an alphameric character into the display buffer occurs at the cursor location, provided the cursor is located in an alphameric character location within an unprotected data field. (An attempt to enter an alphameric character into a protected data field or into an attribute character location is blocked.)

On displays that support extended attributes, the character attributes for each character position are normally set to X'00' when the operator enters data into that position. If the program allows attribute-selection, the character attributes for each character position are set to X'00' if the operator has not selected a specific attribute for the input data.

Successful keyboard entry of the alphameric character causes the cursor to advance to the next character location within the unprotected data field.

Note: *The following descriptions of key functions are applicable to all keyboards, except where noted. In some cases, descriptions of key functions contain SNA protocol terms, references to local copy operations, or Operator Information Area symbols. For a detailed description of these topics, refer to "Local Copy Function" in Chapter 2, Chapter 5, "SNA/SDLC Communication," or Appendix B, "Operator Information Area." Operator Information Area symbols referred to as "Input Inhibit" symbols in this chapter are designated as "Do Not Enter" symbols in Appendix B.*

The ALT key must be held to activate functions shown on the front of keys on the 3278- and 3279-attached keyboards. These functions are SYS, REQ, CLEAR, ERASE INPUT, IDENT, TEST, DEV CNCL, PF1 PF12, PA1, PA2, ALT CURSR, and HOME. The ALT key is also used with the ►► (Right) and ◄◄ (Left) key to move the cursor two locations at a time instead of one. Using the ALT key with a key that has no associated function produces no effect.

Automatic Skip

Upon entry of a character into the last character location of an unprotected data field, the cursor is repositioned according to the attribute character describing the next field.

If the field attribute character defines the next field as (1) alphameric and either unprotected or protected, or (2) numeric and unprotected, the cursor skips the attribute character and is positioned to the first character location in that field.

If the field attribute character defines the field as numeric and protected, the cursor automatically skips that field and is positioned to the first character location of the next unprotected field.

Character-Oriented Keys

A cluster of four keys (located to the right of the main keyboard) moves the cursor one location at a time into any character location. These are ↑ (Up), ↓ (Down), → (Right), and ← (Left). A fifth key, the Backspace key,¹ occupies its

¹ The APL and Text Keyboard features applicable to 3277-2 displays modify this key function; see Appendix D.

normal position on the keyboard. It performs the same functions as the move-cursor-left key. The cursor may be moved into any character location, including unprotected and protected alphameric character and field attribute character locations, through the use of these keys. Operation of these keys does not affect the MDT bit. The ↑ (Up), ↓ (Down), → (Right), and ← (Left) keys move the cursor one location at a time. When the ALT (Alternate) key is pressed and held, the →→ (Right) and ←← (Left) key will move the cursor two locations at a time.

These keys are all capable of causing the cursor to wrap. Horizontal wrap always involves a vertical movement; the cursor repositions to the next or preceding row of characters. Vertical wrap due to operation of the Up or Down keys involves no horizontal movement; the cursor stays in the same character column.

These keys all have typamatic operation at a repeat rate of approximately 10 operations per second. (When a typamatic key is fully pressed, its function is repeated as long as the key is held pressed.)

Field-Oriented Keys

Any of four keys moves the cursor to the first position in a field on a formatted screen. All four key operations can cause the cursor to wrap from the end of the last line on the display and to continue at the beginning of the top line. Operation of these keys, described below, does not affect the MDT bit:

→ (Tab) Key — Moves the cursor to the first character location of the next unprotected data field. In a display with no unprotected fields, the cursor is repositioned to character location 0. The Tab key has typamatic capability at a repeat rate of approximately 10 operations per second.

← (Backtab) Key² — When the cursor is located in the field attribute character position or the first alphameric character location of an unprotected data field or in any character location of a protected data field, this key moves the cursor to the first alphameric character location of the first preceding unprotected data field.² When the cursor is located in any alphameric character location of an unprotected data field other than the first location, this key moves the cursor to the first alphameric character location of that field. In a display with no unprotected fields, the cursor is repositioned to character location 0. The Backtab key on keyboards attached only to 3278 and 3279 units has typamatic capability.

↵ (New Line) Key² — Moves the cursor to the first unprotected character location of the next line. If the display has no unprotected data fields, the cursor is repositioned to character location 0. If the display contains no fields, the cursor is repositioned to the first character position of the next line. The New Line key has typamatic capability at a rate of approximately 10 operations per second.

⏠ (Home) Key — Moves the cursor to the first unprotected character position on a 3278 or 3279 display screen.

² The APL and Text Keyboard features applicable to 3277-2 displays modify this key function; see Appendix D.

ERASE EOF (Erase to End of Field) Key

If the cursor is located in an alphameric character location in an unprotected data field, this key clears the character location occupied by the cursor and all remaining character locations to the right in that field to nulls. The character attributes for all the erased characters are set to X'00'. The operation can wrap from the end of the last line on the display to the end of the field. The cursor does not move as a result of operating this key, and the MDT bit is set to 1.

Operation of this key when the cursor is located in an attribute character location or is within a protected data field causes an input-inhibit condition and disables the keyboard; no character locations are cleared, the cursor is not moved, and the MDT bit is not set.

ERASE INPUT Key

This key clears all unprotected character locations to nulls, resets the MDT bit to 0 in unprotected fields, and repositions the cursor to the first unprotected character location on the screen. The character attributes for all the erased characters are set to X'00'.

On 3278 and 3279 displays, the Alternate (ALT) key must be pressed and held first.

In a buffer with only protected data fields, no character locations are cleared and the cursor is repositioned to character location 0.

If the display contains no field, the entire buffer is cleared to nulls and the cursor is repositioned to location 0.

INS (Insert) MODE Key (3277) , (Insert Mode) Key (3278 or 3279)

The INS MODE key on 3277-attached keyboards and the Insert Mode key on 3278- or 3279-attached keyboards place the keyboard in an insert mode of operation. INSERT MODE is indicated on 3277 displays, and the Insert symbol is displayed in the Operator Information Area on the 3278 or 3279 display screen.

If the cursor is located in an unprotected data field having a null character either in the character location identified by the cursor or in any character location in the field beyond the cursor, operation of an alphameric key causes that alphameric character to be entered at the cursor and the MDT bit to be set to 1. The character formerly occupying the cursor location and all remaining characters within the field (except for null characters or characters to the right of null characters) will be shifted one character location to the right. If the location identified by the cursor location at the time of the insert operation is a null, no character shifting occurs.

After all null characters at or beyond the cursor location in the field have been overwritten, or if there were no null characters, operation of an alphameric key causes the keyboard to become disabled. Field-attribute characters and extended field attributes are not shifted as part of the insert operation. On displays that support extended attributes, the character attributes are shifted with the characters. The character attributes for inserted characters are set to

X'00', except where the application program allows attribute-selection and the operator has selected specific attributes.

If more than one row of characters is contained within the field, a character occupying the last character location in the row is shifted into the first character location of the next row.

Operation of an alphanumeric key while in insert mode when the cursor is located in a field-attribute character location or is within a protected data field disables the keyboard; no character locations are cleared, the cursor is not moved, and the MDT bit is not set.

Operation of the RESET key on 3277 displays returns the keyboard to normal mode.

On 3278 and 3279 displays, operation of the RESET key, ENTER key, or any other key that causes host communication returns the keyboard to normal mode. Operation of the selector light pen or the CURSR SEL (Cursor Select) key also returns the keyboard to normal mode.

DEL (Delete) Key (3277), Delete Key (3278 or 3279)

If the cursor is located in an alphanumeric character location in an unprotected field, operation of the DEL key (3277) or Delete key (3278 or 3279) deletes the character from the character location identified by the cursor and sets the MDT bit to 1 (if not previously set). The cursor does not move. All remaining characters in the unprotected field, to the right of the cursor and on the same row, shift one character location to the left. If the display supports extended attributes, the character attributes for the deleted character are deleted and the other character attributes are shifted left; the character attributes of vacated character positions are set to X'00'. Vacated character locations at the end of the row are filled with nulls. If the unprotected field encompasses more than one row, characters in rows other than the row identified by the cursor are not affected.

Operation of this key when the cursor is located in a field-attribute character location or is within a protected data field disables the keyboard; no character locations are cleared, the cursor is not moved, and the MDT bit is not set.

RESET Key

The RESET key is used to recover from an inhibited keyboard operation that has resulted in a disabled keyboard. When a keyboard is disabled, no other keyboard operations are honored. The RESET key will not reset a disabled keyboard when a command is being executed for the device to which the keyboard is attached, or when a parity error or cursor check is detected in the device buffer.

On 3278 and 3279 displays, when a keyboard is disabled, symbols are displayed on the bottom row of the screen. Pressing RESET restores the keyboard or other input devices, except for Printer Busy, Printer Very Busy, Printer Not Working, Time, or Security Key input-inhibited conditions. Pressing RESET once resets multiple input-inhibited conditions.

When operating in BSC after an AID generating key is pressed, the RESET key will be ignored during the period from poll to the end of a transmission to the host. Prior to the poll, a RESET action will cancel both the AID code and I/O pending. After transmission to the host is ended, RESET will reset the AID code.

RESET causes print ID mode to terminate. The cursor then reappears, and the old printer ID is displayed in the indicator row.

DUP (Duplicate) Key

Operation of this key causes a unique character code to be entered into the display buffer, a Tab key operation to be performed, and the MDT bit to be set to 1. The DUP key is provided on all keyboard types except operator console. The DUP character provides a means of informing the application program that a “duplicate” operation is indicated for the rest of the field in which it is located. The DUP character is transferred as a DUP code when the data is read from the display to the program. No duplicate operation is performed at the 3270. The DUP character, when stored in a device buffer, is displayed as an asterisk(*) on 3277 displays and on 3278 and 3279 displays using mono-case mode, and is printed as an asterisk (*) on a printer. On 3278 and 3279 displays using dual-case mode, DUP is displayed as an asterisk with an overscore ($\overline{*}$).

Pressing the DUP key does not affect the current status of extended attributes and PS selection has no effect on a DUP character.

Operation of this key when the cursor is located in field-attribute character location or is within a protected data field disables the keyboard; no character locations are cleared, the cursor is not moved, and the MDT bit is not set.

FM (Field Mark) Key

Operation of this key causes a unique character code to be entered into the display buffer and the MDT bit to be set to 1. The field mark character provides a means of informing the application program of the end of a field in an unformatted buffer or a subfield in a formatted buffer. The field mark character is transferred as an FM code when the data is read from the display to the program. The field mark character, when stored in a device buffer, is displayed as a semicolon (;) on 3277 displays and on 3278 and 3279 displays using mono-case mode, and is printed as an asterisk (*) on a printer. On 3278 and 3279 displays using dual-case mode, FM is displayed as a semicolon with an overscore ($\overline{;}$). The Field Mark key is not provided on operator console type keyboards.

Pressing the FM key does not affect the current status of extended attributes, and the PS selection has no effect on an FM character.

Operating this key when the cursor is located in a field-attribute character location or within a protected data field disables the keyboard; no character locations are cleared, the cursor is not moved, and the MDT bit is not set.

Program Attention Keys

These keys solicit program action by causing an I/O pending to occur at the display terminal. The program is notified of the interruption by an Attention status indication in locally attached systems and by responding to a poll in remotely attached systems. An Attention Identification (AID) character is generated at the time of the interruption to identify which key caused the interruption, but the MDT bit is not affected.

The program attention keys for 3277 displays are CLEAR, ENTER, CNCL (cancel), TEST REQ, all Program Function (PF) keys, and the Program Access (PA) keys. Operation of the CLEAR key also causes the entire display buffer to be cleared to nulls, positions the cursor to character location 0, and causes all MDT bits to be reset. Operation of any program attention key disables the keyboard, lights the INPUT INHIBITED indicator, and extinguishes the SYSTEM AVAILABLE indicator.

The program attention keys for the 3278 and 3279 displays are CLEAR, ENTER, the Program Function (PF) keys, and the Program Access (PA) keys. The use of a PA or PF key during a System Services Control Point (SSCP) session results in an input-inhibited condition. Refer to "Keyboard Disabled (INPUT INHIBITED Indicator Is On)," later in this appendix. On 3278 and 3279 displays, the operation of the CLEAR key also clears the display screen of all data to nulls (except the indicator row), sets all extended attributes to X'00', and positions the cursor at location 0,0 on the display.

It does not change shift status except that it will remove the NUM symbol, if displayed. It does not perform a reset function. If an alternate screen size has been selected, the CLEAR key will reset the screen to the default size. When SNA/SDLC is used, the action of the CLEAR key depends upon the type of session. In 3270 BSC, the CLEAR key AID code is sent to the host. When SNA/SDLC is used, the CLEAR key AID code is sent to the host when CLEAR is pressed while in the LU-LU session. While in test mode, the CLEAR key does not cause an AID to be sent to the host.

Note: *Not all program attention keys are available on each type of 3270 keyboard.*

TEST REQ Key. The TEST REQ key on 3275 and 3277 keyboards is used to perform the Test Request function (if installed).

SYS (System) REQ Key. When the 3274 operates in remote SNA/SDLC, the operator can use the SYS REQ key for SSCP-SLU and PLU-SLU session switch procedures. SYS REQ also simultaneously initiates keyboard reset and clear functions. SYS REQ performs these functions despite the presence of input-inhibited conditions except (1) when inbound processing is queued for the display station, in which case the Input Inhibited What symbol appears, and (2) when Printer Busy, Printer Very Busy, or Printer Not Working is displayed, which results in no response when SYS REQ is pressed. (Inbound processing queue is the time from when an AID generating key is pressed until regeneration to the line buffer transfer has been completed.)

When a 3277 is attached to a 3274 which is operating with SNA protocol, the SYS REQ key function is obtained by using the two-key sequence TEST REQ key followed by the CLEAR key.

In BSC and 3274-1B or -1D local operation, the SYS REQ key performs the test-request function. The automatic reset function is not available. Refer to “Test Request Read” under “Read Modified Command” in Chapter 1.

The ALT key must be pressed and held while the SYS REQ is pressed.

DEV CNCL (Device Cancel) Key. The operator may use DEV CNCL to cancel a current outstanding print request to a 3262, 3287 or 3289 if input is inhibited because of a Printer Busy or Printer Very Busy condition. A request initiated by the Print key is dequeued, and the keyboard is restored. A host print request is dequeued, and a negative response is sent to the host. The Printer Busy symbol is replaced by the Time symbol.

DEV CNCL is also used to remove Device Not Functional conditions (printer failure, printer not working). Any coexisting malfunction-while-printing symbol is also removed.

Following use of the Print key, the keyboard is restored. After a host-initiated print, the Printer Not Working symbol is replaced by the Time symbol.

During other input-inhibited conditions, DEV CNCL causes no response, except that it is queued or detected (with subsequent indication) during certain Time conditions in other situations. Use of DEV CNCL in other situations results in no indication.

The ALT key must be pressed and held while the DEV CNCL key is pressed to cancel a request and restore the keyboard.

Use of DEV CNCL during a print ID operation at the 3274 causes the operation to terminate. The cursor reappears, and the previous printed ID is displayed in the Operator Information Area near the bottom of the screen.

SHIFT Key 3277, 3278, or 3279



Shift keys perform the upshift function. When the typewriter keyboard becomes ready initially, only characters located on the bottom position of the keytops can be entered from the keyboard. By pressing and holding the Shift key, characters shown on the top position of the keytops can be entered. On 3278 and 3279 displays, the shift “up” state is indicated to the operator in the Operator Information Area on the display screen. Pressing the Shift key will reset the Lock key.

LOCK Key 3277, 3278, or 3279



The Lock key fixes upshift character selection. The Lock key is deactivated by pressing the Shift key. When the Shift key on a 3278 and 3279 typewriter keyboard is used, the shift state is indicated to the operator in the Operator Information Area on the display screen.

NUM Key 3277, 3278, or 3279



The Numeric (NUM) key on the 3277 data entry and data entry keypunch layout keyboards and the Numeric key on the equivalent 3278 and 3279 keyboards are used to perform the upshift function, equivalent to the Shift keys on the typewriter keyboards. The “up” shift state is indicated to the operator in the Operator Information Area on the display screen.

NUM LOCK Key 3277, 3278, or 3279



The Numeric Lock (NUM LOCK) key on the data entry and data entry keypunch layout keyboards used with the 3277 displays and the Numeric Lock key on the data entry and data entry keypunch layout keyboards used with 3278 and 3279 displays fix the upshifted character selection, but will not disable the Numeric Lock feature.

ALPHA Key 3277, 3278, or 3279



When the data entry or data entry keypunch layout keyboards have been programmed for nonalpha shift, characters shown on the bottom of the keytops can be selected by holding the ALPHA key (3277 display keyboards) or the Alpha key (3278 and 3279 display keyboards) and entering the desired characters. When power is applied, the keyboard is in lowercase alpha mode.

CURSR SEL (Cursor Select) Key

The CURSR SEL key on 3278 and 3279 keyboards allows the selector-light-pen-detection function to be performed from the keyboard. The CURSR SEL key may be used on any field defined as a selector-light-pen-detectable field (as described under “Selector-Light-Pen Operations”). However, a cursor-select field does not require the space or null character padding constraints associated with the selector-light-pen-detectable field, and cursor-select can occur within the field on a line different from that of the attribute that describes the field.

Cursor-select operations may be immediate or deferred (as defined for selector-light-pen fields).

The field used for cursor-select operation may also be defined in the following format:

- Basic attribute character as defined for selector light pen.
- Designator character as defined for selector light pen.
- Data character(s) Optional.
- Basic attribute character Next field.

This format is not applicable when using the selector light pen. When defining a cursor-select field, the attribute character may not be located in the last line of the display with the designator character in the first line.

ATTN (Attention) Key

The ATTN key on the 3278 and 3279 keyboards is operable in SNA/SDLC in an SNA LU-LU session, with the following exceptions:

1. When inbound processing is queued for the display.
2. When in Shutdown condition.
3. When in Data Traffic Reset state.
4. When a second or successive ATTN which occurs prior to completion of processing for the first ATTN is ignored (with no indication).

When a 3277 is attached to a 3274 which is operating with SNA protocol, the ATTN key function is obtained by using the two key sequences, TEST REQ key followed by the PA1 key.

Use of ATTN in any session except LU-LU causes an Input Inhibit Minus Function.

The ATTN key is inoperative in BSC and will cause an Input Inhibit Minus Function when pressed.

When operating with a 3274 in SNA/SDLC, use of ATTN during a print ID operation causes the print ID operation to terminate; the cursor reappears, and the previous printer ID is displayed in the Operator Information Area.

CURSR (Cursor) BLINK Key

Pressing the CURSR BLINK key causes the cursor (either the bar or the rectangular cursor) to blink. Activating the key again causes the blinking to stop. This key function is available on keyboards attached to the 3278 or 3279.

ALT CURSR (Alternate Cursor) Key

Pressing the ALT CURSR key while holding the ALT key changes the cursor display. The underlined type of cursor is changed to a rectangular cursor. Conversely, the rectangular cursor is changed to the underlined type cursor by activating the ALT CURSR key. This key function is available on keyboards attached to the 3278 or 3279.

TEST Key

The TEST key on the 3278 or 3279 keyboard is used to invoke test functions resident in the 3274. Pressing the TEST key (while holding ALT key) clears and resets the display screen, and the test mode indication turns on, despite any input-inhibited conditions, with the following exceptions: if Printer Busy, Printer Very Busy, or Printer Not Working is displayed, or if the security key is locked, use of TEST results in no response. The control unit places the device to be tested in test mode, and the operator identifies the test function desired. The operator terminates test mode by pressing the TEST key again.

When the 3274 uses SNA/SDLC, the control unit enters test ownership state.

When the 3274 operates in remote BSC mode, Intervention Required is generated if a command is received for the display when in test mode. The 3274-1B and -1D, in this case, generate Control Check and Intervention Required. When test mode terminates normally, status with Device End is generated.

The test function, described for 3278 and 3279 displays, does not apply to 3277 displays attached to the 3274.

Click Key

A clicking sound may be produced as keys are pressed on keyboards attached to 3278 and 3279 displays. The clicking sound is controlled by operating conditions such as input inhibit. For example, if the clicking sound is enabled and an input-inhibited condition occurs, the key click is then disabled, and vice versa. By pressing the Click key, the operator can activate the clicking sound if it has been turned off or can prevent clicking if it has been activated.

Print Key

The Print key is used to initiate a local copy function from a keyboard attached to a 3278 or 3279 display.

IDENT Key

The IDENT key is used to assign a printer or printer class, while performing a local copy function. (The ALT key must be simultaneously pressed to activate the IDENT key.) When the IDENT key is pressed, the cursor disappears from the screen, and the Printer Assignment symbol appears with two underlined characters in the "nn" position. The operator may then enter the ID in the "nn" position. (Display stations with one of the PS features always select the base character set for the printer ID; if a symbol set is active when the IDENT key is pressed, it is suppressed and then made active again at the end of the printer ID sequence.)

If the specified printer is not authorized (that is, the matrix does not permit the display to copy to the selected device or class of devices), the keyboard is locked and the Input Inhibited Operator Unauthorized symbol is displayed. If the print ID is not in the matrix, the keyboard is locked and the Input Inhibited What Number symbol is displayed. The contents of the printer status field are displayed for the input-inhibited condition, the cursor appears, and the keyboard is locked. The operator must reset and then retry the print ID sequence.

If the selected print class or printer is valid and authorized for this display, the connection indicator will change to indicate the new connection, and print ID mode is terminated. The cursor reappears, and the keyboard remains unlocked.

When in print ID mode, the following rules apply:

1. Numeric information is displayed at the "nn" position in the indicator row. Each character is then checked for validity.
2. The RESET key and other keys or functions that cause a reset operate normally and cause print ID mode to be terminated. The cursor reappears, and the contents of the printer status field are displayed.

3. The ATTN and DEV CNCL keys, the security key, and unsolicited host read and write operations cause the print ID mode to terminate. The cursor reappears, and the contents of the printer status field are displayed in the indicator row.
4. Other keys that function during a keyboard inhibit condition also function while in print ID mode without causing termination.
5. All other keys that are not honored during keyboard inhibit conditions cause the Input Inhibit What symbol to be displayed and terminate print ID mode. In this case, the cursor reappears and the contents of the printer status field are displayed in the indicator row.

Dead Keys, Canadian-French Keyboards

When pressed, the accent keys which show individual accents on the Canadian-French keyboards appear on the display, but the cursor does not move. These accent keys are referred to as “dead keys.” A subsequent character which receives the accent must be keyed next. If the subsequent character is valid, a unique composite character is formed. Refer to the *IBM 3270 Character Set Reference* manual, GA27-2837, for keyboard layouts, I/O codes, and identification of valid accent characters.

Pressing an accent key places the keyboard in dead-key mode, until a valid second key is pressed. When the second character of a dead-key sequence is invalid, only the Shift, DEV CNCL, ALT, Click, ALT CURSR keys, and the Dual Case/Mono Case switch and security key are operational. Use of ATTN in this case causes the Input Inhibited Minus symbol to appear. Use of any other key terminates the operation and causes an Input Inhibited Accent Plus What symbol to appear on the screen.

The selector light pen and the magnetic slot reader (MSR) do not function while in a dead-key sequence. If used, they cause the dead-key sequence to be aborted, and the keyboard is inhibited, with the What symbol displayed.

All other nonkeyboard-related functions that occur during a dead-key sequence are performed normally. If performance of the function causes the dead-key sequence to be aborted, the keyboard is inhibited and the What symbol is displayed after the function has been performed.

In all of these conditions, the dead-key sequence is aborted, and only an accent is displayed at the cursor position. The operator must reset and rekey both the accent and the valid character.

Dead-Key Operations with Programmed Symbols

Dead-key operations when the keyboard is selecting code points in a Programmed Symbol set in loadable storage do not cause a composite character to be displayed. Instead, the character at a third code point is selected. The following chart specifies the resulting code point selected when the indicated combinations are keyed:

First Key	Second Key												
	81 a	C1 A	85 e	C5 E	89 i	C9 I	96 o	D6 O	A4 u	E4 U	83 c	C3 C	40 Other Space Key
Circumflex X'5F'	42	62	52	72	56	76	CB	EB	DB	FB			5F
Grave accent X'79'	A4	64	DO	74					6A	FD			79
Trema X'A1'			53	73	57	77			DC	FC			A1
Acute accent X'5A'			CO	71									5A
Cedilla X'EO'											48	68	EO

All code points are given in EBCDIC, and the hyphen (-) indicates that an input-inhibit-invalid dead-key combination indicator will be displayed if the combination indicated is keyed.

Code points shown are transmitted to the host as part of an inbound transmission.

Attribute-Select Keys

Displays that support the 3270 Structured Field and Attribute Processing option also support the attribute-select keyboards (overlay keyboards include the attribute-select function). The 12 program-function keys at the right of the keyboard, in conjunction with the shift and ALT keys, are used to select extended character attributes that are to be assigned to each character entered from the keyboard. These keys are shown in Figure C-1, and their action explained following the figure.

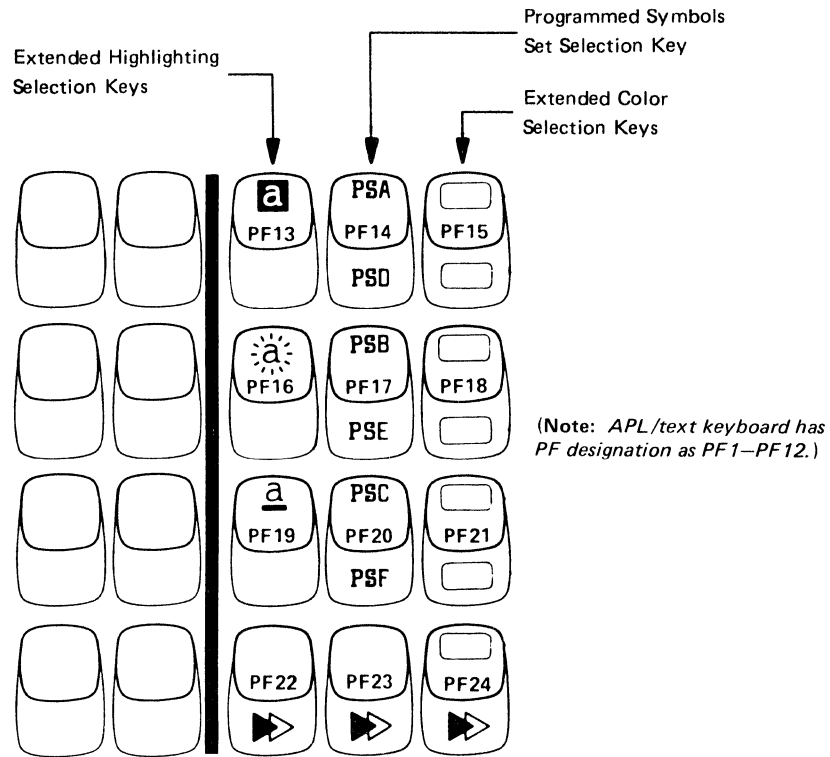
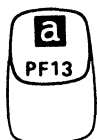

Figure C-1. Attribute Select Keys

Operator selection of extended attributes is restricted to character attributes; extended field attributes are protected against operator input. Character attributes of X'00' are assigned to characters entered, except when the program allows the operator to select attributes and the operator has made a selection. Where a selection has been made, the same attribute assignment is made for each character entered from the keyboard until the operator makes another selection for that attribute-type or until the Set Reply Mode is changed to disable selection. The types of attribute that the operator is allowed to select must be explicitly defined by the application program in the Set Reply Mode function of a Write Structured Field command; if the operator is to select symbol sets, then the Load Programmed Symbols function must also define the set as operator-selectable. When attribute selection is allowed, the Operator Information Area shows which extended attribute is valid for selection and the current status of that attribute. A "field inherit" key (▶) is provided for each type of extended attribute; the operator uses this key to cancel a selected attribute and to cause default to the extended field attribute.

When data is entered from the keyboard, the character attributes related to the location of the data entered into the buffer are updated. If attribute selection is allowed and the operator has selected specific attributes, the code of each selected attribute is loaded into the character attributes. For each type of extended attribute, if selection is not allowed and canceled, the character attribute is set to X'00'.

Extended Highlighting



With uppercase shift, this key selects reverse video as the Extended Highlighting character attribute.



With uppercase shift, this key selects character blink as the Extended Highlighting character attribute.



With uppercase shift, this key selects character underscore as the Extended Highlighting character attribute.



With ALT shift, this key sets "field inherit" as the Extended Highlighting attribute.

Symbol Set

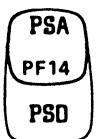

PSA through PSF, with the required shift (uppercase or alternate, depending upon the position of the legend on the key), select the symbol-set character attribute.

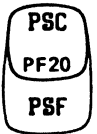
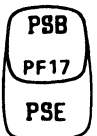

With ALT shift, this key sets "field inherit" as the symbol-set attribute.

Extended Color

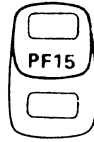

The color codes, with the required shift (uppercase or alternate, depending upon the position of the code on the key), select the extended-color character attribute.

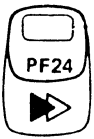
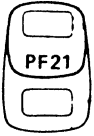

With ALT shift, this key sets "field inherit" as the extended-color character attribute.

Numeric Lock Feature Operation

When the Numeric Lock feature is installed, the characters (0—9), decimal sign, minus sign (-), and DUP may be entered by the operator in a field identified in the field-attribute byte as numeric and unprotected. MSR/MHS input is also accepted. Operating any other key that can enter a displayable character causes an input-inhibited condition. In addition, the NUM symbol lights on the 3278 and 3279 displays. Operating the RESET key enables the keyboard (if disabled), and the INPUT INHIBITED light (3277) or NUM symbol (3278, 3279) goes out. The nondisplay/nonprint attribute bits 4 and 5 and MDT bit 7 operate normally.

The Numeric Lock feature can be overridden as follows:

1. On a data entry keyboard, any character can be entered by pressing (and holding) the Numeric Shift key or the Alpha Key, depending upon the character to be keyed, and then pressing the desired key(s).
2. On a typewriter keyboard, any uppercase character or symbol can be entered by pressing (and holding) the Shift key and then pressing the desired key(s).
3. On an APL or a text keyboard, any non-APL or non-Text uppercase character or symbol can be entered by pressing (and holding) the Shift key and then pressing the desired key(s); also, any APL or Text uppercase or ALT-Shift character can be entered by placing the keyboard in APL mode or Text mode (pressing APL ON/OFF with ALT or TEXT ON/OFF with ALT), pressing (and holding) the Shift key or the ALT key (depending upon the character to be keyed), and then pressing the desired key(s).

Note: *If any devices with attribute-select or overlay keyboards are attached to a control unit, numeric lock for those keyboards is set by an option taken during customizing. The option taken applies to all devices with attribute-select and overlay keyboards; if numeric lock is set off, all these devices have numeric lock off.*

On a 3277 typewriter or operator console keyboard, the characters that can be entered in the field identified in the attribute byte as numeric and unprotected are (0—9), decimal sign, and minus sign (-); in addition, on 3277 typewriter keyboards, when the SHIFT or the LOCK key is operated, the DUP character may be entered by the operator.

Keyboard Disabled (INPUT INHIBITED Indicator Is On)

When INPUT INHIBITED is on (3277 displays), the keyboard and other input devices are disabled. In cases caused by operator key action, the input-inhibited condition can be cleared by using the RESET key unless one of the following conditions coexists:

1. A command is being executed for a device to which the keyboard is attached.
2. A magnetic card read operation is in progress. (OICR operation.)
3. A parity error or cursor check is detected in a terminal buffer. (The INPUT INHIBITED indicator will be off as long as the RESET key is pressed, but will turn on when the RESET key is released.)
4. The security keylock is in the off position. (This condition is cleared by turning on the security keylock.)

The following conditions can be cleared by using the RESET key on all keyboards (attached to 3277, 3278, and 3279 displays):

1. A Program Attention key operation prior to initiation of a command for a device with an attached keyboard.
2. A selector-light-pen attention operation prior to initiation of a command for a device with an attached keyboard.
3. An input-inhibited condition the operator initiated by pressing an alphameric key not included in the numeric key grouping when the Numeric Lock special feature is installed.
4. An attempt by the operator to change the data displayed in a protected display field. (The CLEAR key can also be used in this case, which places nulls in all buffer positions and turns on the INPUT INHIBITED indicator. INPUT INHIBITED can then be turned off by pressing the RESET key prior to initiation of a command for a device with an attached keyboard.)

INPUT INHIBITED is turned on by:

1. Operation of a Program Attention key.
2. A selector-light-pen attention that caused an I/O interruption or that resulted in an operator error.

3. A magnetic slot reader (MSR) or magnetic hand scanner (MHS) operation that caused an I/O interruption. (3278, 3279 only.)
4. Turning the security key to the off position when the Security Keylock feature is installed, when power is applied initially.
5. A system-initiated I/O operation addressed to that unit.
6. Operation of any alphameric key or of the DUP, FIELD MARK, ERASE EOF, or DEL key, when the cursor is in a protected field.
7. Operation of any alphameric key not included in the numeric key grouping when the cursor is in a numeric field, without simultaneously operating either the Alpha or Numeric shift key on a data entry keyboard or the Shift key on a typewrite keyboard, when the Numeric Lock feature is installed on a keyboard.
8. Copying of data in the refresh buffer to another terminal.
9. The occurrence of a Machine Check, Program Check, or Communications Check.
10. The terminal's being in receive state under SNA protocol.

INPUT INHIBITED is turned off by:

1. On 3277 displays: receipt and execution of a WCC with the Keyboard Restore bit on. On 3278 and 3279 displays: receipt and execution of a WCC with the Keyboard Restore bit on when the System Lock or Time symbol is displayed.
2. On 3277 displays: receipt and execution of an Erase All Unprotected command. On 3278 and 3279 display: receipt and execution of an Erase All Unprotected command when the System Lock or Time symbol is displayed.
3. Turning of the security key to the on position (if the INPUT INHIBITED indicator was turned on because the security key was in the off position).
4. Operation of the RESET (except as noted under "Reset Key"), TEST, or SYS REQ keys in BSC or 3274-1B or -1D local operation.
5. Depression of the DEV CNCL key after receipt of a Printer Not Working symbol.
6. Termination of a Time condition.

An I/O operation that leaves the 3274 in a send state but does not unlock the keyboard can be cleared by using the RESET key on the 3278- or 3279-attached keyboards. When INPUT INHIBITED is on, on a 3278 or 3279 display, manual input to the unit from the keyboard or selector light pen is inhibited, except for use of the Shift, ALT CURSR, CURSR BLINK, and Click keys.

INPUT INHIBITED is cleared by a reset action from the control unit or the operator. During an unsolicited write operation or during a buffer transfer when the 3274 is executing a Copy command in BSC, keystrokes are accepted for processing. The 3274 will queue up to four keystrokes and, if the queue capacity is not exceeded, will process the input after the host restores the keyboard.

If the queue capacity is exceeded, all queued keystrokes are discarded, and the What symbol is displayed. The What symbol is also indicated if input is attempted during Time symbol conditions or during Printer Busy or Printer Not Working input-inhibited conditions.

If the input-inhibited condition is caused by a Machine Check, only an operator reset action can reset the device (if it can be reset). Only an operator reset action will reset a device that shows a Communication or Program Check condition. The Communications Check inhibit symbol does not reappear unless it is reencountered by pressing a host communication key on the display keyboard.

Appendix D. APL/Text Feature

The APL and text processing capabilities of the IBM 3270 Information Display System are available on the devices shown in Figure D-1 when attached to an appropriately customized 3274 A, C, D, or 51C unit. These devices must be equipped with the appropriate APL/text and Extended Character Set Adapter or Text Print features.

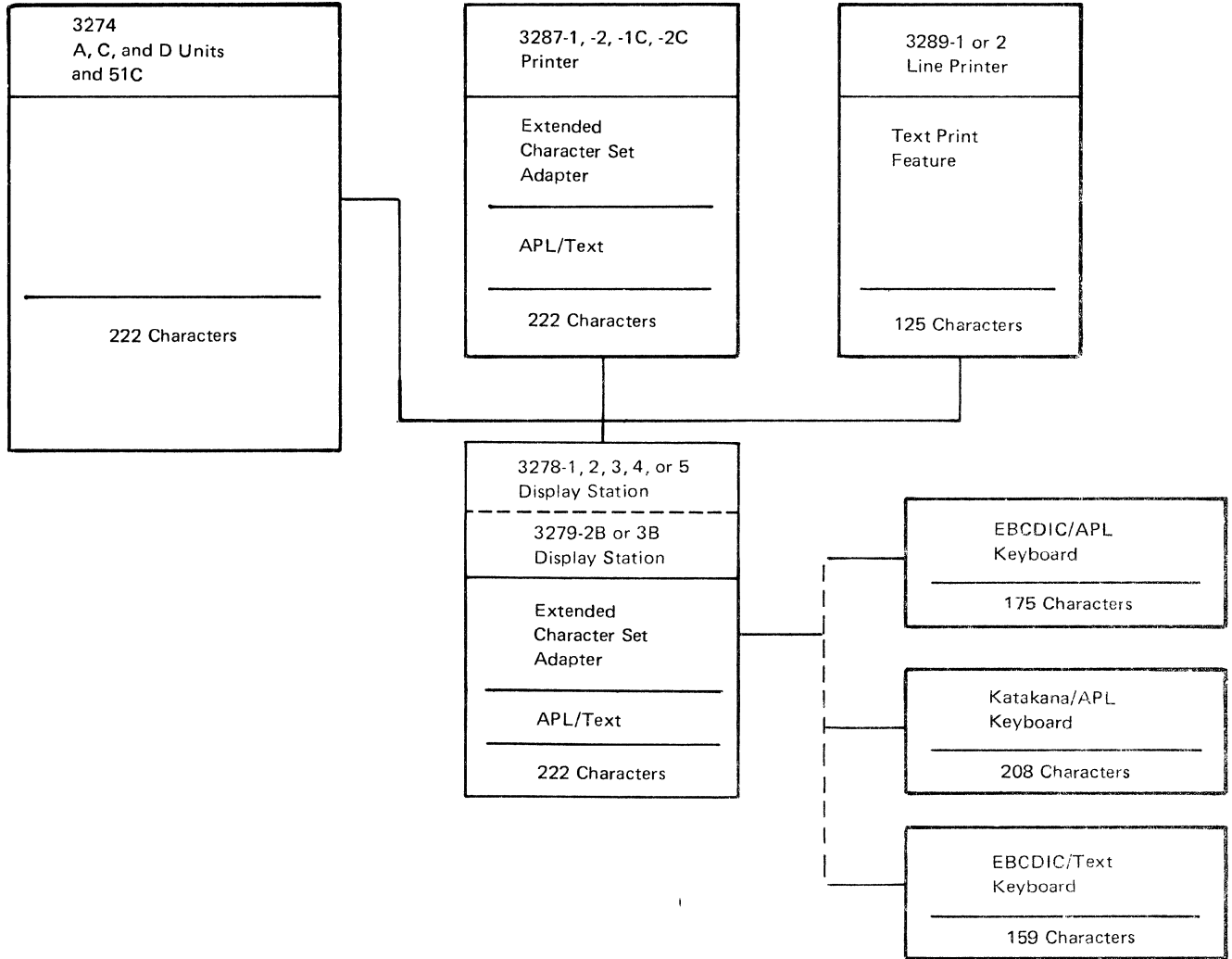

Figure D-1. Diagram of APL/Text Devices

APL/Text and Test Print Data Streams

The I/O interface codes used by the APL/text customized 3274, the 3278 and 3287 with APL/text and Extended Character Set Adapter features, and the 3279 Models 2B and 3B are shown in Figures D-2 and D-3; codes used with Katakana/APL and Extended Character Set Adapter features are shown in Figures D-5 and D-6. Figure D-4 shows National Use differences for the I/O interface code. The I/O interface codes used by the 3289 text print customized 3274 and the 3289 with the Text Print feature are shown in Figure D-7. The 3278/3279/3287 APL/text and the 3289 text print I/O interface codes do not affect the operation of any 3274 data stream commands, orders, or control characters. All 3278/3279/3287 APL-specific characters are specified by 2-byte sequences; each 2-byte sequence consists of a Graphic Escape (hex '08') control character followed by a character code.

The 3274 APL/text data streams:

- Contain 94 EBCDIC characters (plus space).
- Specify all APL- and text-specific characters by using a 2-byte sequence consisting of a hex 08 control character followed by a character code.
- Contain 10 graphic plot characters.

The 3274 text print data streams:

- Contain 93 U.S. English set characters (plus space).
- Use different interchange codes to specify some text-specific characters.

3274 APL/Text and Text Print Customizing Options

The 3274 APL/text customizing option for the 3278, 3279, and 3287 APL/Text and Extended Character Set Adapter features and the 3289 text print customizing option for the 3289 Text Print feature are accomplished with extensions of the configuration code on the 3274 system diskette. The APL/text and 3289 text print configuration code is selectable as part of the 3274 customizing process, provided the 3274 control storage size is adequate.

The 3274 APL/text and 3289 text print customizing options require that EBCDIC be specified when customizing the 3274, and cannot be specified for the 3274 B units (the 3274 D units must be used for local non-SNA attachment).

3278-1, -2, -3, -4 and -5 or 3279-2B and -3B APL/Text

The APL/Text special feature, the Extended Character Set Adapter special feature (prerequisite for the APL/Text feature), and the appropriate APL or text keyboard enable a 3278 or 3279 operator to interact with either APL or text applications as well as existing applications.

Hex 1 ↓ Bits 4567		00				01				10				11				Bits 0,1			
		00	01	10	11	00	01	10	11	00	01	10	11	00	01	10	11	←2,3			
		0	1	2	3	4	5	6	7	8	9	A	B	C	D	E	F	←Hex 0			
0000	0					SP	&	-										12	13	14	0
0001	1							/	É	a	j	11					A	J			1
0010	2					^a	^e	^A	^E	b	k	s					B	K	Ş		2
0011	3					ë			Ë	c	l	t					C	L	T		3
0100	4							À	È	d	m	u					D	M	U		4
0101	5									e	n	v					E	N	V		5
0110	6					^i		^I		f	o	w					F	O	W		6
0111	7					ï		Ï		g	p	x					G	P	X		7
1000	8					ç		Ç		h	q	y					H	Q	Y		8
1001	9								7	i	r	z					I	R	Z		9
1010	A					1	3	6	:												
1011	B					.	4	.	8								^o	^u	^O	^U	
1100	C					<	*	%	9									ü		Ü	
1101	D					()	-	'												ù
1110	E					+	;	>	=												
1111	F					2	5	?	10												

Notes:

1 through 14 are the National use differences. They are shown in Figure D-4.

☐ = Canadian French characters.

- No control characters are shown in this chart.
- All codes can be entered from the keyboard.
- Character code assignments other than those shown within all outlined areas of this chart are undefined. If an undefined character code is programmed, the character that will be displayed or printed is a hyphen (hex 60); also, a hex 60 will be returned on a subsequent read operation. (For control units with Configuration Support C installed, undefined control codes (X'00' to X'3F') cause a negative response (SNA) or an Op Chk (BSC). The character displayed or printed for an undefined character code is unpredictable.) The character displayed or printed for a given undefined character code may be different for other devices. IBM reserves the right to change at any time the character displayed or printed for any undefined character code.
- NL (hex 15), EM (hex 19), FF (hex 0C), and NUL (hex 00) are not displayed or printed. The DUP (hex 1C) and FM (hex 1E) control characters on dual case terminals are displayed as * and ; respectively, and are printed as * and ;.
- DUP (hex 1C) and FM (hex 1E) control characters on mono case terminals are displayed as * and ; respectively, and are printed as * and ;.

Figure D-2. APL/Text Feature, 1-Byte I/O Interface Codes (3274/3278/3279/3287)

		00				01				10				11				Bits 0,1
		00	01	10	11	00	01	10	11	00	01	10	11	00	01	10	11	Bits 2,3
		0	1	2	3	4	5	6	7	8	9	A	B	C	D	E	F	Hex 0
0000	0									~	□	-	α	{	}		⊙	
0001	1					<u>A</u>	<u>J</u>		Λ			°	ε	()	1	1	
0010	2					<u>B</u>	<u>K</u>	<u>S</u>	..	—	—	—	ι	+	-	2	2	
0011	3					<u>C</u>	<u>L</u>	<u>T</u>			—	•	ρ	■	+	3	3	
0100	4					<u>D</u>	<u>M</u>	<u>U</u>			—	n	ω	L	J		4	
0101	5					<u>E</u>	<u>N</u>	<u>V</u>			—			Γ	Γ		5	
0110	6					<u>F</u>	<u>O</u>	<u>W</u>					x	⊥	→		6	
0111	7					<u>G</u>	<u>P</u>	<u>X</u>					\	⊥	T		7	
1000	8					<u>H</u>	<u>Q</u>	<u>Y</u>	v				÷	§	¶		8	
1001	9					<u>I</u>	<u>R</u>	<u>Z</u>									9	
1010	A									↑	▷	∩	∇	△	I	∕		
1011	B									↓	◁	∪	Δ	▽	!	∖	▽	
1100	C									≤	≡	⊥	T		ψ		△	
1101	D									Γ	○			φ	△	ε	⊕	
1110	E									L	±	≥	≠		□	⊗	⊕	
1111	F									→	←	◦		φ	A	Φ		

Notes:

-  Subscripts
-  Superscripts

1. These codes, preceded by a hex 08 control character, transmit the graphics shown.
2. No control characters are shown in this chart.
3. All codes within the solid outlined areas of this chart can be entered from the keyboard; the 10 graphic plot characters within the dashed outlined area cannot be entered from the keyboard.
4. Character code assignments other than those shown within all outlined areas of this chart are undefined. If an undefined character code is programmed, the character that will be displayed or printed is a hyphen (hex 60); also, a hex 60 will be returned on a subsequent read operation. The character displayed or printed for a given undefined character code may be different for other devices. IBM reserves the right to change at any time the character displayed or printed for any undefined character code.

Figure D-3. APL/Text Feature, 2-Byte I/O Interface Codes (3274/3278/3279/3287)

Character Set	Code Key (Note 1) →	1	2	3	4	5	6	7	8	9	10	11	12	13	14
	EBCDIC	4A	4F	5A	5B	5F	6A	79	7B	7C	7F	A1	C0	D0	E0
English (US)	¢		!	\$	—	;	'	#	@	"	~	{	}	\	
Austrian/German	Ä	!	Ü	\$	^	ö	'	#	§	"	β	ä	ü	Ö	
Austrian/German (Alternate)	ö		ü	Ü	—	β		Ä	Ö	ä					
Danish/Norwegian	#	!	ƒ	Å	^	φ	'	Æ	ø	"	ü	æ	å	\	
Danish/Norwegian (Alternate)	φ		å	Å	—	!		Æ	ø	æ					
Finnish/Swedish	§	!	ƒ	Å	^	ö	é	Ä	Ö	"	ü	ä	å	É	
Finnish/Swedish (Alternate)	ö		å	Å	—	!		Ä	Ö	ä					
French	°	!	§	\$	^	ù	'	£	à	"	..	e	è	ç	
Italian	°	!	é	\$	^	ò	ù	£	§	"	!	à	è	ç	
Portuguese (Note 2)		!		\$	^	õ	'	Ã	Ö	"	ç	ã	'	Ç	
Spanish	[Pts	—	ñ	'	Ñ	@	"	..	{	}	\	
Spanish (Alternate)	¢		!	Pts	—	!		Ñ	@	ñ					
English (UK)	\$!	£	—	!	'	#	@	"	-	{	}	\	
Belgian	[!		\$	^	ù	'	#	à	"	..	é	è	ç	
Brazilian/Portuguese	É	!	\$	Ç	^	ç	ã	Ö	Ã	"	~	õ	é	\	
Japanese (English)	£		!	¥	—	!	'	#	@	"	-	{	}	\$	
Spanish Speaking	[\$	—	ñ	'	Ñ	@	"	..	{	}	\	
Canadian (French)	à	!	'	\$	^	ù	'	#	@	"	..	é	è	ç	
International	[!		\$	^	!	'	#	@	"	~	{	}	\	

Notes:

1. See Figure D-2 for code points.
2. Portugal
 - a. Host system to control unit -4C or EO is Ç
 - b. Control unit to host system -EO is Ç
 - c. Control unit to host system -4C (<) is removed.

Figure D-4. National Use Differences I/O Interface Code (3274/3278/3279/3287)

Hex 1 Bits 4567		00				01				10				11				Bits 0,1	
		00	01	10	11	00	01	10	11	00	01	10	11	00	01	10	11	Bits 2,3	
		0	1	2	3	4	5	6	7	8	9	A	B	C	D	E	F	Hex 0	
0000	0					SP	&	-			ソ					\$	0		
0001	1					。	エ	/			ア	タ	-			A	J	1	
0010	2					「	オ				イ	チ	へ			B	K	S	2
0011	3					」	ヤ				ウ	ツ	ホ			C	L	T	3
0100	4					、	ユ				エ	テ	マ			D	M	U	4
0101	5					・	ヨ				オ	ト	ミ			E	N	V	5
0110	6					ヲ	ツ				カ	ナ	ム			F	O	W	6
0111	7					ア					キ	ニ	メ			G	P	X	7
1000	8					イ	-				ク	ヌ	モ			H	Q	Y	8
1001	9					ウ					ケ	ネ	ヤ			I	R	Z	9
1010	A					＆	!			:	コ	ノ	ユ	レ					
1011	B					.	¥	,	#					□					
1100	C					<	*	%	@	サ			ヨ	ワ					
1101	D					()	-	'	シ	ハ	ラ	ン						
1110	E					+	;	>	=	ス	ヒ	リ	”						
1111	F						→	?	"	セ	フ	ル	°						



Notes:

1. No control characters are shown in this chart.
2. All codes can be entered from the keyboard.
3. Character code assignments other than those shown within all outlined areas of this chart are undefined. If an undefined character code is programmed, the character that will be displayed or printed is a hyphen (hex 60); also, a hex 60 will be returned on a subsequent read operation. The character displayed or printed for a given undefined character code may be different for other devices. IBM reserves the right to change at any time the character displayed or printed for any undefined character code.
4. NL (hex 15), EM (hex 19), FF (hex 0C), and NUL (hex 00) are not displayed or printed. The DUP (hex 1C) and FM (hex 1E) control characters on dual case terminals are displayed as * and ; respectively, and are printed as * and ;.
5. DUP (hex 1C) and FM (hex 1E) control characters on mono case terminals are displayed as * and ; respectively, and are printed as * and ;.

Figure D-5. Katakana/APL 1-Byte I/O Interface Codes (3274/3278/3279/3287)

		00				01				10				11				Bits 0,1
		00	01	10	11	00	01	10	11	00	01	10	11	00	01	10	11	Bits 2,3
Hex 1		0	1	2	3	4	5	6	7	8	9	A	B	C	D	E	F	Hex 0
0000	0									~		-	α	{	}			
0001	1					<u>A</u>	<u>J</u>		Λ			°	ε	()	1	1	
0010	2					<u>B</u>	<u>K</u>	<u>S</u>	..			-	ι	+	-	2	2	
0011	3					<u>C</u>	<u>L</u>	<u>T</u>				•	ρ	■	+	3	3	
0100	4					<u>D</u>	<u>M</u>	<u>U</u>				n	ω	L	J		4	
0101	5					<u>E</u>	<u>N</u>	<u>V</u>						Γ	Γ		5	
0110	6					<u>F</u>	<u>O</u>	<u>W</u>					x	Γ	Γ		6	
0111	7					<u>G</u>	<u>P</u>	<u>X</u>					\	Γ	Γ		7	
1000	8					<u>H</u>	<u>Q</u>	<u>Y</u>	v				÷	§	¶		8	
1001	9					<u>I</u>	<u>R</u>	<u>Z</u>									9	
1010	A									↑	▷	∩	∇	△	▽	∇		
1011	B									↓	◁	∪	Δ	∨	!	∖	▽	
1100	C									≤	≡	⊥	⊥	□	ψ	□	△	
1101	D									Γ	○	[]	φ	⊕	⊖	⊕	
1110	E									L	±	≥	≠	□	⊗	⊗	⊗	
1111	F									→	←	°		φ	⊕	⊕		

Notes:

-  Subscripts
-  Superscripts

1. These codes, preceded by a hex 08 control character, transmit the graphics shown.
2. No control characters are shown in this chart.
3. All codes within the solid outlined areas of this chart can be entered from the keyboard; the 10 graphic plot characters within the dashed outlined area cannot be entered from the keyboard.
4. Character code assignments other than those shown within all outlined areas of this chart are undefined. If an undefined character code is programmed, the character that will be displayed or printed is a hyphen (hex 60); also, a hex 60 will be returned on a subsequent read operation. For control units with Configuration Support C installed, undefined control codes from X'00' to X'3F' cause a negative response (SNA) or an Op Chk (BSC). The character displayed or printed for a given undefined character code may be different for other devices. IBM reserves the right to change at any time the character displayed or printed for any undefined character code.

Figure D-6. Katakana/APL 2-Byte I/O Interface Codes (3274/3278/3279/3287)

Hex 1 ↓ Bits 4567		00				01				10				11				Bits 0,1	
		00	01	10	11	00	01	10	11	00	01	10	11	00	01	10	11	Bits 2,3	
		0	1	2	3	4	5	6	7	8	9	A	B	C	D	E	F	Hex 0	
0000	0					SP	&	-				-	0	{	}	\	0		
0001	1						/					a	j	~ ^o	1	A	J		1
0010	2											b	k	s	2	B	K	S	2
0011	3											c	l	t	3	C	L	T	3
0100	4											d	m	u	4	D	M	U	4
0101	5											e	n	v	5	E	N	V	5
0110	6											f	o	w	6	F	O	W	6
0111	7											g	p	x	7	G	P	X	7
1000	8											h	q	y	8	H	Q	Y	8
1001	9											i	r	z	9	I	R	Z	9
1010	A					¢	!	!	:										
1011	B					.	\$,	#	{	}	L	J						
1100	C					<	*	%	@	≤	≠	┌	└						
1101	D	CR				()	_	'	()	[]						
1110	E					+	;	>	=	+	±	≥	≠						
1111	F						└	?	"	+	■	●	-						

Notes:

 Superscripts

1. No control characters except CR (hex 0D) are shown in this chart. The CR control character provides the capability to inhibit line advance after a line of characters is printed.
2. Character code hex A1 causes a ^o (degree) character to print when the 3289 text print belt is installed and a ~ (tilde) character to print when a U.S. English 3289 print belt is installed.
3. Character code assignments other than those shown within the outlined areas of this chart are undefined. If an undefined character code is programmed, the character that will be printed is a hyphen (hex 60); also, a hex 60 will be returned on a subsequent read operation. IBM reserves the right to change at any time the character printed for an undefined character code.
4. NL (hex 15), EM (hex 19), FF (hex 0C), and NUL (hex 00) are not printed. The DUP (hex 1C) and FM (hex 1E) control characters are printed as * and ; respectively.

Figure D-7. 3289 Text Print Feature I/O Interface Codes

APL Keyboards

The 3278/3279 APL keyboards are typewriter-like keyboards with keys that contain both APL and the featured-language characters. The APL characters are colored orange (on white keys). The PF1 through PF12 keys on the APL keyboards are located on the right side of the keyboard instead of on the front of the top row of keys as on non-APL keyboards; PF13 through PF24 keys are not available on APL keyboards. The Numeric Lock feature is available for all APL keyboards.

87- and 88-Key Typewriter/APL Keyboards

The 87-key typewriter/APL (U.S. English) keyboard is shown in Figure D-8 (the Japanese English typewriter/APL keyboard has 88 keys). This keyboard is available in all 3278/3279 keyboard languages.

The typewriter/APL keyboard enables a 3278/3279 operator to enter the 81 APL-specific characters as well as the 94-character-plus-space EBCDIC dual-case character set. The following characters can be entered:

```

With APL 'off' - 94 EBCDIC characters plus space
With APL 'on'  - 81 APL-specific characters plus:
                  10 numerics (0 through 9)
                  26 uppercase alphabet characters
                  16 invariant symbols (excluding & and %)
  
```

When the display station is first turned on, the typewriter/APL keyboard operates like the 75-key typewriter keyboard without APL, with the exception of the PF1—PF12 keys. Pressing the APL ON/OFF key (with the ALT key held down) causes the keyboard to enter APL mode (the letters APL display in the Operator Information Area); in this mode the APL characters on the right half of the keys may be entered (the Shift, Lock, and ALT keys are used to select the desired character on a key). The keyboard is returned to normal (non-APL) mode by pressing the APL ON/OFF key again.

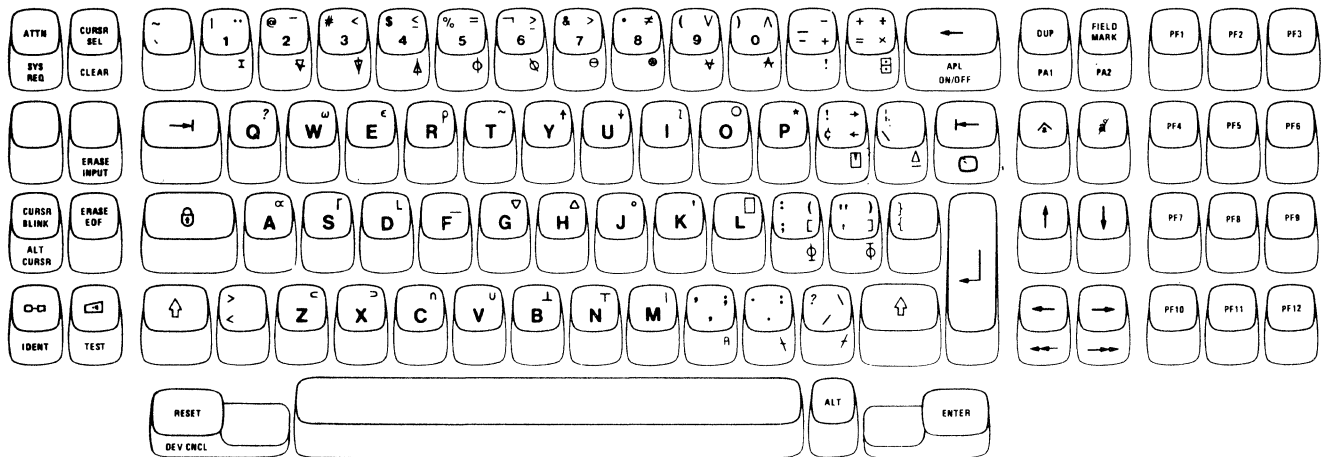

Figure D-8. 87-Key Typewriter/APL Keyboard

88-Key Katakana Typewriter/APL Keyboard

The 88-key Katakana typewriter/APL keyboard (available for IBM World Trade Americas/Far East only) is shown in Figure D-9.

The Katakana typewriter/APL keyboard enables a 3278/3279 operator to enter the 81 APL-specific characters as well as the 127-plus-space Japanese Katakana character set. The following characters can be entered:

- With APL 'off' - 127-character Japanese Katakana set plus space
- With APL 'on' - 81 APL-specific characters plus:
 - 10 numerics (0 through 9)
 - 26 uppercase alphabet characters
 - 16 invariant symbols (excluding & and %))

When the display station is first turned on, the Katakana typewriter/APL keyboard operates like the 88-key Katakana typewriter keyboard without APL, with the exception of the PF1 through PF12 keys. Momentarily pressing the APL ON/OFF key (with the ALT key held down) places the keyboard in APL downshift mode (the letters APL display in the Operator Information Area). APL upshift characters can be entered either by pressing and holding either (upshift) key or by pressing the (Lock) key; when the keyboard is locked in APL upshift mode, pressing either key returns the keyboard to APL downshift mode. The APL characters on the right front of keys can be entered by pressing and holding the ALT key. The keyboard is returned to non-APL mode (ALPHA downshift) by pressing the APL ON/OFF key again.

APL Keyboard World Trade Considerations

The APL programming support does not support certain Canadian-French and Katakana characters on the Canadian-French and Katakana typewriter/APL keyboards. The unsupported Canadian-French characters are all those enterable by a dead-key sequence except , , e, and u. The unsupported Katakana characters are those with I/O interface codes that are not included in the 94-character-plus-space EBCDIC character set. However, the 3274 control units do not block these unsupported codes when they are sent inbound to the host system.

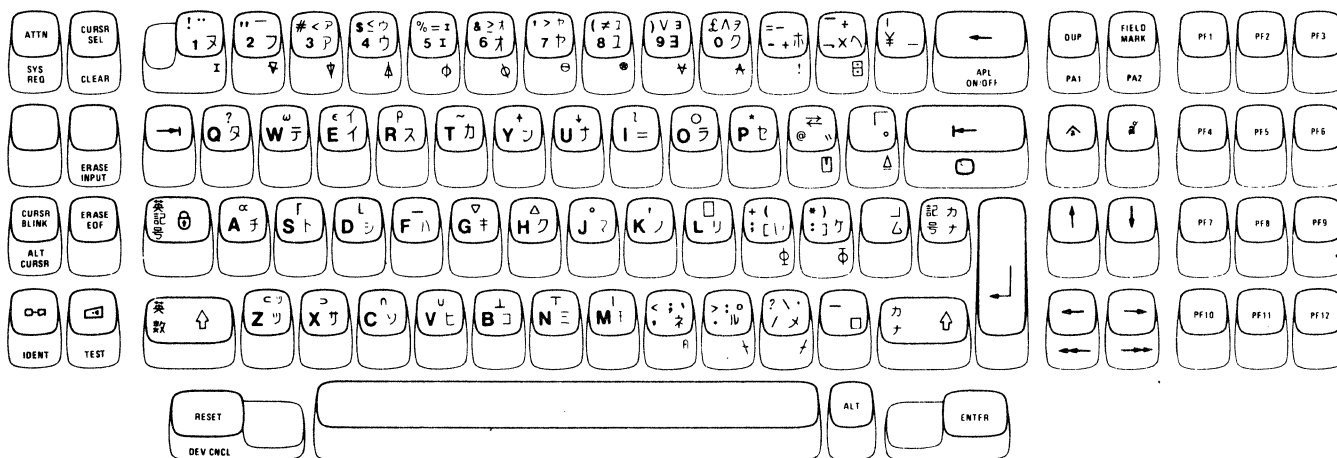

Figure D-9. 88-Key Katakana Typewriter/APL Keyboard

87-Key Typewriter/Text Keyboard

The 87-key typewriter/text keyboard (shown in Figure D-10) is a typewriter-like keyboard with keys that contain both U.S. English and text-specific characters. This keyboard is available for U.S. English only (the text keyboard is not available in IBM Europe/Middle East/Africa countries).

The text-specific characters are colored green (on white keys). The PF1—PF12 keys on the typewriter/text keyboard are located on the right side of the keyboard instead of on the front of the top row of keys as on nontext keyboards; PF13—PF24 are not available on the typewriter/text keyboard.

The 3278/3279 operator can use the typewriter/text keyboard to enter the 65 text-specific characters as well as the 94-character-plus-space U.S. English character set. The following characters can be entered:

```

With Text 'off' - 94 U.S. English characters plus space
With Text 'on'  - 65 text-specific characters plus:
                    10 numerics (0 through 9)
                    26 uppercase alphabet characters
                    26 lowercase alphabet characters
                    9 symbols (. < ; , > ? : ! ~)
  
```

When the display station is first turned on, the typewriter/text keyboard operates similarly to the 75-key typewriter keyboard without text, with the exception of the PF1 through PF12 keys. Pressing the TEXT ON/OFF key causes the keyboard to enter text mode (the letters TEXT display in the Operator Information Area); in this mode the text characters on the right half of the keys may be entered (the Shift, Lock, and ALT keys are used to select the desired character on a key). The keyboard is returned to normal (non-text) mode by pressing the TEXT ON/OFF key again.

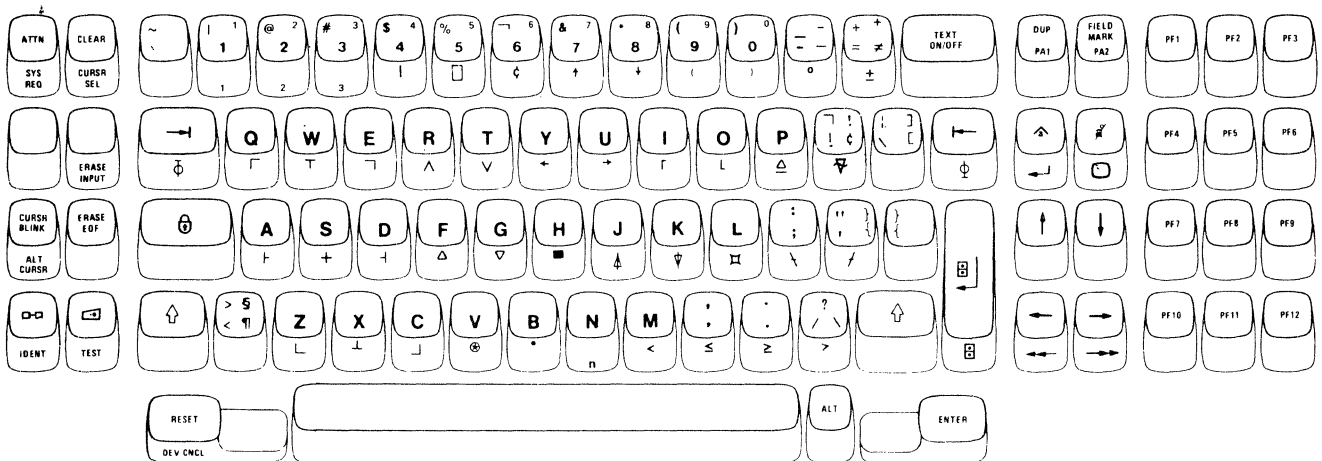

Figure D-10. 87-Key Typewriter/Text Keyboard

3287-1 and -2 with APL/Text

The 3287 APL/Text special feature and its prerequisite Extended Character Set Adapter special feature enable the 3287 to print the following characters:

- 94 EBCDIC characters plus space
- 81 APL-specific characters
- 37 text-unique characters
- 10 graphic plot characters

3289-1 and -2 with Text Print

The 3289 Text Print special feature (not available in IBM Europe/ Middle East/Africa countries) enables the 3289, when equipped with the text print belt, to print the following characters:

- 93 U.S. English characters plus space

Note: This 93-character U.S. English set is identical to the normal 94-character U.S. English set except the tilde (~) symbol is not included.

- 32 TN characters

A 3289 with the Text Print feature can operate with the 125-character text print belt on a 48-, 64-, or 94-character U.S. English print belt at the following maximum speeds in lines per minute (lpm):

- With the 125-character text print belt installed
 - Model 1 = 40 lpm
 - Model 2 = 160 lpm
- With the 48-, 64-, and 94-character print belts respectively
 - Model 1 = 155 lpm, 120 lpm, 80 lpm
 - Model 2 = 400 lpm, 300 lpm, 230 lpm

Note: Actual printer throughput depends upon operational and system characteristics. Maximum print speed may be affected by such factors as communication line speed, control unit load, character set, and application program.

Local or host-initiated copy operations from a 3278/3279 to a 3289, with or without the text Print feature installed, are limited to the normal 3274/3278/3279/3287/3289 94-character U.S. English set.

BSC Copy Command

For control units operating under BSC, if APL- or text-specific characters reside in the device buffer, a copy operation initiated by the BSC Copy command will be allowed only to another ECSA featured device. If the “to” device is not equipped with an ECSA feature, an operation check will be returned to the host.

Local Copy

A local copy from an ECSA featured display with APL/text characters on the screen will print correctly on an ECSA-featured 3287 printer with APL ROS installed. Local copy from an ECSA-featured display with APL/text characters on the screen will be allowed to print on a non-ECSA-featured 3287 printer. The standard EBCDIC character set will print correctly, but APL/text-specific characters will print as EBCDIC characters or hyphens.

Appendix E. Katakana Feature

This appendix contains Katakana unique information interface codes and the keyboard shift operations.

Interface Codes

Figures E-1 and E-2 show the Japanese Katakana EBCDIC interface codes for several control unit/device combinations.

Keyboard Shift Operations

The Katakana keyboards shift operations are different from the other EBCDIC keyboards described in Appendix C. The following paragraphs discuss the unique keys and operations.

LATIN SHIFT and KANA SHIFT Keys—3277

To place the keyboard in the lower shift of either Latin or Katakana (Kana) mode, press and release the desired mode shift key. This enables the characters on the lower portion of each character key to be generated. Holding the shift key depressed while operating the character keys causes the upper-shift characters of the selected mode to be generated.

In addition, a single depression of the Lock key locks the keyboard in the upper shift of the selected mode. A second depression of the Lock key returns the keyboard to the lower shift of the selected mode.

With two exceptions, once a mode is selected, the keyboard remains in that mode until the operator changes the mode by operating the Alternate Shift key. These exceptions are:

1. When power is initially applied, the keyboard is automatically placed in Latin mode.
2. (Data entry keyboards only) - When the cursor enters a numeric field, the data entry keyboard is automatically placed in upper-shift Latin mode. Only 0—9, minus (-), decimal sign, and DUP may be entered when in this mode.

While the cursor remains in the numeric field, the upper-shift Latin mode can be overridden, one character at a time, by depressing the appropriate shift key as follows:

Upper-shift Kana mode - While holding the KANA SHIFT key depressed, press the selected character key.

Lower-shift Kana mode - Press and release the KANA SHIFT key; then press the selected character key.

Upper-shift Latin mode - While holding the LATIN SHIFT key depressed, press the selected character key. This permits keying in upper-shift Latin mode characters other than 0—9, minus (-), decimal sign, and DUP.

Lower-shift Latin mode - Press and release the LATIN SHIFT key; then press the selected character key.

		00				01				10				11				Bits
		00	01	10	11	00	01	10	11	00	01	10	11	00	01	10	11	←0,1
Bits	Hex 1	0	1	2	3	4	5	6	7	8	9	A	B	C	D	E	F	←2,3
4567	↓																	← Hex 0
0000	0	NUL				SP	&	—			ツ					\$	0	
0001	1		SBA			。	エ	/		ア	タ			A	J		1	
0010	2		EUA			レ	ア			イ	フ	ハ		B	K	S	2	
0011	3		IC			レ	ハ			ウ	ツ	ニ		C	L	T	3	
0100	4					、	ユ			イ	テ	マ		D	M	U	4	
0101	5	PT	NL			・	ヨ			ア	ト	ニ		E	N	V	5	
0110	6					ヲ	ツ			カ	ナ	ニ		F	O	W	6	
0111	7					ア				フ	ニ	メ		G	P	X	7	
1000	8					イ	—			ク	ヌ	エ		H	Q	Y	8	
1001	9		EM			ウ				ケ	マ	ト		I	R	Z	9	
1010	A									コ	ノ	ニ	レ					
1011	B						¥	.	#									
1100	C		DUP		RA	<	*	%	@	ア		ヨ	ツ					
1101	D		SF			()	_	'	ン	ハ	ラ	ン					
1110	E		FM			+	.	>	=	ス	ヒ	リ	ハ					
1111	F				SUB		—	?		ヒ	フ	ハ	°					

Notes:

1. Character code assignments other than those shown within all outlined areas of this chart are undefined. If an undefined character code is programmed, the character that will be displayed or printed is not specified. The character displayed by the 3277 for a given undefined character code may be different for other devices. IBM reserves the right to change at any time the character displayed for an undefined character code.
2. Hex codes 4A, 5A, 6A, and 7F are used for CU addressing, device addressing, buffer addressing, and control purposes (for example, WCC and CCC), but have no associated graphic characters.
3. The DUP and FM control characters are displayed or printed as * and ; respectively.
4. For 3277, 3284, 3286, 3287 (with the 3271/3272 Attachment feature), and 3288 terminals attached to a 3274 Control Unit, the NL and EM control characters occupy one character position in the buffer, display or print as · and 9, are never executed, even by printers not operating under Format Control, and are transmitted as hex 45 and F9 to the host on a subsequent read operation.
5. For AID, attribute, write control (WCC), copy control (CCC), CU and device address, buffer address, sense and status characters, bits 0 and 1 are assigned so that each character can be represented by a graphic character.
6. The SUB control character (hex 3F) is not supported for terminals attached to a 3274 Control Unit.
7. For BSC data-link control characters, see Chapter 4.

Figure E-1. Japanese Katakana EBCDIC I/O Interface Code for 3274 Control Units with 3277, 3284, 3286, 3287 (with 3271/3272 Attachment Feature), and 3288 Terminals Attached

		00				01				10				11				Bits ←0,1
Hex 1		00	01	10	11	00	01	10	11	00	01	10	11	00	01	10	11	←2,3
Bits 4567	Hex 0	0	1	2	3	4	5	6	7	8	9	A	B	C	D	E	F	←Hex 0
0000	0	NUL				SP	&	-			ソ					\$	0	
0001	1		SBA			。	エ	/		ア	タ	-		A	J		1	
0010	2		EUA			「	オ			イ	チ	ハ		B	K	S	2	
0011	3		IC			」	ト			ウ	ツ	ホ		C	L	T	3	
0100	4					、	ユ			イ	テ	マ		D	M	U	4	
0101	5	PT	NL			・	ヨ			オ	ト	ミ		E	N	V	5	
0110	6					ヲ	ツ			カ	ナ	ハ		F	O	W	6	
0111	7					ア				キ	ニ	メ		G	P	X	7	
1000	8	GE				イ	-			ク	ヌ	モ		H	Q	Y	8	
1001	9		EM			ウ				ケ	ネ	ト		I	R	Z	9	
1010	A					£	!			コ	ノ	ユ						
1011	B					¥				#		ウ						
1100	C	FF	DUP		RA	<	*	%	@	サ		ヨ	ウ					
1101	D	CR	SF			()	_	'	シ	ハ	ラ	ン					
1110	E		FM			+	:	>	=	ス	ヒ	リ	ッ					
1111	F						「	」	”	ト	フ	ド	°					

Notes:

- Character code assignments other than those shown within all outlined areas of this chart are undefined. If an undefined character code is programmed, the character that will be displayed or printed is a hyphen (-); hex code 60 will be returned on a subsequent read operation. For control units with Configuration Support C installed, undefined control codes from X'00' to X'3F' cause a negative response (SNA) or an Op Chk (BSC). IBM reserves the right to change at any time the character displayed for an undefined character code.
- CR, NL, EM, and FF control characters are displayed or printed as blank characters. The DUP and FM control characters are displayed as * and ; respectively.
- Hex code 6A is used for CU addressing, device addressing, buffer addressing, and control purposes (for example, WCC and CCC), but has no associated graphic character.
- For AID, attribute, write control (WCC), copy control (CCC), CU and device address, buffer address, sense, and status characters, bits 0 and 1 are assigned so that each character can be represented by a graphic character.
- For BSC data-link control characters, see Chapter 4. For the SCS control codes associated with the SNA Character String feature on 3274 (with the 3274/3276 Attachment feature) and 3289 printers, see Chapter 2.
- For 3277, 3284, 3286, 3287 (with the 3271/72 Attachment feature), and 3288 terminals attached to a 3274 Control Unit, when graphic characters £ ! " and - (hex 4A, 5A, 7F, and A1) are programmed, they display or print a # | ' (apostrophe) and ー respectively; on a subsequent read operation, they will be returned as hex 7B, 4F, 7D, and 5F respectively. Furthermore, when control characters NL, EM, FF, and CR are programmed, they are not executed, occupy a single-character position in the buffer, and display or print as 9 < and > respectively; hex codes 45, F9, 4C, and 6E will be returned respectively on a subsequent read operation.

Figure E-2. Japanese Katakana EBCDIC I/O Interface Code for 3274 Control Units with 3262, 3278, 3279, 3287 (with 3274/3276 Attachment Feature), and 3289 Terminals Attached

In all cases, when the selected character has been entered and the key (or keys) has been released, the keyboard returns to upper-shift Latin mode.

When the cursor leaves the numeric field, the keyboard returns to lower shift of the most recent Latin or Kana mode used by the operator. This is independent of whether the last mode was caused by an override by the operator or by the mode being used just prior to entry of the cursor into the numeric field.

Katakana Shift Keys—3278 and 3279

Four shifts [upper and lower left (UL and LL) and upper and lower right (UR and LR)] on the Katakana keyboards are used with the 3278 and 3279 displays:

Shift	Typewriter Keyboard	Data Entry Keyboard	Operator Message
UL	英記号 Alpha Symbol	英数字 Alpha Symbol Numeric	ALPHA ↑
LL	英数 Alphameric	英字 Alpha	ALPHA
UR	カナ記号 KANA Symbol	カナ記号 KANA Symbol	カナ ↑
LR	カナ Katakana	カナ Katakana	カナ

The characters associated with each shift level are shown in the corresponding position of the key tops. In normal operation, the appropriate shift key is pressed and released to enter the required shift level; the keyboard remains in that shift level until another is selected. However, in a programmed numeric field (program attribute), the keyboard is automatically set to the upper left (UL) shift, and all characters for that shift are valid, unless a keyboard with the Numeric Lock feature is being used. The Numeric Lock feature limits the entries to 0—9, minus (-), decimal sign, and DUP. This automatic UL shift may be overridden by pressing and holding the desired shift key; releasing the shift key returns the keyboard to the UL shift.

Holding a shift key when leaving the programmed numeric field causes the keyboard to enter and remain in that shift level until another shift key is pressed.

On a data entry or data entry (keypunch layout) keyboard, the Numeric Lock feature is disabled while the Alpha, Numeric, Latin Shift, Lock, or upper left shift (3278) key is operated.

On a 3277 typewriter or operator console keyboard, the characters that can be entered in the field identified in the attribute byte as numeric and unprotected are (0—9), decimal sign, and minus sign (-); in addition, on 3277 typewriter keyboards, when the Shift, Latin Shift, or Lock Key is operated, the DUP character may be entered by the operator.

Appendix F. Encrypt/Decrypt Feature

Encrypt/Decrypt Products

The IBM Cryptographic Subsystem is a combination hardware and programming implementation of cryptography for data security. It consists of the following separate products:

- IBM Programmed Cryptographic Facility Program Product (OS/VS1 and OS/VS2 MVS only).
- ACF/VTAM (Level 3.0 or higher) Encrypt/Decrypt feature.
- 3274/3276 Encrypt/Decrypt feature.

The first two products reside at the host processor; the third resides in the control unit.

IBM Programmed Cryptographic Facility Program Product

This product contains the following functions: encrypt/decrypt, key generation, and key management. The encrypt/decrypt function is an IBM programmed implementation of the Federal Data Encryption Standard (DES) algorithm as published by the National Bureau of Standards in January 1977 and adopted as the United States Federal Information Processing Standard (FIPS 46) in July 1977.

The other functions of the IBM Programmed Cryptographic Facility generate new keys upon request and in general manage all the keys used throughout the network. Under the IBM key management concept, since the enciphering algorithm is published, protection is derived from keeping the keys secret.

ACF/VTAM Encrypt/Decrypt Feature

This feature provides cryptographic support in ACF/VTAM by:

- Allowing the specification of a physical cryptographic feature on a Logical Unit (LU) basis.
- Being an interface with the Programmed Cryptographic Facility Program Product for enciphering and deciphering messages and key management.
- Supporting cryptographic changes to SNA.

3274/3276 Encrypt/Decrypt Feature

This feature provides hardware implementation of the DES algorithm for encrypting and decrypting data on a TP line. For 3274 installation, it is applicable to the 3274 C Models operating in SNA/SDLC mode. When used with the ACF/VTAM Encrypt/Decrypt feature described above, data transmitted via the transmission subsystem can be safeguarded through cryptography from modification, disclosure, or both. Installed in the control

unit with SDLC line control, this feature provides encrypt/decrypt services for up to 32 attached terminals. Included in the feature are:

- A single secondary LU key (terminal master key) storage element and logic to perform enciphering and deciphering operations for secondary LUs by block-chaining.
- A cryptographic diskette to be used when initially installing or changing the terminal master key in the 3274.
- A security keylock located in the customer access area of the control units.
- A mercury battery, IBM PN 1743456, to sustain the terminal master key when the control unit power is off.

When the Encrypt/Decrypt feature is used in conjunction with other IBM Cryptographic Subsystem products and is operating in an SNA/SDLC environment, data may be transmitted between the control unit and the host computer in a form that precludes accidental or intentional disclosure; neither can the data be modified without detection.

In SNA terminology, communication occurs between network nodes (application programs and terminals), each node being an LU. Data may be transmitted between the host computer (the primary LU) and a terminal attached to the control unit (the secondary LU) once the LUs have established an LU-LU session. When the cryptographic function is *not* used, the data is transmitted in the clear, that is, not enciphered. When the cryptographic function *is* used, the data is enciphered, thus permitting the end-users to communicate the data between the LUs in a secure manner.

It is important to note that only the data transmitted via the transmission subsystem between the host computer and the control unit may be protected by cryptography. Data passing between the control unit and its attached terminals (display stations and printers) is not enciphered.

Two types of cryptographic LU-LU sessions may be established: *required cryptographic* and *selective cryptographic* sessions. In the first type, all data transmitted between the host computer and the control unit is enciphered during the LU-LU session. In the second type, data is enciphered at the option of the application program; thus, enciphering of data can be selected or suppressed by the host LU, but not by the control unit LU.

Establishing Cryptographic Sessions

Before cryptographic session can be established, the ACF/VTAM Encrypt/Decrypt feature must recognize a request for a cryptographic session and determine the cryptographic capability of the host processor and the control unit. The ACF/VTAM Encrypt/Decrypt feature calls the IBM Programmed Cryptographic Facility Program Product to generate a *cryptographic session key* in two versions. The first version is enciphered under the *host master key* and is stored in the host processor. From this first version, the program product produces a second version enciphered under the *secondary LU key*. The secondary LU key is a *key encrypting key* associated with the secondary LU and is used to protect the cryptographic session key during transmission to the secondary LU. The cryptographic session key is used to encipher and decipher data that will be transmitted between the primary and secondary LUs once a cryptographic session has been established.

To establish a cryptographic session, the host processor transmits the enciphered cryptographic session key to the control unit as part of the Bind command. The control unit can decipher the session key, since the secondary LU key is known (having previously been installed in the control unit by a security officer).

Bind Command Processing

In addition to storing the encrypted session key, the control unit takes part in the following cryptographic protocol:

- A pseudo-random value (N) is encrypted under the just-received session key (KS), and this 8-byte quantity EKS(N) is sent to the host as part of the Bind response.
- A valid host will decrypt EKS(N), invert 4 bytes of N, re-encipher the value, and send this 8-byte quantity EKS(N) to the control unit as part of the crypto verification (CRV) command.

The control unit decrypts EKS(N), inverts N, and compares this value N with the original N. If the values are identical, a positive response is sent to the host, and the conditions of a cryptographic protocol have been met. This cryptographic protocol serves two purposes:

1. It verifies that both host and control unit are using the same data encrypting key (KS).
2. It validates the host's cryptographic capability, thus preventing an active wiretapper from using the control unit to decipher captured enciphered data.

The following chart illustrates how the cryptographic protocol fits in with the SNA commands which invoke and terminate a cryptographic session:

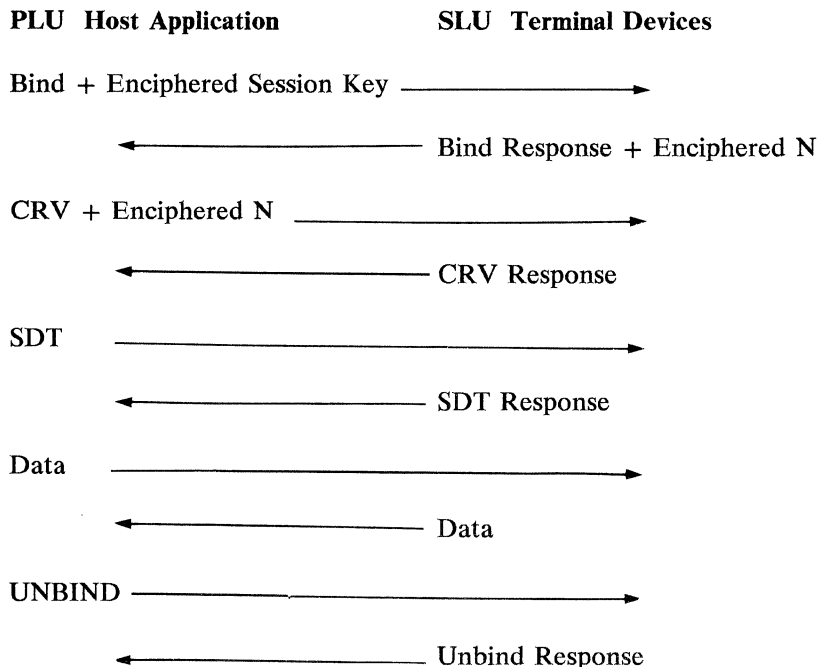

Installing the Secondary LU Key in the 3274

A copy of the secondary LU key (the *terminal master key*) must be installed in the 3274. The procedure to install this key should be performed by someone in a position of trust, such as a security officer. The key can only be entered from the keyboard of a 3278 attached to port A0 of the 3274. To reduce the possibility of exposing the terminal master key prior to installing the key, the procedure requires that the customized system diskette be removed from the 3274 and replaced by the cryptographic diskette. A physical key is then inserted and rotated in a security keylock located inside the customer access area of the 3274. The terminal master key is entered, together with the control unit identification, from the 3278 or 3279 keyboard. At no time is the terminal master key displayed on the display station screen. Once the terminal master key has been installed in the 3274, the security key is removed from the security keylock, and the cryptographic diskette is replaced by the customized system diskette.

Terminal Master Key Verification for the 3274

Once the terminal master key has been installed in the 3274, the 3274 generates a verification pattern based on the terminal master key. Each terminal master key generates a unique verification pattern. To verify that the correct terminal master key is installed in the 3274, the cryptographic diskette is inserted in the 3274. By interrogating the 3274 from the 3278 or 3279 (attached to port A0 of the 3274), the display station operator can check that the terminal master key is correct. This verification procedure can be performed by any operator without compromising the security of the Encrypt/Decrypt feature.

Note: *The characters entered for the terminal master key are hexadecimal characters. Each byte of the key-variable, consisting of two of these hexadecimal characters, must have odd parity. This means that the number of 1 bits in that byte of the key-variable must be odd.*

Appendix G. Request Formatted Maintenance Statistics (RECFMS) Formats

This appendix describes the formats of the four RECFMS responses the 3274 Control Unit can send to the host system in response to an REQMS command.

Counters in type 1, 2, and 3 responses do not wrap when they exceed their maximum value; they maintain the maximum value.

The log areas are reset when:

- The 3274 is turned off (types 1, 2, and 3).
- The concurrent test, section 4, Error Log Erase, is executed for the 3274 CCA/HPCA Adapter (type 3 only).
- The execution of RECFMS is completed normally as the response to an REQMS with a “RESET” request (types 1, 2, and 3).

REQMS Request Type 1—Link Test Statistics

Bytes 14, 15	= Number of times the Test command was received.
Bytes 16, 17	= Number of times the Test response was transmitted.

REQMS Request Type 2—Summary Counters

Byte 14	= Mask bits of the summary counters supported. All supported counters, including those containing zero count, are sent to the host by RECFMS.
Bit 0 = 1	= Machine Check.
Bit 1 = 1	= Communication Check.
Bit 2 = 1	= Program Check.
Bits 3–7	= Reserved.
Bytes 15, 16	= Reserved.
Bytes 17, 18	= Machine Check Summary Counter.
Bytes 19, 20	= Communication Check Summary Counter.
Bytes 21, 22	= Program Check Summary Counter.

REQMS Request Type 3—Communication Adapter Data Error Counts

Byte 14	= Adapter Type. = X'01' = CCA Link Adapter = X'02' = HPCA Link Adapter = X'03'—X'FF' = Reserved
Byte 15	= Mask bits of the Communication Adapter Error Counters supported. All supported counters, including those containing zero count, are sent to the host by RECFMS.
Bit 0 = 1	= Nonproductive Timeout.
Bit 1 = 1	= Idle Timeout.
Bit 2 = 1	= Write Retry.
Bit 3 = 1	= Overrun.
Bit 4 = 1	= Underrun.
Bit 5 = 1	= Connection Problem.
Bit 6 = 1	= FCS Error.
Bit 7 = 1	= Primary Abort.
Byte 16	= Mask bits of the Communication Adapter Error Counters supported. All supported counters, including those containing zero count, are sent to the host by RECFMS.
Bit 0 = 1	= Command Reject.
Bit 1 = 1	= DCE Error.
Bit 2 = 1	= Write Timeout.
Bits 3–7	= Reserved.
Byte 17	= Reserved.
Byte 18	= Nonproductive Timeout Counter.
Byte 19	= Idle Timeout Counter.
Byte 20	= Write Retry Counter.
Byte 21	= Overrun Counter.
Byte 22	= Underrun Counter.
Byte 23	= Connection Problem Counter.
Byte 24	= FCS Error Counter.
Byte 25	= Primary Abort Counter.
Byte 26	= Command Reject Counter.
Byte 27	= DCE Error Counter.
Byte 28	= Write Timeout Counter.

REQMS Request Type 5—3274 Configuration Information

Byte 14	= Always X'00'.
Bytes 15—30	= Installed Patch ID Values.
Byte 31	= Number of RPQs Installed on the 3274.
Byte 32	= Reserved.
Bytes 33—37	= RPQ 1 ID.
Bytes 38—42	= RPQ 2 ID.
Bytes 43—47	= RPQ 3 ID.
Bytes 48—50	= Control Values for Suffix Numbers.
Byte 61	= Feature Disk Level.
Byte 62	= Feature Disk Suffix.
Byte 63	= System Disk Level.
Byte 64	= System Disk Suffix.
Byte 65	= Language Disk Level.
Byte 66	= Language Disk Suffix.
Byte 67	= RPQ 1 Disk Level.
Byte 68	= RPQ 1 Disk Suffix.
Byte 69	= RPQ 2 Disk Level.
Byte 70	= RPQ 2 Disk Suffix.
Byte 71	= RPQ 3 Disk Level.
Byte 72	= RPQ 3 Disk Suffix.

Appendix H. Selector-Light-Pen and Magnetic-Stripe Reading Device Operations

Selector-Light-Pen Operations

The selector light pen, shown in Figure H-1, is a light-sensitive pen that can detect the light emitted from characters displayed on the 3277, 3278, or 3279 displays. With the selector light pen, the operator can select from a list or table of displayed items and can then cause those selections to be passed to the application program.

The selector light pen is operated by pressing the tip of the pen against the screen on fields programmed for selector-light-pen operations.



Figure H-1. Selector Light Pen

Selector-Light-Pen Field Format

A field that is to be used for selector-light-pen operations must be defined in the following format:

	Data Character	Preceding field (on the same line as the SPD field).
	3 Space or Null Characters	Three space or null characters must precede the field-attribute character defining the SPD field unless the attribute character is the first character on the line.
SPD (Selector Pen Detectable) Field Format	Field Attribute Character	The field-attribute character defines the field as displayed and selector-light-pen-detectable. (An SPD field may be protected or unprotected, alphameric or numeric.)
	Designator Character	The designator character which defines the type of operation that will be performed by detection on this field.
	Displayed Data	One or more displayed alphameric characters for sensing by the selector light pen.
	3 Space or Null Characters	Three space or null characters are required when a new field follows on the same line as the SPD field.
	Field Attribute Character	Succeeding field (on the same line as the SPD field).
	Data Character	

The field-attribute character, the designator character, and displayed alphameric characters must be on the same line. If the field extends beyond one line, only those characters on the same line as the attribute character can be detected by the selector light pen. A maximum of 6 detectable fields in the 3277-1, a maximum of 12 detectable fields in the 3277-2, or 3278-1, -2, -3, -4, or 3279, or a maximum of 15 detectable fields in the 3278-5 may precede the last detectable field on any given line.

Designator Characters

Designator characters are used to define two types of selector light pen fields: selection fields and attention fields. Each type of field performs a different selector-light-pen operation.

The selection field is defined by a question mark (?) designator character. When the selector light pen detects on a selection field, the MDT bit in the field-attribute character for that field is set (1) in the display buffer. Also, the designator character is automatically changed on the screen to a greater than (>) sign to provide a visible indication to the operator that the detection was successful. If a mistake was made and the operator again detects on that same field, the > changes to a ? and the MDT bit for that field is reset (0).

The attention field is defined by a space or null designator character. A detection on an attention field causes an I/O pending (attention) at the display. This I/O pending indicates to the program that the selector-light-pen operation has been completed. The program may then issue a Read Modified command to obtain the address of each field that was selected or modified by the operator.

A second type of attention field (for 3278 and 3279 displays) is defined by an ampersand (&) designator character. A selector-light-pen detection on a field containing an ampersand designator sets the MDT bit and causes an ENTER key I/O pending condition at the 3274. The display responds to a poll or Read Modified command, and both the address and the data in each field that was modified by the operator are returned to the application program.

Programming Notes:

- 1. The application programmer should be aware that both normal intensity and high-intensity unprotected fields can be modified by the display station operator to become selector-light-pen-detectable fields.*
- 2. Use of the Selector Light Pen feature without the ampersand (&) designator character is anticipated to be such that the program will correlate the address of each SPD field with the data associated with it. Therefore, to minimize TP line loading, channel loading, and buffer size requirements, only the address of selector-light-pen-detected fields are required to be sent to the application program; the field data is not included.*
- 3. Users who wish to combine selector-light-pen-detect input with keyboard input must use the keyboard or the ampersand designator character to generate the I/O pending. Use of the selector light pen on a space or null designator field or on an attention field to generate the I/O pending will result in transmission of only the addresses of the fields in which the MDT bit was set.*

Figure H-2 shows a sample display with fields defined for selector-light-pen operation. In this sample, "FULL," "50MG," and "4 TIMES" are all preceded by > designator characters to indicate that they were selected by the operator. When the operator detects on the word "EXIT," which has no displayed designator character, an I/O pending occurs and the program obtains the addresses of the three selected fields.

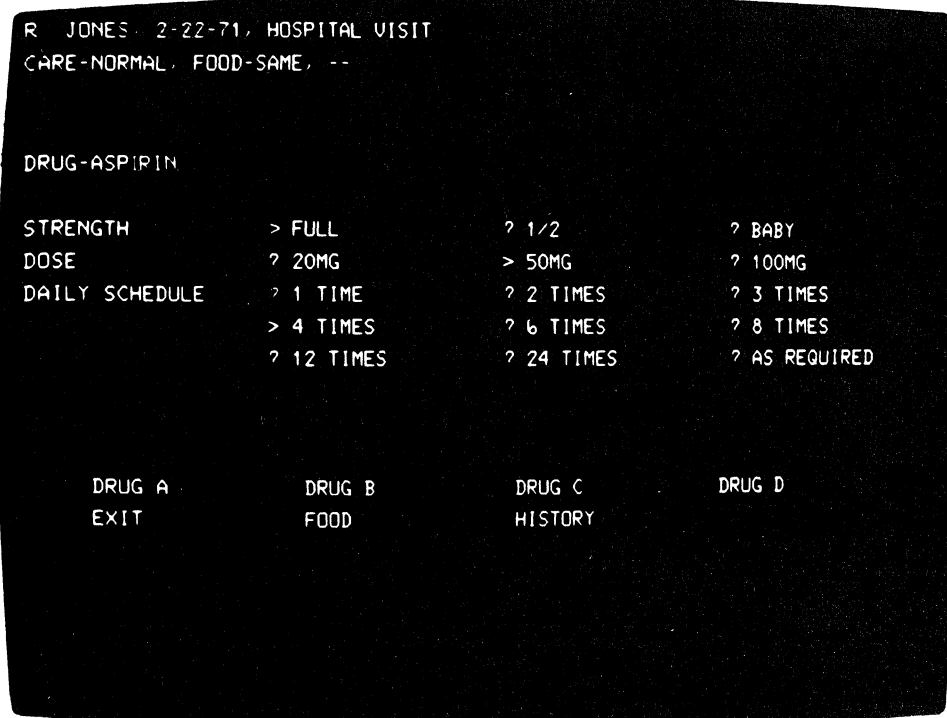
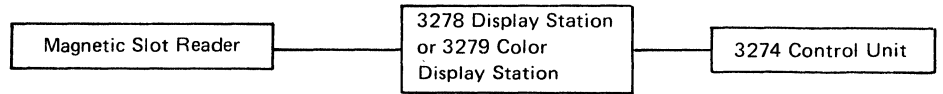

Figure H-2. Sample Display Screen for Selector-Light Pen Operations

Magnetic-Stripe Reading Devices

Three magnetic-stripe reading devices are provided for the 3270 system (Figure H-3):

- Magnetic slot reader (Figure H-4): When attached to a 3278 or 3279 Display Station that is connected to a properly configured 3274 Control Unit, this device reads either the 3277-compatible numeric character set shown in Figure H-14 or the numeric and alphameric character sets shown in Figures H-7 and H-8, respectively.
- Magnetic hand scanner (Figure H-5): When attached to a 3278 or 3279 Display Station that is connected to a properly customized 3274 Control Unit, this hand-held device reads the numeric and alphameric character sets shown in Figures H-7 and H-8, respectively.
- Operator identification card reader (Figure H-6): When attached to a 3277 Display Station, this device reads the 3277-compatible numeric character set shown in Figure H-14.



Reads character set shown in Figure H-14 or numeric and alphameric character sets shown in Figures H-7 and H-8, respectively. The 3274 must be customized appropriately.

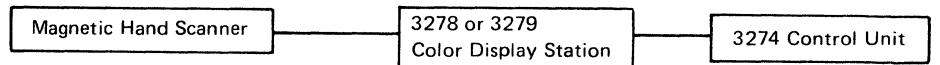

Reads numeric and alphameric character sets shown in Figures H-7 and H-8, respectively. The 3274 must be customized appropriately.

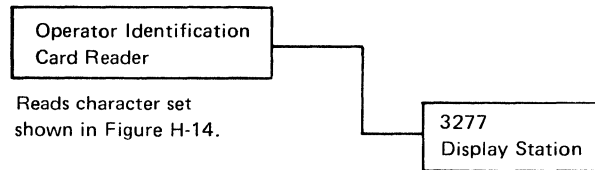

Reads character set shown in Figure H-14.

Figure H-3. Attachment of Magnetic Reading Devices to 3270 System Units

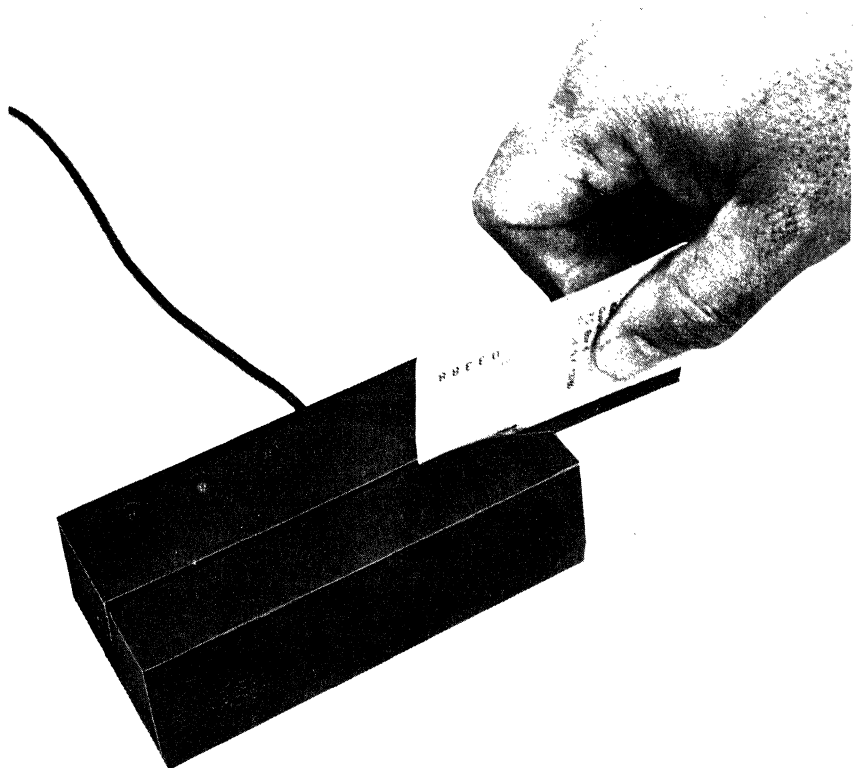

Figure H-4. Magnetic Slot Reader (3278 and 3279 Attachments)



Figure H-5. Magnetic Hand Scanner (3278 and 3279 Attachments)



Figure H-6. Operator Identification Card Reader (3277 Attachment)

Magnetic Slot Reader and Magnetic Hand Scanner

The magnetic slot reader (MSR) and the magnetic hand scanner (MHS), each attached by a cable to a 3278 or 3279 that is, in turn, connected to a properly customized 3274 (Figure H-3), read information encoded on magnetic-stripped documents. The MSR reads the magnetic stripe as the document, such as a card or badge, is passed through the reader's slot. The MHS, on the other hand, reads the magnetic stripe as the scanner is passed over the document, such as a label affixed to a shelf, carton, or other object. The MHS reads in both forward and reverse directions. Both devices can read the numeric and alphameric character sets described below.

Note that the numeric character set (described following), although similar, is *not* the same as the 3277-compatible numeric character set shown in Figure H-14 and described under "Operator Identification Card Reader and Magnetic Slot Reader." The MSR can read all three character sets, that is, the 3277-compatible numeric, numeric, and alphameric character sets shown in Figures H-14, H-7, and H-8, respectively. The MHS, however, can read only the numeric and alphameric character sets shown in Figures H-7 and H-8.

Which character set, or sets, is to be read by the MSR or MHS is specified in the 3274 customizing procedure. Either the 3277-compatible numeric character set (Figure H-14) or the numeric and alphameric character sets (Figures H-7 and H-8) are specified. Note that this specification affects attached 3278s or

3279s only; it has no effect on the operation of 3277s that are also attached to the 3274. The 3277s continue to use the 3277-compatible numeric character set of Figure H-14.

Both devices may be used to log on and off in SNA mode (both LU-LU and SSCP-LU sessions) or in non-SNA mode.

Numeric and Alphameric Character Sets

When the numeric and alphameric character sets (Figures H-7 and H-8) are specified, the header character of the magnetic-stripe record identifies which of the two character sets (numeric or alphameric) is recorded on the magnetic stripe. Note that when these character sets are used, protection, nondisplay, and nonprint of the recorded information are not automatic as when the 3277-compatible numeric character set (Figure H-14) is used. Protection, nondisplay, and nonprint are functions of the header character of the magnetic-stripe record. It continues to be the user's responsibility to provide data protection through proper encoding of the magnetic-stripe record and also to provide control over unauthorized access.

The numeric character set shown in Figure H-7 comprises 10 numeric characters plus space and control characters. Each character consists of a 4-bit code plus an odd parity bit.

The alphameric character set shown in Figure H-8 comprises 10 numeric, 26 alphabetic, and 27 graphic characters, plus space and control characters. Each of the nonnumeric characters is composed of 2 hex characters, with each hex character consisting of 4 bits plus a parity bit. Looking at this as a *paired* 4-bit code, the letter *M*, for example, is recorded as hex D-4, with the hex D being recorded first. In the alphameric character set, each numeric character is composed of a single hex character consisting of a 4-bit code, and, therefore, 2 numeric characters can be recorded in this paired 4-bit code structure. Consequently, when this alphameric character set is being used, either there must be an even number of numeric characters in any contiguous string of numeric characters or, if an odd number of numeric characters are recorded, a filler character (hex A) must be added following the odd-numbered numeric character to preserve the paired 4-bit code structure.

Examples:



For both the numeric and the alphameric character sets, hex characters are recorded low-order bit first ($2^0 2^1 2^2 2^3$ P). (See Figures H-7 and H-8.)

Character	Bit Pattern $\xrightarrow{\text{Direction of Recording}}$					Hex Code	I/O Interface Code Sent to Host			
	2 ⁰	2 ¹	2 ²	2 ³	P		EBCDIC	ASCII	SSCP	
Data	0	0	0	0	1	0	F0	30	F0	
	1	1	0	0	0	1	F1	31	F1	
	2	0	1	0	0	0	F2	32	F2	
	3	1	1	0	0	1	F3	33	F3	
	4	0	0	1	0	0	F4	34	F4	
	5	1	0	1	0	1	F5	35	F5	
	6	0	1	1	0	1	F6	36	F6	
	7	1	1	1	0	0	F7	37	F7	
	8	0	0	0	1	0	F8	38	F8	
	9	1	0	0	1	1	F9	39	F9	
Space character	1	0	1	1	0	D	40	20	40	
Control	Secure data (Note 1)	0	1	0	1	1	A	Not sent	Not sent	X'0450' SSR (Note 6)
	Start Sentinel (SS); Reverse Start Sentinel (Note 2)	1	1	0	1	0	B	Not sent	Not sent	Not sent
	Reserved (Note 3)	0	0	1	1	1	C	Not sent	Not sent	Not sent
	(See Note 4)	0	1	1	1	0	E	Not sent	Not sent	Not sent
	End Sentinel (ES) (Note 5)	1	1	1	1	1	F	Not sent	Not sent	X'1E' IRS (Note 6)

Notes:

1. Hex A, immediately after Start Sentinel (SS), indicates that the data section is secure (protected, nondisplay, and nonprint). Hex A is an error if it appears in the data section.
2. Hex B appearing anywhere but as SS or RSS is an error.
3. Hex C is an error if it appears in the data section.
4. Hex E identifies a 2-character sequence as a control code when located in the second character position of the data section. This control code is not supported by the 3274 and is an error.
5. Hex F is the End Sentinel character. If it is inadvertently included in the data section, it will terminate reading of the data section and the following character will be read as the LRC character.
6. SSR (Secure String Record) and IRS (Interrecord Separator) are sent to SSCP as a bracket for the MSR/MHS data. The Questionable Card symbol is displayed in the Operator Information Area, and the red light on the magnetic slot reader or on the magnetic hand scanner is turned on for all above error conditions except an LRC error, which turns on the red light only.

Figure H-7. Numeric Character Set Used with Magnetic Slot Reader and Magnetic Hand Scanner Attached to a 3278 or 3279 Display Station That Is Connected to a 3274 Control Unit

Character	Bit Pattern					Direction of Recording					Hex Code	I/O Interface Code Sent to Host		
	2 ⁰	2 ¹	2 ²	2 ³	P	2 ⁰	2 ¹	2 ²	2 ³	P		EBCDIC	ASCII	SSCP
0	0	0	0	0	1						0	F0	30	Same I/O Codes as EBCDIC
1	1	0	0	0	0						1	F1	31	
2	0	1	0	0	0						2	F2	32	
3	1	1	0	0	1						3	F3	33	
4	0	0	1	0	0						4	F4	34	
5	1	0	1	0	1						5	F5	35	
6	0	1	1	0	1						6	F6	36	
7	1	1	1	0	0						7	F7	37	
8	0	0	0	1	0						8	F8	38	
9	1	0	0	1	1						9	F9	39	
A	0	0	1	1	1	1	0	0	0	0	C1	C1	41	
B						0	1	0	0	0	C2	C2	42	
C						1	1	0	0	1	C3	C3	43	
D						0	0	1	0	0	C4	C4	44	
E						1	0	1	0	1	C5	C5	45	
F						0	1	1	0	1	C6	C6	46	
G						1	1	1	0	0	C7	C7	47	
H						0	0	0	1	0	C8	C8	48	
I	0	0	1	1	1	1	0	0	1	1	C9	C9	49	
J	1	0	1	1	0	1	0	0	0	0	D1	D1	4A	
K						0	1	0	0	0	D2	D2	4B	
L						1	1	0	0	1	D3	D3	4C	
M						0	0	1	0	0	D4	D4	4D	
N						1	0	1	0	1	D5	D5	4E	
O						0	1	1	0	1	D6	D6	4F	
P						1	1	1	0	0	D7	D7	50	
Q						0	0	0	1	0	D8	D8	51	
R	1	0	1	1	0	1	0	0	1	1	D9	D9	52	
S	0	1	1	1	0	0	1	0	0	0	E2	E2	53	
T						1	1	0	0	1	E3	E3	54	
U						0	0	1	0	0	E4	E4	55	
V						1	0	1	0	1	E5	E5	56	
W						0	1	1	0	1	E6	E6	57	
X						1	1	1	0	0	E7	E7	58	
Y						0	0	0	1	0	E8	E8	59	
Z	0	1	1	1	0	1	0	0	1	1	E9	E9	5A	
φ (EBCDIC);(ASCII)	0	0	0	0	1	0	0	1	1	1	0C	4A*	5B	
! (EBCDIC);(ASCII)	1	0	0	0	0						1C	5A*	5D	
:	1	1	0	0	1						3C	7A	3A	
<	0	0	1	0	0						4C	4C	3C	
*	1	0	1	0	1						5C	5C	2A	
%	0	1	1	0	1						6C	6C	25	
@	1	1	1	0	0	0	0	1	1	1	7C	7C*	40	
.	0	0	0	0	1	1	0	1	1	0	0D	4B	2E	
\$	1	0	0	0	0						1D	5B*	24	
,	0	1	0	0	0						2D	6B	2C	
#	1	1	0	0	1						3D	7B*	23	
(0	0	1	0	0						4D	4D	28	
)	1	0	1	0	1						5D	5D	29	
_	0	1	1	0	1						6D	6D	5F	
'	1	1	1	0	0	1	0	1	1	0	7D	7D	27	
(EBCDIC)														
(ASCII)	0	0	0	0	1	0	1	1	1	0	0E	4F*	21	
⌋ (EBCDIC)														
⌋ (ASCII)	1	0	0	0	0						1E	5F*	5E	
?	0	1	0	0	0						2E	6F	3F	
"	1	1	0	0	1						3E	7F*	22	
+	0	0	1	0	0						4E	4E	2B	
;	1	0	1	0	1						5E	5E	3B	
>	0	1	1	0	1						6E	6E	3E	
=	1	1	1	0	0	0	1	1	1	0	7E	7E	3D	
\	0	1	1	1	0	0	0	0	0	1	E0	E0*	5C	
/	0	1	1	1	0	1	0	0	0	0	E1	61	2F	
&	1	0	1	1	0	0	1	0	1	1	DA	50	26	
-	0	1	1	1	0	0	1	0	1	1	EA	60	2D	
SP	0	0	1	1	1	0	1	0	1	1	CA	40	20	

Figure H-8 (Part 1 of 2). Alphameric Character Set Used with Magnetic Slot Reader and Magnetic Hand Scanner Attached to a 3278 or 3279 Display Station That Is Connected to a 3274 Control Unit

Character	Bit Pattern					Direction of Recording →					Hex Code	I/O Interface Code Sent to Host			
	2 ⁰	2 ¹	2 ²	2 ³	P	2 ⁰	2 ¹	2 ²	2 ³	P		EBCDIC	ASCII	SSCP	
Control	Secure Data; Filler (Note 1)	0	1	0	1	1						A	Not sent	Not sent	X'0450' SSR (Note 6)
	Start Sentinel (SS); Reverse Start Sentinel (RSS) (Note 2)	1	1	0	1	0						B	Not sent	Not sent	Not sent
	(See Note 3)	0	0	1	1	1						C	Not sent	Not sent	Not sent
	Test record (Note 4)	0	1	1	1	0	0	1	1	1	0	EE	Not sent	Not sent	Not sent
	End Sentinel (Note 5)											F	Not sent	Not sent	X'1E' IRS (Note 6)

Notes:

1. Hex A, when located in the first hex character position of the header (that is, immediately following the Start Sentinel (SS) character), indicates that the data section is secure (protected, nondisplay, nonprint). When located in the second hex character position of the header (following hex C), it is recognized as a filler character. It is also recognized as a filler character in the data section when it is the last hex character following a single numeric character or an odd number of consecutive numeric characters.
2. Hex B appearing anywhere but as SS or RSS is an error.
3. Hex C indicates the alphameric character set when located in the first or second hex character position of the header, that is, immediately following the SS character.
4. The hex EE sequence denotes a Test record. The Test card is encoded with hex CAEE in the header and first two hex positions of the data section indicating the alphameric character set, nonsecure data. The 3274 will treat the Test card as a data card. The hex EE will be discarded and the data record displayed. No Auto Enter is performed; however, the data may be sent to the host by pressing the ENTER key, a PF key, or Cursor Select key, by a selector light pen, or by another MSR/MHS Auto Enter operation.
5. Hex F is the End Sentinel character. If it is inadvertently included in the data section, it will terminate reading of the data section and the following character will be read as the LRC character.
6. SSR (Secure String Record) and IRS (Interrecord Separator) are sent to SSCP as a bracket for MSR/MHS data.

The Questionable Card symbol is displayed in the Operator Information Area, and the red light on the MSR or on the MHS hand scanner is turned on for all above error conditions except an LRC error, which turns on the red light only.

*The characters shown for EBCDIC codes 4A, 5A, 7C, 5B, 7B, 4F, 5F, 7F, and E0 are U.S. EBCDIC. For National Use differences, see IBM 3270 Information Display System: Character Set Reference, GA27-2837.

Figure H-8 (Part 2 of 2). Alphameric Character Set Used with Magnetic Slot Reader and Magnetic Hand Scanner Attached to a 3278 or 3279 Display Station That Is Connected to a 3274 Control Unit

MSR/MHS	Minimum Number of Hex codes between Start Sentinel and End Sentinel Characters	Maximum Number of characters between Start Sentinel and End Sentinel Characters	Bit Density in Bits per Millimeter and (Bits per Inch)
Numeric Character Set	7	37	3 (75)
	7	118	5 (127)
Alphameric Character Set ¹	7	37 numerics	3 (75)
	7	18 nonnumerics	3 (75)
	7	118 numerics	5 (128)
	7	59 nonnumerics	5 (128)
	7	37 numerics	8.3 ² (210 ²)
	7	18 nonnumerics	2.3 ² (210 ²)

Note: Encoding across the full-width of the magnetic stripe is recommended for the MSR and is required for the MHS.

¹1 hex code = 1 numeric character

2 hex codes = 1 nonnumeric character or 2 numeric characters

Maximums shown are for *all-* numeric or *all-*nonnumeric characters. If a combination of numeric and nonnumeric characters is recorded, the total number of hex codes must not exceed the numeric character maximum. For example: At 75 bpi, a combination of 20 numeric and 10 nonnumeric characters is permissible.

²MSR only

Figure H-9. Magnetic-Stripe Capacities When Using the Numeric and Alphameric Character Sets

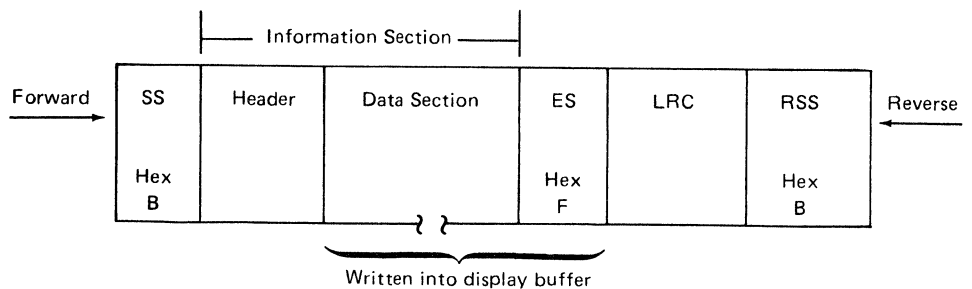

SS = Start Sentinel
 ES = End Sentinel
 LRC = Longitudinal Redundancy Check
 RSS = Reverse Start Sentinel

Figure H-10. Magnetic-Stripe Format (MSR and MHS Using Numeric and Alphameric Character Sets)

If the character immediately following hex A is hex C (hex C is in the second hex character position of the header), the alphameric character set is specified.

Example: BAC32D6E5

Operational Differences because of Screen Format in SNA Mode (LU-LU Session) or Non-SNA Mode

Differences occur in the handling of MSR/MHS data because of screen formatting, whether the data is secure or nonsecure. The descriptions that follow are concerned with non-SNA mode and LU-LU sessions in SNA mode. (For a description of operation in SSCP-LU sessions, see "SSCP-LU Session.")

Secure Data. Whether operating in non-SNA mode or SNA mode, the processing of secure MSR/MHS data always formats the screen by generating a field-attribute character at the current cursor position. When the screen is unformatted (that is, is without attribute characters or fields), an MSR/MHS read operation results in an inbound data stream as shown in Figure H-11.

A formatted screen has at least one field-attribute character defined at initial presentation. This may be the only attribute character, as in the instruction sequence ENTER ID; or many attributes may be required, as, for example, in the instruction sequence NAME, TITLE, ID DEVICE.

Two fields (new data field and previous data field), with the MDT bits set, are sent to the application program, because the 3278 and 3279 treat all information from the MSR/MHS as data until after the information is written into the buffer. Also, the MDT bit is set in the MSR/MHS attribute byte that was initiated when the data was entered. The following examples indicate the processing of secure MSR/MHS data with a formatted screen.

Example 1: When the MSR/MHS field is set up by the application program as an unprotected field containing instruction information (ENTER ID, in the example), the inbound data stream is as shown in Figure H-12.

Example 2: When the screen is formatted and the MSR/MHS field is set up by the application program as an unprotected field, with the cursor directly following an unprotected field-attribute character, the data stream is as shown in Figure H-13.

Nonsecure Data. When nonsecure data is read by the MSR or MHS, no field-attribute character is generated. When the screen is unformatted, the data is displayed. When the screen is formatted and the cursor is located in an unprotected display field, the MSR/MHS data is also displayed. The MSR/MHS data may be sent upstream by means of the ENTER key, a PF key, a CURSR SEL key, the selector light pen, a secure MSR/MHS read operation, or when the 3274 is configured for the Auto-Enter option.

Note: *The Auto-Enter option is intended for situations when the MSR/MHS operator cannot be at the display keyboard. Successful writing of the MSR/MHS data into the display buffer automatically initiates an inbound data stream with the ENTER key AID code (hex 7D).*

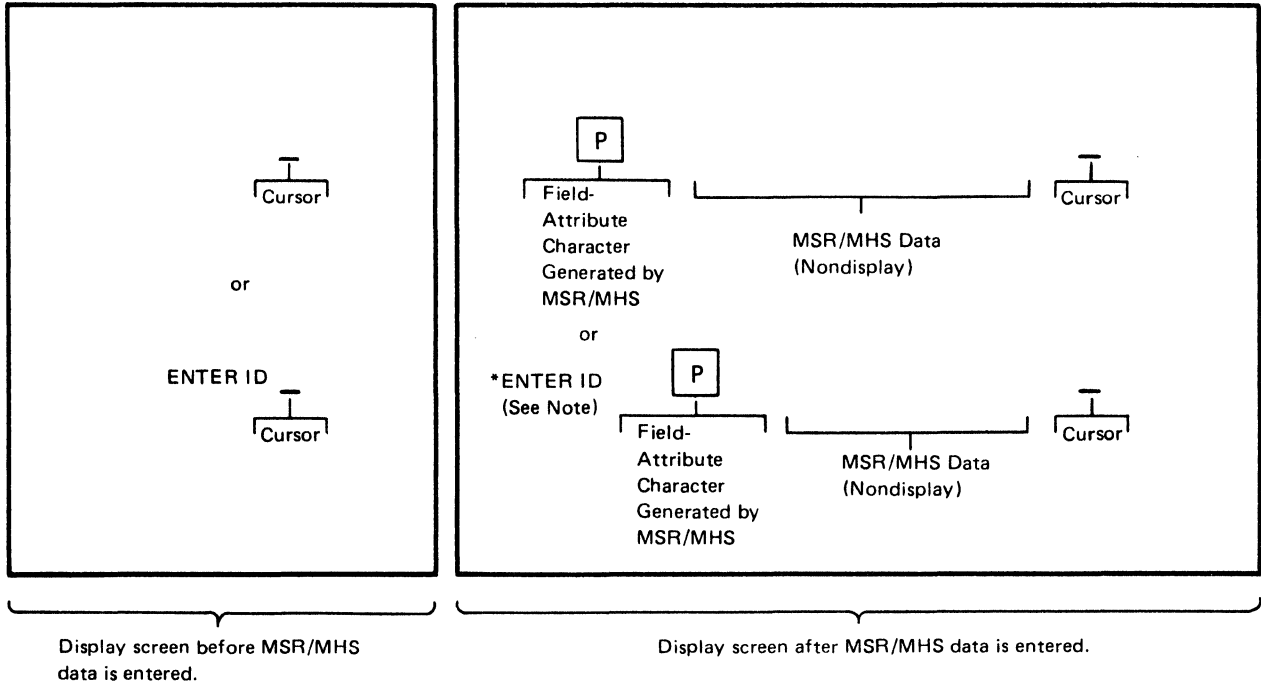

Note: The ENTER ID is not displayed because it is within a nondisplay field, defined by the MSR/MHS-generated field-attribute character.

U = Unprotected field-attribute character

P = Protected field-attribute character

Inbound Data Stream

AID
Cursor Address
SBA
Start of Data Address
Data

Set to indicate MSR/MHS input.

Address of the cursor upon completion of the MSR/MHS read operation.

Set Buffer Address.

Address of the first data character following the field-attribute character.

The MSR/MHS data followed by any additional information present in the display buffer. The additional information can be initiated by the application program as ENTER ID (as shown in the example) or entered by the operator before the MSR/MHS read operation is started.

Note that with an unformatted screen the MSR/MHS data is the first data sent to the application program in the data stream.

Figure H-11. Operation of the Display with an Unformatted Screen (MSR or MHS Using Numeric or Alphameric Character Set)

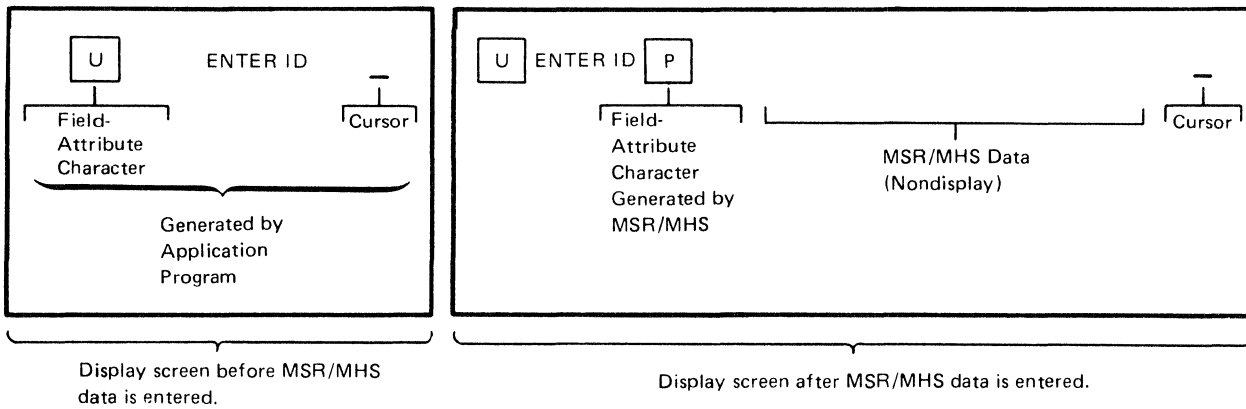

Inbound Data Stream

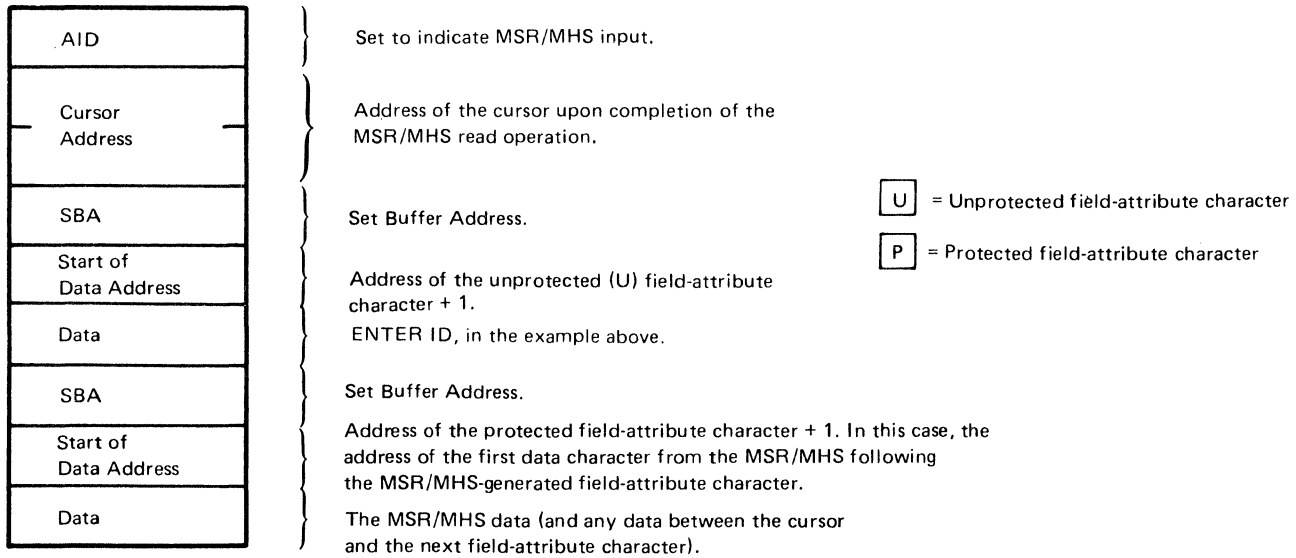
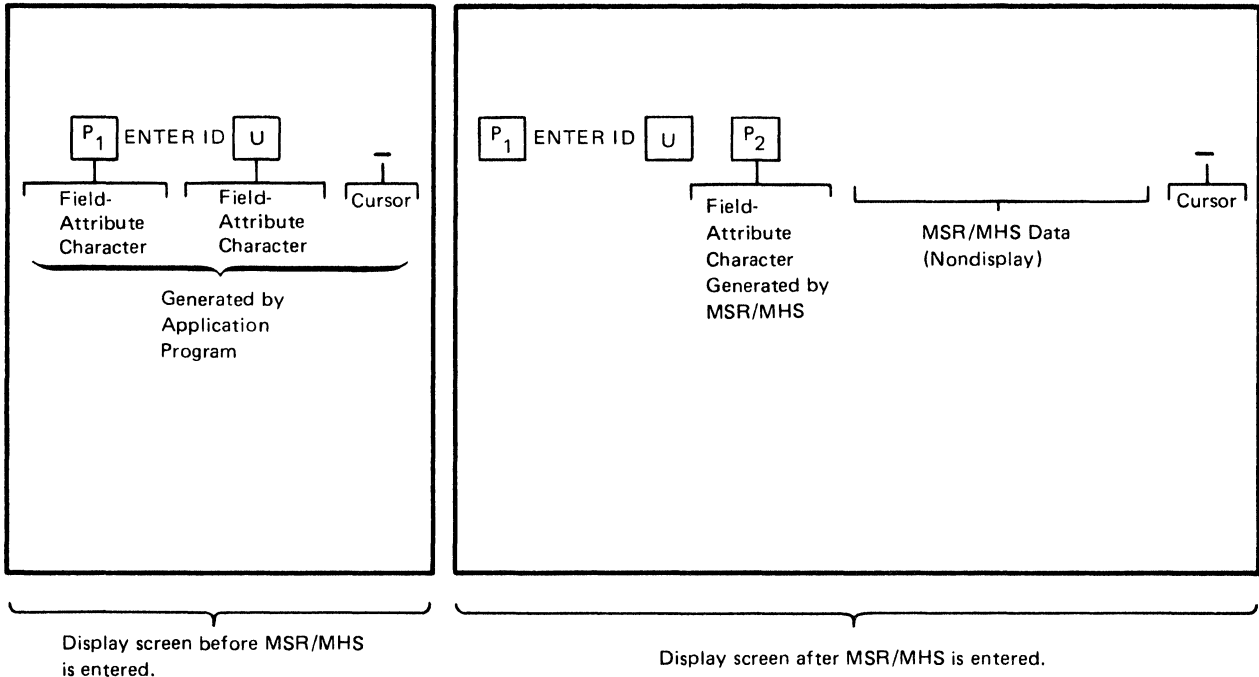

Figure H-12. Operation of the Display with a Formatted Screen (MSR or MHS Using Numeric or Alphameric Character Set), Example 1



U = Unprotected field-attribute character
P = Protected field-attribute character

Note: Rules for positioning modified data on formatted screens apply. The position of MSR/MHS data in the inbound data stream depends on the field position in the format.

Inbound Data Stream

AID	}	Set to indicate MSR/MHS input.
Cursor Address		Address of cursor upon completion of MSR/MHS read operation.
SBA		Set Buffer Address.
Start of Data Address		Address of the unprotected (U) field-attribute character + 1. In the example above, it will be the address of the P ₂ field-attribute character.
SBA		Set Buffer Address.
Start of Data Address		Address of the P ₂ field-attribute character + 1. In this case, the address of the first data character from the MSR/MHS following the MSR/MHS-generated field-attribute character.
Data		The MSR/MHS data (and any data between the cursor and the next field-attribute character).

Figure H-13. Operation of the Display with a Formatted Screen (MSR or MHS Using Numeric or Alphanumeric Character Set), Example 2

Error Conditions. Data is not written into the display buffer if any of the following error conditions exist when the magnetic stripe is read by the MSR or the MHS:

- The cursor is located in a protected field.
- The cursor is located in an attribute character location.
- The display is busy performing another operation.
- The field is too small to contain the MSR/MHS data.

MSR/MHS Validity Tests

The proper use of the MSR/MHS as a secure data-entry device requires that the application program perform certain validity tests. The following guidelines are recommended for proper operation:

1. No field should be accepted as secure data input unless the AID byte (EBCDIC E7; ASCII 58) is set.
2. For application-formatted displays, the application program must know, on the basis of the hardware operation previously performed, the location of the field defined to receive the secure data and the exact location of the entered data. The use of the cursor address present in the data stream, in combination with the AID byte to ensure secure input, is an additional technique that can be used to ensure the integrity of the data. For unformatted displays, the secure data is always presented as the first data entry in the input record to the application program.
3. For application-formatted displays, it is advisable to terminate the secure data field with another attribute byte.
4. No ES (End Sentinel) or LRC character is included in the inbound data stream. Receipt of the AID byte (EBCDIC E7; ASCII 58) ensures valid MSR/MHS secure data.
5. The header information is not included in the inbound data stream. The application program should be prepared to accept the alphameric and special characters shown in Figures H-7 and H-8.
6. If the MSR/MHS field is to be reused, the application program must remove the hardware-generated attribute character and MSR/MHS input data. The location of this attribute character can be derived from the inbound data stream by using one less than the start-of-data address preceding the MSR/MHS data. Additionally, the cursor is located one position beyond the end of the MSR/MHS data field.
7. Data from all fields having the MDT bit set are included in the inbound data stream when the MSR/MHS data is retrieved in response to the MSR/MHS-generated I/O pending.
8. The cursor must be moved out of the MSR/MHS-generated field before further keyboard activity is permitted.
9. If the application program desired to call attention to a particular MSR/MHS secure input, it is recommended that a message be written to the screen and that the WCC include the Sound Alarm bit.

10. A test card, PN 1742659, is delivered with each 3278 Magnetic Reader Control feature. The test card data placed in the display buffer is as follows:

0123456789987654321001234567

Care should be taken that the card is not accidentally auto-entered. The display should be placed in test mode to avoid auto-entering magnetic-stripe information to the host.

SSCP-LU Session

The display screen is unformatted in an SSCP-LU session. When the display keyboard is unlocked, the current cursor position, that is, the “initial cursor position,” identifies the beginning of the operator input area. When using a 3278 or 3279 attached to a 3274, in order for data to be sent to the SSCP, the operator must restrict data entry (both keyboard and magnetic data) to this position and to the following 255 screen positions, or to the last character position of the screen, whichever occurs first. Care should be taken in using the cursor move keys (including Tab, Backtap, and New Line) or the operator may inadvertently enter data outside the operator input area. Pressing the CLEAR key repositions the cursor to the first screen location and defines this location as the new initial cursor position. Because the screen is also cleared, other data may be lost.

When the 3274 is customized for the numeric and alphameric character sets, the MSR/MHS devices may be used for secure logon in the SSCP-LU session. MSR/MHS input is restricted to the operator input area. If MSR/MHS input is attempted outside this area, the data is rejected.

When the MSR/MHS data is secure, a protected nondisplay field-attribute character is generated followed by the MSR/MHS secure data. An unprotected display field-attribute character is then generated following the data. This permits additional keyboard or MSR/MHS data to be written into the display buffer. No Auto-Enter operation is performed. When the ENTER key is pressed, the information is sent to the SSCP. MSR/MHS secure data is bracketed by the SSR and IRS control codes. No SBAs are generated, and no field-attribute characters are sent to the SSCP. Upon transmission to the SSCP, MSR/MHS secure data and associated attribute characters are removed from the operator input area of the screen.

Differences in Operation of ERASE INPUT and ERASE EOF Keys. Because MSR/MHS secure data may be present on the screen, the ERASE INPUT and ERASE EOF (End of Field) keys perform differently. The ERASE INPUT key erases the entire display buffer contents, including the field-attribute characters generated in conjunction with the MSR/MHS read operation. The cursor is repositioned to the first screen location, but the operator input area remains unchanged.

The ERASE EOF key erases all information from the current cursor position to the end of the screen, including the MSR/MHS data and associated attribute characters. If the cursor is located within an MSR/MHS secure data field, the entire field is erased, including the associated attribute characters.

Error Conditions. Data is not written into the display buffer if any of the following error conditions exist when the magnetic stripe is read by the MSR or the MHS:

- The display is busy performing another operation.
- An MSR/MHS read operation is attempted outside the operator input area.
- An attempt is made to overlay other MSR/MHS secure data.
- The keyboard is already locked.

Notes:

1. *In an SSCP-LU session, the inbound RU is limited to 256 bytes of data. Therefore, when an APL/Text-unique keyboard is being used, care must be taken when keying in APL/Text-unique characters not to exceed the 256-byte limit. Each APL/Text-unique character displayed on the screen generates a 2-byte Graphic Escape sequence to be sent to the SSCP and thus may truncate the information sent to the SSCP.*
2. *If a Graphic Escape character with its associated data byte exceeds the 256-byte limit of the inbound RU, neither the Graphic Escape character nor its associated data byte will be included in the inbound RU.*
3. *Because of the APL/Text Graphic Escape character sequence, the IRS control code may be omitted from the inbound RU. This is an error, and the SSCP should send an error message to the operator.*
4. *MSR/MHS secure data is sent to the SSCP bracketed by the SSR and IRS control codes. No ES (End Sentinel) or LRC characters are included in this data stream, and receipt of IRS ensures data validity.*

MSR/MHS Operator Indicators and Alarm

The MSR and the MHS each contain three operator indicators and a buzzer. The indicators are color-coded green, yellow, and red. When all indicators are off, power has not been applied to the MSR/MHS.

Green Indicator On: Indicates that the MSR/MHS is ready to read a magnetic stripe. This indicator is turned on when:

1. The 3278 or 3279 is turned on.
2. The 3278 or 3279 Test/Normal switch is operated.
3. The 3274 IML pushbutton is pressed.
4. The MSR/MHS data has been successfully transferred to the host if this is an Auto-Enter operation; the data has been successfully written into the 3278 or 3279 buffer if this is not an Auto-Enter operation.

Yellow Indicator On: This indicator is turned on when the magnetic stripe has been read successfully by the MSR/MHS. Subsequent read operations are ignored while the yellow indicator is on. The yellow indicator is turned off when either the red or the green indicator is turned on.

Red Indicator On: Indicates that the MSR/MHS data is rejected. The red indicator is turned on when:

1. Invalid magnetic-stripe information (for example, invalid character, LRC error, parity error) is detected by the MSR/MHS hardware.
2. The keyboard is already locked. The operator should check the symbols in the display's Operator Information Area and take the appropriate action.
3. An unsuccessful read operation is detected. The keyboard is locked.

The red indicator is turned off when the yellow indicator is turned on.

The buzzer on the MSR/MHS gives a short tone (one-quarter second) when the green indicator turns on and a longer tone (one second) when the red indicator turns on.

Test Cards

A test card, PN 1742659, is delivered with each 3278 or 3279 Magnetic Reader Control feature. The test card data written into the display buffer is as follows:

0123456789987654321001234567

Care should be taken that the character string is not accidentally sent to the application program.

The test card supplied with the IBM 3630 Plant Communication System may also be used, provided that the 3274 has been customized to use the numeric and alphanumeric character sets. This test card is encoded with CAEE in the header and first two hex positions of the data section, indicating an alphanumeric character set and nonsecure data. The 3274 will accept this test card as a data card, strip off the EE, and display the data following the EE. Auto Enter is not performed; that is, the data is not automatically sent to the host.

If the magnetic stripe of either of the above test cards is read successfully, the MSR/MHS green light is turned on. If the 3278 or 3279 is in test mode, the Do Not Enter and Minus Function symbols are displayed in the Operator Information Area. If the magnetic stripe is not read successfully, the red light is turned on and the Do Not Enter symbol may be displayed in the Operator Information Area.

Note: *The operator identification card reader test card is rejected. The Do Not Enter and Questionable Card symbols are displayed, and the red light is turned on.*

Operator Identification Card Reader and Magnetic Slot Reader

The operator identification card reader (OICR), which is attached by a cable to a 3277 (Figure H-6), reads data, such as a unique operator ID number, encoded on a magnetic-striped card. As the card is inserted into the reader, the ID number is read from the magnetic stripe and written into the display buffer, in nondisplay mode and at the location specified by the cursor. The ID number, therefore, is not displayed on the screen. An I/O pending is generated at the display to inform the program that the ID number can be retrieved and transferred to main storage.

With the 3277-compatible numeric character set, plus control characters (described below and shown in Figure H-14), the maximum number of characters that can be read is 40 characters at 3 bits per millimeter (75 bits per inch). This number includes the SOR, LRC, and either EOR or EOI characters.

Character	Bit Pattern					Hex Code	I/O Interface Code (Note 5)		
	2 ⁰	2 ¹	2 ²	2 ³	P		EBCDIC	ASCII	
Data	0	0	0	0	1	0	F0	30	
	1	1	0	0	0	1	F1	31	
	2	0	1	0	0	2	F2	32	
	3	1	1	0	0	1	F3	33	
	4	0	0	1	0	0	F4	34	
	5	1	0	1	0	1	F5	35	
	6	0	1	1	0	1	F6	36	
	7	1	1	1	0	0	F7	37	
	8	0	0	0	1	0	F8	38	
	9	1	0	0	1	1	F9	39	
Control	(Special - See Note 1)	0	1	0	1	1	A	7A	3A
	SOR, SS, or RSS (Note 2)	1	1	0	1	0	B	7B	23
	EOI (Note 3)	0	0	1	1	1	C	7C	40
	Field Separator (Unassigned)	1	0	1	1	0	D	7D	27
	EOR or ES (Note 4)	0	1	1	1	0	E	7E	3D
	1	1	1	1	1	F	7F	22	

Notes:

1. This character is reserved for operator identification only and must be located in the first data character position.
2. OICR: SOR (Start of Record)
MSR: SS (Start Sentinel); RSS (Reverse Start Sentinel).
3. EOI (End of Inquiry) may also be used as a termination character on the Operator Identification Card Reader (3277 display). This code is treated as an error by the MSR (3278 and 3279 displays). The card is rejected, and the MSR red light is turned on.
4. OICR: EOR (End of Record)
MSR: ES (End Sentinel).
5. Programmers use only the four least-significant bits of the I/O interface code.

Figure H-14. 3277-Compatible Numeric Character Set Used with Operator Identification Card Reader and Magnetic Slot Reader

The magnetic slot reader (MSR), which is attached by cable to a 3278 or 3279 connected to a appropriately configured 3274, reads information encoded on magnetic-stripped cards such as job tickets, operator ID badges, and both large and small credit cards. The recorded information is read from the stripe as the operator passes the card through the slot of the reader. The data is written into the display buffer at the location specified by the cursor, but is not displayed on the screen. If the device supports the Structured Field and Attribute Processing option, the extended attribute buffer is updated. After the information is read, an I/O pending is generated at the display to inform the program that the data can be retrieved and transferred to main storage.

With the 3277-compatible numeric character set (Figure H-14), the maximum number of characters that can be read is:

- 40 characters at 3 bits per millimeter (75 bits per inch) and at 8.3 bits per millimeter (210 bits per inch)
- 100 characters at 5 bits per millimeter (128 bits per inch)

Note: *A minimum of seven characters must be encoded between the Start Sentinel and End Sentinel characters.*

The 3277-compatible numeric character set may be used to log on and log off in SNA mode (LU-LU session only; *not SSCP-LU session*) or in a non-SNA mode.

3277-Compatible Numeric Character Set

The 3277-compatible numeric character set (Figure H-14) comprises 10 numeric characters plus a Field Separator and control characters. Each character consists of a 4-bit pattern plus an odd-parity bit. This bit pattern is recorded with the low-order bit recorded first. A longitudinal redundancy check (LRC) character is placed at the end and is protected by an odd-parity bit of its own.

Characters are recorded, low-order bit first, beginning at the left side of the magnetic stripe when the stripe is at the bottom of the card or badge as you face the magnetic material. The characters are read in one direction only.

Magnetic-Stripe Format (OICR/MSR)

The format used on the magnetic stripe is in the sequence shown in Figure H-15. When the SOR character is read from the magnetic stripe, a field-attribute character is entered automatically into the cursor-identified location of the buffer (provided the cursor is at an unprotected character location). This attribute character defines the following data field as protected, alphameric, and nondisplay or nonprint. As the data characters are read into the buffer, they are stored starting at the first character location after the field-attribute character. As each data character is stored in the buffer, the cursor advances one buffer location. The cursor advancement is all the operator sees on the display screen when using the operator identification card reader. When the operator uses the magnetic slot reader, the cursor does not move as the card is passed through the slot, but is repositioned after the card has been read.

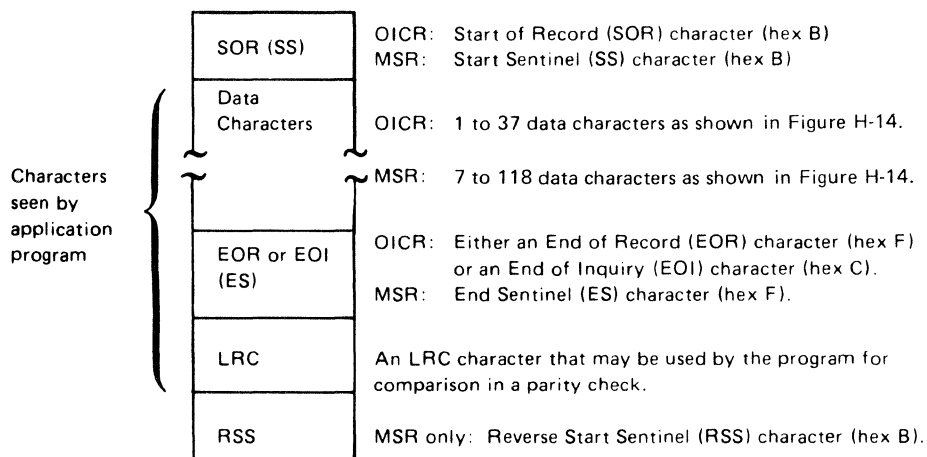

Figure H-15. Magnetic-Stripe Format (OICR and MSR Using 3277-Compatible Numeric Character Set)

Operational Differences because of Screen Format

When the character set of Figure H-14 is being used with the operator identification card reader (OICR) or the magnetic slot reader (MSR), differences exist in the content of the data stream sent to the application program, depending upon whether the display screen is unformatted or formatted.

When an unformatted screen (that is, a screen without attribute characters or fields) is being used, the operation of the display results in an inbound data stream as shown in Figure H-16.

The reader operation formats the screen by the automatic generation of the field-attribute character at the cursor position by the reader. A formatted screen has at least one field-attribute character defined at initial presentation. This may be the only field-attribute character, as in the instruction sequence ENTER ID; or one or more attributes may be required, as, for example, in the instruction sequence NAME, TITLE, ID CARD READER.

The operations of the 3277 with the OICR, or of the 3278 and 3279 with the MSR, are identical when formatted screens are used.

Two fields (new data field and previous data field), with the MDT bits set, are sent to the application program because the displays treat all information from the reader as data until after the information is written into the display buffer. Also, the MDT bit is set in the reader-generated field-attribute character that was initiated when the data was entered.

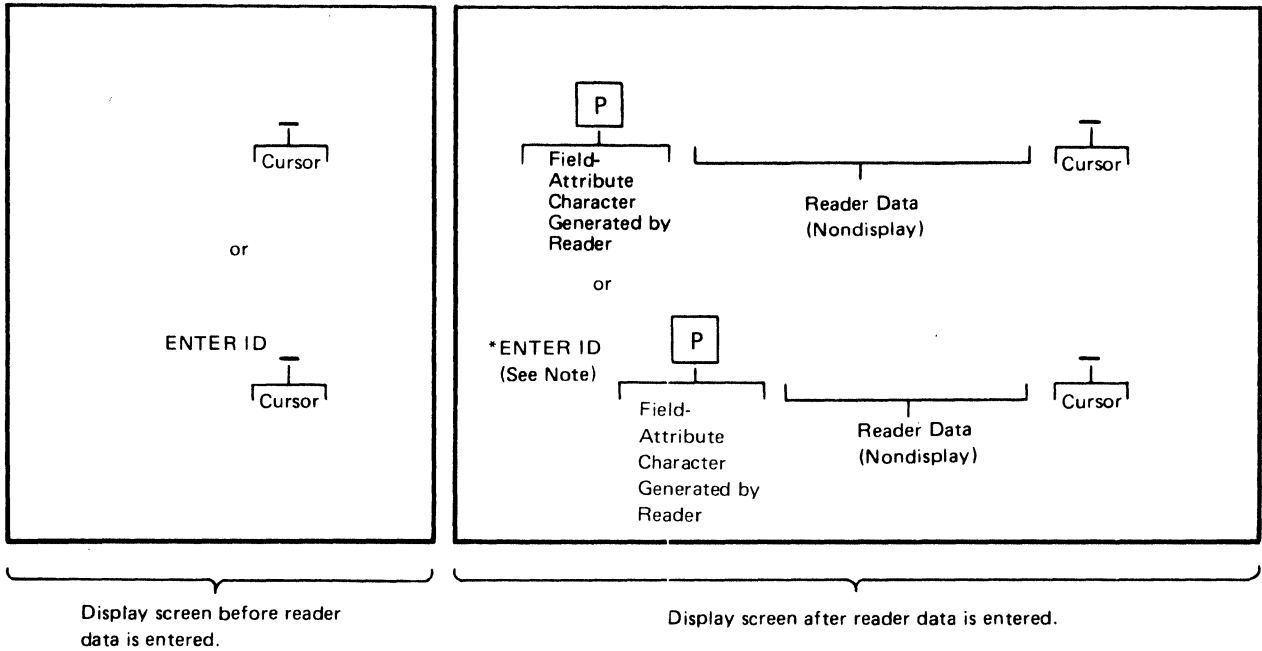

P = Protected field-attribute character

Inbound Data Stream

AID
Cursor Address
SBA
Start of Data Address
Data

Set to indicate input from a magnetic-stripe reading device.

Address of the cursor upon completion of the reader operation.

Set Buffer Address.

Address of the first data character following the field-attribute character.

The reader data followed by any additional information present in the display buffer. The additional information can be initiated by the application program as ENTER ID (as shown in the example) or entered by the operator before the reader operation is started.

Note that with an unformatted screen the reader data is the first text in the data stream sent to the application program.

Figure H-16. Operation of the Display with an Unformatted Screen (OICR or MSR Using 3277-Compatible Numeric Character Set)

The following examples are included to help clarify operation of the reader with a formatted screen:

Example 1: If the OICR/MSR field is set up by the application program as an unprotected field and contains instruction information, the inbound data stream is as shown in Figure H-17.

Example 2: When the OICR/MSR field is set up by the application program as an unprotected field, with the cursor directly following an unprotected field-attribute character, the inbound data stream is as shown in Figure H-18.

Error Conditions (OICR/MSR)

OICR/MSR data will not be written into the display buffer if any of the following error conditions exist when the magnetic stripe is read:

- The SOR (OICR) or SS (MSR) character is not successfully connected to a field-attribute in the display buffer.
- The cursor is located in a protected field.
- The cursor is located in a field-attribute character location.
- The display is busy performing another operation.

OICR/MSR Validity Tests

The proper use of the OICR or MSR as an identification and data-entry device requires that the application program perform certain validity tests. The following guidelines are recommended for proper operation:

1. No field should be accepted as reader input unless the reader AID code is set.
2. For preformatted displays, the application program must know the location of the field defined to receive the reader data and the exact location of the entered data, based upon the hardware operation that was previously defined. The use of the cursor address present in the inbound data stream, in combination with the AID byte to ensure reader input, is an additional technique that can be used to ensure the integrity of the data. For unformatted displays, the reader data is always presented as the first data entry in the input record to the application program.
3. For preformatted displays, it is advisable to terminate the reader data field with another attribute byte.
4. Upon completion of the reader operation, the application program should check for the presence of the EOI/EOR character (OICR) or the ES character (MSR). Absence of this character means the reader data has not been transferred successfully.
5. Upon completion of the reader operation and a successful check for the EOI/EOR (ES) character, the LRC character may be used for a parity check to ensure integrity of the data.

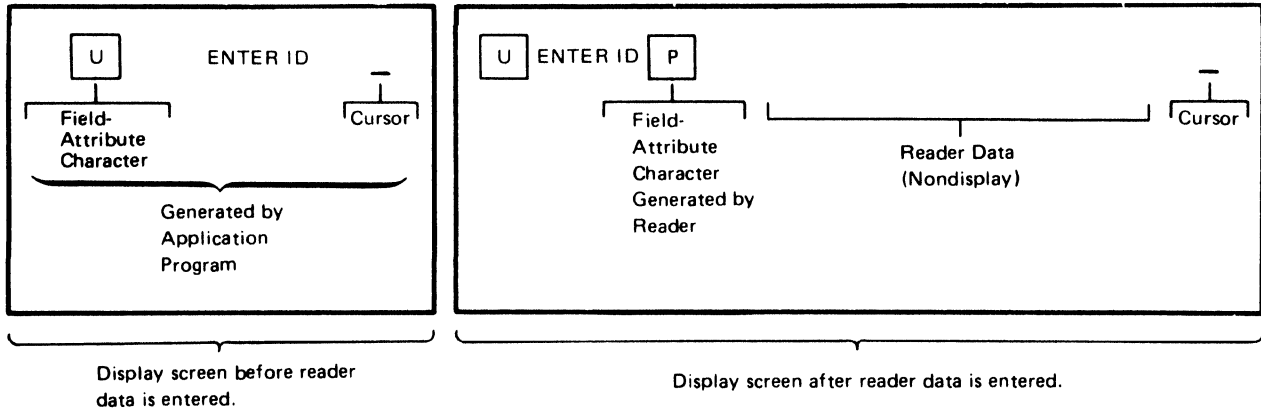

Inbound Data Stream

AID
Cursor Address
SBA
Start of Data Address
Data
SBA
Start of Data Address
Data

Set to indicate input from a magnetic-stripe reading device.

Address of the cursor upon completion of the reader operation.

Set Buffer Address.

Address of the unprotected (U) field-attribute character + 1.

ENTER ID, in the example above.

Set Buffer Address.

Address of the protected field-attribute character + 1. In this case, the address of the first data character from the reader following the protected field-attribute character.

The reader data (and any data between the cursor and the next field-attribute character).

U = Unprotected field-attribute character
P = Protected field-attribute character

Figure H-17. Operation of the Display with a Formatted Screen (OICR or MSR Using 3277-Compatible Numeric Set), Example 1

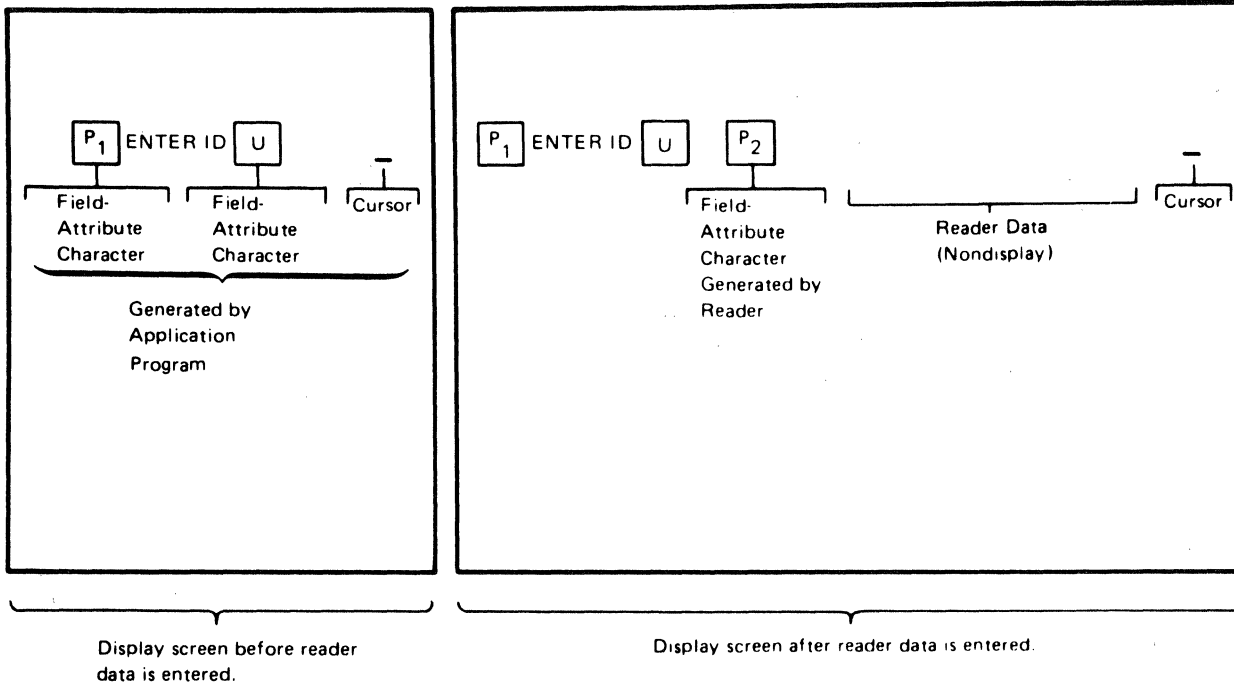

- U = Unprotected field-attribute character
- P = Protected field-attribute character

Note: Rules for positioning modified data on formatted screens apply. The position of reader data in the inbound data stream depends on the field position in the format.

Inbound Data Stream

AID
Cursor Address
SBA
Start of Data Address
SBA
Start of Data Address
Data

- Set to indicate input from magnetic-stripe reading device.
- Address of cursor upon completion of reader operation.
- Set Buffer Address.
- Address of the unprotected (U) field-attribute character + 1. In the example above, it will be the address of the P₂ field-attribute character.
- Set Buffer Address.
- Address of the P₂ field-attribute character + 1. In this case, the address of the first data character from the reader following the P₂ field-attribute character.
- The reader data (and any data between the cursor and the next field-attribute character).

Figure H-18. Operation of the Display with a Formatted Screen (OICR or MSR Using 3277-Compatible Numeric Character Set), Example 2

Because of the makeup of the 3277-compatible numeric character set codes (4 bits plus parity bit), only the right-hand 4 bits are of concern. The application program should set up a 1-byte field initialized to X'0B'. This is the SOR (SS) character, which is not included in the inbound data stream but which is used to compute the LRC. As each character is checked for validity, it is exclusively ORed into this field. This operation should include the EOR/EOI (ES) character and the LRC, resulting in the byte containing zero. If the byte is nonzero, it means the result of the check on the data characters, including EOR/EOI (ES), does not equal the LRC, and a parity error has occurred.

6. If the reader input field is to be reused, the application program must remove the hardware-generated field-attribute character and reader input data. The location of this character can be derived from the inbound data stream by using one less than the start of the data address preceding the input data. Additionally, the cursor is located one position beyond the end of the reader data field.

The card field may be reused if more than one card input is required or if the original attempt was unsuccessful and the application program desires to retry the operation.

7. Text for all fields having the MDT bit set is transferred to main storage when the reader data is retrieved in response to the readergenerated I/O pending.
8. The cursor must be moved out of the reader-generated field before further keyboard activity is allowed.
9. A test card is delivered with each OICR and is available for system validation. The test card data (in 4-bit code) written into the display buffer is as follows:

BB1234567890123456789012345678955ABDEF7

A test card, PN 1742659, is delivered with each 3278 Magnetic Reader Control feature. The test card data placed in the display buffer is as follows:

0123456789987654321001234567F4

Care should be taken that these cards are not accidentally auto-entered. The display should be placed in test mode to avoid auto-entering magnetic-stripe information to the host.

MSR Operator Indicators and Alarm

Refer to "MSR/MHS Operator Indicators and Alarm."

Appendix I. X.21 Switched Network Adapter Feature (3274 Model 51C)

The X.21 switched feature, installed in the 3274-51C and appropriately configured (see the *3274 Customizing Guide*), enables a display operator, using a display's keyboard, to connect the 3274-51C and attached terminals to a host system via the public switched network. The feature provides an adapter and appropriate control code for interfacing the 3274-51C with Data-Circuit Terminating Equipment (DCE) in the public switched network.

Communication with the host is conducted using SNA/SDLC protocols, and line speeds of 2400, 4800, and 9600 bps in a digital switched network are supported.

The *3270 Configurator* publication lists the prerequisite or mutually exclusive features associated with the X.21 feature.

3274-51C X.21 Functions

The subset of X.21 functions supported by the 3274-51C is:

- Address Call, including Abbreviated Call and Closed User Group Call
- Direct Call
- Automatic Answering
- Call Progress Signals
- Controlled Not-Ready state
- Registration/Cancellation Facility

Address Call. A host system can be “dialed” using the keyboard to enter its public switched network address.

Abbreviated Address Call. A host system can be “dialed” using an abbreviated network address.

Closed User Group Call. The number of 3270 systems and host systems that may connect to each other can be limited. “Dialing” of a network number not included in the “dialer’s” user group results in an “access barred” condition.

Direct Call. A host system connection is established without entering its network address. The address must have been predefined to the network.

Automatic Answering. An incoming call from a host system to the 3274-51C is automatically “answered” by the control unit. Operator action is not required to complete the connection.

Call Progress Signals. Call Progress signals from the network are interpreted and displayed by the control unit. They report on the status of outgoing calls (and also indicate results of operations with the Registration/Cancellation Facility).

Controlled-Not-Ready State. Control unit is disconnected from network. Incoming calls are not accepted and a call progress signal to this effect is returned to the caller. Outgoing calls, dialed or direct, cannot be initiated. The control unit can perform offline functions.

Registration/Cancellation Facility. Abbreviated network addresses, and IDs for members of a closed user group, are registered and canceled (with the network) using this facility.

X.21 Inquiry Facility

The 3274-51C support of X.21 switched network operations includes a facility with which an operator can query the control unit about the status of each terminal attached to it, and obtain the address of the currently connected host. (See "Inquiry Facility" at the end of this appendix for a detailed presentation.)

X.21 Keys and Indicators

The X.21 functions are invoked by operator actions at the keyboard (and incoming calls), and the status of the control unit with respect to X.21 functions is signaled to the operator via indicators in the Operator Information Area of the 3278 or 3279 display. (This Appendix does not detail operator actions. See the appropriate Operator's Guides (3278, 3279) for such information.)

The keyboard/display attached to port 0 of the control unit has access to the full complement of X.21 functions. The other terminals (as a group) are assigned function ranging from the full complement to lockout when the 3274 is customized.

The Keys

Keys at positions 38, 3,4,5,6,8, and 15 of the 3278/3279 keyboards are affected when the X.21 feature is installed in the control unit. Six of the seven keys are associated with X.21 function; the seventh, the key at position 15, inherits the load printer matrix function assigned to the key at position 38 if the X.21 feature is not installed. This key is effective *only* on the keyboard at port 0 (see "Printers" in Chapter 2). The *Character Set Reference* publication, GA27-2837, relates key positions to key functions and nomenclature, depending on the keyboard installed.

The six X.21 function keys consist of a "shift" key—the X.21 Extension key (▶) position 38—and five control keys: Direct Call key (▶ DIRECT) position 3, Dial Call key (▶ DIAL) position 4, Local key (▶ LOCAL) position 5, Communication key (▶ COMM) position 6, and the Disconnect key (▶ DISC) position 8.

To activate any of the X.21 control keys (and the ▶ LOAD MATRIX key), the sequence is: press and hold the ALT key (present on all keyboards), press the X.21 extension key (▶), release the ALT and ▶ keys, and press the desired control key. (Decals are provided to mark the keys, the decal is shown in parentheses above.)

The Indicators

X.21 indicators are displayed in the Readiness and System Connection, Do Not Enter, Reminder, and Shifts and Modes areas of the 3278/3279 Operator Information Area. They reflect the state of the control unit with respect to X.21 operations. When the X.21 indicators are accompanied by a Call Progress signal (Nnn), the signal is conveying information about a network operation (Call Progress signals are listed later in this appendix).

The following indicators are displayed in the Reminder area:

Call Ready —
Call Ready with Call Progress signal —Nnn
Dial In (Dialing terminal) —#?
Dial In (other terminals, same control unit) —**
Outgoing Call in Process →
Outgoing Call in Process with Call Progress signal →Nnn
Incoming Call in Process ←
Disconnect in Process —
Local ←599 Communication Reminder with status code 599.)

The following indicator is displayed in the Do Not Enter area:

Operator Communication Check ✕ —

The following indicator is displayed in the Readiness and System Connection area:

In-use N

The following indicator is displayed in the Shifts and Modes area:

Extension mode ►

The X.21 indicators appear alone or in conjunction with other Operator Information Area indicators. In the topic that follows, "X.21 Operations," the X.21 indicators are related to the keyboard actions or control unit states that cause them to be displayed.

X.21 Operations

X.21 switched network operations are initiated and tracked using the keys and indicators just described. The "state" that the control unit is in controls which key functions are applicable at any given time. The keyboard must be in extension mode for any X.21 control key to be active.

Extension Mode

The keyboard is placed in extension mode by pressing the ALT key and the extension key (►), unless the security keylock is off, if or a TEST mode or machine check condition is present. The keyboard remains in extension mode until one of the X.21 control keys is pressed or a reset action occurs.

All keyboard status indicators (e.g., KANA, APL, TEST, etc.) are reset when entering extension mode, and the extension mode indicator (▶) is displayed in the Shifts and Modes area.

If any other than the X.21 control keys, ALT key, and the RESET key is pressed, the Retry indicator is displayed and the extension mode is reset. When extension mode is reset, the status indicator previously active will again be displayed.

While in extension mode:

1. Pressing the extension key resets extension mode.
2. The reset key operates normally and does not reset extension mode.
3. If pressed, the ALT key is ignored.

Ready State

When the 3274-51C is in X.21 Ready state, the Call Ready indicator is displayed, and the ▶ (extension), ▶ DIAL, ▶ DIRECT, and ▶ LOCAL keys or an incoming call are responded to.

The Ready state is entered when:

- a. Power is brought up on the control unit.
- b. The ▶ COMM key is pressed while the control unit is in local mode.
- c. When a Dial In state is ended by use of the ▶ DISC key.
- d. The line is disconnected normally (▶ DISC key or ▶ DISC command).
- e. An outgoing call is rejected by the network. The Call Ready indicator with Call Progress signals is displayed. The ▶ DISC or ▶ COMM keys will clear the Call Progress signal.
- f. The line is disconnected by an error, or an error occurs in the connection process. The Communication Error indicator is displayed (overrides the Call Ready indicator). Pressing the ▶ COMM key will restore the Call Ready indicator.

Dial In State

Pressing the ▶ DIAL key causes the control unit to exit the ready state, to turn off the Call Ready and Extension mode indicators, to and display the Dial In (dialing terminal) indicator at the dialing terminal and the Dial In (other terminal) indicator on the other terminals.

The Dial Call key initiates a keyboard reset and screen clear operation; positions the cursor at the home position, selects the character set in ROS X'00', and resets the Highlighting Color (3279) and Programmed Symbols indicators to the default indications. If the terminal is in a Wait, Device Busy, Device Very Busy, Device Not Functional, or Security Key off condition, the Dial Call key has no effect and extension mode is exited.

The control unit accepts call requests (Dial Call key or Direct Call key pressed) from the terminals on a first-come basis. Once a given terminal has entered a dial request, an attempt to enter a dial request or to change the Dial In state (except for ► DISC) by another terminal is rejected. (The keyboard is inhibited and the Operator Communication Check indicator is displayed.) Test Mode entered on another terminal is allowed and will not affect the Dial In state.

While in Dial In state:

- a. At the dialing terminal: The ► DIAL, ► DIRECT, ► LOCAL, ► DISC, TEST, CLEAR, ENTER, and Other keys are accepted, the ► COMM key is ignored, and AID producing keys (except for CLEAR and ENTER) are rejected with the minus function indicator displayed.
- b. At the other terminals: The ► DIAL, ► DIRECT, and ► LOCAL keys are rejected with an operator communication check displayed.

The ► DISC key, TEST key and Other keys are accepted, the ► COMM key is ignored, and AID producing keys are rejected with the minus function indicator displayed.

- c. Use of the TEST key at the dial-originating terminal aborts the Dial In state.
- d. When dialing, as address digits are entered they are displayed in an unprotected area extending from the home position to column 31 of the screen—the Dial In area. The remainder of the screen is protected, and the Go Elsewhere indicator will be displayed if an attempt is made to enter a digit in the protected area.
- e. Null and blank characters in the Dial In area will be ignored.
- f. If no digit has been entered before the ENTER key is pressed, the ENTER key is rejected and the What? and Call Ready indicators are displayed.
- g. The CLEAR key causes the Dial In area to be cleared. (No AID signal is sent.)
- h. Pressing the ENTER key after entering the dial digits causes the outgoing Call in Process indicator to replace the Dial In indicator, and the ► DIAL, ► DIRECT, and ► LOCAL keys are disabled. (However, if the dial digits are incorrect or invalid, the What? indicator is displayed and Dial In state is reset to the Call Ready state.
- i. The ► DIAL and ► DISC keys in Dial In state clear the screen; the former does not reset the Dial In state; the latter resets the Dial In state to Call Ready state.

The ► DISC, TEST, and Other keys are accepted; the ► COMM key is ignored; and all AID producing keys are rejected with the minus function indicator displayed.

See Figure I-1 for a Dial In state summary.

Action Taken	Response and Operator Information Area Indicator Displayed	
	Dialing Terminal	Other Terminals
Dial Call (▶ DIAL key)	Accepted Z#?	Rejected X f Z Z##
Direct Call (▶ DIRECT key) Enter Outgoing Call-in-Process state	Accepted →Z	Rejected X f Z Z##
Take offline enter Controlled-not- Ready state (▶ LOCAL key)	Accepted →Z599	Rejected X f Z Z##
Cancel Controlled- not-Ready state (▶ COMM key)	Ignored Z#?	Ignored Z#?
Disconnect Line (▶ DISC key) Enter Call Ready State	Accepted Z	Accepted Z
TEST key Enter TEST mode	Accepted TEST Abort dial in	Accepted TEST Z##
ENTER key Enter Outgoing Call-in-Process state	Accepted →Z	Rejected X-f Z##
CLEAR key	Accepted clears Dial-In area Z#?	Accepted clears screen Z##
PA, PF, ATTN, SYS REQ keys	Rejected X-f Z#?	Rejected X-f Z##

Figure I-1. Control Unit/Terminal Responses in Dial-In State

Outgoing Call in Process State

Outgoing Call in Process state is entered via the Dial In state (pressing ENTER after entering the dial digits) or directly from the Ready state when the Direct Call key is used. The Call Ready indicator is replaced with the Outgoing Call in Process indicator and the same keys are enabled/disabled as noted in item h under Dial In state. Call Progress signals may be displayed along with the Outgoing Call-in-Process indicator. (See "Call Progress Signals" later in this appendix.)

Ready-for-Data and Data Transfer States

After line connection has been made but before any sessions with the host have been established (SNA ACTPU/ACTIU sequence), the Outgoing Call-in-Process indicator is turned off and the In-Use indicator is displayed in the Readiness and System Connection area. After session(s) have been established, the Online indicator is also displayed in the same area.

While in the Ready-for-Data and Data Transfer states:

1. The AID producing keys, TEST, ► DISC, and Other keys are accepted.
2. The ► DIAL, ► DIRECT, and ► LOCAL keys are rejected with the Operator Communication Check indicator displayed.
3. The ► COMM key is ignored.

Disconnection-in-Process State

Disconnection-in-Process state is entered when the ► DISC key is pressed or a disconnect command or timeout condition causes the line connection to be broken. The Disconnection-in-Process indicator is displayed until disconnection is complete when the Call Ready indicator is displayed and the control unit returns to Ready state.

While in the Disconnect-in-Process state:

1. TEST and Other keys are accepted.
2. The ► DIAL, ► DIRECT, and ► LOCAL keys are rejected with the Operator Communication Check indicator displayed.
3. The AID producing keys are rejected with the minus function indicator displayed.

The screen will not be cleared. All session-related indicators including the Online indicator, Ownership, System Lock, etc., are cleared.

Incoming Call State

Incoming Call state is entered from Ready state. The Call Ready indicator is replaced with the Incoming Call-in-Process indicator, and, when the connection is completed, the In-Use indicator is displayed. After session establishment, the Online indicator is also displayed.

While in Incoming Call state:

1. The ► DISC, TEST and Other keys are accepted.
2. The ► DIAL, ► DIRECT, and ► LOCAL keys are rejected with the Operator Communication Check indicator displayed.
3. The ► COMM key is ignored.
4. AID producing keys are rejected with the minus function indicator displayed.

Controlled-Not-Ready State

Controlled-Not-Ready state is entered from the Ready state when the ► LOCAL key is pressed. All incoming calls and outgoing call requests are rejected. The Call Ready indicator is replaced with the Communication Reminder indicator accompanied by a status code of 599.

The ► COMM key is used to restore the control unit to Ready state.

While in Controlled-Not-Ready state:

1. The ► COMM, TEST, and Other keys are accepted.
2. The ► DIAL, ► DIRECT, ► DISC keys are rejected with the Operator Communication Check indicator displayed.
3. The AID producing keys are rejected with the minus function indicator displayed.

Call Progress Signals

The Call Progress signals, two digit codes displayed with the Call Ready and Outgoing Call-In-Process indicators, are public switched network originated. They provide information to the control unit and operator concerning outgoing call requests and registration/cancellation operations.

When displayed with the Call Ready indicator, Call Progress signals indicate that:

1. The call request just made has failed and the line is disconnected. The network reason for the failure is specified by the specific signal.
2. The registration/cancellation operation just attempted succeeded or failed.

When displayed with the Outgoing Call-In-Process indicator, Call Progress signals indicate the network status of the call. No operator action should be taken until either the In-Use indicator appears (call successful) or the Call Ready indicator with Call Progress signals appears (call unsuccessful).

Call Progress Signal Handling

The following are the CCITT-defined Call Progress signals for public switched networks:

01 Terminal called	45 Controlled-not-ready
02 Redirected call	46 Uncontrolled-not-ready
03 Connect when free	47 DCE power off
20 No connection	48 Invalid facility request
21 Number busy	49 Network fault in local loop
22 Procedure error	51 Call information service
23 Transmission error	52 Incompatible user
41 Access barred	61 Network congestion
42 Changed number	71 L.T. network congestion
43 Not obtainable	72 RPOA out of order
44 Out of order	81 Registration/cancellation confirmed

Call Progress signals are handled by the control unit according to category, as follows:

Category 1—0x signals: Wait for 1 minute, return to Call Ready state if not successful.

Category 2—2x,6x signals: Retry. The number of retries and the time interval (3 to 20 seconds) between retries is specified at 3274 customization.

Category 3—4x,5x,7x,8x: Go to Call Ready state immediately.

Call Progress signals displayed with the Call Ready indicator are cleared by use of the Dial call, Direct call, Disconnect, Local, or Communication key or by receipt of an incoming call.

Registration/Cancellation Facility

This facility is used to register (with the network) or cancel abbreviated address call sequences or the addresses of the members comprising the closed user group.

To use the Registration/Cancellation Facility, the control unit is placed in Dial In state (the ► DIAL key) and a sequence of numbers indicating the type of registration/cancellation wanted and the specifics is then entered. The exact sequence and content will vary between public switched networks. After completion of a registration/cancellation request, the Call Ready indicator will be displayed with a Call Progress signal indicating success or failure of the request.

Error Conditions

When the Communication Reminder indicator with 3274 error status code is displayed during X.21 operations, the state of the connection can be determined by the In Use indicator. See Appendix A for status code interpretation. If the call is to be retried, the ► COMM key will reset the Communication Reminder indicator. Appendix A should also be referred to for machine-check indicator interpretation and handling.

Inquiry Facility

Concurrent test 3 of the subsystem log and test facility provides X.21-related information when the X.21 feature is installed on the 3274-51C.

Test 3 is invoked by:

1. Pressing and holding the ALT key, and pressing the TEST REQ key.
2. Releasing the ALT and TEST REQ keys.
3. Keying in /3 (slash three).
4. Pressing the ENTER key.

The following eight lines of information will be displayed:

Line 1 01234567 89...

The digits represent the low-order digit of the 3274 port address. Type B ports are always noted following Type A ports; if a Type B port is attached the last (highest) Type A port and the first (lowest) Type B port are separated by two blanks.

Line 2 1, 0, or a - (hyphen) under each position in line 1.

1 indicates the terminal is powered on.
0 indicates the terminal is powered off (or that no terminal is attached to the port).
- indicates that the terminal is disabled due to an error detected at the control unit.

Line 3 d, p, i, or a __ (underscore) under each position in line 1 followed by the letters TYP.

d indicates the terminal is a display.
p indicates the terminal is a printer.
i indicates a terminal other than a display or printer.
__ indicates the terminal has never been powered on (or that no terminal is attached to the port).

Line 4 . (period), : (colon), | (vertical bar), or a * (asterisk) under each position in line 1 followed by the letters COAX.

. indicates no coax cable errors recorded.
: indicates 1 to 9 coax cable errors recorded.
| indicates 10 to 19 coax cable errors recorded.
* indicates 20 or more coax cable errors recorded.

Line 5 . (period), : (colon), | (vertical bar), or a * (asterisk) under each position in line 1 followed by the letters DEV.

. indicates no terminal errors recorded.
: indicates 1 to 9 terminal errors recorded.
| indicates 10 to 19 terminal errors recorded.
* indicates 20 or more terminal errors recorded.

Line 6 + or a blank under each position in line 1 followed by the letters LU.

+ indicates that the terminal is in session with the host.
blank indicates that the terminal is not in session with the host.

Line 7 ## is displayed directly under the letters LU in line 6 followed by one of the following:

- a. The host access (the dialed number) to which the control unit is currently connected.
- b. Four zero digits (0000) if the current connection was made via the ► DIRECT key.
- c. Four hyphens (----) if the control unit's current status is "incoming call in process" or the connection has been made by an incoming call.

Line 8 MMMM CCCC PPPP RRRR XXXX

MMMM is a summary count of 3274 detected machine checks.
CCCC is a summary count of communication checks.
PPPP is a summary count of program checks.
RRRR is a summary count of SDLC Test commands received.
XXXX is a summary count of SDLC Test commands successfully transmitted.

An example follows:

<u>Line</u>	<u>Contents</u>
1	01234567 (No Type B adapter)
2	101111-1
3	ddddppp TYP
4*: COAX
5: DEV
6	+ ++ + LU
7	## 0466443
8	0000 0001 0000 0000 0000

Appendix J. Buffer Address I/O Interface Codes

40 Col		80 Col		132 Col		Position		Buffer Address (Hex)			
<u>R</u>	<u>C</u>	<u>R</u>	<u>C</u>	<u>R</u>	<u>C</u>	<u>Dec</u>	<u>Hex</u>	<u>EBCDIC</u>		<u>ASCII</u>	
01	01	01	01	01	001	0000	000	40	40	20	20
01	02	01	02	01	002	0001	001	40	C1	20	41
01	03	01	03	01	003	0002	002	40	C2	20	42
01	04	01	04	01	004	0003	003	40	C3	20	43
01	05	01	05	01	005	0004	004	40	C4	20	44
01	06	01	06	01	006	0005	005	40	C5	20	45
01	07	01	07	01	007	0006	006	40	C6	20	46
01	08	01	08	01	008	0007	007	40	C7	20	47
01	09	01	09	01	009	0008	008	40	C8	20	48
01	10	01	10	01	010	0009	009	40	C9	20	49
01	11	01	11	01	011	0010	00A	40	4A	20	5B
01	12	01	12	01	012	0011	00B	40	4B	20	2E
01	13	01	13	01	013	0012	00C	40	4C	20	3C
01	14	01	14	01	014	0013	00D	40	4D	20	28
01	15	01	15	01	015	0014	00E	40	4E	20	2B
01	16	01	16	01	016	0015	00F	40	4F	20	21
01	17	01	17	01	017	0016	010	40	50	20	26
01	18	01	18	01	018	0017	011	40	D1	20	4A
01	19	01	19	01	019	0018	012	40	D2	20	4B
01	20	01	20	01	020	0019	013	40	D3	20	4C
01	21	01	21	01	021	0020	014	40	D4	20	4D
01	22	01	22	01	022	0021	015	40	D5	20	4E
01	23	01	23	01	023	0022	016	40	D6	20	4F
01	24	01	24	01	024	0023	017	40	D7	20	50
01	25	01	25	01	025	0024	018	40	D8	20	51
01	26	01	26	01	026	0025	019	40	D9	20	52
01	27	01	27	01	027	0026	01A	40	5A	20	5D
01	28	01	28	01	028	0027	01B	40	5B	20	24
01	29	01	29	01	029	0028	01C	40	5C	20	2A
01	30	01	30	01	030	0029	01D	40	5D	20	29
01	31	01	31	01	031	0030	01E	40	5E	20	3B
01	32	01	32	01	032	0031	01F	40	5F	20	5E
01	33	01	33	01	033	0032	020	40	60	20	2D
01	34	01	34	01	034	0033	021	40	61	20	2F
01	35	01	35	01	035	0034	022	40	E2	20	53
01	36	01	36	01	036	0035	023	40	E3	20	54
01	37	01	37	01	037	0036	024	40	E4	20	55
01	38	01	38	01	038	0037	025	40	E5	20	56
01	39	01	39	01	039	0038	026	40	E6	20	57
01	40	01	40	01	040	0039	027	40	E7	20	58
02	01	01	41	01	041	0040	028	40	E8	20	59
02	02	01	42	01	042	0041	029	40	E9	20	5A
02	03	01	43	01	043	0042	02A	40	6A	20	7C
02	04	01	44	01	044	0043	02B	40	6B	20	2C
02	05	01	45	01	045	0044	02C	40	6C	20	25
02	06	01	46	01	046	0045	02D	40	6D	20	5F
02	07	01	47	01	047	0046	02E	40	6E	20	3E
02	08	01	48	01	048	0047	02F	40	6F	20	3F
02	09	01	49	01	049	0048	030	40	F0	20	30
02	10	01	50	01	050	0049	031	40	F1	20	31
02	11	01	51	01	051	0050	032	40	F2	20	32
02	12	01	52	01	052	0051	033	40	F3	20	33
02	13	01	53	01	053	0052	034	40	F4	20	34
02	14	01	54	01	054	0053	035	40	F5	20	35
02	15	01	55	01	055	0054	036	40	F6	20	36
02	16	01	56	01	056	0055	037	40	F7	20	37
02	17	01	57	01	057	0056	038	40	F8	20	38
02	18	01	58	01	058	0057	039	40	F9	20	39
02	19	01	59	01	059	0058	03A	40	7A	20	3A

40 Col		80 Col		132 Col		Position		Buffer Address (Hex)			
<u>R</u>	<u>C</u>	<u>R</u>	<u>C</u>	<u>R</u>	<u>C</u>	<u>Dec</u>	<u>Hex</u>	<u>EBCDIC</u>		<u>ASCII</u>	
02	20	01	60	01	060	0059	03B	40	7B	20	23
02	21	01	61	01	061	0060	03C	40	7C	20	40
02	22	01	62	01	062	0061	03D	40	7D	20	27
02	23	01	63	01	063	0062	03E	40	7E	20	3D
02	24	01	64	01	064	0063	03F	40	7F	20	22
02	25	01	65	01	065	0064	040	C1	40	41	20
02	26	01	66	01	066	0065	041	C1	C1	41	41
02	27	01	67	01	067	0066	042	C1	C2	41	42
02	28	01	68	01	068	0067	043	C1	C3	41	43
02	29	01	69	01	069	0068	044	C1	C4	41	44
02	30	01	70	01	070	0069	045	C1	C5	41	45
02	31	01	71	01	071	0070	046	C1	C6	41	46
02	32	01	72	01	072	0071	047	C1	C7	41	47
02	33	01	73	01	073	0072	048	C1	C8	41	48
02	34	01	74	01	074	0073	049	C1	C9	41	49
02	35	01	75	01	075	0074	04A	C1	4A	41	5B
02	36	01	76	01	076	0075	04B	C1	4B	41	2E
02	37	01	77	01	077	0076	04C	C1	4C	41	3C
02	38	01	78	01	078	0077	04D	C1	4D	41	28
02	39	01	79	01	079	0078	04E	C1	4E	41	2B
02	40	01	80	01	080	0079	04F	C1	4F	41	21
03	01	02	01	01	081	0080	050	C1	50	41	26
03	02	02	02	01	082	0081	051	C1	D1	41	4A
03	03	02	03	01	083	0082	052	C1	D2	41	4B
03	04	02	04	01	084	0083	053	C1	D3	41	4C
03	05	02	05	01	085	0084	054	C1	D4	41	4D
03	06	02	06	01	086	0085	055	C1	D5	41	4E
03	07	02	07	01	087	0086	056	C1	D6	41	4F
03	08	02	08	01	088	0087	057	C1	D7	41	50
03	09	02	09	01	089	0088	058	C1	D8	41	51
03	10	02	10	01	090	0089	059	C1	D9	41	52
03	11	02	11	01	091	0090	05A	C1	5A	41	5D
03	12	02	12	01	092	0091	05B	C1	5B	41	24
03	13	02	13	01	093	0092	05C	C1	5C	41	2A
03	14	02	14	01	094	0093	05D	C1	5D	41	29
03	15	02	15	01	095	0094	05E	C1	5E	41	3B
03	16	02	16	01	096	0095	05F	C1	5F	41	5E
03	17	02	17	01	097	0096	060	C1	60	41	2D
03	18	02	18	01	098	0097	061	C1	61	41	2F
03	19	02	19	01	099	0098	062	C1	E2	41	53
03	20	02	20	01	100	0099	063	C1	E3	41	54
03	21	02	21	01	101	0100	064	C1	E4	41	55
03	22	02	22	01	102	0101	065	C1	E5	41	56
03	23	02	23	01	103	0102	066	C1	E6	41	57
03	24	02	24	01	104	0103	067	C1	E7	41	58
03	25	02	25	01	105	0104	068	C1	E8	41	59
03	26	02	26	01	106	0105	069	C1	E9	41	5A
03	27	02	27	01	107	0106	06A	C1	6A	41	7C
03	28	02	28	01	108	0107	06B	C1	6B	41	2C
03	29	02	29	01	109	0108	06C	C1	6C	41	25
03	30	02	30	01	110	0109	06D	C1	6D	41	5F
03	31	02	31	01	111	0110	06E	C1	6E	41	3E
03	32	02	32	01	112	0111	06F	C1	6F	41	3F
03	33	02	33	01	113	0112	070	C1	F0	41	30
03	34	02	34	01	114	0113	071	C1	F1	41	31
03	35	02	35	01	115	0114	072	C1	F2	41	32
03	36	02	36	01	116	0115	073	C1	F3	41	33
03	37	02	37	01	117	0116	074	C1	F4	41	34
03	38	02	38	01	118	0117	075	C1	F5	41	35
03	39	02	39	01	119	0118	076	C1	F6	41	36
03	40	02	40	01	120	0119	077	C1	F7	41	37
04	01	02	41	01	121	0120	078	C1	F8	41	38
04	02	02	42	01	122	0121	079	C1	F9	41	39

40 Col		80 Col		132 Col		Position		Buffer Address (Hex)	
R	C	R	C	R	C	Dec	Hex	EBCDIC	ASCII
04	03	02	43	01	123	0122	07A	C1 7A	41 3A
04	04	02	44	01	124	0123	07B	C1 7B	41 23
04	05	02	45	01	125	0124	07C	C1 7C	41 40
04	06	02	46	01	126	0125	07D	C1 7D	41 27
04	07	02	47	01	127	0126	07E	C1 7E	41 3D
04	08	02	48	01	128	0127	07F	C1 7F	41 22
04	09	02	49	01	129	0128	080	C2 40	42 20
04	10	02	50	01	130	0129	081	C2 C1	42 41
04	11	02	51	01	131	0130	082	C2 C2	42 42
04	12	02	52	01	132	0131	083	C2 C3	42 43
04	13	02	53	02	001	0132	084	C2 C4	42 44
04	14	02	54	02	002	0133	085	C2 C5	42 45
04	15	02	55	02	003	0134	086	C2 C6	42 46
04	16	02	56	02	004	0135	087	C2 C7	42 47
04	17	02	57	02	005	0136	088	C2 C8	42 48
04	18	02	58	02	006	0137	089	C2 C9	42 49
04	19	02	59	02	007	0138	08A	C2 C4	42 5B
04	20	02	60	02	008	0139	08B	C2 4B	42 2E
04	21	02	61	02	009	0140	08C	C2 4C	42 3C
04	22	02	62	02	010	0141	08D	C2 4D	42 28
04	23	02	63	02	011	0142	08E	C2 4E	42 2B
04	24	02	64	02	012	0143	08F	C2 4F	42 21
04	25	02	65	02	013	0144	090	C2 50	42 26
04	26	02	66	02	014	0145	091	C2 D1	42 4A
04	27	02	67	02	015	0146	092	C2 D2	42 4B
04	28	02	68	02	016	0147	093	C2 D3	42 4C
04	29	02	69	02	017	0148	094	C2 D4	42 4D
04	30	02	70	02	018	0149	095	C2 D5	42 4E
04	31	02	71	02	019	0150	096	C2 D6	42 4F
04	32	02	72	02	020	0151	097	C2 D7	42 50
04	33	02	73	02	021	0152	098	C2 D8	42 51
04	34	02	74	02	022	0153	099	C2 D9	42 52
04	35	02	75	02	023	0154	09A	C2 5A	42 5D
04	36	02	76	02	024	0155	09B	C2 5B	42 24
04	37	02	77	02	025	0156	09C	C2 5C	42 2A
04	38	02	78	02	026	0157	09D	C2 5D	42 29
04	39	02	79	02	027	0158	09E	C2 5E	42 3B
04	40	02	80	02	028	0159	09F	C2 5F	42 5E
05	01	03	01	02	029	0160	0A0	C2 60	42 2D
05	02	03	02	02	030	0161	0A1	C2 61	42 2F
05	03	03	03	02	031	0162	0A2	C2 E2	42 53
05	04	03	04	02	032	0163	0A3	C2 E3	42 54
05	05	03	05	02	033	0164	0A4	C2 E4	42 55
05	06	03	06	02	034	0165	0A5	C2 E5	42 56
05	07	03	07	02	035	0166	0A6	C2 E6	42 57
05	08	03	08	02	036	0167	0A7	C2 E7	42 58
05	09	03	09	02	037	0168	0A8	C2 E8	42 59
05	10	03	10	02	038	0169	0A9	C2 E9	42 5A
05	11	03	11	02	039	0170	0AA	C2 6A	42 7C
05	12	03	12	02	040	0171	0AB	C2 6B	42 2C
05	13	03	13	02	041	0172	0AC	C2 6C	42 25
05	14	03	14	02	042	0173	0AD	C2 6D	42 5F
05	15	03	15	02	043	0174	0AE	C2 6E	42 3E
05	16	03	16	02	044	0175	0AF	C2 6F	42 3F
05	17	03	17	02	045	0176	0B0	C2 F0	42 30
05	18	03	18	02	046	0177	0B1	C2 F1	42 31
05	19	03	19	02	047	0178	0B2	C2 F2	42 32
05	20	03	20	02	048	0179	0B3	C2 F3	42 33
05	21	03	21	02	049	0180	0B4	C2 F4	42 34
05	22	03	22	02	050	0181	0B5	C2 F5	42 35
05	23	03	23	02	051	0182	0B6	C2 F6	42 36
05	24	03	24	02	052	0183	0B7	C2 F7	42 37

40 Col		80 Col		132 Col		Position		Buffer Address (Hex)			
R	C	R	C	R	C	Dec	Hex	EBCDIC		ASCII	
05	25	03	25	02	053	0184	0B8	C2	F8	42	38
05	26	03	26	02	054	0185	0B9	C2	F9	42	39
05	27	03	27	02	055	0186	0BA	C2	7A	42	3A
05	28	03	28	02	056	0187	0BB	C2	7B	42	23
05	29	03	29	02	057	0188	0BC	C2	7C	42	40
05	30	03	30	02	058	0189	0BD	C2	7D	42	27
05	31	03	31	02	059	0190	0BE	C2	7E	42	3D
05	32	03	32	02	060	0191	0BF	C2	7F	42	22
05	33	03	33	02	061	0192	0C0	C3	40	43	20
05	34	03	34	02	062	0193	0C1	C3	C1	43	41
05	35	03	35	02	063	0194	0C2	C3	C2	43	42
05	36	03	36	02	064	0195	0C3	C3	C3	43	43
05	37	03	37	02	065	0196	0C4	C3	C4	43	44
05	38	03	38	02	066	0197	0C5	C3	C5	43	45
05	39	03	39	02	067	0198	0C6	C3	C6	43	46
05	40	03	40	02	068	0199	0C7	C3	C7	43	47
06	01	03	41	02	069	0200	0C8	C3	C8	43	48
06	02	03	42	02	070	0201	0C9	C3	C9	43	49
06	03	03	43	02	071	0202	0CA	C3	4A	43	5B
06	04	03	44	02	072	0203	0CB	C3	4B	43	2E
06	05	03	45	02	073	0204	0CC	C3	4C	43	3C
06	06	03	46	02	074	0205	0CD	C3	4D	43	28
06	07	03	47	02	075	0206	0CE	C3	4E	43	2B
06	08	03	48	02	076	0207	0CF	C3	4F	43	21
06	09	03	49	02	077	0208	0D0	C3	50	43	26
06	10	03	50	02	078	0209	0D1	C3	D1	43	4A
06	11	03	51	02	079	0210	0D2	C3	D2	43	4B
06	12	03	52	02	080	0211	0D3	C3	D3	43	4C
06	13	03	53	02	081	0212	0D4	C3	D4	43	4D
06	14	03	54	02	082	0213	0D5	C3	D5	43	4E
06	15	03	55	02	083	0214	0D6	C3	D6	43	4F
06	16	03	56	02	084	0215	0D7	C3	D7	43	50
06	17	03	57	02	085	0216	0D8	C3	D8	43	51
06	18	03	58	02	086	0217	0D9	C3	D9	32	52
06	19	03	59	02	087	0218	0DA	C3	5A	43	5D
06	20	03	60	02	088	0219	0DB	C3	5B	43	24
06	21	03	61	02	089	0220	0DC	C3	5C	43	2A
06	22	03	62	02	090	0221	0DD	C3	5D	43	29
06	23	03	63	02	091	0222	0DE	C3	5E	43	3B
06	24	03	64	02	092	0223	0DF	C3	5F	43	5E
06	25	03	65	02	093	0224	0E0	C3	60	43	2D
06	26	03	66	02	094	0225	0E1	C3	61	43	2F
06	27	03	67	02	095	0226	0E2	C3	E2	43	53
06	28	03	68	02	096	0227	0E3	C3	E3	43	54
06	29	03	69	02	097	0228	0E4	C3	E4	43	55
06	30	03	70	02	098	0229	0E5	C3	E5	43	56
06	31	03	71	02	099	0230	0E6	C3	E6	43	57
06	32	03	72	02	100	0231	0E7	C3	E7	43	58
06	33	03	73	02	101	0232	0E8	C3	E8	43	59
06	34	03	74	02	102	0233	0E9	C3	E9	43	5A
06	35	03	75	02	103	0234	0EA	C3	6A	43	7C
06	36	03	76	02	104	0235	0EB	C3	6B	43	2C
06	37	03	77	02	105	0236	0EC	C3	6C	43	25
06	38	03	78	02	106	0237	0ED	C3	6D	43	5F
06	39	03	79	02	107	0238	0EE	C3	6E	43	3E
06	40	03	80	02	108	0239	0EF	C3	6F	43	3F
07	01	04	01	02	109	0240	0F0	C3	F0	43	30
07	02	04	02	02	110	0241	0F1	C3	F1	43	31
07	03	04	03	02	111	0242	0F2	C3	F2	43	32
07	04	04	04	02	112	0243	0F3	C3	F3	32	33
07	05	04	05	02	113	0244	0F4	C3	F4	43	34
07	06	04	06	02	114	0245	0F5	C3	F5	43	35

40 Col		80 Col		132 Col		Position		Buffer Address (Hex)			
<u>R</u>	<u>C</u>	<u>R</u>	<u>C</u>	<u>R</u>	<u>C</u>	<u>Dec</u>	<u>Hex</u>	<u>EBCDIC</u>		<u>ASCII</u>	
07	07	04	07	02	115	0246	0F6	C3	F6	43	36
07	08	04	08	02	116	0247	0F7	C3	F7	43	37
07	09	04	09	02	117	0248	0F8	C3	F8	43	38
07	10	04	10	02	118	0249	0F9	C3	F9	43	39
07	11	04	11	02	119	0250	0FA	C3	7A	43	3A
07	12	04	12	02	120	0251	0FB	C3	7B	43	23
07	13	04	13	02	121	0252	0FC	C3	7C	43	40
07	14	04	14	02	122	0253	0FD	C3	7D	43	27
07	15	04	15	02	123	0254	0FE	C3	7E	43	3D
07	16	04	16	02	124	0255	0FF	C3	7F	43	22
07	17	04	17	02	125	0256	100	C4	40	44	20
07	18	04	18	02	126	0257	101	C4	C1	44	41
07	19	04	19	02	127	0258	102	C4	C2	44	42
07	20	04	20	02	128	0259	103	C4	C3	44	43
07	21	04	21	02	129	0260	104	C4	C4	44	44
07	22	04	22	02	130	0261	105	C4	C5	44	45
07	23	04	23	02	131	0262	106	C4	C6	44	46
07	24	04	24	02	132	0263	107	C4	C7	44	47
07	25	04	25	03	001	0264	108	C4	C8	44	48
07	26	04	26	03	002	0265	109	C4	C9	44	49
07	27	04	27	03	003	0266	10A	C4	4A	44	5B
07	28	04	28	03	004	0267	10B	C4	4B	44	2E
07	29	04	29	03	005	0268	10C	C4	4C	44	3C
07	30	04	30	03	006	0269	10D	C4	4D	44	28
07	31	04	31	03	007	0270	10E	C4	4E	44	2B
07	32	04	32	03	008	0271	10F	C4	4F	44	21
07	33	04	33	03	009	0272	110	C4	50	44	26
07	34	04	34	03	010	0273	111	C4	D1	44	4A
07	35	04	35	03	011	0274	112	C4	D2	44	4B
07	36	04	36	03	012	0275	113	C4	D3	44	4C
07	37	04	37	03	013	0276	114	C4	D4	44	4D
07	38	04	38	03	014	0277	115	C4	D5	44	4E
07	39	04	39	03	015	0278	116	C4	D6	44	4F
07	40	04	40	03	016	0279	117	C4	D7	44	50
08	01	04	41	03	017	0280	118	C4	D8	44	51
08	02	04	42	03	018	0281	119	C4	D9	44	52
08	03	04	43	03	019	0282	11A	C4	5A	44	5D
08	04	04	44	03	020	0283	11B	C4	5B	44	24
08	05	04	45	03	021	0284	11C	C4	5C	44	2A
08	06	04	46	03	022	0285	11D	C4	5D	44	29
08	07	04	47	03	023	0286	11E	C4	5E	44	3B
08	08	04	48	03	024	0287	11F	C4	5F	44	5E
08	09	04	49	03	025	0288	120	C4	60	44	2D
08	10	04	50	03	026	0289	121	C4	61	44	2F
08	11	04	51	03	027	0290	122	C4	E2	44	53
08	12	04	52	03	028	0291	123	C4	E3	44	54
08	13	04	53	03	029	0292	124	C4	E4	44	55
08	14	04	54	03	030	0293	125	C4	E5	44	56
08	15	04	55	03	031	0294	126	C4	E6	44	57
08	16	04	56	03	032	0295	127	C4	E7	44	58
08	17	04	57	03	033	0296	128	C4	E8	44	59
08	18	04	58	03	034	0297	129	C4	E9	44	5A
08	19	04	59	03	035	0298	12A	C4	6A	44	7C
08	20	04	60	03	036	0299	12B	C4	6B	44	2C
08	21	04	61	03	037	0300	12C	C4	6C	44	25
08	22	04	62	03	038	0301	12D	C4	6D	44	5F
08	23	04	63	03	039	0302	12E	C4	6E	44	3E
08	24	04	64	03	040	0303	12F	C4	6F	44	3F
08	25	04	65	03	041	0304	130	C4	F0	44	30
08	26	04	66	03	042	0305	131	C4	F1	44	31
08	27	04	67	03	043	0306	132	C4	F2	44	32
08	28	04	68	03	044	0307	133	C4	F3	44	33

40 Col		80 Col		132 Col		Position		Buffer Address (Hex)			
R	C	R	C	R	C	Dec	Hex	EBCDIC		ASCII	
08	29	04	69	03	045	0308	134	C4	F4	44	34
08	30	04	70	03	046	0309	135	C4	F5	44	35
08	31	04	71	03	047	0310	136	C4	F6	44	36
08	32	04	72	03	048	0311	137	C4	F7	44	37
08	33	04	73	03	049	0312	138	C4	F8	44	38
08	34	04	74	03	050	0313	139	C4	F9	44	39
08	35	04	75	03	051	0314	13A	C4	7A	44	3A
08	36	04	76	03	052	0315	13B	C4	7B	44	23
08	37	04	77	03	053	0316	13C	C4	7C	44	40
08	38	04	78	03	054	0317	13D	C4	7D	44	27
08	39	04	79	03	055	0318	13E	C4	7E	44	3D
08	40	04	80	03	056	0319	13F	C4	7F	44	22
09	01	05	01	03	057	0320	140	C5	40	45	20
09	02	05	02	03	058	0321	141	C5	C1	45	41
09	03	05	03	03	059	0322	142	C5	C2	45	42
09	04	05	04	03	060	0323	143	C5	C3	45	43
09	05	05	05	03	061	0324	144	C5	C4	45	44
09	06	05	06	03	062	0325	145	C5	C5	45	45
09	07	05	07	03	063	0326	146	C5	C6	45	46
09	08	05	08	03	064	0327	147	C5	C7	45	47
09	09	05	09	03	065	0328	148	C5	C8	45	48
09	10	05	10	03	066	0329	149	C5	C9	45	49
09	11	05	11	03	067	0330	14A	C5	4A	45	5B
09	12	05	12	03	068	0331	14B	C5	4B	45	2E
09	13	05	13	03	069	0332	14C	C5	4C	45	3C
09	14	05	14	03	070	0333	14D	C5	4D	45	28
09	15	05	15	03	071	0334	14E	C5	4E	45	2B
09	16	05	16	03	072	0335	14F	C5	4F	45	21
09	17	05	17	03	073	0336	150	C5	50	45	46
09	18	05	18	03	074	0337	151	C5	D1	45	4A
09	19	05	19	03	075	0338	152	C5	D2	45	4B
09	20	05	20	03	076	0339	153	C5	D3	45	4C
09	21	05	21	03	077	0340	154	C5	D4	45	4D
09	22	05	22	03	078	0341	155	C5	D5	45	4E
09	23	05	23	03	079	0342	156	C5	D6	45	4F
09	24	05	24	03	080	0343	157	C5	D7	45	50
09	25	05	25	03	081	0344	158	C5	D8	45	51
09	26	05	26	03	082	0345	159	C5	D9	45	52
09	27	05	27	03	083	0346	15A	C5	5A	45	5D
09	28	05	28	03	084	0347	15B	C5	5B	45	24
09	29	05	29	03	085	0348	15C	C5	5C	45	2A
09	30	05	30	03	086	0349	15D	C5	5D	45	29
09	31	05	31	03	087	0350	15E	C5	5E	45	3B
09	32	05	32	03	088	0351	15F	C5	5F	45	5E
09	33	05	33	03	089	0352	160	C5	60	45	2D
09	34	05	34	03	090	0353	161	C5	61	45	2F
09	35	05	35	03	091	0354	162	C5	E2	45	53
09	36	05	36	03	092	0355	163	C5	E3	45	54
09	37	05	37	03	093	0356	164	C5	E4	45	55
09	38	05	38	03	094	0357	165	C5	E5	45	56
09	39	05	39	03	095	0358	166	C5	E6	45	57
09	40	05	40	03	096	0359	167	C5	E7	45	58
10	01	05	41	03	097	0360	168	C5	E8	45	59
10	02	05	42	03	098	0361	169	C5	E9	45	5A
10	03	05	43	03	099	0362	16A	C5	6A	45	7C
10	04	05	44	03	100	0363	16B	C5	6B	45	2C
10	05	05	45	03	101	0364	16C	C5	6C	45	25
10	06	05	46	03	102	0365	16D	C5	6D	45	5F
10	07	05	47	03	103	0366	16E	C5	6E	45	3E
10	08	05	48	03	104	0367	16F	C5	6F	45	3F
10	09	05	49	03	105	0368	170	C5	F0	45	30
10	10	05	50	03	106	0369	171	C5	F1	45	31

40 Col		80 Col		132 Col		Position		Buffer Address (Hex)			
<u>R</u>	<u>C</u>	<u>R</u>	<u>C</u>	<u>R</u>	<u>C</u>	<u>Dec</u>	<u>Hex</u>	<u>EBCDIC</u>		<u>ASCII</u>	
10	11	05	51	03	107	0370	172	C5	F2	45	32
10	12	05	52	03	108	0371	173	C5	F3	45	33
10	13	05	53	03	109	0372	174	C5	F4	45	34
10	14	05	54	03	110	0373	175	C5	F5	45	35
10	15	05	55	03	111	0374	176	C5	F6	45	36
10	16	05	56	03	112	0375	177	C5	F7	45	37
10	17	05	57	03	113	0376	178	C5	F8	45	38
10	18	05	58	03	114	0377	179	C5	F9	45	39
10	19	05	59	03	115	0378	17A	C5	7A	45	3A
10	20	05	60	03	116	0379	17B	C5	7B	45	23
10	21	05	61	03	117	0380	17C	C5	7C	45	40
10	22	05	62	03	118	0381	17D	C5	7D	45	27
10	23	05	63	03	119	0382	17E	C5	7E	45	3D
10	24	05	64	03	120	0383	17F	C5	7F	45	22
10	25	05	65	03	121	0384	180	C6	40	46	20
10	26	05	66	03	122	0385	181	C6	C1	46	41
10	27	05	67	03	123	0386	182	C6	C2	46	42
10	28	05	68	03	124	0387	183	C6	C3	46	43
10	29	05	69	03	125	0388	184	C6	C4	46	44
10	30	05	70	03	126	0389	185	C6	C5	46	45
10	31	05	71	03	127	0390	186	C6	C6	46	46
10	32	05	72	03	128	0391	187	C6	C7	46	47
10	33	05	73	03	129	0392	188	C6	C8	46	48
10	34	05	74	03	130	0393	189	C6	C9	46	49
10	35	05	75	03	131	0394	18A	C6	4A	46	5B
10	36	05	76	03	132	0395	18B	C6	4B	46	2E
10	37	05	77	04	001	0396	18C	C6	4C	46	3C
10	38	05	78	04	002	0397	18D	C6	4D	46	28
10	39	05	79	04	003	0398	18E	C6	4E	46	2B
10	40	05	80	04	004	0399	18F	C6	4F	46	21
11	01	06	01	04	005	0400	190	C6	50	46	26
11	02	06	02	04	006	0401	191	C6	D1	46	4A
11	03	06	03	04	007	0402	192	C6	D2	46	4B
11	04	06	04	04	008	0403	193	C6	D3	46	4C
11	05	06	05	04	009	0404	194	C6	D4	46	4D
11	06	06	06	04	010	0405	195	C6	D5	46	4E
11	07	06	07	04	011	0406	196	C6	D6	46	4F
11	08	06	08	04	012	0407	197	C6	D7	46	50
11	09	06	09	04	013	0408	198	C6	D8	46	51
11	10	06	10	04	014	0409	199	C6	D9	46	52
11	11	06	11	04	015	0410	19A	C6	5A	46	5D
11	12	06	12	04	016	0411	19B	C6	5B	46	24
11	13	06	13	04	017	0412	19C	C6	5C	46	2A
11	14	06	14	04	018	0413	19D	C6	5D	46	29
11	15	06	15	04	019	0414	19E	C6	5E	46	3B
11	16	06	16	04	020	0415	19F	C6	5F	46	5E
11	17	06	17	04	021	0416	1A0	C6	60	46	2D
11	18	06	18	04	022	0417	1A1	C6	61	46	2F
11	19	06	19	04	023	0418	1A2	C6	E2	46	53
11	20	06	20	04	024	0419	1A3	C6	E3	46	54
11	21	06	21	04	025	0420	1A4	C6	E4	46	55
11	22	06	22	04	026	0421	1A5	C6	E5	46	56
11	23	06	23	04	027	0422	1A6	C6	E6	46	57
11	24	06	24	04	028	0423	1A7	C6	E7	46	58
11	25	06	25	04	029	0424	1A8	C6	E8	46	59
11	26	06	26	04	030	0425	1A9	C6	E9	46	5A
11	27	06	27	04	031	0426	1AA	C6	6A	46	7C
11	28	06	28	04	032	0427	1AB	C6	6B	46	2C
11	29	06	29	04	033	0428	1AC	C6	6C	46	25
11	30	06	30	04	034	0429	1AD	C6	6D	46	5F
11	31	06	31	04	035	0430	1AE	C6	6E	46	3E
11	32	06	32	04	036	0431	1AF	C6	6F	46	3F
11	33	06	33	04	037	0432	1B0	C6	F0	46	30

40 Col		80 Col		132 Col		Position		Buffer Address (Hex)	
R	C	R	C	R	C	Dec	Hex	EBCDIC	ASCII
11	34	06	34	04	038	0433	1B1	C6 F1	46 31
11	35	06	35	04	039	0434	1B2	C6 F2	46 32
11	36	06	36	04	040	0435	1B3	C6 F3	46 33
11	37	06	37	04	041	0436	1B4	C6 F4	46 34
11	38	06	38	04	042	0437	1B5	C6 F5	46 35
11	39	06	39	04	043	0438	1B6	C6 F6	46 36
11	40	06	40	04	044	0439	1B7	C6 F7	46 37
12	01	06	41	04	045	0440	1B8	C6 F8	46 38
12	02	06	42	04	046	0441	1B9	C6 F9	46 39
12	03	06	43	04	047	0442	1BA	C6 7A	46 3A
12	04	06	44	04	048	0443	1BB	C6 7B	46 23
12	05	06	45	04	049	0444	1BC	C6 7C	46 40
12	06	06	46	04	050	0445	1BD	C6 7D	46 27
12	07	06	47	04	051	0446	1BE	C6 7E	46 3D
12	08	06	48	04	052	0447	1BF	C6 7F	46 22
12	09	06	49	04	053	0448	1C0	C7 40	47 20
12	10	06	50	04	054	0449	1C1	C7 C1	47 41
12	11	06	51	04	055	0450	1C2	C7 C2	47 42
12	12	06	52	04	056	0451	1C3	C7 C3	47 43
12	13	06	53	04	057	0452	1C4	C7 C4	47 44
12	14	06	54	04	058	0453	1C5	C7 C5	47 45
12	15	06	55	04	059	0454	1C6	C7 C6	47 46
12	16	06	56	04	060	0455	1C7	C7 C7	47 47
12	17	06	57	04	061	0456	1C8	C7 C8	47 48
12	18	06	58	04	062	0457	1C9	C7 C9	47 49
12	19	06	59	04	063	0458	1CA	C7 4A	47 5B
12	20	06	60	04	064	0459	1CB	C7 4B	47 2E
12	21	06	61	04	065	0460	1CC	C7 4C	47 3C
12	22	06	62	04	066	0461	1CD	C7 4D	47 28
12	23	06	63	04	067	0462	1CE	C7 4E	47 2B
12	24	06	64	04	068	0463	1CF	C7 4F	47 21
12	25	06	65	04	069	0464	1D0	C7 50	47 26
12	26	06	66	04	070	0465	1D1	C7 D1	47 4A
12	27	06	67	04	071	0466	1D2	C7 D2	47 4B
12	28	06	68	04	072	0467	1D3	C7 D3	47 4C
12	29	06	69	04	073	0468	1D4	C7 D4	47 4D
12	30	06	70	04	074	0469	1D5	C7 D5	47 4E
12	31	06	71	04	075	0470	1D6	C7 D6	47 4F
12	32	06	72	04	076	0471	1D7	C7 D7	47 50
12	33	06	73	04	077	0472	1D8	C7 D8	47 51
12	34	06	74	04	078	0473	1D9	C7 D9	47 52
12	35	06	75	04	079	0474	1DA	C7 5A	47 5D
12	36	06	76	04	080	0475	1DB	C7 5B	47 24
12	37	06	77	04	081	0476	1DC	C7 5C	47 2A
12	38	06	78	04	082	0477	1DD	C7 5D	47 29
12	39	06	79	04	083	0478	1DE	C7 5E	47 3B
12	40	06	80	04	084	0479	1DF	C7 5F	47 5E
		07	01	04	085	0480	1E0	C7 60	47 2D
		07	02	04	086	0481	1E1	C7 61	47 2F
		07	03	04	087	0482	1E2	C7 E2	47 53
		07	04	04	088	0483	1E3	C7 E3	47 54
		07	05	04	089	0484	1E4	C7 E4	47 55
		07	06	04	090	0485	1E5	C7 E5	47 56
		07	07	04	091	0486	1E6	C7 E6	47 57
		07	08	04	092	0487	1E7	C7 E7	47 58
		07	09	04	093	0488	1E8	C7 E8	47 59
		07	10	04	094	0489	1E9	C7 E9	47 5A
		07	11	04	095	0490	1EA	C7 6A	47 7C
		07	12	04	096	0491	1EB	C7 6B	47 2C
		07	13	04	097	0492	1EC	C7 6C	47 25
		07	14	04	098	0493	1ED	C7 6D	47 5F
		07	15	04	099	0494	1EE	C7 6E	47 3E

80 Col		132 Col		Position		Buffer Address (Hex)			
R	C	R	C	Dec	Hex	EBCDIC		ASCII	
07	16	04	100	0495	1EF	C7	6F	47	3F
07	17	04	101	0496	1F0	C7	F0	47	30
07	18	04	102	0497	1F1	C7	F1	47	31
07	19	04	103	0498	1F2	C7	F2	47	32
07	20	04	104	0499	1F3	C7	F3	47	33
07	21	04	105	0500	1F4	C7	F4	47	34
07	22	04	106	0501	1F5	C7	F5	47	35
07	23	04	107	0502	1F6	C7	F6	47	36
07	24	04	108	0503	1F7	C7	F7	47	37
07	25	04	109	0504	1F8	C7	F8	47	38
07	26	04	110	0505	1F9	C7	F9	47	39
07	27	04	111	0506	1FA	C7	7A	47	3A
07	28	04	112	0507	1FB	C7	7B	47	23
07	29	04	113	0508	1FC	C7	7C	47	40
07	30	04	114	0509	1FD	C7	7D	47	27
07	31	04	115	0510	1FE	C7	7E	47	3D
07	32	04	116	0511	1FF	C7	7F	47	22
07	33	04	117	0512	200	C8	40	48	20
07	34	04	118	0513	201	C8	C1	48	41
07	35	04	119	0514	202	C8	C2	48	42
07	36	04	120	0515	203	C8	C3	48	43
07	37	04	121	0516	204	C8	C4	48	44
07	38	04	122	0517	205	C8	C5	48	45
07	39	04	123	0518	206	C8	C6	48	46
07	40	04	124	0519	207	C8	C7	48	47
07	41	04	125	0520	208	C8	C8	48	48
07	42	04	126	0521	209	C8	C9	48	49
07	43	04	127	0522	20A	C8	4A	48	5B
07	44	04	128	0523	20B	C8	4B	48	2E
07	45	04	129	0524	20C	C8	4C	48	3C
07	46	04	130	0525	20D	C8	4D	48	28
07	47	04	131	0526	20E	C8	4E	48	2B
07	48	04	132	0527	20F	C8	4F	48	21
07	49	05	001	0528	210	C8	50	48	26
07	50	05	002	0529	211	C8	D1	48	4A
07	51	05	003	0530	212	C8	D2	48	4B
07	52	05	004	0531	213	C8	D3	48	4C
07	53	05	005	0532	214	C8	D4	48	4D
07	54	05	006	0533	215	C8	D5	48	4E
07	55	05	007	0534	216	C8	D6	48	4F
07	56	05	008	0535	217	C8	D7	48	50
07	57	05	009	0536	218	C8	D8	48	51
07	58	05	010	0537	219	C8	D9	48	52
07	59	05	011	0538	21A	C8	5A	48	5D
07	60	05	012	0539	21B	C8	5B	48	24
07	61	05	013	0540	21C	C8	5C	48	2A
07	62	05	014	0541	21D	C8	5D	48	29
07	63	05	015	0542	21E	C8	5E	48	3B
07	64	05	016	0543	21F	C8	5F	48	5E
07	65	05	017	0544	220	C8	60	48	2D
07	66	05	018	0545	221	C8	61	48	2F
07	67	05	019	0546	222	C8	E2	48	53
07	68	05	020	0547	223	C8	E3	48	54
07	69	05	021	0548	224	C8	E4	48	55
07	70	05	022	0549	225	C8	E5	48	56
07	71	05	023	0550	226	C8	E6	48	57
07	72	05	024	0551	227	C8	E7	48	58
07	73	05	025	0552	228	C8	E8	48	59
07	74	05	026	0553	229	C8	E9	48	5A
07	75	05	027	0554	22A	C8	6A	48	7C
07	76	05	028	0555	22B	C8	6B	48	2C
07	77	05	029	0556	22C	C8	6C	48	25

80 Col		132 Col		Position		Buffer Address (Hex)			
R	C	R	C	Dec	Hex	EBCDIC		ASCII	
07	78	05	030	0557	22D	C8	6D	48	5F
07	79	05	031	0558	22E	C8	6E	48	3E
07	80	05	032	0559	22F	C8	6F	48	3F
08	01	05	033	0560	230	C8	F0	48	30
08	02	05	034	0561	231	C8	F1	48	31
08	03	05	035	0562	232	C8	F2	48	32
08	04	05	036	0563	233	C8	F3	48	33
08	05	05	037	0564	234	C8	F4	48	34
08	06	05	038	0565	235	C8	F5	48	35
08	07	05	039	0566	236	C8	F6	48	36
08	08	05	040	0567	237	C8	F7	48	37
08	09	05	041	0568	238	C8	F8	48	38
08	10	05	042	0569	239	C8	F9	48	39
08	11	05	043	0570	23A	C8	7A	48	3A
08	12	05	044	0571	23B	C8	7B	48	23
08	13	05	045	0572	23C	C8	7C	48	40
08	14	05	046	0573	23D	C8	7D	48	27
08	15	05	047	0574	23E	C8	7E	48	3D
08	16	05	048	0575	23F	C8	7F	48	22
08	17	05	049	0576	240	C9	40	49	20
08	18	05	050	0577	241	C9	C1	49	41
08	19	05	051	0578	242	C9	C2	49	42
08	20	05	052	0579	243	C9	C3	49	43
08	21	05	053	0580	244	C9	C4	49	44
08	22	05	054	0581	245	C9	C5	49	45
08	23	05	055	0582	246	C9	C6	49	46
08	24	05	056	0583	247	C9	C7	49	47
08	25	05	057	0584	248	C9	C8	49	48
08	26	05	058	0585	249	C9	C9	49	49
08	27	05	059	0586	24A	C9	4A	49	5B
08	28	05	060	0587	24B	C9	4B	49	2E
08	29	05	061	0588	24C	C9	4C	49	3C
08	30	05	062	0589	24D	C9	4D	49	28
08	31	05	063	0590	24E	C9	4E	49	2B
08	32	05	064	0591	24F	C9	4F	49	21
08	33	05	065	0592	250	C9	50	49	26
08	34	05	066	0593	251	C9	D1	49	4A
08	35	05	067	0594	252	C9	D2	49	4B
08	36	05	068	0595	253	C9	D3	49	4C
08	37	05	069	0596	254	C9	D4	49	4D
08	38	05	070	0597	255	C9	D5	49	4E
08	39	05	071	0598	256	C9	D6	49	4F
08	40	05	072	0599	257	C9	D7	49	50
08	41	05	073	0600	258	C9	D8	49	51
08	42	05	074	0601	259	C9	D9	49	52
08	43	05	075	0602	25A	C9	5A	49	5D
08	44	05	076	0603	25B	C9	5B	49	24
08	45	05	077	0604	25C	C9	5C	49	2A
08	46	05	078	0605	25D	C9	5D	49	29
08	47	05	079	0606	25E	C9	5E	49	3B
08	48	05	080	0607	25F	C9	5F	49	5E
08	49	05	081	0608	260	C9	60	49	2D
08	50	05	082	0609	261	C9	61	49	2F
08	51	05	083	0610	262	C9	E2	49	53
08	52	05	084	0611	263	C9	E3	49	54
08	53	05	085	0612	264	C9	E4	49	55
08	54	05	086	0613	265	C9	E5	49	56
08	55	05	087	0614	266	C9	E6	49	57
08	56	05	088	0615	267	C9	E7	49	58
08	57	05	089	0616	268	C9	E8	49	59
08	58	05	090	0617	269	C9	E9	49	5A
08	59	05	091	0618	26A	C9	6A	49	7C
08	60	05	092	0619	26B	C9	6B	49	2C

80 Col		132 Col		Position		Buffer Address (Hex)			
R	C	R	C	Dec	Hex	EBCDIC		ASCII	
08	61	05	093	0620	26C	C9	6C	49	25
08	62	05	094	0621	26D	C9	6D	49	5F
08	63	05	095	0622	26E	C9	6E	49	3E
08	64	05	096	0623	26F	C9	6F	49	3F
08	65	05	097	0624	270	C9	F0	49	30
08	66	05	098	0625	271	C9	F1	49	31
08	67	05	099	0626	272	C9	F2	49	32
08	68	05	100	0627	273	C9	F3	49	33
08	69	05	101	0628	274	C9	F4	49	34
08	70	05	102	0629	275	C9	F5	49	35
08	71	05	103	0630	276	C9	F6	49	36
08	72	05	104	0631	277	C9	F7	49	37
08	73	05	105	0632	278	C9	F8	49	38
08	74	05	106	0633	279	C9	F9	49	39
08	75	05	107	0634	27A	C9	7A	49	3A
08	76	05	108	0635	27B	C9	7B	49	23
08	77	05	109	0636	27C	C9	7C	49	40
08	78	05	110	0637	27D	C9	7D	49	27
08	79	05	111	0638	27E	C9	7E	49	3D
08	80	05	112	0639	27F	C9	7F	49	22
09	01	05	113	0640	280	4A	40	5B	20
09	02	05	114	0641	281	4A	C1	5B	41
09	03	05	115	0642	282	4A	C2	5B	42
09	04	05	116	0643	283	4A	C3	5B	43
09	05	05	117	0644	284	4A	C4	5B	44
09	06	05	118	0645	285	4A	C5	5B	45
09	07	05	119	0646	286	4A	C6	5B	46
09	08	05	120	0647	287	4A	C7	5B	47
09	09	05	121	0648	288	4A	C8	5B	48
09	10	05	122	0649	289	4A	C9	5B	49
09	11	05	123	0650	28A	4A	4A	5B	5B
09	12	05	124	0651	28B	4A	4B	5B	2E
09	13	05	125	0652	28C	4A	4C	5B	3C
09	14	05	126	0653	28D	4A	4D	5B	28
09	15	05	127	0654	28E	4A	4E	5B	2B
09	16	05	128	0655	28F	4A	4F	5B	21
09	17	05	129	0656	290	4A	50	5B	26
09	18	05	130	0657	291	4A	D1	5B	4A
09	19	05	131	0658	292	4A	D2	5B	4B
09	20	05	132	0659	293	4A	D3	5B	4C
09	21	06	001	0660	294	4A	D4	5B	4D
09	22	06	002	0661	295	4A	D5	5B	4E
09	23	06	003	0662	296	4A	D6	5B	4F
09	24	06	004	0663	297	4A	D7	5B	50
09	25	06	005	0664	298	4A	D8	5B	51
09	26	06	006	0665	299	4A	D9	5B	52
09	27	06	007	0666	29A	4A	5A	5B	5D
09	28	06	008	0667	29B	4A	5B	5B	24
09	29	06	009	0668	29C	4A	5C	5B	2A
09	30	06	010	0669	29D	4A	5D	5B	29
09	31	06	011	0670	29E	4A	5E	5B	3B
09	32	06	012	0671	29F	4A	5F	5B	5E
09	33	06	013	0672	2A0	4A	60	5B	2D
09	34	06	014	0673	2A1	4A	61	5B	2F
09	35	06	015	0674	2A2	4A	E2	5B	53
09	36	06	016	0675	2A3	4A	E3	5B	54
09	37	06	017	0676	2A4	4A	E4	5B	55
09	38	06	018	0677	2A5	4A	E5	5B	56
09	39	06	019	0678	2A6	4A	E6	5B	57
09	40	06	020	0679	2A7	4A	E7	5B	58
09	41	06	021	0680	2A8	4A	E8	5B	59
09	42	06	022	0681	2A9	4A	E9	5B	5A

80 Col		132 Col		Position		Buffer Address (Hex)			
R	C	R	C	Dec	Hex	EBCDIC		ASCII	
09	43	06	023	0682	2AA	4A	6A	5B	7C
09	44	06	024	0683	2AB	4A	6B	5B	2C
09	45	06	025	0684	2AC	4A	6C	5B	25
09	46	06	026	0685	2AD	4A	6D	5B	5F
09	47	06	027	0686	2AE	4A	6E	5B	3E
09	48	06	028	0687	2AF	4A	6F	5B	3F
09	49	06	029	0688	2B0	4A	F0	5B	30
09	50	06	030	0689	2B1	4A	F1	5B	31
09	51	06	031	0690	2B2	4A	F2	5B	32
09	52	06	032	0691	2B3	4A	F3	5B	33
09	53	06	033	0692	2B4	4A	F4	5B	34
09	54	06	034	0693	2B5	4A	F5	5B	35
09	55	06	035	0694	2B6	4A	F6	5B	36
09	56	06	036	0695	2B7	4A	F7	5B	37
09	57	06	037	0696	2B8	4A	F8	5B	38
09	58	06	038	0697	2B9	4A	F9	5B	39
09	59	06	039	0698	2BA	4A	7A	5B	3A
09	60	06	040	0699	2BB	4A	7B	5B	23
09	61	06	041	0700	2BC	4A	7C	5B	40
09	62	06	042	0701	2BD	4A	7D	5B	27
09	63	06	043	0702	2BE	4A	7E	5B	3D
09	64	06	044	0703	2BF	4A	7F	5B	22
09	65	06	045	0704	2C0	4B	40	2E	20
09	66	06	046	0705	2C1	4B	C1	2E	41
09	67	06	047	0706	2C2	4B	C2	2E	42
09	68	06	048	0707	2C3	4B	C3	2E	43
09	69	06	049	0708	2C4	4B	C4	2E	44
09	70	06	050	0709	2C5	4B	C5	2E	45
09	71	06	051	0710	2C6	4B	C6	2E	46
09	72	06	052	0711	2C7	4B	C7	2E	47
09	73	06	053	0712	2C8	4B	C8	2E	48
09	74	06	054	0713	2C9	4B	C9	2E	49
09	75	06	055	0714	2CA	4B	4A	2E	5B
09	76	06	056	0715	2CB	4B	4B	2E	2E
09	77	06	057	0716	2CC	4B	4C	2E	3C
09	78	06	058	0717	2CD	4B	4D	2E	28
09	79	06	059	0718	2CE	4B	4E	2E	2B
09	80	06	060	0719	2CF	4B	4F	2E	21
10	01	06	061	0720	2D0	4B	50	2E	26
10	02	06	062	0721	2D1	4B	D1	2E	4A
10	03	06	063	0722	2D2	4B	D2	2E	4B
10	04	06	064	0723	2D3	4B	D3	2E	4C
10	05	06	065	0724	2D4	4B	D4	2E	4D
10	06	06	066	0725	2D5	4B	D5	2E	4E
10	07	06	067	0726	2D6	4B	D6	2E	4F
10	08	06	068	0727	2D7	4B	D7	2E	50
10	09	06	069	0728	2D8	4B	D8	2E	51
10	10	06	070	0729	2D9	4B	D9	2E	52
10	11	06	071	0730	2DA	4B	5A	2E	5D
10	12	06	072	0731	2DB	4B	5B	2E	24
10	13	06	073	0732	2DC	4B	5C	2E	2A
10	14	06	074	0733	2DD	4B	5D	2E	29
10	15	06	075	0734	2DE	4B	5E	2E	3B
10	16	06	076	0735	2DF	4B	5F	2E	5E
10	17	06	077	0736	2E0	4B	60	2E	2D
10	18	06	078	0737	2E1	4B	61	2E	2F
10	19	06	079	0738	2E2	4B	E2	2E	53
10	20	06	080	0739	2E3	4B	E3	2E	54
10	21	06	081	0740	2E4	4B	E4	2E	55
10	22	06	082	0741	2E5	4B	E5	2E	56
10	23	06	083	0742	2E6	4B	E6	2E	57
10	24	06	084	0743	2E7	4B	E7	2E	58

80 Col		132 Col		Position		Buffer Address (Hex)			
R	C	R	C	Dec	Hex	EBCDIC		ASCII	
10	25	06	085	0744	2E8	4B	E8	2E	59
10	26	06	086	0745	2E9	4B	E9	2E	5A
10	27	06	087	0746	2EA	4B	6A	2E	7C
10	28	06	088	0747	2EB	4B	6B	2E	2C
10	29	06	089	0748	2EC	4B	6C	2E	25
10	30	06	090	0749	2ED	4B	6D	2E	5F
10	31	06	091	0750	2EE	4B	6E	2E	3E
10	32	06	092	0751	2EF	4B	6F	2E	3F
10	33	06	093	0752	2F0	4B	F0	2E	30
10	34	06	094	0753	2F1	4B	F1	2E	31
10	35	06	095	0754	2F2	4B	F2	2E	32
10	36	06	096	0755	2F3	4B	F3	2E	33
10	37	06	097	0756	2F4	4B	F4	2E	34
10	38	06	098	0757	2F5	4B	F5	2E	35
10	39	06	099	0758	2F6	4B	F6	2E	36
10	40	06	100	0759	2F7	4B	F7	2E	37
10	41	06	101	0760	2F8	4B	F8	2E	38
10	42	06	102	0761	2F9	4B	F9	2E	39
10	43	06	103	0762	2FA	4B	7A	2E	3A
10	44	06	104	0763	2FB	4B	7B	2E	23
10	45	06	105	0764	2FC	4B	7C	2E	40
10	46	06	106	0765	2FD	4B	7D	2E	27
10	47	06	107	0766	2FE	4B	7E	2E	3D
10	48	06	108	0767	2FF	4B	7F	2E	22
10	49	06	109	0768	300	4C	40	3C	20
10	50	06	110	0769	301	4C	C1	3C	41
10	51	06	111	0770	302	4C	C2	3C	42
10	52	06	112	0771	303	4C	C3	3C	43
10	53	06	113	0772	304	4C	C4	3C	44
10	54	06	114	0773	305	4C	C5	3C	45
10	55	06	115	0774	306	4C	C6	3C	46
10	56	06	116	0775	307	4C	C7	3C	47
10	57	06	117	0776	308	4C	C8	3C	48
10	58	06	118	0777	309	4C	C9	3C	49
10	59	06	119	0778	30A	4C	4A	3C	5B
10	60	06	120	0779	30B	4C	4B	3C	2E
10	61	06	121	0780	30C	4C	4C	3C	3C
10	62	06	122	0781	30D	4C	4D	3C	28
10	63	06	123	0782	30E	4C	4E	3C	2B
10	64	06	124	0783	30F	4C	4F	3C	21
10	65	06	125	0784	310	4C	50	3C	26
10	66	06	126	0785	311	4C	D1	3C	4A
10	67	06	127	0786	312	4C	D2	3C	4B
10	68	06	128	0787	313	4C	D3	3C	4C
10	69	06	129	0788	314	4C	D4	3C	4D
10	70	06	130	0789	315	4C	D5	3C	4E
10	71	06	131	0790	316	4C	D6	3C	4F
10	72	06	132	0791	317	4C	D7	3C	50
10	73	07	001	0792	318	4C	D8	3C	51
10	74	07	002	0793	319	4C	D9	3C	52
10	75	07	003	0794	31A	4C	5A	3C	5D
10	76	07	004	0795	31B	4C	5B	3C	24
10	77	07	005	0796	31C	4C	5C	3C	2A
10	78	07	006	0797	31D	4C	5D	3C	29
10	79	07	007	0798	31E	4C	5E	3C	3B
10	80	07	008	0799	31F	4C	5F	3C	5E
11	01	07	009	0800	320	4C	60	3C	2D
11	02	07	010	0801	321	4C	61	3C	2F
11	03	07	011	0802	322	4C	E2	3C	53
11	04	07	012	0803	323	4C	E3	3C	54
11	05	07	013	0804	324	4C	E4	3C	55
11	06	07	014	0805	325	4C	E5	3C	56

80 Col		132 Col		Position		Buffer Address (Hex)			
R	C	R	C	Dec	Hex	EBCDIC		ASCII	
11	07	07	015	0806	326	4C	E6	3C	57
11	08	07	016	0807	327	4C	E7	3C	58
11	09	07	017	0808	328	4C	E8	3C	59
11	10	07	018	0809	329	4C	E9	3C	5A
11	11	07	019	0810	32A	4C	6A	3C	7C
11	12	07	020	0811	32B	4C	6B	3C	2C
11	13	07	021	0812	32C	4C	6C	3C	25
11	14	07	022	0813	32D	4C	6D	3C	5F
11	15	07	023	0814	32E	4C	6E	3C	3E
11	16	07	024	0815	32F	4C	6F	3C	3F
11	17	07	025	0816	330	4C	F0	3C	30
11	18	07	026	0817	331	4C	F1	3C	31
11	19	07	027	0818	332	4C	F2	3C	32
11	20	07	028	0819	333	4C	F3	3C	33
11	21	07	029	0820	334	4C	F4	3C	34
11	22	07	030	0821	335	4C	F5	3C	35
11	23	07	031	0822	336	4C	F6	3C	36
11	24	07	032	0823	337	4C	F7	3C	37
11	25	07	033	0824	338	4C	F8	3C	38
11	26	07	034	0825	339	4C	F9	3C	39
11	27	07	035	0826	33A	4C	7A	3C	3A
11	28	07	036	0827	33B	4C	7B	3C	23
11	29	07	037	0828	33C	4C	7C	3C	40
11	30	07	038	0829	33D	4C	7D	3C	27
11	31	07	039	0830	33E	4C	7E	3C	3D
11	32	07	040	0831	33F	4C	7F	3C	22
11	33	07	041	0832	340	4D	40	28	20
11	34	07	042	0833	341	4D	C1	28	41
11	35	07	043	0834	342	4D	C2	28	42
11	36	07	044	0835	343	4D	C3	28	43
11	37	07	045	0836	344	4D	C4	28	44
11	38	07	046	0837	345	4D	C5	28	45
11	39	07	047	0838	346	4D	C6	28	46
11	40	07	048	0839	347	4D	C7	28	47
11	41	07	049	0840	348	4D	C8	28	48
11	42	07	050	0841	349	4D	C9	28	49
11	43	07	051	0842	34A	4D	4A	28	5B
11	44	07	052	0843	34B	4D	4B	28	2E
11	45	07	053	0844	34C	4D	4C	28	3C
11	46	07	054	0845	34D	4D	4D	28	28
11	47	07	055	0846	34E	4D	4E	28	2B
11	48	07	056	0847	34F	4D	4F	28	21
11	49	07	057	0848	350	4D	50	28	26
11	50	07	058	0849	351	4D	D1	28	4A
11	51	07	059	0850	352	4D	D2	28	4B
11	52	07	060	0851	353	4D	D3	28	4C
11	53	07	061	0852	354	4D	D4	28	4D
11	54	07	062	0853	355	4D	D5	28	4E
11	55	07	063	0854	356	4D	D6	28	4F
11	56	07	064	0855	357	4D	D7	28	50
11	57	07	065	0856	358	4D	D8	28	51
11	58	07	066	0857	359	4D	D9	28	52
11	59	07	067	0858	35A	4D	5A	28	5D
11	60	07	068	0859	35B	4D	5B	28	24
11	61	07	069	0860	35C	4D	5C	28	2A
11	62	07	070	0861	35D	4D	5D	28	29
11	63	07	071	0862	35E	4D	5E	28	3B
11	64	07	072	0863	35F	4D	5F	28	5E
11	65	07	073	0864	360	4D	60	28	2D
11	66	07	074	0865	361	4D	61	28	2F
11	67	07	075	0866	362	4D	E2	28	53
11	68	07	076	0867	363	4D	E3	28	54

80 Col		132 Col		Position		Buffer Address (Hex)			
R	C	R	C	Dec	Hex	EBCDIC		ASCII	
11	69	07	077	0868	364	4D	E4	28	55
11	70	07	078	0869	365	4D	E5	28	56
11	71	07	079	0870	366	4D	E6	28	57
11	72	07	080	0871	367	4D	E7	28	58
11	73	07	081	0872	368	4D	E8	28	59
11	74	07	082	0873	369	4D	E9	28	5A
11	75	07	083	0874	36A	4D	6A	28	7C
11	76	07	084	0875	36B	4D	6B	28	2C
11	77	07	085	0876	36C	4D	6C	28	25
11	78	07	086	0877	36D	4D	6D	28	5F
11	79	07	087	0878	36E	4D	6E	28	3E
11	80	07	088	0879	36F	4D	6F	28	3F
12	01	07	089	0880	370	4D	F0	28	30
12	02	07	090	0881	371	4D	F1	28	31
12	03	07	091	0882	372	4D	F2	28	32
12	04	07	092	0883	373	4D	F3	28	33
12	05	07	093	0884	374	4D	F4	28	34
12	06	07	094	0885	375	4D	F5	28	35
12	07	07	095	0886	376	4D	F6	28	36
12	08	07	096	0887	377	4D	F7	28	37
12	09	07	097	0888	378	4D	F8	28	38
12	10	07	098	0889	379	4D	F9	28	39
12	11	07	099	0890	37A	4D	7A	28	3A
12	12	07	100	0891	37B	4D	7B	28	23
12	13	07	101	0892	37C	4D	7C	28	40
12	14	07	102	0893	37D	4D	7D	28	27
12	15	07	103	0894	37E	4D	7E	28	3D
12	16	07	104	0895	37F	4D	7F	28	22
12	17	07	105	0896	380	4E	40	2B	20
12	18	07	106	0897	381	4E	C1	2B	41
12	19	07	107	0898	382	4E	C2	2B	42
12	20	07	108	0899	383	4E	C3	2B	43
12	21	07	109	0900	384	4E	C4	2B	44
12	22	07	110	0901	385	4E	C5	2B	45
12	23	07	111	0902	386	4E	C6	2B	46
12	24	07	112	0903	387	4E	C7	2B	47
12	25	07	113	0904	388	4E	C8	2B	48
12	26	07	114	0905	389	4E	C9	2B	49
12	27	07	115	0906	38A	4E	4A	2B	5B
12	28	07	116	0907	38B	4E	4B	2B	2E
12	29	07	117	0908	38C	4E	4C	2B	3C
12	30	07	118	0909	38D	4E	4D	2B	28
12	31	07	119	0910	38E	4E	4E	2B	2B
12	32	07	120	0911	38F	4E	4F	2B	21
12	33	07	121	0912	390	4E	50	2B	26
12	34	07	122	0913	391	4E	D1	2B	4A
12	35	07	123	0914	392	4E	D2	2B	4B
12	36	07	124	0915	393	4E	D3	2B	4C
12	37	07	125	0916	394	4E	D4	2B	4D
12	38	07	126	0917	395	4E	D5	2B	4E
12	39	07	127	0918	396	4E	D6	2B	4F
12	40	07	128	0919	397	4E	D7	2B	50
12	41	07	129	0920	398	4E	D8	2B	51
12	42	07	130	0921	399	4E	D9	2B	52
12	43	07	131	0922	39A	4E	5A	2B	5D
12	44	07	132	0923	39B	4E	5B	2B	24
12	45	08	001	0924	39C	4E	5C	2B	2A
12	46	08	002	0925	39D	4E	5D	2B	29
12	47	08	003	0926	39E	4E	5E	2B	3B
12	48	08	004	0927	39F	4E	5F	2B	5E
12	49	08	005	0928	3A0	4E	60	2B	2D
12	50	08	006	0929	3A1	4E	61	2B	2F

80 Col		132 Col		Position		Buffer Address (Hex)			
<u>R</u>	<u>C</u>	<u>R</u>	<u>C</u>	<u>Dec</u>	<u>Hex</u>	<u>EBCDIC</u>		<u>ASCII</u>	
12	51	08	007	0930	3A2	4E	E2	2B	53
12	52	08	008	0931	3A3	4E	E3	2B	54
12	53	08	009	0932	3A4	4E	E4	2B	55
12	54	08	010	0933	3A5	4E	E5	2B	56
12	55	08	011	0934	3A6	4E	E6	2B	57
12	56	08	012	0935	3A7	4E	E7	2B	58
12	57	08	013	0936	3A8	4E	E8	2B	59
12	58	08	014	0937	3A9	4E	E9	2B	5A
12	59	08	015	0938	3AA	4E	6A	2B	7C
12	60	08	016	0939	3AB	4E	6B	2B	2C
12	61	08	017	0940	3AC	4E	6C	2B	25
12	62	08	018	0941	3AD	4E	6D	2B	5F
12	63	08	019	0942	3AE	4E	6E	2B	3E
12	64	08	020	0943	3AF	4E	6F	2B	3F
12	65	08	021	0944	3B0	4E	F0	2B	30
12	66	08	022	0945	3B1	4E	F1	2B	31
12	67	08	023	0946	3B2	4E	F2	2B	32
12	68	08	024	0947	3B3	4E	F3	2B	33
12	69	08	025	0948	3B4	4E	F4	2B	34
12	70	08	026	0949	3B5	4E	F5	2B	35
12	71	08	027	0950	3B6	4E	F6	2B	36
12	72	08	028	0951	3B7	4E	F7	2B	37
12	73	08	029	0952	3B8	4E	F8	2B	38
12	74	08	030	0953	3B9	4E	F9	2B	39
12	75	08	031	0954	3BA	4E	7A	2B	3A
12	76	08	032	0955	3BB	4E	7B	2B	23
12	77	08	033	0956	3BC	4E	7C	2B	40
12	78	08	034	0957	3BD	4E	7D	2B	27
12	79	08	035	0958	3BE	4E	7E	2B	3D
12	80	08	036	0959	3BF	4E	7F	2B	22
13	01	08	037	0960	3C0	4F	40	21	20
13	02	08	038	0961	3C1	4F	C1	21	41
13	03	08	039	0962	3C2	4F	C2	21	42
13	04	08	040	0963	3C3	4F	C3	21	43
13	05	08	041	0964	3C4	4F	C4	21	44
13	06	08	042	0965	3C5	4F	C5	21	45
13	07	08	043	0966	3C6	4F	C6	21	46
13	08	08	044	0967	3C7	4F	C7	21	47
13	09	08	045	0968	3C8	4F	C8	21	48
13	10	08	046	0969	3C9	4F	C9	21	49
13	11	08	047	0970	3CA	4F	4A	21	5B
13	12	08	048	0971	3CB	4F	4B	21	2E
13	13	08	049	0972	3CC	4F	4C	21	3C
13	14	08	050	0973	3CD	4F	4D	21	28
13	15	08	051	0974	3CE	4F	4E	21	2B
13	16	08	052	0975	3CF	4F	4F	21	21
13	17	08	053	0976	3D0	4F	50	21	26
13	18	08	054	0977	3D1	4F	D1	21	4A
13	19	08	055	0978	3D2	4F	D2	21	4B
13	20	08	056	0979	3D3	4F	D3	21	4C
13	21	08	057	0980	3D4	4F	D4	21	4D
13	22	08	058	0981	3D5	4F	D5	21	4E
13	23	08	059	0982	3D6	4F	D6	21	4F
13	24	08	060	0983	3D7	4F	D7	21	50
13	25	08	061	0984	3D8	4F	D8	21	51
13	26	08	062	0985	3D9	4F	D9	21	52
13	27	08	063	0986	3DA	4F	5A	21	5D
13	28	08	064	0987	3DB	4F	5B	21	24
13	29	08	065	0988	3DC	4F	5C	21	2A
13	30	08	066	0989	3DD	4F	5D	21	29
13	31	08	067	0990	3DE	4F	5E	21	3B
13	32	08	068	0991	3DF	4F	5F	21	5E

80 Col		132 Col		Position		Buffer Address (Hex)			
R	C	R	C	Dec	Hex	EBCDIC		ASCII	
13	33	08	069	0992	3E0	4F	60	21	2D
13	34	08	070	0993	3E1	4F	61	21	2F
13	35	08	071	0994	3E2	4F	E2	21	53
13	36	08	072	0995	3E3	4F	E3	21	54
13	37	08	073	0996	3E4	4F	E4	21	55
13	38	08	074	0997	3E5	4F	E5	21	56
13	39	08	075	0998	3E6	4F	E6	21	57
13	40	08	076	0999	3E7	4F	E7	21	58
13	41	08	077	1000	3E8	4F	E8	21	59
13	42	08	078	1001	3E9	4F	E9	21	5A
13	43	08	079	1002	3EA	4F	6A	21	7C
13	44	08	080	1003	3EB	4F	6B	21	2C
13	45	08	081	1004	3EC	4F	6C	21	25
13	46	08	082	1005	3ED	4F	6D	21	5F
13	47	08	083	1006	3EE	4F	6E	21	3E
13	48	08	084	1007	3EF	4F	6F	21	3F
13	49	08	085	1008	3F0	4F	F0	21	30
13	50	08	086	1009	3F1	4F	F1	21	31
13	51	08	087	1010	3F2	4F	F2	21	32
13	52	08	088	1011	3F3	4F	F3	21	33
13	53	08	089	1012	3F4	4F	F4	21	34
13	54	08	090	1013	3F5	4F	F5	21	35
13	55	08	091	1014	3F6	4F	F6	21	36
13	56	08	092	1015	3F7	4F	F7	21	37
13	57	08	093	1016	3F8	4F	F8	21	38
13	58	08	094	1017	3F9	4F	F9	21	39
13	59	08	095	1018	3FA	4F	7A	21	3A
13	60	08	096	1019	3FB	4F	7B	21	23
13	61	08	097	1020	3FC	4F	7C	21	40
13	62	08	098	1021	3FD	4F	7D	21	27
13	63	08	099	1022	3FE	4F	7E	21	3D
13	64	08	100	1023	3FF	4F	7F	21	22
13	65	08	101	1024	400	50	40	26	20
13	66	08	102	1025	401	50	C1	26	41
13	67	08	103	1026	402	50	C2	26	42
13	68	08	104	1027	403	50	C3	26	43
13	69	08	105	1028	404	50	C4	26	44
13	70	08	106	1029	405	50	C5	26	45
13	71	08	107	1030	406	50	C6	26	46
13	72	08	108	1031	407	50	C7	26	47
13	73	08	109	1032	408	50	C8	26	48
13	74	08	110	1033	409	50	C9	26	49
13	75	08	111	1034	40A	50	4A	26	5B
13	76	08	112	1035	40B	50	4B	26	2E
13	77	08	113	1036	40C	50	4C	26	3C
13	78	08	114	1037	40D	50	4D	26	28
13	79	08	115	1038	40E	50	4E	26	2B
13	80	08	116	1039	40F	50	4F	26	21
14	01	08	117	1040	410	50	50	26	26
14	02	08	118	1041	411	50	D1	26	4A
14	03	08	119	1042	412	50	D2	26	4B
14	04	08	120	1043	413	50	D3	26	4C
14	05	08	121	1044	414	50	D4	26	4D
14	06	08	122	1045	415	50	D5	26	4E
14	07	08	123	1046	416	50	D6	26	4F
14	08	08	124	1047	417	50	D7	26	50
14	09	08	125	1048	418	50	D8	26	51
14	10	08	126	1049	419	50	D9	26	52
14	11	08	127	1050	41A	50	5A	26	5D
14	12	08	128	1051	41B	50	5B	26	24
14	13	08	129	1052	41C	50	5C	26	2A
14	14	08	130	1053	41D	50	5D	26	29

80 Col		132 Col		Position		Buffer Address (Hex)			
R	C	R	C	Dec	Hex	EBCDIC		ASCII	
14	15	08	131	1054	41E	50	5E	26	3B
14	16	08	132	1055	41F	50	5F	26	5E
14	17	09	001	1056	420	50	60	26	2D
14	18	09	002	1057	421	50	61	26	2F
14	19	09	003	1058	422	50	E2	26	53
14	20	09	004	1059	423	50	E3	26	54
14	21	09	005	1060	424	50	E4	26	55
14	22	09	006	1061	425	50	E5	26	56
14	23	09	007	1062	426	50	E6	26	57
14	24	09	008	1063	427	50	E7	26	58
14	25	09	009	1064	428	50	E8	26	59
14	26	09	010	1065	429	50	E9	26	5A
14	27	09	011	1066	42A	50	6A	26	7C
14	28	09	012	1067	42B	50	6B	26	2C
14	29	09	113	1068	42C	60	6C	26	25
14	30	09	014	1069	42D	50	6D	26	5F
14	31	09	015	1070	42E	50	6E	26	3E
14	32	09	016	1071	42F	50	6F	26	3F
14	33	09	017	1072	430	50	F0	26	30
14	34	09	018	1073	431	50	F1	26	31
14	35	09	019	1074	432	50	F2	26	32
14	36	09	020	1075	433	50	F3	26	33
14	37	09	021	1076	434	50	F4	26	34
14	38	09	022	1077	435	50	F5	26	35
14	39	09	023	1078	436	50	F6	26	36
14	40	09	024	1079	437	50	F7	26	37
14	41	09	025	1080	438	50	F8	26	38
14	42	09	026	1081	439	50	F9	26	39
14	43	09	027	1082	43A	50	7A	26	3A
14	44	09	028	1083	43B	50	7B	26	23
14	45	09	029	1084	43C	50	7C	26	40
14	46	09	030	1085	43D	50	7D	26	27
14	47	09	031	1086	43E	50	7E	26	3D
14	48	09	032	1087	43F	50	7F	26	22
14	49	09	033	1088	440	D1	40	4A	20
14	50	09	034	1089	441	D1	C1	4A	41
14	51	09	035	1090	442	D1	C2	4A	42
14	52	09	036	1091	443	D1	C3	4A	43
14	53	09	037	1092	444	D1	C4	4A	44
14	54	09	038	1093	445	D1	C5	4A	45
14	55	09	039	1094	446	D1	C6	4A	46
14	56	09	040	1095	447	D1	C7	4A	47
14	57	09	041	1096	448	D1	C8	4A	48
14	58	09	042	1097	449	D1	C9	4A	49
14	59	09	043	1098	44A	D1	4A	4A	5B
14	60	09	044	1099	44B	D1	4B	4A	2E
14	61	09	045	1100	44C	D1	4C	4A	3C
14	62	09	046	1101	44D	D1	4D	4A	28
14	63	09	047	1102	44E	D1	4E	4A	2B
14	64	09	048	1103	44F	D1	4F	4A	21
14	65	09	049	1104	450	D1	50	4A	26
14	66	09	050	1105	451	D1	D1	4A	4A
14	67	09	051	1106	452	D1	D2	4A	4B
14	68	09	052	1107	453	D1	D3	4A	4C
14	69	09	053	1108	454	D1	D4	4A	4D
14	70	09	054	1109	455	D1	D5	4A	4E
14	71	09	055	1110	456	D1	D6	4A	4F
14	72	09	056	1111	457	D1	D7	4A	50
14	73	09	057	1112	458	D1	D8	4A	51
14	74	09	058	1113	459	D1	D9	4A	52
14	75	09	059	1114	45A	D1	5A	4A	5D
14	76	09	060	1115	45B	D1	5B	4A	24

80 Col		132 Col		Position		Buffer Address (Hex)			
<u>R</u>	<u>C</u>	<u>R</u>	<u>C</u>	<u>Dec</u>	<u>Hex</u>	<u>EBCDIC</u>		<u>ASCII</u>	
14	77	09	061	1116	45C	D1	5C	4A	2A
14	78	09	062	1117	45D	D1	5D	4A	29
14	79	09	063	1118	45E	D1	5E	4A	3B
14	80	09	064	1119	45F	D1	5F	4A	5E
15	01	09	065	1120	460	D1	60	4A	2D
15	02	09	066	1121	461	D1	61	4A	2F
15	03	09	067	1122	462	D1	E2	4A	53
15	04	09	068	1123	463	D1	E3	4A	54
15	05	09	069	1124	464	D1	E4	4A	55
15	06	09	070	1125	465	D1	E5	4A	56
15	07	09	071	1126	466	D1	E6	4A	57
15	08	09	072	1127	467	D1	E7	4A	58
15	09	09	073	1128	468	D1	E8	4A	59
15	10	09	074	1129	469	D1	E9	4A	5A
15	11	09	075	1130	46A	D1	6A	4A	7C
15	12	09	076	1131	46B	D1	6B	4A	2C
15	13	09	077	1132	46C	D1	6C	4A	25
15	14	09	078	1133	46D	D1	6D	4A	5F
15	15	09	079	1134	46E	D1	6E	4A	3E
15	16	09	080	1135	46F	D1	6F	4A	3F
15	17	09	081	1136	470	D1	F0	4A	30
15	18	09	082	1137	471	D1	F1	4A	31
15	19	09	083	1138	472	D1	F2	4A	32
15	20	09	084	1139	473	D1	F3	4A	33
15	21	09	085	1140	474	D1	F4	4A	34
15	22	09	086	1141	475	D1	F5	4A	35
15	23	09	087	1142	476	D1	F6	4A	36
15	24	09	088	1143	477	D1	F7	4A	37
15	25	09	089	1144	478	D1	F8	4A	38
15	26	09	090	1145	479	D1	F9	4A	39
15	27	09	091	1146	47A	D1	7A	4A	3A
15	28	09	092	1147	47B	D1	7B	4A	23
15	29	09	093	1148	47C	D1	7C	4A	40
15	30	09	094	1149	47D	D1	7D	4A	27
15	31	09	095	1150	47E	D1	7E	4A	3D
15	32	09	096	1151	47F	D1	7F	4A	22
15	33	09	097	1152	480	D2	40	4B	20
15	34	09	098	1153	481	D2	C1	4B	41
15	35	09	099	1154	482	D2	C2	4B	42
15	36	09	100	1155	483	D2	C3	4B	43
15	37	09	101	1156	484	D2	C4	4B	44
15	38	09	102	1157	485	D2	C5	4B	45
15	39	09	103	1158	486	D2	C6	4B	46
15	40	09	104	1159	487	D2	C7	4B	47
15	41	09	105	1160	488	D2	C8	4B	48
15	42	09	106	1161	489	D2	C9	4B	49
15	43	09	107	1162	48A	D2	4A	4B	5B
15	44	09	108	1163	48B	D2	4B	4B	2E
15	45	09	109	1164	48C	D2	4C	4B	3C
15	46	09	110	1165	48D	D2	4D	4B	28
15	47	09	111	1166	48E	D2	4E	4B	2B
15	48	09	112	1167	48F	D2	4F	4B	21
15	49	09	113	1168	490	D2	50	4B	26
15	50	09	114	1169	491	D2	D1	4B	4A
15	51	09	115	1170	492	D2	D2	4B	4B
15	52	09	116	1171	493	D2	D3	4B	4C
15	53	09	117	1172	494	D2	D4	4B	4D
15	54	09	118	1173	495	D2	D5	4B	4E
15	55	09	119	1174	496	D2	D6	4B	4F
15	56	09	120	1175	497	D2	D7	4B	50
15	57	09	121	1176	498	D2	D8	4B	51
15	58	09	122	1177	499	D2	D9	4B	52

80 Col		132 Col		Position		Buffer Address (Hex)			
R	C	R	C	Dec	Hex	EBCDIC		ASCII	
15	59	09	123	1178	49A	D2	5A	4B	5D
15	60	09	124	1179	49B	D2	5B	4B	24
15	61	09	125	1180	49C	D2	5C	4B	2A
15	62	09	126	1181	49D	D2	5D	4B	29
15	63	09	127	1182	49E	D2	5E	4B	3B
15	64	09	128	1183	49F	D2	5F	4B	5E
15	65	09	129	1184	4A0	D2	60	4B	2D
15	66	09	130	1185	4A1	D2	61	4B	2F
15	67	09	131	1186	4A2	D2	E2	4B	53
15	68	09	132	1187	4A3	D2	E3	4B	54
15	69	10	001	1188	4A4	D2	E4	4B	55
15	70	10	002	1189	4A5	D2	E5	4B	56
15	71	10	003	1190	4A6	D2	E6	4B	57
15	72	10	004	1191	4A7	D2	E7	4B	58
15	73	10	005	1192	4A8	D2	E8	4B	59
15	74	10	006	1193	4A9	D2	E9	4B	5A
15	75	10	007	1194	4AA	D2	6A	4B	7C
15	76	10	008	1195	4AB	D2	6B	4B	2C
15	77	10	009	1196	4AC	D2	6C	4B	25
15	78	10	010	1197	4AD	D2	6D	4B	5F
15	79	10	011	1198	4AE	D2	6E	4B	3E
15	80	10	012	1199	4AF	D2	6F	4B	3F
16	01	10	013	1200	4B0	D2	F0	4B	30
16	02	10	014	1201	4B1	D2	F1	4B	31
16	03	10	015	1202	4B2	D2	F2	4B	32
16	04	10	016	1203	4B3	D2	F3	4B	33
16	05	10	017	1204	4B4	D2	F4	4B	34
16	06	10	018	1205	4B5	D2	F5	4B	35
16	07	10	019	1206	4B6	D2	F6	4B	36
16	08	10	020	1207	4B7	D2	F7	4B	37
16	09	10	021	1208	4B8	D2	F8	4B	38
16	10	10	022	1209	4B9	D2	F9	4B	39
16	11	10	023	1210	4BA	D2	7A	4B	3A
16	12	10	024	1211	4BB	D2	7B	4B	23
16	13	10	025	1212	4BC	D2	7C	4B	40
16	14	10	026	1213	4BD	D2	7D	4B	27
16	15	10	027	1214	4BE	D2	7E	4B	3D
16	16	10	028	1215	4BF	D2	7F	4B	22
16	17	10	029	1216	4C0	D3	40	4C	20
16	18	10	030	1217	4C1	D3	C1	4C	41
16	19	10	031	1218	4C2	D3	C2	4C	42
16	20	10	032	1219	4C3	D3	C3	4C	43
16	21	10	033	1220	4C4	D3	C4	4C	44
16	22	10	034	1221	4C5	D3	C5	4C	45
16	23	10	035	1222	4C6	D3	C6	4C	46
16	24	10	036	1223	4C7	D3	C7	4C	47
16	25	10	037	1224	4C8	D3	C8	4C	48
16	26	10	038	1225	4C9	D3	C9	4C	49
16	27	10	039	1226	4CA	D3	4A	4C	5B
16	28	10	040	1227	4CB	D3	4B	4C	2E
16	29	10	041	1228	4CC	D3	4C	4C	3C
16	30	10	042	1229	4CD	D3	4D	4C	28
16	31	10	043	1230	4CE	D3	4E	4C	2B
16	32	10	044	1231	4CF	D3	4F	4C	21
16	33	10	045	1232	4D0	D3	50	4C	26
16	34	10	046	1233	4D1	D3	D1	4C	4A
16	35	10	047	1234	4D2	D3	D2	4C	4B
16	36	10	048	1235	4D3	D3	D3	4C	4C
16	37	10	049	1236	4D4	D3	D4	4C	4D
16	38	10	050	1237	4D5	D3	D5	4C	4E
16	39	10	051	1238	4D6	D3	D6	4C	4F
16	40	10	052	1239	4D7	D3	D7	4C	50

80 Col		132 Col		Position		Buffer Address (Hex)			
R	C	R	C	Dec	Hex	EBCDIC		ASCII	
16	41	10	053	1240	4D8	D3	D8	4C	51
16	42	10	054	1241	4D9	D3	D9	4C	52
16	43	10	055	1242	4DA	D3	5A	4C	5D
16	44	10	056	1243	4DB	D3	5B	4C	24
16	45	10	057	1244	4DC	D3	5C	4C	2A
16	46	10	058	1245	4DD	D3	5D	4C	29
16	47	10	059	1246	4DE	D3	5E	4C	3B
16	48	10	060	1247	4DF	D3	5F	4C	5E
16	49	10	061	1248	4E0	D3	60	4C	2D
16	50	10	062	1249	4E1	D3	61	4C	2F
16	51	10	063	1250	4E2	D3	E2	4C	53
16	52	10	064	1251	4E3	D3	E3	4C	54
16	53	10	065	1252	4E4	D3	E4	4C	55
16	54	10	066	1253	4E5	D3	E5	4C	56
16	55	10	067	1254	4E6	D3	E6	4C	57
16	56	10	068	1255	4E7	D3	E7	4C	58
16	57	10	069	1256	4E8	D3	E8	4C	59
16	58	10	070	1257	4E9	D3	E9	4C	5A
16	59	10	071	1258	4EA	D3	6A	4C	7C
16	60	10	072	1259	4EB	D3	6B	4C	2C
16	61	10	073	1260	4EC	D3	6C	4C	25
16	62	10	074	1261	4ED	D3	6D	4C	5F
16	63	10	075	1262	4EE	D3	6E	4C	3E
16	64	10	076	1263	4EF	D3	6F	4C	3F
16	65	10	077	1264	4F0	D3	F0	4C	30
16	66	10	078	1265	4F1	D3	F1	4C	31
16	67	10	079	1266	4F2	D3	F2	4C	32
16	68	10	080	1267	4F3	D3	F3	4C	33
16	69	10	081	1268	4F4	D3	F4	4C	34
16	70	10	082	1269	4F5	D3	F5	4C	35
16	71	10	083	1270	4F6	D3	F6	4C	36
16	72	10	084	1271	4F7	D3	F7	4C	37
16	73	10	085	1272	4F8	D3	F8	4C	38
16	74	10	086	1273	4F9	D3	F9	4C	39
16	75	10	087	1274	4FA	D3	7A	4C	3A
16	76	10	088	1275	4FB	D3	7B	4C	23
16	77	10	089	1276	4FC	D3	7C	4C	40
16	78	10	090	1277	4FD	D3	7D	4C	27
16	79	10	091	1278	4FE	D3	7E	4C	3D
16	80	10	092	1279	4FF	D3	7F	4C	22
17	01	10	093	1280	500	D4	40	4D	20
17	02	10	094	1281	501	D4	C1	4D	41
17	03	10	095	1282	502	D4	C2	4D	42
17	04	10	096	1283	503	D4	C3	4D	43
17	05	10	097	1284	504	D4	C4	4D	44
17	06	10	098	1285	505	D4	C5	4D	45
17	07	10	099	1286	506	D4	C6	4D	46
17	08	10	100	1287	507	D4	C7	4D	47
17	09	10	101	1288	508	D4	C8	4D	48
17	10	10	102	1289	509	D4	C9	4D	49
17	11	10	103	1290	50A	D4	4A	4D	5B
17	12	10	104	1291	50B	D4	4B	4D	2E
17	13	10	105	1292	50C	D4	4C	4D	3C
17	14	10	106	1293	50D	D4	4D	4D	28
17	15	10	107	1294	50E	D4	4E	4D	2B
17	16	10	108	1295	50F	D4	4F	4D	21
17	17	10	109	1296	510	D4	50	4D	26
17	18	10	110	1297	511	D4	D1	4D	4A
17	19	10	111	1298	512	D4	D2	4D	4B
17	20	10	112	1299	513	D4	D3	4D	4C
17	21	10	113	1300	514	D4	D4	4D	4D
17	22	10	114	1301	515	D4	D5	4D	4E

80 Col		132 Col		Position		Buffer Address (Hex)			
R	C	R	C	Dec	Hex	EBCDIC		ASCII	
17	23	10	115	1302	516	D4	D6	4D	4F
17	24	10	116	1303	517	D4	D7	4D	50
17	25	10	117	1304	518	D4	D8	4D	51
17	26	10	118	1305	519	D4	D9	4D	52
17	27	10	119	1306	51A	D4	5A	4D	5D
17	28	10	120	1307	51B	D4	5B	4D	24
17	29	10	121	1308	51C	D4	5C	4D	2A
17	30	10	122	1309	51D	D4	5D	4D	29
17	31	10	123	1310	51E	D4	5E	4D	3B
17	32	10	124	1311	51F	D4	5F	4D	5E
17	33	10	125	1312	520	D4	60	4D	2D
17	34	10	126	1313	521	D4	61	4D	2F
17	35	10	127	1314	522	D4	E2	4D	53
17	36	10	128	1315	523	D4	E3	4D	54
17	37	10	129	1316	524	D4	E4	4D	55
17	38	10	130	1317	525	D4	E5	4D	56
17	39	10	131	1318	526	D4	E6	4D	57
17	40	10	132	1319	527	D4	E7	4D	58
17	41	11	001	1320	528	D4	E8	4D	59
17	42	11	002	1321	529	D4	E9	4D	5A
17	43	11	003	1322	52A	D4	6A	4D	7C
17	44	11	004	1323	52B	D4	6B	4D	2C
17	45	11	005	1324	52C	D4	6C	4D	25
17	46	11	006	1325	52D	D4	6D	4D	5F
17	47	11	007	1326	52E	D4	6E	4D	3E
17	48	11	008	1327	52F	D4	6F	4D	3F
17	49	11	009	1328	530	D4	F0	4D	30
17	50	11	010	1329	531	D4	F1	4D	31
17	51	11	011	1330	532	D4	F2	4D	32
17	52	11	012	1331	533	D4	F3	4D	33
17	53	11	013	1332	534	D4	F4	4D	34
17	54	11	014	1333	535	D4	F5	4D	35
17	55	11	015	1334	536	D4	F6	4D	36
17	56	11	016	1335	537	D4	F7	4D	37
17	57	11	017	1336	538	D4	F8	4D	38
17	58	11	018	1337	539	D4	F9	4D	39
17	59	11	019	1338	53A	D4	7A	4D	3A
17	60	11	020	1339	53B	D4	7B	4D	23
17	61	11	021	1340	53C	D4	7C	4D	40
17	62	11	022	1341	53D	D4	7D	4D	27
17	63	11	023	1342	53E	D4	7E	4D	3D
17	64	11	024	1343	53F	D4	7F	4D	22
17	65	11	025	1344	540	D5	40	4E	20
17	66	11	026	1345	541	D5	C1	4E	41
17	67	11	027	1346	542	D5	C2	4E	42
17	68	11	028	1347	543	D5	C3	4E	43
17	69	11	029	1348	544	D5	C4	4E	44
17	70	11	030	1349	545	D5	C5	4E	45
17	71	11	031	1350	546	D5	C6	4E	46
17	72	11	032	1351	547	D5	C7	4E	47
17	73	11	033	1352	548	D5	C8	4E	48
17	74	11	034	1353	549	D5	C9	4E	49
17	75	11	035	1354	54A	D5	4A	4E	5B
17	76	11	036	1355	54B	D5	4B	4E	2E
17	77	11	037	1356	54C	D5	4C	4E	3C
17	78	11	038	1357	54D	D5	4D	4E	28
17	79	11	039	1358	54E	D5	4E	4E	2B
17	80	11	040	1359	54F	D5	4F	4E	21
18	01	11	041	1360	550	D5	50	4E	26
18	02	11	042	1361	551	D5	D1	4E	4A
18	03	11	043	1362	552	D5	D2	4E	4B
18	04	11	044	1363	553	D5	D3	4E	4C
18	05	11	045	1364	554	D5	D4	4E	4D

80 Col		132 Col		Position		Buffer Address (Hex)			
R	C	R	C	Dec	Hex	EBCDIC		ASCII	
18	06	11	046	1365	555	D5	D5	4E	4E
18	07	11	047	1366	556	D5	D6	4E	4F
18	08	11	048	1367	557	D5	D7	4E	50
18	09	11	049	1368	558	D5	D8	4E	51
18	10	11	050	1369	559	D5	D9	4E	52
18	11	11	051	1370	55A	D5	5A	4E	5D
18	12	11	052	1371	55B	D5	5B	4E	24
18	13	11	053	1372	55C	D5	5C	4E	2A
18	14	11	054	1373	55D	D5	5D	4E	29
18	15	11	055	1374	55E	D5	5E	4E	3B
18	16	11	056	1375	55F	D5	5F	4E	5E
18	17	11	057	1376	560	D5	60	4E	2D
18	18	11	058	1377	561	D5	61	4E	2F
18	19	11	059	1378	562	D5	E2	4E	53
18	20	11	060	1379	563	D5	E3	4E	54
18	21	11	061	1380	564	D5	E4	4E	55
18	22	11	062	1381	565	D5	E5	4E	56
18	23	11	063	1382	566	D5	F6	4E	57
18	24	11	064	1383	567	D5	E7	4E	58
18	25	11	065	1384	568	D5	E8	4E	59
18	26	11	066	1385	569	D5	E9	4E	5A
18	27	11	067	1386	56A	D5	6A	4E	7C
18	28	11	068	1387	56B	D5	6B	4E	2C
18	29	11	069	1388	56C	D5	6C	4E	25
18	30	11	070	1389	56D	D5	6D	4E	5F
18	31	11	071	1390	56E	D5	6E	4E	3E
18	32	11	072	1391	56F	D5	6F	4E	3F
18	33	11	073	1392	570	D5	F0	4E	30
18	34	11	074	1393	571	D5	F1	4E	31
18	35	11	075	1394	572	D5	F2	4E	32
18	36	11	076	1395	573	D5	F3	4E	33
18	37	11	077	1396	574	D5	F4	4E	34
18	38	11	078	1397	575	D5	F5	4E	35
18	39	11	079	1398	576	D5	F6	4E	36
18	40	11	080	1399	577	D5	F7	4E	37
18	41	11	081	1400	578	D5	F8	4E	38
18	42	11	082	1401	579	D5	F9	4E	39
18	43	11	083	1402	57A	D5	7A	4E	3A
18	44	11	084	1403	57B	D5	7B	4E	23
18	45	11	085	1404	57C	D5	7C	4E	40
18	46	11	086	1405	57D	D5	7D	4E	27
18	47	11	087	1406	57E	D5	7E	4E	3D
18	48	11	088	1407	57F	D5	7F	4E	22
18	49	11	089	1408	580	D6	40	4F	20
18	50	11	090	1409	581	D6	C1	4F	41
18	51	11	091	1410	582	D6	C2	4F	42
18	52	11	092	1411	583	D6	C3	4F	43
18	53	11	093	1412	584	D6	C4	4F	44
18	54	11	094	1413	585	D6	C5	4F	45
18	55	11	095	1414	586	D6	C6	4F	46
18	56	11	096	1415	587	D6	C7	4F	47
18	57	11	097	1416	588	D6	C8	4F	48
18	58	11	098	1417	589	D6	C9	4F	49
18	59	11	099	1418	58A	D6	4A	4F	5B
18	60	11	100	1419	58B	D6	4B	4F	2E
18	61	11	101	1420	58C	D6	4C	4F	3C
18	62	11	102	1421	58D	D6	4D	4F	28
18	63	11	103	1422	58E	D6	4E	4F	2B
18	64	11	104	1423	58F	D6	4F	4F	21
18	65	11	105	1424	590	D6	50	4F	26
18	66	11	106	1425	591	D6	D1	4F	4A

80 Col		132 Col		Position		Buffer Address (Hex)	
R	C	R	C	Dec	Hex	EBCDIC	ASCII
18	67	11	107	1426	592	D6 D2	4F 4B
18	68	11	108	1427	593	D6 D3	4F 4C
18	69	11	109	1428	594	D6 D4	4F 4D
18	70	11	110	1429	595	D6 D5	4F 4E
18	71	11	111	1430	596	D6 D6	4F 4F
18	72	11	112	1431	597	D6 D7	4F 50
18	73	11	113	1432	598	D6 D8	4F 51
18	74	11	114	1433	599	D6 D9	4F 52
18	75	11	115	1434	59A	D6 5A	4F 5D
18	76	11	116	1435	59B	D6 5B	4F 24
18	77	11	117	1436	59C	D6 5C	4F 2A
18	78	11	118	1437	59D	D6 5D	4F 29
18	79	11	119	1438	59E	D6 5E	4F 3B
18	80	11	120	1439	59F	D6 5F	4F 5E
19	01	11	121	1440	5A0	D6 60	4F 2D
19	02	11	122	1441	5A1	D6 61	4F 2F
19	03	11	123	1442	5A2	D6 E2	4F 53
19	04	11	124	1443	5A3	D6 E3	4F 54
19	05	11	125	1444	5A4	D6 E4	4F 55
19	06	11	126	1445	5A5	D6 E5	4F 56
19	07	11	127	1446	5A6	D6 E6	4F 57
19	08	11	128	1447	5A7	D6 E7	4F 58
19	09	11	129	1448	5A8	D6 E8	4F 59
19	10	11	130	1449	5A9	D6 E9	4F 5A
19	11	11	131	1450	5AA	D6 6A	4F 7C
19	12	11	132	1451	5AB	D6 6B	4F 2C
19	13	12	001	1452	5AC	D6 6C	4F 25
19	14	12	002	1453	5AD	D6 6D	4F 5F
19	15	12	003	1454	5AE	D6 6E	4F 3E
19	16	12	004	1455	5AF	D6 6F	4F 3F
19	17	12	005	1456	5B0	D6 F0	4F 30
19	18	12	006	1457	5B1	D6 F1	4F 31
19	19	12	007	1458	5B2	D6 F2	4F 32
19	20	12	008	1459	5B3	D6 F3	4F 33
19	21	12	009	1460	5B4	D6 F4	4F 34
19	22	12	010	1461	5B5	D6 F5	4F 35
19	23	12	011	1462	5B6	D6 F6	4F 36
19	24	12	012	1463	5B7	D6 F7	4F 37
19	25	12	013	1464	5B8	D6 F8	4F 38
19	26	12	014	1465	5B9	D6 F9	4F 39
19	27	12	015	1466	5BA	D6 7A	4F 3A
19	28	12	016	1467	5BB	D6 7B	4F 23
19	29	12	017	1468	5BC	D6 7C	4F 40
19	30	12	018	1469	5BD	D6 7D	4F 27
19	31	12	019	1470	5BE	D6 7E	4F 3D
19	32	12	020	1471	5BF	D6 7F	4F 22
19	33	12	021	1472	5C0	D7 40	50 20
19	34	12	022	1473	5C1	D7 C1	50 41
19	35	12	023	1474	5C2	D7 C2	50 42
19	36	12	024	1475	5C3	D7 C3	50 43
19	37	12	025	1476	5C4	D7 C4	50 44
19	38	12	026	1477	5C5	D7 C5	50 45
19	39	12	027	1478	5C6	D7 C6	50 46
19	40	12	028	1479	5C7	D7 C7	50 47
19	41	12	029	1480	5C8	D7 C8	50 48
19	42	12	030	1481	5C9	D7 C9	50 49
19	43	12	031	1482	5CA	D7 4A	50 5B
19	44	12	032	1483	5CB	D7 4B	50 2E
19	45	12	033	1484	5CC	D7 4C	50 3C
19	46	12	034	1485	5CD	D7 4D	50 28
19	47	12	035	1486	5CE	D7 4E	50 2B
19	48	12	036	1487	5CF	D7 4F	50 21

80 Col		132 Col		Position		Buffer Address (Hex)			
<u>R</u>	<u>C</u>	<u>R</u>	<u>C</u>	<u>Dec</u>	<u>Hex</u>	<u>EBCDIC</u>		<u>ASCII</u>	
19	49	12	037	1488	5D0	D7	50	50	26
19	50	12	038	1489	5D1	D7	D1	50	4A
19	51	12	039	1490	5D2	D7	D2	50	4B
19	52	12	040	1491	5D3	D7	D3	50	4C
19	53	12	041	1492	5D4	D7	D4	50	4D
19	54	12	042	1493	5D5	D7	D5	50	4E
19	55	12	043	1494	5D6	D7	D6	50	4F
19	56	12	044	1495	5D7	D7	D7	50	50
19	57	12	045	1496	5D8	D7	D8	50	51
19	58	12	046	1497	5D9	D7	D9	50	52
19	59	12	047	1498	5DA	D7	5A	50	5D
19	60	12	048	1499	5DB	D7	5B	50	24
19	61	12	049	1500	5DC	D7	5C	50	2A
19	62	12	050	1501	5DD	D7	5D	50	29
19	63	12	051	1502	5DE	D7	5E	50	3B
19	64	12	052	1503	5DF	D7	5F	50	5E
19	65	12	053	1504	5E0	D7	60	50	2D
19	66	12	054	1505	5E1	D7	61	50	2F
19	67	12	055	1506	5E2	D7	E2	50	53
19	68	12	056	1507	5E3	D7	E3	50	54
19	69	12	057	1508	5E4	D7	E4	50	55
19	70	12	058	1509	5E5	D7	E5	50	56
19	71	12	059	1510	5E6	D7	E6	50	57
19	72	12	060	1511	5E7	D7	E7	50	58
19	73	12	061	1512	5E8	D7	E8	50	59
19	74	12	062	1513	5E9	D7	E9	50	5A
19	75	12	063	1514	5EA	D7	6A	50	7C
19	76	12	064	1515	5EB	D7	6B	50	2C
19	77	12	065	1516	5EC	D7	6C	50	25
19	78	12	066	1517	5ED	D7	6D	50	5F
19	79	12	067	1518	5EE	D7	6E	50	3E
19	80	12	068	1519	5EF	D7	6F	50	3F
20	01	12	069	1520	5F0	D7	F0	50	30
20	02	12	070	1521	5F1	D7	F1	50	31
20	03	12	071	1522	5F2	D7	F2	50	32
20	04	12	072	1523	5F3	D7	F3	50	33
20	05	12	073	1524	5F4	D7	F4	50	34
20	06	12	074	1525	5F5	D7	F5	50	35
20	07	12	075	1526	5F6	D7	F6	50	36
20	08	12	076	1527	5F7	D7	F7	50	37
20	09	12	077	1528	5F8	D7	F8	50	38
20	10	12	078	1529	5F9	D7	F9	50	39
20	11	12	079	1530	5FA	D7	7A	50	3A
20	12	12	080	1531	5FB	D7	7B	50	23
20	13	12	081	1532	5FC	D7	7C	50	40
20	14	12	082	1533	5FD	D7	7D	50	27
20	15	12	083	1534	5FE	D7	7E	50	3D
20	16	12	084	1535	5FF	D7	7F	50	22
20	17	12	085	1536	600	D8	40	51	20
20	18	12	086	1537	601	D8	C1	51	41
20	19	12	087	1538	602	D8	C2	51	42
20	20	12	088	1539	603	D8	C3	51	43
20	21	12	089	1540	604	D8	C4	51	44
20	22	12	090	1541	605	D8	C5	51	45
20	23	12	091	1542	606	D8	C6	51	46
20	24	12	092	1543	607	D8	C7	51	47
20	25	12	093	1544	608	D8	C8	51	48
20	26	12	094	1545	609	D8	C9	51	49
20	27	12	095	1546	60A	D8	4A	51	5B
20	28	12	096	1547	60B	D8	4B	51	2E
20	29	12	097	1548	60C	D8	4C	51	3C
20	30	12	098	1549	60D	D8	4D	51	28

80 Col		132 Col		Position		Buffer Address (Hex)	
<u>R</u>	<u>C</u>	<u>R</u>	<u>C</u>	<u>Dec</u>	<u>Hex</u>	<u>EBCDIC</u>	<u>ASCII</u>
20	31	12	099	1550	60E	D8 4E	51 2B
20	32	12	100	1551	60F	D8 4F	51 21
20	33	12	101	1552	610	D8 50	51 26
20	34	12	102	1553	611	D8 D1	51 4A
20	35	12	103	1554	612	D8 D2	51 4B
20	36	12	104	1555	613	D8 D3	51 4C
20	37	12	105	1556	614	D8 D4	51 4D
20	38	12	106	1557	615	D8 D5	51 4E
20	39	12	107	1558	616	D8 D6	51 4F
20	40	12	108	1559	617	D8 D7	51 50
20	41	12	109	1560	618	D8 D8	51 51
20	42	12	110	1561	619	D8 D9	51 52
20	43	12	111	1562	61A	D8 5A	51 5D
20	44	12	112	1563	61B	D8 5B	51 24
20	45	12	113	1564	61C	D8 5C	51 2A
20	46	12	114	1565	61D	D8 5D	51 29
20	47	12	115	1566	61E	D8 5E	51 3B
20	48	12	116	1567	61F	D8 5F	51 5E
20	49	12	117	1568	620	D8 60	51 2D
20	50	12	118	1569	621	D8 61	51 2F
20	51	12	119	1570	622	D8 E2	51 53
20	52	12	120	1571	623	D8 E3	51 54
20	53	12	121	1572	624	D8 E4	51 55
20	54	12	122	1573	625	D8 E5	51 56
20	55	12	123	1574	626	D8 E6	51 57
20	56	12	124	1575	627	D8 E7	51 58
20	57	12	125	1576	628	D8 E8	51 59
20	58	12	126	1577	629	D8 E9	51 5A
20	59	12	127	1578	62A	D8 6A	51 7C
20	60	12	128	1579	62B	D8 6B	51 2C
20	61	12	129	1580	62C	D8 6C	51 25
20	62	12	130	1581	62D	D8 6D	51 5F
20	63	12	131	1582	62E	D8 6E	51 3E
20	64	12	132	1583	62F	D8 6F	51 3F
20	65	13	001	1584	630	D8 F0	51 30
20	66	13	002	1585	631	D8 F1	51 31
20	67	13	003	1586	632	D8 F2	51 32
20	68	13	004	1587	633	D8 F3	51 33
20	69	13	005	1588	634	D8 F4	51 34
20	70	13	006	1589	635	D8 F5	51 35
20	71	13	007	1590	636	D8 F6	51 36
20	72	13	008	1591	637	D8 F7	51 37
20	73	13	009	1592	638	D8 F8	51 38
20	74	13	010	1593	639	D8 F9	51 39
20	75	13	011	1594	63A	D8 7A	51 3A
20	76	13	012	1595	63B	D8 7B	51 23
20	77	13	013	1596	63C	D8 7C	51 40
20	78	13	014	1597	63D	D8 7D	51 27
20	79	13	015	1598	63E	D8 7E	51 3D
20	80	13	016	1599	63F	D8 7F	51 22
21	01	13	017	1600	640	D9 40	52 20
21	02	13	018	1601	641	D9 C1	52 41
21	03	13	019	1602	642	D9 C2	52 42
21	04	13	020	1603	643	D9 C3	52 43
21	05	13	021	1604	644	D9 C4	52 44
21	06	13	022	1605	645	D9 C5	52 45
21	07	13	023	1606	646	D9 C6	52 46
21	08	13	024	1607	647	D9 C7	52 47
21	09	13	025	1608	648	D9 C8	52 48
21	10	13	026	1609	649	D9 C9	52 49
21	11	13	027	1610	64A	D9 4A	52 5B
21	12	13	028	1611	64B	D9 4B	52 2E

80 Col		132 Col		Position		Buffer Address (Hex)			
<u>R</u>	<u>C</u>	<u>R</u>	<u>C</u>	<u>Dec</u>	<u>Hex</u>	<u>EBCDIC</u>		<u>ASCII</u>	
21	13	13	029	1612	64C	D9	4C	52	3C
21	14	13	030	1613	64D	D9	4D	52	28
21	15	13	031	1614	64E	D9	4E	52	2B
21	16	13	032	1615	64F	D9	4F	52	21
21	17	13	033	1616	650	D9	50	52	26
21	18	13	034	1617	651	D9	D1	52	4A
21	19	13	035	1618	652	D9	D2	52	4B
21	20	13	036	1619	653	D9	D3	52	4C
21	21	13	037	1620	654	D9	D4	52	4D
21	22	13	038	1621	655	D9	D5	52	4E
21	23	13	039	1622	656	D9	D6	52	4F
21	24	13	040	1623	657	D9	D7	52	50
21	25	13	041	1624	658	D9	D8	52	51
21	26	13	042	1625	659	D9	D9	52	52
21	27	13	043	1626	65A	D9	5A	52	5D
21	28	13	044	1627	65B	D9	5B	52	24
21	29	13	045	1628	65C	D9	5C	52	2A
21	30	13	046	1629	65D	D9	5D	52	29
21	31	13	047	1630	65E	D9	5E	52	3B
21	32	13	048	1631	65F	D9	5F	52	5E
21	33	13	049	1632	660	D9	60	52	2D
21	34	13	050	1633	661	D9	61	52	2F
21	35	13	051	1634	662	D9	E2	52	53
21	36	13	052	1635	663	D9	E3	52	54
21	37	13	053	1636	664	D9	E4	52	55
21	38	13	054	1637	665	D9	E5	52	56
21	39	13	055	1638	666	D9	E6	52	57
21	40	13	056	1639	667	D9	E7	52	58
21	41	13	057	1640	668	D9	E8	52	59
21	42	13	058	1641	669	D9	E9	52	5A
21	43	13	059	1642	66A	D9	6A	52	7C
21	44	13	060	1643	66B	D9	6B	52	2C
21	45	13	061	1644	66C	D9	6C	52	25
21	46	13	062	1645	66D	D9	6D	52	5F
21	47	13	063	1646	66E	D9	6E	52	3E
21	48	13	064	1647	66F	D9	6F	52	3F
21	49	13	065	1648	670	D9	F0	52	30
21	50	13	066	1649	671	D9	F1	52	31
21	51	13	067	1650	672	D9	F2	52	32
21	52	13	068	1651	673	D9	F3	52	33
21	53	13	069	1652	674	D9	F4	52	34
21	54	13	070	1653	675	D9	F5	52	35
21	55	13	071	1654	676	D9	F6	52	36
21	56	13	072	1655	677	D9	F7	52	37
21	57	13	073	1656	678	D9	F8	52	38
21	58	13	074	1657	679	D9	F9	52	39
21	59	13	075	1658	67A	D9	7A	52	3A
21	60	13	076	1659	67B	D9	7B	52	23
21	61	13	077	1660	67C	D9	7C	52	40
21	62	13	078	1661	67D	D9	7D	52	27
21	63	13	079	1662	67E	D9	7E	52	3D
21	64	13	080	1663	67F	D9	7F	52	22
21	65	13	081	1664	680	5A	40	5D	20
21	66	13	082	1665	681	5A	C1	5D	41
21	67	13	083	1666	682	5A	C2	5D	42
21	68	13	084	1667	683	5A	C3	5D	43
21	69	13	085	1668	684	5A	C4	5D	44
21	70	13	086	1669	685	5A	C5	5D	45
21	71	13	087	1670	686	5A	C6	5D	46
21	72	13	088	1671	687	5A	C7	5D	47
21	73	13	089	1672	688	5A	C8	5D	48
21	74	13	090	1673	689	5A	C9	5D	49

80 Col		132 Col		Position		Buffer Address (Hex)	
R	C	R	C	Dec	Hex	EBCDIC	ASCII
21	75	13	091	1674	68A	5A 4A	5D 5B
21	76	13	092	1675	68B	5A 4B	5D 2E
21	77	13	093	1676	68C	5A 4C	5D 3C
21	78	13	094	1677	68D	5A 4D	5D 28
21	79	13	095	1678	68E	5A 4E	5D 2B
21	80	13	096	1679	68F	5A 4F	5D 21
22	01	13	097	1680	690	5A 50	5D 26
22	02	13	098	1681	691	5A D1	5D 4A
22	03	13	099	1682	692	5A D2	5D 4B
22	04	13	100	1683	693	5A D3	5D 4C
22	05	13	101	1684	694	5A D4	5D 4D
22	06	13	102	1685	695	5A D5	5D 4E
22	07	13	103	1686	696	5A D6	5D 4F
22	08	13	104	1687	697	5A D7	5D 50
22	09	13	105	1688	698	5A D8	5D 51
22	10	13	106	1689	699	5A D9	5D 52
22	11	13	107	1690	69A	5A 5A	5D 5D
22	12	13	108	1691	69B	5A 5B	5D 24
22	13	13	109	1692	69C	5A 5C	5D 2A
22	14	13	110	1693	69D	5A 5D	5D 29
22	15	13	111	1694	69E	5A 5E	5D 3B
22	16	13	112	1695	69F	5A 5F	5D 5E
22	17	13	113	1696	6A0	5A 60	5D 2D
22	18	13	114	1697	6A1	5A 61	5D 2F
22	19	13	115	1698	6A2	5A E2	5D 53
22	20	13	116	1699	6A3	5A E3	5D 54
22	21	13	117	1700	6A4	5A F4	5D 55
22	22	13	118	1701	6A5	5A E5	5D 56
22	23	13	119	1702	6A6	5A E6	5D 57
22	24	13	120	1703	6A7	5A E7	5D 58
22	25	13	121	1704	6A8	5A E8	5D 59
22	26	13	122	1705	6A9	5A E9	5D 5A
22	27	13	123	1706	6AA	5A 6A	5D 7C
22	28	13	124	1707	6AB	5A 6B	5D 2C
22	29	13	125	1708	6AC	5A 6C	5D 25
22	30	13	126	1709	6AD	5A 6D	5D 5F
22	31	13	127	1710	6AE	5A 6E	5D 3E
22	32	13	128	1711	6AF	5A 6F	5D 3F
22	33	13	129	1712	6B0	5A F0	5D 30
22	34	13	130	1713	6B1	5A F1	5D 31
22	35	13	131	1714	6B2	5A F2	5D 32
22	36	13	132	1715	6B3	5A F3	5D 33
22	37	14	001	1716	6B4	5A F4	5D 34
22	38	14	002	1717	6B5	5A F5	5D 35
22	39	14	003	1718	6B6	5A F6	5D 36
22	40	14	004	1719	6B7	5A F7	5D 37
22	41	14	005	1720	6B8	5A F8	5D 38
22	42	14	006	1721	6B9	5A F9	5D 39
22	43	14	007	1722	6BA	5A 7A	5D 3A
22	44	14	008	1723	6BB	5A 7B	5D 23
22	45	14	009	1724	6BC	5A 7C	5D 40
22	46	14	010	1725	6BD	5A 7D	5D 27
22	47	14	011	1726	6BE	5A 7E	5D 3D
22	48	14	012	1727	6BF	5A 7F	5D 22
22	49	14	013	1728	6C0	5B 40	24 20
22	50	14	014	1729	6C1	5B C1	24 41
22	51	14	015	1730	6C2	5B C2	24 42
22	52	14	016	1731	6C3	5B C3	24 43
22	53	14	017	1732	6C4	5B C4	24 44
22	54	14	018	1733	6C5	5B C5	24 45
22	55	14	019	1734	6C6	5B C6	24 46
22	56	14	020	1735	6C7	5B C7	24 47

80 Col		132 Col		Position		Buffer Address (Hex)			
R	C	R	C	Dec	Hex	EBCDIC		ASCII	
22	57	14	021	1736	6C8	5B	C8	24	48
22	58	14	022	1737	6C9	5B	C9	24	49
22	59	14	023	1738	6CA	5B	4A	24	5B
22	60	14	024	1739	6CB	5B	4B	24	2E
22	61	14	025	1740	6CC	5B	4C	24	3C
22	62	14	026	1741	6CD	5B	4D	24	28
22	63	14	027	1742	6CE	5B	4E	24	2B
22	64	14	028	1743	6CF	5B	4F	24	21
22	65	14	029	1744	6D0	5B	50	24	26
22	66	14	030	1745	6D1	5B	D1	24	4A
22	67	14	031	1746	6D2	5B	D2	24	4B
22	68	14	032	1747	6D3	5B	D3	24	4C
22	69	14	033	1748	6D4	5B	D4	24	4D
22	70	14	034	1749	6D5	5B	D5	24	4E
22	71	14	035	1750	6D6	5B	D6	24	4F
22	72	14	036	1751	6D7	5B	D7	24	50
22	73	14	037	1752	6D8	5B	D8	24	51
22	74	14	038	1753	6D9	5B	D9	24	52
22	75	14	039	1754	6DA	5B	5A	24	5D
22	76	14	040	1755	6DB	5B	5B	24	24
22	77	14	041	1756	6DC	5B	5C	24	2A
22	78	14	042	1757	6DD	5B	5D	24	29
22	79	14	043	1758	6DE	5B	5E	24	3B
22	80	14	044	1759	6DF	5B	5F	24	5E
23	01	14	045	1760	6E0	5B	60	24	2D
23	02	14	046	1761	6E1	5B	61	24	2F
23	03	14	047	1762	6E2	5B	E2	24	53
23	04	14	048	1763	6E3	5B	E3	24	54
23	05	14	049	1764	6E4	5B	E4	24	55
23	06	14	050	1765	6E5	5B	E5	24	56
23	07	14	051	1766	6E6	5B	E6	24	57
23	08	14	052	1767	6E7	5B	E7	24	58
23	09	14	053	1768	6E8	5B	E8	24	59
23	10	14	054	1769	6E9	5B	E9	24	5A
23	11	14	055	1770	6EA	5B	6A	24	7C
23	12	14	056	1771	6EB	5B	6B	24	2C
23	13	14	057	1772	6EC	5B	6C	24	25
23	14	14	058	1773	6ED	5B	6D	24	5F
23	15	14	059	1774	6EE	5B	6E	24	3E
23	16	14	060	1775	6EF	5B	6F	24	3F
23	17	14	061	1776	6F0	5B	F0	24	30
23	18	14	062	1777	6F1	5B	F1	24	31
23	19	14	063	1778	6F2	5B	F2	24	32
23	20	14	064	1779	6F3	5B	F3	24	33
23	21	14	065	1780	6F4	5B	F4	24	34
23	22	14	066	1781	6F5	5B	F5	24	35
23	23	14	067	1782	6F6	5B	F6	24	36
23	24	14	068	1783	6F7	5B	F7	24	37
23	25	14	069	1784	6F8	5B	F8	24	38
23	26	14	070	1785	6F9	5B	F9	24	39
23	27	14	071	1786	6FA	5B	7A	24	3A
23	28	14	072	1787	6FB	5B	7B	24	23
23	29	14	073	1788	6FC	5B	7C	24	40
23	30	14	074	1789	6FD	5B	7D	24	27
23	31	14	075	1790	6FE	5B	7E	24	3D
23	32	14	076	1791	6FF	5B	7F	24	22
23	33	14	077	1792	700	5C	40	2A	20
23	34	14	078	1793	701	5C	C1	2A	41
23	35	14	079	1794	702	5C	C2	2A	42
23	36	14	080	1795	703	5C	C3	2A	43
23	37	14	081	1796	704	5C	C4	2A	44
23	38	14	082	1797	705	5C	C5	2A	45

80 Col		132 Col		Position		Buffer Address (Hex)			
R	C	R	C	Dec	Hex	EBCDIC		ASCII	
23	39	14	083	1798	706	5C	C6	2A	46
23	40	14	084	1799	707	5C	C7	2A	47
23	41	14	085	1800	708	5C	C8	2A	48
23	42	14	086	1801	709	5C	C9	2A	49
23	43	14	087	1802	70A	5C	4A	2A	5B
23	44	14	088	1803	70B	5C	4B	2A	2E
23	45	14	089	1804	70C	5C	4C	2A	3C
23	46	14	090	1805	70D	5C	4D	2A	28
23	47	14	091	1806	70E	5C	4E	2A	2B
23	48	14	092	1807	70F	5C	4F	2A	21
23	49	14	093	1808	710	5C	50	2A	26
23	50	14	094	1809	711	5C	D1	2A	4A
23	51	14	095	1810	712	5C	D2	2A	4B
23	52	14	096	1811	713	5C	D3	2A	4C
23	53	14	097	1812	714	5C	D4	2A	4D
23	54	14	098	1813	715	5C	D5	2A	4E
23	55	14	099	1814	716	5C	D6	2A	4F
23	56	14	100	1815	717	5C	D7	2A	50
23	57	14	101	1816	718	5C	D8	2A	51
23	58	14	102	1817	719	5C	D9	2A	52
23	59	14	103	1818	71A	5C	5A	2A	5D
23	60	14	104	1819	71B	5C	5B	2A	24
23	61	14	105	1820	71C	5C	5C	2A	2A
23	62	14	106	1821	71D	5C	5D	2A	29
23	63	14	107	1822	71E	5C	5E	2A	3B
23	64	14	108	1823	71F	5C	5F	2A	5E
23	65	14	109	1824	720	5C	60	2A	2D
23	66	14	110	1825	721	5C	61	2A	2F
23	67	14	111	1826	722	5C	E2	2A	53
23	68	14	112	1827	723	5C	E3	2A	54
23	69	14	113	1828	724	5C	E4	2A	55
23	70	14	114	1829	725	5C	E5	2A	56
23	71	14	115	1830	726	5C	E6	2A	57
23	72	14	116	1831	727	5C	E7	2A	58
23	73	14	117	1832	728	5C	E8	2A	59
23	74	14	118	1833	729	5C	E9	2A	5A
23	75	14	119	1834	72A	5C	6A	2A	7C
23	76	14	120	1835	72B	5C	6B	2A	2C
23	77	14	121	1836	72C	5C	6C	2A	25
23	78	14	122	1837	72D	5C	6D	2A	5F
23	79	14	123	1838	72E	5C	6E	2A	3E
23	80	14	124	1839	72F	5C	6F	2A	3F
24	01	14	125	1840	730	5C	F0	2A	30
24	02	14	126	1841	731	5C	F1	2A	31
24	03	14	127	1842	732	5C	F2	2A	32
24	04	14	128	1843	733	5C	F3	2A	33
24	05	14	129	1844	734	5C	F4	2A	34
24	06	14	130	1845	735	5C	F5	2A	35
24	07	14	131	1846	736	5C	F6	2A	36
24	08	14	132	1847	737	5C	F7	2A	37
24	09	15	001	1848	738	5C	F8	2A	38
24	10	15	002	1849	739	5C	F9	2A	39
24	11	15	003	1850	73A	5C	7A	2A	3A
24	12	15	004	1851	73B	5C	7B	2A	23
24	13	15	005	1852	73C	5C	7C	2A	40
24	14	15	006	1853	73D	5C	7D	2A	27
24	15	15	007	1854	73E	5C	7E	2A	3D
24	16	15	008	1855	73F	5C	7F	2A	22
24	17	15	009	1856	740	5D	40	29	20
24	18	15	010	1857	741	5D	C1	29	41
24	19	15	011	1858	742	5D	C2	29	42
24	20	15	012	1859	743	5D	C3	29	43

80 Col		132 Col		Position		Buffer Address (Hex)			
R	C	R	C	Dec	Hex	EBCDIC		ASCII	
24	21	15	013	1860	744	5D	C4	29	44
24	22	15	014	1861	745	5D	C5	29	45
24	23	15	015	1862	746	5D	C6	29	46
24	24	15	016	1863	747	5D	C7	29	47
24	25	15	017	1864	748	5D	C8	29	48
24	26	15	018	1865	749	5D	C9	29	49
24	27	15	019	1866	74A	5D	4A	29	5B
24	28	15	020	1867	74B	5D	4B	29	2E
24	29	15	021	1868	74C	5D	4C	29	3C
24	30	15	022	1869	74D	5D	4D	29	28
24	31	15	023	1870	74E	5D	4E	29	2B
24	32	15	024	1871	74F	5D	4F	29	21
24	33	15	025	1872	750	5D	50	29	26
24	34	15	026	1873	751	5D	D1	29	4A
24	35	15	027	1874	752	5D	D2	29	4B
24	36	15	028	1875	753	5D	D3	29	4C
24	37	15	029	1876	754	5D	D4	29	4D
24	38	15	030	1877	755	5D	D5	29	4E
24	39	15	031	1878	756	5D	D6	29	4F
24	40	15	032	1879	757	5D	D7	29	50
24	41	15	033	1880	758	5D	D8	29	51
24	42	15	034	1881	759	5D	D9	29	52
24	43	15	035	1882	75A	5D	5A	29	5D
24	44	15	036	1883	75B	5D	5B	29	24
24	45	15	037	1884	75C	5D	5C	29	2A
24	46	15	038	1885	75D	5D	5D	29	29
24	47	15	039	1886	75E	5D	5E	29	3B
24	48	15	040	1887	75F	5D	5F	29	5E
24	49	15	041	1888	760	5D	60	29	2D
24	50	15	042	1889	761	5D	61	29	2F
24	51	15	043	1890	762	5D	E2	29	53
24	52	15	044	1891	763	5D	E3	29	54
24	53	15	045	1892	764	5D	E4	29	55
24	54	15	046	1893	765	5D	E5	29	56
24	55	15	047	1894	766	5D	E6	29	57
24	56	15	048	1895	767	5D	E7	29	58
24	57	15	049	1896	768	5D	E8	29	59
24	58	15	050	1897	769	5D	E9	29	5A
24	59	15	051	1898	76A	5D	6A	29	7C
24	60	15	052	1899	76B	5D	6B	29	2C
24	61	15	053	1900	76C	5D	6C	29	25
24	62	15	054	1901	76D	5D	6D	29	5F
24	63	15	055	1902	76E	5D	6E	29	3E
24	64	15	056	1903	76F	5D	6F	29	3F
24	65	15	057	1904	770	5D	F0	29	30
24	66	15	058	1905	771	5D	F1	29	31
24	67	15	059	1906	772	5D	F2	29	32
24	68	15	060	1907	773	5D	F3	29	33
24	69	15	061	1908	774	5D	F4	29	34
24	70	15	062	1909	775	5D	F5	29	35
24	71	15	063	1910	776	5D	F6	29	36
24	72	15	064	1911	777	5D	F7	29	37
24	73	15	065	1912	778	5D	F8	29	38
24	74	15	066	1913	779	5D	F9	29	39
24	75	15	067	1914	77A	5D	7A	29	3A
24	76	15	068	1915	77B	5D	7B	29	23
24	77	15	069	1916	77C	5D	7C	29	40
24	78	15	070	1917	77D	5D	7D	29	27
24	79	15	071	1918	77E	5D	7E	29	3D
24	80	15	072	1919	77F	5D	7F	29	22
25	01	15	073	1920	780	5E	40	3B	20
25	02	15	074	1921	781	5E	C1	3B	41

80 Col		132 Col		Position		Buffer Address (Hex)	
R	C	R	C	Dec	Hex	EBCDIC	ASCII
25	03	15	075	1922	782	5E C2	3B 42
25	04	15	076	1923	783	5E C3	3B 43
25	05	15	077	1924	784	5E C4	3B 44
25	06	15	078	1925	785	5E C5	3B 45
25	07	15	079	1926	786	5E C6	3B 46
25	08	15	080	1927	787	5E C7	3B 47
25	09	15	081	1928	788	5E C8	3B 48
25	10	15	082	1929	789	5E C9	3B 49
25	11	15	083	1930	78A	5E 4A	3B 5B
25	12	15	084	1931	78B	5E 4B	3B 2E
25	13	15	085	1932	78C	5E 4C	3B 3C
25	14	15	086	1933	78D	5E 4D	3B 28
25	15	15	087	1934	78E	5E 4E	3B 2B
25	16	15	088	1935	78F	5E 4F	3B 21
25	17	15	089	1936	790	5E 50	3B 26
25	18	15	090	1937	791	5E D1	3B 4A
25	19	15	091	1938	792	5E D2	3B 4B
25	20	15	092	1939	793	5E D3	3B 4C
25	21	15	093	1940	794	5E D4	3B 4D
25	22	15	094	1941	795	5E D5	3B 4E
25	23	15	095	1942	796	5E D6	3B 4F
25	24	15	096	1943	797	5E D7	3B 50
25	25	15	097	1944	798	5E D8	3B 51
25	26	15	098	1945	799	5E D9	3B 52
25	27	15	099	1946	79A	5E 5A	3B 5D
25	28	15	100	1947	79B	5E 5B	3B 24
25	29	15	101	1948	79C	5E 5C	3B 2A
25	30	15	102	1949	79D	5E 5D	3B 29
25	31	15	103	1950	79E	5E 5E	3B 3B
25	32	15	104	1951	79F	5E 5F	3B 5E
25	33	15	105	1952	7A0	5E 60	3B 2D
25	34	15	106	1953	7A1	5E 61	3B 2F
25	35	15	107	1954	7A2	5E E2	3B 53
25	36	15	108	1955	7A3	5E E3	3B 54
25	37	15	109	1956	7A4	5E E4	3B 55
25	38	15	110	1957	7A5	5E E5	3B 56
25	39	15	111	1958	7A6	5E E6	3B 57
25	40	15	112	1959	7A7	5E E7	3B 58
25	41	15	113	1960	7A8	5E E8	3B 59
25	42	15	114	1961	7A9	5E E9	3B 5A
25	43	15	115	1962	7AA	5E 6A	3B 7C
25	44	15	116	1963	7AB	5E 6B	3B 2C
25	45	15	117	1964	7AC	5E 6C	3B 25
25	46	15	118	1965	7AD	5E 6D	3B 5F
25	47	15	119	1966	7AE	5E 6E	3B 3E
25	48	15	120	1967	7AF	5E 6F	3B 3F
25	49	15	121	1968	7B0	5E F0	3B 30
25	50	15	122	1969	7B1	5E F1	3B 31
25	51	15	123	1970	7B2	5E F2	3B 32
25	52	15	124	1971	7B3	5E F3	3B 33
25	53	15	125	1972	7B4	5E F4	3B 34
25	54	15	126	1973	7B5	5E F5	3B 35
25	55	15	127	1974	7B6	5E F6	3B 36
25	56	15	128	1975	7B7	5E F7	3B 37
25	57	15	129	1976	7B8	5E F8	3B 38
25	58	15	130	1977	7B9	5E F9	3B 39
25	59	15	131	1978	7BA	5E 7A	3B 3A
25	60	15	132	1979	7BB	5E 7B	3B 23
25	61	16	001	1980	7BC	5E 7C	3B 40
25	62	16	002	1981	7BD	5E 7D	3B 27
25	63	16	003	1982	7BE	5E 7E	3B 3D
25	64	16	004	1983	7BF	5E 7F	3B 22

80 Col		132 Col		Position		Buffer Address (Hex)	
R	C	R	C	Dec	Hex	EBCDIC	ASCII
25	65	16	005	1984	7C0	5F 40	5E 20
25	66	16	006	1985	7C1	5F C1	5E 41
25	67	16	007	1986	7C2	5F C2	5E 42
25	68	16	008	1987	7C3	5F C3	5E 43
25	69	16	009	1988	7C4	5F C4	5E 44
25	70	16	010	1989	7C5	5F C5	5E 45
25	71	16	011	1990	7C6	5F C6	5E 46
25	72	16	012	1991	7C7	5F C7	5E 47
25	73	16	013	1992	7C8	5F C8	5E 48
25	74	16	014	1993	7C9	5F C9	5E 49
25	75	16	015	1994	7CA	5F 4A	5E 5B
25	76	16	016	1995	7CB	5F 4B	5E 2E
25	77	16	017	1996	7CC	5F 4C	5E 3C
25	78	16	018	1997	7CD	5F 4D	5E 28
25	79	16	019	1998	7CE	5F 4E	5E 2B
25	80	16	020	1999	7CF	5F 4F	5E 21
26	01	16	021	2000	7D0	5F 50	5E 26
26	02	16	022	2001	7D1	5F D1	5E 4A
26	03	16	023	2002	7D2	5F D2	5E 4B
26	04	16	024	2003	7D3	5F D3	5E 4C
26	05	16	025	2004	7D4	5F D4	5E 4D
26	06	16	026	2005	7D5	5F D5	5E 4E
26	07	16	027	2006	7D6	5F D6	5E 4F
26	08	16	028	2007	7D7	5F D7	5E 50
26	09	16	029	2008	7D8	5F D8	5E 51
26	10	16	030	2009	7D9	5F D9	5E 52
26	11	16	031	2010	7DA	5F 5A	5E 5D
26	12	16	032	2011	7DB	5F 5B	5E 2A
26	13	16	033	2012	7DC	5F 5C	5E 2A
26	14	16	034	2013	7DD	5F 5D	5E 29
26	15	16	035	2014	7DE	5F 5E	5E 3B
26	16	16	036	2015	7DF	5F 5F	5E 5E
26	17	16	037	2016	7E0	5F 60	5E 2D
26	18	16	038	2017	7E1	5F 61	5E 2F
26	19	16	039	2018	7E2	5F E2	5E 53
26	20	16	040	2019	7E3	5F E3	5E 54
26	21	16	041	2020	7E4	5F E4	5E 55
26	22	16	042	2021	7E5	5F E5	5E 56
26	23	16	043	2022	7E6	5F E6	5E 57
26	24	16	044	2023	7E7	5F E7	5E 58
26	25	16	045	2024	7E8	5F E8	5E 59
26	26	16	046	2025	7E9	5F E9	5E 5A
26	27	16	047	2026	7EA	5F 6A	5E 7C
26	28	16	048	2027	7EB	5F 6B	5E 2C
26	29	16	049	2028	7EC	5F 6C	5E 25
26	30	16	050	2029	7ED	5F 6D	5E 5F
26	31	16	051	2030	7EE	5F 6E	5E 3E
26	32	16	052	2031	7EF	5F 6F	5E 3F
26	33	16	053	2032	7F0	5F F0	5E 30
26	34	16	054	2033	7F1	5F F1	5E 31
26	35	16	055	2034	7F2	5F F2	5E 32
26	36	16	056	2035	7F3	5F F3	5E 33
26	37	16	057	2036	7F4	5F F4	5E 34
26	38	16	058	2037	7F5	5F F5	5E 35
26	39	16	059	2038	7F6	5F F6	5E 36
26	40	16	060	2039	7F7	5F F7	5E 37
26	41	16	061	2040	7F8	5F F8	5E 38
26	42	16	062	2041	7F9	5F F9	5E 39
26	43	16	063	2042	7FA	5F 7A	5E 3A
26	44	16	064	2043	7FB	5F 7B	5E 23
26	45	16	065	2044	7FC	5F 7C	5E 40
26	46	16	066	2045	7FD	5F 7D	5E 27

80 Col		132 Col		Position		Buffer Address (Hex)			
R	C	R	C	Dec	Hex	EBCDIC		ASCII	
26	47	16	067	2046	7FE	5F	7E	5E	3D
26	48	16	068	2047	7FF	5F	7F	5E	22
26	49	16	069	2048	800	60	40	2D	20
26	50	16	070	2049	801	60	C1	2D	41
26	51	16	071	2050	802	60	C2	2D	42
26	52	16	072	2051	803	60	C3	2D	43
26	53	16	073	2052	804	60	C4	2D	44
26	54	16	074	2053	805	60	C5	2D	45
26	55	16	075	2054	806	60	C6	2D	46
26	56	16	076	2055	807	60	C7	2D	47
26	57	16	077	2056	808	60	C8	2D	48
26	58	16	078	2057	809	60	C9	2D	49
26	59	16	079	2058	80A	60	4A	2D	5B
26	60	16	080	2059	80B	60	4B	2D	2E
26	61	16	081	2060	80C	60	4C	2D	3C
26	62	16	082	2061	80D	60	4D	2D	28
26	63	16	083	2062	80E	60	4E	2D	2B
26	64	16	084	2063	80F	60	4F	2D	21
26	65	16	085	2064	810	60	50	2D	26
26	66	16	086	2065	811	60	D1	2D	4A
26	67	16	087	2066	812	60	D2	2D	4B
26	68	16	088	2067	813	60	D3	2D	4C
26	69	16	089	2068	814	60	D4	2D	4D
26	70	16	090	2069	815	60	D5	2D	4E
26	71	16	091	2070	816	60	D6	2D	4F
26	72	16	092	2071	817	60	D7	2D	50
26	73	16	093	2072	818	60	D8	2D	51
26	74	16	094	2073	819	60	D9	2D	52
26	75	16	095	2074	81A	60	5A	2D	5D
26	76	16	096	2075	81B	60	5B	2D	24
26	77	16	097	2076	81C	60	5C	2D	2A
26	78	16	098	2077	81D	60	5D	2D	29
26	79	16	099	2078	81E	60	5E	2D	3B
26	80	16	100	2079	81F	60	5F	2D	5E
27	01	16	101	2080	820	60	60	2D	2D
27	02	16	102	2081	821	60	61	2D	2F
27	03	16	103	2082	822	60	E2	2D	53
27	04	16	104	2083	823	60	E3	2D	54
27	05	16	105	2084	824	60	E4	2D	55
27	06	16	106	2085	825	60	E5	2D	56
27	07	16	107	2086	826	60	E6	2D	57
27	08	16	108	2087	827	60	E7	2D	58
27	09	16	109	2088	828	60	E8	2D	59
27	10	16	110	2089	829	60	E9	2D	5A
27	11	16	111	2090	82A	60	6A	2D	7C
27	12	16	112	2091	82B	60	6B	2D	2C
27	13	16	113	2092	82C	60	6C	2D	25
27	14	16	114	2093	82D	60	6D	2D	5F
27	15	16	115	2094	82E	60	6E	2D	3E
27	16	16	116	2095	82F	60	6F	2D	3F
27	17	16	117	2096	830	60	F0	2D	30
27	18	16	118	2097	831	60	F1	2D	31
27	19	16	119	2098	832	60	F2	2D	32
27	20	16	120	2099	833	60	F3	2D	33
27	21	16	121	2100	834	60	F4	2D	34
27	22	16	122	2101	835	60	F5	2D	35
27	23	16	123	2102	836	60	F6	2D	36
27	24	16	124	2103	837	60	F7	2D	37
27	25	16	125	2104	838	60	F8	2D	38
27	26	16	126	2105	839	60	F9	2D	39
27	27	16	127	2106	83A	60	7A	2D	3A
27	28	16	128	2107	83B	60	7B	2D	23

80 Col		132 Col		Position		Buffer Address (Hex)	
<u>R</u>	<u>C</u>	<u>R</u>	<u>C</u>	<u>Dec</u>	<u>Hex</u>	<u>EBCDIC</u>	<u>ASCII</u>
27	29	16	129	2108	83C	60 7C	2D 40
27	30	16	130	2109	83D	60 7D	2D 27
27	31	16	131	2110	83E	60 7E	2D 3D
27	32	16	132	2111	83F	60 7F	2D 22
27	33	17	001	2112	840	61 40	2F 20
27	34	17	002	2113	841	61 C1	2F 41
27	35	17	003	2114	842	61 C2	2F 42
27	36	17	004	2115	843	61 C3	2F 43
27	37	17	005	2116	844	61 C4	2F 44
27	38	17	006	2117	845	61 C5	2F 45
27	39	17	007	2118	846	61 C6	2F 46
27	40	17	008	2119	847	61 C7	2F 47
27	41	17	009	2120	848	61 C8	2F 48
27	42	17	010	2121	849	61 C9	2F 49
27	43	17	011	2122	84A	61 4A	2F 5B
27	44	17	012	2123	84B	61 4B	2F 2E
27	45	17	013	2124	84C	61 4C	2F 3C
27	46	17	014	2125	84D	61 4D	2F 28
27	47	17	015	2126	84E	61 4E	2F 2B
27	48	17	016	2127	84F	61 4F	2F 21
27	49	17	017	2128	850	61 50	2F 26
27	50	17	018	2129	851	61 D1	2F 4A
27	51	17	019	2130	852	61 D2	2F 4B
27	52	17	020	2131	853	61 D3	2F 4C
27	53	17	021	2132	854	61 D4	2F 4D
27	54	17	022	2133	855	61 D5	2F 4E
27	55	17	023	2134	856	61 D6	2F 4F
27	56	17	024	2135	857	61 D7	2F 50
27	57	17	025	2136	858	61 D8	2F 51
27	58	17	026	2137	859	61 D9	2F 52
27	59	17	027	2138	85A	61 5A	2F 5D
27	60	17	028	2139	85B	61 5B	2F 24
27	61	17	029	2140	85C	61 5C	2F 2A
27	62	17	030	2141	85D	61 5D	2F 29
27	63	17	031	2142	85E	61 5E	2F 3B
27	64	17	032	2143	85F	61 5F	2F 5E
27	65	17	033	2144	860	61 60	2F 2D
27	66	17	034	2145	861	61 61	2F 2F
27	67	17	035	2146	862	61 E2	2F 53
27	68	17	036	2147	863	61 E3	2F 54
27	69	17	037	2148	864	61 E4	2F 55
27	70	17	038	2149	865	61 E5	2F 56
27	71	17	039	2150	866	61 E6	2F 57
27	72	17	040	2151	867	61 E7	2F 58
27	73	17	041	2152	868	61 E8	2F 59
27	74	17	042	2153	869	61 E9	2F 5A
27	75	17	043	2154	86A	61 6A	2F 7C
27	76	17	044	2155	86B	61 6B	2F 2C
27	77	17	045	2156	86C	61 6C	2F 25
27	78	17	046	2157	86D	61 6D	2F 5F
27	79	17	047	2158	86E	61 6E	2F 3E
27	80	17	048	2159	86F	61 6F	2F 3F
28	01	17	049	2160	870	61 F0	2F 30
28	02	17	050	2161	871	61 F1	2F 31
28	03	17	051	2162	872	61 F2	2F 32
28	04	17	052	2163	873	61 F3	2F 33
28	05	17	053	2164	874	61 F4	2F 34
28	06	17	054	2165	875	61 F5	2F 35
28	07	17	055	2166	876	61 F6	2F 36
28	08	17	056	2167	877	61 F7	2F 37
28	09	17	057	2168	878	61 F8	2F 38
28	10	17	058	2169	879	61 F9	2F 39

80 Col		132 Col		Position		Buffer Address (Hex)			
R	C	R	C	Dec	Hex	EBCDIC		ASCII	
28	11	17	059	2170	87A	61	7A	2F	3A
28	12	17	060	2171	87B	61	7B	2F	23
28	13	17	061	2172	87C	61	7C	2F	40
28	14	17	062	2173	87D	61	7D	2F	27
28	15	17	063	2174	87E	61	7E	2F	3D
28	16	17	064	2175	87F	61	7F	2F	22
28	17	17	065	2176	880	E2	40	53	20
28	18	17	066	2177	881	E2	C1	53	41
28	19	17	067	2178	882	E2	C2	53	42
28	20	17	068	2179	883	E2	C3	53	43
28	21	17	069	2180	884	E2	C4	53	44
28	22	17	070	2181	885	E2	C5	53	45
28	23	17	071	2182	886	E2	C6	53	46
28	24	17	072	2183	887	E2	C7	53	47
28	25	17	073	2184	888	E2	C8	53	48
28	26	17	074	2185	889	E2	C9	53	49
28	27	17	075	2186	88A	E2	4A	53	5B
28	28	17	076	2187	88B	E2	4B	53	2E
28	29	17	077	2188	88C	E2	4C	53	3C
28	30	17	078	2189	88D	E2	4D	53	28
28	31	17	079	2190	88E	E2	4E	53	2B
28	32	17	080	2191	88F	E2	4F	53	21
28	33	17	081	2192	890	E2	50	53	26
28	34	17	082	2193	891	E2	D1	53	4A
28	35	17	083	2194	892	E2	D2	53	4B
28	36	17	084	2195	893	E2	D3	53	4C
28	37	17	085	2196	894	E2	D4	53	4D
28	38	17	086	2197	895	E2	D5	53	4F
28	39	17	087	2198	896	E2	D6	53	4F
28	40	17	088	2199	897	E2	D7	53	50
28	41	17	089	2200	898	E2	D8	53	51
28	42	17	090	2201	899	E2	D9	53	52
28	43	17	091	2202	89A	E2	5A	53	5D
28	44	17	092	2203	89B	E2	5B	53	24
28	45	17	093	2204	89C	E2	5C	53	2A
28	46	17	094	2205	89D	E2	5D	53	29
28	47	17	095	2206	89E	E2	5E	53	3B
28	48	17	096	2207	89F	E2	5F	53	5E
28	49	17	097	2208	8A0	E2	60	53	2D
28	50	17	098	2209	8A1	E2	61	53	2F
28	51	17	099	2210	8A2	E2	E2	53	53
28	52	17	100	2211	8A3	E2	E3	53	54
28	53	17	101	2212	8A4	E2	E4	53	55
28	54	17	102	2213	8A5	E2	E5	53	56
28	55	17	103	2214	8A6	E2	E6	53	57
28	56	17	104	2215	8A7	E2	E7	53	58
28	57	17	105	2216	8A8	E2	E8	53	59
28	58	17	106	2217	8A9	E2	E9	53	5A
28	59	17	107	2218	8AA	E2	6A	53	7C
28	60	17	108	2219	8AB	E2	6B	53	2C
28	61	17	109	2220	8AC	E2	6C	53	25
28	62	17	110	2221	8AD	E2	6D	53	5F
28	63	17	111	2222	8AE	E2	6E	53	3E
28	64	17	112	2223	8AF	E2	6F	53	3F
28	65	17	113	2224	8B0	E2	F0	53	30
28	66	17	114	2225	8B1	E2	F1	53	31
28	67	17	115	2226	8B2	E2	F2	53	32
28	68	17	116	2227	8B3	E2	F3	53	33
28	69	17	117	2228	8B4	E2	F4	53	34
28	70	17	118	2229	8B5	E2	F5	53	35
28	71	17	119	2230	8B6	E2	F6	53	36
28	72	17	120	2231	8B7	E2	F7	53	37
28	73	17	121	2232	8B8	E2	F8	53	38

80 Col		132 Col		Position		Buffer Address (Hex)	
R	C	R	C	Dec	Hex	EBCDIC	ASCII
28	74	17	122	2233	8B9	E2 F9	53 39
28	75	17	123	2234	8BA	E2 7A	53 23
28	76	17	124	2235	8BB	E2 7B	53 24
28	77	17	125	2236	8BC	E2 7C	53 40
28	78	17	126	2237	8BD	E2 7D	53 27
28	79	17	127	2238	8BE	E2 7E	53 3D
28	80	17	128	2239	8BF	E2 7F	53 22
29	01	17	129	2240	8C0	E3 40	54 20
29	02	17	130	2241	8C1	E3 C1	54 41
29	03	17	131	2242	8C2	E3 C2	54 42
29	04	17	132	2243	8C3	E3 C3	54 43
29	05	18	001	2244	8C4	E3 C4	54 44
29	06	18	002	2245	8C5	E3 C5	54 45
29	07	18	003	2246	8C6	E3 C6	54 46
29	08	18	004	2247	8C7	E3 C7	54 47
29	09	18	005	2248	8C8	E3 C8	54 48
29	10	18	006	2249	8C9	E3 C9	54 49
29	11	18	007	2250	8CA	E3 4A	54 5B
29	12	18	008	2251	8CB	E3 4B	54 2E
29	13	18	009	2252	8CC	E3 4C	54 3C
29	14	18	010	2253	8CD	E3 4D	54 28
29	15	18	011	2254	8CE	E3 4E	54 2B
29	16	18	012	2255	8CF	E3 4F	54 21
29	17	18	013	2256	8D0	E3 50	54 26
29	18	18	014	2257	8D1	E3 D1	54 4A
29	19	18	015	2258	8D2	E3 D2	54 4B
29	20	18	016	2259	8D3	E3 D3	54 4C
29	21	18	017	2260	8D4	E3 D4	54 4D
29	22	18	018	2261	8D5	E3 D5	54 4E
29	23	18	019	2262	8D6	E3 D6	54 4F
29	24	18	020	2263	8D7	E3 D7	54 50
29	25	18	021	2264	8D8	E3 D8	54 51
29	26	18	022	2265	8D9	E3 D9	54 52
29	27	18	023	2266	8DA	E3 5A	54 5D
29	28	18	024	2267	8DB	E3 5B	54 24
29	29	18	025	2268	8DC	E3 5C	54 2A
29	30	18	026	2269	8DD	E3 5D	54 29
29	31	18	027	2270	8DE	E3 5E	54 3B
29	32	18	028	2271	8DF	E3 5F	54 5E
29	33	18	029	2272	8E0	E3 60	54 2D
29	34	18	030	2273	8E1	E3 61	54 2F
29	35	18	031	2274	8E2	E3 E2	54 53
29	36	18	032	2275	8E3	E3 E3	54 54
29	37	18	033	2276	8E4	E3 E4	54 55
29	38	18	034	2277	8E5	E3 E5	54 56
29	39	18	035	2278	8E6	E3 E6	54 57
29	40	18	036	2279	8E7	E3 E7	54 58
29	41	18	037	2280	8E8	E3 E8	54 59
29	42	18	038	2281	8E9	E3 E9	54 5A
29	43	18	039	2282	8EA	E3 6A	54 7C
29	44	18	040	2283	8EB	E3 6B	54 2C
29	45	18	041	2284	8EC	E3 6C	54 25
29	46	18	042	2285	8ED	E3 6D	54 5F
29	47	18	043	2286	8EE	E3 6E	54 3E
29	48	18	044	2287	8EF	E3 6F	54 3F
29	49	18	045	2288	8F0	E3 F0	54 30
29	50	18	046	2289	8F1	E3 F1	54 31
29	51	18	047	2290	8F2	E3 F2	54 32
29	52	18	048	2291	8F3	E3 F3	54 33
29	53	18	049	2292	8F4	E3 F4	54 34
29	54	18	050	2293	8F5	E3 F5	54 35
29	55	18	051	2294	8F6	E3 F6	54 36

80 Col		132 Col		Position		Buffer Address (Hex)	
R	C	R	C	Dec	Hex	EBCDIC	ASCII
29	56	18	052	2295	8F7	E3 F7	54 37
29	57	18	053	2296	8F8	E3 F8	54 38
29	58	18	054	2297	8F9	E3 F9	54 39
29	59	18	055	2298	8FA	E3 7A	54 3A
29	60	18	056	2299	8FB	E3 7B	54 23
29	61	18	057	2300	8FC	E3 7C	54 40
29	62	18	058	2301	8FD	E3 7D	54 27
29	63	18	059	2302	8FE	E3 7E	54 3D
29	64	18	060	2303	8FF	E3 7F	54 22
29	65	18	061	2304	900	E4 40	55 20
29	66	18	062	2305	901	E4 C1	55 41
29	67	18	063	2306	902	E4 C2	55 42
29	68	18	064	2307	903	E4 C3	55 43
29	69	18	065	2308	904	E4 C4	55 44
29	70	18	066	2309	905	E4 C5	55 45
29	71	18	067	2310	906	E4 C6	55 46
29	72	18	068	2311	907	E4 C7	55 47
29	73	18	069	2312	908	E4 C8	55 48
29	74	18	070	2313	909	E4 C9	55 49
29	75	18	071	2314	90A	E4 4A	55 5B
29	76	18	072	2315	90B	E4 4B	55 2E
29	77	18	073	2316	90C	E4 4C	55 3C
29	78	18	074	2317	90D	E4 4D	55 28
29	79	18	075	2318	90E	E4 4E	55 2B
29	80	18	076	2319	90F	E4 4F	55 21
30	01	18	077	2320	910	E4 50	55 26
30	02	18	078	2321	911	E4 D1	55 4A
30	03	18	079	2322	912	E4 D2	55 4B
30	04	18	080	2323	913	E4 D3	55 4C
30	05	18	081	2324	914	E4 D4	55 4D
30	06	18	082	2325	915	E4 D5	55 4E
30	07	18	083	2326	916	E4 D6	55 4F
30	08	18	084	2327	917	E4 D7	55 50
30	09	18	085	2328	918	E4 D8	55 51
30	10	18	086	2329	919	E4 D9	55 52
30	11	18	087	2330	91A	E4 5A	55 5D
30	12	18	088	2331	91B	E4 5B	55 24
30	13	18	089	2332	91C	E4 5C	55 2A
30	14	18	090	2333	91D	E4 5D	55 29
30	15	18	091	2334	91E	E4 5E	55 3B
30	16	18	092	2335	91F	E4 5F	55 5E
30	17	18	093	2336	920	E4 60	55 2D
30	18	18	094	2337	921	E4 61	55 2F
30	19	18	095	2338	922	E4 E2	55 53
30	20	18	096	2339	923	E4 E3	55 54
30	21	18	097	2340	924	E4 E4	55 55
30	22	18	098	2341	925	E4 E5	55 56
30	23	18	099	2342	926	E4 E6	55 57
30	24	18	100	2343	927	E4 E7	55 58
30	25	18	101	2344	928	E4 E8	55 59
30	26	18	102	2345	929	E4 E9	55 5A
30	27	18	103	2346	92A	E4 6A	55 7C
30	28	18	104	2347	92B	E4 6B	55 2C
30	29	18	105	2348	92C	E4 6C	55 25
30	30	18	106	2349	92D	E4 6D	55 5F
30	31	18	107	2350	92E	E4 6E	55 3E
30	32	18	108	2351	92F	E4 6F	55 3F
30	33	18	109	2352	930	E4 F0	55 30
30	34	18	110	2353	931	E4 F1	55 31
30	35	18	111	2354	932	E4 F2	55 32
30	36	18	112	2355	933	E4 F3	55 33
30	37	18	113	2356	934	E4 F4	55 34

80 Col		132 Col		Position		Buffer Address (Hex)	
R	C	R	C	Dec	Hex	EBCDIC	ASCII
30	38	18	114	2357	935	E4 F5	55 35
30	39	18	115	2358	936	E4 F6	55 36
30	40	18	116	2359	937	E4 F7	55 37
30	41	18	117	2360	938	E4 F8	55 38
30	42	18	118	2361	939	E4 F9	55 39
30	43	18	119	2362	93A	E4 7A	55 3A
30	44	18	120	2363	93B	E4 7B	55 23
30	45	18	121	2364	93C	E4 7C	55 40
30	46	18	122	2365	93D	E4 7D	55 27
30	47	18	123	2366	93E	E4 7E	55 3D
30	48	18	124	2367	93F	E4 7F	55 22
30	49	18	125	2368	940	E5 40	56 20
30	50	18	126	2369	941	E5 C1	56 41
30	51	18	127	2370	942	E5 C2	56 42
30	52	18	128	2371	943	E5 C3	56 43
30	53	18	129	2372	944	E5 C4	56 44
30	54	18	130	2373	945	E5 C5	56 45
30	55	18	131	2374	946	E5 C6	56 46
30	56	18	132	2375	947	E5 C7	56 47
30	57	19	001	2376	948	E5 C8	56 48
30	58	19	002	2377	949	E5 C9	56 49
30	59	19	003	2378	94A	E5 4A	56 5B
30	60	19	004	2379	94B	E5 4B	56 2E
30	61	19	005	2380	94C	E5 4C	56 3C
30	62	19	006	2381	94D	E5 4D	56 28
30	63	19	007	2382	94E	E5 4E	56 2B
30	64	19	008	2383	94F	E5 4F	56 21
30	65	19	009	2384	950	E5 50	56 26
30	66	19	010	2385	951	E5 D1	56 4A
30	67	19	011	2386	952	E5 D2	56 4B
30	68	19	012	2387	953	E5 D3	56 4C
30	69	19	013	2388	954	E5 D4	56 4D
30	70	19	014	2389	955	E5 D5	56 4E
30	71	19	015	2390	956	E5 D6	56 4F
30	72	19	016	2391	957	E5 D7	56 50
30	73	19	017	2392	958	E5 D8	56 51
30	74	19	018	2393	959	E5 D9	56 52
30	75	19	019	2394	95A	E5 5A	56 5D
30	76	19	020	2395	95B	E5 5B	56 24
30	77	19	021	2396	95C	E5 5C	56 2A
30	78	19	022	2397	95D	E5 5D	56 29
30	79	19	023	2398	95E	E5 5E	56 3B
30	80	19	024	2399	95F	E5 5F	56 5E
31	01	19	025	2400	960	E5 60	56 2D
31	02	19	026	2401	961	E5 61	56 2F
31	03	19	027	2402	962	E5 E2	56 53
31	04	19	028	2403	963	E5 E3	56 54
31	05	19	029	2404	964	E5 E4	56 55
31	06	19	030	2405	965	E5 E5	56 56
31	07	19	031	2406	966	E5 E6	56 57
31	08	19	032	2407	967	E5 E7	56 58
31	09	19	033	2408	968	E5 E8	56 59
31	10	19	034	2409	969	E5 E9	56 5A
31	11	19	035	2410	96A	E5 6A	56 7C
31	12	19	036	2411	96B	E5 6B	56 2C
31	13	19	037	2412	96C	E5 6C	56 25
31	14	19	038	2413	96D	E5 6D	56 5F
31	15	19	039	2414	96E	E5 6E	56 3E
31	16	19	040	2415	96F	E5 6F	56 3F
31	17	19	041	2416	970	E5 F0	56 30
31	18	19	042	2417	971	E5 F1	56 31
31	19	19	043	2418	972	E5 F2	56 32

80 Col		132 Col		Position		Buffer Address (Hex)			
R	C	R	C	Dec	Hex	EBCDIC		ASCII	
31	20	19	044	2419	973	E5	F3	56	33
31	21	19	045	2420	974	E5	F4	56	34
31	22	19	046	2421	975	E5	F5	56	35
31	23	19	047	2422	976	E5	F6	56	36
31	24	19	048	2423	977	E5	F7	56	37
31	25	19	049	2424	978	E5	F8	56	38
31	26	19	050	2425	979	E5	F9	56	39
31	27	19	051	2426	97A	E5	7A	56	3A
31	28	19	052	2427	97B	E5	7B	56	23
31	29	19	053	2428	97C	E5	7C	56	40
31	30	19	054	2429	97D	E5	7D	56	27
31	31	19	055	2430	97E	E5	7E	56	3D
31	32	19	056	2431	97F	E5	7F	56	22
31	33	19	057	2432	980	E6	40	57	20
31	34	19	058	2433	981	E6	C1	57	41
31	35	19	059	2434	982	E6	C2	57	42
31	36	19	060	2435	983	E6	C3	57	43
31	37	19	061	2436	984	E6	C4	57	44
31	38	19	062	2437	985	E6	C5	57	45
31	39	19	063	2438	986	E6	C6	57	46
31	40	19	064	2439	987	E6	C7	57	47
31	41	19	065	2440	988	E6	C8	57	48
31	42	19	066	2441	989	E6	C9	57	49
31	43	19	067	2442	98A	E6	4A	57	5B
31	44	19	068	2443	98B	E6	4B	57	2E
31	45	19	069	2444	98C	E6	4C	57	3C
31	46	19	070	2445	98D	E6	4D	57	28
31	47	19	071	2446	98E	E6	4E	57	2B
31	48	19	072	2447	98F	E6	4F	57	21
31	49	19	073	2448	990	E6	50	57	26
31	50	19	074	2449	991	E6	D1	57	4A
31	51	19	075	2450	992	E6	D2	57	4B
31	52	19	076	2451	993	E6	D3	57	4C
31	53	19	077	2452	994	E6	D4	57	4D
31	54	19	078	2453	995	E6	D5	57	4E
31	55	19	079	2454	996	E6	D6	57	4F
31	56	19	080	2455	997	E6	D7	57	50
31	57	19	081	2456	998	E6	D8	57	51
31	58	19	082	2457	999	E6	D9	57	52
31	59	19	083	2458	99A	E6	5A	57	5D
31	60	19	084	2459	99B	E6	5B	57	24
31	61	19	085	2460	99C	E6	5C	57	2A
31	62	19	086	2461	99D	E6	5D	57	29
31	63	19	087	2462	99E	E6	5E	57	3B
31	64	19	088	2463	99F	E6	5F	57	5E
31	65	19	089	2464	9A0	E6	60	57	2D
31	66	19	090	2465	9A1	E6	61	57	2F
31	67	19	091	2466	9A2	E6	E2	57	53
31	68	19	092	2467	9A3	E6	E3	57	54
31	69	19	093	2468	9A4	E6	E4	57	55
31	70	19	094	2469	9A5	E6	E5	57	56
31	71	19	095	2470	9A6	E6	E6	57	57
31	72	19	096	2471	9A7	E6	E7	57	58
31	73	19	097	2472	9A8	E6	E8	57	59
31	74	19	098	2473	9A9	E6	E9	57	5A
31	75	19	099	2474	9AA	E6	6A	57	7C
31	76	19	100	2475	9AB	E6	6B	57	2C
31	77	19	101	2476	9AC	E6	6C	57	25
31	78	19	102	2477	9AD	E6	6D	57	5F
31	79	19	103	2478	9AE	E6	6E	57	3E
31	80	19	104	2479	9AF	E6	6F	57	3F

80 Col		132 Col		Position		Buffer Address (Hex)			
R	C	R	C	Dec	Hex	EBCDIC		ASCII	
32	01	19	105	2480	9B0	E6	F0	57	30
32	02	19	106	2481	9B1	E6	F1	57	31
32	03	19	107	2482	9B2	E6	F2	57	32
32	04	19	108	2483	9B3	E6	F3	57	33
32	05	19	109	2484	9B4	E6	F4	57	34
32	06	19	110	2485	9B5	E6	F5	57	35
32	07	19	111	2486	9B6	E6	F6	57	36
32	08	19	112	2487	9B7	E6	F7	57	37
32	09	19	113	2488	9B8	E6	F8	57	38
32	10	19	114	2489	9B9	E6	F9	57	39
32	11	19	115	2490	9BA	E6	7A	57	3A
32	12	19	116	2491	9BB	E6	7B	57	23
32	13	19	117	2492	9BC	E6	7C	57	40
32	14	19	118	2493	9BD	E6	7D	57	27
32	15	19	119	2494	9BE	E6	7E	57	3D
32	16	19	120	2495	9BF	E6	7F	57	22
32	17	19	121	2496	9C0	E7	40	58	20
32	18	19	122	2497	9C1	E7	C1	58	41
32	19	19	123	2498	9C2	E7	C2	58	42
32	20	19	124	2499	9C3	E7	C3	58	43
32	21	19	125	2500	9C4	E7	C4	58	44
32	22	19	126	2501	9C5	E7	C5	58	45
32	23	19	127	2502	9C6	E7	C6	58	46
32	24	19	128	2503	9C7	E7	C7	58	47
32	25	19	129	2504	9C8	E7	C8	58	48
32	26	19	130	2505	9C9	E7	C9	58	49
32	27	19	131	2506	9CA	E7	4A	58	5B
32	28	19	132	2507	9CB	E7	4B	58	2E
32	29	20	001	2508	9CC	E7	4C	58	3C
32	30	20	002	2509	9CD	E7	4D	58	28
32	31	20	003	2510	9CE	E7	4E	58	2B
32	32	20	004	2511	9CF	E7	4F	58	21
32	33	20	005	2512	9D0	E7	50	58	26
32	34	20	006	2513	9D1	E7	D1	58	4A
32	35	20	007	2514	9D2	E7	D2	58	4B
32	36	20	008	2515	9D3	E7	D3	58	4C
32	37	20	009	2516	9D4	E7	D4	58	4D
32	38	20	010	2517	9D5	E7	D5	58	4E
32	39	20	011	2518	9D6	E7	D6	58	4F
32	40	20	012	2519	9D7	E7	D7	58	50
32	41	20	013	2520	9D8	E7	D8	58	51
32	42	20	014	2521	9D9	E7	D9	58	52
32	43	20	015	2522	9DA	E7	5A	58	5D
32	44	20	016	2523	9DB	E7	5B	58	24
32	45	20	017	2524	9DC	E7	5C	58	2A
32	46	20	018	2525	9DD	E7	5D	58	29
32	47	20	019	2526	9DE	E7	5E	58	3B
32	48	20	020	2527	9DF	E7	5F	58	5E
32	49	20	021	2528	9E0	E7	60	58	2D
32	50	20	022	2529	9E1	E7	61	58	2F
32	51	20	023	2530	9E2	E7	E2	58	53
32	52	20	024	2531	9E3	E7	E3	58	54
32	53	20	025	2532	9E4	E7	E4	58	55
32	54	20	026	2533	9E5	E7	E5	58	56
32	55	20	027	2534	9E6	E7	E6	58	57
32	56	20	028	2535	9E7	E7	E7	58	58
32	57	20	029	2536	9E8	E7	E8	58	59
32	58	20	030	2537	9E9	E7	E9	58	5A
32	59	20	031	2538	9EA	E7	6A	58	7C
32	60	20	032	2539	9EB	E7	6B	58	2C
32	61	20	033	2540	9EC	E7	6C	58	25
32	62	20	034	2541	9ED	E7	6D	58	5F

80 Col		132 Col		Position		Buffer Address (Hex)			
R	C	R	C	Dec	Hex	EBCDIC		ASCII	
32	63	20	035	2542	9EE	E7	6E	58	3E
32	64	20	036	2543	9EF	E7	6F	58	3F
32	65	20	037	2544	9F0	E7	F0	58	30
32	66	20	038	2545	9F1	E7	F1	58	31
32	67	20	039	2546	9F2	E7	F2	58	32
32	68	20	040	2547	9F3	E7	F3	58	33
32	69	20	041	2548	9F4	E7	F4	58	34
32	70	20	042	2549	9F5	E7	F5	58	35
32	71	20	043	2550	9F6	E7	F6	58	36
32	72	20	044	2551	9F7	E7	F7	58	37
32	73	20	045	2552	9F8	E7	F8	58	38
32	74	20	046	2553	9F9	E7	F9	58	39
32	75	20	047	2554	9FA	E7	7A	58	3A
32	76	20	048	2555	9FB	E7	7B	58	23
32	77	20	049	2556	9FC	E7	7C	58	40
32	78	20	050	2557	9FD	E7	7D	58	27
32	79	20	051	2558	9FE	E7	7E	58	3D
32	80	20	052	2559	9FF	E7	7F	58	22
33	01	20	053	2560	A00	E8	40	59	20
33	02	20	054	2561	A01	E8	C1	59	41
33	03	20	055	2562	A02	E8	C2	59	42
33	04	20	056	2563	A03	E8	C3	59	43
33	05	20	057	2564	A04	E8	C4	59	44
33	06	20	058	2565	A05	E8	C5	59	45
33	07	20	059	2566	A06	E8	C6	59	46
33	08	20	060	2567	A07	E8	C7	59	47
33	09	20	061	2568	A08	E8	C8	59	48
33	10	20	062	2569	A09	E8	C9	59	49
33	11	20	063	2570	A0A	E8	4A	59	5B
33	12	20	064	2571	A0B	E8	4B	59	2E
33	13	20	065	2572	A0C	E8	4C	59	3C
33	14	20	066	2573	A0D	E8	4D	59	28
33	15	20	067	2574	A0E	E8	4E	59	2B
33	16	20	068	2575	A0F	E8	4F	59	21
33	17	20	069	2576	A10	E8	50	59	26
33	18	20	070	2577	A11	E8	D1	59	4A
33	19	20	071	2578	A12	E8	D2	59	4B
33	20	20	072	2579	A13	E8	D3	59	4C
33	21	20	073	2580	A14	E8	D4	59	4D
33	22	20	074	2581	A15	E8	D5	59	4E
33	23	20	075	2582	A16	E8	D6	59	4F
33	24	20	076	2583	A17	E8	D7	59	50
33	25	20	077	2584	A18	E8	D8	59	51
33	26	20	078	2585	A19	E8	D9	59	52
33	27	20	079	2586	A1A	E8	5A	59	5D
33	28	20	080	2587	A1B	E8	5B	59	24
33	29	20	081	2588	A1C	E8	5C	59	2A
33	30	20	082	2589	A1D	E8	5D	59	29
33	31	20	083	2590	A1E	E8	5E	59	3B
33	32	20	084	2591	A1F	E8	5F	59	5E
33	33	20	085	2592	A20	E8	60	59	2D
33	34	20	086	2593	A21	E8	61	59	2F
33	35	20	087	2594	A22	E8	E2	59	53
33	36	20	088	2595	A23	E8	E3	59	54
33	37	20	089	2596	A24	E8	E4	59	55
33	38	20	090	2597	A25	E8	E5	59	56
33	39	20	091	2598	A26	E8	E6	59	57
33	40	20	092	2599	A27	E8	E7	59	58
33	41	20	093	2600	A28	E8	E8	59	59
33	42	20	094	2601	A29	E8	E9	59	5A
33	43	20	095	2602	A2A	E8	6A	59	7C
33	44	20	096	2603	A2B	E8	6B	59	2C

80 Col		132 Col		Position		Buffer Address (Hex)	
R	C	R	C	Dec	Hex	EBCDIC	ASCII
33	45	20	097	2604	A2C	E8 6C	59 25
33	46	20	098	2605	A2D	E8 6D	59 5F
33	47	20	099	2606	A2E	E8 6E	59 3E
33	48	20	100	2607	A2F	E8 6F	59 3F
33	49	20	101	2608	A30	E8 F0	59 30
33	50	20	102	2609	A31	E8 F1	59 31
33	51	20	103	2610	A32	E8 F2	59 32
33	52	20	104	2611	A33	E8 F3	59 33
33	53	20	105	2612	A34	E8 F4	59 34
33	54	20	106	2613	A35	E8 F5	59 35
33	55	20	107	2614	A36	E8 F6	59 36
33	56	20	108	2615	A37	E8 F7	59 37
33	57	20	109	2616	A38	E8 F8	59 38
33	58	20	110	2617	A39	E8 F9	59 39
33	59	20	111	2618	A3A	E8 7A	59 3A
33	60	20	112	2619	A3B	E8 7B	59 23
33	61	20	113	2620	A3C	E8 7C	59 40
33	62	20	114	2621	A3D	E8 7D	59 27
33	63	20	115	2622	A3E	E8 7E	59 3D
33	64	20	116	2623	A3F	E8 7F	59 22
33	65	20	117	2624	A40	E9 40	5A 20
33	66	20	118	2625	A41	E9 C1	5A 41
33	67	20	119	2626	A42	E9 C2	5A 42
33	68	20	120	2627	A43	E9 C3	5A 43
33	69	20	121	2628	A44	E9 C4	5A 44
33	70	20	122	2629	A45	E9 C5	5A 45
33	71	20	123	2630	A46	E9 C6	5A 46
33	72	20	124	2631	A47	E9 C7	5A 47
33	73	20	125	2632	A48	E9 C8	5A 48
33	74	20	126	2633	A49	E9 C9	5A 49
33	75	20	127	2634	A4A	E9 4A	5A 5B
33	76	20	128	2635	A4B	E9 4B	5A 2E
33	77	20	129	2636	A4C	E9 4C	5A 3C
33	78	20	130	2637	A4D	E9 4D	5A 28
33	79	20	131	2638	A4E	E9 4E	5A 2B
33	80	20	132	2639	A4F	E9 4F	5A 21
34	01	21	001	2640	A50	E9 50	5A 26
34	02	21	002	2641	A51	F9 D1	5A 4A
34	03	21	003	2642	A52	E9 D2	5A 4B
34	04	21	004	2643	A53	E9 D3	5A 4C
34	05	21	005	2644	A54	E9 D4	5A 4D
34	06	21	006	2645	A55	E9 D5	5A 4E
34	07	21	007	2646	A56	E9 D6	5A 4F
34	08	21	008	2647	A57	E9 D7	5A 50
34	09	21	009	2648	A58	E9 D8	5A 51
34	10	21	010	2649	A59	E9 D9	5A 52
34	11	21	011	2650	A5A	E9 5A	5A 5D
34	12	21	012	2651	A5B	E9 5B	5A 24
34	13	21	013	2652	A5C	E9 5C	5A 2A
34	14	21	014	2653	A5D	E9 5D	5A 29
34	15	21	015	2654	A5E	E9 5E	5A 3B
34	16	21	016	2655	A5F	E9 5F	5A 5E
34	17	21	017	2656	A60	E9 60	5A 2D
34	18	21	018	2657	A61	E9 61	5A 2F
34	19	21	019	2658	A62	E9 E2	5A 53
34	20	21	020	2659	A63	E9 E3	5A 54
34	21	21	021	2660	A64	E9 E4	5A 55
34	22	21	022	2661	A65	E9 E5	5A 56
34	23	21	023	2662	A66	E9 E6	5A 57
34	24	21	024	2663	A67	E9 E7	5A 58
34	25	21	025	2664	A68	E9 E8	5A 59
34	26	21	026	2665	A69	E9 E9	5A 5A

80 Col		132 Col		Position		Buffer Address (Hex)			
<u>R</u>	<u>C</u>	<u>R</u>	<u>C</u>	<u>Dec</u>	<u>Hex</u>	<u>EBCDIC</u>		<u>ASCII</u>	
34	27	21	027	2666	A6A	E9	6A	5A	7C
34	28	21	028	2667	A6B	E9	6B	5A	2C
34	29	21	029	2668	A6C	E9	6C	5A	25
34	30	21	030	2669	A6D	E9	6D	5A	5F
34	31	21	031	2670	A6E	E9	6E	5A	3E
34	32	21	032	2671	A6F	E9	6F	5A	3F
34	33	21	033	2672	A70	E9	F0	5A	30
34	34	21	034	2673	A71	E9	F1	5A	31
34	35	21	035	2674	A72	E9	F2	5A	32
34	36	21	036	2675	A73	E9	F3	5A	33
34	37	21	037	2676	A74	E9	F4	5A	34
34	38	21	038	2677	A75	E9	F5	5A	35
34	39	21	039	2678	A76	E9	F6	5A	36
34	40	21	040	2679	A77	E9	F7	5A	37
34	41	21	041	2680	A78	E9	F8	5A	38
34	42	21	042	2681	A79	E9	F9	5A	39
34	43	21	043	2682	A7A	E9	7A	5A	3A
34	44	21	044	2683	A7B	E9	7B	5A	23
34	45	21	045	2684	A7C	E9	7C	5A	40
34	46	21	046	2685	A7D	E9	7D	5A	27
34	47	21	047	2686	A7E	E9	7E	5A	3D
34	48	21	048	2687	A7F	E9	7F	5A	22
34	49	21	049	2688	A80	6A	40	7C	20
34	50	21	050	2689	A81	6A	C1	7C	41
34	51	21	051	2690	A82	6A	C2	7C	42
34	52	21	052	2691	A83	6A	C3	7C	43
34	53	21	053	2692	A84	6A	C4	7C	44
34	54	21	054	2693	A85	6A	C5	7C	45
34	55	21	055	2694	A86	6A	C6	7C	46
34	56	21	056	2695	A87	6A	C7	7C	47
34	57	21	057	2696	A88	6A	C8	7C	48
34	58	21	058	2697	A89	6A	C9	7C	49
34	59	21	059	2698	A8A	6A	4A	7C	5B
34	60	21	060	2699	A8B	6A	4B	7C	2E
34	61	21	061	2700	A8C	6A	4C	7C	3C
34	62	21	062	2701	A8D	6A	4D	7C	28
34	63	21	063	2702	A8E	6A	4E	7C	2B
34	64	21	064	2703	A8F	6A	4F	7C	21
34	65	21	065	2704	A90	6A	50	7C	26
34	66	21	066	2705	A91	6A	D1	7C	4A
34	67	21	067	2706	A92	6A	D2	7C	4B
34	68	21	068	2707	A93	6A	D3	7C	4C
34	69	21	069	2708	A94	6A	D4	7C	4D
34	70	21	070	2709	A95	6A	D5	7C	4E
34	71	21	071	2710	A96	6A	D6	7C	4F
34	72	21	072	2711	A97	6A	D7	7C	50
34	73	21	073	2712	A98	6A	D8	7C	51
34	74	21	074	2713	A99	6A	D9	7C	52
34	75	21	075	2714	A9A	6A	5A	7C	5D
34	76	21	076	2715	A9B	6A	5B	7C	24
34	77	21	077	2716	A9C	6A	5C	7C	2A
34	78	21	078	2717	A9D	6A	5D	7C	29
34	79	21	079	2718	A9E	6A	5E	7C	3B
34	80	21	080	2719	A9F	6A	5F	7C	5E
35	01	21	081	2720	AA0	6A	60	7C	2D
35	02	21	082	2721	AA1	6A	61	7C	2F
35	03	21	083	2722	AA2	6A	E2	7C	53
35	04	21	084	2723	AA3	6A	E3	7C	54
35	05	21	085	2724	AA4	6A	E4	7C	55
35	06	21	086	2725	AA5	6A	E5	7C	56
35	07	21	087	2726	AA6	6A	E6	7C	57
35	08	21	088	2727	AA7	6A	E7	7C	58

80 Col		132 Col		Position		Buffer Address (Hex)			
R	C	R	C	Dec	Hex	EBCDIC		ASCII	
35	09	21	089	2728	AA8	6A	E8	7C	59
35	10	21	090	2729	AA9	6A	E9	7C	5A
35	11	21	091	2730	AAA	6A	6A	7C	7C
35	12	21	092	2731	AAB	6A	6B	7C	2C
35	13	21	093	2732	AAC	6A	6C	7C	25
35	14	21	094	2733	AAD	6A	6D	7C	5F
35	15	21	095	2734	AAE	6A	6E	7C	3E
35	16	21	096	2735	AAF	6A	6F	7C	3F
35	17	21	097	2736	AB0	6A	F0	7C	30
35	18	21	098	2737	AB1	6A	F1	7C	31
35	19	21	099	2738	AB2	6A	F2	7C	32
35	20	21	100	2739	AB3	6A	F3	7C	33
35	21	21	101	2740	AB4	6A	F4	7C	34
35	22	21	102	2741	AB5	6A	F5	7C	35
35	23	21	103	2742	AB6	6A	F6	7C	36
35	24	21	104	2743	AB7	6A	F7	7C	37
35	25	21	105	2744	AB8	6A	F8	7C	38
35	26	21	106	2745	AB9	6A	F9	7C	39
35	27	21	107	2746	ABA	6A	7A	7C	3A
35	28	21	108	2747	ABB	6A	7B	7C	23
35	29	21	109	2748	ABC	6A	7C	7C	40
35	30	21	110	2749	ABD	6A	7D	7C	27
35	31	21	111	2750	ABE	6A	7E	7C	3D
35	32	21	112	2751	ABF	6A	7F	7C	22
35	33	21	113	2752	AC0	6B	40	2C	20
35	34	21	114	2753	AC1	6B	C1	2C	41
35	35	21	115	2754	AC2	6B	C2	2C	42
35	36	21	116	2755	AC3	6B	C3	2C	43
35	37	21	117	2756	AC4	6B	C4	2C	44
35	38	21	118	2757	AC5	6B	C5	2C	45
35	39	21	119	2758	AC6	6B	C6	2C	46
35	40	21	120	2759	AC7	6B	C7	2C	47
35	41	21	121	2760	AC8	6B	C8	2C	48
35	42	21	122	2761	AC9	6B	C9	2C	49
35	43	21	123	2762	ACA	6B	4A	2C	5B
35	44	21	124	2763	ACB	6B	4B	2C	2E
35	45	21	125	2764	ACC	6B	4C	2C	3C
35	46	21	126	2765	ACD	6B	4D	2C	28
35	47	21	127	2766	ACE	6B	4E	2C	2B
35	48	21	128	2767	ACF	6B	4F	2C	21
35	49	21	129	2768	AD0	6B	50	2C	26
35	50	21	130	2769	AD1	6B	D1	2C	4A
35	51	21	131	2770	AD2	6B	D2	2C	4B
35	52	21	132	2771	AD3	6B	D3	2C	4C
35	53	22	001	2772	AD4	6B	D4	2C	4D
35	54	22	002	2773	AD5	6B	D5	2C	4E
35	55	22	003	2774	AD6	6B	D6	2C	4F
35	56	22	004	2775	AD7	6B	D7	2C	50
35	57	22	005	2776	AD8	6B	D8	2C	51
35	58	22	006	2777	AD9	6B	D9	2C	52
35	59	22	007	2778	ADA	6B	5A	2C	5D
35	60	22	008	2779	ADB	6B	5B	2C	24
35	61	22	009	2780	ADC	6B	5C	2C	2A
35	62	22	010	2781	ADD	6B	5D	2C	29
35	63	22	011	2782	ADE	6B	5E	2C	3B
35	64	22	012	2783	ADF	6B	5F	2C	5E
35	65	22	013	2784	AE0	6B	60	2C	2D
35	66	22	014	2785	AE1	6B	61	2C	2F
35	67	22	015	2786	AE2	6B	E2	2C	53
35	68	22	016	2787	AE3	6B	E3	2C	54
35	69	22	017	2788	AE4	6B	E4	2C	55
35	70	22	018	2789	AE5	6B	E5	2C	56

80 Col		132 Col		Position		Buffer Address (Hex)			
R	C	R	C	Dec	Hex	EBCDIC		ASCII	
35	71	22	019	2790	AE6	6B	E6	2C	57
35	72	22	020	2791	AE7	6B	E7	2C	58
35	73	22	021	2792	AE8	6B	E8	2C	59
35	74	22	022	2793	AE9	6B	E9	2C	5A
35	75	22	023	2794	AEA	6B	6A	2C	7C
35	76	22	024	2795	AEB	6B	6B	2C	2C
35	77	22	025	2796	AEC	6B	6C	2C	25
35	78	22	026	2797	AED	6B	6D	2C	5F
35	79	22	027	2798	AEE	6B	6E	2C	3E
35	80	22	028	2799	AEF	6B	6F	2C	3F
36	01	22	029	2800	AF0	6B	F0	2C	30
36	02	22	030	2801	AF1	6B	F1	2C	31
36	03	22	031	2802	AF2	6B	F2	2C	32
36	04	22	032	2803	AF3	6B	F3	2C	33
36	05	22	033	2804	AF4	6B	F4	2C	34
36	06	22	034	2805	AF5	6B	F5	2C	35
36	07	22	035	2806	AF6	6B	F6	2C	36
36	08	22	036	2807	AF7	6B	F7	2C	37
36	09	22	037	2808	AF8	6B	F8	2C	38
36	10	22	038	2809	AF9	6B	F9	2C	39
36	11	22	039	2810	AFA	6B	7A	2C	3A
36	12	22	040	2811	AFB	6B	7B	2C	23
36	13	22	041	2812	AFC	6B	7C	2C	40
36	14	22	042	2813	AFD	6B	7D	2C	27
36	15	22	043	2814	AFE	6B	7E	2C	3D
36	16	22	044	2815	AFF	6B	7F	2C	22
36	17	22	045	2816	B00	6C	40	25	20
36	18	22	046	2817	B01	6C	C1	25	41
36	19	22	047	2818	B02	6C	C2	25	42
36	20	22	048	2819	B03	6C	C3	25	43
36	21	22	049	2820	B04	6C	C4	25	44
36	22	22	050	2821	B05	6C	C5	25	45
36	23	22	051	2822	B06	6C	C6	25	46
36	24	22	052	2823	B07	6C	C7	25	47
36	25	22	053	2824	B08	6C	C8	25	48
36	26	22	054	2825	B09	6C	C9	25	49
36	27	22	055	2826	B0A	6C	4A	25	5B
36	28	22	056	2827	B0B	6C	4B	25	2E
36	29	22	057	2828	B0C	6C	4C	25	3C
36	30	22	058	2829	B0D	6C	4D	25	28
36	31	22	059	2830	B0E	6C	4E	25	2B
36	32	22	060	2831	B0F	6C	4F	25	21
36	33	22	061	2832	B10	6C	50	25	26
36	34	22	062	2833	B11	6C	D1	25	4A
36	35	22	063	2834	B12	6C	D2	25	4B
36	36	22	064	2835	B13	6C	D3	25	4C
36	37	22	065	2836	B14	6C	D4	25	4D
36	38	22	066	2837	B15	6C	D5	25	4E
36	39	22	067	2838	B16	6C	D6	25	4F
36	40	22	068	2839	B17	6C	D7	25	50
36	41	22	069	2840	B18	6C	D8	25	51
36	42	22	070	2841	B19	6C	D9	25	52
36	43	22	071	2842	B1A	6C	5A	25	5D
36	44	22	072	2843	B1B	6C	5B	25	24
36	45	22	073	2844	B1C	6C	5C	25	2A
36	46	22	074	2845	B1D	6C	5D	25	29
36	47	22	075	2846	B1E	6C	5E	25	3B
36	48	22	076	2847	B1F	6C	5F	25	5E
36	49	22	077	2848	B20	6C	60	25	2D
36	50	22	078	2849	B21	6C	61	25	2F
36	51	22	079	2850	B22	6C	E2	25	53

80 Col		132 Col		Position		Buffer Address (Hex)			
R	C	R	C	Dec	Hex	EBCDIC		ASCII	
36	52	22	080	2851	B23	6C	E3	25	54
36	53	22	081	2852	B24	6C	E4	25	55
36	54	22	082	2853	B25	6C	E5	25	56
36	55	22	083	2854	B26	6C	E6	25	57
36	56	22	084	2855	B27	6C	E7	25	58
36	57	22	085	2856	B28	6C	E8	25	59
36	58	22	086	2857	B29	6C	E9	25	5A
36	59	22	087	2858	B2A	6C	6A	25	7C
36	60	22	088	2859	B2B	6C	6B	25	2C
36	61	22	089	2860	B2C	6C	6C	25	25
36	62	22	090	2861	B2D	6C	6D	25	5F
36	63	22	091	2862	B2E	6C	6E	25	3E
36	64	22	092	2863	B2F	6C	6F	25	3F
36	65	22	093	2864	B30	6C	F0	25	30
36	66	22	094	2865	B31	6C	F1	25	31
36	67	22	095	2866	B32	6C	F2	25	32
36	68	22	096	2867	B33	6C	F3	25	33
36	69	22	097	2868	B34	6C	F4	25	34
36	70	22	098	2869	B35	6C	F5	25	35
36	71	22	099	2870	B36	6C	F6	25	36
36	72	22	100	2871	B37	6C	F7	25	37
36	73	22	101	2872	B38	6C	F8	25	38
36	74	22	102	2873	B39	6C	F9	25	39
36	75	22	103	2874	B3A	6C	7A	25	3A
36	76	22	104	2875	B3B	6C	7B	25	23
36	77	22	105	2876	B3C	6C	7C	25	40
36	78	22	106	2877	B3D	6C	7D	25	27
36	79	22	107	2878	B3E	6C	7E	25	3D
36	80	22	108	2879	B3F	6C	7F	25	22
37	01	22	109	2880	B40	6D	40	5F	20
37	02	22	110	2881	B41	6D	C1	5F	41
37	03	22	111	2882	B42	6D	C2	5F	42
37	04	22	112	2883	B43	6D	C3	5F	43
37	05	22	113	2884	B44	6D	C4	5F	44
37	06	22	114	2885	B45	6D	C5	5F	45
37	07	22	115	2886	B46	6D	C6	5F	46
37	08	22	116	2887	B47	6D	C7	5F	47
37	09	22	117	2888	B48	6D	C8	5F	48
37	10	22	118	2889	B49	6D	C9	5F	49
37	11	22	119	2890	B4A	6D	4A	5F	5B
37	12	22	120	2891	B4B	6D	4B	5F	2E
37	13	22	121	2892	B4C	6D	4C	5F	3C
37	14	22	122	2893	B4D	6D	4D	5F	28
37	15	22	123	2894	B4E	6D	4E	5F	2B
37	16	22	124	2895	B4F	6D	4F	5F	21
37	17	22	125	2896	B50	6D	50	5F	26
37	18	22	126	2897	B51	6D	D1	5F	4A
37	19	22	127	2898	B52	6D	D2	5F	4B
37	20	22	128	2899	B53	6D	D3	5F	4C
37	21	22	129	2900	B54	6D	D4	5F	4D
37	22	22	130	2901	B55	6D	D5	5F	4E
37	23	22	131	2902	B56	6D	D6	5F	4F
37	24	22	132	2903	B57	6D	D7	5F	50
37	25	23	001	2904	B58	6D	D8	5F	51
37	26	23	002	2905	B59	6D	D9	5F	52
37	27	23	003	2906	B5A	6D	5A	5F	5D
37	28	23	004	2907	B5B	6D	5B	5F	24
37	29	23	005	2908	B5C	6D	5C	5F	2A
37	30	23	006	2909	B5D	6D	5D	5F	29
37	31	23	007	2910	B5E	6D	5E	5F	3B
37	32	23	008	2911	B5F	6D	5F	5F	5E
37	33	23	009	2912	B60	6D	60	5F	2D

80 Col		132 Col		Position		Buffer Address (Hex)			
R	C	R	C	Dec	Hex	EBCDIC		ASCII	
37	34	23	010	2913	B61	6D	61	5F	2F
37	35	23	011	2914	B62	6D	E2	5F	53
37	36	23	012	2915	B63	6D	E3	5F	54
37	37	23	013	2916	B64	6D	E4	5F	55
37	38	23	014	2917	B65	6D	E5	5F	56
37	39	23	015	2918	B66	6D	E6	5F	57
37	40	23	016	2919	B67	6D	E7	5F	58
37	41	23	017	2920	B68	6D	E8	5F	59
37	42	23	018	2921	B69	6D	E9	5F	5A
37	43	23	019	2922	B6A	6D	6A	5F	7C
37	44	23	020	2923	B6B	6D	6B	5F	2C
37	45	23	021	2924	B6C	6D	6C	5F	25
37	46	23	022	2925	B6D	6D	6D	5F	5F
37	47	23	023	2926	B6E	6D	6E	5F	3E
37	48	23	024	2927	B6F	6D	6F	5F	3F
37	49	23	025	2928	B70	6D	F0	5F	30
37	50	23	026	2929	B71	6D	F1	5F	31
37	51	23	027	2930	B72	6D	F2	5F	32
37	52	23	028	2931	B73	6D	F3	5F	33
37	53	23	029	2932	B74	6D	F4	5F	34
37	54	23	030	2933	B75	6D	F5	5F	35
37	55	23	031	2934	B76	6D	F6	5F	36
37	56	23	032	2935	B77	6D	F7	5F	37
37	57	23	033	2936	B78	6D	F8	5F	38
37	58	23	034	2937	B79	6D	F9	5F	39
37	59	23	035	2938	B7A	6D	7A	5F	3A
37	60	23	036	2939	B7B	6D	7B	5F	23
37	61	23	037	2940	B7C	6D	7C	5F	40
37	62	23	038	2941	B7D	6D	7D	5F	27
37	63	23	039	2942	B7E	6D	7E	5F	3D
37	64	23	040	2943	B7F	6D	7F	5F	22
37	65	23	041	2944	B80	6E	40	3E	20
37	66	23	042	2945	B81	6E	C1	3E	41
37	67	23	043	2946	B82	6E	C2	3E	42
37	68	23	044	2947	B83	6E	C3	3E	43
37	69	23	045	2948	B84	6E	C4	3E	44
37	70	23	046	2949	B85	6E	C5	3E	45
37	71	23	047	2950	B86	6E	C6	3E	46
37	72	23	048	2951	B87	6E	C7	3E	47
37	73	23	049	2952	B88	6E	C8	3E	48
37	74	23	050	2953	B89	6E	C9	3E	49
37	75	23	051	2954	B8A	6E	4A	3E	5B
37	76	23	052	2955	B8B	6E	4B	3E	2E
37	77	23	053	2956	B8C	6E	4C	3E	3C
37	78	23	054	2957	B8D	6E	4D	3E	28
37	79	23	055	2958	B8E	6E	4E	3E	2B
37	80	23	056	2959	B8F	6E	4F	3E	21
38	01	23	057	2960	B90	6E	50	3E	26
38	02	23	058	2961	B91	6E	D1	3E	4A
38	03	23	059	2962	B92	6E	D2	3E	4B
38	04	23	060	2963	B93	6E	D3	3E	4C
38	05	23	061	2964	B94	6E	D4	3E	4D
38	06	23	062	2965	B95	6E	D5	3E	4E
38	07	23	063	2966	B96	6E	D6	3E	4F
38	08	23	064	2967	B97	6E	D7	3E	50
38	09	23	065	2968	B98	6E	D8	3E	51
38	10	23	066	2969	B99	6E	D9	3E	52
38	11	23	067	2970	B9A	6E	5A	3E	5D
38	12	23	068	2971	B9B	6E	5B	3E	24
38	13	23	069	2972	B9C	6E	5C	3E	2A
38	14	23	070	2973	B9D	6E	5D	3E	29
38	15	23	071	2974	B9E	6E	5E	3E	3B

80 Col		132 Col		Position		Buffer Address (Hex)			
R	C	R	C	Dec	Hex	EBCDIC		ASCII	
38	16	23	072	2975	B9F	6E	5F	3E	5E
38	17	23	073	2976	BA0	6E	60	3E	2D
38	18	23	074	2977	BA1	6E	61	3E	2F
38	19	23	075	2978	BA2	6E	E2	3E	53
38	20	23	076	2979	BA3	6E	E3	3E	54
38	21	23	077	2980	BA4	6E	E4	3E	55
38	22	23	078	2981	BA5	6E	E5	3E	56
38	23	23	079	2982	BA6	6E	E6	3E	57
38	24	23	080	2983	BA7	6E	E7	3E	58
38	25	23	081	2984	BA8	6E	E8	3E	59
38	26	23	082	2985	BA9	6E	E9	3E	5A
38	27	23	083	2986	BAA	6E	6A	3E	7C
38	28	23	084	2987	BAB	6E	6B	3E	2C
38	29	23	085	2988	BAC	6E	6C	3E	25
38	30	23	086	2989	BAD	6E	6D	3E	5F
38	31	23	087	2990	BAE	6E	6E	3E	3E
38	32	23	088	2991	BAF	6E	6F	3E	3F
38	33	23	089	2992	BB0	6E	F0	3E	30
38	34	23	090	2993	BB1	6E	F1	3E	31
38	35	23	091	2994	BB2	6E	F2	3E	32
38	36	23	092	2995	BB3	6E	F3	3E	33
38	37	23	093	2996	BB4	6E	F4	3E	34
38	38	23	094	2997	BB5	6E	F5	3E	35
38	39	23	095	2998	BB6	6E	F6	3E	36
38	40	23	096	2999	BB7	6E	F7	3E	37
38	41	23	097	3000	BB8	6E	F8	3E	38
38	42	23	098	3001	BB9	6E	F9	3E	39
38	43	23	099	3002	BBA	6E	7A	3E	3A
38	44	23	100	3003	BBB	6E	7B	3E	23
38	45	23	101	3004	BBC	6E	7C	3E	40
38	46	23	102	3005	BBD	6E	7D	3E	27
38	47	23	103	3006	BBE	6E	7E	3E	3D
38	48	23	104	3007	BBF	6E	7F	3E	22
38	49	23	105	3008	BC0	6F	40	3F	20
38	50	23	106	3009	BC1	6F	C1	3F	41
38	51	23	107	3010	BC2	6F	C2	3F	42
38	52	23	108	3011	BC3	6F	C3	3F	43
38	53	23	109	3012	BC4	6F	C4	3F	44
38	54	23	110	3013	BC5	6F	C5	3F	45
38	55	23	111	3014	BC6	6F	C6	3F	46
38	56	23	112	3015	BC7	6F	C7	3F	47
38	57	23	113	3016	BC8	6F	C8	3F	48
38	58	23	114	3017	BC9	6F	C9	3F	49
38	59	23	115	3018	BCA	6F	4A	3F	5B
38	60	23	116	3019	BCB	6F	4B	3F	2E
38	61	23	117	3020	BCC	6F	4C	3F	3C
38	62	23	118	3021	BCD	6F	4D	3F	28
38	63	23	119	3022	BCE	6F	4E	3F	2B
38	64	23	120	3023	BCF	6F	4F	3F	21
38	65	23	121	3024	BD0	6F	50	3F	26
38	66	23	122	3025	BD1	6F	D1	3F	4A
38	67	23	123	3026	BD2	6F	D2	3F	4B
38	68	23	124	3027	BD3	6F	D3	3F	4C
38	69	23	125	3028	BD4	6F	D4	3F	4D
38	70	23	126	3029	BD5	6F	D5	3F	4E
38	71	23	127	3030	BD6	6F	D6	3F	4F
38	72	23	128	3031	BD7	6F	D7	3F	50
38	73	23	129	3032	BD8	6F	D8	3F	51
38	74	23	130	3033	BD9	6F	D9	3F	52
38	75	23	131	3034	BDA	6F	5A	3F	5D
38	76	23	132	3035	BDB	6F	5B	3F	24
38	77	24	001	3036	BDC	6F	5C	3F	2A

80 Col		132 Col		Position		Buffer Address (Hex)			
R	C	R	C	Dec	Hex	EBCDIC		ASCII	
38	78	24	002	3037	BDD	6F	5D	3F	29
38	79	24	003	3038	BDE	6F	5E	3F	3B
38	80	24	004	3039	BDF	6F	5F	3F	5E
39	01	24	005	3040	BE0	6F	60	3F	2D
39	02	24	006	3041	BE1	6F	61	3F	2F
39	03	24	007	3042	BE2	6F	E2	3F	53
39	04	24	008	3043	BE3	6F	E3	3F	54
39	05	24	009	3044	BE4	6F	E4	3F	55
39	06	24	010	3045	BE5	6F	E5	3F	56
39	07	24	011	3046	BE6	6F	E6	3F	57
39	08	24	012	3047	BE7	6F	E7	3F	58
39	09	24	013	3048	BE8	6F	E8	3F	59
39	10	24	014	3049	BE9	6F	E9	3F	5A
39	11	24	015	3050	BEA	6F	6A	3F	7C
39	12	24	016	3051	BEB	6F	6B	3F	2C
39	13	24	017	3052	BEC	6F	6C	3F	25
39	14	24	018	3053	BED	6F	6D	3F	5F
39	15	24	019	3054	BEE	6F	6E	3F	3E
39	16	24	020	3055	BEF	6F	6F	3F	3F
39	17	24	021	3056	BF0	6F	F0	3F	30
39	18	24	022	3057	BF1	6F	F1	3F	31
39	19	24	023	3058	BF2	6F	F2	3F	32
39	20	24	024	3059	BF3	6F	F3	3F	33
39	21	24	025	3060	BF4	6F	F4	3F	34
39	22	24	026	3061	BF5	6F	F5	3F	35
39	23	24	027	3062	BF6	6F	F6	3F	36
39	24	24	028	3063	BF7	6F	F7	3F	37
39	25	24	029	3064	BF8	6F	F8	3F	38
39	26	24	030	3065	BF9	6F	F9	3F	39
39	27	24	031	3066	BFA	6F	7A	3F	3A
39	28	24	032	3067	BFB	6F	7B	3F	23
39	29	24	033	3068	BFC	6F	7C	3F	40
39	30	24	034	3069	BFD	6F	7D	3F	27
39	31	24	035	3070	BFE	6F	7E	3F	3D
39	32	24	036	3071	BFF	6F	7F	3F	22
39	33	24	037	3072	C00	F0	40	30	20
39	34	24	038	3073	C01	F0	C1	30	41
39	35	24	039	3074	C02	F0	C2	30	42
39	36	24	040	3075	C03	F0	C3	30	43
39	37	24	041	3076	C04	F0	C4	30	44
39	38	24	042	3077	C05	F0	C5	30	45
39	39	24	043	3078	C06	F0	C6	30	46
39	40	24	044	3079	C07	F0	C7	30	47
39	41	24	045	3080	C08	F0	C8	30	48
39	42	24	046	3081	C09	F0	C9	30	49
39	43	24	047	3082	C0A	F0	4A	30	5B
39	44	24	048	3083	C0B	F0	4B	30	2E
39	45	24	049	3084	C0C	F0	4C	30	3C
39	46	24	050	3085	C0D	F0	4D	30	28
39	47	24	051	3086	C0E	F0	4E	30	2B
39	48	24	052	3087	C0F	F0	4F	30	21
39	49	24	053	3088	C10	F0	50	30	26
39	50	24	054	3089	C11	F0	D1	30	4A
39	51	24	055	3090	C12	F0	D2	30	4B
39	52	24	056	3091	C13	F0	D3	30	4C
39	53	24	057	3092	C14	F0	D4	30	4D
39	54	24	058	3093	C15	F0	D5	30	4E
39	55	24	059	3094	C16	F0	D6	30	4F
39	56	24	060	3095	C17	F0	D7	30	50
39	57	24	061	3096	C18	F0	D8	30	51
39	58	24	062	3097	C19	F0	D9	30	52
39	59	24	063	3098	C1A	F0	5A	30	5D

80 Col		132 Col		Position		Buffer Address (Hex)			
R	C	R	C	Dec	Hex	EBCDIC		ASCII	
39	60	24	064	3099	C1B	F0	5B	30	24
39	61	24	065	3100	C1C	F0	5C	30	2A
39	62	24	066	3101	C1D	F0	5D	30	29
39	63	24	067	3102	C1E	F0	5E	30	3B
39	64	24	068	3103	C1F	F0	5F	30	5E
39	65	24	069	3104	C20	F0	60	30	2D
39	66	24	070	3105	C21	F0	61	30	2F
39	67	24	071	3106	C22	F0	E2	30	53
39	68	24	072	3107	C23	F0	E3	30	54
39	69	24	073	3108	C24	F0	E4	30	55
39	70	24	074	3109	C25	F0	E5	30	56
39	71	24	075	3110	C26	F0	E6	30	57
39	72	24	076	3111	C27	F0	E7	30	58
39	73	24	077	3112	C28	F0	E8	30	59
39	74	24	078	3113	C29	F0	E9	30	5A
39	75	24	079	3114	C2A	F0	6A	30	7C
39	76	24	080	3115	C2B	F0	6B	30	2C
39	77	24	081	3116	C2C	F0	6C	30	25
39	78	24	082	3117	C2D	F0	6D	30	5F
39	79	24	083	3118	C2E	F0	6E	30	3E
39	80	24	084	3119	C2F	F0	6F	30	3F
40	01	24	085	3120	C30	F0	F0	30	30
40	02	24	086	3121	C31	F0	F1	30	31
40	03	24	087	3122	C32	F0	F2	30	32
40	04	24	088	3123	C33	F0	F3	30	33
40	05	24	089	3124	C34	F0	F4	30	34
40	06	24	090	3125	C35	F0	F5	30	35
40	07	24	091	3126	C36	F0	F6	30	36
40	08	24	092	3127	C37	F0	F7	30	37
40	09	24	093	3128	C38	F0	F8	30	38
40	10	24	094	3129	C39	F0	F9	30	39
40	11	24	095	3130	C3A	F0	7A	30	3A
40	12	24	096	3131	C3B	F0	7B	30	23
40	13	24	097	3132	C3C	F0	7C	30	40
40	14	24	098	3133	C3D	F0	7D	30	27
40	15	24	099	3134	C3E	F0	7E	30	3D
40	16	24	100	3135	C3F	F0	7F	30	22
40	17	24	101	3136	C40	F1	40	31	20
40	18	24	102	3137	C41	F1	C1	31	41
40	19	24	103	3138	C42	F1	C2	31	42
40	20	24	104	3139	C43	F1	C3	31	43
40	21	24	105	3140	C44	F1	C4	31	44
40	22	24	106	3141	C45	F1	C5	31	45
40	23	24	107	3142	C46	F1	C6	31	46
40	24	24	108	3143	C47	F1	C7	31	47
40	25	24	109	3144	C48	F1	C8	31	48
40	26	24	110	3145	C49	F1	C9	31	49
40	27	24	111	3146	C4A	F1	4A	31	5B
40	28	24	112	3147	C4B	F1	4B	31	2E
40	29	24	113	3148	C4C	F1	4C	31	3C
40	30	24	114	3149	C4D	F1	4D	31	28
40	31	24	115	3150	C4E	F1	4E	31	2B
40	32	24	116	3151	C4F	F1	4F	31	21
40	33	24	117	3152	C50	F1	50	31	26
40	34	24	118	3153	C51	F1	D1	31	4A
40	35	24	119	3154	C52	F1	D2	31	4B
40	36	24	120	3155	C53	F1	D3	31	4C
40	37	24	121	3156	C54	F1	D4	31	4D
40	38	24	122	3157	C55	F1	D5	31	4E
40	39	24	123	3158	C56	F1	D6	31	4F
40	40	24	124	3159	C57	F1	D7	31	50
40	41	24	125	3160	C58	F1	D8	31	51

80 Col		132 Col		Position		Buffer Address (Hex)			
<u>R</u>	<u>C</u>	<u>R</u>	<u>C</u>	<u>Dec</u>	<u>Hex</u>	<u>EBCDIC</u>		<u>ASCII</u>	
40	42	24	126	3161	C59	F1	D9	31	52
40	43	24	127	3162	C5A	F1	5A	31	5D
40	44	24	128	3163	C5B	F1	5B	31	24
40	45	24	129	3164	C5C	F1	5C	31	2A
40	46	24	130	3165	C5D	F1	5D	31	29
40	47	24	131	3166	C5E	F1	5E	31	3B
40	48	24	132	3167	C5F	F1	5F	31	5E
40	49	25	001	3168	C60	F1	60	31	2D
40	50	25	002	3169	C61	F1	61	31	2F
40	51	25	003	3170	C62	F1	E2	31	53
40	52	25	004	3171	C63	F1	E3	31	54
40	53	25	005	3172	C64	F1	E4	31	55
40	54	25	006	3173	C65	F1	E5	31	56
40	55	25	007	3174	C66	F1	E6	31	57
40	56	25	008	3175	C67	F1	E7	31	58
40	57	25	009	3176	C68	F1	E8	31	59
40	58	25	010	3177	C69	F1	E9	31	5A
40	59	25	011	3178	C6A	F1	6A	31	7C
40	60	25	012	3179	C6B	F1	6B	31	2C
40	61	25	013	3180	C6C	F1	6C	31	25
40	62	25	014	3181	C6D	F1	6D	31	5F
40	63	25	015	3182	C6E	F1	6E	31	3E
40	64	25	016	3183	C6F	F1	6F	31	3F
40	65	25	017	3184	C70	F1	F0	31	30
40	66	25	018	3185	C71	F1	F1	31	31
40	67	25	019	3186	C72	F1	F2	31	32
40	68	25	020	3187	C73	F1	F3	31	33
40	69	25	021	3188	C74	F1	F4	31	34
40	70	25	022	3189	C75	F1	F5	31	35
40	71	25	023	3190	C76	F1	F6	31	36
40	72	25	024	3191	C77	F1	F7	31	37
40	73	25	025	3192	C78	F1	F8	31	38
40	74	25	026	3193	C79	F1	F9	31	39
40	75	25	027	3194	C7A	F1	7A	31	3A
40	76	25	028	3195	C7B	F1	7B	31	23
40	77	25	029	3196	C7C	F1	7C	31	40
40	78	25	030	3197	C7D	F1	7D	31	27
40	79	25	031	3198	C7E	F1	7E	31	3D
40	80	25	032	3199	C7F	F1	7F	31	22
41	01	25	033	3200	C80	F2	40	32	20
41	02	25	034	3201	C81	F2	C1	32	41
41	03	25	035	3202	C82	F2	C2	32	42
41	04	25	036	3203	C83	F2	C3	32	43
41	05	25	037	3204	C84	F2	C4	32	44
41	06	25	038	3205	C85	F2	C5	32	45
41	07	25	039	3206	C86	F2	C6	32	46
41	08	25	040	3207	C87	F2	C7	32	47
41	09	25	041	3208	C88	F2	C8	32	48
41	10	25	042	3209	C89	F2	C9	32	49
41	11	25	043	3210	C8A	F2	4A	32	5B
41	12	25	044	3211	C8B	F2	4B	32	2E
41	13	25	045	3212	C8C	F2	4C	32	3C
41	14	25	046	3213	C8D	F2	4D	32	28
41	15	25	047	3214	C8E	F2	4E	32	2B
41	16	25	048	3215	C8F	F2	4F	32	21
41	17	25	049	3216	C90	F2	50	32	26
41	18	25	050	3217	C91	F2	D1	32	4A
41	19	25	051	3218	C92	F2	D2	32	4B
41	20	25	052	3219	C93	F2	D3	32	4C
41	21	25	053	3220	C94	F2	D4	32	4D
41	22	25	054	3221	C95	F2	D5	32	4E

80 Col		132 Col		Position		Buffer Address (Hex)			
R	C	R	C	Dec	Hex	EBCDIC		ASCII	
41	23	25	055	3222	C96	F2	D6	32	4F
41	24	25	056	3223	C97	F2	D7	32	50
41	25	25	057	3224	C98	F2	D8	32	51
41	26	25	058	3225	C99	F2	D9	32	52
41	27	25	059	3226	C9A	F2	5A	32	5D
41	28	25	060	3227	C9B	F2	5B	32	24
41	29	25	061	3228	C9C	F2	5C	32	2A
41	30	25	062	3229	C9D	F2	5D	32	29
41	31	25	063	3230	C9E	F2	5E	32	3B
41	32	25	064	3231	C9F	F2	5F	32	5E
41	33	25	065	3232	CA0	F2	60	32	2D
41	34	25	066	3233	CA1	F2	61	32	2F
41	35	25	067	3234	CA2	F2	E2	32	53
41	36	25	068	3235	CA3	F2	E3	32	54
41	37	25	069	3236	CA4	F2	E4	32	55
41	38	25	070	3237	CA5	F2	E5	32	56
41	39	25	071	3238	CA6	F2	E6	32	57
41	40	25	072	3239	CA7	F2	E7	32	58
41	41	25	073	3240	CA8	F2	E8	32	59
41	42	25	074	3241	CA9	F2	E9	32	5A
41	43	25	075	3242	CAA	F2	6A	32	7C
41	44	25	076	3243	CAB	F2	6B	32	2C
41	45	25	077	3244	CAC	F2	6C	32	25
41	46	25	078	3245	CAD	F2	6D	32	5F
41	47	25	079	3246	CAE	F2	6E	32	3E
41	48	25	080	3247	CAF	F2	6F	32	3F
41	49	25	081	3248	CB0	F2	F0	32	30
41	50	25	082	3249	CB1	F2	F1	32	31
41	51	25	083	3250	CB2	F2	F2	32	32
41	52	25	084	3251	CB3	F2	F3	32	33
41	53	25	085	3252	CB4	F2	F4	32	34
41	54	25	086	3253	CB5	F2	F5	32	35
41	55	25	087	3254	CB6	F2	F6	32	36
41	56	25	088	3255	CB7	F2	F7	32	37
41	57	25	089	3256	CB8	F2	F8	32	38
41	58	25	090	3257	CB9	F2	F9	32	39
41	59	25	091	3258	CBA	F2	7A	32	3A
41	60	25	092	3259	CBB	F2	7B	32	23
41	61	25	093	3260	CBC	F2	7C	32	40
41	62	25	094	3261	CBD	F2	7D	32	27
41	63	25	095	3262	CBE	F2	7E	32	3D
41	64	25	096	3263	CBF	F2	7F	32	22
41	65	25	097	3264	CC0	F3	40	33	20
41	66	25	098	3265	CC1	F3	C1	33	41
41	67	25	099	3266	CC2	F3	C2	33	42
41	68	25	100	3267	CC3	F3	C3	33	43
41	69	25	101	3268	CC4	F3	C4	33	44
41	70	25	102	3269	CC5	F3	C5	33	45
41	71	25	103	3270	CC6	F3	C6	33	46
41	72	25	104	3271	CC7	F3	C7	33	47
41	73	25	105	3272	CC8	F3	C8	33	48
41	74	25	106	3273	CC9	F3	C9	33	49
41	75	25	107	3274	CCA	F3	4A	33	5B
41	76	25	108	3275	CCB	F3	4B	33	2E
41	77	25	109	3276	CCC	F3	4C	33	3C
41	78	25	110	3277	CCD	F3	4D	33	28
41	79	25	111	3278	CCE	F3	4E	33	2B
41	80	25	112	3279	CCF	F3	4F	33	21
42	01	25	113	3280	CD0	F3	50	33	26
42	02	25	114	3281	CD1	F3	D1	33	4A
42	03	25	115	3282	CD2	F3	D2	33	4B
42	04	25	116	3283	CD3	F3	D3	33	4C

80 Col		132 Col		Position		Buffer Address (Hex)			
<u>R</u>	<u>C</u>	<u>R</u>	<u>C</u>	<u>Dec</u>	<u>Hex</u>	<u>EBCDIC</u>		<u>ASCII</u>	
42	05	25	117	3284	CD4	F3	D4	33	4D
42	06	25	118	3285	CD5	F3	D5	33	4E
42	07	25	119	3286	CD6	F3	D6	33	4F
42	08	25	120	3287	CD7	F3	D7	33	50
42	09	25	121	3288	CD8	F3	D8	33	51
42	10	25	122	3289	CD9	F3	D9	33	52
42	11	25	123	3290	CDA	F3	5A	33	5D
42	12	25	124	3291	CDB	F3	5B	33	24
42	13	25	125	3292	CDC	F3	5C	33	2A
42	14	25	126	3293	CDD	F3	5D	33	29
42	15	25	127	3294	CDE	F3	5E	33	3B
42	16	25	128	3295	CDF	F3	5F	33	5E
42	17	25	129	3296	CE0	F3	60	33	2D
42	18	25	130	3297	CE1	F3	61	33	2F
42	19	25	131	3298	CE2	F3	E2	33	53
42	20	25	132	3299	CE3	F3	E3	33	54
42	21	26	001	3300	CE4	F3	E4	33	55
42	22	26	002	3301	CE5	F3	E5	33	56
42	23	26	003	3302	CE6	F3	E6	33	57
42	24	26	004	3303	CE7	F3	E7	33	58
42	25	26	005	3304	CE8	F3	E8	33	59
42	26	26	006	3305	CE9	F3	E9	33	5A
42	27	26	007	3306	CEA	F3	6A	33	7C
42	28	26	008	3307	CEB	F3	6B	33	2C
42	29	26	009	3308	CEC	F3	6C	33	25
42	30	26	010	3309	CED	F3	6D	33	5F
42	31	26	011	3310	CEE	F3	6E	33	3E
42	32	26	012	3311	CEF	F3	6F	33	3F
42	33	26	013	3312	CF0	F3	F0	33	30
42	34	26	014	3313	CF1	F3	F1	33	31
42	35	26	015	3314	CF2	F3	F2	33	32
42	36	26	016	3315	CF3	F3	F3	33	33
42	37	26	017	3316	CF4	F3	F4	33	34
42	38	26	018	3317	CF5	F3	F5	33	35
42	39	26	019	3318	CF6	F3	F6	33	36
42	40	26	020	3319	CF7	F3	F7	33	37
42	41	26	021	3320	CF8	F3	F8	33	38
42	42	26	022	3321	CF9	F3	F9	33	39
42	43	26	023	3322	CFA	F3	7A	33	3A
42	44	26	024	3323	CFB	F3	7B	33	23
42	45	26	025	3324	CFC	F3	7C	33	40
42	46	26	026	3325	CFD	F3	7D	33	27
42	47	26	027	3326	CFE	F3	7E	33	3D
42	48	26	028	3327	CFF	F3	7F	33	22
42	49	26	029	3328	D00	F4	40	34	20
42	50	26	030	3329	D01	F4	C1	34	41
42	51	26	031	3330	D02	F4	C2	34	42
42	52	26	032	3331	D03	F4	C3	34	43
42	53	26	033	3332	D04	F4	C4	34	44
42	54	26	034	3333	D05	F4	C5	34	45
42	55	26	035	3334	D06	F4	C6	34	46
42	56	26	036	3335	D07	F4	C7	34	47
42	57	26	037	3336	D08	F4	C8	34	48
42	58	26	038	3337	D09	F4	C9	34	49
42	59	26	039	3338	D0A	F4	4A	34	5B
42	60	26	040	3339	D0B	F4	4B	34	2E
42	61	26	041	3340	D0C	F4	4C	34	3C
42	62	26	042	3341	D0D	F4	4D	34	28
42	63	26	043	3342	D0E	F4	4E	34	2B
42	64	26	044	3343	D0F	F4	4F	34	21
42	65	26	045	3344	D10	F4	50	34	26

80 Col		132 Col		Position		Buffer Address (Hex)			
R	C	R	C	Dec	Hex	EBCDIC		ASCII	
42	66	26	046	3345	D11	F4	C1	34	4A
42	67	26	047	3346	D12	F4	D2	34	4B
42	68	26	048	3347	D13	F4	D3	34	4C
42	69	26	049	3348	D14	F4	D4	34	4D
42	70	26	050	3349	D15	F4	D5	34	4E
42	71	26	051	3350	D16	F4	D6	34	4F
42	72	26	052	3351	D17	F4	D7	34	50
42	73	26	053	3352	D18	F4	D8	34	51
42	74	26	054	3353	D19	F4	D9	34	52
42	75	26	055	3354	D1A	F4	5A	34	5D
42	76	26	056	3355	D1B	F4	5B	34	24
42	77	26	057	3356	D1C	F4	5C	34	2A
42	78	26	058	3357	D1D	F4	5D	34	29
42	79	26	059	3358	D1E	F4	5E	34	3B
42	80	26	060	3359	D1F	F4	5F	34	5E
43	01	26	061	3360	D20	F4	60	34	2D
43	02	26	062	3361	D21	F4	61	34	2F
43	03	26	063	3362	D22	F4	E2	34	53
43	04	26	064	3363	D23	F4	E3	34	54
43	05	26	065	3364	D24	F4	E4	34	55
43	06	26	066	3365	D25	F4	E5	34	56
43	07	26	067	3366	D26	F4	E6	34	57
43	08	26	068	3367	D27	F4	E7	34	58
43	09	26	069	3368	D28	F4	E8	34	59
43	10	26	070	3369	D29	F4	E9	34	5A
43	11	26	071	3370	D2A	F4	6A	34	7C
43	12	26	072	3371	D2B	F4	6B	34	2C
43	13	26	073	3372	D2C	F4	6C	34	25
43	14	26	074	3373	D2D	F4	6D	34	5F
43	15	26	075	3374	D2E	F4	6E	34	3E
43	16	26	076	3375	D2F	F4	6F	34	3F
43	17	26	077	3376	D30	F4	F0	34	30
43	18	26	078	3377	D31	F4	F1	34	31
43	19	26	079	3378	D32	F4	F2	34	32
43	20	26	080	3379	D33	F4	F3	34	33
43	21	26	081	3380	D34	F4	F4	34	34
43	22	26	082	3381	D35	F4	F5	34	35
43	23	26	083	3382	D36	F4	F6	34	36
43	24	26	084	3383	D37	F4	F7	34	37
43	25	26	085	3384	D38	F4	F8	34	38
43	26	26	086	3385	D39	F4	F9	34	39
43	27	26	087	3386	D3A	F4	7A	34	3A
43	28	26	088	3387	D3B	F4	7B	34	23
43	29	26	089	3388	D3C	F4	7C	34	40
43	30	26	090	3389	D3D	F4	7D	34	27
43	31	26	091	3390	D3E	F4	7E	34	3D
43	32	26	092	3391	D3F	F4	7F	34	22
43	33	26	093	3392	D40	F5	40	35	20
43	34	26	094	3393	D41	F5	C1	35	41
43	35	26	095	3394	D42	F5	C2	35	42
43	36	26	096	3395	D43	F5	C3	35	43
43	37	26	097	3396	D44	F5	C4	35	44
43	38	26	098	3397	D45	F5	C5	35	45
43	39	26	099	3398	D46	F5	C6	35	46
43	40	26	100	3399	D47	F5	C7	35	47
43	41	26	101	3400	D48	F5	C8	35	48
43	42	26	102	3401	D49	F5	C9	35	49
43	43	26	103	3402	D4A	F5	4A	35	5B
43	44	26	104	3403	D4B	F5	4B	35	2E
43	45	26	105	3404	D4C	F5	4C	35	3C
43	46	26	106	3405	D4D	F5	4D	35	28
43	47	26	107	3406	D4E	F5	4E	35	2B

80 Col		132 Col		Position		Buffer Address (Hex)			
R	C	R	C	Dec	Hex	EBCDIC		ASCII	
43	48	26	108	3407	D4F	F5	4F	35	21
43	49	26	109	3408	D50	F5	50	35	26
43	50	26	110	3409	D51	F5	D1	35	4A
43	51	26	111	3410	D52	F5	D2	35	4B
43	52	26	112	3411	D53	F5	D3	35	4C
43	53	26	113	3412	D54	F5	D4	35	4D
43	54	26	114	3413	D55	F5	D5	35	4E
43	55	26	115	3414	D56	F5	D6	35	4F
43	56	26	116	3415	D57	F5	D7	35	50
43	57	26	117	3416	D58	F5	D8	35	51
43	58	26	118	3417	D59	F5	D9	35	52
43	59	26	119	3418	D5A	F5	5A	35	5D
43	60	26	120	3419	D5B	F5	5B	35	24
43	61	26	121	3420	D5C	F5	5C	35	2A
43	62	26	122	3421	D5D	F5	5D	35	29
43	63	26	123	3422	D5E	F5	5E	35	3B
43	64	26	124	3423	D5F	F5	5F	35	5E
43	65	26	125	3424	D60	F5	60	35	2D
43	66	26	126	3425	D61	F5	61	35	2F
43	67	26	127	3426	D62	F5	E2	35	53
43	68	26	128	3427	D63	F5	E3	35	54
43	69	26	129	3428	D64	F5	E4	35	55
43	70	26	130	3429	D65	F5	E5	35	56
43	71	26	131	3430	D66	F5	E6	35	57
43	72	26	132	3431	D67	F5	E7	35	58
43	73	27	001	3432	D68	F5	E8	35	59
43	74	27	002	3433	D69	F5	E9	35	5A
43	75	27	003	3434	D6A	F5	6A	35	7C
43	76	27	004	3435	D6B	F5	6B	35	2C
43	77	27	005	3436	D6C	F5	6C	35	25
43	78	27	006	3437	D6D	F5	6D	35	5F
43	79	27	007	3438	D6E	F5	6E	35	3E
43	80	27	008	3439	D6F	F5	6F	35	3F
		27	009	3440	D70	F5	F0	35	30
		27	010	3441	D71	F5	F1	35	31
		27	011	3442	D72	F5	F2	35	32
		27	012	3443	D73	F5	F3	35	33
		27	013	3444	D74	F5	F4	35	34
		27	014	3445	D75	F5	F5	35	35
		27	015	3446	D76	F5	F6	35	36
		27	016	3447	D77	F5	F7	35	37
		27	017	3448	D78	F5	F8	35	38
		27	018	3449	D79	F5	F9	35	39
		27	019	3450	D7A	F5	7A	35	3A
		27	020	3451	D7B	F5	7B	35	23
		27	021	3452	D7C	F5	7C	35	40
		27	022	3453	D7D	F5	7D	35	27
		27	023	3454	D7E	F5	7E	35	3D
		27	024	3455	D7F	F5	7F	35	22
		27	025	3456	D80	F6	40	36	20
		27	026	3457	D81	F6	C1	36	41
		27	027	3458	D82	F6	C2	36	42
		27	028	3459	D83	F6	C3	36	43
		27	029	3460	D84	F6	C4	36	44
		27	030	3461	D85	F6	C5	36	45
		27	031	3462	D86	F6	C6	36	46
		27	032	3463	D87	F6	C7	36	47
		27	033	3464	D88	F6	C8	36	48
		27	034	3465	D89	F6	C9	36	49
		27	035	3466	D8A	F6	4A	36	5B
		27	036	3467	D8B	F6	4B	36	2E
		27	037	3468	D8C	F6	4C	36	3C

132 Col		Position		Buffer Address (Hex)			
<u>R</u>	<u>C</u>	<u>Dec</u>	<u>Hex</u>	<u>EBCDIC</u>		<u>ASCII</u>	
27	038	3469	D8D	F6	4D	36	28
27	039	3470	D8E	F6	4E	36	2B
27	040	3471	D8F	F6	4F	36	21
27	041	3472	D90	F6	50	36	26
27	042	3473	D91	F6	D1	36	4A
27	043	3474	D92	F6	D2	36	4B
27	044	3475	D93	F6	D3	36	4C
27	045	3476	D94	F6	D4	36	4D
27	046	3477	D95	F6	D5	36	4E
27	047	3478	D96	F6	D6	36	4F
27	048	3479	D97	F6	D7	36	50
27	049	3480	D98	F6	D8	36	51
27	050	3481	D99	F6	D9	36	52
27	051	3482	D9A	F6	5A	36	5D
27	052	3483	D9B	F6	5B	36	24
27	053	3484	D9C	F6	5C	36	2A
27	054	3485	D9D	F6	5D	36	29
27	055	3486	D9E	F6	5E	36	3B
27	056	3487	D9F	F6	5F	36	5E
27	057	3488	DA0	F6	60	36	2D
27	058	3489	DA1	F6	61	36	2F
27	059	3490	DA2	F6	E2	36	53
27	060	3491	DA3	F6	E3	36	54
27	061	3492	DA4	F6	E4	36	55
27	062	3493	DA5	F6	E5	36	56
27	063	3494	DA6	F6	E6	36	57
27	064	3495	DA7	F6	E7	36	58
27	065	3496	DA8	F6	E8	36	59
27	066	3497	DA9	F6	E9	36	5A
27	067	3498	DAA	F6	6A	36	7C
27	068	3499	DAB	F6	6B	36	2C
27	069	3500	DAC	F6	6C	36	25
27	070	3501	DAD	F6	6D	36	5F
27	071	3502	DAE	F6	6E	36	3E
27	072	3503	DAF	F6	6F	36	3F
27	073	3504	DB0	F6	F0	36	30
27	074	3505	DB1	F6	F1	36	31
27	075	3506	DB2	F6	F2	36	32
27	076	3507	DB3	F6	F3	36	33
27	077	3508	DB4	F6	F4	36	34
27	078	3509	DB5	F6	F5	36	35
27	079	3510	DB6	F6	F6	36	36
27	080	3511	DB7	F6	F7	36	37
27	081	3512	DB8	F6	F8	36	38
27	082	3513	DB9	F6	F9	36	39
27	083	3514	DBA	F6	7A	36	3A
27	084	3515	DBB	F6	7B	36	23
27	085	3516	DBC	F6	7C	36	40
27	086	3517	DBD	F6	7D	36	27
27	087	3518	DBE	F6	7E	36	3D
27	088	3519	DBF	F6	7F	36	22
27	089	3520	DC0	F7	40	37	20
27	090	3521	DC1	F7	C1	37	41
27	091	3522	DC2	F7	C2	37	42
27	092	3523	DC3	F7	C3	37	43
27	093	3534	DC4	F7	C4	37	44
27	094	3525	DC5	F7	C5	37	45
27	095	3536	DC6	F7	C6	37	46
27	096	3527	DC7	F7	C7	37	47
27	097	3528	DC8	F7	C8	37	48
27	098	3529	DC9	F7	C9	37	49
27	099	3530	DCA	F7	4A	37	5B

132 Col		Position		Buffer Address (Hex)	
<u>R</u>	<u>C</u>	<u>Dec</u>	<u>Hex</u>	<u>EBCDIC</u>	<u>ASCII</u>
27	100	3531	DCB	F7 4B	37 2E
27	101	3532	DCC	F7 4C	37 3C
27	102	3533	DCD	F7 4D	37 28
27	103	3534	DCE	F7 4E	37 2B
27	104	3535	DCF	F7 4F	37 21
27	105	3536	DD0	F7 50	37 26
27	106	3537	DD1	F7 D1	37 4A
27	107	3538	DD2	F7 D2	37 4B
27	108	3539	DD3	F7 D3	37 4C
27	109	3540	DD4	F7 D4	37 4D
27	110	3541	DD5	F7 D5	37 4E
27	111	3542	DD6	F7 D6	37 4F
27	112	3543	DD7	F7 D7	37 50
27	113	3544	DD8	F7 D8	37 51
27	114	3545	DD9	F7 D9	37 52
27	115	3546	DDA	F7 5A	37 5D
27	116	3547	DDB	F7 5B	37 24
27	117	3548	DDC	F7 5C	37 2A
27	118	3549	DDD	F7 5D	37 29
27	119	3550	DDE	F7 5E	37 3B
27	120	3551	DDF	F7 5F	37 5E
27	121	3552	DE0	F7 60	37 2D
27	122	3553	DE1	F7 61	37 2F
27	123	3554	DE2	F7 E2	37 53
27	124	3555	DE3	F7 E3	37 54
27	125	3556	DE4	F7 E4	37 55
27	126	3557	DE5	F7 E5	37 56
27	127	3558	DE6	F7 E6	37 57
27	128	3559	DE7	F7 E7	37 58
27	129	3560	DE8	F7 E8	37 59
27	130	3561	DE9	F7 E9	37 5A
27	131	3562	DEA	F7 6A	37 7C
27	132	3563	DEB	F7 6B	37 2C

Appendix K. Compression of Symbol Definition Bit Strings

Symbol definition bit strings can be transmitted by the LPS structured field function in uncompressed or compressed form. The 3274 control units (Configuration Support C installed) can expand the compressed symbol definitions into the full dot pattern required by the display or printer.

An uncompressed symbol definition requires either 18 bytes of data (display) or 10 bytes of data (printer) to be transmitted. Compression, as described in this appendix, is a method for reducing the number of bytes (bits) transmitted.

An uncompressed symbol definition is created by dividing the character cell within which a symbol is formed into bytes (slices) as shown in the next section. The symbol is defined by encoding the bits (dots) in each byte (slice) as a B'1' if the dot is to be "on," and a B'0' if off. The dot pattern representing the symbol is thus formed. Byte (slice) 1 is understood to represent the leftmost upper 8 dots in the display matrix or the left-most 8 dots in the printer matrix. The string of 144 bits (display) or 80 bits (printer) thus encoded represents the uncompressed symbol definition. A comparison process, comparing digits (4 bits) in the uncompressed bit string to reference digits selected from the same bit string is used to compress the data.

Character Cell Division

The character cell for a display or printer character position is divided into slices as shown following. A slice corresponds to a byte, the bits to dots.

Bits	0		Slice 3							
	1	S	0	1	2	3	4	5	6	7
	2	l	5							
	3	i	6							
	4	c	7							
	5	e	8							
	6	1	9							
	7		10							
	0	S	11							
	1	l	12							
	2	i	13							
	3	c	14							
	4	e	15							
	5	2	16							
	6		17							
	7		18							

Display (9 x 16)

Bits	0													
	1	S												
	2	l												
	3	i												
	4	c												
	5	e												
	6	1	2	3	4	5	6	7	8	9	10			
	7													

Printer (10 x 8)

Once the character cell has been sliced in an appropriate manner, the slices can be thought of as forming a data string, beginning with slice 1, the zero bit in each slice at the left.

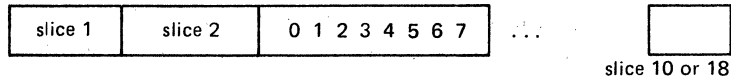

As noted, each group of 4 bits is termed a digit. The bit string forming the symbol definition is compressed by comparing each digit with the corresponding digit in a preceding slice, or zero, and the compressed bit string is generated according to the matches and mismatches that occur in the comparison process.

The Compression Process

In creating a Type 2 (display) or Type 6 (printer) compressed bit string for an individual symbol, an algorithm based on one of four comparison rules is used. So that the 3274 can subsequently expand the compressed string, a *header* (of 1 to 4 bits) is used at the start of each symbol definition to signal which of the four comparison rules was used in the compression.

The compressed bit strings for all the symbols being defined are concatenated without regard for byte boundaries, and then *terminator bits* are added to make the total bit string fit into an integral number of bytes.

To summarize so far, Type 2 or Type 6 data defining a full set of symbols in a Load Programmed Symbols structured field function looks like this:

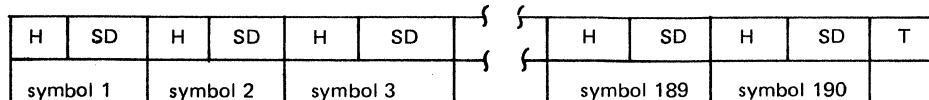

H = header bit(s)
SD = symbol-definition bits
T = terminator bits

The following material describes comparison rules and header bits, creating the compressed bit string, terminator bits, and examples of compressing the symbol-definition bit string for the symbol in Figure K-1.

The Comparison Rules and Header Bits

The four comparison rules that follow are used in creating a compressed symbol-definition bit string from a Type 1 (display) or 5 (printer) uncompressed symbol-definition bit string. Encoding the results of the comparison is discussed under "Creating the Compressed Bit String."

- Comparison Rule 1 (Header bit = B'0')

Each digit is compared with a digit consisting of zero bits.

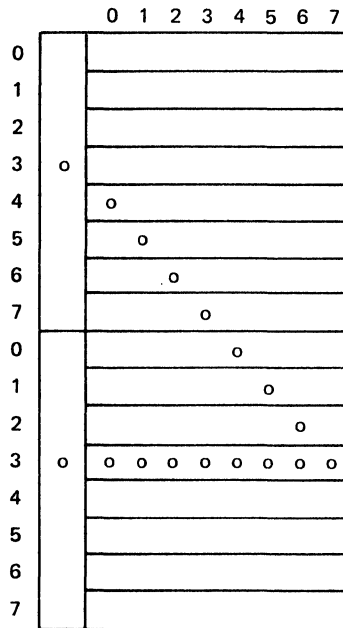

In Type 1 data format, the dot pattern for this example symbol would be transmitted in 18 bytes having the following values:

- Slice 1: B'00010000' = X'10'
- Slice 2: B'00010000' = X'10'
- Slice 3: B'00000000' = X'00'
- Slice 4: B'00000000' = X'00'
- Slice 5: B'00000000' = X'00'
- Slice 6: B'00000000' = X'00'
- Slice 7: B'10000000' = X'80'
- Slice 8: B'01000000' = X'40'
- Slice 9: B'00100000' = X'20'
- Slice 10: B'00010000' = X'10'
- Slice 11: B'00001000' = X'08'
- Slice 12: B'00000100' = X'04'
- Slice 13: B'00000010' = X'02'
- Slice 14: B'11111111' = X'FF'
- Slice 15: B'00000000' = X'00'
- Slice 16: B'00000000' = X'00'
- Slice 17: B'00000000' = X'00'
- Slice 18: B'00000000' = X'00'

Figure K-1. Type 1 Data Format – An Example Dot Pattern Encoded

- **Comparison Rule 2 (Header bits = B'10')**

Each digit is compared with the corresponding digit in the previous slice; for example, the first digit of slice 2 is compared with the first digit of slice 1, the second digit of slice 2 with the second digit of slice 1, the first digit of slice 3 with the first digit of slice 2, and so on. Since slice 1 has no previous slice, compare each digit of slice 1 to a zero digit.

- **Comparison Rule 3 (Header bits = B'110')**

Each digit is compared with the corresponding digit in the next-to-previous slice; for example, the first digit of slice 3 is compared to the first digit of slice 1, the second digit of slice 3 with the second digit of slice 1, the first digit of slice 4 with the first digit of slice 2, and so on. Since slices 1 and 2 have no next-to-previous slice, compare each digit of slices 1 and 2 to a zero digit.

- **Comparison Rule 4 (Header bits = B'1110')**

No comparison required. A blank symbol. The symbol definition consisted of zero bits only.

Creating the Compressed Bit String

The digit comparisons are encoded by taking the digits 4 at a time (2 slices—the slice-pair referred to in following discussions) and comparing them to their corresponding digits in a reference slice-pair that you have created (following the comparison rules). Because the digits are compared 4 at a time, it is convenient to regard the 18 slices of the type 1 data string or the 10 slices of a type 5 data string symbol definition as being made up of 9 or 5 slice-pairs. The digits of the slice-pairs are compressed as follows:

- Step 1

Compare the first Type 1 or 5 slice-pair with the reference slice-pair.

- Step 1A

When the two slice-pairs are identical, put a *0* bit in the symbol-definition bit string, and repeat step 1 for the next slice-pair.

- Step 1B

When the two slice-pairs are not identical, put a *1* bit in the symbol-definition bit string, and proceed to step 2.

- Step 2

Compare, in turn, each digit in the Type 1 or 5 slice-pair with the corresponding digit in the reference slice-pair.

- Step 2A

For each digit that matches (that is, the digits being compared are the same), put a *0* bit in the symbol-definition bit string.

- Step 2B

For each digit that does not match (that is, the digits being compared are not the same), put a *1* bit in the symbol-definition bit string *followed by a copy of the 4 bits of the nonmatching digit from the Type 1 or 5 slice-pair.*

- Step 3

Repeat steps 1 and 2 in a similar manner through to the ninth slice-pair of a Type 1 string or the fifth slice-pair of a Type 5 string.

When the bit strings for all the symbols have been created and concatenated, the Type 2 or Type 6 data string is completed with 1 bits to make up an integral number of bytes. *There must be at least 4 of these terminator 1 bits—even if they spill over into a further byte.* The number of 1 bits required thus ranges from 4 (minimum) to 11 (maximum).

Examples of the Compression Algorithm in Use

The following three examples show how a Type 1 data string for a particular symbol is compressed into a Type 2 data string. In these examples, the symbol whose Type 1 data string being compressed is the one shown in Figure K-1. Here is the data string for that symbol, presented as nine slice-pairs:

- Slice-pair 1: X'1010'
- Slice-pair 2: X'0000'
- Slice-pair 3: X'0000'
- Slice-pair 4: X'8040'
- Slice-pair 5: X'2010'
- Slice-pair 6: X'0804'
- Slice-pair 7: X'02FF'
- Slice-pair 8: X'0000'
- Slice-pair 9: X'0000'

For the particular symbol used in these examples, comparison rule 1 yields the shortest bit string; for any other symbol, however, the comparison rule that yields the shortest bit string depends on the symbol's particular dot pattern.

Example of Algorithm Using Comparison Rule 1

Slice-pairs being compared according to Rule 1:		Step 1: Compare slice-pairs. For a match, generate B'0'. For a mismatch, generate B'1', and do step 2.			
Reference slice-pair	Type 1 slice-pair	Step 2: Compare digits. For a match, generate B'0'. For a mismatch, generate B'1' followed by a copy of the bits in the nonmatching Type 1 digit.			
		Digit 1	Digit 2	Digit 3	Digit 4
X'0000'	X'1010'	1	1 0001	0	1 0001
X'0000'	X'0000'	0			
X'0000'	X'0000'	0			
X'0000'	X'8040'	1	1 1000	0	1 0100
X'0000'	X'2010'	1	1 0010	0	1 0001
X'0000'	X'0804'	1	0	1 1000	0
X'0000'	X'02FF'	1	0	1 0010	1 1111
X'0000'	X'0000'	0			
X'0000'	X'0000'	0			

Figure K-2. Example of Compression Algorithm Using Comparison Rule 1

With Comparison Rule 1, the header is B'0' and the symbol-definition bit string is created by comparing each Type 1 slice-pair with an all-zeros reference slice-pair as shown in Figure K-2. The resultant bit string, including the header, is thus:

```
0110 0010 1000 1000 1110 0001 0100 0110 0100 1000 1010 1100
0010 1001 0100 1011 1111 1111 00
```

Note that the original Type 1 bit string of 144 bits is compressed to 74 bits.

Example of Algorithm Using Comparison Rule 2

Slice-pairs being compared according to Rule 2:		Step 1: Compare slice-pairs. For a match, generate B'0'. For a mismatch, generate B'1', and do step 2.			
		Step 2: Compare digits. For a match, generate B'0'. For a mismatch, generate B'1' followed by a copy of the bits in the nonmatching Type 1 digit.			
Reference slice-pair	Type 1 slice-pair	Digit 1	Digit 2	Digit 3	Digit 4
X'0010'	X'1010'	1	1 0001	0	0
X'1000'	X'0000'	1	1 0000	0	0
X'0000'	X'0000'	0			
X'0080'	X'8040'	1	1 1000	0	1 0100
X'4020'	X'2010'	1	1 0010	0	1 0001
X'1008'	X'0804'	1	1 0000	1 1000	0
X'0402'	X'02FF'	1	0	1 0010	1 1111
X'FF00'	X'0000'	1	1 0000	1 0000	0
X'0000'	X'0000'	0			

Figure K-3. Example of Compression Algorithm Using Comparison Rule 2

With Comparison Rule 2, the header is B'10', and the symbol-definition bit string is created by comparing each Type 1 slice-pair with a reference slice-pair composed of the previous slices as shown in Figure K-3. The resultant bit string, including the header, is thus:

```
1011 0001 0001 1000 0000 0111 0000 1010 0011 0010 0100 0101
1000 0110 0001 0100 1010 0101 1111 1111 1110 0001 0000 000
```

Note that the original Type 1 bit string of 144 bits is compressed to 95 bits.

Example of Algorithm Using Comparison Rule 3

Slice-pairs being compared according to Rule 3:		Step 1: Compare slice-pairs. For a match, generate B'0'. For a mismatch, generate B'1', and do step 2.				
Reference slice-pair	Type 1 slice-pair	Step 2: Compare digits. For a match, generate B'0'. For a mismatch, generate B'1' followed by a copy of the bits in the nonmatching Type 1 hexadecimal digit.				
		Digit 1	Digit 2	Digit 3	Digit 4	
X'0000'	X'1010'	1	1 0001	0	1 0001	0
X'1010'	X'0000'	1	1 0000	0	1 0000	0
X'0000'	X'0000'	0				
X'0000'	X'8040'	1	1 1000	0	1 0100	0
X'8040'	X'2010'	1	1 0010	0	1 0001	0
X'2010'	X'0804'	1	1 0000	1 1000	1 0000	1 0100
X'0804'	X'02FF'	1	0	1 0010	1 1111	1 1111
X'02FF'	X'0000'	1	0	1 0000	1 0000	1 0000
X'0000'	X'0000'	0				

Figure K-4. Example of Compression Algorithm Using Comparison Rule 3

With Comparison Rule 3, the header is B'110' and the symbol-definition bit string is created by comparing each Type 1 slice-pair with a reference slice-pair composed of the next-to-previous slices as shown in Figure K-4. The *resultant bit string*, including the header, is thus:

```

1101 1000 1010 0010 1100 0001 0000 0011 1000 0101 0001 1001
0010 0010 1100 0011 0001 0000 1010 0101 0010 1111 1111 1110
1000 0100 0010 0000

```

Note that the original Type 1 bit string of 144 bits is compressed to 112 bits.

Appendix L. Indicators and Controls (3277, 3284, 3286, 3288)

This appendix describes the indicators and controls associated with each unit. The explanation of the indicators and controls listed in Figure L-1 follows:

APL ON/OFF: This momentary-contact switch on the APL keyboard replaces the Backspace key on the typewriter keyboard. When pressed once, APL mode is turned on and APL characters may be entered. When pressed again, APL mode is turned off and the APL keyboard operates as a typewriter keyboard (except for the replaced Backspace key).

Indicator or Control	3270 Unit		
	3277	3284, 3286	3288
APL ON/OFF (key)	A		
APL ALT (key)	A		
ALT (Ind)	T		
ALT ON/OFF (key)	T		
CODE (key)	T		
OFF-PUSH (Sw, Ctl)	X		
BIT RATE (Sw)			
DISCONNECT (Sw)			
INSERT MODE (Ind)	X		
INPUT INHIBITED (Ind)	X		
SYSTEM AVAILABLE (Ind)	X		X
Sys Avl (Ind)			X
SYSTEM READY (Ind)			
SYNC SEARCH (Ind)			
SELECTED (Ind)			
FLAG DETECT			
CU ACTIVE			
OFF HOOK/AUTO ANSWER (Ind)			
TRANSMIT (Ind)			
STATUS (Ind)			
POWER ON LOCAL MODE (Sw)			
POWER OFF LOCAL MODE (Sw)			
MAIN LINE ON/OFF (Sw)			
LOC/REM (Sw)			
ON LINE/OFF LINE (Sw)			
I/O INTF DSBLD (Sw)			
POWER ON/OFF (Sw)		X	X
Power On (I)/Power Off (O) (Sw)			X
Carriage Restore (Pb)			X
Start Test (Sw)			X
VFC Selector (Sw)			X
POWER ON (Ind)			
Ready (Ind)			X
Ops Chk (Ind)			X
Address I.D. (Label)	X	X	X

Key: Sw – Switch PB – Pushbutton X – Basic
 Ctl – Control A – APL Keyboard Feature D – Dial Feature
 Ind – Indicator T – Text Keyboard Feature S – SDLC

Figure L-1. Indicators and Controls for Terminals 3277, 3284, 3286, and 3288

ALT ALT: While this key is held down with APL ON, additional APL characters may be entered with the APL keyboard. With APL OFF, this key functions as a standard Backtab key.

ALT: This indicator, a light above the ALT ON/OFF key on the Text keyboard, indicates the status of ALT (Text keyboard alternate) mode.

ALT ON/OFF: This momentary-contact switch, on the text keyboard, replaces the Backspace key on the typewriter keyboard. When pressed once, ALT (Altnerate) mode is turned on and Text keyboard characters may be entered. When pressed again, ALT mode is turned off and the Text keyboard operates as a typewriter keyboard (except for the replaced Backspace key).

CODE: While pressed, this Text keyboard shift key allows the operator to enter and display the Text character on the front face of each character key.

OFF-PUSH: This triple-function concentric switch/control is used to control the application of power to the unit and also to control the brightness (outer knob) and contrast (inner knob) of the displayed image.

INSERT MODE: This indicator is turned on by the keyboard INS MODE key to show that the unit is in insert mode of operation. It is turned off by the keyboard RESET key.

INPUT INHIBITED: When lighted, this indicator shows that manual input to the unit from the keyboard, selector light pen, or operator identification card reader is inhibited.

It is turned on by:

1. Operation of any program attention key.
2. A selector-light-pen-attention operation that caused an I/O interruption to occur.
3. An operator-identification-card-reader operation that caused an I/O interruption to occur.
4. Turning the security keylock to the OFF position if the Security Keylock feature is installed.
5. Initiation of a printout at an unbuffered printer attached to the 3275.
6. A system-initiated I/O operation addressed to that unit and it remains on for only the duration of the I/O operation.
7. Operation of any alphameric key or the DUP, FIELD MARK, ERASE EOF, or DEL keys when the cursor is in a protected field.
8. Operation of any alphameric key not included in the numeric key grouping when the cursor is in a numeric field, without simultaneously operating either the ALPHA or NUMERIC shift key (when the Numeric Lock special feature is installed).
9. Detected of a parity or cursor check in the device buffer.

It is turned off by:

1. Receipt and execution of a WCC with the Keyboard Restore bit set.
2. Receipt and execution of an Erase All Unprotected command.
3. Turning the security keylock to the ON position (if it was turned on because the security keylock was in the OFF position).
4. Operation of the keyboard RESET key, with the following exceptions:
 - a. The device is selected and executing a command from the control unit.
 - b. The display station is in process of reading a magnetic card from the operator identification card reader.
 - c. A printout is in process at the attached 3284-3.
 - d. A parity or cursor check has been detected.
5. Termination of an unbuffered printer printout (if it was turned on because an unbuffered printer printout was initiated).
6. Correction of a parity or cursor check condition and resetting of the error status by a Write or Erase/Write command addressed to that device.

SYSTEM AVAILABLE (3277), Sys Avl (3288): When lighted, this indicator shows that the unit has had successful communication with the system and is available to accept an operator-initiated transmission to the system.

It is turned on by successful completion of a Write, Erase/Write, Erase All Unprotected, Copy, Read Modified, or Read Buffer command, in local or remote operation.

It is turned off by:

1. Any operator-generated I/O interrupt.
2. A parity or cursor check and resulting I/O interrupt.
3. Turning the security keylock to the OFF position.

Power On/Power Off (Coded | and O): This two-position rocker switch is used to control power to the 3288.

Carriage Restore: The Carriage Restore pushbutton on the 3288 advances the forms to a predetermined print line established by the initial forms positioning and by the settings of the VFC Selector switches.

Start Test: This switch on the 3288 is used in conjunction with the test switches, located on the test switch panel (under the top cover), to initiate offline test printouts.

VFC Selector: The VFC Selector switches on the 3288 are set (00—00) by the operator to determine the number of lines skipped in a VFC operation.

Ready: When lighted, this indicator shows that the 3288 is ready to receive transmissions from the control unit. It is turned on after a successful power-on sequence, when the belt is up to speed, and when the printer is ready to print data.

It is turned off by:

1. Open machine covers.
2. Open print unit.
3. Running out of forms.
4. A paper motion failure (forms jam, torn forms, or missing feed holes).
5. An overheated printer mechanism.
6. A hardware failure requiring a repair action.

Ops Chk: When blinking, this indicator shows that the 3288 not-ready condition (shown by the Ready indicator being off) can be corrected by the operator.

It is turned on by:

1. Open machine covers.
2. Open print unit.
3. Running out of forms.
4. A paper motion failure.
5. The TEST switch (on test switch panel) in other than the ON LN (On Line) position.

It is turned off when the condition that caused it to light is corrected.

Address I.D. (identification): Provision is made on each display station and printer to identify both the physical (hexadecimal) and symbolic addresses assigned to that unit at installation time.

Appendix M. Abbreviations

A

A Attention
ACK Positive acknowledge
AID Attention Identificaton
ALPHA Alphameric
A/N Alphameric/numeric
APL A programming language
ASCII American National Standard Code for Information Interchange
async Asynchronous
atb Attribute

B

B Busy
BB Begin bracket
BCC Block check character
BETB Between-bracket state
BIU Basic information unit
BOC Bus-out check
bps Bits per second
BSC Binary synchronous communication

C

C Column
CAW Channel address word
CC Control check, Chain Command (flag)
CCC Copy control character
CCW Channel control word

CD Change direction
CE Channel End
char. Character
cmd Command
CNCL Cancel
cps Characters per second
CPU Central processing unit
CR Command Reject
CRT Cathode-ray tube
CRV Crypto Verification
CSW Channel status word
ctl Control
CTS Clear to Send
CU Control unit
CUE Control Unit End

D

D display
DAA Data access arrangement
DB Device Busy
DC Data Check
DCE Data-Circuit Terminating Equipment
DE Device End
dec Decimal
DEL Delete
DISC Disconnect
DLE Data link escape

DM Disconnect mode

DR Definite response

DUP Duplicate

E

EAU Erase All Unprotected

EB End brackets

EBCDIC Extended binary-coded decimal interchange code

EC Equipment Check

ECSA Extended Character Set Adapter

EFI Expedited flow indicator

EIA Electronic Industries Association

EM End of message

ENP Enable Presentation

ENQ Enquiry

EOF End of Field

EOI End of Inquiry

EOR End of Record

EOT End of Transmission

ERP Error recovery procedure(s)

ESC Escape

ETB End of Transmission Block

ETX End of Text

EUA Erase Unprotected to Address

E/W Erase/Write

EX (response) Exception

F

FF Forms feed

FID Format identifier

FIE Function interpret error

FM Field mark, function management

FMH Function Management Header

FRMR Frame reject

G

GP General Poll

H

Hex Hexadecimal

HT Horizontal Tab

Hz Hertz

I

I (format) Information

IC Insert Cursor

ident Identification

IML Initial machine load, initial microprogram load

Ind Indicator

INS Insert

IOS Input/Output Supervisor

IR Intervention Required

IRS Interrecord separator

ITB End of intermediate transmission block

K

kbd Keyboard

L

LF Line feed

LIC Last in chain

LRC Longitudinal redundancy check

LU Logical unit

LU/SSCP Logical unit/system services control point

M

MCL Multiuse Communication Loop

MDT Modified data tag

MHS Magnetic hand scanner

MPP Maximum presentation position

MSR Magnetic slot reader

N

NA or N/A Not applicable

NAK Negative acknowledge

NCP Network control program

NL New Line

NS (format) Nonsequenced

NUL Null

O

OC Operation Check

OCIR Operator Identification Card Reader

P

P Printer, protected

PA Program access

PF Program function

PLU Primary Logical Unit

PS Programmed Symbols

PSI Primary to secondary indicator

PT Program Tab

R

R Row

RA Repeat to Address

RB Read Buffer

RBM Read Buffer Modified

Rd Mod Read Modified

RECFMS Record Formatted Maintenance Statistics

Req Request

REQMS Request Maintenance Statistics

RH Request/response header

RM Read Modified

RNR Request not ready

RP-Q Read Partition-Query

R/R Request/response

RR Request ready

RSP Response

RTS Request to send

RU Request response unit

RVI Reverse interrupt

S

S (format) Sequenced

SA Selection addressing

SBA Set Buffer Address

SCS SNA Character String

SDLC Synchronous data link control

SF Start Field

SHF Set Horizontal Format

SI Suppress Index

SIOF Start I/O Fast Release

SLU Secondary logical unit

SM Status Modifier

SNA Systems network architecture

SNBU Switched network backup

SNRM Set normal response mode

SOH Start of heading

SOR Start of record

SP Space, Specific Poll

SPD Selector pen detect

SRM Set Reply Mode

S/S Status and sense

SSCP System services control point

SSR Secure string record

STX Start of text

SUB Substitute

SVF Set Vertical Format

sw Switch

SYN Synchronous idle

T

TC Transmission Check

TCU Transmission control unit

TH Transmission header

TTD Temporary text delay

U

U Unprotected

UA Unnumbered acknowledgment

UC Unit Check

UE Unit Exception

US Unit Specify

V

V Volts

VFC Vertical forms control

VTAM Virtual Telecommunications Access Method

W

WACK Wait before transmit

WCC Write control character

WSF Write Structured Field

Appendix N. Glossary

The terms in this glossary are defined here as they apply to the 3270 Information Display System.

access method. A technique for moving data between main storage and input/output devices.

AID. See *attention identifier*.

alphanumeric field. A field that may contain any alphabetic, numeric, or special characters.

alternate character set. A character set, located in the terminal, from which characters are obtained for display and printing by using the graphic escape character in the data stream.

alternate cursor. An image reversal of each dot in the character cell at the cursor position.

attention. An I/O interruption generated asynchronously by a display station, usually as the result of an action taken by the operator of the device.

attention identification (AID). A code that the terminal sends in the inbound data stream to identify the operator action or structured field function that caused the data stream to be sent to the application program. An AID is always sent as the first byte of the inbound data stream. Structured fields in the data stream may also contain an AID.

attribute. A characteristic.

attribute select keyboard. A keyboard that enables the operator, when permitted by the program, to change the character attributes of the keyed-in character.

attribute type. A code that identifies the characteristics from which the associated set of attribute values can be selected. See also *extended color*, *extended highlighting*, and *character set*.

attribute value. A code immediately following the attribute type in the data stream that specifies a particular characteristic from the set defined by the attribute type.

audible alarm. A special feature that sounds a short, audible tone automatically when a character is entered from the keyboard into the next-to-last character position on the screen. The tone can also be sounded under program control.

automatic polling. (1) A hardware feature of a telecommunications unit that processes a polling list, polling the terminals in order and handling negative responses to polling without interrupting the central processing unit. At the end of the list, polling is automatically begun again at the beginning of the list. Synonymous with *autopoll*. (2) See also *polling*.

automatic skip. After entry of a character into the last character position of an unprotected display field, automatic repositioning of the cursor from a protected and numeric field to the first character position of the next unprotected display field.

autopoll. Same as *automatic polling*.

auto-skip. Same as *automatic skip*.

base color. The capability to display or print all characters in a field, in one of four colors, on a color terminal by using combinations of the field protection and the field intensify bits of the field attribute.

Binary Synchronous Communications (BSC). Data transmission in which character synchronism is controlled by timing signals generated at the sending and receiving stations.

blink. An extended highlighting attribute value (for emphasis) of a field or character.

block matrix. The total array of dots that can be used to describe a graphic character for a 3270 display or printer.

bracket. In VTAM, an exchange of data between an application program and a logical unit which accomplishes some task.

BSC. See *Binary Synchronous Communications*.

buffer address. The address of a location in the buffer at which one character can be stored.

CCC. See *copy control character*.

category A terminals. Terminals that can be attached to type A adapters. For example the 3278 and 3279 Displays, the 3287 Models 1, 2, 1C and 2C, the 3262 Models 3 and 13, and the 3289 Models 1 and 2 Printers.

category B terminals. Terminals that can be attached to type B adapters. For example the 3277 Display, the 3284, 3286, 3287 Models 1 and 2, and 3288 Printers.

character attribute. The properties of a character with respect to its color, highlighting, and character set. See also *extended field attribute*.

character buffer. The read/write storage used by a partition for storing character or graphic data for display or printing on a terminal.

character position. A location on the screen at which one character can be displayed; also, an addressed location in the buffer at which one character can be stored.

character set. (1) A defined collection of characters in a loadable or nonloadable set selected by means of a local character set identifier. (2) An attribute type in the extended field and character attributes. (3) An attribute passed between session partners in the Start Field Extended, Modify Field, and Set Attribute orders.

clear indicator. In VTAM, a SESSIONC indicator sent by one node to another that prevents the exchange of messages and responses.

cluster control unit. (1) A device that can control the input/output operations of more than one device. A remote cluster control unit can be attached to a host CPU only via a communications controller. A cluster control unit may be controlled by a program stored and executed in the unit, or it may be controlled entirely by hardware. (2) See also *communications controller*.

command. An instruction that directs a control unit or device to perform an operation or a set of operations.

communications controller. (1) A type of communication control unit whose operations are controlled by a program stored and executed in the unit. Examples are the IBM 3704 and 3705 Communications Controllers. (2) See also *cluster control unit*.

control character. A character used in conjunction with a Write command to specify that a control unit is to perform a particular operation.

control codes. The hexadecimal values hex 00 through hex 3F, and hex FF in the 3270 data stream.

conventional 3270. A locally attached 3270 terminal or a remotely attached 3270 terminal that uses the BSC line discipline.

copy control character (CCC). A character used in conjunction with the Copy command to specify the type of data to be copied.

copy operation. An operation that copies the contents of the buffer from one display station or printer to another display station or printer attached to the same control unit.

cursor. A unique symbol that identifies a character position in a screen display, usually the character position at which the next character to be entered from the keyboard will be displayed.

data stream. All data transmitted through a channel in a single read or write operation to a display station or printer.

data transfer. In telecommunications, the sending of data from one node to another.

data transfer mode. A set of facilities (including the macro instructions needed to use them) that enable the application program to communicate with terminals.

definite response 1. In VTAM, a response that indicates whether its associated message was successfully forwarded to its final destination (such as the display screen of an output device).

definite response 2. In VTAM, a response that indicates that the node sending the response has accepted recovery responsibility for the associated message.

designator character. A character that immediately follows the attribute character in a selector-pen-detectable field. The designator character controls whether a detect on the field will or will not cause an attention. For a nonattention-producing field, the designator character also determines whether the modified data tag for the field is to be set or reset as the result of a selector-pen detect.

detectable. An attribute of a display field; determines whether the field can be sensed by the selector pen.

display field. A group of consecutive characters (in the buffer) that starts with an attribute character (defining the characteristics of the field) and contains one or more alphameric characters. The field continues to, but does not include, the next attribute character.

dot. One point in a printer or display block matrix.

Erase All Unprotected (EAU) command. A command that clears all unprotected fields to nulls, resets modified data tags in all unprotected fields, unlocks the keyboard, resets the attention identifier, and

repositions the cursor to the first character of the first unprotected field.

Erase Unprotected to Address (EUA) order. An order that erases all unprotected positions (inserts nulls) from the current buffer address up to, but not including, the specified stop address.

Extended Attribute Buffer (EAB). A buffer for storing extended field attributes and character attributes.

extended color. (1) A capability that allows color terminals to display or print fields or characters in colors using extended field and character attributes. (2) An attribute type in the extended field attribute and character attribute.

extended field attribute. Additional field definition to the field attribute that controls defining additional properties such as color, highlighting, character set, and field validation. The extended field attribute is altered by information passed in the Start Field Extended and Modify Field orders.

extended highlighting. (1) A function that provides blink, reverse video, and underscore for emphasizing fields or characters on devices supporting extended field attributes and character attributes. (2) An attribute type in the extended field attribute and character attribute. (3) An attribute passed between session partners in the Start Field Extended, Modify Field, and Set Attribute orders.

field. See *display field*.

field attribute. A control character stored in the character buffer in the first character position of a field. For those devices supporting the 3270 data stream, a field attribute defines protected/unprotected, alphanumeric/numeric, detectable/nondetectable, display/nondisplay, intensity, and modified data tag (MDT).

field inherit. A bit setting in the character attribute which defaults the character properties to the extended field attributes or device default if the buffer is unformatted.

FME response. See *definite response 1*.

formatted display. A screen display in which a display field, or fields, has been defined as a result of storing at least one attribute character in the display buffer.

general polling. (1) An input technique for remote 3270 devices in which special invitation characters are sent to a device control unit instructing that

control unit to begin transmission from all devices ready to enter data. (2) See also *polling* and *specific polling*.

Insert Cursor (IC) order. An order that displays the cursor at the current buffer address.

intensified display. An attribute of a display field; causes data in that field to be displayed at a brighter level than other data displayed on the screen.

leased line. See *nonswitched line*.

line control characters. Characters that regulate the transmission of data over a line; for example, delimiting messages, checking for transmission errors, and indicating whether a station has data to send or is ready to receive data.

local. Pertaining to the direct attachment of devices by channels to a host CPU. Contrast with *remote*.

logical unit. The combination of programming and hardware of a teleprocessing subsystem that comprises a terminal for VTAM.

MDT. See *modified data tag*.

modified data tag (MDT). A bit in the attribute character of a display field, which, when set, causes that field to be transferred to the channel during a read-modified operation. The modified data tag may be set by a keyboard input to the field, a selector-pen detection in the field, a card read-in operation, or program control. The modified data tag may be reset by a selector-pen detection in the field, program control, or ERASE INPUT key.

Modify Field (MF). An order that allows specified field attributes to be modified.

nonswitched line. A connection between a remote 3270 unit and a computer that does not have to be established by dialing.

order code. A code that may be included in the write data stream transmitted for a display station or printer; provides additional formatting or definition of the write data.

order sequence. A sequence in the data stream that starts with an order code and includes a character

address and/or data characters related to the order code.

outgoing group. In systems with TCAM, that section of a message handler that manipulates outgoing messages after they have been removed from their destination queues.

polling. A technique by which each of the terminals sharing a communications line is periodically interrogated to determine whether it requires servicing.

Prepare to Read (PTR). A command for a local 3274-1D that allows the terminal to know the next program action.

program attention key. Any key on the keyboard that solicits program action by generating an I/O interruption. The keys are the CLEAR key, ENTER key, TEST REQ key, CNCL key, program function keys, and program access keys. Each program attention key is associated with a unique attention identification (AID) character.

program function (PF) key. A program attention key that may be defined to solicit program action that usually requires data to be read from the buffer of the display station. If a Read Modified command is issued in response to the program function key interruption, the attention identifier (AID) and all display fields in which the modified data tags are set are transferred to the program.

Program Tab (PT) order. An order that advances the current buffer address to the address of the first character location of the next unprotected field.

Programmable Symbols (PS). Customer-defined symbols, a maximum of 190 symbols to a programmed symbol set.

protected field. A display field for which the display operator cannot use the keyboard or operator identification card reader to enter, modify, or erase data.

remote. Pertaining to the attachment of devices to a central computer through a communication control unit. Contrast with *local*.

Repeat to Address (RA) order. An order that stores a specified alphameric or null character in up to 480 buffer locations, starting at the current buffer address and ending at, but not including, the specified stop address.

RRN response. See *definition response 2*.

SDLC. Synchronous data link control.

selector pen. A pen-like instrument that may be attached to the display station as a special feature. When pointed at a detectable portion of an image and then activated, the selector pen senses the presence of light at a display field and produces a selector-pen detect.

selector-pen detect. The sensing by the selector pen of the presence of light from data in a display field that has the detectable attribute. Depending on the designator character of that display field, the detection and location information is identified on the screen (and stored in the buffer) or may produce an interrupt that is transmitted to the CPU.

SESSIONC indicators. In VTAM, indicators that can be sent from one node to another without using SEND or RECEIVE macro instructions. SDT, clear, and STSN are SESSIONC indicators. All SESSIONC indicators are sent with a SESSIONC macro instruction.

Set Attribute (SA) order. An order that associates attributes in the EAB with individual characters.

Set Buffer Address (SBA) order. An order that sets the buffer address to a specified location.

specific polling. (1) A polling technique that sends invitation characters to a device to find out whether the device is ready to enter data. (2) See also *general polling* and *polling*.

Start Field (SF) order. An order that indicates a specified location which contains an attribute byte and not a text character.

Start Field Extended (SFE) order. An order that generates an extended field attribute in the EAB and at the current buffer location.

Structured Field. A data stream format that permits variable-length data and controls to be parsed into its components without having to scan every byte.

Suppress Index (SI) order. An order that generates the suppress index character, valid only for the 3288-2 printer. This character inhibits a line index to allow overprinting.

switched line. A communication line in which the connection between the computer and a remote terminal is established by dialing.

telecommunications network. In a telecommunication system, the combination of all terminals and other telecommunication devices and the lines that connect them.

terminal. (1) A point in a system or communication network at which data can either enter or leave.
(2) Any device capable of sending and receiving information over a communication channel.

terminal-initiated logon. A logon request that originates from the terminal.

unformatted display. A screen display in which no attribute character (and, therefore, no display field) has been defined.

unprotected field. A display field for which the display station operator can manually enter, modify, or erase data.

WCC. See *write control character*.

wraparound. The continuation of an operation (for example, a read operation or a cursor movement operation) from the last character position in a buffer to the first character position in the buffer.

write control character (WCC). A character used in conjunction with a Write command to specify that a particular operation, or combination of operations, is to be performed at a display station or printer.

Write Structured Field (WSF) command. A command used for processing structured fields.

3270 data stream. A coded character data stream.

Index

- abbreviations M-1
- abort function 5-64
- ACF/VTAM Encrypt/Decrypt feature F-1
- ACK 0 (Even Acknowledge) 4-7
- ACK 1 (Odd Acknowledge) 4-8
- activate logical unit 5-3
- activate physical unit 5-3
- ACTLU 5-3, 5-8
- ACTPU 5-3, 5-8
- address byte (local operation) 3-1
- address I/O interface codes J-1
- AID code 1-42 (Fig. 1-17)
- alphanumeric attribute C-6
- alternate cursor C-1
- APL keyboards D-9
- APL/Text Feature (Appendix D) D-1–D-13
- APL/Text I/O interface codes D-3, D-4
- APL/Text National Use differences D-5
- asynchronous status 3-9, 5-52
- attribute character bit assignments 2-8 (Fig. 2-5)
- attribute characters 2-7
- attribute defaults 1-39
- attribute selection keys C-14
- attribute types and values 1-38, 1-39
- attributes 1-15, 1-38, 1-39
- automatic polling 4-2

- Base Color 2-7
- Base Color switch 2-7, 2-9
- BCC (*See* block check character)
- between bracket sharing 5-43
- Between Bracket state 5-4
- Between Brackets state 5-32
- Bid 5-15
- Binary Synchronous Communication (*See* BSC)
- Bind 5-10, 5-11, 5-12, 5-13
- Bind check 5-65
- Bind command processing with Encrypt/Decrypt F-3
- Bind default 5-65
- block check character 4-2, 4-3
- blocking write data 4-17
- bracket/chain – host-initiated 5-24
- bracket/chain – host/SLU contention 5-25
- bracket/chain – LU Type 2 5-24
- bracket protocol 5-18, 5-19
- Bracket state errors 5-33
- Bracket states 5-32
- BSC (Binary Synchronous Communication)
 - Copy command with APL/Text D-13
 - line discipline 1-67
 - remote operations 4-1
- buffer address I/O interface codes (Appendix J) J-1
- buffer addressing for terminals 2-1–2-4
- buffer addressing (12/14 bit) 1-15
- buffer data relationship to printed data 2-22
- buffer size (printers) 2-53

- Cancel 5-14, 5-28
- Cancel Print switch 2-31
- Carriage Return (CR) 2-24
- CAW 3-1
- CCW 3-1, 4-1, 4-11
- CCW error recovery 5-58
- Chaining 5-19, 5-20
 - chaining of commands (local operation) 3-5
 - change direction 5-20
 - channel commands 5-45 (Fig. 5-16)
 - channel-detected errors 3-14
 - channel-detected errors (SNA) 5-55
 - channel programs 3-1
 - character display attribute 2-6
 - character generator error 2-52
 - character set differences 1-69
 - channel program (BSC) 4-1
 - Chase 5-15
 - Clear 5-14
 - code structures for BSC operations 4-1
 - color attribute type 2-10
 - command-chaining error conditions 2-52
 - command codes 1-13 (Fig. 1-10)
 - command flow (SNA) 5-4
 - command initiation (local operation) 3-3
 - command sequences 4-10, 4-11
 - commands 1-12, 1-13
 - contention for printer use 2-49
 - contention state 5-29
 - control character I/O codes 1-10
 - control commands 1-59
 - control mode (BSC) 4-3
 - copy buffer transfers 1-62
 - Copy command 1-59
 - copy control character (CCC) 1-59, 1-60
 - copy data stream 1-60
 - cursor C-1
 - customizing options with APL/Text D-2

- DACTLU 5-9
- DACTPU 5-3, 5-8
- DAF 5-6
- data flow 1-2
- data link control characters 4-6, 4-7
- data link errors 5-35
- Data Pending states 1-53
- data streams 1-12
- data traffic state 5-29
- data transfer 1-3
- deactivate logical unit (DACTLU) 5-3
- deactivate physical unit (DACTPU) 5-3
- Dead-Key operations C-14
- deciphering messages F-1
- definite responses 5-22
- DES algorithm F-1
- designator characters H-2, H-3
- device addressing 1-11
- device addressing for SNA terminals 5-7
- device-detected errors 3-13
- disconnect 5-62
- display buffer addresses 2-3
- display fields 2-5
- displays, model differences 2-18
- DUP character 2-19

- enciphering messages with Encrypt/Decrypt F-1
- Encrypt/Decrypt F-1
- ending status 3-9, 5-52
- ending status bit configurations 3-9 (Fig. 3-6)
- EOT to a text block 4-30
- Erase All Unprotected command 1-59, 1-65

- Erase Unprotected to Address order 1-14, 1-36
- Erase/Write command 1-19
- ERPI state 5-31
- error recovery procedures
 - 3274-1B, -1D 3-13, 3-14
 - remote BSC 4-27-4-30
 - SNA 5-75
- error recovery protocols 5-31
- errors detected (remote BSC) 4-30
- establishing cryptographic sessions F-2
- ETB 4-2
- ETX 4-2
- exchange station ID 5-62, 5-63
- extended attributes 2-6, 2-9
- extended color 2-10
- extended highlighting 2-10

- field attribute character 2-7, 2-8
- field attribute type 2-6, 2-7
- FM character 2-19
- FM data 5-17
- format control with shared printers 2-50
- formatted display images 2-2, 2-5
- forms feed (FF) 2-23
- Function Management Header 1 1-26

- General Poll sequences 4-11-4-16

- host acknowledgment 1-55
- host-initiated local copy with SNA/SDLC 2-47
- host interference with operator copy 2-46
- host retry 1-52

- In Bracket state 5-33
- inbound message handling 5-40
- Inbound Transparent Transmission 4-4
- Inbound Transmissions 1-52
- indicator codes A-1-A-18
- information (I) frame 5-63
- initial status 5-50, 5-51, 5-52
- INOP 1-52
- Insert Cursor order 1-14, 1-35
- Integrated Communications Adapter 4-1
- interface codes 1-4-1-10 (Figs. 1-3-1-8)
- interface codes for buffer addresses (Appendix J) J-1
- interface operations (local) 3-1

- Katakana
 - interface codes E-2, E-3
 - I/O interface codes for APL/Text D-6, D-7
 - shift keys (3278) E-4
 - shift operations E-1
 - unique information E-1
- key functions (Appendix C) C-1-C-20
- key generation, encrypt/decrypt F-1
- key management, encrypt/decrypt F-1
- keyboard functions C-2, C-3
- keyboard types C-2

- line formatting 2-21
- Link Test Statistics (RECFMS) G-1
- Load Programmed Symbols (LPS) 1-26
- loading printer matrix 2-37
- local attachment 3-1
- local control units (non-SNA) 3-1
- local copy function 2-32
- local copy function with BSC 2-43
- local copy with APL/Text D-13

- local operations (non-SNA) 3-1, 3-2
- logical unit status (LUSTAT) 5-72
- LU status (LUSTAT) 5-16
- LU type 1 5-21
- LU type 2 5-21
- LU type 2 screen size Bind 1-21
- LU type 3 1-23, 5-21
- LU type 3 Bind format 1-24
- LU-LU error reporting 5-36
- LU-LU sessions, types of 5-3
- LUSTAT 5-72
- LUSTAT inbound 5-31

- magnetic hand scanner (MHS) H-7-H-19
- magnetic slot reader (MSR) H-7-H-19
- magnetic-stripe reading devices H-4-H-6
- master station 4-3
- matrix structure 2-35
- message handling 5-39, 5-40
- message response 4-16 (Fig. 4-3)
- MF order 1-14, 1-37
- mode transitions 2-40
- Modify Field (MF) order 1-14, 1-37
- multipoint data link mode 4-1

- NAK (negative acknowledge) 4-8
- National Use differences for APL/Text D-5
- New Line (NL) 2-23
- No Operation command 1-59, 1-66
- nonsequenced acknowledgment 5-62
- nonswitched line data link control 6-2
- Normal Read state 1-53
- Numeric Lock feature C-17

- OAF 5-6
- operational sequences (BSC) 4-10
- operator identification card reader H-22
- operator-initiated copy 2-45
- operator symbols (Appendix B) B-1-B-19
- Orders 1-14, 1-33-1-38
- outbound message handling 5-39

- spacing 5-20
- page length control 2-25
- Pending Begin Bracket state 5-32
- PLU (primary logical unit) 5-2
- poll sequences 4-11
- primary logical unit 5-2
- print classes 2-34, 2-35
- Print key 2-43, 2-45
- print line length 2-21
- Printer Authorization Matrix 2-32-2-42
- Printer Authorization Matrix structure 2-34-2-36
- printer class structure 2-34
- printer control (SNA) 5-42
- printer error conditions 2-52
- printer formatting 2-32
- printer local mode 2-33
- printer matrix
 - defining 2-35, 2-36
 - device descriptors 2-38
 - loading 2-37
 - screen format 2-38
- printer model-dependent differences 2-53
- printer Mono/Dual Case control 2-50
- Printer mode 2-33
- Printer Not Assigned condition 2-48
- Printer Not Functional condition 2-48

- printer orders 2-21
- printer selection 2-43
- printer shared mode 2-34
- Printer Status symbols 2-40
- printer System mode 2-34
- printer types 2-20
- printout operations 2-24, 2-26
- Program Attention switch 2-31
- Program Tab order 1-14, 1-35
- programmed cryptographic facility F-1
- programmed symbol set 2-12
- protected attribute 2-7
- protected messages 1-68

- Query Reply Structured Fields 1-46–1-52

- RCV (receive) state 5-31
- Read Buffer command 1-41
- Read CCW sequence 5-56
- Read Command processing 1-55
- read heading 1-43
- Read Modified command 1-43
- Read Modified All command 1-46
- Read Partition-Query processing 1-58
- Read states 1-53
- Read State transitions 1-54
- Read type command sequences 4-21–4-26
- Ready to Receive (RTR) 5-16
- Receive state 5-31
- recovery from error conditions A-1–A-18
- redundancy checking 4-6
- remote chaining (BSC) 4-11
- remote control unit and device addressing 4-14, 4-15
- remote operations
 - BSC 4-1
 - BSC channel programs 4-1
 - SDLC 5-60
- Repeat to Address order 1-14, 1-36
- request/response
 - header 5-2
 - unit 5-2
- required cryptographic sessions F-2
- Reset/Active state 5-29
- Restart Reset command 5-59
- Retry States 1-53
- reverse video 2-17
- RH (request/response header) 5-2
- RTR 5-16
- RU category 5-6
- RU lengths 5-33
- RU (request/response unit) 5-2
- RVI to selection addressing sequence 4-30

- SA order 1-15, 1-38
- screen size, setting 5-38
- SCS (SNA character string) control codes 2-27
- SCS Data structured field 1-31
- SDLC station address 5-63
- SDT 5-14
- Secondary colors 2-15
- secondary logical units 5-2
- secondary LU key F-2, F-3
- Security keylock 1-70, 2-20
- segmenting
 - inbound 5-35
 - outbound 5-34
- Select command 1-59, 1-63–1-65
- Select RB command 1-64
- Select RBP command 1-65
- Select RM command 1-64
- Select RMP command 1-64
- Select WRT command 1-65
- selecting control units 3-1
- selecting print classes 2-33, 2-34
- selection addressing 4-17, 4-18
- selection addressing sequence 4-17
- Selection (local ops) 3-3
- selective cryptographic sessions F-2
- selector-light-pen operations H-1
- Send state 5-30
- sense bit description 1-66, 1-67
- sense bits, abbreviations for 5-12
- sense codes (SNA) 5-67
- Sense command 1-66
- Sense conditions 5-7 (Fig. 5-6)
- Sense ID command 1-66
- sequence error recovery procedures 5-64
- session processing states 5-29
- Set Attribute (SA) order 1-15, 1-38
- Set Buffer Address order 1-14, 1-33
- Set Normal Response 5-62
- setting screen size 1-19–1-25
- SF order 1-14, 1-33
- SFE order 1-14, 1-37
- shared mode 7-39
- short read 1-45
- Shutdown 5-17
- Shutdown command 5-5
- Shutdown Complete 5-17
- Signal 5-16
- signal from host 5-26
- Single-plane symbol set 2-14
- slave station 4-3
- SLU 5-2
- SNA
 - Bind command 5-10
 - character string for printers 2-20, 2-26–2-31
 - commands 5-8
 - commands received 5-20 (Fig. 5-5)
 - commands sent 5-20 (Fig. 5-6)
 - commands, types of 5-7–5-20
 - local control units 3-1
 - printer control 5-42
 - reference data 5-65
 - responses 5-22
 - sense codes 5-67
 - sessions 5-2, 5-3
 - source device list 2-35
 - Specific Poll sequence 4-11, 4-12, 4-14
 - split vertical (¶) character 2-54
 - SRM structured field 1-30
 - SSCP 5-2, 5-3
 - SSCP-PU session 5-3
 - SSCP-Secondary LU session 5-3
 - SSCP-SLU contention 5-38
 - start data traffic 5-14
 - Start Field Extended (SFE) order 1-14, 1-37
 - Start Field order 1-14, 1-33
 - Start I/O Fast Release 3-8
 - Status and Sense bytes 4-21, 4-24, 4-25
 - Status and Sense conditions (Remote BSC) 4-28
 - status bits, abbreviations for 3-7
 - Status byte generation 3-5, 3-6
 - Status Indicator Codes (Appendix A) A-1–A-18

- Structured Field functions 1-25, 1-26
- Structured Field orders 1-37
- SUB character 1-41
- Summary Counters (RECFMS) G-1
- Suppress Index (SI) 2-23
- symbol set attribute type 2-11
- sync check error 2-52
- system logoff 5-41
- system logon 5-40, 5-41
- System mode 2-34, 5-42
- System Services Control Point (SSCP) 5-3
- tab stop C-4
- terminal ID 5-63
- terminal identification and addressing 5-63
- terminal master key F-1, F-4
- terminal master key verification F-4
- terminating LU-LU session 5-5
- test command/response 5-62
- test request function 1-67
- test request read 1-45
- test request read heading 1-45
- text blocking 4-1, 4-5
- text mode 4-3
- text print
 - data streams (APL/Text) D-2
 - I/O interface codes D-7
- TH (transmission header) 5-2
- timeout controls 5-64
- transmission formats, SNA/SDLC 5-1-5-4
- transmission header 5-2, 5-6
- transparent mode 4-3
- transparent monitor mode 4-3
- tributary stations 4-2
- triple-plane symbol set 2-14
- type 1 LU-LU session 5-3
- type 2 LU-LU session 5-3
- type 3 LU-LU session 5-3
- typewriter/APL keyboard D-9
- typewriter/text keyboard D-11
- Unbind 5-13
- unformatted displays 2-2
- usable area 1-48
- uppercase and lowercase printouts 2-53
- Vertical Forms Control (VFC) 2-25
- Write Control Character (WCC) 1-16, 1-17
- World Trade considerations for APL keyboard D-10
- Write CCW sequence 5-56
- Write commands 1-15, 1-16-1-25
- Write commands (LU type 3) 1-23
- Write-type command sequences 4-17-4-21
- WSF Command 1-25
- XID 5-62, 5-63
- X.21 Host Load Matrix key 2-37
- X.21 Switched Network Adapter feature
 - Call Progress signals I-8
 - control unit/terminal responses I-6
 - Dial-In state I-4
 - extension mode I-3
 - functions I-1
 - inquiry facility I-9
 - keys and indicators I-2, I-3
 - Ready state I-4
- 87-key typewriter/APL keyboard D-9
- 87-key typewriter/text keyboard D-11
- 88-key Katakana typewriter/APL keyboard D-10



Technical Newsletter

This Newsletter No. GN31-1135

Date 7 Apr 1982

Base Publication No. GA23-0061-0

File No. S360/S370/S3/4300

Previous Newsletters GN31-1318

**IBM 3270 Information Display System:
3274 Control Unit Description and Programmer's Guide**

© Copyright IBM Corp. 1980

This Technical Newsletter provides replacement pages for the subject publication. The pages to be inserted and/or removed are:

iii through vi	2-13, 2-14
1-1 through 1-4	2-19 through 2-24
1-4.1 (added), blank	2-24.1 (added), blank
1-5, 1-6	5-1, 5-2
1-15, 1-16	5-9, 5-10
1-25, 1-26	5-13, 5-14
1-35, 1-36	A-7, A-8
1-47 through 1-52	A-17, A-18
1-52.1 (added), blank	B-17, B-18
1-63 through 1-66	

A change to the text or to an illustration is indicated by a vertical line to the left of the change.

Summary of Amendments

This Technical Newsletter provides changes to previous information and adds the IBM 3230 and IBM 3268 Printers Model 2 to the devices that can be attached to the 3274 Control Unit.

Note: Please file this cover letter at the back of the manual to provide a record of changes.



Technical Newsletter

This Newsletter No. GN31-1318
Date 3 April 1981
Base Publication No. GA23-0061-0
File No. S360/S370/S3/4300/8100-09
Previous Newsletters None

**IBM 3270 Information Display System:
3274 Control Unit Description and Programmer's Guide**
© Copyright International Business Machines Corporation 1980

This Technical Newsletter provides replacement pages for the subject publication. Pages to be replaced are:

iii through x	1-49, 1-50	5-43 through 5-60
1-1 through 1-4	1-59 through 1-70	A-5 through A-8
1-7, 1-8	2-19 through 2-22	A-11 through A-16
1-11 through 1-14	2-31, 2-32	B-1, B-2
1-19, 1-20	2-47 through 2-52	B-5 through B-8
1-25 through 1-26.3	3-1 through 3-14	D-1, D-2
1-31, 1-32	4-1 through 4-4	
1-43 through 1-46	5-35, 5-36	

A change to the text or to an illustration is indicated by a vertical line to the left of the change.

Summary of Amendments

This Technical Newsletter provides technical and editorial changes to previous information, adds a description of the 3270DS structured field, and notes, where appropriate, the 3274 Control Unit Models 21A, 21B, 21C, 21D, 31A, 31C and 31D.

Note: *Please file this cover letter at the back of the publication to provide a record of changes.*

IBM 3270 Information Display System
3274 Control Unit
Description and Programmer's Guide

READER'S
COMMENT
FORM

Order No. GA23-0061-0

This manual is part of a library that serves as a reference source for systems analysts, programmers, and operators of IBM systems. This form may be used to communicate your views about this publication. They will be sent to the author's department for whatever review and action, if any, are deemed appropriate. Comments may be written in your own language; use of English is not required.

IBM may use or distribute any of the information you supply in any way it believes appropriate without incurring any obligation whatever. You may, of course, continue to use the information you supply.

Note: Copies of IBM publications are not stocked at the location to which this form is addressed. Please direct any requests for copies of publications, or for assistance in using your IBM system, to your IBM representative or to the IBM branch office serving your locality.

How did you use this publication?

- | | | | |
|--------------------------|-------------------------------------|--------------------------|------------------------|
| <input type="checkbox"/> | As an introduction | <input type="checkbox"/> | As a text (student) |
| <input type="checkbox"/> | As a reference manual | <input type="checkbox"/> | As a text (instructor) |
| <input type="checkbox"/> | For another purpose (explain) _____ | | |

Is there anything you especially like or dislike about the organization, presentation, or writing in this manual? Helpful comments include general usefulness of the book; possible additions, deletions, and clarifications; specific errors and omissions:

Page Number:

Comment:

What is your occupation? _____

Newsletter number of latest Technical Newsletter (if any) concerning this publication: _____

If you wish a reply, give your name and address:

IBM branch office serving you _____

Thank you for your cooperation. No postage stamp necessary if mailed in the U.S.A. (Elsewhere, an IBM office or representative will be happy to forward your comments or you may mail directly to the address in the Edition Notice on the back of the title page.)

NOTE: Staples can cause problems with automated mail sorting equipment. Please use pressure sensitive or other gummed tape to seal this form.

Reader's Comment Form

Cut or Fold Along Line

Fold and tape

Please Do Not Staple

Fold and tape



NO POSTAGE
NECESSARY
IF MAILED
IN THE
UNITED STATES

BUSINESS REPLY MAIL
FIRST CLASS PERMIT NO. 40 ARMONK, N.Y.

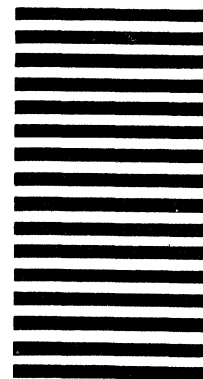

POSTAGE WILL BE PAID BY ADDRESSEE:

International Business Machines Corporation
Department 52Q
Neighborhood Road
Kingston, New York 12401

Fold and tape

Please Do Not Staple

Fold and tape





International Business Machines Corporation
Data Processing Division
1133 Westchester Avenue, White Plains, N.Y. 10604

IBM World Trade Americas/Far East Corporation
Town of Mount Pleasant, Route 9, North Tarrytown, N.Y., U.S.A. 10591

IBM World Trade Europe/Middle East/Africa Corporation
360 Hamilton Avenue, White Plains, N.Y., U.S.A. 10601