

GA27-2742-1

Systems

**Operator's Guide for
IBM 3270 Information
Display Systems**

IBM

Second Edition (July, 1972)

This is a major revision of GA27-2742-0 and incorporates Technical Newsletter GN31-3001. Operating instructions for the printer and operator identification card reader have been added. Comments and corrections have been incorporated throughout the manual.

Any system changes affecting this publication will be reported in subsequent revisions or Technical Newsletters. Additional copies of this manual can be obtained through IBM branch offices.

Text for this publication has been prepared with the IBM SELECTRIC® Composer.

A form is provided at the back of this publication for reader's comments. If the form has been removed, comments may be addressed to: IBM Systems Development Division, Product Publications, Dept. 520, Neighborhood Road, Kingston, N.Y., 12401

© Copyright International Business Machines Corporation, 1971, 1972

Table of Contents

First Words to the Operator	1
Quick Reference	3
Operating the 3270*	4
Introduction to Display Station Operation	5
Operator Controls	7, 8
The Display Image	8
Indicators	15–19
Keyboards	20
Typewriter Keyboard*	24
Data Entry Keyboard*	44
Operator Console Keyboard*	62
Printer Operation*	76
Operator Identification	
Card Reader	88
A Typical Job	90
Correcting Operator Errors	90
Trouble with Your Machine	92
Operator Trouble Report	92
Extras for the 3270*	100
Selector Pen	101
Security Key Lock	105
Audible Alarm	106
Numeric Lock Feature	109
Understanding the 3270*	110
Data Processing	111
Display Stations	114
The IBM 3270 Information Display System	115
Index	119

*The complete table of contents for each section is on the first page of that section.

Operator's Notes

We'd Like Your Opinion

IBM will welcome your comments on this manual, both favorable and unfavorable. Your name and address are needed for those cases where we will want to reply.

So, why not let us know what you think of this book. The pre-stamped, pre-addressed Reader's Comment Form at the back is your communications link with the author. Write your comments on the form and drop it in the mail.

As a 3270 Information Display System operator you may operate display stations, selector pens, or operator identification card readers, depending on the equipment needs of your organization. You may also be required to monitor the operation of printer units. The purpose of this manual is to help you prepare for these various operating tasks.

Readers of this manual need no previous knowledge of computers, display system equipment, or data processing. General background information is provided to introduce you to data processing and computers. If you have no experience in this area, begin by reading the section entitled "Understanding the 3270"; it is the section at the back of the book that has black-tabbed pages. With the knowledge gained there, you should have no trouble with the section titled "Operating the 3270". If you are already an operator, you may find this book helpful as a reference source.

Operator controls, indicators, and keys for all models of 3270 display stations, keyboards, and printers are discussed in detail along with typical operating and error recovery procedures.

In this book.

.You will find operating instructions and operating tips for the versatile IBM 3270 family of display stations.

.You will take your first steps on the road to an interesting and rewarding career opportunity.

If you are going to operate a display station, you will find instructions beginning on page 5.

If you are interested in printer operations, refer to page 76.

Instructions for using the operator identification card reader are given on page 88.

Selector pen operation is described on page 101.

Operator's Notes

We'd Like Your Opinion

IBM will welcome your comments on this manual, both favorable and unfavorable. Your name and address are needed for those cases where we will want to reply.

So, why not let us know what you think of this book. The pre-stamped, pre-addressed Reader's Comment Form at the back is your communications link with the author. Write your comments on the form and drop it in the mail.

POWER SWITCH

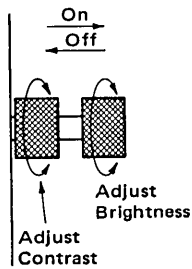

INDICATORS

**SYSTEM AVAILABLE
INPUT INHIBITED**

System will accept data or signals from your display station. Turns on if you:

1. Attempt to change protected data.
2. Attempt two input operations at the same time (card reader, selector pen, keyboard).
3. Insert too many characters into a field (Insert Mode).
4. Press CLEAR, ENTER, TEST REQ, or any PA or PF key. Turn off with RESET key.

INSERT MODE

Insert characters into displayed data. Turn on with INS MODE key. Turn off with RESET key.

SYSTEM READY

Your display station is ready to communicate with the system.

SYNC SEARCH

Your display station is available for selection by the computer.

**SELECTED
STATUS**

Your display station is selected by the computer.

Your display station is giving the computer its status (usually error status).

TRANSMIT

Your display station is transmitting to the computer (over telephone lines.)

KEYBOARD

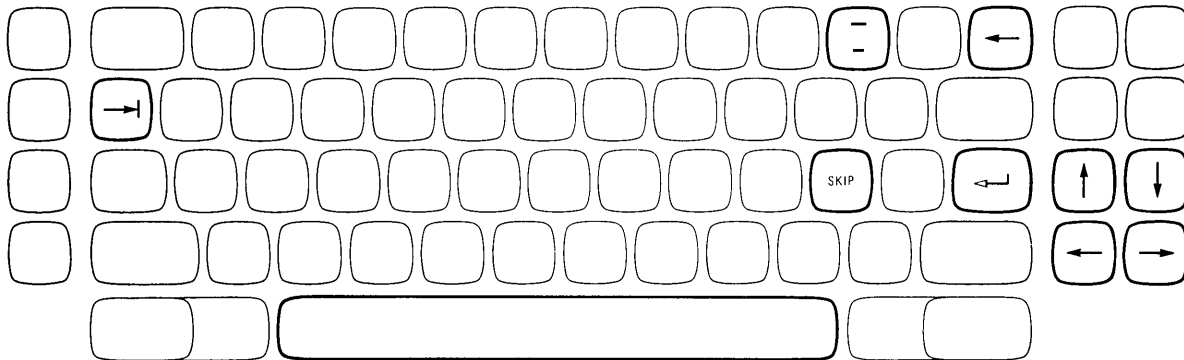

Typamatic keys repeat their function when held down.

- CLEAR** Blanks all of screen and positions cursor in upper left.
- ERASE INPUT** Blanks all input fields on your screen.
- ERASE EOF** Blanks from cursor to end of field.
- INS MODE** Inserts character(s) into displayed data.
- DEL** Removes character(s) from displayed data.
- TEST REQ** Calls for testing by the program.

- Tab
- ← New Line
- ↑ Move cursor up
- ↓ Move cursor down
- ← Move cursor left
- Move cursor right

SOMETHING IS WRONG

Is this it? Have you tried this?

Display Station won't turn on.

Make sure the power cord is plugged into the wall outlet.

No clicks when keys are pressed.

Is INPUT INHIBITED indicator off? RESET key turns it off.

For more information on troubles, see page 92.

Table of Contents

Introduction to Display Station Operation	5
Power (OFF-PUSH) Switch	7
Brightness Control	8
Contrast Control	8
The Display Image	8
Fields and Formatted Displays	10
Input Fields	11
Numeric Fields, Data Entry Application	11
High-Intensity Data	12
Protected Data	12
Cursor	13
Cursor Wrap	14
Common Indicators	15
SYSTEM AVAILABLE	15
INSERT MODE	16
INPUT INHIBITED	16
3275 Indicators	18
SYSTEM READY	18
SYNC SEARCH	19
SELECTED	19
TRANSMIT	19
STATUS	19
Keyboards	20
Typewriter Keyboard (contents)	24
Data Entry Keyboard (contents)	44
Operator Console Keyboard (contents)	62
A Typical Job	90
Correction of Operator Errors	90
Trouble with Your Machine	92
Operator's Trouble Report	92

INTRODUCTION TO DISPLAY
STATION OPERATION

If possible, sit at a display station as you read this part of the book so that you can use the switches and keys as you read about them. By doing this, you can more quickly become a skillful 3270 operator. If your display station has a keyboard attached and if some point is not clear as you read, pause for a moment to press the key and watch the result. Keep in mind, however, that the purpose of some of the control keys is to notify the computer that your display station requires service by the program. Pressing any of these keys when the System is ready (SYSTEM AVAILABLE indicator is on) interrupts the program. In case you do not have a keyboard provided with your display station, you'll only be required to make initial adjustments to the display station (as explained in this section).

If your organization has what is called a sign-on procedure and your display station is not signed-on, you can press any key without affecting the program or the computer. A sign-on procedure allows the program to ignore any interrupts received from an unsigned-on display station.

There are many variations of the three basic types of 3270 display stations shown in Figure 1 on page 6. Operating procedures are similar even though screen sizes and appearances of some of the units are slightly different.

The only difference between the two upper displays is that the larger screen holds four times as many characters as the small one. Their indicators and controls are the same, and display station operation is identical.

The labels located to the right of the screen are indicator names. Display stations like the two top ones in Figure 1 have no lights associated with these names. An area of the screen directly beside each of the three labels displays a bright square as an indication of the associated condition.

The combination power on/off and brightness/contrast control switch is located near the screen's lower-left corner (labeled OFF-PUSH). The brightness/contrast control feature of the switch allows you to adjust the display intensity to a comfortable viewing level.

3275 display stations like the bottom one handle their own communications with the computer, usually over telephone lines. They have eight indicators and use small lights to indicate the conditions. Three of these indicators are identical, in name and purpose, with the three on all the other display stations. The other five indicators have been added to tell the operator of the communications as they are taking place. When the indicators are discussed, the three common ones will be presented first, followed by the five that are used only on displays like the one on the bottom.

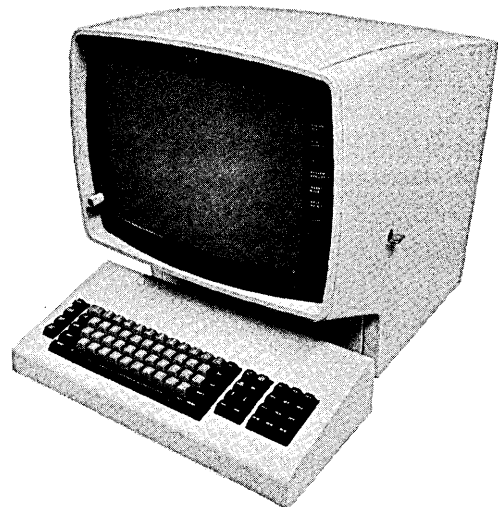
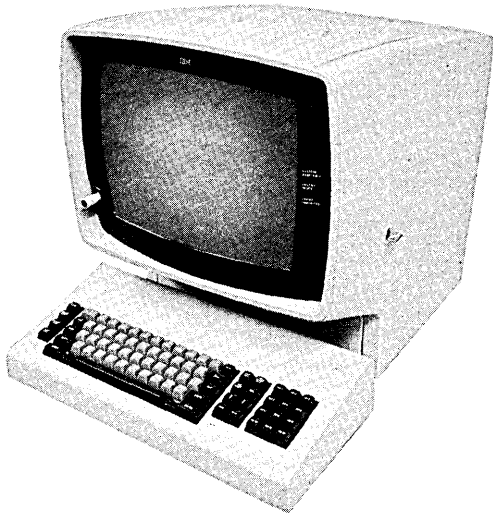

Figure 1. There are three basic types of 3270 display stations.

We will begin by turning on power. We will then proceed from adjusting and interpreting the display image, through explaining the indicators, and, if your display station uses a keyboard, to understanding all of the keys on the keyboard.

Pull out the switch labeled OFF-PUSH to apply power to your display station. The red portion, visible at the base of the switch when it is pulled out, is a reminder to turn power off before leaving your display. A delay of a few seconds is built in to allow the machine to warm up. After this delay, a short horizontal bar will appear in the upper-left portion of the screen (in the first character position on line one).

When you are ready to turn off your display station, just push the switch back in.

Power (OFF-PUSH) Switch

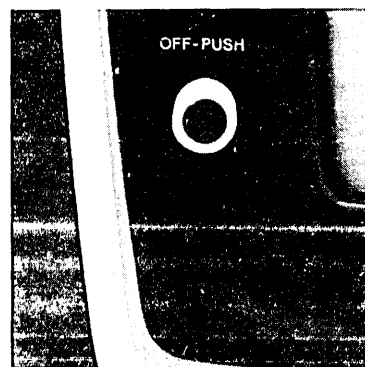

Figure 2. When the horizontal bar appears, your display station is warmed up and ready to operate.

Brightness Control

You can adjust the brightness of the characters displayed on the screen by turning the outer control knob of the switch labeled OFF-PUSH to the left or to the right. Turning it to the right makes the display image brighter; to the left, dimmer. There is no correct setting for the brightness of the image. Experiment with this control until you find the setting that is most convenient and comfortable for your viewing.

Contrast Control

The contrast control is another aid in adjusting your display for comfortable viewing. If your organization uses two intensity levels to display characters (explained on page 12, under the heading "High Intensity Data"), the contrast control varies the difference between these two levels. (The contrast control is the inner control knob on the OFF-PUSH switch.) As with the brightness control, there is no correct setting of the contrast control; you must experiment until you find the contrast level that satisfies you.

The Display Image

If your display station does not have a keyboard or selector pen attached, you simply apply power with the OFF-PUSH switch and adjust the brightness/contrast controls to make the unit ready for operation. From this point on, operation is controlled by the program, and you may only monitor information displayed on the screen. If you do not have a keyboard, you should now read about the indicators on your display station (as described starting on page 15 under the title "Common Indicators"). If you do not have a keyboard but have a selector pen attached to your display station, read about the indicators on page 15, and then refer to page 101 for a description of selector pen operation. If you have a display station with a keyboard, continue reading this section.

Before we talk about the keyboard, there are some things you should know about what you can expect to see on your display screen.

As we have said before, the 3270 Information Display System can be used by many different organizations, all with very different kinds of jobs to be done. Even within one organization, there are many different applications for 3270 display systems. Today's computers are capable of processing many different jobs at the same time. Therefore, it is possible that you could be working on one job while the operator next to you is doing

completely different and unrelated work. The image on your two screens would probably be completely different.

Figure 3 is a typical display image; you will be referred to this image in some of the discussions that follow. Keep in mind that this example is only one of many possible display images. Your organization may not even require this type of image. The references made to it, however, apply to all images.

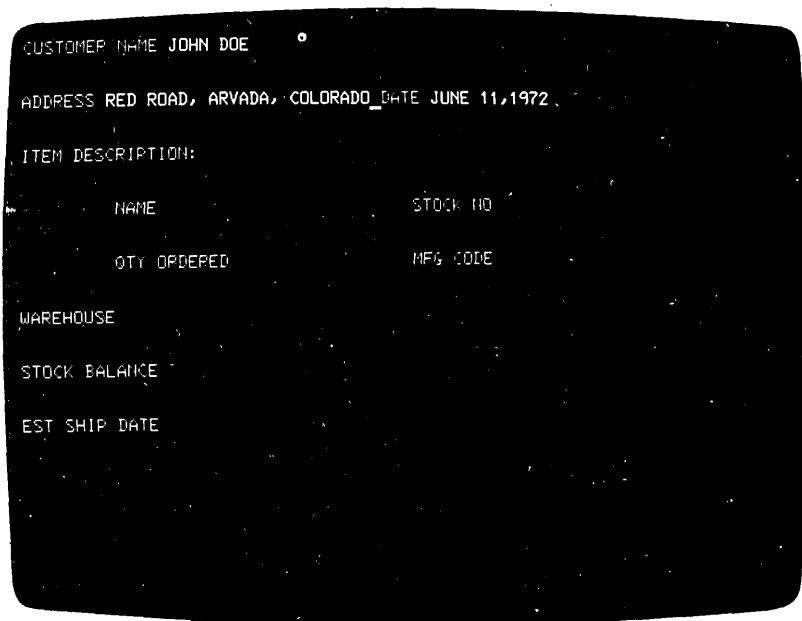

Figure 3. The image on your screen might look like this.

As you can see, the display image looks much like information typed on a sheet of paper. Notice, too, that the organization and content of this form are no different from the organization and content of handwritten and hand-processed documents. The same type of information is always recorded in the same areas. This is true of all documents, as can be seen by examining the arrangement of a standard bank check.

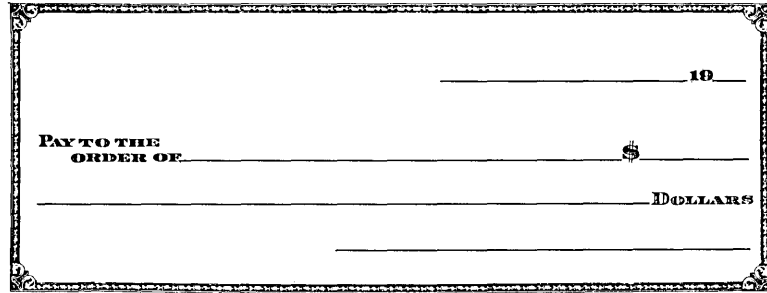

Figure 4. Bank checks have a standard arrangement.

The upper right portion is usually reserved for the date. The center is for the name of the party to whom the check is made payable and the amount of the check. The lower right portion usually contains the space for the signature of the person writing the check.

Fields and Formatted Displays

The various areas of bank checks that always contain the same type of information or data are called "fields" in data-processing language, for example, the "date" field, or the "signature" field. Most documents to be entered into a computing system will be organized by fields.

This practice of standardizing the arrangement of data originated because the person using the information could do his job much faster knowing that one type of data would appear at the same location on every document.

When a display station screen is divided into fields, it makes working with the display station quicker and easier for both the display station operator and the computer program. The application program divides the screen into fields and establishes the rules as to what each field will contain. The program then knows that the same type of information will always be displayed in the same location. Knowing this, the program can process the data from the screen much quicker. The operator can also perform her job more efficiently having this information.

When a screen is divided into fields, it is known as a formatted screen. A screen that the program has not divided into fields is known as an unformatted screen. Each job that you work on could use a different format or none at all; therefore, you may be working with both formatted and unformatted screens.

Input Fields

You will see basically two types of fields on your screen. One is primarily for the use of the program; you cannot key data into this type of field. All of your entries will be into the other type. For this reason, in the remainder of this manual, fields that you can key data into will be referred to as input fields or input areas. Each application program User's Guide will tell you which are the input fields for that particular job.

Once a field is assigned to one type of data in a job, those character positions should not be used for other data items in that job. For example, one field on the screen in Figure 3 is called "Stock No.". That is the only type of information you will key into it. You will not, for instance, key the digits of a "Mfg Code" number into the "Stock No." field. (Otherwise, the display station keyboard will stop functioning or a message will appear on the screen telling you of the error.)

There is no rule stating that fields must always be a certain length or that there will always be the same number of fields on the screen. The length of a field is normally arrived at by determining, from the type of information which will be entered in the field, the longest possible length of one entry. In many cases, this is known. For example, all Stock numbers could be the same length, 9 digits; therefore, the field for Stock numbers is 9 character spaces long. When the maximum length is not known, as in a field marked for customer name, maximum length must be estimated by some method, and the field length must be set from that estimate.

The number and names of fields that you will see on your screen will depend on the job you are doing and the application program that is operating in the computer.

Numeric Fields Date Entry Application

Fields that normally contain only numbers (Stock number, manufacturer's code number, etc.) are known as Numeric fields. Such fields are used in organizations whose jobs are largely of the data-entry type.

Rapid entry of numeric data is made possible by using a Data Entry keyboard (described on page 45). When your screen is formatted, the Data Entry keyboard automatically shifts to Numeric Mode when the cursor enters a numeric field. Therefore, if you have a Data Entry keyboard, numeric fields help to increase your operating speed.

The Program User's Guide for the program that you're working with designates which are the numeric fields.

Figure 3 shows two other features of the 3270 which you can expect to see often. The most apparent of these is called "High-Intensity Data".

High-Intensity Data

This feature of the 3270 allows the display of fields (selected by the application program) at a brighter than normal intensity. Use of this feature makes the high-intensity data stand out from the other data displayed on the screen. Many companies make effective use of this feature by displaying the field names at normal intensity and the operator-keyed data at high intensity.

Protected Data

Not quite so obvious in Figure 3 are the protected data fields. They are the fields displayed at low intensity. We mentioned before that, in most jobs, there will be some areas on the screen where you won't be able to type. You won't be able to change field names (titles), for instance. In Figure 3, "Stock No." is a field name and would probably be protected data.

The protected data feature aids your operation because you don't have to worry about making a mistake and destroying part of the data on your screen. The INPUT INHIBITED indicator will come on if you attempt to change (type over, erase, insert, or delete characters) any data in a protected field.

The blank field directly following "Stock No." is the unprotected stock number input field. You would key stock numbers from your source document into this unprotected area.

The Program User's Guide for the program that you're working with designates which fields on the screen contain protected data and which are your input areas.

Cursor

The cursor is probably the most important characteristic for you to understand when working with the image. You'll find that the flexibility of the cursor makes operating the 3270 much easier and more enjoyable than operating a typewriter or a keypunch. One advantage of the 3270 is that the complete document you are working with is always in full view; another is that moving the cursor is easier and faster than repositioning the carriage of a typewriter or transporting the card in a keypunch.

The cursor appears on the screen as an underline to the character position in which it is located.

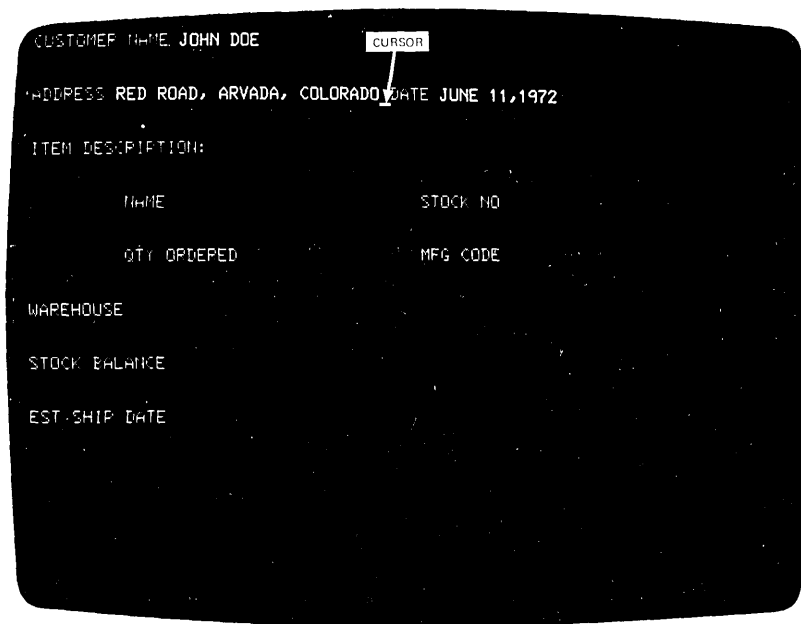

Figure 5. The cursor looks like an underscore.

That's right; it was the cursor that appeared on your screen when you turned power on. It marks the position on the screen that the next character entered from the keyboard will occupy. It may be moved about freely on the screen, using certain keyboard control keys, without interfering with other characters. You will also notice, when entering characters from the keyboard, that the cursor moves to the right one space as each character is entered.

You may see the cursor apparently changing locations by itself. However, it can be moved about on your screen by the computer program, and when the cursor appears to be moving by itself the program is repositioning it for you.

Cursor Wrap

The cursor control keys are located on the keyboard and described in the keyboard sections. They move the cursor in either the horizontal (left or right) or vertical (up or down) direction on the display station screen. If you hold down the control key that moves the cursor to the right, the cursor will move off the right side of the face of the screen and will reappear one line lower on the left side. This is called cursor wrap. In effect, the cursor wraps around behind the screen. It also wraps when moved to the left, and it will reappear one line higher on the right side of the screen.

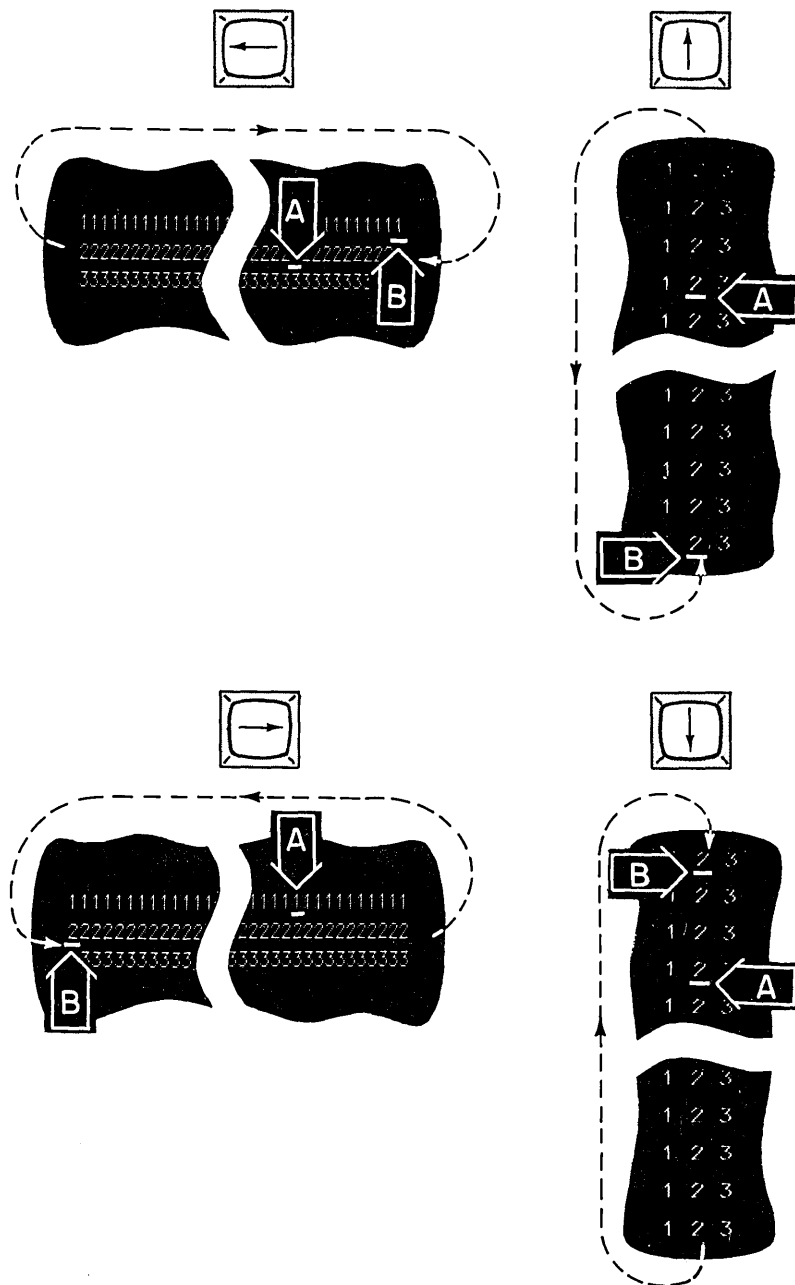

Figure 6. The cursor wraps when you move it off any edge of the screen.

Cursor wrap also occurs when the cursor is moved up or down. Notice that, in these cases, the cursor reappears in the same character position (on the opposite edge of the screen) that it occupied before moving off the screen; there is no shift left or right. In the examples in Figure 6, pressing and holding the indicated keys when the cursor is located at A moves the cursor to B.

Let's investigate the display station indicators. You already know that they are located to the right of the screen on the face of the display. As you will see, their names alone describe their functions quite well.

SYSTEM AVAILABLE, INSERT MODE, and INPUT INHIBITED are on all display stations. No matter which display station you have, the purpose and meaning of each of these indicators are always the same.

The SYSTEM AVAILABLE indicator, on or off, will not greatly affect the local operation of your display station. It is only an indication that the program in the computer is running and, if your display station has an attached keyboard or selector pen, that it will accept interruptions from your machine. If the indicator is not on, the keys that depend on the program to accomplish their function will not be effective. In fact, if you press one of these keys when the system is "not available", the INPUT INHIBITED indicator will come on and data from your keyboard will not be accepted. The RESET key (described later in the "Keyboard" sections) will reset this condition and turn off the INPUT INHIBITED indicator.

Common Indicators

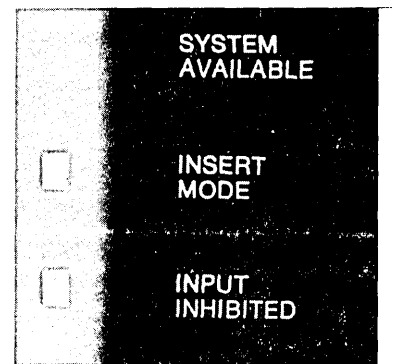

SYSTEM AVAILABLE Indicator

INSERT MODE Indicator

The INSERT MODE indicator applies only to display stations with keyboards. It tells you that your machine is in Insert Mode. It comes on when you press the INS MODE key. To turn it off, press the RESET key on the keyboard.

Insert Mode allows you to insert a character, or characters, into an existing line on your screen without destroying any of the data already there. The new characters are inserted at the cursor location, and the data to the right of that location is shifted right one character position for each character inserted. Later, when you read the discussion for the INS MODE key in your keyboard section, more details and an example of an Insert Mode operation will be presented.

INPUT INHIBITED Indicator

The INPUT INHIBITED indicator tells you that all of the input devices on your display station are disabled. You cannot key any data from your keyboard or, if you have a Selector Pen, you cannot select any items with it. If a display station is installed without a keyboard, selector pen, or operator identification card reader, the INPUT INHIBITED indicator will light only under program control. Before explaining the conditions that cause a display station's input devices to be inhibited, we will discuss the way in which your keyboard is disabled.

There is no mechanical keyboard lock associated with preventing the use of the keyboard, such as there is on keypunch keyboards. That is, when input is inhibited, the keys on your keyboard are not physically locked in one position; you can still press them down normally. On your display station, when input is inhibited, the keyboard's electrical circuits (triggered by pressing the keys) are deactivated, and the click that you normally hear when any key is pressed stops. The result is like pressing the keys when your display station is turned off; they go down, but nothing happens.

The reasons why the INPUT INHIBITED indicator will come on are:

1. If you attempt to change, in any way, the data contained in a protected field, INPUT INHIBITED will turn on and your keyboard will be disabled.

2. To communicate between your display station and the computer program, some of the keys on the keyboard will cause signals to be sent directly to the computer. To prevent interruption of these signals, the INPUT INHIBITED indicator turns on when any of the following keys are pressed: CLEAR, ENTER, TEST REQ, and any PA or PF key. The INPUT INHIBITED indicator will also turn on when a selector pen is in use.

Note: The program may or may not turn off INPUT INHIBITED as a result of receiving one of these signals. If it does turn it off, it may do it so quickly you won't realize that it was on. There may be times, however, when the program will be busy and not able to take immediate action on your signal. During these times, INPUT INHIBITED will be on longer.

3. One input operation must be completed before another can begin. If your display station has a selector pen or a card reader, remember that they, like your keyboard, are input devices. If an operation started with one of your input devices is not completed, and if you attempt to input data with one of the other devices, that device will have no effect and the INPUT INHIBITED indicator will turn on.
4. If your display station has the Numeric Lock optional feature, INPUT INHIBITED will turn on if you key a non-numeric character into a formatted numeric field.

To turn off INPUT INHIBITED and activate your input devices, press the RESET key.

3275 Indicators

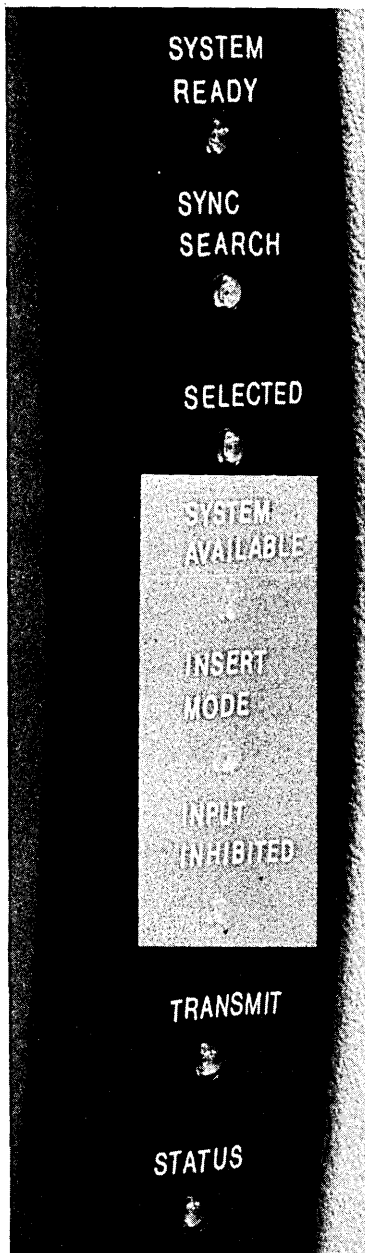

SYSTEM READY Indicator

SYSTEM READY, SYNC SEARCH, SELECTED, TRANSMIT, and STATUS are the five indicators found only on display stations that communicate directly with the computer over telephone lines.

When SYSTEM READY is on, you know that the telephone lines are properly conditioned and that your display station is ready to communicate with the computer.

SYNC SEARCH Indicator

SYNC SEARCH tells you that your display station is available if the computer should want to select it for communication. If a display station is selected and is in the process of displaying information sent to it by the computer, it cannot be selected for further communication until the first task is completed.

SELECTED Indicator

SELECTED is on while your display station is selected by, and is communicating with, the computer.

TRANSMIT Indicator

TRANSMIT comes on when your display station is sending data over telephone lines to the computer.

STATUS Indicator

Your display station must tell the computer when it detects an error; it must inform the computer of its status. The STATUS indicator is on when an equipment problem exists in the display station which is not caused by the operator.

Keyboards

Having a keyboard as part of a 3270 Information Display System is optional. That is, the display station need not have a keyboard at all. However, the majority of 3270 users will want one because applications for a display station without a keyboard are limited. To the operators of the majority of 3270 display stations then, the keyboard will be their main contact with the display station and, through it, with the computer system.

With these things in mind in the discussions that follow, the keyboard has been considered, as the majority of operators will consider it, the heart of their 3270 display station.

The keyboard controls the display station and provides a means of signaling the program. It is through the keyboard that you display data on the display screen.

The 3270 operates like a typewriter but, in several ways, it offers improved performance. Without looking at your keyboard, you can easily find the home-row keys. The F and J keys on typewriter keyboards have a deeper than normal depression on the key face. On data entry keyboards, the three numeric keys on the home row (4, 5, and 6) have this deeper depression. Locating these keys by touch will help your operating speed and reduce your errors.

Typing on the keyboard prints the characters on the screen instead of on paper. This is a great improvement when you have to correct typing errors. Just move the cursor to the error and key in the correct character. You can also easily check anything you have keyed because the whole document is always visible.

Your keyboard contains an adjustment that allows you to hear a click when you press any of the keys. You can control the volume of the click or you can turn it off completely. Generally, the click tells you that your keyboard is operational and that the data you are keying is being accepted. Absence of a click indicates that the keyboard input is inhibited. Therefore, by being aware of the clicking, and of its absence, you can easily tell when the operation of your keyboard is not normal. When operation is not normal, your display station indicators aid you in correcting the problem.

The control for adjusting the volume of the click is located under the keyboard, near the rear left corner. To change the volume of the click, tilt the keyboard forward and turn the adjustment screw counterclockwise to raise the volume or clockwise to lower the volume. Then, reposition the keyboard, and press the keys to check that the volume level is right for your operating environment.

Three major types of keyboards can be attached to the 3270 display station:

1. The Typewriter keyboard, which resembles a standard typewriter keyboard.
2. The Data Entry keyboard, which resembles the IBM keypunch (024-026-029-129) keyboard.
3. The Operator Console keyboard, which resembles the computer operator's keyboard located on the computer itself.

If you are familiar with any of these keyboards, you already know what most of the 3270 keys do. The remainder of this section contains a discussion of each keyboard type. The Typewriter keyboard is presented first, followed by the Data Entry keyboard, and then by the Operator Console keyboard.

There are two versions of Typewriter keyboards because a choice is provided in the selection of special symbols (as explained in the notes on pages 34 and 35).

The main difference that you will notice between the Typewriter and Data Entry keyboards is the location of the numeric keys. On the Typewriter keyboard, they are all on the top row of keys. On the Data Entry (keypunch-type) keyboard, they are placed on all four of the rows around the right-hand home keys.

If your display station is an Operator Console at the computer center, turn to page 59 for the discussion of your keyboard. Otherwise, compare your keyboard with Figures 7 and 8 to determine which discussion you should read next.

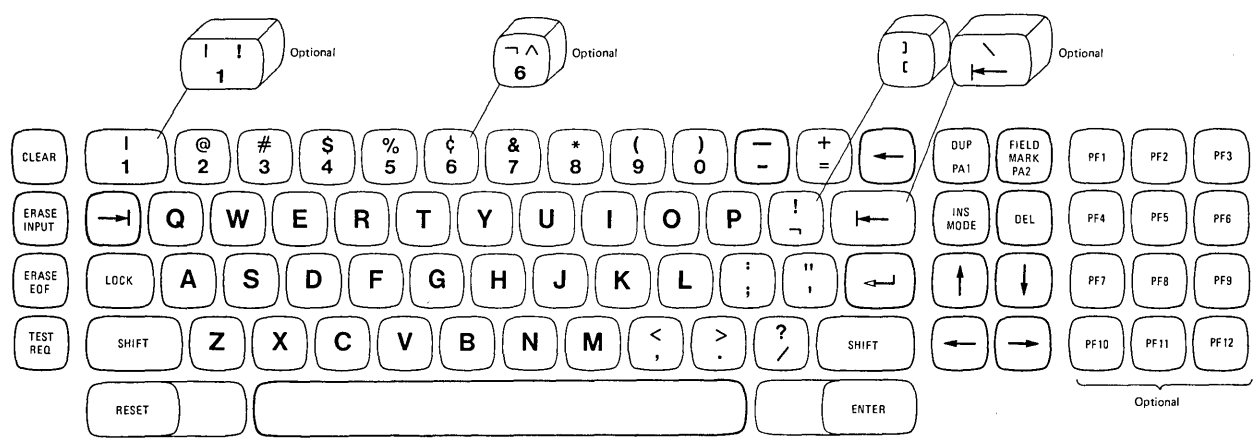

If your keyboard looks like this, turn to page 24.

Figure 7. A Typewriter Keyboard

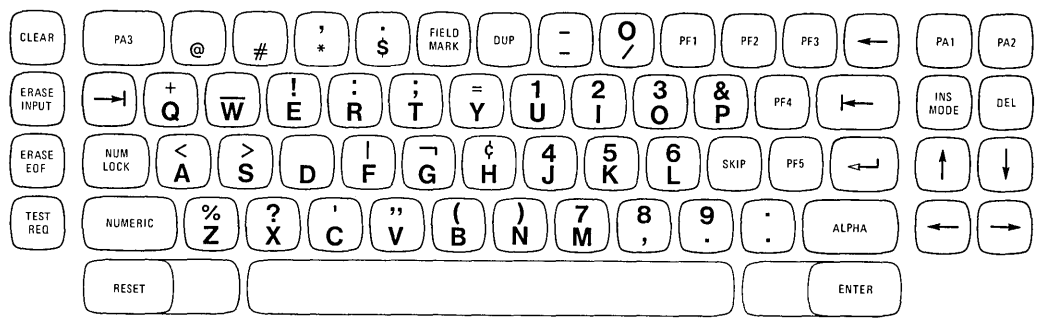

If your keyboard looks like this, turn to page 44.

Figure 8. A Data Entry Keyboard (Keypunch-type)

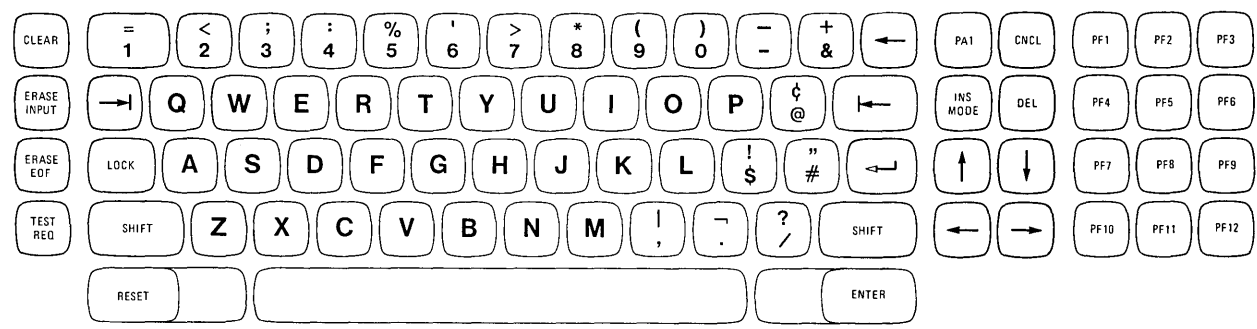

If your keyboard looks like this, turn to page 62.

Figure 9. An Operator Console Keyboard

Operator's Notes



IBM will welcome your comments on this manual, both favorable and unfavorable. Your name and address are needed for those cases where we will want to reply.

So, why not let us know what you think of this book. The pre-stamped, pre-addressed Reader's Comment Form at the back is your communications link with the author. Write your comments on the form and drop it in the mail.

We'd Like Your Opinion

Table of Contents

Introduction	25
Typamatic Keys	26
SHIFT/LOCK Keys	26
Alphabet Keys	27
Space Bar	27
Numeric Keys	28
Cursor Control Keys	28
Moving the Cursor to the Beginning of a Field	29
New Line Key	29
Tab Key	30
Back Tab Key	31
Moving the Cursor One Character Space	32
Horizontal Positioning Keys	32
Vertical Positioning Keys	33
Backspace Key	33
Symbols and Punctuation Marks	34
CLEAR Key	36
ERASE INPUT Key	36
ERASE EOF Key	36
TEST REQ Key	37
RESET Key	37
DUP Key	37
FIELD MARK Key	38
PA1 and PA2 Keys	38
INS MODE Key	38
DEL Key	41
ENTER Key	41
PF1–PF12 Keys	42

Introduction

The Typewriter keyboard resembles a standard typewriter keyboard in appearance and key layout. In fact, most of the keys do the same thing as the keys of the same name on a typewriter keyboard.

Many different types of organizations will use the Typewriter keyboard, and each one has unique needs and, possibly, special character requirements. IBM provides six versions of the Typewriter keyboard to meet the needs of everyone who uses the 3270 Information Display System.

Differences between the versions are small and they affect only a few special symbols. All symbols, no matter what version keyboard you have, are defined on page 34 under the heading "Symbols and Punctuation Marks". The only other difference in versions is that your keyboard may or may not have twelve additional keys, PF1–PF12, located to the right of the normal typewriter keys. The discussion of these keys is included on page 42.

The characters that can be displayed consist of 26 uppercase alphabetic characters, 10 numeric characters, and 26 symbols and punctuation marks. The keyboard also contains the control keys that are required to format and enter an input message. Operation of any of the character keys causes the character indicated on the key to be displayed on the screen in the position marked by the cursor.

Keys that have two characters on their faces can display either of them, depending upon the position of the SHIFT key. The lower character displays when the character key is pressed and the keyboard is in the unshifted mode (the SHIFT key not depressed). To display the upper character, you must hold the SHIFT key down while pressing the character key or depress and release the LOCK key before pressing the character key.

Typamatic Keys

Some of the keys, like some of those on electric typewriters, are called typamatic keys. This means that they have the ability to repeat their character or their function automatically if held down. The keys that have this capability are shown in Figure 10.

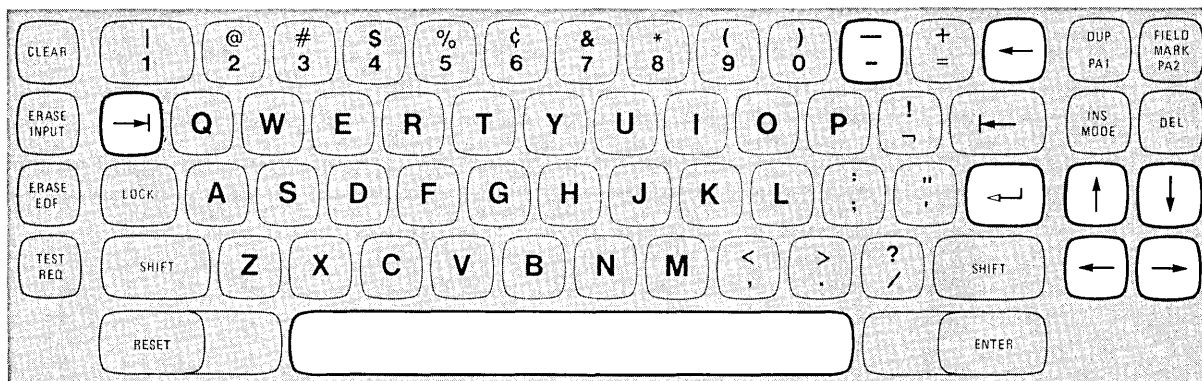
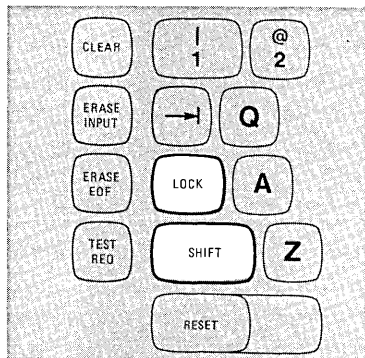

Figure 10. The typamatic keys increase your operating speed.

The discussion of each key also mentions the typamatic capability if it applies.

SHIFT/LOCK Keys



The SHIFT and LOCK keys are the same as on a standard typewriter keyboard. When either the left or the right SHIFT key is pressed, the upper symbols shown on the dual character keys will display when their respective keys are pressed. If the character key has no upper symbol (such as the Alphabet keys), the SHIFT key has no effect. The SHIFT keys are nonlocking and must be held down.

Pressing the LOCK key electronically locks the keyboard in a shifted (uppercase) condition. When the LOCK key is used, you don't have to hold the SHIFT key down, and both hands are free for typing. Press either SHIFT key when you are ready to return the keyboard to the unshifted (lowercase) condition. This releases the electronic lock.

Alphabet Keys

The characters on the faces of the Alphabet keys are always displayed as capitals (uppercase characters). The capital (uppercase) letter on the face of the key is displayed on your screen whether an alphabet key is operated with the SHIFT key held down or with no shift.

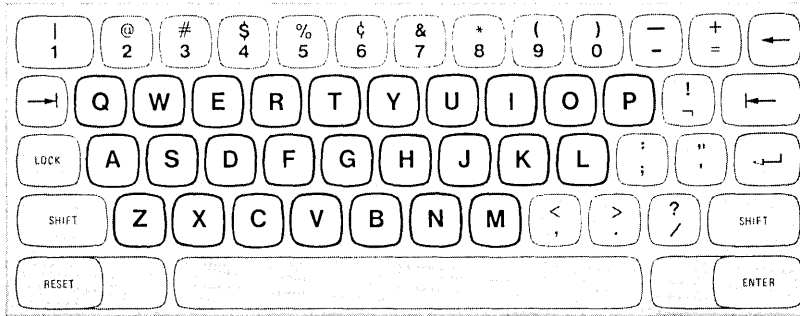

Space Bar

On the 3270, unlike a typewriter or a keypunch, a space is considered an actual character that occupies a position on the face of the screen. When the Space Bar is pressed, a space is entered on the screen and will replace whatever character is presently in that position. For this reason, the Space Bar should not be used to position the cursor.

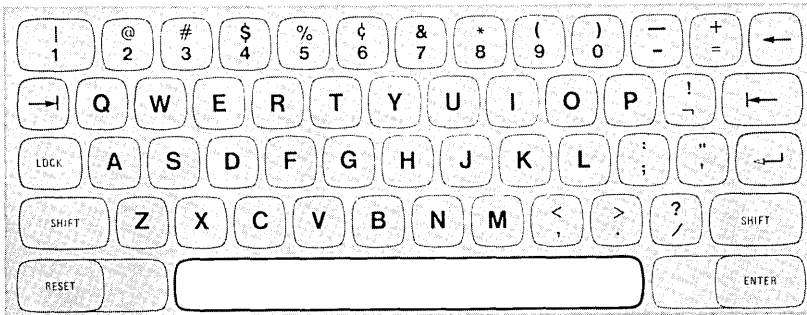

The Space Bar has typamatic capability if held down.

Numeric Keys

When operated with no shift, each of the numeric keys displays the digit shown on the lower half of the key. When operated with the SHIFT key held down, each key displays the symbol shown on the upper half of its face.

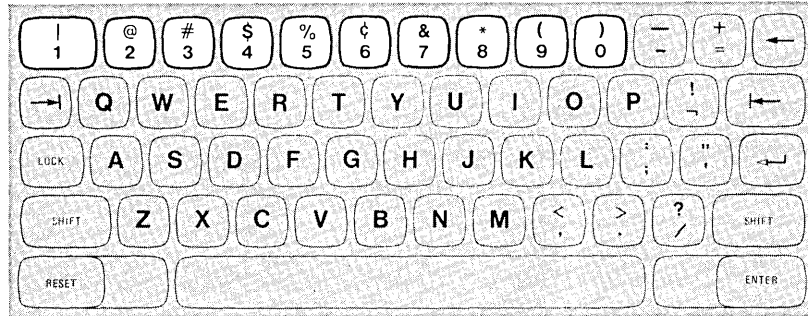

Cursor Control Keys

All of these keys have a common function. They provide a means of positioning the cursor without affecting any of the information already on the screen.

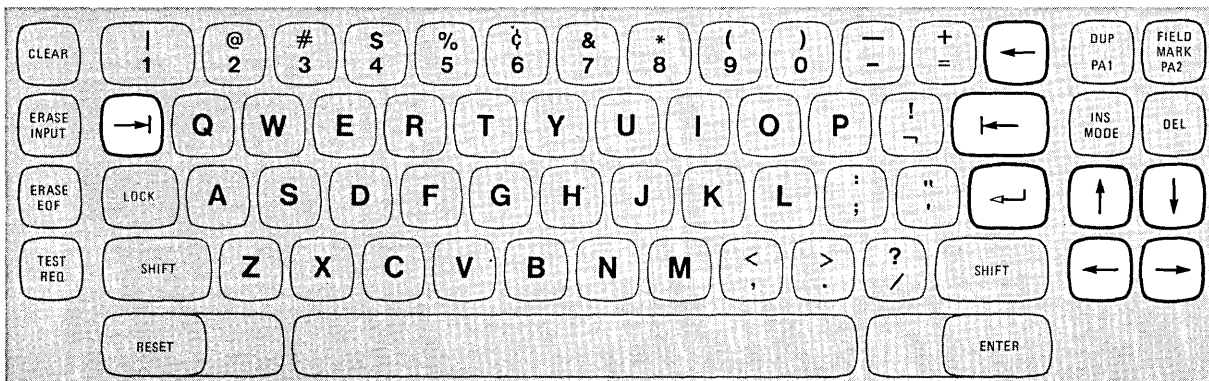

Figure 11. Use the cursor control keys to reposition the cursor.

Because the position of the cursor determines where the next character you key will be entered, it is important to know how to move the cursor to any location on the screen. Also, you'll

want to be able to move the cursor around quickly to correct any errors you might detect while working.

These keys are divided into two types:

1. Those which move the cursor to the first character location in a field.
2. Those which move the cursor one character position at a time.

Moving the Cursor to the Beginning of a Field

New Line Key

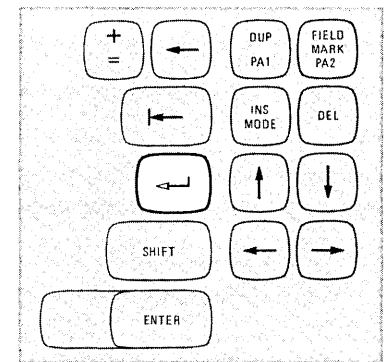

The New Line key moves the cursor to the first new line on the screen containing the first unprotected character location in which you can type. This new cursor location depends on the existing data displayed and on the screen format.

When the New Line key is pressed, there are five possible new cursor locations where you may begin entering data.

1. If the screen is unformatted, the cursor is moved to *the first character position in the next line*.
2. If the screen is formatted, the cursor moves to one of three locations:
 - a. *The first character position in the next line*, as shown in the middle example of Figure 12. Pressing the New Line key when the cursor is located at A moves the cursor to B. In this case, there is no protected field or character present at the first character position in the next line; therefore, the cursor is positioned at the left margin in the next line.
 - b. *A character position within the next line*, as shown in the top example in Figure 12. In this case, the cursor is placed in the first unoccupied location past the protected field called "Item Description".
 - c. *A character position on the first new line available*. It may happen that the first new line contains all protected fields. Therefore, the cursor must keep searching until some new line is found containing the first unoccupied character location in an unprotected field.
3. *If all character positions on the screen are protected, the cursor is repositioned to the first character location on line 1.*

The New Line key is typamatic and will move the cursor quickly from line to line.

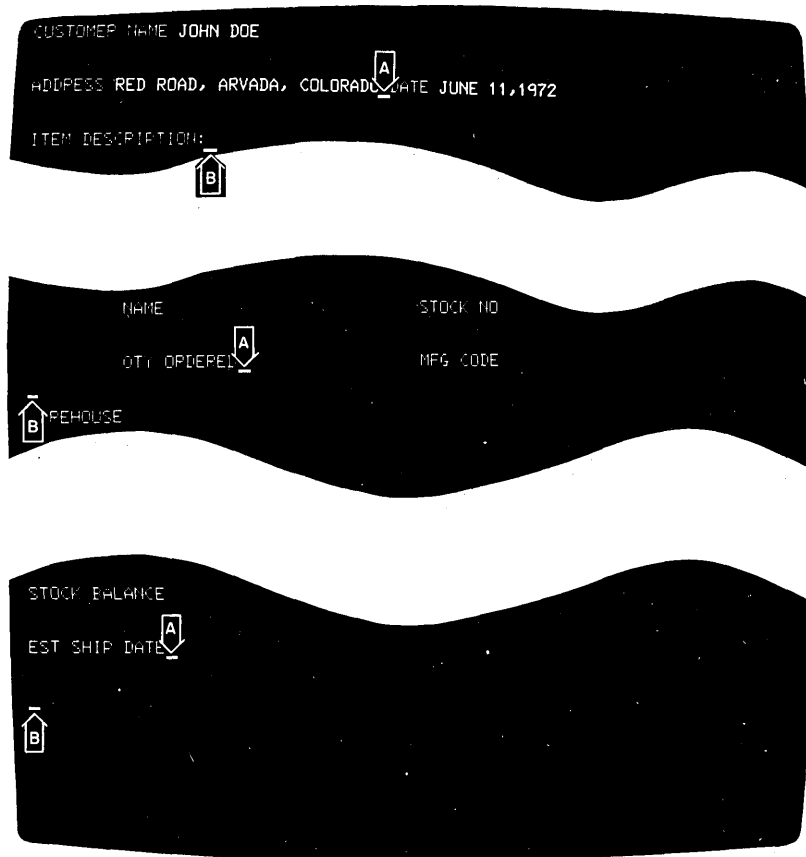
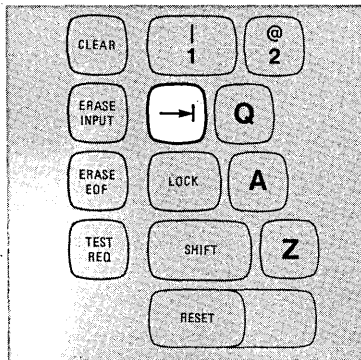

Figure 12. The New Line key moves the cursor to a new line.

Tab Key



Pressing the Tab key moves the cursor to the right to the first character location of the next unprotected data field. For example, in Figure 3 (page 9), the cursor is located in the field entitled "ADDRESS". The operator has just finished keying Red Road, Arvada, Colorado and could now press the Tab key to move the cursor quickly to the next field, "Date", to begin keying in that information. In the examples in Figure 13, pressing the Tab key when the cursor is located at A moves the cursor to B.

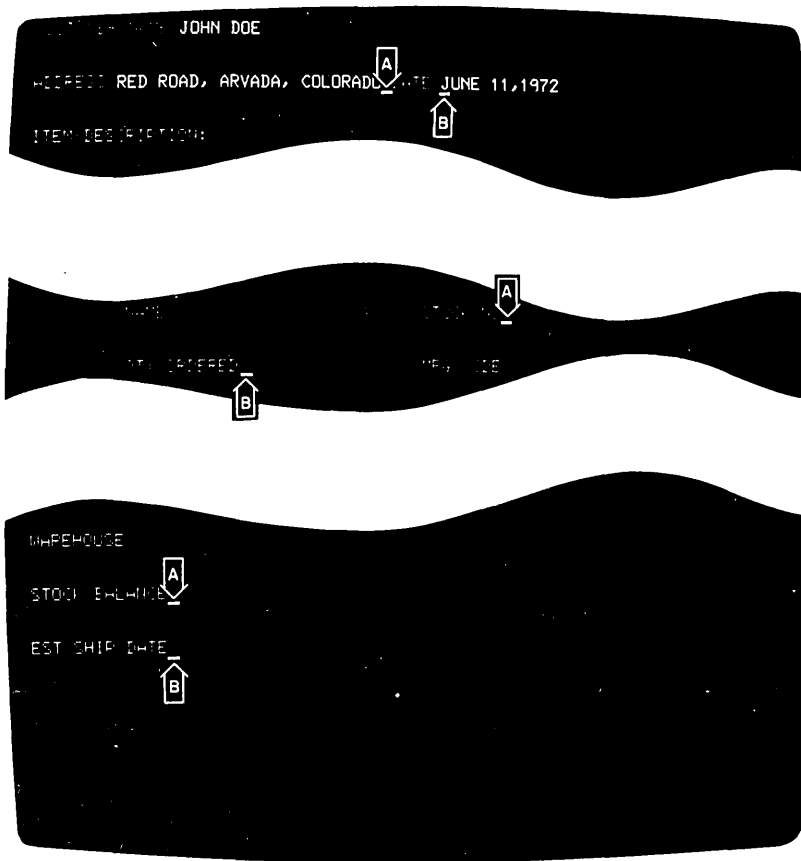

Figure 13. The Tab key moves the cursor to the next input field.

Pressing the Tab key moves the cursor to the first character location on line 1 if the screen is not formatted or if there are no unprotected data fields. Tab also has typamatic capability that allows you to move the cursor quickly from field to field.

The Back Tab key moves the cursor back to the first character position in an input field. In the top example in Figure 14, when Back Tab is pressed, the cursor moves from the end of the "ADDRESS" field (location A) to the first character location in that field, the R in RED.

If the cursor is already in the first character position of an input field, and if you press the Back Tab key, the cursor will then move back to the first character position of the preceding input field. This case is shown in the lower example in Figure 14.

Back Tab Key

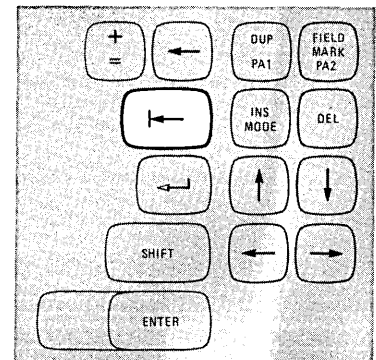

When the operator was about to enter the "Mfg Code" at location A, it was noticed that the "Qty Ordered" No. was missing. Therefore, the operator pressed Back Tab, which moved the cursor back to the first character position of the "Qty Ordered" field.

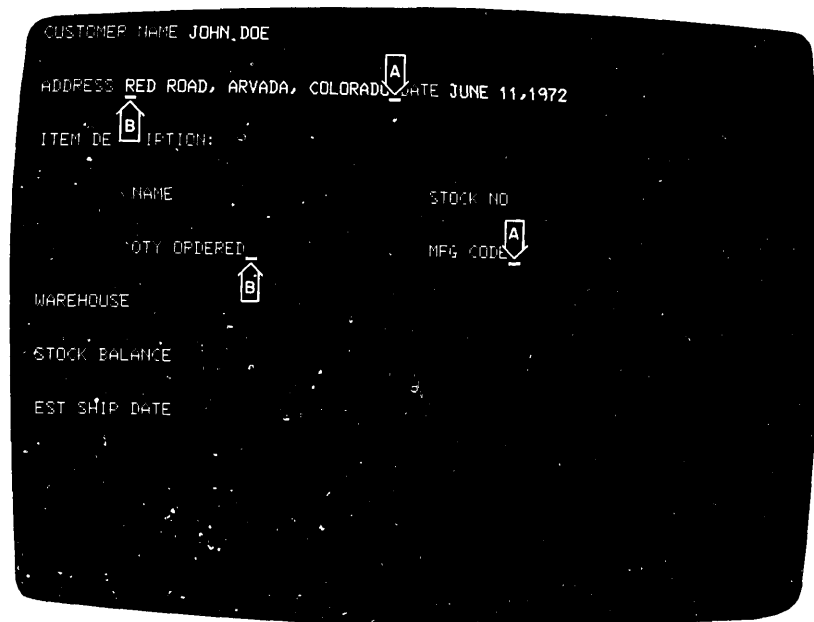
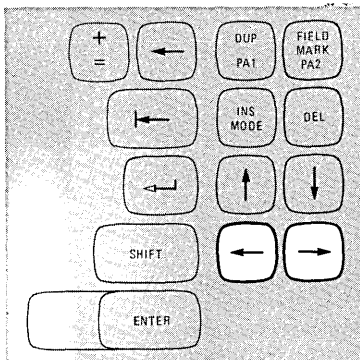

Figure 14. The Back Tab key moves the cursor back to the beginning of an input field

Moving the Cursor One Character Space

Horizontal Positioning Keys



Pressing either of the two horizontal positioning keys (right → or left ←) moves the cursor in the direction of the arrow, one character position at a time. The keys are typamatic so that you can move the cursor any distance quickly with only one depression of the key. If you hold down the control key that moves the cursor to the right, the cursor will move off the right side of the screen and will reappear one line lower on the left side (as explained on page 14). The cursor will also wrap when moved to the left and will reappear one line higher on the right side of the screen.

Operating the two vertical cursor positioning keys (up ↑ or down ↓) moves the cursor in the direction of the arrow, one line at a time. The keys are typamatic to allow you to move the cursor any number of lines quickly and with only one depression of the key. If a vertical positioning key is held down, cursor wrap occurs. In this case, the cursor reappears in the same character position, on the opposite edge of the screen that it occupied before moving off the screen.

Vertical Positioning keys

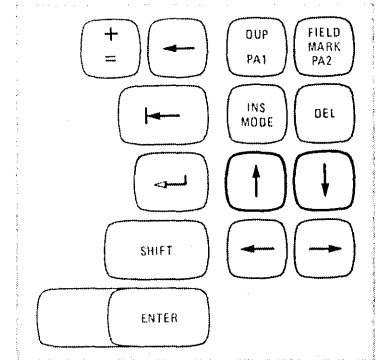

Pressing the Backspace key moves the cursor one character space to the left for each depression of the key. This key operates exactly like the horizontal (left) positioning key and is also typamatic. (This duplication of key function is provided for operator convenience.)

Backspace Key

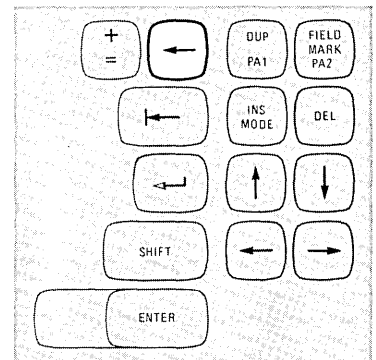

Symbols and Punctuation Marks

These characters are divided into two groups because of their physical locations. The first group contains the symbols that are located on the upper part of the keys that have the numerals 1 through 0 on the lower half. The second group are those characters located on keys that have two special symbols on them. The symbol that appears on the upper half of a key requires depression of the SHIFT key to display it. Figures 15 and 16 show the locations of all symbols and give each symbol's name.

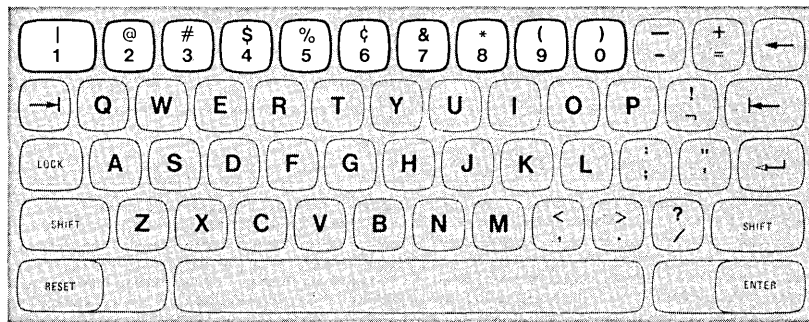

NUMERIC KEY

1 } see note
 1 }
 2
 3
 4
 5
 6 } see note
 6 }
 6 }
 7
 8
 9
 0

UPPER HALF of NUMERIC KEY

| = logical OR, vertical bar
 ! = exclamation point
 @ = at sign
 # = number sign
 \$ = dollar sign
 % = percent sign
 ¢ = cent sign
 ¬ = logical NOT sign
 ^ = circumflex, caret
 & = ampersand
 * = asterisk
 (= left parenthesis
) = right parenthesis

Note: Symbols found on numeric keys 1 and 6 depend upon the version of the typewriter keyboard provided.

Figure 15. Some symbols are located on numeric keys.

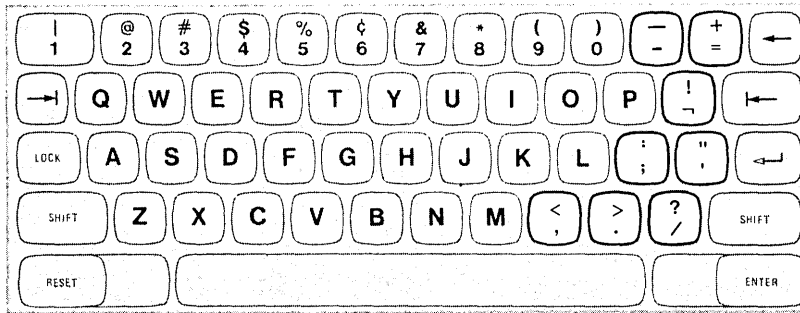

LOWER SYMBOL

- = minus sign
- = = equals sign
- ¬ = logical NOT sign
- ; = semicolon
- ' = apostrophe
- , = comma
- . = period
- / = slash
-] = closing bracket (see note)

UPPER SYMBOL

- = underscore
 - + = plus sign
 - ! = exclamation point
 - : = colon
 - " = quotation mark
 - < = less than sign
 - > = greater than sign
 - ? = question mark
 - [= opening bracket
 - \ = back slash
- } see note

Note: The opening and closing brackets [] and the back slash are symbols that are not illustrated but which may be present, depending upon the version of the keyboard provided.

Figure 16. Some keys contain only symbols and punctuation marks.

CLEAR Key

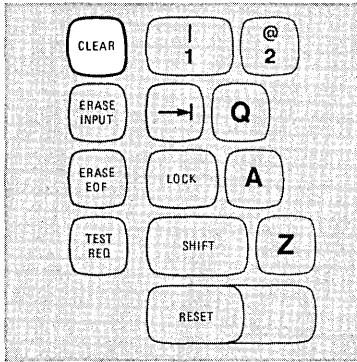

Pressing the CLEAR key blanks every character position on the face of the screen, establishes an unformatted display, and positions the cursor to the first character position on line 1. Your display station signals the computer program, informing it that the CLEAR key has been pressed. While this signaling is taking place, the INPUT INHIBITED indicator comes on, making your keyboard inactive. Most programs will reply to the signal by turning off the indicator. This, however, is up to the program. Therefore, the INPUT INHIBITED indicator may remain lighted after a CLEAR key depression. In this case, press the RESET key to turn off the indicator. The User's Guide for the program with which you are working will explain that program's response to a CLEAR key depression.

ERASE INPUT Key

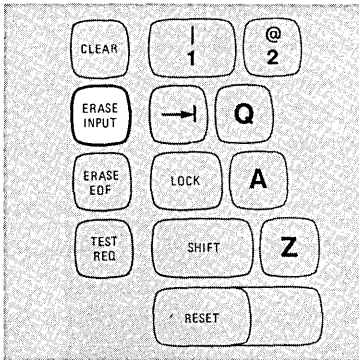

Press the ERASE INPUT key to blank or erase all input fields on your screen. If you have a permanently displayed document on the screen, for example, as shown in Figure 3 (page 9), and your job is to fill in the blanks, all those areas in which you can enter data will be erased. The cursor will also move to the first character location in the first field in which you can begin keying input data.

Pressing the ERASE INPUT key while working with an unformatted screen erases all character locations and moves the cursor to the first character location on the top line of the screen.

ERASE EOF Key

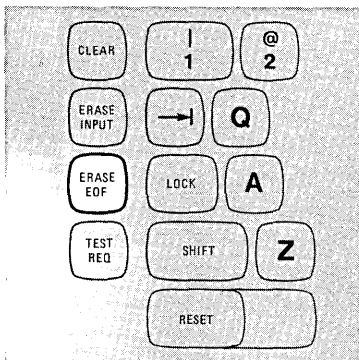

Pressing the ERASE EOF (Erase End of Field) key erases or blanks character positions in the input field in which the cursor is located. All character positions from the cursor location to the end of the field are erased. The cursor, however, does not move.

A possible use of this key can be shown by supposing that you have entered wrong information when keying in a field. You would press the Back Tab key to return the cursor to the beginning of the field, press the ERASE EOF key to erase the incorrect information, and then key in the correct information.

Pressing the TEST REQ key sends a unique signal to the computer, telling the program that a test message is on the screen. While this signaling is taking place, the INPUT INHIBITED indicator turns on, making your keyboard inactive. The program, replying to the signal, normally turns off the indicator and tells you what to do next by displaying a message on your screen.

Pressing the TEST REQ key normally tells the program that your display station may be failing and some testing of it is required. If you are not familiar with its use, ask your supervisor what the procedures are for using the TEST REQ key.

TEST REQ Key

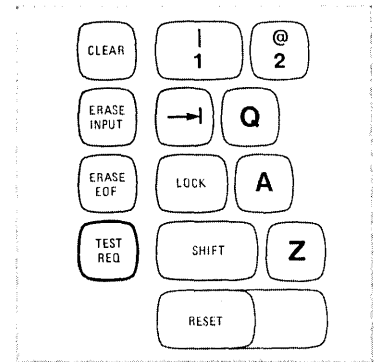

Pressing the RESET key resets the INSERT MODE and INPUT INHIBITED indicators. However, the RESET key will not reset these conditions during the short period when your display station is sending data to, or receiving data from, the computer. Thus, it may be possible for you to press the RESET key and not accomplish the desired reset. If this happens, press the key again to reset the condition.

RESET Key

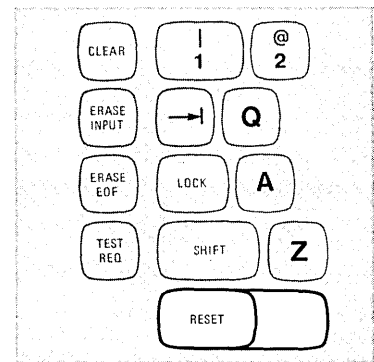

Pressing the DUP key while holding the SHIFT key down displays an asterisk (*) in the character position occupied by the cursor. Also, as a result, the cursor advances to the first character location of the next input data field. When pressed without the SHIFT key being held down, this key performs as described under the heading "PA1 and PA2 Keys".

The DUP operation is intended to provide the operator with a fast method of filling in the information that is the same for every document (such as the date). The DUP key tells the program that a duplication operation is required. The program you are working with, however, determines the use of the DUP key. To verify its use, you must check the User's Guide for that program.

DUP Key

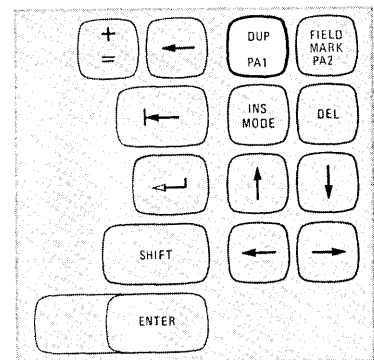

FIELD MARK Key

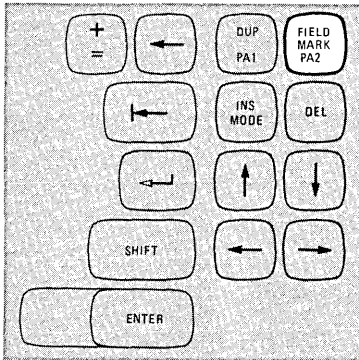

Pressing the FIELD MARK key while holding the SHIFT key down displays a semicolon (;). This key is used when operating with an unformatted display. It indicates the end of a field to the program. When pressed without the SHIFT key being held down, this key performs as described under the heading "PA1 and PA2 Keys".

PA1 and PA2 Keys

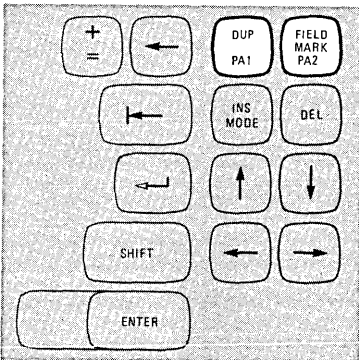

PA1 and PA2 are Program Access keys, and they perform the function that their name implies; that is, they provide a means of signaling the program or getting access to it. While your display station is signaling the program, the INPUT INHIBITED indicator comes on, making your keyboard inactive. Most programs, when replying to these keys, will turn off this indicator. However, this is up to the program. The program that is operating in the computer at the time also determines how these keys will be used. To determine their exact function, refer to the appropriate Program User's Guide. If the INPUT INHIBITED indicator remains on for an abnormally long period after one of the PA keys is pressed, press the RESET key to turn it off.

INS MODE Key

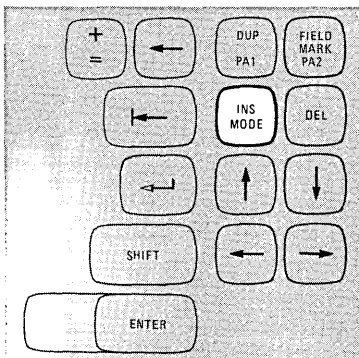

The purpose of Insert Mode is to allow you to insert a character or characters into the middle of a field without disturbing the information that is already displayed there. Pressing the INS MODE key places the keyboard in the Insert Mode of operation. The INSERT MODE indicator turns on to remind you that your keyboard is in Insert Mode.

All of the keyboard control keys perform normally when in Insert Mode. You will notice, however, that when any of the alphanumeric keys are pressed in Insert Mode, the 3270 display station performs a unique operation. The following example explains this operation.

A quick glance at the information you have keyed tells you that in the field entitled "ADDRESS" you entered "RED ROAD, ARVADA, COLORADO" instead of "RED MAPLE ROAD, ARVADA, COLORADO".

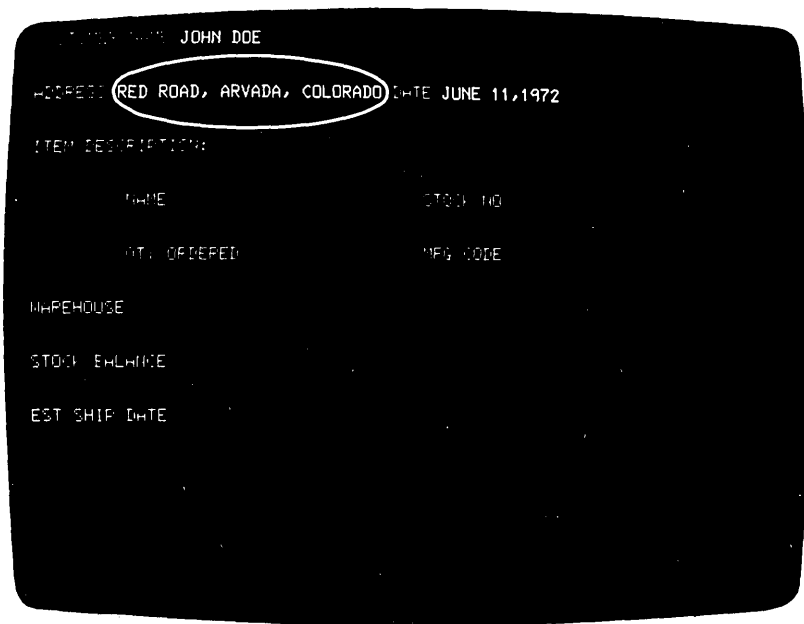

Figure 17. Use the INS MODE key to insert missing information.

To correct this error, using Insert Mode, you would move the cursor to the character position containing the R in the word ROAD.

RED ROAD, ARVADA, COLORADO

(This is the position where the word MAPLE should begin.)

Pressing the INS MODE key places the keyboard in Insert Mode. Now, keying of the word MAPLE, followed by one Space Bar depression, results in the sequence shown in Figure 18.

<u>Key Pressed</u>	
	ADDRESS: RED <u>R</u> OAD, ARVADA, COLORADO
M	ADDRESS: RED MR <u>O</u> AD, ARVADA, COLORADO
A	ADDRESS: RED MAR <u>A</u> OAD, ARVADA, COLORADO
P	ADDRESS: RED MAP <u>R</u> OAD, ARVADA, COLORADO
L	ADDRESS: RED MAPL <u>R</u> OAD, ARVADA, COLORADO
E	ADDRESS: RED MAPLE <u>R</u> OAD, ARVADA, COLORADO
Space	ADDRESS: RED MAPLE <u>R</u> OAD, ARVADA, COLORADO

Figure 18. Inserting a word moves some displayed data to the right.

The missing word has been inserted without disturbing the data following it. You may have noticed that, as characters are inserted, all characters to the right of the cursor are shifted into the blank character positions to the right of the last displayed character. The INPUT INHIBITED indicator will turn on and your keyboard will be disabled if you try to insert more characters than the field will hold.

As a general rule, the number of characters you can insert into a field is limited to one character less than the number of blanks remaining in that field. For example, in Figure 3 (page 9), the field titled "NAME" is 25 characters long and the customer's name, "JOHN DOE", takes up 8 of those character positions. There are 17 blank character positions remaining in the field; therefore, you could insert 16 additional characters.

If a field is a large one and covers more than one line, and if the situation calls for it, during the insert operation, characters will shift from the end of one line to the beginning of the next.

Pressing the RESET key returns the keyboard to its normal mode of operation and turns off the INSERT MODE indicator. The correction made, you would now move the cursor to the next character position into which you want to enter data.

Pressing the DEL key when the cursor is located in an unprotected field deletes the character occupying the position underlined by the cursor. It erases the character without leaving a blank space. All characters in the field to the right of that position are then shifted left one position. An example of its use is the case where you have incorrectly typed Junne 11, 1972, on the screen. To correct this error with the DEL key, you would move the cursor to the position of the extra n with the cursor positioning key or the backspace key: Junne 11, 1972. Pressing the DEL key erases the n and the characters to the right of it move left one space, resulting in: June 11, 1972. The correction made, you would now move the cursor to the next character position into which you want to enter data.

DEL Key

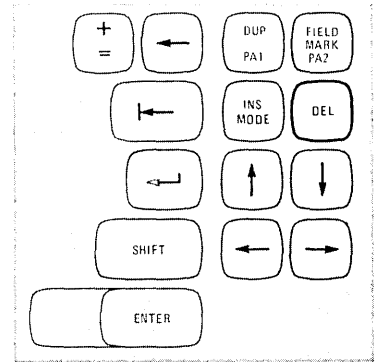

Pressing the ENTER key tells the program that you have completed your message and are ready for the information on the screen to be entered into the computer. While your display station is signaling the program, the INPUT INHIBITED indicator comes on, making your keyboard inactive. Most programs, when acting on an ENTER key signal, will turn off this indicator. This is up to the program, however, and you must refer to the appropriate Program User's Guide to determine what action will occur. If the INPUT INHIBITED indicator remains on for an abnormally long period after use of the ENTER key, press the RESET key to turn it off.

ENTER Key

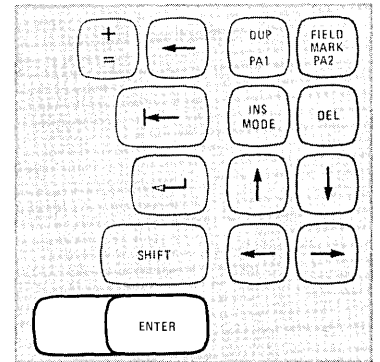

PF1–PF12 Keys

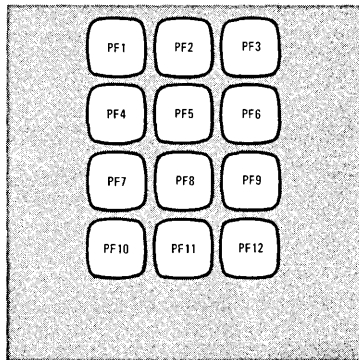

In addition to the functions permanently assigned to other keys (such as, Backspace, Tab, Backtab, etc.), application programs can assign other programmable functions to the PF (Program Function) keys.

Application programs can define the action that will occur when any one of the PF (Program Function) keys is pressed. By doing this, each program can tailor the keyboard to fit its specific needs. This adds flexibility to the 3270 keyboard and makes it a more powerful input device. One program might replace the document on the screen with a different one whenever PF1 is pressed. When working with a different program, pressing PF1 might be a signal that you have keyed in all of the source data that you have available.

To determine the use of each key and the action it causes, refer to the User's Guide of the application program with which you are working.

By now you should be quite familiar with your display station. If there is any area that you're still not sure about, turn back and reread the section that discusses it. Press the key or keys in question, and watch the result. If you still have questions, now is the time to get them answered. Ask your supervisor or an experienced operator for an explanation.

For examples of the work normally done on 3270 display stations and further discussions of errors and correction of operator errors, turn to page 90.

Operator's Notes**We'd Like Your Opinion**

IBM will welcome your comments on this manual, both favorable and unfavorable. Your name and address are needed for those cases where we will want to reply.

So, why not let us know what you think of this book. The pre-stamped, pre-addressed Reader's Comment Form at the back is your communications link with the author. Write your comments on the form and drop it in the mail.

Table of Contents

- Introduction 45
- Typamatic Keys 46
- Numeric (Shift) Key 46
- NUM LOCK Key 46
- ALPHA (Shift) Key 47
- Alphabet Keys 47
- Space Bar 48
- Numeric Keys 48
- Cursor Control Keys 49
 - Moving the Cursor to the Beginning of a Field 49
 - New Line Key 49
 - SKIP Key 51
 - Tab Key 51
 - Back Tab Key 52
 - Moving the Cursor One Character Space 53
 - Horizontal Positioning Keys 53
 - Vertical Positioning Keys 53
 - Backspace Key 53
- Symbols and Punctuation Marks 54
- CLEAR Key 55
- ERASE INPUT Key 55
- ERASE EOF Key 55
- TEST REQ Key 56
- RESET Key 56
- DUP Key 56
- FIELD MARK Key 56
- PA1, PA2, and PA3 Keys 57
- INS MODE Key 57
- DEL Key 59
- ENTER Key 60
- PF Keys 60
- Blank Keys 60

Introduction

The Data Entry keyboard combines the best features of the standard typewriter keyboard with those of the familiar key-punch keyboard. The alphabet keys are arranged according to the standard typewriter touch system, and a group of the right-hand keys serves two purposes, for digits as well as letters. These keys are arranged exactly like the corresponding keys on a keypunch keyboard. A rapid three-finger touch system for the numeric keys can be used from the normal home position of the standard alphabetic keyboard. The touch system for the 10 numeric keys is: index finger for the 1, 4, and 7; middle finger for the 2, 5, and 8; and ring finger for the 0, 3, 6, and 9.

All other keys that have two characters on the key face also have two purposes. The character displayed is determined by which of the two keyboard modes (Alphabetic or Numeric) the keyboard is in when the key is pressed. Alphabetic Mode is the normal state of the keyboard, and the lower character on the key face displays when you press the key with the keyboard in this mode. To display the upper character, you must shift the keyboard into Numeric Mode. This is done by pressing the NUMERIC key or the NUM LOCK key. A more detailed discussion of these keys is presented later.

Whenever the cursor enters a program-defined numeric input field on your screen, the display station will automatically shift the keyboard to Numeric Mode. After you have keyed your input digits into the field, and as the cursor leaves the numeric field, the keyboard shifts back to Alphabetic Mode. This permits you to key an alphabetic field with both hands. Then, without shifting your hands from the home position or pressing any keys to shift modes, you can key a numeric field with the right hand only. While keying in the numeric field, your left hand is free for document handling if it is required. As you become a skilled operator, this feature will aid you in increasing your working speed.

If the cursor has entered a program-defined numeric input field, placing the keyboard in Numeric Mode, and if you must enter one or more alphabetic characters, press the ALPHA shift key which is provided for this situation; then, key in the desired alphabetic characters.

Typamatic Keys

Some of the control keys, like some keys on electric typewriters, are known as typamatic keys. This means that they have the ability to repeat their operation or display their character automatically if held down. The keys that have this capability are highlighted in Figure 19.

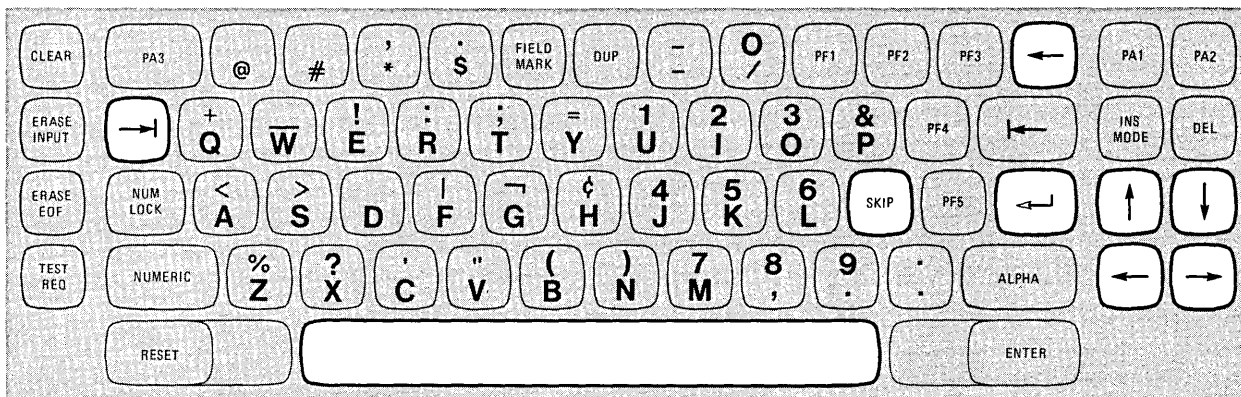
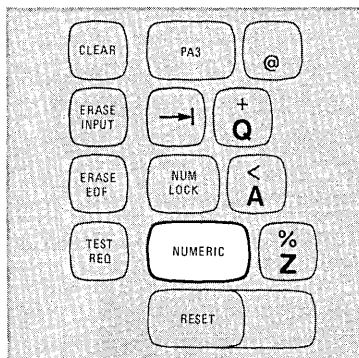

Figure 19. The typamatic keys increase your operating speed.

The discussion of each typamatic key will remind you of its typamatic capability.

NUMERIC (Shift) Key



Pressing the NUMERIC key shifts the keyboard into Numeric Mode for as long as the key is held down. Numeric Mode causes the top character shown on each key to be displayed when that key is pressed. The NUMERIC key is nonlocking and must be held down.

NUM LOCK Key

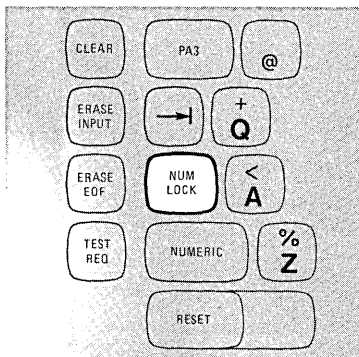

Press the NUM LOCK key when it is necessary to shift the keyboard into Numeric Mode and it is not convenient to hold the NUMERIC key down while completing your operation. The keyboard will remain locked in Numeric Mode until you press the NUM LOCK key again. At that time, it will shift back to Alphabetic Mode.

You'll remember that when the cursor enters a numeric field on a formatted screen, the keyboard automatically shifts to Numeric Mode. When one or more alpha characters must be keyed, and when the cursor is located in a numeric field on a formatted screen, press the ALPHA key to shift the keyboard into Alphabetic Mode. The ALPHA key is nonlocking and must be held down.

ALPHA (Shift) Key

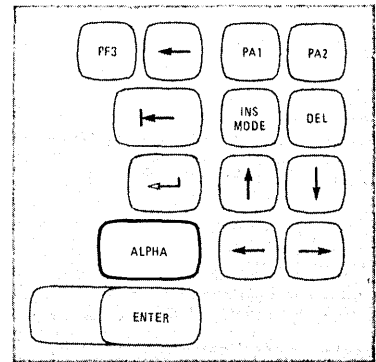

Alphabet Keys

All but one of the Alphabet keys (the D) are dual character keys. The alpha character (on the lower half of the key face) will display when the key is pressed while the keyboard is in Alphabetic Mode (its normal mode). When pressed while the keyboard is in Numeric Mode, each of these keys displays the digit or symbol on the upper half of the key face. Remember that the keyboard is in Numeric Mode when the NUMERIC key is being held down, when the NUM LOCK key has been pressed once, or whenever the cursor is in a formatted numeric field. All alphabetic characters are always displayed as capital letters.

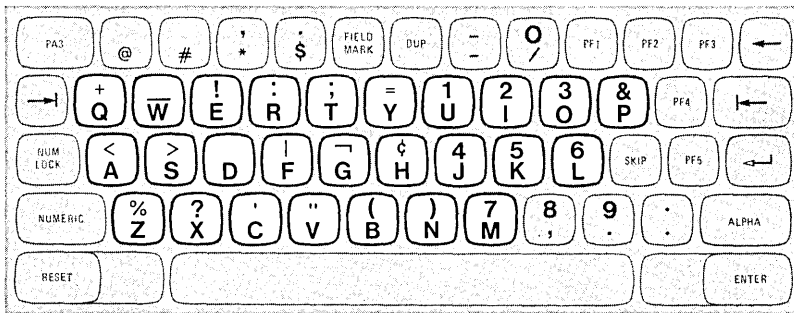

Space Bar

On the 3270, unlike a typewriter or a keypunch, a space is considered an actual character that occupies a position on the face of the screen. When the Space Bar is pressed, a space is entered on the screen and will replace whatever character is presently in that position. Therefore, the Space Bar should not be used to position the cursor.

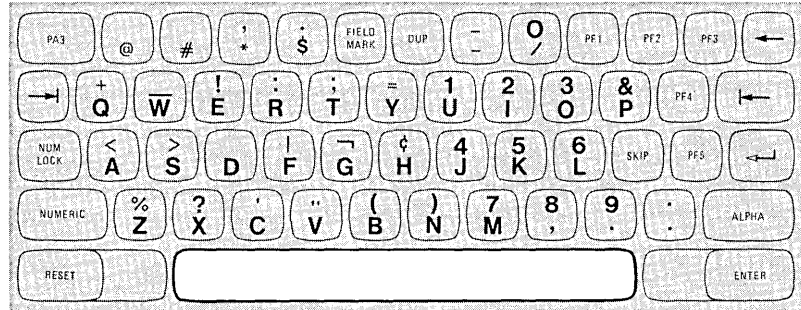

The Space Bar has typamatic capability if held down.

Numeric Keys



Pressing any numeric key displays the digit on the upper half of its key face when the keyboard is in Numeric Mode. The character on the lower half of the key face is displayed when the key is pressed while the keyboard is in Alphabetic Mode.

Remember that the normal mode of your keyboard is Alphabetic Mode. The keyboard automatically shifts to Numeric Mode when your screen is formatted and the cursor enters a numeric field. At all other times, you must press the NUMERIC or the NUM LOCK keys to shift to Numeric Mode.

Cursor Control Keys

All of these keys have a common function. They provide a means of positioning the cursor without affecting any of the information that is already on the screen.

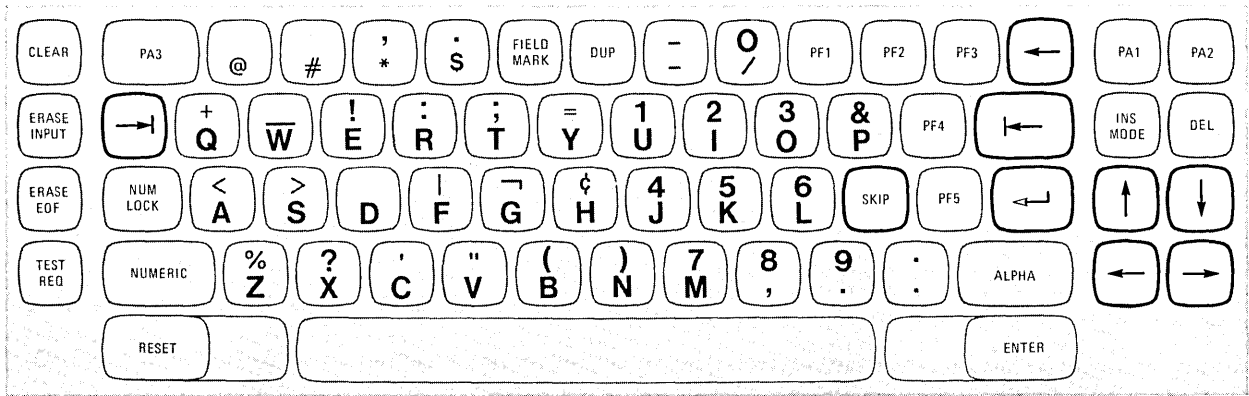

Figure 20. Use the cursor control keys to reposition the cursor.

Because the position of the cursor determines where the next character you type will be entered, it is important to know how to move the cursor to any location on the screen. Also, you'll want to be able to move the cursor quickly to correct any errors you might detect while working.

Cursor control keys are divided into two types:

1. Those that move the cursor to the first character location in a field.
2. Those that move it one character position at a time.

Moving the Cursor to the Beginning of a Field

New Line Key

The New Line key moves the cursor to the first new line on the screen containing the first unprotected character location in which you can type. This new cursor location depends on the existing data displayed and on the screen format.

When the New Line key is pressed, there are five possible new cursor locations where you may begin entering data.

1. If the screen is unformatted, the cursor is moved to *the first character position in the next line*.
2. If the screen is formatted, the cursor moves to one of three locations:

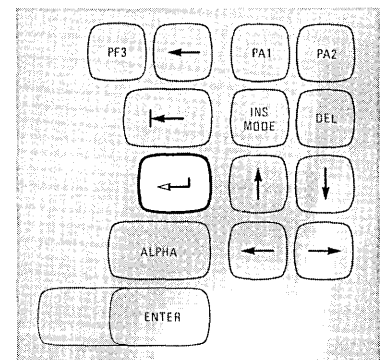

- a. *The first character position in the next line*, as shown in the middle example of Figure 21. Pressing the New Line key when the cursor is located at A moves the cursor to B. In this case, there is no protected field or character present at the first character position in the next line; therefore, the cursor is positioned at the left margin in the next line.
 - b. *A character position within the next line*, as shown in the top example in Figure 21. In this case, the cursor is placed in the first unoccupied location past the protected field called "Item Description".
 - c. *A character position on the first new line available*. It may happen that the first new line contains all protected fields. Therefore, the cursor must keep searching until some new line is found containing the first unoccupied character location in an unprotected field.
3. *If all character positions on the screen are protected, the cursor is repositioned to the first character location on line 1.*

The New Line key is typamatic and will move the cursor quickly from line to line.

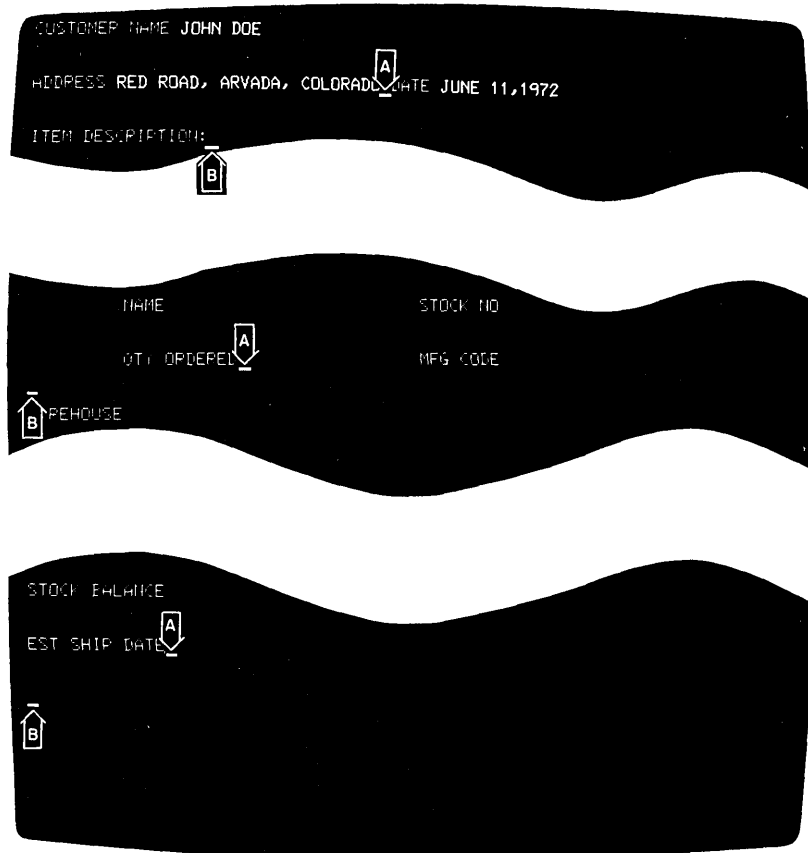
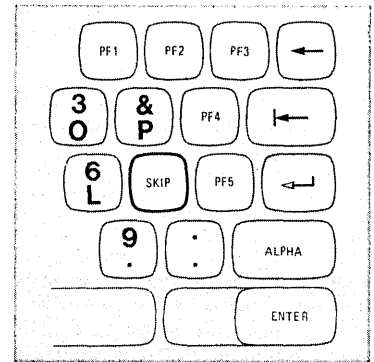

Figure 21. The New Line key moves the cursor to a new line.

The purpose and operation of the SKIP key are identical with those of the Tab key. Both keys have typamatic capability that allows you to move the cursor quickly from field to field. This duplication of function is provided for operator convenience. The Tab key is on the left side of the keyboard and the SKIP key is nearer the right side.

SKIP Key



Pressing the SKIP or the Tab key moves the cursor to the right to the first character location of the next unprotected data field. For example, in Figure 3 (page 9), the cursor is located in the field entitled "ADDRESS". The operator has just finished keying Red Road, Arvada, Colorado and could now press the Tab key to move the cursor quickly to the next field, "Date", to begin keying in that information. In the examples in Figure 22, pressing the Tab key when the cursor is located at A moves the cursor to B.

Tab Key

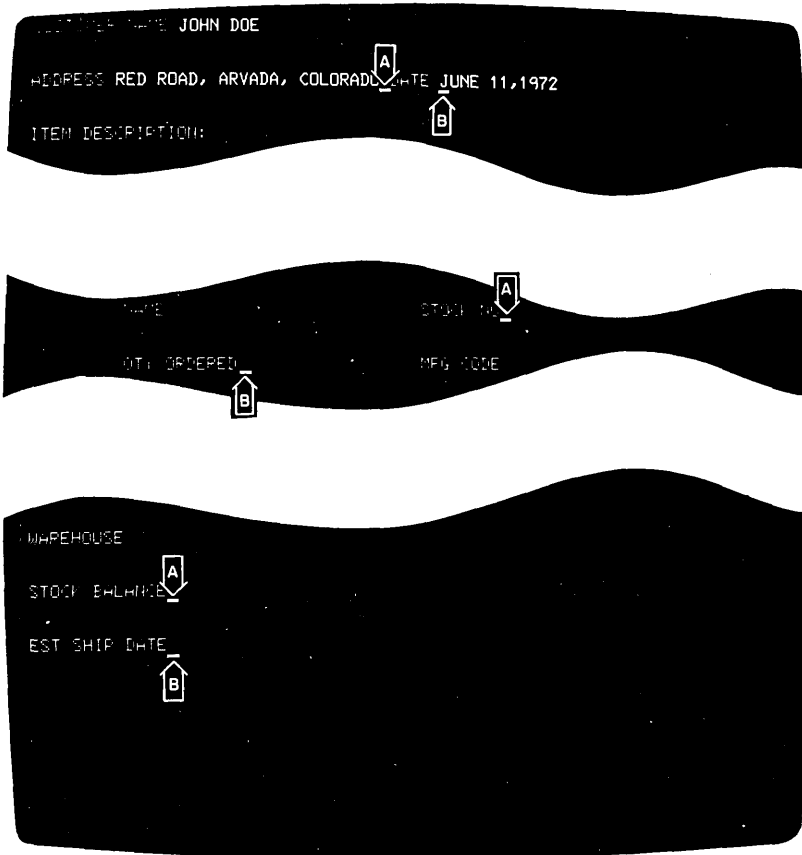
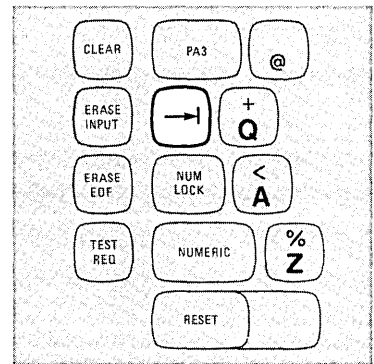
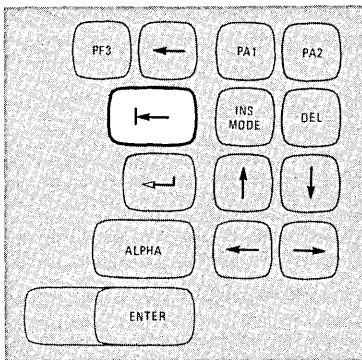

Figure 22. The SKIP or the Tab key moves the cursor to the next input field.

Pressing the SKIP or the Tab key moves the cursor to the first character location on line 1 if the screen is not formatted or there are no unprotected data fields. SKIP and Tab have typamatic capability that allows you to move the cursor quickly from field to field. Note that the SKIP, Tab, and New Line keys all advance the cursor to the first character position of an unprotected field and that, in addition, the New Line key places the cursor in the first new line available (not having all protected fields).

Back Tab Key



The Back Tab key moves the cursor back to the first character position in an input field. In the top example in Figure 23, when Back Tab is pressed, the cursor moves from the end of the "ADDRESS" field (location A) to the first character location in that field, the R in RED.

If the cursor is already in the first character position of an input field, and you press the Back Tab key, the cursor will then move back to the first character position of the preceding input field. This case is shown in the lower example in Figure 23. When the operator was about to enter the "Mfg Code" No. at location A, it was noticed that the "Qty Ordered" was missing. Therefore, the operator pressed Back Tab, which moves the cursor back to the first character position of the "Qty Ordered" field.

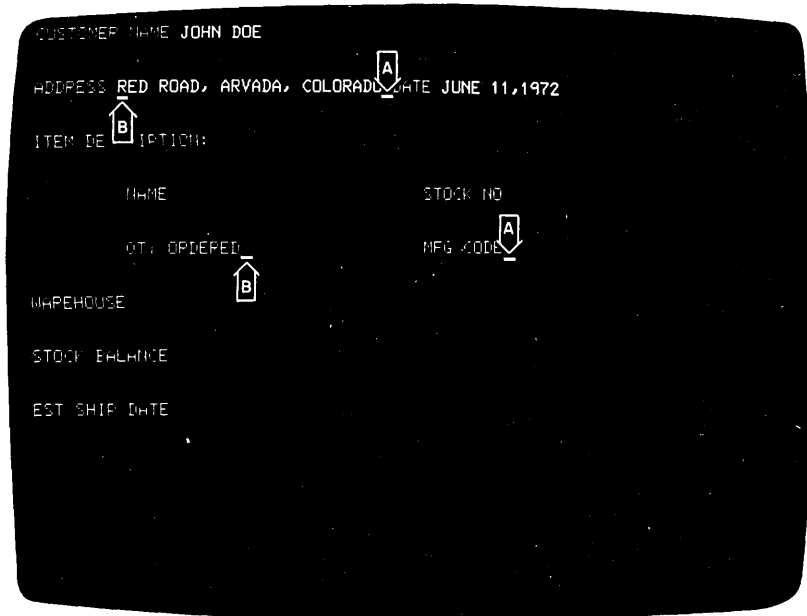

Figure 23. The Back Tab key moves the cursor back to the beginning of an input field.

When your screen is unformatted, the Back Tab key repositions the cursor to the first character location on line 1.

Moving the Cursor One Character Space

Pressing either of the two horizontal positioning keys (right → or left ←) moves the cursor in the direction of the arrow, one character position at a time. The keys are typamatic so that you can move the cursor any distance quickly with only one depression of the key. If you hold down the control key that moves the cursor to the right, the cursor will move off the right side of the screen and will reappear one line lower on the left side. This is called cursor wrap (as explained on page 14). The cursor will also wrap when moved to the left and will reappear one line higher on the right side of the screen.

Horizontal Positioning Keys

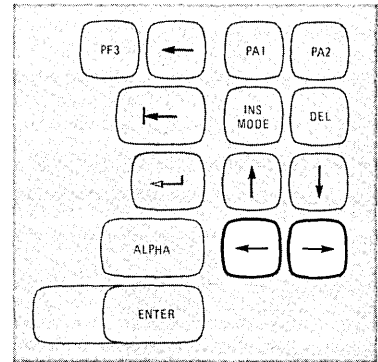

Operating the two vertical cursor positioning keys (up ↑ or down ↓) moves the cursor in the direction of the arrow, one line at a time. The keys are typamatic to allow you to move the cursor any number of lines quickly and with only one depression of the key. If a vertical positioning key is held down, cursor wrap occurs. In this case, the cursor reappears in the same character position on the opposite edge of the screen that it occupied before moving off the screen.

Vertical Positioning Keys

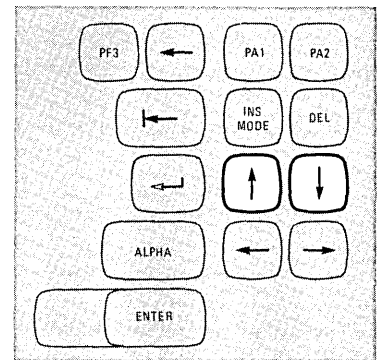

Pressing the Backspace key moves the cursor one character space to the left for each depression of the key. This key operates exactly like the horizontal (left) positioning key. (The duplication of function is provided for operator convenience.)

Backspace Key

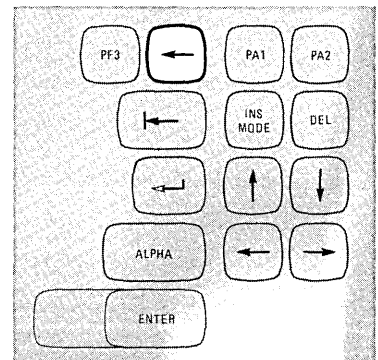

Symbols and Punctuation Marks

The locations of the 27 keys that contain symbols and punctuation marks are shown in Figure 24. You must press the NUMERIC (shift) key, along with the symbol key, to display the symbol that appears on the upper half of the key face.



- | | | | |
|----|-----------------------|---|----------------------------|
| @ | = at sign | = | = equals sign |
| # | = number sign | & | = ampersand |
| * | = asterisk | < | = less than sign |
| , | = comma (see note 1) | > | = greater than sign |
| \$ | = dollar sign | | = logical OR, vertical bar |
| . | = period (see note 2) | ^ | = logical NOT |
| - | = minus sign | ¢ | = cent sign |
| / | = slash | % | = percent sign |
| + | = plus sign | ? | = question mark |
| _ | = underscore | ' | = apostrophe |
| ! | = exclamation mark | " | = quotation mark |
| : | = colon | (| = left parenthesis |
| ; | = semicolon |) | = right parenthesis |

Note 1 = one uppercase and one lowercase

Note 2 = two uppercase and two lowercase

Figure 24. Many of the keys contain symbols and punctuation marks.

Pressing the CLEAR key blanks every character position on the face of the screen, establishes an unformatted display, and positions the cursor to the first character position on line 1.

Your display station signals the computer program, informing it that the CLEAR key has been pressed. While this signaling is taking place, the INPUT INHIBITED indicator comes on, making your keyboard inactive. Most programs will reply to the signal by turning off the indicator. This, however, is up to the program. Therefore, the INPUT INHIBITED indicator may remain lighted after a CLEAR key depression. In this case, press the RESET key to turn off the indicator. The User's Guide for the program with which you are working will explain that program's response to a CLEAR key depression.

CLEAR Key

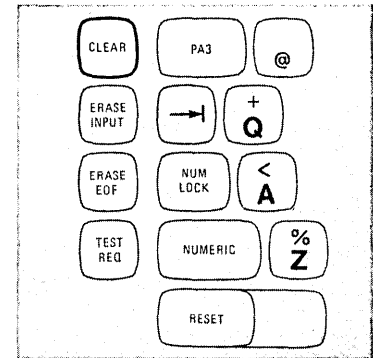

Press the ERASE INPUT key to blank or erase all input fields on your screen. If you have a permanently displayed document on the screen, for example, as shown in Figure 3 (page 9), and your job is to fill in the blanks, all those areas in which you can enter data will be erased. The cursor will also move to the first character location in the first field in which you can begin keying input data.

Pressing the ERASE INPUT key while working with an unformatted screen erases all character locations and moves the cursor to the first character location on the top line of the screen.

ERASE INPUT Key

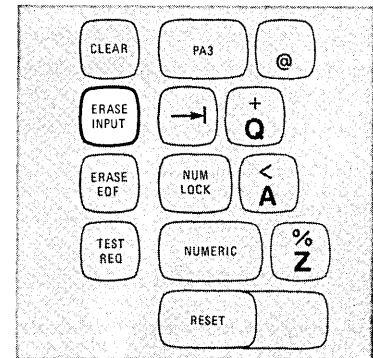

Pressing the ERASE EOF (Erase End of Field) key erases or blanks character positions in the input field in which the cursor is located. All character positions from the cursor location to the end of the field are erased. The cursor, however, does not move.

A possible use of this key can be shown by supposing that you have entered wrong information when keying in a field. You would press the Back Tab key to return the cursor to the beginning of the field, press the ERASE EOF key to erase the incorrect information, and then key in the correct information.

ERASE EOF Key

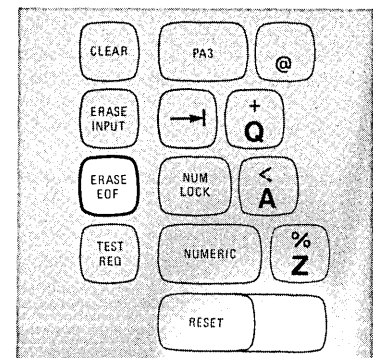

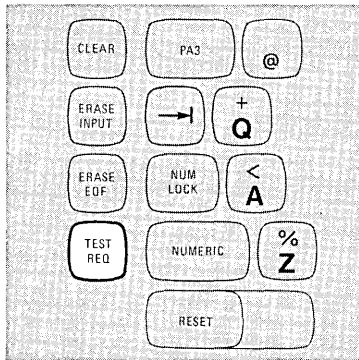
TEST REQ Key

Pressing the TEST REQ key sends a unique signal to the computer, telling the program that a test message is on the screen. While this signaling is taking place, the INPUT INHIBITED indicator turns on, making your keyboard inactive. The program, replying to the signal, normally turns off the indicator and tells you what to do next by displaying a message on your screen.

Pressing the TEST REQ key normally tells the program that your display station may be failing and some testing of it is required. If you are not familiar with its use, ask your supervisor to explain the procedure for using the TEST REQ key.

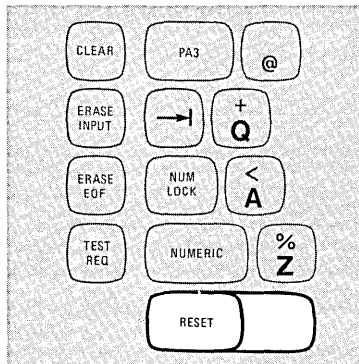
RESET Key

Pressing the RESET key resets the INSERT MODE and INPUT INHIBITED indicators. However, the RESET key will not reset these conditions during the short period when your display station is sending data to, or receiving data from, the computer. Therefore, it may be possible for you to press the RESET key and not accomplish the desired reset. If this happens, press the key again to reset the condition.

DUP Key

Pressing the DUP key displays an asterisk (*) in the character position occupied by the cursor. Also, as a result, the cursor advances to the first character location of the next input data field.

The DUP operation is intended to provide the operator with a fast method of filling in the information that is the same for every document (such as the date). The DUP key tells the program that a duplication operation is required. The program you are working with, however, determines the use of the DUP key. To verify its use, you must check the User's Guide for that program.

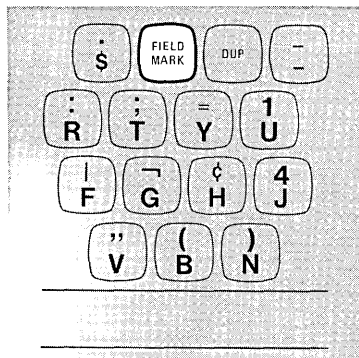
FIELD MARK Key

Pressing the FIELD MARK key causes a semicolon (;) to be displayed. This key is used when operating with an unformatted display. It indicates the end of a field to the program.

PA1, PA2, and PA3 are Program Access keys, and they perform the function that their name implies; they provide a means of signaling a program or gaining access to it. While your display station is signaling the program, the INPUT INHIBITED indicator comes on, making your keyboard inactive. Most programs, when replying to these keys, will turn off this indicator. However, this is up to the program. The program that is operating in the computer at the time also determines how these keys will be used. To determine their exact functions, refer to the appropriate Program User's Guide.

If the INPUT INHIBITED indicator remains on for an abnormally long period after one of the PA keys is pressed, press the RESET key to turn it off.

PA1, PA2, and PA3 Keys

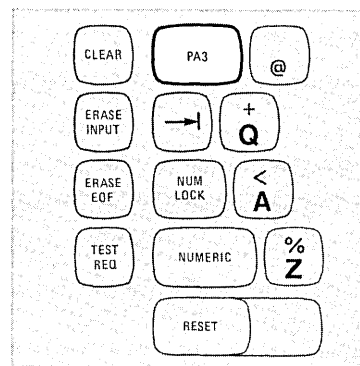
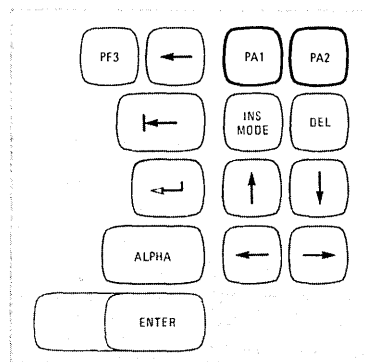

The purpose of Insert Mode is to allow you to insert a character, or characters, into the middle of a field without disturbing the information already displayed there. Pressing the INS MODE key places the keyboard in the Insert Mode of operation. The INSERT MODE indicator turns on to remind you that your keyboard is in Insert Mode.

All of the keyboard control keys perform normally when in Insert Mode. You will notice, however, that when any of the alphameric keys are pressed in Insert Mode the 3270 display station performs a unique operation. The following example explains this operation.

A quick glance at the information you have keyed tells you that in the field entitled "ADDRESS" you entered "RED ROAD, ARVADA, COLORADO" instead of "RED MAPLE ROAD, ARVADA, COLORADO".

INS MODE Key

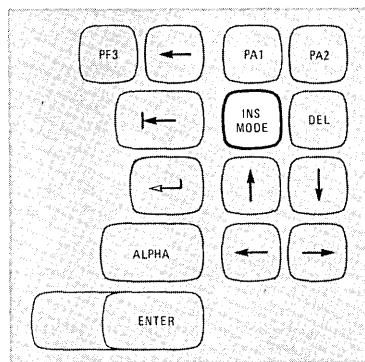

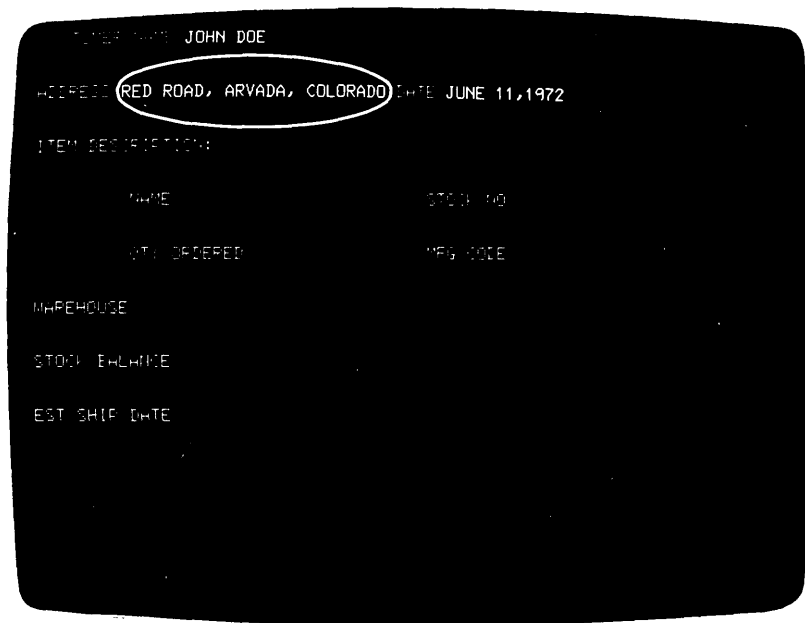

Figure 25. Use the INS MODE key to insert missing information.

To correct this error, using Insert Mode, you would move the cursor to the character position containing the R in the word ROAD.

RED ROAD, ARVADA, COLORADO

(This is the position where the word MAPLE should begin.)

Pressing the INS MODE key places the keyboard in Insert Mode. Now, keying of the word MAPLE, followed by one Space Bar depression, results in the sequence shown in Figure 26.

Key Pressed	Terminal Display
	ADDRESS: RED <u>R</u> OAD, ARVADA, COLORADO
M	ADDRESS: RED <u>M</u> ROAD, ARVADA, COLORADO
A	ADDRESS: RED <u>MA</u> ROAD, ARVADA, COLORADO
P	ADDRESS: RED <u>MAP</u> ROAD, ARVADA, COLORADO
L	ADDRESS: RED <u>MAPL</u> ROAD, ARVADA, COLORADO
E	ADDRESS: RED <u>MAPLE</u> ROAD, ARVADA, COLORADO
Space	ADDRESS: RED <u>MAPLE</u> <u>R</u> OAD, ARVADA, COLORADO

Figure 26. Inserting a word moves some displayed data to the right.

The missing word has been inserted without disturbing the data following it. You may have noticed that, as characters are inserted, all characters to the right of the cursor are shifted into the blank character positions to the right of the last displayed character. The INPUT INHIBITED indicator will turn on and your keyboard will be disabled if you try to insert more characters than the field will hold.

As a general rule, the number of characters you can insert into a field is limited to one character less than the number of blanks remaining in that field. For example, in Figure 3, the field titled "NAME" is 25 characters long and the customer's name, "JOHN DOE", takes up 8 of those character positions; therefore, you could insert 16 additional characters.

If a field is a large one and covers more than one line, and if the situation calls for it, during the insert operation, characters will shift from the end of one line to the beginning of the next.

Pressing the RESET key returns the keyboard to its normal mode of operation and resets the INSERT MODE indicator. The correction made, you would now move the cursor to the next character position in which you want to enter data.

Pressing the DEL key when the cursor is located in an unprotected field deletes the character occupying the position underlined by the cursor. It erases the character without leaving a blank space. All characters in the field to the right of that position are then shifted to the left one position. An example of its use is the case where you have made a mistake and typed Junne 11, 1972, on the screen. To correct this error with the DEL key, you would move the cursor to the position of the extra n with the cursor-positioning key or the backspace key: June 11, 1972. Pressing the DEL key erases the n, and the characters to the right of it move left one space, resulting in: June 11, 1972. The correction made, you would now move the cursor to the next character position in which you want to enter data.

DEL Key

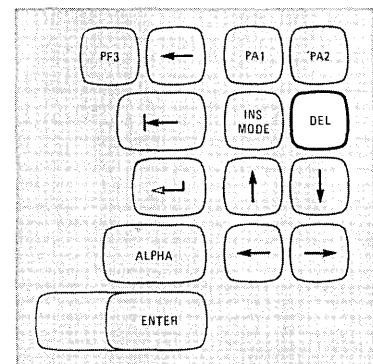

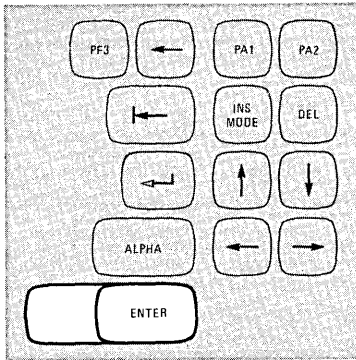
ENTER Key

Pressing the ENTER key tells the program that you have completed your message and are ready for the information on the screen to be entered into the computer.

While your display station is signaling the program, the INPUT INHIBITED indicator comes on, making your keyboard inactive. Most programs, when acting on an ENTER key signal, will turn off this indicator. This is up to the program, however, and you must refer to the appropriate Program User's Guide to determine what action will occur. If the INPUT INHIBITED indicator remains on for an abnormally long time after use of the ENTER key, press the RESET key to turn it off.

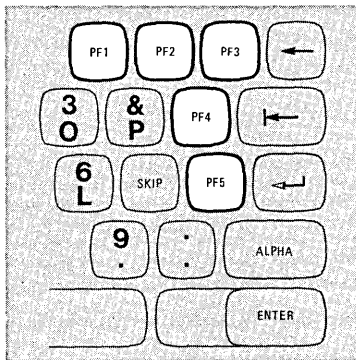
PF Keys

The keys labeled PF1–PF5 are Program Function keys. As their name implies, their purposes are determined by the particular program that you're working with. Each key sends a unique signal to the computer, which the program can detect. While your display station is signaling the program, the INPUT INHIBITED indicator comes on, making your keyboard inactive. Most programs, when replying to these keys, will turn off this indicator. However, this is up to the program. To find the purposes and operations of these keys, refer to the User's Guide for the Application Program with which you are working.

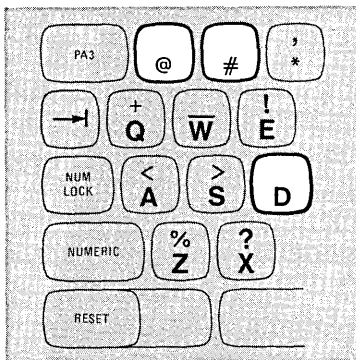
Blank Keys (in Numeric Mode)

When the keyboard is in Numeric Mode and the cursor is in an input field, three keys (@, #, and D) generate a space when pressed. The top portion of the key face on these keys is blank.

By now, you should be quite familiar with your display station. If there is any area that you're still not sure about, turn back and reread the section that discusses it. Press the key or keys in question, and watch the result. If you still have questions, now is the time to get them answered. Ask your supervisor or an experienced operator for an explanation.

For examples of the work normally done on 3270 display stations and further discussions of errors and correction of operator errors, turn to page 90.

Operator's Notes

We'd Like Your Opinion

IBM will welcome your comments on this manual, both favorable and unfavorable. Your name and address are needed for those cases where we will want to reply.

So, why not let us know what you think of this book. The pre-stamped, pre-addressed Reader's Comment Form at the back is your communications link with the author. Write your comments on the form and drop it in the mail.

Table of Contents

Introduction	63
Typamatic Keys	64
SHIFT/LOCK Keys	64
Alphabet Keys	65
Space Bar	65
Numeric Keys	66
Cursor Control Keys	66
Moving the Cursor to the Beginning of a Field	67
New Line Key	67
Tab Key	67
Back Tab Key	68
Moving the Cursor One Character Space	68
Horizontal Positioning Keys	68
Vertical Positioning Keys	68
Backspace Key	69
Symbols and Punctuation Marks	69
CLEAR Key	70
ERASE INPUT Key	70
ERASE EOF Key	71
TEST REQ Key	71
RESET Key	71
PA1 Key	72
INS MODE Key	72
DEL Key	74
ENTER Key	74
CNCL Key	74
PF1–PF12 Keys	75

Introduction

The Operator Console keyboard is similar to the 3270 Typewriter keyboard. They both resemble a standard typewriter keyboard in appearance and key layout. In fact, most of the keys perform a function similar to the corresponding keys on a typewriter keyboard.

On the 3270 Operator Console keyboard, key location is the same as that on the operator consoles used with System/360 and System/370: the 1052-7, the 3210, and the 3215 keyboards.

The characters that can be displayed consist of 26 uppercase alphabetic characters, 10 numeric characters, and 26 symbols and punctuation marks. Operation of any of the character keys causes the character indicated on the key to be displayed on the screen in the position marked by the cursor.

The keyboard also contains the control keys that are required to format and enter an input message. Twelve additional program function keys (PF1–PF12) are located to the right of the standard typewriter-like keyboard. Their functions are programmable and add flexibility to your keyboard. You can specify to the program that whenever the designated key is pressed certain predetermined actions should occur (for example, clear the entry area and position the cursor to the first character position in the entry area).

On many computer systems, the program positions the cursor for you. Note that your keyboard provides control keys that can perform many of your desired actions without help from the program. By using these keys, you can save the programmable keys for more unique requirements.

Typamatic Keys

Some of the keys, like some of those on electric typewriters, are called typamatic keys. This means they have the ability to repeat their character or their function automatically if held down. The keys that have this capability are highlighted in Figure 27.

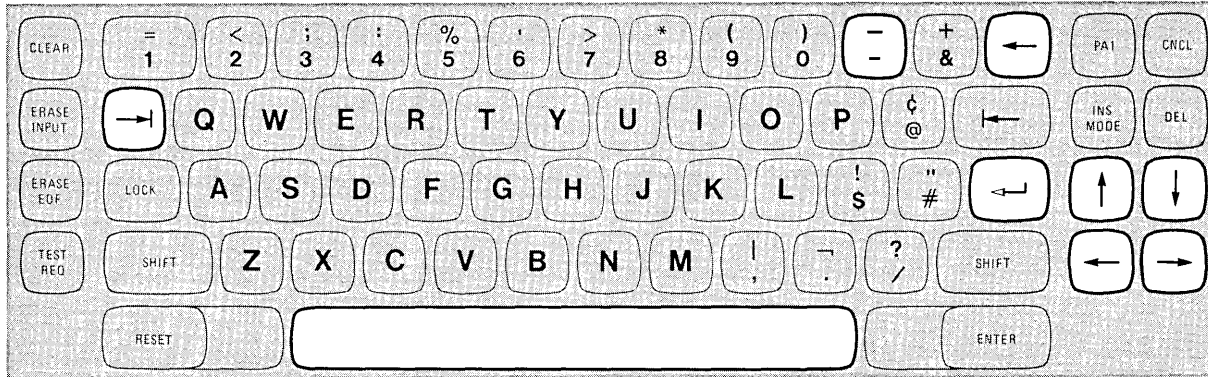
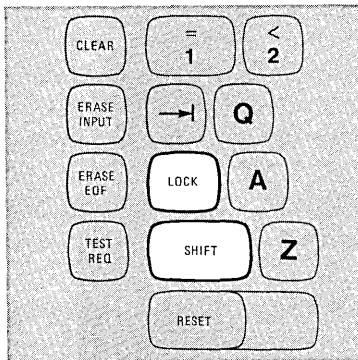

Figure 27. The typamatic keys increase your operating speed.

The discussion of each key also mentions this capability if it applies.

SHIFT/LOCK Keys



The SHIFT and LOCK keys perform the same function as on a standard typewriter keyboard. Press the SHIFT key to shift the keyboard to uppercase and make possible the entry of the upper symbol shown on the dual character keys. The SHIFT key is nonlocking and must be held down. If the character key has no upper symbol (such as the Alphabet keys), the SHIFT key has no effect.

Pressing the LOCK key electronically locks the keyboard in a shifted (uppercase) condition. When the LOCK key is used, you don't have to hold the SHIFT key down; therefore, both hands are free for typing. When you are ready to return the keyboard to the unshifted (lowercase) condition, press either SHIFT key momentarily. This releases the electronic lock.

Alphabet Keys

The characters on the faces of the Alphabet keys are always displayed as capitals (uppercase characters). The capital (uppercase) letter on the face of the key is displayed on your screen whether an alphabet key is operated with the SHIFT key pressed or with no shift.

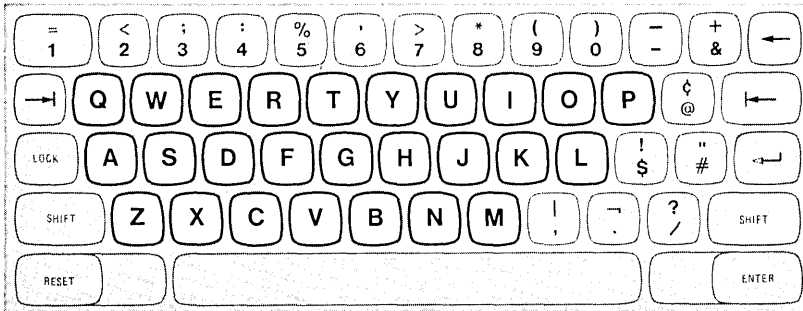

Space Bar

On the 3270, unlike on a typewriter or a keypunch, a space is considered an actual character that occupies a position on the face of the screen. When the Space Bar is pressed, a space is entered on the screen and will replace whatever character is presently in that position. Thus, the Space Bar should not be used to position the cursor.

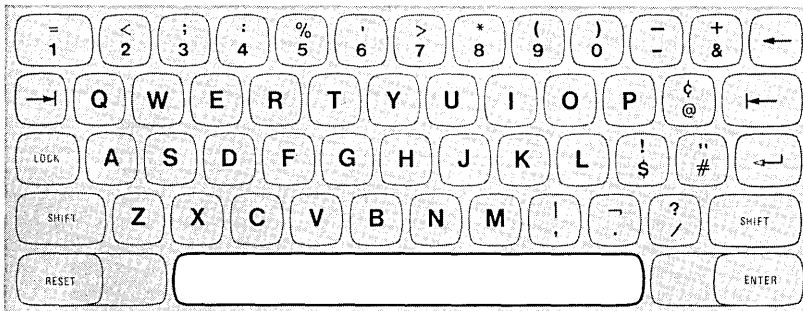

The Space Bar has typamatic capability if held down.

Numeric Keys

When pressed with no shift, each Numeric key displays the digit shown on its lower half. When operated with the SHIFT key pressed, Numeric keys display the symbols shown on the upper half of each key.

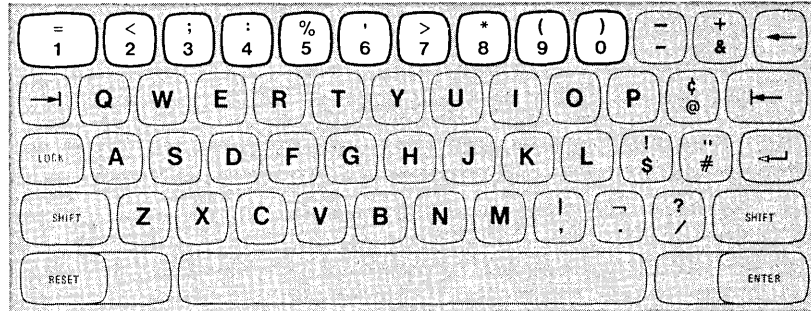

Cursor Control Keys

All of these keys have a common function. They provide a means of positioning the cursor without affecting any of the information already on the screen.

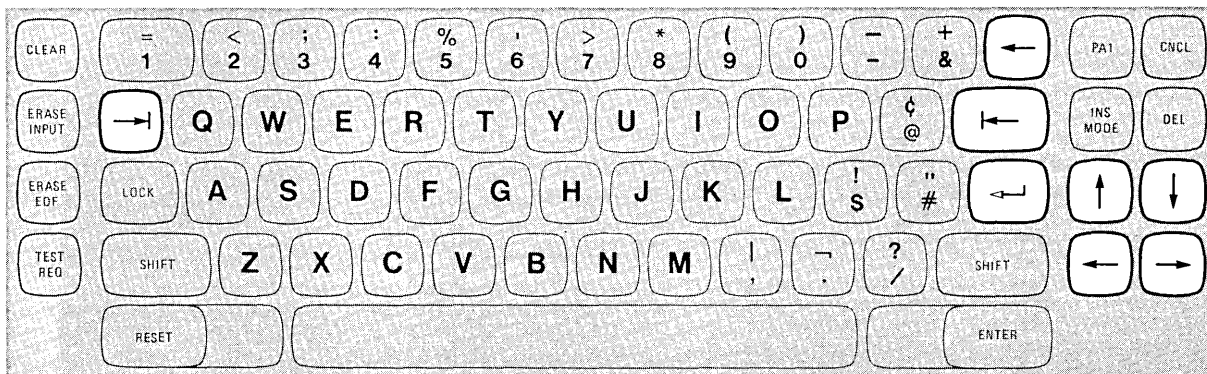

Figure 28. Use the cursor control keys to reposition the cursor.

Because the position of the cursor determines where the next character you type will be entered, it is important to know how to move the cursor to any location on the screen. Also, you'll want to be able to move the cursor quickly to speed up your

communications with the program. All of the cursor control keys can cause the cursor to wrap.

These keys are divided into two types:

1. Those which move the cursor to the first character location in a field.
2. Those that move it one character position at a time.

Moving the Cursor to the Beginning of a Field

New Line Key

If the screen is unformatted, the New Line key positions the cursor to the first character position of the next line.

On a formatted screen, the results of pressing the New Line key are determined by the way the screen is formatted. The cursor is positioned, on the new line, to the first location in which you can type (the first unprotected character position). For example, when the cursor is outside the entry area on your screen, you could use the New Line key to position the cursor to the first character position in the entry area if, as often is the case, that is the only unprotected area on your screen.

If no unprotected character positions exist on the screen, the cursor is repositioned to the first character location on line 1.

The New Line key is typamatic and will move the cursor quickly from line to line.

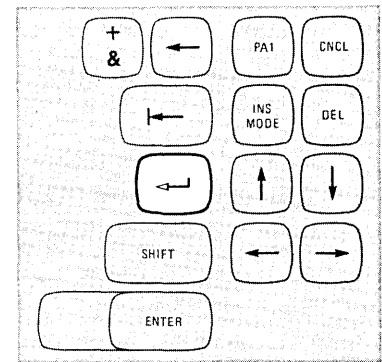

Pressing the Tab key moves the cursor to the right to the first character location of the next unprotected data field. If the entry area is the only unprotected area on your screen (the only area into which you can key data), the Tab key will always position the cursor to the first character position in that area, just as the New Line key does.

Pressing the Tab key moves the cursor to the first character location on line 1 if the screen is not formatted or there are no unprotected data fields. Tab also has typamatic capability.

Tab Key

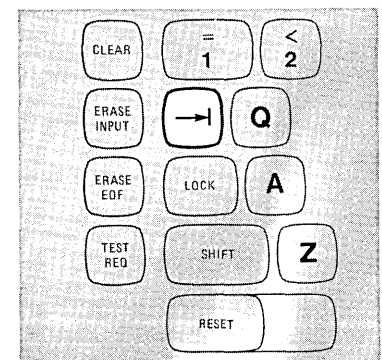

Back Tab Key

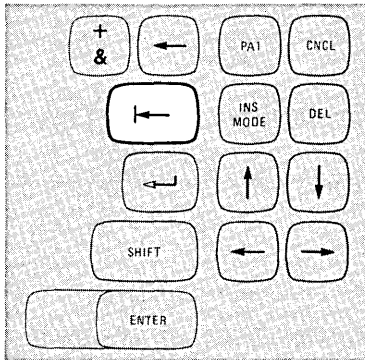

Operation of the Back Tab key is affected by the current position of the cursor. When the cursor is located within an unprotected field at a location other than the first character location of that field, the Back Tab key repositions it to the first character location.

When the cursor is already located in the first location of an unprotected field, the Back Tab key repositions it to the first character location of the first unprotected field to the left of its present location.

Back Tab is the only cursor control key that does not have typamatic capability.

*Moving the Cursor
One Character Space*

Horizontal Positioning Keys

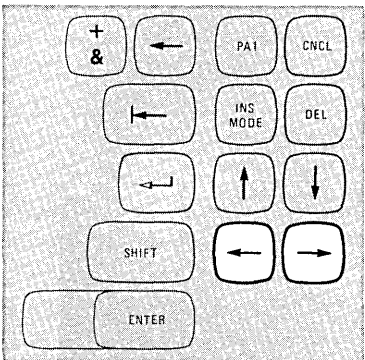

Pressing either of the two horizontal positioning keys (right →, or left ←) moves the cursor in the direction of the arrow, one character location at a time. The keys are typamatic so that you can move the cursor any distance quickly with only one depression of the key. If you hold down the control key that moves the cursor to the right, the cursor will move off the right side of the screen and will reappear one line lower on the left side (as explained on page 14). The cursor will also wrap when moved to the left and will reappear one line higher on the right side of the screen.

Vertical Positioning Keys

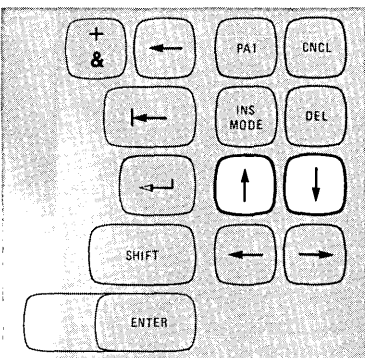

Pressing the two vertical cursor positioning keys (up ↑, or down ↓) moves the cursor in the direction of the arrow, one line at a time. The keys are typamatic to allow you to move the cursor any number of lines quickly and with only one depression of the key. If a vertical positioning key is held down, cursor wrap occurs. In this case, the cursor reappears in the same character position on the opposite edge of the screen that it occupied before moving off the screen.

Pressing the Backspace key moves the cursor one character space to the left for each depression of the key. This key operates exactly like the horizontal (left) positioning key and is also typamatic. (The duplication of key function is provided for operator convenience.)

Backspace Key

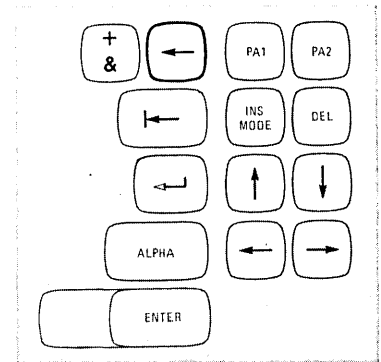

Symbols and Punctuation Marks

These characters are divided into two groups because of their physical locations. The first group contains the symbols that are located on the upper part of the keys that have the numerals 1 through 0 on the lower half. The second group are those characters located on keys that have two special symbols on them. The symbols that appear on the upper half of a key require depression of the SHIFT key to be displayed. Figures 29 and 30 show the locations of all symbols and give each symbol's name.

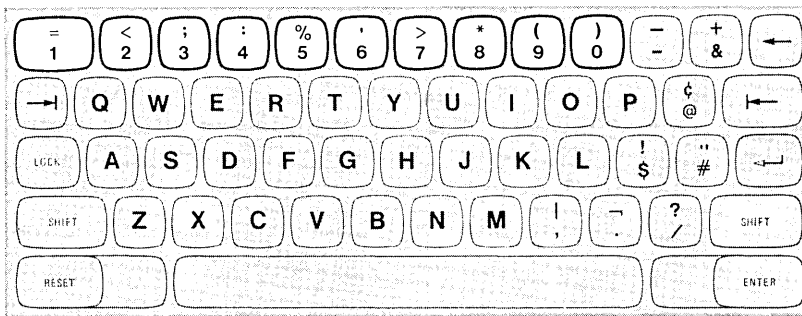

NUMERIC KEY

- 1
- 2
- 3
- 4
- 5
- 6
- 7
- 8
- 9
- 0

UPPER HALF of NUMERIC KEY

- = = equals sign
- < = less than sign
- ; = semicolon
- : = colon
- % = percent sign
- ' = apostrophe
- > = greater than sign
- * = asterisk
- (= left parenthesis
-) = right parenthesis

Figure 29. Some symbols are located on the numeric keys.

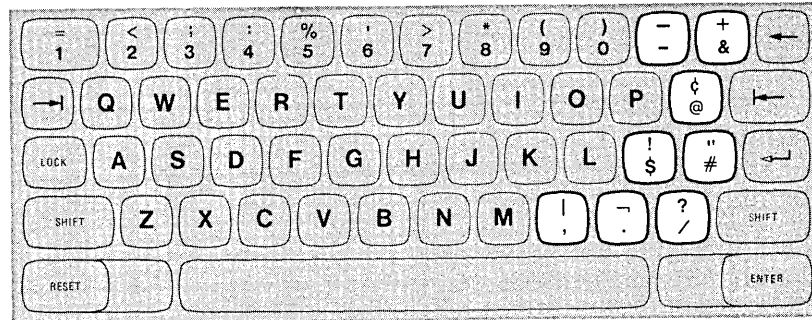

LOWER SYMBOL	UPPER SYMBOL
- = minus sign	— = underscore
& = ampersand	+ = plus sign
@ = at sign	¢ = cent sign
\$ = dollar sign	! = exclamation mark
# = number sign	" = quotation mark
, = comma	= logical OR, vertical bar
. = period	¬ = logical NOT
/ = slash	? = question mark

Figure 30. Some keys contain only symbols and punctuation marks.

CLEAR Key

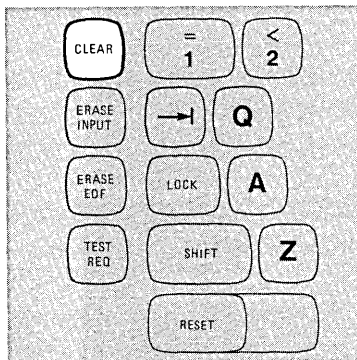

Pressing the CLEAR key blanks every character position on the face of the screen, establishes an unformatted display, and positions the cursor to the first character position on line 1.

Most operating systems will not allow the operator console to be cleared while it is on-line. Refer to the User's Guide for the program with which you're working for its recommendations on the use of the CLEAR key.

ERASE INPUT Key

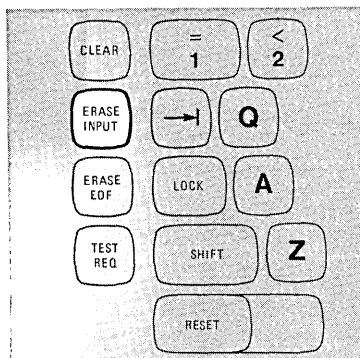

Pressing the ERASE INPUT key blanks or erases all unprotected character locations and moves the cursor to the first unprotected character position on the screen. This key erases all areas into which you can enter data. It also moves the cursor to the first character location in the first field in which you can begin typing. You could erase the entry area on your screen by pressing ERASE INPUT.

Pressing the ERASE EOF (Erase End of Field) key erases or blanks character positions in the field in which the cursor is located. All character positions from the cursor location to the end of the field are erased. The cursor, however, does not move.

A possible use of this key can be shown by supposing that you have entered wrong information when keying in an input field. You could press the Back Tab key to return the cursor to the beginning of the field, press the ERASE EOF key to erase the incorrect information, and then key in the correct information.

ERASE EOF Key

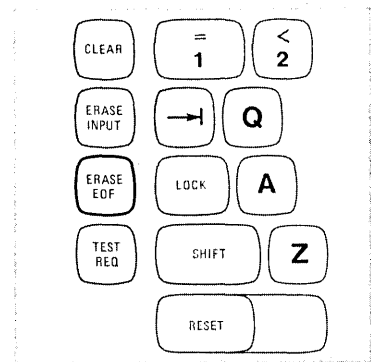

Pressing the TEST REQ key sends a unique signal to the computer, telling the program that a test message is on the screen. While this signaling is taking place, the INPUT INHIBITED indicator turns on, making your keyboard inactive. The program, replying to the signal, normally turns off the indicator and tells you what to do next by displaying a message on your screen.

The TEST REQ key is normally used in testing a failing display station, and certain procedures must be followed. If you are not familiar with its use, refer to the appropriate Program User's Guide or ask your supervisor to explain the procedure(s) for using this key.

TEST REQ Key

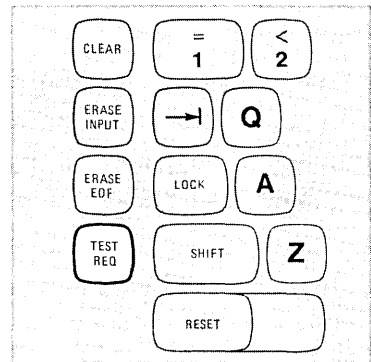

RESET Key

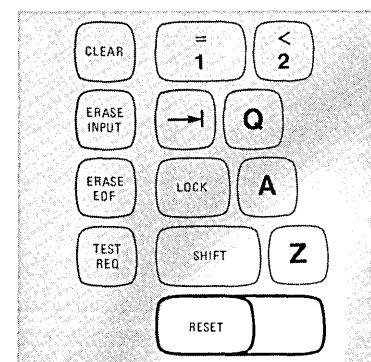

Pressing the RESET key resets the INSERT MODE and INPUT INHIBITED indicators. However, the RESET key will not reset these conditions during the short period when your display station is sending data to, or receiving it from, the computer. Thus, it may be possible for you to press the RESET key and not accomplish the desired reset. If this happens, press the key again to reset the condition.

PA1 Key

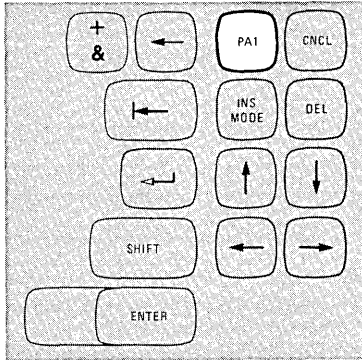

PA1 is a Program Access key, and it performs the function that its name implies. It provides a means of signaling the program or getting access to it. The program that is operating in the computer at the time this key is pressed determines how it will be used. To determine its exact function, refer to the appropriate Program User's Guide.

INS MODE Key

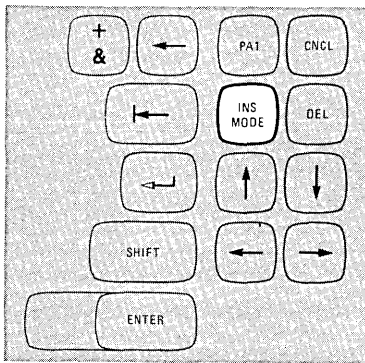

The purpose of Insert Mode is to allow you to insert a character, or characters, into the middle of a field without disturbing the information already displayed there. Pressing the INS MODE key places the keyboard in the Insert Mode of operation. The INSERT MODE indicator turns on to remind you that your keyboard is in Insert Mode.

All of the keyboard control keys perform normally when in Insert Mode. You will notice, however, that the 3270 display station performs a unique operation when any of the alphanumeric keys are pressed in Insert Mode. The following example explains this operation.

A quick glance at your screen tells you that the reply you keyed is missing the word TO.

```

1 00 IBM0001 WTOR MESSAGE 1
2 IBM0002 NON-ACTION MESSAGE 1
3- COMMAND
41 REPLY 00, 'ANSWER TO WTOR MESSAGE 1'
5 IBM0003 NON-ACTION MESSAGE 2
6- COMMAND
7 IBM0004 NON-ACTION MESSAGE 3
81 01 IBM0005 WTOR MESSAGE 2
91 IBM0006 INTERVENTION REQUIRED MESSAGE 1
10- IBM0007 INFORMATION MESSAGE 1
11- COMMAND
121 REPLY 01, 'ANSWER TO WTOR MESSAGE 2'
13 IBM0008 NON-ACTION MESSAGE 2
14- IBM0009 INFORMATION MESSAGE 2
151 IBM0010 ACTION MESSAGE 1 THAT IS OVER 72 CHARACTERS AND HAS TO BE
161 CONTINUED ON THE NEXT LINE
171 02 IBM0011 WTOR MESSAGE 3
18- IBM0012 INFORMATION MESSAGE 3
19- COMMAND
20 IBM0013 NON-ACTION MESSAGE 3_
1 2 3 4 5 6 7 8 9 10 11 12
1FF1521 *ENTER* *CANCEL* *D C, **
REPLY 07, 'ANSWER WTOR MESSAGE 8'
1EE159E MESSAGE WAITING

```

Figure 31. Use the INS MODE key to insert missing information.

It should read:

REPLY 07, 'ANSWER TO WTOR MESSAGE 8'

To correct this error using Insert Mode, you would move the cursor to the character position containing the W in WTOR.

REPLY 07, 'ANSWER WTOR MESSAGE 8'

(This is the position where the word TO should begin.)

Pressing the INS MODE key places the keyboard in Insert Mode. Now, keying of the missing information results in the sequence shown in Figure 32.

Key Pressed	
T	REPLY 07, 'ANSWER <u>T</u> TOR MESSAGE 8'
O	REPLY 07, 'ANSWER <u>TO</u> TOR MESSAGE 8'
Space	REPLY 07, 'ANSWER <u>TO</u> WTOR MESSAGE 8'

Figure 32. Inserting information moves some displayed data to the right.

The missing data has been inserted without disturbing the data that follows it. You may have noticed that, as characters are inserted, all characters to the right of the cursor are shifted into the blank character positions to the right of the last displayed character. The INPUT INHIBITED indicator will turn on, and your keyboard will be disabled if you try to insert more characters than the field will hold.

As a general rule, the number of characters you can insert into a field is limited to one character less than the number of blanks remaining in that field.

If the field is a large one and covers more than one line, and if the situation calls for it, during the insert operation, characters will shift from the end of one line to the beginning of the next.

Pressing the RESET key returns the keyboard to its normal mode of operation and resets the INSERT MODE indicator. The correction made, you would now move the cursor to the next character position into which you want to enter data.

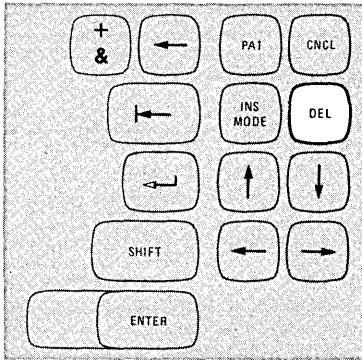
DEL Key

Pressing the DEL key when the cursor is located in an unprotected field deletes the character occupying the position underlined by the cursor. It erases the character without leaving a blank space. All characters in the field to the right of that position are then shifted left one position. An example of its use is the case where you have incorrectly keyed REPPLY 07 on the screen. To correct this error with the DEL key, you would move the cursor to the position of the extra P with the cursor-positioning key or the backspace key: REPPLY 07. Pressing the DEL key erases the P and the characters to the right of it move left one space, resulting in: REPLY 07. The correction made, you would now move the cursor to the next character position into which you want to enter data.

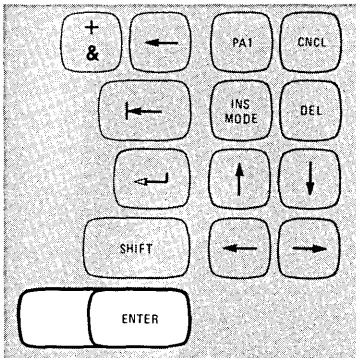
ENTER Key

Pressing the ENTER key signals the program to indicate that you have completed your message and are ready for the information on the screen to be entered into the computer.

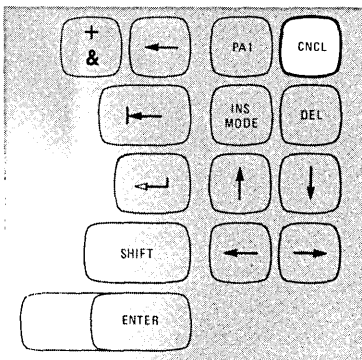
CNCL Key

Pressing the CNCL (Cancel) key sends a unique code to the computer. Normally, the cancel signal causes the program to clear the input (entry) area and reposition the cursor to the first character location in that field. However, the application program in use at the time determines the exact function of this key. Check the Program User's Guide for a description of the action taken as a result of pressing the CNCL key.

In addition to the functions permanently assigned to other keys (that is, DUP, Backspace, Tab, Backtab, etc.), application programs can assign other programmable functions to the PF (Program Function) keys. Each program can tailor the keyboard to fit its specific needs. Therefore, these assigned functions could be different for every application program. This adds flexibility to the keyboard and makes it a much more powerful input device.

To determine the use of each key and the action it causes, refer to the User's Guide of the application program with which you are working.

PF1–PF12 Keys

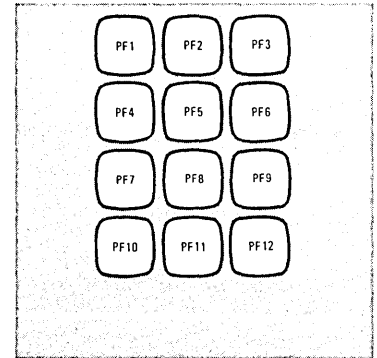

By now, you should be quite familiar with your display station. If there is any area that you're still not sure about, turn back and reread the section that discusses it. Press the key, or keys, in question, and watch the result. If you still have questions, now is the time to get them answered. Ask your supervisor or an experienced operator for an explanation.

For a discussion of what you should do when you have trouble with your machine, turn to "Trouble With Your Machine" on page 92.

Table of Contents

Introduction 77

Print Mechanism 78

 Platen/Pin Feed 78

 Print Head/Ribbon Cartridge 79

 Test Switches 79

 PRINT PAT/ON LN/PRINT BFR or PRINT PAT/ON

 LN Switch 80

 START PRINT and MODE 1/MODE 2 Switches 80

Paper Handling Controls 80

 Paper-Advance Knob/Vertical Alignment Vernier 80

 Line-Feed Select Lever 81

 Copy-Control Lever 81

Installing Forms in the Printer 81

Replacing the Ribbon 84

Placing an Off-Line Printer in On-Line Status 86

Introduction

A typical printer is shown in Figure 33. When a printer has been installed and placed in operation, it functions automatically under control of the program. Normally, you need only add paper and replace the ribbon when it becomes worn. In addition, if the need arises, you should know how to prepare an off-line printer for on-line service. To understand printer operation, you should learn the location and purpose of the main parts of the unit and the operating controls.

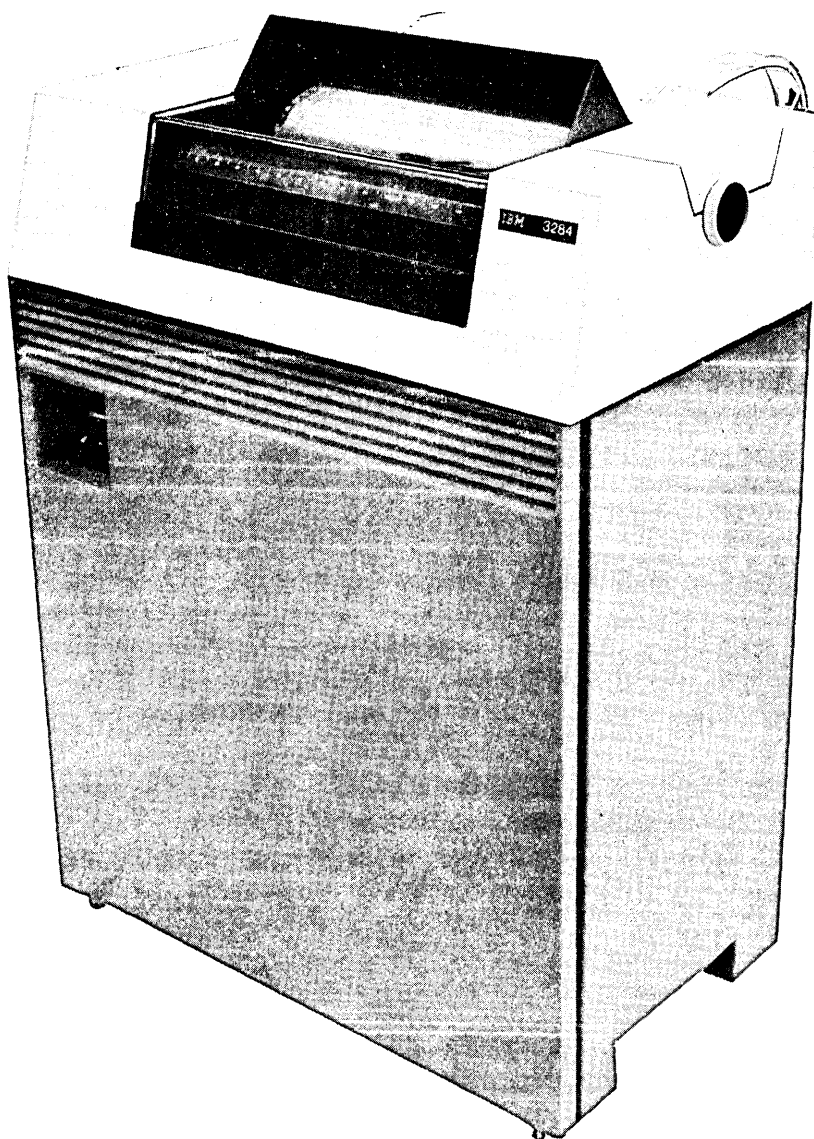

Figure 33. Typical Printer

Print Mechanism

When you look through the transparent top cover, you will notice that the mechanism resembles a typewriter but without a keyboard attached. To see the parts more clearly, raise the top cover by placing your finger tips under the recessed front edge of the cover and lifting upward. With the cover raised you'll see all the parts and controls shown in Figure 34.

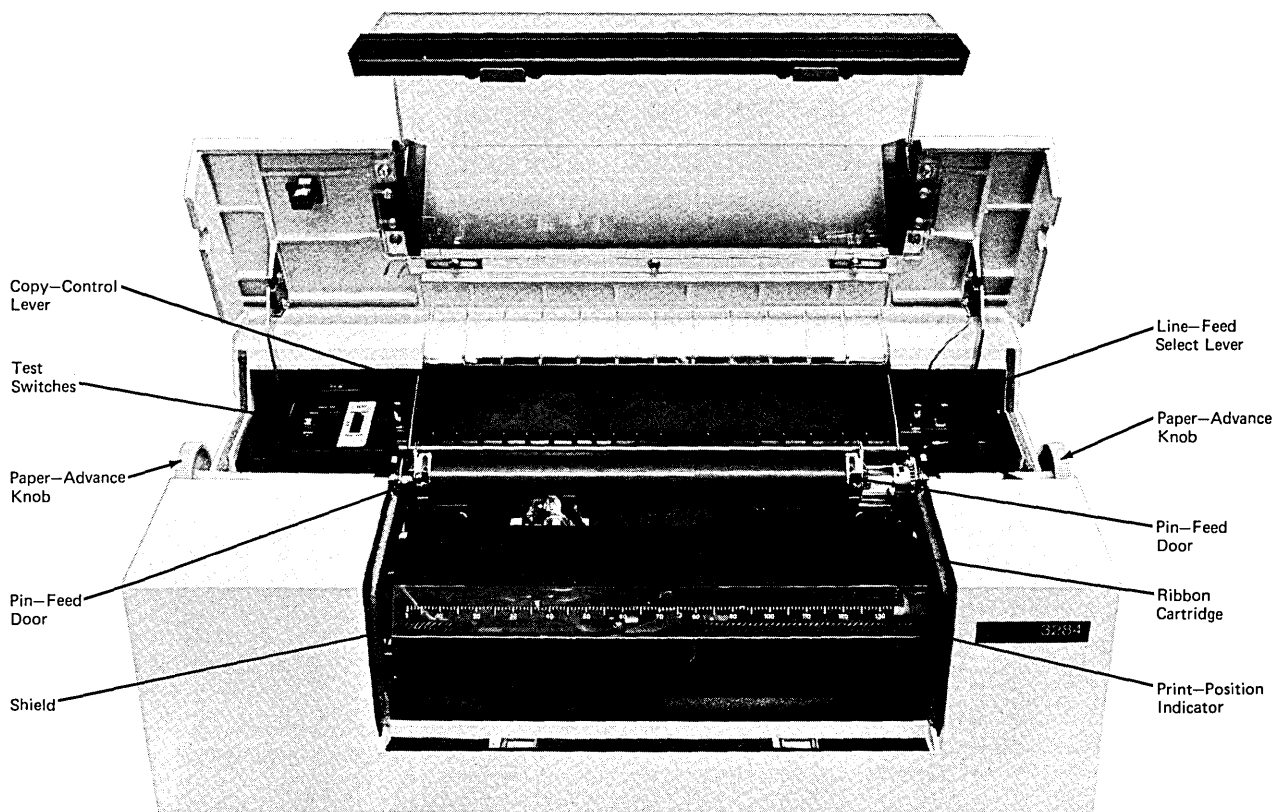

Figure 34. Printer Operating Controls

Platen/Pin Feed

The paper folds around the platen as in a typewriter; however, unlike a typewriter, the paper is held by pins extending from each end of the platen. The pins pass through holes near the left and right edges of the paper. The pin-feed doors close over the edges of the paper (to keep the pins properly engaged in the paper and to keep the paper firmly against the platen).

Print Head/Ribbon Cartridge

The print head forms the characters, which are printed automatically by program control. The print ribbon is contained in a cartridge attached to the print head. The ribbon is threaded around the print head as shown in Figure 38. When the print head is signaled by the program, it moves across the platen and strikes the ribbon and paper for each letter, causing a message to be printed on the paper.

Test Switches

A small test switch panel (Figure 35) having three switches is located on the left side of the platen. All positions of the switches are used for servicing the printer. Some switch positions are used by the operator. You will use the switches, if required, to carefully align the paper with the print line when installing new paper forms. You'll also operate switches when changing the ribbon cartridge and placing the printer in on-line and off-line status. Instructions for using the switches are given in the procedures where they are used.

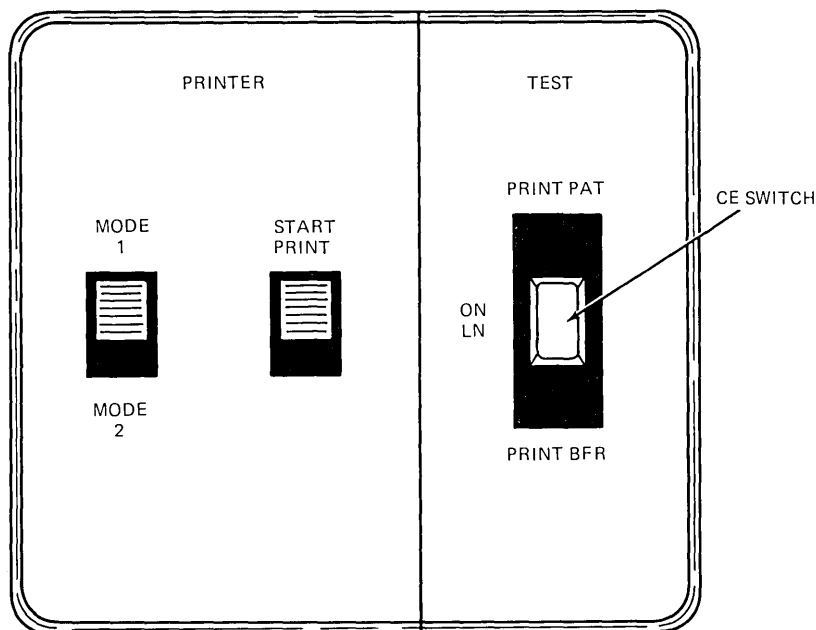

Figure 35. Test Switch Panel

**PRINT PAT/ON LN/PRINT BFR
or PRINT PAT/ON LN Switch**

This switch (also called the CE switch) is a two- or three-position switch, depending on the type of printer. The purpose of the three-position switch is to place the printer on-line (ON LN position) or in either of two off-line test positions: print pattern (PRINT PAT) or print buffer (PRINT BFR). The two-position switch found on some printers does not have the PRINT BFR position. You will use only the ON LN and PRINT PAT positions of this switch. (The PRINT BFR position is normally for service personnel.)

When the printer is operational and under control of the computer program, this switch will be in the ON LN position. When you must place the printer off-line (for example, when preparing to change a ribbon cartridge), the switch is placed to the PRINT PAT position.

**START PRINT and
MODE 1/MODE 2 Switches**

These switches are used in a sequence. Once the printer has been placed off-line (by moving the right test switch to the PRINT PAT position), either of two print patterns may be selected (by placing the mode switch in the MODE 1 or MODE 2 position). Then, by sliding the START PRINT switch forward, the printer will be activated to print out the selected pattern. The MODE 2 position produces an H pattern used for precise paper alignment; this is the only mode used by the operator.

Paper Handling Controls**Paper-Advance Knob/
Vertical Alignment Vernier**

The paper-advance knob provides an adjustment for approximate positioning of the paper forms in the printer. You'll find the paper-advance knob at the right end of the platen. When you rotate the knob, the platen and paper move together. As you turn the knob you can see how the pins coming from the platen fit the holes in the ends of the paper and "feed" the paper through the machine.

The vertical alignment vernier provides an adjustment for exact positioning of paper forms. This control is activated by pressing in and rotating the paper-advance knob from the right side of the printer.

To position the paper more accurately (when, for example, you use lined paper forms and the message characters are to be printed on the lines), you press in and rotate the paper-advance knob to align the paper with the print line. Since there is no marker or guide on the print head to indicate where the print line occurs on the paper, instructions are given in the procedure for installing paper forms. This procedure involves locating the print line by causing the printer to print a row of H's.

The line-feed select lever allows you to select single or double line-spacing. Pushing the lever back causes the printout to be double-spaced; pulling forward produces a single-spaced printout.

Line-Feed Select Lever

The copy-control lever allows you to adjust the space between the platen and the print head (so that forms of different thickness may be inserted in the printer).

Copy-Control Lever

When a forms stand is provided, paper forms are placed on the lower platform of the forms stand and are inserted through a slot at the rear of the printer. They pass between the platen and the print head and exit over the top of the printer. The forms are then stacked on the top platform of the forms stand. (Figure 36 shows how forms are stacked on the forms stand and where the forms enter and exit the printer.) When the printer runs out of paper, the platen rotates for a short time, causing a clicking sound. If you do not hear the sound of the platen, you can easily look through the transparent top cover on the printer and see

Installing Forms in the Printer

that paper is needed. Also, when paper runs out, a control signal is sent to the computer, indicating that an operator is needed at the printer.

To insert paper, face the front of the printer and proceed as follows: (It is not necessary to turn power off at the printer.)

1. Place your finger tips under the recessed front edge of the top cover and lift upward.
2. Raise the plastic safety shield containing the print-position indicator by pulling upward on the shield edge near the platen.
3. Push the copy control lever back to allow maximum opening between the print head and the platen.
4. Raise both doors covering the pin-feed mechanism at the ends of the platen.

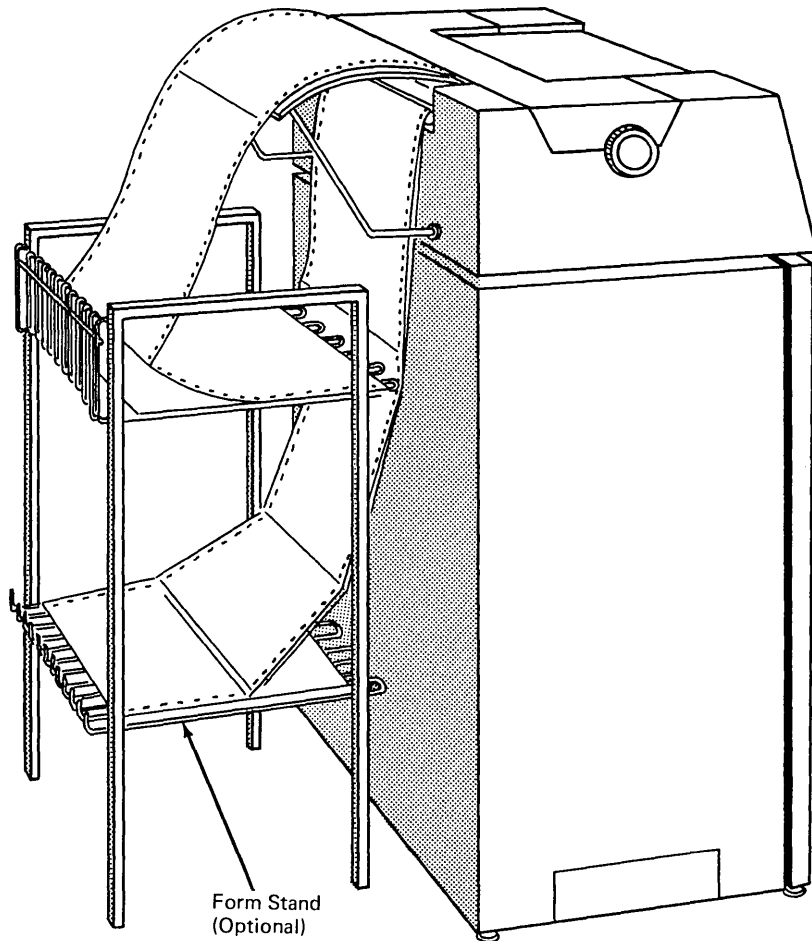

Figure 36. Printer with Forms Stand

From the rear of the machine, perform the following:

5. Check that you have the correct size paper forms for your printer. The paper may be 13", 13-5/8", or 14-3/8" wide.
6. If a forms stand is provided with the printer, place the new paper forms on the lower rack of the stand.
7. Insert the starting edge of the first form sheet in the paper feed slot, with the side to be printed on facing down. The forms enter easily if started with one corner entering the feed slot first.
8. Push the forms through the slot until the front edge is seen passing under the platen.

From the front of the machine, perform the following:

9. Pull the front edge of the form forward a short distance, bend it around the platen, and align the paper horizontally until the holes at each side of the paper fit on the pins of the pin-feed mechanism.
10. Close the pin-feed doors.
11. Set the copy-control lever to the correct position required by the number of parts in the form being used:

Position	Type of Form Used
1 — (Closest to the front of the printer)	One-part
2 —	Two- or three-part
3 ■	Four-part
4 ■	Five- or six-part
5 ■ (maximum spacing)	

12. Set the line-feed select lever by pulling forward for single-spacing or pushing back for double-spacing.
13. Press in and rotate the paper-advance knob to approximately align the form with the print line. If required to move the form backward, rotate the paper-advance knob backward, and pull the form from behind the machine to keep the form from buckling at the print head.
14. If more precise alignment is necessary, set the TEST PRINT PAT/ON LN/PRINT BFR switch to the PRINT PAT position and the MODE switch to MODE 2; then, push and release the START PRINT switch. A continuous line of H's prints, as shown in Figure 37. This will show where the print line is on the paper. Then press in and rotate the paper-advance knob to more closely align the form with the print line. Return the TEST PRINT PAT/ON LN switch to ON LN. When the paper is properly aligned, rotate the paper-advance knob to feed the paper through the paper exit slot in the cover.
15. Close the cover.

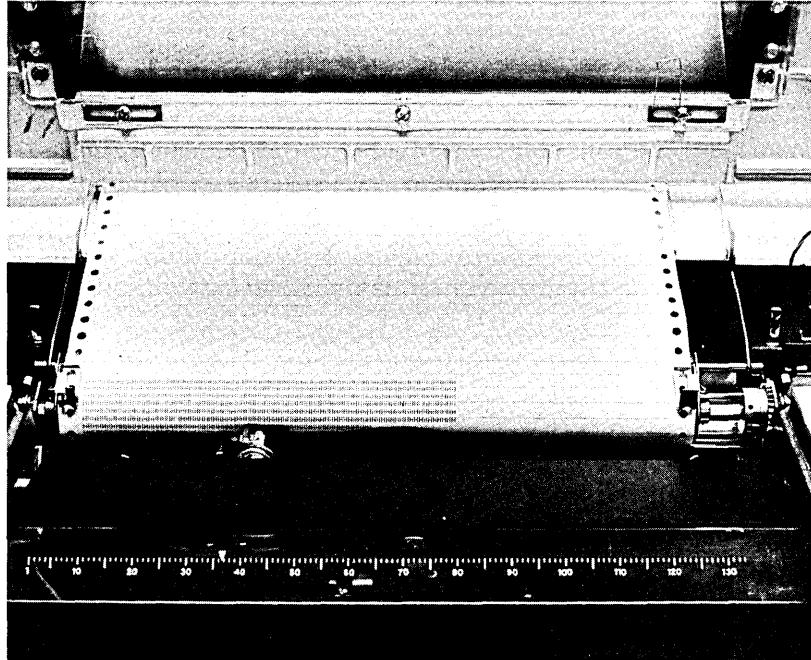

Figure 37. H-Pattern Printout

Replacing the Ribbon

1. Flip the POWER ON/OFF switch to OFF.
2. Place your finger tips under the recessed front edge of the top cover and lift upward.
3. Set the TEST PRINT PAT/ON LN/PRINT BFR switch to TEST PRINT PAT.
4. Flip the POWER ON/OFF switch ON, and be ready to quickly turn power OFF when the print head has moved about halfway across the carriage. (You may have to repeat this procedure a few times to center the print head.)
5. Push the copy-control lever back for maximum distance between print head and platen.
6. Raise the plastic safety shield containing the print-position indicator by pulling upward on the shield edge near the platen. On the inside of the shield you will see a decal showing how the ribbon is threaded around the print head. This mechanism is shown in Figure 38, with associated reference numbers.

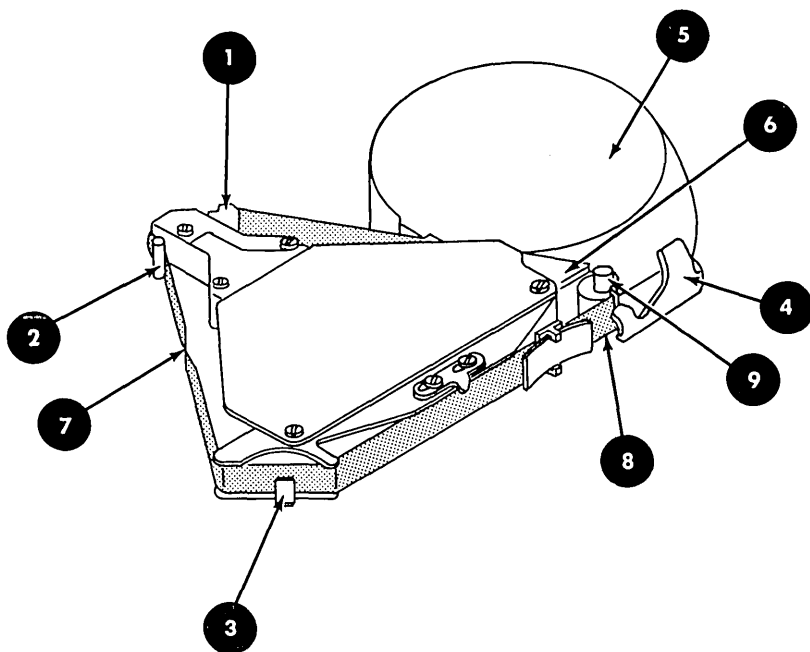

Figure 38. Ribbon Cartridge

7. Remove the ribbon from under plastic guide **1** and from around guide posts **2** and **3**.
8. With your left hand, pull and hold the ribbon cartridge latch **4** while rotating the ribbon cartridge **5** counterclockwise with your right hand to release the cartridge from the aligning fingers **6**.
9. Lift out the ribbon cartridge. (If you rotate the cartridge back and forth, it comes out easier.)

To install the new ribbon cartridge, proceed as follows:

10. With your left hand, pull and hold the cartridge latch **4**.
11. Seat the cartridge on the pivot, and rotate the cartridge clockwise to engage the aligning fingers **6** with the aligner.
12. Release the cartridge latch **4**.
13. Thread the ribbon around the print head. (Be careful not to get oil on the ribbon, from the oil wick.) Work the ribbon under the plastic guide **1**, in front of the print head, and back around the front guide post **2**.
14. Locate the twist **7** in the ribbon between the front and rear guide posts **2** and **3**.

15. Place the ribbon over the rear guide post **3**
16. Remove and discard the tab **8** (not shown) protecting the ribbon entrance to the cartridge. It's important that you remove the tab.
17. Rotate the drive roll knob **9** counterclockwise to take up the ribbon slack. Continue rotating the knob until you know the ribbon is feeding properly.
18. Close the safety shield.
19. Set the copy-control lever for the recommended thickness.
20. Set the TEST PRINT PAT/ON LN switch to ON LN.
21. Close the printer cover. It is important that the cover be closed securely.
22. Flip the POWER ON/OFF switch to ON.

Placing an Off-Line Printer in On-Line Status

When the printer is operating, or is ready to operate, with the computer, it is said to be on-line. Use the following procedure to place an off-line printer in operational on-line status:

1. Raise the printer top cover by placing your finger tips under the recessed front edge of the cover and lifting upward.

2. Place the PRINT PAT/ON LN/PRINT BFR switch (located on the left side of the platen) in the PRINT PAT position.
3. Check that the POWER switch (located on the left side of the front cover, below the print mechanism) is OFF.
4. Plug the power cord connector into the wall receptacle, and connect the signal cable.
5. Turn the POWER switch ON; check that the platen turns to the next line position and that the print head moves across the carriage and returns to print position 1, as indicated by the print position indicator.
6. Check that there is paper in the machine; if necessary, add paper according to the procedure given on page 81.
7. Place the PRINTER MODE switch in the MODE 2 position. Then push and release the START PRINT slide switch and note that the unit automatically prints a line of H's. If the characters are weak and difficult to read, replace the ribbon according to the procedure on page 84.
8. Place the PRINT PAT/ON LN/PRINT BFR switch in ON LN, and close the top cover. Your printer has now been checked and is ready for operation under program control.

If, at this time, the printer does not operate under program control, raise the top cover and recheck the following items:

1. Check that the paper is installed correctly by rotating the paper advance knob a few times to see that the paper moves evenly with the platen.
2. Check that the PRINT PAT/ON LN/PRINT BFR switch is in the ON LN position and that the POWER switch is ON.
3. Lower the top cover; make sure that it is closed tightly.

If the printer still does not function, tell your supervisor and, if it is consistent with your organization's policy, fill out the OPERATOR TROUBLE REPORT as described on page 92.

Description

The Operator Identification Card Reader is a special attachment for the 3270 display station and is used to send coded messages to the computer. The card reader is attached to the display station through a 30-inch cable, as shown in Figure 39. When your display station is equipped with a card reader, you can send a coded message to the computer by inserting a special magnetic-striped card into the reader. You may be required to use a card reader in your organization when, for example, you begin operating the display station.

A specially designed (coded) credit card may also be used to update an account or request information about accounts. The code, which identifies the person using the card reader or which represents an account number, is contained on a magnetic stripe attached to the back of the card.

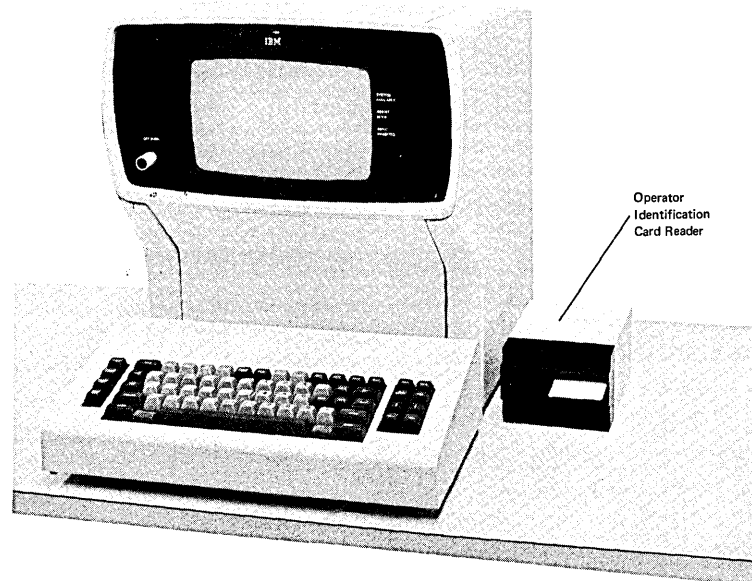

Figure 39. Operator Identification Card Reader

Card Reader Operation

When selection status is obtained by the card reader, keyboard, selector pen, and I/O operations are inhibited. To operate the card reader:

1. Turn on the display station, or, if you are using the display station, complete the present job.
2. Ask your supervisor, or check the Program User's Guide, and position the cursor in an unprotected data field specified for your display station. Remember that if the cursor is placed in a protected data field the data from the magnetic striped card will not be read into the system.
3. Insert the magnetic card into the top slot at the front of the reader, with the brown magnetic stripe face-down and to the left. The card will automatically be drawn into the reader and ejected through the bottom slot.

While the card is passing through the reader, check that the cursor moves across the screen. (Card reader data will not be visible on the screen.) The cursor movement means that the code has been sent to the computer. If the cursor does not move as the card passes through the reader, then the card reader was not selected. If there is a failure (as indicated by either a computer message response or by the card reader not obtaining select status), try again to use the card reader by repeating steps 1, 2, and 3. Check carefully that:

1. No other operations are in progress at the display station.
2. The cursor is positioned on the screen as stated in the Program User's Guide.
3. The card is inserted correctly into the reader.

If the failure is still present after repeating the procedure, obtain a different magnetic card and try again. If failure still occurs, tell your supervisor. Also, if consistent with your organizational policy, fill out the OPERATOR TROUBLE REPORT as described on page 92.

A Typical Job

For a better idea of the type of work you'll be doing on your display station, let's look over the shoulder of an experienced 3270 operator performing a typical job. After being assigned a job and receiving the source documents, the first thing the operator does is contact the computer when ready to begin working. To accomplish this, many organizations have sign-on procedures. At these locations, the computer normally ignores all signals or interruptions from a display station that is not signed on. A sign-on procedure is simply a method of informing the program that an operator will be working on the display station being signed on. It usually consists of the operator keying in a personal identification code and job number. Your supervisor will tell you what action you must take and what your organization's procedures are.

Correction of Operator Errors

When ready to begin working, the operator signals the program again, probably with one of the Program Access keys. A formatted display appears on the screen, and the operator begins to key data from the source document.

As you can see, the operator misspelled the word being typed. (Even experienced operators make mistakes.)

You noticed that, having realized the mistake, the operator corrected it immediately. The cursor was moved back to the incorrect letter (with the cursor control key). Then, the correct letter was keyed, replacing the incorrect one on the screen. After that, the cursor was moved back to where the operator had stopped, and keying from the source document was resumed.

Misspelling words and accidentally keying the wrong letter are the most common errors. They are also very easy to correct, and you should have no problems with them.

After typing the whole record, our experienced operator makes sure the SYSTEM AVAILABLE indicator is on, and presses ENTER. The ENTER key tells the program that data from the display station is ready to be entered into the computer.

If there are no equipment errors in transferring the information from the display station to the computer, the data the operator has just typed (in the input fields) disappears from the

screen. The field names are still displayed, however, and the operator begins keying from the next source document.

Errors that turn on the only error indicator on your display station (INPUT INHIBITED) are those that you can make while keying from a source document. If we watched long enough, we might see our experienced operator make a mistake that would immediately cause the input from the keyboard to be inhibited. However, we could have a long wait. For this reason, listed below are the operator mistakes that cause the keyboard input to be inhibited.

When the cursor is located within a protected field, the INPUT INHIBITED indicator will turn on if the operator:

1. Attempts to change the protected data by keying any alphameric character.
2. Attempts to erase protected data by pressing the ERASE EOF key or the DEL key.
3. On a Data Entry keyboard, attempts to enter an alphabetic character in a numeric field without first pressing the ALPHA shift key.

When the display is in Insert Mode, the INPUT INHIBITED indicator will turn on if the operator:

4. Attempts to insert too many characters in a field. (As a general rule, the number of characters that can be inserted is limited. Usually, the limit is one character less than the number of blank positions between the last displayed character and the first displayed character in the next field. For an example of the Insert limit, reread the discussion of the INS MODE key.)

Before pressing the RESET key to turn off the indicator, you should determine why it turned on. The INPUT INHIBITED indicator informs you that the input from your keyboard has been inhibited. If you have made an error or attempted an incorrect procedure, you want to be able to correct your mistake quickly and continue with your work.

The User's Guide for the program that you are working with explains the rules and procedures you must follow when doing your job. Violation of one of these rules or procedures is not considered an error by your display station; therefore, no indicator will come on. However, this type of error is detected by the program, and a message will normally be displayed on your screen to inform you of your mistake and tell you how to correct it.

Trouble With Your Machine

In addition to recognizing your own errors and being able to correct them, you'll want to be able to recognize when your display station isn't working properly. This section describes machine malfunctions and tells you what to do when you encounter them.

If you pull out the OFF-PUSH switch to turn your display station on, then wait the normal warm-up time, and nothing appears on your screen, and pressing keys has no effect, you probably have a power problem. Before calling your supervisor, make sure that the power cord from your display station is plugged into the wall outlet.

Operator Trouble Report

Power trouble and other possible troubles with your display station are described in the OPERATOR TROUBLE REPORT on page 93. You are the person most familiar with your display station; therefore, you can best describe any trouble you might encounter. For this reason, as soon as you are sure you have a machine problem, and if consistent with organizational policy, please fill in an OPERATOR TROUBLE REPORT as completely as possible. Additional copies of this form are provided at the end of this manual, and, if needed, you can get more from your supervisor.

Notice that the trouble report is divided into five parts: POWER FAILURE, INDICATORS, DISPLAY FAILURE, KEYBOARD FAILURE, and PRINTER FAILURE. On all failures, you should complete the INDICATORS section along with all other sections that describe your display station's failure.

After completing the trouble report, give it to your supervisor when you tell her (him) of the failure. If your display station needs to be serviced, your trouble report will be a great help to the service representative.

OPERATOR TROUBLE REPORT
TYPEWRITER KEYBOARD

POWER FAILURE

Display station won't turn on.

Display station was operating; went dead.

Noticed smoke or unusual odor at the time.

FAILURE OF

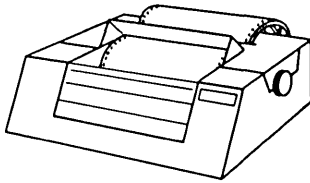

Printer

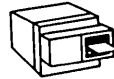

Operation Identification Card Reader



Selector Pen

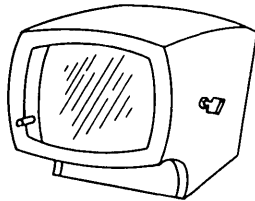

Display Station

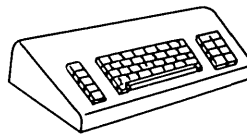

Keyboard

INDICATORS

Mark the indicators on when failure occurred.

- SYSTEM READY
- SYNC SEARCH
- SELECTED
- SYSTEM AVAILABLE

- INSERT MODE
- INPUT INHIBITED
- TRANSMIT
- STATUS

One or more indicators:

- Light when they should not.
- Don't light when they should.

DISPLAY FAILURE

The image on the screen looks like:

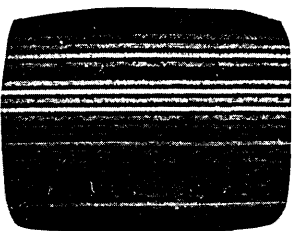
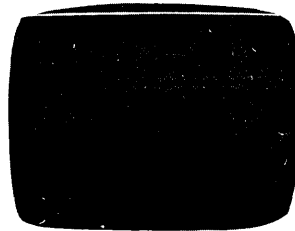

Nothing displays on screen:

- It's completely blank.
- It's glowing brightly.
- Image is too bright or too dim and cannot be adjusted.

CURSOR

- is missing or too short or too long.
- is normal but no characters display.
- won't move.
- is in wrong place (not below characters).
- more than one cursor.

OPERATOR TROUBLE REPORT

TYPEWRITER KEYBOARD
FAILURE

Mark all failing keys.

- All keys fail.
 All character keys fail.

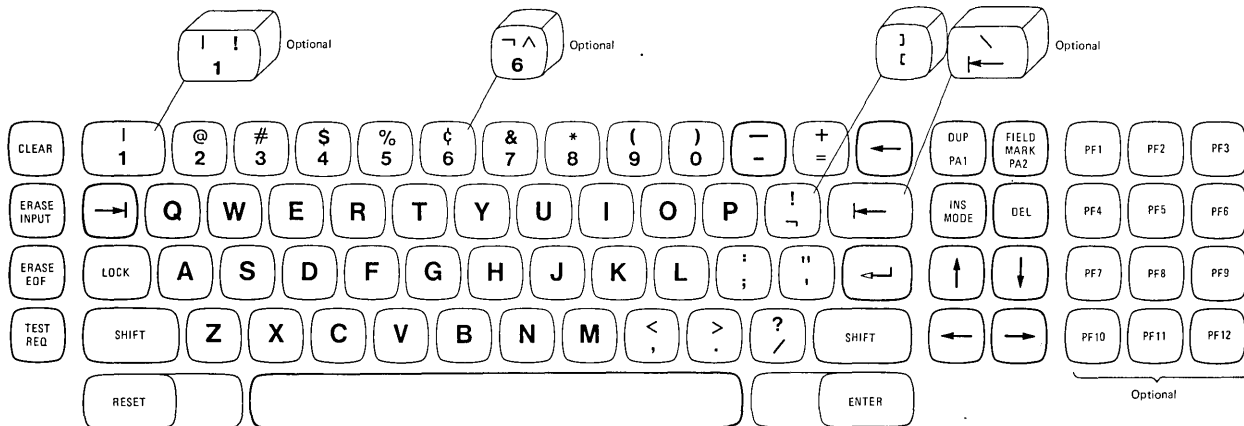

Operator comments about the failure.

PRINTER FAILURE

MESSAGE PRINTOUT ERRORS

- Carriage moves but does not print on paper.
- Wrong or missing characters in printout, incomplete message, or the printer starts or stops at the wrong location.
- Printer carriage will not stop at end of printout.
- Prints incorrect number of characters per line (40, 64, 80, 120, 126, or 132).
- Incomplete message; starts or stops at wrong point
- Left or right margin is uneven.

INDIVIDUAL CHARACTER PRINT ERRORS

- Specific row of dots missing; no other failure.
- Partial characters printed; garbled characters.
- Extra dots in characters; or solid squares printed.

PLATEN INDEXING FAILURE

- Platen never indexes.
- Too many indexes.
- Paper does not eject when supply is depleted while printing.
- Platen fails on multiple index.

MISCELLANEOUS MALFUNCTIONS

- Printer prints with cover open; On-Line Mode.
- Printer prints without paper.
- Message buffer failures.
- System receives an equipment check from the printer, but the printer does not print an "X" on the line following the message in error.

OPERATOR TROUBLE REPORT
DATA ENTRY KEYBOARD

POWER FAILURE

Display station won't turn on.

Display station was operating; went dead.

Noticed smoke or unusual odor at the time.

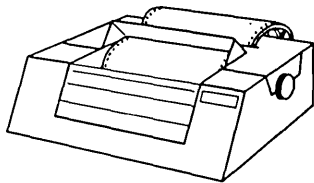

Printer

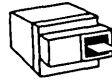

Operation Identification Card Reader



Selector Pen

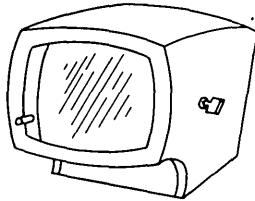

Display Station



Keyboard

FAILURE OF

INDICATORS

Mark the indicators on when failure occurred.

- SYSTEM READY
- SYNC SEARCH
- SELECTED
- SYSTEM AVAILABLE

- INSERT MODE
- INPUT INHIBITED
- TRANSMIT
- STATUS

One or more indicators:

- Light when they should not.
- Don't light when they should.

DISPLAY FAILURE

The image on the screen looks like:

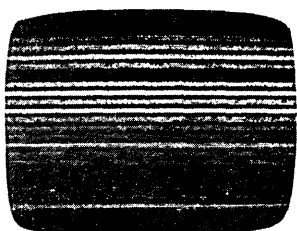

Nothing displays on screen:

- It's completely blank. It's glowing brightly. Image is too bright or too dim and cannot be adjusted.

CURSOR

- is missing or too short or too long.
- is normal but no characters display. won't move.
- is in wrong place (not below characters).
- more than one cursor.

OPERATOR TROUBLE REPORT

DATA ENTRY KEYBOARD
FAILURE

Mark all failing keys.

- All keys fail.
 All character keys fail.

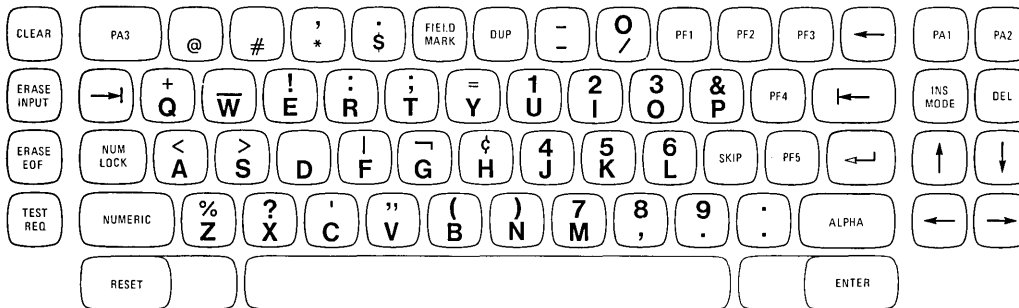

Operator comments about the failure.

PRINTER FAILURE

MESSAGE PRINTOUT ERRORS

- Carriage moves but does not print on paper.
- Wrong or missing characters in printout, incomplete message, or the printer starts or stops at the wrong location.
- Printer carriage will not stop at end of printout.
- Prints incorrect number of characters per line (40, 64, 80, 120, 126, or 132).
- Incomplete message; starts or stops at wrong point.
- Left or right margin is uneven.

INDIVIDUAL CHARACTER PRINT ERRORS

- Specific row of dots missing; no other failure.
- Partial characters printed; garbled characters.
- Extra dots in characters; or solid squares printed.

PLATEN INDEXING FAILURE

- Platen never indexes.
- Too many indexes.
- Paper does not eject when supply is depleted while printing.
- Platen fails on multiple index.

MISCELLANEOUS MALFUNCTIONS

- Printer prints with cover open; On-Line Mode.
- Printer prints without paper.
- Message buffer failures.
- System receives an equipment check from the printer, but the printer does not print an "X" on the line following the message in error.

OPERATOR TROUBLE REPORT
OPERATOR CONSOLE KEYBOARD

Display station won't turn on.

Display station was operating; went dead.

Noticed smoke or unusual odor at the time.

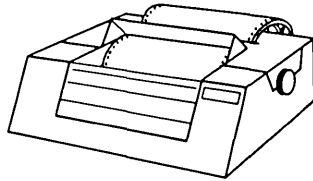

Printer

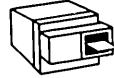

Operation Identification Card Reader



Selector Pen

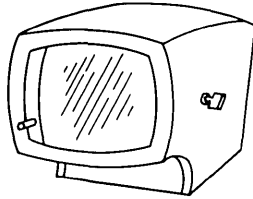

Display Station

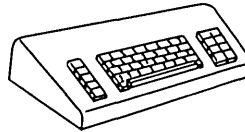

Keyboard

FAILURE OF

INDICATORS

Mark the indicators on when failure occurred.

- SYSTEM READY
- SYNC SEARCH
- SELECTED
- SYSTEM AVAILABLE

- INSERT MODE
- INPUT INHIBITED
- TRANSMIT
- STATUS

One or more indicators:

- Light when they should not.
- Don't light when they should.

DISPLAY FAILURE

The image on the screen looks like:

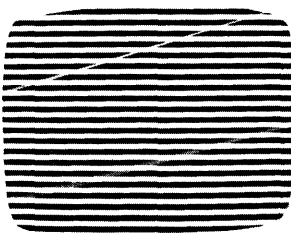
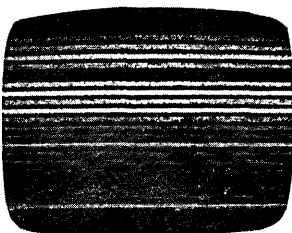
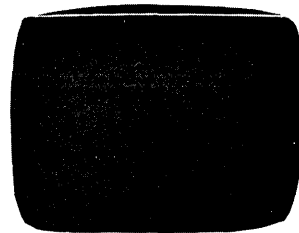
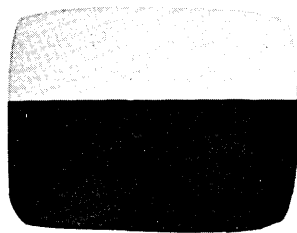

Nothing displays on screen:

- It's completely blank.
- It's glowing brightly.
- Image is too bright or too dim and cannot be adjusted.

CURSOR

- is missing or too short or too long.
- is normal but no characters display.
- won't move.
- is in wrong place (not below characters).
- more than one cursor.

OPERATOR TROUBLE REPORT

OPERATOR CONSOLE
KEYBOARD FAILURE

Mark all failing keys.

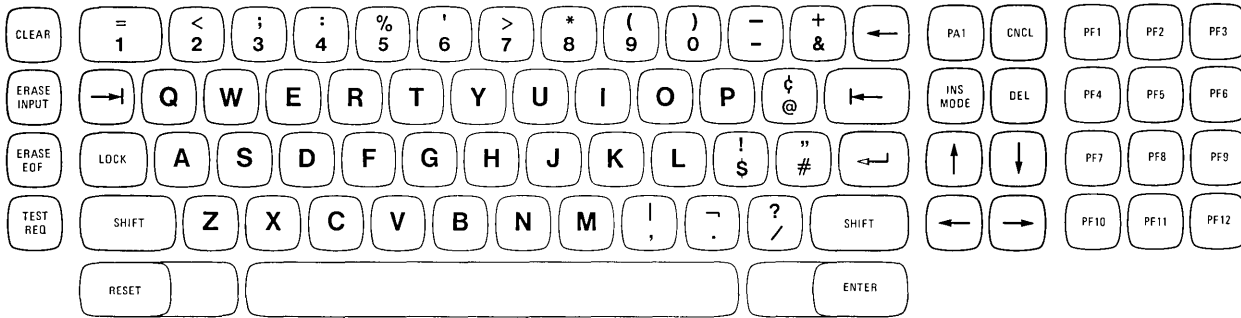

Operator comments about the failure.

PRINTER FAILURE

MESSAGE PRINTOUT ERRORS

- Carriage moves but does not print on paper.
- Wrong or missing characters in printout, incomplete message, or the printer starts or stops at the wrong location.
- Printer carriage will not stop at end of printout.
- Prints incorrect number of characters per line (40, 64, 80, 120, 126, or 132).
- Incomplete message; starts or stops at wrong point.
- Left or right margin is uneven.

INDIVIDUAL CHARACTER PRINT ERRORS

- Specific row of dots missing; no other failure.
- Partial characters printed; garbled characters.
- Extra dots in characters; or solid squares printed.

PLATEN INDEXING FAILURE

- Platen never indexes.
- Too many indexes.
- Paper does not eject when supply is depleted while printing.
- Platen fails on multiple index.

MISCELLANEOUS MALFUNCTIONS

- Printer prints with cover open; On-Line Mode.
- Printer prints without paper.
- Message buffer failures.
- System receives an equipment check from the printer, but the printer does not print an "X" on the line following the message in error.

Operator's Notes



We'd Like Your Opinion

IBM will welcome your comments on this manual, both favorable and unfavorable. Your name and address are needed for those cases where we will want to reply.

So, why not let us know what you think of this book. The pre-stamped, pre-addressed Reader's Comment Form at the back is your communications link with the author. Write your comments on the form and drop it in the mail.

Table of Contents

Selector Pen	101
How It Works	102
How It's Used	103
Making Selections	104
Changing Selections	104
Security Key Lock	105
How It's Used	105
Removal	106
Audible Alarm	106
Numeric Lock Feature	109

Selector Pen

The Selector Pen feature is an easy-to-operate accessory for a 3270 display station. It allows you to request additional information about data displayed on the screen. As you can see in Figure 40, there are only two parts to the Selector Pen feature: the selector pen and, for your convenience, the pen holder.

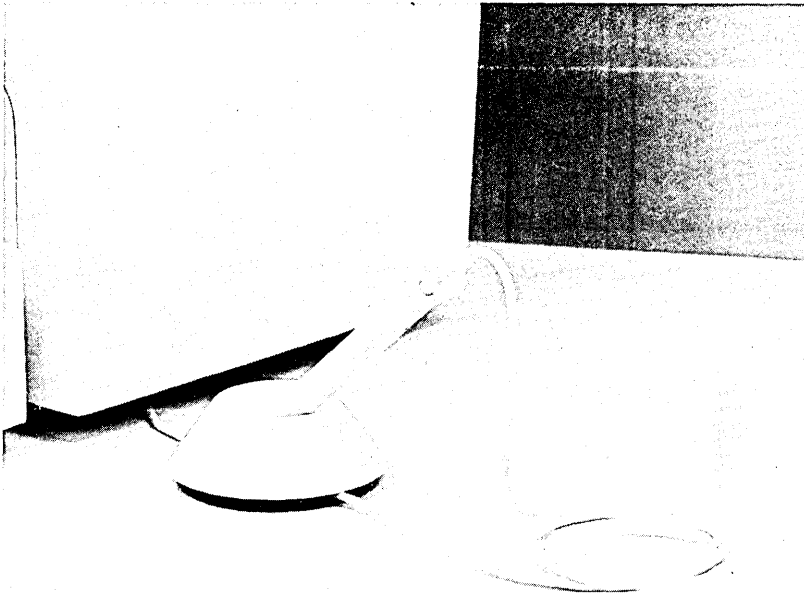

Figure 40. The selector pen detects characters on the screen.

How It Works

The point of the pen contains a device that can detect the light of a character on the screen. This device checks for the presence of a character only when a switch, also located in the point of the pen, is activated. The switch is spring-loaded and is activated by placing the point of the pen on the screen and pushing the barrel of the pen toward the screen.

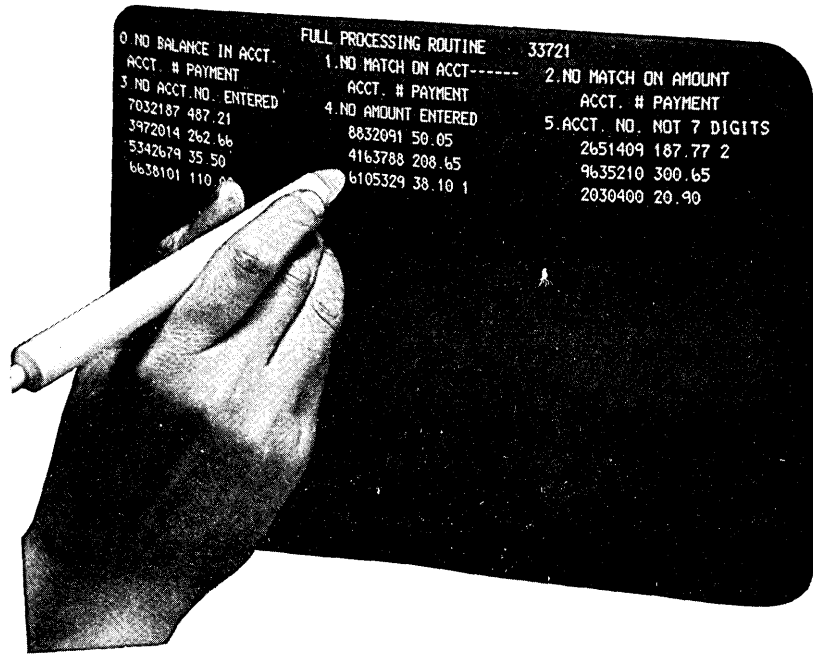

Figure 41. When using the selector pen, correct positioning of the tip of the pen is important.

How It's Used

In all applications for the selector pen, a list or a table is displayed, and the operator selects items from it with the selector pen. Although all applications are basically similar, a user's specific application could be unique. Your supervisor will explain your organization's application(s) and the way you are to use your selector pen.

The first character of each selectable field on your screen is called the designator character. There are only two possible designator characters and, by remembering them, you can identify the fields that you can select. The designator character will be either a question mark (?) or a greater-than sign (>).

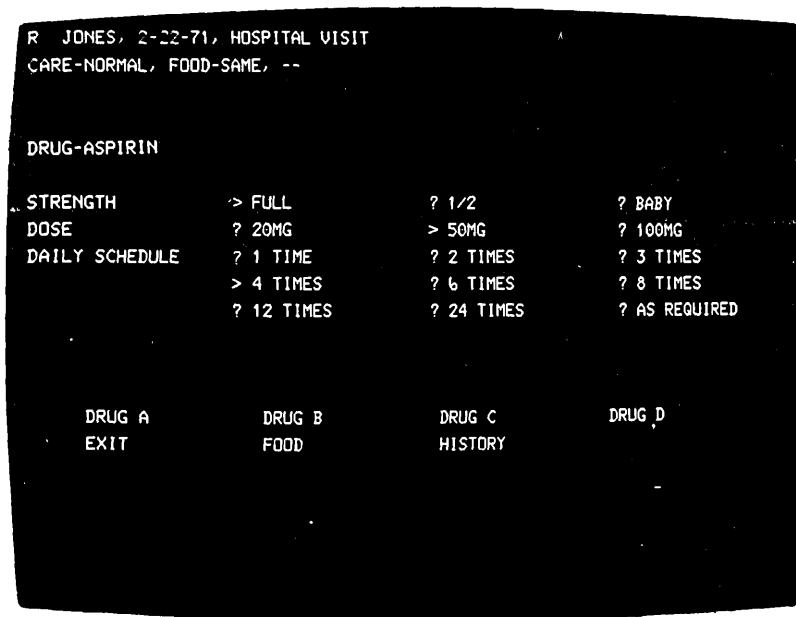

Figure 42. Designator characters tell you much about the data on your screen.

Making Selections

To see more clearly which fields on your screen are light-pen-detectable, press the end of the selector pen against the palm of your hand. This will cause lines to appear through all light-pen-detectable fields.

Initially, the designator characters (the first characters) of most detectable items on your screen will be question marks. To select an item, place the point of the pen directly over any character in that item and push the pen toward the screen to detect it. The question mark at the beginning of that item will change to a greater-than sign to indicate that the item has been selected. Positioning the pen incorrectly (not directly over the intended character or over a character in another item) can cause the wrong item, or no item, to be selected. Therefore, you should always verify that the designator character has been changed after you have selected an item from your screen.

Changing Selections

If you select a wrong item, you can correct your mistake by selecting a character from the incorrect item a second time with the selector pen. This will change the greater-than sign back to a question mark and deselect the item. The correct item can then be selected.

After you have completed your selections from the screen (more than one selection can be made), locate a field that is selectable but doesn't have a designator character. Selecting this item (the word EXIT in Figure 42) turns on the INPUT INHIBITED indicator and indicates to the program that you have completed your selections, and the data you have selected can now be acted upon by the program.

Remember, Figure 42 is only an example. The way you end a selector pen operation depends on the computer program, and each job could be different. Always refer to the User's Guide for the program with which you are working for specific instructions.

Security Key Lock

The Security Key Lock feature improves a user's data processing security. An organization using this feature has the ability to lock its 3270 display stations and allow only authorized operators (those issued keys) to operate them.

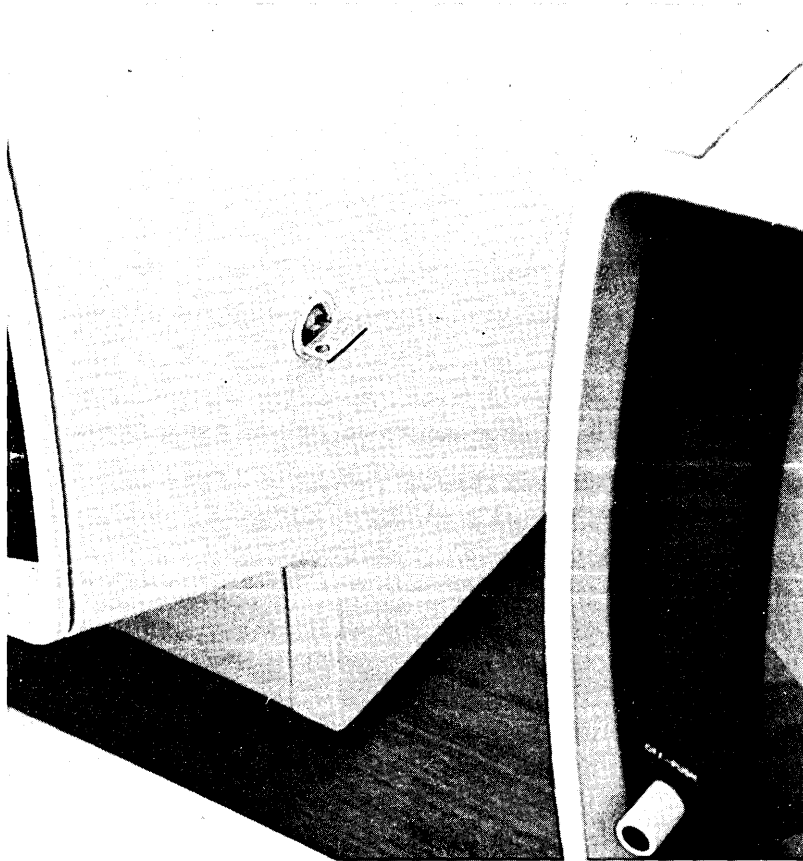

Figure 43. Only authorized operators can use a display station that has a security key lock.

How It's Used

A display station with a security key lock installed cannot be operated until the key is inserted and turned on. To prepare a display station equipped with a security key lock for operation, put the key in the lock and turn it on; then, pull out the OFF-PUSH switch. As soon as the cursor appears on the screen, you can begin work on your display station.

Removal

The key must remain in the lock as long as you wish to operate your display station. Also remember to remove the key if you are going to be away from your display station for a long period. The key cannot be removed while in the on position, and turning it off immediately blocks all entry or retrieval of information.

Audible Alarm

3270 display stations can be equipped with an audible alarm. This is a feature of your display station that can't be seen but that you should be aware of.

A high-pitched tone sounds for about 1 second every time the audible alarm is activated.

The audible alarm always sounds when you enter a character into the next to last character position on your screen. The cursor wraps from the last character position on the screen to the first character position on the screen after a character is keyed into that last position. This is normal operation. If you key another character after the cursor has wrapped, it will be entered into the first character position on line 1 of your screen. In this situation, you wouldn't want to key on line 1 because doing so would destroy the data already displayed there. In this case, the alarm is a warning to you.

The computer program that you are working with also can activate the alarm. To do so, it sends a signal to your display station. The User's Guide for that program will tell you if the audible alarm will sound and, if so, the different reasons for sounding it.

The volume of the audible alarm is adjustable. The adjustment control knob is located behind the front cover of the display station, as shown in Figure 44. Generally, you will not have to adjust the volume once it has been set for your operating environment.

If you want to change the volume of the alarm, first remove the display station front cover. If your display station has a small screen, like the one shown in Figure 46, remove the front cover by lifting upward on the latch under the front edge of the cover, where the cover meets the table top. Then, turn the audible alarm adjustment knob to the right to raise the volume or to the left to lower it, as required. If you are operating a large-screen display station, unlatch the front cover by pushing down on the

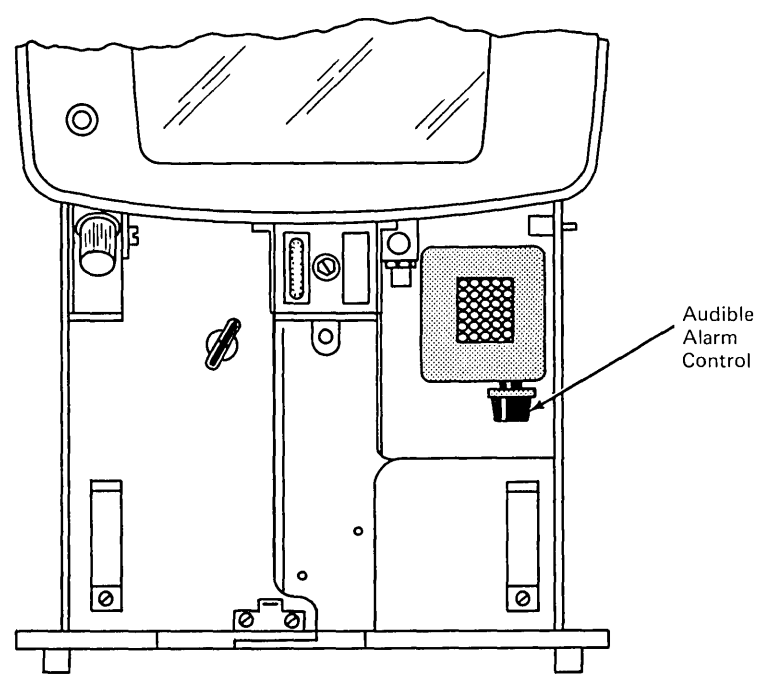
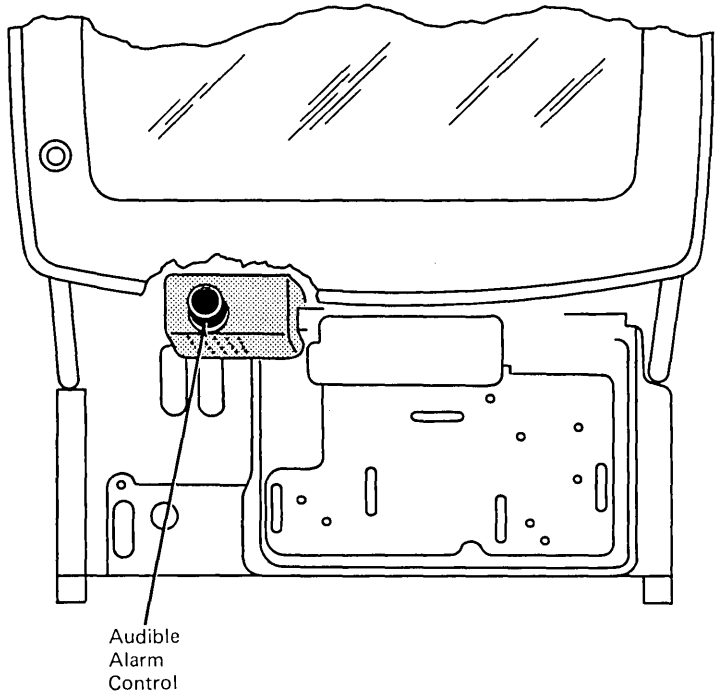

Figure 44. The display station audible alarm control is located behind the front cover.

latch located in the center of the front edge of the cover, just below the display tube. As the cover is released, lift it off the two guide pins that hold it to the base of the unit. Then, turn the alarm adjustment knob to the right or left, to raise or lower the volume as needed. You should test the new volume level before replacing the cover.

To test the new volume level, the next-to-last character position must be in an unprotected input field. If your display station does not have an unprotected input field in this area of the screen, check the application program User's Guide or ask your supervisor for instructions to obtain one. When you have an unprotected input field in this area of the screen, move the cursor and key in a character in the next-to-last position on the screen; then, listen to the level of the alarm. To check the sound level again, press the backspace key and, then, a character key. If the sound is not at the desired volume, readjust the alarm control knob and test the sound level again. When the volume setting is correct, press the ERASE INPUT key and replace the display station front cover.

Numeric Lock Feature

When installed on a 3270 display station, the Numeric Lock feature limits the characters that you can key into a field designated by the program as a Numeric field. This feature was designed primarily for use with Data Entry keyboards as an aid to operators who rarely look at the screen. However, it can be installed on any of the 3270 display station models.

You'll remember that when the cursor enters a Numeric field on your screen your display station automatically shifts to Numeric Mode if you have a Data Entry keyboard. When this happens, if your display station has the Numeric Lock feature installed, the only keys that you can key into the Numeric field are the digits 0 through 9, special characters, period (.) and hyphen (-), and the DUP key. All other keys are "locked out", and pressing any other key will turn on the INPUT INHIBITED indicator and disable your keyboard. Therefore, if you key a non-numeric character into a Numeric field, you will realize your error without looking at the screen.

In some cases, the job you're doing may require keying into a Numeric field characters other than the few allowed by the Numeric Lock feature. Therefore, if you are required to, you can override this feature and key any "locked out" character into the Numeric field. This is done by pressing the NUMERIC key or the ALPHA key, depending on the character to be keyed. For example, if a comma (,) must be keyed, press and hold the NUMERIC key and then press the comma key. If you have a series of characters to enter in Numeric Mode, press and release the NUM LOCK key; then, press the character keys and again press NUM LOCK. If an N must be keyed, press and hold the ALPHA key and, then, press the N key. Using this method, you can enter "locked out" characters without error.

Table of Contents

Data Processing	111
The Data Processing System	111
Input Section	113
Processing Section	113
Output Section	114
Display Stations	114
The IBM 3270 Information Display System	115
Screen Size	115
Keyboard Types	115

Data Processing

The following discussion briefly describes data processing and the part you and your display system equipment play in the data processing of your organization.

First, you must understand that the data in "data processing" refers to all of the information or records required by your organization to conduct its business. This is a lot of information to think about, so, for our discussion, let's consider only the data required for payroll administration, a common part of all business. The data (information) required to perform this function includes the names of all employees, the number of hours each employee worked, her (or his) rate of pay, the number of overtime hours he or she worked (if any), the amount of money to be withheld, and all other facts needed to pay everyone the correct amount.

The processing in "data processing" refers to all the work involved in accomplishing a particular data processing job. In a data processing "payroll" job, the processing involves: providing the computer with the required data, determining (with the data) each employee's paycheck amount, printing all of the checks, and updating the records.

Putting the two together then, data processing is the performance of jobs or tasks by processing the required data.

Although data processing has always been a major part of running an organization, it hasn't always been called data processing. Before the development of the computer, almost all processing of data was done by hand. Today, most of it is done by computer systems and in much less time than before.

The Data Processing System

You will be operating a machine that is part of your organization's data processing system. To give you some knowledge of the other machines in that system, we will now examine the different groups of machines that make up a typical data processing system. The points discussed will hold true even though some of the machines that are mentioned may not be included in all data processing systems.

Regardless of the information to be processed or the equipment used, all data processing systems can be divided into the three basic sections shown in Figure 45: INPUT, PROCESSING, and OUTPUT. Each section performs one of the basic functions that all data processing systems must accomplish.

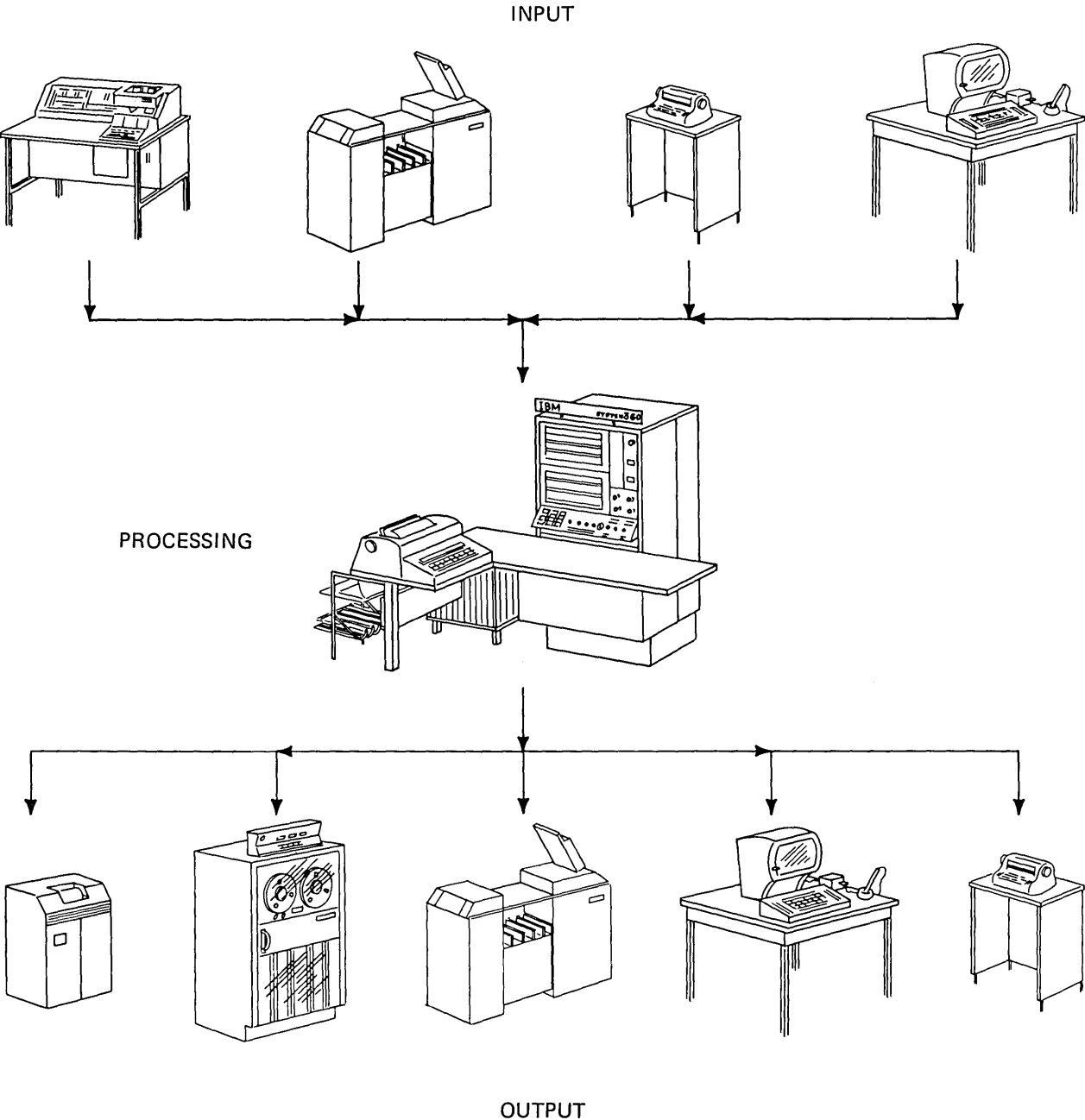

Figure 45. All data processing systems have input, processing, and output sections.

Input Section

An input machine is any machine that provides for entry of outside data (information) into the system. This definition can be used to determine if a machine is part of the input section of a data processing system. Input machines may be located at the computer center or at remote locations where they communicate with the system over telephone lines.

Most of the data needed to perform a job is produced by people. As a result, it is handwritten or typed on one kind of form or another. A computer cannot process this data. These forms are the source of the input data to be entered into the computer. Thus, the data at this point is called source data.

Part of the job of the machines in the input section of a data processing system is the translation of the source data into a form that the computer can understand. These machines translate the source data and record it in the computer's language; also, and perhaps most important, they enter it into the data processing system. As you type from the source documents, you and your 3270 display station will be performing this type of work. Note that the selector pen and operator identification card reader are also input devices which assist you in communicating with the computer.

The importance of the input section in a data processing system can't be stressed enough. You may be the best typist in the world, but if you are given inaccurate information to type, your completed typing won't be of much value. The same is true of any data processing system. The best computer in the world can produce results (output) of value only with accurate input data.

The machines that make up the input section, though small compared with some of those in the processing section, are vital to the success of the data processing system. Keypunches and card readers, typewriter terminals, and display stations are some types of input machines.

Processing Section

The computer center, as you might guess, is where the computer is located. Once the system has all the information it needs for the intended job, the required work must be performed. This is done at the computer center by the group of machines that make up the processing section of a data processing system.

Several types of machines at the computer center process the data. Working together, they are used to sort the data, test it, perform computations on it, and otherwise use it to accomplish the assigned job.

Note that we said these machines are used to process data. The computer program uses the computer's capabilities.

Although a computer system is a group of machines capable of doing many jobs, its actions must be directed. The machines and the program are two separate things; however, they must work together to form an operating computer system. One can do nothing without the other. The program operates within the computer and directs the machines in the computer system to accomplish the assigned job.

Output Section

After the work has been completed, the results must be made available. This is done by the machines that make up the output section of a data processing system.

Output from a data processing system can be in various forms. Printers, tape drives, card punches, and display stations are only a few examples of output machines; the most widely used is the printer. Printers can provide printed checks for payroll jobs, printed bills for customer billing jobs, printed reports, or any number of other types of output for all kinds of jobs.

Display Stations

Did you notice that display stations are included in both the input and output sections of a data processing system? The operator of a display station provides the computer with input as information is keyed from the source document onto the display station's screen. The operator records the data and enters it as input into the system. At an airlines office, another operator receives an output of the company's system when, to check on the availability of a seat on the Denver to Kansas City flight, the operator displays the reservation list on the screen. As an output device, a display station without a keyboard may be all that is required.

These are only two examples of the many uses of a versatile display station. The IBM 3270 is such a display station.

The IBM 3270 Information Display System

Several different models of 3270 display stations are offered to meet the needs of many different organizations and applications. Operation of all models is very similar, and, once you are an experienced 3270 operator, you will feel comfortable operating any model.

Each model has a unique designation, but none of the designations will be presented here. Instead, only the important physical differences that you might notice will be mentioned.

Screen Size

There are three basic types of 3270 display stations, but only two different screen sizes. The large screen holds four times as many characters as the small one.

3270 display stations like the one on the bottom in Figure 46 have five more indicators than the two other types. There are no other real differences, and operation of all types is very similar.

Keyboard Types

Some 3270 users may have unique applications that don't require a keyboard. However, most of the 3270 display stations will have keyboards attached, and you'll have to examine that keyboard to find the other major differences.

Basically, three different keyboards are available to meet the varying needs of the many different organizations that will be using 3270 display systems. These are shown in Figure 47. One of these closely resembles a standard typewriter keyboard, another is like a keypunch keyboard, and the third resembles the keyboard used by a computer operator. Any one of these can be attached to any display station type. The only differences between the three keyboards are in the characters supplied and their arrangement on the keys.

If you are not located near your computer center, you may never see an Operator Console keyboard. This keyboard is used by computer operators and has been designed to make their communication with the computer easier and faster.

You are now ready to learn the operation of your display station. Turn to "Operating the 3270" (page 5).

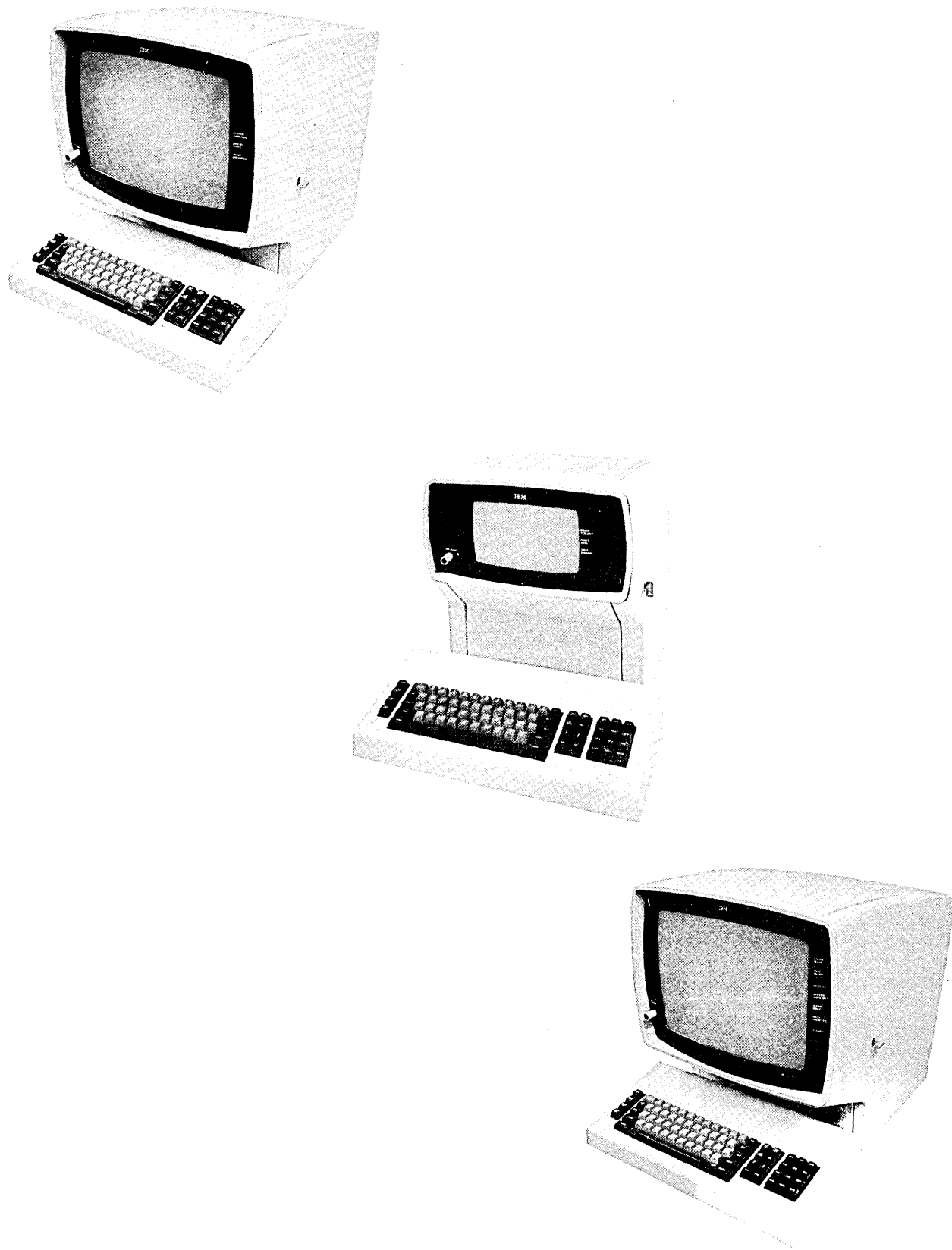
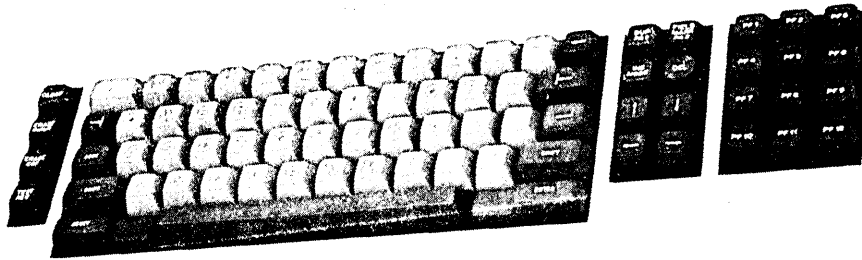
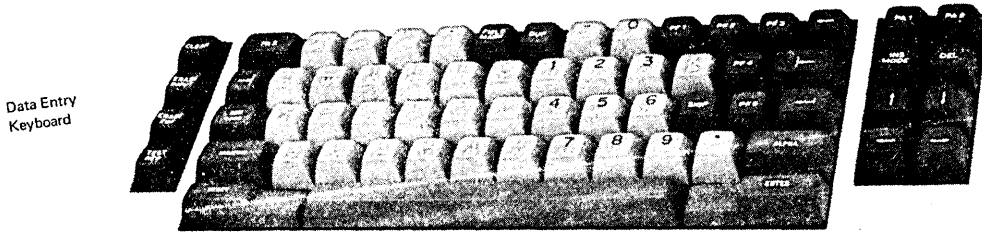

Figure 46. Operating all types of 3270 display stations is very similar.



Typewriter Keyboard



Data Entry Keyboard

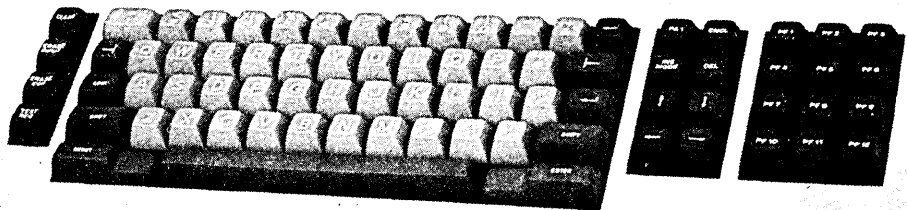

Operator Console Keyboard

Figure 47. There are basically three types of 3270 keyboards.

Operator's Notes

We'd Like Your Opinion

IBM will welcome your comments on this manual, both favorable and unfavorable. Your name and address are needed for those cases where we will want to reply.

So, why not let us know what you think of this book. The pre-stamped, pre-addressed Reader's Comment Form at the back is your communications link with the author. Write your comments on the form and drop it in the mail.

- ALPHA (Shift) Key 47
- Alphabet Keys* 27, 47, 65
- Audible Alarm 106

- Back Tab Key* 31, 52, 68
- Backspace Key* 33, 53, 69
- Blank Keys (in numeric mode) 60
- Brightness Control 8

- Cancel (CNCL) Key 74
- Card Reader Operation 89
- Characters:
 - Adjusting Brightness 8
 - Adjusting Contrast 8
 - Deleting* 41, 59, 74
 - Inserting* 38, 57, 72
- CLEAR Key* 36, 55, 70
- Clearing the Screen (*See* CLEAR Key)
- CNCL Key 74
- Common Indicators 15
- Contrast Control 8
- Controls/Switches, Discussion 7
- Copy Control Lever 81
- Correction of Operator Errors 90
- Cursor 13
- Cursor Control Keys* 28, 49, 66
- Cursor, Moving (*See* Cursor Control Keys)
- Cursor, Positioning (*See* Cursor Control Keys)
- Cursor, Program Control of 13
- Cursor Wrap 14

- Data Entry Keyboard 44
- Data Processing 111
- Data Processing System 111
- Data, Protected 12
- DEL Key* 41, 59, 74
- Deleting Characters (*See* DEL Key)
- Designator Characters 103
- Disabled Keyboard (*See* INPUT INHIBITED Indicator)
- Display Image 8
- Display Stations 114
- DUP Key* 37, 56, None

- Ending a Field (*See* FIELD MARK Key)
- ENTER Key* 41, 60, 74
- ERASE EOF Key* 36, 55, 71
- ERASE INPUT Key* 36, 55, 70
- Erasing Input Fields (*See* ERASE INPUT Key)
- Extras for the 3270 100

- Features, Optional:
 - Audible Alarm 106
 - Numeric Lock 109
 - Security Key Lock 105
 - Selector Pen 101
- FIELD MARK Key* 38, 56, None
- Fields:
 - Definition 10
 - Input 11
 - Numeric 11
 - Protected 12
- Formatted Display 10
- Forms, Installation of 81

- High Intensity Data 12
- Horizontal Positioning Keys* 32, 53, 68
- How To:
 - Adjust Brightness of Characters 8
 - Clear the Screen* 36, 55, 70
 - Continue Work after an Error 90
 - Delete a Character* 41, 59, 74
 - Determine Your Keyboard Type 22
 - Erase All Input Fields* 36, 55, 70
 - Erase An Input Field* 36, 55, 71
 - Insert a Character* 38, 57, 72
 - Locate Information in This Book 1
 - Move Cursor* 28, 49, 66
 - Report a Machine Problem 92
 - Turn Off Indicators* 37, 56, 71
 - Turn Power On/Off 7
 - Unlock Keyboard* 37, 56, 71
 - Use Audible Alarm 106
 - Use Numeric Lock 109
 - Use Security Key Lock 105
 - Use Selector Pen 101

- IBM 3270 Information Display System 115
- Indicators:
 - Common 15
 - INPUT INHIBITED 16
 - INSERT MODE 16
 - SELECTED 19
 - STATUS 19
 - SYNC SEARCH 19
 - SYSTEM AVAILABLE 15
 - SYSTEM READY 18
 - TRANSMIT 19
 - 3275 18
- Indicators, Turning Off (*See* RESET Key)

*This subject is discussed in each keyboard section. Refer to the page that applies to your keyboard: 1st reference is to Typewriter keyboard; 2nd, Data Entry keyboard; 3rd, Operator Console keyboard.

- Input Fields 11
- INPUT INHIBITED Indicator 16
- Input Machines 113
- Input Section 113
- INS MODE Key* 38, 57, 72
- INSERT MODE Indicator 16
- Inserting Characters (See INS MODE Key)
- Installing Forms in the Printer 81

- Keyboard:
 - Clicks When Key Is Pressed 20
 - Data Entry 44
 - Disabled (See INPUT INHIBITED Indicator)
 - Keying Sound 20
 - Modes 45
 - Operator Console 62
 - Type, How to Determine 22
 - Types Available 115, 21
 - Typewriter 24
- Keyboards, Introduction to 20
- Keys (See individual key name)

- Length of Fields 11
- Line-Feed Select Lever 81
- Locked Keyboard (See INPUT INHIBITED indicator)

- Moving the Cursor One Character Space* 32, 53, 68
- Moving the Cursor to the Beginning of a Field* 29, 49, 67

- New Line Key* 29, 49, 64
- NUM LOCK Key 46
- Numeric Field 11
- Numeric Keys* 28, 48, 66
- Numeric Lock Feature 109
- NUMERIC (Shift) Key 46

- OFF-PUSH Switch 7
- Operator Console Keyboard 63
- Operator Identification Card Reader 88
- Operator Trouble Report 92
- Output Machines 114
- Output Section 114

- PA1 Key* 38, 57, 72
- PA2 Key* 38, 57, None
- PA3 Key* None, 57, None
- Paper-Advance Knob/Vertical Alignment Vernier 80
- Paper Handling Controls 80

- Placing an Off-Line Printer in On-Line Status 86
- Platen/Pin Feed 78
- PF1–PF5 Keys 60
- PF1–PF12 Keys* 42, None, 75
- Positioning the Cursor (See Cursor Control Keys)
- Power Switch 7
- Print Head/Ribbon Cartridge 79
- Print Mechanism 78
- PRINT PAT/ON LN/PRINT BFR or PRINT PAT/ON LN SWITCH 80
- Printer Operation 77
- Processing Section 113
- Program Function Keys (See PF1–PF12 Keys)
- Protected Data 12

- Quick Reference 3

- Replacing the Ribbon 84
- RESET Key* 37, 56, 71

- Screen Size 115
- Security Key Lock:
 - Removal 106
 - Use of 105
- SELECTED Indicator 19
- Selector Pen: 101
 - Changing Selections 104
 - How It Works 102
 - How It's Used 103
 - Making Selections 104
- SHIFT/LOCK Keys* 26, None, 64
- Sign-On Procedure 5
- SKIP Key 51
- Source Data 91
- Space Bar* 27, 48, 65
- START PRINT and MODE 1/MODE 2 Switches 80
- STATUS Indicator 19
- Switches/Controls:
 - Display Station 7
 - Printer 79
- Symbols and Punctuation Marks* 34, 54, 69
- SYNC SEARCH Indicator 19
- SYSTEM AVAILABLE Indicator 15
- SYSTEM READY Indicator 18

- Tab Key* 30, 51, 67
- TEST REQ Key* 37, 56, 71
- Test Switches 79

*This subject is discussed in each keyboard section. Refer to the page that applies to your keyboard: 1st reference is to Typewriter keyboard; 2nd, Data Entry keyboard; 3rd, Operator Console keyboard.

TRANSMIT Indicator 9
Trouble Report, Operator 92
Trouble with Your Machine 92
Turning On Power 7
Typamatic Keys* 26, 46, 64
Typewriter Keyboard 25
Typical Job, A 90

Understanding the 3270 110

Vertical Positioning Keys* 33, 53, 68

*This subject is discussed in each keyboard section. Refer to the page that applies to your keyboard: 1st reference is to Typewriter keyboard; 2nd, Data Entry keyboard; 3rd, Operator Console keyboard.

Operator's Notes

We'd Like Your Opinion

IBM will welcome your comments on this manual, both favorable and unfavorable. Your name and address are needed for those cases where we will want to reply.

So, why not let us know what you think of this book. The pre-stamped, pre-addressed Reader's Comment Form at the back is your communications link with the author. Write your comments on the form and drop it in the mail.

OPERATOR TROUBLE REPORT TYPEWRITER KEYBOARD

Display station won't turn on.

Display station was operating; went dead.

POWER FAILURE

Noticed smoke or unusual odor at the time.

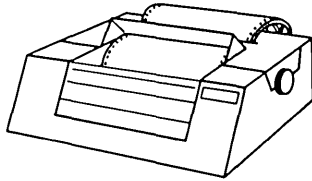

Printer



Operation Identification Card Reader

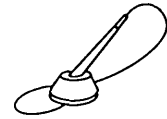

Selector Pen

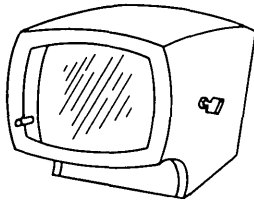

Display Station

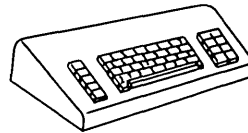

Keyboard

FAILURE OF

INDICATORS

Mark the indicators on when failure occurred.

- SYSTEM READY
- SYNC SEARCH
- SELECTED
- SYSTEM AVAILABLE

- INSERT MODE
- INPUT INHIBITED
- TRANSMIT
- STATUS

One or more indicators:

- Light when they should not.
- Don't light when they should.

DISPLAY FAILURE

The image on the screen looks like:

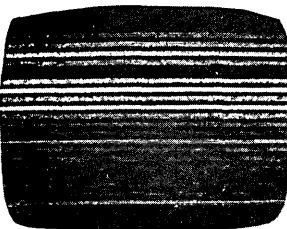
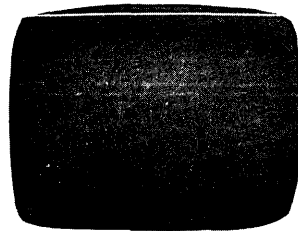
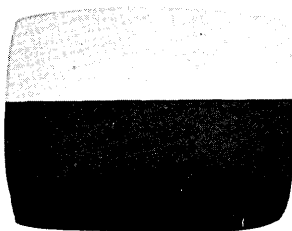

Nothing displays on screen:

- It's completely blank.
- It's glowing brightly.
- Image is too bright or too dim and cannot be adjusted.

CURSOR

- is missing or too short or too long.
- is normal but no characters display.
- won't move.
- is in wrong place (not below characters).
- more than one cursor.

OPERATOR TROUBLE REPORT

TYPEWRITER KEYBOARD
FAILURE

Mark all failing keys.

- All keys fail.
 All character keys fail.

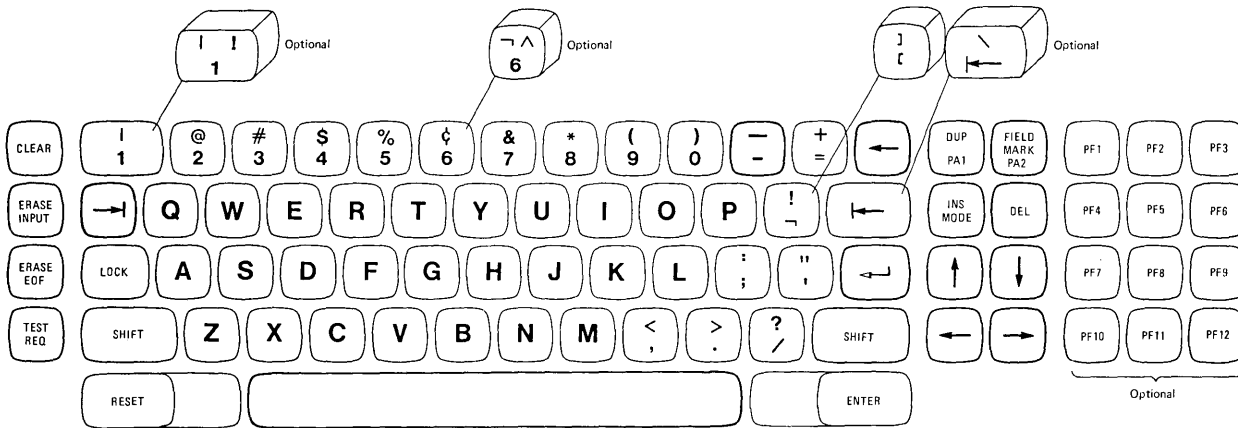

Operator comments about the failure.

PRINTER FAILURE

MESSAGE PRINTOUT ERRORS

- Carriage moves but does not print on paper.
- Wrong or missing characters in printout, incomplete message, or the printer starts or stops at the wrong location.
- Printer carriage will not stop at end of printout.
- Prints incorrect number of characters per line (40, 64, 80, 120, 126, or 132).
- Incomplete message; starts or stops at wrong point
- Left or right margin is uneven.

INDIVIDUAL CHARACTER PRINT ERRORS

- Specific row of dots missing; no other failure.
- Partial characters printed; garbled characters.
- Extra dots in characters; or solid squares printed.

PLATEN INDEXING FAILURE

- Platen never indexes.
- Too many indexes.
- Paper does not eject when supply is depleted while printing.
- Platen fails on multiple index.

MISCELLANEOUS MALFUNCTIONS

- Printer prints with cover open; On-Line Mode.
- Printer prints without paper.
- Message buffer failures.
- System receives an equipment check from the printer, but the printer does not print an "X" on the line following the message in error.

OPERATOR TROUBLE REPORT
DATA ENTRY KEYBOARD

POWER FAILURE

Display station won't turn on.

Display station was operating; went dead.

Noticed smoke or unusual odor at the time.

FAILURE OF

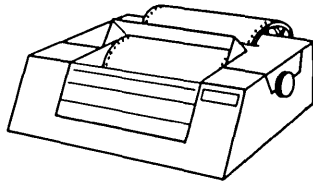

Printer

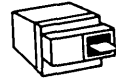

Operation Identification Card Reader

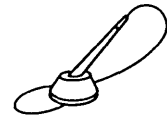

Selector Pen

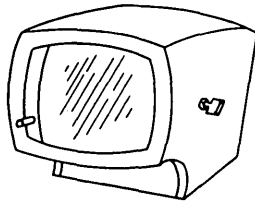

Display Station

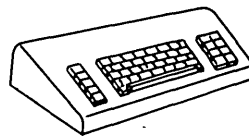

Keyboard

INDICATORS

Mark the indicators on when failure occurred.

- SYSTEM READY
- SYNC SEARCH
- SELECTED
- SYSTEM AVAILABLE

- INSERT MODE
- INPUT INHIBITED
- TRANSMIT
- STATUS

One or more indicators:

- Light when they should not.
- Don't light when they should.

DISPLAY FAILURE

The image on the screen looks like:

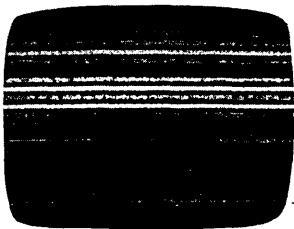

Nothing displays on screen:

- It's completely blank. It's glowing brightly. Image is too bright or too dim and cannot be adjusted.

CURSOR

- is missing or too short or too long.
- is normal but no characters display. won't move.
- is in wrong place (not below characters).
- more than one cursor.

OPERATOR TROUBLE REPORT

DATA ENTRY KEYBOARD
FAILURE

Mark all failing keys.

- All keys fail.
 All character keys fail.

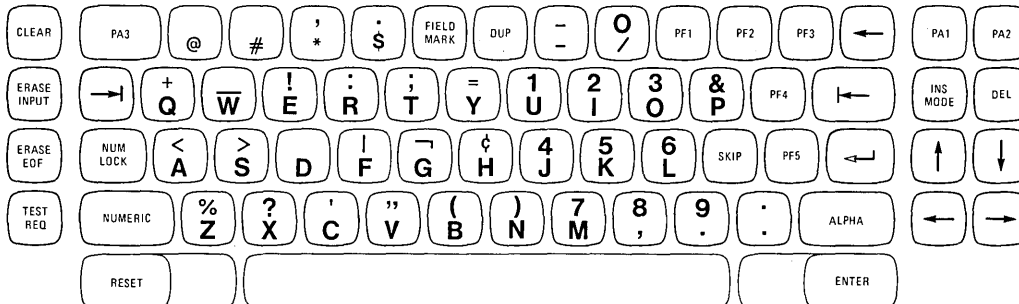

Operator comments about the failure.

PRINTER FAILURE

MESSAGE PRINTOUT ERRORS

- Carriage moves but does not print on paper.
- Wrong or missing characters in printout, incomplete message, or the printer starts or stops at the wrong location.
- Printer carriage will not stop at end of printout.
- Prints incorrect number of characters per line (40, 64, 80, 120, 126, or 132).
- Incomplete message; starts or stops at wrong point.
- Left or right margin is uneven.

INDIVIDUAL CHARACTER PRINT ERRORS

- Specific row of dots missing; no other failure.
- Partial characters printed; garbled characters.
- Extra dots in characters; or solid squares printed.

PLATEN INDEXING FAILURE

- Platen never indexes.
- Too many indexes.
- Paper does not eject when supply is depleted while printing.
- Platen fails on multiple index.

MISCELLANEOUS MALFUNCTIONS

- Printer prints with cover open; On-Line Mode.
- Printer prints without paper.
- Message buffer failures.
- System receives an equipment check from the printer, but the printer does not print an "X" on the line following the message in error.

OPERATOR TROUBLE REPORT
OPERATOR CONSOLE KEYBOARD

Display station won't turn on.

Display station was operating; went dead.

Noticed smoke or unusual odor at the time.

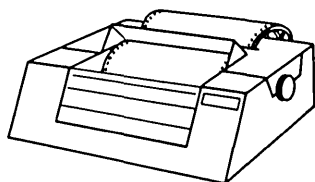

Printer

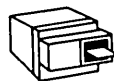

Operation Identification Card Reader

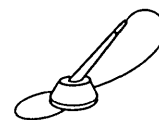

Selector Pen

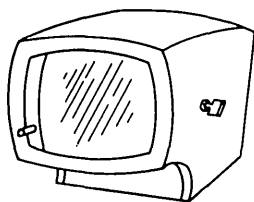

Display Station

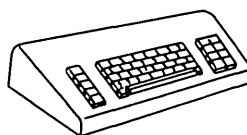

Keyboard

FAILURE OF

INDICATORS

Mark the indicators on when failure occurred.

- SYSTEM READY
- SYNC SEARCH
- SELECTED
- SYSTEM AVAILABLE

- INSERT MODE
- INPUT INHIBITED
- TRANSMIT
- STATUS

One or more indicators:

- Light when they should not.
- Don't light when they should.

DISPLAY FAILURE

The image on the screen looks like:

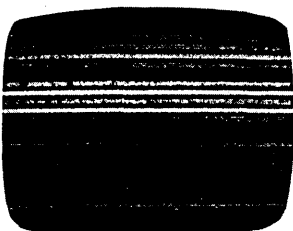

Nothing displays on screen:

- It's completely blank.
- It's glowing brightly.
- Image is too bright or too dim and cannot be adjusted.

CURSOR

- is missing or too short or too long.
- is normal but no characters display.
- won't move.
- is in wrong place (not below characters).
- more than one cursor.

OPERATOR TROUBLE REPORT

OPERATOR CONSOLE
KEYBOARD FAILURE

Mark all failing keys.

CLEAR	= 1	< 2	; 3	: 4	% 5	' 6	> 7	* 8	(9) 0	- &	+ ←	PA1	CNCL	PF1	PF2	PF3	
ERASE INPUT	→	Q	W	E	R	T	Y	U	I	O	P	¢ @	←	INS MODE	DEL	PF4	PF5	PF6
ERASE EOF	LOCK	A	S	D	F	G	H	J	K	L	! \$	" #	↵	↑	↓	PF7	PF8	PF9
TEST REQ	SHIFT	Z	X	C	V	B	N	M	,	. /	?	SHIFT	←	→	PF10	PF11	PF12	
RESET																	ENTER	

Operator comments about the failure.

PRINTER FAILURE

MESSAGE PRINTOUT ERRORS

- Carriage moves but does not print on paper.
- Wrong or missing characters in printout, incomplete message, or the printer starts or stops at the wrong location.
- Printer carriage will not stop at end of printout.
- Prints incorrect number of characters per line (40, 64, 80, 120, 126, or 132).
- Incomplete message; starts or stops at wrong point.
- Left or right margin is uneven.

INDIVIDUAL CHARACTER PRINT ERRORS

- Specific row of dots missing; no other failure.
- Partial characters printed; garbled characters.
- Extra dots in characters; or solid squares printed.

PLATEN INDEXING FAILURE

- Platen never indexes.
- Too many indexes.
- Paper does not eject when supply is depleted while printing.
- Platen fails on multiple index.

MISCELLANEOUS MALFUNCTIONS

- Printer prints with cover open; On-Line Mode.
- Printer prints without paper.
- Message buffer failures.
- System receives an equipment check from the printer, but the printer does not print an "X" on the line following the message in error.

READER'S COMMENT FORM

Operator's Guide for
IBM 3270 Information Display Systems

IBM welcomes your comments on this manual, both favorable and unfavorable. Write them on this form and drop it in the mail.

If you have technical questions or if you want to order publications, make your inquiries or requests to a representative of the IBM branch office serving your locality.

● I rate this book

As a learning aid:

..... Very Good Fair Poor Very
Good				Poor

As a reference source:

..... Very Good Fair Poor Very
Good				Poor

On the ease of finding
wanted facts:

..... Very Good Fair Poor Very
Good				Poor

● How would you improve this book?

● Other comments:

Name _____
Job _____
Address _____

Reply desired?
Yes
No

Thank you for your comments. No postage necessary if mailed in the U.S.A.

Your comments, please . . .

Your comments, together with your answer to the questions on the back of this form will help us produce better publications for your use. Your comments will be carefully reviewed by the persons responsible for writing and publishing this material. All comments and suggestions become the property of IBM.

Cut or Fold Along Line

Fold

Fold

First Class
Permit 40
Armonk
New York

Business Reply Mail
No postage stamp necessary if mailed in the U.S.A.

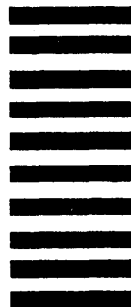

Postage will be paid by:

International Business Machines Corporation
Department 520
Neighborhood Road
Kingston, New York 12401

Fold

Fold

Operator's Guide for IBM 3270 Printed in U.S.A. GA27-2742-1



International Business Machines Corporation
Data Processing Division
1133 Westchester Avenue, White Plains, New York 10604
(U.S.A. only)

IBM World Trade Corporation
821 United Nations Plaza, New York, New York 10017
(International)



International Business Machines Corporation
Data Processing Division
1133 Westchester Avenue, White Plains, New York 10604
(U.S.A. only)

IBM World Trade Corporation
821 United Nations Plaza, New York, New York 10017
(International)