

# Integrated Services Digital Network (ISDN) Standards

## In this report:

ISDN Goals .....	-102
ISDN Standards Organizations .....	-103
ISDN Standards Descriptions.....	-103
Common Channel Signaling .....	-115
Common Channel Signaling System Number 7 .....	-116

## Synopsis

### Editor's Note

This report adds new information on evolving Broadband ISDN (B-ISDN) and ISDN internetworking standards introduced in the last CCITT study period and updates information on Common Channel Signaling System Number 7.

### Report Highlights

ISDN is a network architecture using digital technology to support integrated voice, data, and image services through standard interfaces over standard twisted-pair telephone wire. This report explains ISDN architecture, issues, and goals. It provides a snapshot of CCITT I-Series ISDN standards (called "Recommendations"), identifying and briefly summarizing each Recommendation. It also describes the relationship, states the progress, and amplifies the issues of evolving ISDN concepts and related issues, such as Broadband ISDN, Signaling System #7, common channel signaling, and ISDN addressing and routing. To obtain copies of actual ISDN standards, readers should contact the CCITT's U.S. representative, the American National Standards Institute (ANSI) (New York, NY); or Omnicom Inc. (Vienna, VA), a licensed distributor of ISDN and OSI standards documents.

# Analysis

ISDN is a network architecture using digital technology to support integrated voice, data, and image services through standard interfaces over standard twisted-pair telephone wire. The telecommunications industry recognizes ISDN as a means of integrating telecommunications services and modernizing public networks to make information movement and management more efficient.

Besides improving telco networks, ISDN offers several advantages to end users that, while perhaps not unique, provide an attractive package. These advantages include the reduced cost and cleaner transmission provided by end-to-end, all-digital transmission; access to different network services over a single link, instead of requiring a different line for each service; a small set of standard customer-network interfaces, facilitating equipment moves and changes; and a range of new services and applications (some not yet invented) facilitated by ISDN's out-of-band signaling protocols.

Few users have yet embraced ISDN. Most understand ISDN's advantages, but off-the-shelf applications using ISDN capabilities are not widely available. In response to this need, the National Institute of Standards and Technology (NIST) formed the North American ISDN User's Forum in June 1988. The Forum has formalized the process of identifying and developing ISDN applications based on specific user needs and has identified over 100 ISDN applications. These are being used by industry groups to develop implementation criteria for transforming application profiles into ISDN products.

Many communications carriers, including the major interexchange carriers and the BOCs, now offer tariffed ISDN services in many regions of the country. According to Nick Lippis (Northeast Consulting Services, Boston, MA), the three major interexchange carriers will have ISDN primary rate access available from 100 percent of their points of presence (POPs) by late 1990 or early 1991. For the BOCs, ISDN basic rate services will not reach a

reasonable threshold (approximately 12 percent of the more than 26,000 central offices) until 1992 (*Data Communications*, May 1990). Currently, the number of ISDN access lines ordered by end users remains comparatively small: BOC customers have installed fewer than 60,000. Approximately 22 percent of 6 million Centrex lines, however, will be equipped with ISDN basic rates by the end of 1991 (Northern Business Information/Datapro).

It is in the carriers' best interests to migrate users to ISDN services. The carriers will gain great economies through implementing all-digital ISDN services, including reduced equipment and maintenance costs. Enhanced services offered in conjunction with clear-channel signaling should mean increased revenues. As soon as carriers can offer cost-effective ISDN services, they will push user migration to those services from private networks.

Public network users will not be the only ones to benefit from ISDN. Corporations with large private networks can also convert to ISDN standards. By using PBXs and T1 resource managers equipped with primary rate interfaces, users can link widespread and remote sites through ISDN primary rate trunk services offered by the major interexchange carriers. Corporate ISDN networks will provide a platform for linking private and public network facilities (hybrid networking). Yet, connecting users of local basic rate ISDN services in different serving areas remains problematic. BOC trials connecting ISDN exchanges are under way, but ISDN interworking standards are still being refined.

Few of ISDN's advantages can be realized without comprehensive and widely accepted standards. As digital communications evolve from islands of ISDN located in large, metropolitan areas into a ubiquitous public ISDN network, communications carriers and users alike will depend on the CCITT and its worldwide representatives to forge ISDN connectivity among different entities. This report provides an overview of ISDN standards, focusing on the user-network interface and broadband ISDN protocols.

## ISDN Goals

The first two words in ISDN, *Integrated Services*, define the goals of the entire enterprise: to combine all communications services currently offered over separate networks into a single network to which

any subscriber has access over common facilities, through a single plug in the wall. The Integrated Services concept will also include some services not yet available, other services not currently regarded as communications oriented, and other services still to be invented. The conventional services intended for the ISDN are voice telephony, circuit and packet switched data communications, switched and nonswitched dedicated circuits, text message services (such as telex and electronic mail), and facsimile. New services envisioned for the ISDN are enhanced telephony, home telemetry, videoconferencing, and variations on videotex. Proposed telephony enhancements include the extension of such present-day PBX features as call forwarding, camp-on, and voice messaging on a network-wide basis and the introduction of new features such as caller identification (in which the receiving telephone or terminal displays the number of the calling telephone or terminal), simultaneous voice and data conversations between the same endpoints, and such call-in-progress information as elapsed time and current charges. Home telemetry encompasses such features as remote burglar alarms, remote meter reading, and remote environmental control (i.e., control of temperature, humidity, lights, and appliances through the network). Videotex services might include those offered by the network provider (e.g., telephone directories) and those offered by other agencies or businesses through the network (e.g., postal code directories or shopping catalogs).

To provide all these services through a common interface, two technical features are considered necessary: digital local transmission loops and common channel signaling. The principal advantages of digital transmission for the local loop, in addition to its capability to provide integrated services, are large bandwidth and relative immunity to channel noise. The principal advantage of common channel (clear channel) signaling is that it allows a clear channel for network signaling and protocol services by separating the overhead needed to request and maintain those services from the services themselves, among the benefits being faster call setup and teardown times. We discuss common channel signaling at greater length later in this report.

---

## **ISDN Standards Organizations**

Current work on international ISDN standards is the responsibility of a number of CCITT study groups. The CCITT is a branch of the International Telecommunications Union (ITU), itself an arm of the United Nations. Direct membership in the CCITT belongs to nations. Thus, most countries are represented by their Postal, Telegraph, and Telecommunications ministries (PTTs).

The U.S. representative to the CCITT is the American National Standards Institute's (ANSI's) Standards Committee T1 (no relation to T1 circuits), an organization sponsored by the Exchange Carriers Standards Association (ECSA). The T1 subcommittee focusing on ISDN is called T1D1. The T1D1 subcommittee participates in the CCITT's international body related to ISDN standards but also proposes ISDN standards unique to U.S. networks pending approval by ANSI.

ISDN standards relate closely to the International Organization for Standardization (ISO) seven-layer Reference model for Open Systems Interconnection (OSI). The two standards are independent of each other, although ISDN protocols were developed with the OSI framework in mind. ISDN occupies the lowest three layers of the OSI model: Physical (Layer 1), Data Link (Layer 2), and Network (Layer 3), which constitute the transmission substrata of OSI. Specific network applications, such as network management and electronic mail, occupy the higher OSI layers and thus can be integrated on top of ISDN protocols. Such applications will provide much of the future functionality being touted for ISDN; conversely, ISDN will provide a more versatile communications medium for advanced applications. OSI and ISDN are complementary standards that, in the future, will allow different networks to interoperate.

---

## **ISDN Standards Descriptions**

In 1981, the CCITT issued its first statement of direction concerning ISDN. The CCITT works in four-year study periods; in 1984, it approved a series of ISDN Recommendations, called the I-Series, which specify the user-network interface. These were published in that year's CCITT "Red Books." Some of those standards are unfinished; some were completed during the 1985 to 1988 session, forming part of the CCITT "Blue Books."

Figure 1.  
CCITT I-Series Recommendations for ISDN

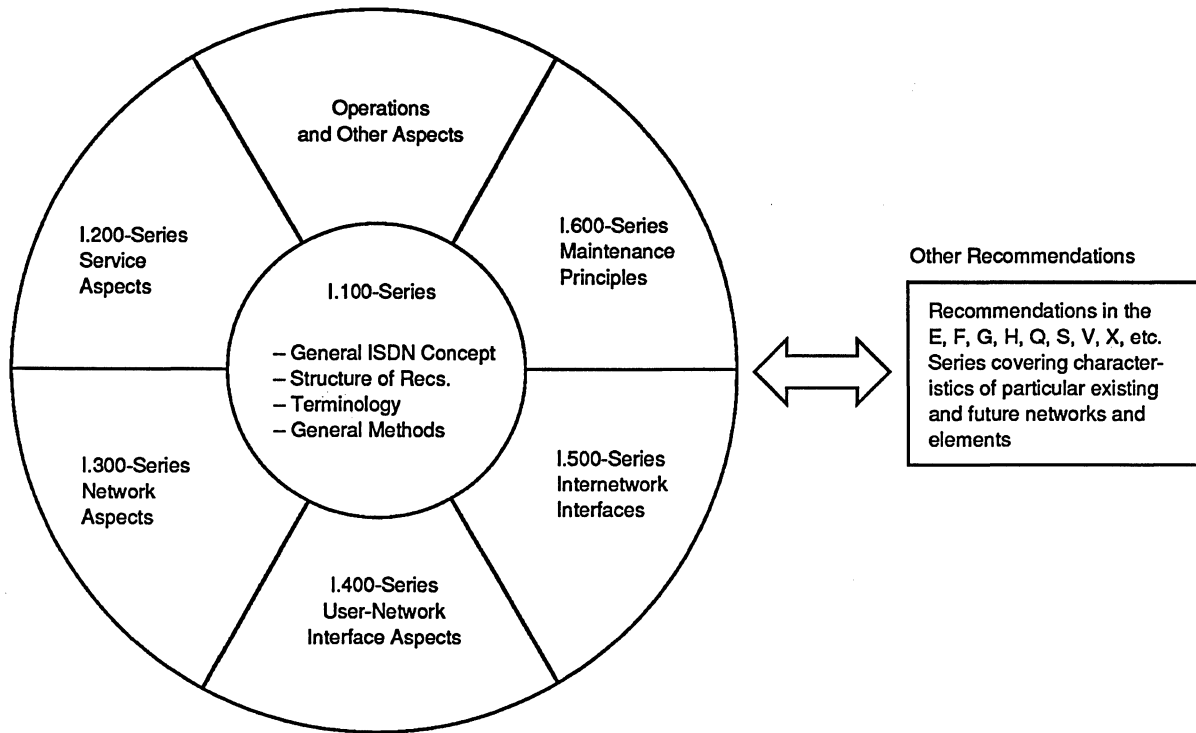

Note: Models, reference configurations, tools, methods, are contained in the appropriate I-Series Recommendations.

The I-Series Recommendations revolve around basic concepts in the I.100 Series. The I-Series also depend on and relate to other CCITT Recommendations, shown on the right.

Source: CCITT.

Some ISDN Recommendations, including Broadband ISDN and numbering and addressing for the U.S. market, have been more difficult to resolve and will not be finalized until the 1992 session or later. These recommendations are discussed in more detail later in this report.

Current CCITT I-Series Recommendations are published in the CCITT Blue Books, Volume III, Fascicles III.7, III.8, and III.9. We summarize the I-Series in this section.

### I-Series Recommendations

I-Series Recommendations describe ISDN principles, service capabilities, network characteristics, user-network interfaces, internetwork interfaces, and maintenance principles (see Figure 1).

### I.100-Series

The I.100-Series is a comprehensive introduction to ISDN, describing fundamental ISDN principles, terminology, characterization, and methods.

- *I.110 General Structure—I.100 Series:*  
Outlines all I-Series Recommendations.
- *I.111 Relationship with Other Recommendations Relevant to ISDN:*  
Provides references to other CCITT Recommendations relevant to ISDNs and/or used in developing the I-Series, including the G-Series (telephone connections and transmission systems), Q-Series (switching and signaling systems), V-Series (data communications over telephone networks), and X-Series (data communications and message handling).
- *I.112 Vocabulary of Terms for ISDNs:*

Defines terms considered essential to understanding and applying ISDNs.

- *I.113 Vocabulary of Terms for Broadband ISDN:*

Defines terms considered essential to understanding and applying Broadband ISDNs.

- *I.120 Integrated Service Digital Networks (ISDNs):*

Describes ISDN principles and evolution.

- *I.121 Broadband Aspects of ISDN:*

A guideline to evolving Broadband ISDN (B-ISDN) standards for the 1989 to 1992 study period.

- *I.122 Framework for Providing Additional Packet Mode Bearer Services:*

An architectural framework to evolving support for packet switched terminals through ISDN for the 1989 to 1992 study period. It also describes interworking such services to I.462-/CCITT X.31-based services or public packet switched data networks.

- *I.130 General Modeling Methods:*

Provides a method for characterizing telecommunications services and defines network capabilities needed by an ISDN to support those services.

- *I.140 Attribute Technique for the Characterization of Telecommunication Services Supported by an ISDN and Network Capabilities of an ISDN:*

Describes the ISDN Attribute Technique used to characterize telecom services and lists all attribute values used in I-Series Recommendations.

- *I.141 ISDN Network Charging Capabilities Attributes:*

Identifies capabilities for charging users for ISDN costs and lists associated attributes.

- *I.150 Broadband ISDN ATM Functional Characteristics:*

Describes the asynchronous transfer mode (ATM) protocol used in Broadband ISDN networks.

## **I.200-Series**

The I.200-Series describes ISDN-provided telecommunications services, encompassing *bearer*

*services, teleservices*, and associated supplementary services. ISDN recommendations do not define applications that may use those services.

- *I.210 Principles of Telecommunication Services Supported by an ISDN and the Means to Describe Them:*

Provides a method for classifying and describing telecommunications services supported by an ISDN, as defined in I.130.

- *I.211 Broadband ISDN Service Aspects:*

Defines the services supported by Broadband ISDNs.

- *I.220 Common Dynamic Description of Basic Telecommunication Services:*

Describes basic telecom services using circuit switched connections from an end-user perspective.

- *I.221 Common Specific Characteristics of Services:*

Details common service characteristics for both basic and supplementary services, such as the concept "busy," which help form a relationship between services.

- *I.230 Definition of Bearer Service Categories:*

Defines bearer services, which encompass lower layer network functions at OSI Reference Model layers 1 through 3, such as dedicated leased lines.

- *I.231 Circuit-Mode Bearer Service Categories:*

Describes circuit switched services at bit rates from 64K to 1920K bps and supports various user applications.

- *I.232 Packet-Mode Bearer Services Categories:*

Describes packet switched services using X.25 encoding, including virtual call and permanent virtual circuits as well as connectionless and user signaling services.

- *I.240 Definitions of Teleservices:*

Defines six teleservices, which encompass both lower and higher layer network functions at OSI Reference Model layers 1 through 7: telephony, Teletex, Telefax, Mixed mode (text and facsimile), Videotex, and Telex.

- *I.241 Teleservices Supported by an ISDN:*

Describes the six teleservices identified in I.240.

- *I.250 Definition of Supplementary Services:*  
Defines seven classes of supplementary services supported by an ISDN contained in Recommendations I.251 through I.257. Supplementary services complement or support bearer services and teleservices and cannot stand alone.
  - *I.251 Number Identification Supplementary Services:*  
Describes eight supplementary services provided to callers and called parties based on manipulating ISDN number information.
  - *I.252 Call Offering Supplementary Services:*  
Describes six supplementary services primarily based on call forwarding and call transfer techniques.
  - *I.253 Call Completion Supplementary Services:*  
Describes three supplementary services: Call Waiting, Call Hold, and Completion of Calls to Busy Subscribers.
  - *I.254 Multiparty Supplementary Services:*  
Describes two supplementary services: Conference Calling and Three-Party Service.
  - *I.255 Community of Interest Supplementary Services:*  
Describes two supplementary services: Closed User Group and Private Numbering Plan.
  - *I.256 Charging Supplementary Services:*  
Describes three supplementary services: Credit Card Calling, Advice of Charge, and Reverse Charging.
  - *I.257 Additional Information Transfer Supplementary Service:*  
Describes User-to-User Signaling (UUS) between ISDN users over the signaling channel.
- I.300-Series**
- The I.300-Series describes network aspects of ISDN. These encompass network functional principles; an ISDN reference model; numbering, addressing, and routing principles; connection types; and performance objectives.
- *I.310 ISDN Network Functional Principles:*  
Provides a common understanding of ISDN terminal, network, and specialized service center aspects plus a general understanding of I-Series network Recommendations. Forms a baseline for other Recommendations in the I.300 Series.
  - *I.311 Broadband ISDN General Network Aspects:*  
When completed, will describe B-ISDN network aspects.
  - *I.320 ISDN Protocol Reference Model:*  
Models the ISDN flow of user and control information to, through, or inside an ISDN. Identifies commonalities and differences between ISDN and CCITT Recommendation X.200, the Reference Model for Open Systems Interconnection. Describes the ISDN planes of user information and control (signaling) information, ISDN management, and Interworking.
  - *I.321 Broadband ISDN Protocol Reference Model and Its Application:*  
When completed, will describe B-ISDN information and signaling flows.
  - *I.324 ISDN Network Architecture:*  
Provides a functional description of an ISDN and a guideline to specifying ISDN capabilities.
  - *I.325 Reference Configurations for ISDN Connection Types:*  
Shows how reference configurations can be developed for ISDN connection types (explained in I.340) on which hypothetical reference connections (HRXs) are based.
  - *I.326 Reference Configuration for Relative Network Resource Requirements:*  
Evaluates relative network resource requirements associated with providing ISDN services, the first step in evaluating costs for ISDN services.
  - *I.327 Broadband ISDN Functional Architecture:*  
When completed, will provide a functional description of a B-ISDN.
  - *I.330 ISDN Numbering and Addressing Principles:*

- Provides general concepts, principles, and requirements of the ISDN numbering plan. Defines ISDN number and ISDN address and various relationships.
- *I.331 Numbering Plan for the ISDN Era:*  
Describes the ISDN numbering plan and addressing principles. Also covered in CCITT Recommendation E.164.
  - *I.332 Numbering Principles for Interworking between ISDNs and Dedicated Networks with Different Numbering Plans:*  
Provides a near-term and long-term framework for implementing interworking schemes between numbering plans of present dedicated public networks and ISDNs.
  - *I.333 Terminal Selection in ISDN:*  
Provides overall principles on “terminal selection” in ISDN; i.e., procedures implemented by an ISDN to solicit an answer or rejection response from an ISDN terminal situated behind an ISDN interface.
  - *I.334 Principles Relating ISDN Numbers/ Subaddresses to the OSI Reference Model Network Layer Addresses:*  
Clarifies the concepts and terminology relating ISDN numbers and subaddresses to each other and to OSI network layer addresses.
  - *I.335 ISDN Routing Principles:*  
Provides basic routing principles defining the relationship between ISDN services (described in the I.200-Series) and ISDN network capabilities (described in the I.300-Series). Addresses the relevance of these principles to the proposed ISDN routing plan, indicating factors involved in processing a call.
  - *I.340 ISDN Connection Types:*  
Describes connection types between ISDN reference points supporting basic ISDN services, performed at the lower network layers.
  - *I.350 General Aspects of Quality of Service and Network Performance in Digital Networks, Including ISDN:*  
Describes, illustrates, and relates the concepts of Quality of Service and Network Performance. Identifies performance concerns and generic performance parameters.
  - *I.351 Recommendations in Other Services Including Network Performance Objectives that Apply at Reference Point T of an ISDN:*  
Points to CCITT Recommendations G.821 and G.822, which apply to ISDN reference point T, pertaining to error performance and controlled slip rate objectives in international digital connections.
  - *I.352 Network Performance Objectives for Connection Processing Delays in an ISDN:*  
Provides values for connection processing delays used as design objectives in network planning and system design.
  - *I.361 ATM Layer Specification for Broadband ISDN:*  
When completed, will specify the asynchronous transfer mode (ATM) layer, which resides above the B-ISDN physical layer and delivers “cells” to the B-ISDN medium.
  - *I.362 Broadband ATM Adaptation Layer (AAL) Functional Description:*  
When completed, will describe AAL functions, which map user service-specific information into ATM cells.
  - *I.363 ATM Adaptation Layer Functional Specification:*  
When completed, will provide a functional description of the ATM Adaptation Layer.
- I.400-Series**  
The I.400-Series encompasses different versions of the interface between users and an ISDN network, the “user-network interface,” including specifications for the Basic and Primary Rates. Layers 1, 2, and 3 specifications for the S and T reference points are also given. Last, the I.400-Series explains procedures for multiplexing subrate channels and for adapting non-ISDN terminals to an ISDN network.
- *I.410 General Aspects and Principles Relating to Recommendations on ISDN User-Network Interfaces:*  
Gives examples of user-network interface applications; describes objectives, characteristics, and capabilities.
  - *I.411 ISDN User-Network Interfaces—Reference Configurations:*

Defines ISDN reference configurations describing the possible ISDN access arrangements. Describes two concepts used in defining reference configurations: functional groups (NT1, NT2, TE1, TE2, and TA) and reference points (R, S, T, U, and V).

- *I.412 ISDN User-Network Interface Structures and Access Capabilities:*

Defines channel types (B, D, and H), the interface structures (basic rate and primary rate), and capacities.

- *I.413 ISDN User-Network Interface with Broadband Capability:*

When completed, will describe the B-ISDN user-to-network interface.

- *I.420 Basic User-Network Rate Interface:*

References Recommendations I.412, I.430, I.440, I.441, I.450, and I.452, which define and specify the basic user-network interface.

- *I.421 Primary Rate User-Network Interface:*

References Recommendations I.412, I.431, I.440, I.441, I.450, I.451, and I.452, which define and specify the primary rate user-network interface.

- *I.430 Basic User-Network Interface—Layer 1 Specification:*

Defines the physical, electrical, functional, procedural, and power characteristics for point-to-point and point-to-multipoint operation through the ISDN basic rate interface at reference point S or T.

- *I.431 Primary Rate User-Network Interface, Layer 1:*

Defines the electrical, format, and usage characteristics for point-to-point operation through the ISDN primary rate interface at reference points S and T.

- *I.440 ISDN User-Network Interface Data Link Layer—General Aspects:*

Refers to CCITT Recommendation Q.920, Volume VI, Fascicle VI.10, which provides general principles on the ISDN Layer 2 protocol used on the D-channel—Link Access Protocol D (LAPD).

- *I.441 ISDN User-Network Interface Data Link Layer Specification:*

Refers to CCITT Recommendation Q.921, Volume VI, Fascicle VI.10, which specifies the LAPD protocol based on the ISO's High-Level Data Link Control (HDLC) Recommendation. Specifies operation for one or more data links over the D-channel, frame sequence control, error control, and flow control.

- *I.450 ISDN User-Network Interface Network Layer, General Aspects:*

Refers to CCITT Recommendation Q.930, Volume VI, Fascicle VI.11, which provides general principles of the Layer 3 service for user-to-network signaling.

- *I.451 ISDN User-Network Interface Network Layer Specification:*

Refers to CCITT Recommendation Q.931, Volume VI, Fascicle VI.11, which specifies the ISDN protocol for user-to-network signaling. Specifies procedures for establishing, maintaining, and clearing network calls/connections.

- *I.452 Generic Procedures for the Control of the ISDN Supplementary Services:*

Refers to CCITT Recommendation Q.932, Volume VI, Fascicle VI.11, which defines generic procedures for controlling supplementary services at the user-network interface.

- *I.460 Multiplexing, Rate Adaptation and Support of Existing Interfaces:*

Describes how a bit stream lower than 64K bps is adapted into a 64K bps B-channel. Describes how multiple subrate channels are time-division multiplexed into a single 64K bps B-channel. Describes how non-ISDN bit rates (except 56K bps—see I.464) are adapted to ISDN-specified rates of 8K, 16K, 32K, or 64K bps.

- *I.461 Support of X.21, X.21 bis, and X.20 bis Based Data Terminal Equipments (DTEs) by an ISDN:*

Refers to CCITT Recommendation X.30, Volume VIII, Fascicle VIII.2, which describes rate adaptation, establishing and clearing calls, and data synchronization.

- *I.462 Support of Packet Mode Terminal Equipment by an ISDN:*

Refers to CCITT Recommendation X.31, Volume VIII, Fascicle VIII.2, which describes how X.25 packet switched terminals are supported



on an ISDN. Specifies two different rate adaptation techniques (HDLC or I.461), packet-level handling and establishing and clearing calls.

- *I.463 Support of Data Terminal Equipments (DTEs) with V-Series Type Interfaces by an ISDN:*  
Refers to CCITT Recommendation V.110, Volume VIII, Fascicle VIII.1, which describes how terminals connected to V-Series modems are supported on an ISDN. Specifies Layer 1 interface conversion, rate adaptation, establishing and clearing calls, and data synchronization.
- *I.464 Multiplexing, Rate Adaptation and Support of Existing Interfaces for Restricted 64K-bit-per-second Transfer Capability:*  
A variation on I.460, I.464 describes how Restricted 64K bps (56K bps) interfaces are supported on an ISDN. The eighth bit of each octet is automatically set to 1 in support of existing networks with Restricted 64K bps channels.
- *I.465 Support by an ISDN of Data Terminal Equipment with V-Series Type Interfaces with Provision for Statistical Multiplexing:*  
Refers to CCITT Recommendation V.120, Volume VIII, Fascicle VIII.1.
- *I.470 Relationship of Terminal Functions to ISDN:*  
Gives direction to potential terminal functions, providing more detailed examples than the general functions described in I.310.

### **I.500-Series**

The I.500 Series encompasses Recommendations for communicating between different ISDN networks or between ISDN and dedicated networks (called interworking or internetworking). They deal with the network aspects of interworking.

- *I.510 Definitions and General Principles for ISDN Interworking:*  
General principles for internetworking within and among ISDNs and between ISDNs and other networks.
- *I.511 ISDN-to-ISDN Layer 1 Internetwork Interface:*  
Defines interworking at Layer 1, including reference configuration and interworking functions.

- *I.515 Parameter Exchange for ISDN Interworking:*

Describes how different ISDNs exchange network parameters for internetworking, such as terminal compatibility, modem type, and voice encoding parameters.

- *I.520 General Arrangements for Network Interworking between ISDNs:*

Describes general arrangements and functions for the ISDN-to-ISDN interface.

- *I.530 Network Interworking between an ISDN and a Public Switched Telephone Network (PSTN):*

Describes general arrangements for interworking between an ISDN and a PSTN for both voice and data services.

- *I.540 General Arrangements for Interworking between Circuit Switched Public Data Networks (CSPDNs) and ISDNs for the Provision of Data Transmission:*

Refers to CCITT Recommendation X.321, Volume VIII, Fascicle VIII.6.

- *I.550 General Arrangements for Interworking between Packet Switched Public Data Networks (PSPDNs) and ISDNs for the Provision of Data Transmission:*

Refers to CCITT Recommendation X.325, Volume VIII, Fascicle VIII.6.

- *I.560 Requirements to be Met in Providing Telex Service within the ISDN:*

Refers to CCITT Recommendation U.202, Volume VII, Fascicle VII.2.

### **I.600-Series**

The I.600-Series encompasses general maintenance principles of ISDN subscriber access and subscriber installation.

- *I.602 Application of Maintenance Principles to ISDN Subscriber Installation:*

Describes optional maintenance for a subscriber installation, except for mandatory physical and electrical interface characteristics required in I.430 and I.431. Associated protocols are specified in CCITT Recommendation Q.940.f

- *I.603 Application of Maintenance Principles to ISDN Basic Accesses:*

Figure 2.  
Schematic Overview of the ISDN User Interfaces

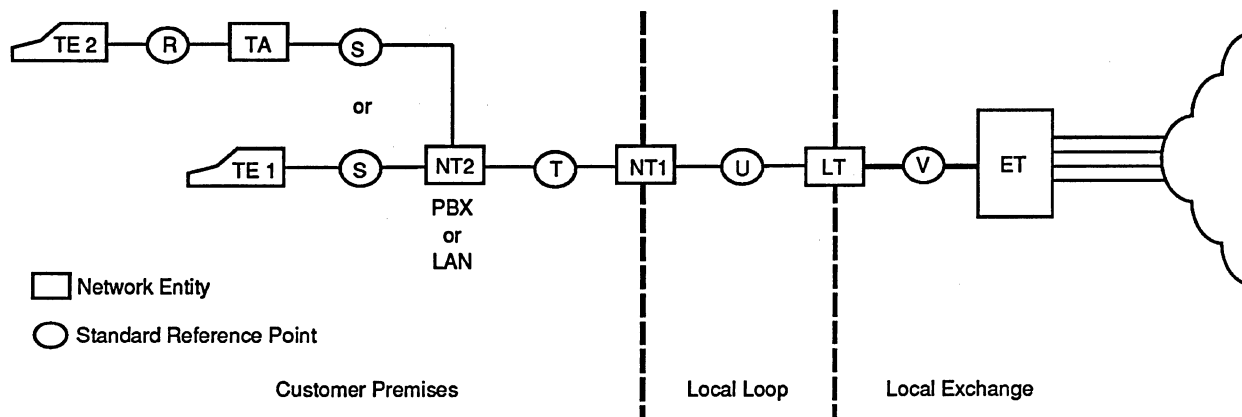

TE2 is a non-ISDN subscriber terminal, connecting through the R-interface to an ISDN via a Terminal Adapter (TA). TE1 is an ISDN terminal. Either connects over the S-Interface to NT2, the local communications controller (possibly a LAN or digital PBX). The T-interface connects NT2 to NT1, which terminates the local loop at the customer premises; the loop is the U-interface. LT, the loop termination, ends the local loop at the local switching exchange. It connects to ET, the exchange terminal (local exchange switch) through the V-interface.

Describes maintenance for the network portion of basic access (144K bps) attached directly to a central office switch. Explains the concept of “controlled maintenance” for maintaining subscriber basic access.

- *I.604 Application of Maintenance Principles to ISDN Primary Rate Accesses:*

Describes maintenance and troubleshooting for the Primary Rate interface from the network side, following principles from I.603.

- *I.605 Application of Maintenance Principles to Static Multiplexed ISDN Basic Accesses:*

Describes maintenance for a multiplexed basic rate interface, controlled by the network, including the V<sub>4</sub> interface.

### The User-Network Interface

The user-network interface concept contained in the I.400-Series describes a common user interface to an ISDN. It encompasses the functions of several network entities (pieces of communications hardware); defines several standard reference points (interfaces between network entities); and specifies a number of communications channels (portions of the network bandwidth), establishing a number of protocols for using those channels. In ISDN nomenclature, Network Entity names comprise two letters and optionally include a number

(e.g., TE1, LT, NT2); Channel names are a single letter from the first half of the alphabet, sometimes combined with a number (e.g., B, D, H1); and Standard Reference Point names are a single letter from the second half of the alphabet (e.g., R, S, T). Figure 2 is a schematic illustration of the reference configuration.

### Network Entities

The physical devices that constitute the common user interface in the reference configuration model (I.411) comprise the following:

- TE1—(Terminal Equipment—Type 1) a terminal device equipped with a standard ISDN physical interface.
- TE2—(Terminal Equipment—Type 2) a terminal device equipped with a non-ISDN physical interface such as V.24 (RS-232-C) or X.21. ISDN does not support this type, which would require a terminal adapter (TA).
- TA—(Terminal Adapter) an interface adapter for connection of one or more TE2 devices to the network. Equivalent to a protocol or interface converter.
- NT2—(Network Termination) a possibly intelligent device responsible for the user’s side of the connection to the network, performing such functions as multiplexing and switching.

Figure 3.  
ISDN Physical Configurations

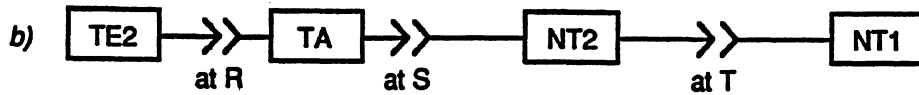
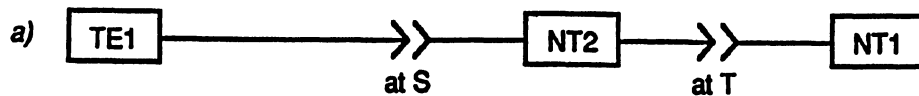

Configurations where ISDN physical interfaces occur at reference points S and T

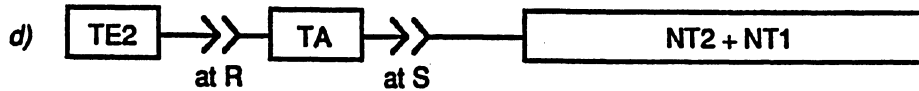
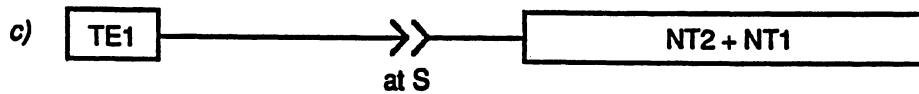

Configurations where ISDN physical interfaces occur at reference point S only

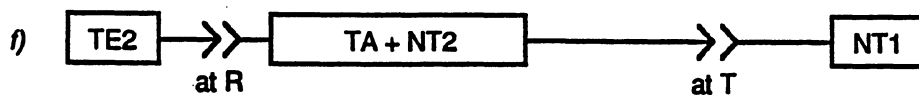
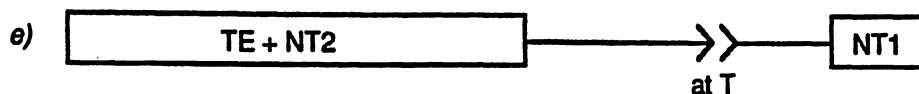

Configurations where ISDN physical interfaces occur at reference point T only

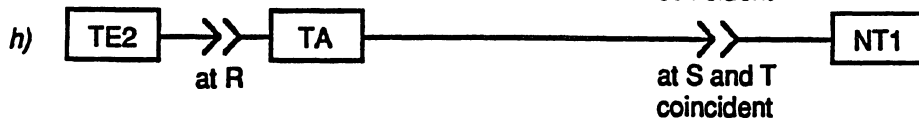
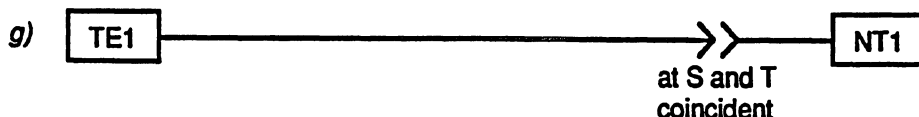

Configurations where a single ISDN physical interface occurs at a location where both reference points S and T coincide

 Physical interface at the designated reference point

 Equipment implementing functional groups

Examples of physical interface configurations at the R, S, and T reference points.

Source: CCITT.

- NT1—a device responsible for the carrier's side of the connection, performing such functions as signal conversion and maintenance of the loop's electrical characteristics. These functions are similar to those provided by DSU/CSUs.
- LT—(Loop or Link Termination) the equivalent of NT1 at the carrier's central switching office; NT1 and LT terminate the local loop at their respective ends.

- **ET**—(Exchange Termination) the carrier's local exchange switch.

At first glance, the functions of these entities seem obvious; in practice, however, things are more complicated. Some devices, especially TE1 and NT2, might take various forms. Others, such as ET, might not be single devices at all. In general, TE2, the non-ISDN terminal, is a present-day telephone, data terminal, voice/data workstation, or similar communicating device. TE1 may be its ISDN-compatible equivalent or may be a terminal cluster controller, a multiplexer, or a very local branch of a local area network. In the schematic drawing, NT1 equals the Data Service Unit (DSU) and Channel Service Unit (CSU) in AT&T's current Dataphone Digital Service. NT2 will probably be a digital PBX or a local area network. The central office switch (ET) may be a single, digital device such as AT&T's No. 5 ESS (currently only a circuit switch) or may be a cluster of specialized devices for terrestrial circuit switching, satellite uplink, and packet switching.

#### User-Network Reference Points

The reference points specified in the CCITT reference configuration model (I.411) determine boundaries between ISDN functions; these do not, however, necessarily correspond to discrete interfaces between user-premises equipment (see Figure 3). The reference points include the following:

- **R**—a reference point between a non-ISDN terminal (i.e., TE2) and a terminal adapter; the reference point between TE2 and TA.
- **S**—a reference point between a terminal and the network; the reference point between TE1, or TA and NT2.
- **T**—a reference point between the subscriber's portion of the network and the carrier's portion; the reference point between NT2 and NT1. Requires a four-wire interface.
- **U**—the carrier's local loop; the reference point between NT1 and LT. Requires a two-wire interface.
- **V**—the reference points between the carrier's end of the local loop and the exchange switching equipment; the reference point between LT and ET.

The S and T reference points are most important to the end user. In fact, the reference configuration specifies these two reference points as identical. Recommendation I.411 provides several possible examples of equipment configurations grouped around the R, S, and T reference points (see Figure 4). Multiplexing and switching can occur at any one of several places on the user side of the T interface.

A CCITT standard for the U reference point has been slow to develop, because Europe considers it a network component proprietary to the carriers. In Europe and Canada, the user network ends at the NT2 level; therefore, the CCITT never addressed a U-interface standard. In the U.S., however, the U interface connects user-premises equipment to the network at the NT1 level.

An ANSI line coding standard for the U-interface was adopted in 1988 for use in North America. Called Two Binary One Quaternary (2B1Q), it is based on a four-level signaling code and operates over a single wire pair. Although somewhat complex, the new coding standard provides many advantages over previous Basic access arrangements, including full-duplex operation over two wires and extended transmission range. The CCITT is evaluating 2B1Q for use as an international ISDN standard.

#### User-Network Communication Channels

In general, the reference configuration specifies two types of channels: transparent and nontransparent. Transparent channels may carry the user's choice of voice or high-speed data services independently of protocol. Nontransparent channels have been assigned specific protocols for specific functions in the network. The currently specified channels are:

- **B**—(bearer) a transparent digital channel of 64K bps, to be used for digital, voice, or high-speed data transmission.
- **D**—a nontransparent digital channel of 16K or 64K bps, used for signaling in association with one or more B-channels; also to be used for telemetry and for low-speed, packet switched data.
- **H**—(high speed) transparent digital channels, roughly equivalent to current T-carrier channels, used for carrying multiplexed data, data and voice, or facsimile at rates of millions of

*Figure 4.*  
*Sample Implementations of NT1 and NT2 Functions*

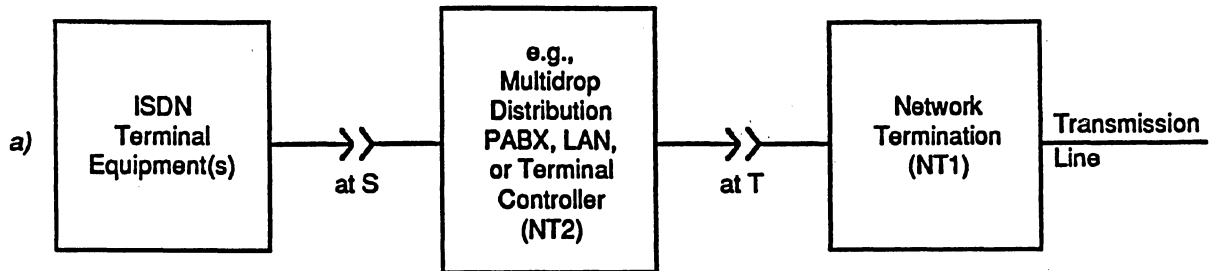

An implementation (see Figure 2a) where ISDN physical interfaces occur at reference points S and T.

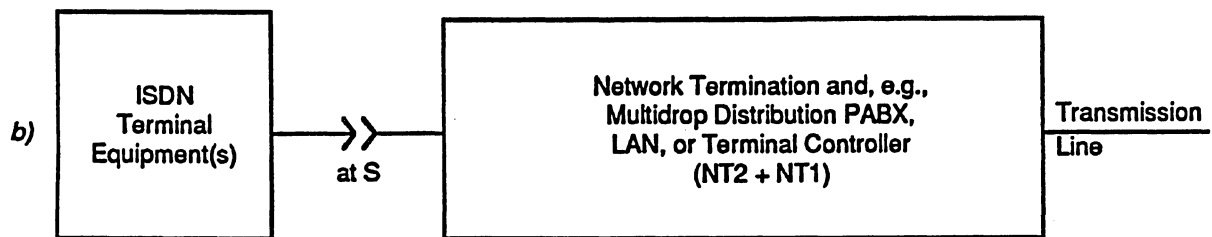

An implementation (see Figure 2c) where ISDN physical interfaces occur at reference point S but not T.

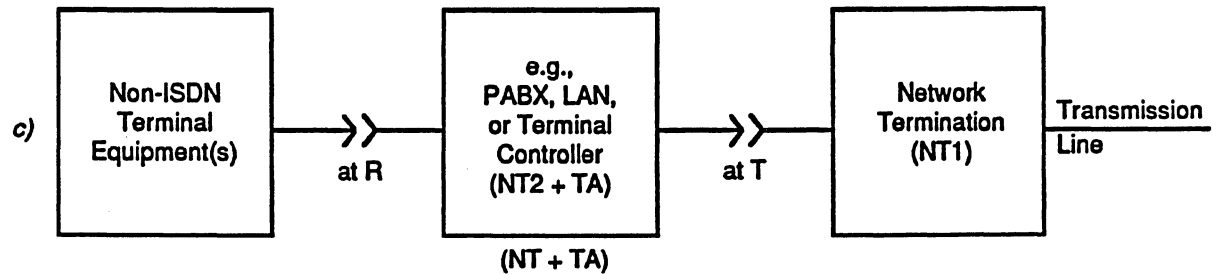

An implementation (see Figure 2f) where ISDN physical interfaces occur at reference point T but not S.

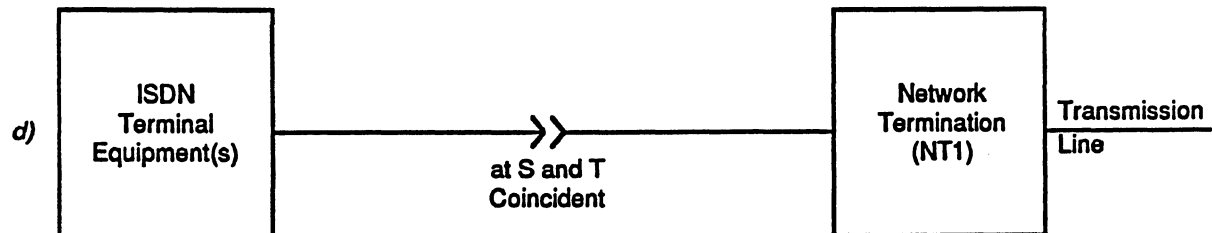

An implementation (see Figure 2g) where a single ISDN physical interface occurs at a location where both reference points S and T coincide.

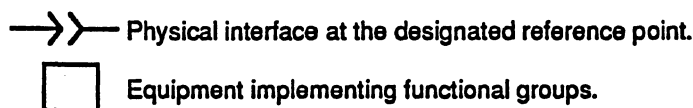

Source: CCITT.

bits per second. Although H-channels have not been fully defined, an H0 channel will operate at 384K bps; an H1 channel will operate at 1535K bps (H11) or 1920K bps (H12). An H4 broadband version has been proposed that would operate at 135M bps.

In the preceding listing, A- and C-channels are missing. Originally meant to accommodate analog telephone connections and related signaling, these channels are viewed as obsolete by the CCITT and will not be specified in the I-Series Recommendations. Nevertheless, old analog subscriber loops will continue to be terminated on ISDN switches while the network migrates to digital subscriber loops.

The goal is to provide all users with some combination of B-channels in association with a single D-channel for signaling (i.e., call establishment, call progress monitoring, call termination, and enhanced telephone features). The heaviest users may require one or more H-channels. Two specific levels of service are planned:

- A Basic Rate service providing two 64K bps B-channels and one 16K bps D-channel per interface (2B+D). The Basic Rate service would allow two voice connections (or one voice and one data connection) or two data connections over the B-channels along with one or more low-speed, low-priority packet switched data or telemetry exchanges over the D-channel. The total data rate is 192K bps, with 144K bps available to users.
- A Primary Rate service providing twenty-three 64K bps B-channels and one 64K bps D-channel (23B+D). This service is based on the U.S. T1 specification of 1.544M bps. The European Primary Rate service, based on the CEPT specification of 2.048M bps, provides 30 B-channels and 1 D-channel (30B+D).

The 64K bps bandwidth for the B-channel is based on the currently accepted bit rate necessary for pulse code-modulated (PCM) digital voice. Some technologies coming into use, such as Adaptive Differential Pulse-Code Modulation (ADPCM), allow compression of the digital voice stream into 32K bps. Should such technologies become commonplace, a single B-channel could, in theory, carry two voice conversations or one voice call and 32K bps of data.

Figure 5.  
The ISDN Addressing Format

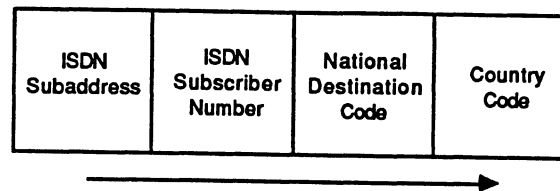

### ISDN Numbering Plan

Another ISDN goal is the deployment of a numbering and addressing plan, CCITT I.331, allowing a graceful evolution from analog telephony. The telephone country codes for I.331 were borrowed from CCITT Recommendation E.163; the rest of the numbering scheme devolves to each individual country. The quest for a U.S. ISDN numbering plan is a politically hot subject that has been stalemated by the industry. Technical difficulties include devising a uniform numbering scheme and transferring data calls between different types of networks. Bellcore is the administrator of the North American Numbering Plan (NANP), but the ISDN numbering plan must be approved by the ANSI T1D1 subcommittee. Bellcore is acting the role of mediator and has proposed an interim numbering plan to cover the period ending in 1995; if necessary, the FCC will resolve the deadlock.

The objective of the ISDN numbering plan is to identify unique physical interfaces, virtual interfaces, and multiple interfaces at reference point T and point-to-point and multipoint configurations at reference point S. An ISDN address comprises a 15-digit international number plus an ISDN subaddress of up to 32 digits (see Figure 5).

Representatives of U.S. long-distance carriers formed an organization to represent their interests regarding an ISDN numbering plan. Called the Interexchange Carrier Industry Committee, it allows interexchange carriers to discuss issues brought up in industry forums.

### Broadband ISDN

Broadband ISDN (B-ISDN) is intended to provide communications services at bit rates much higher than U.S. T1 and European CEPT transmission channels. Providing two aggregate bit rates of around 155M bps and 600M bps, B-ISDN will support such applications as high-quality television,

videoconferencing, and video telephony; high-speed facsimile, image, and graphics communications; and broadband data communications. ISDN planners are now devising broadband networks with subscriber interfaces that make use of H2 (32.768M and 44.16M bps), H3 (60M to 70M bps), and H4 (132.48M to 138.24M bps) channels.

Although a general B-ISDN framework and principles were established in the last study period, comprehensive B-ISDN specifications will not be completed until the middle or end of the 1989 to 1992 study period—and possibly not until later. The CCITT's Study Group XVII is preparing 13 B-ISDN Draft Recommendations and has made their swift completion a priority.

Although originally mired in controversy, B-ISDN's direction has been resolved and is moving in parallel with efforts on Synchronous Optical Network (SONET) standards. Developed by Bell Communications Research (Bellcore) in the U.S., SONET was conceived as an evolutionary step in developing all-digital public networks using fiber optic backbones. It is a carrier technology supporting bit rates from 51M bps to 82.5G bps. SONET standardizes fiber interfaces and will reduce carrier costs, simplify carrier and user connections, and stimulate broadband service offerings.

Although they address different markets, SONET and B-ISDN are complementary concepts and share similar techniques and principles at the lower OSI layers. Perhaps the most important is a switching/multiplexing technique called asynchronous transfer mode (ATM) (see Figure 6). In ATM, user information is organized into blocks of a predefined length. Each block is appended with a header, forming a *cell*. Associating cells with user calls or channels at the opposite end of transmission is directed by information in the cell header. Cells need not be placed in any particular order, or synchronized, in the SONET bit stream; hence the use of the term "asynchronous."

ATM is radically different from the conventional synchronous transfer mode (STM) used by carriers today, which organizes information frames by predefined time slots, using time-division multiplexing and switching. ATM has several advantages over STM, including more efficient bandwidth utilization; eventually, most public telecommunications networks will conform to ATM. An ATM standard is not expected until 1991 or 1992; therefore, broadband services based on cell

relay techniques will probably not be available until the late '90s. B-ISDN and SONET trials are scheduled in the interim but will probably use *frame relay*, an access method for fast-packet networks using variable-length information blocks. Experts expect that frame relay will be upwardly compatible with future cell relay techniques.

### Common Channel Signaling

In telephony, signaling is the process of establishing, maintaining, accounting for, and terminating a connection between two endpoints. Most telephone users are familiar with certain forms of signaling, namely the basic means of establishing calls—pulse dialing and dual-tone multifrequency (DTMF, better known by the AT&T trademark "Touch-tone"). Both of these signaling techniques are transmitted *in-band*, along the same channel as the voice conversation (or data session). In-band signaling generates tremendous overhead for the carrier, since all signaling information must be carried end to end and since signaling uses up part of the channel that otherwise could carry part of the actual exchange between users. On heavily multiplexed channels, such as those on trunks between switching offices, overhead multiplies, causing inefficient use of large portions of the network.

Figure 6.  
B-ISDN Protocol Model for ATM

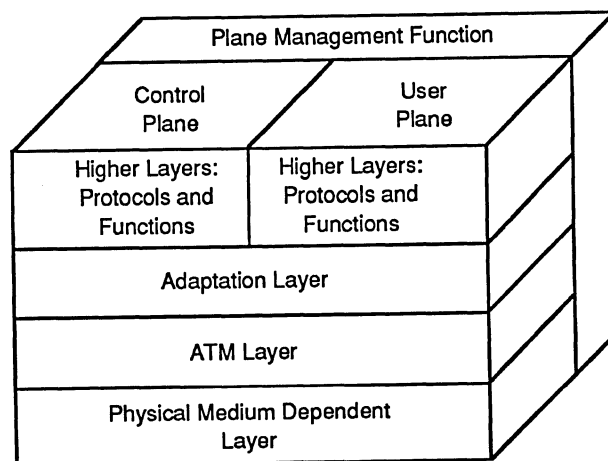

Source: CCITT.

With common channel signaling, all signaling information is carried *out of band* on a special digital signaling channel. This can be a relatively low-bandwidth channel, since digital signaling uses bandwidth many times more efficiently than the analog signaling methods previously mentioned. It also allows for quicker establishment and routing of calls, since the call establishment and routing information is sent ahead over a less crowded channel.

The bit rate of the D-channel in the reference ISDN interfaces relative to that of the collected B-channels is a good example of the efficiency of out-of-band, digital signaling. In the Basic Rate specification, the D-channel occupies one eighth the combined bandwidth of the two B-channels. In the U.S. version of the Primary Rate specification, the D-channel uses the same bandwidth as 1 of the 23 B-channels. Even with these efficiencies, only a small fraction of the D-channel bandwidth will be used for signaling. The leftover bandwidth may be used for applications such as telemetry, videotex, or packet switched data.

---

## Common Channel Signaling System Number 7

Communicating between different ISDN networks hinges on carriers' implementing the CCITT's Common Channel Signaling System Number 7 (CCSS7), an out-of-band signaling protocol designed for high-speed backbone networks. CCSS7's end-to-end signaling capabilities provide a reliable and flexible communications medium for passing routing information between switches and routing centers.

To implement CCSS7, carriers must build a separate signaling network parallel to the information-carrying network, using special signaling switches. In the U.S., ANSI's T1X1 subcommittee is the standards group responsible for the ISDN User Part of CCSS7 (as well as for 64K bps clear-channel capability) and is working with T1D1 on coordinating CCSS7 and D-channel call establishment procedures.

Although not specifically developed for ISDN, CCSS7 is a natural fit for ISDN switch-to-switch signaling requirements. ISDN deployment is predicated on the ubiquitous availability of CCSS7 facilities; using CCSS7 in a digital environment, the telephone companies can also provide

other new intelligent services. All of the major interexchange carriers have deployed or nearly deployed CCSS7. Most of the BOCs and larger independent LECs are also converting to CCSS7, although it will take them longer to do so.

CCSS7 uses packet switching to transmit signaling information and comprises two parts. The Message Transfer Part (MTP) provides communication between intelligent network nodes for call establishment, disconnection, supervision, and billing. The User Part accommodates user-defined requirements for intelligent services; it uses the MTP to relay these user signals. The User Part deals with the content and coding of the signaling messages. CCSS7 User Parts correspond to the OSI Model higher layers, although CCSS7 does not yet follow the clean segmentation in the upper four layers suggested by the OSI model.

CCSS7's structure is generally based on the OSI Reference Model. CCSS7 is composed of protocol specifications for the first three layers of the OSI model, a small number of functions at Layers 4 through 7, as well as several functions above Layer 7 (the true application level, particularly for interworking with computerized Operations Systems that monitor the telephone plant and collect telemetry data—systems also used to design, engineer, provision, and maintain the plant).

Layer 1 specifies the physical, electrical, and functional characteristics of a signaling link (type A, B, or C). It pertains, for example, to the plug characteristics for a DSU/CSU, to voltages required to identify a bit, and so on.

Layer 2 defines the functions and procedures for transferring signaling messages between two physical nodes over a link in an error-free and reliable manner, pertaining to message blocking and retransmissions. Messages are transmitted using signal units patterned after the CCITT's High-Level Data Link Control (HDLC) protocol.

Layer 3 defines networking (transport) functions common to all individual links in the end-to-end circuit. It provides the means to multiplex several logical links on a single physical link. In the signaling environment, this implies the capability to carry control information about several calls on one channel call. CCITT Q.701 to Q.707 specify the MTP, which comprises all three layers. The MTP provides a service similar, but not identical, to an X.25 network.



The OSI model specifies four other layers, which are, in ascending order, Transport, Session, Presentation, and Application Support. CCSS7 ISDN User Part corresponds to these higher layers, although the clean segmentation suggested by the OSI model is not followed in the upper four layers. When CCSS7 was being developed, the higher OSI layers were not yet fully defined (they are now); thus, there is an ongoing effort to migrate CCSS7 protocols to the OSI model.

Currently there are three versions of CCSS7:

- The true CCITT recommendation formulated in 1980 and 1984 and codified in the standards Q.701 to Q.741.
- The AT&T Communications and Telecom Canada specification of the CCITT protocols, worked out in 1985.
- The American National Standards Institute (ANSI) T1X1 Working Group specification of the CCITT protocols, worked out in 1986.

The last two systems are based on the first, with additional specifications on the options incorporated by CCITT for national use. International communications using CCSS7 is becoming a reality; yet, national networks will differ in their particular domestic interpretation of some of the protocol fields. CCSS7 will be the primary signaling method between an ISDN and public switched telephone networks (PSTNs), other ISDNs, value-added networks (VANs), and private networks. ■

