

CompuWriter CompuWriter Jr., and International

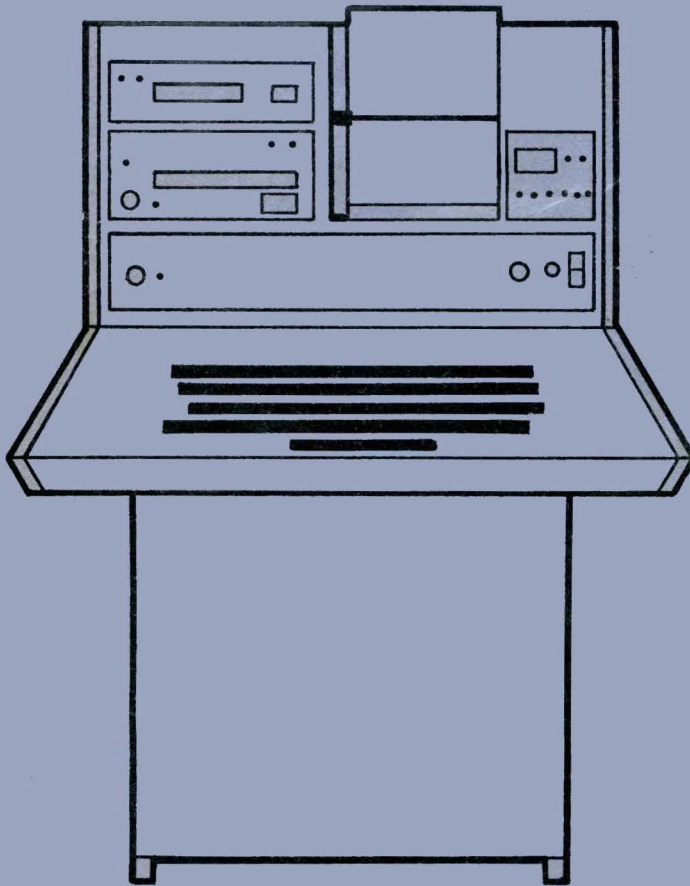

Technical Manual

cg compugraphic

26402-001

PREVENTIVE MAINTENANCE SCHEDULE COMPUWRITER JR, I, II; CG UNIVERSAL (Universal Photo Units)

	JAN	FEB	MAR	APR	MAY	JUN
	1 2 3 4 5	1 2 3 4	1 2 3 4 5	1 2 3 4 5	1 2 3 4 5	1 2 3 4 5
FILTERS	<input type="checkbox"/>	<input type="checkbox"/>	<input type="checkbox"/>	<input type="checkbox"/>	<input type="checkbox"/>	<input type="checkbox"/>
FILM ROLLERS	<input type="checkbox"/>	<input type="checkbox"/>	<input type="checkbox"/>	<input type="checkbox"/>	<input type="checkbox"/>	<input type="checkbox"/>
	JUL	AUG	SEP	OCT	NOV	DEC
	1 2 3 4 5	1 2 3 4 5	1 2 3 4 5	1 2 3 4 5	1 2 3 4 5	1 2 3 4 5
FILTERS	<input type="checkbox"/>	<input type="checkbox"/>	<input type="checkbox"/>	<input type="checkbox"/>	<input type="checkbox"/>	<input type="checkbox"/>
FILM ROLLERS	<input type="checkbox"/>	<input type="checkbox"/>	<input type="checkbox"/>	<input type="checkbox"/>	<input type="checkbox"/>	<input type="checkbox"/>

- INSTRUCTIONS -

1. WEEKLY-Vacuum clean fibre glass filter and wash metal filter with detergent. Replace filters as required.
2. WEEKLY-Brush or vacuum the film rollers and bearing plate area.
3. AS REQUIRED-Clean font strips with CG Font & Film cleaner 56996.
4. AS REQUIRED-Clean lens(es) with lens tissue and Isopropyl alcohol (90% or better).
5. AS REQUIRED-Open film cassette and remove bits of paper.

GENERAL CLEANING-Vacuum the keytop with a soft brush attachment.
Wipe exterior of machine with mild detergent and water.

LUBRICATION-No lubrication is required in this machine.

WARNING: REMOVE PLUG FROM OUTLET WHEN PERFORMING PREVENTIVE MAINTENANCE.

Film Rollers

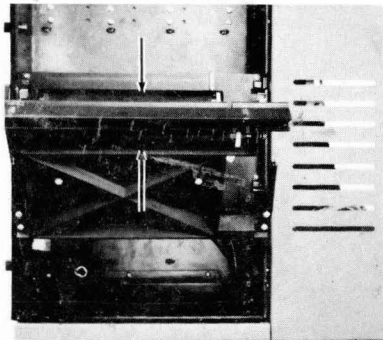

Filter - CompuWriter I & JR

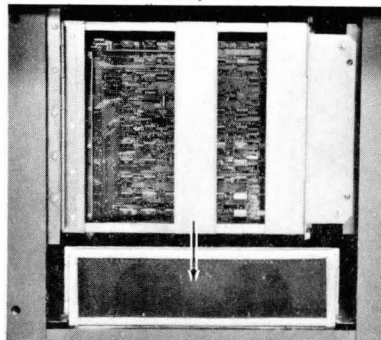

Filters - CompuWriter II & CG Universal

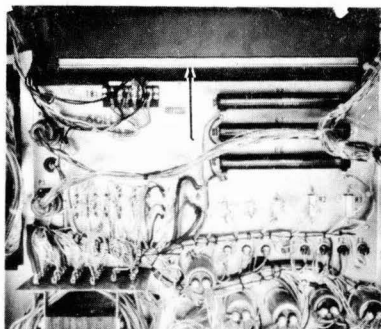
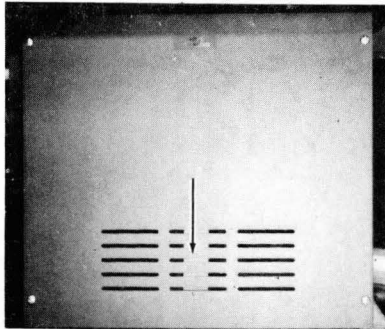

PREVENTIVE MAINTENANCE SCHEDULE COMPUWRITER JR, I, II; CG UNIVERSAL (Universal Photo Units)

	JAN	FEB	MAR	APR	MAY	JUN
	1 2 3 4 5	1 2 3 4	1 2 3 4 5	1 2 3 4 5	1 2 3 4 5	1 2 3 4 5
FILTERS	<input type="checkbox"/>	<input type="checkbox"/>	<input type="checkbox"/>	<input type="checkbox"/>	<input type="checkbox"/>	<input type="checkbox"/>
FILM ROLLERS	<input type="checkbox"/>	<input type="checkbox"/>	<input type="checkbox"/>	<input type="checkbox"/>	<input type="checkbox"/>	<input type="checkbox"/>
	JUL	AUG	SEP	OCT	NOV	DEC
	1 2 3 4 5	1 2 3 4 5	1 2 3 4 5	1 2 3 4 5	1 2 3 4 5	1 2 3 4 5
FILTERS	<input type="checkbox"/>	<input type="checkbox"/>	<input type="checkbox"/>	<input type="checkbox"/>	<input type="checkbox"/>	<input type="checkbox"/>
FILM ROLLERS	<input type="checkbox"/>	<input type="checkbox"/>	<input type="checkbox"/>	<input type="checkbox"/>	<input type="checkbox"/>	<input type="checkbox"/>

- INSTRUCTIONS -

1. WEEKLY-Vacuum clean fibre glass filter and wash metal filter with detergent. Replace filters as required.
2. WEEKLY-Brush or vacuum the film rollers and bearing plate area.
3. AS REQUIRED-Clean font strips with CG Font & Film cleaner 56996.
4. AS REQUIRED-Clean lens(es) with lens tissue and Isopropyl alcohol (90% or better).
5. AS REQUIRED-Open film cassette and remove bits of paper.

GENERAL CLEANING-Vacuum the keytop with a soft brush attachment.
Wipe exterior of machine with mild detergent and water.

LUBRICATION-No lubrication is required in this machine.

WARNING: REMOVE PLUG FROM OUTLET WHEN PERFORMING PREVENTIVE MAINTENANCE.

Film Rollers

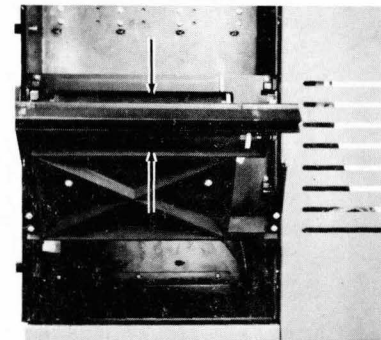

Filter - CompuWriter I & JR

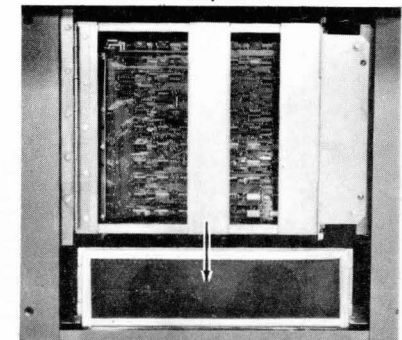

Filters - CompuWriter II & CG Universal

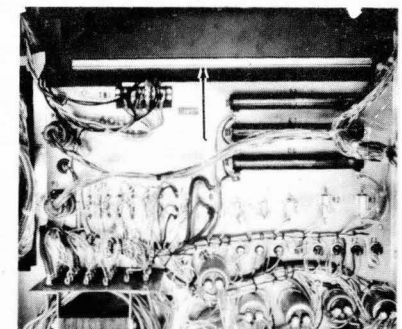
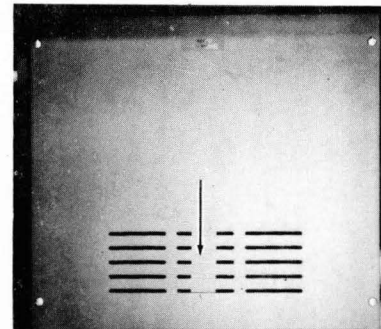

**COMPUWRITER,
COMPUWRITER JR., AND
COMPUWRITER INTERNATIONAL
Technical Manual
(Serial No.s 4000 and Above)**

**Field
Service
Publications**

325-671 REV 1

October, 1975

The information in this manual is intended to augment the knowledge and training of the serviceman maintaining COMPUGRAPHIC equipment. Users of this manual are encouraged to suggest changes or corrections by submitting such information in writing to Field Service Publications.

This document discloses subject matter in which COMPUGRAPHIC CORPORATION has proprietary rights. Neither receipt nor possession thereof confers or transfers any right to reproduce or disclose the document, any part thereof, any information contained therein, or any physical article or device, or to practice any method or process, except by written permission from or written agreement with COMPUGRAPHIC CORPORATION.

TABLE OF CONTENTS

	Page		Page
SECTION I INTRODUCTION			
1.1 GENERAL DESCRIPTION	1-1	3.3.1 General	3-2
1.2 SPECIFICATIONS	1-1	3.3.2 Testing the Character Display	3-2
1.3 SYSTEM CONFIGURATION	1-1	3.3.3 Testing the Line Length Display	3-6
1.4 FUNCTIONAL CONCEPT	1-2	3.3.4 Testing the Keyboard Unit	3-6
1.5 OPTIONAL FEATURES	1-3	3.4 ADJUSTMENTS	3-6
1.6 CONTROLS AND INDICATORS	1-3	3.4.1 General	3-6
1.6.1 Front Control Panel	1-3	3.4.2 Exciter Lamp Adjustment	3-7
1.6.2 Internal Control Panel	1-4	3.4.3 Font Clock Adjustment	3-7
1.7 OPERATING PROCEDURES	1-5	3.5 REPAIR	3-8
1.8 OPERATING SUPPLIES AND ACCESSORY ITEMS	1-5	2.5.1 General	3-8
1.9 INSTALLATION AND CHECKOUT	1-5	3.5.2 Logic Board Removal and Insertion	3-8
1.10 SCHEMATICS AND DRAWINGS	1-5	3.5.3 Logic Extended Board	3-8
SECTION II THEORY OF OPERATION			
2.1 INITIALIZING SYSTEM (PRIME)	2-1	3.5.4 Repairing Bent Connector Pins	3-8
2.2 SYSTEM CLOCK	2-1	3.5.5 Character Display Replacement	3-8
2.3 MEMORY TIMING	2-1	3.5.6 Line Length Display Replacement	3-9
2.4 DATA PROCESSING SEQUENCE	2-1	3.5.7 Panel Indicator Lamp Replacements	3-9
2.5 KEYBOARD ENTRY INTO MEMORY	2-2	3.5.8 Keyboard Repair	3-9
2.6 SPACEBAND/INSERT SPACE/DISC. HYPHEN	2-2	3.5.9 Installation of Insert and Accent Board	3-10
2.7 PC1 AND PC2 FUNCTIONS	2-2	3.5.10 Width Card Maintenance	3-10
2.8 PC5 AND PC6 FUNCTIONS	2-3	3.5.11 Component Replacement	3-10
2.9 CASE CHANGE	2-4	3.5.12 Replacement Parts	3-11
2.10 AUTOMATIC LINE ENDING	2-4	SECTION IV SYSTEM POWER SUPPLY	
2.11 MANUAL LINE ENDING	2-5	4.1 GENERAL	4-1
2.12 LETTERSPACING	2-5	4.2 BASIC FUNCTIONS	4-1
2.13 PC7, PC8, AND END OF LINE FUNCTION	2-6	4.3 POWER SUPPLY CIRCUIT DESCRIPTION	4-1
2.14 ODD SPACEBAND WIDTH VALUE	2-6	4.4 ADJUSTMENT, MEASUREMENT, AND FUSES	4-2
2.15 FLASH AND ESCAPE FUNCTIONS	2-6	4.5 TROUBLESHOOTING	4-2
2.16 FILM FEED	2-7	4.5.1 General	4-2
2.17 LENS CARRIAGE CONTROL	2-7	4.5.2 Fuse Replacement	4-2
2.18 CHARACTER DISPLAY	2-8	4.5.3 Voltages Missing	4-2
2.19 INSERT SPACE, QUAD CODES	2-8	4.5.4 Loss of Regulation	4-2
2.20 CANCEL CHARACTER, WORD, LINE	2-8	4.5.5 Troubleshooting Chart	4-5
2.21 SPACE ONLY	2-9	SECTION V HIGH POWER SUPPLY	
2.22 FLASH ONLY	2-9	5.1 DESCRIPTION	5-1
2.23 NO-LEAD FUNCTION	2-9	5.2 BASIC CIRCUITS	5-1
2.24 MULTIJUST FUNCTION	2-9	5.2.1 General	5-1
2.25 PLUS ONE UNIT	2-9	5.2.2 Ionizing Potential	5-1
2.26 PLUS ONE POINT	2-9	5.2.3 Trigger Pulse	5-1
2.27 MEMORY FULL	2-9	5.3 SERVICING	5-1
SECTION III MAINTENANCE			
3.1 GENERAL	3-1	5.3.1 Troubleshooting	5-1
3.2 PREVENTIVE MAINTENANCE	3-1	5.3.2 High Voltage Adjustment (Density)	5-1
3.2.1 Font Strip Cleaning, Storage, and Repair	3-1	5.3.3 Repair	5-3
3.2.4 Filter Cleaning	3-1	5.4 REPLACEMENT PARTS	5-3
3.2.5 Film Cassette Cleaning	3-2	SECTION VI GLOSSARY OF TERMS	
3.3 TROUBLESHOOTING	3-2	6.1 GENERAL	6-1
		6.2 MAJOR ELEMENTS	6-1
		6.3 FLIP-FLOPS	6-1

TABLE OF CONTENTS (Continued)

	Page		Page
APPENDIX A BLOCK DIAGRAM NOTATION	A-1	APPENDIX B FLOW CHARTS	B-1
A.1 GENERAL	A-1		
A.2 INFORMATION WITHIN THE BLOCK	A-1	SUPPLEMENT	
A.3 INPUT TERMS	A-1	COMPUGRAPHIC FIELD SERVICE DISTRICT OFFICES	
A.4 ARROW DESIGNATIONS	A-1	PARTS CATALOG	
A.5 INPUT AND OUTPUT PINS	A-1	PARTS ORDER FORM	
A.6 FLIP-FLOP INPUTS	A-1	INSTALLATION CHECKLIST	
A.7 MULTIPLE GATING STRUCTURES	A-1	PREVENTIVE MAINTENANCE SCHEDULE	

SECTION I

INTRODUCTION

1.1 GENERAL DESCRIPTION

The CompuWriter, CompuWriter JR., and CompuWriter International are direct-input keyboard phototypesetters which produce justified or ragged right text in point sizes of 5 to 24 points and in a variety of styles, e.g., quadded left, right, and center. Each model uses Compugraphic 2900 fonts and appropriate width board (except for the CompuWriter JR. model which does not require a width board). Its twin-lens capability allows both original and doubled sizes to be obtained from the same font. Copy can be set up to 45 picas on eight-inch film. An optional Floating Accent/Insert Leader Board (standard on the CompuWriter International model) permits uses of accent fonts and automatic insert leader calculations (Refer to Figure 1-1).

The line being typeset may be edited prior to being printed by using the features listed below:

- Cancel Character with corrected display
- Cancel Word with corrected display
- Cancel Line with corrected display
- Display of last 32 characters entered
- Marching display of entire line in memory
- Line measure display, count-down
- Amount oversight display
- Calculate line length without printing



Figure 1-1 CompuWriter System

1.2 SPECIFICATIONS

Input:	Keyboard
Justification:	Manual or Automatic
Hyphenation:	Automatic and discretionary
Spacebands:	Controlled, Automatic
Quadding:	Automatic
Ragged Right:	Automatic
Insert Space:	Automatic
Letterspacing:	Controlled, Automatic
Paper Width:	3", 6", or 8"
Font Capacity:	One font strip containing one duplexed font. (Two 90-character faces.)
Line Length:	Any length through 45 picas inclusive
Type Sizes:	5 to 12 point
Leading:	From 0 to 31 1/2 points in 1/2-point increments
Length:	32 inches
Width:	31 inches
Height:	42 inches
Weight:	330 pounds (approx.)
Electrical:	110 volts; 60 cycles; 15 amps; 3-prong grounded plug (A separate line from junction box is required).
Environmental:	Maximum operating temperature 85° F

1.3 SYSTEM CONFIGURATION

The CompuWriter Phototypesetting System is comprised of the following:

Keyboard - Delivers data to the computer in the form of a 6-level TTS code representing characters, space codes, etc.

Control Panel - Dictates format information such as line length, leading value, lens, and Manual-Auto line ending.

Computer - Interprets the codes, stores them in memory, makes justification calculations and directs the drive motors to produce the desired result. Also provides the flash command which photographs the proper characters after locating them on the font strip.

System Power Supply - Converts the line power to the various voltage levels required by the computer, keyboard, drive motors, displays, etc.

H.V. Power Supply - Converts a low voltage into approximately 800 volts which is used to illuminate the flash lamp.

Font Strip - Contains the characters that comprise the output copy.

Exciter Lamp & Photocell - Generate clock pulses which keep the computer informed as to the location of the characters.

Lens - Projects a sharp image of the font strip character onto the photographic paper. The lens is driven sideways to scan across the paper by a drive motor. This machine has two lenses, one lens produces twice the image size as the other.

Paper Supply - Photomechanical paper, three, six or eight inches wide. The paper is advanced into the cassette by the leading motor.

Cassette - Light-proof metal container for the output copy of photographic paper. When it is removed from the machine, the contents of cassette are developed in a chemical processor.

1.4 FUNCTIONAL CONCEPT

The CompuWriter System functions basically as follows (refer to Figure 1-2):

The switch settings on the Control Panel inform the Computer of the line length to be typeset, the amount of leading etc.

When the Keyboard is operated, it sends data codes to the Computer Logic where the codes are processed.

The Computer locates the character on the Font Strip by counting clock pulses which are generated by the exciter lamp and photo pickup. When the desired character is in front of the lens, the Computer sends a flash command to the High Voltage Power Supply, which delivers the flash voltage to the Flash Lamp.

The Flash Lamp ignites, illuminating the character which is projected through the lens onto the photosensitive paper. The lens then steps aside slightly to project the next character alongside the first.

At the end of each line, the photosensitive paper advances in preparation for the next line.

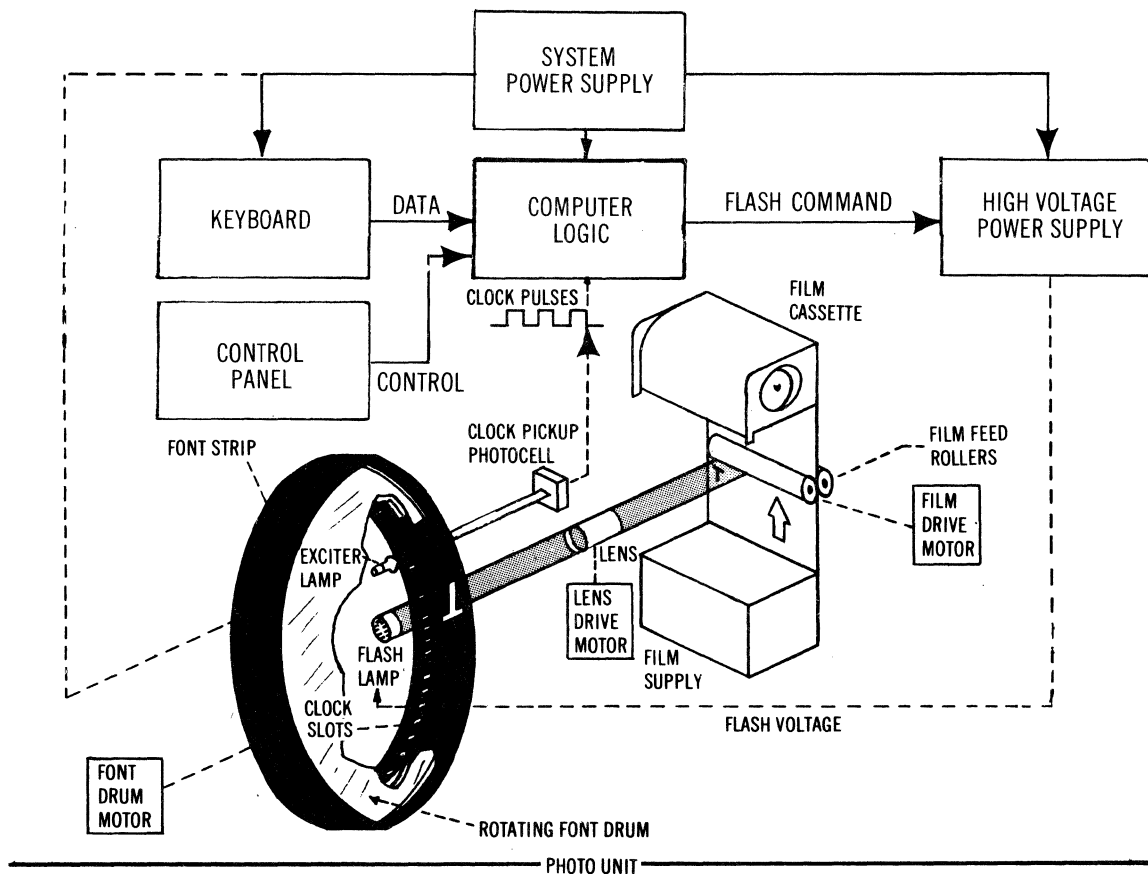

Figure 1-2 Functional Concept

When the typesetting is completed, the operator advances the paper into the cassette several inches to avoid exposure of the copy, then develops the contents in a chemical processor.

1.5 OPTIONAL FEATURES

Logic Board "D", which contains Insert Leader program and Floating Accent functions. (Standard on International Model).

1.6 CONTROLS AND INDICATORS

1.6.1 Front Control Panel

The Front Control Panel is located on the Photo Unit above the Keyboard. The various controls and indicators located on the Front Control Panel are listed and described in Table 1-1 (Figure 1-3).

Table 1-1 Front Controls and Indicators

CONTROL/INDICATOR	TYPE	DESCRIPTION
Prime	Pushbutton Switch	When pressed, the system is initialized to begin processing. If pressed while system is processing will reset the entire system.
Leading	Pushbutton Switch	When pressed, feeds photomechanical paper. This button should be held pressed for at least four seconds before and after processing to ensure that no copy is exposed.
Leading Points	2-Position Toggle Switches (6)	The LEADING POINT switches are set to the amount of interline spacing desired. Spacing depends upon the point size of the font, added to the number of points of white space desired between lines. Switches are activated in the up position.
Lines Measure	Thumb Wheel Switch	The LINE MEASURE switches are preset to the amount of units, in octal code, that are to be in the line length. The number of units in a line is based on the length of the line in picas and the Font Set Size.
Out of Film	Indicator Lamp (red)	Illuminates when the photosensitive paper supply is empty.
Power On	2-Position Rocker Switch/Indicator (red)	When in top position, applies power to the equipment and illuminates the indicator lamp.
Line End	2-Position Toggle Switch	When in AUTO position, the Computer automatically ends and justifies the line. The manual position requires keying of Return code to end the line.
Letterspace	2-Position Toggle Switch	When in ON position, automatic letterspacing is performed.
Overset Lamp	Indicator Lamp	When illuminated, indicates a system hang-up due to an excess of characters keyed into a line. Requires cancelling and manual line ending.
Line Display	Pushbutton Switch	When held depressed causes full line of data to sequentially display.
Justification Range Lamp	Indicator Lamp	Illuminates when line is within the justification range set on the Justification Range Switches.
Line Counter	Mechanical Counter	As each line processes, increments to indicate total lines processed can be mechanically reset.
Line Length Display	Numerical Display Module	Gives numerical readout in units of remaining line length. Starts with preset line length and decreases as each new character is keyed.
Character Display	32-Character Display Module	Shows last 32 characters and functions keyed into system.

Table 1-1 Front Controls and Indicators (continued)

Audio Tone	Tone Generator	Momentary Tone (high pitch)	Keying
		Continuous Tone (high pitch)	Memory within 32 characters of full
		Continuous Tone (low pitch)	Line within Justification Range.
		Those occur only if Line Length not overflowed or not in calculate mode.	

1.6.2 Internal Control Panel

The Internal Control Panel is located under the top front cover. The various controls located on the

Internal Control Panel are listed and described in Table 1-2 (Figure 1-4).

Table 1-2 Internal Control Panel

CONTROL	TYPE	DESCRIPTION
Justification	2-Position Toggle Switches (4)	Defines number of units remaining (range) wherein line can be ended, either manually or automatically.
Letterspace Range	2-Position Toggle Switches (4)	Defines maximum spaceband value before letterspacing can occur.
Min. Word Space	2-Position Toggle Switches (4)	Defines minimum spaceband value.
Logic Test	2-Position Toggle Switch	ON position causes justification logic to repeatedly calculate data already keyed. Primarily a troubleshooting aid.
Photo Unit Test	2-Position Toggle Switch	ON position causes Photo Unit to repetitively typeset the last line of data in Memory. A Troubleshooting aid; also useful where a repetitive line of data is to be typeset.
Ragged Right	2-Position Toggle Switch	ON position disables justification process to give a ragged-right margin.

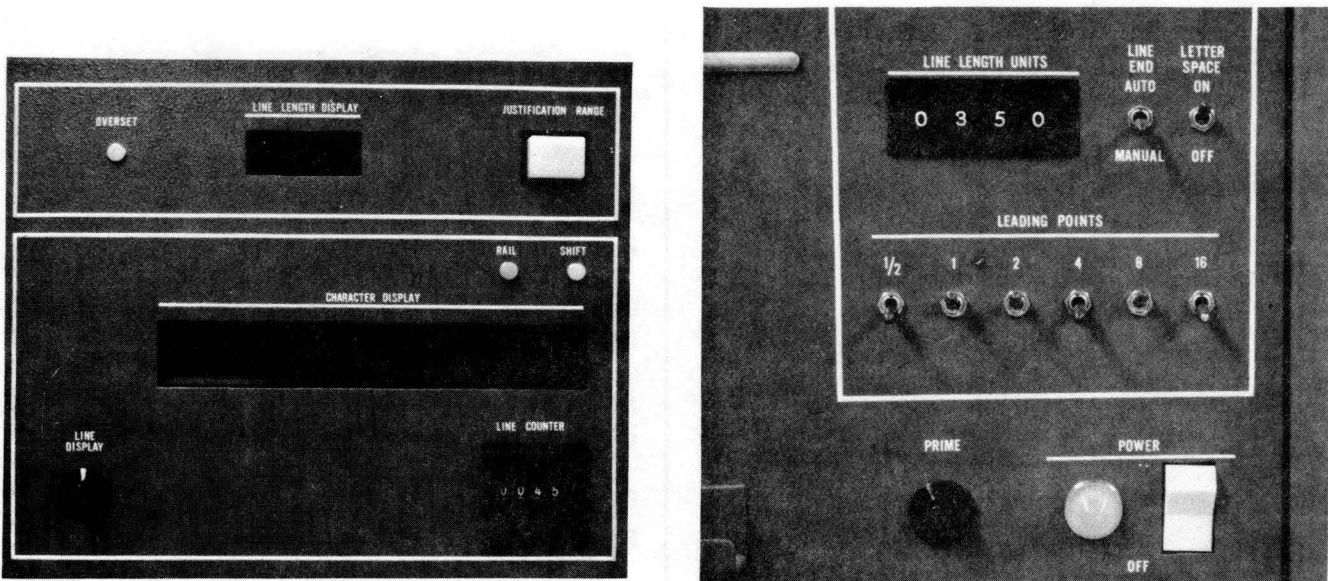

Figure 1-3 Front Panel Controls and Indicators

SECTION II

THEORY OF OPERATION

2.1 INITIALIZING SYSTEM (PRIME)

NOTE

Block diagrams referenced in the following circuit descriptions are located at the end of the section. Refer to Appendix A for a description of block diagram notation.

Prime is initiated whenever the operator presses the PRIME button located on the front panel. Prime loads Width Counter with value in Line Length switches, and fills Memory with Return codes because at gates H5, F6, and H6 (Figure 2-4-1) select lines 1 and 2 are forced high by PMAB. This in turn presents a Return code to the three input lines of the Input Register MUX. Prime also forces select lines SO and S1 high thru gates D2, C1, and H8. Memory is then presented Return codes for as long as the PRIME Switch is depressed. As a result, at completion of the prime operation, the Memory has been completely loaded with Return codes which have no function other than to establish some definitive condition for each Memory location. These are also used to define start of a line of data during reprocessing of a line. An automatic prime is generated whenever the machine is turned on. One-shot IC5 on the Power Supply and Driver Board 29496 is triggered with the +5 volts coming up to level. This biases transistor Q14 whose collector goes to ground, PM ff will set and prime the system. After a 300-ms pulse output, one-shot IC5 resets and PM ff is reset.

NOTE

Auto Prime will not completely fill memory with return codes.

2.2 SYSTEM CLOCK

The timing pulses used in the processing logic consists of sixteen X-times. These pulses are 500 ns in width occurring every microsecond. A retriggerable one-shot (500ns) (Figure 2-3-2) triggers itself each time the Q side goes high. The output of the 500 ns one-shot alternately sets and resets the Master Clock ff, which in turn, counts into the X-Time Counter. The output of the X-Time Counter is presented to the two X-Time Decoders. If the "D" stage of the X-Time Counter is reset, then X-Time Decoder K9 will be enabled producing X1 thru X8. When the "D" stage is set, then X-Time Decoder E7 is enabled producing X9-X16. For synchronization, the Master Clock must be reset to enable either decoder. See System Clock Timing Diagram Figure 2-1.

2.3 MEMORY TIMING

The CompuWriter Memory is of a shift register type

and serves as a buffer between the Keyboard, Calculation Logic, and the Photo Unit. The purpose of the Memory is to store information from the Keyboard and to allow the continuous processing of information without regard to the Photo Unit operation. Once stored, the information is recirculated continuously through the 256 positions. Input to the Memory is made at position zero, and the output is taken from position 255.

Five counter registers circulate in phase with Memory. The purpose of each of these registers is as follows:

- Input Address Register (IAR) increments ahead by one with each character keyboarded into Memory.
- Output Address Register 1 (OAR1). If out of phase with IAR, tells logic to remove a character from Memory for processing and then increments ahead by one. This will continue until OAR1 is in phase with IAR.
- Output Address Register 2 (OAR2). When not in phase with IAR tells logic to display character at the Character Display and is then incremented ahead by one. This will continue until OAR2 is in phase with IAR.
- Output Address Register 3 (OAR3). Will increment ahead each time a character is taken to Photo Unit to be flashed and escaped. When in phase with OAR4, indicates that all data keyed in has been taken to Photo Unit.
- Output Address Register 4 (OAR4). Tells Photo Unit when to take data out of Memory for the flash and escape sequences. Each time a line has been calculated and a line ending point has been determined. OAR4 is advanced ahead by the number of keyed codes in that line, making it equal with IAR.

The Memory is driven by alternately developing 01D and 02D drive pulses from discrete power driver circuits. These signals are the result of 01 and 02 flip-flops (Figure 2-3-1) setting and resetting. The 01 ff is set when the 0C ff is set, and the 02 ff set when 0C ff is reset. The clock occurs at the trailing edge of X16 time. At X9 time, both the 01 ff and the 02 ff are reset. See Memory Loading Timing Diagram, Figure 2-2.

2.4 DATA PROCESSING SEQUENCE

The basic sequence of data processing is outlined below. Subsequent paragraphs describe in further detail how the processing occurs.

1. Each code from the keyboard is loaded into the Character Memory and the IAR advances ahead by one.
2. The PC1 ff sets and width for the code is encoded by the Width Board ROM's plus three units. The complement of the width value is loaded into the PGC. If a Spaceband or an Insert Space code is being read, one count is added to the Spaceband Counter. OAR1 is then advanced ahead by one.
3. The PC2 ff sets and PC1 resets, the PGC is counted up to full condition and coincidentally an equal count is subtracted from the preset line measure in the WC, thereby reducing the count in the WC by the character width value. The Space Counter is loaded with the value of the Spaceband Minimum Switches and the PC2 ff resets.
4. The PC5 ff sets and loads the compliment of the value in the Spaceband Counter into the PGC.
5. The PC6 ff sets and the PC5 ff resets. The PGC is counted up to full condition while coincidentally the WCR is reduced by the same amount. The Space Counter receives a count of one and PC6 ff resets.
6. Steps 4 and 5 repeat until the value in the Space Counter exceeds the value set in the Justification Range Switches.
7. Steps 1 thru 6 repeat until the WC is reduced to zero in the automatic mode, or if a manual line ending mode, a Return code is read.
8. If the value on the Letterspace Minimum Switches is less than the value in the Space Counter, a unit or more of letterspacing is added to each character.
9. The PC7 ff sets and resets the OAR1 to beginning of the line.
10. The PC8 ff sets and loads the width of the character at OAR1 Memory position into the Width Memory, OAR1 is advanced by one, and the PC8 ff resets. The PC8 ff sets and resets for each Memory position of the line until the Return code at end of the line is read, thus, all character widths of the line are loaded into the Width Memory.
11. The End Line ff sets and advances OAR4 ahead by the amount of codes in the line thereby making OAR4 equal with the IAR.
12. Each character is flashed and escaped and OAR3 is advanced by one count for each character until OAR3 equals OAR4.

2.5 KEYBOARD ENTRY INTO MEMORY

When a key such as a lower case "t" is pressed, the keyboard generates a Strobe pulse and also presents a TTS code to the Input Buffer Register. (Figure 2-4-1). The Keyboard Strobe at gate H3 (Figure 2-4-2) clocks the 1A ff set. Gates B4 and E1 (Figure 2-4-1) compare the 1A ff and 2A ff to 1B ff and 2B ff, if equal, the output is a low. However, with the 1A ff set, the output is high. Therefore, gates C1 and E1 (Figure 2-4-1) receives two highs; since Store ff is reset, a STR signal is developed. STR clocks the KB0-KB5 bits into the Input Buffer Register. IAR0 and STR at gates D1 and D4 (Figure 2-4-2) will set the Store ff at X2 time. Store, in turn, will set the 1B ff causing \overline{EQ} (Gates B4-E1, Figure 2-4-1) to go low. Store is presented thru gate C1, (Figure 2-4-1) to select input S0 of the Input Register MUX. As only S0 is high, the contents of the Input Buffer Register is enabled thru the MUX to Memory. Store also advances the IAR (Input Address Register) (Figure 2-4-2) by one. At the next X2 time, Store resets. This completes the sequence for storing a character in Memory.

2.6 SPACEBAND/INSERT SPACE/DISC. HYPHEN

Input of a code for a Spaceband, an Insert Space, or a Discretionary Hyphen is handled just as other data, the IAR is advanced and the code is stored in Memory. However, while the code is available at the output of the Input Register MUX (Figure 2-4-1), IR0-IR5 addresses the Text Decoder ROM's (Figure 2-3-2) and a SB, IS, or DH signal is developed. The SB, IS, or DH signal at gate F6 (Figure 2-4-2) presents a high to the "D" input of Insert Tape Feed ff (ITF). At Store and X1 time, the Insert Tape Feed ff is set (Figure 2-4-3) which advances the 1A and 2A ff thru gates F3 and H3 (Figure 2-4-2). \overline{EQ} will go high and with Store resetting at X2 time, a STR signal is developed out of gate C1 and E1. STR with IAR0 again set the Store ff. With ITF set, both S0 and S1 line of the Input Register MUX are high thru gates D2, C1, and H8 (Figure 2-4-1). Therefore, a TF code at gates H5, F6, and H6 (Figure 2-4-1) is monitored and is taken thru the Input Register MUX to Memory and stored. Store advances 1B and 2B so EQ again goes low. At the next X2 time, Store ff resets. A Tape Feed code has now been added to Memory after the Spaceband, Insert Space, or DH code. This will be used to carry the width of the spaceband or Insert Space code if greater than 64 units, and also the Return code if either of the three codes are used as a line ending point.

2.7 PC1 AND PC2 FUNCTIONS

With each keyboard code, the IAR is advanced by one ahead of OAR1. Gates D1 and C1 (Figure 2-5-2) monitor this condition. If PC5 or PC6 is not set, then a Logic Pulse (LP) is generated. PC7 being reset at

this time, enables the setting of PC1 ff thru gate C1. PC1 at gate A2 gives a PC1N2 signal.

The character code (IR0-IR5) at OAR10 position is presented to ROMS 1 and 2 of the Width Board (Figure 2-7-2). The Width Board produces widths for both Upper and Lower Case. If both enable lines S0 and S1 are low, Width MUX inputs I0 will be selected to give Lower Case widths. If an Upper Case character, then line S0 will be high which selects inputs I1. For Spacebands, the enable line S1 is forced high and input lines I2 of the Width MUX are selected, giving input from the Spaceband Minimum switches. The Width MUX outputs are presented to the A inputs of Adder H11 (Figure 2-7-1). The B inputs come from Width Adder Circuits gates H10, D11, and C11. The amount at the B inputs will be three units which adds to the width values from the Width Board ROM's 1 and 2. This is required because the ROM values are established at three units less than the character widths. Adder H11 sums the two inputs and its output (W1-W16) is presented to the Spaceband Width MUX and gates K9 and H9 insert the value of its complement to the Pulse Generator Counter (PGC). When PC1N2 is developed, the complement is loaded into the PGC, and the Space Counter (H5, F6, and F5) is reset.

At the next X5 time, when PC2 sets and PC1 resets, signal PC1N2 will be lost. At this time, the Space Counter (H5, F6, and F5) is loaded with the amount set on the Spaceband Minimum switches providing the ISF ff is not set. Also, the Justification Range ff (JR) and No Letterspace ff (NLS) set with the next X4 pulse (Figure 2-5-4). If no spaceband has been keyboarded, they will both reset at the next X4 time.

When the PC1 ff resets and with the PC2 ff set, X6 pulses count into the PGC and also the Width Counter (F3, F2, and F1) thru gate E4 at X6 time (Figure 2-5-3). The direction of the width count is up or down, depending on the UP ff (Figure 2-5-4) being set or reset. If an overflow occurs or the No Calculate ff (NCF) is set, then the UP ff is set and the count will be up. If the UP ff is reset, the count will be down. Note that when Prime was pressed, the value of the Line Length switches was loaded into the Width Counter and UP ff was reset. For each X6 time a count is added to the PGC and reduced from the WC until PGC Full (PGCF) occurs. At each X7 time, the content of WC is loaded into WCR by way of gate E8 and in turn is presented to the Line Length Display Decoders. The Line Length Display gives a visual read out of the reduced line length. PGCF enables PC2 ff to reset and the PC5 ff to set at X5 time.

If the code is a Spaceband, then the Spaceband Counter (E10 and F10) increments its count by one at X7B time. If an Insert Space or Quad code was

keyboarded, then the Insert Space ff will be set and only IS codes are counted into the Spaceband Counter.

2.8 PC5 AND PC6 FUNCTIONS

Each character initiates a sequential processing thru PC5 and PC6, but unlike PC1 and PC2 the processing may cycle thru a number of times for each character until a determination is made whether the line is within the value preset on the Justification Range Switches. How many times PC5 and PC6 cycle is determined at gates A8, A7, A6, and B9 (Figure 2-6-2) which enables PC5 to Set.

When the PC5 ff sets at the end of PC2 (Figure 2-6-2), the Spaceband Width MUX is enabled to present the count in the Spaceband Counter to the PGC (Figure 2-6-1) where it is loaded in at X6 time. The next X5 time sets the PC6 ff and resets PC5 ff. With PC6 set, every X6 pulse adds a count to the PGC and decrements from the value in the WCR (Figure 2-5-3) by one. The PC6 ff remains set until either the PGC becomes full (PGCF) or OF1 occurs (from the Line Length Display Decoders, Figure 2-5-3) which indicated no count is remaining in WCR. If PGCF occurs first, then the Space Counter (H5, F6, and F5, Figure 2-6-1) increments its count by one at X7 time. At the next X5 time PC6 will be reset and PC5 will be set, loading the Spaceband Count into PGC. This cycle repeats with WCR counting down each time by the number of Spacebands and the Space Counter being incremented for each cycle.

As this is happening, the count in the Space Counter is monitored by the two gates at K5 (Figure 2-6-1). When the count equals the amount set on the Justification Range Switches or the Letterspace Minimum Switches the associated flip-flop resets at X4 times. If either the Justification Range ff or the No Letterspace ff is still set when PGCF occurs, PCB resets and the cycle starts again with the setting of PG5 at X5 time. Note that for PC5 to set, gates A8, A7, and A6 (Figure 2-6-2) must have all seven inputs high. One of these inputs must have either JR or a NLS signal for its input. Therefore, the JR ff or the NLS ff must be set. For that to be true, the Space Counter must not exceed either of the two switch settings. If so, PC5 and PC6 will stop cycling inhibiting any attempt at further justifying at that point. Other inputs to gates A8, A7, and A6 are: $\overline{SBC0}$, which requires at least one Spaceband or Insert Space to be keyed; $\overline{QLF-SC2-SC4}$ and $\overline{QLF-SC8}$, which states that if a QL code is received the Space Counter cannot exceed six or eight; \overline{UP} and $\overline{OF1}$, meaning a count remains in the WCR; and last is $\overline{PC7}$ and \overline{JUST} , which requires that the Ragged Right Switch be in OFF position.

When PC5 can no longer set and yet width still remains in the WCR, the PC1 ff is enabled to set and

process the next input code. The above described process continues with each character keyboarded until eventually a Return code is read in PC1. The Return code could be automatically inserted (see description for Automatic Line Ending) or manually inserted (see description for Manual Line Ending). Upon reading the Return code in PC1N2, PC7 will set, and PC5 and PC6 will start cycling for the last time on the Return code, calculating the width of the spacebands. With each cycle, a count is added to Space Counter until WCR overflows stopping the cycle. The line has now been calculated and the widths for the characters are now ready to be stored in Memory in PC8.

2.9 CASE CHANGE

Keying of either a Shift Lock or a Shift (1 and 2) key will set the Upper Case Insert (UCI) ff (Figure 2-4-3) provided an Upper Case condition does not already exist (Case Shift ff set). The count is advanced in the 1A and 2A ff's by the Keyboard Strobe. The Store ff sets at IAR0 time due to the unequal condition between the 1A, 2A ff's and the 1B, 2B ff's (monitored by gates B4, E1). The Store and UCI ff's condition gates D2, C1, and H8 to enable select lines S0 and S1 on the Input Register MUX (Figure 2-4-1) so that the I3 input lines to the MUX are selected. Since the UCI ff is set, Encoder Gates H5, H6, F6 inserts an Upper Case code into the MUX I3 inputs and this, in turn, is stored in the Character Memory. The Store operation increments the count in the 1B and 2B ff's removing the not equal condition between them and the 1A, 2A ff's.

Coincidentally with storage of the Upper Case code, Upper Case Bit (UCB) is loaded into the Width Memory (WI32 line) because of the set condition of the Case Shift ff (set by Upper Case Insert ff). The upper case condition is indicated to the operator by illumination of the SHIFT lamp which is held on by the Case Shift ff. The Case Shift ff remains set until a Shift or Shift Lock key is released. With the Case Shift ff set, all subsequent character inputs to the Character Memory will at the same time have a case bit loaded into the Width Memory. Thus when the characters are read from Memory, the Case Bit selects Upper Case widths from the Width Board (Figure 2-7-3, gate E5 for S0 select line of Width MUX) to be inserted into the width processing circuits. The Case bit also adds a 32 count into the Character Register (Figure 2-8-4) for selecting an Upper Case Character on the font strip.

When either the Shift Lock or a Shift (1 or 2) key is released, the Lower Case Insert ff is clocked set, initiating a sequence of events similar to that just described for Upper Case Insert except now the changes condition the circuitry for processing Lower Case characters. Basically, the following occurs:

- Case Shift ff resets turning off the SHIFT lamp.
- LCI at Encoder Gates H5, H6, F6 encode a LC code which is stored in the Character Memory.
- Since Case Shift ff is reset, UCB is not true, therefore, a zero bit (low level) is loaded into the Case line of the Width Memory by Store.
- Subsequent character inputs also have a zero bit in the Case line of the Width Memory, which in turn, selects lower case widths from the Width Board.

If a cancel function is used and the Unshift code is removed by the cancel from Memory. The SHIFT lamp must again be illuminated. Gates D4 and E6 permit the Case Shift ff to set when the case bit is seen at X2 time.

2.10 AUTOMATIC LINE ENDING

As each character is keyed into the Memory, width is reduced from WC until eventually, if a Return code is not keyed, the WC will go to zero and OF1 is developed (Figure 2-5-3). The OF 1 signal thru gates E8 and B7 sets the UP ff at X6 time and the Overflow ff (OF) at X7 time. As a result, the OVERSET lamp comes on, indicating the line is full. The OF at gate A4 (Figure 2-5-4) generates a Lock Out (LOUT) signal which inhibits any additional codes from being entered into Memory by inhibiting gate H6 that is used to advanced the IAR.

For automatic justification to occur, the Auto Line ff must be set. For this, either of the following two conditions must be met:

1. • Spaceband code being read.
 - At least one prior spaceband in the line, or Justification Switch off.
 - Justification Range ff set, or Justification Switch off.
 - PC1 ff set, PC2 not set (PC1N2 time).
2. • Discretionary Hyphen code being read.
 - Width Count greater than ten ($WC > 10$).
 - Justification Range ff set, or Justification Switch off.
 - PC1 ff set, PC2 ff not set (PC1N2 true).

These conditions are monitored at gates A2, A3 and when one or the other is satisfied, the Auto Line ff sets at X8 time. Auto Reset gate B3 monitors for an Overflow of the WC (OF) and when it occurs, an AR signal is generated which sets the Reset line ff at X8 time.

The Reset Line ff now holds OAR1 reset while the Memory continues shifting until the beginning of the line is in position for reading. When the beginning

code is read, the Reset Line ff resets allowing the OAR1 to increment along with the Memory. During this period while the OAR1 is being held reset, the output of Memory is being monitored at gates A4, C2, B2 for a decoded TF signal (last frame of SB/TF combination). When this occurs, the Return Insert ff (RTI) sets at X4 time.

The Input Register MUX now looks at the output of gates H5, F6, and H6 which is encoding a Return code due to the RETI at the input. This Return code is then loaded into Memory in place of the Tape Feed code. The next code seen after the Tape Feed is the Spaceband code which will set the Return Delay ff (RETD) at X1 time. At X2 time, the Return Insert ff (RETI) resets. At X4 time, the Return Delay ff is reset and the Tape Feed Insert ff is set due to the Spaceband code being read from Memory. The Tape Feed Insert ff at gates D2, C1 and H8 forces high both the S0 and S1 select lines of the Input Register MUX (Figure 2-4-1). The Input Register MUX now looks at the output of gates H5, F6, and H6 which now is a Tape Feed code due to all lows at their output. The Tape Feed code is loaded into Memory in place of the Spaceband code. At the next X2 time, the Tape Feed Insert ff is reset and when the Return code at the end of the last line is seen, the RSL ff resets.

A Discretionary Hyphen and Tape Feed code sequence is another possible line ending point. However, instead of the Tape Feed Insert ff setting, the Hyphen Insert ff (HFI sets). This will present a Hyphen code to the Input Register Mux. The HFI also presents a high to the S1 select line thru gate H8, which presents the writing of the Hyphen code into Memory.

If the Auto Line ff (Figure 2-6-4) is not set when the OF ff is set, a Lockout (LOUT) signal is developed at gate A4 (Figure 2-5-4). LOUT at gate H6 (Figure 2-4-2) inhibits the advancing of IAR with each Store signal, thereby preventing any character from being keyed into Memory. The operator must now cancel back out of overflow and manually insert a Return (see paragraph 2.10 Manual Line Ending) or a Discretionary Hyphen code (for Automatic Line Ending).

2.11 MANUAL LINE ENDING

Whenever the Auto/Manual switch is in the Manual position, the operator must insert a Return code at the end of each line. The Return code in PC1 will set the PC7 ff thru gates B5 and B8 (Figure 2-6-3) if the NLS ff is set (gate C4). If the NLS is not set, then letterspacing will be done (see letterspacing) and PC7 ff will wait until that calculation is finished, then set thru gates B8 and B11. The PC5 and PC6 ff's will cycle, calculating the width of the spacebands. When the WCR reaches zero, the line is finished being

calculated and the widths are ready to be stored in Memory in PC8.

2.12 LETTERSPACING

At some point in the line, a Return code will be read in PC1, whether by automatic insert or manually keyed. At this time, a decision will be made as to whether to attempt Letterspacing Calculations or to go into PC7 (Figure 2-7-2). The most important consideration is whether NLS ff is set or reset. If it is reset, it is assumed that the Space Counter has exceeded the value placed in the Letterspace Minimum switches by the operator. Other considerations needed to inhibit PC7 from setting and allowing letterspacing are Letterspace Switch on, Ragged Right Switch off, JUST, and SBC0, NCF, QLF, ISF flip-flops off.

If any of these conditions are not met, the PC7 ff will set and no letterspacing will be allowed. Assume for now that all conditions are not met and a PC1R signal is seen at gate B10. PC7 not being set enables the gate B10 to output a high and set the Letterspace Count One ff (LSC1) (Figure 2-7-2). The PC1R signal also sets the Reset Line ff thru gates A5, A6, B7 (Figure 2-6-4), which will hold OAR10 from advancing until the next Return code is read in Memory. At this point, OAR10 is now at the beginning of the line again and out of phase with IAR0 by the number of codes in the line. The logic now calculates the line, cycling from PC1 to PC6 for each character. This time, however, an extra unit of width will be added to each letterspaceable character in the line. Letterspaceable characters are determined by gate H6 (Figure 2-3-3), which monitors the Flash Only ff, the Space Only ff, a Flash Inhibit signal from the Text Decoder ROM's, and Switch K5. If any of these are low (not true), then LS will be high, and letterspacing for that character will be inhibited. Character Minus One ff (Figure 2-7-3) will set with the first letterspaceable character in the line, but it will be set too late for that character to have an extra unit of width added.

All subsequent characters will have an extra unit of width added via gate H10 (Figure 2-7-3) which outputs a high to the B1 input of the Width Adder. This input is enabled by the Character Minus One ff along with an LSC1, an LS, and a PC1-8 via gates H10 and F9. (Figure 2-7-3). Since the Width Adder also has its A1 and A2 inputs high because of gate C11, three units of width is added to each width value from the Width Board. The sum output will now be four units which is added to the width from the Width Board at gate H11 (Figure 2-7-1). Therefore, for each letterspaceable character in the line, the value in W1 thru W16 will be increased by one, which in turn loads the PGC and reduces the WC accordingly. When the Return code at the end of the line is read, the logic again looks at the NLS ff

and determines if PC7 should set again. It does this by looking at the NLS ff. Since each character width was increased, the Space Counter does not have to expand as large as it did before to justify the line. If that amount is enough to reset the NLS ff, PC7 will be inhibited from setting thru gate C4 (Figure 2-6-3). The Spaceband Counter is checked by gates B8 and B11 for the number of Spacebands in the line. If the amount is greater than 1 (SBC + 1) PC7 will set. If the Spaceband Counter is at one, and the Space Count is greater than the Letterspace Minimum Switch setting, the LSC1 will reset and LSC2 will set. As the Return code is read, OAR10 is reset back to the beginning of the line. The line will now be recalculated but this time two units of width are added to each character. If at the Return code, the NLS ff is still reset, then LSC1 will set again and LSC2 will remain set. The line will again be recalculated with three units of width for each character up to the Return code at which time PC7 will be set thru gates B8, B11, and B5 by LSC1, LSC2, and OF.

Occasionally, overflow occurs during Letterspace Calculation (Width Counter goes to zero). When this happens, the Overflow and UP ff's are set, PC1R and OF thru gate B10 will set the Letterspace Overflow resetting the LSC1 and LSC2 ff's thru gates B10 and A2 (Figure 2-7-2). The line continues calculating until the Return code is read, but no letterspacing will occur.

2.13 PC7, PC8, AND END OF LINE FUNCTION

When the PC7 ff sets, the Reset line ff holds OAR10 (Figure 2-7-1) until the beginning of the line. OAR10 and IAR0 are out of phase, producing a Logic Pulse (LP). At X2 time with a LP signal, PC8 is set, and the value on W1 thru W16 which includes any letterspace width that is to be added to each character, is loaded thru the Width Input MUX (Fig. 2-7-1) and gates F9, H9, and K9 into the Width Memory, F10 and H10.

When a Spaceband Code is read in PC8, gate F8 (Figure 2-7-4) puts Select Line S0 of the Width Input MUX high. This enables the value on lines SC1 thru SC32 to load into the Width Memory. At X16 time the SB + 1 ff sets (Figure 2-7-4). The next code seen will be the Tape Feed code, which forces the SC64 thru SC2048 counts to be loaded into Width Memory by the SB + 1 ff enabling the Select Line S1 of the Width Input MUX. At X16 time, gate E7 will reset the SB + 1 ff.

When a Return code is seen in PC8, it sets the End Of Line ff (EL) and enables via gates F8 both Select lines S0 and S1 to go high. With S0 and S1 high, the Film Feed value from the Leading Point Switches is written by gates F9, H9, and K9 into Memory. The EL ff (Figure 2-7-1) being set will load OAR4 ahead

of OAR3 by an amount equal to number of codes in that line. Since OAR3 and OAR4 are out of phase, the Busy light will be enabled thru gates B10, B11, K2. On the next X16 time, the EL ff resets. The line initially keyboarded has now been justified and loaded into Memory in preparation to Flash and Escape.

2.14 ODD SPACEBAND WIDTH VALUE

At the end of a line when the Spaceband Width is being calculated for each spaceband, sometimes the PGC does not completely fill before an OF1 signal is generated. The amount left in the PGC is equal to the number of spacebands that will receive the calculated amount presently stored in the Space Counter. Subsequent spacebands in the line will receive one additional unit of width.

As an example of this, if there are 10 spacebands in a line and only 32 units left to be divided equally between them, some will have three units and some four units. At the first three passes of PC5 and PC6, the overflow of PGC (PCG F) will add a count into the Space Counter at X7 time (Figure 2-7-4). On the fourth pass, only two counts will be added to the PGC before OF1 signal is generated. This leaves the PGC with a deficit of eight and a count of seven in the Spaceband Counter (assuming a count of four was loaded into the SC at PC5). Nothing more is done until PC8 when a Spaceband code is read, then a count is added at X6 time to the PGC, leaving a deficit of only seven. As each subsequent spaceband is read, another count is added to the PGC, until eight spacebands have been read. At this point, the PGCF signal is generated and presented to the Space Counter Add ff. At X16 time, the SB + 1 ff is set and remains set until the next X16 time. This, however, is the Tape Feed code which enables the reset side of the SB + 1 ff thru gate E7 (Figure 2-7-4). When the SB + 1 ff resets, the Space Counter Add ff, which is enabled by PGCF, receives a clock pulse and is set. On the next X7 time, the Space Counter receives a count pulse and increments to eight. At X8 time, Space Counter Add ff is forced reset. The new width for the remaining two spacebands in the line is now eight. The same procedure is used for Insert Space codes as well.

2.15 FLASH AND ESCAPE FUNCTIONS

When the OAR30 and OAR40 are out of phase, and the CHAR ff and the Reverse ff are not set, and the Escape (ESC) signal is not true, then the PR2 ff will be enabled to set (at X2 time) thru gates B6 and C6 (Figure 2-8-2). The PR2 will force set the CHAR ff (Figure 2-8-1) at X4 time and the Width ff at X5 time. Also, at X4 when the PR2 ff is set, both the Character Register (Figure 2-8-4) and Film/Width Counter (Figure 2-8-4) are loaded with contents of Memory (Character and Width information respectively) at

OAR30 position (Figure 2-8-2). OAR3 is then incremented ahead by one at the following X1 time and the PR2 ff is reset with the next X2 time pulse.

When the clock pickup circuit is triggered by the delay slot on the font, the leading edge of the Delay Pulse triggers the Clock One-Shot to give an 80 μ s pulse. Since the delay on the font is greater than 80 μ s, the Clock One-Shot will reset in time to allow the Delay One-Shot (2 μ s) to trigger on the trailing edge of the Delay Pulse. At the end of the 2 μ s, the Delay One-Shot resets and the SYNC ff is set with the first clock after the delay signal. SYNC setting permits the counting into the Clock Counter with each resetting of the Clock 80 μ s One-Shot. Comparator gates C3 and D3 are continuously comparing the contents of the Character Register with the Clock Counter. When they become equal, a CE signal is generated which enables the CHAR ff to reset thru gate A3 (Figure 2-8-1) with the next setting of the Clock One-Shot. When the CHAR ff resets, the character is flashed by a voltage switched on the High Voltage Power Supply.

The CHAR ff resetting also enables the OSCG ff (OSC Generator, Figure 2-8-2) to set via gate E1 and A5 at X2 time. The OSCG permits the OSCD ff (OSC Divider) to set at X3 time. The resultant Osc pulses output thru gate C6. With each OSC pulse, a count is added to the Film/Width Counter. Also, thru gate A1, the A and B ff's set and reset according to the output of gate E4 (Figure 2-8-3). With each change in the A and B ff's, the lens carriage is moved one position. At the trailing edge of the OSC pulse, a 2.5-ms one-shot is triggered and the resulting pulse holds the OSCG ff reset for the 2.5-ms period. OSC pulses will be generated every 2.5-ms until the Film/Width Counter is full and a F/WC pulse is generated. F/WC presents a high to the reset side of the Width ff (Figure 2-8-1) and at X5 time the Width ff is reset. Resetting of the Width ff triggers an ESC (Escape) pulse at gates E1 and H1, triggering the 25-ms One-Shot. The 25-ms pulse inhibits the setting of the CHAR ff, assuring that the lens carriage has time to settle down before the CHAR ff can be reset again.

The flashing and escaping process repeats with each character in Memory until the OAR30 comes in phase with OAR40 on a Return code.

2.16 FILM FEED

When a Return code is read and the PR 2 ff is set, gates D9 and D10 (Figure 2-8-1) output a high, setting the Film Feed ff at X5 time. Also, the Film/Width Counter is loaded with the contents of the Leading switches. When the 25-ms One-Shot resets, Gates E1 and H5 (Figure 2-8-2) output a high to set the OSCG ff at X2 time. At X3 time, the OSCD ff will set, and at X4 time gates E5 and F1

develop an OSC/2 pulse. With the trailing edge of the X4 time, the 25-ms One-Shot triggers, resetting the OSCG ff. When the OSCG ff sets again, the OSCD ff will reset at X3 time and no OSC/2 pulse is available at the output of gates E5 and H1. Every other time the OSCG ff sets, a OSC/2 pulse is generated and a count is added to the Film/Width Counter. With each OSC/2 pulse, the C and D ff's will set or reset according to their former state. The outputs of the C and D ff's toggle the lens motor drivers to step the Leading Motor one position. When the F/WC pulse is generated, the Film Feed ff is reset, triggering the 25-ms One-Shot thru gates E1 and H1.

Also, when the Return code was seen at PR2 time, the Reverse ff set thru gates D10 and K11 (Figure 2-8-2) at X5 time. The Reverse ff thru gate A5 (Figure 2-8-3) generates a BACK signal which reverses the sequence by which the A and B ff's set, moving the lens carriage back to the left hand margin. When the Left Margin Switch is activated, the Reverse ff is reset.

2.17 LENS CARRIAGE CONTROL

When the system is primed either by power turn-on or by the PRIME switch, a PMCC signal is generated which resets the B3 latch (Figure 2-8-3) enabling a Step Out signal (SOUT). This in turn enables (via gate E1, H1) the OSCG ff to toggle, generating OSC pulses to drive the lens motor. The lens motor moves the lens to the margin switch. Which one, depends on the condition of the Reverse ff. If the Reverse ff is reset, the lens goes to the Right Margin Switch which sets the Reverse ff causing the lens to go to the Left Margin Switch. If the Reverse ff is set to begin with, the lens goes directly to the Left Margin Switch, causing the Reverse ff to reset. When the Reverse ff resets, latch B3 sets due to the set condition of the SOUTF ff which occurred at X1 time after the Reverse ff set. When the B3 latch sets, the SOUT counter is enabled to count up (BACK is not true when the Reverse ff is reset). When the Lens Motor has moved seven steps from the Left Margin Switch, gate B1 decodes the seven-count in the SOUT Counter and sends a CNT7 signal which resets the SOUTF ff at X1 time. This stops OSC pulses to the Lens Motor (OSCG ff is disabled from setting). The lens is now at the left margin position in preparation for typesetting a line. Note that with the initial setting of the B3 latch, it stays set enabling the SOUT Counter to count up or down with the forward and reverse movement of lens. At each return to the left margin, the repositioning by seven steps is repeated.

A similar operation occurs at end of a line. When the Reverse ff (Fig. 2-8-2) is set by a Return code at PR2 time, the SOUT ff (Step Out) will set at X1 time.

SOUT ff setting will generate an OSC pulse just as the Width ff did and permits the A and B ff's to set and reset. As the lens carriage reaches the Left Margin Switch, the Reverse ff resets, changing the direction of the lens carriage to forward. Gate B3 (Figure 2-8-3) outputs a high and sets latch B3 to allow the counting of OSC pulses into the SOUT Counter. When the count reaches a seven, gate B1 outputs a CNT7 signal which resets the SOUT ff thru gate A3. The lens carriage is now seven steps off the Left Margin Switch. This is the starting position of the line.

2.18 CHARACTER DISPLAY

When the IAR is advanced ahead by one, it becomes out of phase with the Display Address Register OAR20. This results in a high being presented thru gates B5 and C5 to the set side of the Display Character Memory ff (DCM) (Figure 2-9-3) and at X3 time the flip-flop is set. The DCM ff then clocks the Character Display Input Register CD0-CD5 (Figure 2-9-2) with the contents of IR0-IR5 at OAR20 Memory position. The DCM ff also presents a high to the set side of the Display Character ff (DC) thru gate C2 (Figure 2-9-4) which sets at X8 time. Both the DCM ff and the DC ff being set, develops a present Data Pulse to the Display thru gate H5 (Figure 2-9-2). The 175-ms One-Shot (Figure 2-9-4) is inhibited from setting because of the DLS forcing it reset. The DCM ff at X1 time then advances OAR2 ahead by one to put it back in phase with the IAR. On the following X3 time, DCM ff is reset.

Whenever a Case bit accompanies a character code on the IR0-IR5 lines and the character code is not a SB, or IS, or CW/TF, then the Display Case ff (D Case) sets (Figure 2-9-2), presenting a high to the Case input of the Display.

If after more than 32 characters have been entered into the line and the operator desires to reread the line, the operator presses the DISPLAY LINE button. Doing so sets the K5 latch (Figure 2-9-4) which develops a clock that sets the Display Line (DL, Figure 2-9-1) and also enables a high to the reset side of the DC ff. With the first cycle of the OAR20 and IAR0 (they are in phase), both the Display Line Slow ff (DLS) and the Display Reset ff (DRP) will set, due to the DL ff being set. The DRP ff generates (via Gate C5) a clear signal to the Display, causing stored data in the Display to be cleared.

On the second cycle of $\overline{\text{OAR20}}$ and $\overline{\text{IAR0}}$, the Reset Display ff (Figure 2-9-1) sets because of the DRP, OAR20 input to gates H7 and C6. On the trailing edge of OAR20 and IAR0, the positive pulse from gate B10 resets the DRP ff, removing the clear signal to the Display. The RSD ff being set, inhibits the advancement of OAR2 thru gate B10 until a

Return code is read, which thru gate B8 resets the RSD ff. The IAR0 and OAR20 are now out of phase by the amount of codes in that line. Since the DCM ff sets when the IAR0 and OAR20 are out of phase, the character at OAR20 is clocked into the Display with the setting of the DC ff. However, since this time the ff is reset, the 175-ms One-Shot triggers, inhibiting the resetting of the DC ff. When the 175-ms resets, the DC ff resets at X8 time, allowing the DCM ff to set again and advance OAR2 by one position. This repeats until the OAR20 and IAR0 are in phase clocking the DRP ff reset (via gate B10) and ending the sequence.

The Blank Latch is used only when the RSD ff is activated by AR or CNCL and will be reset when the IAR0 and OAR20 are in phase again.

2.19 INSERT SPACE, QUAD CODES

When a Quad Left code (QL) is keyboarded, the QLF (Figure 2-9-4) sets at X6 time during PC1N2. The Quad code is decoded thru the Text Decoder ROM's as an Insert Space code (IS). At X8 time, the IS ff will set. If the Insert Space key is used, then only the IS ff will be set.

The IS ff inhibits the counting of Spacebands into the Spaceband Counter at gate C3 (Figure 2-5-1) and allows only Insert Space codes to be counted. The width of the spacebands will be the value set on the Spaceband Minimum Switches. The Space Counter will not receive any Load signal because of the IS ff being set. This allows the Insert Space code to be treated just as a Spaceband code, except that the Space Count now starts at zero.

The Quad code is decoded thru the Text Decoder ROM's. The Quad Left ff being set inhibits thru gate A8, A7, A6, B8, and B9 (Figure 2-6-2) the resetting of PC5 when the Space Count is at a count of six. The Quad Left ff also enables thru gate C4, B5 and B8 (Figure 2-6-3) the setting of PC7 when a Return code is read in PC1.

2.20 CANCEL CHARACTER, WORD, LINE

When a Cancel Character, Word, or Line Key is pressed, its respective flip-flop will set at X3 time. Gates E5 and K8 (Figure 2-4-4) then outputs a CNCL signal which holds the IAR from advancing until the flip-flop resets. This effectively removes the codes from Memory since the IAR can now address these locations with new data.

If the Cancel Character ff (Figure 2-4-4) is set, then the first character seen in Memory that is not a Tape Feed code will set the Cancel Remember ff at X3 time. The Cancel Remember ff enables the Cancel Character ff to reset at the next X3 time.

If the Cancel Word ff is set, then the first IS code or SB code read from Memory will set the Cancel Remember ff. The Cancel Word ff then resets at the following X3 time. In the event a Return code is seen before the Cancel Remember ff becomes set, the Cancel Word ff remains reset.

When the Cancel Line key is pressed, the Cancel Line ff sets thru gate H4 at concurrence of IAR0 and X3 time. When the Return code at the beginning of the line is read from Memory the Cancel Line ff resets at X3 time.

2.21 SPACE ONLY

When the SO/FO key is pressed and the keyboard is in the Shift Condition, an SO signal is developed at gate C11 (Figure 2-3-3). The SO signal will permit the setting of the Space Only ff at X9 time of PC1 or PC8. Gate H6 develops an LS inhibit level (Figure 2-3-3) that prevents the character from being letter-spaced. The line will now calculate normally until the flash and escape sequence, except the Space Only code will be treated as a non-letterspaceable character. When the SO code is seen at PR2 and X6 time, the Space Only Pulse ff (Figure 2-3-4) sets. This does not prevent the CHAR ff from setting at this time. However, when the next character is available at PR2 time, the CHAR ff will be inhibited from setting. If, during the next PR2 and X6 time the character is not a UC or LC code, the Space Only Pulse ff resets. Therefore the character after the Space Only code does not flash but its width does escape.

2.22 FLASH ONLY

When the SO/FO key is pressed and the keyboard is in the Lower Case position, the Flash Only ff will set thru gate C11 (Figure 2-3-3). With the Flash Only ff set, the character following will not have its width used in the calculation of the line. This is accomplished by gates E5 (Figure 2-7-3) developing a high to the S0 and S1 select lines of the Width MUX. S0 and S1 being high enables input lines I3 to Adder H11. Since the I3 lines are tied low, no width is obtained from the Width MUX for the character after the Flash Only code. During PC8, no width will be loaded into the Width Memory. The character will still be allowed to flash normally.

2.23 NO-LEAD FUNCTION

The No-Lead function inhibits the leading after a line of copy. This is accomplished when the NL/MJ key is pressed in the upper case position. When the NL/MJ is seen in PR2 and X6 time, the No Lead Pulse ff (Figure 2-3-4) sets. This inhibits gates D9

and D10 (Figure 2-8-1) from allowing the setting of the Film Feed ff. Since the Film Feed ff does not set, no leading takes place. When the Return code is seen at PR2 and X6 time, the No Lead Pulse ff resets.

2.24 MULTIJUST FUNCTION

The Multijust function prevents the returning of the lens carriage to the left hand margin and also prevents film advance (leading) at the end of the line. This is accomplished when at PR2 and X6 time, a NL/MJ code in lower case position is seen. Both the Multijust Pulse ff (Figure 2-3-4) and the No Lead Pulse ff will set. The No Lead Pulse ff now functions just as described for the No Lead Function. The Multijust Pulse ff inhibits gates D11 and K11 (Figure 2-8-2) from outputting a high, thereby, preventing the Reverse ff from setting.

2.25 PLUS ONE UNIT

The Plus One Unit function (+1U key) causes one unit of width to be escaped. As the +1UP code and Case are presented at gate H10 (Figure 2-7-3), a one count is added to the Width Adder, and is loaded into Memory as a width of 1 unit. (Figure 2-8-1). In the Flash and Escape sequence, the CHAR ff does not set, since the +1UP code is a Flash Inhibit code (FI). However, the Width ff does set to escape one unit of width.

2.26 PLUS ONE POINT

The Plus One Point function (+1 Point key) adds one extra point of leading from the line just typeset. To do this, a +1UP signal is developed at the output of the Text Decoder ROM's (Figure 2-3-3) each time a +1UP code is seen at IR0-IR5. The +1UP signal is presented to gate F8 (Figure 2-7-1) with Case, and the output is loaded into Width Memory thru gates F9, H9, and K9 in PC8. When the +1UP and Case signals are seen at PR2 time, gates D10 and D9 (Figure 2-8-1) enable the Film Feed ff to set at X5 time. The Film/Width Counter is loaded with the complement of two, and a normal leading operation then occurs.

2.27 MEMORY FULL

As an OAR30 is developed on each Memory cycle, the Memory Full ff (Figure 2-5-2) sets at X1 time. At OAR3-32 time, the Memory Full ff resets. If, however, an IAR0 occurs (gates C1 and H8) before the Memory Full ff can be reset, then the Speaker One-Shot (Figure 2-4-4) is triggered with each cycle of Memory. The Speaker One-Shot enables gates F6, E6, and I4 to turn on the speaker each IAR32 time. This repeats until the IAR0 and Memory Full ff are more than 32 positions out of phase.

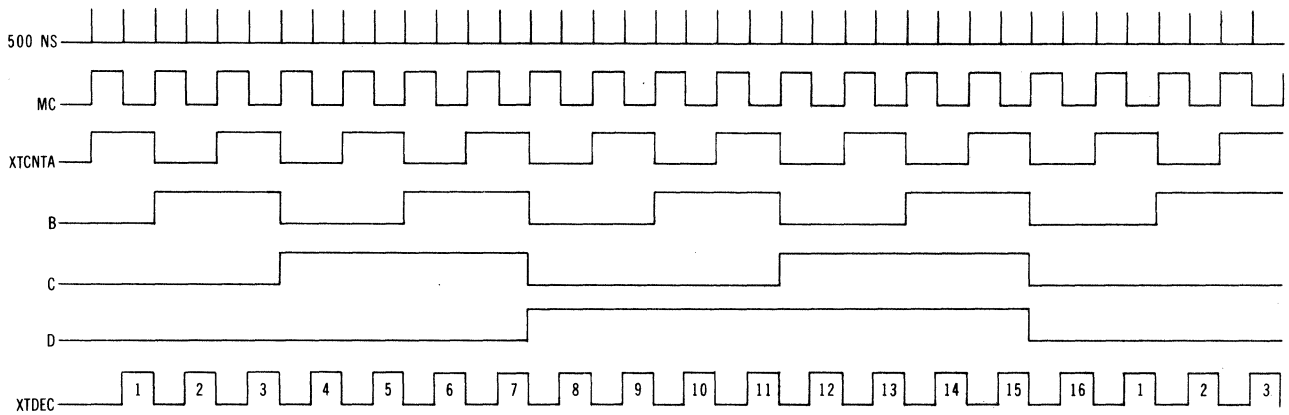

Figure 2-1 System Clock Timing Diagram

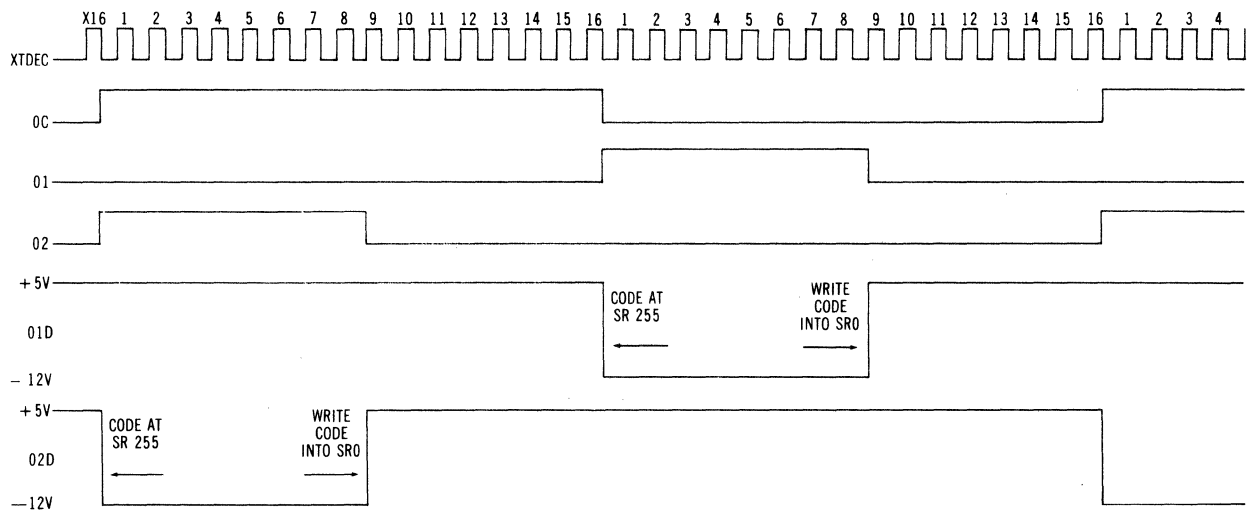

Figure 2-2 Memory Loading Timing Diagram

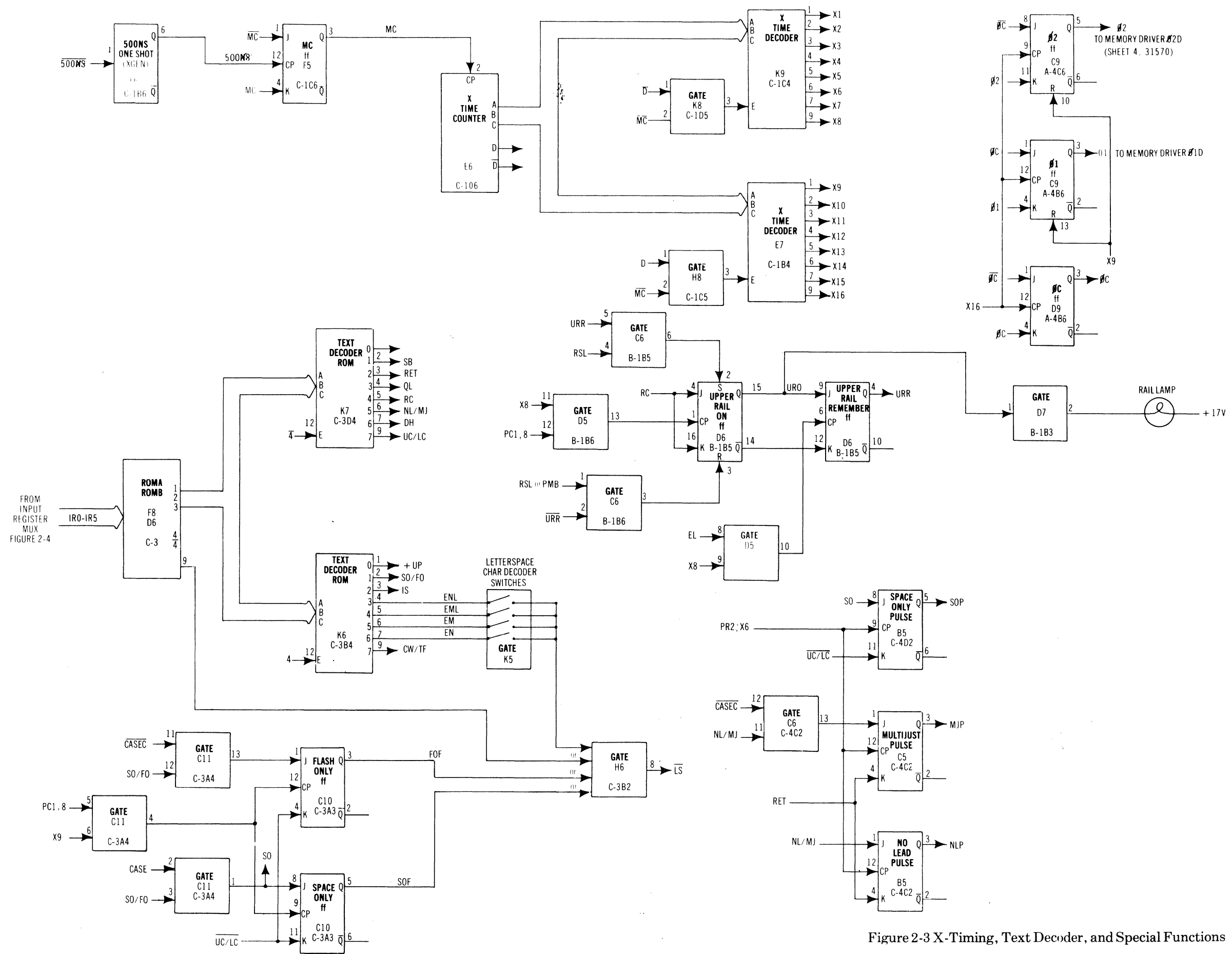

Figure 2-3 X-Timing, Text Decoder, and Special Functions

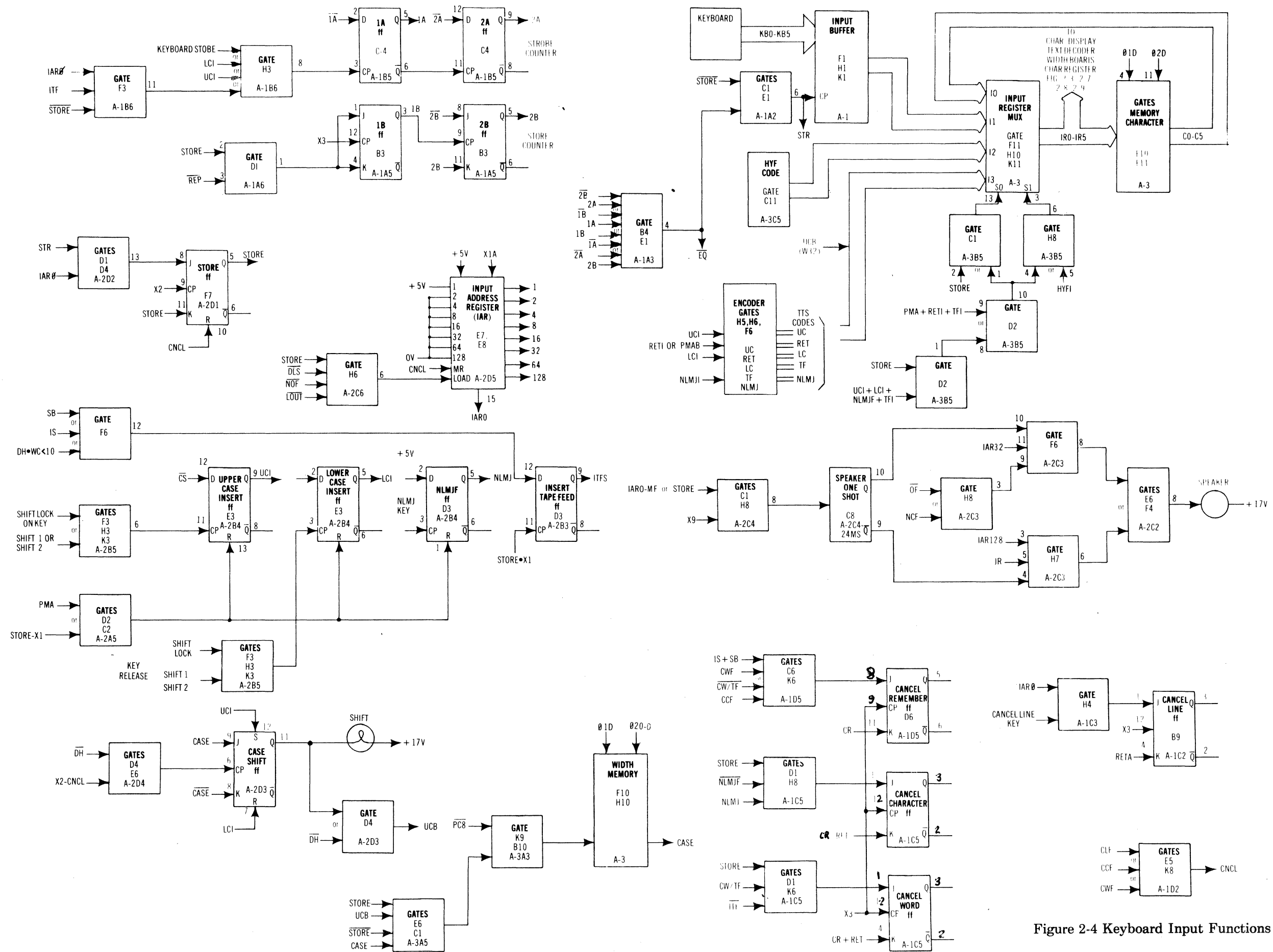

Figure 2-4 Keyboard Input Functions

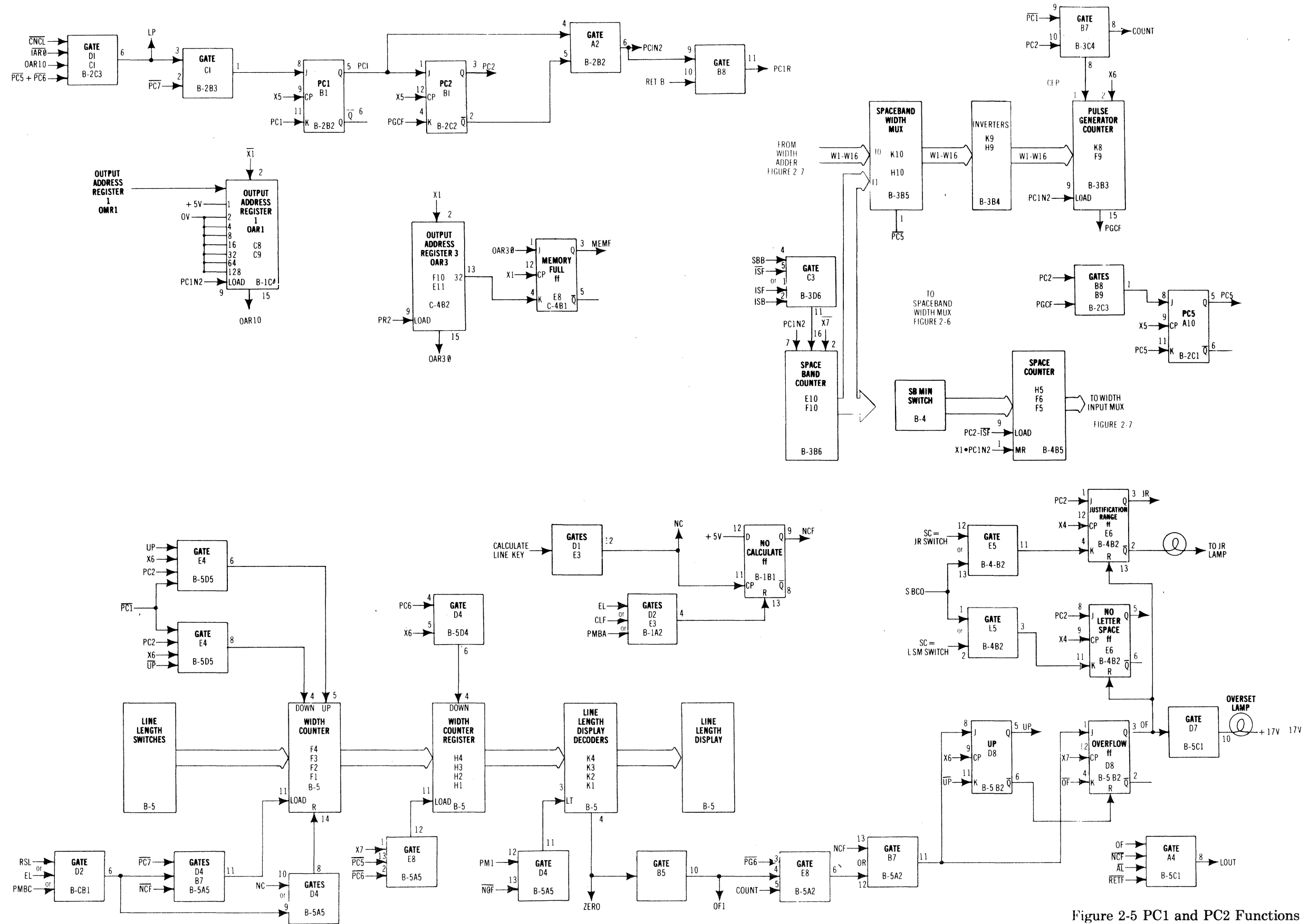

Figure 2-5 PC1 and PC2 Functions

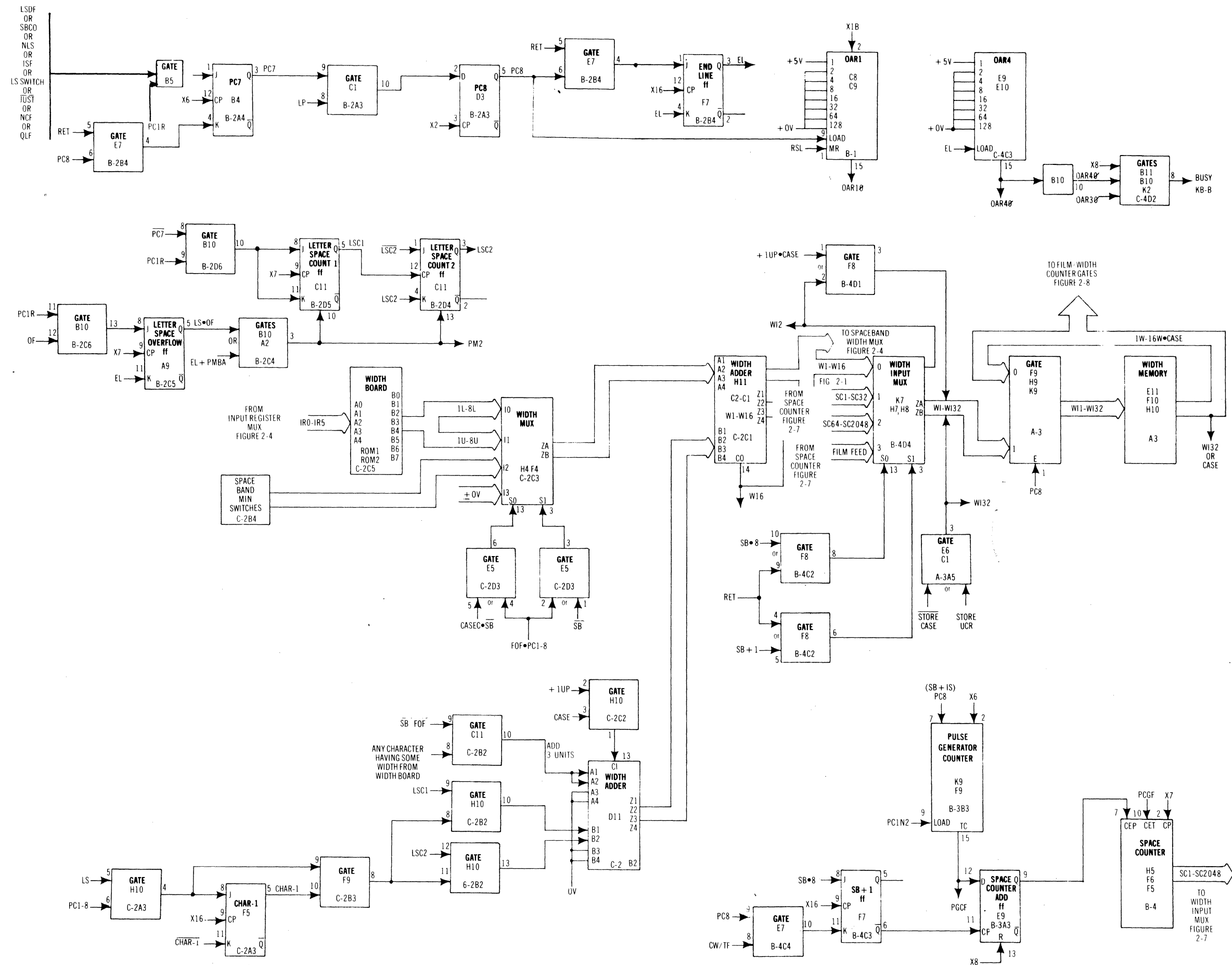

Figure 2-7 PC7, PC8, End Line Functions

SECTION III MAINTENANCE

3.1 GENERAL

Maintenance of the CompuWriter is divided into four categories as described below:

Preventive	Maintenance performed periodically to keep the the equipment operating with minimum wear and malfunction.
Adjustments	Mechanical and electrical adjustments required for correct operation of the unit.
Trouble-shooting	Methods for determining and isolating malfunctions.
Repair	Procedures for correcting malfunctions.

Maintenance of the basic system, including keyboard, displays, and logic, is detailed within this section. For detailed maintenance of other major assemblies, refer to the sections below:

Section IV	Power Supply
Section V	H.V. Power Supply
Addendum	Universal Photo Unit

The tools and test equipment listed below **are** recommended for the Service Engineer maintaining the system.

- Spring scale, 0 to 2 lb
- Oscilloscope, general purpose
- Volt-ohmmeter, general purpose
- Wrenches, assorted
- Screwdrivers
- Allen wrenches
- Bearing puller

3.2 PREVENTIVE MAINTENANCE

Table 3-1 summarizes the Preventive Maintenance for the purpose of convenience. Refer to the other sections as directed.

Table 3-1 Preventive Maintenance Summary

PERIOD	ITEM	INSTRUCTIONS
As required	Lenses	Clean with industrial grade isopropyl alcohol (90%) using soft lens tissue.
As required	Keytop, Front	Vacuum keytop area using soft brush attachment. Clean front panel and cabinet with alcohol on lint-free cloth.
As required	Fonts	Clean with CG Font and Film cleaner per par. 3.2.1
Weekly	Filter	Vacuum clean filter per par. 3.2.4
Weekly	Film Cassette	Open empty cassette and remove bits of paper.

3.2.1 Font Strip Cleaning, Storage, and Repair

CLEANING (AS REQUIRED)

Remove the font strip from the drum and clean both sides using CG Font and Film Cleaner #56996 or industrial grade isopropyl alcohol, 90% or better.

STORAGE

Store the font strips in their individual plastic envelopes, taking care that the fonts are clean before inserting in the envelope. Dust particles are abrasive and can scratch the emulsion if care is not taken.

REPAIR

Scratches on the font strips that show on the output copy may be repaired by placing the font strip on a light table, emulsion side up, and using a graphic pen with India ink. Opaque photo touch-up fluids can also be used.

3.2.2 Lens Cleaning [As Required]

Clean dust or grime off the lenses using soft lens tissue or eyeglass tissue moistened with industrial grade alcohol, 90% or better. Wipe off with clean, dry tissue.

3.2.3 Keytop, Front Panel and Cabinet Cleaning

Vacuum the keytops using a soft brush attachment. Clean the front panel using a soft, lint-free cloth moistened with alcohol.

3.2.4 Filter Cleaning [Weekly]

CAUTION

A dirty filter can cause the machine to overheat and fail. Clean filter once a week, or more often if conditions are dusty.

1. Remove the power plug from wall outlet.

WARNING

Do not change filter with line voltage applied to the machine.

2. Remove the rear, main-frame panel (4 fasteners).
3. Slide filter out of holder. (See Figure 3-1)
4. Vacuum clean the filter. Replace with new filter every six months, or more often if needed.

WARNING

Do not use blowing air under pressure to clean fiber glass filter. Particles of glass may cause injury to the eye.

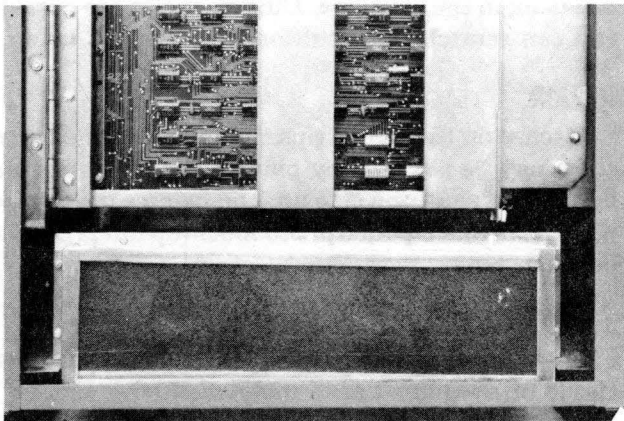

Figure 3-1 Location Of Filter

3.2.5 Film Cassette Cleaning [As Required]

Open the empty cassette by loosening the knurled and slotted end screw. Remove bits of paper and ensure that no paper materials are jammed in the entrance channel. Reassemble the cassette.

3.3 TROUBLESHOOTING

3.3.1 General

Most equipment failures can be isolated using the following guide. Prior to making any adjustments or replacements, first determine symptom(s) of the malfunction. This is done by carefully analyzing equipment operation. How does operation differ from normal operation? Are all switches set correctly? Is copy obtained?

With such information, decide in which of the three categories the symptoms belong, then use the troubleshooting guides that follow.

• ELECTRICAL

An electrical failure is one in which machine performance is affected by input line voltage, loss of one or all logic voltages, or a blown fuse. Refer to Figure 3-2 to solve an electrical problem.

• REGISTRATION

A registration failure can be attributed to either a mechanical or logic problem. Registration symptoms normally appear on the output copy in the form of erratic spacing, character misalignment, garbled type, or perhaps poor leading. Refer to Figure 3-3 to solve a registration problem.

• JUSTIFICATION

A justification failure can be caused either by a mechanical or a logic problem. The symptom normally appears as an improper line length, (either too long or too short) characterized by excessive or no letterspacing, and/or no spaceband expansion. If machine cannot start processing or stops during actual processing, this also indicates a justification failure. Refer to Figure 3-4 to solve a justification problem.

3.3.2 Testing The Character Display

A basic check of the Character Display lamps and drivers can be accomplished as follows: each of the 32 positions is made up of a 5 x 7 dot pattern. There is no one character in this system that will light all 35 dots. Use the following sequence to test all 32 positions, all dots.

1. Press PRIME. All positions should be blank.
2. Key: L, Repeat.
3. Key: (PRIME), H, Repeat.
4. Key: (PRIME), T, Repeat.
5. Key: (PRIME), THIN SPACE, Repeat.

This would indicate that all drivers and lamps are working properly, but may not validate 100% of the display circuitry. Using the block diagram in Figure 3-6 and the following procedure, isolate the fault to a functional area.

1. If the output copy agrees with the display, the fault is likely the circuits from the keyboard to the machine logic, inclusive.
2. If the output copy agrees with the keyboard, but the display is incorrect, the fault is likely in the Character Display Input Registers (E2, F2, H2, of logic board A).
3. If the display omits some dots, or includes dots improperly, the fault is likely in the Character Display Unit. Refer to par. 3.5.5 for replacement information.

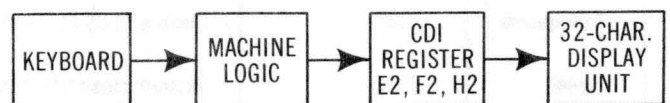
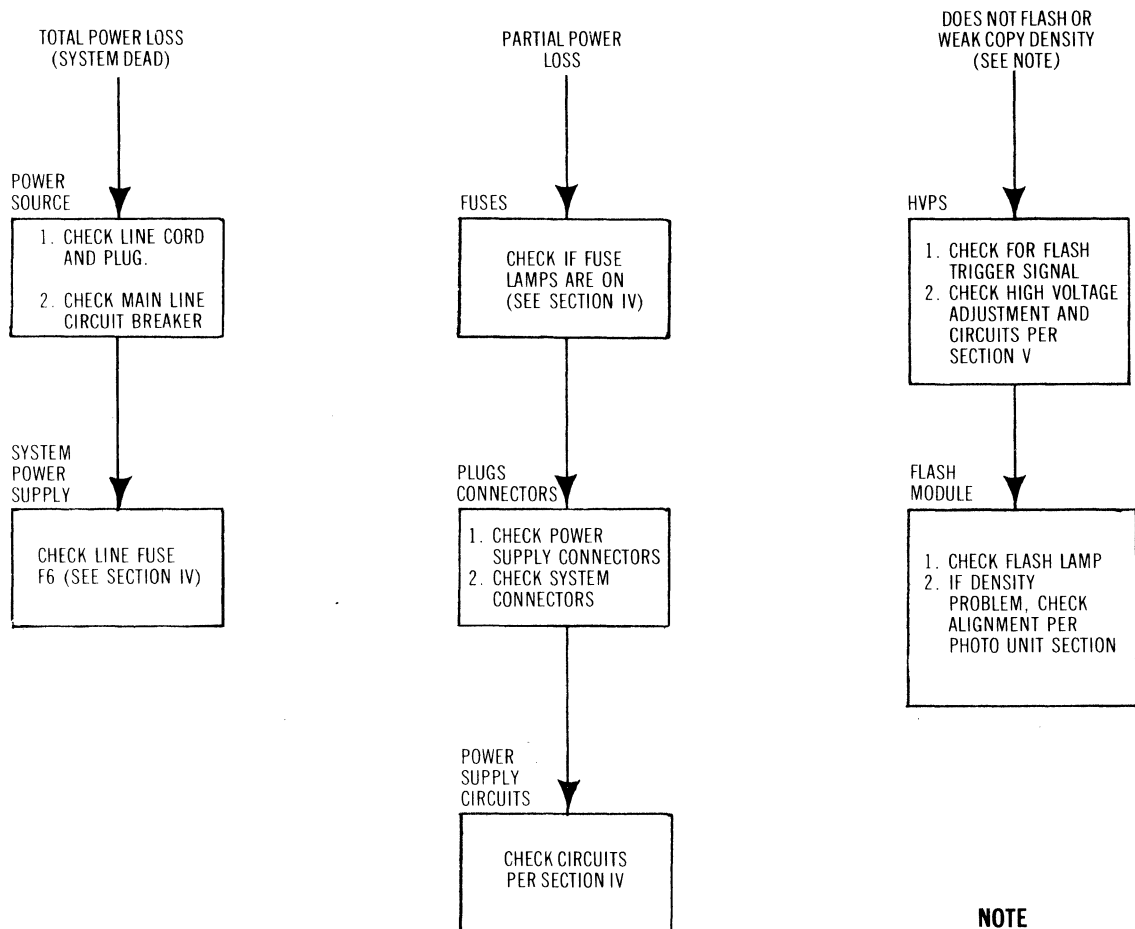

Figure 3-6 Character Display Block Diagram



NOTE
 IF DENSITY PROBLEM, ALSO CHECK FOR
 OLD CHEMICALS OR PAPER, DIRTY FONT
 STRIPS ETC.

Figure 3-2 Electrical Troubleshooting Guide

REGISTRATION FAILURE

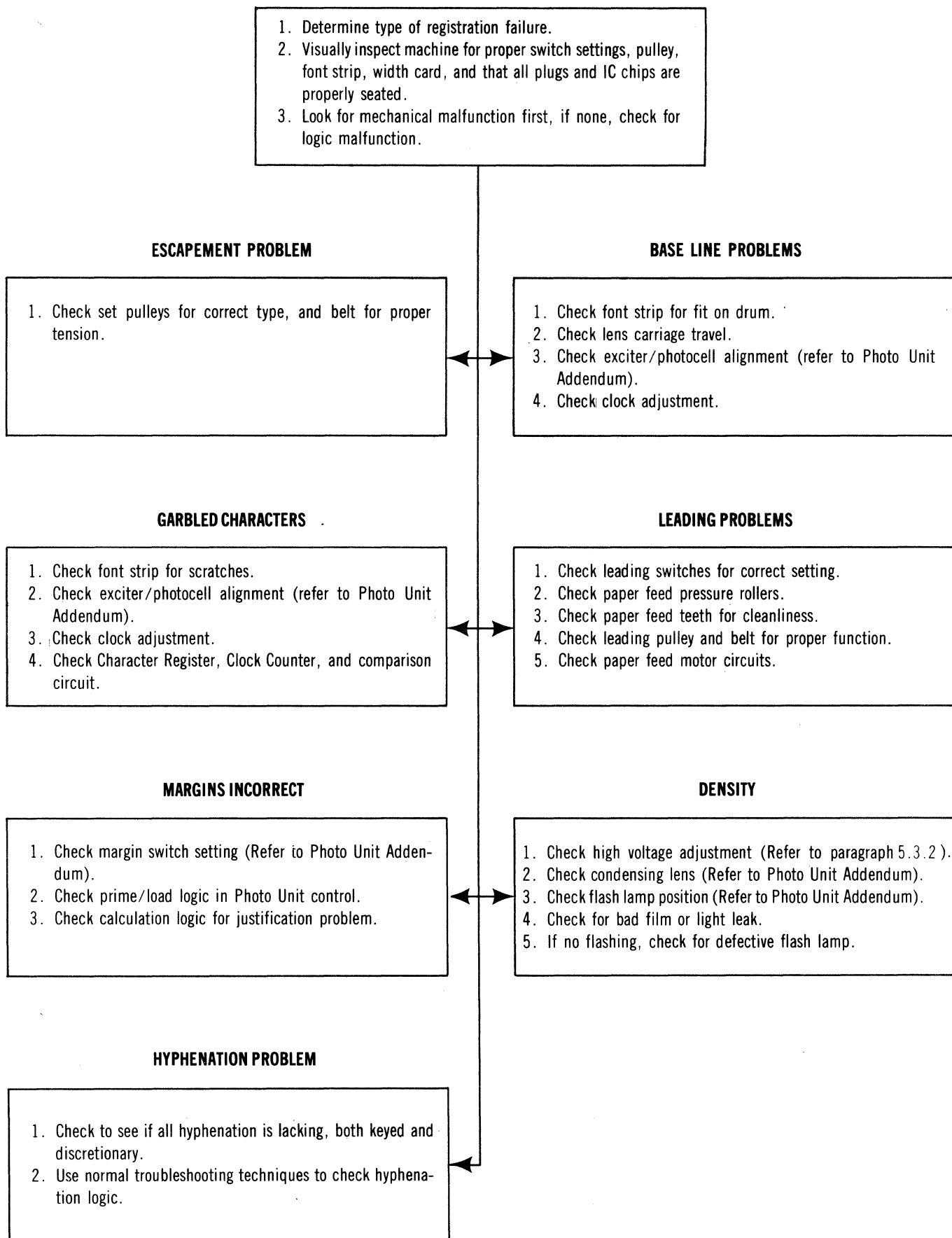

Figure 3-3 Registration Troubleshooting Guide

JUSTIFICATION FAILURE

1. Visually inspect machine for proper switch settings, pulley, font strip, width card, and all IC chips properly seated.
2. If copy is obtained, examine carefully for type of justification failure.
3. If copy is not obtained, examine operation to determine which program cycle failed, if Photo Unit operated, or if machine started processing.
4. For justification failures look to logic problems prior to mechanical problems.

CANNOT START PROCESSING

1. Press PRIME button and check lens carriage position and if PC1 mode is on.
2. Check NO FILM indicator and paper transport.
3. Check to see if OVERSET indicator lamp is on.
4. Check keyboard for proper operation. Replace if necessary.
5. Visually inspect entire machine for correct switch settings, width card seated properly, etc.

STOPS DURING PROCESSING

1. Check for OVERSET lamp on.
2. Visually inspect machine for correct switch settings and pulleys.
3. Check keyboard for proper operation.
4. Check clock pulses per par. 3.4.3.
5. Isolate to a program cycle by using normal troubleshooting procedures.

LONG/SHORT LINES PROBLEMS

1. Check for spaceband widths and letterspace between characters.
2. Utilizing normal troubleshooting procedures, isolate problem to specific area and locate program cycle causing error.
3. Check PC5 and PC6 cycles to determine if correct calculations are being performed.
4. Check data insertion functions and memory logic.

QUADDING PROBLEM

1. Check for operation of all quadding sequences.
2. Using normal troubleshooting procedures, check the insert space logic and data insertion logic for proper quadding.

Figure 3-4 Justification Troubleshooting Guide

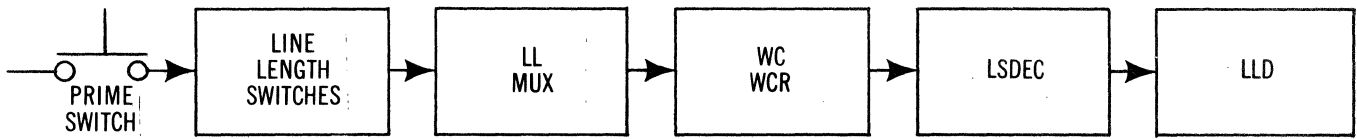

Figure 3-7 Line Length Display Block Diagram

3.3.3 Testing the Line Length Display

The illuminator lamps may be tested simply by pressing the PRIME button. Each of the four positions should display an eight. If a failure is observed, refer to par. 3.5.5 for display replacement information.

If the lamps check out without problems, the fault may in most cases be isolated to the faulty circuit by using the following troubleshooting procedures along with the block diagram in Figure 3-7.

1. Set 0000, 1111, 2222, (etc.) on the Line Length Switches, pressing PRIME after each set. See that the LLD duplicates the switch settings.
2. The output of the WCR should register (in BCD) the value of each digit on the Line Length Switches. A logic comparison between the WCR output and the switch settings would validate the circuits up to the LSDEC lamp-segment decoder.
3. The LSDEC (K1-K4) on logic board B may be tested by comparing the BCD inputs with the abcdefg outputs. Use Figure 3-8 to determine which output lines are required to illuminate the desired segments.

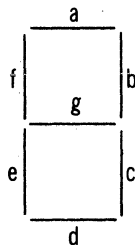

Figure 3-8 LED Segment Identification

4. The LLD contains segment LEDs and their drivers. If the LEDs do not light with the proper lines (abcdefg) closed, then the driver(s) are likely to be at fault and it will be necessary to replace the LLD module. Refer to par. 3.5.6 for replacement instructions.

3.3.4 Testing the Keyboard Unit

The fault may in most cases be isolated using the block diagram in Figure 3-9. Each key element when pressed generates two separate pulses from the middle two terminals. The pulses are of short duration (30-50 μs) and must be viewed on a scope, as they will not register on a multimeter.

1. If a single key is suspected, check to see that it develops a data pulse and a strobe pulse at the two middle terminals. If defective, replace the key module. Refer to par. 3.5.7 for replacement instruction.
2. If a number of incorrect characters are flashed, check the TTS code for each, one at a time at the INBUF outputs. If the codes are correct at this point, the machine logic is at fault.
3. INBUF can be checked by pressing the \$ key (012), checking each of the 012 outputs for a high and each of the 345 outputs for a low; then press the M key and check each of the 345 outputs for a high and each of the 012 outputs for a low. Note that a STR (STORE) signal is necessary to write the keyboard information into the INBUF.

3.4 ADJUSTMENTS

3.4.1 General

The electrical and mechanical adjustments are summarized in Tables 3-2 and 3-3 and are further described in the paragraphs that follow. The serviceman performing the adjustments for the first time should follow the procedures as described. After some experience, the serviceman may need only refer to the summary in the tables.

NOTE

The adjustment specifications should be maintained within a tolerance of ± 3 percent, otherwise degradation of system performance may occur.

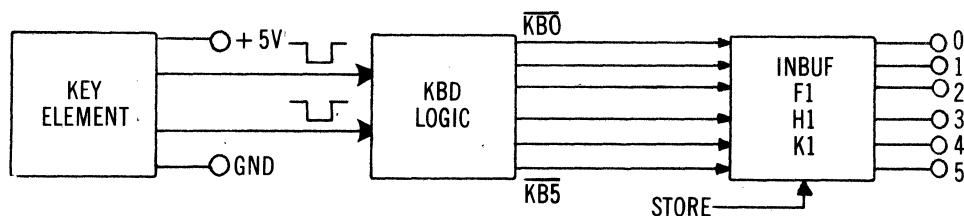

Figure 3-9 Keyboard Troubleshooting Block Diagram

3.4.2 Exciter Lamp Adjustment

1. Perform Exciter Lamp/Photocell Alignment per par. 3.5 of Universal Photo Unit Addendum before performing this adjustment.
2. Attach scope vertical input to pin K1-13 of Logic Board C.
3. Adjust rheostat on HVPS tray until the peaks are just starting to be clipped and the voltage is about -0.7 volts. (See Figure 3-10).



Figure 3-10 Exciter Lamp Adjustment

3.4.3 Font Clock Adjustment

1. Attach scope vertical input to pin C1-10 of Logic Board C.

2. SYNC externally on pin C1-6 of Logic Board C.
3. Adjust R8 on Logic Board C for a 80- μ s pulse width (See Figure 3-11).

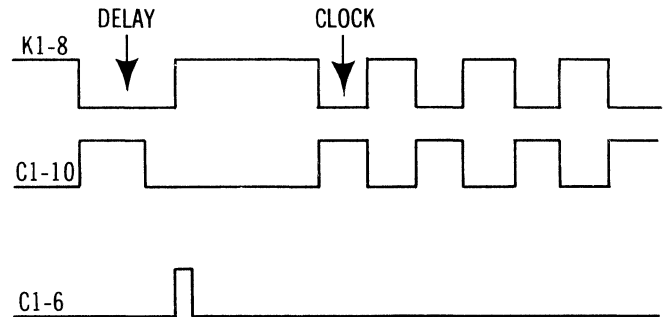

Figure 3-11 Font Clock Adjustment

Table 3-2 Electrical Adjustments

ADJUSTMENT	COMPONENT	INSTRUCTIONS
Clock Pulse	R8 on Logic Board C	Adjust for an 80- μ s pulse at pin C1-10 of Logic C. Sync positive on pin C1-6 (See par. 3.4.2)
Copy Density	R9 on HVPS	Adjust for \approx 800 VDC at terminals 4 and 6 of TB1, HVPS. (See par. 5.3.2)
Exciter Lamp	Rheostat on HVPS tray	Adjust for slight clipping at pulse peaks (about -0.7 volts) viewed at pin K1-13 of Logic Board C. (See par. 3.4.2)

Table 3-3 Mechanical Adjustments*

ADJUSTMENT	COMPONENT	INSTRUCTIONS
Exciter lamp position	Exciter lamp assembly	Position lamp so that elliptical image is focused on the photocell slit. Lamp should clear font clip by 1/16 inch minimum.
Clock pickup photocell	Photocell assembly	Position photocell vertically to permit largest size character to pass through aperture window without top or bottom clipping.
Flash lamp alignment	Flash module	Position housing to clear drum surface by two inches, minimum; condensing lens should clear font clip by 1/16 inch, minimum. If copy is too light on right side, move Flash module to right, and vice versa. If unable to evenly fill full 48-pica column adjust condenser lens.
Font drum belt tension	Font drum motor	Loosen motor mounting screws. Allow motor weight to tense belt. Tighten the mounting screws.
Font retainer spring tension	Spring base	Loosen screws and adjust position of spring base so that two pounds of force is required to deflect the retainer 1/16 inch.
Lens carriage travel	Ball bushings	Adjust ball bushing so that carriage moves freely across entire length of rods with 12 ounces of force.
Leading belt tension	Leading motor	Loosen motor mounting screws. Adjust for belt tension requiring 1 1/4 pounds of force to give 1/4 inch of deflection.
Margins	Margin switches	Left margin should be 1/4 inch from edge of photomechanical paper. Right margin switch should be set to give .0125" (1/8 inch) clearance between nylon carriage bearing and lead-screw shaft bearing.

*For detailed instructions on performing the mechanical adjustments, refer to Section III of attached Universal Photo Unit Addendum.

3.5 REPAIR

3.5.1 General

The procedures for repairing the various assemblies of the CompuWriter Systems are outlined in the following paragraphs. In some cases, reference is made to the section dealing with the respective assembly wherein detailed procedures are described.

3.5.2 Logic Board Removal and Insertion

With both hands, firmly grasp upper and lower lugs. Simultaneously, pull both lugs out toward you until contacts have cleared connector. Grasp metal support on outer edge of board and pull straight out (See Figure 3-12).

To insert, place correct logic board between guides. Then, slowly push logic board until contact with connector is made. Now position both upper and lower lugs on upper and lower metal support, and push in.

3.5.3 Logic Extender Board

Use the Logic Extender Board whenever troubleshooting of a logic board is required. To do this, remove the logic board to be tested. Insert the extender board so that the metal clip is on your left, then push on board until it is firmly placed in the connector. Now, insert the logic board and position metal clip as shown (See Figure 3-13).

3.5.4 Repairing Bent Connector Pins

Connector pins bent by improper insertion of cards can in most cases be repaired as follows:

1. With power turned off, insert screwdriver blade vertically into bent connector pins, moving blade to separate them (See Figure 3-14).
2. Carefully insert board and inspect mating before restoring power to equipment.

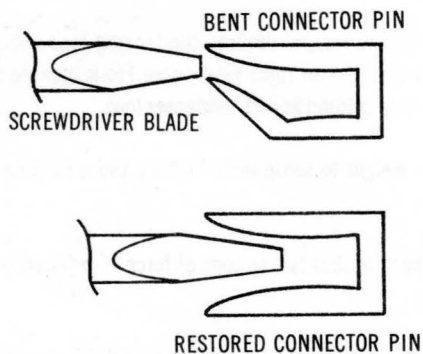

Figure 3-14 Connector Pin Repair

3.5.5 Character Display Replacement

Due to the very sensitive nature of the devices in the logic circuits of this display, it will be necessary to replace it as a module should it fail. Extreme care should be given to installing the replacement module (See Figure 3-15).

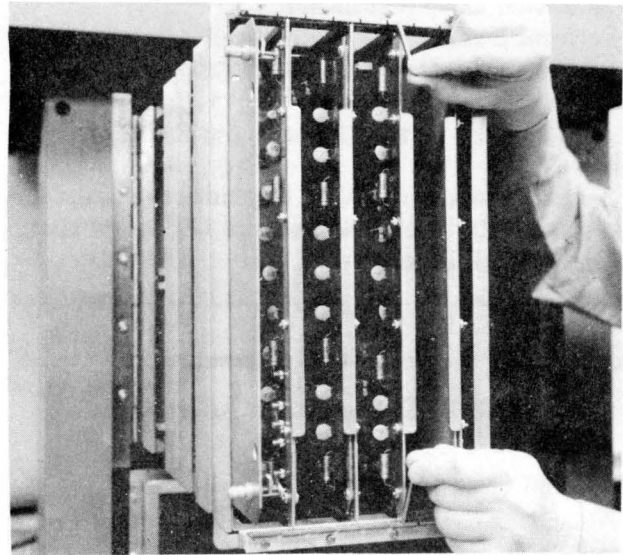

Figure 3-12 Logic Board Removal

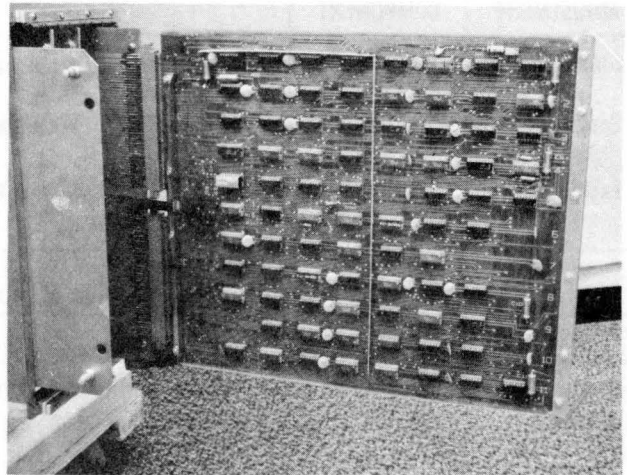

Figure 3-13 Logic Extender Board

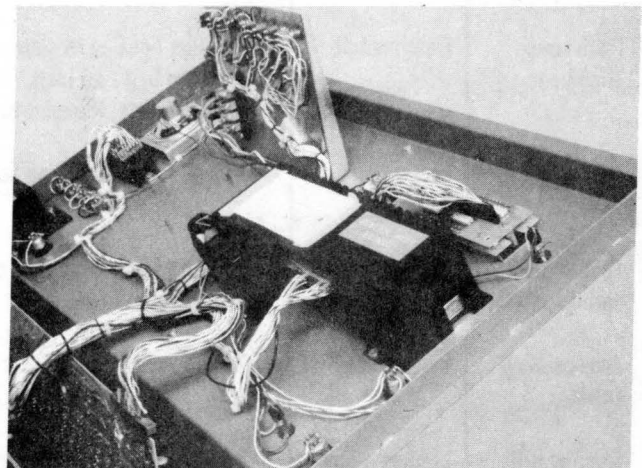

Figure 3-15 Replacement of Displays

NOTE

Follow the instructions on the warning tag supplied with the Line Length Display Unit.

3.5.6 Line Length Display

When it has been determined by the procedures outlined in paragraph 3.3.3 that the Line Length Display is at fault, then the entire unit should be replaced. Do this as follow: (See Figure 3-15).

- Remove the connector.
- Unscrew the two screws securing the unit.
- Remove the faulty unit and reinstall the new unit, taking care to orient it the same as the old unit. Secure with the screws and reconnect connector.

3.5.7 Panel Indicator Lamps Replacement

Follow the procedure below for replacing panel indicator lamps (referred to as "C" lights).

WARNING

Disconnect AC power while performing replacement.

1. Remove the plug from the faulty lamp (See Figure 3-16).
2. Compress the spring clip with pliers and remove.
3. Push the lamp through the front panel opening.
4. Insert replacement lamp, using the original spring clip.

<u>Lamp Color</u>	<u>CG Order No.</u>
White	57101-001
Amber	57101-002

If new spring clip is required use CG# 54188-001

3.5.8 Keyboard Repair

Repair of the keyboard consists of replacing the module if the logic should fail, or replacing an individual element if one is proven faulty.

The part numbers for the two different replacement modules are: Pulse-type switch, (MFG 1SW17R) 54825-001; Level-type switch, (MFG 1SW11R) 54441-001.

CAUTION

Do not interchange the two types of keyswitch Modules.

The key location number is etched on the bottom of the circuit board. Key locations 2,18,38,44,58,65 and 76 require part number 54441-001. All other locations require part number 54825-001. The element is matched to the housing and MUST be changed as a module. The procedure is as follows:

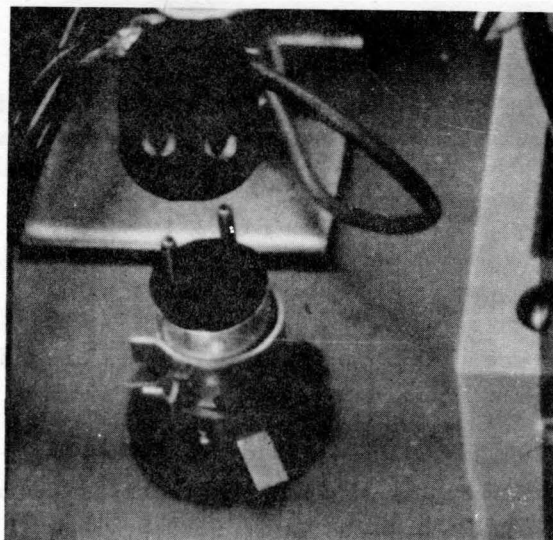

Figure 3-16 Panel Lamp Assembly

1. Remove the plastic keyface by depressing an adjacent key and prying upwards on the keytop with a screwdriver.
2. Turn the circuit board over and locate the proper pins (4). Unsolder the pins and clean excess solder from around the holes.
3. Insert the extracting tool (supplied with module) to release the retaining springs. Remove the housing by pulling upwards on the plunger (See Figure 3-17).
4. Orient the new element within the new housing so the pin nearest the dot will be connected to +5V ((dot towards top of keyboard) See Figure 3-18). Insert the housing until it clicks in place. Solder the four pins and replace the keytop.

CAUTION

Do not apply excess heat when soldering as it can damage the element.

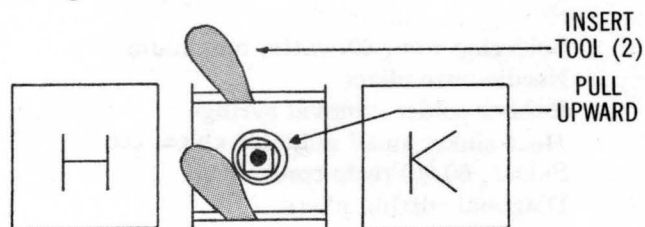

Figure 3-17 Removing Keyswitch Module

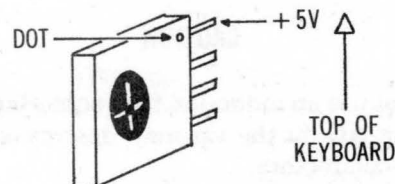

Figure 3-18 Orientation Of New Element

3.5.9 Installation of Insert and Accent Board

The Insert and Accent Board is optional on domestic models and standard equipment on International models. To install this board on a machine not already equipped, proceed as follows:

- Remove jumper plugs from connectors A and C (See Figure 3-19).
- Insert Logic board 32056 into location D on Logic gate.

3.5.10 Width Card Maintenance

If problems occur with the Width Cards, check for the following:

- Width Cards inserted in the guides and pressed firmly into connector so as to give good contact with all pins.
- Check connector pins (Figure 3-20). If a pin is bent or broken, remove bottom connector, then pull the defective pin-group up through the top and insert new pin group. Note that pins are molded in groups of four with plastic. Reconnect bottom connector.

3.5.11 Component Replacement

The procedure for replacing an electronic component is outlined here and should serve as a general procedure for most components. Components such as transistors, diodes, resistors, and capacitors are normally mounted on the top (component) side of the circuit board (See Figure 3-21). The leads pass through holes in the board and are soldered to the conductive foil on the bottom of the board. Look for polarity or other identifying mark before replacing.

TOOLS — the tools recommended for component replacement are:

- Soldering iron, 40 watts, maximum
- Needle-nose pliers
- Rubber solder removal syringe
- Heat sinks, small alligator chips, etc.
- Solder, 60/40 resin core
- Diagonal cutting pliers

CAUTION

Do not use an induction type soldering gun, as the AC on the tip may destroy certain semi-conductors.

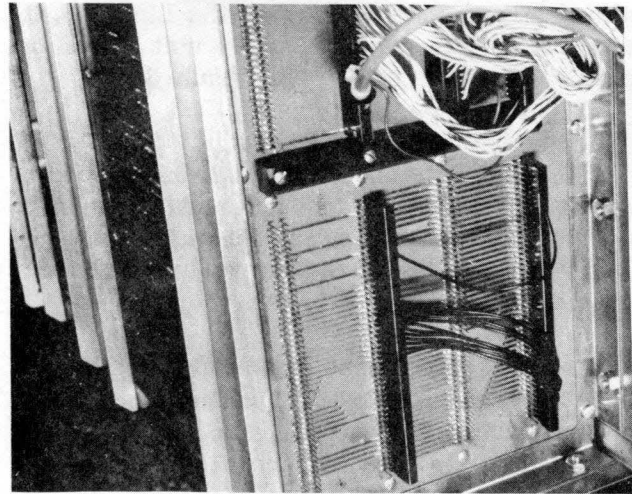

Figure 3-19 Installation of Insert and Accent Logic Board

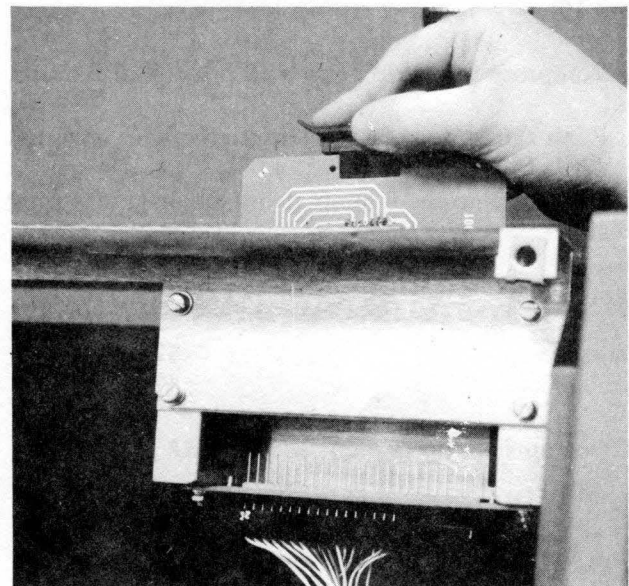

Figure 3-20 Repair of Width Card Connector

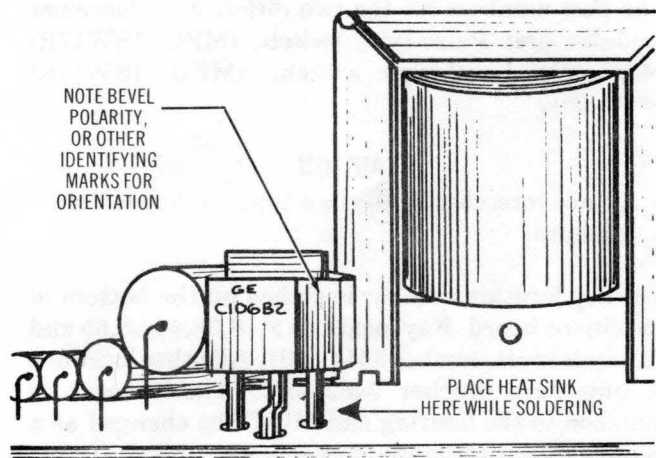

Figure 3-21 Component Replacement

1. **With power off, remove circuit board from system and invert to foil side.**
2. Apply iron to solder joints and pull components straight outward from board.
3. Clean excess solder from foil terminals with iron and syringe.
4. Form leads as required and insert replacement component into board (watch polarity). Place heat sinks on leads near component.
5. Apply iron to lead and foil while applying solder to joint. Hold iron on joint only as long as required. Repeat for other leads.
6. Snip off excess lead length at foil side of board. Remove heat sinks and test circuit board in machine.

3.5.12 Replacement Parts

Order replacement parts from the Compugraphic Parts Order Department, 65 Industrial Way, Wilmington, Mass. 01887. For part numbers and component nomenclature, refer to the Parts Catalog section of this manual or to the respective assembly and parts list drawings of the equipment print package.

SECTION IV SYSTEM POWER SUPPLY

4.1 GENERAL

The system power supplies discussed in this section are as follows:

Part No.	Input Requirements
31545-501	115VAC, 60 Hz
31545-502	115 VAC, 50 Hz
31545-503	230 VAC, 60 Hz
31545-504	230 VAC, 50 Hz

For component differences in these power supplies, refer to schematic 32428 and parts list 31545. Functionally, all four supplies operate the same with outputs as listed in Table 4-1.

Table 4-1 Power Supply Output Data

VOLTAGE	REGULATED	MEASURE AT	SYSTEM FUNCTION
-12VDC	Yes	J4 pins 9, 7	Memory Registers on Logic Boards
-5VDC	Yes	J2 pins 8, 1	Keyboard, Character Display Logic Boards
+5VDC	Yes	Terminals 1, 2	System Logic, Photo Unit, Control Panel, Displays, Keyboard
+17VDC	No	J5 pins 9, 7	Control Panel Lights, Speaker
+20VDC	No	J5 pins 5, 7	High Voltage Power Supply
+28VDC	No	Terminals 7, 8	Lens and Leading Motors
+120VDC	No	J1 pins 7, 1	High Voltage Power Supply
+250VDC	No	J1 pins 3, 2	Character Display

4.2 BASIC FUNCTIONS

Functional aspects of the system power supply are depicted in Figure 4-1. Refer to schematics 32429 and 29496 for detailed circuit information. Basic operation is as follows.

The alternating current input voltage is changed by transformer T1 into appropriate voltages for deriving the various rectified, filtered, and regulated (where applicable) DC outputs. As shown in the block diagram of Figure 4-1, the functions are divided between Power Supply Assembly 31545 and Power Supply and Drive PCB Assembly 29496. The latter assembly also has transistor driver circuits which buffer signals from the logic to the Lens and Leading motors, Line Counter, and Justification Range lamp. Also, a one-shot/driver circuit generates a Prime signal with development of the plus five-volts DC

output whenever system power is turned on.

4.3 POWER SUPPLY CIRCUIT DESCRIPTION

The following description is referenced to schematics 32428 and 29496. The basic AC voltages used to develop the various outputs of the Power Supply are taken from transformer T1 and full-wave rectified, filtered, and applied to their respective output or regulating circuit, as the case may be. Note that the +250 VDC, +120 VDC, +28 VDC, +20 VDC, and +17 VDC outputs are not regulated; therefore, some ripple and voltage fluctuation can be expected.

The +5 VDC, -5 VDC, and -12 VDC outputs are regulated, the latter two by IC regulators REG1 and REG2, respectively, which are part of Power Supply Assembly 31545. Each of these regulators features internal thermal overload protection and internal, short circuit, current-limit protection.

4.4 ADJUSTMENT, MEASUREMENT, AND FUSES

The +5 volt output is adjustable (R23, Figure 4-4) and should be maintained at a tolerance of three percent. The other regulated outputs (-5 and -12 volts) will maintain a constant level but are not adjustable. The unregulated outputs are not critical and should be measured only to determine if they are approximately at listed levels (See Table 4-1). The -5 volt and -12 volt regulators have built-in short circuit protection and therefore are not fused. The line fuse F6 is on the main power supply assembly 31545. All other outputs except the +17 VDC, which is dropped from the +20 VDC output, have an indicator lamp to indicate fuse condition and also that an output voltage is present. Refer to Table 4-1 for proper locations to measure voltage outputs and to paragraph 4.5.2 for fuse replacement information. Also refer to Figures 4-2 and 4-3 for illustration of power supply areas.

4.5 TROUBLESHOOTING

4.5.1 General

As a basic first step, check if all fuse indicators are illuminated. If not, follow the replacement and checkout procedures given in paragraph 4.5.2. If the fuses are good, then check voltage levels and adjustment per paragraph 4.4. If these checks reveal a malfunction, follow the procedures outlined in paragraphs 4.5.3, 4.5.4, and 4.5.5 to locate the defect.

4.5.2 Fuse Replacement

When a fuse blows, replace with one of proper rating as specified in Table 4-2.

Remove the appropriate connection to the load circuit and then replace the blown fuse with one of equal value. If the supply voltage remains at the proper level, it is very likely that the problem is on the load side of the connector. Sometimes a cable or harness wire grounds to the chassis when the insulation becomes worn or damaged. Also, check if other items, such as a loose washer or nut is causing a short on a printed circuit board or between terminals. First perform the simple checks before going into detailed troubleshooting or replacement procedures.

4.5.3 Voltages Missing

If all fuses are good, but circuits do not work due to missing voltages, one likely cause is a connector that has worked loose or fallen off. Another possibility is a broken wire in the harness or a broken wire at the connector.

4.5.4 Loss of Regulation

When the regulated +5 Volt output cannot be adjusted, or stays at an excessively high or low voltage level, it has lost its regulation. This may be caused by a failure of the adjustment pot, the reference diode, or a shorted or open transistor. Remove the load per paragraph 4.5.2 and make voltage checks, or remove power and check components with an ohmmeter. If the -5 volt or -12 volt regulators (RG1, RG2) malfunction, replace with a new regulator module.

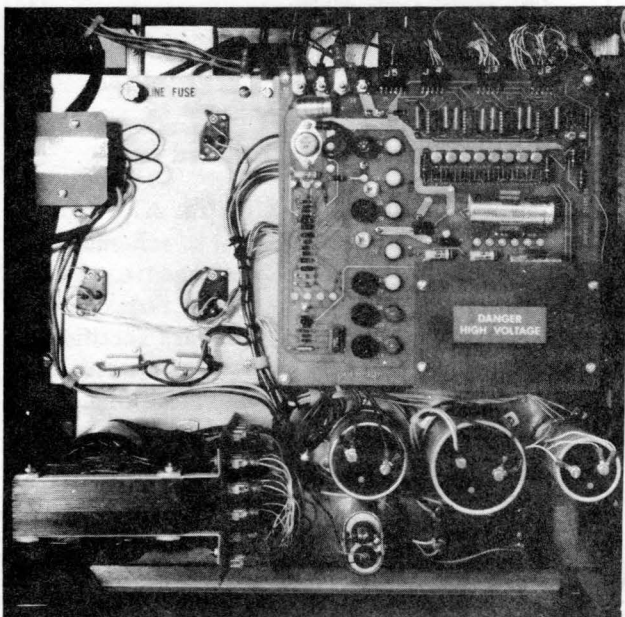

Figure 4-2 Power Supply Assembly

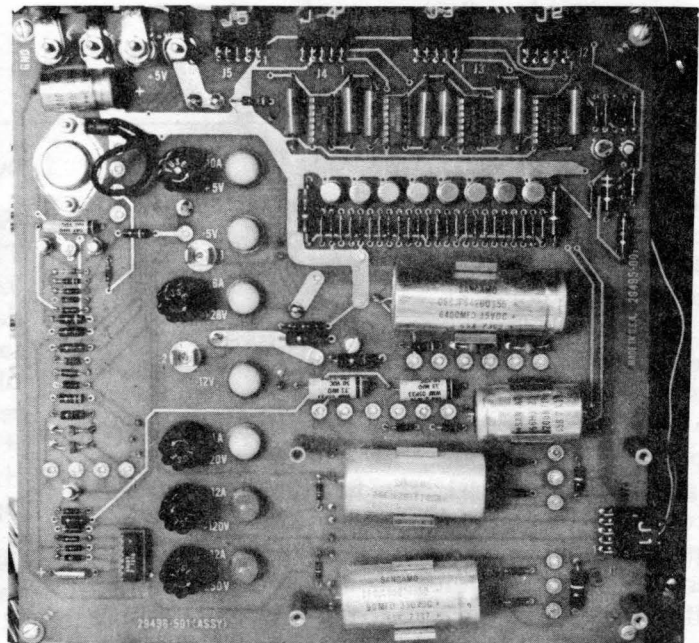

Figure 4-3 Power Supply and Driver PCB Assembly

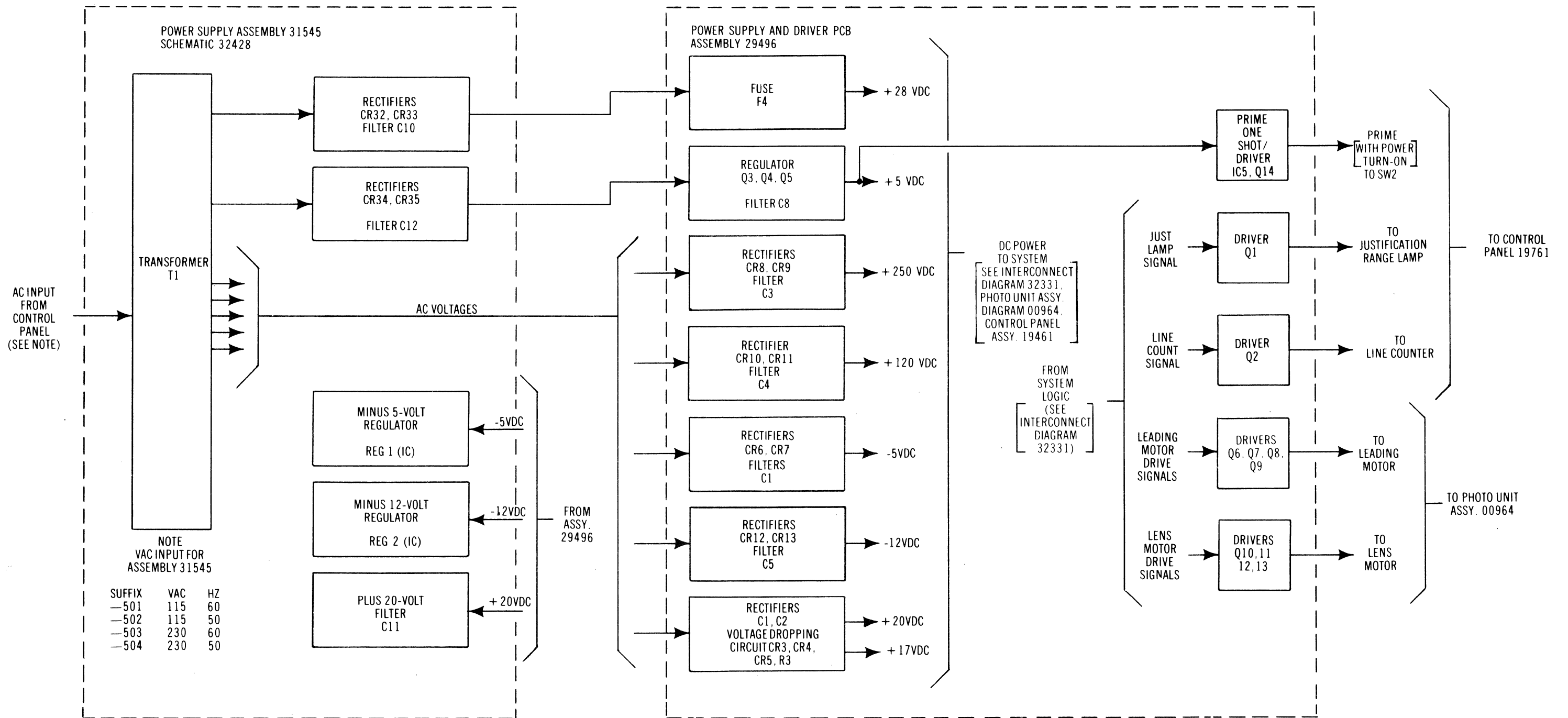

Figure 4-1 System Power Supply Block Diagram

4.5.5 Troubleshooting Chart

Symptoms not covered by the preceding text may be found in Table 4-3. Generally, perform the simple procedures first, and only replace components when certain that they are defective. See Section III, paragraph 3.5.11 for a component replacement procedure.

The +5 VDC output is regulated by a differential voltage comparator circuit and series regulator as depicted by the block diagram in Figure 4-4. In this regulator, the output voltage is sampled at potentiometer R23 and compared by comparator Q3, Q4 with a constant reference voltage (+5 volt zener diode CR34). The resulting output from the comparator is a function of the voltage level at the +5 volt output and is amplified by Q5 for controlling Series Regulator Q14. As a result, the series regulator conducts more or less, depending on direction of required regulation, thereby varying its impedance (and voltage drop) to regulate the output voltage.

For example, if the output voltage attempts to increase (either by a line voltage increase or a decrease in load), the emitter to base bias on transistor Q4 is increased, causing a corresponding increase in conduction (refer to schematics 32429 and 29496). As a result, the voltage drop across common emitter R19 increases, thereby reducing the bias (and conduction) of Q3. Note that the base voltage of Q3 is established and held relatively constant by zener diode CR34 and

the voltage divide network of R18 and R22.

In the present example, a decrease in conduction of Q3 is effectively an increase in impedance of the top portion (R19, Q3) of voltage divider network R19, Q3, and R24. Therefore, the emitter to base bias of amplifier Q5 is decreased (base goes more negative). This results in a reduced conduction of Q5 and therefore a more negative voltage (decrease in bias) is applied to the base of Q14. The resulting decrease in conduction of Q14 causes an increase in voltage drop across Q14 (effectively higher impedance) and thereby, increases the negative potential in respect to ground of the center tap on Transformer T1. This produces a corresponding reduction in voltage at the +5 volt output in respect to ground.

An increase in load at the +5 volt output or a decrease in AC line voltage (conditions which would decrease voltage at the +5 volt output) will cause the converse of the above described circuit functions, thereby increasing output voltage.

A repositioning of the voltage adjust potentiometers R23, will work similarly to the above described operations to adjust the +5 volt output to either a higher or lower level (depending on direction of adjustment) except now the change in bias of Q4 is effected by the change in the adjustment of R19 instead of a change in output potential.

CAUTION

Do not install a fuse of higher current rating or lower voltage rating than specified, otherwise proper circuit protection will not be provided.

Table 4-2 Fuse Data

CIRCUIT	FUSE	AMPS	VOLTS	CG PART NO.
Line (115V)	F6	5	250	51697-001
Line (230V)	F6	3	250	51052-001
+5V	F5	10	32	50524-001
+20V	F1	1	250	56563-002
+28V	F4	6	250	56563-001
+120V	F3	1/8	250	56563-003
+250V	F2	1/8	250	56563-003

If the replacement fuse blows, then check for a circuit overload (excess current) either in the load circuits or in the supply itself.

Table 4-3 Troubleshooting Chart

SYMPTOM	PROBABLE CAUSE	RECOMMENDED ACTION
Line fuse F6 continually blowing	Short at T1 wiring Capacitor C9 shorted Transformer T1 shorted Rectifying diode (s) shorted Large capacitor (s) shorted	Check wiring, terminals Check C9 with ohmeter Check T1, then replace Check and replace Check and replace
All supply voltages varying	Excessive line voltage variation Intermittent short at T1 Capacitor C9 open Failure of T1	Ensure that machine is on a separate line Check wiring, terminals Check wiring and C9 Check and replace
+ 5 volts improper or varying	R23 wiper arm dirty or misadjusted CR34 diode failure Transistor failure	Power off; turn R23 both ways then set voltage par 4.4 Check and replace Check and replace
- 5 or -12 volts improper or varying High ripple on DC level	RG1; RG2, failure Failure of diode(s) Open-circuited filter capacitor (s)	Check and replace Power off; check diodes with ohmeter Jumper replacement capacitor in parallel with suspect; replace
Output voltages missing or improper	Failure of diode (s) T1 shorting Open connection Fuse blown	Power off; check diodes with ohmeter Check and replace Check connection Check and replace

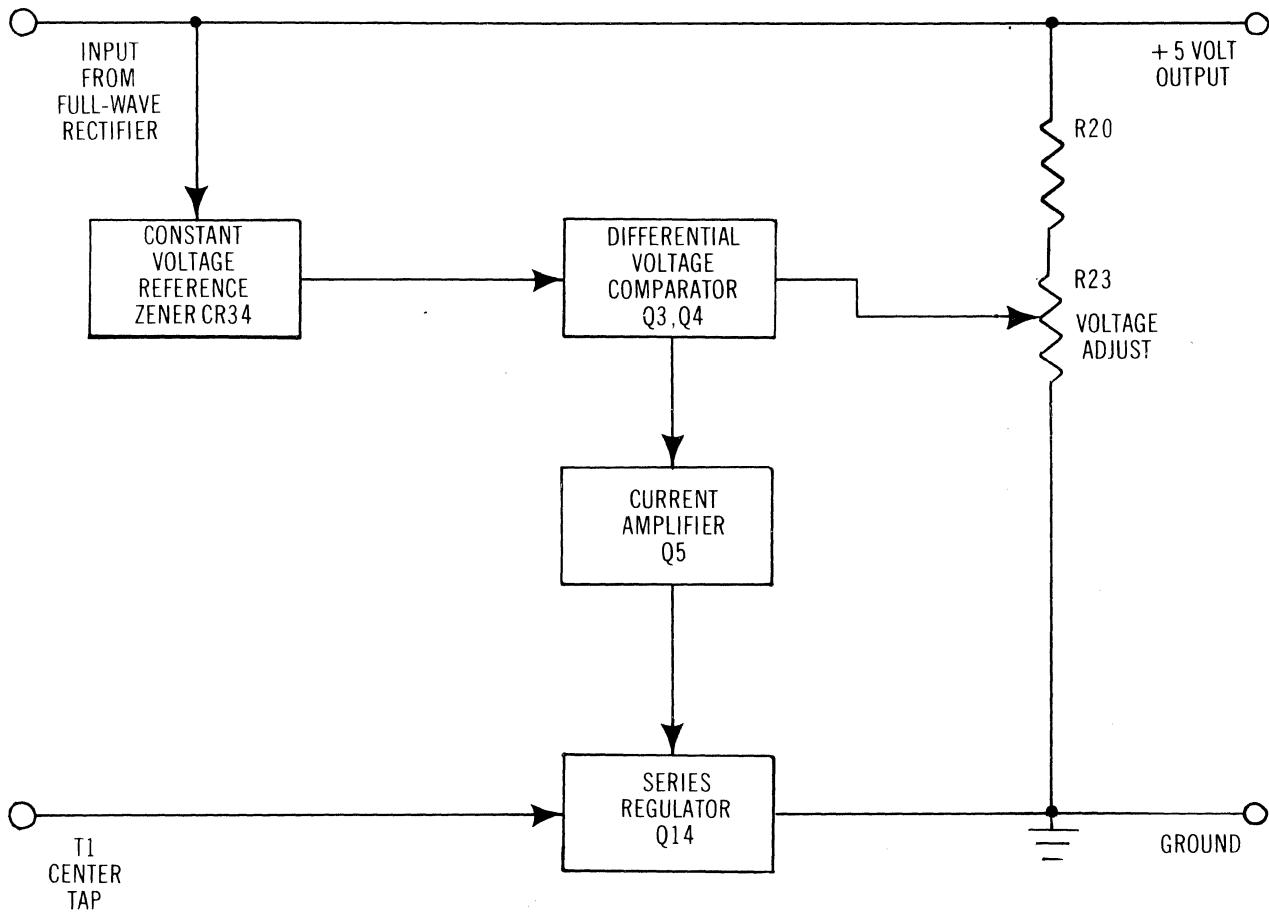

Figure 4-4 Plus Five-Volt Regulator Block Diagram

SECTION V

HIGH VOLTAGE POWER SUPPLY

5.1 DESCRIPTION

The HVPS is a module consisting of transistors and other components mounted on a circuit board located in a tray on the right side of the Photo Unit. The purpose of this module is to develop the trigger pulse and ionizing potential for the Flash Module. The ionizing potential is adjusted by varying a potentiometer that is mounted on the board.

5.2 BASIC CIRCUITS

5.2.1 General

Refer to Figure 5-1 or Schematic Drawing 29051 (P/O equipment print package) for a better understanding of the circuit theory that follows.

5.2.2 Ionizing Potential

The ionizing potential for the flash tube is developed as follows:

A variable regulator (Q1, Q2, Q3, Q4, R9) converts a 20-volt DC input to about 15 volts of regulated DC (adjustable by potentiometer R9, High Voltage Adjustment Control). An oscillator (Q5, Q6, T1) converts the 15 VDC to 650 VAC which is rectified by a diode bridge circuit and filtered by capacitor C2. The resulting 800 VDC, or so, (adjustable by R9) is applied to the anode of the flash tube for ionizing its gases (flashing) when the tube is triggered. Note that the density of the output is directly affected by the potential at the anode of the flash tube and that it is adjusted by potentiometer R9.

5.2.3 Trigger Pulse

The trigger pulse works in conjunction with the ionizing potential to break down the xenon gas in the flash tube, causing it to ionize (flash). The trigger pulse is developed as follows:

A flash signal from the system logic is inverted by transistor Q8 to trigger solid state switch SCR1. Storage capacitor C5 is charged to 120 VDC until the SCR1 triggers thereby providing a discharge path to ground. When C2 discharges, the resulting change in magnetic flux in the pulse transformer primary (flash module) causes a high-voltage, positive spike at the secondary. This spike at the grids of the flash tube trigger the tube gases into ionization (flashing).

5.3 SERVICING

5.3.1 Troubleshooting

Operator level and Technician level troubleshooting instructions are contained in Tables 5-1 and 5-2 respectively.

WARNING

The HVPS module develops voltages which are hazardous. Shut power off when replacing fuses, and remove plug from wall when replacing the HVPS module.

5.3.2 High Voltage Adjustment [Density]

The high voltage level (800 volts, nominal) affects the density of the output copy. If the density is incorrect, adjust as follows:

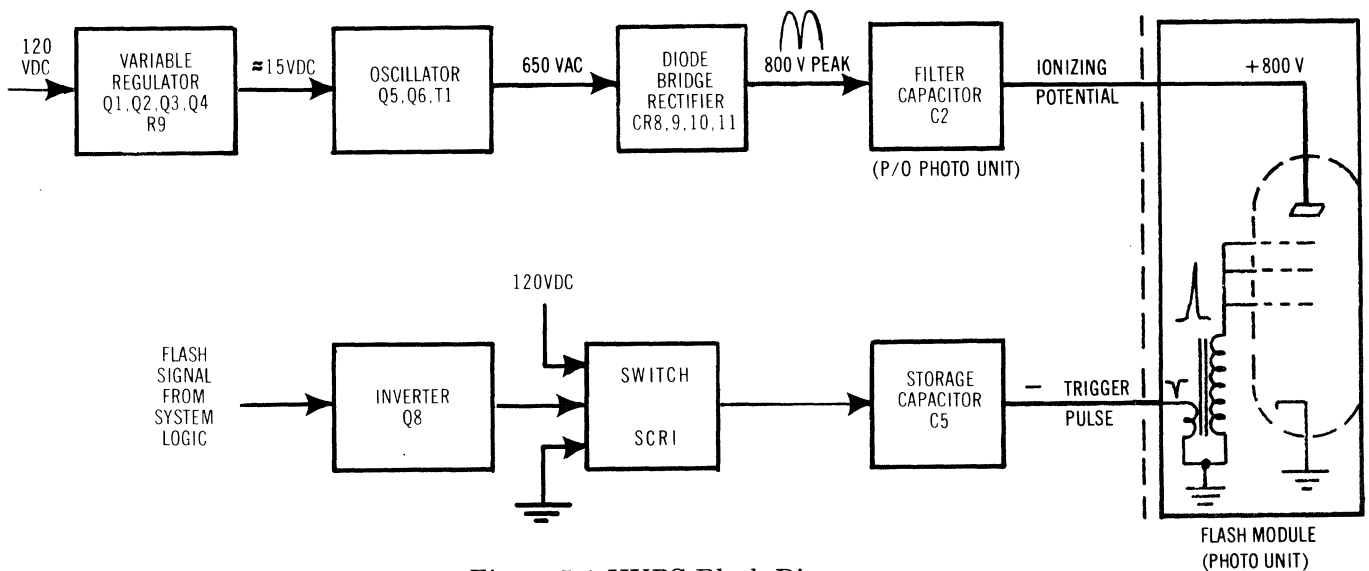

Figure 5-1 HVPS Block Diagram

Table 5-1 Operator Level Troubleshooting

SYMPTOM	PROBABLE CAUSE	INSTRUCTION
No flash	High voltage adjustment too low. Flash lamp burned out.	Perform adjustment per par. 5.3.2 Replace flash lamp per instructions in Universal Photo Unit Addendum section.
Copy density too low	Dirty font strip Dirty lens Exhausted chemicals HV adjustment too low, Inefficient flash lamp	Clean with CG Film Cleaner Clean with industrial alcohol or CG Film Cleaner Replace chemicals. Do not increase HV to compensate when chemicals are weakened. Perform adjustment per 5.3.2. Replace flash lamp per attached Universal Photo Unit Addendum.
Copy density too high	HV adjustment too high Out of date film	Perform adjustment per Par. 5.3.2 Replace old film
Garbled characters output copy	Dirty font strip	Clean with CG Film Cleaner

Table 5-2 Technician Level Troubleshooting

SYMPTOM	PROBABLE CAUSE	INSTRUCTION
Copy density varying	Line voltage variations C2 breaking down Flash lamp old	Put machine on separate AC line Replace C2 Replace flash lamp
High ripple, 800v	CR8, CR9, CR10, CR11 C2 open	Replace defective diode Replace C2
High	Defective 120 volt input C5 open	Check Low Voltage Power Supply Replace C5
No flash	Missing Flash command C6, Q8, CR19, CR20 SCR1 bad Flash lamp defective	Use Line Repeat function (Test Switch No. 3) and check Flash signal at terminal 13. Replace defective component Replace SCR1 Replace flash lamp

- For greater density, adjust R9 clockwise approximately one half to one full turn. (Accessible thru inner-most hole in panel below font drum. See Figure 5-2).
- For less density, adjust R9 counter-clockwise one-half to one full turn.
- A nominal value is 800 VDC measured at pins 4 and 6 of TB1.

NOTE

Weak chemicals, dirty font strip, old film or improper flash assembly alignment may also cause density to be incorrect.

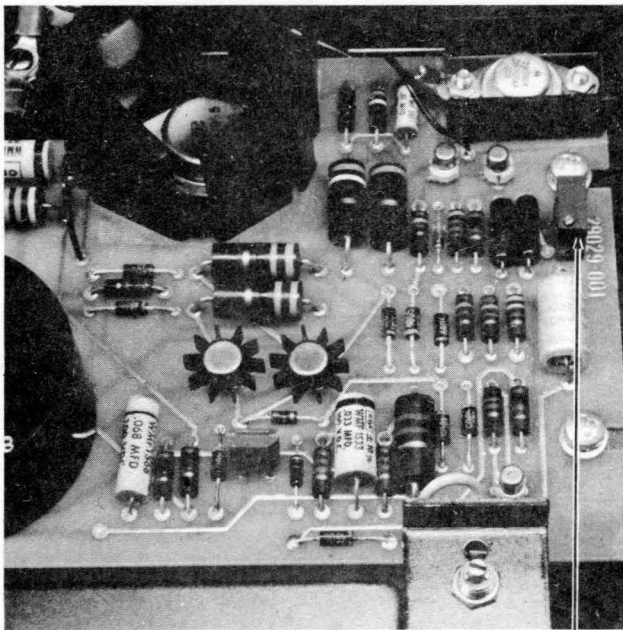

Figure 5-2 HVPS Adjustments

R9

5.3.3 Repair

HVPS BOARD REPLACEMENT

1. Remove power plug from wall outlet.
2. Lift Photo Unit cover and pull HVPS from recessed position.
3. Remove the four screws at the corners of the circuit board.
4. Removing one terminal screw at a time, transfer the wires to the terminals of the replacement board. Make certain that the terminal jumper lugs are properly connected.
5. Place the new board into position on the mounting posts and tighten the four screws.
6. Turn R9 counter-clockwise prior to turning the power on.
7. Perform HVPS adjustment per par. 5.3.2

COMPONENT REPLACEMENT

If individual components are to be replaced on a board, refer to the procedures outlined in Section 3 paragraph 3.11.

5.4 REPLACEMENT PARTS

The HVPS board may be ordered by Part No. 29051-501. For component part numbers, refer to the assembly and associated parts list drawings CG No. 29051 (Part of equipment print package). Replacement HVPS boards and component parts are available from the Compugraphic Parts Order Department, 65 Industrial Way, Wilmington, Mass. 01887.

SECTION VI GLOSSARY OF TERMS

6.1 GENERAL

The major logic elements, flip-flops, registers, etc., comprising the circuitry for the CompuWriter systems are listed below along with a brief description of their function, logic location, and schematic location.

6.2 MAJOR ELEMENTS

NAME	DESCRIPTION	LOGIC LOCATION	SCHEMATIC LOCATION
ADD	Adder	H11	C-2C1
AROM	Address ROM	D6-F8	C-3C5
CDIR	Character Display Input Register	E2-F2-H2	A-5
CE	Count Equal	C3-D3	C-5B2
CR	Character Register	C4-D4	C-5B2
CT	Clock Tracking Counter	C2-D2	C-5C2
F/WC	Film/Width Counter	C7-C9-D8	C-5
IAR	Input Address Register	E7-E8	A-2D5
INBUF	Input Buffer	F1-H1-K1	A-1
IRMUX	Input Register Multiplexer	F11-H11-K11	A-3C4
LSDEC	Line Space Decoder	K1-K2-K3-K4	B-5
MEM	Memory	E11-F10-H10	A-3C2
OAR1	Output Address Register One	C8-C9	B-1C4
OAR2	Output Address Register Two	D7-C7	A-5B2
OAR3	Output Address Register Three	E11-F10	C-4B2
OAR4	Output Address Register Four	E9-E10	C-4C3
PGC	Pulse Generator Counter	F9-K8	B-3C3
SBC	Spaceband Counter	E10-F10	B-3C5
SBWMUX	Spaceband And Width Multiplexer	H10-K10	B-3C5
SC	Space Counter	H5-F5-F6	B-4B5
SOUTC	Step-Out Counter	B2	C-6D3
TDROM	ROM Text Decoder	K6-K7	C-3
WADD	Width Adder	D11	C-2B2
WC	Width Counter	F1-F2-F3-F4	B-5
WCR	Width Counter Register	H1-H2-H3-H4	B-5
WIMUX	Width Input Multiplexer	H8-K7	B-4D4
WMUX	Width Multiplexer	F4-H4	C-2C3
XCNT	X-Time Counter	E6	C-1D6
XTDEC	X-Time Decoder	E7-K9	C-1C4

6.3 FLIP-FLOPS

NAME	DESCRIPTION	LOGIC LOCATION	SCHEMATIC LOCATION
A & B	Lens Drive FF	E2	C-5A2
ALF	Auto Line FF	B4	B-5D3
CCF	Cancel Character FF	D6	A-1C5
C & D	Leading Drive FF	F3	C-6C2
CHAR	Character FF	D1	C-4B4
CHAR-1	Character Minus One FF	F5	C-2A3
CLF	Cancel Line FF	B9	A-1C3
CLK	Clock FF	C1	C-5C3

Flip-Flops (continued)

NAME	DESCRIPTION	LOGIC LOCATION	SCHEMATIC LOCATION
CR	Cancel Remember FF	D6	A-1D5
CS	Case Shift FF	E4	A-2D3
CWF	Cancel Word FF	D5	A-1C5
DC	Display Character FF	E4	A-5B3
D CASE	Display Case FF	B7	A-5A3
DCM	Display Character Memory FF	D5	A-5A2
DELAY	Delay FF	C1	C-5D3
DRP	Display Reset Pulse FF	B6	A-5C3
EL	End Of Line FF	F7	B-2B4
FF	Film Feed FF	E3	C-4D4
FOF	Flash Only FF	C10	C-3A3
HYFI	Hyphen Insert FF	D10	B-3D1
ISF	Insert FF	C5	B-1B3
ITFS	Insert Tape Feed FF	D3	A-2B3
JR	Justification Range FF	E6	B-3B2
LCI	Lower Case Insert FF	E3	A-2B4
LSCI	Letterspace Character 1 FF	C11	B-2D5
LSC2	Letterspace Character 2 FF	C11	B-2D4
LSOF	Letterspace Overflow FF	A9	B-2C5
MC	Master Clock FF	F5	C-1C6
MEMF	Memory Full FF	E8	C-4B1
MJP	Multijust Pulse FF	C5	C-4C2
NCF	No Calculate FF	D3	B-1B1
NLMJF	No Lead Multijust FF	D3	A-2B4
NLP	No Lead Pulse FF	B5	C-4C2
NLS	No Letterspace FF	E6	B-3B2
OF	Overflow FF	D8	B-4B2
OSCD	Oscillator Divider FF	F2	C-6C4
OSCG	Oscillator Generator FF	F2	C-6B4
PC1	Program Cycle One FF	B2	B-2B2
PC2	Program Cycle Two FF	D1	B-2C2
PC5	Program Cycle Five FF	A10	B-2C1
PC6	Program Cycle Six FF	A10	B-2D1
PC7	Program Cycle Seven FF	B4	B-2A4
PC8	Program Cycle Eight FF	D3	B-2A3
PM	Prime FF	D9	A-4A5
PR2	Printer Ready Two FF	E8	C-4A4
QLF	Quad Left FF	C5	B-1B3
RET1	Return Insert FF	D9	B-3C1
RETD	Return Delay FF	D9	B-3C1
REV	Reverse FF	A2	C-4A5
RLF	Rail FF	C5	C-5A3
RSD	Reset Display FF	B9	A-5D1
RSL	Reset Line FF	A9	B-1C4
SB + 1	Spaceband Plus One FF	F7	B-3C3
SBC + 1	Spaceband Counter Greater Than One FF	E9	B-3A6
SCA	Space Counter Add FF	E9	B-3A3
SOF	Space Only FF	C10	C-3A3
SOP	Space Only Pulse FF	B5	C-4D2
SOUTF	Step-Out FF	A2	C-6D5

Flip-Flops (continued)

NAME	DESCRIPTION	LOGIC LOCATION	SCHEMATIC LOCATION	NAME	DESCRIPTION	LOGIC LOCATION	SCHEMATIC LOCATION
SPKP	Speaker FF	C8	A-2C4	1B-2B	1B FF, 2B FF	B3	A-1A5
STORE	Store FF	F7	A-2D1	175MS	175 Millisecond One-Shot	C8	A-5B2
SYNC	SYNC FF	D1	C-5D2	2.5MS	2.5 Millisecond One-Shot	F6	C-6B3
TFI	Tape Feed Insert FF	D10	B-3C1	25MS	25 Millisecond One-Shot	A4	C-4B5
UCI	Upper Case Insert FF	E3	A-2B4	500NS	500 Nanosecond One-Shot	F6	C-1B6
UP	UP FF	D8	B-4B2	70MS	70 Millisecond One-Shot	A4	C-4D3
URO	Upper Rail On FF	D6	B-1B5	0C	Phase Clock	D9	A-4A5
UPR	Upper Rail Remember FF	D6	B-1B5	01	Phase One	C9	A-4B5
WIDTH	Width FF	E3	C-4C5	02	Phase Two	C9	A-4C5
1A-2A	1A FF, 2A FF	C4	A-1B5	—			

APPENDIX A

BLOCK DIAGRAM NOTATION

A.1 GENERAL

The following paragraphs describe the notation used in the block diagrams of Section II. Effective usage of the block diagrams requires a thorough understanding of the notation system.

A.2 INFORMATION WITHIN THE BLOCK

Refer to Figure A1. The name of the element appears near the top of the block. The chip location(s) appears at the center. The four-digit notation near the bottom indicates the logic board, the logic schematic sheet and the location on the schematic (A through D, 1 through 6).

A.3 INPUT TERMS

The terms at the input to each logic block indicate the conditions required to enable the function at the output. A term with a bar over it means that it must NOT be present in order to enable the function ($\overline{\text{MONE}}$, Figure A2).

AND, OR — When more than one signal is required at an input line, a comma is used to denote AND (UM, SYNC2V; Figure A3). When only one input is required to enable the function, the inputs are separated by “or” (UM, SYN2B or 48Q; Example 3). The exclusive-OR gate is signified by the symbol ‘ \neq or ’ at the input.

A.4 ARROW DESIGNATIONS

Arrows are used to indicate the direction of logic flow. The wide arrow \Rightarrow is used to indicate that several related signal lines are bundled together (Figure A4).

When a signal is derived from a prior identified function, an open arrow \Rightarrow is used, eliminating several blocks of lesser interest to the function being illustrated. Refer to Figure A5. The thought flow is as follows: “State Zero (from the 7200) is processed by several circuits to yield FINSH”.

A.5 INPUT AND OUTPUT PINS

Refer to Figure A2. The pin numbers to most of the blocks appear at the inputs and outputs to aid in troubleshooting.

In the case of multiple elements in one block (B12, C03), pins 9, 10, 11 are the inputs to gate B12 (the topmost location tag) and pin 12 is the output pin of C03 (the bottom location tag).

A.6 FLIP-FLOP INPUTS

There are two types of flip-flops that are represented in the block diagrams: D type (Data) and JK. Both work in conjunction with a CP (Clock Pulse), but they handle input data differently.

D-TYPE FLIP-FLOP — Refer to Figure A6. If SYNC0 (which is applied to the D input) is high, SYNC1 ff is set when OSC occurs at the CP input. If SYNC0 is low when OSC occurs, SYNC1 ff is reset. Thus, with one Data input, a D flip-flop may be set or reset in conjunction with a CP.

The R and S inputs allow the flip-flop to be reset and set directly, without the need of a CP. R and S override efforts to control the flip-flop at the D input.

JK FLIP-FLOP — Refer to Figure A7. The J input is used to set the flip-flop (J high when CP occurs) and the K input is used to reset the flip-flop (K high when CP occurs). When both J and K inputs are high CP causes the flip-flop to toggle (change state). The JK flip-flop also has R and S inputs for resetting and setting directly without the need of a CP.

A.7 MULTIPLE GATING STRUCTURES

Figure A8 shows the scheme used to illustrate a multiple gating function. The inputs shown will be used when it is necessary to show more than one line performing a gating function to any logic element in the system. Note that a multiple AND gate is shown with three inputs enabling the memory function. Also shown is a multiple line address input to the bottom of the block. This configuration will be used to depict a location or address selection within the logic element as specified by an external addressing function. Proper activation of this address will yield the specified location contents at the output of the logic element.

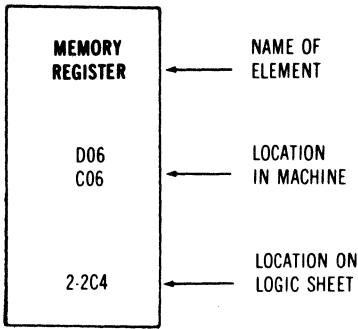

Figure A-1 Block Information

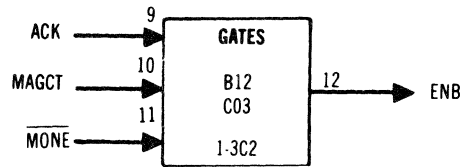

Figure A-2 Input Terms and Connections

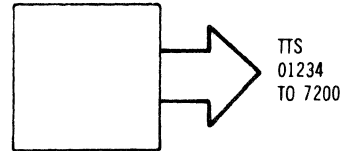

Figure A-4 Multiple Signals

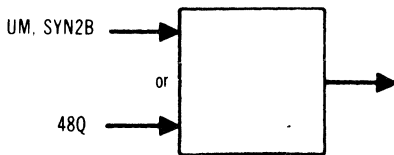

Figure A-3 Input And, OR

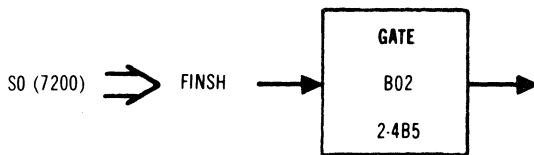

Figure A-5 Multiple Block Inputs

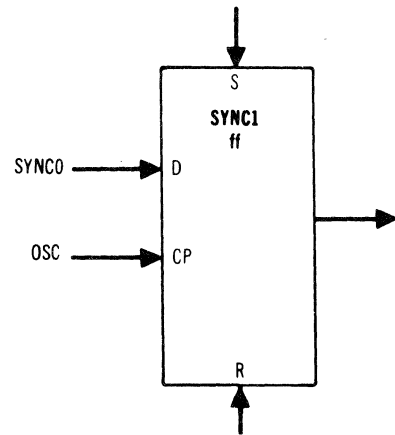

Figure A-6 D-Type Flip-Flop

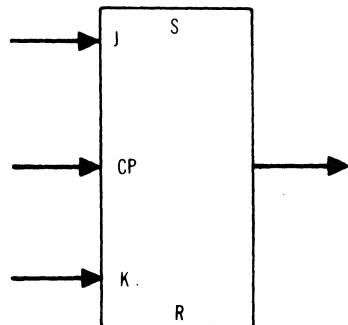

Figure A-7 JK Flip-Flop

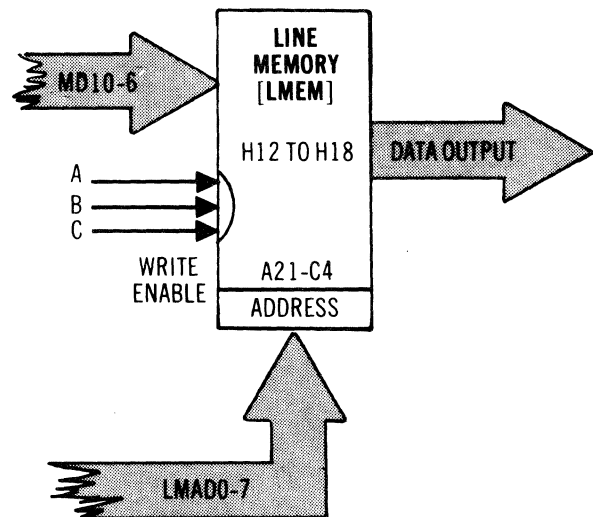
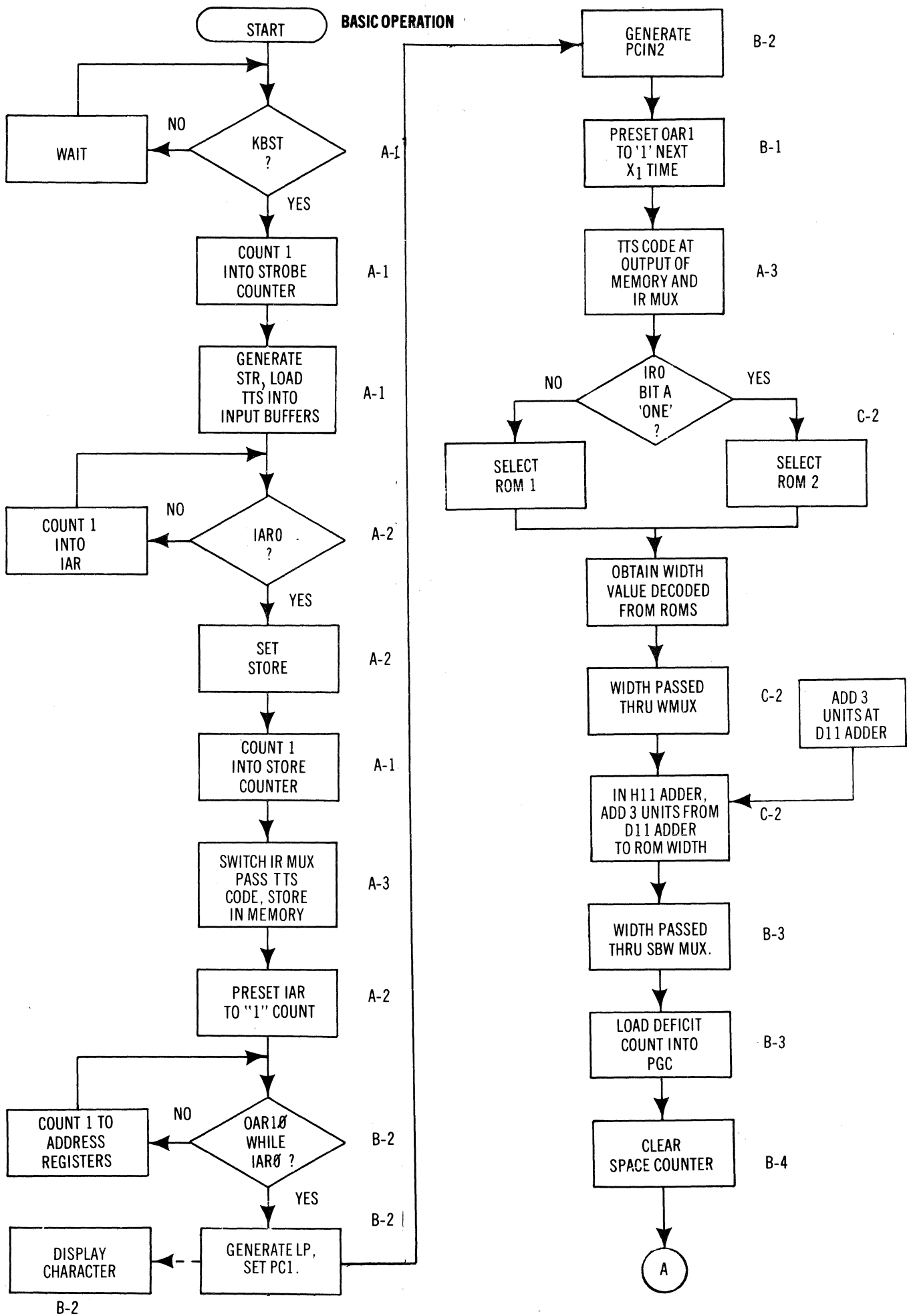

Figure A-8 Multiple Gating Function

APPENDIX B

LOGIC FLOW CHARTS

	Page
BASIC OPERATION	B-2
CHARACTER DISPLAY	B-8
DISPLAY LINE	B-9
CANCEL WORD	B-12
CANCEL CHARACTER	B-13
CANCEL LINE	B-14
INSERT SPACE	B-15
TAPE FEED FOLLOWING IS OR SB	B-16
SHIFT	B-17
RELEASE SHIFT	B-17
NO LEAD/MULTIJUST	B-18
UPPER RAIL	B-19
AUTO LEADER	B-20



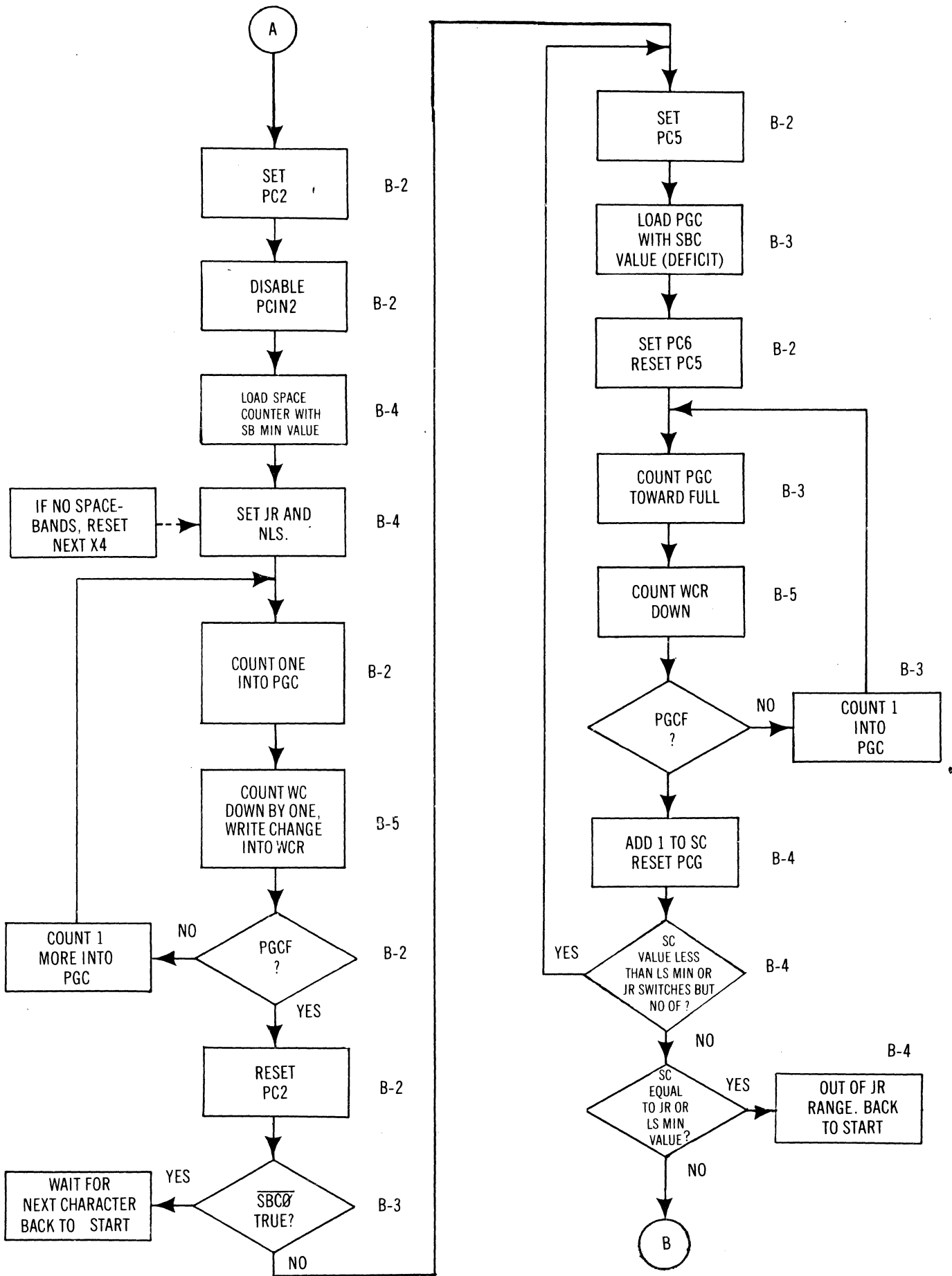

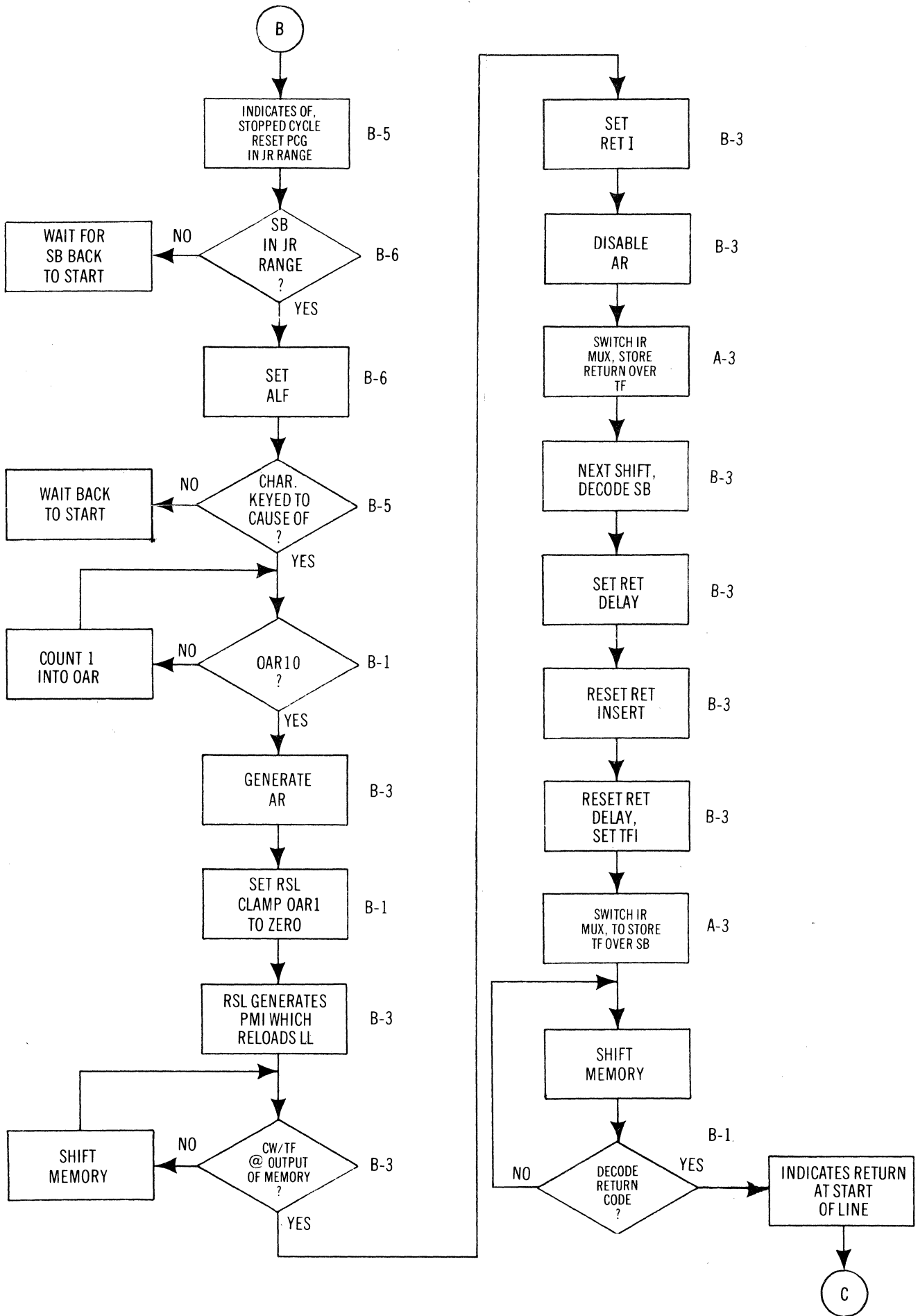

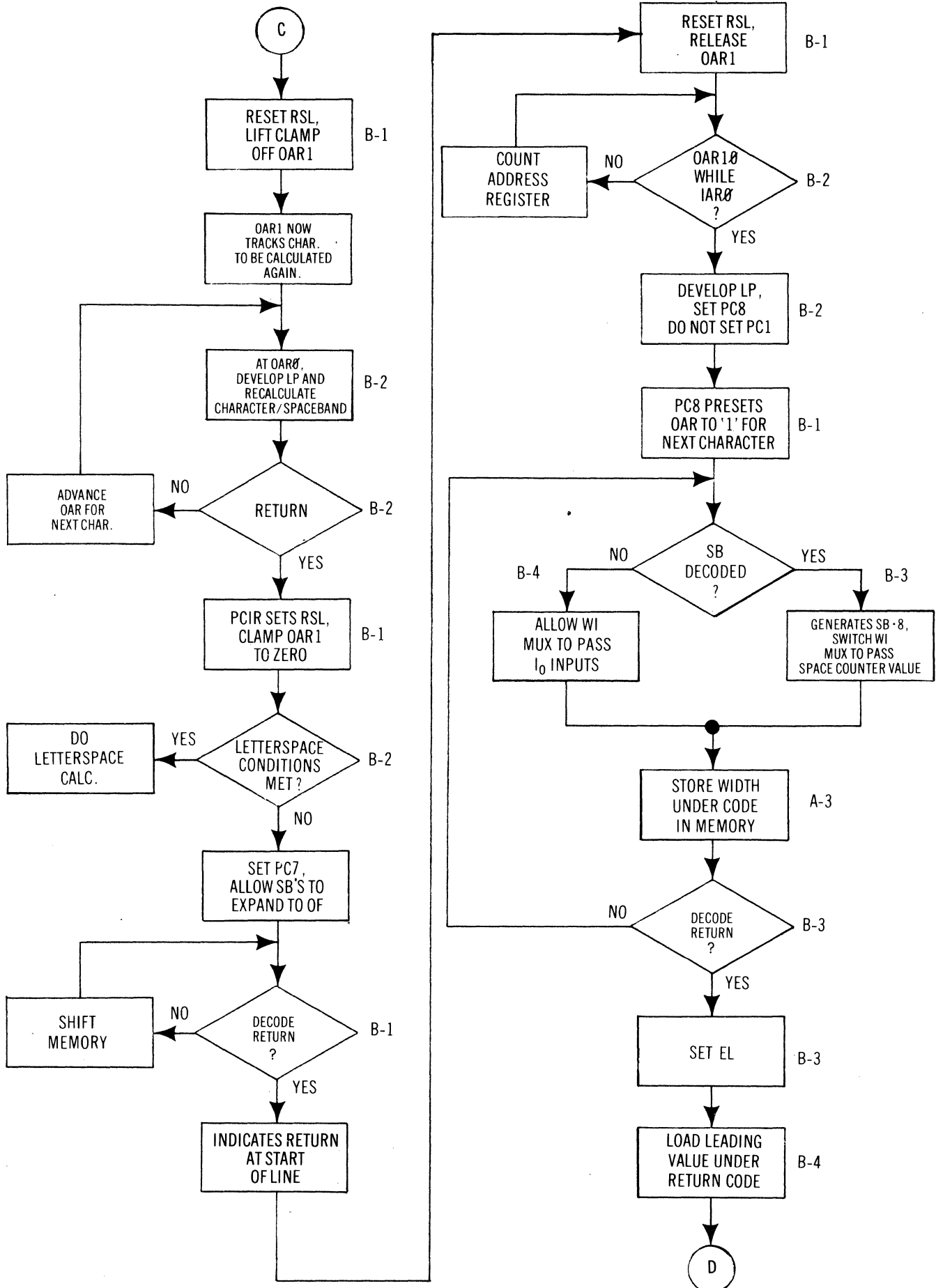

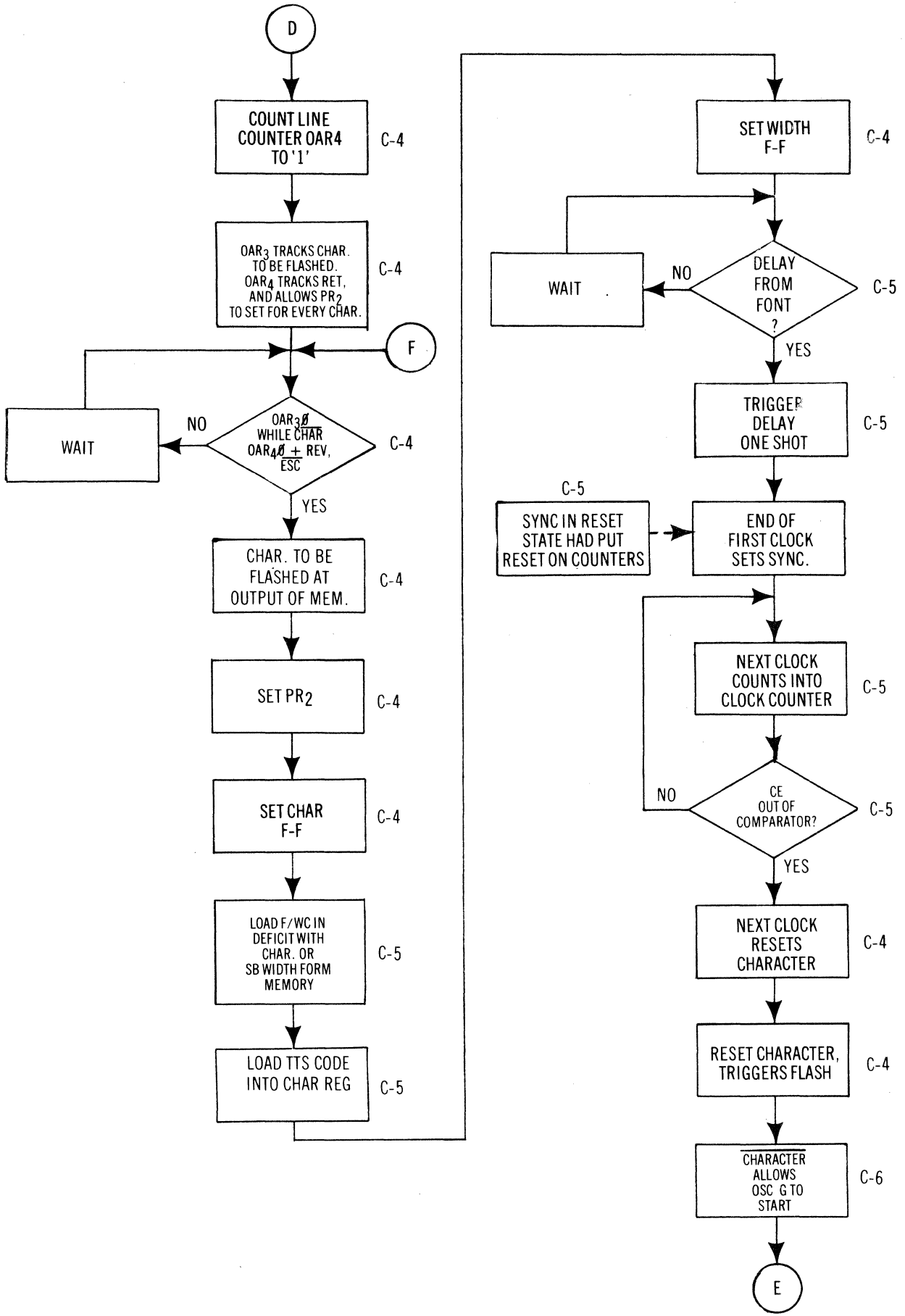

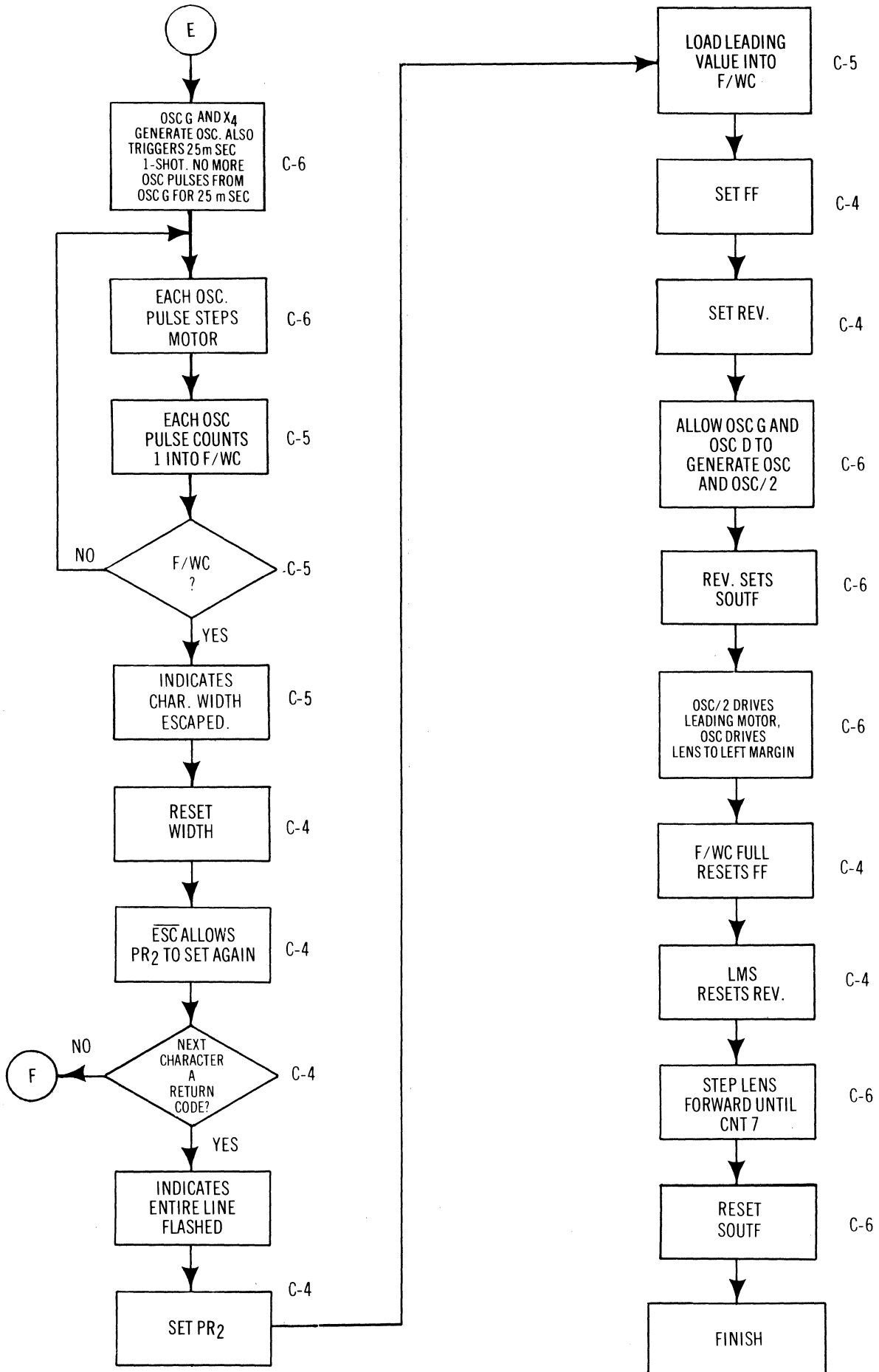

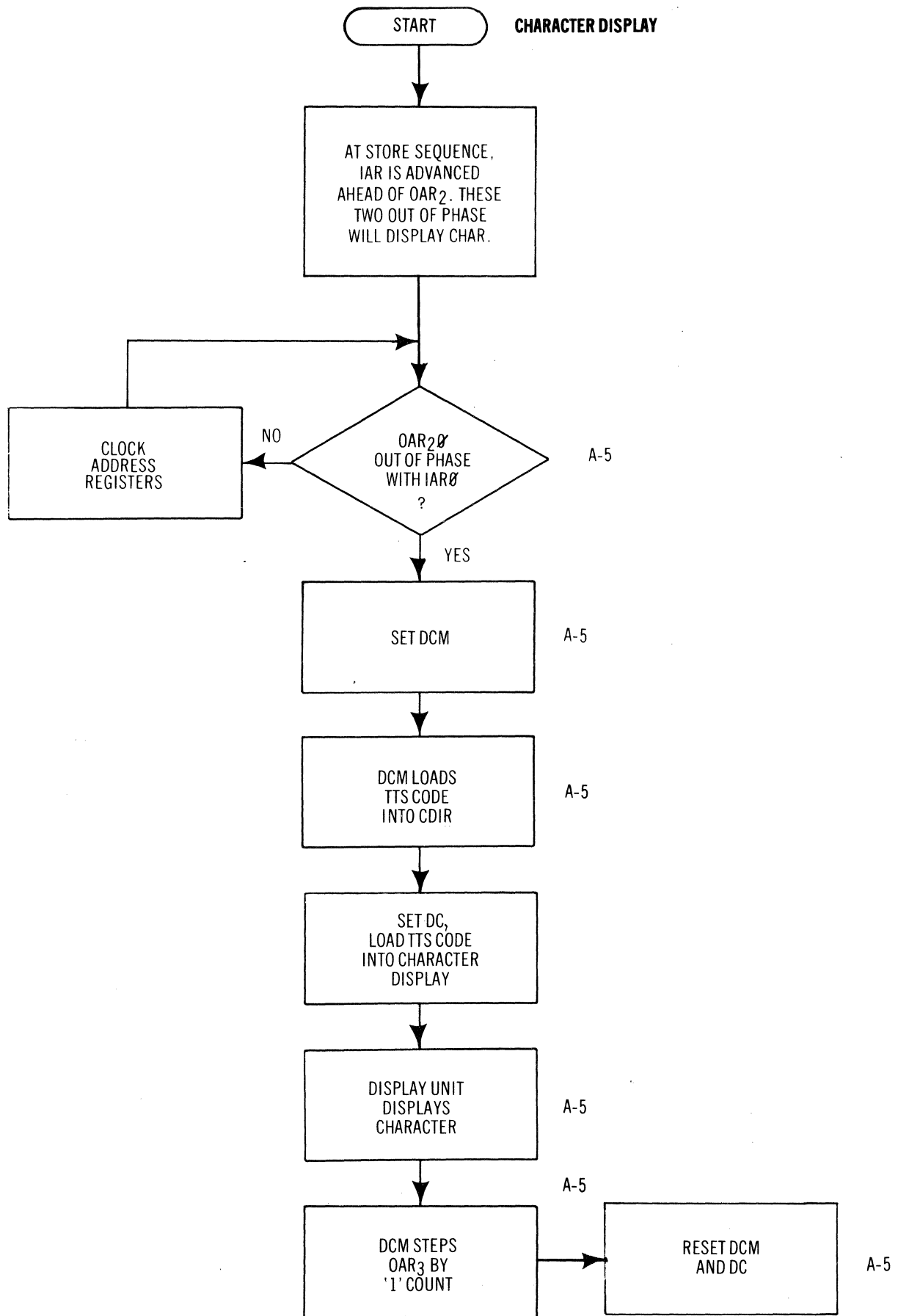

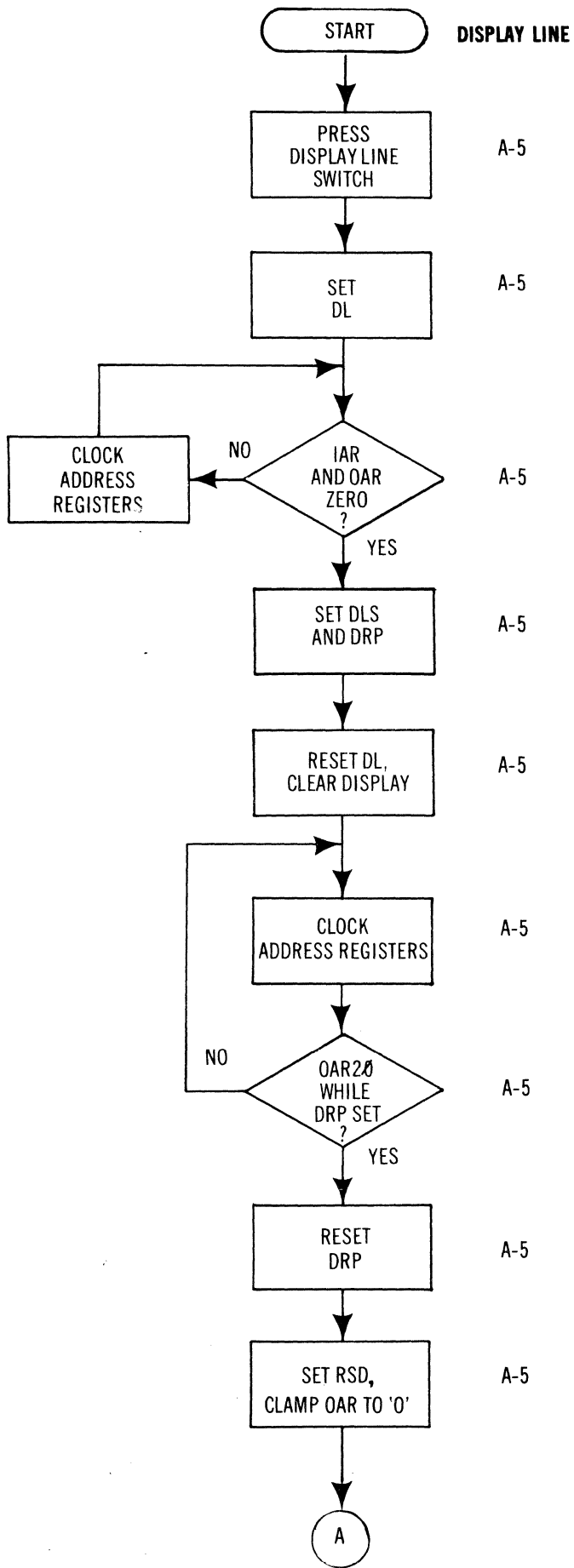

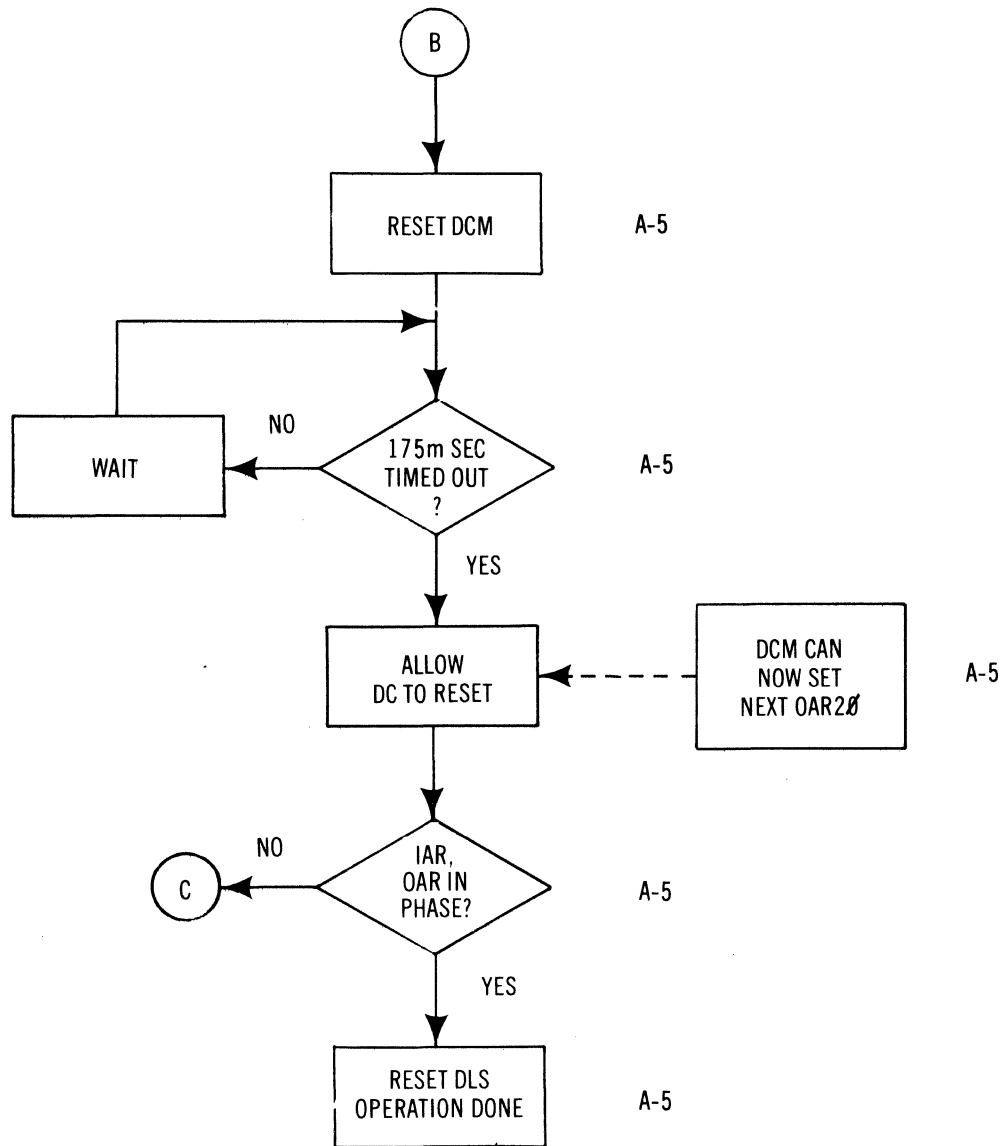

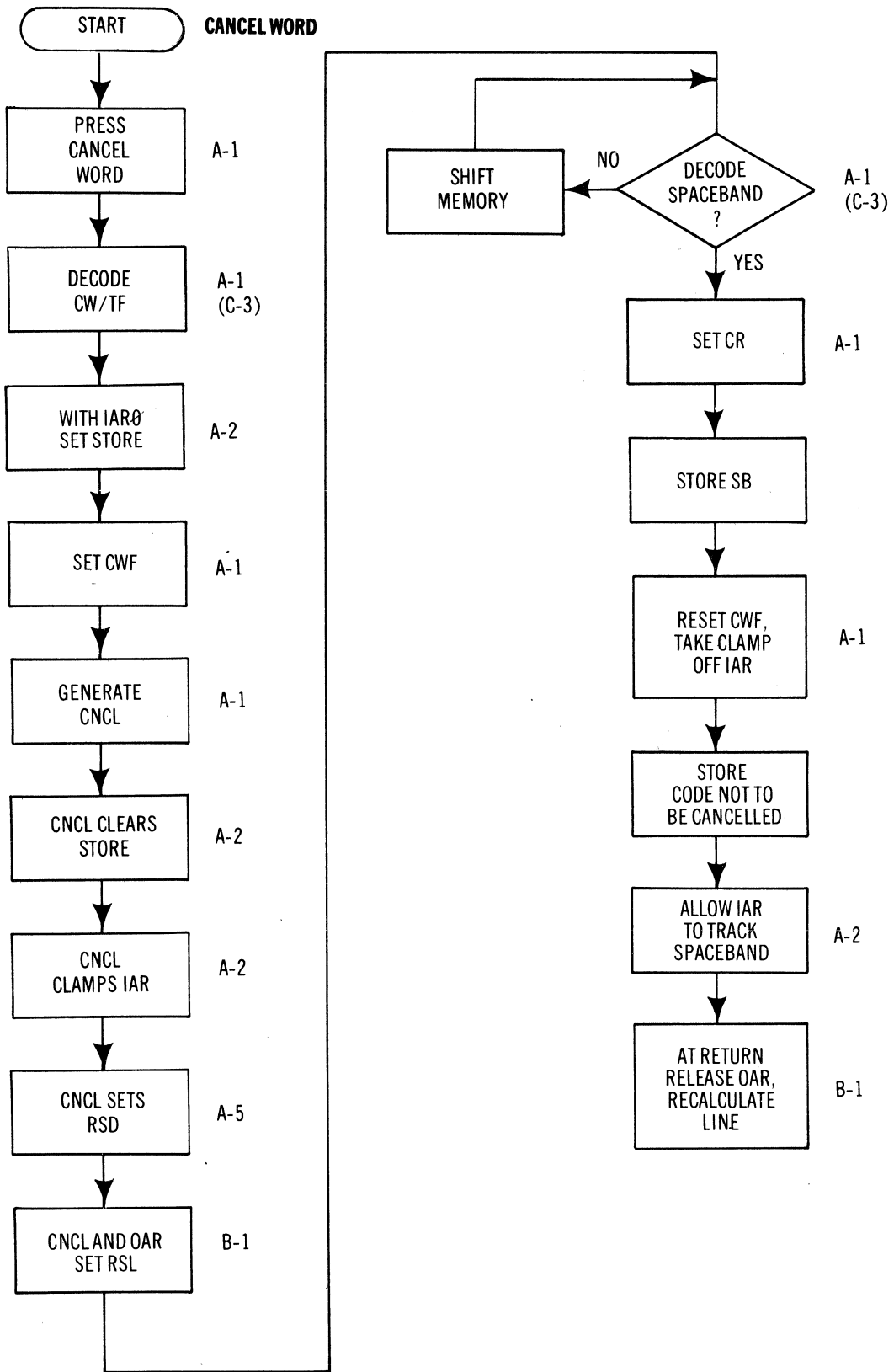

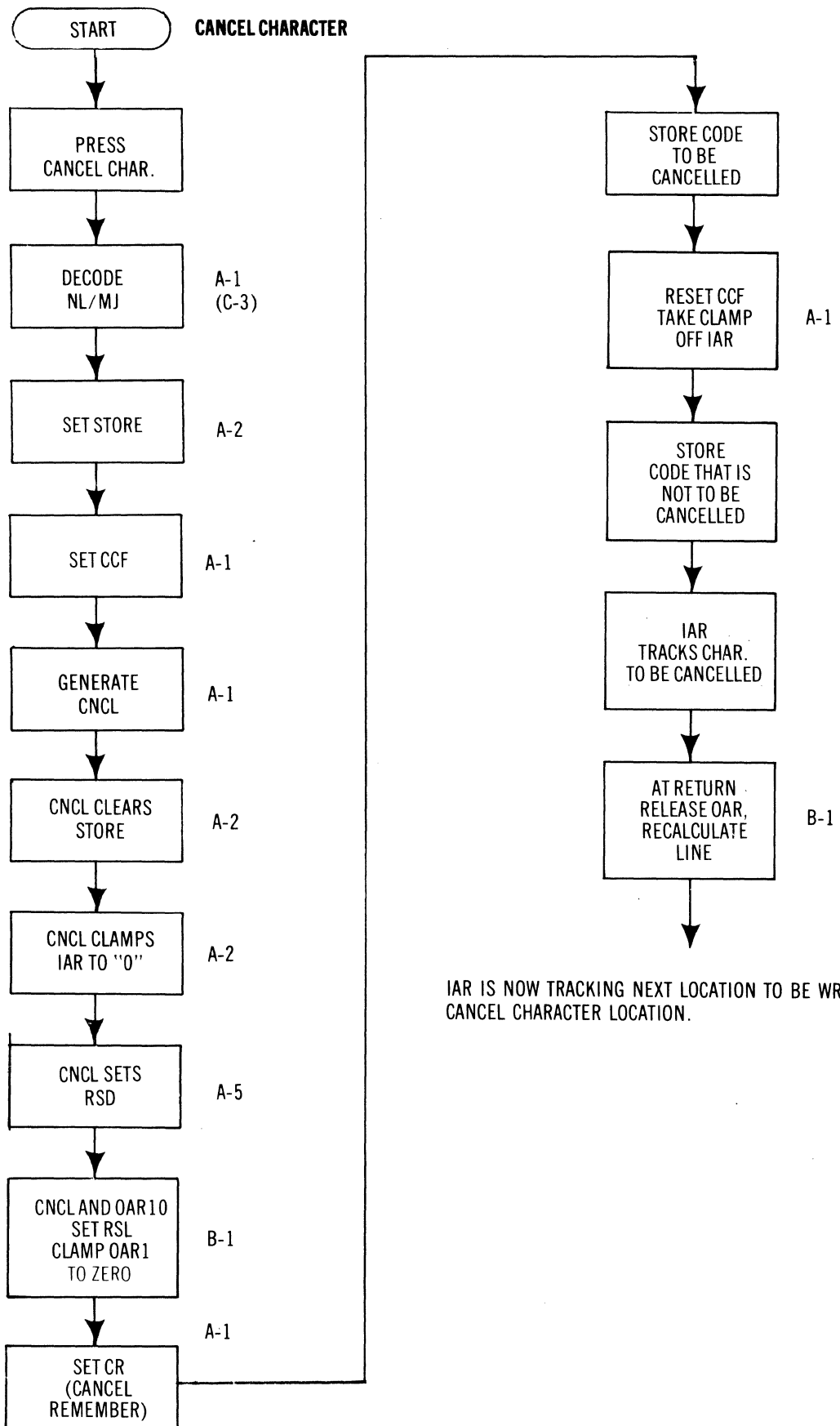

IAR IS NOW TRACKING NEXT LOCATION TO BE WRITTEN INTO, OR CANCEL CHARACTER LOCATION.

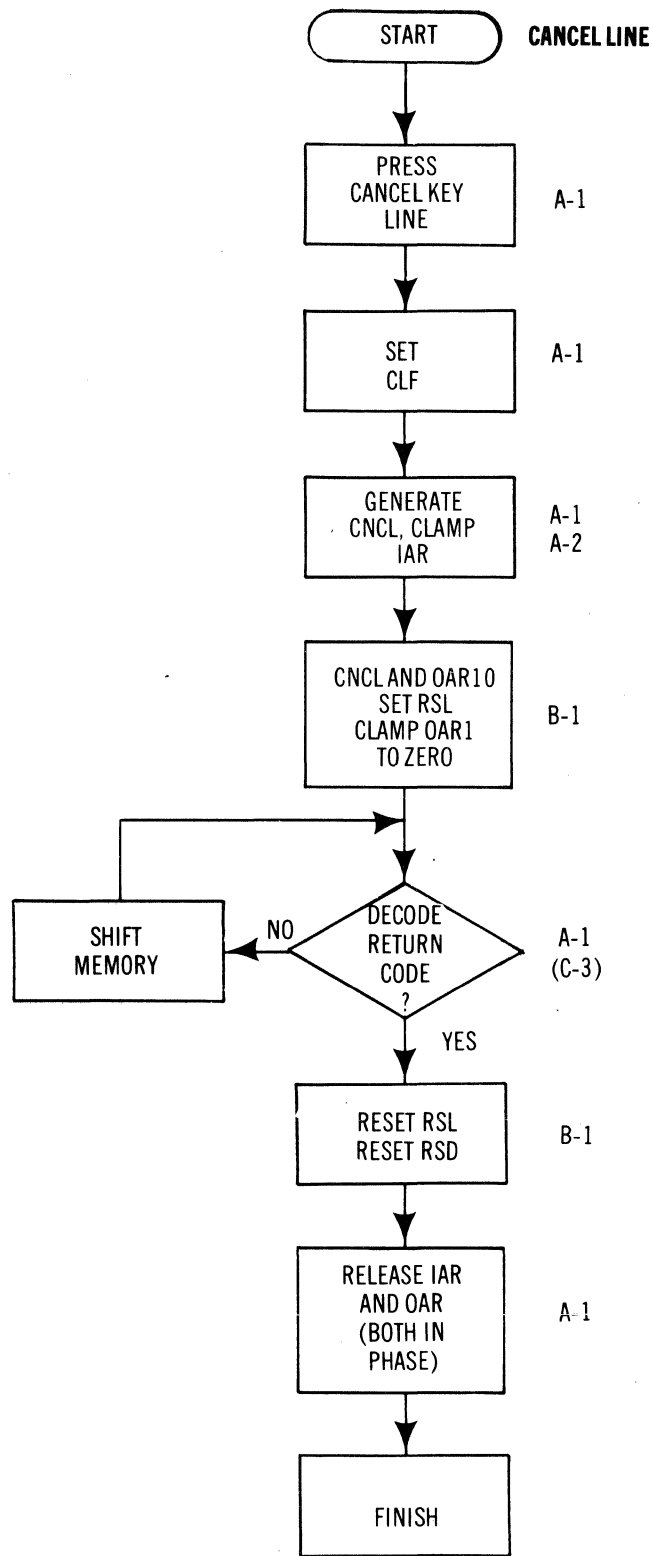

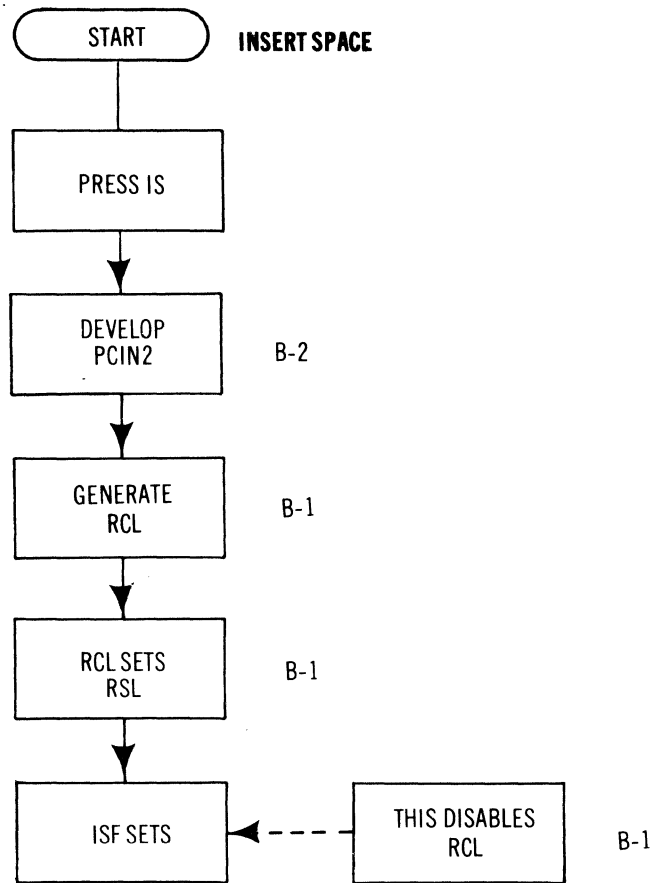

SETTING RSL WILL CAUSE THE LINE TO BE RECALCULATED. HOWEVER, ISF PREVENTS SB'S BEING COUNTED AND NOW SPACEBAND COUNTER COUNTS INSERT SPACE CODES.

ISF ALSO PREVENTS THE SPACE COUNTER FROM BEING LOADED WITH THE SB MIN. VALUE.

ISF PREVENTS SB. 8 FOR SPACEBANDS, INSTEAD SB. 8 IS DEVELOPED FOR IS CODES.

DURING PC8, SB GETS VALUE FROM SB MIN. SWITCHES.

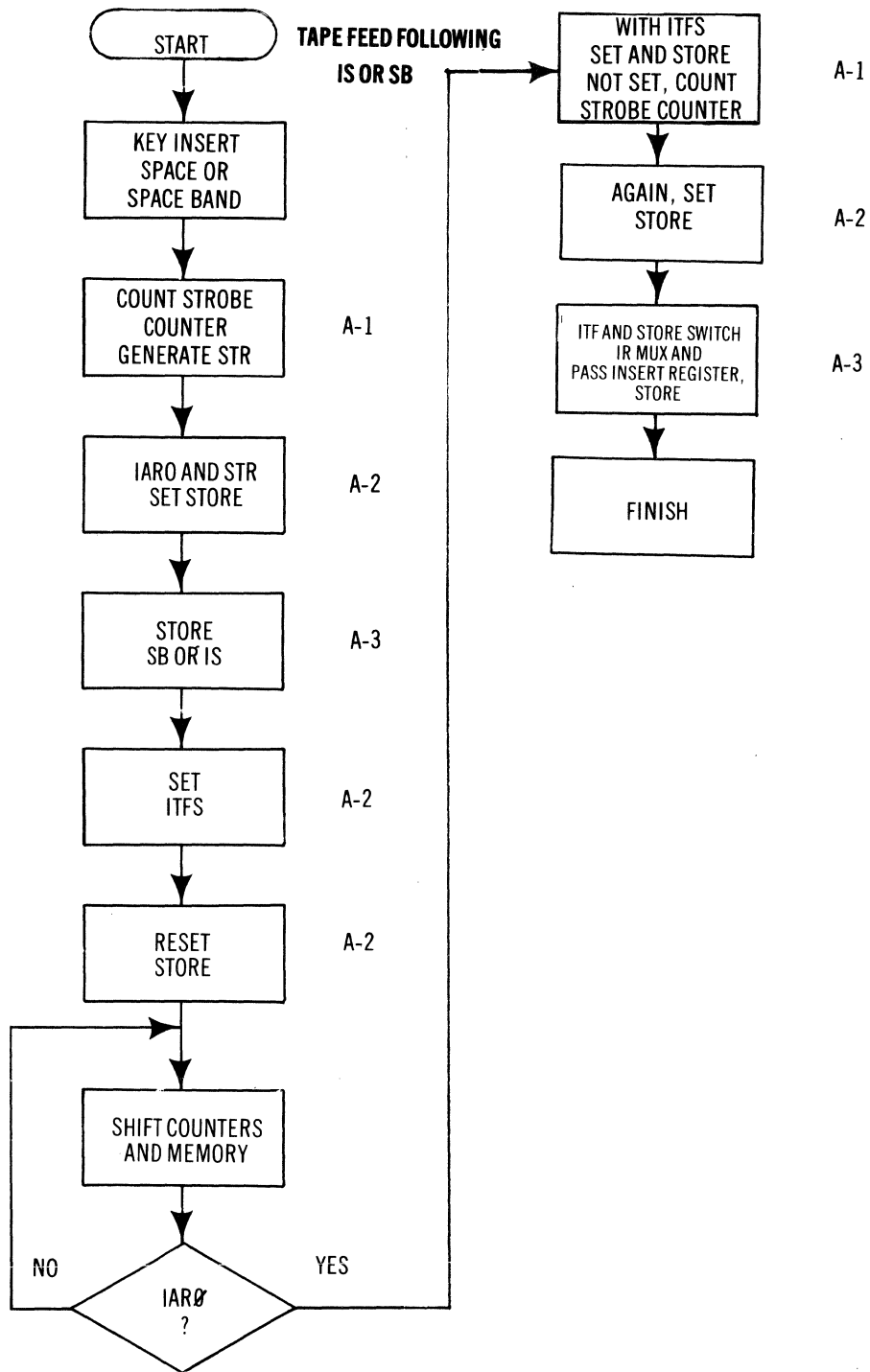

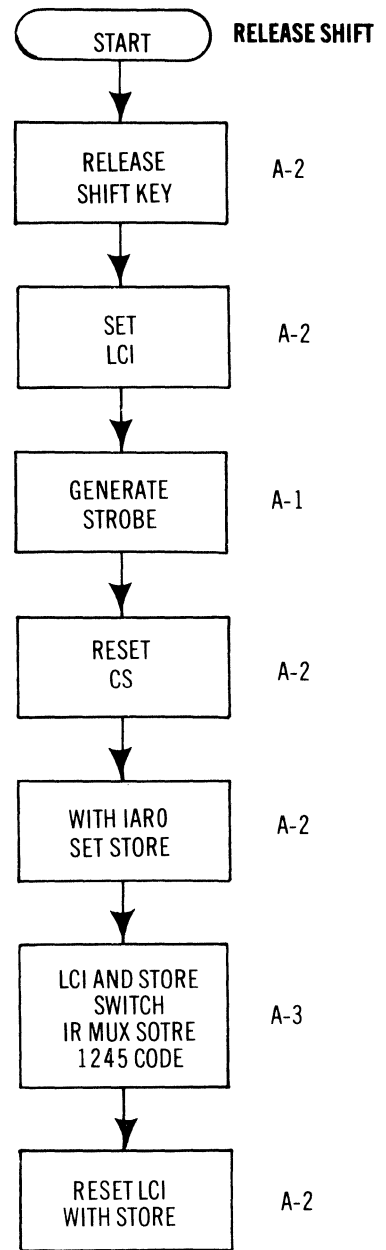
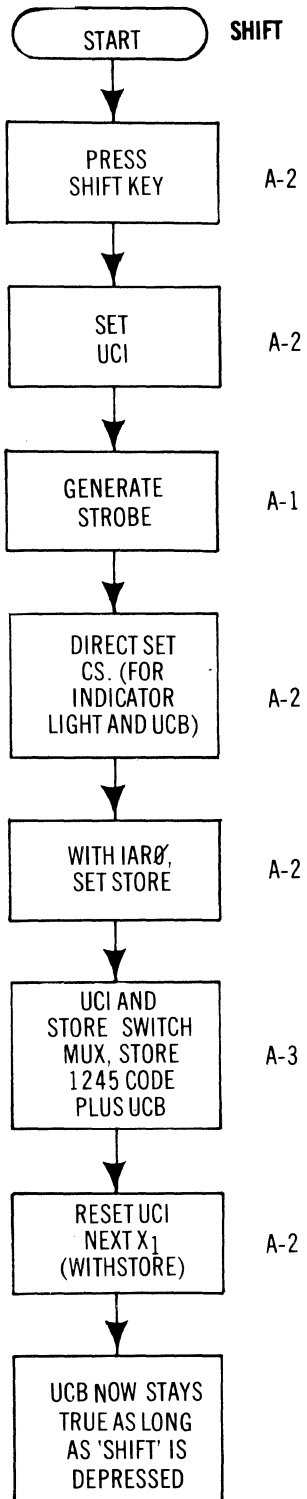

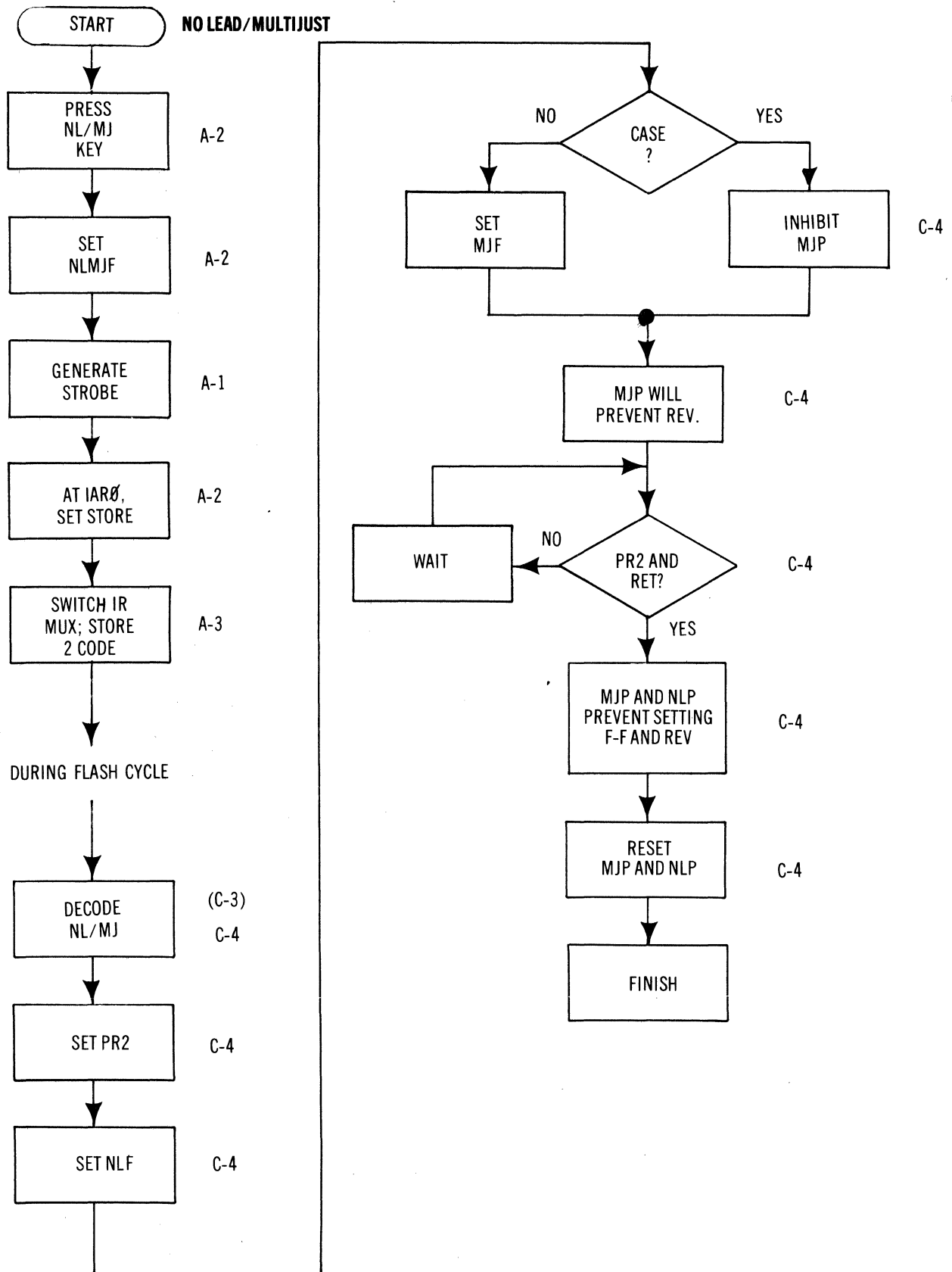

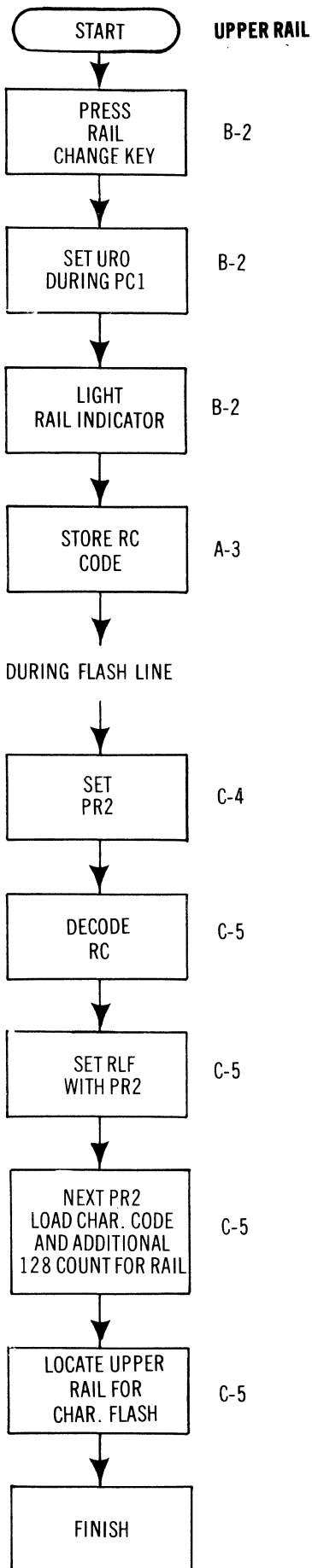

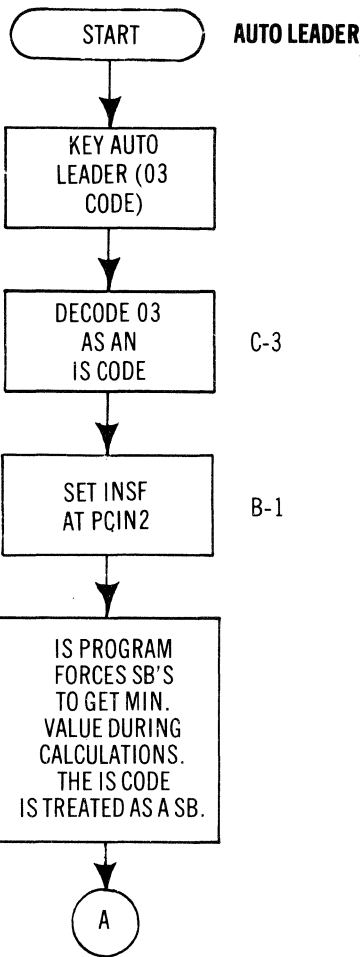

AFTER THE MACHINE HAS CALCULATED ALL CHARACTERS AND WIDTHS, THE PC8 CYCLE LOADS WIDTHS IN MEMORY. UP TO THIS POINT, THE MACHINE FUNCTIONS AS IF AN INSERT HAD BEEN KEYED. THE ONLY DIFFERENCE IS THAT THE WIDTH OF THE IS IS LOADED UNDER A SUPER SHIFT CODE. THIS 'IS' CODE HAS THE WIDTH REQUIRED FOR LEADERS. DONE, THE LOGIC PLACES A TF AFTER THE CODE. BEFORE THE FLASH CYCLE, MEMORY WOULD APPEAR AS THIS:

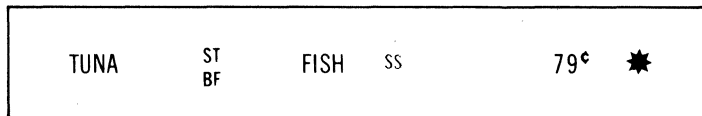

NOTE THAT LEADERS
ARE NOT PLACED IN MEMORY

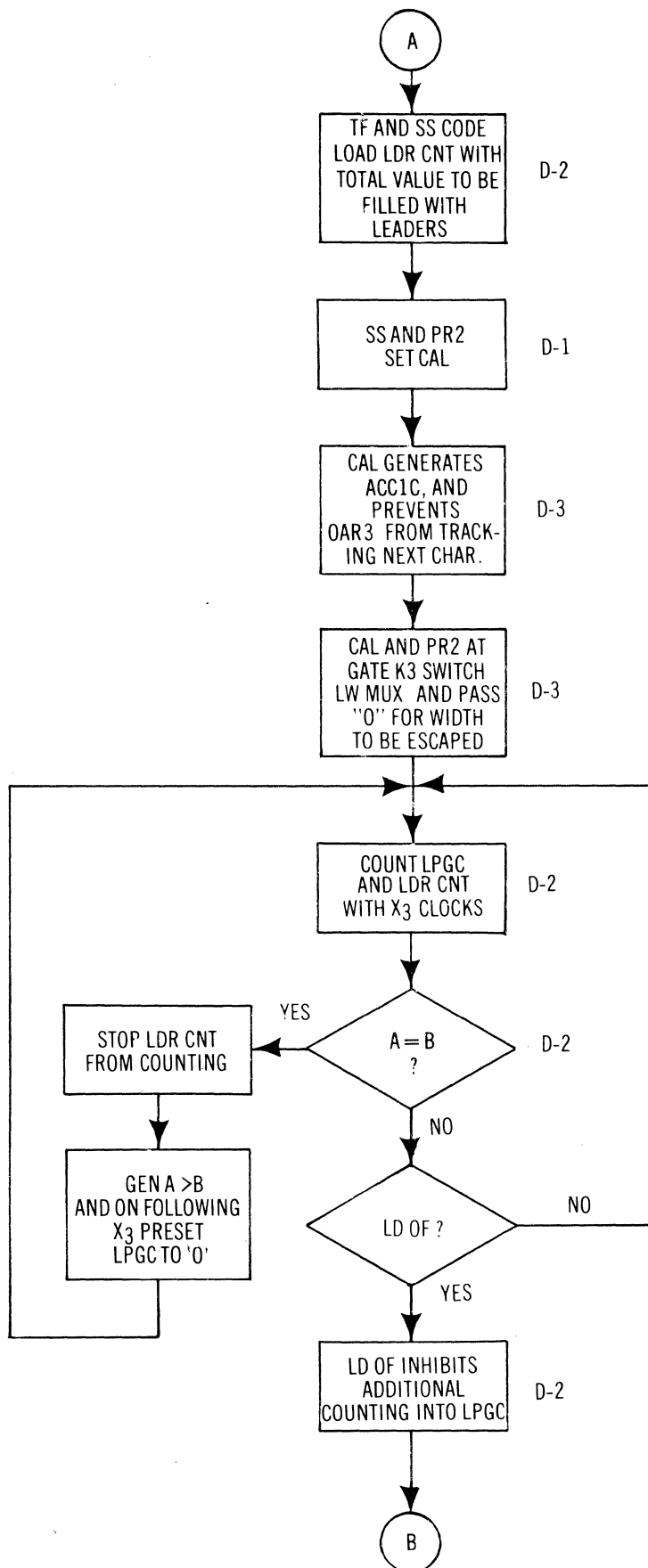

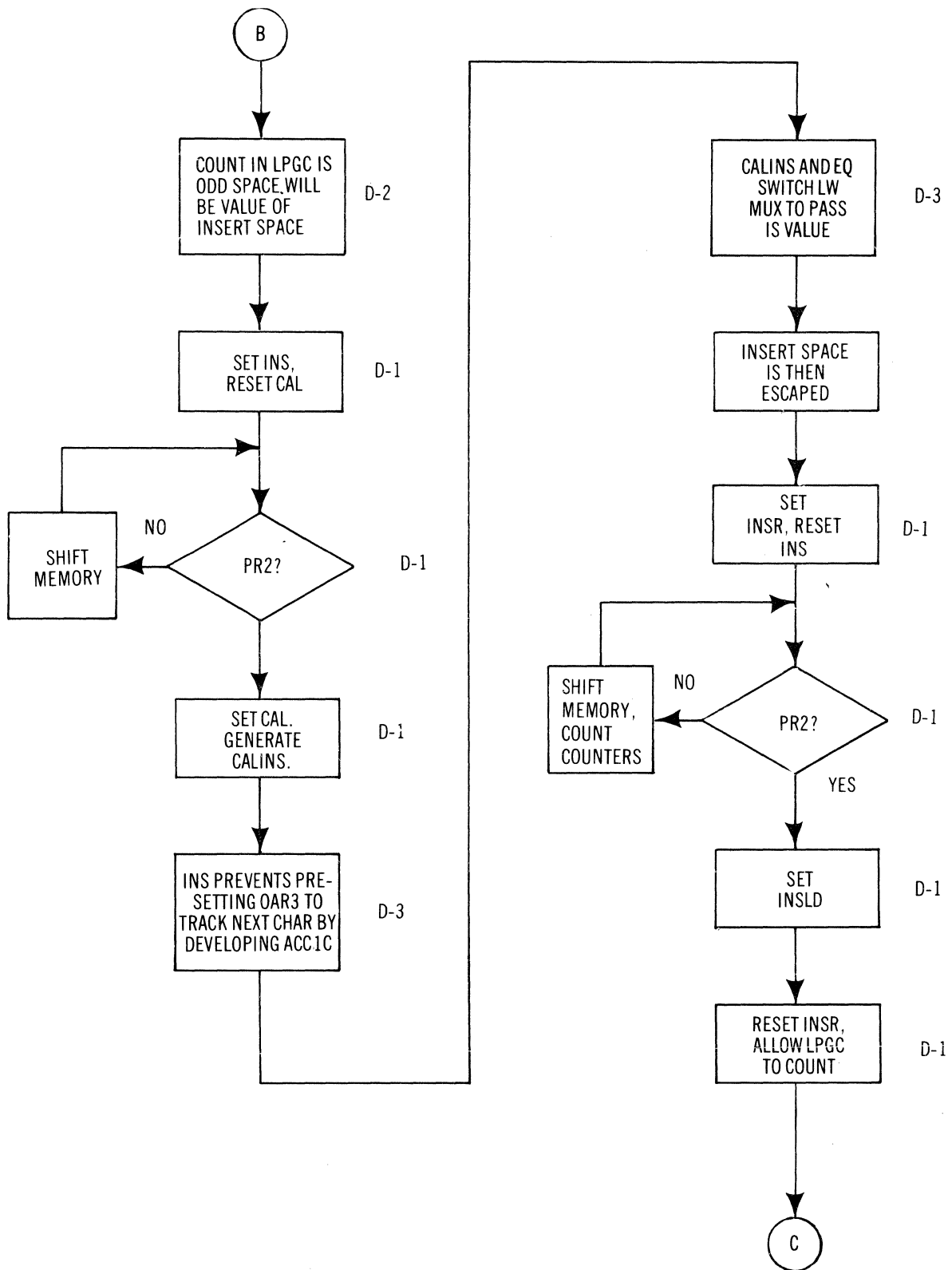

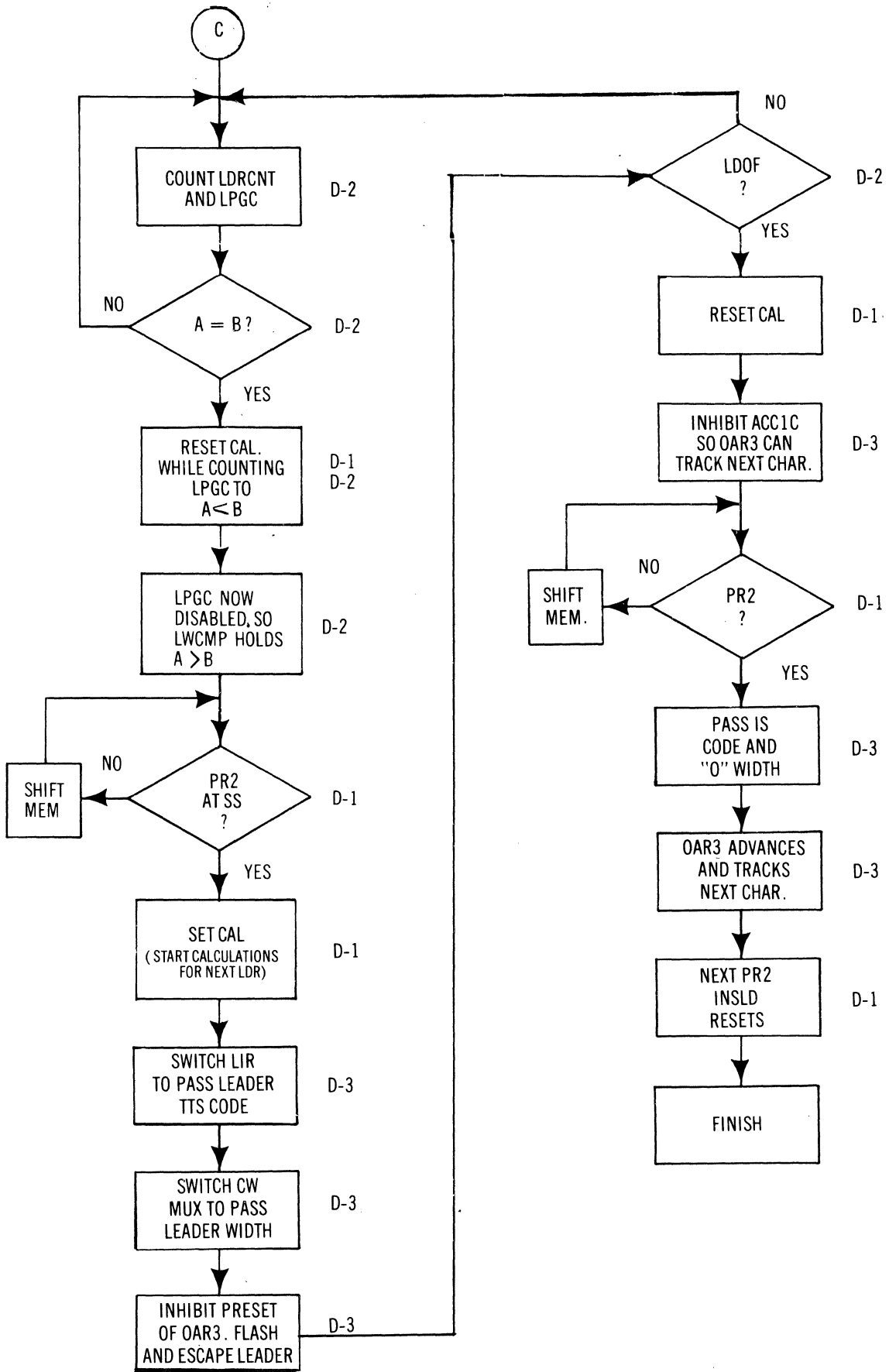

Compugraphic Field Service District Offices

<p>Compugraphic Corporation North Atlantic Service District 65 Industrial Way Wilmington, MA 01887 Phone 617-658-5000</p>	<p>Compugraphic Corporation Pacific Service District 2908 G Oregon Court Torrance, CA 90503 Phone 213-320-6440</p>
<p>Compugraphic Corporation New York Service District Suite 1888 2 Penn Plaza New York, New York 10001 Phone 212-594-8540</p>	<p>Compugraphic Corporation Northwest Service District Centennial Building 25 102nd Ave., N.E. Bellevue, WA 98004 Phone 206-454-5015</p>
<p>Compugraphic Corporation Mid-Atlantic Service District 1901 No. Moore Street Rosslyn, VA 22209 Phone 703-525-1740</p>	<p>Compugraphic Corporation Midwest Service District Suite 106 4th & State Streets 2 Gateway Center Kansas City, KS 66101 Phone 913-371-0200</p>
<p>Compugraphic Corporation South Atlantic Service District 2627 Lantrac Court Decatur, GA 30032 Phone 404-981-9100</p>	<p>Compugraphic Corporation Southwest Service District Suite 407 Carillon Tower East 13601 Preston Road Dallas, TX 75240 Phone 214-661-8940</p>
<p align="center">Compugraphic Corporation Central Service District Midwest Distribution 527 West Golf Road Arlington Heights, IL 60005 Phone 312-640-1330</p>	

COMPUWRITER, COMPUWRITER JR. AND COMPUWRITER INTERNATIONAL PARTS CATALOG

Serial Numbers 4000 and Above

INDEX

Description	Page
Instructions For Ordering	2
Basic System	3
Control Panel Assembly	4
Font Drive Assembly	6
Logic and Cooling Assemblies	7
Paper Feed Assembly	8
Photo Unit	10
Power Supply Assembly	12
Twin Lens Carriage Assembly	14
Width Card Connector Assembly	15
IC Chip Reference Chart	16

INSTRUCTIONS FOR ORDERING

To order a part whether by phone, teletype, or mail, specify the following:

- Compugraphic part number and description of part.
For IC chips, include board number and chip location.
- Quantity of each item being ordered.
- Model number of unit for which part is being ordered.
- Serial number of unit for which part is being ordered.
- Corporate name of firm.
- Shipping Address of firm, including ZIP code.
- Full name of person ordering part(s).
- To whose attention the part(s) should be sent.
- Customer purchase order number, if any.
- Any specific shipping methods required by customer.

ORDERS, U.S. AND CANADA

To order replacement parts, with the exception of fonts, width plugs, width cards, keyboard PROM cards, set gears, or pulleys, address orders to:

COMPUGRAPHIC CORPORATION
ATT: SERVICE PARTS DEPT.
65 INDUSTRIAL WAY
WILMINGTON, MA 01887
TELEPHONE (617) 658-5008

To order fonts, width plugs, width cards, keyboard PROM cards, set gears, or pulleys contact your Regional Sales Office or:

COMPUGRAPHIC CORPORATION
ATT: TYPE DIVISION
66 CONCORD ST.
WILMINGTON, MA 01887
TELEPHONE (617) 944-6555

For rapid service on fonts and associated hardware customers can use Telefont by calling (617) 944-6555 exts. 460 or 652. There is a 20 % surcharge on Telefont orders.

ORDERS OUTSIDE U.S. AND CANADA

Address orders to dealer where the equipment was purchased.

INSTRUCTIONS FOR RETURNING DEFECTIVE PARTS

RETURNS, U.S. AND CANADA

To return defective parts other than fonts, width plugs, width cards, keyboard PROM cards, set gears or pulleys, proceed as follows:

- Package each part with a completed Returned Goods Credit/Replacement Request form or a letter explaining why the part is being returned and the action Compugraphic is expected to take. Be sure to identify Model and Serial No. of equipment from which the defective part was removed (particularly necessary for warranty items). Also, include the following address information:
 - Corporate name of equipment owner
 - Shipping address of firm returning the part
 - To whose attention a replacement part is to be sent
- Send part with requested information **prepaid** to:

COMPUGRAPHIC CORPORATION
ATT: SERVICE RETURNED GOODS DEPARTMENT
65 INDUSTRIAL WAY
WILMINGTON, MA 01887
TELEPHONE (617) 944-6555 EXT. 332

To return fonts, width plugs, width cards, keyboard PROM cards, set gears or pulleys, proceed as follows:

- Before returning item, contact Type Division Returned Goods Department either by letter or phone (see address and phone number below) describing the problem with the part and requesting instructions. This step is important as it will provide the quickest resolution of a type problem.
- When instructions are received to return an item, proceed as instructed being sure to include all requested information, samples of copy, etc.
- Address inquiries and return of type parts to:

COMPUGRAPHIC CORPORATION
ATT: TYPE DIVISION RETURNED GOODS DEPARTMENT
66 CONCORD STREET
WILMINGTON, MA 01887
TELEPHONE (617) 944-6555 EXT. 470

RETURNS OUTSIDE U.S. AND CANADA

For returns outside U.S. and Canada, contact dealer where equipment was purchased.

BASIC SYSTEM

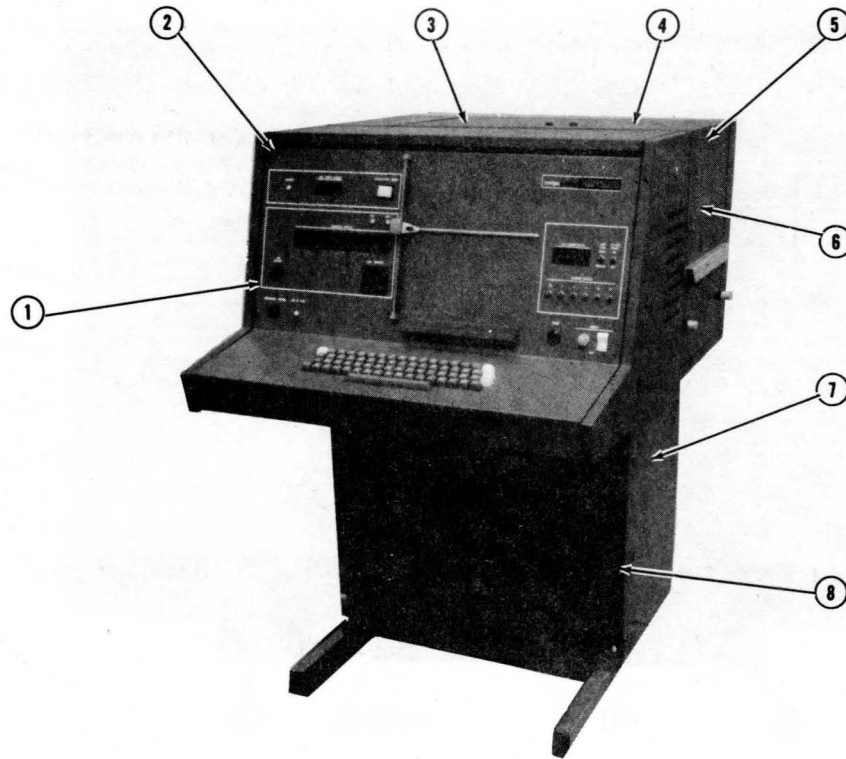

ILLUSTRATION REFERENCE	PART NO.	DESCRIPTION	SCHEMATIC REFERENCE	COMMENTS
1		Paper Feed Assembly		
2		Control Panel Assembly		
3		Twin Lens Carriage Assembly		
4		Font Drive Assembly		
5		Width Card Connector Assembly		
6		Photo Unit		
7		Logic and Cooling Assemblies		
8		Power Supply Assembly		

CONTROL PANEL ASSEMBLY [Front and Rear]

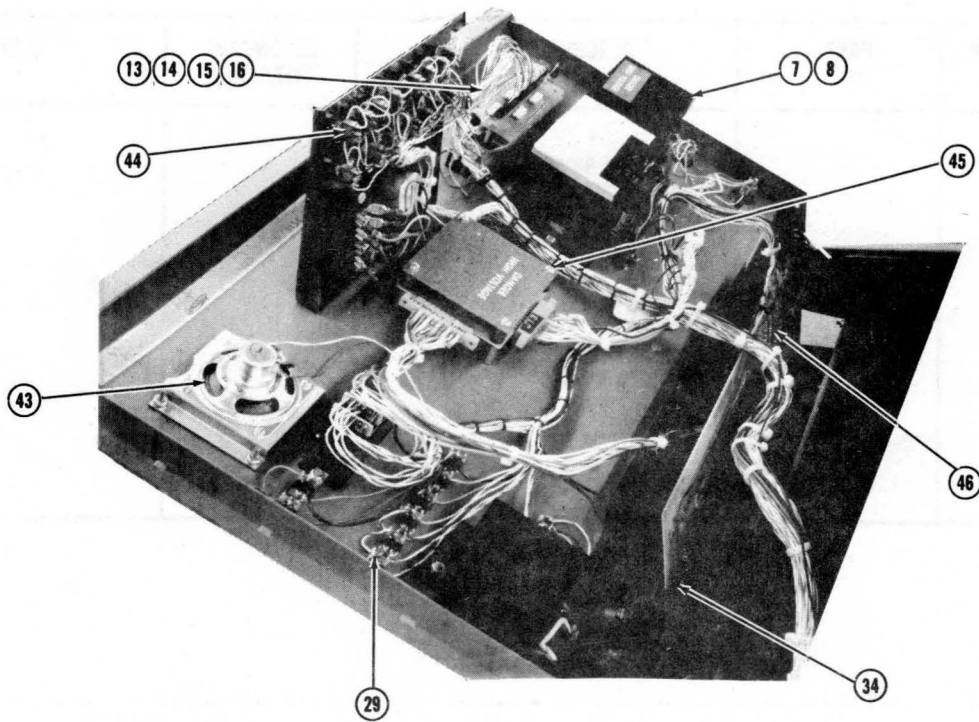
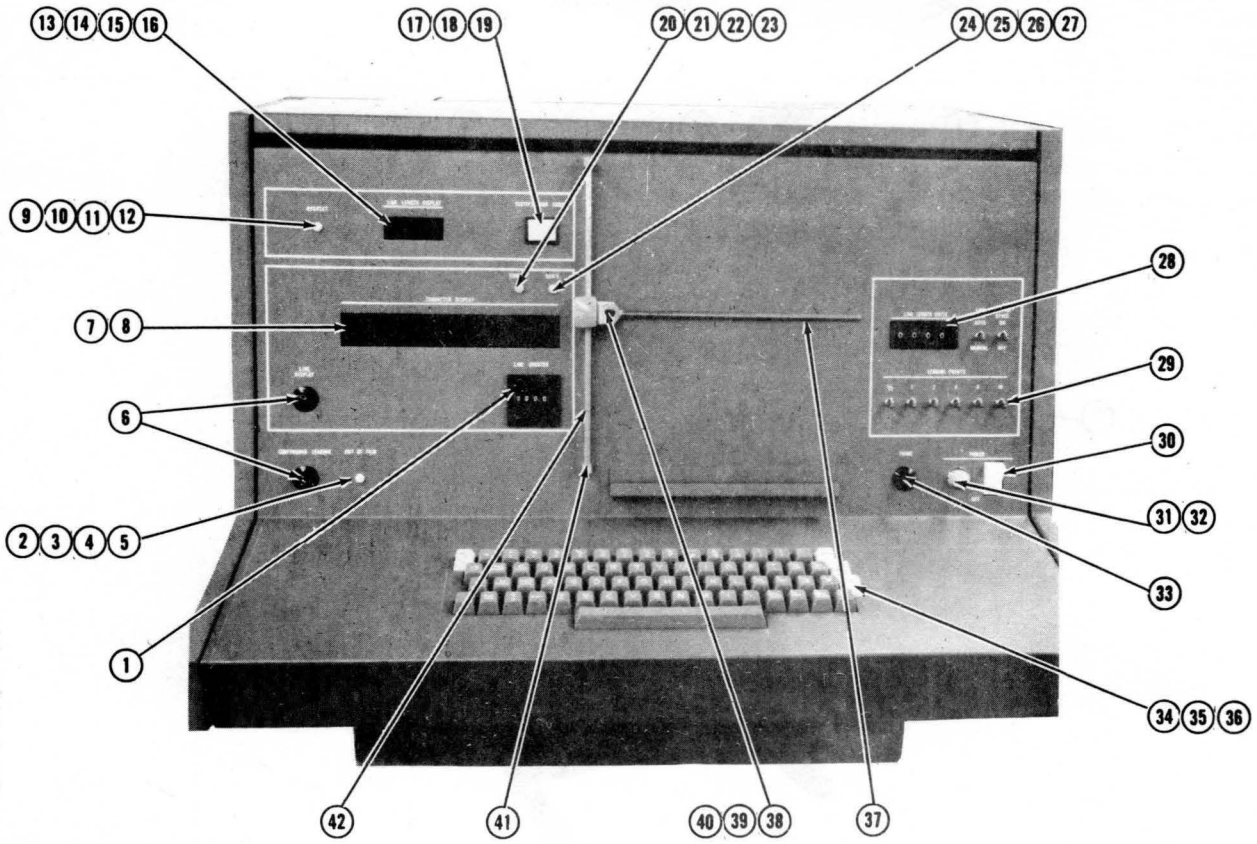

ILLUSTRATION REFERENCE	PART NO.	DESCRIPTION	SCHEMATIC REFERENCE	COMMENTS
1	53949-002	Line Counter		
2	57101-001	C Light White		
3	54192-001	Socket Holder		
4	54188-001	Lamp Socket Clip		
5	54187-001	Rubber Washer		
6	53434-001	Push Button Switch		
7	56194-001	Alphanumeric Display		
8	56144-001	Alphanumeric Display		CompuWriter International Only
9	57101-001	C Light (white)		
10	54192-001	Socket Holder		
11	54188-001	Lamp Socket Clip		
12	54187-001	Rubber Washer		
13	29024-501	P.C. Board Assembly		
14	31504-503	P.C. Board Assembly		
15	32265-001	None Glare Window		
16	51646-001	Nylon Washer		2 Each
17	50361-001	#327 Lamp		
18	54189-001	Push Button Cap		
19	54190-001	Indicator Base		
20	57101-002	C Light (Yellow)		
21	54192-001	Socket Holder		
22	54188-001	Lamp Socket Clip		
23	54187-001	Rubber Washer		
24	57101-001	C Light (White)		
25	54192-001	Socket Holder		
26	54188-001	Lamp Socket Clip		
27	54187-001	Rubber Washer		
28	54191-001	Thumbwheel Switch		
29	52086-001	Toggle Switch		Typical 8 Places
30	54342-001	Power Switch		
31	51434-002	Neon Lamp		
32	54325-001	Indicator Assembly		Less Lamp
33	53434-001	Push Button Switch		
34	54447-003	Keyboard Assembly		
35	54441-001	Keyswitch (1 SW11R)		
36	54825-001	Keyswitch (1 SW 17R)		
37	32196-001	Line Guide		
38	54346-001	Knob		
39	54347-001	Spring		
40	54348-001	Bushing		
41	54344-001	Rod Mount		2 Each.
42	19285-001	Rod		
43	17364-502	Speaker Assembly		
	54125-001	Speaker Only		
	50237-001	Diode Only		
44	52086-001	Toggle Switch		Typical 15 Places
45	26449-501	Display Interface (Less ROM's)		CompuWriter International Only
46	32209-501	Logic Interface Board		

FONT DRIVE ASSEMBLY

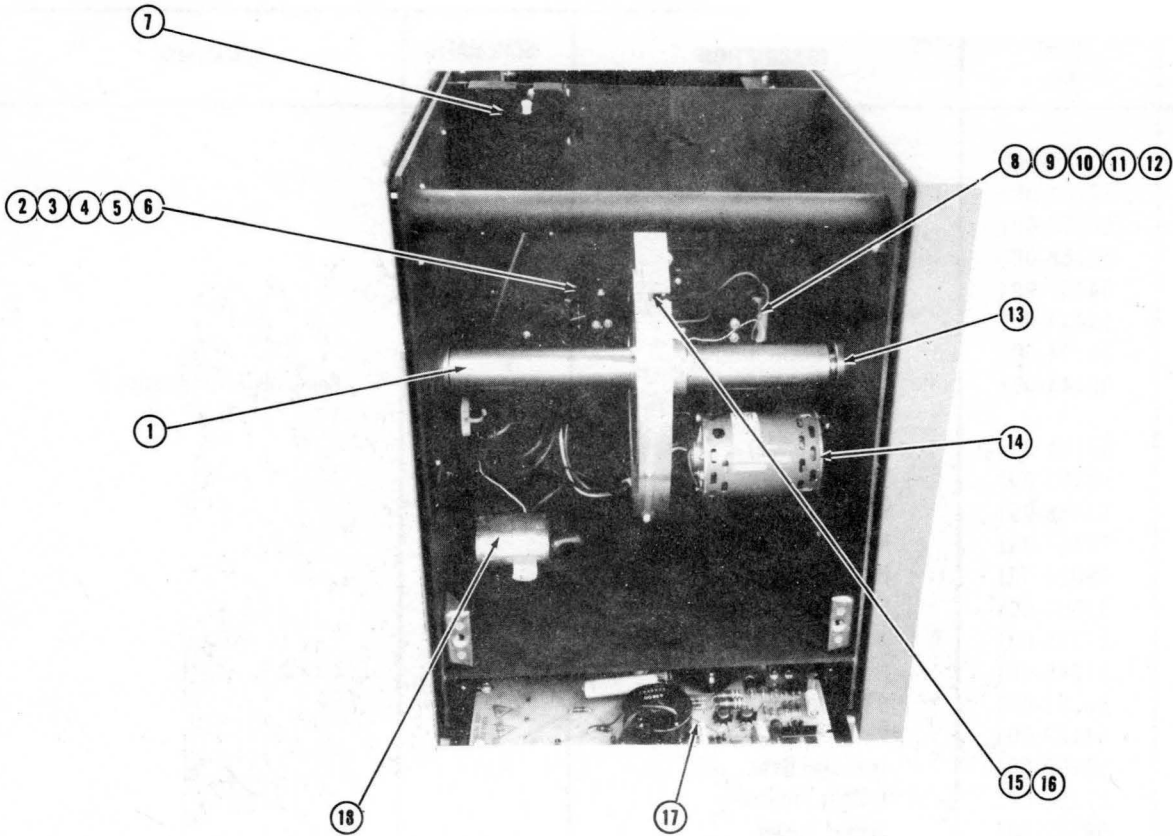

ILLUSTRATION REFERENCE	PART NO.	DESCRIPTION	SCHEMATIC REFERENCE	COMMENTS
1	56386-001	Font Shaft Bearing		
2	34317-001	Exciter Lamp Assembly		
	52695-001	Exciter Lamp (CM 20-3)		Use for Replacement
	90116-001	Plastic Tubing		
	56418-001	Lug		2 Each
3	56288-001	Set Screw		
4	27821-001	Rubber Cushion		
5	53601-001	Photo Transistor (LS 4030)		
6	14595-001	Timing Mask		
7	57102-001	Interlock Switch		
8	52526-002	Flash Lamp (FX 189)		
9	54146-001	Trigger Module		
10	19336-501	Condensing Lens		
11	53897-001	Nylon Screw		
12	57600-001	Capacitor		
13	56386-001	Font Shaft Bearing		
14	56387-001	Font Drum Motor		
15	26466-001	Font Drum and Shaft Assembly		
16	14198-501	Font Retainer Spring		
17	29051.501	H.V. Power Supply		
18	56260-001	Starting Capacitor		

LOGIC AND COOLING ASSEMBLIES

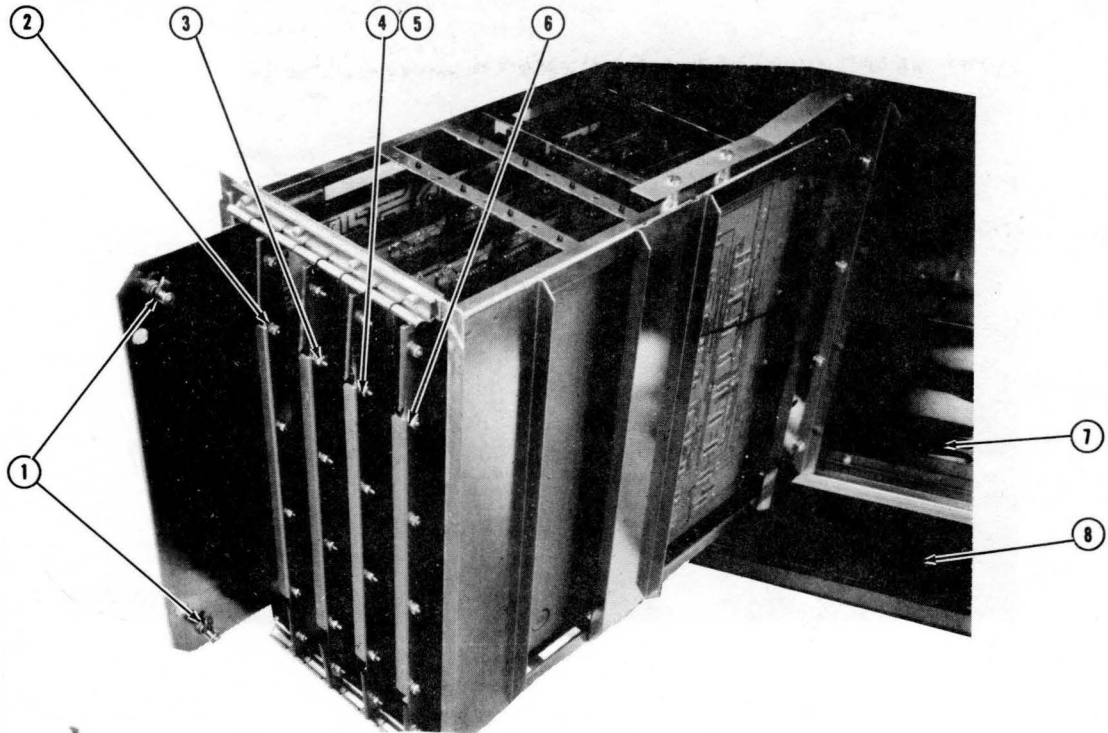

ILLUSTRATION REFERENCE	PART NO.	DESCRIPTION	I.C. REFERENCE	COMMENTS
1	52609-001	Adjustable Fastener		
2	31570-501	Logic A Board Assembly	31570*	For All Versions
3	19755-501	Logic B Board Assembly	19755*	For All Versions
4	32174-501	Logic C Board Assembly	32174*	For CompuWriter Jr Only
5	19757-501	Logic C Board Assembly	19757*	For CompuWriter and International only
6	32056-501	Logic D Board Assembly	32056*	For CompuWriter International Only
7	54466-001	Fan		
8	56945	Filter		

*Note See Pages: P.16 (31570)
P.17 (19755)
P.18 (32174)
P.19 (19757)
P.20 (32056)

PAPER FEED ASSEMBLY

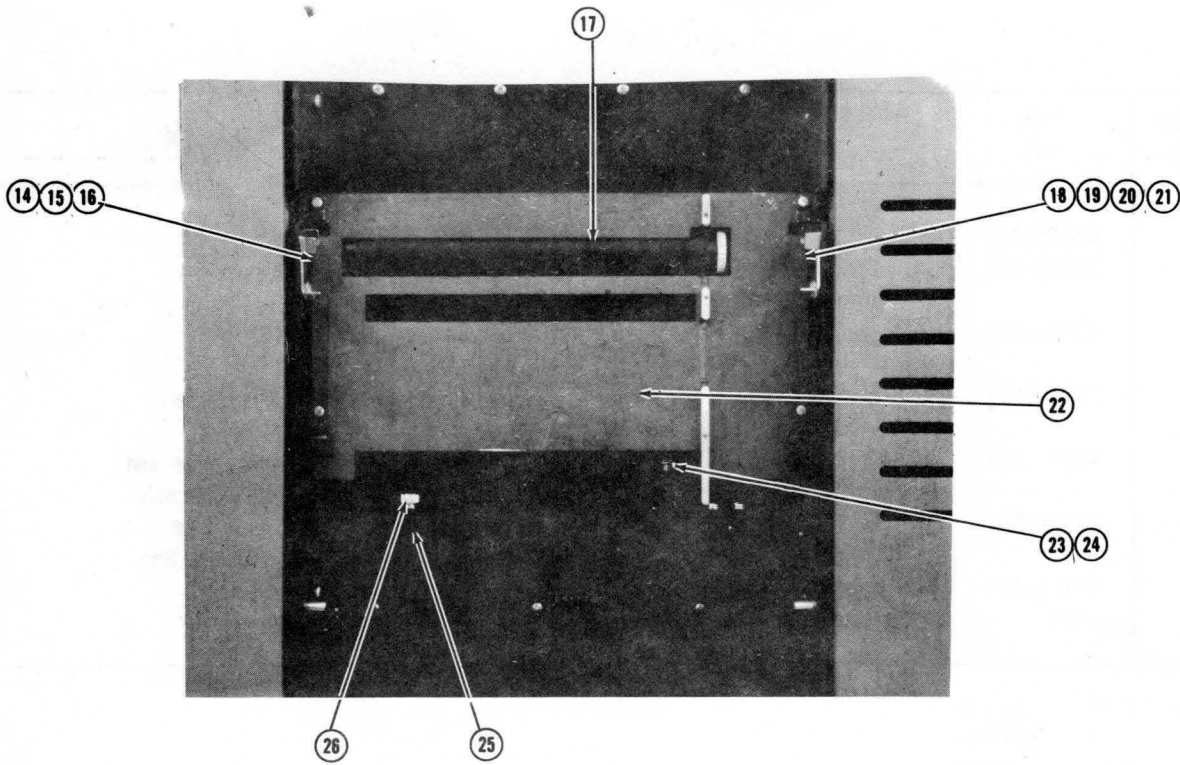
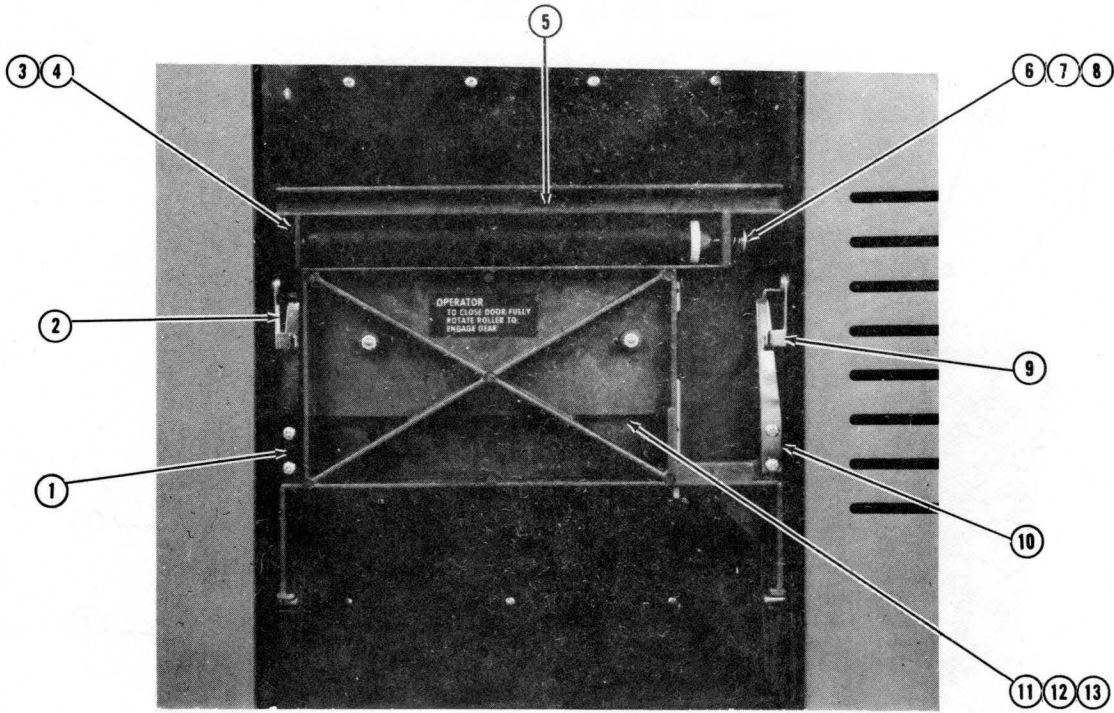

ILLUSTRATION REFERENCE	PART NO.	DESCRIPTION	SCHEMATIC REFERENCE	COMMENTS
1	27986-001	Spring Latch		
2	27992-001	Latch		
3	56449-001	Bearing		
4	52290-001	Retaining Ring		
5	19529-001	Drive Shaft Assembly		Front
6	56481-001	Compression Spring		
7	50317-001	Flat Washer		
8	50110-001	Retaining Ring		
9	27992-002	Latch		
10	27986-002	Spring Latch		
11	29407-001	Compression Spring		2 Each - Not Shown
12	27919-001	Platen		
13	27977-501	Backing Plate Assembly		
14	29001-001	Spacer		
15	17581-001	Key		
16	56449-001	Bearing		
17	19528-001	Drive Shaft Assembly		Back
18	56481-001	Helical Compression Spring		
19	50317-001	Washer		
20	50110-001	Retaining Ring		
21	56449-001	Bearing		
22	27922-001	Aperture Assembly		
23	56531-001	Switch Actuator		
24	52667-001	Switch (Paper Out)		
25	27981-001	Spring and Bracket Assembly		
26	50086-001	Thumbscrew		

PHOTO UNIT [Left and Right Side]

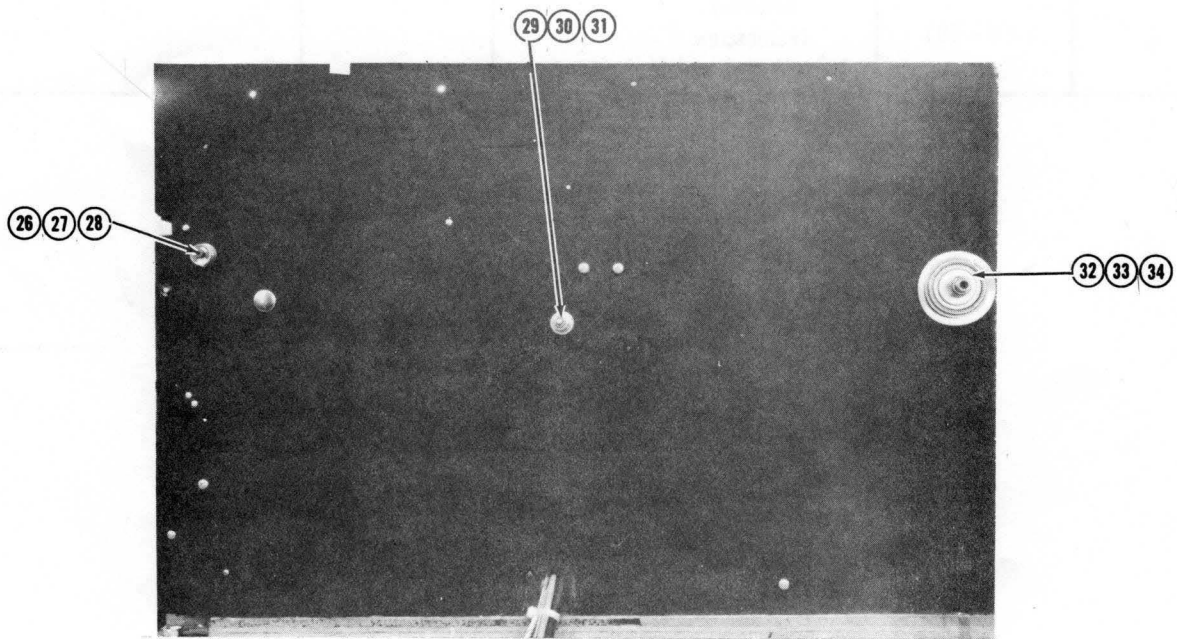
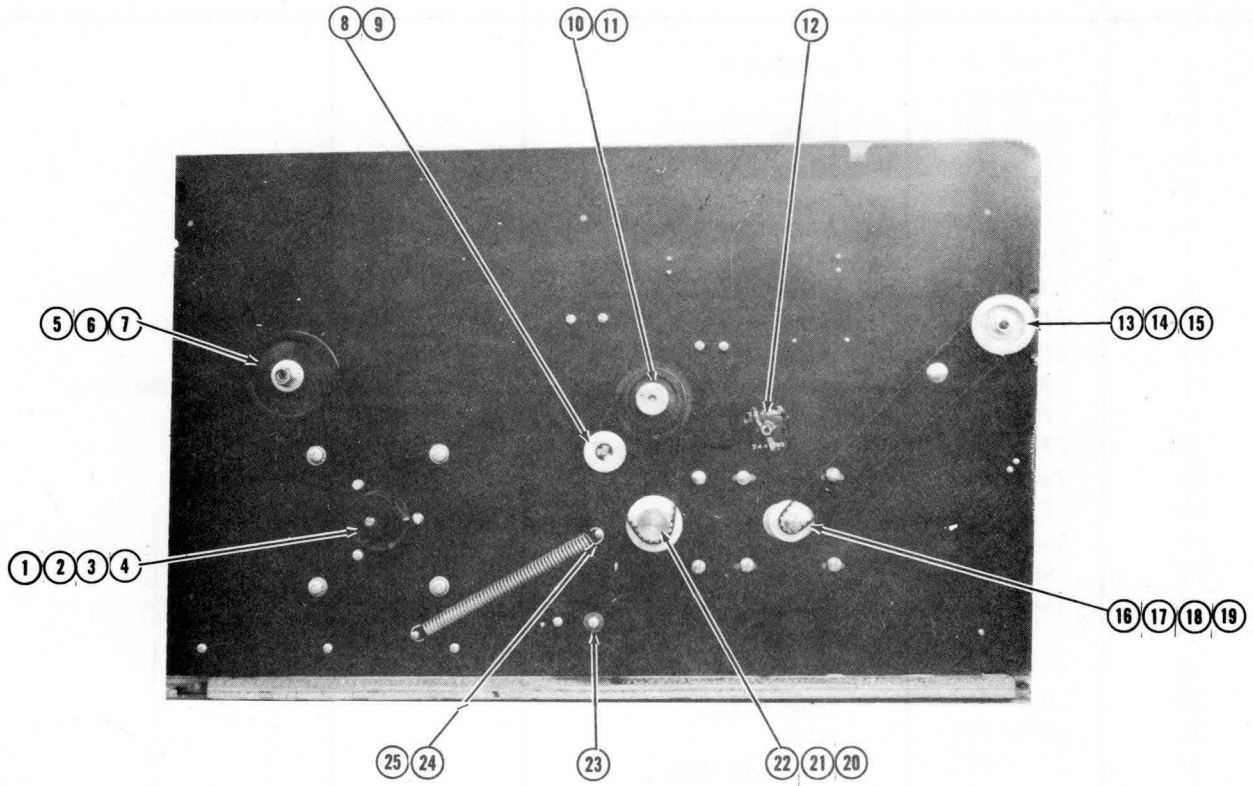

ILLUSTRATION REFERENCE	PART NO.	DESCRIPTION	SCHEMATIC REFERENCE	COMMENTS
1	13896-001	Motor Pully (22T)		60 Hz
2	15710-001	Motor Pully (24T)		50 Hz
3	57008-001	Set Screw		
4	56461-012	Timing Belt		
5	29067-001	Drum Pully (44T)		
6	53360-001	Elastic Stop Nut		
7	54119-001	Flat Washer		
8	27994-001	Idler Pulley		
9	50110-001	Retaining Ring		
10	29004-001	Lead Screw Pully		
	56352-002	Spring Pin		
11	29175-001	Gear Change Nut		
12	52086-001	Toggle Switch		
13	27991-001	Pulley		
14	52436-001	Elastic Stop Nut		
15	50317-001	Flat Washer		
16	29003-005	Pulley		
17	33261-001	Spacer		
18	50317-001	Flat Washer		
19	53825-002	Nylon Screw		
20	56461-008	Timing Belt		
21	27998-001	Pulley Screw		
22	29003-012	Motor Pulley		
23	29189-001	Idler Spacer		
24	56356-001	Extension Spring		
25	29188-001	Idler Pivot		
26	56481-001	Helical Compressing Spring		
27	50317-001	Flat Washer		
28	50110-001	Retaining Ring		
29	56528-001	Compression Spring		
30	51218-001	Elastic Stop Nut		
31	50316-001	Flat Washer		
32	56425-001	Wave Spring		
33	53360-001	Elastic Stop Nut		
34	54119-001	Flat Washer		

POWER SUPPLY ASSEMBLY

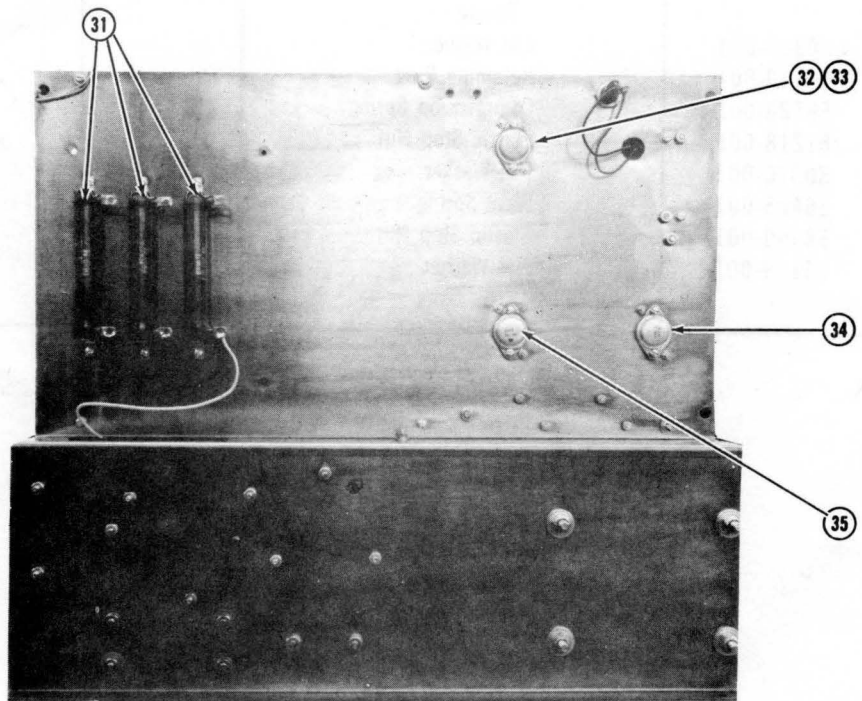
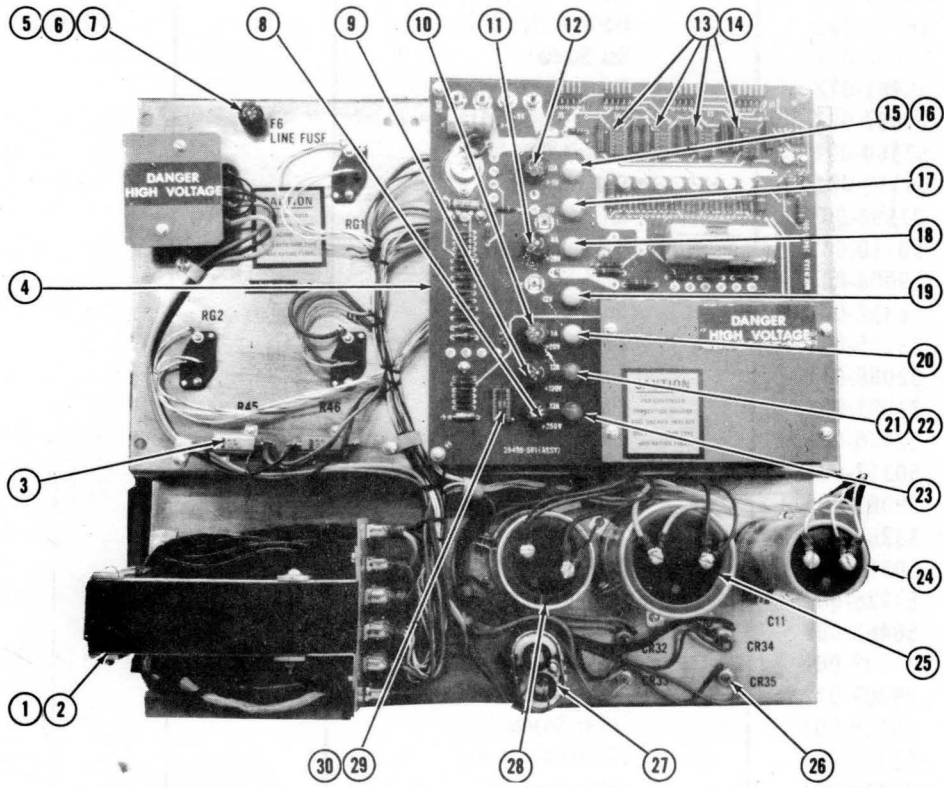

ILLUSTRATION REFERENCE	PART NO.	DESCRIPTION	SCHEMATIC REFERENCE	COMMENTS
1	56586-001	Transformer		60Hz, 115/230V Systems
2	56605-001	Transformer		50 HZ, 115/230V Systems
3	53652-002	Resistor .1 OHM, 25 Watt		
4	29496-501	Power Supply Driver Assembly		
5	50720-001	5 Amp Fuse Slo-Blo		115V Systems
6	57678-027	3 Amp Fuse Slo-Blo		230V Systems
7	53921-001	Fuse Holder		Typical 6 Places
8	56563-003	1/8 Amp Fuse		
9	56563-003	1/8 Amp Fuse		
10	56563-002	1 Amp Fuse		
11	56563-001	6 Amp Fuse		
12	50524-001	10 Amp Fuse		
13	56198-001	I.C. Socket (14 Pin)		
14	55036-001	I.C. #7406		
15	50996-001	Indicator Light Holder		Typical 5 Places
16	50847-001	Lamp #CM 338		
17	50847-001	Lamp #CM 338		
18	53512-001	Lamp #CM 344		
19	50847-001	Lamp #CM 338		
20	53512-001	Lamp #CM 344		
21	52888-001	Indicator Light Holder		Typical 2 Places
22	52872-001	Lamp #NE-2J		
23	52872-001	Lamp #NE-2J		
24	54065-004	Capacitor 17K Mfd, 35V		
25	54066-001	Capacitor 29K Mfd, 50V		
26	50606-001	Diode IN1200A		
27	54418-001	Capacitor 3 Mfd, 660V		
28	54058-010	Capacitor 65K Mfd, 15V		
29	55025-001	I.C. #9602		
30	56199-001	I.C. Socket (16 Pin)		
31	56355-001	Resistor 25 Ohm, 50 Watt		
32	50887-001	Power Transistor Socket		Typical 3 Places
33	56295-001	Regulator A7805		
34	56297-001	Regulator A7812		
35	54045-001	Transistor 2N5301		

TWIN LENS CARRIAGE ASSEMBLY

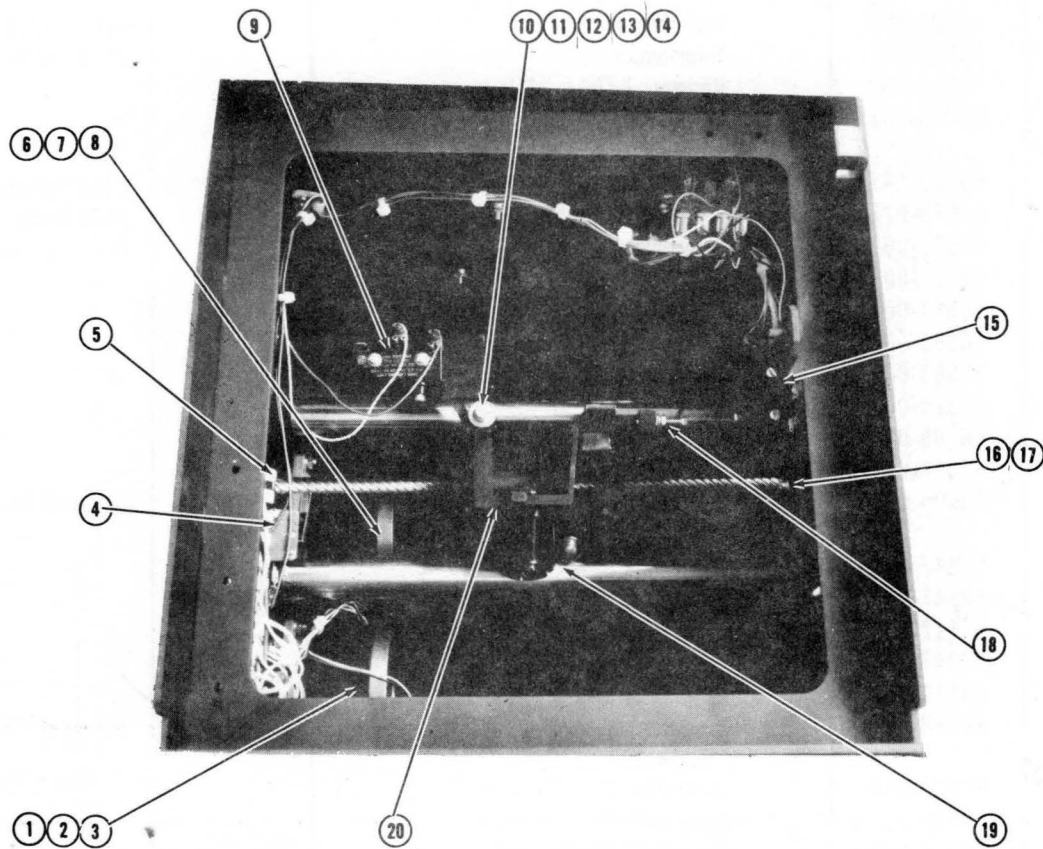

ILLUSTRATION REFERENCE	PART NO.	DESCRIPTION	SCHEMATIC REFERENCE	COMMENTS
1	56519-001	Drive Motor		
2	56352-001	Spring Pin		
3	56366-001	Lug		6 Each
4	56374-001	Margin Switch		
5	56449-001	Bearing		
6	56519-001	Drive Motor		
7	56352-001	Spring Pin		
8	56366-001	Lug		
9	56375-001	Limit Switch		
10	56423-001	Bearing		Typical 6 Places
11	29010-001	Bearing Sleeve		Typical 6 Places
12	52791-001	Screw		Typical 6 Places
13	50315-001	Flat Washer		Typical 6 Places
14	50306-001	Lock Washer		Typical 6 Places
15	56375-001	Limit Switch		
16	56420-001	Lead Screw		
17	56449-001	Bearing		
18	53279-001	90mm Lens		
19	53280-001	110mm Lens		
20	29005-501	Twin Lens Carriage Assembly		Less Lens

WIDTH CARD CONNECTOR ASSEMBLY

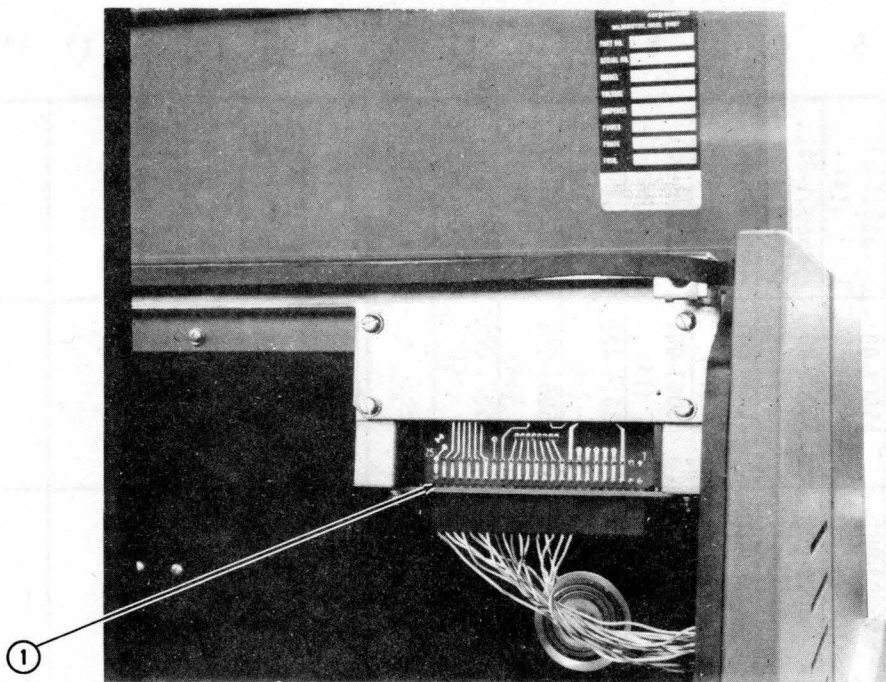

ILLUSTRATION REFERENCE	PART NO.	DESCRIPTION	SCHEMATIC REFERENCE	COMMENTS
1	31989-501	Connector Assembly (Male to Male)		Alternate 32203-501

**IC CHIP REFERENCE CHART
COMPUTER LOGICA [31570]**

	A	B	C	D	E	F	H	K
1	55003-001 (14)	55036-001 (14)	55001-001 (14)	55002-001 (14)	55003-001 (14)	55011-001 (14)	55011-001 (14)	55011-001 (14)
2		55006-001 (14)	55002-001 (14)	55002-001 (14)	55011-001 (14)	55011-001 (14)	55011-001 (14)	55003-001 (14)
3	55027-001 (14)	55016-001 (14)		55011-001 (14)	55011-001 (14)	55001-001 (14)	55027-001 (14)	
4		55029-001 (14)	55011-001 (14)	55002-001 (14)	55012-001 (16)	55036-001 (14)	55027-001 (14)	
5		55006-001 (14)	55002-001 (14)	55016-001 (14)	55005-001 (14)	55003-001 (14)	55001-001 (14)	55001-001 (14)
6		55016-001 (14)	55001-001 (14)	55016-001 (14)	55001-001 (14)	55005-001 (14)	55006-001 (14)	55001-001 (14)
7		55011-001 (14)	55024-001 (16)	55024-001 (16)	55024-001 (16)	55016-001 (14)	55005-001 (14)	55003-001 (14)
8		55001-001 (14)	55025-001 (16)		55024-001 (16)		55001-001 (14)	55003-001 (14)
9		55016-001 (14)	55016-001 (14)	55016-001 (14)		55010-001 (14)	55010-001 (14)	55010-001 (14)
10		55002-001 (14)	56195-005 (16)	56195-001 (16)	55003-001 (14)	55051-001 (16)	55051-001 (16)	55003-001 (14)
11		56195-005 (16)	56266-001 (16)		55051-001 (16)	55021-001 (16)	55021-001 (16)	55021-001 (16)
12								
13								
14								
15								
16								
17								
18								
19								
20								

1
2
3
4
5
6
7
8
9
10
11
12
13
14
15
16
17
18
19
20

1
2
3
4
5
6
7
8
9
10
11
12
13
14
15
16
17
18
19
20

A B C D E F H K

IC CHIP REFERENCE CHART
COMPUTER LOGIC B [19755]

	A	B	C	D	E	F	H	K	
1	55003-001 (14)	55016-001 (14)	55002-001 (14)	55027-001 (14)	51695-001 (16)	55045-001 (16)	55045-001 (16)	55009-001 (16)	1
2	55001-001 (14)	55001-001 (14)	55005-001 (14)	55005-001 (14)		55045-001 (16)	55045-001 (16)	55009-001 (16)	2
3	55006-001 (14)	55007-001 (14)	55001-001 (14)	55011-001 (14)	55003-001 (14)	55045-001 (16)	55045-001 (16)	55009-001 (16)	3
4	55006-001 (14)	55016-001 (14)	55007-001 (14)	55001-001 (14)	55006-001 (14)	55045-001 (16)	55045-001 (16)	55009-001 (16)	4
5	55007-001 (14)	55002-001 (14)	55016-001 (14)	55002-001 (14)	55001-001 (14)	55024-001 (16)	55024-001 (16)	55006-001 (14)	5
6	55001-001 (14)	56195-001 (16)	55001-001 (14)	55012-001 (16)	55016-001 (14)	55024-001 (16)	56195-001 (16)	55035-001 (14)	6
7	55005-001 (14)	55001-001 (14)	55003-001 (14)	55036-001 (14)	55002-001 (14)	55016-001 (14)	55021-001 (16)	55021-001 (16)	7
8	55007-001 (14)	55001-001 (14)	55024-001 (16)	55016-001 (14)	55005-001 (14)	55001-001 (14)	55021-001 (16)	55024-001 (16)	8
9	55016-001 (14)	55002-001 (14)	55024-001 (16)	55016-001 (14)	55011-001 (14)	55024-001 (16)	55003-001 (14)	55003-001 (14)	9
10	55016-001 (14)	55002-001 (14)	55003-001 (14)	55011-001 (14)	55024-001 (16)	55024-001 (16)	55023-001 (16)	55023-001 (16)	10
11	55003-001 (14)	55005-001 (14)	55016-001 (14)						11
12									12
13									13
14									14
15									15
16									16
17									17
18									18
19									19
20									20
	A	B	C	D	E	F	H	K	

	A	B	C	D	E	F	H	K	
1	55001-001 (14)	55006-001 (14)	55025-001 (16)	55011-001 (14)	55006-001 (14)	55003-001 (14)	55001-001 (14)	55027-001 (14)	1
2	55012-001 (16)	55020-001 (14)	55024-001 (16)	55024-001 (16)	55011-001 (14)	55016-001 (14)	55001-001 (14)	55036-001 (14)	2
3	55002-001 (14)	55001-001 (14)	55042-001 (16)	55042-001 (16)	55016-001 (14)	55011-001 (14)	55003-001 (14)	55003-001 (14)	3
4	55025-001 (16)	56195-001 (16)	55019-001 (16)	55019-001 (16)	55030-001 (14)	55021-001 (16)	55021-001 (16)	56195-003 (16)	4
5	55002-001 (14)	55016-001 (14)	55016-001 (14)		55001-001 (14)	55016-001 (14)	55003-001 (14)	56266-001 (16)	5
6		55006-001 (14)	55002-001 (14)	26430-174 (16)	55024-001 (16)	55025-001 (16)	55006-001 (14)	55038-001 (16)	6
7			55024-001 (16)	55001-001 (14)	55008-001 (16)	55003-001 (14)	55003-001 (14)	55008-001 (16)	7
8		55029-001 (14)	55001-001 (14)	55024-001 (16)	55016-001 (14)	26430-173 (16)	55001-001 (14)	55001-001 (14)	8
9		56195-001 (16)	55024-001 (14)	55001-001 (14)	55024-001 (16)	55001-001 (14)	55003-001 (14)	55008-001 (16)	9
10		55003-001 (14)	55016-001 (14)	55005-001 (14)	55024-001 (16)	55024-001 (16)	55002-001 (14)		10
11	55001-001 (14)	55006-001 (14)	55002-001 (14)	55013-001 (16)	55024-001 (16)	55003-001 (14)	55013-001 (16)	55003-001 (14)	11
12									12
13									13
14									14
15									15
16									16
17									17
18									18
19									19
20									20
	A	B	C	D	E	F	H	K	

IC CHIP REFERENCE CHART
COMPUWRITER LOGIC C [19757]

IC CHIP REFERENCE CHART
COMPUWRITER JR. LOGIC C [32174]

	A	B	C	D	E	F	H	K
1	55001-001 (14)	55006-001 (14)	55025-001 (16)	55011-001 (14)	55006-001 (14)	55003-001 (14)	55001-001 (14)	55027-001 (14)
2	55012-01 (16)	55020-001 (14)	55024-001 (16)	55024-001 (16)	55011-001 (14)	55016-001 (14)	55001-001 (14)	55036-001 (14)
3	55002-001 (14)	55001-001 (14)	55042-001 (16)	55042-001 (16)	55016-001 (14)	55011-001 (14)	55003-001 (14)	55003-001 (14)
4	55025-001 (16)	56195-001 (16)	55019-001 (16)	55019-001 (16)	55030-001 (14)	55021-001 (16)	55021-001 (16)	56195-002 (16)
5	55002-001 (14)	55016-001 (14)	55016-001 (14)		55001-001 (14)	55016-001 (14)	55003-001 (14)	56266-001 (16)
6		55006-001 (14)	55002-001 (14)	26430-174 (16)	55024-001 (16)	55025-001 (16)	55006-001 (14)	55038-001 (16)
7			55024-001 (16)	55001-001 (14)	55008-001 (16)	55003-001 (14)	55003-001 (14)	55008-001 (16)
8		55029-001 (14)	55001-001 (14)	55024-001 (16)	55016-001 (14)	26430-173 (16)	55001-001 (14)	55001-001 (14)
9		56195-001 (16)	55024-001 (16)	55001-001 (14)	55024-001 (16)	55001-001 (14)	55003-001 (14)	55008-001 (16)
10		55003-001 (14)	55016-001 (14)	55005-001 (14)	55024-001 (16)	55024-001 (16)	55002-001 (14)	
11	55001-001 (14)	55006-001 (14)	55002-001 (14)	55013-001 (16)	55024-001 (16)	55003-001 (14)	55013-001 (16)	55003-001 (14)

	A	B	C	D	E	F	H	K
1								
2								
3	26430-205 (16)							
4	26430-206 (16)							
5								
6								
7								

IC CHIP REFERENCE CHART
COMPUWRITER LOGIC D [32056]

	A	B	C	D	E	F	H	K
1								
2						55002-001 (14)	55001-001 (14)	
3					55001-001 (14)	55005-001 (14)	55001-001 (14)	55005-001 (14)
4					55001-001 (14)	55002-001 (14)	55016-001 (14)	55006-001 (14)
5					55002-001 (14)	55036-001 (14)	55002-001 (14)	55003-001 (14)
6					55016-001 (14)	55006-001 (14)	55016-001 (14)	55003-001 (14)
7					55003-001 (14)	55024-001 (16)	56266-001 (16)	26430-175 (16)
8					56266-001 (16)	55023-001 (16)	56195-001 (16)	55023-001 (16)
9					55042-001 (16)	55024-001 (16)	55021-001 (16)	55023-001 (16)
10					55024-001 (16)	55024-001 (16)	55021-001 (16)	55023-001 (16)
11							55019-001 (16)	55013-001 (16)
12								
13								
14								
15								
16								
17								
18								
19								
20								



compugraphic
 Service Parts Dept.
 65 Industrial Way
 Wilmington, MA 01887

PARTS ORDER SO-

DATE / /	<input type="checkbox"/> CHARGE	<input type="checkbox"/> WARRANTY	P.O. NO.
CUSTOMER CODE 	DISTRICT ORDER NUMBER — —		

SHIP TO:	BILL TO:

DESCRIPTION	PART NUMBER	QTY.	UNIT PRICE	BILL CODE

REMARKS:

SYSTEM	ORDER CODE	BILLING CODE	SHIP VIA:
MODEL NO. <hr/> SERIAL NO. <hr/> INSTALLATION DATE <hr/>	<input type="checkbox"/> PRIORITY 1 <input type="checkbox"/> PRIORITY 2 <input type="checkbox"/> PRIORITY 3 <input type="checkbox"/> OTHER SEE REMARKS	<input type="checkbox"/> CHARGE <input type="checkbox"/> CHARGE & CREDIT <input type="checkbox"/> NO CHARGE REASON N/C <hr/> <hr/>	<hr/> <hr/> SPECIAL INSTRUCTIONS: <hr/> <hr/> <input type="checkbox"/> SERVICE ENG. REPLACEMENT

ORIGINATED BY:	RECEIVED BY:	APPROVED BY:	PROCESSED BY:

•PLEASE COMPLETE ALL SHADED AREAS.
 •THIS FORM SHOULD NOT BE USED TO ORDER PHOTOGRAPHIC SUPPLIES OR TYPOGRAPHIC ITEMS.
 •FOR U.S. AND CANADIAN USE ONLY.

COMPUWRITER/COMPUWRITER JR. INSTALLATION CHECKLIST

(Serial Nos. 4000 and above)

I
N
S
T
R
U
C
T
I
O
N
S

This checklist should be followed each time equipment is installed. Note and explain any deviation from these instructions both on the checklist and on the Installation Report.

For additional information in performing any check, refer to the CompuWriter Maintenance Manual, CompuWriter Applications Manual, logic and schematics, and other documents such as FEAT's as may be necessary.

This check list is complete only when the following items on the last page have been filled in:

- CG CompuWriter Serial Number
- Installation Date
- Service Engineer's Signature
- Service Engineer's Employee Number
- Customer's Signature and Date Signed

After completion, the checklist is left with the customer, with the exception of the last page which is routed with the installation report.

POWER OFF

- 1. Check 115 vac 60 hz receptacle for proper grounding. Ensure that the line is isolated and at proper voltage level.
- 2. Visually check CompuWriter for any damage. Inform the customer of any damage incurred in shipment so a claim may be initiated with the carrier. Then check the following:
 - A. Check invoice for parts shipped versus parts received. Record and report all back ordered and missing items from shipment.
 - B. Check all fuses for proper value.
 - C. Visually check the logic boards for loose IC Chips.
 - D. Check all cables to be sure that good contacts are made.
 - E. Check terminals on large electrolytic capacitor for tightness (Main Power Supply).
 - F. Check for tight lens and lead screw. Check font drum, leading, and set pulley belts for correct tension. Adjust if necessary. Refer to UPU Addendum, pages 3-1 and 3-2.
 - G. Check filter, replace or clean if necessary.

POWER ON

- 1. Turn power on, press prime and check fans for operation.
- 2. Check supply voltages:

A.	+120 vac	J1-7, J1-1
B.	+120 vdc	J5-5, J5-7
C.	-12 vdc	J2-8, J2-1
D.	+5 vdc $\pm 5\%$	1-2
E.	+250 vdc	J1-3, J1-2
F.	+28 vdc	7-8
G.	-5 vdc	J4-9, J4-7
H.	+17 vdc	J5-9, J5-7

The +5V is regulated and can be adjusted by the trimpot on the regulator board. Refer to CompuWriter Maintenance Manual, Section V.

- 3. Pull H.V.P.S. from its recessed position and check the flash module voltage across terminals 4 and 6; this voltage should be 600 to 900 vdc.
- 4. Check clock pulse at K1-13 of logic board C ; adjust exciter lamp rheostat located under font drum on H.V.P.S. tray if necessary. Refer to CompuWriter Maintenance Manual, Section III.
- 5. Check font clock pulse adjustment at C1-10 of logic board C - sync externally on pins C1-6 of logic board C. Adjust R8 on logic board C for an 80- μ s pulse width. Refer to CompuWriter Maintenance Manual.
- 6. Check Line Length Display by pressing PRIME switch.
- 7. Check character display and photo unit by typing alphabet in upper and lower case.
- 8. Check for letterspacing using the following: LL 430, letterspacing minimum switch 20, spaceband minimum switch 12, justification range switch 31. Keyboard ten M's-spaceband-ten M's-return. Repeat with Letterspace Switch off.
- 9. Check leading switches.
- 10. Check character review of line by depressing the Line Display Button. Refer to CompuWriter Application Manual.
- 11. Check Ragged Right Switch.
- 12. Check Justification Range Light, Audio Tone, and Overflow Light.
- 13. Check left margin in 1.2X and 2.4X.
- 14. Check for proper installation of font strip and width card (if CompuWriter Model).
- 15. Check base alignment by running a line of lower and upper case M's on one line. Examine output copy to see if base alignment of M's is even.

CUSTOMER INSTRUCTION

1. Show and explain the operation and use of the following controls and indicators. Refer your explanation to the CompuWriter Application Manual.

A. Internal Controls

1. Letterspace Minimum Switch
2. Spaceband Minimum Switch
3. Justification Range Switch
4. Ragged Right Switch
5. Logic and Photo Unit Test Switches

B. Control Panel

1. Rail Indicator
2. Overset Indicator
3. Justification Range Indicator
4. Shift Indicator
5. Line Display Switch
6. Line Counter
7. Continuous Leading Switch
8. Out of Film Light
9. Line Length Unit Indicator/Switch
10. Letterspace On/Off Switch
11. Leading Point Switches
12. Prime
13. Power On/Off Switch
14. Line End Auto and Manual Switch

2. Show and explain the procedures and functions listed below. Refer your instruction to the CompuWriter Application Manual.

A. Keyboard Procedures and Functions

1. Straight Matter
2. Mixing Light and Bold Faces
3. Flush Left, Right and Center Lines
4. Calculate Line
5. Discretionary Hyphen
6. +1 Point
7. +1 Unit
8. No Lead
9. Multiple Justification
10. Cancel Character, Word and Line
11. Space Only
12. Flash Only
13. Repeat (Leader and Rule Calculations)

- B. Demonstrate how to change width boards. (If CompuWriter Jr. Model, not required).

- C. Demonstrate proper installation of font strip. Be sure to tell operator to rotate the font wheel slowly after the font strip is installed to make sure the font strip is not hitting anything.

- D. Demonstrate procedure for changing set pulley. Press Prime twice after installing pulley and check to ensure pulleys are tight. Also, ensure that the proper pulleys are used for the font selected.

- E. Explain the use of Line Length Charts and how to set Line Length Switches.
- F. Demonstrate how to load film. Check No Film light. Explain the use of the continuous button to load film into cassette before and after running test.
- G. If line lengths longer than 33 picas are used, be sure lens blocking plate is in place over the lens not being used.
- H. Explain and demonstrate how to select either the 1.2X or 2.4X lens.

CUSTOMER MAINTENANCE

- 1. Cover the maintenance items below with the person who will most likely be involved in maintaining the equipment.
 - A. Affix the CompuWriter Preventive Maintenance Schedule to the outside rear panel of Photo Unit.
 - B. Perform the maintenance listed on the schedule, explaining each item as you proceed.
 - C. Demonstrate how to clean the lens and focal area.
 - D. Demonstrate how to clean and store font strips. Use Isopropyl Alcohol 90% or CG Font and Film Cleaner part no. 56996.
 - E. Indicate what to look for in the Exciter Lamp area.
 - 1. Shape of light on photocell mask slit.
 - 2. Where the mask is and how to reglue it.
 - 3. How to change the Exciter Lamp and adjust it properly.
- 2. Instruct customer in procedure for ordering parts.
 - A. Fonts, Width boards and paper are ordered through Compugraphic Marketing (617-944-6555).
 - B. All other parts are ordered through the Compugraphic Parts Order Department (617-658-5008 or 658-5009).
- 3. Instruct customer in procedure for returning items for repair or credit and the information required on the Returned Goods Form.

