

Model 6455 Cartridge Tape System

Loaded with Features — Loaded with Benefits.

Kennedy products have always provided innovative new features. And these features have always provided added benefits and convenience for the user. For instance, our Model 6455 offers these features and benefits:

Feature: Start/Stop Operation

Benefit: Drive can emulate a 1/2" tape drive by providing the ability to perform selective file back-ups, file-restructuring, journaling and software updates.

The drive is effectively a 1/2" Tape Drive in a smaller package.

Feature: Hard Read Error Spec. of 1 in 10¹¹ bits.

Benefit: Best data reliability of any tape cartridge drive. Gives the user confidence in the integrity of the back-up medium.

Feature: On-board Diagnostics

Benefit: Drive can be tested off-line with no test equipment required. Use of S.A. also lowers the MTTR.

Feature: Cartridge Jam Protection

Benefit: Protects the cartridge from damage if cartridge jams. This is accomplished by sensing a current surge and then disabling the motor, thus insuring that the cartridge will not be damaged.

Feature: High Density Recording

Benefit: Storage capacity of 23 MB on a single cartridge.

Feature: Optional industry standard 1/2" tape interface.

Benefit: Operates with existing tape couplers and software. The drive operates as though it were a 1/2" tape drive without having to modify existing hardware or software.

By now you can see what we're driving at. Model 6455 is full of unique features and benefits for you. For the complete story, write or call us today.

KENNEDY

An Allegheny International Company

1600 Shamrock Ave., Monrovia, CA. 91016

(213) 357-8831 TELEX 472-0116 KENNEDY

TWX 910-585-3249

CIRCLE NO. 1 ON INQUIRY CARD

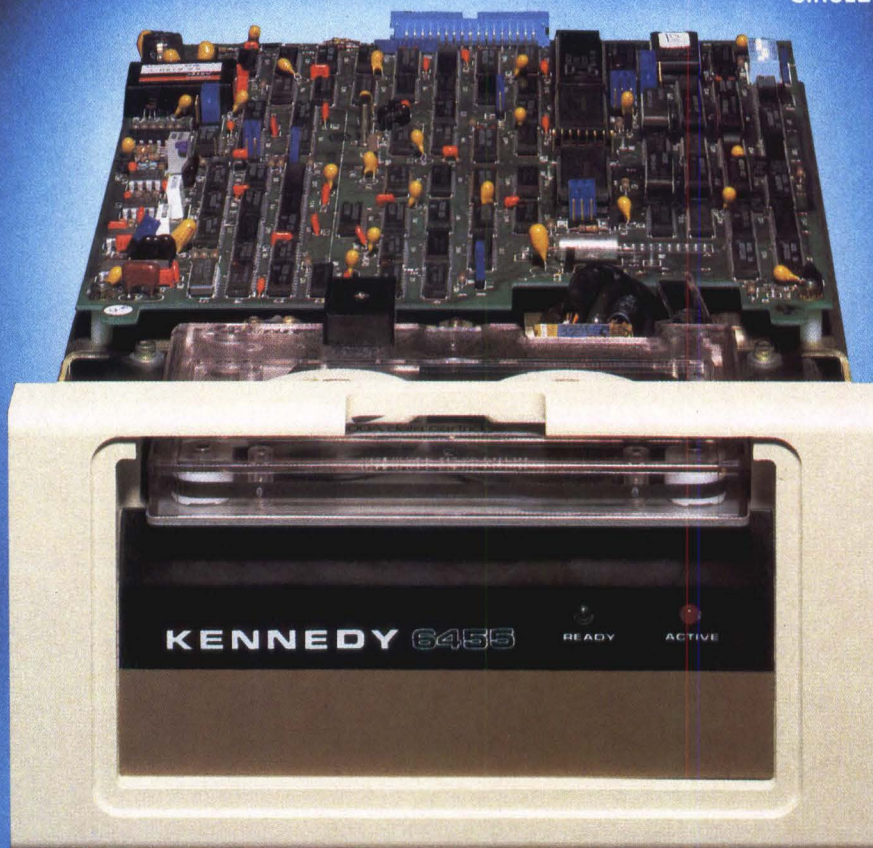

KENNEDY • QUALITY • COUNT ON IT

Introducing COMPAQ PLUS, the first high-performance portable personal computer.

The makers of the COMPAQ™ Portable Computer, the industry standard, announce another breakthrough—the COMPAQ PLUS™ Portable Personal Computer. No other personal computer can handle so much information in so many places.

The new COMPAQ PLUS offers an integrated ten-megabyte fixed disk drive in a portable.

Plus a bigger payload

How much is ten megabytes?

Enough to tackle jobs that can't be conveniently handled on most personal computers.

A mailing list of 100,000 names and addresses.

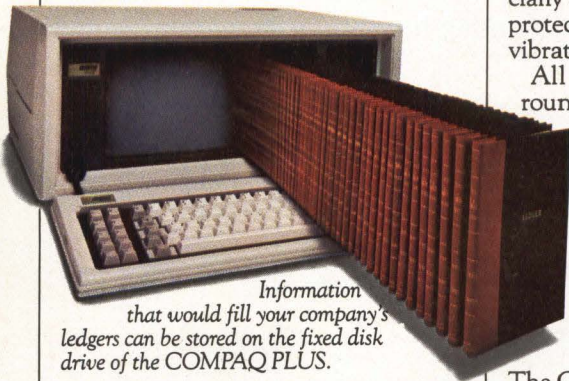

Information that would fill your company's ledgers can be stored on the fixed disk drive of the COMPAQ PLUS.

Inventory records on a quarter million items.

The entire San Francisco phone book, with room left for Peoria.

Your most used programs can be permanently kept on the fixed disk drive of the COMPAQ PLUS, ready to call up and run.

Store a library of accounting programs—payables, receivables, general ledger, and payroll—with the company's books. Then take them to a board meeting or a branch office.

Your inventory control program and your inventory records can go with you to the factory. Your building specs and your project management programs can go with you to the construction site.

The high-capacity portable multiplies the productivity of every program it runs.

Plus more programs

The COMPAQ PLUS runs all the popular programs written for the IBM® Personal Computer XT, available in computer stores all over the country. And they run with no modification whatsoever.

You're buying a computer to solve problems. Why not have more problem-solving programs to choose from?

Plus a traveler's toughness

A true portable has got to be tough. The COMPAQ PLUS is.

Its fixed disk drive is designed specifically to travel. Rough roads and hard landings don't bother it because a specially designed shock isolation system protects the disk from jolts and vibration.

All the working components are surrounded by a unique aluminum frame with cross-members that strengthen it side-to-side, front-to-back, and top-to-bottom.

Does a portable personal computer really have to be this tough? Take a look at your briefcase and then decide.

Plus a lot more

The COMPAQ PLUS comes with a 360K byte diskette drive for entering new programs and copying data files.

The COMPAQ PLUS also works with optional printers, plotters, and communications devices designed for

The COMPAQ Portable, the industry standard in portable personal computers. ▼



The problem-solving power of a high-performance desktop personal computer can now go where you need it.

IBM's personal computer family.

It has two IBM-compatible slots for adding optional expansion boards. With companion programs, they'll let you network with other personal computers, communicate with your headquarters computer files or add memory capacity if your needs grow.

When you see all that COMPAQ PLUS has to offer, you'll be pleasantly surprised by the price. The fact is, it costs hundreds less than comparably equipped desktop personal computers.

See the first high-performance portable personal computer. The COMPAQ PLUS—performance, programs, productivity. Plus problem-solving power.

For the name of the Authorized Dealer nearest you, call 1-800-231-0900.

©1983 COMPAQ Computer Corporation
COMPAQ™ and COMPAQ PLUS™ are trademarks of
COMPAQ Computer Corporation.
IBM® is a registered trademark of International Business
Machines Corporation.

The new COMPAQ PLUS, the first high-performance portable personal computer. ▼

COMPAQ PLUS™

Mini-Micro Systems

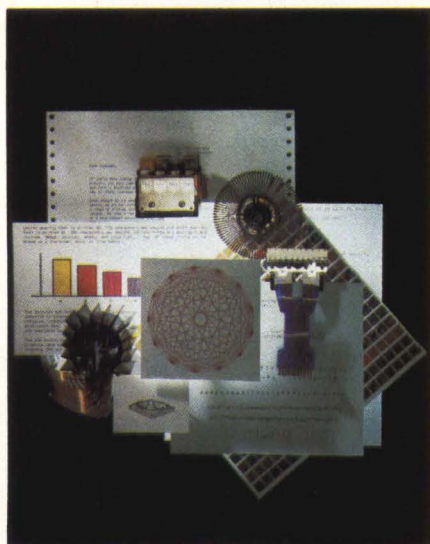

Cover art direction by Vicki Blake; photography by Steve Grohe, Boston; subject material courtesy of Misco (supplies), Diablo (parts and printouts), Alphacom (parts and assemblies), Printec (castings and mechanicals), Epson (parts)

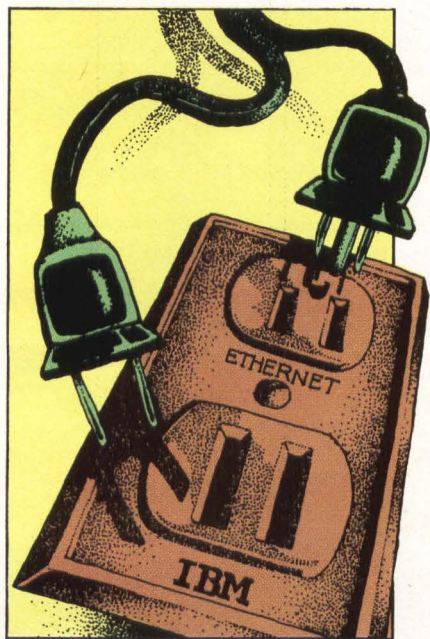

p. 31 IBM exhibits its LAN standard

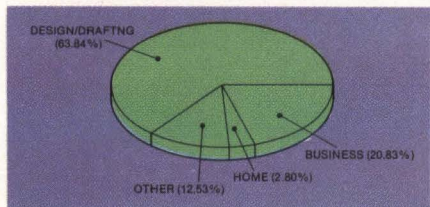

p. 100 Color is no longer a question

MINI-MICRO WORLD

News

- 31 IBM demonstrates ring proposed as LAN standard
- 33 DEC emulates itself with VT100 successor
- 35 Battle of the boards: Intel challenges DEC's supremacy
- 38 PC-compatibles, 'window' software highlight jam-packed Comdex
- 42 Compaq, Eagle, Radio Shack, Xerox unveil portable computers
- 50 Wang joins burgeoning market for 'secure' PCs in government
- 55 Epson OEM strategy includes higher-performance printers
- 61 Two companies beat DEC to the punch with RDBMs for VAX
- 64 Heard on the Hill: Congress to consider telephone, R&D legislation
- 66 High-capacity removable media challenges floppy backup

Corporate and Financial

- 77 Xerox plans to fight for personal computer niche
- 81 Corporate and financial briefs

International

- 87 Microcomputers, printers highlight Munich Systems '83 show
- 88 BASF poised to re-enter U.S. disk drive market

INTERPRETER

- 100 Printers and plotters vie for color hard-copy market
- 111 Competition heats up in growing fault-tolerant computer market
- 135 Business graphics for UNIX offer few choices

FEATURES

- 149 **Feature Highlights**
- 152 **Product profile: correspondence-quality serial printers . . .** impact printers continue to outdistance non-impact technologies.
- 197 **'New technology' printers challenge daisy wheels . . .** ink-jet, thermal and non-impact page printers jockey for position.
- 211 **Matrix printer combines letter-quality text, color graphics . . .** new printers by Dataproducts illustrate design trade-offs.
- 223 **Ink-jet printer handles text, graphics . . .** drop-on-demand technique produces software-controlled bit-mapped images.
- 233 **Microcomputer operating systems compete in portability and performance . . .** the new OSs are more portable, but cross-porting still poses problems.

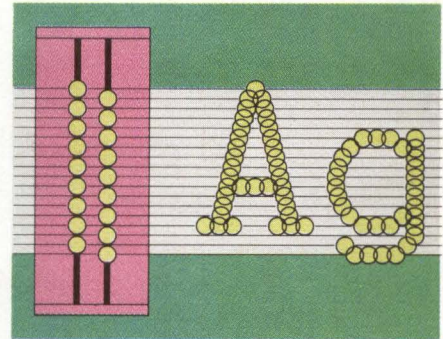

p. 152 Established trends continue

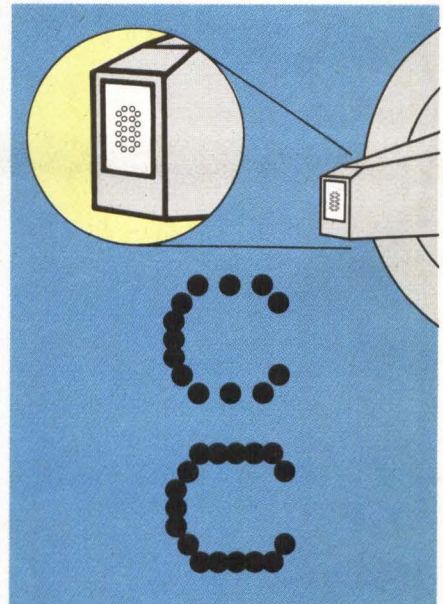

p. 211 Matrix printer offers LQ text

DEPARTMENTS

- | | |
|-------------------|----------------------------|
| 4 Editorial Staff | 262 Calendar |
| 7 Editorial | 267 New Products |
| 10 Letters | 296 Classified Advertising |
| 15 Breakpoints | 299 Career Opportunities |
| 81 Box Score | 306 Index to Advertisers |

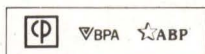

MINI-MICRO SYSTEMS (ISSN 0364-9342) is published monthly (with additional issues in spring, summer and fall) by Cahners Publishing Company, Division of Reed Holdings, Inc., 221 Columbus Avenue, Boston, MA 02116. Norman L. Cahners, Chairman; Saul Goldweitz, President; Ronald G. Segel, Financial Vice President and Treasurer. MINI-MICRO SYSTEMS is published by the Cahners Magazine Division; J. A. Sheehan, President; William Platt, Executive Vice President. Circulation records are maintained at Cahners Publishing Co., 270 St. Paul St., Denver, CO 80206. Second class postage paid at Denver, CO 80202 and additional mailing offices. Postmaster: Send address changes to MINI-MICRO SYSTEMS, 270 St. Paul St., Denver, CO 80206. MINI-MICRO SYSTEMS is circulated without charge by name and title to U.S. and Western Europe based corporate and technical management, systems engineers, and other personnel who meet qualification procedures. Available to others at the rate of \$55.00 per year in the U.S.; \$60.00 in Canada and Mexico; \$75.00 surface mail in all other countries; \$120 foreign air mail (15 issues). Single issues \$4.00 in the U.S.; \$5.00 in Canada and Mexico; \$6.00 in all other countries.

©1984 by Cahners Publishing Company, Division of Reed Holdings, Inc. All rights reserved.

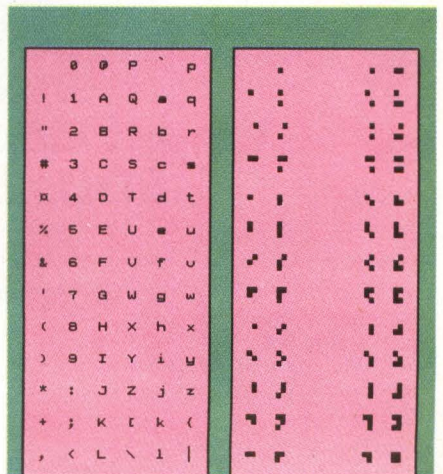

p. 223 Implementing drop-on-demand

This book can save your company a lot of money.



**You can rent
all these products
NOW!**

Amplifiers	1
Wave and Distortion Analyzers	1
Logic Analyzers	1
Microwave Link Analyzers	2
Data Link Analyzers	3
Network Analyzers	3
Power Line Analyzers	4
Sound and Vibration Analyzers	5
Spectrum Analyzers	5
Attenuators	6
Calibrators	6
Cameras	7
Counters	7
Couplers	8
Desktop Computers	8
Filters	10
Function Generators	10
Noise Generators	10
Pulse Generators	10
Signal Source Generators	11
Switch Frequency Generators	11
Generators/Synthesizers	12
Analog Voltage, Current and	13
Resistance Meters	13
Digital Meters	14
Power Meters and Thermistors	16
Microprocessor Development and	17
Analysis	17
PROM Programmers	19
Oscillators	20
Oscilloscopes	20
Printers	23
D.C. Power Supplies	24
Probes	25
Digital Printing	25
Recorders/Plotters	25
Event Recorders	25
Magnetic Tape Recorders	26
Oscillographic Recorders	26
Strip Chart Recorders	26
Temperature Recorders	27
X-Y Recorders	27
Sources	28
Synthesizers	28
Data Terminals	28
Graphics Terminals	29
Modems and Acoustic Couplers	29
Test Bridges	30
Test Chambers	30
Test Sets	30
Index	30
Terms and	
Conditions	Inside Back Cover

Catalog

Genstar Rental Electronics, Inc.

It's free, too.

GSA Contract GS-04S-23560

GENSTAR
Rental Electronics, Inc.
(800) 227-8409

In California (213) 887-4000 • (415) 968-8845 • (714) 879-0561

This coupon brings you a recession-beating catalog by return mail

- It's free, so send it quick! The equipment I'm most interested in is: _____
- I'd also like a free catalog on "like new" items you're selling. _____
- Don't wait. Call me today at: _____

NAME _____ TITLE _____

ORGANIZATION _____

ADDRESS _____ MAIL STOP _____

CITY/STATE/ZIP _____

TELEPHONE _____

Complete coupon and mail to: Genstar Rental Electronics, Inc, 6307 De Soto Ave., Suite J, Woodland Hills, CA 91367 MMS-184 © Genstar Rental Electronics, Inc. 1983

CIRCLE NO. 4 ON INQUIRY CARD

STAFF

Vice President/Publisher
S. Henry Sacks

Editor-in-Chief
George V. Kotelly

Managing Editor
James F. Donohue

Executive Editor:
Alan R. Kaplan

Senior Editor: **Lori Valigra**

Associate Editor: **Edward S. Foster**,
Los Angeles, (213)826-5818

Associate Editor: **Roy R. Friedman**

Associate Editor: **Sarah Glazer**

Associate Editor: **Gary Legg**

Associate Editor: **Tom Moran**,

San Jose, (408)296-0868

Associate Editor: **Robert A. Sehr**,

San Jose, (408)296-0868

Associate Editor: **David R. Simpson**

Associate Editor: **Jesse Victor**

Assistant Editor: **David Bright**

Assistant Editor/New Products: **Steven F. Frann**

Assistant Editor/Research: **Adrienne DeLeonardo**

Contributing Editors:

London: **Keith Jones**, (011-441-661-3040)

Data Communications: **Walter A. Levy**

Computer Architecture: **Efrem Mallach**

Office Automation: **John Murphy**

Frankfurt: **Maureen O'Gara**

Artificial Intelligence: **Steven Roberts**

Washington, D.C.: **Stephen J. Shaw**, (301)320-2273

Product Profiles: **Malcolm L. Stiefel**

Database Systems: **Harvey Weiss**

Editorial Production

Senior Copy Editor: **Frances T. Granville**

Production Editor: **Mary Anne Weeks**

Copy Editor: **Susan A. English**

Word Processing: **Kathleen Appignani**

Administrative Assistant: **Frances C. Michalski**

Editorial Services

Helen M. Benedict, **Laura Downey**,

Jeanne Howat, **Robin Sheehan**

Assistant to the Publisher: **Linda L. Lovett**

Art Staff

Art Director: **Vicki Blake**

Assistant Art Director: **Douglas Glen**

Artist: **Anne Tregay**

Production Staff

VP Production: **Wayne Hultzky**

Supervisor: **William Tomaselli**

Production Manager: **Nancy Norton**

Composition: **Diane Malone**

Director of Graphics: **Lee Addington**

VP/Research: **Ira Siegel**

Group Circulation Manager: **Sherri Gronli**

(303)388-4511

Marketing/Promotion Staff

Marketing Director: **Richard B. Dalrymple**

Promotion Director: **Susan Rapaport**

Promotion Coordinator: **Elizabeth Gotoff**

Promotion Coordinator: **Wendy Whittemore**

Editorial Offices

Boston: 221 Columbus Ave., Boston, MA

02116.(617)536-7780. **Los Angeles:** 12233 W.

Olympic Blvd., Los Angeles, CA 90064. **San Jose:**

3031 Tisch Way, San Jose, CA 95128. **New York:**

205 E. 42nd St., New York, N.Y. 10017. **London:** IPC

Business Press, Quadrant House, The Quadrant,

Sutton Surrey, SM2 5AS, England.

Reprints of Mini-Micro Systems articles are

available on a custom printing basis at

reasonable prices in quantities of 500 or more.

For an exact quote, contact Art Lehmann,

Cahners Reprint Service, Cahners Plaza, 1350 E.

Touhy Ave., Box 5080, Des Plaines, IL 60018.

Phone (312)635-8800.

Gould... Innovation and Quality in Computers

We just gave the computer industry something to reach for. A new standard... performance/footprint.

Introducing the Gould CONCEPT 32/67. Performance in a size as accommodating as its price.

From the 32-bit performance leader comes yet another minicomputer product line other suppliers can only hope to duplicate. The 2-MIPS-class, cost and space-saving CONCEPT 32/67.

We scrimped on size, but that's all. The 32/67 gives you top computational power in 1/5 to 1/3 the floor space of the

competition. And it's packed with features. Performance up to 2.6 MIPS. Largest cache in a mini... 32K byte two-way set associative with separate 16K banks for data and instructions. And, 16M byte task addressing in a base register mode. All at a price that matches its size.

MIPS/SQ. FT.*

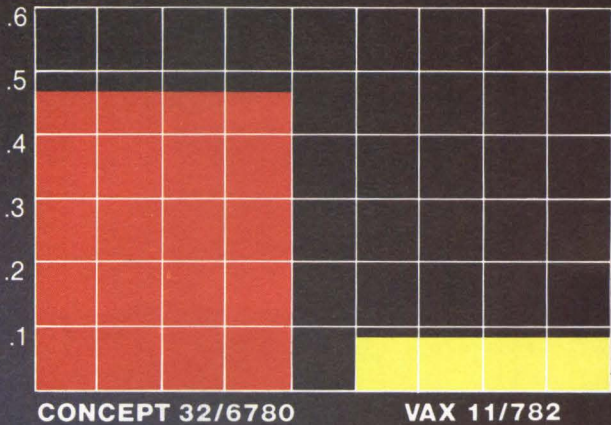

MIPS/\$10,000* (Equivalent System Price)

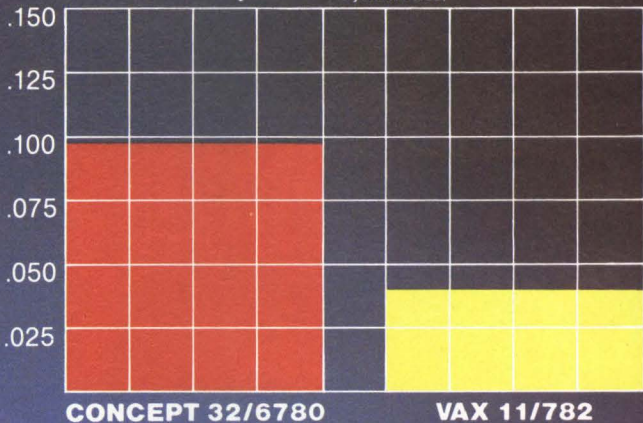

* All chart data from published competitive information.

For more information about the new standard of minis, call or write: **Gould Inc., Computer Systems Division**
6901 West Sunrise Boulevard
Fort Lauderdale, Florida 33313. 1-800-327-9716.



VAX 11/782



GOULD
Electronics

CIRCLE NO. 5 ON INQUIRY CARD

IT'S FEBRUARY 21, 1984
DO YOU KNOW
WHAT YOUR
COMPETITION IS DOING?



THEY'RE UNDER THE DOME
WITH OVER 500
SOFTWARE COMPANIES.



The International Conference
and Tradefair for the Software Industry
Tuesday-Thursday, February 21-23, 1984
10:00 AM to 5:00 PM Daily
The Superdome, New Orleans

For Registration and Hotel Information call today

Produced by Northeast Expositions, 822 Boylston Street, Chestnut Hill, MA 02167 Telephone: 617-739-2000 or 800-841-7000

CIRCLE NO. 6 ON INQUIRY CARD

Systems in Manufacturing: a pause before growth

As you read this issue, you'll notice that the "Systems in Manufacturing" section is missing. This omission is intended to whet your appetite for a new section that will appear in place of "Systems" next month. In concept, though, it won't be a new section—simply an expanded one.

Over the past year and a half, "Systems" concentrated on computer system application articles, products and information that dealt primarily with robotics and industrial/factory automation. At its initiation, it seemed adequate editorial coverage.

The new section will continue to cover those editorial goals, but it won't stop there. It will also cover applications of integrated computer systems in engineering, government, education, finance and trade. Its purpose will be to describe applications and uses of innovative value-added minicomputer- and microcomputer-based systems that solve work-related problems. The editorial thrust will target you, our readers—system integrators.

Why is this change important to you? As a value-added OEM, value-added reseller or value-added user, you've seen computers, in just the past year and a half, find uses and applications in virtually every commercial and non-commercial enterprise. And so, *Mini-Micro Systems* changes to keep pace with the pervasive computer market. We will continuously strive to improve *Mini-Micro Systems'* usefulness to you as your primary source of computer system integration information.



George V. Kotlley

George Kotlley
Editor-in-Chief

CAHNERS PUBLISHING COMPANY

Cahners Magazine Division

*publishes the following specialized
business magazines and directories:*

Building/Construction Group

*Brick & Clay Record
Building Design & Construction
Building Supply & Home Centers
Ceramic Industry
Construction Equipment
Professional Builder
Security Distributing & Marketing
Security World
Specifying Engineer*

Foodservice Group

*Foodservice Equipment Specialist
Hotels & Restaurants International
Restaurants & Institutions*

Electronic/Computer Group

*Business Computer Systems
EDN
Electronic Business
Electronic Packaging & Production
Mini-Micro Systems
Semiconductor International*

Manufacturing Industries Group

*Appliance Manufacturer
CPI Purchasing
Design News
Design News Directories
Modern Materials Handling
Packaging
Plastics World
Purchasing
Traffic Management
U.S. Industrial Directory*

Fischer Medical Group

*Emergency Medicine
The Journal of Cardiovascular
Medicine
Transitions-Medicine and the Aging
Process*

Newsletter Division

*Electronic Business Forecast
Plastic Business News
Buying Strategy Forecast
Early Warning Forecast
Transport (De)Regulation Report
Hazardous Materials Transportation
Oil Spill Intelligence Report
Tradeshow Week
Chain Marketing & Management*

Cahners Exposition Group

*is the largest producer, operator and
manager of trade and consumer shows
in the world . . . with over 100 shows,
6,000,000 square feet of exhibition
space and total annual attendance of
over three million.*



**CAHNERS
PUBLISHING COMPANY**

221 Columbus Avenue
Boston, MA 02116
617/536-7780

DON'T A DRIV A STR

We're the world's leading manufacturer of micro peripheral disk drives. Which means that, whenever

TAKE E FROM ANGER.

you need a reliable 5¼" floppy, 5¼" Winchester or 8" ThinLine™ floppy, we're the supplier you can rely on.

Tandon

THE MOST SUCCESSFUL DISK DRIVE COMPANIES YOU EVER HEARD OF.

Telex: 194794. Regional Sales Offices: Boston (617) 938-1916 • New York (201) 449-7720 • Atlanta (404) 934-0620 • Chicago (312) 530-7401
Frankfurt, West Germany 6107-2091, Telex 411547 • London, England (0734) 664-676 Telex: 848411. Distributors: Hall-Mark, Kierulff, Schweber.

CIRCLE NO. 8 ON INQUIRY CARD

Letters

FCC AND REGULATIONS

To the editor:

I am totally outraged by your article, "Manufacturers work out last RFI kinks as final FCC deadline approaches" (MMS, September 1983, Page 127). I have had the real-life experience of trying to find out what these regulations are and get them interpreted. The truth is that no one knows, including the Federal Communications Commission (FCC), and no one is in a hurry to clear the air.

To perform these tests, we must first buy \$10,000 to \$20,000 worth of computer equipment to provide an environment to install the equipment we wish to test. Next, we must pay a testing lab \$1,200 per day to perform the tests. We don't know which test to perform because there is no clear guideline to distinguish class A products from class B products. It gets very muddy, especially if you connect class A and class B products. We requested a ruling. How long will that take? Or will our request get lost or ignored? That is the easiest way to get through the paperwork in Washington.

As your article made clear, there was no problem with electromagnetic interference (EMI) from computers before the FCC made these unnecessary regulations.

This type of regulation is no burden on Digital Equipment Corp. or Hewlett-Packard Co., as your article mentioned, because they can detail a staff of engineers and lawyers to deal with it and construct "100-foot-diameter air-supported" test sites. It is a very big burden on small companies. It greatly increases our costs. It stretches development time and forces our digital engineers to educate themselves in a new field. The FCC makes zero effort to provide technical guidance.

The best solution for small companies may be to stay away from the computer field and develop test or medical equipment, which is not covered by the regulations.

Small companies would save many millions of dollars if the FCC would come out with a way of meeting the requirements without testing. For example, in the area of computer interfaces there could be requirements for shielding and grounding cables. By following such specifications, the requirements would be deemed met without expensive testing. The result

would be the same in terms of "protecting the public" without the huge economic waste and stifling of small business and technological creativity. If we can't get rid of these stupid regulations, at least they could be administered in a way that won't kill the goose that lays the golden eggs.

Norman L. Rogers
President
Decmation
Santa Clara, Calif.

SPREADSHEET UPDATE

To the editor:

Regarding your article on minicomputer spreadsheets (MMS, September 1983, Page 172). An important omission was made: PortaCalc. This is a PDP-11 or VAX spreadsheet containing database-management system (DBMS) extraction, 3-D models, matrix math, a graphics package, a file interface and much more.

The most important feature of PortaCalc is its price: it can be obtained as number 11-SP-47 with machine-readable source and documentation for \$70 per copy by members of DECUS at the DECUS program library in Marlboro, Mass. It is written in FORTRAN-66, the only universal assembler, and has well-isolated and -documented machine dependencies.

Glenn C. Everhart
Mount Holly, N.J.

MODULA-2 VS. ADA

To the editor:

I must react negatively to the article about Modula-2 (September 1983, Page 183). You were had. Change "module" to read "package," change "definition

module" to read "package specification," change "implementation module" to read "package body," change "module SYSTEM" to read "package STANDARD," and then you can change "Modula-2" to read "Ada."

The authors slipped this by you with no references to Ada, which is now an American National Standards Institute standard, soon to be the International Standards Organization standard. This article merely adds a bit more life to the now useless Pascal language. Pascal has made its contribution and should be retired.

Sam Harbaugh
Palm Bay, Fla.

Authors' response:

We agree with Mr. Harbaugh's conclusion—Pascal ought to be retired. However, his comments regarding similarities between Modula-2 and Ada are misleading. While Modula-2 and Ada have similar capabilities, the differences are notable.

The Modula-2 language report is 25 pages long; the Ada language reference manual is more than 250 pages long. Pascal programmers can learn Modula-2 in a few days; Ada is so complex that an entire sub-industry has sprung up to fill the need for "Ada education."

We wish to pose the following questions to Mr. Harbaugh and to programmers and system integrators. Have you read the Ada language reference manual? Do you understand it? If not, you might find Modula-2 attractive.

A. Winsor Brown
Richard E. Gleaves
Volition Systems
Del Mar, Calif.

NEXT MONTH IN MMS

Disk drives get the feature spotlight in the February issue of Mini-Micro Systems. There will be a hardware profile that concentrates on interfaces, controllers and the technological innovations that increase performance relative to standard-height drives. The article contains tables of both floppy and Winchester manufacturers' offerings.

Other features include:

- a discussion of the testing of Winchester and floppy drives.
- a look into the future of disk systems.

**5-40 Megabytes
Available Now**



**Add it all up, and
you get today's finest range
of Winchester disk drives**



You can figure it out for yourself. With storage capacities of between 5 and 40 megabytes (formatted), and offering both 5¼" and 3½" models, Rodime has developed today's finest range of Winchester disk drives.

Take the Rodime 200 series. Launched in April 1982, it was the first to offer a full range of storage capacities from 5 to 20 megabytes and is currently providing reliable memory storage for many of the leading manufacturers of 8- and 16-bit business microcomputers.

Take the Rodime RO 206 and RO 208. With storage capacities of 30 and 40 megabytes, these high-performance drives have an average access time of 55 ms. As you'd expect, they're designed specifically to meet the memory requirements of today's 16-bit multi-user microcomputers, at highly competitive prices.

And, finally, take Rodime's RO 350 3½" Winchester. With storage capacities of 5 and 10 megabytes, the RO 350 is the first of a new generation of rugged Winchesters designed primarily to bring the benefits of Winchester technology to the hostile environment of portable microcomputers.

It all adds up. Take Rodime's RO 200, 206, 208 and 350 together and you've got the finest range of Winchester disk drives. Add Rodime's outstanding reputation for reliability, its manufacturing capacity, and its ability to deliver large volumes reliably, and you'll see why Rodime has its numbers resoundingly right.

If your systems still aren't using Rodime Winchesters, then someone, somewhere has got their numbers wrong.

RODIME

right from the beginning

Rodime PLC
Rodime, Inc.
Corporate Offices and Marketing
Rothesay House
Rothesay Place, Glenrothes, Fife, KY7 6PW
Scotland

U.K. Manufacturing Division
Rodime PLC
Nasmyth Road
Southeast Industrial Estate
Glenrothes, Fife KY6 2SD, Scotland

U.S. Sales Office—California
25801 Obrero, Suite 6
Mission Viejo, California 92691
Telephone (714) 770-3085 Telex 728317

U.S. Sales Office—Texas
1106 Clayton Lane, Suite 202 West
Austin, TX 78723
Telephone (512) 453-5135 Telex 767139

U.S. Manufacturing Division
Rodime, Inc.
Box No. 273487
Boca Raton, Florida 33431

CIRCLE NO. 9 ON INQUIRY CARD

**DO YOU HAVE
THE DRIVE
TO SUCCEED?**

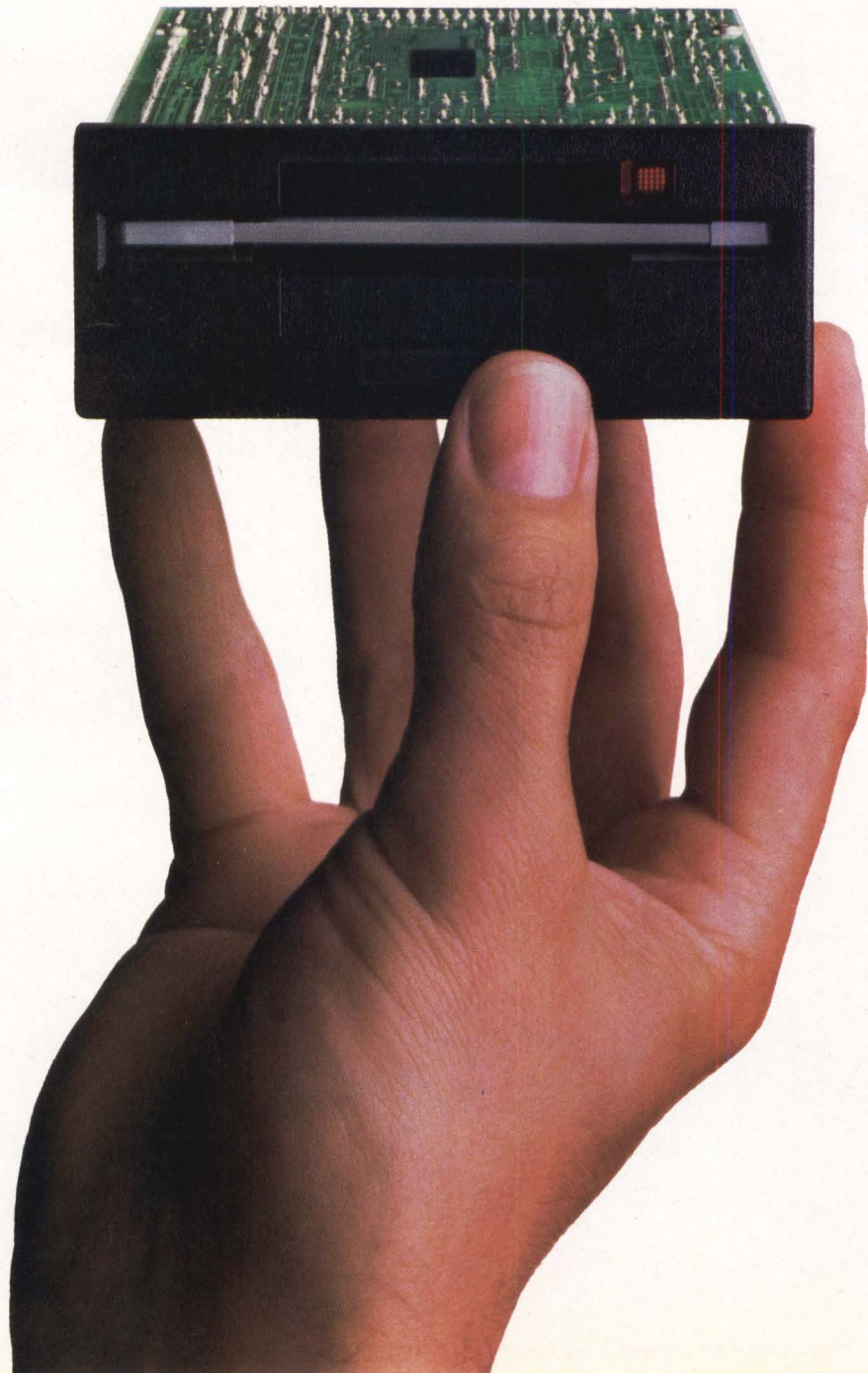

You do?

Good. So do we.

Shugart's 3.5" microfloppy drive. The SA300 by name.

And, considering where the personal/home/portable computer market is headed (betterfastercheapersmallerwithmorestorage), it's not a moment too soon.

It's also quite an achievement. One that allows you to engineer a wealth of advantages into smaller, more competitive systems.

Take the most obvious advantage, for instance.

Size. With the SA300 you can make your personal and home systems less imposing, more, well, personal. Our microfloppy takes up 75% less room than a standard sized Minifloppy.™

And it weighs just a tad over a pound. So your portable system can be more, you guessed it, portable, even with two drives in it.

Yet the SA300 still delivers 500 Kbytes in the single-sided version (1 Mbyte in the double-sided version) and uses less power, worst case, than an 8-watt night-light.

It's also so quiet, you can't hear it running unless you put your ear right down on top of it.

And with an MTBF of over 10,000 power-on hours, it should run for quite some time.

Then, of course, there's the not-so-small matter of the industry standard 3.5" microfloppy diskette.

Which offers a few important advantages of its own.

Like Minifloppy compatibility.

A track density that allows room for a generous upgrade path to more capacity.

And a hard shell plastic media cartridge for protection against the rigors of pocket and purse, with an automatic head access shutter as a last line of defense against little computer users who eat a lot of peanut butter and jelly.

Want to learn more?

We'll do a private Micro-floppy Workshop right in your office. And you'll have the chance to talk with media manufacturers and our own applications engineers about your plans for a big design win.

Call your local Shugart Sales Office to set it up. But do it soon.

You'd be amazed at what you can do with a little drive.



The 3.5" Micro-Cartridge provides maximum media protection.

Shugart

Right from the start.

It's such an enormous waste of time and talent (not to mention money) having people waiting around for their turn at the expensive Tektronix.

Especially when you can buy enough CIT-414s to go around for about the same money.

A CIT-414 costs eight to 10 times less than a Tektronix 4014. Yet, a CIT-414 is completely 4010/4014 compatible.

So every engineer or designer can have his own terminal to do his CAD modeling and previewing.

A Tektronix® 4014 for everyone is expensive.

A CIT-414 isn't.

You get a variable scale factor for changing image size, relocatable origin, special write modes, and switchable video.

You get compatibility with most major graphics software packages, including PLOT 10,TM DISSPLA,[®] TELL-A-GRAPH,[®] SAS/GRAPH,TM and DI3000/GRAFMAKER.[®]

And like all CIE graphics and video display terminals,

the full featured CIT-414 is thoroughly tested

and built with the industry's highest Meantime Between Failure rate.

For more information, just write or call. CIE Terminals, 2505 McCabe Way, Irvine, CA 92714-6297 (714) 660-1421. Call toll free 1-800-854-5959. In California, call 1-800-432-3687.

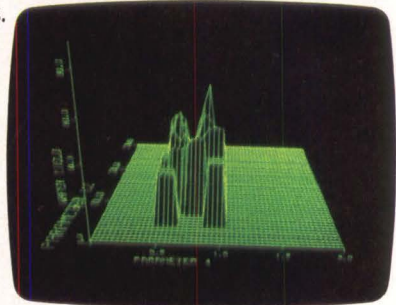
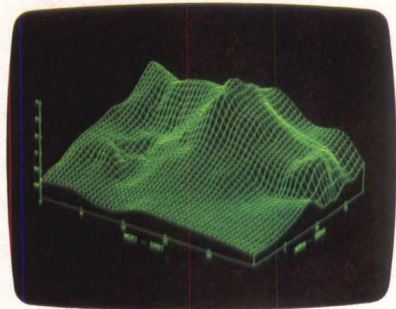

CIE TERMINALS
A CITO ELECTRONICS COMPANY

® Tektronix is a Registered Trademark of Tektronix, Inc. DISSPLA and TELL-A-GRAPH are Registered Trademarks of ISSCO. DI3000/GRAFMAKER is a Registered Trademark of Precision Visuals. TM Plot 10 is a Trademark of Tektronix, Inc. SAS/GRAPH is a Trademark of SAS Institute, Inc.

© 1983 CIE Terminals

CIRCLE NO. 11 ON INQUIRY CARD

Breakpoints

POWER SUPPLY ORDER PRESAGES PCjr

Because IBM's order for 3 million switching power supplies suitable for the PCjr also is said to contain a requirement for an unspecified number of 60W power supplies, industry analysts are speculating that the PCjr's delayed shipping was the result of radio-frequency interference and video interface problems with the original supplies. Industry observers say that the increase in power from 33W to 60W could be necessary to power peripheral devices, including a second integrated disk drive, that could be added. IBM does not usually discuss its agreements with suppliers. Rick Scott, spokesman for the IBM Entry Systems division, says, "There really isn't any room for a second drive in there. About half of the inside of the system is taken up by the single half-height drive, and the other half is taken up by the disk controller, the slot for the 64K-byte memory and display-expansion card and the slot for the internal modem."

NEC READIES FIRST NON-IMPACT PRINTERS

NEC Information Systems Inc., Lexington, Mass., will reportedly introduce two non-impact printers this year to serve as top-of-the-line models. A thermal-transfer printer that could be introduced as early as the first quarter prints at 4 to 6 pages per minute with a line-wide, 240-dot-per-inch thermal array. The company has also been developing a color ink-jet printer, but it is not as close to reaching the market as the thermal-transfer unit. Observers note the two printers appear to be direct competitors with the thermal-transfer and ink-jet models from Diablo Systems Inc.—the EPM 1 thermal-transfer model priced at \$4,995 and the Series C color ink-jet priced at \$1,250. NEC is expected to introduce its units at similar or lower prices.

DISK DRIVE COMPANIES LIMIT PLANS DURING HOLIDAYS

Disctron Inc., a subsidiary of Computer & Communications Technology Corp., has announced it will pull out of the cost-competitive dynamic market for 5¼-inch Winchester. The company had been manufacturing four drives with capacities as high as 20M bytes. Disctron also announced the 700 series of high-performance drives at the 1982 Comdex Show and was only recently ramping up production of the product. Production low-end drives, meanwhile, will be phased out. The company will continue to manufacture its 10M-byte, 8-inch cartridge and 40M-byte, 8-inch fixed Winchester.... At Shugart Corp., executives laid off 150 manufacturing and management employees after lower than expected sales. Shugart cites less-than-enthusiastic acceptance of its half-height minifloppy drive and slower production ramp-up for the company's new 3½-inch microfloppy and half-height, 5¼-inch Winchester disk drives.... Maxtor Corp. and Evotek Corp., manufacturers of high-performance, 5¼-inch Winchester, also laid off some employees. The companies reportedly expected higher production schedules than they experienced. Maxtor notes that its cutbacks involved "temporary" help and are part of maturing.

AMCODYNE PLANS FIXED/REMOVABLE WINCHESTER CARTRIDGE DRIVES

Amcodyne Inc., Longmont, Colo., should add the 7070, a 35M-byte fixed, 35M-byte removable 8-inch Winchester cartridge drive, to its 25/25 model 7110 line. The 7070 is the result of demand from customers using a Digital Equipment Corp. 14-inch RKO 7 fixed/removable drive, say Amcodyne officials. The Amcodyne 7070 is expected to be introduced in March at a price above the 7110's but below DEC's. The company will continue to offer the 7110 to its customers, company officials say.

READ-ONLY OPTICAL DISK OFFERS LOW-COST INFORMATION RETRIEVAL

A read-only optical-disk player is expected this spring from Reference Technology Inc., Boulder, Colo. It will act as a record player for microcomputers, playing disks that have been manufactured in high volumes. The disks contain electronic information,

Breakpoints

such as financial data and legal archives, which is now typically transmitted by expensive on-line data services. The player is expected to sell for \$4,000 to \$12,000; the disks, less than \$20 each in large quantities.

TELEVIDEO SIGNS WITH COMPUTERLAND, SHIPS PT

TeleVideo Systems Inc., Sunnyvale, Calif., has signed an agreement with the ComputerLand retail chain. The agreement states that ComputerLand will distribute TeleVideo's three IBM PC-compatible computers—the TPC 2 portable, the Tele PC and the Tele XT. The 450 ComputerLand stores will each receive six TeleVideo systems per month for a year. TeleVideo will ship the TPC 2 this month and the Tele PC and the Tele XT in February. The pact represents a significant distribution shift for TeleVideo, which had previously sold its products through OEMs and distributors. Meanwhile, TeleVideo is beginning European and domestic shipments of its PT portable personal terminal this month (MMS, November 1983, Page 27).

INFORUNNER WILL INTRODUCE LOW-PRICED DAISY-WHEEL PRINTER

Inforunner Corp., Santa Monica, Calif., which entered the U.S. printer market last year with the low-cost Riteman dot-matrix printer, is expected to offer its first daisy-wheel printer early this year. With the low end of the daisy-wheel printer market becoming increasingly competitive, Inforunner is planning to offer a 10 character-per-second (cps) printer at a retail price of less than \$300. The price undercuts those of 12-to 18-cps daisy-wheel printers from Juki Industries, Brother International and Star Micronics. Japanese manufacturer Alps Manufacturing Co. makes the Riteman for Inforunner, but it is not known if Alps will manufacture the daisy-wheel printer.

TECHFILES: A quick look at industry developments

Micro files: The Radio Shack division of Tandy Corp. introduced the TRS-80 model 2000 personal computer at Comdex, and it could prove to be the most formidable competitor for the IBM PC yet. The desktop system has a full 16-bit data path and runs MS-DOS on an Intel 80186 at 8 MHz. The model 2000 includes as much as 768K bytes of RAM, two thin-line 720K-byte minifloppy disk drives and an optional 10M-byte Winchester disk drive. It also features an optional 14-inch red/green/blue (RGB) monitor with better resolution than the PC—640 by 400 non-interlaced in eight colors vs. 320 by 200 in four colors. A basic model 2000 system with the Intel 80186 processor, 128K bytes of parity-checking RAM, two 720K-byte (formatted) floppy disk drives, an RS232C port, a parallel printer port and a low-profile, detachable keyboard with 12 function keys and MS-DOS sells for \$2,750. A 12-inch, green monochrome monitor is \$249 extra, an eight-color monitor, \$799. Tandy is offering the Winchester disk version, the 2000 HD, without a monitor for \$4,250. The model 2000 uses less desk space than does the IBM PC. It accepts four cards that a user can plug in without removing the system's cover. Price of comparable expanded configurations is 10 percent to 15 percent lower than the PC's. The system became available in Tandy's 1,100 Radio Shack Computer Centers on Dec. 1....

Manufacturers in Taiwan are ready to flood world markets with "look-alike" and "fake" IBM PCs (MMS, July 1983, Page 11), according to a report from International Resource Development (IRD), Norwalk, Conn. For example, Taiwan Mycomp is reportedly making a PC clone, as are Multitech International and Mitac. IRD speculates IBM Corp. may license some of these efforts instead of emulating Apple Computer Inc.'s approach of legal action.... **National Semiconductor Corp.** is announcing the availability of Genix, a port for Berkeley 4.1 Unix for the company's NS16000 microprocessors. National Semiconductor officials say Genix will use the 16000 family's demand-paged virtual-memory and floating-point capability. Genix will sell for \$30,000. An OEM-adaptable source-code version that includes 1,400 pages of documentation will also be available.... **STM Electronics Corp.**, Menlo Park, Calif., has introduced an IBM-PC

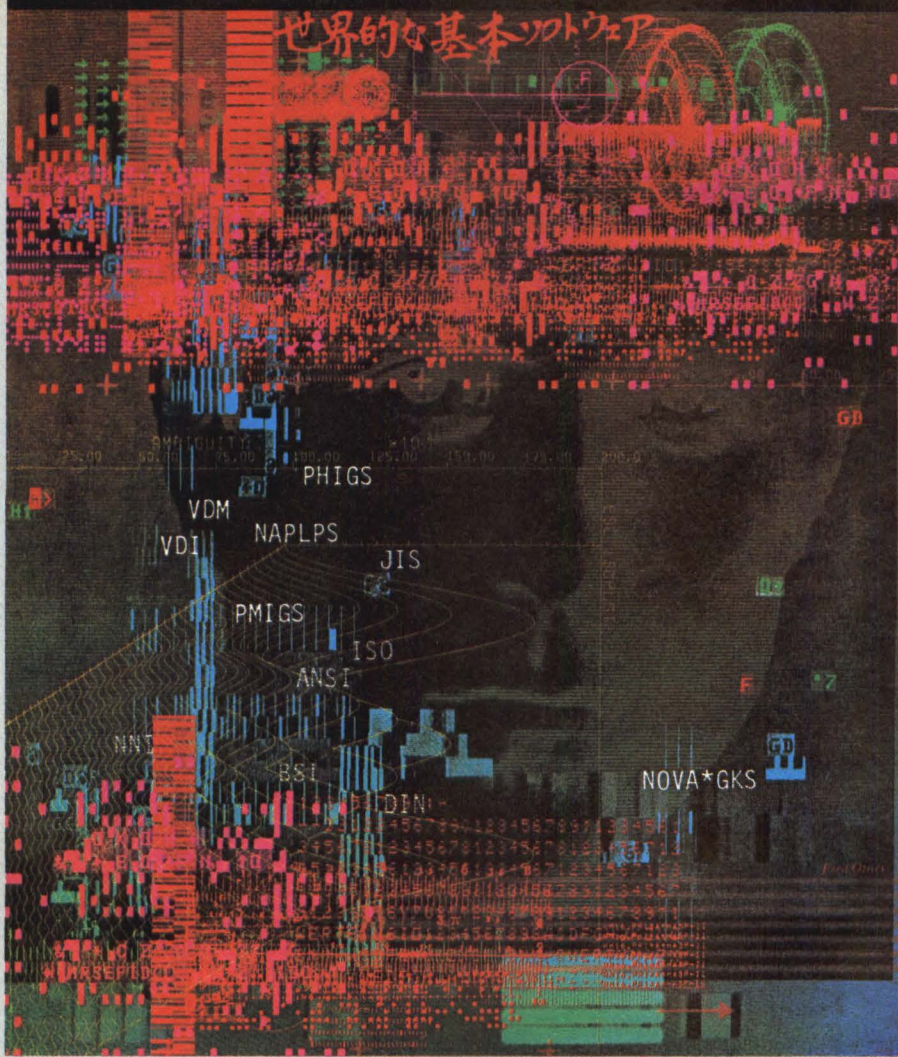

**When the world
of computer graphics
required standards,
the world of standards
acquired NOVA*GKS.**

Computer graphics takes an unprecedented step into reality with NOVA*GKS™ software from Nova Graphics International.

Years of innovative research make NOVA*GKS today's most advanced, full implementation of the Graphical Kernel System (GKS), the international graphics standard. Because of its unique, distributed architecture, NOVA*GKS allows multiple hardware configurations in host, workstation, and microcomputer environments.

A graphics development tool, NOVA*GKS makes it easier to design and construct graphics applications. In a fraction of the traditional time. In addition, applications using NOVA*GKS are totally device independent. Even portable.

To learn more about NOVA*GKS and its bottom-line competitive advantages, contact us today. We'll show you how NOVA*GKS and the Nova Graphics International support team can put your products on the leading edge of an escalating, worldwide market.

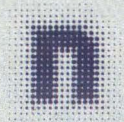

**NOVA GRAPHICS INTERNATIONAL
CORPORATION**

"World Standard Software"

1015 Bee Cave Woods Austin, Texas 78746 USA (512) 327-9300, Telex 767109

CIRCLE NO. 12 ON INQUIRY CARD

HOW DOES 1 = 50?

With SUPER STAR... The First S-100 Computer
To Use a 5 MB Removable Cartridge.

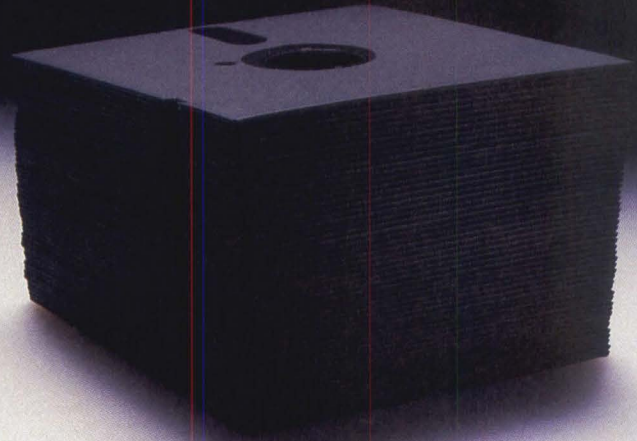
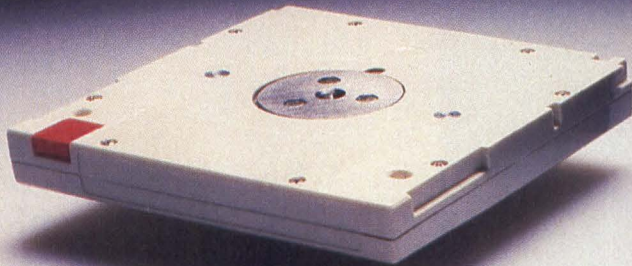

Advanced Digital's new SUPER STAR™ is the first of a family of S-100-based computer systems to be equipped with a 5-1/4" 5-MB Fixed/ 5-MB Removable Cartridge Winchester disk drive (10 MB on-line storage capacity) as standard. Now you can have the capacity of up to 50 floppy diskettes and the speed and convenience of 100% backup using the industry-standard Dyan 5-MB cartridge.

SUPER STAR is the ideal system for business, professional, and educational applications. Its CP/M* operating system (standard) gives you access to a vast library of readily available software programs. The six-slot motherboard allows plenty of room for expansion.

And as your business grows, SUPER STAR can grow with you. If you need more memory, just plug it in. SUPER STAR is based on the S-100 IEEE standard. To add more users, simply add Advanced Digital's SUPER SLAVE™ processor boards



and TurboDOS* operating system. Now you've got an extremely powerful, multi-user, multi-tasking, multi-processing SUPER STAR computer system for up to four users.

SUPER STAR is truly a Super computer system. Look at these outstanding features:

- New Slim-Line Profile
- 5-1/4", 10-MB Winchester Disk Drive, 5-MB Fixed, 5-MB Removable Cartridge
- 5-1/4", Half-High, 48TPI Floppy Disk Drive (Osborne Format Compatible)
- Six Slot Motherboard

- Switch-selectable 110/220V Power
- Up to 4 Users With SUPER SLAVES And TurboDOS
- CP/M Operating System Standard
- One Year Warranty

SUPER STAR is the perfect system for applications requiring large data storage capacity, speed, performance, reliability, and dependable, convenient back-up capability. And at a suggested retail price of \$5,000, SUPER STAR is a SUPER VALUE.

See the entire Advanced Digital product line, including the new SUPER STAR, at your local, quality computer dealer or contact:



5432 Production Dr.,
Huntington Beach, CA 92649
Phone: (714) 891-4004
Telex: 4722065 ITTSCSMA

*CP/M is a trademark of Digital Research Corp.
TurboDOS is a trademark of Software 2000 Inc.

SUPER STAR, SUPER SIX, SUPER SLAVE are
trademarks of Advanced Digital Corp.

For European Distributor, contact: (714) 891-4004

Breakpoints

compatible portable weighing 17 pounds and using a 16-line liquid-crystal display (LCD). The STM personal computer employs the Intel 80186 processor, which is reportedly in short supply. Maximum memory is 512K bytes. The system includes two 1M-byte, half-height floppy disk drives and an integral 40-column thermal printer. Prices start at \$3,000, and shipments are scheduled to begin in April. A \$2,500 desktop version will also be available....Two multiuser microcomputers, bundled with integrated, menu-operated business-application software, are available from **Onyx Systems Inc.**, San Jose, Calif. The UNIX System III-based machines come with word-processing, spreadsheet, electronic-mail and database-management programs in an integrated-software package called the Onyx Office. A minimal configuration for the C5012D desktop unit includes 512K bytes of RAM, five serial ports, a Centronics-compatible parallel port, a 5¼-inch Winchester disk drive with 14M or 21M bytes of storage and a 17M-byte cartridge-tape drive. The model C5012V is a larger, floor-standing unit. System prices begin at \$11,900....**Sord Computer Corp. said at Comdex it plans to introduce the Gypsy "knee-top," or lap-sized, portable computer priced at \$900 to \$1,000 and to be available in May or June.** The Gypsy will include a 3.4-MHz complementary-metal-oxide-semiconductor (CMOS) Z80A, 64K bytes of ROM, 32K bytes of RAM, with 32K bytes more as an option, a 40-character-by-8-line LCD and a microcassette recorder. Standard interfaces will include an RS232C port, a parallel port, a Centronics printer interface, a ROM cartridge interface and a Bell standard modem. A later model is expected to have a built-in modem. The Gypsy's 72-key ASCII keyboard will have six function keys and a toggled numeric pad within the normal keypad. Internal nickel-cadmium batteries will keep the computer operating for as long as eight hours. Options will include a microfloppy drive, a CRT terminal, a bar-code reader, a magnetic-card reader and a thermal printer.

SOFTCON preview: The first annual SOFTCON software industry show will be staged Feb. 21-23 at the Superdome in New Orleans. The show's sponsor, Northeast Expositions Inc., Chestnut Hill, Mass., has signed more than 600 exhibitors for 1,000 booths and is expecting 18,000 attendees. Judging from preliminary information, many of the software introductions will be personal-computer-oriented for vertical and educational markets, as well as integrated packages. **Lotus Development Corp.**, creator of the popular 1-2-3 integrated-software package, should announce software with communications capabilities. **Micro Software International, Noumenon Corp., Personal Computer Management Corp. and Softrend** should announce integrated decision-support packages. **Northeast Expositions says Adam Osborne will resurface at the show with a new software company called Software Seed Capital Corp.** **Data Management Associates**, Wilmington, Del., plans to introduce the Machine Integrated Code (MAGIC) business language. MAGIC runs on CP/M-, MP/M- and MS-DOS-based systems. **Mini-Computer Business Applications Inc.**, Montrose, Calif., should introduce its Micro Level II accounting and distribution packages that run under RM COBOL.

Graphics files: Better graphics should be the key feature of IBM's next PC, which is expected by April. The new system will include a 32-KHz display for 640-by-400-dot, eight-color resolution. The new driver board is likely to allow monochrome and color graphics displays to run with the same high-resolution character set, and the on-board raster buffer is expected to use 256K-bit chips. Industry observers speculate that the display and driver board will be bought from OEM Intelligent Systems Corp. (ISC), Norcross, Ga. ISC subsidiaries Princeton Graphic Systems (PGS) and Quadram Corp., formerly an OEM customer of PGS, are leaders in the plug-compatible mainframe display and board markets, respectively. IBM would supply Quadram with the memory chips.

Terminal files: CIE Systems, Inc., Irvine, Calif., a subsidiary of C. Itoh Electronics Inc.,

Breakpoints

introduced the CIT-467 color graphics terminal at Comdex. **Priced at \$2,995, the CIT-467 terminal allows simultaneous use of VT100 alphanumeric and Tektronix 4027A color graphics commands.** With a resolution of 572 by 480 pixels, the terminal has a Tektronix 4010/4014 emulation mode for monochrome graphics....**Applied Digital Data Systems (ADDS) Inc.**, Hauppauge, N.Y., introduced the Mentor 1000 workstation at Comdex. The workstation is designed to operate MS-DOS application programs while providing a transparent interface between host Mentor systems. It features a resolution of 640 by 480 pixels and optional color graphics. It operates as a standalone system running MS-DOS or CP/M. Base price is \$3,395, and availability is expected in the first quarter of this year....**Esprit Systems Inc.**, Melville, N.Y., has introduced the ESP 6310 low-end alphanumeric terminal. Priced at \$695, the terminal features a 14-inch diagonal screen with 24 lines by 80 columns and a 25th status line, a tilt-and-swivel monitor with a non-glare screen and a detached, low-profile keyboard. Esprit officials say the new terminal can emulate TeleVideo Systems Inc.'s Plus, ADDS' Regent 25/Viewpoint and Lear Siegler's ADM3A.

Random disk files: Seagate Technology and Atasi Corp. have canceled negotiations only a month after announcing an agreement in principle to merge. Seagate had offered 7.2 million shares of stock worth about \$130 million for Atasi. Officials at both companies now say it would be more beneficial to remain independent. Industry observers believe Atasi will now make a public offering it had planned before the acquisition talks rather than seek another suitor....**Shugart Corp.** is expected to announce a manufacturing license for a high-end 5¼-inch drive. Sources indicate that Quantum Corp., founded by a number of Shugart veterans, has the inside track....A 5¼-inch Winchester disk drive recently announced by Eicon Research Ltd., Cambridge, England, uses as much as 256K bytes of cache RAM to increase access time. The drive comes in 10M- or 20M-byte (formatted) capacities. Eicon says the maximum time to get a sector from the cache is 100 µsec., compared with a typical maximum of 200 msec. from a Winchester....**The Telelok floppy disk drive from Vault Corp., Westlake Village, Calif., allows telephone transmission of programs in a form that apparently prevents illegal copying in most cases.** An extension of the company's recently introduced Prolok copy-protection product, Telelok uses "fingerprinted" diskettes at transmission and reception sites to encrypt and decrypt, respectively, transmitted software. To run a received program, an authorized recipient needs a decryption disk, many of which correspond to an encryption disk. Users can make backup copies of programs, but the disk fingerprints can't be copied. Telelok is available for MS-DOS and will soon be available for other operating systems. Vault's OEM customers include Ashton-Tate and American Telephone & Telegraph Co....At Comdex, **Sord president Takayoshi Shiina announced plans to enter the Winchester disk drive market this year.** The company will make 10M- and 27.4M-byte drives at a projected rate of 5,000 per month....Raymond Brooke, co-founder of Computer Memories Inc. (CMI), Chatsworth, Calif., has resigned as vice chairman and director of planning for the company. Brooke was promoted to those positions just two weeks earlier, after turning over the president's office to Irwin Rubin. Brooke reportedly was uncomfortable in CMI's fast-growing environment and hopes to launch another start-up. Internal sources at CMI say Brooke plans to form a company to manufacture optical drives that will be smaller and less expensive than Shugart's recently announced Optimem drives....With Quarter-Inch Cartridge (QIC) -2 and QIC-24 interfaces common on ¼-inch tape drives at last fall's Comdex show, the committee for those standards looked ahead to the next generation of tape drives. The 12-member committee was directed to initiate standards for a device-level interface, a high-capacity tape-drive interface and a sub-5¼-inch form factor.

Printer files: Janome Sewing Machine Co. Ltd., Tokyo, made its first public showing in



C.ITOH ELECTRONICS HAS SOME NEW IDEAS ABOUT DOING BUSINESS IN THE WORLD.

We've long recognized that success in today's ever-changing marketplace requires a willingness to try something new. To bring the technology of marketing up to the technology of the 80's.

At C.Itoh Electronics, that means more than offering the latest product advancements. It means using the innovative marketing and capital resources necessary to bring those products to the world.

That's why, from the very beginning, C.Itoh Electronics has consistently maintained a strategy of total involvement in the high technology electronics industry. This includes marketing a wide variety of industrial electronic products, while at the same time, engaging in research

and development, cross licensing and venture capital investing.

In addition to developing and marketing its own unique products, C.Itoh Electronics buys products from many international manufacturers and sells them through U.S. sales offices, sales representatives, distributors and OEM's. More than 10 Japanese manufacturers who market their products in the U.S. are currently represented.

C.Itoh Electronics also procures products from more than 30 U.S. based manufacturers and markets them worldwide, mainly to Japan, where these products are then distributed through C.Itoh's affiliate companies. C.Itoh Electronics is always searching for new product

ideas to develop and bring to market.

No other company is better at bringing high technology to market. Perhaps, because in addition to exploring new ways of doing business, few other companies can draw on the experience and global resources of C.Itoh & Co., Ltd., our parent company. This multi-national organization has more than 125 years of business experience and thousands of employees linked through a worldwide network of 181 offices in 81 nations. These include 41 offices in Japan and 403 affiliated companies around the world—with annual sales exceeding \$50 billion.

It's no wonder that when it comes to bringing high technology to market, C.Itoh Electronics has the best ideas.

C.ITOH ELECTRONICS

A World of Quality

HOW TO MAKE YOUR SUPERMICRO LIVE UP TO ITS NAME.

Add DSD's RAMTRAC™ MULTIBUS® controller.

You're building a supermicro. A 16/32-bit CPU on one end. And a high-capacity 5¼" Winchester on the other.

Now, what are you going to put in the middle? A plain vanilla controller?

That's a little like a Ferrari with a Ford transmission. All show and not much go.

On the other hand, you could use a controller that's especially built to wring every last bit of performance out of supermicros.

DSD's RAMTRAC controller.

It controls Winchesters, floppies and tape. All on a single MULTIBUS board.

And it's packed with performance features like pipelined architecture for quick system throughput, support for the new high-capacity 15-head Winchesters, 24-bit addressing to run with the most powerful microprocessors, and 32-bit ECC.

Not to mention file oriented tape transfers, on-board data separation, and a whole lot more.

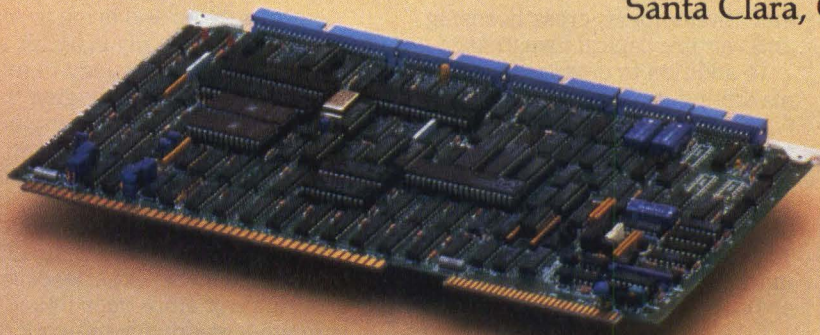

Match a RAMTRAC controller to your application.

Our line of three RAMTRAC controllers emulate Intel's® iSBC® 215, iSBX™ 217 and iSBX™ 218. And they're compatible with all SA460-, SA850-, SA1000-, and ST506-type drives.

Just select the model that's right for your application.

Model	5217	6217	7217
Winchester	5¼"	5¼"	8"
Floppy	5¼"	8"	8"
Tape	QIC-02	QIC-02	QIC-02

Call DSD for details.

If your supermicro is going to live up to its name, you really ought to take a look at our RAMTRAC controllers, today. The easiest way to do that is to call the DSD Sales office in your area for a copy of our RAMTRAC controller data sheet.

Eastern Region Sales and Service: Norwood, MA, (617) 769-7620. Central Region Sales and Service: Dallas, TX, (214) 980-4884. Western Region Sales: Santa Clara, CA, (408) 727-3163.

DATA SYSTEMS DESIGN

INTERNATIONAL SALES: Australia 03/544 3444; Belgium and Luxembourg 02/720 9038; Canada 416/625 1907; Denmark 02/63 22 33; Finland 90/88 50 11; France 03/411 5454; Hong Kong and Peoples Republic of China 03/696231; Israel 52-52444; Italy 02/4047648; Japan, Osaka 06/323 1707, Tokyo 03/345 1411; Netherlands 02977-22456; New Zealand 04/693 008; Norway 02/78 94 60; Singapore, Malaysia, and Indonesia 2241077; Spain 01/433 2412; Sweden 08/38 03 70; Switzerland 01/741 41 11; United Kingdom 7073/34774; West Germany and Austria 089/1204-0; Yugoslavia 61/263 261. RAMTRAC™ and HyperDiagnostics are trademarks of Data Systems Design, Inc., Intel,® MULTIBUS,® iSBC® and iSBX™ are trademarks of Intel Corporation. ©1983 Data Systems Design, Inc.

CIRCLE NO. 15 ON INQUIRY CARD

Breakpoints

the United States of ink color-platen, dot-matrix printers at Comdex. The company has adopted a technology in which a cylindrical platen containing seven color bands moves in front of the paper while a dot-matrix print head moves behind the paper, striking the paper against the inked platen. Each color band on the platen is easily removable and prints as many as 2 million characters. Janome will not set a price for its printers until it establishes a separate U.S. marketing arm for them. Retail price of the 132-column, dual-mode CP-1018 color printer, which prints at a maximum speed of 180 characters per second (cps), is expected to be less than \$1,200....**Hewlett-Packard Co. introduced the 300-line-per-minute HP2563 matrix line printer** at Comdex. Price is \$3,200 in quantities of 1,000. HP also introduced two low-speed laser printers employing a 12 page-per-minute print engine from Ricoh Co. Ltd. and HP's proprietary controller. The HP2687A has an end-user price of \$12,500; the HP2688A, which adds a graphics controller to the package, is priced at \$29,900. Both models feature a resolution of 300 by 300 dots per inch (dpi) and the ability to print four fonts on a page....**IBM will begin marketing a version of its 4250 printer to OEMs.** The IBM 4250, introduced at the National Computer Conference last May, employs electro-erosion technology for computer-based publishing applications. Resolution of 600 by 600 dpi allows near-phototypesetting quality without wet chemical processing. Prices for the OEM version range from \$12,600 each for 100 units to \$10,500 each for 400 or more units....Along with demonstrating the long-awaited low-cost LBP-CX laser printer, **Canon U.S.A. Inc., Lake Success, N.Y., made Comdex the site for its initial thrust into the impact printer arena.** The 80-column PW-1080 and the 156-column PW-1156 are serial dot-matrix models printing at 160 cps. The printers feature a near-letter-quality print mode with a 24-by-16-dot matrix, a graphics printing mode, down-loadable character sets and the ability to print four character styles on a line. Prices are \$595 for the PW-1080 and \$895 for the PW-1156. Canon is the most aggressive supplier of non-impact printers, with such products as the LBP-CX targeted at high-end daisy-wheel markets, the A1210 color ink-jet printer offered through Radio Shack and, reportedly, the thermal printer offered by IBM with the PCjr. Observers are, therefore, surprised to see Canon venture into the crowded market for more traditional dot-matrix technology....**Star Micronics Inc.,** the U.S. marketing subsidiary of Star Manufacturing of Japan, **made its anticipated entry into the daisy-wheel printer market with the PowerType printer.** The new printer uses a 96-petal daisy wheel and prints at 18 cps. List price is \$499. Star Micronics also revealed it is beginning OEM sales of all its printer products, which include dot-matrix and thermal units as well as the new fully-formed-character printer. The company had previously sold its products only through distributors.

Notes from overseas: Interactive Data Machines (IDM), the British dealer for U.S. IBM SuperVAR Computer Distributors Inc., has formed a subsidiary called Unison Technology. Unison will bring Altos Computer Systems' Pick operating system version for an 8086 processor to Europe under an exclusive distribution arrangement. Altos' operation in Europe has not actively sold the Pick-based Altos 586 machine, causing rumors that it had shelved the system. Meanwhile, IDM parent Universal Computer Ltd., from which it is now separated, has set up another Pick subsidiary—**Universal Computer Systems.** Universal will handle Datamedia Corp.'s Pick/MC68000 implementation. The subsidiary will sell products much as Universal sells Ultimate's Pick-based Honeywell Level 6s, selling both directly and through sub-dealers.

After three years of R&D, the Technical University of Munich's Computer Institute has produced a working prototype of the Future real-time process-control-oriented fault-tolerant system. The question remains whether the product will make it to market. If it is not purchased, institute director George Faerber, who is also president

Breakpoints

of German computer maker Peripherie Computer Systeme (PCS), may move Future into the PCS product line and possibly into Cadmus Computer, PCS' exclusive U.S. distributor. Future's Modula-2-based/RMX-like operating system is being switched from the LSI-11/23s it was developed on to the MC68000 architecture PCS favors and uses.

Former **Computer Europe** president James Minotto has resurfaced as chairman of the new U.K. franchise operation Interface Network. Backed by \$1.5 million in local venture-capital funds, the start-up plans 80 shops selling six brands of business and professional computers. Franchises will cost \$15,000. Terms include \$187,500 in capitalization and a \$187,000 credit line. The effort could encroach on U.S. operations such as Businessland, which is contemplating expansion into the U.K. market.

Olivetti SpA has made one of its first European high-tech investments outside of Italy, taking a 25 percent, more than \$1 million second-round financing position in fledgling British software house **Sphinx Ltd.** The six-month-old start-up, the brainchild of former Zilog Inc. European marketing manager Pamela Geisler, is chartered to become a worldwide clearinghouse for UNIX application programs via distribution/support pacts with Santa Cruz Software Inc., Unisoft and Human Computing Resources Corp. Phase two of Olivetti's business plan is to have Sphinx resell a 32-bit system with communications from Bridge Computer Systems and portable units from Gavilan Computer Corp., both Zilog spin-offs. Olivetti's goal is to reach \$7.5 million in revenues in three years. The New York-based Olivetti venture-capital arm reportedly has \$100 million for backing U.S. and European companies.

Apollo Computer Systems Inc. is considering establishing a large R&D/production facility in the United Kingdom. The company, which says its corporate goal is to reach \$1 billion in worth by 1988, is particularly interested in British software engineers. If the company decides to go ahead with its plan, it could have 100 U.K. employees by year-end. Long-term intentions are to have a British roster of 500. Further diversification could follow in Japan.

Digital Equipment Corp. may be the first company to take advantage of the new British custom law that allows a manufacturer to import goods, add value and re-export them without paying duties when the goods depart. DEC has re-established an on-site duty-free center at its facility in Ayr, Scotland, where manufactured and semi-manufactured items can be held duty-free for five years. The new regulations also simplify the paperwork importers must do to gain access to their goods. Thanks to a new computer system, when all of DEC's U.K. plants set up duty-free centers, the company will be able to give a single computer tape once a month to customs authorities. The tape will list the company's imports and re-exports. DEC developed the VAX VMS system in collaboration with Scotland's Computer Management Group Information Services. The system handles British tariffs, calculates the duty and computes changes in rates and valuations in world currencies. Computer Management should begin selling the system in Britain and the Common Market this quarter.

This month, Japanese consumers should be able to buy wristwatch computers. **A Seiko watch group company is supposed to introduce the first wrist computer with a 2,000-character memory, a keyboard that fits into a shirt pocket and a Microsoft BASIC controller measuring 14 by 20 cm.** Seiko says the unit will store 100 words in two languages. The display, keyboard and controller communicate without wires through electromagnetic induction and should make the unit compatible with personal computers. The controller is also fitted with a 20 character-per-line printer. The wrist computer will be priced at \$80, the keyboard at \$20 and the controller at \$120.

**IBM PC-XT?
Davong gives you
more for less!**

Before you buy an IBM® XT, there is something you should know. An IBM® PC with a Davong hard disk is a better value. You can get more capability and capacity, higher disk throughput, easier upgrade, and better backup. All for less money.

You deserve better backup. Floppy backup just isn't adequate for large hard disks. Davong has optional tape cartridge backup systems for safe, secure, fast, high capacity backup of your files. (Tape backup available for both IBM PC and IBM XT.)

Do more, faster. A Davong hard disk with Multi-OS™ is up to three times faster than an IBM XT. Multi-OS gives you a real choice of operating systems by supporting DOS 1.1, DOS 2.0, CP/M-86™, Concurrent CP/M™, and Pascal. And extra features, like programmable disk cache, flexible volume mapping, and local area networking support, make your disk more useful.

Davong gives you more for a lot less money. And Davong hard disk systems are available, now, at more than 800 computer dealers.

DAVONG CHALLENGES THE IBM XT

	IBM XT	IBM PC & Davong hard disk
Capacity		
Capacity range	10-20 MB	5 to 128 MB
Upgrade unit capacities	10 MB	5,10,15, 21,32 MB
Features		
Backup	Floppy	18 MB tape cartridge & Floppy
Password protection	No	Yes
Flexible volume configuration	No	Yes
Local networking	No	Yes
Programmable disk cache	No	Yes
Throughput* (milliseconds/512 bytes)		
1000 sequential records:		
Write time	27	11.2
Read time	18.8	7.4
Random access	28.3	11.8 (with cache)
Price		
Suggested retail price		
Add-on 10 MB drive	\$3390	\$2395

*IBM DOS 2.0, IBM PC-XT vs. IBM PC with Davong Multi-OS

®Registered trademarks. ™Trademark.

Your IBM PC deserves Davong.



Davong Systems, Inc. □ 217 Humboldt Court □ Sunnyvale, California 94086
Telephone: (408) 734-4900

CIRCLE NO. 16 ON INQUIRY CARD

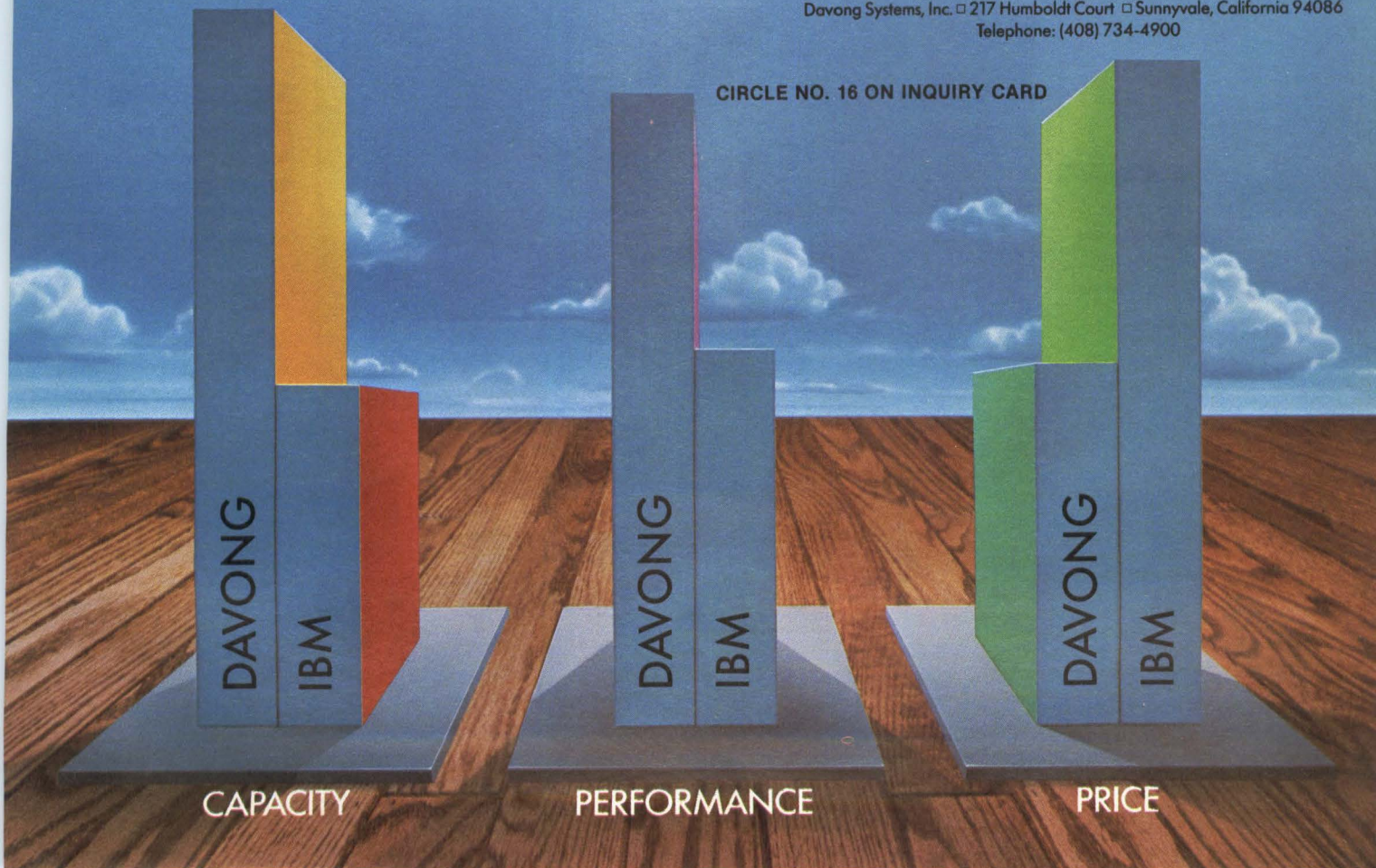

Apollo recognizes the fact that there are two sides to every professional.

*There's a part of
a professional
that involves
their profession.*



*Then there's the part
that goes to meetings,
makes presentations,
does budget, prepares
documents.*

According to recent reports, people who work with computers spend some 30% of their day working in their chosen profession. And 70% of their day just getting things done.

So we're announcing some ways for making better use of both sides of their day.

For starters, we've set some new standards in high performance workstations. By introducing a new set of Apollo computational nodes so

fast you don't have to wait for them to figure out anything. Even when you're working on Solids Modeling, Image Analysis, Finite Element Analysis, and VLSI Design.

The Apollo DN 660 and DN 460.

Inside you'll find up to 4 MB of main memory. With full 32-bit architecture and an integrated hardware floating point unit. And enough power to handle up to 24 concurrent processes, each with up to 256 MB of virtual address space. Plus high resolution bit map graphics that among other things, can do area

fills at up to 320 million bits per second.

In other words, they've got all the power of a high performance supermini like the VAX* 11/780. Except that they sit at a desk. And go for a fourth of the price.

But even more important, each DN 660 and 460 workstation node you add to the Apollo DOMAIN network adds power instead of taking it away. Because each is a 32-bit workstation with network wide virtual memory that lets all Apollo nodes share data, software, programs, and peripherals transparently across the network.

But we've also introduced software that helps professionals work with the other side of their work: DOMAIN Professional Support Services. With Document, Mail, Calc, Calendar and File. All based on the more complex needs of the professional. And fully integrated with your application programs. So you can do all your work on the same system.

All of which should come as a very welcome development to every professional. Because we at Apollo are not simply making computers. We're making workstations that work for professionals.

For more information call or write Marketing Services Director, Dept. B1, Apollo Computer, 15 Elizabeth Drive, Chelmsford, Massachusetts 01824 (617) 256-6600, ext. 6608.

The power of a high-end 32-bit supermini at your desk for a fraction of the price.

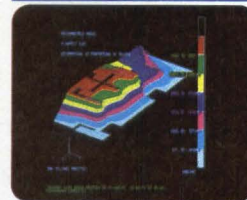
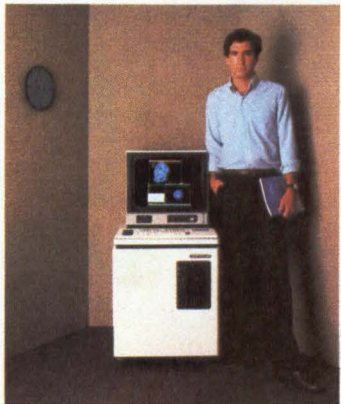

The DN 660 and DN 460 can do state-of-the-art Finite Element Analysis at state-of-the-art speed.

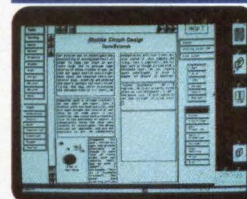

They work on documents the way professionals work.

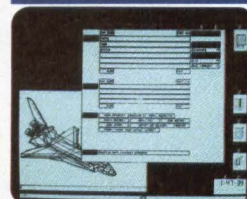

They do Electronic Mail, Filing and Calendar Management.

apollo

CIRCLE NO. 17 ON INQUIRY CARD

*VAX is a trademark of Digital Equipment Corporation.





The American Dream is still alive.

A belief in excellence

Remember what it was like? Sunday morning. You're still not quite awake, but already you've got fifty pounds of paper on your back. It's raining. And old Mrs. Henriksen's paper just skidded off her porch into the thorn bushes.

Now what do you do? Leave it there and go on? Of course not. For you, there's no choice. You go find it and put it where it belongs.

That spirit—the spirit of doing things right no matter what it takes—isn't dead. Not at ATASI. We not only talk quality. We deliver it.

Example: Every one of our 5¼-inch Winchester disk drives is tested 22 different ways before it goes out of the door, including an extended burn-in at 120° F.

Example: Our platters all have dedicated landing zones, so that they preserve your customer's data even in the event of an emergency power-down.

Example: The acceptable ambient temperature range for our drives is up to 33% greater than the acceptable range for our competitors.

We could go on and on. But we'd rather prove our point with a demonstration.

For more information, call or write ATASI, 2075 Zanker Road, San Jose, CA 95131, (408) 995-0335.

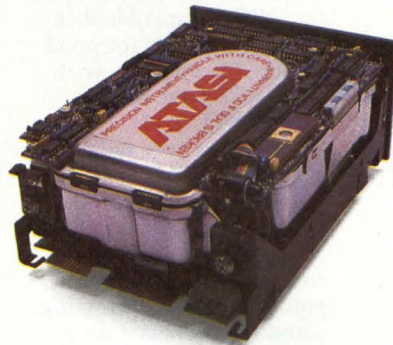

ATASI

© 1983 ATASI Corporation

CIRCLE NO. 18 ON INQUIRY CARD

DATARAM TAKES THE LEAD IN VAX COMPATIBILITY

Three new products establish Dataram as the leader in VAX compatibility.

Our single-board UDA50 compatible controller and our VMS-compatible BULK MEMORY system are industry firsts. Add to that our new 1.0 MB VAX-11/780 memory, and you will understand why Dataram is the VAX-compatible leader.

Call us at (609) 799-0071 today, and learn more about these exciting new products.

1 UDA50 Compatible Controller

Our new S35 controller establishes a new standard for DEC-compatible disk controllers. And for good reasons. It operates with any SMD drive on the VAX (or PDP-11) UNIBUS, at speeds in excess of 2.0 MB/sec. Its speed allows you to take advantage of the popular Fujitsu Eagle. It provides command stacking and enhanced error correcting...and it's packaged on a single hex board.

DEC, PDP, UNIBUS, VAX, and VMS are trademarks of Digital Equipment Corporation.

2 VAX/VMS Compatible BULK SEMI

Our new BS-207 BULK SEMI system offers something never before available — BULK SEMI power and performance for VAX/VMS systems.

BULK SEMI, operating as a high-speed swapping device, has delivered up to 50% improvement in throughput.

Up to 64 MB of high-speed BULK SEMI with ECC standard. Dual-port capability available.

3 1.0 MB VAX-11/780 Memory

Our new DR-278 will operate with all VAX-11/780 computers using DEC's new MS780-E memory systems. But more than simply a direct replacement for the MS780-F memory module, the Dataram DR-278 offers bus disable switch, LED status indicators, and reduced chip count that improves reliability and reduces power consumption. Best of all it's available, today, at a lower cost.

DATARAM

Dataram Corporation □ Princeton Road □ Cranbury, NJ 08512 □ (609) 799-0071 □ TWX: 510-685-2542

Mini-Micro World

NEWS

IBM demonstrates ring proposed as LAN standard

IBM Corp. publicly demonstrated the token-passing baseband ring technology it is proposing as a local-area network (LAN) standard for the first time at the recent Telecom '83 exhibition in Geneva, Switzerland. But system integrators who value IBM compatibility need not panic. IBM officials stressed that the 4M-bit-per-second (bps) ring is only a prototype, and it looked like one.

Five devices operated on the ring: two Personal Computers, a Displaywriter, a printer and a file server based on a Series/1 minicomputer. Each of the five devices was interfaced via adapter circuitry housed in a cumbersome rack-mountable box. IBM officials attributed its size to the use of standard transistor-to-transistor logic (TTL) chips, insisting that the unit could eventually be contained on one small PC card measuring about 2.6 by 3.8 inches. To emphasize the point, IBM displayed a bare card it had produced in that size. But Texas Instruments Inc., the company IBM hired more than a year ago to produce the necessary custom circuitry, could give no indication of when the equipment would be ready.

IBM used the five devices to show that the ring can support multiple simultaneous sessions—in this case, three—although only one station at a time can hold the message frame, a key feature of the ring. The demonstration showed the two PCs sending simple messages to each other, the Displaywriter sending files to the file server and the file server sending files to the printer. Officials said the company's aim was to demonstrate that the specifica-

tion it is proposing to the Institute of Electrical and Electronics Engineers (IEEE) is viable.

Also highlighted was the possibility of linking rings. But company officials concede no such capability is available yet, even though the address space in the message-frame structure provides 2 bytes each for ring number and station number. The officials claim two rings should be able to pass messages even if operating at different speeds.

The Geneva event, which is staged every four years, is the world's largest showcase of telecommunications products. It is appropriate that the IBM demonstration was held in Geneva, the home of the European Computer Manufacturers Association (ECMA), which—in advance of the IEEE—adopted the IBM proposal as its baseband token-passing ring standard. Moreover, the center for worldwide development of IBM's prototype ring is the company's research laboratory in nearby Zurich, Switzerland. IBM refers to the prototype as the "Zurich Ring." Hans Müller, a member of the ring's development team, notes that the team is cooperating with IBM's information systems and communications group in Raleigh, N.C., on testing a simple, standard male/female connector designed for physically attaching any type of station. It plugs into an identical connector contained in what IBM calls a wall concentrator, or distribution panel. The panel provides multiple connectors to support multiple stations in a star formation.

Müller believes the passive nature of the distribution panel is one of the advantages of the Zurich

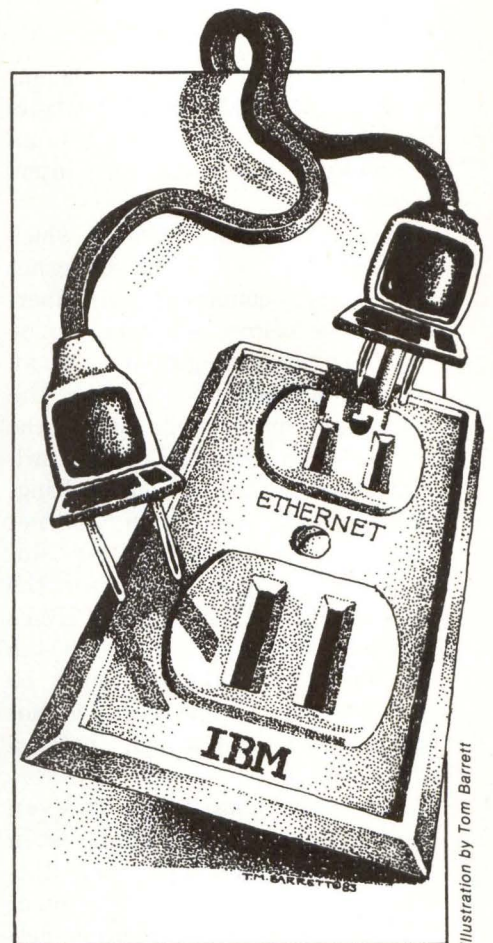

Illustration by Tom Barrett

IBM's prototype LAN, a competitor to Xerox's Ethernet, employs a passive distribution panel for multiple connections of workstations.

Ring over Ethernet, which uses the carrier sense multiple access/collision detection (CSMA/CD) access method. Stations wanting to access Ethernet require a powered transceiver.

The IBM demonstration also underlined the Zurich Ring's ability to employ a variety of transmission media other than coaxial cable. Because each station on a ring captures and repeats each message, even when the station is not in data-transmission mode, shielded twisted-pair cable can be used instead of coaxial cable. The elimination of tapping with transceivers allows the use of fiber-optic cable. Fiber can potentially support data rates of around 30M bps over

Mini-Micro World

NEWS

distances greater than 1,000m., according to IBM. Another attraction of fiber-optic cable is its immunity to electromagnetic interference.

Digital Equipment Corp., which has invested heavily in Ethernet technology, counters that fiber-optic cable as long as 1,000m. can be used to link segments in an Ethernet without reducing the maximum length of the rest of the bus—2,800m. But DEC acknowledges that, unlike the Zurich Ring, the fiber-optic parts of an Ethernet cannot support transmitting stations. Thus, DEC recognizes the importance of IBM's work. "IBM's size will make it a force in the [LAN] market. But it would be naive to think that DEC is not looking into token rings," notes a DEC official.

Hewlett-Packard Co. is even more definitive about its interest in token-ring technology. Wim Roelandts, research and development manager at HP's information networks division in Cupertino, Calif., says token rings offer greater distances than Ethernet and are more "deterministic." But, he adds, "In practice, the ring will run at 2M bps, not 4M bps. At 2M bps, Ethernet would certainly also be deterministic."

IBM's description of the Zurich Ring as deterministic underlines one of the ring's key features. Company officials note that the token-passing method allows system designers to predict the lengths of the average delay and of the greatest possible delay in communicating with another station attached to the ring. Token rings also permit the assignment of different priorities to different messages. For example, it can give high priority to such synchronous information as real-time voice, a feature that should appeal to private branch

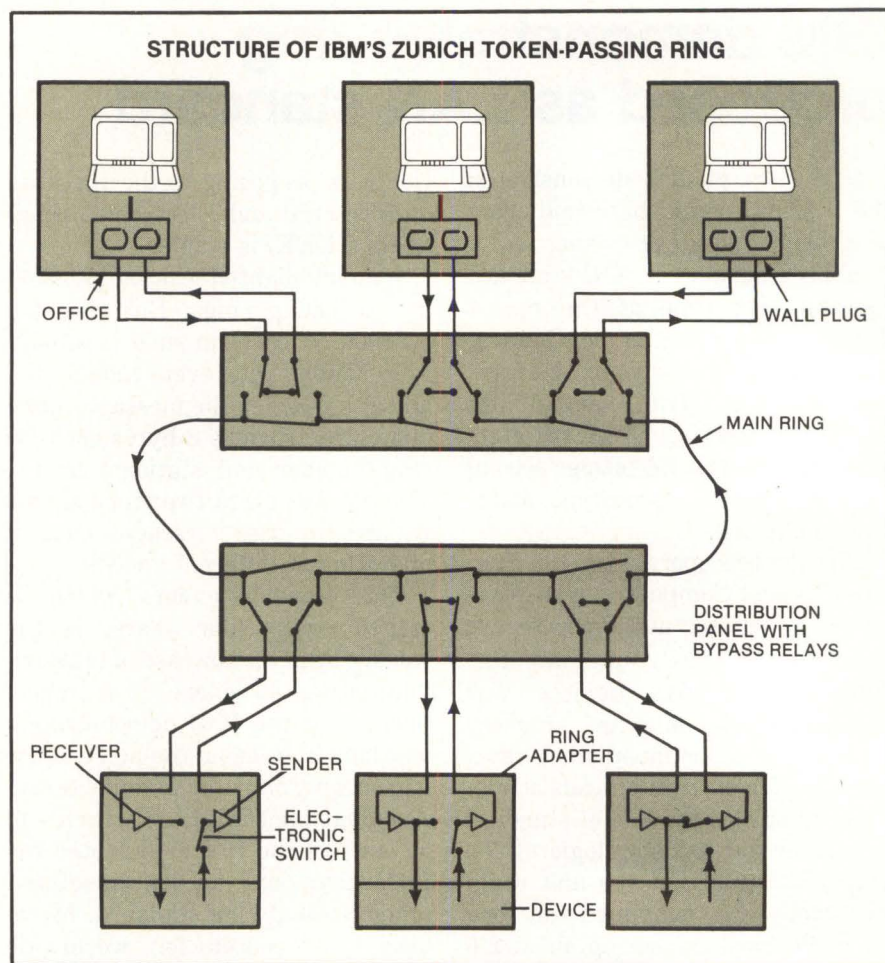

The Zurich Ring consists of a set of interconnected distribution panels placed at various locations in a building. Each panel contains bypass relays that allow inactive or malfunctioning stations to be bracketed out of the ring. Each panel can be linked to several stations by a star-shaped wiring arrangement. Each device operating on the ring is equipped with an adapter that contains receive, transmit and interface circuitry.

exchange (PBX) vendors. The synchronous bandwidth manager, a special ring attachment, can order stations sending asynchronous information to stop transmitting and instruct synchronous stations to exchange messages. The manager uses 2 bits in the physical-control field of the Zurich Ring frame—the reservation and frame indicators—for these functions.

HP's Roelandts points to a fundamental disadvantage of the Zurich Ring compared with Ethernet: the need to regenerate a token

if it is lost. IBM tackles the problem by providing every adapter with the ability to act as a monitor for performing fast recovery. While the monitor can be active in only one adapter at a time, control can be transferred to another monitor if necessary. The monitor handles three basic error situations: a lost token, a duplicated "free" token and a permanently circulating "busy" token. In the last case, the monitor checks a bit called the monitor indicator in the physical-control field. In normal operation, the last

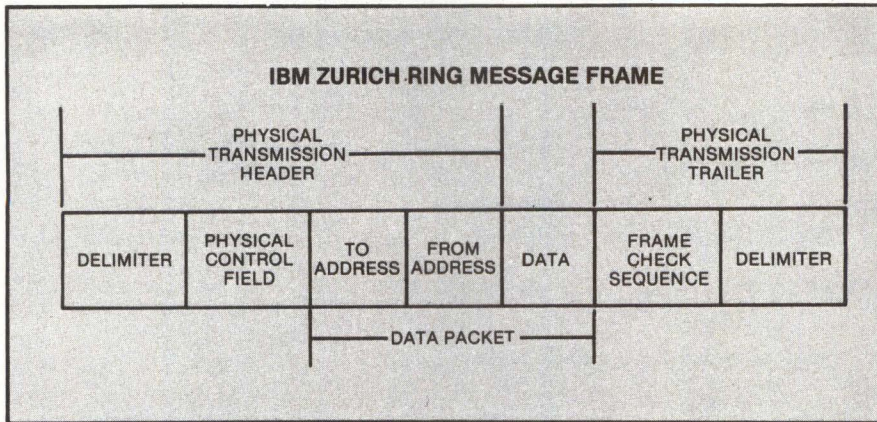

Transmissions on the IBM token-passing Zurich Ring are in the form of message frames. Each frame carries information for controlling ring operation, as well as the user's message, and is regenerated by each device's adapter. A token bit in the physical-control field controls access to the ring. If a device adapter has a message to transmit, it waits for the token bit to indicate "free" and turns it to "busy" on the fly, adding its message to create a complete message frame. When the adapter gets the frame back

after the message has been copied by the receiving station, it sets the token bit back to zero and removes the message. If the adapter has nothing to transmit, it enters repeat mode, in which it regenerates and retransmits the only messages it receives. The adapter also examines the "to" address of each frame passing through. When it detects its own address, it enters receive mode, in which it copies the frame and then regenerates and retransmits it.

transmitting adapter would set the bit at zero, indicating that the token bit is free rather than stuck on busy.

Another fundamental problem of Zurich Ring technology is that, if one of the stations fails and stops

repeating the frame message, the entire ring can be lost. To solve this problem, IBM has designed an automatic bypass relay into the distribution panel. The relay reportedly can remove a failed station and restore the ring in no more than 2 msec. The company also designed circuitry into each adapter's repeater to provide rapid restoration of the timing synchronization of the stations on the ring.

Another disadvantage—"timing jitter"—limits the total number of stations to 256. Timing jitter is caused by linear distortion of the cable between adapters and concentrators. Each station gets its timing information from the message received from the previous station, so jitter can accumulate. This eventually leads to intermittent synchronization failures that cause burst transmission errors, according to IBM. The circuitry designed into each adapter's repeater helps control the problem. —Keith Jones

DEC emulates itself with VT100 successor

Sequels to hit movies can often do great at the box office without straying from the tried-and-true formulas of their predecessors. Digital Equipment Corp. may have noticed that fact when it prepared for the premiere of its own "Rocky II"—the VT200 terminal series.

DEC can hardly be blamed for not changing too many things in its successor to the VT100 family, a group of terminals with an installed base that DEC estimates at more than 500,000 units. The VT220, VT240 and VT241, originally expected as early as the first quarter of last year, were subjected to enough speculation and scrutiny to



The VT220, which anchors Digital Equipment Corp.'s new VT220 family of display terminals, comes in a two-piece ergonomic package with logic circuitry housed in the monitor. Single-unit price is \$1,295, \$415 less than the current VT102 price.

Mini-Micro World

NEWS

keep a Hollywood gossip columnist busy until the terminals' final unveiling in November (MMS, November 1983, Page 69).

The main surprise left was the price of the new units. In single-unit quantities, the VT220 alphanumeric terminal is priced at \$1,295—\$415 less than the price of the VT102 alphanumeric unit. Art Campbell, DEC's terminal products group manager, explains that the company hoped to "set the standard for performance in this market with the 220, much as it did with the VT100." But DEC also felt it should be considerably more aggressive in pricing the 220.

The VT220 employs the same detached keyboard as the DEC Rainbow personal computer, and a similar monitor. With a 12-inch-diagonal CRT screen and an amber, green or white, 24-line-by-80 or -132-column display, the new terminal incorporates all capabilities of the VT100 series and is compatible with the VT52. The new terminal features an improved ergonomic package including the detached keyboard, a tilt-and-swivel monitor and a non-glare display. It is also smaller and lighter than the VT102. The terminal has 15 programmable function keys, a CRT blanking function that turns off the display after 30 minutes of non-use and down-loadable character sets that users can design.

The VT240 incorporates all the text-display features of the 220, plus graphics. Priced at \$2,195, the VT240 supports DEC's proprietary remote graphics instruction set (ReGIS) from the VT125, priced at \$3,800. Resolution is 800 by 240 pixels. The VT241 will offer full-color graphics with a 13-inch diagonal screen for \$3,195. The 240 and 241 come as a three-piece package with a monitor, a keyboard and a system box that includes room for add-ons such as an integrated

FEATURE COMPARISON OF VT 102 AND VT 220		
VT 102		VT 220
92 keys	Keyboard	103, DIN standard
1	Programmable function keys	15
non-glare screen optional, 12-in.	Display	non-glare screen standard, 12-in.
128 ASCII	Character set	256 multinational 94 character down-line-loadable from host
110 to 19,200 baud	Min./max. transmission rate	75 to 19,200 baud
Set commands	Setup mode	menu-driven, plain language (English, German or French)
18 in. wide 14½ in. high 20 in. deep	Size	13 in. wide 11 in. high 14 in. deep
41.5 lbs.	Weight	30.5 lbs.

modem. The graphics terminals will also offer Tektronix 4010 and 4014 compatibility.

One reason the VT200 family took so long to appear is that DEC wanted to prevent a problem of the VT100 supply falling behind demand almost from the day of introduction. Emulators were quick to profit by DEC's mistake. This time, DEC decided to delay the official announcement of the product until it had built sufficient production capacity, says Campbell. He says lead times on the VT100 series were sometimes as long as a year, but he thinks DEC has enough VT200s to prevent that from happening. "We expect to ramp up production to equal VT100 family production by June," he adds. DEC's Taiwan facility, which already supplies some monitors and keyboards for DEC's personal computers, is producing the VT220.

DEC's well-publicized sales difficulties with its personal computers may raise doubts about the advisability of patterning the VT200 family on the Rainbow. Campbell argues, "If anything, any problems in sales of the personal computers

leave more production capacity open for the terminals," Campbell says. "We might have an issue if sales of the personal computers start outstripping demand, in which case we could have temporary problems with production priorities."

While Campbell expects the VT200 family eventually to replace the VT100 series, he says DEC expects to continue manufacturing the VT100 family in "fairly high volumes" this year. "It has been our experience that when you bring out a replacement product, you generally find the older model continues to sell with much greater strength than you might reasonably expect." Even though the VT220 has more features and up-to-date ergonomics than the VT100 and is lower priced, DEC does not plan any immediate price adjustment on the older models.

It is also true that most of the VT220's features exist on products from other suppliers at prices lower than \$1,000. Some of those products comply with the American National Standards Institute (ANSI) 3.64 standard, to which DEC also

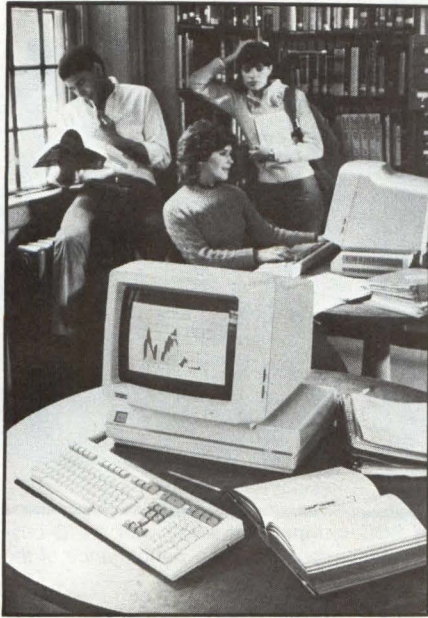

Digital Equipment Corp.'s VT241 color graphics terminal supports DEC's proprietary ReGIS and Tektronix 4010/4014 graphics instruction sets. Unit price is \$3,195.

don't think the functions come as any great surprise at this point, but \$1,295 is definitely a very aggressive price for DEC," opines Robert Sanekoff, manager of Dataquest Inc.'s Display Terminal Industry Service. "They still have a good backlog on the VT100; it's almost as if they will be competing with themselves in pricing the new product that low."

Companies offering products that are potential emulators of the VT200 are also pleased. "It is a

fairly aggressive price for them on a terminal with some very impressive features," notes Steve Fryer, vice president of marketing for CIE Terminals Inc., Irvine, Calif., a company whose entry into the terminal business was strict VT100 emulation. The CIE 101E, priced at \$1,495, has many of the same features as the VT220, Fryer points out, although it has a 14-inch screen, an additional page of memory and still employs a VT100-type keyboard. Fryer foresees a market for straight VT200 emulators. "I think DEC will sell all they can make, and I expect we will be able to participate as well," he says.

—Edward S. Foster

conforms. Campbell does not see the VT220 as part of the ANSI-compatible terminal market. "There are a host of terminals locked in a death struggle at the low end of the market," he says. "We have chosen not to compete at that level." He says DEC will stay with a premium product and continue to add features rather than get into an area with little or no profit margin.

Some features that might be added to the VT200 family include larger displays and color for alphanumeric. Campbell says DEC considered such possibilities for the VT220 but instead placed priority on production synergy between the VT200 family and personal computers. "Over time, bigger probably will be better as far as screen size goes," Campbell acknowledges. He expects eventually to see bigger screens for the 200 family. DEC also considered adding color capability to the VT200 but decided that monochrome gives "the function you need right now, and the advantages of color would not pay for the extra cost," Campbell adds.

Observers see the VT220's price as its most intriguing aspect. "I

Battle of the boards: Intel challenges DEC's supremacy

Giants Intel Corp. and Digital Equipment Corp. are sharpening their swords for the battle of the lucrative single-board computer (SBC) market. The question still remains: whose approach is better: Intel's—rapid, flexible technology turnaround—or DEC's—a more mature, stable system orientation?

Intel grew into a billion-dollar company largely on the strength of its semiconductor business. Intel processors such as the 8088, 8086 and 80186 are very much in demand for the IBM Personal Computer, the scores of PC clones and many other microcomputers. And other Intel

chips such as math and graphics coprocessors are also in demand.

DEC, meanwhile, gained its status as the leading minicomputer manufacturer mainly on the strength of its systems, software and peripherals.

According to Dataquest Inc. estimates, the board-level market should reach \$1 billion in 1988, more than double the 1983 total. The 16-bit minicomputer market is evolving from the system to the board level. Brad Smith, senior analyst at Dataquest's Small Computer Industry Service, notes that the 8-bit segment of the market has

	1982	1983	1984	1985	1986
8-bit	170	180	191	190	180
16-bit	250	293	350	422	500
32-bit	—	1	3	12	46

Source: Dataquest Small Computer Industry Service

Mini-Micro World

NEWS

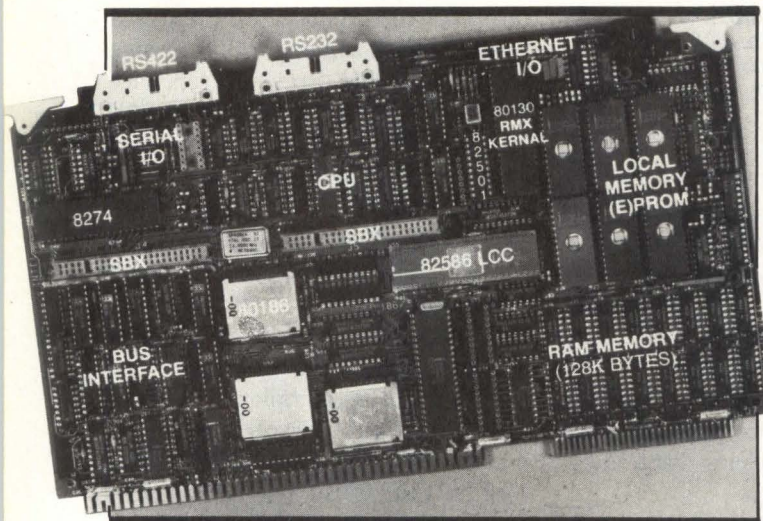

Intel is pushing for the SBC lead with products such as the 186/51 COMMputer. The board houses the 80186 CPU, 80131 operating-system firmware, the 82586 LAN coprocessor and the 82501 Ethernet serial interface.

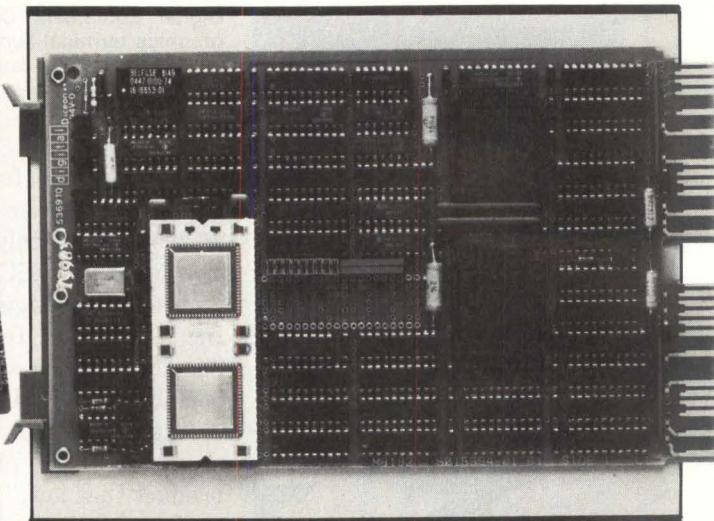

DEC plans to blow the SBC competition away with the Q-bus-based LSI-11/73, which provides four times the performance of the LSI-11/23 SBC, DEC says.

stabilized and that the 32-bit segment is still in its infancy. The real action in the market is in the 16-bit arena. In 1984, the 16-bit SBC market should total \$350 million. In contrast, the 8-bit sector should peak at \$191 million, and the 32-bit portion should reach only \$3 million.

"We're talking about big bucks here," says Smith. "What used to be the 16-bit mini business is becoming the SBC business." One reason is that OEMs can now use 16-bit SBCs in \$10,000 packages that provide a performance level similar to that of a minicomputer that sold for \$80,000 three or four years ago.

DEC, with about \$70 million in 1983 revenues from its Q-bus-based SBCs, is the leader in the SBC market, Smith says. Intel is a close second, and Motorola Inc. and others are lagging far behind. Intel hopes to become number one next year. To enhance their positions, both Intel and DEC are constantly improving the performance and functionality of their SBCs. Recent examples are Intel's 186/51 COMMputer and DEC's LSI-11/73.

Intel began shipping the COMMputer in November. It is the first Multibus-based product that integrates several VLSI chips, including the 80186 CPU, the 80130 operating-system firmware, the 82586 local-area network (LAN) coprocessor and the 82501 Ethernet serial interface, on one board. The COMMputer has 128K bytes of dual-ported RAM and can support as much as 192K bytes of standard erasable, programmable, read-only memory (EPROM). It also has RS232C and RS422A/449 programmable interfaces and two Multimodule sockets for I/O expansion. Price is \$3,000.

Tom Kinhan, general manager of Intel's OEM modules operation, says the COMMputer can be used as a communicating SBC, a bus master in a multiprocessor system or as an intelligent front-end processor.

Due to be shipped by this month is DEC's dual-height Q-bus-based LSI-11/73, the first board-level implementation of the complementary-metal-oxide-semiconductor (CMOS) J11 microprocessor, or "PDP-11/70 on a chip." The LSI-11/

73 reportedly provides PDP-11/70-level performance, or roughly four times the performance of a dual-height LSI-11/23. The LSI-11/73 has floating-point capability and 8K bytes of on-board cache memory.

Another advantage of the LSI-11/73, DEC claims, is that there is much application software available for Q-bus-based systems. Applications written for RSTS and all PDP-11 operating systems also run on the LSI-11/73. The system is downwardly compatible with previous Q-bus-based processors. Replacing an LSI-11/23 board with an LSI-11/73 board requires only minor configuration changes, DEC says. Single-quantity price is \$2,180.

Dataquest's Smith says DEC's Q-bus is sometimes criticized for having a non-standard number of bits—22. But DEC contends that the Q-bus, which can address 4M bytes of memory, is quite popular. The company says it has shipped more than 300,000 of its Q-bus-based LSI-11 board-level processors since their introduction in 1975.

—David A. Bright

new
**The CONCEPT AVT+
In a word: capability.**



THE CONCEPT AVT+ DISPLAY TERMINAL

ANSI standard conformance, DEC VT100 software compatibility, eight pages of memory, 80/132 columns, windowing, multiple computer connections...and a full range of practical ergonomic features. Capabilities which enable all terminal users to maximize their productivity and explore their creativity. Only from Human Designed Systems.

CIRCLE NO. 20 ON INQUIRY CARD

Introducing the new *concept* AVT+ display terminal from Human Designed Systems. Simply the smartest interactive display terminal available today. And at a very competitive price.

It starts with ANSI standard (X3.64-1979) conformance and DEC VT100 software compatibility, and incorporates superior human design features, advanced functionality and highest quality construction. A commitment to quality that is reflected in each of the individual components.

The *concept* AVT+ keyboard is ergonomically designed for optimum operator comfort, incorporating a VT100-style numeric pad for DEC software compatibility. And it builds on those human design features with a range of capabilities that make the *concept* AVT+ an ideal choice for smart terminal users.

The *concept* AVT+ offers up to eight pages of display memory that eliminates unnecessary

*Quantity one. DEC and VT are trademarks of Digital Equipment Corporation.

\$1295*

hardcopy printouts and provides a powerful tool for applications requiring multiple formats and storage of large volumes of text; non-volatile memory that enables users to permanently configure a terminal for their needs or applications; windowing that allows users to create individual displays within display memory; programmable function keys which transmit data and/or execute terminal commands; up to three additional communications ports for connection to other peripherals and computers; flexible user networking and functionality for use in a wide range of different applications, including multiple computer connections; and much more.

The new *concept* AVT+. More to offer at its price for terminal users than any other terminal available today.

human designed systems, inc.

3440 Market Street, Philadelphia, PA 19104
215-382-5000

Human Designed Systems. We're redefining terminal performance.

Atlanta — (404) 391-9763; Boston — (617) 329-3510; Chicago — (312) 825-2960; Dallas — (214) 437-1888; Delaware — Infocon: (302) 239-2942; Denver — (303) 469-1953; Hawaii — Gray Associates: (808) 261-3751; Houston — (713) 952-1403; Los Angeles — (213) 410-9454; Northern New Jersey — Infocon: (201) 624-1372; New York City Area — Infocon: (212) 689-8833; New York State — Naco Electronics: Rochester: (716) 223-4490; Syracuse: (315) 699-2651; San Francisco — (415) 692-4184; Washington, DC — International Systems Marketing: (301) 279-5775; Argentina — Itron SA: (01) 774-9369; Australia — Computer Clarity Pty. Ltd.: (02) 241 3385; I. O. Peripheries Pty. Limited: (02) 427 3555; Belgium — BELCOMP: 091/25 22 88; Canada — CALL Systems: Toronto: (416) 362-1063; Denmark — ADCOM Data Aps: 1-19 44 66; Finland — Modulsystem OY: 0-6926511; France — Walton: (1) 226.06.90; Singapore — DTS Singapore: (65) 33-88-566; Switzerland — Mittek ag: 01/461 22 52; United Kingdom — Shandell Systems Ltd.: 02407-2027; Venezuela — H. Blohm SA: 2 541.21.22; West Germany — COMKO Computersystemges, mbH: 0221-48 30 51.
INTERNATIONAL DISTRIBUTORSHIP INQUIRIES INVITED.

PC-compatibles, 'window' software highlight jam-packed Comdex

The recent Comdex show featured a rash of IBM PC-compatible system introductions, a continuation of the PC software "window wars," portable computers and a spate of marketing ploys by companies attempting to gain visibility among the more than 83,000 attendees and 1,400 exhibitors. The wave of PC-compatibles reinforced the PC and MS-DOS as industry standards.

Leading Edge Products Inc., Canton, Mass., showed a PC-compatible personal computer employing a 7-MHz Intel 8088 and having seven slots. Two 320K-byte, 5¼-inch, half-height floppies provide storage. The system also includes a keyboard that is a replica of the IBM PC's. A 128K-byte model with Leading Edge word-processor software and GW BASIC retails for \$2,895.

Micro Craft Corp., Dallas, demonstrated its MC68000-based Dimension personal computer. Micro Craft claims the machine can run software designed for any personal computer. A \$4,545 system with two 800K-byte, 5¼-inch floppy disk drives and 256K bytes of memory runs CP/M-68K. A user can add emulator boards that accept MS-DOS, Apple, CP/M and other operating systems. The user can configure the disk drives according to the specified machine and operating system. Extra disk drives, 10M- and 50M-byte Winchester and a \$1,095 16-slot expansion chassis are available.

The Comdex showstopper—exemplified by VisiCorp's Visi^{On} and Microsoft Corp.'s Windows—was software that can display and transfer parts of several files and programs on one screen. Microsoft's Windows, an OEM-only product, is an extension and enhancement of MS-DOS that allows multiple applications to be run and displayed simultaneously. Microsoft president Jon Shirley says it can run any application developed for Windows on any MS-DOS machine and on 99 percent of applications designed for MS-DOS. Companies supporting Microsoft's Windows include Rana Systems (for Apple systems), Altos Computer Systems Inc., Burroughs Corp., Columbia

Data Products Inc., Compaq Computer Corp., Convergent Technologies Inc., Data General Corp., Digital Equipment Corp., Eagle Computer Inc., Hewlett-Packard Co., Honeywell Inc., Bytec Management Corp., Radio Shack, Seequa Computer Corp., TeleVideo Systems Inc., Texas Instruments Inc., Wang Laboratories Inc., Zenith Data Systems, ITT Systems Inc., which showed the program on its new XTRA personal computer, and others. IBM Corp. is also expected to announce support for the system. Windows is expected to be available by the second quarter of this year. OEMs are expected to set their own prices.

Digital Research Inc., Pacific Grove, Calif., released two new versions of Concurrent CP/M-86. The retail-only version competes with Microsoft's Windows MS-DOS extension. Unlike Windows, the Digital Research system performs multitasking, displaying four jobs at once. However, unlike Windows, the Digital Research program cannot transfer data between windows. Company officials say the system was easy to create because it is basically an enhanced Concurrent CP/M-86. The promotional price, effective through March, is \$150. A generic OEM version features PC-DOS 1.1 compatibility, can be configured in multiuser mode and supports networking via the company's DR Soft/Net. The price is negotiable.

Structured Systems Group Inc., Oakland, Calif., has introduced the WindowMaster program, which reportedly runs any MS-DOS or CP/M-86 application while displaying the jobs in windows. WindowMaster runs under MS-DOS. Structured Systems recommends using WindowMaster on a system with a hard disk. CP/M-86 programs must be copied to the hard disk; an interpreter then changes them to the MS-DOS format. WindowMaster allows data to be transferred between windows. With the company's proprietary spreadsheet and other applications, WindowMaster retails for \$495.

The Jack2 integrated software package from Business Solutions Inc., Kings

Park, N.Y., is based on a single-workspace concept. So is the integrated package from Ovation Technologies, Canton, Mass. Jack2 has spreadsheet, word-processing, graphics and database-management functions that can simultaneously appear on the screen without windows. The system uses icon and cursor commands such as "find" and "copy." Jack2 can print multiple columns of text. Retail price is \$495.

DayFlo Inc., Irvine, Calif., unveiled its first product, an integrated software package that presents word-processing and database-management functions through a desktop metaphor that closely parallels the working methods of office professionals. Expected to be available in February for the IBM PC XT, PC XT-compatibles and the IBM PC with attached hard disks, the DayFlo package allows switching between functions without changing program modules. Instead, a series of files and records are created within what the company calls an unstructured, "associative" database-management system. Residing on the "desktop" are 20 readily accessible active files that are listed in a help file. These files can be swapped between the desktop and the main database. The package allows global searches and requests for data to be accomplished from any record, so that interruptions can be handled on an ad hoc basis. Using a command-log feature, the \$495 program transfers ASCII files to other types of hardware. Once set up, the command log attaches handshaking and control characters to the files being transferred. The program occupies 500K bytes on two floppy disks and, using demand paging, runs on 256K bytes or more of RAM. DayFlo representatives say the host interface can readily be configured to a number of hardware systems in the future. The company plans to provide spreadsheet, accounting and graphics functions.

Apple Computer Inc., Cupertino, Calif., under market pressure from market leader IBM's Personal Computer product line, announced at Comdex that it has extended the capabilities of



Microsoft's Windows software was an audience-grabber at Comdex. It exemplified a trend toward window software, user-friendly software many consider to be in its infancy.

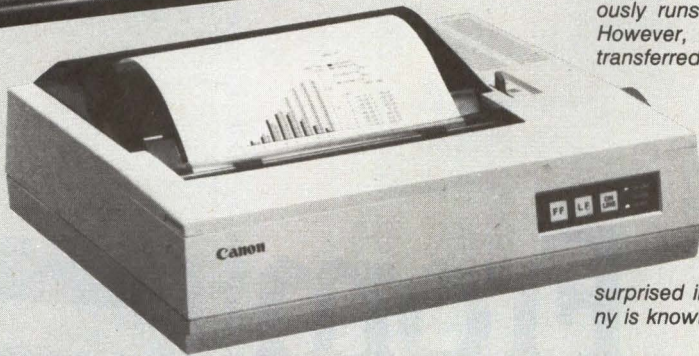

Digital Research Inc.'s new retail version of Concurrent CP/M-86 follows the window software trend: it simultaneously runs and displays four programs. However, it does not allow data to be transferred between windows.

Canon U.S.A.'s introduction of the PW-1080 impact dot-matrix printer surprised industry watchers. The company is known for its non-impact printers.

its Apple II microcomputers. Announcements include the new ProDOS operating system, which enables the Apple II to communicate with mass-storage devices such as the company's ProFile Winchester disk drive. ProDOS speeds disk access and provides hierarchical file management for ProFile users. Apple also revised its Pascal Development system to support ProFile. The ProFile disk drive for the Apple II should be available this month. Also announced for the Apple II is a Lisa-like mouse and new software called Mousepaint. The two products, combined as the AppleMouse II, allow users to design charts, diagrams and free-hand drawings using a mouse cursor controller. AppleMouse II is scheduled for availability early this year. Products for the Apple II and III computers include the AppleWorks integrated software package for the Apple II and the III E-Z Pieces for the Apple III. Both packages can be used at work or home and include word-processing, spreadsheet

and database-management functions. AppleWorks is based on ProDOS, which is compatible with the Apple III's sophisticated operating system. AppleWorks requires an Apple IIe personal computer with 64K bytes of memory, an 80-column card, a floppy disk drive and a monitor. Suggested retail price is \$250, and availability from authorized Apple dealers is scheduled for March. The III E-Z Pieces package requires an Apple III with 256K bytes of memory. Suggested retail price is \$295, and scheduled availability is this month. Yet another product from Comdex is the Apple Workbench, a developers' tool for the Apple II and III including a DOS programmer's tool kit and a ProDOS technical reference manual. Apple hopes to open the Apple II so that software developers will be able to use ProDOS readily. Along with demonstrating the long-awaited low-cost LDB-CX laser printer, Canon U.S.A. Inc., Lake Success, N.Y., made Comdex the site for its initial

thrust into the impact printer arena. The 80-column PW-1080 and the 156-column PW-1156 are serial dot-matrix models printing at 160 characters per second (cps). The printers feature a near-letter-quality print mode with a 24-by-16-dot matrix, a graphics printing mode, down-loadable character sets and the ability to print four character styles on a line. Prices are \$595 for the PW-1080 and \$895 for the PW-1156. Canon is the most aggressive supplier of non-impact printers, with such products as the LDB-CX, targeted at high-end daisy-wheel markets, the A1210 color ink-jet printer, offered through Radio Shack, and, reportedly, the thermal printer offered by IBM with the PCjr. Observers were, therefore, surprised to see Canon venture into the crowded market for more traditional dot-matrix technology. —Mini-Micro editors that contributed to this article are David A. Bright, Edward S. Foster, Gary Legg, Tom Moran, Robert A. Sehr and Lori Valigra

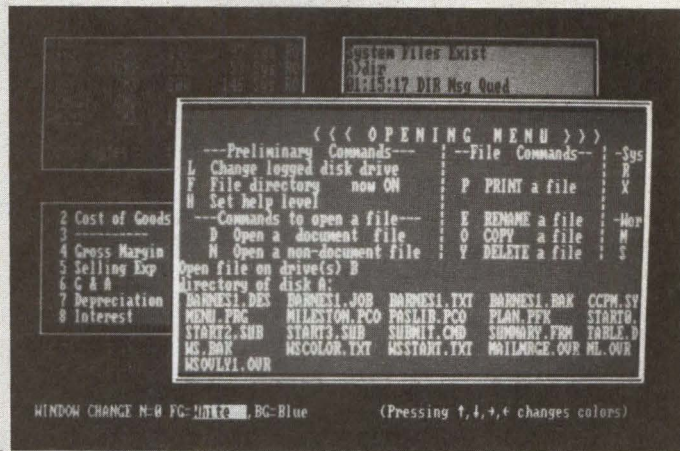

From



,

Most people in the industry know Dataproducts for our line printers.

The world's largest OEMs sell them with their systems. For 22 years, they have set the standards for quality and reliability.

We make more than line printers. Much more.

In fact, Dataproducts makes more different kinds of computer printers than any inde-

pendent printer manufacturer.

All of them to the same high standards.

Like the little dot matrix printer in the picture. It prints drafts at 180 characters per second. Typewriter quality letters at 35 cps.

It prints high resolution graphics. Spreadsheets, labels and multi-part forms.

And its price is right in line with the personal computers it

was designed to work with. Low.

It is not, however, Dataproducts' only dot matrix machine. We make no less than ten distinctly different matrix printers.

Some print in beautiful full color.

Others have bar coding firmware built in.

We also make a family of office-duty daisywheel printers, our DP-Series. They cost less

Dataproducts computer printers.

to



than you might expect to pay for a solid, Dataproducts printer. Some of the leaders in word processing systems sell them as their own.

We make special encoding printers for check imprinting and other financial applications. Ruggedized and high-security printers for the government.

We make printer ribbons and other supplies.

We support everything we

sell with a worldwide customer services organization.

And yes, we do keep advancing our own line printing technology. The big machine you see on this page prints 2,000 lines a minute.

It is designed to print millions of pages a year with minimum service. Some customers find it the most cost effective printer on the market.

Over the years, we have

learned more than anybody about when and where and how people use their computer printers. What jobs they need them to perform.

We build a dependable Dataproducts printer for just about every one of those jobs.

Write us at 6200 Canoga Avenue, Woodland Hills, CA 91365. Or phone (818) 887-3924. In Europe, 136-138 High Street, Egham, Surrey, TW 20 9HL England.



Nobody puts ideas on paper so many ways.

CIRCLE NO. 21 ON INQUIRY CARD

Mini-Micro World

NEWS

Compaq, Eagle, Radio Shack, Xerox unveil portable computers

Adam Osborne's Osborne Computer Corp. may have filed for bankruptcy, but the portable computer business he virtually invented is thriving. Recent significant introductions in that increasingly competitive field include portable computers from four companies that

have established their own beachheads in the microcomputer market.

Compaq Computer Corp., Houston, and Eagle Computer Inc., Los Gatos, Calif., have introduced IBM PC XT-compatible portables. Compaq, whose new product is called the Compaq Plus, has reported

sales of nearly \$59 million on more than 28,000 of its earlier IBM PC-compatible Compaq portables in the first nine months of 1983. The company is a major force in the portable computer market. In October, Compaq took further advantage of its success by filing for

COMPARING THE NEW PORTABLES

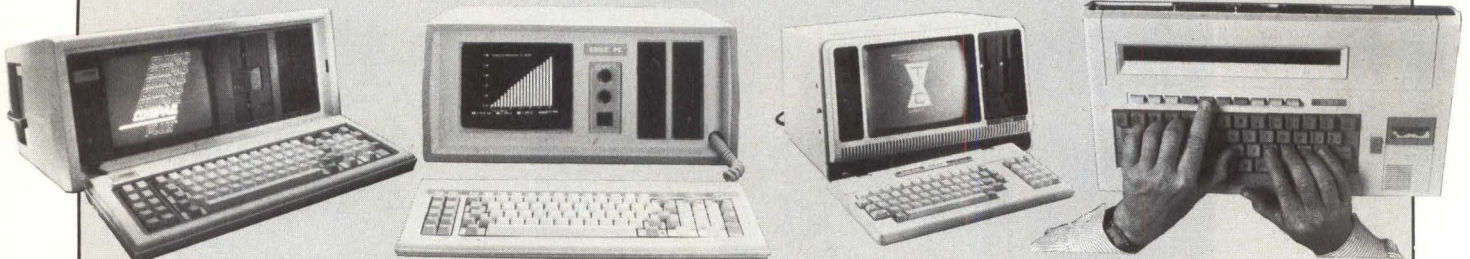

Company, product	Compaq Computer Corp. Compaq Plus	Eagle Computer Inc. Eagle Spirit XL	Tandy Corp./Radio Shack TRS-80 model 4P	Xerox Corp. Xerox 1810
Physical size	20 x 8 1/2 x 16 in.	19 3/8 x 8 3/8 x 15 9/10 in.	16 1/2 x 9 3/4 x 13 1/2 in.	16 x 2 x 9 in.
Weight	31 lbs.	33 lbs.	26 lbs.	5 lbs.
Processor, main memory	8088, 128K expandable to 640K	8088, 128K expandable to 640K	Z80A, 64K expandable to 128K	NSC800 (CMOS version of the Z80C), 16K CMOS RAM, 64K dynamic RAM
Display	9 in. CRT, 25 x 80	9-in. CRT, 25 x 80	9-in. CRT, 24 x 80	3-line, 80-character LCD
Keyboard	Detachable, identical to IBM PC XT	Detachable, "enhanced" IBM	Detachable, 70 keys, numeric pad, 3 function keys, cursor keys	63 keys, 10 function keys, cursor keys
Peripherals	10M-byte, 3 1/2-in. fixed Winchester, 360K-byte, 5 1/4-in. floppy	10M-byte, 5 1/4-in. fixed Winchester 360K-byte, 5 1/4-in. floppy	2 184K-byte, 5 1/4-in. floppies	Plug-in ROM packs (as much as 64K), microcassette for data or voice recording, built-in 300 to 1200-baud direct-connect modem, external microphone/ speakerphone
I/O	Centronics port	2 RS232C, 1 Centronics port	RS232C, Centronics port; external buffered I/O bus; supports 1 to 4 optional Winchesters	RS232C, Centronics port,
Operating system	MS-DOS	MS-DOS, CP/M 86	TRS-DOS 6	CP/M
Price	\$4,995	\$4,795	\$1,799	\$2,195
Availability	Now	Now	Now	Now
Included	RF modulator, RGB and composite video output, GW BASIC derivatives	Monochrome and color graphics display card with composite and RGB output, GW BASIC	Can use RAM upgrade to emulate disk drive, software print spooler, Microsoft BASIC	32K-byte system ROM, rechargeable nickel-cadmium batteries, RF modulator, clock with alarm, Microsoft BASIC
Options	8087 coprocessor, slots for 2 add-in boards, RS232C port	8087, slots for 4 add-in boards, Flexmenu and Flexkey	640 x 240 screen upgrade, internal direct-connect modem (modem takes up Rs232C port), Model III TRS-DOS, LDOS, CP/M plus 3.0, 1 to 4 5M-byte Winchesters	Video monitor, 1850 base unit, leather briefcase

Sell The Computer That Blew Their Socks Off At Comdex.



The name is HeadStart™, the microcomputer that wowed the crowd at Las Vegas.

We're accepting orders now for the smallest, smartest, fastest, most powerful business computer you can buy.

But they're going fast. Better make sure your competition doesn't beat you to us.

To order, call or write: Intertec, 2300 Broad River Road, Columbia, SC 29210. Phone: 803-798-9100.

CIRCLE NO. 157 ON INQUIRY CARD

intertec™



THE CLASSIC METHOD OF

You know, bringing up applications software is just like bringing up a new baby. You stay up around the clock. Teach it everything you know. Help it get bigger and smarter every day. And before you know it, your software outgrows its old computer.

So you get a bigger computer. With a brand new operating system. But when you give the original machine the old heave-ho, out go all those wonderful applications right along with it.

At Wicat though, we realize how much your software means

to you. So we created the first family of totally compatible grown-down mainframes.

Every one of them gives you the same mainframe operating system. Our own MCS, or the industry standard UNIX.[®] Plus nine mainframe language compilers.



COMPUTER UPGRADES.

Best of all, we've grown all this raw mainframe power down into a whole range of sizes. From a single-user desktop to a full-blown 48-user system. So you can start with an \$8,000 machine and move all the way up to a \$100,000 machine. Without losing one iota

of your original software investment. And without abandoning your original hardware.

If you'd like to know more, call or write us for complete information. Wicat Systems. P.O. Box 539, 1875 South State, Orem, UT 84057. (801) 224-6400.

We'll show you how to hang on to your software investment. And how to upgrade without taking a bath.

WICATsystems™

The grown-down mainframes.

Mini-Micro World

NEWS

its first public stock offering.

The Radio Shack division of Tandy Corp., Fort. Worth, Texas, has transformed its desktop TRS-80 model 4 into the portable model 4P, and Xerox Corp. has unveiled a 5-pound portable manufactured by Sunrise Systems Inc., Carrollton, Texas.

Both the Compaq Plus and Eagle's new offering, the Spirit XL, are built around the Intel 8088 and have 128K bytes of RAM, expandable to 640K bytes, a 10M-byte Winchester disk drive, a 360K-byte, 5¼-inch floppy disk drive, a 9-inch CRT screen and a detachable keyboard. Both machines undercut the price of a comparably equipped IBM PC XT. List price of an XT with 128K bytes of RAM, a 360K-byte floppy disk drive and the PC-DOS operating system is \$5,735. The Compaq Plus and Eagle Spirit XL sell for \$4,995 and \$4,795, respectively. Compaq also is offering a \$2,500 fixed-disk upgrade option to convert its floppy-based system into a Compaq Plus.

A drawback of incorporating a Winchester disk drive into a portable computer is that the Winchester adds weight. The Compaq Plus at 31 pounds and the Eagle Spirit XL at 33 pounds strain the limits of "portability." The Compaq without a Winchester weighs 28 pounds.

The Compaq Plus is basically the same as a Compaq, except that the Plus includes a Rodime 3½-inch Winchester and has different ROM chips and ribbon cables from the Compaq. The Compaq Plus runs MS-DOS 2.0, while the Compaq runs MS-DOS 1.0.

The Eagle Spirit XL is Eagle's first portable. The company's three previous product lines are the IIE series of Z80-based machines, the PC series of 8088-based systems and the Eagle 1600 series, which uses the 8086 processor.

MOBILE COMPUTER MARKET					
	1983	1984	1985	1986	1987
Hand held					
Units (thousands)	750	1,200	2,000	3,000	4,200
\$ Value (millions)	218	300	420	540	630
Portables					
Units (thousands)	175	350	500	750	975
\$ Value (millions)	262	490	650	900	1073
Transportables					
Units (thousands)	260	250	225	200	150
\$ Value (millions)	442	425	360	320	225

Source: InfoCorp

The transportable sector of the mobile computer market has peaked, according to InfoCorp. That sector includes models with built-in CRT screens, like the new Compaq Plus, Eagle Spirit XL and Tandy model 4P.

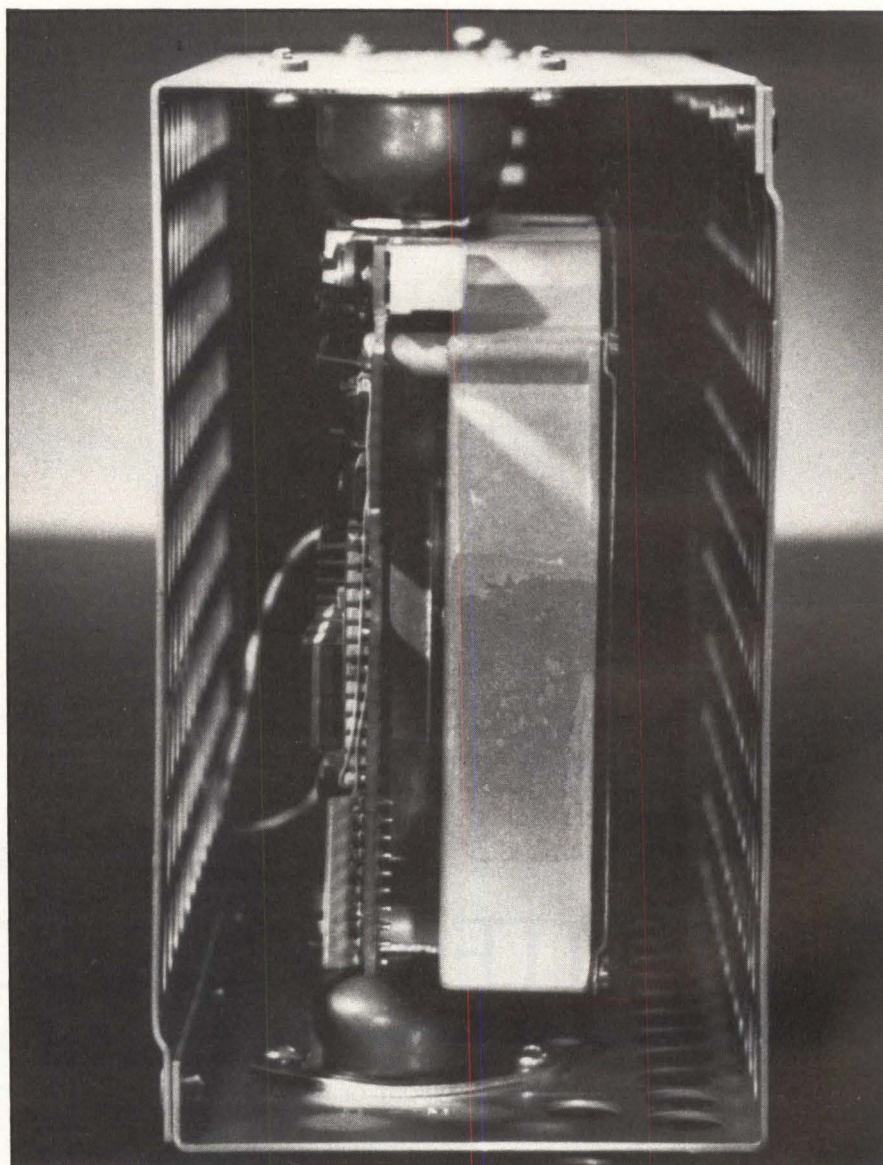

The Compaq Plus' 10M-byte 3½-inch Winchester disk drive is shock-mounted inside a 5¼-inch form factor metal cage for reliability in three ways: normal floppy drive shock mounts in the chassis, drive mounts in the cage and built-in shock protection in the drive.

EMULEX TALKS DEC

9

IN THE PALM OF YOUR HAND...

Think about it. Over 40 megabytes of system software, application programs, data files and archival records in a compact package that fits in the palm of your hand. With storage costs as low as 60¢ per megabyte. It's the ¼-inch streaming tape cartridge—rapidly becoming the exchange medium of the decade. And only Emulex makes it as simple to join in the exchange as plugging in another TS11 tape system from DEC.

MAKING ¼-INCH LOOK LIKE ½-INCH...

Software transparent? Of course. But the new Emulex streaming tape couplers and subsystems not only make the ¼-inch tape cartridges look like ½-inch tape to your RT11, RSX11M and RSTS-E software, they also make them perform like a standard TS11 tape system. CDC's new Sentinel drive, for example, can emulate all the start-stop features of a reel-to-reel drive. The Emulex couplers perform standard TS11 data reliability diagnostics and on power-up also perform extensive self-tests.

COUPLERS TO COMPLETE SUBSYSTEMS...

Nothing halfway about it. Designing a new system or upgrading an old one? Emulex streaming tape cartridge couplers are available for the full range of DEC micro/mini computers. Just plug the new Emulex TC05 coupler into your LSI-11 QBus or a TC15 coupler into your PDP-11 or VAX-11 Unibus. Both units are designed to interface with the Sentinel streaming tape drive. Or if you want to add streaming tape to an existing LSI-11, PDP-11 or VAX-11 installation, take a look at Emulex's new Vault subsystems—plug-in coupler, cable (up to 10 feet) and a compact desktop cabinet that houses both a Sentinel drive and its own 115-volt or 250-volt power supply.

A NEW GENERATION OF 5¼-INCH DISKS...

Emulex is preparing you, too, for the next step up in 5¼-inch disk capacities. It's simple mathematics. Disk data-transfer rates equal the speed of rotation times the bit density. Double the disk capacity (above the present practical limit of about 70 megabytes) by doubling the number of bits per inch (no problem, with present-day media and heads) and you've raised the transfer rate far above the 600 kilobytes-per-second limit of the standard ST-506 disk interface. Solution: Emulex's new SC05 controllers for linking LSI-11 processors to the new generation of ESDI (Enhanced Small Disk Interface) high-capacity disk drives. The new limit? Up to 1.8 megabytes per second.

FROM THE EMULEX FILE...

Emulex continues to expand. Our headquarters facilities in Costa Mesa, California, will soon have a new two-story building with 60,000 extra square feet of floor space. By the end of next year we'll have 212,000 square feet in the Costa Mesa complex. Thank you DEC end users and OEMs!



CIRCLE NO. 23 ON INQUIRY CARD

3545 Harbor Blvd., P.O. Box 6725
Costa Mesa, California 92626
Toll-free (800) 854-7112, in Calif. (714) 662-5600.

JANUARY 1984

Surface Mount Technology: The Wave of the Future.

Higher density, greater reliability and improved system efficiency are among the reasons board-level manufacturers, such as WD, are eagerly pursuing Surface Mount Technology. The next generation in printed circuit manufacturing, the process allows direct hi density mounting of VLSI devices and packaged arrays on the circuit board. WD has agreed to acquire an equity position in Array Technology of San Jose, a CMOS Gate Array and Surface Mount Technology company, with design and production commitments aimed at keeping WD at the forefront of board manufacturing technology.

Telenet certifies the WD2511 for X.25 Network Interface.

GTE's Telenet, the public data network and de facto industry standard, has certified the WD2511 as an approved interface device for operation on the Telenet X.25 Network. The WD2511 implements the link level of the X.25 protocol with an advanced VLSI controller. To gain certification, the WD2511 had to meet the networking standards set by the CCITT and Telenet. Certification means that systems manufacturers who desire to make their equipment Telenet compatible may use the WD2511 Packet Switching Controller to interface the Telenet Network with the assurance that they will meet the exacting X.25 link level standards.

WD second sources TI 99118A/28A/29A Video Display Processors.

Home computer and video/arcade game companies currently using or planning to use Texas Instruments' TMS9918A/9928A/9929A family of single chip video display processors can now depend on WD as an alternate source of volume supply. WD has received a license from TI to manufacture the three LSI components, significantly broadening WD's CRT and display controller product offerings. The WD9918 features a composite video output, while the WD9928 and WD9929 interface with encoder circuitry for color monitors. The WD9929 offers the 625 line European TV format.

WD employment up 38% over a year ago.

VLSI Circuit Designers, Process Engineers and Senior Technicians with wafer fab experience, and Product Engineers specializing in test, are all in great demand at WD. With first quarter fiscal 1984 sales up 166% over the previous year, job openings have reached record levels at WD. Continued emphasis on customer service has created openings for Sales Managers and FAEs for the many new sales offices being opened across the country and worldwide. Interested parties should mail resumes to: S.R. Blaue, Western Digital Corporation, Personnel Dept., 2445 McCabe Way, Irvine, CA 92714.

WESTERN DIGITAL
C O R P O R A T I O N

2445 McCabe Way, Irvine, CA 92714 • (714) 863-0102 • TWX 910-595-1139

Mini-Micro World

NEWS

The Spirit XL's keyboard is similar to an IBM Selectric typewriter's keyboard, and the Compaq Plus keyboard layout is identical to that of the IBM PC XT. The Compaq Plus has a Centronics-compatible port and two slots for IBM PC XT-compatible expansion boards. An RS232C port is optional. The Spirit XL includes a Centronics port, two RS232C ports and four expansion slots.

Another difference between the Compaq Plus and the Spirit XL is the size of their Winchesters: the Spirit XL's is 5¼ inches, while the Compaq's is 3½ inches. Compaq president Rod Canion says his company ensures drive reliability by mounting the Compaq Plus drive inside a shock-isolation cage that is the same size as a 5¼-inch floppy drive. Because the 3½-inch drive weighs less, it requires less energy to damp its motion in its three mountings.

Despite the Eagle and Compaq systems' price advantage over the PC XT, the XT has the advantage of the IBM logo. And, although neither Compaq nor Eagle is struggling, it remains to be seen whether their machines can succeed in the long term in portability and price/performance.

Radio Shack's bid in the transportable, non-IBM-compatible market is the 26-pound TRS-80 model 4P with 64K bytes of RAM, expandable to 128K bytes, a 9-inch, 24-line-by-80-character CRT terminal, an RS232C port, a Centronics port, two 184K-byte, 5¼-inch floppy disk drives and a detachable keyboard with 70 keys plus a numeric pad, cursor-control keys and three function keys.

The model 4P is said to run all of the model 4's proprietary software on its 4-MHz Z80A. The 4P can also sense and read disks formatted for the TRS-80 model III. The system includes the TRS-DOS 6 proprie-

tary operating system and supports model III TRS-DOS, LDOS and CP/M Plus 3.0. The model 4P has an external, buffered I/O bus that supports as many as four optional 5M-byte Winchester drives. The RS232C port can be dedicated to an optional internal auto-dial/-answer, direct-connect, 300-baud modem. A basic 64K-byte 4P is priced at \$1,799.

Xerox's first portable computer is the "knee-top," or lap-sized, Xerox 1810. Weighing 5 pounds, the 1810 can run for about 10 hours on its rechargeable nickel-cadmium (NiCd) batteries. The 1810's CPU is the NSC800, a low-power complementary - metal - oxide - semiconductor (CMOS) version of the Z80, and it sports a 16K-byte CMOS RAM along with 64K bytes of dynamic RAM.

The 1810 uses a built-in micro-cassette recorder that records data and voice through a direct-connect, auto-dial speaker phone or a built-in 300- to 1,200-baud direct-connect modem. It also includes a built-in keyboard with cursor-control keys and 10 function keys, an RS232C port, a Centronics port and a three-line, 80-character liquid-crystal display. The \$2,195 system also has 32K bytes of system ROM and an RF modulator for output to a television screen.

For a traveler who wants to send files, memos or electronic mail to a central office, Xerox offers the optional model 1850 with two 500K-byte, 5¼-inch floppy disk drives and a direct-connect modem. The 1850 has both 8088 and Z80 processors, combined with 128K bytes of RAM, expandable to 512K bytes. The 1850 has no keyboard, but by connecting the 1810 keyboard to the 1850 base station, a user can run programs written for CP/M and MS-DOS. Also, by leaving the 1850 modem connected, a traveler with an 1810 can call into

a central office, down-load software from a disk to the 1810's RAM and store finished work on the disks. The 1850 is priced at \$2,495 and weighs 15 pounds.

Competition for the 1810 could come from several directions, including higher-end "briefcase-sized" portables such as Gavilan Computer Corp.'s Gavilan and Teleram Communications Corp.'s T-3000, or from less expensive machines, such as Convergent Technologies Inc.'s WorkSlate, Radio Shack's model 100 and Epson America Inc.'s HX-20.

Despite slow sales of previous Xerox microsystems such as the 820, Dwight F. Ryan, president of Xerox Business Systems Group, says Xerox intends to become a major player in the personal computer market. "We believe the portable computer is a natural extension of our personal computer product line," he says. He expects portable computers, especially briefcase-sized ones, to be the fastest growing segment of the microcomputer market.

John Kiefer, senior analyst at InfoCorp, Cupertino, Calif., agrees with Ryan's estimate of the knee-top market. "We see portables [knee tops] as the real growth segment in microcomputers," he says. "We expect the product to evolve." He expects that evolution to include use of a "flying keyboard" with a limited display that will plug into a larger system. Kiefer does not see an imminent massive shakeout in the portable computer market. "It's still a very new market," he says. "There will be lots of entrants, and the market will support a number of vendors over the next two to three years." InfoCorp estimates indicate that the knee-top systems' annual sales will mushroom from \$262 million in 1983 to more than \$1 billion in 1987.

—Tom Moran

Wang joins burgeoning market for 'secure' PCs in government

Rounding out its line of office-network products for "secure" government applications, Wang Laboratories Inc. has introduced the 75PC-T, a 16-bit microcomputer under review by the National Security Agency (NSA). The NSA will test the unit to certify that it meets criteria for allowable levels of RF emissions. If approved, the 75PC-T will join Wang's office-information systems (OISs) and Alliance office systems in defense and other applications requiring very low RF levels to thwart unauthorized detection.

Wang unveiled the 75PC-T in November at the Federal Office Automation Conference. Six weeks earlier at the Federal Computer Conference, the company brought out a ¼-inch cartridge-tape drive and the 7556CT Alliance workstation. NSA quickly approved the peripherals and placed them on the October edition of the Preferred Products List (PPL), the official government catalog of electronic office equipment certified to process classified information. Fully suppressed equipment meets the current national standard (NACSIM 5100A). A company spokesman says Wang expects the new microcomputer to be listed in this month's issue of the PPL.

The 75PC-T is a modified version of the 16-bit Wang Professional Computer. The new unit can be used on a standalone basis or as a workstation in the PPL-listed OIS/Alliance systems. The 75PC-T features 128K bytes of RAM, expandable to 640K bytes; eight expansion slots; a 5¼-inch, dual-sided, double-density diskette drive that stores as much as 360K bytes of data; RS232/military-specification



Wang's 16-bit 75PC-T microcomputer is the company's latest entrant in the federal Tempest market for "secure" word- and data-processing applications.

(MIL) 188C and MIL 188-144-compatible asynchronous serial interface port; a programmable system clock and two self-diagnostic systems.

With an optional communications feature, the 75PC-T can emulate a standard teletypewriter (TTY) and other asynchronous TTY devices. The diskette drives can also read single-sided, double-density diskettes formatted with MS-DOS or IBM Corp.'s PC-DOS.

Tempest NACSIM 5100A regulations governed the development of the 75PC-T. Tempest is the name for the study and control of spurious electronic signals emitted from information-processing equipment. The regulations reportedly limit RF emissions to less than 10 μ V. per m. (MMS, June 1980, Page 111). In comparison, standards set by the Federal Communications Commission for commercial computer equipment allow RF emissions of 100 μ V per m. and 200 μ V per m., depending on RF-emission frequency.

To meet the stringent Tempest

standards, Wang employed the same types of RF containment and suppression techniques on the 75PC-T as used on the Tempest-accredited OIS/Alliance systems. The 75PC-T's 12-inch display monitor incorporates a mesh screen to filter emission, and the interiors of the keyboard, the drive and the monitor cases are coated with an anti-emission paint. RF suppression filters are placed on the system's power leads, and a copper sheath surrounds the coaxial cable that interconnects the keyboard and the electronics unit containing the processor and disk drives. Unlike the OIS/Alliance workstations, a fiber-optic cable links the electronics unit and the video monitor. Although more expensive than other cable, fiber-optic cable has an advantage in Tempest applications because it does not emit RF.

Other security features of the 75PC-T include removable storage media that can be placed in secure areas when the microprocessor is not in use. The system's volatile memory enables a user to erase

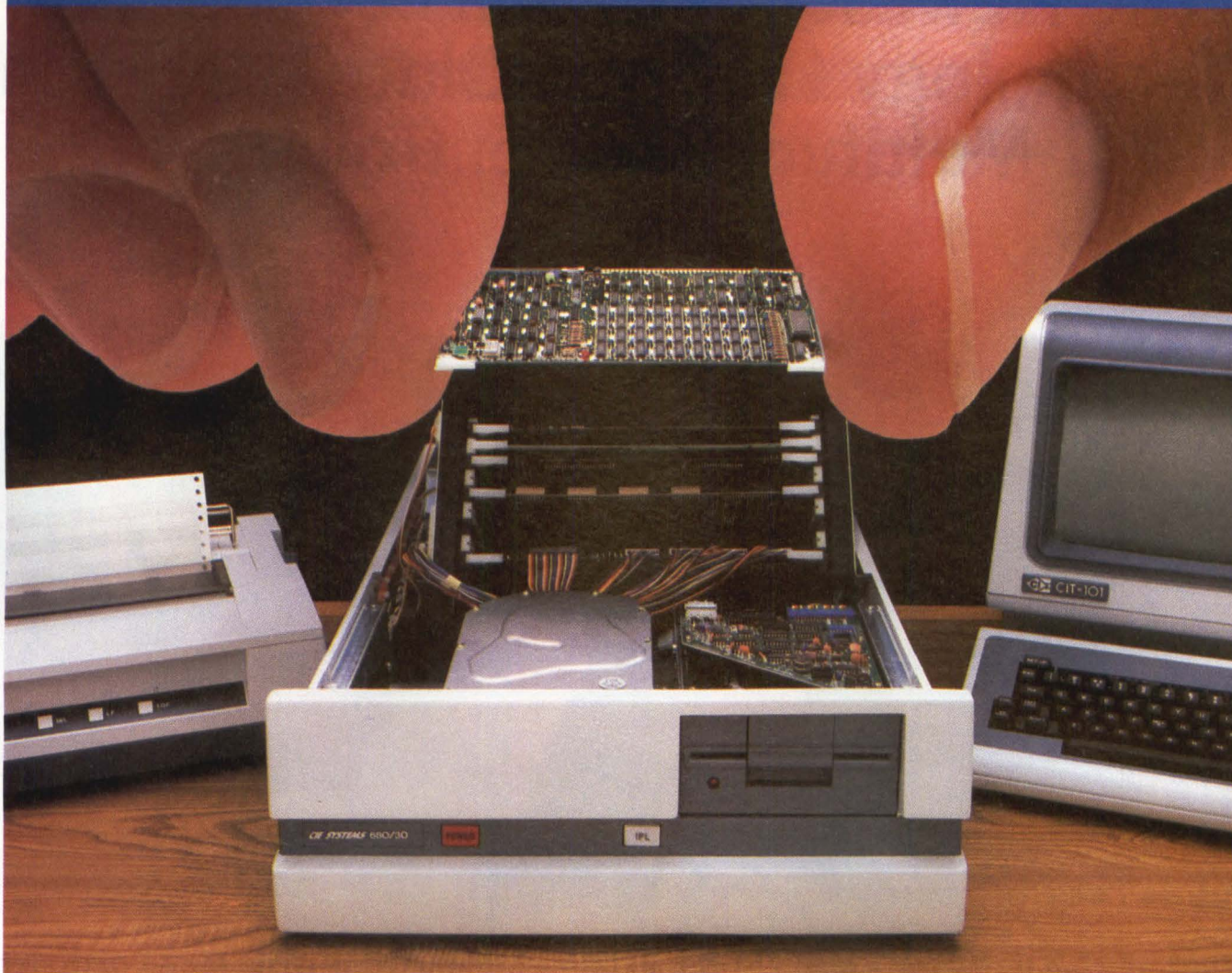

Our giant commitment to OEMs

BOARDS TO SYSTEMS. YOU NAME IT.

CIE Systems is committed to being your source for the very latest in micros and all that goes with them.

The micros are the CIES 680™ Business Computers with the advanced 32/16-bit 68000 micro-processor and Intel's Multibus™ architecture. So from boards to systems, you can easily configure your product line for virtually any business.

There are four 680 models. The 680/30 (shown above), 680/20 (on the right), 680/35 and the 680/40.



The 680/30 and 680/35 will accommodate up to eight interactive users. The 680/20 expands to four users. And the 680/40 expands to as many as 20 users.

Disk capacities range from 10 to 300 Mbytes, memory from 256K to one Mbyte.

Operating systems include REGULUS™ (UNIX™ compatible) and RM/COS™.

Language processors include BASIC, FORTRAN, COBOL and PASCAL.

Applications offered are general accounting, financial worksheet and word processing, as well as a wide range of vertical applications.

And you can include PRO-IV™ the applications processor that allows you to develop applications in one-tenth the time or modify applications in one-hundredth the time it normally takes.

Boards up to complete CIES 680 systems. Our name or your name on them. That's an ongoing commitment to OEMs from CIE Systems, the company backed by the third largest trading company in the world with well over \$50 billion in sales.

Just call or write CIE Systems, Inc., 2515 McCabe Way, Irvine, CA 92713-6579 (714) 660-1800. Call toll free 1-800-437-2341. In California, call 1-800-458-6279.

CIE SYSTEMS
A CITI/TOH ELECTRONICS COMPANY

™ CIES 680 is a Trademark of CIE Systems, Inc.
Multibus is a Trademark of Intel Corporation.
REGULUS is a Trademark of Alcyon Corporation.
UNIX is a Trademark of Bell Laboratories.
RM/COS is a Trademark of Ryan-McFarland Corporation.
PRO-IV is a Trademark of Data Technical Analysts, Inc.

© CIE SYSTEMS, INC., 1983

The Newest Innovation in Controller Technology From the Oldest Name in Multifunction Controllers.

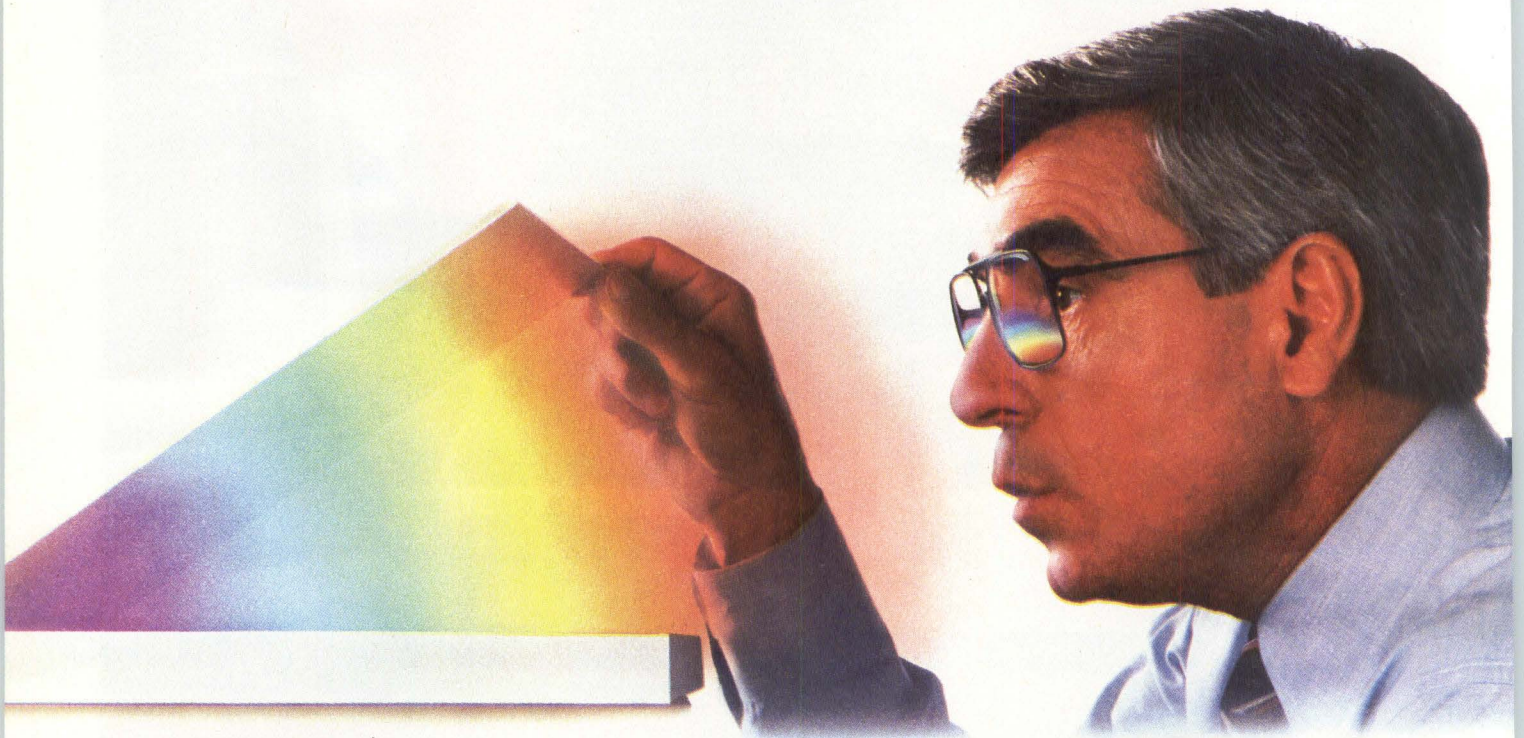

Introducing the World's First LSI-II Emulating Multifunction Disk/Tape Controller.

Say hello to SPECTRA 25, the cornerstone of our new family of high-performance disk/tape controllers designed for use with DEC's LSI-II computer.

This revolutionary Q-Bus compatible single quad board lets you interface any combination of two SMD disks and four formatted 1/2-inch tape drives. By using extended commands to program the onboard E²PROM, you can easily select drive mixing, mapping, and many other features—all without removing the controller from the system.

The SPECTRA 25 emulates DEC's RM02/5 and RM80 disk subsystems, and DEC's TSII tape subsystem. It also provides complete emulation for operation with DEC's RT-II, RSX-IIM, RSX-IIM-PLUS and RSTS/E operating systems.

To further enhance system performance, Spectra Logic offers SPECTRA STREAM™ software, a streaming tape backup utility that can back up an entire 80MB drive in only seven minutes.



Spectra Logic first introduced the multifunction concept back in 1979. And we've been quietly revolutionizing the market ever since with families of controllers that provide the high-performance, proven reliability, and added value you need to stay competitive.

We also offer the industry's most comprehensive one year warranty, responsive nationwide service, and ongoing technical support.

SPECTRA 25 is the latest innovation in controller technology from the company with peripheral vision. Spectra Logic. For further information, including complete technical specifications, call or write us today.

Spectra Logic Corporation
1227 Innsbruck Drive, Sunnyvale, CA 94089
(408) 744-0930 TWX 910-339-9566
TELEX 172524 SPL SUVL

International Sales Office:
Belgium (32) (2) 5134892

SPECTRA LOGIC

SPECTRA STREAM is a trademark of Spectra Logic Corporation. © 1983 Spectra Logic Corporation

WHICH TWIN HAS THE TANDBERG?

The ergonomic terminal that puts performance at your fingertips

When it comes to performance, the keyboard of the new TDV 2200S puts more features at your fingertips than any other terminal on the market today. Features such as sixteen soft switches that store and recall up to 416 commonly used words, phrases or code sequences; up to 1024 different characters in a single terminal including mathematic and semi-graphic symbols, Latin, Greek, Cyrillic and other alphabets; full editing and cursor control capabilities; a ten key numeric pad; and communications keys for character, page, block or line/field transmission.

The TDV 2200S will emulate virtually any popular terminal and protocol. It can be equipped with up to 56K bytes of memory and some models will store up to eight pages of data. It has an 8085-2 chip for ultra-high speed processing; superb communications capabilities including networking; and optional high resolution business graphics.

But the TDV 2200S is a lot more than a high performance terminal. It is also the first terminal that met the stringent requirements of the German ergonomic standard for operator comfort and safety. This means that the screen not only tilts, but it swivels, raises and lowers to fit all size people, in any room light at any angle. And the keyboard doesn't merely detach. It's a low profile work

of art, so slim that it can be used in complete comfort on a standard desk.

To ease operator eye strain the TDV 2200S features a 15" green on green or black on white screen with big letters; a 70Hz flicker-free refresh rate; an anti-reflex tube and matte finish to minimize reflection and a patented Equilite video system that displays both vertical and horizontal lines with the same intensity.

But to truly appreciate the performance and comfort of the TDV 2200S you should really try one for yourself. We'll be happy to put one at your fingertips. Just give us a call. Tandberg Data, Inc., P.O. Box 99, Labriola Court, Armonk, New York 10504. Phone: (914) 273-6400, Telex: 137357 Tanberg Arnk.

TANDBERG DATA

Tandberg Data, Inc.

CIRCLE NO. 149 ON INQUIRY CARD



AT LAST. IMMEDIATE NETWORK ACCESS IN HEAVY TRAFFIC. INTRODUCING UniLAN.™

Until today, no single access method could give you absolutely optimal performance every minute of every day. Token-passing, for instance, is fine for the heavy traffic of real-time voice or file transfers, but far less effective for asynchronous, bursty traffic. CSMA/CD, on the other hand, handles bursty traffic well but gets bogged down in heavy traffic. So if your traffic patterns change, from day to day or minute to minute, yesterday's networks can hold you back.

Enter UniLAN from Applitek.

In one network, it combines the immediate access of CSMA/CD and the guaranteed access of token passing, automatically shifting back and forth according to the character and load of the traffic. And outperforming any single method you have ever seen.

Take the checkered flag on any circuit from the start.

When it comes to performance, UniLAN is first off the starting line with its speed of 10 mega bits per second. This speed gives you more, and more, and more, messages on the network. And they get to their destinations faster.

UniLAN also lets you choose the cable technology that suits

The only network that automatically shifts gears according to traffic.



you best. Broadband or baseband coaxial cable. Or optical fiber. In fact, UniLAN helps you get more performance out of broadband than other systems. It not only provides variable message length, but it also compensates for loop delay, which dramatically reduces the idle time between messages, and makes for more efficient use of the bandwidth.

The decision you can live with. Long into the future.

The same versatility that optimizes your network minute to minute, also adapts to your long-term changes. So when today's terminals are replaced by tomorrow's personal computers, UniLAN continues to provide peak performance, without the cost and chaos of adding a new network.

In short, UniLAN gives you extra performance today. And eliminates the risk if your needs change tomorrow.

For more information, write or call: Applitek Corp., 107 Audubon Rd., Wakefield, MA 01880 (617) 246-4500.

CIRCLE NO. 26 ON INQUIRY CARD

Applitek

Trademark of Applitek Corporation. Patent pending.

Mini-Micro World

NEWS

memory easily when the power is off. Finally, the system's software requires the user to know the system identification code and a user password, which is not shown on the screen when entered.

To demonstrate that the 75PC-T meets Tempest NACSIM 5100A specifications, Wang submitted a unit to Atlantic Research Corp., an NSA-approved independent testing laboratory, for Tempest tests. The results were passed to the NSA-sponsored Special Committee on Compromising Emanations (SCOCE), which comprises representatives of various government agencies using Tempest equipment. After review by NSA's Tempest Qualification Subcommittee, SCOCE is expected to place the 75PC-T on the PPL, says Phillip Thomas, Wang product line manager for advanced security products. "We have been totally passed by Atlantic Research's reports," says Thomas.

Prices for the 75PC-T range from \$4,900 for a single-drive system to \$7,500 for the OIS/Alliance Archiving version with communications software. Optional memory-expansion cards sell for \$660 for 128K bytes, \$1,090 for 256K bytes and \$2,190 for 512K bytes. List price of additional 512K-byte diskette drives is \$685, and the Wang graphics card is priced at \$315. In comparison, a commercial Professional System with one drive and 128K bytes of memory is \$3,435.

The market for Tempest-accredited computers and peripherals is a small but significant part of Wang's marketing plans. Sales of Tempest equipment represent about one-third of all the company's sales to the federal government, Thomas says, or approximately \$60 million in revenues for 1982-1983. Of 116 items listed in the mid-1983 PPL edition, the company representative

says, 25 percent are Wang products. Indicating the company's optimism about the growing size of the Tempest market, Thomas projects that 10,000 75PC-T systems will be shipped next year. Deliveries should begin in April.

Additional Tempest products are expected from Wang shortly. More communication ports will be added to the microcomputer, other terminals and workstations. The company also plans to introduce this year a 10M-byte intelligent controller for its Tempest systems.

Because of the classified nature of the Tempest market and its relative immaturity, the size of the market is difficult to estimate, says Bob Dornan, federal analyst with market research company International Data Corp. But interest in the Tempest market is growing as the major computer manufacturers begin to modify their commercial

microcomputers and peripherals to meet RF emission standards. "There's a great deal of excitement and interest in the Tempest area," says Dornan.

Wang is likely to face stiff competition for Tempest-accredited terminals and standalone microcomputers from IBM, which reportedly has submitted its Personal Computer to an independent lab for Tempest testing. In recent government action, the Federal Bureau of Investigation awarded Burroughs Corp. a \$32.7 million contract for several thousand Tempest-accredited microcomputers. Zenith Data Systems has reportedly received a Navy/Air Force contract for 10,000 microcomputers. Other strong contenders in the Tempest market include Digital Equipment Corp., Honeywell Inc. and Systematics Inc.

—Stephen J. Shaw

Epson OEM strategy includes higher-performance printers

Just as Toyota and Datsun eventually grew bored with dominating the low end of the automotive market, Epson Corp. of Japan, the pre-eminent supplier of low-cost dot-matrix printers, has decided that adding some sportier models to its line couldn't hurt.

Epson America Inc., Epson's U.S. marketing subsidiary, with headquarters in Torrance, Calif., has in the past few months begun showing potential OEM customers a variety of printers it plans to introduce over the next six months. The products include several non-impact devices. But the first printer slated for introduction is the LQ-1500, a multifunctional dot-

matrix printer employing a 24-pin print head.

Japanese entries in the market for 24-pin serial printers have been coming thick and fast recently, led by Toshiba Corp., with its P1350 printer. "Obviously, we are not the first to enter the market with this technology," concedes Joseph Cornyn, vice president and general manager of Epson America's OEM division. "What we hope to do, however, is repeat our success with products like the MX-80 by hitting a price/performance level that will establish a new standard for the industry." The LQ-1500 is expected to carry a retail price of approximately \$1,500, with production

Mini-Micro World

NEWS

shipments scheduled for as early as the last months of 1983.

The LQ-1500 prints at a maximum speed of 200 characters per second (cps) in draft mode, 67 cps in what Epson calls its near-letter-quality mode and 57 cps in its highest-resolution text mode. Characters in the high-resolution mode are structured with a maximum of 37 dots horizontally and 17 dots vertically. In graphics mode, the printer achieves a resolution of 240 dots per inch (dpi).

The LQ-1500's 24-pin print head has 0.01-inch-diameter wires in three staggered rows of eight. Rather than using multiple passes for the higher-resolution modes, the head operates in different speeds and can slow down for greater horizontal and diagonal fill. Text printing is bidirectional with logic-seeking capabilities; bit-image graphics printing is unidirectional.

The LQ-1500 uses the 96-character ASCII set and 11 international character sets. Enlarged, condensed and proportional versions of pica and elite characters are included in the firmware. The standard interface is the Epson-style 8-bit parallel, and RS232C and IEEE 488 interfaces are available.

Epson is aiming the LQ-1500 at the high-end, serial matrix market for multifunctional office printing, a market crowded with contenders such as Anadex Inc. and Centronics

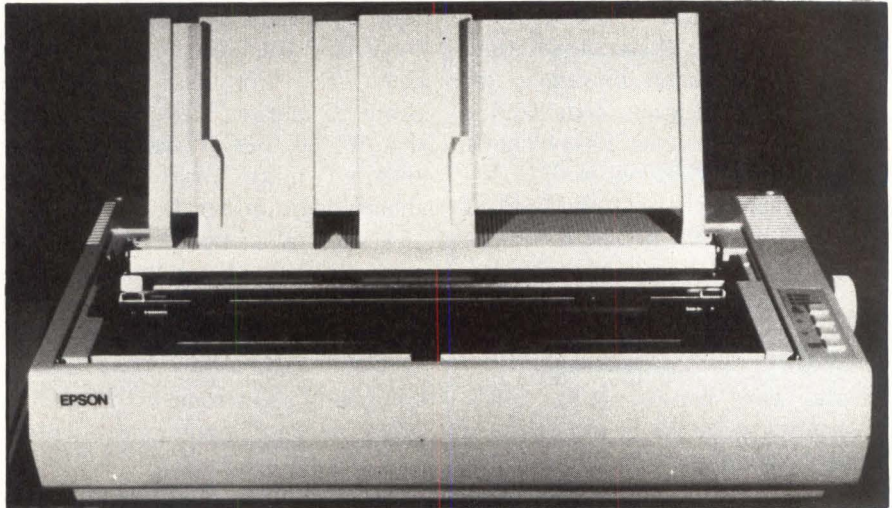

The LQ-1500 represents Epson's first entry in the more fully featured dot-matrix printer market. The printer uses a 24-pin print head and is expected to retail for about \$1,500.

Data Computer Corp. Epson and some of its Japanese compatriots chased many such contenders out of the low-end market. It is a market in which serious competition is expected soon from non-impact technologies, and Epson is apparently hedging its bets there, as well. The company expects to be shipping an ink-jet printer by April. That unit will be similar in performance to the LQ-1500 and targeted at essentially the same market.

"There will be some significant differences between the two printers," says Abram Fuks, product development manager for Epson's peripheral products group. Resolution on the ink-jet printer should be

a little better, and it will probably cost more, Fuks notes. Detailed specifications of the ink-jet printer are not available, but it is reportedly a 24-nozzle drop-on-demand, one-color unit that will likely share software commands nearly identical with those of the 24-pin serial matrix printer.

Along with the impact and ink-jet printers, Epson has shown output samples of several non-impact printers, including low-end thermal and thermal-transfer models. Topping off Epson's new printer line is an electrophotographic page printer that Cornyn anticipates will be available in the second quarter of this year. It uses a liquid-crystal shutter imaging system rather than the laser used in most xerographic printers. Resolution is said to be 240 by 240 dpi, and speed is approximately 8 pages per minute. Cornyn and Fuks are aware that low-cost printers are rumored from Canon and others, but they are convinced that Epson's page printer will compete in print quality and price.

While all of Epson's new printers are expected to be available through the company's distributors and from

COMPARISON OF MORE FULLY FEATURED PRINTERS

	Toshiba P1350	Fujitsu DPL24	Epson LQ1500
Maximum print speed (cps)	192	240	200
Near-letter-quality mode (cps)	100	80	67
Other print mode(s) (cps)		160 (correspondence)	57 (proportional)
Resolution (dpi)	180 x 180	180 x 360 (half step)	180 x 360 (half step)
End-user price	\$2,195	\$1,950	about \$1,500

IF YOU'RE BOARD WITH YOUR SASI DISK CONTROLLER SUPPLIER,

CUT IT OUT.

Compared to Western Digital's new SASI disk controller solutions, other 1410-type offerings seem just plain boring. Western Digital offers a more creative approach, one that gives you more flexibility and lower cost. Here's how.

Buy our new WD1002-SHD board, based on our powerful VLSI WD1010 Winchester controller chip plus our WD1100-13 ECC device and WD1015-02 Buffer Manager device. They represent a higher level of integration than the ICs used on competing boards, for reduced component count and better reliability.

Or you can build your own board using our VLSI SASI Chip Set. So you can take advantage of our higher level of integration to reduce your manufacturing and test costs. We make it easy for you by providing kitted chip sets, schematics, pc artwork and the engineering assistance you need to ensure success.

Clip the coupon and get a WD1002-SHD board for just \$220 or a SASI Chip Set of 3 devices for free.

So if you're sole-sourced on 1410-type controllers, broaden your alternatives. Think smart. Get SASI. From Western Digital, the world's largest manufacturer of VLSI and board-level disk controllers.



Fight Boarddom with WD SASI Solutions

Now there are two solid alternatives when it comes to 1410 SASI disk controllers: a WD board. Or a WD SASI Chip Set.

Buy one evaluation board for just \$220. Or we'll send you one chip set for free.

- Please send me more information on WD's family of disk controller subsystems and VLSI.
- Please send me a free WD SASI Chip Set.
- Here's my check or Company P.O. for \$220 (CA residents add 6% sales tax) for a WD1002-SHD board.
- Please bill my VISA, MASTERCARD (circle one).

ACCT. NO. _____ EXP. DATE _____

SIGNATURE _____

HOME ADDRESS _____

NAME _____

TITLE _____

COMPANY _____

ADDRESS _____

CITY _____ STATE _____ ZIP _____

PHONE _____ EXT. _____

Send to: Western Digital Corporation
Literature Department
2445 McCabe Way
Irvine, CA 92714

WESTERN DIGITAL
C O R P O R A T I O N

MUMMS THE ANSWER.

**SEAGATE INTRODUCES
THE ONLY WAY TO GET
100MB IN HALF THE HEIGHT
OF THE LEADING
PERSONAL COMPUTER.**

Enter the new Seagate ST8100, a compact, high capacity Winchester disc drive that features a fast 30msec average access time, and that sets new standards for low price and high performance.

The ST8100 is a high performance, half-high 8" Winchester designed

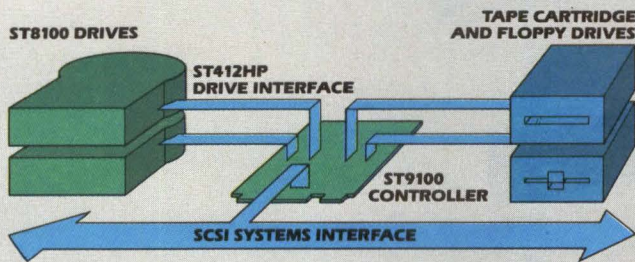

for the new generation of desktop Multi-User Memory Systems (MUMS™). And like all Seagate products, it has been carefully engineered for high-volume production and uncompromising reliability and quality.

There's more. To take full advantage of the power of the ST8100,

Seagate introduces the ST9100 — a high-speed controller that features Seagate's ST412HP (High Performance) drive interface and the Small Computer Systems Interface (SCSI). The ST9100 controller can handle up to two ST8100 drives for a total disc capacity of 200MB, plus a 1/4" tape cartridge drive for backup and an optional floppy disc drive.

Seagate's new ST8100 drive and ST9100 controller do much more than set new price/performance standards for multi-user, multi-tasking, high capacity mass storage. Together, they are the answer to a true MUMS system.

For further information, call Seagate today.

ST8100 Drive		
Capacity (unformatted):	102.1MB	Drive Level Interface Standard: ST412HP (High Performance)
Media:	Gamma-Ferric Oxide Coated	Transfer Rate: 10MBit/second
Number of discs/diameter:	Three/8" (200mm)	Dimensions: 2.312" (5.872 cm) X 8.50" (21.59 cm) X 14.25" (36.2 cm)
Heads:	Minislider (Manganese-Zinc Ferrite)	
Actuator Type:	Linear Voice Coil	
Average Access Time:	30msec	
ST9100 Controller		
Bus independent disc/tape file transfers, eliminating host backup responsibility		
Built-in data separators for disc and tape		
32-bit ECC and diagnostics that guarantee data integrity		
Bad-sector mapping capability		

"Turning the tide in information storage"

Seagate 

920 Disc Drive, Scotts Valley, CA 95066, (408) 438-6550, TELEX 176455SEAGATESCVL

Regional Sales Offices:
 Newport Beach, California, (714) 851-9964; San Jose, California, (408) 286-7580; Woodland Hills, California, (213) 884-2699; St. Petersburg, Florida, (813) 577-1199;
 Schaumburg, Illinois, (312) 397-3727; Hopkinton, Massachusetts, (617) 435-6961; Dallas, Texas, (214) 783-6711.
Authorized U.S. Distributors: Arrow Electronics, Pioneer Electronics and Wyle Laboratories

European Sales Offices:
 Gassnerstrasse 5, 8000 Munich 19, West Germany, 49 89 177017, TELEX 524275 SEAG D

©1983 Seagate Technology
 MUMS and Seagate are trademarks of Seagate Technology.

TIME is MONEY



OEM 200 doesn't waste either.

You can't afford to waste time waiting for your printer to finish before your computer can move on to something else. The OEM 200 is designed for **THRUPUT**. The large print buffers, high speed space skip and fast paper advance combine to generate 'usable' speed, not simply impressive spec sheet figures!

With the OEM 200's unusually large buffers, you can print and process simultaneously.

NO WAITING.

Most printers have very small buffers - 2K or 4K at most. Our 150 CPS wide carriage OEM 200 comes standard with a 4K buffer which is expandable to 20K, 36K, or 68K. MPI offers the biggest buffers in the business!

The OEM 200 has other outstanding features like an optional SoftSwitch™ front panel keypad and a fast and impressive near letter quality mode. Our exclusive applications packages (AP-PAKS), providing enhanced graphics printing along with a vast selection of decorative type styles, are available for selected microcomputers.

At a suggested list price of \$1045, the OEM 200 won't take your life's savings either. **STOP WASTING TIME AND MONEY. BUY AN OEM 200 FROM MPI — The American Printer Company!**



Call Us For More Information At: **(800) 821-8848**

Model shown with optional SoftSwitch™ keypad



Micro Peripherals, Inc.
4426 South Century Drive
Salt Lake City, Utah 84123
(801) 263-3081

Mini-Micro World

NEWS

its OEM division, Cornyn believes the higher-performance printers represent a particularly strong thrust for the OEM side. However, observers suspect that Epson is committed primarily to sales of its desktop and portable computer systems through its network of distributors in the United States. As a result, they question how much attention Epson will give its OEM business. But Cornyn has no doubt about Epson Japan's commitment to his OEM sales operation. "Epson

Japan is putting a lot of weight on what we tell them our needs are and how we see the U.S. market developing," he says. "These new printers are the first example, and I think future products will reflect our input even more." He adds that Epson's international division in Japan was recently reorganized to include a separate OEM group to respond to customer needs.

Cornyn also notes that the U.S. OEM division will modify and customize products for customers.

"For the FX series printers, we are changing the cabinet and adding a universal power supply to help differentiate the OEM products, as well as offering customized firmware," he states. "Staffing and tooling to do that work here is not a trivial commitment for a Japanese company." Epson expects to modify and customize the OEM versions of future products, including its new printers and disk drives.

—Edward S. Foster

Two companies beat DEC to the punch with RDBMSs for VAX

While rumor has it that Digital Equipment Corp. will unveil a relational database-management system (RDBMS) for its VAX superminicomputers, other companies, including Relational Technology Inc. and Cincom Systems Inc., have rushed to beat DEC to the punch with RDBMSs.

The advantage of RDBMSs over other database-management systems (DBMSs) is that RDBMSs' tabular structure eliminates the need for a user to "navigate" sequentially through a set of records to find information.

Relational Technology, Berkeley, Calif., has introduced INGRES/NET, one of the first networking utilities for RDBMSs, and Cincom, Cincinnati, has added a relational user interface to its essentially non-relational system. The companies are targeting a market that could grow from \$590 million in 1983 to \$1.7 billion in 1987, according to International Data Corp., Framingham, Mass.

Relational Technology's INGRES/NET utility links the company's INGRES RDBMS on VAXs running VMS and UNIX. Using

INGRES/NET on a VAX system allows the application programs to reside in a user's system and send high-level query statements over the DECnet network to the INGRES RDBMS, which is nested with a remote database. The RDBMS performs required operations on the database and then replies to queries with only the data that meets the user's specifications. When the user sends updates to the database, the RDBMS responds only with the status of the changes.

Relational Technology executive vice president Gary Morgenthaler calls INGRES/NET a step toward "a single global view of data" within a distributed system. "We're calling INGRES with INGRES/NET a distributed-access system because it's not yet a distributed DBMS." Although INGRES/NET allows users to access remote databases interactively, a user needs separate copies of the RDBMS when working with local and remote databases because of problems in maintaining concurrency. If two users attempt to modify one record simultaneously, arbitration is used to decide which of them will be "backed out"

of the database. A journal of changes is kept so that if a user must be backed out the database can be restored to its original state.

Concurrency control over communications networks is complex because error conditions and timing problems are compounded by the fact that networks sometimes assume that a data link is broken if responses are not received promptly. Concurrency is the main obstacle to distributed relational database management's becoming a reality.

Another player in the market—Cincom—calls its ULTRA DBMS for VAX systems an "interactive database system." ULTRA adds a front-end relational "veneer" that acts as an interface between users and Cincom's basically-network DBMS. According to industry analysts, Cincom is working to preserve its large installed user base by offering the ULTRA system until it is ready to replace the underlying network DBMS with an RDBMS. Users could then slowly convert to an RDBMS without developing new application programs.

Competitor Oracle Corp., Menlo

WHY RELATIONAL DATABASES?

Relational database-management systems (RDBMSs) are the third and most recent level of database-management-system (DBMS) evolution. Hierarchical systems, which were standard in the 1960s, have a branching tree structure that looks much like a corporate organizational chart, with each record connected to one "parent" record above it. Accessing a record requires intimate knowledge of the entire structure and can be done only in batch mode. In networking systems, such as the Conference on Data Systems Languages (CODASYL) model, a record can have more than one parent, but "physical pointers" that indicate connections between records are required to "navigate" the database. Network DBMSs are on-line systems but need a database administrator to maintain the system.

RDBMSs organize records in tables with rows and columns defined according to common data elements, which makes access independent of storage and index techniques. The system can look at one attribute of a group of records and then create new tables with records that can still be related to their original fields.

The central dictionary that keeps track of what resides in the database is organized relationally, so that a user need specify only the information he needs, not how that information is to be found. If, for example, frequency tables for insurance coverage, employee type and hobbies are set up and a user requests insurance information for all managers whose hobby is skydiving, then a query optimizer looks at the frequencies.

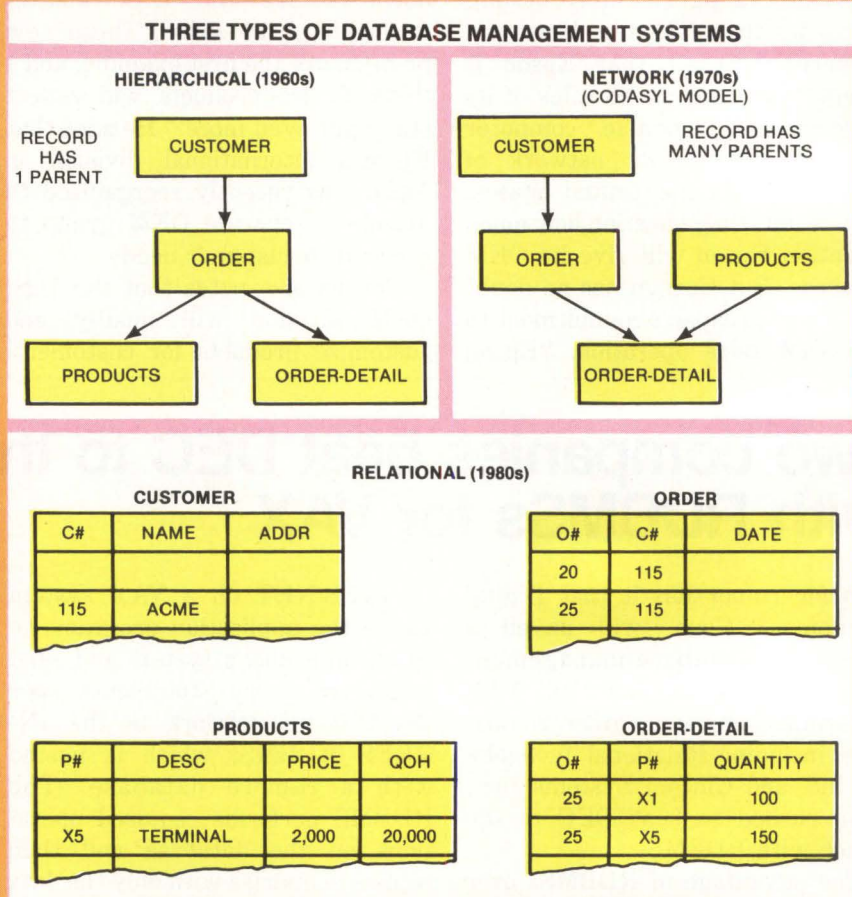

Hierarchical database systems, standard in the 1960s, and network database systems, standard in the '70s (such as the CODASYL model), operate sequentially, using "physical pointers" to access records one at a time. Relational systems, the current standard, organize records in rows and columns according to common data elements, enabling random access of a record.

The optimizer then decides whether first examining the records relating only to skydivers is likely to be the

fastest way to extract relevant records.

Park, Calif., constantly upgrades the storage manager section of its Oracle RDBMS. Although Relational Technology claims INGRES consistently wins competitive benchmarks over other RDBMSs, comparing the performance of different vendors' DBMSs is extremely difficult. Dave Roberts, Eastern region vice president of Oracle, points out that such

comparisons are usually not complete. "I could construct benchmarks that would show Oracle carrying out some functions 100 times faster than INGRES, and I'm sure Relational could do the same," he says.

Available now, INGRES/NET sells for \$5,000 for the first node in a network and for \$2,500 for each succeeding node. INGRES ranges from \$20,000 to \$40,000 for a

supported license, and prices for unsupported licenses begin at \$12,500, with quantity discounts available. The annual renewal fee is \$4,000. A version designed for microcomputers, Micro-INGRES, is list-priced at \$1,995. Cincom Systems' ULTRA sells for \$49,400 to \$74,900 with a \$6,000 one-time installation charge.

—Tom Moran

*UNIX UNLIMITED

When you buy a UNIX system from Cambridge Digital, you get our famous "Edge". Choose any fully configured DEC, NCR, or PCS system ready to go, with a full range of supported UNIX operating systems, and all of the application packages you need.

Data base management systems, word processors, spread sheet programs, data acquisition packages, languages, cross compilers, emulators, you name it. Cambridge Digital offers you more choices in UNIX-based software than anyone else in the business.

Combine the latest technology available with the system of your choice:

- UNITY from Human Computing Resources, a System III UNIX that runs on all PDP-11s and VAX.
- VENIX from VenturCom, a real-time System III UNIX that runs on PDP-11s and the IBM PC.

- MUNIX from Periphore Computer Systems, a System III UNIX that runs on the PCS QU68000, and MC68000 system designed for the Qbus.

- System III from NCR, a System III UNIX that runs on Tower, a 68000 system designed for the Multibus.

Cambridge Digital's "Edge" guarantees the latest approach to full service technical support, system updates, reconfiguration assistance, and more.

For unlimited UNIX power call or write.

Main Office Dept. 7401

P.O. Box 568, 65 Bent St.,

Cambridge, Massachusetts 02139.

Telex 92-1401/COMPUMART CAM.

800-343-5504. In Mass. call 617-491-2700.

New York District Office 516-935-3111.

**Cambridge
Digital**

DIVISION OF COMPUMART.

The Edge in System Integration.

800-343-5504

In Massachusetts call 617-491-2700

CIRCLE NO. 27 ON INQUIRY CARD

*UNIX is a trademark
of Bell Laboratories.



Stock, Boston/Bohdan Hrynewych



HEARD ON THE HILL



By Stephen J. Shaw
Contributing Editor, Washington

Congress to consider telephone, R&D legislation

Getting back to work after the Christmas recess, the U.S. Congress faces a full slate of legislation affecting the computer industry, including provisions for research and development projects.

Tax credits for business R&D expenditures are scheduled to expire on Dec. 31, 1985. After intense lobbying, reports the American Electronics Association (AEA), the Reagan administration has agreed to support a three-year extension of the credits if the statutory definition of R&D can be narrowed to prevent abuses.

Sens. Lloyd Bentsen (D-Texas) and John Danforth (R-Mo.) are expected to introduce legislation for a permanent tax-credit extension with a more acceptable definition of R&D. Reps. James Shannon (D-Mass.) and Guy Vander Jagt (R-Mich.) are expected to follow suit in the House.

Many of legislative issues are carry-overs from last year. The Senate version of the new Export Administration Act is one. The House of Representatives passed its version of the bill, H.R. 3231, in late October

with the support of computer trade groups. But the measure was not acted on by the Senate before adjournment in November.

A major provision of the bill is that validated export licenses are not necessary for computer equipment shipped to countries—including Japan and several European countries—that are members of the Coordinating Committee (COCOM) and intended for re-export. Instead, companies in COCOM countries receiving the equipment would be required to apply for a re-export license from COCOM. The United States could then veto the application if it felt that re-export of an item in question would harm U.S. national-security interests.

Other items expected to be considered in 1984 include:

• **The Universal Service Act:** Reps. Tim Wirth (D-Colo.) and John Dingell (D-Mich.) are attempting to modify a Federal Communications Commission decision to levy a \$2 fee on consumers and a \$6-per-month charge on businesses for access to long-distance telephone service. The

monthly charges, estimated to total \$3 billion annually, are scheduled to take effect April 3. The access fees are intended to replace the subsidy of local service by long-distance revenues.

• **Antitrust exemptions for joint R&D:** A variety of legislation has been introduced to exempt joint, high-tech R&D ventures from antitrust laws. The two main pieces of legislation that have received the general support of the computer industry are S. 737, introduced in the Senate by Sen. Charles Mathias (R-Md.), and H.R. 1952, introduced in the House by Rep. Michael Synar (D-Okla.).

• **Domestic content:** H.R. 1234 would mandate production of a minimum percentage of components in automobile products, including microcomputers, in the United States. The AEA has joined 25 other industry associations in opposing the measure, contending that the bill violates general agreements on tariffs and trade and is too protectionist in tone.

© 1983 by General Automation, Inc.™ Zebra is a trademark of General Automation, Inc.™ PICK and™ ACCESS are trademarks of PICK Systems. SORBUS® is a registered trademark of Management Assistance Inc.

RIDE YOUR WAY TO SUCCESS ON A ZEBRA.™

Hitch your application software to a Zebra by GA and watch your sales take off.

The reason is Zebra's ability to outdistance the competition. The fact is, Zebra is faster and more powerful than any other multi-user microcomputer system in its class. Inside every Zebra beats the heart of the powerful Motorola MC68000® microprocessor. Allowing up to 64 different users to perform a variety of tasks including standard accounting, word processing, business graphics and financial spreadsheets. All simultaneously. And every Zebra can accommodate a wide range of industry-oriented applications as well.

Zebra appeals to virtually all customers because it's so friendly. Zebra utilizes the



PICK™ Operating System. And with ACCESS™ the system's information management and retrieval language, Zebra speaks English. So training and instruction are minimal.

Zebra also runs the Microsoft XENIX™ Operating System opening up an infinite variety of applications for commercial, engineering and scientific tasks.

Another nice thing about Zebra is its modular growth. As your customer's business grows, Zebra grows with it.

Zebra follows in the tracks of over 30,000 satisfied users of GA computers worldwide. And like every reliable GA computer, Zebra keeps running year after year. In the United States, service for Zebra is available through SORBUS®, the number one rated service organization in the country. And our dealers are backed by GA's professional field sales and technical support organizations.

Zebra is off and running. With a national ad campaign, co-op plans, sales material and some of the most profitable margins in the industry. Call or write now for more information. GA, 1045 South East St., P.O. Box 4883, Anaheim, CA 92803 (714) 778-4800; Toll-free 1-800-556-1234, Ext. 41. In CA, 1-800-441-2345, Ext. 41.

ZEBRA BY GA

FOR MORE INFORMATION, CIRCLE NO. 196 (ENDUSER).

FOR MORE INFORMATION, CIRCLE NO. 197 (RESELLER).

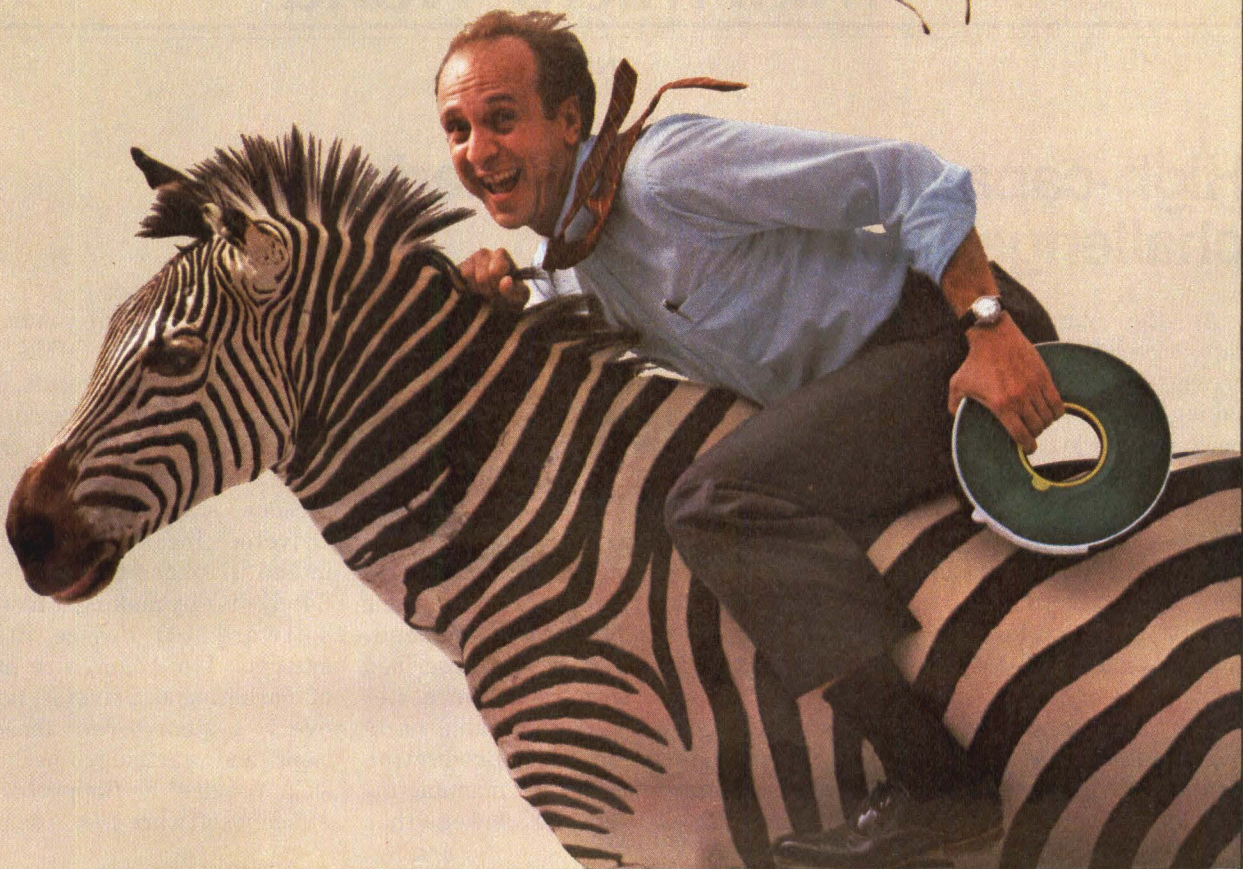

INTRODUCING NOTHING.™

The five printers in our Nothing Series offer a simplicity of design so uncluttered that you may wonder what makes them run. And run. And run.

It's Nothing. Just good, sound engineering.

Our printers give you Nothing where our competition gives you something.

Lots of little somethings. Gears to jam. Wheels to warp. Springs to come unsprung. Linkages to snap.

Our printers are designed for easy maintainability. Superior

durability. And high print quality. With print speeds from 40 cps NLQ to 200 cps draft. Cut sheet feed plus color, graphics and demand document printing.

Infoscribe. Nothing is quieter. Nothing is more reliable. Nothing is priced better in its class.

And that's really something.

INFOSCRIBE®

2720 South Croddy Way, Santa Ana, CA
92704 USA (714) 641-8595 Telex: 692422
Inside California, call (800) 223-8595
Outside of California, call (800) 222-8595.

NOTHING IS BETTER.

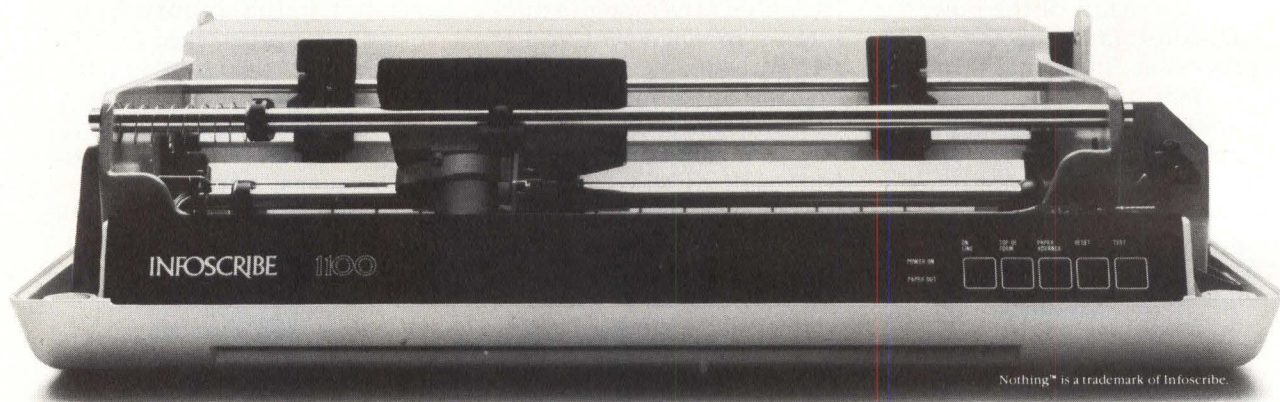

Nothing™ is a trademark of Infoscribe.

Mini-Micro World

NEWS

High-capacity removable media challenges floppy backup

As the numbers and storage capacities of desktop systems increase, system manufacturers are taking a new look at the old issue of backup. Desktop systems using 5¼-inch Winchester drives are expected to boost the number of drives manufactured at a compounded annual rate of 82 percent in 1982-1987, according to a recent report by William Frank, an analyst with InfoCorp, a Cupertino, Calif., market research concern.

The floppy disk, the primary backup device for desktop systems in the past, finds itself threatened by low-cost tape drives from

companies like Cipher Data Products Inc., San Diego, and Tandon Corp., Chatsworth, Calif. (MMS, May 1983, Page 23), and now by a lower-cost cartridge drive from DMA Systems Corp., Santa Barbara, Calif.

The sales potential for cartridge drives is enormous, says disk drive analyst Jim Porter, because of their improved reliability and speed. Cartridge drives can be described as devices that put Winchester technology into a removable package. However, the production numbers of cartridge manufacturers have been far lower than

expected because of volume manufacturing problems (MMS, August 1983, Page 44). As a result, it will be a while before analysts can give an accurate forecast of the cartridge drive's true potential.

Some start-ups, however, like Drivetec Inc., San Jose, Calif., intend to extend the useful life of a floppy disk by making it more than a software I/O device in future systems. Ivo Adam, vice president of marketing at Drivetec, notes that every system—even those using tape and cartridge backup—will still require a floppy drive for efficient software I/O. Adam doesn't

Mini-Micro World

NEWS

believe the I/O function can be cost-effectively transferred to either tapes or cartridges. Since most systems require a floppy drive, use of the Drivetec SuperMinifloppy drive provides "almost-free" back-up, Adam believes.

"The sharp drop in the cost of media is directly responsible for the widespread availability of computers today," says Adam. "A user can now get a floppy disk for a couple of dollars to store as much information as he used to be able to store on the huge systems for thousands of dollars."

Richard Troutte, president of DMA, believes that users and system integrators will pay a higher price if they can be assured a product is highly reliable. The company has introduced a 7.5M-

BACKUP CHOICES FOR DESKTOP SYSTEMS			
Drive	Media cost	Drive cost	Capacity (bytes)
Drivetec SuperMinifloppy	\$5-\$7	\$333	3.3M
48 tpi standard	\$2	\$100-\$150	300K
DMA 360	\$35	\$500	7.5M
Cipher Floppytape	\$20	\$300	35M

byte Winchester cartridge that it will market against floppy drives when production volumes are geared up in April.

Aimed at small business system users, the DMA 360 drive will sell for less than \$500 in small OEM quantities, and the cartridge will sell for \$35 in small OEM quantities. The prices are as much as 10 times

higher than the price of an average floppy drive and disk, but Troutte insists the cartridge can compete. "The cost per megabyte will come down as production volumes go up," Troutte says. "The precision and reliability of Winchester technology will make the cartridge a better buy."

Troutte says it would take as

NOTHING™ IS MORE RELIABLE.

Nothing is always more reliable than something. That's a truth good engineers know instinctively. The less pieces you design into a machine, the less there is to go wrong.

Which is why we spent 4 years developing dot matrix printers that have all the features you want without all the parts you don't need.

And an astounding 85% of the parts our printers do have are identical from model to model, which helps OEMs substantially reduce spares costs and inventory and service

training. Which in turn lowers the time and cost of service to end users. And our unique configuration flexibility means you don't have to pay for something when you want Nothing.

Open up one of our five Nothing series printers. One look will tell you there's really Nothing to it.

And Nothing can save you more in downtime and service bills.

INFOSCRIBE®

2720 South Croddy Way, Santa Ana, CA
92704 USA (714) 641-8595 Telex: 692422
Inside California, call (800) 223-8595
Outside of California, call (800) 222-8595.

NOTHING IS BETTER.

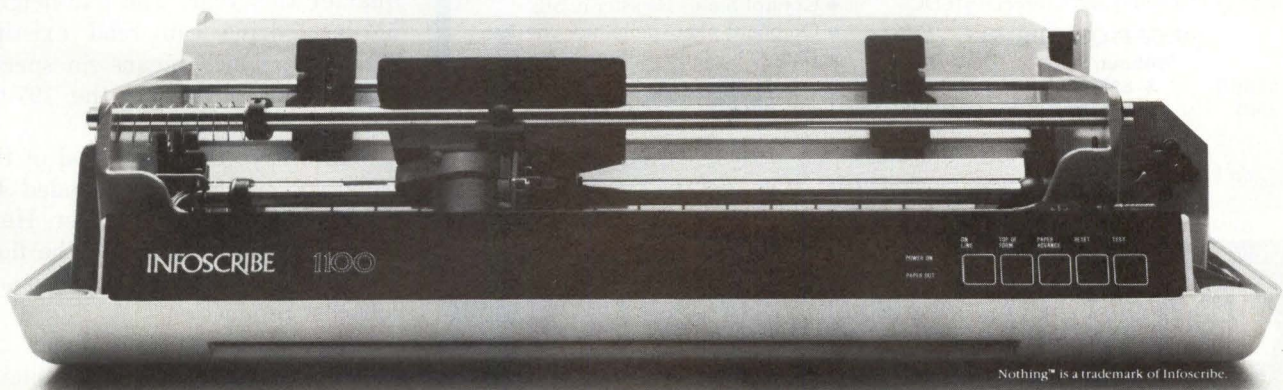

Nothing™ is a trademark of Infoscrite.

Mini-Micro World

NEWS

many as 25 standard 300K-byte floppies to achieve a capacity equal to the 7.5M-byte DMA 360. "Even if the user can get diskettes for \$2 apiece, that still means \$50 in diskettes," he adds.

Troutte says there is concern about the reliability of floppy disks. "Floppy disks are the least reliable media available," he insists. Diskettes are subject to rapid wear in normal use, he adds, and are extremely sensitive to temperature and environmental conditions. In contrast, he notes, cartridges are sealed and opened only when the media touches the head.

Troutte claims reliability of high-capacity drives like the Drivetec product has not been proven. He notes that even 96 track-per-inch (tpi) drives that can store 1M byte

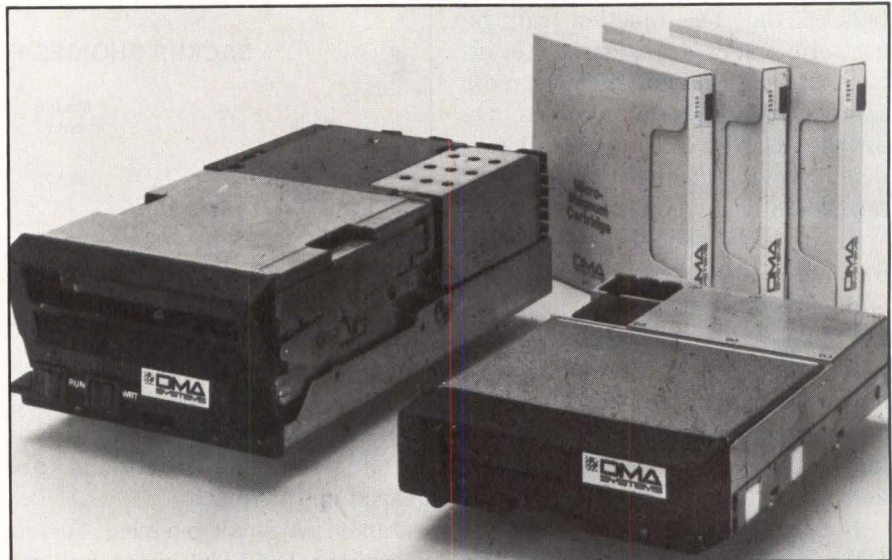

The 7.5M-byte DMA System 360 disk cartridge drive (right) competes against floppy drives for users and system integrators willing to pay a higher price for the assurance of high reliability. The earlier Micro Magnum (left) targets higher-priced streaming-tape drives.

are questionable in some quarters.

"IBM, for example, retained a seven-year-old 300K-byte floppy drive in the XT, despite the lowered capacity ratio between the floppy and the Winchester," he adds.

Drivetec is shipping a 3.2M-byte floppy disk drive introduced at the 1982 Fall Codex show (MMS, February 1983, Page 26) that seeks to provide low-cost backup to systems like the IBM PC-XT that have a minimum of 10M bytes of Winchester storage.

Drivetec expected to ship about 5,000 of its drives last year and anticipates shipping as many as 15,000 by the end of the first quarter this year. The half-height, 5¼-inch drive can read existing diskettes, which means no special media is required for the 197-tpi drives.

Adam says the main goal of the company, which was founded by Shugart Associates founder Herb Thompson—who invented the floppy disk while at IBM Corp.—is low-cost production.

There is a question about the sense of using higher-capacity drives when IBM has set a

CHRISLIN MEMORY

MULTIBUS MEMORY 512KB TO 2 MB EDC

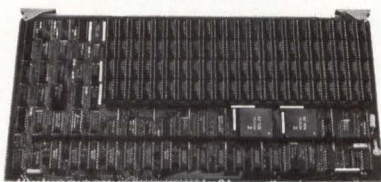

- Error Detecting and Correcting (EDC).

SINGLE QTY. PRICE:

	Without/EDC	W/EDC
512KB	\$ 895.00	\$1495.00
2MB	\$5995.00	\$6495.00

LSI 11 MEMORY 256KB TO 1 MB

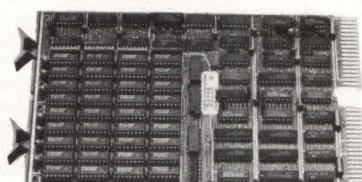

- Control Status Register (CSR)
- On board parity generator checker.
- Battery back-up mode.

SINGLE QTY. PRICE:

256KB	\$525.00
-------	----------

NEW! MORE MEMORY ON A SINGLE CARD THAN ANY OTHER MANUFACTURER
2MB QBUS ERROR DETECTING AND CORRECTING
CALL FOR MORE DETAILS! NEW!

OFFERING QUALITY WITH AFFORDABLE PRICING™



Chrislin Industries, Inc.

31352 Via Colinas • Westlake Village, CA 91362 • 213-991-2254
TWX 910-494-1253 (CHRISLIN WKVG)

MULTIBUS is a trademark of Intel Corp. LSI, QBUS are trademarks of Digital Equipment Corp.



UDS gives 212 users three ways to go!

212A—Today's most popular modem. UDS offers a fully Bell-compatible unit with complete local and remote test capability. Select 0-300 or 1200 bps for full-duplex asynchronous communication. The UDS 212A is FCC certified for direct connection to the dial-up telephone network, and available in multi-channel, rack-mounted configuration.

SINGLE UNIT PRICE **\$595**

212 LP — Compatible with 212As at the 1200 bps, full-duplex asynchronous communication rate. No power supply or AC connection required; the 212 LP derives its operating power directly from the telephone line. Ideal for applications requiring 212A capability at 1200 bps only. The 212 LP is direct-connect certified.

SINGLE UNIT PRICE **\$445**

212A/D — Identical to the 212A, with automatic dialing capability added! The unit stores and dials up to five 30-digit numbers. CRT menu prompting, single-stroke commands and automatic test capabilities are provided. The 212A/D is direct-connect certified.

SINGLE UNIT PRICE **\$645**

 **Universal Data Systems**

 **MOTOROLA INC.**
Information Systems Group

5000 Bradford Drive, Huntsville, AL 35805. Telephone 205/837-8100; TWX 810-726-2100

DISTRICT OFFICES:

Old Bridge, NJ, 201/251-9090 • Blue Bell, PA, 215/643-2336 • Atlanta, 404/998-2715 • Glenview, IL, 312/998-8180 • Columbus, OH, 614/895-3025 • Boston, 617/875-8868
Richardson, TX, 214/680-0002 • Englewood, CO, 303/694-6043 • Houston, 713/988-5506 • Tustin, CA, 714/669-8001 • Mountain View, CA, 415/969-3323

CIRCLE NO. 29 ON INQUIRY CARD

Created by Dayner/Hall, Inc., Winter Park, Florida

“DOTS INC

Besides 45 cps letters, you can print documents, rough drafts and data at up to 250 cps. Plus charts, graphs and graphics—in virtually limitless colors.

An understatement. Print flexibility includes up to 6 resident fonts, italics and proportional spacing. Plus bar codes, OCR, scientific and international fonts. Or, you can download your own unique fonts.

Handles universal single and continuous forms up to 15" wide automatically. Multi-part forms, preprinted forms—you can even generate your own forms.

Actual size, unretouched printout. Even under 4.4X magnification, you still can't see the dots.

Print resolution accurate to .0014 inch. Dot addressable graphics to 240V x 720H.

You can't see the dots in this letter quality printout. That's what makes the revolutionary AMT 45 cps dot matrix computer printer so incredible. In fact, it's the first computer printer that's better-than-letter.



You've never seen anything like it. Our new AMT printer is the first dot matrix that prints with *perfect* letter quality. Now that's incredible. But that's not all. The AMT dot matrix is so flexible, functional and letter-perfect, it replaces the office daisywheel, plotter and conventional dot matrix data printer.

In fact, the AMT is so powerful and versatile it can match the system demands of the most sophisticated computer. Yet it's astonishingly easy to use.

We could go on and on. About systems modularity. Simplified maintenance. Third-party service. Intelligent ribbon systems. Software flexibility. Special applications. And much more.

But all it takes is one look at the AMT in action. Write to Michael Allison, V.P. Sales, Advanced Matrix Technology Inc., 1157 Tourmaline Drive, Newbury Park, CA 91320. Or call (805) 499-8741.

The AMT better-than-letter™ printer. Dots incredible.

STOCKING REP. INQUIRIES INVITED.

CIRCLE NO. 30 ON INQUIRY CARD

REDIBLE."



MT
Advanced Matrix
Technology Inc.

The first better-than-letter printer.

At last, a modem that goes where you want.

And does what you want.

The S-100 Modem™ by U.S. Robotics. 300/1200 baud. Auto dial/answer. A limited two-year warranty. Just \$449.*

And it's fully-programmable with Telpac™—USR's telecommunications software package.

**Suggested list for S-100 Modem with complete manual and phone cord. Telpac software (optional) — \$79.00.*

S-100 Modem, TELPAC, USR logo and U.S. Robotics are trademarks of U.S. Robotics Inc.



U.S. ROBOTICS INC.
1123 WEST WASHINGTON
CHICAGO, ILLINOIS 60607
(312) 733-0497



Mini-Micro World

NEWS

“standard” with 300K-byte, 48-tpi drives. Another question concerns the reliability of the Drivetec drive. Adam responds to that by saying removable cartridges have not established a reputation for reliability either. “Shipments of DMA’s first cartridge drive [the 5¼-inch fixed/removable Micro Magnum 5/5] have not been as high as they would have expected,” Adam says. “Every company from Control Data Corp. to SyQuest Technology has had problems with cartridges.”

Troutte says DMA had to hunt for ways to package the electronics, cartridge and mechanism into a half-height footprint. “We went to the automotive industry for one answer [where to put the electronics]—a folding printed-circuit board that actually curls up and around the head/disk assembly, making use of every possible inch,” he says. He believes the new cartridge will work well.

To keep cost low, the company has designed the drive so that the cartridge can be formatted by a user—like a floppy disk—rather than in the factory, as is now the case. On-board microprocessor firmware permits the user to write servo information on a blank cartridge when it is inserted into the drive. Once formatted, the cartridge can be interchanged with any other DMA 360 drive. In addition, the cartridge can also be used in a Micro Magnum drive.

—Robert A. Sehr

NEXT MONTH IN MMS

Be sure to check the February issue of Mini-Micro Systems for the “new and improved” Systems in Manufacturing section. Its new title, Integrator, reflects expanded coverage.

"PERSONAL"

OFFICE-GRADE WORD PROCESSING SOFTWARE



IBM PC



DEC 20



PDP-11



VAX-11/780



VAX-11/782



VAX-11/730



VAX-11/750



PRIME



APOLLO



HARRIS



MASSCOMP



WICAT

MUSE

MUSE Software now runs on more computers than ever.

MUSE now operates on Prime, Harris, Apollo, WICAT, IBM PC, Masscomp, and the complete line of DEC computers, VAX and PDP-11 included.

And because MUSE is office-grade word processing, you get all the features that make word processing fast and easy. Menus, prompts, messages, single key-stroke functions, and a what-you-see-is-what-you-get screen display are but a few of MUSE's powerful capabilities.

To see for yourself how important office-grade word processing can be to your office, call us to arrange a 30-day trial. On your computer, of course.



**MARC SOFTWARE
INTERNATIONAL, INC.**
260 Sheridan Avenue, Suite 200
Palo Alto, CA 94306
(415) 326-1971

Distributorship inquiries welcome. International offices located in Tokyo, Japan, The Hague, Netherlands, and Genova, Italy.



DEC 10



IBM PC/XT

CIRCLE NO. 32 ON INQUIRY CARD

Our UNIX Micro GE's Industrial

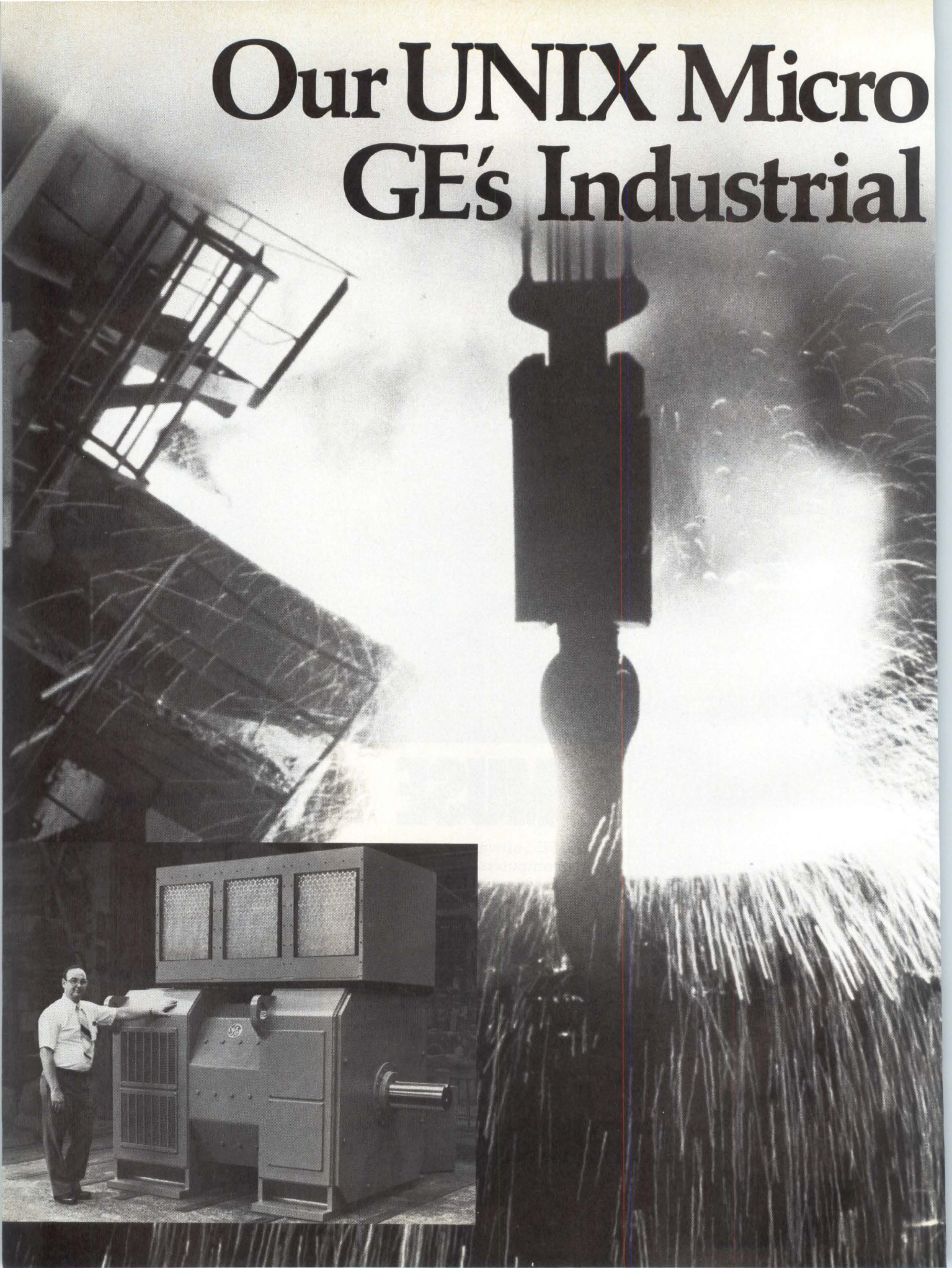
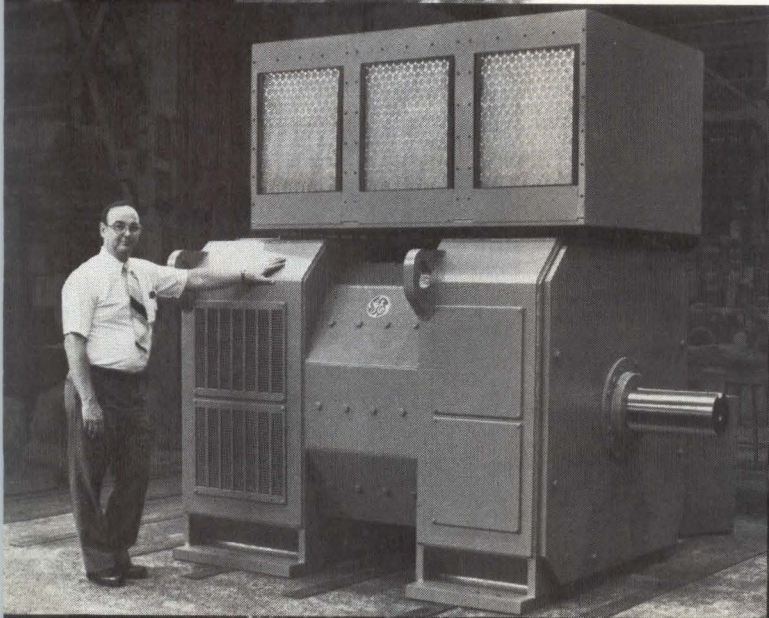

Systems Fine-Tune DC Motors.

We're Dual Systems.

And when the people at GE needed a microsystem as an engineering design tool for industrial DC motor applications, they turned to us.

After all, our high speed microsystems have performed in the clutch for Boeing and Sony and Ford and United Press International, just to name a few.

And for three years we've been delivering 68000-based systems, full UNIX* Version 7 with Berkeley enhancements, and IEEE-696/S-100 bus conformance. That's longer than anyone else.

Which brings us to our newest high-performance micro, the 83/80. Featuring the full UNIX capabilities of Version 7 or System III, the 83/80 can handle up to twelve users and provides a standard 512 KB of dynamic RAM with parity that's expandable to 3.25 MB.

And we've backed it with a full one-year warranty.

Our 83/80 incorporates a high-throughput SMD controller and an 80 mega-byte Winchester disk drive with 20-25 milliseconds average seek time. And our backup memory is well worth remembering — it consists of an 8" floppy disk with 1 MB of storage.

In addition, you'll find our 83/80 delivers increased performance through its Dual ported full-track disk buffer and proprietary controller circuiting. More users can access with better response time.

It's also very well-educated. Our 83/80 can read or write up to an entire track of data in a single disk rotation, regardless of where the disk-head settles on a given track.

That's smart.

The C programming language comes standard with UNIX, of course. Other optional languages include FORTRAN-77, PASCAL, RM/COBOL®, LISP and BASIC. And that's just for starters. Optional software includes data base and administrative packages like INGRES and UNIFY.

And the sticker price? Quantity 10 at \$14,693.

For further information, please write or telephone our Marketing Department at 415/549-3854.

We'll be glad to tell you about one powerful microsystem that's revved up and ready-to-go.



DUAL

Dual Systems Corporation
2530 San Pablo Avenue
Berkeley, CA 94702

*UNIX is a trademark of Bell Laboratories.

© RM/COBOL is a registered trademark of the Ryan McFarland Corporation.

CIRCLE NO. 34 ON INQUIRY CARD

\$995

buys the roots of every PC application you'll ever want to grow.

METAFILE® is bursting with potential.

The METAFILE System gives users of IBM PCs, XTs or compatibles all the software they need to grow their own unique solutions to information management problems.

With the METAFILE System you can easily prepare text and create data bases, forms, menus and reports—and tie them all together, integrated. Either on the spur of the moment, or during the development of structured formal applications for others to use.

Unlike multi-function systems that force together a collection of software pieces, the METAFILE System is—from its very foundation—a single integrated architecture. One high-level language drives all its facilities. No need to learn (or teach others) a variety of inconsistent languages.

If your company has an Information Center, the METAFILE System helps meet your goals of faster application development, personal computer software standardization, and the training of users to design their own solutions.

The most appreciated advantage of your METAFILE System may be ease, or speed, or freedom. But the net result, in all cases, is higher productivity.



**Sensor-based Systems, National Service Desk
Dept. MMS-14, 1701 East Lake Ave.
Glenview, IL 60025**

Please send _____ METAFILE® Abridged Version kits at \$25.00 each including postage and handling. Or _____ METAFILE® full system version at \$995.

- Check or Money Order enclosed
- Send C.O.D. (\$2.00 additional per order)
- Visa/MasterCharge #:

Exp. Date _____ (Please sign below)

Name _____
 Firm _____
 Address _____
 City _____
 State _____ Zip _____
 Phone No. (____) _____
 Signature _____

\$25

lets you sample the beauty of it all.

For just \$25, a special ABRIDGED VERSION will let you experience—and show others—the almost unlimited potential of the METAFILE System. The Abridged Version is a fully functional kit including system disk, demonstration disk, and a 72-page "get-acquainted" guide. Use the order form below, or call the toll-free number.

METAFILE Version 7, the full-capacity licensed system, for \$995, is available along with training, consultation and periodic upgrades through seven regional offices. Sold only through authorized METAFILE agents.

NOTE: System Requirements.

METAFILE Abridged Version runs in 128K memory, using PC-DOS 1.1 or 2.0, with one 320K floppy drive plus any other disk storage device.



**To order by phone, call toll-free:
1-800-323-3731
or (312) 724-0310.**

METAFILE®

Integrated Information Management System

Fastest way to grow PC applications

CIRCLE NO. 35 ON INQUIRY CARD

Mini-Micro World

CORPORATE AND FINANCIAL

Xerox plans to fight for personal computer niche

The reorganization of Xerox Corp.'s various computer products divisions last year, coupled with the decision from corporate headquarters in Stamford, Conn., to sell or close all 54 Xerox retail outlets, led many to believe the company is retreating from the small business systems arena. But the person responsible for Xerox's non-copier products says that isn't the case. "We are not abandoning the personal computer field by a long shot," says Robert V. Adams, vice president of the new Xerox Systems Group, which includes computer systems, printers, plotters, electronic typewriters and facsimile machines. "We have some homework to do because the face of the business has changed a lot, but we are still very interested in the low end of that market and still interested in approaching it through multiple marketing channels."

Adams insists that the sale of Xerox's retail chain to the newly formed Genra Group, in which Xerox will have an equity position, should be seen as facing market realities, not raising a white flag. "When we set up the stores, we did not have the retail outlets that were appropriate for selling these types of systems. All we had were basically hobbyist stores." Now, there are some good retail chains for personal computers, but they don't view a vendor favorably if it has its own store chain. "We needed to put our retail outlets at arm's length so that we could more readily get our products into the Businesslands, ComputerLands and Sears Business Centers," he says. Xerox is also organizing its direct sales force: each sales group will sell the entire

product line rather than only a part.

The personal computer market is another in which recent changes have forced Xerox to rethink its product strategy. There, the success of the IBM PC will affect future Xerox offerings. "I think of the PC phenomenon...(as the) unleashing of literally hundreds of independent software companies that needed to have a standard to write their software on," says Adams. "That growing body of software competence has now revolutionized the PC business, and we have to hook into that somehow." Xerox was one of the early personal computer suppliers to open its doors to independent software writers.

Industry observers suggest that Adams might be downplaying the challenge facing him. "In the personal computer business at least, Xerox is going to find it very difficult to play a major role," says Christine Hughes, office systems analyst at the Gartner Group, Stamford, Conn. "Xerox now has a disappointing image as far as the personal computer is concerned. Part of the problem is the way they positioned the original 820: they introduced it as a desktop, a word processor, an Ethernet terminal. And, at the retail level particularly, you have to stake out your position much more clearly."

Sanford J. Garrett, a financial analyst who tracks Xerox for Paine Webber, sees the sale of Xerox's retail outlets as part of an incomplete shift in marketing strategy. "The stores themselves were operating in the red to a minor degree, although stores that had been open at least a year were in the



Robert V. Adams, Xerox group vice president and president of the company's Systems Group, says the company "typically has a focus based on technology rather than low cost. We continue to bring some very innovative products to market, but you could fault us for not always moving fast enough."

black. It is a mild embarrassment, though, to be selling them now that others are using the same essential concept successfully. Once again, Xerox was early to market and failed to take advantage of it." Garrett does not, however, see Xerox's moves as an indication that the company is leaving the systems business. "Absolutely not—it is an integral part of Xerox's corporate strategy. The trend seems to be that, instead of keeping the computer products in a standalone situation, they are rolling sales responsibilities for those products over to the copier side." He believes the copier group has been pushing for an integrated sales force.

It is unclear in which areas Xerox is making or losing money. For the nine months ending Sept. 30, 1983, the company showed a net income of

Mini-Micro World

CORPORATE AND FINANCIAL

\$387 million, an increase of 23 percent over the first nine months of 1982. Profits from the company's copier and information systems businesses, however, were down 10 percent from the previous year. Xerox attributes that to revenue declines in copiers and duplicators, as well as to other factors. Adams contends most of the products in the systems group showed a profit.

Adams concedes that Xerox must catch up to others in the market. He believes many products will give his group considerable leverage in the office-automation market. Such products include laser printers from the Printing Systems division, Diablo Systems Inc.'s daisy-wheel and other serial printers and Versatec Inc.'s electrostatic plotters. These products represent about half of the Systems Group's business. Adams notes that laser printers turned a profit for Xerox for the first time in 1983.

In bringing the laser printers, along with the Diablo and Versatec products, into the Systems Group, Adams has opened the door to internal conflicts as the various technologies begin to overlap in the market. Adams acknowledges that a conflict exists between daisy-wheel printers on the one hand and low-end ink-jet, thermal and laser units on the other. He says, "We are going to hedge our bets. I wanted to get Diablo into this organization so that we could develop a seamless strategy in marketing these different technologies for putting marks on paper."

The paper-based office is Xerox's target, Adams says. That market includes printers and copiers from the Reprographics Group as well as electronic typewriters, word processors and facsimile devices. He believes there is a fairly significant difference between document processing and data processing. "The

same kind of device may do both, but there is a different design center," based on what a user intends to do. He explains that Xerox has "a very different point of view from an IBM, which sees everything built around its data-processing hub, or an AT&T, which is concerned with mixing voice and data. We say paper is here and will continue to play a role in the automated office."

Xerox has had some success in competing directly with IBM Corp. in the electronic typewriter market. Xerox has reportedly captured a more than 20 percent share of that market, a figure that Adams terms a fair estimate. He feels that the company can leverage the Memory-writer line of electronic typewriters in its broader office products strategy, particularly in relation to the 860 word-processing system. "The 860 is still selling very well for us, and we plan on selling a lot through 1984," Adams says. "It is an older technology in a fast-moving market segment, so we have to figure out a way to get that capability onto lower-cost machinery." He believes one way to do that would be to enhance the Memory-writer so it could perform many of the same functions as the 860. He thinks Xerox should focus on the market for a good secretarial workstation and not get too mesmerized by personal computers.

Adams states that the Xerox Star workstation has not been consigned to history. "We are moving a number of them, and there isn't the slightest doubt in my mind that we're on the right track." Xerox will continue to pursue niche markets for the Star and eventually make it a more general-purpose workstation, he says. Adams admits the Star is still losing money for Xerox, partially because of accounting procedures.

One curious aspect of Xerox's reorganization is that its disk drive manufacturing subsidiaries, Shugart Corp. and Century Data Systems Inc., are not in the Systems Group. That has fueled speculation that Xerox might sell one or both. Adams contends the restructuring was done to balance the work load among the group vice presidents. "I find it very convenient to buy from Shugart and Century, so I wouldn't encourage the company to get out of those businesses," he adds.

With product successes in such disparate areas as high-speed laser printing and electronic typewriters, a critical product offering for Xerox continues to be the Ethernet local-area network (LAN). Adams says Xerox's goal is to link the company's products into "a proper office network." He believes Ethernet does for document handling what IBM's Systems Network Architecture (SNA) does for data processing. "Remember how roundly criticized IBM was for SNA when they introduced it? It was too big, too cumbersome and too hard to use. People don't laugh at it any more; they just ask how they can hook in. With a little luck, we will do the same thing with Ethernet."

Xerox has installed more than 500 Ethernet LANs, Adams says, and will soon announce arrangements with other hardware vendors to adopt Ethernet. He concedes that the LAN business has not taken off nearly as fast as Xerox had hoped, partly because of an expected IBM LAN. "IBM is so powerful that, whenever they come into the marketplace, the way they do it becomes a de facto standard," he says. He hopes that IBM's LAN will come out soon and that Xerox can hook into the standards that evolve from it. "I don't feel IBM's coming out with it will cause any more

A minimum of moving parts and an exceptionally rugged design make the CI-600 from CIE Terminals the *first* 600 LPM matrix line printer you can depend on.

And when you compare the CI-600 with other 600 LPM line printers, you'll find others either do a lot less, cost a lot more, or both.

The CI-600 is plug-in compatible with virtually every type of computer system, including IBM and DEC.[®] It doubles the throughput of our CI-300.

It gives you 600 LPM data processing and letter quality to 170 LPM. It has variable shuttle speeds. And it delivers graphics up to 4800 DLPM.

The CI-600 is ideal for retail, business, engineering and scientific graphics applications, all of which are easily accessed and used. And there's more.

You get high resolution graphics for Bar Codes, Optical Character Recognition, Form Generation, Labels and Word

Processing. An unusually small print head diameter for needle-sharp character clarity. Hundreds of unique character fonts. And three built-in interfaces, two parallel and one serial.

There are also two paper-loading points—front and bottom. Plus flexible line spacing and line feed speed.

If you'd like the same quality, but don't need as much speed, we also offer the CI-300—with 300 LPM data processing and 85 LPM of letter quality.

The CI-600 and CI-300 come to you from CIE Terminals, a new company of C. Itoh Electronics, one of the world's most experienced printer companies.

To find out more about the CI-600—the *first* 600 LPM line printer that really works—and its cousin, the equally dependable CI-300, just write or call.

A 600 LPM built on a simple principle.

It really works.

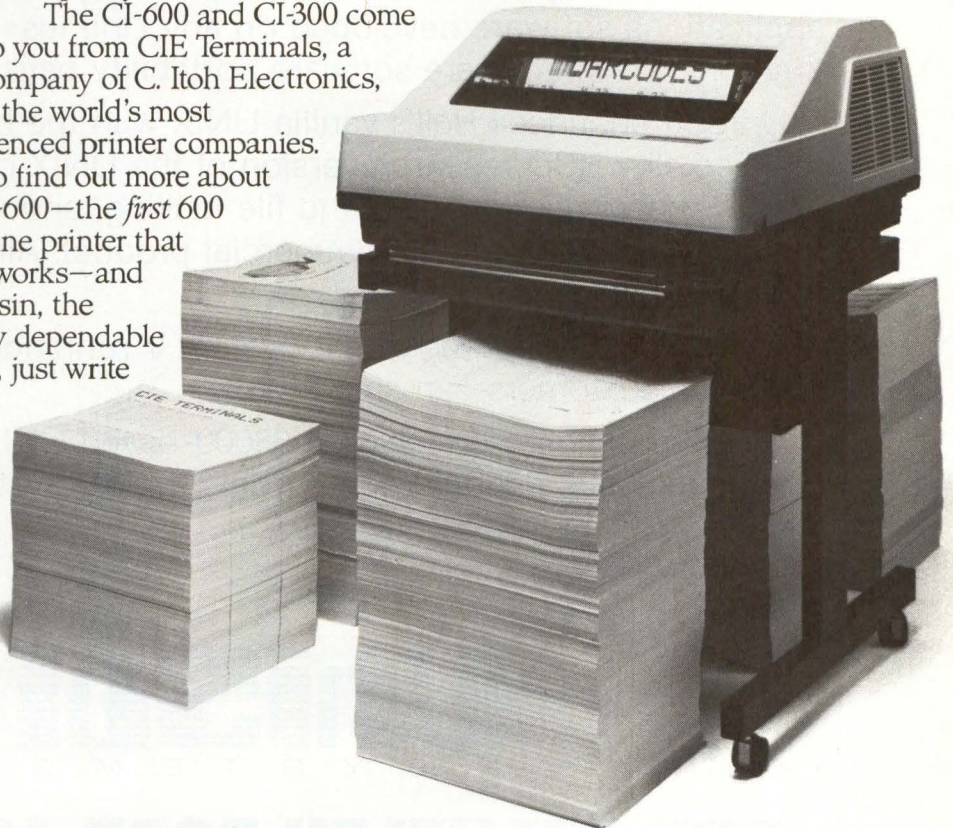

CIE TERMINALS

A new company of
C. ITOH ELECTRONICS, INC.

2505 McCabe Way, Irvine, CA 92714-6297. (714) 660-1421. Call toll-free 1-800-854-5959.
In California, call toll-free 1-800-432-3687.

[®] DEC is a Registered Trademark of Digital Equipment Corporation.

© CIE Terminals, Inc. 1983

CIRCLE NO. 36 ON INQUIRY CARD

In microcomputers today, UniSoft sets the standard.

AT&T has recently been advertising that their UNIX™ operating system will be the standard OS for microcomputers. That's true. But if you want AT&T's UNIX software on micros today, talk to UniSoft Systems.

UniSoft has been delivering AT&T's UNIX adapted for 68000-based microcomputers for two years. More than 50 different computer systems run the UniSoft software, UniPlus+.™ At each Bell release level, all these systems are object code compatible. This means that applications software developed on any UniPlus+ system will work on any other. This is where software portability pays off.

UniSoft enhances Bell's vanilla UNIX with the best features from the Berkeley BSD research version of the UNIX operating system. IP/TCP networking, record and file locking, and virtual memory from UniSoft turn UNIX into a commercial product. All this added value is still Bell-compatible.

Don't wait six months to get System V running on your hardware. UniSoft's customers can ship it now.

If you're building or selling a 68000-based UNIX system, your operating system should come from UniSoft Systems, the UNIX experts.

UniSoft
S Y S T E M S

THE BERKELEY PORT AUTHORITY

*UNIX is a trademark of Bell Laboratories

739 Allston Way, Berkeley, CA 94710 • (415) 644-1230
TWX II 910 336-2145 • UUCP ucbox!unisoft!unisoft

Mini-Micro World

CORPORATE AND FINANCIAL

difficulty for us than its not coming out with it."

Both the Gartner Group's Hughes and Paine Webber's Garrett agree that integrating office products through Ethernet is a key to Xerox's success, but both believe the company must introduce low-cost LAN products soon. "We see Ethernet as one of the main standards for networks in the future, but Xerox won't benefit if it doesn't bring out less expensive products allowing users to hook on," comments Hughes. "Xerox cannot afford to just bring out innovative products—they have to be a price/performance leader as well."

—Edward S. Foster

Wet ink

Burroughs Corp., Detroit, has grabbed a \$48.6 million contract with the FBI. The bureau will use Burroughs' TEMPEST security system in its Washington headquarters and in 61 U.S. cities. The contract covers 6,200 TEMPEST-qualified B 20 microcomputer workstations and 3,400 TEMPEST-qualified printers....**Gould Inc.** has awarded a five-year, \$50 million contract to **Control Data Corp.**, Minneapolis, for CDC OEM disk and tape drives. The drives will be incorporated into Gould's superminicomputers and desktop workstations....**Metheus Corp.**, Hillsboro, Ore., has signed a \$24 million deal with Hyundai Electronics Industries Co., Seoul, South Korea. Methus will supply Hyundai with more than 2,000 graphics display controllers and computer-aided-engineering workstations through December 1985. Hyundai will use the Methus products internally and will sell them through OEM channels in the Asian market....**Priam Corp.**, San Jose,

BOX SCORE OF EARNINGS					
This monthly table lists the revenues, net earnings and earnings per share in the periods indicated for companies in the computer and computer-related industries. Parentheses denote losses. Comments are from corporate summaries unless otherwise noted.					
Company	Period	Revenues	Earnings	Eps	
Advanced Micro Devices Inc.	6 mos. 9/25/83	\$236,494,000	\$20,279,000	.35	
	6 mos. 9/26/82	169,462,000	7,699,000	.15	
Burroughs Corp.	9 mos. 9/30/83	3,074,215,000	114,398,000	2.72	
	9 mos. 9/30/82	3,065,668,000	106,828,000	2.54	
Control Data Corp.	9 mos. 9/30/83	3,333,800,000	113,000,000	2.94	
	9 mos. 9/30/82	3,175,300,000	111,300,000	2.95	
Dataproducts Corp.	6 mos. 9/24/83	172,134,000	8,101,000	.40	
	6 mos. 9/25/82	156,242,000	5,969,000	.31	
Emulex Corp.	3 mos. 9/25/83	13,024,825	2,541,846	.40	
	3 mos. 9/26/82	5,690,212	840,758	.18	
Gould Inc.	9 mos. 9/30/83	982,500,000	53,900,000	1.19	
	9 mos. 9/30/82	941,300,000	59,600,000	1.39	
Honeywell Inc.	9 mos. 10/2/83	4,125,000,000	139,300,000	6.10	
	9 mos. 10/3/82	3,918,200,000	184,900,000	8.27	
IBM Corp.	9 mos. 9/30/83	27,283,000,000	3,622,000,000	5.98	
	9 mos. 9/30/82	23,290,000,000	2,909,000,000	4.89	
Intel Corp.	9 mos. 9/30/83	789,529,000	68,973,000	.64	
	9 mos. 9/30/82	660,444,000	22,007,000	.24	
NCR Corp.	9 mos. 9/30/83	2,591,462,000	173,226,000	6.31	
	9 mos. 9/30/82	2,463,825,000	140,440,000	5.26	
National Semiconductor Corp.	16 wks. 9/18/83	432,523,000	10,904,000	.41	
	16 wks. 9/19/82	350,381,000	64,000	.00	
Priam Corp.	3 mos. 9/30/83	26,189,000	3,992,000	.24	
	3 mos. 9/30/82	10,753,000	92,000	.00	
Prime Computer Inc.	9 mos. 10/2/83	373,669,000	22,500,000	.47	
	9 mos. 10/3/82	317,492,000	32,731,000	.72	
Ungermann-Bass Inc.	9 mos. 9/30/83	17,087,000	835,000	.05	
	9 mos. 9/30/82	7,533,000	214,000	.02	
Wang Laboratories Inc.	3 mos. 9/30/83	412,000,000	38,900,000	.29	
	3 mos. 9/30/82	305,000,000	25,000,000	.20	

Comments: **Dataproducts Corp.** reported a backlog of \$175 million, an increase of \$40 million from a year earlier. Revenues for the second quarter were \$91.5 million, compared to \$84.4 million a year earlier. Net income for the quarter grew to \$5.2 million, or 25 cents per share, from \$3.4 million, or 17 cents per share. **IBM Corp.**'s financial picture remained rosy, as the company racked up third-quarter net earnings of \$1.3 billion, or \$2.14 per share, up from \$1 billion, or \$1.75 per share, a year previously. IBM said worldwide demand for its 3380 Disk Storage Device was building, and shipments of the 308x mainframes were high, as

was demand for the new 3178 and other terminals, the new System/36, and the Personal Computer. Orders for the new 4361 and 4381 mid-range processors were also strong, the company said. "We remain optimistic about the future of our business," stated IBM chairman John R. Opel. Local-area-network vendor **Ungermann-Bass Inc.**'s revenues for the quarter more than doubled from \$3 million a year earlier to \$6.7 million. Net income for the quarter was \$891,000, or 5 cents per share, compared to \$91,000, or 1 cent per share, a year earlier.

Calif., has signed a two-year, \$7 million contract with Molecular Computer to supply Priam's 8-inch Winchester disk drives and Smart-E intelligent interfaces. The equipment will be used in Molecular's Supermicro multiprocessor, multi-user 8/16 systems....**Pertec Com-**

puter Corp., Irvine, Calif., will supply \$21 million worth of its new XL50 data-entry systems to Sperry Corp. over an 18-month period. Sperry will sell the systems with its mainframes....**Sky Computers Inc.**, Lowell, Mass., has reached an agreement with Cromemco Inc. to

WHOEVER FINIS

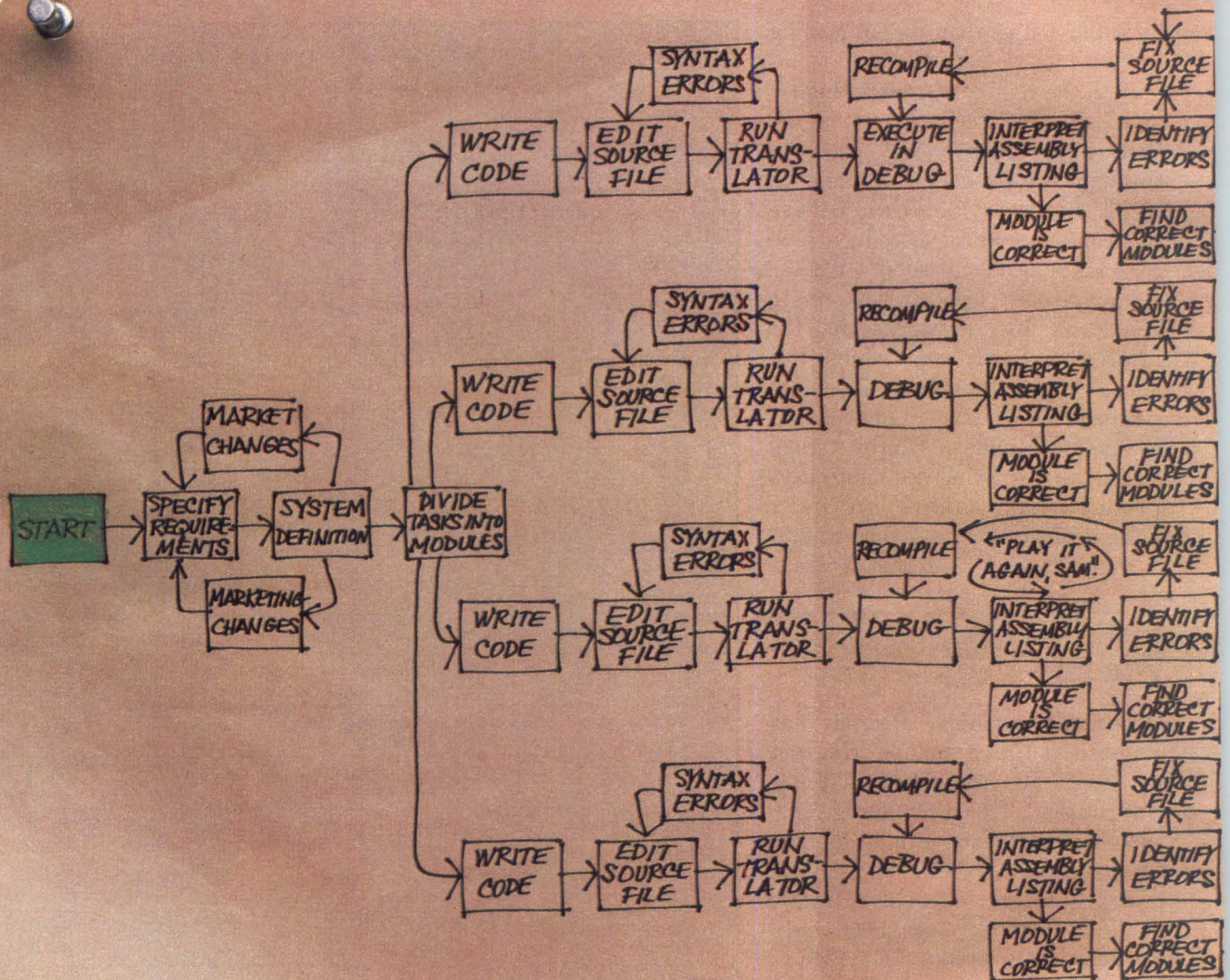

It's a wonder anything ever gets finished. Fortunately, it doesn't have to be that way. Even though you're developing a complex system, the system development can be simple. And timely.

With development tools from Intel. The most complete, fully-integrated set of hardware and software development tools in the industry.

You can work in a variety of high level languages—PL/M, Pascal, FORTRAN or C—from the very beginning. And our tools will keep you at that high level where you're most productive.

Take our PSCOPE debugger. It lets you

detect and patch all program errors at the source level in your choice of PL/M, Pascal, or FORTRAN. Then you recompile just once.

Same for our LINK utility.

It allows someone to work in Pascal and someone else to work in PL/M, and then makes short work of the integration.

Very slick. But you're also going to love SVCS and MAKE.

SVCS stands for Software Version Control System and it functions as a data base manager that automatically logs who makes changes, when, and why.

Then our MAKE utility automatically finds the correct versions of each module, automati-

HES FIRST WINS.

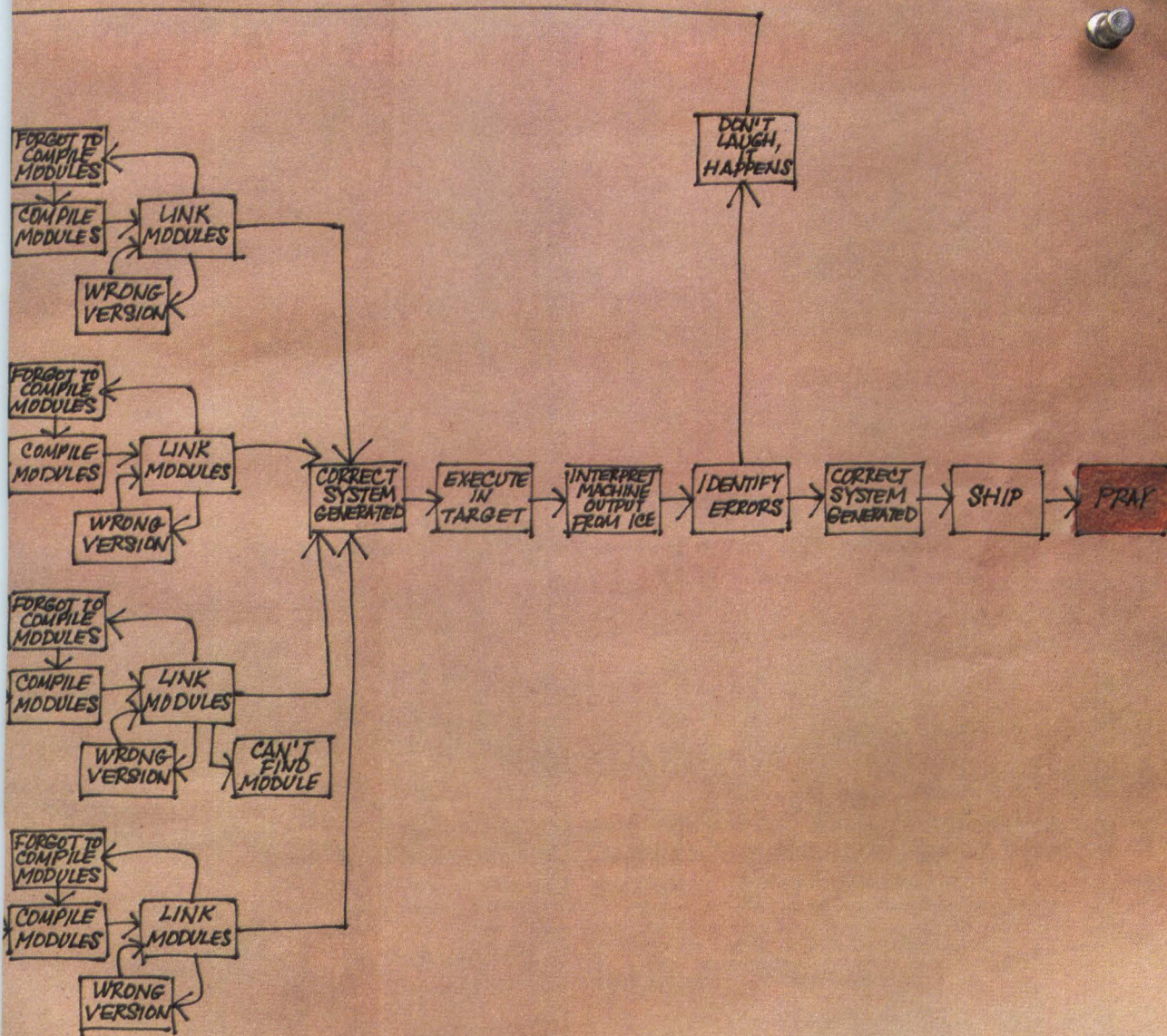

cally recompiles those modules that need it, and produces the complete, correct system. Automatically, of course.

Which brings us to I²ICE™, our Integrated Instrumentation and In-Circuit Emulation System. I²ICE uses the same high level human interface as PSCOPE, so you don't have to learn a new one. It also emulates at full speed, real time, to eliminate any tricky little timing problems. And of course, it supports every processor in the iAPX86 family.

We also have a variety of Intellect™ Development Systems for them to plug into.

Not to mention the best in project management and control, our Network Development

System, NDS II, allows you to share resources and communicate throughout the process.

What's more, these tools are available at the same time as the silicon they were made for.

Engineering assistance and training workshops are available as well. As is a lot more information.

Just call (800) 538-1876. In California, (800) 672-1833. Or write Intel, Lit. Dept. I-8, 3065 Bowers Ave., Santa Clara, CA 95050.

But do it soon. Whoever finishes first wins. Everybody else just finishes.

intel delivers solutions

© 1983 Intel Corporation

CIRCLE NO. 38 ON INQUIRY CARD

THE WY-50. PRETTY PRICE

A NEW GENERATION OF LOW-COST TERMINALS FROM WYSE.



Never before could you buy so much terminal for such a small price. It took revolutionary design to do it. Design a lot of people couldn't accomplish for the price. But we did.

In fact, the WY-50 introduces a new standard for low-cost terminals. You get a compact, full-featured design that meets the most advanced European ergonomic standards. A larger screen with 30% more viewing area. And a price tag that won't break the bank.

The WY-50 sells for only \$695.00.

FEATURES:

- 14" screen.
- 80/132 column format.
- Soft-set up mode.
- High resolution characters.
- Low-profile keyboard.
- Industry compatible.
- Only \$695.00.

For more information on the revolutionary design, outstanding features

and unique good looks of the new WY-50, contact WYSE TECHNOLOGY and we'll send you a brochure filled with everything you need to know.

The WY-50. More than just a pretty face.

CIRCLE NO. 39 ON INQUIRY CARD

WYSE

Make the Wyse Decision.

WYSE TECHNOLOGY 3040 N. First St., San Jose, CA 95134, 408/946-3075, TLX 910-338-2251, Outside CA call toll-free, 800/421-1058, in So. Ca 213/340-2013.

Mini-Micro World

CORPORATE AND FINANCIAL

integrate Sky's Fast Floating Point (FFP) processor into Cromemco Inc.'s S-100-based computers. The value of the agreement is estimated at \$1.5 million.

Annual report

While Digital Equipment Corp. was slipping recently, competitor **Data General Corp.** managed to keep a fairly even keel for its fiscal year ended Sept. 24, 1983. Revenues for the year were \$828.9 million, up from \$805.9 million a year earlier. Net income was \$23.1 million, or \$1.93 per share, off slightly from the \$24.7 million, or \$1.83 per share, of the previous year. For the last 16 weeks of the fiscal year, net income shot up to \$10.7 million, or 86 cents per share, from \$0.6 million, or 5 cents per share. Revenues for that period were \$271.8 million, compared to \$251.8 million for the previous year. DEC president Edson de Castro says DG has seen "a steady, though moderate, improvement in orders."

Personalities

Andrew C. Knowles has replaced Ralph Linsalata as president and chief executive officer of Lexidata Corp., which has had its financial

ups and downs over the past three years. Lexidata, Billerica, Mass., builds raster graphics terminals and workstations.

Linsalata will remain a member of Lexidata's board and will continue as a consultant to the company.

Knowles spent 14 years at Digital Equipment Corp., where he started the PDP-11 and terminal businesses and managed the technical products group. His most recent position was vice president and group manager of DEC's Small Systems Group.



Do lightning storms "pull the plug" on your computer efficiency?

Electrical storms can cause "terminal paranoia" for small computer and word processing operators. And that causes some totally unnecessary work disruptions. A sensible solution is both available and affordable. Check out Liebert environmental control and power protection systems. Call **614/888-0246**.

We help make your computer investment pay off!



Accommodate2



Mini-Mate



World leader in computer support systems.



Mini-Center



Challenger2

Liebert Corporation, 1050 Dearborn Drive,
P.O. Box 29186, Columbus, Ohio 43229,
614/888-0246 Telex: 246655 LIEBERT WOGN

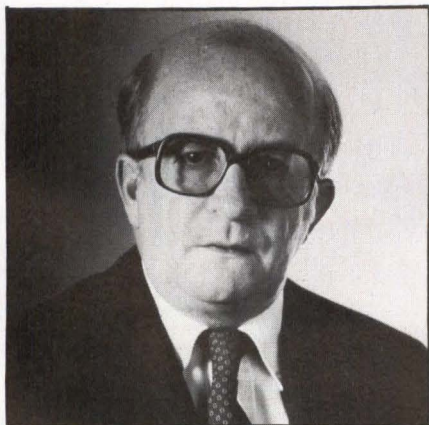

Andrew C. Knowles, Lexidata Corp.'s new president and chief executive officer, spent 14 years as a manager at Digital Equipment Corp.

The 68000 Yes List

SOFTWARE NOW AVAILABLE

1. UniFLEX™ Operating System
2. BASIC
3. COBOL
4. FORTRAN
5. 68000 Relocating Assembler
6. 68000 Linking Loader
7. Sort/Merge
8. Editor
9. Advanced Spooler
10. BASIC Precompiler
11. Floating Point Package
Scientific Functions Package
12. Utilities

*UNIX is a trademark of Bell Laboratories.
UniFLEX and The Masterminds of Advanced Systems Software are
trademarks of Technical Systems Consultants, Inc.*

Manufacturers or systems integrators:

Our list of 68000 software is now available for licensing to run with UniFLEX™ or UNIX™ operating systems. These products are also available for the 6809 microprocessor.

Technical Systems
Consultants, Inc.
111 Providence Road
Chapel Hill, NC 27514
919-493-1451
TWX 510-920-0540

The Masterminds
of Advanced Systems
Software™



Mini-Micro World

INTERNATIONAL

Microcomputers, printers highlight Munich Systems '83 show

Nixdorf Computer AG, West Germany's leading small systems manufacturer, unveiled three 16-bit microcomputers—the Micro 3, 5 and 7—at the recent Systems '83 show in Munich, Germany. The show served as a forum for the introduction of several other microcomputers and printers.

The Micro 3, 5 and 7 are the latest additions to Nixdorf's 8870 family, which uses the Niros 8870 operating system. Nixdorf officials say the three systems are incompatible with the IBM Personal Computer.

The three models differ in the size of mass storage provided and the number of users supported. The single-user Micro 3 comes with twin 5¼-inch floppy disk drives, and the Micro 5, which can support two users, has twin 8-inch floppy disk drives. The Micro 7 provides 5M or 10M bytes of Winchester disk storage and supports two to seven users. Nixdorf officials note the new machines are configured around a semi-custom gate-array processor rather than a 16-bit device.

Japanese microcomputer vendors were also much in evidence at the Munich show. They showcased at least three machines configured around the Intel 8088 processor and running under MS-DOS. Sharp Electronics (Europe) Ltd. unveiled the PC-5000. It employs a liquid-crystal display with a 640-by-80-dot resolution. The horizontal resolution of 640 dots equals that of the IBM PC color version, but company officials are uncertain about the PC-5000's compatibility with the IBM PC.

Toshiba Europe launches the T-300 series of color microcomputers with 640-by-500-dot resolution screens. Company representatives



Two computers from Japan's Sord are configured around Motorola MC68000 processors. The M68 incorporates a 10-MHz MC68000. The M685 is based on the Universe computer from Charles River Data Systems, which employs a 12.5-MHz MC68000 as its CPU and a 6.25-MHz MC68000 as an I/O processor.

are uncertain about the T-300's IBM compatibility. Sanyo Electric also announced an 8088-based MS-DOS host machine, the MBC 550, which company officials describe as "not 100 percent PC compatible."

Sord Computer Corp. demonstrated the M685, which will be available in the United States this year. The M685 is based on the Universe supermicroprocessor from Charles River Data Systems Inc. Sord recently signed an agreement with Charles River that included an investment by the Japanese company in the U.S. manufacturer.

Sord also exhibited the 10-MHz, MC68000-based M68. It comes with a color monitor providing a 640-by-400-dot resolution. Software includes Sord's PIPS spreadsheet, graphics and text-processing package. Choice of operating environments includes CP/M-68K and MS-DOS.

One highlight of printer activity came from the West German parent of Philips Peripherals Inc., San Francisco, which used the show to demonstrate a color printer soon to be added to its GP 300 family of impact matrix machines. Henneke Buck, Philips' OEM distribution manager, says the printer changes printing color by moving a striped

ribbon cassette to produce black, red, blue or yellow. Buck notes that other features of the color unit will be essentially the same as those of other GP 300 printers, including a maximum speed of 300 characters per second (cps) and an 18-needle print head. Buck expects shipments of the color printer to start early this year.

Japan's C. Itoh & Co. unveiled the 1550C and 8510C color versions of its 1550S and 8510S impact matrix units, which print 80 and 136 columns, respectively. The units use a three-color, striped ribbon.

Observers see low noise and letter-quality printing as two of the most important features of the Wenger 4/1 from Wenger Datentechnik, Reinach, Switzerland. Wenger export manager Werner Happel says the new 4/1 will spearhead a planned offensive in the United States. Happel says Wenger hopes to take a booth at the 1984 National Computer Conference to seek U.S. outlets. The 4/1 runs at 400 cps in data-processing mode and 110 cps in letter-quality mode. Happel says letter quality is achieved in one pass by moving the head in half-dot increments so that the dots overlap. The head has two columns of nine needles each. The

Mini-Micro World

INTERNATIONAL

second column can be moved up and down at high speeds to join the dots printed by the first column.

Wenger sales manager Robert Geering claims the printer's noise level is just over 48 dBA when one is standing 1m. from the printer. This level complies with the European Computer Manufacturers Association (ECMA) 74 standard and satisfies Swedish legislation that specifies a maximum level of 55 dBA at that distance. Wenger controls noise by using fewer holes in the printer casing and increasing the damping, Geering explains.

Officials of Brother International GmbH, the European arm of



The T-300 from Japan's Toshiba is configured around the Intel 8088 micro-processor, runs under MS-DOS and comes with a screen showing 640 by 500 dots. Here, it is acting as a terminal to the West German public videotex system, Bildschirmtex.

Japan's Brother International, discussed but did not demonstrate the 80-column, Epson-compatible HR-5 printer, which is scheduled for shipment early this year. The HR-5 weighs 5 pounds and measures 303 by 175 by 65 mm. (12.12 by 7 by 2.6 inches), small enough to fit into a briefcase while leaving room for a hand-held computer. The machine runs on four standard-sized flashlight batteries and can print at 30 cps on thermal or ordinary paper using a thermal ribbon. The nine-needle head forms characters from a 9-by-9 dot matrix. Interfaces can be RS232C or Centronics.

—Keith Jones

BASF poised to re-enter U.S. disk drive market

BASF, a major force in the U.S. magnetic media market, appears ready to enhance its product line dramatically by adding floppy and Winchester disk drives, which it already sells in Europe.

Officials at the company's Ludwigshafen, West Germany, headquarters say the supervisory board of BASF is expected to make a decision about selling Winchester and floppy drives soon. They have not selected which products to sell in the United States, but a likely candidate is the 15M-byte, 5¼-inch 6188 Winchester, which is 1.6 inches high. The 6188 was launched at the October Systems '83 show in Munich, Germany, along with the 1.32-inch-high 6128 and 6148 floppy disk drives. They provide unformatted capacities of 500K and 1.5M bytes, respectively, and complete a family of three slim-line drives started by the 1M-byte 6138, which was introduced at last year's Hanover Fair.

Another BASF product is the

two-headed 5¼-inch 6238 floppy drive. It stores as much as 2M bytes and has two positioning systems with ceramic heads that share a direct-drive motor.

If BASF does enter the U.S. disk drive market, it will not be its first entrance. The company acknowledges "a test production" attempt to manufacture 8-inch Winchesters at a plant in Los Gatos, Calif. Officials believe that attempt failed partly because of a lack of adequate customer service. BASF sold the operation about two years ago to Kennedy Co., which continues to build and sell the BASF units as the 6170 series.

BASF will ship drives from

Europe to the United States, although company officials envision eventual U.S. production. One possibility for a U.S.-produced drive is a Sony Corp.-compatible 3½-inch microfloppy. BASF officials hint that such a product could emerge by year-end from the BASF Systems Corp. plant in Bedford, Mass. That plant now manufactures Sony-compatible 3½-inch media. BASF officials say it is too early to comment on the BASF offering in the fledgling micro-Winchester market, in which Control Data Corp. and Rodime Plc. are now the pioneers (MMS, May 1983, Page 32).

—Keith Jones

BASF'S FUTURE U.S. PRODUCT LINE-UP COULD INCLUDE:

- 6128, a 500K-byte, 1.32-inch-high floppy disk drive
- 6138, a 1M-byte slim-line floppy disk drive, the first of three family members
- 6148, a 1.5M byte, 1.32-inch-high floppy disk drive
- 6188, a 15M-byte, 1.6-inch-high, 5¼-inch Winchester disk drive
- 6238, a two-headed, 5¼-inch floppy disk drive with 2M bytes memory
- a Sony-compatible 3½-inch microfloppy disk drive

**NO OTHER PERSONAL
COMPUTER COMPANY
HAS BEEN UP
AND RUNNING SO LONG.**

N C R

EST. 1884

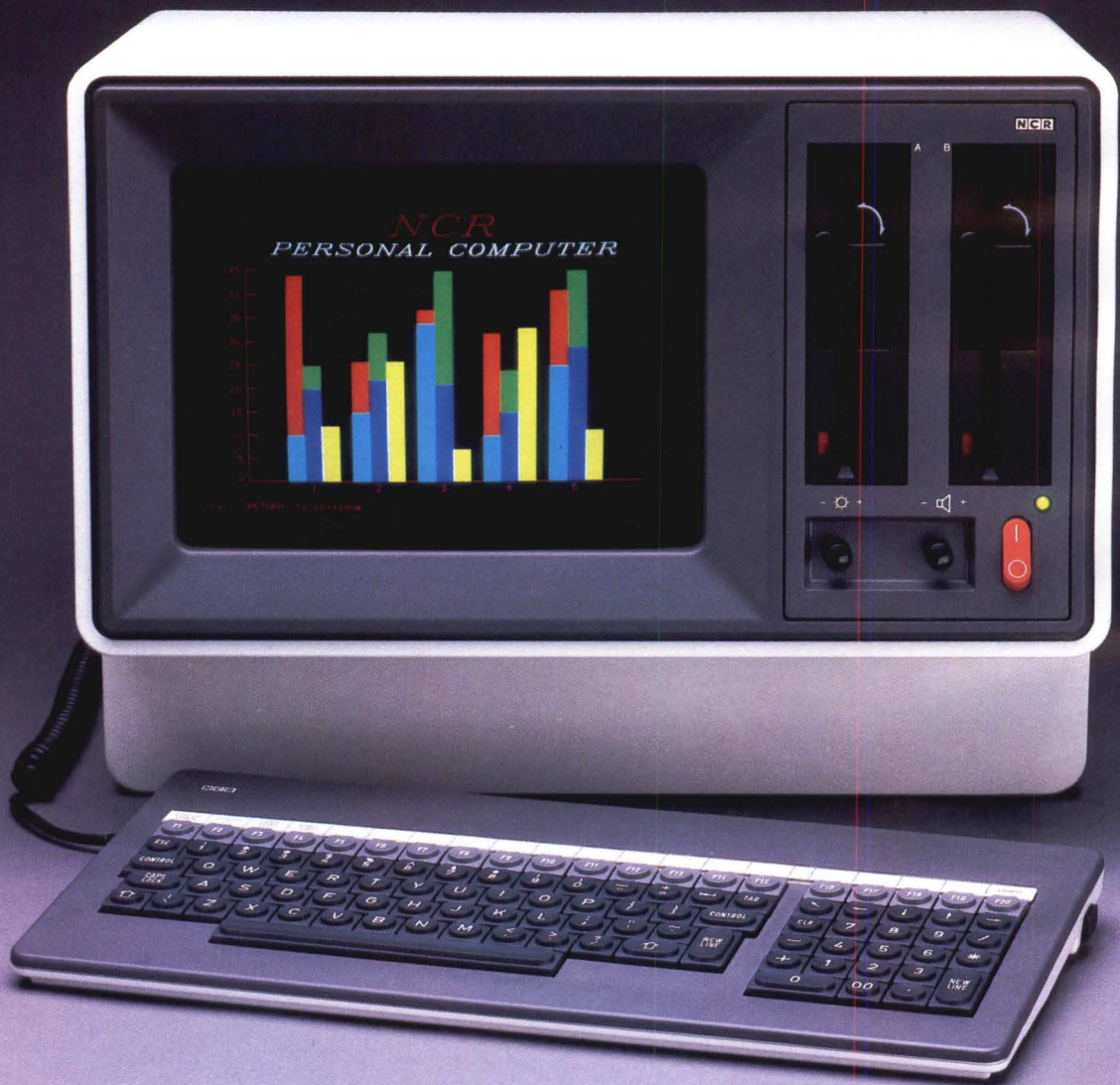

PRESENTING THE ONLY 100-YEAR-OLD PERSONAL COMPUTER.

TOO MANY COMPUTERS, TOO FEW CHOICES.

With the personal computer shakeout at hand, people are beginning to ask some hard questions about personal computer companies.

Of the 200 or so personal computer companies now operating, how many have the resources to fully support their products? How many can offer the experience and financial strength of 100 successful years in business?

How many can provide in-depth sales and maintenance training to dealers? How many have actually done so?

How many have thousands of qualified field engineers in place throughout the nation? How many can back up their commitments to technical advancement with truly significant R&D budgets?

How many will even be making personal computers a few years from now, much less sustaining their commitment to their customers beyond 1990?

Companies that can answer those questions positively are the only real choices the personal computer user really has. There aren't many. And they're getting fewer all the time.

THE NCR PERSONAL COMPUTER.

That's why we developed the NCR Personal Computer. By all these criteria, it's the best choice for PC users.

For over 100 years, we've been helping businesspeople solve their problems. As a result, they believe in our products. And they trust our support before and after the sale.

They're not surprised to hear that NCR builds a dual 8/16-bit Personal Computer with up to 512K that runs CP/M* and MS DOS.* They expect it from NCR.

Nor are they surprised by our Personal Computer's other advanced features. Like superior color graphics. 20 programmable function keys. Windowing capabilities. Expansion slots for quick, in-the-field upgrades. A remarkable plug-in diagnostic module.

All in a box smaller than those of its leading competitors. Plus a software library that includes the majority of the most widely used packages.

They expect nothing less from NCR. And neither should you.



POINT OF SALE SYSTEM

PRICE LEVEL: DATE: 10-30-83 TRANS NO: 6

TYPE OF SALE: 1 CUST ACCT

SUBTOTAL	50.00	DEPOSIT AMOUNT	0.00
DISCOUNT AMOUNT	0.00	AMOUNT DUE	52.00
TAX	2.90	AMOUNT TENDERED	55.00
SWP'G & HNDL	0.00	CHANGE	2.50

NCR

Keyboard with numeric keypad and function keys.

Cash drawer containing various coins and bills.

SOMETIMES IT'S BETTER TO BUY RETAIL.

THE NCR PERSONAL RETAIL COMPUTER.

No other company is better qualified to build a Personal Retail Computer than NCR.

We pioneered the cash register, back in 1884. Since then, we've continually enhanced new retail management technology. From small point-of-sale terminals to state-of-the-art, multi-user inventory management systems.

Our Personal Retail Computer is the first of a new breed. An advanced retail management system with all the capabilities of a powerful personal computer. All in one small package. And all designed with the experience of 100 years as the world's largest supplier of retail systems firmly in mind.

HOW TO SELL RETAIL.

It's easy.

The NCR name is a quick foot in the door. And from there on, the Personal Retail Computer's advanced features sell themselves.

The PRC comes with 256K of memory, expandable to 512K with a plug-in cartridge. An electronic cash drawer and a choice of a receipt or an 80-column report printer, or both, complete the hardware package.

But it's the PRC's retail management capabilities that make it such an easy sell.

First of all, it's easy to use. Really easy. 9 dedicated function keys handle standard transaction sequences with a single keystroke. Keying errors

are easily corrected, eliminating time-consuming voiding procedures. Helpful screen messages, in plain English, guide clerks step-by-step through each transaction.

Commands are in plain English, too, so clerks don't have to be trained to remember confusing codes. And with an optional bar code reader, sales data can be fed into the system automatically.

The system is secure, as well as easy to use. Access is granted or denied by an I.D. number verification routine. And sensitive sales information can be password-protected, field by field.

And of course sales reports can be automatically generated by salesperson and item at any time during or after the business day. So users can keep better control of their business.

To extend that control even further, our optional Inventory Management software can store up to 19 separate facts about as many as 32,000 unique inventory items.

Inventory levels are then automatically displayed and adjusted during each sale, giving store managers a clear picture of what they have on hand at what prices. A CPA-recommended profitability index is an integral part of the package.

To make our retail management system into a complete company management system, our retail software can be interfaced with general accounting packages.

All at a price far lower than a traditional retail management system.

Surprised?

You shouldn't be.

ESTABLISHING BETTER INTERPERSONAL COMMUNICATIONS.



NCR'S PERSONAL COMPUTER NETWORK.

A personal computer can become an even more effective business tool if it offers facilities for exchanging ideas and data between departments and offices.

The NCR File Sharer lets our PC do just that. It can connect up to 64 PCs, from most major manufacturers, with the latest local area network technology.

PCs in the network can access databases and share files, records and peripherals. That helps every member of an organization work together, with the same common information, at the lowest possible cost.

The File Sharer offers system storage from 10-32MB, enough for most applications.

Because some corporate data is not meant to be shared, extensive security features are available to protect individual files from unauthorized access.

Despite its advanced capabilities, our Personal Computer network is easy to install. Right in your customer's office.

More PCs can be added to the network at any time.

And upgrades are available to expand its capabilities even further.

Impressive?

Yes. But by now that should come as no surprise.

CHOOSING THE RIGHT COMPUTER COMPANY IS EVEN MORE IMPORTANT THAN CHOOSING THE RIGHT COMPUTER.



Founded 1884.

A dependable, stable company with 100 years of experience delivering innovative products to help businesses solve their problems.

\$3½ billion strong.

We're the second largest supplier of business information systems in the world. We'll be around after the personal computer shakeout.

65,000 employees worldwide.

Including 16,000 service personnel in hundreds of service locations. That's a dedication to serving the business information market here-today-gone-tomorrow computer companies can't match.

A steady record of technical innovation.

Including the first production 32-bit VLSI mainframe on a chip.

Commitment to quality.

Everything we do, we do well. From design to manufacturing to training, service, and support.

GOOD NEWS FOR DEALERS, SOFTWARE DEVELOPERS AND COMPUTER ENTREPRENEURS.

Until now, computer dealers like you have been at the mercy of one or two major suppliers. And a couple hundred companies who'd like you to believe they're going to make it big.

Now you and your customers have a choice.

A company that's a strong traditional force in computers. One that's financially capable of playing the game for years to come. One with a name that first-time buyers know and trust.

To find out how to become an Authorized NCR Personal Computer Dealer, just call or write us today.

We also know there are a lot of talented PC software developers out there who feel as if they're lost in the crowd. Well, we're looking for a few of the very best to help us add depth to our already broad software line.

We also know that there are countless entrepreneurs all fighting for attention in one big aftermarket.

And we want you to fight on our team.

Because we're committed to the future of the NCR Personal Computer and future generations to come.

We're committed to supporting our products. And doing so on a scale no upstart start-up can begin to match.

Which is just what you'd expect from NCR.

NCR PERSONAL COMPUTER

Feature Highlights

- Integrated design with small footprint
- VLSI technology
- Dual processors (8/16-bit)
- Customer installable
- Monochrome or color display
- Customer upgradable
- Fully illustrated self-training documentation
- Industry standard I/O interfaces
- Expandable memory and disk storage
- Detachable low profile keyboard
- Easy-to-use diagnostic cartridge
- Industry standard operating systems
- Powerful graphic processor
- Windowing capabilities

Central Processor	Z-80A* 8-bit (4 MHz) 8088 16-bit (5 MHz)
Memory	RAM—64K Upgradable to 512K ROM—4K
Graphic Processor Memory	32K (monochrome) 96K (color)
Video Display	12" monochrome green/black or color 24 lines 80 characters/line 640 x 400 dot addressable
Keyboard	Detachable low profile Alphanumeric + numeric key pad 20 programmable function keys
Disk Drives	Configured with two flex disks or one flex disk and one Winchester disk
Flex Disk	5 1/4-inch integrated Double density, double sided 500 KB each unformatted 320 KB each formatted
Winchester Disk	5 1/4-inch 10 MB integrated or 30 MB external

Peripheral Adapter	Centronics parallel interface RS232C serial interface	
Communications Adapter	RS232C serial interface (async.) NCR local area network interface	
Operating System	CP/M, [®] MS-DOS [®]	
Physical Dimensions	Processor	Keyboard
Height	14.9 in.	1.5 in.
Width	18.1 in.	16.9 in.
Depth	14.6 in.	8.5 in.
Weight	52.9 lbs	3.3 lbs
Environmental		
Operating Temperature	50-95°F	
Relative Humidity	20-80%	

PERSONAL RETAIL COMPUTER

256K Memory
Retail Management Software
RS-232C Interface
Electronic Cash Drawer
Centronics Interface
Choice of Receipt or 80 Column Printers (option)

NCR LOCAL AREA NETWORK

Transmission Rate	1 megabit per second
Transmission Link	Twisted pair cable, up to 4000 feet in length
Network Access Technique	CSMA
Users/Devices Connectable	64
FILE SHARER	
I/O Processor	On-board RAM and controlware
Fixed Disk	10-32MBytes

Specifications subject to change without notice.
*CP/M[®] is a registered trademark of Digital Research.
MS-DOS[®] is a registered trademark of Microsoft Corporation.
Z-80[®] is a registered trademark of Zilog Corporation.
Products for delivery in the USA will comply with appropriate FCC rules.



Dealer Marketing Division

NCR Corporation, World Headquarters, Dealer Marketing Division, Dayton, OH 45479
Nationwide (800) 222-1235. In Ohio (513) 445-2380. In Canada (800) 268-3966.

EMULATION PLUS + AMBER

FROM AMPEX

The figures are in. Ampex Emulation Plus terminals with ergonomically superior Amber now outsell our white and green phosphor VDT's 4 to 1. But the choice is still yours. With all three colors available as standard on all three Ampex ASCII editing terminals, you've got flexibility.

Built-in flexibility to emulate up to 20 popular models*, with eight resident character sets in your choice of detached selectric-type or programmer

*Including models from TeleVideo, Lear Siegler, ADDS, Hazeltine, DEC, and SOROC.

keyboards. Price flexibility, starting with our new low-cost D125, on up to our D150 and D175. Flexibility to customize both hardware and firmware. And most importantly, maintenance flexibility through a nationwide network of TRW service centers. That's total flexibility.

Find out why Ampex Emulation Plus terminals with Amber are challenging the market with loads of features and flexibility at a price you won't believe. Call your nearest Ampex distributor, or give us a call direct at 213-416-1575.



AMPEX
COMPUTER PRODUCTS DIVISION

200 North Nash Street
El Segundo, California 90245

Ampex Corporation • One of The Signal Companies 

CIRCLE NO. 42 ON INQUIRY CARD

**AT LAST,
A HIGH
PERFORMANCE,
RELATIONAL
DATA BASE SYSTEM
FOR YOUR
PRODUCTION-
ORIENTED VAX
ENVIRONMENT.**

ULTRA

You've come to expect high levels of performance from your DEC™ VAX™ hardware. And you should expect no less from your data base software.

That's why Cincom introduced the ULTRA INTERACTIVE DATA BASE SYSTEM™—a next generation relational technology that combines high performance with practical, ease of use implementation.

New Generation Architecture

The secret behind ULTRA's interactive high performance is its unique architecture. An architecture built on a solid foundation of the very latest in relational subject data base technology. In-line control and security are achieved through the ULTRA In-Line Directory while relational implementation is achieved through the unique ULTRA Logical User View and the new Data Base Management facility. Combined, these components provide interactive synergism between users, programmers and the data they wish to access.

For multiple-machine applications that can range from scientific to high volume transaction oriented business systems, ULTRA provides VAX users the control and consistency needed to build high performance, low overhead, high quality systems that can be readily used by both programmers and by the burgeoning number of end-users. ULTRA also facilitates the latest in subject data base strategies for optimum data storage, retrieval and data manipulation.

Integrated Components

The integrated components which provide this unparalleled power include:

- **The ULTRA Logical User View.** Modern, relational technology to insulate users and application programs from data structures and navigation requirements.

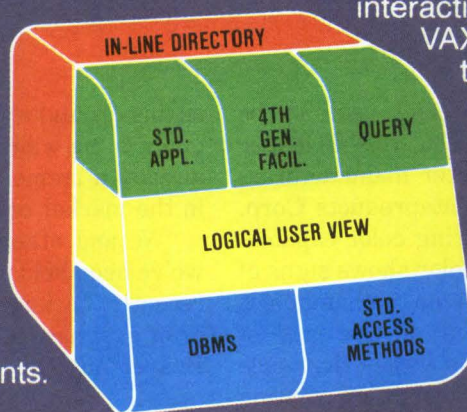

ULTRA, the architecture of the next generation of interactive data base technology for the VAX environment.

- **The ULTRA In-Line Directory.** Centralized control during program execution. Integration. Security.
- **The ULTRA DBMS.** High performance. Powerful. Faultless non-stop processing. Supports normalized data structures.
- **The ULTRA Intelligent Query and Reporter.** Direct end-user access. Flexible and easy to use.
- **The ULTRA Data Manipulation Language.** So powerful even the most complex processing can be handled using four commands: GET, INSERT, UPDATE, DELETE.

The Ultimate In Interactive Data Base Software For The VAX Environment

Like no other data base system available today ULTRA enables you to achieve the full potential of your VAX system. As your company evolves, ULTRA keeps right in step. And ULTRA is completely compatible with TIS™, our next generation data base system for the IBM mainframe.

So now you can implement Cincom's "IBM-DEC Connection" to link your strategic and tactical applications. In fact, the compatibility is so close, applications built on your IBM can be modified to run on VAX, or vice-versa. An ULTRA/TIS combination is the perfect IBM-DEC Connection.

For an in-depth brochure on the ultimate in interactive data base software for the VAX environment, simply contact our Marketing Services Department, 2300 Montana Ave., Cincinnati, OH 45211, or call us direct.

800-543-3010

(In Ohio: 513-661-6000)
(In Canada: 416-279-4220)

Cincom Systems

Mini-Micro Interpreter

An analysis of news, issues and trends affecting the computer industry

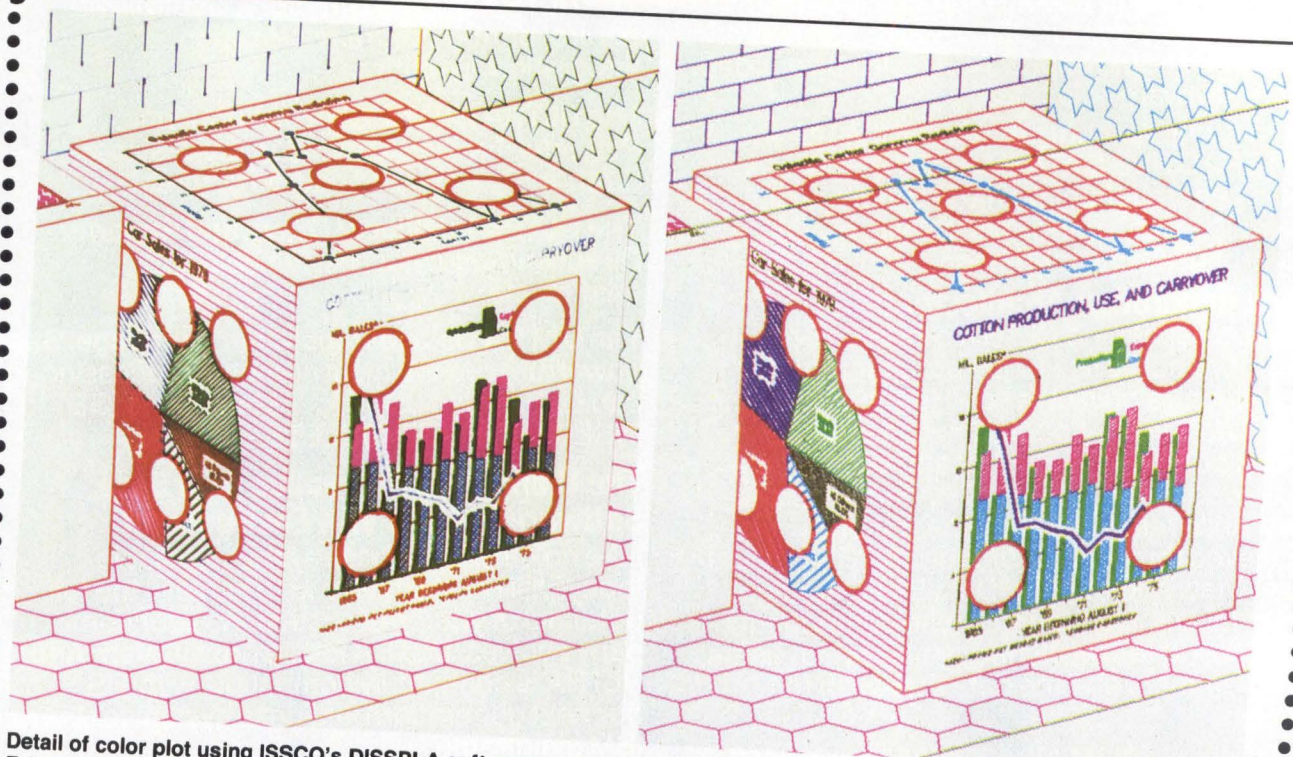

Detail of color plot using ISSCO's DISSPLA software produced on the Zeta 8 pen plotter from Nicolet Zeta Corp. (A) and on the Tektronix 4691 ink-jet color copier (B). In B, the plot was rasterized by the Lasergraphics UI-100T universal interface to achieve the full resolution of the ink-jet device. (Courtesy of ISSCO Graphics Software.)

Printers and plotters vie for color hard-copy market

By Edward S. Foster

The question about color hard copy used to be whether or not it was really needed, but this no longer seems to be the case. Old-line printer manufacturers such as Diablo Systems Inc. and Dataproducts Corp. are hurrying into technologies offering color capabilities. In the CRT terminal market, color shows signs of becoming a standard feature even on alphanumeric displays. Graphics houses complain of the lack of hard-copy support devices while the voices that once were raised to dismiss the necessity for color printing are now nearly silent.

The current question is: which of the host of competing technologies will succeed in cashing in on the growing demand for full-color hard copy? It is a question many feel will be answered soon. "We are definitely in for a year of major changes in the color hard-copy area," predicts Gary Laroff, marketing manager of product development for Integrated Software Systems Corp. (ISSCO), San Diego. "Anybody

sitting around waiting for the next technology is always going to be waiting for the next technology." There is already a tremendous choice supplied by vendors now in the market or about to enter it, he comments.

"We and others in the color graphics business feel we've been held up by the lack of hard-copy output until recently," acknowledges Robert Hoke, general manager of graphics peripherals products for Tektronix Inc., Beaverton, Ore. "We've seen a major breakthrough over the last year or so in real color output."

Most observers segment the color market into products for home computers, business graphics and computer-aided-design/computer-aided-manufacturing (CAD/CAM) applications. The home computer market, with output devices priced at less than \$800, will probably develop around videotex and teletext applications. The business graphics market, with devices priced at less than \$1,000 for those used with personal computers to as much as \$15,000 for those used in

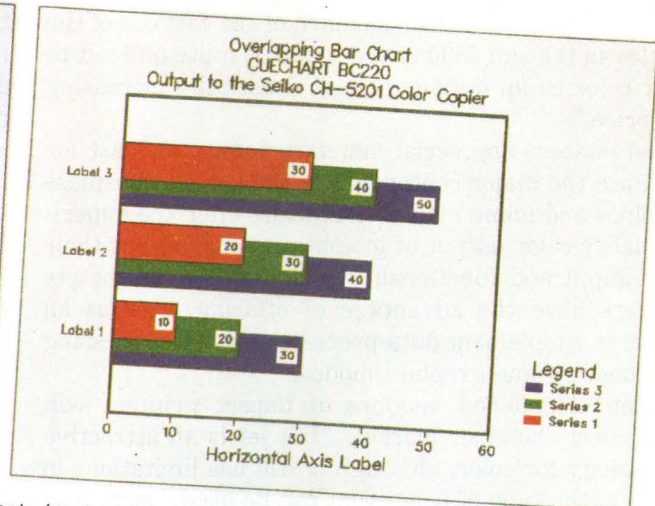
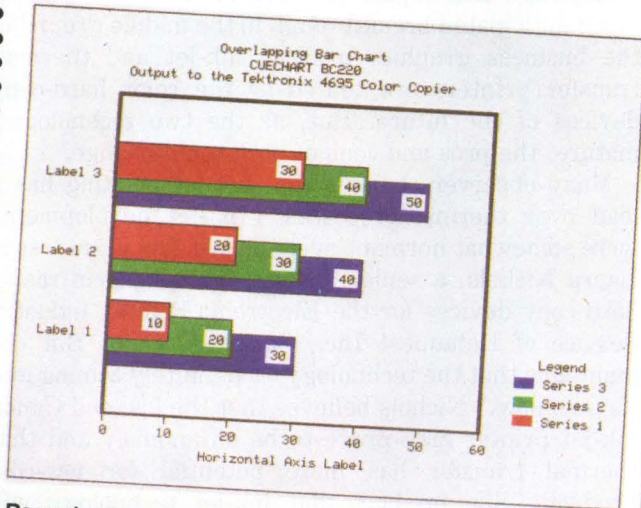

Reproductions of hard copy from a Tektronix 4105 terminal connected to the Tektronix 4695 ink-jet color copier (A) and from a Seiko DSCAN 2412 terminal connected to the Seiko DSCAN CH-5201 thermal-transfer printer (B). (Courtesy of ISSCO Graphics Software.)

distributed-processing environments, is the promised land toward which most suppliers are aiming their new products. The CAD/CAM and scientific market is the most mature and requires the most sophisticated output, with devices priced as high as \$100,000 on the market.

"Within each of the three major segments, there are three possible market strategies for vendors," notes Neil Kleinman of the Pacific Technology Center of market research company International Data Corp. (IDC) in Santa Monica, Calif. The first strategy he mentions is to produce a me-too product with better price/performance, such as recently introduced low-cost pen plotters. An alternative is to introduce new technology or higher performance at a lower price, as Hewlett-Packard Co. did with its 7580 series pen plotter. The third strategy is to provide new high-end capabilities at a relatively high price, as did Versatec Inc. with its color plotter and Seiko Instruments U.S.A. Inc. with its thermal unit. Kleinman sees hard-copy demand spurring the market to more than three times its current revenues by 1986.

System integrators trying to choose a hard-copy color technology face a host of complex trade-offs. Jim Warner, president of Precision Visuals Inc., Boulder, Colo., assesses the current choices for the business

graphics market as pen plotters, dot-matrix impact printers and ink-jet units. "Pen plotters are great for overhead transparencies but extremely slow. Impact printers provide moderate resolution and speed, while ink-jet printers are complex devices with quite a few moving parts but sophisticated output," he explains. Warner believes that color laser-xerographic printers, which are not yet on the market, will "eventually take over," but he believes that will not happen soon.

Dennis Jay Cagan, vice chairman of David Jamison Carlyle Corp., Culver City, Calif., a hardware and software distributor, says that his company generally recommends lower-cost pen plotters for business graphics applications. "There are some very good, solid devices now for under \$2,000 and even some for under \$1,000," he says. "Now that Diablo is starting to ship its ink-jet color printer, however, we see that as an alternative in many business applications."

Assessing technologies

Printer manufacturers that wish to respond to the various segments of the color market can find themselves dealing with technologies far removed from their experience. Mannesmann Tally, Kent, Wash., which has developed color versions for both its matrix line printers and high-speed serial printers, adopted pen

The Interpreter

plotter technology for a low-end color device. "Color has yet to be introduced on any of the low-end matrix printers," points out Robert Malone, Mannesmann Tally's vice president of corporate planning and development. "We have driven so much of the cost out of the printer in the sub-\$500 range that it is quite difficult to offer color as an option without drastically increasing the price."

Pen plotters and serial matrix printers, at least for now, are the major contenders in the low-end business graphics and home markets. Plotters offer the superior-quality color output of graphs and charts, but their throughput and functionality is limited. Serial matrix printers have the advantage of offering color as an option to supplement data-processing, word-processing and monochrome graphics modes.

Even established vendors of impact printers will soon affect the color market. "Ink jet is an attractive technology for color, although it still has limitations in terms of the type of paper that can be used," says Neil Kleinfeld, vice president of marketing and planning for Centronics Data Computer Corp., Hudson, N.H. He believes that thermal technology yields fine dot sizes but is still plagued by the high cost of consumables. "I don't expect any one technology to dominate, although I think that impact printers will prevail in many areas," he comments.

John Henry, director of product marketing for Dataproducts' Serial Printer Group, Milford, N.H. (a division formed primarily from Dataproducts' recent acquisition of Integral Data Systems Inc.), agrees that serial matrix printers will continue to claim a significant share of the market even with the emergence of non-impact technologies. "Color impact printing is a good solution to the problem," he asserts, "in that you get reasonable resolution, speed and color on the same printer that can do other applications. Impact printers will hold their own, but I do like some of the other technologies that have been demonstrated."

Henry and others point to Canon U.S.A. Inc.'s A2410 ink-jet printer with a single-quantity price of less than \$700 as a low-end unit that could stimulate the entire color hard-copy market. "It's going to help make users more aware of the possibilities for color hard copy," says Henry. "When people see what you can get at that price, it will draw their attention to higher performance products as well." At the opposite end of the spectrum is the color electrostatic plotter from Versatec, Santa Clara, Calif. It draws considerable praise and reportedly sells well despite a \$90,000 price tag by satisfying the need for high-resolution, complex E-sized plots in such applications as integrated-circuit design and seismography.

The future looks bright for non-impact printers

Although non-impact printers have yet to make a much-anticipated breakthrough in the middle ground of the business graphics market, ink-jet and thermal-transfer printers are touted as the color hard-copy devices of the future. But, as the two technologies mature, the pros and cons of both could change.

Many observers believe that ink-jet printing has a lead over thermal processes. "Ink-jet developments were somewhat dormant over the last few years," says Laura Nichols, a senior analyst specializing in raster hard-copy devices for the Electronic Printer Industry Service of Dataquest Inc., San Jose, Calif. But she maintains that the technology "is definitely coming into its own now." Nichols believes that the low-end Canon ink-jet printer may prove to be an anomaly and that thermal transfer has more potential for low-cost products. She predicts that ink-jet technology will move toward applications requiring high-quality color output.

On the other hand, IDC's Kleinman believes that thermal transfer printers could give higher resolution than ink-jet printers. "You can get a smaller point and control it more easily than you can shooting a drop of ink," he points out.

Ian Mallender, president of non-impact technology research company Advanced Technology Resources, El Dorado, Calif., feels it may be too soon to try to predict how ink-jet and thermal-transfer technologies will fall in the market. "We haven't really seen the results of color developments in thermal transfer yet, although I believe we will see some significant developments next year," he speculates. He believes that much of the technology that has reached the market so far has been the result of research and development by materials suppliers rather than by printer manufacturers. As printer companies learn to optimize thermal-transfer technology for specific applications, its real potential will be seen. Mallender expects the color quality of ink-jet printers to approach that of photographs. "For continuous-tone output, ink-jet is probably far more suitable than thermal technologies," he maintains.

Many in the printer industry assume that the ultimate color hard-copy device will be based on a technology that employs toner, such as laser xerography, electrostatic or magnetic printing. In monochrome, such technologies already produce resolutions far superior to those of ink-jet and thermal-transfer technologies and allow unrivaled printing speed. Others caution that a technology using toner usually requires at least three passes to produce full color, making already-complex technologies more so by using

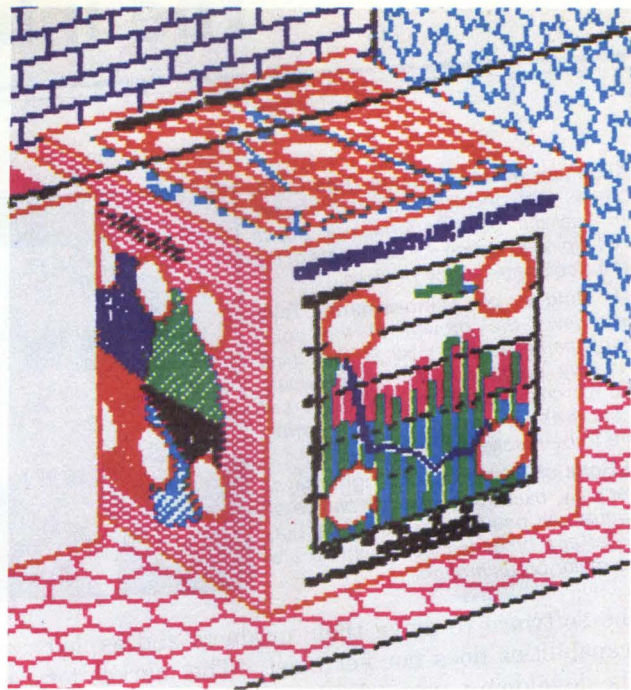
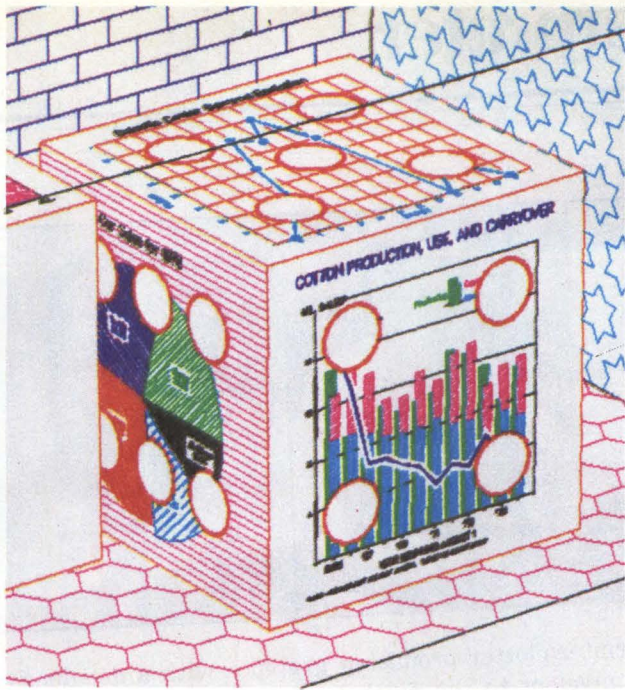

Hard copy using a Tektronix 4691 ink-jet color copier off a Tektronix 4115B terminal (with 4115B option 9 interface) at terminal resolution of 1,280 by 1,024 (A), and the same plot employing the Tektronix 4695 ink-jet connected with a Tektronix 4105 terminal at terminal resolution of 480 by 360 (B). (Courtesy of ISSCO Graphics Software.)

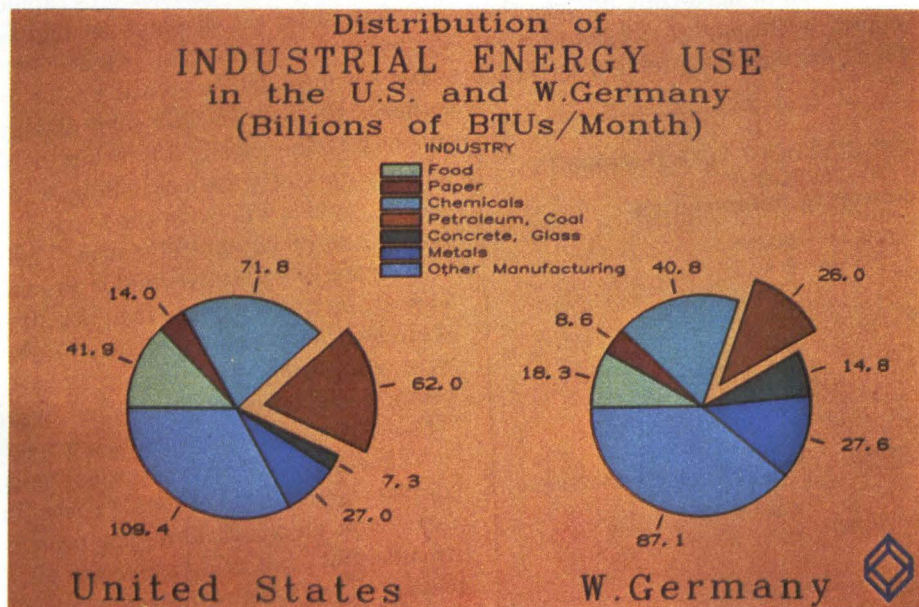

This reproduction is from a slide made of Applicon PVI ink-jet output. (Courtesy of Precision Visuals.)

additional parts while cutting throughput. Mallender also points out that black-ferrite particles in the ink limit color quality in toner-based systems.

Devices not always associated with hard copy are film recorders, or slide-composition systems, which make superior color slides from computer-generated graphics. Such units, however, suffer from high costs for both the device and for operation. Prices are beginning to drop, however, with the entry of such

companies as Polaroid Land and Eastman Kodak Co. into the market. ISSCO's Laroff sees such technologies as soon becoming viable alternatives to printers and plotters.

Software and standards lag behind

A number of issues besides technological competition must be addressed before the market for color hard copy can fully mature. Many printer vendors complain

The Interpreter

Neil Kleinman of International Data Corp. (left) states that printer/plotter vendors are finding "realistic price/performance points that are helping to define the segments of the market for color hard-copy devices."

Robert Malone of Mannesmann Tally (center) views the growth of the color hard-copy market as very slow. "I don't think there is any question about the ultimate demand for color output, but there are still some substantial questions concerning software to be resolved," he comments.

Robert Hoke of Tektronix Inc. (right) says, "Until recently, users only had the choice of what I would call 'pseudo-color' devices, but, with ink jet and other technologies, we are seeing a major breakthrough."

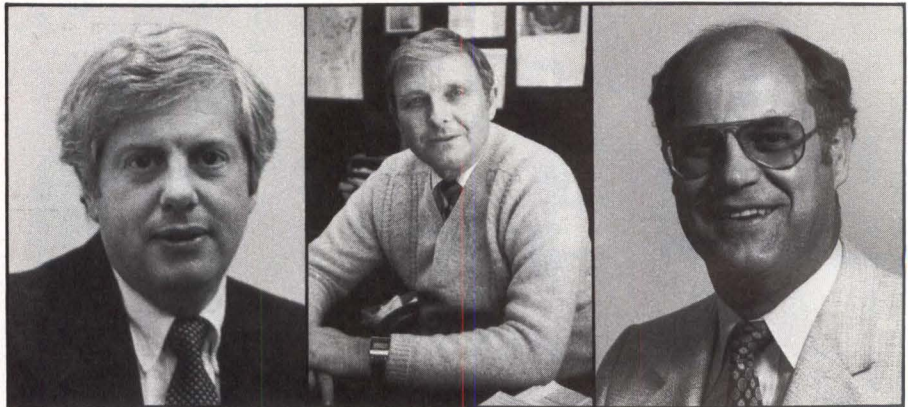

that the software to drive their products and exploit their capabilities does not yet exist. "The market for color is developing very slowly, and that is partly because the software is not keeping up with the capabilities of our units, particularly in the microcomputer market," says Mannesmann Tally's Malone.

On the other hand, vendors of graphics software and color displays decry the lack of hard-copy devices that can produce color copies with quality similar to what appears on the screen. Part of the problem is that a

printer/plotter producing graphics with a dot density equivalent to the pixel density on a graphics display does not have the vivid colors or saturated appearance of the display. While pointing to sales of color terminals as a justification for the color hard-copy market, printer and plotter suppliers are reluctant to see their applications tied to those of color on graphics displays. "Color is often used on displays to highlight items for the operator's convenience," notes Centronics' Kleinfeld. "It's not intended to create a color image to present to others." He believes that color displays don't necessarily beget the need for color hard copy. Instead, application software combining word processing with color graphics will drive the market, he predicts. "That is going to be an explosive area," he says.

Warner of software vendor Precision Visuals would like to see more printer manufacturers tackle some of their own software problems. "We're very impressed with companies like Lasergraphics, which put the vector-to-raster converter in hardware," he proclaims. "It's a tremendous processing burden to have to do that in the software." Warner also feels that a printer supplier shouldn't hold its breath in anticipation of agreement on a virtual device interface (VDI). "It's a valiant effort but still rather far off," he says. In the meantime, he feels printer companies would do well to support the North American Presentation Level Protocol Syntax (NAPLPS) standard as one that is fairly established and defined.

Development of standards relating to color hard copy will probably advance slowly until users' needs are better defined. "We really can't be sure what the user is going to perceive as adequate resolution and what he'll pay for it," says Dataproducts' Henry. Kleinman of IDC echoes these sentiments: "None of us are really expert when it comes to color hard copy. It's still hard to quantify the demand for color or to be sure what applications it might find. We just know that it's going to be an area of tremendous growth." □

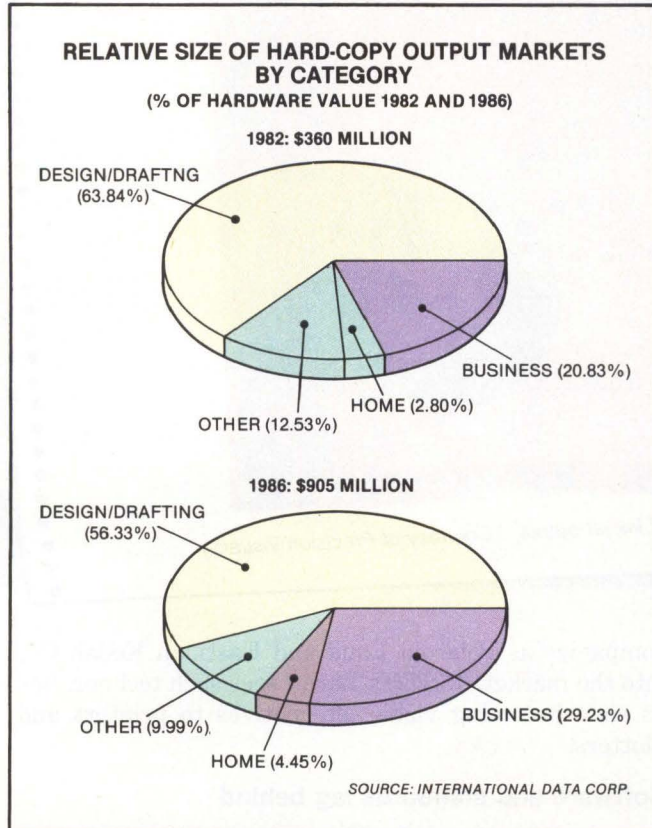

International Data Corp. expects the market for color hard-copy devices to reach almost \$1 billion by 1986.

What's better than **78** software vendors supporting your products?

These firms already supply or are in the process of releasing software packages to support Houston Instrument digitizers and plotters. Their packages are developed in concert with Houston Instrument to ensure smooth and trouble-free operation. New vendors are added to the list on virtually a daily basis.

Want to know what vendors supply plotter packages for your computer? Clip the coupon and fill in the required data. We'll send you your software list by return mail.

1. A2 Devices
2. ABW Corp
3. AHA, Inc.
4. American Foundryman Society
5. Andrews Group
6. Apple Dealers
7. AutoDesk, Inc.
8. BG Graphics System
9. Big Tree Software Corp.
10. Billings Computer Corp.
11. Bonner & Moore Computing Co.
12. Bridge Computer Co.
13. Business & Professional Software
14. Charlotte Computing
15. Chessel Robocom Corp.
16. Com-Code Associates
17. Computer Aided Design
18. Computer Mathware
19. Control Data Corporation
20. Cosmos Software Co.
21. Covington Computer Co.
22. CRIS
23. D. J. R. Associates
24. DaSoft Design Systems
25. Decision Resources, Inc.
26. E. Bishoff
27. Enercomp
28. Enertronics
29. Ganesa Group International
30. General Computer Technologies
31. Graphics Software, Inc.
32. Ground Water Consultants
33. ISSCO
34. InfoGraphics, Inc.
35. Innovative Software
36. Interactive Microware, Inc.
37. J. S. Staedtler, Inc.

38. Jared Graphics
39. Laboratory Computer Systems
40. Libra Laboratories, Inc.
41. Lotus Development
42. Mattson Instrument
43. Measurement Master, Inc.
44. Mesa Graphics
45. Metasoft Corp.
46. Micrografx

47. Micro Control Systems, Inc.
48. Microcomputer Graphics, Inc.
49. Milwaukee Area Technical College
50. Nexus Research
51. North Star Dealers
52. Omicron Software
53. PAFEC Engineering Consulting, Inc.
54. Pacific Basin Graphics
55. Peachtree Software, Inc.
56. Peerless Engineering
57. Penguin Software
58. Personal CAD Systems, Inc.
59. Porter & Porter Engineering
60. Porto-ble Systems
61. PrimeSoft Corp.
62. R & M Biometrics
63. Redding Group, Inc.
64. SAS Institute
65. Scientific Educational Business Systems
66. Signal Technology, Inc.
67. SoftKey, Inc.
68. Softel, Inc.
69. Softrend
70. Software Publishing Company
71. Software Consulting Group
72. Stoneware, Inc.
73. T & W Systems, Inc.
74. Tesseract Assoc.
75. Transparent Data Systems, Inc.
76. Universal Engineering Supply
77. Visual Inspection Products
78. West Coast Consultants
79. Willdan Associates

79 vendors supporting your products.

With over a Hundred Customized Programs

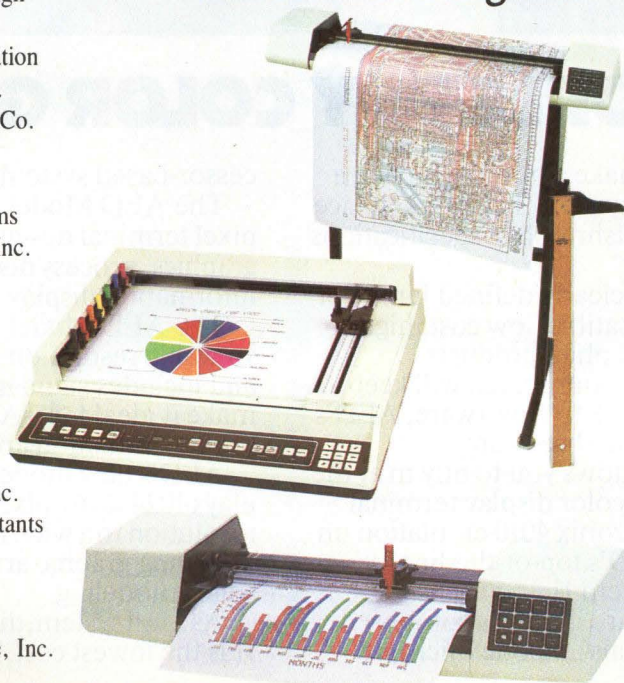

Attention Software Vendor. If we inadvertently missed you, or if you have a program to be included in the future, please contact the HI Software Support Group.

**Mail to: Houston Instrument,
P.O. Box 15720
Austin, TX 78761**

Send me your list of software vendors supplying plotter packages for my computer.

Name _____
Address _____
City _____
State _____ Zip _____
Computer _____

houston instrument

8500 Cameron Rd. / Austin, TX 78757 / (512) 835-0900
P.O. Box 15720, Austin, TX 78761 TWX 910-874-2022

CIRCLE NO. 44 ON INQUIRY CARD





SOME PEOPLE BUY COLOR GRAPHICS,

It's easy to make a mistake buying a color graphics system. The marketplace is a confused mishmash of specifications and claims.

Try to find a clearly defined family of upwardly compatible, low cost, high quality color graphics products.

Chances are, your search will keep bringing you back to Colorware, AED's family of graphics hardware.

Colorware allows you to buy in at the low end with a color display terminal and retain Tektronix 4010 emulation on through to AED's top-of-the-line Colorware System 11.

The Colorware family is composed of three terminals and one micropro-

cessor-based system.

The AED Model 512 is a 512 x 512 pixel terminal designed for business graphics, process display and scientific information display applications.

The AED Model 767 provides a viewable resolution of 767 x 574 pixels and includes standard features that make it ideal for CAD/CAE, cartography, simulation and animation.

AED's new model 1024 terminal displays 1024 x 767 pixels, providing high resolution to a wide range of applications including graphic arts, CAD/CAE and solids modeling.

As a full system, the Colorware System 11 is the lowest cost, high resolution,



BUT SOME PEOPLE BUY COLORWARE.™

stand-alone system available.

All four products offer 256 simultaneous colors with a 16.8 million color palette. Eight memory planes. User-definable symbols. Bit pad support. And AED's 12 years of experience in electronics manufacturing.

All but the model 512 feature anti-aliasing, reference grids and polygon fills.

The complete Colorware family offers you the confidence of knowing you can stay with AED and all of the industry standard software packages while meeting your long-term growth needs.

Colorware is also easy on your budget. Each Colorware family product is priced significantly less than comparable systems.

With all of the Colorware advantages within one family of related products, you're assured that AED has the high-performance terminal or complete system that's right for your particular application.

And you know you won't have to change companies when your needs change. Call or write us for the full story.

Colorware from AED. The full family of color graphics hardware that stands out from the rest.

AED COLORWARE

440 Potrero Avenue, Sunnyvale, CA 94086 (408) 733-3555

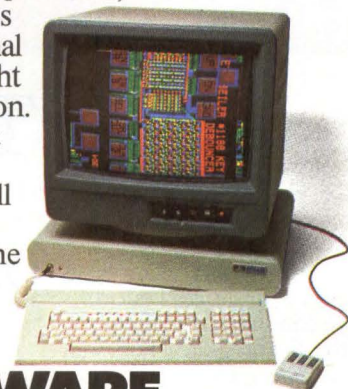



Speed. Convenience. Productivity.
All good intentions. All up in smoke.
All because too many personal
computers proved too much of a good
thing. And caused problems for your
people. Incompatible programs,
inaccessible information, inconsis-
tent data, uncoordinated efforts.

But we can put out all those
fires with our Integrated Personal
Business Computer. Because our IPBC

The road to hell is paved with good intentions.

contains all the hardware and software
you need to combine the convenience
of personal computing with the power

of your corporate data base.
With our IPBC, your people
can access all the complete, consistent
information in your corporate com-
puter and use it in their personal
computers. And vice versa. With-
out rekeying. Without errors.
And without giving up their favo-
rite programs. Because, as a 16-bit per-
sonal computer, our IPBC runs the new
MS-DOS™ based programs for the IBM-

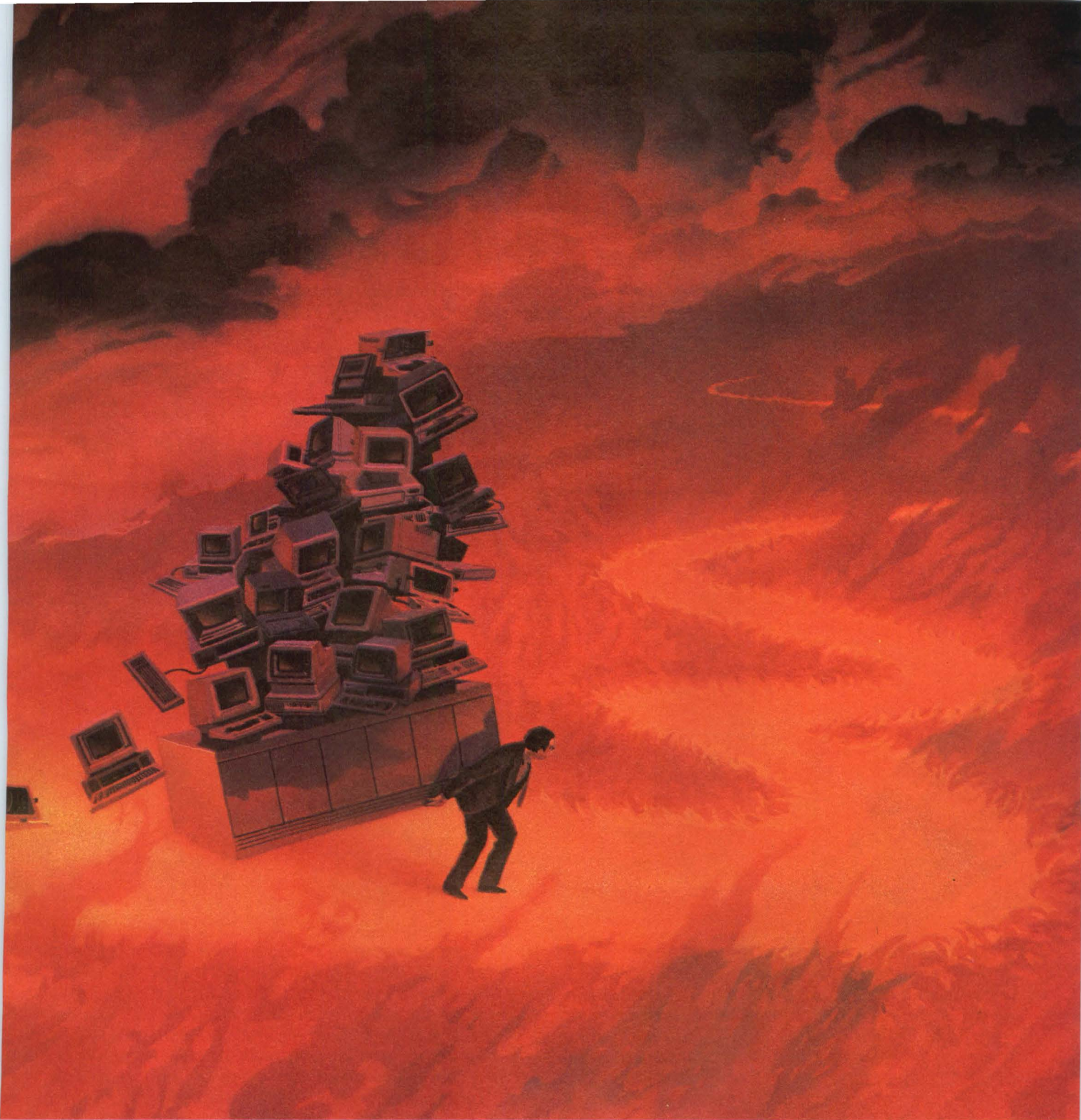

PC.[™] Right off the shelf. And it runs all the popular CP/M[®] based programs too.

Then at the touch of a button, the IPBC becomes a terminal that lets your people run programs on most host computers, including IBM, DEC and HP.

Which means that with just one piece of hardware from one supplier, you can give everybody what they expected from personal computing. And what you expect from your



corporate MIS investment.

So call Direct at (408) 980-1414, extension 315. Or write us at 4201 Burton Drive, Santa Clara, California 95054. We'll show you how to travel the road to Integrated Personal Business Computing.

Without getting burned.

DIRECT

Draw Your Own Conclusions.

**With The Netway Communications Processor,
The Lines Of Communication Go Anywhere You Want.**

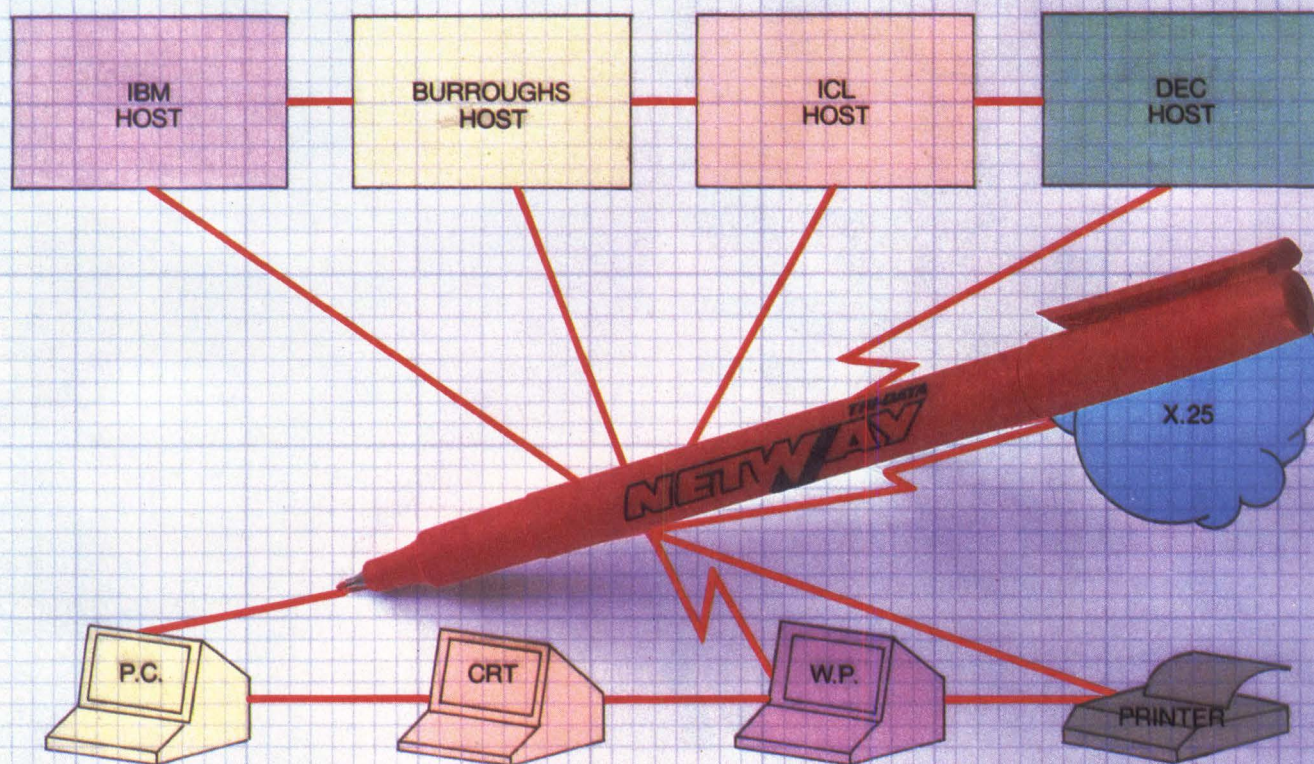

Let us introduce the next generation of communications processing. It's a product so versatile that it can support multiple and dissimilar protocols at the same time—IBM 3270 BSC, SNA, Burroughs, ASCII Start/ Stop, ICL, and many others. A product so powerful that it can network together up to 8,120 workstations and hosts of various kinds. A product so affordable that you can start using it for as low as \$7920.

It's the Netway™ Communications Processor from Tri-Data. The first product that makes it both practical and economical to build networks out of dissimilar hosts and workstations.

With it, you can draw your own conclusions. Because the Netway Communications Processor is a **single solution** you can use in a number of ways, **right now**—as a gateway, a cluster controller, an X.25 PAD, even as a nodal pro-

*Netway is a trademark of Tri-Data Corporation.

cessor where its cost can be a fraction of the competition's. It's a high throughput solution, and one that can be easily customized or upgraded in the field.

As an OEM or systems integrator, you can use the Netway Communications Processor to enter new markets, quickly and profitably. Or to secure a more competitive position in an existing market. As an end user, you can use it to increase utilization of installed equipment and achieve significant savings from equipment purchases and line costs.

The Netway Communications Processor. Call or write today for more information. The conclusions you draw will be money in the bank.

Tri-Data 505 East Middlefield Road
Mountain View, CA 94043
(415) 969-3700
TELEX: 172282 TWX: 910 379 6978

NETWAY
TRI-DATA



CIRCLE NO. 47 ON INQUIRY CARD

Competition heats up in growing fault-tolerant computer market

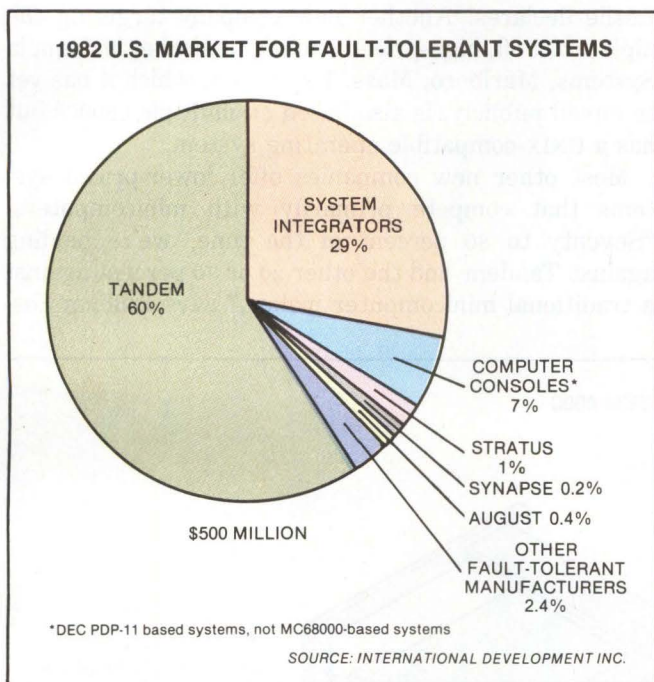

Tandem Computers Inc. dominated the market for fault-tolerant computers in 1982. However, Joan de Regt, a consultant for International Resource Development Inc., expects three or four other manufacturers to gain major portions of the market as well. System integrators primarily "provide software overlays to standard computers arranged in redundant multiprocessor configurations," she notes.

By Sarah Glazer

A computer doesn't catch the flu. It doesn't embezzle, get drunk or even take coffee breaks. But it is vulnerable to its own types of problems. A logic circuit can fail, making it say with confidence that two plus two equals five. Memory can fail, wiping out pieces of a database or, worse, part of a stored program to use the data. And the whole system can go into a tailspin if someone mistakenly alters an operating instruction.

The need to guard against such failures brought fault-tolerant computers into existence. In the 1970s, many industries began relying on computers not just to provide backup files but to handle minute-to-minute operations. Airline reservations, banking and stock market transactions are just a few areas in which people began to rely on computers for real-time operations. As these computer users discovered how disruptive it could be if the system was down, they demanded protection.

The first company to manufacture a fault-tolerant computer was Tandem Computers Inc., Cupertino, Calif. Since shipping its first systems in 1976, Tandem became one of the success stories of the computer industry, with annual revenues growing from \$7 million in 1977 to more than \$400 million in fiscal year 1983, according to company estimates in October. And the market for fault-tolerant computers is expanding rapidly, say industry analysts. Research company International Resource Development (IRD) Inc., Norwalk, Conn., predicts that the U.S. market for fault-tolerant computer systems will be \$4.2 billion in 1987 and \$28 billion in 1992.

While it's no surprise that other companies have since entered this growing market, it is surprising that almost every one is a new company, most financed with venture capital. Their approaches to fault tolerance are all slightly different, and each has designed its products with a particular segment of the computer market in mind. The lack of competition from traditional computer companies, say most of the new manufacturers, exists because established companies face a dilemma: to build a fault-tolerant machine economically, they would have to abandon compatibility with their existing product line. Of the established computer companies, only a few have entered the market. And none has a system that observers put in the same class of fault tolerance as those from the new manufacturers.

Manufacturers target transaction processing

Most manufacturers of fault-tolerant computers say they are focusing on applications for on-line transaction processing—an extremely fast-growing market. Infocorp, a Cupertino, Calif., computer research company, predicts that the worldwide market for transaction-processing equipment will grow from \$8.3 billion in 1982 to \$27.8 billion in 1986.

"Fault tolerance is a basic requirement for on-line transaction processing," says Steve Schmidt, vice president of product marketing for Tandem. "When updating a database in real time, you can't afford to have the computer fail." He claims that for 90 percent of Tandem's customers on-line transaction processing is the primary application.

Tandem's systems are based on 16- and 32-bit minicomputers in contrast to most of the new manufacturers' machines, which are based on microprocessors.

The Interpreter

Base price for a Tandem 16-bit system with only two processors is \$200,000. For the company's new 32-bit TXP, prices start much higher, at more than \$320,000 for a system with only two processors. But, since Tandem's strategy is to provide large-scale computing capability to the Fortune 500 and 1000 largest U.S. companies, Schmidt says he sees other high-priced systems, supplied mainly by IBM Corp. and Digital Equipment Corp., as Tandem's main competition.

Other fault-tolerant computer manufacturers are also eyeing the market for powerful, expensive systems. One is Synapse Computer Corp., Milpitas, Calif. The Synapse N+1 is based on multiple MC68000 microprocessors manufactured by Motorola Inc., Austin, Texas. A "basic starter system" with six processors, 7M

bytes of memory and peripherals is priced at more than \$300,000, says president Mark Leslie, and he calls a system priced at \$800,000 "smallish." Tandem and IBM are Synapse's competition for the relational-database segment of the on-line transaction-processing market, Leslie declares. Another new company targeting the high-powered, high-priced end of the market is Sequoia Systems, Marlboro, Mass. Its system, which it has yet to unveil publicly, is also based on multiple 68000s but has a UNIX-compatible operating system.

Most other new companies offer lower-priced systems that compete primarily with minicomputers. "Seventy to 80 percent of the time, we're bidding against Tandem and the other 20 or 30 percent against a traditional minicomputer maker," says William Fos-

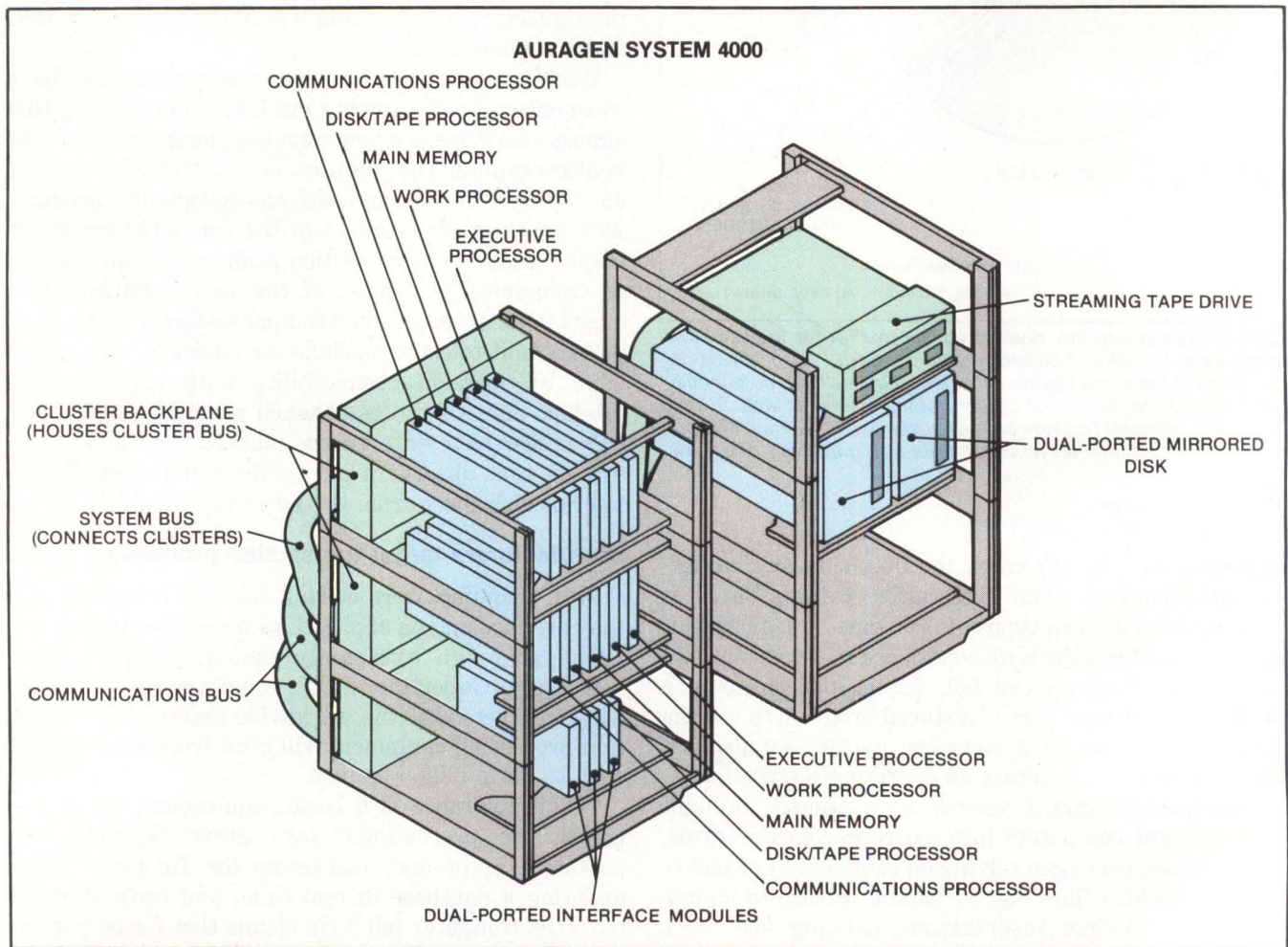

The Auragen System 4000 links multiprocessor modules called clusters. Within each cluster, the executive processor, an MC68000, contains 128K bytes of cache memory, the operating-system kernel and software for message handling and automatic fault tolerance. The work processor, two 68010s, contains application programs and software for page, program and file servers. The communications

processor, another 68000, contains 128K bytes of cache memory and software for interfacing terminals and communications. The disk/tape processor is a bit-slice processor with a 3M-bit-per-second transfer rate. Each cluster can have 1M byte to 8M bytes of demand-paged virtual memory.

PERKIN-ELMER USERS:

The first compatible disk controller that's an intelligent alternative.

Completely compatible with
Perkin-Elmer's IDC system.

Full emulation permits
disk pack exchange
with P-E drives.

Macrolink performance,
pricing and support.

Uses standard
system
diagnostics.

No software
patches required.

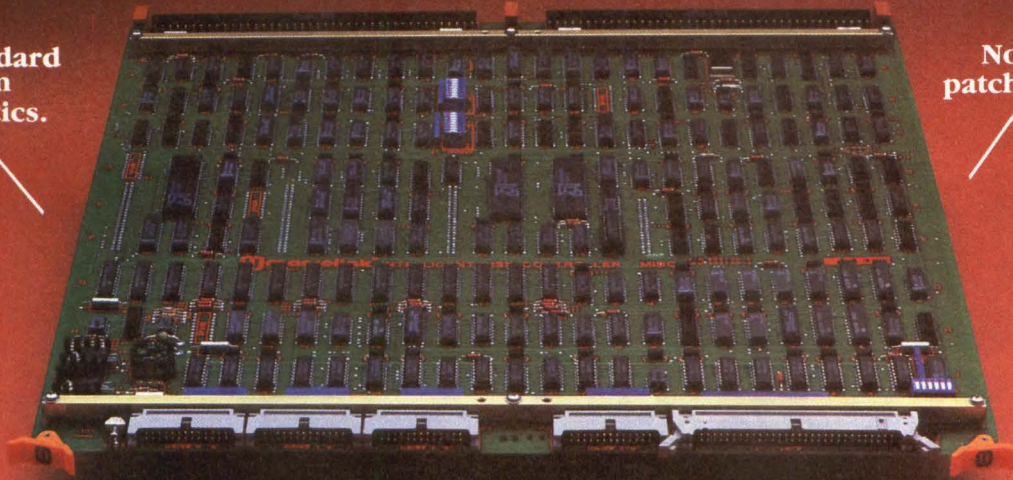

Only our Macrolink Intelligent Disk Controller (MIDC) offers full software and disk pack compatibility with the P-E IDC system. Using such advanced features as on-board ECC logic and micro-coded bit slice technology, MIDC corrects errors of up to 11 bits without operating system overhead. And when you plug this single-board controller into your Series 3200 CPU, you

can mix or match four SMD drives from independent suppliers to put up to 2400 Mbytes on line.

MIDC is shipped from stock with installation manual, cables and a one-year limited warranty. Of course, it comes complete with the high reliability, tested performance and attractive pricing you'd expect from the world leader in P-E interfaces.

Find out about the largest family of P-E compatibles going—

including memory, COMM, tape and more. Call today for prices and details. MACROLINK INC. 1150 East Stanford Court, Anaheim, CA 92805-6887. Telephone (714) 634-8080. TWX 910-591-1671.

**Installed and serviced
nationwide—call for details.**

 **macrolink®**

CIRCLE NO. 48 ON INQUIRY CARD

Everything for Perkin-Elmer systems, except the computer.

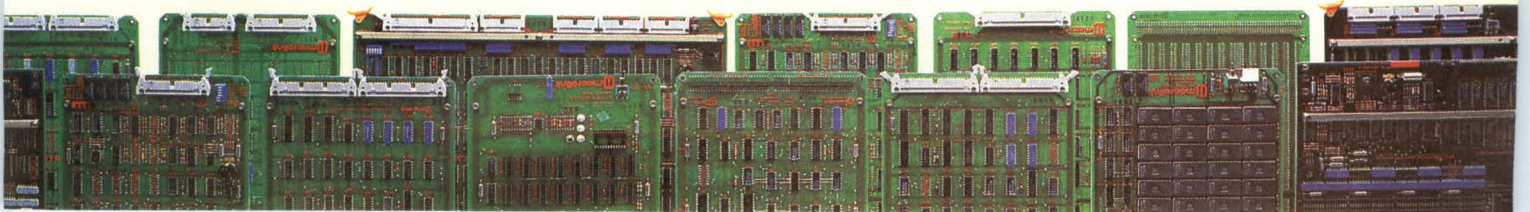

There are a lot of powerful reasons to write software for HP systems.

TM



You're looking at two of them.

An enhanced UNIX™ operating system. And the cash bonuses you'll earn when you sell your UNIX-compatible applications with an HP system.

Those are compelling reasons to participate in HP's special program for software companies.

We have a whole range of products that can run UNIX, from our popular line of MC 68000-based machines to our powerful 32-bit systems. And we'll be expanding that range all the time.

While we're giving you a wider choice of products for your programs, we're also making it even easier for you to write them.

We've developed an especially powerful version of the industry standard UNIX, called HP-UX. Its enhancements provide for graphics, data base management and networking, to name just a few.

When you team up with HP, you have our full service organization behind you. Our factory and field support teams are dedicated to problem-

solving. So, if you or your customers have any questions about HP-UX, just give us a call. We're ready to help.

And we're ready to make your efforts very rewarding. When your customer buys an HP system because of your application, we'll give you a cash bonus of 30% of your software's sales price — up to 6% of the net HP system's price. Our only restriction is that, to qualify for the bonus, your software must sell for at least \$10,000.

There are lots of other good reasons to write HP-compatible software for UNIX or any of our other operating systems. To find out all about them, write to Hewlett-Packard, Attn: Gwen Miller, Dept. 102190, 19447 Pruneridge Avenue, Cupertino, CA 95014. In Europe, contact Henk van Lammeren, Hewlett-Packard Nederlands B.V., Dept. 08170, P.O. Box 529, 1180 AM Amstelveen, The Netherlands.

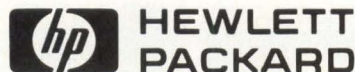

UNIX is a trademark of Bell Laboratories.

BD02315

The Interpreter

ter, president of Stratus Computer Inc., Natick, Mass. The Stratus/32, based on multiple 68000s, has a proprietary operating system. The price for a typical single-module configuration is \$217,000, and the computer is suitable for "any type of on-line transaction-

processing application," Foster states.

More specialized is the market defined by Auragen Systems Corp., Fort Lee, N.J., which manufactures a multiple-68000-based system with a UNIX-compatible operating system. Auragen is focusing on applications

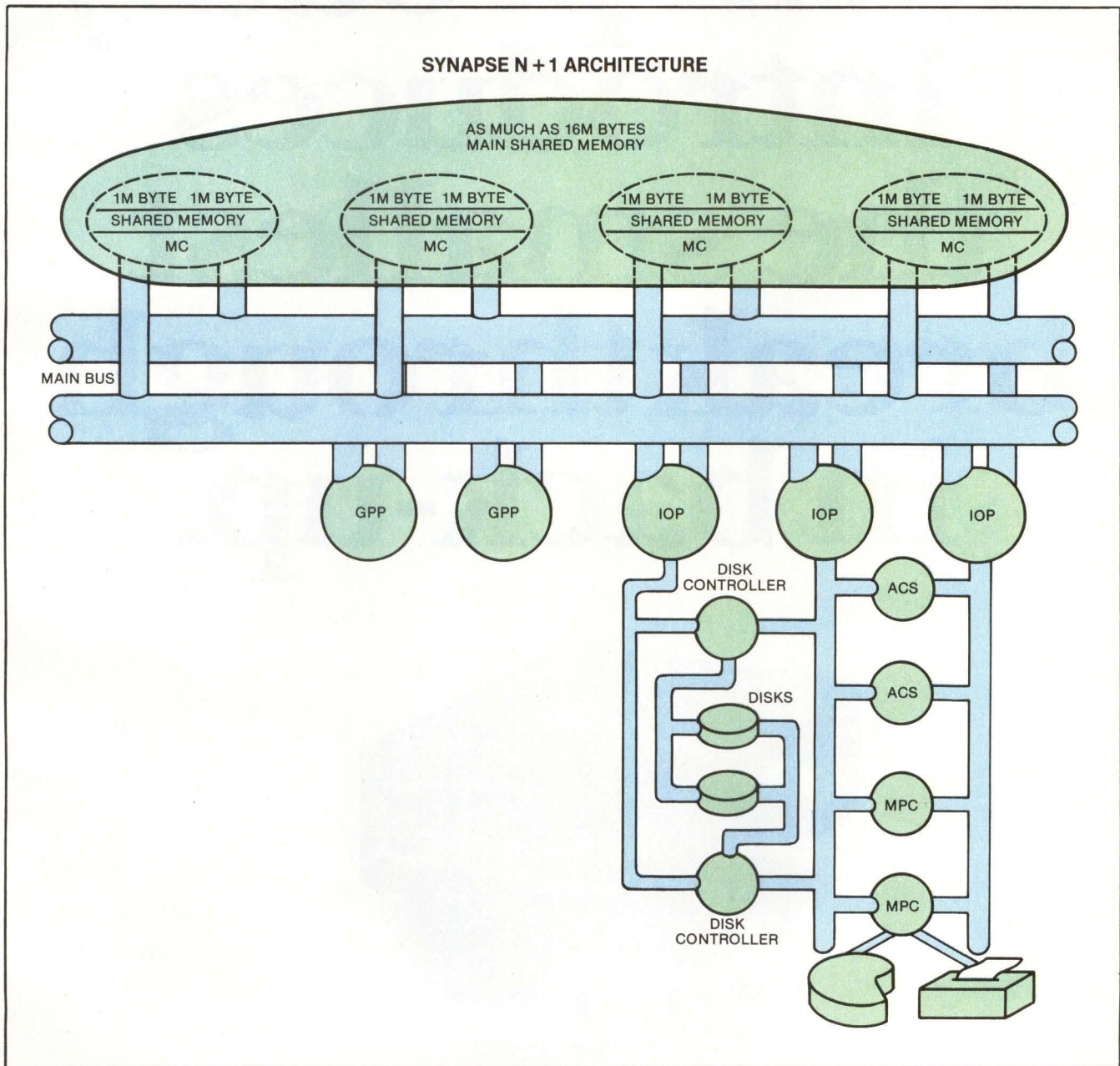

The Synapse N+1 has a single, shared memory that holds operating software, application programs, control structures and work queues. It is accessed by memory controllers (MCs). All transfers between memory and processors take place over two buses having an aggregate transfer rate of 64M bps. General-purpose processors (GPPs), MC68000s, execute user programs and most operating-

system instructions and have 16K bytes of cache memory. Input/output processors (IOPs), also 68000s, each have 128K bytes of local memory, which holds part of the operating system. IOPs manage advanced communications subsystems (ACSs), disk controllers and multiple-purpose controllers (MPCs) for other peripheral devices.

**Irwin proudly
introduces
the smallest
breakthrough
in back-up.**



Amazingly small...a 3½ inch form factor!

It was no small achievement.

In fact, no one believed we could fit 10 megabytes of formatted capacity in a minicartridge. And make it function with absolute reliability.

But we did it. Thanks to state-of-the-art, closed-loop servo technology.

We call it the Irwin 210. Some people are calling it a breakthrough in desktop and portable microcomputer back-up.

It requires only the smallest effort.

The Irwin 210 asks very little of you.

There's no change or addition to the microcomputer hardware. Because the unit has an industry standard minifloppy interface, it plugs right in to your existing controller.

The software required to integrate the Irwin Tape Drive with your computer can be written in as little as 8 hours. Irwin even provides streaming and start/stop software for the IBM PC-XT™.

Available at a surprisingly small price.

What may surprise you even more than the size of our tape drive is the price.

The Irwin 210 is available for about the cost of a floppy disk drive. Significantly less than you might expect.

Too small for you? Then check out our 5¼ inch half-high.

You'd expect someone with Irwin's experience in magnetics technology to offer you even more.

And you'd be right.

Along with the 3½", we have 5¼" half-high tape drives. *True* 5¼" half-highs, including electronics. Available for evaluation, with 30-day delivery.

Think small.

To see the Irwin 210 in action—or to find out more about our product breakthroughs—call 1-313-996-3300 and ask for Lance Roman.

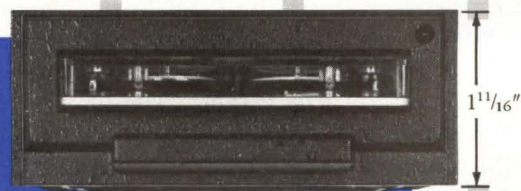
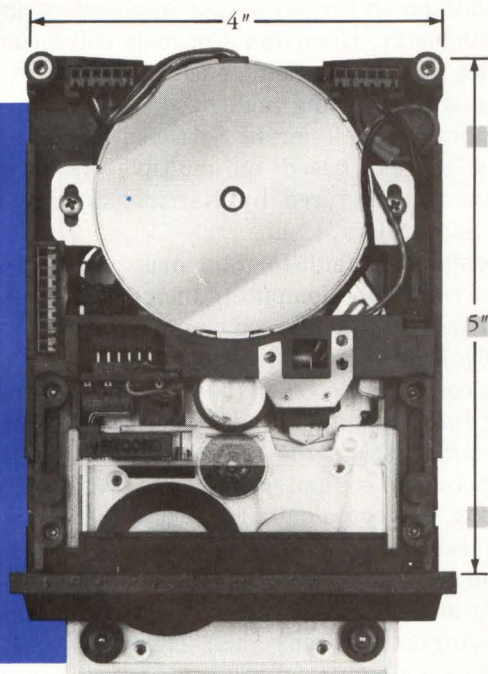

Irwin Magnetics
2311 Green Road
Ann Arbor, Michigan 48105
313/996-3300
TWX 810-223-6050

IRWIN
MAGNETICS

CIRCLE NO. 50 ON INQUIRY CARD

IBM PC-XT is a trademark of International Business Machines.

The Interpreter

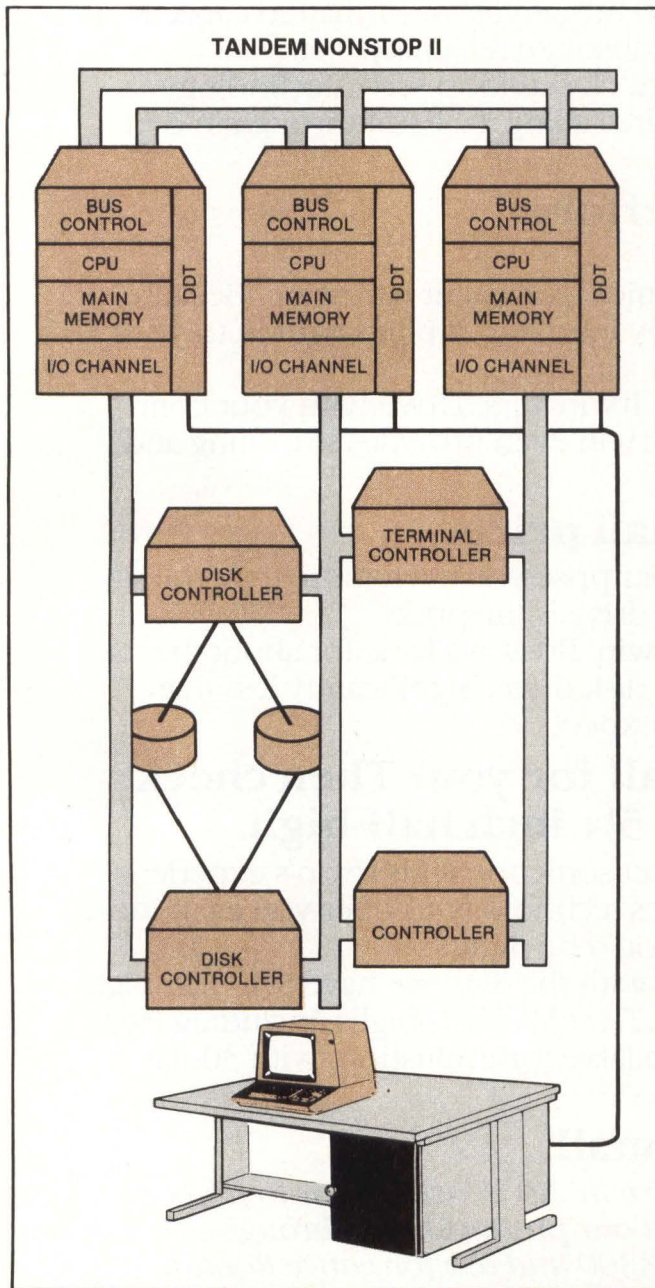

In the Tandem NonStop II, each processor module is an autonomous computer that can have a maximum of 8M bytes of main memory. It also has its own power supply, diagnostic data transceiver (DDT) for diagnostics and input/output processor that can support as many as 32 device controllers. Modules are linked by two independent buses with an aggregate transfer rate of 25M bps.

that are "transaction-oriented and heavily into communications," says president Rick Martin. Its database-management system is based on the system supplied by Oracle Corp., Menlo Park, Calif. With an entry-level price of \$138,000 for a System 4000 that has two

multiprocessor clusters, the system competes with minicomputers and with high-powered microcomputers that have distributed architectures such as systems made by Plexus Computers Inc. or Convergent Technologies Inc., says Martin.

Yet another 68000-based system with a UNIX-compatible operating system is manufactured by Computer Consoles Inc., Rochester, N.Y. Although the Power 5/55 was introduced just this October, it follows in the footsteps of the company's DEC PDP-11-based fault-tolerant system, which claims 60 percent of the directory-assistance applications for continental U.S. telephone companies, says Robert H. Koski, Computer Consoles' director of corporate planning. He explains that the company developed the 68000-based system because it wanted a more economical way to build a more powerful system than to use a bigger DEC machine. In addition to targeting new applications in the telephone industry, Computer Consoles will focus on vertical office systems markets, such as law offices. The last company targeting mid-sized transaction-processing applications is Tolerant Systems, San Jose, Calif., with a system based on multiple NS16000 microprocessors manufactured by National Semiconductor Corp., Santa Clara, Calif.

At the low-end of the fault-tolerant market are two companies. One is Parallel Computers Inc., Santa Cruz, Calif., which makes a system based on multiple 68000s. The other is NoHalt Computers, Farmingdale, N.Y., which makes a computer based on the Z80 microprocessor from Zilog Inc., Campbell, Calif. Priced at \$46,000 for a 16-line configuration, the NH-1000 from NoHalt can replace personal computers, allowing users to access a common, protected database, claims president Anthony Cantasano.

An exception to the overwhelming focus on transaction processing among manufacturers of fault-tolerant computers is August Systems Inc., Tigard, Ore. It makes a machine for industrial process control, based on 8086 microprocessors made by Intel Corp., Santa Clara, Calif. With a typical price of \$150,000, the Can't Fail 300 is rugged enough to operate on a factory floor and is input/output-intensive rather than database-oriented like transaction-processing systems, explains John Wensley, chairman and founder. Another difference in the process-control market is that users can't tolerate an occasional error or short period of downtime, he maintains. In addition to competing with manufacturers of traditional factory-floor computers such as Foxboro Corp. and Gould Inc., Wensley sees competition emerging from systems houses and from

ISN'T THAT THOUGHTFUL ISN'T THAT THOUGHTFUL



Words Alone Don't Describe The Lasergrafix™ 1200 Printer.

The QMS Lasergrafix 1200 is a breakthrough in electronic page printing. But words alone just don't describe it. Because QMS designed the Lasergrafix 1200 to do so much more than words. With a built in intelligent controller that takes simple print commands through your normal data stream. Built-in applications firmware eliminates the need for additional software — and frees your computer's resources for other work.

The difference is graphic — for all your business, scientific and individual printing needs. Create forms that have multiple typefaces and letters up to ten inches high — all on the same line. CAD/CAM. Bit mapped and vector graphics. Pie charts. Bar charts. Even barcodes. At a crisp resolution of 90,000 dots per square inch. With a printing speed of 12 pages per minute.

And, of course, letter quality word processing.

The Lasergrafix 1200 interfaces with just about any computer system. With versatility that lets you take business graphics to the limits of your imagination. Ask for a demonstration. You'll discover that the whisper-quiet performance of the Lasergrafix 1200 speaks softer than words.

And says a whole lot more.

QMS®

QUALITY MICRO SYSTEMS, INC.

P.O. Box 81250 Mobile, AL 36689

Telephone (205)633-4300 Telex RCA 26 60 13

WHERE IMAGINATION LEADS

- Send me the Lasergrafix 1200 Information Packet, samples of mixed fonts, graphics and everything else it does.
- Please contact me to arrange a demonstration.

Name: _____ Title: _____

Company: _____

Address: _____

Type of system you are now using: _____

Number of print workstations you are considering: _____

Prime applications for printer: _____

QUALITY MICRO SYSTEMS, INC.
P.O. Box 81250 · Mobile, AL 36689

MM

The Interpreter

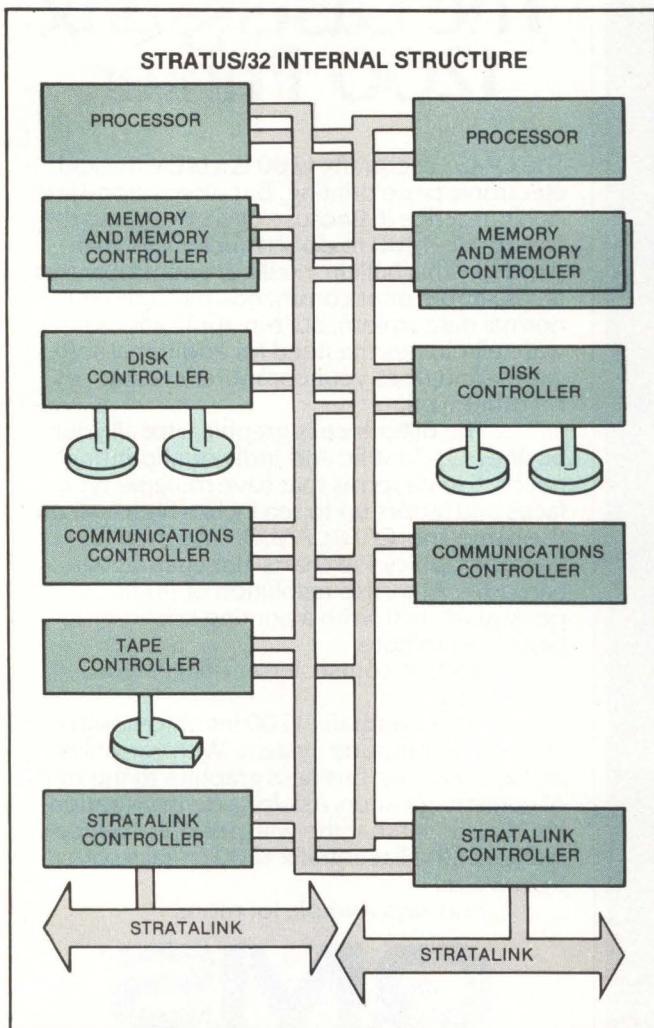

In the Stratus/32, every component except the tape controller has a duplicate doing the same work at the same time. The processor contains two MC68000 pairs, one that runs the operating system and another for user programs. A maximum of two memory controllers per processor can each control 2M bytes of main memory. Data transfer within a module takes place over a bus with a transfer rate of 16M bps. Between modules, data travels over a local-area network called Stratalink. With two Stratalinks connecting modules, the transfer rate is 2.8M bps.

several new manufacturers developing fault-tolerant machines for process control.

Ease of expansion: a big selling point

Suppliers of fault-tolerant computers may be attracted to the transaction-processing market because of its growth potential, but the distributed architectures and message-based operating systems of most fault-tolerant computers are also particularly well-suited to the demands of these applications. "We have features

traditional computer vendors don't have," says Tandem's Schmidt. In addition to fault tolerance, he cites the ability to expand a system easily.

Not only do applications such as automatic teller machines, point-of-sale terminals and communications controllers need to reduce computer downtime, but they also must be able to grow easily. Growing past the capacity of a traditional mainframe or minicomputer means installing a bigger machine and abandoning the outgrown one. But this isn't true for most fault-tolerant computers. With designs that link processors so that one can take over for another, they can also add processors easily to increase power. This offers a growth path with greater flexibility than that of a standard minicomputer or mainframe.

This advantage will give new manufacturers their strongest edge against competitors in the long run, believes Synapse's Leslie. "A lot of people will have a story to tell in fault tolerance," he says, predicting that the traditional manufacturers will eventually offer such features. The chance of success for a new system, Leslie believes, depends on what it offers in addition to fault tolerance. "If differentiation from other systems is small, it probably won't have much chance in the marketplace," he speculates.

In agreement is Auragen's Martin. "Fault tolerance gets us in the door," he says of orders for his company's systems, the first of which was expected to be delivered in November. But the final decision to buy can depend on other features: distributed architecture, communications capability, a database-management system or ease of expansion.

Fault-tolerant systems differ considerably in ability to expand easily. Operating systems and architectures limit the number of processor boards (for microprocessor-based systems) or minicomputers that can be added economically. A user may want to increase processing power without adding power supplies, disks and so forth, says Omri Serlin, head of ITOM International Co., Los Altos, Calif., a research and consulting company that tracks the fault-tolerant computer market. For example, a bank adding more automatic teller machines may need to increase the number of transactions the system can handle, while the size of the database stays constant.

"An architecture like Synapse's is more amenable to expansion," Serlin says, because its processors form a pool, and, "as more processors are plugged in, more transactions per second can be handled." In contrast, a Stratus system's ability "to accommodate a growing work load is very limited," he claims, because of the

HOW FAULT TOLERANCE WORKS

Although every fault-tolerant computer manufacturer has its own way of protecting against failure, the methods fall into two general categories: hardware- and software-based designs. Hardware-based designs depend on redundant components, so if one fails a duplicate component can take over without interruption.

Software-based designs also have duplication, but it's not one for one. Rather than every processor, for example, having a duplicate in case it fails, operating-system software deals with a faulty processor by directing its work load to another processor in the system. Therefore, remaining components share the work load of a faulty one, and much less duplication is necessary.

Companies in the hardware-based category include Stratus Computer Inc., August Systems Inc. and NoHalt Computers. Those in the software-based category include Tandem Computers Inc., Synapse Computer Corp., Auragen Systems Corp., Computer Consoles Inc., Tolerant Transaction Systems, Parallel Computers Inc. and Sequoia Systems.

Each method has its strengths and weaknesses, comments Omri Serlin, who heads ITOM International Co., Los Altos, Calif., a research and consulting company with a specialty in the fault-tolerant computer market. The software-based approaches are "more amenable to expandability," he says, while the hardware-based approaches can "give you a higher level of confidence that hardware is doing fault recovery."

Serlin compares hardware-based methods of dealing with a failure to a tire blowout on a truck that has two tires on each end of its axles. "There's another piece of the system that continues to operate without having to recover," he explains, because "both pieces were working on the same thing at the same speed."

William Foster, president of Stratus, explains that, in his company's computer, each processor board has two Motorola MC68000 chips, both doing exactly the same jobs, with a

comparator regularly comparing their outputs. In addition, a redundant board with two more 68000s carries out identical operations elsewhere. If one comparator finds an inconsistency—hence, a failure in one of the 68000s it watches over—its board is isolated from the system. Meanwhile, the other set of chips on the redundant board carries on with no interruption. Each board also has duplicate sets of support chips for the 68000s that perform address mapping, clocking and other functions. August's hardware-based approach to fault tolerance is similar, although its redundancy is threefold: a voter polls and compares the outputs of three Intel 8086 microprocessors.

Software-based approaches to fault tolerance differ more from manufacturer to manufacturer. A Tandem system has multiple processors (minicomputers), and its operating system includes a checkpointing process to implement fault tolerance. "For each process in the system, you have a backup process in some other processor," Serlin explains. "The primary process keeps sending checkpoints to the other processor that define the state of the process. Should the primary fail, the backup can pick up from the last good checkpoint and continue as if nothing had happened."

A system programmer must manually assign each process to a primary and backup processor, and, if work is balanced inexpertly, system performance can suffer. In addition, an application programmer must manually add the checkpoints to an application program or use Tandem's highly structured programming tools to write applications. Serlin believes the Tandem approach requires "a substantial amount of skill to implement properly."

Auragen's approach is similar to Tandem's, Serlin says, but its checkpointing scheme requires less traffic between the primary and the backup and is implemented automatically by the operating system. "The application programmer doesn't need

to worry about it," he declares.

Auragen president Rick Martin explains that Auragen's system, based on multiple MC68000s, has a process server that schedules jobs to be run and is connected to processors by a very high-speed bus. The process server knows which 68000 is doing the least at any moment, and it assigns work accordingly. To let the process server know everything is working properly, each 68000 sends out an "I'm alive" message every second. If a 68000 fails, the process server gets no "I'm alive" message from it and stops assigning it work.

Martin says that, under the first release of Auragen's operating system, any error in a cluster (one of the system's multiprocessor modules) would take the entire cluster down, although other clusters could continue. Subsequent software releases "allow you to take individual boards out of the cluster without taking the cluster down," he maintains.

Synapse's system is also based on multiple MC68000s. However, rather than having a single processor that assigns work, each 68000 assigns itself a job when it is idle, from one overall work queue. Synapse president Mark Leslie compares this process to a bank in which customers waiting for a teller form one line, with the person at the head of the line moving to the first free teller. "This means that performance is not badly degraded if there is a failure," he maintains, because when a failure occurs work is distributed evenly among the remaining processors.

In addition, processors share one large memory, so that "every processor has independent access to all data all the time," Leslie explains. ITOM's Serlin believes this reliance on shared memory is a "problem" that makes Synapse's system "not really as fault-tolerant" as some other systems. "When shared memory goes, you may lose pieces of the operating system, work queues and status indicators," he points out. To recover from such a failure, the system must be rebooted.

EPSON QUALITY PRODUCTS FOR THE OEM.

INTRODUCING THE EXTRAORDINARY EPSON OEM FAMILY OF FLOPPY DRIVES

SERIES	SMD 100		SD 500			SD 300
MEDIA SIZE	3½"		5¼" (1/2 High)			5¼" (1/3 High)
	4" x 1.57" x 5.98"		5.75" x 1.6" x 7.68"			5.75" x 1.1" x 9.27"
Max. Capacity (2 Sides) (Unformatted)	500 KB	1000 KB	500 KB	1000 KB	1604 KB	500 KB
Drive Motor Speed	300 RPM	300 RPM	300 RPM	300 RPM	360 RPM	300 RPM
Track Density	67.5 TPI	135 TPI	48 TPI	96 TPI	96 TPI	48 TPI
Access Time	6 msec	3 msec	6 msec	3 msec	3 msec	15 msec

500KB to 1.6MB and access times down to 3 msec. And the one-third height 5¼" drive is the industry's slimmest.

But that's only part of the story. What really makes them extraordinary is the fact that they're Epson drives. Designed and built by the people who have made "quality in quantity" their trademark around the world.

That means they're designed and engineered with such state-of-the-art features as noise and RF shielding, ultra-high precision head positioning and loading, perfect disk centering, reduced power consumption and heat generation. But, even more importantly, it means they're manufactured by the people who have established the lowest rejection rate in the industry. When you buy Epson, you buy confidence.

If you'd like more information about the extraordinary Epson family of floppy drives and how they can solve your storage problems, write or call us today.

SW Region (714) 250-0111 • NW Region (408) 985-8828
SE Region (404) 458-9666 • NE Region (617) 245-8007
CENTRAL Region (815) 338-5810

Extraordinary is the best word we could find to describe the new Epson family of 3½" and 5¼" floppy disk drives. Because there is nothing ordinary about them.

The 3½" drives, for instance, feature two-sided capacities up to 1MB. And some draw so little power they can operate on batteries.

The half-height 5¼" drives offer capacities from

EPSON
EPSON AMERICA, INC.
OEM Products Division
Peripherals Group
3415 Kashiwa Street, Torrance,
CA 90505 (213) 533-8277
Telex: 182412

5 MB in a 5¹/₄"?

25 MB in an 8"?

The equivalent of 10 volumes—3,000 double-spaced pages—can be stored on a single 5MB Dysan 5¹/₄" rigid disk cartridge . . . *five times* the capacity of a high-density floppy diskette! The portability and interchangeability of a cartridge, *plus* the reliability of Winchester technology.

And all without having to search through a whole library of floppy diskettes.

Also available is the Dysan 8" rigid disk cartridge, with an unprecedented 25MB capacity—15,000 double-spaced pages of text or alphanumeric data.

They're the reason why more and more business professionals are deciding on rigid disk cartridges for their microcomputer storage needs. Compatible with 8" removable drives, such as those from Amcodyne, Discron, Century Data Systems, and Vermont Research; and 5¹/₄" removable drives, such as the DMA MAGNUM 5/5.

The size of a floppy. The reliability of a Winchester. Another Dysan first, from the leader in rotating magnetic storage media.

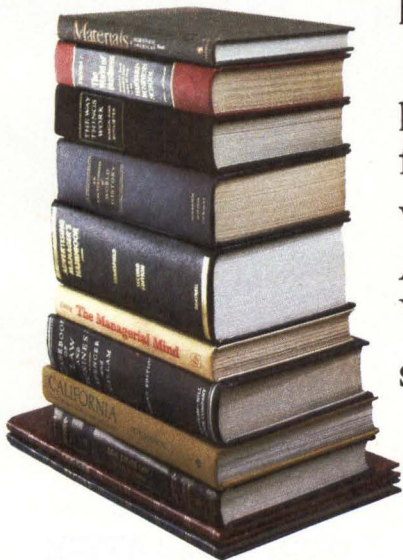

Call TOLL FREE (800) 551-9000 and ask for "Dept. 50" to find out more about the storage technology of the future.

 **Dysan**[®]
CORPORATION

Corporate Headquarters
5201 Patrick Henry Drive
Santa Clara, CA 95050
(800) 551-9000

Introducing the Whizzard® 3355. Now you can break the speed limit without paying the price.

Whizzard 3355. Meet the Whizzard 3355, the newest computer graphics system from Megatek. Up to 400 thousand vectors per second. The fastest high speed performance of any system in its price range, thanks to our Graphics Engine™ Upward software compatibility with every Whizzard. And a high resolution color raster display with 2D real-time dynamic transformations.

Now you can have the speed you want, and pay a lot less for it in the bargain.

The Whizzard 3355 is a full-function computer graphics system that cost-effectively supports your graphics applications. Especially in the areas of mechanical or electronic CAD, simulation, or command and control. And its RS232C interface, with its own 16-bit processor and up to 512 Kbyte dedicated local RAM, offloads the host computer and allows serial communications.

The Whizzard 3355's standard features include a 19" 1024² 60 Hz non-interlaced monitor, 16 simultaneously displayable colors out of a possible 4096, complex 2D graphics transformations (rotate, translate, continuous scale, and clip), and proprietary local processor with serial interface. You also get VT-100™ emulation, an ergonomic keyboard, and a host of available options. Then there's graphics software. Megatek's WAND™, TEMPLATE® and a wide variety of third party application packages, too.

The Whizzard 3355. High-speed performance, and true cost-effectiveness.

That's Megateknology.

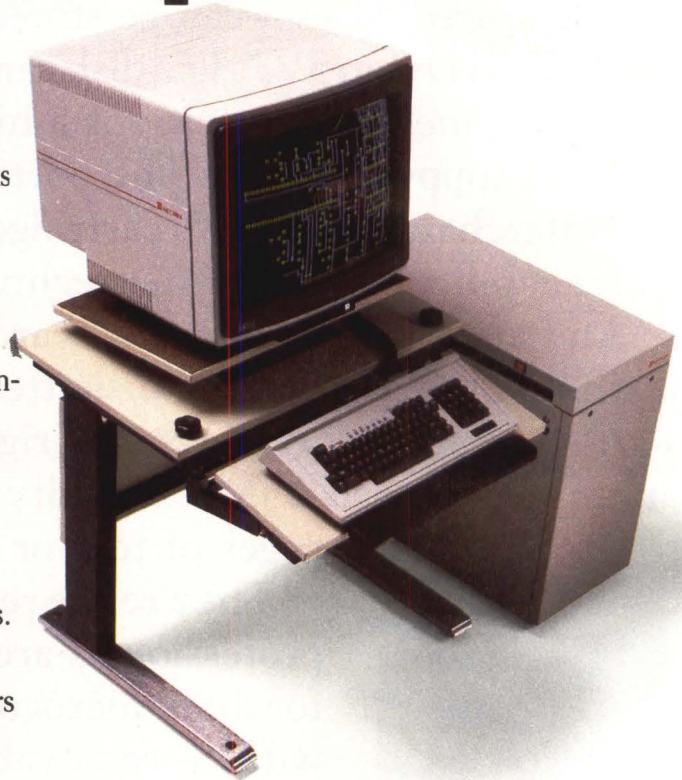

That's Megateknology.™

**MEGATEK
CORPORATION**
A UNITED TELECOM COMPANY
Making History out of State-of-the-Art

World Headquarters • 9605 Scranton Road • San Diego, California 92121 • 619/455-5590 • TWX: 910-337-1270
European Headquarters • 34, avenue du Tribunal-Fédéral • CH-1005 Lausanne, Switzerland • Telephone: 41/21/20 70 55 • Telex: 25 037 mega ch

VT-100 is a trademark of Digital Equipment Corporation

The Interpreter

high degree of duplication required to increase the system's size. Past a certain point, "you can't expand the basic unit but must tack on another unit over a local-area network," he explains. Serlin places Tandem, Auragen, Tolerant and other manufacturers with software-based approaches to fault tolerance different from Synapse's (see "How fault tolerance works," Page 121) between the two extremes.

Serlin believes a trade-off exists between systems that are highly expandable and those that have high levels of fault recovery because of much hardware redundancy. Although the Synapse system is highly expandable, he believes its shared memory design makes it "not really as fault tolerant." Not only does a fault in the shared memory or the main bus require downtime to roll transactions back to a consistent point, but, Serlin says, "I am yet to be convinced" that no corruption of the database results.

Ease of programming: another key issue

Another area in which systems differ is in ease of programming applications. Some systems, such as those from Stratus, Auragen and Synapse, automatically implement fault tolerance, either through their operating systems or hardware designs. Other systems require that programmers insert special instructions, assign backup work loads or structure programs in a certain way to implement fault tolerance. Among these systems are those from Tandem and Computer Consoles.

Because fault recovery in an Auragen computer is performed automatically by the operating system, it is "transparent to the user," says Auragen's Martin. Applications written under UNIX System III can run without changes. In contrast, he points out, "you need to program fault tolerance into Tandem's software." Programmers must be experienced doing this, or systems performance suffers, Martin believes.

"There is no performance penalty for running non-stop [Tandem's name for fault tolerance]," insists Tandem's Schmidt. In addition, he says the company's high-level programming tools can automatically add special instructions for programmers. Martin counters that many Tandem customers choose to run most applications in "regular mode," because the performance penalty of making them fault-tolerant is so high. Programming tools add another layer of software that slows the system down. And even when using the tools, programmers aren't free of constraints because their programs must conform to predetermined structures.

Martin concedes that those features of Auragen's operating system that automatically implement fault

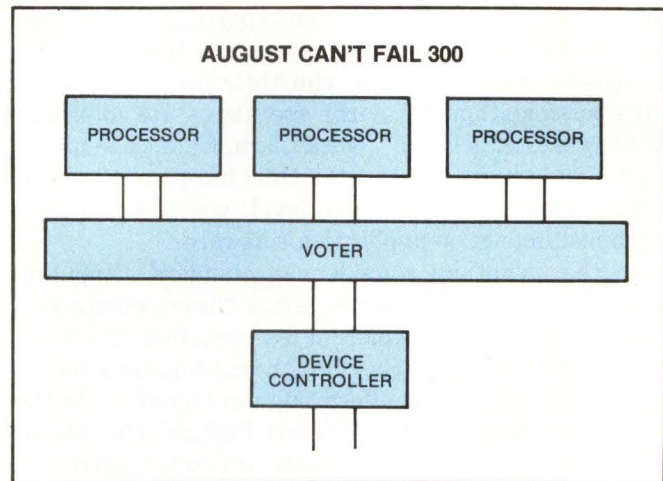

The August Can't Fail 300 has a three-way voting system. Each processor, containing an Intel 8086, does identical work and is polled by the voter for results of every task. If one processor disagrees with the other two, voter logic overrides its result. The voter continues to poll the disagreeing processor, but, if the fault was not intermittent and the processor continues to disagree, the system records a hardware fault.

tolerance slow down the system slightly. But he maintains that avoiding this penalty would require more duplication of hardware and a higher price for the system.

Incompatibility with standard computers

Far more significant to users than the performance or price penalties required to achieve fault tolerance is the fact that fault-tolerant systems are not compatible with traditional computers, believes ITOM's Serlin. "It's the biggest limiting factor on the market," he emphasizes. The manager of a centralized computer department has to "hurt very badly—with an on-line application always down and customers on his back—before he'll accept a solution that is not IBM- or DEC-compatible," Serlin comments.

Message-based operating systems of fault-tolerant computers are by nature incompatible with procedural-based operating systems of traditional computers. Manufacturers of standard computers face this problem in developing fault-tolerant systems, Serlin believes. Introducing a fault-tolerant system would require both "new hardware and a new approach to software," he says. Serlin expects neither IBM nor DEC to take such a step because "they would have to depart from compatibility with their existing bases."

The only way to avoid such a departure would be to implement redundant hardware throughout a system, much like Stratus and August do, he muses. However, while these two companies use off-the-shelf micro-

The Interpreter

processors to make such an approach affordable, manufacturers of standard computers would require expensive custom logic to run their instruction sets. "It's possible, though," Serlin speculates. He notes that Trilogy Systems Corp., Santa Clara, Calif., has hinted that forthcoming products will incorporate fault-tolerant features at the chip level, which would have "minimal impact on application software."

In the meantime, suppliers of standard computers are introducing what Serlin terms "intermediate systems" with some fault-tolerant features. IBM announced a system that links System/I minicomputers into a configuration it claims offers "high availability." In the process-control market, Hewlett-Packard Co. makes the Systemsafe/1000, which contains two HP1000 microcomputers in a backed-up configuration. And DEC introduced the VAXcluster system that links VAX superminicomputers with a high-speed interface and a passive star coupler (MMS, August, Page 54).

David Chanoux, in charge of VAX product management for DEC, agrees with Serlin that staying compatible with existing software contradicts developing an ideal fault-tolerant architecture. "That's the nature of the beast," he concedes, "and the customer has to decide which is more important to him." Rather than offering fault-tolerance, the VAXcluster lets a user design a system "to fail in a predictable manner," Chanoux explains. This might include automatic backup or manual restarting, depending on the application. The VAXcluster uses the VMS operating system, but application programs written for single machines need modifications to take advantage of high-availability features.

DEC's market focus for the VAXcluster is "traditional VAX markets—engineering, office, scientific and industrial," says Chanoux, rather than those applications that "can't afford 10 seconds of downtime." However, he acknowledges that a new DEC software product, VAX-11 ACMS, which he calls "DEC's first VAX product specifically designed for transaction processing," may change the market focus.

Although Chanoux knows of no plans at DEC to introduce a truly fault-tolerant system, Joan de Regt, a consultant for IRD, believes that "a large percentage of all computers will be fault-tolerant by 1992." □

LOOKING AHEAD IN MMS

The coming year brings a third special issue. Slated for publication in mid-June, the **Mini-Micro Computer Digest** will prove an indispensable selection guide to minicomputers and microcomputers.

For your best
investment in printers.
Call your nearest Qume distributor today.

United States:

American Calculator & Computer
(205) 933-2344—AL
Almac Electronics
(206) 643-9092—WA
Anacomp (206) 881-1113—CA, UT, WA
Anthem Systems (415) 342-9182—CA
Bohlig & Associates (612) 922-7011—MN
Butler Associates (617) 964-5270—CT, MA
Byte Industries
(800) 972-5948 (CA Only)
(800) 227-2070 (Outside CA)
David Jamison Carlyle
(213) 410-9250—CA, CO, HI, IL, NJ, TX
Computers & Peripherals Int.
(315) 476-6664—NY
The Datastore (609) 779-0200—NJ
Equipment Resources (404) 955-0313—GA
Future Information Systems
(212) 732-3905—NYC
Gentry Associates
(305) 859-7450—FL, GA, LA, NC, SC, TN
Inland Associates (913) 764-7977—KS
InterACT Computer Systems
(704) 254-1949—FL, GA, NC
Kierulff Electronics
(800) 338-8811—AZ, CA, CO, CT, FL, GA, MA,
MD, MN, MO, NC, NJ, OH, OK, TX, UT, WA, WI
MA/COM-Alanhus Data
(301) 770-1150—MD
MicroAmerica Distributing
(800) 431-7660 (MA Only)
(800) 343-4411 (Outside MA)—CA, MA, TX
Midwest Microcomputers (419) 782-1115—OH
National Computers Syndicate
(312) 459-6400—IL, MN
Pacific Mountain States
(800) 272-3222—CA, WA
PAR Associates
(308) 371-4140—CO, UT
PCA Microsystems (512) 654-4711—TX
PCS, Inc. (214) 247-9946—TX
Pioneer Electronics
(301) 921-0660—AL, FL, GA, MD, NC, PA
Polygon Industries
(504) 834-7658—LA
Printer Warehouse (213) 829-5493—(CA Only)
(800) 245-9812—(Outside CA)
R.C. Data (408) 946-3800—CA
Rudor Communications (212) 245-5509—NYC
Schweber
(800) 645-3040—AL, CA, CT, FL, GA, IA, IL,
MA, MD, MI, MN, NJ, NY, OH, OK, PA, TX, WI
Southern Microcomputer
(305) 621-4237—FL
Tek-Aids Industries
(312) 870-7400—IL, PA, TX
Terminal Rentals (714) 832-2414—CA
Terminals Unlimited
(800) 336-0423—24 Locations
Tricom (516) 483-9700—NY
Unico (512) 451-0251—TX
Western New York Computer
(716) 381-4120—NY

Canada:

Abacus Data Services
(416) 677-9555—Ontario
Datamex (416) 781-9135—Ontario, Quebec
DataTech Systems
(604) 479-7117—Alberta, BC, Ontario
Data Terminal Mart
(416) 677-0184—Alberta, BC, Nova Scotia,
Ontario, Quebec
Future Electronics
(416) 697-7710—Alberta, BC, Ontario, Quebec
Micro Distributing (604) 941-0622—BC
Printerm Data (416) 977-1711—Ontario

Qume[®]
A Subsidiary of ITT

DON'T PAY MORE FOR A PRINTER THAT DELIVERS LESS.

COMPARISON CHART

	Printing speed (cps)	Avg. hours before repair*	User-changeable multiple interfaces	Mfr's suggested retail price
Diablo 630 API	40	4,000	YES	\$2340
NEC 7700 Series	55	2,000	NO	\$2595
Qume SPRINT 11/55 PLUS	55	5,500	YES	\$1990

**Qume's
SPRINT 11/55 PLUS™
outperforms NEC**
and Diablo† for a
lot less money.**

A simple comparison tells the whole story. Qume's new SPRINT 11/55 PLUS™ daisywheel printer is tops in performance, with a steady speed of 55 characters per second. Print quality that's second to none. And the industry's best reliability rating—equal to almost three years of all-day, five-day-a-week business use without a single repair.

That's nearly a year longer than its closest rival.

And the SPRINT 11/55 PLUS is a perfect fit for most popular business computers, via our inexpensive plug-in interface modules.

That means you won't have to change printers when you upgrade your current system.

It's this kind of value that has made Qume one of the largest manufacturers of letter-quality printers in the world.

So don't pay more for less. Choose Qume's SPRINT 11/55 PLUS—the best printer you can buy. *And* the best buy in printers. For more information, contact the Qume distributor nearest you. Or write Qume Corporation, 2350 Qume Drive, San Jose, CA 95131.

**Qume printers.
Your best investment
in productivity.**

Qume®
A Subsidiary of ITT

See distributor listing
on opposite page.



*Mean Time Before Failure at 25% duty (manufacturer's published data)

**NEC is a registered trademark of Nippon Electric Company

†Diablo is a registered trademark of Xerox Corp.

CIRCLE NO. 55 ON INQUIRY CARD

Primage I for the long run.

In high volume situations, where a printer must work overtime producing letter quality documents, Primage I is the winner hands down. It's a high-quality daisy printer that runs at 45 cps—all day every day. Yet, with a fully automatic sheet feeder, it costs hundreds of dollars less than its closest competitor.

This cost-performance breakthrough is the result of an exclusive patented control technology which enables relatively low-cost stepping motors to drive the printer with the speed and precision of far more expensive servo-type motor drives. The simplified design and reduced part count increases the printer's reliability as well as reducing its cost.

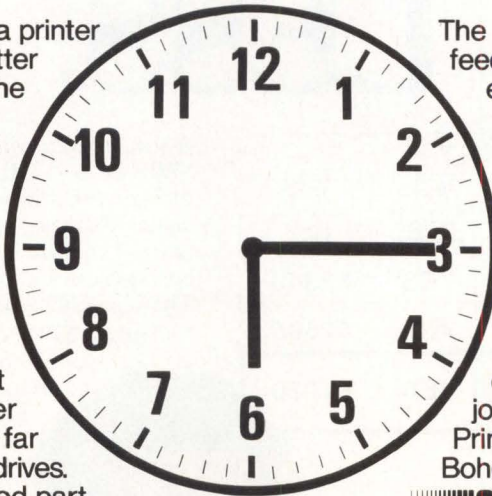

The controls are simplified. Paper feeding is easier. The choice of fonts is expanded. And the unique 100-spoke daisy wheel provides selectable multiple languages that can be changed by a remote host system.

It's running circles around printers with sheet feeders that cost up to 50% more. So contact Primages and find out what Primage I can do for your operation its very first day on the job—and for the long run ahead.

Primages Inc., 620 Johnson Avenue, Bohemia, NY 11716 (516) 567-8200.

**PRIMAGES
INC.**



MOXON ELECTRONICS, INC.
Anaheim, CA 714-635-7600
San Jose, CA 408-298-7290
San Diego, CA 714-565-1557
Lodi/Sacramento, CA 209-334-1961

J.J. WILD, INC.
Needham, MA 617-449-5600
Southbury, CT 203-264-9494
Merimack, NH 603-424-4717

CWE 2
Arlington Hts., IL 312-439-9880
Cedar Rapids, IA 319-362-4116
Fort Wayne, IN 219-747-7661

MILWAUKEE, WI
414-351-6123
COLUMBUS, OH
614-451-5117

JAMES I. HIGHSMITH & CO.
Charlotte, NC 704-333-7743
Richmond, VA 804-745-5555
Huntsville, AL 205-536-6666
Orlando, FL 305-422-5794
Boca Raton, FL 305-368-9194
Tucker, GA 404-493-1055

DYTEC SOUTH AND WEST
Maryland Hts., MD 314-569-2990
Lenexa, KS 913-888-0215
RUSH DRAKE ELECTRONICS INC.
Portland, OR 503-224-3145

POWER HOUSE
Sioux Falls, SD 605-335-7181
QED
Willow Grove, PA 215-657-5600

MICROSYSTEMS MARKETING INC.
Austin, TX 512-452-2842
Richardson, TX 214-669-2380
Stafford, TX 713-491-6550
SOUTHWEST PERIPHERALS
Phoenix, AZ 602-267-7536
Tucson, AZ 602-792-2100

What do you need for your **dig** **al** system?

Find **it** at **DEXPO® East 84.**

Simply everything for your DEC* computer.

Like most other Digital customers, you're probably always looking for new ways to get more out of your computer system. Today, that demands the very latest DEC-compatible products and services. And for more than 10,000 owners, managers, users and dealers of DEC computers, that demands a visit to DEXPO East 84.

Here's why you should be there, too.

New DEC-compatibles are being introduced almost every day. Software. Hardware. Services and supplies. Even complete systems. You need to explore, examine and evaluate *all* your choices. In one place. At one time. Without distractions. And you can only do it at DEXPO East 84.

The most complete exhibition of DEC-compatibles yet.

Some 400 vendors will be at DEXPO East 84 to demonstrate thousands of products and services that work with your DEC equipment. You'll find a spectrum of software for your Rainbow*. Plenty of peripherals for your PDP-11*. All the facts on compatibles for your VAX* . . . and *more* . . . for every DEC computer.

ANNOUNCING THE FIRST CONFERENCE FOR DEC-USING EXECUTIVES

For the first time, DP managers, MIS directors and top corporate executives can attend a DEC-oriented conference covering today's crucial information management issues. The four-day conference features sessions on Office Automation, Personal Computers, Computer Graphics, Communications, Security and more. The conference is sponsored by IRUS, the national independent DEC-user association, in cooperation with DEXPO East 84.

For complete information mail the attached reply card. Or write to Expoconsul International, Inc., Dept. DE, 55 Princeton-Hightstown Road, Princeton Junction, NJ 08550.

DEXPO® East 84

The Fifth National DEC*-Compatible
Industry Exposition and Conference

**Bayside Exposition Center
Boston**

**April 3-6, 1984
Tuesday-Friday**

*Registered trademark of Digital Equipment Corporation.

"Backup claims



Low
Cost
Small Size
High Capacity
Innovative

High Performance
Interchangeable
Operator Control
Star

were too confusing. Then I called Cipher™

Whether you need a 1/2" tape drive compatible with streaming or start/stop software, we have your solution with our Microstreamer® or CacheTape™.

Or whether you need a 1/4" cartridge tape drive compatible with QIC or floppy disk standards, we have your solution with our 540 or FloppyTape™.

The next time you find backup confusing, call the leader. No matter what your system requirements are, we have the tape drive that meets your backup needs. Call or write us today for a free product brochure.

cipher®
data products, inc.

10225 Willow Creek Road, P.O. Box 85170
San Diego, California 92138
Telephone (619) 578-9100, TWX: 910-335-1251

European subsidiaries in:
United Kingdom (phone: 0276-682912),
West Germany (phone: 089-807001/02),
France (phone: 1-668-87-87)

CIRCLE NO. 58 ON INQUIRY CARD

Performance
Reliability
Convenience
Standardization
Reliability

MULTIBUS BOOST™

XYLOGICS CONTROLLERS ADD THRUST TO YOUR MULTIBUS® SYSTEM.

THE 450 SMD DISK CONTROLLER.

It simply outperforms any other high capacity Multibus disk controller.

With DMA speed up to 3.0 MB/sec. Non-interleaved data transfer up to 1.9 MB/sec. And 2 or 8KB FIFO buffering. The Xylogics 450. The fastest SMD disk controller available anywhere for Multibus applications.

And its unparalleled versatility and capacity make it the choice of OEMs. It supports as many as four SMD disk drives, is programmable to any configuration, and works with any 16, 20 or 24 bit address system.

All this power resides on a single IEEE-796 bus compatible board. Multiboost from Xylogics. Is it any wonder that Xylogics has sold more high performance Multibus peripheral controllers to more major OEMs than anyone else in the world?

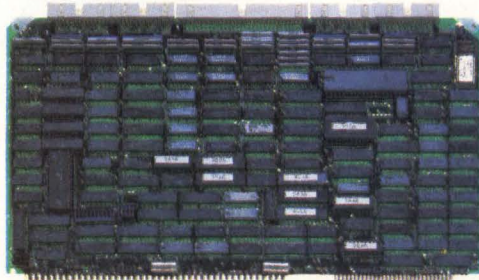

THE 472 TAPE CONTROLLER.

The state-of-the-art Multibus tape controller that outperforms all others in price and features.

Fast DMA up to 3.0 MB/sec. Channel control for true high-speed streaming with no repositioning. And 2 or 8KB FIFO buffering. The Xylogics 472. The fastest Multibus tape controller on the market.

And the most advanced. The 472 supports up to eight Pertec formatted streaming and start/stop tape drives. Runs at speeds up to 125 ips and at densities up to 6250 bpi GCR. Programmable to any drive mix. And it occupies only one backplane slot in any 16, 20 or 24 bit address Multibus system.

Expand the universe of Multibus microprocessing with Multiboost from Xylogics. The peripheral performance leader.

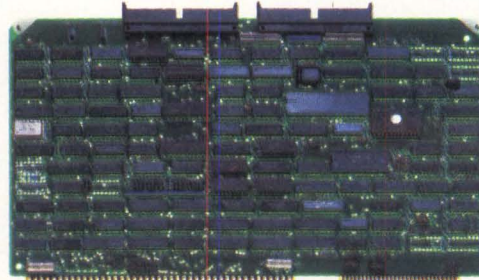
A large, stylized graphic of flames in shades of red, orange, and yellow, positioned at the bottom of the advertisement.

Xylogics®

The Peripheral Performance Leader.

144 Middlesex Turnpike, Burlington, MA 01803
Tel: (617) 272-8140 TWX: 710-332-0262
(800) 225-3317 outside of Massachusetts

Xylogics European Headquarters (Slough, U.K.)
Tel: (0753) 78921 Telex: (851) 847978

*MULTIBUS is a registered trademark of Intel Corp.
**MULTIBOOST is a trademark of Xylogics, Inc.

CIRCLE NO. 59 ON INQUIRY CARD

The Interpreter

Business graphics for UNIX covers a small canvas

By Sarah Glazer

Software seldom holds center stage in the computer industry for long. The spotlight usually focuses on equipment—the newest microcomputer or the most powerful chip. One exception is the UNIX operating system. Developed and licensed by AT&T, UNIX, a set of codes that runs on a spectrum of machines, generated lasting excitement. Manufacturers of many new computers designed their systems around UNIX, while software houses vied to adapt UNIX to older computers. Voices from all quarters proclaimed it as the

ideal operating system for a range of computer applications.

Although the word "UNIX" appears prominently in announcements of many new products, no major manufacturer has seriously endorsed the operating system. Computers running UNIX haven't been as successful as supporters predicted. And, despite a flurry of development work, software packages are almost non-existent for some applications.

Business graphics is notably lagging behind many

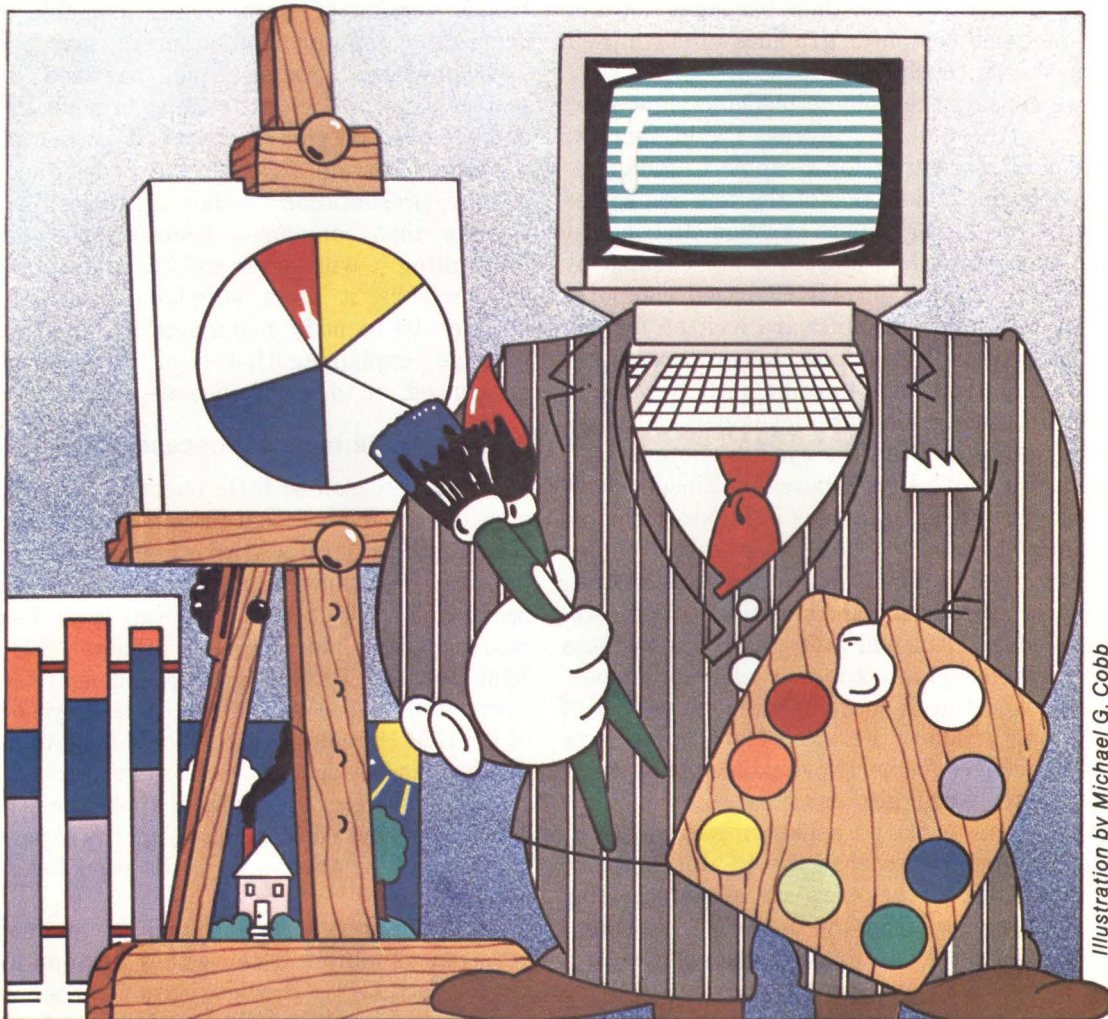

Illustration by Michael G. Cobb

The Interpreter

other software areas. With software houses marketing so few packages, some manufacturers of UNIX-based computers don't offer graphics at all. The reason for the lack of graphics is complex, say observers. It reflects both the small market share claimed by UNIX machines as well as particular hardware and software problems unique to the market niche that most of these computers address. The thorniest problem is how to offer graphics on multiuser systems that don't have graphics processors dedicated to each terminal.

Most action in the graphics market is in sophisticated applications such as computer-aided design and in personal computer products, says Peter Marvit, a market analyst for Yates Ventures, Los Altos, Calif., a research company specializing in UNIX. In the middle ground of multiuser microcomputers—prime UNIX territory—"there aren't a whole lot of machines out there," he declares. "There isn't a high enough volume of UNIX-based systems" to tempt many suppliers of sophisticated graphics to scale their packages down or suppliers of personal computer graphics to move their products up, Marvit concludes.

"People are chasing the volume machine right now: the IBM PC and those like it," agrees David Tarrant, vice president of marketing for Graphic Communications Inc., Waltham, Mass., one of the few companies selling a UNIX business graphics package. In contrast to the large and established market share claimed by the IBM PC, the market for UNIX-based computer systems is in its infancy. Of software written for any new class of computers, Tarrant estimates, "graphics is usually one of the last things to come out," because of technical hurdles facing software developers. "There's more to graphics than meets the eye," he notes.

One manufacturer of a UNIX-based multiuser microcomputer not yet offering graphics is Plexus Computers Inc., Santa Clara, Calif. "We will eventually offer graphics," reports director of marketing James Groff. "Right now, word processing and spreadsheets are still ahead in demand." Plexus will wait until more business graphics are introduced into the market before choosing a package "we want to continue supporting," Groff explains. Among products he expects to appear are sophisticated packages formerly available only on much bigger computers. Groff also anticipates innovations inspired by successes in the personal computer market. "The UNIX community watches the PC marketplace like a hawk. Software developers are already getting pressure for integration" from the success of integrated packages such as 1-2-3 from Lotus Development Corp.

It was while working on a product for the IBM PC and other 16-bit personal computers such as Digital

Although the technical requirements for business graphics aren't nearly as stringent as those for scientific and engineering applications, graphics used for presentations and reports take a variety of forms. Shown here are typical presentation-quality pie charts, bar graphs and line graphs. (Photos courtesy of Precision Visuals) ►

Equipment Corp.'s Rainbow, Hewlett-Packard Co.'s HP150 and NEC America Inc.'s Advanced Professional Computer that Graphic Communications developed its UNIX package. Tarrant explains that designers wrote the original version of Graphwriter in the BASIC programming language and later converted it to Pascal and C. "We converted the PC version to run in MS-DOS [a personal computer operating system developed by Microsoft Corp.] under C, and a lot of that development was done on a UNIX system," he notes. Last summer, the company began marketing this development package as a UNIX version of Graphwriter. Rather than selling it to end users as it does the MS-DOS versions (which retail for \$595), the company is making the UNIX version of Graphwriter available only under license to computer manufacturers, says Tarrant.

Graphwriter produces pie, bar and line charts; scatter plots; text charts such as organizational charts; and combination pie/bar charts. It is "not an analytical package," Tarrant stresses, but is designed for "high-quality, presentation business graphics." Although he reports that companies licensing the package are integrating it with other software, Graphic Communications sells it as a standalone package. Tarrant declines to identify manufacturers using the UNIX package, explaining that their products are not yet announced, or to specify license fees.

Bit-mapped terminals a necessity

Another reason so little business graphics software runs under UNIX is that presentation-quality graphics that can be integrated with other software requires the hardware capabilities of bit-mapped terminals. "The problem is that, technically, you can't feed multiple bit-mapped graphics screens off one CPU," explains John Hewlett, XENIX product manager for Microsoft Corp., Bellevue, Wash. (XENIX is Microsoft's version of UNIX.) He emphasizes, "You'd have to have a CPU driving each terminal." However, most multiuser computer systems for business applications have dumb, character-oriented terminals—not the expensive terminals containing their own CPUs used for engineering applications.

Ironically, this isn't a problem for less sophisticated personal computers because they have only one terminal for each CPU. Hewlett classifies the latest single-user systems as "heavily graphics" and describes all

3-Month Treasury Bills

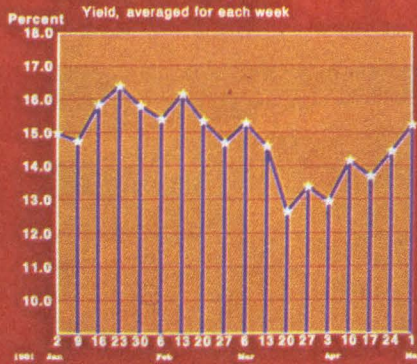

Prepared by Precision Visuals, Inc.

The Cable TV Market

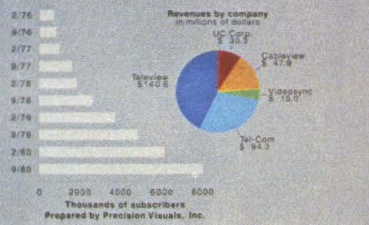

Prepared by Precision Visuals, Inc.

The Cable TV Market

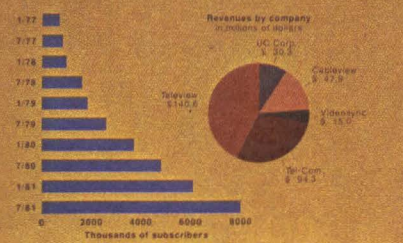

Prepared by Precision Visuals, Inc.

Personal Income Other Than Wages and Salaries

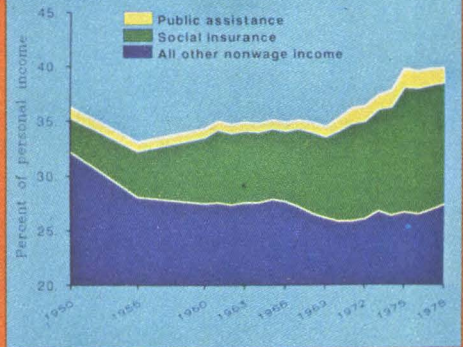

Argent Energy Sales History and Two-Year Forecast

(Figures in millions of dollars)

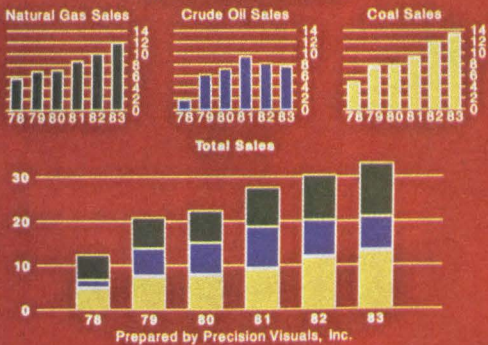

Prepared by Precision Visuals, Inc.

INDUSTRIAL ENERGY USE (Billions of Btu's/Month)

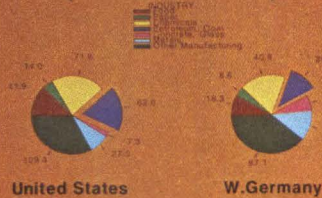

Prepared by Precision Visuals, Inc.

Computer Graphics Market

(By Application)

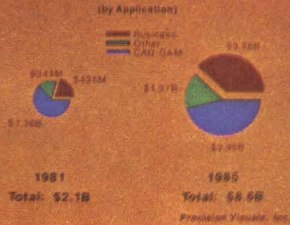

FINANCIAL HIGHLIGHTS

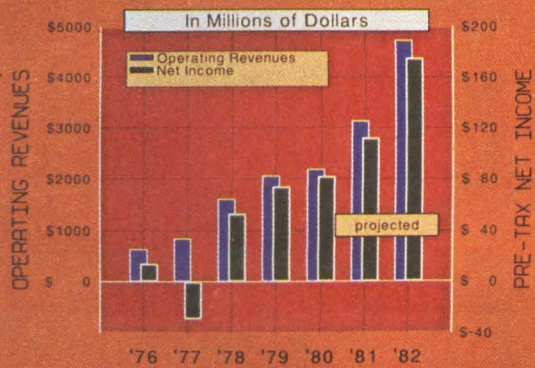

The Texas Instruments Quite simply, the best on the market today.

"This is the machine IBM
should have designed.

It is the optimum
personal computer."

Popular Computing
October 83

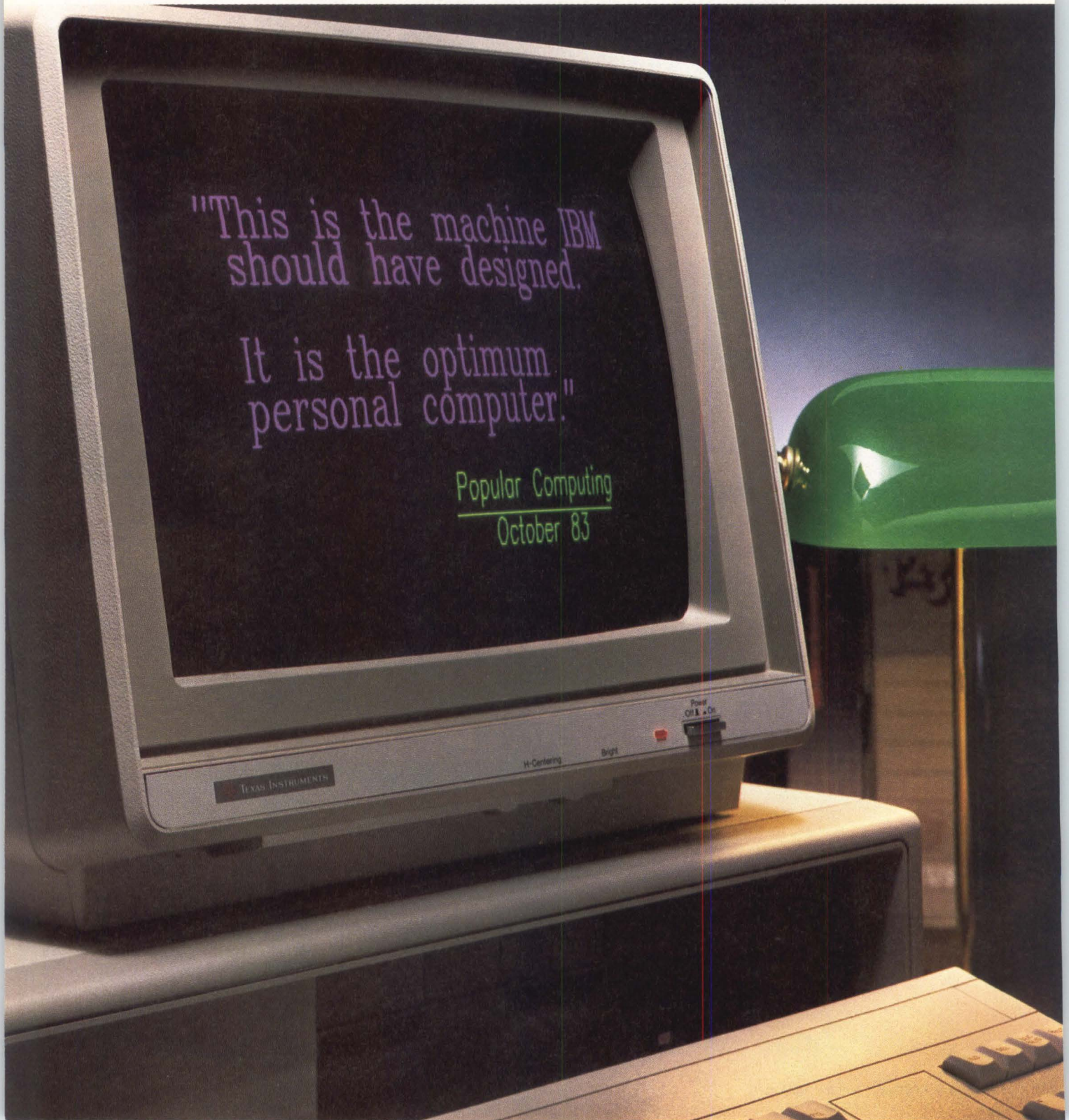

Professional Computer. personal computer And tomorrow.

For your best performance and productivity,
rely on the TI Professional Computer.

Critics have called it "the machine IBM should have designed." And "the optimum personal computer." And thousands of demanding business and professional people have had similar praise for the design, software availability and dependability of the Texas Instruments Professional Computer. Here's why.

Best internal design.

With the TI Professional Computer, you avoid the possibility of computer underbuy or overbuy. Unlike IBM, our standard PC can grow to XT capability — so you don't have to choose between a PC or an XT. If you need more computer after you buy the standard TI Professional Computer, add features like internal memory up to 768K RAM. And internal 10 megabyte Winchester disk. Or other expansion capabilities which you can add using our 5 built-in option slots. So you get more computer without buying a new one.

Best graphics.

Our high resolution monitors give you some of the sharpest displays available, 3-plane graphics and the capability for 8 simultaneous colors or monochrome shades (IBM and Apple give you only 4). Plus, unlike IBM, the same software runs on either the color or monochrome monitor.



Best software available today.

Literally hundreds of third-party software packages are available for the TI Professional Computer. Including the best-sellers like Lotus 1-2-3™. TI and leading third-party software suppliers are committed to developing new programs to help keep your business ahead.

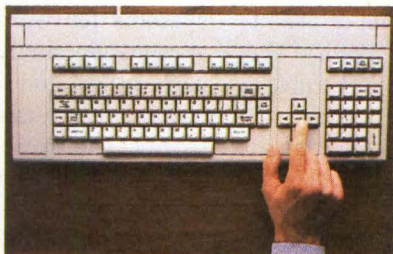

Best keyboard.

Superior design makes this the easiest to use keyboard. You get 12 programmable function keys for faster, easier use. Separate numeric keypad and cursor controls. And isolated edit/delete keys to prevent accidental loss of data.

Best new features for the future.

Come in to a participating dealer today for a demonstration of the TI Professional Computer using our revolutionary speech recognition† capability. Soon you will be able to add the recently announced Speech Command™ option to the TI Professional Computer. This will enable you to operate the computer with simple voice commands. Which lets you work a lot faster and easier.

Best support equipment.

We offer companion equipment like the OMNI 800* Model 850 and 855 printers for reliable hard copy output. And, in early 1984, the EtherLink™ Local Area Network to connect your office workstations. All backed by the TI worldwide network of service and support.

See the TI Professional Computer for yourself. It is, quite simply, the best. Today and tomorrow. Now at participating ComputerLand stores and independent dealers. For the location nearest you, and answers to questions about your computing needs, call 1-800-527-3500.



**TEXAS
INSTRUMENTS**
Creating useful products
and services for you.

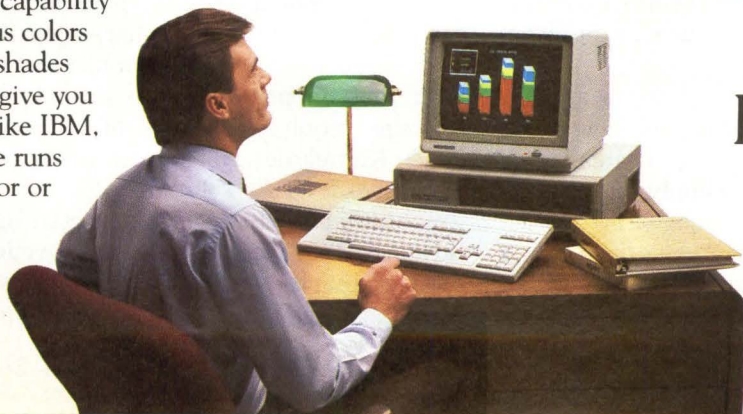

* OMNI 800 and Speech Command are trademarks of Texas Instruments Incorporated.
EtherLink is a trademark of 3Com Corporation.
1-2-3 is a trademark of Lotus Corporation.

† Now being demonstrated nationwide. Available early 1984.
Copyright © 1983 Texas Instruments 2773-04OPC

The Interpreter

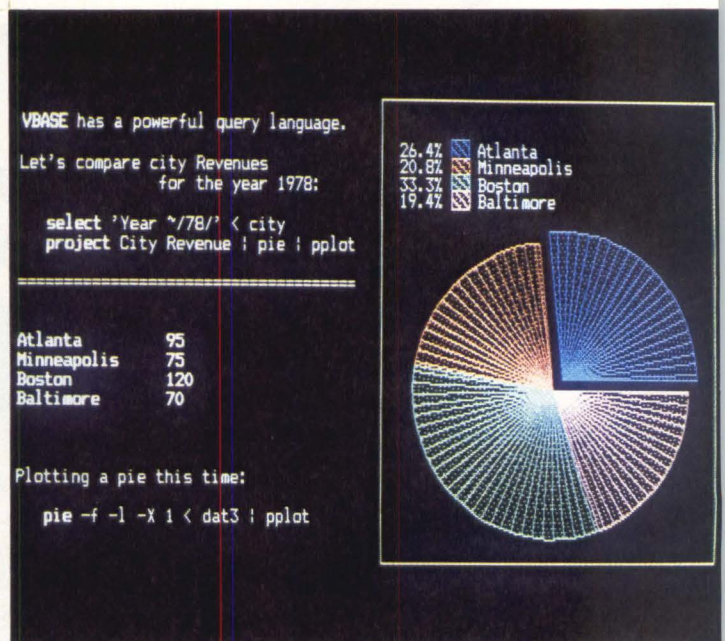
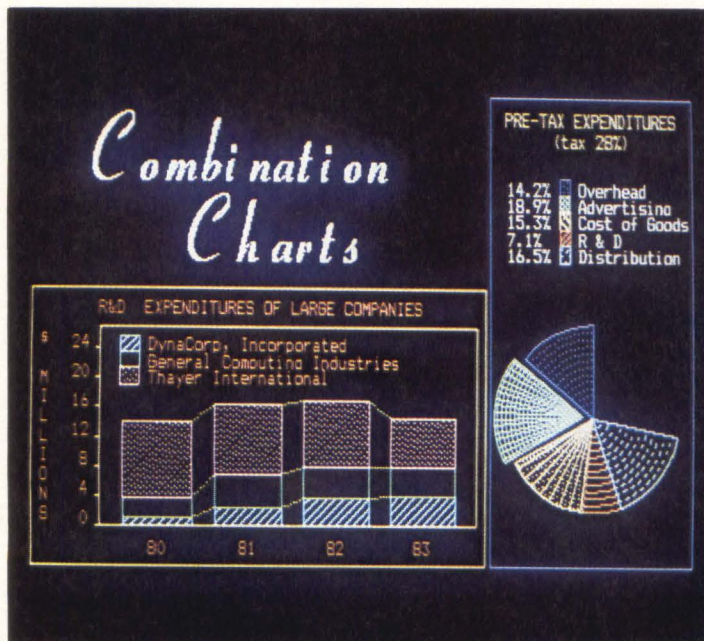

Some of the more sophisticated graphics packages can combine different elements on a single screen. In the photograph of the screen labeled "Combination Charts," a pie chart and a bar graph illustrate

two related statistics. The other photograph shows two windows for text and one for graphics on the same screen. (Photos courtesy of VenturCom Inc.)

Microsoft's new MS-DOS software as "graphics oriented." Microsoft has not yet decided to modify this graphics software to run under XENIX. "Hardware has been the negating issue," he declares. Since each manufacturer of a multiuser system "will have to invent its own scheme to have a processor driving each terminal," Hewlett believes that graphics packages may need significant modification to run on different UNIX-based systems.

Facing these complexities, some manufacturers are opting to ignore the graphics issue. "Bit-mapped graphics is really not part of our marketplace right now," states Sharon Barnard, UNIX product manager of Onyx Systems Inc., San Jose, Calif., supplier of a UNIX-based computer system. She explains that Onyx doesn't offer terminals with bit-mapped capabilities and that the company can't help customers who want graphics on Onyx systems. She adds, "Until we define the market and decide how it impacts our market niche, we won't be doing anything."

Auragen Systems Corp., Fort Lee, N.J., is another manufacturer of a UNIX-based system that now offers neither bit-mapped terminals nor graphics capabilities. Commenting on company plans to supply such terminals and graphics in the future, manager of product planning Michelle Blank says, "You can't just buy a graphics package; you also have to consider the other interfaces." She would like to use software that allows

systems for word processing, database management, spreadsheet analysis and graphics to communicate with each other and work together. "Most of the office-automation packages that exist now have everything except the graphics," Blank reports. She believes software suppliers are "holding off" on graphics because they want to offer the quality that requires bit-mapped displays but are stymied by "hardware restraints."

Tackling the challenge of integrating graphics

Despite these problems, some manufacturers do offer business graphics on their UNIX systems. CIE Systems Inc., Irvine, Calif., a subsidiary of the Japanese company C. Itoh Electronics Inc., offers a package for its System 680/20 that can use data from its electronic spreadsheet to generate color-coded pie charts, bar graphs, scatter plots and 3-D bar graphs, says director of product marketing Al Kernek. The system can store finished graphics and print them along with text on printers with graphics capability. The package requires the use of bit-mapped terminals, which Kernek describes as "a problem because they're expensive." CIE's solution is an optional bit-mapped graphics board that can be inserted into the standard terminal. Two versions for color terminals and one for black-and-white terminals sell for \$995 to \$1,195, Kernek reports. "I see the cost continually going down

Introducing the Freedom 200. No other VDT gives you more, for less.

For only \$745, the Freedom 200 gives you more user-relevant functions and optimized ergonomic features than any other standard VDT.

You get 106 keys, clustered for maximum user efficiency.

Plus 10 user-programmable non-volatile function keys (256 bytes worth) for a host of applications.

Plus 11 cursor control keys, including tab by word for easy editing.

Plus flexible non-volatile set-up modes, full page or status line, to easily configure your terminal exactly the way you want it.

Plus user-definable smooth scrolling regions, with selectable scroll rates.

Plus split-screen capability.

Plus 128 ASCII characters, with 86 extended graphic characters for forms creation.

Plus non-embedded attributes (visual and data entry).

Plus double-high/double-wide characters.

Plus programmable answerback message for enhanced security.

Plus programmable time out, to prolong the life of your screen.

Plus easy serviceability, and space for add-on boards.

Plus two-page standard memory in emulation modes and one-page memory in native mode, with additional memory optional.

Plus 8 foreign character sets.

Plus TeleVideo 950 and Lear Siegler ADM 31 emulation.

Plus more.

To find out more, contact your local Liberty dealer or distributor.

Or call Liberty direct.

(415) 543-7000.

No other VDT gives you more, for less.

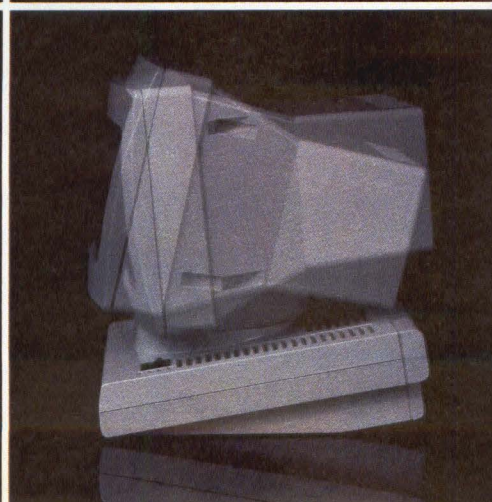
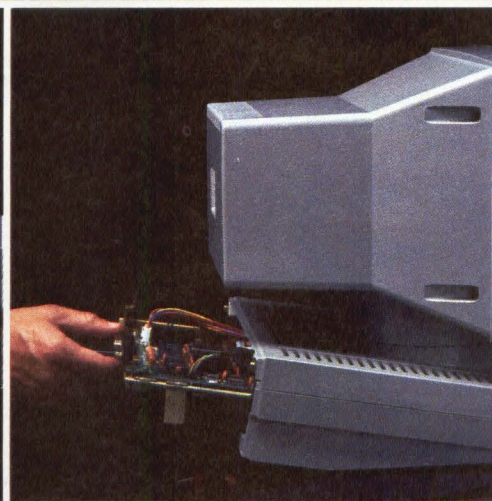
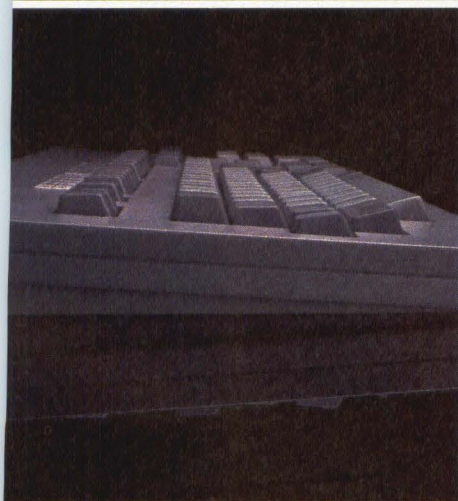

 **LIBERTY**

© Liberty Electronics 1984.

CIRCLE NO. 158 ON INQUIRY CARD

4

It's Fast In Any Language.

SAGE
Time-It
February 3-5, 1984
Reno, Nevada
Register now! It's your opportunity to learn where high performance supermicro computer technology is going.

When it comes to software development, the difference between a Sage IV computer and other micros is like day and night.

With the Sage Computer it'll take you fewer days and nights to finish your program.

Speed is the reason. Speed resulting from the fast MC68000 microprocessor, fast architecture, fast operating systems, and blinding transfer rates.

The fact is, even we are surprised by the amount of software that's developed on Sage Computers.

So if you're a programmer, maybe you should spend some time learning how much time you could save using a Sage IV.



standards and programs written under it are highly portable to other micros.

CP/M advocates please note that Digital Research has developed **CP/M-68K** for Sage hardware, providing a truly complete software development environment. Versions of **Pascal, BASIC, C-BASIC, C,** and **FORTRAN 77**, as well as a very fast **APL**, may be used under this operating system.

The Sage IV is also blindingly fast when

If you found your language here, you just found your computer. The 16-bit, 2-million operation/sec Sage IV micro with up to one MByte RAM and 18-MByte internal hard disk.

For more information and the name of your nearest SAGE dealer, call us today. And be sure to ask about our new software catalog describing over 200 application programs for Sage computers.

Sage Computer Corporate Office,
4905 Energy Way, Reno, Nevada
89502. Phone (702) 322-6868
TWX: 910-395-6073/SAGE RNO

Eastern United States
Sage Computer
15 New England
Executive Park
Suite 120, Burlington, MA
01803 (617) 229-6868

The Hottest Languages And Operating Systems.

Programs in nearly all of the important languages can be written on the Sage computer.

Included in the price is the **p-SYSTEM** operating system which supports **Pascal, BASIC,** and **FORTRAN.**

Other operating systems are optional. For **UNIX** fans there's **IDRIS**, which runs up to twice as fast (even without a Sage computer). **IDRIS** conforms to **USR/Group Standards Committee**

running **hyperFORTH** with its extended programmer and user interfaces.

Besides **IDRIS**, other **Multi-User** operating systems that run on the Sage Computer are **PDOS, MBOS,** and **MIRAGE.**

A log of excitement has been brewing in the Pascal World over Niklaus Wirth's new **MODULA 2**—and it's available for Sage computers. So is **ADA**, for the record.

© 1983 Sage Computer all rights reserved
Sage & Sage IV are trademarks of Sage Computer



SAGE
COMPUTER
The computer you don't wait for!

APL Fortran HYPERFORTH
IDRIS MBOS
p-SYS G
CP/M 68K Mirage

The Interpreter

for bit-mapped graphics," he maintains. "But it does require chips and an additional board."

CIE's graphics package was developed by Pacific Basin Graphics, a San Francisco software house that will market the package independently in addition to its agreement with CIE. CIE hadn't finalized the price of the package by mid-November, but Kernek expected to sell it as a standalone product for "substantially under \$1,000." In addition to the menu-driven portion intended for non-programmers, the package includes a graphics subroutine library priced separately that allows programmers to generate custom graphics. Kernek says that Pacific Basin did the integration with the Ultracalc spreadsheet and that integration with CIE's accounting software would be a mutual effort. "We can integrate it with any data files that are ASCII standard," he claims.

Sophisticated features built into UNIX make integrating graphics much easier than under many other operating systems, emphasizes Gig Graham, executive vice president of VenturCom Inc., Cambridge, Mass., a software house that offers graphics under VENIX, its version of UNIX. "We employ all the UNIX utilities to manipulate data," he says. For example, the portions of a database or spreadsheet that will be used to generate graphics make up a new file. The graph itself is formed by primitives—bar, pie and line graphs, for example—which are also UNIX utilities but which don't take the differences between monitors into account. The primitives "pipe" data to machine-dependent graphics filters and adjust and scale output depending on scale and resolution of a monitor. "As long as there is a standard input stream in a format that graphics filters understand, the graphics primitives can understand what to do with it," Graham explains.

He says that a VENIX graphics package retails for \$500 but is most often bundled with a database or spreadsheet package. He expects a graphics/database package to retail for \$800 or less. VENIX graphics requires bit-mapped terminals and, like all VENIX products, runs only on the IBM PC and PC-compatibles and on the DEC Professional, PDP-11 and Micro-11. Some bugs are still not worked out, Graham concedes. In mixing text and graphics, he admits, "we haven't yet developed a way to treat color graphics in the middle of text."

Sophisticated graphics scale down for business

A few business graphics packages running under UNIX are products that originated as powerful mainframe-based packages with features sophisticated enough for engineering applications. Among these is

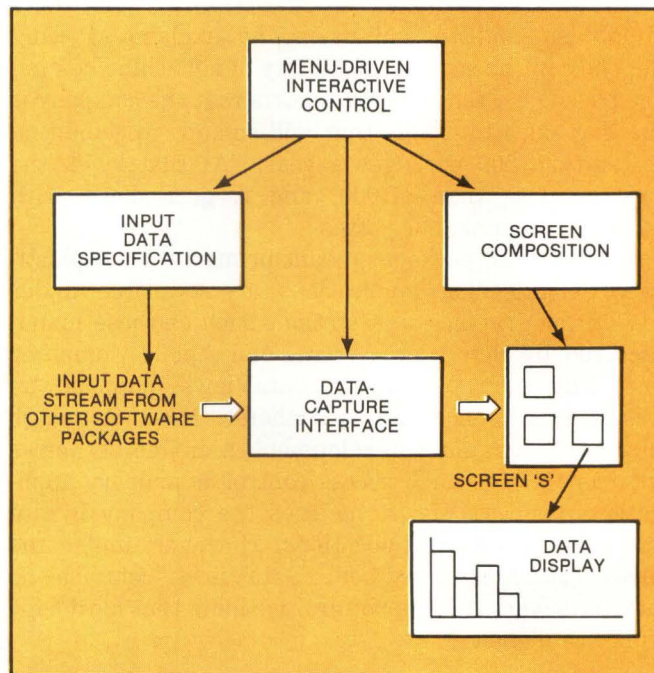

This schematic shows a graphics package that is integrated with other software packages in the system. A user first sees a menu of graphics display formats and can specify both the composition of the screen and the input data that will generate the graphics. When input data is fed through the data-capture interface, it appears as a previously formatted graph on the screen or, with the aid of device drivers, as paper copy. (Source: Visual Intelligence Corp.)

Grafmaker from Precision Visuals Inc., Boulder, Colo., based on the company's DI-3000 core product. Developed for mainframes, it now runs under UNIX on microcomputers based on Motorola Inc.'s MC68000 microprocessor. Grafmaker makes the usual bar, line and pie charts, plus combinations of these. It can use interactive input and store compiled graphics so that they can be integrated with other packages such as spreadsheets, says John Thompson, Precision Visuals' product manager for business graphics software.

Grafmaker, Thompson explains, is a "library of FORTRAN subroutines" intended for experienced FORTRAN programmers. Precision Visuals also offers an end-user, business graphics package called Grafmaster, but it is available only under the VMS operating system for DEC VAX minicomputers. Thompson declines to say whether Grafmaster will become available under UNIX, commenting only that "it's something we've certainly talked about."

Grafmaker under UNIX is available only by license to OEMs, says Steve Frederickson, vice president of third-party sales at Precision Visuals. "There are so many different flavors of UNIX and so many floppy disk formats" that the company would rather let OEMs

The Interpreter

supply support to end users, he explains. Pricing depends on the size and capability of a machine hosting the package. Frederickson reports that the company is limiting sales to OEMs that will commit to selling no fewer than 200 packages a year. "At that level, the price is less than \$1,000, and it goes down with increased volume," he states.

A number of packages meant primarily for sophisticated engineering applications are available under UNIX for graphics workstations such as those manufactured by Sun Microsystems and Apollo Computer Inc. One such package is DataViews, supplied by Visual Intelligence Corp., Amherst, Mass. Although director of graphics development Alan Morse names instrumentation and process control as primary applications for DataViews, he says the company is also targeting business applications. However, unlike the other packages described, DataViews contains no device drivers to run printers, meaning that hard copy is not available.

Reacting to Lisa

Rather than being influenced by engineering-oriented features, business graphics packages are affected far more immediately by tightly integrated, easy-to-use systems such as Apple Computer Inc.'s Lisa, say some observers. "UNIX is on a collision course with Lisa," insists Jim Fleming, a consultant for the UNIX software and consulting company Unir Corp., Indianapolis. Lisa and UNIX-based microcomputer systems offer many of the same sophisticated, integrated features, he says, "but Lisa gives the impression that everything is integrated from day one, while UNIX says: 'let's get all the fundamental pieces working and integrate them at the last minute.'" Of the two approaches, Fleming credits the UNIX piecemeal route as more "flexible" and ultimately more useful to diverse users. However, he cautions that the immediate appeal of Lisa-like fully integrated products could give these systems such a large market share that "UNIX could become something hard to use" simply by being in the minority.

Yates Ventures' Marvit points out that the Lisa will be supporting two versions of UNIX—Microsoft's XENIX and Unisoft Systems' Uniplus. However, even under UNIX, the Lisa will use its window-based front end, including graphics features called Lisa Draw. "That's a great area for Lisa Draw," he stresses. "My understanding is that Microsoft and Unisoft are developing nothing of the business graphics sort."

Microsoft's Hewlett agrees that there are no immediate plans to develop graphics under XENIX. "We're trying to determine where multiuser operating systems are going to go," he reports. "I don't think multiuser operating systems are going to systems with a CPU driving each terminal," which would be necessary to support bit-mapped graphics. Instead, he predicts that graphics applications will predominate on single-user systems networked together. "For the future, Microsoft believes the single-user networked systems will be more dominant than multiuser systems for most companies," Hewlett states. And this view translates into concentrating graphics development on the company's single-user operating system, MS-DOS, rather than on XENIX.

However, Hewlett admits, "It's not clear where the market's going to go." Yates Ventures' Marvit agrees: "There's so much ferment going on now that the UNIX market will either blow its stack and explode or will fizzle." In the meantime, he says of UNIX business software packages, "Graphics is a great untapped market." □

**New Inmac Catalog
jam-packed
with computer/
wp supplies.**



Yours free!

Accurately called "the bible of the industry," it's loaded with great products and ideas for your personal computer, minicomputer or word-processing system. You'll enjoy:

■ **One-stop shopping.** Over 2,000 products to choose from.

■ **Easy ordering.** Mail, phone, or TWX. Verbal P.O.'s welcome.

■ **Fast delivery.** 24-hour shipment. Overnight emergency shipments available.

■ **45-day trial.** Full refund if not completely satisfied.

■ **Guaranteed quality.** All products field-tested to highest standards.

■ **Lower shipping costs.** 8 fully stocked distribution centers serving the U.S.

For fastest delivery of your free 100-page Inmac catalog, call 1(800) 547-5444. 1(800) 547-5447 in California.

inmac

Catalog Dept., 2465 Augustine Drive, Santa Clara, CA 95051
Please be sure to include your phone number.

NAME _____

PHONE _____

COMPANY _____

ADDRESS _____

CITY _____

STATE _____

ZIP _____

144127

THE MAINFRAME THAT CAN BE IN 1000 PLACES AT THE SAME TIME.

CADMUS 9000. The Distributed UNIX™ Mainframe.

This is the system with mainframe power in a single network node. The mainframe that gets stronger with each node added. And it gives any individual user transparent access to any file, program, device or peripheral on the network. In short, the Cadmus 9000 is the alternative to large minicomputers in computationally intense applications.

The operating system is pure UNIX with all the resources of UNIX System V and the Berkeley enhancements. And the system's C-Compiler is uniquely optimized for efficiency on our 32-bit virtual memory processor.

Networking through our unique UNISON™ software provides the full resources of the network from all computational nodes with network-wide virtual memory demand paging. And the interprocessor bus is connected by a 10 Mbit Ethernet™ or 50 Mbit fiber optic LAN.

In addition, comprehensive graphics, development and decision support tools facilitate graphics

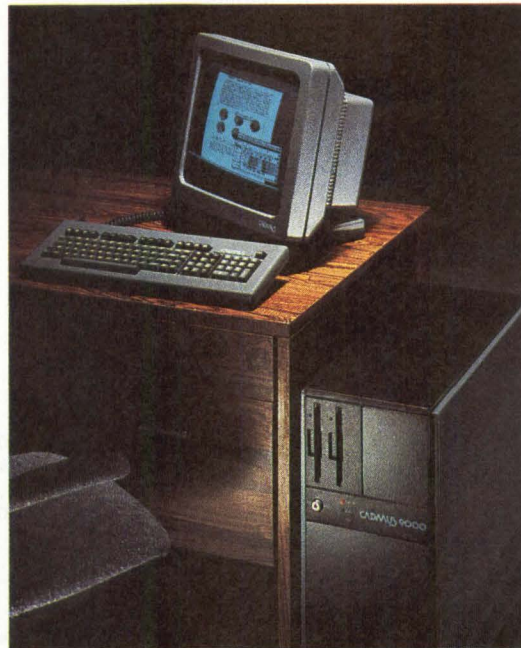

applications in a windowed, multiple process environment.

Finally, we support every Cadmus 9000 with Thunderbolt™ service that puts an engineer at your door anywhere in the country within 24 hours. Guaranteed.

To find out more about the most powerful distributed UNIX system in the world, contact Cadmus Computer Systems at 617-453-2899. Or mail the coupon.

CADMUS
COMPUTER SYSTEMS

Please send me product literature on the Cadmus 9000.

Cadmus Computer Systems, Inc.
600 Suffolk Street, Lowell, MA 01854

NAME _____

TITLE _____

COMPANY _____

ADDRESS _____

CITY _____ STATE _____ ZIP _____

Cadmus, Cadmus 9000 and UNISON are trademarks of Cadmus Computer Systems, Inc.
Thunderbolt is a service mark of Cadmus Computer Systems, Inc. UNIX is a trademark and service mark of Bell Laboratories.
Q-Bus is a trademark of Digital Equipment Corporation.

Ethernet is a trademark of Xerox Corporation. Cadmus products are available in Europe through PCS GmbH Munich, West Germany (089) 678040.

YOU NEED THESE FEATURES IN YOUR MULTIBUS SYSTEM!

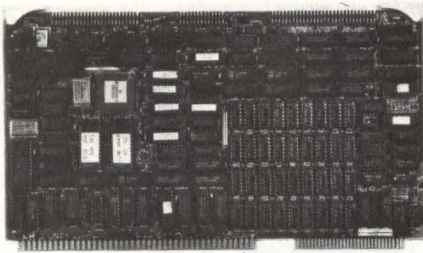

Features of the **SBC-3200** Single Board Computer

- 16/32 Bit Single Board Computer
- 12.5 MHz 68000 or 68010 Processor (16 MHz available 1st qtr. 1984)
- Dual Bus Architecture
- Plus+Bus Allows Future System Upgrades to 68020 Processor
- 256K Bytes or 1 Megabyte of On-Board High Speed RAM
- 2 RS-423 Asynchronous Ports
- Full 24 Bit Multibus* (IEEE 796) Addressing
- "Post Office" Communications FIFO Scheme
- 32K Bytes of EPROM
- Full UNIX** III Implementation

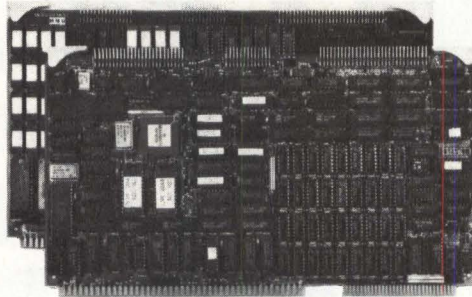

Features of the **MMU-3200** Memory Management Unit

- 16/32 Bit Memory Management Unit
- Centronics Parallel Port
- Real Time Battery Backed Up Clock
- Allows for Virtual Memory Implementations
- Fastest Memory Mapping Implementation Possible
- IEEE 796 Compatible

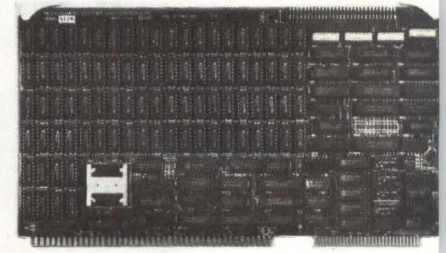

Features of the **HDMC-512** Dynamic RAM Memory

- World's Fastest 512K Bytes of Dynamic RAM Expandable to 2 Megabytes
- 4K Bytes of On-Board High Speed Cache Memory
- 20 nsec Minimum RAM Access Time
- Dual Bus Architecture Allows Fault Tolerant and Clustered Processing
- Error Detection/Correction
- Error Syndrom Bit Latching
- Self Initialization During Powerup
- IEEE 796 Compatible

*Multibus is a registered trademark of Intel
**UNIX is a registered trademark of Bell Labs

This is a unique new OEM concept from Measurement Systems & Controls, Inc. The Board Level Products can be used alone or as a complete 16 bit board set with Unix III operating system implemented. This allows OEMs to configure and package a system to their particular specifications. The Unix III Operating System is Industry Standard UniPlus featuring multi-user or single-user capability, "C" compiler, tree-structured file system, text preparation and formatting, more than 150 utilities ported as part of the standard system, source code control system (SCCS), program and documentation locator, terminal independent library, C-shell, and reads CP/M files.

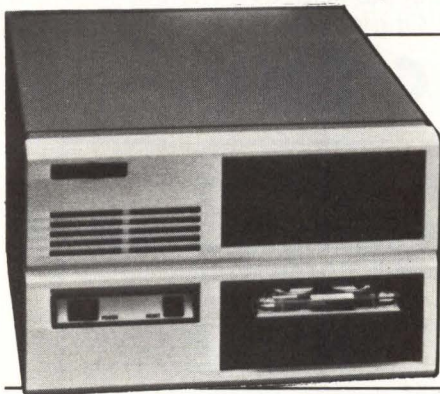

Voyager Multi-User Systems

The Voyager is a 16/32 bit multi-user system available in several configurations. Features of the Voyager are:

- 12.5 or 16 MHz 68000 or 68010 Processor
- 768K Bytes of High Speed Dynamic RAM with Expandable Cache Memory
- Dual Bus Architecture
- Ability to Upgrade to 68020 (32 Bit Data Path) Processor
- Full 24 Bit Multibus (IEEE 796) Addressing
- 10 Serial I/O Ports
- 50 or 70 Megabytes 5 1/4" Hard Disk
- 20 or 45 Megabyte Tape Back-Up Utilizing Quick II Interface
- 8" 1.26 Megabyte Floppy
- 9 Slot Multibus Motherboard
- Unix III Operating System Ability to Read CP/M Files
- Languages: RM/COBOL, SVS PASCAL, SVS BASIC-PLUS, ADA, SMC BASIC, SVS FORTRAN-77

Discounts for Dealers/Distributors and OEMs are available.
Contact Measurement Systems & Controls, Inc.

**Measurement
Systems &
Controls, Inc.**

1601 W. Orangewood Ave.
Orange, CA 92668
Tel: (714) 633-4460
TWX/TLX: 910-593-1350 SYSTEMGRP ORGE

FLOPPIE PPP COPPIER®

Series 4000 — ADC's system breakthrough that copies both sides of double-sided diskettes at once!

Just as efficiently and smoothly as your office copier, ADC's new Series 4000 Floppie Copier® automatically initializes and copies thousands of duplicate diskettes per hour—and doubles your throughput for double-sided diskettes!

Unlike other blackbox-type duplicators, Series 4000 gives you total single-master control of up to 16 slave stations—each simultaneously working on an entirely different diskette size and format. Since inventing the original Floppie Copier, ADC's developed over 300 different formats—and dozens of different protection schemes to prevent pirates from copying your Floppie Copier "copies."

ADC's own industry-standard-setting Robotic Disk Handler is built into each Series 4000 slave unit, automatically loading and unloading up to 100 diskettes with patented gentle fingers that eliminate the disk destruction of other systems. Floppie Copier assures you of perfect "copies" every time with true CRC control of both ID and data fields, instead of the indiscriminate duplication favored by some of our copy-cat imitators.

Compare and you'll come back to the original—especially now that the new Floppie Copier is even further ahead with simultaneous double-sided duplication—another ADC first!

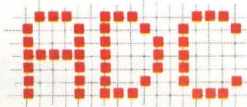
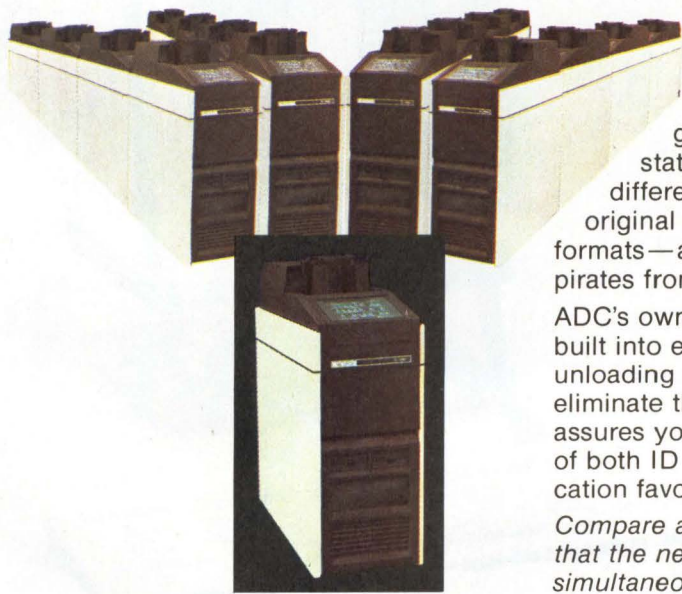

APPLIED DATA
COMMUNICATIONS

14272 Chambers Road, Tustin, CA 92680
(714) 731-9000

CIRCLE NO. 63 ON INQUIRY CARD

First and still foremost in media duplication and test technology



More Buzz For Your Buck

These smart terminals soar over current technology to bring your system to new levels of performance and economy. Naturally, they're both from the terminal/system architects at Beehive.

Users find the ATL-004 and ATL-008 very friendly, thanks to Beehive's unique multiple-use soft function keys. High-speed communication interfaces are another important part of the package. So is a swarm of additional productivity advantages and economic attributes. What's more, this powerful pair matches your price/performance needs precisely.

Fewer Bucks

Go with the ATL-004—Beehive's low-cost ANSI standard. Features include "user friendly" menu driven Terminal Configuration Manager (TCM) and VT-100 compatibility. This is one super forms data entry terminal!

More Buzz

The ATL-008 is ANSI X3.64 terminal with VT-100 compatibility as well. It incorporates a full screen Terminal Configuration Manager (TCM) and combines with remarkable editing features, large RAM/

ROM capacity for extended operations, and program download to provide maximum flexibility.

Get your system humming with either—or both—Beehive ATL models. Contact us now and discover how we'll deliver much more buzz for your buck.

For more details contact:
Beehive, 4910 Amelia Earhart Drive,
Salt Lake City, Utah 84125, Toll
Free Number: 1-800-453-9454.



BEEHIVE™



Sales Offices:

CALIFORNIA Costa Mesa 714/540-8404, Sunnyvale 408/738-1560 • FLORIDA Hollywood 305/920-2711 • ILLINOIS Arlington Heights 312/593-1565
MASSACHUSETTS Woburn 617/933-0202 • MISSOURI Independence 816/356-4402 • NEW JERSEY Colonia 201/381-9883 • NORTH CAROLINA Greensboro 919/854-2694
TEXAS Dallas 214/239-3330 • UTAH Salt Lake City 801/355-6000 • WASHINGTON, DC (VA) Falls Church 703/573-1261

CIRCLE NO. 64 ON INQUIRY CARD

FEATURE HIGHLIGHTS

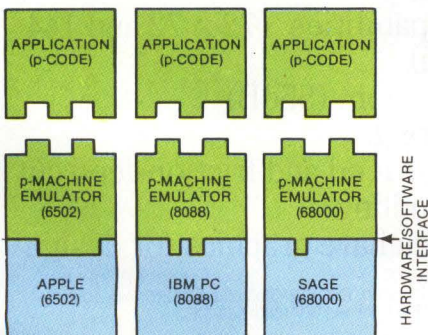
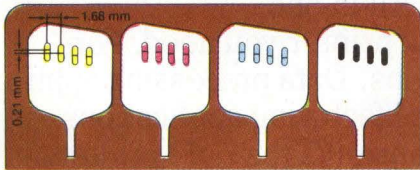
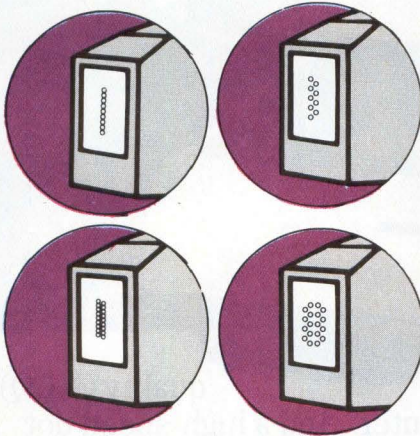
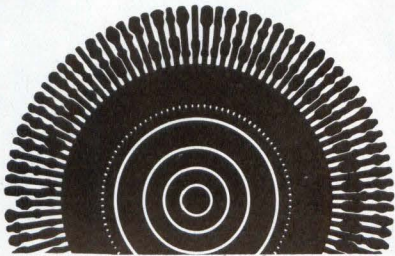
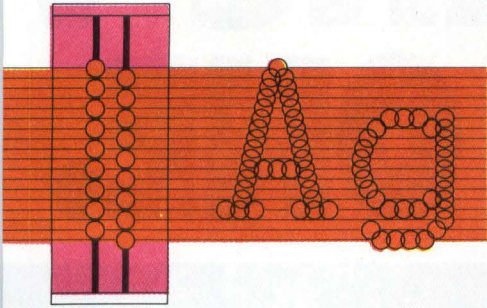

PRINTERS: Established trends in the correspondence-quality printer market are continuing: impact matrix units are coming down in price and going up in print quality, and daisy-wheel printers are inching up in throughput. Beginning on p. 152, MMS presents a product profile of **correspondence-quality printers**, which includes two manufacturers' tables containing 40 companies and more than 70 product offerings. . . **New-technology printers** such as near-letter-quality impact matrix, ink-jet and non-impact page printers are hurting daisy-wheel printer shipments. One reason is the rapid improvement in price and performance this new generation of printers is exhibiting. Non-impact printer noise levels are decreasing, page-printer prices are dropping, and the programmable resolutions of impact matrix printers are improving steadily. Check p. 197 for further details. . . New print-head designs and character formations are producing **letter-quality output from dot-matrix printers**. Two new dot-matrix printers from Dataproducts Corp, detailed beginning on p. 211, lend insight into the trade-offs required to achieve this output level. . . Offering a brighter printed image and higher reliability, **ink-jet printers** now entering the market provide serious competition to daisy-wheel and matrix devices for end users who want hard-copy, color-graphics output from their computers. An example of such a device is the Diablo Systems Inc. Series C printer, which uses a drop-on-demand design that minimizes clogging and air-bubble problems and furnishes dual-mode output, two standard ASCII character sets and bit-mapped, 120-dpi color-graphics images. Turn to p. 223 for more information.

SOFTWARE: Microcomputer operating systems (OSs) are becoming bigger and more capable, and they sport more features than earlier versions. In a profile starting on p. 233, MMS studies more than 40 manufacturers' offerings and finds that, although a standard micro OS doesn't exist yet and cross-porting is still a non-trivial task, it's now easier to move application programs from one OS to another.

INTRODUCING V BUY ONE.

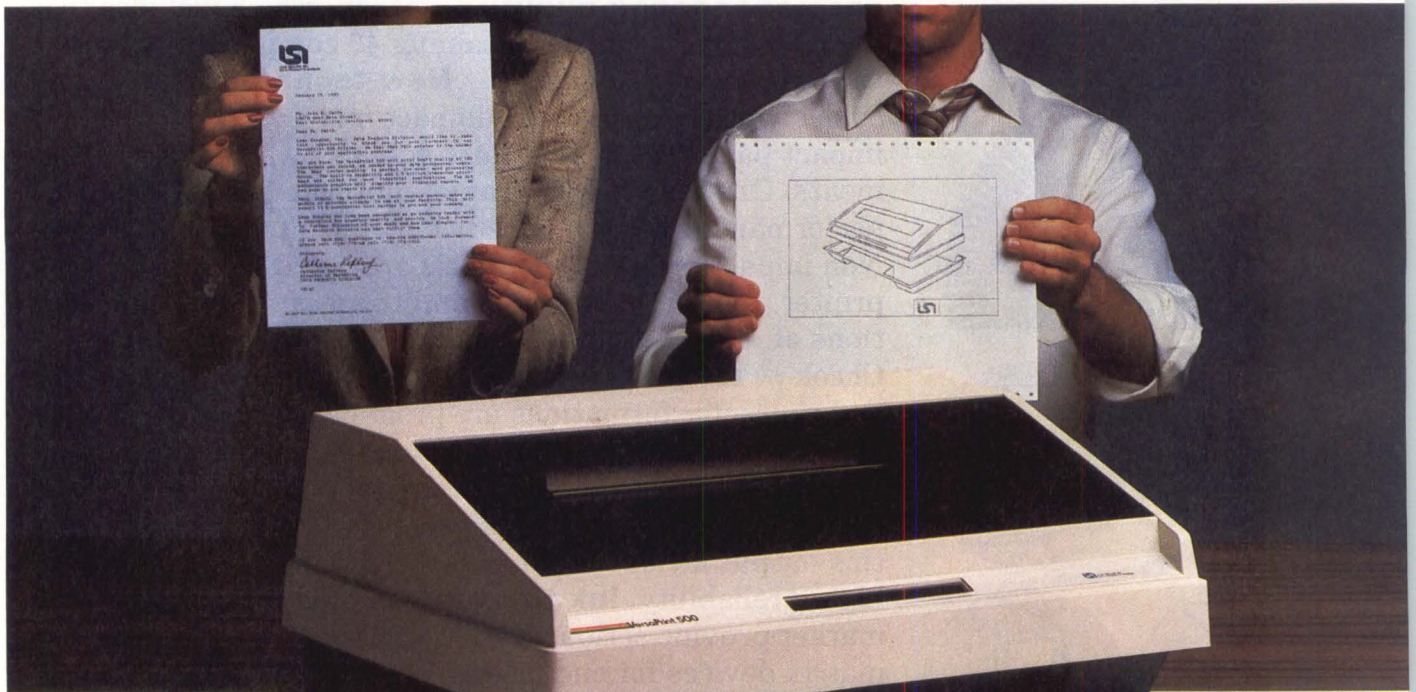

Introducing the one printer so versatile, it's like getting three. The VersaPrint 500™ Series printer is a full-color graphics printer. A near-letter-

quality (NLQ) printer. And a high-speed dot matrix printer. All in one.

It's the only printer you need. For office applications. Data processing applications. Or manufacturing applications.

That's because it's the only printer that offers all this:

- NLQ printing.
- Graphic capabilities. (72 x 72 and 144 x 144 dpi)
- Quiet operation. (55dB)
- Color printing.
- Both tractor feed and friction-feed cut sheet handling.

Now you can have graphics for design



Quieter than a typewriter.

Sales & Service: Boston (617) 456-8228 • Chicago (312) 279-7710 • Houston (713) 780-9440 • Los Angeles (714) 774-1010, Ext. 219 • Philadelphia (215) 245-4080
• San Francisco (415) 828-6941 • England (04867) 80666 • From the states of CT, DE, MA, MD, NJ, NY, RI, VA and WV (800) 523-5253.

ERSAPRINT 500.™

GET THREE.

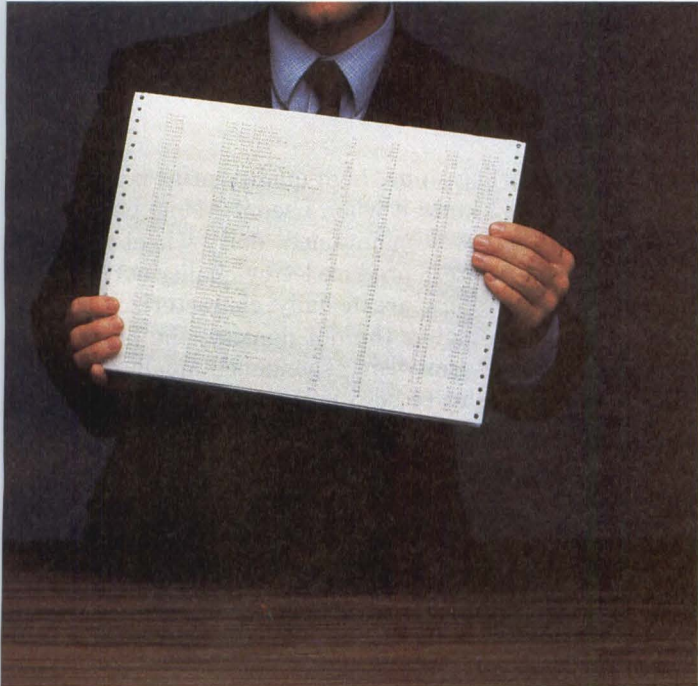

applications on the same high throughput printer that gives you 136 columns for spreadsheets and reports. And all this on an NLQ printer that's actually more quiet than a typewriter.

You can run it at 180, 90 or 45 cps, for draft, memo or NLQ quality. At any speed, with its 1.5 billion character printhead you know it's reliable.

VersaPrint 500™ is another innovative implementation of state-of-the-art technology from Lear Siegler, the world's favorite manufacturer of reliable, high quality terminals. It's backed by the

broadest network of full service centers anywhere, with walk-in Express Depot™ service, on-site service and extended warranty service in 3,000 cities nationwide.

Call 800-LEAR-DPD or 714-774-1010 for more information and the name of your nearest distributor.

Remember, there's only one printer that offers everything VersaPrint 500™ offers.

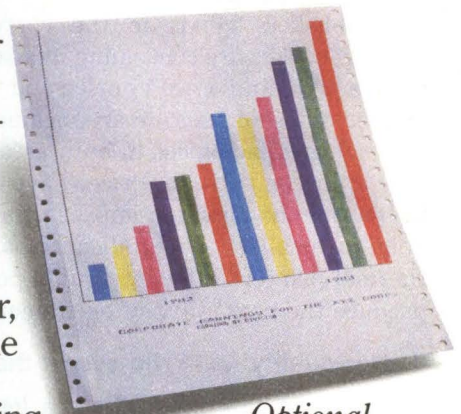

Optional full color printing.

The one printer versatile enough to replace three.

Please send me further information about the MM 1/84 VersaPrint 500™ series.

NAME _____

TITLE _____

COMPANY _____

ADDRESS _____

CITY _____ STATE _____

ZIP _____ PHONE _____

Mail to: Lear Siegler Data Products Division
714 North Brookhurst St., Anaheim, CA 92803
Or Call: 800-LEAR-DPD (800-532-7373)

LS® LEAR SIEGLER, INC.
DATA PRODUCTS DIVISION

EVERYBODY MAKES PRINTERS. ONLY WE MAKE LEAR SIEGLERS.

OEM Sales: • Chicago (312) 279-5250 • Houston (713) 780-2585 • Los Angeles (714) 774-1010, ext. 582 • New York (516) 549-6941 • San Francisco (415) 828-6941
• England (04867) 80666 VersaPrint 500™ and Express Depot™ are trademarks of Lear Siegler, Inc.

Product profile: correspondence-quality

Price decreases and performance improvements in the impact-printer market continue to shut out non-impact technologies

Established trends in the correspondence-quality printer market are continuing unabated: impact matrix units are coming down in price and up in print quality, and daisy-wheel printers are inching up in throughput. Technological advances in both areas have contributed to healthy competition. Prices have dropped so dramatically that the new non-impact printers have not been able to establish a significant market position. But thermal printers offer intriguing possibilities and may produce the next wave of excitement.

'Letter-quality' is in the eye of the beholder

How does one differentiate a letter-quality printer from a near-letter-quality (NLQ) printer? It's easy to argue that each individual can readily decide for

himself: "Like pornography, high-quality print is difficult to define, but I know it when I see it." Most people would agree that well-maintained daisy-wheel and thimble-element printers produce letter-quality output. Impact matrix printers are usually characterized as NLQ printers: the higher the dot density, the higher the quality. The term "correspondence quality" is generally used to refer to both letter-quality and NLQ printers.

Tests can measure the relative legibility of various character sets at various dot densities. Tests could be conducted by simply asking participants to sample print in various fonts and dot densities and then count the number of correct and incorrect answers, paying particular attention to symbol confusion (for example, mistaking an "s" for an "e," or a "g" for a "q"). The percentage of correct answers for each font averaged over the number of participants is a reasonable measure of legibility, which is, in turn, an effective indicator of print quality.

Alternatively, a person could use common-sense

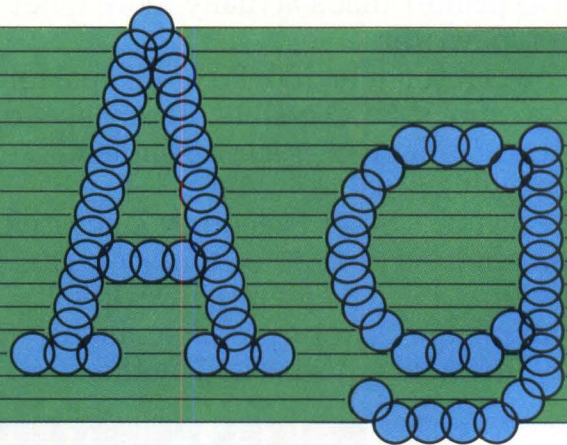
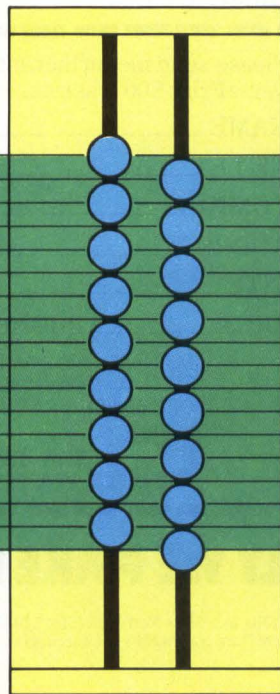

serial printers

MALCOLM STIEFEL, Contributing Editor

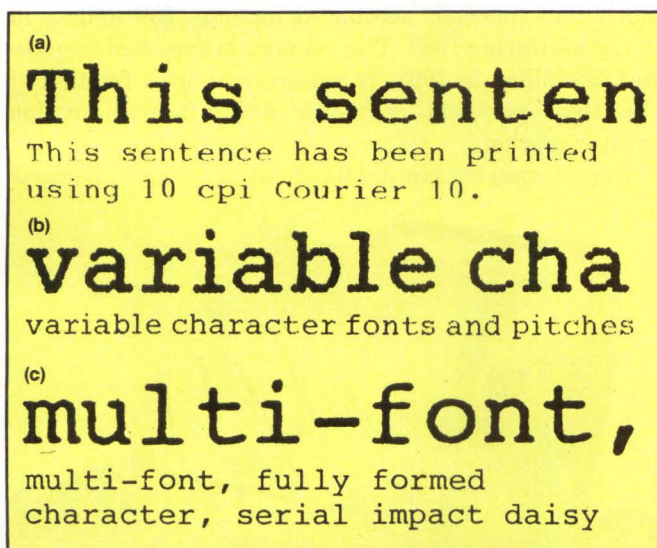

Fig. 1. Courier print samples from three printers. The Fujitsu DPL24 dot-matrix printer (a) uses a 24-wire single-pass print head and runs at 100 cps with a character density of 10 cpi and a 24-by-24 dot matrix. The Philips GP300 dot-matrix printer (b) runs at 80 cps and has an 18-by-25 dot matrix in Courier font. Primage's Image 1 daisy-wheel printer (c) operates at 45 cps with 10 cpi.

distinctions to measure print quality. For example,

- Strokes that should be solid should not appear broken. A reader could look at the letter "e" or "s" in a printout produced by an old 5-by-7 dot-matrix printer to appreciate this point.

- The letters "g," "y," "q," "p" and "j" should appear with full descenders.

- Underlining a word should not render it illegible.

- Adjacent characters should not touch, except in script (cursive writing) fonts.

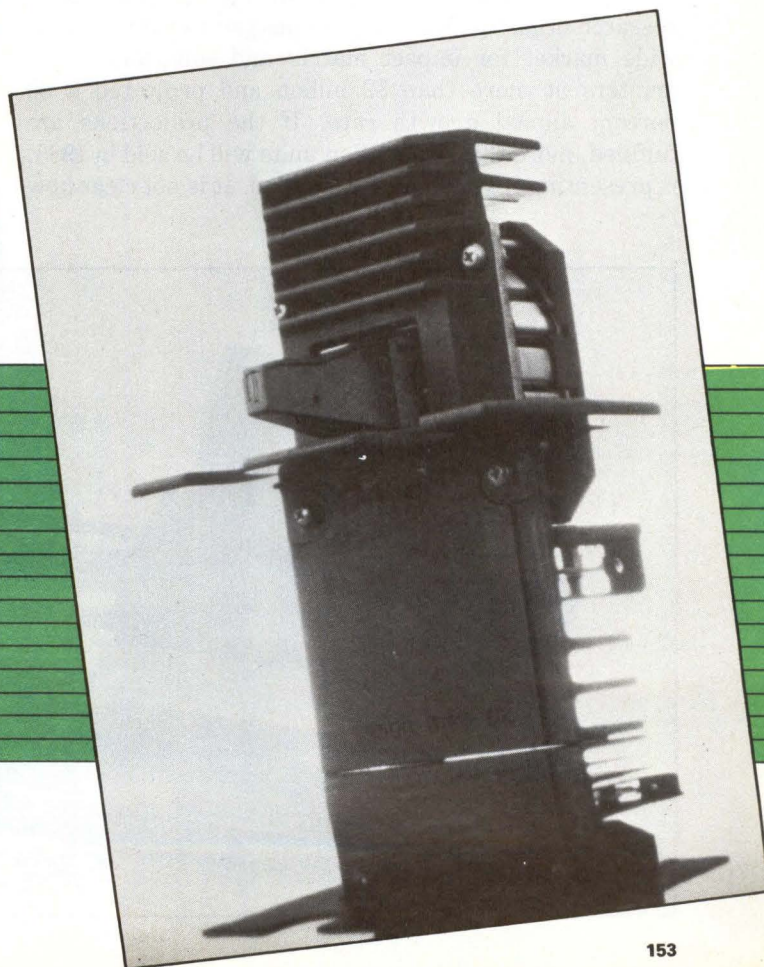

The Anadex Inc. WP-6000 print head employs two offset columns of nine print needles each. As the print head moves horizontally across the paper, needles corresponding to the desired character are actuated. As many as 18 dots can be printed in a single vertical line.

Matrixes smaller than 11 dots horizontally by 9 dots vertically cannot meet these minimum criteria for print quality. For this profile, then, NLQ printers are defined as those offering at least 11-by-9 dot-matrix output. Ideally, dot-matrix characters should be indistinguishable from those printed with daisy-wheel printers or typewriters. Strong evidence exists that this goal is already within reach (Fig. 1).

This profile includes all solid-font serial printers (daisy-wheel and thimble-element printers) and all NLQ (better than 11-by-9 dot matrixes) impact matrix printers. All the printers surveyed sell for less than \$5,000, providing a profile of the office-automation printer market. (Line printers, which generally sell for more than \$5,000, were not surveyed, nor were non-impact printers such as thermal, electrostatic and ink-jet units, which cannot yet produce correspondence quality.)

Market remains stable

To meet the soaring demand in office-automation applications, the market for correspondence-quality printers is expanding. Datek Inc., a Newton, Mass., research organization, recently pegged the 1982 worldwide market for impact matrix and solid-font serial printers at more than \$2 billion and projected a 30 percent annual growth rate. If the projections are fulfilled, more than 1.5 million units will be sold in 1985, representing revenues of \$4.5 billion. It is not clear how

the market will divide between the dot-matrix and the daisy-wheel units, but dot-matrix printers are coming on strong as they overcome the legibility problems that, until recently, have hampered their acceptance in office applications.

Industry analysts do not expect non-impact printers

Matrixes smaller than 11 by 9 dots cannot meet the minimum criteria for near-letter-quality printing.

to gain a significant market share over the next decade. According to a recent report by International Resource Development, a Norwalk, Conn., research company, the non-impact technologies, such as ink jet, electrostatic and thermal, accounted for only \$39 million in revenues during 1983. This number is expected to grow to \$295 billion in 1992, representing only a fraction of the total personal computer and office-automation printer market.

Impact matrix printers dominate the market because

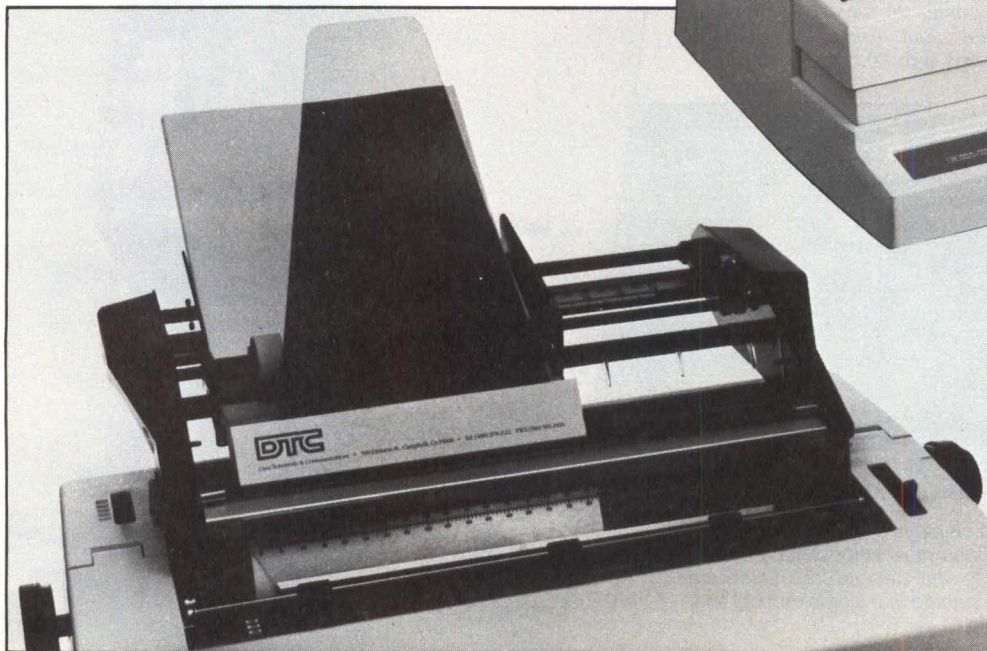
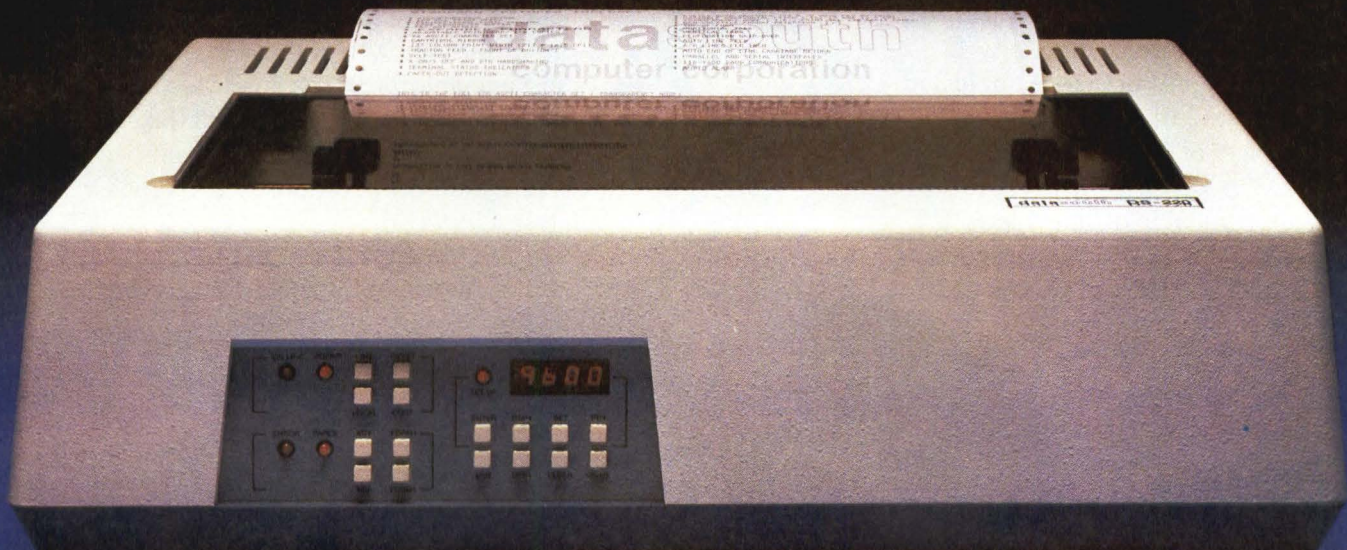

Fig. 2.
Cut-sheet feeders target the office-automation market, specifically, word-processing applications. Data Terminals & Communications' EZ Mate unit (left) attaches to Brother printers. The unit holds 150 sheets of paper as large as 14 by 14 inches. Hewlett-Packard provides an optional dual-sheet feeder (right) for its model 2601A daisy-wheel printer, which prints at 40 cps and accepts letter- or legal-size paper. The feeder facilitates concurrent handling of letters and envelopes.

HIGH PERFORMANCE

NOW AVAILABLE IN A THREE-SPEED



SPEED

Class

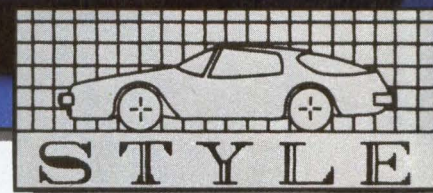

INTRODUCING THE NEW DS 220 MULTI-MODE MATRIX PRINTER

First there was the Datasouth DS180. The original high-performance printer. The printer that raised the standards of on-the-job performance to new heights. A tough act to follow.

And now, following in the same tradition, is the new Datasouth DS220. State-of-the-art performance, taken to higher levels. In a new 3-speed multimode form. Ready to run data, near letter quality and graphics output—in a single printer.

At data speed, the Datasouth DS220 leaves competitors in the dust. By using high speed tabbing to zip over blank spaces and true logic seeking to print the next available

character, the Datasouth DS220 charges through printed copy at speeds rivaling more expensive line printers.

At 40 CPS NLQ speed, the Datasouth DS220 creates near letter quality output with the kind of class that might make you wonder if it was produced by a daisy wheel printer. With its fine tuned 18 x 48 dot matrix, multiple fonts are produced with the precise clarity required for word processing applications.

And for graphics, the Datasouth DS220 adds high performance style to popular microcomputer applications programs through high resolution dot

addressable output. Sharp new details emerge from business charts and graphs, and engineering drawings.

And those are just its printing capabilities. Its fully instrumented dashboard allows push button programming of up to fifty features for forms control, communications and print style selection.

Best of all, the Datasouth DS220 costs much less than you might expect for a high performance three speed. Go to your nearest showroom and run a Datasouth DS220 through the gears. See how little it costs to own three high performance printers in one high performance package.

datasouth

H I G H P E R F O R M A N C E M A T R I X P R I N T E R S

AVAILABLE NATIONWIDE
THROUGH OUR NETWORK OF
SALES AND SERVICE DISTRIBUTORS

CALL TOLL FREE:
1-800-224-4528

Datasouth Computer Corporation
Box 240947 • Charlotte, NC 28224
704/523-8500 • Telex 6843018 DASOU UW

CIRCLE NO. 66 ON INQUIRY CARD

The terminal that's a perfect fit anywhere in your company.

Qume's new QVT 108™ terminal has the power and flexibility to handle everything from routine order entry to the most demanding management-level applications. It outperforms competitive terminals, with sophisticated features like 22 user-programmable functions, 12 editing functions, a user-defeatable 25th status line, a menu set-up mode, and two full pages of screen memory.

The QVT 108 is easy to use, with complete emulation of Televideo's 925*, 920*, or 912* terminals at the stroke of a key. And your staff will love its superior ergonomics. The QVT 108 has a detached,

CIRCLE NO. 67 ON INQUIRY CARD

low-profile keyboard, height-adjustable to different handrest positions. A tilt-swivel screen in green or amber, with an optional 14-inch display for even better readability. Plus many other features to keep people comfortable and productive.

Best of all, the QVT 108 is priced to fit just as comfortably within your budget. Talk to your Qume sales office about the terminal that's ideal for everyone in your company. Or write Qume Corporation, 2350 Qume Drive, San Jose, CA 95131.

Qume QVT terminals.
Your best investment in productivity.

Qume®
A Subsidiary of ITT

QUME CORPORATION
HEADQUARTERS
2350 Qume Drive, San Jose, CA 95131

CALIFORNIA
San Jose (408) 942-4111
Culver City (213) 410-1458
Santa Ana (714) 957-4040

COLORADO
Aurora (303) 752-3000

ILLINOIS
Hoffman Estates (312) 490-9320

OHIO
Dayton (513) 439-0469

TEXAS
Irving (214) 659-0745

NEW JERSEY
Edison (201) 225-5005

MASSACHUSETTS
Bedford (617) 275-3200

GEORGIA
Decatur (404) 284-8500

GERMANY
Düsseldorf
PH 211743016

ENGLAND
Reading, Berkshire
PH: 734-584-646

FRANCE
Boulogne
PH: (1) 6082334

CANADA
Quebec
PH: (514) 695-3837



QVT 108
This chapter provides a general introduction of how the terminal operates. A description of the hardware and software as well as general operating procedures are also provided. Detailed operating information is available in the computer and its application software.

OPERATING PROCEDURE FOR THE QVT 108

The QVT 108 is a video terminal which uses a keyboard and display to communicate with a computer. The terminal can work connecting with the computer while working. Figure 1-1 shows a general outline of the terminal structure. Operations for each part are explained during the first quarter. This and the rest of the manual is written in English currency exchange rates. The French text is...

*Televideo 925, 920, and 912 are registered trademarks of Televideo Corporation.

they provide a mix of features, coupled with proven designs and high reliability, that no other type of printer can match. Non-impact printers have not overcome serious drawbacks that have detracted from their forte: quiet operation. Thermal and electrostatic non-impact printers require special paper that is relatively costly and available from only a few suppliers. A thermal-transfer technique that works with plain paper has yet to surface. Ink-jet printers have been slow to overcome reliability problems—the ink tends to clog print-head nozzles.

A typical dot-matrix printer comes with two or three levels of print density. High density (at least a 12-by-18 dot matrix) produces NLQ output. Low-density outputs are typically 7 by 9 or 9 by 9 and are used for draft-quality output. The barely legible 5-by-7 fonts have virtually disappeared from the market. In most cases, a dot-matrix printer produces high-density characters at substantially lower speeds. The still-popular two-pass technique, in which the print head makes two passes over each line, with the head slightly offset vertically on the second pass, was used in the earliest NLQ printers, which first surfaced in 1980. The technique gives a nine-wire print head the print quality of an 18-wire head. The difference is speed. An 18-wire head can accomplish in a single pass what a nine-wire head can in two passes. The nine-wire unit's throughput is less than half that of the 18-wire unit because the

DO-IT-YOURSELF CHARACTER SETS

Daisy-wheel printers typically are accompanied by a drawerful of interchangeable wheels that provide fonts in several foreign languages and for special purposes such as optical character recognition. To counter, many dot-matrix printer vendors offer PROM-based fonts that can be changed by plugging new PROMs into the printer circuit boards, the ability to down-load character sets from a host, or both. Printek Inc. goes a little further with its 900 series of dot-matrix printers: the operator's manual includes instructions for designing customized character sets and for loading the new characters from the host computer to the printer.

The characters are defined in a cell that is 12 dots wide by 9 dots high. Each row is divided into three "nibbles" of 4 bits each, and the bit pattern in each nibble is specified by the 4 least-significant bits of an ASCII character. The following ASCII characters are used:

Character	Hex value	Value of least significant bits
@	40	0000
A	41	0001
B	42	0010
D	44	0100
E	45	0101
H	48	1000
I	49	1001
J	4A	1010

Zeros represent white space, while ones represent positions in which dots are printed. Thus, "@" is used to define an empty nibble in which no dots are printed. For example, in a design for lowercase "d," the corre-

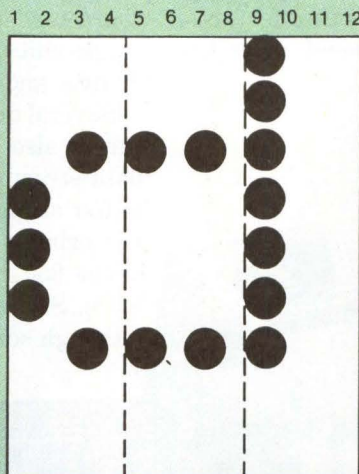

sponding pattern of 27 ASCII characters is @@H @@H BJH H@H H@H H@H BJH @@@ @@@.

In the Printek 900 series, downloading of the character from the host starts with transmission of an Escape character sequence to place the printer in the character-definition mode. This is followed by the name of the ASCII character to be redefined (in this case, "d"), followed by the 27-character string and another Escape sequence to terminate the character-definition mode.

The design of the character "d" illustrates several of the conventions and restrictions used in designing dot-matrix characters:

- The two lowest rows, reserved

for underscores and characters with descenders, are kept blank.

- The right-most column is always kept blank to leave space between successive printed characters, and, for characters such as "d," the three right-most columns are kept blank for better legibility.

- A character should be composed of 14 to 18 dots, "to ensure long print-head life," according to the Printek manual.

- The bit patterns do not permit two adjacent 1-bits in a row, although two adjacent 1-bits can be entered in column form; moreover, character combinations within a row—such as AH—that would produce two adjacent 1-bits (0001 followed by 1000) are prohibited.

The restriction against successive 1-bits in a row stems from the basic design of the print head: it moves as it prints. Therefore, when a wire strikes the ribbon to make a dot, the wire must be given time to retract to its "home" position. Meanwhile, the print head moves through the next column of dots. Consequently, the print head cannot print two successive dots in a row.

To achieve high-density printing, some print heads employ two columns of wire in staggered or parallel rows. One set handles the odd-numbered columns, and the other handles the even-numbered columns. Alternatively, some printers use single-column print heads but make two or three passes over each character in a line with a vertical offset of one-half- or one-third-dot diameter to produce near-letter-quality output.

PRINTERS

nine-wire unit is designed to print only from left to right in NLQ mode, while the 18-wire unit prints from right to left and from left to right.

Character quality of the two units also differs. With the nine-wire print head, the paper must remain perfectly still during passes, and the horizontal print head position at the start of the second pass must be within 0.005 inches of its first-pass starting position. Otherwise, the dots do not register properly, and a shadow appears.

This does not suggest, however, that all the advantages are on the side of the denser print head. Because the wires in 18- and 24-wire print heads are thin (0.005 inches in some 24-wire heads), the force of impact is concentrated in a smaller area. Consequently, high-wire-count print heads have a shorter life expectancy.

Dot-matrix printers boast a cluster of other features. Following the lead of ink-jet printer vendors, a few

companies, such as Envision, JDL and Lear Siegler Inc., offer color impact matrix units using multicolor ribbons. Color printing is an attention-getter, but not many users have widespread need for color output. Large companies might keep one or two color units to handle special requirements, but small companies generally shy away from color printers because of their cost. Analysts expect that, like color copiers, color-printer manufacturers will have difficulty entering the market.

Some dot-matrix units, such as Printek Inc.'s 900 series, accept user-defined character sets from the host computer. These complement the standard fonts defined in PROM firmware within the printer (see "Do-it-yourself character sets," Page 157).

In response to office needs, vendors of daisy-wheel and matrix printers are beginning to offer cut-sheet feeders (Fig. 2) as well as the traditional tractor feed for fan-fold paper and friction feed for continuous-roll paper. Further evidence that printer designers are becoming more sensitive to office environments is the introduction of Facit/Dataroyal's two low-noise daisy-wheel printers. The model 4565 operates at 65 dBa, 40 characters per second (cps) and sells for \$1,895 in single-unit quantities; model 4560 operates at less than 60 dBa and 22 cps and sells for \$1,095.

Several dot-matrix and daisy-wheel printer manufacturers also offer printer buffers. In these units, the data stream from the host computer is routed to the buffer at high speed (9,600 or 19,200 baud) and sent to the printer at lower speed (35 cps—the equivalent of about 350 baud), thereby freeing the host for other work. Size of a typical print buffer is 2,000 characters, although some, such as Data Terminals & Communica-

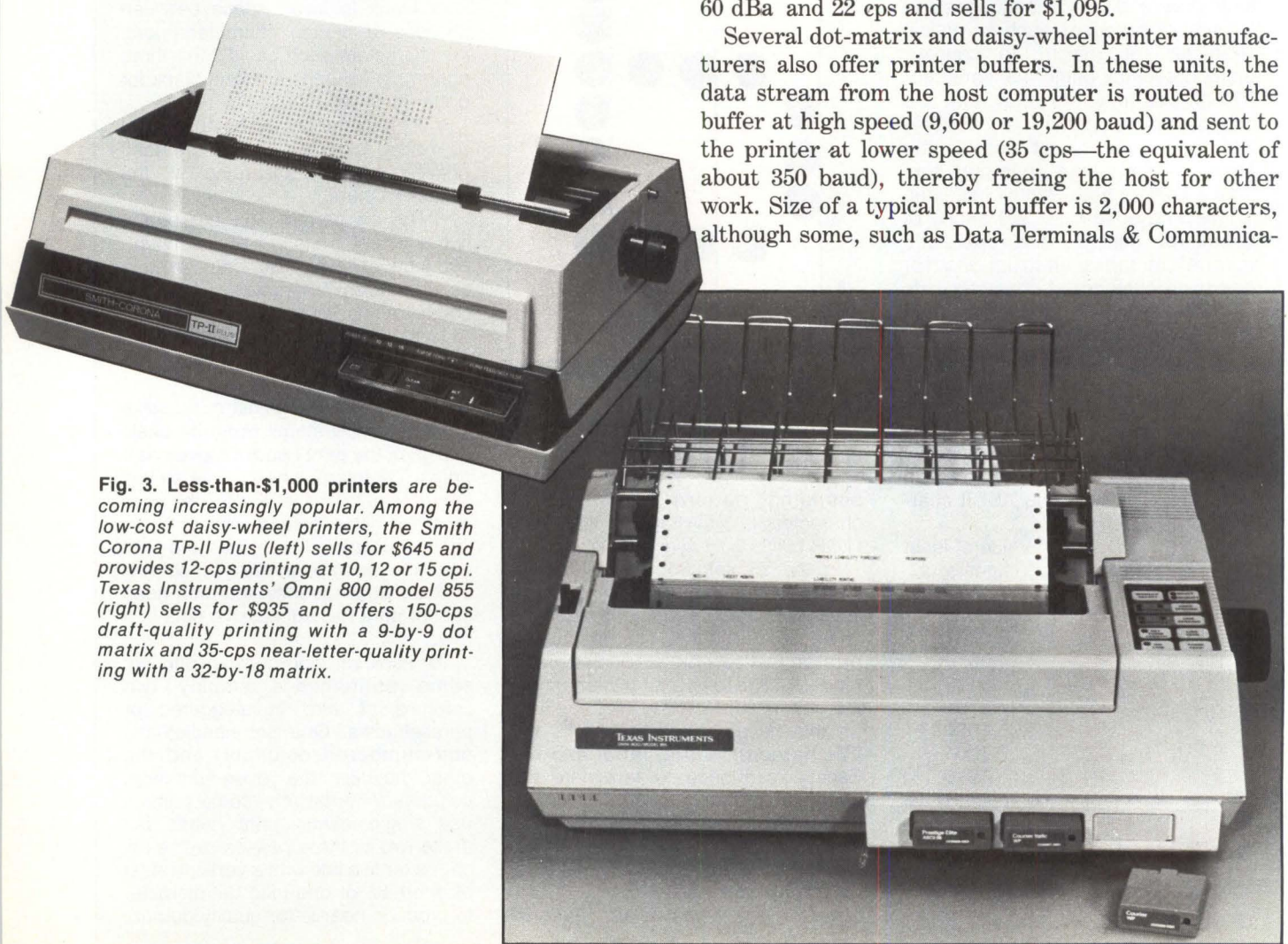

Fig. 3. Less-than-\$1,000 printers are becoming increasingly popular. Among the low-cost daisy-wheel printers, the Smith Corona TP-II Plus (left) sells for \$645 and provides 12-cps printing at 10, 12 or 15 cpi. Texas Instruments' Omni 800 model 855 (right) sells for \$935 and offers 150-cps draft-quality printing with a 9-by-9 dot matrix and 35-cps near-letter-quality printing with a 32-by-18 matrix.

PRINT SPEED VS. PRICE

Graph (A) shows a plot of print speed vs. price for the dot-matrix printers and the daisy-wheel/thimble printers found in the product table. When several speeds are listed for a dot-matrix printer model, the lowest speed has been plotted, reflecting the highest-quality print for the unit.

Along with the individual data points, the figure shows plots of two straight lines that provide least-squares fits to the respective sets of data points. For dot-matrix printers, the equation of the line is

$Speed = 72.6 + (0.0043) \times (Price)$
where speed is expressed in characters per second and price is given in dollars. The co-efficient 0.0043 is the slope of the line, and 72.6 is the print-speed value at the lowest end of the least-squares line. The equation for the least-squares line for the daisy-wheel printers is

$$Speed = 19.6 + (0.0098) \times (Price).$$

The plot for dot-matrix printers suggests no obvious relationship between price and speed. Several printers selling for more than \$2,000 are slower than units selling for less than \$2,000. This randomness is reflected in the nearly horizontal slope of the least-squares fit line, which confirms the notion that printer speed and price are somewhat uncorrelated. Consequently, buyers must look at other characteristics that account for price differences.

The situation is somewhat different for daisy-wheel and thimble printers. In this case, throughput and cost are very much correlated, as suggested in the pattern of the data points and the steeper slope of the least-squares line. The figure also indicates that unit

throughput at the low end—those selling for less than \$1,000—is very low. Every offering with a single-quantity price of less than \$1,100 runs at 25 characters per second (cps) or slower, and no unit selling for less than \$1,000 manages more than 12 cps. In contrast, the low-end of the speed range for dot-matrix units is 35 cps.

At the other end of the spectrum, the two daisy-wheel units in the product table—Telex Computer Products Inc.'s 286F and Fujitsu America Inc.'s SP830—run at 80 cps, but both are in the \$3,000 to \$5,000 range. Among the dot-matrix printers, the fastest one listed, Micro Peripherals Inc.'s Print-Mate 150, runs at 150 cps (albeit with a rather modest 11-by-9 dot matrix) but sells for only \$995 in single-unit quantities. Another unit with high throughput, Dataproducts Corp.'s M100, at 140 cps, sells for \$3,000.

The lack of correlation between the speed of near-letter-quality (NLQ) printers and the price of dot-matrix printers raises the question: what other factor determines the price of these units? The answer is draft-quality printing speed. Graph (B) supports this conclusion. In (B), the least-squares lines are again shown, this time embedded within a unit square; that is, all speed and price data have been normalized and scaled to cover the range 0 to 1, and the least-squares lines have been recalculated.

The normalization and scaling process for the dot-matrix printer NLQ speed data was as follows: As (A) indicates, the range of NLQ speeds for dot-matrix printers is 35 to 150 cps, a 115-cps range. Then, for each data point, the normalized value is given by

$$Speed:NLQ:norm = [(Speed - 35) / 115]$$

A similar process was performed for price and daisy-wheel printer speed data. The least-squares-lines were then computed. For NLQ dot-matrix printers,

$$Speed:NLQ:norm = 0.35 + (0.14) \times (Price:NLQ:norm)$$

For daisy-wheel printers,

$$Speed:DW:norm = 0.18 + (0.72) \times (Price:DW:norm)$$

In addition, for comparison purposes, another line was calculated for dot-matrix printers, this time using draft-quality printing speed in place of NLQ speed. The results were:

$$Speed:Draft:norm = 0.11 + (0.72) \times (Price:Draft:norm)$$

These three lines are plotted as solid lines in (B), along with a dotted line that joins (0,0) and (1,1). The dotted line defines the least-squares fit for any completely linear relationship between dependent and independent variables. Thus, the closer a least-squares line comes to the dotted line, the more linear the relationship it represents. Conversely, more horizontal lines reflect more random relationships between the underlying variables. The message of (B) seems clear: draft-quality print speed determines the price of dot-matrix printers, even if they have the resolution, logic and print heads that produce NLQ output at lower speeds.

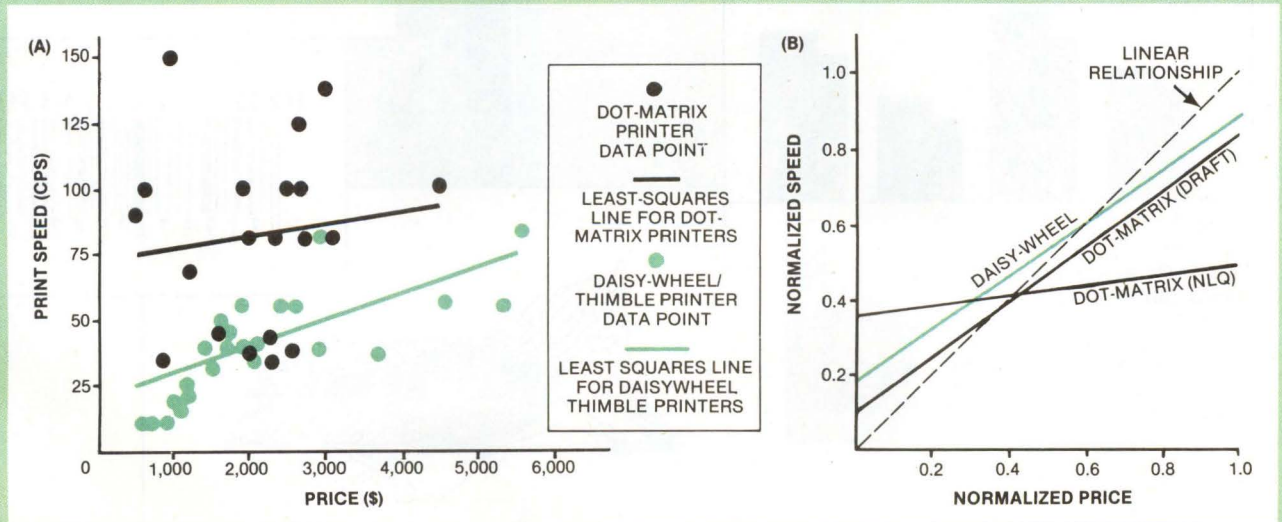

tions' DTC Stylewriter, hold as many as 64,000 characters. A host can fully load a 64,000-character buffer at 19,200 baud in about 30 seconds, while the buffer takes 30 minutes to empty to a 35-cps printer.

Dot-matrix vs. daisy-wheel printers

Both dot-matrix and daisy-wheel printers sell in the \$500 to \$5,000 range. Dot-matrix units generally run faster in NLQ or draft mode (600 cps in the case of Florida Data Corp.'s OSP 120/130) than the daisy-wheels (as fast as 80 cps for Fujitsu America Inc.'s SP830 and Telex Computer Product Inc.'s 286F). In the less-than-\$1,000 market, dot-matrix printers are much faster (Fig. 3). The higher-priced daisy-wheel units are faster than the lower-priced ones, and the higher-priced dot-matrix units generally have higher draft-

quality speeds. The relationship between NLQ speed and price is less well-defined (see "Print speed vs. price," Page 159).

Most dot-matrix printers provide bit-addressable graphics, often with resolutions as high as 180 by 180 dots per inch, to enable such functions as the printing of graphics, bar codes and oversized characters (Fig. 4). Large characters can be used to produce paper originals from which overhead transparencies can be made. Printers such as the Envision 430 permit direct printing on transparencies to eliminate the intermediate paper-to-transparency process.

Daisy-wheel printers counter matrix units' dot-addressability ability with graphics symbols, or printed characters that can be combined to produce simple graphs and charts. As awkward as it is to use graphics in dot-matrix printers (unless a user employs graphics-manipulation software), it is more difficult to exploit the partial graphics symbols in the daisy wheels because very few graphics packages are available. However, some of the symbols are handy in limited ways. For example, large dots can be used as "bullets" on view graphs.

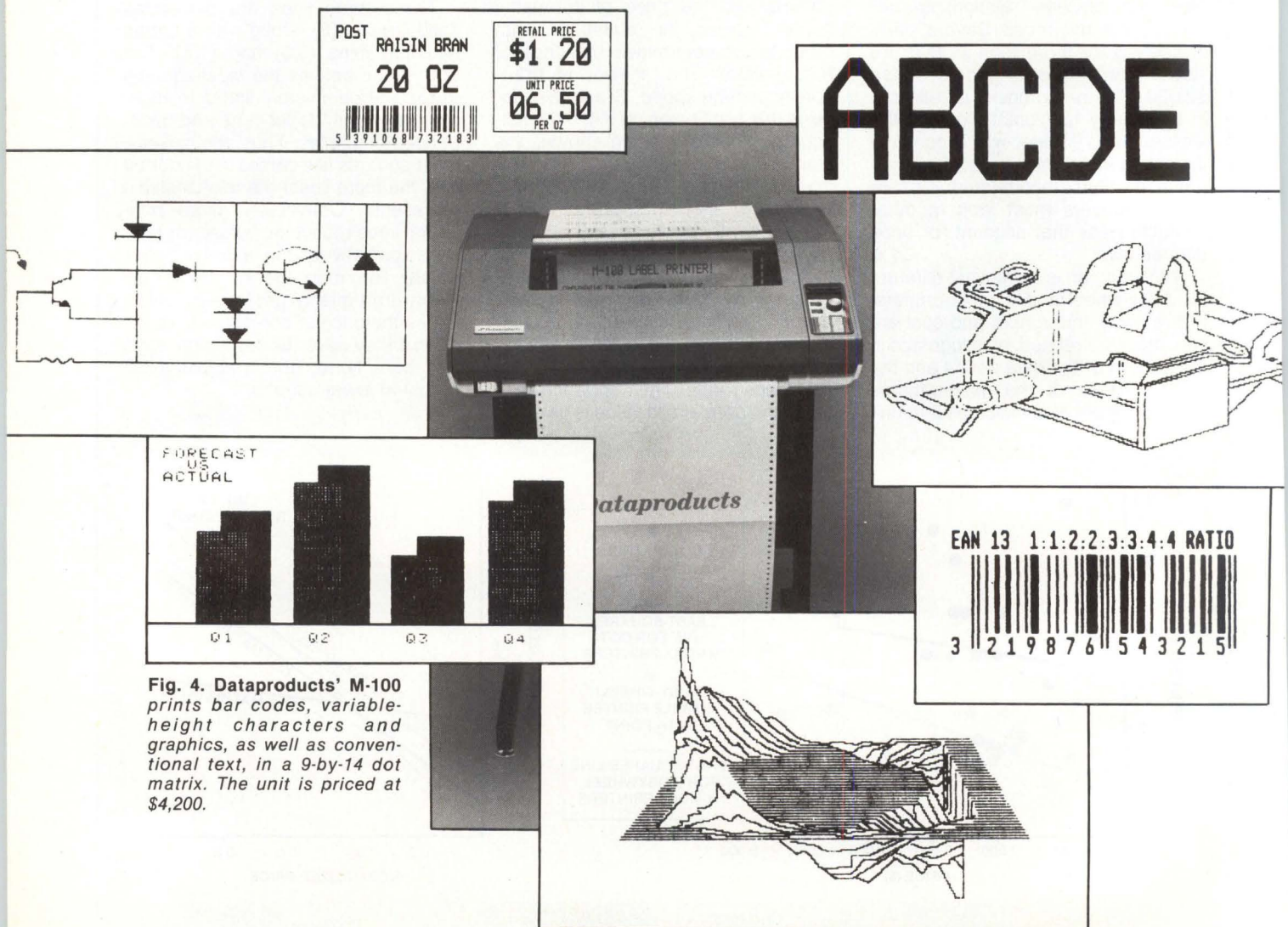
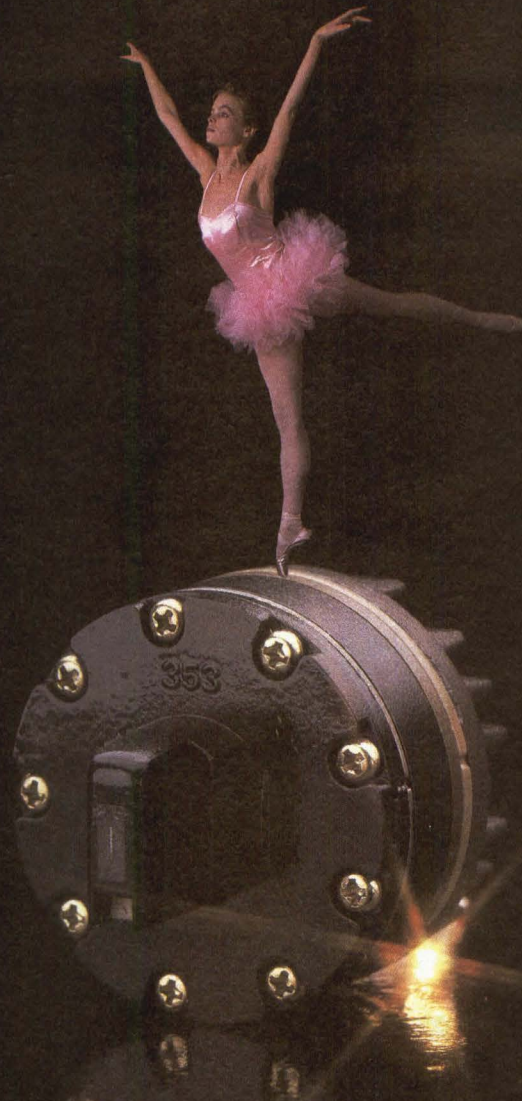

Fig. 4. Dataproducts' M-100 prints bar codes, variable-height characters and graphics, as well as conventional text, in a 9-by-14 dot matrix. The unit is priced at \$4,200.



THE PRINT HEAD THAT'S BUILT LIKE A SHERMAN TANK.

PERFORMS LIKE A BALLERINA.

Choose a printer that won't crack under pressure. Our secret weapon? Okidata's stored-energy, non-ballistic print head. It has one moving part instead of three which means a smaller heat sink, less maintenance, and ultimately, an extremely low cost of ownership. For added durability, its armature is laser welded, not soldered. And its tough tungsten pins crank out 200,000,000 characters with ruthless precision.

But, a virtually invincible print head isn't the only reason our nationwide network of service people get so few calls. Okidata printers have exceptional MTBF and MTTR ratings; up to 4000 hours and as little as fifteen minutes, respectively. And no duty

cycle limitations.

Yet, all this rugged reliability is delivered with the speed and grace of a prima ballerina. Inside their stamped steel bodies, our fastest models perform at up to 350 cps bi-directionally, with short line seeking logic and fast horizontal and vertical slew. As for style, our correspondence quality truly rivals a daisy-wheel's at speeds up to 85 cps. All models boast superior talents for their modest prices. Most, for instance, accept downline loadable character sets.

Plus, Okidata's compatibility is unlimited, and our technical staff can make alterations to fit your special OEM needs. Our innovations get

standing ovations. For our latest product specification sheets, call 1-800-OKIDATA. In New Jersey, (609) 235-2600. Okidata, Mt. Laurel, NJ 08054.



OKIDATA

A subsidiary of Oki Electric Industry Company Ltd.

Thermal printers hold future promise

The availability of high-quality printers at reasonable prices does not alone guarantee that those devices will find a home in every automated office. Users also want high-speed, quiet printers that will print in a wide variety of fonts on plain paper. Users will also take graphics capability if they can get it, but it is still a frill in most cases.

Neither the daisy-wheel nor the dot-matrix printer completely fills the bill for all needs. Neither is especially quiet, and both are too slow for some applications. Daisy-wheel print quality is acceptable, but dot-matrix print quality still leaves something to be desired. One way to illustrate this is to compare a dot-matrix printer with a phototypesetter, which produces graphic-arts-quality output. The highest resolution for a dot-matrix printer is 180 by 180 dots per inch (dpi), while even a low-end phototypesetter achieves a 700-by-700-dpi resolution.

Opportunities exist for competing technologies to

meet all user requirements. Daisy-wheel and thimble printers fall short because their speed will probably not improve much and they will always be noisy. It is likewise questionable whether the print quality of impact dot-matrix technology can compare favorably with that of daisy-wheels.

The solution may come from thermal-transfer printers, which offer intriguing possibilities: silent operation coupled with acceptable cost and throughput, plain-paper printing, bit-addressable graphics and print quality that could rival that of phototypesetters if a laser instead of a wire matrix were used as the heat source. Such a printer could go beyond mere proportional spacing to make more effective use of paper by "kerning," or overlapping the "territory" of adjacent characters to tighten words. For example, in the word "To," part of the "o" could fit under the horizontal bar of the "T." No one has yet announced a printer of this type, nor has anyone hinted that such a unit is being developed. However, the necessary technology is in place, and the possibility exists. □

Malcolm Stiefel, now a group leader at Mitre Corp., Bedford, Mass., has worked as a systems analyst, systems engineer and programmer on military command-and-control, hospital-administration, investment-securities and municipal information systems.

LOW COST DISK BACKUP OR DATA LOGGING FOR RS-232 ■ MULTIBUS* ■ S-100 ■ Q-BUS**



FEATURING:

- 15M bytes of formatted storage per cartridge
- Read/Write at up to 1.2M bytes per minute, 30 ips
- High speed 90 ips search
- Full system hardware and software compatibility
- Proven data reliability
- Streaming or start/stop operation
- Optional serpentine recording
- Tape Archive Utility software for disk backup and restore (S-100 and Multibus)
- Small desktop size

Come to Digi-Data for all your 1/4" and 1/2" tape drive requirements. Digi-Data has been designing and manufacturing tape drives and subsystems for 21 years.



DIGI-DATA CORPORATION
 8580 Dorsey Run Road
 Jessup, MD 20794
 Tel. (301) 498-0200
 TWX 710-867-9254
 ® ... First In Value

In Europe contact:
 Digi-Data Ltd.
 Kings House
 18 King Street
 Maidenhead, Berkshire
 England SL6 1EF
 Tel. 0628 29555-6
 Telex 847720

*Trademark of Intel Corp.

**Trademark of Digital Equipment Corp.

OUR MICRO/11 STANDS ALONE

You know about the advantages of a Micro/11 computer system. What you may not know is that it's available now. Our MDB Micro/11 is functionally equivalent to the DEC Micro/PDP-11* providing an 11/23 Plus, 256KB RAM, 10.4 MB Winchester and 1 MB Dual Floppy sub-system. But there's more.

This low-cost, compact and highly flexible work station provides the exclusive feature of being software driver and media compatible to the RX02. This unique capability allows diskette transfer to and from other DEC systems. Also, unlike the DEC unit, our Winchester is RL02 software compatible. Even optional 20 MB RL02 or RP02 emulating Winchesters are available to enhance your system.

When it comes to interface mod-

ules, however, the MDB Micro/11 has lots of company. The system, with its 8 quad slot (16 dual slot), Q-22 backplane and its rear distribution panel, accommodates all of MDB's unequalled repertoire of FCC compliant Q-bus controllers and interfaces. They include multiplexors, line printer controllers, disk and tape controllers, high speed DMA modules and interprocessor-

links. As for price, we won't hold you up there either. Single units cost only \$7,800 and substantial discounts are available for quantity purchases.

So why wait? It's all available now. Start by contacting us today. You won't be alone.

FOR ITS AVAILABILITY AND CAPABILITY

*Trademark of Digital Equipment Corporation.



MDB THE WORLD'S LARGEST
SYSTEMS INC. INDEPENDENT MANUFACTURER
OF COMPUTER INTERFACES.

Available on GSA contract #GSOOK8401S5502

Corporate Headquarters
1995 N. Batavia Street, Box 5508
Orange, California 92667-0508
714-998-6900 TWX: 910-593-1339 FAX: 714-637-4060

MDB Systems Europe, Inc.
9 route des Jeunes
CH-1227 Geneva (Switzerland)
Tel. (41) (22) 439410 Telex 421341 mdb ch
FAX (41) (22) 439414

MDB Systems, U.K., Ltd.
Everitts House
426 Bath Road
Slough, Berkshire (England) SL1 6BB
Tel. (06286) (67377) Telex (847185) WWTSLO
FAX (41) (2812) (3507)

Circle 70 for Q-Bus. Circle 193 For Micro/11

Will Fujitsu's SCSI INTERFACE Please Stand Up?

For some time now, the disk drive industry has talked about the SCSI Interface. But all this talk has resulted in very little action. Until now. Today a leader in the SMD market is offering their OEM customers the

option of the SCSI Interface. That leader is Fujitsu America Inc.

SCSI, the ANSI-approved small computer systems interface, is a byte wide intelligent interface designed for host computer systems and peripheral units and can transfer data at up to 2MB/s. The computer and peripherals are inter-

connected on an eight port matrix bus, which enables any port to initiate communication to any of the other seven ports.

Fujitsu America now offers the state-of-the art SCSI interface option on the high performance 8" M2312 drive which has a capacity of 84 MB and an average positioning time of 20ms. Previously this drive was only available with an SMD interface.

A significant advantage of the SCSI interface is that it reduces the cost of interconnecting the drive to a computer. The integral SCSI controller replaces the need for an SMD controller. The only other requirement is a low cost host adapter.

Fujitsu America is committed to keeping you on the leading edge of disk drive technology. So whether you stand up for SCSI or for SMD, you can always count on Fujitsu... for innovation, for technical leadership, and above all for enduring quality.

For more information contact the Fujitsu America Sales Office nearest you. Northwest: (408) 988-8100, East Coast: (617) 229-6310, Southwest: (714) 558-8757. Europe: 44-1/493-1138.

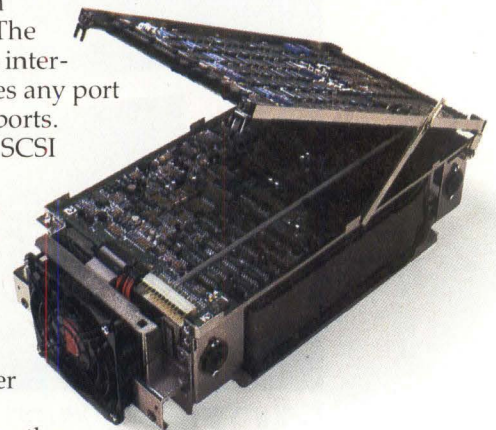



Color. Exciting, radiant color printing from the most recognized and respected printer company in the industry, Diablo. Your imagination together with our color ink jet printer can unleash brilliantly colorful presentations and reports on the unsuspecting corporate world.

Diablo color ink jet printing makes a splash!

And the price of success couldn't be more reasonable, only \$1250.* So what are you waiting for? A Diablo color ink jet printer can be brightening your future—NOW.

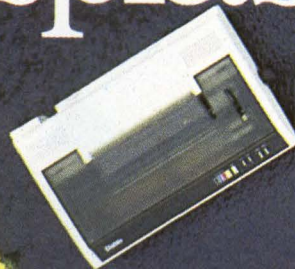

Especially for the IBM and Apple compatible personal computers or small business systems, Diablo's color ink jet runs under today's most popular operating systems software.

Diablo

CIRCLE NO. 72 ON INQUIRY CARD

DIABLO SYSTEMS, INC.
A Xerox Company
P.O. Box 5030
Fremont,
California 94537

For Diablo distributor or dealer
ext. 186 (800) 556-1234;
in CA (800) 441-2345.

Xerox® and Diablo® are trademarks of Xerox Corporation. IBM® is a trademark of IBM Corporation. Apple® is a trademark of Apple Computer.

*Suggested retail price, actual price may vary.

SIEMENS

A closer look at a far better printer.

Our new ultra-silent PT-88 is one of the lowest cost plain paper ink-jet printers available today, with reliability figures far better than those of the latest serial impact technology.

When a quiet working environment is important—in the office, home, school, or medical facility—the PT-88 gives you just what you want.

Exceptional print quality, maximum reliability, and money-saving performance all in one compact, ultra-silent unit. From its innovative "drop-on-demand" ink-jet printing system to its self-test capability, this functionally-styled printer offers the most advanced features to those who require consistent printing quality at the lowest cost of ownership.

For further information contact:
Siemens Communication Systems, Inc.
California - (714) 991-9700
Georgia - (404) 441-0882
Illinois - (312) 671-2810
New York - (516) 752-1323
Massachusetts - (617) 935-2234

Graphics printing in bit image.

The PT-88 has an adjustable tractor-feed mechanism and accommodates low-cost, margin-perforated fanfold, single-sheet, or roll paper in various widths up to 9 7/8" (250mm).

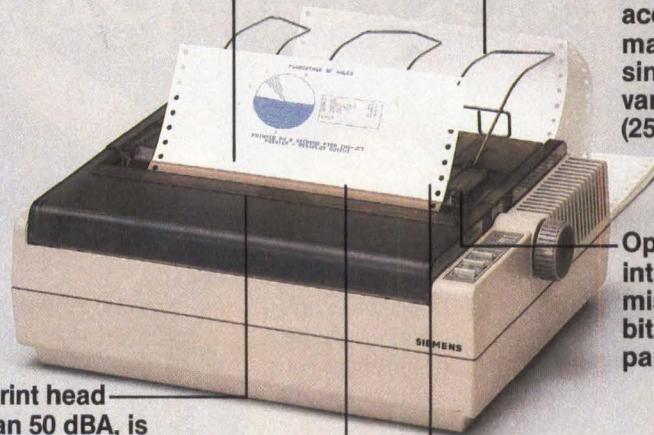

Ultra-silent ink-jet print head operates at less than 50 dBA, is maintenance-free, and has a rated life in excess of 10 billion characters.

Optional RS 232C, and TTY serial interfaces with standard transmission speeds from 110 to 9600 bit/s. Centronics-type 8-bit parallel interface also available.

High quality, bi-directional printing at 150 cps in a variety of user-selectable character sets.

96 characters (upper and lower case characters), programmable line pitch (10, 12, or 16.5 cpi).

The silent PT-88 jet printer... from Siemens.

CC/3020-023 SIQ 841

CIRCLE NO. 152 ON INQUIRY CARD

SOLID FONT SERIAL PRINTERS

Company, Model	Printing method	Print speed (cps)	Chars./line	Horiz. print density (cpi)	Vert. print density (lpi)	Simul. copies	Character sets	Paper width (inches)	Paper transport	Interfaces [protocols]	Unit price (\$)	Notes, features, options	Circle No.
APPLE COMPUTER INC. 20525 Mariani Ave. Cupertino, CA 95014 (408) 996-1010													848
A3M0025	daisywheel	40	132, 158, 198	10, 12, 15	6, 8	6	ASCII	15	friction feed	RS232C	2,195		
BROTHER INT. CORP. 8 Corporate Place Piscataway, NJ 08854 (201) 981-0300													787
HR 15/25	daisywheel	13, 23	132, prog.	10, 12, 15, prog.	6	5	Upper and lower case ASCII	11, 13	friction feed	RS232C, Centronics [X-on/X-off]	599; 995	quantity pricing available, contact manufacturer for name of distributor	
C. ITOH ELECTRONICS INC. P.O. Box 66903 5301 Beethoven St. Los Angeles, CA 90066 (213) 306-6700													849
A-10	daisywheel	18	115, 138	10, 12, 15	6, 8, prog.	4	ASCII, variety of fonts	15	friction feed, tractor feed, cut sheet feeder	RS232C, Centronics [300 to 2.4K baud, X-on/X-off, DTR, ETX/ACK]	995	Noise level 62 dB or lower	
F-10	daisywheel	40, 55	136, 163	10, 12, prog.	6, 8, prog.	4	ASCII, variety of fonts	16	friction feed, tractor feed, cut sheet feeder	RS232C, Centronics [110 to 9.6K baud, X-on/X-off, DTR, ETX/ACK]	1,995; 2,400	optional word pro- cessing com- mands provide proportional spac- ing and special character wheel selection	
COMREX INTERNATIONAL INC. 3701 Skypark Drive, Suite 120 Torrance, CA (213) 373-0280													850
ComRiter CR-I	daisywheel	17	132, 158, 198	10, 12, 15	3, 4, 6	6	ASCII, script, pica, elite, Grade 12, Brougham, Quadro, Prestige, 11 foreign languages	16.5	tractor feed	RS232C, current loop, Centronics, Qume Sprint 3	1,019	2K-byte buffer for word processing features: super- script, subscript, backspace, under- line and boldface	
ComRiter CR-II	daisywheel	12	110, 132, 165	10, 12, 15	3, 4, 6	5	ASCII, script, pica, elite, Grade 12, Brougham, Quadro, Prestige, 11 foreign languages	13.5	tractor feed, cut sheet feeder optional	RS232C, Centronics [X-on/X-off]	599	5K-byte buffer for word processing features: super- script, subscript, backspace, under- line, boldface, double strike, and proportioned spac- ing. Keyboard optional for elec- tronic typewriter application.	

SOLID FONT SERIAL PRINTERS

Company, Model	Printing method	Print speed (cps)	Chars./line	Horiz. print density (cpi)	Vert. print density (lpi)	Simul. copies	Character sets	Paper width (inches)	Paper transport	Interfaces (protocols)	Unit price (\$)	Notes, features, options	Circle No.
DAISYWRITER Div. of Computers Int. Inc. 3540 Wilshire Blvd. #401 Los Angeles, CA 90010 (213) 386-3111													851
Model 2000	daisywheel	40	132, 158, 198, 264	10, 12, 15, 20	6, 8	8	ASCII, graphics symbols, 18 foreign languages, absolute and relative vector plotting compatible with Diablo HYLOT	16.5	tractor feed, friction feed, cut sheet feeder	RS232C, current loop, Centronics, IEEE-488 [X-on/X-off, DTR, ETX/ACK, emulation for: Diablo 630, 1600 Series; Qume Sprint 9/11; NEC 3500, 5500 and 7700 Series; Centronics 737; IBM PC]	1,395	48K-byte data buffer	
DATA TERMINALS AND COMMUNICATIONS 590 Division St. Campbell, CA (408) 378-1112													852
DTC Stylewriter	daisywheel	12, 25	110, 132, 165	10, 12, 15	6, 8, prog.	5	ASCII, OCR A, OCR B, 20 typestyles, 15 foreign languages	3 to 13.5	friction feed; tractor feed and cut sheet feeder optional	Centronics	899	35K-byte data buffer, 64K-byte buffer optional; red and black printing, software selectable vertical and horizontal spacing	
DTC 380Z	daisywheel	32	132, 158, 198	10, 12, 15	6, 8, prog.	6	ASCII, OCR A, OCR B	3 to 16.5	friction feed; tractor feed and cut sheet feeder optional	RS232C, Centronics, IEEE-488 [50 to 19.2K baud, X-on/X-off, DTR, ETX/ACK]	1,495	48K-byte data buffer, automatic proportional spacing and centering	
DATAPRODUCTS CORP. 6200 Canoga Ave. Woodland Hills, CA (213) 887-8451													853
DP-35, DP-55	daisywheel	35, 55	132, 158, 196	10, 12, 15	6, 8	6	ASCII, OCR A, OCR B, over 100 fonts, several foreign languages, graphics symbols	3 to 15	friction feed, tractor feed and cut sheet feeder optional	RS232C, current loop, Centronics, Qume, Diablo [75 to 9.6K baud, X-on/X-off, DTR, RTS, ETX/ACK]	1,995; 2,495	Optional 3K-byte input buffer. Optional firmware word processing package with: automatic centering, bold print, shadow print, underlining and right justification.	
DECISION DATA COMPUTER CORP. 100 Whitmer Road Horsham, PA 19044 (215) 674-3300													854
6355-01	daisywheel	55	132, 158, 197	10, 12, 15	4, 6, 8	6	96 char. EBCDIC	15	tractor feed, friction feed, cut sheet feeder	[IBM 5256]	4,550 (Q1); 4,050 (Q50)	for use with IBM Systems 34, 36 and 38	

You just might find a better 1/4" tape drive out there. Someday.

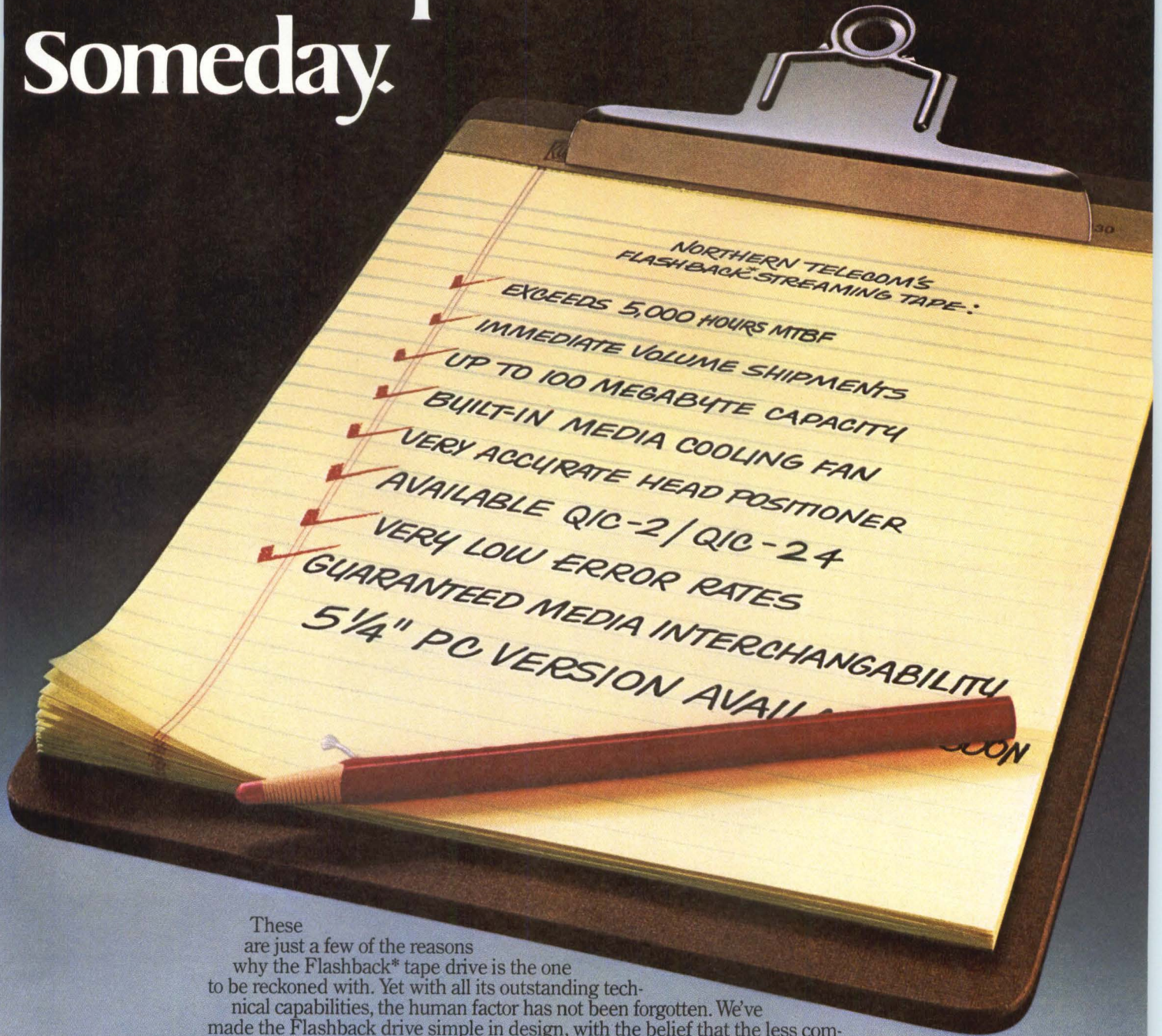

These are just a few of the reasons why the Flashback* tape drive is the one to be reckoned with. Yet with all its outstanding technical capabilities, the human factor has not been forgotten. We've made the Flashback drive simple in design, with the belief that the less complicated the make-up, the greater the reliability. We've made it simple to use, allowing for easy cartridge insertion/ejection. And we made it convenient: it uses standard DC power supply voltages.

The highest capacity to date. Simplicity in design. And the quality and reliability inherent in the Northern Telecom name. That's a combination that other 1/4" tape drives have yet to beat. Perhaps someday they will. But then, don't you need your drives now?

If you do, and you'd like more information or an evaluation unit, call us. We're available with the answers. Now. (313) 973-4600. Or write, Northern Telecom Inc., Memory Systems Division, 100 Phoenix Drive, P.O. Box D, Ann Arbor, MI 48106.



CIRCLE NO. 77 ON INQUIRY CARD

SOLID FONT SERIAL PRINTERS

Company, Model	Printing method	Print speed (cps)	Chars./line	Horiz. print density (cpi)	Vert. print density (lpi)	Simul. copies	Character sets	Paper width (inches)	Paper transport	Interfaces (protocols)	Unit price (\$)	Notes, features, options	Circle No
DIABLO SYSTEMS, INC.													855
P.O. Box 5030 Freemont, CA 94537 (415) 786-5000													
620 API, 630 API, 630 ECS	daisywheel	25, 40	132, 158, 198	10, 12, 15	prog.		ASCII, OCR B, graphics symbols	15.2	tractor feed, friction feed, cut sheet feeder	RS232C, Centronics, IEEE-488 [300 to 9.6K baud, X-on/X-off]	1,095; 2,340; 2,595		
FACIT INC. (Sweden)													856
Facit Inc. (USA) 235 Main Dunstable Road Nashua, NH 03062 (603) 883-4157													
Facit 4560	daisywheel	22	130, 155, 195	10, 12, 15, prog.	6, 8, 12	6	ASCII, Teletex and 40 other fonts	15.4	tractor feed, friction feed, cut sheet feeder	RS232C [300 to 9.6K baud, X-on/X-off, DTR, ETX/ACK]	1,095 (Q1); 765 (Q50)	2K-byte buffer, noise level less than 60 dB	
Facit 4565	daisywheel	40	136, 163	10, 12, prog.	6, 8	3	ASCII, 45 fonts	16	tractor feed, friction feed, cut sheet feeder	RS232C [300 to 2.4K baud, X-on/X-off, DTR, ETX/ACK]	1,895 (Q1); 1,420 (Q50)	noise level less than 65 dB	
FUJITSU AMERICA INC.													857
3075 Oakmead Village Drive Santa Clara, CA 95051 (408) 988-8100													
SP320	daisywheel	48	136, 163, 204	10, 12, 15	3, 6, 8	6	ASCII, graphics symbols, variety of fonts	4 to 16	tractor feed, friction feed	RS232C, current loop, Centronics [150 to 9.6K baud, X-on/X-off, DTR, ETX/ACK]	1,595 (Q1); 1,150 (Q50)	available first quarter 1984	
SP830	daisywheel	80	136, 163, 204	10, 12, 15	3, 6, 8	6	ASCII, graphics symbols, variety of fonts	4 to 16	tractor feed, friction feed, cut sheet feeder	RS232C, current loop, Centronics, Hyttype II, Qume 3 and 5 [150 to 9.6K baud, X-on/X-off, DTR, ETX/ACK]	2,950	allows graphics at 11,520 points/ square inch	
HARRIS CORP.													858
Computer Systems Div. 2101 W. Cypress Creek Rd. Ft. Lauderdale, FL 33309 (305) 974-1700													
Harris 8730	thimble	33	136, 163, 203	10, 12, 15	6		ASCII, graphics symbols	3 to 16	friction feed, tractor feed, cut sheet feeder	RS232C, RS-422 [110 to 9.6K baud, X-on/X-off, ETX/ACK; reverse chan- nel Bell 103A, E, F, G, H; 113A acoustic coupler]		Noise level with covers 58 dB	

THE CENTRONICS PRINTSTATION 350.



THIS IS WHAT PRINTSTATION TECHNOLOGY IS ALL ABOUT.

Since its introduction in late 1981, the innovative Centronics technology behind the Printstation 350 Series has received OEM praise for its paper handling and reliability. With new Printstation family additions, we now offer new capabilities and higher speeds. Now, more than ever, the Printstation 350 family will provide OEMs with the flexibility to meet all their printing needs. Bar code printing. Large characters. Color. Graphics. More Multipass fonts. More speeds, from 50 cps (multipass) to over 400 cps (10 cpi). And more efficiency with an outstanding new breakthrough: a 1-, 2- or 3-bin automatic sheet and envelope feeder option.

Add these new capabilities to proven Printstation 350 innovations such as true multi-function paper-handling, and family design with 80% parts commonality—and you have the ideal OEM printer choice for all three information processing categories.

DATA PROCESSING.

Printstation 350 means exceptional throughput—approaching line printer speeds in DP applications such as: □ Program listings □ Business reports □ Data logging □ Spread sheets . . . using full 6-part, single sheet or fan-folded forms . . . and capable of operating at 100% duty cycle.



BUSINESS PROCESSING.

Whether in an office or on a loading dock, whatever a business needs, a Printstation 350 will print: □ Bar code tickets □ Mailing labels □ Insurance forms □ Purchase orders □ Sales charts & graphs □ Invoices . . . on business cut sheet, instant tear-off and sprocket-feed forms . . . with graphics . . . and without afterthought options.

WORD PROCESSING.

A Printstation 350 means complete job flexibility with a choice of fixed pitch or proportional fonts for: □ Business correspondence □ Office memos □ Proposals □ Personalized and form letters □ Envelope addressing.

And with our new automatic sheet/envelope feeder you can maximize operator productivity at an amazingly low cost.

Attractive and quiet enough for every office but right at home in a warehouse, teller station or shipping department. — That's Printstation 350. From Centronics—the first choice of OEMs worldwide. For a copy of our new Printstation 350 brochure, write Centronics Data Computer Corp., One Wall Street, Hudson, N.H. 03051. Tel. (603)883-0111

**CENTRONICS®
PRINTSTATIONS**

CIRCLE NO. 73 ON INQUIRY CARD

LOW-COST RS-232 NETWORKING.

THE ANY-PORT-TO-ANY-PORT SMART SWITCH. \$895.

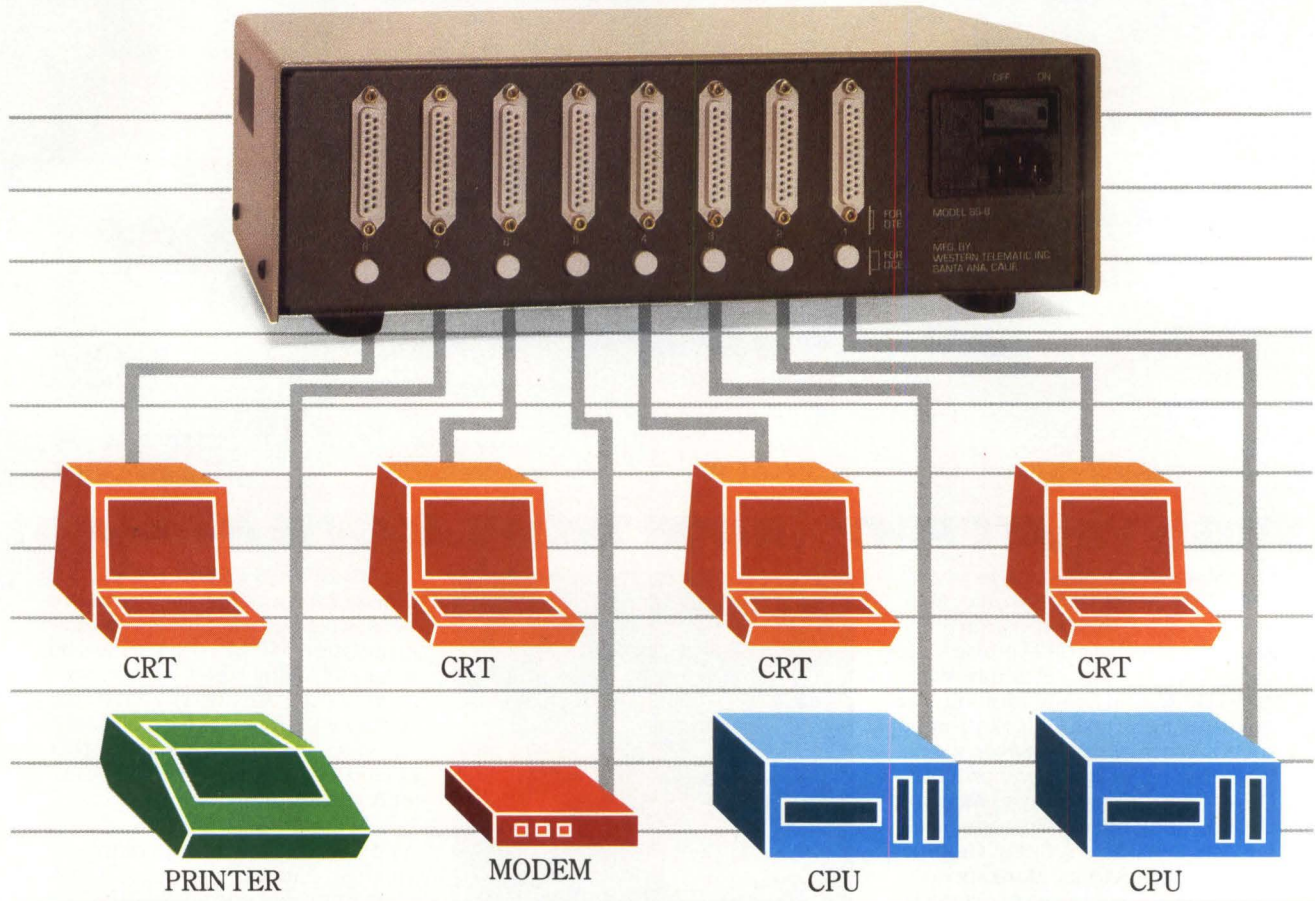

Here's an affordable way to switch up to eight RS-232 ports in any interconnection. Any port can select any other port, with up to four pairs of ports communicating at the same time. Push-buttons define each port as either DTE or DCE, for quick and easy installation.

The Smart Switch is controlled by simple user-friendly commands. A 2-character sequence lets you select a

port, determine status, and log-off. If the selected port is busy, it's smart enough to let you know when that port is available. What's more, it can optionally time-out connected ports not in use.

Use the Smart Switch to create your own low-cost network linking a number of terminals, printers or computers. Use it to give as many as seven users

access to a single I/O port on your computer, or six users access to two different computer systems. Or use it with any distributed computer environment.

To learn more about the SS-8 Smart Switch, call David Shumway toll-free at (800) 854-7226. In California call (714) 979-0363. Or write Western Telematic, Inc., 2435 South Anne Street, Santa Ana, California 92704. Or telex 467741.



wti western telematic inc.

SOLID FONT SERIAL PRINTERS

Company, Model	Printing method	Print speed (cps)	Chars./line	Horiz. print density (cpi)	Vert. print density (lpi)	Simul. copies	Character sets	Paper width (inches)	Paper transport	Interfaces (protocols)	Unit price (\$)	Notes, features, options	Circle No.
Harris 8745	thimble	55	136, 163, 203	10, 12, 15	6		ASCII	5.5 to 16	friction feed, tractor feed, cut sheet feeder	RS232C, current loop [110 to 1.2K baud, X-on/X-off, ETX/ACK]			
HEWLETT-PACKARD CO.													859
Vancouver Div. P.O. Box G 006 Vancouver, WA 98668 (206) 254-8110													
HP2601, HP2602	daisywheel	40, 25	132, 158	10, 12, prog.	prog.	6	Variety of languages	15.2	friction feed, tractor feed, cut sheet feeder	RS232C [110 to 9.6K baud, X-on/X-off, ETX/ACK]	1,950; 3,920	word processing enhancements such as shadow print, underlining, proportional spacing are supported in HP computer software packages	
MDX Trivex													860
Div. Mohawk Data Sciences Co. 3180 Redhill Ave. Costa Mesa, CA 92626 (714) 546-7781													
Model 8010	thimble	55	136, 163	10, 12	6, 8	6	ASCII, EBCDIC	3 to 15	friction feed, tractor feed, cut sheet feeder	IBM Coax Type 'A' [IBM 3270]	5,235 (Q1); 4,970 (Q50)	plug-compatible with IBM 3270 peripherals	
NEC INFORMATION SYSTEMS													786
5 Militia Drive Lexington, MA 02173 (617) 863-5720													
2000 Series	thimble	20	136	10, 12, 15, prog.	6, 8, prog.	7	over 50 print thimbles available, ASCII, graphic symbols	16	friction feed, tractor feed, cut sheet feeder	RS232C, Centronics [Diablo emulation available]	1,095	2K-byte data buffer, word processing software available, noise level less than 60 dB	
2050	thimble	20	136	10, 12, 15, prog.	6, 8	7	over 50 print thimbles available, ASCII, graphic symbols	16	friction feed, tractor feed, cut sheet feeder	[IBM PC parallel]	1,250	2K-byte data buffer, word processing software available, noise level less than 60 dB	
3000 Series	thimble	20, 35, 55	136	10, 12, 15, prog.	6, 8	7	over 50 print thimbles available, ASCII, graphic symbols	16	friction feed, tractor feed, cut sheet feeder	RS232C Centronics [Diablo emulation available]	1,995	2K-byte data buffer, noise level less than 60 dB	
3550	thimble	30	136	10, 12, 15, prog.	6, 8	7	over 50 print thimbles available, ASCII, graphic symbols	16	friction feed, tractor feed, cut sheet feeder	[IBM PC parallel]	2,250	2K-byte data buffer, noise level less than 60 dB	
7700 Series	thimble	55	136	10, 12, 15, prog.	6, 8	7	over 50 print thimbles available, ASCII, graphic symbols	16	friction feed, tractor feed, cut sheet feeder	RS232C, Centronics [Diablo emulation available]	2,600; 3,000	2K-byte data buffer, noise level less than 60 dB, word processing software available	
7750	thimble	55	136	10, 12, 15, prog.	6, 8	7	over 50 print thimbles available, ASCII, graphic symbols	16	friction feed, tractor feed, cut sheet feeder	[IBM PC parallel]		2K-byte data buffer, noise level less than 60 dB, word processing software available	

R&D had certain requirements that had to be met; manufacturing, accounting and marketing had others. Then microcomputers started showing up on desktops, with modems and printers here and there. Now you face the task of making it all work together. Sharing resources. Sharing information. And making more effective use of the information processing equipment you've already invested in.

NET/ONE LEAVES YOU IN CONTROL OF EQUIPMENT DECISIONS.

Net/One® is a general purpose communications system that turns equipment from different vendors into a fully functional, fast, powerful, information processing network. Because it can connect equipment from virtually any vendor, you remain free to choose equipment based on capability, rather than compatibility.

Off the shelf, Net/One supports industry-standard equipment interfaces—Async, Bisync, SDLC, through RS-232, V.35, RS-449 and IEEE-488 — as well as many high speed parallel interfaces. The list is expanding every month. But if you have special equipment that isn't in that list, Net/One is the only local area network that's fully programmable at every level so special interface protocols can be added now, or when you need them, later.

BROADBAND, BASEBAND, OR ANY COMBINATION THEREOF. YOU CALL THE SHOTS ON MEDIA, TOO.

Net/One is the only local communications system that gives you the option of broadband or baseband or a combination of both, with architecture that will allow you to add other media such as fiber optics in the near future.

YOU DON'T HAVE TO KNOW EXACTLY WHERE YOU'RE GOING TO BUY A NETWORK THAT WILL GET YOU THERE.

Everything about Net/One has been designed to respond to your needs, as they evolve, and to remain fully adaptable to evolving communications technology. System architecture is completely modular, so it can grow at the

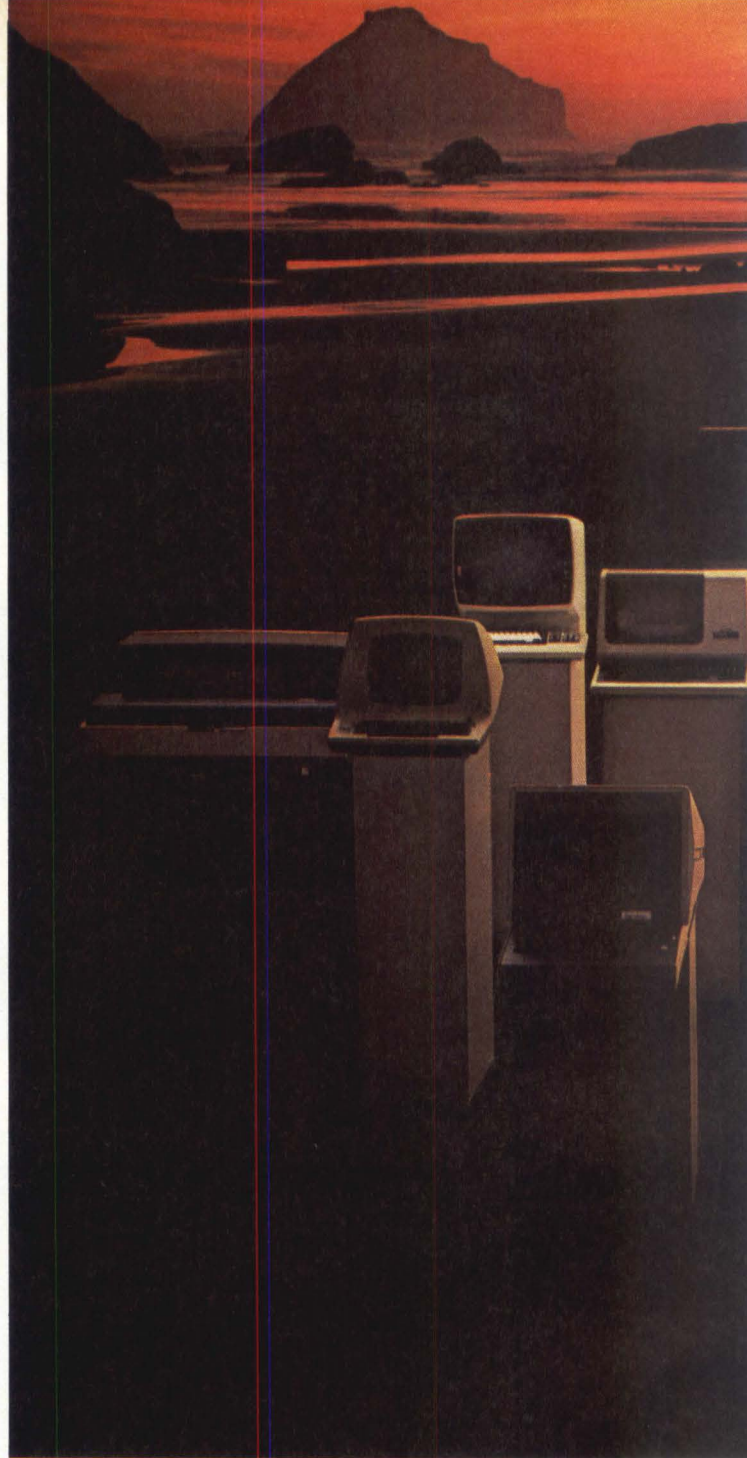

Net/One turns the e now into the netwo

Net/One is a registered trademark of Ungermann-Bass, Inc. © 1983 Ungermann-Bass, Inc.



same time and in the same direction you do. Regardless of the direction that turns out to be.

When separate divisions within a company or a campus need to share resources, one Net/One system can be bridged to others, and to remote networks. These bridges can interconnect baseband, broadband, or Net/One systems that include both. And like vendor independence and media independence, this bridging capability is available now from Ungermann-Bass.

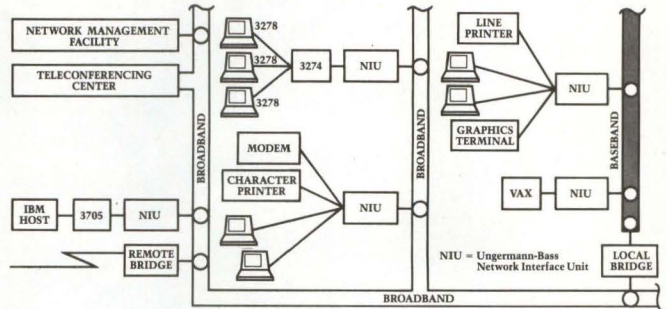

NOW, THE IMPORTANT DIFFERENCE BETWEEN TALKING A GREAT NETWORK AND DELIVERING ONE.

We've been installing Net/One since July of 1980. Hundreds of our systems are already out there moving information for people like Control Data, Caltech, Fairchild, ITT, RCA, Boston University, U.S. Forest Service, and Ford Aerospace.

So we can do more than talk about what you need in a local area network. We can actually deliver one, now. And we can refer you to a long list of customers who are actually using one (or two or three) now.

Let's talk about how to turn the equipment you have, now — whatever it is — into the network you want, now. And the network that can take you wherever you want to go from here. Net/One.

Ungermann-Bass, Inc., 2560 Mission College Boulevard, Santa Clara, California 95050. Telephone (408) 496-0111.

Net/One from Ungermann-Bass 

equipment you have work you want. Now.

Flashback* is changing the way America changes tapes.

At last, your users can make greater use of their time. Because they're not going to be changing tapes anywhere near as often. With Northern Telecom's $\frac{1}{4}$ " streaming cartridge tape drive, now they've got up to 100 megabytes of very accommodating memory. (100 megabytes!) Enough to back up most disk drives in one convenient tape. But that's not the only impressive thing about Northern Telecom's Flashback tape drive.

It has QIC-2 interface and QIC-24 interchangeability. Accepts standard cartridges. Is engineered for easy tape change. (That is, when you have to change tapes.) Also accommodates 9 or 12 track tapes, written at 30 or 90 ips— with 450- or 600-foot tapes.

Plus, has built-in diagnostics to detect problems before they occur. And simplicity of design, which simply means you can depend on our tape drive any time of night or day. But would you expect anything less of Northern Telecom?

With all that in mind, don't you think it's time you got the back-up memory system that's really going to back you up? Then call us at (313) 973-4600. Or write, Northern Telecom Inc., Memory Systems Division, 100 Phoenix Drive, P.O. Box D, Ann Arbor, MI 48106. Or, better yet, order an evaluation unit. We think your customers are going to like the change.

CIRCLE NO. 76 ON INQUIRY CARD

nt northern
telecom

SOLID FONT SERIAL PRINTERS

Company, Model	Printing method	Print speed (cps)	Chars./line	Horiz. print density (cpi)	Vert. print density (lpi)	Simul. copies	Character sets	Paper width (inches)	Paper transport	Interfaces (protocols)	Unit price (\$)	Notes, features, options	Circle No.
----------------	-----------------	-------------------	-------------	----------------------------	---------------------------	---------------	----------------	----------------------	-----------------	------------------------	-----------------	--------------------------	------------

OLYMPIA USA

Route 22
Box 22
Sommerville, NJ 08876
(201) 722-7000

785

ESW 3000	daisywheel	40, 50	150, 180, 225	10, 12, 15	6	7	ASCII, OCR B	8.5 to 17	friction feed	RS232C, Centronics, IEEE-488 [RTS/CTS, Qume Sprint 5, Diablo 650, switch selectable half/full duplex]	1,899	4K-byte data buffer, noise level under 62 dB	
ESW 102	daisywheel	17	141, 212	10, 12, 15	6		ASCII, OCR B	.17	friction feed	RS232C, Centronics, IEEE-488 [X-on/X-off, optional Qume Sprint 5, Diablo 630]	999	4K-byte data buffer, noise level under 65 dB	
Electronic Compact	daisywheel	14	115, 172	10, 12, 15	6	5	ASCII, OCR B	14.4	friction feed	RS232C, Centronics [X-on/X-off, RTS/CTS, DSR/DTR, optional Diablo 630]	649	160 character data buffer, noise level under 65 dB	

PRIMAGES INC.

620 Johnson Ave.
Bohemia, NY 11716
(516) 567-8200

861

Image I	daisywheel	45	135, 162	10, 12, 15, prog.	6, prog.	6	6 foreign languages	17	friction feed, tractor feed, cut sheet feeder	RS232C, Centronics, Qume Sprint 3, Diablo Hytype II [110 to 9.6K baud, X-on/X-off, DTR]	1,695 (Q1); 1,330 (Q50)	noise level less than 65 dB with cover	
---------	------------	----	----------	-------------------	----------	---	---------------------	----	---	---	-------------------------	--	--

QUME CORP.

A subsidiary of ITT Corp.
2350 Qume Dr.
San Jose, CA 95131
(408) 942-4000

862

Sprint 11/40, Sprint 11/55	daisywheel	40, 55	132, 158, 198	10, 12, 15	6, 8		upper and lower case ASCII	15	friction feed, tractor feed, cut sheet feeder	RS232C, Centronics, IBM PC [110 to 9.6K baud, X-on/X-off, DTR]	1,661 (Q1); 995 (Q50); 1,895 (Q1); 1,137 (Q50)		
Sprint 11/40-130 Plus	daisywheel	40	132, 158, 198	10, 12, 15	6, 8		upper and lower case ASCII	15	tractor feed, friction feed, cut sheet feeder	RS232C, Centronics [110 to 9.6K baud, X-on/X-off, DTR]	1,895		
Sprint 11/40-130 Wide Track	daisywheel	40	195, 235, 293	10, 12, 15	6, 8		upper and lower case ASCII	22	tractor feed, friction feed, cut sheet feeder	RS232C, Centronics [110 to 9.6K baud, X-on/X-off, DTR]	2,870		

SOLID FONT SERIAL PRINTERS

Company, Model	Printing method	Print speed (cps)	Chars./line	Horiz. print density (cpi)	Vert. print density (lpi)	Simul. copies	Character sets	Paper width (inches)	Paper transport	Interfaces (protocols)	Unit price (\$)	Notes, features, options	Circle No.
RADIO SHACK Tandy Corp. 300 One Tandy Center Ft. Worth, TX 76102 (817) 390-3839													863
DWII and DWP Series	daisywheel	18, 25, 43	110, 136	10, 12, 15	3, 5, 6	6	upper and lower case ASCII	15	tractor feed, friction feed, cut sheet feeder	Centronics	799; 1,295; 1,995	quantity pricing available as a response to RFQ	
SILVER-REED AMERICA INC. 8665 Hayden Place Culver City, CA 90230 (800) 421-4191													784
EXP 500	daisywheel	14	101, 121, 151	10, 12, 15		4	Courier, gothic mini, graphic symbols	12	friction feed, optional tractor feed	RS232C, Centronics [300 to 9.6K baud, Diablo 1610 emulation]	599	supports WordStar and other micro-computer word processing packages, noise level less than 65 dB	
EXP 550	daisywheel	17	132, 157	10, 12, 15, prog.		5	Courier, gothic mini, graphic symbols	17	friction feed, optional tractor	RS232C, Centronics [300 to 9.6K baud, Diablo 1610 emulation]	895	supports WordStar and other micro-computer word processing packages, noise level 65 dB or less	
EXP 770	daisywheel	31	132, 157	10, 12, 15		5	Courier, gothic mini, graphic symbols	17	friction feed	RS232C, Centronics [300 to 9.6K baud, Diablo 630]	1,265	2K-byte data buffer expandable to 48K bytes	
SMITH-CORONA 65 Locust Ave. New Canaan, CT 06840 (203) 972-1417													864
TP-II Plus	daisywheel	12	105, 126, 157	10, 12, 15	3, 4, 6	4	upper and lower case ASCII	13	tractor feed, friction feed, cut sheet feeder	RS232C, Centronics [50 to 19.2K baud, X-on/X-off, DTR]	645	quantity pricing available; contact manufacturer for quotes	
TELEX COMPUTER PRODUCTS INC. 6422 East 41st Street Tulsa, OK 74135 (918) 627-1111													830
Telex 286F	daisywheel	80	132, 158	10, 12	6, 8		ASCII, accepts 127- or 96-character printwheels		tractor feed, friction feed	Attaches to IBM 3274/3276 or Telex 174/2740/276 controller	5,350	plug-compatible with IBM 3287	
VIVITAR COMPUTER PRODUCTS P.O. Box C-96975 Bellevue, WA 98009 (206) 454-9250													829
Transtar 120, 130	daisywheel	14, 18	150 to 225	prog.	prog.	4	upper and lower case ASCII, many printwheels available	3.5 to 12; 3.5 to 17	friction feed, optional tractor feed	RS232C, Centronics, [X-on/X-off, DTR, ETX/ACK]	599; 895	quantity orders serviced by distributors, contact Vivitar for the name of the distributor near you; printers are compatible with all major microcomputer word processing packages such as: PeachText, WordStar, using existing Diablo 1610/1620 routines	

Why OEMs Love PRINTEK

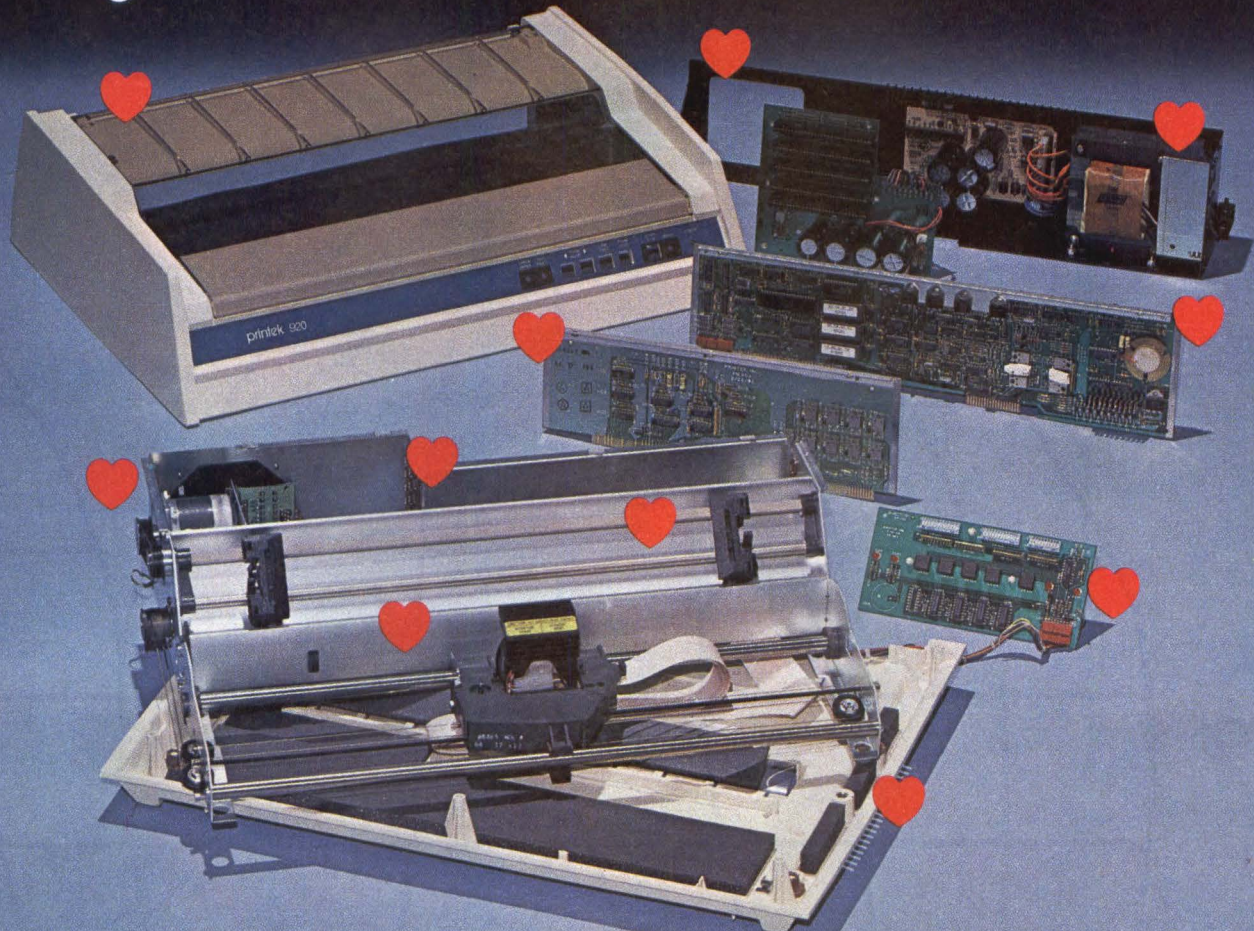

OEMs love PRINTEK in many ways, for many things. For the product with its sophisticated simplicity that is easily adapted and customized. For the company that is responsive to special requirements and support. Consider these PRINTEK points—and be prepared to fall in love.

- ♥ **Elegant cabinetry** with molded-in color to avoid chipping and discoloration problems (color changes available)—break away clear polycarbonate top with interlock—easily customized front label. Flame retardant NORYL® material.
- ♥ **Universal power supply**—heat-sinked for protection, with VDE transformer spacings, ready to operate world-wide. Large I/O cutout for multiple custom connectors. FCC, UL, CSA, VDE compliance.
- ♥ **Intelligent microprocessor design**—architecture permits customized interface control, up to 20 print functions are software-controllable.
- ♥ **Processor bus option slots** (910/920) allows ready development of custom I/O, memory, fonts, etc. Model 930 option permits custom memory and I/O.
- ♥ **ROM capacity:** 910: 32K program, 48K fonts
920: 32K program, 48K fonts
930: 56K program, 80K fonts
- ♥ **Extra dipswitch positions** on front control panel for custom needs (variable line lengths, communication protocols, etc.)
- ♥ **Rugged chassis** with extruded cross member for stability and simplicity (910/920), heavy duty motors, ball bearings, fan cooling, shock isolators.

NORYL is a registered trademark of GE.

- ♥ **Long-life printhead.** Features heat sink, ruby bearings, oiled wipers and high grade shaft finishes for long life, encapsulated coils for efficient thermal dissipation, 1 year warranty, easy replacement. 9 and 18 wire designs.
- ♥ **Quick-change adjustable tractors** with snap-out shafts (930 also has friction feed).
- ♥ **Unique encoder** assures accurate position detection and speed control. Logic seeking/Bidirectional design.
- ♥ **Multiple paper feed paths** with easy-change bottom paper guide. Accepts up to 16" fanfold (930 also accepts single sheets).
- ♥ **All documentation provided**—Product (available disks for quick edits), Service, Spares suggestions.



Three multi-function models to love. Model 910: 200/45 cps speeds. Model 920: 340/80 cps. Model 930: 200/80 cps. Call toll-free for information.

Printek, Inc., Benton Harbor, MI 49022
616/925-3200 TWX 810-270-3112

1-800-368-4636

printek 

best thing next to your computer

CIRCLE NO. 78 ON INQUIRY CARD

WHEN WE INTRODUCED OUR PEOPLE HAD

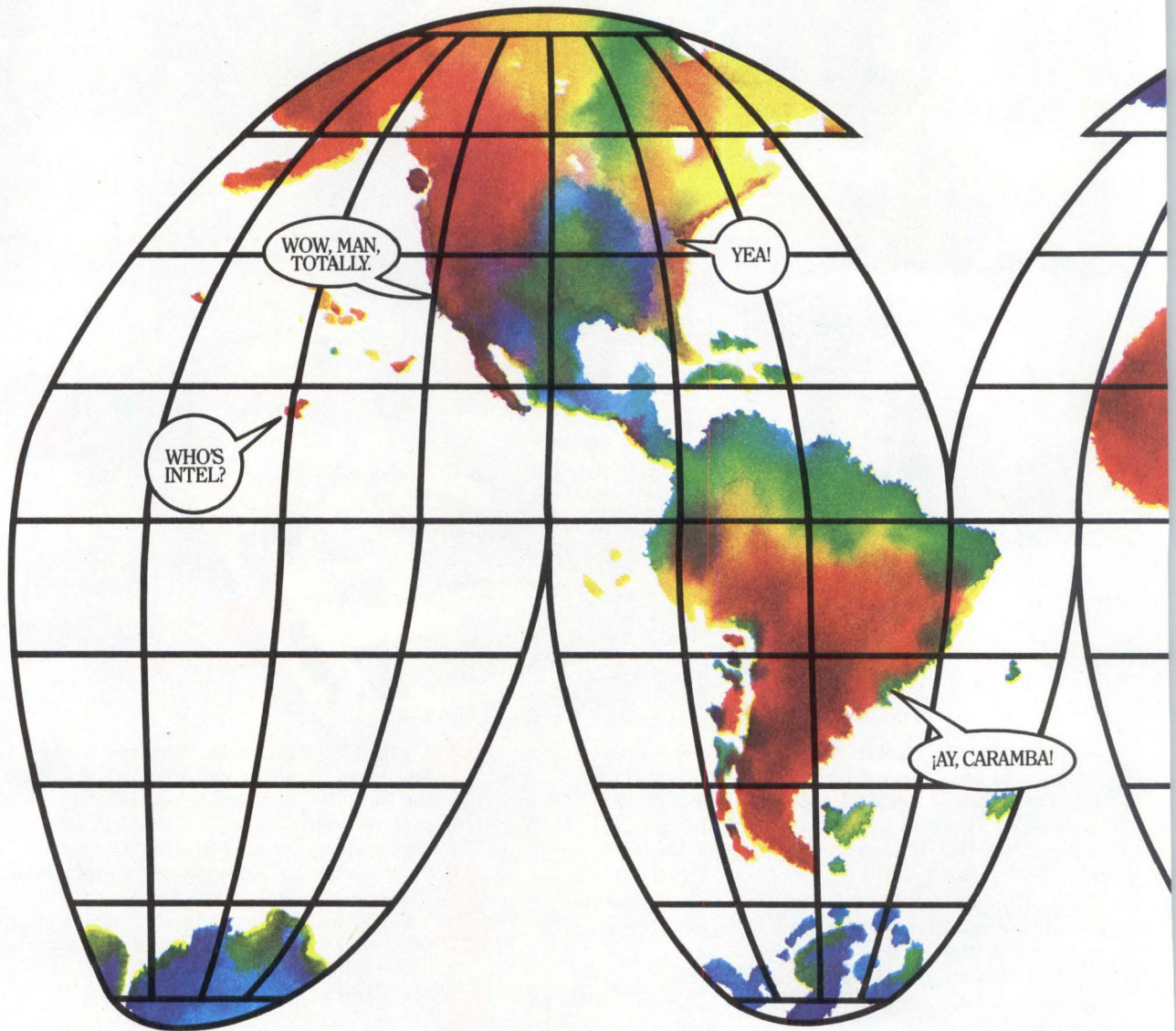

Not everyone is happy about it.

For instance, our new 286/310 multi-user, multi-tasking OEM supermicro is going to make guys who push minis awfully uncomfortable.

You see, it's based on our advanced iAPX 286 microprocessor, the most powerful 16-bit processor in the world. To which we've added our 80287 math co-processor as a, shall we say, turbocharger?

That little bit of technological tinkering makes it a very fast supermicro. Faster than a VAX*

11/750. In fact, according to independent benchmarks, the 286/310 is the world's fastest Xenix* supermicro.

It doesn't do too badly in iRMX™ real time OEM applications, either (3x the performance of any comparably-priced system.)

The kicker is the 310 costs less than \$10,000. And that's list, quantity one. OEM quantities are so much less expensive it's embarrassing.

But before you start thinking about all the money you can make with the 310, let us tell you



286/310 Supermicro System

NEW SUPERMICRO SYSTEM, LITTLE TO SAY.

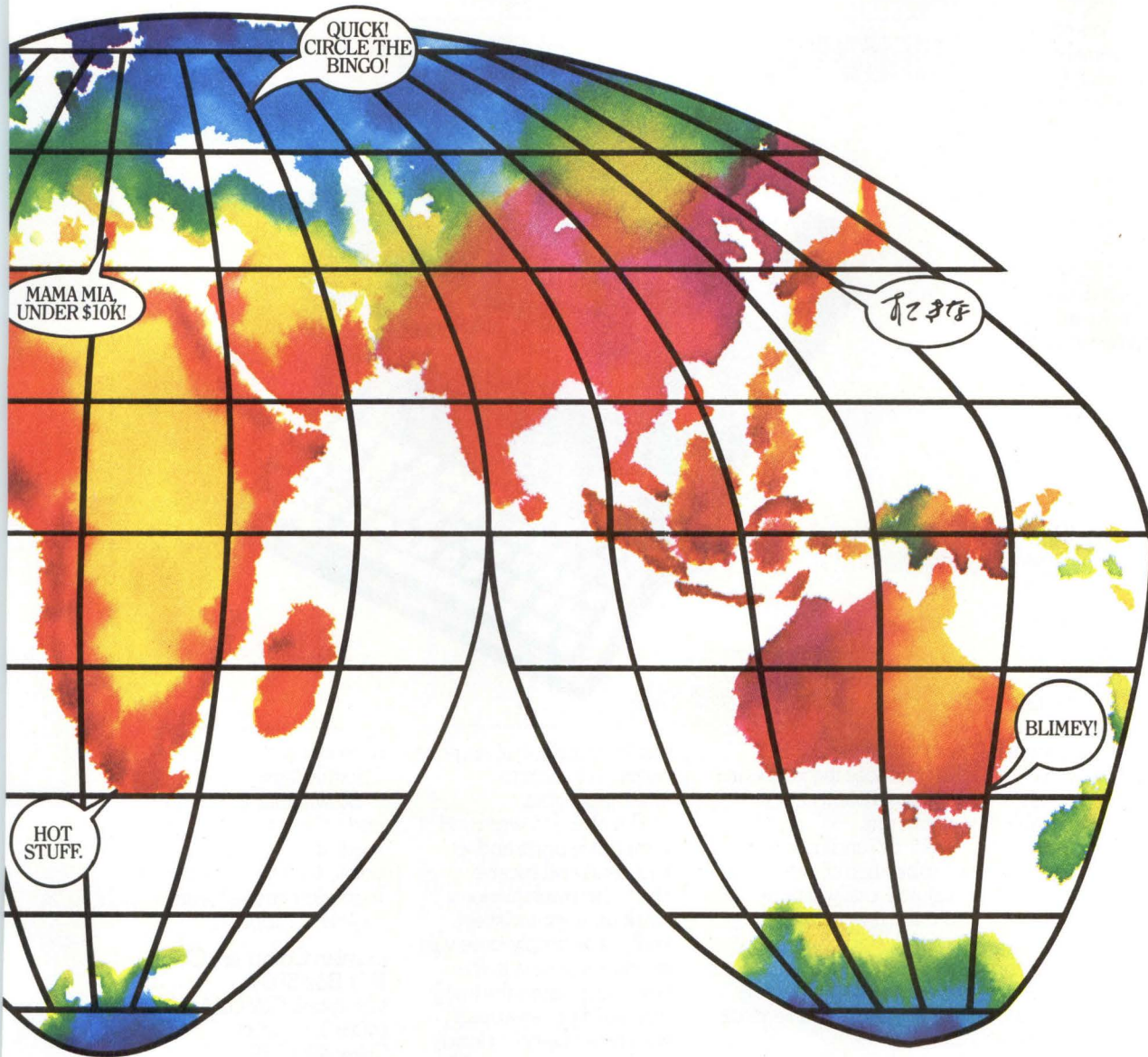

a little about how easy it'll be.

Like all Intel systems, the 286/310 is built on standards.

The MULTIBUS® architecture. The iRMX real time operating system. Ethernet® networks and protocols. And the Xenix® operating system. Not to mention the world's most-written-for microprocessor architecture, the 8086 family.

All of which makes the 310 a very open system. Open to all kinds of OEM configurations. And enhancements like integrated software, interactive speech, graphics, networking, even software-in-silicon. And that means it's also open to new markets and new opportunities.

You'll also be able to find service and support for you and your customers' systems from more than 80 service centers worldwide.

Which is what you'd expect from a company with more than a billion dollars in sales.

So get the information you need on the world's fastest supermicro. Including a series of independent benchmarks. Call toll-free, (800) 538-1876. In California, (800) 672-1833. Or write Intel, Lit. Dept. S8, 3065 Bowers Avenue, Santa Clara, CA 95051.

Enough said.

intel® delivers
solutions

*Ethernet is a registered trademark of Xerox Corp. *Xenix is a fully licensed version of UNIX** and a registered trademark of Microsoft, Inc. *VAX is a registered trademark of Digital Equipment Corporation. **UNIX is a registered trademark of Bell Laboratories. © 1983 Intel Corporation.

CIRCLE NO. 79 ON INQUIRY CARD

THIS IS NOT THE MOST AMAZING PART.

By any measure of modern achievement, a nine-pound, 16-bit, battery-powered business computer is quite amazing. The attachment of a five-pound correspondence-quality printer makes it even more so.

The Gavilan mobile computer is the first ultra-portable system designed for complete field automation. It lets professionals on the move type, compute, store, recall and print hundreds of pages of information practically anywhere, without the need for electrical hook-up or external battery packs.

BUT THIS IS.

The key to the Gavilan's success as a stand-alone mobile computer lies below its surface. The Gavilan operating system has made possible two advancements that make it the first completely viable computer for mobile professionals.

The first is its fully integrated software. Yes, fully integrated. Its CapsuleWare™ software programs are contained within storage capsules that plug interchangeably into the computer.

No other microcomputer offers the degree of software integration afforded by the Gavilan shared data format of CapsuleWare.

The complete set of CapsuleWare programs includes CapsuleWord™ word processing, CapsuleCalc™ calculation & analysis, CapsuleOffice™ portable secretary, CapsuleComm™ communications and CapsuleForm™ forms processing.

Secondly, the Gavilan's primary user interface is not the keyboard, but instead, a built-in pressure-sensitive touch panel that not only selects, but executes, commands. With the full capabilities of a mouse, this simple "point

CORRESPONDENCE-QUALITY
50 CHARACTER PER SECOND
PRINTER WITH SELF-CONTAINED
BATTERY PACK WEIGHS FIVE POUNDS

3 1/2" FLOPPY DISK DRIVE
360 KBYTES FORMATTED

8 LINE X 80 CHARACTER
LCD SCREEN WITH ABILITY
TO DRIVE A 24 LINE X 80
CHARACTER VIDEO MONITOR

10-KEY NUMERIC PAD

CAPSULEWARE AND MEMORY
EXPANSION CAPSULES

TOUCH PANEL WITH
COMMAND FUNCTIONS ALLOWS
TOUCH-SENSITIVE POINTER
CONTROL OF ON-SCREEN MENUS,
DOCUMENTS, NUMBERS AND TEXT

FULL-SIZE
TYPEWRITER KEYBOARD

and tap" interface all but replaces the keyboard in normal computing operations.

For the end user, the combination of these two features totally eliminates the need to key-in complicated computer commands to enter and exit separate programs, and manipulate menu items or data.

For the value-added OEM, this means being able to establish a totally new market niche with a uniquely competitive product.

LEAVE YOUR COMPETITION BACK IN THE OFFICE.

Suddenly, the practicality of the Gavilan system is creating a demand for vertical market software packages from the widest diversity of mobile professionals ever—from field auditors to field correspondents, sales representatives to service representatives, insurance

agents to industrial engineers, architects to anthropologists.

The ability to write and print-out reports and letters, send and receive electronic transmissions, work up a spreadsheet analysis or simply store vast quantities of data in the field is capturing the imaginations of professionals who never before considered a computer a viable working tool away from the office.

SOFTWARE IN A CAPSULE— A POWERFUL NEW INNOVATION REWARDS UNLIMITED DEVELOPMENT OPPORTUNITIES.

The Gavilan mobile computer was built for the broadest range of applications program development. Programs can be written by OEMs or end users. In MS/DOS or Gavilan's own operating environment. On 3 1/2"

microfloppy diskettes or CapsuleWare.

So whether you're an end user or an OEM, we've made it amazingly easy for you to take the next step in hardware and software: mobile computing.

Gavilan Computer Corp.
P.O. Box 5004
Campbell, CA USA 95008
(408) 379-8000
Telex 4991278 GVLN US

Gavilan



Gavilan, CapsuleWare, CapsuleWord, CapsuleCalc, CapsuleOffice, CapsuleComm, and CapsuleForm are trademarks of Gavilan Computer Corporation. MS/DOS is a trademark of Microsoft Corporation.

The New FUJITSU BAND PRINTER

Series When You Know How They're Built,
You'll Choose Fujitsu.

That's because the entire Fujitsu Band Printer Series is built to perform, built to fit and built to last. You'll get crisp, high-quality printing when and where you need it.

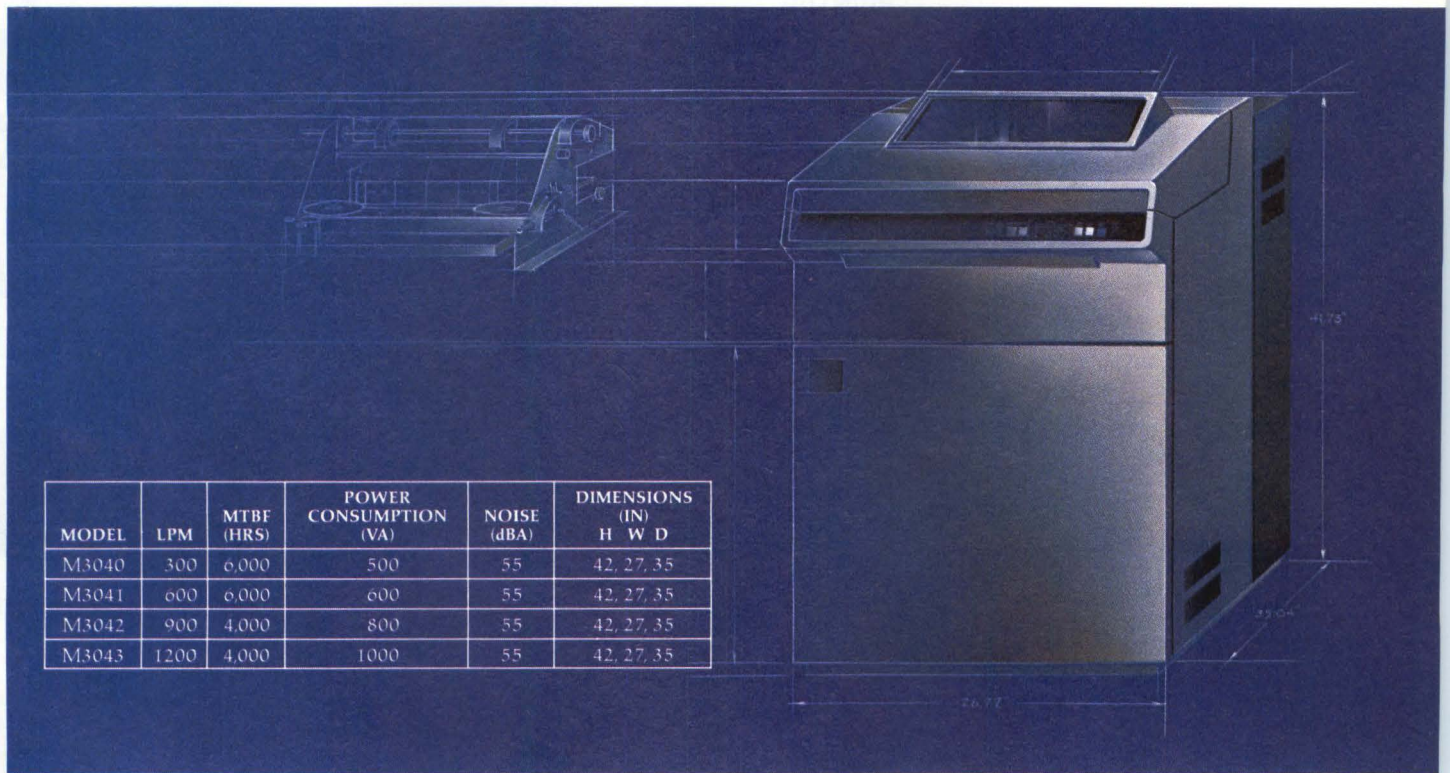

MODEL	LPM	MTBF (HRS)	POWER CONSUMPTION (VA)	NOISE (dBA)	DIMENSIONS (IN)		
					H	W	D
M3040	300	6,000	500	55	42	27	35
M3041	600	6,000	600	55	42	27	35
M3042	900	4,000	800	55	42	27	35
M3043	1200	4,000	1000	55	42	27	35



High reliability is also built into the Fujitsu printer design. You'll find 6000 hours of Mean Time Between Failure (MTBF) and exceptionally high parts commonality. Service requirements are infrequent and, if needed, are simple to perform.

Fujitsu's band printers are surprisingly compact. They're designed to fit into the smallest space, and at 55 decibels, they're peacefully quiet.

The Fujitsu Band Printer Series is available in speeds ranging from 300 LPM to 1200 LPM in the M3040, M3041, M3042 and M3043 models. Each printer sets a new standard in price/performance. For more information, contact Fujitsu at 3075 Oakmead Village Drive, Santa Clara, CA 95051, or give us a call at (408) 988-8100.

FUJITSU

WESTREX DOT MATRIX PRINTERS

800 SERIES

PRINT HEAD LOW PROFILE, LOW WEIGHT Model 801

- 7-Needle Vertical Array
- Low Power Consumption
- 100% Duty Cycle
- 100 Million Character Life

OEM PRICES
\$55 for 100 quantity



WESTREX 800 Series of alphanumeric, bi-directional printers include split platen printers, flat bed slip document printers and 51 column journal printers in a variety of standard models to suit a wide spectrum of OEM applications. All WESTREX 800 Series printers utilize the same simple, reliable drive system, head position sensors, ribbon transport mechanism and other quality tested components for maximum cost effectiveness.

Basic models illustrated (left) are obtainable with various options to suit your application needs. Data sheets with technical specifications for each of these products are available upon request.

PRINTER CONTROLLER Model 6500

It provides all of the drive circuits and intelligence required as the controller for WESTREX 800 Series two-station, slip/document and journal serial impact dot matrix printers, Models 820, 840 and 850. Parallel, Serial or TTY interfaces are available.

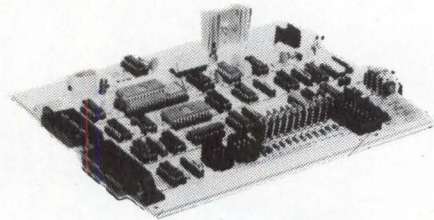

ALL MODELS
Bi-Directional
Print 150 cps
@ 12 cpi
3.45 mm
Character Height

WESTREX 80 SERIES DOT MATRIX PRINTERS

WESTREX 80 Series of new, low cost, printer mechanisms include a split platen printer with two independent paper feeds and a 38-column single station printer.

This series is designed for use in ECR/POS systems, data logging, mobile printer applications, financial and customer-activated terminals. Both have optional slip/check validation capability.

Data is printed at 100 cps in any pattern desired, based upon a 7-needle vertical dot array. Single and double width and double struck characters can be generated under software control. Printhead life is 75 million characters; ribbon life is greater than 4 million characters.

A separate compact paper handler is available for either printer. A motor-driven rewind feature is optionally available with the paper handler.

NEW!



SINGLE STATION PRINTER MODEL 81

- Prints full 38 columns @ 13 characters per inch
- Character height is 3.45 mm (0.136")
- Accepts conventional rolled receipt paper (78.5 mm or 3¹/₂" wide)



SPLIT PLATEN PRINTER MODEL 82

- Prints 18 columns @ 13 characters per inch on each independently controlled print station
- Tear-off blade is provided on the receipt station
- Unitized paper handler with motorized rewind (optional)

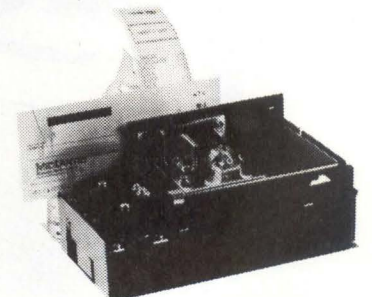

Auxiliary feature deck offers logo print and receipt paper cut-off



For full details, write or call us

WESTREX OEM PRODUCTS
Litton

51 Penn Street, Fall River, MA 02724, (617) 676-1016 TELEX: 1651490 Relay WNJW
IN FRANCE — WESTREX OEM PRODUCTS, 103-105 Rue de Tocqueville, 750 Paris, France 01-766-322-70 TELEX: 610148
IN SWEDEN — WESTREX OEM PRODUCTS, Box 3503, S-17203 Sundbyberg, Sweden 46/8 +981100 TELEX: 12129

**LESS THAN
\$100 OEM PRICE
(250 quantity)**

NEAR LETTER QUALITY IMPACT MATRIX SERIAL PRINTERS

Company, Model	Print matrix	Print speed (cps)	Chars./line	Horiz. print density (dpi)	Vert. print density (dpi)	Simul. copies	Character sets	Paper width (inches)	Paper transport	Interfaces (protocols)	Unit price (\$)	Notes, features, options	Circle No.
ANADEX INC.													831
9825 De Soto Ave. Chatsworth, CA 91311 (213) 998-8010													
WP-600	18 x N	125, 285	80, 220	10, 12, 16.5	6, 8, 12, 16	5	ASCII, bit-mapped graphics, bar codes Helvetica, Serita, scientific, italic, user character set downline loadable	3 to 15	tractor feed, friction feed, cut sheet feeder	RS232C, RS422, Centronics, Diablo 630 [110 to 19.2K baud, X-on/X-off, ETX/ACK]	2,700	4.5K- to 20.5K-byte data buffer	
DATAPRODUCTS CORP.													832
6200 Canoga Ave. Woodland Hills, CA 91365 (213) 887-8451													
M-100, M-100L	9 x 14	140	132	5, 8.4, 10, 16.7	6, 8	6	ASCII, OCR A, OCR B, Hangul, Arabic, French, bit-mapped graphics and graphics symbols PROM-resident, user character set downline loadable	3 to 15	tractor feed	RS232C, RS422, current loop, Centronics, Dataproducts; up to 500K char./sec. parallel [110 to 9.6K baud, X-on/X-off, DTR, RTS]	3,000; 4,200	bar codes and variable-height text and graphics (M-100L)	
DATASOUTH CORP.													833
4216 Stuart Andrew Blvd. Charlotte, N.C. 28210 (704) 523-8500													
DS220	18 x 48	40, 100, 220	132	5, 6, 8.25, 10, 12, 16.5	6, 8	6	ASCII, bit-mapped graphics	3 to 15	tractor feed, friction feed, cut sheet feeder	RS232C, Centronics [110 to 9.6K baud, X-on/X-off, DTR]	1,995	50 features set via front keypad	
DURANGO SYSTEMS INC.													834
3003 North First St. San Jose, CA 95134 (408) 946-5000													
Poppywriter, Model 1720	9 x 9, 36 x 18	40, 165	132, 218	10, 12, 16.5	3, 4, 6, 8	6	ASCII, graphics symbols, PROM-resident	3.7 to 14.4	tractor feed, friction feed, cut sheet feeder	RS232C, RS422, Centronics [110 to 19.2K baud, X-on/X-off]	2,495		
ENVISION													835
631 River Oaks Parkway San Jose, CA 95134 (408) 946-9755													
Model 420, 430	12 x 18, 36 x 18	100, 300	80, 132	10, 12, 18	3, 6, 8	4	ASCII, Katakana, bit-mapped graphics, user character set downline loadable	4.5 to 15	tractor feed, friction feed, cut sheet feeder	RS232C, Centronics, Diablo 630 [300 to 38.4K baud, 60K char./sec. X-on/X-off, DTR]	4,450; 5,450	color printer/plotters; Model 430 Vectorprinter accepts vector data like a pen plotter; both models can print on transparencies	

NEAR LETTER QUALITY IMPACT MATRIX SERIAL PRINTERS

Company, Model	Print matrix	Print speed (cps)	Chars./line	Horiz. print density (cpi)	Vert. print density (lpi)	Simul. copies	Character sets	Paper width (inches)	Paper transport	Interfaces [protocols]	Unit price (\$)	Notes, features, options	Circle No.
FACTIT INC. (USA) 235 Main Dunstable Rd. Nashua, NH 03062 (603) 883-4147													836
Facit 4512	9 x 9, 18 x 20	140	132, 224	10, 12, 17	6, 8	3	ASCII, national character sets, italics, bit-mapped graphics, graphics symbols, double-height characters, PROM resident	4 to 15	tractor feed, friction feed	RS232C, current loop, Centronics; up to 20K char./sec. parallel [110 to 9.6K baud, X-on/X-off, DTR, ETX/ ACK]	1,195 (Q1); 835 (Q50)	2K-byte data buffer	
FLORIDA DATA CORP. 600D John Rodes Blvd. Melbourne, FL 32935 (305) 259-4700													837
OSP 120,OSP 130		600 max.	132, 237	10, 12, 15, 16.5	6, 8	6	ASCII, bit-mapped graphics, PROM resident	3 to 15	tractor feed, friction feed, cut sheet feeder	RS232C, Centronics, Dataproducts [9.6K to 19.2K baud, X-on/X-off, DTR]	3,900; 4,100		
FUJITSU AMERICA INC. 3075 Oakmead Village Drive Santa Clara, CA 95051 (408) 988-8100													838
DPL24	24 x N	100, 200	136, 163, 244	10, 12, 18	3, 4, 6, 8, 12	5	ASCII, bit-mapped graphics, graphics symbols, PROM resident	4 to 16	tractor feed, friction feed, cut sheet feeder	RS232C, current loop, Centronics [150 to 9.6K baud, X-on/X-off, DTR]	1,950 (Q1); 1,500 (Q50)	Available first quarter 1984	
GENERAL ELECTRIC CO. G.E. Drive Waynesboro, VA 22980 (703) 949-1000													839
Model 3184	9 x 9, 9 x 18, 7 x 16	45, 180	136	10, 12, 13.1, 15, 16.7	3, 4, 6, 8	6	ASCII, 16 national character sets, dot-addressable graphics	3.2 to 15.5	tractor feed, cut sheet feeder	Serial RS232C, Centronics parallel up to 100K char./sec. [110 to 9.6K baud]	2,230		
Model 3304	9 x 9, 7 x 7, 9 x 18, 7 x 14	100, 200, 300	136, 227	10, 12, 13.1, 15, 16.7	3, 4, 6, 8	6	ASCII, 16 national character sets, dot-addressable graphics	3.2 to 15.5	tractor feed, cut sheet feeder	Serial RS232C, Centronics parallel up to 100K char./sec. [110 to 9.6K baud]	2,490		
Model 3404	9 x 9, 9 x 18, 7 x 14	100, 400	136, 227	10, 12, 13.1, 15, 16.7	3, 4, 6, 8	6	ASCII, 16 national character sets, dot-addressable graphics	3.2 to 15.5	tractor feed, cut sheet feeder	RS232C, Centronics parallel up to 100K char./sec. [110 to 9.6K baud]	2,650		



© Stewart Daniels 1983

UNIFY[®], The Number One UNIX DBMS, Brings All The Pieces Together.

Finally, a relational data base management system that unites all the best in state of the art technology. UNIFY provides more power, more performance, more flexibility, and more user friendly features than any other microcomputer DBMS on the market. No wonder UNIFY is the number one selling UNIX DBMS. Consider:

It's the most powerful. UNIFY is the most powerful relational DBMS available on a microcomputer today. That's because it features the only multiuser microcomputer implementation of the industry standard IBM SQL relational query language.

It's the fastest. Independent benchmarks have ranked UNIFY number one in performance time and time again.

It's the easiest to use. UNIFY's fully menu driven design makes it easy for anyone to develop data base applications.

UNIFY is currently available on microcomputers from DEC, Altos, NCR, Pixel, Onyx, Forward Technology, Fortune, Cosmos, Codata, Masscomp, Metheus, Momentum, Plexus, Perkin-Elmer, SGS, and Zilog — with more to come.

If you'd like more information about the number one UNIX DBMS, please call or write:

UNIFY
CORPORATION

9570 S.W. Barbur Blvd.
Portland, OR 97219

(503) 245-6585

UNIFY is a registered trademark of UNIFY Corporation.
UNIX is a trademark of Bell Laboratories.

CIRCLE NO. 79 ON INQUIRY CARD

If you've been waiting for a supermicro with UNIX* System V on a 68010-based processor, stop.

Introducing the Callan Unistar™ 300. It's the single best supermicro you can buy. For a couple of reasons:

One, the 10MHz 68010 CPU. It's the newest, fastest, best. It crunches numbers in a snap. And works beautifully with the new UNIX.

Two, the new UNIX System V. It's faster than UNIX System III. On the Unistar 300, it supports a host of languages. And when it comes to portability, flexibility and system support, nothing comes close.

There's more. The Unistar 300 allows for expansion to 172M bytes of high-speed disk storage with integral tape backup—all within one enclosure that easily fits under a desk.

Its convenient 12-slot Multibus* chassis lets you easily add options like networking, communications, floating point array processors and more. Up to 2M bytes of main memory provide real power for every user. And nationwide service is available through ITT/Courier.

Unistar 300. Finally a supermicro with super everything. Available today from Callan. For more information contact Callan Data Systems, 2645 Townsgate Road, Westlake Village, CA 91361. (800) 235-7055. In California (805) 497-6837. TELEX 910 336 1685.

Callan Unistar

*Callan and Unistar are trademarks of Callan Data Systems. UNIX is a trademark of Bell Labs. Multibus is a trademark of Intel Corporation.



SUPER. MICRO.

CIRCLE NO. 81 ON INQUIRY CARD

NEAR LETTER QUALITY IMPACT MATRIX SERIAL PRINTERS

Company, Model	Print matrix	Print speed (cps)	Chars./line	Horiz. print density (cpi)	Vert. print density (lpi)	Simul. copies	Character sets	Paper width (inches)	Paper transport	Interfaces [protocols]	Unit price (\$)	Notes, features, options	Circle No.	
JDL CO. LTD.													840	
332 Pine St., Suite 610 San Francisco, CA 94104 (415) 956-3926														
P-750	24 x N	58, 116	151, 181	10, 12	6, 8	4	ASCII, Katakana, 6 fonts, bit-mapped graphics, PROM-resident	5 to 17	tractor feed, friction feed, cut sheet feeder	RS232C, Centronics parallel up to 60K char./sec. [110 to 9.6K baud]		6 color printing		
LEAR SIEGLER INC.													841	
714 N. Brookhurst St. Anaheim, CA 92803 (714) 774-1010														
VersaPrint 500	14 x 18	180	136, 224	5, 6, 7.5, 10, 12, 16.5	3, 4, 6, 8	6	ASCII, 7 foreign languages, bit-mapped graphics, PROM-resident	3.5 to 14	tractor feed, friction feed, cut sheet feeder	RS232C, current loop, Centronics [X-on/X-off, DTR]	1,695	Color operation		
MICRO PERIPHERALS INC.													842	
4426 South Century Dr. Salt Lake City, UT 84107 (800) 821-8848														
PrintMate 99	7 x 9, 11 x 9	100 max.	80, 96, 136	10, 12, 17	6, 8		upper and lower case ASCII, graphics, software-selectable, PROM-resident	1 to 9.5	tractor feed, friction feed, optional cut sheet feeder	RS232C, current loop, Centronics, IEEE-488 [110 to 9.6K baud, X-on/X-off]	599	AP-PAK applications package software allows design of fonts, logos, graphs, bar charts, etc.		
PrintMate 150	7 x 9, 11 x 9	150	136, 163, 231	10, 12, 17	6, 8		ASCII, bit-mapped graphics, software-selectable, PROM-resident	3 to 15	tractor feed	RS232C, current loop, Centronics, IEEE-488 [150 to 9.6K baud, X-on/X-off]	995	AP-PAK applications package software allows design of fonts, logos, graphs, bar charts, etc.		
PHILIPS PERIPHERALS INC.													843	
385 Oyster Pt. Blvd. #12 San Francisco, CA 94080 (415) 952-3000														
GP300, GP300L	9 x 9, 18 x 25, 18 x 50, 36 x 50	80, 300	120, 237	10, 12, 15, 16.5	3, 4, 6, 8	6	ASCII, OCR A, OCR B, 95 character sets, bit-mapped graphics, graphics symbols, PROM-resident	15.7	tractor feed, friction feed, cut sheet feeder	RS232C, RS422, current loop, Centronics [300 to 19.2K baud, X-on/X-off, DTR, ETX/ACK]	2,836 (Q1); 2,305 (Q50); 3,058 (Q1); 2,448 (Q50)			
PLESSEY PERIPHERAL SYSTEMS													844	
17466 Daimier Irvine, CA 92714 (714) 540-9945														
LCQ50		90, 150	80, 132		6, 8		ASCII, 7 international character sets, 24 fonts, bit-mapped graphics, mosaic graphics, graphics symbols			RS232C, Centronics [X-on/X-off]	535	256-byte data buffer, optional 4K-byte data buffer with X-on/X-off protocol		

NEAR LETTER QUALITY IMPACT MATRIX SERIAL PRINTERS

Company, Model	Print matrix	Print speed (cps)	Chars./line	Horiz. print density (cpi)	Vert. print density (dpi)	Simul. copies	Character sets	Paper width (inches)	Paper transport	Interfaces (protocols)	Unit price (\$)	Notes, features, options	Circle No.
PRINTEK INC.													845
1517 Townline Road Benton Harbor, MI 49022 (616) 925-3200													
Model 910, 920	9 x 9, 12 x 9, 24 x 18	45, 80, 200, 340	136, 163, 181, 227	10, 12, 13.3, 16.7	6, 8, prog.	6	ASCII, OCR A, OCR B, bit- mapped graphics, graphics symbols, PROM resident, software selectable	2.5 to 16	tractor feed	RS232C, Centronics [300 to 9.6K baud, X-on/X-off, ETX/ACK]	1,595; 2,395	Noise level less than 60 dB	
Model 930	9 x 9, 36 x 18	80, 200	136, 163, 181, 227	10, 12, 13.3, 16.7	6, 8, prog.	6	ASCII, OCR A, OCR B, bit- mapped graphics, graphics symbols, PROM resident, software selectable	2.5 to 16	tractor feed, friction feed, cut sheet feeder	RS232C, Centronics [300 to 9.6K baud, X-on/X-off, ETX/ACK]	1,995	Noise level less than 60 dB	
RADIO SHACK													846
300 One Tandy Center Ft. Worth, TX 76102 (817) 390-3631													
DMP-2100	24 x 36	100, 160	132, 220	5, 6, 7.5, 10, 12, 16.5	6, 8, 12	4	ASCII, inter- national fonts, bit-mapped graph- ics and graphics symbols	15	tractor feed, friction feed, cut sheet feeder	Centronics	1,995	quantity pricing available as a response to RFQ	
TEXAS INSTRUMENTS INC.													847
P.O. Box 202145 H-619 Dallas, TX 75220 (800) 231-4717													
Omni 800 Model 810	7 x 7, 9 x 7, 12 x 7, 23 x 28	35,220	218 max. prog.	10, 12, 14.6 prog.	6, 8, prog.	9	ASCII, Courier, Helvetica, elite, graphics symbols, bar code charac- ters, user character set downline loadable	3 to 15		RS232C, Centronics [X-on/X-off]	2,295	3K-byte data buffer	
Omni 800 Model 855	9 x 9, 32 x 18	35, 150	218 max. prog.	10, 12, 15	3, 4, 6, 8	3	ASCII, 7 fonts, bit- mapped graphics, graphics symbols, user character set downline loadable	3 to 11	tractor feed, friction feed, cut sheet feeder	RS232C, Centronics [300 to 9.6K baud, DC1/DC3, ETX/ACK]	935	4K-byte data buffer	

NEXT MONTH IN MMS

Disk drives get the feature spotlight in the February issue of MiniMicro Systems. There will be a hardware profile that concentrates on interfaces, controllers and the technological innovations that increase performance relative to standard-height drives. The article contains tables of both floppy and Winchester manufacturers' offerings.

Other features include:

- a discussion of the testing of Winchester and floppy drives.
- a look into the future of disk systems.

Be sure to check the February issue of Mini-Micro Systems for the "new and improved" Systems in Manufacturing section. Its new title, Integrator, reflects expanded coverage.

In addition to robotics and factory automation, it will cover applications of integrated computer systems in engineering, government, education, finance and trade. Its purpose is to keep pace with computer trends in all aspects of commercial and non-commercial markets.

HOW TO LOSE WAIT™ AND WIN CUSTOMERS WITH MICROBUFFER.™

Bells and whistles don't sell data processing systems to serious users. Time-saving features do. And that's exactly what MICROBUFFER™ is all about.

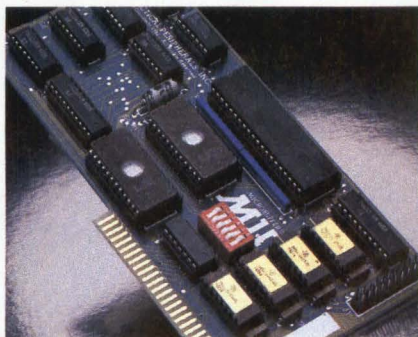

MICROBUFFER II

Think of it as a "WAIT LOSS" aid for your micro-based system. Because MICROBUFFER lets users process data without waiting for printers and modems to do their thing.

Talk about efficiency! With printers printing, modems transmitting and processors processing—all at the same time—your system becomes a far more productive office automator.

LOSING WAIT IS PAINLESS

You won't need to re-invent the wheel to add MICROBUFFER (and value!) to your system. And you won't have to mortgage the farm to finance the enhancement.

MICROBUFFER is very attractively priced. And design-in is a snap. In fact, there are board level versions

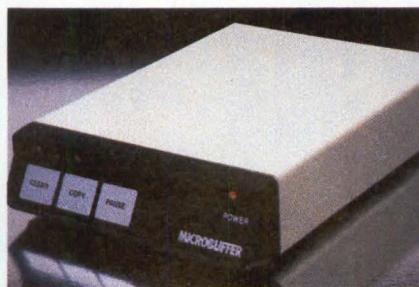

MICROBUFFER INLINE

that slip right into Apple computers and into Epson printers. The stand-alone models require only a simple hook-up and will interface virtually any computer and RS232C printer or modem.

In short, there's a low-cost MICROBUFFER for just about any configuration. Parallel or serial. With buffering capability up to 64K, expandable to 256K, of output data. All with complete graphics routines and text formatting controls.

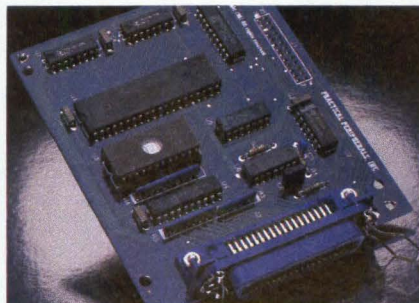

MICROBUFFER/E

GUARANTEED WAIT LOSS

MICROBUFFER is no toy. It's a rugged, continuous-duty system component that's so well-designed and built, we back it with a *five-year*

warranty. Try finding another printer/modem buffer (or any peripheral) with a guarantee like that.

Sound like a good way to win more customers? So what are you waiting for? Call or write today for more information. We're ready to help you LOSE WAIT right now with MICROBUFFER—another practical product from Practical Peripherals.

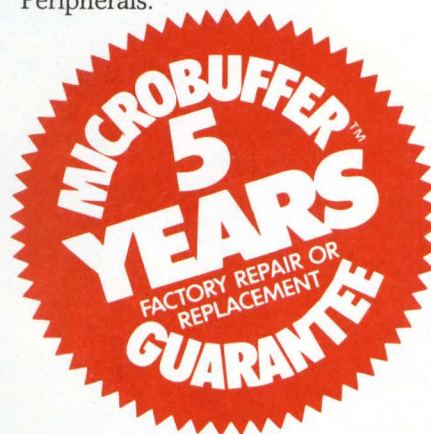

EVALUATION OFFER

Specially-priced evaluation units are available for qualified OEM customers. Ask your salesman for details. Limit one evaluation unit per company.

PRACTICAL PERIPHERALS

31245 La Baya Drive
Westlake Village, CA 91362 USA
(213) 991-8200 • TWX 910-336-5431

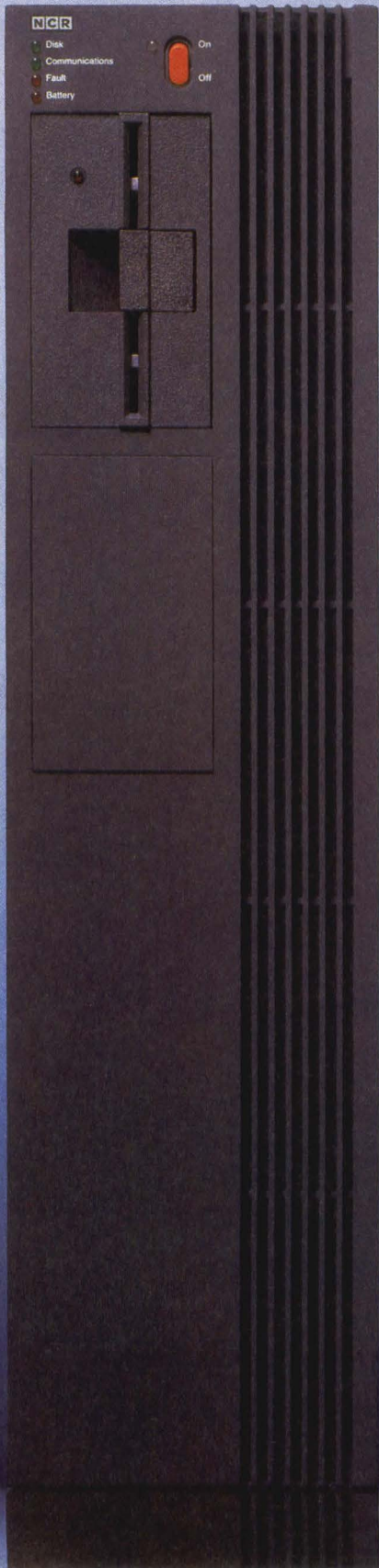

INTRODUCING THE BEST THING NEXT TO THE TOWER.

Introducing Tower™ Annex.

It's a mass storage add-on that transforms the original Tower into the even more powerful Tower Complex. With up to 228MB. Plus streaming tape.

Now Tower 1632 by itself has always been a formidable rival for the minicomputer. With as much as 2MB of ECC memory. Plenty of mass storage. Industry standard flexibility.

Our operating system derived from UNIX* for maximum portability. And full communications capability for both peer level and host networking.

So if you're a minicomputer OEM, the Tower Complex may really have you worried. But we have the answer to your problem.

Instead of losing out as our competitor, why not become a winner again—by becoming a Tower OEM? Towers and Tower Complexes are substituting for minicomputers everywhere else—why not in your product line as well?

You'll have better performance, reliability and profits. Because nothing stands up to Tower 1632. Except Tower Annex. Call us at 1-800-222-1235 to learn more.

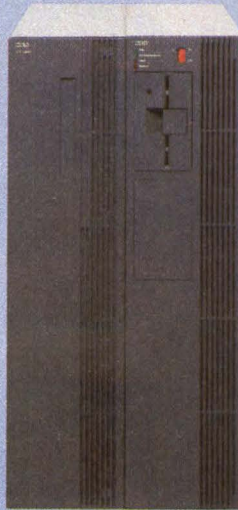

BUILT FOR SYSTEMS BUILDERS.
TOWER 1632.

NCR
OEM Marketing Division

NCR Corporation, World Headquarters, OEM Marketing Division, Dayton, OH 45479. Nationwide (800) 222-1235. In Ohio (513) 445-2380. In Canada (800) 268-3966.

*UNIX is a trademark of Bell Laboratories.

CIRCLE NO. 83 ON INQUIRY CARD

9-track compatibility.

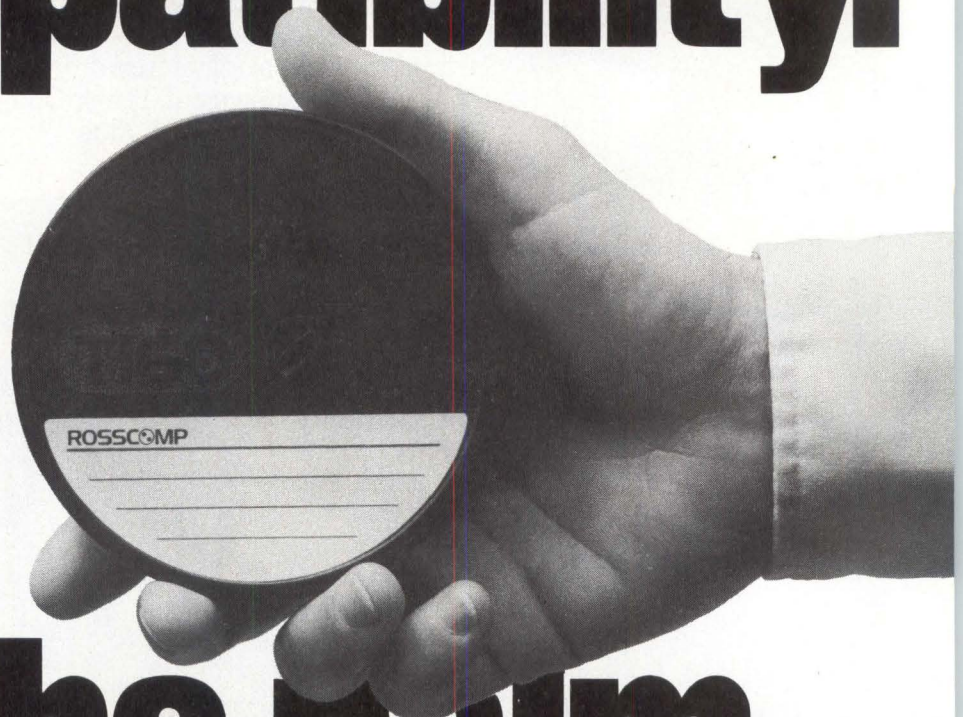

In the palm of your hand.

At last, you have a small choice for back-up in the 9-track world.

Because the Rosscomp D169 tape drive can actually replace those refrigerator-sized dinosaurs you've been using up till now. And you don't lose one megabyte in the process. In fact, our drive significantly lowers your total system cost.

Because the Rosscomp D169, with 160 Mbytes of storage, gives you twice the capacity of what you're probably using now. At less than half the cost. It features an 8-inch floppy-sized envelope. Standard 1/2" tape.



Guaranteed data interchangeability. And a 20 minute dump time.

Just take the D169, plug it into your industry-standard 9-track interface, and run it. Never has 9-track interface-to-interface compatibility been simpler. Or smaller. In fact, in the space you're using for your larger drives, you can insert two D169s, and still have room left for a power supply.

So give us a call at Rosscomp. Especially if you're tired of that big world out there. And say good-bye to your refrigerator.

ROSSCOMP

We're backing up your future.

16643 Valley View Avenue, Cerritos, CA. 90701 (213) 926-5533

CIRCLE NO. 84 ON INQUIRY CARD

When critics rate you tops, what do you do for an encore?



*"VISUAL 50 is in a class by itself for visual quality; the character set is unusually clear and sharp."**

*"The VISUAL 50 is the most promising new terminal to come out so far, especially in light of its price."***

*"We consider this terminal to be one of today's best products in price/performance, its incorporation of ergonomically designed features and its broad range of functionality."***

Feature Comparison Chart *

Feature	ADDS 60	VISUAL 50	TeleVideo® 925	Zenith 19	Wyse 100
Style	4	4	4	3	5
Overall Quality	2	5	3	4	3
Keyboard	3	5	2	4	2
Rollover/false keying	5	5	3	4	4
Video Quality	1	5	4	4	3
No. of attributes	5	5	5	2	5
Attribute method	2	5	2	4	2
Suitability for micros	2	5	3	5	3
	24	39	26	30	27
List Price	\$895	695	995	895	995

*MICROSYSTEMS—March 1983

**THE ERGONOMICS NEWSLETTER—August 1982

Meet the VISUAL 55

The VISUAL 50, widely acclaimed as the best performing low cost terminal in the industry, is a tough act to follow. But the new VISUAL 55 extends its predecessor's performance even further by adding 12 user-programmable non-volatile function keys, extended editing features and selectable scrolling regions ("split screen").

Both the VISUAL 50 and VISUAL 55 offer features you expect only from the high priced units. For example, the enclosure is ergonomically designed and can be easily swiveled and tilted for maximum operator comfort. A detached keyboard, smooth scroll, large 7 x 9 dot matrix characters and non-glare screen are only a few of the many human engineering features.

Another distinctive feature of the VISUAL 50 and VISUAL 55 is their

emulation capability. Both terminals are code-for-code compatible with the Hazeltine Espirit,[®] ADDS Viewpoint,[®] Lear Siegler ADM3A and DEC VT52.[®] In addition, the VISUAL 55 offers emulations of the Hazeltine 1500/1510 and VISUAL 200/210. Menu-driven set-up modes in non-volatile memory allow easy selection of terminal parameters.

And you're not limited to mere emulation. Unbiased experts rate the combination of features offered by the VISUAL 50/55 family significantly more attractive than competitive terminals.

Both VISUAL terminals are UL and CSA listed and exceed FCC Class A requirements and U.S. Government standards for X-ray emissions.

Call or write for full details.

VISUAL

 See for yourself

Visual Technology Incorporated
540 Main Street, Tewksbury, MA 01876
Telephone (617) 851-5000. Telex 951-539

CIRCLE NO. 85 ON INQUIRY CARD



Our first DEC compatible storage products are second to none.

They had to be good. We knew that, so we put a lot into them. We made sure they had all the important features you've been looking for but could never find until now.

LSI-11 55MB TAPE-STREAMING BACKUP

Take the reliable CS-300, for example. It gives LSI-11 users a large capacity and very cost-effective storage backup for Winchester disk drives. The new system combines one of our powerful peripheral processors with a 1/4 inch cartridge tape streamer based on the new QIC-02 interface of the Archive Sidewinder or Cipher Quarterback tape drives. It fits into any LSI-11 chassis, requires no software driver or diagnostic changes, supports two drives and uses one dual slot. Two configurations are available, a 20MB or a 45MB system (extendable to 55MB).

PDP-11 SINGLE-BOARD EMBEDDED TAPE CONTROLLER

Then there is the high performance TC-200 which is a micro-programmed magnetic-tape peripheral processor designed to support the DEC line of PDP-11 Unibus computers. It is extremely cost-effective, takes only one SPC backplane slot instead of the 2-4 usually required and contains the logic necessary to control four tape drives at speeds from 25IPS to 125IPS. Data is verified while writing with read-after-write error checking logic.

This is just the beginning. We're going to keep coming at you with state-of-the-art developments from our storage products' pipeline which is already full of projects scheduled for early release. For more information call, write or send us the coupon today.

MM 1/84

CST COMPUTER STORAGE TECHNOLOGY, INC.
1369 S. State College Boulevard, Anaheim, CA 92806
714/778-3656 • TELEX 704449 • CABLE COMSTORTEC, UD

Please send me more information on the CS-300 and TC-200.
 Have a representative call.

Name _____
Title _____ Phone _____
Company _____
Address _____
City _____ State _____ Zip _____

DEC LSI and PDP are trademarks of Digital Equipment Corporation.

CIRCLE NO. 86 ON INQUIRY CARD

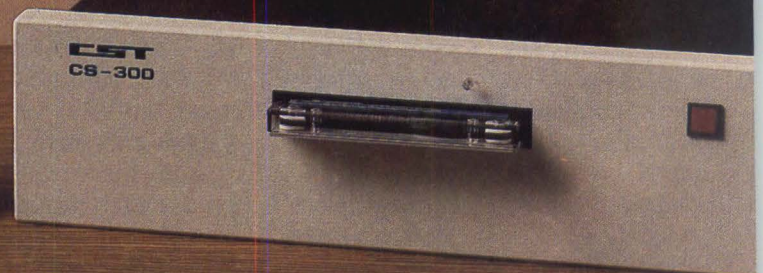

COMPUTER STORAGE TECHNOLOGY, INC.

'New technology' printers challenge daisy wheels

EDWARD WEBSTER, Datek Information Services Inc.

Impact matrix units lead the way, while ink-jet, thermal and non-impact page printers jockey for position

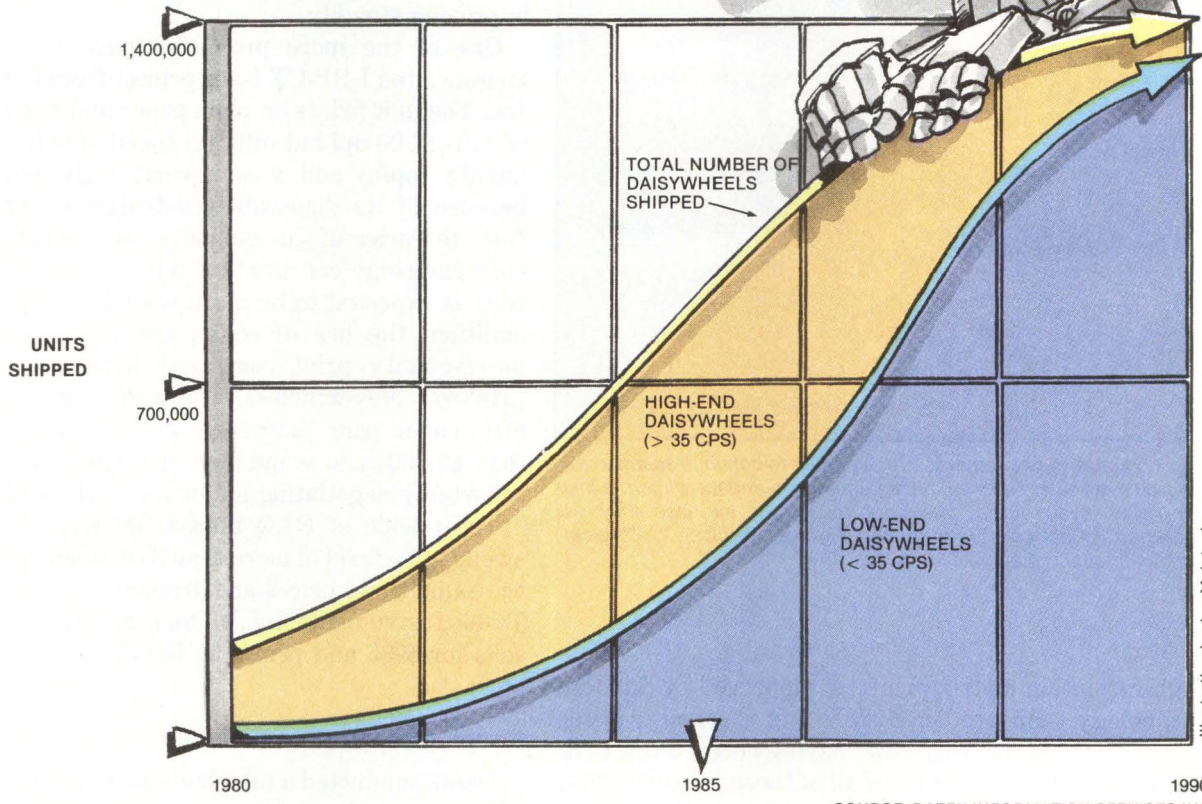
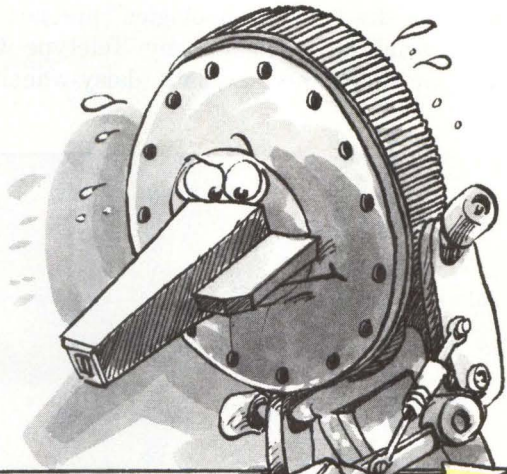

Illustration by Jon McIntosh

SOURCE: DATEK INFORMATION SERVICES INC.

Annual daisy-wheel printer shipments are starting to be adversely affected by new-technology printers, led by near-letter-quality impact matrix units. These technologies, including ink-jet and non-impact page printers, are influencing the high-end daisy wheels more significantly than they are the low-end daisy wheels.

Despite some analysts' predictions, the United States will be far from a "paperless society" in 1987. Instead, a variety of forces will fuel significantly greater growth in the printer market than many have envisioned. By that time, what we now call letter-quality (LQ) and near-letter-quality (NLQ) printers, currently associat-

ed with office applications, will dominate the overall market. New technologies such as ink-jet, thermal-transfer and non-impact page printers are gaining, but the main short-term threat to daisy-wheel printers is the impact matrix printer, with higher speeds, NLQ output and high-resolution graphics.

New technologies lagging behind

Many of the "new technologies" are not that new. Ink-jet printers, pioneered by Teletype Corp. and others in the 1960s, predate daisy-wheel printers.

	1978	1983	1988
Acoustic noise (dBa)			
impact	65	58	53
non-impact	55	55	50
Dots per inch			
impact	68.5	285	285
non-impact	240	240-300	240-480
Expendables cost (per page)			
low-volume impact	5¢	5¢	5¢
high volume non-impact (incl. maintenance)	1.5¢	1.5¢	1.5¢
Hardware price (end user)			
Low-speed impact (55 cps)	\$5,000	\$3,500	\$2,000
High speed letter quality non-impact (60 ppm +)	\$350,000	\$70,000	\$50,000
MTBF (hours)			
low-end impact (< 35 cps)	1,500	2,500	3,000
high-end impact (> 35 cps)	2,000	3,000	4,000
Paper handling (all desktop printers)			
	pin-feed optional and manual sheets	pin-feed and optional sheet feed attachment	integrated sheet feed

SOURCE: DATEK INFORMATION SERVICES INC.

Fig. 1. Printer improvements are expected to continue steadily over the next five years. The main advantage of non-impact printers is their low noise level, but as their dot resolutions increase they will challenge impact units' print quality. Figures are given for "typical" printers in each category.

High-resolution matrix printers, pioneered by Sanders Technology, appeared in 1978. Only thermal-transfer printers qualify as truly new, having entered the U.S. market in 1983. Shipments of all of these printer types, however, account for less than 10 percent of the overall market. Likewise, the expected boom in "intelligent copier printers" that was predicted in 1980-1981 failed to materialize.

Impediments to the new printers' market acceptance include hardware costs, interface problems, perceived reliability problems and lack of software. A printer that offers graphics and "electronic," mathematical and scientific fonts requires a large amount of storage and programming. Researching, selecting, programming and packaging a single font can cost more than \$100,000 and might involve ongoing licensing costs if the font was

developed jointly. And the typical keyboard is inadequate for entering the virtually limitless number of fonts, graphics and formats possible with a high-resolution matrix printer. In addition, printer manufacturers and OEMs until recently have underestimated the investment needed to provide interfaces for high-resolution matrix printers. In the late 1970s, OEMs were generally enjoying a boom in "old technology" printers, so there wasn't much motivation to wrestle with the problems of advanced-technology printers.

Datek Information Services Inc.'s U.S. printer market figures, released in mid-1983, show that page printers and high-resolution impact matrix printer shipments made up only about 6 percent of the 420,000 LQ and NLQ (at least 18 overlapped vertical dots) printers shipped in 1982. Although the shipment figures did not indicate a move toward the new technologies, it is evident that the new generation of printers was exhibiting rapid improvements (Fig. 1). Non-impact printer noise levels were decreasing, page-printer prices were dropping, and the programmable resolutions of impact matrix printers were improving steadily.

One of the more promising page printers is the long-awaited LBP-CX laser printer from Canon U.S.A. Inc. The unit prints on plain paper and has a resolution of 240 or 300 dpi but offers a speed of only 8 pages per minute (ppm) and a somewhat high cost per copy because of its disposable cartridge system. Judging from the price of the cartridge (\$65) and the fact that each cartridge can produce 2,000 copies, the cost per copy is expected to be more than 4 cents per page. In addition, the use of cold pressure fusing results in lower-quality print compared with heat-fused laser printers. Nevertheless, the end-user price of such plain-paper page printers could end up at much less than \$5,000, and a number of major U.S. OEMs are reportedly negotiating major contracts with Canon.

The trickle of NLQ impact dot-matrix entries has swelled to a flood of more than 25 available products. At the same time, prices are dropping, as exemplified by Texas Instruments Inc.'s Omni 800 model 855, which sells for \$935 and prints at 150 characters per second (cps).

Keeping customers satisfied

Datek conducted a telephone survey of more than 500 office-automation planners and managers regarding their use of non-daisy-wheel printers in the office, plans regarding purchase of such printers over the next three years, buying habits and motivations, applications and general level of "printer awareness." Almost three-fourths of the sites used only daisy-wheel printers (Fig. 2). Of the respondents, 19 percent used ink-jet printers, all of which were IBM Corp. 6640s, suggesting the population was heavily weighted in the direction of IBM word-processing users. The 6640 is the only NLQ ink-jet printer on the market, and since it is no longer in production it seems reasonable to expect that ink-jet

It took over 100 years for America to do for the football what Zilog did for the computer in just three.

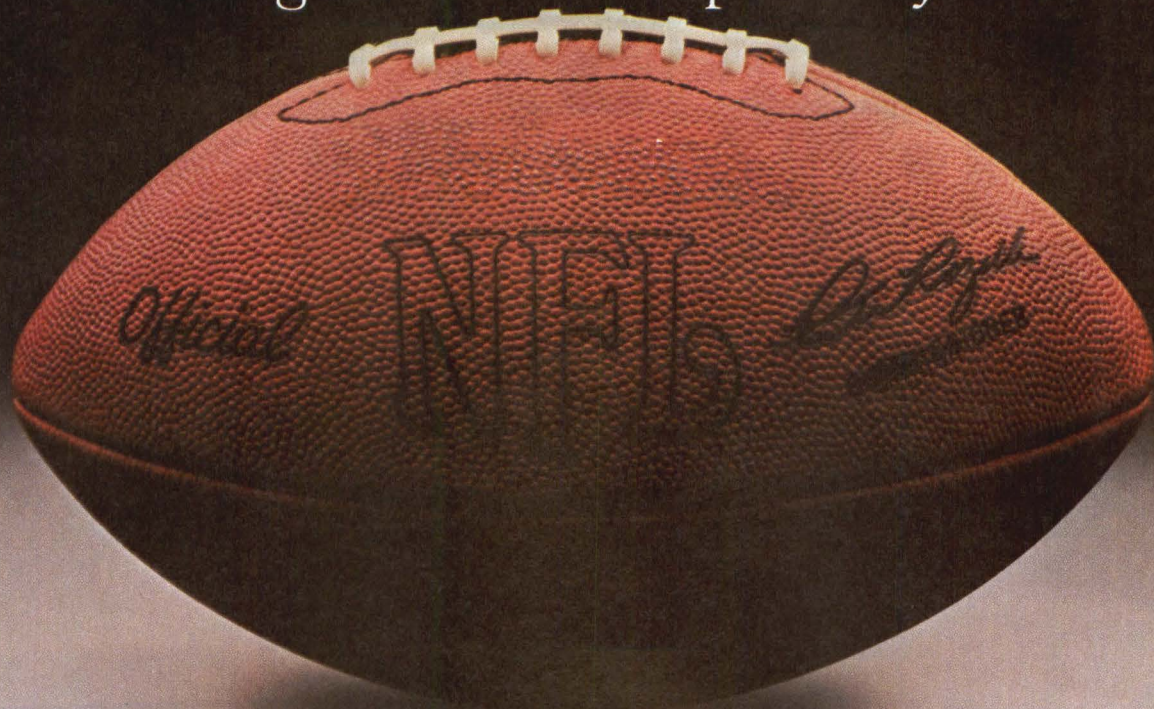

The next time you think about buying a computer system, think about the football. Because the evolution of its design clarifies the important distinction between too much and too little.

In 1869, Rutgers beat Princeton with a pumpkin-shaped ball in the first intercollegiate football game ever played. Like the mainframe computer, the ball was fine for a ground-breaking game, but had some pretty serious limitations.

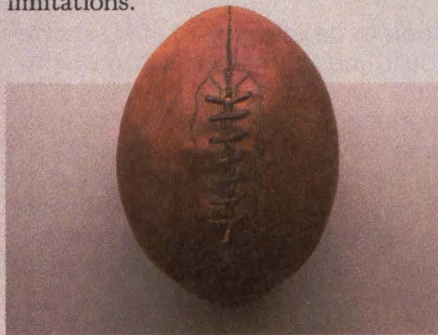

In 1874, Harvard played Montreal with a slimmer, watermelon-shaped ball good for running but not for passing. Like the personal computer, that ball was alright for individual effort, but didn't do much for teamwork.

Somewhere between pumpkin and watermelon was a solution just right for any game situation—the modern football. Likewise, Zilog's System 8000 supermicros offer the right solution for most business appli-

cations. They're much more powerful than personal computers and priced far less than mainframes and minis.

Between too much and too little computer is the right solution for business applications—the System 8000.

Thousands of our high-performance, 16-bit multi-user supermicros have proven themselves in environments from offices to oil tankers. They provide everything you need. Like the UNIX* operating system and software migration tools to protect your software investment—today and tomorrow.

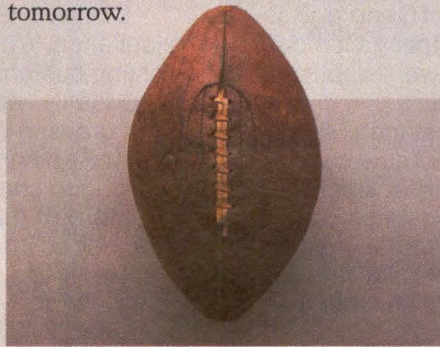

System 8000 provides portability of your applications, so you're not locked into one vendor.

Like access to applications through RSVP, our Referred Software Vendor Program. Like nationwide service tailored to your needs. Plus, in-depth technical support at every level—in the field and at our home office. And it's hard to outgrow our family of supermicros which start at less than \$15,000.

It took more than 100 years for the right football to come along. Fortunately, the right solution in a computer system is here today from Zilog, a company who is also a leader in microprocessor technology. Call Zilog Systems Division at (800) 841-2255. Or write: Zilog Systems Division, Corporate Publications, 1315 Dell Avenue, MS C2-6, Campbell, CA 95008.

*UNIX is a trademark of Bell Laboratories. Zilog, Inc. is licensed by Western Electric, Inc.



**Systems
Zilog**

an affiliate of EXON Corporation

CIRCLE NO. 87 ON INQUIRY CARD

**A BIG CHANGE
THAT HASN'T CHANGED
OUR PRODUCTS
IS OUR NEW NAME.**

GENICOM



Normally, you might not trust a product with a new name. But while all of our products have a new name, they also have a proven history of quality and reliability.

That's because Genicom was formerly the Data Communication Products Department of General Electric. Now an independently owned company, Genicom will continue the same product line we established with GE...only the name has changed.

Our Genicom 3000 family, for instance, still offers the same performance features already preferred by users and the design flexibility so important to OEM's, distributors, retailers and dealers. Speeds from 40 to 400 cps. Single or dual mode printing. Type quality from EDP to NLQ. Multi-color printing. Graphics. Selectable type fonts, American craftsmanship and more.

Of course, we'll also offer Genicom 2000 tele-

printers and the soon to be introduced 4000 shuttle matrix printers. You'll find we have the same complete product line that we had with GE. We have the same corps of experienced employees, the same facilities, and the same nationwide service network.

But above all, we have a new commitment to excellence. Which means, while we continue to serve existing customers with established products like our 3000 family, we plan to introduce more products to meet growing needs.

At Genicom, we've changed our name and we're planning to change the future with more innovations, and more of the quality you've come to expect from us under any name.

Genicom Corporation, One General Electric Drive, Dept. M321, Waynesboro, VA 22980. In Virginia, call 1-703-949-1170.

GENICOM

For the solution to your printing needs call
TOLL FREE 1-800-437-7468

CIRCLE NO. 88 ON INQUIRY CARD

printers over the next few years will make up a still smaller slice of the office printer market. Exxon Office Systems Co. has just begun shipping the only other current U.S.-developed LQ ink-jet printer, the 965, and it is too early to predict its market success. In any case, non-daisy-wheel printers should not significantly affect the volume of office printer shipments in the near future (Fig. 3).

Fig. 2. Distribution of printer technologies. All of the ink-jet units are IBM 6640s, indicating that the survey was weighted toward IBM users. Figures were derived from more than 500 office-automation sites. The percentages add to more than 100 percent because some sites reported using both daisy-wheel printers and one or more of the other printer types.

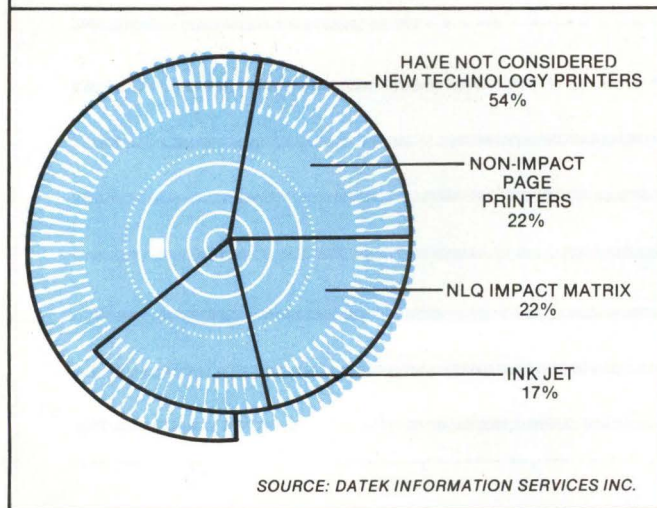
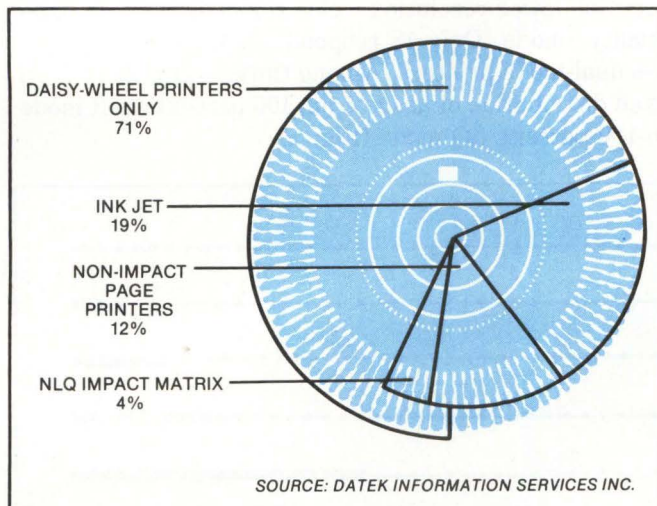

Fig. 3. Other technologies considered by daisy-wheel printer users. More than half have not considered switching to a new technology, while approximately equal percentages have considered one of the three competing technologies. Total percentages exceed 100 percent because some respondents were considering more than one technology.

Printer/workstation configurations are not directly related to the type of printer technology used in offices. The speed of the new-technology printers (such as the 92-cps IBM 6640 and the 36-ppm IBM 6670 page printer) is significantly higher than that of daisy-wheel printers. Thus, one would expect fewer printers per workstation in sites using new-technology printers. However, analysis indicates an almost-identical ratio of 2.3 workstations per printer in both the new-technology printer sites and the daisy-wheel-only sites. Among the explanations are that daisy-wheel printers typically are not retired after new-technology printers are bought, new-technology printer sites have less "keystroke-intensive" applications and that the higher speed of the new printers is not yet being fully used.

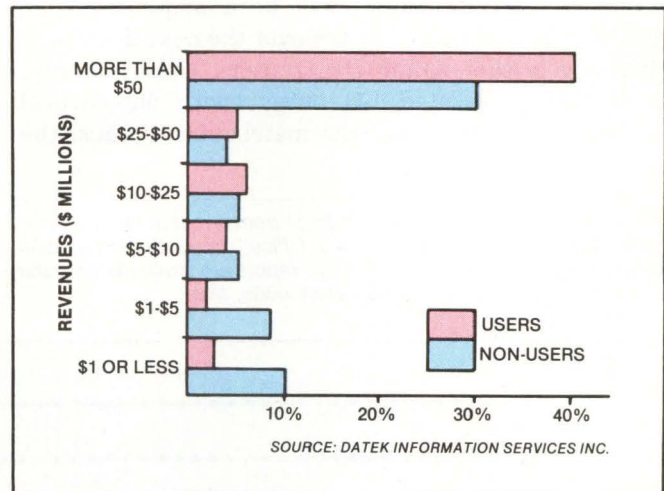

Fig. 4. The ratio of users to non-users of "new technology" printers such as ink-jet, impact matrix and non-impact page printers is directly related to organization size, as expressed in company revenues.

Large organizations are the pioneers

Most new-technology printers are in companies with more than \$50 million in annual revenues (Fig. 4). The printer technology used is also related to the type of business. The lowest ratio of users to non-users is in manufacturing, retailing and transportation. The highest ratio of users to non-users is in banking/finance and utilities.

Users who plan to switch technologies outnumber those who do not plan to switch except in government, education, retailing and medicine. Decision-makers are aware of alternative printing technologies and have buying decisions in the works. The question is when this interest will translate into sales, and which technologies will reap the greatest benefits. In attempting to make such predictions, the two most formidable unknowns are thermal-transfer printers and high-resolution, impact matrix printers.

Thermal-transfer printers appeared in the United States in 1983 in the form of proven Japanese products.

For several years, the technology has been successful for low-cost output for portable terminals and computers, color graphics and quiet word-processing output. U.S. manufacturers seem anxious to explore thermal printing, in part because it involves relatively modest development costs, but thermal-transfer printers will probably not make a significant market impact in the next five years.

Impact matrix printers gaining rapidly

Impact matrix printers will be a major factor in reshaping the printer industry over the next five years, especially in the LQ and NLQ areas. Until recently, users have associated LQ output with daisy-wheel printers and NLQ output with matrix units because the

matrix print quality has fallen short of the solid-font text of daisy wheels. But impact matrix technology is well-proven, reliability is relatively high, hardware and expendables costs are relatively low, and print-head innovations are improving speed as well as output quality. The staggered-array head, which significantly enhances print quality, is now the basis for many high-print-quality impact matrix printers, including Wang Laboratories Inc.'s 5577, Digital Equipment Corp.'s LA 100, Genicom's 3000 series and Advanced Matrix Technology's Office Printer.

The software impediment is also dissolving. The recent availability of powerful spreadsheet packages and other graphics programs is creating a strong demand for printers with graphics capability, and matrix units, with their high resolutions and speed, are best-suited for these applications. Matrix printers over the next five years will capitalize on the integrated software, personal computer market.

Dual-mode operation is unique to non-daisy-wheel printers, but users often want draft material to look as similar to final output as possible and therefore seldom use the lower-resolution "electronic data-processing-quality" mode. Only 18 respondents of more than 500 use dual-mode printers. Among those users, there is an even distribution of usage from 100 percent draft mode to 100 percent LQ mode (Fig. 5).

This article contains selected findings from a recent study—"New Technology Printers for Tomorrow's Office" by Datek Information Services Inc. Details of the 267-page report are available from the publisher at Datek, P.O. Box 68, Newtonville, Mass.

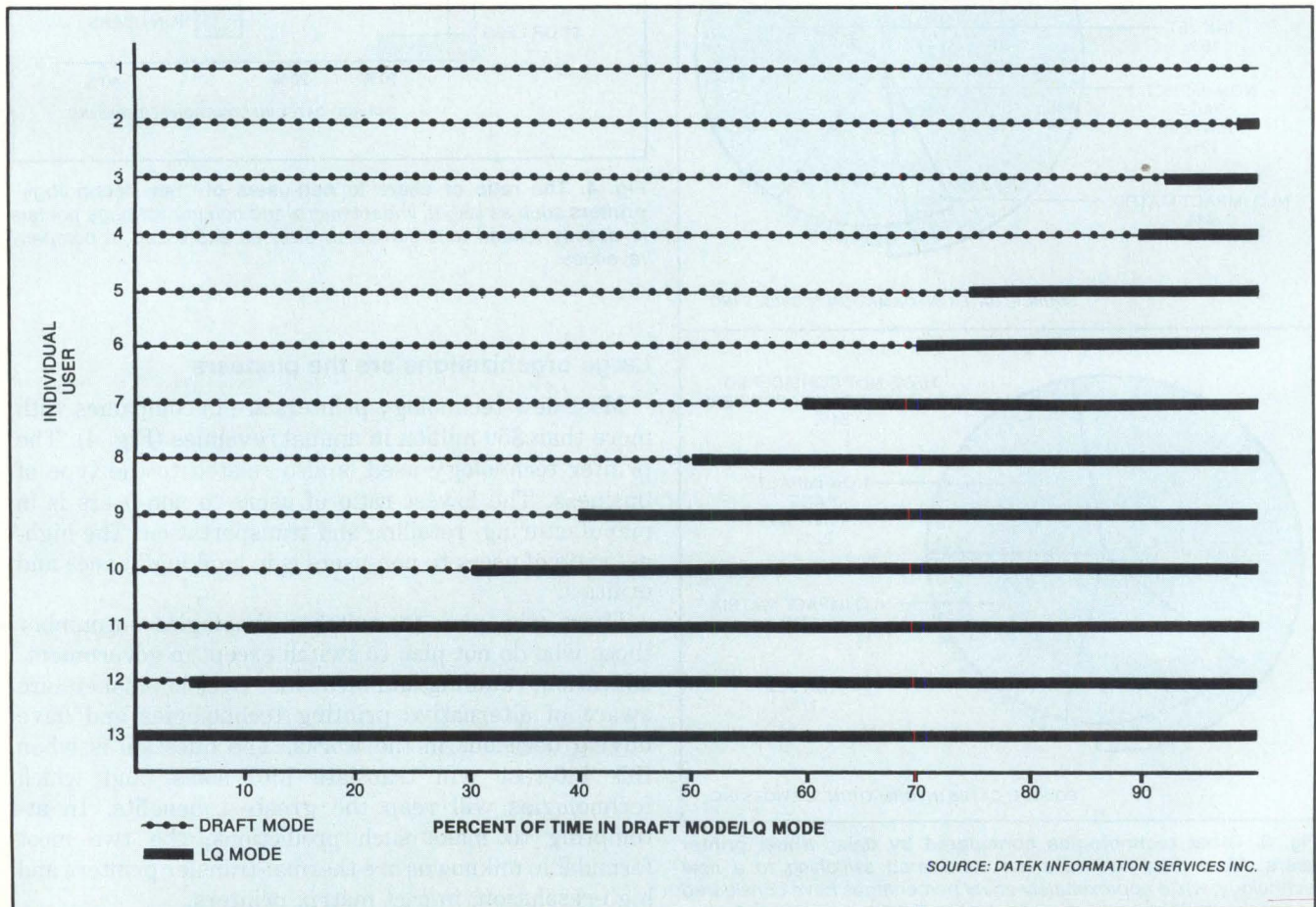

Fig. 5. A comparison of draft mode vs. LQ mode among respondents using multimode impact matrix printers shows that only 13 respondents could provide data on how usage varies between draft mode and LQ mode, but the distribution is surprisingly even.

PIECE OF MIND

CompuPro's System 816.

The fastest, most cooperative computer you can buy.

OEMs and systems integrators are busy people. Too busy to waste time with an uncooperative computer system. That's why every System 816 from **CompuPro** is built to work long and hard without a whine or a whimper.

More Dependable.

With ten years of pioneering successes built into it, the System 816 is backed by the industry's longest warranty coverage. Depending on your needs, our warranties range from 12 to 36 months. Most other computer manufacturers expect you to be satisfied with 90 days, which typically covers parts only.

You can also depend on complete hardware and software support, flexible configurations and upgrades, and system training.

More Powerful.

The System 816 squeezes more performance out of the IEEE-696/S-100 bus than any other system you can buy. A choice of CPUs—and up to 4 Mbytes of our exclusive M-Drive/H™ RAM disk—give multiple workstations all the speed and power they can ask for. Standard RAM memory is expandable to one megabyte or more.

Disk storage capacity ranges up to 4.8 Mbytes on floppy drives and as much as 320 Mbytes per controller on hard disk.

CompuPro®

A GODBOUT COMPANY

3506 Breakwater Court, Hayward, CA 94545

CP/M and CP/M-86 are registered trademarks and CP/M-68K, MP/M-86, Concurrent CP/M-86 and FORTRAN 77 are trademarks of Digital Research Inc. CP/M 8-16 and MP/M 8-16 are compound trademarks of Digital Research Inc. and CompuPro.

MINI-MICRO SYSTEMS/January 1984



More Versatile.

All family members share a common modular architecture. So it's a simple matter to upgrade or reconfigure any of them to keep up with your needs. All the while maintaining complete software compatibility up and down the line.

And the S-100 bus allows you the flexibility to plug in any compatible board to add graphics capabilities or boards for your own unique applications.

You also get your choice of operating environments, including CP/M®, CP/M-86®, Concurrent CP/M-86™, MP/M-86™ and CP/M-68K™, and our own CP/M®8-16™ and MP/M™8-16™.

At the programming level, the System 816 family supports Pascal, C, FORTH, BASIC, COBOL, PL/1, FORTRAN 77™ and more.

More Information.

Your customer's satisfaction is important to both of us, so don't get stuck with a system that's more of a hindrance than a help. Send in the coupon and find out what peace of mind is all about.

For business, scientific and industrial computing solutions, call **(415) 786-0909** ext. 506 for the location of our dealers worldwide, or the **Full Service CompuPro System Center** nearest you.

- Send me your free System 816 brochure.
- Send me the name of my nearest Full Service CompuPro System Center or dealer.

NAME _____
TITLE _____
ADDRESS _____
CITY _____ STATE _____ ZIP _____

Mail to: CompuPro, Attn: Sales Dept.
3506 Breakwater Court, Hayward, CA 94545

Prices and specifications subject to change without notice.

System 816 front panel design shown is available from **Full Service CompuPro System Centers** only.

©1983 COMPUPRO

CIRCLE NO. 89 ON INQUIRY CARD

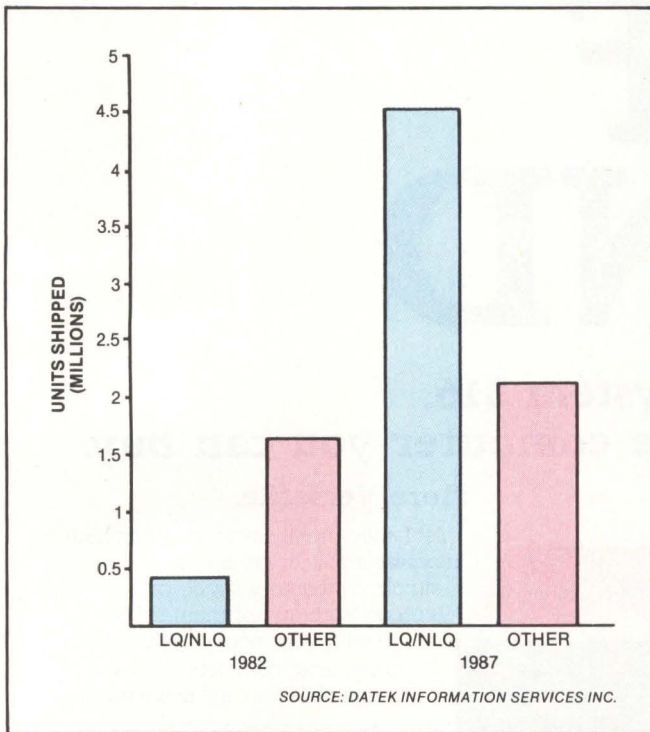

Fig. 6. Units-shipped comparison between LQ/NLQ and other (less-than-NLQ) printers in 1982 and 1987 shows that multimode impact matrix printers account for a reversal and comprise almost 70 percent of the 4.5 million units forecast to be shipped in 1987.

The U.S. printer market will mushroom from around 2 million units shipped in 1982 to more than 6.5 million in 1987, but the proportion in each print-quality category will reverse (Fig. 6). In 1982, it was 3:1 in favor of less-than-NLQ printers, but, by 1987, it is expected to be 2:1 in favor of LQ/NLQ printers.

Which technologies will benefit most from this explosion in the demand for higher-quality print? The answer is that almost 70 percent of the 1987 market is expected to go to NLQ impact matrix printers, most of which will be used for general applications rather than pure word processing. Around 25 percent of the 1987 market will go to daisy-wheel printers, with the inexpensive low-end units significantly outnumbering the high-end (35 cps and faster) units. Low-cost laser printers and NLQ impact matrix printers will challenge high-end daisy wheels. Non-impact technologies are expected to represent only a minor slice, although, in absolute terms, ink-jet, thermal-transfer and non-impact page printers will grow rapidly. □

Edward Webster is president of Datek Information Services Inc., Newtonville, Mass., a consulting and publishing company specializing in digital printers.

PRINTRONIX

DOMESTIC DISTRIBUTOR TERRITORIES

- NM: El Paso Cty, TX
BFA Corporation
(505) 292-1212 TWX/TLX: 910-983-1157
- PR: VI
Compu-tec Systems Corp.
(809) 781-7880 TWX/TLX: 325-2326
- N. DE; S. NJ; E. PA
Denco Data Equipment
(215) 542-9876 TWX/TLX: 510-661-0638
- N. IA; MN; ND; SD; W. WI
Dytec North
(612) 645-5816 TWX/TLX: 910-563-3724
- S. IL; S. IA; KS; MO; NE
Dytec South
(314) 569-2990 TWX/TLX: 910-764-0840
- AL; FL; GA; LA; MS; NC; SC; TN
Gentry Associates
(305) 859-7450 (800) 432-2226 (Florida)
TWX/TLX: 810-850-0136
- CA; N. ID; NV; OR
Group III Electronics
(213) 643-6997 TWX/TLX: 910-348-7103
- N. NJ; NYC
Logon/TMA
(201) 646-9222 TWX/TLX: 710-991-9710
- KY; MI; OH; W. PA; WV
Lowry & Associates
(313) 227-7067 TWX/TLX: 810-242-1519
- S. DE; MD; VA; DC
Mesa Technologies, Inc.
(301) 948-4350 (800) 638-2039
TWX/TLX: 710-828-9702
- NY State
NACO Electronics
(315) 699-2651 TWX/TLX: 710-541-0439
- AZ; S. ID; MT; VT; WY
Par Associates
(303) 371-4140 TWX/TLX: 910-932-0180
- N. IL; IN; E. IA; E. WI
Peak Distributors, Inc.
(312) 255-0707 TWX: 910-687-2267
- HI
Peripherals of Hawaii
(808) 538-7797
- CT; ME; MA; NH; RI; VT
S & S Electronics
(617) 458-4100 TWX/TLX: 710-343-3456
- AK
Sector Systems
(907) 276-8825
- AR; OK; TX
U. S. Data Associates
(214) 680-9700 TWX/TLX: 910-867-4838

PRINTRONIX

SALES OFFICES

- Atlantic Regional Office**
Printronic
7½ Harris Road, Nashua, NH 03060
(603) 888-6140 TWX: 710-228-8017
- Central Regional Office**
Printronic
700 E. Ogden, Suite 202, Westmont, IL 60559
(312) 325-3662 TWX: 910-651-0116
- No. Calif. District Office**
Printronic
50 W. Brokaw Road, Suite 64, Rm. 101
San Jose, CA 95110
(408) 297-8045 TWX: 910-338-2290
- Southeast District Office**
Printronic
P.O. Box 12008, 8000 S. Orange Ave., #109
Orlando, FL 32809
(305) 859-5574 TWX: 810-850-0240
- Southwest District Office**
Printronic
9451 LBJ Freeway, Suite 220, Bldg. B
Dallas, TX 75243
(214) 680-3168/3169 TLX: 758-760
- Western Regional Office**
Printronic
17500 Cartwright Road, P.O. Box 19559
Irvine, CA 92713
(714) 863-1900 TWX: 910-595-2535

PRINTRONIX

INTERNATIONAL OFFICES

- For names and addresses of International Offices and Distributors, contact Printronix International Headquarters:
- Printronic**
17500 Cartwright Road, P.O. Box 19559
Irvine, CA 92713 U.S.A.
(714) 863-1900 TWX: 910-595-2535

A PRINTER FOR EVERY NEED AND EVERY SPEED.

If you're looking for a dependable lineup of printers, look at Printronix. We've got it all in the family.

From Word Processing at 80 LPM, Graphics at 150 LPM, to high-volume Data Printing at 2000 LPM, Printronix printers do it all, without skipping a

beat. In fact, they're the only printers built to take the pressure of continuous duty processing in the most rigorous environments.

And, in addition to industrial durability, our unique hammerbank technologies give you superior

print quality and outstanding graphics capability.

For printers for every need and every speed, come to Printronix. The best printer line for your bottom line.

For more information, please write or call today.

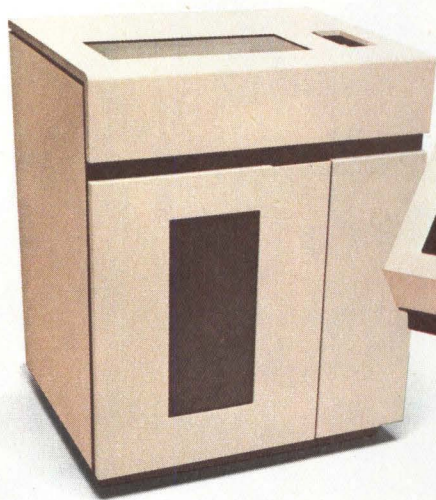

P-Series

The P-Series consists of our proven printer/plotters, the P300 and P600. At 300 LPM, the P300 can combine bar codes, OCR and alphanumerics all in one dependable package to bring you the best in medium-speed line printer capabilities.

And, with twice the throughput of our P300, the extra-rugged P600 is truly an industrial printer, designed for all your heavy-duty processing tasks.

Plus, there's our new P-Series XQ. Enhanced versions of our P300 and P600, delivering high-speed draft print and compressed print in an office-quiet cabinet.



DataPrinter

Our DataPrinter series gives you the most reliable band printer performance available, using a precision hammer actuator system evolved from chain printer technology.

DataPrinter's fully-formed character bands offer superior print quality for your super-mini and mainframe data processing needs,

at speeds from 600 LPM to a blistering 2000 LPM.

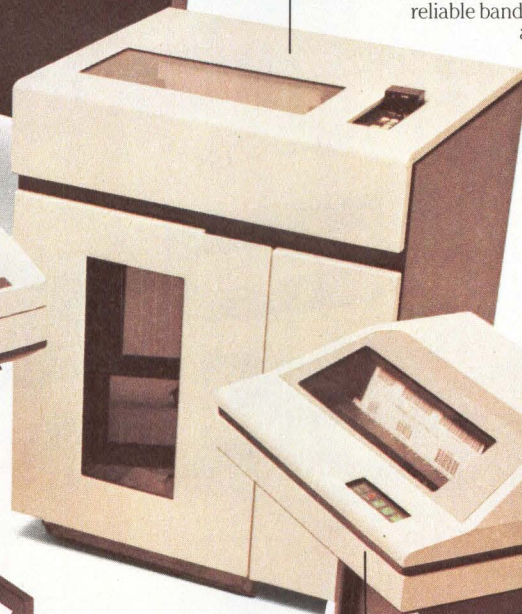

MVP

Our MVP is the business printer that really means business. It's the world's first and only microcomputer line printer which puts the dependability of our P-Series into a smaller package.

The MVP is truly the Most Versatile Printer, with selectable speeds ranging from 80 LPM to 200 LPM, and full graphics capability. It's the perfect printer for all your multi-user, multi-application needs.



The 4160 GraphicPrinter

The 4160 GraphicPrinter combines the reliability and versatility of Printronix technology with higher dot density. Perfect for applications requiring high resolution graphics.



THE FIRST LINE IN PRINTERS.

PRINTRONIX

17500 Cartwright Road
P.O. Box 19559, Irvine, CA 92713
714/863-1900 TWX: 910-595-2535

Outside California: 800-556-1234, ext. 66
In California, 800-441-2345, ext. 66

Leapfrog



Holloway

to 32 bits!



The 32-Bit Advantage

For OEMs and system integrators, getting the jump on the competition means leapfrogging to the most advanced technology available. Today, that means making the jump to 32-bit architecture. Now. When it can give you a decisive advantage.

32-Bit Memory on a 32-Bit Bus

The Universe 68/05 is a true 32-bit system because it handles 32-bit data transfers in parallel on its 20Mb/sec VERSAbus, while most 68000-based machines are still limping along with 16-bit buses. With the next generation of processors (like the MC68020), a full 32-bit bus will be a requirement on *all* systems. VERSAbus is there now, and it's non-proprietary.

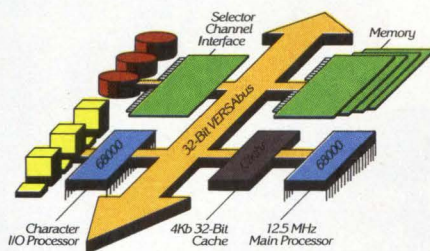

32-Bit Cache, 12.5MHz 68000

Our new Universe 68/05 is the first general-purpose computer built and delivered using the new 12.5MHz 68000 microprocessor. Its 4Kb 32-bit cache memory virtually eliminates wait states, while a separate 68000 I/O processor offloads the main 68000. Its MIPS rate – 1.25 million instructions per second – outstrips a VAX 11/750 that costs several times as much.

UNOS is a trademark of Charles River Data Systems, Inc. UNIX is a trademark of Bell Laboratories. VERSAbus is a trademark of Motorola. VAX is a trademark of Digital Equipment Corporation.

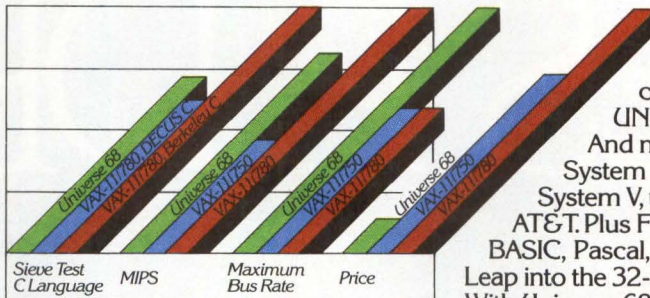

Universe 68 provides performance comparable to VAX, at a price far below VAX.

32/64-Bit Hardware Floating Point

Our new IEEE-format hardware floating point unit handles 32- and 64-bit operands fast. In fact, with floating point performance in the 40-50K flops range, it holds its own very nicely with VAX-level machines. Yet the Universe 68's price tag is only a fraction of a VAX's.

The First 32-Bit System Under \$10,000

The Universe 68/05's under-\$10,000 OEM-quantity-one price includes 32-bit central processor, 10Mb Winchester, 1.26Mb floppy, 256Kb RAM (expandable to 3Mb), and four serial I/O ports (expandable to 64). You can build multiterminal systems around a 68/05 at a cost-per-user that will embarrass workstation systems. For even more horsepower and expandability, you can hop over to the compatible Universe 68/37 or 47.

The 32-Bit, Real-Time, Bell UNIX UNOS, our multi-user, multi-language



operating system, brings real-time, transaction-oriented capabilities to the UNIX-compatible world. And now we also offer CRDS System V, a derivative of UNIX System V, under license from AT&T. Plus Fortran, RM/COBOL, BASIC, Pascal, C, and DBMS. Leap into the 32-bit future now. With Universe 68 from Charles River Data Systems.

UNIXTM

NOW RUNS ON

UNOSTM

MM1

Send me "The Insider's Guide to the Universe," an informative 24-page discussion of the technical concepts behind the Universe 68 family of computers.

Have a sales engineer call.

Name _____

Company _____

Address _____

City _____ State _____ Zip _____

Telephone _____

Return to Charles River Data Systems, 983 Concord St., Framingham, MA 01701 (617) 655-1800



CHARLES RIVER DATA SYSTEMS

TAKE ONE FOR A TEST DRIVE.

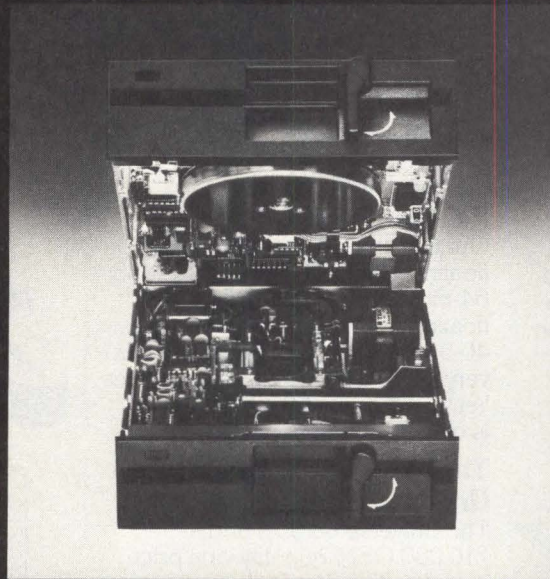

Introducing the 1984 TEACS.

A full line of 5 1/4 inch half-high flexible disk drives. Available in single/double sided, 48 tracks per inch/96 tracks per inch, single/double density.

With Teac's exclusive system of half-high at half power you get less heat build-up, less media expansion and disk off-tracking problems. Which means more reliability plus more adaptability.

And, Teac's brushless DC direct drive motors are proven mileage champs with up to 10,000 hours MTBF. Which only goes to show, as always, Teac quality pays off down the road.

TEAC ICPD
BUILT TO FANATICAL STANDARDS.

COPYRIGHT 1983. TEAC INDUSTRIAL COMPUTER PRODUCTS DIVISION. 7733 TELEGRAPH ROAD, MONTEBELLO, CALIFORNIA 90640

CIRCLE NO. 92 ON INQUIRY CARD

Designed-in toughness

The Microscience HH-612 is a half-height (1.625") 5.25-inch Winchester disk drive, weighing only 3 pounds, that delivers a big 10 MB of formatted data storage.

The HH-612's long list of advanced features add up to one simple fact: this drive is tough! Using plated media, microprocessor-controlled closed loop servo-positioning, microprocessor-controlled spindle motor, four-corner shock absorber mounting, embedded guard bands, and extensive on-board diagnostics, the Microscience design team has come up with a drive rugged enough for desktop, portable and other hard-use environments.

But consider this as well: the HH-612's advanced electronics

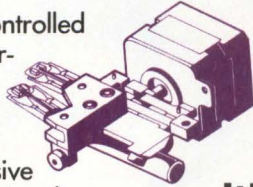

ease the load on supplier tolerances to keep reliability high. And the HH-612 has been designed with a number of key off-the-shelf parts, so sources of supply won't run dry. Each drive goes through a Microscience-designed testing and quality assurance program that can't be matched anywhere in the industry. That's why we can offer a full-year parts and labor warranty.

Okay, the Microscience HH-612 is tough. But how about ready?

It's ready to ship

You've probably been hearing some delivery promises the last year or so. Well, if you want more than just promises, ask Microscience for immediate delivery of evaluation units, and watch us

respond. We're ready to ship the product today. Not just one, but volume deliveries to meet your production schedule.

How can we do it, when so many other disk drives are still on the drawing board? Because we designed a tough drive that can be built in quantity.

And we've got the people, the clean-room production lines, the test equipment, the sales and support groups all in place.

We'll prove how tough and ready the HH-612 really is. Call or write Microscience. Today.



 **Microscience
International
Corporation**

575 E. Middlefield Road
Mountain View, CA 94043
(415) 961-2212

CIRCLE NO. 93 ON INQUIRY CARD

TOUGH AND READY

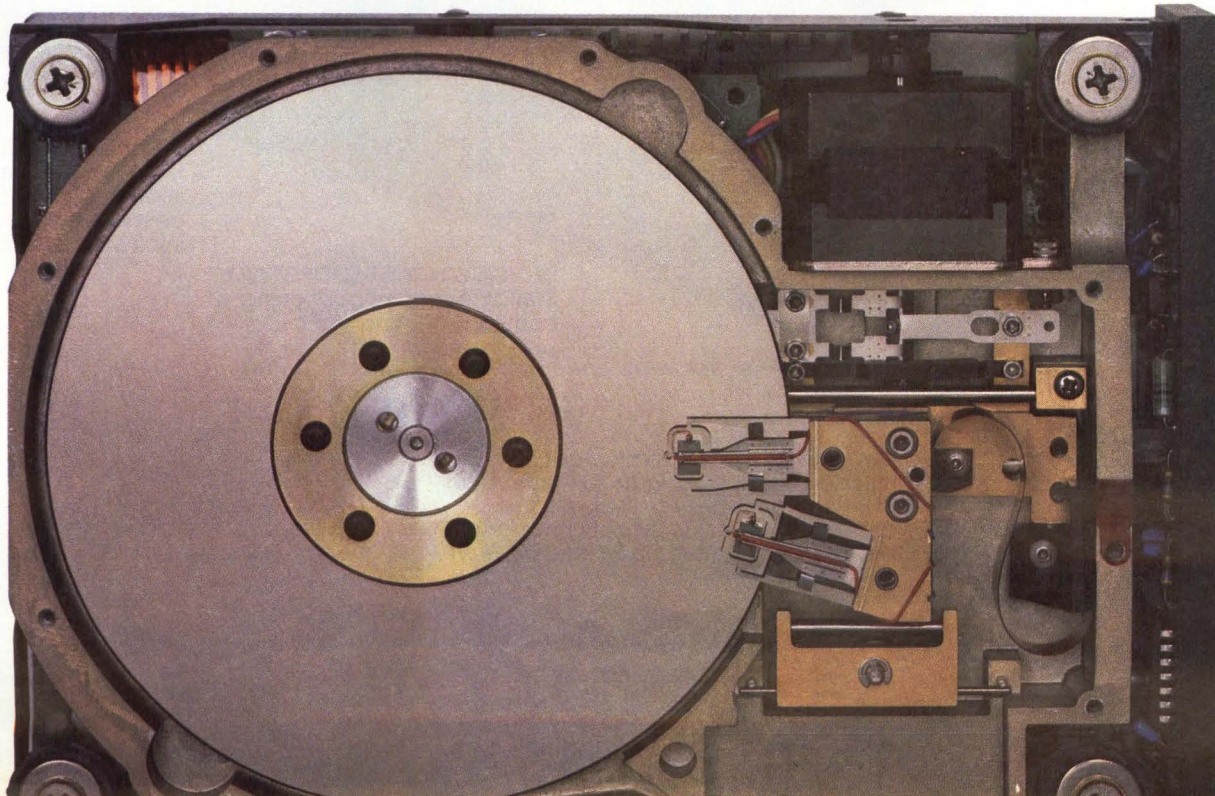

NOW—SUPER-PERFORMING 5¼" WINCHESTERS WITH BUILT-IN RELIABILITY.

AVAILABLE NOW
21 or 36
MBYTE CAPACITIES.

TWO INTERFACE OPTIONS:
4.84 MHz (NRZ I/O data) or 5.0 MHz (MFM I/O data, compatible to ST506/ST412).
The transfer rates permit WREN to be matched with off-the-shelf controllers for easy systems integration.

ROTARY VOICE COIL ACTUATOR provides 45-millisecond average access time including head settling.

NEW
45 mSec
AVERAGE SEEK TIME.

HEADS never land on data areas. All WREN drives use a dedicated media zone for head take-off and landing.

UNIQUE SHOCK-MOUNTED BASE deck assembly isolates heads and media from external vibration. Automatic actuator restraint and manual shipping lock prevent head movement during shipment.

DEDICATED CLOSE-LOOP SERVO SYSTEM for added positioning accuracy and maximum system performance.

VERTICAL OR HORIZONTAL MOUNTING in the same space as a 5-1/4" FDD permits easy integration into FDD-based systems.

T H E W R E N™

The Model 9415 WREN disk drive gives you a host of value-added features. From microcomputer and LSI control logic to special-formula media, high technology has finally delivered a 5-1/4" winchester with more reliability.

Compare for yourself. Call your local Arrow or Kierulff distributor today. Or write: OEM Product Sales, HQN08H, Control Data Corporation, P.O. Box 0, Minneapolis, MN 55440.



GD CONTROL DATA

Matrix printer combines letter-quality text, color graphics

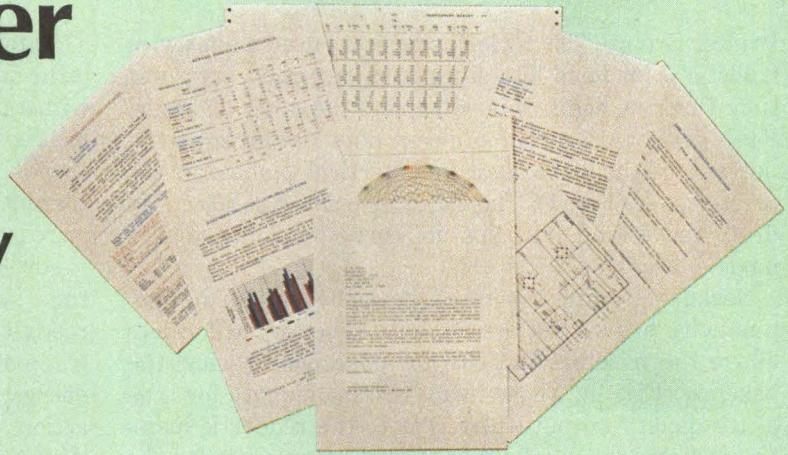

RICHARD A. WILLIAMS, Dataproducts Corp.

Dataproducts' new printers involve trade-offs in speed, print quality and reliability

Dot-matrix printers generally do not offer letter-quality output equaling that of solid-font printers. However, new print-head designs and character-formation techniques have now made that possible. The design of two new dot-matrix printers from Dataproducts Corp., a 200-character-per-second (cps) and a 400-cps unit, lend insight into the trade-offs required to achieve this output level. Major decision areas included print-head configuration, needle diameter and material selection.

Print-head design involves trade-offs

Dot-matrix print heads consist of metal wires or pins, called needles, that are controlled by small electromagnetic solenoids. There is usually one solenoid per needle. Electrical current is applied to the solenoid, which propels the needle against the ribbon and paper. Needle motion is synchronized with head and paper movement. After the needle is activated, the solenoid field collapses, allowing the needle to return to its original position. Designing the print head involves a number of speed-vs.-dot-density trade-offs relating to needle configuration, diameter, materials and timing.

Dataproducts' new printers evolved from the P-Series printers, which were first shipped in 1982 by Integral Data Systems (now Dataproducts Serial

PRINTERS

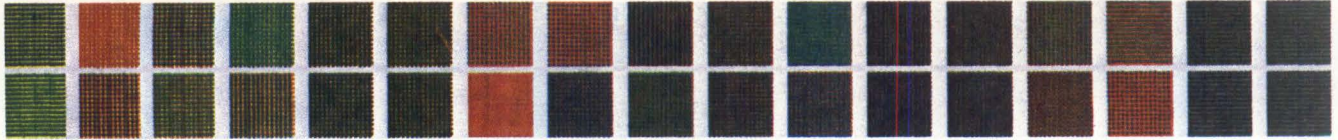

Printer Group). The P-Series printers used a nine-wire ballistic print head in a staggered, two-row configuration. One row had five needles, and the other had four. Each dot could overlap adjacent dots 10 percent to 20 percent in the horizontal and vertical planes on the printer page (Fig. 1). The P-Series printed at 200 cps in draft mode and 110 cps in correspondence-quality mode.

Serial dot-matrix printers typically use an in-line, nine-wire print head, usually with seven wires for dots above the baseline and two for descenders below the baseline (Fig. 2). These heads are inadequate for true letter-quality output—text that to the reader is indistinguishable from solid-font text. Design goals for the new printers dictated that the print head produce letter-quality output and achieve a 400-cps print speed in single-pass draft-quality mode.

The printer generates a character in a first pass and then follows in a second pass at a vertical spacing of 1/44 inch.

The first design choices concern the needles. The traditional nine-needle, in-line head configuration cannot achieve either the desired print quality or speed. A traditional 18-needle staggered design (Fig. 3) would provide the quality but not the speed. The company resolved this dilemma by placing nine needles in four rows of 4, 5, 5 and 4 dots each (Fig. 4). This approach more than doubles the speed limit of the traditional 18-needle design, as defined by mechanical stress limitations.

Another important print-head design consideration is the trade-off between print quality and print-head life. Wire wear is a prime cause of failure in matrix print heads, due to the peening (flattening or bending) effect caused when the print wire strikes the paper. The smaller the needle diameter, the faster the peening. Likewise, the larger the needle diameter, the higher the reliability. At the same time, the needle must minimize the perceptible dot separation, or cusp, to generate letter-quality print.

Analysis of various cusp sizes indicated that a vertical distance of 0.012 inches between dot centers would provide the desired resolution. A wire diameter of 0.014 inches was selected to bridge print quality and head life. The slight increase in wire diameter allowed an expected head life of 500 million characters.

Materials selection is a third critical factor in the print-head design. Print heads must be built to withstand repeated temperature cycling. Some dot-matrix printers use powdered metal, but, at high speeds, this substance generates too much eddy current and heat. To minimize eddy current and increase the duty cycle, glass-filled plastics are used.

For high speed, needle “out and return” time—the time spent striking and returning the needle to its ready-to-fire position—must be minimized. Thus, a trade-off exists between velocity and damping, or the energy dissipation resulting from the strike-and-return action. The solution was to use non-linear springs on the print-head needles. The non-linear springs allow an adjustment of the needle’s striking force for the best compromise between speed, damping and adequate impression on multipart forms. The maximum impression force can print one original and five copies.

The mass of the wire is as important as its diameter. The greater the mass, the darker the dot it makes. More energy is needed, however, to move the greater mass at an equal velocity. With these principles in mind, tungsten rather than steel was chosen as the wire material because of tungsten’s lower mass and superior strength and durability. Although the lower mass results in a lighter dot, the difference is not perceptible.

The 18-needle head uses a nine-needle configuration for the 200-cps model and the full 18 needles for the 400-cps model. Using the same head in both models reduces manufacturing and inventory costs.

Print techniques determine print qualities

Most near-letter-quality matrix printers use a multi-pass printing technique, which reduces throughput. In cases in which 18 or more print needles are available, it is usually necessary to lower carriage speed to give the controller more time to access and format the additional dots. Since horizontal dot spacing is a factor of the speed at which the print head moves across the page, it is theoretically possible to print with any horizontal resolution. The typical print wire is about 14 mils (0.0014 inches) in diameter, and the dot on the page smudges out to about 15 mils. Legibility does not increase perceptibly at horizontal resolutions greater than 100 dots per inch (dpi).

Two elements control vertical resolution: vertical needle spacing in the head and vertical paper control. Print heads have either a non-overlapping vertical column or multiple columns with needle spacing that allows vertical dot overlap. Vertical overlapping requires increased controller complexity.

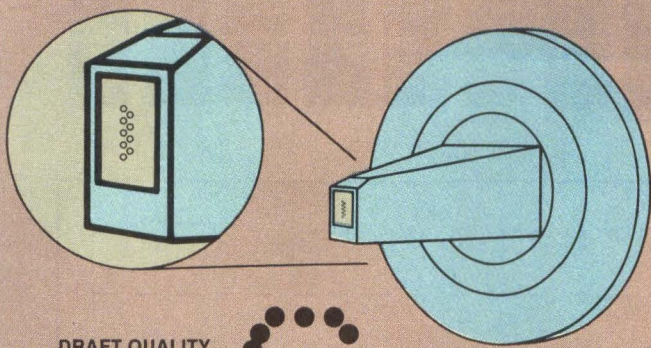

DRAFT QUALITY
9 HIGH
18 WIDE

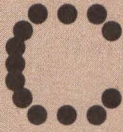

TEXT QUALITY
9 HIGH
24 WIDE

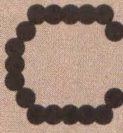

LETTER QUALITY
18 HIGH
36 WIDE
2 PASS
● FIRST PASS
○ SECOND PASS

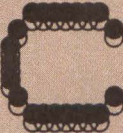

DETAILS

- 0.014 WIRE DIAMETER
- 0.0122 PITCH
- DRAFT = 180 DPI
- TEXT = 240 DPI
- LETTER = 360 DPI

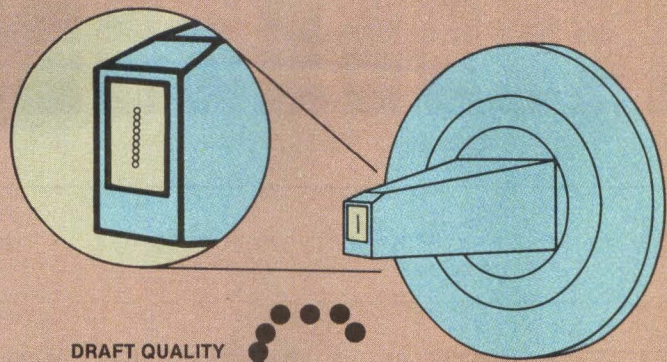

DRAFT QUALITY
9 HIGH
18 WIDE

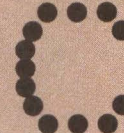

TEXT QUALITY
9 HIGH
24 WIDE



LETTER QUALITY
18 HIGH
36 WIDE
2 PASS
● FIRST PASS
○ SECOND PASS

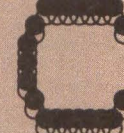

DETAILS

- 0.014 WIRE DIAMETER
- 0.014 PITCH
- DRAFT = 180 DPI
- TEXT = 240 DPI
- LETTER = 360 DPI

Fig. 1. A typical nine-needle print head has a staggered array of four and five wires.

Fig. 2. Traditional nine-needle dot-matrix print-heads arrange the needles in a straight line. These in-line heads typically use seven wires for printing above the baseline, reserving two wires for descenders below the baseline.

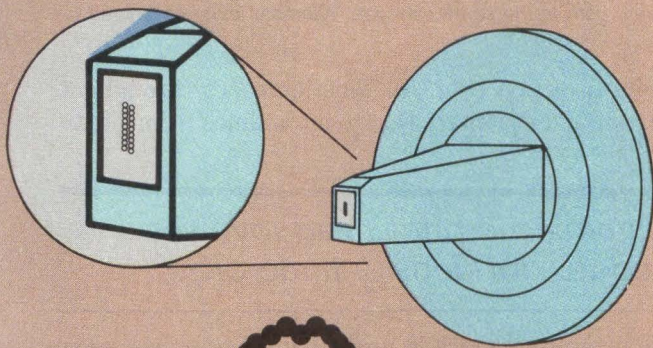

DRAFT QUALITY
18 HIGH
18 WIDE

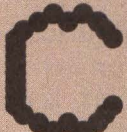

TEXT QUALITY
18 HIGH
24 WIDE



LETTER QUALITY
18 HIGH
36 WIDE



DETAILS

- 0.012 WIRE DIAMETER
- 0.006 PITCH
- ROW 1/30 IN. APART
- DRAFT = 180 DPI
- TEXT = 240 DPI
- LETTER = 360 DPI

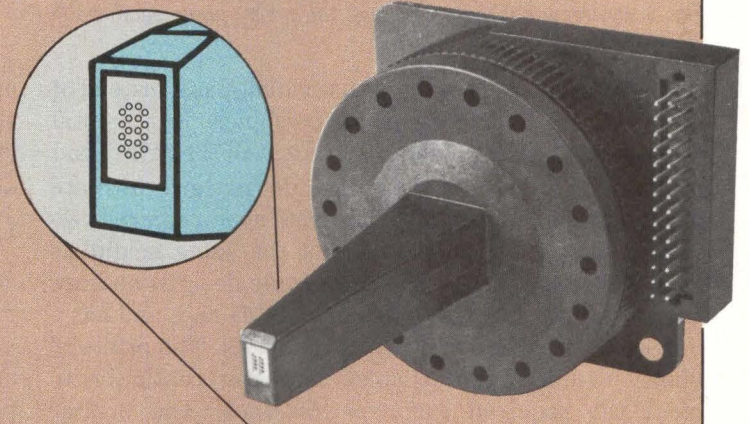

DRAFT QUALITY
9 HIGH
18 WIDE

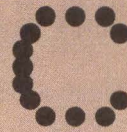

TEXT QUALITY
9 HIGH
24 WIDE
1 PASS

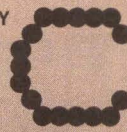

LETTER QUALITY
18 HIGH
36 WIDE
2 PASS
● FIRST PASS
○ SECOND PASS

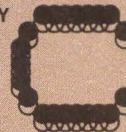

DETAILS

- 0.014 WIRE DIAMETER
- 0.0122 PITCH
- ROWS 1/30 IN. APART
- DRAFT = 180 DPI
- TEXT = 240 DPI
- LETTER = 360 DPI

Fig. 3. A typical 18-needle staggered print-head configuration is arranged with two straight lines of nine needles each, offset one-half dot from each other.

Fig. 4. The design of Dataproducts' 18-wire staggered print head reduces the mechanical stress associated with traditional dual in-line 18-needle heads.

PRINTERS

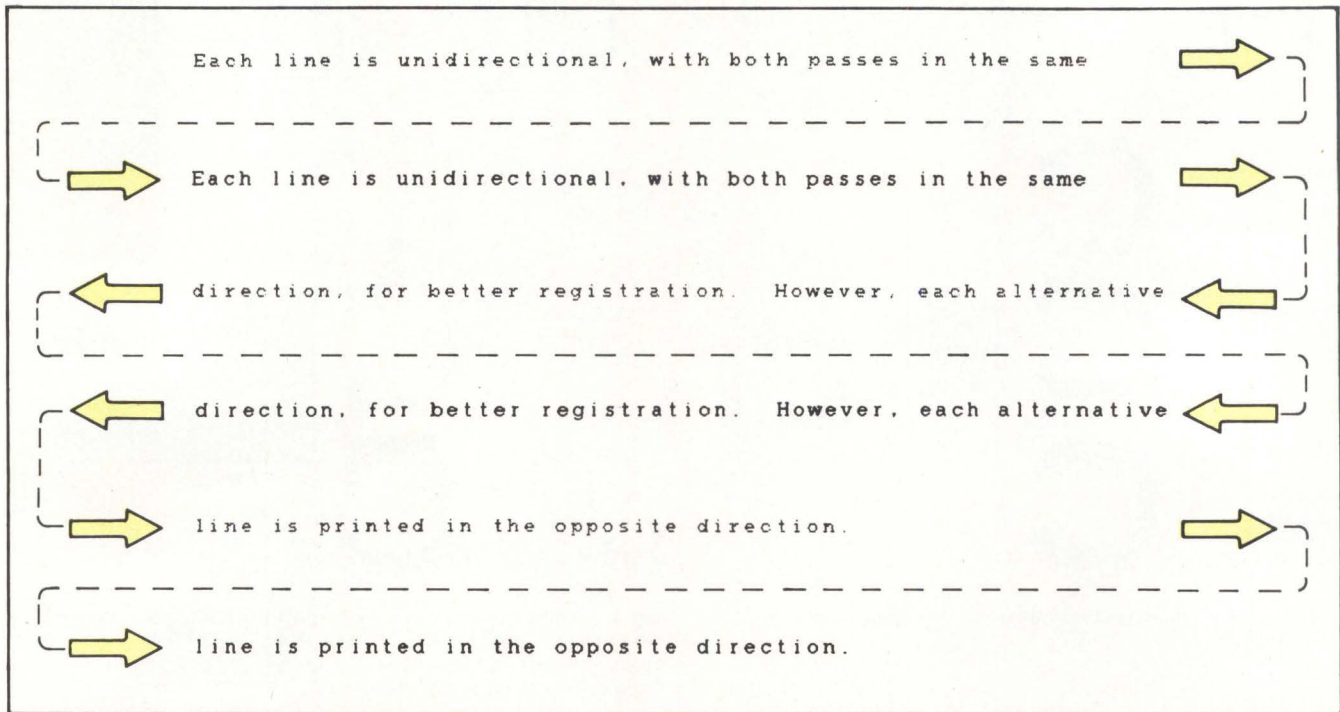
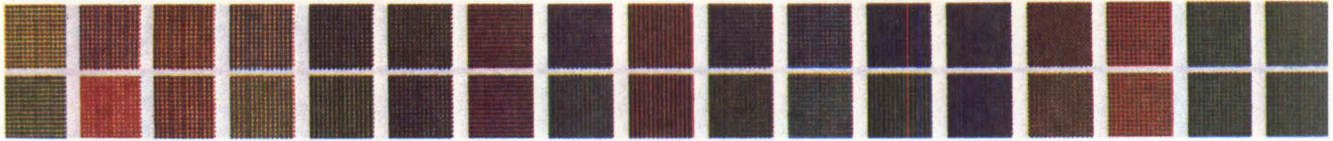

Fig. 5. Bidirectional logic seeking. The printer prints each line in two passes, both in the same direction. Alternate lines are printed in opposite directions.

The Dataproducts printers use a dual-pass, instead of a multipass, technique that combines incremental vertical paper motion with two passes of the print head over the print line, interleaving a dot pattern to create letter-quality characters. The print head requires two passes to generate characters of the same height as those printed by traditional 18-needle designs because the Dataproducts' matrix is only half as high and has a vertical character formation of nine dots. The printers' ability to microspace enables character resolution to meet the required cusp specifications. The printer generates a character in a first pass and then follows in a second pass at a vertical spacing of $\frac{1}{44}$ inch. The resulting density of 360 dpi produces letter-quality type.

The printers use bidirectional logic seeking. Each line is unidirectional, with both passes in the same direction, but each successive line is printed in the

opposite direction (Fig. 5). This increases throughput 15 percent over printers that print all lines from left to right.

Designing the print head involves speed-vs.-dot-density trade-offs.

The printers operate in draft (data-processing), text and letter modes. Drafts are printed at 400 cps in one pass using an 18-by-9 matrix. Text is printed at 240 cps in one pass using a 24-by-9 matrix, and letters are printed at 70 cps in two passes using a 36-by-18 matrix. All matrix sizes are for 10 characters per inch (cpi), which can also be set to 12 or 17.1 cpi. All qualities are printed three phase, meaning that each needle can fire during every third head position.

Dot-matrix printers have graphics capabilities that

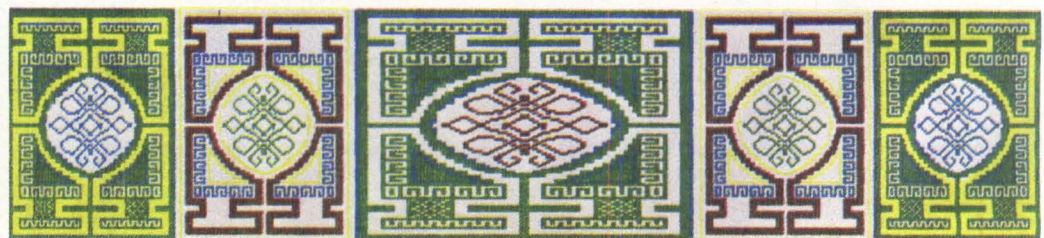

Fig. 6. Needle-addressable graphics produced by the 400-cps Dataproducts printer has 168-by-168-dpi resolution, which was achieved using $\frac{1}{44}$ -inch vertical increments under host control.

DEC PRIME DATA GENERAL IBM WANG HP TANDEM PERKIN-ELMER

RELIABLE REMOTE PRINTING WITHOUT THE COSTS

At up to 1800 LPM

BREAK YOUR REMOTE PRINTING BOTTLENECK

The Remote Line Printer System (RLPS, patent pending) *Obsoletes* all current solutions for high speed, cost effective minicomputer based remote printing! Quite simply, the RLPS "looks" like a locally attached printer to your system.

DOUBLE OR TRIPLE YOUR THROUGHPUT

The RLPS plugs into the parallel printer port and accepts data in the more *efficient* parallel mode. Combined with its advanced data compression techniques, the RLPS provides speeds up to 1800 LPM as compared to the typical 500 LPM limitation with serially attached line printers.

DATA INTEGRITY AT LOW COST

The RLPS uses modern X.25 level 2 protocol to assure data integrity and eliminate the need for costly communications hardware to detect errors.

SAVE UP TO 50% IN TRANSMISSION COSTS

The RLPS' improved throughput results in cost savings of up to 50% or more in a dial-up environment *OR* increased availability of a private wire for better system utilization.

ABSOLUTELY NO SOFTWARE COSTS

The RLPS doesn't require a communications operating system and special software handlers. Further, the RLPS eliminates the need for reprogramming; *both* local and remote users have the same version of applications software.

PLUG COMPATIBILITY AND FLEXIBILITY

For maximum versatility, the RLPS can be configured for applications in the same building as your system, cross town, cross country and even over satellite circuits! Plug compatibility with a wide range of systems including those manufactured by DEC, DATA GENERAL, HEWLETT-PACKARD, TANDEM, PRIME, WANG, HONEYWELL, and IBM is *GUARANTEED*.

DIGITAL ASSOCIATES, THE PRINTER SOURCE, is America's leading independent supplier of plug compatible line printer systems. We offer the largest selection available, savings of up to 50% off your system vendor's prices, quick delivery, nationwide service, a full line of printer controllers and communications interfaces and complete product support with a full line of ribbons and supplies.

For further information on the RLPS or plug compatible line printer systems, call our hotline, (203) 327-9210 today.

The Printer Source...



better printers at better prices

1039 East Main Street
 Stamford, Connecticut 06902
 (203) 327-9210

You don't need a computer to talk to another computer.

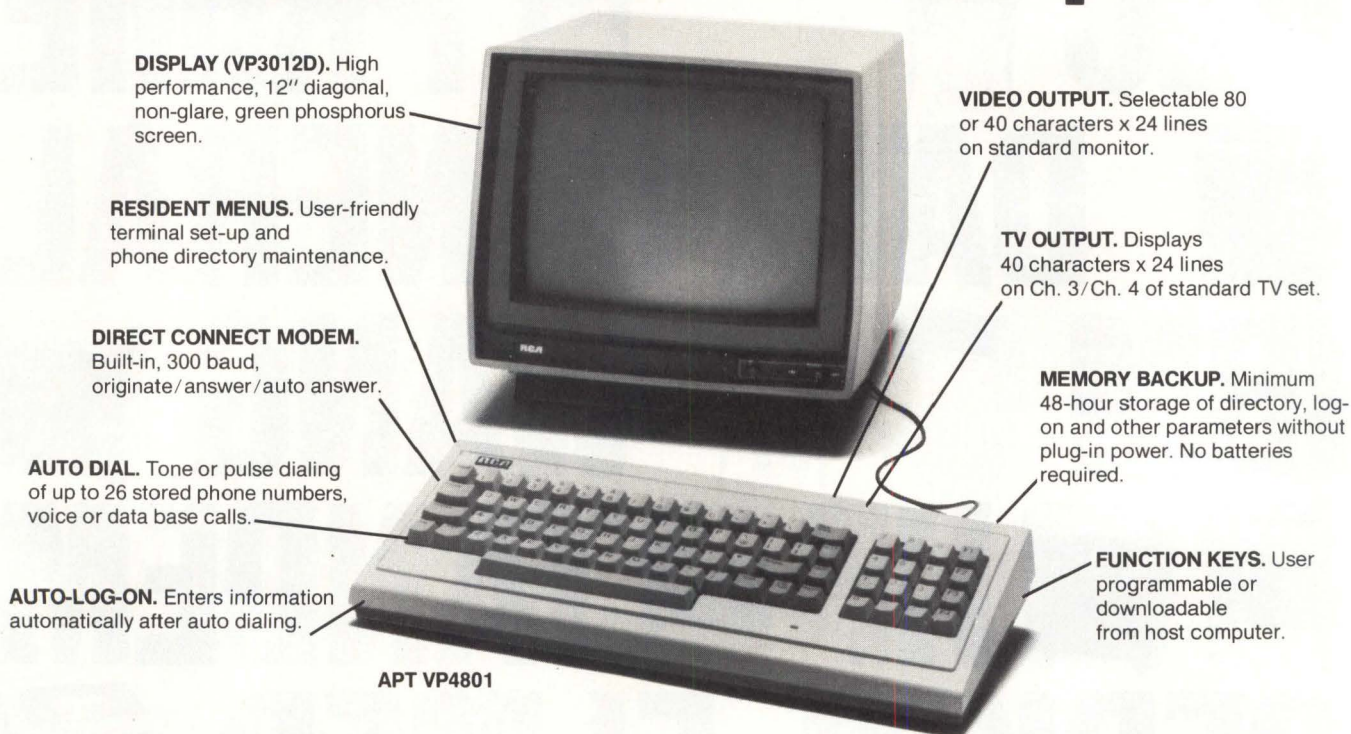

The new RCA APT (All Purpose Terminal) expands your data communications capabilities for a lot less money.

For business, professional and personal data communications, you'll find more user-friendly features and greater communications capabilities in the RCA APT than in other terminals selling for up to three times the price.

The new APT terminals are ideally suited to multi-data base time sharing and dedicated, direct computer-connected applications. They feature menu-controlled operation and a programmable "personality" to match specific communications requirements for your data bases.

A single keypress can dial a stored number, send the log-on sequence to the host computer, and return terminal control to the user. Password protection prevents unauthorized access to designated numbers. APT can also be used as an auto-dialer for voice communications.

OTHER FEATURES

RS232C port for direct computer connections at data rates to 9600 baud, or for connecting high speed modems and other accessories. Parallel printer port for hard copy. Numeric keypad, can dial phone numbers not in terminal directory. Built-in speaker with adjustable volume control for audio monitoring of phone line. Smooth scroll display. Automatic screen blanking to reduce possibility of burn. Briefcase size: 17" x 7" x 2". Weight: under 4 lbs.

Quite simply, matching features with price, there is no other professional quality terminal available today that can do as much at such low cost.

APT terminals list for \$399, in your choice of full stroke or membrane keyboard versions. Either style is also available with a display monitor for \$598 list. The data display monitor alone, VP3012D, \$229 list.

For more information—or to order—call 800-RCA-0094. In Penna., call 800-RCA-0421. Or write for fully descriptive brochure to RCA MicroComputer Products, New Holland Avenue, Lancaster, PA 17604. OEM and dealer pricing available. The new RCA APT. Expansive. Not expensive.



RCA

PRINTERS

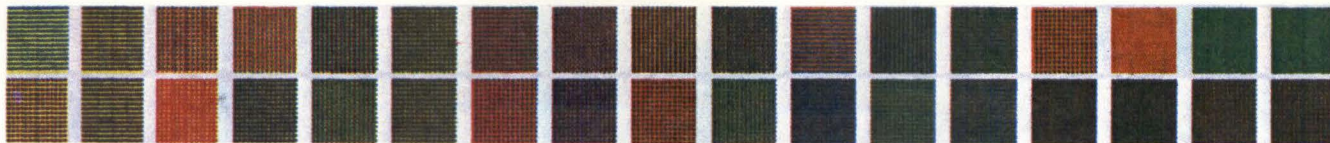

computers often cannot use because of inadequate software support. Some graphics output is the result of "screen dumps" from computers, which often provide image resolutions about 15 percent less than the printer's. Dataproducts' printers generate high-resolution (168 by 168), needle-addressable graphics (Fig. 6). In standard dot-graphics mode, the printers produce a density of 84 dpi both horizontally and vertically at 15 inches per second (ips). By printing single phase at half speed (7.5 ips), horizontal density increases to 168 dpi. A host computer can control the printers in 1/44-inch vertical increments, producing resolution as great as 168 by 168.

Despite the fact that high-quality color graphics are in great demand, few solutions are available in the dot-matrix printer market. One of the reasons for this lack of product availability is the fact that dot-matrix units have difficulty generating multicolor images. Reasons for this include ribbon, print-head and paper-movement mechanics, as well as ink, toner and paper problems.

Dataproducts' printers implement color printing with a red/green/blue/black, yellow/magenta/cyan/black or black/black/black/black four-band ribbon combination. Three colors plus black are required because true black cannot be attained by mixing the three primaries.

Wire wear is a prime cause of failure in matrix print heads due to the peening effect caused by the print wire striking the paper.

The 3/4-inch Dataproducts ribbon is housed in a cartridge that rests on a platform. The platform tilts up and down at the edge nearest the platen (Fig. 7). A small stepper motor aligns the appropriate color band with the print head. The print head need not cover a complete line before the ribbon is stepped to a different

SUMMARY SPECIFICATIONS

- **Model:** names were not available at press time
- **Speed:** 30, 80, 85, 160, 200, 240, 400 characters per second
- **Column width:** 80, 132
- **Horizontal density:** 5, 6, 8.5, 10, 12, 13.3, 17.1 characters per inch
- **Vertical density:** 2, 4, 6, 8 lines per inch
- **Matrix size:** 18 by 9 (draft), 24 by 9 (text), 36 by 18 (letter)
- **Character sets:** ASCII (Helvetica), five international languages
- **Paper width:** 5 to 16 inches
- **Paper handling:** tractor feed, friction feed (cut-sheet feed optional)
- **Number of copies:** six
- **Buffer size:** 8K bytes standard, 24K bytes maximum
- **Interfaces:** RS232C, Centronics parallel
- **Noise level:** less than 60 decibels

Dataproducts' new line of dot-matrix printers includes a 200-cps unit (left) and a 400-cps unit (right). Both printers are available in 80- and 132-column versions.

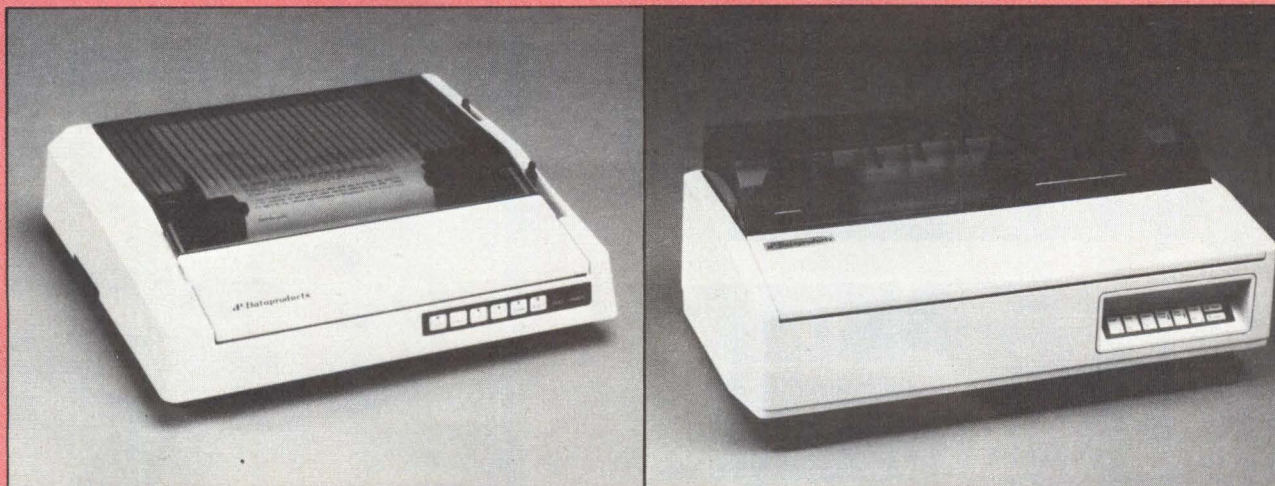

PRINTERS

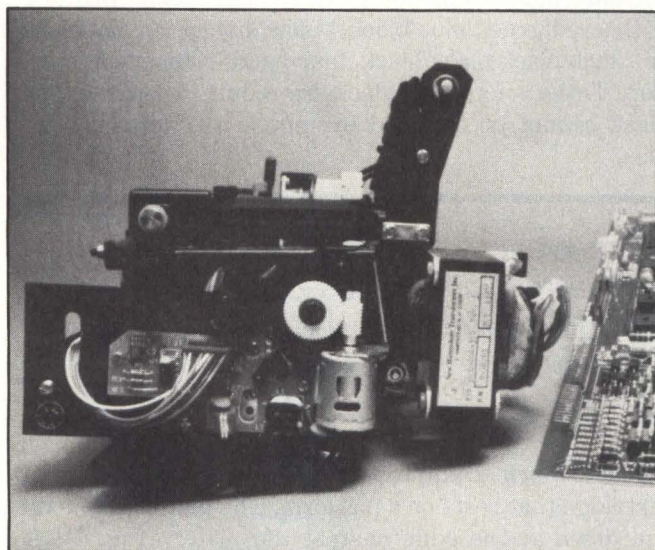
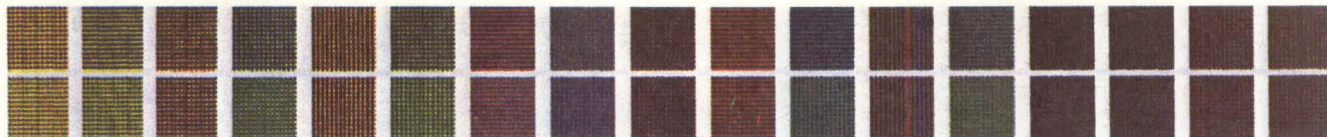

Fig. 7. The printer cartridge houses the 3/4-inch, four-band color ribbon system. A DC motor with an attached cam shifts the ribbon to align the appropriate band with the print head. The ribbons can be a red/green/blue/black, a yellow/magenta/cyan/black or a black/black/black/black combination.

color. This is in contrast to the traditional method of making multiple unidirectional passes over a line—one full pass per color. Printing colors from lightest to darkest reduces pigment contamination.

Dataproducts evaluated three ribbon-shifter designs. The first is a print-head design that returned to the left margin for each new color and pressed a plastic element that mechanically raised and lowered the ribbon. It proved accurate but relatively noisy and slow due to the extra returns. Another approach, involving a solenoid mechanism, was accurate and much faster but was too noisy and unreliable. The final design uses a DC motor with an attached cam and an optical sensor. This closed-loop system, while not quite as fast as the solenoid, is the most accurate and quiet of all the methods evaluated. □

Richard A. Williams is director of engineering at Dataproducts Corp.'s Serial Printer Group, Milford, N.H.

The flexible particle counter for rigid disks.

Designed specifically to measure particle contamination in computer disk drives, this new counter, with its sample flow rate adjustable from 0.3 to 1.4 LPM, can qualify 5 1/4, 8 and 14-inch drives with a 0.3 μm sensitivity.

The all new Model 5000 features an RS-232-C computer interface for automation, six channels of particle size information, and a closed-loop air system with filtered air return line.

Call or write for more information on this exciting new particle counter. 141 Jefferson Drive, Menlo Park, CA 94025. (415) 325-7811.

PACIFIC
SCIENTIFIC

HAC/ROYCO
INSTRUMENTS DIVISION

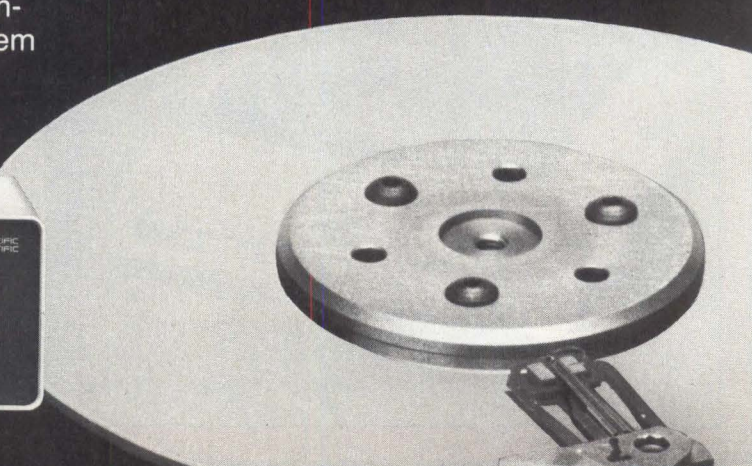
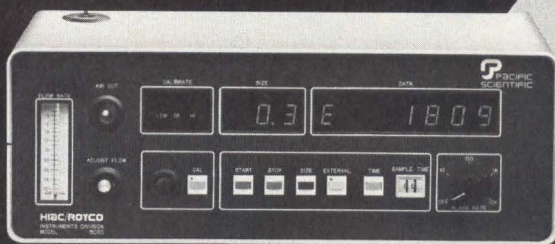

The Only Way
 You Can Get Q-BUS* Compatibility
 And Interface Flexibility
 With ANY or ALL These
 5¼" Winchester Drives
 is With
 These Two Controllers

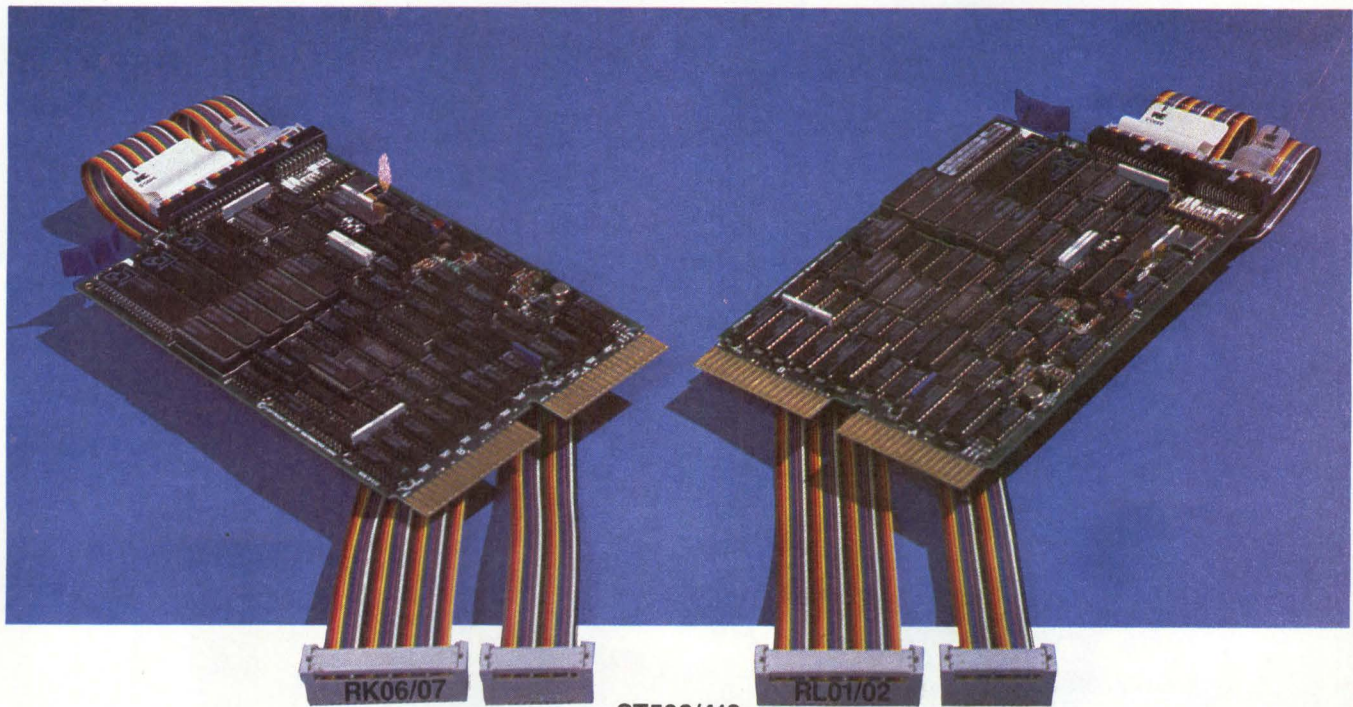

AMPEX	FUTITSU	MINISCRIBE	SEAGATE
ATASI	IMI	MPI (Micro Peripherals)	SHUGART
ATHENAEUM	MAXTOR	NEC	SYQUEST
CDC	MEMOREX	NISSEI SANGYO	TANDON
CMI	MICROPOLIS	PRIAM	TOKYO ELECTRIC
COGITO	MICROSCIENCE	QUANTUM	TULIN
DISCTRON (RMS)	INTERNATIONAL	RODIME	VERTEX

THE ONLY WAY!

You can't get it with DEC. Or any other independent controller manufacturer.

That's because these controllers feature DILOG's exclusive Universal Formatting™. That means you can mix or match any two compatible drives (ST506/412), regardless of heads, parameters, capacity, etc. This powerful feature offers you real flexibility in drive selection now...and expansion in the future. It's simple as unplugging one drive and plugging in another.

Model DQ615

- RK06/07 compatible
- Formatted drive capabilities 222.4 MB
- Maximum 8 logical units—two physical

Model DQ614

- RL01/02 compatible
- Formatted drive capacities 41.6 MB
- Maximum 4 logical units—two physical

They both have enhanced 32-bit ECC, 22-bit addressing and RT-11, RSX-11, RSTS and TSX-Plus.

DILOG Universal Formatting™ is also offered for the largest SMD I/O drives. And for your back up there are controllers for ½" tape, ¼" cassette and 5¼" and 8" floppy drives.

Contact your nearest sales office, distributor or DILOG directly for complete data on the way to unmatched Q-BUS compatibility and drive flexibility...THE ONLY WAY!



DISTRIBUTED LOGIC CORPORATION

12800 Garden Grove Blvd. ■ Garden Grove, CA 92643 ■ (714) 534-8950 ■ TLX 681399
 64-A White Street ■ Red Bank, NJ 07701 ■ (201) 530-0044
 12 Temple Square ■ Aylesbury, Buckinghamshire, England HP 20 2QL ■ 44 (0296) 84101 ■ TLX 837038

*Trademark of Digital Equipment Corp.

CIRCLE NO. 98 ON INQUIRY CARD

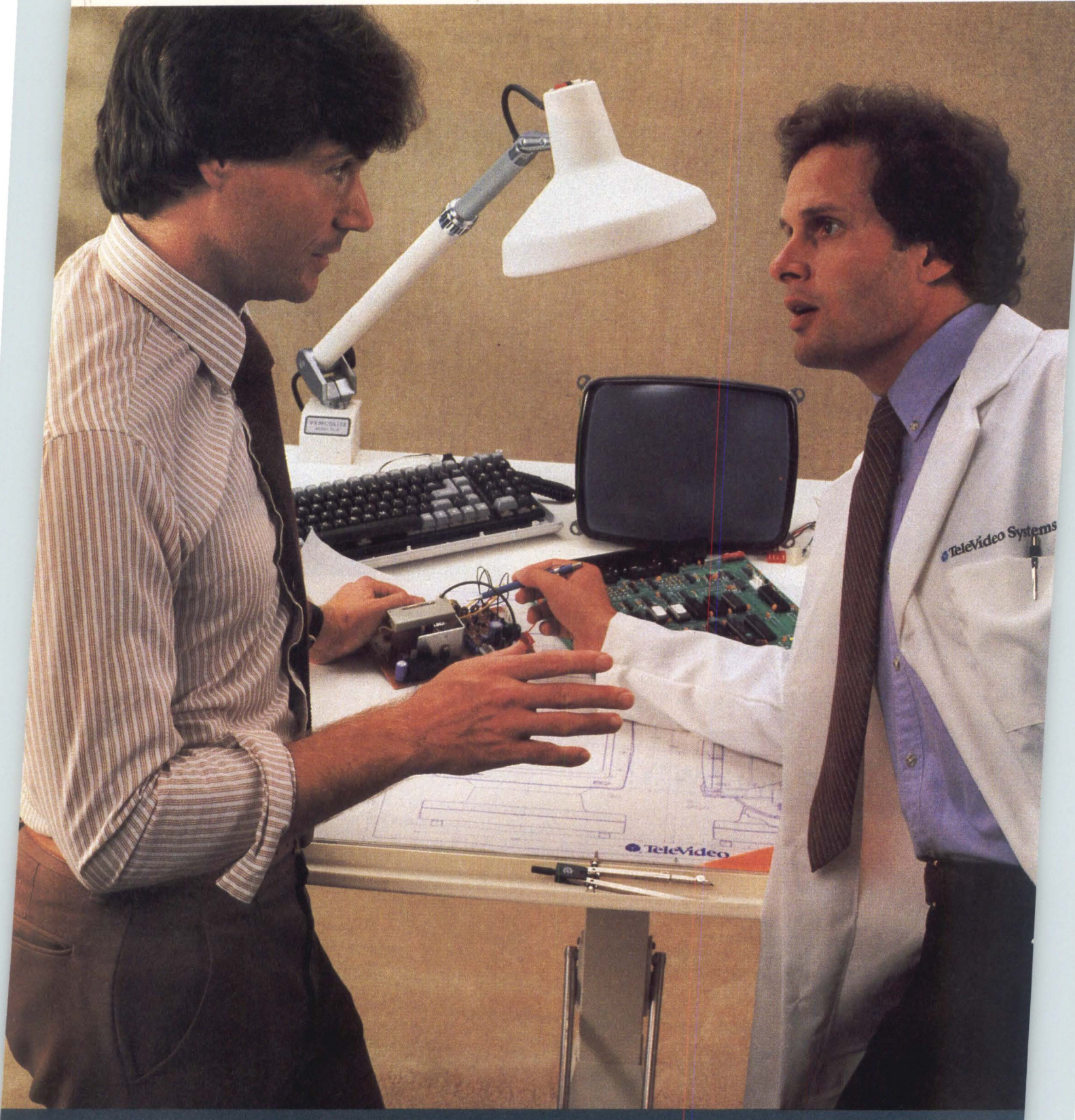

TELEVIDEO'S OEM BOOM. FULL PARTNERSHIPS AVAILABLE.

To get where you want to go in the OEM universe, you need a partner. One who can go the distance with you. A vendor who puts design innovation, reliability and flexibility first. We're TeleVideo® and we do just that. That's why we're the independent industry leader in terminals.

TeleVideo assigns you one applications engineer throughout design, manufacture and delivery. Our goal is not just to meet your specs but also your business requirements. We'll manufacture your terminals in the new state-of-the-art facility we've built for OEM custom assembly. We'll test the units your way. With your QC standards.

We keep the contract simple, back you up with continued technical support, and live up to the TeleVideo reputation for quick delivery and reliability. That minimizes your risks.

Our partnerships with present OEMs are long term successes. That's because TeleVideo combines innovative modular design and serviceability with pioneering work in ergonomics and protocol standards.

Experience the confidence of a partnership with TeleVideo for yourself. Contact us today, whatever your terminal requirements. It's time we explored your corner of the OEM universe together.

Call us at (800) 538-8725 for more information (in California call (408) 745-7760) or contact your nearest TeleVideo office.

California/Santa Ana	(714) 476-0244	New York/New York	(516) 496-4777
California/Sunnyvale	(408) 745-7760	Texas/Dallas	(214) 258-6776
Georgia/Atlanta	(404) 399-6464	Central Europe (The Netherlands)	(31) 2503-35444
Illinois/Chicago	(312) 397-5400	Northern Europe (United Kingdom)	(44) 9-905-6464
Massachusetts/Boston	(617) 890-3282	Southern Europe (France)	(33) 1-686-4412

GET IN ON
THE BOOM.™

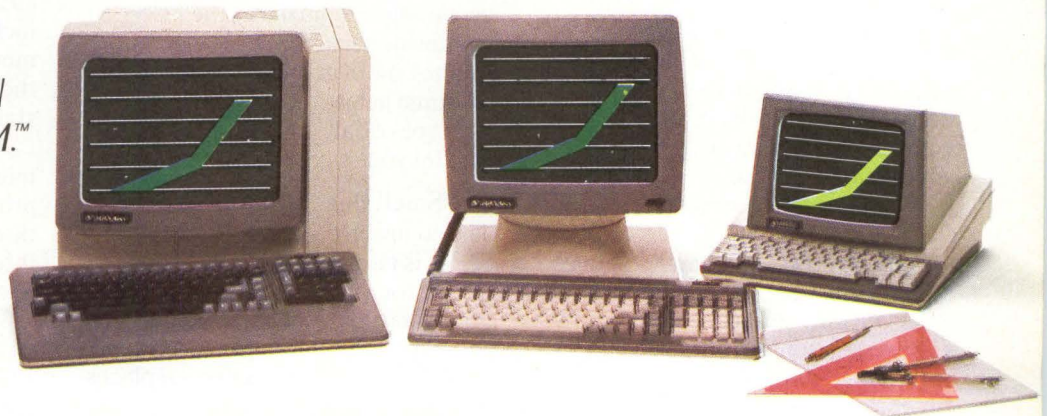

TeleVideo® Terminals

TeleVideo Systems, Inc.

CIRCLE NO. 99 ON INQUIRY CARD

CalComp Digitizers for Applications of All Types

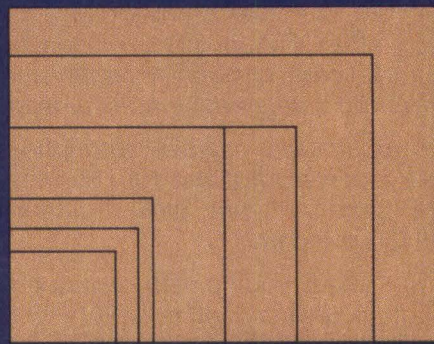
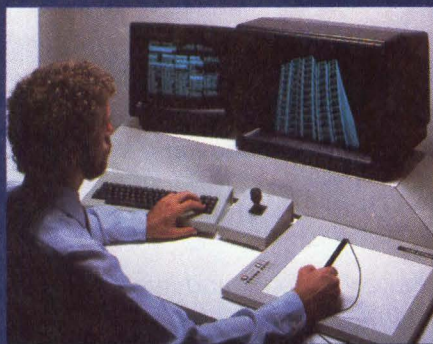
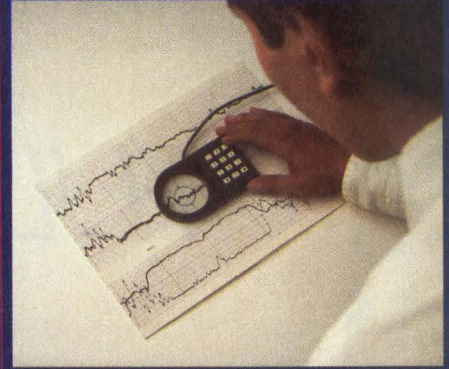
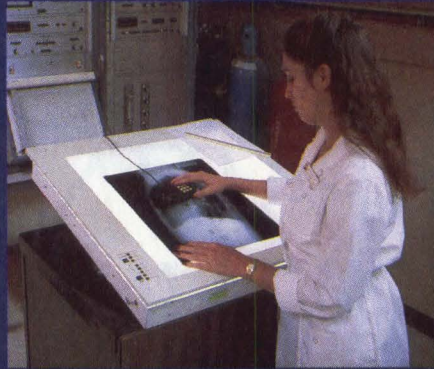
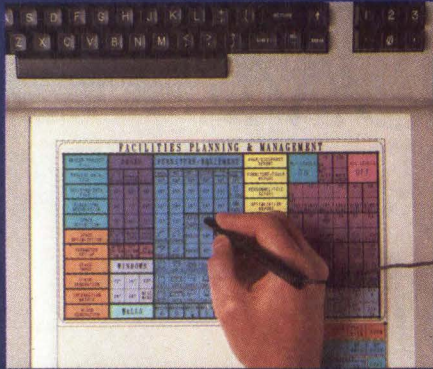

For more than 20 years, CalComp has been known for its broad range of plotters. What may not be as well known is that CalComp also produces a full line of digitizers.

Digitizers present a whole new world of data entry. Replacing the traditional T-square and ruler in drafting applications, digitizers let you input coordinate locations or dimensions, thereby letting your computer see what you draw.

Today, throughout the world, you'll find CalComp digitizers acting as a computer's eyes for varied applications such as:

- Tracking architectural building design details
- Charting utility maps and pipelines
- Measuring tumors and quantifying electrocardiograms
- Preparing isometric drawings

And, hundreds of other innovative time saving, money saving applications.

As you trace or draw on a digitizer — which is an electronically sensitized grid board — your computer captures each point accurately and stores it.

CalComp Digitizer active surface sizes range from 298mm (11.7 inch) square to 1524 x 1188mm (60 x 44 inch).

The Complete Range

CalComp's full line of digitizers, from the smallest to the largest, in standard surfaces, backlighted tables and even rear-projected models, is becoming recognized as the worldwide performance leader.

The type of graphic data being captured helps you decide the size and type of CalComp digitizer that's best for you.

The Small One

The compact, durable CalComp 2000 Series is ideal for OEMs, systems integrators and personal computer uses where low cost cursor control and menu selections are needed. It's single pen or 4-button cursor replaces both a keyboard and a joystick.

This 298mm (11.7 inch) square digitizer is plug compatible with most digitizers on the market and features a resolution of 0.127mm (200 lines per inch) with precision accuracy of $\pm 0.635\text{mm}$ (0.025 inch).

The Powerful One

The versatile, sophisticated CalComp 9000 Series is available in a range of sizes from 305 x 305mm (12 x 12 inch) to 1524 x 1188mm (60 x 44 inch) in solid and backlighted surfaces. Rear projected surfaces are available in special sizes.

The high precision 9000 Series has an accuracy of $\pm 0.263\text{mm}$ (0.0105 inch) with resolution of 40 lines per mm (1000 lines per inch), incorporating the latest technology in surface stability.

The powerful 9000 Series utilizes microprocessor technology while providing maximum operation flexibility, accuracy, and multiple interfaces with simultaneous operation.

For complete information call or write: CalComp, 2411 W. La Palma Ave., P.O. Box 3250, Anaheim, CA 92803. In continental U.S., except California, call (800) 556-1234, ext 156. In California call (800) 441-2345, ext. 156.

CALCOMP
A Sanders Graphics Company
SANDERS

Ink-jet printer handles text, graphics

Drop-on-demand technique produces software-controlled bit-mapped images



Color graphics images composed of mosaic elements can be created using software modules available with the Series C printer.

Operating at 20 characters per second in four- and five-pass unidirectional or bidirectional printing modes, the Series C ink-jet printer interfaces with IBM Personal Computers and functions in shared applications in office environments.



C.C. YANG, Ph.D., Diablo Systems Inc.

Ink-jet color printers are coming into their own. Offering a brighter printed image and higher reliability, units now entering the market are providing serious competition to daisy-wheel and matrix devices for end users who want hard-copy, color-graphics output from their computers. The Diablo Systems Inc. Series C color ink-jet printer, for example, uses a drop-on-demand design that minimizes clogging and air-bubble problems and furnishes dual-mode output: two standard ASCII character sets plus bit-mapped, 120-dot-per-inch (dpi), color-graphics images.

Implementing a drop-on-demand design

Ink-jet printers use a synchronous, continuous-stream or an asynchronous, drop-on-demand technique. The synchronous, continuous-stream method produces an ongoing supply of ink controlled by electrical charges that direct the ink and target its flow. Unused ink droplets are steered to gutters that pick up the ink and return it to a reservoir.

The Series C printer employs the asynchronous, drop-on-demand technique using 16 nozzles—four for each of three basic “process” colors (yellow, magenta

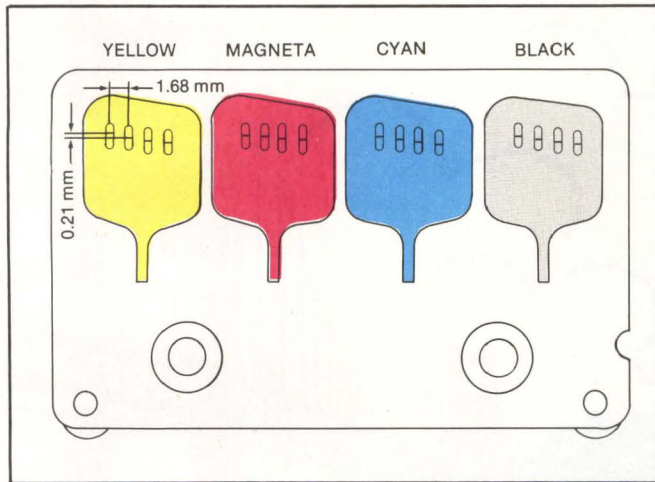

Fig. 1. Four nozzles for each color, plus black, produce 120 drops per inch on paper or transparencies from the 16-nozzle head. This view of the platen shows units arranged at a horizontal pitch of 1.68 mm, and a vertical pitch of 0.21 mm.

and cyan) and black (Fig. 1). Non-toxic, water-based ink reaches the nozzles through a capillary effect and is pushed out onto paper or plastic transparency material

Negative pressure in the ink-jet assembly pressure chamber is one factor that helps prevent nozzle-clogging and the intake of air into various parts of the delivery system.

by a piezoelectric vibrating element. The drop-on-demand mechanism comprises three major parts: an ink-inlet channel, a pressure chamber and the piezo vibrator. The ink inlet is connected to a reservoir separated from the pressurized area (Fig. 2).

Creating a dot on a printed page is relatively simple. After ink is absorbed into the nozzle by capillary action, a driving voltage is applied to the piezo vibrator. This action causes a diaphragm in the pressure chamber to bend inward. As it bends, it reduces the volume of the pressure chamber, and a corresponding amount of ink is pushed out of the nozzle. When the vibrator returns to

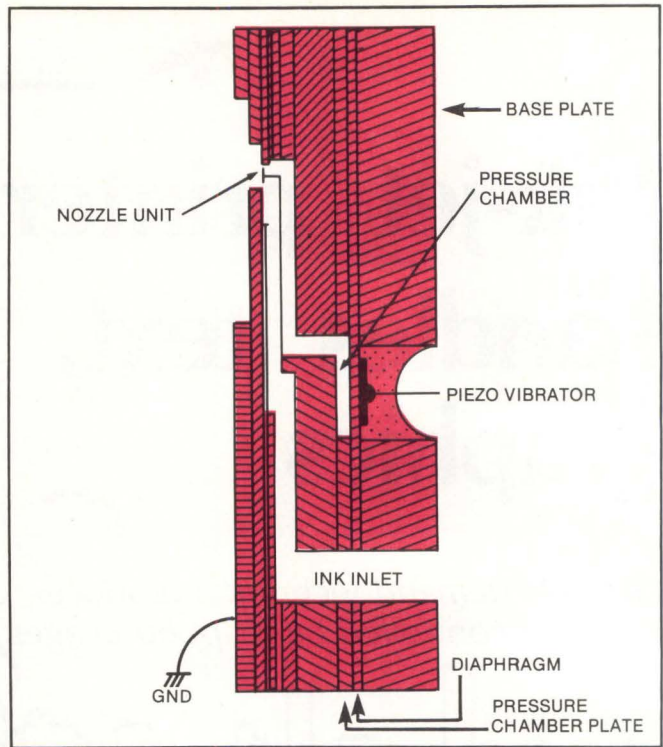

Fig. 2. The drop-on-demand ink-jet nozzle assembly (side view) has three major parts—an ink-inlet channel, a pressure chamber and a piezo vibrator. Ink reaches the tip of the nozzle by capillary action. It is pushed out onto the paper when voltage is applied to the piezo vibrator, which bends the diaphragm inward, reducing pressure-chamber volume.

its original state, negative pressure in the chamber causes ink to be drawn back from the tip of the nozzle into the chamber. This negative pressure effect is part of the Series C's design that helps prevent two serious drawbacks of ink-jet printers: nozzle-clogging and the ingestion of air into various parts of the delivery system.

Reducing clogging, air bubbles

The problem of clogged ink-jet nozzles is well known to system integrators and end users. It is a special problem in designs that do not adequately control the ink flow or the pressure on the ink supply. Ink comes into contact with air and dries, collecting inside and around the nozzle—jamming the system and creating continuing maintenance headaches.

The second drawback, microair bubbles, is less familiar, potentially more difficult to prevent and equally harmful to printer operation. Air bubbles become entrapped and enlarged within the pressure chambers and the ink supply route. If permitted to agglomerate rapidly, they can impede the ink supply and create inconsistencies in ink ejection, reducing a printer's reliability and increasing its failure rate.

The Series C printer attacks both of these problems by retaining ink in reservoirs away from the source of electrical charges and pressure. Ink is drawn through the ink inlet by capillary effect. The design maintains a

PICK UP WHERE IBM[®] LEAVES OFF.

Portable or desktop, you're way ahead when you pick up CORONA PC™. Because we give you everything you've ever wanted in an IBM¹-compatible PC and more. For a great deal less.

COMPATIBLE AND MORE.

Our systems run all software that conforms to IBM PC programming standards. And the most popular software does.

We deliver twice the memory, with room for eight times as much.

We deliver a fast-access 320K floppy drive, a communication port and an improved IBM PC keyboard with indicator lights.

Our systems include high-resolution monitors (12" desktop, 9" portable) for crisper, cleaner displays, and both have built-in high-resolution graphics (640 x 325).

You get a complete system, ready to go to work.



MORE VERSATILITY.

With all the necessary features built into the main unit, the four expansion slots can be used for your special needs. For example, color or our optional 10MB hard disk.



MORE SPEED.

Our RAM-disk software gives you temporary disk-type storage that works many times faster than disks.

PLUS SOFTWARE.

Our systems come with the operating system: MS-DOS.² A programming language:

GW BASIC.² A training course: PC Tutor.³ A professional word processor: MultiMate.⁴ Plus DOS utilities and demonstration programs. Or you can get the p-System⁵ from N.C.I. and write or run portable Pascal packages.

ALL FOR A GREAT DEAL LESS.

Even with all the extra features and performance, our systems still cost significantly less than the equivalent IBM PC.

Drop by your nearest CORONA PC dealer for a very convincing demonstration. Or contact us at 31324 Via Colinas, Westlake Village, CA 91361.

(213) 991-1144 or (800) 621-6746 toll-free. Telex 658212 WSLK, in Europe 76066 CDS NL.



© Corona Data Systems 1983. 1. TM International Business Machines. 2. TM Microsoft. 3. TM Comprehensive Software Support. 4. TM Softword Systems. 5. TM University of California.



CORONA[™]
data systems, inc.

CIRCLE NO. 101 ON INQUIRY CARD

Now you don't have to be rich to be powerful.

Riches and power don't always go together. Take Plexus, for instance. The world's most powerful UNIX*-based supermicros.

Powerful because multiple processors share the UNIX load. So processing power is distributed to where it does the most good.

Terminal I/O. Disk I/O. Data communications. And, of course, data processing.

Our unique architecture also lets us bring you the world's first UNIX Network Operating System (NOS). So you can combine Plexus systems in an Ethernet network for even more power.

NOS gives you real time, continuous access to files. From anywhere in the network.

Files are also updated on the same basis. So everyone in the network works with up-to-the-minute data. Automatically.

No waiting for file transfers. And that's a decided improvement over everything else that's out there.

You also get to save money on powerful UNIX-based software, including COBOL, FORTRAN, Pascal, BASIC, and C. Database management and word processing, too. As well as hundreds of third party UNIX packages.

Plus our own software and main-

tenance support. And even a software referral service for your OEM programs.

Does all this make us expensive? Absolutely not.

In fact, Plexus systems cost thousands of dollars less than the minicomputers we outperform.



To get a better idea of just how good that performance is, come get a demonstration. Call 800-528-6050, ext. 1444. In Arizona, 800-352-0458, ext. 1444. Or write Ralph Mele at Plexus Computers, Inc., 2230 Martin Avenue, Santa Clara, CA 95050.

You see? You don't have to be rich to be powerful. Just smart.

PLEXUS
Built for speed.

constant supply of ink behind the nozzle tip. This prevents the vacuum effect, which permits air ingestion at nozzle tips.

Air bubbles can be generated where liquid is confined within a non-sealed space, such as an ink reservoir, under vacuum conditions. Minute amounts of air also come through the nozzles following application of ink and become trapped in the nozzles or the ink-supply lines. However, the Series C's steel pressure chamber

does not include an area compliant enough to allow a strong vacuum effect to induce air to fill space vacated by the ink.

Achieving dual-mode output

In addition to improving the color quality and the reliability of their ink-jet designs, manufacturers have responded to growing end-user demand for more versatile output through expanded character fonts, new software that adds to a printer's repertoire and integration of text and graphics.

The Series C printer, for example, lets users work with standard ASCII character sets and/or bit-mapped image printing. The first mode features primary and supplementary sets for a total of 192 characters. The primary set includes 94 characters that are assigned standard addresses, plus four additional characters,

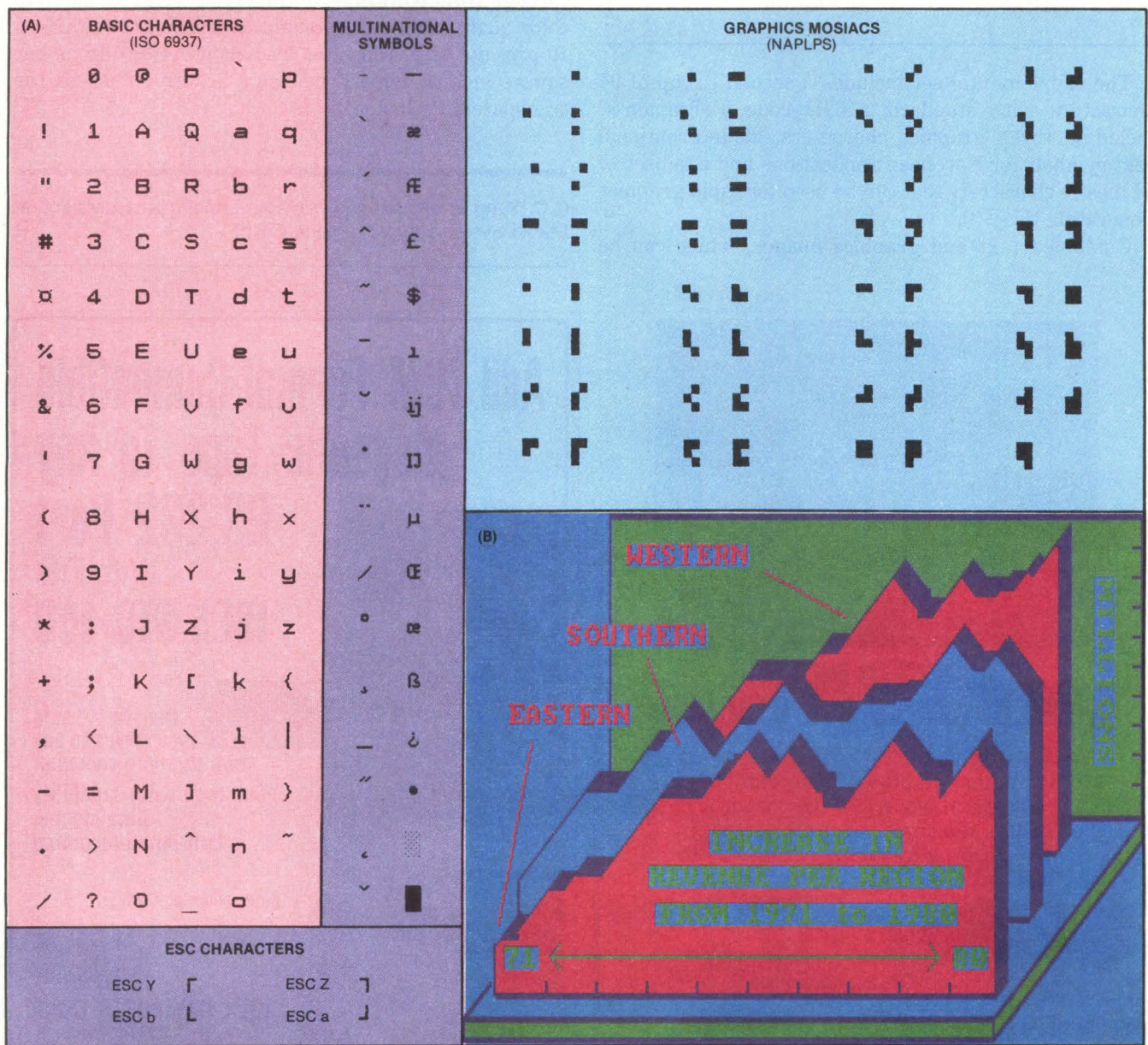

Fig. 3. Two standard ASCII character sets (A) include basic characters, multinational symbols, North American Presentation Level Protocol Syntax (NAPLPS) standard graphics mosaics for rapid graphics generation and escape (ESC) characters for forming perimeters around charts or illustrations. Software commands permit generation of complex color images, integrating text and graphics (B).

termed "ESC" characters, that are addressed by escape sequences. These character elements provide horizontal and vertical elements for producing the corners of boxes and forming perimeters around charts, graphs and illustrations.

Graphics mosaics speed the generation of complex graphs and figures.

The supplemental set includes a second group of 94 characters with standard ASCII code assignments, including three graphics characters, 29 international text symbols for European applications and a subset of 64 mosaic characters that can be used for rapid graphics generation (Fig. 3).

Combined text and graphics images, which can be

intermixed on a single line, are specified by system operator commands. Text characters are printed as a 12-by-16-dot matrix; graphics symbols can be printed in a matrix as large as 12 by 20. Print characters are addressed using a 7- or an 8-bit addressing mode.

The printer can produce 120-dpi images in the bit-mapped mode. In this mode, the entire printable area on a page is considered part of the image area. End users can assign a color to each dot position or picture element (pixel) within the image area and specify it as a print or a non-print area through interface commands that can be duplicated for color overlays. For example, to produce a green pixel, an end user would address a pixel by first commanding yellow, then cyan (process blue). The printer's bit-mapping capability also offers a cost-effective way of producing higher-quality transparencies.

The Series C uses inks that allow light to be reflected through from both sides of the Mylar sheet to maintain color quality and image brightness. The printer's 8- to 10- μ in. dot size translates into about 14,000 drops per square inch, a density that significantly enhances the transparency's image.

C.C. Yang is engineering manager, non-impact division, at Diablo Systems Inc., Fremont, Calif.

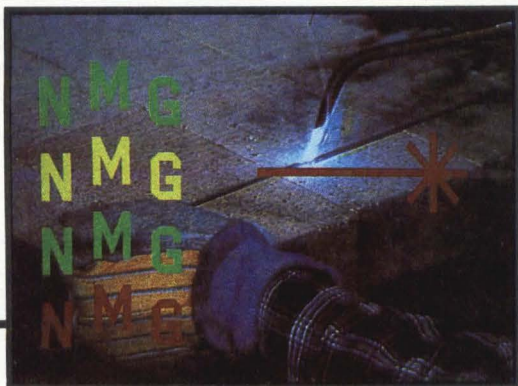

**COMPOSITE PICTURE:
HI-RES GRAPHICS and NTSC VIDEO**

The GraphOver 9500 is a high-speed computer graphics generator that gen/locks to any NTSC video input and overlays its high resolution color graphics. This creates a composite picture in both RGB and NTSC. For more information, call us at: 617-547-4344



GraphOver 9500



New Media Graphics Corporation
279 Cambridge Street No. 5 • Burlington, MA 01803

CIRCLE NO. 102 ON INQUIRY CARD

**Add IBM Format-Compatible
Magnetic Tape To Any
RS-232 Port
With The
IBEX STC-100**

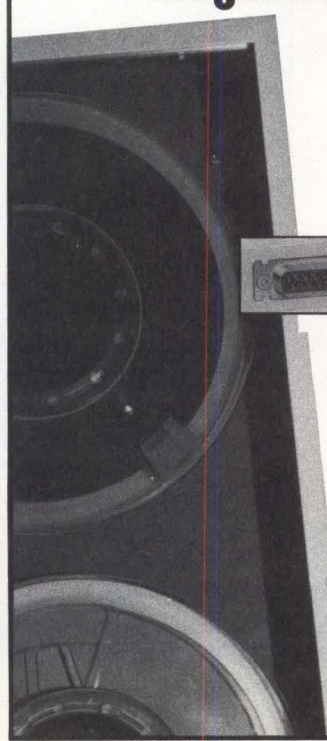

Plug-In 1/2" mag.
tape drives to any
mini or micro computer
Full read/write capability
Data logging
Call-detail recording

Write, phone or TWX
for information



IBEX COMPUTER CORP.
20741 Marilla St.
Chatsworth, CA 91311
(213) 709-8100
TWX: 910-493-2071

CIRCLE NO. 103 ON INQUIRY CARD

David, Jack & PAT™

Size has always been a most formidable foe. Tales of David and Goliath and Jack and the Beanstalk are clear examples of how "Bigger is not always better". In fact, throughout history, all great giant killers have had one thing in common...small size but a surprisingly big capability.

And now, there's PAT, Dysan's unique Performance and Alignment tester that cuts giant floppy drive problems down to size.

PAT is the first hand-held intelligent tester for flexible diskette drives. Used in conjunction with Dysan's Digital Diagnostic Diskette (DDD)™, PAT's versatile and precise testing capabilities can test drive alignment and performance criteria. Plus, PAT also checks read/write data handling functions and serves as an

exerciser without the use of additional equipment, all with minimal operator instruction. And best of all, PAT sells for a small fraction of what the big testers cost.

PAT's Giant-Size Capabilities Include:

- Head radial alignment
- Head positioner linearity
- Head azimuth alignment
 - Index timing
- Head positioner skew
 - Spindle speed
- Read/write verification
- Seek test verification

For quality assurance, field service, incoming inspection, engineering evaluation and field disk drive sales, discover PAT. Another big difference from Dysan.



For more information on PAT, call toll free (800) 551-9000 or (408) 988-3472.

Dysan
CORPORATION

Corporate Headquarters
5201 Patrick Henry Drive
Santa Clara, CA 95050
(800) 551-9000
(408) 988-3472

DON'T COMPROMI

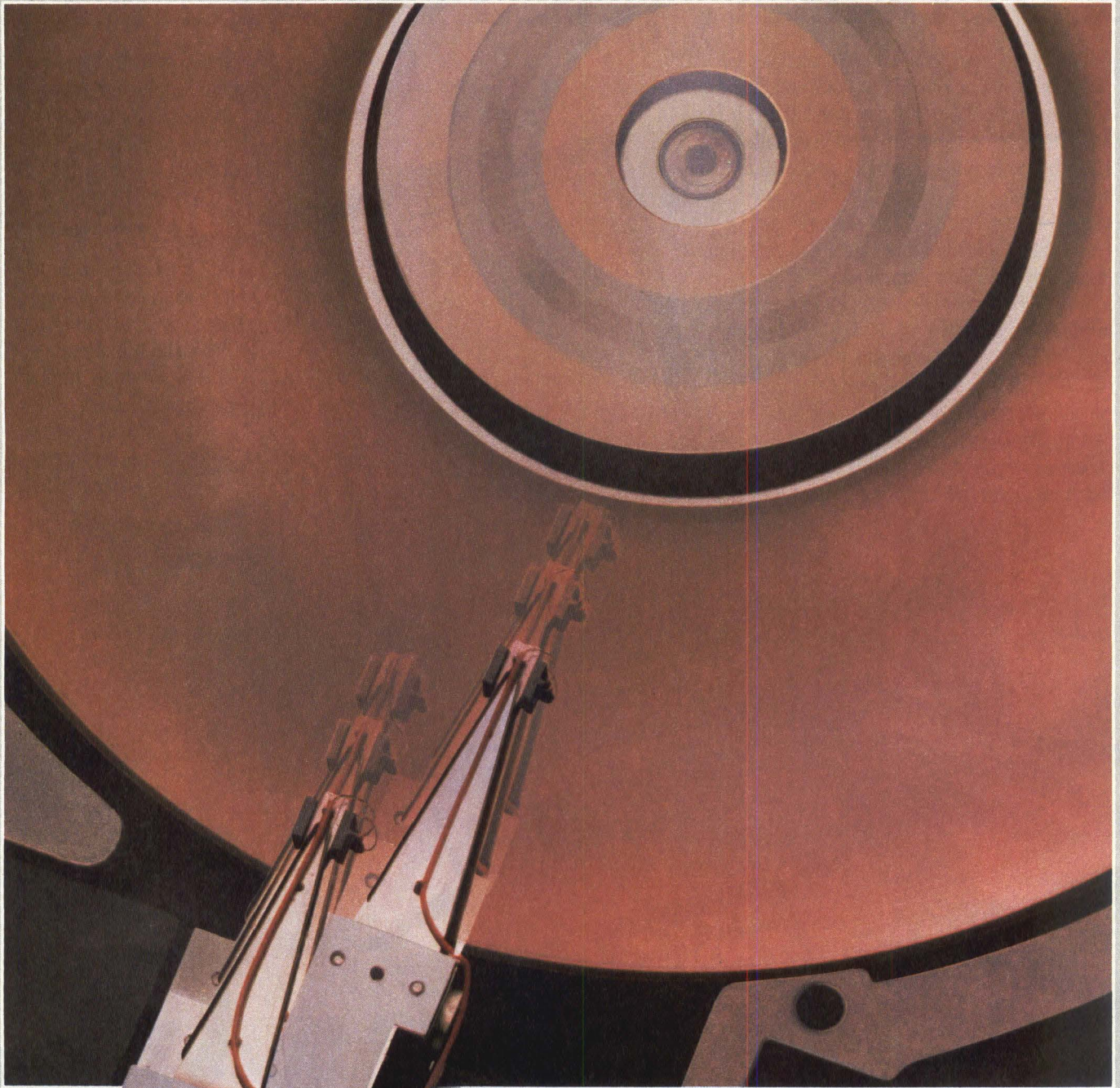

Regional Sales Offices:

Newport Beach, California, (714) 851-9964;
San Jose, California, (408) 286-7580;
Woodland Hills, California, (213) 884-2699;
St. Petersburg, Florida, (813) 577-1199;
Schaumburg, Illinois, (312) 397-3727;
Hopkinton, Massachusetts, (617) 435-6961;
Dallas, Texas, (214) 783-6711.
Authorized U.S. Distributors: Arrow Electronics,
Pioneer Electronics and Wyle Laboratories

European Sales Office:

Gassnerstrasse 5, 8000 Munich 19, West Germany, 49 89 177017, TELEX 524275 SEAG D

©1983 Seagate Technology

SE ON HALF-HIGHS

Introducing the fastest 5¼" 12MB half-high Winchester, the Seagate ST212, the rugged drive that manufacturers of portable and desktop computers have been waiting for. Now you can get a 65msec average access time drive that can withstand a 40G shock.



Don't compromise performance. Seagate's new ST212 is more than 15% faster than its nearest competitor. We also made it durable, reliable and manufacturable in volume, using improved oxide coated media and low-mass minislidder heads.

Don't compromise compatibility. Only Seagate's new ST212 single platter, four head design is completely hardware and software compatible with our ST412, the number one standard height drive. And for even greater systems performance, Seagate now offers its ST9000, a low-cost SCSI-based controller.

Don't compromise your Winchester standards. Only Seagate ships the widest range of 5¼" Winchesters in volume, and at prices OEMs can count on. In 1983, Seagate will ship more than 400,000 Winchester disc drives, all backed with a full one year warranty and our industry-leading "105% Guarantee" program.

Don't compromise. Call Seagate today. We're shipping ST212 drives in volume!



The Uncompromising ST212

Unformatted capacity (MB)	12.76
Formatted capacity (MB)	10
Average access time (ms)	65

"Turning the tide in disc technology"

Seagate 

920 Disc Drive, Scotts Valley, CA 95066, (408) 438-6550, TELEX 176455SEAGATESCVL

CIRCLE NO. 105 ON INQUIRY CARD

Power Problem #12

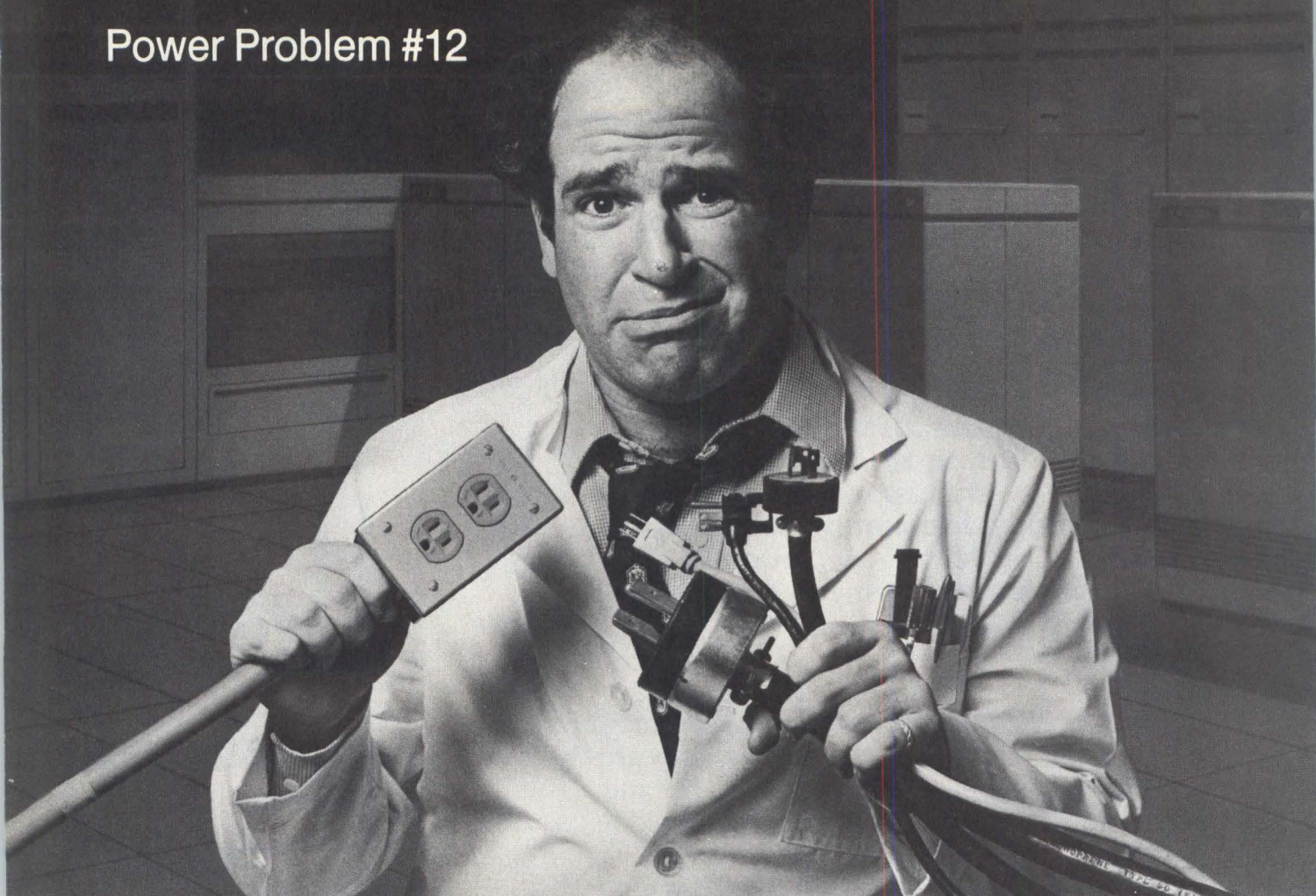

HOW DO YOU FIND AN OUTLET FOR YOUR COMPUTER POWER FRUSTRATIONS?

Answer: With a Line 2® power conditioner from Topaz.

Line 2 power conditioners deliver noise-free, regulated AC power to all your computer equipment, while solving the frustrating problems of plug/receptacle incompatibility.

Typical AC power is often unfit for computer use. Momentary sags and surges in voltage can wipe out memories and ruin computer programs. Noise on the line often becomes mistakes on the disk. Line 2 power conditioners with PowerLogic® control make all these problems disappear.

PowerLogic control is an innovative microcomputer technology that brings the speed and accuracy of computers to the power conditioning process. Precise, one-cycle correction of voltage variations plus

exceptional suppression of power-line noise enable Line 2 power conditioners to provide complete protection against virtually all power disturbances that can affect your computer.

And because the shape of your power plug can be just as critical as the shape of your power, Line 2 power conditioners offer optional panels that provide up to eleven various receptacles — ensuring plug compatible outlets for all your computer equipment.

For complete information about how Line 2 power conditioners can end your computer power frustrations, return this ad with your name and address, mark the reader service card, or call us:

Topaz
9192 Topaz Way
San Diego, CA 92123-1165
(619) 279-0831
TWX 910-335-1526

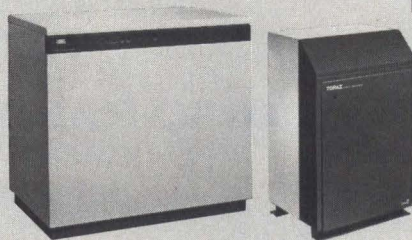

TOPAZ[®]
SQUARE D COMPANY

CIRCLE NO. 108 ON INQUIRY CARD

Microcomputer operating systems compete in portability and performance

GARY LEGG and ROY FRIEDMAN, Associate Editors

High-level-language operating systems move to new hardware with relative ease, but porting applications to new OSs is still far from trivial

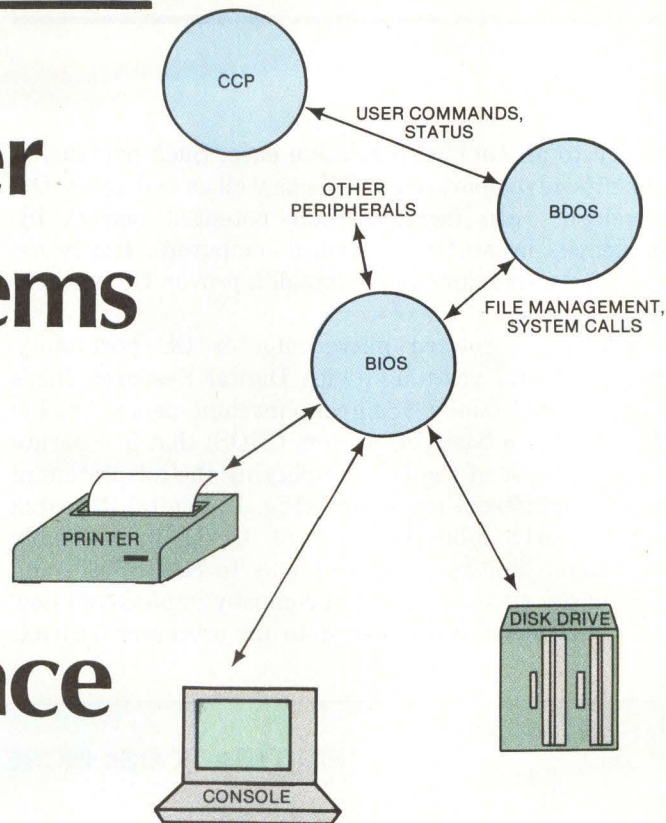

Fig. 1. CP/M organization separates hardware-dependent functions in the basic I/O system (BIOS) from hardware-independent functions in the basic disk operating system (BDOS) and console command processor (CCP). To move CP/M to a new hardware environment, an OEM needs to modify only the BIOS.

Operating systems (OSs) for microcomputers have become bigger, more capable and packed with more features than those offered a short while ago (MMS, September 1982, Page 237). They're also more portable—some running not only on different computers but also on different CPUs. And, although a standard microcomputer operating system doesn't yet exist and cross-porting is still a non-trivial task, it's now easier to move application programs from one OS to another.

Directory includes development systems

The OS directory, which begins on Page 246, covers microcomputer OSs for general-purpose and software-development applications. Excluded are OSs that do not support mass storage or file management. OSs lacking these features are typically used for real-time instrumentation and control. Such OSs are compact and efficient—often implemented in as little as 4K bytes of ROM. Examples are Hunter & Ready Inc.'s VRTX and

JMI Consultants Inc.'s C Executive. *Mini-Micro Systems* will cover real-time executives in a future product profile.

More than 80 percent of the systems in the OS directory run on 16-bit processors. In addition, the directory's checklist of OS features shows that many of the systems rival minicomputer OSs in performance, mimicking the microcomputer's pursuit of minicomputer performance in the hardware arena. This year's hottest OS is UNIX, which originated on a minicomputer but now runs on a rapidly increasing number of microcomputers.

Portability is top priority

Approximately one-fourth of the directory's OSs are available for more than one CPU. Some have simply been rewritten in each processor's native assembly language, but many OSs are now written in high-level languages, allowing them to move from one hardware

device to another with relative ease. Such portability benefits developers and OEMs as well as end users. OS developers can increase their potential market by implementing an OS on several computers. Hardware manufacturers can quickly install a proven OS on their new systems.

The trend toward microcomputer OS portability began several years ago with Digital Research Inc.'s CP/M. CP/M family OSs group machine-dependent I/O functions in a basic I/O system (BIOS) that is separate from the rest of the OS, simplifying the adaptation of CP/M to different processors (Fig. 1). Digital Research wrote early 8-bit versions of CP/M in assembly language, limiting those versions to 8080- 8085- and Z80-based systems. But the company implements new OSs in C, allowing adaptation to any processor with a C

compiler. Digital Research also supplies its CP/M-68K operating system for 68000-based machines with a C run-time library compatible with UNIX. As a result, many applications written in C under UNIX run under CP/M-68K without modification. CP/M-68K comes configured for Motorola Inc.'s EXORmacs development system; to bring up CP/M-68K on a different system, the OEM must create a customized BIOS.

Although source-code portability among operating systems is helpful, most microcomputer application software comes only in object form, and object code usually isn't portable. The p-System, distributed by SofTech Microsystems Inc., addresses this problem by compiling programs into "p-code" for a virtual machine called the p-machine, instead of generating native machine code. This allows different hardware systems to present a uniform object-code interface to application and system software—including the OS itself (Fig. 2). The p-System executes p-code on a p-machine emulator, which is written in native machine code and comprises about 10 percent of the system's code.

PIGGYBACK OSs INCREASE SOFTWARE UTILITY

A popular way of increasing application-program portability is to run one operating system (OS) as a task under another. In some cases, both OSs run in native code on the same processor while, in other cases, software emulates one of the OSs. UNIX programs that emulate the p-System or CP/M are typical.

The greatest shortcoming of simulating an OS in software is speed. Some application programs run too

slowly on a software-simulated OS to be useful. Speed usually isn't a problem, though, when combining OSs without simulation. When both OSs run in native code on the same CPU, they can often run together with little apparent speed loss.

An interesting twist in the piggyback-OS strategy uses different processors to run different operating systems on the same hardware. It isn't a new approach—plug-in boards

for changing a computer's "personality" have long been available. What is new, however, is multiple OSs that are standard features on sophisticated professional computers. For example, Data General Corp.'s new Desktop Generation systems for small businesses can run MS-DOS or CP/M-86 concurrently with DG's MP/AOS, RDOS or AOS.

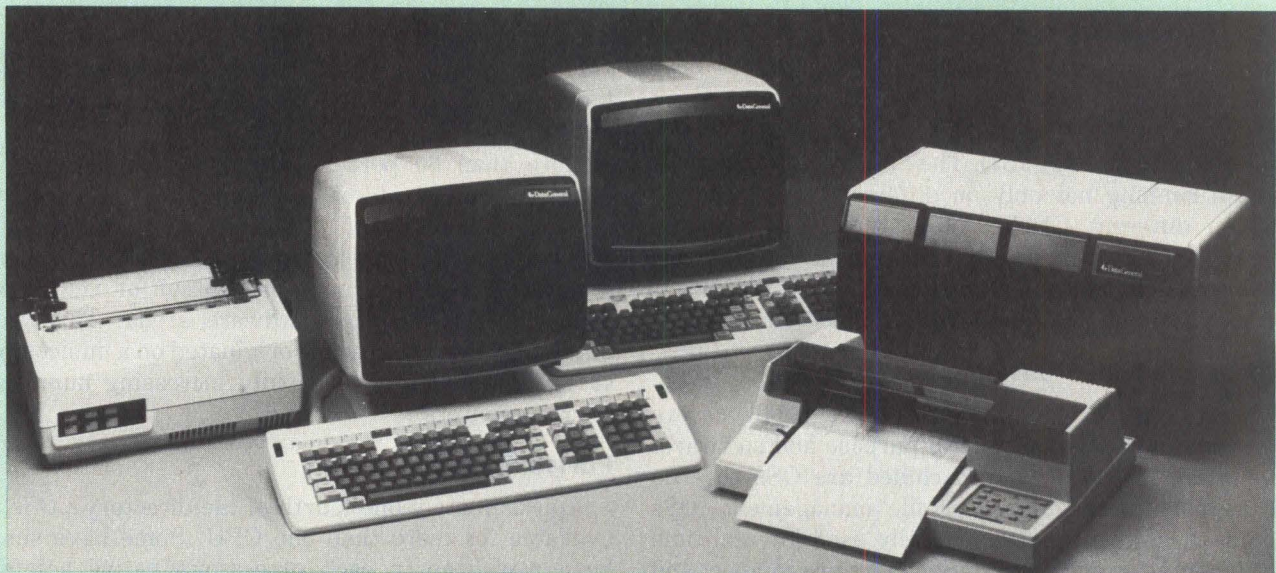

Computers that run two operating systems as a standard feature are a new trend. Models 10 and 10/SP of Data General Corp.'s Desktop Generation run CP/M-86 or MS-DOS concurrently with RDOS, AOS or MP/AOS. The systems contain Intel Corp.'s 8086 CPU in addition to DG's MicroEclipse.

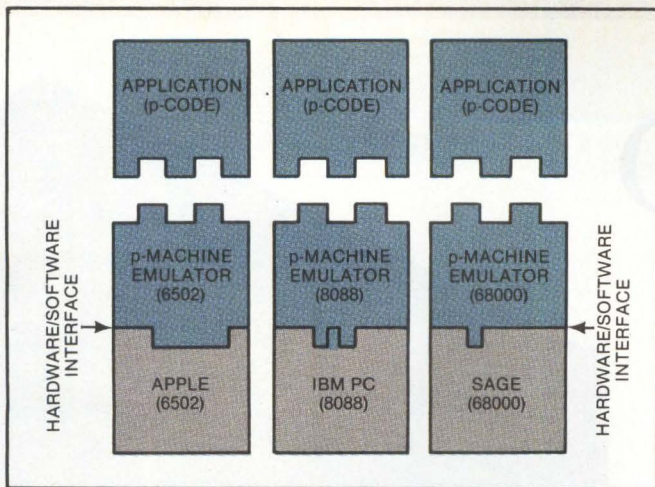

Fig. 2. Presenting a common interface to application programs, p-System software runs on a variety of hardware systems.

The price for object-code portability is reduced execution speed. P-machine emulation is slower than native-code execution for programs that are CPU-intensive, but the slowdown is virtually eliminated for programs that are "I/O bound," making heavy use of external I/O operations. Because business programs often are I/O bound, many business-software developers market portable p-code programs that perform very well (see "Choosing an OS for software development," below).

UNIX contends with look-alikes and derivatives

UNIX was developed at Bell Telephone Laboratories Inc. on Digital Equipment Corp. minicomputers, but versions of it now run on many desktop microcomputers and microcomputer-based engineering workstations. UNIX-compatible and -inspired systems also abound.

CHOOSING AN OS FOR SOFTWARE DEVELOPMENT

By John Meek
Timberline Systems Inc.

Software developers spend far too much time rewriting old programs instead of writing new ones. Rewriting programs limits the number of products a company can develop and drains potential profits. Timberline Systems Inc., a developer of integrated business software, confronted this problem by evaluating four operating systems (OSs)—CP/M, MS-DOS, UNIX and the p-System—in terms of software portability and ease of product development.

The first aspect of portability that Timberline examined was the difference in screen and keyboard attributes between several machines. Keyboard symbols can mean different things on different machines, but none

of the four OSs was outstanding in handling these differences. The p-System, however, was slightly better than the others. Another aspect of portability evaluated was the level at which code could be transported. Using the p-System, both source and object code were portable between machines. With the other OSs, object code was portable only when a program was transferred to a machine with the same CPU as the source machine. The p-System was rated the highest of the four operating systems on portability, followed by UNIX, CP/M and MS-DOS.

The second criterion for evaluating the four operating systems was ease of product development. Unlike the other OSs, the p-System came with a capable integrated editor. Linking usually was not necessary when the

p-System was used, but it sometimes was required with the other three OSs, depending on which languages were used. The more linking a developer must do, the more time it takes to put programs together. The p-System also has a compact instruction set (p-code) that uses significantly less memory than the native code produced by the other systems, allowing larger applications to reside in memory.

After completing its evaluations, Timberline decided that it was not feasible to write application software for multiple OSs. Instead, they made a single choice: the p-System.

John Meek is manager of research and development for Timberline Systems Inc., Portland, Ore.

OPERATING SYSTEMS

EVALUATION CRITERIA	CP/M	p-System	UNIX	MS-DOS
1. Portability	average	excellent	good	average
A. Source code?	yes	yes	yes	yes
B. Object code?	sometimes	yes	sometimes	sometimes
C. Time required to transport software to new machines	moderate	shortest	moderate	moderate
2. Ease of product development	average	excellent	good	average
A. Integrated editing?	no	yes	separate	no
B. High level languages?	yes	yes	yes	yes
C. Separate compilations?	yes	yes	yes	yes
D. Separate linking step?	sometimes	seldom	sometimes	sometimes
E. End-user friendliness	poor	fair	poor	good

Timberline Systems Inc.'s evaluation matrix rates CP/M, the p-System, UNIX and MS-DOS and finds the p-System the most portable.

The Micro Solution

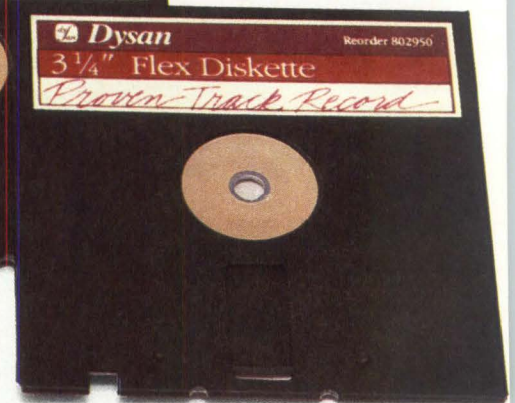
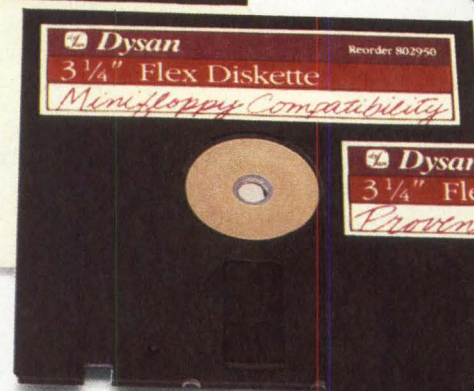

Finally, there is a total solution for your microfloppy needs . . .

The Dysan 3 1/4" Flex Diskette.™

It assures a source of high quality duplication services from Dysan's established production facilities.

It includes both alignment and Dysan's exclusive Digital Diagnostic Diskettes (DDD) for trouble-free drive operation and media interchangeability.

It utilizes a high performance, cost-effective and widely available media, selected specifically for minifloppy plug compatibility.

Its flexible jacket bends without damage, and optimizes media lifetime in contaminated environments.

It is from the same company who standardized the minifloppy with Shugart and the 5.25" Winchester drive with Seagate.

Considering supporting services, minifloppy compatibility, product availability and proven performance, it's apparent there is only one complete microfloppy standard.

The Dysan 3 1/4" Flex Diskette.
CIRCLE NO. 106 ON INQUIRY CARD

3 1/4" Flex Diskette is a registered trademark of Dysan Corporation.



Corporate Headquarters
5201 Patrick Henry Drive
Santa Clara, CA 95050
(800) 551-9000, Department 50
(408) 988-3472

MINI-MICRO SYSTEMS/January 1984

Contributing to UNIX's strength are joint-development agreements, announced in May, between

Western Electric Co. and four major semiconductor manufacturers. Intel Corp., Motorola, Zilog Inc. and National Semiconductor Corp. are now porting UNIX System V to their 80286, 68000, Z8000 and 16032 microprocessors. Under the terms of the agreements, Western Electric will own the resulting source code, but the semiconductor companies will be able to sell

MOVING APPLICATIONS TO A NEW OS

Users acquiring a new hardware system and operating system (OS) often must be concerned with incompatible languages, file structures and OS system calls when transferring application software to the new system. If the source and target systems have incompatible languages or dialects, moving programs usually involves a "bridge" compiler that converts the operations and data structures of the source language to those of the target environment (MMS, October 1983, Page 305). Handling incompatible file structures and OS system calls is

more of a problem. For example, the source system may support indexed sequential file access while the target system doesn't. Even if the source and target languages are identical, OS system calls may differ for functions such as graphics and communications that are outside the scope of the languages. Resolving these incompatibilities usually requires changing source code and installing a run-time emulation package.

There are special concerns when moving from a single-user to a multiuser environment, as is common

when upgrading from an 8- to a 16-bit system. Programs written for a single-user system don't lock records and files or release devices after use—essential functions in a multi-user system.

A final concern is an incompatible tape or disk format, which prevents direct transfer of program and data files. Fortunately, there are utility programs that can help. For example, SofTech Microsystems Inc. provides a utility that allows various systems to read a "universal-format" 5 $\frac{1}{4}$ -inch floppy disk.

PORTING UNIX ON THE 68000

By Jeff Schriebman
UniSoft Systems Corp.

(Editor's Note: The following account describes UniSoft Systems Corp.'s procedure for porting its UniPlus (+) implementation of the UNIX operating system to specifically configured 68000-based hardware systems. Other procedures for porting UNIX might differ in some details.)

The first requirement for porting to a unique 68000-based hardware configuration is the existence of detailed specifications for the memory-management unit (MMU) and all devices that comprise the hardware configuration. Other requirements are the availability of diagnostic programs and a down-loading routine able to receive information from a support computer via an RS232C interface.

After diagnostic programs verify that the various hardware elements are functioning properly, writing standalone code—a program that will run on the hardware without UNIX—begins. Standalone code is necessary because initial work is in a bare-hardware environment without software support except from the down-loading routine. Serial I/O drivers and disk drivers—written in

the standalone environment by following the hardware specifications—are tested as they're written. The test program also exposes idiosyncracies in the memory and disk hardware.

The next task is constructing a prototype file system containing all the necessary utilities for operating the UNIX operating system. After down-loading this file system to the new hardware, a utility program verifies that the down-load occurred correctly and then writes the file system to disk. Following this, the UNIX kernel is created by rewriting the standalone drivers as multiuser UNIX drivers.

Now, porting begins in earnest: the new UNIX—cloned from a generic kernel and accompanied by new drivers and MMU modifications—is brought up on the target hardware. Because the first 20 or so down-loads usually don't produce the desired results, it's necessary to continuously modify code. At least 50 percent of the porting schedule is consumed at this stage. If the target hardware has familiar disk drivers and an MMU to which a new system has been previously ported, the new UNIX system might boot successfully in less than a week. With unfamiliar disk

drivers and a new MMU, the debugging process can take as long as 3 months.

More debugging is needed after the first appearance of a shell prompt on the system's terminal, but the prompt means that a basic UNIX is up and, if not running, at least limping on the target system. UniSoft then runs a proprietary program that updates the system. The program scans the system for missing files, requests those files from the host computer and down-loads them to the target computer. When the program completes, the target machine holds a fully equipped operating system that includes hundreds of utilities and a complete file system.

The final porting step is the acceptance test, which contains a set of programs that tests critical sections of the new kernel and device drivers. Acceptance testing verifies that the newly developed OS for the target machine is robust, complete and ready for distribution.

Jeff Schriebman is president of UniSoft Systems Corp., Berkeley, Calif.

For a limited time only!

30% off Hewlett-Packard's bar code reader in a complete evaluation kit.

Get started with bar codes.

Now through February 29th, 1984, HP is offering a complete bar code kit including one of our new bar code readers, all for just \$795.00. That's 30% off the reader alone! The kit provides materials you need to understand and use bar code technology—a technology that is rapidly becoming the industry standard for accurate, easy and inexpensive data entry. Bar codes are by far one of the best alternatives to slow, error-prone keyboard entry.

Increase your productivity.

Bar codes can increase productivity in a variety of applications—inventory control, work-in-process tracking, distribution tracking, records management, point-of-sale, and government packaging and shipping. The Department of Defense, the automotive industry and many manufacturers have adopted and are implementing bar code technology.

And there isn't a better way to get started using bar codes than with HP's useful and informative kit. Our new bar code reader is easy to use and very flexible. It reads the two standard industrial codes: 3 of 9 and Interleaved 2 of 5, plus



the UPC and EAN commercial codes. It's easy to hook up to your CRT terminals, personal computers and other host computer systems. All you need is a standard RS-232-C interface and a RS-232-C cable. And the cable comes in the kit! Along with a lot more!

For just \$795.00, your kit includes the following items:

- HP's most flexible bar code reader—a \$1,150.00 value!
- RS-232-C cable and adaptor to make it easy to connect to your equipment.
- Bar code print samples from HP's new dot matrix printers.

■ A variety of bar code labels.

■ Comprehensive information about bar code technology. Auerbach's computers in manufacturing series supplement entitled "Bar Code System Elements: Definitions and Specifications." HP's 28-page Applications Note on "Elements of Bar Code Systems."

■ Technical literature about HP's bar code equipment to help you assemble a complete bar code system.

All for the low price of \$795.00. Call our TOLL FREE number to order your kit today. Limit one kit per order. Available in the U.S.A.

only. Offer expires February 29, 1984. For technical literature only, write to Hewlett-Packard, Attn: Greg Huber, 350 West Trimble Road, San Jose, CA 95131.



Call today and save 30%!

(800) 227-9770

In California, Alaska and Hawaii, call collect, 415/965-7643.



Put a little tape backup in your DEC microcomputer.

SMS' DSX-11 is a complete DEC microcomputer with 80Mb Winchester and 1/4" cartridge tape backup. With over 20Mb per tape cartridge, Winchester backup has never been so easy. Emulating DEC's latest TS11 tape device, standard RT-11 and RSX-11M software makes disk backup, system boot, media interchange, archiving and software distribution a snap!



256Kb main memory (expandable 4Mb)

Expansion space for 15 dual height modules.

LSI-11/23 16 bit CPU with memory management.

4 Serial ports.

Advanced disk controller with ECC, flaw management, bootstrap, error retry and non-interleaved data transfer.

PDP-11* architecture compatible with RT-11, RSX-11M and UNIX** software.

17.8Mb, 35.6Mb or 71.2Mb Winchester disk.

Self test with LED display of system faults.

Start/stop tape supports file operations.

Compact 3M Cartridge.

TAPE CONTROLLER ONLY AVAILABLE FOR VOLUME REQUIREMENTS.



**Scientific Micro
Systems, Inc.**

777 E. Middlefield Road
Mountain View, California 94043
(415) 964-5700

AUTHORIZED SMS DISTRIBUTOR FOR DEC
Q-BUS PRODUCTS: FIRST COMPUTER
CORPORATION (312) 920-1050

SMS SALES OFFICES:

Phoenix, Arizona (602) 978-6621;

Boston, MA (617) 246-2540; Atlanta, Georgia

(404) 296-2029; Morton Grove, Illinois (312)

966-2711; Yorba Linda, California (714) 993-3768.

* Trademark of Digital Equipment Corporation. ** Trademark of Western Electric.
MINI-MICRO SYSTEMS/January 1984

object versions of generic UNIX System V ports. Customers wanting ports for specifically configured systems can do the ports themselves or turn to a specialist software house such as UniSoft Systems Corp. (see "Porting UNIX on the 68000," Page 237). Motorola product-information manager Jeff Gorin says a software house doing a specific-system port would license UNIX source from Western Electric; in the case of the 68000, Motorola would then supply the software house with source code and documentation for the generic 68000 port. Motorola also provides a version of UNIX System V, called System V/68, on its EXORmacs development system, and the company is planning a port to its VME/10 desktop design station.

Many microcomputer OSs rival minicomputer OSs in performance, mimicking the microcomputer's pursuit of minis in the hardware arena.

Many companies continue to provide UNIX-like OSs or derivatives of UNIX Version 7 and System III, the predecessors of System V. Because System V doesn't have all the enhancements that customers might want, these and other systems remain practical alternatives. John Ulett, marketing manager for Microsoft Corp.'s XENIX (an OS derived from UNIX Version 7 and System III), says System V isn't friendly enough for business use, one of the largest application areas of 16-bit systems. XENIX replaces the standard UNIX shell with a user interface similar to that of Microsoft's MultiPlan spreadsheet program. Countering arguments that System V is or will be the UNIX standard, Ulett notes that XENIX now has about 60 percent of the installed UNIX base on microcomputers. Microsoft is also aware of a need for compatibility among operating systems. Version 3.0 of XENIX and Version 2.0 of the company's single-user MS-DOS, both released last spring, have compatible shells that present a common interface to users of the two systems. In addition, programs developed under MS-DOS 2.0 guidelines are source-code compatible with XENIX.

Compatibility at the kernel level among the many UNIX and UNIX-like systems continues to increase, with *usr/group*, an association of UNIX-system marketers, leading the drive toward standardization. The group doesn't require adherence to its standard kernel, but it asks UNIX vendors to acknowledge whether they conform to it. Conformance by a large number of vendors would enable independent software developers to market programs able to run on a wide variety of systems.

This publication
is available in microform.

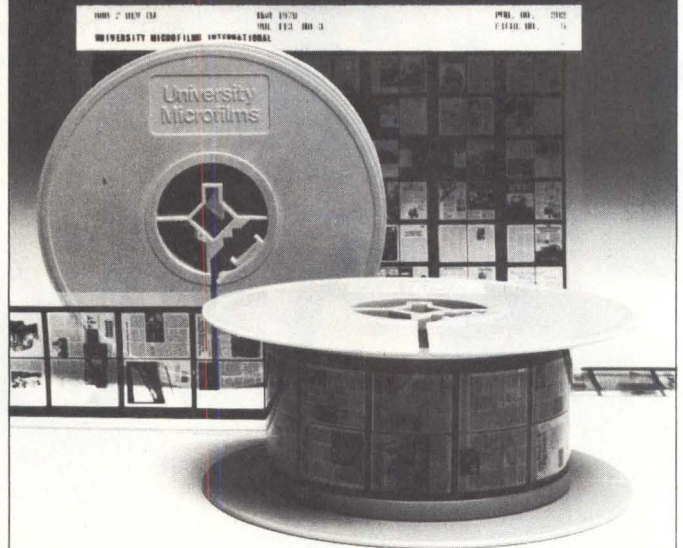

University Microfilms International

Please send additional information
for Mini-Micro Systems

(name of publication)

Name _____

Institution _____

Street _____

City _____

State _____ Zip _____

300 North Zeeb Road
Dept. P.R.
Ann Arbor, Mi. 48106
U.S.A.

30-32 Mortimer Street
Dept. P.R.
London W1N 7RA
England



2-way power line carrier breaks the grip of hard wiring for monitoring and control.

Until recently, dedicated hardwiring was the only reliable solution for communicating analog and digital data to and from building control points.

Because Energy Methods modular, 2-way Power Line Carrier system communicates monitoring and control data over your building's existing AC power wiring, the expensive, messy, time-consuming task of hardwiring is avoided. You can transmit and receive digital and analog data with the assurance that the data is correct and that *all* the data is getting through.

The key to drastic reductions in the installed cost of building automation, submetering, and energy management systems is our product line of 2-way Remote Transponders. The Transponders not only receive and perform commands at the control point, but also return information to the central controller. Data from up to 2,047 different control points can include load status for confirmation of

command execution, alarm conditions, and analog data such as temperature.

It saves and it works.

Ask for proof.

Save yourself the high cost of hardwiring and gain the ability to easily expand or recon-

figure your control and monitoring system. We've got the proof. Send for our report: "APPLICATIONS AND BENEFITS OF 2-WAY POWER LINE CARRIER." Ask for a demonstration of our 2-way PLC over your own facility wiring. Contact Energy Methods, a subsidiary of Butler Mfg. Co., 177 Main St., West Orange, NJ 07052. Write or call TOLL FREE 1-800-2-WAY PLC. In New Jersey call 201-736-1811.

**ENERGY
METHODS**

A Subsidiary of Butler Manufacturing Company

For Literature, Circle No. 194.

For Demonstration Circle No. 195.



Applications &
Benefits of
**2-WAY
Power Line
Carrier**

Integrating Federal Desktops With Mainframes

The Federal Government — the largest single purchaser of information systems integration products in the world — is the “capitol” market delivered by **FEDERAL DP EXPO**. It’s literally a multi-billion dollar market.

This year’s **FEDERAL DP EXPO** celebrates its 10th anniversary. And once again, the show will bring you face-to-face with government decision-makers who will be looking for the newest, most productive and cost-efficient methods of integrating small information systems with existing and new mainframes.

And, to relate technology to current policy and management issues, attendees depend on the **FEDERAL DP EXPO** Conference — featuring over 100 nationally prominent consultants, industry leaders, and government authorities.

Make sure you are there, too. Find out how you can exhibit in the 10th Annual **FEDERAL DP EXPO**. Call us today, toll-free at (800) 325-3330. In Massachusetts, call (617) 449-6600.



World's leading producer of computer conferences and expositions including FEDERAL DP EXPO, INTERFACE, COMDEX/Winter, COMDEX/Spring, COMDEX/Fall, COMDEX/Europe, COMDEX in Japan, the nationwide COMPUTER SHOWCASE EXPOs, and The BYTE COMPUTER SHOWS.

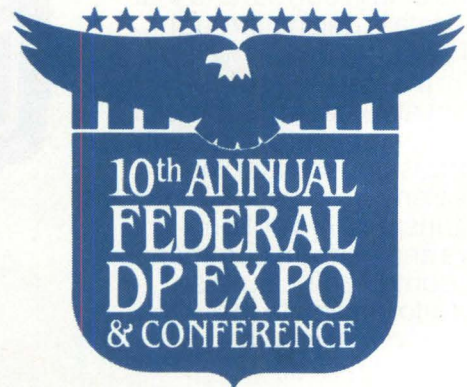

April 17 - 19, 1984
The Washington DC Convention Center

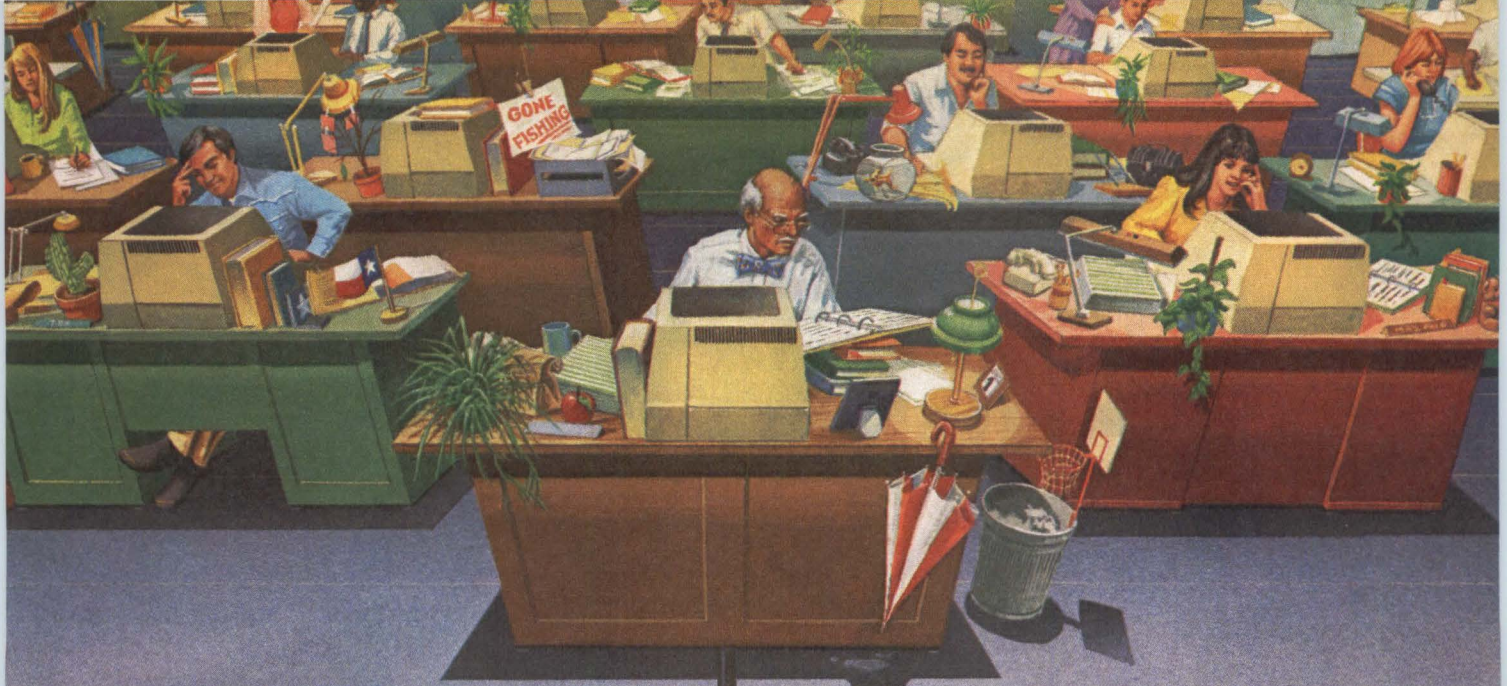

1 TO 128. 1 KM AWAY.

WITH 1 CABLE. AND ATTACH.

From Able.

With a single cable, an Attach* subsystem connects up to 64 terminals, in various configurations, to one or more host DEC computers. Additional Attach sub-systems will connect up to 64 more terminals.

And each single cable can span 1 km, about two-thirds of a mile, between any DEC Unibus host computer in the system and Attach, or between Attach subsystems.

Attach gives you much greater freedom in locating terminals and CPU's, while greatly reducing wiring, line costs, and power consumption.

In fact, Attach gives you much greater freedom in operating your entire system. That's because terminals can be dynamically configured with any CPU interfaced with the system, all at the touch

*Patent Pending

of a few keys. Terminals can be switched instantly, individually or in clusters, to the appropriate CPU.

MAKES OBSOLETE...OBSOLETE.

Attach reduces obsolescence by design and in practice. As Attach's capabilities are enhanced in the future, any new options you choose to add will easily interface with your existing system. Your system will simply get better, not outdated.

Whether you have 28 or 128 terminals, discover the simple way to attach them to your DEC Unibus CPU's, up to 1 km away. With one cable.

Discover Attach. No other long-line terminal support goes as far.

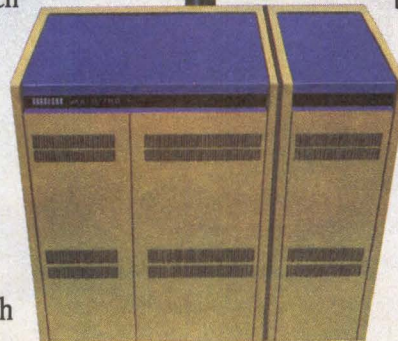

The communications specialists.
CIRCLE NO. 156 ON INQUIRY CARD

1732 Reynolds Avenue, Irvine, California 92714. Call toll free: 800-332-2253. In the Irvine area: (714) 979-7030. Or, TWX: 910-595-1729
DEC, Unibus and VAX are trademarks of Digital Equipment Corporation.

How Cromemco makes its System One doubly valuable.

The Cromemco System One gives you all the versatility and performance you need to tackle the most complex computing problems.

Dual microprocessors give you a 68000-based machine

that also runs Z-80 programs. The 68000, with its 32-bit architecture, gives you superior processor capabilities and is supported by an extensive line of high level software. The Z-80A lets you

use the largest base of existing application software available. Now you can get the best of both worlds in one integrated, expandable, low-cost system.

It's available with either

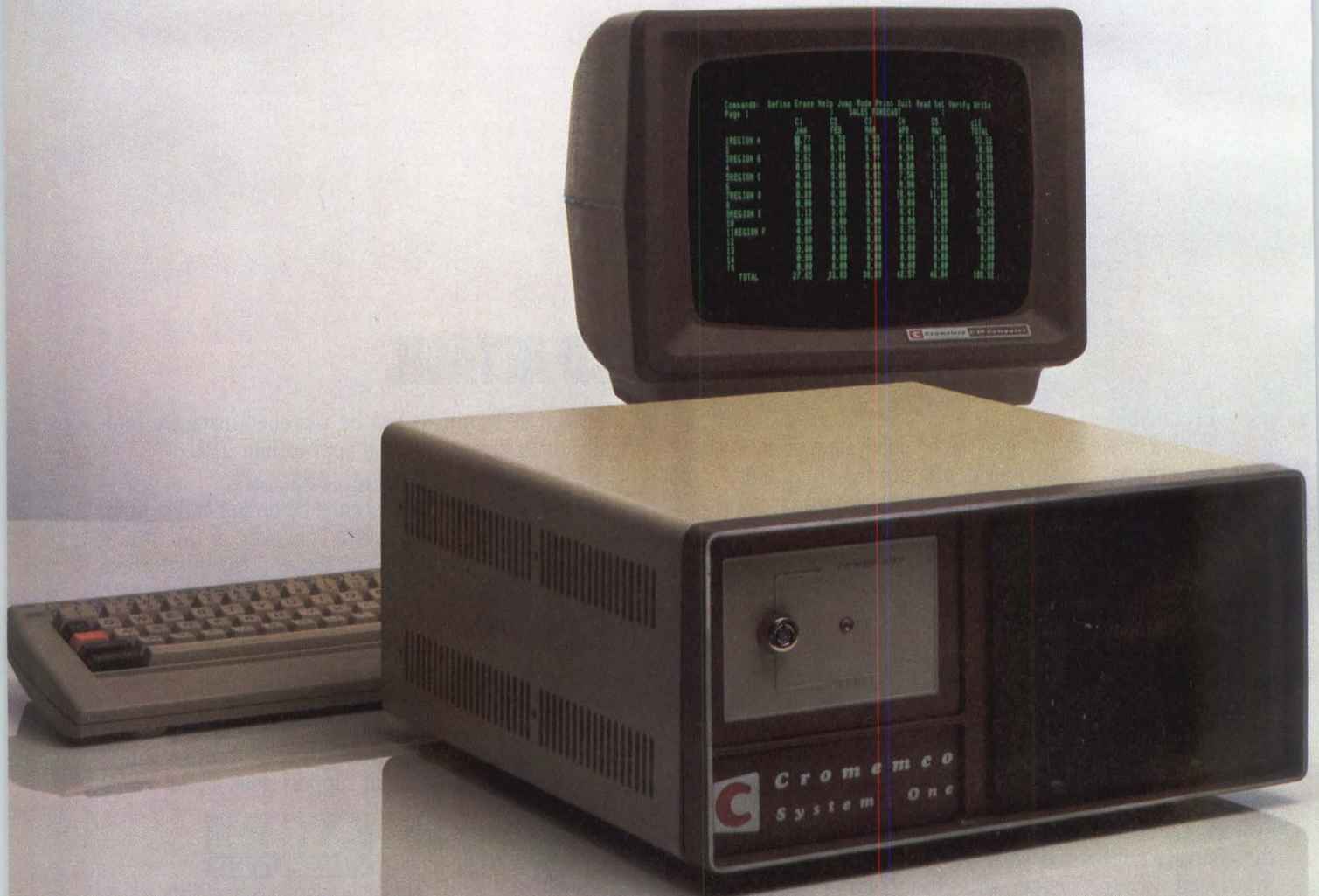

a full 21 Mbyte hard disk and a floppy disk or with two floppy disk drives. That puts enough processing power at your fingertips to tackle the tough jobs. But with Cromemco, you get more.

Software is where Cromemco's System One really shines. The CROMIX* operating system, inspired by the UNIX* system, runs on both the 68000 and Z-80A and provides a similar user interface, improved file security, and record level locking. CROMIX is so flexible it lets you run your CP/M* based programs, too.

We offer a full complement of high level languages as well, including FORTRAN, PASCAL, COBOL, C, BASIC, and ASSEMBLER.

The System One is a desktop computer and can support one user or multiple users. It is one of Cromemco's full range of expandable computer systems.

Since all Cromemco systems are based upon the standard IEEE-696 bus, you can configure and expand them with our broad line of board level products. To enhance throughput, our systems can use our C-10 personal com-

puter as an intelligent terminal.

Whenever your applications require reliable computing for business or engineering use, Cromemco gets the job done.

Call us today for our new Systems Catalog or for our nearest dealer or distributor. Or write Cromemco, Inc., 280 Bernardo Avenue, P.O. Box 7400, Mountain View, CA 94039. Tel. (415) 964-7400. In Europe: Cromemco A/S, Vesterbrogade 1C, 1620 Copenhagen, Denmark.

Cromemco



*CROMIX is a registered trademark of Cromemco, Inc.
UNIX is a trademark of Bell Laboratories
CP/M is a registered trademark of Digital Research

CIRCLE NO. 112 ON INQUIRY CARD

MICROCOMPUTER OPERATING SYSTEMS

General information					General features				Memory management				
					Network support	Multituser	Multi tasking	Multi processing	Overlays	Swapping	Segmentation	Dynamic relocation	
Supplier	Operating system	CPU	Required memory (K bytes)	Languages supported									
Alcyon Corp. 8716 Production Ave. San Diego, CA 92121 (619) 578-0860	REGULUS	68000	128	BASIC, C, COBOL, DIBOL, FORTRAN-77, Pascal, assembler	•	•	•	•	•	•	•	•	•
Apple Computer Inc. 10260 Bandley Dr. Cupertino, CA 95014 (408) 996-1010	DOS 3.3	6502	32	BASIC, assembler					•				
	SOS	6502	96	BASIC, FORTRAN, Pascal, assembler					•		•		
Applied Systems Corp. 26401 Harper Ave. St. Clair Shores, MI 48081 (313) 779-8700	O/S	8085, Z80, 8086, 8088, 68000	16-32	BASIC, COBOL, FORTRAN, assembler	•	•	•	•	•				
Boston Systems Office Inc. 469 Moody St. Waltham, MA 02154 (617) 894-7800	UMD	8048, 8051, 8080A, 8085A, 8086, 8088, F8, 6800, 6802, 6805, 6809, Z8000, 68000, 1802, 1805, 6502, TMS9900, TMS1000, Z80, others	64	Pascal, assembler		•			•		•		
Charles River Data Systems 983 Concord St. Framingham, MA 01701 (617) 655-1800	UNOS	68000	256	BASIC, C, FORTRAN, Pascal, assembler	•	•	•		•	•	•	•	•
CompuPro 3506 Breakwater Ct. Hayward, CA 94545 (415) 786-0909	CP/M 8-16	8085/8088	128	Languages compatible with CP/M-80 or CP/M-86					•				•
	MP/M 8-16	8085/8088	194	Languages compatible with CP/M-80 or CP/M-86		•	•		•				•
Convergent Technologies Inc. 2500 Augustine Dr. Santa Clara, CA 95051 (408) 727-8830	CTOS	8086	256	BASIC, C, COBOL, FORTRAN-77, Pascal, assembler	•	•	•	•	•				
Creative Solutions Inc. 4801 Randolph Rd. Rockville, MD 20852 (301) 984-0262	MULTI-FORTH	68000	32	FORTH, assembler	•	•	•		•	•			
Data General Corp. 4400 Computer Dr. Westboro, MA 01580 (617) 366-8911	DOS	MICRO NOVA	64	BASIC, FORTRAN, assembler	•	•	•		•	•			
	MP/AOS	MICRO ECLIPSE	192	BASIC, FORTRAN, Pascal, assembler		•	•	•	•	•	•	•	•
	MP/OS	MICRO NOVA	6-64	BASIC, FORTRAN, Pascal, assembler	•		•		•	•	•		
Digital Equipment Corp. 77 Reed Rd. Hudson, MA 01749 (800) 225-9222	RSX-11M	LSI-11	48	BASIC, COBOL, FORTRAN, assembler	•	•	•				•		
	RT-11	LSI-11	24	APL, BASIC, FOCAL, FORTRAN, assembler	•		•		•		•	•	•

FOR GENERAL AND DEVELOPMENT APPLICATIONS

Peripheral management							File management						Price	Comments	Circle no.
Hard disk	Cartridge disk	Modems	Magnetic tape	Paper tape	I/O multi buffering	Spooling	Sequential	Contiguous	Random	Indexed sequential	Multilevel directory	Password security			
•	•	•	•		•	•	•	•	•	•	•	•	\$2000	System calls compatible with UNIX versions 6 and 7, UNIX System III. Supports real-time tasks. Price shown is for end user.	788
	•	•			•		•		•				\$200	Runs on Apple II.	789
	•	•			•		•		•		•		\$250	Free with Apple III system.	
•		•					•		•			•	—	Price depends on configuration.	790
	•	•	•	•	•	•			•			•	\$1000-\$4900	Requires 512K-bytes disk storage.	791
•	•				•	•	•	•	•	•	•	•	\$3000	UNIX compatible; has real-time extensions.	792
•	•	•		•		•	•	•	•	•			\$450	Runs 8-bit, 16-bit applications simultaneously on system 816's dual-processor architecture.	793
•		•	•		•	•			•			•	\$1000	Runs 8-bit, 16-bit applications simultaneously in multiuser environment on System 861's dual-processor architecture.	
•		•	•		•	•	•	•	•	•	•	•	—	Comes with model AWS and IWS hardware. Distributed OS supports workstations via local-area network.	794
•		•	•		•	•	•	•	•		•	•	\$1500-\$5000	Versions available for 16-, 32-bit processors.	795
	•	•	•		•			•	•	•	•	•	\$1900		796
•	•		•		•	•	•	•	•	•	•		\$6500	Compatible with MP/OS, full development and execution available under AOS and AOS/VS.	
	•	•	•		•				•	•	•		\$2000	Compatible with MP/AOS. Full development and execution available under AOS and AOS/VS.	797
•		•			•	•	•	•	•	•	•	•	\$8600		
	•	•			•	•	•		•				\$3620		

MICROCOMPUTER OPERATING SYSTEMS

General information					General features			Memory management				
					Network support	Multituser	Multi tasking	Multi processing	Overlays	Swapping	Segmentation	Dynamic relocation
Supplier	Operating system	CPU	Required memory (K bytes)	Languages supported								
Digital Research Inc.												
Box 579 Pacific Grove, CA 93950 (800) 227-1617, ext 400; in CA, (800) 772-3545, ext 400	CP/M PLUS	8080, Z80	64	C, CBASIC, CIS, COBOL, Pascal MT +, PL/1, assembler					•			•
	CP/M-86	8086, 8088	64	BASIC, CBASIC, C, CIS COBOL, Level II COBOL, Pascal MT +, PL/1, assembler	•				•			•
	CP/M-68K	68000	64	BASIC, CBASIC, C, CIS COBOL, Level II COBOL, Pascal MT +, PL/1, assembler	•				•			•
	concurrent CP/M-86	8086, 8088	256	BASIC, CBASIC, C, CIS COBOL, Level II COBOL, Pascal MT +, PL/1, assembler	•	•	•		•			•
	MP/M-II	8080, 8085, Z80	48	BASIC, CBASIC, C, CIS COBOL, Pascal MT +, PL/1, assembler	•	•	•		•			•
	MP/M-86	8086, 8088	64	BASIC, CBASIC, C, CIS COBOL, Level II COBOL, Pascal MT +, PL/1, assembler	•	•	•		•			•
Eyring Research Institute Inc.												
1455 W. 820 N. Provo, UT 84601 (801) 375-2434	EDS 68/11	68000	32	BASIC, Pascal, assembler	•	•	•		•			•
	PDOS	9900, 9995, 99000	32	BASIC, FORTH, Pascal, assembler	•	•	•		•			•
	PDOS 68000	68000	32	BASIC, Pascal, assembler	•	•	•		•			•
Forth Inc.												
2309 Pacific Coast Hwy. Hermosa Beach, CA 90254 (213) 372-8493	POLYFORTH II	8080, Z80, 8086, 9900, 6809, 68000, LSI-11, PDP-11	16	FORTH, assembler		•	•		•			
Hemenway Corp.												
101 Tremont St. Boston, MA 02108 (617) 426-1931	MSP/68000	68000	32	BASIC, Pascal, PLMH, assembler			•	•	•			•
	MSP/Z8002	Z8002	32	PLMH, assembler			•		•			•
Hewlett-Packard Co.												
Data Systems Div. 11000 Wolfe Rd. Cupertino, CA 95014 Phone local office	RTE-A	A600 +	128	BASIC, FORTRAN-77, Pascal, assembler	•	•	•		•	•	•	
Human Computing Resources Corp.												
10 St. Mary St. Toronto, Ontario M4Y 1P9 (416) 922-1937	UNITY	16032, 68010	256	C, FORTRAN-77, Pascal, RATFOR, assembler	•	•	•			•	•	•
InfoSoft Systems Inc.												
80 Washington Norwalk, CT 06856 (203) 866-8833	I/OS	8080, 8085, Z80	24	BASIC, MBASIC, C, COBOL, FORTH, FORTRAN, MUMPS, Pascal, PILOT, RATFOR, assembler	•			•	•			
	MULTI/OS	8080, 8085, Z80	48	BASIC, MBASIC, C, COBOL, FORTH, FORTRAN, MUMPS, Pascal, PILOT, RATFOR, assembler	•		•	•	•			

FOR GENERAL AND DEVELOPMENT APPLICATIONS

Peripheral management							File management					Price	Comments	Circle no.	
Hard disk	Cartridge disk	Modems	Magnetic tape	Paper tape	I/O multi buffering	Spooling	Sequential	Contiguous	Random	Indexed sequential	Multilevel directory				Password security
•	•	•	•	•	•	•			•			•	\$350	Accommodates 1 to 16 disk drives, each capable of storing 512M bytes.	798
•	•	•	•	•	•	•	•	•	•				\$60	Configured for IBM PC/XT.	
•	•	•	•	•	•	•	•	•	•				\$350	Generic system to be configured by OEM.	
•	•	•	•	•	•				•			•	\$350	Available on IBM PC, IBM PC XT, DEC Rainbow, TI Professional.	
•	•	•	•	•	•	•	•	•	•			•	\$450	Generic system to be configured by OEM.	
•	•	•	•	•	•	•	•	•	•			•	\$650	Generic system to be configured by OEM.	
•	•	•	•	•	•	•	•	•	•				\$1500-\$2000	Same as PDOS, but with a user shell that simulates an RT/11 system.	799
•	•	•	•	•	•	•	•	•	•				\$1500	Runs on TM990/101, 102, 103; standard 9995 SBC.	
•	•	•	•	•	•	•	•	•	•				\$1500		
•	•	•	•	•	•	•	•	•	•			•	\$600-\$3200	Available for 86/12, 86/30 and 88/25 SBC, IBM PC, VAX and Apple with Z80.	800
•	•	•	•	•	•	•	•	•	•				—	Price depends on license type.	801
•	•	•	•	•	•	•	•	•	•				—	Price depends on license type.	
•	•	•	•	•	•	•	•	•	•			•	\$2000	Password/security and spooling are options. Supports 128M bytes of virtual memory. Runs on models 6 and 26, MICRO/26.	802
•	•	•	•	•	•	•	•	•	•			•	\$90-\$1800	Implementation of UNIX with demand-paged virtual-memory management. Price depends on volume and number of users. Source price is \$25,000.	803
•	•	•	•	•	•	•	•	•	•				\$225	Dual tasks handle program, spooler.	804
•	•	•	•	•	•	•	•	•	•				\$900	Accommodates 1 to 16 tasks.	

Archive's to building

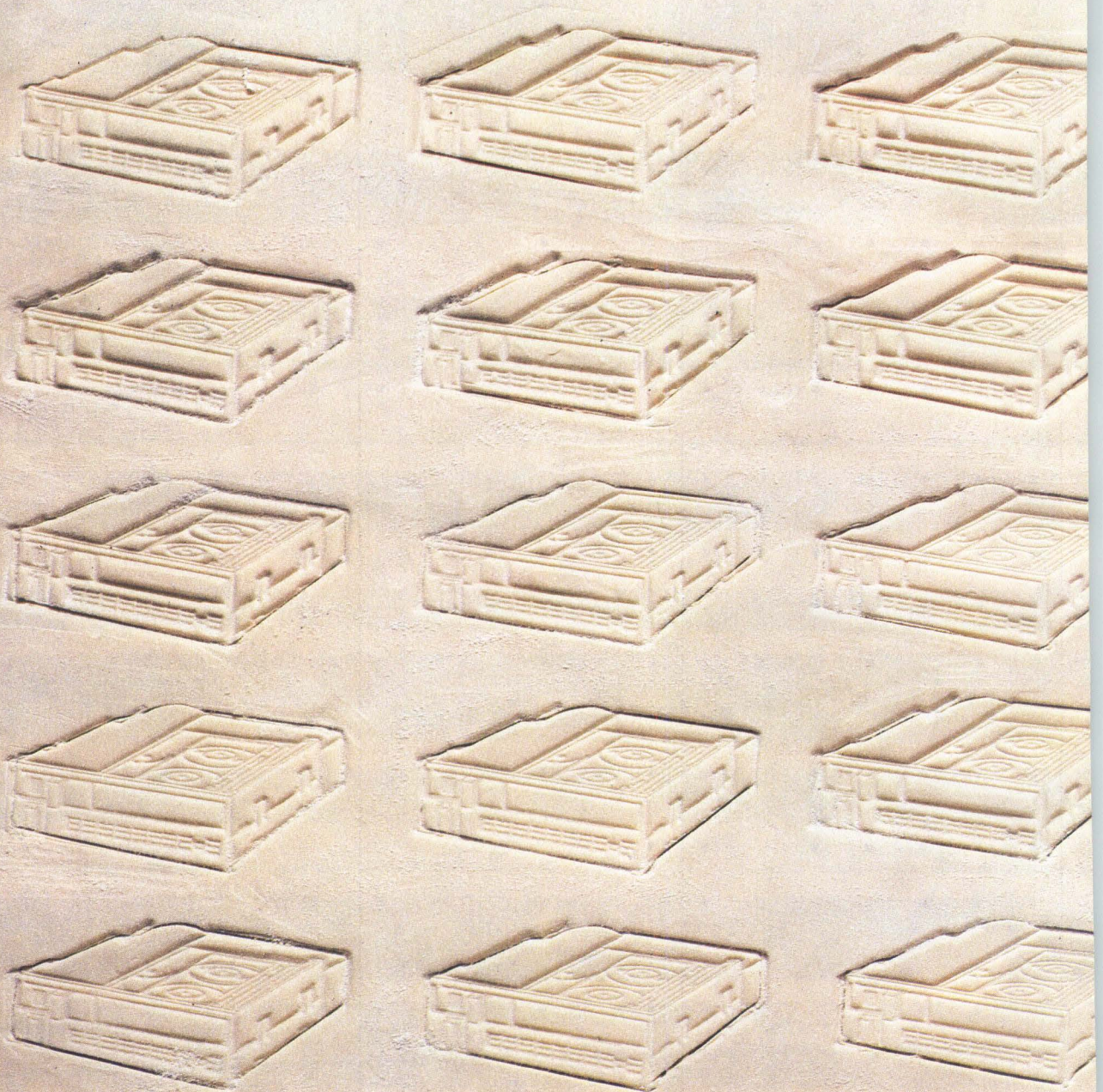

approach 1/4" streamers.



Mass production.

Our goal was to create a design so simple and a production line so unerringly accurate that we could turn out 1/4" streamers by the thousands with cookie-cutter consistency.

At Archive, that goal was met. In the last three years, we've shipped more than 50,000 streamers—nearly three times as many drives as the rest of the industry combined.

Others are still learning how to build streamers in quantity. But we perfected our production process years ago.

Today we're shipping over 5,000 streamers each month. And everything is in place to boost our capacity to 15,000 streamers per month.

Of course we haven't sacrificed quality for quantity. Our 98% reliability rate is among the industry's best.

But still, we're improving our products. For example, our recent advancements in LSI technology have reduced the number of parts in our newest streamers by 40%. So there's even less of a chance that something will go wrong.



Archive offers 8", 5 1/4" full-height and 5 1/4" half-height streaming tape drives.

You'll like our approach to mass production. It means if anyone is going to be able to turn out a perfect batch of streamers, it's Archive. For more information, write Archive Corporation, 3540 Cadillac Avenue, Costa Mesa, CA 92626. Or call (714) 641-0279.

ARCHIVE
CORPORATION

CIRCLE NO. 113 ON INQUIRY CARD

MICROCOMPUTER OPERATING SYSTEMS

General information					General features			Memory management				
Supplier	Operating system	CPU	Required memory (K bytes)	Languages supported	Network support	Multituser	Multi tasking	Multi processing	Overlays	Swapping	Segmentation	Dynamic relocation
	UNI/OS	8080, 8085, Z80	32	BASIC, MBASIC, C, COBOL, FORTH, FORTRAN, MUMPS, Pascal, PILOT, RATFOR, assembler	•			•	•	•		
Intel Corp. 3065 Bowers Ave. Santa Clara, CA 95051 (408) 987-8080	iRMX 86	8086, 8088	48-348	BASIC, C, COBOL, FORTRAN, Pascal, PL/M-86, assembler	•	•	•		•		•	
	iRMX 286R	80286	48-348	BASIC, C, COBOL, FORTRAN, Pascal, PL/M-86, assembler	•	•	•		•		•	
Kontron Electronics 5730 Buckingham Pkwy. Culver City, CA 90230 (415) 361-1012	μNIX	68000	1024	Pascal, assembler	•	•	•	•	•	•	•	•
Lantech Systems Inc. 9635 Wendell Rd. Dallas, TX 75243 (214) 340-4932	uNETix	8086/8088	256	BASIC, C, FORTRAN, Pascal, assembler			•			•	•	•
	uNETix-DFS-VFS	8086/8088	512	BASIC, C, FORTRAN, Pascal, assembler	•	•	•			•	•	•
Mark Williams Co. 1430 W. Wrightwood Ave. Chicago, IL 60614 (312) 472-6659	Coherent	8086, 68000, PDP-11	256	C, assembler		•	•	•		•	•	
Microsoft Corp. 10700 Northrup Way Bellevue, WA 98004 (206) 828-8080	MS-DOS	8086, 8088	32	BASIC, C, COBOL, FORTRAN, LISP, Pascal, assembler	•				•	•	•	
	XENIX	8086, 80286, 68000, Z8000, 16032	256	BASIC, C, COBOL, FORTRAN, Pascal	•	•	•		•	•	•	
Microwave Systems Corp. 5835 Grand Ave. Des Moines, IA 50312 (515) 279-8844	OS-9	6809	4, 16	BASIC, C, COBOL, Pascal, assembler		•	•		•		•	•
Motorola Semiconductor Products Inc. Box 20912 Phoenix, AZ 85036 (602) 829-3501	System V/68	68000	384	BASIC, C, assembler		•	•			•	•	•
	VERSADOS	68000	384	C, FORTRAN, Pascal, assembler	•	•	•	•			•	
Multi Solutions Inc. 660 Whitehead Rd. Lawrenceville, NJ 08648 (609) 695-1337	S1	68000, 8086	6-10	BASIC, C, FORTRAN, Pascal, assembler	•	•	•	•	•	•	•	•
National Semiconductor Corp. 2900 Semiconductor Dr. Santa Clara, CA 95051 (408) 737-5000	GENIX	16032	512	C, Pascal, assembler	•	•	•		•	•		

FOR GENERAL AND DEVELOPMENT APPLICATIONS

Peripheral management							File management					Price	Comments	Circle no.	
Hard disk	Cartridge disk	Modems	Magnetic tape	Paper tape	I/O multi buffering	Spooling	Sequential	Contiguous	Random	Indexed sequential	Multilevel directory				Password security
•	•	•	•	•	•	•	•	•	•	•	•	•	\$300	Accommodates as many as 255 processors via communications network.	805
•	•	•			•		•	•	•		•	•	\$6000	Supports iSBC, 86 and 88 boards, bubble memory. Application software is compatible with iRMX 286R OS. Price is for OEM license.	806
•	•	•			•		•	•	•		•	•	\$6400	Supports iSBC 286/10 board, bubble memory. Application software is compatible with iRMX 86 OS. Price is for OEM license.	807
•	•	•	•	•	•	•	•		•		•	•	\$23,000-\$30,000		808
•	•	•	•	•	•	•	•	•	•		•	•	\$299	Transparent networking, PC-DOS emulation, micro to mainframe link, dynamic load balancing.	809
•	•	•	•	•	•	•	•	•	•		•	•	\$449, \$599	Transparent networking, PC-DOS emulation, micro to mainframe link, dynamic load balancing.	810
•		•	•		•	•	•		•		•	•	—	UNIX-compatible system. Price varies with hardware.	811
•	•	•	•	•	•	•	•	•	•	•	•	•	—	Sold only to hardware manufacturers. Minimal multi-tasking available; Other languages available from other sources.	812
•	•	•	•	•	•	•	•		•		•	•	—	Available from OEMS. UNIX System III with enhancements.	813
•	•	•	•	•	•	•	•	•	•	•	•	•	\$200, \$500	ROM version requires 4K RAM; disk version requires 16K. Level 1 version (\$200) is for smaller systems; level 2 (\$500) supports as much as 2M-bytes memory. Has C source compatibility with UNIX.	814
•	•	•	•	•	•	•	•		•		•	•	NA	UNIX system V implementation.	815
•	•	•	•			•	•	•	•	•	•	•	NA	Used in VERSAmodule SBC or in customer-designed hardware using 68000.	816
•	•	•	•	•	•	•	•	•	•	•	•	•	NA	Supports system calls and features of UNIX kernel. Supports file transfers to and from CP/M, MS-DOS, FLEX, p-System, IBM 3741, DEC FILES-11 and UNIX.	817
•		•			•	•			•		•	•	NA	Demand-paged UNIX system. Requires 20M-byte disk.	818

Continued on page 258

An association dedicated to addressing the marketing concerns of manufacturers of computer peripherals and related products.

Over 25 companies have joined the newly-formed PMA. They have recognized that a trade association can be an effective tool in responding to common marketing interests such as:

- **INDUSTRY STANDARDS**
- **TRADE SHOWS**
- **SALES CHANNELS**
- **GOVERNMENT REGULATIONS**

PMA MEMBERS*

Amcodyne Inc.
Longmont, CO

Amlyn Corp.
San Jose, CA

Ball Electronic Systems Division
Broomfield, CO

Beehive International
Salt Lake City, UT

Burr-Brown Data Acquisition and Control Systems Division
Tucson, Ariz.

Cipher Data Products, Inc.
San Diego, CA

Control Data Corp.
Minneapolis, MN

Data Electronics, Inc.
San Diego, CA

Envision
San Jose, CA

Evotek
Fremont, CA

Facit, Inc., Data Products Div.
Nashua, N.H.

International Memories Inc. (IMI)
Cupertino, CA

Iomega Corp.
Ogden, UT

Liberty Electronics USA
San Francisco, CA

MegaVault
Woodland Hills, CA

Micro Peripherals, Inc.
Salt Lake City, UT

Miniscribe Corp.
Longmont, CO

Pertec Peripherals Corp.
Chatsworth, CA

Seagate Technology
Scotts Valley, CA

TEAC Corporation
Montebello, CA

Vermont Research Corp.
North Springfield, VT

Xico Inc.
Santa Monica, CA

Xylogics Inc.
Burlington, MA

*as of July 15, 1983

*NEW MEMBERS

as of Oct. 1983

BDT Products, Inc.
Irvine, CA

California Computer Products, Inc.
Anaheim, CA

Century Data Systems
Anaheim, CA

Hewlett-Packard Co.
Boise, ID

Priam Corporation
San Jose, CA

Wabash Datatech, Inc.
Rolling Meadows, IL

If your company is a manufacturer of disk drives, tape drives, printers, terminals, controllers, and/or other peripheral devices, we urge you to join the PMA. Please use the coupon below to send for a membership application.



c/o Mini-Micro Systems
221 Columbus Avenue
Boston, MA 02116

Please send me:

Membership Application Form

NAME _____

COMPANY _____

STREET _____

CITY _____ STATE _____ ZIP _____

TEL. _____

CIRCLE NO. 114 ON INQUIRY CARD

MINI-MICRO SYSTEMS/January 1984

In a world where what is promised is seldom delivered, we have earned a reputation for dependability. Whenever industry needs better ideas in flexible media, Verbatim responds.

We were the first to develop and manufacture in volume the 5 Mbyte, 8" disk. The first high-volume producer of the 5¼" minidisk, as well as the 96 tpi minidisk. And the first U.S. company to produce the new 3½" microdisk.

But then, leadership comes naturally to Verbatim. Having manufactured over

200,000,000 disks of all sizes and densities, we're the world's leading producer. In fact, one out of every four disks sold is made by Verbatim.

We maintain complete manufacturing facilities around the world as well as across the United States. Each plant is staffed with its own highly-trained service organization, ready to solve any customer problem.

Our commitment also shows in our continuing series of technology seminars. Purely non-commercial, these educa-

tional conferences are designed to keep engineers informed of the latest developments in flexible media.

It's all part of the Verbatim response. Advanced technology. Quality media. Reliable service.

So if it's flexible media you need, give us a call. We'll respond to your instructions, verbatim.

Verbatim®

323 Soquel Way, Sunnyvale, CA 94086
(408) 245-4400

CIRCLE NO. 115 ON INQUIRY CARD

Nothing's better than a Verbatim response.

Date _____ Hour 2:15

To Mike

WHILE YOU WERE OUT

M Verbatim OEM Rep

Of _____

Phone 408-737-7771

Telephoned	Returned Call <input checked="" type="checkbox"/>	Left Package
Please Call	Was In	Please See Me
Will Call Again	Will Return	Important

Message Verbatim can do it!

PRINTED IN USA

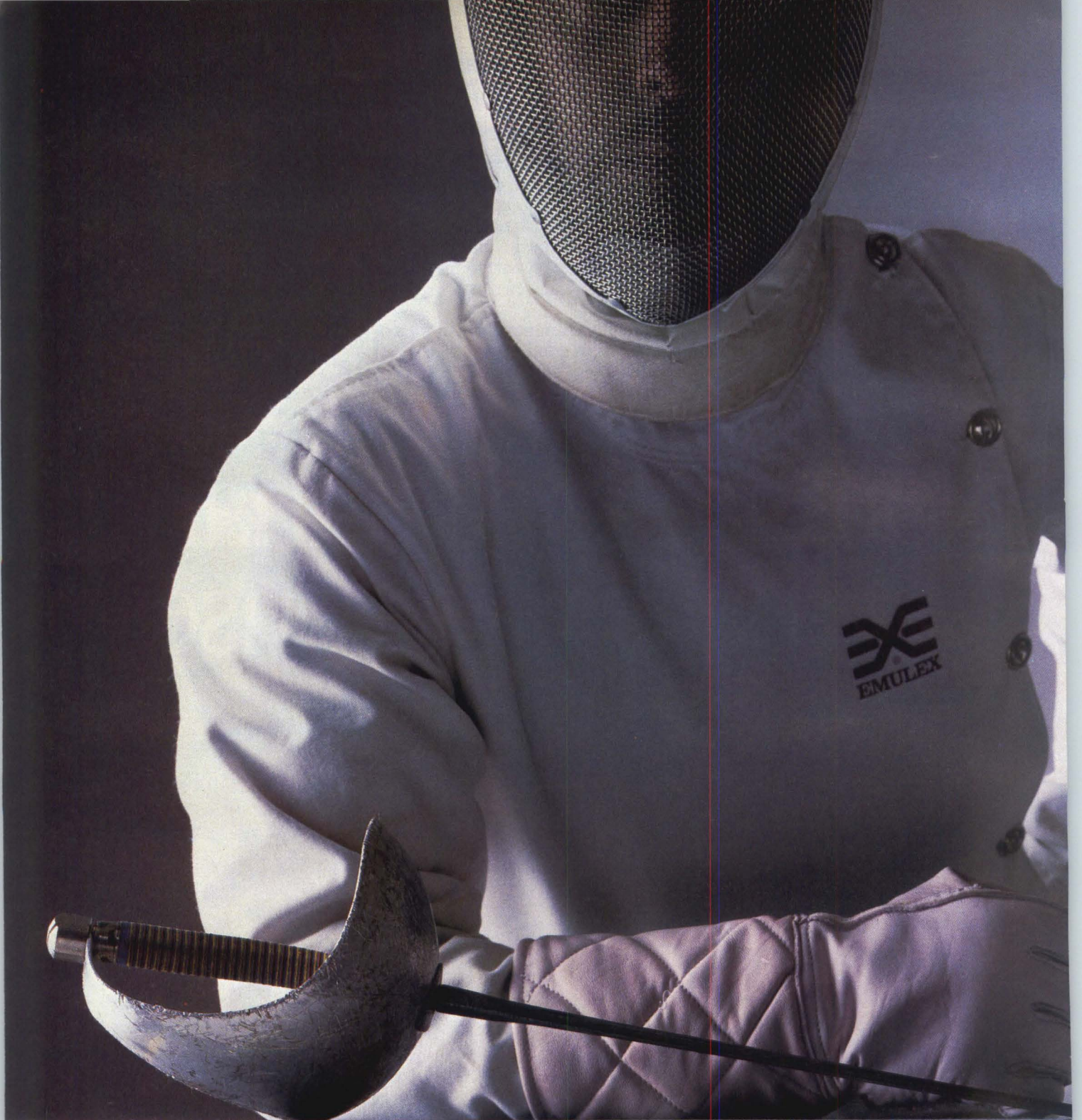

SABRE

Storage and backup problems on your QBus? SABRE™ has a sharp solution.

SABRE™ is a cut above anything on the market. It's a new concept in high-capacity, high-performance mass storage. A 5¼" Winchester/cartridge disk package for use with operating systems that run on DEC LSI-11 through 11/23+ microcomputers. SABRE's an innovative, RL02 software transparent storage alternative that puts 41.6 Mbytes on-line and delivers balanced backup through a versatile, removable cartridge disk. All in a compact, rack-mountable package.

Standard interfaces/transparent software.

SABRE hits the mark for reliable, high-speed, low-cost storage with convenient, efficient backup. Its UC01 host adapter plugs into any single-quad width QBus slot, and provides the Small Computer System Interface (SCSI) system-level bus for SABRE and up to five additional I/O devices. Through exact RL02 emulation, SABRE runs existing operating and diagnostic software as is. With logical RL02 images on both the fixed and removable media drives, volume backup is a snap.

Hard disk backup performance.

The ruggedized cartridge drive provides hard disk backup performance and reliability. Many times faster than either floppies or tape, it also provides the versatility to handle program entry, data storage and can function as a system disk. Overall, the 5¼" Winchester/cartridge disk combination gives system-level performance which *exceeds* multiple RL02's in many applications.

Efficient system packaging.

Space-saving SABRE is 5¼" high, slips into any standard 19" Retma enclosure and comes complete with power supply, host adapter and connecting cables. It needs one-eighth the space and draws one-quarter of the power of four RL02's. Further, SABRE slashes hardware and installation costs by eliminating the need for a separate system bootstrap, bus terminator and clock control board.

For more information on SABRE or any of the high-quality Emulex communications, disk, tape and packaged subsystem products, call toll-free (800) 854-7112. In California (714) 662-5600.

SABRE's Features

Size	Compact 5¼" height x 19" width package contains 31.2 MB (3x RL02) 5¼" Winchester disk and 10.4 MB (1x RL02) removable 8" cartridge disk.
Capacity	Equivalent to four (4) DEC RL02's.
Speed	Overall performance significantly increased over tape and floppies, especially in throughput and backup time.
Transparency	Runs standard RL02 diagnostics and operating software.
Flexibility	Removable cartridge disk; SCSI Bus interface allows up to five (5) I/O devices; single-board host adapter.
Reliability/Durability	Winchester technology; ruggedized cartridge disk construction; shock mounts; hermetically sealed HDA for protection against contamination.
Price/Performance	Lower cost per box and per MB in virtually all applications.

GSA Contract #: GSOOK8401S5575 *SABRE is a trademark of Emulex Corporation. DEC, LSI and QBus are trademarks of Digital Equipment Corporation.



3545 Harbor Blvd., P.O. Box 6725,
Costa Mesa, California 92626.

The genuine alternative.

CIRCLE NO. 116 ON INQUIRY CARD

MICROCOMPUTER OPERATING SYSTEMS

Continued from page 253

General information					General features				Memory management			
Supplier	Operating system	CPU	Required memory (K bytes)	Languages supported	Network support	Multituser	Multi tasking	Multi processing	Overlays	Swapping	Segmentation	Dynamic relocation
	STARPLEX II	Z80A	NA	BASIC, FORTRAN, Pascal, assembler, other CP/M- and MP/M-compatible languages			•	•	•			
Phase One Systems Inc. 7700 Edgewater Dr., Suite 830 Oakland, CA 94621 (415) 562-8085	OASIS	Z80	56	BASIC, COBOL, assembler		•	•		•	•	•	
	OASIS-16	8086, 8088, 16000, 68000	192	BASIC, C, COBOL, assembler		•	•		•	•	•	•
RCA Microsystems Rte. 22 Somerville, NJ 08876 (800) 526-3862 in NJ, (201) 685-6533	Microdisk op sys	1805	60	BASIC, Pascal, PL/M					•			
Ryan-McFarland Corp. 609 Deep Valley Dr. Rolling Hills Estates, CA 90274 (213) 541-4828	RM/COS-COS990	990	64	COBOL	•	•	•			•	•	•
	RM/COS-COS68000	68000	128	COBOL	•	•	•			•	•	
SGS Semiconductor Corp. 1000 E. Bell Rd. Phoenix, AZ 85022 (602) 867-6245	SUNIX	Z8002	512	BASIC, C, COBOL, Pascal, Z80 and Z8000 assembler	•	•	•		•	•	•	
Smoke Signal 31336 Via Colinas Westlake Village, CA 91362 (213) 889-9340	OS9	6809	64	BASIC, C, COBOL, Pascal, assembler	•	•	•	•		•		•
SofTech Microsystems 16885 W. Bernardo Rd. San Diego, CA 92127 (619) 451-1230	p-System	Z80, 6502, 6809, 8080, 8086, 9900, 68000, LSI-11	64	BASIC, FORTRAN-77, Pascal, assembler	•		•			•	•	•
Software Dynamics 2111 W. Crescent, #G Anaheim, CA 92801 (714) 635-4760	SDOS	6809	56	BASIC, 6800 and 6809 assembler	•	•	•					
Technical Systems Consultants, Inc. 111 Providence Rd. Chapel Hill, NC 27514 (919) 493-1451	FLEX	6800, 6809	20	BASIC, C, FORTRAN, Pascal, assembler		•	•		•	•	•	•
	UNIFLEX	6809, 68000	256	BASIC, C, COBOL, FORTRAN, Pascal, assembler	•	•	•	•	•	•	•	•
TeleSoft 10639 Roselle St. San Diego, CA 92121 (619) 457-2700	ROS	8086, 68000	320-576	Ada, 68000 assembler, 8086 interpreter					•			
UniSoft Systems Corp. 2405 Fourth St. Berkeley, CA 94710 (415) 644-1230	UNIPLUS +	68000	256	Ada, BASIC, COBOL, FORTRAN, assembler	•	•	•			•	•	•
UTC/Mostek Corp. 1215 W. Crosby Rd. Carrollton, TX 75006 (214) 466-6000	M/OS-80	Z80	64	Languages compatible with CP/M			•		•	•		

FOR GENERAL AND DEVELOPMENT APPLICATIONS

Peripheral management							File management						Price	Comments	Circle no.	
Hard disk	Cartridge disk	Modems	Magnetic tape	Paper tape	I/O multi buffering	Spooling	Sequential	Contiguous	Random	Indexed sequential	Multilevel directory	Password security				
•		•				•	•		•		•			—	Runs on STARPLEX II development system. Price depends on configuration.	814
•		•	•		•	•	•	•	•	•		•		\$850		
•		•	•		•	•	•		•	•	•	•		\$1495		
		•			•		•							\$300	Runs on MS2000 with 3.5-in. Sony disk drive.	815
•	•	•			•									\$1700	Supports 3780/2780 communications. Runs on models DS/1-36 and BS/200-800. COBOL compiler, \$1250.	816
•	•	•	•		•		•	•	•	•	•	•		\$1700	Supports 3780/2780 communications. COBOL compiler, \$1250.	817
•		•	•		•	•	•		•		•	•		NA	UNIX compatible.	818
•		•	•		•	•	•	•	•	•	•	•		\$500	UNIX-like system.	819
•	•	•	•		•	•	•	•	•	•	•	•		—	Per-copy royalty ranges from \$4 (qty 75,000) to \$24 (qty 2000). Run-time-only system also available. Installed on computers from more than 40 manufacturers.	820
•	•				•		•	•	•	•		•		\$782	Price includes BASIC compiler, editor. Available on several computer systems, including Radio Shack color computer and Motorola Exorciser.	821
•	•	•	•		•		•	•	•					\$150	Available for various hardware systems.	822
	•	•	•		•	•	•		•		•	•		\$550		
•		•			•	•	•		•					—	Price depends on configuration.	823
•	•	•	•		•	•			•		•	•		\$750-\$1500	UNIX with Berkeley enhancements. Prices are for single-user and multiuser versions, respectively.	824
•	•	•	•		•	•	•		•					\$325-\$495		

MICROCOMPUTER OPERATING SYSTEMS

General information					General features		Memory management			
					Network support	Multitasking	Overlays	Swapping	Segmentation	Dynamic relocation
Supplier	Operating system	CPU	Required memory (K bytes)	Languages supported						
VenturCom Inc. 215 First St. Cambridge, MA 02142 (617) 661-1230	VENIX	8086, 8088	196	BASIC, C, FORTRAN-77, Pascal, assembler	•	•	•	•	•	•
Volition Systems Box 1236 Del Mar, CA 92014 (619) 481-2286	MOS	8080, Z80, 8086, 8088, 68000	60-64	Pascal, MODULA-2, assembler		•	•			
Whitesmiths Ltd. 97 Lowell Rd. Concord, MA 01742 (617) 369-8499	IDRIS	8080, 68000, PDP-11	96-128	C, Pascal, assembler	•	•	•	•	•	•
Wintek Corp. 1801 South St. Lafayette, IN 47904 (317) 742-8428	UCSD Pascal	6800	56	BASIC, FORTRAN, Pascal, assembler			•	•		•
	WIZRD	6800	32	BASIC, C, assembler		•				

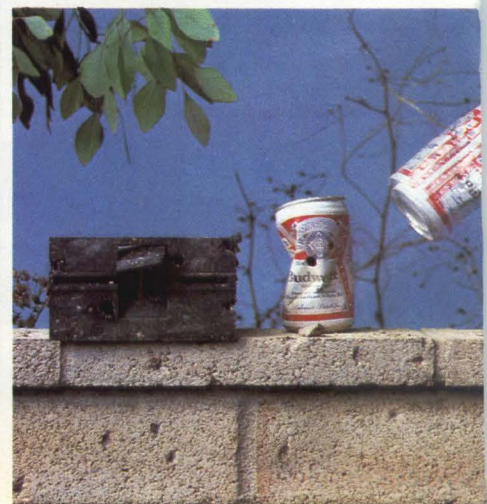
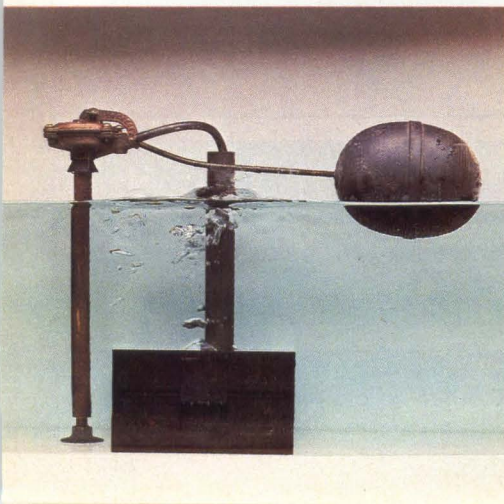
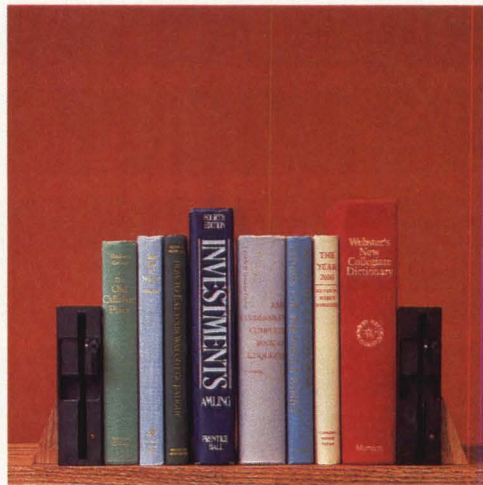
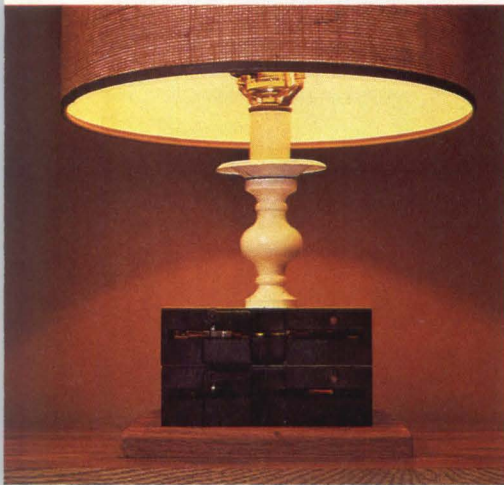

FOR GENERAL AND DEVELOPMENT APPLICATIONS

Peripheral management							File management					Price	Comments	Circle no.	
Hard disk	Cartridge disk	Modems	Magnetic tape	Paper tape	I/O multi buffering	Spooling	Sequential	Contiguous	Random	Indexed sequential	Multilevel directory				Password security
•		•	•		•	•					•	•	\$800-\$2400	UNIX system available for IBM PC, other computers.	825
		•						•	•	•			\$595	Pascal-like p-code system. Price includes language compilers, screen editor and utilities.	826
•	•	•	•		•	•	•		•		•	•	\$550	Source compatibility with UNIX (V7, System III, System V). File system compatible with UNIX V6. Supports all UNIX V6 system calls except PTRACE.	827
		•					•	•	•				\$675	Runs on Sprint 68.	828
					•	•			•				\$495		

Six things you can do with your obsolete floppies.

Floppies were fine in their day. But they just don't make sense with the professional desktop computers of today.

What's the answer? The DMA 360 removable 5¼" Winchester. It's exactly the same size as a 5¼" half-height floppy drive — but that's where the similarity stops.

The DMA 360 gives you hard-disk reliability. Floppies don't.

The DMA 360 protects your data in a totally sealed cartridge. Floppies don't.

The DMA 360 packs 10 megabytes on a single ANSI-standard cartridge. Floppies don't. It takes up to 33 floppy disks to achieve an equal capacity.

The DMA 360 even has a lower cost-per-megabyte than a floppy. But it gives you so much more.

Like an average access time of 98 milliseconds. A transfer rate of 625 kilobytes per second. And an error rate that's on par with the most reliable conventional Winchester disk drives.

There's no way you'd get that kind of performance from a floppy!

In fact, anything you can do with a floppy, you can do even better with a DMA 360. That's

why we call it the floppy replacement.

For more information on what you can do with your obsolete floppies, write DMA Systems, 601 Pine Avenue, Goleta, CA 93117. Or call us at (805) 683-3811, Telex 658341.

Introducing the floppy replacement: DMA Systems' new half-height removable 5¼" Winchester.



DMA
SYSTEMS

The Removable Winchester Company.

PROGRAMMABLE COMMUNICATIONS TRANSLATOR



MSI's PCT-100 IS A CONFIGURABLE IN-LINE RS-232 PROTOCOL AND DATA TRANSLATOR WHICH CAN PROVIDE:

- * TERMINAL OR PRINTER EMULATION
- * DEC OR IBM SYSTEM COMPATIBILITY
- * MACRO-FUNCTION KEYS
- * "TYPE-AHEAD" AND DATA BUFFERING
- * BAUD RATE CONVERSION
- * HANDSHAKE PROTOCOL TRANSLATION (E.G. CTS/RTS, XON/XOFF)

THE PCT-100 CONFIGURATION IS EASILY ENTERED AND MODIFIED USING A BUILT-IN EDITOR, COMPILER, AND DEBUGGER. CODING TRANSLATION ALGORITHMS IS SIMILAR TO PROGRAMMING A CALCULATOR.

WITH POWER SUPPLY AND CASE, THE PCT-100 IS \$398 FOR SINGLE UNIT QUANTITIES.

Method Systems Incorporated
19751 SOUTH LAKESHORE BOULEVARD
EUCLID, OHIO 44119
(216) 531-0404

CIRCLE NO. 118 ON INQUIRY CARD

IBM 3278/3178 Terminal Users... "ADD-ON" PERSONAL COMPUTING CAPABILITY!

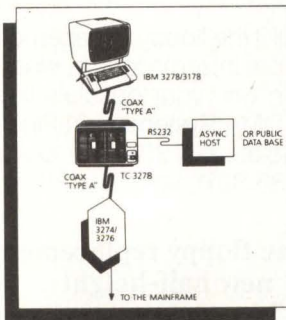

AVATAR's TC3278 terminal converter gives local computing power, communications, data storage and file transfer capabilities to your terminals. And switches between standard terminal operation and local computing with the flick of a switch.

AVATARTM

IBM is a registered trademark of International Business Machines Corp.

CIRCLE NO. 119 ON INQUIRY CARD

- **Includes** industry standard software
CP/M and MS-DOS (IBM compatible)
WordStar, word processor
Spreadsheet and simple to use utilities
- **Allows** dual host access
Converts 3278/3178 to VT 100 for async ASCII host, remote hosts, public database access
- **Host** file transfer for data sharing and local printing
- **Simple** to use, easy to install, requires **NO** modification to terminal
- **Cost Effective** enhancement to existing equipment

For more information, call Avatar Technologies Inc.
99 South Street
Hopkinton, MA 01748
(617) 435-6872

Calendar

JANUARY

- 15-18 "Integrating the Digital Office" Seminar**, Fort Lauderdale, Fla., sponsored by the International Communications Association (ICA). Contact: Reginald R. Bernard, Interim Seminar Committee, ICA, 1 State Farm Plaza, Bloomington, Ill. 61701, (309) 766-2666.
- 17-19 Southcon/84 High-Technology Electronics Exhibition and Convention**, Orlando, Fla., sponsored by Electronic Conventions Inc. Contact: Nancy Hogan or Kent Keller, Electronic Conventions Inc., 8110 Airport Blvd., Los Angeles, Calif. 90045, (213) 772-2965.
- 17-19 Mini/Micro Southeast-84 Computer Conference and Exhibition**, Orlando, Fla., sponsored by Electronic Conventions Inc. Contact: Nancy Hogan or Kent Keller, Electronic Conventions Inc., 8110 Airport Blvd., Los Angeles, Calif. 90045, (213) 772-2965.
- 17-20 "Microprocessor Software, Hardware & Interfacing" Course**, Anaheim, Calif., sponsored by Integrated Computer Systems. Contact: Ruth Dordick, Integrated Computer Systems, 6305 Arizona Place, P.O. Box 45405, Los Angeles, Calif. 90045, (213) 417-8888. Also to be held Feb. 7-10 in Washington, March 13-16 in Los Angeles and March 27-30 in Baltimore.
- 17-20 "Data Communications" Course**, San Diego, sponsored by Integrated Computer Systems. Contact: Ruth Dordick, Integrated Computer Systems, 6305 Arizona Place, P.O. Box 45405, Los Angeles, Calif. 90045, (213) 417-8888. Also to be held Jan. 31 - Feb. 3 in Washington, Feb. 7-10 in Boston and March 6-9 in Palo Alto, Calif.
- 17-20 "Computer Network Design and Protocols" Course**, Baltimore, sponsored by Integrated Computer Systems. Contact: Ruth Dordick, Integrated Computer Systems, 6305 Arizona Place, P.O. Box 45405, Los Angeles, Calif. 90045, (213) 417-8888. Also to be held Jan. 24-27 in Palo Alto, Calif., Feb. 28 - March 2 in Washington and March 13-16 in Los Angeles.
- 19-21 Data West**, Pasadena, Calif., sponsored by Information Processing Group. Contact: Cliff and Doug Mitchell, Information Processing Group, 13135 Ventura Blvd., Suite 300, Studio City, Calif. 91604, (213) 792-5111.
- 24-27 "Designing Dedicated/Embedded Computer Systems" Course**, Washington, sponsored by Integrated Computer Systems. Contact: Ruth Dordick, Integrated Computer Systems, 6305 Arizona Place, P.O. Box 45405, Los Angeles, Calif. 90045, (213) 417-8888. Also to be held Feb. 7-10 in Boston, Feb. 14-17 in Los Angeles and March 27-30 in Washington.
- 25-27 Business Telecommunications Exposition**, East Rutherford, N.J., produced by TEG Inc., The Exposition Group. Contact: Michael C.J. Houston, Vice President of Sales, TEG Inc., 9128 Columbia Ave., North Bergen, N.J. 07047, (201) 662-1318.



“We bought an IBC Middi Cadet™ because no other system could do the job.”

Sue Kardas
 Director of Career Training
 Burlington Area Vocational-Technical Center



“When the Burlington Area Vocational-Technical Center needed a multi-user system for student training, we considered many multi-user systems, but in demo after demo there was too much of a user delay.

Then IBC contacted us, and offered to demonstrate the Middi Cadet’s multi-user capabilities—we were skeptical, but we gave it a try.

First, the Middi Cadet ran 9 users doing word processing without any delays. As a second test, we had the Middi operating 3 terminals each on word processing, accounting and BASIC programming. Again, no user delay. This was the multi-user, multi-tasking system we had been looking for.

With the Middi Cadet, we got a higher speed Z80B processor, a very fast hard disk drive and enough memory to do the job (512K Bytes).

On top of that, we felt that we got a very good price from an excellent vendor. Our system was delivered and installed two weeks later. Since then we’ve been so pleased with the Middi that we’re planning to buy another. With two systems providing 18 stations we will be equipped to offer training in all aspects of information processing.”

Circle 198 for End Users

The Middi Cadet is a 10 user system that includes a 6MHz, Z80B CPU; 256 to 512K Bytes of RAM memory; a 20 MB, 5¼” hard disk drive and a one megabyte 5¼” floppy disk drive.



For more information on the Middi Cadet, see your local IBC dealer.

To locate the dealer nearest you, call or write:

OUTSIDE THE USA

IBC Integrated Business Computers

21592 Marilla Street
 Chatsworth, CA 91311
 (213) 882-9007 TELEX NO. 215349

WITHIN THE USA

IBC DISTRIBUTION

1140 36th Street, Suite 212
 Ogden, Utah 84403
 (801) 621-2294

Circle 199 for Dealers

Reprints Reprints Reprints

Reprints of articles which have appeared in Cahners' magazines can easily become an important means of increasing your marketing results. This complete reprint service is available to you at a very low cost.

There are innumerable ways Cahners' reprints can be of vital assistance to your company's total marketing program. They are exceptionally valuable promotion pieces, particularly when you use them as part of a Cahners' Direct Mail Program.

Here are some uses which just scratch the surface of the many ways you can make reprints go to work for you and build your company's profits.

- Direct mail to customer and prospect lists.
- Trade show hand-outs
- Envelope stuffers.
- Leave-behind pieces
- Direct mail to stockholders
- Sales tools for sale staff
- Use at company meetings
- Publicity Releases
- For display at corporate, field and show-room offices.
- Educate sales personnel
- Welcome new customers
- Demonstrate market superiority
- Direct mail to special lists
- Followup on inquiries about your product
- Announce a new product development

These are just a few of the ways you can strengthen your company's position as a leader in your market. Fast, high-quality service for all your reprint needs are available through Cahners' Reprint Service.

Mini-Micro Systems

FOR DETAILS, CONTACT:

A.W. Lehmann, Manager
Cahners Reprint Services
Cahners Plaza
P.O. Box 5080
1350 E. Touhy Avenue
Des Plaines, IL 60018
(312) 635-8800

CIRCLE NO. 120 ON INQUIRY CARD

Calendar

JAN. 30 - FEB. 1

"Microprocessors—Tools for Production and Inventory Management" Seminar, Palm Springs, Calif., sponsored by the American Production and Inventory Control Society. Contact: Marie Curcio, American Production and Inventory Control Society, 500 W. Annandale Rd., Falls Church, Va. 22046-4274, (800) 368-3402.

JAN. 31 - FEB. 3

Communications Networks 1984 Conference & Exposition, Washington, managed by ICW/Conference Management Group. Contact: Louise Myerow, Registration Manager, ICW 1984, P.O. Box 880, Framingham, Mass. 01701, (617) 879-0700.

"Distributed Processing, Mini & Microcomputer Implementations" Course, Palo Alto, Calif., sponsored by Integrated Computer Systems. Contact: Ruth Dordick, Intergrated Computer Systems, 6305 Arizona Place, P.O. Box 45405, Los Angeles, Calif. 90045, (213) 417-8888. Also to be held March 20-23 in Washington and March 27-30 in Boston.

FEBRUARY

7-10 "Implementing Local Area Networks" Course, Washington, sponsored by Integrated Computer Systems. Contact: Ruth Dordick, Integrated Computer Systems, 6305 Arizona Place, P.O. Box 45405, Los Angeles, Calif. 90045, (213) 417-8888. Also to be held Feb. 28 - March 2 in Palo Alto, Calif., April 3-6 in Boston and April 24-27 in Washington.

14-17 Online '84, Seventh European Congress Fair for Technical Communications, Berlin, West Germany, sponsored by Online GmbH. Contact: Online GmbH, Postfach 10 08 66, Nevigeser Strasse 131 D-5620 Velbert 1, West Germany, Telephone: (0 20 51) 2 30 71.

20-22 Office Automation Conference, Los Angeles, sponsored by the American Federation of Information Processing Societies (AFIPS) Inc. Contact: Ann-Marie Bartels, AFIPS Inc., 1815 N. Lynn St., Arlington, Va. 22209, (703) 558-3617.

MARCH

19-22 FOSE '84, Eighth Annual Federal Office Systems Expo, Washington, produced by National Trade Productions Inc. Contact: Jacqueline Voigt, National Trade Productions Inc., 9418 Annapolis Rd., Lanham, Md. 20706, (301) 459-8383 or (800) 638-8510.

21-23 SOFTCON, New Orleans, produced by Northeast Expositions. Contact: Northeast Expositions, 822 Boylston St., Chestnut Hill, Mass. 02167, (617) 739-2000 or (800) 841-7000.

The New WY1000 Microcomputer

BUILDING BLOCKS

Powerful, Affordable, Expandable.

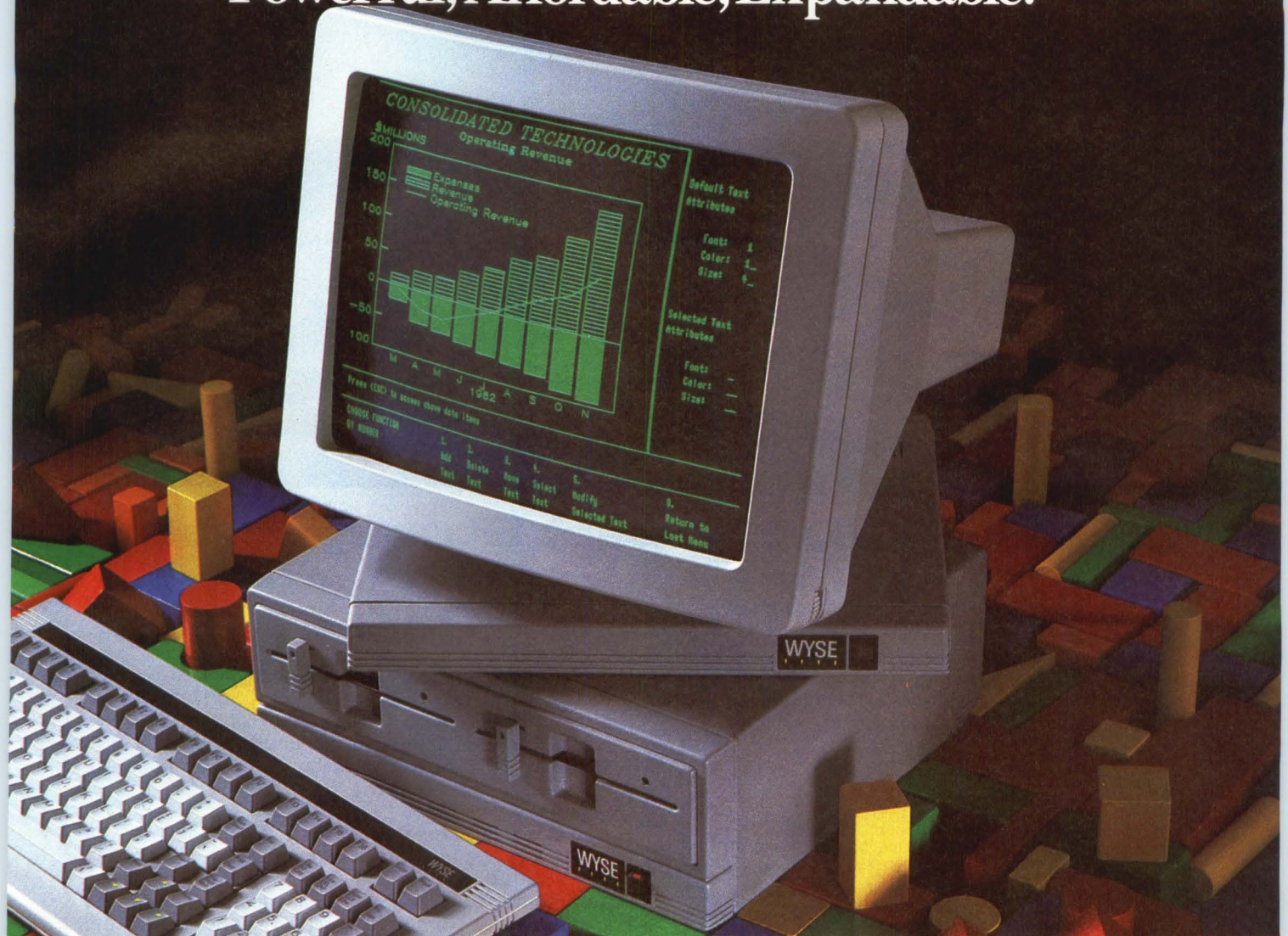

The WY1000 stacks up to be a lot of machine from a few simple pieces. By adding the WY1000 microcomputer to the good-looking, ergonomic WY50 display terminal, we created the most exciting concept in desktop workstations on the market today.

We also added sophisticated high resolution graphics, suitable for the most demanding applications.

Plus, we added color capability, when used with our color terminal.

And on top of that, we added a Winchester Disk Drive option providing an additional 10 megabytes of storage.

FEATURES:

- 80186 16 Bit 8 MHz Processor
- 128KB to 768KB RAM Memory
- Two Floppy Disk Drives (725 KB)
- Optional 10 MB Winchester Drive
- RS232 & RS422 Serial Ports
- Optional Graphics/Color Graphics
- Networking Capability
- CP/M™, MS-DOS™ Compatible
- Priced from only \$1995

Best of all, we priced the WY1000 from only \$1995. It all adds up to a system builder's dream.

For a complete brochure on the WY1000 contact Wyse Technology toll free at 800/421-1058.

CIRCLE NO. 121 ON INQUIRY CARD

WYSE

Make the Wyse Decision.

WYSE TECHNOLOGY 3040 N. First St., San Jose, CA 95134, 408/946-3075, TLX 910-338-2251, Outside CA call toll-free, 800/421-1058, in So. CA 213/340-2013.

The Long Wait Is Over

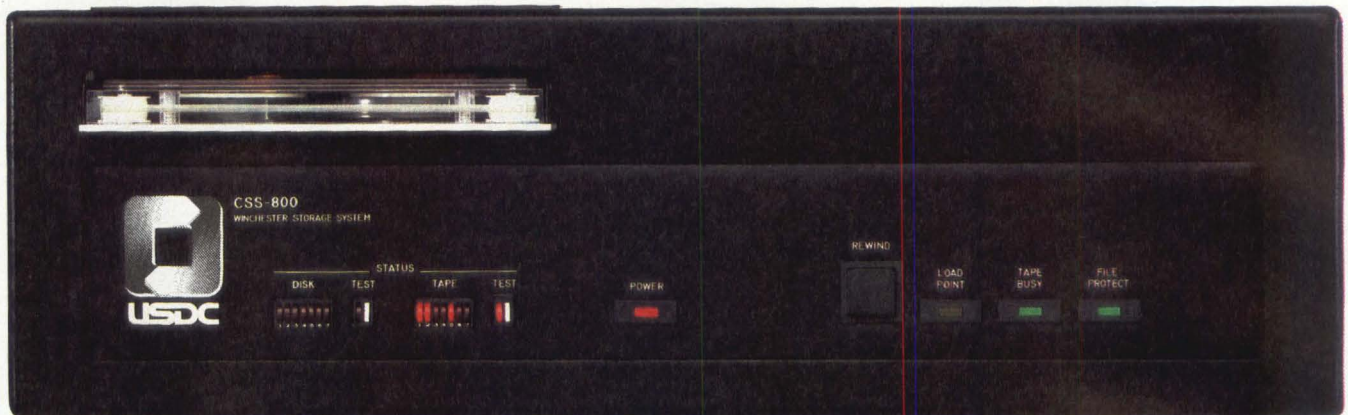

The CSS-800 Compact Storage System

Work loads are growing, you need more storage, your system can't keep up the pace, and everyone's waiting for you to come up with an answer. The CSS-800 is the answer you've been waiting for—a storage system with larger capacity and data management features needed to upgrade system performance.

When long waits for disk access hold back your system and limit its throughput, faster storage is the key to performance. The CSS-800's exclusive architecture with cache memory and look-ahead buffering can speed throughput up to 90%. Where other systems control data flow simplistically, the 800 strategically responds to software and data usage without adding to host overhead time. With 70 Mbytes of disk storage, your mini or micro can store more data, handle more concurrent users, run large programs more effectively, and do more processing in less time than ever before.

When More Is Less Our 70-Mbyte disk and integral cartridge tape backup are housed in a rackmount or desktop package 5¼ inches high and weighs only 42 pounds. Each controller can accommodate three add-on storage systems for a total on-line capacity of 280 Mbytes. When space is as important as time, you can't beat the CSS-800.

When More Costs Less The CSS-800 is priced below any other system with comparable capacity to give you the best cost per Mbyte and price/performance ratios in the industry. The 800 gives you more

capacity and greater speed for less money than you'd spend for an ordinary disk drive.

On DEC Now! Totally DEC* compatible, the CSS-800 emulates the RK07 disk and TU10 tape drives so there is DEC system support available now under RSX-11M, RSTS/E, and RT-11 operating system as well as DSM, TSX and UNIX. Q-bus or Unibus host interfaces are standard features.

And Don't Wait for Repairs We also know that you need a storage unit that is dependable as well as fast. The CSS-800 uses Winchester technology to achieve maximum availability. Built-in diagnostics assure the reliability of all drives, controllers, and interfaces. Modular design makes repairs fast and easy. We've backed the 800 with TRW's nationwide service program to insure prompt and complete maintenance.

U.S. Design Corporation is a leader in providing performance enhancements for the mini/micro computer community. Call us toll free at (800) 368-2811 TODAY and we'll show you the technology of TOMORROW.

*DEC, RK07, TU10, RSX-11, RSTS/E, RT-11, DSM, Q-Bus and Unibus are registered trademarks of Digital Equipment Corporation. TSX is a registered trademark of S & H Computers. UNIX is a registered trademark of Bell Laboratories.

U.S. DESIGN CORPORATION

5100 Philadelphia Way
Lanham, Maryland 20706
(301) 577-2880 (800) 368-2811
TWX 710-826-0417



CIRCLE NO. 122 ON INQUIRY CARD

New Products

SYSTEMS

Single-board computer combines CPU, data communications

Intel Corp.'s iSBC 186/51 COMMputer board combines a single-chip microcomputer and data-communications capabilities with industry-standard networking software, making the package suitable for a wide range of communications and computation applications.

The COMMputer is partitioned into three sections: the central computer, I/O, including local-area network (LAN) interconnection, and shared, dual-ported RAM. Intel's 16-bit iAPX 186 microprocessor and the 80130 operating-system firmware provide the computation facilities. I/O is centered on the Ethernet access provided by the 82586 LAN coprocessor and the 82501 Ethernet serial interface components. The 82586 local communications controller relieves the CPU of many tasks associated with network control. Two programmable serial interfaces—RS232C and RS422A/RS449—are also on the board. The board has 128K bytes of dual-ported RAM, expandable to 256K bytes. The iAPX 186, Ethernet controller and any other bus masters on the Multibus can access memory.

Intel's iNA 960 software supports the iSBC 186/51 with transport-layer ser-

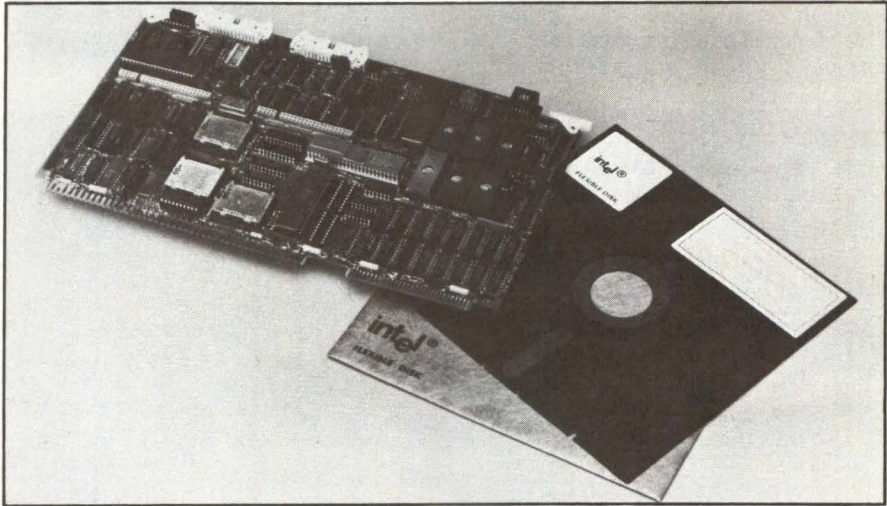

Intel Corp.'s iSBC 186/51 COMMputer single-board communications computer and iNA 960 local-area networking software can operate as an intelligent front-end that performs communications-related tasks in a communications-intensive system.

vices and network management. Transport-layer services include message integrity, data-rate matching and support of multiple connections and variable-length messages. Network-management services encompass collection of network-usage statistics and

isolation and detection of faults. The iSBC 186/51 COMMputer sells for \$3,000, and iNA 960 network software sells for \$5,000. **Intel Corp.**, 3065 Bowers Ave., Santa Clara, Calif. 95051, (503) 640-7324.

Circle No 300

3D design system can be upgraded

A compact unit for the office environment, the Comet mechanical CAD/CAM system accommodates one to 12 workstations. The baseline configuration consists of a 32-bit CPU with 1M byte of main memory, a 160M-byte Winchester disk drive, a 45M-byte cartridge-tape drive, a 16-color Meteor workstation, geometric modeling software for 2D and 3D mechanical design and AGILE, the vendor's high-level user programming language. The Meteor intelligent workstation features a 60-Hz non-interlaced 1,024-by-768-pixel-resolution color display. Other Meteor standards for the Comet system are local pan, zoom, entity pick and entity dragging. \$95,000. **Graphics Technology Corp.**, 1651 University Blvd. N.E., Albuquerque, N.M. 87102, (505) 242-8200. **Circle No 301**

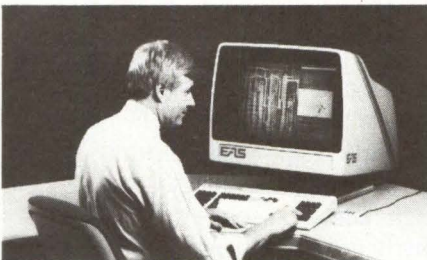

CAD/CAE workstation suits PC-board design

The EAS/700 series engineering workstation and PC-board design system features integrated, interactive automatic placement, automatic routing and real-time design-rule checking. Its PC-board design package handles boards with as many as 16 layers. The office-automation package contains a word processor with integrated graphics that provides engineering documentation support. Hardware features

include a 1,024-by-780-pixel-resolution display, a 10-MHz MC68000 processor with 1M byte of memory, a graphics display system with Intel 8086/8087 processors, a menu-driven UNIX operating system, a 19M-byte, 5¼-inch Winchester disk drive, a 1M-byte, 5¼-inch floppy disk drive, an ANSI keyboard and a graphics input mouse. \$48,450, color system; \$40,750, monochromatic system. **Engineering Automation Systems Inc.**, 936 Silas Dean Highway, Wethersfield, Conn. 06109, (203) 529-3200. **Circle No 302**

Microcomputer drives 60 manufacturers' peripherals

The Caribe microcomputer line offers a selection of BLIS/COBOL or BITS/BASIC operating systems. It executes off-the-shelf software written in BASIC, COBOL, FORTH, FORTRAN or Pascal for Data

New Products

SYSTEMS

General computers and accommodates peripherals from more than 60 manufacturers. The CPU uses the Fairchild 9445 microprocessor, a 16-bit chip clocked at 16 MHz. In multiuser/multitasking environments, it supports as many 20 terminals with no software changes. Five standard configurations offer 20M, 30M and 50M bytes of fixed Winchester

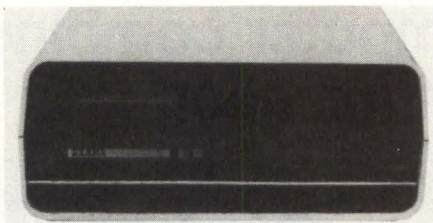

disk storage and streaming-tape backup. Price of a nine-user configuration is \$13,830. **Rianda Electronics**, 2535 Via Palma, Anaheim, Calif. 92801, (714) 995-6552. **Circle No 303**



SONEX kills printer noise beautifully.

Hard walls reflecting printer chatter? Thick, rich, lush carpeting might cut much of the noise, but SONEX acoustical foam will absorb four times as much noise at about the same cost. The anechoic wedge surface looks good, and its open-cell structure absorbs, deflects, scatters and de-energizes sound energy. It will silence annoying disk drive and fan hum, or kill noise from collators, shredders, copiers...anything noisy. Call us at 612/521-3555 or write us at 3800 Washington Avenue North, Minneapolis, MN 55412

illbruck/usa
techniques with foams

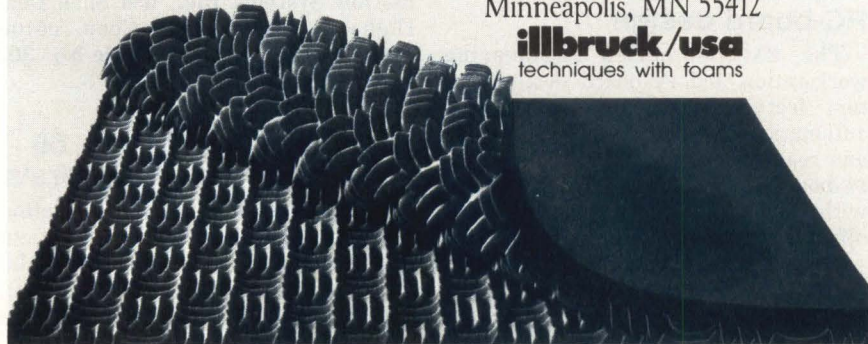

CIRCLE NO. 123 ON INQUIRY CARD



System supports micro development projects

The EXORset 110 8-bit development system and OEM desktop controller feature the MC6809 microprocessor, 56K bytes of RAM, 24K bytes of EPROM/ROM, a printer interface, a serial I/O port and a triple 16-bit programmable counter/timer device. It has an ASCII keyboard with 16 user-definable function keys and a 12-inch screen that can display 22 lines of 80 characters, 16 lines of 40 characters or 320-by-256-dot resolution graphics. The EXORset controller has a four-slot card cage for EXORcisor/Micromodule boards. The floppy disk controller module occupies one slot. Standard software includes the XDOS operating system, a linking loader, an editor and a 6809 8-bit macro assembler. An EXORbug monitor is provided in firmware. \$5,900. **Motorola Semiconductor Products Inc.**, P.O. Box 20912, Phoenix, Ariz. 85036, (602) 244-6900.

Circle No 304

Workstation develops RMX-86 software

The model 95/86 RMX workstation, an RMX-86 microcomputer system for RMX-86 software developers, consists of a 10M-byte Winchester disk drive, a 500K-byte floppy disk drive, 512K bytes of RAM and an 8086/8087 dual-processor set. The boards are housed in a system chassis that offers six expansion card slots and one expansion 8-inch disk

NEW



Now it's easy for anyone to pick an SMD drive that works with DG's BMC.

Custom Systems' new BMX-1 makes over 60 hard disk drives plug-compatible with your Eclipse/MV Series mini.

Our fully emulating BMX-1 Disk Controller lets you interface most any SMD disk drive with the Data General BMC (Burst Multiplexor Channel). Regardless of capacity. Regardless of speed.

No other disk controller gives you that kind of flexibility, that kind of unlimited choice. Only the BMX-1 lets you choose the disk drives that offer you the exact performance you need at the price you want to pay.

CSI's BMX-1 offers four disk drive connect ports with software configurable drive characteristics on a port by port basis. Break-through technology in the use of E²-PROMS eliminates switches and makes all functions selectable via downline loaded software.



Like other CSI controllers, the BMX-1 offers complete FCC chassis compliance.

Get the complete BMX-1 story from Custom Systems Inc., 6850 Shady Oak Road, Eden Prairie, MN 55344, (612) 941-9480. Telex 290975 for international distributors.



CUSTOM SYSTEMS INC

New Products

SYSTEMS

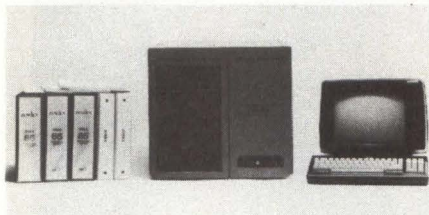

drive peripheral slot. Software tools for developing utility and device-driver application software come standard, including ED, ASM86, LINK86, LOC86 and LIB86. PL/M, Pascal, FORTRAN and C are optional. \$14,425. **Zendex Corp.**, 6644 Sierra Lane, Dublin, Calif. 94568, (415) 828-3000. **Circle No 305**

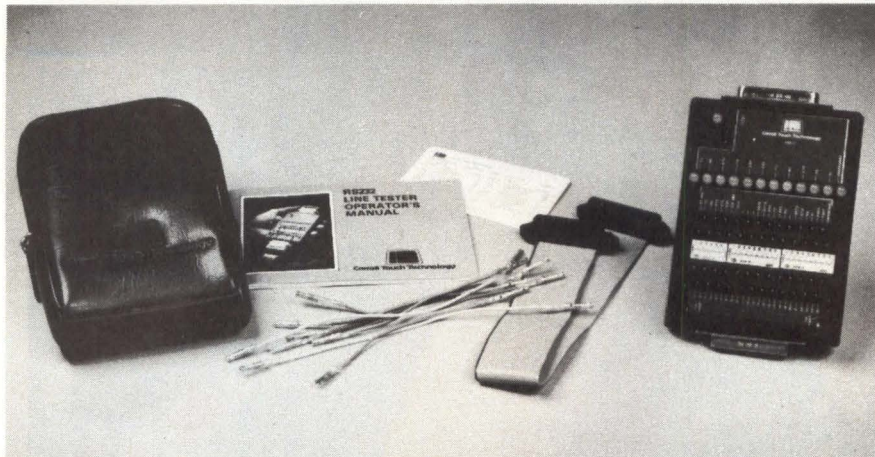

Not communicating? The 232LT gets you talking.

Carroll's 232LT line tester/breakout box lets you examine the status of the RS-232 interface, simplifying troubleshooting and computer installation. Dual-color LEDs indicate the precise state—marking ($\leq -3V$), spacing ($\geq +3V$) or undefined (between $-3V$ and $+3V$)—for the twelve most frequently-used lines. An extra LED is provided for monitoring additional lines.

Each signal line contains a DIP switch which can be opened to allow cross-patching. Pins located on either side of the DIP switches are useful as test points for meters and oscilloscopes.

The 232LT is signal-line powered, eliminating the annoyance of batteries, and it has the additional advantage of using a minimum signal current. Each LED provides a 3mA load at typical voltage levels of $\pm 12V$. (Stacking three LEDs in parallel can provide a 9mA approximation to the 10mA current limit of RS-232 drivers).

Accessories include jumpers, extension cable, user's manual, vinyl carrying case, and a handy RS-232/ASCII reference card. Guaranteed for one year. Priced at \$175.00 (includes shipping); quantity discounts available. Distributor inquiries invited.

For immediate delivery or further information, call or write:



Carroll Touch Technology
a subsidiary of **AMP** Incorporated

2902 Farber Drive 217/351-1700
Champaign, IL 61821 TWX 910 245-0149

CIRCLE NO. 125 ON INQUIRY CARD

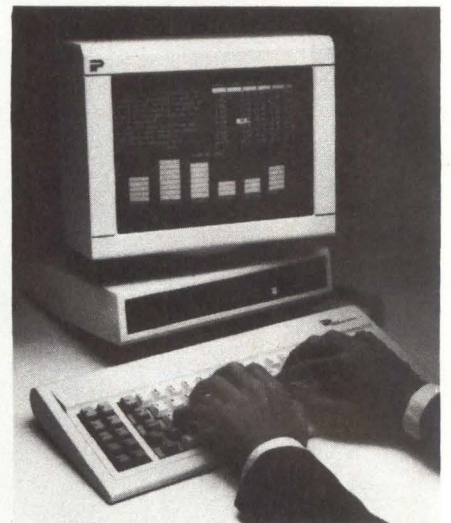

Microcomputer offers 16-bit performance

The Pronto Series 16 microcomputer uses Intel's iAPX186 microprocessor and comes with 128K bytes of RAM, expandable to 1M byte. It includes serial and parallel ports, a clock/calendar and a system security ROM. Four configurations are available with various combinations of 5¼-inch, 800K-byte floppy disk drives and 5M-byte removable hard disk drives. The computer runs software written to operate under MS-DOS 2.0. \$2,995 to \$5,995. **Pronto Computers Inc.**, 3170 Kashiwa St., Torrance, Calif. 90505, (213) 539-6400.

Circle No 306

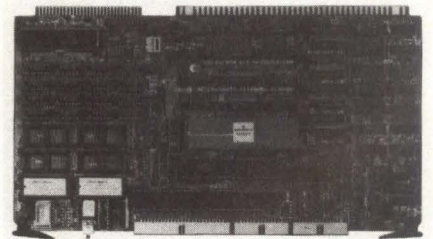

Board implements MC 68000 on Multibus

Operating as a standalone computer system for real-time applications or as a system CPU with support and special function boards on the Multibus/IEEE-796 bus, the OB68K1A single-board computer features a 10-MHz MC68000 microprocessor. It is supported by 32K

Do these tough demands blow your graphics apart?

1. Power & speed!

Dual processor power.
Rapid area fill and draw.

2. Simplicity & compatibility.

ANSI X3.64. TEK 4010, 4014
and 4027 compatible.

3. Full featured graphics.

Host graphics support and
terminal primitives.

4. Dot addressability.

Vector drawing and point plotting.

5. Brilliant raster color.

64 color palette.

6. Affordability.

\$1995*

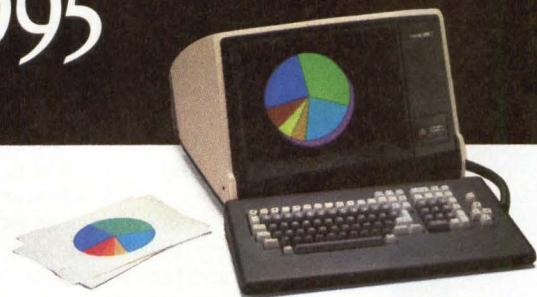

PRICE/PERFORMANCE BREAKTHROUGH! The new Intecolor 2427 advanced graphics terminal puts the pieces together.

Even managers explode, evaluating terminals to satisfy *all these demands*. And at a reasonable price.

Solution: Try the Intecolor 2427, for only \$1995.

Capitalizing on over 10 years of experience in the design and manufacture of color graphics terminals, Intelligent Systems has put it all together in the Intecolor 2427.

Check out the features. Compare the price. Then contact Marketing Communications at 404/449-5961. TWX 810 766 1581.

*Single-evaluation unit. U.S. domestic only. To evaluate the 2427 at this 100-piece price, your order must be received by 3/31/84. Single piece price is \$2695.

 **Intecolor**[®]
AN INTELLIGENT SYSTEMS COMPANY
Intecolor Drive, 225 Intecolor Park, Norcross, Georgia 30092

1. Dual Processor Power: 16-bit Z8002 graphics processor for rapid area fill and polygon drawing. 8-bit 8085 independent alphanumeric terminal functions processor. Plus independent keyboard processor.
2. Convenience/Compatibility: Extended ANSI X3.64 control system with VT100 features. Integrated graphics and alphanumeric menu set-up. Compatible with TEK 4010, 4014, 4027 terminals and Plot 10. Interactive color graphics. Easy conversion to color.
3. Complete Graphics Capabilities: Supported by popular host graphics packages. Terminal resident TEK 4027-like graphics primitives. Full featured bit-map graphics.
4. Dot Addressability: Absolute addressing of points for point plotting with complex graphics. 560H x 288V. Full three-bit pixel array. 80 characters by 24 line alphanumeric display.
5. Raster Color: Brilliant 64-color palette with color mapping. Eight displayable colors. Self converging, 13" diagonal CRT.
PLUS: Enhanced Text Features: Five character sets (two are user-definable). Two vector character sets. **ANSI X3.64:** Industry standard control sequences. Easy to implement. **Two Full Pages of Screen RAM:** Simplifies graphics programming. **72 Function Keys (optional):** Speeds up programming. **Clean, Simple Design:** Assures reliability, cost efficiency. **VT100 Features:** Familiar DEC functions.

CIRCLE NO. 126 ON INQUIRY CARD

New Products

SYSTEMS

or 128K bytes of dual-ported dynamic RAM that provides zero wait states through a hardware refresh controller. The board also offers two RS232C ports, which, when used with an optional MACSBUG or VERSABUG monitor program, allow a standard terminal on one port and down-loading from a host

computer on the other. Additional I/O is provided by 40 lines of programmable parallel I/O organized as two 16-bit parallel ports with control lines. \$1,495, 32K-byte version. **Omnibyte Corp.**, 245 W. Roosevelt Rd., Bldg. 1-5, W. Chicago, Ill. 60185, (312) 231-6880.

Circle No 307



Personal computer features touch-screen display

The HP 150 personal computer features a touch-screen display that makes the computer easy to learn and operate for novices. The computer employs an 8088 16-bit microprocessor (with 256K bytes of RAM) to run the MS-DOS-2.0 operating system. Under MS-DOS, the HP 150 can run many popular programs, including WordStar, VisiCalc and the Condor database manager, that have been enhanced with touch-screen and soft-key capabilities. The computer also has a 9-inch green screen that displays 80 columns by 24 rows, a thin-line keyboard, two RS232 interfaces, one HP-IB interface and dual, 3½-inch, 270K-byte floppy disk drives. \$3,995. **Hewlett-Packard Co.**, 1820 Embarcadero Rd., Palo Alto, Calif. 94303.

Circle No 308

UNIX workstation features mass-storage options

Measuring 10½ by 14¼ by 21 inches, the Minibox multiuser UNIX workstation houses the vendor's HK68 microcomputer, four or six Multibus card slots, single or dual floppy disk drives and as much as 420M bytes of Winchester disk storage. The HK68 provides an MC68000 CPU, a floppy disk drive controller, Winchester and tape interfaces, four to eight serial ports and 750K bytes of RAM in two of the four or six Multibus card slots. The Minibox has two forward and two rear disk drive bays. The forward bay can contain one or two 5¼-inch floppy drives with a 5¼-inch Winchester or tape drive below. The rear bay can contain one or two 5¼-inch Winchester drives. A C compiler is built in. Approximately \$8,359 (100 units). **Heurikon Corp.**, 3001 Latham Dr., Madison, Wis. 53713, 1 (800) 356-9602.

Circle No 309

NEW

ONE SIZE FITS ALL



Heurikon presents Minibox - a multiuser UNIX workstation based on its powerful HK68™ single board microcomputer and Uniplus+™ UNIX System III or System V operating system with Berkeley enhancements.

Designed with the OEM in mind, *one size fits all*. Both compact and flexible, the Minibox includes within its 10.5" w x 13.9" h x 20.5" l frame a 200 or 400 watt power supply, six slot Multibus™ card cage, (4-5 available for user use!), single double density floppy disk drive, streamer tape drive, and 31 or 65 Mbyte Winchester drive (expandable to 280 Mbytes). All this within the same cabinet! System status LEDs on the front panel inform the user of CPU and disk drive activity.

With Uniplus+™, Minibox becomes a flexible and affordable tool for program development, text preparation, and general office tasks. Included is a full "C" com-

piler, associated assembler and linker/loader. Optional languages are:

Macro assembler, ISO Pascal compiler, FORTRAN-77 compiler, RM-COBOL™, SVS BASIC (DEC BASIC compatible interpreter), SMC BASIC (Basic-Four BB3 compatible interpreter), and Ada™. Other utilities include UltraCalc™ multiuser spread sheet, Unify™ DBM, Ethernet™, and floating point processor. Alternate operating systems available are PolyForth™, Regulus™, CP/M 68K™, and others.

*UNIX is a trademark of Bell Laboratories. Unify is a trademark of Unify Corp. UltraCalc is a trademark of Olympus Software. Ethernet is a trademark of Xerox Corp. Uniplus+ is a trademark of UniSoft Corp. PolyForth is a trademark of Forth, Inc. Regulus is a trademark of Alcyon Corp. CP/M-68K is a trademark of Digital Research. Ada is a registered trademark of the U.S. government, Ada Joint Program Office. RM-COBOL is a trademark of Ryan-McFarland Corp. HK68 is a trademark of Heurikon Corp. Multibus is a trademark of Intel Corp.

MINI BOX

HEURIKON 3001 Latham Drive
Madison, WI 53713
800/356-9602
In Wisconsin
608/271-8700

1983
Telex 469532

CIRCLE NO. 127 ON INQUIRY CARD

BUSINESS COMPUTER SYSTEMS

JUNE 1983/\$2.95

THE MAGAZINE FOR BUSINESS COMPUTER USERS

A CAHNERS PUBLICATION

Shaping Work to People
through Ergonomics

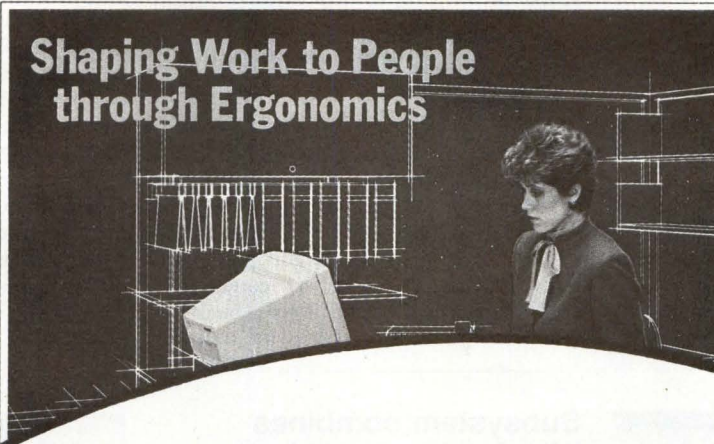

Business Computer Systems
is the first and only computer publication
to audit the brands of computers
in use by its readers and the specific applications
for which these computers are being used.

BUSINESS COMPUTER SYSTEMS

Our Circulation is the Market

Cahners Publishing Company 221 Columbus Avenue / Boston, MA 02116 / (617)536-7780

CIRCLE NO. 128 ON INQUIRY CARD

New Products

DISK/TAPE

Low-cost, removable Winchester replaces floppies

The DMA 360 removable, half-height, 5¼-inch Winchester disk drive for desktop and personal computers stores 7.5M bytes on an American National Standards Institute (ANSI) standard Winchester disk cartridge. The device has a 98-msec. average access time and a 625K-byte-per-second data-transfer rate. Error rates are similar to those of conventional Winchester disk drives: one in 10¹⁰ in the read mode, one in 10¹² in write mode and one in 10⁶ during seek. The drive is compatible with the standard ST-506 interface, form and power requirements.

Safety features of the drive include a 30-second purge cycle and an air-

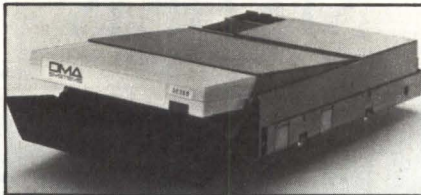

filtration system. The drive also features fully retracted heads that are dynamically loaded. This method of loading the head onto a spinning disk avoids damage to heads and media by not allowing the two to come into contact. For user convenience, the drive offers a pull-out-top drawer and an

angular spring-loaded sleeve for media loading and correct cartridge positioning. A 1½-inch cartridge overhand provides a handle for easy media loading and unloading.

On-board microprocessor firmware permits a user to write servo information on a blank cartridge when it is inserted into the drive. Once formatted, the cartridge is interchangeable with all DMA 360 drives.

Scheduled for evaluation-order shipment in the first quarter of 1984, the DMA 360 is priced at \$500 in OEM quantities. **DMA Systems Corp.**, 601 Pine Ave., Goleta, Calif. 93117, (805) 683-3811. **Circle No 310**



HP-compatible Winchesters offer storage sharing

The Series 3000 line of 5¼-inch Winchester disk subsystems for Hewlett-Packard computers consists of 12 models offering storage capacities of 5M, 10M or 15M bytes and optional built-in 3½-, 5¼- or 8-inch floppy disk drives. All configurations come in a 4.2-by-15.5-by-17.5-inch enclosure for tabletop use. The series is hardware, software and media compatible with all HP technical and personal computers, including the HP 1000, 9000, Series 200, Series 100, Series 80, 98XX desktops, 250 and 64000 development systems. Connection to these computers is via the HP-IB interface. Average data-transfer rate is 174K bytes per second. An optional multiport feature supports disk sharing among two or three different HP computers. Prices start at \$2,860. **Bering Industries Inc.**, 747 E. Brokaw Rd., San Jose, Calif. 95112, (408) 298-8552.

Circle No 311

Subsystem combines Winchester, cartridge tape

The models 8055 and 4055 peripheral subsystems incorporate an 82.9M- and 41.4M-byte (unformatted) capacity 8-inch Winchester disk drive, respectively, and a ¼-inch cartridge tape drive for backup in a 19-inch rack-mountable chassis. Both Winchester disk drives have 30-msec. average access times and 1,209K-byte per second data-transfer rates. They are available with SMD, ANSI X3T9.3/143 or Picobus interfaces. The cartridge-tape transport is a four-track device that uses serpentine recording. It stores 11.5M to 23M bytes, depending on tape length. It is available with the vendor's Picobus embedded formatter or an intelligent adapter that lets the cartridge emulate a nine-track, reel-to-reel transport with no operating-system software changes. Model 8055: \$5,300 (100 units); Model 4055: \$4,600 (100 units). **Kennedy Co.**, 1600 Shamrock Ave., Monrovia, Calif. 91016, (213) 357-8831.

Circle No 312

3½-inch Winchesters store 10M bytes

The Rodime 350 series of 3½-inch Winchester disk drives suits applications in portable computers and teleprinters. Model RO 351 is a single-platter drive with 5M bytes of formatted storage; model RO 352 is a

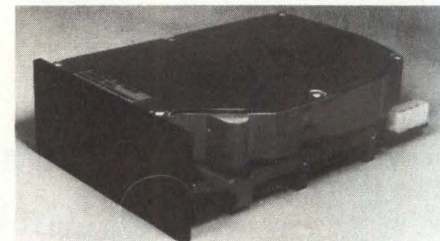

two-platter drive with 10M bytes of formatted storage. Each drive measures 1.625 by 4 by 5.25 inches, uses the ST-506 interface and has 5V and 12V power requirements. Data are recorded at 600 tpi with more than 11,000 bpi. Average access times are 85 msec.; data-transfer rates are 5M bits per second. RO 351, \$730 (100 units); RO 352, \$940 (100 units). **Rodime Plc**, 25801 Obrero, Mission Viejo, Calif. 92691, (714) 770-3085.

Circle No 313

Winchester features compensation servo

The three-platter, 25.52M-byte, 5¼-inch ST-425 Winchester disk drive combines a stepper motor for read/write head positioning with a temperature-compensation servo for increased track density. The drive, an upgrade of the company's ST-412 (12M-byte) and ST-419 (19M-byte) 5¼-inch Winchesters, is compatible with industry-standard ST-506 controllers. Average access time is 60 msec. Track density is 480 tpi,

Buy of the Century



Century Data Systems' New 590 Megabyte Winchester Disk Memory

AMS 571—our largest, fastest disk memory—is loaded with value. New thin film heads and oxide media put 590 megabytes into a very compact, very economical package. To enhance system performance we've increased the data transfer rate to 1.98 megabytes per second while reducing the average head positioning time to 19 milliseconds. All for OEMs. And all at a very competitive price!

What's more, the AMS 571 gives your system a record low cost of ownership. Combining traditional Century Data Systems quality with inherent Winchester reliability,

we've created a disk memory with an MTBF in excess of 10,000 power-on hours. A disk memory with quality built in for a lifetime of reliability.

Here's a terrific disk memory with great flexibility. Design your controller to pack all this new performance into your system—or to emulate practically any other Winchester disk memory.

Find out how the buy of the Century gives you a strong competitive edge in quality, capacity, performance, and price. Contact: Century Data Systems, 1270 N. Kraemer Boulevard, Anaheim, CA; (714) 999-2660.

 **Century Data Systems**
A Xerox Company

New Products

DISK/TAPE

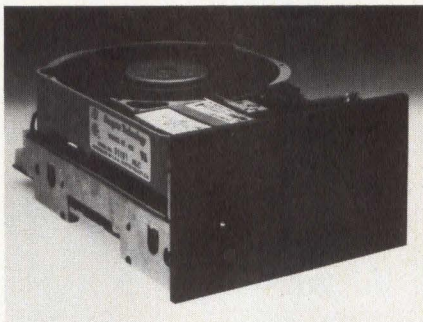

yielding 408 cylinders for a capacity of 4.25M bytes per surface. Data-transfer rate is 5M bits per second. \$1,090 (500 units). **Seagate Technology**, 920 Disc Dr., Scotts Valley, Calif. 95066, (408) 438-6550.

Circle No 314

5 1/4-inch Winchester stores 50M bytes

The model TM705 closed-loop 5 1/4 Winchester disk drive stores 50M bytes (unformatted) on three plated disks. High-density recording is performed on five data surfaces, with the sixth

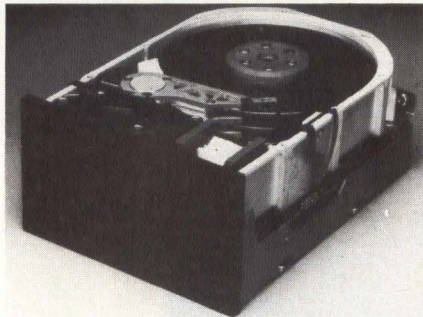

dedicated to servo control. The drive has a track density of 1,000 tpi and a lineal density of 10,416 bytes per track. The drive's closed-loop servo system, featuring a rotary voice-coil positioning arm, provides a 39-msec. average access time. Other features include a brushless DC motor and a 5M-bit-per-second data-transfer rate. Approximately \$1,000 (OEM quantities). **Tandon Corp.**, 20320 Prairie St., Chatsworth, Calif. 91311, (213) 993-6644.

Circle No 315

Tape transport features top-loading reel

This top-loading version of the PCT-1000 1/2-inch, nine-track tape transport fits in a standard 8-inch dual

floppy disk drive footprint. The transport is IBM and ANSI compatible, recording 800 (NRZI) and 1,600 bpi (phased encoded) as well as switch-selectable dual-density 3,200/1,600 bpi. The transport operates at 100 ips in streaming mode for Winchester backup applications, and at 25 and 50 ips in a simulated start/stop mode. Using 3,600 feet of tape on a 10 1/2-inch reel, the PCT-1000 stores 138M bytes. \$1,950 (OEM quantities). **Ibex Computer Corp.**, 20741 Marilla St., Chatsworth, Calif. 91311, (213) 709-8100.

Circle No 316



40M-byte tape drive backs up Winchesters

The Companion model 400 series comprises three miniature reel-to-reel tape drives providing backup and storage for Winchester disk drives. Model 440 stores 40M bytes per nine-track tape. The drives fit the same half-height form factor as 5 1/4-inch Winchester and minifloppy drives. The system's drive mechanisms offer synchronized twin motors and electronic tape-tension control. The system has a bit-error ratio of 10¹⁰. When operating at 90 ips, model 440 transfers data at 112.5K bytes per second. The drives are compatible with the SASI and the QIC 2 interface. Prices start at \$350 (OEM quantities). **Memtec Corp.** Keewaydin Dr., Salem, N.H. 03079, (603) 893-8080.

Circle No 317

3 1/4-inch microfloppy stores 1M bytes

The TC 1000 Drivette double-sided microfloppy disk drive offers 1M byte of unformatted storage capacity on 3 1/4-inch floppy diskettes. The drive suits portable computer systems, programmable instrumentation, word-



processing and point-of-sale systems. Average access time is 175 msec.; data-transfer rate is 250K bits per second. Hardware features encompass a direct-drive spindle motor, a lead-screw head-actuator mechanism that records at 140 tpi and read/write and motion-control electronics boards. \$295 (evaluation quantities). **Tabor Corp.**, Lyberty Way, Westford, Mass. 01886, (617) 692-2535.

Circle No 318



Tape-storage system holds 67M bytes

The Data Library is a 67M-byte addressable magnetic-storage system. It uses a pre-formatted, removable, 1/4-inch tape cartridge that allows block-addressable data access. Each 600-foot cartridge delivers MFM recording on 16 tracks with a density of 10,000 bpi. Each track has 4,096 blocks, and each block has 1,024 bytes of data. The average data-transfer rate is 35K bytes per second. Interface adapters are available for popular computer systems including SASI, QIC-02, S-100, GPIB, RS232C, Multibus, IBM PC (DOS 2.0) and Apple (DOS 3.3) computers. \$3,900. **Advanced Digital Information Corp.**, 723 Ninth Ave., Building A, Kirkland, Wash. 98033, (206) 822-5579.

Circle No 319

SIMPLE.

Instant networking, independent of computer and peripheral brands.

Creating a micro and mini computer network has been costly and confusing. Communications hierarchy has prevented many types and various kinds of equipment from sharing information. Until now.

Introducing StationMate. One unit that joins mini computers, micro computers, terminals, and printers. It's transparent. So different brands and types of computers and peripherals can easily interface. StationMate allows you to construct a comprehensive communications network. *Inexpensively.*

Users can select the information they need from the unit they want. StationMate can

StationMate provides local area networking with XLAN™, the simple communications con-

only \$1,450.00. StationMate makes communications simple. *Incredibly.*

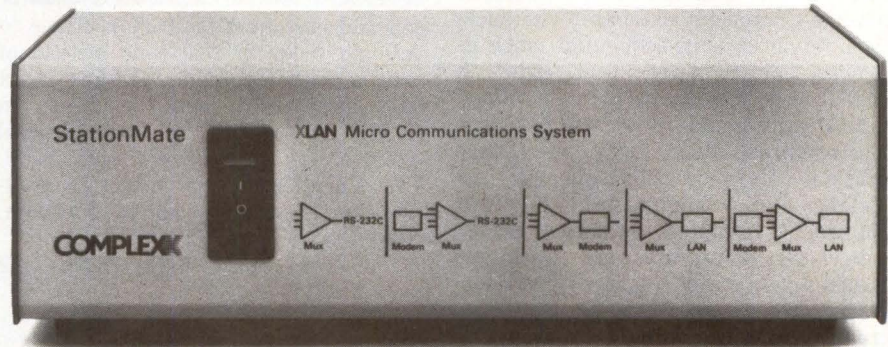

cept from Complexx. All you need is StationMate and an inexpensive shielded-pair cable. Besides local area net-

StationMate. The link you've been missing. See your local dealer or contact Complexx for the name

Teleprocessing

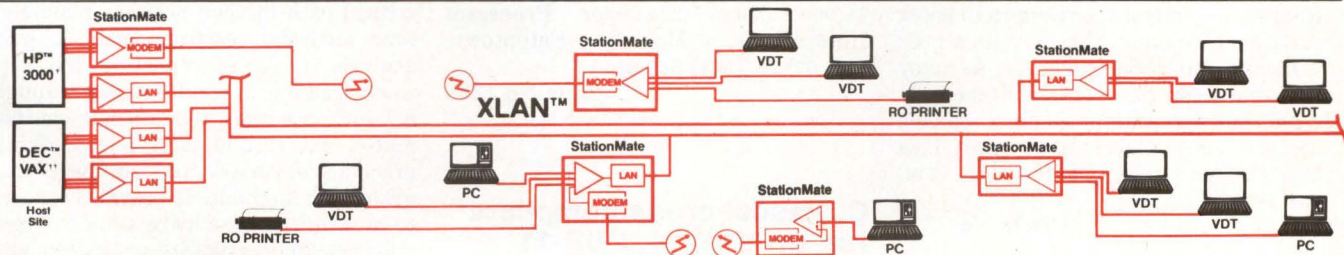
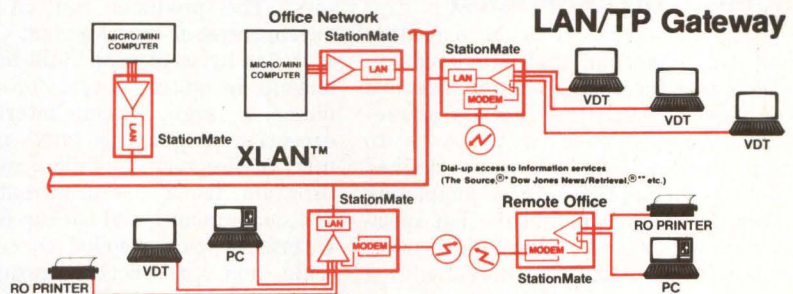
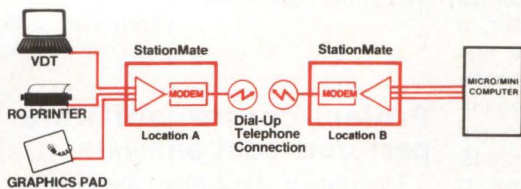

Local Networking

address any port in the network either by its assigned digital code or by its common identifying name. So everyone has access to all the local or remote computers, mass storage files, and peripheral devices connected in the network. *Immediately.*

working, StationMate permits access to remote workstations via an internal dial-up modem. And it serves as a gateway for teleprocessing access to all LAN resources. You couldn't get all of this in one unit. Until now. And the suggested retail price is

of the dealer or distributor nearest you. *Complexx Systems, Inc., 4930 Research Drive, Huntsville, AL 35805. 205/830-4310.*

COMPLEXX™

*The Source is a registered trademark of The Source Telecomputing Company, a subsidiary of the Reader's Digest Association. **Dow Jones News/Retrieval is a registered trademark of Dow Jones & Company, Inc. †HP 3000 is a registered trademark of Hewlett Packard. ††DEC VAX is a registered trademark of Digital Equipment Corporation.

New Products

SOFTWARE

Data Interface runs on IBM PC

The Personal Computer Data Interface (PCDI) runs on the IBM PC and XT with 256K bytes of memory. It provides ASCII or EBCDIC communication at 300 or 1200 baud with IBM mainframes running under the VM/370 operating system and with Standard and Poor's on-line Compustat database. The package retrieves time-sequential (such as weekly or monthly) host data. A full-screen editor permits scrolling, global editing and subsetting. PCDI also restructures data in Data Interchange Format (DIF) or Basic Sequential List format for transmission to other programs. Graphics products include pie charts, histograms, line charts and scatter plots. \$250, single copy; \$30,000, corporate license. **Applied Microsystems Inc.**, P.O. Box 832, Roswell, Ga. 30077, (404) 475-0832.

Circle No 320

Program supports application generation

Genpro supports creation, execution and maintenance of application code on 8086/8088 microcomputers and acts as a multiuser, multitasking database-management system with access to multiple files. A user links pre-defined routines for applications by completing fill-in-the-blanks worksheets that specify data-field details, transaction codes, screen layouts, field attributes, editing requirements and field positions. Runpro, a companion to Genpro to boost run-time efficiency, also permits a user to modify application software. As many as 15 files can be open simultaneously within an application. Genpro, \$5,000; Runpro, \$400. **Capro Inc.**, 12781 Pala Dr., Garden Grove, Calif. 92641, (714) 891-1109.

Circle No 321

Package provides data management for VAX-11

The Smartform data-management package runs on DEC VAX-11 computers under all operating systems, enabling a user to define data-entry form layouts; specify sequential and indexed file structures, and append, retrieve, replace and delete records. Programmers

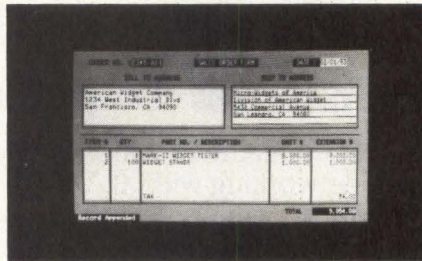

can add custom data-entry routines to validate fields in real time instead of waiting for completion of the form. VAX RMS query processing routines in Smartform permit multiuser general query access with concurrency control. Prices begin at \$4,200. **Signal Technology Inc.**, 5951 Encina Rd., Goleta, Calif. 93117, (805) 683-3771.

Circle No 322

Package supports cross development for TI micros

The XI Core cross-development package and XI macro assembler support software design for TI 320, 7000, 9000 and 9995/9900 microprocessors. The products run on Intellec microprocessor-development systems with 64K bytes of RAM. Built-in utilities include an editor, a text formatter, a linker, a target system interface and execution program, a PROM programmer, a directory and file-management program, display and print routines and disk-maintenance and backup functions. Interfaces are provided to control TI AMPL and XDS microprocessor emulators. \$2,900 to \$3,000, Core package; \$1,000, macro assembler. **Processor Innovations**, 1 Main St., Eatontown, N.J. 07724, (201) 542-6500.

Circle No 323

C, Pascal cross compilers run on VAX-11, PDP-11

Intended for embedded systems, InterC and InterPas are C and Pascal cross compilers for 8086/8088/80186 and 68000 microprocessors. They run on DEC VAX-11 and PDP-11 computers. Each package includes librarian, linker, locator, loader-formatters and lister development tools. The loader-formatters down-load software to emulation hardware or resident monitors. The lister produces source and error

listings, cross reference listings, a global symbol map and a line and locate map. Object code is ROMable through use of a supplied ROM processor. \$3,995 alone; \$4,995 with assembler. **Intermetrics Inc.**, 733 Concord Ave., Cambridge, Mass. 02138, (617) 661-1840.

Circle No. 324

Software tool serves computer-aided science

The Interval 4.0 software package provides user access to signal processing, waveform analysis, graphics and language capabilities for solving scientific and engineering problems. Meaningful English commands perform synthesis, graphing and measuring functions. Signal-processing features include Fourier transforms, time sequence modeling by linear prediction and S- and Z-plane eigen-frequency extraction. Graphics capabilities comprise polar, 3D and rectilinear graphics. The package runs on DEC VAX and Prime minicomputers and supports monochrome and color terminals. \$26,000. **Interval Corp.**, Department 100, 1 Speen St., MS 240, Framingham, Mass. 01701, (617) 879-4064.

Circle No 325

Project-control software performs cost analysis

Plantrac, a standalone, menu-driven professional project-planning and -control software package, performs critical path method network planning, time analysis, resource analysis, cost analysis, progress reporting and network drawing. It guides a user through network creation and amendment (as many as 12,500 activities) using precedence, arrow or bar-chart diagramming methods. It provides reports to highlight and compare schedule, cost and resource activities on screen and printed in standard tabular, histogram, bar-chart and user-designed formats. The package runs on Z80- or 8088-based microcomputers under the PC-DOS, MS-DOS, CP/M or TRSDOS operating systems. It can be leased for \$3,000 for the first year and \$1,000 for each subsequent year. **Computerline Ltd.**, 95 Merrymount Rd., Quincy, Mass. 02169, (617) 773-0001.

Circle No 326

DATARAM OFFERS MORE DATA GENERAL COMPATIBLE MEMORY THAN ANYONE. FOR GOOD REASONS.

Dataram has been delivering Data General-compatible memory since 1974, today offering the industry's most extensive range of such products — from ADD-IN memory to BULK MEMORY disc emulation systems.

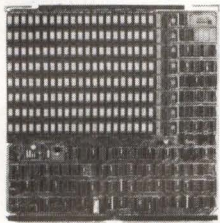

AND STILL GROWING. We've just introduced a versatile, highly reliable 1.0 MB ADD-IN for Data General's NOVA 4 and ECLIPSE S/140 minicomputers, which puts it at the head of an already impressive class of ADD-INS:

DATARAM ADD-IN	MAXIMUM CAPACITY	DATA GENERAL MINI
DR-240 (semi)	1.0 MB	NOVA 4; ECLIPSE S/140
DR-225 (semi)	1.0 MB	ECLIPSE S/130 AND OTHERS
DR-123S (semi)	256 KB	NOVA 3
DR-123 (core)	32 KB	NOVA 3
DR-124 (core)	32 KB	NOVA 2
DR-1200 (core)	32 KB	NOVA 1200

ADDING MORE THAN MEMORY. And we don't stop with ADD-IN memory products — we can expand the capability of your Data General mini with a family of BULK MEMORY systems. Performance-proven systems that emulate Data General fixed head disc systems — but add the important advantages of solid-state speed and reliability. Making it ideal for disc swapping and more.

MORE THAN COMPATIBLE. Many of Dataram's products incorporate enhancements not available from comparable Data General products. For example, our 1.0 MB NOVA 4 compatible ADD-IN provides an extra ECC bit (giving you 6 ECC, rather than Data General's 5 ECC bits), transparent to the host mini, which allows full double-bit error detection.

AND FOR LESS COST THAN YOU'D EXPECT for highly reliable, proven memory products.

Any way you look at it, Dataram can do a lot in general to meet your requirements for Data General memory. But be specific — give us a call today to discuss your requirement.

ECLIPSE, NOVA, AND NOVADISC are registered trademarks of Data General Corporation.

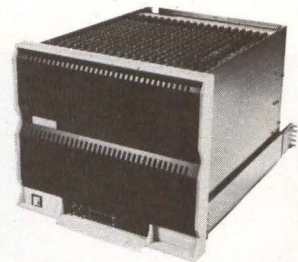

DATARAM BULK MEMORY	EMULATION	MAXIMUM CAPACITY
BS-303 (semi)	6063/6065 (AOS compatible)	8.0 MB
BC-303 (core)	6063/6065	2.0 MB
BS-301 (semi)	NOVADISC	4.0 MB
BC-301 (core)	NOVADISC	2.0 MB

DATARAM

Dataram Corporation □ Princeton Road □ Cranbury, New Jersey 08512 □ (609) 799-0071 □ TWX: 510-685-2542

CIRCLE NO. 131 ON INQUIRY CARD

New Products

PRINTERS



Digital plotter holds paper electrostatically

The model 6801 six-pen/six-color intelligent digital plotter generates characters, symbols, circles, axes and grids. Using the plotter's built-in character generator, a programmer can produce more than 100 legal alphanumeric characters. Plotting speed is 400 mm. per second (16 ips) along the x and y axes. The DIN A4 (8½-by-11-inch) plotting area electrostatically holds paper or transparent film. Disposable fiber-tip or ink pens with different line thicknesses and colors are selected and changed under program control. Centronics parallel, RS232C and GP-IB interfaces are available. \$1,995. **Soltec Corp.**, 11684 Pendleton St., Sun Valley, Calif. 91352, (800) 423-2344.

Circle No 327



Printer features programmable characters

An 80-column, 160-character-per-second, dot-matrix printer, the Sprinter features a parallel port, high-speed space skip-over, five character sets including correspondence quality, built-in friction- and tractor-feed mechanisms, user-programmable character design, a 4K-byte buffer expandable to

68K bytes and graphics capability. Options include an IEEE-488 interface, an RS232 interface and the vendor's SoftSwitch keypad with battery-backed RAM. The SoftSwitch controls horizontal tabbing, selection of alternate character sets, form length, line feed on carriage return, baud rate, horizontal print density, vertical tab stops, vertical line density and auto perforation skips. \$795. **Micro Peripherals Inc.**, 4426 S. Century Dr., Salt Lake City, Utah 84107, 1 (800) 821-8848.

Circle No 328

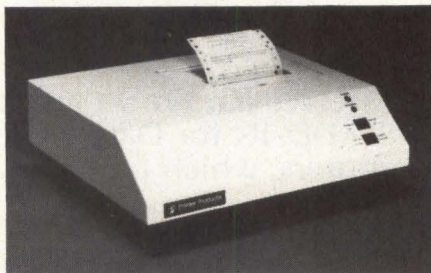

Label printer outputs data in 40 columns

The model S400L impact matrix label printer suits process-control, inspection and shipping applications. This 40-column printer prints a 96-character ASCII set at 48 cps on 4½-inch-wide fanfold or roll paper. Interfaces include RS232C, Centronics or 20-mA current loop. Prices start at \$845. **Printer Products**, 24 Denby Rd., Allston, Mass. 02134, (617) 787-2030.

Circle No 329



Printers accommodate remote communications

The PRU7270, PRU7271 and PRU7272 impact dot-matrix printers produce 132 characters per line at 10 cpi at 400 cps on 15-inch-wide paper. They feature a 96-character international ASCII set with seven switch-selectable alternate national character sets. Characters are formed by a 7-by-7-dot matrix. The

printers can print one original and as many as four copies in one pass. Double-width characters printed at 200 cps are available. The printers communicate asynchronously with Honeywell host processors through RS422A direct (PRU7270), RS232C remote (PRU7271) and RS232C direct (PRU7272) interfaces. \$3,450. **Honeywell Inc.**, 200 Smith St., Waltham, Mass. 02154, (617) 895-6616.

Circle No 330



Printer loads paper automatically

The model 120 daisy-wheel printer has an automatic paper-loading system that allows the controlled loading of cut-sheet paper to one of four positions. Printing speed is 14 cps with DIP-switch-selectable spacings of 10, 12 and 15 cpi. The printer is compatible with major word-processing software using Diablo routines for boldface, underscore, superscript and subscript printing. A Centronics-compatible 8-bit parallel interface is standard. \$599. **Vivitar Computer Products**, P.O. Box C-96975, Bellevue, Wash. 98009, (206) 454-9250.

Circle No 331

Office page printers use laser technology

These non-impact printers based on laser printing technology are intended for use in offices and print workstations. The HP 2687A desktop text printer and the larger HP 2688A text and graphics printer use standard sheets of 8½-inch or A4/B paper. Each prints at 12 pages per minute with 300-dpi resolution. The HP 2687A allows selection of as many as four character fonts per printed page, two of which permanently reside in the machine and two of which are user-changeable. A variety of character fonts is available in cartridge form, including script, courier, letter Gothic and pica. The printer offers word-processing features such as horizontal

EPSON QUALITY PRODUCTS FOR THE OEM.

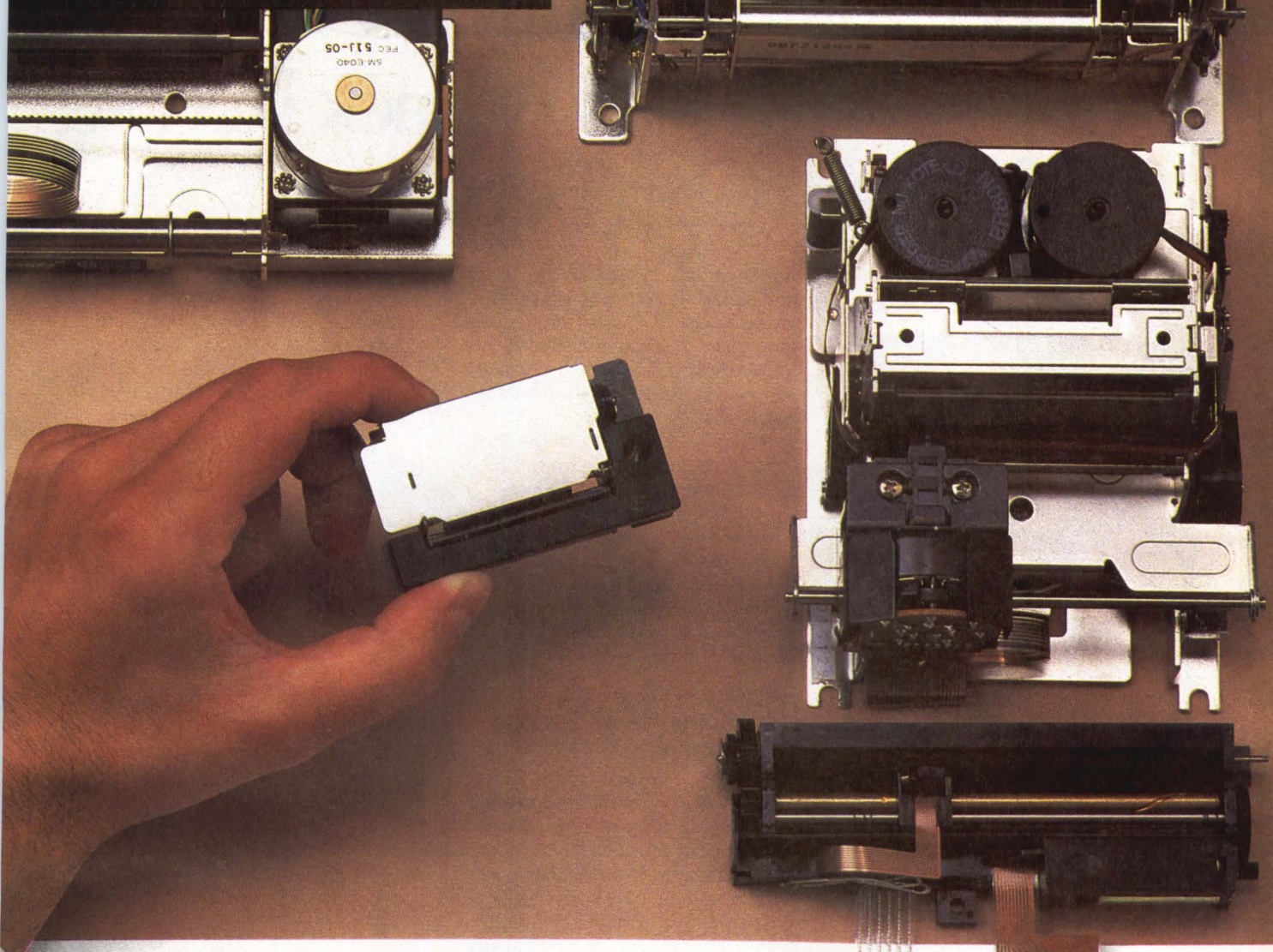

EPSON PRINTER MECHANISMS: THEY COME WITH A HELPING HAND.

PORTABLE/HAND-HELD COMPUTER PRINTERS				
Model	Head	Columns	Speed	Weight
M1XX	Impact Shuttle	16 to 40	0.4 to 0.7 LPS	2.1 oz
M2XX	7 wire impact	21 to 31	2.4 LPS	28.0 oz
M5XX	7 wire impact	40	3.0 LPS	59.0 oz
M12XX	Thermal	40	0.5 LPS	5.2 oz
M3XXX	9 wire impact	80	80 CPS	4.4 lb

You've heard that Epson delivers more printer mechanisms than anyone else. That's true. More than 600,000 shipped per month.

You've heard that our out-of-box failure rate is measured in 10ths of a percent. True again.

But maybe you're concerned that the leader in ECR and POS printers is too busy to worry about your application. *Not a chance!*

That's how we got where we are. By caring about your problems. Lending you a helping hand in selecting a printer for your application. Helping you package it as an integral part or as a stand-alone. And always delivering a cost-effective, quality solution. On schedule.

The printer mechanisms shown here can easily be designed into portable and hand-held computers. We have many more. In many variations. For many applications. Call or write us today. Let us start by giving you a helping hand.

SW Region (714) 250-0111 • NW Region (408) 985-8828
SE Region (404) 458-9666 • NE Region (617) 245-8007
CENTRAL Region (815) 338-5810

EPSON
EPSON AMERICA, INC.
OEM Products Division
Printer Group
3415 Kashiwa Street, Torrance,
CA 90505 (213) 533-8277
Telex: 182312

Only One Ultra-High Capacity Floppy Drive Has A Track Record You Can Bet On.

The Amlyn 3.2 Megabyte 5¼" Single Diskette Drive...

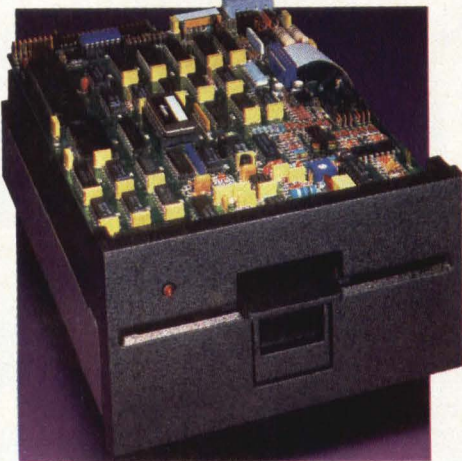

18 months of solid proof: Amlyn's 170tpi runs as dependably as 48tpi.

It's a fact.

Amlyn's super-high-density floppy drive technology is not merely state-of-the-art. It's also tried and true.

Because when you're putting together a new system, you're staking your reputation. So it's nice to know that thousands of Amlyn high-density drives are already out in the world. Specifically, our 8 megabyte MiniPac drives—using the same 170tpi technology as our new single-diskette model.

And the record shows they're working like champs. Just like good old 48tpi. So well, in fact, that several second sources are already employing our techniques.

The reliability data is actually pretty remarkable. And a copy is yours free, just for the asking.

Keep it simple and you keep it reliable.

We know what floppy disk drives have to go through.

That's why we keep ours clean and uncomplicated. With conservative design. No pushing of technology beyond reliable limits.

That's why we've focused on the

fundamentals. Like fast access times and rock-solid accuracy. That's why we've used an elegantly simple closed-loop servo. A Mylar optical scale integrated into the carriage, to internally compensate for any environmental changes.

A single-reference-track diskette that's readily available from multiple suppliers. And which provides incredible tracking precision without head alignment hassles. A microprocessor-controlled stepper motor that gives 88ms average access time. And virtually eliminates audible noise.

Terrific system-cost advantages. And it's easy to integrate.

The price is more good news. Amlyn memory has one of the best price-performance ratios in the business.

And when you consider the design-time economies of simplified interface and formatting, the savings really begin to multiply. Amlyn's standard SA850 interface and 500Kbit transfer rate need only the most minimal controller and software modifications.

In other words, don't be surprised when you have an Amlyn diskette drive running on your prototype in two days to two weeks. Seriously.

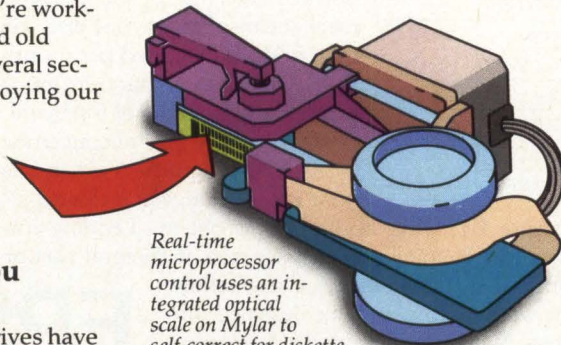

Real-time microprocessor control uses an integrated optical scale on Mylar to self-correct for diskette dimensional changes due to environment.

Evaluate it immediately on your Apple or IBM PC.

If you have an annual requirement for 100 or more units, we've got a deal for you:

Right now you can buy up to five units at some rather attractive trial-offer discounts. And that includes both drives and evaluation subsystems.

These ready-to-go Success Kits let you plug in and play on any Apple II or IBM PC that might be available.

And, believe it or not, even a non-technical person can have them up and operating in less than two hours.

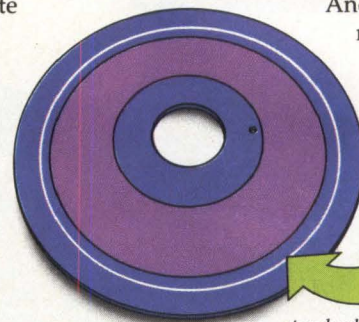

Amlyn drives use industry-standard UHR-II diskettes with a single reference track. No need for you to embed additional servo information in data tracks. (Of course, Amlyn also reads existing 48-, 96- and 100tpi diskettes.)

Model 1860 Single-Diskette Drive: 3.2Mbyte Double-Sided	\$300.
Model 9710 Success Kit: Evaluates the 1860 on Apple II	\$795.
Model 9720 Success Kit: Evaluates the 1860 on IBM PC	\$795.
Model 5850 Five-Diskette Drive: 8Mbyte Single-Sided MiniPac	\$500.
Model 9610 Success Kit: Evaluates the 5850 on Apple II	\$995.
Model 9620 Success Kit: Evaluates the 5850 on IBM PC	\$995.

Call now.

Don't wait.

Because the sooner you get an Amlyn ultra-high capacity floppy drive into your system, the sooner you get the jump on your competition.

And isn't that what this business is all about?

Amlyn Corporation, 2450 Autumnvale Drive, San Jose, California 95131
Phone: (408) 946-8616
TWX: 910-379-0029, TLX: 171627
In Europe, call: (32) (2) 513 87 94

amlyn
Advancing flexible disk drive technology

Products

PRINTERS

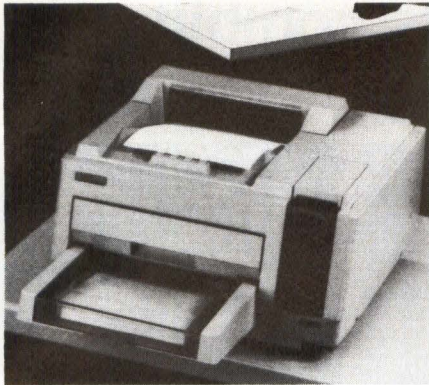

cursor positioning, proportional spacing, automatic underlining and landscape- or portrait-print orientation for formatting flexibility. The HP 2688A can combine 32 fonts on one page. It provides page rotation and 2:1 and 4:1 reduction. HP 2687A: \$12,800, HP 2688A: \$29,950. **Hewlett-Packard Co.**, 1820 Embarcadero Rd., Palo Alto, Calif. 94303. **Circle No 332**

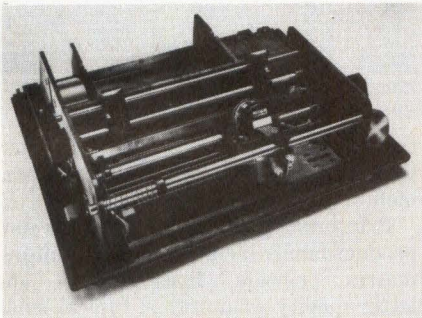

80-column printer mechanism aimed at OEMs

The model 9/80 ME 80-column printer mechanism features independent horizontal and vertical axis control for accurate dot placement in multipass printing and computer-graphics output. Based on a 9-by-7 array, it prints as fast as 200 cps. The unit has front, bottom and rear paper entrances, with top and back paper exits. It has space for an internally housed roll paper, provision for mounting a sheet feeder for 8½-by-11-inch cut paper or envelopes and accepts externally housed, fan-fold, sprocket-driven paper. It handles standard paper stock, carbon or carbonless forms and gummed or pressure-sensitive labels. \$299. **Hi-G Printers Corp.**, 96 W. Dudleytown Rd., Bloomfield, Conn. 06002, (203) 242-3048. **Circle No 333**

Brighter writer.



Our DP-55 daisywheel is a bit more clever than most. A digital status display tells you what it's doing as it prints, and how you can help when it doesn't. It can save you time and money, and that's just plain smart. Call your printer distributor. Or contact Dataproducts at (213) 887-3924, 6200 Canoga Avenue, Woodland Hills, CA 91365. In Europe, 136-138 High Street, Egham, Surrey, TW 20 9HL England.

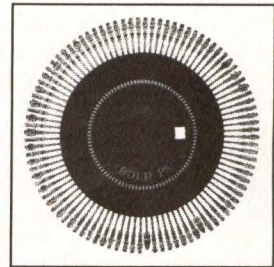

Dataproducts Daisywheel Printers

CIRCLE NO. 134 ON INQUIRY CARD

OUTSTANDING STAND-ALONE BOARDS.

SMC's Stand-Alone boards stand out in the crowd. Our **HAWK I** Video Terminal Board provides all the circuitry to build a "SMART" CRT Terminal, featuring enhanced video attributes and screen editing capabilities. Our **ARCNET-LINK** Board connects any computer with an RS-232 port to a high-performance ARCNET® local area network. For complete details, contact Standard Microsystems Corporation, 35 Marcus Boulevard, Hauppauge, NY 11788 (516) 273-3100.

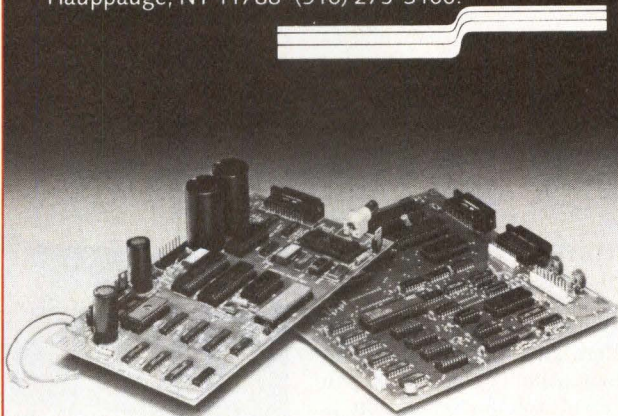

STANDARD MICROSYSTEMS. THE ONE TO WATCH.

ARCNET® is a registered trademark of the Datapoint Corporation

CIRCLE NO. 137 ON INQUIRY CARD

New Products

TERMINALS

Interactive displays, control units combine 3270 emulation, ergonomic design

Raytheon Data Systems has introduced the PTS-1000/4000 product family of IBM 3270-compatible displays, printers and control units that feature reliability and ergonomic design. The product family includes three interactive displays, three control units and five printers.

The R1078-X, a 12-inch diagonal monochrome terminal, uses an 8085 microprocessor with 48K bytes of RAM and 24K bytes of ROM. It offers a cursor-position indicator, an unprotect-field indicator, automatic dim after 15 minutes and automatic top-of-form on local prints.

The R4078-X, a 15-inch diagonal monochrome terminal, and the R4079-X, a 13-inch diagonal, four-color display, extend the capabilities of the R1078-X display with larger and configurable screen formats, additional memory and APL/TEXT character support. All three displays support Raytheon's full line of input/output peripheral devices.

The three controllers, in remote and local configurations, support a wide range of data-processing applications. The R1076 display terminal/control unit supports as many as seven additional display and printer terminals using IBM 3276 communications protocol. The R1074 large cluster-control unit supports as many as 32 display and printer terminals using the IBM 3274 communications protocol. The R4074 cluster controller offers additional capabilities such as local format storage, extended memory, increased communication speeds and local channel attachment. It supports IBM 3276 and 3274 communi-



Raytheon Data Systems' PTS-1000/4000 product family includes a 12- and a 15-inch diagonal display, printers and control units that provide 3270 data-processing functions.

tions protocols with dedicated-line or channel-communications attachment.

All controllers offer three coaxial-cabling options: conventional star, multidrop or coaxial multiplexing. They operate in BSC, SNA and airline link control environments.

Ergonomic features incorporated into the PTS-1000/4000 terminals include tilt-and-swivel display heads, movable low-profile keyboards with sculpted keys and stepped rows and etched CRTs available in green, amber or white phosphors. In addition, colors used on

the display housing reduce contrast transitions in office and work environments.

Printer support for the PTS-1000/4000 product family includes screen printers, matrix printers, line printers and letter-quality printers. A typical small cluster remote system, with four displays and one 150-cps matrix printer, is priced at \$13,170. **Raytheon Data Systems**, 1415 Boston-Providence Highway, Norwood, Mass. 02062, (617) 762-6700.

Circle No 334

Color terminals offer dual-display architecture

The ID-200 family of color graphics terminals offers dual-display architecture, NTSC compatibility, hardware pan and 16 levels of zoom. Resolution is 1,280 by 480 pixels on a 14-inch screen; display writing rate is as high as 1.25M pixels per second. The terminal provides a palette of eight or 16 fundamental colors with 10⁷⁷ user-selectable graphics pattern elements for creating textures,

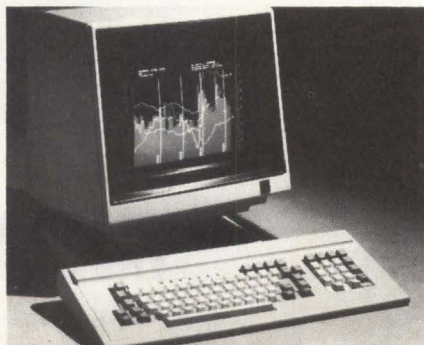

patterns and hues. The terminal can display as many as eight windows simultaneously and can perform polygon fill and seed fill with fill-until and fill-while algorithms. It has graphics command compatibility with Tektronix models 4010, 4014 and 4027 terminals and multipage editing features compatible with the DEC VT132 terminal. \$4,000. **ID Systems Corp.**, 4089 Leap Rd., Hilliard, Ohio 43026, (614) 876-1595.

Circle No 335



High-resolution terminal meets CAD, CAE needs

This Tektronix 4014-compatible color graphics terminal features a resolution of 1024 by 768 viewable pixels. The VHR19 can concurrently display eight colors from a palette of 4,096 on its 19-inch, bit-mapped screen. It supports graphics commands such as point, line, circle, arc, polygon fill, color, zoom and pan. It includes four sizes of Tektronix character sets and two graphics character sets, one of which is user definable. The terminal is also compatible with DEC's VT100 and the industry-standard ANSI X3.64 communications protocol. Its detached keyboard has 113 keys and supports 36 programmable function keys. Other features encompass an RS232C port, a DMA channel, an auxiliary I/O port and a serial/parallel printer port. \$3,995 (100 units). **Intecolor Corp.**, Intecolor Drive, 225 Technology Park, Norcross, Ga. 30092, (404) 449-5961.

Circle No 336

Engineering workstation fits on a desktop

The 4620 color raster-scan workstation, comprising a color graphics terminal, a keyboard and a tablet, fits on an engineer's desk. The ergonomically designed workstation offers a tilt-and-swivel 13-inch monitor that features eight colors, four graphics planes and hardware-generated alphanumerics. It provides 60-Hz non-interlaced resolution in a 672-by-504 format. The terminal uses Intel's 80186 16-bit microprocessor and includes 256K bytes of program memory, expandable to 756K bytes, four RS232C ports and optional dual 1M-byte, 5¼-inch slimline floppy disk drives. \$17,500. **Applicon**, 32 Second Ave., Burlington, Mass. 01803, (617) 272-7070.

Circle No 337

Heavy duty.

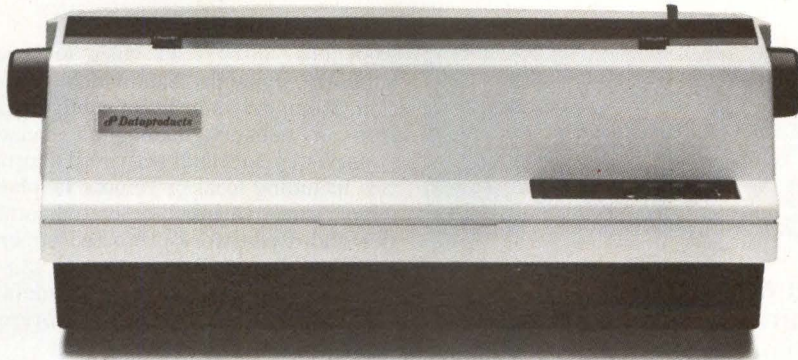

If you can't afford printer downtime, pick the ones designed to take all the punishment you can dish out and still keep printing. Our 35 and 55 character-per-second daisywheels print sheaves of crisp, sharp letters at doubletime, with never a moan or groan. Call your distributor. Or contact Dataproducts at (213) 887-3924, 6200 Canoga Avenue, Woodland Hills, CA 91365. In Europe, 136-138 High Street, Egham, Surrey, TW 20 9HL England.

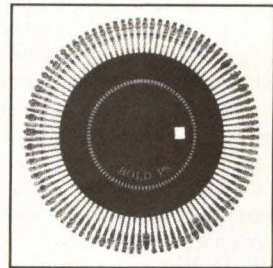

Dataproducts Daisywheel Printers

CIRCLE NO. 135 ON INQUIRY CARD

NOW IBM-TYPE PERSONAL COMPUTERS CAN GO PUBLIC.

SMC's ARCNET-PC board provides a simplified interface between the IBM® Personal Computer (PC) bus and an ARCNET® token passing local area network. It connects up to 255 computers and permits them to share disk files and printer resources, as well as send electronic mail to any system on the network. It does all this at a high performance 2.5 Megabit data rate, yet at a low cost due to the use of SMC's VLSI local area network chip set. For complete details, contact Standard Microsystems Corporation, 35 Marcus Boulevard, Hauppauge, NY 11788 (516) 273-3100.

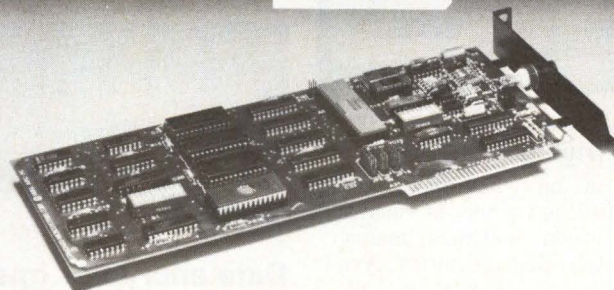

STANDARD MICROSYSTEMS. THE ONE TO WATCH.

IBM® is a trademark of the International Business Machine Corporation
ARCNET® is a registered trademark of the Datapoint Corporation

CIRCLE NO. 138 ON INQUIRY CARD

New Products

DATACOMM



Data compressor doubles communications speed

Installed between data-terminal equipment and a standard communications modem, the Datamizer data-compression unit allows twice the volume of data to be transmitted over standard, unconditioned phone lines at speeds as high as 19,200 bps. The unit contains a data-compression algorithm that reduces repetitively transmitted characters into short codes. It is also a four-channel statistical multiplexer that can multiplex a different half- or full-duplex protocol at an independent rate on each channel. The unit supports all common asynchronous and synchronous protocols, including bisynch and HDLC. \$4,950. **Symplex Communications Corp.**, 2002 Hogback Rd., Ann Arbor, Mich. 48104, (313) 973-1164.

Circle No 338

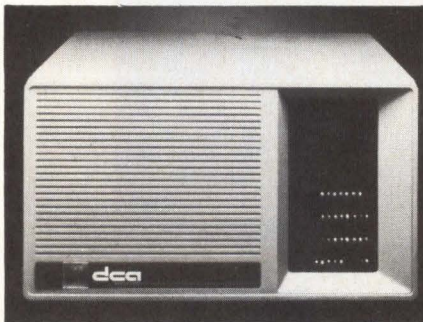

Unit provides multiplexing for LANs

Megalink, a bit-synchronous time-division multiplexer, provides voice and data transmission, network management and diagnostic capabilities. Available in tabletop or rack-mounted enclosures, it comprises its own standalone network or integrates into any of the vendor's networks. The product features trunk speeds from 50 to 1.544M bps, support of two to 128 ports that operate at speeds from 50 to

256K bps, integrated voice and data support, dynamic bandwidth contention, menu-driven system configuration from a network manager's console, supervisory terminal-activated diagnostics including local or remote loopback, supervisory terminal-activated statistics and a password-protected supervisor control port. Prices start at \$3,800. **Digital Communications Associates Inc.**, 303 Technology Park, Norcross, Ga. 30092, (404) 448-1400.

Circle No 339

Upgrade handles communications

The BabyTalk intelligent communications-management interface plugs into an IBM Personal Computer, Texas Instruments Professional Computer and other bus-compatible computers. It contains a Z80 microprocessor, 64K bytes of dual-ported RAM and an auto-dial, auto-answer, direct-connect modem that operates at 300, 600 and 1,200 baud. BabyTalk emulates 3270/BISYNC and 3270/SNA, 2770, 2780, 3700, 3780 BATCH/BISYNC and HASP/BISYNC and a wide range of asynchronous terminals such as the DEC VT100, TeleVideo 950 and Hazeltine 1500. BabyTalk's serial or parallel port can be used for background print spooling. The board also has a real-time clock/calendar with battery backup for programmable message dispatching. \$895. **Microlog Inc.**, 222 Route 59, Suffern, N.Y. 10901, (914) 368-0353.

Circle No 340



Data encryptor operates as fast as 112K bps

The Datacryptor III encryption device secures data over point-to-point wide-band circuits at data rates as high as 112K bits per second. It operates synchronously on full-duplex, leased-

line facilities and is equipped with v.35 and RS232 interfaces wired in parallel. Either interface can be used, depending on network data-rate requirements. No configuring or strapping is required. The device uses the DES algorithm in the single-bit cipher-feedback mode, which provides protocol transparency. The unit also electronically produces encryption keys by a pseudo random-number generator. \$4,995. **Racal-Milgo**, P.O. Box 520399, Miami, Fla. 33152, (305) 592-8600.

Circle No 341

X.25 packet supports 32 ports

The Multi-PAD X.25 model 232 two-trunk packet assembler/disassembler for interfacing asynchronous terminals and hosts to X.25 networks supports eight to 32 ports. It is available in two versions: model 232 connects trunks to X.25 links at speeds from 1.2K to 19.2K bits per second, and model 232HS handles trunk speeds as high as 64K bits per second. The 232's ports can connect with asynchronous terminals operating at speeds from 50 to 9,600 bps. Each port is configurable individually for type of connection, SVC or PVC service, speed and parity. The units conform to all three levels of CCITT recommendation X.25 as well as X.21 bis, v.24, x.28, x.29 and x.121. \$10,000 to \$16,000. **Dynatech Packet Technology Inc.**, 6464-G General Green Way, Alexandria, Va. 22312, (703) 642-9391.

Circle No 342

Device automates voice, data communications

Designed to work with personal computers such as the IBM PC, Compaq and other MS-DOS-based computers, the Cygnet Communications CoSystem is a Z80 microprocessor-based voice- and data-communications system. In addition to simultaneous desk-to-desk voice- and data-teleconferencing capabilities over normal telephone lines, the product offers electronic-mail capabilities, programmable function keys, automation of PBX special calling functions, automatic database access, terminal emulation, detailed records of all communications

Mighty write.



This is the word processing printer built to survive the rigors of the office. Our heavy duty DP-Series daisywheels whisk out crisp, letter-perfect documents – hour after hour, month after month – without a whimper. Call your printer distributor. Or contact Dataproducts at (213) 887-3924, 6200 Canoga Avenue, Woodland Hills, CA 91365. In Europe, 136-138 High Street, Egham, Surrey, TW 20 9HL England.

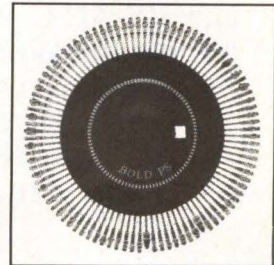

Dataproducts Daisywheel Printers

CIRCLE NO. 136 ON INQUIRY CARD



activities, calendar/time management and intelligent telephone features such as speed dial, last number and automatic redial from an extended directory. \$1,495 with a 300-baud modem, \$1,845 with a 1,200-baud modem. **Cygnnet Technologies Inc.**, 1296 Lawrence Station Rd., Sunnyvale, Calif. 94089, (408) 734-9946.

Circle No 343

Packet-communication unit has 32 ports

LocalNet 20/220 S-Mux, a modular packet-communications unit, offers as many as 32 ports in a single chassis. Users can incrementally add any mix of two-port modular packet-communication processors. Initial offerings include asynchronous PCPs, with bisynchronous and encrypted PCPs scheduled for early 1984 availability. The chassis includes a frequency agile broadband modem and a common power supply. Each PCP contains software for the modem interface, the attached device interface and implementation through level 6 of the seven-layer ISO Open Systems Interconnection model for data communications. The product uses a 6-MHz Z80 microprocessor for each PCP and employs a proprietary digital arbitration scheme for modem sharing by the PCPs. Users can configure each port of a PCP to operate at data rates between 75 and 19,200K bits per second. \$345 per port fully configured. **Sytek Inc.**, 1225 Charleston Rd., Mountain View, Calif. 94043, (415) 966-7346.

Circle No 344

S100 CONTROLLER BOARDS BUILD MORE VERSATILE SYSTEMS.

SMC's S100 controller boards present new opportunities in system design. Our **QSI05100** board provides 4 independent serial I/O channels for simultaneous use of a variety of peripherals. The **FDCS100** board controls up to 4 floppy disk drives for removable mass storage capability. The **VRAMS100** board adds advanced video display capabilities, including smooth scrolling and double-height, double-width data rows. Our **ARCNET®-S100** board links up and controls a network of up to 255 computers. For complete details, contact Standard Microsystems Corporation, 35 Marcus Boulevard, Hauppauge, NY 11788 (516) 273-3100.

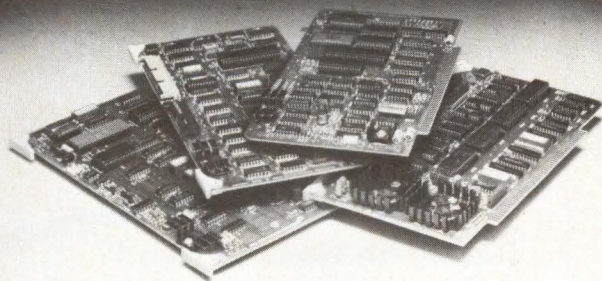

STANDARD MICROSYSTEMS. THE ONE TO WATCH.

ARCNET® is a registered trademark of the Datapoint Corporation

CIRCLE NO. 139 ON INQUIRY CARD

Want to hook IBM?

Terminals. Personal Computers. ASCII devices. Hook them all into the IBM world with the new AVATAR™ PA1000 Protocol Converter.

The PA1000 provides low-cost IBM 3278/2 terminal emulation and coaxial connection to an IBM 3274/3276 cluster controller. Then, a single keystroke switches you back into the asynchronous world through an auxiliary RS-232-C port to access other computer systems, public information services or copy a screen to a printer.

Our microprocessor-based unit provides user-selectable rates up to 9600 baud, terminal keyboard configu-

rations, screen management and local or remote print functions. And, you can hook the PA1000 to a modem for remote dial-in access.

Simple, economical access to the world of IBM, just when you thought there was no answer. At \$995, getting hooked has never been so affordable. For more information on our AVATAR PA1000 Protocol Converter, contact Avatar Technologies Inc.

99 South Street
Hopkinton, MA 01748

Or call us at
(617) 435-6872.

AVATAR™

Making IBM smarter since 1983.

IBM is a registered trademark of International Business Machines Corp.



Products

DATA COMM



Communications translator is programmable

The PCT-100 is a configurable in-line RS232 protocol and data translator. Two full-duplex RS232 ports, each configurable from 50 to 19,200 baud, are selectable for data-set or -terminal operation. An internal processor that asynchronously executes a translation algorithm for each port translates data and protocol information in real time. Translation algorithms, coded in Communications Translation Language, are stored in non-volatile electrically-erasable programmable read-only memory. The device is available as a printed-circuit board or as a standalone unit. \$369. **Method Systems Inc.**, 19751 S. Lakeshore Blvd., Euclid, Ohio 44119, (216) 531-0404. **Circle No 345**

Subsystem provides 3270 communications

The PS-3270/BSC family of 3270 emulation subsystems plugs into IBM PC, IBM PC XT and other compatible personal computers. Using the PS-ICP intelligent communications processor board and 3270 emulation software, the subsystems relieve the personal computer of the communication load. Depending on selected hardware and software options, the subsystems emulate the following IBM 3270 systems: level 1 emulates a single-station IBM 3276-2 control unit display station with attached 3287 printer, level 2 emulates a small cluster-system IBM 3276 control unit/display station with 3287 printer and three down-line display stations, and level 3 emulates a large cluster-system IBM 3274-51C cluster controller with the 3287 printer and 13 3278-2 display stations. The PS-ICP communications processor includes a Z80B microprocessor, 64K bytes of dual-ported, parity-protected memory, a parallel printer port and as many as four programmable serial ports. Level 1: \$1,295, level 2: \$1,990, level 3: \$2,685. **ABM Computer Systems**, 23362 Peralta Dr., Laguna Hills, Calif. 92653, (714) 859-6531. **Circle No 346**

SAVE YOUR 8 BIT SYSTEM Join the 16/32 Bit Revolution Through Evolution, For Under \$600



Would you like to run CPM86™, CONCURRENT CPM86™, CPM68K™, MS-DOS™, IBM™ PC APPLICATIONS, DEVELOP and TEST 16/32 BIT SOFTWARE, or add an INTELLIGENT HIGH SPEED RAM DISK to YOUR SYSTEM?

You can with the HSC CO16 ATTACHED RESOURCE PROCESSOR:

CO16 with either 8086, 80186, or 68000 16 bit micro-processor and up to 768K Bytes of parity checked RAM may be connected to virtually any Z80 based computer system or APPLE 2E computer system.

An 8 bit system equipped with CO16 retains all of its original capabilities PLUS it has the added ability to run most 16 bit operating systems and applications.

Prices start at \$595.00 which includes the CO16 processor with 128K bytes of memory, two volume user manual, and the HSC Software Development System. Hardware options include memory expansion to 768K bytes, attractive desk top enclosure with power supply, and the INTEL™ 8087 Math Co-processor (available on CO1686 only). Software options include CPM86, CPM68K, Concurrent CPM86, or MS-DOS™ operating systems. The UNIX™ operating system will be available in the second quarter of 1984.

For Information on CO16 Contact
HSC INC.

Box 86
Herkimer, NY 13350
(315) 866-2311



Dealer and OEM inquiries are invited.

CIRCLE NO. 142 ON INQUIRY CARD

CUSTOM CONTROLLER BOARDS MEET UNIQUE STANDARDS.

Whatever your needs are in a controller board, SMC can meet them. We have the capability to modify our standard board products to your own unique specifications. Since we use the latest VLSI technology, we can usually do it faster, more reliably and at a lower cost than anyone else. In fact, in the last year, we've designed custom boards for the airline, banking and medical instrumentation industries. Now let us show what we can do for you. For complete details, contact Standard Microsystems Corporation, 35 Marcus Boulevard, Hauppauge, NY 11788 (516) 273-3100.

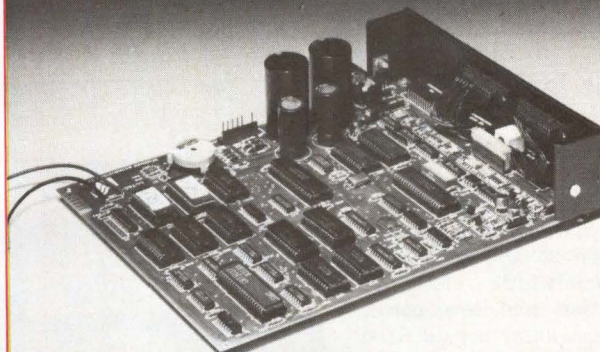

STANDARD MICROSYSTEMS. THE ONE TO WATCH.

CIRCLE NO. 140 ON INQUIRY CARD

New Products

SUBASSEMBLIES

VME subsystem performs image processing

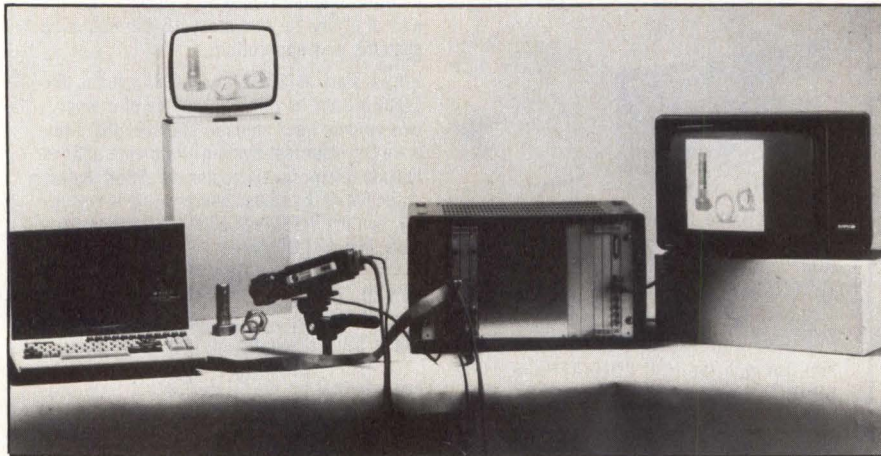

Data-Sud Systems DSSEIMAG image-processing subsystem includes three VME boards, a video camera and a diskette with MC68000 image-processing routines.

Designed for use with the Fairchild CCD3000 video communications camera, the DSSEIMAG VME-bus image-processing subsystem consists of an acquisition board that performs image acquisition and digitization and interlaced-mode image digitization in 34 msec., an image memory board, a display board and an image-processing software library. Using the MC68000 microprocessor, the subsystem suits automatic visual applications such as measuring, counting, routing and quality inspections.

The image memory board is a dual-ported 256K-byte RAM board that allows the CPU to store and process images without interacting with the display. The image is a page of 512 by 512 bytes.

The display board provides an output

for display on a black-and-white video monitor. It consists of an 8-bit digital-to-analog converter and a DC/DC converter for the camera power supply.

The standard software library is a package of programs written in MC68000 assembler and compatible with Pascal and BASIC. It includes zoom; coordinate definition; and addition, averaging or subtraction of parts of different images.

Two versions of the subsystem are available. The DSSEIMAG-56, priced at \$7,500, uses a 6-bit analog-to-digital (A/D) converter to provide 64 gray levels; the DSSEIMAG-58 uses an 8-bit A/D converter to provide 256 gray levels. **Data-Sud Systems/U.S. Inc.**, 2219 S. 48th St., Suite J, Tempe, Ariz. 85282, (602) 966-3953. **Circle No 347**

Scan monitor features 40-MHz video bandwidth

The Patriot model 8835, a 1,280-by-1,024-resolution, 19-inch, fast scan monitor, features high-voltage regulation, horizontal scanning frequency ranges between 25 and 38 KHz, a 40-MHz video bandwidth, electronic geometry correction and low power consumption. The monitor uses a fixed convergence in-line gun with a 0.31-mm.-pitch shadow mask. It is available with optional long-persistence phosphors and high-contrast glass. It suits

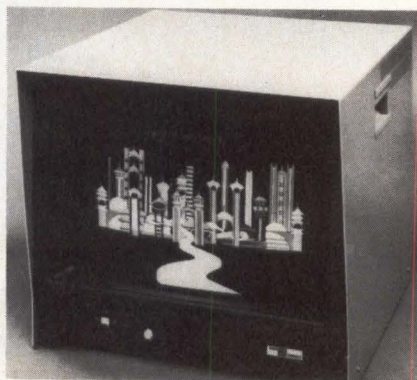

CAD/CAM, seismic, imaging, process-control and military applications. Less than \$2,500. **Aydin Controls**, 414 Commerce Dr., Fort Washington, Pa. 19034, (215) 542-7800.

Circle No 348

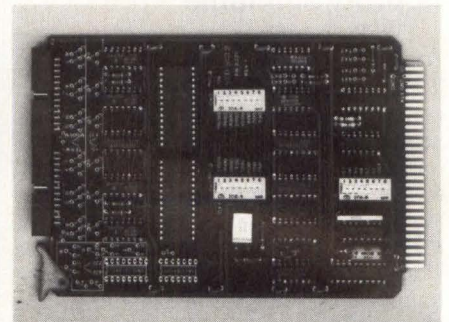

Interface board features switch-selectable rates

The STD SIO-2 board is a general-purpose, I/O-mapped, serial interface card for the STD bus. It provides two independent RS232C-type serial channels that can operate at switch-selectable speeds from 150 to 19,200 baud. The board also supports polled or interrupt modes, terminal- or modem-type connection, an optional RS422 channel and switch-selectable board addressing. \$185 (two to nine units). **Forethought Products**, 87070 Dukhobar Rd., Eugene, Ore. 97402, (503) 485-8575.

Circle No 349

CPU board serves scientific applications

This 8088-based CPU board features a ROM-resident basic input/output system that offers MS-DOS-compatible calling conventions. Designated the CP-88, the board can operate without a video board or a keyboard and can come up as an RS232 board. When used in this fashion with a RAM board and the vendor's six-slot expansion chassis, the CP-88 serves as a remote-control box at the end of a host computer in process-control applications. The CP-88 can also be combined with a memory board, a video board and a floppy disk drive board in a 12- or 18-slot chassis supplied by the vendor and operate as a hardware- and software-compatible IBM PC "work-alike." \$476. **Electro Design Inc.**, 690 Rancheros Dr., San Marcos, Calif. 92069, (619) 471-0680.

Circle No 350

Mini-Micro Systems

The leading monthly computer publication

The Value Added Market

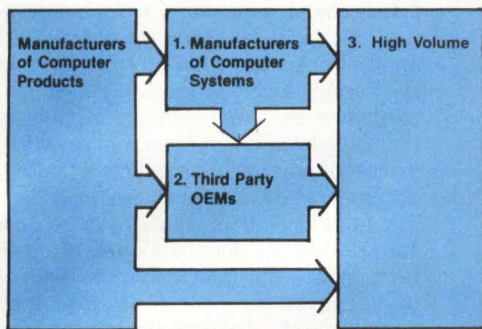

The Value Added Market

Over 112,000 computer professionals with extensive computer knowledge and an appreciation of how system elements function together—these are Mini-Micro Systems readers.

Our readers are continuously searching for opportunities to *add value*. That makes them *very valuable* to you.

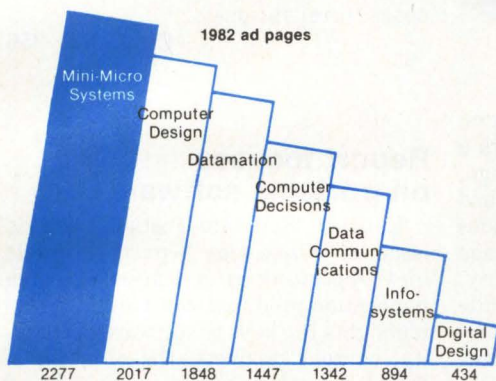

Leader in Ad Pages

More advertising pages ran in Mini-Micro Systems in 1982 than any other monthly publication serving computer professionals. Figures were taken directly from the C — Systems Report.

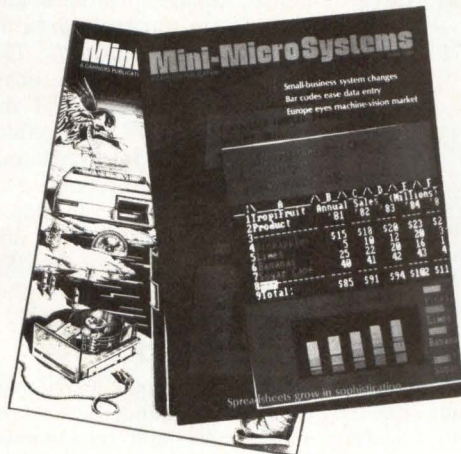

Leading Monthly Publication

According to the 23rd Annual Business Publication Advertising Scoreboard—the Gallagher Report, Mini-Micro Systems led monthly computer publications in 1982.

MINI-MICRO SYSTEMS continues to be the leading monthly computer publication for OEMs, system integrators, high volume end users, including manufacturing, engineering and scientific end users.

Mini-Micro Systems
Readers that add value

New Products

LITERATURE

Data book outlines products

The *1983 Computer Products Data Book* contains data-sheet information for computer products including STD-Z80-bus (8-bit) and VMEbus (16-bit) systems, Mostek MD and SD/SDE series Z80 microcomputer modules and hardware-software-development systems. The edition also supplies information on software products and the MK8200 general-purpose memory system. \$10. **Mostek Corp., Technical Literature Distribution**, 1215 W. Crosby Rd., Mail Station 2205, Carrollton, Texas 75006, (214) 466-6000.

Circle No 351

Text introduces Pascal numerical analysis

An Introduction to Numerical Analysis with Pascal by L.V. Atkinson and P.J. Harley concentrates on the Pascal implementation of numerical methods and shows the application of general data structures to numerical computation. It assumes familiarity with Pascal but also provides a summary and its applications to numerical processes. 448 pages, \$16.95. **Addison-Wesley Publishing Co. Inc., Engineering, Mathematics and Statistics Division**, Reading, Mass. 01867, (617) 944-3700.

Circle No 352

Guide describes UNIX System III

The *UNIX System III Guide* for microcomputer users describes UNIX-System III software, including Berkeley enhancements and the UniPlus+ version. The guide covers software commands, libraries and UNIX system calls. The text is suitable for users unfamiliar with UNIX software. \$25. **Pacific Micro Tech**, Department 120, 5819 Poinsett Ave., El Cerrito, Calif. 94530, (415) 841-3991.

Circle No 353

Software directory covers 16-bit Altos

This 108-page software directory describes more than 190 application-software products, networking/communications packages, languages and utilities that are compatible with

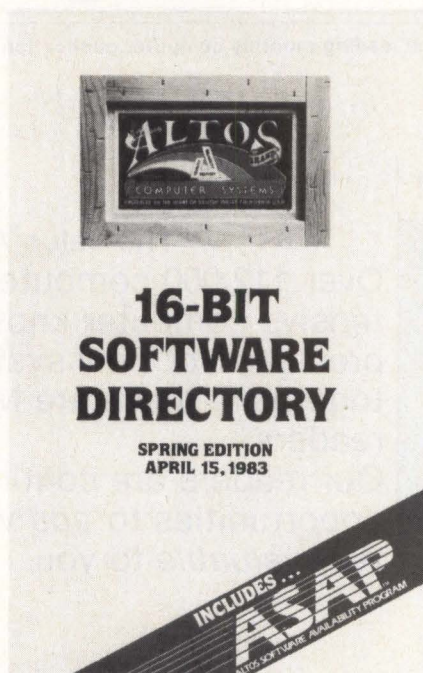

Altos 16-bit multiuser microcomputers. *The 16-Bit Software Directory* offers a concise description of each package, listing compatible Altos computers and operating systems. It also provides information on pricing, the language written in and source-code availability. Application-software listings include general business packages and vertical packages. \$7.50. **Altos Computer Systems**, 2641 Orchard Parkway, San Jose, Calif. 95134, (408) 946-6700.

Circle No 354

Reference aids management of software

General Electric's *Software Engineering Handbook* presents a universally applicable methodology for the development of software and effective management techniques to control that development. By following the methodology outlined in the handbook, readers can determine software project status, generate accurate cost estimates and project schedules, overcome snags in the development phase and reduce delays, incorporate development input from key personnel at 11 levels, produce more cost-effective, reliable software and lower software development costs. \$225. **Technology Marketing Corp., General Electric Co.**, 120 Erie Blvd., Schenectady, N.Y. 12305, (518) 385-2211.

Circle No 355

Supplement updates software directory

The 500-page *Supplement to the Small Systems Software and Services Sourcebook I* contains 1,750 new listings of application software, systems software and utilities such as database-management programs, word processing, graphics and commercial applications. Information provided in the listings includes operating systems, hardware and programming languages that a package will run on or with, prices, number of installations, training, documentation and services provided. The Supplement also contains more than 150 revisions, deletions and changes that update the information in Sourcebook I. \$125 for Sourcebook I and its Supplement. **Information Sources Inc.**, 1807 Glenview Rd., Glenview, Ill. 60025, (312) 724-9285.

Circle No 356

Report focuses on portable software

Entitled "Software Portability," this issue of *Technology Growth Markets and Opportunities* (a market research publication produced 20 times annually) highlights the keys to software portability, current products, the direction of developments, future products and projections of the future portable software market in 1982-1987. The report discusses the competitive environment, criteria for success and the rate at which the market will unfold. \$95. **Creative Strategies International**, 4340 Stevens Creek Blvd., Suite 275, San Jose, Calif. 95129, (408) 249-7550.

Circle No 357

Basic robotic concepts detailed

Basic Robotic Concepts, a 270-page book by John M. Holland, details the design, maintenance and implementation of robotic systems. It covers motion control, manipulators, mobility and vision. An overview of current industrial and experimental robots accompanies explanations of the capabilities and limitations of various robotic systems. \$19.95. **Group Technology Ltd.**, P.O. Box 87, Check, Va. 24072, (703) 651-3153.

Circle No 358

“If you want to do OEM computer business in the U.S., you’d better go to the Invitational Computer Conferences in Boston, Dallas, Minneapolis, Orange County, Washington, D.C., Los Angeles, Ft. Lauderdale, ...We do!”

Experienced marketing management knows that the best way to reach the technical decision maker/buyer is to meet him where he lives and works, demonstrate operating equipment and provide him with the technical information he needs. Over the past 12 years successful marketers have found the Invitational Computer Conferences to be the most cost-efficient, effective method of covering their U.S. computer industry customer base.

The exclusive, one-day, OEM conferences will be held in ten major market areas throughout the United States and are attended by a select, invited audience of OEM's, systems houses and quan-

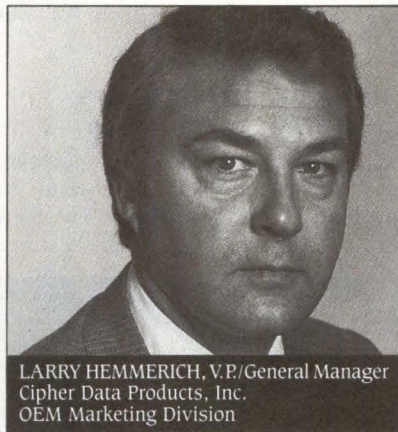

LARRY HEMMERICH, V.P./General Manager
Cipher Data Products, Inc.
OEM Marketing Division

tity end users. Guests can attend a variety of technical seminars and view operating displays of the newest computer and peripheral equipment. The informal setting makes it easy to meet with potential customers one-on-one and the simple table-top displays keep exhibit costs at a minimum.

Exhibit your products at the Invitational Computer Conferences with these top companies:

1983-1984 Series

Sept. 13, '83	Newton, MA
Sept. 29, '83	Minneapolis, MN
Oct. 18, '83	Valley Forge/ Philadelphia, PA
Oct. 20, '83	Washington, D.C./ Vienna, VA
Nov. 8, '83	Houston, TX
Nov. 10, '83	Dallas, TX
Jan. 9, '84	Irvine, CA
Feb. 7, '84	Ft. Lauderdale, FL
Feb. 28, '84	Los Angeles, CA
Mar. 1, '84	Palo Alto, CA

For more information call or write:
B.J. Johnson
& Associates, Inc.
3151 Airway Ave. #C-2
Costa Mesa, CA 92626
(714) 957-0171



Adaptive Data & Energy Systems Amcodyne, Inc. Amlyn Corp. Anadex Inc. Archive Corp. AVIV Corp. Braemar Computer Devices, Inc. Cipher Data Products, Inc. Control Data Corp.	Cynthia Peripheral Corp. Dataram Corp. Digital Equipment Corp. Dysan Corp. EXO Corp. Fujitsu America, Inc. IBM Corp. Integral Data Systems, Inc.	International Memories, Inc. Iomega Corp. KENNEDY An Allegheny Int'l Co. Maxtor Corp. MegaVault Micro Peripherals Inc. NEC Information Systems, Inc.	Pertec Peripherals Corp. Pioneer Magnetics, Inc. Priam Corp. Printronic, Inc. Quantum Corp. Qume Corp. Raymond Engineering, Inc. ROSSCOMP Corp.	Seagate Technology Spectra Logic Corp. Tabor Corp. Tandberg Data, Inc. Tecstor, Inc. THORN EMI Technology, Inc. Telex Computer Products, Inc. Trilog, Inc. 3M Data Recording Products	Universal Data Systems Vermont Research Corp. Vertex Peripherals Corp. Wilson Laboratories, Inc. World Storage Technology Wangtek Xylogics, Inc.
---	---	---	--	---	--

New Products

LITERATURE

Data sheet details software interface

This two-page data sheet details Omnar Corp.'s menu-driven personal computer software interface that allows IBM PC and IBM PC-compatible microcomputers to interact on-line directly with a mainframe or minicomputer that uses the Pick operating system. The data sheet lists technical specifications such as the interface's ability to transfer data at any speed as high as 9,600 baud. It also describes the interface's menu-driven commands and its ability to provide validation of records and data transmitted on both the host and personal computers. **Omnar Corp.**, 12517 Chandler Blvd., Suite 100, N. Hollywood, Calif. 91607, (213) 985-3004.

Circle No 359



features high-density and economy cartridges. It also presents a storage-capacity-vs.-tape-length and recording-density chart. **Data Electronics Inc.**, 10150 Sorrento Valley Rd., San Diego, Calif. 92121, (619) 452-7840.

Circle No 360

hardware and services, from 40 independent third-party vendors in 14 application areas including electronic, civil, chemical and nuclear engineering. The catalog also lists compatible hardware peripherals and service/consulting firms. **Apollo Computer Inc.**, 15 Elizabeth Dr., Chelmsford, Mass. 01824, (617) 256-6600.

Circle No 361

Brochure describes technical courses

These eight-page, color brochures describe a variety of four-day technical courses offered by Integrated Computer Systems in computer networks, digital processing, software, microprocessors and man/machine systems. The brochures list course contents and time and place offered and detail the course benefits and who should attend. Enrollment information is included. **Integrated Computer Systems**, 3304 Pico Blvd., P.O. Box 5339, Santa Monica, Calif. 90405, (800) 421-8166.

Circle No 362

Brochure covers cartridge products

The vendor's line of ¼-inch digital tape cartridges is described in an eight-page color brochure. The brochure

Catalog lists software for Apollo computers

The 200-page catalog of applications for the Domain lists more than 120 application programs, as well as

EXTEND YOUR TRANSMISSION DISTANCES

You can extend the 50-foot transmission distance for RS-232-C cable assemblies to 250 feet maximum with our low density (long distance) cable (LDC).

Specify length when ordering. RS-232-C standard data cable assemblies are also available.

24 AWG CONDUCTORS TWISTED INTO PAIRS TO REDUCE CROSS-TALK

LOW DENSITY, 15 MIL POLY-ETHELENE TO REDUCE CAPACITANCE (12.5 pf/ft)

.002" ALUMINUM POLYESTER TO SHIELD AGAINST EMI

GROUNDING DRAIN WIRE

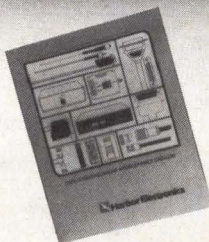

Send for our new catalog.

PART NO.	PRICE
LDC-25-V	\$17.50 + .80/ft.
LDC-12-V	\$16.50 + .45/ft.
LDC-06-V	\$14.00 + .30/ft.



Harbor Electronics

650 Danbury Road, Ridgefield, CT 06877
Call TOLL FREE 800-243-4794 • In CT: (203) 438-9625

CIRCLE NO. 145 ON INQUIRY CARD

This publication is available in microform.



University Microfilms International

300 North Zeeb Road
Dept. P.R.
Ann Arbor, Mi. 48106
U.S.A.

30-32 Mortimer Street
Dept. P.R.
London W1N 7RA
England

CIRCLE NO. 146 ON INQUIRY CARD

Get results with

Mini-Micro Systems

CAREER OPPORTUNITY SECTION...

When you advertise in **Mini-Micro Systems**, you can be sure of reaching only the people you are trying to recruit. Every reader is a potential employee. We reach the highest percentage of all significant personnel in our industry. You'll find us not only effective, but a more economical magazine.

for space reservation
contact:

Peggy Gordon
203-964-0664

Classified Ads

inventions wanted

Inventors, Entrepreneurs, Product Promoters

wanted to display concepts at
national technology trade show.

Call: 1-800-528-6050 X831

CIRCLE NO. 225 ON INQUIRY CARD

publications

The microLETTER

Finally a national newsletter especially for programmers! If you want to cash in on the ever growing market for microcomputer software, you don't want to be without The microLETTER. As this free-for-all market grows, the formula for success keeps changing. Keep up each month with The microLETTER! Twelve month subscription is only forty-two dollars. Subscribe today - write.

DATASAFE CORPORATION
P.O. Box 590505
Houston, TX 77259

CIRCLE NO. 226 ON INQUIRY CARD

Copy Deadline:

Space reservations and
advertising copy must

be received by the 10th
of the month preceding
the issue date. Camera-
ready mechanicals
must be received by the
15th of the month pre-

ceding the issue date.
For example, to appear
in the February issue,
copy must be received
by January 10; mechanicals
by January 15.

hardware



**HEWLETT
PACKARD**
Desktop & Mini
Computer
Systems

**SAVINGS ON ALL
MODELS**

9845B/C 9000⁺ Non-HP memory
9836A 9826A and peripherals

CALL OR WRITE FOR FREE CATALOG

digital resources inc.

Box 23051 Portland, OR 97223 USA
503-246-0202
International Sales Telex 360-143

CIRCLE NO. 227 ON INQUIRY CARD

services

TAPE----- 8" DISKETTE COPYING

DISKETTE-SINGLE SIDED, SINGLE
DENSITY (SSSD) TAPE-1/2", 800/1600 BPI;
ASCII/EBCDIC TAPE TO DISKETTE/
DISKETTE TO TAPE CALL/WRITE!

PROFESSIONAL DATA SERVICES

385 Woodley Rd., Santa Barbara,
CA 93108 (805) 969-6993

CIRCLE NO. 228 ON INQUIRY CARD

software

IBM-PC - PLOT-10

PC-PLOT-II is an intelligent emulation of the Tektronix Model 4010 graphics terminal which runs on the IBM-PC. The program allows display and creation of picture files when connected to a host computer running PLOT-10 (tm) or compatible software. The user may save picture data files on a local diskette as they are received from the host. The program also includes local printer control, and a serial line debug mode. Utility programs included allow the drawing of a local picture data file on the screen, plotting it on a HP Model 7470A pen plotter, printing on a local printer, and scaling. VISA, MasterCard, checks, PO's accepted. \$75.00

MicroPlot Systems Co.
1897 Red Fern Dr.
Columbus, Ohio 43229
614-882-4786 Telex 62186730

CIRCLE NO. 229 ON INQUIRY CARD

software

Floppy Disk Conversions

We can convert 55 different formats
on 5 1/4-inch or 8-inch disks.

Program Automation Inc.
385 Main St.
Metuchen, NJ 08840
(201) 494-3330

CIRCLE NO. 231 ON INQUIRY CARD

MicroPERT®

**Project Management
for Tektronix, IBM PC, XT**

For information, call or write
SHEPPARD SOFTWARE COMPANY
4750 Clough Creek Rd.
Redding, CA 96002
(916) 222-1553

CIRCLE NO. 232 ON INQUIRY CARD

real-time systems

MAGNAFLUX SOFTWARE SYSTEMS

*Microprocessor-based solutions for
industry*

—instrumentation, data acquisition; —scientific programming; —communications programming; —controllers

MAGNAFLUX Software Systems (212)
937-6930 38-07 Hunters Point Ave.,
L.I.C., NY 11101

A division of MAGNAFLUX Corporation.

CIRCLE NO. 233 ON INQUIRY CARD

CLASSIFIED ADVERTISING ORDER FORM

Mini-Micro Systems classifieds reach more mini-micro people

Rates: \$80.00 per column inch (non-commissionable)
6x program earns 5% discount; 12x program earns 10% discount.

There is no charge for typesetting classified listings. Plan approximately 50 average words to a column inch, 8 lines of approximately 38 characters per line (3 inch maximum). Please send clean typewritten (double-spaced) copy.

Category: The following categories are available; be sure to specify the category you wish to be listed under: Business Opportunities, New Literature, Selling, Buying, Trading, Seminars, Services, Software, Supplies & Accessories. (Other categories may be employed at our discretion.)

Run this ad in _____ (number issues) Reader Inquiry No. YES NO
Ad size 1 col. wide by _____ inches deep Under _____ (category)
Check enclosed for \$ _____ (Pre-paid orders only)

Signature _____

Name _____ Title _____

Company _____ Telephone No. _____

Address _____

City _____ State _____ Zip _____

**MAIL TO: Linda L. Lovett, Classified Advertising, Mini-Micro Systems,
221 Columbus Ave., Boston, MA 02116**

Mini-Micro MARKETPLACE

A special section for advertisers of hardware, software and services.

READERS: Please circle reader service numbers for additional information.

DESIGN MASTER

Complete Color CAD
Graphics S-100 System



Only \$12,500 (8 bit version - \$9995)

Features:

DMP 41 Plotter	Choice of Terminal
Auto CAD Software	Concurrent CP/M 86
8/16 Dual Processor	GDL A-1000 Controller
256K Memory	Hi-Res RGB Monitor
10M Hard Disk	10 Slot S-100 Frame
512x480 Resolution	8" D.S., D.D. Disk

Total Access Systems, 2054 University Ave.,
Suite 200, Berkeley, CA 94704

415-540-8066

CIRCLE NO. 200 ON INQUIRY CARD

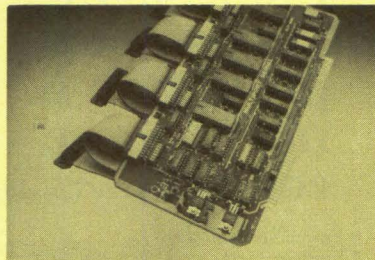

Multi-Port Serial Card for S-100
(IEEE-696) Systems

Designers who need an IEEE-696 serial interface card have a choice of either 2 or 4 ports with the Multi-Port Serial Card. Each port can operate as either a "data set" or as a "data terminal." Independent baud rate generators for each port (50 - 19.2k baud) and an 8-level vectored interrupt controller are provided. 36" cables are included.

Single Qty: \$280.00 (4-port), \$210.00 (2-port).

Call: 1-800-426-8936

Dealer and OEM inquiries are invited.
Seattle Computer Products, Inc.
1114 Industry Dr., Seattle, WA 98033

CIRCLE NO. 201 ON INQUIRY CARD

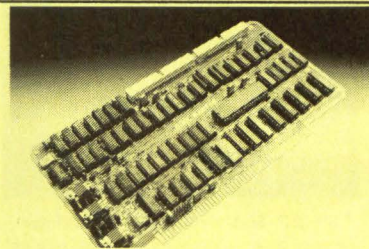

Floppy Disk Controller for S-100
(IEEE-696) Systems

Disk Master™ by Seattle Computer controls as many as four 8" and four 5.25" floppy disk drives simultaneously, in any combination. It can be configured for virtually any floppy disk drive on the market. The Disk Master based on the 1793 disk controller chip. It is fully IEEE-696 compatible and can be used with CPU's operating to 10MHz.

Single Qty: \$325.00

Call: 1-800-426-8936

Dealer and OEM inquiries are invited.

Seattle Computer Products, Inc.
1114 Industry Drive
Seattle, Wa 98033

CIRCLE NO. 202 ON INQUIRY CARD

PERIPHERALS

Specialists in everything in computers and peripherals. Aside from the Main Frames, we are good at:

- CRT Displays • Disk Drives
 - Printers • Key Boards
 - Power Supplies
 - I/O Expansion Kits
 - PROM Programmers/Eraser
 - Connector Assemblies
 - Board Computers
 - Microprocessors
 - ICs • LSIs • Semiconductors
- ETC.

When inquiring, please specify your requirements in details.

KAI SHOJI CORP.

Shibuya, P.O. Box 166
Shibuya ku, Tokyo 150, JAPAN Telex: J28551 KAIHSOJI

CIRCLE NO. 203 ON INQUIRY CARD



ADVANCED COMPUTER SYSTEMS: THE RSX-11M+ SPECIALISTS

ANNOUNCES THE ARRIVAL
OF THE LSI-11/73 BASED
CM-300/Q22 COMPUTER
SYSTEMS WITH RSX-11M+

CM-300/Q22 computer systems can now be configured with DEC'S NEW KDJ11 LSI-11/73 CPU, giving these systems 11/70 PERFORMANCE AT LSI-11 PRICES. CM-300/Q22 systems can be configured with up to 1200MB of fixed Winchester disk, up to 4MB of main memory and up to 32 terminals. System back-up is provided by an industry standard 9 track 1/2" 1600 BPI microstreamer tape drive or a DEC RL02. Optional software packages include accounts receivable/payable, payroll, general ledger, order entry, mailing list, FORTRAN 77, FMS-11 and BASIC +2.

An LSI-11/73 based 300MB system including RSX-11M+ license, media and documentation, with a VT101 terminal may be purchased for under \$26,000.

Call A.C.S. and let us configure a hardware/software solution for your specific problems.



250 Prospect Street
Waltham, Massachusetts 02154
617-894-3278

CIRCLE NO. 204 ON INQUIRY CARD

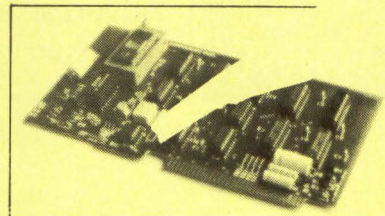

APPARAT PROM BLASTER FOR THE TRS-80, APPLE, OR IBM PC

Apparat's Prom Blasting system (A.P.B.) will program most 24-pin EPROM's, including the Motorola 64K device (68764). The package comes complete with interface card, a complete set of personality modules, software on disk and a detailed instruction manual. The cost of the A.P.B. system is \$119 (\$129 for the IBM). TRS-80 versions may require the Apparat Bus-Extender at \$69.95, or a user-supplied power supply and cable.

For details on the A.P.B. system, contact Apparat, Inc., located at 4401 S. Tamarac Parkway, Denver, Colorado 80237, or call Apparat's technical/service department at 303-741-1778.

CIRCLE NO. 205 ON INQUIRY CARD

NEW!

PROM PROGRAMMER FOR THE MULTIBUS

The I.E.E.E. 796 Version of the well known Promblaster™. This board programs 1K x 8 to 32 x 8 eeproms: 2508, 2716, 2732, 2732A, 2763, 2764, 2764A, 27128, 27256

- Function as an I/O device
- Uses fast programming algorithm on 2764's and up

Software: Written in C, and menu-driven. Contact:

ADS Ackerman Digital Systems
216 West Stone Ct., Villa Park, IL 60181
(312) 530-8992

CIRCLE NO. 206 ON INQUIRY CARD

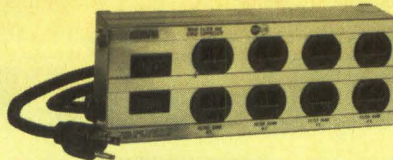

ISOBAR...cleans up your line power! The most complete computer protection available!

More features to prevent errors, false print-out, disc skips! *Only IsoBar has 3-way spike protection, noise suppression for RFI plus isolated filter banks!* Prevents components in your system from interfering with each other and erratic line power from damaging the system!

Models \$55 to \$98. Free brochure.

Call 1-312-642-6871 or write:

INDUS-TOOL, Dept. BT
325 W. Huron, Chicago, IL 60610

CIRCLE NO. 207 ON INQUIRY CARD

COMPLETE 68000 DEVELOPMENT TOOLS FOR VAX/VMS*

- MOTOROLA PASCAL → 68000 optimizing cross-compiler.....\$2995
- MOTOROLA 68000 relocatable cross-assembler.....\$ 995
- MOTOROLA cross-linker.....\$ 995
- VMS ↔ VERSADOS† file transfer.....\$ 395

All products run in VAX native mode. Developed in cooperation with Motorola for guaranteed EXORMACS/VERSADOS† compatibility.

*tm Digital Equipment Corp. †tm Motorola

octal

INCORPORATED

1951 Colony Street, Mountain View, CA 94043
(415) 962-8080 Telex: 172933

CIRCLE NO. 208 ON INQUIRY CARD



SP-2000 80 Column Industrial Printer

Featuring an extremely rugged cabinet and totally enclosed paper supply, this unit is designed for the shop floor and can withstand the oily atmospheres, dirt and wide temperature extremes which create problems for its office counterpart. Removable 19" RETMA rack ears allow this printer to be table top or rack mounted. Standard inputs are RS-232, 20 mA or XON XOFF. 115V/230V-50-400 HZ power input is standard.

Physical dimensions are 19" x 7" x 12" with rack ears installed. Price in single quantities is \$925.00. Delivery is 30-45 days ARO.

Syntest Corporation Tel-617-481-7827
40 Locke Dr. TWX 710 390 7659
Marlboro, MA 01742

CIRCLE NO. 209 ON INQUIRY CARD

Pioneers in microcomputer protection & interference control Free Catalog

- Power line isolators
- Spike/surge suppressors
- Power line filter/suppressors
- Twist type socket protection
- Line voltage regulators
- Line conditioners
- Modem protectors



Electronic Specialists

171 S. Main, Natick, MA 01760 (617) 655-1532
Toll Free Order Desk 1-800-225-4876

CIRCLE NO. 210 ON INQUIRY CARD

CROSS SOFTWARE FOR MICROPROCESSORS

COMPILERS — PASCAL & C
ASSEMBLERS & META-ASSEMBLERS
LINKING LOADERS — LIBRARIANS
INTERACTIVE SIMULATORS

- | | |
|----------------------------|-------------------|
| 8048 6800 1804 Z8 2650 | • Portable |
| 8051 6801 1805 Z80 F8 | |
| 8080 6802 1806 Z8002 3870 | • Affordable |
| 8085 6805 2900 9900 Others | |
| 8086 6809 2901 9940 | • Compatible |
| 8087 68000 6301 9989 | • Professional |
| 8088 1802 6500 99000 | • Source Licenses |

These programs written in Pascal and Fortran, will run on most mini and mainframe computers.

For more information, contact:

microTeC

505 W. Olive Ave., Suite 325
P.O. Box 60337
Sunnyvale, California 94086
Phone:(408) 733-2919 TLX: 4990808

CIRCLE NO. 211 ON INQUIRY CARD

ORDER FORM

Advertise in the MINI-MICRO MARKETPLACE

Please run my advertisement in the following issues

Please specify category:

- Software Hardware
- Literature Services
- Other _____

1983 RATES

1x	3x	6x	12x	18x
\$560	\$540	\$520	\$500	\$480

EFFECTIVE MARCH 1984

1x	3x	6x	12x	18x
\$630	\$570	\$550	\$535	\$520

MATERIALS

- Glossy photo with 50-75 words. We will typeset your ad at no charge.
- Camera ready artwork.
- Film negatives: right reading emulsion side down.

AD SIZE: 2 1/4" x 3 1/16"

COMPANY _____

ADDRESS _____

CITY _____

STATE _____

ZIP _____

TELEPHONE _____

SIGNATURE _____

Space reservation by the first week of the month proceeding issue date.

- Materials enclosed
- Materials to come
- Please send information

Send to: Lorraine Marden, **MINI-MICRO SYSTEMS**
221 Columbus Ave.
Boston, MA 02116

15% Agency commission to accredited agencies. Please specify agency.

PEOPLE



...A Key Element In Our Commitment To Quality In Telecommunications

By any standard of measurement, GTE is a large and successful company. We reached our present market position by our corporate commitment of "working together to be the best." Locating talented professionals whose ideas and expertise will keep us at the forefront is our quest.

Network Systems in Phoenix is involved in the development of hardware/software for advanced digital switching systems for telecommunications applications. From high speed, multi-processed switching to optical transmission, we're making significant advances. We invite you to bring your best to GTE.

SYSTEMS ENGINEERS/APPLIED RESEARCH

Play a key role in helping technology meet the challenges of R & D for voice/data communications and package switching. A BSCS/EE and experience in data communications networks or digital circuit design are required.

SYSTEMS TEST ENGINEERS

To write test plans for multi-processor, distributed processing telephone switching systems. A BSEE and 3 to 5 years of digital design or test experience on large scale systems are required. MSEE preferred.

SOFTWARE DEVELOPMENT ENGINEERS

To develop on-line software for call processing, diagnostics, maintenance and administration. BSEE or CS and high level language development of real-time software experience required.

HARDWARE DESIGN ENGINEERS

To design hardware systems for on-line, real time communications systems. BSEE, TTL logic design and telephony experience required.

For complete career details, please send your resume or letter outlining your qualifications to: GTE Network Systems, Manager Human Resources, Dept. 7315, 2500 W. Utopia Road, Phoenix, AZ 85027. An equal opportunity employer m/f/h.



Network Systems
Research and Development

Working Together To Be The Best
CIRCLE NO. 240 ON INQUIRY CARD

FORM FOLLOWS FUNCTION

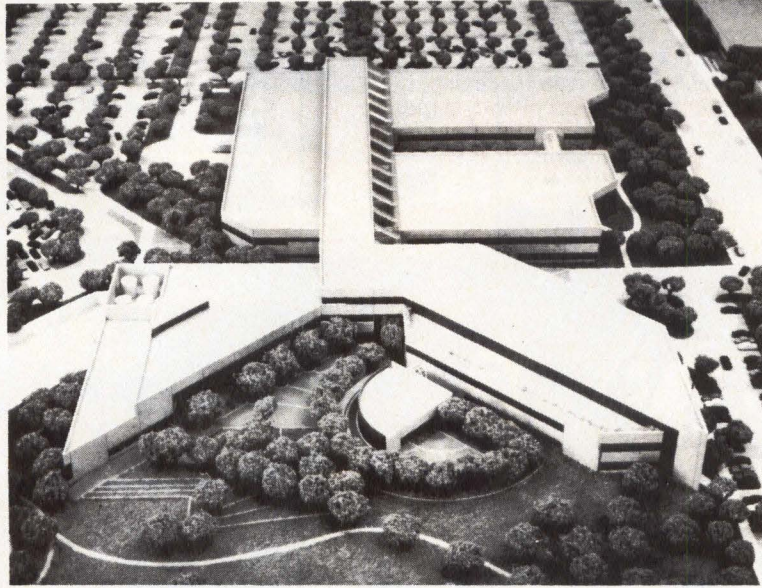

In 1980, Northrop Corporation's Electronics Division began the most challenging and comprehensive facilities expansion program in its history. In 1983, it is a reality. This has created an aesthetically dynamic and functionally superb building complex to meet the company's unparalleled growth.

Our new facility provides an ultra-advanced support and laboratory environment. That's important, because we're committed to people, and that means high visibility for employees, plus challenging opportunities in state-of-the-art electronics.

Discover the excellent salaries and benefits that await those chosen for Northrop Electronics Division. If you are an experienced professional with our commitment to excellence, consider these opportunities:

*Instrument & Control Engineers
Systems Test & Integration Engineers
Automated Test Equipment Engineers
Avionics/ATE Engineers
Component Design Engineers
Digital Engineers
Electromechanical Designers & Checkers
Test & Evaluation Engineers
Logic Design Engineers
Reliability/Components Engineers
Testing Engineers
CAD/CAM Engineers*

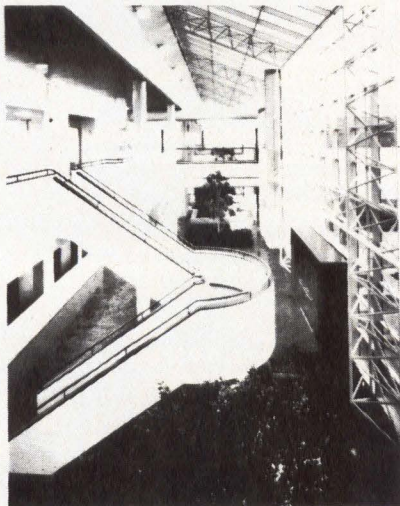

Clip and send the mini-resume and we'll get back to you A.S.A.P. Send it to:

Professional Employment
2301 W. 120th Street, N1/2027
Dept. MM1283
Hawthorne, CA 90250

U.S. CITIZENSHIP REQUIRED
Equal Opportunity Employer M/F/H

MINI-RESUME

Name _____

Address _____

City _____

State _____ Zip _____

Home Phone _____

Work Phone _____

The best time to reach me is _____

I'm currently with _____

My title is _____

Position desired _____

My skills are _____

ELECTRONICS DIVISION

NORTHROP

Making advanced technology work.

CIRCLE NO. 241 ON INQUIRY CARD

SYSTEM ENGINEER: M.S. in Systems Engineering or M.S. candidate with thesis. To develop the control systems, micro-processor, I/O drivers, communication protocols, controllers and interfacing application software to networks. Must have coursework in Simulation Optimization & Computational Methods, Control System Component Design & Advance Multivariable System. Must bring transcript to interview. \$1,950.00/mo., 40-hr/wk. Apply at the **Texas Employment Commission, Houston, Texas**, or send resume to the **Texas Employment Commission, TEC Building, Austin, Texas, 78778, Job Order #2511126**. Ad Paid by An Equal Employment Opportunity Employer.

Personal computer users:

FOR FREE ACCESS TO A BETTER JOB CALL CLEO.

(213) 618-8800 (408) 294-2000
(415) 482-1550 (714) 476-8800
(619) 224-8800
Standard ASCII code
Access assistance:
(213) 618-1525

CLEO

Computer Listings of Employment Opportunities

ENGINEERS

Choice positions available in New England and Nationwide.

UNIX & "C"
Mini/Micro Software
Test Engineers
Network Development
Logic Design
Graphics

All fees & expenses paid. Call or send resume to:

LARSEN PERSONNEL
1492 Highland Avenue
Needham, MA 02192
(617) 449-3840

Serving the high tech industries.

UNIX

National Registry
of UNIX job
openings and
UNIX Professionals
P.O. Box 19949
Dept. MMS
Houston, TX 77224
Please send resumes.



Scientific Placement, Inc.

MAKING A BOLD COMMITMENT

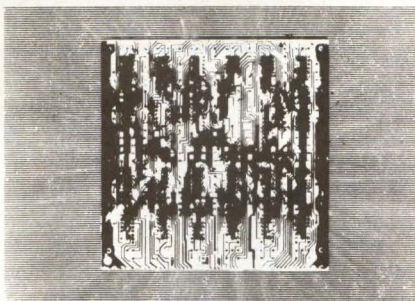

TO ADVANCED TECHNOLOGY

RCA ATL... You'll Be Hearing A Lot More About Us.

For years, ATL, a vital part of the Government Systems Division, has been a low profile, high technology R & D arm for RCA's development facilities, including renowned Princeton Labs. As a VHSIC II contractor, RCA ATL is well known for its contributions, and for its significant evolution of technology, in such areas as VLSI circuit technology, signal processing, microprocessor systems and electro-optics, to name a few. Our expanded role transcends virtually all RCA technical areas...our character is to identify new technologies from basic research through concept development and actual products. It's a highly visible entity, and you can be part of this growing custom-design center. Our current and on-going opportunities include:

- VLSI Design Engineers
- VLSI Architecture Engineers
- Artificial Intelligence technologists
- Image Processing Specialists
- Systems Engineers
- Software Engineers
- Robotic Vision and Sensor Specialists
- Millimeter Wave Integrated Circuits Specialists
- Digital Systems Engineers
- Signal Processing Specialists
- Staff Technical Advisors for Microwave Systems and Signal Processing

VLSI DESIGN ENGINEERS

We are especially interested in VLSI Design Engineers, at all levels, with a background in custom, semi-custom and standard cell designs.

You can learn the details, and more about the outstanding compensation program and professional growth, by sending your resume TODAY. RCA ATL, Front and Cooper Sts., Building 3-2M, Camden, N.J. 08102. We are an Equal Opportunity Employer.

RCA

Advanced Technology Laboratories

Where New Technology Begins

MICROPROCESSORS

We are currently recruiting for several of our client companies who have immediate opportunities for JUNIOR to SENIOR level professionals to develop microprocessor based hardware and software systems for commercial and defense applications. Requirements exist for Design, Development & Integration Engineers, Test Engineers, Software Engineers, Systems Engineers, Systems Programmers and Programmer Analysts for projects in the following areas:

- DIGITAL SWITCHING SYSTEMS
- C3 SYSTEMS
- COLOR GRAPHICS
- VOICE/DATA COMMUNICATIONS
- LOCAL AREA NETWORKS (LAN)
- ELECTRONIC WARFARE/SURVEILLANCE
- IMAGE STORAGE & RETRIEVAL
- PROCESS CONTROL SYSTEMS
- SECURE COMMUNICATIONS SYSTEMS

This is your opportunity to join growing companies in the forefront of state-of-the-art microprocessor based systems development. Our client companies offer excellent starting salaries (\$27,000-64,000), strong benefits packages, as well as, the opportunity for rapid advancement. TODAY send your resume or call:

(800) 336-3755

In VA. Call Collect (703) 790-1284

STAFFING CONSULTANTS

8027 Leesburg Pike Vienna, VA. 22180
Client Companies pay all fees

CIRCLE NO. 243 ON INQUIRY CARD

EMPLOYMENT SERVICE FOR PROGRAMMERS AND ANALYSTS

National Openings With Client Companies
and Through Affiliated Agencies

Scientific and commercial applications • Software development and systems programming • Telecommunications • Control systems • Computer engineering • Computer marketing and support.

Call or send resume or rough notes of objectives, salary, location restrictions, education and experience (including computers, models, operating systems and languages) to either one of our locations. Our client companies pay all of our fees. We guide; you decide.

RSVP SERVICES, Dept. MM
Suite 700, One Cherry Hill Mall
Cherry Hill, New Jersey 08002
(609) 667-4488

RSVP SERVICES, Dept. MM
Suite 211, Dublin Hall
1777 Walton Road
Blue Bell, Penna. 19422
(215) 629-0595

From outside New Jersey, call toll-free 800-222-0153

RSVP SERVICES

Employment Agents for Computer Professionals

CIRCLE NO. 244 ON INQUIRY CARD

How to become a SUCCESSFUL CONSULTANT in your own field.

Have you ever wished you could quit your job and start working for yourself?

Well, maybe you can! Many people are amazed when they discover the tremendous amount of professional experience and specialized knowledge they've accumulated — experience and knowledge that others will gladly pay for. Literally thousands of people who made that discovery are now prospering as **Independent consultants.**

The way to begin is by reading *How to Become a Successful Consultant in Your Own Field*, by Hubert Belmont.

Clear, straightforward, packed with solid information and advice, this authoritative manual tells you everything you need to know to establish your own independent consulting practice. Here's a sampling of the contents:

- What does it take to be a successful consultant? (See Chapter 1.)
- How to get started. (See Chapter 3.)
- How to operate your business — a collection of "tricks of the trade." (See Chapter 5.)
- What to charge your clients — plus five helpful rules on fees. (See Chapter 6.)
- Why you should **never** work on a contingency (speculative) basis. (See Chapter 7.)
- Ingenious ways to promote yourself — and make people want your services. (See Chapter 9.)
- Contracts: why you should **avoid** them at all costs. (See Chapter 10.)
- Just what do consultants do all day? (See Chapter 11.)
- How to market your ideas. (See Chapter 11.)
- Why you'll never have to worry about competition. (See Chapter 13.)
- And much more!

Perhaps no one is better qualified to have written this book than Hubert Belmont. He has served as consultant to more than 70 major corporations and trade associations, including the U. S. Chamber of Commerce, McGraw-Hill, the Electronic Industries Association, Evelyn Wood Reading Dynamics and the Smithsonian Institution. Yet he made the decision to become a consultant only after being fired from an executive position at the age of 43. You'll learn first-hand how he did it — and how **you** can do it, too!

How to Become a Successful Consultant in Your Own Field is just \$20 (tax-deductible if you use it for business purposes), and you're fully protected by this **unconditional money-back guarantee:** Keep the book for three weeks. If you're dissatisfied with it for any reason whatever, simply return it and **every penny of your \$20 will be promptly refunded** — no questions asked!

How many times have you told yourself that you're not getting anywhere — that it's time to think seriously about a major change in your career? **Don't put it off another day!** Clip and mail the coupon now!

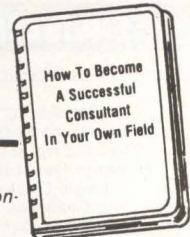

Enclosed is my check or money order for \$20. Rush me, postpaid, *How to Become a Successful Consultant in Your Own Field*, by Hubert Belmont. I understand that I have the right to return the book within three weeks for a complete refund if I'm in any way unhappy with it.

Name _____
Address _____
City _____ State _____ Zip _____

The Consultant's Library
Suite 1108
815 15th St., N.W.
Washington, D.C. 20005

More and more advertisers of minicomputers, microcomputers, CRT terminals, printers, disk drives, memories, modems, distributed data processing systems, etc., are consistently turning to **MINI-MICRO SYSTEMS.** Call **Peggy Gordon** at **203-964-0664.**

FUTURE!

SENIOR MANAGER SOFTWARE DEVELOPMENT

ISC Systems Corporation, the leader in microprocessor-based terminal systems for the banking industry (with over 1000 customers), is seeking a senior level manager to lead our new product development software team.

You must possess a combination of state-of-the-art technical, business and managerial skills along with a history of successful new software product introductions. You will work closely with executive management, marketing, and hardware engineering in a team environment. You must have the diplomacy and tact to accept new ideas, examine those ideas, and communicate your recommendations. Create and drive the development effort (languages, operating systems, development tools, database management systems, and networking in a microprocessor environment), as well as help keep other team members on track. Excellent project and people management skills, as well as the self-confidence to make good business decisions will be critical to your success.

You must have at least 10 years experience developing software in the mini- or micro-computer world. Microprocessor experience required. The salary is open for the right individual. If you are a perfect match for these requirements, please forward your resume to: **Bill Baumann**,

equal opportunity employer



**ISC SYSTEMS
CORPORATION**
P.O. Box TAF C-8
Spokane WA 99220
1-800-541-0570

CIRCLE NO. 245 ON INQUIRY CARD

HUGHES

SOFTWARE DESIGN ENGINEERS

Technology leader Hughes Aircraft Company in Tucson, Arizona, needs software professionals with experience in minicomputer and microprocessor applications, to handle specifications, design, coding, debugging, and documentation for special-purpose software systems, distributed systems, and system-level software for automatic test positions.

Proficiency in mini and microcomputer assembly language, digital hardware instrumentation, or real-time operating systems. BSCS or BSEE with 3 plus years of experience preferred.

Hughes offers competitive salaries and outstanding benefits.

For more information, please call (602) 295-8925, or send your resume to Cathleen Woodward, Hughes Aircraft Company, Employment Dept. MM-1, P.O. Box 11337, Tucson, AZ 85734.

Creating a new world with electronics

HUGHES

HUGHES AIRCRAFT COMPANY
Proof of U.S. Citizenship Required
Equal Opportunity Employer

MISSILE SYSTEMS—TUCSON

CIRCLE NO. 246 ON INQUIRY CARD

Computer Consultants Corner

Mini-Micro Systems

Circulation

Over 112,000 technically sophisticated professionals in computer operations/systems management, data communications, engineering management, systems engineering/integrators, educators and systems programming specialists.

To place your ad in **Mini-Micro Systems** call or write:

Peggy Gordon
Recruitment Manager
CAHNERS PUBLISHING CO.
999 Summer St.
P.O. Box 3809
Stamford, CT 06905
(203) 964-0664

MINI-MICRO SYSTEMS/January 1984

VAX/VMS ON-SITE COURSES

- Timeshare Users
- Real-Time Programmer

Mini & Micro Educ. Services
Walter Gallant
(800) 824-7888 Ext. M4573

CIRCLE NO. 247 ON INQUIRY CARD

6800/68000 Experts

- Microprocessor hardware and software design
- Industrial control specialists
- Hierarchical software design methodology
- Complete prototype facilities

CLIENTS INCLUDE: Sohio • Elgar • Schlumberger • Motorola • Gulf Oil • Carborundum • Renal Systems

CSA Computer System Associates
7562 Trade St., San Diego, CA 92121 (619) 566-3911

CIRCLE NO. 248 ON INQUIRY CARD

ELECTRICAL NOISE PROBLEMS SOLVED in Electronic Data Processing and Microprocessor Based Control Systems **CALL (814) 466-6559**

Dr. E. Thomas Chesworth, P.E.
Seven Mountains Scientific Inc.
Boalsburg, PA 16827

TKC • THE KEENAN CORPORATION

FCC 15J WE WROTE THE BOOK

"Digital Design for Interference Specifications"

- FCC/VDE & Static Retrofit and Testing
- "Front End" Design Guidance

R. Kenneth Keenan, Ph.D.

8609 66th Street North Pinellas Park, FL 33565
(813) 544-2594

CIRCLE NO. 249 ON INQUIRY CARD

Microprocessor-Based Product Development

BIT-SLICE • 8-BIT • 16-BIT
2901 • 6502 • 8080 • 8085 • 8086
8088 • Z80 • 68000 • LSI-11

**Data Acquisition • Graphics • Networks
Office Automation • Typesetting
Word Processing**

small system design 225A Lowell Road, Hudson, NH 03051
Telephone 603-880-1322

Taking ideas from conception to production.

CIRCLE NO. 250 ON INQUIRY CARD

CONTRACT SYSTEMS ENGINEER

- Bachelors: Chemical Engr.; Univ. of Wis.
- Masters: Industrial & Systems Engr.; Univ. of Fla.
- Advanced Graduate Record Exam: 95%
- 18 yrs. applying computers toward industrial process control
- Hour, Day, Week, Month Rates
- Anywhere, Anytime, Anything, Any-Language

Discuss with **BILL WEDEL**, 904-932-4315

CIRCLE NO. 251 ON INQUIRY CARD

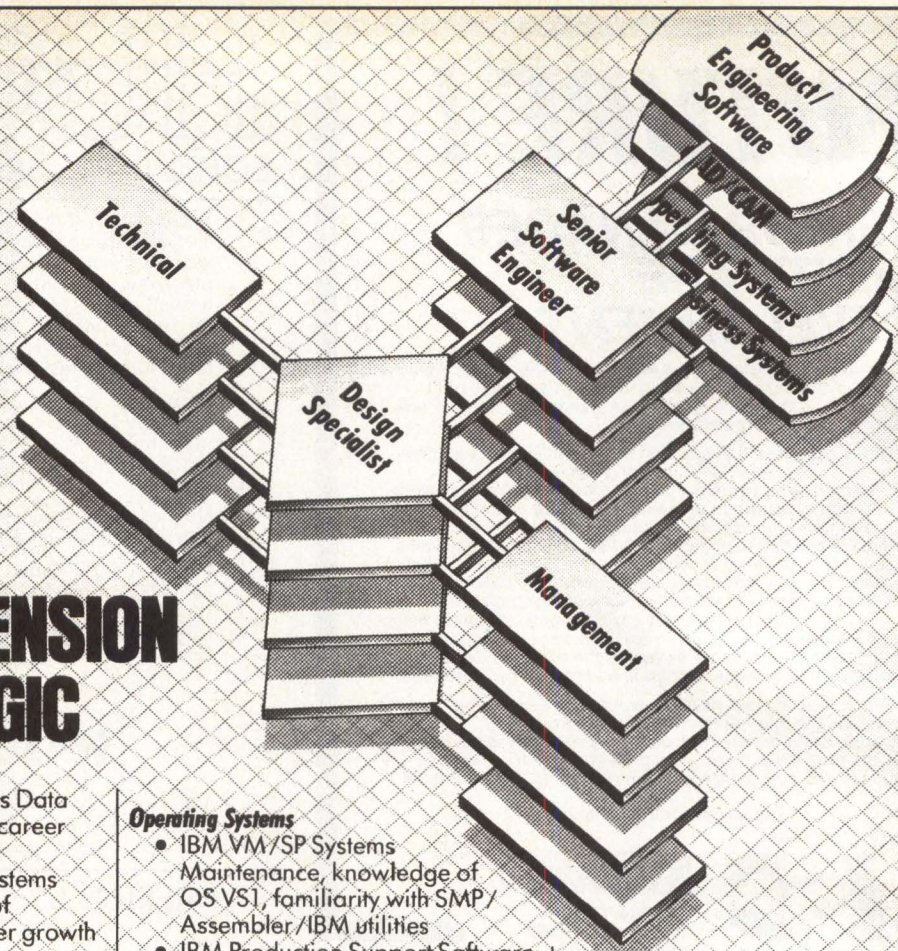

MULTIDIMENSION CAREER LOGIC

Coming to General Dynamics Data Systems Division is a logical career move because:

We provide skilled data systems professionals a wide range of opportunities for stable career growth and success.

We support the largest, multinational coproduction program in history... the F-16 Falcon, which means high visibility, diverse and challenging assignments and industry recognition — whether your career goals lead to technical specialization or management.

Software Engineers and Applications Programmers with a BS degree and at least 3 years' experience may find themselves working in one or more of the following areas:

Business Systems

- COBOL — Business Applications on IBM 3033, 3081, CDC CYBER, TANDEM or IBM 8100
- Database Management Systems, IMS DB/DC
- IBM Data Dictionary, VSAM, IMS Utilities, ADF, Database Design
- RAMIS, Model 204, other relational DBMS
- TSO, SPF, JCL

Operating Systems

- IBM VM/SP Systems Maintenance, knowledge of OS VSI, familiarity with SMP/Assembler/IBM utilities
- IBM Production Support Software: PAN*DA, RAMIS, ASM2, ABEND-AID, Disk Management
- CDC CYBER COMPASS Assembler and NOS-BE Systems Maintenance
- CDC CYBER NOS/BE System User Support using CDC FORTRAN, Interactive Systems
- VAX VMS Operating System Maintenance and Application Programming
- IBM, VAX Systems Configuration and Planning

Product/Engineering Software

- Scientific programming, real-time processing, graphics, digital signal or numerical analysis on DEC PDP 11 or VAX 11/780, Harris, IBM or CDC Mainframes
- Man-in-the-loop simulation applications using Digital/Analog/Array Processor Computer Systems
- C³ Systems, Ada Language Developments, Software Engineering Technology

- Modern and Classical Control Theory, Estimation Theory, Parameter Identification Methodology

CAD/CAM

- Knowledge of CADAM Internals
- COMPUTERVISION System Internals
- APT-AC Systems Software
- CAD/CAM Architecture

We offer a comprehensive benefits package which includes: competitive salaries, medical and dental insurance, savings/stock investment program, plus exclusive use of our fully equipped, 80-acre recreation facility and 18-hole, championship golf course.

If this is the kind of career logic that appeals to you, please send your resume to: **D.H. Huckaby, Division V.P./Director, Central Center, Data Systems Division, P.O. Box 748-044, Mail Zone 5300, Fort Worth, TX 76101.**

GENERAL DYNAMICS

Data Systems Division

An Equal Opportunity Employer, M/F, U.S. Citizenship Required

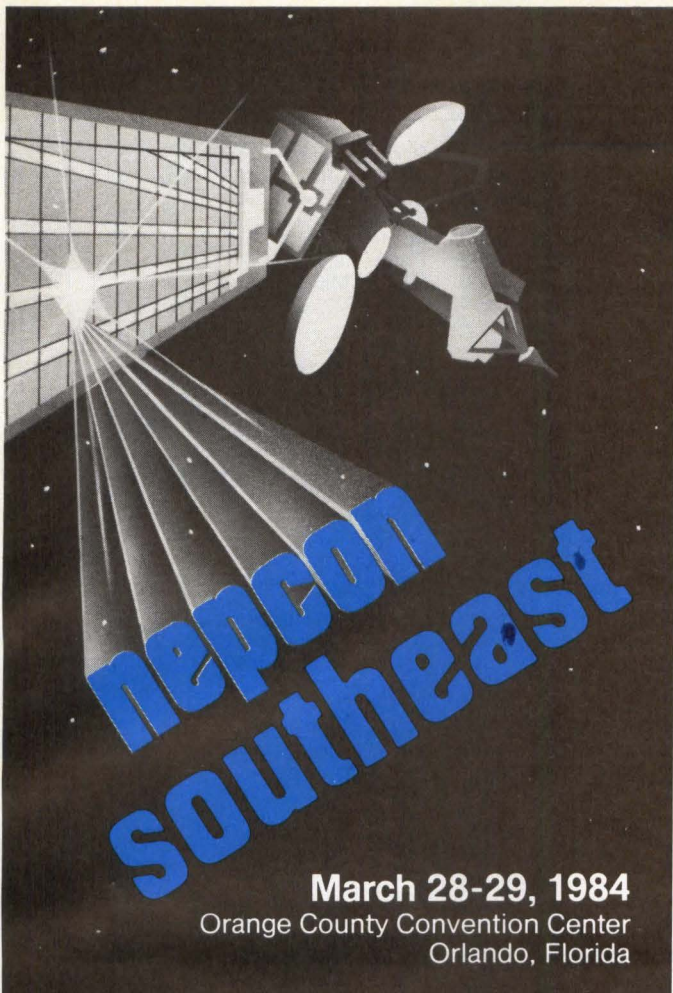

nepcon southeast

March 28-29, 1984

Orange County Convention Center
Orlando, Florida



National Electronic Packaging and Production Conference

nepcon southeast Conference/Exhibition	Packaging
	Production
	Testing

Organized by:



Cahners Plaza, 1350 E. Touhy Ave.
P.O. Box 5060, Des Plaines, IL 60018
(312) 299-9311 TLX 256148 CEGCGO DSP

ELECTRONICS ENGINEERS:

Down-to-earth manufacturing know-how...

...for production, assembly and testing of electronic products

Hundreds of Displays

- The industry's leading suppliers will bring their best production equipment, tools, hardware, materials and services to NEPCON Southeast '84
- **PLUS** state-of-the-art test systems, equipment and instruments will be displayed in a special section of the exhibit floor.

Don't miss this exclusive opportunity to see and compare products in the region's only showcase designed to help you increase productivity and improve the quality of your company's output.

Innovative Conference Program

—pinpoints cost-saving methods, new production ideas and assembly techniques to make your job easier!

- **12 Technical Sessions** cover CAD/CAM; PCB design, materials and manufacturing; soldering cleaning; surface mounting technology; testing; thermal control; static elimination . . . and more.
- **Professional Advancement Course.** 6 hours of concentrated instruction on "CAD/CAM for PCB Design."
- **Practical Workshop** shows you how to "Develop Test Strategy."

Make plans NOW to attend.

Free Admission to Exhibits.

Send coupon for details.

NEPCON Southeast '84, c/o Cahners Exposition Group, Cahners Plaza, 1350 E. Touhy Ave., P.O. Box 5060, Des Plaines, IL 60018

Please send me application for FREE ADMISSION to the exhibits; also include program details and exhibitor list.

Name _____

Title _____

Company _____

Address _____

City _____ State _____ Zip _____

Phone (____) _____ Telex _____

Make Copies of Coupon for Associates

Advertisers Index

Able Computer	243	Energy Methods	241	Peripherals Marketing	254
Advanced Digital Corp.	18	Epson America, Inc.	122, 281	Plexus Computers	226
Advanced Matrix Technology Inc.	70-71	ExpoConsul International	129-131	Practical Peripherals	191
AED Inc.	106-107	Fujitsu America Inc.	164	Primages	128
Amlyn Corp.	282	Fujitsu America Inc.-Printer Div.	183	Printek Corp.	179
Ampex Corp., Memory Products Div.	97	Gavilan Computer Corp.	182	Printronic Inc.	204-205
Apollo Computers	26-27	G.E. Genicom Corp.	200	Quality Micro Systems	119
Applied Data Communications (ADC)	147	General Automation	65	Qume	126-172, 156
Applitek	54	Genstar REI Sales	4	RCA	216
Archive Corp.	250-251	Gould Inc., S.E.L. Computer Systems Div.	5	Rodime	11
Atasi Corp.	28-29	Harbor Electronics	294	Rosscomp Corp.	194
Beehive International	148	HSC Inc.	289	Sage Computer Technology	142
C. Itoh Electronics	21	Heurikon Corp.	272	Scientific Micro Systems	239
Cadmus Computer Systems	145	Hewlett-Packard	114, 238	Seagate Technology	58-59, 230-231
Cahners Exposition Group	305	Hiac/Royco	218	Sensor-Based Systems	76
Cahners Publishing Co.	7	Houston Instrument Div. of Bausch & Lomb	105	Shugart Corp.	12-13
CalComp (California Computer Products)	222	Human Designed Systems Inc. (HDS)	37	Siemens Corp.	166
Callan Data Systems	188	IBC/Integrated Business Computers	263	Softcon	6
Cambridge Digital Systems (Div. of Compumart)	63	Ibex Computers Corp.	228	Spectra Logic	52
Carrol Touch Technology	270	Illbruck/USA	268	Standard Micro Systems 283, 285, 287, 289	
Centronics Data Computer Corp.	171	Infoscribe	66-67	Tandberg Data Inc.	53
Century Data System (a Xerox Co.)	275	Inmac	144	Tandon Corp.	8-9
Charles River Data Systems	206-207	Intecolor Corp., an Intelligent Systems Co.	271	TEAC Corp. of America	208
Chrislin Industries, Inc.	68	Intel Corp.	82-83, 180-181	Technical Systems Consultants	86
CIE Systems	51	Interface Group	242	TeleVideo Systems Inc.	220-221
CIE Terminals	14, 79	Intertec Data Systems Corp.	43	Texas Instruments Inc.	138-139
Cincom Systems	98-99	Invitational Computer Conferences	293	3R Computer Corp.	262, 288
Cipher Data Products, Inc.	132-133	Irwin Magnetics	116-117	Topaz Electronics Div.	232
Compaq Computer Corp.	1	Kennedy Co.	C2	TriData	110
Complex Systems Inc.	277	Lear Siegler Inc.	150-151	Ungermann-Bass	174-175
CompuPro	203	Liberty Electronics USA	141	Unify Corp.	187
Computer Storage Technology	196	Liebert Corp.	85	Unisoft Systems	80
Control Data Corp.—OEM	210	Macrolink	113	Universal Data Systems Inc.	69
Corona Data Systems	225	Marcsoftware International Inc.	73	U.S. Design Corp.	266
Cromenco Inc.	244-245	MDB Systems Inc.	163	U.S. Robotics	72
Custom Systems Inc.	269	Measurement Systems & Control	146	Verbatim Corp.	255
Dataproduct	40-41, 283, 285, 287	Megatek Corp.	124	Visual Technology Inc.	195
Dataram	30, 279	Method Systems Inc.	262	Western Digital	48, 57
Datasouth Computer Corp.	155	Micom Systems Inc.	C4	Western Peripherals Div. of Wespercorp	C3
Data Systems Design Inc.	22	Microscience International	209	Western Telematic, Inc.	172
Davong Systems	25	Mini-Micro Systems	240, 264, 273, 291	Westrex OEM Products	184
Diablog Systems Inc. (A Xerox Co.)	219	MPI (Utah)	294, 295	Wicat Systems Inc.	44-45
Digi-Data Corp.	162	NCR Corp.	89-96	Wyse Technology	84, 265
Digital Associates	215	NCR, OEM Marketing Div.	192-193	Xylogics, Inc.	134
Dilog (Distributed Logic Corp.)	219	New Media Graphics	228	Zilog Inc.	199
Direct Inc.	108-109	Northern Telecom	169, 176		
DMA Systems	260-261	Nova Graphics International Corp.	17		
Dual Systems	74-75	Okidata Corp.	161		
Dysan Corp.	123, 229, 236				
Emulex Corp.	47, 256-257				

This index is provided as an additional service. The publisher does not assume any liability for errors or omissions.

REGIONAL SALES OFFICES

BOSTON

Robert K. Singer
National Sales Manager

Norma E. Lindahl
Assistant To The National Sales
Manager

John J. Fahey
Eastern Regional Manager
221 Columbus Ave.
Boston, MA 02116
(617) 536-7780

PHILADELPHIA

Richard W. Molden
Regional Manager
999 Old Eagle School Rd.
Wayne, PA 19087
(215) 293-1212

CHICAGO

Robert D. Wentz
Regional Manager
Cahners Plaza
1350 E. Touhy Ave.
P.O. Box 5080
Des Plaines, IL 60018
(312) 635-8800

DALLAS

Don Ward, Regional Manager
13740 Midway Suite 515
Dallas, TX 75234
(214) 980-0318

DENVER

John Huff, Regional Manager
270 St. Paul St.
Denver, CO 80206
(303) 388-4511

LOS ANGELES

Len Ganz
Regional Manager
12233 West Olympic Blvd.
Los Angeles, CA 90064
(213) 826-5818

ORANGE COUNTY

Debra Huisken, Regional Manager
2041 Business Center Drive
Suite 109 Irvine, CA 92715
(714) 851-9422

SAN FRANCISCO

Frank Barbagallo
Regional Manager
Rick Jamison, Regional Manager
Sherman Building, Suite 1000
3031 Tisch Way
San Jose, CA 95128
(408) 243-8838

AUSTRIA

Elan Marketing Group
Neutor g. 2
P.O. Box 84
1010 Vienna, Austria
Tel: 43-222-663012 or -638461

ISRAEL

Elan Marketing Group
13 Haifa St., P.O. Box 33439
Tel Aviv, Israel
Tel: 972-3-252967 or -268020 Telex: 341667

JAPAN

Tomoyuki Inatsuki
General Manager
Trade Media Japan Inc.
R. 212 Azabu Heights
1-5-10 Roppongi Minato-ku,
Tokyo 106 Japan
Tel: (03) 587-0581

SWEDEN

Elan Marketing Group
Humlegardsgatan Nr. 5
11446 Stockholm, Sweden
Tel: 46-8-677243 or -676243

WEST GERMANY

Elan Marketing Group
Sudring 53
7240 Norb/Neckar, West Germany
Tel: 49-7451-7828

U.K.-BENELUX

Elan Marketing Group
World Trade Center for Electronics
Pastoor Peter Str. 34, P.O. Box 2085
5600CB Eindhoven, Netherlands
Tel: 31-40-442575

Career Opportunities

Peggy Gordon
Recruitment Advertising Manager
999 Summer Street P.O. Box 3809
Stamford, CT 06905
(203) 964-0664

Cahners Magazine Division

J.A. Sheehan, President
William Platt, Executive Vice President
Tom Dellamaria, VP/Production and
Manufacturing

Circulation

Denver, CO:
(303) 388-4511
Earl Mosley, Group Manager
Barbara Pike, Manager

from out of the West...

TAPE DIMENSION III

DEC COMPATIBLE CONTROLLERS

Tape Dimension III is the only buffered tri-density (GCR/PE/NRZI) TS-II™-emulating controller on the market. The combination of its unique asynchronous handshake design and 64K byte buffer enables it to take full advantage of bus speeds without the risk of causing data late conditions in other bus transfer operations. It makes Tape Dimension III particularly adaptable to systems with high speed disk drives.

The 64K byte buffer provides total immunity to data late conditions, even at high-speed data rates on a highly populated peripheral bus. In fact, Tape Dimension III actually has greater capability than the TS-II!

Tape Dimension III is completely software-transparent to the VAX™ and PDP-II™ Unibus environment including diagnostics in VMS.

The Tape Dimension III controller supports up to four dual-density (Pertec compatible) drives or four tri-density (STC or TELEX type) drives. It is a single embedded hex PC board that fits into any standard SPC slot.

This new dimension in tape transfer dramatically reduces the ratio of protocol to information data. And tremendously increases the efficiency of Unibus utilization. Find out how much it can improve your system throughput. Call or write today for complete information. WESTERN PERIPHERALS, Div. of WESPERCORP, 14321 New Myford Rd., Tustin, CA 92680, Tel: (714) 730-6250, Cable WESPER, TWX 910-595-1775, Telex 472 0629. Wesper International GmbH, Tel: 089 982420. Wesper International (U.K.), Tel: (44) 0276-20934.

TS-II, VAX and PDP-11 are trademarks of Digital Equipment Corporation.



western peripherals

Division of **WESPERCORP**

CIRCLE NO. 2 ON INQUIRY CARD

STOP!

Don't put in more lines for your terminals.

Put more on the lines you already have.

Are you installing new terminals faster than you can string new communications lines for them? Don't bother to put in more lines. Chances are that your existing wires can carry several times as much data as they do now — with a little help.

The INSTAMUX470, one of the components of MICOM's INSTANET™ "instant" local network, can give them the help they need by providing:

Local Multiplexing

of up to eight asynchronous terminals on the same double twisted-pairs of wires conventionally used to support only a single terminal or telephone.

Data Rates to 19,200 bps

Each terminal operates as if it has its own dedicated 19,200 bps line to the computer or data PABX, and all terminals can operate simultaneously — without interference.

Integral Line Driver

To eliminate the need for modems or line drivers for each individual terminal.

No Transmission Delay

Unlike regular multiplexors, the INSTAMUX is designed *specifically* for in-house use. As a result, it doesn't introduce transmission delays of any kind, and the multiplexed system's response "feels" the same to the terminal operator.

And for users of MICOM's INSTANET Local Networks, there's still another advantage: INSTAMUX is available as an integral plug-in module for the Micro600 Data PABX.

What's more, INSTAMUX costs less — *much* less — than the line drivers you'd need if each terminal had its own set of wires.

Don't get strung out. Call or send today for literature describing the INSTAMUX470 and its applications.



Faced with stringing miles of wire for new terminal clusters?



INSTAMUX™ brings speedy relief from that local networking headache.

MICOM® *MicroComputers for DataCommunications™*

MICOM SYSTEMS, Inc. • 20151 Nordhoff Street • Chatsworth, CA 91311 • Telephone (213) 998-8844 • TWX 910/494-4910
Regional Sales/Service • Atlanta, GA • (404) 435-2999 • Boston, MA • (617) 527-4010 • Chicago, IL • (312) 789-2430
Dallas, TX • (214) 258-0774 • St. Louis, MO • (314) 576-7626 • Teaneck, NJ • (201) 836-4000
MICOM-BORER Ltd. • Bel Court • 15 Cradock Road • Reading, Berkshire RG20JT, England • (0734) 866801 • Telex 847135

Available *now* from these stocking reps...

AK: Anchorage (907) 561-1776 / Juneau (907) 789-4101 • AL: (800) 327-6600 • AR: (214) 620-1551 • AZ: (602) 994-5400 • CA: Anaheim (714) 635-7600 / Lodi (209) 334-1961 / San Diego (619) 565-1557 / San Jose (408) 298-7290 • CO: Colorado Springs (303) 594-0880 / Denver (303) 777-8070 • CT: (617) 235-5520 • DE: (609) 779-0200
FL: (800) 432-4480 • GA: (800) 327-6600 • HI: (808) 537-9758 • IA: (402) 895-5850 • ID: (801) 466-6522 • IL: (312) 255-4820 • IN: (317) 846-2591 • KS: (816) 252-3700
KY: (502) 228-5401 • LA: (800) 327-6600 • MA: (617) 235-5520 • MD: (301) 261-4344 • ME: (617) 235-5520 • MI: (313) 588-2300 • MN: (612) 425-4455 • MO: Independence (816) 252-3700 / St. Louis (314) 721-0401 • MS: (800) 327-6600 • MT: (801) 466-6522 • NC: (800) 327-6600 • ND: (612) 425-4455 • NE: (402) 895-5850 • NH: (617) 235-5520
NJ: North (201) 569-2353 / South (609) 779-0200 • NM: Albuquerque (505) 292-1212 / Las Cruces (505) 524-9693 • NV: (714) 635-7600 • NY: Albany (518) 459-5891 / Buffalo (716) 662-4568 / New York City (201) 569-2353 / Rochester (716) 442-5631 / Syracuse (315) 638-2042 • OH: Cleveland (216) 524-5930 / Dayton (513) 434-7500
OK: (405) 478-5000 • OR: (503) 224-3145 • PA: East (609) 779-0200 / West (412) 892-2953 • RI: (617) 235-5520 • SC: (800) 327-6600 • SD: (612) 425-4455
TN: (800) 327-6600 • TX: Dallas (214) 620-1551 / Austin (512) 327-8600 / El Paso (915) 542-1762 / Houston (713) 353-7728 • UT: (801) 466-6522 • VA: (301) 261-4344
VT: (617) 235-5520 • WA: (206) 454-2383 • WI: (414) 784-9379 • WV: East (301) 261-4344 / West (412) 892-2953 • WY: (303) 777-8070 • Washington, DC: (301) 261-4344
Puerto Rico: (809) 723-9689

CIRCLE NO. 3 ON INQUIRY CARD