

JULY 22, 1976

WHY 'STANDARD' 16-KILOBIT RAMS AREN'T INTERCHANGEABLE/75

IEEE election: where the candidates stand on the issues/78

Technology update: bar-graph displays/114

FOUR DOLLARS A MCGRAW-HILL PUBLICATION

Electronics®

Hybrid circuits and components

LIBRARY
STATE TECHNICAL INSTITUTE
AT MEMPHIS

**SPECIAL
REPORT**

1470 168298 MURRAY SEP 70
STATE TECHNICAL INST
FREEMAN LIBRARY 017823
5983 MACON COVE
MEMPHIS TN

36134



The snap action switch

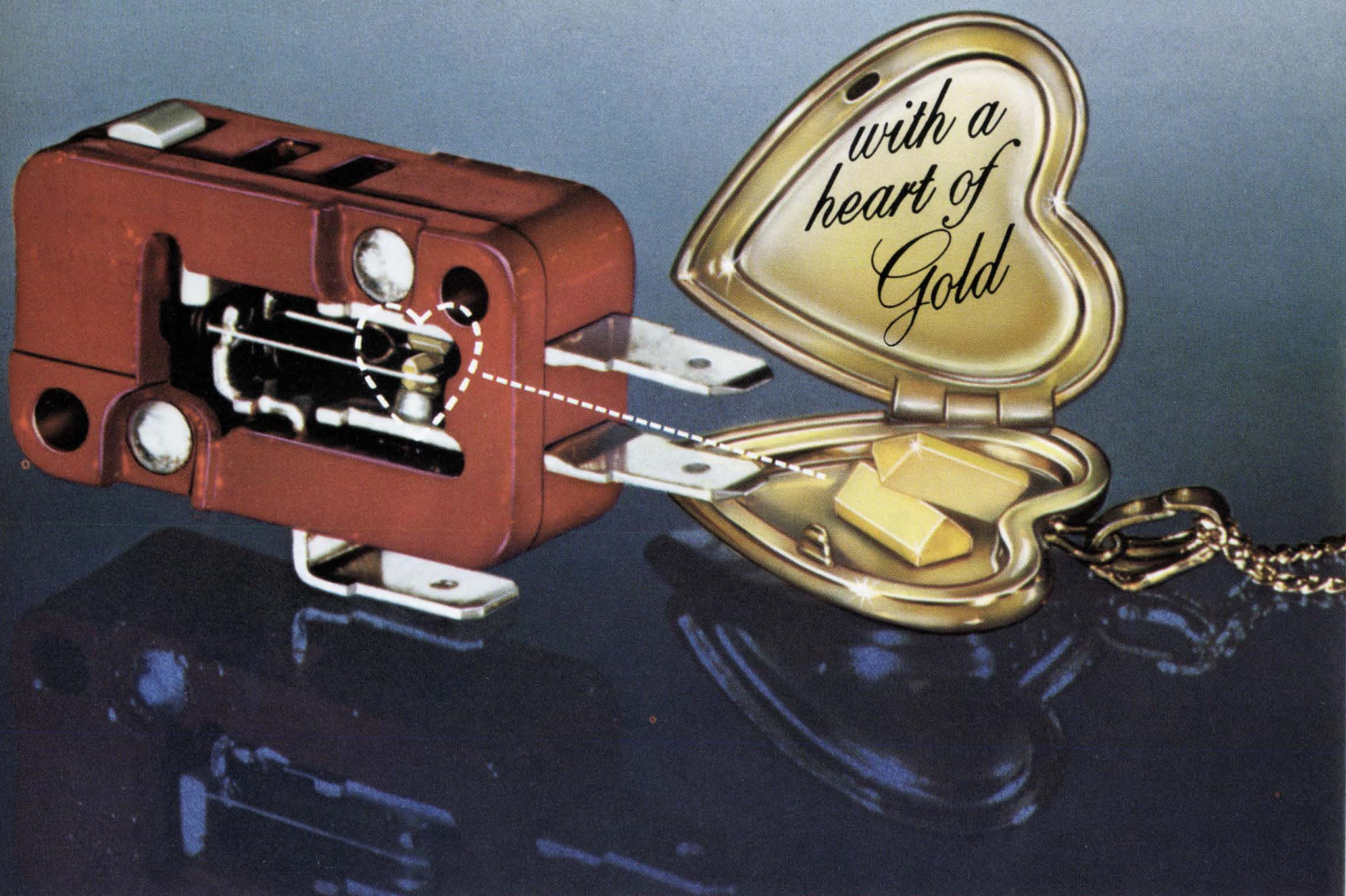

...for **POSITIVE** switching in low energy circuits

Now your 4 to 100 milliamper, 4 to 30 volt circuits can have the same high reliability you've learned to love in Cherry snap action switches. Because, our "heart of gold" snap action switches have the same long life coil spring mechanism, the same large overtravel as all of our snap action switches.

They also have gold crosspoint contacts. A configuration with knife-edge contact area so small (9 millionths of a square inch)... with contact force so great (about 5,000 psi)... and gold alloy so pure and film-free... you are absolutely assured of positive contact every time. For 50 million operations and beyond.

Cherry Gold Crosspoint Contact Switches are available in virtually every snap action design in

Cherry's big catalog. And you *know* what a wide variety of switch types, sizes and mounts *that* is. Choose any switch design from a basic open or general purpose to a panel mount pushbutton, low torque, miniature, subminiature or subminiature module. Chances are 99 to 1 that the switch you have chosen is available with gold crosspoint contacts. Which will make designing low energy circuits a whole lot easier... and a whole lot *better*. (No love letters, please.)

For free test sample and complete catalog, just TWX 910-235-1572... or PHONE 312-689-7700.

CHERRY



Cherry switches now available locally from distributors.

CHERRY ELECTRICAL PRODUCTS CORP., 3608 Sunset Avenue, Waukegan, IL 60085

Circle 900 readers service card

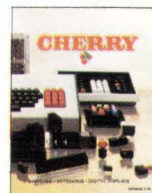
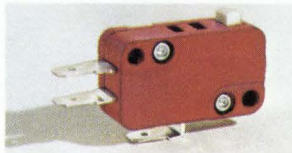

We not only wrote the book,

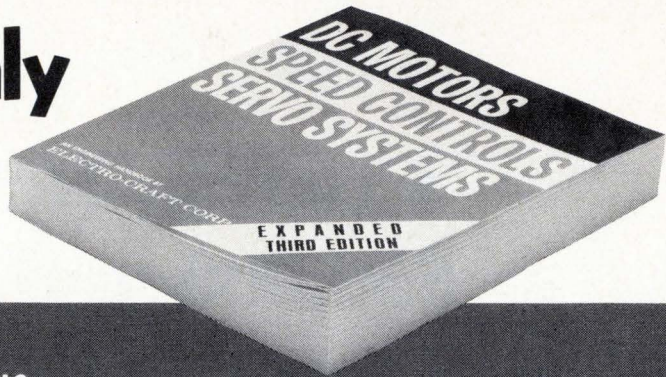

SPEED CONTROLS

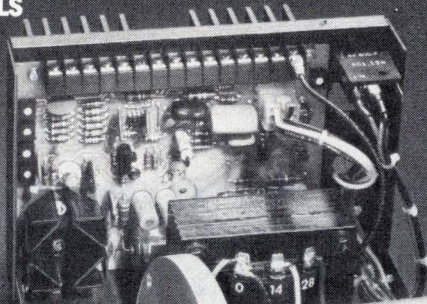

DC MOTORS

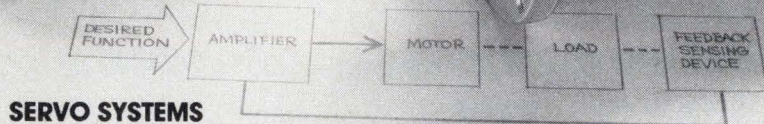
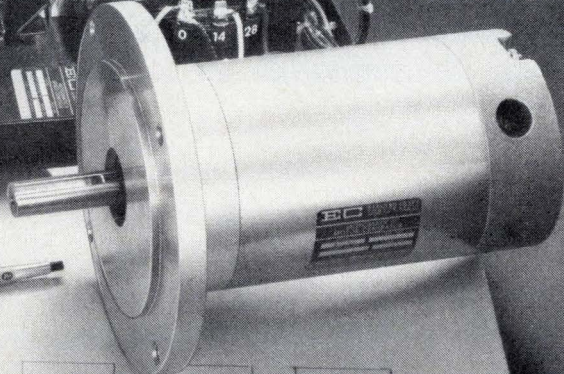

SERVO SYSTEMS

we make the products, too.

The "bible" of the industry. Over 35,000 now out in use. In its third edition. And Electro-Craft wrote the book.

That's expertise. And our products reflect it. Over 100 different products. And 300 different applications that we know of for sure. We stake our reputation on every product. A reputation earned by 16 years of innovation, reliability and integrity. That's a lot of years of experience in a

young dynamic industry like ours.

You can put this expertise to work for you. In custom designs or off-the-shelf standards. One unit or thousands. You get our service both ways. Just give us a call at (612) 935-8226.

If by chance you don't have the Electro-Craft Handbook shown here, a \$10.00 value, just send us your business card and \$1.00 to cover handling and postage.



ELECTRO-CRAFT CORPORATION

1600 Second Street South, Hopkins, Minn. 55343 • Tel. (612) 935-8226

**Custom IC's cost
\$50,000 and take a
year to develop.**

BALDERDASH!

With Interdesign's simple yet elegant approach, you can get your circuit integrated for \$1,800 in three weeks. No headaches.

Reduce production costs. Shrink size. Increase reliability. Protect your design from nosey competitors.

Production quantities from 1,000 to 100,000 or more in eight weeks.

Do you want to know more?

**Call 800/538-1730 toll-free
for our brochure.**

In California call 408/734-8666

interdesign
THE REAL CUSTOM IC HOUSE

1255 REAMWOOD AVENUE
SUNNYVALE, CALIFORNIA 94086

41 Electronics Review

PHOTOVOLTAICS: New solar-cell approach makes headway, 41
CONSUMER: Color-TV imports spur U.S. defense, 42
OPTOELECTRONICS: Bell encouraged by fiber tests, 43
SOLID STATE: Bi-FET yields sample-and-hold IC, 44
INSTRUMENTS: Card tester clips onto IC, 46
INDUSTRIAL: Neutrons help dope thyristor silicon, 48
COMPUTERS: Sanders puts chips on IBM technique, 48
NEWS BRIEFS: 48
COMPONENTS: F-14 radar need spawns hi-rel capacitors, 50

63 Electronics International

ITALY: Gas laser cuts ceramic substrates in curves, 3E
AROUND THE WORLD: 63

75 Probing the News

MEMORIES: 16-k RAMs still less than standard, 75
YOU AND YOUR CAREER: Who will manage the IEEE's changes? 78
ELECTRONICS ABROAD: Automated road-safety signs studied, 82
COMPANIES: Amphenol picks up the pieces, 87
Thomson-CSF deals from strength, 88

91 Technical Articles

SPECIAL REPORT: Hybrid-circuit technology keeps rolling, 91
DESIGNER'S CASEBOOK: Gates and inverter synchronize signal, 110
Frequency-doubler produces square-wave output, 111
TECHNOLOGY UPDATE: Electronic bar graphs compare at a glance, 114
ENGINEER'S NOTEBOOK: Precision sample-and-hold stores voltage, 120
TTL logic tester displays *H* or *L*, 121
Quick calculation gives filter-capacitor value, 121
Pre-emphasizer speeds fm-tuner measurements, 122

126 New Products

IN THE SPOTLIGHT: Bipolar bit slices advance fast, 126
MICROPROCESSORS: 8080 emerges as top device, 128
SEMICONDUCTORS: National unveils automotive ICs, 135
MICROWAVES: HP adds more assemblies, 140
MATERIALS: Dry plating catalyst is acid-free, 149
INDUSTRIAL: Electronic brake stops motors fast, 158

Departments

Publisher's letter, 4
Readers' comments, 6
News update, 8
Editorial, 10
People, 14
Meetings, 30
Electronics newsletter, 35
Washington newsletter, 57
Washington commentary, 58
International newsletter, 65
Engineer's newsletter, 124
New literature, 168
New books, 175

Highlights

The hearty hybrids, 91

Instead of wilting before the advance of monolithic technology, hybrid circuits are going commercial in great numbers.

Part 1 of this special

report covers the latest processes and materials, and Part 2 describes the rise of chip components. Shown on the cover are a d-a converter chip (a), several multilayer nonceramic substrates (b), some thick-film instrumentation amplifiers (c), and an active thin-film circuit on a silicon substrate (d).

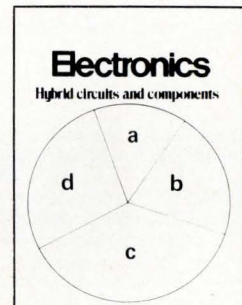

16-pin 16-kilobit RAMs are still nonstandard, 75

Despite agreement on the 16-pin layout, manufacturers of 16,384-bit semiconductor random-access memories are still being distinctly individualistic when it comes to implementing each pin's functions. Users, less than happy with the situation, are hesitating to switch over to the device.

Election will determine IEEE's rate of change, 78

Whichever of the three candidates becomes president and whether or not the constitutional amendments pass, changes at the Institute of Electrical and Electronics Engineers are inevitable. The questions actually at issue are: how much, and how soon?

Bar-graph displays enlighten at a glance, 114

Columns of light-emitting diodes or other light sources present meter readings with digital accuracy and analog lucidity. This special report surveys the variety of displays now available.

And in the next issue . . .

Special report on optical communications: sources, fibers, and detectors, coupling, splices, and connectors.

EDITOR-IN-CHIEF: Kemp Anderson

EXECUTIVE EDITOR: Samuel Weber

MANAGING EDITOR: Arthur Erikson,
International

SENIOR EDITORS: Laurence Altman,
Ray Connolly, Lawrence Curran,
John Johnsrud, H. Thomas Maguire,
Stephen E. Scrupski

ART DIRECTOR: Fred Sklenar

ASSOCIATE EDITORS: Howard Wolff,
Gerald M. Walker, Alfred Rosenblatt

DEPARTMENT EDITORS
Aerospace/Military: Ray Connolly
Circuit Design: Don Blattner
Communications & Microwave:
Richard Gundlach
Components: Lucinda Mattera
Computers: Stephen E. Scrupski
Consumer: Gerald M. Walker
Industrial: Margaret A. Maas
Instrumentation: Andy Santoni
New Products: H. Thomas Maguire
Michael J. Riezenman
Packaging & Production: Jerry Lyman
Solid State: Laurence Altman

CHIEF COPY EDITOR: Margaret Eastman

COPY EDITORS: Everett C. Terry, Ben Mason

ART: Charles D. Ciatto, *Associate Director*

EDITORIAL SECRETARIES: Janet Noto,
Julie Gorgoglione, Penny Roberts

FIELD EDITORS

Boston: Lawrence Curran (Mgr.), Pamela Leven
Los Angeles: Larry Waller (Mgr.)
Midwest: Larry Armstrong (Mgr.)
New York: Bruce LeBoss (Mgr.)
San Francisco: Bernard Cole (Mgr.)
Judith Curtis
Washington: Ray Connolly (Mgr.)
Frankfurt: John Gosch
London: William F. Arnold
Paris: Arthur Erikson
Tokyo: Charles Cohen

McGRAW-HILL WORLD NEWS

Editor: Michael Johnson
Brussels: James Smith
Madrid: Dom Curcio
Milan: Andrew Heath
Moscow: Peter Gall
Paris: Joel Stratte-McClure
Stockholm: Robert Skole
Tokyo: Colin Gibson

PUBLISHER: Dan McMillan

DIRECTOR OF MARKETING: Pierre J. Braudé

MARKETING ADMINISTRATION MANAGER:
Wallis Clarke

CIRCULATION MANAGER: Nancy L. Merritt

MARKETING SERVICES MANAGER:
Tomlinson Howland

RESEARCH MANAGER: Margery D. Sholes

Although integrated-circuit designers are packing ever more elements onto one semiconductor chip, there seems to be no let-up in demand for hybrid circuits. Indeed, hybrid-circuit makers are borrowing some of the tricks and techniques, such as IC chip packaging and computer-aided design of intricate conductive patterns, used by the IC manufacturers.

So much is going on in hybrid technology that we have put together a special report, which starts on page 91. In the 19-page report, you'll find details on such topics as what hybrid circuits can do today, where materials progress stands, the trends in interconnection and packaging, what's available in passive circuitry, and what a user can expect from manufacturers in addition to the devices.

The report was put together by Jerry Lyman, our packaging and production editor, and Lucinda Mattera, our components editor. Says Jerry: "Monolithic semiconductor technology is both the hybrid's greatest competitor and an additional stimulus to the success and expansion of hybrid technology. There have always been predictions that, as IC chips get even more complex, the need for hybrids will be eliminated. And in many cases it's true that the new LSI has eliminated older hybrid designs. But, overall, the new LSI has simply become another component for still larger and still denser hybrids."

1976 is an important election year. The national conventions and the campaigns for President have, of

course, grabbed a lot of headlines. But for the EE, there's another election coming up this year, and it promises to have a significant effect on his career. Three candidates are in the running for president of the IEEE, and all three are committed to changing the organization's approach to professional and career-related matters.

On page 78, we're publishing a detailed look at the candidates and what they propose, as well as a summary of the proposed amendments to the IEEE constitution and how the candidates stand on them. Associate editor Jerry Walker, who is in charge of career coverage, calls the election "easily the most important vote by members since the IEEE was broadened into a professional as well as a technical information society some five years ago."

An IEEE watcher for a number of years now, Jerry, who can maintain an independent stance because he is not a member of the institute, has reported at length on issues and personalities and assiduously covered IEEE meetings and events. In fact, his work on *Electronics* editorials about EE-career problems won him a Neal award last year. We think you'll find his round-up will provide valuable insight into this year's IEEE election.

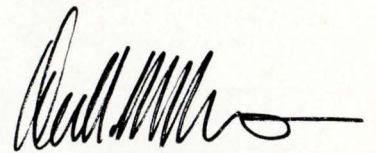

July 22, 1976 Volume 49, Number 15
95,800 copies of this issue printed

Published every other Thursday by McGraw-Hill, Inc. Founder: James H. McGraw 1860-1948. Publication office 1221 Avenue of the Americas, N.Y., N.Y. 10020; second class postage paid at New York, N.Y. and additional mailing offices.

Executive, editorial, circulation and advertising addresses: *Electronics*, McGraw-Hill Building, 1221 Avenue of the Americas, New York, N.Y. 10020. Telephone (212) 997-1221. Teletype 12-7960 TWX 710-581-4879. Cable address: MCGRAW HILL NEW YORK.

Subscriptions limited to professional persons with active responsibility in electronics technology. Publisher reserves the right to reject non-qualified requests. No subscriptions accepted without complete identification of subscriber name, title, or job function, company or organization, and product manufactured or services performed. Subscription rates: in the United States and possessions \$12.00 one year, \$30.00 three years; Canada and Mexico \$14.00 one year, \$32.00 three years; Europe \$35.00 one year, \$87.50 three years; Japan, Israel and Brazil \$60 per year; Australia and New Zealand \$80.00 per year, including air freight; all other countries \$40.00 per year. Limited quota of subscriptions available at higher-than-basic rate for persons outside of field served, as follows: U.S. and possessions and Canada \$25.00 per year; Europe \$40.00; Japan, Israel and Brazil \$85.00; all other countries \$50.00. Single copies: \$4.00. Please allow four to eight weeks for shipment.

Officers of McGraw-Hill Publications Company: Gordon L. Jones, President; Paul F. McPherson, Executive Vice President; J. Elton Tuo-
hig, Executive Vice President-Administration; Gene W. Simpson, Group Vice President; Senior Vice Presidents: Ralph Blackburn, Circulation; John B. Hoglund, Controller; Ralph R. Schulz, Editorial; David G. Jensen, Manufacturing; Vice Presidents: James E. Boddorf, Planning & Development; Edward E. Schirmer, Marketing Administration.

Officers of the Corporation: Harold W. McGraw, Jr., President; Chief Executive Officer, and Chairman of the Board; Robert N. Landes, Senior Vice President and Secretary; Ralph J. Webb, Treasurer.

Title registered in U.S. Patent Office; Copyright ©1976 by McGraw-Hill, Inc. All rights reserved. The contents of this publication may not be reproduced in whole or in part without the consent of copyright owner.

Subscribers: The publisher, upon written request to our New York office from any subscriber, agrees to refund that part of the subscription price applying to copies not yet mailed. Please send change of address notices or complaints to Fulfillment Manager; subscription orders to Circulation Manager, *Electronics*, at address below. Change of address notices should provide old as well as new address, including postal zip code number. If possible, attach address label from recent issue. Allow one month for change to become effective.

Postmaster: Please send form 3579 to Fulfillment Manager, *Electronics*, P.O. Box 430, Hightstown, N.J. 08520.

All function generators need **WAVEGUARD™** because nobody's perfect!

Accidents happen! With the high density of today's circuit boards, it's easy to damage your present generator by accidentally touching a voltage source with the output probe.

WAVEGUARD™ protects against this kind of accident. Without WAVEGUARD it costs you both valuable design time *and* money to repair.

When you invest \$495 in our Model 5100B, you have 15 waveforms at your probe tip, protected by WAVEGUARD — the only sure way to keep your generator functional.

Remember, The WAVEMAKER™ from Krohn-Hite are the only guys who offer WAVEGUARD. Call (617) 580-1660 or any of the offices listed below.



KH KROHN-HITE CORPORATION

Avon Industrial Park, Avon, Mass. 02322 • (617) 580-1660, TWX 710-345-0831

SALES OFFICES: **ALA.**, Huntsville (205) 534 9771. **ARIZ.**, Scottsdale (602) 957 9110. **CAL.**, San Jose (408) 292 3220. Inglewood (213) 674 6850. **COL.**, Denver (303) 773 1218. **CONN.**, Glastonbury (203) 633 0777. **FLA.**, Orlando (305) 894 4401. **GEO.**, Atlanta (404) 448 2365. **HAWAII**, Honolulu (808) 941 1574. **ILL.**, Des Plaines (312) 298 3600. **IND.**, Indianapolis (317) 244 2456. **MD.**, Baltimore (301) 321 1411. **MASS.**, Lexington (617) 861 8620. **MINN.**, Minneapolis (612) 884 4336. **MO.**, Kansas City (816) 454 5836. St. Louis (314) 423 1234. **N.C.**, Burlington (919) 227 3639. **N.J.**, Cherry Hill (609) 482 0059. **N.M.**, Albuquerque (505) 255 2330. **N.Y.**, E. Syracuse (315) 437 6666. Rochester (716) 328 2230. Vestal (607) 785 9947. Elmont (516) 488 2100. **OHIO**, Chesterland (216) 729 2222. Dayton (513) 434 8993. **OKLA.**, Tulsa (918) 299 2636. **ORE.**, Portland (503) 297 2248. **TEX.**, Addison (214) 661 0400. Houston (910) 881 5532. **VA.**, Falls Church (703) 573 8787. **WASH.**, Bellevue (206) 454 3400. **CANADA**, Montreal, Quebec (514) 341 7630. Ottawa, Ontario (613) 235 5121. Toronto, Ontario (416) 445 9900. Vancouver, British Columbia (604) 253 5555. Halifax, Nova Scotia (902) 454 8321. St. John's, Newfoundland (709) 726 2422.

The smaller, lighter self-contained Cesium Frequency Standard

... from OSCILLOQUARTZ

one of the world's largest and most technically competent manufacturers of quartz crystal oscillators, comes this new Primary Frequency Standard. Now, a new source of precision time and frequency generation and measurement systems plus a new standard of reliability and operating simplicity. Most competitively priced.



It is complete — with 110/220 VAC and 24 VDC Power Supplies, a 5-hour Internal Standby Battery, Monitoring and Control Devices — in a 19" rack with 1, 5 and 10 MHz outputs on front and rear.

Heart of this self-contained Primary Standard is the compact cesium beam tube developed by Frequency & Time Systems to permit the exceptional performance-to-size ratio of the Model 3200. ALSO NEW—the Oscilloquartz low-cost Model 3000 Cesium Beam Frequency Source in 1/2 ATR Rack Size.

Complete engineering and performance specifications available on Model 3200 Cesium Frequency Standard and Model 2200 Quartz Frequency Standard and Clock.
Write: 182 Conant St., Danvers, MA 01923 or call (617) 777-1255
TELEX 94-0518

MODEL 3200	
Accuracy (0°C to +50°C)	$\pm 1 \times 10^{-11}$
Reproducibility	$\pm 5 \times 10^{-12}$
Stability	$\pm 2 \times 10^{-13}$
Outputs	1, 5 & 10 MHz
Power Supplies	110/220 VAC $\pm 10\%$ primary (45 - 440 Hz) 20 - 30 VDC (floating) secondary
Standby Battery	5 hrs at 25°C (fast charging)

"A STEP AHEAD . . . IN TIME"

**Frequency and
Time Systems**

Readers' comments

Urging corrective maintenance

To the Editor: Please permit me to answer D.D. Dempsey's letter [March 4, p. 60] by expanding the philosophy of good maintenance practice. Three rules apply to both electrical and mechanical systems:

- If it is working properly, as determined by analysis, let it alone.
- Fix only what needs to be fixed.
- Replace only what is defective.

Few failures are due to components wearing out. In large systems, incorrect design, assembly, installation, alignment, testing, handling, operation, or application cause most failures. The underlying factors are human ignorance, expediency, and negligence—not wear or attrition from normal usage.

Experience shows a direct correlation between frequency of preventive maintenance (PM) and failure rate. When troubleshooting a problem, the question usually is asked, "What did you last do to the equipment?" Types of failures associated with PM include a cable left off or cross-connected, cables pinched on doors, loose connections, power supplies accidentally shorted out, loose washer inside the equipment, a wrench left inside the waveguide, circuit cards not seated, switches left in wrong positions, parts accidentally damaged, and nuts, latches, plugs, and covers not fastened properly.

Corrective maintenance (CM), defined as unscheduled PM, is when problems are taken out of the equipment. PM is when they are put in. Maintenance—both CM and PM—should be a continuous activity with the aim of increasing reliability and eliminating downtime.

PM should be scheduled only when degradation has been detected or when some component has reached the end of its useful life. The goal should be no failures or PM at all—100% system availability for extended periods. Maintenance by analysis is more difficult, and it requires more work, competence, and judgment, but should result in safer, more reliable systems.

J. J. Kush
APO San Francisco 96245

MEDICAL INSTRUMENTATION CONNECTORS

Connectors so reliable they're being used in human implantations... the kind of reliability you need in medical-instrumentation applications. We've got them—and more—in microminiatures and in standard and miniature circulars.

All designed with the size, weight and density factors that lower your installed costs, and all with the Cannon pluses of quality, selection, distribution and delivery.

For reliability and economy, look to our "Cost Cutter" circulars: KO Series: Quick connect/disconnect miniatures for general medical instrumentation. K Series: Quick connect/disconnect standards for power and general medical instrumentation. MC Series: Environmentally sealed,

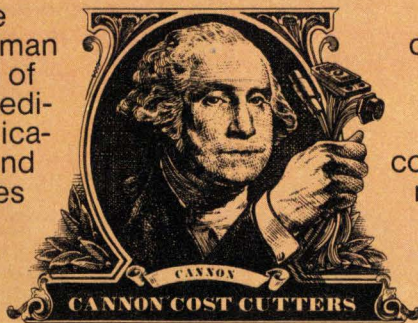

moisture-resistant, high-density subminiatures for surgical instrumentation.

XLR Series: Quick-disconnect, low-profile connectors with right-angle receptacles that mount in the rear of instruments and are ideal for multiple monitoring and instrumentation testing and checkout equipment.

For reliability and economy in a much smaller package, rely on Cannon microminiature connectors.

Use these ultraminiature, high-performance connectors to solve your most difficult space problems... in any application where you would usually depend on our standard and miniature circulars if you weren't cramped for space. They give you the same number of contacts and pins as standard connectors in just a quarter of the space!

Write for our "Cannon Cost Cutters" brochure today. ITT Cannon Electric, 666 East Dyer Rd., Santa Ana, CA 92702. **Toll-free, 24 hours (800) 854-3573;** in California, **(800) 432-7063.**



Six decades on the leading edge of interconnect technology.

CANNON ITT

Get the scope you need—Now!

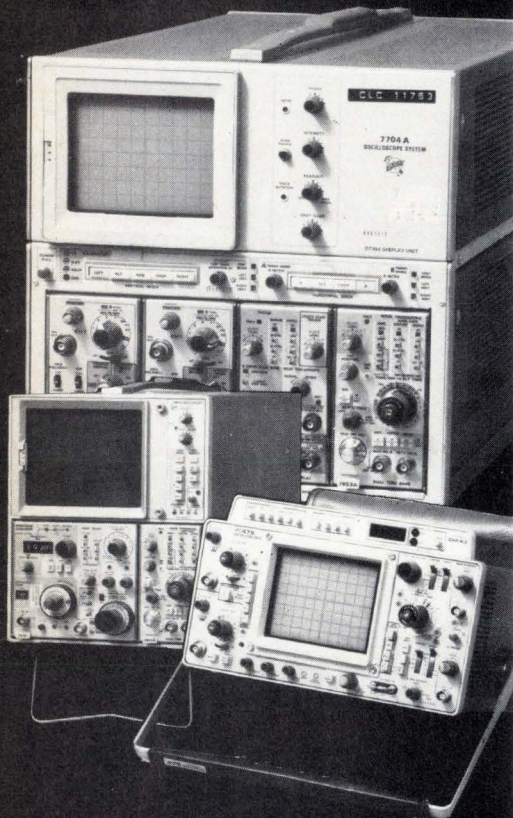

Our "Instrument Professionals" will tell you which scope will do the job best, at the lowest cost, make immediate delivery and guarantee performance.

Write or call for data on our other specialties: Instrument Leasing • Computer Peripherals • Equipment Sales • Instrument Service.

Circle 8 on reader service card

Call Get our FREE Catalog

Continental Rentals

Div. Continental Leasing Co., Inc.
175 Middlesex Turnpike, Bedford,
MA, 01730 (617) 275-0850

Metuchen, NJ (201) 549-8500;
Gaithersburg, MD (301) 948-4310; TX
(214) 357-1779; Elk Grove, IL (312)
439-4700; Costa Mesa, CA (714)
540-6566; Santa Clara, CA (408)
735-8300; Los Angeles, CA (213) 477-7521

News update

■ The latest version of Threshold Technology Inc.'s data-entry terminal, the Threshold 500, is doing well—100 orders have been received by the Delvan, N.J., firm. The automatic speech-recognition system is built around Digital Equipment Corp.'s LSI-11 16-bit microcomputer [*Electronics*, June 26, 1975, p. 25]. Threshold is awaiting an order worth more than \$250,000 from the New York Commodities Exchange for about 25 terminals. Like those delivered to the United Parcel Service in an estimated \$700,000 order, the units for the exchange will be wireless so that operators are free to move around with a transceiver belt-pack. The 500, at \$10,000 slightly more than half the price of the preceding VIP 100 system, was to have been designed around an in-house microcomputer using a commercial 8-bit microprocessor. "But the LSI-11 was available and ready to go, and it gave us the same capability at about the same price," says marketing vice president John C. Collins. The LSI-11 supplants the Data General Nova 1200 minicomputer employed in the earlier model. Threshold says it also has received orders for automatic speech-recognition systems from Olin Winchester, Continental Can, and Reynolds Metals.

■ One of the first rules for making money in the digital-watch game is to strive for as much vertical integration as possible. To that end, Fairchild Camera & Instrument Corp. last year said it was considering making its own quartz oscillator crystals [*Electronics*, Aug. 7, 1975]. After all, the company does already make its own C-MOS circuits and light-emitting-diode and liquid-crystal displays. But now, while confirming that Fairchild is still interested in buying a quartz-crystal facility some day, a spokesman says that the "economics of the situation" rule out such a purchase at this time. The delay may be partly attributed to Fairchild's sales figures, which show a \$93 million drop from 1974 to \$291,542,000.

NEW 3½ Digit Multimeter from B&K-PRECISION



B&K-PRECISION
MODEL 283—\$170

...you'll want it for its features
...but its the price that will sell you!

- High intensity LED display is easily read from at least 6 feet in the brightest room
- Measures AC and DC voltage, AC and DC current and resistance.
- 0.5% DC accuracy
- 100% overrange (1000 scale reads to 1999).
- Automatic polarity
- Automatic decimal point
- Flashing overrange indication on display
- Four voltage ranges to 1000V
- Four current ranges to 1000mA.
- Six resistance ranges to 10 meg.
- In-circuit resistance measurements at voltage levels below conduction threshold of semiconductors.
- Overload protection on all ranges

Complete new circuitry makes the Model 283 the most dependable and versatile 3½ digit multimeter you can buy. The extra-bright display allows you to use it where other units would cause reading problems. The selectable "low ohms" function permits accurate measurement of semiconductor shunted resistors.

An optional, internal battery pack (BP-83, \$50.00) provides 8 hours of continuous use on one overnight charging and charges when the Model 283 is in use on 115/230 VAC.

Your B&K-PRECISION distributor has the Model 283 in stock and will be glad to demonstrate its features to you. Call him, or write for additional information.

B&K PRECISION

PRODUCTS OF DYNASCAN
6460 W. Cortland Avenue
Chicago, IL 60635 312/889-8870
In Canada: Atlas Electronics, Toronto

Circle 184 on reader service card

Magnecraft's line of 1200 stock relays just increased . . . by another series.

WHY WAIT FOR SOLID STATE? Our family of 24 solid state relays provides current ratings from 2.5 to 40 amps, with switching capacity up to 480 VAC. All models incorporate optoisolation between input and output, and zero-voltage switching. Screw type clamps and Faston "Quick-Connect" terminals are available on packages which are interchangeable with others. Output switching reflects the latest state-of-the-art technology. Both the high-reliability dual SCR approach and the more economical triac approach are available.

Magnecraft is committed to providing design engineers with the best solution for their switching applications. It is with a complete understanding of the areas where solid state relays provide the most reliable and economical switching solution, that we've included this family in our line of stock relays.

For complete information and specifications, WRITE FOR OUR SOLID STATE RELAY PRODUCT BULLETIN. Magnecraft Electric Co., 5575 N. Lynch Ave., Chicago, IL 60630



Magnecraft[®]
ELECTRIC COMPANY

Are you going to vote?

Any member of the Institute of Electrical and Electronics Engineers eligible to vote who skips this year's election ballot is missing an important opportunity to strike a blow for professional progress.

This year's election is probably the most important the IEEE has had since it was organized. At stake is the selection of the men who will lead the institute during a year in which sweeping changes are in store. There are also a couple of important amendments on the ballot (see p. 78).

The days when the IEEE was run like a country club and the elections were merely token approvals of pre-ordained candidates appear to be over. The small percentage of members who voted in prior elections under such circumstances is understandable, but there is no reason for such apathy now.

Various IEEE sections around the country have invited the two petition candidates for president, Irwin Feerst and Robert Rivers, to address their meetings, insisting that their members learn as much as possible about the issues these two have raised. Not surprisingly, the presence of petition candidates for president and executive vice president has moved the board-nominated candidates toward a more responsive stance, as well.

There is a mood of reform in the air, and the activists are trying to get the inert majority aware of the importance of this ballot.

Unfortunately, others appear to be dragging behind, and some leaders have even been bad-mouthing the candidates, rather than airing the issues.

What changes are in store? Programs for the U.S. Activities Board will most certainly be reviewed, revamped, and set into motion. The voters must decide on a key issue: should the IEEE take steps to control the quality and quantity of EEs entering the profession, and should present practitioners be certified?

Closely related to this question is a clear need to reform the institute's budget and its financial planning. And here's a dilemma, for it will be impossible for the IEEE to finance all of the traditional technical and educational activities and at the same time administer the new professional programs. Priorities must be assigned, and new plans admitted only if less effective programs are cut. Who will set the priorities? Obviously, the top elected officers, working with the board of directors, will set the tone and pace.

None of the changes, particularly the career-related ones, are short-term. Thus, this election will have long-range impact, which makes the participation of members all the more important. Last year only 36% of eligible voters bothered to return their ballots for the first two-way race for president. With so much at stake, it would be regrettable if this election did not evoke a better response than that.

Microprocessing becomes a buyer's market.

If you're a MOS microprocessor customer, the last few years haven't been a whole lot of laughs.

One supplier had all the good stuff, made all the rules, told you what you could buy. And when. And for how much.

But something happened to change all that: Advanced Micro Devices.

We make the best microprocessor in the world, the Am9080A, and we make all the support circuits you need. They're yours now, off the shelf, at competitive prices. That's right. Competitive.

But we make more than microprocessor products. We make you a promise:

We'll sell you any part, in any quantity, bundled or unbundled. You're the customer.

So, if you suddenly find yourself having an easier time buying microprocessors, just remember why. And who.

If you're shy, and you're just not sure how to say thank you, an order would be really nice.

Write or phone Advanced Micro Devices, The Buyer's Market.

Ours and Theirs. (The 9080A)

Specification	AMD	Intel
Minimum Instruction Cycle Time	1 microsecond	1.3 microseconds
Maximum Power Dissipation (at 1.3 microsec. 0.70 μ s)	829 milliwatts	1307 milliwatts
Output Drive	3.2mA @ .4V	1.9mA @ .45V
Minimum Input High Voltage	3.0V	3.3V
MIL-STD 883	Standard	Special
Price per 100	\$21.00 (Am9080A)	\$40.00 (C8080A)

Ours and Ours. (Am9080A System Circuits)

AMD Part Number	Description	Availability
CPU		
Am9080A/-2/-1/-4	Speeds to 250 nsec. 0 to 70°C	In Dist. Stock
Am 9080A/-2	Speeds to 380 nsec. -55 to +125°C	In Dist. Stock
Static Read/Write Random Access Memories		
Am9101A/B/C/D	256x4 22 Pin Speeds to 250 nsec.	In Dist. Stock
Am91L01A/B/C	256x4 22 Pin Speeds to 300 nsec.	In Dist. Stock
Am9102A/B/C/D	1Kx1 16 Pin Speeds to 250 nsec.	In Dist. Stock
Am91L02A/B/C	1Kx1 16 Pin Speeds to 300 nsec.	In Dist. Stock
Am9111A/B/C/D	256x4 18 Pin Speeds to 250 nsec.	In Dist. Stock
Am91L11A/B/C	256x4 18 Pin Speeds to 300 nsec.	In Dist. Stock
Am9112A/B/C/D	256x4 16 Pin Speeds to 250 nsec.	In Dist. Stock
Am91L12A/B/C	256x4 16 Pin Speeds to 300 nsec.	In Dist. Stock
Am9130A/B/C/D/E	1024x4 22 Pin Speeds to 200 nsec.	In Dist. Stock
Am9140A/B/C/D/E	4096x1 22 Pin Speeds to 200 nsec.	In Dist. Stock
Dynamic Read/Write Random Access Memories		
Am9050C/D/E	4Kx1 22 Pin Speeds to 200 nsec.	In Dist. Stock
Am9060C/D/E	4Kx1 18 Pin Speeds to 200 nsec.	In Dist. Stock

AMD Part Number	Description	Availability
Mask Programmable Read-Only Memories		
Am9208/B/C/D	1Kx8 Speeds to 250 nsec.	Available Now
Am9214	512x8 500 nsec.	Available Now
Am9216B/C	2Kx8 300 nsec.	Available Now
Erasable Read-Only Memories		
Am1702A	256x8 1.0 μ sec.	In Dist. Stock
Am2708	1024x8 450 μ sec.	3rd Q. 1976
Processor System Support Circuits		
Am8212	8-bit I/O Port	In Dist. Stock
Am8216	Non-Inverting Bus Transceiver	3rd Q. 1976
Am8224	Clock Generator	In Dist. Stock
Am8226	Inverting Bus Transceiver	3rd Q. 1976
Am8228	System Controller	In Dist. Stock
Am9551	Programmable Communications Interface	3rd Q. 1976
Am9555	Programmable Peripheral Interface	3rd Q. 1976
Am9557	Direct Memory Access Controller	1st Q. 1977
Am9559	Priority Interrupt Controller	1st Q. 1977
Am25LS138	1 of 8 Decoder	In Dist. Stock
Am25LS139	Dual 1 of 4 Decoder	In Dist. Stock
*Am25LS240	8 bit Inverting Bus Transceiver	3rd Q. 1976
*Am25LS241	8 bit Non Inverting Bus Transceiver	3rd Q. 1976
*Am25LS273	8 bit Common Clear Latch	3rd Q. 1976
*Am25LS374	8 bit 3-state Latch	3rd Q. 1976
*Am25LS377	8 bit Common Enable Latch	3rd Q. 1976

*All combine high performance and low power in space saving 20-pin package

CPU: 9080A = 480 nsec. -2 = 380 nsec. -1 = 320 nsec. -4 = 250 nsec.

MEM: A = 500 nsec. B = 400 nsec. C = 300 nsec. D = 250 nsec. E = 200 nsec.

Advanced MOS/LSI

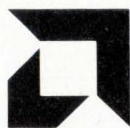

Advanced Micro Devices • 901 Thompson Place, Sunnyvale, California 94086 • Telephone (408) 732-2400 • Distributed nationally by Hamilton/Avnet, Cramer and Schweber Electronics.

Circle 260 on reader service card

"Now you can build a for less than the cost of

"Our new monolithic CMOS A/D converter makes low-cost, 3-digit DVMs a reality. With it you can put precision digital readouts into applications that did not make economic sense in the past. With the Siliconix LD130, you can modernize products such as thermometers, dashboards, test consoles, industrial meters and controls at a cost competitive with ordinary analog meters."

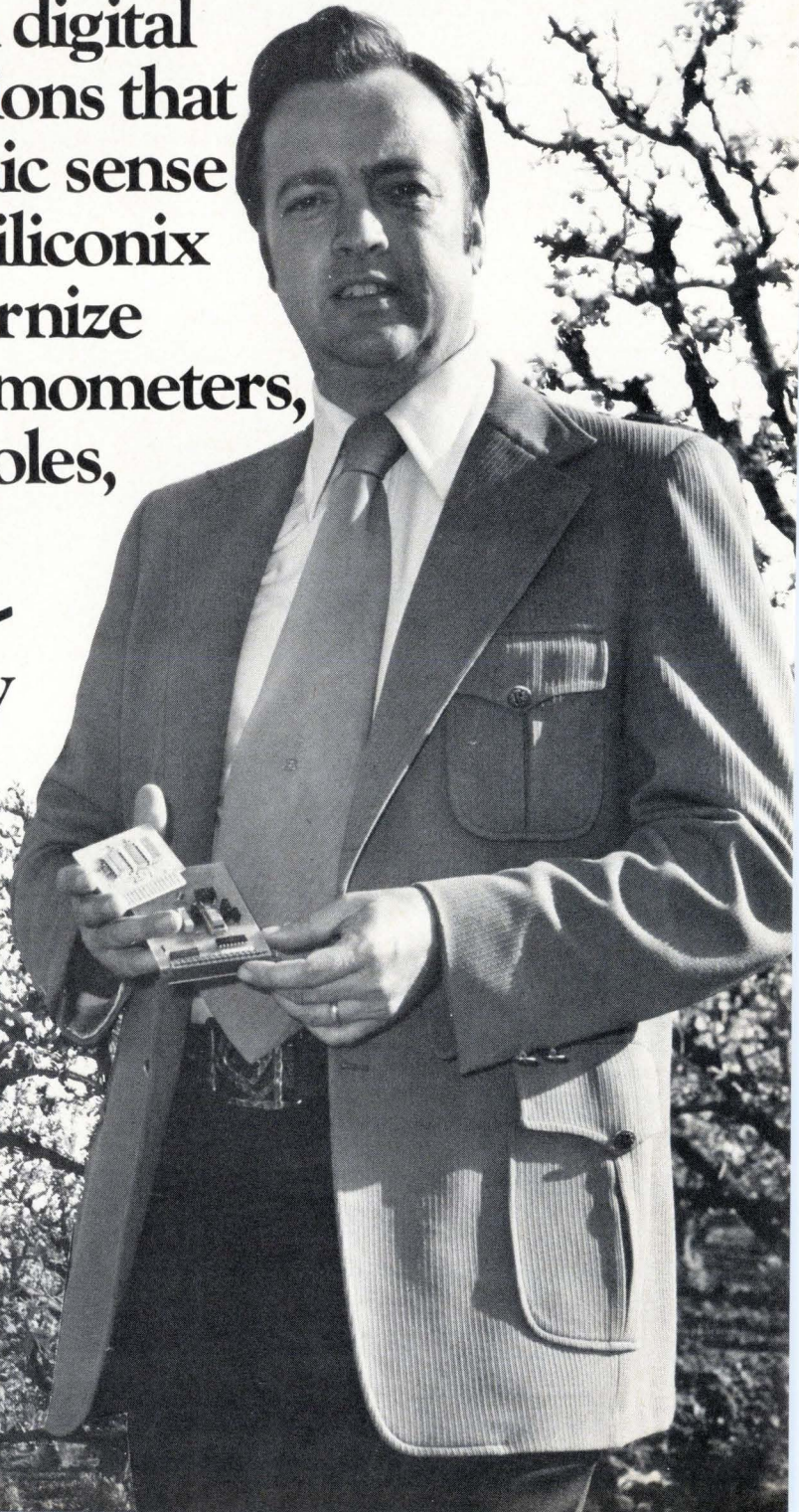

quality digital meter a cheap analog meter."

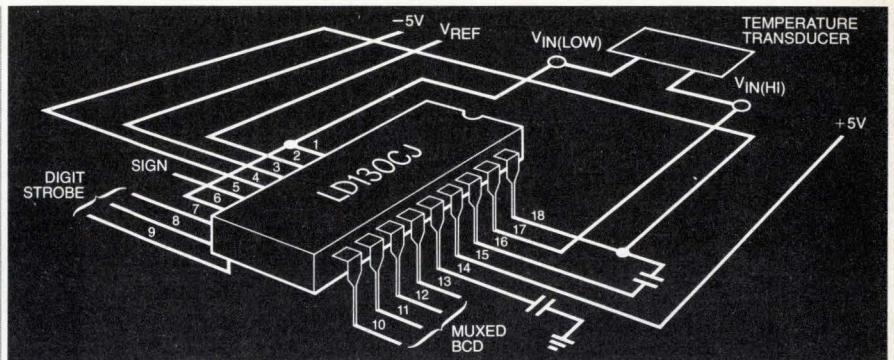
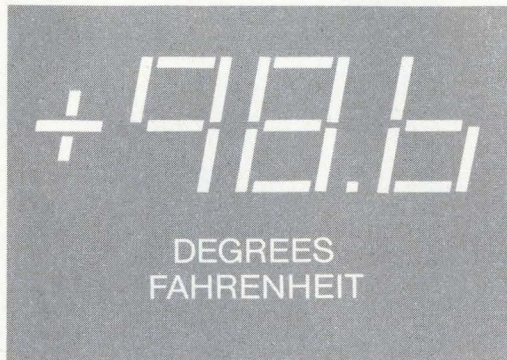

"At Siliconix, we call the LD130 'everyman's digital voltmeter chip'.

"Almost any high volume product that requires a meter can be made more attractive and useful with this sophisticated, low power, 3-digit DVM chip. In addition to the visibility and style of digital readout, the LD130 provides 10 to 20 times the accuracy and much higher resolution than analog meters.

"Moreover, the LD130 imposes none of the design restrictions of 'cheap' analog meters. Its full 3-digit range of ± 999 allows almost any variable, such as very high and very low temperatures, to be measured. In contrast, a person can at best resolve one part in 100 using an inexpensive analog meter.

"Automatic zeroing, automatic polarity outputs, and auto-ranging outputs eliminate zero adjust potentiometers, switch the \pm sign, and allow automatic control of decimal points and range scaling resistors.

" $\pm 5V$ CMOS construction enables the LD130 to operate efficiently with any standard CMOS or TTL logic. The multiplexed BCD outputs are easily interfaced with 'intelligent' microprocessor-based systems. This format is also ideal for the widest range of digital displays.

"Accuracy is $\pm 0.1\%$ of reading ± 1 count. Accuracy is maintained automatically by Siliconix' exclusive quantized feedback design (patent applied for) which continuously corrects for zero drift. This same feature has made the Siliconix $\pm 3\frac{1}{2}$ digit LD110/LD111 DVM set the most widely used by designers of professional instruments and control systems.

"Just as important, the LD130 is easy and inexpensive to use. Unlike most DVMs, it requires no precision resistors and capacitors, no external temperature compensation, no dual tracking references, no operational amplifiers or input buffers. These have been eliminated by state-of-the-art chip design.

"Since only low-cost components are needed with the 18-pin LD130, it allows complete meter/display subsystems to be built into products for less than \$15 (1K quantities).

"The LD130 is your opportunity to create new products and upgrade your present ones. Now you can build a quality digital meter for your system at a cost you can afford."

To order the LD130CJ (\$8.75 at 100 lot), contact our franchised distributors: Components Plus, Cramer, Elmar, Hamilton/Avnet, Pioneer, Quality Components or R. A. E. For more details, call or write Siliconix, 2201 Laurelwood Road, Santa Clara, CA 95054, (408) 246-8000.

S Siliconix incorporated

NOW AVAILABLE!

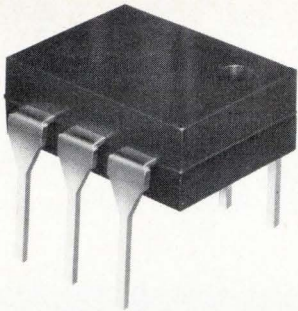

5KV OPTICAL ISOLATORS IN 6-PIN DIPS

Industry's first 5KV isolators to be offered in the popular 6-pin dual in-line package are available now! They are directly interchangeable with standard industrial 6-pin isolators... **UL approved**... **No. E58979**. Circle R.S. NO. 220

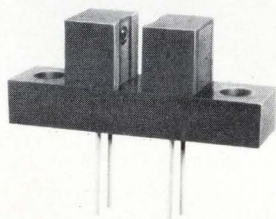

STANDARD OPTICAL SWITCHES

Six, low-cost off-the-shelf optical switches are available as direct replacements for such popular devices as the H13A1, A2; H13B1, B2; MCA 8, 81 and MCT 8, 81. Both phototransistor and photodarlington versions are available from factory stocks. Circle R.S. NO. 221



LOW-COST PHOTODETECTORS & LEDs

Spectronics provides industry's largest selection of standard off-the-shelf detectors and LEDs. Direct replacements for such popular industrial types as: LED55CF, BF, B, C; SSL315, 15, 35; TIL31, 81, 23, 24; and TIL601-616 Series. Call today for prices and deliveries. Circle R.S. NO. 222

Call Spectronics for everything you need in opto.
We make optoelectronics work... for you!



Spectronics
INCORPORATED

830 E. Arapaho, Rd.
Richardson, Texas 75080
(214) 234-4271

People

Careful growth is Baily's key
for word-processing Lexitron

That there's more to doing business than being first in a new field is a lesson that Richard Baily should have learned well. Recently appointed president of Lexitron Corp., a Chatsworth, Calif., manufacturer of word-processing equipment, Baily earlier headed Singer's Business Machines division, which, after grabbing an early lead in retail point-of-sale terminals, went under this year in a sea of red ink and a \$325 million tax writeoff.

"The Singer approach was to attack the market—go after a big share and expand rapidly," he recalls. "But ultimately, you can't afford expansion for expansion's sake. At Lexitron, you might say we will be conservatively aggressive, looking for stability as well as growth."

New field again. At Lexitron, 52-year-old Baily is once again president of a firm in a relatively new field—word processing. And within this field, Lexitron is considered No. 1 in sales of automated typing and editing systems with cathode-ray-tube displays, which, Baily says, are easier to use than systems employing only a typewriter or printer.

He's determined to maintain this position, despite the recent entry of such giants as Xerox Corp. and Digital Equipment Corp., plus the competition of a dozen other companies with CRT-based systems [*Electronics*, July 8, p. 38]. Looming over the arena, of course, is IBM Corp., which holds the commanding position in word processing with its automated but displayless typewriter gear.

With sales this year running ahead of last year's \$15 million, Lexitron is expanding its marketing operations. The firm has been strong in Southern California and Washington, D.C., but not in the Northeast, notes Baily. However, Lexitron will also stress technical innovations, such as the recently announced high-speed, tape-cassette reading system used with its CRT



Mail call. For Baily, word processing will bring electronic mail in the future.

terminals for entering and storing information.

Electronic mail. As for the future, the most exciting prospect Baily foresees is the emergence of electronic mail via word-processing systems. "With some type of electronic document-preparation terminal and point-to-point communications links, you've got electronic mail," he explains. With this, you could deliver a business letter across the country electronically," bypassing the Postal Service.

RCA's Santilli sees
SOS as a big edge

Although some in the industry viewed RCA Corp. as a Johnny-come-lately when it entered the volatile memory and microprocessor fields last year, Richard A. Santilli, new vice president for sales and international operations at the Solid State division, Somerville, N.J., thinks otherwise.

"There's a point when it doesn't pay to enter a business, and that's when it's well along on the maturity curve and into high-volume production and depressed pricing," says the 41-year-old electrical engineer and 20-year RCA veteran. "But I don't believe that's the case with

SERIES 40's Frequency Marker ends frequency-chasing and control-twiddling.

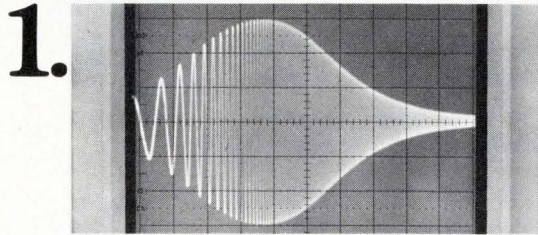

Sweep the Unit Under Test. Here, for example, is the output of a filter being swept from 600 Hz to 60 KHz on channel 1 of the scope.

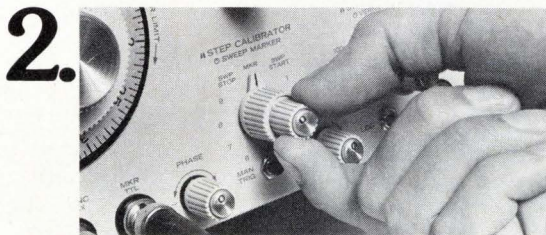

Select Sweep Marker. On Interstate's new F47 function generator, you select "Marker" and set its TTL output on the scope's channel 2.

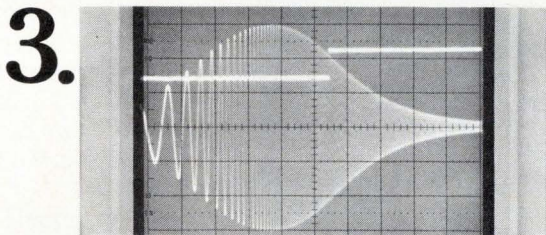

Adjust the vernier. Then you fine-tune the marker vernier to pinpoint the TTL step at the exact position on the waveform for which you want to know the frequency. On the scope shown, the marker is positioned at the 70% roll-off point... the -3 db level.

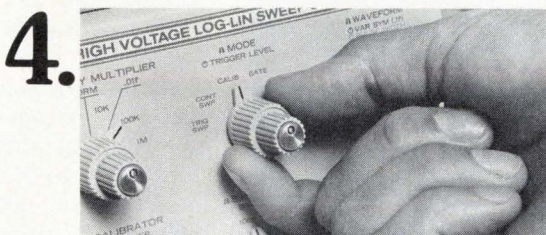

Select Calibrate Mode. Next, you switch from the Continuous Sweep Mode to the Calibrate Mode.



Get the exact frequency. A counter at the F47's output will then display the precise frequency at which the filter's -3 db point occurs.

SERIES 40 Function Generators - New from INTERSTATE



SERIES 40 is the only function generator line with marker, 10-step frequency calibrator, state-of-the-art high output voltage to 40 v p-p open circuit, and Interstate's exclusive direct-reading sweep width control. The best function generators money can buy from \$475 to \$695. Write for the new SERIES 40

INTERSTATE
ELECTRONICS CORPORATION

Subsidiary of A-T-O Inc.

catalog for complete specifications and prices.

If you really need programmable synchro instrumentation



...then you really need DDC.

After all, what company is more logical to go to? DDC, having set the pace in synchro converters, is the one company you'd expect to know the most about synchro instrumentation . . . and you're right! That's why we are able to offer the fullest and finest line of programmable standards, synchro and resolver test instruments and computer-interfaced angle indicators/shaft encoders. Our line of solid state instrumentation contains units ranging from the low-cost 3 or 4-digit "panel meter" configuration SR-300 . . . to the fully ruggedized HMSR-102A, a $\pm 0.01^\circ$ angle indicator designed to meet the environmental requirements of MIL-T-21200. Our portable MSR-236 is a two-speed indicator. In our SR-202 and SR-400 you will find all the best features of remote and manual control in a half-rack, pushbutton-controlled indicator and simulator. Both are capable of interfacing with just about every commonly used synchro or resolver at various voltages and frequencies with accuracies to $\pm 0.01^\circ$. No trims, no calibrations with these DDC instruments . . . and all are guaranteed for accuracy and performance. Just a reminder . . . if you really need systems, we're also the logical ones to come to.

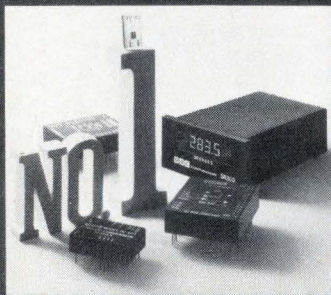

And if you really need programmable synchro instrumentation
... we're NUMBER ONE.

DDC

ILC DATA DEVICE CORPORATION

A Wholly Owned Subsidiary of ILC Industries, Inc.

AIRPORT INTERNATIONAL PLAZA BOHEMIA, LONG ISLAND, N.Y. 11716 (516) 567-5600

APPLICATIONS AND SERVICE CENTERS

CALIFORNIA: 2750 Bellflower Blvd.,
Long Beach 90815 (213) 597-5744

EUROPE: England: The Sanctuary,
Oakhill Road, Surbiton, Surrey Tel: 01-399-7262

Interested engineers, write or call Steve Muth or send for our 164-page product line catalog.

People



Veep. Innovation in microprocessors is coming, says RCA's Richard A. Santilli.

memories, and especially with microprocessors. There's a lot of room for innovation."

SOS. RCA's contribution will come from its silicon-on-sapphire technology applied to complementary-MOS and n-channel devices, Santilli says. And, so far, RCA's 1,024- and 4,096-bit SOS random-access memories and C-MOS microprocessors are doing "extremely well" with bookings on plan and expected to total several million dollars this year, he asserts.

Santilli, who moved up from vice president for bipolar ICs and could be next in line to head the RCA division, points to the coupling of MOS's low noise and low power with the high speed of bipolar devices as the reasons SOS should do well. And, once SOS makes its impact in memories, Santilli plans to apply it to microprocessors.

In addition to new-product efforts, Santilli will be pulling together a worldwide sales organization and consolidating planning operations that had been split up before. "You have to think of it as a worldwide business and not a North American and an international business," Santilli says. He'll be responsible for domestic and international sales and distributor marketing, as well as directing the division's international operations that have previously reported directly to general manager Bernard V. Vonderschmitt.



MEASUREMENT COMPUTATION

innovations from Hewlett-Packard

NEWS

JULY 1976

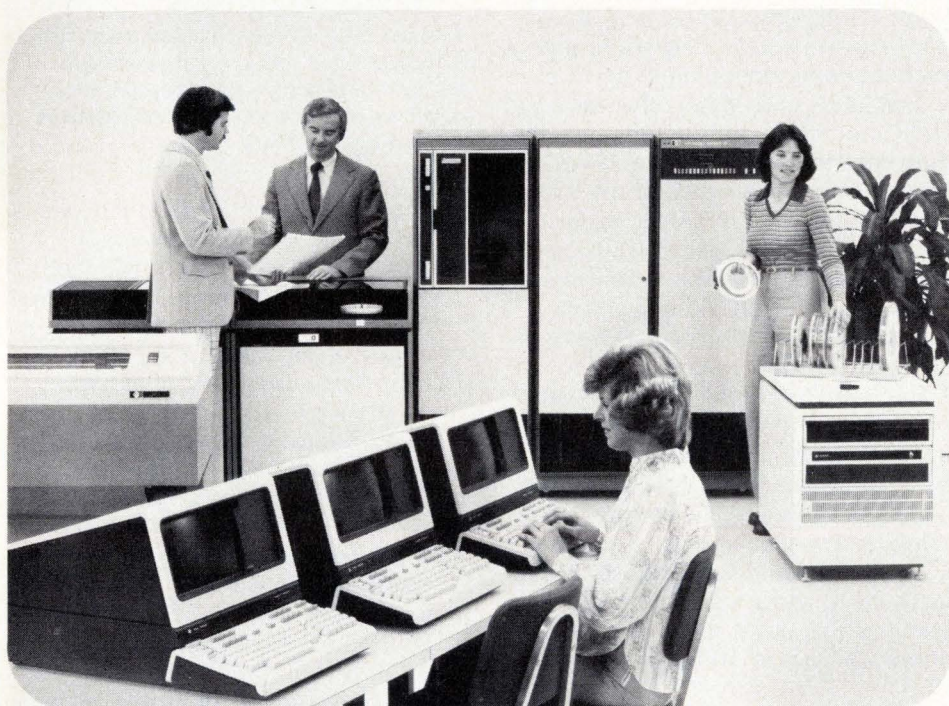

HP 3000 Series II systems are a powerful combination of software and hardware designed to deliver optimum performance.

Manage fast-growing data bases efficiently with new HP 3000 computer

As a terminal-oriented, general purpose computer, the new HP 3000 Series II is designed to operate in both batch and interactive terminal environments. Three compatible models allow you to select the configuration needed for present applications whether yours is a small or large organization or a corporate division. As your needs grow, the HP 3000 Series II can be upgraded—main memory can be expanded to 512K bytes.

Big system capabilities include:

- Fault control main memory—detect and correct memory errors with *no* reduction of speed
- Teleprocessing—data entry and processed-data-return via telephone lines
- Multi-terminal update and inquiry
- Data and file security
- On-line program development
- Job accounting
- Input and output spooling—for optimum use of peripherals
- Multiprogramming—for concurrent batch and terminal operations
- Remote job entry to large computers

in this issue

Instruments
“talk” and “listen”
with HP interface

Automatic RF network
measurements

New mini-processor board
for your instruments

- Five most popular commercial programming languages
- Data base management software (IMAGE/QUERY)
- Virtual memory

The HP 3000 Series II has been job-performance rated. Benchmark results are available to help you choose the proven capability that you need.

The HP 3000 Series II functions as a complete, independent data processing center, or as a satellite in a network of large computers.

If you plan to install a computer or upgrade your present system, you owe it to yourself to get all the facts. Check E on the HP Reply Card and we will send you a brochure with all the details.

High power pulse generator ideally suited for varied applications.



The highly flexible and carefully controlled output pulse characteristics of the Hewlett-Packard 214A make this pulse generator well suited to many applications. With output amplitude continuously variable from 80 mV to 100 V into a 50Ω load and fast (<15 ns) transition times, as well as minimum jitter, this pulse generator is particularly well suited for such applications as driving high-power modulators, semiconductor device testing, laser system testing, nuclear research and biomedical research.

Some of the more unusual applications of the 214A are:

1. A scientist at the University of California's Coastal Marine Laboratory used the 214A to measure the sound transmission in the head of a porpoise.
2. Engineers at the Convair Aerospace Division of General Dynamics in California used their 214A to find flaws in material by ultrasonic interference spectroscopy.
3. A French scientist used the 214A to measure the mobility of radioactive ions.

In addition to these applications, other engineers and scientists have used the 214A as a modulator driver in laser research and a pulse stimulus in basic material research. If you have an application for a pulse source that requires a high power signal, up to 200 watts, or a good, general purpose pulse generator for your lab, consider the HP 214A.

For additional details, check B on the HP Reply Card.

New multi-family logic clip speeds IC troubleshooting

Hewlett-Packard's new **548A logic clip** troubleshoots IC digital logic circuits faster than ever:

- Its LEDs show logic states of 16 IC pins at once—a "truth table" display.
- It automatically adapts to TTL, DTL, RTL, CMOS and HTL circuits, and automatically seeks Vcc and ground.
- It's overload protected to 30V dc, to avoid damage from linear ICs.
- It draws <15 μA per pin—no circuit loading worries.

Use it with in-circuit stimuli or replace the system clock with our 546A Multi-Family Logic Pulser and slowly step sequential logic devices through a cycle to verify operation.

The 548A joins three other new HP IC troubleshooters to bring you the most modern set of handheld logic troubleshooting instruments available:

- **The 547A Current Tracer** lights up when held on or close to circuits carrying logic pulses from 1 mA to 1A. Troubleshoot wired-AND/OR busses, three-state busses, or pinpoint the one bad device on a stuck node.
- **The 546A Logic Pulser** is programmable to give one pulse per command, a 1, 10, or 100 Hz stream or a burst of 10 or 100 pulses. It drives TTL or CMOS high nodes low and low nodes high for stimulus/response testing.
- **The 545A Multi-Family Logic Probe** lights up to show logic highs, lows or bad level. Its pulse stretcher catches pulses as short as 10 ns.

Check C on the HP Reply Card.

The 548A logic clip is so easy to use that you can concentrate on the circuit under test instead of the test equipment.

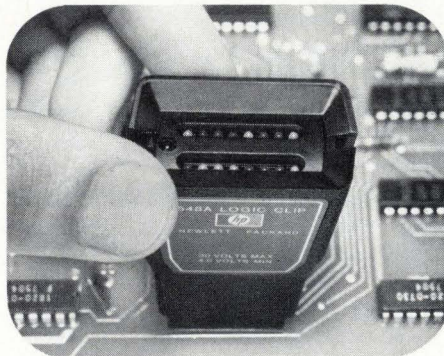

NEW "minicomputer on a board" is user programmable

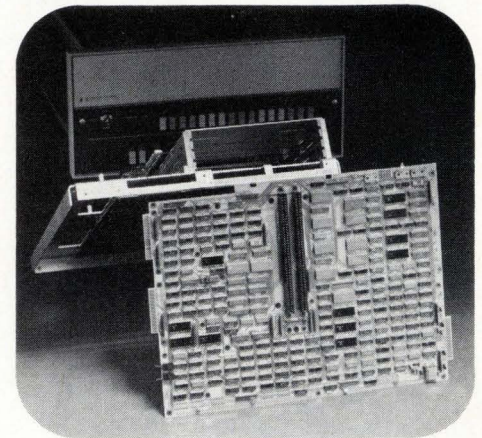

The new K-Series mini-processor board, which is hardware and software compatible with HP's 21MX Series of minicomputers, is supported by HP's powerful distributed systems software and hardware.

For the first time, Hewlett-Packard is offering the 21MX K-Series mini-processor components. Conveniently packaged for integration into your systems, the series includes the 2108K mini-processor board, instruction ROMs, front panel control assembly, and a choice of 18-slot or 8-slot cages.

As a 24-bit microprocessor, it is capable of performing a register-to-register add in one 325-ns cycle.

With the 12728E instruction set ROM, it becomes compatible with 21MX processor options, peripherals and operating systems.

Users can also benefit from the complete library of 21MX software systems for standard high level languages and microprogramming language, including the powerful new RTE-III Real-Time Executive operating system.

Systems which could be designed around the HP processor include spectrometers, numerical control units, smart terminals, graphic display systems, medical diagnostic systems and other test equipment. A broad range of peripherals and instrumentation interfaces are available.

The 2108K gives you an opportunity to design high performance processing into your system. Accessories are priced separately. OEM discounts are available for quantity purchases.

For more information, circle A on the HP Reply Card.

Accurate measurements in hard-to-reach spots using touch-hold probe on new DMM

The touch-hold probe accessory for the new Hewlett-Packard 3½ digit, five-function autoranging digital multimeter allows the user to "freeze" the reading on the display—a convenience when probing closely-packed circuit boards.

Autoranging and manual modes: ac voltage, dc voltage and resistance can be measured either autorange or manually selected ranges. Select autorange to speed readings and minimize reading error—the LED readout always displays appropriate units. For repetitive readings, or ac and dc current measurements, use the manual mode, selecting from at least five ranges for each function...again the appropriate units will be automatically displayed on the high-efficiency LED annunciators.

Eliminate the need for both a high frequency ac voltmeter and a low-range ohmmeter inasmuch as the 3435A operates over a bandwidth five times greater than most comparably priced DMMs. Measure up to 1200V rms between 30 Hz and 100 kHz, with mid-band accuracy of 0.3% of reading plus three digits. Or, test resistance from a new low range of 20Ω full scale up to 20 MΩ. Dc voltages up to 1200V are

measured with a full-year best accuracy of 0.1% of reading plus one digit. Ac and dc current ranges extend from 20 μA to 2A. All inputs are protected; polarity is automatically sensed and displayed, and autozero occurs before each reading. Open circuit voltage on the ohm terminal, at its lowest range, does not exceed 5 volts, thus preventing damage to most solid-state devices.

Contact and transformer winding resistance are easily measured with 10 milliohm sensitivity. 100 μA sensitivity on the ac and dc ranges make the 3435A ideal for both bench and field applications.

An extensive line of accessories also includes probes for measuring ac voltages at frequencies as high as 700 MHz and dc voltage up to 40 kV.

The standard 3435A is ac line or battery operated and includes batteries and recharging circuitry. If you don't need battery operation, Option 001 gives you line operation only. A rack mounting model is also available. The touch-hold probe is an inexpensive accessory.

For more details, check F on the HP Reply Card.



With new touch-hold probe, you can concentrate on your circuit, conveniently hold the measurement, and read the 3435's display after removing the probe. You are confident of measuring at the right point without accidentally shorting the circuit.

HP logic state analyzer speeds digital design and logic troubleshooting

In the TABLE mode, the 1600S displays up to 16 lines of code, and up to 32 bits wide, with their sequential relationships in familiar logic notation.

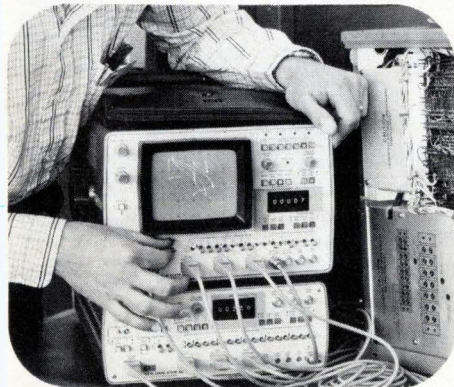

In the MAP mode, you can examine the unique "fingerprint" of every logic system.

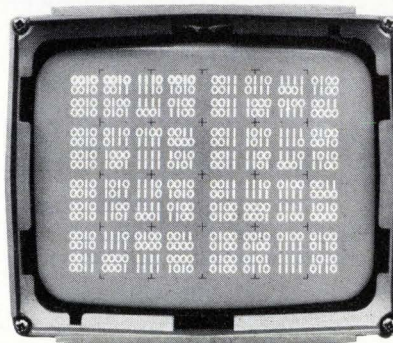

If you've ever spent more time than you care to account for in looking for the source of elusive digital problems, you will appreciate the effectiveness of using an HP logic state analyzer.

Look inside your operating circuit, right on the busses and qualifier lines. The HP 1600S logic state analyzer gives

you two ways to view system operation—**MAPPING** and **TABLE**.

MAPPING, which consists of a display of interconnected dots, offers a dynamic overall view of the program flow.

Each dot represents a specific data word with its position determined by the binary content of the word and its brightness indicates its relative frequency of occurrence. Once the suspected problem area is located, switch to the **TABLE** display mode.

Now, look at events leading up to, surrounding, or following the trigger word. Or, page through a program up to 99 999 clock cycles beyond your trigger point.

Circle D on the HP Reply Card for your copy of an 8-page brochure.

HP calculators control your instruments with easy do-it-yourself interfacing

NEW 4-channel tape recorder offers 32:1 time base expansion or compression plus remote control via HP-IB option



Easily interface your instruments—scanners, counters, spectrometers, meters, converters and many others—with an HP calculator, thus achieving greater efficiency of the use of their outputs. An automated system giving you results and reports faster and easier will eliminate manual readings, adjustments and calculations, freeing you for creative project management.

HP-IB

The new HP 9815 and HP 9825 computing controllers make interfacing practical and inexpensive. Whether your interfacing application is simple data logging, dedicated instrument control, or large system integration, these controllers can save you time and money while increasing productivity.

Converting the signals from one device into signals the connecting device can use, or vice versa, is now simplified. You simply plug the correct interface card into the back of the controller that fits your need. Connect your instrument to the other end of the I/O card, program your controller with a few simple instructions, and you're ready to put your automated system to work.

Types of interfaces available for the 9815 and 9825 include:

HP-IB—Hewlett-Packard Interface Bus—up to 14 instruments with built-in HP-IB capability can be interconnected to a computing controller via this interface system, HP's implementation of IEEE Standard 488-1975. Bi-directional, asynchronous communication is now possible between many instruments.

BCD—The Instrumentation/Measurement Interface—the majority of instruments produced today output four-bit parallel BCD data.

Bit-Parallel—The General Purpose Interface—choose either 8 or 16-bit parallel input bus and an 8 or 16-bit parallel latched output bus combination. Use this interface to connect to HP devices such as plotters, tape readers, printers, or other equipment such as scanners, scanning electron microscopes, etc.

The HP 9815 calculator is an inexpensive alternative to manual monitoring of an instrument or small system.

For large complex instrumentation systems, the HP 9825 can interface to as many as 42 measuring instruments through its three I/O slots. The internal processing speed is so fast that transferring data and commands, accepting inputs, analyzing data, and printing or plotting results appear to happen simultaneously.

For additional details on selecting the calculator and/or the interface that will best meet your needs, check Q on the HP Reply Card.

A new four-channel (0.6 cm) ¼-inch instrumentation tape recorder, the HP 3964A, has all of the standard features of the recently announced eight-channel HP 3968A ITR but at a much lower price.

Versatility, portability and durability are factors that will interest both the individual researcher and the OEM user, both for laboratory and field use.

Record at six tape speeds from 15/32 ips to 15 ips. Standard features include remote control, internal AC/DC calibrator, tape/tach servo mode and flutter compensation. Channel 2 may be interrupted for voice annotation; microphone and speaker are included.

FM recording is from DC to 5 kHz with a signal-to-noise ratio (SNR) of 48 dB at 15 ips. Direct recording is from 50 Hz to 64 kHz with SNR of 38 dB.

For additional information on additional features and options, check H on the HP Reply Card.

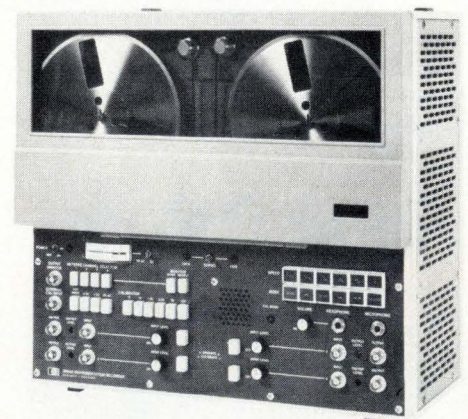

HP-IB

With increased time base expansion, rapidly changing signals can be slowed down and recorded by strip chart or oscillographic recorders for detailed analysis. Low frequency signals can be scaled up for observation on an oscilloscope.

How to make your spectrum analyzer measurements more accurate

Just published is a new application note, AN 150-8, a comprehensive discussion of spectrum analyzer accuracy considerations. Factors that determine amplitude and frequency accuracy are examined and procedures for obtaining the best accuracy are presented. Special cases such as swept measurements, low-level signals and closely spaced signals are described.

For your copy, check T on the HP Reply Card.

Boost low level signals with new 1300 MHz preamp

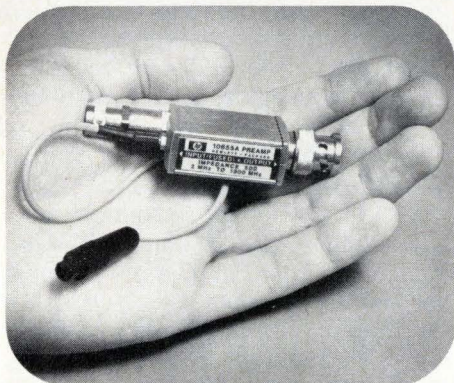

Noise figure of new preamp is less than 8.5 dB.

The new HP 10855A preamp enhances measurements of very low level signals by 22 dB minimum. Uses include amplifying "on-the-air" signals for measurement with counters or spectrum analyzers and restoring the loss of scope divider probes. The 10855A boosts the input sensitivity of HP counters by a factor of 10.

This preamp features ± 1 dB flat response from 2 MHz to 1300 MHz, with 50 Ω input and output impedances. This covers the VHF and UHF television, mobile communications and TACAN/DME bands. An input fuse prevents costly preamp damage.

The 10855A operates conveniently with HP measuring instruments having probe power outlets (see counter above right) or will work with a separate probe power supply such as the HP 1122A.

For more information, check R on the HP Reply Card.

Two HP-IB compatible counters measure UHF and TACAN/DME frequencies



HP-IB

The compact HP 5305B is designed for bench and portable applications in communications service; the HP 5328A is a full capability Universal Counter including precision frequency and time interval measurement for bench and systems use in laboratory or production test.

New capabilities extend two HP counters to 1300 MHz with 20 mV sensitivity to cover the VHF and UHF TV and mobile communications bands, TACAN/DME, and AM and FM broadcast bands. Each also includes a first for electronic counters—a probe power outlet to drive an accessory 22 dB ($\times 10$) preamp. The HP 10855A Preamp (plugged into 5328A counter above) enables the measurement of very low level signals. See article to the left.

Model 5305B operates with the 8-digit 5300B mainframe for frequency measurements from 50 Hz to 1300 MHz. A phase-locked multiplier gives $\times 1000$ resolution for rapid, accurate, automatic audio tone measurements to 10 kHz. With both extended high frequency range and improved audio range resolution, the 5305B is ideal for servicing mobile communications equipment that uses tone modulation for digital transmission.

The 5305B is one of eight snap-on modules for the 5300B measurement system. Any of seven other modules can be snapped onto the 5300B upper "readout module" in place of the 5305B in less than 30 seconds to convert the 5300B for other frequency or time interval measurements, or to a digi-

tal multimeter for ac/dc volts/ohms. Other accessories that snap between upper and lower halves include a battery pack and charger, a digital-to-analog converter for high resolution plots on analog recorders, and an HP-IB module for outputting digital data to the Hewlett-Packard Interface Bus.

With the HP 5328A Universal Counter, Option 031 adds 1300 MHz frequency measurement range to the extensive period, time interval, totalizing, ratio and voltage measurement capability of this 8-digit counter (9 digits optional).

The 5328A achieves its extended versatility by any of eight options which are either factory or field installable in about an hour. In addition to Option 031, there's: an ultra-stable time base option for higher accuracy, complete remote operation via the Hewlett-Packard Interface Bus, choice of two different built-in DVMs, a third frequency input channel up to 512 MHz with 9-digit display and a high performance time interval option.

For more information, check N on the HP Reply Card.

The HP 8640B now phase locks with 500 Hz resolution. Companion down converter extends output down to 5 kHz

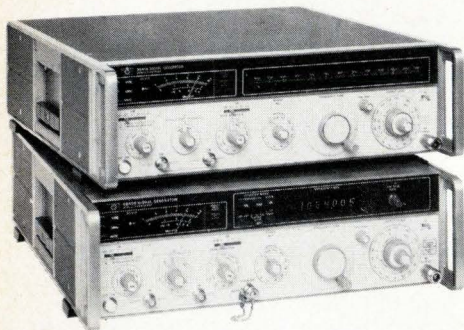

Models 8640A/B signal generators are now offered with improvements in resolution, power, and modulation settability.

Some mobile FM receivers (especially in Europe) are now using channel spacing of 12.5 kHz to increase communications capacity. To meet this need, the HP 8640B signal generator now features an additional half digit of phase lock resolution across its entire band of 500 kHz to 1024 MHz. (500 Hz lock points from 100 MHz to 1 GHz).

Internal design changes provide simplified front panel operation for output power and modulation settings. New, low-power counter circuits and other component changes have reduced heat and component count for added reliability.

The same power and modulation changes have been made in the HP 8640A slide-rule-dial tuning signal generator.

For additional technical information on this increased capability of the 8640A/B signal generators and the 11710A down converter, check P on the HP Reply Card.



The model 11710A down converter extends the frequency range of the 8640A/B down to 5 kHz.

New 5 kHz to 550 kHz down converter

Design and service of AM-FM broadcast receivers often require test signals for both RF bands as well as the standard IF frequencies at 262 kHz and 455 kHz.

The HP 11710A down converter, as an accessory for the above-mentioned 8640A/B, provides a frequency range of 5 kHz to 500 kHz by mixing a 5.0 to 5.5 MHz carrier from the 8640 signal generator with a fixed 5 MHz oscillator in the 11710A.

Calibrated output level is preserved from 0 to -107 dBm, and the calibrated modulations may be set on the 8640. Intermixing spurious is more than 80 dBc (dB below carrier) and harmonics are more than 30 dB down. For user convenience, an RF switch bypasses the down converter and eliminates the need to switch cables when using the standard 8640 band.

New miniature 18 and 26.5 GHz microwave detectors ideal for designing into equipment

Equipment designers who require a broadband microwave detector with excellent performance and small dimensions now have an answer.

The HP 33330B detector covers the frequency range 0.010 to 18 GHz with excellent flatness (± 0.6 dB to 18 GHz). Package size is ideal for designing into small spaces. Total length of the package is 4.2 cm (1.70 in) and diameter is .97 cm (0.38 in). The model 33330C extends the frequency range to 26.5 GHz with reduced performance.

RF input is 50 Ω with an SWR of less than 1.5 to 18 GHz. The connector is the new APC-3.5 precision sub-miniature which exhibits outstanding reliability and repeatability even after 1000 connections. The APC-3.5 is fully compatible with the industry-standard 3.5 mm SMA series. The video output connector mates with the SMC series, which is especially well suited for the miniature cabling of modern equipment.

Models 33330B/C utilize the same field-replaceable diode module developed by Hewlett-Packard for measurement-quality microwave detectors and are specifically designed for use in rugged environmental conditions.

For more details, check K on the HP Reply Card.



HP 33330B microwave detector (.010 to 18 GHz) is of very small size for use in OEM equipment

New low loss absorptive modulators cut insertion loss 0.5 dB

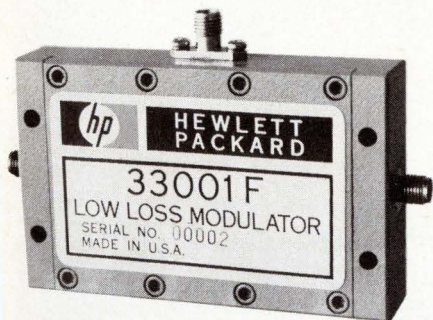

New hermetically sealed semiconductor devices in a rugged overall package are matched at all attenuation levels.

Three new HP absorptive modulators 33001E/F, 33008E) provide at least 0.5 dB improvement in insertion loss over previously available models. This improvement has been made possible by incorporating Hewlett-Packard low-loss PIN diodes into the modulators.

Absorptive modulator applications include level setting, wideband amplitude modulation, pulse modulation and switching. The absorptive modulators present constant impedance and therefore are useful where load sensitive sources are used.

These absorptive modulators are electronically controllable attenuators over the frequency range from 3.7 to 8 GHz. Each product covers greater than one octave and presents a good impedance match ($Z_0 = 50\Omega$) at both RF ports for all values of attenuation.

For technical data, check J on the HP Reply Card.

High reliability test programs for microwave transistors

If your procurement needs are immediate and you need microwave transistors screened by high-reliability test programs, Hewlett-Packard offers four levels of high-reliability testing patterned after MIL-S-19500.

Applications for these "off-the-shelf" microwave transistors include satellite equipment, avionics, radar, military radio and communications.

Four small-signal NPN transistors are presently offered: 35824A for general use to 1 GHz; 35826E for microstrip use to 4 GHz; 35829E optimized for high "tuned" gain at 2 GHz; and 35866E optimized for low noise at 4 GHz.

Details of these test programs are described in a new technical data sheet. For your copy, check I on the HP Reply Card.

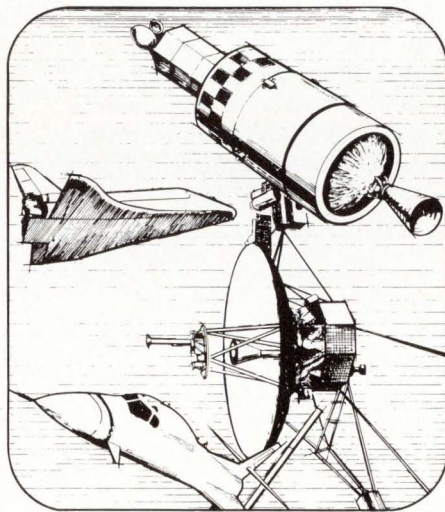

New low-power monolithic displays

Now available from Hewlett-Packard is a new series of large monolithic LED displays for instrument design. These magnified displays require only 1/3 the power of conventional seven-segment displays while offering excellent readability in high ambient light conditions.

Close digit-to-digit spacing allows over 4 digits per inch in a pre-aligned

multi-digit package.

The 5082-7265/75/85/95 series comes in 5 and 15-digit packages with centered or right-hand decimal points.

These devices are available from any franchised HP distributor.

For a technical data sheet, check M on the HP Reply Card.

Four new .43" universal overflow digits

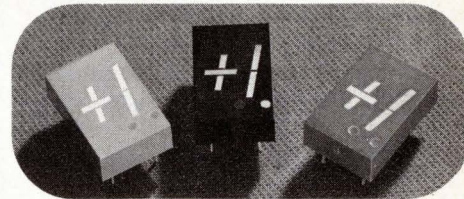

Overflow digits expand HP display family.

Available in red, high-efficiency red, yellow or green these devices can be driven common anode or common cathode because both leads of each LED are brought out to separate pins. Right-hand decimal point is a standard feature on this 5082-7756 series.

These devices are available from any franchised HP distributor.

For more information, check L on the HP Reply Card.

New microwave components short form catalog

Microwave circuit designers will want this new 4-page quick reference guide to Hewlett-Packard's line of diodes and transistors. A condensed review of the company's microwave components, this new brochure gives important specifications of HP's microwave transistors, and PIN, IMPATT, step recovery and Schottky diodes. Also included are condensed specifications of MIS capacitor chips and a printed circuit balanced mixer.

For your copy, check S on the HP Reply Card.

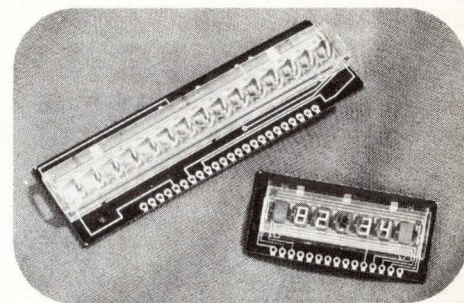

Make RF network measurements automatically— cassette programs simplify system start-up

Hewlett-Packard's new 1.3 GHz network analyzer, the 8505A, brings unprecedented capability to RF network characterization: 100 dB dynamic range, high-resolution digital data read-out with analog display, direct measurement of group delay, and a unique electronic line stretcher to measure deviation from linear phase.

The 8505A is also the most programmable network analyzer available today, permitting the analyzer to combine with the programmable HP 9830 calculator through the Hewlett-Packard Interface Bus (HP-IB) to become an immensely powerful *automatic* network analyzer.

Key advantages of automating the network analyzer include: extreme measurement accuracies (by virtue of the system's ability to measure, store, then subtract such vector errors as frequency response, directivity and source match) ability to make many measurements quickly, and the ability to manipulate data and format results in a suitable form.

Unique to this new automatic analyzer is its "**Learn Mode**" of operation which makes it possible to automate measurements *without programming*. A single key stroke can cause the calculator to store (Learn) the front-panel control settings of the network analyzer. These can later be recalled which re-



HP-IB

Model 8507A Automatic Network Analyzer, 500 kHz—1.3 GHz, dramatically reduces the time and cost of executing complicated tests.

turns the analyzer to its original test conditions. An entire test procedure can be created without writing a single program line!

A fully-configured automatic analyzer, Model 8507A, includes the 8505A analyzer, 8503A s-parameter test set, 9830 calculator (controller)

with printer, necessary interfaces, cables, calibration kit, table and cassette programs which permit you to start making measurements immediately.

For more details, check O on the HP Reply Card.

East-4 Choke Cherry Road, Rockville, MD 20850
Ph. (301) 948-6370.

South-P.O. Box 10505, Atlanta, GA 30348
Ph. (404) 434-4000.

Midwest-5500 Howard Street, Skokie, IL 60076,
Ph. (312) 677-0400.

West-3939 Lankershim Blvd, North Hollywood, CA
91604, Ph. (213) 877-1282.

Europe-7, rue du Bois-du-lan, P.O. Box, CH-1217, Meyrin-2,
Geneva, Switzerland, Ph. (022) 41 54 00.

Canada-6877 Goreway Drive, Mississauga, Ontario,
L4V 1M8, Ph. (416) 678-9430.

Japan-Yokogawa-Hewlett-Packard Ltd., Ohashi
Bldg., 1-59-1 Yoyogi, Shibuya-ku,
Tokyo 151, Ph. 03-370-2281/92.

HEWLETT  PACKARD

Sales and service from 172 offices in 65 countries.

 MEASUREMENT
COMPUTATION **NEWS**
innovations from Hewlett-Packard

July/August 1976

New product information from

HEWLETT-PACKARD

Editor: Iona M. Smith

Editorial Offices:

1507 Page Mill Road
Palo Alto, California, 94304 U.S.A.

CAUTION: 50,000 VOLTS



LET ERIE DESIGN and BUILD YOUR HIGH VOLTAGE POWER SUPPLIES and VOLTAGE MULTIPLIERS

When you talk about designing and packaging miniature, low current High Voltage Power Supplies and Voltage Multipliers, the name ERIE should come to mind first. Why? *No other manufacturer of these sophisticated devices has its own capacitor and rectifier technology in-house.* Only ERIE does it all. Our many years experience in producing State of the Art high voltage capacitors and high voltage silicon rectifiers — plus an unsurpassed technology in circuit designing, packaging and encapsulation, makes ERIE an ideal source for your high voltage component needs. From very low input voltages, ERIE can produce output voltages up to 50,000 volts. Application for these compact, high reliability devices includes night-vision image intensification systems. Apollo TV cameras. CRT displays. Avionics systems exposed to rugged environments. Industrial, commercial and military equipments . . . an almost infinite variety of applications. So bring ERIE in early. Let us design and build *your* High Voltage Power Supplies and Voltage Multipliers. We're equipped to handle large or small volume orders . . . in-house.

Write for our 32-page catalog . . .
High Voltage Components and
Devices . . . or for technical
assistance, call

613/392-2581

ERIE TECHNOLOGICAL PRODUCTS, INC.
Erie, Pennsylvania 16512



MOSTEK'S MK 4027-2. HIGH PERFORMANCE STARTS WITH ACCESS TIME.

150ns

With MOSTEK's new 4K RAM your system performance can match data sheet specs.

At 150 ns access time (worst case), the MK 4027-2 is the fastest 16-pin 4K RAM in the industry. It appears even faster when compared to 18 or 22-pin 4Ks that require high-level clocks and differential outputs. In this comparison, our 150ns is actually better than their 120ns.

But fast MOS memory can't be used efficiently unless you can surround it with high performance logic. You can with the MK 4027 because it's completely Schottky-TTL compatible with a max V_{IL} spec of .8 volts. And a wide $\pm 10\%$ tolerance on all power supplies is a standard feature from MOSTEK.

Gated \overline{CAS} , another new MK 4027 feature, provides an expanded timing window to compensate for timing skews encountered in the multiplexing operation. This window is a full 25% of overall access time.

The MK 4027 can further upgrade system performance with an improved output drive capability. It sources 5mA and sinks 3.2 mA while driving a 100 pF load. Other 4Ks drive only one TTL load and 50 pF.

By employing essentially all dynamic internal circuitry, the MK 4027 dissipates very little DC power. This allows the device to remain much cooler in operation than competitive products and is one reason for its outstanding reliability.

A new operating mode improves access time to 100ns.

It's called "page mode," an addition to the normal cycles of read, write, read-write, and read-modify-write. In a nutshell, page mode allows for successive memory operations at multiple column locations at the same row address with increased speed — 100ns — and decreased power.

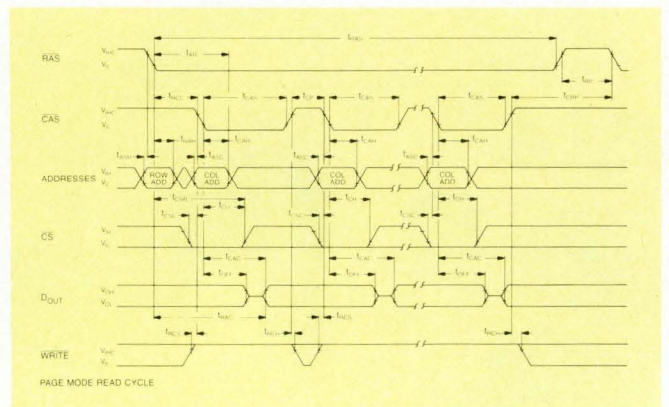

Page mode is not limited to any single chip. Since the \overline{CS} input can be used to select or disable any cycle(s) in a series of "page" cycles, the page boundary can be extended to multiple 4K memory blocks.

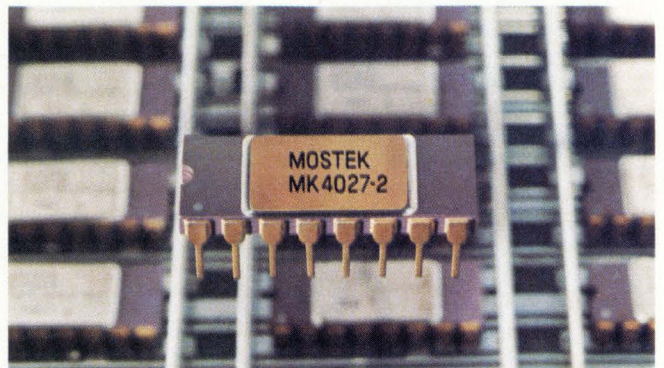
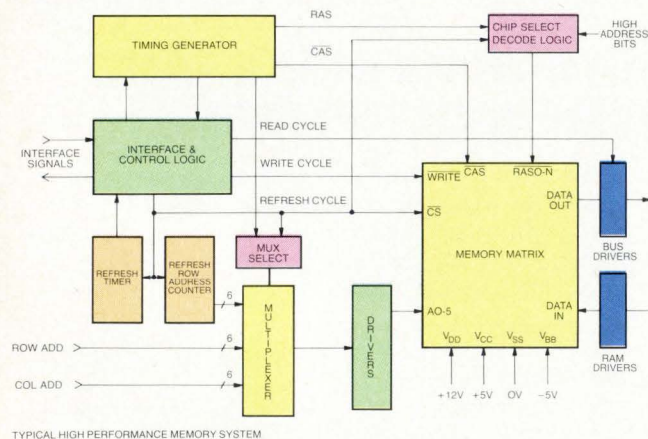

MOSTEK's 16-pin package reduces memory board size 50% over 22-pin packages.

How about density — yours and ours?

As you might expect the MK 4027 is in the industry standard 16-pin package allowing the greatest possible density for your high performance memory system.

We've been working on our own density, too. At 104 mils x 140 mils the MK 4027-2 is the smallest 4K RAM in the industry.



Reliability? MOSTEK sets the standard.

The fastest, the smallest, the most versatile is not automatically the best. Not without MOSTEK quality. Every 4K RAM MOSTEK ships is subjected to these screens and stresses: pre-burn at high temperature, temperature cycling, centrifuge, dynamic burn-in at 125° C, and final test with wide guardbands.

High Performance 4K RAMs . . . Here's your choice.

	16-pin MK 4027-2	18-pin TI 4050-2	22-pin 2107B
FEATURES			
Access Time	150ns	200ns	200ns
Cycle Time	320ns	400ns	400ns
Read/Modify/Write	350ns	600ns	520ns
Worst Case Power			
Dissipation	462mw	478mw	680mw
V _{IL} (all inputs)	0.8v	0.6v	0.6v
V _{IH} (data, address)	2.2v	2.2v	2.4v
V _{IHC} (clocks)	2.4v	12.0v	12.0v
Clock Cap.	7pF (max)	33pF (max)	25pF
Power Supply Tol.	±10%	±5%	±5%
Page Mode	YES	NO	NO

MOSTEK's 16K RAM is coming soon.

In addition to an unlatched output, MOSTEK's 16K RAM will include all the features found in our high performance 4K. This means Schottky-TTL compatibility, ±10% tolerance on power supplies, page-mode, gated $\overline{\text{CAS}}$ and low power. Designing and testing with MOSTEK's MK 4027's in your production systems now is a logical "first step" toward an efficient 16K system.

Want more information? There's an application note and data sheet package that tells the complete MK 4027 story. Write on your letterhead to MS 402 for quick response. Or pick up the literature package and a sample at your local MOSTEK distributor.

MOSTEK

1215 West Crosby Road, Carrollton, Texas 75006
 (214) 242-0444
 In Europe, Contact:
 MOSTEK GmbH, TALSTR, 172, 7024 Filderstadt-1,
 West Germany
 Telephone: (0711) 701096

Meetings

IFIP Congress 77, International Federation for Information Processing, Four Seasons Sheraton Hotel, Toronto, Canada, Aug. 8-12.

Conference on Algorithms for Image Processing, Engineering Foundation (New York, N.Y.), Franklin Pierce College, Rindge, N.H., Aug. 8-13.

Symposium on Control in Transportation Systems, IFAC, IFIP, and IFORS, Ohio State University, Columbus, Aug. 9-13.

Symposium on the Simulation of Computer Systems, National Bureau of Standards and Association for Computing Machinery, NBS, Boulder, Colo., Aug. 10-12.

Applied Superconductivity Conference, IEEE, Stanford University, Calif., Aug. 17-20.

20th Annual SPIE Technical Symposium and Instrument Display, Society of Photo-Optical Instrumentation Engineers, Town and Country Hotel, San Diego, Aug. 23-27.

Parallel Processing International Conference, IEEE and Wayne State University, Walden Woods Resort and Conference Center, Walden Woods, Mich., Aug. 24-27.

Comcon 76 Fall, IEEE, Mayflower Hotel, Washington, D.C., Sept. 7-10.

Communication '76, Montan Ausstellungs GmbH, (Mulheim a/d Ruhr, West Germany), Gruga Messe Halls, Essen, West Germany, Sept. 7-10.

1976 International Machine Tool Show, National Machine Builder's Association (McLean, Va.), International Amphitheatre and McCormick Place, Chicago, Sept. 8-17.

Oceans '76, Marine Technology Society and IEEE, Sheraton-Park Hotel, Washington, D.C., Sept. 13-15.

The image shows five small, gold-colored Thin-Trim capacitors with two leads each, arranged on a green background. In the upper right, a portion of a Pulsar Watch is visible, showing its internal circuitry and a capacitor being used for trimming.

Thin-Trim[®] capacitors

Tucked in the corner of this Pulsar Watch is a miniature capacitor which is used to trim the crystal. This Thin-Trim capacitor is one of our 9410 series, has an adjustable range of 7 to 45 pf, and is .200" x .200" x .050" thick.

The Thin-Trim concept provides a variable device to replace fixed tuning techniques and cut-and-try methods of adjustment. Thin-Trim capacitors are available in a variety of lead configurations making them easy to mount.

A smaller version of the 9410 is the 9402 series with a maximum capacitance value of 25 pf. These are perfect for applications in sub-miniature circuits such as ladies' electronic wrist watches and phased array MIC's.

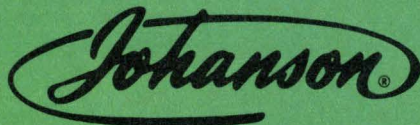
The logo for Johanson Manufacturing Corporation, featuring the name "Johanson" in a stylized, cursive script font enclosed within an oval border.

Johanson Manufacturing Corporation
Rockaway Valley Road
Boonton, New Jersey 07005
(201) 334-2676 TWX 710-987-8367

No. Galileo is not the little old Napa Valley winemaker.

Galileo Electro-Optics Corp. isn't little nor relatively old. And no, we don't make wine either. Galileo is simply one of the world's largest producers of optical communication cable.

Our new Galite™ family consists of five completely different types of optical communication cable. Because the Galite family is the widest range of cables available anywhere, we can thus service your particular needs best.

All Galite cables are immune to electromagnetic interference (EMI/RFI), are much lighter than coaxial cable, eliminate cross talk between channels and have a higher information carrying capacity than conventional cable. And all are available right now from current stock.

Galite 3000 is a truly new and unique optical communication cable. And because of our exclusive



rights to a patented glassmaking process, Galileo is its only source in North America. These fibers are constructed of high purity glass to reduce attenuation. The cladding glass, deposited by this patented process, is impervious to organic solvents and retains its unique properties at temperatures where plastic fibers deteriorate.

Galite 3000 is a step index optical fiber for transmitting data primarily from 70 to 330 meters/230 to 1100 ft. This range accommodates most current market applications such as link-

ing computer terminals, shipboard and aircraft communication and control systems, and automated process controls.

For more information, write: Galileo Electro-Optics Corporation, Galileo Park, Sturbridge, Mass. 01518. Or call us at (617) 347-9191.

Imagine what we could be doing for you right now.

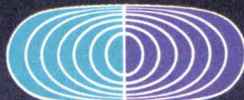

Galileo Electro-Optics Corp. Galileo Park, Sturbridge, Massachusetts 01518, (617) 347-9191

Circle 31 on reader service card

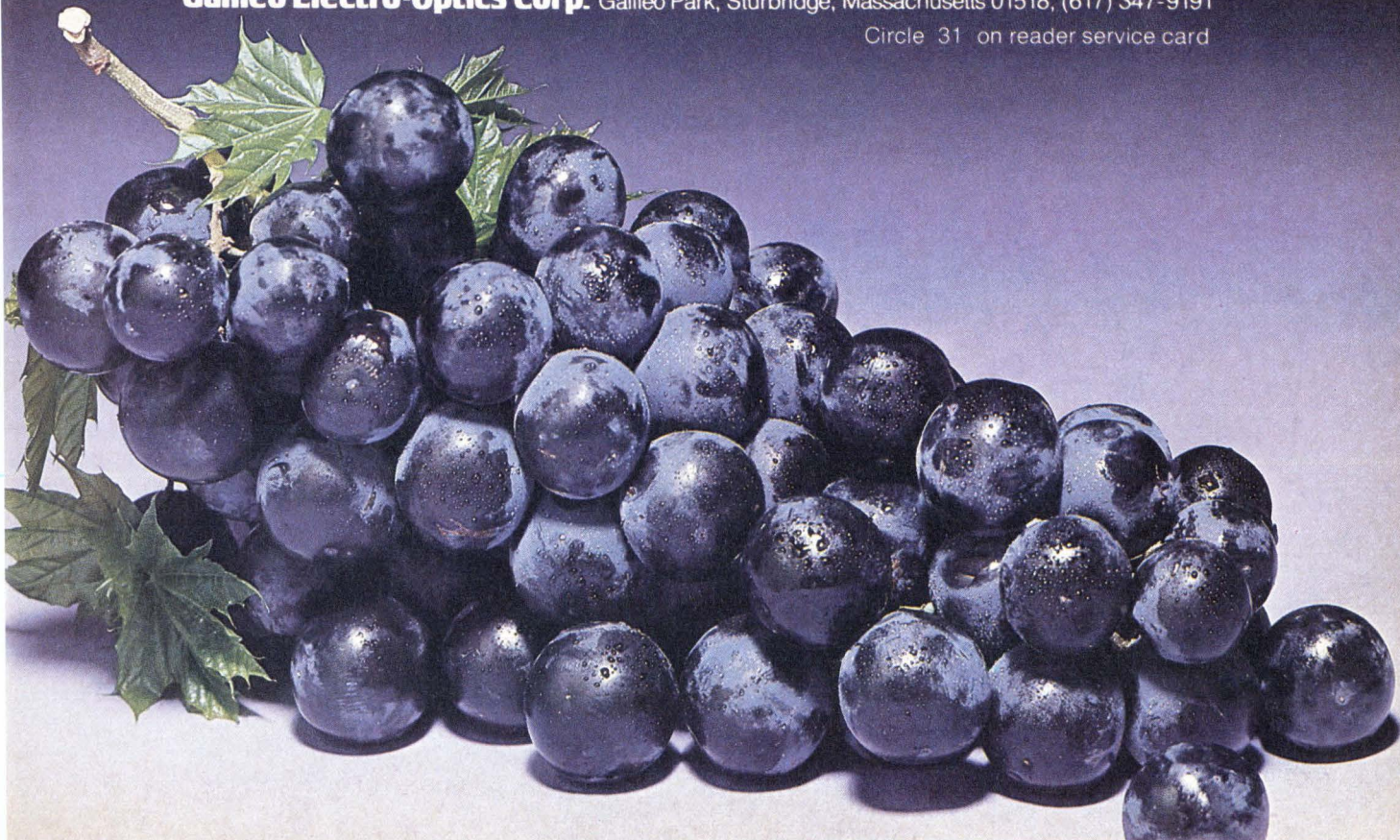

Our \$995* CPU is actually less than half the price of the 8080 or 6800 CPU.

And it's just the beginning of your saving. On-chip RAM, ROM and timers make an even bigger difference. Difference in cost. Difference in reliability and difference in manufacturing time. The following is the whole price/performance story of our F8 system, from minimum configurations to expanded systems.

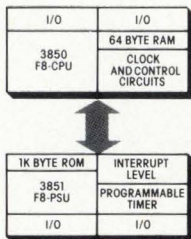

Lowest cost configuration

Our minimum configuration F8 is perfect for controlling home appliances, braking systems, vending machines, ignition systems and other uses with modest memory and I/O requirements.

Two chips do it all – a \$9.95 PSU (Program Storage Unit) and F8 CPU (Central Processing Unit) for \$9.95. The CPU is an 8-bit device, with a cycle time of 2 micro-seconds. It's the heart of all F8 microprocessors. It includes 70 instructions, 64-byte RAM (Random Access Memory), instruction register, accumulator, 16 individually controllable I/O lines, power-on reset, on-chip clock and control lines to other devices.

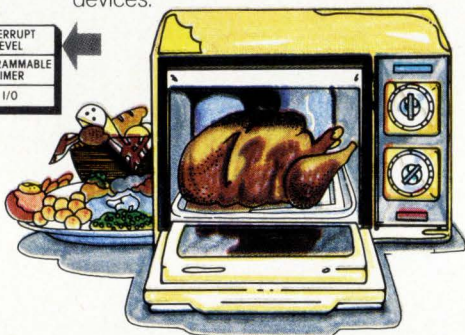

The PSU features a 1K byte ROM (Read Only Memory), program counter, 16 individually controllable I/O lines, 8-bit data port, stack register, incrementer/adder, and programmable timer and interrupt.

We're the only manufacturer in the world to offer this 2-chip performance. The 8080 requires 7 chips (9 chips with timer) to do the same thing.

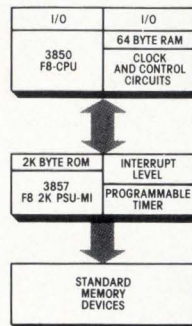

Double the program storage

If you need more program space, just substitute PSU's. Our new 2K byte PSU offers twice the ROM for only \$14.95.

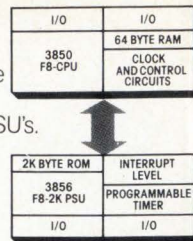

Built-in interface to external memory

But suppose you need a couple of RAM's added to your CPU and 2K/PSU. Again, substitute PSU's for one with a built in memory interface. Avoid paying for extra chips. Order our new 2K/PSU-MI for \$14.95. This is super microprocessor power on 4 chips.

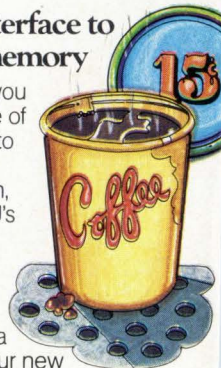

The 8080 takes 10 chips (12 with timer) to do the same thing.

Fairchild's \$9.95 F8 Microprocessor

Half the Cost Twice the Versatility

A system that needs no ROM

If you don't want to commit to ROM, consider interfacing RAM and/or PROM (Programmable Read Only Memory) directly into the CPU. This approach is ideal when your production run is under 1,000 units, and for development prior to long production runs.

This F8 configuration uses only four chips: a CPU, a \$7.45 SMI (Static Memory Interface with interrupt and programmable timer) and two 2K PROMs.

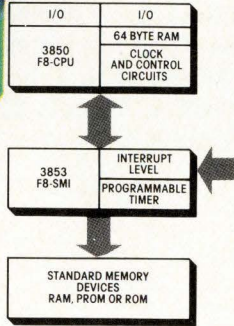
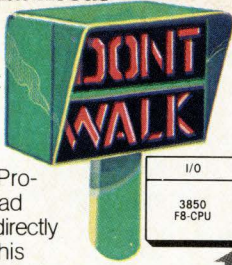

Where more I/O is needed

By adding our \$6.45 PIO (Parallel I/O) to this aforementioned configuration, you gain 16 I/O ports, another level of interrupt and a programmable timer. Now you have the perfect 5-chip microprocessor system for electronic scales, paper tape and cassette tape handlers, electronic games, traffic light control, cash register and similar applications.

Competitors take 10 chips to do the same thing.

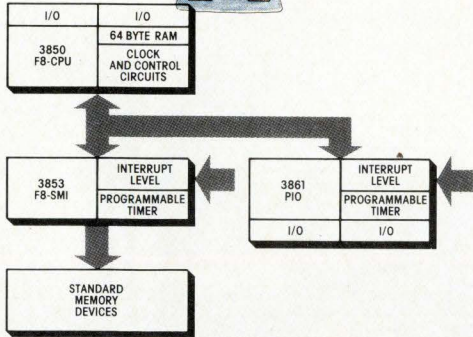
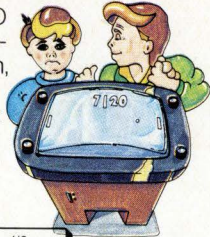

Memory intensive systems

In memory intensive applications like message concentrators, floppy disc controllers, and store-and-forward message switching you'll enjoy big benefits with the F8's DMI (Dynamic Memory Interface).



This \$7.45 device fits between your CPU and dynamic (or static) memory WITHOUT A MEMORY REFRESH CHIP.

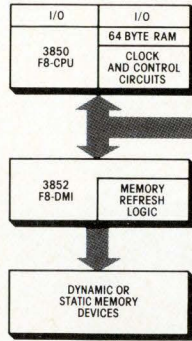

Memory refresh logic is built into the DMI, and operates in sync with the CPU. Your CPU never stops. There's no cycle stealing. No performance degradation. We are the only manufacturer in the world to offer this advantage.

A supercharger for this memory intensive configuration is DMA (Direct Memory Access).

This \$5.95 option comes in one chip. It creates a direct link between your memory and external data. All functional and internal system timing

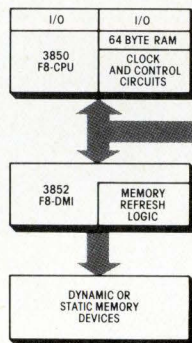
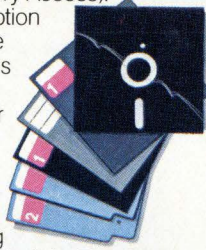

is built in. The DMA can run at 500K bytes/sec and never slows down the rest of the system.

Expand your system

Interchangeability and compatibility are maximized for you. All inter-component timing is built in. Gang PSU's. Add PIO's. Daisy-chain multiprocessor systems.

To cut design time even more, you'll enjoy our Formulator™. Think of it as an instant breadboard—a system developer, tester, debugger, and more. Of all hardware/software development aids on the market, this one is easiest to operate. Easiest to understand.

Discover how easy it is to assemble your own microprocessor. We provide a spectrum of hardware and software development aids. Everything you need including kits, hardware simulators and full program development support.

And then we will show you how to do it all, step by step in our brand new brochure, "THE PATHS OF LEAST RESISTANCE—Four Optimum Ways To Bring Your Microprocessor Product To Market". Write us now, your competitors probably will. We know ours will. Fairchild Micro Systems 1725 Technology Dr. San Jose, CA 95119 (408) 998-0123

FAIRCHILD

*All prices quoted are for 100 to 999 plastic packaged parts, effective Sept. 1, 1976.

Hot-molded resistors provide low temperature coefficient and unmatched reliability.

The Resistance Temperature Coefficient of Allen-Bradley hot-molded fixed resistors is typically less than 200 PPM over the entire resistor range shown in the normal equipment operating temperature of +15°C to +75°C. Excellent RTC ratings have always been an Allen-Bradley benefit. And consistency of Allen-Bradley resistors means repeatable results and tight performance patterns. Allen-Bradley resistors offer the **lowest cost—on the board—**where it counts!

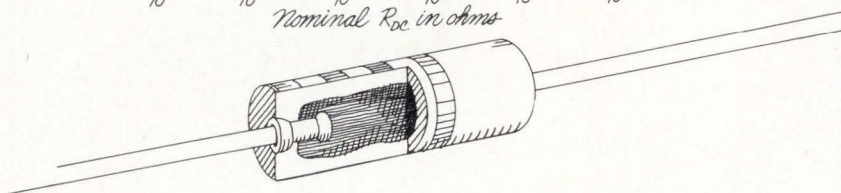
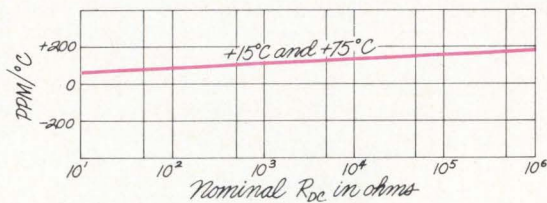

Reliability

is unsurpassed. Over 700 million unit test hours without a single failure.

No coatings

Insulation and resistance element integrally molded into one solid structure.

Pulse handling

characteristics offer outstanding protection against surges and transients.

Quality in the best tradition.



ALLEN-BRADLEY
Electronics Division
Milwaukee, Wisconsin 53204

Packaging twist keeps 10-A relay price below \$3

A novel packaging concept will shortly allow Theta-J Relays Inc. to introduce a solid-state relay that's rated at 10 amperes and will sell for less than \$3 in quantities of 10,000. Edward T. Rodriguez, the company's chairman and technical director, says the price of the ac unit will be **\$7 or \$8 less than that of comparably rated solid-state relays** on the market today.

The package will accommodate units with ratings from 4 to 20 A and is essentially a slightly longer and higher TO-220 package. The trick is that the triac output portion of the circuit is actually the base of the package, with the triac's posts serving as solder or weld posts for the photocell that Theta-J uses in its relays. The top of the triac package also supports the power transistor that completes the relay circuit. Rodriguez looks for applications in photocopying equipment and large appliances, such as washers, dryers, and dishwashers.

HP signs first distributor deal

Hewlett-Packard Co., Palo Alto, Calif., **has made its first move into marketing its instrumentation products through distributors.** HP has signed Elmar Electronics Inc. in Mountain View, Calif., part of the Electronics Distribution group of Wyle Laboratories of El Segundo, Calif. Elmar will stock the low-cost digital troubleshooting gear—including logic probes, pulsers, clips, comparators, and current tracers—made by HP's Santa Clara division.

Although HP has marketed the components produced by its HPA division through distributors, it has not followed some of its competitors into instrument distribution, but continued to handle the lines through a field sales force.

RCA processor to control latest nuclear bomb

In what must be the most explosive application yet for the microprocessor, Sandia Laboratories' newest thermonuclear weapon will be controlled by RCA Corp.'s 8-bit Cosmac 1802. Sandia chose to use a microprocessor in its B77 megaton-range bomb for the same reasons hundreds of designers have: **the need for compact, cost-effective decision-making.**

As the first bomb to be developed in 15 years for missile warheads and artillery projectiles, the B77 succeeds two other weapons and offers a wide range of delivery options: free fall, radar-fuzing, contact-fuzing, and several types of parachute drops, in addition to backup modes. The microprocessor makes several dozen decisions that formerly required relays, switches, and discrete hardware. With the new design, "the weapon can respond to digital transmissions from the aircraft, as well as the traditional 28-volt signals," says Sandia.

Burroughs 800 family gets a new member

With its B 6800, the Burroughs Corp. of Detroit has added a new series to its 800 family of medium- to large-scale computers. The family started last year with the B 2800, B 3800, and B 4800 [*Electronics*, Dec. 25, 1975, p. 36].

The systems feature multiprocessor architecture with central processors operating at 6.7 megahertz, four input/output processors, 16 data-communications processors, and up to 15.7 megabytes of directly addressable core memory. **The B 6800 has more than twice the performance of the earlier B 6700 systems**, but maintains machine-code compatibility. Purchase prices range from \$778,000 to \$4,019,800.

Although the earlier models in the 800 family used semiconductor memory—bipolar in the B 4800 and MOS in the B 2800 and B 3800—the B 6800 uses planar core memory “because its performance and cost per byte are more cost-effective for this particular system,” according to a Burroughs spokesman. A multichip microprocessor similar to the central processor of the recently introduced B 80, a small general-purpose system, [*Electronics*, May 13, p. 38] is built into a maintenance processor to monitor system operation and aid service personnel in running diagnostic software.

Is \$5.99 the lowest price calculators can reach?

How low can calculator prices drop? Nobody knows for sure, but the \$5.99 price tag placed **on a five-function, 8-digit model** by a Los Angeles discount drug chain must be close to the floor. The manufacturer, APF of New York, confirms that this is the lowest price yet for its Mark 40 model, and adds that this is as cheap as it can go.

The firm's calculators, built around a General Instrument logic chip, are made in Japan. The Mark 40, not surprisingly the low model in the line, has four arithmetic functions and a percent key. A year ago it was priced at \$15.99, and it still sells for \$9 to \$10 in some parts of the country.

Ohio-Nuclear denies EMI charges over tomography patents

Ohio-Nuclear Corp. denies charges brought by Britain's EMI Ltd. that it has **violated nine EMI patents covering computerized axial tomography**, a body-scanning technique. Richard S. Grimm, president of Technicare Corp. of Solon, Ohio, the parent firm of Ohio-Nuclear, says, “EMI's causes of action are lacking basis in fact and are inconsistent.” The British firm's suit was filed in U.S. District Court in Cleveland.

FCC approves standard for phone plugs, jacks

Interconnection of non-Bell telephone equipment took a major step forward in mid-July with the issuance of **the nation's first standard specifications for plugs and jacks** by the Federal Communications Commission. That the specifications adopted for interconnecting all hardware except PBX and key systems were those of American Telephone & Telegraph Co. proved no surprise, although the detailed conditions attached to AT&T licensing and fees chargeable to other manufacturers in the 100-page order evoked strong interest. Independent equipment makers are now anxious to get standards developed for PBX and key systems as well [*Electronics*, April 29, p. 26].

In terminating its Docket 20774 with the ruling, the FCC praised the AT&T designs as “technically and economically sound,” adding that it found no others that were “more versatile or cheaper to produce.” Cited in the order are modular plugs with either six or eight “positions”—a term FCC says refers to “pins” since all plugs do not always have a full complement of pins—and mini-ribbon connectors with 50 positions.

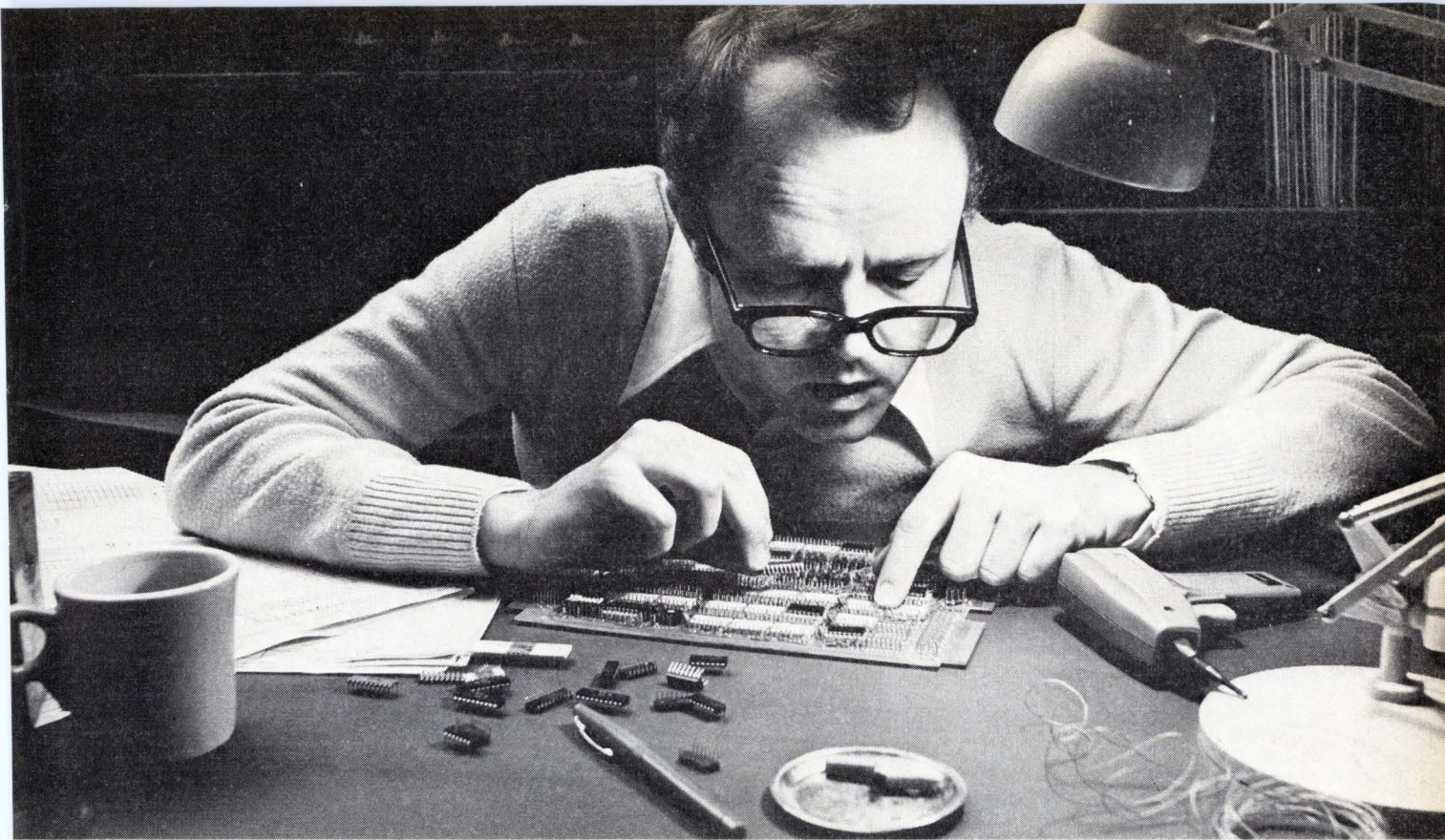

Buy our boards now if you want to stop buying them later.

If you're thinking of making your own micro-computer boards sometime in the future, ours are the only boards to buy right now.

Because the chips on our microNOVA boards are the same ones you can buy in the microNOVA chip set.

Which means you can switch from microNOVA boards to our microNOVA chips anytime you want.

The microNOVA board is a full 4K micro-computer. With a number of standard features. Like power-fail/auto-restart. Real-time clock. NOVA instruction set with hardware stack. Hardware multiply/divide. Data channel logic.

Yet all the above computer costs only \$589, in OEM quantities of 100*.

Which is a lot of computer for a little money.

Because it's a NOVA computer, the microNOVA board comes with powerful run-time software. Like

RTOS, our NOVA-compatible, field proven realtime executive. And it runs both Assembler and FORTRAN.

And because the microNOVA board comes from Data General, it comes with the manuals, technical publications, services, training courses and seminars you'd expect from a large minicomputer company.

Yet the microNOVA 4K board is only one member of an entire family. Besides the board (and all the supporting boards), you can get complete development systems. Or you can get completely packaged MOS minicomputers. Or chip sets that include the mN601 CPU, plus all the supporting chips.

So if you want to end up in the chips, call our toll free number, 800-225-9497. (Unless you're in Massachusetts. In which case, call 1-617-485-9100, EXT. 2509.)

microNOVA:

A giant reduction in the NOVA line.

DataGeneral

Data General, Route 9, Southboro, Mass. 01772 (617) 485-9100. Data General (Canada) Ltd., Ontario.
Data General Europe, 15 Rue Le Sueur, Paris 75116, France. Data General Australia, Melbourne (03) 82-1361

*Prices quoted are FOB Southboro and apply to the U.S. Taxes excluded. NOVA is a registered trademark of Data General Corporation.

The Hard Hats

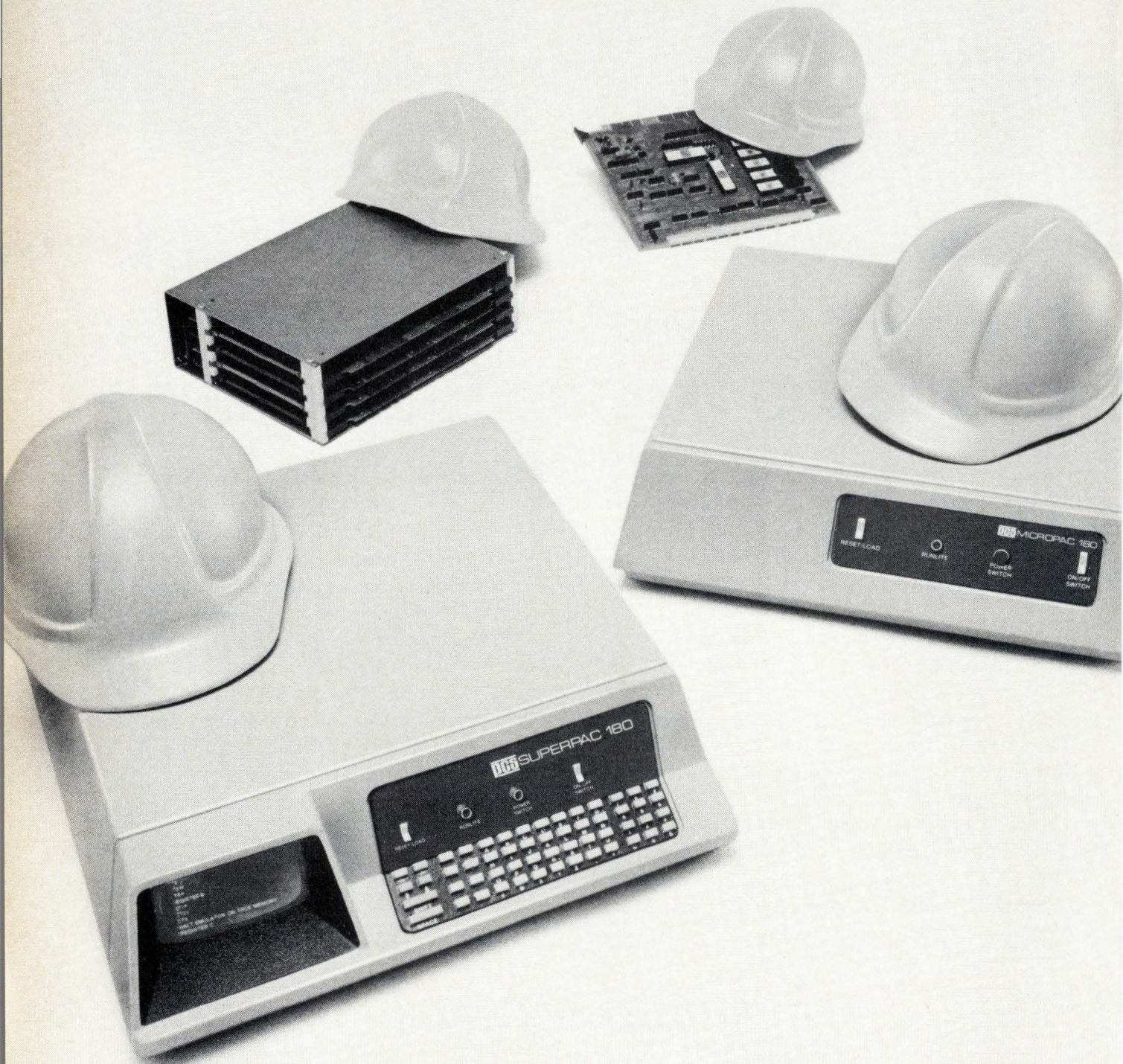

Introducing the first microcomputers tough enough to survive in the real industrial world. And, at a price you can afford.

The PCS 180 Series. From single board micros for under \$300* to packaged systems with integrated CRT and full ASCII keyboard for \$995*. Microcomputers that won't cook in sealed enclosures. With memories that stay up when the power goes off. No one can beat the price. No one can best the performance.

PCS 180s are designed for dirty, corrosive environments. Gathering, analyzing, and sorting data. Monitoring instruments. Starting, stopping, and regulating events. Even communicating with other computers. No matter what the application, there's a PCS 180 ready to put on its hard hat and go to work for you.

SUPERPAC 180. The most advanced general-purpose microcomputer on the market today. Priced at \$995*, the SuperPac 180 gives the system builder both full ASCII keyboard and CRT display capability in a single, low-cost attractive package. Desk-top or rack-mounted, SuperPac 180 includes a PCS 1806 microcomputer, as well as a four-slot chassis, power supply, and self-contained keyboard and CRT control unit. The SuperPac 180 provides 16 lines of 16 or 64 characters, 1024 directly addressable character locations, programmable cursor, blink, and reverse video capabilities.

MICROPAC 180. A low-cost, rack-mountable industrial microcomputer system priced at \$695*. The MicroPac 180 includes a PCS 1806 microcomputer, as well as a four-slot chassis, power supply, and industrial front panel with on-off switch and status indicators.

PCS 1810. A single board micro with 256 bytes of CMOS RAM, plus provisions for up to 1K bytes of RAM and 3K bytes of EROM/ROM. The PCS 1810 features power fail/auto restart and built-in battery backup that can support the CMOS RAM for up to 10 days. The unit also includes a crystal-controlled clock, 16 digital inputs and outputs, a serial I/O port, a tri-state bus port, and DMA capability. All for \$290*.

For applications where built-in battery backup

is not important and where more memory is required, PCS offers the 1806 with 1K bytes of RAM and provisions for 7K bytes of EROM/ROM. All for \$265*.

Both microcomputers are available with standard four, eight, and twenty slot chassis with power supply at prices starting at \$450*.

All PCS microcomputers offer a full range of peripherals designed to enhance program development and support production systems. PCS software permits easy "trouble shooting" and saves programming time by eliminating much of the duplication and repetition that program writing often involves.

Whether you're an OEM or end user, whether you buy in small, medium, or large quantities, PCS offers a cost-effective solution to your automation problem. Equipment in modular construction that makes configuring, changing or expanding a system easy, economical, and trouble free.

PCS systems — a new era in process control.

.....

Please send me more information about PCS single board microcomputers the micropac 180

Please have a salesman call.

Name _____ Title _____

Company _____

Street _____

City _____ State _____

Telephone _____ Zip _____

.....

Process Computer Systems, Inc.
5467 Hill 23 Drive, Flint, MI 48507 313-767-8920
TWX-810-235-8667

*In quantities of 50

If you haven't had a Model 3500 demo yet here are 7 reasons why you should.

Data Precision's Model 3500 5½ digit multi-meter gives you more at reduced costs.

1. BCD Output and Digital Control

Parallel BCD output and digital control signal capability at *no extra cost*.

2. Ratio Measurements

DC/DC and AC/DC ratio measurement capability at *no extra cost*.

3. High Normal Mode and Common Mode Rejection

Model 3500 performance is significantly more effective in rejecting normal mode and common mode signals up to 80dB NMRR and up to 160dB CMRR.

4. Hi-Frequency Measurements

The Model 3500 AC voltage measuring capability is specified up to 100KHz.



5. High and Low Range ACV Measurement Capability

Provides a measurement capability of AC voltages on 5 range scales, including the low scale with 1µV resolution and a high scale to 700 volts RMS.

6. Zero Stability

Model 3500 incorporates Tri-Phasic™ auto-zeroing performance eliminating the need for zero adjustment between measurements on any range and any function.

7. Price *

High quality performance and accuracy for \$995 complete.

The Model 3500 has a 6 months basic DC accuracy of ±0.007% of reading ±1 LSD, full auto-ranging from 1 microvolt to 1000V (DC or AC peak) and 1 milliohm through 12 Megohms resistance, 20% overranging and an easy-to-read ½ inch planar display.

The Model 3500 also features our Tri-Phasic™ conversion cycle, Ratiohm™ resistance mode, and Isopolar™ referencing, circuit techniques that increase performance and decrease price.

*Price USA

To arrange an immediate demonstration or for technical data and a comparative analysis of the Model 3500 contact: Data Precision, Audubon Road, Wakefield, MA. 01880 (617) 246-1600. TELEX (0650) 949341.

 DATA PRECISION®
...years ahead

Larger cells, solar concentrator yield more power

Key to work at Sandia Labs is fabricating silicon cells that are 15% efficient and can withstand extreme heat

The photovoltaic conversion program heaps most of its attention—not to mention study contracts and hardware purchases—on the hunt for a low-cost solar cell. However, there's a different approach that is making considerable headway: Sandia Laboratories' so-called "concentrator subsystem."

Sandia, in Albuquerque, N.M., is working for the Energy Research and Development Agency. The approach uses a plastic Fresnel lens to intensify sunlight by focusing it on each larger-than-conventional silicon cell. The concentrator increases electrical output and is able to achieve a given wattage with fewer cells. By contrast, the low-cost-cell program at Jet Propulsion Laboratories hopes to make photovoltaic power competitive by finding cheaper ways to fabricate and assemble the silicon cells.

The keystone of the Sandia method is silicon cells, developed by Sandia, that are at least 15% efficient in converting sunlight to electricity. By comparison, the NASA standard from which ERDA measures is 13% efficiency. "We feel fairly certain of fabricating these 15% cells within the next few weeks since we're already getting 14%," states Jerry G. Fossum, who, along with Edward L. Burgess, spearheads the effort. Sandia has to design and build its own cells not only to

achieve efficiencies not available from vendors, but to get cells that withstand high temperatures—in the 100° C range—caused by the "multi-sun" approach.

Better design. Three principal improvements in cell design clear the way to 15% efficiency on a repeatable basis in volume production, they point out. Most important is the wafer's optimized pattern of the active element: a wagon-wheel-like shape with spokes tapering out from the center. An enclosing ring on the perimeter of the cell acts as the main electrode, and the spokes are collectors. Using a circular electrode, instead of the usual center "bus bar," has several advantages, Fossum says. One is that it greatly reduces the shadowing effect that inhibits efficiency of conventional cells; it also makes better contacts than a bus bar. Finally, in preparing photolithographic masks for production, the circular pattern is much easier to align.

The second improvement is to lower the resistivity of the substrate, to 0.3 ohm-centimeter from 1 to 2 ohm-centimeters. This minimizes relative degradation of voltage at high-temperature operation. And third, a p⁺ diffusion technique on the cell back produces better ohmic contact for higher currents.

The Sandia developers are convinced that they can reach 18% efficiency by improving present techniques, but believe that is the ultimate level possible with single-crystal silicon junctions. The most serious limitation of silicon is an inherent material contamination that keeps carrier lifetime short.

With these 15% cells, which oper-

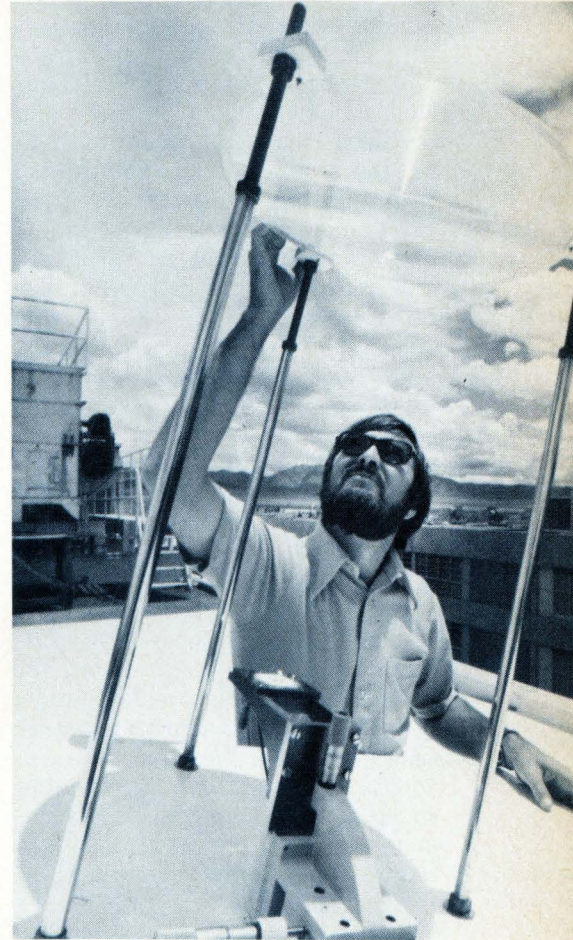

Bright outlook. Sandia Labs' approach to solar energy uses a Fresnel lens to concentrate the sun's rays on a cell. Technique is called a concentrator subsystem.

ate at a "50-sun" illumination level, Sandia is ready to put together a prototype 1-kw photovoltaic test-bed array. This will use 135 lenses and 135 cells (about 7.4-w output each) to produce, not only the 1 kw of electrical power, but by integrating it with a backup system to be heated by resulting high temperatures, an additional 5 kw.

Sandia will ask for bids next year on a 10-kw system as the next step toward operating a 100-kw unit in 1978. At that point, before which Fossum and Burgess see no technological obstacle, they feel the concentrator multisun approach will start to prove more cost-effective than the one-sun, flat plates in the JPL program.

Based on the 100-kw system, which uses two-axis tracking, the

Sandia concentrator system in volume production could supply energy costing about \$150 per square meter of silicon, the team predicts. This is equivalent to \$1 to \$1.50 per watt. Both are enthusiastic about further improvements, projecting that 1978 performance can be doubled by 1980, based on today's 15% cells, operating at 100-sun illumination levels.

At JPL, Robert Forney, who manages the low-cost-silicon-cell program, says the Sandia 1978 energy cost projections, converted to a flat solar array operated without a concentrator, are equivalent to about \$500/m², or \$5 per watt. This represents JPL's 1979 goal, he says. "But they can't be compared on a one-to-one basis," he cautions, since each "works better than the other" in different areas. The concentrator, for example, needs bright sunlight to be effective, and its high-temperature operation calls for some kind of cooling. Also, as the JPL program succeeds in bringing down silicon-cell price, the concentrator would benefit considerably. □

Consumer electronics

Color-TV imports spur U. S. defense

The Little Big Horn for America's color-television-receiver makers may be refought at 701 E. St., N.W., Washington, D.C., home of the International Trade Commission. That's where GTE Sylvania Inc., and its Philco subsidiary, are calling themselves General Custer and are labeling Japan's five major color-TV manufacturers the Indians. Sylvania and Philco say they and other U.S. set makers are about to be massacred in this country by a Japanese conspiracy to take over the \$2.7 billion U.S. color-TV market—the only home-entertainment electronics market not yet lost to offshore production—and they want the ITC to stop it.

Jurisdiction. But the ITC, caught in a jurisdictional dispute with the

An escape-clause action?

Some Federal analysts of the U.S. television industry believe domestic manufacturers will "go all the way" and seek Federal protection from color-television imports by appealing for invocation of escape-clause sections of U.S. tariff laws. Escape-clause rules can be applied by the President if an industry shows that imports threaten its domestic production capability with destruction. Although it is invoked only rarely—most recently by the specialty-steel industry—an escape-clause action "is probably the best route for color-television producers now," says one trade specialist. "It is quicker than the courts, the Treasury, or the International Trade Commission," he explains, "and fewer specifics in terms of the precise nature of injury are needed" to get an initial favorable ruling. "Those details come later when a specific form of relief for domestic producers is worked out."

Treasury Department, is unlikely to decide before August whether or not it can hear the Sylvania/Philco complaint. Meanwhile, the latest figures show Japan's share of the recovering U.S. color-TV market to be rising sharply from 1975 recession levels. In the first 1976 quarter, imports from Japan climbed 170% to 426,070 sets worth \$75 million, compared to 157,288 sets, valued at \$27.9 million, in the comparable 1975 quarter. The increase gave Japan a 26% share of the 1.6-million-set U.S. market for the period, more than double Japan's 12.5% share of 1.36-million-set market in the first 1975 quarter. The figures are from the Electronic Industries Association.

The Japanese tactic is to go after the portable and table-model color-TV market because it accounts for nearly two thirds of U.S. color sales. And their success, say U.S. sources, is based on two major factors: First, Sanyo Electric took over as Sears, Roebuck's supplier when Warwick dropped out. At the same time, Panasonic came back into the market after virtually sitting out for a year because of recall problems. Second, U.S. price leaders—such as Admiral and General Electric—have abdicated their leadership to pursue the high end of the market. They left Philco as a low-price leader.

The sources also point out that the Japanese sales are to dealers, who buy heavily in the first half of the year. They need price leaders to draw customers to their stores, and most of the low-price models these

days are coming from Japan.

The complaint charges that 13 companies owned by Japan's five major color-TV manufacturers—Hitachi, Mitsubishi Electric, Sanyo Electric, Sharp, and Toshiba—have conspired since 1966 to monopolize the U.S. market. To pull it off, the complaint alleges, the Japanese have been dumping sets and charging predatory prices below cost, in violation of U.S. trade laws. But dumping is "the exclusive jurisdiction of the Secretary of the Treasury," that department has told the ITC.

Delay. The Treasury's claim to jurisdiction and its effect on slowing the proceedings has been likened by several industry observers to an antitrust suit by the Zenith Radio Corp. against 31 Japanese TV manufacturers. Filed 22 months ago, that action is still awaiting trial.

Why Sylvania went to the ITC, rather than the Treasury, can be deduced from this comment by one Government electronics analyst. "Treasury found the Japanese were dumping TV sets in this country in 1971," he recalls, "but nothing significant ever happened after that judgment. There were no penalties or restrictions on imports to speak of, and industry has not forgotten that."

Should the ITC be unable to hear the complaint of Sylvania/Philco and the Zenith court action is still delayed, some Federal trade specialists expect U.S. manufacturers to move later this year to limit Japanese imports under escape-clause

sections of U.S. tariff laws, rather than by direct appeal to the Treasury [see "An escape-clause action?" p. 42]. □

Optoelectronics

Bell 'encouraged' by fiber tests

Having tested an experimental fiber-optic telephone link for six months, the Bell System is convinced that the "light pipes" will have an important place in communications systems of the future. The verdict came at a public demonstration of the test system in Atlanta.

"These experiments have given nothing but encouragement as to the technical feasibility of optical-fiber communications," says Joseph Mullins, head of the digital trunks department at Bell Laboratories, Holmdel, N.J. "The big questions, however, are those of demand and cost, which will determine much more than technology how fast and how extensively these systems find use."

Field trials at the Western Electric Co. cable works in Norcross, Ga., near Atlanta, concentrated on communications between central offices, the category telephone com-

Cable TV uses fibers

Bell isn't alone in looking to fiber optics to solve its transmission and crowding problems. In New York City, TelePrompTer Manhattan Cable Television Inc. is using an 800-foot fiber-optic link to carry TV signals from microwave equipment on the roof of a high-rise building to its head-end equipment 34 floors below. The signals are then sent over existing coaxial cables to subscribers.

And General Telephone and Electronics Corp. is busily completing plans for its fiber-optic field trials later this year. The system, which will use fiber cables supplied by General Cable Corp., Greenwich, Conn., will carry commercial voice traffic between operating telephone exchanges somewhere in southern California.

The TelePrompTer system's optical-fiber cable was assembled by Belden Wire and Cable Corp., Geneva, Ill., with fibers supplied by Fiber Communications Inc. of Orange, N.J. The cable has six individual fibers, but only one fiber, measuring 90 micrometers in diameter, carries three analog TV channels. The step-index fiber (10-dB/km loss, 20-MHz bandwidth) could handle five channels; if commercially available graded-index fibers with a pulse dispersion of 1 nanosecond had been used, it would have been possible to handle 167 TV channels.

panies call interoffice trunking. This trunking is of particular interest for metropolitan applications, since the extremely small size of fiber-optic cables would ease overcrowding in cable ducts.

And, just as important, the low loss of optical fibers would reduce the number of manhole repeater stations. If the fiber-optic system could bridge these distances without the need for intermediate repeaters, most electronics in manholes could be eliminated. The distances in cities aren't great. In Manhattan, for

example, all interoffice trunks are less than 5 kilometers long; in Boston, which is more typical, about 90% of the trunks are less than 7 kilometers long.

Test. Total losses in the Georgia test, including connectors and splices over a link that totaled 10.9 km, were 6 decibels/km—2 dB less than the design goal. And no problems were encountered with a transmission rate of 44.7 megabits per second—great enough to carry more than 48,000 two-way voice circuits and a higher rate than is needed in

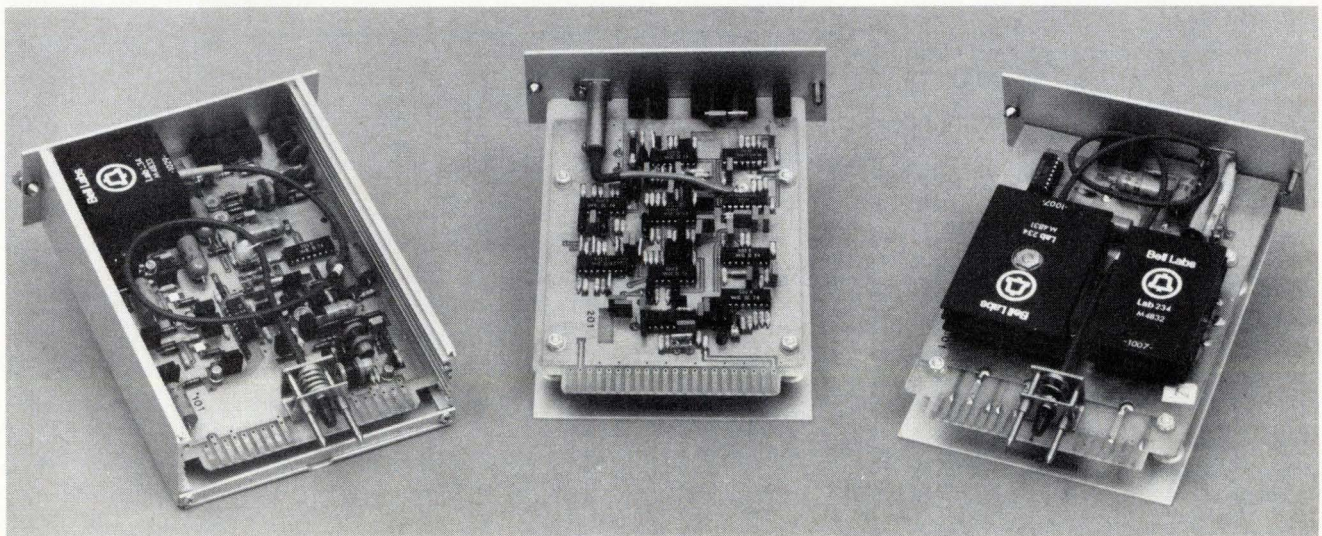

On trial. The repeaters used in the Bell System's Atlanta trial contain three modules: receiver, decision-timing circuit, and transmitter. The receiver package (left) contains an agc amplifier, low-pass filter, peak detector, and variable high-voltage generator. The transmitter module (right) contains the control package, the laser package itself, fiber pigtail, and single-fiber connectors.

most telephone applications.

At the test installation, the cable, made by Western Electric and Corning Glass Works, contained 144 individual fibers. The two 2,000-foot cables were pulled from a fiber-guide distributing frame into standard plastic ducts through two man-holes and back again, a distance of about 1,000 ft. At a distributing frame, both ends of the same fiber cable were fanned out, and individual fibers were interconnected with splices to provide still longer lengths of cable, or for arrangement in a series of repeated spans. The objective of this field trial was to find out how the fiber-optic repeaters and other components interfaced with existing telephone plant and to determine how well the fiber cables would withstand the rigors of an operating environment.

Conditions. Double-hetero-junction gallium-aluminum-arse-

nide laser diodes transmitted at 820 nanometers to produce a minimum of 0.5 milliwatt into a fiber pigtail and connector. At this level, a receiver sensitivity of -54 dBm (4 nanowatts) is sufficient to accommodate a network loss of 46 dB, including system margin for the 44.7-Mb/s transmission rate at a usable bit-error rate. The receiver performance turned out to be better than needed.

"It's possible that in the early 1980s there will be substantial Bell System use of this technology," says George C. Dacey, vice president, transmission systems, Bell Labs, speaking at a demonstration of the test system. However, Dacey adds, "special applications that take advantage of the unique properties of optical fibers, such as high immunity to electrical noise or the very large bandwidth-to-fiber size, could occur earlier." □

Solid state

Bi-FET yields sample-and-hold IC from National featuring low price

National Semiconductor Corp., long considered the industry's major innovator in low-cost linear integrated circuits, has done it again with a monolithic sample-and-hold chip. The commercial version (0° to 70°C) of the device, designated LF 398 [*Electronics*, July 8, p. 27], contains the entire sample-and-hold function, except the external holding capacitor, and will sell for \$3.65. Two military versions, which have longer temperature ranges are available.

All major linear-IC suppliers have monolithic sample-and-hold devices in development, but the only other single-chip device commercially available is the Harris Semiconductor division's high-performance 2420, a dielectrically isolated unit that's heavily used in military equipment. A commercial version of this device for industrial data-acquisition systems costs about three times more than the National chip. The cheapest hybrid on the market

with comparable specifications appears to be Burr-Brown's HC 80KP, which sells for \$34. Most other hybrids are \$60 to \$100.

National made its circuit with its

Bi-FET linear process, a combination of bipolar and ion-implanted junction field-effect transistors on the same chip. FET input operational amplifiers, of course, aren't new; National first used them to improve the dc-input characteristics of general-purpose operational amplifiers, but this is the first time the company has built Bi-FETs into such complex linear functions as sample-and-hold devices. Moreover, the company intends to use the Bi-FET in future converter products.

Perfect match. So far as the sample-and-hold circuit is concerned, the Bi-FET combination is perfect for the input structure of its output amplifier (see diagram), points out Robert Dobkin, design manager for these linear-circuit products.

"That's because of its low drift rates (100 millivolts per second at 125°C) and low input offset currents (a few hundred nanoamperes) for the hold capacitance, and that's crucial to the measurement's accuracy." High offsets on the capacitor would result directly in measurement errors. The other two amplifiers are standard bipolar designs.

Moreover, the amplifier's JFET inputs also give the sample-and-hold chip respectable droop rates—as low as 5 millivolts per minute, when used with a 1-microfarad hold capacitor. And since JFETs are less

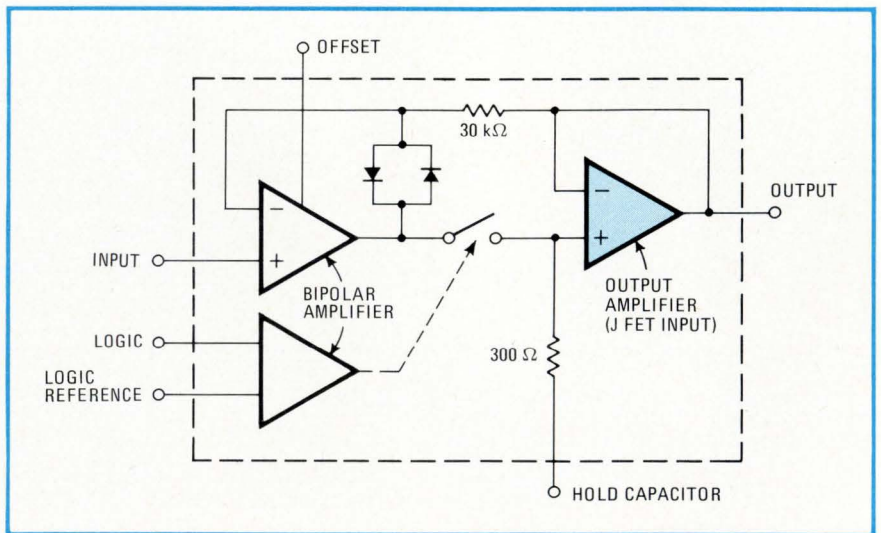

Sample-and-hold circuit. Single-chip device from National is made with Bi-FET process. It is a linear technique and combines bipolar and ion-implanted J-FETs on the chip.

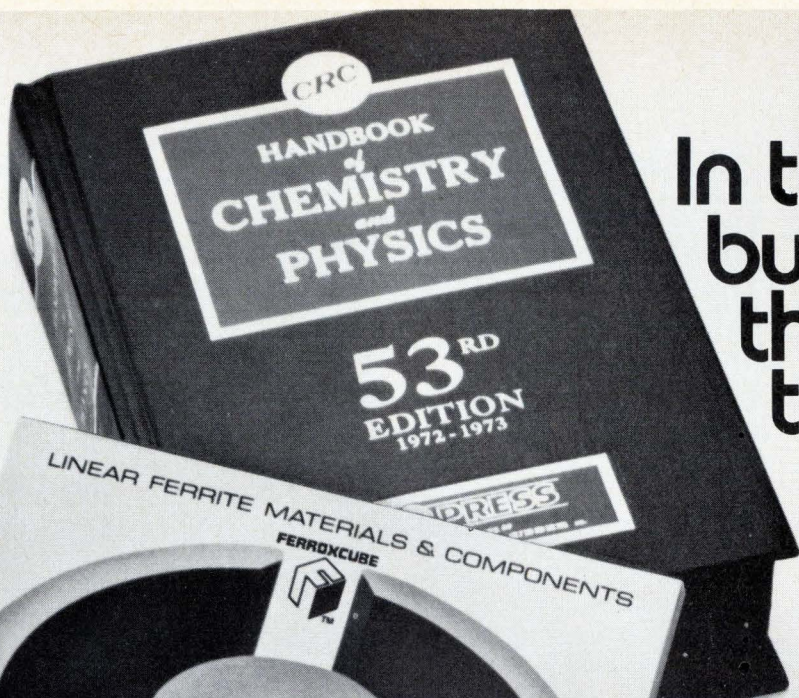

In this business, there are two reliable sources.

Having problems calculating efficiency, voltage or temperatures? Turn to the big book. Having problems designing for applications that demand high Q, high stability of inductance, and minimum volume? Or, low power losses at high flux density? Turn to the little book.

Turn to the Cube.

Ferroxcube offers the most complete, most diversified selection of linear ferrite materials. You get the electrical properties you want. In a broad variety of sizes and shapes. You get consistent quality. And you get delivery, when you want it, where you want it.

We're reliable. Ask the competition.

It's good business to second source yourself. The little book belongs on your bookshelf. Send for your free copy of the new Ferroxcube Linear Ferrite catalog today.



Ferroxcube Corporation
Saugerties, N. Y. 12477



Name

Title

Business

Address

City State Zip

E-776



FERROXCUBE CORPORATION
A North American Philips Company

Electronics review

noisy than alternative MOS input devices, they contribute to both accuracy and long-range high-temperature stability.

Specifications. Acquisition times are 5 microseconds (1,000 picofarads), unity-gain accuracy is within 0.005%, offset voltage is 3 millivolts, and input-bias current is 25 nA.

Burr-Brown Research Corp., a major supplier of hybrid devices, is looking at the National model with an eye to "incorporating it into our own hybrid systems," says Joe Santen, product manager for Burr-Brown's data conversion line. He concedes that the National single-chip part "has roughly the same performance as our lowest-cost hybrid package containing seven or eight chips." But he points out that the National unit needs an external holding capacitor, as well as some form of nulling circuit to deal with the offset current in many applications—additional external componentry that's not necessary with hybrid versions containing in-package holding capacitors and laser-trimmed front ends. □

Instruments

Card tester clips onto ICs

In testing a digital printed-circuit board, a small instrument company in Florida bypasses the board's edge connector and connects its tester directly to the board's integrated circuits. What's more, claims the company, Testline Instruments Inc. of Titusville, the entire testing and fault-diagnosis procedure is faster and more reliable.

Board test systems that can perform similar tests, or additional tests such as verifying that an entire pc board is functioning properly, cost three or four times more and are larger and heavier. Manual logic probes, pulsers, and test clips are priced lower, but are more time-consuming and expensive to operate. "There's really nothing directly competitive," says Robert E. Ander-

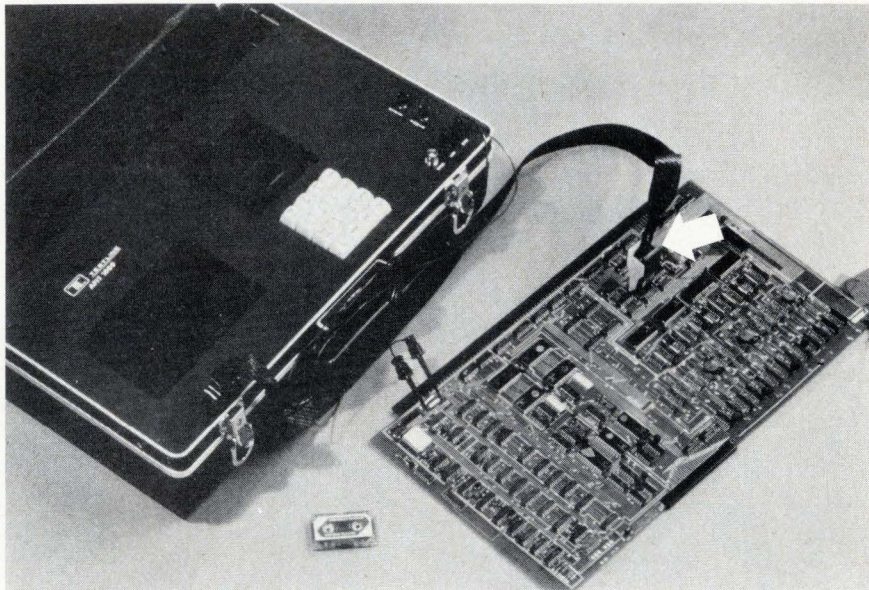

Checkout. Clipped onto an integrated circuit (arrow), Testline instrument's board tester pin-points bad ICs and faulty signal paths. The maker promises faster tests.

son, vice president of automatic-test-equipment consultant Omnicomp Inc., Phoenix.

"Using the IC as a connector, we're testing the logic of a board in a particular area," says Testline president Roger Boatman. "And with a low-impedance driver, we can isolate any fault that has occurred, differentiating between a board problem and an IC problem."

Test clip-on. Boatman's \$4,500 suitcase-sized model AFIT 1000 portable tester [*Electronics*, April 29, p. 26] is connected to each IC on the board through special 16- or 24-pin test clips. It drives the IC's inputs with a signal from a low (2-ohm) source impedance. This low impedance is critical, Boatman explains, because the impedance at a failed device's input is about 3 ohms, while the highest impedance exhibited by a common board problem such as a solder splash is less than 0.1 ohm. If a 2-ohm source can drive the IC, the failure is in the chip, since a board failure would short out the signal.

In production-line testing, says Boatman, "our confidence level [that the tester's good/bad decision is correct] is between 80% and 90%. One \$150,000 card-edge tester we analyzed claimed a 95% confidence level, but turned out to have under

an 80% success rate in go/no-go testing and only 3% confidence in isolating the fault. Also, our confidence level is well above 95% on boards returned from the field for repair, compared with over 50% bad boards tested as good by a \$35,000 field-service card-edge tester." In addition, points out Boatman, "If you address the board from the edge connector, you cannot pinpoint internal faults. We can."

The signal is fed to each IC input in a narrow high-current pulse. This pulse has enough power to override stuck-at-0 or stuck-at-1 conditions. But it's applied for so short a time that it cannot destroy the IC.

6800 control. The tester is controlled by a Motorola 6800 microprocessor and its support circuitry. "The microprocessor does everything," says Boatman, from debouncing switch contacts to setting up the test sequence, generating the timing signals, controlling a cassette reader that stores the test program, and generating the end-of-test tones—high for a good IC or board, low for a failure.

The power supply in the tester, besides serving the internal circuitry, also provides a single, 5-volt level at up to 7 amperes to the board under test. Other voltages must be provided externally. To

Good news from Hughes:

Now you can actually reduce system cost by using our hybrid microcircuit modules.

If you're designing circuits that have to be both cost-effective and high in reliability, it will probably pay you to talk with us.

We've developed a system for condensing circuit requirements into the most efficient hybrid packages possible. And we can help you reduce size and weight as well as manufacturing costs.

Here's how we do it: We design the hybrid circuits, develop the prototypes, manufacture custom components, then assemble, test, and guarantee the total hybrid package. We make both thick film and thin film hybrids. We use hermetically-sealed metal and ceramic packages. And we make custom MOS devices and bipolar chips right here in-house.

We produce hybrid modules in volume quantities at competitive prices, as well as small quantities for product development.

Result: Now you can work with the one company best equipped and experienced to handle your job from concept through production.

We must be doing a lot of things right, because we're one of the leading producers of custom hybrid circuits.

So when it comes to hybrids, call on Hughes. Especially if quality is as important as price. Write for additional information: 500 Superior Avenue, Newport Beach, CA 92663, Att'n. Hybrid Dept. Or call

(714) 548-0671, ext. 204.

HUGHES

HUGHES AIRCRAFT COMPANY
MICROELECTRONIC
PRODUCTS DIVISION

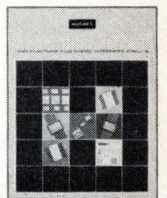

minimize the size and weight of the power supply, it's turned on for 200 μ s, during which the test takes place, and then off for 200 milliseconds. □

Industrial

Neutrons help dope thyristor silicon

When a West German consortium of electrical firms was picked to install a 500-kilovolt direct-current transmission system for Canada's Nelson River project, part of the credit for winning the contract went to the high-performance thyristors Siemens AG had available.

With a peak off-state voltage of 3.2 kilovolts and a maximum on-state current of 800 amperes, the thyristors greatly reduce equipment costs because fewer of them need be used for converting three-phase power into high-voltage than lower-powered thyristors.

A prerequisite in making such high-powered thyristors, the German firm says, is silicon with a homogeneous distribution of the dopant. Uniform doping is achieved with a new Siemens-developed process in which the silicon is bombarded with neutrons, and phosphorus as the dopant is built into the silicon crystal after it has been grown.

Doping. In conventional doping methods, gaseous phosphorus, for example, is used to dope the silicon during the crystal-pulling process. But, as a result of variations in crystal growth in both radial and axial directions, the phosphorus is distributed unevenly through the silicon. While such lack of homogeneity does not matter in low-power semiconductors, it adversely affects the characteristics of high-powered components, especially in high-performance thyristors such as the Siemens BStR68 slated for the Canadian project.

The neutron-bombarded homogeneously doped (NBH) silicon process, exploits a relatively simple nuclear-physical phenomenon: nuclear

News briefs

Hughes to second-source RCA processor

RCA Corp. has signed Hughes Aircraft Co. as a second source for its CMOS microprocessor, the 8-bit CDP1802. RCA says the agreement covers the basic processor, standard support circuits, evaluation kits, software-development systems, and related hardware. Hughes also receives an option on SOS versions.

NATO production of F-16 under way

Six Netherlands plants of VFW-Fokker GmbH are beginning work on major components of more than 500 F-16 fighter planes for U.S. and NATO forces. The \$190 million contract was awarded by the prime contractor, General Dynamics Corp. The deal, which could reach nearly \$205 million when materials costs are added, confirms reports that European production of the F-16 would begin prior to final Pentagon acceptance of the plane for the U.S. Air Force, which is scheduled to take place later this year [*Electronics*, June 10, p. 45].

Tracor, Systron-Donner merge

Tracor Inc. and Systron-Donner Corp. have agreed in principle to merge. Tracor, in Austin, Texas, is a technological-products and service company, while Systron-Donner, in Concord, Calif., makes instruments, transducers, and sensing devices. The terms of the merger call for a quarter share of Tracor common stock plus a quarter of a new preferred Tracor stock for each share of Systron-Donner stock.

Ex-TI aide named Commerce Undersecretary

Edward O. Vetter, who retired last November as executive vice president and chief financial officer of Texas Instruments Inc., has been nominated by President Ford to be Undersecretary of Commerce. The appointment of Vetter, who is 55, must be confirmed by the Senate. He succeeds James A. Baker in the post.

transmutation of silicon into phosphorus. Silicon consists of the isotopes Si-28, Si-29, and Si-30. When bombarded by neutrons, these isotopes change to Si-29, Si-30 and Si-31. Although the isotopes Si-29 and Si-30 are stable, the Si-31 isotope is radioactive.

By emitting a beta particle, however, isotope Si-31 turns into the phosphorus isotope P-31, which is stable. Thus, the combination of neutron bombardment and isotope transmutation produces a high degree of uniformity in phosphorus doping.

Radiation In the NBH process, which is carried out for Siemens at nuclear-reactor facilities in Germany, silicon rods are exposed to neutron radiation for about two hours. The rods may be up to 80 centimeters long and 125 millimeters in diameter. Because of its short half-life period, the radioactivity of silicon isotope Si-31 decays in about

three days. After that time, the radiation-exposed silicon rod can be handled and processed in the same way as nonbombarded silicon, Siemens says. □

Computers

Sanders uses IBM network technique

Systems network architecture, the technique introduced by IBM Corp. in 1974 to improve the efficiency of teleprocessing systems, hasn't taken the computer network world by storm yet. But officials at the Sanders Data Systems group are betting that IBM's development will make SNA the standard data-communications technique by 1980. To back that conviction, Sanders is equipping its 8170 cathode-ray-tube terminal system with the SNA option

Granted, our new ADM-3 is basic. Especially if you compare it with all the smart video terminals around (our ADM-1 or -2, for example). But the \$995 unit price puts it into a different perspective.

As simple as it is, the ADM-3's one-card brain can help you move a lot of data. And it's compatible with most popular computers. That means, it fits all kinds of applications. Including yours.

Here's what you get for \$995. 12" diagonal screen. Full or half duplex operation at 11 selectable data rates. Bright, easy-to-read characters — 960 or 1920,* displayed in 12 or 24 rows of 80 letters. 59 data entry keys arranged like on a typewriter which keeps operator training short and basic, too. What's more, our ADM-3 is alert. It says "beep" when you come to the end of a line. The rest of the time, it just keeps cool and quiet.

Our DUMB TERMINAL also offers you room for

*1920 Characters is an option available at additional cost.

improvements. Its RS 232C interface extension port lets you hook up hard copy printer, magnetic tape recorder or additional (smarter) data terminals.

And with a few options, you can make our ADM-3 answer back. Increase its vocabulary by adding upper and lower case. Transmit and receive independently selectable rates. Even enter just numbers on a numeric key pad.

After counting all its limited blessings, you have to admit one thing: you simply couldn't ask for more for \$995. At this low level, you can afford to order a dozen or more DUMB TERMINALS (and buy them at our even lower quantity discount price).



DUMB TERMINAL. SMART BUY.

LEAR SIEGLER, INC.
ELECTRONIC INSTRUMENTATION
DIVISION DATA PRODUCTS



714 N. Brookhurst St.
Anaheim, CA 92803
Telephone:
(714) 774-1010

INTRODUCING THE \$995 DUMB TERMINAL.

Thinking about custom hybrids? Collins has a lot to offer.

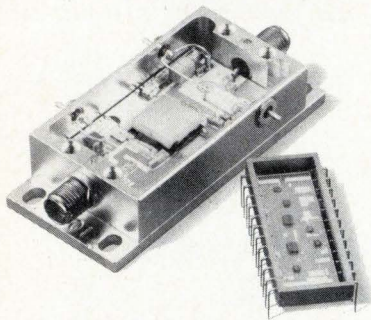

If you are considering hybrids, consider Collins. Our capabilities include:

For Conventional Hybrids:

- Thick Film
- Thin Film
- Laser Resistor Trim
- Low and High Density
- Multiple Packages
- Beam Lead

For RF Hybrids:

- Microstrip (UHF and Microwave)
- Up- and Down-Converters
- Power Amplifiers
- Low Noise Amplifiers (LNAs)
- Local Oscillators
- Integrated RF Systems

They are proven in Aerospace and Aviation Applications.

We meet MIL-STD-883/MIL-M-38510.

Our capabilities include Analog/Digital Auto Test at Temperature, Custom Design Implementation, and Design Specification.

Our production facilities are among the most advanced in the world. Collins has, in its more than 12 years of hybrid experience, built over 4,000 hybrid designs. They're all in our database. Our technical teams are eager to work with you.

Put us to your test.

For more information contact:

Hybrid Microelectronics Marketing,
Collins Radio Group,
Rockwell International,
Dallas, Texas 75207.
Tel. 214/690-5937.



**Rockwell
International**

...where science gets down to business

50 Circle 50 on reader service card

Electronics review

and making it available early next year.

Sanders Data Systems group is the first terminal manufacturer other than IBM to publicly demonstrate the SNA technique [*Electronics*, July 8, p. 28]. The group, in Nashua, N.H., is going after the replacement market for IBM 3270 display terminals, some of which have the SNA option.

Architecture. The network architecture embodied in SNA includes a line-control discipline—the IBM-developed synchronous data-link control (SDLC) for message formatting and transmission procedure [*Electronics*, Aug. 8, 1975, p. 76]—plus a communications-access method and a communications-control program. Sanders officials maintain that SNA goes much further than today's predominant binary synchronous control, which, they explain, encompasses only the line-control discipline.

Brooks Hilliard, product-marketing manager, says SNA offers full- or half-duplex transmission instead of only half-duplex, as binary synchronous control does. It also allows batch or serial applications to be handled by the same communications lines and terminals, instead of dedicating separate lines and hardware to each kind of task.

In practice, these advantages mean less expense because fewer communications lines are required, and the technique establishes a single discipline for all types of computer communications.

A Sanders 8170 series display terminal, replacing the IBM 3270, can communicate with the System/370 host computer directly or through whichever IBM programable front-end processor is used in the system. The front-end processor houses the network-control program containing the SNA logic. The host mainframe contains the SNA access-method program, which is normally IBM's virtual telecommunications method.

Network. Such a network could accommodate a variety of Sanders terminals: the 8172 local interactive CRT units, linked directly to the virtual telecommunications access

method by means of a channel interface; the 8171 remote interactive CRT devices, which would be connected to the front-end processor by SDLC lines, and the 8181 programable cluster CRT terminal controllers with disk, which can access their own or the host's data base, or both.

Sanders demonstrated its prototype 8170 terminal by accessing the host System/370 model 158 immediately after the IBM 3270 terminal, which had just done the same job, was unplugged.

Thomas Colligan, manager of marketing support for the Data Systems group, says SNA will add \$1,000 to the purchase price of a typical 8171 to control 12 CRT terminals, or lease for \$50 a month. □

Components

F-14 radar need spawns capacitors

Because Hughes Aircraft Co.'s Aerospace Group could not buy metalized film capacitors back in 1969 to satisfy the high-reliability needs of the F-14 radar system, it had to quickly start its own development program. The F-14 radar needed 0.5-microfarad, 20,000-volt capacitors that could operate for 27,000 hours, but available commercial units were failing in tests after only 20 hours.

Not only did the Hughes development program soon meet F-14—and also F-15—specifications, but its findings show promise in improved high-energy-density capacitors for a variety of applications. Specifically, in one program funded by NASA, Hughes has built medium-voltage metalized film capacitors that improve energy densities by a factor of 10 over present ones, from 0.01 to 0.1 joule per gram in a representative 2-microfarad, 500-v rating.

Says Robert D. Parker, staff engineer in the Culver City, Calif., components and materials laboratories: "What we've come up with is an array of better design principles, materials, and processes. Now we can

Why General Instrument chose General Instrument for Omega.

For as long as there have been TV tuners, the premier producer has been the F.W. Sickles Division of General Instrument.



So, when Sickles set out to make their electronic TV tuning system, the goal was never in question. Theirs would have to be the most advanced TV tuning system ever made.

That's what they told us at General Instrument Microelectronics. A tall order, but a must, if we were to design and produce the MOS circuitry.

The system, called Omega, would, among other things, have to select all 82 channels electronically, via keyboard, and display them digitally, on-screen or off. It would have to have the ability to fine-tune all channels independently. Retain the tuning data in its memory when power was off. And, as Sickles insisted, without CMOS, and without a battery.

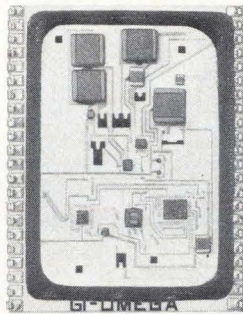

It would have to remember, and keep remembering (where other electronic systems forget), to turn on where it last turned off. Fine-tuned to the same channel. The system would have to be remoteable. Display time on-screen. And, at the user's option, operate in a favorite 16-channel mode.

In sum, it would have to be microelectronics at its best.

Why did Sickles choose us? Because they believed we could deliver that. And deliver it, we did.

Omega is far and away the most advanced TV tuning system ever made. And is very naturally finding its way into the world's most advanced TV receivers. Helping make them so.

As we can help make a product you may have in mind, the best that microelectronics can make it.

General Instrument Microelectronics, at 600 West John Street, Hicksville, N.Y. 11802, 516-733-3107.

We help you compete.

**GENERAL INSTRUMENT CORPORATION
MICROELECTRONICS**



The CROWN M-600 will drive shake tables, speaker coils, sonar transducers or servo motors.

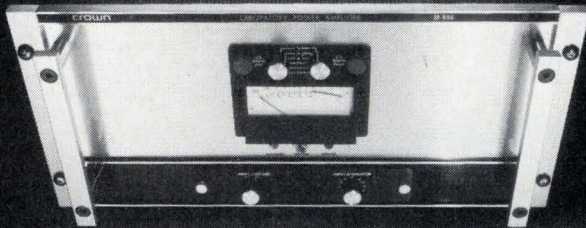

The Crown M-600 Amplifier is good at driving transducers, no matter what they're used for.

It's immune to damage from shorted, open or mismatched loads.

It operates continuously at full rated power.

It will give you up to 78 volts RMS. It will give you up to 1000 watts into 4 ohms, DC to 15 KHz. It works into any impedance. Compare the M-600 to any other amp in its frequency range, no matter what it's used for.

We're especially interested in helping you answer any application questions you might foresee for the M-600. Tell us your problem. We may already know a solution.



1718 W. Mishawaka Road, Elkhart, Indiana 46514
219/294-5571

Electronics review

pick from these for a particular circumstance."

Parker explains that the Hughes effort was necessary because "not too many people wanted to produce high-reliability, high-power capacitors for aircraft." Component companies concentrating on volume selling to television-set manufacturers hadn't changed basic materials or techniques much since the 1920s, he says.

Because the key characteristic for capacitor efficiency is film with a high dielectric constant, Hughes put intensive effort into the basic research questions of finding and choosing new materials and measuring performance. At one time for the NASA program, 18 new materials were being investigated. The winner, polyvinylidene fluoride, had dielectric-constant ratings in the 11-12 range, three to four times better than previous materials. "We were the first to use it, and it is as close as we've come to the magic stuff," Parker says. But even this material has the limitation of a thermal dissipation factor of 3%, higher than for more common films.

Ironing out wrinkles. To overcome a critical capacitor manufacturing problem—wrinkles—which Hughes' studies pinpointed as the cause of most operating failures, the lab developed a proprietary winding technique. Wrinkles happen when material overlaps and bunches in the winding process.

The Hughes lab is now working on pulse capacitors under an Air Force contract, seeking densities as high as 500 joules per pound at 20 pulses per second. These units would permit airborne power supplies to be only 10% the weight of present ones.

Also, a separate company-funded program has tested capacitors of up to 18 kilovolts, operating for nearly one hour in a pulse-forming network at 40 pulses per second. The performance of high-voltage capacitors of this type will be important in future laser-fusion developments, Parker notes, as well as in a contemplated 10-megawatt orbiting power station. □



15th

JAPAN ELECTRONICS SHOW '76

OCTOBER 22-27 1976 TOKYO

- Place:** Tokyo International Trade Center
Period: October 22 through 27, 1976
Sponsor: Electronic Industries Association of Japan
Exhibition Hours: 10:00a.m. to 5:00 p.m.
Admission: Free. Visitors will be registered at the entrance.



For details of the '76 JES (15th), please write to

JAPAN ELECTRONICS SHOW ASSOCIATION
No. 24 Mori Bldg., 23-5, Nishi-shimbashi 3-chome, Minato-ku, Tokyo, Japan

Alps Electronics Parts the active driving force behind the electronics industry

Alps supplies switches, variable resistors, TV tuners, variable capacitors, FM tuners, magnetic heads, tape decks and keyboard switches, among others.

Keyboard switch AKC9
(for TV remote controller)

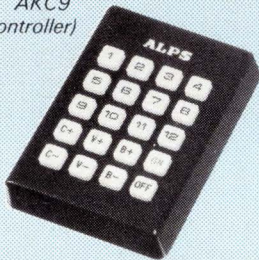

Brand new mechanical keyboard switches for color TV remote control have now become available from Alps Electric. The device is featured with coffee proof, tactile feedback, two-make contacts, and exceptionally low pricing.

Keyboard switch AKB3000
(for terminal keyboards)



Low profile terminal keyboards with mechanical contacts for more than 10 million operational life is offered by Alps Electric. So called "\$50 keyboards" will positively break through every low end terminal requirements.

Multiple controls KM Series
(for mobile equipments)

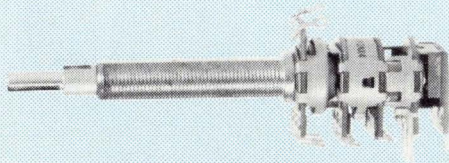

KM, DM series have full controls for complete versatility in compact for mobile equipments. Your favorable combination of switches and potentiometers available.

ALPS

ALPS ELECTRIC CO., LTD.

For more informations.....

Please contact with our representatives stationed at the below.

HEAD OFFICE: 1-7, YUKIGAYAOTSUKA-CHO, OHTA-KU, TOKYO, JAPAN
NEW YORK OFFICE: 77 NORTH CENTRE AVENUE, ROCKVILLE CENTRE, N.Y.11570 U.S.A.
DÜSSELDORF OFFICE: 4 DÜSSELDORF, KARL-RUDORF STR. 178 W.GERMANY

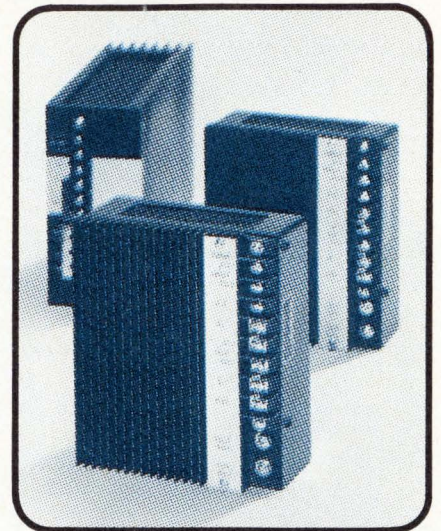

SWITCHING POWER SUPPLIES

- **COMPACT AND LIGHT-WEIGHT!**
- **LOWER PRICE WITH HIGHER RELIABILITY!**
- **SIMPLER CIRCUITS BUT HIGHER EFFICIENCY!**



MODEL NO.	OUTPUT VOLTAGE (V)	OUTPUT CURRENT (A)
YP-0510A	5	10
YP-0525A		25
YP-0550A		50
YP-1204A	12	4
YP-1210A		10
YP-1220A		20
YP-1504A	15	4
YP-1510A		10
YP-1520A		20
YP-2402A	24	2
YP-2405A		5
YP-2410A		10
YP-3002A	30	2
YP-3005A		5
YP-3010A		10

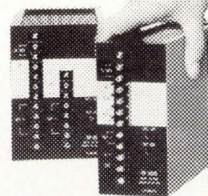

Sole Distributor :
WAMCO Technical Sales, Inc.
705 W. 16th St. Costa Mesa
Calif. 92627, U. S. A.
Tel. No. (714)-833-9361 or
(714)-642-5100
TELEX No.678-459.

YUTAKA ELECTRIC MFG. CO., LTD.
No. 228 KARIYADO NAKAHARA-KU, KAWASAKI
CITY KANAGAWA PREF-211 JAPAN
TELEX: J22890 CABLE: TLX-J22890 YUTACO

The Noise Loading Test Set

MEV8

The MEV8 consists of the Noise Receiver ML415A and the Noise Generator MG431A. It is best to measure the performance of radio relay and cable systems for frequency division multiplex telephony under conditions closely approaching those of actual operation.



- Meets the latest CCIR and CCITT recommendations.
- Suitable for systems of 24 to 2700 channels or more (10kHz to 18MHz).
- Easy replacement of plug-in filters and accomodation up to 7 measuring frequencies simultaneously.
- Direct reading dial of noise level (absolute or relative) and noise ratio (NPR or S/N) with or without weighting.
- TRANSMISSION LEVEL dial and DIFFERENCE FROM TL dial facilitating measurements.
- Easy operation by remote control from the Noise Receiver to Noise Generator.
- Low intrinsic thermal noise minimized at -130 dBm.
- Inband and out-of-band measurements.

Anritsu

ANRITSU ELECTRIC CO., LTD.
MEASURING INSTRUMENTS DIVISION

SALES DEPARTMENT:
4-12-20, Minami-azabu, Minato-ku, Tokyo 106, JAPAN
Phone: (03) 446-1111/Telex: 0-242-2353
Cable: ANRITDENKI TOKYO

Circle 186 on reader service card

Volgen's Mag Amp Switchers MS Series

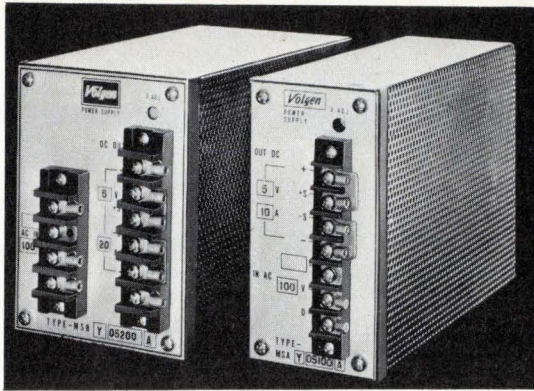

- High Reliability
- Low Cost
- High Efficiency
- AC input Type and DC input Type
- Outputs from 5V to 24V, from 2.5A to 50A. (Input 117 VAC)
- 20 KHz Switching.

■ Pulse Width Control by Mag Amp (Fast response Type)

Model	MSAY05100B-117	MSAY0560C-24
Input	117VAC ± 10%	24VDC ± 10%
Output	5V 10A	5V 6A
Line regulation	± (0.05% + 5mV)	± (0.05% + 5mV)
Load regulation	0.5% (0 ⇒ 100%)	0.5% (0 ⇒ 100%)
Ripple and Noise	60mV P-P	60mV P-P
Recovery time	1 m sec (30% ⇒ 100%)	1 m sec (30% ⇒ 100%)
Efficiency	70%	60%
Ambient OP Temperature	-10°C ~ +50°C	-10°C ~ +50°C
Size (W x H x D)	60 x 120 x 190	60 x 120 x 190

Volgen Electric Co., Ltd.

Head Office: 4-12-5 Meguro Meguro-ku,
Tokyo, Japan.

Tel: 03-715-3125

Factory: Meguro (Tokyo) and Niigata

Circle 55 on reader service card

This
Publication
is Available in
MICROFORM

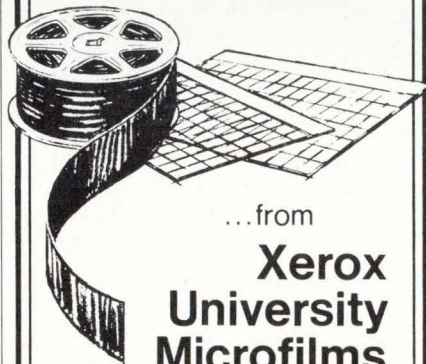

...from

**Xerox
University
Microfilms**

300 North Zeeb Rd.,
Ann Arbor, Mich. 48106
(313) 761-4700

PLEASE WRITE
FOR COMPLETE
INFORMATION

Gas Sensing Semiconductor

FIGARO GAS SENSOR

TGS quickly senses
even small
amount
of gas.

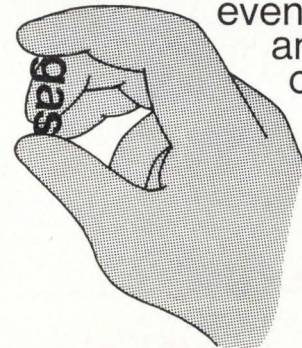

New Models,
some with highly sensitive
CO sensor, now on the market.

Please contact the address below directly for
catalogs and price/delivery information.

FIGARO ENGINEERING INC.

3-7-3, Higashitoyonaka, Toyonaka City, Osaka 560,
Japan/Tel: (06) 849-2156

Cable: FIGARO TOYONAKA/Telex: 05286155 FIGARO J

Circle 244 on reader service card 55

The New Standard

in 16-pin 4K RAMs

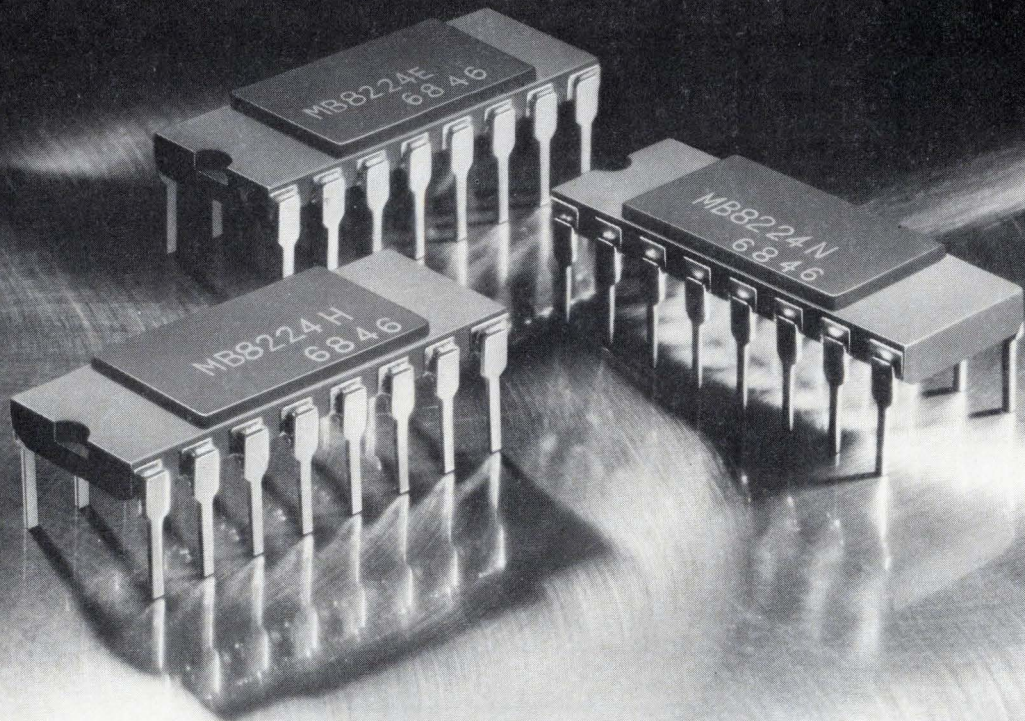

NMOS DYNAMIC RAM MEMORIES

MB8224N/E/H Family

FUJITSU
SEMICONDUCTOR

Fujitsu believes in offering you the newest technology to meet your continuously expanding semiconductor memory requirements. And the new MB 8224 N-channel silicon gate dynamic MOS 4K RAM family from Fujitsu continues that tradition. The MB 8224 family offers the fastest speed available in the industry-standard 16-pin package, low power dissipation and a wealth of features that add up to the widest choice and the highest performance. How does the MB 8224 stack up against your present device? Take a look.

Top speed for 16-pin package

The MB 8224 is available in three versions that offer a substantial speed advantage, and at the same price you're now paying! Thanks to superior Fujitsu fabrication and know-how, you get speeds of 280ns (type N), 230ns (type E), and an outstanding 200ns (type H)—and there are other benefits, too. Circle 56 on reader service card

With the MB 8224 device, you also get low power dissipation of only 470mW per chip (27mW in standby) and the great new feature of $\pm 10\%$ tolerance on all power supplies. Yes, with superior speed, reduced power and greater supply tolerances, the MB 8224 from Fujitsu puts you way ahead in performance and savings.

Full-featured and compact

The MB 8224 is full-featured, yet compact for higher system densities. This device employs the unique multiplexing and latching techniques for address inputs standard throughout the industry. Thus, it is fully usable for add-on circuits, or as a replacement to boost speed without costly circuit changes. Other features of the MB 8224 include three-state output and low capacitance inputs for full TTL-compatible operation, $\overline{\text{RAS}}$ only refresh, page mode option, and much more. In total, the MB 8224

is the best choice for high-density/low-cost memory applications.

Proven reliability and available now

The Fujitsu MB 8224 NMOS dynamic RAM family is built by Fujitsu, a maker with proven reliability. Our stringent production and testing standards and our capacity to meet your requirements all add up to savings and performance that can't be beat. So contact Fujitsu now for the MB 8224, or any of your other semiconductor requirements. Availability is NOW!

Write or call for more information to Fujitsu California, Inc., Laboratory Division, 1280 East Arques Ave., Sunnyvale, California 94086, phone: 408-735-0735 telex: 346393.

FUJITSU LIMITED
Communications and Electronics
Tokyo, Japan

Washington newsletter

U.S. is wary of French plan to share Japanese technology

Officials of the U. S. Departments of State and Defense are carefully watching action on proposals by France that it form with Japan a new organization "for the mutual development of electronics technology," despite a cool first response by Japan. The U.S. thinks the French maneuver is motivated by a desire **to bolster the French military-electronics industry**, especially in aircraft communications.

Lack of enthusiasm by Japan's Ministry of International Trade and Industry "apparently stems from the fear that France will not be able to contribute significantly to Japanese electronics expertise, and the union will become a one-way street," says U.S. officials. Although MITI turned down the idea of government participation, it left the door open to private industrial deals, spurring numerous visits by Thomson-CSF and others for talks with companies like Hitachi, Fujitsu, Nippon Electric, and Toshiba. Japan's price for cooperation: abolition or reduction of French import restrictions on Japanese electronic products.

Sun Oil negotiating to purchase Datran

Data Transmission Co. (Datran) of Vienna, Va., the only specialized carrier to offer a unique fully digital dedicated and switched transmission capability, and which is on the brink of financial failure, **may have found a purchaser**. Sun Oil Co. is actively negotiating to buy Datran for a reported price of \$30 million, significantly less than Datran's investment in its nationwide network. It is not clear yet whether Sun's interest is in a tax write-off or whether it wants to seriously pursue the communications business. The acquisition must take place before Sept. 15, Datran's "drop-dead" date.

Color-TV sets, car radios lead June sales rise

Sales of consumer-electronic products, led by color-television sets and auto radios, continued to rise in June, **reflecting the upturn in the U.S. economy**. Color-TV receiver sales to dealers rose 11.7% from June 1975 to 690,027 units, says the Electronic Industries Association. Totals for the first six months rose to nearly 3.2 million sets, up 12.5% from a year ago. Monochrome-receiver sales rose 2.4% in June to 481,427 units, although the 2.2 million total for the first six months was only 1.2% above last year's level. June auto-radio sales of nearly 1.6 million units represented a major 51.2% advance over the 1975 figure.

Federal data-link standard set for September adoption

A Federal telecommunications standard for control of bit-oriented data links has been proposed for adoption in September by the National Communications System, the network operated for Federal users by the General Services Administration. Known as Federal Standard 1003, the document was developed by a task force of the American National Standards Institute and will apply to the **design and procurement of all equipment and systems for Federal use** after its adoption.

The ANSI document, X3SL34/589, specifies control procedures for transmitting data between computers, concentrators, and terminals over telecommunications circuits. The standard requires that links be capable of handling any data code or pattern and operate with relatively high efficiency in an interactive pattern. Before the final standard's adoption, the NCS Technology & Standards Office is seeking written comments by Aug. 31. The NCS/TSO address is Washington, D.C. 20305.

An international plan for direct broadcast satellites

One of the more thoughtful proposals for an international agreement on the development and use of direct broadcast satellites was advanced in Munich early this month by John Eger prior to his resignation from the Ford Administration as acting director of the White House Office of Telecommunications Policy. If the Eger proposal before the Supranational Association for Communications Research is to become a reality under some future Administration, it will need the support of the nation's telecommunications industry. Highlights of Eger's speech are presented here for its consideration.

—Ray Connolly.

The revolution in communications, it seems to me, is even more important than the transportation revolution, and it is immeasurably more promising. At the same time, it is more threatening, or it seems to be, perhaps because of the vast changes telecommunications has already brought to almost every aspect of our lives, to all people, to all nations large and small, to all regions of the world. And now this revolution promises to bring even more changes to us all. Computers and satellites and the rest of our still developing communications technology promise changes even more profound.

Impact of DBS

Let us consider a specific technological development—direct broadcasting via satellite.

Direct broadcast satellites can leap national borders and cross cultural lines. They are capable of sending a signal into a small home or community receiving antenna no larger than 1 meter in size. And because they can thus spread information and knowledge so easily and at so little cost to the receiver, these direct broadcast satellites are attractive. They are an inevitable development.

DBS technology is now under active study not only in the United States, but in Canada, Japan, the USSR and other countries. But perhaps the best known of the DBS experiments is the ATS-6 satellite launched by NASA not long ago.

The Japanese are investigating receiving antennas that may be built for as little as \$100 each, which approaches the cost of an ordinary vhf and uhf antenna already in popular use. And, perhaps of greater significance, without

being a DBS system *per se*, the Soviet Union has recently advanced plans for an auspicious 11-satellite system, capable of tying the entire Communist world together, and capable of adding other, probably less developed countries, as desired, using its Stationar technology.

So you can see that the technology is all but here to bring about change. But already there is a fear that it may bring an end to cultural diversity, and that those who are rich in information and technology may use DBS to impose their culture on the developing nations of the world.

I don't believe this can happen. I don't mean to suggest such fears are entirely groundless. This technology which promises so much can be abused. I think we already know how to respond to the promise and to the threat of this new technology.

Beginning a dialogue

In facing the challenge posed by this technology and its global potential, all of us must join with other free societies in beginning a dialogue, robust and open discussion that can lead, perhaps as a starting point, to agreement on the international rules, procedures, and policies that will govern DBS—but hopefully that can lead to something even more important: a consensus among the free peoples of the world as to the shape, the form, the dimensions, the role, this telecommunications revolution will have in our lives.

Let us begin now. There are, of course, ongoing meetings in the U.N. There will be discussions of broadcasting satellites early in 1977 in Geneva when we have a World Administrative Radio Conference. But we need not delay our separate effort. Let us convene a meeting, call a conference to set the Free World's communications agenda, and resolve the issues, overcome the differences that stand between us.

I believe that the democracies, in making our telecommunications technology fully serve mankind, must take the lead. For not to take the lead may be to lose it—and to lose the lead is to lose man's oldest hope, man's basic right, his basic need to make life better, to improve the quality of life on earth for everyone. But more, to lose the lead may be to lose the thing we most cherish—freedom.

NOW! SINGLE IN-LINE RESISTOR NETWORKS WITH IMPROVED PERFORMANCE

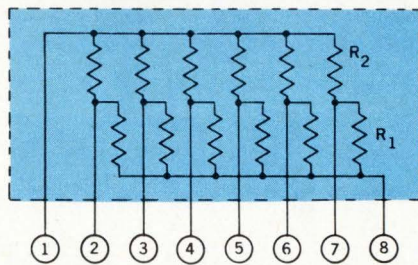
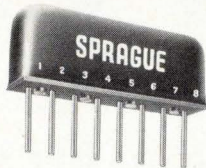
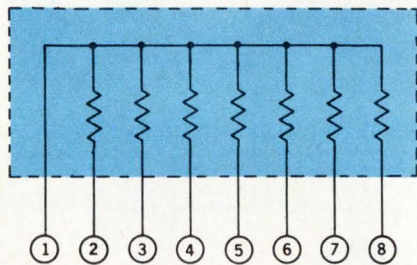

BOARDABLE AND AFFORDABLE

Low Cost and **High Density Configuration**

are only two of the features of Sprague Type 216C Metanet® Resistor Networks. Now, you can also enjoy the benefits of improved power dissipation, better temperature coefficient of resistance, and closer standard resistance tolerance.

Save Board Space. Single in-line design permits vertical installation, which allows more units to be seated in less space. This mounting style also results in improved high-frequency performance and significant in-place cost reduction.

Better TCR. Typical temperature coefficient of resistance is within ± 200 ppm/°C, cutting previous allowable limit almost in half.

Up-graded Power Dissipation. Individual terminating, pull-up/pull-down, and interface networks are capable of dissipating 250 mW per resistor at 70°C, an increase of 100% over previous designs.

Closer Resistance Tolerance. Standard resistance tolerance for each resistor is $\pm 2\%$, with other tolerances between $\pm 1\%$ and $\pm 5\%$ available on special order.

Proven Product Line. Sprague has more than fifteen years of experience in the development and manufacture of precision thick-film resistor networks, which include individual terminating, pull-up/pull-down, interface, and dual terminating designs.

For complete technical data, write for Engineering Bulletin 7041A to:
Technical Literature Service, Sprague Electric Co.,
35 Marshall Street, North Adams, Mass. 01247.

4SZ-5124R1



THE BROAD-LINE PRODUCER OF ELECTRONIC PARTS

Say When.

Introducing the Consul 520. Now you can get exactly what you need in teletypewriter compatible equipment. Without paying for what you don't need. Check the features below and say when.

Let's say you need:

- Inquiry-response capabilities.
- Remote controls to X-Y address or position the cursor up, down, forward, backward and home.
- Audible alarm and keyboard lockout.
- 12" screen; 24 lines with 80 character positions per line.
- Dark lettering on light background for increased legibility.
- Bonded faceplate TV monitor.
- Five transmission rates, switch selectable.
- Scrolled or wraparound display.
- Automatic line feed button.
- EIA RS232 or 20 milliampere current loop.
- Video output.
- Full-duplex or half-duplex transmission.

It's the Consul 520. The meat-and-potatoes basic that's pure prime quality. It features as standard what most terminals call options. Single unit price, \$1595.



- Maybe you need all the above features, plus:
- Hard-copy capability with printer interface.
 - Cursor control keys.
 - Numeric pad.
 - Rack-mounting option.

It's the Consul 580. Like all our terminals, the 580 has an extended warranty option, and OEM/Educational discounts. Single unit price, \$1795.



Moving right along, we drop the printer interface, and give you the above, plus:

- Protected formats.
- Block transmission to cut down on CPU functions and considerably reduce software needs.
- Selective transmission of only variable data.
- Upper and lower case ASCII display.
- Shift and lock keys.
- Transmission by page, partial page, line or character.
- Look-ahead cursor positioning to suppress trailing blanks.
- Automatic tabbing between fields.
- Half-intensity.
- Blinking at two rates.
- Remote recognition of cursor position.

*It's the Consul 920.
With its sophistication
and flexibility, the 920
is a network designer's
dream. Without a
nightmare price.
Single unit price,
\$2600.*



Still with us? Then you need the works:

- Graphics that show everything from bar charts to diagrams.
- Alphanumeric annotation of graphics.
- Line insert or delete; remote or local.
- Character insert or delete.
- Overwriting.
- Parallel and serial peripheral interfaces.
- Remote or local printing.

*It's the Consul 980.
Top of the line,
and acts like it.
You simply can't
buy better.
Single unit price,
\$2800.*

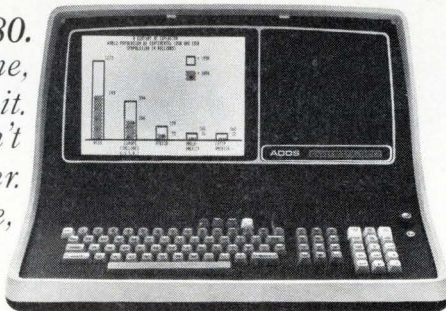

Now. If you've said when, we'll say where:
Applied Digital Data Systems Inc., 100 Marcus Blvd.,
Hauppauge, New York 11787 (516) 231-5400

ADD5

Now you can rent ADDS terminals through the General Electric
Instrumentation and Communication Equipment Service.



If you need HYBRIDS...

TELEPHONE HIGH BAND ACTIVE FILTER

1000pF NPO CERAMIC CHIP CAPACITOR

MULTILAYER CONDUCTORS

μ A741 OP AMP IC

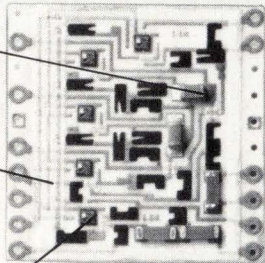

AUDIO FREQUENCY MODULATOR

1.0 μ F TANTALUM CHIP CAPACITOR

6.8 MEGOHM THICK FILM RESISTOR

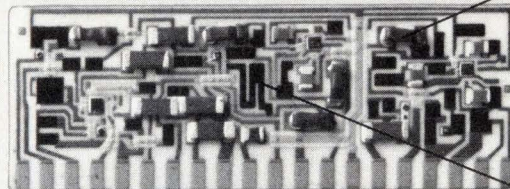

MULTICHANNEL TIME DELAY

4.7 μ F TANTALUM CHIP CAPACITOR

SOLDERABLE TERMINAL PAD

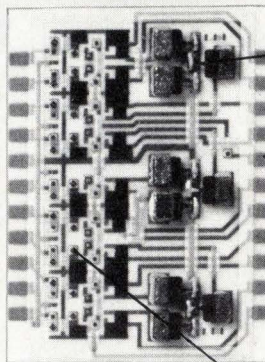

13-BIT MULTIPLYING DAC

13-BIT THIN FILM R-2R BINARY LADDER NETWORK

CUSTOM MOS IC

DIELECTRICALLY ISOLATED HIGH SLEW RATE OP AMP

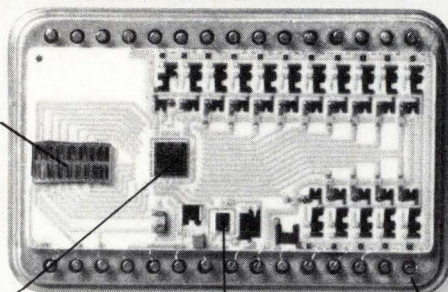

PROJECTION WELD SEAL HERMETIC PACKAGE

2N2907A SILICON CHIP TRANSISTOR

you should know about BECKMAN!

We offer *expert* application assistance and *quality products* at *competitive prices*.

Beckman Hybrids can solve your system packaging problems in:

- Active Filters and Telephone Tone Filter/Modem products
- DACs and ADCs from Industrial to Military standards
- Power Linears from Amplifiers to Voltage Regulators
- Complex Customs from Passive Substrates to Multilayer Digital hybrids

For fast response, call (714) 871-4848, Ext. 1776

Beckman®
HELIPOT DIVISION

CO₂ laser from Italy can cut ceramic substrates in curves

A pulsed carbon-dioxide laser from Italy is coming to the rescue of manufacturers of custom, or low-production-volume, hybrid circuits. The LDS 100, developed by Magneti Marelli, a company in the Fiat group, not only does conventional scribing, but can also drill holes and cut the delicate ceramic thick- and thin-film substrates in curved patterns, as well as straight lines. The laser can cut, shape, and drill a substrate in a day.

Substrates can be cut to dimensions and shapes that adhere closely to particular specifications, and the time-consuming and costly tooling-up process to prepare special substrate designs can be virtually eliminated. Magneti Marelli says: "A production requirement of some 25 hybrids with different drilled configurations in a year can amortize the investment cost of \$75,000 to \$82,000. If you have to produce a million or more hybrid circuits, then it pays to make a mold. But if it's a matter of a few thousand or if you need to test a variety of prototypes, the LDS 100 laser can be valuable."

The laser puts out 100 watts of continuous-wave power at a wavelength of 10.6 micrometers, but an electronic-trigger system in the tube allows a short, concentrated beam. At its peak power of 1,000 w, the LDS 100 produces a power density of 10 megawatts per square centimeter, whereas an earlier model gave only 2 MW/cm².

To drill or cut, the beam creates a pulsed series of shaped, overlapping perforations—a proprietary process that, the company says, creates no stress in the substrate. A drilled or cut substrate may be dropped into liquid nitrogen (-196°C) without cracking or showing other signs of stress. The secret lies in a combination of the geometry of the perforating action and the pulsed beam's peak-power density.

The laser, which comes with a built-in pulse generator that has controls for pulse duration and amplitude, is linked via an interface to an X-Y table controlled by a mini-computer for moving the substrate.

The pulsed beam can cut through ceramic, glazed ceramic, and glass substrates of standard 0.6-millimeter thickness. In fact, it can deal with thicknesses up to 3 mm, drilling at speeds up to 5 mm/s and scribing at up to 8 cm/s. In operation, the beam from the stationary water-cooled CO₂ tube is directed

by reflectors onto a 90° deflector and focusing unit, while the substrate moves on the X-Y table. Programs for cutting different shapes, stored on paper tape, can be readily changed.

Magneti Marelli, which originally developed the laser scriber/drill for use in its own plants for the production of custom circuits, is aiming to sell the device mainly in the European market, especially in Germany, Britain, France, and Italy. But the company is also interested in the U.S. market. □

Around the world

Soft mask boosts semiconductor yield for Ferranti

Ferranti Semiconductors in the UK has nearly doubled its semiconductor yield by means of a silver-halide emulsion for making "soft" masks, applied in the photoresist stage of fabrication. The emulsion, developed in a three-year yield-improvement program, contains a proprietary chemical.

The emulsion, called High Definition One Millimask, is being introduced by Agfa-Gevaert, of Antwerp, Belgium, in cooperation with Ferranti. The British company, using slices with chips more than 100 mils square, in a typical batch is getting mask efficiencies of 97% and yields of about 60%. The emulsion with the chemical has cut in half the mean grain size of silver halide to about 300 angstroms and reduced grain dispersion in the emulsion to 200 to 500 angstroms. It is used with a 1:1 projection system.

This fineness of grain, says Ferranti, virtually wipes out pinholes or defects in clear areas on first masks produced from master masks and increases sharpness of the edges for improved accuracy—all for about 10% the cost of "hard" mask materials. Moreover, with the emulsion, Ferranti says, "you can reverse-process an emulsion plate to get zero defects [no pinholes] in the opaque areas of a mask, as well. This is a great yield advantage that hard materials like iron oxide don't have."

German adapter sends taxi locations digitally

An identification system for radiotelephone-equipped taxis enhances communications with the control center and allows vehicles to be identified by digital numbers over voice channels. With the new system, from West Germany's AEG-Telefunken, the driver can identify himself merely by pushing a button. This action sends the multidigit number assigned to his vehicle in binary code to the control center for display on the dispatcher's monitoring board. The identification system, implemented by an adapter called Teledat, minimizes voice traffic on the radio channels, leaving more time for necessary transmissions.

What's more, when a driver is involved in a holdup or other dangerous situation, he can push a hidden button that alerts the control center and other taxi drivers. The digital data representing the identification number is enshrouded in the speech signal without disturbing it. Sending the number takes only 38 milliseconds.

**You can buy
this Spectrum Analyzer
and take a big chunk
out of your budget.**

**You can rent
this Spectrum Analyzer
and get more
equipment out of
your budget.**

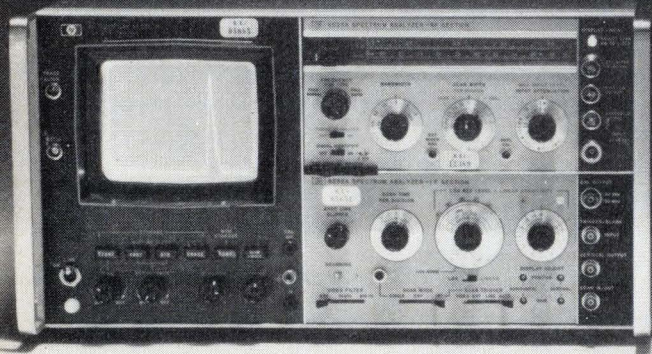

Even the best equipment budget can only go so far. And at the price you pay for electronic test equipment nowadays, that's not very far at all.

Unless you rent your equipment from REI.

When you rent from us, there's no large cash outlay. You pay only for the time you have your instruments, and you return them when you're through. So you never have to spend your money on idle equipment.

Getting more for your money is just one reason for renting from REI. Immediate delivery is another. We have over \$10 million in inventory in fully stocked centers around the country. And, when you have short-term needs, you can rent equipment for just as long as you need it, and make it pay for itself.

REI stocks over 8,000 fully checked-out test instruments, and they're ready whenever you are. For the full story on renting, as well as our low prices, send in the coupon for prompt delivery of our free illustrated catalog... or call us now for your immediate requirements.

Rental Electronics, Inc.
99 Hartwell Avenue, Lexington, Mass. 02173
Please send me your free instrument rental catalog:

Name _____ Title _____

Company _____

Address _____

City _____ State _____ Zip _____

Tel. Number _____

Rental Electronics, Inc. 

A PEPSICO LEASING COMPANY

Burlington, MA (617) 273-2770 • Gaithersburg, MD (301) 948-0620 • Oakland, NJ (201) 337-3757 • Ft. Lauderdale, FL (305) 771-3500
• Des Plaines, IL (312) 827-6670 • Dallas, TX (214) 661-8082 • Mountain View, CA (415) 968-8845 • Anaheim, CA (714) 879-0561
• Rexdale, Ontario (PLC Leasing Ltd.) (416) 677-7513

Circle 64 on reader service card

Cut in Japanese phone-gear buys laid to scandal . . .

Japan's ongoing Lockheed scandal has indirectly caused Nippon Telegraph and Telephone Public Corp. to reduce equipment orders and has accelerated the drive by its potential suppliers to expand their export markets instead. Because of disruptions attributable to the scandal, the Diet session that ended on May 25 **failed to pass the revision of the telecommunications law needed to allow NTT to raise its rates.**

Without this extra revenue of \$213 million a month, the telephone company tentatively has slashed \$385 million from its planned budget of about \$5 billion for the fiscal year that began April 1, forcing major NTT suppliers, including Nippon Electric Co., to turn to export markets. For the first quarter, which ended in June, NEC reports initial export orders of \$126 million, about 20% higher than had been planned. However, smaller companies that cannot switch sales to export markets are hurting badly. NTT hopes the Diet will amend the telecommunications law in extraordinary session so that rates can be increased Oct. 1.

. . . as British TV makers seek controls on Japanese imports

A public outcry against allegedly increasing Japanese encroachment on the British consumer-electronics market—coupled with behind-the-scenes pressure for government-imposed import quotas—will soon be made by heavyweights GEC, Thorn, Philips, and its UK subsidiary, Mullard Ltd. And Mullard, Britain's only remaining color-tube maker, is becoming increasingly anguished about losing money on its color operations. The so-called "group of four" is expected to publicize its detailed projection of a declining "home" industry, should the government take no action against audio and video imports.

In private talks with the Department of Trade, however, **they will explore a quota system on imported color TV sets and a cutback in imported monochrome sets in exchange for pledges by the Japanese to buy more components within the UK.**

France orders Metaconta switches for phone network

ITT, although forced to sell its French subsidiary le Matériel Téléphonique to the large Thomson electronics groups for \$160 million last May, has just landed an order for five new Metaconta space-division switching systems.

While LMT has won a contract for two systems, ITT's remaining wholly owned French subsidiary, **Compagnie Générale des Constructions Téléphoniques (CGCT)** has won contracts for the other three, which it will develop in association with the Thomson-owned Société Française Ericsson. Further orders for three Ericsson-developed Axe exchanges are expected to be placed later this year.

CGCT is also picking up telephone contracts outside of France. This week, it signed a \$12 million contract with the Ivory Coast's PTT to extend the West African nation's telephone system by installing a central electric switching system and adding 20,000 new lines.

Germans increase computer levels

According to the latest Diebold statistics, the number of computers installed in West Germany as of the first of this year stood at 24,801 units, representing a value of \$8.64 billion. Process computers checked in with 11,379 units—or nearly half of the total—which is 33.8% more than at the beginning of 1975. **Overall, though, the annual percentage increase for all computers combined continued to level off, Diebold says.**

Yugoslavs to assemble Philips EDP gear for Eastern Bloc . . .

Philips Data Systems in the Netherlands and Iskra in Yugoslavia have agreed in principle for the latter company to assemble Philips computer equipment for East European markets. **Iskra will start out by building the Philips office computer of the P-300 series.** The machine will initially be for the Yugoslav market and later for export to Poland, the Soviet Union, Czechoslovakia, East Germany, Romania, Hungary, and Bulgaria. The five-year agreement also provides for Iskra to give technical support to Philips computer systems already installed in Yugoslavia.

. . . as Mullard in UK readies Philips n-MOS drive

Philips of the Netherlands, mounting a major attack on memory, microprocessor, industrial, and television markets, will double its production capacity in n-channel, silicon-gate metal-oxide-semiconductor products when a new \$5.4 million production area in subsidiary Mullard Ltd.'s Southampton, England, plant, cranks up. **First product is a 22-pin dynamic 4,096-bit random-access memory also made by the company's Signetics plant in Sunnyvale, Calif.,** with 16- and 18-pin versions under consideration.

Likely to follow are a 16,384-bit RAM, automotive and industrial circuits, a reduced-chip-size version of Signetics' 2650 microprocessor, and a custom five-chip Teletext decoder, for which Mullard sees a total industry market of 600,000 units by 1979. Intended for both European and U.S.-bound circuits, the plant's production will jump to 1,500 3-inch slices per day when Philips' full \$12.6 million investment is completed during the next five years.

Japanese firm sells 3-inch sapphire wafers below \$40

Kyoto Ceramic Co. in Japan is mass-producing 3-inch sapphire wafers with a 0.6-micrometer epitaxial silicon layer deposited by the vapor-phase process. The company intends initially to supply the wafers in Japan for less than \$40 each, regardless of purchase volume. However, as shipments increase, quantity discounts are planned. **In the U.S., they cost about \$50 each in small quantities. Samples have been supplied to Japanese manufacturers since April.**

The wafers are believed to be the first produced by the edge-fed growth process licensed by Tyco Laboratories Inc. of Waltham, Mass. They are considerable cheaper in Japan than SOS wafers of similar quality that Union Carbide Corp., of New York produces by the Czochralski process. These cost about \$50 each in quantity by the time they are delivered to Japanese manufacturers.

German firm sees healthy growth for hi-fi market

An optimistic forecast for West Germany's high-fidelity equipment market comes from Grundig AG, the country's largest entertainment-electronics producer. According to the Nuremberg firm, **hi-fi unit sales in 1976 and 1977 will increase by 8% to 10% per year, while the rise in value this year over last will amount to 11%**—from \$155 million to \$172 million. And with the saturation level only at a bit more than 20%. The number of combinations is expected to increase from 375,000 this year to 460,000 in 1977.

DON'T FIGHT THE RELAY MAZE

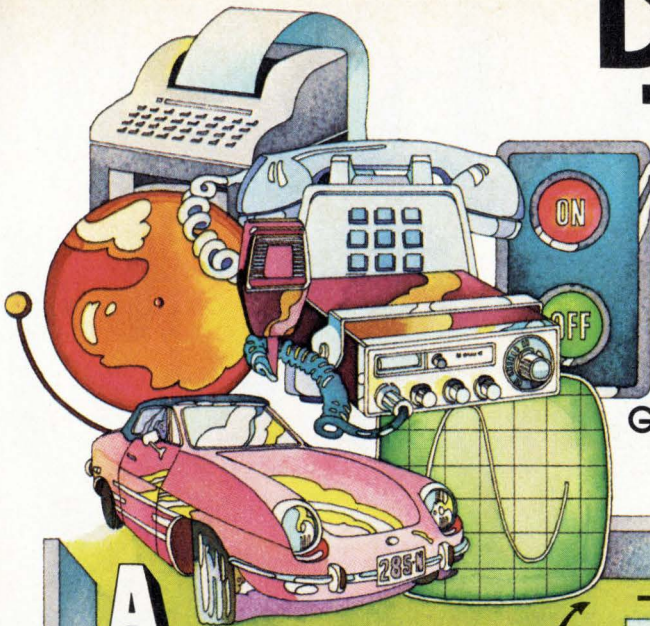

PROBLEM:
Go directly from relay requirement "A" to optimum relay specification "B" for any application.

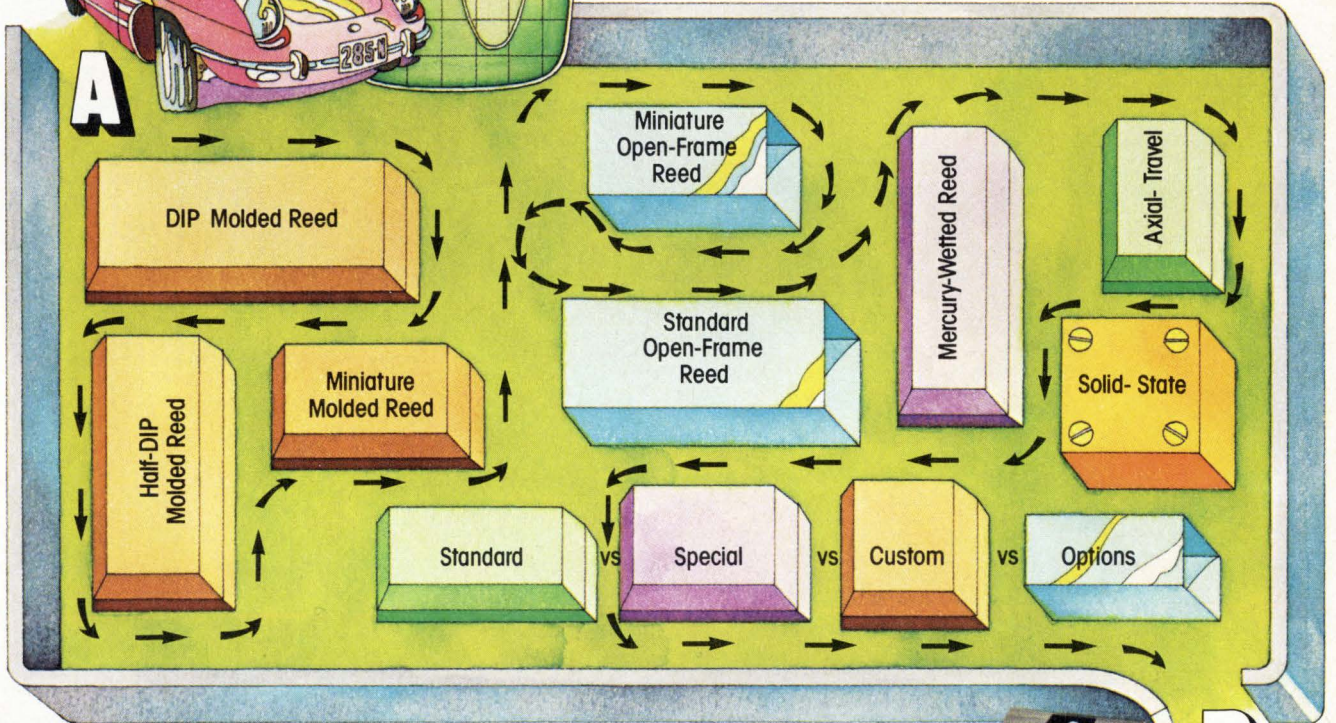

Just follow the leader: GORDOS

Because we're the only relay company that makes all its own switches, we know relays from the inside out — and make more than anyone else. More types... more versions of each type.

And, we accept single responsibility for maintaining high standards of quality for every one. So, when matching the optimum relay to an application, we help keep tradeoffs down. We offer a broad perspective unmatched by suppliers with fewer alternatives... a greater product base from which to select special-purpose relay solutions others just don't have... plus the technological expertise to avoid high custom-design costs often by simply modifying a standard solid-state, axial-travel, or reed relay design.

The fact is: there's really no reed or solid-state relay problem Gordos can't handle... usually right off the shelf. So, don't fight your way through the relay maze — call Gordos.



For Data On	Ask For Bulletin
Molded-Epoxy DIP Reed Relays	RR407
Miniature Molded-Epoxy Reed Relays	RR408
Mercury-Wetted Reed Relays	RR409
Open-Frame Reed Relays	RR406
Axial-Travel Relays	ATR601
Solid-State Relays	SS502

GORDOS

Gordos Corporation, 250 Glenwood Ave., Bloomfield, N.J. 07003 • Telephone: (201) 743-6800 • TWX: 710-994-4787
Grangestone Industrial Estate, Girvan, Ayrshire, Scotland • Telephone: Girvan 3581-2-3-4 • Telex: 851778500

Circle 67 on reader service card 67

Our 4K RAM
our 4K RAM.

is faster than

Our fast 4K RAM.

Model No.	Access Time	Read/Write Cycle Time	Read/Modify/Write Cycle Time
MM5270 (18-pin)	200 ns	400 ns	580 ns
MM5271* (18-pin)	250 ns	400 ns	560 ns
MM5280 (22-pin)	200 ns	400 ns	520 ns
MM5281* (22-pin)	250 ns	400 ns	510 ns

*Chip enable is TTL compatible.

Our faster 4K RAM.

Model No.	Access Time	Read/Write Cycle Time	Read/Modify/Write Cycle Time
MM5270A (18-pin)	150 ns	300 ns	400 ns
MM5271A* (18-pin)	200 ns	300 ns	400 ns
MM5280A (22-pin)	150 ns	300 ns	370 ns
MM5281A* (22-pin)	200 ns	300 ns	370 ns

*Chip enable is TTL compatible.

National Semiconductor Corporation,
2900 Semiconductor Drive, Santa Clara, CA 95051

E722

Gentlemen:
Kindly rush data sheets on your fast, and faster, 4K RAMs.

Name _____ Title _____

Company _____

Address _____

City _____ State _____ Zip _____

 **National Semiconductor**

OPEN FRAME OR

...Powertec gives

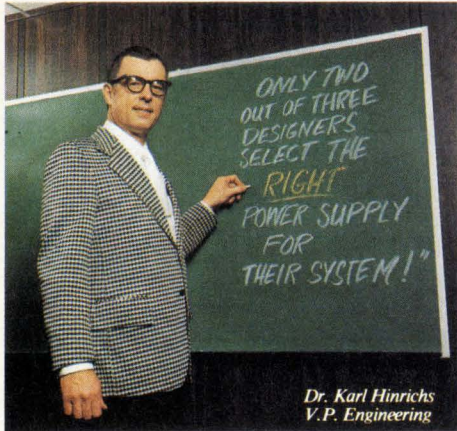

Dr. Karl Hinrichs
V.P. Engineering

When is a power supply wrong?

Our discussion here pertains to *types* of power supplies. *Not brands.*

There are, of course, inferior products on the market which the buyer should avoid. But even if all supplies were equal in quality, the designer still faces many problems.

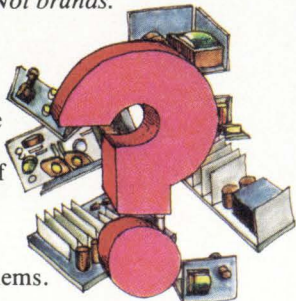

For simple mounting, the choice is open frame

While open frame supplies are complete in themselves, sub-modules require the addition of heatsinks and transformers along with associated wiring and assembly. Consequently, the former are far more easily mounted. So with plenty of space and a model that meets all specs, open frame is generally the easiest to utilize.

For continuous I/O power selection, choose sub-modules

The output voltage ranges of open frame supplies are discontinuous, while sub-modules are available for any voltage between 1.2 and 30V. This means there are "gaps" in the open frame ratings, and if your system falls into one of these, you'll have to "overbuy" or order a "special". Sub-module transformers are easily custom designed to specific needs,

including input voltage, tolerance and frequency as well as output voltage and current.

Whistles and bells... a sure way to raise costs

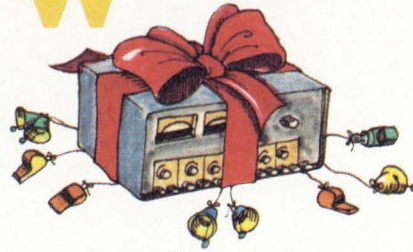

An excellent basic principle is, *never overbuy.* For example:

Overvoltage Protection (OVP)— only about one in 10,000 power supplies will fail in an over voltage mode; thus, at a cost of approximately \$8.00 each, OVP's may not be justified in low and medium-cost end products.

Logic Inhibit— normally required only with multiple outputs.

Remote Voltage Adjustment— necessary when access to the supply mounted adjustment is limited or when "front panel" adjustment is required. If remote is desirable, it should be built in; add-on's are possible, but supplies vary widely as to ease of implementation of this function.

Sub-modules fit the "space left over"

Sub-modules offer considerably more flexibility than open frames, primarily

because of their building block concept. If forced air cooling is utilized, power density can be increased (size decreased) with sub-modules since the heatsinks can be reduced in size. Conversely, a 12-amp open frame is the same size, with or without forced air.

Dollars and cents... the bottom line!

If your production run calls for 100 or more supplies, and/or if your system requires over 3 outputs, the sub-module approach will most likely serve you best economically. Also, the overall operating efficiency of sub-modules may be better (less waste heat) since the transformer is tailored more to specific needs. For shorter runs of non-complicated systems, however, the open frame concept is the prime choice.

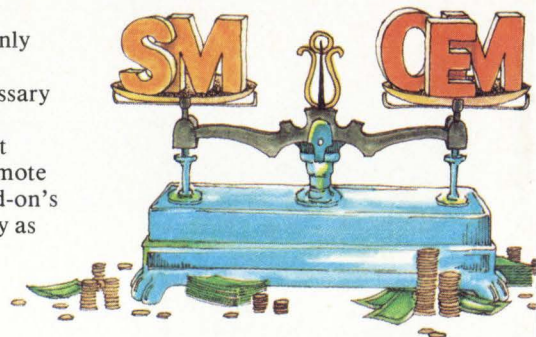

When outputs get into the several hundred watt range, consideration should be given to switching regulated supplies, where operating efficiency far exceeds that of linear-type supplies and costs are comparable.

BASIC CRITERIA FOR SELECTING THE RIGHT POWER SUPPLY

Considerations	Sub-Module	Open Frame
Minimum cost power supply, no special features required	—	Most economical for uncomplicated requirements
Restricted system space	Much greater flexibility	—
Fast, easy installation	—	Simply bolt on, make connections
Possible system design changes (e.g., prototype stage, system upgrade, etc.)	Versatility offers better chance of meeting new requirements	—
Voltage requirements not within standard open-frame ranges	Range continuous between 1.2 and 30V	—
Quantity	Most economical in large quantity	Most economical in small quantity
Availability	Multiple sources	Commodity item
Operation with abnormal input voltage	Readily adapted	Limited variations
Sequenced turn-on/off in multi-output system	Logic inhibit standard	Not available
Remote voltage adjustment	Removable voltage adjustment standard	Requires new potentiometer, PCB modification

SUB-MODULE...?

you a choice.

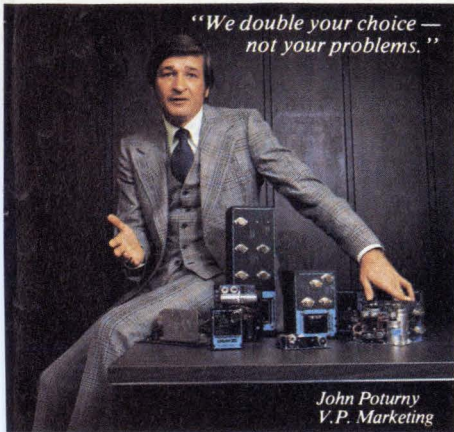

Improved electronics offer higher efficiency. 115/230 Vac input and electrostatic shielding are standard on every unit. Regulation and thermal characteristics have been improved and expanded. There are fewer components and less hard wiring. Each OEM II has a one-year warranty and a lifetime guarantee on power silicon semi-conductors. Plus all the features you look for in an open frame power supply.

Powertec's SM Series provides a standard solution to even the most sophisticated custom requirements. Its combination of features add up to extreme design flexibility.



OEM FEATURES

- Adjustable current limiting
- Remote sensing
- Programming capability
- AC input options
- Metal film resistors
- All hermetic power semiconductors
- Conservatively rated capacitors
- Output screw terminals
- 100% computer tested
- U.L. recognized

SM FEATURES

- 10 basic case sizes
- 1.2V to 30V, up to 75A
- Single and multiple outputs
- Built-in rectifier, filter, regulator, OVP
- Adjustable voltage, current limit, OVP
- Logic inhibit function
- Remote sensing
- Readily removable, locking voltage adjustment potentiometer
- U.L. recognized

At Powertec you not only choose from one of the broadest model ranges in the industry, you also choose the *type* of power supply best suited for your application.

This is especially important in today's smaller designs where fit, flexibility, and the exact combination of features are vital. Obviously, no one type of supply will satisfy all. There *must* be a *choice*. Which is why Powertec offers both OEM open frame power supplies and sub-module power components. By doubling your choice, we fit the power supply to the system so you don't have to tailor the system to the supply . . . whether you build or buy.

54 OEM II models

These second generation open frames are even better than their standard-setting predecessors. And there are more models to choose from.

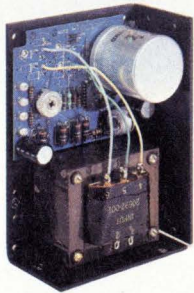

40 single output models provide 70 different outputs. 24 multiple output models are available in both duals and triples.

60 SM models

With Powertec's line of sub-module power components, there is a voltage and power rating for virtually every application.

You can order them fully assembled or build them yourself. Simply select the appropriate off-the-shelf power component for your system, and add your own transformer and heatsink. Or let Powertec supply the complete package. Either way, or with intermediate variations, configurations are practically unlimited.

So the next time you face a decision on selecting the right power supply, give yourself a choice. It could save you both time and money while improving your system design . . . whether you build or buy. Start off by discovering the quality choice at Powertec.

Free
"Make or Buy
Decisions Aid"

Another instructive booklet from Powertec.



SEND FOR PRODUCT BROCHURES

168 DeSoto Avenue, Chatsworth, California 91311 • (213) 882-0004 • TWX 910-494-2092

POWERTEC

Circle 71 on reader service card

**“We’ll sell
you the best,
lowest priced
132-column
printer
available
anywhere.”**

Bob Howard, President, Centronics



But the low initial price for the Centronics 700 Series 132-column printer isn't the whole story.

It's the lower cost of ownership based on the 700's inherent reliability and simplified construction.

The 700's unique modular construction using four different modules — printing, electronics, forms handling and keyboard — and less moving parts mean easier maintenance, lower cost and a smaller spares inventory.

Write for the full details of this tremendous offer . . . and information on the rest of the printers and teleprinters in the new Centronics 700 Series.

Centronics means more than low price.

And more than hardware. It's the widest range of models, features, options • Financially strong • Proven delivery response • Over 70,000 printers installed • 109 world-wide sales/service locations • Stringent quality control • Advanced R&D and manufacturing • Long-term spare parts availability • Customizing for specific needs.

CENTRONICS IS PRINTERS®

Centronics Data Computer Corp., Hudson, N.H. 03051, Tel. (603) 383-0111, Twx. 710-228-6505, Tlx. 94-3404; Eastern Region: (617) 272-8545 (MA); Central Region: (513) 294-0070, Twx. 810-459-1784 (OH); Western Region: (714) 979-6650, Twx. 910-595-1925 (CA) Centronics Data Computer (Canada) Ltd., Ontario, Tel. (603) 883-0111, Twx. 710-228-6505; Centronics Data Computer (UK) Ltd., Cheam, Surrey, England, Tel. 643 0821-4, Tlx. 851 945756; Centronics Data Computer, GmbH, 6 Frankfurt/Main., West Germany, Tel. 663321/22, Tlx. 841 413224; Centronics of Puerto Rico, Dorado, Puerto Rico, Tel. (809) 796-1881, Tlx. 3859349

TERADYNE'S J401: THE FULL CAPABILITY IC TEST SYSTEM EVERY ENGINEER CAN USE.

Until now, the complexities of test programming have kept all but a few specialists from using IC test systems. Everyone else had to queue up at the programmer's desk or do without the kind of information that was really needed.

Now there's a J401. A fully programmable test system for T²L ICs with up to 24 pins, complete with built-in CRT, printer, and mag tape unit, that any engineer can learn to use in minutes.

For IC producers this means immediate access to vital process control information. For IC users it means the data necessary to choose components and vendors intelligently. And the ability to extract from field returns the information needed to improve product quality and yield.

The performance and flexibility of a large, computer-operated test system.

The J401 delivers the flexibility ordinarily associated only with larger, more expensive systems. It can datalog any forced or measured function and it can generate an x-y plot of any two parameters. The system also operates as a high throughput go/no-go tester for the production line or incoming inspection.

Product data fast. Higher product yield.

For the semiconductor manufacturer, the easy-to-use J401 allows errors to be spotted before they can begin to multiply. QC engineers can use it to evaluate devices, determine test margins, and check device lots.

The electronic equipment manufacturer will find the J401 useful in monitoring vendor-to-vendor and lot-to-lot variations.

It enables him to spot device characteristics that could be contributing to problems. And QC personnel can use the system to analyze failures and reduce service costs.

A system for meeting the real objectives of incoming inspection.

The J401 gives you fast go/no-go testing with an important difference. It gives control over the way devices are tested. By pushing a few keys you can change test conditions, bin out top-quality ICs, or have data-logging to support returns. All in seconds. This is incoming inspection as it should be.

It's a Teradyne.

Each J401 is built for hard use on the factory floor. Each is supported by Teradyne's ten-year circuit module warranty, a 24-hour telephone troubleshooting service, and a worldwide field service backed up by local parts stocking centers.

For complete information on the J401, write:
Teradyne, 183 Essex Street,
Boston, Massachusetts. In Europe:
Teradyne, Ltd., Clive House,
Weybridge, Surrey, England.

WE SELL PRODUCTIVITY.

TERADYNE



CHICAGO (312) 298-8610/DALLAS (214) 231-5384/NEW ENGLAND (617) 458-1256/NEW YORK (201) 334-9770
SUNNYVALE (408) 732-8770/LONDON (0932) 51431/PARIS 073 16 98/ROME 59 47 62/MUNICH (089) 33 50 61/TOKYO (03) 406-4021

16-k RAMs still less than standard

Pinouts of devices made by TI, Intel, and Mostek are the same, but functions of the pins vary from manufacturer to manufacturer

by Bernard Cole, San Francisco bureau manager

Now that the industry has settled on the 16-pin version as the standard pinout for the 16,385-bit random-access memory, everything is settled. Right?

Wrong. Many manufacturers and users are beginning to realize that what they have is a pseudo-standard, because everyone is going his own way, as far as functionality is concerned. While manufacturers seem to have settled on what appears to be the same pinout for the 16-k RAM, they seem intent on expressing their individuality in how they implement the functions of each particular pin: latched or non-latched outputs, precharging outputs high or low, floating the outputs or letting them reflect the internal data, and using either 64 or 128 refresh cycles.

And, although the user is not back in the forest as he was with the 4,096-bit RAM thickets of 16-, 18-, and 22-pin packages, he is finding that 16-k RAMs in 16-pin packages are not interchangeable. He must put out the money and put in the time to design boards that accommodate a number of different functional approaches—a chore he had to do before “standardization.” And reactions from potential users vary from minor irritation to serious concern.

Trivial differences. Brian Croxon, business manager for memory systems at Digital Equipment Corp. in Maynard, Mass., regards the differences among the 16-k RAMs that he has evaluated—those devices made by Intel Corp., Texas Instruments, and Mostek Corp.—as really a trivial matter. “We’re seeing samples that follow the usual mode,” he ob-

USER REQUIREMENTS					
User	Output latch	Input latch	Refresh cycles	Data out valid at write	Other
Honeywell	Originally yes, now prefer w/o	Yes	64 (will take 128)	No preference	
DEC	No	Yes	128		
Burroughs	No	Originally no, now will use	64 or 128	DO = DI (will take w/o)	Would like precharge low at read
Sperry Rand	Yes	Yes (implied)	64	No preference (implied)	
NCR	No preference				
HP	No preference				
Univac	Yes				
Consensus	No	Yes	128	No preference	

serves. “The vendors want to be able to say that they have 16-k RAMs out, that they’re moving ahead in technology, and a number of them are supplying small quantities for prototype development. We expect further iterations in design and more compatibility.”

For instance, Croxon has observed variations from specified voltages and clock timing—a vendor may specify a clock timing of 50 nanoseconds, but it may actually be 60 ns or 70 ns. And if the user wants 0.8 volt on the transistor-transistor-logic input, the part may deliver 0.6 V, instead, which results in less noise immunity.

Nonetheless, “these are trivial at this point in the development cycle,” Croxon notes, “and the users

have to tweak their processes to get there.”

Regarding latched or unlatched outputs (Intel’s are latched, Mostek’s and TI’s aren’t), that dissimilarity causes Croxon a little more concern, since DEC can’t commit to a part as early as it might like to “because we have to worry a bit about the availability of a second source. If we have an unlatched part, we have to design a system with a latch—a flip-flop—before the data goes onto the bus, and we’d rather not do that if we can get the latch in the RAM.”

DEC would rather not design two kinds of boards to accommodate latched or unlatched outputs, which translates into a “bit of delay,” he says. Still, he adds that, even if some

Probing the news

of these small variations are worked out, DEC probably wouldn't commit to a vendor yet because he doesn't expect significant volume production of the parts this year, and he wants more than one source.

Deterrent. Lou Pezzi, manager of memory development at Interdata Inc., Oceanport, N.J., says the lack of true compatibility of 16-k RAMs "is definitely a deterrent in our going in on them." However, he adds that by the time Interdata is ready to use 16-k RAMs in large quantities—which would be around the spring of next year—there will probably be enough vendors around with compatible 16-k parts.

Pezzi says that real standardization would hasten the spread of 16-k parts into more machines. "But I don't think the 16-k will have the same impact that the 4-k did. The 4-k was important as it obsoleted the 1-k RAM, but the 16-k, while it will allow us to build higher-density boards, won't displace the 4-k in memory systems."

Meanwhile, a spokesman at one major memory-systems organization notes that, although most of the memory vendors have assigned the same functions to the same pins, at least two additional levels of standardization are required to get truly compatible parts.

The second level—where the pins have the same logic interface—hasn't been achieved, the spokesman says. "There appears to be a fairly substantial battle shaping up between Intel and Mostek, with Intel taking the data-latch approach and Mostek going the non-data-latch route," he says. The third level, which is the most difficult, relates to timing. It would be ideal for one part to fit in one socket and another in another socket without any change in the circuits' timing.

"From the user's standpoint, it is of absolute importance that the device manufacturers achieve the first and second levels of compatibility. The third level is highly desirable, especially when one is in the phase of product development when he is pushing the speed capability of the product and getting it to go faster

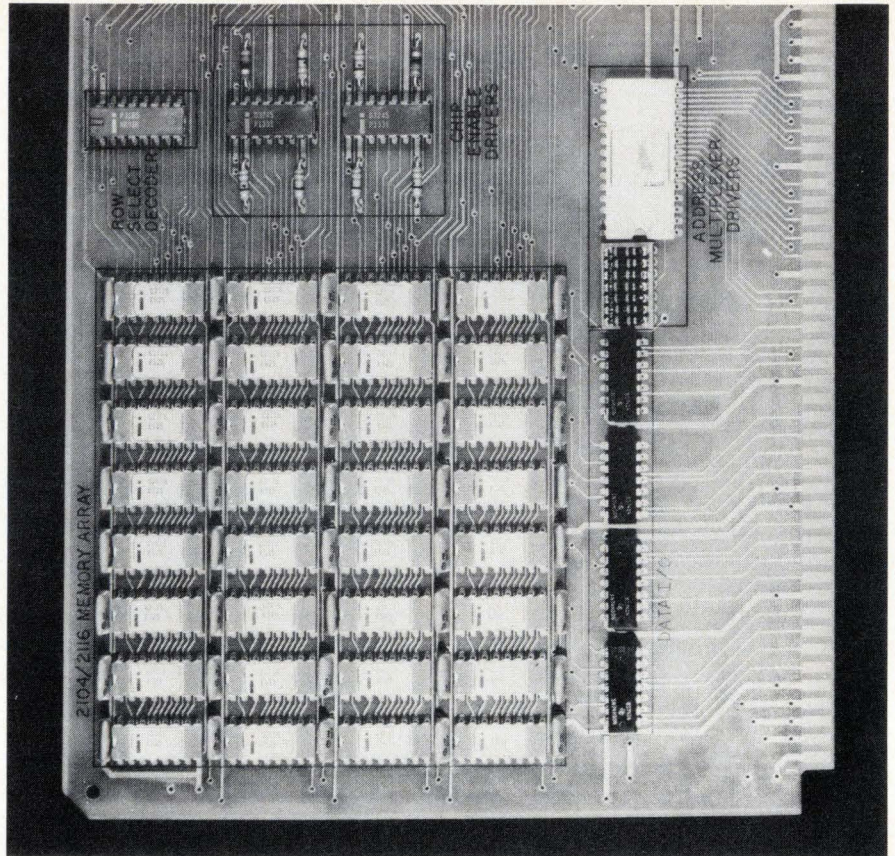

On board. These 16-k random-access memories from Intel feature latched output. Those from Mostek and Texas Instruments, on the other hand, have unlatched outputs.

and faster," the spokesman says.

A spokesman for Burroughs Corp. in Detroit, Mich., observes that if there were real standardization on 16-k RAMs, the ultimate performance of systems would improve, because, as one engineer has put it, "You could then write a spec compatible with everyone else's part and could push the limits on all specs. As a result, yields would go up." However, says the Burroughs source, this means "compatibility with characteristics beyond pinout alone."

Not here. Actual standardization, point out designers at several user companies, would advance the use of 16-k RAMs by a year. "But it's too late now," says one designer. "Standardization is already not here, and it really pays in that crucial first year, as people would start designing with the assurance that there would be two sources. The fact that there is no real compatibility means we have to wait a year for other vendors to come out with compatible parts. This delays real volume production by a whole year."

Nonetheless, many users, Sperry Univac and Hewlett-Packard among them, are believed to be looking hard at several 16-k RAM parts and designing them into products. Both are believed to be negotiating major orders with one of the 16-k RAM suppliers for parts to be used in next-generation systems.

One large user notes that in the early stages of his firm's 16-k RAM program, it found more standardization at this point than it did with 4-k RAMs. "Most of the 16-k devices that have come out really are not that far apart," he says, noting that device manufacturers recognized "that the 4-k problem we had was bad and really hurt the market." Such recognition, he adds, will "help the 16-k RAM come on a bit easier, although it is a more complex device than the 4-k RAM."

An HP systems designer says precisely that complexity impels greater standardization. "We should have pinout standardization in the 4-k RAMs," he says, somewhat testily, "and be working toward further levels of standardization in the 16-k." □

What's new in solid state ...

RCA races on with popular memory types: 14 now, 10 coming up.

From a virtual standing start in 1974, we've already introduced 14 of the most popular RAMs and ROMs. By year's end there will be 24—a comprehensive lineup of devices that are directly interchangeable or pin compatible with 62 types from 19 manufacturers of industry standards ... often with improved performance as a dividend.

RCA memories span NMOS, CMOS, and SOS technologies. Organizations range from 4 words x 8 bits up to 512 words x 8 bits, with emphasis on standard 1K and 4K arrangements. And these products are now available in volume from several facilities including our newest, most highly automated plant, designed and equipped to produce with a high degree of uniformity.

All of which shows RCA is totally committed to winning your confidence as a front-running, wide-range memory supplier. To help you program RCA memory products into your design we've put together a pocket-size Memory Interchangeability Guide. Ask for it at your local RCA Solid State distributor. Or contact RCA.

1974			
NMOS	MW7001D	CMOS	CD4039AD
CMOS	CD4036AD	CMOS	CD4061AD
1975			
SOS	MWS5001D	SOS	MWS5501D
SOS	MWS5040D	SOS	MWS5540D
1976			
Now ...			
NMOS	MW4050D	NMOS	MW4060D
NMOS	MW4050DVI	NMOS	MW4060DVI
NMOS	MW4050DV2	NMOS	MW4060DV2
Coming ...			
NMOS	MW4051	SOS	MWS5001A
NMOS	MW4101	SOS	MWS5580
NMOS	MW4104	CMOS	CD40024
NMOS	MW4111	CMOS	CD40032
NMOS	MW4112	CMOS	CD40061

Write: RCA Solid State, Box 3200, Somerville, N.J. 08876; Ste. Anne de Bellevue H9X 3L3, Canada; Sunbury-on-Thames, U.K.; Fuji Bldg., Tokyo, Japan.

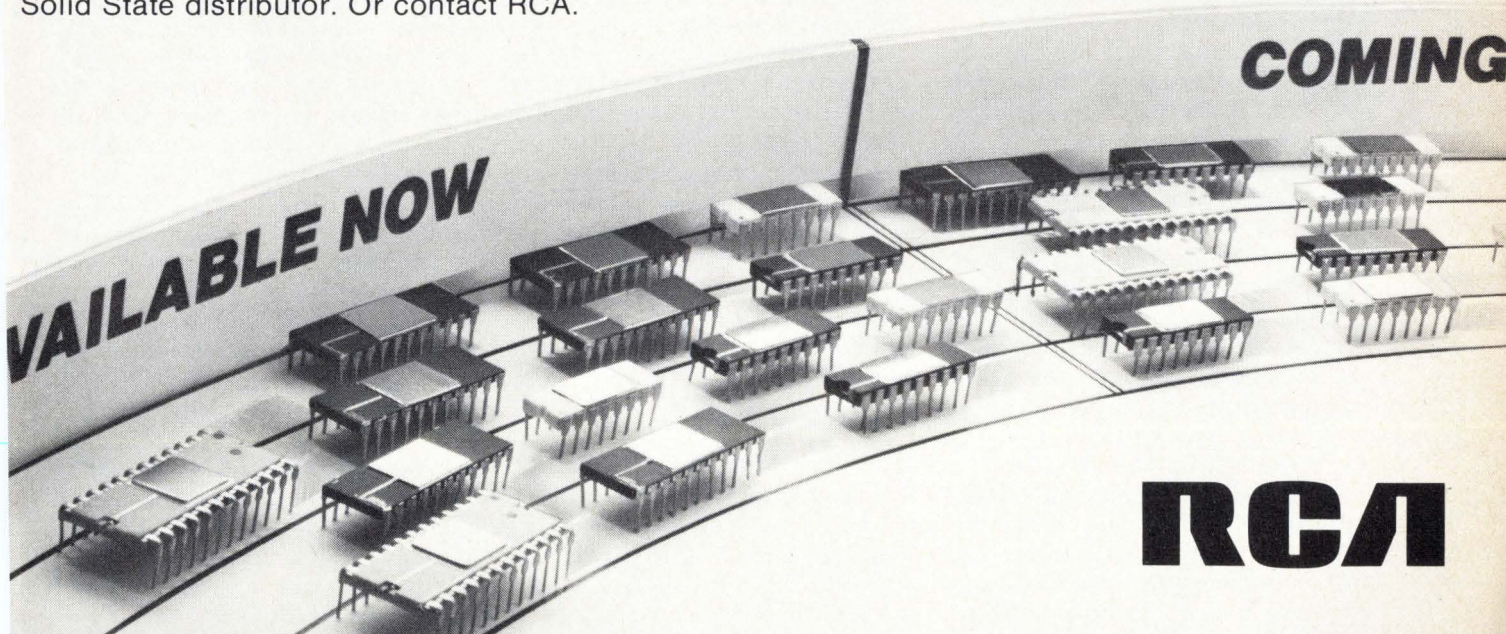

RCA. Fastest moving house in memory.

Circle 77 on reader service card

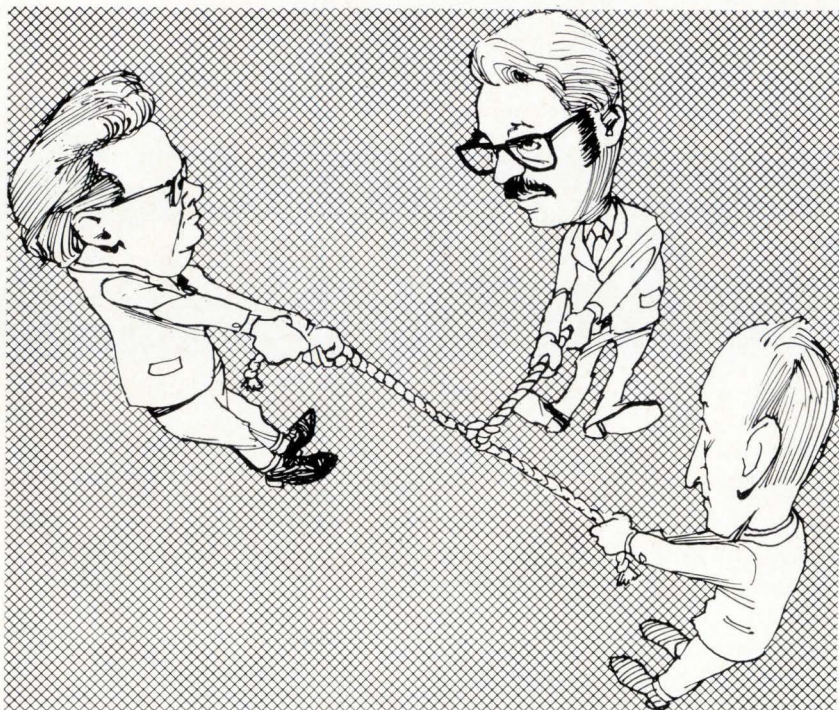

For president. Vying are, left to right, Robert Rivers, Irwin Feerst, Robert Saunders.

Who will lead IEEE into change?

by Gerald M. Walker, Associate Editor

No better sign of the turmoil and the urge for reform among many members of the Institute of Electrical and Electronics Engineers can be found than this year's election ballot, which will be mailed to eligible voters next month.

For one thing, there are two candidates for president and one candidate for executive vice president who got on the ballot by petition to challenge the slate nominated by the board of directors. For another, there are two proposed constitutional amendments put on by petition of members and a third likely to come at the deadline. It all adds up to easily the most important vote by members since the IEEE was broadened into a professional as well as a technical-information society some five years ago.

There will be changes in the institute in the coming year, no matter what the outcome—the difference will be in the amount of change and the time it takes to accomplish it. Depending on who is elected, the IEEE next year could redirect its pro-

fessional activities toward more active career-related programs, reorganize the paid staff, open executive committee and board meetings to members, reorient the content and direction of Spectrum magazine, and overhaul the budget.

These changes would be the beginning of a renewal of the IEEE that would take several years. And if either or both of the constitutional amendments are passed, individual members will have a louder voice than ever in the future direction of the IEEE (see "Fair play, dues increases also issues," p. 80).

Despite the usual statements about maintaining the technical superiority of the IEEE, this election revolves around career-related issues. In fact, it has been dissatisfaction with the institute's professional side that created the petition candidacies for president of Irwin Feerst, constant IEEE critic, and Robert Rivers, presently director of division IV and a board member, and of Carleton Bayless, region VI director, for executive vice president.

These challengers felt that the board-nominated candidates were not up to the tasks ahead. However, the board's men, Robert Saunders, vice president of regional activities, for president, and Robert Briskman, vice president of technical activities, for executive vice president, believe as strongly that they represent the best means of revamping the institute efficiently because they are accepted by the governing officials.

Diversity. Starting with the presidential candidates, it would be hard to find three engineers more diverse in views, style, and background. Feerst is abrasive to the point of being insulting, but in his years of jousting with the IEEE windmill, he has made cogent and appealing arguments on behalf of the grass-roots members to strengthen the engineering career. His single-minded commitment to leading the institute in his direction has won him a hard core of followers, but some enemies as well.

"Survival of the IEEE is the most pressing problem from two aspects,"

Announcing a BiMOS breakthrough...

The RCA 3140. Most useful op amp since the 741.

For the price of a 741, the CA3140 is a lot more op amp. One that is often far more cost effective, considering circuit and component savings, than BI-FET and other higher priced op amps.

MOS/FET input makes the difference.

In fact, CA3140 is a giant step closer to the ideal. It gives you the big advantages of MOS/FET input...*plus* bipolar speed and high supply voltage operating capability: 4 to 44 V, dual or single supply. MOS/FET input means very high input impedance: 1.5 T Ω typ. Very low input current: 10 pA typ. at ± 15 V. Low input offset voltage: as low as 2 mV max. Wide common-mode input voltage range—can be swung 0.5 V below negative rail. In addition, output swing complements input common-mode range, permitting full utilization of low supply voltages (down to 4 V). When it's driving power transistors, the output swings to within 0.2 V of the negative rail. And PMOS input devices are

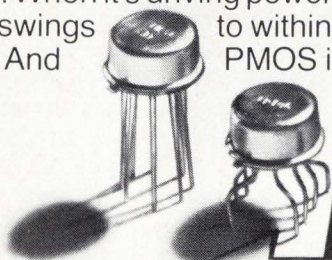

MOS/FET

BiMOS

BIPOLAR

CA3140 vs. 741 at a glance		
	CA3140T,S	CA741CT,S
Input Resistance R_i (M Ω)	1,500,000	2
Input Current I_i (pA)	10	80,000
Slew Rate, SR (closed loop) (V/ μ s)	9	0.5
Gain-Bandwidth Product, f_T (MHz)	4.5	1.0

protected by rugged bipolar diodes.

Versatile building block

The CA3140 can perform standard and many other applications. Such as ground-referenced single-supply amplifiers. Sample and hold amplifiers. Long-duration timers/multivibrators. Photocurrent instrumentation. Peak detectors. Active filters. Tone controls. Function generators. Power supplies. Intrusion alarm systems.

Send for 13 useful circuits.

To show you how useful the CA3140 is, we've designed it into 13 typical circuits. To get these circuits plus other information, contact your RCA Solid State distributor. Or RCA. Write: RCA Solid State, Box 3200, Somerville, N.J. 08876; Ste. Anne de Bellevue H9X 3L3, Canada; Sunbury-on-Thames, U.K.; Fuji Bldg., Tokyo, Japan.

RCA

RCA. Full house in Linear ICs.

Circle 79 on reader service card

Now there's a
universal computer-based
in-circuit/functional
test system with extensive
digital test capability.



FAULTFINDER[®] FF303

The new FF303 provides two separate in-circuit test approaches. Analog testing procedures use guarding techniques for straightforward component fault isolation. Pulse techniques are used for digital testing of all combinatorial and sequential logic independent of the surrounding circuitry. The FF303 can be configured with up to 928 analog test points and 1216 digital test points.

In-circuit test programming is done with a Faultfinder extension of BASIC which permits on-line editing and simplified, high-level language programming with user nomenclature.

The FF303 is a complete, flexible in-circuit test system for your production floor with low-cost software generation and unique capabilities for testing hybrid boards. We'd like to show you what it can do for you. Write or call for complete information.

Circle 80 on reader service card

FF **FAULTFINDERS Inc.**
15 AVIS DRIVE, LATHAM, NY 12110 (518) 783-7786

Irvine, CA
Sunnyvale,
Park Ridge, IL
Faultfinders GmbH, Eschborn, Germany

Cicero, IN
Waltham, MA

Probing the news

he says. "First is financial survival, for the institute is in serious difficulties which the treasurer admits have been caused by budget errors, poor income estimate, and poor expense control. The second, and more important, is the disenchantment of members with the IEEE and how it's run. Basic to an organization run by volunteers is the good will and faith of its members."

Among Feerst's many proposals, he would, if elected, request the resignation of the general manager Herbert Schulke, sell the Piscataway, N.J., facilities, and establish an EE legal defense fund, publish or make available to members minutes of board and executive committee meetings, reevaluate the functions of the groups and societies, and reorganize the content of Spectrum to carry profession-oriented articles.

The other petition candidate, Rivers, is given to elaborate analyses and lists of ideal goals, but his determination for action—not just talk—is apparent by his decision to challenge the board while still one of its members. "We need to turn on the control area: control supply and demand of engineers, and control education quality. Opposition to this is not so much from educators as from industry," he remarks. "The educators, it turns out, are part of the solution, not part of the problem. They don't want to turn out 'junk,' but engineers with career possibilities. Industry may have a long-term support for high-quality engineers, but the system is corrupted by short-term decisions to get the most engineers for the least money to solve this year's problems."

Review. If elected, Rivers would immediately appoint advisory teams to draw up concrete recommendations for changes in the IEEE and programs to accomplish them to be put into action at the beginning of the one-year term. He would include in this initial task a review of the staff organization. Rivers would release summaries of all executive committee and board meetings to the press and would try to set up an institute newsletter to carry information promptly to members. The

last order of business at every meeting would be to approve the minutes, rather than wait for the next meeting. Spectrum would be shifted to a subscription technical publication with the proceeds to support the newsletter.

Saunders, an affable educator caught up in a close race, has the advantage of continuity going for him. He, too, would devote personal attention to strengthening professional affairs. "Now that we have a program developed," Saunders explains, "We need to turn attention to manning and action. I am disturbed to find only about 2,000 members active in professional activities committees compared to 20,000 to 30,000 in the technical and educational committees. We must expand involvement to get a program implemented." As for the "sunshine" issue, Saunders would put minutes of executive committee and board meetings in a reading room at headquarters for anyone to read—both approved and unapproved—and make copies available for a nominal sum.

Both Briskman and Bayless are concerned with reorganizing the operations of IEEE, starting with the U.S. Activities Board, which is the main professional-action arm of the institute. Both would work hard at putting the organization on firmer financial planning ground, particularly in budget making. And both want to extend the initial short-range efforts into coherent long-range planning. Finally, both candidates believe that they can work well with whomever wins the presidential race, though they have their personal choices—Bayless for Rivers, and Briskman for Saunders.

The propositions on the ballot concern procedures to publicize future propositions—the so-called "fair play amendment"—and to submit future dues increases to a vote of the members.

The board recommends a vote against the first proposition. Feerst and Rivers favor it, while Saunders is opposed. Bayless also backs it but Briskman doesn't. On the dues question, the board is opposed. Feerst and Rivers back it; Saunders is against it. Bayless and Briskman both disapprove. □

VALOX

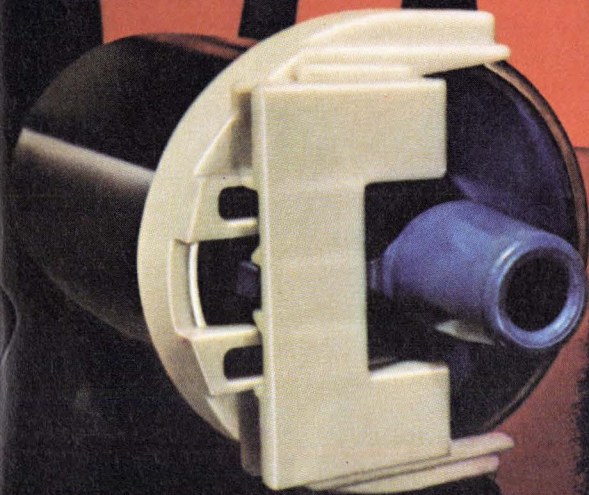

First polarized coil connector.

One of Detroit's better ideas, the polarized connector for ignition coil systems was conceived in VALOX resin. Unlike nylon, VALOX resin offered superior electricals and dimensional stability in both high heat and moist environments plus outstanding chemical resistance and excellent flexural strength for the unique snap-fit design.

First mil-spec thermoplastic polyester.

Hughes switched from DAP for its connector as VALOX resin became the first thermoplastic polyester to meet military specifications. It provided unsurpassed chemical resistance, excellent dimensional stability and a 40% cost savings without sacrificing high heat resistance.

First portable hot lather dispenser.

The Hot Shave Capsule™, a Clairol first, is another appliance first for VALOX resin. VALOX resins offered a unique combination of excellent properties including chemical and heat resistance, UL Bulletin 94 V-O performance, electricals and glossy appearance. All at attractive costs.

For more data, write VALOX Products
Section 266, General Electric Company
One Plastics Ave., Pittsfield, MA 01201.

YOUR FIRSTS MAKE US FIRST.

WHAT THE WORLD IS COMING TO: GE PLASTICS
LEXAN® NORYL® VALOX® GENAL®

GENERAL  ELECTRIC

Circle 81 on reader service card

Electronics abroad

Europe maps road-safety plan

by James Smith, McGraw-Hill World News, Brussels



Warning signs. To coordinate numerous national highway-safety programs, 11 European countries plan to share project responsibilities, avoiding market splintering.

Enhancing safety on Europe's highways may lead to a fat new market for electronic hardware—if Europe's national governments succeed in coordinating their largely different approaches. This fall, 11 members of Cost, a 19-government coordinating body on science and technology, will sign the papers launching a three-year study of electronic aids to road safety.

Developing reliable road-condition-detection equipment and transmitting the data in a meaningful way to drivers is only part of the problem. Some big questions—such as what information drivers should have—are still unanswered. And the biggest problem of all is not the meshing of current research work, but the molding of that work and follow-on experimenting into one big Europe-wide road-safety system.

Cost-30, as the project is called, will cover nine categories involving detection of highway incidents and meteorological conditions, as well as the transfer of traffic and safety information to motorists by radio and by variable-signal panels. Parallel studies will look at drivers' needs for information and their ability to assimilate it.

A steering committee, on which

the Common Market Commission may also sit as observer, will coordinate the project. The commission, which served as secretariat during the planning phase, wants to forestall development of separate national safety systems, which would fractionalize the Common Market on national lines, as happened with computers and telephone systems.

The Cost-30 research breaks down along a number of lines.

- Paris-based Institut de Recherche des Transport, France's official representative, is investigating roadside transmitters, and three firms are developing prototypes that IRT will soon test. Problems include the operating limits and whether drivers, who will probably have to buy receivers, will accept the plan.

- The French are also coordinating the working group on driver-information needs. IRT is polling French drivers on whether they think they need or will adapt to safety devices and whether they're willing to spend money on such services. As in other countries, French drivers now receive government radio broadcasts on road conditions, and one of the questions is whether it wouldn't be more practical to expand this system rather than introduce a costly road-transmitter scheme.

- Finland, which has probably the most elaborate road-surface-monitoring effort, is coordinating that working group. The system will use a combination of standard airport-type wind and fog monitors located at the roadside. Surface water will be detected by radar, and ice and temperature sensors, being developed by the Helsinki firm Vaisala Ltd., will be placed in the road surface at depths from 1 to 50 centimeters. Climate stations located every

400 meters will be scanned every 15 seconds. The system, operating for two years on a 100-meter stretch at the Helsinki airport, will undergo more testing on 2 kilometers of highway near Helsinki next winter.

- In Sweden, the Cost project is a sophisticated automated incident-detection system under test in a 2-kilometer zone on a six-lane highway south of Stockholm. Unlike systems in Holland and the U.S., the Swedish approach monitors traffic density, rather than road occupancy. The disadvantage may be high installation costs, though its developer, LM Ericsson, claims these may be offset by lower software costs. Induction loops 75 meters long are installed at 500-m intervals in slots 5 millimeters deep in the road surface across all traffic lanes. Roadside detectors are scanned every 3 seconds by a computer, which compares lane readings in all stations to track traffic flow.

- The Dutch, who are responsible for area broadcasting of traffic information, are also drawing up specifications with Philips for a 10-km road-occupancy monitoring system to be operating by the end of 1977. The system, which Philips will eventually produce industrially, will collect on-line data through microprocessors spaced at 1-km intervals and linked to a central computer. The Dutch, also testing road-surface and fog-monitoring systems near Amsterdam, may tie these in later.

- West Germany will coordinate roadside displays. It already has such a warning system operating on a dangerous 8-km stretch on the Stuttgart-Munich autobahn and a traffic-control system on a 50-km-diameter area of autobahns near Frankfurt. Though no inter-

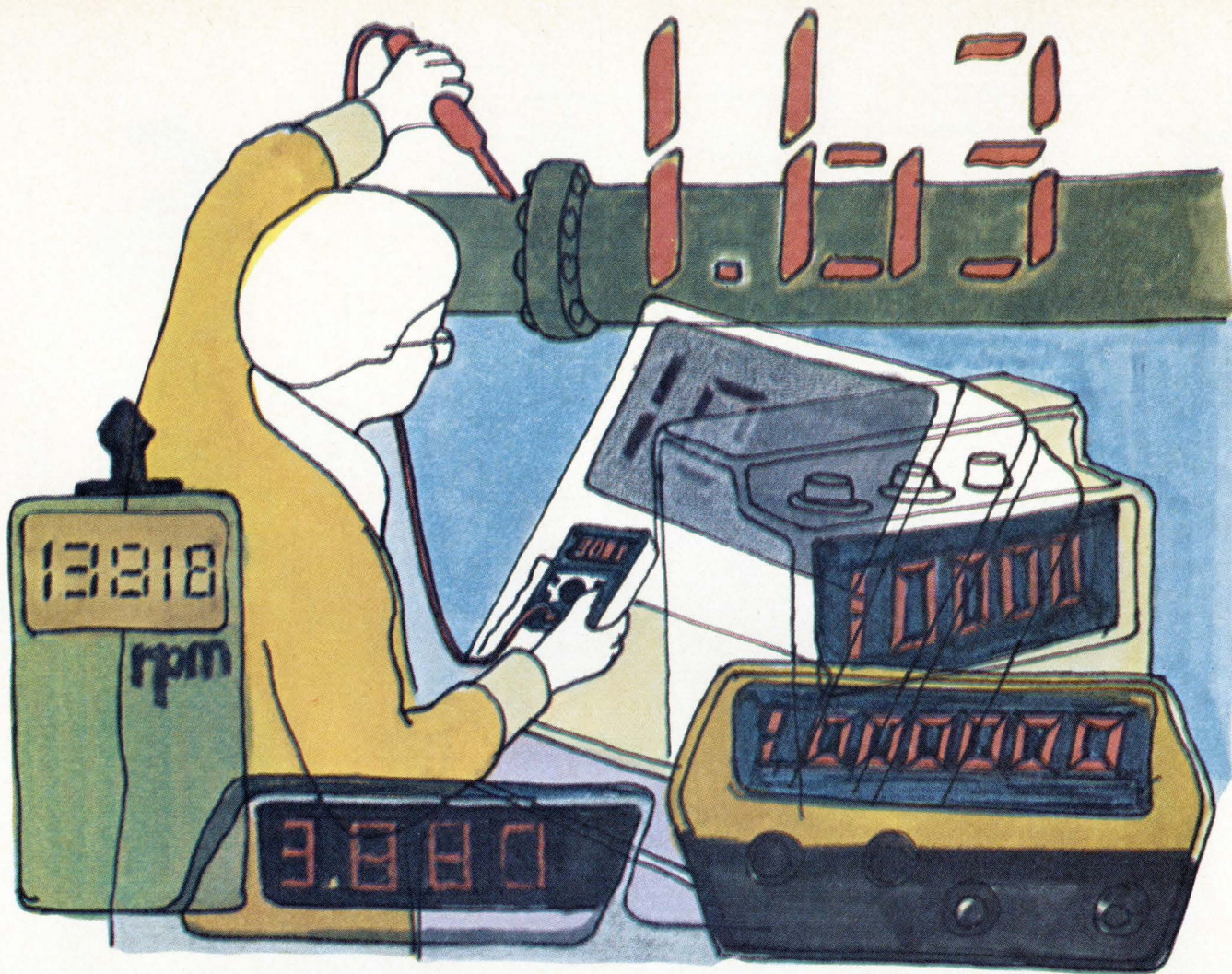

**Most new instrumentation products
are built around custom integrated circuits.
Most of them are made by Micro Power Systems.**

Our sole business since 1971 has been helping original equipment manufacturers exploit advanced CMOS and Bipolar LSI technology to improve product performance and reduce production costs. We've helped design and produce numerous proprietary LSI circuits for our customers in the fields of instrumentation, digital timekeeping, communications, and medical electronics.

Applications for this type of LSI in industrial instrumentation products have increased dramatically in the past few years. Custom LSI has produced major technical improvements in the

products themselves and has enabled many companies to achieve dramatic market advantages.

Because of our experience, we now have an unusually extensive capability for development and production of specialized ICs for use in virtually all types of instrumentation equipment, particularly A-to-D and D-to-A converters. If you're considering total integration of any of the following products, we urge you to write or phone us immediately:

- Portable Multimeters • DVMs
- Frequency Counters • LED Decoder/Drivers • Leak Detectors • Ph Meters • Diagnostic Testers • Chemical Monitors
- Gas Analyzers • Portable Tachometers • CB Power Meters

Our knowledge of the custom LSI approach to instrumentation products can help you to evaluate its potential benefits in your own terms. This can lead to your acquisition of a protectable, fully proprietary circuit. If your need is immediate, we invite you to contact Rich Koury, Manager, or ask for Instrumentation Product Marketing at (408) 247-5350.



We sell more than circuits. We sell solutions.

3100 Alfred Street, Santa Clara, California 95050

Alabama
INTEREP ASSOCIATES
205/881-3677

Arizona
SUMMIT SALES
602/994-4587

Arkansas
SIEMENS CORPORATION
817/261-6543

California-Northern & East Bay
QUADREP, INC.
408/733-7300

California-Southern (L.A.)
VARIGON ASSOCIATES
213/679-0621

California-Southern (San Diego)
S. R. ELECTRONIC
714/565-8411

Colorado
OMEGA, LTD.
303/758-1508

Connecticut
ANCHOR
ENGINEERING CORP.
203/658-6261

Connecticut-(Fairfield County)
ERA, INC.
516/822-9890

Kansas
DY-TRONIX, INC.
816/737-1100

Kentucky
DOLFUSS-ROOT & CO.
513/433-6776

Louisiana
SIEMENS CORPORATION
817/261-6543

Maine
ANCHOR ENGINEERING CORP.
617/964-6205
KCA COMPONENTS INC.
617/861-9024

Maryland
J. A. MAGUIRE & CO., INC.
301/377-0223

Massachusetts
ANCHOR ENGINEERING CORP.
617/694-6205
KCA COMPONENTS, INC.
617/861-9024

Michigan
CMP INC.
313/477-7700

Minnesota
CAHILL ASSOCIATES, INC.
612/646-7217

Mississippi
INTEREP ASSOCIATES
205/881-3677

New Hampshire
ANCHOR ENGINEERING CORP.
617/964-6205
KCA COMPONENTS, INC.
617/861-9024

New Jersey-Northern
ERA, INC.
516/822-9890

New Jersey-Southern
J. A. MAGUIRE & CO., INC.
609/665-5136

New Jersey-Southern
THOMAS ASSOCIATES, INC.
609/854-3011

New Mexico
A. Q. ELECTRONICS
505/255-8701

New York-Metropolitan
ERA, INC.
516/822-9890

New York-Upstate
ELECTRA SALES CORP.
315/455-5783
ELECTRA SALES (Rochester)
716/436-4030/4037

North Carolina
J. A. MAGUIRE & CO., INC.
919/725-7777

Pennsylvania-Eastern
THOMAS ASSOCIATES
609/854-3011
J. A. MAGUIRE & CO., INC.
609/665-5136

Pennsylvania-Western
DOLFUSS-ROOT & CO.
412/561-4125

Rhode Island
KCA COMPONENTS, INC.
617/861-9024
ANCHOR ENGINEERING CORP.
617/964-6205

South Carolina
J. A. MAGUIRE & CO., INC.
919/723-5980

South Dakota
CAHILL ASSOCIATES
612/646-7217

Tennessee
INTEREP ASSOCIATES, INC.
205/881-3677

Tennessee (East)
J. A. MAGUIRE & CO., INC.
919/723-5980

Texas (except El Paso County)
SIEMENS
817/261-6543

Texas (El Paso County only)
A. Q. ELECTRONICS
915/545-2363

Connecticut-(except Fairfield County)
KCA COMPONENTS
617/861-9024

Delaware
THOMAS ASSOCIATES, INC.
609/854-3011

Delaware
J. A. MAGUIRE & CO., INC.
301/377-0223

District of Columbia
J. A. MAGUIRE & CO., INC.
301/377-0223

Florida
PERROTT ASSOCIATES INC.
305/275-1132
PERROTT ASSOCIATES INC.
305/792-2211
PERROTT ASSOCIATES INC.
813/585-3327

Georgia
INTEREP ASSOCIATES
404/394-7756

Idaho
OMEGA, LTD.
801/266-9617

Illinois-Southern
DY-TRONIX, INC.
314/731-5799

Illinois-Northern
METCOM ASSOCIATES CORP.
312/696-1490

Indiana
ELECTRA REPS, INC.
317/255-4147

Iowa
GASSNER & CLARK CO.
319/393-5763

Missouri-Eastern
DY-TRONIX, INC.
314/731-5799

Missouri-Western
DY-TRONIX, INC.
816/737-1100

Montana
OMEGA, LTD.
303/758-1508

Nebraska-Eastern
DY-TRONIX, INC.
816/737-1100

Nebraska-Western
OMEGA, LTD.
303/758-1508

Nevada-Northern
QUADREP, INC.
408/733-7300

Nevada-Southern
VARIGON ASSOCIATES
213/679-0621

North Dakota
CAHILL ASSOCIATES, INC.
612/646-7217

Ohio-Northern
DOLFUSS-ROOT & CO.
216/333-7504

Ohio-Southern
DOLFUSS-ROOT & CO.
513/433-6776

Oklahoma
SIEMENS
817/261-6543

Oregon
RAY OVER SALES
206/454-4551

Utah
OMEGA, LTD.
801/266-9617

Vermont
KCA COMPONENTS, INC.
617/861-9024
ANCHOR ENGINEERING CORP.
617/964-6205

Virginia
J. A. MAGUIRE & CO., INC.
301/377-0223

Washington
RAY OVER SALES
206/454-4551

West Virginia
DOLFUSS-ROOT & CO.
412/561-4125

Wisconsin-Eastern
METCOM ASSOCIATES CORP.
312/696-1490

Wisconsin-Western
CAHILL ASSOCIATES, INC.
612/646-7217

Wyoming
OMEGA, LTD.
303/758-1508



When it comes to components, we're solid in every state.

Our strength comes from an 8 billion dollar company with over 550 million in worldwide component sales. Our sophisticated organization of salesmen and representatives and a distributor network with over 50 U.S. stocking locations is supported from strategically located U.S. manufacturing facilities with world-wide backup.

It's a complete service system designed to make your component buying a whole lot easier—north, south, east, and west.

We can anticipate and provide for your every component need, including: Tantalum, Aluminum Electrolytic, Ceramic, Film, Metalized Film, and Stacked Metalized Film Capacitors, Transistors, Zener Diodes, Tuning Diodes, Rectifiers, Hall Effect Devices, Ferrites, Flash Tubes, Voltage Protection Devices, LED's and LED Drivers.

To support future market requirements, Siemens spends 2 million dollars each working day in R&D. We maintain a dominance in high rel and commercial component production and have earned a reputation for quality and customer service that we go out of our way to protect.

To learn how Siemens and its products can be of service to you, wherever you may be, write or call: Siemens Corporation, Components Group, 186 Wood Avenue South, Iselin, New Jersey 08830, (201) 494-1000.

SIEMENS

Circle 85 on reader service card

Probing the news

nationally agreed-on system of symbols exists, several countries are already installing such panels along routes. But so far, the signs tend to provide nonuniform information.

■ The British Transport and Road Research Laboratory, which will be chief coordinator for the Cost study on in-vehicle displays, is working on an advanced matrix roadside sign, which will display the type of traffic disturbance in international symbols and the distance before the motorist encounters it. Actual experience with matrix signs could provide data on what information should be displayed inside cars.

Such in-car visual units, if not too costly, would solve one disadvantage of oral transmission systems: what language to use. Some French experts in Cost, for example, want to transmit in four languages, including a local language, such as Breton, in some areas. Belgium is coordinator for intelligibility of messages.

■ The Swiss, long known for their neutrality, have the tricky job of selecting and testing a complete European system. Originally planned as a second step lasting two years, this stage was canceled after it became apparent that various governments would not pay for it. Now the job of defining and deciding whether or not to test the system has been relegated to one of the Cost study groups, so that, essentially, the answer has been postponed.

It may well be that Cost-30 will agree only on European driver-information requirements and a system of software, and various national industries may work out their own technical solutions. "What is important is that the driver is assured of uniform, understandable data from one country to another and that he does not have to have expensive or duplicate equipment when he crosses a frontier," says Christian Garric, head of the Common Market Commission's inland transport department. "But industry also has a stake," says Garric, "in avoiding a market that is unduly compartmentalized." □

Coming through...

with people, ideas, products—
whatever it takes to get the job done



Wire, cable and cord sets usually cost less to buy than install. And poor performance can cut into your product's profitability deeper than potential savings on an initial buy. Belden is ready with whatever it takes to get the job done right.

BROAD LINE: Belden comes through with thousands of standards that fit your toughest environmental and application needs. And if a standard won't work, we will custom design an answer to your need.

ENGINEERING HELP: When you have problems in stripping, terminating, installing, fabricating, safety engineering, ordering, quality control, or want information on the codes or design parameters, ask a Belden specialist. "Hot-line" assistance is as near as 317-966-6681. Call and see.

UNIQUE PUT-UP CAPABILITY: Ask about Belden's UNREEL® dispensing system. Pays out wire continuously without snarls, backlash, or tensioning devices. One company cut processing time by 30%*

And Belden is coming through with a lot more. A design kit that covers performance characteristics, costs, material capabilities. And we've increased production capability for shorter lead times, great delivery.

Quality wire, cable and cord—whatever it takes to protect your bottom line performance every day. Belden Corporation, Electronic Division, P.O. Box 1327, Richmond, IN 47374, 317-966-6661.

8-6-6

*Information available upon request.



Circle 86 on reader service card

Coming through...
with new ideas for moving electrical energy

Copyright © 1976 by Belden Corporation

Companies

Amphenol picks up pieces

Earnings nose-dive, attributed to lag in new-product work, brings shakeup and reorganization of connector leader

by Larry Armstrong, Midwest bureau manager

How does the leader in the \$550 million connector industry suddenly find itself with plummeting profits? And what does it do to change that condition? The Amphenol Components group of Bunker Ramo Corp. started with a sweeping shakeup and reorganization, instituted by Bunker Ramo president George S. Trimble to snap the largest part of his corporation out of the doldrums.

The Amphenol group's mainstay was connectors, but it also turned out potentiometers, trimmers, sensors, and other components. The group earned \$23,590,000 in 1974, which was 70% of Bunker Ramo's income, but in 1975, the numbers dropped to \$3,692,000 and 47%, respectively. Trimble traces the problems to lack of new products.

For example, AMP Inc. came out with a solderless version of Amphenol's ribbon connector three years before Amphenol and TRW Cinch Connectors. This has hurt Amphenol in the phone business. After sharing with Cinch the Western Electric ribbon connector purchase, Amphenol has seen Cinch get the lion's share of the \$20 million to \$25 million deal for 1976-77.

Also, Amphenol was late getting out with stamped, formed, machine-applied contacts for the commercial/industrial market. It also hasn't been a factor in plastic connectors for consumer products and appliances, and has yet to develop a mass-termination technique for flat cable.

Spiral. When things turn sour, stories start to spiral around the company and the industry. The "inside" rumor in this instance was that money was being siphoned from Amphenol to bolster other parts of

Bunker Ramo, particularly to develop a line of minicomputer-based bank-teller terminals and to continue development of supermarket point-of-sale terminals, an operation that was closed in 1975.

Trimble's reaction to that rumor: "It's not true. You don't pump money out of an operation unless you want it to die. In fact, it's gone the other way. Over the last five years, the cash has moved from the corporation to the operating divisions. Of that total, Amphenol got 59%. If you wonder where the money came from, it was the bank's—we borrowed it."

In the Amphenol group, the Industrial division had been the biggest money maker—and became the biggest problem—in 1975. It was there that the reorganization began. Last winter, senior vice president and group executive John Buchholz, the man who ran the entire Amphenol troupe, was sent to the division to turn it around. In the spring, he left the company. At the same time, Trimble's reorganization took effect.

Centralization. Basically, Amphenol's management is being centralized. Also, says Trimble, "Corporate-wide, we've established a matrix structure, a combination of functional and product management." Previously, the Amphenol components group had been broken into divisions—Industrial, Cadre, Connector, RF, Instruments, and Sales—each with its own marketing, engineering, and profit-and-loss responsibilities. In the new arrangement, instead of a group, there is an Amphenol division for all Bunker Ramo connector products. More importantly, marketing, engineering, finance, and profit-and-loss respon-

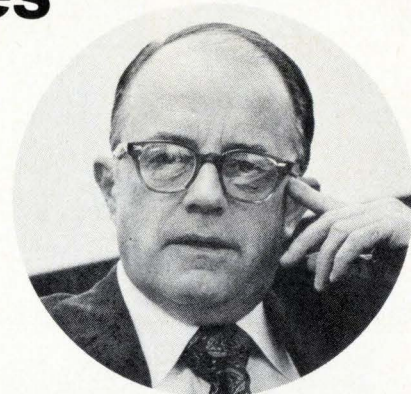

sibilities are centered at the division level. But, although the engineering chiefs—product engineering, advanced-products engineering, and systems engineering—in Amphenol and the other divisions, for example, report to the divisional general manager, they also report to the Bunker Ramo director of engineering, and that's where the matrix comes in.

"Most companies do not formalize the matrix structure," says Trimble, "because they stumble over the idea of everyone working for two bosses. But it's simple if you know what you're responsible to each one for." Also, marketing functions, formerly set by product, are now identified by customer.

The way the table of organization reads now, the Amphenol division will be headed by Francis J. Cunningham, who was president of the Electronic Systems division in Westlake, Calif. Under Cunningham, James T. Boyd will head the connector operation, Carlo J. Palombaro the Cadre operation, Joseph V. Malek the RF operation, and R.C. Genis the Canadian operation.

At the corporate level, Amphenol is one of five divisions reporting to Trimble. The others are Information Systems, Instruments, Electronics Systems, and Borg Textiles. What the changes mean is explained by one insider: "We were accustomed to being measured on the bottom line. Now we have to get used to his structured, hands-on style." □

Companies

Thomson-CSF deals from strength

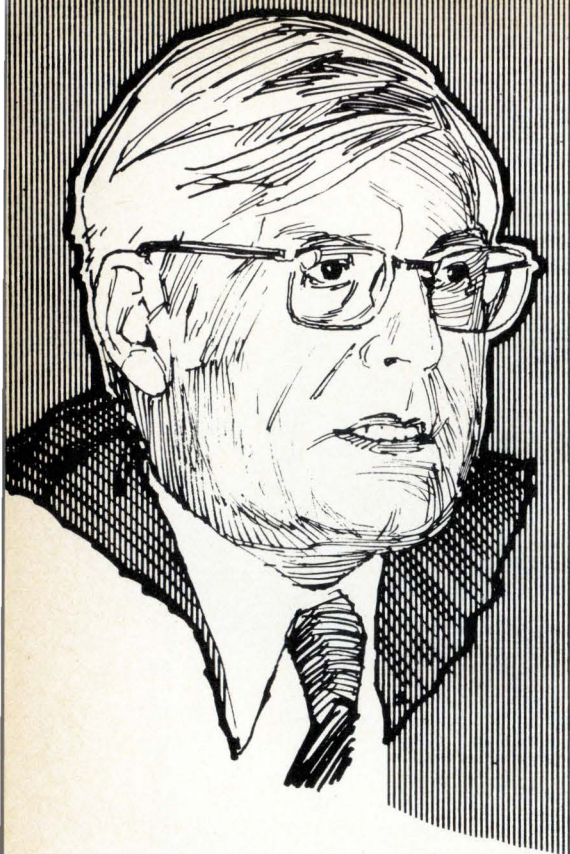

No one in the history of the French electronics business has ever ended his career more brilliantly than the late Paul Richard, the long-time president of the Thomson-Brandt group. Richard, after several years of astute maneuvering, early this year convinced French president Valéry Giscard d'Estaing that the group's Thomson-CSF was best suited to "Frenchify" one subsidiary of ITT and another of L M Ericsson, which between them had a substantial share of the telephone-hardware market. So, Thomson-CSF catapulted itself into the "market of the century" by buying control of ITT's Le Matériel Téléphonique (LMT) and Ericsson's Société Française Ericsson. As a result, Thomson-CSF stands to get 35% or so of a market for electronic switching equipment that will be counted in the billions of dollars as the government-run phone system rushes to put its inadequate network into shape.

But in early June, Richard died suddenly—before he could put the wrappings on the going-away present he'd managed to acquire for Thomson-CSF not long before his expected retirement. Now that task has fallen on two of the management team that worked with Rich-

ard. Michel Walhain has stepped up to the top job at Thomson-Brandt, and Jean-Pierre Bouyssonnier has been named president and managing director of Thomson-CSF (left).

To get a line on how Thomson-CSF will look with a new and different telephone business added to its traditional lines of high-technology equipment and components, *Electronics* talked with Bouyssonnier and one of his key aides, Edouard Guigonis, who heads Thomson-CSF's export company. Here is the gist of that conversation.

Q. How are you going to integrate Le Matériel Téléphonique into Thomson-CSF? Will it keep its identity or take on a Thomson-CSF coloration?

Bouyssonnier: It's obvious that LMT and Société Française Ericsson are going to become elements of the Thomson Group and will have to fit into our overall planning. But the philosophy behind the structure of Thomson-CSF is decentralization. Each unit, whether it's a division or a subsidiary, handles a specific domain. LMT and Ericsson-France will be treated in the same way. They'll have a large degree of independence.

Q. How important will telephone switching be in your total sales now that you control LMT?

Bouyssonnier: This year the LMT switching business will run about \$435 million, Thomson-CSF will do about \$1.3 billion, and the new minicomputer unit about \$175 million. That works out to about 25% for switching.

Q. You've had success selling things like radars, traffic-control equipment, and broadcast equipment in export markets. Can people who sell that

sort of hardware—where performance based on high technology is a major sales argument—also sell telephone equipment, where technology changes relatively slowly?

Guigonis: In the final analysis, telephone equipment is sold to governments, and we have contacts with the governments in countries where we have potential markets. But we're not going to attack Western Electric in the U.S., Siemens in West Germany or anything like that.

Q. Since you don't plan to go into the U.S. telephone market, do you have something else in mind?

Bouyssonnier: Well, during the past two years we've made two important acquisitions—Dumont Electron Tubes and CBS Laboratories. We've attacked specific market segments, and we don't intend to attack the U.S. market on a broad front with our full line of products.

Q. In LMT, your components-producing divisions now have a few captive customers. How far will this go in easing the problems they're having, particularly for Sescosem, the semiconductor division?

Bouyssonnier: It's sure that LMT and SFE will give them some preferential outlets. This will help, but it won't be enough to solve the problem. It's more complicated than that.

Q. Do you think that Sescosem will put a French-designed micro-processor on the market?

Guigonis: We have a second-source arrangement with Advanced Micro Devices for their bit-slice micro-processor, and we've just signed an agreement with Motorola for the M6800. Unless we get support from the government, we don't expect to develop one ourselves. □

Let's not talk about hybrid circuit capability.

Products like these talk for themselves.

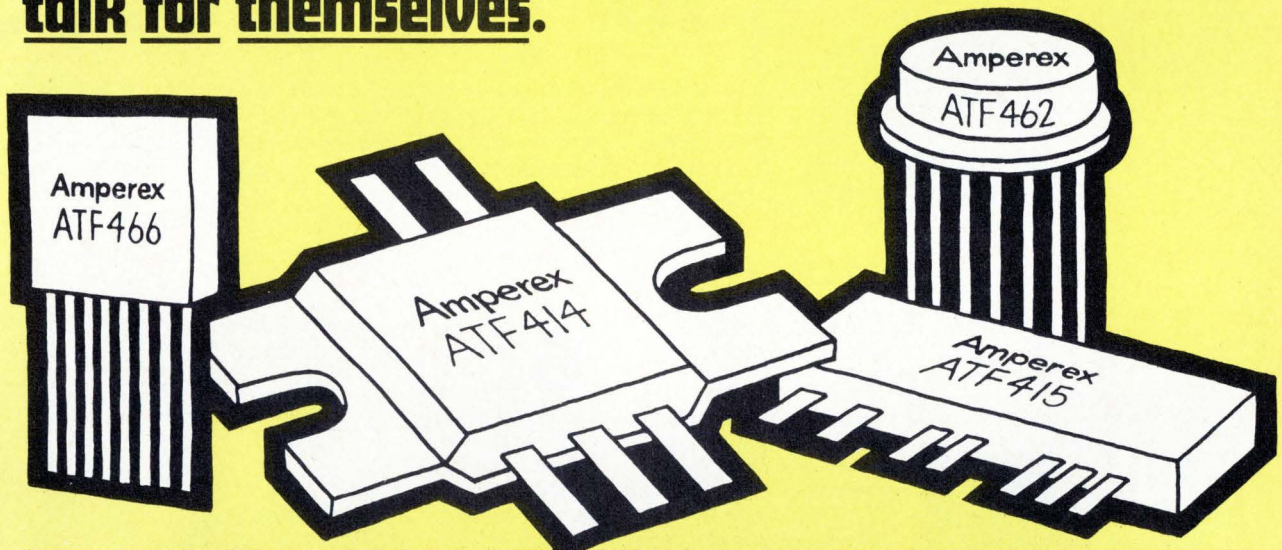

AMPLIFIERS FOR VHF-UHF, TV CHANNEL PREAMPS, ACTIVE FILTERS, ETC.				DRIVERS FOR PIN DIODES, DATA LINES, MOS CLOCKS, ETC.			
TYPE	DESCRIPTION	FEATURES	PRICE each (1K Quantity)	TYPE	DESCRIPTION	FEATURES	PRICE each (1K Quantity)
ATF414	Wideband Amplifier, High output.	Bandwidth: 40-890 MHz. Noise Figure: 7 dB Gain: 15 dB	\$11.10	ATF456A	Very High Speed Pin Diode Driver for Switches	Speed: 4 nsec TTL Comp.	\$25.00
ATF415	Wideband Amplifier, Low noise.	Bandwidth: 40-890 MHz. Noise Figure: 4 dB Gain: 15 dB	\$ 8.00	ATF462 ATF463	Linear Driver for Pin Diodes; for Attenuators.	Temperature—Compensation— Speed: 2 μsec.	\$16.80 \$15.90
ATF417	Wideband Amplifier, Low noise, high gain.	Bandwidth: 40-890 MHz. Noise Figure: 4 dB Gain: 26 dB	\$ 9.50	ATF466 ATF467A	Fast-Inverting/ Non-Inverting Pair for Pin Diode Switches	Speed: 10 nsec. TTL Comp.	\$22.00 \$19.00
ATF419	Wideband Amplifier, Medium output.	Bandwidth: 40-890 MHz. Noise Figure: 6 dB Gain: 15 dB	\$ 8.00	ATF468	Medium Speed, High Current Driver for Pin Diode Switches	$I_{out} = \pm 500$ mA. TTL Comp.	\$32.00
ATF431	Gyrator Element for Active Filters	Output Voltage: ± 10 V. Gain Accuracy: ± 0.18	\$ 4.70	ATF474	MOS Clock Driver	Rep. Rate: 2 MHz Load: 750 pf.	\$22.00
				ATF481	Navy NTDS Data Line Driver	Load: 10,000 pf. 41,667 words/sec.	\$26.85

In the years since our early breakthroughs in precision analog circuits, we've helped write a whole new book on circuit technology. In addition to the standard types shown above, we offer a custom hybrid circuit capability that can take your design idea and turn it into hardware. A major portion of our business is in the military custom hybrid area where we regularly perform environmental testing and screening to MIL-STD-883B.

Thin film . . . thick film . . . molded plastic or hermetic seal . . . we've got them all. For complete technical data on any of the standard hybrid IC products listed above, and for additional information on our custom hybrid circuit capability, contact: Amperex Electronic Corporation, Solid State and Active Devices Division, Slatersville, Rhode Island 02876. Telephone: 401-762-9000.

Amperex®

TOMORROW'S THINKING IN TODAY'S PRODUCTS

A NORTH AMERICAN PHILIPS COMPANY

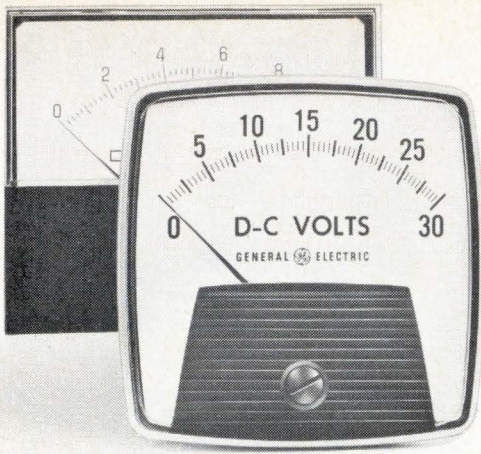

How to pick the right panel meter for your product.

The choice you make in panel meters can do a lot to help or hurt your product. Yet it's not all that difficult to pick the right one, even if panel meters aren't your specialty. Here are nine easy steps many experts follow to make sure they choose the right panel meter every time.

GE solves your mounting problems by ultrasonically placing studs to match your panel cutouts... for new or replacement meters.

1 Make sure the panel meter will fit your exact mounting requirements.

Only those panel meters whose barrel diameters and mounting hole locations will match your panel cutout are worth considering. Otherwise, you'll get stuck later with costly drawing changes, new setups, and redrilling operations.

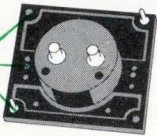

2 Choose the scale you think your customers will find easiest to read.

Make sure the digits and subdivisions can be easily read from a reasonable distance. Check the shape of the pointer. Does it help or hurt readability?



GE has BIG LOOK® and HORIZON LINE® styles in 1 1/2 to 4 1/2" cases. Front or rear mounting. Edgewise meters. Custom and optional features through GE Modification Centers, too.

3 Specify the style and size you think will work best and look best on your product.

Smart looks can sell. Your product's panel meters are often the very first "embellishments" your customer notices.

4 Determine what accuracy class you need.

Accuracy to $\pm 2\%$ of full scale is by far the most common. You can, of course, get cheaper, less accurate panel meters. Or pay a premium for higher accuracy when the application truly demands it.

5 Find out what the panel meter's loading effect will be on your product.

ANSI C39.1 Specs pretty well dictate these guidelines. But check them yourself to make sure the terminal resistance of your dc instrument, or the burden data of your ac instrument, won't overburden your circuit.

6 Choose between taut-band or pivot-&-jewel suspension.

Both have their advantages. Taut-band construction is extremely durable, friction-free and resistant to shock. Pivot-&-jewel instruments, on the other hand, have the inherent stability and strength to work best in most high vibration environments.



Taut-band

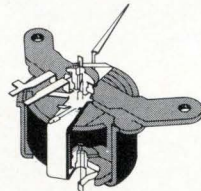

Pivot-&-jewel

GE makes both. We'll gladly help pick the right one for you.

7 Analog or digital?

You be the judge. Digital applications are hampered by power supplies and background signal "noise." They add more to the cost of your product. And it's next-to-impossible to quick-scan them or to monitor rapid change. Analog panel meters still outsell digitals by nearly 10 to 1.

8 Make sure it will work in dirty environments.

Since you can't control where your customer might use your product, you'd better make sure your panel meters are sealed in a good, tight case.

9 Then, if you're still undecided, consider the manufacturer's reputation.

Make sure your choices are reliable, that the manufacturer will stand behind them, and that the panel meters meet all ANSI specifications for performance.

Specify General Electric... just for good measure.

For a free guide entitled "Pick the Right Panel Meter" (GEA-10340) and our complete Catalog (GEP-307), write to General Electric Co., Section 592-65, Schenectady, N. Y. 12345.

592-65

GENERAL  ELECTRIC

Hybrid-circuit technology



keeps rolling along

Riding high on a surge of technological innovation, improved hybrids are triumphing in new fields as a cost-effective circuit-assembly technique

Hybrid techniques

Advances in materials, components, processes, ensure hybrid prosperity in the LSI age

by Jerry Lyman
Packaging & Production Editor

□ The billion-dollar hybrid-circuit industry is starting to transcend its old military/aerospace limits and expand into the more lucrative, high-volume fields of computers, business machines, telecommunications, and industrial equipment. In these areas, the attraction of the technology is its cost-effectiveness and its reliability as a circuit-assembly technique. These two factors have, for example, made hybrid circuits the No. 1 assembly method in the mass markets of automotive electronics and digital watches.

Additionally, new developments in IC chip packaging, which get away from the use of bare chips, are allowing almost complete automation of the hybrid process—an automation that is lowering costs while raising yields and reliability. Other cost-cutting developments in the process are the availability of new nonceramic substrates, the development of lower-cost conductive and resistive thick-film inks, and the use of computer-aided design (CAD) to generate complex artwork.

Monolithic semiconductor technology is both the hybrid's greatest competitor and an additional stimulus to the success and expansion of hybrid technology. There

have always been predictions that, as IC chips get even more complex, the need for hybrids will be eliminated. And in many cases it's true that the new LSI has eliminated older hybrid designs.

But overall the new LSI has simply become another component for still larger and still denser hybrids. For example, extremely large memories have been built with standard 4,096-bit random-access-memory chips on large multilayered substrates. Hybrids seem to be evolving into a multilayered interconnect package with only active chips on the surface—a sort of super chip carrier.

While LSI will always be denser and less costly than hybrids, the older technology can still boast lower tooling costs and quicker turnaround, the ability to mix different logic families plus discretives, higher power dissipation, reparability and easy modification, better performance, and the capability of matching pairs of active or passive discrete components.

LSI, a mainly digital technique, has forced the hybrid industry into the use of large multilayered hybrids. The multileaded LSI chips call for an extremely dense interconnection pattern that cannot be achieved on one level. This has led to hybrid thick-film packages with up to 15 conductive layers, having chip densities of 20 to 40 units per square inch. This density cannot be achieved by any other packing technique.

Thick-film technology is going off in all sorts of directions to meet the demand for more multilayering, while also responding to a level cost-reduction call. The technology is in the process of adopting new inks, new substrates, and new multilayering methods, while new lower-cost methods of component attachment are becoming available for both technologies. In general, the thin-film process has become a mature technology, with few changes seemingly in store for the future except possibly a method of multilayering or use of radically new substrates.

Hybrids today

About 70% of all hybrids produced are thick-film types, the rest being thin-film. Thick-film hybrids are circuits or systems built by screening and firing alternate conductive, resistive, and dielectric pastes onto a ceramic substrate. Thin-film hybrids have resistors and conductors vacuum-deposited onto a flat substrate. Active components are attached to both types.

The basic advantages of hybrid technology are:

- Small size and weight.
- Wide operating frequency range because of short lines and low capacitance.
- Increased reliability because of a reduction in interconnections.
- Functional trimmability.
- Compatibility with all types of active and passive chips and packages.
- Efficient thermal dissipation.

1. Nonceramic substrates. Specially plated, epoxy-glass boards manufactured by Dyna-Craft can be used for hybrid applications like digital watches, calculators or displays, where IC chips are epoxy-die-attached and ultrasonically wire-bonded to substrates.

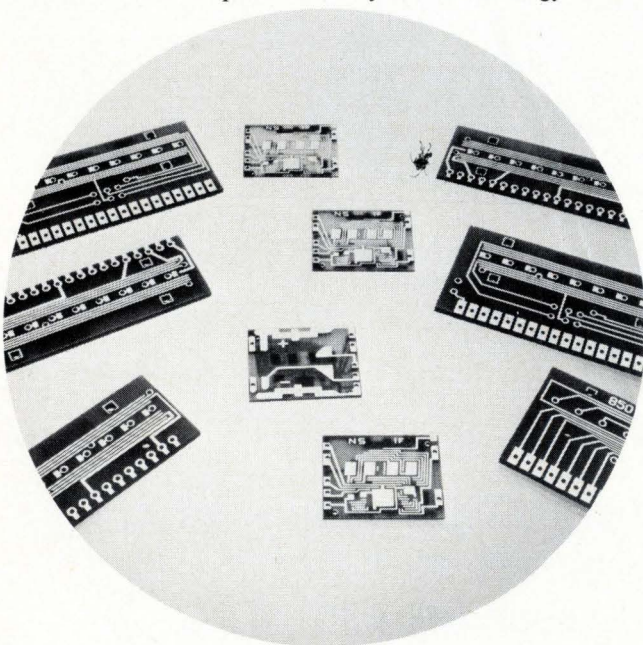

- Easy conversion of thick film to automated operation for cost reduction.
- Economical small production runs.
- Ease of achieving close component tolerances.

Thick or thin

The two hybrid technologies—thick and thin film—are not competitors. In fact, each has carved out separate application areas defined by the properties of each method. This is why most hybrid manufacturers have both a thin- and thick-film hybrid capability. Since thin film can pack interconnecting lines (2-mil lines and 2-mil spaces) more densely than thick-film (10-mil lines and 10-mil spaces), it is ideally suited for high-density single-sided packages. The properties of thin-film resistive metals (nichrome or tantalum nitride) make for resistors with lower temperature and ratio-tracking coefficients than is possible with thick-film types. For instance, thin-film resistors have temperature coefficients in the range of ± 25 parts per million per degree celsius. A pair of these resistors will track at ± 1 ppm/ $^{\circ}\text{C}$. Thick-film types have a temperature coefficient in the 100-to-250-ppm/ $^{\circ}\text{C}$ range, and pairs will track to ± 20 ppm/ $^{\circ}\text{C}$. The low noise level of thin-film resistors makes them suitable for the preamplifier applications.

Thin-film resistors have a limit of 5,000 to 1 in the range of resistor values that can be fabricated on a given substrate. The same parameter for thick film is as high as 10^7 to 1. In addition, thick-film capacitors are widely available, whereas thin-film technology has mainly an interconnective and resistive capability.

In microwave applications thin-film technology has earned a dominant position over thick-film. This is due to the requirement for fine line widths where interconnections are part of a transmission line or path.

Thick-film hybrids are less costly to make since the basic equipment needed (inks, screens, screeners, ovens) is a smaller investment than complex evaporation or sputtering equipment for thin films. Another great advantage of thick films is that they can be multilayered for extremely dense applications. Thin-film hybrid multilayering is still in the laboratory stage.

At times, the two technologies are blended. It is quite

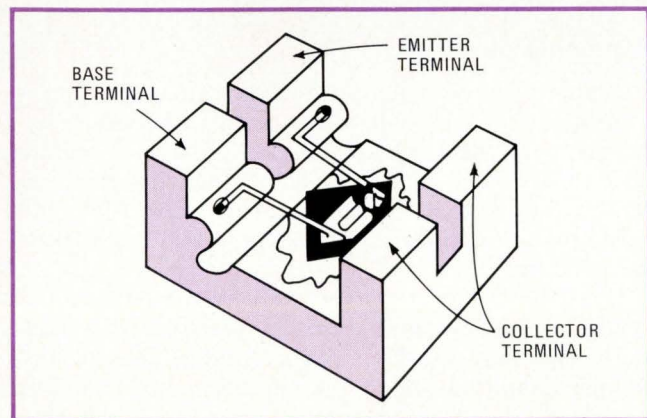

2. LID. The leadless inverted device (LID) is a ceramic body with elevated terminal pads. Here, a transistor has been die-attached and wire-bonded. The entire unit is sealed with a drop of epoxy, making the device almost immune to damage from handling.

common to find thin-film resistor networks on glass or silicon substrates used as chip components on thick-film hybrids on ceramic substrates. This often occurs in data converters, voltage regulators, or any thick-film application requiring precision resistors.

In microwave applications at RCA's Government and Commercial Systems Missile and Surface Radar division, Moorestown, N.J., for instance, a thick-film resistor is screened and fired on an ultrasoother ceramic substrate. Then the fine-line gold interconnections are put on with standard thin-film techniques.

Another microwave application of mixed hybrid technology takes place at Applied Technology, a division of Itek in Mountain View, Calif. The bottom of a hybrid substrate is screened as a ground plane, and the top side has a thin-film interconnect sputtered on. A thin-film line is sputtered around one edge of the substrate to tie the ground plane to the top of the substrate. The sputtering process deposits a thin metal layer on a surface in a vacuum, using a cathode made of the metal.

In general, thin film's accurate and stable resistors allow the manufacture of high-accuracy circuits such as sample-and-hold, precision voltage references, digital-to-analog and analog-to-digital converters, instrumentation amplifiers and preamplifiers, and active filters. Thick-film hybrids are suited to almost any application (especially if they use thin-film resistors). As far as the high-volume consumer, industrial, and automotive fields are concerned, it is a thick-film world on the basis of cost alone. Also, thick-film hybrids have a much higher power capability (up to hundreds of watts) than thin-film hybrids, which basically must operate at a low power level because of the low current-carrying capability of their fine lines.

Hybrid thin-film processes

Thin-film hybrid circuitry encompasses three approaches. Resistors may be deposited directly on a monolithic chip and laser-trimmed on the chip to provide improved performance, or they may be deposited on an oxidized silicon or ceramic wafer. Typically, 60 to 500 resistor networks are delineated by photoresist techniques on a single 2-inch wafer. The wafer is subsequently probed, scribed, diced, and inspected. The individual resistor-network dies are then treated like semiconductor or IC chips.

Thin-film resistors also may be deposited by evaporation or sputtering on a ceramic circuit substrate. Photoetching can lay out the resistor network, as well as the interconnecting path and chip pads. Following final assembly of the IC and capacitor chips, the circuit can be completed by trimming the resistors.

Usually nickel chromium (nichrome) or tantalum nitride is picked as the resistor material, and gold is used for the conductors. In the process used by Micro Networks, Worcester, Mass.—it's representative of today's techniques—nichrome is deposited on a substrate of silicon, glass, or ceramic under computer regulation of pressure, deposition rate, and the oxidation of nickel and chromium. Without breaking the vacuum, a layer of nickel is evaporated, followed by a layer of gold. The gold is used for interconnections, while the nickel is

Hybrid techniques

used to prevent interaction between the nichrome and gold. Then photolithographic maskings etch the resistors and conductor paths on the substrates.

Thin-film-hybrid manufacturing resembles the manufacture of ICs and semiconductors, without the diffusion steps. Thick-film manufacturing, on the other hand, is a process closer to printing. Substrates are manufactured by a screen-and-fire process. The precision, stainless-steel screens have 80 to 400 openings per inch. A precise image of a hybrid's connection patterns is projected onto a photographic emulsion on the screen, sensitized, and developed. A simple one-sided hybrid with screened-on resistors might only require two to four screens; a multilayered hybrid would require perhaps two screens per layer.

The thick-film process

Usually a squeegee forces conductive ink through the screen onto a ceramic substrate. After air drying, the substrate is fired in a furnace with a carefully controlled temperature profile. Next, a dielectric or resistive ink is screened onto the ceramic, and the procedure is repeated. Unlike the thin-film process, this method lends itself to automated screeners feeding substrates on a conveyor belt into automated ovens.

The result is the 10-mil-wide conductive patterns that have been accepted as a standard by most U.S. thick-film-hybrid manufacturers. This spacing has been found to give much better yields than the narrower lines that can be fabricated (as low as 2 mils). On the whole, the thick-film hybrid is getting away from thin lines. Many manufacturers would rather add a layer of interconnections than go to finer lines on one layer. Several companies are getting finer conductive lines by first

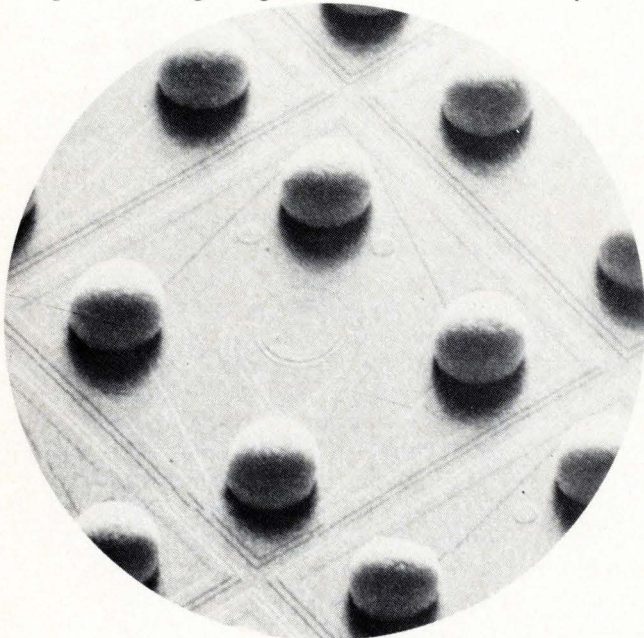

screening and firing on conductive inks and then etching the width of the lines down.

In many ways the hybrid thick-film process resembles silk-screening. The ceramic substrate is equivalent to canvas or paper, the stainless-steel screen is equivalent to a silk screen, and the various hybrid inks or pastes are equivalent to paints.

On the substrate, the screenable thick-film materials look rather like artwork, but they serve very practical purposes—ending up as conductors, bonding pads, vias, resistors, insulating layers, capacitors, adhesives, solders, and surfaces to which later on to attach lead frames or covers.

Hybrid inks

Any paste, or ink, has three components: a functional phase, a binder, and a vehicle or carrier. The functional phase is the chemical compound that will serve as conductor, resistor, dielectric, or capacitor. The binder cements the functional phase to the substrate. The vehicle or carrier is a liquid, containing the first two elements, that makes the ink suitable for screening.

For a conductive paste, for instance, the functional phase may be a powdered metal or powdered metal alloy, while suitable resistive or dielectric materials are introduced for resistive and dielectric pastes. The binder may be glass or occasionally a reactive oxide, and the vehicle is composed of resins and solids.

Conductive pastes available are pure gold, silver, and nickel, compounds like platinum-gold, platinum-silver-gold, palladium-gold, palladium-silver, palladium-copper-silver, and platinum-silver. For military, aerospace, or avionic hybrid hardware where active and passive chips are eutectically die-bonded and ultrasonic or thermocompression wire-bonding is used, gold is the preferred conductor. Most of the other materials are more suited for reflow-soldering of components.

Resistive pastes available are mostly based on ruthenium oxides and cover a resistance range of 3 ohms per square to 10 megohms per square, with temperature coefficients as good as 50 ppm/°C. Capacitor dielectrics of barium titanate are available with dielectric constants ranging from 8 to 1,500 along with a whole range of temperature coefficients.

Non-noble inks

Copper is the only high-conductivity material that is both bondable and solderable, the two methods of attachment used with hybrids. In addition, it has good adhesion to alumina, good thermal conductivity, good solder leach-resistance, good microwave properties, and good radiation resistance. Moreover, it will not migrate into ceramic.

These important properties are why the laboratories of almost all thick-film-hybrid manufacturers are evaluating new nitrogen-fired copper and dielectric inks. Sample quantities are at present becoming available

3. Flip chip. Solder bumps on the chip metalization are the key to economical assembly of the reflow-soldered flip chip. Advantages of this leadless package are lower assembly costs, greater yield than the chip-and-wire process, and an ability to be easily tested.

from Du Pont, Wilmington, Del., Electro Materials Corp. of America (EMCA), Mamaroneck, N.Y., Electro Science Laboratories Inc. (ESL), Pennsauken, N.J., and Thick Film Systems, Santa Barbara, Calif.

Even though the basic cost of copper is much lower than gold, manufacturing costs have made copper paste only slightly less expensive than gold pastes and more expensive than silver. So there will be no great savings in using copper unless the price of gold skyrockets again. Adrian Rose, technical service manager at ESL, predicts the copper pastes will penetrate into industrial and computer applications and then into automotive and consumer use. Most of these applications use reflow soldering in which heat is applied to two materials that have already been coated with solder.

Copper does have several disadvantages. It requires a nitrogen-fired furnace, while the hybrid industry is based on air-fired types. Also, it offers no screenable resistor material, although this is in the research and development stage at several ink companies.

Another non-noble ink in fairly heavy use is nickel, for screening interconnections on the ceramic boards of plasma displays. Unlike gold, nickel conductors do not sputter from the plasma's action—something that would contaminate the display.

Resistors on top

The surface of the dielectric layer in hybrids is neither smooth nor stable enough to support a thick-film resistor. The stress and strains of the dielectric can change the value and temperature coefficient of the screened resistor. The problem is to match the dielectric to the resistor, but the solution usually is to use discrete passive components.

However, ESL and EMCA now have dielectrics designed for screened-on resistors, and Du Pont will come out with a screenable dielectric fairly soon. Thick Film Systems' engineers have come up with a different approach. They have a special ruthenium-based resistor ink that can be screened on top of a mating dielectric.

Various hybrid companies are evaluating both approaches, and it will probably take at least a year for any decision. At any rate, there is another problem with screened-on passives: how to trim a resistor on the top of a multilayered substrate without causing a short or open in the next layer. Jason Provance, vice president of Thick Film Systems, suggests lowering the power on the laser trimmer or using abrasive trimming as possible solutions to the difficulty.

Ceramic and nonceramic substances

Most hybrids are constructed on aluminum-oxide ceramic substrates, with occasional use of beryllium oxide for a substrate that must dissipate high power (BeO has about six times the thermal conductivity of alumina). Thick-film circuitry is usually screened onto a 96% pure alumina (Al_2O_3) substrate, which has a surface finish in

the 25-microinch range. Thin films, on the other hand, are sputtered or evaporated onto a 99.5% alumina substrate with a smooth surface finish ranging from 10 to 1 microinches.

To house the large hybrids being produced, alumina substrates are being supplied up to a 6-by-6-in. size. For minihybrids and passive networks, substrates as small as 0.05 in. are available.

In the small runs of typical custom military-aerospace hybrids, the 10-cents-per-square-inch cost of the ceramic is negligible, compared to the cost of semiconductor chips and labor. However, in applications that use ICs in chip form, like calculators or digital watches, where product runs go to at least 50,000 units, cost of the substrate is important. So the Mica Corp., Culver City, Calif., and others have developed rigid plastic substrates clad on one or both sides with a thin copper foil (typically 200 microinches thick).

Mica's new copper-coated plastic laminates range in price from 3 cents per square inch for glass-epoxy to 6 cents per square inch for a Xylok type (a high-temperature resin) to 10 cents per square inch for types based on Triazine A or polyimide.

Aside from the lower cost, the metalized substrates provide panel sizes up to 18 by 24 in. (vs 4 by 4 in. for ceramic). Extremely fine lines are possible because, unlike thick film, these circuits do not require screen printing (production line widths are 4 mils compared to 10 mils using thick-film technology).

High line density is achievable and repeatable at high production yields at much lower cost than thin-film processes on ceramic. The substrates may be multilayered, and active and passive chips can be bonded to the laminates using standard techniques.

For hybrid substrates that are to have active chips attached, gold-nickel fine-line conductor patterns are plated on, using the copper cladding as a plating electrode. A single immersion in a suitable etchant quickly removes the remaining thin copper.

With the proper platings on the etched copper pat-

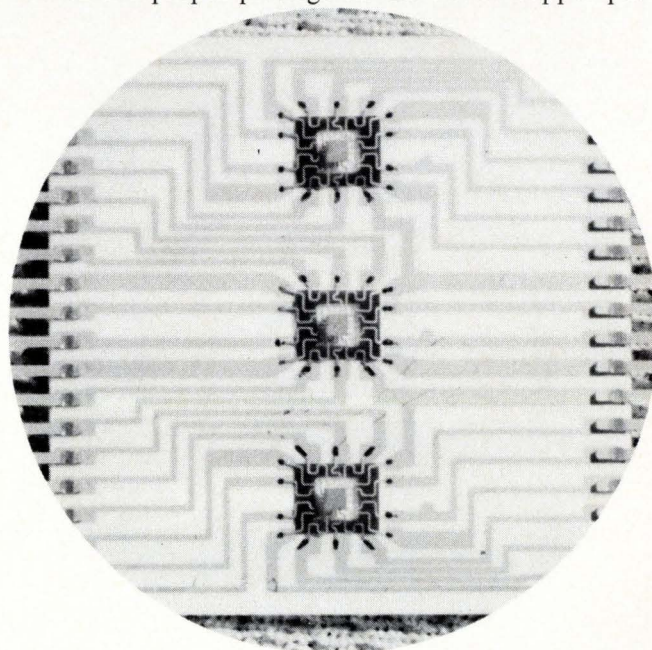

4. Chips on film. A prototype multichip thin-film assembly, built at RCA's Solid State division, uses pretested IC chips on tape carriers. The film-carrier packaged chips are wire-bonded to the thin-film conductive pattern by semi-automated machinery.

Hybrid techniques

terns, it is generally possible to use ultrasonic aluminum wire bonding on glass-epoxy substrates; ultrasonic gold-ball bonding on polyimide- and Triazine-A-based substrates; pulsed thermocompression bonding and solder reflow on all of the four Mica substrates, and thermocompression on the Xylok and Triazine-A substrates.

Other boards

Manufacturing wire-bondable substrates out of glass-epoxy laminate is not exclusive to Mica. Dyna Craft Inc., Santa Clara, Calif., a subsidiary of National Semiconductor, produces large numbers of fine-line specially plated glass-epoxy substrates (Fig. 1) for its parent's displays and calculators.

Most of the hybrid developments at Johns Hopkins University's Applied Physics Laboratory, Laurel, Md., are in the thin-film field. However R.E. Hicks and D. Zimmerman are using hybrid substrates made from Pyralin, a copper-clad polyimide glass-epoxy laminate [*Electronics*, June 12, p. 36]. This approach was successfully used in an experimental navigational receiver, and the technique has since been applied to other systems at the lab.

Packaging engineer Fred Muccino, of APL, prefers to use a copper-coated glass-epoxy board as a basic substrate instead of alumina. With glass-epoxy, he points out, all fabrication uses standard photoetching processing; ordinary tools are adequate for drilling and shaping, and there is no loss of material during modification or parts replacement.

Components attached to Muccino's nonceramic substrate are chip capacitors and resistors. The semiconductors, diodes, and transistors are leadless inverted devices. Solder cream is used to attach all chip

components to the substrate, with a hot plate reflowing the solder at the interface. With this attachment process, components could be changed as many as 20 times—there is no loss of metallic contact as with thick- or thin-film techniques after only a few chip removals.

Getting attached actively

In the customized hybrid fields of avionics, military, aerospace, and medical implants, where relatively few high-reliability items are turned out, there are two main techniques of attaching active components to the hybrid substrate. They are the chip-and-wire method and, to a much lesser extent, the use of beam-leded chips.

In the chip-and-wire method, all active components are in the chip, or die, form. Inspection is a significant problem, because the microscopic probing equipment often damages the chip under test. After inspection, chips are connected to the substrate by the eutectic or epoxy method.

Eutectic bonding brazes the silicon of the die to the gold of the pad at about 400°C, creating a gold-silicon alloy. Even though this process is highly reliable, it is expensive and does not permit replacement of a chip.

This has brought on the use of organic adhesives such as epoxy as an alternative to eutectic attach. Parts attached with epoxy can be replaced fairly easily. However, the military still tends to favor eutectic bonding since it feels there isn't enough long-term experience with epoxy bonding. In commercial hybrids using chip-and-wire construction, all die attachment is with epoxy.

After die-bonding, fine metal wires are thermocompression-bonded or ultrasonically bonded between the chip pads and the substrate. Thermocompression bonding consists of applying concentrated heat and pressure to the points where wires are attached to both chip and substrate. Ultrasonic wire-bonding consists of producing sufficient heat at the junction between the wire and pad to create a weld. Ultrasonic bonding usually uses aluminum or gold wires, while thermocompression uses gold wires.

Beam leads

To avoid the difficulties of the chip-and-wire approach, the beam-leded chip was created. This device replaces the separate wire leads with gold beam leads, which are grown apart of the chip production process. The leads are basically extended input/output pads 4 to 5 mils wide. Instead of mechanically scribing and breaking the individual die from the wafer, an etching operation is used.

During assembly, the beams are aligned with the substrate pads. A wobble-bonding process is used, which heats each of the beams sequentially so that they make eutectic bonds with the pads. The width of the beams means the bonds are strong enough for separate die bonding *not* to be required as it is in the chip-and-wire method of attachment.

5. Ceramic chip carriers. The ceramic chip carriers, used to house integrated-circuit chips on this multilayered hybrid substrate, make active chips easy to test and replace. Small hybrid substrates may also be enclosed in the carriers for the same reasons.

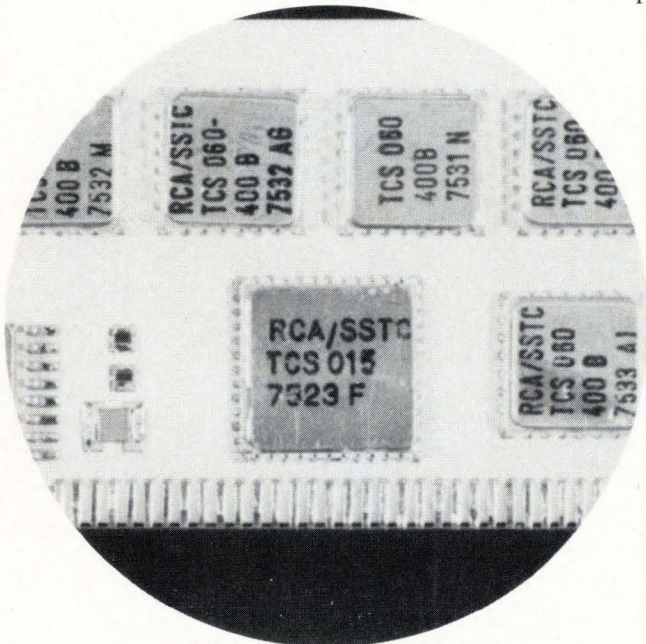

Many hybrid companies are successfully using beam-lead chips. However, availability is a major problem, since only Texas Instruments, Raytheon, and Motorola manufacture them. Also, only a limited number of IC types is available, which often leaves manufacturers no choice but to mix beam-leaded and conventional chips.

Even with automatic bonding, both chip-and-wire and beam-lead devices are bonded serially. And the great amount of handling in wafer probing, scribing, chip probing, several optical inspections, and bonding combine to keep the overall yield down. So four different approaches—the LID, the flip chip, the film carrier, and the chip carrier—have evolved to produce chip packages for hybrids that can be batch-processed by the reflow-soldering process, are testable without damage, and can be handled easily.

LIDs and flip chips.

The LID (leadless inverted device) is basically a chip in a ceramic body with elevated terminal pads made with a three-layer metalization (molybdenum, nickel, and gold). An IC or transistor chip is eutectically die-bonded to a cavity on the body. Then the chip's pads are wire-bonded to the LID's pads as shown in Fig. 2. After inspection, the chip and leads are sealed with a drop of epoxy, resulting in a strong ceramic package.

Sole supplier for the device is Amperex Electronic Corp., Slatersville, R.I., which offers a good range of active devices in LIDs. The smallest—discrete transistors, diodes, and field-effect transistors—are 43 by 75 by 35 mils. Medium-size LIDs, used for 14- and 16-pin ICs, are typically 190 mils square. A 32-pin, 300-mil-square package is Amperex's largest LID.

Amperex can put a customer-specified chip in a LID, but tends to shy away from handling proprietary devices because it has no control over the chip screening, probing, and inspection.

Perhaps the main advantage of the LID is that it can be reflow-soldered, eliminating the need for the skilled operators required for wire bonding. "LIDs can be attached to a substrate in 10 to 15 seconds in a batch operation," says Ronald Goga, marketing manager of Amperex. "Since the LID is completely encapsulated in epoxy, it can take a tremendous amount of shock. We've had devices survive 60,000 g."

Another big advantage is increased hybrid-circuit yields. Goga says that, in Amperex' own thick-film hybrid operation, yields of 90% are realized the first time through on a finished unit, vs about 50% for a chip-and-wire hybrid. And he says that any parts that do fall out are easily replaced.

The complete encapsulation of the chips eliminates the breakage problems inherent in testing and handling. In addition, LIDs may be tested for such parameters as switching time, high- and low-current operation, matching transistor pairs, special selections at odd biases, and other parameters—in contrast with bare chips, which

usually are probed only for dc static parameters.

LIDs have two disadvantages. Not every digital logic or linear IC is available off the shelf from Amperex. Also, for high-density hybrid packages, the 14- and 16-pin ICs take up much more real estate than a bare chip.

Nevertheless, the LID is in fairly heavy use. For instance Motorola Communications, Fort Lauderdale, Fla., uses them in a pager application, General Electric in Lynchburg, Va., is applying LIDs in mobile communications, and Applied Physics Laboratory in Silver Springs, Md., is using LIDs in a pacemaker hybrid module and communication hybrids.

Flip chips

Another alternative to the bare chip is the flip chip. This is a semiconductor device designed for face-down reflow-soldering on any type of hybrid. (Chip-and-wire devices require face-up wire bonding.) This technology, developed by IBM in the 1960s, is known there as the "controlled-collapse technique." The main difference between them and conventional IC chips is that all flip-chip contacts are made on the active (front) side of the chip. The chip itself is protected by a glass layer over the active area and its metalization. Solder bumps are formed on the chip for the reflow connections.

Flip-chip bumps are nominally 95% lead and 5% tin and, on transistor chips, are on 0.018-inch centers (Fig. 3). The bump is typically 6 mils in diameter and 4 mils high. The chips are 30 by 30 mils in area and 11 to 13 mils thick.

Micro Components Corp., Cranston, R.I., and Motorola Semiconductor Products group, Phoenix, Ariz., are the only open-market suppliers of flip-chip devices in the United States. IBM, Delco, and Fairchild Semiconductor Products, Mountain View, Calif., manufacture their own devices, but they are not for sale. Both Micro Components and Motorola offer only a limited number of bumped ICs and discretes—mainly discrete transistors, diodes, FETs, and linear ICs. Both companies will "bump" a customer's own chip. The largest IC from ei-

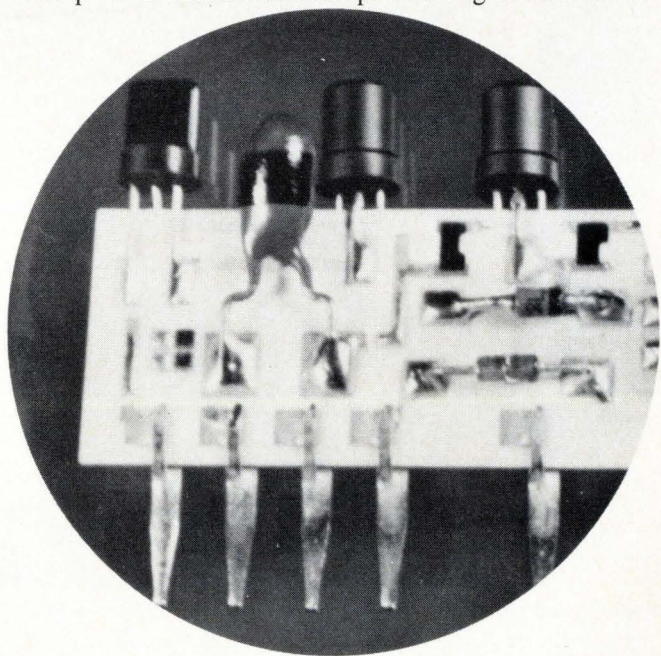

6. Hybrids with discretes. Much hybrid business involves flow soldering of discrete components to ceramic substrates, rather than bonding of bare chips. Shown is a Centralab tachometer driver using discrete components and screened-on resistors.

Hybrid techniques

ther company has 16 leads. However, devices in the 40-bump range have been demonstrated experimentally.

"The chief advantage of solder-bumped chips is their cost-saving potential for the hybrid customer," says Egons Rasmanis, vice president of sales for Micro Components. He estimates that the cost to a hybrid maker is 3 cents per wire bond. For a 16-pin IC then, the manufacturer saves 96 cents per IC position by using solder bumps (16 wires by two bonds per wire by 3 cents).

In general, the cost of assembling a flip chip into a hybrid circuit, regardless of the number of leads involved, is even less than the cost of eutectic diebonding. The labor and material costs of wire bonding are completely eliminated. In addition, savings are realized because of higher yields in assembly, lower capital-equipment requirements, and excellent rework capability.

The glass-coated chips also enhance reliability and eliminate requirements for expensive hermetic encapsulation of individual components. Also, the bumped devices are cut to very accurate dimensions and can be automatically handled and tested without damage. Probing or testing is through the solder bumps, and scratches fortunately just disappear during the reflow-solder operation.

The chief disadvantage of flip-chip devices today is that there just isn't enough variety of device types—particularly in digital ICs. "There is no reason why most digital logic families can't be bumped, but we won't do it until there is a demand from our customers," says Dave Cavanaugh, product engineering manager for flip chips at Motorola.

Both Micro Components and Motorola Semiconductor have been approached by companies who wanted to apply the solder-bumped chips to film carriers—which is another method for eliminating lead bonding on hybrids.

The film-carrier system uses a sprocketed, nonconductive film with a copper surface etched into IC microinterconnections [*Electronics*, Dec. 25, 1975, p. 61]. Specially bumped IC chips are automatically gang-bonded to the inner leads of the tape interconnects. In a hybrid operation, the chips would be tested on the tape and then cut out, placed on a substrate, and either soldered or wire-bonded down.

This method lends itself to automatic attachment of the chip to the hybrid. However, it isn't possible to buy chips already on tape; bumped chips with the proper metallurgy aren't available, and low-cost equipment for bonding the tape is lacking. So this method is still very much in the future. Honeywell Information Systems, Phoenix, Ariz., has been applying film carriers to large thick-film multilayer hybrids, for some time. RCA in Somerville, N.J., has bonded film carriers to thin-film hybrids (Fig. 4).

Ceramic carriers

Still another method of avoiding lead bonding to a substrate is the ceramic chip-carrier: small, leadless, square, cofired ceramic gold-plated packages, in a variety of sizes. Lead metalization is connected internally to gold solder pads on the bottom face of the units.

These packages allow a user to employ standard die-attachment and to wire-bond a chip to the cavity of the carrier. In this way he dodges the problem of limited availability of LIDS, flip chips, and film-carrier hybrids.

Once in the carrier, the encased chip can be tested in a computer-controlled IC tester with a special socket for accepting the chip carrier. Then it is sealed and reflow-

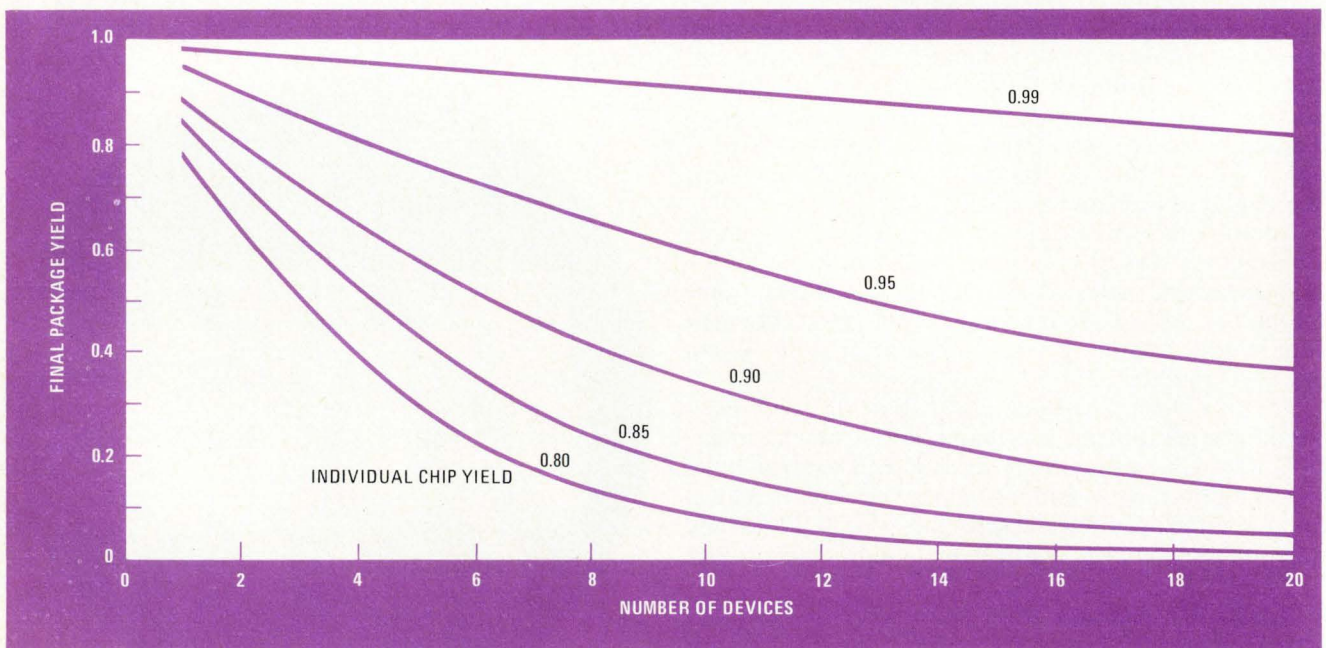

7. Chip yield vs hybrid yield. Active-chip yield may drastically affect overall hybrid yield. For instance, a chip yield of 0.8 gives a hybrid yield of about 0.15 for a 10-chip package. A chip yield of 0.95 gives a hybrid yield of 0.62 for the same unit.

soldered to a ceramic substrate. Even with the carrier sealed, it is still testable because the leads extend through the carrier. Also it is relatively easy to remove a ceramic carrier from a substrate and substitute a new chip in a carrier.

About the only disadvantage of the carrier is that it is relatively large. However, it is extremely well suited for expensive LSI, like memories and microprocessors, where the large hybrid substrate often has very little passive circuitry.

RCA, Moorestown, N.J., is using the ceramic chip carriers in a series of plug-in programable waveform modules housed on standard plug-in ceramic multilayer boards. An RCA fast-Fourier-transform memory module with 12 chip carriers and 2 flatpacks is shown in Fig. 5.

RCA has built up special test substrates with square Zebra elastomeric conductors resting on each carrier's substrate pads. A Zebra conductor is a frame of alternating vertical conductive and nonconductive strips. It is a solderless interconnection between carrier and substrate. To test a chip carrier, it is simply pressed against its own Zebra on the motherboard. This saves the trouble of soldering a bad chip in a carrier to the motherboard substrate.

Attaching discretes

While ultraminiature hybrids use chip and wire and the alternatives to it, a great part of the worldwide hybrid industry is committed to reflow-soldering standard packaged devices onto ceramic substrates with screened-on resistors and conductors.

An example is the Centralab thick-film tachometer driver shown in Fig. 6. It has three epoxy-cased low-level transistors, a power transistor, a discrete tantalum capacitor, discrete diodes and screened-on resistors. Unlike in chip-and-wire hybrids, there are more discrete components on the back of the substrate.

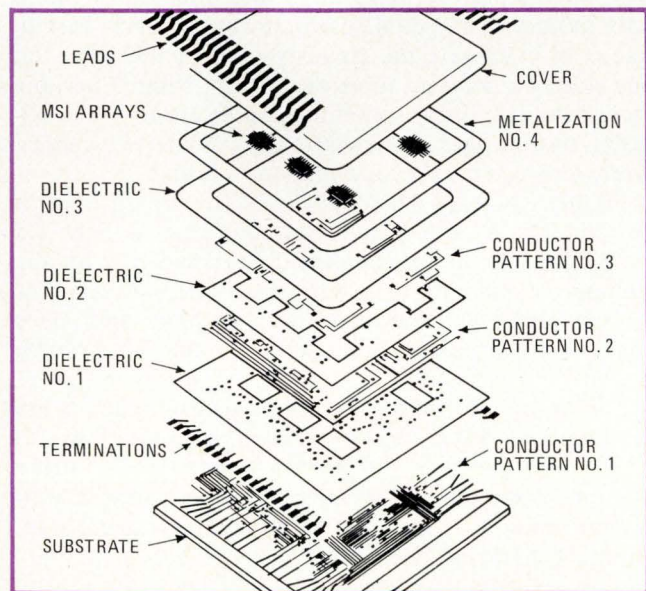

8. Screen and fire. This exploded view shows the buildup of a multilayered thick-film hybrid made by the sequentially screen-and-fire process. Screen printing can be repeated many times, and substrates with as many as 15 conductive layers have been fabricated.

Two years ago, Centralab, a Milwaukee, Wis., firm, had both chip-and-wire and solder-reflow capability, but it found the commercial market didn't want the more sophisticated packaging. "Automotive, data-processing, industrial-control, consumer-electronics, and telecommunications hybrid parts needed low-cost, high-yield, automated production, rather than high parts density," says Duane Kobs, the firm's general manager for thick-film circuits.

Centralab, where thick-film was first used in a proximity fuze during World War II, has a highly automated operation in which silver palladium or silver is the basic interconnection. Carbon or cermet resistors are screened on, and anything that may be reflow-soldered is attached to a substrate. Since this system is tied to off-the-shelf components, delivery is no problem. Cost is low because all discretes can be attached in one batch-soldering operation. Yet the usual advantages of hybrids—substantial size and weight reductions, better performance, and increased reliability—still exist.

Other companies in the discrete-component hybrid field are Sprague Electric Co., Nashua, N.H., Sprague Electromag, Belgium, and CIT-Alcatel in France. CIT-Alcatel, a telephone equipment producing company in the Compagnie Générale d'Electricité group, has a micro-electronics division that will turn out some 2.5 million hybrids this year. Most will be thin-film types from a fully automated production line.

The company's attitude toward active-component attachment, which reflects the opinion of most European hybrid manufacturers, is not quite the same as Sprague and Centralab in the U.S. "We use bare chips only when there's no other possibility. Whenever we can, we persuade customers to accept prepackaged chips with provision for connections by reflow soldering," says Claude François, sales manager.

"Sometimes—mainly for military equipment—the package has to be so tight that chips are necessary. Under these conditions, the active chip can't be fully tested until the circuit has been fabricated. As a result costs double or triple compared to a circuit having prepackaged chips. Many circuits have to be repaired or discarded."

François doesn't think chips are worthwhile unless the density of the package makes them mandatory. He'd like to see more beam leads, flip chips, or—best of all—chips on tape (film carriers). The film carriers would be ideal for the tape-based automatic production equipment that his firm has put into service.

Like CIT-Alcatel, all the other manufacturers in the U.S. and Europe who attach components by reflow-soldering are looking toward the flip chip to increase component density without losing the advantages of batch processing. Meanwhile, many European hybrid companies, CIT-Alcatel included, are reflow-soldering transistor, diode, and IC chips prepackaged in a small, leaded, plastic package onto their hybrid substrates. These components, which have several names, being known as Timtors (TI's version), SOT-23 (Philips, Amperex, Siemens), Micropax (SGS-ATES), and Minimold (Nippon Electric Corp.), are not manufactured in the U.S. and are just starting to become available here.

Hybrid techniques

Centralab is already evaluating these devices.

Now, mainly transistors and diodes in three-leaded packages (3 by 3 by 0.85 mm) are available in the U.S. and Europe. However, SGS-ATES, an Italian firm, is about to come out with a line of linear ICs in its Micropax package. Medium-power transistors are available from Amperex in a slightly large SOT-89 (4.6-by-2.6-by-1.6-mm) package.

As with the flip chip, there is a complete lack of digital types in this small plastic chip carrier. However these units, about the size of capacitor chips, can easily be handled by automated equipment for testing and placement and soldering.

Hybrid testing

Testing of hybrids, especially the chip-and-wire types, can be broken into three phases: active-chip testing, bare-substrate testing, and functional testing. Most hybrid manufacturers agree that malfunctioning active chips are the biggest cause of low hybrid yields.

Figure 7, from RCA, Moorestown, shows how chip yield affects hybrid yield. For a 10-chip hybrid, a chip yield of 0.8 gives a hybrid yield of about 0.15. A chip yield of 0.95 gives a hybrid yield of about 0.62. These results suggest that 100% inspection of IC and semiconductor chips is mandatory to ensure a good yield.

But most hybrid companies do not completely test every incoming chip and wafer because of the cost of inspection and the potential damage from handling of chips. On the assumption that they will pick up the bad chips in functional test, many companies order chips to their specification and test only samples.

However, several hybrid manufacturers do inspect incoming chips and wafers 100%. Typical of these quality-

control-conscious companies are Teledyne Microelectronics, Circuit Technology, Raytheon Quincy, Lockheed Missiles and Space Co., and Autonetics. At Teledyne, a staff of 35 subjects each incoming wafer or package of chips to two visual inspections and electrical tests at 25°C and 125°C. "In the dice test area, the chip yields fluctuate like a yoyo from week to week" says Les Sutton, manager of application engineering at Teledyne. "Yields from the same vendor vary from 95% to 65%. If the yield kept constant, we could let up on inspection and set an acceptable quality level . . . Our average hybrid has 30 chips, so with 95% chip yield, we'd be in the rework business. We have made hybrids with 100 chips with no rework."

Substrate testing for simple one- or two-sided hybrids is usually confined to complete optical inspection and no electrical inspection. Larger samples of complex multilayer substrates are checked with IC probe cards, the resistance bridge of laser trimmers, and, in one instance, by a miniature bed of nails feeding into an automatic continuity tester. (A bed of nails is a test fixture with many spring pins on top.)

Most hybrids are functionally tested by only three types of automatic testers: the extremely large and costly (\$500,000 and up) LSI testers like the Fairchild 5000 or Tektronix 3260, large functional testers like the HP 9500, and for certain jobs, calculator-controlled testers. The Fairchild and Tektronix testers are used extensively throughout the hybrid industry, since they can test either hybrids or ICs. The HP 9500 is especially suited for testing both analog and digital hybrids.

Multilayer hybrids

Multilayer, or multilevel, hybrids consist of conductive layers connected by thin vertical metal channels (vias) through layers of isolating dielectric. They have evolved as the original transistors developed into ICs with small-scale and, later, large-scale integration. With only transistors and diode chips, it was relatively easy to screen or evaporate the circuitry used in the 1960s on one side of a ceramic substrate. As the circuits became more complex, it was sometimes necessary to use cross-overs: thin bridges of dielectric that isolate two successively screened conductors from one another.

Finally, with the development of the digital IC with 14-, 16-, 22-, 32- and even 40-pin connections, there just wasn't any way to put complex digital or digital-analog circuits on one side of a substrate. The solution was multilayering, which evolved from avionics and space work, where an extreme reduction in space and volume is vital.

For all practical purposes, only thick-film circuits are multilayered. There are two main methods of multilayering on ceramics: sequential screening and firing and the cofired method. A method of fabricating a non-ceramic multilayer substrate with polyimide as the insulating dielectric has been in use since 1974.

9. Cofired multilayer. A complete silicon wafer (master slice) will be housed within the circular portion of this cofired multilayered ceramic substrate. The back surface of the substrate has a heat sink attached to dissipate the heat of the wafer.

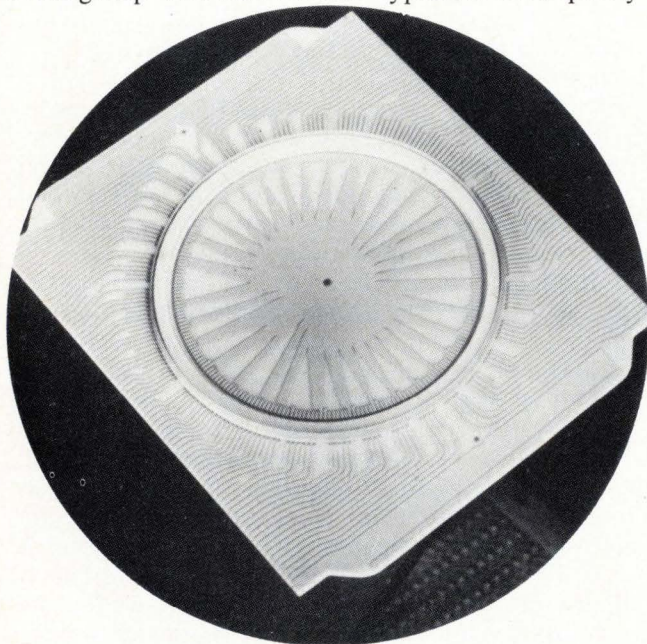

The oldest and most common of the layering methods is the so-called sequential-screening process. The first step is to screen a conductive layer of ink on an alumina substrate and then fire it. The second step is to screen and dry a dielectric-layer with windows for vias. This step is repeated, and the two layers are fired. Then a second conductive layer is screened over the insulating layer, filling the vias. This layer is fired, and the process is repeated as required by the circuit or system interconnections. Figure 8 shows the steps in the sequential method of fabricating a four-layer thick-film hybrid.

Sequential screening

Hybrids with as many as 15 conductive layers have been made by this method, but most types in large production runs have two to six layers, since yield is reduced as the number of layers is increased. The advantages of this process are that it uses readily available equipment, it can be inspected at each step, it is cost-effective, and it is conducive to quick delivery.

The main disadvantage is that the process requires many steps—typically three screenings per conductive layer. Moreover, dielectric and resistive inks are not compatible, although several ink manufacturers are on the verge of solving this problem. But it is not yet possible to screen resistors into multilayer substrates—although by using partial multilayers, an area with resistors can be left as a single layer.

Cofired ceramics

The cofired multilayering process, based on the use of uncured (green) ceramic tapes, can only form interconnections, since no resistor system now exists. The process also is used for construction of LSI packages and ceramic chip-carriers. Metalization, typically tungsten or molybdenum, is screened on the ceramic tape and interconnected through vias. The screened layers are laminated together and then fired in a furnace with a hydrogen atmosphere at 1,600°C.

This process forms a one-piece structure, in which the customer—a hybrid manufacturer—sees only vias in the top and bottom surfaces. He must evaporate or sputter a layer of thin-film gold on the top and bottom surfaces and etch on his own interconnects and pads.

Advantages of the cofired multilayer system—supplied by the Electronic Products division of the Minnesota Mining & Manufacturing Co., St. Paul, Minn., and Ceramic Systems, San Diego, Calif.—include the monolithic all-ceramic structure with no glass interface, high strength, and high temperature stability. It also offers increased thermal conductivity and high circuit density. The one big disadvantage is the extensive tooling and lead time required for the type of substrate—12 to 20 weeks, depending on complexity of the job.

According to 3M engineers, who have already made 15-layer cofired substrates, there seems to be no limit to the number of layers that can be stacked. One 3M 15-

layer substrate has 220 chips attached over its 3½-by-3½-in. surface and 3,000 vias. The cofired substrate of Fig. 9 has a complete wafer (master slice) on one side and a heat sink on the other.

At least two companies that have been using the sequential screening process—Raytheon Industrial Components Operation in Quincy, Mass., and the Electro-Optical and Data Systems Group of Hughes Aircraft Co., Culver City, Calif.—are trying to develop universal cofired substrates. With such a product, their customer would order a cofired substrate with specified standard inner conductive layers and vias but he would customize the top and bottom to suit his application.

Nonceramic multilayering

Pactel Corp., Westlake Village, Calif., has developed a nonceramic multilayer substrate for complex high-density circuits. This system uses polyimide for the insulating layers.

The process starts on a conductive temporary support (15 by 18 in.) with an ultrasmooth finish. A photoresist is put on, and the desired conductive pattern and vias are exposed onto the surface. After this, a conductor (typically gold, nickel, or copper) is plated on by the additive method. Then a layer of polyimide is put over the conductive pattern everywhere except the vias.

The polyimide, with the pattern locked on, is then peeled away from the support, and the process is repeated for other layers. The layers are then laminated to an aluminum substrate to provide mechanical strength and heat-transfer capabilities.

Using this technique, Pactel's engineers can create substrates with as many as five layers with 3- to 4-mil lines on the conductive layers—a resolution nearly as good as that of thin-film conductors. Because of the fine line widths, Pactel claims, it can eliminate 30% to 40% of the layers required for a ceramic sequentially screened substrate. There are no limitations on the size of the substrate, and any method of chip attachment can be used because of the excellent thermal properties

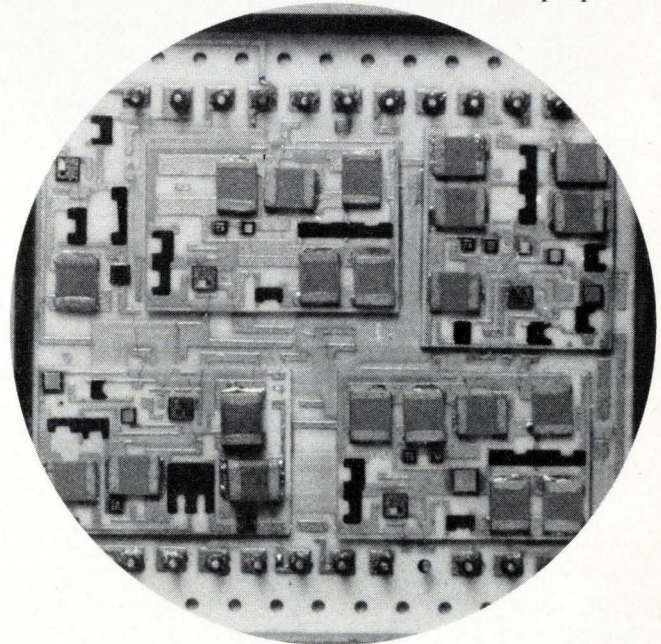

10. Hybrids on hybrids. Since thick-film resistors normally cannot be screened on the top layer of a multilayered surface, many manufacturers instead screen the resistors onto small ceramic substrates, trim them, and mount them on the main substrate.

Hybrid techniques

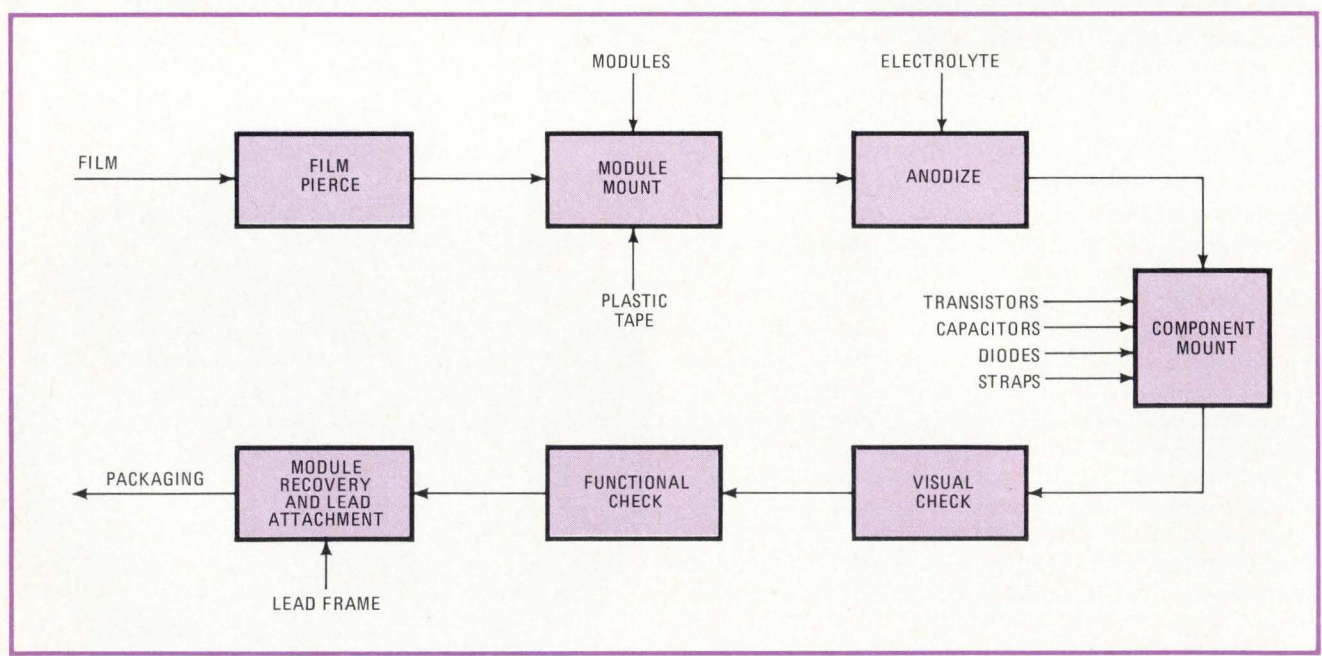
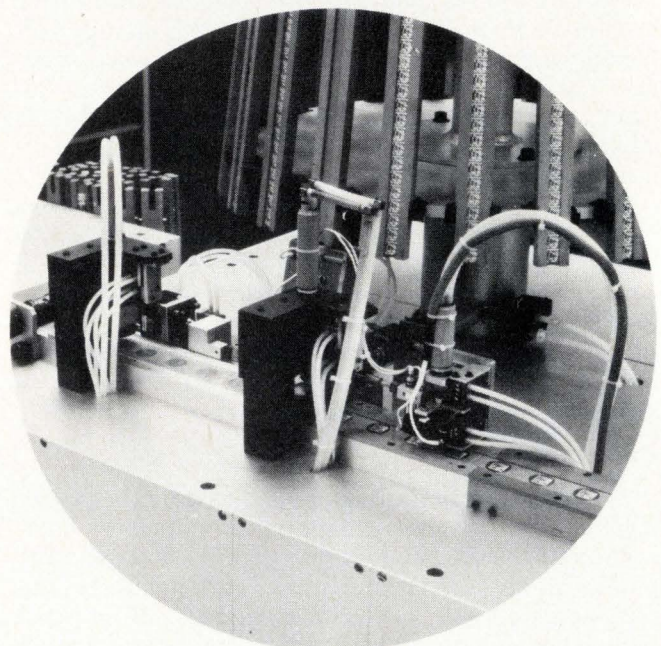
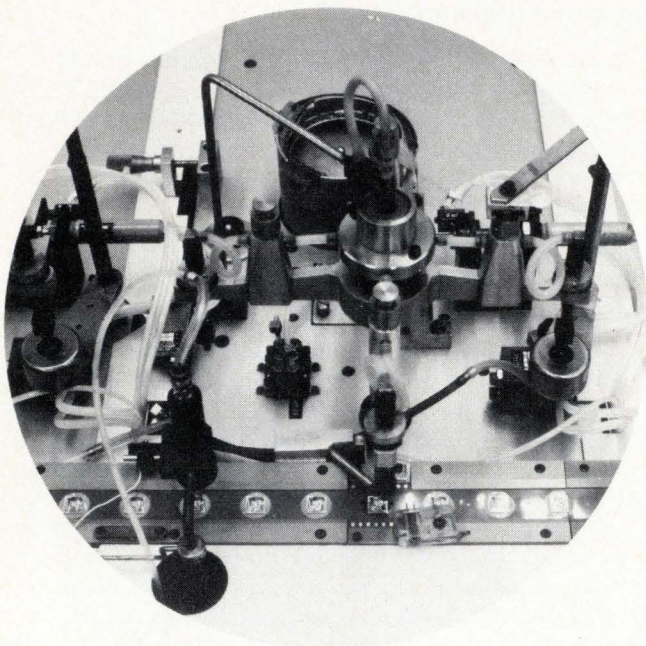
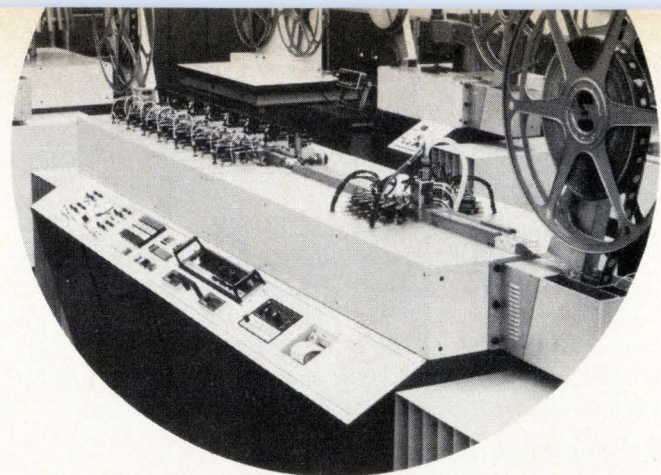

11. Automated hybrid production. CIT-Alcatel, a French firm, uses an automated system for production of thin-film hybrids. A 35-mm polyester film carries substrates throughout the entire process. The machine shown at left attaches modules to the tape. The upper right machine trims the thin-film resistors, while the lower right machine mounts and solders all active and passive components.

of the substrate with its built-on heat sink.

Advantages of this type of multilayering are lower cost, higher density, and better resistance to shock and vibration than are possible with other methods.

Hybrid tricks

Even without multilayering, the hybrid designer has many options for increasing circuit density. By screening both sides of a thin-film substrate, it is possible to mount all active chips on top and all discrete and screened components on the bottom. Interconnections can be wired or made through the leads brazed to the substrate.

Another method is to stack circular substrates on risers, making interconnections through the risers. By far the most popular technique is to use hybrids on hybrids. Most motherboards have only the interconnections plus a few discrete passives. Finished hybrids are mounted on the ceramic motherboard. This approach is extensively used for the Navy's NAFI boards.

The hybrid in Fig. 10, manufactured by General Instrument, uses four small substrates because testing in sections keeps the yield of completed hybrids high. Also, if this were a multilayer single substrate, no thick-film resistors could be screened and laser-trimmed on top layer.

Another version of the hybrid-on-hybrid can be generated with a ceramic chip-carrier. The largest ceramic carriers can accept small hybrid substrates. In one such application, a small ceramic-packaged hybrid, serving as an interconnection, is being used to change the circuit function of a large complex hybrid substrate.

Hybrid automation

Many independent hybrid manufacturers in the U.S.—both thick- and thin-film—are committed to the chip-and-wire method, since it suits tightly packed, complex military hardware. The relatively small quantities of units involved do not warrant such equipment as automatic screeners, conveyer belts, and parts placers used on automated production lines. Often the only automation is laser trimmers and automatic test equipment. Usually the finished substrate ends up in a room full of manually operated bonding equipment.

Centralab, whose hybrid output is based on soldering discrete parts to a substrate, has a completely automated line in Lafayette, Ind., where substrates are screened, fired, trimmed, tinned, tested, and coated. Typical machinery installed includes magazine-fed automatic screeners, probe fixtures, and automatically positioned laser heads for thick-film-resistor trimming.

CIT-Alcatel's microelectronic division in Montrouge, France, has an interesting fully automated line for thin-film hybrids that have thin-film resistors sputtered on and discrete components soldered on (Fig. 11). Other automatic equipment sputters on connections, pads and resistors before the substrates enter at the point labeled "modules" in Fig. 11. A 35-millimeter opaque polyester film is used as the medium for moving substrates through the system.

The first machine punches windows 20 mm in diame-

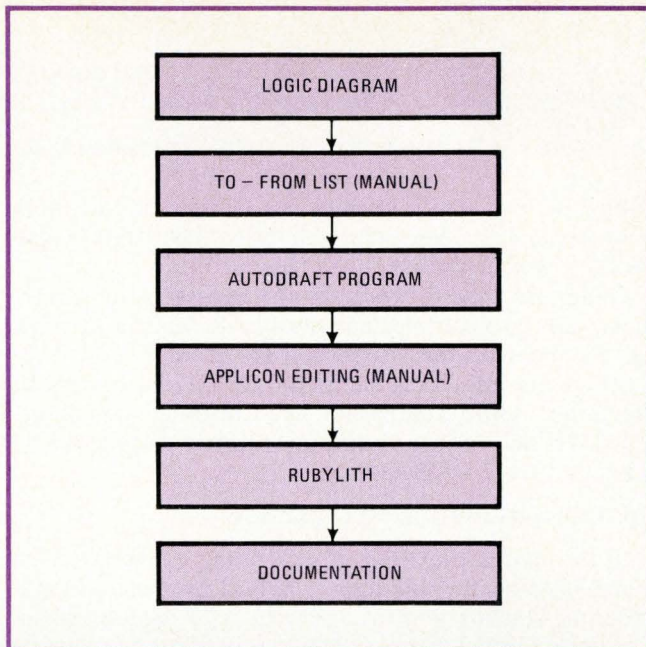

12. CAD. Cost-effective fabrication of extremely dense multilayered hybrids can really only be done with the assist of computer-aided design. The system shown has cut the cost of manual hybrid artwork and documentation at RCA, Moorestown, by a factor of three.

ter on 38-mm centers on the film. The second machine (Fig. 11b) feeds substrates loaded in magazines down to the moving polyester tape, where they contact adhesive pads in the windows fastened to the film. The pads are automatically cut from a special plastic tape that will handle temperature as high as 250°C.

Next, the film with the attached substrate is fed into a resistor-trimmer that uses the anodizing principle as shown in Fig. 11 (upper right), where the film-attachment machine is in the background. The trimmer can adjust as many as 10 resistors in one step or as many as five in two steps. At the end of the machine, a programmable scanner checks all resistor values, including those not subject to trimming.

The component-mounting machine (Fig. 11, lower right) is set up to serially attach as many as three Timtors, one chip capacitor, one diode, and one strap. The machine orients each component, picks it up, transports it, deposits flux, and solders components to the substrate. Next, there is a semiautomatic visual check. Throughput is 200 modules per hour, and yield is 99.5%.

The next position is a functional check by computer-controlled automatic test equipment. Finally, the last machine detaches good modules from the film and attaches them to lead frames at the rate of 240 modules per hour. Bad modules are left on the film.

CIT-Alcatel is working on a "double-film" assembly method. This uses a 35-mm film to carry the substrates and a 16-mm film at right angles to the first for carrying all discrete components. This would eliminate the need for separate magazines for each component type.

As was mentioned earlier, the trend in hybrids is toward extremely large, all-digital, multilayered units carrying hundreds of LSI devices. The number of interconnection points on such devices is immense—a small

hybrid with only 10 LSI chips can contain 500 or more interconnections. Many large hybrids have 10,000 connections in a single layer.

Generating the artwork for the necessary screens or masks can be a complex and costly job. Months of effort can be spent on the design and layout of one of these complex hybrids. To speed up the design phase, some of the large hybrid companies have installed computer-aided-design services or contracted their designs out to firms that have a CAD facility.

Computer-aided design of hybrids

In the manual method of generating artwork, which is still used by the majority of hybrid producers worldwide, the starting point is a schematic or logic diagram. The designer decides on conductor width and spaces, as well as the number of conductive layers. Then the design is laid out on graph paper with a scale 10 to 20 times final size.

When the design is satisfactory, a circuit layout is detailed, using the proper line widths and spaces on accurate graph paper. In highly complex designs, this step is repeated for each conductive and nonconductive material. After the layout of each layer is completed, the rubylith artwork is cut on a light table, using the various layout drawings as masters.

A fully automated hybrid-design system at RCA, Moorestown, is shown in flow graph form in Fig. 12. This system is built around an Appicon graphic terminal, which is used interactively to edit or redesign the hybrid created by a large data base from digitized information from a logic diagram. RCA, Moorestown, which uses this system to generate artwork for thick-film screen and to create drawings for hybrid assembly and inspection, has cut the time and cost of generating hybrid artwork and documentation by 300%.

So far, CAD is used only by a small number of custom-hybrid manufacturers, where the cost of the automation is offset by the savings in manhours. Many large independent hybrid producers that still prefer to lay out all their hybrids manually say CAD is not cost-effective because the system is not used often enough.

It is interesting to note that Centralab, a company that deals with mostly one- and two-sided commercial and industrial hybrids, is awaiting delivery of an Appicon to automate its artwork generation. For Centralab, the 25%-to-50% savings on the sheer volume of different designs each year will justify the cost.

For hybrid manufacturers without CAD capability, design services such as Algorex Data Corp., Syosset, N.Y., or Automated Systems Inc., El Segundo, Calif., are available. Both companies have large computer facilities with programs committed to design of hybrid artwork.

Most hybrids, whether for space, military, avionics, industrial, automotive, or consumer use, are built

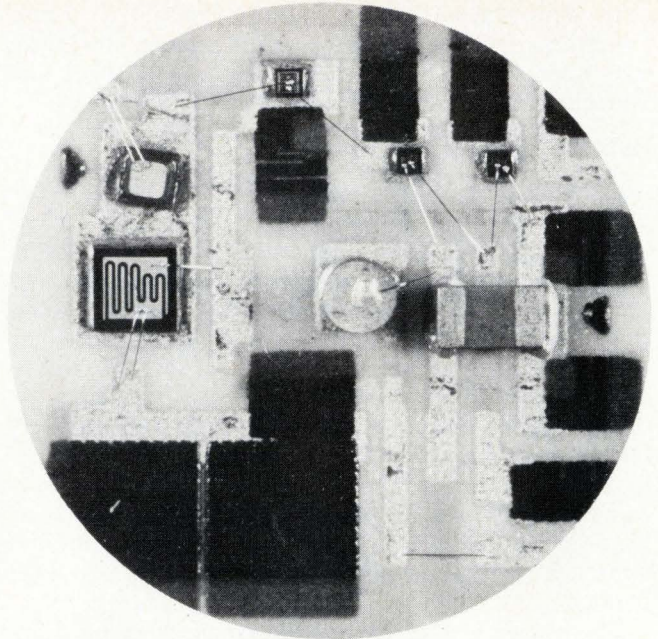

13. Hybrid heater. Thick-film resistors are used as heating elements in a 25-watt thermistor-controlled heater on a $\frac{3}{4}$ -by- $\frac{1}{2}$ -inch beryllia substrate. The heater, built by Integrated Microsystems Inc., is used in a solid-state oscillator manufactured by Watkins-Johnson.

around linear and digital ICs, discrete transistors, and FETs. However, there is no limit to the circuits hybrids can handle.

An unusual thick-film hybrid built by Integrated Microsystems Inc., Mountain View, Calif., for Litton's Data Systems division, Van Nuys, Calif., carries a LED matrix that acts as an alphanumeric display. The top of the three-layer, ceramic, $1\frac{1}{2}$ -by-3-in. substrate has more than 32 lines per inch of LEDs. A total of 144 holes and 191 vias connect the substrate to electronic circuitry (drivers and logic) that programs the display.

A hybrid heater

The relatively uncrowded hybrid of Fig. 13 is a 25-w thermistor-controlled heater on a $\frac{3}{4}$ -by- $\frac{1}{2}$ -in. beryllia substrate. Thick-film resistors on the substrate are used as heater elements for external, solid-state oscillators on this hybrid, built by Integrated Microsystems for the Watkins-Johnson Co. An external resistor programs the temperature of the hybrid heater element.

Itek's Applied Technology division has designed a group of specialized optoelectronic hybrids for systems that warn pilots that their planes are being tracked by a laser ranging system. These hybrids have special optical windows in their lids. Mounted on the hybrid under the lids are an optoelectronic sensor and electronic circuitry. A laser beam passes through the window and activates the hybrid's warning circuitry.

A data-keyboard-switch matrix mounted in a 3-by-3-in. space has been built in a ceramic substrate by Centralab. Alphanumeric keyboard symbols are screened onto the top of the substrate. The bottom has two custom ICs, screened-on resistors, and a conductive thick-film interconnection. The entire unit acts as a capacitively coupled keyboard. □

Chip components, both active and passive, augment capabilities of hybrid circuits

by Lucinda Mattera
Components Editor

□ Though almost any conventional component can be found in a hybrid circuit, unpackaged chips undoubtedly dominate wherever a complex circuit must also be small and lightweight. Chips that come without packages are, of course, far outnumbered by the already packaged devices—so much so that it's slightly surprising to realize that unpackaged versions are obtainable in all four major component categories. The greatest variety exists in semiconductors, with capacitors next and resistors and inductors in third and fourth place.

As a rule, passive chip components are fabricated with the same thick- or thin-film techniques as the interconnect patterns laid down on the hybrid substrates. For example, thick-film chip resistors and capacitors may be screened, sprayed, or painted on their base. Similarly, for thin-film chip versions of resistors and capacitors, some form of evaporation or sputtering is generally used.

Fragile—handle with care

The lack of a package does create problems. Without its physical protection, chip components, particularly semiconductors, are easily damaged through scuffing or actual breakage. As a result, they often must be shipped

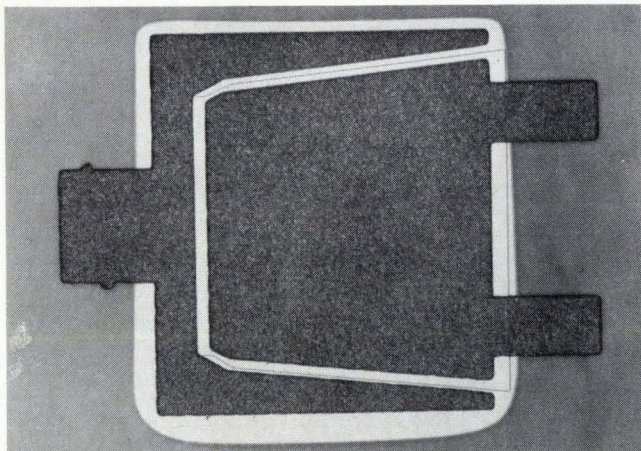

A sprinkling of beam leads. Comparatively few chip components are available with beam leads—just a limited selection in semiconductors, capacitors, and resistors. This device from Sprague, is a thin-film capacitor in which silicon oxide serves as the dielectric.

in special containers and require special carriers through assembly stages. Also, they are hard to label, and the great majority are left unmarked and quite anonymous.

Electrically, too, the solitary chip presents unique problems. A package creates a stabilized electrical environment for a device, guarding it against moisture and dissipating excess heat. But in a hybrid circuit, the chip top is usually exposed, making it vulnerable during handling to moisture, scratches, and the like. Chip components, therefore, especially semiconductors, must be tested more extensively both electrically and visually than equivalent packaged devices.

Mounting style depends on the chip component itself, and some styles are commoner than others. Individual or discrete thick-film resistors and capacitors, for example, usually have terminations that allow them to be soldered in place or connected with conductive epoxy. Thin-film passive chips, though, are more like active devices, and they require wire bonding or can be purchased as beam-leaded parts from only a few manufacturing sources.

Semiconductors are most commonly available as standard chips—that is, they must be epoxied or eutectically bonded in place, then electrically connected with wire bonds. Flip-chips, beam leads, and leadless-inverted-device packages are alternative approaches, but few semiconductor houses offer them.

Semiconductor dice are plentiful

Nearly every active device normally sold in a package is available without a package. There are two notable exceptions—optically coupled isolators and the newest large-scale-integrated circuits, including some memories and all microprocessors. Optical couplers are more or less hybrid assemblies themselves, and they depend on their packaging for their isolation. Highly complex LSI devices are difficult enough to test when packaged, let alone when in chip form.

It's not common knowledge, but most major semicon-



For precision. Thin-film resistor networks provide excellent tracking accuracies and very tight absolute tolerances. This wafer, made by Analog Devices, shows the fine geometries that can be achieved with thin films—each substrate contains eight independent resistors.

ductor houses will sell any of their products as chips. In fact, quite a few will supply chips at the slice level, before the wafer is scribed and the chips separated.

Semiconductor dice can be ordered, even in small quantities, directly from the manufacturers, although the larger houses prefer to deal with volume orders at the factory level. National Semiconductor Corp., Santa Clara, Calif., for instance, supplies wafers to Semiconductor Specialists Inc., Salem, Mass., which tests and processes them for small-quantity orders. Signetics Corp., Sunnyvale, Calif., on the other hand, has a minimum-order level of 100 pieces for its linear ICs and charges an additional nominal fee of about \$250.

Only for volume orders, however, say for thousands of pieces, do chip prices begin to fall below those of the packaged equivalents. For smaller orders, prices tend to be about the same as for packaged devices. When that happens, it's most probably because of lower yields, depressed by the detailed visual inspection and extra electrical tests to which the unpackaged devices are generally subjected.

Tables 1, 2, and 3 outline the broad selection of digital and linear ICs, as well as discrete semiconductors, available as chips. For each generic device type, the approximate range of chip size is indicated. But since it's impossible to list here every specific device type offered in chip form, users should certainly check with their vendors before abandoning hope for the availability of a particular chip.

Quite a few semiconductor manufacturers are extending themselves to help their customers who buy chips.

For digital ICs, Motorola Semiconductor Products Inc., Phoenix, Ariz., now offers a thermal electrical stress test at wafer probe. Through overvoltage and leakage testing, it is intended to screen out electrically weak devices that may even meet all their other specified parameters.

Special assistance from vendors

Similarly, within a month or so, Precision Monolithics Inc. of Santa Clara, Calif., expects to guarantee the specifications of its linear ICs at wafer probe. The result, says the firm, will be chip customers who know exactly what they are buying and a vendor who knows exactly what he's selling.

Linear ICs from Texas Instruments Inc., Dallas, Texas, are electrically probed individually at room temperature at the wafer stage. This wafer screen, which is designed to guarantee each device's dc performance to data-sheet limits at 25°C, is continually being improved to maximize device yields at temperature extremes.

Plastic is also being brought to the aid of the chip user, both in his production process and at the receiving stage. Sprague Electric Co., North Adams, Mass., already supplies its discrete-semiconductor chips in expanded-wafer form—stuck by adhesive to a polyester carrier with the orientation they had prior to scribing and break-apart. Such a die system lends itself to chip removal and mounting by automatic equipment.

Other kinds of plastic carriers are becoming popular with the shippers of semiconductor dice. At Siliconix Inc., Santa Clara, Calif., which specializes in field-effect devices, individual chips are packaged in plastic waffle-like carriers, with a sheet of anti-static paper to simplify

TABLE 1: DIGITAL INTEGRATED CIRCUITS

Device	Type	Chip size, approx. (mils)	Chip area, approx. (mils ²)
Gates and buffers	Single	30 by 35 — 50 by 55	1,050 — 2,750
	Dual	30 by 35 — 50 by 60	1,050 — 3,000
	Triple	45 by 50 — 65 by 70	2,250 — 4,550
	Quad	35 by 40 — 65 by 75	1,400 — 4,875
	Hex	55 by 55 — 70 by 85	3,025 — 5,950
Flip-flops	Single	50 by 50 — 70 by 90	2,500 — 6,300
	Dual	45 by 50 — 75 by 80	2,250 — 6,000
Multivibrators	Single	45 by 50 — 50 by 55	2,250 — 2,750
	Dual	55 by 65 — 70 by 80	3,575 — 5,600
Counters	Binary	50 by 90 — 100 by 110	4,500 — 11,000
	Decade	50 by 90 — 100 by 110	4,500 — 11,000
MSI and LSI circuits	Register	60 by 60 — 100 by 125	3,600 — 12,500
	Multiplexer	50 by 55 — 75 by 80	2,750 — 6,000
	Decoder	60 by 60 — 105 by 130	3,600 — 13,650
	Arithmetic	50 by 55 — 100 by 105	2,750 — 10,500
	Parity	50 by 60 — 70 by 95	3,000 — 6,650
	Memory	From 90 by 100	From 9,000

removal without damaging the parts, and whole wafers are packaged in evacuated heat-sealed plastic bags.

Compared to active devices, the selection of passive chip components is slim. But of the three classes, chip capacitors offer the greatest variety, in terms of both available devices and number of vendors.

Sorting out chip capacitors

Chip capacitors generally use one of three different dielectric materials: ceramic (as is well known) or tantalum or thin metal-oxide film (as is less well known). Within each of these groups, there are several categories of performance (Table 4).

At first sight, ceramic dielectrics present a confusing picture. A closer look, though, reveals they are usually based on a barium-titanate formulation and can be broadly broken down into three popular types—high stability, stable K, and high K, where K represents the dielectric constant of the material. High-stability ceramics are frequently also referred to as NPO dielectrics, stable-K types as X7R dielectrics, and high-K types as Z5U dielectrics.

High-stability ceramics are intended for applications where high Q factors are essential and very little capacitance drift with temperature can be tolerated. Typically, the dielectric constant for this type ranges from approx-

imately 8 to 150, and the temperature coefficient of capacitance is guaranteed to be within ± 30 ppm/ $^{\circ}\text{C}$ over -55°C to $+125^{\circ}\text{C}$.

Stable-K dielectrics are for bypassing and coupling applications in which some capacitance drift and moderate Q values are acceptable. For this group, dielectric constant varies from about 250 to 2,400, and capacitance changes by no more than $\pm 15\%$ (from the value at room temperature) over the range of -55°C to $+125^{\circ}\text{C}$.

High-K ceramic capacitors are general-purpose devices, exhibiting fair to poor stability. Their value may change by as much as $+22\%$, -56% from their room-temperature nominal for a temperature swing from -55°C to $+125^{\circ}\text{C}$. However, because of their high dielectric constant, from 2,500 to 15,000 or more, they offer the best volumetric efficiency of all the ceramics.

Cheaper metals for electrodes

Ceramic chip capacitors are often built as multilayer structures, especially when it's necessary to obtain high values of capacitance. Alternating the dielectric and the electrode metal in layers yields a stack of capacitors, connected in parallel, as it were, so that their values add. The electrodes are brought out from the stack to the end terminations.

Customarily, a precious-metal alloy, usually silver-

TABLE 2: LINEAR INTEGRATED CIRCUITS

Device	Type	Chip size, approx. (mils)	Chip area, approx. (mils ²)
Analog switches	Single	20 by 20	400
	Quad	30 by 40 — 55 by 60	1,200 — 3,300
	Multiplexer	30 by 40 — 70 by 80	1,200 — 5,600
Op amps	Single	40 by 40 — 70 by 90	1,600 — 6,300
	Dual	35 by 40 — 70 by 90	1,400 — 6,300
	Quad	60 by 65 — 75 by 75	3,900 — 5,625
	Precision	40 by 45 — 55 by 100	1,800 — 5,500
Comparators	Single	30 by 30 — 50 by 55	900 — 2,750
	Dual	40 by 40 — 60 by 80	1,600 — 4,800
	Quad	50 by 55	2,750
Timers	Single	55 by 60	3,300
	Dual	65 by 75	4,875
	Quad	80 by 105	8,400
Voltage regulators	General-purpose	40 by 45 — 90 by 90	1,800 — 8,100
	Precision	45 by 50 — 60 by 70	2,250 — 4,200
Interface	Sense amplifiers	55 by 55 — 60 by 70	3,035 — 4,200
	Peripheral/display drivers	45 by 45 — 105 by 105	2,025 — 11,025
	Line receivers/drivers	40 by 45 — 65 by 70	2,025 — 4,550
	Data converters	60 by 85 — 85 by 150	5,100 — 12,750
Communications circuits	Video amplifiers	40 by 40 — 50 by 55	1,600 — 2,750
	Phase-locked loops	50 by 55 — 70 by 75	2,750 — 5,250
	Fm subsystems	40 by 55 — 80 by 95	2,200 — 7,600

Hybrid components

palladium, is used for the electrode-and-termination system. But because of the expense of noble metals, this approach may tie up as much as half of the capacitor price in the metalization system. A few manufacturers are in the process of developing less costly alternatives—and one, namely USCC/Centralab, Los Angeles, has already come up with a substitute base-metal system. This contains chiefly nickel and, as a result, the company has been able to cut prices by 30% to 50%.

Most ceramic chip capacitors have a working voltage rating of 50 vdc at 125°C. However, both Sprague and Semtech Corp., Newbury Park, Calif., offer devices having kilovolt ratings. Semtech even has custom formulations up in the multi-microfarad range at ratings as high as 300,000 v. The company supplies high-voltage capacitor slabs, which the user cuts up himself to obtain the capacitance he needs.

As a rule, ceramic chip capacitors have fixed values—but not always. Vitramon Inc. of Bridgeport, Conn., offers a line of chips with values that can be incrementally adjusted either up or down, even after installation. The adjustment points lie on the top of the chips.

Still tantalum for high capacitance

Despite the proliferation of ceramic chip capacitors, tantalum-based devices are holding their own. These polarized (electrolytic) capacitors are the best practical choice when values of several microfarads or higher are needed. Even with multilayer high-K ceramics, only about 10 microfarads at most can be achieved. And generally, the stability of high-K ceramics is not as good as that of tantalum.

As might be expected, tantalum chips are made with a different termination at one end so that they can be

inserted in a circuit for proper current flow. One common technique is to shape one of the terminals like a "T." Or, the anode terminal might have a protrusion, as it does on Sprague's solid-electrolyte tantalum chips.

Thin-film metal-oxide capacitors are available from only a few sources. Made with either a silicon or tantalum oxide, they provide relatively low values of capacitance. However, they are physically compatible with active semiconductor chips, since they are a mere 3 to 8 mils thick. In contrast, ceramic chip capacitors are much thicker, typically around 50 mils high. Some of the thin-film devices are even available with beam leads, and others can be adjusted in value.

Resistors—singles and arrays

Chip resistors can be divided into two groups: discrete devices and networks containing two or more resistors on the same substrate. In either case, the selection is somewhat limited—for a good reason. With a thick-film hybrid, it's a simple matter to add another screening step and just print the necessary resistors right on the substrate. They can even be trimmed into value once the rest of the circuit is complete.

Most discrete chip resistors are made with a cermet thick-film material, which yields temperature coefficients of ± 200 to ± 300 ppm/°C. Power ratings vary from less than 100 milliwatts to about 300 mW for chips measuring from 50 by 50 by 20 mils up to 155 by 50 by 20 mils. Resistance values generally range from around 1 ohm up to over 15 megohms, with standard tolerances of $\pm 5\%$ to $\pm 20\%$. But some companies, like Dale Electronics Inc. of Norfolk, Neb., can supply chips even to $\pm 1\%$ tolerances. A few firms, for instance, Sprague and Varadyne Industries Inc., Santa Monica, Calif., offer a selection of both chip resistors and chip capacitors.

Other chip resistors tend to be special-purpose devices, intended for power-handling jobs or other special circuit functions. For instance, some chips have unusually high resistance values, say on the order of teraohms, while others provide power ratings of 0.5 watt

TABLE 3: DISCRETE SEMICONDUCTORS

Device	Type	Breakdown voltage (V)	Current rating	Chip size, approx. (mils)
Diodes	General-purpose	75 - 720	100 mA - 600 mA	15 by 15 - 35 by 35
	Switching	65 - 100	0.1 mA - 500 mA	10 by 10 - 20 by 20
	Rectifier	50 - 1,000	1 A - 55 A	40 by 40 - 180 by 200
	Zener	1.8 - 200	0.33 mA - 21 mA	20 by 20 - 25 by 25
Transistors	General-purpose bipolar	10 - 300	1 mA - 2 A	15 by 15 - 30 by 30
	Switching bipolar	4 - 60	1 mA - 3 A	10 by 15 - 30 by 30
	Power bipolar	25 - 325	50 mA - 60 A	20 by 20 - 275 by 275
	JFET	25 - 275	0.06 mA - 700 mA	10 by 15 - 45 by 45
	MOSFET	6 - 150	5 mA - 35 mA	15 by 15 - 45 by 65
Thyristors	SCR	15 - 800	0.8 A - 60 A	30 by 30 - 650 by 650
	Diac	20 - 600	2 A - 55 A	20 by 20 - 650 by 650
	Triac	25 - 800	4 A - 60 A	90 by 90 - 650 by 650

TABLE 4: CAPACITORS

Dielectric	Type	Capacitance range	Value tolerance	Voltage rating (WVdc)	Temperature coefficient*	Chip size, approx. (mils)
Ceramic	High stability (NPO)	1 pF – 0.068 μ F	\pm 0.5 pF – \pm 20 %	25 – 200	\pm 30 ppm/ $^{\circ}$ C	35 by 35 by 25 – 520 by 520 by 70
	Stable K (X7R)	100 pF – 1.8 μ F	\pm 5% – + 80%, –20 %	25 – 200	\pm 15%	50 by 40 by 40 – 520 by 520 by 70
	High K (Z5U)	150 pF – 10 μ F	\pm 20% – + 80%, –20 %	25 – 100	+ 22%, –56 %	35 by 35 by 25 – 520 by 520 by 70
	High-voltage NPO	18 pF – 0.039 μ F	\pm 5% – \pm 20 %	500 – 5,000	\pm 30 ppm/ $^{\circ}$ C	230 by 190 by 150 – 610 by 560 by 250
	High-voltage X7R	180 pF – 0.39 μ F	\pm 10% – + 80%, –20 %	500 – 5,000	\pm 15 %	250 by 200 by 150 – 650 by 600 by 250
Tantalum	Solid electrolyte	0.1 μ F – 100 μ F	\pm 5% – \pm 20 %	4 – 50	+ 12%, –10 %	100 by 50 by 50 – 285 by 150 by 150
Thin film	Metal oxide (MOS)	1 pF – 220 pF	\pm 0.5 pF – \pm 20 %	50	+ 35, \pm 15 ppm/ $^{\circ}$ C – + 25, \pm 100 ppm/ $^{\circ}$ C	20 by 20 by 3 – 60 by 60 by 8
	Tantalum oxide	100 pF – 3,000 pF	\pm 5% – \pm 10 %	12 – 50	+ 200, \pm 50 ppm/ $^{\circ}$ C	35 by 30 by 3 – 65 by 60 by 3

*Over temperature range of -55° C to $+125^{\circ}$ C

or so. And in addition to conventional rectangular-shaped chip resistors, CTS Microelectronics Inc., Lafayette, Ind., offers a line of cylindrical devices that can be mounted through a hole in a pc board.

Because thick-film hybrid packages so very frequently come complete with screened-on resistors, thick-film resistor networks are not available as unpackaged chips, for the most part. However, don't forget that the thick-film hybrid manufacturer often has the capability to print his own resistors. Even thick-film capacitors can be screened directly onto the substrate in a multilayer hybrid.

Thin films for precision

Resistor networks made of thin films, on the other hand, are more readily available as unpackaged chips, and they provide better stability and accuracy than their thick-film counterparts, but at higher cost. Thin-film networks are best suited to applications where precision is a must, as in digital-to-analog converters and instrumentation amplifiers.

Individual resistor tolerances may be as low as 1% as deposited or 0.005% after laser trimming. Temperature coefficients are also excellent, down to \pm 1 or even \pm 0.5 ppm/ $^{\circ}$ C. Chip sizes range from a small 35-mil square to larger rectangular units measuring 200 by 600 mils.

The thin-film resistive material may be nickel chromium (often called nichrome), tantalum nitride, or cobalt chromium. There is a variety of substrate materials, too, including glass, silicon, sapphire, and ceramics like alumina and beryllia. The metalization may be either aluminum or gold, and generally the chips are passivated for environmental protection.

The combination chosen depends on the application. Nickel chromium provides the tightest accuracies and

temperature coefficients, while tantalum nitride offers moderate performance at lower cost. Among the substrates, glass and alumina are good all-around performers, whereas sapphire and beryllia excel in high-power applications. The temperature properties of silicon, of course, match those of active chips.

What are some of the combinations available? The resistors group of Analog Devices Inc.'s Microelectronics division, Wakefield, Mass., offers nickel chromium on alumina and beryllia; HyComp Inc., Maynard, Mass., puts nickel chromium on glass, ceramic, silicon, or sapphire; both Sprague and Hybrid Systems Corp., Burlington, Mass., deposit nickel chromium or tantalum nitride on silicon; and Allen-Bradley's Electronics division markets cobalt chromium on glass. The Sprague networks are beam-lead devices.

Chip inductors reach millihenries

Like discrete chip resistors, chip inductors are available from relatively few vendors. They are fabricated by vacuum-depositing alternate layers of metal and insulator or by winding a fine wire as a coil.

In general, they cover the range of 10 nanohenries to 10 millihenries, at tolerances of \pm 5% to \pm 20%, depending on the value. For wound types, chip sizes are moderate, ranging from 105 by 100 by 85 mils to about 165 by 135 by 115 mils.

Adjustable as well as fixed-value types are available, although prices for the adjustable models can be rather high, in the neighborhood of several dollars apiece. Chip inductors may even be purchased in magnetically shielded versions, like those offered by Vanguard Electronics Co., Inglewood, Calif. □

Reprints are available at \$3.00 each. Write to Electronics Reprint Dept., P.O. Box 669, Hightstown, N.J. 08520. Copyright 1976 by Electronics, a McGraw-Hill publication.

NAND gates and inverter synchronize control signal

by Robert L. White

Applied Research Laboratories, University of Texas, Austin, Texas

In many sequential digital systems that respond to a rising pulse edge, control signals must be synchronized to the clock pulses. These control signals are usually obtained by decoding the desired states of a sequential counter that is driven by the system clock (Fig. 1a). Since the counter and decoder have propagation delays, the decoded control signal is delayed or skewed relative to the system clock, as illustrated in Fig. 1b. But as the clock frequency of the system gets higher, the skew time may become a significant portion of the clock cycle and cause erratic circuit operation.

One example of this problem is encountered with an accumulator operating with a 15-megahertz clock. On the rising edge of every 40th clock pulse, a control signal transfers data from the accumulator to a data register. The control-signal skew causes the data to be transferred at some instant between the clock edges, rather than at the edges. Since the accumulator output is

changing between clock edges, its value is uncertain at the instant of data transfer, and the system's operation is erratic.

But the skew of the control signal can be reduced to a negligible value by configuring the sequential system as shown in Fig. 2a. The clock of Fig. 1 becomes $\overline{\text{clock}}$, and inverters are added to the $\overline{\text{clock}}$ line. One inverter is shown as a 74S04, but it could be one gate of a 74S00 IC. The other inverter is the top NAND gate in the 74S00. Also, $\overline{\text{clock}}$ drives an input of a NAND gate in the control-signal line. The decoder in Fig. 2 responds one clock-pulse sooner than the one in Fig. 1.

The synchronizing effect of the inverter and NAND gates can be seen in Fig. 2b. Line 3 shows that the control signal waveform is in the high state until the decoder output goes high. This event occurs at the $(N - 1)$ th clock pulse, i.e., one clock period before the rising edge of the control signal.

After the decoder output goes high, the control signal remains high until $\overline{\text{clock}}$ also goes high. After $\overline{\text{clock}}$ goes high, the inputs of the two NAND gates are the same. Therefore, the control-signal and clock waveforms are alike; their falling edges and the subsequent rising edges virtually coincide at the leading edge of the Nth clock pulse. The only skew remaining is the difference between the propagation delays in the two NAND gates. With a 74S00 IC, the difference between the delays in

1. Skewed up. In a digital system that requires synchronization of clock and control signal, propagation delays in counter and decoder cause erratic circuit operation. Block diagram (a) shows how control signal is delayed relative to clock pulse, and timing diagram (b) shows waveforms for clock and control signal.

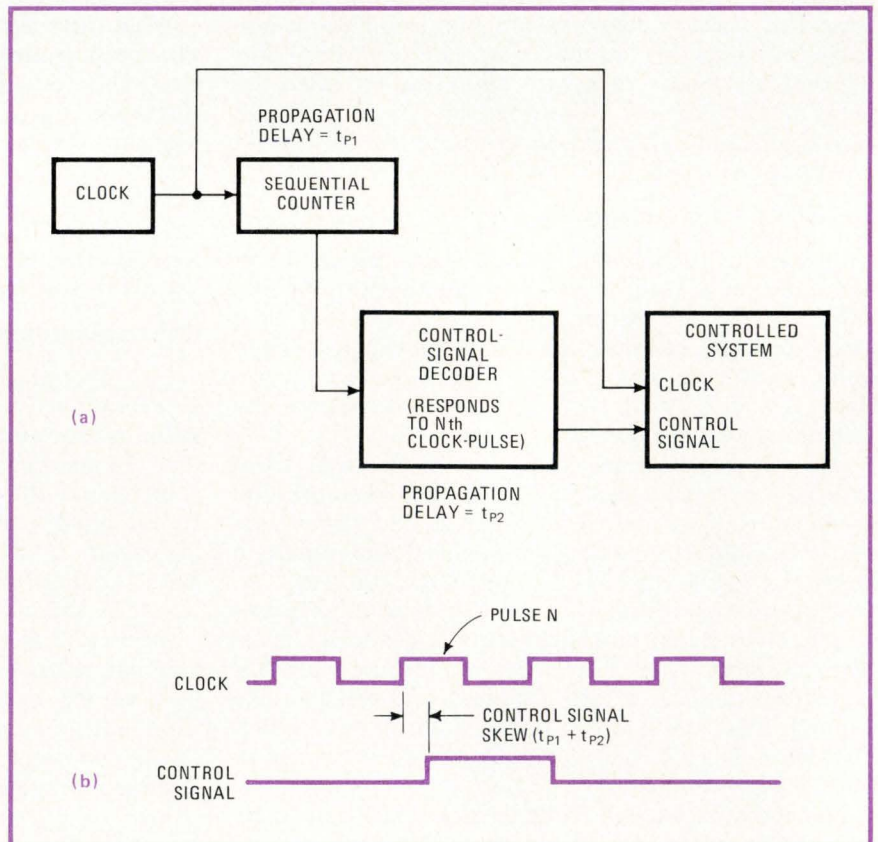

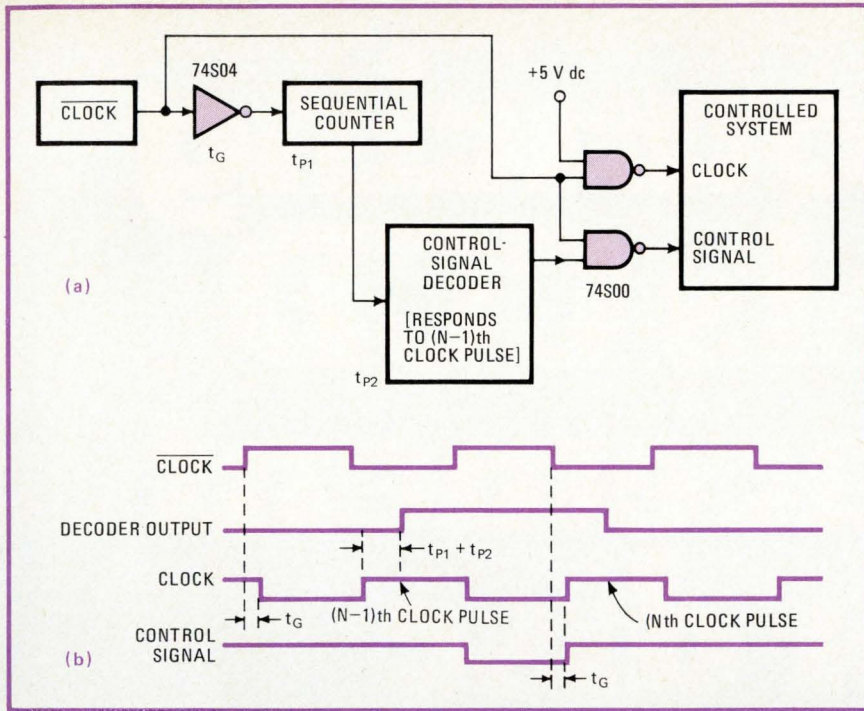

2. Squared away. By adding inverter and NAND gates to circuit and changing decoder to respond one pulse earlier than in Fig. 1, the control signal and clock pulse are synchronized accurately. After rising, the control signal is always high except for the half clock period before its next rising edge.

the two NAND gates was less than 1 nanosecond.

The circuit discussed above provides a control signal with a rising edge that is closely synchronized with the rising edge of the clock. Its applications involve the

transfer of data in high-speed digital systems. The circuit can be used for any application requiring a precisely timed signal transition that does not occur on every edge of the clock pulse. □

Frequency-doubler produces square-wave output

by Robert L. Taylor
I&F Electronics, Nashville Tenn.

Most digital frequency-doublers use edge-detection techniques to produce two narrow output pulses per input pulse. Although these types of doublers work well, they have the disadvantage of producing highly asymmetrical outputs and usually cannot be cascaded to ob-

1. Basic frequency-doubler. The monostable multivibrator produces two output pulses for each cycle of input waveform. One output pulse is triggered on falling edge of A_1 , and second output pulse is triggered when B goes high after spiking low. If output pulse width is set for 50% duty cycle at one frequency, it is asymmetrical at other frequencies. The time delays are shown disproportionately large.

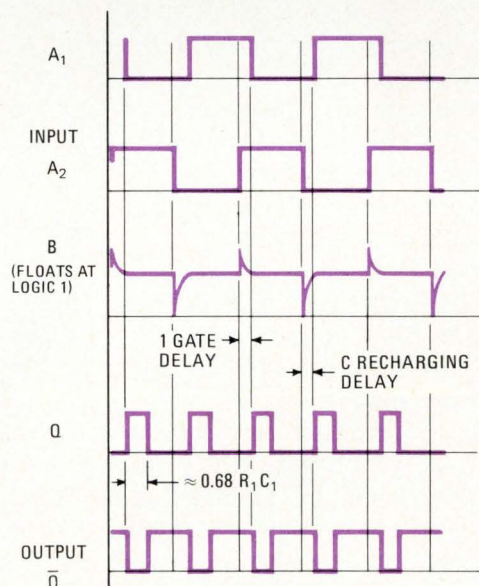
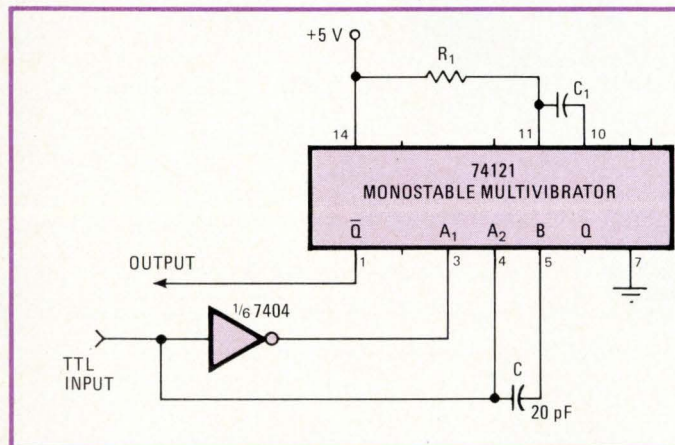

Announcing Intel's CCD replacement for disc and drum memories.

Now you can replace small, fast access, disc and drum memories with Intel's new solid state CCD memory called IN-65 Megachassis™. Each Megachassis contains 2 megabytes of CCD serial memory with expansion in 2 megabyte increments up to 16 megabytes or more.

Built with Intel™ 2416 CCD serial memory components, the IN-65 Megachassis™ gives you solid state reliability and low power. And since all components are on plug-in, circuit boards trouble shooting and repair time are greatly reduced.

In most applications this new 2 megabyte CCD Memory will be utilized as a block-oriented random access memory (BORAM). It can transfer data of variable block lengths at rates up to one word every 550 nanoseconds. Since worst-case latency is only 256 microseconds, the IN-65 can also be used in applications that are beyond the capability of most conventional rotating memories.

If you'd like more information, use the bingo card and we'll send you a IN-65 Megachassis™ product description. If you're in a hurry, use the coupon, or write: Intel Memory Systems, 1302 N. Mathilda Avenue, Sunnyvale, California 94086.

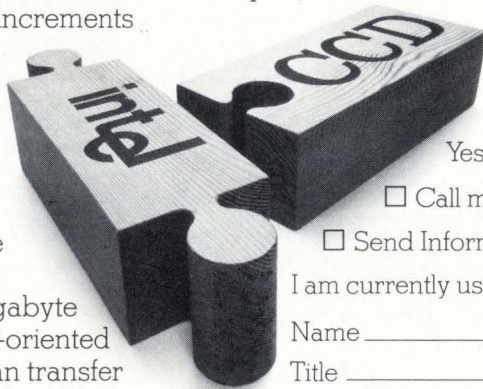

Yes, I'm interested in the IN-65.

Call me. Tel. No. _____

Send Information.

I am currently using: _____

Name _____

Title _____

Company _____

Address _____

City/State/Zip _____

intel memory systems
A DIVISION OF INTEL CORPORATION

Circle 112 on reader service card

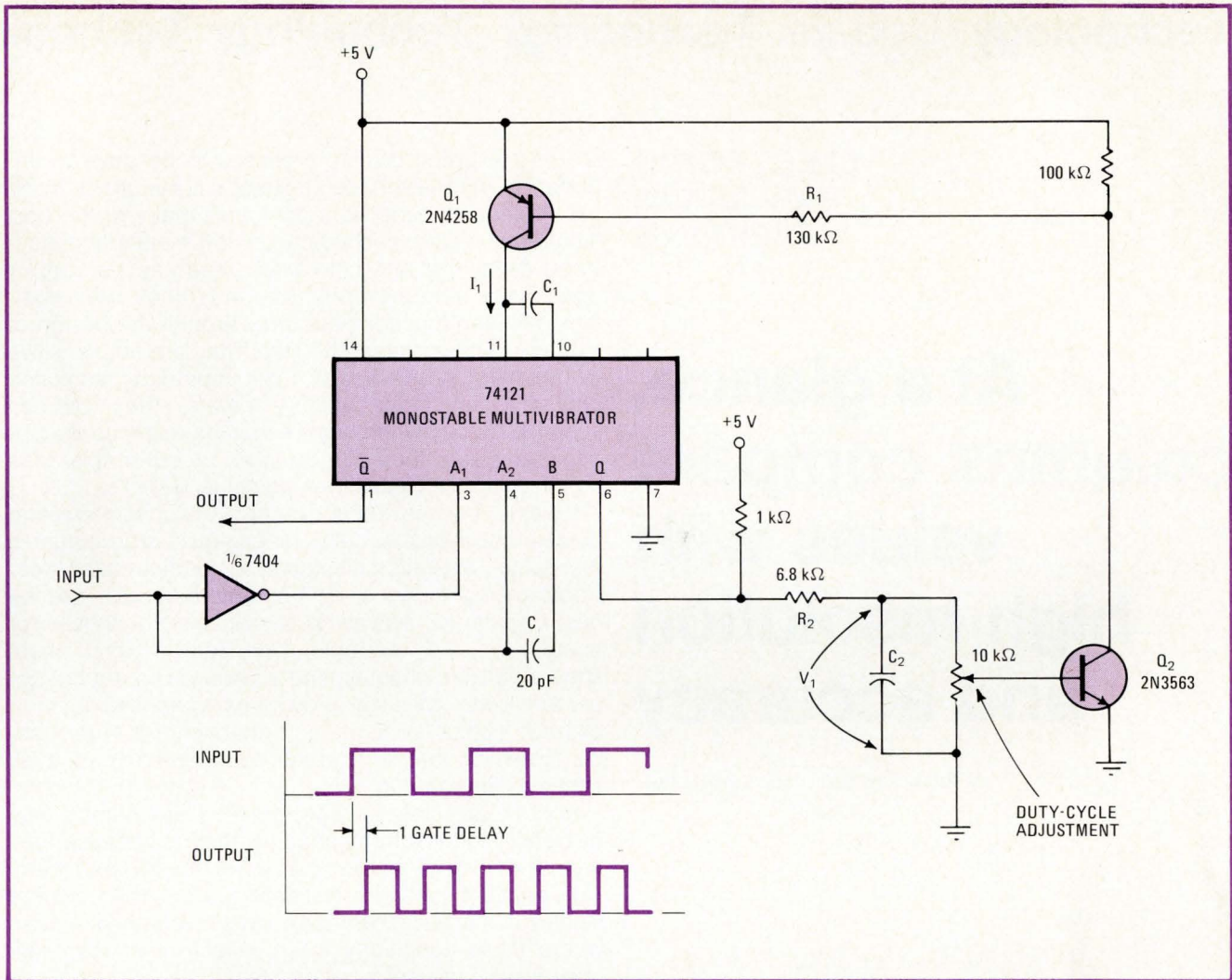

2. Constant duty cycle. Addition of feedback loop to circuit of Fig. 1 makes duty cycle of output wave independent of input frequency. Triggering of output pulses is the same as in the basic circuit, but the pulse width is automatically adjusted for the duty cycle set by the potentiometer. Here the pot setting gives a square wave at the doubled frequency. Delays of 30 or 40 ns are negligible at frequencies below 1 MHz.

tain higher multiplication factors. These problems can be eliminated by use of a monostable frequency-doubler with a modified version of H.P.D. Lanyon's feedback system [see "One-shot with feedback loop maintains constant duty cycle," *Electronics*, July 24, 1975, p. 93].

The basic doubler circuit and its timing diagram are illustrated in Fig. 1. The propagation delay introduced by the inverter allows the 74121 monostable multivibrator to trigger on the rising edge of the input wave, and the 20-picofarad capacitor triggers on the falling edge. Since both edges of the input are detected, the output frequency is twice the input frequency. By selecting the proper R_1C_1 value, a 50% duty cycle could be obtained with the circuit of Fig. 1, but only for one fixed input frequency.

In the improved circuit arrangement shown in Fig. 2, the output pulses from Q are filtered by R_2C_2 to produce a voltage V_1 that is directly proportional to the input frequency. A portion of V_1 , tapped off the 10-kilohm potentiometer, is amplified and inverted in transistor Q₂. The amplified voltage is applied through R_1

to transistor Q₁, which serves as a controlled current source that feeds the timing circuit of the 74121. The value of R_1 is chosen to limit I_1 to a maximum of 5 milliamperes.

In operation, the 10-kΩ symmetry potentiometer is adjusted for a 50% duty cycle output. If the input frequency increases, V_1 increases proportionally and causes Q₂ to conduct more. This draws more base current from Q₁ and causes its collector current to rise. An increase in I_1 produces a corresponding decrease of output pulse width, tending to lower V_1 . The high gain of this negative feedback loop keeps the output duty cycle very near 50% over about a 1,000:1 frequency range. Best results occur when the maximum frequency f_{max} is less than $1/(800 C_1)$, where C_1 is in farads and f is in hertz. The size of capacitor C_2 is chosen to provide good filtering action for V_1 at the lowest frequency used—that is, C_2 is greater than $1/(1,000 f_{min})$. Other parts values and transistor types are not critical. □

Designer's casebook is a regular feature in *Electronics*. We invite readers to submit original and unpublished circuit ideas and solutions to design problems. Explain briefly but thoroughly the circuit's operating principle and purpose. We'll pay \$50 for each item published.

**ELECTRONIC
BAR-GRAPH
DISPLAYS**

**At a glance,
columns compare
values with
high resolution
and accuracy**

by Andy Santoni, *Instrumentation Editor*

□ The bar-graph display promises to become an important component in the engineer's repertoire of front-panel readouts because it combines many of the best features of electromechanical analog meters and electronic digital displays. Like digital readouts, bar graphs don't suffer from overshoot and they don't have complex damping functions that may require the design of external compensating circuitry. They are not sensitive to mounting position, and they offer high resolution and accuracy. Like analog meters, they can be scanned quickly when high-resolution readings are unnecessary, and they display peak or out-of-tolerance conditions more clearly than do digital devices.

Whether they use incandescent lamps, light-emitting diodes, liquid-crystal cells, or gas-discharge columns (see table), bar-graph displays—sometimes called electronic analog meters or light-column readouts—are the best medium for displaying two or more quantities for comparison. For example, one light column might show a variable quantity, and a second column the upper and lower limits. Or a row of bar graphs might indicate the output levels in each channel of a multichannel system so that an operator could determine that all channels are working.

In such applications, light-emitting bar graphs may be better than electromechanical meters because they are easier to see. On the other hand, for some of them, high ambient lighting or reflections may wash out the display. If it is necessary to replace mechanical meters where these conditions exist, reflective liquid-crystal meters avoid the wash-out problem.

When it is necessary to set a control for a maximum meter reading, the electromechanical device may be better because its movement has a higher resolution than the electronic device, even if its scale does not. Electronic bar-graph meters have drawbacks in com-

ELECTRONIC BAR-GRAPH PANEL METERS					
Display type	Light output	Operating voltage (V)	Power consumption (W)	Full-scale response	Typical meter cost per column
Incandescent lamp	Extremely high	28	18 - 30	1.0 s	\$750
Light-emitting diode	High	6	2.5	15 ms	\$130
Reflective liquid crystal	None	5 - 10	< 2	0.5 s	\$100 - 150
Transmissive liquid crystal	Very high	5 - 10	10	0.5 s	\$100 - 150
Gas-discharge (plasma)	High	125 (ac)	15	0.5 s	\$125 - 175

mon with electromechanical meters, too. Parallax may cause reading errors in bar graphs if their scales are not in the same plane as their light columns. In this respect, digital meters hold a clear advantage.

Bar-graph displays share a number of drawbacks with digital readouts, too. Although an electromechanical meter can often be connected directly to a circuit under test to take a voltage or current measurement, digital and bar-graph meters must include some sort of signal-conditioning circuitry. For digital instruments, this circuitry takes the form of an analog-to-digital converter, often a dual-slope integrator. Bar-graph meters must have circuitry of similar complexity to convert an analog input to a form the display can use.

As a result, bar-graph meters may be a great deal more expensive than their mechanical counterparts. They can approach analog meters in cost only when very poor resolution—on the order of 20%—can be tolerated. This resolution may be sufficient for automobile-dashboard displays like fuel-level indicators, where a simple row of five lamps will do the job.

At the opposite end of the performance spectrum, where resolution, accuracy, and reliability must be high—military and aerospace applications, for example—the price of a bar-graph display can be steep. The Avionics division of Canadian Marconi Co., Montreal, makes an incandescent bar-graph display that can cost more than a thousand dollars per bar (Fig. 1).

Using a filament

The Canadian Marconi display has a set of incandescent bulbs that feed light through optical fibers to generate segments of a column. Either 28 or 33 lamps are used, depending on the required resolution.

Since the size of each segment at the end of the light pipes can be different, the bar graph can have different resolutions at different points. For example, the section of the display near which most measurements are made can contain a relatively large number of segments for high resolution, and the section of the display near zero can have relatively poor resolution. While the average resolution of the 33-segment display is only about 3%, resolution and accuracy in the most-used section can be better than 1%.

In addition, the Canadian Marconi readouts include a digital display in the same package as the bar graph. The bar graph can be scanned for a quick reading of the displayed quantity's order of magnitude or color-coded for a clear visual indication of out-of-tolerance or other conditions. The digital meter can be read for a more precise measurement.

These displays are usually purchased in assemblies of six or seven instruments in a package with the necessary conversion circuitry and power supplies. The price for a package that includes two pairs of displays and other circuitry is about \$2,000.

Such a high price can be justified in military-avionics

applications, where high reliability and sturdiness are necessary. The alternative instrument for aircraft cockpits is the servo-driven-tape meter, which is equally expensive and has slow response to changes in input values.

However, Canadian Marconi displays take less than a second to respond to a full-scale change in input, and so are fast enough to meet the demand, and they have the highest light output of all the electronic bar-graph displays and can be read in direct sunlight.

The difficulty of reading light-emitting-diode displays

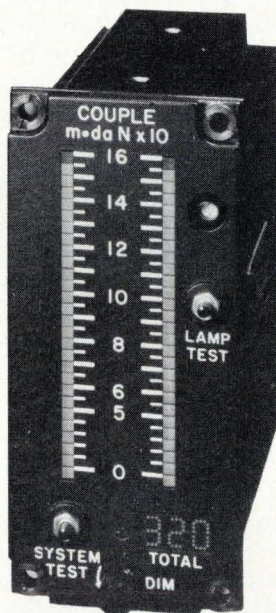

1. **Glowing column.** Incandescent lamps feeding light through optical fibers form a bar-graph display in this meter from Canadian Marconi. Its rugged package and bright display are designed to withstand the environment of aircraft cockpits.

when ambient light is high is the major weakness of LEDs for bar graphs. The AnaLed panel meters from Simpson Electric Co., Chicago, are fine under most conditions, but, like most readouts, cannot easily be seen outdoors or in an airplane cockpit, where light reflected from the display's front surface is high.

A standard left-zero AnaLed panel meter contains 53 light-emitting diodes: 50 for scale graduation, one for overrange, one for underrange or negative input, and one for zero. The zero LED is on whenever power is applied to the instrument.

Turning on LEDs

The LED array is fed by a resistor-ladder network and 52 operational amplifiers, which act as comparators (Fig. 2). The ladder network divides a 5-V reference signal to provide graduated references for each op amp. The input signal is divided by a range-resistor network, filtered if direct current, and amplified to

range from 0 to 5 V. The amplified signal is fed to the second input of each operational amplifier.

The connections to the positive and negative inputs of the string of op amps are alternated, and the wiring to each LED is reversed as necessary to match, so that current drawn from the positive and negative power supplies is balanced. When the signal and reference-voltage inputs to an op amp become equal, the output of the amplifier switches and turns on the LED.

With a 5-V reference voltage, the difference between reference voltages at successive comparators in a standard AnaLed is 100 millivolts. Since the comparators switch from full on to full off within a 2-mV band, an individual LED lights at a voltage within 0.04% of full scale. Adding in the tolerances of the reference resistors, the accuracy at a point on the display is within 0.1%, well within the 2% resolution of the instrument.

The meter is self-contained in that, like an electromechanical meter, it accepts an analog signal and provides a display proportional to the signal's level. It also provides the single greatest advantage of an electro-mechanical meter—trend indication—along with a zero and a full-scale value.

Since there are no inertia-producing mechanical components and no analog-to-digital conversion circuits, the AnaLed's response is virtually instantaneous, and there is no overshoot. There is no time delay between measurement and display, as with digital panel meters. Like digital panel meters, however, the AnaLed requires an external power supply to light the LEDs and drive the other circuitry.

Another approach to building an LED bar-graph display is being used by General Electric Co., Wilmington, Mass., to produce meters bright enough for aircraft-cockpit applications. The devices combine 96-segment light columns with seven-segment digital readouts, all LEDs, in a single package. High apparent brightness is achieved by strobing the LEDs with large peak currents. Constant-current drivers reduce intensity variations between lamps, and pulse-width modulation of the drive current varies display brightness.

Cutting current demand

Where minimum power consumption is required, liquid-crystal displays seem to offer the most attractive alternative. They consume negligible power and can be operated at fairly low voltages. Liquid-crystal displays offer the same advantages in bar-graph format as they do in digital watch displays. Along with low power consumption, LCDs are readable in direct sunlight, especially when used in the reflective mode.

Since LCDs emit no light of their own, some form of backlighting must be used when ambient light is insufficient or if the LCD is used in a transmissive mode. This can detract from their advantage of low power consumption. Another drawback of LCDs is that when the bar-graph segments are scanned or multiplexed to

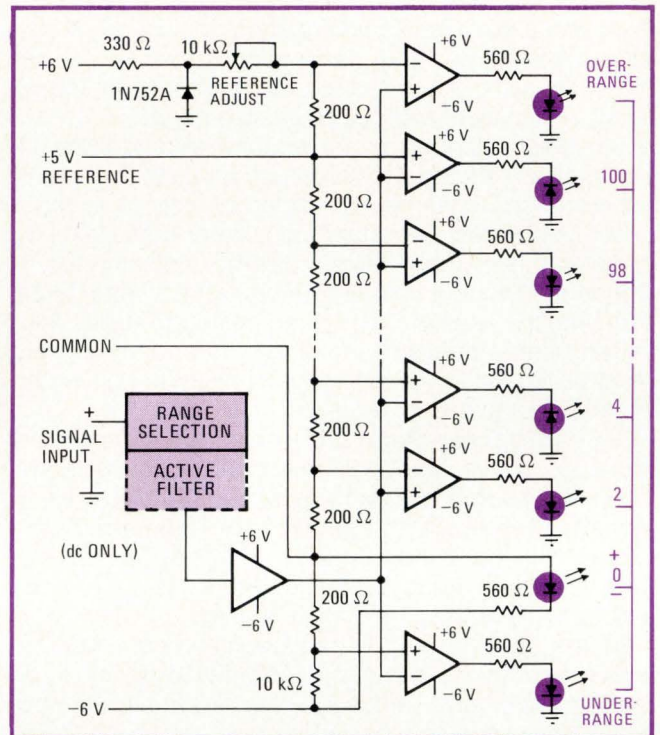

2. Diode row. For a linear display in a row-of-LEDs bar graph, the values of the reference resistors in this Simpson Electric circuit are made equal. For a logarithmic or otherwise nonlinear output, the resistors can be selected for the proper conversion.

cut down on the number of input leads required, voltages often fall between full-on and full-off levels, so readings may not be consistent. North Hills Electronics Inc., Glen Cove, N.Y., gets around this problem by sandwiching two liquid crystal layers [*Electronics*, May 13, 1976, p. 31].

With this technique, the individual bar segments can be addressed as a matrix, yet the voltage applied to the liquid-crystal material is either full on or full off. The display does not operate at half-voltage, a condition that could lead to an unstable display.

North Hills has developed panel meters using two-layer LCDs and is now looking for a manufacturer with the production and marketing facilities to handle a product that must be sold in volume to be competitive.

Firing a plasma

One type of bar-graph display that is already available in high volume and in a variety of configurations (Fig. 3) is the gas-discharge light column. Burroughs Corp.'s Electronic Components division in Plainfield, N.J., supplies gas-discharge bar graphs with either linear or circular scales. The array is made with a ceramic substrate and a glass front plate separated by a spacer (Fig. 4). A segmented pattern of conductive material is screened onto the ceramic substrate to form the cathodes, and transparent anodes are screened on

the glass front plate. The package is evacuated, filled with neon gas, and sealed.

The Burroughs display employs a glow-transfer technique to minimize the number of wires connected to it. In a standard bar-graph package, which contains two columns of 200 segments, addressing each segment independently would require 401 input leads. Instead, the gas-discharge glow is established at a single point, and the glow is then transferred sequentially up the display to the desired segment height.

Stretching the glow

A three-phase clock and a reset-clock signal control the transfer of glow along the panel. To initiate a scan, the glow-establishing, or reset, cathode is first turned on. When the first-phase clock signal turns on, the first cathode, and every third cathode after that, is also turned on. Since glow can only be transferred by one cathode spacing, only the first cathode lights. As soon as the glow is established near the first cathode, the flow of current through the anode current-limiting resistor reduces the anode voltage to a level that is high enough to maintain the glow at this cathode but too low to cause ionization at any other cathode.

The next clock phase turns off the drive to the first cathode and turns on the second cathode. Since the reset cathode is off, ionization cannot occur in this area, but flow from the first cathode can be transferred to the second cathode. The last clock phase transfers glow to the third cathode.

As the clock signals repeat, the cathode buses are sequentially grounded, causing the glow to transfer down the panel. The size of the displayed bar is varied by turning off the anode voltage when the proper height is reached. This is accomplished by driving the anode with the output of a comparator. The inputs to the comparator are the input signal and a ramp whose peak value is proportional to a full-scale indication on the meter. When the ramp is equal to the input voltage, the drive to the display is turned off.

Burroughs Self-Scan panels are also available as complete meters, in a package with drive circuitry and panel-mounting hardware, from the International Instruments division of Sigma Instruments Inc., Orange, Conn. Called Lumigraphs, the dual-bar units can display an input signal in neon orange on one column and a set point for alarm or control in red on the second column. An optional self-annunciator can flash the appropriate bar or combination of bars when an alarm or out-of-range condition occurs. Prices range from \$250 to \$375 in small quantities, and the annunciation option is an additional \$15 to \$25.

A different method for building a gas-discharge bar-graph display is being used by Beckman Information Displays division, Scottsdale, Ariz. The firm has developed and delivered a dc-driven display for avionics applications. A much brighter display is achieved by driv-

ing individual segments with dc voltages, instead of multiplexing the input signal. In addition, brightness can be varied over a 100:1 range. However, the display requires a large number of interconnections.

Now under development at Beckman is a series of gas-discharge readouts that, like Burroughs', use a multiplexing scheme to minimize the number of leads. The units should be on the market this fall.

Another gas-discharge bar-graph display is under development at the National Electronics division of Varian Associates, Geneva, Ill. Operation of the National bar-graph display is similar to that of a shift register. Glow is established at the first segment of the display, then the glow is shifted down the column by a clock signal. When the proper segment has been lighted, the unit moves into a hold mode so that no further shifting takes place.

Either the single segment representing a reading or all segments up to that segment can remain lit, so the display can look like either a pointer or a bar graph. To change a display, either the present reading is erased and a new one is fed in, or the driving circuitry remembers the present reading and shifts the glow up or down the column to a new position. The interface to the light column consists of 20 wires—one for each 10s segment and one for each 1s segment—for a 100-element bar.

National is using the glow-shifting technique in a series of dot-matrix alphanumeric displays, and the bar-graph project is a development effort. The future of this effort is uncertain because National is planning to sell its plasma-display business.

Among the other display technologies that could be

3. Total package. Gas-discharge bar graphs are available as components or complete with driving circuitry, as in this Sigma Instruments panel meter. This package is designed to meet the seismic requirements of the nuclear-power industry.

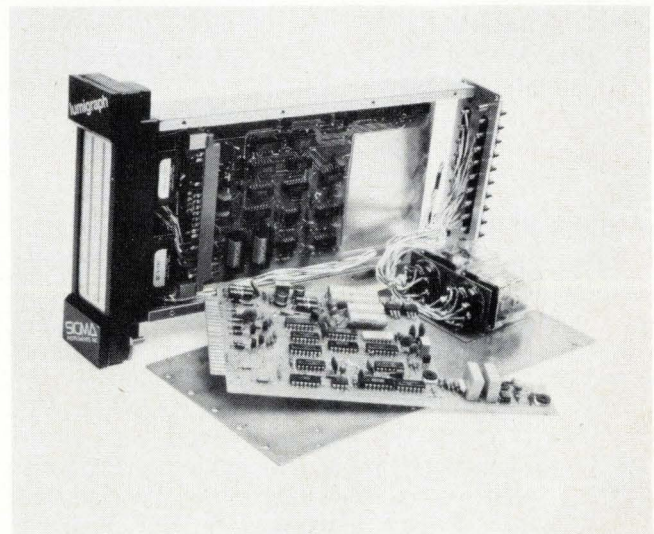

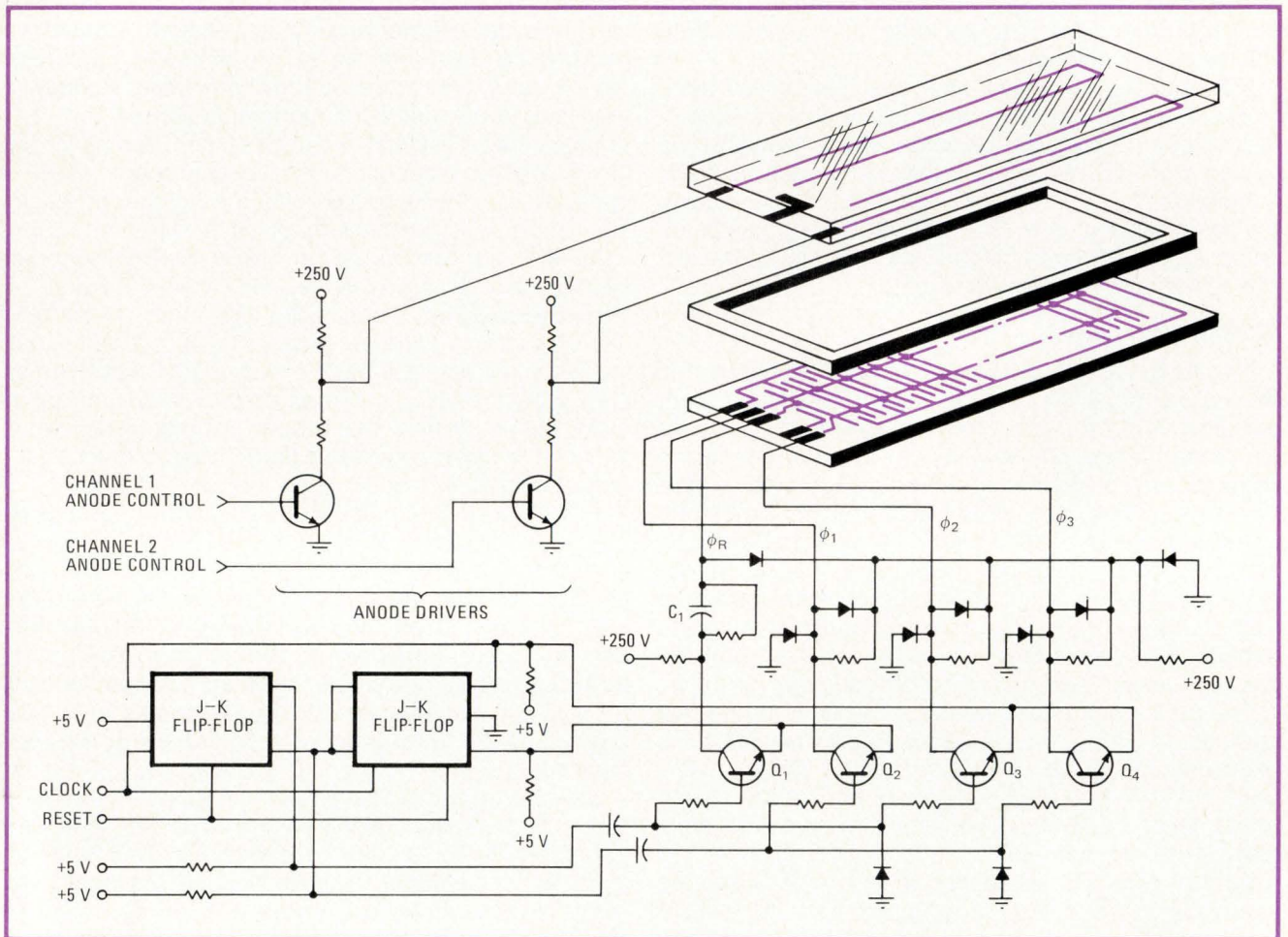

4. Driving. After glow is established above a keep-alive cathode, it can be rapidly transferred to the reset cathode when that cathode is grounded by turning off Q_1 . Glow is then propagated up the bar graph by sequentially grounding $\phi_1, \phi_2, \phi_3, \phi_1, \phi_2$, etc.

applied in bar-graph meters in the future is the electro-luminescent panel. This type of display takes advantage of the light emitted by a phosphor when an electric field is applied to it.

Several laboratories are now developing various types of flat-panel electro-luminescent displays. Earlier efforts resulted in, among other products, a line of seven-segment displays from Sylvania. But widespread use was stymied by short lifetimes.

Displaying the future

The operating lifetime of both ac- and dc-driven electro-luminescent cells, most of which use zinc-sulfide phosphors, has improved significantly in the past few years. The improvements can be traced to changes in phosphor materials and preparative treatments.

Smith Industries Ltd., London, in conjunction with Phosphor Products Ltd., has developed a dc-driven electro-luminescent display for automotive applications. The panel contains both bar-graph and digital displays.

The Smiths displays are based on polycrystalline

copper- and manganese-doped zinc-sulfide powder phosphors. The devices are fabricated on glass substrates on which transparent conductors are coated. The substrate is etched to provide the required light-emission patterns and electrical lead-ins.



The basic yellow color may be externally filtered to provide readily discriminated green and red displays. Light emission, which takes place at the junction of the transparent conducting film and the phosphor layer, is uniform over the entire electrode area. However, individual phosphor particles cannot be resolved with the naked eye.

The electro-luminescent displays cannot yet meet all the demands of the automotive environment—temperature, humidity, vibration, and electrical transients—coupled with the required visual appeal and low cost. But indications are that they will be available in the early 1980s. □

ACKNOWLEDGMENT. Some material for this article was derived from two studies, "Analog Panel Meters" and "Digital Panel Meters" by Lewis I. Solomon and Edward A. Ross of Venture Development Corp., Wellesley, Mass.

In the production of Hybrid IC's... the initial cost of the components is not the determining factor in the total cost of your circuit.

Watch your processing costs... and watch your yields!
Here's a comparison of how the LID compares with the CHIP
for holding down those hidden process costs
and for building up your circuit yields.

	 LIDS	 CHIPS	
1 Are they available in production quantities for a wide range of applications?	YES	YES	From simple logic diodes to monolithic IC's, Amperex has LIDS to fill your needs.
2 Are they available in a wide enough product mix to satisfy your total circuit needs?	YES	YES	Amperex will customize any LID semiconductor types you require... for quick delivery... in any quantity... to supplement their broad line of catalog types.
3 Is the product available fully screened to JAN TX and/or MIL STD 883 requirements?	YES	NO	LIDS are the only true microminiature components available from a manufacturer prescreened to complete JAN TX and/or MIL STD 883 Level B requirements.
4 Do they permit you to guarantee your circuit yields and production costs?... in advance?	YES	NO	LIDS come to you fully characterized, specified and pre-tested for all parameters. You can predict highest circuit yields and quote your customer with confidence.
5 Are they available in matched pairs as standard types?... off-the-shelf?... economically?	YES	NO	The LID is easily matched for a variety of electrical parameters. Closely matched pairs are available right out of the Amperex catalog!
6 Do they eliminate the need for specialized handling equipment?	YES	NO	LIDS are readily positioned on your substrate by hand without costly optical or mechanical equipment.
7 Are they designed for economical production attachment?	YES	NO	The reflow solder technique permits simultaneous bonding of all the LIDS to the substrate. Costly, yield-reducing semiconductor bonding operations are eliminated; labor is greatly reduced.
8 Do they use reliable, low temperature-attachment techniques which prevent parameter drift?	YES	NO	LIDS are bonded to the substrate via low-temperature soldering (200°C for 10 seconds). There is no drift... no change of parameters... no yield loss.
9 Does the finished circuit lend itself to easy reparability?	YES	NO	A LID can be replaced, if necessary, with localized heating without affecting the rest of the circuit, thereby increasing your yield.
10 Which of the two components will make the following formula approach a minimum: $\text{cost of components} + \text{cost of processing} + \text{cost of yield} = \text{total cost of circuit.}$			The LID... obviously! We've shown you why your IC processing costs and yield costs are lower with LIDS... now, pick up your telephone and call our LID Product Manager at 401-P02-9000 and he'll show you how low our LID prices really are today.

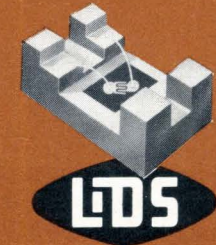

Amperex LIDS are available in production quantities for every sophisticated hybrid IC application. Included are logic diodes (including duals), matched pairs (FETs and bipolar), zener diodes, NPN and PNP general purpose amplifiers and switches, low level amplifiers, logic switching transistors and core drivers and low on-resistance D/A switches.

Applications in which LID semiconductors are currently in wide use include RF and UHF/VHF amplifiers, digital-to-analog converters, low frequency instrumentation amplifiers, logic applications in computer peripheral equipment, active filters, ladder networks, multiplexers and decoders and operational amplifiers.

LID hybrid circuits serve a wide variety of markets including the most severe aerospace and subspace military programs. For details about the programs and applications utilizing LID circuits, contact: LID Product Manager, Amperex Electronic Corporation, Solid State and Active Devices Division, Slatersville, Rhode Island 02876; Telephone: 401-762-9000.

Amperex

TOMORROW'S THINKING IN TODAY'S PRODUCTS

A NORTH AMERICAN PHILIPS COMPANY

Circle 119 on reader service card

Precision sample-and-hold stores voltage for a week

by B. K. Lunde and F. A. Schmidt
Iowa State University, Ames, Iowa

A voltage can be sampled and held for a week or more with at least 99.9% precision by an analog-to-digital converter followed by a digital-to-analog converter. The a-d converter is triggered when the voltage is to be sampled, and its output is used by a d-a converter to set a programable power supply. The supply then continues to furnish that voltage for as long as desired.

This circuit is useful in automating the electrotransport process for purifying metals. In this process, a direct current passes through a metal rod, heating it by internal resistance and producing charge carriers that sweep impurities along with them to one end of the rod. The current necessary to reach a specific temperature is known at the beginning of the run, and the voltage necessary to provide this current should be held for the remainder of the run.

The circuit to do this is shown in the figure. The timer, a spring-driven or motor-driven clock mechanism to control some switches, first connects the current control of the power supply to R_1 , which holds the current at the desired level of 86.5 amperes. An override constant-voltage control is also used to put an upper limit on the output voltage of the supply during this time.

After three minutes, when the sample has reached a stable condition at about 1,600°C, the a-d converter is triggered to read the voltage across the rod. This voltage

is about 3.1 volts for a rod resistance of 0.037 ohm. The signals from the a-d converter are fed into a d-a converter, and, after the conversion is complete, the timer applies the output of the d-a converter to the power supply. This commands the supply to furnish the same voltage it was applying at the time of the trigger. The inverting amplifier is necessary in the system to correct the polarity, because a control voltage of about -2 v is applied to the supply to provide a +3.1-v output. For safety of the sample rod, the timer switches the current control resistor to R_2 , somewhat larger than R_1 , which puts an upper limit on the current supplied.

This program of applying a chosen current and then continuing to furnish the voltage which that current requires is necessary because purification is optimum at a particular temperature. The most accurate automatic way of attaining this temperature is to apply a specified current. The diameter, resistivity, and emissivity of separate samples of metal vary less from one to another than the resistance of the assembly, which includes adaptors and vacuum feed-throughs. It is therefore necessary to specify the current, rather than the voltage, at the start of the purification experiment. However, it is desirable to keep the voltage, rather than the current, constant for the remainder of the run, because, as purification continues, the sample deforms and the resistance rises. If constant current were applied, the increased resistance would cause enough of an increase in power and temperature to melt the metal and end the run prematurely.

The circuit shown holds the voltage across the metal rod constant and equal to that required for a specified current at the beginning of the experiment. This voltage is held for the remainder of the run, about a week, by the digital number stored in the d-a converter. □

Holds the voltage. A-d and d-a converters sample and hold a voltage for a week at a time. Timer triggers a-d converter to measure voltage, and d-a converts it back to analog signal that controls output voltage of power supply. This control signal can be held indefinitely, stored as a precise digital number. Entire process of purifying metal rod is started by timer.

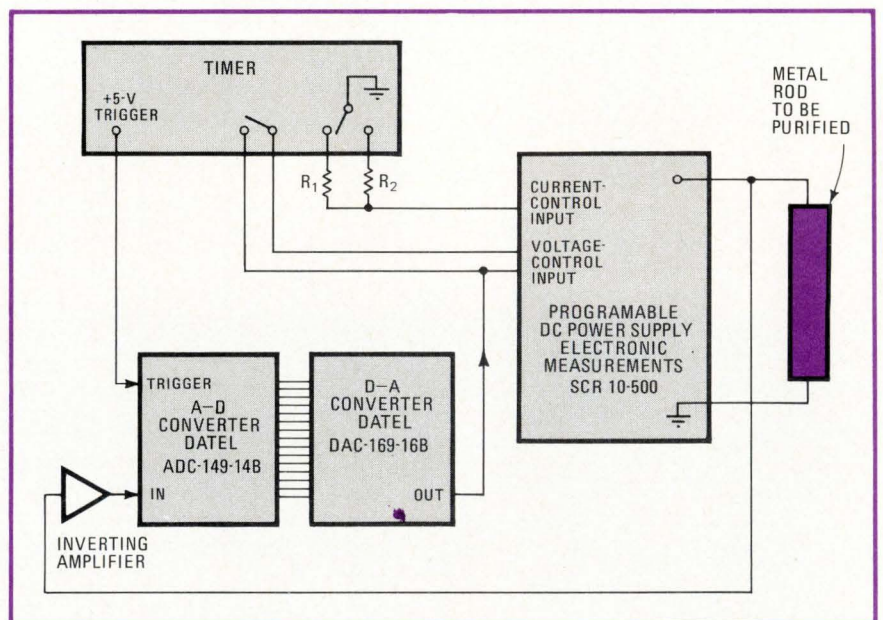

TTL logic tester displays H or L

by Andrzej Gorajek
Polish Radio and TV Research Department, Warsaw, Poland

One of the world's simplest logic testers for integrated circuits can be built of a single transistor-transistor-logic package and a seven-segment light-emitting diode. The setup displays an *H* when the probe of the tester is floating or touching a pin at high logic level. When the probe touches a pin at the low logic level, the LED displays an *L*. As shown in the figure, gates G_1 and G_2 , together with resistors R_1 and R_2 , form a simple voltage monitor that has a trip point of 1.4 volts. Gate G_3 is simply an inverter.

The display section of the tester consists of the common-anode alphanumeric LED and current-limiting resistors R_3 , R_4 , and R_5 . At TTL-voltage levels, the resistors limit the current through each segment to about 10 milliamperes. And since segments e and f are grounded through R_5 , they are always lighted.

When the input voltage at the probe is less than the

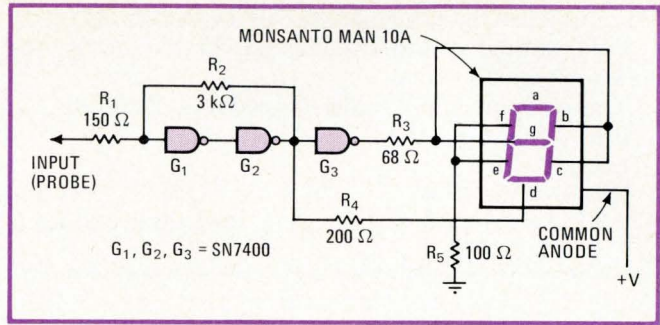

IC logic tester for TTL. Voltage monitor, which indicates whether input voltage is above or below 1.4 volts, displays an *H* or an *L* (for high or low logic-level) respectively. For high-impedance state or floating input, an *H* is displayed.

1.4-v trip point, the output of G_2 is low, and segment d lights up. Then segments d, e, and f are on, and the LED appears as an *L*. When the input level is greater than 1.4 V, the output of G_3 is low. Segments b, c, and g light up and, along with e and f, form an *H*. If the clock signal is applied to the tester, the LED displays a superposition of *L* and *H*—an *H*.

This complete tester can be mounted in a small plastic package, and its power supply can be taken from the circuit under test. □

Quick calculation gives filter-capacitor value

by Jerry J. Norton
LaBarge Electronics, Tulsa, Okla.

The minimum capacitance required for a given amount of ripple from a rectifier/filter power supply can be calculated simply from the expression:

$$\text{Ripple voltage/peak voltage} = T/RC$$

As illustrated in the figure, ripple voltage E_R is the difference between the peak and valley output voltages, ($E_P - E_V$). The ripple period, T , is the inverse of the power-line frequency for a half-wave rectifier, or half that value for the full-wave rectifier shown. Resistance R is the load through which current is being driven.

This short-cut technique for finding C holds to about 25% ripple. It assumes that the charging time for C is small, compared to its discharge time through R , so that T is virtually equal to t_d . In that case:

$$(E_P - E_V)/E_P = E_R/E_P = 1 - \exp(-T/RC)$$

Note that as T/RC approaches zero, the ripple voltage also approaches zero, but especially note that for small values of T/RC , the right-hand side of the equation approaches T/RC .

Therefore the C value for 10% ripple is found by setting T/RC equal to 0.1, and if ripple must be held to 1%, T/RC must equal 0.01. The error from this approx-

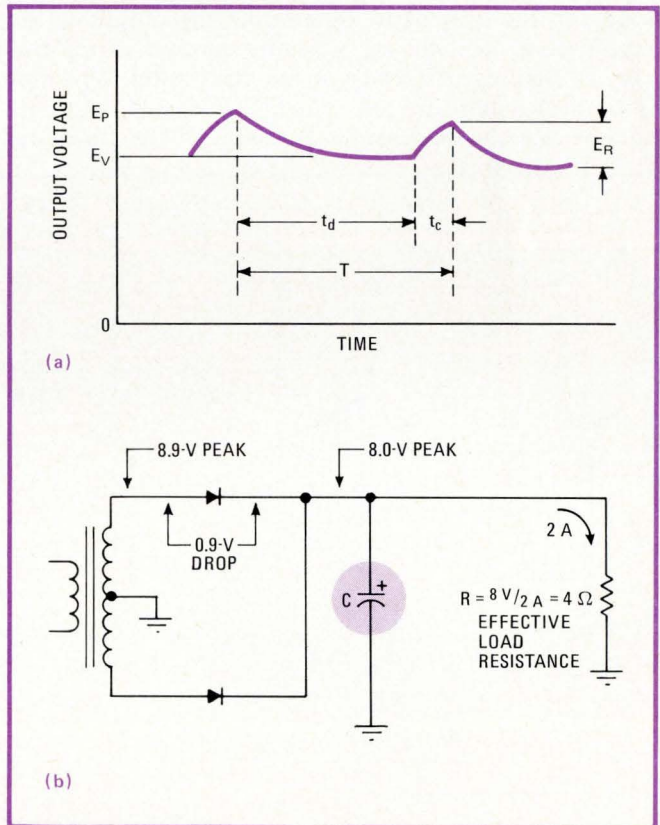

How much C? For a given amount of ripple in output of rectifier/filter power supply, the minimum value of capacitor C is closely approximated by expression $E_R/E_P = T/RC$. Output waveform is shown in (a), and full-wave rectifier circuit is shown in (b). Numerical values are those of example in text.

imation is less than the tolerance in the capacitors used.

For example, consider the circuit shown, and use the following circuit values:

Transformer: 12.6 v center-tapped rms, 50/60 Hz

Peak voltage: 8.9 v

Load: 8 v, 2 A

Diode drop: 0.9 v

Then $E_p = 8.9 - 0.9 = 8.0$ v peak, the load resistance is

$8 \text{ v} / 2 \text{ A} = 4$ ohms, and T is 0.01 second for 50 Hz or 0.00833 s for 60 Hz.

For 1% ripple, $C = T / 0.01R = 250,000$ microfarads, yielding 0.08 v pk-pk ripple. For 10% ripple, $C = T / 0.1R = 25,000 \mu\text{F}$, giving 0.8 v pk-pk ripple.

Allowing slightly more ripple saves considerably on capacitance in the filter, and the regulator can handle that ripple. □

Pre-emphasizer speeds fm-tuner measurements

by M. J. Salvati

Sony Corp. of America, Long Island City, N. Y.

An fm tuner has a nonlinear frequency response because it contains a de-emphasis network to cancel the high-frequency boost added at the transmitter. Performing frequency-response measurements on such tuners is tedious; measured voltage must be recorded and correction factors added at each of the test frequencies to arrive at the "true" frequency response.

The pre-emphasizer circuit shown in Fig. 1 eliminates the extra notation, the need to look up correction factors, and the arithmetic, by altering the output of the modulation oscillator in the same manner as the frequency shaping performed at the transmitter. This unit is connected into the test setup between the audio oscillator and the audio-input terminal of the fm-signal

generator, as shown in Fig. 2. With the pre-emphasizer compensating for the de-emphasis in the tuner, the tuner output should ideally be a constant voltage at all audio-frequencies from 30 hertz up through 15 kilohertz. Any variation from uniform output indicates imperfect frequency response in the tuner.

The pre-emphasizer circuit operates by means of a frequency-selective network in the feedback to the inverting input of a 741 operational amplifier. This configuration allows the network to be identical to the de-emphasis network used in the tuner under test. The 75-microsecond de-emphasis network used in fm tuners in the U.S. is shown installed; a switch can be added to select another network, such as the 50- μs standard used in European receivers, or the National Association of Broadcasters compensation for tape or for phonograph.

Battery operation (with economical 9-volt transistor-radio batteries) makes the unit independent and eliminates the possibility of ground-loop-induced hum in the measurement system. □

Engineer's notebook is a regular feature in Electronics. We invite readers to submit original design shortcuts, calculation aids, measurement and test techniques, and other ideas for saving engineering time or cost. We'll pay \$50 for each item published.

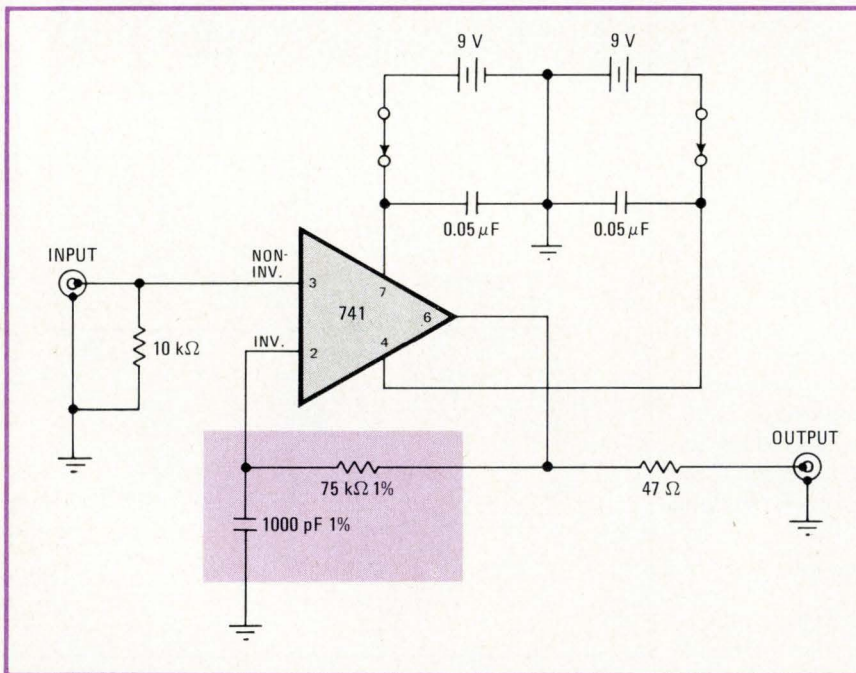

1. Pre-emphasizer. Feedback network to inverting input of op amp has same frequency characteristic as the de-emphasizer in fm tuner; this results in a frequency response alteration complementary to that of the tuner. Circuit shown here has the 75- μs network that is standard in American fm broadcasting.

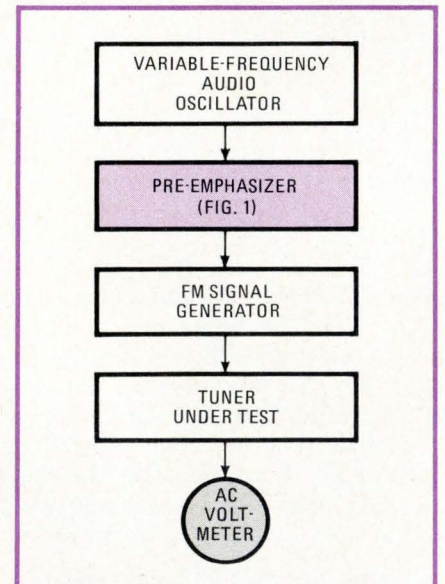

2. Flat-out testing. With pre-emphasizer that uses same frequency-selective network as tuner, this test circuit gives a flat audio output for a good tuner. The pre-emphasizer could be put between the tuner and the volt-meter, but the arrangement shown gives a better signal-to-noise ratio.

Motorola Sets The B-Series CMOS Data Book STANDARD.

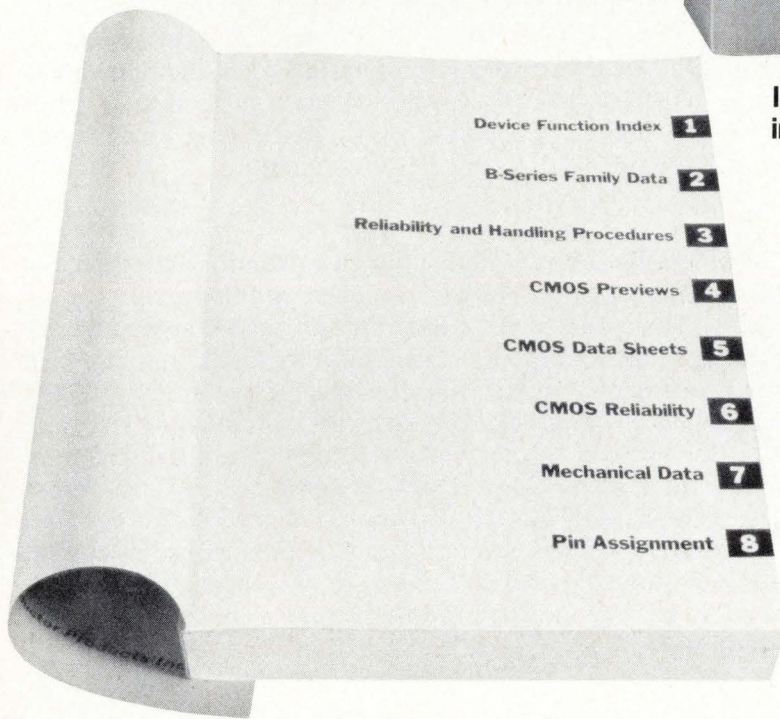
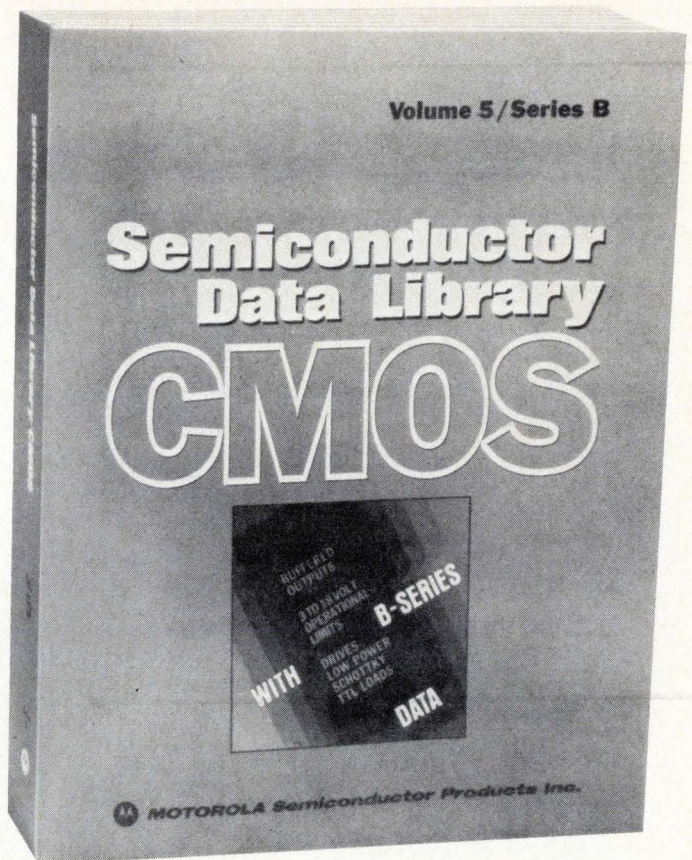

Industry B-Specs in Brand New All-CMOS 575-Page Volume

Written with the very latest industry-wide B-Series CMOS specifications formulated under JEDEC cognizance, and in easiest-to-use format, this is destined to overnight become *the* authoritative data book on CMOS integrated circuits.

The book covers over 100 parts in the new Motorola B Series, representing the broadest line of presently available B Series CMOS in SSI, MSI and LSI complexities. It also features CMOS LSI circuits.

That's design flexibility. And it's all yours in one easy-to-use reference work.

The book has just come off the presses, so your authorized Motorola distributor will have initial stock within 10 days. Call him now to reserve your \$2.50 copy for immediate delivery, or send your check to: Motorola Semiconductor Products Inc., P.O. Box 20912, Phoenix, AZ 85036. We'll have a copy in the mail to you within 24 hours of availability.



MOTOROLA Semiconductors
— CMOS reliability at its best

Engineer's newsletter

More programmers joining semiconductor company payrolls

One little-noted aspect of the microprocessor's impact on the electronics industry is how it is shifting job patterns. By now, although hard data is difficult to obtain, the feeling is that the **semiconductor industry is hiring new programmers and software designers at a higher monthly rate than the computer industry itself.** This is making software design the fastest-growing new discipline in the semiconductor industry. Now totaling less than 10% of the professionals working at semiconductor companies, this percentage could reach well over 30% in two years—that's several thousand employees. Experienced computer specialists, suddenly finding new and lucrative outlets for their services, have been jumping over to semiconductors in ever increasing numbers and loving the freewheeling environment. Right now, the semiconductor industry is playing catch up to the computer industry in software sophistication. More speculatively, if the trend continues, the semiconductor industry may replace the computer industry as the major force in reducing software costs for the designers of computer-based systems.

Lost and found: the SR-52 calculator has 30 extra registers

To the surprise of Texas Instruments designers, the SR-52 programmable calculator has some 30 addressable data registers—not just two. Credit for the discovery goes to Philip R. Geffe, a senior engineer at Lynch Communications Systems Inc., Reno, Nev., who says **locations 70 through 99 can all be used for storing information when the machine is in its calculator mode.** (In *Electronics*, June 24, p. 122, William S. Morgan of LeTourneau College, Longview Texas, noted only locations 98 and 99.) Texas Instruments has verified Geffe's claim.

Why plastic ICs should visit a sauna

A big enemy of plastic ICs is water vapor, which may penetrate the package and corrode the chip's metalization. The problem is that existing permeability tests, besides being difficult and time-consuming, are practically useless at high temperatures because mercury vapor is used in the measuring element. A better test measures permeability directly. Developed at Allied Chemical Corp.'s speciality chemical division in Toledo, Ohio, this test can be carried out at almost any temperature, reaches equilibrium in just 1 hour, and works on almost any thickness of material. It's simple, too. The plastic sample is placed in a cell and degassed with a nitrogen purge. Water vapor is then introduced and, with the aid of a thermal conductivity sensor connected to a potentiometer recorder, **the rate at which the water vapor passes through the sample is determined.**

LED has enough leeway to handle 120-V ac peak

Elliot S. Simons, Polaroid Corp., Cambridge, Mass., takes exception to an Engineer's Newsletter item [*Electronics*, June 10, p. 132] in which Alan R. Miller says you can connect a light-emitting diode directly to a 120-volt ac line if you put a capacitor in series with the LED. Says Simons: "If the switch is turned on when the ac voltage is near its peak, the uncharged capacitor will pass a high current through the diode and probably burn it out." Logical as Simons' objection sounds, **Miller is standing firmly by his idea—"I've yet to experience a burnout," he reports.**
—Laurence Altman

Are you using your \$20,000 mainframe set-up wisely? If you're using it to sweep anywhere in the 1 MHz to 1.4 GHz range, then you know it's only doing a fraction of the job you bought it for.

But think about this: if you used a Wavetek Model 2001 Sweep/Signal Generator instead of a plug-in to work below S-Band, your mainframe would be free for other high frequency testing at the same time.

Besides its range of 1 MHz to 1.4 GHz,

the Model 2001 has an output of 10mW that's flat to within 0.5dB. This solid-state designed unit features excellent linearity and low spurious content. Plus, the 2001 is programmable—with remote control of center frequency, bandwidth and output level over the 20dB range of its PIN diode attenuator. Not to mention its start/stop mode of operation, (in addition to Δf), or its flexible birdy by-pass marker system.

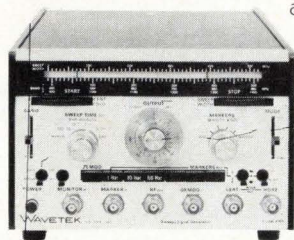

Now let's get down to prices. An equivalent low-frequency sweep plug-in will run you at least \$2,200. And it'll tie up your mainframe while you're using it.

On the other hand, you can get a Model 2001 for just \$1,850.* And untie your mainframe at the same time. It's like having your cake and eating it, too. WAVETEK Indiana, Inc. P.O. Box 190, Beech Grove, Indiana 46107 Phone (317) 783-3221 TWX 810-341-3226

*US domestic price only.

WAVETEK®

Circle 125 on reader service card

Don't tie up your microwave mainframe.

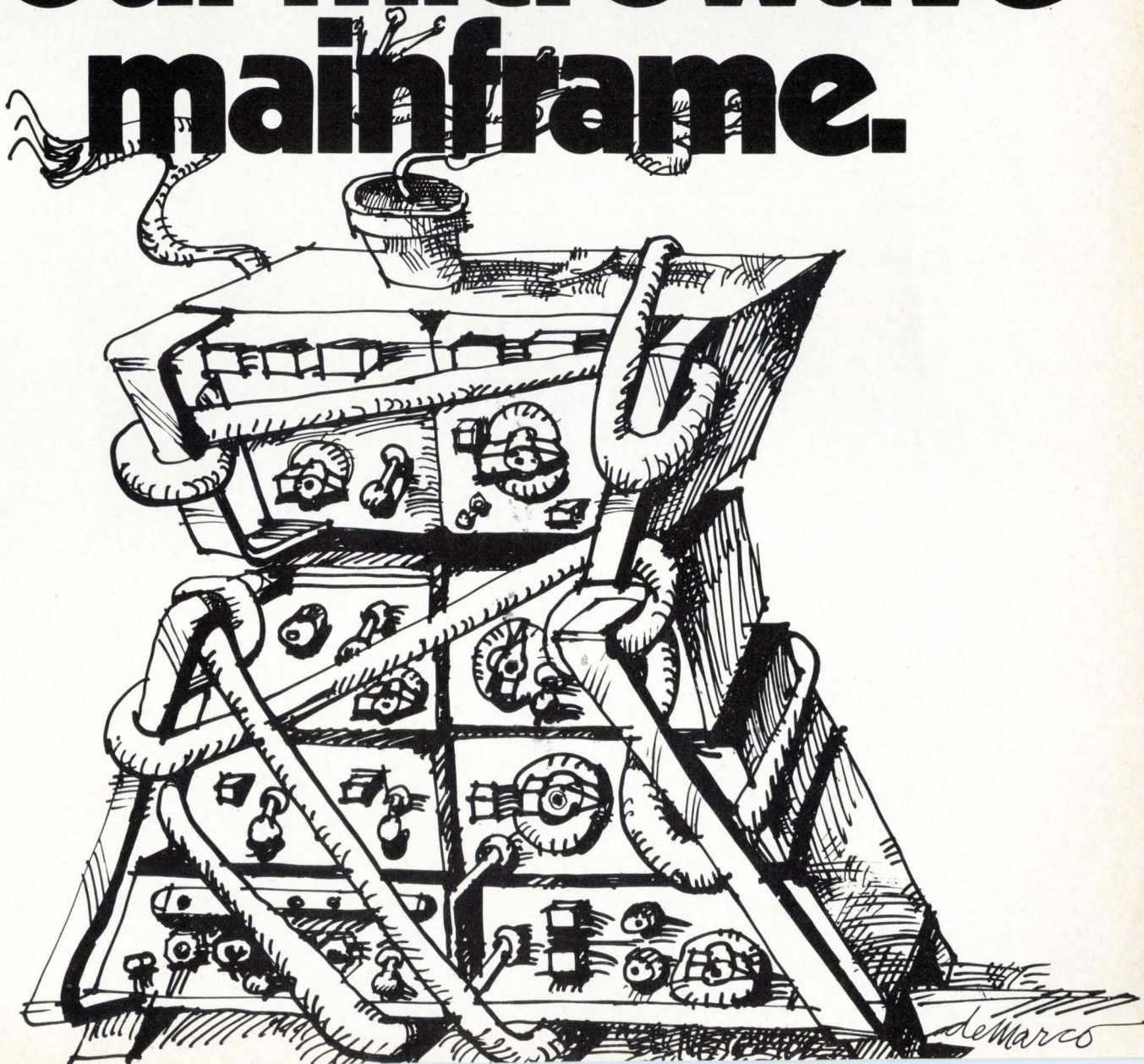

Bipolar bit slices advance fast

High-performance devices are finding new applications in process-control equipment, as well as in minicomputers, memories

by Bernard Cole, San Francisco bureau manager

Although most attention in the microprocessor world has been focused on the burgeoning MOS families, an upsurge of activity has been going on among the higher-performing bipolar bit-slice entries. Fueled by an increased demand for these products in process-control equipment, as well as continuing interest in the more traditional minicomputer and memory-control applications, suppliers have been moving fast with development and marketing of bipolar bit slices.

Also, after two years or so of focusing their efforts on building bipolar large-scale-integrated building blocks for computers, 2- and 4-bit-slice makers such as Signetics,

Monolithic Memories, Intel, Advanced Micro Devices, and Fairchild are beginning to see a much larger market for high-speed, 150- to 250-nanosecond machine/machine interface controllers consisting of a central-processing element and a microprogrammed sequencer/controller, or just a sequencer/controller and read-only-memory combination.

According to Clive Ghest, applications and system manager at Monolithic Memories, perhaps as much as 60% of the bipolar-processor market (estimated at \$6 million in 1976 and growing at 100% a year) is going into the controllers, rather than the traditional minicomputers.

"And this percentage will increase in the future," he says, "as more emphasis is placed on smart peripherals and distributed control."

Just as stripped-down, 2- to 20-microsecond MOS processors are aimed at replacing electromechanical devices—as well as microcomputer systems with the over-powerful 8080 and 6800 (used because nothing else was available)—so too are the 150- to 250-nanosecond bipolar slice/sequencer combinations aimed at replacing systems containing three or four boards of standard small-scale-integrated or medium-scale-integrated TTL and minicomputers used as controllers. Of the \$450 million a year transistor-transistor-logic market, as much as 80% is ripe for replacement by minimum-chip 2- and 4-bit slice/sequencer systems.

Manufacturers already in the market are Intel, with the 3001 microprogram-control unit (MCU), part of its 2-bit bipolar slice family; Advanced Micro Devices, with its 2909 microprogram sequencer, part of its 2900 4-bit-slice family; and Signetics, with its second-sourced version of the 3001. The 40-pin 3001 MCUs from Signetics and Intel are both built with a Schottky TTL process and feature about a 45-nanosecond cycle time and an addressability of 512 microinstructions. In addition to working with central-processor elements in such computer-oriented applications as pipelined look-ahead-carry controller processors, ripple-carry processors, and multiprocessor systems, the 3001 is designed to work as a high-speed controller in a stand-alone ROM-MCU combination that sequences at rates

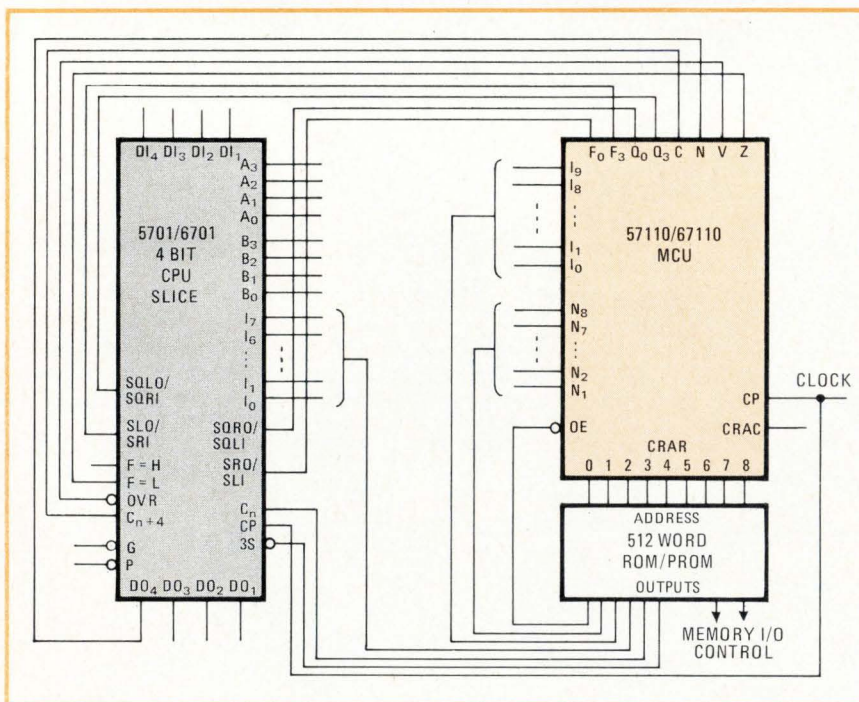

Typical setup. Monolithic Memories' 57110/67110 microprogram controller/sequencer in typical high-speed-controller configuration is hooked up to 4-bit CPU slice.

that go as high as 10 megahertz.

The AMD2909 is a cascable 4-bit slice-oriented sequencer in which two devices allow addressing of up to 256 words of microprogram and three devices allow addressing of up to 4,096 words. The device contains a four-input multiplexer that is used to select the instruction register, branch input, microprogram counter, or file as the source of the next microinstruction address.

New devices. New sequencer/controller devices, from Signetics, Monolithic Memories, and Fairchild—with high-speed controller applications in mind—have been designed as more general-purpose machines, capable of working with either 2- or 4-bit slices, and with any slice family.

Signetics' new 8X02 control store sequencer, for example, is designed as a replacement for the 3001. In addition to most of the features of the 3001—such as a 9-bit microprogram-address register, 4-bit program latch, two flag registers, 11 address-control functions, and eight flag-control functions—the 28-pin low-power Schottky device has twice the addressing range (1,024 microinstructions) and will also incorporate a four-level stack. In addition, it will work with the 4-bit-slice 2900 family.

Fixed instructions. The new 57110/67110 microprogram controller from Monolithic Memories is a good example of another trend in the bipolar-slice world—fixed instruction sets. The 40-pin controller, says Ghest, consists of a microprogram sequencer capable of addressing 512-word pages of memory and having subroutine capability, a loop counter used for repeating loops of microcode, again with subroutine capability, all the branch logic required in a bit-slice system, and shifting logic connections to provide shifting options for bit slices.

But it's the set of eight instructions that makes the 57110/67110 so powerful, because these instructions allow continued, conditional, and unconditional jumps, subroutine jumps and subroutine return, and a special subroutine jump that allows

any piece of existing code to be used as a subroutine. A unique branching system, based upon controlling the least significant bit of the address register directly from the branch condition logic, allows two-way branching at each clock period and four-way branching in conjunction with the loop counter. The controller, says Ghest, can be used with all the conventional bit slices as well as its own 6701 4-bit slice and a faster version called the 6701.

Fairchild is expected to bring its bipolar Macrologic family into the mainstream of the bit-slice world with the selective use of integrated injection logic. The first of these is a microprogram sequencer—the 9408—a 40-pin device with a 10-bit address that can directly address control memories with microprograms of up to 1,024 words. In addition, it has a fixed repertoire of 16 instructions—four unconditional branches, eight conditional, a fetch, and a return from subroutine. The sequencer can be operated in a pipeline or non-pipeline mode, has a four-instruction input and push-down/pop-up stack, allowing nesting of subroutines up to four levels.

With conventional I^2L , it has been difficult to achieve speed performances better than 20 ns per gate. However, combining this logic with Fairchild's Isoplanar oxide-isolation technique, has yielded a device with a 4-ns gate delay. The result is that the 9408 has about a 60-ns cycle time.

The price in quantities of 100 for commercial versions is \$55 each for the Monolithic Memories 67110; \$23.30 for the Intel 3001; \$31.50 for the Signetics 8X02; and \$12 for AMD's 2909. Prices have not been set on Fairchild's 9408, but samples are available.

Advanced Micro Devices Inc., 901 Thompson Pl., Sunnyvale, Calif. 94086 [344]
Fairchild Camera and Instrument Corp., 464 Ellis St., Mountain View, Calif. 94042 [345]
Intel Corp., 3065 Bowers Ave., Santa Clara, Calif. 95051 [346]

Monolithic Memories Inc., 1165 E. Arques Ave., Sunnyvale, Calif. 94086 [347]
Signetics Corp., 811 E. Arques Ave., Sunnyvale, Calif. 94086 [348]

COIL-LER

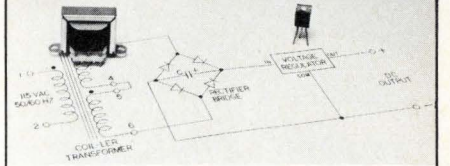

STOCK P.C. POWER TRANSFORMERS

- For use with 3-terminal IC voltage regulators
 - Printed circuit mounting
 - For power supplies for most integrated circuit families
- TTL LOGIC ECL LOGIC
CMOS LINEAR—OP AMPS
- 36 models in stock

Write or phone for complete data sheet.

CUSTOM TRANSFORMERS, COILS, TOROIDS

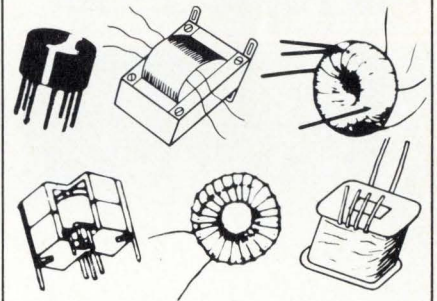

Our precision manufacturing facility produces a full range of medium, miniature or ultra-miniature size transformers and coils — bobbin or toroidal wound. We can meet both your specs and your delivery dates whether for prototype, small or large productions runs. Our experienced engineers are at your service.

Write or phone for information or quotes.

COIL-LER MANUFACTURING, INC.

2-E Town Line Circle Rochester, N.Y. 14623
716/442-6630
Representatives in Principal Cities

INTRODUCING A NEW
REVOLUTIONARY
 MULTI-DIGIT
 SOLID STATE READOUT

BELOW \$1.

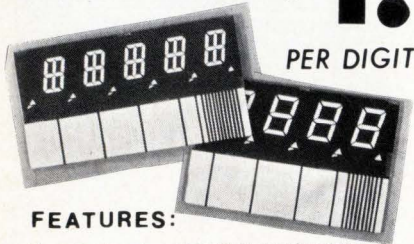

FEATURES:

- Non-fatiguing ELECTROLUMINESCENT light
- Space saving thin profile
- Wired for multiplexing
- Low a.c. power consumption
- Compatible with IC logic decoders and segment drivers
- Rugged, pluggable laminated plastic construction

SPECIAL TRIAL OFFER

ORDER FROM STOCK at **97¢** per digit, any of the following multi-digit readouts having 2 to 5 digits:
 1/2" high with 9-segments
 0.6" high with 7-segments
 (minimum order--\$10.)



T.L. ROBINSON CO., INC.
 P.O. BOX D, EAST AURORA, N.Y. 14052
 TEL. (716) 652-2111 TELEX: 91566

Circle 128 on reader service card

MICRO68
 Microprocessor

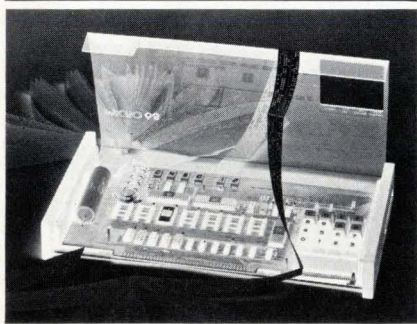

The MICRO-68 is a completely assembled computer, for only \$430. Built around the Motorola/AMI/Hitachi 6800 microprocessor, MICRO-68 has its own integral power supply, 16 button keyboard, six digit LED display, and 128 words of RAM. The 512 word MON-1 PROM contains the service routines necessary to load programs, inspect and edit, insert break points for debugging, and execute. Memory expansion to 64K and full I/O can be obtained with convenient edge connectors.

The MICRO-68 can be expanded with a complete line of EPA peripherals, resulting in the power to accomplish the most demanding applications.

EPA Electronic Product Associates, Inc.

1157 Vega St., San Diego, CA 92110
 (714) 276-8911

128 Circle 191 on reader service card

New products

Microprocessors

8080 emerges as top device

8-bit microprocessor is supported by wide variety of hardware and software

During the past year, the Intel-originated 8080 family of microprocessors has clearly emerged as the dominant device—both in the numbers of major semiconductor manufacturers acting as alternate sources and in the amount of hardware, software, and support equipment built around it. Among the most recent 8080-oriented products are a programable read-only-memory simulator, a micro-computer with multiprocessing capability, three other microcomputers, two power supplies, another alternate source for the 8080 family, and a transient suppressor for use with any microprocessor.

PROM simulator. Capable of simulating two programable read-only memories as large as 1,024 bytes by 8 bits, the MM80-211 is offered as an option to Ramtek's MM80—an 8080 microprocessor in-circuit



emulator. The simulator, which is simply a memory extension for the MM80, "eliminates the need for stockpiling expensive PROMs and gives the designer much faster turn-around time," claims Ramtek product manager Larry Krummel. In use, the PROM (or ROM) being simulated is replaced by a cable and plug from the simulator. The operator has front-panel controls for selecting true/complement data and write

protection. A self-contained power supply keeps the memory from losing its contents when either the MM80 or the user system is turned off. For increased capacity, multiple units can simply be daisy-chained.

Multiprocessor. As many as six processors can be connected to a single shared memory block (or several noncontiguous memory blocks) of an IMSAI 8080 computer by means of an inexpensive set of hardware introduced by IMS Associates. The hardware consists of a bus-multiplexing board (priced at \$399 assembled or \$325 unassembled), a timing and control board (\$305 assembled or \$225 in kit form), and a bus-extension board, one of which is required for each processor, at \$65. The total memory allowed each processor is 64 kilobytes minus the amount of the shared-memory block. With the IMSAI multiprocessing technique, each processor can operate either independently or on a shared basis with one or more peripherals. Since the basic IMSAI 8080 computer sells for \$931 assembled or \$599 unassembled, a complete multiprocessor system for such complex applications as high-speed telemetry-data acquisition, reformatting, and timesharing with simultaneous batch processing can cost as little as \$2,000.

Microcomputer for control. The MC80 Micro Controller, intended for applications in process control, instrumentation, and communications, is contained on a single card and has a capacity of 256 words of random-access memory (expandable to 512 words) and 2 kilobytes

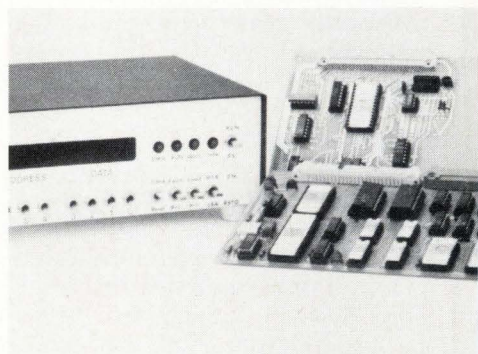

Step up DC-to-DC converter

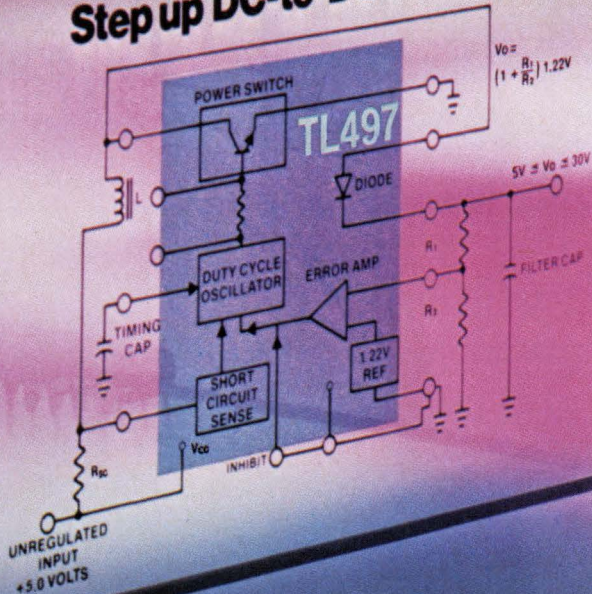

Inverting DC-to-DC converter

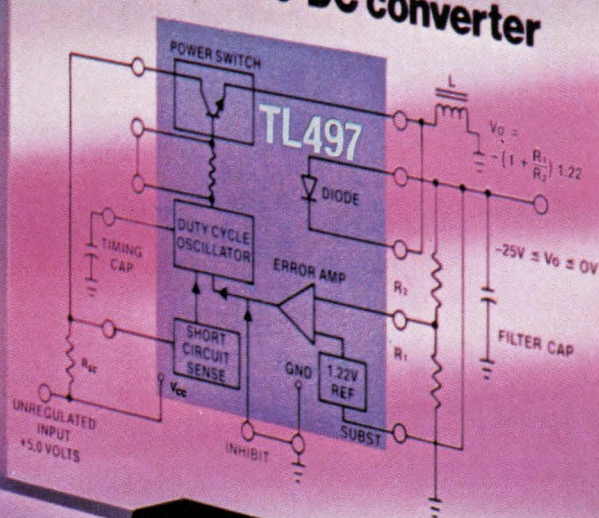

LINEAR IC'S

Introducing TI's innovative one-chip switching regulator

The primary components for a switching voltage regulator are now yours on a single chip. In TI's new TL497. It combines adjustable output voltage with high efficiency. Conserves space. Saves money — only \$2.18 in lots of 100.

- Can be wired as a step up, step down, or inverting converter (see illustration above).
- Switching currents to 500 mA.
- 35V maximum output voltage.
- Provides typical line regulation of 0.2% and typical load regulation of 0.4%.

The TL497 greatly simplifies the addition of a microprocessor or MOS memory to a TTL p.c. board. Two

TL497s will generate the required +12V and -5V supplies on the board.

New, low-cost shunt regulator
Cost is now no barrier to using temperature-compensated

references in such applications as TV varactor tuning systems, digital voltmeters, counters, and power supplies. TI's new TL430 adjustable shunt regulator — in three-lead TO-92 plastic package — costs only \$0.68 in 1K quantities.

Output is adjustable from 3.0 to 30V. Current range is 600 μ A to 100 mA. Dynamic impedance is typically less than 1.5 ohms.

For more details on these economical, self-contained, integrated regulators, clip and return the coupon below.

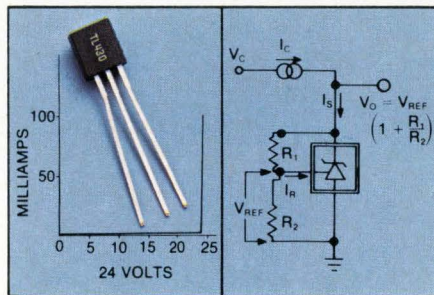

TI 7800/7900 series fixed voltage regulators AVAILABLE NOW

POSITIVE OUTPUT VOLTAGE	1 A (TO-220)	500 mA (TO-220)	100 mA (TO-220)	NEGATIVE OUTPUT VOLTAGE	1 A (TO-220)	500 mA (TO-220)
2.5			78L02			
5	7805	78M05	78L05	5	7905	79M05
6	7806	78M06	78L06	6	7906	79M06
			(6.2V)			
8	7808	78M08	78L08	8	7908	79M08
12	7812	78M12	78L12	12	7912	79M12
15	7815	78M15	78L15	15	7915	79M15
18	7818			18	7918	
20		78M20		20		79M20
24	7824	78M24		24	7924	79M24

Texas Instruments
P. O. Box 5012, M/S 964
Dallas, Texas 75222

E722

Please send me information on the following:

- | | |
|---|---|
| <input type="checkbox"/> TL497 Switching Regulator | <input type="checkbox"/> TL600 Series Analog Switches |
| <input type="checkbox"/> TL430 Adjustable Shunt Regulator | <input type="checkbox"/> TL089 Chopper Op Amp |
| <input type="checkbox"/> 7800/7900 Series Regulators | <input type="checkbox"/> RC 4558 Op Amp |
| <input type="checkbox"/> 78M/79M Series Regulators | <input type="checkbox"/> RC 4136 Op Amp |
| <input type="checkbox"/> 78L Series Regulators | <input type="checkbox"/> LF 155 Op Amp Series |
| <input type="checkbox"/> New TI Linear Catalog to be published Summer, 1976 | |

NAME _____ TITLE _____

COMPANY _____

ADDRESS _____

CITY _____ STATE _____ ZIP _____

The only thing more reliable than these solid state sensors is the company behind them.

MAGNETICALLY OPERATED 103 SR MONITORS AND CONTROLS OPERATION OF CONVEYOR SYSTEMS IN REMOTE AREAS.

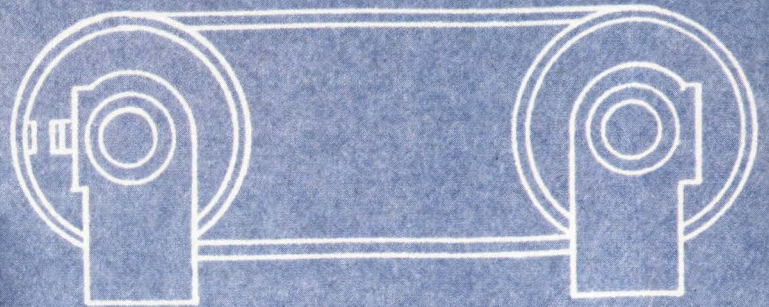

THE XK PROXIMITY SENSOR IN COMPUTER TAPE TRANSPORTS REVERSES TAPE REELS BY SENSING FERROUS FOIL AT END OF TAPE.

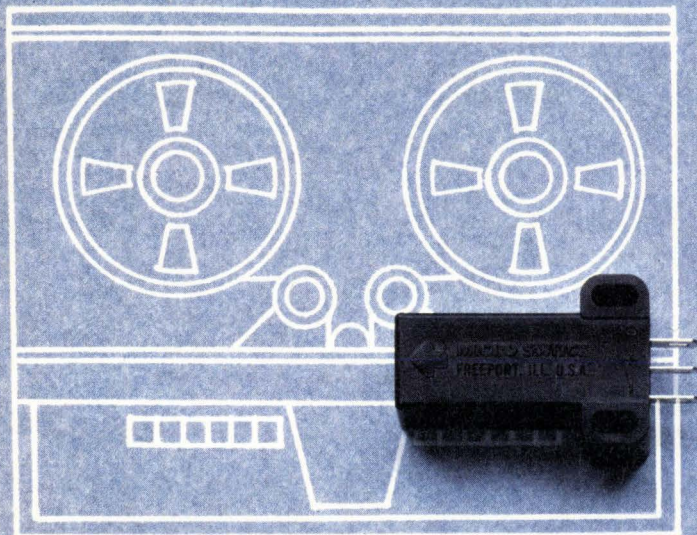

VANE OPERATED AV POSITION SENSOR INSURES THAT ELECTRONIC SEWING MACHINES WILL REMAIN IN THE SELECTED MODE.

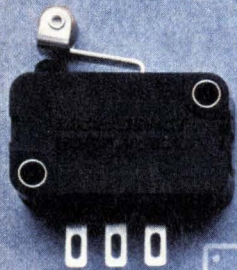
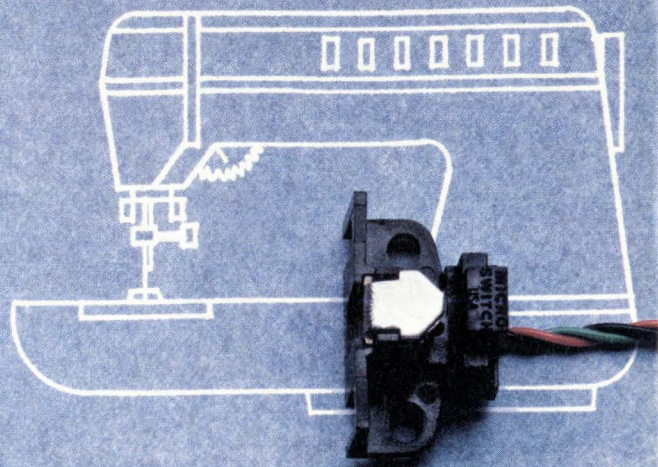

XL MECHANICALLY OPERATED SOLID STATE SWITCH USED IN MANY LIMITING FUNCTIONS ON COMPUTER PRINTERS AS IN THE CARRIAGE RETURN, PAPER SUPPLY, ETC.

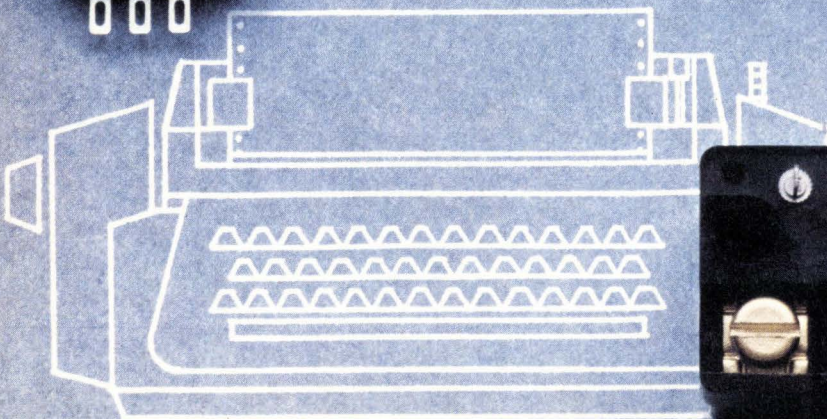

ES HALL EFFECT CURRENT SENSORS USED IN PRINTERS TO PREVENT CURRENT SURGE FROM DAMAGING EQUIPMENT.

New products

Who knows more about solid state switching technology than the company that pioneered the solid state keyboard in 1968?

That's why so many designers want the MICRO SWITCH name on their solid state sensors.

MICRO SWITCH makes a wide variety of maintenance-free solid state sensors. Proximity sensors. Current sensors. Mechanically and vane operated sensors.

Choose between 5 VDC or 16 VDC with a built-in voltage regulator. All offer zero speed operation with some up to 100 Chz. And all offer broad temperature operating ranges of -40° to +150°C. Each one is ruggedly constructed for long life. The Hall effect IC has been performance-tested through billions of operations without failure.

And what MICRO SWITCH solid state sensors don't do is just as important as what they do. There's "no touch" operation. There's no contact bounce. Most are unaffected by dust and dirt.

You'll find them in everything from medical to computer equipment. From tachometers to home appliances. But that's only natural.

MICRO SWITCH has been a leader in its field since we introduced the first snap-action switch in 1932. We've established a reputation for dependability, not only in our products, but in our service. But don't take our word for it. Just ask someone who's used a MICRO SWITCH product.

If you believe there's more reliability than solid state construction, choose MICRO SWITCH. You'll get all the advantages of solid state design, and all the advantages of MICRO SWITCH technology and experience.

For more information, call our nearest MICRO SWITCH Branch Office or Authorized Distributor.

MICRO SWITCH

FREEPORT, ILLINOIS 61032

DIVISION OF HONEYWELL

MICRO SWITCH products are available worldwide through Honeywell International.

Circle 192 for Data;
131 for Salesman call.

of PROM. Other significant features are buffered address and data lines, two 8-bit parallel input/output ports, a crystal clock for the easy generation of standard baud rates, and a 488-nanosecond cycle time. Manufactured by Gnat Computers, the MC80 is supported by a power-supply board and a communications-control board. The unit sells for \$189, and delivery time is 30 days.

Microcomputer for design. The MiniMicro Designer from E&L Instruments is aimed at both engineering and educational users who may

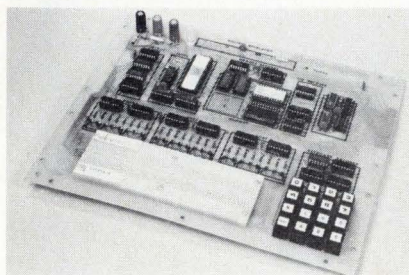

have no microcomputer experience. The microcomputer has a keyboard for data entry and a solderless breadboarding area. The system, which is expandable to the full capability of the 8080, is backed by three modules of self-paced text and experiments plus more than 500 pages of experimental text in E&L's Bugbook III. Prices start at \$125; delivery is from stock.

Programed Logic System. Supplied with 1 kilobyte of random-access memory, sockets for 4 kilobytes of read-only memory, an interrupt in-

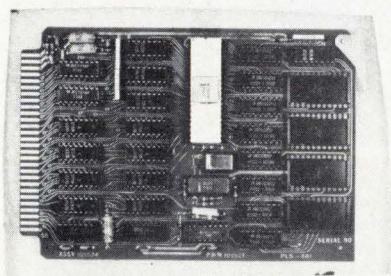

put, a crystal clock, two 8-bit TTL input ports, and three 8-bit TTL output ports, the PLS-881 Programed Logic

System is well suited for a wide variety of dedicated control applications. The entire 8080A-based microcomputer is mounted on a single card that measures 4.5 by 6.5 inches. The card has a 56-pin edge connector with the pins located on 0.125-inch centers. The PLS-881 sells for \$350, dropping to \$190 each in quantities in excess of 500. As with all Pro-Log modules, after purchasing 250 PLS-881 cards, the customer receives a complete set of free manufacturing plans, allowing him to build the system in-house. The cards are available from stock.

Open-frame power supply. Designed for small 8080 microcomputer systems, Alpha Power's model 1CMP power supply is a triple-output unit that delivers +5 v at 1 ampere, +12 v at 0.25 A, and -5 v at 0.4 A. All outputs have current-foldback protection against excessive loading, and the +5-v output also has over-voltage protection, which is set at 6.8 v \pm 7%. The supply operates from 105-125/210-250-v ac lines at any frequency from 47 to 63 hertz. The price is \$39.95 in singles, dropping to \$31.96 in lots of 100.

Modular power supplies. Two line-operated power supplies designed for powering 8080 microprocessors



and several popular families of random-access memory are being marketed by Semiconductor Circuits Inc. Delivering short-circuit-protected outputs of +12 v at 300 milliamperes and -5 v at 200 mA with 0.2% line and load regulation, the supplies are electrically identical, but differ in their mechanical con-

New products

figuration. The model LCD5808 is constructed for mounting on a printed-circuit board, while the CM5808 is for chassis mounting. In unit quantities, the CM5808 sells for \$64.95, and the LCD5808 is priced at \$58.95. Overvoltage protection adds \$7 to the price of either unit. For three to nine units the prices

drop to \$48.50, \$45, and \$6.50, respectively. Delivery time is from stock to two weeks.

Alternate source. The latest alternate source for the 8080 family of integrated circuits is National Semiconductor. The National unit, which is called the INS8080A, is a direct

replacement for Intel's 8080A device. "One of the factors that distinguish National from other manufacturers of the 8080A is our commitment to build all of the most popular support circuits in the family," states Bill Baker, director of the company's microprocessor group. Right now, 23 members of the 8080A family are available from stock in sample quantities. These devices include the microprocessor itself, a clock generator, a system controller, an 8-bit input/output port, a programable peripheral interface, an asynchronous communications element, a one-of-eight decoder, an inverting bus driver, a noninverting bus driver, and an assortment of RAMs, ROMs, and PROMs. The INS8080A currently carries a price tag of \$19.95 in hundreds; in 1977, for quantities in excess of 10,000, the price will be below \$12.

Transient protector. Designed specifically for the protection of microprocessors, a new series of Transzorb transient-voltage suppressors from General Semiconductor Industries has response times of less than 1 nanosecond. Clamping factor—the ratio of clamping voltage to breakdown voltage—is only 1.33 at full rated power and 1.20 at 50% of full power. In hundreds, the μ P series devices sell for \$2.36 each. Delivery is from stock to four weeks.

Ramtek Corp., 585 No. Mary Ave., Sunnyvale, Calif. 94086 [361]

IMS Associates Inc., 14860 Wicks Blvd., San Leandro, Calif. 94577 [362]

Gnat Computers, 8869-C Balboa Ave., San Diego, Calif. 92123 [363]

E&L Instruments Inc., 61 First St., Derby, Conn. 06418 [364]

Pro-Log Corp., 852 Airport Rd., Monterey, Calif. 93940 [365]

Alpha Power Inc., 9020 Eton Ave., Canoga Park, Calif. 91304 [366]

Semiconductor Circuits Inc., 306 River St., Haverhill, Mass. 01830 [367]

National Semiconductor Corp., 2900 Semiconductor Dr., Santa Clara, Calif. 95051 [368]

General Semiconductor Industries Inc., 2001 W. Tenth Pl., Tempe, Ariz. 85281 [369]

BAUSCH & LOMB StereoZoom[®] microscope

The inspector with the perfect record

Almost twenty years on the job and still the industry leader. High resolution optics throughout the entire zoom range, and bright, sharp images over a wide field of view mean less eyestrain, less fatigue, and a lower percentage of errors. And that means tighter production control, less returned product and more satisfied customers.

The Bausch & Lomb StereoZoom Microscope—dependable quality at economical prices. Write for a free catalog today and discover why the Bausch & Lomb StereoZoom outsells all competitive stereomicroscopes in the electronics market... worldwide.

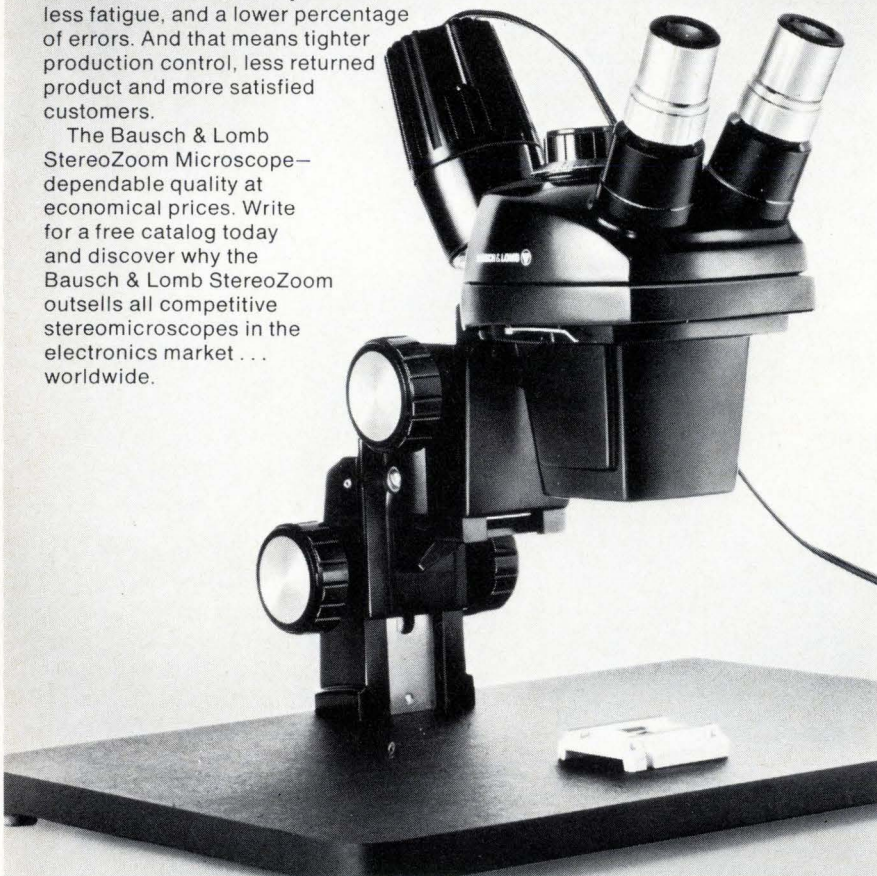

Bausch & Lomb, Scientific Optical Products Division,
62307 North Goodman Street, Rochester, N.Y. 14602.

Dialight sees a need:

(Need: A switch for all reasons.)

Reason 1: Dialight offers three switch configurations to meet all your needs—*snap-action switches with silver contacts* for moderate-level applications, *snap-action switches with gold contacts* for intermediate-level applications, and *wiping-action switches with gold contacts* for low-level applications. Each of these ranges is served by two switching actions—momentary (life: 600,000 operations) and alternate (life: 250,000 operations).

Reason 2: Dialight's snap-action and wiping-action switches come in a new modular design concept . . . a common switch body for either high or low current operation. All 554 series switches and matching indicators have the same rear-panel projection dimensions.

The snap-action switching mechanism guarantees a fast closing and opening rate. This insures that contact force and contact resistance

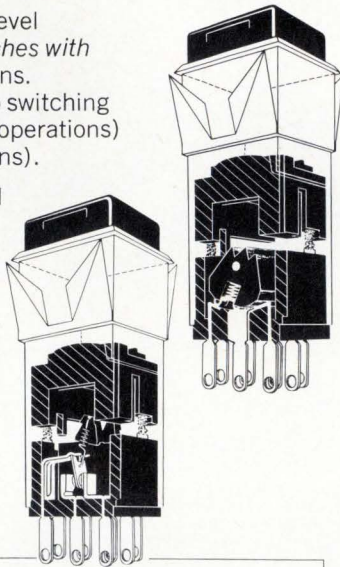
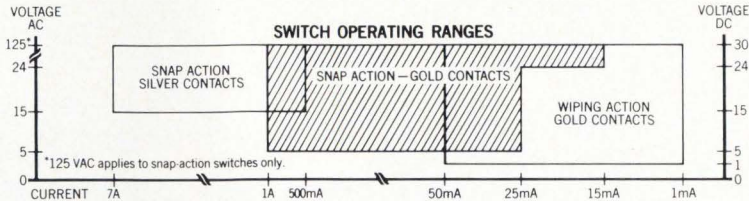

types. There are over 240 switch variations to choose from.

The 554 illuminated switch, designed for front of panel lamp replacement, gives you a choice of five different bezel sizes . . . $\frac{3}{4}$ " x 1", $\frac{5}{8}$ " x $\frac{3}{4}$ ", $\frac{3}{4}$ " square, $\frac{5}{8}$ " square, and $\frac{1}{2}$ " square. The first four sizes are also available with barriers. You also get a choice of six cap colors . . . white, blue, amber, red, green, and light yellow . . . four different underlying filter colors . . . red, green, amber, and blue and a variety of engraved or hot-stamped legends . . . over 300 cap styles . . . over 100,000 combinations.

There is also a variety of terminal connections . . . solder blade, quick connect, and for PC board insertions.

Reason 4: Dialight's 554 series is designed as a *low cost switch with computer-grade quality.*

Reason 3: Dialight offers a wide variety of panel and snap-in bezel mounting switches with momentary and alternate action configurations in SPDT and DPDT

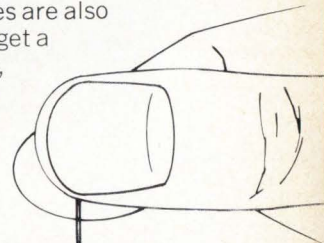

\$1.65 EACH
P/N 554 - 1121
(1K PRICING)
See Dialight

PRODUCT SELECTOR GUIDE

SWITCHING ACTIONS	Snap-Silver contacts		Snap-Gold contacts		Wiping-Gold contacts	
	SPDT	DPDT	SPDT	DPDT	SPDT	DPDT
MOMENTARY	<input type="checkbox"/>	<input type="checkbox"/>	<input type="checkbox"/>	<input type="checkbox"/>	<input type="checkbox"/>	<input type="checkbox"/>
ALTERNATE	<input type="checkbox"/>	<input type="checkbox"/>	<input type="checkbox"/>	<input type="checkbox"/>	<input type="checkbox"/>	<input type="checkbox"/>
OPTIONS						
	PUSH BUTTON CAP SIZES					
	$\frac{1}{2}$ " Sq.	$\frac{5}{8}$ " Sq.	$\frac{5}{8}$ " x $\frac{3}{4}$ "	$\frac{3}{4}$ " Sq.	$\frac{3}{4}$ " x 1"	
BEZEL MOUNTING TO ACCOMMODATE	<input type="checkbox"/>	<input type="checkbox"/>	<input type="checkbox"/>	<input type="checkbox"/>	<input type="checkbox"/>	
BEZEL MOUNTING WITH BARRIERS TO ACCOMMODATE	<input type="checkbox"/>	<input type="checkbox"/>	<input type="checkbox"/>	<input type="checkbox"/>	<input type="checkbox"/>	
PANEL MOUNTING TO ACCOMMODATE	<input type="checkbox"/>	<input type="checkbox"/>	<input type="checkbox"/>	<input type="checkbox"/>	<input type="checkbox"/>	
MATCHING INDICATORS	<input type="checkbox"/>	<input type="checkbox"/>	<input type="checkbox"/>	<input type="checkbox"/>	<input type="checkbox"/>	

are independent of the switch's actuation speed.

In the wiping-action switch, the contacts are under constant pressure (A unique Dialight design). This insures long life with a minimum build-up of contact resistance.

Both switch types are tease-proof.

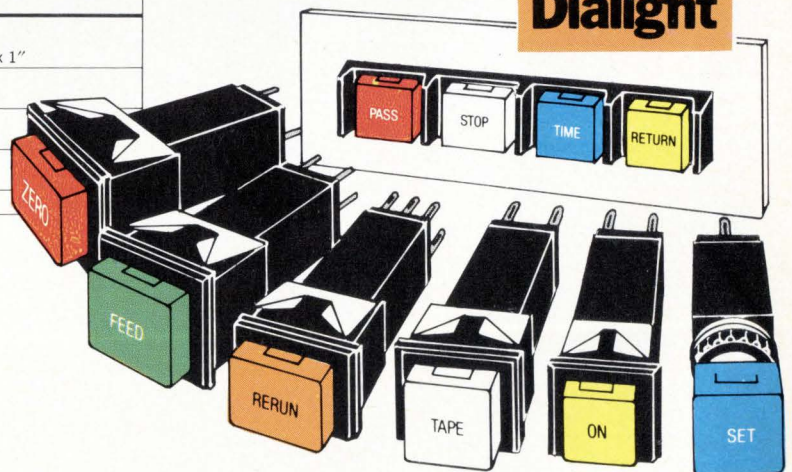

DIALIGHT

A North American Philips Company
203 Harrison Place, Brooklyn, N.Y. 11237
(212) 497-7600

A Line for All Reasons

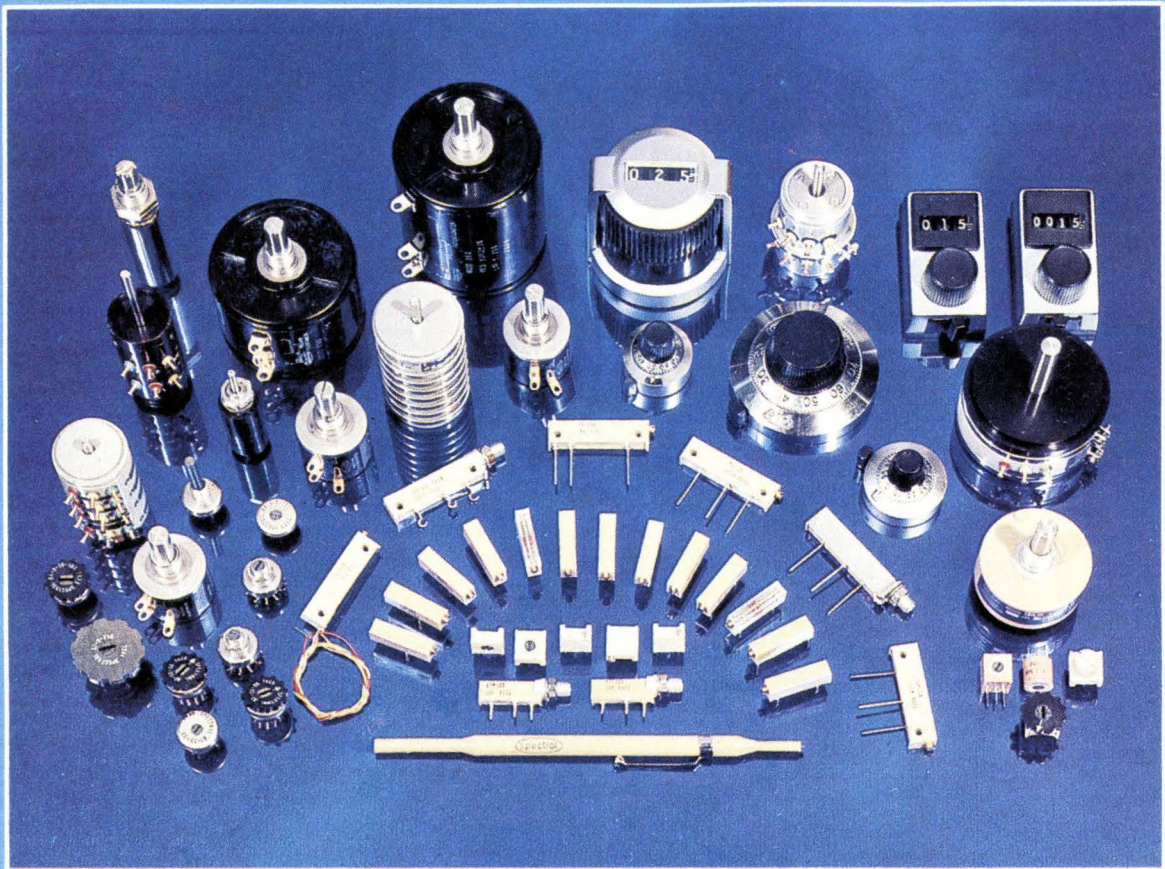

Pots, Dials, Trimmers, Switches

Need standard or special precision pots for industrial or military applications? Turns-counting dials for your front panels?

Trimmers for your minis, or miniature rotary switches for your peripherals? Whatever you need - we

have a line for all reasons. In fact, the only thing we don't have are high prices. For

more information on any of our four lines of "quality components", call or write.

Spectrol

SPECTROL ELECTRONICS GROUP

UNITED STATES Spectrol Electronics Corporation 17070 E. Gale Avenue, City of Industry, Calif. 91745, U.S.A. • (213) 964-6565 • TWX (910) 584-1314

UNITED KINGDOM Spectrol Reliance Ltd. Drakes Way, Swindon, Wiltshire, England • Swindon 21351 • TELEX: 44692

ITALY SP Elettronica spa Via Carlo Piscane 7, 20016 Pero (Milan) Italy • 35 30 241 • TELEX: 36091

New products

Semiconductors

National unveils automotive ICs

First units are a pair of tachometer/switches that sell for \$1.65

Be alert for National Semiconductor Corp. to be in volume production soon with a family of standardized industrial/automotive functional integrated-circuit blocks. They're blocks based on custom circuits that were designed originally for the auto industry.

The first of these, available now for \$1.65 each in 100-up quantities, is the IM2907/2917 series of tachometer speed switches. Basically monolithic frequency-to-voltage converters, they have a high-gain operational amplifier/comparator and are designed to operate a relay, lamp, or other load as soon as the input frequency reaches or exceeds a selected rate.

The 62-by-69-mil tachometer uses a charge-pump technique and offers frequency doubling for low ripple, full input protection in two versions, and an output that swings to ground for a zero-frequency input. The op amp/comparator has a floating transistor as its output. This feature allows either a ground- or supply-referred load of up to 50 milliamperes. The collector may be taken above its supply voltage up to a maximum collector-to-emitter voltage of 28 volts.

One of the two basic configurations, the 2907, is an eight-pin device with a ground-referenced tachometer input and an internal connection between the tachometer output and the op-amp noninverting input. This version is well suited for single-speed or -frequency switching or fully buffered frequency-to-voltage conversion applications.

The second and more versatile configuration provides a differential

tachometer input and an uncommitted op-amp input. With this version the tachometer input may be floated, and the op amp becomes suitable for active-filter conditioning of the tachometer output or for other applications.

Both configurations are available with an active shunt regulator connected across the power leads. The regulator clamps the supply so that stable frequency-to-voltage and frequency-to-current operations are possible with any supply voltage and a suitable resistor.

Other features include a zener regulator on chip in the IM2917 version (to allow accurate and stable frequency-to-current conversion), built-in hysteresis with either differential input or ground-referenced input, and $\pm 0.3\%$ linearity.

Soon to be added to this family are the IM1830, a monolithic bipolar IC designed for use in fluid-detection systems, and the IM1815, an adaptive sense-amplifier-default gating circuit for applications in engine control.

National Semiconductor Corp., 2900 Semiconductor Dr., Santa Clara, Calif. 95051 [411]

IC voltage regulators can be adjusted over more than 25 V

Offered in both positive- and negative-voltage versions, a new IC voltage regulator has an adjustment terminal that permits its output to be varied by more than 25 volts. The positive-voltage LAS 15U has an adjustment range of +4 to +30 v dc, while the LAS 18U is adjustable

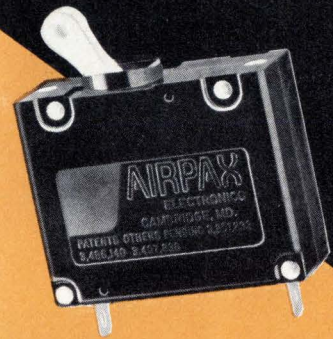

Reset or Regret



... the choice is yours!

In the event of an overload in the equipment you build, does your customer reset or regret? If you use Airpax electromechanical circuit protectors, your equipment is put back into service with a simple flip of the handle.

But if a fuse is used, does your customer know how to replace it? Can he spare the time? Or does he call you for service? Regrettably, expensive downtime occurs and, as far as he is concerned, you are to blame.

Sure, you can use fuses. But for more positive protection and reset capability—at little or no more cost than the combination of fuse, fuse holder, and power switch—specify:

AIRPAX™

Electromagnetic Circuit Protectors



Send for Short Form Catalog 2013.

AIRPAX ELECTRONICS/CAMBRIDGE DIVISION
Cambridge, Maryland 21613
Circuit Breakers, Switches, Glass/Ceramic-to-Metal Seals
Other Airpax Divisions:
CONTROLS DIVISION, Fort Lauderdale, Fla.
Instruments for Laundry
AMERICAN DATA, Huntsville, Alabama
TV Products

SUPER ROM



Faster than a speeding MPU!

Here is the 16K ROM of the future.

With a maximum access time of 450 ns, the S6831 is ready for this generation of microprocessors—and the next! And it's an unbeatable ally of sophisticated calculators and other demanding applications.

Four versions of this speedy marvel give you pinout compatibility with all the slower 16K ROMs. And a turnaround time of eight weeks means you can improve your product in a hurry.

Whether you're building an AMI 6800 micro-computer or another powerful system that needs fast, low-power memory, our 16K ROM will give you:

Maximum access time of 450 ns

Low power of 150 mw average

S6831 is pinout similar to the S6830 (8K)

S6831A is pinout compatible with the Intel 2316A and 8316A

S6831B is pinout compatible with the Intel 2316B and 8316B

S6831C is pinout compatible with the EA4600

N-Channel silicon gate depletion load technology

2K x 8 bit organization

Static operation

Three-state data output

Three chip enable inputs

Single 5-volt power supply

TTL compatible Input/Output

Want to get SuperROM on your side? Step into a phone booth and call your nearest AMI distributor or sales office. Or write to AMI, 3800 Homestead Road, Santa Clara CA 95051.

It's a sure way to fight obsolescence.

**it's
standard
at AMI**

AMERICAN MICROSYSTEMS, INC.

Here's AMI:

SALES OFFICES

Long Beach CA • (213) 595-4768
San Jose CA • (408) 249-4550
Altamonte Springs FL • (305) 830-8889
Elk Grove Village IL • (312) 437-6496
Norwood MA • (617) 762-0726
Livonia MI • (313) 478-9339
Minneapolis MN • (612) 559-9004
Monsey NY • (914) 352-5333
Cleveland OH • (216) 292-6850
Ambler PA • (215) 643-0217
Richardson TX • (214) 231-5721

DISTRIBUTORS

ARROW ELECTRONICS:
Minnesota—Bloomington (612) 888-5522
CENTURY ELECTRONICS:
New Mexico—Albuquerque (505) 292-2700
Utah—Salt Lake City (801) 487-8551
CESCO ELECTRONICS, LTD.:
Canada—Montreal (514) 735-5511
COMPONENT SPECIALISTS, INC.:
Texas—Dallas (214) 357-4576
Houston (713) 771-7237
INTERMARK ELECTRONICS:
Washington—Seattle (206) 767-3160
SCHWEBER ELECTRONICS:
California—Costa Mesa (213) 924-5594
and (714) 556-3880
Connecticut—Danbury (203) 792-3500
Florida—Hollywood (305) 927-0511
Georgia—Atlanta (404) 449-9170
Illinois—Elk Grove Village (312) 593-2740
Iowa—Cedar Rapids "Lorenz Sales"
(319) 393-6912

Maryland—Rockville (301) 881-3300
Massachusetts—Waltham (617) 890-8484
Michigan—Troy (313) 583-9242
Minnesota—Edina (612) 941-5280
New Jersey—Somerset (201) 469-6008
New York—Rochester (716) 461-4000
Westbury (516) 334-7474
Ohio—Beachwood (216) 464-2970
Texas—Austin (512) 837-2890
Dallas (214) 661-5010
Houston (713) 784-3600

Canada—Mississauga, Ont. (416) 678-9050
SEMICOMP CORP.:

California—Newport Beach
(213) 971-5253 and (714) 833-3070
STERLING ELECTRONICS:
Arizona—Phoenix (602) 258-4531
Louisiana—Metairie (504) 887-7610
Massachusetts—Watertown (617) 926-9720
New Jersey—Perth Amboy (201) 442-8000
New Mexico—Albuquerque (505) 345-6601
Texas—Dallas (214) 357-9131
Houston (713) 627-9800

Virginia—Richmond "Meridian Electronics"
(804) 359-0221

R.V. WEATHERFORD CO.:

Arizona—Phoenix (602) 272-7144
California—Anaheim (714) 547-0891
Glendale (213) 849-3451
Palo Alto (415) 493-5373
Pomona (714) 623-1261
San Diego (714) 278-7400
Colorado—Englewood (303) 761-5432
New Mexico—Albuquerque (505) 842-0868
Texas—Dallas (214) 243-1571
Houston (713) 688-7406
Washington—Seattle (206) 243-6340

REPRESENTATIVES

AMMON & RIZOS:
Oklahoma—Oklahoma City (405) 373-2748
Texas—Dallas (214) 233-5591
Houston (713) 781-6240

BARNHILL FIVE:

Colorado—Denver (303) 426-0222

BENEKE & McCAUL:

Missouri—Grandview (816) 765-2998
St. Louis (314) 567-3399

CAN TEC REPRESENTATIVES, INC.:

Ontario—Milton (416) 457-4455

Ontario—Ottawa (613) 225-0363

Quebec—Pierre Soudis (514) 620-3121

COULBOURN DEGRIF, INC.:

Maryland—Baltimore (301) 247-4646

HADDEN ASSOCIATES:

California—San Diego (714) 565-9445

HECHT, HENSCHEN & ASSOCIATES, INC.:

Arizona—Phoenix (602) 275-4411

LOWREY & ASSOCIATES:

Michigan—Brighton (313) 227-7067

MASIN-ESCO, INC.:

New Jersey—North Caldwell (201) 226-2550

New York—Syosset (516) 364-0310

NORTHWEST MARKETING ASSOCIATES:

Washington—Bellevue (206) 455-5846

OASIS SALES, INC.:

Illinois—Elk Grove Village (312) 640-1850

PRECISION SALES COMPANY:

New York—Syracuse (315) 458-2223

REP. INC.:

Alabama—Huntsville (205) 881-9270

Georgia—Tucker (404) 938-4358

North Carolina—Raleigh (919) 851-3007

TECHNICAL REPRESENTATIVES, INC.

Indiana—Indianapolis (317) 849-6454

New products

from -2.6 to -30 v dc. Both units can deliver currents as high as 1.5 amperes. The regulators have maximum line regulation to within 2% of the output voltage and load regulation to within 0.6%. Maximum temperature coefficient is 0.03%/°C. As with the company's existing fixed-voltage regulators, the LAS 15U and LAS 18U have built-in current limiting, automatic thermal shutdown, and safe-operating-area compensation. In quantities of 500 pieces, the LAS 15U sells for \$2.85, and the LAS 18U is priced at \$4.05.

Lambda Electronics Corp., 515 Broad Hollow Rd., Melville, N.Y. 11746 [414]

Monolithic JFET amplifiers require very little power

Designed to replace the discrete-component assemblies generally used to buffer high-impedance sources such as piezoelectric transducers and capacitive microphones,

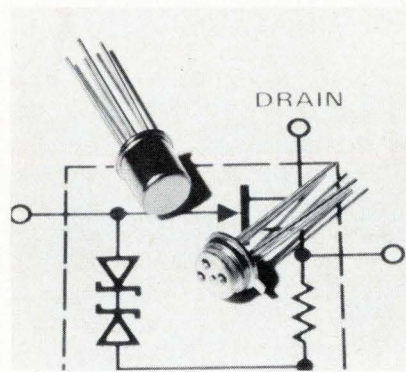

a pair of monolithic JFET preamplifiers offers current drains as low as 10 microamperes from single dc supplies of 1.3 to 30 volts. Believed to be the first such monolithic devices, the preamplifiers have a minimum input resistance of 200 megohms (5,000 megohms, typical). The model T100, which operates at drain currents in the range of 10 to 50 μ A, has a minimum voltage gain of 0.4 (0.6, typical) and a maximum output resistance of 3,500 ohms (1,500 ohms, minimum). The T300 operates at drain currents from 70 to 350 μ A. Its minimum voltage gain is 0.3 (0.45, typical), and its output

resistance is a minimum of 500 ohms and a maximum of 1,300 ohms. Prices, in 100-up quantities, are 67 cents for the T100 and 60 cents for the T300. The units are housed in TO-72 metal cans. Unpackaged chips are also available at 60 cents each for both versions. Delivery is from stock.

Siliconix, 2201 Laurelwood Rd., Santa Clara, Calif. 95054. Phone (408) 246-8006 [415]

10-bit monolithic d-a unit has maximum error of 0.05%

A 10-bit monolithic digital-to-analog converter uses a novel method of laser trimming to achieve a maximum error (relative to full-scale output) of 0.05% while selling for only \$9.95. The automatic laser-trimming technique uses a laser to cut shorting bars that connect parallel resistive structures on the chip. Thus the trimming can be done during the computer-controlled wafer-probe process. Conventional laser trimming involves the cutting of actual thin-film or thick-film resistive material. The new devices are the MC3410, which is rated for operation from 0 to 70°C and sells for \$9.95, and the MC3510, which has a temperature range of -55 to 125°C and sells for \$14.95. Both prices are for hundreds. The units, which have a typical settling time of 250 nanoseconds, do not include output buffer amplifiers or voltage references.

Technical Information Center, Motorola Semiconductor Products Inc., P.O. Box 20294, Phoenix, Ariz. 85036 [413]

Npn power transistors switch in 250 nanoseconds

A line of npn switching power transistors offers operation up to 450 volts at a continuous current of 10 amperes and a switching time of only 250 nanoseconds. The triple-diffused planar devices have typical saturation voltages of 1.0 v at 7 A. Available from stock, the devices are believed to be the fastest power

Positively uniform.

Batch-after-batch consistency. That's the reason new Kodak micro positive resist 809 can offer you less waste, higher yields, and better process reliability.

In addition, you get wide processing latitude, fast exposure, and high-quality results with contact, projection, and proximity printing.

And because the solids remain in solution, it needs no refiltering for at least twelve months.

For details, write Eastman Kodak Company, Department 412L (48-G), Rochester, N.Y. 14650.

RESULTS COUNT

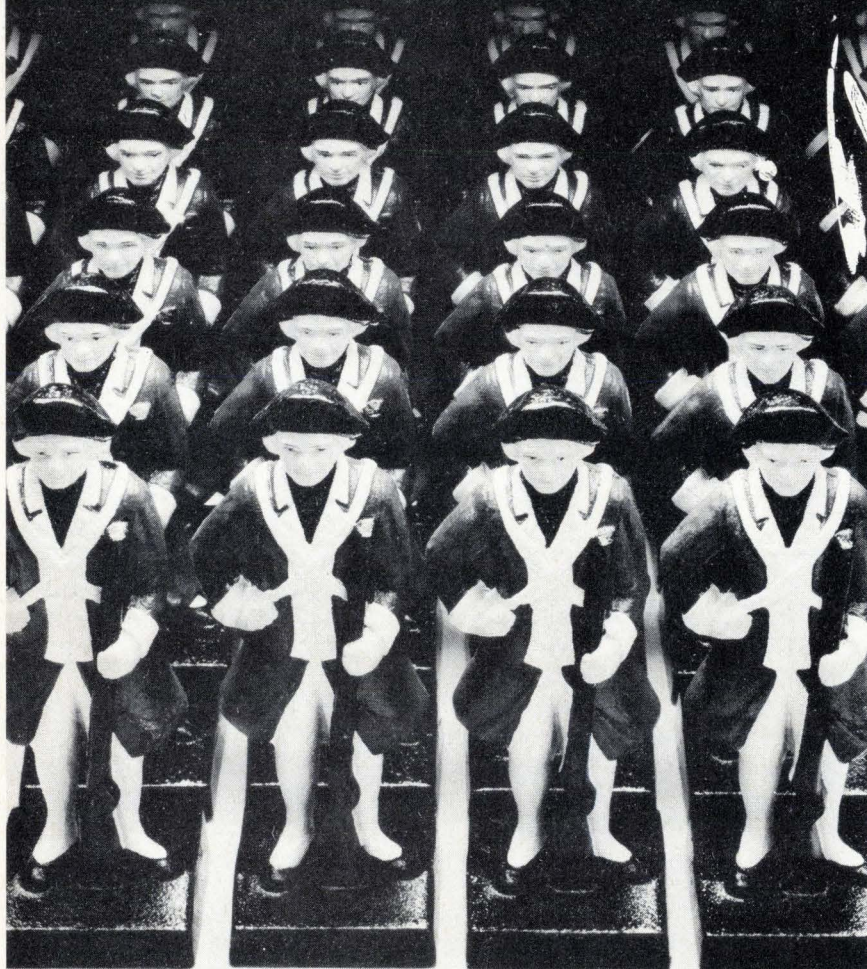

Kodak micro positive resist 809

New products



switchers currently available.

TRW Power Semiconductors, 14520 Aviation Blvd., Lawndale, Calif. 90260 [417]

Tab-mount triacs have high dv/dt ratings

A high-voltage series of tab-mount Thyrotab triacs with repetitive peak off-state voltage ratings from 50 v to 1,000 v makes use of center-gate geometry for dv/dt ratings as high as 400 volts per microsecond. The critical dv/dt rating is typical, not minimum, but it holds at full rated voltage and at a case temperature of 80°C. Offered in electrically isolated, nonisolated, and internally triggered isolated versions, the triacs are available with rms current ratings of 4, 6, 8, 10, and 15 amperes.

Thyrotek Corp., P.O. Box 5407, 611 109th St., Arlington, Texas 76011. Phone E. Eugene Uecker at (817) 265-7381 [418]

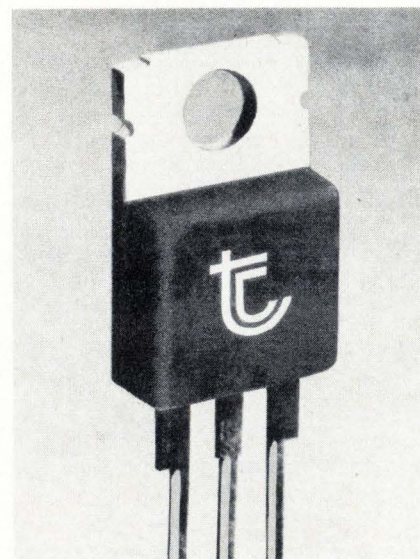

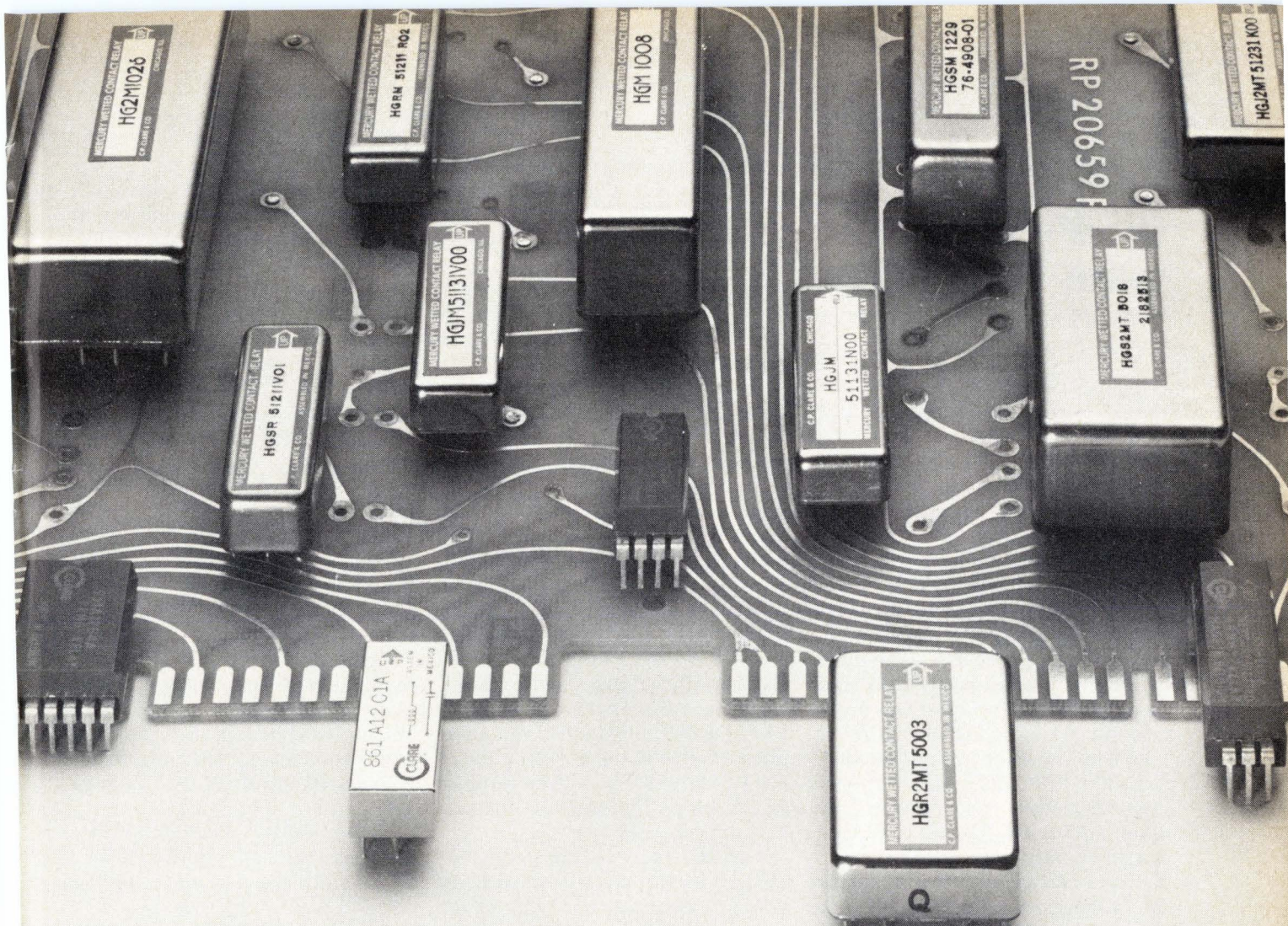

There's a CLARE MERCURY-WETTED RELAY for every PCB application.

From microvolt to 500 volt levels. Nanoamperes to 2 amps. DC to megahertz frequencies. Clare can supply a reliable mercury-wetted relay to enhance operations for process control, data logging/acquisition, automatic component/system testing, telecommunications, whatever.

Every Clare mercury-wetted relay is designed to lead a long and productive life. Billions of operations. Constant ON, OFF impedances—every operation. No contact wear, no contact bounce.

Just call your Clare Representative, or contact C. P. Clare & Company, 3101 W. Pratt Avenue, Chicago, Illinois 60645. Phone (312) 262-7700.

QUALITY, SERVICE, RELIABILITY

**C. P. CLARE & COMPANY
GENERAL INSTRUMENT CORPORATION**



Use CLARE mercury wetted relays across the board.

Circle 139 on reader service card

New products

Microwaves

HP adds more assemblies

Product trio includes nanosecond-transition diode switches

Within recent months, the Microwaves group of Hewlett-Packard Components, traditionally a devices-oriented operation, has been steadily building up its line of microwave assemblies. And now the company is offering a trio of high-performance products, highlighted by a series of high-speed broadband diode switches. The other two products are a companion switch driver that is compatible with transistor-transistor logic and a series of low-loss absorptive modulators. (The photo shows a diode switch with a companion driver.)

The diode switches are available as hermetic coaxial modules (33640

series) or as complete units (33140 series) that include connectors, bias circuit, and integral dc return. These switches are built with p-i-n diodes that permit attenuation level to be varied smoothly and repeatedly with changes in bias level, claims HP. Models containing either two or four diodes are available.

With an appropriate driver, switching speed is excellent, involving a maximum rise time of 5 nanoseconds and a maximum fall time of 7 ns. Operating frequency for the units is dc to 18 gigahertz, and maximum insertion loss over this range varies from 0.5 to 3 decibels. The control-voltage range is -60 to +1 V, while control current is 200 milliamperes for the two-diode models and 400 mA for the four-diode models. At 25°C, rf power ratings are 2 W for continuous-wave operation, 16 W for the pulsed mode. In quantities of one to nine, prices range from \$45 to \$170 each, depending on the model. Delivery is from stock to within six weeks.

Although intended as a companion part for the 33140 series of diode switches, the model 33190A driver

can be used to minimize the operating time of any single-pole single-throw diode switch. This driver, by compensating for the minority-carrier lifetime of p-i-n diodes, converts TTL inputs to the bias levels needed to achieve nanosecond switching times with diode switches.

The unit requires bias supply voltages of +5 and -12 v. Typically, steady-state open-circuit output voltage is -10 v for a logic 0, +3 v for a logic 1. For both logic 0 and logic 1, the minimum available output current is 40 mA. Operating temperature can range from -65°C to +95°C. In single-unit quantities, the 33190 switch driver is priced at \$100 each. Delivery time ranges from stock to six weeks.

There are three new absorptive modulators, each covering more than an octave band and providing 50-ohm matched impedance at all attenuation levels. They can handle incident rf powers of 2 W average, 100 W peak.

Model 33001E provides 45 dB of isolation, with an insertion loss of 2.5 dB from 8 to 12 GHz, 3 dB from 12 to 15 GHz, and 3.5 dB from 15 to 18 GHz. Model 33001F has 80-dB isolation and the same insertion loss as the 33001E from 8 to 15 GHz, increasing to 4 dB from 15 to 18 GHz. Offering 45 dB of isolation, model 33008E holds insertion loss to 1.8 dB over the range of 3.7 to 8 GHz. Unit prices range from \$495 to \$730, depending on the model, and delivery is from stock to eight weeks.

Hewlett-Packard Co., 1501 Page Mill Rd., Palo Alto, Calif. 94304 [401]

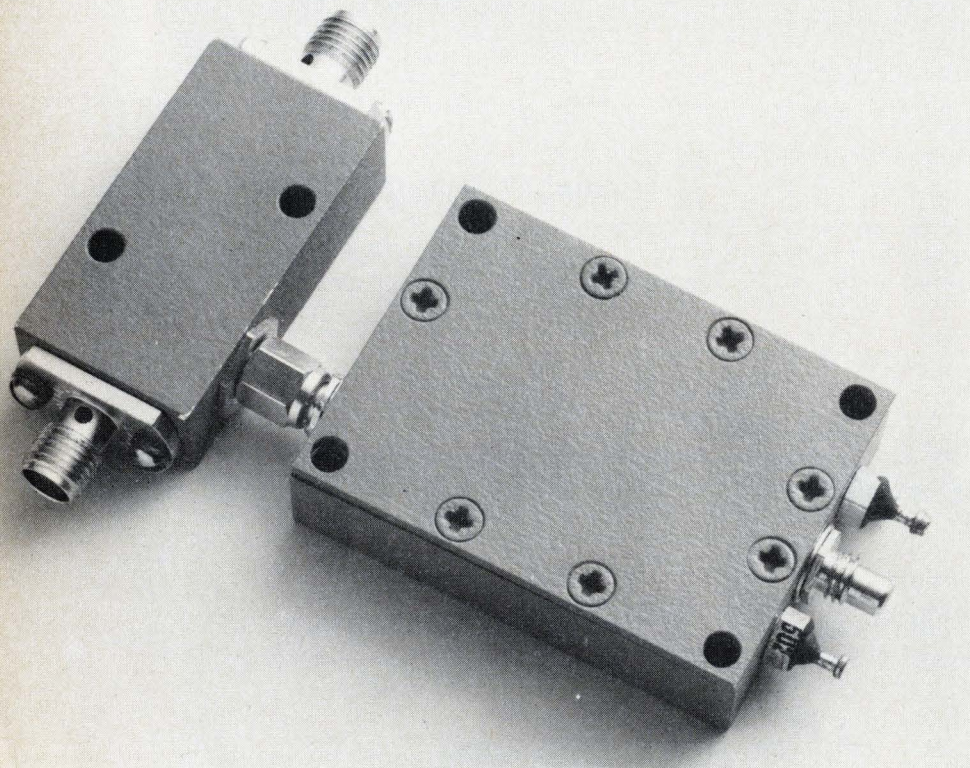

Flexible coaxial cables operate to 18 gigahertz

Two companies have developed flexible coaxial cables to replace inconvenient semi-rigid cable for applications at frequencies as high as 18 gigahertz. Malco Microdot's entry (shown) is called Gigahertz 141. Designed to replace commonly used RG 402/U, it not only makes bending fixtures unnecessary, but its crimped terminations reduce assem-

GR's Network Analyzer Costs Less and Performs Better

In the market for a high-performance network analyzer? The choice usually boils down to three instruments. All three are excellent products and the final selection typically centers around how important certain specifications are to one's applications. If *overall value* is the deciding criteria, then GR's widely used 1710 RF Network Analyzer has a definite edge. Here's why:

	GR 1710	HP 8407*	HP 8505*
Price	\$9,850	\$ 10,625	\$22,500
Frequency Range	0.4 to 500 MHz	0.1 to 110 MHz	0.5 to 1300 MHz
Polar Display	Yes	Yes	Yes
Group Delay	\$ 495 option	No Option	Yes
Dynamic Range	115 dB	80 dB	100 dB
Resolution	0.025dB	0.25 dB	0.1 dB

*Based on information contained in HP's 1976 Catalog

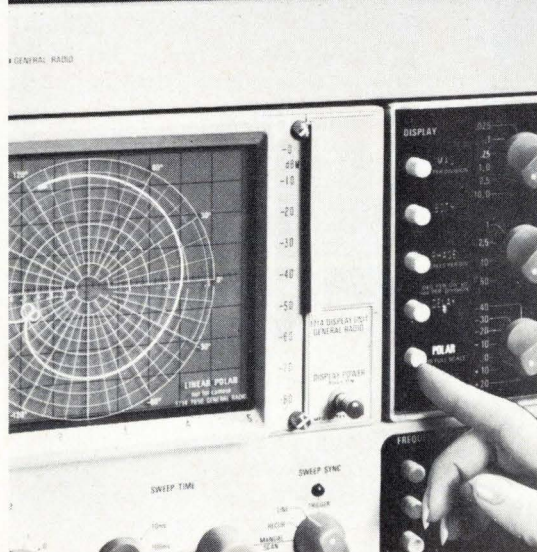
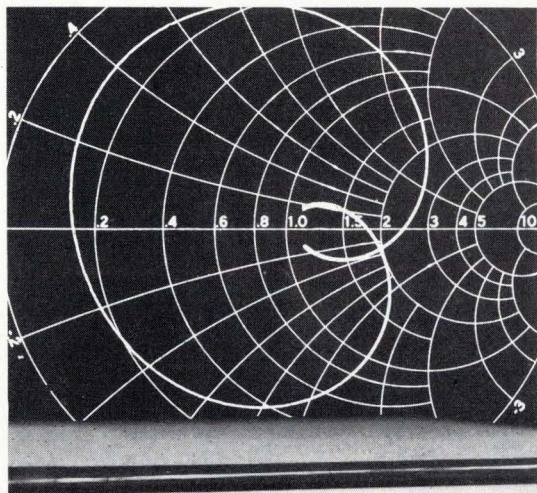

Now, of course, there are many more specs to compare and GR doesn't win in all areas, but the specs cited above are among the most important... including price. Unfortunately, one important feature of the GR 1710 that doesn't show up in the specs is its convenience of operation. Nothing can be more simple than GR's pushbutton switching from displays of magnitude to phase, or to both magnitude and phase, to delay, or to polar.

To get the full story on the capabilities of the GR 1710 request a copy of "RF Network Analysis", a 12-page brochure that describes the 1710 plus all its options and accessories. We'll also include a copy of Application Note 7, which describes how simple it is to make measurements with a GR 1710 at frequencies up to 2000 MHz or even higher.

Write to GenRad, 300 Baker Avenue, Concord MA 01742 or call one of the numbers listed below:

Atlanta 404 394-5380	New York (NY) 212 964-2722
Boston 617 646-0550	(NJ) 201 791-8990
Chicago 312 992-0800	San Francisco 408 985-0662
Dallas 214 234-3357	Washington, DC 301 948-7071
Dayton 513 294-1500	Toronto 416 252-3395
Los Angeles 714 540-9830	Zürich (01) 55 24 20

GR 1710 prices start at \$9700. Order now (after you make your own comparison, of course).

 **GenRad**

New products

bly costs while virtually eliminating rejections, since no soldering of joints is necessary. Phase stability is as much as 10 times better than that of RG 402/U. Gigahertz 141 has a maximum phase shift at 18 GHz of 3° when wrapped two turns around a 1.5-inch mandrel. For a cable connected to an SMA connector with a

right-angle bend at the rear of the connector, maximum VSWR at 16 GHz is 1.25, and attenuation, at 18 GHz, is 100 dB per 100 feet.

W.L. Gore & Associates has a flexible microwave coaxial cable assembly called Gore-Tex. Available as a complete assembly of cable and connectors, Gore-Tex is available in

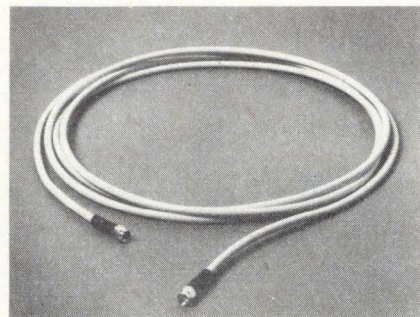

any desired length. At present it comes only with type SMA male connectors on both ends. Offering insertion losses up to 25% below those of 0.141-inch semi-rigid cables, a 10-foot length of Gore-Tex is guaranteed to have no more than 5 dB of insertion loss at 18 GHz. The cable has a characteristic impedance of 50 ohms ± 1 ohm, and its VSWR is 1.05 plus 0.02 times the frequency in gigahertz. Its operating temperature range is -66 to 200°C .

Malco—South Pasadena, 220 Pasadena Ave., South Pasadena, Calif. 91030. Phone Bill Hayes at (213) 682-3351 [403]

W.L. Gore & Associates Inc., 555 Paper Mill Rd., Newark, Del. 19711. Phone (302) 738-4880 [404]

BAUSCH & LOMB

StereoZoom[®] 5 microscope

Meet the new MORE and LESS microscope

MORE in optics . . . **MORE** in mechanics . . . **LESS** in price.

This new StereoZoom 5 completes the royal family of world-leading Bausch & Lomb Stereomicroscopes. Fills the need in electronics for a middle zoom range of 0.8X-4.0X (5:1 ratio) with higher resolving power for accurate inspection and quality control of micro-circuits.

More in optics. Higher resolution . . . 200 lines/mm at 4X. Better color correction. Less distortion. Flatter fields . . . no refocusing to see detail at edge of wide field. Zooming is fast with image continuously in focus through full range, while maintaining full working distance of 4". Workers see more, faster, easier, more accurately.

More in mechanics. Tighter precision tolerances for better alignment, smoother operation. Eye-pieces can be locked in to prevent theft or tampering, but they are still rotatable.

StereoZoom 5 is directly interchangeable with other Bausch & Lomb pods, and can be used with many of the existing StereoZoom modules and accessories. Attractive new modern styling and professional black and white finish.

Less in price. Priced lower than other stereomicroscopes with equivalent features.

More . . . There's more to the new StereoZoom 5 story. Discover this exciting new instrument by arranging for a free, no-obligation demonstration. Catalog 31-2436 is also available just for the asking.

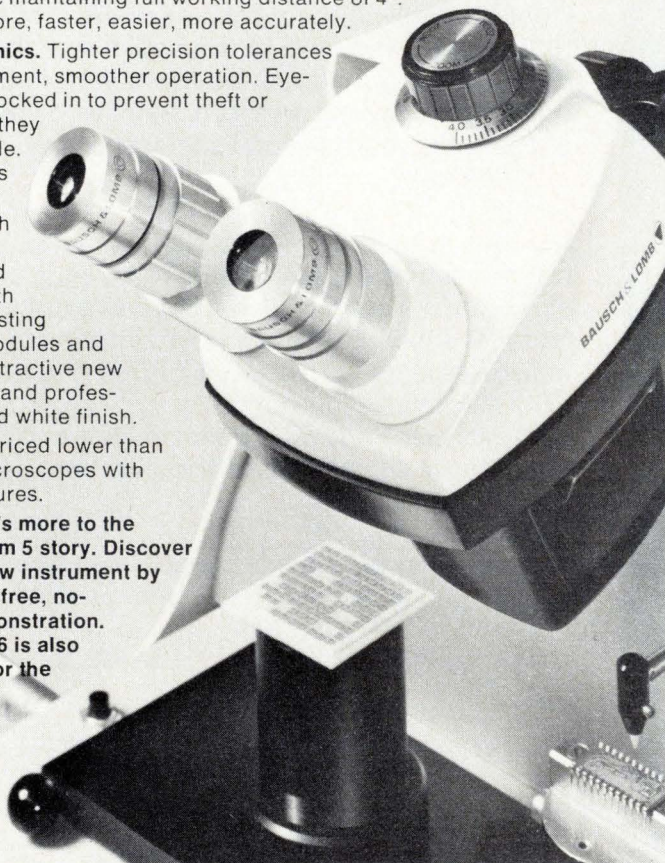

Bausch & Lomb, Scientific Optical Products Division, 30407 N. Goodman St., Rochester, N.Y. 14620
In Canada: Bausch & Lomb, Scientific Optical Products Division, 2001 Leslie St., Don Mills, Ont. M3B 2M3

Detectors cover

26.5 to 110 GHz

Two series of millimeter-wave detectors cover the frequency range from 26.5 to 110 gigahertz in six bands. The 4482XH series consists of six broad-band devices, each of which covers a full band. The units are flat to within 1.5 dB up to 75 GHz and to within 2 dB through 110 GHz. Minimum sensitivities are 100

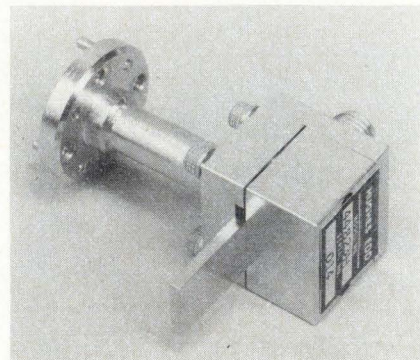

BME™ Capacitors- Proven Reliability For Automotive Applications

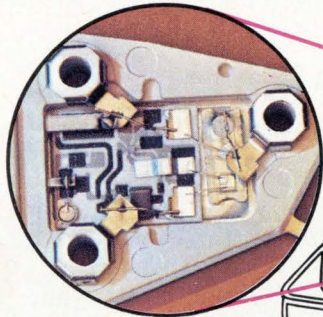

Voltage Regulators

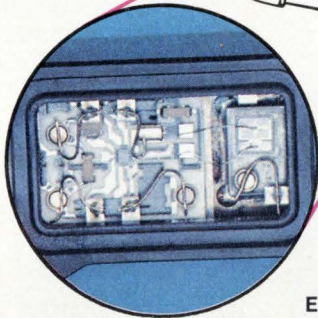
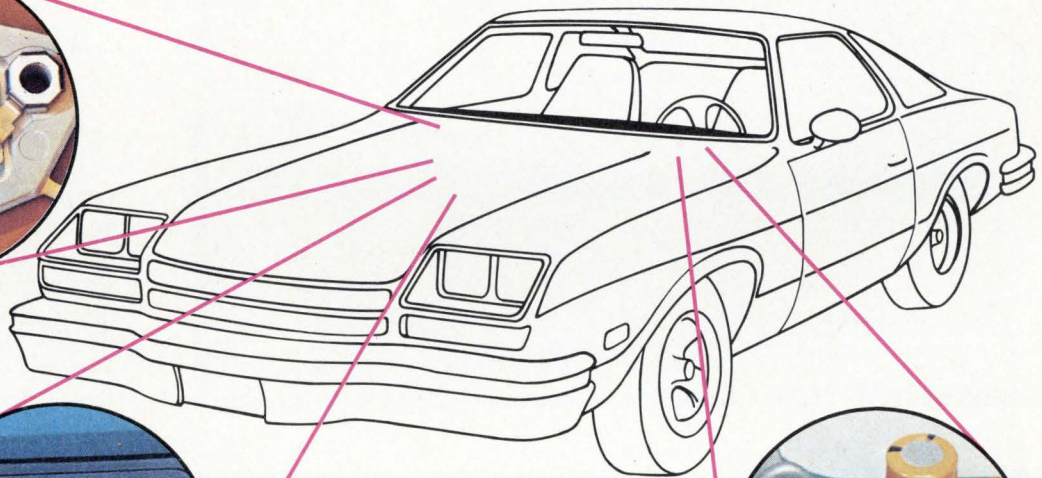

Electronic Ignition Systems

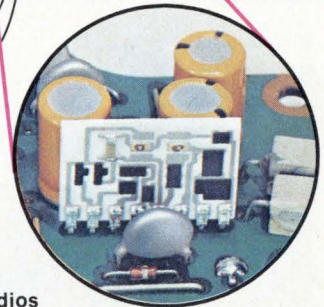

Radios

USCC/Centralab, the major supplier of monolithic ceramic capacitors to the largest manufacturers of automotive hybrid electronics.

The automotive environment can be considered the ultimate proving ground for component reliability. Under-the-hood systems provide a hostile environment where moisture, temperature extremes, shock and vibration are constant. It is a tremendous challenge to supply a component economical enough for an automotive application which can stand up to their rigorous specifications.

And Centralab is there, providing over 3.9 million BME-Chip™ Capacitors which are in 2.25 million domestic cars and light trucks. Over 11 billion unit life hours in ignition systems, voltage regulators and radios, without a single known failure. That's reliability!

Compare your requirements with those of the automotive industry. We're sure you'll choose BME™ Capacitors . . . reliability and availability at a low cost.

Please write on company letterhead for complete technical test reports.



USCC/CENTRALAB Electronics • GLOBE-UNION INC.

4561 Colorado Boulevard • Los Angeles, Ca. 90039 • (213) 240-4880

FROM \$2000

When it comes to graphics...
WE'VE GOT YOUR NUMBER

Maps, charts, aerial photos...if the information you need is graphical, the Numonics Digitizer can turn it into good, straight numbers. The Numonics Digitizer is desk top size, but offers a 30"x36" working area with resolution down to the closest 0.01". Very economical. . .and yet it has standard features like big readout and parallel BCD-buffered output. Plus optional direct measuring capability for area and curve length, with or without scaling. As quickly as you set the scale and trace the graphics, we've got your number. Let us tailor our digitizer into a data handling system that's right for you.

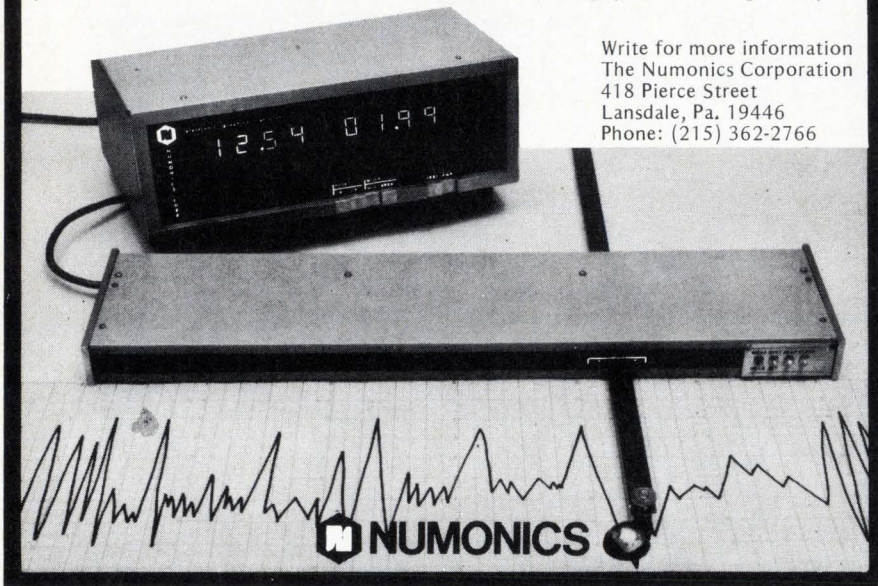

Write for more information
The Numonics Corporation
418 Pierce Street
Lansdale, Pa. 19446
Phone: (215) 362-2766

Circle 193 on reader service card

65 watts of reliable power in frequencies of 10 to 2500 MHz.



And here's what we built into our new 15122.

- solid state circuitry
- short and open circuit protection
- frequency stability $\pm .001\%$
- external pulse or AM modulation
- internal square wave modulation
- low tube cost/operating hour
- qualified to MIL-STD-461 and 810

You have now ended your search for a stable, reliable 65 watt oscillator. Just call or write for detailed engineering data. Or ask for a demonstration.

MCL, INC., 10 North Beach Avenue,
LaGrange, Illinois 60525. (312) 354-4350

It has six different plug-in heads

Model	Freq. (MHz)	Pwr. (MIN)
6047	10-50	65
6048	50-200	65
6049	200-500	65
6050	400-1000	65
6051	1000-2000	40
6052	2000-2500	35



144 Circle 144 on reader service card

New products

millivolts per milliwatt to 75 GHz and 75 mV/mW to 110 GHz.

The 4483XH series consists of six narrow-band tunable detectors with typical instantaneous bandwidths of 5 GHz. Minimum sensitivities are 200 mV/mW to 75 GHz and 100 mV/mW to 110 GHz. Both series have prices that start at \$750 and delivery times of 60 to 90 days.

Hughes Electron Dynamics Division, 3100 West Lomita Blvd., Torrance, Calif. 90509. Phone (213) 534-2121 [405]

Variable attenuator spans 6 to 120 dB

The model 933 continuously variable attenuator handles up to 2 watts of average power while providing attenuation from 6 to 120 dB. Calibrated at 1-dB intervals at 0.5 gigahertz, the unit is rated for operation up to 1.0 GHz. It is useful up to 3.0 GHz, however, with slightly reduced specifications. Minimum insertion loss is 4.0 dB with calibration starting at 6 dB. Worst-case VSWR on both input and output is 2.30, but VSWR is reduced as the attenuation is increased, dropping to 1.20 at the input when the attenuation is 15 dB. The model 933, which is supplied with a stand for bench use, sells for \$690. A companion unit, the 933P, is intended for panel mounting; it sells for \$650. Both units are available from stock to 45 days.

Weinschel Engineering Co., Inc., Gaithersburg, Md. Phone (301) 948-3434 [407]

Microwave receiver is programmable

Intended for use in computer-controlled antenna-measurement systems, the series 1770 programmable microwave receiver covers the frequency range from 1 to 18 gigahertz in the automatic mode, but may also be operated manually to 90 GHz. An optional low-frequency converter extends the frequency range down to 100 megahertz. Specifically de-

HUGHES

HUGHES AIRCRAFT COMPANY
CONNECTING DEVICES DIV.

Today we
supply the spark
for America's
defense.

Connections were much simpler 200 years ago. Torch the fuse and the cannon fired.

Supplying the vital spark that makes a modern weapon system do its job is a lot more complicated.

That's where we come in. For many years, primes and OEMs for military and aerospace products have depended on us to provide the vital links in their electronic systems—flat cable, etched circuitry, connectors, and total interconnection systems.

Our high-rel connections have to be the best. They're used in systems like Phoenix, Maverick, Lance, Minuteman, AWACS, F-14, F-15, Space Shuttle, Viking, Sonobuoy, F-4, A-7, Condor, Standard Missile, F-18, AAH, Cruise Missile, F-8, Trident, Hobo, Sprint and many more.

To learn how we can serve your interconnection needs, contact Jack Maranto or Dave Cianciulli: Hughes Connecting Devices, 17150 Von Karman Ave., Irvine, CA 92714.

Or call (714) 549-5701.

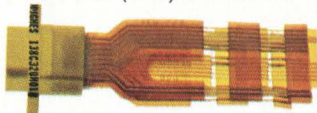

**Hughes
Connecting Devices**

Circle 145 on reader service card

33% more power to the people.

**Power/Mate presents
Econo/Mate II.**

The open frame power supply.

Now Power/Mate brings you 33% more power in the same package size with the second generation of our Econo/Mate series.

The size is the same, the basic components are the same for easy interchangeability. But that's where the similarity ends.

Econo/Mate II adds features like dual AC primary and a plug-in IC regulator for improved regulation.

And Econo/Mate II is tough. Computer design, quality control, and Power/Mate's experience helps insure 100,000 hr. MTBF even at this higher power output.

But for all its features, Econo/Mate II is still, most of all, economical.

We wouldn't call it Econo/Mate if it wasn't.

Econo/Mate II is in stock, ready for delivery. Send for our free brochure.

Prices start at \$19.95.

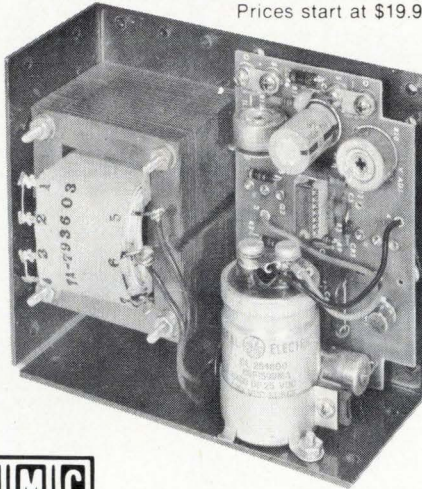

POWER/MATE CORP.

World's largest manufacturer of quality power supplies.

514 South River Street/Hackensack, N.J. 07601/Phone (201) 343-6294 TWX 710-990-5023

Circle 146 on reader service card

New products

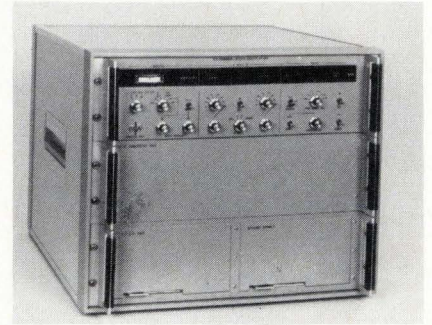

signed to measure antenna phase and amplitude characteristics, the receiver has a 60-dB dynamic range and may be operated as a two-channel system with independent mixers or as a three-channel system with two channels sharing a mixer by means of an rf switch. The 1770 sells for approximately \$23,000; its exact price depends upon the selected options.

Scientific-Atlanta Inc., 3845 Pleasantdale Rd., Atlanta, Ga. 30340. Phone John Detwiler at (404) 449-2000 [408]

**Solid-state amplifiers
cover 3.7 to 8.4 GHz**

Built with gallium arsenide field-effect transistors, a line of thin-film hybrid amplifiers has been designed for communications applications



over the frequency range from 3.7 to 8.4 gigahertz. A typical unit in the line, the model N6203, covers the range from 3.7 to 4.2 GHz with a noise figure of 2.6 dB (240 K), a gain of 50 dB, and a third-order intercept point of +20 dBm.

Narda Microwave, Plainview, N. Y. 11803. Phone J.P. Schindler at (516) 433-9000 [410]

**OVER 70,000 CHANNELS!
that's our record**

A record no one can blot, smudge or smear.

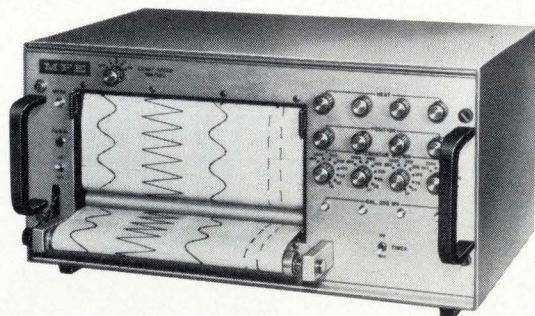

- One through eight channels
- Inkless thermal recorder
- True rectilinear coordinates
- Up to seven chart speeds
- OEM - rack - portable models
- Eight or eleven step attenuator
- Event and timer markers
- Front panel calibration
- Paper take-up
- Most lightweight & compact available
- 50 mm or 100 mm wide channels
- Digital printer accessory for simultaneous printing and recording

Call or write Bill Beaulieu for additional information.



Keewaydin Drive
Salem, N.H. 03079
Tel. 603-893-1921
TWX 710-366-1887
TELEX 94-7477



146 Circle 194 on reader service card

The Ansley "D" Connector...

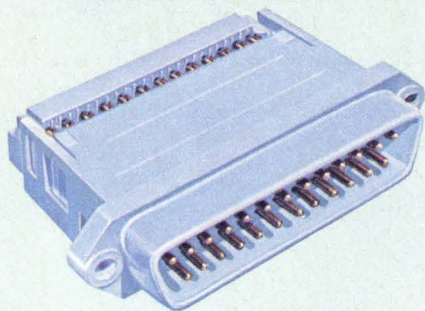

Our new series of male and female "D" connectors offer you a cost effective external mass termination cable and connector system second to none. Its uniqueness begins with a one-piece "D" connector package that meets industry standards for size, pin spacing, and contact reliability. With no loose parts to match up, positive cable-to-contact alignment is assured. Conductors are mass terminated in seconds with our standard BLUE MACS™ hand or bench tools. The results? Faster installation, higher reliability.

Contact pins are spaced on .054" centers — a perfect fit for any standard inter-cabinet "D" type connector application. Our new "D" connectors are designed to mate with standard 50 mil pitch flat cable as well as our new, improved jacketed cable — the only flexible flat cable engineered specifically for out-of-cabinet use.

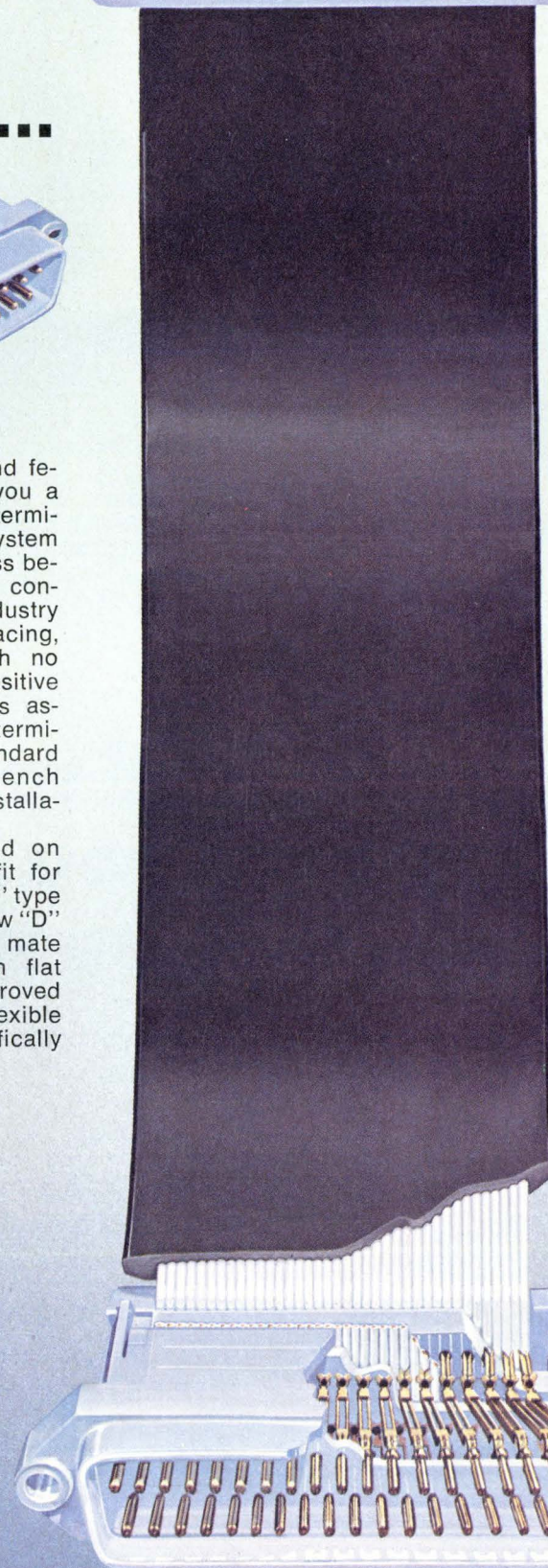
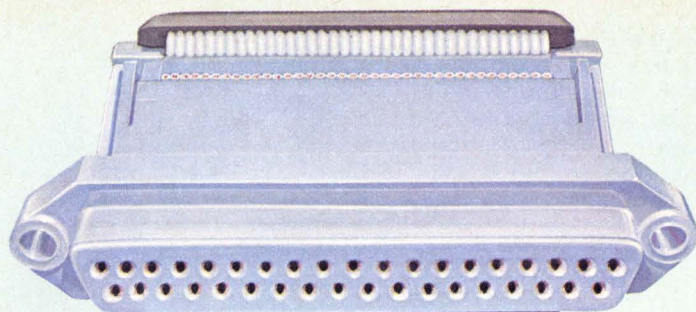

a new meaning to cost effectiveness.



The Ansley BLUE MACS™ jacketed cable is U.L. listed for external interconnection of electronic equipment. Electrically, it outperforms standard jacketed twisted pairs in typical I/O applications. And there's no special zipper lock tubing required — reducing the need for an extra cable accessory. Installation is faster, easier. And like all Ansley connectors, you can daisy chain our "D" types anywhere in the cable — along with our DIP socket, card edge, or pc board connectors.

Cable alignment and high contact reliability is assured — because both cable and connector are grooved for absolute alignment. Our patented TULIP™ 4-point insulation-displacing contacts are permanently fixed and sealed-in to provide a reliable, gas-tight, corrosion-free mass termination.

For the full reliability/cost effectiveness story and technical data, call or write:

T&B / Ansley

The mass termination company.

**T&B/Ansley Corporation • Subsidiary
of Thomas & Betts Corporation**
3208 Humboldt St. • Los Angeles, CA
90031 • Tel. (213) 223-2331 •
TWX 910-321-3938

**Available through authorized
Ansley distributors**

In Canada: T&B/Ansley, Ltd.
700 Thomas Ave.,
Industrial Park
Iverville, P.Q.

Model 211—read and write. Similar to Model 210 in function, including card capturing, except also writes to up-date encoded data—mass-transit ticketing, etc. Features a tachometer-controlled motor and control circuitry, gear-driven rollers, to meet stringent requirements for card encoding.

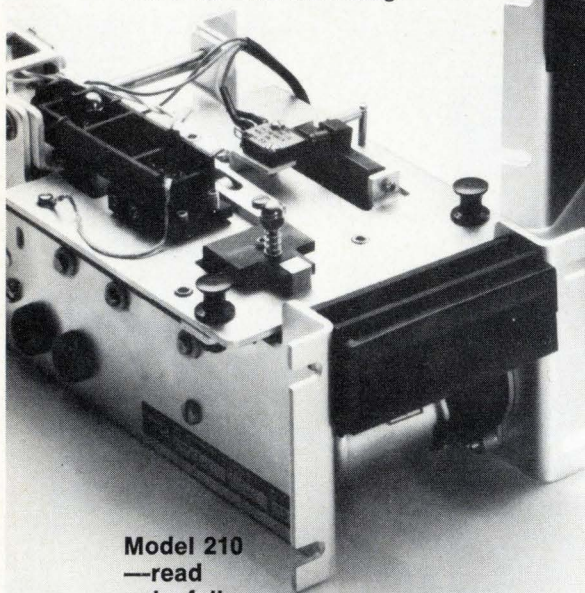

Model 210—read only, fully automated. Highly engineered for read functions in unattended remote stations. Also verifies, returns, or captures stolen or expired cards. Widely used for magnetic-encoded banking, travel, credit cards.

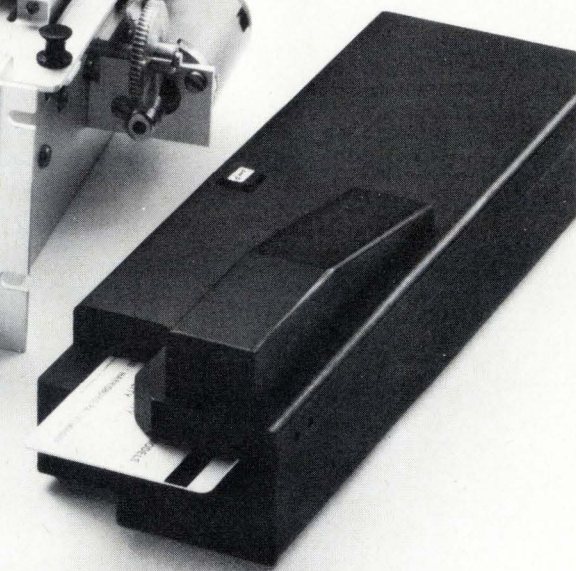
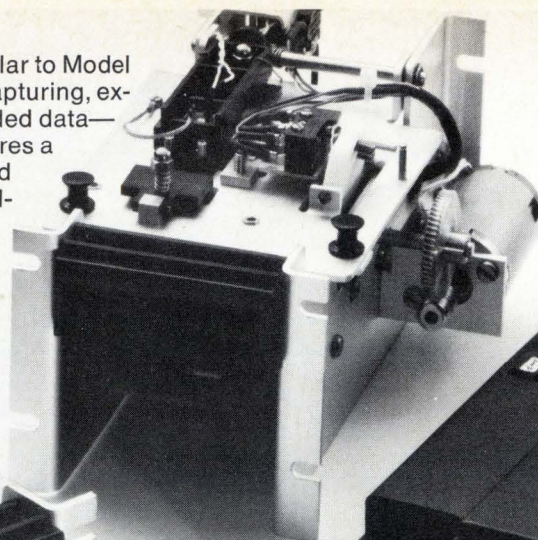

Model 75—read only. Reliable, low-cost way to enter data into a computer from stand-alone peripherals. Ideal for identification, access control, credit validation. Manually operated, so no external power for transport. Extremely low profile.

AMP magnetic card readers. Just the features you need, for the savings you want.

We make such a wide variety, you get a reader that's just right for your application. You're not locked in with buying a unit that's loaded with features you can't use.

And you avoid the expense of custom-made specials for standard work. Yet AMP magnetic card readers have such built-in versatility, they quickly adapt in the field for special-purpose duty—with a wide range of options for multifunctions and control.

AMP magnetic card readers conform to ANSI specifications on total equipment, and come to you electronically interfaced, ready to work with other components in your system.

No other manufacturer offers such complete, economical variety—in compact, space-saving packages.

For immediate information, contact: AMP Capatron Division, Elizabethtown, Pa. 17022. (717) 367-1105.

AMP is a trademark of AMP Incorporated.

AMP
INCORPORATED

New products

Materials

Dry catalyst is acid-free

Safe-handling granules also cut printed-circuit manufacturing costs

Electroless copper plating solutions, used in the additive printed-circuit process, are formulated so that a reaction will initiate only in the presence of a suitable catalyst. Normally the catalyst, a liquid containing some hydrochloric acid, is added to additional acid and water to form a catalyst bath.

Borg Warner Chemicals has now developed what is said to be the first dry catalyst for use in electroless plating of copper, gold, and nickel on nonconductive substrates. The catalyst was originally used to plate nickel electrolessly on ABS plastic surfaces. DRI-CAT 3 is a palladium-containing catalyst in a free-flowing granular material, rather than in the standard liquid form. It is compatible with present liquid catalysts, allowing easy changeover from a liquid to a dry catalyst. To use the dry catalyst, water and acid and the material are combined in a bath.

DRI-CAT 3 is safe to use and handle, since it contains no acid. It will not cause burns and can be swept up if spilled. It costs less to store and ship than its liquid counterpart (1 gallon of solid equals 16 gallons of liquid catalyst).

The dry catalyst, with a 30% greater absorption rate for palladium than liquid catalysts, results in lower work-bath concentration without changing the plating cycle. Moreover, bail-out (loss of hydrochloric acid) is reduced by 75% and there are less drag-out losses (catalyst leaving with the board) because of the more diluted working bath.

DRI-CAT 3 is currently being used by several electronics manufacturers in their printed-circuit fa-

cilities, both for additive and plated through-hole applications. In general, the use of the dry catalyst has reduced the cost per square foot of plated boards by 30%.

DRI-CAT 3 can also be used in electronic applications other than pc boards. A resistor company has used the catalyst to plate nickel electrolessly on a ceramic substrate for a power resistor.

Borg-Warner Chemicals, Borg Warner Corp. International Center, Parkersburg, W. Va. 26101 [476]

Thick-film copper is screenable and solderable

A copper conductor composition for use in thick-film hybrids, ground planes, power devices, and microwave applications is being introduced by the Du Pont Co.'s Electronic Materials division.

Copper conductor 9922 has a resistivity of less than 1.3 milliohms/square at 25-micrometer thickness. It has good printing characteristics, giving line resolution of 125-200- μ m (5-8-mil) lines and spaces. The composition fires at 900°-950°C in commercial nitrogen-atmosphere furnaces, and no preburnoff of organics is required.

Copper conductor 9922 has high adhesion to alumina substrates, and its aged adhesion averages 2.3 kilograms (5.0 pounds) after 150°C aging.

The copper conductor is solderable with tin/lead solders and has good solder leach resistance. It may also be plated.

In microwave application, high-frequency losses are comparable to those of thin-film conductors.

Du Pont Co., Wilmington, Del. 19898. Phone (302) 774-2358 [477]

Sapphire substrates aimed at microstrip uses

Sapphire substrates for microwave integrated circuits are available in a variety of sizes up to six inches

EMR Model 1510 Digital Real-Time Spectrum Analyzer

Q When is 256 equal to 500?

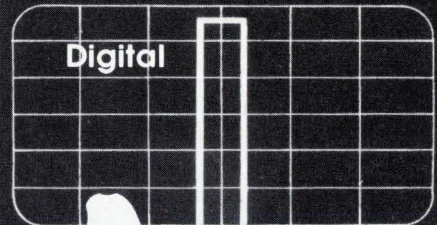
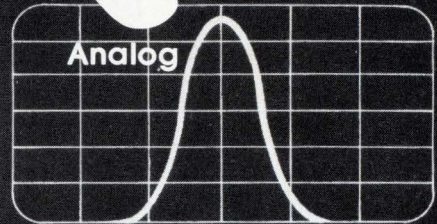

A In the digital real-time spectrum analyzer with a 1024 block size and a theoretically perfect filter shape.

It's a question of effective noise bandwidth—2.0 with the analog filters

of conventional 500-line time compression analyzers, and 1.0 with the Model 1510 Digital Real-Time Spectrum Analyzer. The result: 256 digital lines are equivalent to 500 analog lines, ideal for extracting periodic signals buried in random noise or separating closely-spaced spectral components. You get extra convenience features, too. Like a built-in CRT display with all control settings indicated on the CRT. A 60+ dB dynamic range. An intensified spot cursor with LED display of amplitude in dB, frequency and integration time remaining. And, a capability for changing weighting function by simply changing a PROM. For more details, write or call: EMR-Telemetry, Weston Instruments, Inc., Box 3041, Sarasota, Fla., 33578; (813) 371-0811.



EMR Schlumberger

Circle 149 on reader service card

922 TO-

FROM THE COMPANY WHERE PRICING IS AS IMPORTANT AS TECHNOLOGY

NPC is expanding its Silicon Epoxy Transistor line and product-families listed below are available from stock. More to come!



PART NO.	DESCRIPTION	UNIT COST AT 1,000	PART NO.	DESCRIPTION	UNIT COST AT 1,000
2N3903/4	NPN General Purpose Amp/Switch, Cu Lead Frame	\$.11/.12	2N4400/01	NPN Medium Speed, Medium Current Switch, Cu Lead Frame	\$.13/.14
2N3905/6	PNP General Purpose Amp/Switch, Cu Lead Frame	.11/.12	2N4402/03	PNP Medium Speed, Medium Current Switch, Cu Lead Frame	.13/.14
2N4123/24	NPN General Purpose Amp, Cu Lead Frame	.10/.11	NPC2369	NPN High Speed, Low Current Switch, Cu Lead Frame	.15
2N4125/26	PNP General Purpose Amp, Cu Lead Frame	.10/.11	NPCA18	NPN Very Low Noise Amp, Cu Lead Frame	.23
2N5088/89	NPN Low Noise Amp, Cu Lead Frame	.14/.15	NPC918	NPN VHF Oscillator, Cu Lead Frame	.23
2N5086/87	PNP Low Noise Amp, Cu Lead Frame	.14/.15	2N4248/49/50	PNP Low Noise Amp, Cu Lead Frame	.14
2N5209/10	NPN Low Noise Amp, Cu Lead Frame	.14/.15	NPC3638/A	PNP Medium Speed Switch, Cu Lead Frame	.16
NPCA20/21/22	NPN General Purpose Amp, Cu Lead Frame	.11	NPC3390	NPN Tight Beta General Purpose Amp, Cu Lead Frame	.14
NPCA70	PNP General Purpose Amp, Cu Lead Frame	.12	NPCD05/D55	Complementary General Purpose Amp, Cu Lead Frame	.11
			NPCD06/D56	Complementary Low Voltage Drivers, Cu Lead Frame	.11
			NPCH10	NPN High Frequency Amp, Cu Lead Frame	.21
			NPCH17	NPN VHF Oscillator, Cu Lead Frame	.28
			2N5208	PNP VHF Oscillator, Cu Lead Frame	.17
			NPCA42/43	NPN High Voltage Amp, Cu Lead Frame	.23/.20
			NPC92/93	PNP High Voltage Amp, Cu Lead Frame	.22/.19
			2N5225	NPN General Purpose Amp, Cu Lead Frame	.11
			2N5226	PNP General Purpose Amp, Cu Lead Frame	.11
			NP5.9V.5	5.9V TO-92 Reference, Cu Lead Frame	.10



6660 VARIEL AVENUE • CANOGA PARK, CALIFORNIA 91303
(213) 887-1010 • TELEX 69-8481 • TWX 910-494-1954

150 Circle 150 on reader service card

New products

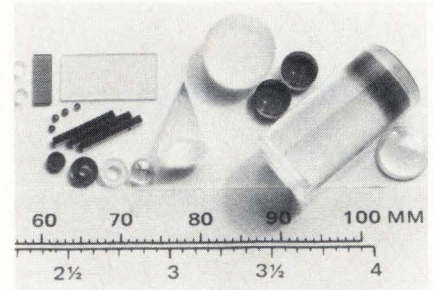

square. With a dielectric constant of 9.4 along the optic axis, sapphire is well suited to microstrip applications. Seven crystal orientations are offered: 0°, 30°, 60°, and 90°, as well as 1102, 1120, and 0001.

Marketing Dept., Bird Precision Jewels, One Spruce St., Waltham, Mass. 02154. Phone (617) 894-0160 [478]

Copper-loaded solder protects wire, foils

Copper-loaded solder is intended to prevent fine-gauge copper wires and thin copper foils from dissolving during the soldering process. This dissolving action often embrittles wire or foil during fabrication so that later on it breaks during field use. The new solder, called Savbit, reduces the solution of copper to as little as 1% of what happens with high-performance 60/40 tin/lead alloys. Its wetting rate, flow characteristics, conductivity, and capillary force are almost identical with 60/40 solder, and the required soldering temperature is only slightly



Electronics/July 22, 1976

PMI's Universal DAC.

**The stuff
dreams are
made of.**

The DAC-08 is more than the world's fastest monolithic DAC (settling in 85 nsec. typ.); it is a true current output device . . . a *digitally controlled current source*. And it features true 8-bit accuracy: **1/2LSB max. over temp.**

It can deliver wide output voltage swings without loss of linearity, since its impedance approaches infinity.

The DAC-08 is universal in its applications because its logic threshold is universal. It accepts TTL, CMOS, P- and N-MOS—any digital input. It's right at home in μP designs. And if you're interested in 4-quadrant multiplication, you'll want to know that you can do it with only two DAC-08's.

Free Sample

If you just want the data sheet, circle the number below. But if you would like to run some tests on a DAC-08, write us on your letterhead and tell us what your application is. We'll get a sample to you fast, along with appropriate Application Notes.



Precision Monolithics, Inc.
1500 Space Park Drive,
Santa Clara, CA 95050
(408) 246-9222, TWX: 910-338-0528
Cable MONO.

Circle 151 on reader service card

UNIVERSAL LOGIC INTERFACE
DIGITAL FILTERS
FOUR QUADRANT ALGEBRAIC FUNCTIONS
VIDEO DECODING
DIGITAL MULTIPLICATION
PROGRAMMABLE SUPPLIES
Line driving
4-quadrant multiplication
Digital Gain Control
DIFFERENTIAL INPUT A/D CONVERTER
DIGITAL DIVISION

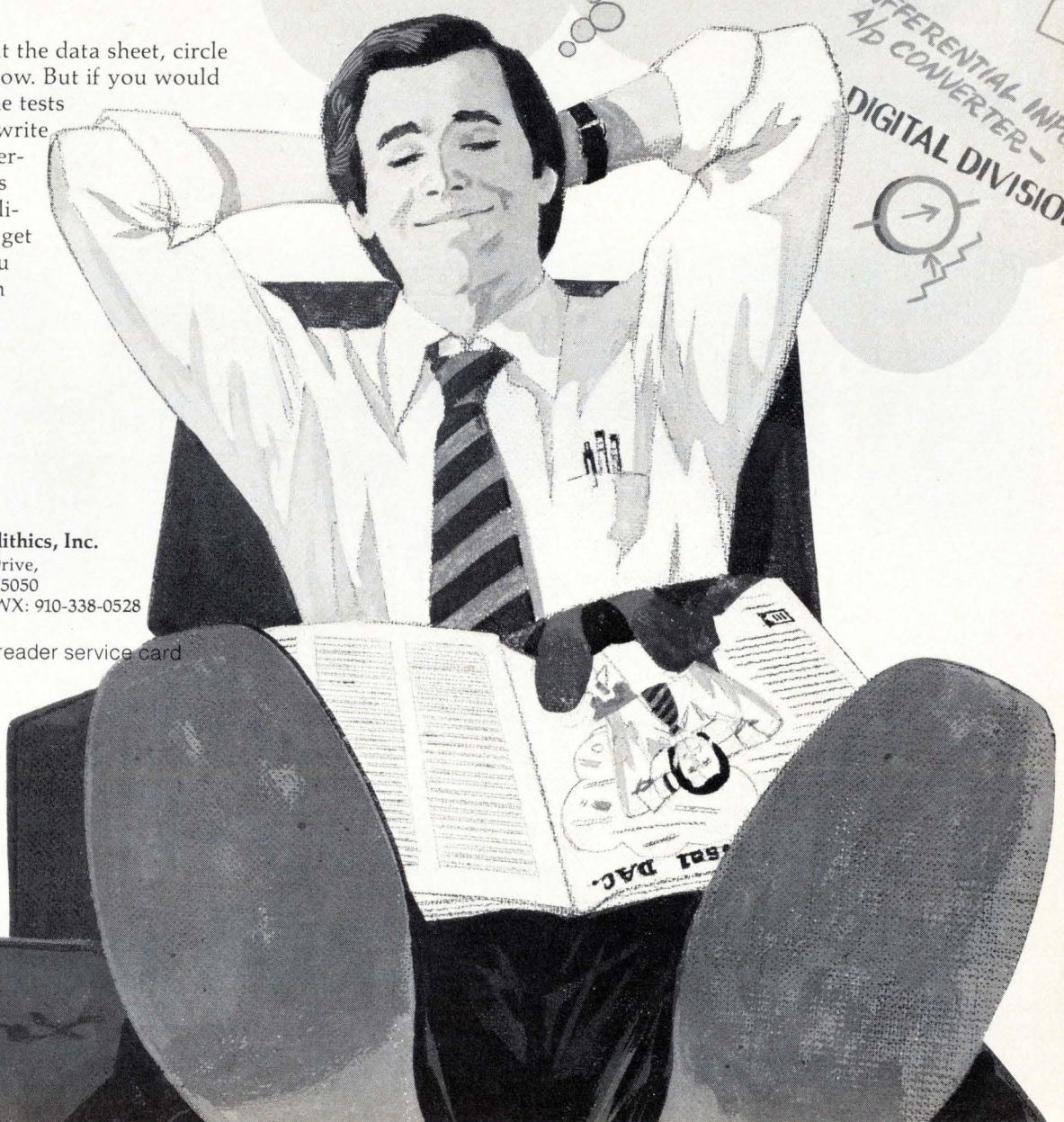

Hutson TRIACs and SCRs Use BEO as Isolator ... You Get Quality, Service and Low Cost!

You expect the best . . . and you get it with Hutson. Hutson uses BEO as an isolator to give maximum thermal dissipation. That's quality. You can't beat Hutson service and dependability, either. And the cost is low - less than \$1.00 in quantity!

Hutson's only business is the manufacture of solid state components. We know what you need and when you need it.

For TRIACs and SCRs, call Hutson . . . or contact one of the Hutson representatives nearest you.

DISTRIBUTORS

CALIFORNIA Fullerton: Zeus West (814) 871-0391; Newport Beach: Semicomp (714) 833-3070; San Diego: Semicomp (714) 560-0373; San Leandro: KEA Electronics (415) 352-2277. **CONNECTICUT** Norwalk: Harvey Electronics (203) 853-1515. **FLORIDA** Clearwater: Diplomat-Southland (813) 443-4514; Miami: All American Transistor (305) 754-5531. **INDIANA** Indianapolis: Sheridan Sales (317) 547-7777. **KANSAS** Overland Park: Sheridan Sales (913) 383-1636. **MASSACHUSETTS** Burlington: Zeus Components (617) 273-0750. **MICHIGAN** Farmington: Sheridan Sales (313) 477-3800. **MINNESOTA** Minneapolis: Cassidy (612) 835-7744. **MISSOURI** Florissant: Sheridan Sales (314) 837-5200. **NEW JERSEY** Cinaminson: Wilshire Electronics (215) 627-1920; Elizabeth: Thor Electronics (201) 354-2420. **NEW YORK** Elmsford: Zeus Components (914) 592-4120; Rochester: Rochester Radio (716) 454-7800. **OHIO** Beachwood: Sheridan Sales (216) 831-0130; Cincinnati: Sheridan Sales (513) 761-5432; Dayton: Sheridan Sales (513) 277-8911. **PENNSYLVANIA** Pittsburgh: Sheridan Sales (412) 244-1640. **TEXAS** Dallas: KA Electronics (214) 634-7870; Houston: Altair/Houston (713) 462-3029; Richardson: Altair/Dallas (214) 231-5166. **UTAH** Salt Lake City: Diplomat/Alta (801) 486-7227. **WISCONSIN** Milwaukee: B & W Electronics (414) 545-8380.



HUTSON INDUSTRIES

P.O. Box 34235
2019 West Valley View Lane
Dallas, Texas 75234
(214) 241-3511
TWX 910-860-5537

EUROPEAN OFFICE
30 Rue Pierre Semard
Yerres, 91, France
Telephone: Paris 925-8258
TELEX 210-311

Circle 152 on reader service card

C. Itoh Introduces Low Cost, Full Alpha-Numeric, Dot-Matrix Impact Printers

BOYSWEAR - NYLON JACKET	12.43
HOUSEWARES - MEAS. CUP	2.67
MENSWEAR - SWEATER	18.25
SUB TOTAL	33.35
TAX (6%)	2.00

TOTAL 35.35

AMOUNT TENDERED 40.00

CHANGE 4.65

THANK YOU... COME AGAIN
XYZ DEPARTMENT STORE

PRINTED BY

LRC 7040
MATRIX PR

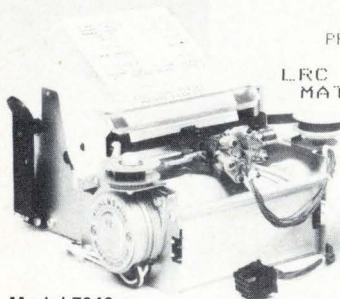

Model 7040

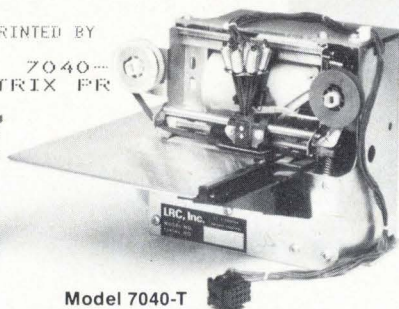

Model 7040-T

- Speed: 1.25 L/S (on 60 Hz) • Print Line Capacity: 3 1/3"
- Media: Max. 3/8" Roll, or ticket • Multi-Copy Capability
- Print Solenoid Power: 40 VDC ± 10% • 40-Column Capacity (at 12 characters to the inch)
- Motor(s): 100-125 VAC, 50/60 Hz
- Variable font and density capability under software control
- Simple electronic interface



C. ITOH ELECTRONICS, INC.

Los Angeles Office: 5301 Beethoven Street, Los Angeles, CA 90056, Tel (213) 390-7778
New York Office: 280 Park Avenue, New York, N.Y. 10017, Tel (212) 573-9456, 573-9467

Developed and Manufactured by
LRC, INC., RIVERTON, WYOMING, U.S.A.

152 Circle 195 on reader service card

Electronics/July 22, 1976

New products

higher. Savbit, which is patented, is available only from Multicore. It is supplied with five separate cores of rosin-based flux. The price is approximately \$3 a pound, depending upon gauge, quantity, and world metals prices. Delivery is from stock.

Multicore Solders, Westbury, N. Y. 11590 [479]

Temperature-indicating crayons span 125°–800°F

Temperature-indicating crayons that cover the temperature range from 125°F (52°C) to 800°F (427°C) are offered in a kit of 20 crayons for \$10. Each crayon melts at a differ-

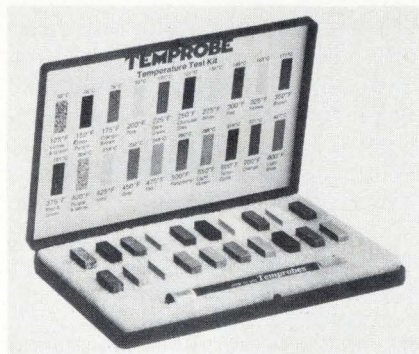

ent temperature and is accurate within 1% of the designated melting point. Made of nontoxic materials, the crayons leave a chalk-like mark on objects below their rated temperatures, and a liquid smear on hotter surfaces. The \$10 kit includes the 20 crayons, along with a holder and a carrying case.

Omega Engineering Inc., P.O. Box 4047, Stamford, Conn. 06907. Phone (203) 359-1660 [480]

Lubricant made for use on plugs, switches, slip rings

Electrical-contact lubricant Metronlube is recommended for use on plugs, slide switches, slip-ring assemblies, and in similar applications. Effective even when contact force is high, the lubricant can re-

sealed high density miniature switching

for 12 PDT to 108 PDT with MIL-R-5757 protection against humidity ... sand ... dust ... moisture ... corrosion ... splash ... explosion ... built to withstand shock/vibration!

HERMETICALLY SEALED

Tbar[®]
SERIES
881/981
RELAYS

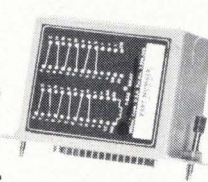

12PDT/24PST

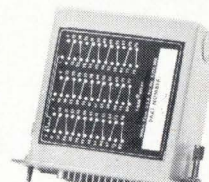

24PDT/36PST

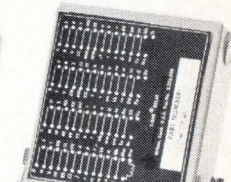

34PDT/48PST

Hermetically sealed glass and metal-to-metal enclosures backfilled for ground support and selected airborne applications. Mates with MS connectors. Pulse operated magnetic latching available. 48 circuits switched in a space as small as 1 3/4" x 4 3/8" x 4 7/8".

Interested? Write or phone T-Bar today for complete facts, prices, quantity discounts.

Tbar[®] INCORPORATED

SWITCHING COMPONENTS DIVISION

141 Danbury Road, Wilton, CT 06897 • Telephone: 203/762-8351 • TWX: 710/479-3216

Circle 153 on reader service card

Line Isolated Standard

To eliminate ground loops, power line interruptions and aberrations, EDC's new Calibrator/Source offers:

- $\pm 0.1 \mu\text{V}$ to 10V output • Accuracy $\pm 0.003\%$
- 10MA output current • Noise $1 \mu\text{V}$
- Internal battery-run 8 hrs., rechg. 4 hrs.
- Ext power - 115 Vac, 12 Vdc or 28 Vdc
- Absolute line isolation
- Model MV 216A - \$1195.

Write or phone Bob Ross for details. 11 Hamlin St. Boston, MA 02127 (617) 268-9696



ELECTRONIC DEVELOPMENT CORPORATION



Use it for its connections, or use it for its pull.

A P Super-Grip™ IC Test Clips grip dips without slips or shorting between the pins. Our patented "contact comb" prevents shorting while our superior gold-plated phosphor bronze terminals make contact. And our top-side hanger for probes to simplify "hands-free" in-circuit testing. And this gutsy little clip has the right kind of pull for unequalled ease in pulling ICs, too. Some of its best friends are dips.

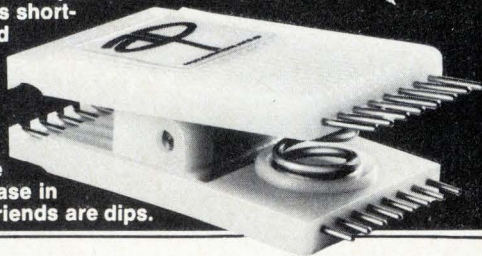

A P has a Super-Grip™ Clip for any DIP.

MODEL	ROW-TO-ROW DIMENSION	PART NUMBER	PRICE
TC-8	.3 in.	923695	\$ 7.35
TC-14	.3 in.	923698	\$ 4.50
TC-16	.3 in.	923700	\$ 4.75
TC-16LSI	.5/.6 in.	923702	\$ 8.95
TC-18	.3 in.	923703	\$10.00
TC-20	.3 in.	923704	\$11.55
TC-22	.4 in.	923705	\$11.55
TC-24	.5/.6 in.	923714	\$13.85
TC-28	.5/.6 in.	923718	\$15.25
TC-36	.5/.6 in.	923720	\$19.95
TC-40	.5/.6 in.	923722	\$21.00

Ohio and California Residents Add Sales Tax. All orders subject to acceptance at factory.

Write us for the full line
A P Products catalog.



A P PRODUCTS INCORPORATED

Box 110-E Painesville, OH 44077 (216) 354-2101

For quick phone service, call
the A P distributor nearest you:

(201) 224-8032	(513) 236-9900
(206) 682-5025	(516) 483-9200
(213) 768-3800	(516) 883-0999
(215) 698-4000	(612) 488-0201
(216) 587-3600	(617) 237-6340
(312) 298-8580	(617) 273-1860
(313) 525-1800	(617) 879-0860
(314) 863-7800	(713) 350-6771
(412) 782-2300	(713) 777-1666
(415) 326-5432	(803) 253-5333
(415) 969-9240	(914) 664-0088

(If no distributors in
your area, call factory)

Circle 154 on reader service card

NOW DDU

A COMPLETELY
INTERFACED



LOGIC DELAY LINE

Data Delay Devices has developed a digital delay unit, series DDU, which eliminates the interfacing in T²L circuits.

With the following advantages:

- T²L input and outputs
- 1500NS total delay
- Fast rise — Time on all taps
- Up to 10 taps
- Each tap isolated and with 10T²L Fan-out capabilities
- Exact delay at each tap

Request spec. sheet DDU

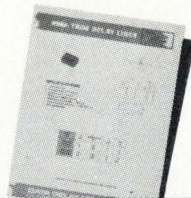

DATA DELAY DEVICES

253 CROOKS AVE., CLIFTON, N.J. 07011

Tel. (201) 772 1106



154 Circle 198 on reader service card

New products

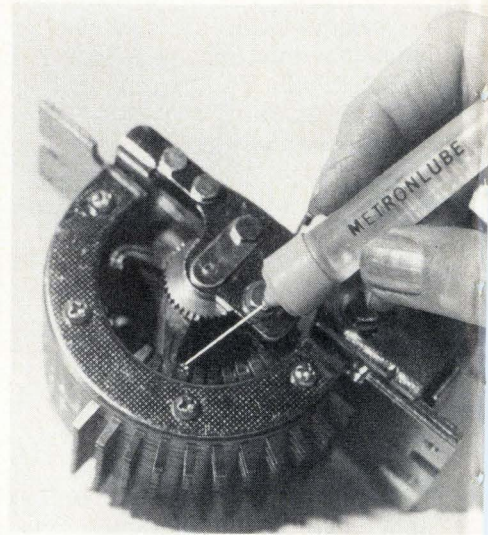

duce the coefficient of friction for copper, silver, and gold-plated surfaces down to the range of 0.05 to 0.15. Metronlube is colorless, chemically neutral, water-repellant, physiologically safe, non-gumming, and silicon-free. Useful over the temperature range from -55°C to 250°C, the material is supplied in a Metron Marker pen with a needle-like applicator. The applicator's 0.026-inch opening makes it very easy to position the lubricant. Metronlube-filled pens sell for \$3.95 each individually, or \$3.65 each for five or more. An extremely thin applicator with an orifice of only 0.013 in. is available for 50 cents more per pen.

Metron Optics, Box 690, Solana Beach, Calif. 92075. Phone (714) 755-4477 [341]

Conductive coating comes in spray cans

Providing a high level of conductivity in a tough, durable film with good adhesion to most properly prepared surfaces, E-KOTE 61 is an economical electrically conductive coating packaged in aerosol spray cans. It contains neither silver nor widely used substitutes such as copper or carbon.

E-KOTE 61 is designed and packaged to provide durable electrical grounding, electrostatic control, and electromagnetic-interference shield-

Electronics/July 22, 1976

The portable logic analyzer

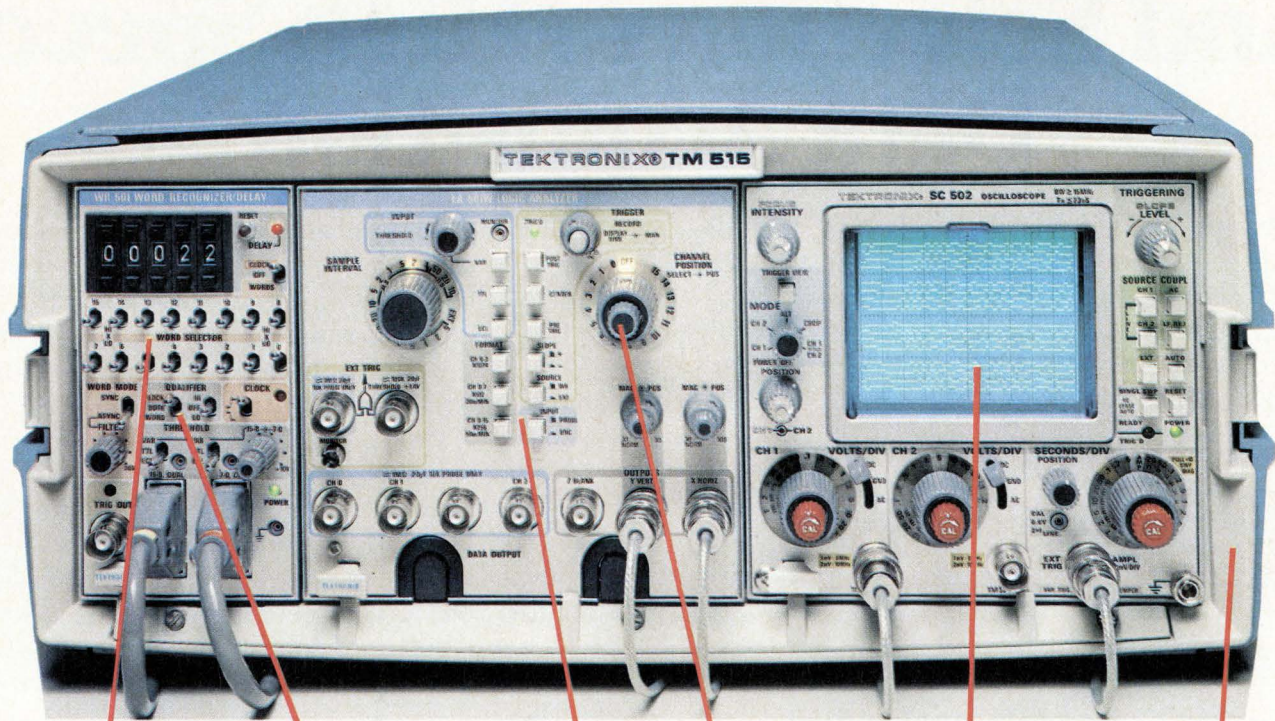

16-CHANNEL WORD RECOGNITION. Event digital delay to 99,999; delay by words or clock pulses.

FORMATTABLE MEMORY.
16 channels x 256 bits at 20 MHz
8 channels x 512 bits at 50 MHz
4 channels x 1024 bits at 100 MHz asynchronously; 50 MHz synchronous sampling.

SC 502 DUAL-CHANNEL OSCILLOSCOPE, one of many displays for the LA 501W Logic Analyzer.

QUALIFIER INPUT. Extend word recognizer to 17 bits, and/or selectively store data into memory.

CHANNEL POSITION CONTROL. Enables you to superimpose any two channels for easy timing comparisons.

AS PORTABLE AS CARRY-ON LUGGAGE. Shown in the TM 515 Traveler Mainframe.

Choose the TM 515 Traveler Mainframe with the LA 501W Logic Analyzer and the SC 502 Oscilloscope, and you have a complete logic analysis system in a suitcase. The Traveler Mainframe is as attractive as carry-on luggage and so compact that it can be stowed under an airplane seat or packed in the trunk of your car.

Choose the TM 506 power module/mainframe with the LA 501W, and you can set your logic analysis system up on the bench or rackmount it.

Whichever way, the LA 501W is a lab-quality logic analyzer you can use with virtually any oscilloscope or X-Y monitor.

The LA 501W acquires 4, 8, or 16 channels and stores 1024, 512, or 256 bits at a time. As much as 90% of the memory can be used to store pretrigger data.

Data is displayed for easy interpretation: biphasic timing tick marks help you read the timing diagram, and the channel position control allows you to make comparisons easily between any two channels.



The LA 501W also features active $1\text{ M}\Omega/5\text{ pF}$ probes that won't load down the circuit under test. Independent probe thresholds—TTL, ECL, and Variable ($\pm 10\text{ V}$)—that make the instrument compatible with virtually all logic families. Event digital delay, by words or clock pulses, to 99,999.

Prices for the system shown above are: LA 501W Logic Analyzer \$4450, SC 502 Oscilloscope \$1,200, and TM 515 Instrument Mainframe \$325.

For more information on the LA 501W, contact the Tektronix Field Engineer near you for a demonstration. Or send for your copy of our brochure, "Tektronix Logic Analyzers," by writing Tektronix, Inc., P.O. Box 500, Beaverton, OR 97077. U.S. sales prices are F.O.B. Beaverton, OR.



TEKTRONIX®

committed to
technical excellence

Unmatched Performance and Selection in High Speed Data Acquisition

Ultra-high speed ADC's and DAC's, sample-holds, multiplexers, and super-fast op amps. Individually, they're outstanding — many without peer. Collectively, they are carefully matched to provide the fastest data acquisition systems available. Anywhere.

Ultra-High Speed ADC's	Resolution	Conv Time	Gtd Throughput Rate with 4855S/H*	Add a 4550 Multiplexer Time per Channel	Throughput
4130	8-bits	0.75 μ s	1.25 MHz	1.10 μ s	909 kHz
4131	10-bits	1.00 μ s	940 kHz	2.12 μ s	471 kHz
4133	12-bits	2.50 μ s	377 kHz	3.30 μ s	303 kHz

*Model 4855 features 250 nsec acquisition time to 0.01% and an aperture time of 2 nsec max.

For high speed MIL-applications, our 4058, a true 12-bit microcircuit DAC, features ultra-fast, ultra-stable operation from -55°C to $+125^{\circ}\text{C}$ with 100% screening available to MIL-STD-883.

Settling at 200 nsec to 0.01% max and providing 10 V @ 50mA output, our 1430 IC op amp is still the performance leader. Combine it with 4058: without question the fastest 12-bit hybrid voltage DAC. Anywhere.

The industry's fastest MDAC's — that's our 4070 series. 8, 10, or 12-bit resolution, 500 nsec settling to 0.1%, and inputs up to 7 MHz.

High Speed Current DAC's — our 4060 series give you a competitive and compatible selection, with a guaranteed settling of 85 nsec to $\pm 0.1\%$.

Radar pulse digitizing, video digitizing, FFT, simultaneous sample-hold systems, CRT displays, and waveform synthesis — applications where only Teledyne Philbrick can give you the complete high speed solution. And, a new series of Application Bulletins will facilitate your high speed design. Just write for them.

Teledyne Philbrick, Allied Drive, Dedham, MA 02026 — Telephone (617) 329-1600. In Europe, Telephone 673.99.88, Telex 25881, or write 181 Chaussee De La Hulpe, 1170 Brussels.

TELEDYNE PHILBRICK

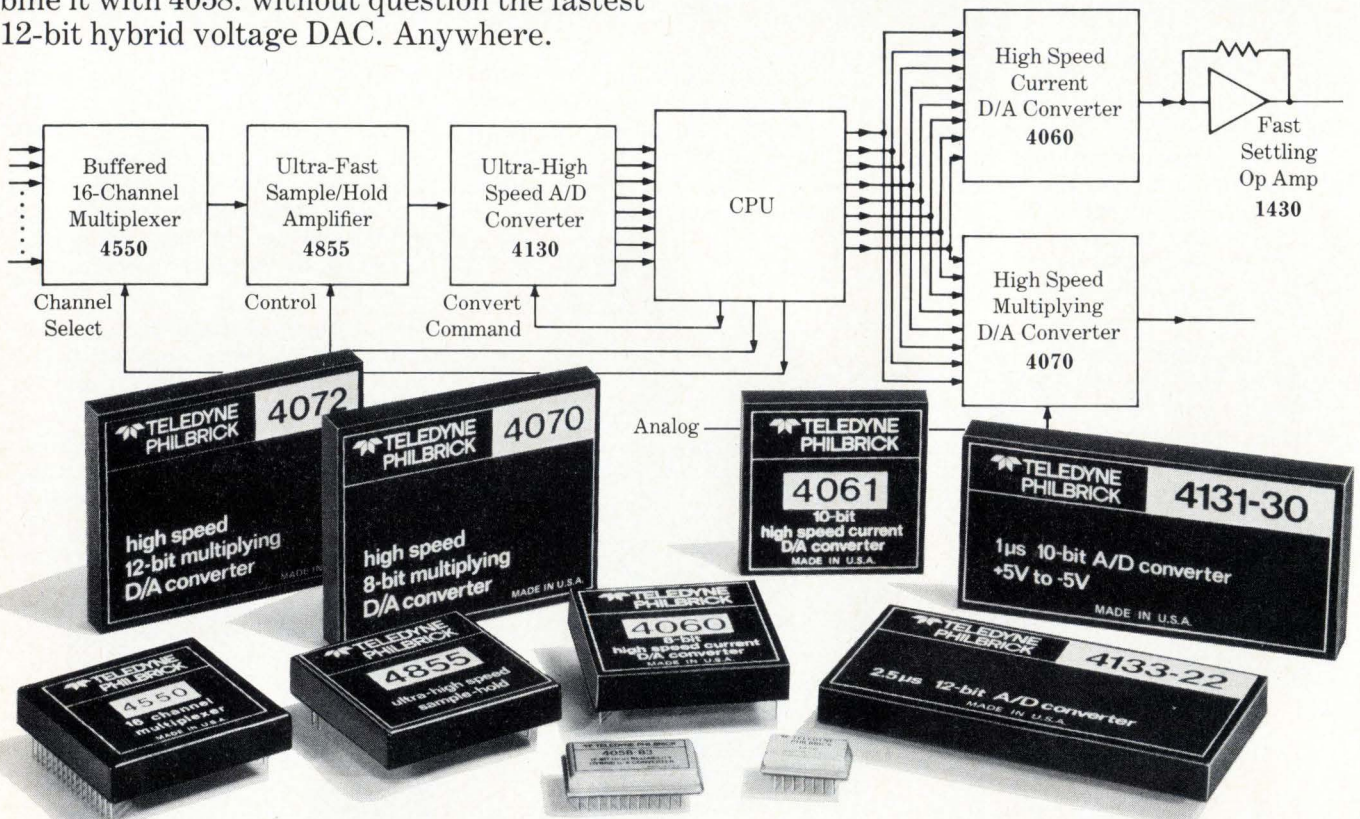

New products

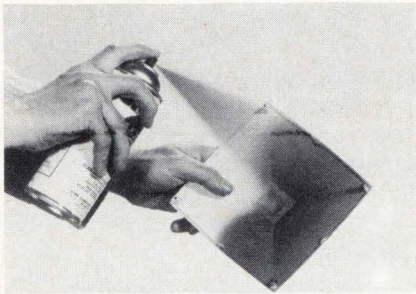

ing of structural foam enclosures and other plastic components found in business machines, computers, peripheral equipment, printers, and data-entry and memory terminals.

Acme Chemicals & Insulation Co., Division of Allied Products Corp., P.O. Box 1404, New Haven, Conn. 06505. Phone (203) 562-2171 [342]

Foil is processed for forming magnetic shields

Fully heat-treated foil in a special alloy for forming magnetic shields is offered in any width to 15 inches. Known as Eagle AAA, the foil is suitable for designing prototype shields, experimentation, product evaluation, and the small-volume production of shields for cathode-ray-tube necks, transformers, amplifiers and photomultiplier tubes. Available with or without adhesive backing, in thicknesses of 0.004, 0.006 and 0.010 inch, the foil is easily cut and formed by scissors or paper cutter. Initial permeability is 100,000, and maximum permeability is 200,000. Prices range from \$1 to \$20 per lineal foot, depending on width and quantity.

Eagle Magnetic Co. Inc., P.O. Box 24283, Indianapolis, Ind. 46224. Phone John L. Coddington at (317) 297-1030 [343]

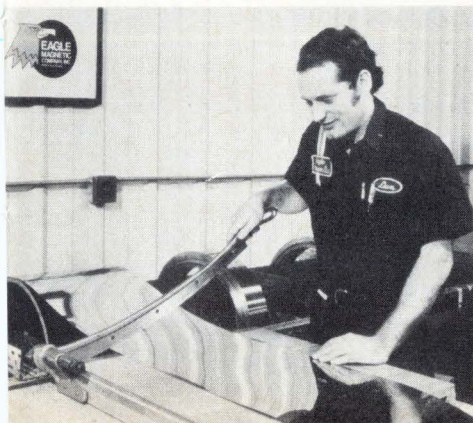

Paying More Than \$295 For Waterproof Load Cells?



Why?

Designing electronic weighing, force measuring or test systems for all weather use? You won't find a price this low for any other *waterproof* and *barometrically insensitive* strain gage load cell—especially one offering an error band of less than $\pm 0.04\%$!

Buy a definite competitive edge in price and performance with Sealed Super-Minis that operate in tension or compression—with capacities to 1,000 pounds.

For detailed specifications on 5 pound to 100 ton capacity load cells, call—write Interface, 7401 E. Butherus Dr., Scottsdale, AZ USA 85260. (602) 948-5555, Telex 668-394.



Low Profile



Minibeam



Super-Mini

Interface
ADVANCED FORCE MEASUREMENT

Circle 157 on reader service card

ONE-CHIP SYSTEM LOGIC #1.

NEW AM/FM FREQUENCY SYNTHESIZER. ONE-CHIP ELECTRONIC TUNING.

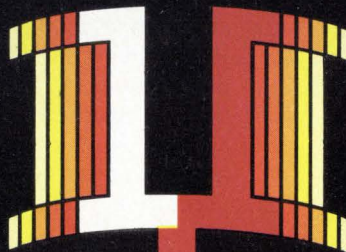

Now a single LSI chip that performs all digital control functions for generating AM/FM/CB radio freqs. Uses PLL techniques. Up to 2000 AM/FM channels possible. Simply order from stock: #8X08.

Send book titled *One-Chip System Logic*. Clip coupon to letterhead.

Name Title

Tel. M.S.

811 E. ARQUES, SUNNYVALE, CA. 94086

THINK
Signetics

a subsidiary of U.S. Philips Corporation

© 1976

Circle 199 on reader service card

157

New products

Industrial

Electronic brake stops motors fast

Unit applies dc to decelerate rotors without reversing them

High-power drills, saws, centrifuges, and similar rotating machines can take from 5 to 10 minutes to coast to a stop—a situation that is both time-wasting and potentially dangerous. Now a Short Stop model, which can stop motors rated at up to 60 horsepower in as little time as it takes them to get up to speed, is available for automatic braking of contactor-controlled ac motors.

Like earlier lower-powered units, the SS-460 operates by rectifying a portion of the ac line current and injecting it into the motor. This creates a stationary field that exerts a powerful braking action with no possibility of reversing the motor. When the motor is stopped, the dc is removed automatically to prevent heating and to allow restarting.

Stopping time can be made no shorter than machine startup time, but it can be made longer, if desired, by means of an adjustment that changes the fraction of the line current rectified to provide the dc stopping field. Thus devices that may be sensitive to rapid deceleration may be stopped more gradually, but still much faster than normal friction would stop them.

Housed in a standard NEMA 12

type oil-tight case, the SS-460 can be mounted either at the machine it is controlling or at a remote location. Installation is simple; only six wires must be connected. Two go to the motor, two to the power line, and two to the contactor.

The 60-hp unit is designed for use with three-phase 440-volt lines. Conversion for use with 220-v lines adds \$25 to the single-quantity price of \$1,000. The SS-460 weighs 40 pounds and has a delivery time of stock to two weeks. The manufacturer has indicated that a similar unit, with a capacity of 100 hp, will be available in the near future.

Ambi-Tech Industries Inc., 861 Washington Ave., Westwood, N.J. 07675. Phone M. C. Baum at (201) 666-0504 [371]

Bridge signal-conditioner comes complete in module

More than merely an instrumentation amplifier, the model 165 Bridgesensor module from Calex is a complete signal conditioner containing an internal-reference circuit, a bridge supply, and a comparator. The module measures 2 by 2 by 0.6 inches. It can operate from a single-supply voltage; the model 165A Bridgesensor uses +15 volts dc, and model 165B operates from unregulated +28 v dc. The user needs only to connect the transducer bridge and the single-supply voltage to the Bridgesensor for it to provide the bridge-excitation voltage, amplify the transducer-bridge output, and compare the output against the internally generated reference voltage.

With single-supply operation, the instrumentation-amplifier output has a range of 50 millivolts to 10 volts. With the inputs shorted together, the instrumentation-amplifier section may be connected for an output of either 50 mv or 5 v. The input offset can be externally trimmed to assure a constant offset over the full gain range. With a dual supply, the instrumentation amplifier may also be connected for an output of ± 10 v.

Unit price of the 165A is \$84 and,

»TTL-155«

Transistorized logic elements for error — free electronic brains

- 100 per cent quality control by every rating
- minimum power consumed · negligible weight
- minimum on-off time · wide range of temperatures
- extra-strong structure

Delay, ps:	
on	15
off	22
Max. voltage:	
supply, V	+ 5.5
input, V	+ 4.5
Max. output current, mA:	
high level	1
low level	16
Noise voltage, V	0.4
Static power per one element, mW	25
Dimensions, mm	19.5 x 6.5 x 3.8
Working temperature range, °C.	-10 to +70
Acceleration, g:	
at vibration within frequency range	
5 to 2000 Hz	10
5 to 5000 Hz	—
at repeated impacts	35
at linear acceleration	50
at single impacts	150

TTL-155 Integral microcircuits for computers & automatic control — the transistorized logic that is up to the world's highest standards,

supplied in any quantities by



ELORG

32/34 Smolenskaya-Sennaya
Moscow 121200, USSR
Telex 7586

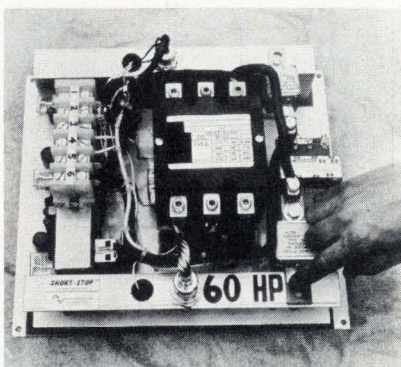

Plug-in protection for μ P's and minicomputers



SOLA ELECTRIC **SB**
SOLA BASIC

Sola's Minicomputer Regulator provides a dedicated power line plus crucial line-voltage protection.

A small investment can give your equipment both a dedicated line and protection against malfunction and damage due to brownouts and other line voltage irregularities.

The portable Sola Minicomputer Regulator accepts line voltage variations from 95 to 130 volts . . . then stabilizes output within $\pm 3\%$ variation. Output remains within $\pm 5\%$ operational range even when power line voltages drop to 65% of nominal. The unit responds to all line or load variations in less than 25 milliseconds, and provides complete isolation from electronic noise. All by simply plugging it in—no need for an electrician.

The Minicomputer Regulator. Part of Sola's complete selection of line voltage regulation devices—CVS constant voltage transformers . . . computer line Solatrons for large-frame computers . . . UPS and standby power systems.

They are all in stock at your Sola distributor. Or contact Sola Electric, 1717 Busse Road, Elk Grove Village, Illinois 60007. Phone (312) 439-2800.

Think of us as your DEDICATED LINE.

Circle 159 on reader service card

Finally,
a \$5.00 solid state relay that
doesn't end up costing you \$150.

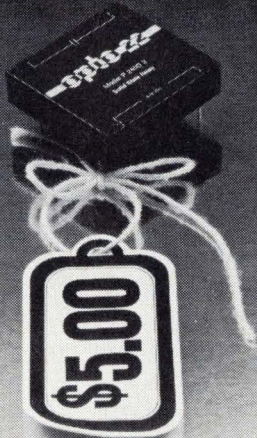

The last thing you need is an "inexpensive" relay that creates a costly problem. That's why you should know about the new P-Series SSR from OPTO 22. Built-in reliability means you don't have to worry about the SSR failing during functional testing; or, worse yet, causing an expensive service call later.

This compact SSR ($\frac{3}{8}$ " thin package) is packed with high performance features: Photo-isolation, zero voltage switching, built-in snubber, high surge current capacity, and an honest 2-amp current rating. Available for 120 and 240VAC, this OPTO 22 P-Series is the best \$5.00 SSR you can buy!

opto 22®

5842 Research Drive, Huntington Beach, Calif. 92649
Call (714) 892-7676 for next day shipment

Circle 200 on reader service card

ONE-CHIP SYSTEM LOGIC #2. NEW DESKEW FIFO. ONE-CHIP PARALLEL DATA DESKEWING.

Breakthrough. Synchronize parallel data with 1 new LSI chip per track. 2 inputs for each track. 16 bits each input, all commonly clocked. 2 versions: #8X03 10V CMOS compatible; #8X04 T²L compatible. Both reduce costs in high performance peripheral controllers.



I want to read your book on *One-Chip System Logic*. Coupon's clipped to letterhead.

Name _____ Title _____
Tel. _____ M.S. _____
811 E. ARQUES, SUNNYVALE, CA. 94086

THINK

signetics

a subsidiary of U.S. Philips Corporation

©1976.

Circle 201 on reader service card 159

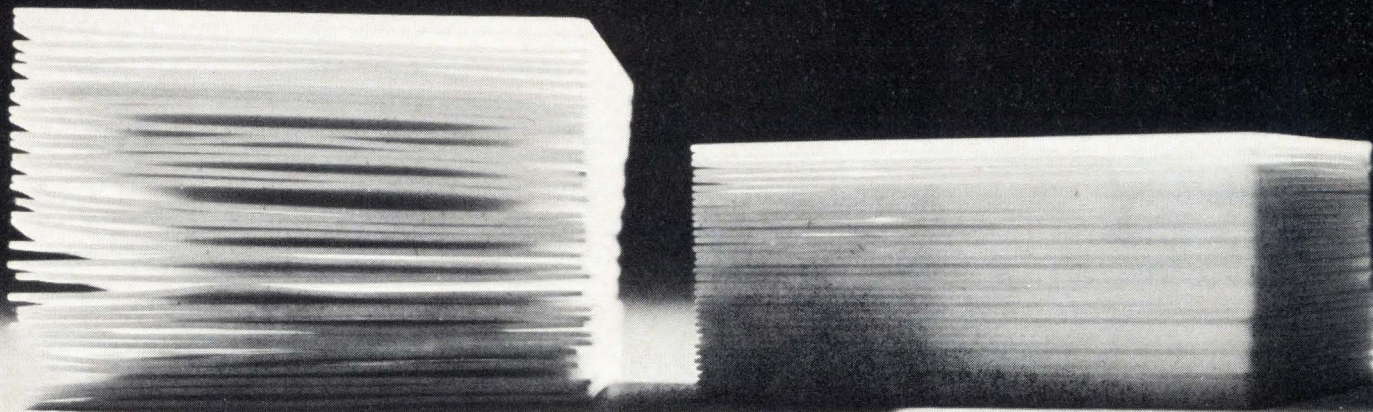

ARE WARPED SUBSTRATES CAUSING YIELD PROBLEMS?

ASK FOR EXTRA FLAT ALSIBASE[®] SUBSTRATES.

Now you can get flatter, more uniform alumina substrates to meet hybrid circuit design requirements—without costly grinding!

Production runs of AISiBase brand alumina substrates, flat within .003" per inch (within .002" per inch on certain sizes), are available on special order from 3M.

This camber breakthrough from 3M, the pioneer in substrate technology, can mean improved yield, longer screen life and less breakage in hybrid processing.

If you have a design need for flatter substrates for thick or thin film hybrids, call or write:

Technical Ceramic Products Division,
3M Company, Sales Dept., Laurens, South
Carolina 29360, (803) 682-3215.

3M
COMPANY

New products

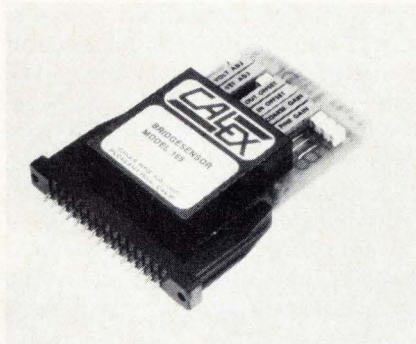

of the 165B, \$94. Delivery is from stock to two weeks.

Calex Mfg. Co. Inc., 3305 Vincent Rd., Pleasant Hill, Calif. Phone Rick Belford at (415) 932-3911 [378]

Modular reference junction provides 10 channels

Offered in modular form, a 10-channel reference junction, the SL100, receives 10 thermocouple wire pairs with guards. It provides transition of the wires to copper conductors and electronically compensates the selected pair relative to 0°C. Compensation for any wire type is available for the 10-channel group, and any reference temperature can be provided. The compact SL100 measures 6 inches long by 3.14 in. wide by 1.06 in. thick with outer cover and connector installed.

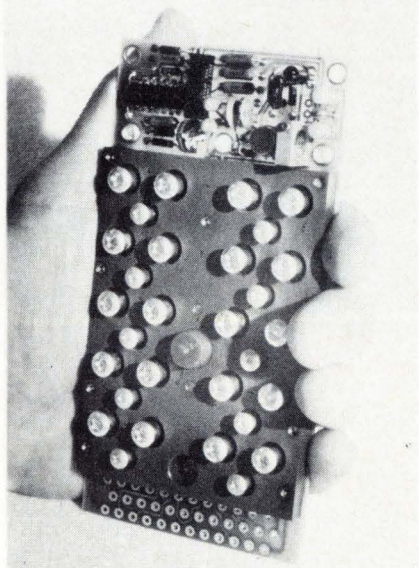

Scanbe·gram

- RE: LASTING CONTACTS WITH US-2 SOCKETS
- GONE FOREVER - FUNKY I.C. SOCKET CONTACTS...SCANBE'S NEW US-2 LOW PROFILE SOCKETS FEATURE UNIQUE EDGE WIPE CONTACT...UTILIZE GAS-TIGHT DESIGN CONCEPTS... PLUS HIGH TENSILE STRENGTH NICKEL-SILVER ALLOY.
- GONE TOO - SOLDER WICKING...PATENTED ANTI-WICKING BARRIER DOES IT, WITHOUT WAFERS...NO MORE FLUX ENTRAPMENT OR INTERMITTENT SHORTS.
- US-2 MEETS OR EXCEEDS EIA STDS...ALL POPULAR SIZES.
- GET ALL SPECS AND DETAILED MATERIAL INFO...SEND FOR FREE US-2 SOCKET, TEST REPORT, SPEC SHEET.

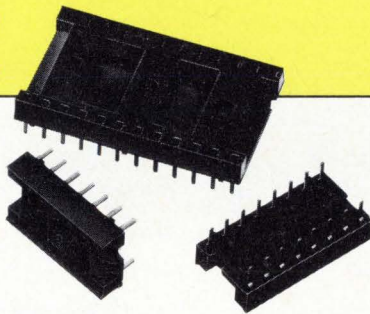

"Imitated... never duplicated."

SCANBE
CANOGA INDUSTRIES

Scanbe Manufacturing Corp.
3445 Fletcher Ave., El Monte, CA 91731
Tel: (213) 579-2300 • TWX: 910-587-3437

Circle 202 on reader service card

ONE-CHIP SYSTEM LOGIC #3 NEW CRC GENERATOR/CHECKER. ONE-CHIP ERROR-CHECKING.

Eight polynomials in one chip.
Detects serial digital data errors including SDLC type. I²L with on-chip TTL interface. Order #8X01.

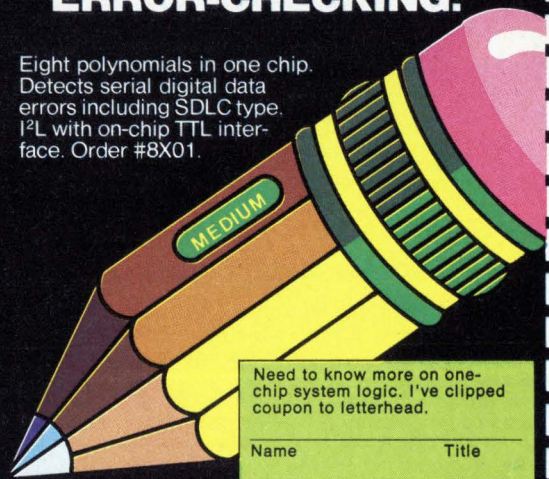

Need to know more on one-chip system logic. I've clipped coupon to letterhead.

Name _____ Title _____
Tel. _____ M.S. _____
811 E. ARQUES, SUNNYVALE, CA. 94086

THINK
Signetics

a subsidiary of U.S. Philips Corporation

©1976.

THE \$2000 MICROCOMPUTER MISTAKE (HOW TO AVOID IT)

There's more to ICC microcomputer systems than just filling your order. Before you spend a cent we help you understand how the powerful ICC microsystem provides the exact microcomputer to fit your application.

And our micro-sized 3" x 2" standard and custom Abacus™ modules developed over the last 9 years provide all the expandability and design flexibility your microsystem needs.

Now you can do virtually everything minicomputers do at a fraction of the cost. No more simulation guessing games. Our hands-on Microware™ supplies all the hardware/software tools you need to be system-ready in the shortest possible time.

Send for the free facts today.

Free for all. Get into it.

Hurry, rush me my microcomputer information.

Name _____

Date _____

Address _____

Phone _____

City/State/Zip _____

Application _____

Information Control Corp.,
9610 Bellanca, Los Angeles,
CA 90045 (213) 641-8520.

ICC MICROSYSTEM
HARDWARE/SOFTWARE/SUPPORT

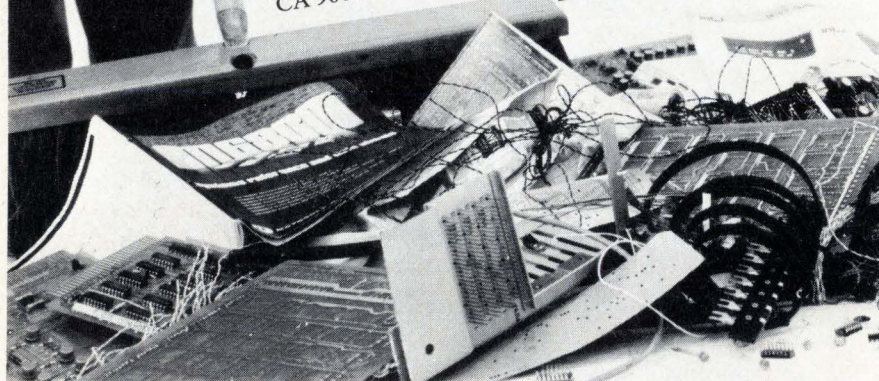

Circle 162 on reader service card

Own your own holder to hold your own!

Hold your own copies of Electronics in specially designed slipcase holders. They'll keep your Electronics library neat and handy—a permanent information file, issue by issue.

Just complete the coupon and mail to Jesse Jones. He'll process your order upon receipt, postpaid.

ELECTRONICS BOXER
Jesse Jones Box Corporation
2250 E. Butler St., Philadelphia, Pa. 19137

Please send me: boxes @ \$4.25 each; 3 boxes @ \$12.00; 6 boxes @ \$22.00.
My check or money order is enclosed.

Name: _____

Address: _____

City: _____

State: _____

Zip: _____



New products

The customer has a choice of solder pins that are 0.040 in. in diameter or a ribbon-cable edge connector. The unit is factory-calibrated and sealed. It comes ready to bolt directly to a data-logger rear panel or a 19-in. rack. Oversize truss-head screws and large binding posts are provided to accommodate up to No. 14 AWG thermocouple wire. Less than 500 milliwatts of roughly regulated power is required. Price for a 10-channel unit is \$180 each in quantities of five.

San Diego Instrument Laboratory, 7969 Engineer Rd., San Diego, Calif. 92111. Phone (714) 292-0646 [374]

Intrinsic safety barriers

offer pre-assembled design

Built on the terminal-block assembly concept, intrinsic safety barriers from Bailey Meter Co. are designed for safety of process-control measurement equipment operating in hazardous locations containing flammable gases or vapors. The series 766 barriers feature pre-assembled design and require minimal field assembly. Barriers for 4-to-20-milliamper input loops are equipped with internal precision resistors for development of the measured signal. Each barrier also has internal ground-reversed voltage protection and fault isolation between loops.

Bailey Meter Co., Subsidiary of Babcock & Wilcox, Wickliffe, Ohio 44092. Phone (216) 943-5500 [376]

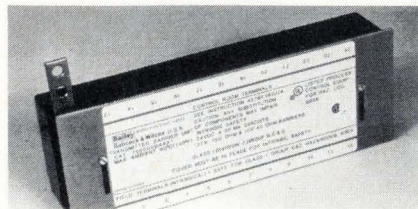

Miniature accelerometer has built-in amplification

Containing its own charge converter, an accelerometer from En-

TAPE TRANSPORTS... engineered with the designer in mind



The new Braemar CS-400 full-feature digital cassette transport system is ready to go.

- Ideal for microprocessor use.
- Features read/write amps.
- Auto-Sync phase encode/decode
- Compact size, low power consumption

All the features of our CD-200 transport, plus full electronics.

- Only one supply voltage and two moving parts
- Handy push-to-open latch
- Short IRG, excellent speed control

Use the coupon to check out either or both units.

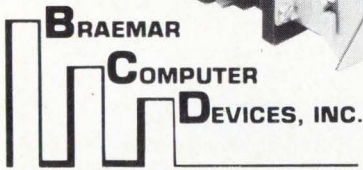

**BRAEMAR
COMPUTER
DEVICES, INC.**
11950 TWELFTH AVENUE SOUTH
BURNSVILLE, MINNESOTA 55337
(612) 890-5135

**THE DIGITAL CASSETTE PEOPLE
OVER 30,000 IN THE FIELD**

YES!

- Send info on the new CS-400.
- Tell me about the CD-200.
- I'd like a demonstration.

Name _____
 Title _____
 Firm _____
 Address _____
 City _____ State _____ Zip _____
 Phone _____

Circle 163 on reader service card

SMART new data system learns from your finger to do YOUR job



1. Measure up to 248 low level signals accurately, immune from noise—*analog, digital, non linear*. Print them out, tape them, feed your computer (alarms too!).
2. Key program—with one finger—all clock timing, scan intervals, channel gains, I/O, engineering units, powerful subroutines like automatic programming and optional integration. Everything to do your job.

In the new PD-2064, a proven microprocessor, RAMs, and ROMs replace a bushel of expensive circuitry to make a versatile, standardized data acquisition system for general or specific jobs. Get more data *reduced* per dollar. Call about immediate shipment from stocking program. Request Bulletin B110 from Esterline Angus Instrument Corporation, P.O. Box 24000, Indianapolis, IN 46224. 317/244-7611.



Circle 203 on reader service card

ONE-CHIP SYSTEM LOGIC #4 NEW CONTROL STORE SEQUENCER. ONE-CHIP MICROINSTRUCTION SEQUENCING.



8 microfunctions
—TSK, POP, RST,
etc. in 52ns. All
essential sequenc-
ing functions.
1K addressability,
4 level stack. Low
power Schottky/
LSI technology. Order #8X02.

Clip coupon to letterhead for
book on this and all one-chip
system logic products.

Name _____ Title _____
 Tel. _____ M.S. _____
 811 E. ARQUES, SUNNYVALE, CA. 94086

**THINK
Signetics**

a subsidiary of U.S. Philips Corporation

©1976.

Circle 204 on reader service card 163

Nothing—not even a scope or a voltmeter or even another logic tester. Because CSC's Logic Monitor™ 2 is the most convenient, efficient way ever developed to monitor circuit activity in digital IC's: it provides instant and continuous display of static and dynamic states of DIP IC's up to 16 pins.

Its built-in power supply, high input impedance and selectable logic thresholds provide the most accurate monitoring of counters, shift registers, gating networks, etc., on big, bright LED's. And because there is no loading of the circuit under test, logic level shifts, false triggering and power sup-

ply loading (that can occur with some equipment) are problems of the past.

LM-2 is a second-generation IC test instrument consisting of two units—a connector/display and a switchable precision voltage reference power supply. In operation, the threshold switch on the power supply is set to the proper logic family (RTL, DTL, TTL, HTL or CMOS). A clip lead is connected to the ground (plus VCC lead, in the case of CMOS), and the connector/display unit simply clipped over the IC under test. That's it.

Each of the 16 pins on the connector/display unit automatically

connects to the corresponding IC pin without any possibility of shorting, and feeds one input of a voltage comparator circuit. The other input is fed from a precision selectable voltage source. When the voltage on a particular pin is more positive than the reference (logic "1"), the corresponding LED lights—at any pulse frequency from DC to 30KHz (50% duty cycle).

If you're looking for an easy way to monitor digital circuits, LM-2 with its 16 channels of automatically-in-sync information and fast, instinctive operation, can't be beat. You won't find anything like it, anywhere near the price.

CSC'S LOGIC MONITOR 2. AT \$124.95, NOTHING ELSE LETS YOU DO SO MUCH SO FAST AND SO WELL FOR SO LITTLE.

Fully isolated power supply module—Constant, bright LED readings without drawing power from circuits under test

Sturdy, high impact construction throughout—At CSC, part of making a good thing means making it to last

Clip module slips easily over IC—Now, checking static and dynamic states of dual in-line IC's of up to 16 pins is literally a snap

Non-corrosive nickel-silver contacts—For maximum reliability and minimum contact resistance

Selectable threshold level—Matches characteristics of logic family under test—RTL, DTL, TTL, HTL or CMOS

Precision plastic guides and flexible web*—For short-free positive contact with IC under test

Big, bright 16-LED display—More information and no more eyestrain—get a picture of everything that's happening *simultaneously*

High input impedance—100K impedance for minimum circuit loading

CONTINENTAL SPECIALTIES CORPORATION



EASY DOES IT

For more information, see your distributor or write for our catalog and distributor list.

44 Kendall St., Box 1942 New Haven, CT 06509 • 203-624-3103 TWX: 710-465-1227 West Coast office: Box 7809, San Francisco, CA 94119 • 415-421-8872 TWX: 910-372-7992 Canada: Len Finkler Ltd., Ontario

New products

devco is annular in form and makes its vibration measurements in the shear mode. Incorporation of the converter is said to make it the first annular shear accelerometer with built-in amplification. The shape of the unit also simplifies installation, since the center hole is used with a mounting bolt. This configuration allows 360° orientation of the coaxial connecting cable. The accelerometer, model 2251, has a wide dynamic range and a standardized sensitivity of 5 millivolts per g, $\pm 3\%$. Full scale covers ± 500 g and the device is linear within $\pm 1\%$ over the full range. Nominal frequency response is $\pm 5\%$ from 4 to 8,000 hertz, and output impedance is less than 150 ohms.

Endevco, Dynamic Instrument Division, 30700 Rancho Viejo Rd., San Juan Capistrano, Calif. 92675. Phone (714) 493-8181 [377]

TOPICS

Industrial

Theta Instrument Corp., Fairfield, N.J., has announced an optical BCD encoder network for use where destruction of data because of a power failure would be catastrophic. The encoder provides an absolute value of shaft position at all times. . . .

Transtector Systems, Monterey Park, Calif., has developed an equipment protector for use against destructive overvoltages arising from switching inductive loads, power-company switching, contact arcing, static discharge, induced lightning, and continuous overvoltage conditions. . . . An electronic torque limiter from **Huima Specials B.V. of Enschede, the Netherlands**, can set the torsion rate of electrically operated butterfly, ball-and-gate valves and control taps at 50% greater than the normal torque with full protection of the motor, transmission, and devices being driven. . . .

Houston Instrument, Austin, Texas, has announced that its Complot PTC-5 plotter controller will now accept input from the IBM 5100 portable computer.

Now you can get Lambda power supply quality from Adtech Power ...much faster!

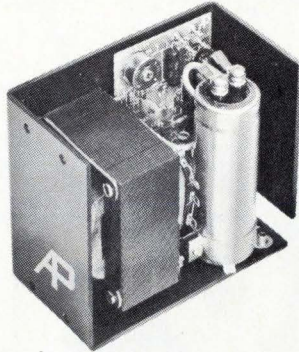

If you lean towards Lambda power supplies because of the quality of the key components they use, you can lean on us now, because we use Lambda components, too. They're exactly the same. But Lambda is huge. We are small enough to move more quickly on your order, shaving weeks off Lambda's typical delivery. So if you are used to Lambda quality, get used to us for fast delivery! Write for catalogs, reps and prices.

ADTECH POWER 

1621 South Sinclair St., Anaheim, California 92806 • (714) 634-9211

Circle 165 on reader service card

ONE-CHIP SYSTEM LOGIC #5

NEW 8-BIT INTERPRETER. ONE-CHIP CONTROLLER.

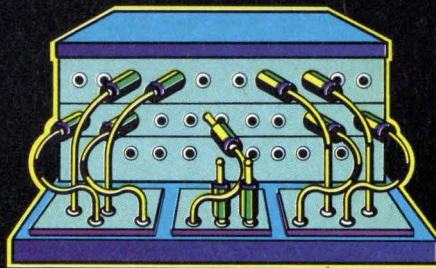

Finally, bipolar fixed instruction microcontroller on a single chip. Eliminates up to 150 SSI and MSI packages. Advanced Schottky LSI technology. 250 nanoseconds instruction cycle time. 8 powerful instructions. Order #8X300.

Coupon attached to my letterhead for *One-Chip System Logic* book.

Name _____ Title _____

Tel. _____ M. S. _____
811 E. ARQUES, SUNNYVALE, CA. 94086

THINK
Signetics

a subsidiary of U.S. Philips Corporation

©1976.

Introducing One-Chip System Logic.

You get one-chip solutions to multiple-function problems!

Until now, when you wanted high-performance, you had to pay the high price. When you wanted low price, your performance options were limited.

That's exactly why Signetics has developed its line of "One-Chip System Logic" LSI products. To give you the best of both worlds. You get multiple functions on one chip. Great to build your own designs around. Great to upgrade from TTL and Schottky SSI and MSI. Great to save you time, hassle, board space, and reduce associated logic for overall lower systems cost.

"One-Chip System Logic" incorporated high-performance I²L and LS technologies and interfaces with TTL. The key is Signetics 1/4 inch die capability which allows design and production of sophisticated LS building blocks.

System logic is one of the many LSI product families offered by Signetics including the MOS 2650 and bipolar 3000 series microprocessor.

Now, here are Signetics stock products

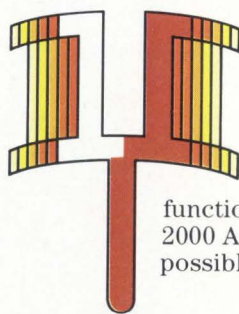

1 One-chip electronic tuning

(#8X08 AM/FM Frequency Synthesizer).

Do away with mechanical tuning and frequency generation forever.

It performs all digital control

functions and gives you up to 2000 AM/FM/CB channels possible.

2 One-chip parallel data deskewing

(#8X03 & 8X04 Deskew FIFO).

Now, one chip synchronizes parallel data on a per-track basis and offers lowest system cost. It's easy to design with and solves a lot of multiple circuit problems while you're at it.

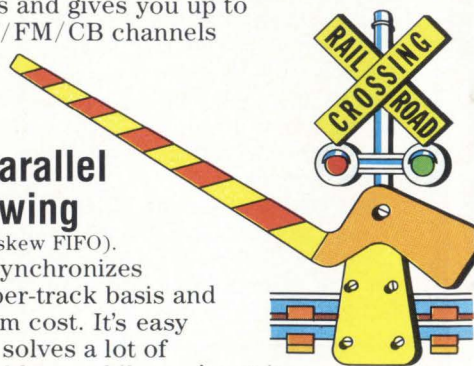

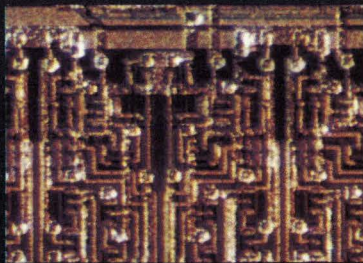

1. New AM/FM Frequency Synthesizer. 8X08

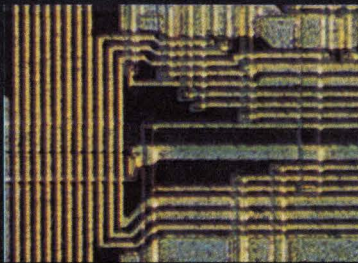

2. New Deskew FIFO. 8X03/04

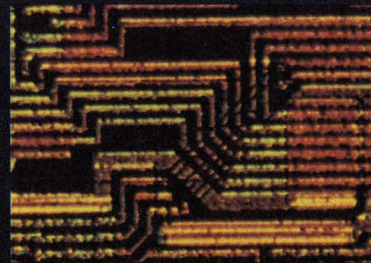

3. New CRC Generator/Checker. 8X01

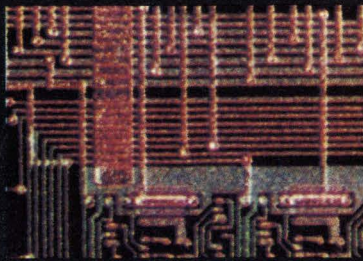

4. New Control Store Sequencer. 8X02

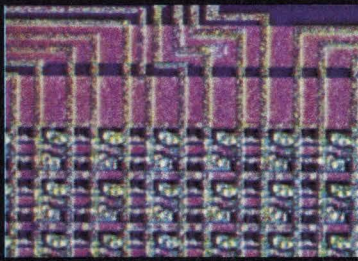

5. New 8 Bit Interpreter. 8X300

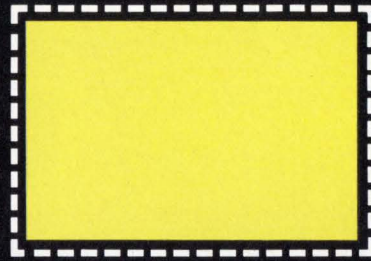

6. Your 1977 Solutions.

The only logical way to improve performance and save on systems cost.

3 One-chip error-checking

(#8X01 CRC Generator/Checker).

Eight polynomials for error detection of serial digital data. Detects SDLC type remainder. Easy-to-work with at an easier-to-live-with lower systems cost.



4 One-chip microinstruction sequencing

(#8X02 Control Store Sequencer).

You get 8 functions — everything you need for most efficient microprogramming. With low power Schottky LSI technology, 28 pin DIP with 1024 word addressability, and more.



5 One-chip central controlling

(#8X300 8 Bit Interpreter)

Control oriented bipolar fixed instruction microprocessor on one LSI chip. Eliminates up to 150 discrete SSI/MSI chips. You get easy programming and fast processing — 250ns instruction cycle time.

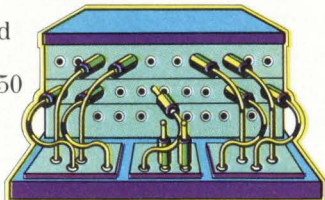

6 One-chip to solve your future needs.

Signetics has written a whole book detailing all of the instock standard products with a future products preview of "One-Chip System Logic." It shows you how Signetics is more responsive to your exact mixture of requirements. It includes a function/requirement questionnaire: tell us what you want us to develop as standard product in the system logic family for your next application. Read the book and send us the card.

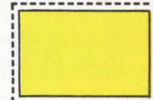

Attach this to your letterhead for fast response.

- Send me the whole book titled "One-Chip System Logic — Multiple Functions on One-Chip Now and in the Future."
- I have lots of questions. Please call me.
- Have a Field Applications Engineer make an appointment soon.

My application is _____

Name _____ Title _____

Telephone _____ Mail Stop _____

THINK Signetics

811 E. Arques Ave., Sunnyvale, Ca. 94086

© 1976.

a subsidiary of U.S. Philips Corporation

The IC Converters that match the spec sheets.

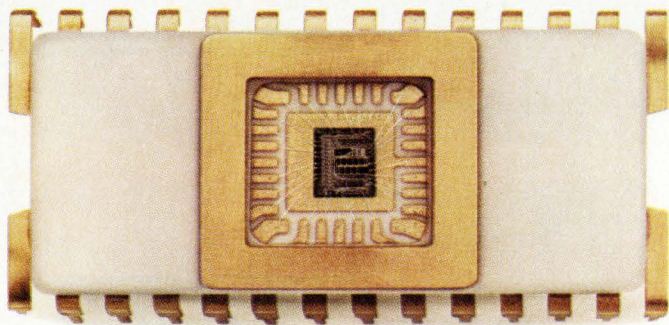

Complete electrical testing plus a rigorous Quality Control inspection and testing are your best assurance that what you see on the spec sheet is what you get. In every one of our precision 8, 10 and 12-bit devices.

Analog Devices' IC Converters give you the solutions to the very real problems of cost, reliability and per-

formance. And they boast specs you can believe in. From the real company in precision measurement and control—Analog Devices, Norwood, MA 02062. Telephone: (617) 329-4700.



The real IC Converter company.

Circle 168 on reader service card

The book that turns businessmen into best sellers.



Many who've read it are now reaping the rewards. Because they've found that U.S. exports are a \$95 billion a year business, that exporting creates both company profits and company growth, that U.S. goods have never been more competitive in international markets. Above all, they've found that, with the help available from the U.S. Commerce Department, selling overseas is no more difficult than selling at home. And this fact-filled book can prove the same to you. Write Charles W. Hostler, Deputy Assistant Secretary for International Commerce, U.S. Department of Commerce, BIC 8C, Washington, D.C. 20230.

U.S. Department of Commerce



A Public Service of This Magazine & The Advertising Council

New literature

Mica. What is mica? What is it used for? How is it applied? The answers to these questions, along with data on many varieties of mica, including the high-temperature type, are sup-



plied in a 12-page reference booklet and catalog put out by Midwest Mica & Insulation Co., 4853 West 130 St., Cleveland, Ohio 44135. Circle 421 on reader service card.

Quality control. The Transactions of the American Society for Quality Control's 30th Annual Technical Conference contains 86 unabridged papers that emphasize the close positive correlation between quality control and profitability. Copies of the 558-page book may be ordered by sending \$9 (ASQC members) or \$13 (nonmembers) to ASQC, 161 W. Wisconsin Ave., Milwaukee, Wis. 53203.

Renting instruments. A 14-page brochure entitled "Test Equipment: Think of It as Money" outlines the management considerations in making the rent/lease/buy decision. Financial, operational, and strategic factors are detailed, and a way to quantify the decision is presented. Illustrated case studies are included. Copies of the brochure can be obtained from United States Instrument Rentals Inc., 951 Industrial Rd., San Carlos, Calif. 94070 [423]

SC/MP microprocessor. National Semiconductor's SC/MP (for simple,

The **RIGHT** Flexible Disk Drives and Systems Are Made At Remex.

The **right** flexible disk drive has format flexibility — accepting IBM format, soft sectored and 32 hole hard sectored disks in the same unit — while addition of a sector generator option permits creation of alternative hard sectored formats.

The **right** drive offers unit select for up to four drive daisy chain — overlap seek — DC/DC conversion, eliminating outside negative voltage requirements — and separate data and clock outputs at the interface.

The **right** drive has fast throughput with 6 ms track to track access.

The **right** drive has a unique high reliability design — die cast frame — supported lead screw head positioning — operator interlock for media protection — and a foolproof write enable feature.

The **right** flexible disk system is custom designed for the exact requirements of the quantity buyer — one to four or more drives — formatting of both IBM and hard sectored media interchangeably — double density electronics where required — interface to any mini/micro computer — packaged in rack mount or desk top configurations according to application — and software ranging from simple driver to a complete operating system.

The **right** flexible disk system is made by REMEX — the only flexible disk drive manufacturer with both the total capability to design, manufacture and maintain custom systems for individual applications — and the total commitment to the specialized needs of the quantity systems buyer.

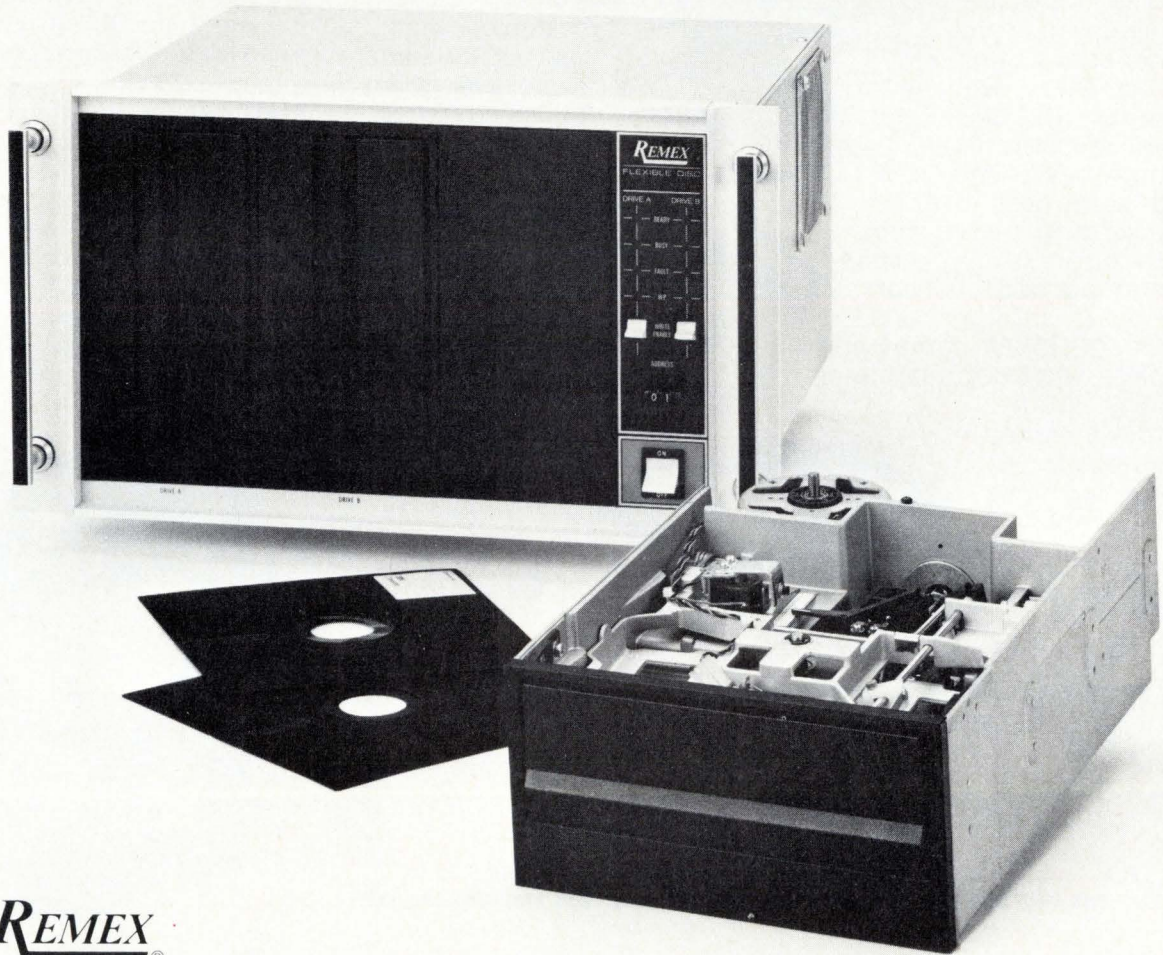

REMEX[®]



**Peripheral
Products**

Ex-Cell-O Corporation

1733 E. Alton Street, P.O. Box 11926, Santa Ana, California 92711,
(714) 557-6860, TWX (910) 595-1715. In Europe and the U.K.: SpA, Microtecnica,
Via Madama Christina 147, Torino, Italy 10126.

Circle 169 on reader service card

Stamp out "IC Hotfoot"



Hot soldering irons can be murder on delicate electronics components such as IC's. That's why the DIGI-DESIGNER will become your bugs' best friend. It's a solderless breadboarding instrument that can save you time and burned out parts.

DIGI-DESIGNER comes complete with clock, dual pulsars, logic monitors, voltage switches,

built-in 5 volt supply, binding posts for external power, input/output BNC's, and more. Everything you'll need for fast, efficient circuit design.

TM DIGI-DESIGNER. It means the end of "IC Hotfoot" and the start of efficient, creative circuit design for you. U.S. price - \$70.00 (in kit form). For more information and our current catalog, complete and send in the following coupon.

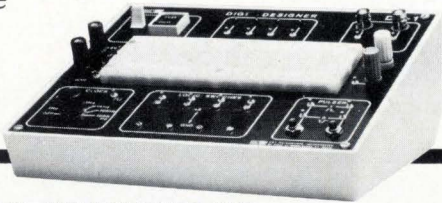

E&L INSTRUMENTS, INC.

61 First Street, Derby, Conn. 06418 (203)735-8774

Please send me your current catalog and more information on DIGI-DESIGNER.

Name _____

Address _____

City _____ State _____

Zip _____ Telephone _____

cost-effective microprocessor) is thoroughly explained in a 65-page handbook that can be obtained by sending a \$3 check to the Marketing Services Dept., National Semiconductor Corp., 2900 Semiconductor Dr., Santa Clara, Calif. 95051. (California residents should add 6% sales tax.) The handbook, which includes six tables and 35 illustrations, contains sufficiently detailed information for the preliminary design of a SC/MP-based system.

Coax connectors. A 64-page catalog of standard coaxial-cable connectors from Amphenol covers Uhf, N, C, SC, HN, Twin, and Triax types. Application information, assembly instructions, and dimensional data are provided along with electrical, environmental, and mechanical specifications. Catalog STD-1, "Amphenol Standards," is available from Bunker Ramo Rf division, 33 E. Franklin St., Danbury, Conn. 06810

Mobile-communications testing. MobCat 76 is a 12-page catalog of test equipment for mobile communications gear. Included in the catalog are directional rf wattmeters, coaxial rf loads, absorption wattmeters, and various accessories. The catalog is offered by Bird Electronic Corp., 30303 Aurora Rd., Cleveland, Ohio [426]



Mobile Communications Support Test Equipment

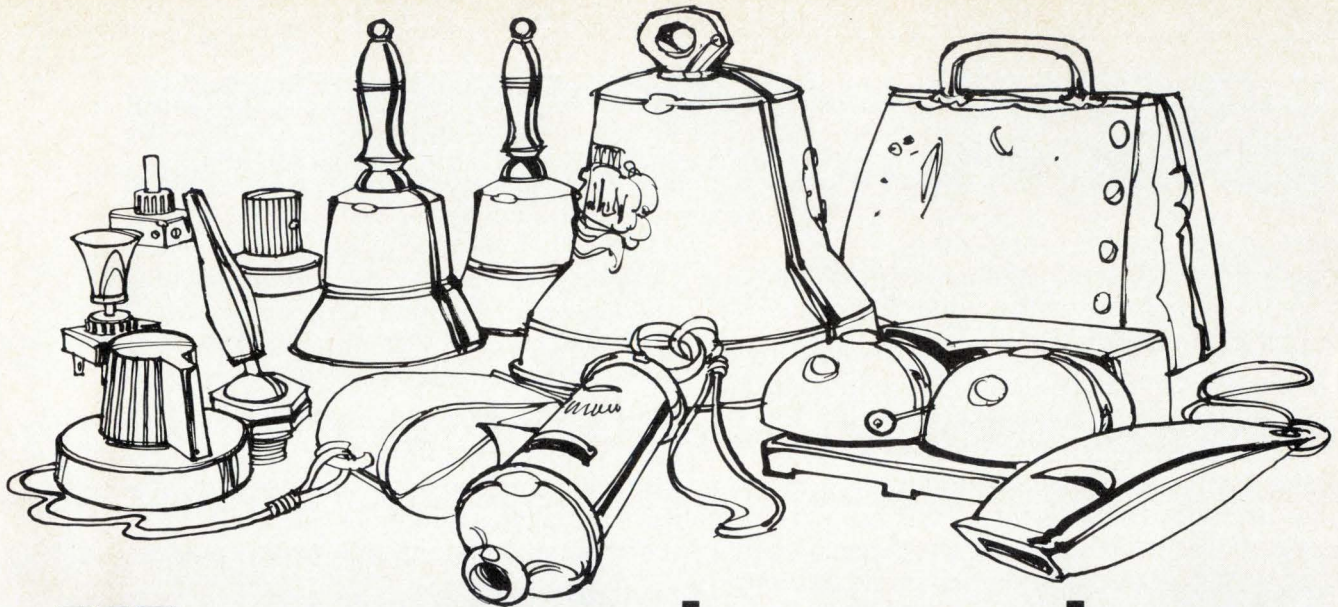

FFT spectrum analysers used to be all knobs, bells and whistles. And cost the earth.

Not any more.
The Plessey FFT is no nonsense and low cost.

For OEM and end user applications, the Plessey Microsystems range of SPM FFT analysers is designed to be used for production instrumentation, scientific applications and volume OEM products.

Controlled by a simple TTL interface, Plessey FFT can be added onto mini-

Plessey FFT offers a good deal more for a great deal less.

or microcomputers or used as stand-alone modules.

If you are into signal processing, production monitoring, vibration analysis, acoustics, OTF measurement, image processing, electrocardiography, infrared Fourier spectroscopy, or biomedical analysis, you ought to discover more about the Plessey range of SPM FFT modules.



PLESSEY MICROSYSTEMS

David Tarrant, Plessey Microsystems
Water Lane, Towcester
Northamptonshire
England NN12 7EG
Telephone Towcester (0327) 50312
Telex 31628

J. Jhu, Plessey Microsystems
1674 McGaw Avenue, Irvine
California 92714
Telephone (714) 540 9945
Twx 910 595 1930

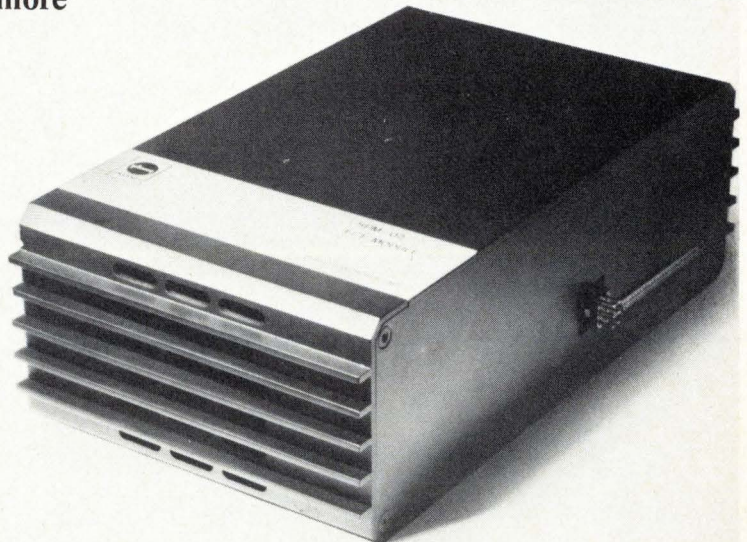

If you're not now in the fast-growing data communications equipment market, chances are you will be.

Data communications is one of the fastest-growing electronic equipment markets in the U.S.—during the decade of the '70's, better than 15-20% per year, compounded!

Manufacturers of data processing equipment have recognized the unique nature of *data communications* and have established profit centers to pursue the market for *data communications equipment*. IBM, Burroughs, Sperry-Univac, Honeywell and Digital Equipment Corp. are just a few of the major data processing companies who have separate marketing arms for *data communications*, complete with new products, sales forces, etc. The Bell System, too, through its Teletype Corp., Bell Labs, and Western Electric, has introduced new *data communications equipment*.

Chances are you are going to be a part of the data communications market. There's no better place to start than getting the flavor of the marketplace, equipment, and services than from a copy of "*Basics of Data Communications*".

"*Basics of Data Communications*" is a 316-page compilation of essential articles which have appeared in Data Communications magazine. From the basic, tutorial, still state-of-the-art

information published in the 1972 and 1973 Deskbook issues (now out of print), on through information on the practice of present-day data communications, this book includes forty-seven articles covering more than eleven key areas.

"*Basics of Data Communications*" was edited by Harry R. Karp—Chief Editor of Data Communications magazine. It is the only book of its kind available anywhere that deals with practical aspects of data communications.

Available this month.

Price: \$12.50

Discounts of 40% orders of ten copies or more.

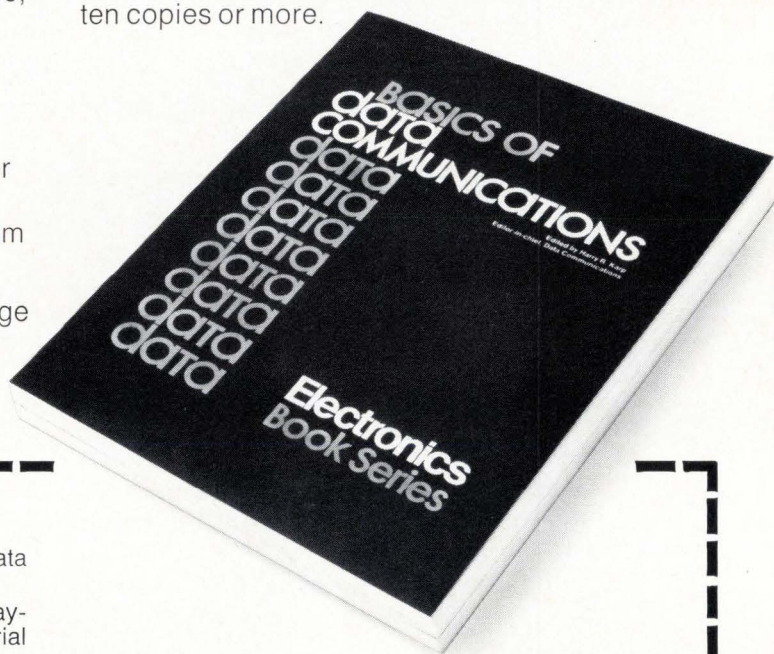

Electronics Book Series

PO Box 669, Hightstown, N.J. 08520

Send me _____ copies of "*Basics of Data Communications*" at \$12.50 per copy.

I must be fully satisfied or you will refund full payment if the books are returned after ten day trial examination.

Payment enclosed Bill firm Bill me

Credit Cards Charge My Book To

American Express Master Charge
 Diners Club BankAmericard

Acct. No. _____

Date Card Expires _____

Interbank No. _____

(1st No's. above name on Mastercharge only.)

Name _____

Title _____

Company _____

Street _____

City _____

State _____

Zip _____

Signature _____

**Electronics
Book Series**



Announcing the Sykes OEM Floppy System Kit. An idea whose time has come.

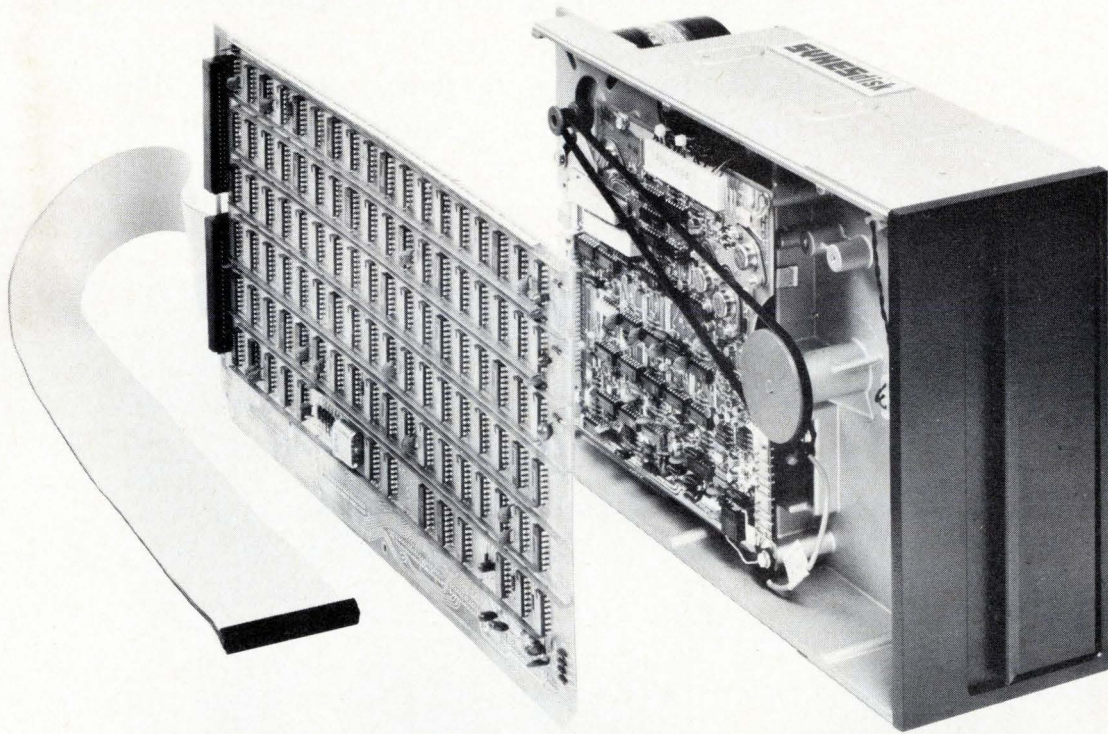

With our \$1,398 kit and your imagination, nothing can stop you now.

Sooner or later someone was bound to offer all the pieces—a smart controller, disk drives, interface cables—everything you need to build the machine of your dreams. Everything you need to talk to your microprocessor.

And wouldn't you know Sykes would be the company to put all the pieces together for you in one kit?

THE KIT. The Sykes OEM Floppy System Kit gives you either an IBM compatible or Dual Density controller; one, two, three or four floppy disk drives per controller; interface cables from controller to disk drive; hardware interface for microprocessors.

PERFORMANCE. The heart of the kit, of course, is our controller. It provides hardware for what you ordinarily do in software. It saves time and money in developing, documenting and maintaining your system. You get the following hardware features with either the IBM

compatible (256K Bytes per diskette) or the Dual Density (630K Bytes/diskette) controller:

- Hardware address search
- Automatic sector and track sequencing
- FIFO buffer for asynchronous operation
- Automatic CRC generation and detection

PACKAGING. *The packaging is unique; the total controller is contained on a single PC board and pancakes directly to one disk drive giving you minimum volume requirements for your overall system.*

INTERFACES ONLY AN OEM COULD LOVE. When your microprocessor interfaces with our OEM Floppy Kit you'll use only 13 I/O lines. That's right, just 13: 1 Reset line, 3 Control lines, 1 Flag line and 8 Bi-directional data lines. Our unique 8-bit Bi-directional bus is

configured to transmit disk commands, status and data. Its simplicity drastically reduces the number of I/O lines, and connector requirements normally required in disk interfaces.

If you are using a standard mini, we've probably got a plug compatible interface and software for that too.

PRICE. Just \$1,398 buys you a single drive kit at quantity one. Obviously, attractive OEM quantity discounts are available.

WE MANUFACTURE WHAT WE SELL.

Sykes manufactures *all* the elements of our OEM Floppy Kit. Our disk drive has been extensively field tested, with several thousand of them in use right now throughout the world.

SEND US YOUR AUTOGRAPH.

Drop us a brief note asking for more information on the OEM Floppy Kit. Or call our marketing department at (716) 458-8000. Telex 97-8326.

“I’ve had offers from other companies, but I’m staying right here. I believe in Fairchild because Fairchild believes in me. If you work hard and take advantage of the training they offer, there’s no limit to your advancement opportunities here. I did and I’ve advanced rapidly in 4½ years. Sure my salary has increased significantly, but even more important is the challenge and job satisfaction I’ve received. I can’t think of anything another company could offer me that I’m not already getting at Fairchild.”

Hank Miranda
Manufacturing Manager
Bipolar Memory Wafer Fab

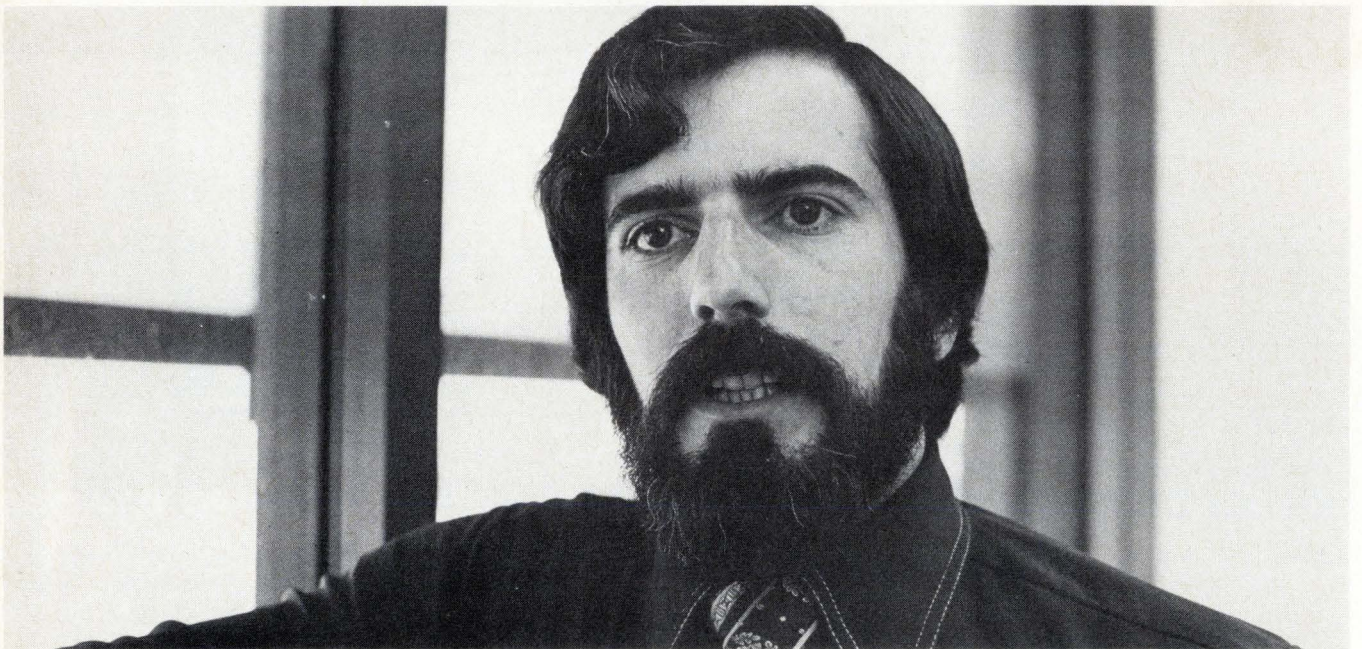

Fairchild offers more of what you work for.

FAIRCHILD
CAMERA AND INSTRUMENT
CORPORATION

Fairchild has opportunities at many levels for talented design, product and process engineers. For detailed information on specific openings, send your resume to: Director of Professional Staffing, 464 Ellis Street, MS 22-0100, Mountain View, CA 94042. An Equal Opportunity Employer M/F.

Classified section

FOR EMPLOYMENT
AND SALES OPPORTUNITIES

RATES \$46 per advertising inch (1/4"). Commissionable.

SIZES 1/4" to 10" deep in widths of one column (1 1/4"), two (3 1/4"), three (5 1/4"), and four (7").

CLOSING Two weeks prior to mailing.

MAILING One week prior to issue date.

ISSUE DATE Every other Thursday.

AD ORDERS/BOX NUMBER ANSWERS

Send to Electronics, Post Office Box 900, New York, N.Y. 10020.

POSITIONS VACANT

FIELD SERVICE

Electronics for Yachting, Ft. Lauderdale, Florida requires a man strong in Single Sideband communications setup and repair. FCC second class radiotelephone license required. Please submit resume to Electronics for Yachting, Inc., 1525 S. E. 16th Street, Ft. Lauderdale, Fla. 33316

Position Available—Need BS Eng. + U.S. exper. in engineering or technical sales. Fee paid by employer. Over 1,000 U.S. client co's. Est. 1959. Send resume & present salary. Atomic Personnel, Inc., Box L, 1518 Walnut, Phila, PA 19102.

Director of Electronics and Media Services—A person to direct the Media Center, and to service and direct the use of electronic equipment. The candidate should have training and experience in servicing video and digital equipment. The candidate should be familiar with the commercial market in electronic devices and video equipment and materials. To begin in September 1976 or earlier. Send letter of application and vita by 2 August to Dr. David Wee, Assistant Dean of the College, St. Olaf College, Northfield, MN 55057. An equal opportunity employer.

EMPLOYMENT SERVICE

Electronics' Industry Newsletter tells you which firms have current employment opportunities, in the field of Electronics, for all types of Engineers, Sales Representatives, Technicians, Executives, Computer Personnel and others. Latest product information is also reported. For information write: Electronics' Industry Newsletter, Dept. 304A, 23573 Prospect Avenue, Farmington, MI 48024.

DON'T forget the Box Number when answering the replies.

CHECK for Accuracy.

INCORRECT

Box Numbers may result in a delay in re-forwarding your reply.

New books

Analysis and Design of Digital Circuits and Computer Systems, Paul M. Chirlian, Matrix Publishers Inc. (Champaign, Ill.), 606 pp., \$16.95.

Calculator Users' Guide and Dictionary, Charles J. Sippl, Matrix Publishers, 428 pp., \$9.95 (paper).

Automatic Testing: Systems and Applications, Roy Knowles, McGraw-Hill, 246 pp., \$14.00.

Content Addressable Parallel Processors, Caxton C. Foster, Van Nostrand Reinhold, 233 pp., \$11.95.

Solid State Pulse Circuits, David A. Bell, Reston, 434 pp., \$16.95.

Manual for Operational Amplifier Users, John D. Lenk, Reston, 292 pp., \$16.95.

Almost All About Waves, J.R. Pierce, MIT, 213 pp., \$3.95. (paper).

Instrument Transducers—An Introduction to Their Performance and Design, 2nd ed., Hermann K.P. Neubert, Oxford University Press, 348 pp., \$37.00.

Mathematics for Electronics, Charles M. Thomson, Prentice-Hall, 634 pp., \$12.95.

Linear Motion Electric Machines, S.A. Nasar and I. Boldea, Wiley-Interscience, 293 pp., \$18.95.

A User's Handbook of D/A and A/D Converters, Eugene R. Hnatek, Wiley-Interscience, 472 pp., \$24.95.

Digital Troubleshooting—Practical Digital Theory and Troubleshooting Tips, Richard E. Gasperini, Hayden, 180 pp., \$9.95 (paper).

The People Side of Systems, Keith London, McGraw-Hill, 281 pp., \$15.00.

Elsevier's Telecommunication Dictionary in Six Languages (English/American, French, Spanish, Italian, Dutch, German), W.E. Clason, Elsevier, 630 pp., \$47.95.

PC plug-in transformers

New flat-head design

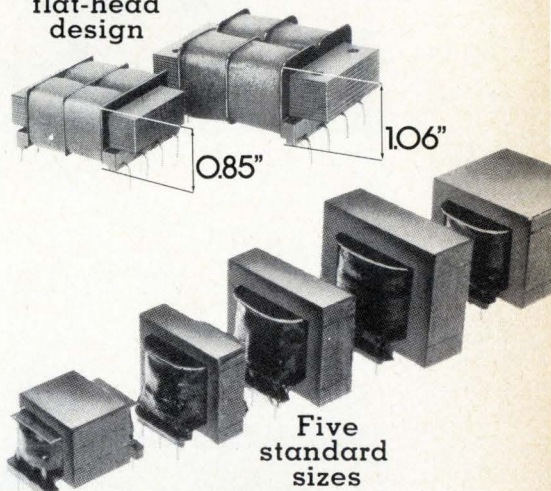

Five standard sizes
not just more, but more kinds—all available off-the-shelf

- 200 ratings
- 5-120 volts
- 8 ma to 4.8 amps
- single or dual primaries
- 1 to 24 VA

We've made it our business to keep availability and price more than competitive, with no performance compromise. Add to that a uniquely comprehensive selection, complete with exclusive low-profile flat-head transformers as low as 0.85" inches high...

you get it all, with Signal.

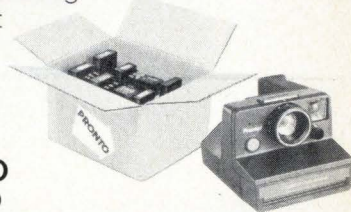

AND, SHIPPED PRONTO

We guarantee 48-hour shipment of your prototype (1-4 pc.) order, or you get the Polaroid "PRONTO" camera free.

FREE CATALOG

Lists over 1000 standard transformer and choke designs, from 1 to 10,000 VA. Write or call: Signal Transformer Co., Inc., 1 Junius St., Brooklyn, N.Y. 11212; phone: (212) 498-5111.

signal
TRANSFORMER

The Answer Book. It makes your job easier. \$25.

"WHO MAKES WHAT?"

**"WHAT COMPANIES
MAKE THE PRODUCTS
I NEED?"**

(See alphabetical directory
of 4000 products)

**"WHERE ARE THEIR
NEAREST
SALES OFFICES?"**

**"WHO ARE THEIR
DISTRIBUTORS?"**

**"WHAT ARE THEIR
LOCAL PHONE
NUMBERS?"**

(See alphabetical directory
of 6000 manufacturers)

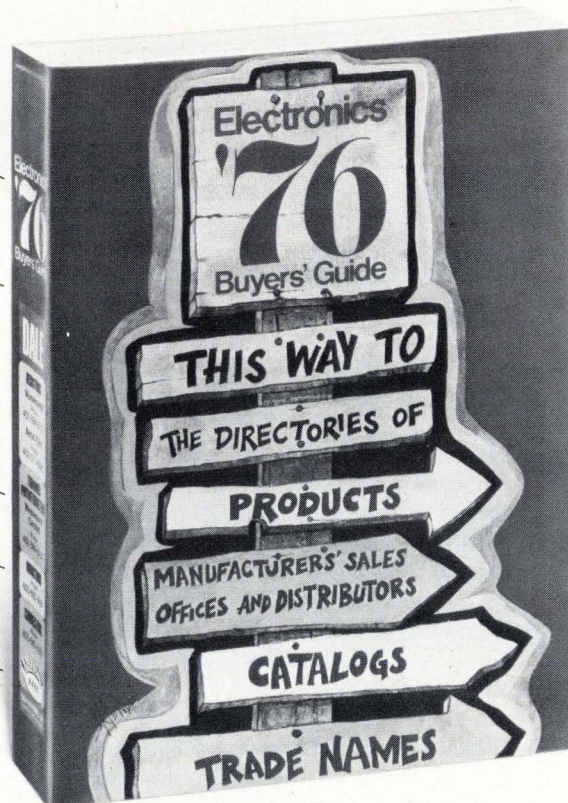

**"HOW CAN I GET THEIR
CURRENT CATALOGS
FAST?"**

(See directory of catalogs
by product and by company,
including catalog inquiry
card for 5-second ordering,
page 901)

**"WHO MANUFACTURES
THIS TRADE NAME?"**

(See directory of trade
names, page 1276)

**Special no-risk offer. If The Answer Book is not everything
we say it is and more, return the book to us within
ten days and we will refund your \$25.**

Electronics Buyers' Guide (EBG) is as easy to use as your telephone directory. The whole international world of electronics is at your fingertips. Great emphasis is put on *localizing* the information you need. You won't have to call half-way across the country to company headquarters because we list local sales offices and distributors.

To order from our Directory of Catalogs, simply circle the corresponding number on the Inquiry ("bingo") Card and mail. This way you get *current* catalogs. Also, semi-annually we mail out an updated list of current catalogs plus a "bingo card." The Answer Book's objective: Make your job easier.

Electronics Buyers' Guide

1221 Avenue of the Americas
New York, N.Y. 10020

Yes, send me a copy of The Answer Book.

I've enclosed \$25 (USA and Canada only, elsewhere send \$35). Full money back guarantee if returned within 10 days.

Name _____

Company _____

Street _____

City _____

State _____

Zip _____



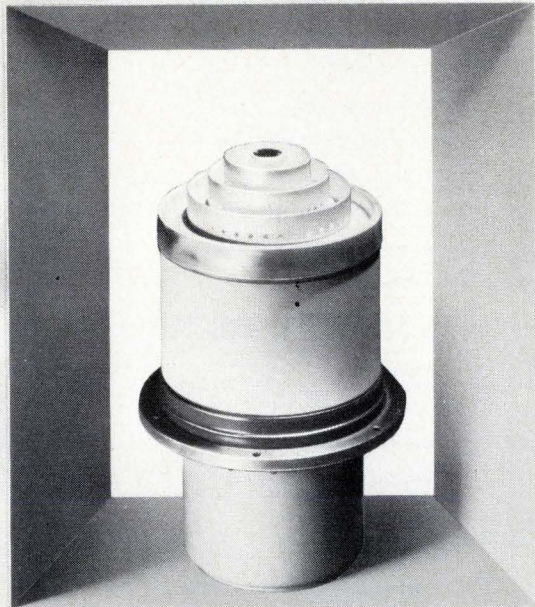

A brighter day for radio broadcasting, with our new high-power tetrode line

From 50 to 500 kW of carrier power from a single-tube RF final stage. Pyrobloc® grids plus Hypervapotron® cooling, for an eye-opening combination of power, compact size, overload safety, light weight, performance and operating reliability! Five different tubes for any high-power short-wave radio broadcasting application, all with the latest and best in power-grid tube technology from a world leader: THOMSON-CSF.



THOMSON-CSF

THOMSON-CSF ELECTRON TUBES / 750 BLOOMFIELD AVENUE / CLIFTON NJ 07015 / TEL. : (201) 779 1004 / TWX : 710 989.7149

France - THOMSON-CSF Division Tubes Electroniques / 38, rue Vauthier / 92100 BOULOGNE-BILLANCOURT / Tel. : (1) 604 81.75

Germany - THOMSON-CSF Elektronenröhren GmbH / Leerbachstr. 58 / 6000 FRANKFURT am MAIN 1 / Tel. : (0611) 71.72.81

Italy - THOMSON-CSF Tubi Elettronici SRL / Viale degli Ammiragli 71 / I - 00136 ROMA / Tel. : (6) 638 14.58

Japan - THOMSON-CSF Japan K.K. / TBR Building / Kojimachi 5-7 / Chiyoda-Ku / TOKYO / 〒 102 / Tel. : (03) 264 6341

Spain - THOMSON-CSF Tubos Electronicos S.A. / Alcalá 87 / 7º Dcha / MADRID 9 / Tel. : (1) 226 76.09

Sweden - THOMSON-CSF Elektronrör AB / Box 27080 / S 10251 STOCKHOLM 27 / Tel. : (08) 22 58 15

United Kingdom - THOMSON-CSF Electronic Tubes Ltd / Ringway House / Bell Road / Daneshill / BASINGSTOKE RG24 0QG / Tel. : (0256) 29155 / Telex : 858865

Electronics advertisers

July 22, 1976

Adtech Power Inc.	165	Fairchild Camera & Instrument	174	Precision Monolithic Inc.	151
Advanced Micro Devices	11	Fairchild Systems Technology	32, 33	Process Computer Systems, Inc.	38, 39
° AEG Telefunken	7E, 12E	Faultfinders Inc.	80	° RCA Electro-optics and Devices	5E
■ Airpax Electronics	135	‡ Ferroxcube Corp.	45	RCA Solid State Division	77, 79
Allen Bradley Company	34	Frequency & Time Systems	6	‡ Rental Electronics Inc.	64
Alps Electric Co. Ltd.	54	‡ Fujitsu Limited	56	T.L. Robinson Company, Inc.	128
American Microsystems Inc.	136, 137	■ Galileo Electro-optics Corp	31	■ Rockwell International Collins Radio Hybrid Circuits	50
■ AMP Incorporated	148	■ General Electric Panel Meter	90	Scanbe Mfg. Corp.	161
■ Amperex Electronics Corporation	89, 119	‡ General Electric-Valox	81	° SEPA S.p.A.	2
■ Analog Devices Inc.	168	General Instrument Corporation, Microelectronics Division	51	° Siemens A.G. Munich	62
Anritsu Electric Co., Ltd.	55	■ GenRad	141	‡ Siemens Components Division	84, 85
Ansley Electronics Corp.	147	Gordos Corp.	67	‡ Signal Transformer	175
■ AP Products Incorporated	154	■ Hewlett-Packard	17-26	Signetics Inc.	157, 159, 161, 163, 165, 166, 167
‡ Applied Digital Data Systems	60, 61	■ Hughes Aircraft Company	47, 145	Siliconix	12, 13
° AUR EL Componenti Electronici	10E	Hutson Industries	152	Sola Electric	159
Bausch & Lomb Inc.	132, 142	ILC Data Devices	16	° Solartron/Schlumberger	2E, 9E, 11E
° Bayer AG	15E	Information Control Corporation	162	■ Spectrol Electronics Corp.	134
‡ Beckman Instruments Inc. Helipot Division	62	Intel Memory Systems	112	Spectronics Incorporated	14
Belden Corporation	86	‡ Interdesign	2	Sprague Electric Company	59
B&K Precision Division Dynascan Corporation	8	■ Interface Inc.	157	Sykes Datatronics	173
■ Bourns Inc.	4th C	■ Interstate Electronics Corp.	15	Systron Donner Concord Instrument	179
Braemar Computer Devices	163	‡ ITT Cannon Electric	7	‡ T-Bar, Incorporated	153
° Burr Brown Research Inc.	84	° ITT Cannon Europe	45	° TEAC Corp.	61
Carborundum Company	3rd C	Japan Electronics Show Assoc.	53	■ Tektronix Inc.	155
Centronics	72, 73	■ Johanson Manufacturing Corp.	30	Teledyne Philbrick	156
■ Cherry Electrical Products Inc.	2nd C	Krohn Hite Corporation	5	Teradyne Inc.	74
■ C. Itoh Electronics	152	■ Lear Siegler-Data Prod. Div.	49	Texas Instruments Components	129
■ Coil-Ler Mfg. Inc.	127	° Logabax	64	Thermotron Corporation	180
° Communication Associates Inc.	69	■ Magnecraft Electric Company	9	Thomson CSF	177
■ Continental Rentals	8	° Magneti Marelli	7	° Ultra Electronics Components Ltd.	85
■ Continental Specialties	164	■ MCL Inc.	144	U.S. Capacitor Corporation	143
‡ C. P. Clare & Company	139	■ MFE Corporation	146	Volgen Electric	55
Crown Industrial	52	Micro Power Systems	83	■ Wavetek Indiana	125
Data Delay Devices	154	Micro Switch Division of Honeywell	130, 131	° Don White Consultants Inc.	175
Data General Corporation	37	■ Miller Stephenson Chemical Inc.	181	XLO-REMEK	169
■ Data Precision	40	3M Technical Ceramic Products	160	° Yokogawa Electric Works Ltd.	56
■ Dialight Corporation	133	Mostek Corp.	28, 29	Yutaka Electric Co., Ltd.	54
■ Eastman Kodak Company Graphics Division	138	■ Motorola Semiconductor	123		
Electro-Craft Corp.	1	‡ National Semiconductor Corporation	68, 69		
° Electrol	153	■ Nikkei Electronics	182		
‡ Electronic Development Corporation	153	Nucleonic Products Co. Inc.	150		
Electronic Product Associates, Inc.	128	Numonics Corp.	144		
■ EL Instruments	170	■ Opto 22	159		
Elorg Electronorgtechnica	158	° Philips Elcoma	1E		
EMR-Telemetry	149	■ Plessey Co. Ltd.	171		
■ Erie Technological Products Co. Inc.	27	■ Powermate	146		
Esterline Angus Instrument Corporation	162	■ Powertec Inc.	70, 71		

■ For more information of complete product line see advertisement in the latest Electronics Buyers Guide
 ° Advertiser in Electronics International
 ‡ Advertiser in Electronics domestic edition

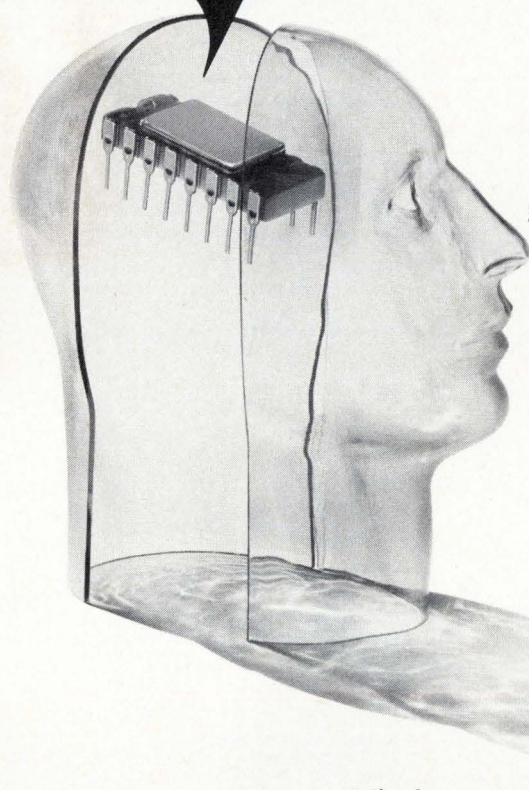
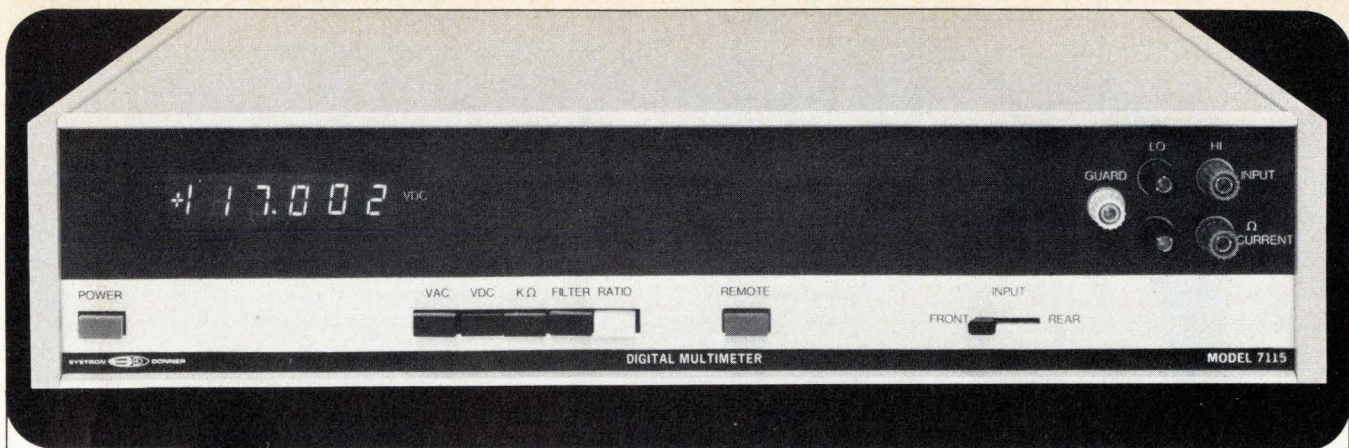

Go SDVM*

*Systron-Donner "smart" DVM

Meet Model 7115, the industry's first **microprocessor-** based digital multimeter. It does what no conventional DVM could hope to do:

Automatic zero/self calibration. Using its computing power and built-in memory, Model 7115 continually calibrates itself against drift and component aging. Similarly, it detects and corrects for zero drift and offset error. Result: accurate readings all the time!

Self-diagnosis. Microprocessor power again. Out-of-limit conditions or failures are signalled

on the front panel; internal LED's direct the operator to their location inside.

High-speed autoranging. A rapid new S-D autoranging technique finds the correct range, goes there immediately and reads. It's not only a big improvement for bench use, but systems users can now use autoranging.

Command performances. An optional keyboard for programming the Model 7115 allows it to linearize and normalize, run comparison programs for checking out-of-tolerance conditions, multiply by a constant, average readings... and much more.

These features, too. Up to 100 readings/sec. • DC accuracy of $\pm 0.002\%$ rdg. • Parallel programming or ASCII option • True RMS AC volts option • High accuracy resistance measuring option.

Get the full story on the first SDVM from Scientific Devices, or contact us at 10 Systron Drive, Concord, California 94518. Phone (415) 676-5000. Overseas, contact Systron-Donner in Munich; Leamington Spa, U.K.; Paris (Le Port Marly); Melbourne.

SYSTRON  DONNER

Director of Technical Services

Candidate's background should include electrical engineering and business management experience. Principle accountability will be to insure effective administration of technical activities, programs and projects. Applicants must demonstrate communication and management skills plus the ability to motivate, guide and direct. Present or potential IEEE membership desirable.

Send resume and salary history to:

Eugene G. Logan, Personnel Manager



THE INSTITUTE OF
ELECTRICAL AND
ELECTRONICS
ENGINEERS, INC.

345 E. 47 St. NY, NY 10017

Equal Opportunity Employer M/F

Circle 180 on reader service card

Take out a little insurance today.

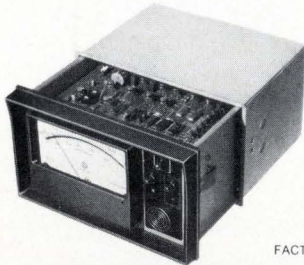

FACTORY MUTUAL APPROVED

Thermotron's Productsaver® offers fail-safe protection against product damage during high and low temperature testing. Visual and audible alarms plus contact closures protect against temperature extremes within a -125°F (87.2°C) to 375°F (190.5°C) range. Ruggedly built and accurate to ¼%, Productsaver® wears a very comfortable price tag. For more details on the protection it provides, write for literature today.

THERMOTRON CORPORATION

Kollen Park Drive, Holland, Michigan 49423
(616) 392-1492



THERMOTRON®

180 Circle 206 on reader service card

Advertising Sales Staff

Pierre J. Braudé New York [212] 997-3468
Paris Tel: 720-73-01
Director of Marketing

Atlanta, Ga. 30309
100 Colony Square, 1175 Peachtree St., N.E.
[404] 892-2868

Boston, Mass. 02116: James R. Pierce
607 Boylston St. [617] 262-1160

Chicago, Ill. 60611:
645 North Michigan Avenue
Robert W. Bartlett (312) 751-3739
Robert M. Denmead (312) 751-3738

Cleveland, Ohio 44113: William J. Boyle
[716] 586-5040

Dallas, Texas 75201:
2001 Eryant Tower, Suite 1070
[214] 742-1747

Denver, Colo. 80203: Harry B. Doyle, Jr.
123 Speer Blvd. #400
[303] 837-1010

Detroit, Michigan 48202: Robert W. Bartlett
1400 Fisher Bldg.
[313] 873-7410

Houston, Texas 77002: Paul Reiss
601 Jefferson Street, Dresser Tower [713] 659-8381

Los Angeles, Calif. 90010: Robert J. Rielly
Bradley K. Jones, 3200 Wilshire Blvd., South Tower
[213] 487-1160

New York, N.Y. 10020
1221 Avenue of the Americas
Warren H. Gardner [212] 997-3617
Michael J. Stoller [212] 997-3616

Philadelphia, Pa. 19102: Warren H. Gardner
Three Parkway,
[212] 997-3617

Pittsburgh, Pa. 15222: Warren H. Gardner
4 Gateway Center, [212] 997-3617

Rochester, N.Y. 14534: William J. Boyle
9 Greylock Ridge, Pittsford, N.Y.
[716] 586-5040

San Francisco, Calif. 94111: Don Farris
Robert J. Rielly, 425 Battery Street,
[415] 362-4600

Paris: Alain Offergeld
17 Rue-Georges Bizet, 75 Paris 16, France
Tel: 720-73-01

Geneva: Alain Offergeld
1 rue du Temple, Geneva, Switzerland
Tel: 32-35-63

United Kingdom & Scandinavia: Robert Ghey
Tel: 01-493-1451, 34 Dover Street, London W1

Scandinavia: Andrew Karnig and Assoc.
Kungsholmsgatan 10
112 27 Stockholm, Sweden
Tel: 08 51 68 70 Telex: 179 51

Milan: Luigi Rancati
1 via Baracchini, Italy Phone 86-90-656

Brussels: Alain Offergeld
23 Chaussee de Wavre
Brussels 1040, Belgium
Tel: 13-73-95

Frankfurt/Main: Fritz Krusebecker
Liebigstrasse 27c, Germany
Phone 72 01 81

Tokyo: Tatsumi Katagiri, McGraw-Hill
Publications Overseas Corporation,
Kasumigaseki Building 2-5, 3-chome,
Kasumigaseki, Chiyoda-Ku, Tokyo, Japan
[581] 9811

Australasia: Warren E. Ball, IPO Box 5106,
Tokyo, Japan

Business Department

Thomas M. Egan,
Production Manager [212] 997-3140

Carol Gallagher
Production Manager International [212]
997-2045

Dorothy Carter, Production Manager Do-
mestic
[212] 997-2908

Frances Vallone, Reader Service Manager
[212] 997-6057

Electronics Buyers' Guide

George F. Werner, Associate Publisher
[212] 997-3139

Regina Hera, Directory Manager
[212] 997-2544

One Thomas Edison is not enough.

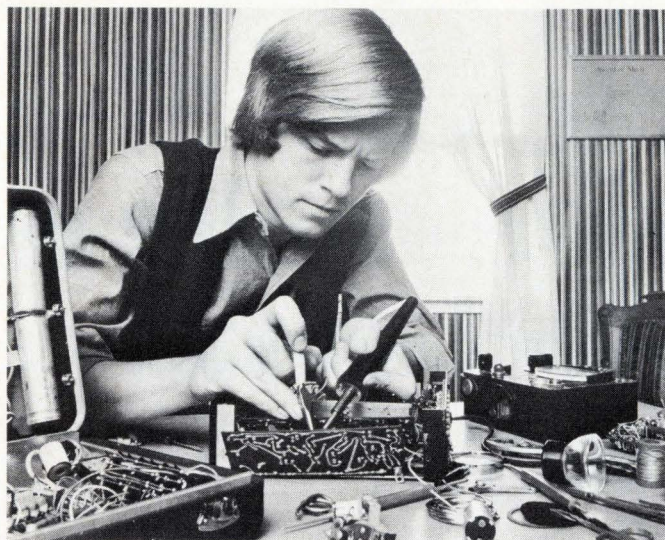

The world, with all its problems and difficulties, needs all the Edisons it can get. And while true genius is rare, there will always be a need for people who can continue what he began.

But there are two problems. Finding talented people. And developing their talents.

You can help with the first problem if you know a high school graduate who is interested in electricity or electronics.

If so, we can solve the second problem. The Navy offers what we believe to be some of the world's finest

training in advanced electronics. We can take a qualified young man or woman with no prior training, and, in a few months, have him well on the way to being not only an electronics expert, but a confident, mature individual.

Then, when his education is completed, he'll have the opportunity to see much of the world while he works with the most sophisticated electronic equipment he'll ever see. For which he'll receive a good salary as well as all Navy benefits.

We'd be happy to send more information about the Navy advanced electronics program. Simply send in the coupon below.

Because you may be helping someone who can help the world.

The Navy.

Capt. Robert W. Watkins
Navy Opportunity Information Center
P.O. Box 2000, Pelham Manor, N.Y. 10803

Please send more information on the Navy's Advanced Electronics Program. (If you don't want to wait, call 800-841-8000 toll-free, anytime.)

NAME _____
(Please Print)
ADDRESS _____
CITY _____ PHONE _____
STATE _____ ZIP _____

Clean 100 contacts in 10 seconds?

With MS-230 "Contact Re-Nu"®. This powerful aerosol cleaner sprays away dirt, carbon, other contaminants. Contains "Freon" TF. Restores continuity almost instantly to relay and switch contacts. Won't harm insulation. Leaves no residue. Non-conductive, nonflammable, non-toxic. MS-238 "Clean'nLube", same as MS-230, but contains a light lubricant.



miller-stephenson

E-7U

Danbury, Connecticut 06810 • (203) 743-4447

- Enclosed is \$2.00 for 16 oz. sample (MS-230).
- Enclosed is \$2.00 for 16 oz. sample (MS-238).
- Please send FREE literature and prices.

I intend to use MS-230/MS-238 on

Name..... Title/Dept.....

Company.....

Address.....

CHICAGO • LOS ANGELES • TORONTO / Dist. in • ITALY • GERMANY • FRANCE
• GREAT BRITAIN • SWITZERLAND • LEBANON • SPAIN • NETHERLANDS

" Registered trademark of Miller-Stephenson Chemical Co., Inc.

FREON is Du Pont's registered trademark for its fluorocarbon compounds.

Every other week we talk to the 32,329 decision-makers in Japan's electronics industry.



The way they talk back is astonishing.

us more about the readers who send in the Information Service Card. Here is what we learned: 57.4% of the readers who returned the card for additional product information acknowledged that they participate in or influence the purchasing decision of their companies.

Of this group, 31% said they were solely responsible for decision making, and 67.4% said they were partially responsible.

After learning more about the product or service offered, 25% of our readers wanted to buy it or wanted to think more about it.

And, in the long run, more than 50% of the respondents decided either to buy the product or are still debating whether or not to buy it.

Seven magazines in Japan communicate with management and professional engineers. But only one influences the influentials. That's us, Nikkei Electronics, the *Electronics* of Japan.

If you're thinking about selling the electronics decision-makers in Japan, talk to them in our pages. Contact Mr. H.T. Howland, Marketing Services Manager, Electronics, McGraw-Hill Publications Company, 1221 Avenue of the Americas, New York, N.Y. 10020. Telephone: (212)997-6642. Or talk to any member of McGraw-Hill's sales staff in the U.S. or Europe. Or contact us directly in Japan.

We communicate.

Each bi-weekly issue of Japan's most influential electronics magazine contains a Reader Information Service Card (exactly like the one in the magazine you're reading now, except in a different language).

One important way we're able to tell how our influence works with management and professional engineers in the Japanese electronics industry is the way they respond to our advertising by returning the card.

In a word, the response is phenomenal.

Recently we asked the Marketing Information Center of Tokyo, an independent research organization, to tell



Nikkei Electronics: Ask anybody who can read us.