

DECEMBER 12, 1974

Switching brings efficiency to private data networks/91

Thermal design, part 10: heat pipes tackle special jobs/114

What designers should know about rare-earth magnetic materials/119

LIBRARY
STATE TECHNICAL INSTITUTE
AT MEMPHIS

FOUR DOLLARS A MCGRAW-HILL PUBLICATION

Electronics®

*The
watchmakers
show
their wares*

1420 TCH598 MCSA9 JUN75
STATE TECHNICAL INSTITUTE
MS NF WALKER
5983 MACON COVE
MEMPHIS TN

38134



Dialight sees a need:

(Need: The widest choice for your every application.)

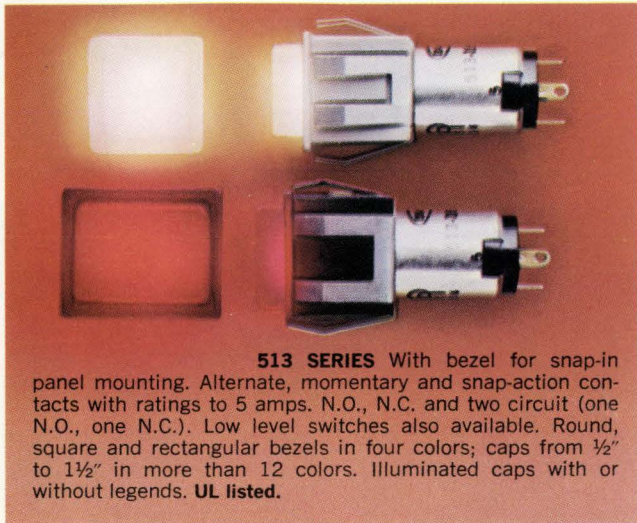

513 SERIES With bezel for snap-in panel mounting. Alternate, momentary and snap-action contacts with ratings to 5 amps. N.O., N.C. and two circuit (one N.O., one N.C.). Low level switches also available. Round, square and rectangular bezels in four colors; caps from 1/2" to 1 1/2" in more than 12 colors. Illuminated caps with or without legends. **UL listed.**

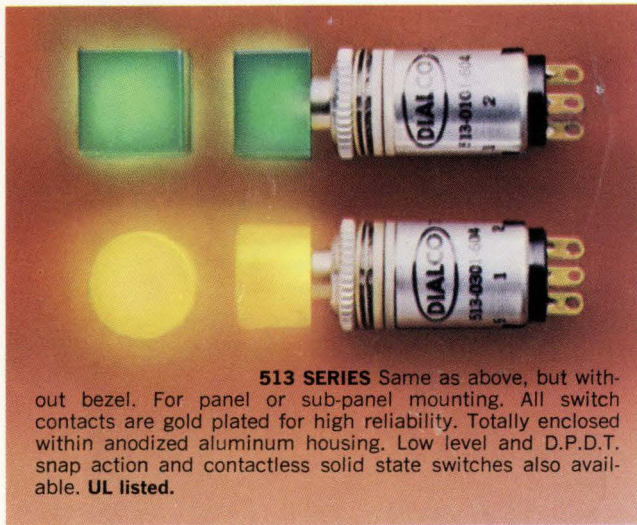

513 SERIES Same as above, but without bezel. For panel or sub-panel mounting. All switch contacts are gold plated for high reliability. Totally enclosed within anodized aluminum housing. Low level and D.P.D.T. snap action and contactless solid state switches also available. **UL listed.**

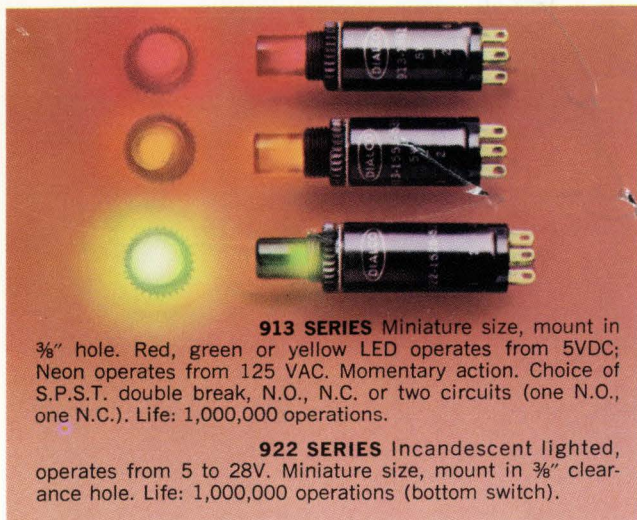

913 SERIES Miniature size, mount in 3/8" hole. Red, green or yellow LED operates from 5VDC; Neon operates from 125 VAC. Momentary action. Choice of S.P.S.T. double break, N.O., N.C. or two circuits (one N.O., one N.C.). Life: 1,000,000 operations.

922 SERIES Incandescent lighted, operates from 5 to 28V. Miniature size, mount in 3/8" clearance hole. Life: 1,000,000 operations (bottom switch).



545 SERIES Low priced thumbwheel switches available in standard and miniature sizes with BCD or decimal format. Positive detents for easy action. Miniature switch snaps together, no tools or hardware needed, on 3/16" centers. Gold bifurcated contacts assure high reliability. Rugged design allows operation from -25°C to +85°C. Modern low profile—recessed on panel face to eliminate accidental activation.



PUSH BUTTON CAPS Round, square and rectangular shapes in wide variety of sizes and colors. With hot stamped, engraved or film legends.



Dialight, the company with the widest choice in switches, LEDs, indicator lights and readouts, looks for needs . . . your needs . . . and then they develop solutions for your every application. No other company offers you one-stop shopping in all these product areas. And no other company has more experience in the visual display field. Dialight helps you do more with these products than any other company in the business, because we are specialists that have done more with them. Talk to the specialists at Dialight first. You won't have to talk to anyone else. Send for your free new copy of Dialight's brochure on illuminated push button switches and matching indicator lights. Write today.

DIALIGHT

Dialight, A North American Philips Company
203 Harrison Place, Brooklyn, N. Y. 11237
(212) 497-7600

See Dialight.

Circle 900 on reader service card

1+1=10

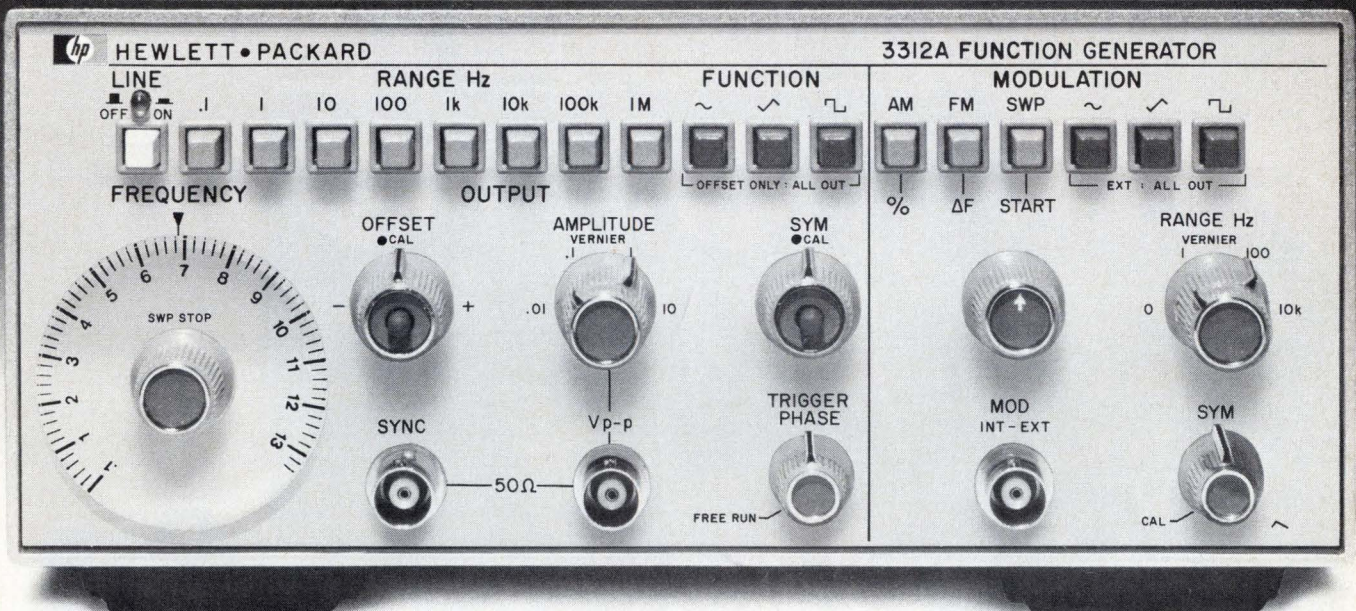

Two function generators in one box equals ten good reasons to buy one.

This new function generator gives you FM signals, AM signals, dc levels, sweeps, sine waves, square waves, triangle waves, ramps, tone bursts and single or multiple pulses. You get all these functions for only \$900* plus many other

output waveforms. And you get top performance too...like square waves that don't become sine waves above 10MHz. For all the details on this dual function generator—HP's 3312A—give your local HP field engineer a call today.

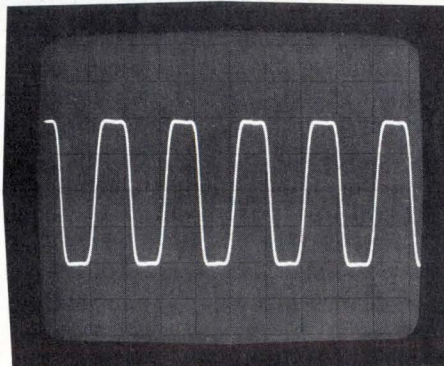

Unretouched scope display of the 3312A's 10 MHz square-wave output, showing 18 nsec rise time.

HEWLETT  PACKARD

Sales and service from 172 offices in 65 countries.
1501 Page Mill Road, Palo Alto, California 94304

Circle 1 on reader service card

Handle Troublesome Signals Easily With HP Variable-Persistence Scopes.

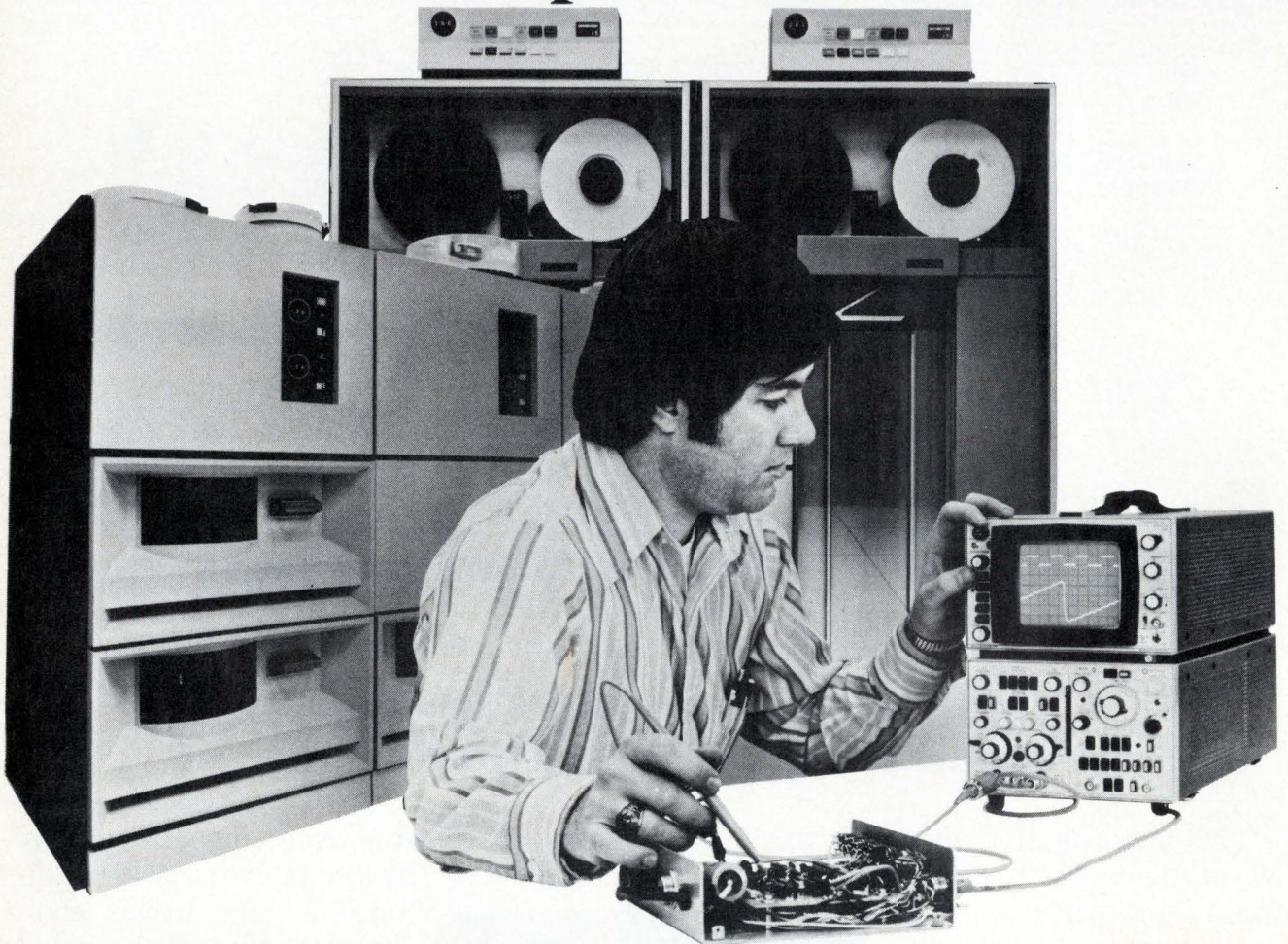

Because the unique capabilities of variable persistence in HP's 180 systems tackle these difficult measurement problems with much more ease than the conventional scope you're probably now using.

Dim traces—low rep-rate signals are brightened by the integrating characteristics of variable persistence so you can observe them clearly in normal ambient light...even at rep-rates below 1 Hz.

Transients—digital noise pulses or other single-shot events are made visible by the high writing speed of HP's mesh-type storage and variable persistence.

Slow-moving waveforms—electromechanical events or transducer outputs that appear as a "bouncing ball" on conventional scopes will be displayed as a continuous trace with variable persistence, allowing more accurate voltage

and timing measurements.

Two storage mainframes give you a choice of writing speeds. And a broad selection of plug-ins lets you tailor your scope to meet specific needs. To get the maximum performance for your storage-scope dollar, look to HP.

For more information about the 180 system, contact your local HP field engineer. Or, write Hewlett-Packard, 1501 Page Mill Road, Palo Alto, California 94306.

HEWLETT  PACKARD

Sales and service from 172 offices in 65 countries.
1501 Page Mill Road, Palo Alto, California 94306

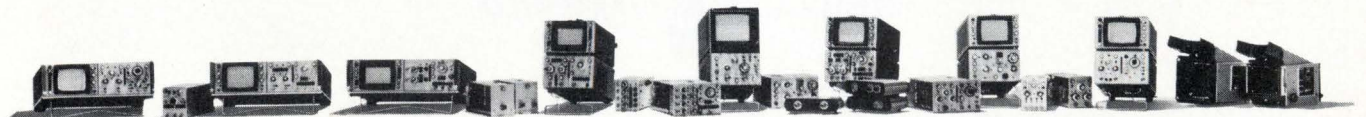

56 Electronics International

GREAT BRITAIN: 1-bit Boolean processor aimed at switching, 56
JAPAN: Multichannel optical waveguide is made of plastic, 56
AROUND THE WORLD: 57

33 Electronics Review

MICROPROCESSORS: Microcomputer design needs no extra circuits, 33
CONSUMER: Calculator design approach is applied to watches, 34
MEDICAL: Emergency medical teams get FCC aid, 35
AVIONICS: FAA makes requests for digital air control system, 35
SOLID STATE: Motorola designs a logic for military, space use, 36
Million-unit market predicted for microprocessors, 38
NEWS BRIEFS: 38
PACKAGING & PRODUCTION: Beam-lead parts get own carrier, 40
MATERIALS: Bell System progressing with aluminum cable, 42

69 Probing the News

MEETINGS: Speed and power at the IEDM, 69
COMPONENTS: Manufacturers catch up, 72
COMMUNICATIONS: The AT&T antitrust suit, 76
AVIONICS: Grumman adds new simulators, 82

91 Technical Articles

COMMUNICATIONS: Electronic switching improves data networks, 91.
CONSUMER: For solid-state watches, the time is at hand, 95
DESIGNER'S CASEBOOK: Rectifying wide-range signals precisely, 107
Power-failure detector is good for short lapses, 109
Complementary lighting control uses few parts, 111
THERMAL DESIGN: Part 10, Heat pipes cool in tight spaces, 114
MATERIALS: Rare-earth permanent magnets gain applications, 119
ENGINEER'S NOTEBOOK: Program measures RLC nets, 124
Voltage-regulated power supply delivers constant current, 126

130 New Products

IN THE SPOTLIGHT: Chip contains 16-bit microprocessor, 130
COMPONENTS: Film capacitors go beyond 1 microfarad, 133
INSTRUMENTS: Multimeter resolves 1 microvolt, 139
SEMICONDUCTORS: Power transistor built for fast switching, 147
SUBASSEMBLIES: DEC 'unbundles' data-acquisition board, 153
DATA HANDLING: Low-priced reader handles single cards, 160
MATERIALS: 170

Departments

Publisher's letter, 4
Readers comment, 6
40 years ago, 8
People, 14
Meetings, 24
Electronics newsletter, 29
News update, 46
Washington newsletter, 53
Washington commentary, 54
International newsletter, 59
Engineer's newsletter, 128
New literature, 173

Highlights

Cover: Digital-watch industry takes shape, 96

Confident that problems of styling and cost will soon be solved, watch companies, semiconductor manufacturers, and electronic-watch-only makers are vying for a promising but as yet embryonic market. Part 1 of this article covers the state of the technology, Part 2 discusses the industry.

What if the Government wins against AT&T? 69

Obstruction of competition, not the efficiency of the Bell System, is what AT&T will have to answer for in court, and if the Justice Department prevails, a host of contenders for the interconnect market stands ready.

Data network exploits electronic switching, 91

An Illinois firm will shortly replace the private lines of its data-communications network with switched connections, which are more efficient and by now technologically feasible. Also in prospect is decentralized network control, with the main computer operating remote switches.

How to cool it with heat pipes, 114

An overheated region in an electronic system can be economically cooled if one end of a heat pipe is located near by. The geometries and materials of these devices are by now well enough understood to make them a practical design option, says Part 10 of the Thermal Design series.

And in the next issue . . .

Europe in 1975: *Electronics'* annual market forecast . . . a single-chip 16-bit microprocessor.

EDITOR-IN-CHIEF: Kemp Anderson

EXECUTIVE EDITOR: Samuel Weber

MANAGING EDITORS: Lawrence Curran, *News*;
Arthur Erikson, *International*

SENIOR EDITORS: John Johnsrud,
H. Thomas Maguire, Laurence Altman,
Ray Connolly, Stephen E. Scrupski

ART DIRECTOR: Fred Sklenar

ASSOCIATE EDITORS: Howard Wolff,
Gerald M. Walker, Alfred Rosenblatt

DEPARTMENT EDITORS
Aerospace/Military: Ray Connolly
Circuit Design: Wallace B. Riley
Communications & Microwave:
Stephen E. Scrupski
Components: Lucinda Mattera
Computers: Wallace B. Riley
Consumer: Gerald M. Walker
Industrial: Margaret A. Maas
Instrumentation: Andy Santoni
New Products: H. Thomas Maguire,
Michael J. Riezenman
Solid State: Laurence Altman

COPY EDITORS: Margaret Eastman,
Everett C. Terry, Bill Dunne

ART: Charles D. Ciatto, *Associate Director*
Patricia Cybulski, *Assistant Director*

PRODUCTION EDITOR: Arthur C. Miller

EDITORIAL SECRETARIES: Janet Noto,
Julie Gorgoglione, Penny Roberts

FIELD EDITORS

Boston: Gail Farrell
Los Angeles: Paul Franson (Mgr.)
Midwest: Larry Armstrong (Mgr.)
New York: Ron Schneiderman (Mgr.)
San Francisco: Bernard Cole (Mgr.)
Judith Curtis
Washington: Ray Connolly (Mgr.)
Larry Marion
Frankfurt: John Gosch
London: William F. Arnold
Paris: Arthur Erikson
Tokyo: Charles Cohen

McGRAW-HILL WORLD NEWS

Director: Ralph R. Schulz
Bonn: Robert Ingersoll
Brussels: James Smith
London: Marvin Petal
Madrid: Dom Curcio
Milan: Peter Hoffmann, Andrew Heath
Moscow: Peter Gall
Paris: Michael Johnson, Richard Shepherd
Stockholm: Robert Skole
Tokyo: Mike Mealey

PUBLISHER: Dan McMillan

DIRECTOR OF MARKETING: Pierre J. Braudé

ADVERTISING SALES SERVICE MANAGER:
Wallis Clarke

BUSINESS MANAGER: Stephen R. Weiss

CIRCULATION MANAGER: Nancy L. Merritt

MARKETING SERVICES MANAGER:
Tomlinson Howland

RESEARCH MANAGER: Margery D. Sholes

Electronics is changing the face of the traditional watch—and of the tradition-bound timepiece business. But, contrary to early expectations, the process is turning out to be a slow one.

To bring you up to date on the progress of the electronic watch—especially the digital models with displays made from liquid crystals and light-emitting diodes—we have put together the report that starts on page 96. In this nine-page wrap-up you'll find details about both the technology that spawned the electronic watch and the marketing factors that have shaped its infancy.

In the report, consumer editor Jerry Walker and solid state editor Larry Altman conclude: "Until now consumers have not beaten a path to anyone's door, and part of the reason may be the lackluster promotion the digital watch has received. Be that as it may, the drift of technology portends a traumatic period for an industry that has been orderly and predictable for a few hundred years. It appears that over the

long haul, vertical integration, a process already underway, will be critical in establishing the successful competitors in the market."

One of the year's big technological events is the International Electron Devices Meeting, and, as every year, we have rounded up the major developments that surfaced at the conference. Our detailed coverage starts on page 69.

The big news: digital processing devices have been made denser and faster, and the power-handling capabilities of microwave devices have been pushed up at higher frequencies. But there were a host of other innovations reported at the meeting—from C-MOS random-access memories to injection logic—and you'll find the most important included in our three-page report.

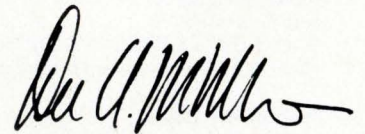

We're looking for a computer editor

The ideal candidate for this position will have an engineering degree, as well as extensive experience in the design of computers, or computer-based systems and components. The candidate must, of course, have writing ability.

In covering the stimulating new developments in technology our editors travel extensively, interview the people who make electronics the dynamic field it is, and write and edit technical articles.

As part of McGraw-Hill, one of the world's leading publishing companies, we offer excellent working conditions and fringe benefits. And, the salary level is as good as or better than industry rates for engineers.

If you are interested and have the necessary qualifications, send your résumé with salary requirements to: The Executive Editor, ELECTRONICS Magazine, 1221 Avenue of the Americas, New York, N.Y. 10020.

December 12, 1974 Volume 47, Number 25
94,645 copies of this issue printed

Published every other Thursday by McGraw-Hill, Inc. Founder: James H. McGraw 1860-1948. Publication office 1221 Avenue of the Americas, N.Y., N.Y. 10020; second class postage paid at New York, N.Y. and additional mailing offices.

Executive, editorial, circulation and advertising addresses: Electronics, McGraw-Hill Building, 1221 Avenue of the Americas, New York, N.Y. 10020. Telephone (212) 967-1221. Teletype TWX N.Y. 710-581-5234. Cable address: MCGRAWHILL N.Y.

Subscriptions limited to persons with active, professional, functional responsibility in electronics technology. Publisher reserves the right to reject non-qualified requests. No subscriptions accepted without complete identification of subscriber name, title, or job function, company or organization, including product manufactured or services performed. Subscription rates: qualified subscribers in the United States and possessions, Canada, and Mexico \$12.00 one year, \$24.00 three years; all other countries \$25.00 per year, except Japan and Israel \$50.00 per year, Brazil \$40.00 per year, Australia and New Zealand \$60.00 per year, including air freight. Limited quota of subscriptions available at higher-than-basic rate for persons outside of field served, as follows: U.S. and possessions and Canada, \$25.00 one year, all other countries \$50.00. Single copies: \$4.00.

Officers of the McGraw-Hill Publications Company: John R. Emery, President; J. Elton Tuohig, Executive Vice President-Administration; Gene W. Simpson, Group Publisher-Vice President; Senior Vice Presidents: Ralph Blackburn, Circulation; Walter A. Stansbury, Editorial; John D. Hoglund, Controller; David G. Jensen, Manufacturing; Gordon L. Jones, Marketing; Jerome D. Luntz, Planning & Development.

Officers of the Corporation: Shelton Fisher, Chairman of the Board and Chief Executive Officer; Harold W. McGraw, Jr., President and Chief Operating Officer; Wallace F. Traendly, Group President; McGraw-Hill Publications Company and McGraw-Hill Information Systems Company; Robert N. Landes, Senior Vice President and Secretary; Ralph J. Webb, Treasurer.

Title registered in U.S. Patent Office; Copyright ©1974 by McGraw-Hill, Inc. All rights reserved. The contents of this publication may not be reproduced in whole or in part without the consent of copyright owner.

Subscribers: The publisher, upon written request to our New York office from any subscriber, agrees to refund that part of the subscription price applying to copies not yet mailed. Please send change of address notices or complaints to Fulfillment Manager; subscription orders to Circulation Manager, Electronics, at address below. Change of address notices should provide old as well as new address, including postal zip code number. If possible, attach address label from recent issue. Allow one month for change to become effective.

Postmaster: Please send form 3579 to Fulfillment Manager, Electronics, P.O. Box 430, Hightstown, N.J. 08520.

4 filters in 1

Model 3202 offers two independent low-pass or high-pass channels or single channel band-pass or band-reject from 20 Hz to 2 MHz.

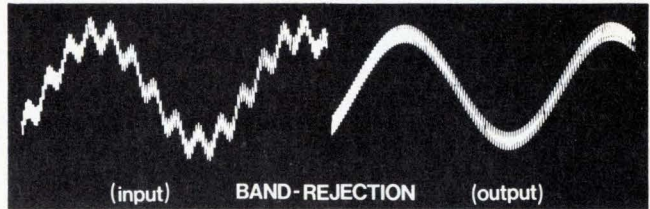
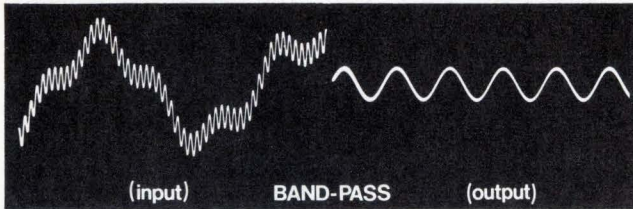
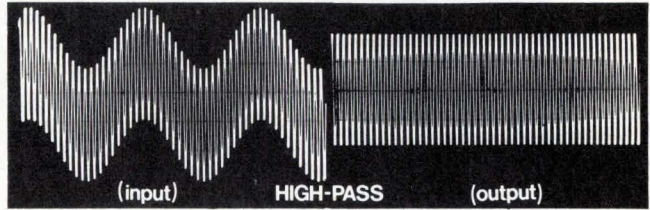
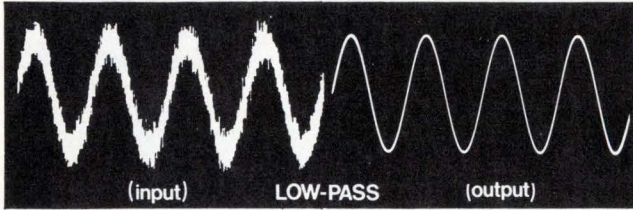

For only \$895, Model 3202 provides the flexibility essential for complex frequency or time domain measurements.

FUNCTIONS: Low-pass—direct coupled with low drift.
High-pass—upper 3 dB at 10 MHz. Band-pass—continuously variable. Band-rejection—variable broad band or sharp null.

TWO RESPONSE CHARACTERISTICS: (1) Fourth-order Butterworth or (2) simple R-C (transient free).

ZERO-dB INSERTION LOSS: All-silicon amplifiers provide unity gain passband response. 24 dB per octave slopes per channel extend to at least 80 dB.

90-dB DYNAMIC RANGE: Low hum and noise (less than 100 microvolts) eliminate costly preamplifiers.

For fast action, call: (617) 491-3211

TWX: 710-320-6583, Krohn-Hite Corporation, 580 Massachusetts Ave., Cambridge, Mass. 02139, U.S.A.

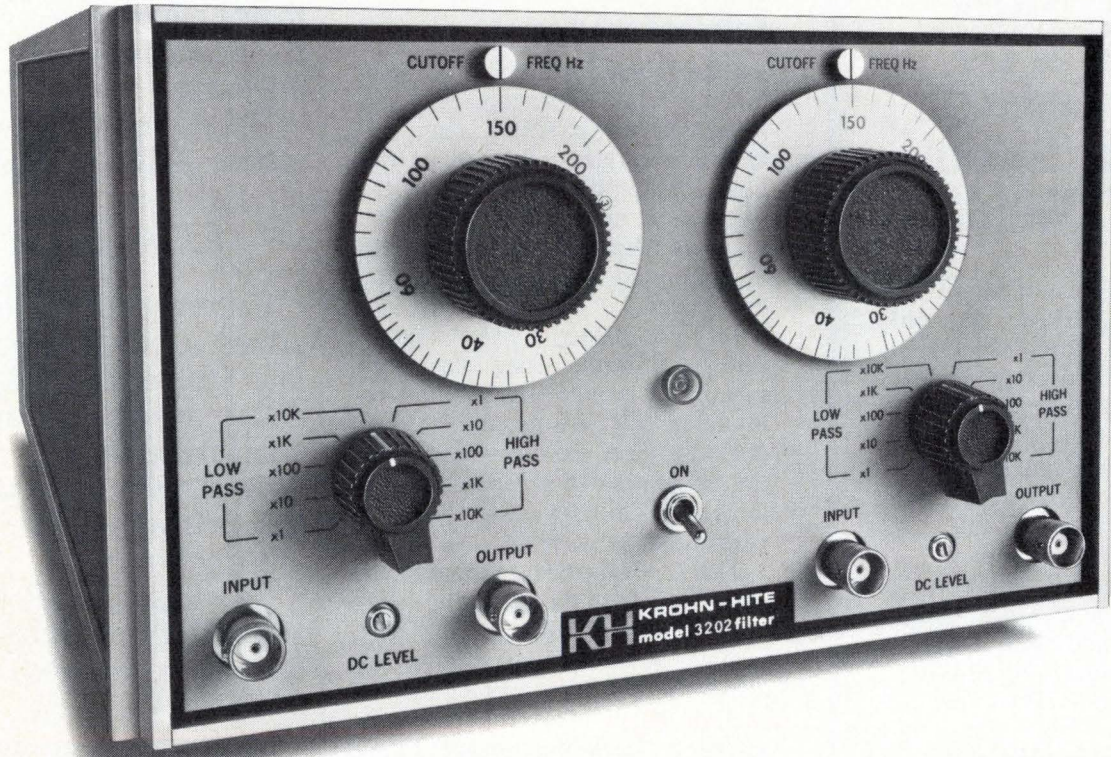

KH KROHN-HITE CORPORATION

580 Massachusetts Avenue, Cambridge, Massachusetts 02139

SALES OFFICES: ALA, Huntsville (205) 534-9771; ARIZ., Scottsdale (602) 947-7841; CAL., San Jose (408) 292-3220, Inglewood (213) 674-6850; COLO., Denver (303) 934-5505; CONN., Glastonbury (203) 633-0777; FLA., Orlando (305) 894-4401; HAWAII, Honolulu (808) 941-1574; ILL., Des Plaines (312) 298-3600; IND., Indianapolis (317) 244-2456; MASS., Lexington (617) 861-8620; MICH., Detroit (313) 526-8800; MINN., Minneapolis (612) 884-4336; MO., St. Louis (314) 423-1234; N.C., Burlington (919) 227-3639; N.J., Haddonfield (609) 795-1700; N.M., Albuquerque (505) 299-7658; N.Y., E. Syracuse (315) 437-6666, Rochester (716) 328-2230, Vestal (607) 785-9947, Elmont (516) 488-2100; OHIO, Cleveland (216) 261-5440, Dayton (513) 426-5551; PA., Pittsburgh (412) 371-9449; TEX., Houston (713) 688-9971, Richardson (214) 231-2573; VA., Alexandria (703) 354-1222; WASH., Seattle (206) 624-9020; CANADA, Montreal, Quebec (514) 636-0525, Toronto, Ontario (416) 444-9111, Stittsville, Ontario (613) 836-4411, Vancouver, British Columbia (604) 688-2619.

Circle 5 on reader service card

Cool as a
cucumber

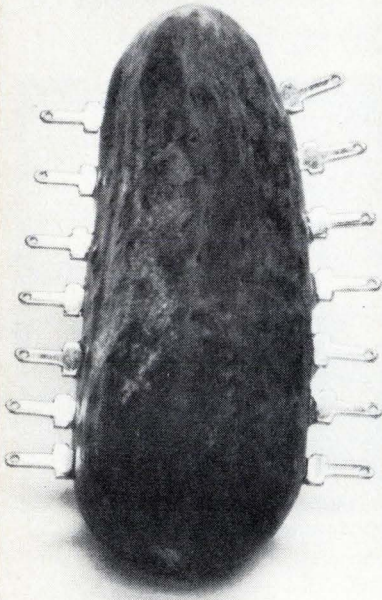

Temperature sensitive hybrids welded with Raytheon DC Welders.

Rectangular or round—weld them fast—and cool—with a Raytheon DC welder... from the widest power range of models available. For more data or a free evaluation of your welding needs—call Tom Daley or Keith Nutter, Raytheon Company, Production Equipment Department, 676 Island Pond Road, Manchester, N.H. 03103. (603) 668-1600.



Readers comment

Others pushed for standard, too

To the Editor: The articles "Instrument makers seek a language," and "Standard instrument interface simplifies system design" [*Electronics*, Sept. 19, p. 67, and Nov. 14, p. 95, respectively] are very interesting.

However, while the contribution of the Hewlett-Packard Co. to worldwide bus standardization has been very valuable, your writers do not seem to be aware of the initiatives taken by a number of European firms and research establishments. It was the German Electrotechnical Committee for trade standards, for example, that in 1971 proposed establishment of the International Electrotechnical Commission's working group for programmable instruments. The H-P scheme was introduced at the first meeting of the IEC working group in October 1972.

A. S. Lodder
N.V. Philips' Gloeilampenfabrieken
Eindhoven, the Netherlands

Relay has one magnet

To the Editor: In the article, "Self-latching relays offer six poles" [*Electronics*, Aug. 8, p. 131], it is said that "a latching relay is limited to two-pole configurations because of the interaction between its permanent magnets. Three latching relays must be connected in parallel if six poles are needed."

In point of fact, North American Philips Controls Corp. has been making a six-pole latching reed relay since 1971. We did, at first, try to combine three two-pole relays, but the interaction of the magnets was too great. This is what led us to invent our 45 Series relay.

This is not the conventional latching relay where the reeds and magnets are placed inside the coil form. Instead, low-reluctance iron paths direct the coil and magnet flux to each of the six reeds. It is only necessary to have one magnet, thus there is no interaction. Only 75 milliwatts are required to latch or unlatch the relay.

Harry I. Hamilton
North American Philips Controls
Corp.
Frederick, Md.

Liquid Rivets, Bolts, Nails, Staples, Etc.

One drop goes a long way in fastening almost anything to almost anything.

Metals, for instance. And plastics. And ceramics. And rubber.

Eastman 910[®] adhesive bonds fast, too. Almost instantaneously. With only contact pressure.

Tensile strength? Up to 5,000 psi at room temperature.

New Eastman 910 MHT and THT grades hold when the heat is on. Even over 400°F.

For further data and technical literature, write: Eastman Chemical Products, Inc., Kingsport, Tennessee 37662.



After all the noise, the quiet logic of HiNIL and 74C CMOS keeps you on the right track.



May 10, 1869. Promontory, Utah. The rumble of wheels, the hiss of escaping steam, the shouts of the celebrating crowd filled the skies with a deafening roar when they drove the golden spike that joined the Central Pacific and Union Pacific Railroads.

But today, when you link Teledyne's high noise immunity logic, HiNIL, and our 74C CMOS together in your digital or analog/digital control designs, you'll no longer have to worry about spikes or noise. Teledyne invented HiNIL to meet the need for high noise immunity found in practically all digital systems. The success of this large and still growing family has made Teledyne a leading supplier of logic for high noise applications.

Just put HiNIL on input-output lines to block heavy noise transients and drive high current peripheral devices. And use CMOS in the middle to minimize power dissipation and increase speed and circuit density. The combination of HiNIL's guaranteed 3.5V noise margin and 74C's low power dissipation lets them quiet almost any kind of system with high noise problems.

Our two logics interface directly, too. Standard 74C drives HiNIL directly and HiNIL drives more than 50 CMOS loads. Simply connect both to an inexpensive 12 or 15V $\pm 1V$ power supply. You can even connect linear circuits to the same supply for extra savings.

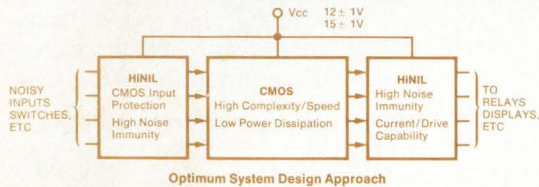

HiNIL eliminates the need for drivers because it sources up to 15mA and sinks up to 65mA. That's ample capability for display tubes, LEDs, lamps and relays.

And with HiNIL you save on filter capacitors, get the extra flexibility and economies of diode-expandable inputs, and have a choice of active or passive pullup and open collector outputs.

There's plenty of board-shrinking MSI in both families, too.

So write or call Teledyne today to find out about our HiNIL and 74C CMOS lines. We'll show you how easy it is to block out all the noise and stay on the right track.

TELEDYNE SEMICONDUCTOR

1300 Terra Bella Avenue, Mountain View, California 94043 Tel: (415) 968-9241 TWX: 910-379-6494 Telex: 34-8416

ENGLAND: Heathrow House, Cranford, Hounslow, Middlesex, Tel: (44) 01-897-2503 Telex: 851-935008

FRANCE: 90, Avenue Des Champs Elysees, 75008 Paris, Tel: 2563069 Telex: 842-29642

WEST GERMANY: Albert Gebhardtstrasse 32, 7897 Tiengen, Tel: 7741-5066 Telex: 841-792-1462

JAPAN: Nihon Seimei-Akasaka Bldg. (3F), 1-19, Akasaka 8-chome, Minato-ku, Tokyo 107, Tel: 03-405-5738 Telex: 781-2424241

Additional offices in West Germany, Hong Kong and the United States. Representatives and distributors worldwide.



No Offense

Non-PCB (polychlorinated biphenyl) . . . non-toxic . . . non-polluting. That's new Sprague ECCOL® A-C Capacitors . . . developed for today's ecology-conscious world.

Equipment manufacturers using capacitors with polychlorinated biphenyl impregnants are finding that some nations have prohibited the import of products containing PCB.

ECCOL® capacitors have been designed to meet industry needs for PCB-free capacitors. They exhibit essentially identical electrical performance characteristics to those of long-used askarel capacitors. Their operating life and reliability are also equivalent. Even the size of ECCOL® Capacitors is similar to previous designs, except for a slight increase in case height.

Drawn-case ECCOL® Capacitors are available in a wide range of capacitance values from 1 to 55µF, with four voltage ratings from 300 to 660 VAC.

For complete technical data, write for Engineering Bulletin 4550 to:
Technical Literature Service
Sprague Electric Company,
35 Marshall Street
North Adams, Mass. 01247

4SP-4113



THE BROAD-LINE PRODUCER OF ELECTRONIC PARTS

40 years ago

From the pages of *Electronics*, December, 1934

The costs of police radio

Why is police radio hard to sell? The manufacturers have good equipment and they want to sell it. The municipal authorities want to buy it. But the situation isn't as ideal as might appear. For one thing, city finances have been in such condition that funds for so useful a service as police radio have not been available. This situation is improving, as city financial affairs have improved, and as Federal funds for public works become available. But the availability of funds is not the only problem.

City fathers, seeing the possibility of obtaining funds for police radio, must attack a tough technical problem before they can decide what sort of system they need and how much they must pay for it. Having no technical training, they are faced with two alternatives: they can hire a consultant to decide the technical questions, or they can call in the salesmen and believe what they are told. Neither alternative is pleasant. The consulting engineer is expensive, and the salesmen may be prejudiced.

Often as a compromise the police chief's nephew, who owns a ham station, is called in. He builds and installs a home-made transmitter, known as "composite" among the elite. Thereby the industry loses a contract; and thereby, often, the police department gets poorly engineered equipment which cannot give good continuous service.

Steel auto tops bring problems

All-steel tops are to be used on a large scale in the automobile production of 1935. This will mean that radio antennas will have to be of the underslung type. Already the space is scant under the chassis, and in these few inches between ground and car body, the antenna will have to be hung, as far from the car and as close to the ground as possible. Under these conditions, average radio pickup may be as little as one-fifth of that provided by an antenna in the car roof.

Don't worry about systems compatibility.

S-D already has.

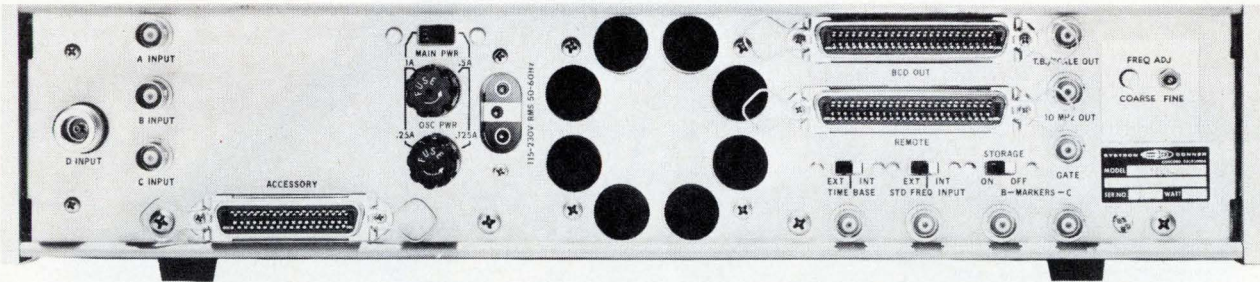

Systron-Donner manufactures a complete line of programmable instruments for systems applications. They were **meant** to be programmable right

Voltmeters: 4 wire ratio capability • True RMS AC • High speed/high noise rejection • 1000V protection on all ranges and functions

Power Supplies: Optically isolated • Programmable polarity, current and voltage • Addressable memory allows 16 supplies per I/O buss

Counters: Completely programmable including trigger levels • 50, 200, 512 MHz or 3 GHz models • 10 ns one shot T.I.M./period

Pulse Generators: All pulse parameters programmable • 50 MHz repetition rate • Current sink capability

from the start. Here are but four of S-D's many easy-to-interface instruments:

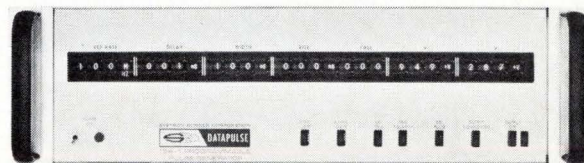
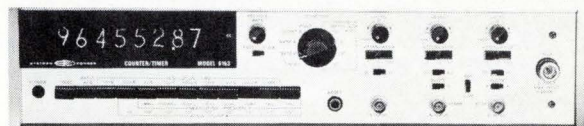
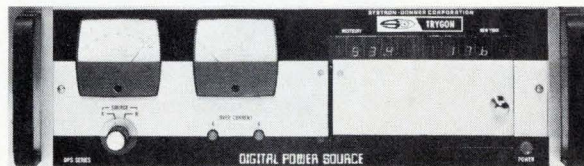

For immediate information on Systron-Donner's broad line of instruments for systems, call us collect on our Quick Reaction line: (415) 682-6471. Or you may contact your Scientific Devices office or S-D Concord Instruments Division, 10 Systron Drive, Concord, CA 94518. Europe: Systron-Donner GmbH, Munich, W. Germany; Systron-Donner Ltd., Leamington Spa, U.K.; Systron-Donner S.A., Paris (Le Port Marly) France. Australia: Systron-Donner Pty. Ltd., Melbourne.

SYSTRON  DONNER

YIELD



In 1974 you probably didn't worry about it. In 1975 your job may depend on it.

Until now, it seemed that only people in the semiconductor industry cared about yield.

But now all that's changed.

With today's tight economy, everyone is worrying about yield. Because to raise yield is to raise profits. To ignore yield is to invite disaster.

The big question now is how to get the greatest yield per dollar invested. For the most profit.

The answer: Think Yield. Not just at the end of the production line, but right from the beginning. Because the most wasteful thing you can do is to add value to a bad part.

Looking at yield in this manner cuts costs two ways. It cuts labor costs, because the earlier a defect is detected, the cheaper it is to find. And it cuts equipment costs by simplifying the hardware requirements.

As the leading producer of semiconductor test equipment, we've long looked at the entire production process in terms of yield. Which is why we feel that any testing program that places the entire burden of quality on final testing alone is missing the point — the defects that drive yield down are of several totally different types, each requiring specialized attention.

And specialized attention is what we offer. Along with the largest line of automatic test equipment in the business.

Let's look at the possibilities:

1. Incoming Inspection. It may be right to sample test. Or to 100% test. Whatever your yield needs are, we have a complete line of state-of-the-art inspection instruments and systems — for ICs, transistors, diodes, zeners, FETs, relays, capacitors, resistors, SCRs and thyristors.

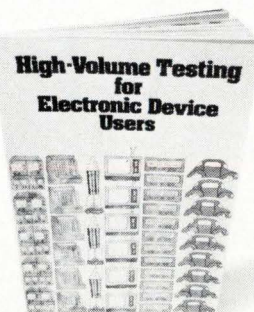
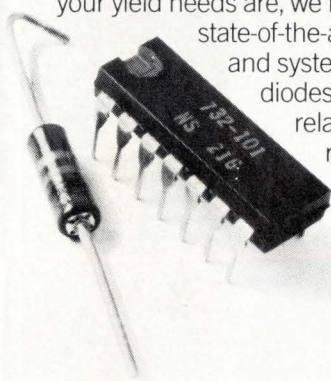

2. Bare-Board Testing. This depends on the

value and complexity of your bare boards. Our solid-state-switched systems can test a board (even multilayer types) with several thousand points in seconds, identifying opens and shorts in the board's own nomenclature. We even offer mechanical fixturing for turnkey systems.

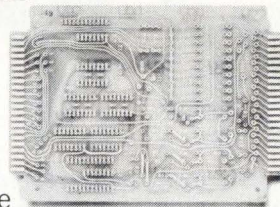

3. Loaded-Board Testing. Our circuit test systems with "guided-probe"

troubleshooting allow technically unskilled operators to pinpoint errors quickly and reliably. This means you no longer need to use valuable technicians for chasing down routine soldering and insertion errors.

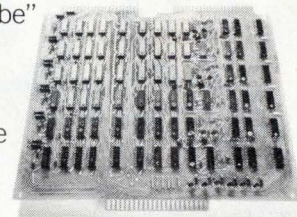

4. Backplane Testing. With only a fixture

change, the same systems that test bare boards can also test backplanes, eliminating systems test problems caused by misserviced backplanes. Daisy-chained fixture cards make connection to the test system quick and easy.

Now which kinds of testing are best for you? That's where our total experience can help. Because only through a total look at your production situation can you be sure you're getting the greatest yield per dollar invested.

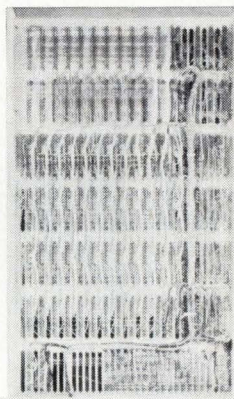

For the most profit.

For starters, why not write for our free booklet "High-Volume Testing for Electronic Device Users."

Soon.

Teradyne, Inc., 183 Essex Street, Boston, Massachusetts 02111.

Think Yield
TERADYNE

20 million LED digits can't be wrong.

Litronix DL-707 0.3" high digit has same superior features as DL-747 below.

Litronix DL-747 has 0.6" high digits 44% larger in area than digits from any other major supplier.

Mitered corners increase eye appeal.

Light pipe spreads illumination evenly.

Mounted on DIP with standard pin spacing.

DL-747 with cap in place over light pipes.

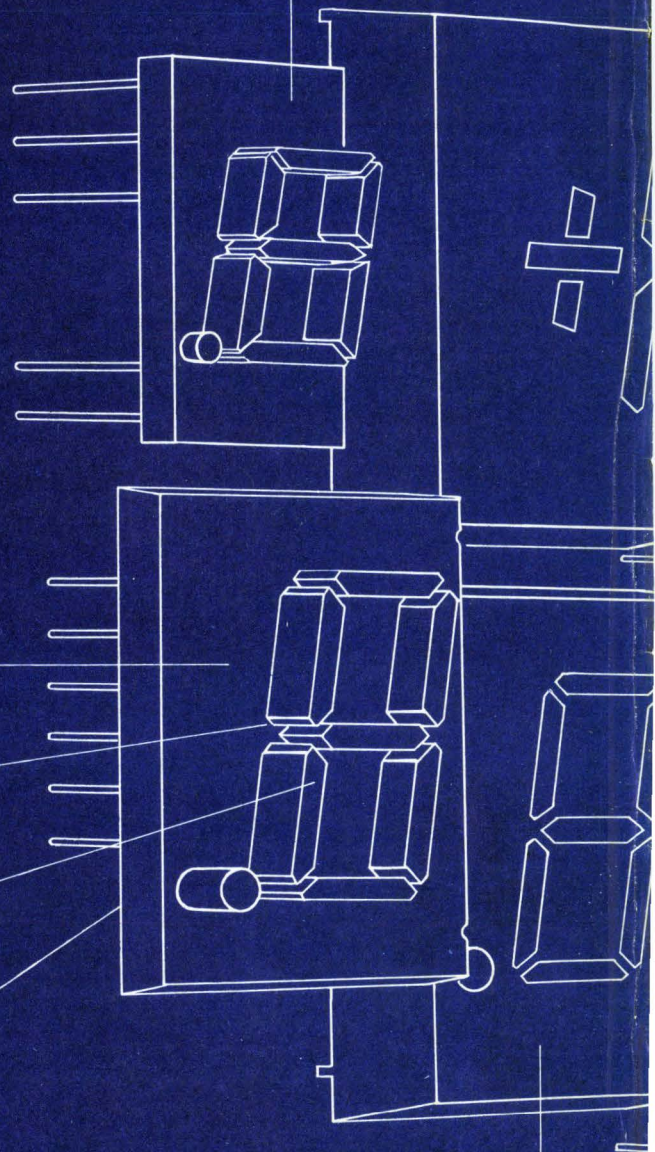

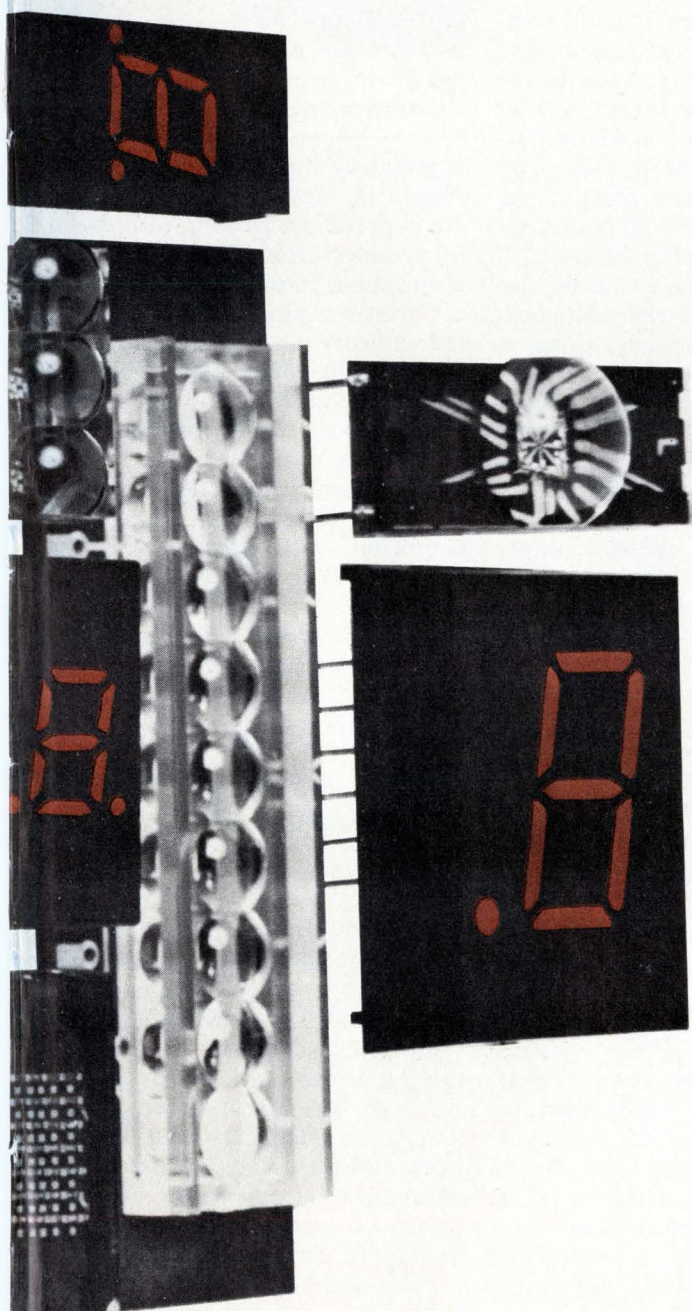

You'll find major advantages in dealing with the world's largest supplier of LEDs—the one that's shipped over 20 million LED digits to date and will deliver many millions more in 1974.

For openers, the Litronix product line is so broad that you can get exactly what you need. Sizes from 0.1" to 0.6". Colors like red and orange today, with yellow and green in volume production soon. Common anode or common cathode. And polarity overflow digits in many sizes.

Perhaps even more important, you're assured of a consistent, reliable product. Litronix doesn't buy any high-technology parts from others. We make everything in-house—starting with the basic GaAsP materials. The result is that we have better overall control: high brightness, proven reliability and assured delivery.

Litronix has two plants in the U.S. and three more overseas to keep the LEDs flowing. Because our volume is large, our prices are very, very competitive.

The drawing at left of our big 0.6"-high DL-747 shows some of the superior characteristics of the popular Litronix 700 Series displays.

Contact us right now for LED displays, LED lamps, opto-isolators, or phototransistors. We know we can meet your needs. Like we say, over 20 million LED digits can't be wrong.

Litronix, Inc., 19000 Homestead Road, Cupertino, CA 95014. Phone (408) 257-7910. TWX 910-338-0022.

**No wonder
we're No.1
in LEDs**

litronix

MORE POWER MORE BANDWIDTH

Our Model 503L is an ultra-wideband RF power amplifier whose wide range of frequency coverage and power output provides the user with the ultimate in flexibility and versatility in a laboratory instrument. Easily mated with any signal generator, this completely solid state unit amplifies AM, FM, SSB, TV, pulse and other complex modulations with minimum distortion.

Constant forward power is continuously available regardless of the output load impedance match, making the 503L ideal for driving highly reactive loads.

Unconditional stability and instantaneous fail-safe provisions in the unit provide absolute protection from damage due to transients and overloads. This low cost instrument, covers the frequency range of 1.6 to 540 MHz with a linear power output of 3 watts . . . and there's no tuning. Priced at \$995.*

Applications include:

- Laboratory instrumentation
- Communication systems
- Laser modulation
- RFI/EMI testing
- Spectroscopy

*USA and Canada



For further information or a demonstration contact

ENI, 3000 Winton Road South,
Rochester, New York, 14623.

Call 716-473-6900.

Or TELEX 97-8283 ENI ROC.

ENI

The world's leader
in solid-state power amplifiers.

People

Carter looks for still more changes

Tom Carter's phone started ringing almost immediately after the Justice Department announced that it was filing an antitrust suit to force American Telephone & Telegraph Co. to, among other things, divest itself of Western Electric (see p. 76). Since he had already "gone to the well" with AT&T, his friends, as well as the press, wanted to know Carter's reaction. "AT&T and the Bell System's heyday has passed," responded Carter. "I think we're going to see quite a change at AT&T."

Carter, a short, sturdy Texan, also responded in 1959, when, as president of Carter Electronics Corp. in Dallas, he got a complaint from AT&T about one of his products. Called the Carterfone, it enabled mobile-radio users to connect to virtually anyone in the world via telephone.

The base-station operator simply placed the handset of a telephone dialed to the desired number atop the Carterfone, which was wired to the base radio. But AT&T, which had fought for years against the connection of any "foreign" device to its equipment, took Carter into court to force him to stop marketing the Carterfone.

Some 10 years and "damn near a fortune" later, in Carter's words, the Federal Communications Commission, which had been handed the ball by the courts, ruled in its now famous 1968 Carterfone decision that suppliers other than the Bell System's Western Electric could lease or sell their own equipment to telephone users. And they could interconnect it with the Bell System or independent telephone companies.

Result. What did Carter get out of it? "I settled for half a million dollars [from AT&T] and a new industry," he says. In less than six years, the interconnect industry claims it has reached levels of more than 300 equipment suppliers, an estimated \$300 million worth of equipment installed during the past year alone, and its own trade association. Carter



Ready. Tom Carter of Carterfone fame isn't afraid of Western Electric.

is president of that group, the North American Telephone Association. He is president, as well, of his own interconnect firm, Telephone Communications Inc. in Dallas.

Carter was also one of the first in the industry to testify earlier this year before the Senate Subcommittee on Antitrust and Monopoly, which was investigating vertical integration within the telecommunications industry.

As for the prospect of eventually competing with Western Electric, the Bell System's captive manufacturing arm, Carter says "That doesn't bother me a bit, as long as they stand on their own two feet. And that means without AT&T money behind them."

McNiel sees solar cells for power

Unusual as it may seem, a company producing photovoltaic solar cells has for its president a man whose background in semiconductor or solid-state technology is virtually nil. But James C. McNiel Jr. of Mobil Tyco Solar Power Corp. is no stranger to the energy field. He had been director of field research into alternative sources of energy at Mobil Oil Co. when the oil-industry giant tapped him for a new job.

"The commercial development of solar cells is still at an early stage," the 53-year-old McNiel points out. And Mobil Oil wanted to get involved.

Both he and Mobil are enthusiastic about the solar-cell field—the oil

Join 'em... the growing crowd using MOSTEK's 16-pin 4K RAM!

The crowd of MOSTEK's 4K RAM users continues to grow. Why this preference for MOSTEK's 16-pin MK4096 over 22-pin alternates? Let's review a few of the reasons:

MOSTEK saves you memory board space. You can pack over twice the memory in the same board space as the 22-pin designer, without increasing power dissipation. The result is a more compact and efficient system.

MOSTEK leads in 4K performance. Check the comparative performance table for proof!

MOSTEK gives you direct compatibility with TTL, DTL, ECL and CMOS. The MK4096 will interface

directly with these popular logic families *without* the special high-voltage clock drivers required by 22-pin RAMs. Fewer address drivers are required also.

COMPARATIVE PERFORMANCE—16-PIN VS 22-PIN RAMs

PARAMETER	MOSTEK	2107	4030
Power Diss.	375 mW	425 mW	690 mW
Input Levels			
Input 0 (Max)	0.8	0.8	0.6
Input 1 (Min)	2.4	3.0	2.2
Output Levels			
Output 0 (Max)	0.4 at 2 mA	0.45 at 1.8 mA	0.4 at 3.2 mA
Output 1 (Min)	2.4 at 5 mA	2.4 at 100 μ A	2.4 at 2 mA
Access Time	300 ns	300 ns	300 ns
Read Cycle Time	425 ns	500 ns	470 ns
Write Cycle Time	425 ns	700 ns	470 ns
Output Data			
Hold Time	260 ns	40 ns	30 ns
Clock			
Characteristics	2 TTL Clocks 7 pF	One 12V Clock 21 pF	One 12V Clock 27 pF

MOSTEK's 4K RAM is easy to use.

You can use readily available automatic handlers both for incoming test operations and in circuit board assembly. Not so with 22-pin versions!

Want still more reasons to join the MOSTEK 4K RAM team? Then contact MOSTEK at 1215 West Crosby Road, Carrollton, Texas 75006, (214) 242-0444—or your local MOSTEK distributor or representative. In Europe contact MOSTEK GmbH, TALSTR 172, 7024 Bernhausen, West Germany, Tel. (0711) 70 10 96.

MOSTEK®

Circle 15 on reader service card

MOSTEK moves forward...in memories.

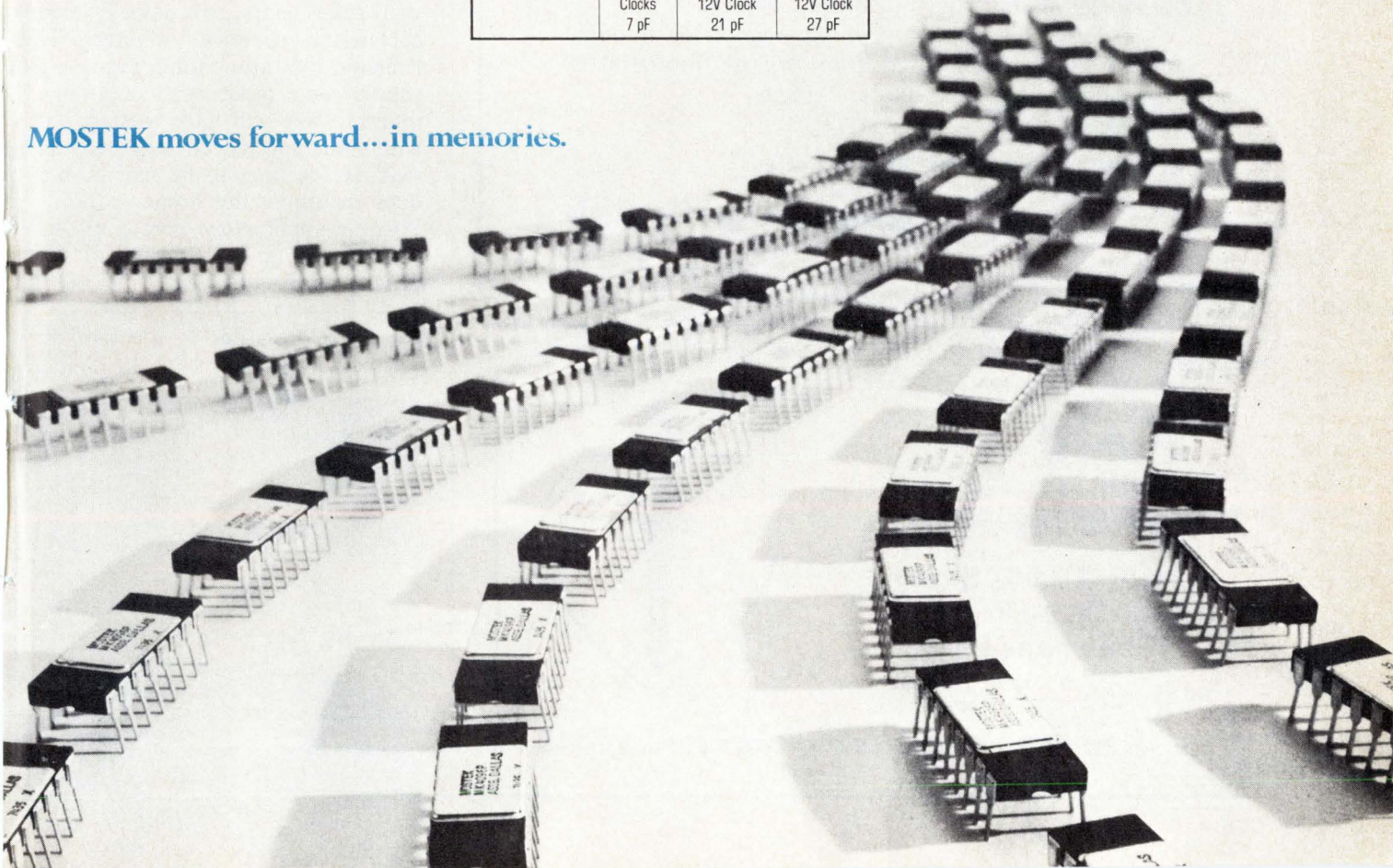

the Champ

problem solver



Bausch & Lomb StereoZoom 7 Microscope with Coaxial Illuminator is the answer to your need for full field, full aperture illumination; full color, high contrast imaging and better resolution.

This unique form of incident illumination eliminates surface glare from highly reflective surfaces and also effectively illuminates low contrast objects.

You zoom over a magnification range of 15X through 280X. Field diameter ranges from 0.55 in. through 0.03 in. Working distance is 3.0 in.—0.56 in.

Send today for our catalog 31-15 and our FREE DEMONSTRATION offer.

BAUSCH & LOMB 

SCIENTIFIC OPTICAL PRODUCTS DIVISION

62312 Bausch Street, Rochester, N. Y. 14602

StereoZoom. Reg. T.M.
Bausch & Lomb

Circle 16 on reader service card

Fight Them All

Heart Attack, Stroke
High Blood Pressure
Rheumatic Fever



Help your Heart... Help your Heart Fund

People

company to the tune of \$30 million, which it will supply to Mobil Tyco over the next seven years. McNiel talks about equipment costs for solar electric power coming down during this time by more than a factor of 100—to \$400 to \$500 per kilowatt. This, he observes, would make solar-cell-power competitive with nuclear energy for public utilities.

Supplying McNiel with the know-how and technology he needs are engineers from Tyco Laboratories, which has been developing a method for growing solar cells by pulling ribbons of silicon from a melt [*Electronics*, April 4, p. 99]. Mobil owns 80% of the new joint venture, which occupies Tyco facilities in Waltham, Mass.

McNiel is hoping soon to grow the 1-inch-wide silicon in ribbons between 50 and 100 feet long, up considerably from the present six-foot lengths, and to grow multiple ribbons simultaneously. McNiel's engineers also have their sights set on doubling the efficiency of the present cells—to 20%.

Getting to the point of having solar cells for central power stations will take years, of course, and McNiel, a chemical engineer by training, indicates Mobil Tyco may supply some other products in the interim. "We will have to start out with some specialized markets," he says. He declines to be specific but does mention "the home market." Possible applications here could be chargers for auto batteries, or for driving simple appliances.

Sun power. There's action in photovoltaic cells for Mobil Tyco's James C. McNiel, Jr.

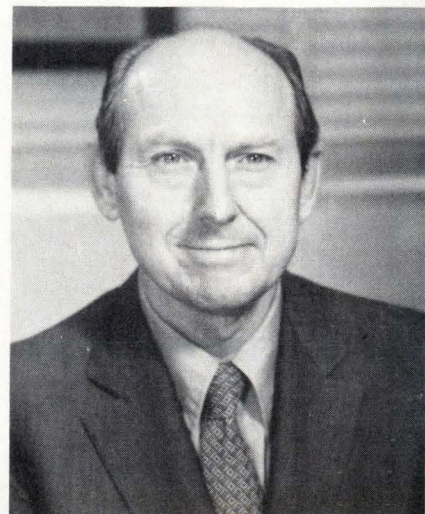

The AMP displation system

Its sole purpose for being is to lower your applied costs. This system completely eliminates the need for wire preparation of any kind. So the time and labor costs of stripping, cutting and soldering wire are likewise eliminated.

AMP displation is straightforward and remarkably reliable. Once you appreciate the engineering principle, we think you'll be anxious to put it into practice. And cut your applied costs considerably.

The contacts themselves are stamped and formed from high-conductivity beryllium copper, then plated with gold over nickel. And gang-loaded into the housings. They accept unstripped #22-28 solid-conductor wires and most #24-28 stranded wires — with any type of insulation up to .045" in diameter.

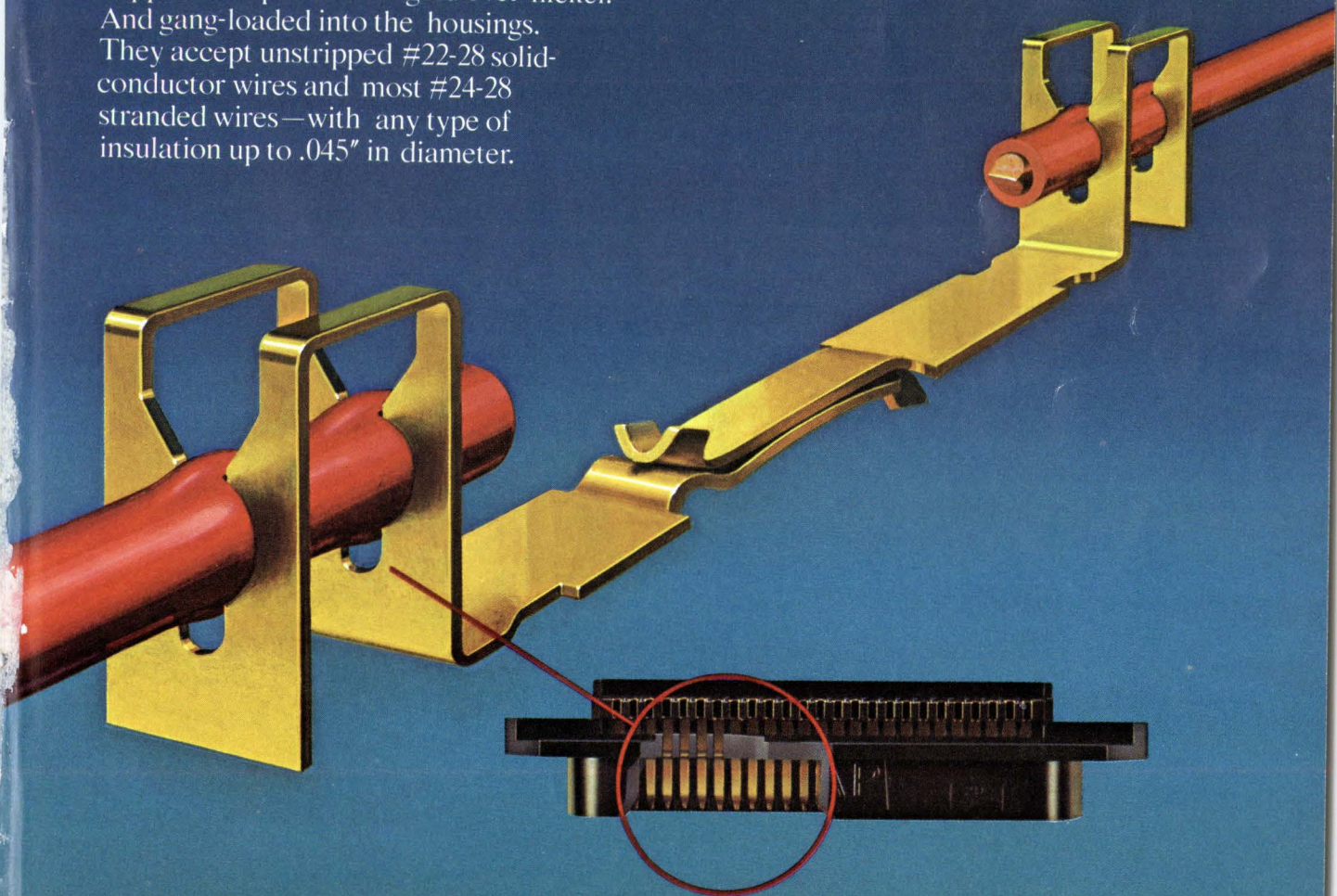

The Slotted-Beam Principle

The basis of the system is the Slotted-Beam Contact — with its precisely controlled dimensions over two planes. In the termination process, the unstripped wire is pressed into the double contact slots by the specially designed tooling. The front slot of the contact displaces the insulation and extrudes the wire with a wiping action to assure stable electrical contact, while the rear slot design provides insulation support and strain relief. Excess wire is automatically sheared by the application tool. That is displacement: a reliable, high-quality, gas-tight, electrical and mechanical connection that withstands vibration and shock.

The tooling to make it work

The tooling is designed to do one thing only — provide terminations with speed, precision and reliability.



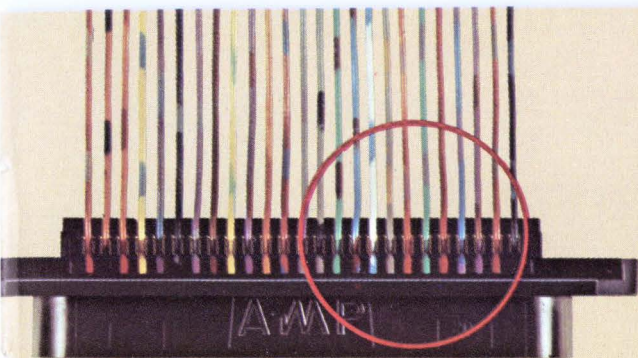

Gang terminations

The portable, bench-mounted tool provides gang terminations in one stroke. It terminates the wires and cuts them to length at speeds up to 10 lines per minute (including fanning).

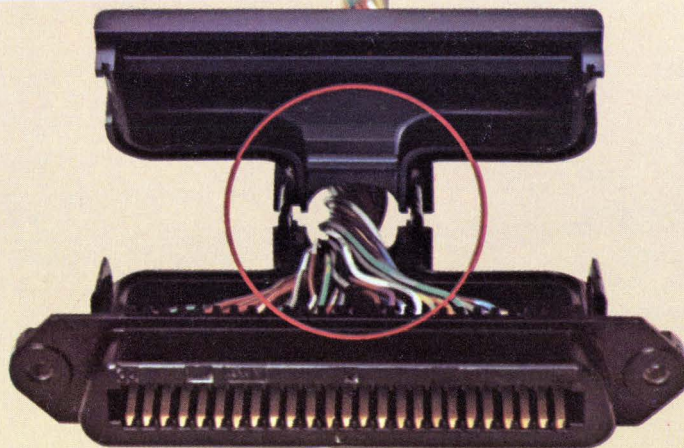

Strain relief

This prevents strain at the point of termination, and assures you of a firm, long-lasting contact under virtually all conditions.

Actual costs

Translated into economics, your in-plant installation costs can average a frugal 3-1/2¢ to 5¢ a line/mated pair. And in field installations you can expect to reduce your hook-up costs by as much as 90%.

Other tools offering low applied cost

The power-operated, semi-automatic tool, for factory use, can terminate up to 20 lines per minute. It works sequentially, two wires at a time. There's also a palm-held tool for making one-at-a-time terminations. It gives you the same precision and reliability as the others, but at speeds depending on the operator. If you need to repair or replace individual contacts, there's a simple hand tool that does it easily. And makes single-wire terminations in the field, too.

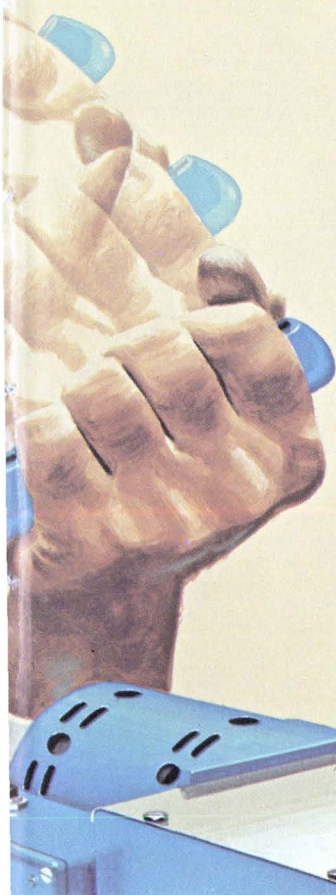

CHAMP connectors

The tremendous variety of CHAMP connector housings gives you remarkable versatility in using AMP Slotted-Beam Contacts.

The housings are preloaded and made of high-impact, high-dielectric-strength, self-extinguishing thermoplastic. So they're more robust than metal-clad housings.

CHAMP connectors are currently available in 14, 24, 36, 50 and 64 positions (on .085" centers); 90° standard or low profiles; or 180° strain reliefs; screw-type or bale-lock connectors or panel mounts; back-to-back connectors; plug to plug, plug to receptacle, and receptacle to receptacle.

There are also other types for flat flexible cable and free-standing contacts that mount directly onto pc boards.

Every CHAMP connector and panel mount is fully intermateable and interchangeable with existing connectors and mounts.

The biggest advantage of the AMP displacement system is that there are so many ways to take advantage of it. The application possibilities are staggering. Almost anywhere you've used solder terminations, the AMP Slotted-Beam Terminations can drastically cut your applied costs.

Some of its great potential is already being realized in pc edge connectors and interface board assemblies for applications like computer peripheral units, office equipment, cash registers and copiers. And these are just a beginning.

This is indeed the greatest solderless-termination technique ever shown. But it doesn't end here — not by a longshot. Write to us for our catalog. It's the first step toward lowering your applied costs. AMP Incorporated, Harrisburg, Pa. 17105. Or call (717) 564-0101.

AMP
INCORPORATED

AMP and CHAMP are trademarks of AMP Incorporated.

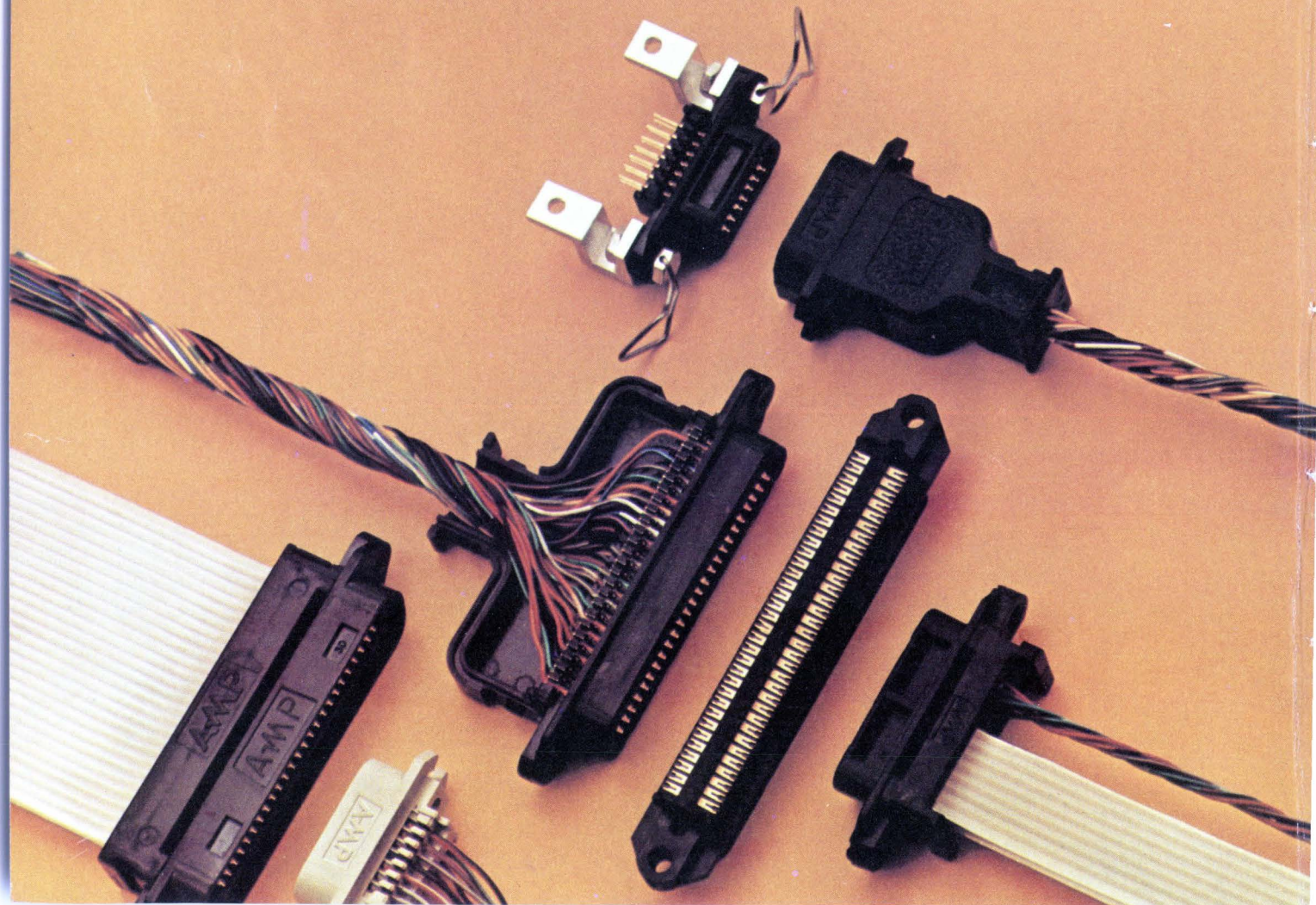

Others are trying to develop microcomputers like these.

Ours are for sale now.

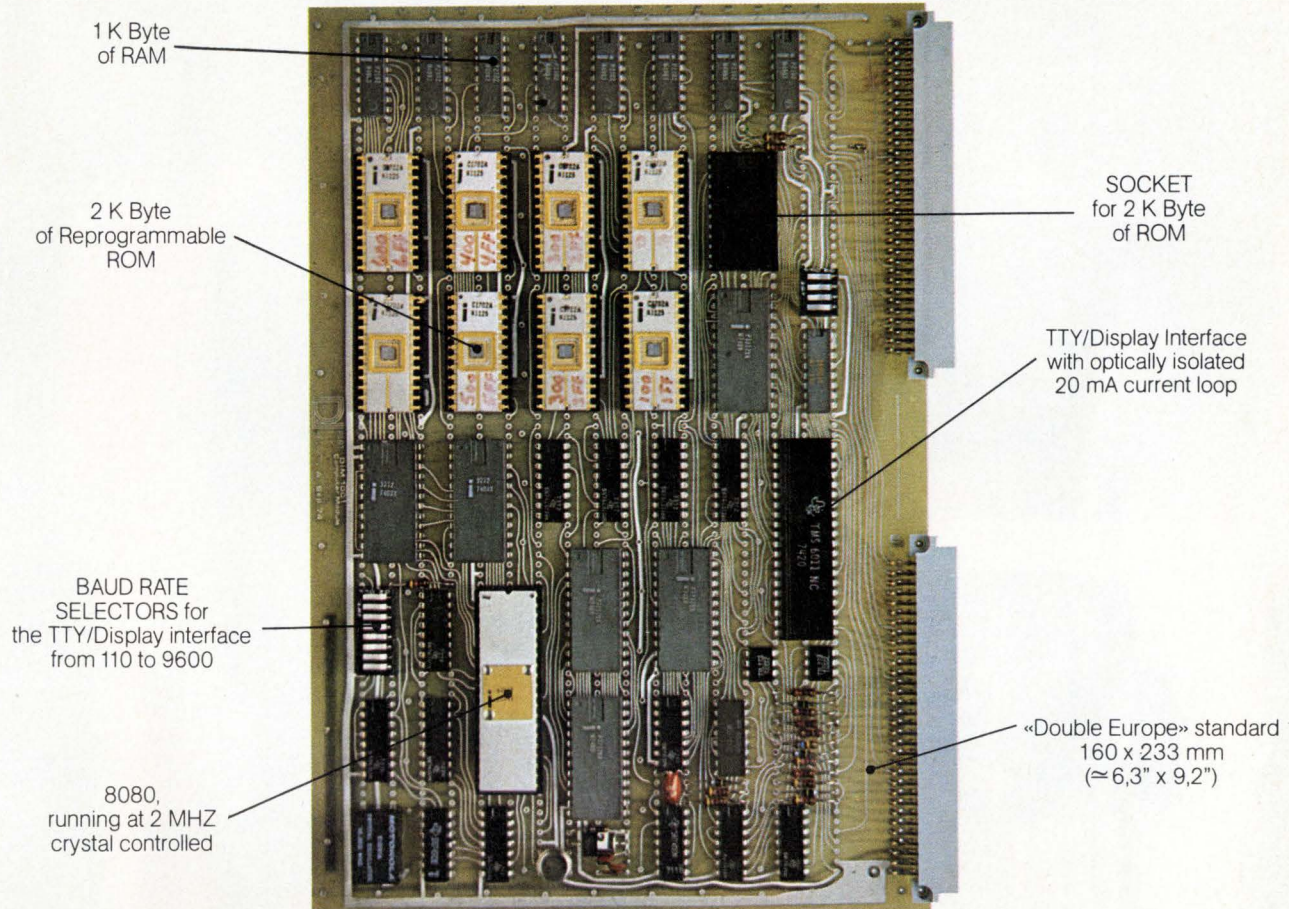

HOLTER, YGR

We've developed a micro-computer that's ahead of its time.

The MYCRO-1 is a truly complete computer on a single printed circuit board. Simply connect a teletype or display and a power supply and the computer is ready to work.

Need more memory? Add on a 4K byte RAM or erasable PROM modules, any mix up to 64 K. On the connectors,

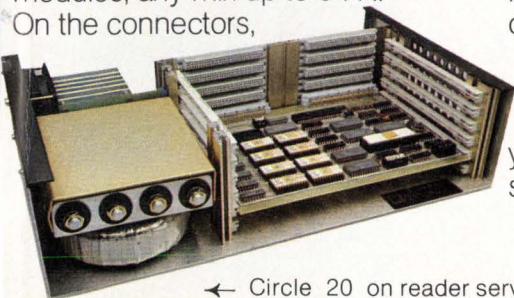

the MYCRO-1 has a 16-bit address bus, an eight-bit bidirectional data bus and all the necessary signals for memory read/write, input/output control, eight interrupt control lines and DMA control. All TTL-compatible and buffered for output drive and low input load.

Power supply and cabinet? If you don't plug it into your own system we can also supply a small

complete box.

If you're interested in new developments in micro-computers, we think you'll be interested in the MYCRO-1 and associated modules. For further information write to Data Industri Pilestredet 75 C, P.O.Box 7175H Oslo 3, Norway.

Our microcomputers are available from stock at prices you'll like.

DATA INDUSTRI
A member of Norway's largest electronics group, Elektro Union.

← Circle 20 on reader service card

Circle 21 on reader service card

HIGH RELIABILITY

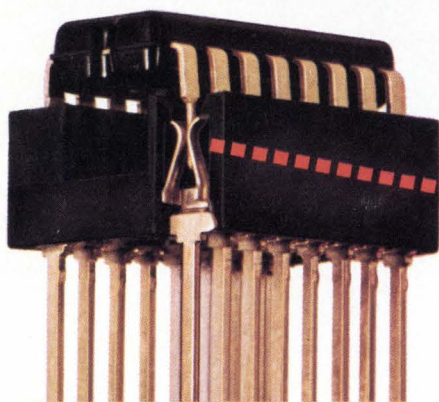

Get the **high reliability** that eliminates trouble. RNDIP sockets make contact with the wide, flat sides of your IC leads. This provides **100% greater surface contact** for positive electrical connection.

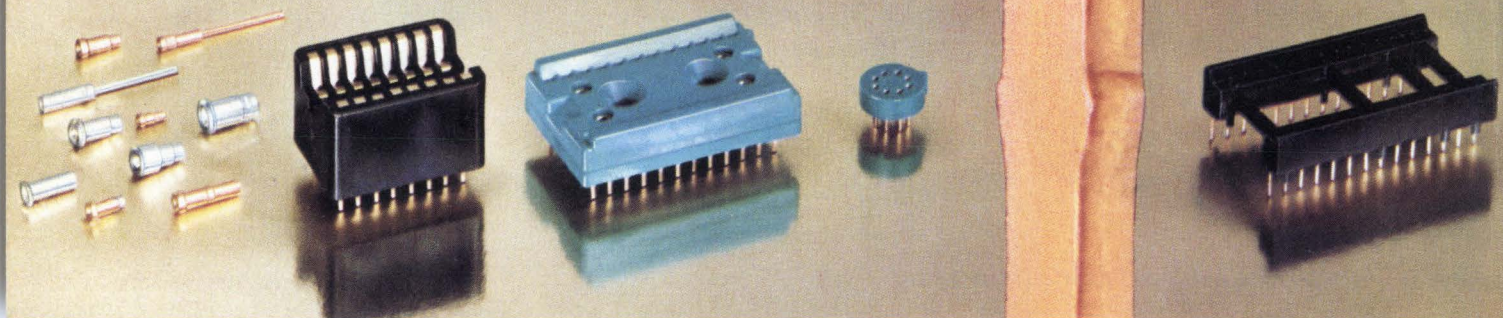

DIP SOCKETS **for the price you're paying for junk!**

Robinson Nugent "side-wipe" DIP sockets make 100% greater contact than any edge-bearing socket on the market.

This 100% greater contact with the wide, flat surface of your IC leads is your guarantee of unmatched reliability. This RN "side-wipe" contact provides constant low contact resistance. No edge-bearing contact can possibly deliver this long term dependability. This designed-in reliability of RN DIP sockets is your assurance of trouble-free IC interconnects—yet they cost no more than ordinary sockets.

Put an end to troublesome junk sockets! Write today for catalog and informative book "What to Look for in IC Interconnects." It's free from RN—the people who make more kinds of high reliability IC sockets than anyone.

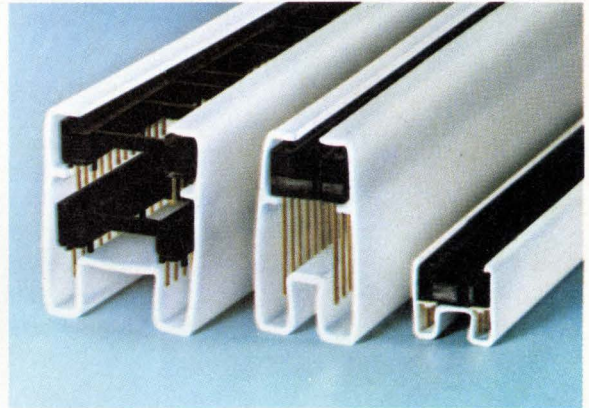

They're even packaged for high reliability.

"Protecto-pak"[®] packaging delivers consistently perfect RN sockets to your production line—for automated or manual assembly.

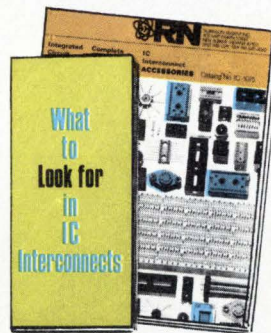

RN ROBINSON NUGENT, INC.

800 East Eighth Street • New Albany, Indiana 47150 • Phone: (812) 945-0211

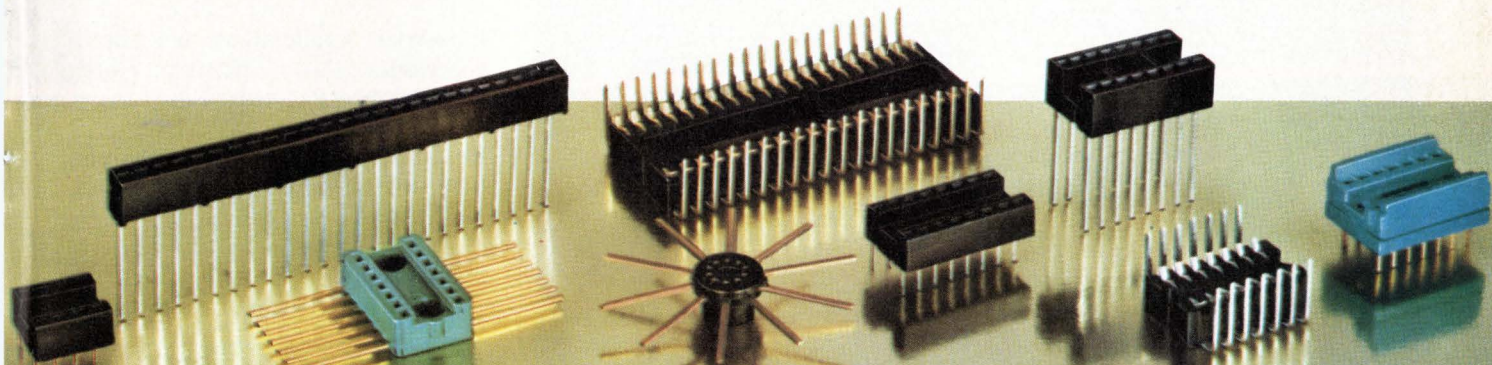

High reliability IC sockets . . . we've got 'em all!

Circle 23 on reader service card

CABLE-BILITY WOVEN'S FLAT GOT IT!



Ribbon Cable IC Interconnects Custom Harnesses

A total source for flat interconnect systems, Woven Electronics offers unlimited design capabilities combining signal/power transmission with specialized functions. Independently insulated conductors give tighter transmission control, more protection, allow easy lead exposure.

Specify sizes, color coding, insulations, custom break-outs without restrictions of other cable forms.

Cable and ability. Get the best of both from one source.

WOVEN ELECTRONICS

P.O. Box 189 Mauldin, South Carolina 29622
803/963-5131

Meetings

Plated Printed Circuits Conference, New York University, Ambassador East, Chicago, Ill., Dec. 16-17.

Optical Fiber Transmission Topical Meeting, IEEE, Williamsburg Lodge, Williamsburg, Va., Jan. 7-9.

Computer Architecture, IEEE, University of Houston, Houston, Texas, Jan. 20-22.

Reliability and Maintainability Symposium, IEEE et al., Sheraton Park Hotel, Washington, D.C., Jan. 28-30.

Physics of Compound Semiconductor Interfaces, University of California, Los Angeles (UCLA), Feb. 4-6.

Wincon—Aerospace & Electronic Systems Winter Convention, IEEE, Aerospace & Electronics Systems Society, Americana Hotel, Los Angeles, Calif., Feb. 5-7.

Nepcon '75 West and International Microelectronics Exhibition, Industrial Scientific Conference Management Inc. (Chicago, Ill.), Anaheim Convention Center, Anaheim, Calif., Feb. 11-13.

CAD/CAM III, Computer Aided Design & Computer Aided Manufacturing, Society of Manufacturing Engineers, Hyatt Regency O'Hare Hotel, Chicago, Ill., Feb. 11-13.

International Solid State Circuits Conference, IEEE, Marriott Hotel, Philadelphia, Pa., Feb. 12-14.

Comcon Spring—Computer Conference, IEEE, Jack Tar Hotel, San Francisco, Calif., Feb. 25-27.

Industrial Applications of Microprocessors, IEEE, Sheraton Hotel, Philadelphia, Pa., March 11-12.

Reliability Physics Symposium, IEEE, MGM Grand Hotel, Las Vegas, Nev., April 1-3.

Southeastcon '75, IEEE, Sheraton Center, Charlotte, N.C., April 6-9.



YOU'RE LOOKING at the PERFECT SOURCE for CRYSTALS, OSCILLATORS and CRYSTAL FILTERS

ERIE is bursting with a full line of QUARTZ CRYSTALS . . . with deliveries to meet your production schedules. 1 kHz to 200 MHz . . . AT, JT, DT, NT, SL, 5°X, GT.

We have exotic crystals and very simple crystals, low frequency and high frequency crystals. And we manufacture and test to meet or exceed Mil-C-3098 standards. ERIE provides a better crystal because we control our total manufacturing process in-house.

Our broad line of CRYSTAL OSCILLATORS range from low cost TTL dip package types to complex high stability, high reliability oscillators . . . both military and industrial types.

When it comes to CRYSTAL FILTERS, ERIE can design and manufacture the filter best suited to your application. There is virtually no limit to the variety we produce . . . including Monolithic Crystal Filters.

So come to ERIE for a fast, accurate and down-to-earth answer to your frequency control problem. One factor remains constant . . . you'll get a fair, cost-conscious answer. We have the technology and the products to implement effective crystal performance.

WRITE FOR OUR CATALOG
OR CALL 717/249-2232
FOR ENGINEERING AND
PRICING HELP.

ERIE FREQUENCY CONTROL
453 LINCOLN ST., CARLISLE, PENNSYLVANIA 17013
DIVISION OF ERIE TECHNOLOGICAL PRODUCTS, INC



Circle 25 on reader service card

The fastest single clock 4K NMOS RAM operates on the least power.

It's the only one with a second source.

There's just no doubt about it. Motorola's new MCM6605L NMOS 4K RAM is the coolest in operation, and the fastest single clock design available.

The tables tell the story. One makes device vs. device comparisons and the other shows what the differences mean in system applications.

It's a good idea to have a questioning attitude in this day and age, so we've provided the system power equations. Apply them to your own system size requirements, to any hypothetical system, or simply check the accuracy of our demonstrated figures. Go ahead, prove to yourself that the MCM6605 has the lowest system power requirements by a wide margin.

Results of these comparisons are significant for several reasons. The most obvious is probably the smaller battery required for battery back-up for non-volatile operation. Reduced cooling requirements and the ability to operate with smaller, less expensive standard power supplies are also important factors.

4K NMOS RAM COMPARISON

Device	MAX I _{DD} (Active) (mA)	MAX I _{DD} (Standby) (mA)	V _{DD} (Volts)	Number of refresh cycles/2 ms	Memory access time (ns)	Memory cycle time Read/Write (ns)
MCM6605	36	0.020	12	32	210	370/490
MK4096P	30	1.0	12	64	350	500/500
TMS4030	41	0.5	12	64	300	470/470
2107A	34	0.1	12	64	300	500/700

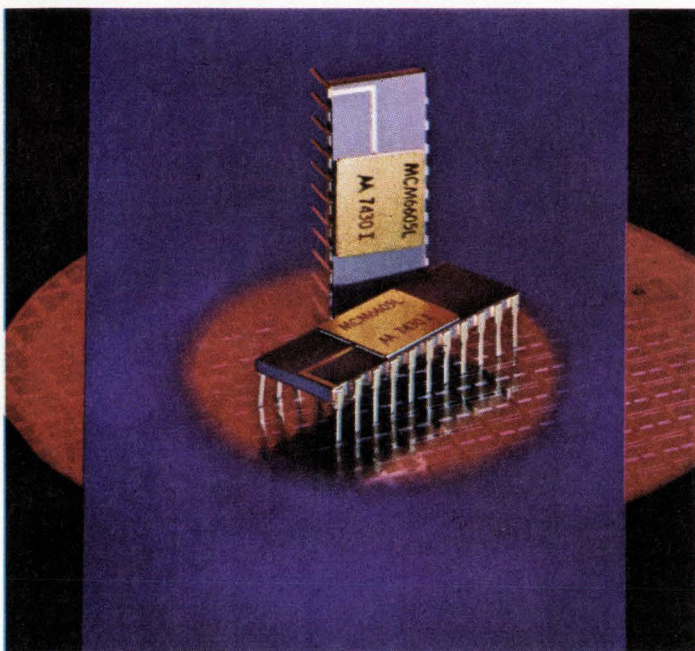

THE EQUATIONS FOR POWER

1. Active memory system power:

$$P_o = M \left(\frac{MCT}{SCT} \right) (I_{DDA}) (V_{DD}) + (N-1) (M) \left[\left(\frac{MTC}{T} \right) (I_{DDA}) (V_{DD}) + \left(\frac{T-MCT}{T} \right) (I_{DDs}) (V_{DD}) \right]$$

2. Standby memory system power with refresh:

$$P_o = (N) (M) \left[\left(\frac{MCT}{T} \right) (I_{DDA}) (V_{DD}) + \left(\frac{T-MCT}{T} \right) (I_{DDs}) (V_{DD}) \right]$$

Where: $N = \frac{\text{System word size}}{4096}$ $T = \text{Period between refresh cycles} = \frac{2\text{msec}}{\# \text{ of ref cycles}}$
 $M = \text{Number of bits}$ $I_{DDA} = \text{Active } I_{DD}$
 $MCT = \text{Memory cycle time}$ $I_{DDs} = \text{Standby } I_{DD}$
 $SCT = \text{System cycle time}$

There are subtleties involved, too, such as the number of refresh cycles required, which can significantly increase standby power. But the best way to illustrate is with the tables. All pertinent dc parameters are taken directly from the most recently available data sheets of the manufacturers, themselves.

Plenty of MCM6605 Advantages

Speed: The device comparison table tells it all. With an access time of 210 ns and read/write cycle times of 370/490, none of the major competitive devices are as fast.

Optimized Pin-Outs: Voltages are on the corner pins, an advantage for several reasons. It's easier to lay out the PC board, and the larger allowable bus lines make line impedance lower, very important in dynamic memory systems because of the high dynamic surge currents. Bypassing is easier, too, which reduces the capacitance required.

New Interface Parts designed for 4K RAMs: Motorola circuit designers have recognized the unique interface requirements of NMOS memory systems. The first in a new family of interface devices is the MC3459, a Quad NMOS Memory Address Driver. The MC3460 Quad NMOS Memory Clock Driver will follow.

Only the MCM6605 Has a Second Source

Mere pin compatibility isn't interchangeability. As the photograph of an operational 16K by 16 bit add-on PDP-11 memory system demonstrates, the 6605 type RAMs supplied by AMI are direct, electrical, plug-in replacements for Motorola's MCM6605. No other 4K NMOS RAM has that type of second source. No other.

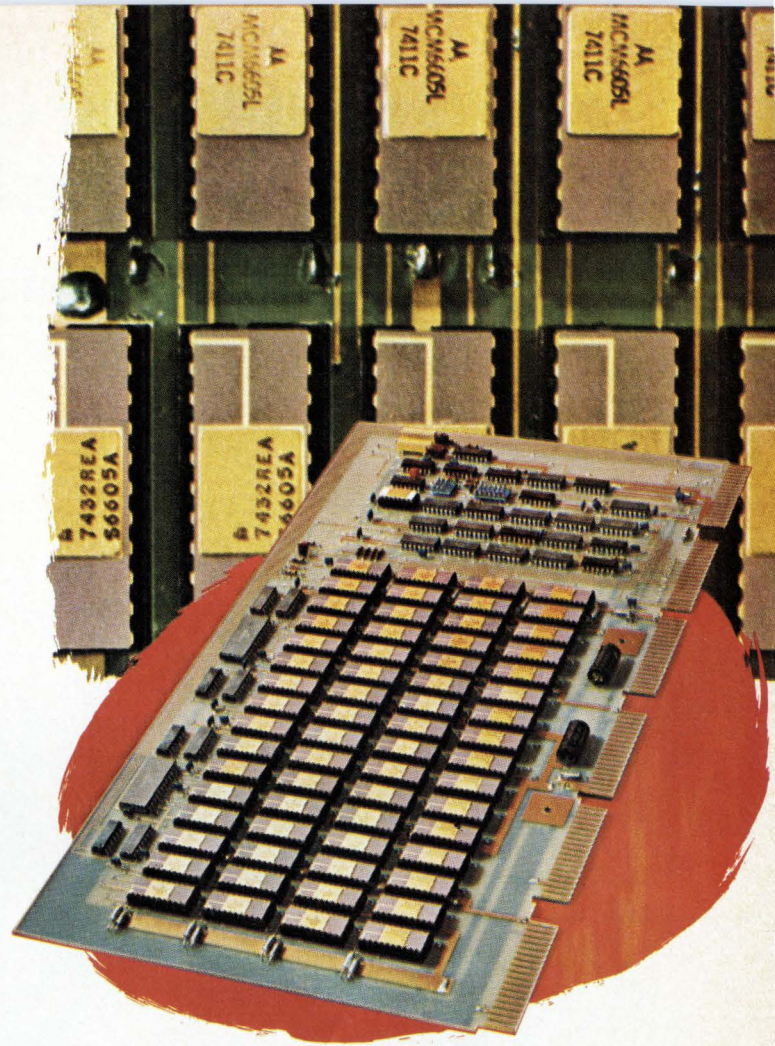

NMOS MEMORY SYSTEM COMPARISON

Memory System Organization	32 K Words X 8 Bits			256 K Words X 32 Bits		
	MCM6605	MK4096	TMS4030	MCM6605	MK4096	TMS4030
Semiconductor* Memory	MCM6605	MK4096	TMS4030	MCM6605	MK4096	TMS4030
Memory cycle time	490 ns	500 ns	470 ns	490 ns	500 ns	470 ns
Memory system cycle time	600 ns	600 ns	600 ns	600 ns	600 ns	600 ns
System power Active	3.0 Watts	3.4 Watts	3.8 Watts	18.6 Watts	45.1 Watts	39.2 Watts
Standby (with refresh)	0.23 Watts	1.13 Watts	0.85 Watts	7.4 Watts	36.0 Watts	27.2 Watts

*2107A comparison is not shown because the write cycle time is not fast enough to meet the chosen system cycle time.

Where to use the MCM6605

The MCM6605 will go just about anywhere there is a memory system. It's ideal for large main memories, for small main RAM memories, for microprocessors used with smart or POS terminals, and as a small buffer memory. We've indicated its application in add-on memories, and the MCM6605 can even be used as erasable ROM for debugging microcomputer system programs. How's that for usefulness.

At this time, the MCM6605 is available only from the

factory on orders placed through a Motorola Sales Office.

Applications and additional technical information is now available on request from Motorola Semiconductor Products Inc., P.O. Box 20912, Phoenix, AZ 85036, or by circling the reader service number. Your reward will be well worth your effort. MCM6605 . . . the fastest single clock 4K NMOS RAM. It has the lowest power requirements and it is the only one with a second source.



MOTOROLA MOS
— for the advantage in memory systems.

There's only one cermet film resistor with enough design improvements to set a new standard of quality.

Ultra thick solder coated wire leads are both weldable and solderable.

Capless design does away with problems associated with end cap construction.

Conformal coating provides outstanding insulation properties.

Alumina core is physically and thermally strong to resist fractures.

Crisp, clear, dual markings for easy identification.

We blended our extensive fixed resistor knowhow with 15 years of cermet experience to produce an outstanding cermet film resistor. And we've developed unique manufacturing techniques that let us provide consistent quality.

Available in preferred resistance values (E96 Series) from 10 ohm to 1 meg; higher values available on special order. 1/4 watt at 70°C; 1/8 watt at 125°C; 1% tolerance; 100 PPM. Size 0.250 L. by 0.090 D.

Available in tape reels if you prefer.

Approved to MIL-R-10509 for Style RN55, Characteristic D. Write Allen-Bradley Electronics Division, 1201 South Second Street, Milwaukee, Wisconsin 53204 for complete technical details on Type CC. International Division, Milwaukee, Wisconsin 53204. Canada: Allen-Bradley Canada Limited, Cambridge, Ontario. United Kingdom: Allen-Bradley Electronics, Limited, Jarrow, County Durham NE32 3EN.

If you're really serious about cost, be serious about quality.

Circle 28 on reader service card



ALLEN-BRADLEY

Milwaukee, Wisconsin 53204

EC69

TI super Schottky, Motorola LSI in the works

Maintaining the breakneck speed at which digital-circuit techniques are improving, two of the big semiconductor manufacturers, Texas Instruments and Motorola, **are well into major programs for new bipolar logic families.**

TI, in an explosive development, has developed a Schottky II family of SSI and MSI standard logic circuits with 1-to-2-nanosecond propagation delays. Although the company has released no details, this super Schottky line, which operates from a single 5-volt power supply, offers better performance than today's ECL 10-k family in standard easy-to-use Schottky pinouts. The product development for the first group of super Schottky has already been completed. **In fact, samples have been available to prime customers since last spring.** But because of market conditions, TI has not decided whether to announce the product.

Moreover, the same super Schottky process is being applied to LSI processor-type circuits for a very-high-performance microprocessor chip set that will be available in late 1975. It would have instruction execution speeds as fast as in mainframe controllers using today's SSI emitter-coupled logic. These new LSI circuits would play with the new MSI processor parts the company has already begun to introduce.

Motorola's new bipolar LSI circuits, which will be compatible with 10-k ECL, also fall in the 1- to 2-ns range. Although the company isn't ready to disclose the technology it used, Motorola has been working with a **triple-diffused emitter-follower technique** acquired from TRW, as well as developing a proprietary **constant-current (C³L) bipolar process** (see p. 36), that with its 1-ns and 1 milliwatt-per-gate specs, could provide the necessary LSI performance. As for the company's MECL 20K—the family of ECL parts twice as fast as 10k—it has been formally dropped in favor of the new LSI program. On the other hand, Motorola's sub nanosecond ECL program (called 100k ECL) is still moving vigorously ahead.

Mostek chip set for calculators has power of micro

Disguised on preliminary data sheets as a "12-digit calculator set," a two-chip circuit now being sampled by Mostek Corp. **could also be paraded as a number-crunching microprocessor.** The arithmetic logic unit chip, designated MK50075, contains four 15-digit (60-bit) registers, 30 status bits, and keyboard input and display format sections. The accompanying 11,264-bit ROM is final-gate-mask-programable and also carries seven 4-by-15-bit registers and two subroutine address registers. The system can be expanded by adding up to 16 additional ROM chips. A 60-instruction set gives two levels of subroutine nesting, and instruction execution time is 250 microseconds. Since **adding two 15-digit numbers takes only 250 microseconds,** possible uses as a microprocessor include in point-of-sale terminals, accounting and banking machines, some automotive applications, and of course, calculators.

In fact, the sets will make their debut in two handheld calculators from Corvus, Mostek's subsidiary, at the January Consumer Electronics Show for delivery in March or April. One, the model 600, is a four-function, 10-digit machine for financial applications. It has full memory, a percent key, and a gross-profit-margin key. The other calculator, model 500, is a scientific machine featuring 10-digit mantissa, two-digit exponent, and reverse Polish notation. The 600 will sell for "more than \$100;" the 500 for "less than \$200," says Corvus.

Carter, Goeken to start firm

Look for Tom Carter, president of TelePhone Communications Inc., Dallas, and the namesake behind the FCC's landmark 1968 Carterfone decision (see related story, p. 14), and John D. Goeken, founder of MCI Communications Inc. and the specialized common carrier industry, **to form their own nationwide telecommunications service organization.** Carter and Goeken, who resigned the presidency of MCI several months ago, plan to announce Carter-Goeken Inc.'s plans within the next few weeks.

National puts Darlington, C-MOS on one chip

In a major effort to crack the telecommunications market, National Semiconductor has developed the **first high-voltage C-MOS dual relay driver for the telephone industry.** To do it, National has made a significant advance: **it has placed bipolar Darlington transistors on the same monolithic chip with C-MOS.** To make the part, National tinkered with its C-MOS process to handle the high (50 to 60 volts) breakdowns needed for telephone applications. At the same time, with the Darlington, the new device provides the high current outputs needed to drive phone lines.

The part, designated 74C908, is now undergoing characterization tests. Its voltage breakdown will range typically from 35 to 50 v, output source currents from 250 to 350 milliamperes, supply voltage 3 to 15 v, and it will feature zero standby power. Prime parts, designated as high-voltage phone relay drivers, **will be specified at about 56 v breakdown.**

18-pin package added to 4-k catalog

Making waves in the 4-k RAM market, Texas Instruments has managed to squeeze its 4,096-bit RAM into an 18-pin package. In addition, the sense amplifier and some internal circuitry have been redesigned to offer a maximum access time of 200 nanoseconds for both the 18-pin version and a new 22-pin TMS4060.

Instead of multiplexing addresses, as Mostek does in its 16-pin 4-k design, TI's 18-pin device has its data input and data output pins tied together internally, eliminating chip select and V_{cc} pins. The common data input/output makes the 18-pin 4-k, designated the TMS 4050, only applicable to bus-oriented systems, and a three-state TTL bus-interface gate is needed to get on and off the bus.

Having dropped the 5-volt V_{cc} pin, TI generates it on the chip from the + 12-v supply, so logic can be shut off without losing the contents of the memory. A 5-v external supply and pull-up resistors are still necessary, however, to drive the bus from the part's open drain output. The chip-select function will be handled by chip-enable and read/write lines. Power dissipation—360 milliwatts active and 6 mW standby with refresh—remains the same.

Addenda

IBM and the Justice Department will finally go to trial Feb. 18, some six years after the U.S. charged IBM with violating the Sherman Antitrust Act. . . . A "highly experimental" approach to magnetic-bubble storage systems in garnet film is being tried by IBM researchers. They're packing bubbles close together in a regular array resembling a crystalline lattice, and instead of detecting bubble absence or presence, the system **depends on magnetization direction in the bubble wall.**

Fused-In-Glass reliability by Unitrode

for zeners and rectifiers

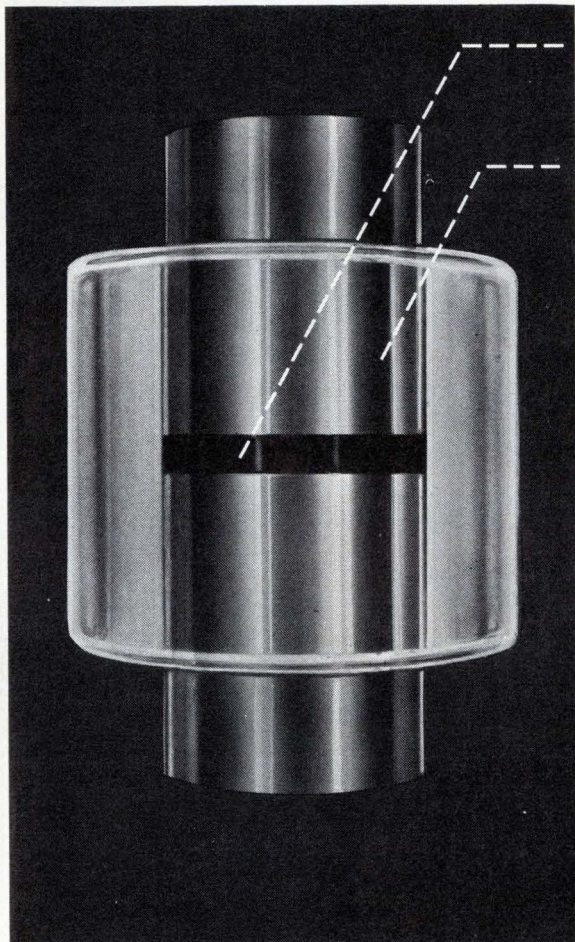

{ Diffused silicon die metallurgically bonded between two pins.

{ Hard glass sleeve fused directly to die and pins provides a voidless monolithic structure...seals out moisture and contaminants...virtually indestructible.

True high reliability is impossible if the design of a zener or rectifier permits anything to destroy the integrity of the chip. Unitrode's exclusive construction has been revolutionizing military reliability specifications since its introduction. Constant process improvements and new products for today's sophisticated electronic equipment maintain Unitrode's leadership.

When you need hi-rel zeners or rectifiers, talk to us. We're today's leader in hi-rel products. Send for our new *Fused-In-Glass Reliability* brochure. Or, for more information, call us at (617) 926-0404.

Unitrode makes over 1000 different hi-rel zeners and rectifiers. Full performance ranges are available in JAN, JANTX, and JANTXV types.

Product	Ratings
Zeners and surge suppressors*	1-10 W; 6.8-400 V
Rectifiers*	1-50 A; 50-1000 V; recovery times to 25 ns

*Available as high-voltage and high-current assemblies, and bridges.



UNITRODE

580 PLEASANT STREET, WATERTOWN, MA 02172

A SPRAGUE FIRST!

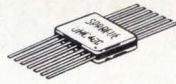

100V BREAKDOWN QUAD POWER DRIVERS with

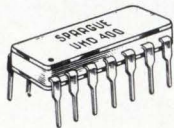
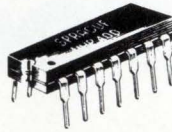

suppression diodes

INCORPORATE
MONOLITHIC
LOGIC GATES
DRIVING
HIGH-CURRENT
SWITCHING
TRANSISTORS

- Inputs compatible with DTL/TTL
- 500mA output current capability/driver
- Pinning compatible with Series 54/74 networks
- Transient-protected outputs on relay drivers
- High-voltage output capability/driver: 100 V, Series 500; 70 V, Series 400-1; 40 V, Series 400
- Available in plastic DIP, hermetic DIP, and flat-packs

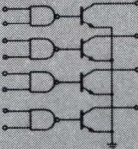
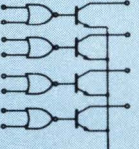
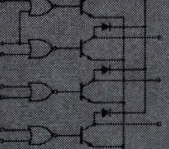
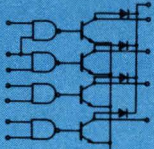
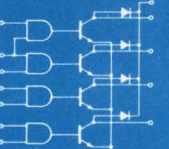
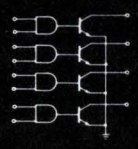
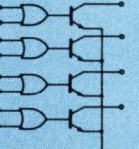
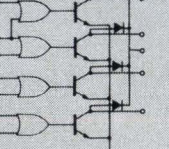
 <p>Type 400/400-1/500 Quad 2-Input AND Power Drivers</p>	 <p>Type 402/402-1/502 Quad 2-Input OR Power Drivers</p>	 <p>Type 403/403-1/503 Quad OR Relay Drivers</p>
 <p>Type 406/406-1/506 Quad AND Relay Drivers</p>	<p>SPRAGUE... the pioneer in power drivers</p>	 <p>Type 407/407-1/507 Quad NAND Relay Drivers</p>
 <p>Type 408/408-1/508 Quad 2-Input NAND Power Drivers</p>	 <p>Type 432/432-1/532 Quad 2-Input NOR Power Drivers</p>	 <p>Type 433/433-1/533 Quad NOR Relay Drivers</p>

For the name of your nearest stocking distributor, call or write to C. F. Scott, Digital Circuit Operations, Semiconductor Division, Sprague Electric Company, 115 Northeast Cutoff, Worcester, Mass. 01606. Telephone 617-853-5000.

For Engineering Bulletin 29300B, write to Technical Literature Service, Sprague Electric Co., 35 Marshall St., North Adams, Mass. 01247.

THE BROAD-LINE PRODUCER OF ELECTRONIC PARTS



Microcomputer on four chips needs no external circuits

First effort by Europeans partitions unit into matched LSI chips for wide range of 8-bit processing functions

Most of today's MOS microcomputers are designed around single central processing chips containing all control and processing functions. The chip is connected via buses to standard general-purpose memory and input/output circuits.

But West Germany's Olympia Werke AG in Wilhelmshaven is developing a concept that could increase flexibility and decrease the number of circuits needed for performing many control and processing applications. Borrowed from calculator design, the new concept treats the microcomputer as a special function and partitions it into four large-scale-integrated circuit chips. Unlike most of today's microcomputers, these LSI chips operate only with each other.

Moreover, the chips are self-contained and do not require additional standard memory and I/O interface circuits for implementing most microcomputer applications. For simple controller functions, for example, as few as two chips would suffice, while for complex 8-bit process-control systems the full set, together with external standard random-access-memory components, would be needed.

Desk top. The first units of what Olympia calls its CP 3-F chip set are slated for a desktop computer with printer—basically a calculator with memory—to be marketed next year.

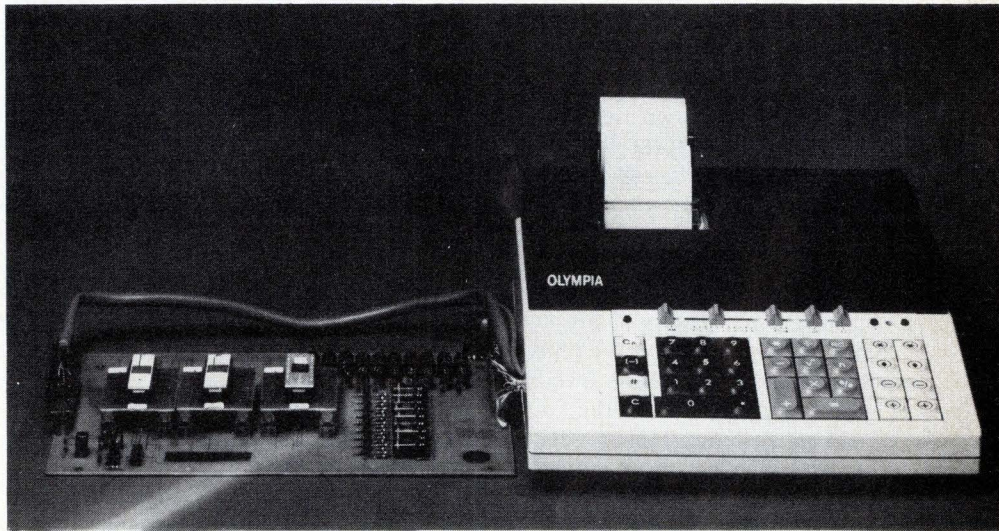

Circuits. Built with new types of LSI microprocessor circuits, desktop computer with printout is first of the products to be introduced by West Germany's Olympia Werke. Chips are being fabricated by three European semiconductor manufacturers.

And Olympia, a \$270 million subsidiary of AEG-Telefunken, the German electronics giant, undoubtedly intends to use the chip set in other products as well. In addition, a Telefunken spokesman asserts that some 25 European equipment makers are interested in the chips for their own products. He declined, however, to identify any of them.

Circuits will be supplied by three European semiconductor manufacturers beginning early next year, with equipment from Olympia coming to market a few months later. The circuit manufacturers are AEG-Telefunken in Heilbronn, West Germany, and General Instrument Europe and SGS-Ates, both based in Italy. Significantly, all circuits are interchangeable even though different MOS technologies are being used by the three to implement the designs. AEG-Telefunken is using a

double ion-implanted metal-gate process, SGS-Ates a silicon-gate process, and General Instrument Europe an aluminum-gate-nitride process.

Setup. The four-chip system consists of an 8-bit parallel CPU containing a 48-byte RAM and 8-bit I/O channel, a microprogrammable read-only memory, a data RAM and a combination microprogrammable ROM and data RAM chip. These chips have been designed so that a functional system can be built without the use of external logic or control registers. The minimum configuration consists of the 8-bit CPU chip with a 48-instruction set having a minimum cycle time of 5 microseconds, plus the microprogrammable ROM chip.

These two chips contain all the logic, binary, and decimal operations, as well as other processing

functions necessary for simple controller systems. The set of 48 instructions is sufficient to handle instructions for most controllers and many processors—for example, logic, binary and decimal operations, shifting, constant multiplications, and subprograms. The micro-programable ROM is organized in a convenient 1,024-by-8-bit format. Four registers serve as address counters and recirculating memories, and two I/O channels handle the bus requirements for all the 8-bit-instructions.

If more computing power is required, a user can select the data RAM and ROM/RAM chip. The data unit consists of a 128-by-8-bit RAM, address register, and an 8-bit I/O channel that is designed to interface directly with the CPU chip. The program and data memory are contained on a 768-by-8-bit ROM and an 18-by-8-bit RAM that have been designed to interface directly with the other members of the family.

The microprocessor set can be used for even more complex systems, since it is possible to expand the memory capacity to 16,000 8-bit words without additional I/O circuits. Along with the system, Olympia will supply a Fortran cross-assembler, a simulation program, and necessary test equipment. All circuits are supplied in a 40-pin dual in-line packages that operate from -5-volt and -17-v power supplies. □

Consumer electronics

Calculator approach applied to watches

Harnessing years of know-how in calculator circuits, Mostek Corp. has developed a watch circuit to drive light-emitting diode displays that eschews the traditional binary counter architecture for one that recalls circuit techniques used for calculators.

And in a version for liquid crystal watches, the Carrollton, Texas, firm has stuck to the conventional approach, but has managed to build

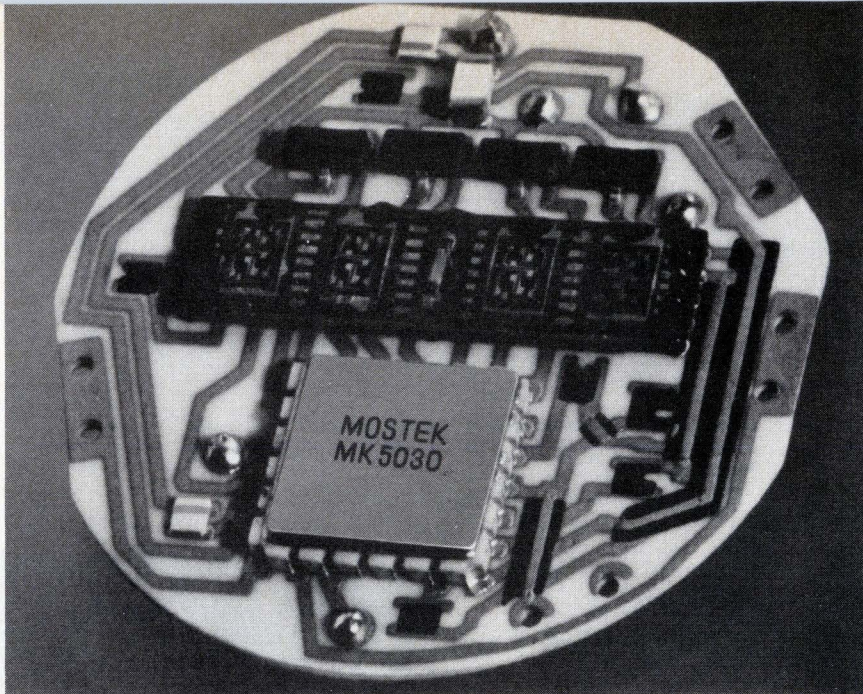

Demo. To show how few components are needed with its single-chip watch circuit, Mostek built a watch module with light-emitting diode display.

both the low-voltage divider chain and the high-voltage output driver sections on the same chip. Both single-chip watch circuits are built with complementary metal oxide semiconductors.

"The calculator-type architecture and circuit implementation may be of little importance to the end user," says David Leonard, manager of C-MOS design, "but it portends interesting things for the future."

Wrist watches could be built with more functions—they could easily include calculators, for example. And an alarm clock wrist-watch chip could be implemented by adding another small register loop and serial comparator to the present chip.

Change. A departure from traditional clock architecture, the Mostek LED watch circuit uses a recirculating dynamic shift register to hold time information, and the chip's control logic is implemented with two-phase clocked logic. The immediate advantage, says Leonard, is a reduction in chip size—an advantage that Mostek has capitalized on by designing low-resistance LED segment drivers directly on the chip. These drivers, which replace seven external bipolar transistors, require one quarter of the 136 x 159 mil chip.

The chip also allows a high-speed testing capability via a test pin that

can be used to write serial data into the dynamic registers. And the design provides an output at half the external crystal frequency, shortening the time needed to tune the quartz crystal, and therefore to tune the watch. Most competing watch circuits that use a similar 32,768-hertz crystal, Leonard says, provide an output of only 1,024 Hz or less.

A blanking signal, to allow time between digit strobes, prevents ghosting of the display, while on-chip pull-up transistors and debounce circuitry allow the use of normally-open, close-to-case input switches for activating the display and setting time. Leonard expects two versions of the circuit—for 12- and 24-hour watches with hours, minutes, seconds, and date—to be in volume production in the first quarter.

Also due early next year, and being sampled now, is perhaps the only available single-chip circuit for liquid crystal watches with hours, minutes, seconds and date. Unlike early LCD watch circuits, which have their divider-chains implemented in 1.5-volt silicon gate C-MOS and decoder/drivers in metal-gate MOS on a second chip to handle the higher voltage display, the Mostek chip takes advantage of ion-implantation to adjust threshold voltages of n- and p-channel transistors on the single metal-gate chip. The resulting

circuit operates at 1.5 v, with the exception of an 8-v output driver section.

The higher voltage needed to drive the LCD is generated by an off-chip multiplier that can be built in several ways, such as with an inductive pulse transformer, or an inductive ringing-type dc-to-dc converter, Leonard says. This circuit also requires a 32,768 Hz quartz oscillator time base. □

Medical electronics

Emergency medical teams get FCC aid

Optimism for increased sales in the next 12 months is rare right now in the electronics industries. But a new

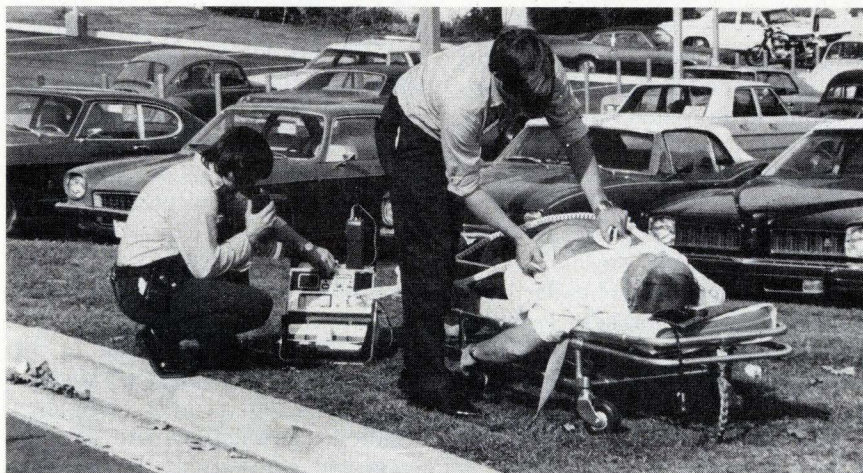

On the spot. Coronary Observation Radio System from Motorola Inc. is used by Arlington, Va., fire department to radio electrocardiographs to hospital emergency room.

market for emergency medical communications and diagnostic equipment may develop with the issuance last month by the Federal Communications Commission of long-awaited frequency allocations.

Estimates are that some 3,500 emergency medical squads across the country may each equip themselves with up to \$10,000 worth of diagnostic gear that could communicate back to hospital emergency rooms. About 500 others already have such gear, industry sources estimate, and about 1,000 teams have

a simple two-way radio-frequency link.

"In the past, it has been an unregulated, unorganized situation," says industry consultant John J. Renner, president of Advanced Technology Systems Inc., Arlington, Va. Now, eight frequency-pairs in the 450-to-470-megahertz portion of the spectrum are allocated for communication between hospital and ambulance. The pairs are:

- Telemetry (of such things as electrocardiographs) to be transmitted from mobile units on 468.0, 468.025 and 468.050 MHz. Paired with these are frequencies for stationary units—463.0, 463.025, 463.050 MHz.

- Five frequency pairs for doctor-attendant voice communication for en-route treatment—463.075/468.075, 463.100/468.100, 463.125/468.125, 463.150/468.150

and 463.175/468.175 MHz.

- Two frequency pairs to be used by dispatchers of emergency medical teams—460.525/465.525 and 460.550/465.550 MHz.

- Dual data/voice frequencies for portable-unit signals to be relayed by short-range radio-frequency repeaters in the ambulance—458.025, 458.075 and 458.175 MHz. These frequencies are to be shared with existing highway call boxes, but output limits of the portable units are low to prevent interference—1 watt for paging units, 2.5 w for ECG units.

Previously the FCC had allocated frequencies, but none was for coordinated data/voice signals. The FCC has named the mobile/stationary pairs Med One, Med Two, Med Three, etc. "Med Eight," 463.175 MHz for base and mobile units, 468.175 MHz for mobile units alone, will be promoted as the standard nationwide frequency for communication from one regional medical service system to another, according to industry officials. "But a lot of planning and coordination has yet to be done," one adds.

Standards. Once the FCC allocated frequencies, equipment manufacturers had to set up standards. This happened last month, but it took some heavyhanded action by the American Hospital Association and the U.S. Department of Health, Education and Welfare. After "chaotic and irrational" purchases of equipment without coordinated frequency planning, the AHA and HEW halted all emergency medical service planning and funding last summer until makers established standards.

Two sticky issues had to be negotiated: which subcarrier frequency to use for the telemetry signal, and the subtone for activating receivers. On Nov. 15, a committee of industry and Government leaders decided that 1,400 hertz should be the subcarrier frequency for telemetering the ECG signal. □

Avionics

RFPs are out for digital air control

More than 150 companies have asked for the request for proposals on the Federal Aviation Administration's Discrete Address Beacon System. The request, six months late [*Electronics*, April 4, p. 88], was made available Dec. 3. At stake is an estimated \$6 to \$10 million contract for a DABS prototype that will enable aircraft pilots and ground controllers to communicate more re-

liably by resorting to digital signals in place of voice. In addition, the system will improve radar surveillance of the airways from the ground by allowing controllers to selectively address the aircraft they wish to see on their cathode-ray-tube displays.

But far more important than the prototype award, to come next September, is the eventual production run. This could be worth upwards of \$300 million for ground equipment and hundreds of thousands of airborne electronics for domestic use alone, say FAA officials. Installation is to begin about 1980, and DABS will be compatible with the existing radar and voice communication systems during the 10- to 15-year changeover period.

In the system, ground-based interrogation signals will be at 1,030 megahertz at a 4-megabits-per-second data rate with differential phase-shift keyed modulation. Reply signals from aircraft at 1,090 MHz will be at a 1-Mb/s rate. Aircraft location messages will be in 52-bit segments, while ground-generated information such as weather and landing-field conditions will be 112 bits long.

A 24-bit code for aircraft identification also is in the reply message. DABS ground equipment would interrogate aircraft individually for identification, then display flight plan and aircraft characteristics such as speed and range for the flight controller from data stored in computer memory on the ground.

Industry teams combining expertise in ground and airborne systems design will bid. They are:

- Texas Instruments, Dallas, which will get avionics assistance from Collins Radio division, of Rockwell International Corp., Newport Beach, Calif.

- Bendix Communications division, Bendix Corp., Baltimore, which will look for ground-equipment help from Univac Inc., successful designer of the FAA's ARTS III air-traffic-control display.

- Burroughs Corp.'s Special Systems division, Paoli, Pa., is talking avionics with Cardion Electronics

division, General Signal Corp., Woodbury, N.Y.

- Hazeltine Corp., Greenlawn, N.Y., whose avionics support will come from Narco Avionics division of Narco Scientific Industries Inc., Fort Washington, Pa.

Bids are due Feb. 11, 1975. The FAA says it also plans to request that the International Civil Aviation Organization adopt a DABS-type system for worldwide use. Laying the groundwork for an international DABS agreement, the FAA has signed a memorandum of understanding with the British on a common digital-signal format. □

Solid state

New Motorola logic for military, space

Military users of integrated circuits are interested in fast logic that's resistant to radiation, but they usually have to sacrifice one for the other. A new family of bipolar logic—complementary constant-current logic—appears to offer the military the best of both worlds.

To the high speed of bipolar logic, designers at Motorola's Semiconductor Products division have added MOS-like high density and low power consumption.

The result is a logic which, al-

though it doesn't quite match the packing density or minuscule power consumption of newer bipolar logic such as Texas Instruments' integrated injection logic (I²L), easily surpasses I²L's speed. Moreover, the new logic has a much simpler structure and can be fabricated to be much more resistant to radiation. With its speed and radiation resistance, C³L should be attractive for military and space uses, points out Motorola's Arthur W. Peltier, product development manager for special digital circuits. However, it is not scheduled for any specific program now.

Packed. C³L's packing density of 60 to 120 gates per square millimeter lies between conventional transistor-transistor logic's 20 gates/mm² and I²L's 120 to 200 gates/mm². And C³L can be fabricated so its speed-power product will be less than 2 picojoules per gate, not as low as the 0.1-to-0.7-pJ level of I²L devices but far superior to TTL's 100-pJ figure.

It is in speed, however, where C³L truly excels. Its gate propagation time of under 2 nanoseconds rivals that of emitter-coupled logic, a bipolar logic noted for its high-speed performance. Comparable figures for I²L and TTL are 30 ns and typically 10 ns, respectively.

In addition, the processing of C³L can be tailored to meet a range of operational requirements. Diffusion isolation between circuit components and gates results in the least costly, though relatively slow, units. Higher speed can be achieved with passive oxide isolation, as incorporated in Fairchild Semiconductor Products' Isoplanar process or in Raytheon Semiconductor's V-ATE, and for highest speed coupled with radiation hardness, dielectric isolation can be used.

The high packing density of C³L is due to its simple transistor-gate structure, shown in the schematic. The gate consists of only a pnp current-source transistor, an npn switching transistor (usually Schottky-clamped), and a few Schottky barrier diodes, some of which are fabricated in the same

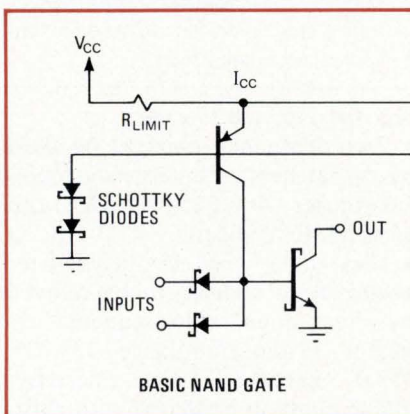

Simpler. Gate structure of Motorola's C³L logic combines pnp and Schottky transistors and Schottky diodes for high packing density and radiation resistance.

Time Interval Readout, a Digital Multimeter, and Your Choice of Oscilloscopes--- All in One Portable Instrument

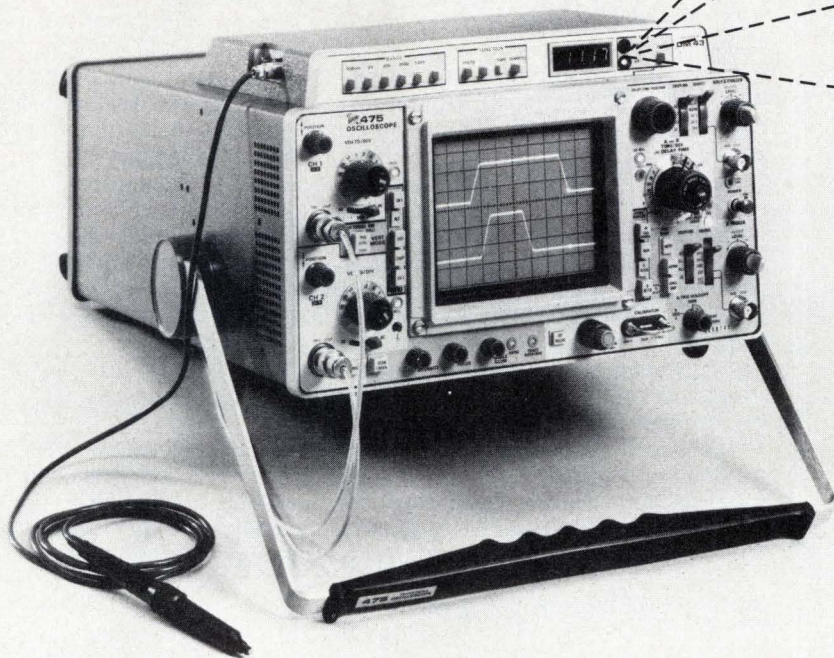

Complete Measurements

Direct digital readout of time intervals with improved resolution, 1% accuracy, increased freedom from error, and greater operator convenience. Dc voltage measurements with an accuracy of 0.1%. Resistance measurement with 0.75% accuracy. Temperature measurement from -55°C to $+150^{\circ}\text{C}$. A built-in DMM adds all of these capabilities to the Tektronix laboratory quality, dual channel, delayed sweep Portable Oscilloscopes.

Since the DMM operates independently of the oscilloscope, you can monitor temperatures or dc voltages while simultaneously displaying waveforms.

Price/Performance and Choice

You can select the optimum Portable Oscilloscope/DMM for your application from four high performance models. They all provide outstandingly cost-effective measurements in the laboratory, in production, and in the field.

100 MHz bandwidth, 5 mV/div vertical sensitivity, and a built-in DMM make the 465 DM43 a price/

performance leader at \$2470. The 475 DM43 extends these capabilities to 200 MHz at 2 mV/div for only \$3225. The unique 466 DM43 combines fast transfer storage to 100 MHz (1350 cm/ μs stored writing rate) and variable persistence storage with a built-in DMM in one rugged portable instrument for \$4555. If your application doesn't require the full 1350 cm/ μs stored writing rate, the 464 DM43 offers all other features of the 466 DM43 for only \$3925.

More For Your Money

Prices for all of these instruments are for complete functioning units including probes. And Tektronix extras such as precision dc voltage measurement, temperature measurement, resistance measurement, trigger view, and scale factor readout add still more value for your instrumentation dollar.

To find out more about these innovations in portable instrumentation, contact your local Tektronix Field Engineer or write: P.O. Box 500, Beaverton, Oregon 97077. In Europe write: Tektronix, Ltd., P.O. Box 36, St. Peter Port, Guernsey, C.I., U.K.

For demonstration circle 36 on reader service card
Circle 37 on reader service card



TEKTRONIX®
committed to
technical excellence

small isolation tube forming the collector of the npn transistor. In contrast, the Schottky TTL gate uses four transistors, plus diodes.

Two types of Schottky diodes are used, and in fact, operation depends on the differing characteristics of the diodes. The voltage reference diodes and the Schottky transistor clamps have platinum silicide contacts, which yield a high contact potential of 525 millivolts. But the input blocking diodes (which can be fabricated in the collector tube of the preceding stage for space saving) must have low contact potential for the logic to operate.

Normally, the npn transistor would be a Schottky-clamped device with a collector-emitter saturation voltage (V_{ce}) of 250 mV, but, to counter neutron degradation, a gold-doped transistor with 150 mV V_{ce} could be used with dielectric isolation for radiation environments.

The gate, which implements the NAND function, operates as input signals switch the constant current of the pnp transistor. When all inputs are high, current into the npn transistor turns it on. Conversely, when one input is low, the current flows through its input diode, turning the output transistor off.

The simple structure results in a five-output gate that requires only 12 square mils, says Peltier. A low-power C-MOS circuit of similar complexity would have an area of 65 mils², and an n-MOS gate, 25 mils². Peltier says a 1,000-gate array is within the reach of present technology and could be built on a 150-by-150-mil chip. □

Solid state

Millions predicted for microprocessors

Despite great interest shown this year in microcomputer chip sets, only about 100,000 will have been shipped by the year's end, according to Norman F. Zimbel, a member of the consulting firm of Arthur D.

News briefs

Connector manufacturers feeling business effects

Slumps in auto, appliance and home electronics markets have begun to take their toll among the industry's connector makers. Citing declining orders, TRW/Cinch Connectors, a TRW Inc. division, in Elk Grove, Ill., has laid off about 15% of its personnel over the past 3 months.

Employment at Amphenol Industrial division, Chicago, and Amphenol Connector division in Broadview, Ill., has been reduced 20% to 25% over the past year. At Burndy Corp., Norwalk, Conn. about 10% of the company's domestic workforce was released in the past few weeks. Business was excellent during the first 9 months of the year, a spokesman said, but lately Burndy began noticing a "declining rate in incoming orders."

AMP Inc. in Harrisburg, Pa. has been laying off production personnel at several of its facilities, which supply parts to the automotive and major appliance industries, since about June. The layoffs picked up in the past few weeks and now are affecting non-production people. AMP officials won't give any number but indicate that about 10% of its U.S. workforce has been laid off. A year ago, AMP employed approximately 14,800 people worldwide.

ITT Cannon Electric division, Santa Ana, Calif. laid off 101 "indirect" people out of 2,450 four weeks ago in what it describes as an anticipation of a downturn in business.

And Elco Corp. has cut its entire production staff at its Willow Grove, Pa. headquarters—close to 200 people—and moved production of its connector products from there to its El Segundo, Calif. and Huntington, Pa. operations. All that remains at Willow Grove is the company's corporate offices. Total employment at Elco was about 900 at the beginning of the year.

X-rays a problem again in color TV

Matsushita Electric Corp. of America has stopped shipping its Panasonic color TV model CT-994 following notice by the Department of Health, Education and Welfare that "under special operating conditions created in the laboratory to cause set failure, this model did not comply with radiation standards." The set is a 9-inch model, approximately 14,000 of which have been sold nationwide. Panasonic is now cooperating with HEW on a modification program of the CT-994 and will inform distributors, dealers, and consumers of its details.

DEC readies new minicomputer

Digital Equipment Corp. has introduced the first member of a new family of 16-bit minicomputers. Called the PDP-11/04, and developed expressly for original-equipment manufacturers, the new model features a single-board central processor that utilizes transistor-transistor logic. It has a 4,096-bit MOS memory and a read-only memory hardware "bootstrap" loader. Read-only memory diagnostics, direct memory access, and four-level interrupt structure are standard, and the full PDP-11/05 instruction set is employed. The new model is priced at \$2,495 in single units, \$1,647 in quantities of 50. Deliveries are scheduled for July 1975.

Bowmar hits TI with antitrust suit

Bowmar Instrument Corp. has filed suit against Texas Instruments in Federal court in Fort Wayne, Indiana charging violations of the Sherman and Clayton antitrust acts in the hand-held calculator industry. In general, Bowmar charges TI with deceitful misrepresentation, antitrust violations, conversion of trade secrets, violations of the Robinson-Patman Act and fraudulent patent practices. Specifically, the allegations include that TI purposely cut back supplies of essential components promised to Bowmar and others, and sold calculators "below their cost" and "at predatory prices". Bowmar is seeking injunctive relief and treble damages totaling \$240 million. TI says the Bowmar charges are totally without merit.

The spec sheets tell you what should happen.

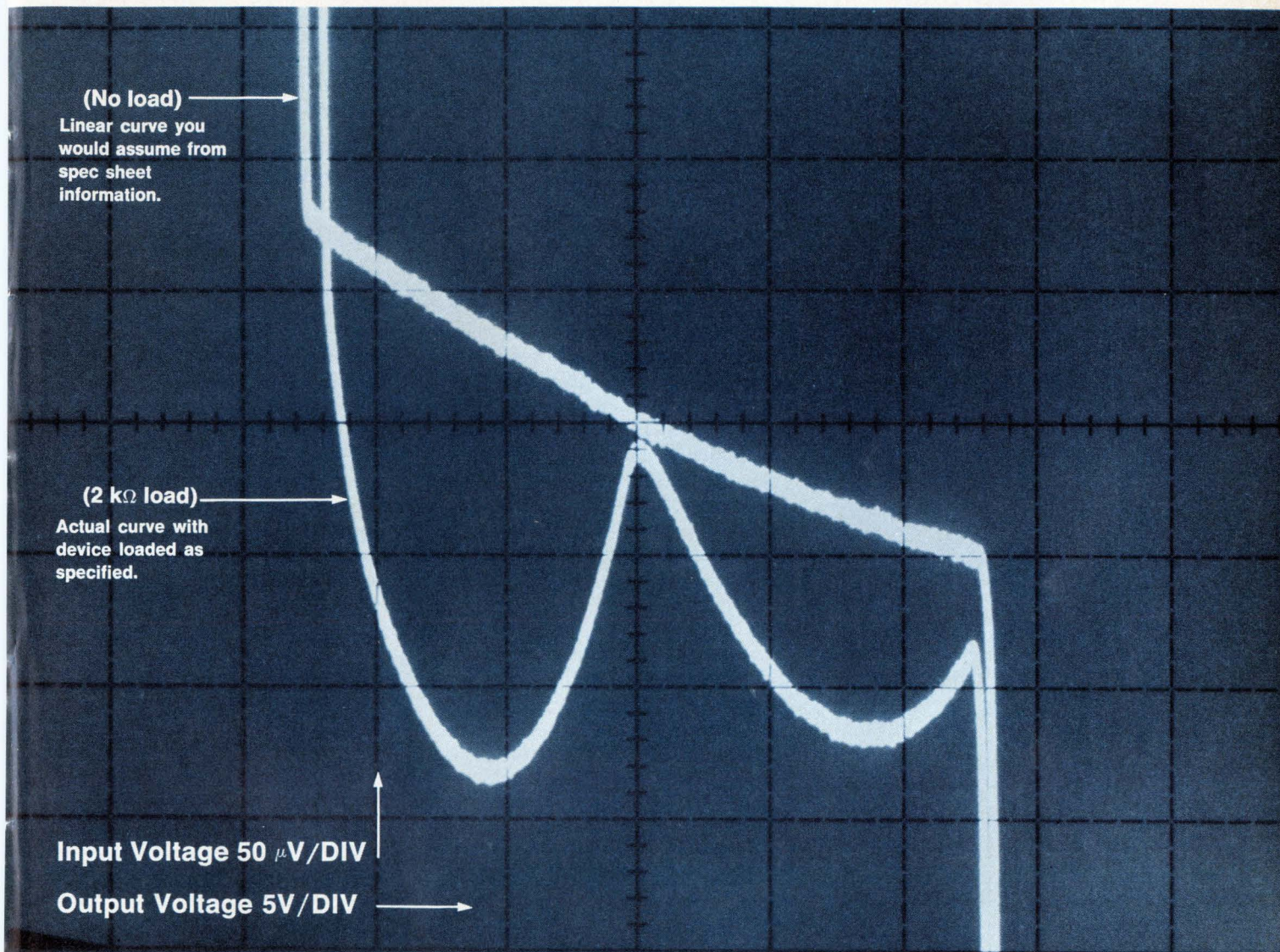

The 577 shows you what did.

When you're designing circuits using linear IC's, you count on spec sheets for the information you need. Generally, gain, CMRR and power supply rejection ratio are given as the ratios of voltage changes measured between discrete points. You assume a "linear" integrated circuit has a linear gain curve (a straight line) with no spurious excursions. But an actual device operating in real-life conditions isn't always linear. Often it produces very irregular curves that may make a big difference in your finished circuit.

These irregular curves are hidden from meters, digital read-outs and go no-go indicators. In fact, a Curve Tracer with its CRT display is the only way to see what is actually happening across the entire operating range of the device you're testing.

The Tektronix 577/178 Curve Tracer will measure and display gain. Offset voltage. Input bias current. Common-mode rejection ratio. And power supply rejection ratio. In addition, the 577/178 displays thermal effects. Popcorn (or flicker) noise. And parameter nonlinearities. And the 577/178 has a storage display to retain curves for comparison or detailed evaluation. Yet it costs only \$3100.

For demonstration circle 38 on reader service card
Circle 39 on reader service card

To learn about the pitfalls of linear IC performance and measurements write to Tektronix for pamphlets No. A3040, and A3061. For more information contact your local Tektronix Field Engineer, or write Tektronix, Inc., P.O. Box 500, Beaverton, Oregon 97077. In Europe write Tektronix Ltd., P.O. Box 36, St. Peter Port, Guernsey, Channel Islands.



AMERICAN

MADE

Tolerance SCHAUER 1-Watt ZENERS

Immediate Shipment Low Prices

ANY voltage from 2.0 to 16.0

Quantity	Price each
1-99	\$1.07
100-499	.97
500-999	.91
1000-4999	.86
5000 up	.82



Write for complete
rating data and other
tolerance prices.

Buy the kit- Save a lot



Kit contains a 51-piece assortment of SCHAUER 1% tolerance 1-watt zeners covering the voltage range of 2.7 to 16.0. Three diodes of each voltage packaged in reusable poly bags. Stored in a handy file box. Contact your distributor or order direct.

A \$54.57 value for

ONLY **\$24⁵⁰**

Semiconductor Division

SCHAUER

Manufacturing Corp.

4514 Alpine Ave. Cincinnati, Ohio 45242

Telephone: 513/791-3030

Electronics review

Little Inc., Cambridge, Mass.

But Zimbel, speaking last week at the Arthur D. Little-sponsored First National Microprocessor Conference in Boston, estimated this number will grow to anywhere between 2 million and 3.5 million units per year in about five years, with a total market value of between \$280 million and \$475 million.

Lincoln Young, marketing manager for microcomputers at Motorola Semiconductor Products division, Phoenix, Ariz., is even more optimistic. In five years he estimates there will be more than 16-million microcomputers in use, breaking down to 4.8 million in computers, 8.4 million in industry, 2 million in consumer products, and 1 million in Federal systems.

Young says that in 1974 the market price of an OEM product using a microprocessor now averages \$1,000, and this will drop to \$500 in 1976.

About 80% to 90% of microprocessors will be sold as chip sets rather than individual devices, he believes, and in the future he looks for larger, more cost effective packages of standard building blocks.

Coming. About 80% of the cost of a microprocessor is for memory and input/output circuitry, and David F. Millet, also of ADL, looks for some changes. In the near future he sees non-volatile semiconductor memory eliminating the need for backup power supplies. And he also anticipates that there will be larger, easier to use memories matched to their central processing units. But he notes, "It is in I/O devices that the microprocessor industry is truly in its infancy." The additional transistor-transistor logic needed to interface to the microprocessor chips eliminates many of the benefits of large scale integration (see page 33). The external circuitry adds considerably to the cost of the system.

He sees the development of more "idealized" I/O devices—ones that will accept and enter data with timing and levels matched to the requirements of the CPU. An extra but important advantage of this is that it could relieve the CPU for more im-

portant functions and increase throughput. This could allow designs which might have used two or three microprocessor chips to get by with only one. □

Packaging & production

Beam-lead parts get own carriers

Beam-lead integrated circuits appear ideal for many high-reliability military applications, but not by virtue of their small size alone. They also reduce the number of "wire" bonds compared to the number of flying bonds in an ordinary IC—an important reliability factor.

But the use of beam leads has been held back, partly by the difficulty of handling and making contact to the tiny chips during the

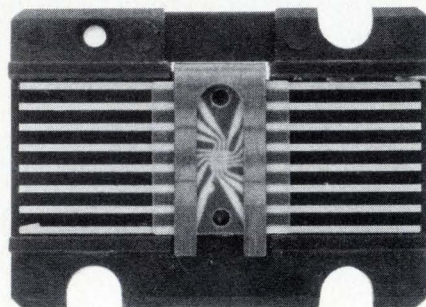

Holder. Clip on Autonetics carrier holds beam-lead device for handling and test.

burn-in and testing required for military programs. Test fixtures can be used for small-scale work, but are impractical for handling production quantities of the chips, which are as small as 14 mils square and 2 mils thick.

An apparent solution is at hand in a special beam-lead carrier developed by Charles L. Stoner of the Mechanical Design division of Sandia Laboratories, Albuquerque, N.M. The design has since been modified by a number of semiconductor manufacturers and users.

The carrier is similar in appearance to the "Barnes" IC carrier developed by Barnes Engineering Corp., Stamford, Conn., and widely

the 30Hz Resolution Revolution

30 Hertz Resolution Useful All the Way to 1800 MHz

There is no smearing from drift or FM in this 200 Hz/div display, even though the total sweep time is 20 seconds. Signals are resolved to 70 dB down even though they are only 500 Hz apart. Center frequency is 1555MHz.

It is generally understood that High resolution means the ability to distinguish between signals differing little in frequency. Actually, the design that makes 30 Hz resolution possible results in more than just the ability to distinguish between close together signals. The design of the 7L13 means better sensitivity, -128 dBm; less drift, under 2kHz per hour; less FM, under 10 Hz phase locked; it means less noise . . . it means the revolutionary analyzer performance that is available from Tektronix, Inc. in the 7L13.

Because of the resolution revolution, the performance of your edge-of-the-art circuitry and devices can now be quantified, not guessed at. A discussion or demonstration of TEKTRONIX Spectrum Analyzer performance can be arranged by any Tektronix Field Engineer. Call him or use one of the two reader service numbers below.

7L13 Spectrum Analyzer \$7300

7613 Option 6 Variable Persistence Mainframe w/Spectrum Analyzer Graticule \$2800

TEKTRONIX, INC., P. O. Box 500
Beaverton, Oregon 97077

For demonstration circle 183 on reader service card

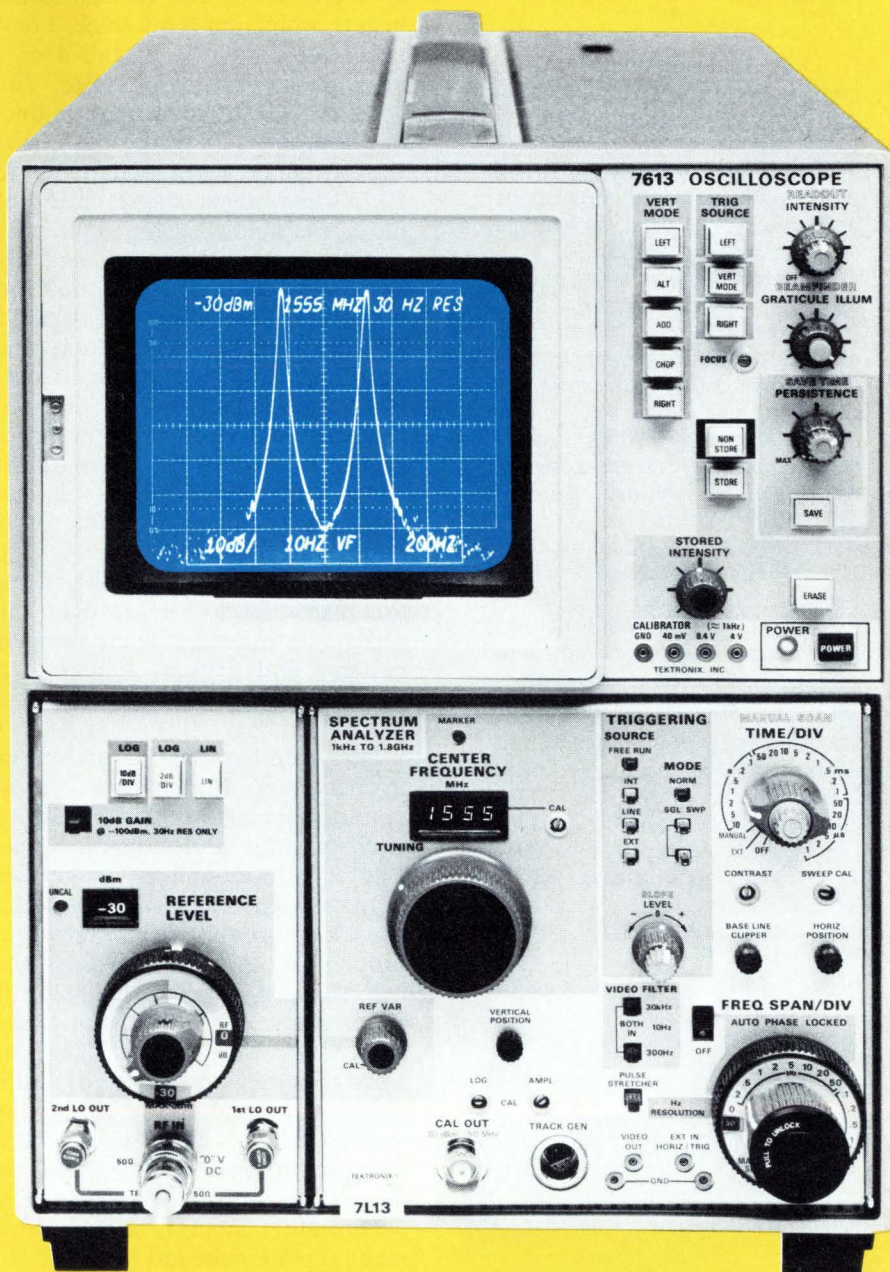

Circle 41 on reader service card

How to ship small packages in a big hurry.

DELTA'S DASH

DELTA AIRLINES SPECIAL HANDLING

On DASH shipments Delta guarantees delivery on the flight or routing you specify between most Delta cities.

Packages accepted up to 50 lbs. with length plus width plus height not to exceed 90" total, with only one dimension exceeding 30".

Deliver to Delta's ticket counter or airport air freight terminal at least 30 minutes prior to scheduled departure time. Shipments may be picked up at either location 30 minutes after flight arrival.

Delta's exclusive "Dashboard" control procedure insures constant tracking of your shipment from delivery to pick-up.

DASH charges are nominal. Check Delta reservations for charges between specific points. Pay in cash, by company check, most general-purpose credit cards, special credit arrangements or on government shipments by GBL.

DELTA
The airline run by professionals

Rate examples (Tax included)

Atlanta-Washington	\$21.00
Boston-Miami	\$26.25
Cincinnati-Louisville	\$21.00
Cleveland-Phoenix	\$26.25
Los Angeles-New Orleans	\$31.50
Dallas-Los Angeles	\$26.25
San Francisco-Atlanta	\$31.50
Philadelphia-Houston	\$26.25
New York-Tampa	\$26.25

For details, call Delta reservations.



Delta is ready when you are.

Electronics review

used for automatic processing and testing of semiconductor devices. It provides a standard lead and handling configuration for automated test equipment, permitting easy testing of ICs that have different physical packages, such as flat packs, dual in-line packages and TO-5 cans. The carriers also protect the devices during shipment and handling.

Transparent. Stoner's version uses a transparent plastic carrier with gold conductors that connect to the beams, which are 1/2 mil thick, 3 or 4 mils wide, and may extend 4 or 5 mils beyond the chip's edge. The standard unit accepts semiconductors with up to 14 leads, but special versions may accommodate up to 50. A clear plastic clamp on top of the carrier holds the chip in place.

At least two military systems designers are planning to use modified versions of the carriers. Lockheed Missiles and Space Co., Sunnyvale, Calif., plans to use them in electronic systems for the Trident submarine missile. The Autonetics group of Rockwell International Corp., Anaheim, Calif., will use them for its Micron navigation system [*Electronics*, Oct. 3, p. 43]. These companies use flexible Kapton plastic preforms to adapt the carrier to different semiconductor patterns and devices. A glass cap and metal clip hold the chips in place.

Lockheed has gone beyond burn-in and testing. It also is using automated placement and bonding equipment for fabricating the beam-lead chips into systems. Its version of the carrier has a small hole in the glass top through which a vacuum probe can hold and position the chip where it is to be bonded. Scott Bonis, senior staff scientist at Lockheed, says the company is looking at ways to eliminate the need for the hole, which complicates carrier manufacturing, but "much more complex equipment would be required for unloading." Autonetics, on the other hand, is sticking with manual placement and bonding.

The carriers used by Autonetics are made by the ITT Cannon Electric subsidiary at its Phoenix, Ariz.

plant. Lockheed has obtained carriers from Cannon, AMP Inc., Harrisburg, Pa., and the Semiconductor division of Raytheon Co., Mountain View, Calif. Barnes Engineering is also making the new carriers. All of the carriers are still classified as experimental, but Lockheed hopes to receive production quantities of beam-lead devices supplied in the new carriers by the end of the year. At Autonetics, Micron production is at least three years off.

Arthur L. Sattler, supervisor of component engineering at Autonetics, says the goal is to buy fully tested beam-lead parts in their carriers from semiconductor makers, as is now done with flat-pack ICs. Eventually the carriers would be throw-away parts. Prospective semiconductor suppliers include Texas Instruments, Dallas; the Semiconductor Products division of Motorola, Inc., Phoenix; RCA Corp., and Raytheon. □

Materials

Aluminum cable to replace copper

Since 1966, Bell System telephone operating companies have tried using multipair aluminum cable in an attempt to get around the high and often rapidly fluctuating cost of copper. There were problems at first, but now a new waterproof aluminum cable developed by Bell Laboratories and Western Electric Co. is rolling out of WE's Atlanta Works. Company officials believe it will fulfill a significant share of the waterproof-cable requirements over the next few years.

Water and corrosion-proofing has been the biggest problem. Bell started with air-core cables containing aluminum conductors and more recently tried petroleum jelly between the air spaces of the wires to fight off corrosion. These were cheaper than copper cables, but had drawbacks and limited acceptance.

The air-core cables were reliable

An even better ROMmate for your micro-processor.

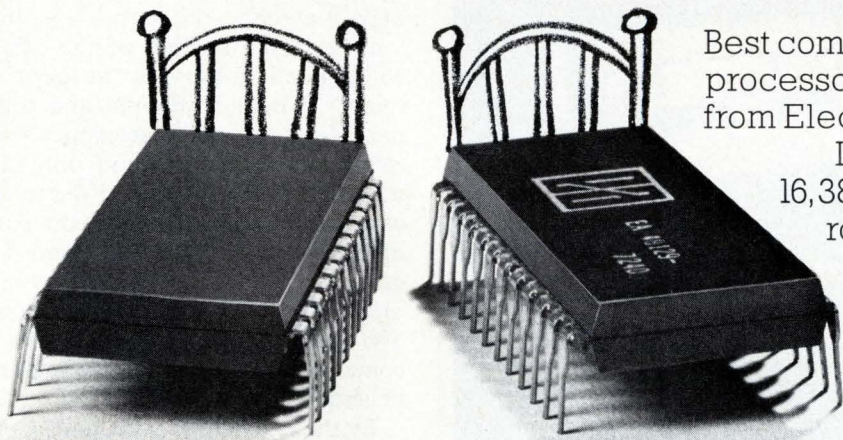

Best companion yet for your 8-bit micro-processor is the new 4900 MOS ROM from Electronic Arrays.

It brings your microprocessor 16,384 bits of program storage at rock-bottom cost—less than 1/10 cent per bit in sizeable quantities. And it's fast enough to keep up with microprocessor clock rates like 1 MHz. (Guaranteed maximum access time is 950 ns).

16K bits. Better than 1 μ sec access.

The EA 4900 has a popular 2048 \times 8 organization that

can be converted to 4096 \times 4 by external wiring. Power dissipation is a low .032 mW/bit. Outputs can be OR-wired with other 4900s.

The 4900 doesn't ask for much in the way of support. No clock because it's static. No external address decoders—they're on the chip. No external pull-up resistors—they're on the chip too. And only two power supplies: +5v and -12v.

You can get custom-programmed EA 4900s in 6 to 8 weeks. They come in 24-pin DIPs, either ceramic or silicone molded. Price in silicone packages is \$22 in quantities of 100.

Contact Electronic Arrays, Inc., 550 E. Middlefield Road, Mountain View, Calif. 94043. Phone (415) 964-4321.



**electronic
arrays**

industries' largest selection of SCR Phase Controlled Power Supplies

CALL TOLL FREE 800-631-4298

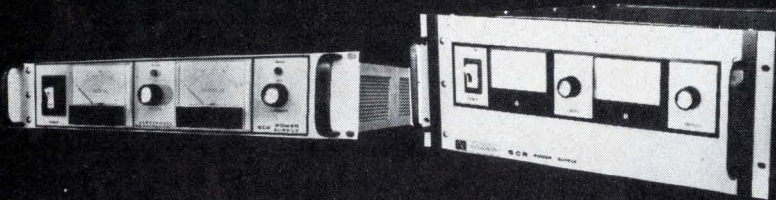

E/M has expanded its former 2.5, 5.0 and 10.0 kw SCR Models to now include 27 new models with power ratings of 600w, 1200w and 2000 watts. All models are 0.1% regulated in both the voltage and current mode of operation with automatic crossover. Remote programming and sensing are standard on all models as well as forced air cooling and automatic over-temperature protection. The three lower power ratings are all single phase input, while the three higher power ratings are all three phase input. As expected, E/M has maintained its position of providing the highest power output per mechanical volume in the industry for equipment of this type. Front panel heights being 3½" on 600w, 5¼" on 1200w, 7" on 2000w and 2500w, 8¾" on 5000w and 12¼" on 10,000w models.

Volts	600w		1200w		2000w		2500w		5000w		10,000w	
	Amps	\$	Amps	\$	Amps	\$	Amps	\$	Amps	\$	Amps	\$
0-6									600	2200		
0-7.5	85	500	125	850	200	1000	300	1400				
0-10	60	500	100	850	150	1000	250	1400	500	2200		
0-20	30	425	50	750	90	900	125	1300	250	1800	500	2700
0-30							100	1300	200	1800		
0-40	16	425	30	750	50	900	60	1300	125	1700	250	2500
0-50											200	2700
0-60	11	425	20	750	35	900						
0-80	8	425	14	750	25	900	30	1300	60	1700		
0-100											100	2700
0-120							20	1300	40	1700		
0-150	4	425	7	750	13	900						
0-160							15	1300	30	1700	60	2500
0-250							10	1300	20	1800	40	2700
0-300	2	450	3.5	850	6	1000						
25-500							5	1600	10	2200	20	2700
10-600	1	450	1.5	850	3	1000						

SEE EEM VOL. 1,418-430 FOR ADDITIONAL PRODUCT INFORMATION

ELECTRONIC MEASUREMENTS INC.

405 ESSEX ROAD, NEPTUNE, NEW JERSEY 07753

Phone: (New Jersey) (201) 922-9300 • (Toll-Free) 800-631-4298

Specialists in Power Conversion Equipment



Electronics review

and significantly cheaper than copper cables used in similar applications, but were larger, required waterproofed splices, and had to be pressurized to keep moisture out. The new waterproof aluminum cable and associated hardware overcomes or compensates for these drawbacks, says Roy Collins, Bell Labs' Atlanta supervisor for systems and applications engineering.

Foam insulation. The key to waterproofing this new aluminum cable, explains Collins, is a foam-plastic insulating material developed by Bell Labs and Western Electric to coat the outside of the cable.

The Bell System uses almost 600 million pounds of copper a year, about 75% of it in wire for telephone loop and exchange-area cables. Western Electric, says Collins, predicts a savings of 20 to 30% with the new material, although over the long term, production of the cable will depend on the cost "at the moment" of both aluminum and copper. He points out that copper was selling for \$1.40 a pound only six months ago, but it's now closer to 74 cents a pound. Meanwhile, the cost of aluminum has gone up—from 50 cents a pound for mill product six months ago to about 60 cents now. The present price of copper is welcome, adds Collins, but "no one believes it will stay there."

By the end of this year, adds Collins, the Atlanta Works will have delivered approximately 300 million conductor-feet of the new cable to four operating companies. Next year, he says, they will get some 3,500 million conductor feet.

To get the cable to operating companies without delay and to gear production to demand, the new cable will at first be manufactured in controlled amounts for pre-scheduled installations. Based on a joint study by American Telephone & Telegraph Co., Bell Laboratories, and Western Electric to determine the telephone companies' potential demand for the new cable and its long-range manufacturing cost, Collins says the cable may become available throughout the Bell System by the end of 1975. □

Introducing the new 4½-digit DPM from WESTON®



Weston, the first to introduce DPM's, completes their third generation product line.

Users of the Weston 2½ and 3½ digit units are well aware of Weston quality. The new Model 1234 provides the same outstanding price/performance, this time with 4½ digits and 10 microvolts sensitivity.

Outstanding accuracy and stability are provided through use of the Weston patented Dual Slope Integration* technique. Accuracy and stability specifications extend over operating temperatures of 0 to 50°C.

Display readout is a seven segment gas discharge planar packaged in the Weston "industry standard" high impact glass reinforced case.

Basic ranges are 100 mV through 1000V with sample speeds variable to 30 per second. Other standard options are BCD, remote decimal point positioning and line voltage operation for worldwide use. If you have been looking for a 4½ digit DPM, it will be worth your time to take a minute and return the coupon. We will send you everything you need to know about our new Model 1234. For the sales office closest to you, dial toll free (800) 645-9200, or in New York State, call collect (516) 294-0990.

In Europe: Schlumberger Instruments and Systems, 12 Place Des Etats Unis, 92120 Montrouge, France.

Weston Instruments
614 Frelinghuysen Ave.
Newark, N. J. 07114

Tell me more about Weston Model 1234 DPM.

I also want to know about

- Weston APM's
- Other Weston DPM's
- Weston DMM's
- Weston VOM's
- Weston Frequency Counters

Name _____

Company _____

Address _____

City _____ State _____ Zip _____

Phone _____

Have a salesman call.

We're either first or best. Or both.

WESTON® WESTON
Schlumberger

News update

Heathkit varactor TV sales exceeding forecast

Television receiver sales this year have been slow, but not for the Heath Co. of Benton Harbor, Mich. Sales of its \$650 color TV kit, featuring full vhf and uhf varactor tuning, are running 30% ahead of anticipated totals. And for Christmas, the firm has extended two features of the set—an on-screen clock and channel display—down to 15-, 17-, and 19-inch color screen sizes, using new RCA picture tubes with in-line gun and slotted mask. Varactor tuning, however, remains a top-of-the-line feature; it's not on the smaller sets for economy reasons. Instead, those models feature comparable detent tuners for vhf and uhf. The only apparent problem with the \$650 kit, says Heath, was that instead of appearing in the fall of 1973 as scheduled [March 15, 1973, p. 26], it wasn't available until the beginning of 1974 [Jan. 10, 1974, p. 36].

Raytheon beam-lead carrier boosts sales

Semiconductor people may have their faults, but false modesty isn't one of them. So when Raytheon Semiconductor quietly labeled its new chip-testing and shipping carrier for beam leads "the biggest turn-on for beam-lead sales in five years," the planet continued to spin at its usual speed. But it turns out that Raytheon really has something there, because the company reports that sales have increased fivefold since the innovation was introduced [Nov. 22, 1973, p. 26]. Gene Selven, director of marketing, says that sales now are in the "several hundreds of thousands" per month. Raytheon has about 145 beam-lead devices on the market, he says, and plans to add another 40 next year. Half of the customer base lies in military applications, with the remainder in high-reliability commercial sectors such as pacemakers and hearing aids. As for the carrier itself, it's designed with test contacts that hold the tiny beam leads, allowing users to test them as though they were packaged components. And if further proof of the popularity of beam-lead carriers is needed, such companies as Autonetics, Sandia, and Barnes also offer them [see p. 40].

VideoBeam projection TV looks for big market

Giant-screen projection television for consumer use can't be considered a pressing necessity, but then neither was the automobile when it was first offered. And there's a company in Cambridge, Mass., called Advent Corp. that figures its system, called VideoBeam, might be just the thing to prove that analogy. The system, which incorporates its projection optics inside each of three color tubes [Dec. 20, 1973, p. 38], has so far sold 1,000 copies at \$2,795, says the firm, mostly to commercial and industrial users, with only 20% to

30% of its sales in the consumer market. But Henry Kloss, president of Advent, says he expects consumer sales to start rising rapidly next year. What's more, Kloss adds, he believes that in five years some 20% of all TV sets sold will be projection models. Meanwhile, Advent has started production of its model 1000A, which has quick-stop tuning for both uhf and vhf, as well as internal modifications aimed to make the system more reliable and easier to repair.

Technovation nears ferroelectric memory

For several years now, Technovation Inc. of Sault Ste. Marie, Mich., has been pushing slowly but steadily toward development of a high-density ferroelectric memory using a thin film of potassium nitrate [April 10, 1972, p. 48]. Now it says it has come a little closer to a producible device, with nonvolatile 256-bit and 1,024-bit chips expected to be ready by the end of this year and 4,096-bit chips in 1975. George A. Rohrer, the president and developer, claims that the 1,024-bit array occupies an area of the ferroelectric material only 32 mils square, compared to about 120 mils square for conventional semiconductor devices, excluding the decoder. So far, his designs comprise only the bit cells; the next step is to add a semiconductor decoder to the chip.

HPA silicon Impatt finds way into prototypes

"We're just beginning to see systems use," says an official of Hewlett-Packard's HPA division in Palo Alto, Calif. He's talking about a new Impatt diode structure—a ring-shaped, silicon, double-drift mesa diode—developed at HPA last year [Dec. 20, 1973, p. 25]. The promise of the development is major changes in microwave and millimeter-wave design by making high-power silicon Impatts available and solid-state systems practical. The devices are now attracting a lot of prototyping business, says the company, with customers in telecommunications, missiles, and radar testing the diodes. According to George Phund, an associate engineer at HPA, the anticipated threat of gallium arsenide as a competitor has faded because of manufacturing and reliability problems with the material. Meanwhile, HPA's primary effort with its silicon models has been in the development of cw devices at lower frequencies. Two parts have been made: a single-drift diode at 2 watts and a double-drift at 3.3 W. In addition, around March the company will introduce a 6 gigahertz, higher power diode with a minimum of 1.75 W for single Impatt diodes, and 3 W for doubles, with gigahertz ranges from 5.9 to 8.4. Phund notes that HPA has already tripled its original production volume figures and the devices are on back order.

Howard Wolff

Intended to bring *Electronics* readers up to date on news stories of the past months.



Behind every Rotron fan and blower... Application Engineering

No product is any better than the job it will do for you.

That's why Rotron's staff of Application Engineers are always available to help you use air most effectively—avoiding the potential problems of incorrect choice of fan or blower—assuring you the most for your air moving money.

They know their business. They draw upon more than 25 years of experience in the application of precision air moving devices. They have available to them the best equipped laboratories for testing and evaluation of specific air mover to system combinations. And, of course, they know their product.

That doesn't mean you'll need a factory-based application engineer every time you use a Rotron fan and blower. The variety and quality of products available to you, the wealth of knowledge that exists throughout the sales and distributor organization—and your own knowledge—will usually combine to provide just the right air mover for you.

But when a question does arise . . . when you *do* need help . . . your Rotron Application Engineer is there . . . on the phone or at your plant . . . with the answer.

Why settle for less when the best costs no more?



ROTRON INC.

Woodstock, N. Y. 12498 □ 914 • 679-2401 □ TWX 510-247-9033
Pacific Div., Burbank, Cal. 91506, 213•849-7871 • Rotron B.V., Breda, Netherlands, Tel: 79311, Telex: 844-54074

18351



The Nova 830.
A little less of a good thing.

It has come to our attention that there are people who don't need all the speed of our 840.

So we've come up with a computer that goes a little slower. And costs a lot less.

The Nova 830.

The 830 uses our low-cost 32K byte memory boards.

But aside from that, you can't tell an 830 from an 840.

The 830 comes with the 840's Memory Management and Protection Unit that lets you expand up to 256K bytes, all of which are fully supported.

And it has the 840's Mapped Real Time Disc Operating System that helps you develop programs as much as it helps run them. (MDROS is one of Data General's family of compatible operating systems. So it can handle all our high level languages and all our peripherals.)

Like the 840, the 830 is a natural for dual operations: Timesharing and Batch, Remote Job Entry and Batch, Timesharing and Remote Job Entry, or if you're so inclined, Batch and Batch.

And like the 840, you can get an 830 in 45 days. Or less.

Unlike the 840, you can get an 830 with 128K bytes of memory for \$23,150.

Data General

The computer company you can understand.

• Data General Corporation, Southboro, Massachusetts 01772, (617)485-9100.
Datagen of Canada Ltd., Hull, Quebec (819)770-2030/Data General Europe, Paris, France 504-23-44.

Circle 49 on reader service card

Introducing Reliability Services, a revolutionary plan for all IC users, designed to dramatically reduce IC & Semiconductor failures in the field.

1.

Our Microelectronic Testing Laboratories have proven that testing isn't enough

Testing isn't enough!

This we've learned over a 5 year period at our Microelectronic Testing Laboratories (MTLs) where IC's & semiconductors are subject to extensive thermal shock & burn-in before screening.

The industry is starting to agree with us. This year alone, our 3 regional MTL centers will precondition & test over 20,000,000 components for over 100 electronic companies, large and small.

Why precondition before testing?

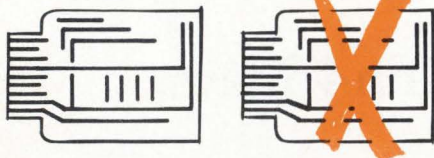

Take two identical boards, each with 100 IC's. If the IC's are routinely tested before the board is assembled a couple of bad ones will be uncovered. However, another 2 or 3 weak IC's will slip through, yet will likely fail within a few months.

Suppose these bad IC's found their way into your product. Even if the board failed in your plant it could cost \$50 for rework. And a field service call might run into the hundreds.

Preconditioning before testing can catch these culprits before they get into your product or system.

How preconditioning works

At MTL we've streamlined military "high reliability" testing for commercial use by choosing 3 phases which yield the best cost/value ratio.

These are: (1) Thermal shock (2) Burn-in (3) Testing

Phase One: Thermal Shock



Thermal shock, which consists of alternately immersing IC's in 0°C to 100°C liquid to liquid (5 min dwell, 10 sec transfer) from 3 to 15 times, duplicates in minutes the mechanical stress devices would experience in a lifetime. Mechanically sound components show no ill effects. Weak IC's develop broken bonds, chip fractures, poor passivation, etc., which would never have been uncovered by testing alone.

Phase Two: Burn-in



Next, devices are aged in a burn-in chamber for up to 168 hours at 100°C with bias applied. Both thermal shock and passivation problems will be activated during burn-in and will show up in testing. By compressing 8 months into a week, failure trends are spotted.

Phase Three: Testing



Now devices are thoroughly tested using high speed computer controlled test systems

(like our Hustlers) & specialized equipment such as analog testers, curve tracers, sampling scopes, etc. Tests can be functional, parametric or whatever is required.

Devices which fail the tests are shipped back for credit, which is better than having them end up in your product.

The importance of preconditioning

Component quality fluctuates widely from month to month as seen on the graph. Can you afford to gamble on a batch of bad IC's or discretes ruining your product?

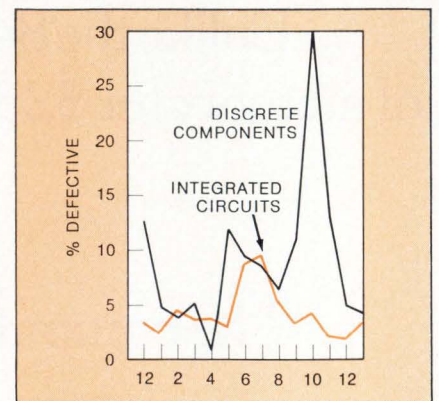

2.

Our "Hustler" automatic testers have fastest throughput & easiest programming

We know testing. We also build testers. Our Hustler line is great, according to our many customers who include the largest IC makers & users.

CMOS measurements to 1 nanoamp.

Why are Hustlers preferred?



Hustler 44

For one thing, Hustlers test more IC's in less time than our competitors. Up to 120,000 MSI devices per hour. That's because of our unique DC/functional parallel test

technique with separate force & monitor cards (PECs) for each pin of the device under test.

Also, Hustlers are the easiest to program using simple English language software which doesn't require a computer programmer.

Our Hustler 44 can make parametric & functional tests on a wide variety of ICs, including CMOS with 1 nanoamp leakage measurement resolution.

Micro-programmable pattern generator for RAMSs

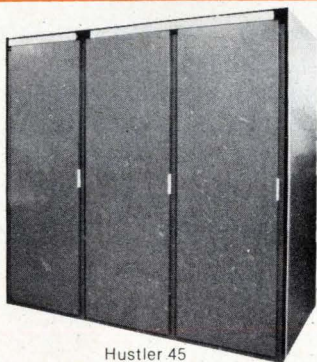

Hustler 45

Our Hustler 45 is a 10MHz clock rate tester with a built-in programmable pattern generator for making functional & dynamic tests on RAMS & LSI logic.

When it comes to testing our Hustler 44s, 45s & 50s have put it all together.

3.

Introducing Reliability Services — a revolutionary new plan for anyone who uses IC's & semiconductors

Why re-invent the wheel?

Hundreds of companies use our MTL centers. Maybe you should. But possibly your volume warrants in-house preconditioning & testing.

So what do you do?

Scour the market for thermal shock & burn-in equipment? Evaluate all kinds of special test equipment? Spend months deciding on the right IC test system. More months writing test programs & debugging software?

There's no need to. We've already done it for you.

How our Reliability Services plan works



One of our experienced Reliability Services analysts will visit your plant. He'll analyze your needs, based on the type & volume of IC's, the tests required and other criteria.

At Datatron, this information will be fed into a specially programmed computer, carefully analyzed and a detailed report prepared.

The report will show monthly savings using our Reliability Services

plan, whether you should use our Microelectronics Test Lab, or set one up in your own facility, and the improvement in failure rate you can expect.

Your decision will be easier now that you have all the facts.

Setting up an operation MTL in your own facility



If "in house" is the way to go, Datatron will install a complete Microelectronic Testing Lab in your own facility. Tailor made to fit your needs.

We'll lease & maintain the right IC test system & specialized test equipment.

From our vast Reliability Services library, we'll provide field-proven programs to test your IC's & semiconductors. Plus new programs as you need them.

We'll provide all thermal shock equipment, burn-in chambers & burn-in fixturing. We build it all ourselves.

A Reliability Service expert will train your people at your plant. And will be on call when needed.

We'll take care of all hardware — preventative maintenance & emergency service as well.

We'll even provide a semi-annual audit to see if your needs have changed.

That's why our Reliability Services program is revolutionary. If you're using IC's it can improve your product's reliability and save you money besides.

Datatron — We've Put It All Together.

Mail this VIC* today *Very important coupon

Send Reliability Services data

Send Hustler literature

Send MTL brochure

Contact me regarding _____

Name _____

Company _____

Address _____

City _____

State/zip _____

Phone _____

datatron inc.

1562 Reynolds Ave., Santa Ana, California 92705 • (714) 540-9330
Mailing Address: P.O. Box 11427, Santa Ana, California 92711

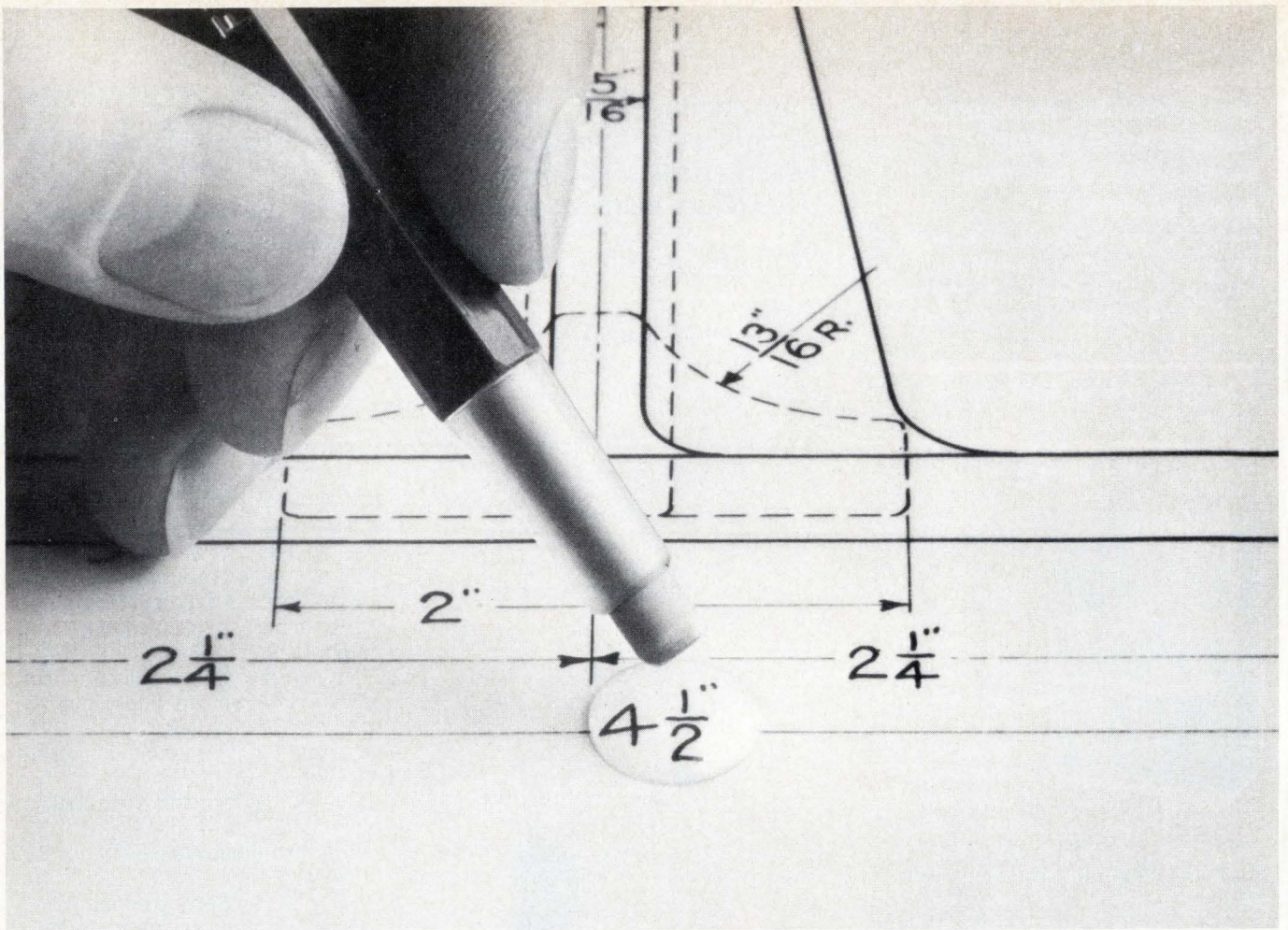

Get the drop on redrawing drudgery.

Shortcuts with Kodagraph materials can turn drafting hours into minutes.

Nobody likes to retrace a whole drawing just because a few revisions are necessary. You don't have to if you make a second original on Kodagraph wash-off film. Simply wet-erase what you don't want—using plain water and a soft eraser—draw in the new details and the job is done.

If on the other hand, you're faced with repetitive details, draw them once. And then order as many Kodagraph film or paper reproductions as you need. Cut them out,

tape down on drawing form, rephotograph and you have a new original.

When you need to restore a battered, old drawing, have a reproduction made on Kodagraph film. Stains virtually disappear. Weak lines come back strong. And you end up with a crisp, legible black-on-white print.

Get the details.

Write for information on how you can reduce drafting time with photoreproduction techniques. Eastman Kodak Company, Business Systems Markets Division, Dept. DP807, Rochester, N.Y. 14650

Kodak products for engineering data systems.



Washington newsletter

DOD record budget for fiscal 1976 seen politically unpalatable

Pentagon budget officials are showing signs of discouragement with plans to get congressional approval next year of the record \$101 billion fiscal 1976 defense budget. **The reason: strongly negative reaction on Capitol Hill to President Ford's cutbacks in the current 1975 spending plan.** Of the \$517.7 million in proposed economies, only \$381 million would be actually held back this year, with the remaining economies occurring in future years.

Only three weapons systems, for which Congress added funds this year that DOD never requested, would be affected—\$18.5 million for 48 Army UH-1H helicopters and \$305.6 million for 24 A-7D fighters and 12 F-111 interceptors, both for the Air Force and both built in Texas by LTV Aerospace and General Dynamics Corp. The cuts would save no more than \$35.5 million in outlays this fiscal year, according to DOD. "If this Congress is balking at these," moans one DOD budget officer, "just think of what we'll be up against in January," when Capitol Hill will be packed with "all those young liberals in the House."

Technology applications of Bell Labs hit in study for FCC

Defending AT&T's existing structure against the Justice Department's antitrust suit, chairman John D. deButts likes to cite the Federal Communications Commission's own contract study. The study, by consultants Touche Ross & Co., lavishly praises Western Electric Co. for "efficient performance," which has produced "lower costs" that "have been passed on to operating companies in the form of lower prices." **Nevertheless, the 132-page summary of the unreleased study also contains lengthy and specific criticisms of Bell Laboratories.**

Though the "basic research effort at Bell Labs is outstanding," by the Touche Ross estimate, **"the rate of introduction of new technology appears slow."** In particular, Bell Labs is criticized for "hesitancy to utilize new technology not invented at BTL"; "lack of follow-up once a field has been established. . . . [and being] slow in coming out with improved products, design changes"; a "lack of response to operating company needs. . . . particularly true in noncompetitive areas." Moreover, the size of the organization is called "somewhat ponderous," leading to overlap and duplication in jobs and programs.

\$15 million ATS satellite may be scrapped by NASA

A grounded \$15 million satellite may be cannibalized due to a Federal policy decision, announced earlier this year, that limits the National Aeronautics and Space Administration to developmental programs, not operating commercial systems. The backup Applications Technology Satellite-F, to be delivered to NASA early next year, **may be dismantled and its parts used on future satellites or stripped down for use as a less powerful relay.** NASA study teams will determine its fate by mid-1975.

The satellite, rocket, and preparation costs of a second ATS-F launch would cost NASA \$45 million. Hughes Aircraft, however, puts the cost of launching **one of its Anik/Westat satellites able to perform the same functions at half that.** ATS-F contractor Fairchild Industries, Germantown, Md., failed to find foreign buyers, and stands to lose \$10 million in launch preparation fees. ATS-6, launched last May, relays educational programming and experimental communications signals for civil aviation and maritime uses, and it will relay educational programming in India after changing orbit next summer [*Electronics*, May 2, p. 69].

The scenarios raised by AT&T vs the U.S.

Today's version of the ever-popular Washington game Scenario, which involves posing "what-if" questions about the future of AT&T, began long before the Justice Department's antitrust division sued in November for the breakup of the Bell System. The Federal Communications Commission has been putting those questions for nearly a decade. Nevertheless, the Justice Department's answers to the question of how competition should evolve within the nation's rapidly expanding telecommunications industry are generating a whole new series of scenarios for Government game players.

What if Western Electric . . . ?

What happens if AT&T is ordered to divest itself of its manufacturing capability, and the \$7 billion Western Electric Co. is then split up into two or more companies, as the Government wants? Some U.S. trade officials respond warmly to the prospect of Western Electric expanding into the world's export markets and making a major contribution to the U.S. trade balance in telephone equipment. Exports last year amounted to a paltry \$25.2 million compared to the \$125 million in imports.

"With Western Electric hovering over the domestic market like a protective angel, U.S. telecommunications manufacturing has never really been able to develop," observes one Federal trade specialist. "With a foreign demand for communications expanding at a much faster rate than ours, an independent Western Electric could do very nicely abroad."

That scenario appears to have occurred to Western Electric already, if its participation this fall in a two-week overseas telecommunications sales mission to Poland, Rumania, and Yugoslavia under the Commerce Department's sponsorship is any indication.

What clouds that sunny prospect is the probability that a global Western Electric most likely would go multinational, establishing overseas plants to serve local and regional markets. Not only would that course add little to the U.S. gross national product, it might even subtract from it should Western Electric choose to ship parts offshore for low-cost foreign assembly and reimportation under the nominal "value added" tariffs. Clearly, the scenarios that may be posed about the future of Western Electric are boundless.

So are the questions that arise as natural alternatives to a Western Electric that is able to

view the world as its marketplace. The U.S., for example, still represents the most highly developed segment of that market—and the value of an open and competitive U.S. market has not been lost on such international telecommunications heavyweights as IIT, L M Ericsson, Philips, or Nippon Electric.

What of Bell Labs?

If the Justice Department's scenario for AT&T's future offers some answers for the court about the future of Western Electric, it suggests none about Bell Telephone Laboratories, with its \$500 million annual operating costs. Bell Labs is an anomaly in American industry, and the Justice Department apparently doesn't know what should be done with it.

If Bell Labs were spun off with Western Electric or left with a diminished AT&T, neither company probably would be willing—much less able—to pick up the full tab for maintaining the level of effort that has made the nation the acknowledged world leader in telecommunications R&D.

Changes to come

The present image of Bell Labs and its corporate parents seems unlikely to change dramatically for a couple of years at least. As chairman John D. deButts has put it, AT&T does not intend to alter its way of doing business "one iota until we get an order from a court."

But change is coming to Ma Bell, nevertheless. AT&T, with its admittedly well-run organization, has seen it and been fighting it for years. Now, with the catalytic action of the courts introduced, the public will see it, too.

IBM long ago proved that antitrust suits make incredibly dull reading for most citizens, yet the situation is different for Bell. "Most of us don't have computers and couldn't care less about their future," says one Government attorney. "But you can't say that about telephones."

Those differences and others cannot, must not, be overlooked by the scenarists contemplating the future of U.S. telecommunications. Bell is already showing signs that it is responding to a newly interested public. It is a response that is leading nervous competitors to ask: what if AT&T cuts the ground out from under the Government by accelerating adoption of interconnection standards that eliminate much of the rationale for charging monopoly? That is but one of the more interesting scenarios being posed in Washington.

—Ray Connolly

At Motorola, **CMOS** is a form of plant life...

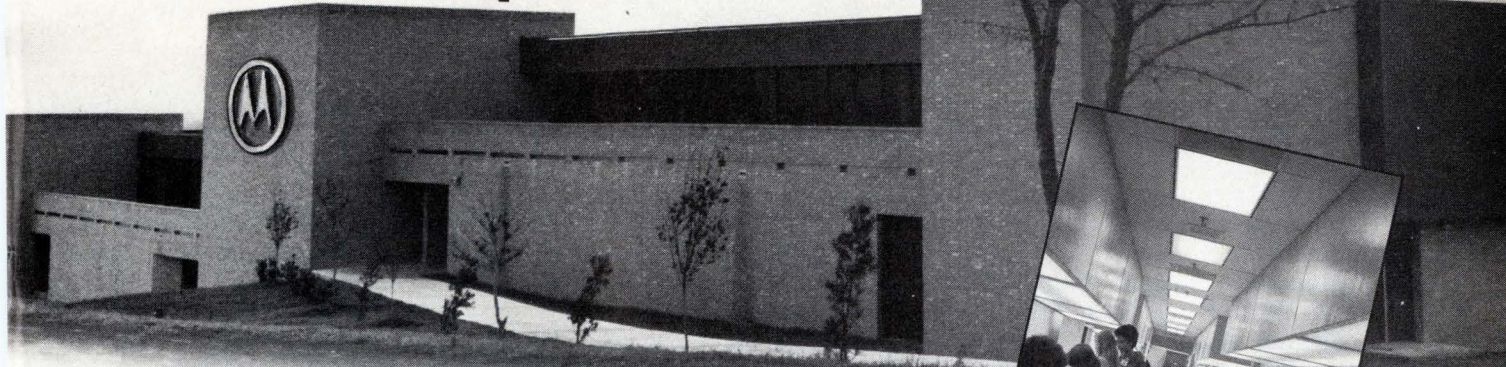

This plant— *Austin, Texas*

Newest and largest of Motorola's CMOS facilities is at Austin, Texas. Dubbed "Silicon Ranch" by local hands, the Austin plant was designed exclusively for MOS fabrication with each module a specialized facility for one of the varied MOS technologies. The first CMOS module featuring the world's most automated line came into full production during 1974 and yields are phenomenal. Silicon Ranch utilizes more of the most up-to-date probe and test equipment than any other facility in the world, too. It's now the heart of Motorola's CMOS worldwide operations.

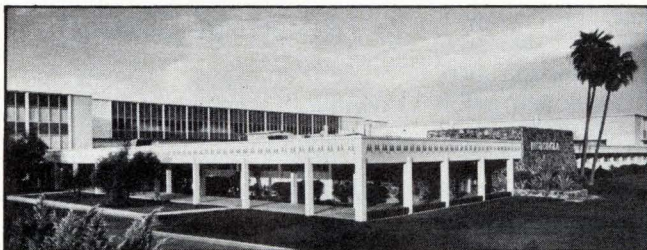

This plant— *Phoenix, Arizona*

Phoenix is the proving ground and original home of the MC14000/MC14500 McMOS* line. It was here that Motorola's first CMOS explorations were carried out back in 1969, and here, too, that McMOS was introduced in 1971 as the first coherently systems oriented CMOS family.



This plant— *East Kilbride, Scotland*

Motorola's third major CMOS facility is the fabrication and test operation in East Kilbride, Scotland. This modern plant is in full scale production to meet the needs of Western Europe.

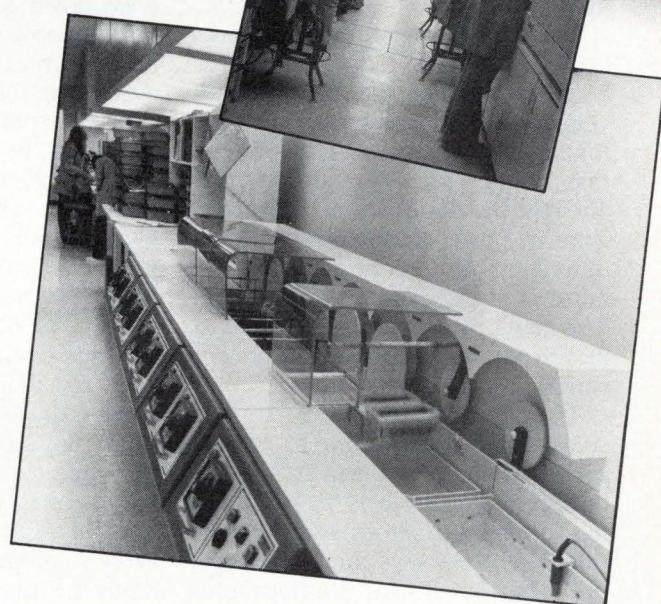
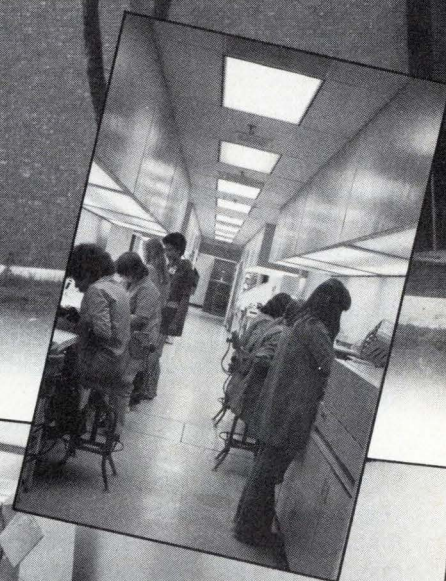

Considering the growing capacity at Austin, and the contributions of Phoenix, East Kilbride, and other CMOS facilities, it's no wonder that McMOS is available today as no CMOS has ever been available. Considering the yields Motorola is now obtaining on its McMOS lines, it's no wonder prices have been reduced as they have. Considering McMOS MC14000/MC14500 CMOS will pay off in your designs.

For a new CMOS Interchangeability Guide designed to help you switch from ordinary CMOS to Motorola's lower cost McMOS MC14000/MC14500 Series, circle the reader service number or write to Motorola Semiconductor Products Inc., P.O. Box 20912, Phoenix, AZ 85036.



*McMOS is a trademark of Motorola Inc.

MOTOROLA McMOS
Complementary MOS for Contemporary Systems

Circle 55 on reader service card

1-bit Boolean processor provides cheap programmable logic for switching

A **1-bit Boolean processor** is being touted as an economical alternative to either large-scale or small-scale-integration techniques for programmable logic applications in switching circuits. Anthony W. Sweet, principal research engineer in the Switching division of Standard Telecommunications Laboratories Ltd., says the processor would be ideal for a host of applications in industrial control, telephone communications, and even low-cost traffic-light controllers.

Sweet says his parent company, ITT Components Europe, aims to begin producing the processors a year from now. LSI is too expensive for the custom switching market, he says, and SSI, though flexible enough, has unfavorable characteristics in power dissipation, area required for printed circuits, and the number of interconnections needed. The new processor could be used in new products to replace bulkier conventional logic systems.

The device, which Sweet says was constructed as the minimal processor to evaluate Boolean equations, "struck me as the best way of dealing with a set of information or logic functions." He says the entire logic unit consists of two flip-flops plus some memory elements. "The rest is direct addressing of the RAM and the input and outputs," he explains.

Having built a working model in TTL and now building a number of them, Sweet says the processors are fairly easy to make. It looks like a 40-pin LSI package, but "it is 1-bit serial machine. It does 1 bit at a time." Consequently, "you sacrifice speed, but for these applications, you don't need speed anyway." Typical speeds are in milliseconds, rather than microseconds.

Array. A conventional sequential switching circuit is built around a combinational circuit, actually an array of logic gates and memory ele-

ments that are flip-flops. The combinational circuit acts essentially as a traffic cop. The sequential switching circuit's performance is completely defined by a set of Boolean equations. To program a system, the combinational circuit could be replaced by a read-only memory, but the ROM would be too big. For an array of 10 memory elements, 491,520 bits would be needed for only five inputs and five outputs.

Another approach is to break the ROM down into two portions in a programmable logic array with an AND matrix and an OR matrix. The size of the matrixes depends on the Boolean equations defining the logic functions to be performed. This more complex approach requires far fewer ROM bits to carry out any given function than the simpler ROM method—a total of 2,700 bits, divided between 1,800 for the AND matrix and 900 for the OR matrix for a system having five inputs, five outputs, and 10 memory elements.

Also, the ROM is relatively fast because the signal-propagation delay through the two matrixes is constant and is roughly equal to two gate delays only. But the programmable logic array's program memory cannot easily be shared between identical functional units, and the logic functions must be kept simple.

The Boolean processor returns to the simple concept of the sequential switching circuit. The 1-bit processor consists of 12 inputs, 12 outputs, and 38 bits of random-access memory. It requires an 8-bit program word and could be programmed by any of the standard ROMs and PROMs that have 8 bits per word, Sweet says. The processor consists of input and output staticizers connected to a circuit between the RAM and a logic unit. A staticizer is a storage device for converting time-sequential data into static parallel form. The logic unit interacts with

an address-and-instruction-decode unit, which is connected to a ROM connected to a counter.

The inputs and outputs end at the staticizers. The read/write RAM holds the now-formalized memory elements. A 1-bit data bus handles all data flow between the inputs, outputs, and memory elements via the logic unit. The logic unit, under control of the program word, acts as a temporary store, or accumulator, and it contains the circuitry necessary to execute the basic Boolean operations of AND, OR, and NOR. □

Japan

Optical waveguide is made of plastic

Polymer plastics are being used to fabricate contiguous rows of triangular optical waveguides in sheets. One side of the sheet is flat, and the other consists of alternating triangular grooves and projections. One end of the row, oriented perpendicularly to flat copy, can pick up images simultaneously and transmit them for short distances.

The optical waveguides are being developed to pick up entire pages for facsimile transmission, and they will probably also be adapted to other types of optoelectronic equipment. Hiroshi Nomura is head of the development group at the Ibaraki Electrical Communication Laboratory of the Nippon Telegraph and Telephone Public Corp.

As a facsimile receptor, one end of the waveguide sheet is made wide enough to span the width of a flat manuscript. The manuscript can move linearly past the waveguide array's pick-up end. In other systems, the manuscript must oscillate or rotate. The other end of the sheet

is bent into a cylinder with its axis parallel to the waveguides. An optoelectronic device rotating near the edge of the round waveguide array picks the images off the fiber ends in sequence.

Experimental sheets, about 100 micrometers thick, have been fabricated. Their size, 20 centimeters long by 8 cm wide, is nearly half that required for practical facsimile applications. Sheets can be interconnected in pairs side by side along their edges. These pairs can be stacked into blocks so that the waveguide ends could form optoelectronic displays. However, these transmission lines cannot be very long because of the high intrinsic losses in the plastic materials used.

Diffusion. In fabrication, equilateral triangular ridges are simultaneously diffused on the surface of a sheet of polycarbonate having a high refractive index to produce a row of optical transmission lines. The experimental sheets have 10 triangular projections per millimeter for a density of 10 fibers per millimeter in the finished sheet. Sheets have been made by a variety of methods, but liquid-casting appears to be most satisfactory.

Methyl acrylate monomer is mixed with water and methanol so that it does not dissolve the polycarbonate sheet. The mixture is diffused from both sides of the sheet for about an hour at room temperature to produce triangular ridges clad with a plastic having a lower refractive index than their interiors.

These clad fibers are adequate for short transmission lines, such as those used in facsimile and optical-character-recognition equipment. Self-focusing fibers, needed for transmitting information, can be produced by raising the diffusion temperature to about 50°C.

Radiation. To prevent the monomer from diffusing out of the sheet, it is irradiated with gamma rays from a cobalt-60 source to produce a graft polymerization. The diffused material becomes polymethyl acrylate, and long linear molecules are interconnected occasionally with other long molecules to become a

Around the world

Maker of small calculators spins off expertise

Experience in manufacturing bargain-price calculators is being channeled to other products aimed at a worldwide market by Sinclair Radionics Ltd., St. Ives, England. The first product is the DM2 3½-digit (2,000-count) multimeter. It is designed around an MOS LSI chip, powered by a 9-volt battery, weighs 1 kilogram, and is priced at about \$140. It has a maximum voltage sensitivity of 1 V full-scale. Also in development are a digital panel meter, a digital watch, and a miniature monochrome television set with a 2-inch screen that is projected to sell for less than \$120.

Electronics in supertanker is worth \$1 million

The Sea Saint, first of 15 supertankers built at Sweden's Kockums shipyard, contains some \$1 million worth of electronic gear. The 355,000-ton tanker, which has been delivered to Salen Shipping Co. of Stockholm, is equipped with two computers, and a radio-video system to entertain and instruct the crew of 35. One of the Norwegian-made Kongsberg SM-4 computers is for loading and load control, and the other is for supervision of the machine room, navigation, and piloting.

Prolific designer serves the world

A 50-man company called Elektor, headquartered in a Dutch village not far from Aachen, West Germany, has more customers than any electronic-circuit designer in the world. Headed by Bob van der Horst, a 47-year-old self-taught engineer, Elektor's engineers and technicians dream up all sorts of hobby circuits, breadboard them, debug them, and then print them in a magazine published in Dutch, German, and English. Circulation has been expanded recently to Sweden, Italy, and Israel.

Siemens demonstrates cordless headset

Some new television sets are expected next year to provide a distortion-free cordless headset, developed by Siemens AG, which can be used with any type of audio system. Modulated infrared signals, rather than wires, feed signals to the headset. The IR beam is transmitted by eight Siemens LD 241 photodiodes, which emit 120 milliwatts. The headset contains a BPW 34 photodiode with 9 square millimeters of active area.

SAW receiver snags its own satellite code

An asynchronous receiver module using surface-acoustic-wave (SAW) technology speeds up recognition of its address buried about 30 dB below the interference level in satellite communications transmissions. The receiver was developed by a team from the University of Edinburgh, Scotland. The team says asynchronous SAW operation reduces the lock-on time in code-division, multiple-access, spread-spectrum systems from a typical time of 1 second to about 10 milliseconds.

permanent part of the plastic-sheet structure. Precise radiation dosage is important because excess radiation turns the polycarbonate yellow, which increases losses.

The initial polycarbonate has an index of refraction of about 1.6, and the methyl acrylate has an index of 1.49 to 1.5. Diffusion of the material having the lower refractive index lowers the index in the cladding region by 1% to 2% below that in the guide region. This is sufficient to prevent loss of light, even when the

fibers are bent in a rather small radius.

Loss of the fibers is about 0.5 decibel per centimeter, which is about 10 times that of polycarbonate under optimum conditions. Much of the loss appears to arise from voids and crystalline imperfections caused during the solvent-casting process. Loss is expected to be lowered to about 0.1 dB per centimeter, which would keep loss down to 2 dB or 3 dB at the lengths used in practical equipment. □

Here are two of the world's best oscilloscopes.

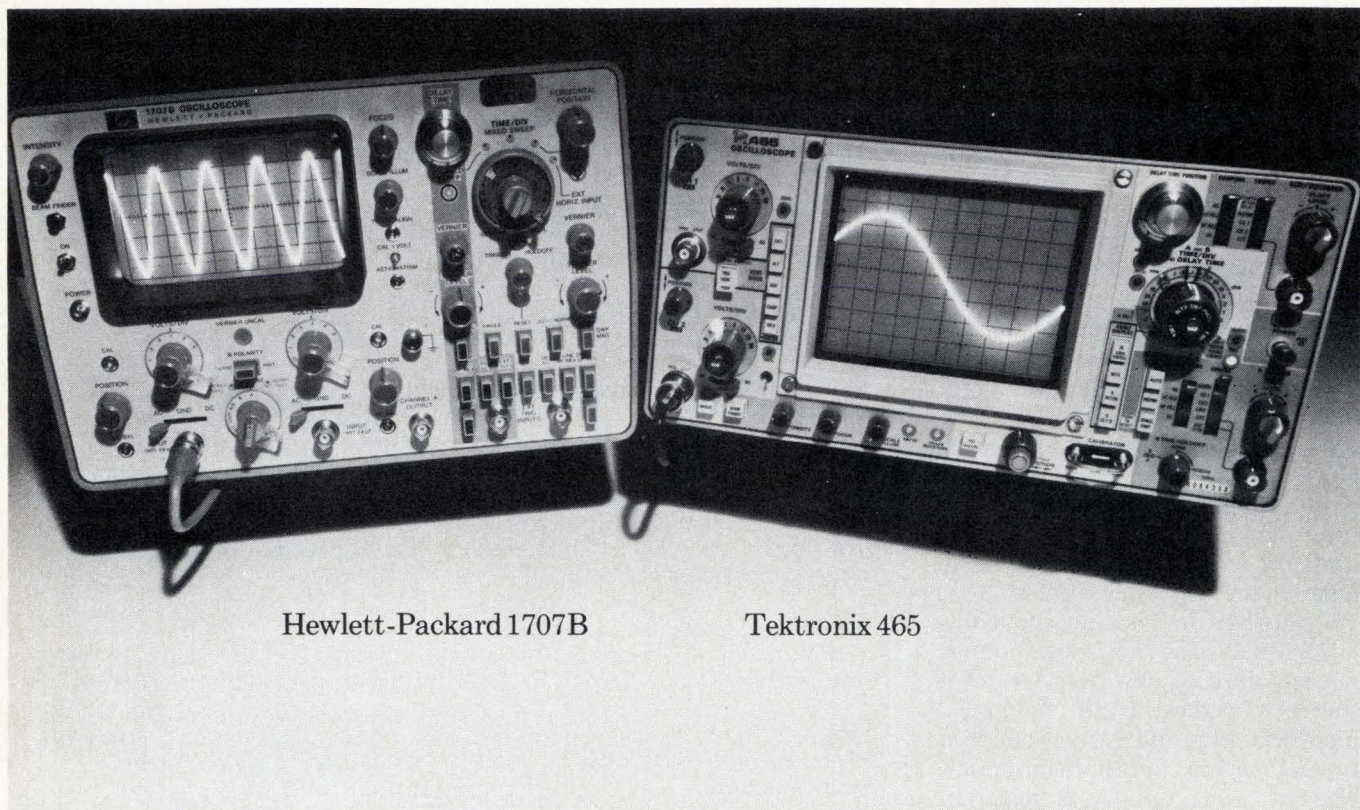

Hewlett-Packard 1707B

Tektronix 465

Here's why you shouldn't own either one.

You can lease one for as little as \$45 per month.

We can give you immediate delivery on either the Hewlett-Packard 1707B or the Tektronix 465, in quantity.

The Hewlett-Packard scope lease is \$45 per month for 36 months. The Tektronix 465 is \$50 per month for 36 months.

Anyway you choose, leasing is the best thing that ever happened to a tight capital equipment budget. You pay for your scope as you use it ... and you pay for it out of the profits it generates.

Call your closest Instant Inventory Center and ask us about short term rentals, delivery, and other lease terms for scopes or any other electronic equipment you need, up to and including minicomputers.



Anaheim, California (714) 879-0561
Dallas, Texas (214) 661-8082
Fort Lauderdale, Florida (305) 771-3500
Gaithersburg, Maryland (301) 948-0620
Burlington, Massachusetts (617) 273-2770
Mountain View, California (415) 968-8845
Oakland, New Jersey (201) 337-3757
Rexdale (Toronto) Ont., Canada (416) 677-7513
Des Plaines, Illinois (312) 827-6670

Rental Electronics, Inc.

A **PEPSICO** leasing company.

International newsletter

Honeywell-Bull is tempted to join Unidata company

Honeywell-Bull may be on the brink of plunging into an alignment with the 17-month-old European Unidata computer trio—Siemens, Philips, and Compagnie Internationale Pour l'Informatique. French president Valéry Giscard d'Estaing is in the midst of a series of urgent cabinet meetings aimed at **deciding how and when Honeywell-Bull should team up with CII to give the French company new muscle in dealing with its Dutch and German partners.**

Proposals include a joint Honeywell-Bull-CII company in which French interests would have a majority share and would cover markets in France, Spain, Italy, and French-speaking Africa. The loose Unidata association would be tightened, and Honeywell would win rich new markets that are now the protected hunting ground of the Unidata trio. **In return, Honeywell would open the door to the U.S. market, now beyond the reach of Unidata's present partners.**

Defense cuts won't impact electronics makers in UK now

Little immediate commercial impact is expected from the UK's long-awaited austere defense review announced this month. One company spokesman, **noting that fewer men should need more electronics, says his company is heavily oriented toward the export market anyway.** Details of the cut will be spelled out in a government white paper due out in February. **The government seeks to lop off about \$11 billion in defense spending during the next 10 years.**

Major programs, such as the multirole combat aircraft (MRCA) remain intact, although possibly subject to a stretchout. The big initial cuts come from reducing forces and overseas commitments. **But equipment suppliers may feel a pinch over the long run because the government intends to reduce the number of attack surface ships by one seventh, conventional submarines by a quarter, and afloat support ships by a third.** Corresponding slashes are expected in new ships and planes.

Tunisia offers savings to German components firms

By shifting production of certain electronic components to Tunisia, West German firms could reduce costs as much as 45%. That's the estimate of officials of the German Electrical Industries Association after surveying manufacturing potential in the North African country. The investigation was triggered by the anxiety of German firms that they would lose ground to imports because of the fast-rising labor costs in manufacturing such components as switches, connectors, and relays.

It was estimated that manufacturing television receivers in Tunisia would cut costs by 45%, and the cut for loud-speakers would be 31%. Labor costs in Tunisia are as much as 83% lower than in West Germany, and the large reservoir of manpower is said to be highly productive. Tunisia also guarantees substantial tax incentives, capital protection, and the right to transfer profits out of the country.

Japanese integrate chroma and remote tuning on TV chips

Low-cost color-signal processing and economical, failure-free remote tuning will probably result from new integrated circuits developed for television in Japan. **Hitachi Consumer Products Research Center has developed a one-chip chroma IC encapsulated in a 24-pin dual in-line**

plastic package. The single chip eliminates almost a third of the external parts required for the three chroma ICs now common on most all-solid-state receivers.

In a new remote tuner developed by Toshiba, an MOS IC for signal processing is the key to its potentially low cost. Using an ultrasonic approach, the remote tuner attains noise-immunity through application of frequency-shift-keyed signals. The digital-processing IC in the receiver portion of the tuner is a p-channel chip measuring 2.39 by 1.89 millimeters. Both developments were disclosed at the IEEE Fall Conference of Broadcast and Television Receivers last week in Chicago.

Nordic planes must get transmitters for air rescue

Emergency crash-locator transmitters will soon be required aboard all aircraft registered in the Nordic nations. **Norway, which has about 500 civilian planes, has set a Jan. 1 deadline.** Sweden, which has the largest number of private planes—about 1,000—had hoped to require the beacons by next June, but delays in equipping the nation's search and rescue aircraft with receivers and localization equipment have postponed the requirement until January 1976.

Finland, which has about 400 aircraft, and Iceland are following suit. The need for emergency equipment is not so urgent in Denmark, which has a small area and heavy population, but is seeking the gear for its Greenland territory. No special type of transmitter is being specified, **but performance standards are expected to be similar to those enforced in Canada and in some states in the U.S.,** standards which include automatic operation after crashes.

Marots contracts go to two consortiums headed by British

Contracts worth \$48 million have been awarded by the European Space Research Organization (ESRO) to two British firms in connection with Marots, the maritime communications satellite to be launched in 1977. **A \$22 million contract to build the 902-pound spacecraft went to Hawker Siddeley Dynamics,** which leads a consortium composed of Engins Matra of France, ERNO of West Germany, Aeritalia of Italy, and Saab-Scania of Sweden. **Marconi Space and Defence Systems Ltd. heads a consortium to supply the 123-pound communications subsystem for \$26 million.**

In addition to challenging the U.S. Maresat, to be launched earlier by the Comsat General Corp., Marots is expected to spark international competition among suppliers of shipboard terminals. Marconi and Redifon in the UK are geared up to market such terminals [*Electronics*, June 13, p. 65], while Scientific Atlanta Inc. has won a Comsat contract to supply 200 terminals for Maresat [*Electronics*, Nov. 14, p. 38]. **Marots, based on Hawker Siddeley's orbital test satellite to be launched in 1975, will be geostationary over the Atlantic. The uplink will operate at 14 gigahertz and the downlink at 11 GHz.**

Oman installs PAL TV system

The Sultanate of Oman is installing a five-transmitter PAL color-television network, to be completed by next fall. **West Germany's Siemens AG heads a consortium fulfilling the \$15.5 million contract.** An American transport aircraft flew in two TV-transmission vans last month for partial coverage of the birthday of Sultan Qaboos Bin Said.

Again. The heir apparent of the digital temperature indicator world is a chip off the old Doric block.

Using a single custom-designed "super chip", the Doric Series 400 Trendicators have 75% fewer parts. With less to fail, MBTF is 10 years. And since they need only 1.5 watts of power, they run nice and cool. They're reliable. Very.

Flexibility, versatility, or whatever you want to call it, is another strong feature. For example, you can measure six TC types with one unit (J,K,T,R,S & B). Switching from degrees F to degrees C or vice versa is a snap (built-in). Field range/type change is just as easy.

The looks are pretty snappy too. Big *readable*

LED's. Cast aluminum case, no tacky plastic. And a clean compact size (a little larger than a 1 lb. box of sugar).

Same stellar Doric performance, with prices starting at \$299 for onesey, twoseys. A paltry \$799 for the 12 range 1° model. A few coins more for the 0.1° version.

Call Frank Schulte COLLECT at (714) 565-4415 or write Doric Scientific, 3833 Ruffin Rd., San Diego, CA 92123. Be sure to ask him about our infinite life warranty.

Doric Scientific

An armadillo among the sheep.

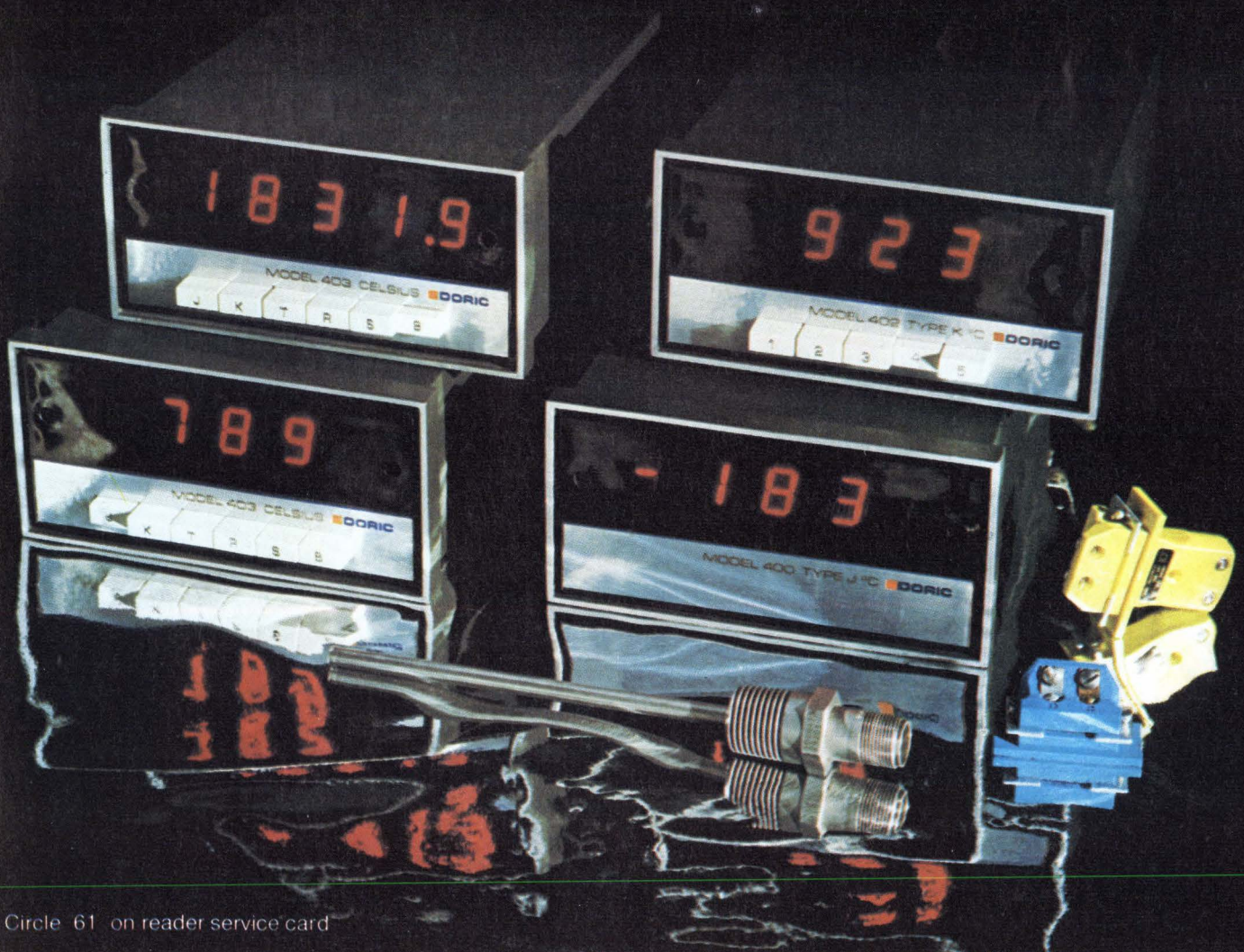

SIEMENS

Where

Quality

Must Endure

In today's competitive and fast-changing electronic world, the word "quality" is frequently used. At Siemens, quality is more than just a word. It's a tradition. One that's been synonymous with the Siemens contribution to technological progress for more than one hundred years.

To maintain this leadership, Siemens invests over two million dollars each working day on research and development, improving today's products and planning tomorrow's. This has helped Siemens pioneer in such components as metallized film capacitors, integrated circuits, surge-voltage protectors, relays and switches, semiconductors and ferrites.

To broaden its product line and strengthen its production, Siemens has acquired Dickson Electronics Corporation—a long respected name in zener diodes, tantalum capacitors and hybrid circuits—and combined it with its existing components division into the new Siemens Components Group. The result is local availability of over 50,000 different component configurations, all with the highest performance characteristics to serve industry's needs.

Whatever your industry, if your quality must endure, select components whose quality endures. Siemens.

To learn more about Siemens, write for our comprehensive new brochure "Siemens in the United States."

Siemens Corporation

186 Wood Avenue South, Iselin, N.J. 08830
(201) 494-1000





The world of Siemens Components.

Circle 63 on reader service card

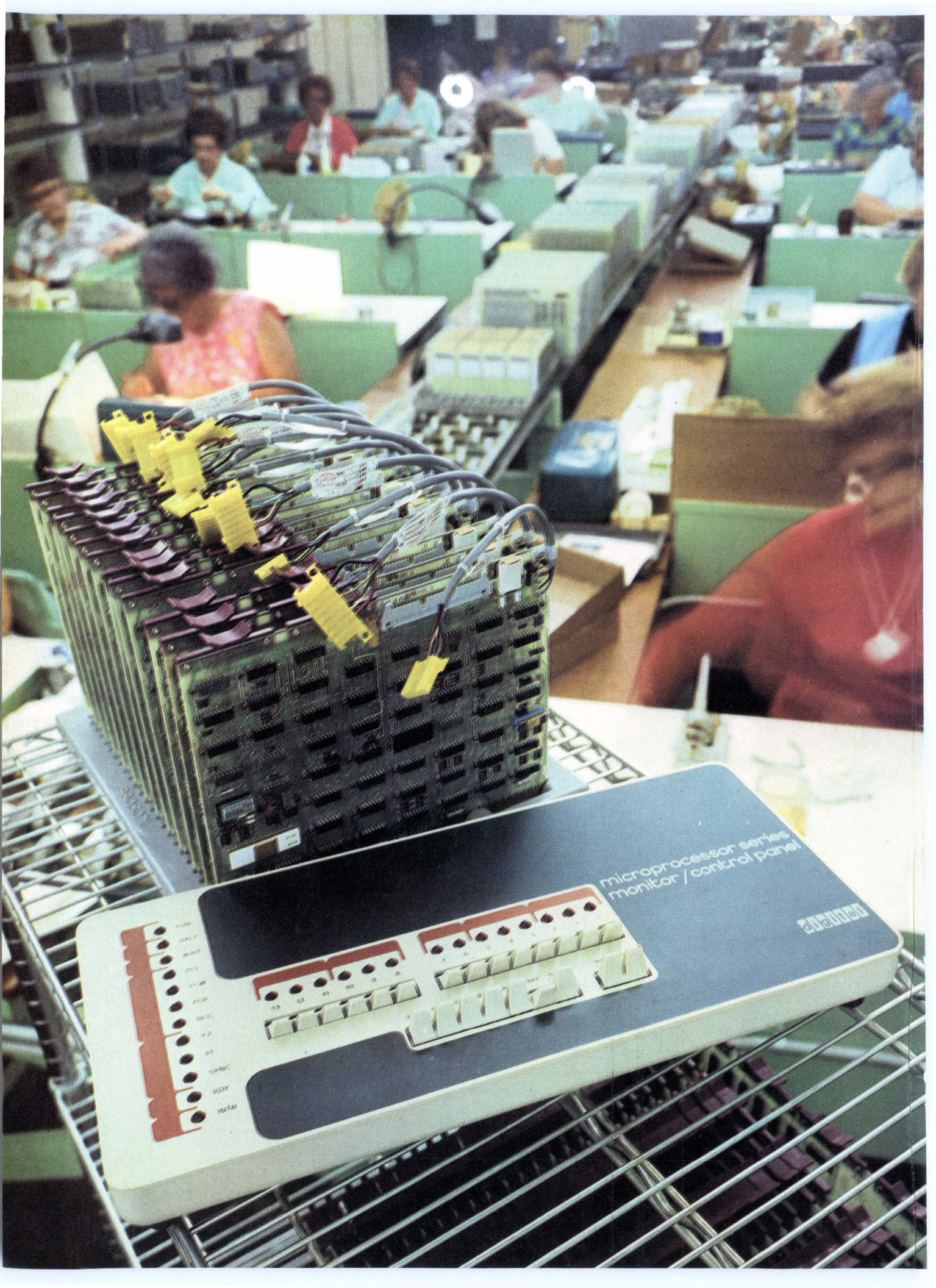

The MPS microprocessor series: get it now and get it going. In volume from the Components Group.

The MPS microprocessor series of modules is available now. We designed it using only standardly available components with a proven track record. So we can make it and we can make it work.

Plus, the MPS is easy to get up and going. Its external circuitry is TTL-compatible, which means you can interface to your computer or controller using Digital's broad line of standard logic modules.

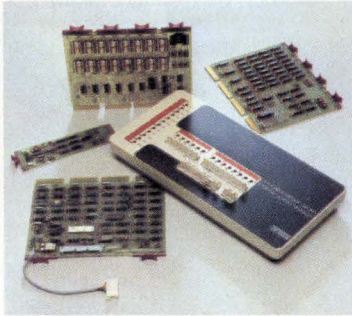

Software development is easier, too. Control programs are prepared on a small, low-cost PDP-8 minicomputer, using the MPS software development kit of six basic programs. And the modular construction of the MPS allows you to buy only what you need for your application.

Physically, the MPS is a series of four building-block modules and an optional control panel. A basic, fully-operational processor can be assembled from as few as two modules: the CPU and a memory module.

The CPU is an 8-bit parallel processor, employing reliable P-channel MOS/LSI technology. It will directly address up to 16K words of memory; cycle time is 12.5 μ sec. Reprogrammable memory (PROM) is available in 256-word increments. Read-write memory (RAM) is available in

1K-word increments.

An external-event-detection module implements nine levels of priority-arbitration. These include application-defined six-level priority interrupt schemes, AC and DC power-failure detection capability, and the processor-controlled functions of Halt and Restart.

Volume buying will get you a very attractive discount. The MPS is priced at \$476 for CPU and 1K of RAM, in quantities of a hundred.

So pick up the phone and dial 800-225-9480. Toll-free from 8:30 AM to 5:00 PM Eastern time. (US only. Massachusetts residents, please dial (617) 481-7400, extension 6656.)

We're the Components Group of Digital Equipment Corporation, One Iron Way, Marlborough, Massachusetts 01752.

In Canada: Digital Equipment of Canada Limited, P.O. Box 11500, Ottawa, Ontario, K2H8K8. (613) 592-5111, extension 127.

In Europe: 81 Route de l'Aire, 1211 Geneva 26, Telephone: 42 79 50.

\$476.00
IN QUANTITIES OF
A HUNDRED

digital
COMPONENTS
GROUP

**Unbundling the world's most
popular minicomputer systems.**

When we say Brand-Rex Vylink™ wires

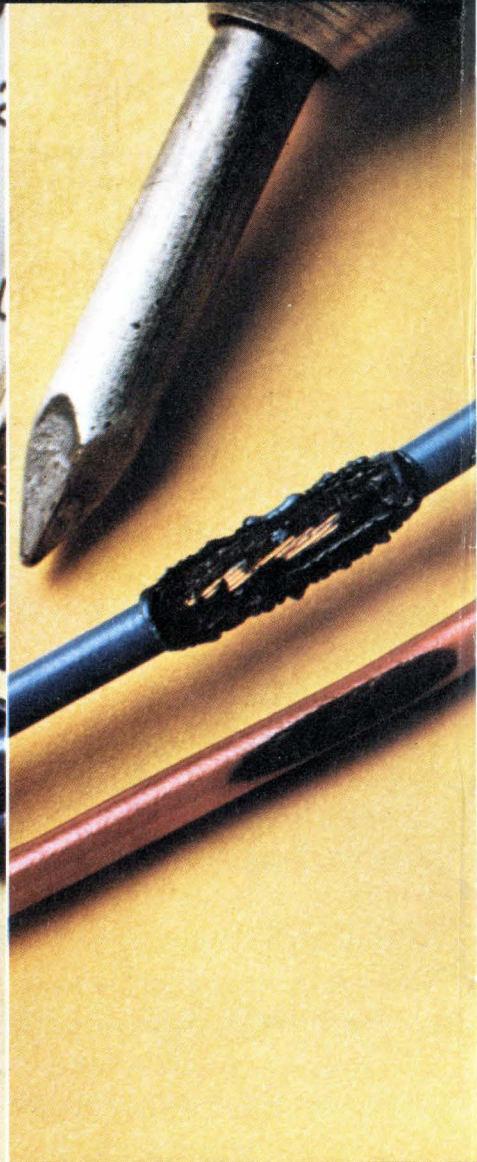
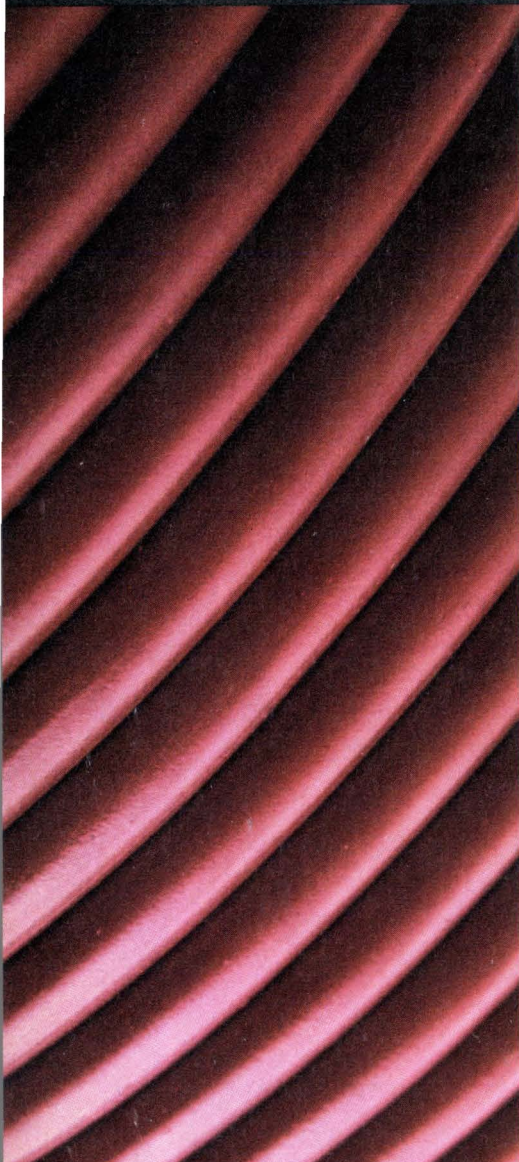

Vylink is the Brand-Rex trade name for its tough irradiated PVC insulated wire and cable. A thermosetting material, it has superior heat resistance, is unaffected when accidentally touched by a solder iron and has outstanding cut-through, abrasion and chemical resistance – all in addition to vinyl's inherent non-flammability (it meets UL's FR-1 requirements), high dielectric strength and insulation resistance.

Five important processing and operating characteristics of Vylink and conventional PVC insulated wires are compared in the following panels. Test procedures and Vylink's properties are detailed in Brand-Rex specification BR-790. Write for your copy to Brand-Rex Company, Willimantic, Conn. 06226. Tel. (203) 423-7771.

Heat Resistance

After 96 hours at 350°F, Vylink is unaffected, conventional PVC flows. Vylink wire provides far greater protection against current overloads and high temperature environments. It is recommended for shrink-tubing and wave solder cable terminations where wires are exposed to heat guns or solder baths – an excellent low-cost substitute for the premium-priced "high temperature" wires usually used in this application.

Solder Resistance

When a weighted solder iron (1½ lbs. force) is applied to the wire surface, conventional PVC insulation melts almost instantly; Vylink, though it may exhibit slight surface discoloration, shows no substantial change – even after several minutes. Regardless of method – hand gun, solder dip, wave soldering – Vylink insulation will neither shrink back nor melt. Shorts due to soldering are avoided. Circuit integrity is assured.

and cables are tough, we prove it.

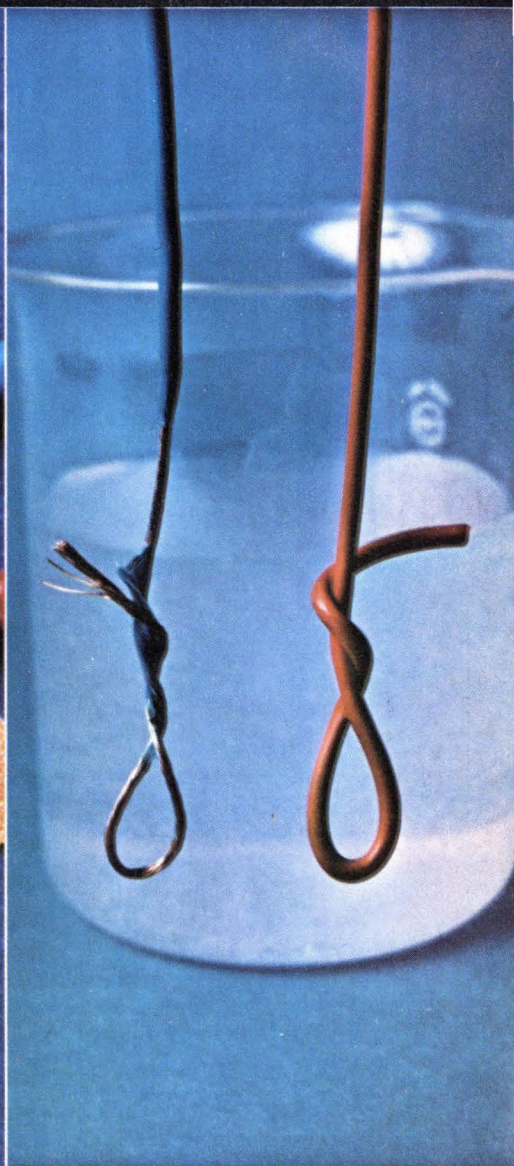
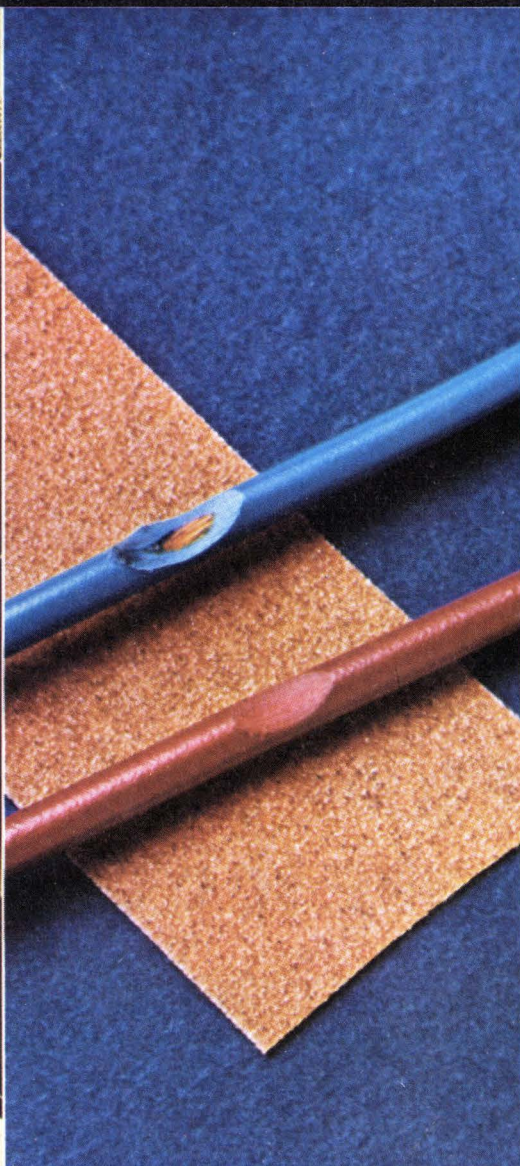
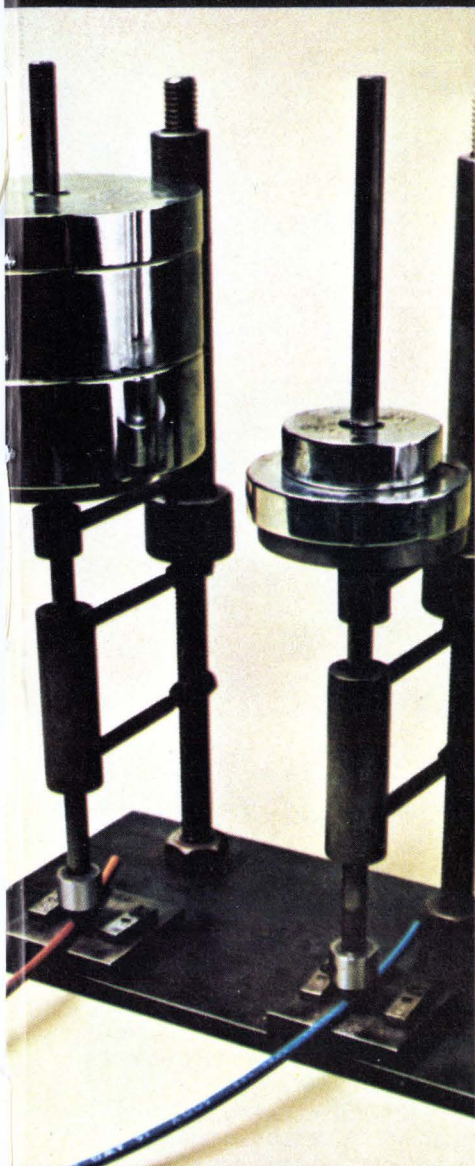

Cut-through Resistance

The relative resistance of *Vylink* and conventional PVC insulated wires to penetration may be demonstrated by applying a 90° V cutting edge attached to a weighted plunger perpendicularly to samples of each. To have the specimens cut through in the same length of time, *Vylink* wire must be subjected to at least 5 times the weight. This extra toughness makes thinner insulation walls possible without compromising physical properties. The result — lighter weight, smaller diameter, but equally reliable, cable.

Abrasion Resistance

In this test, a predetermined weight presses a conventional PVC wire sample against a moving 400 grit, aluminum oxide abrasive tape until the insulation has been worn away and conductor exposed. By comparison, more than half the insulation remains when the same amount of tape abrades *Vylink* insulated wire under identical conditions. This toughness permits the use of thinner insulation which UL recognizes by rating 6½ mil wall *Vylink* wire at 125 volts (UL Style 1472).

Chemical Resistance

Electronic bombardment of the specially formulated *Vylink* compound causes a change in the molecular structure and transforms this PVC material from a thermoplastic to a thermosetting plastic. *Vylink*, like all thermosets is generally inert to chemicals and solvents. When *Vylink* and conventional PVC are boiled for two hours in MEK (methyl ethyl ketone), a good solvent for vinyls, *Vylink* is virtually unaffected; conventional PVC is completely dissolved.

Circle 67 on reader service card

BRAND-REX

4,000 solutions in search of a problem.

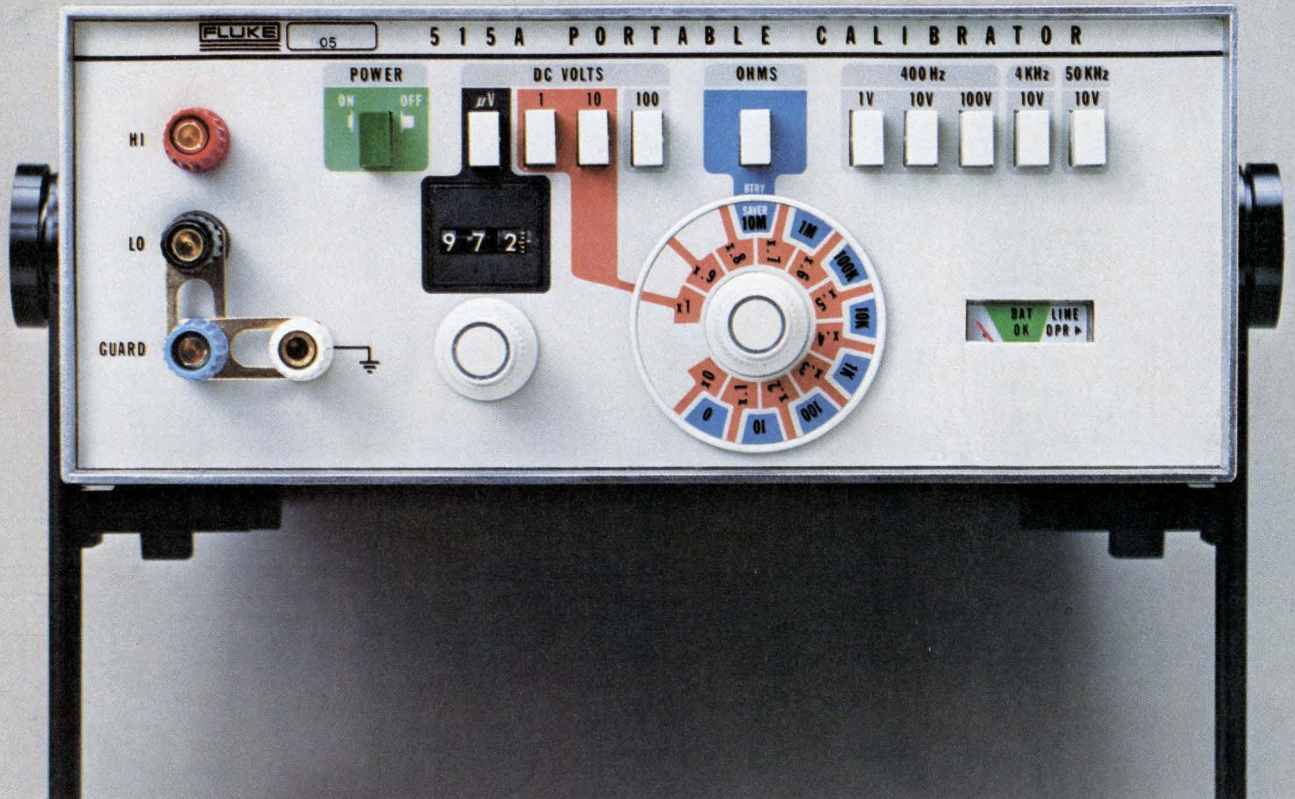

The new Fluke portable cal lab. You take it to the job.

Here's a new approach to calibration sure to save you time, trouble and money. Take the new Fluke 515A Portable Calibrator to the site—save time. Calibrate equipment in place—save trouble. Do most of your calibrations with this one low cost standards lab—save money.

Think how good it will be with the new Fluke 515A Portable Calibrator at your fingertips. Now, solve most of your cal problems on-site. Keep your digital voltmeters, multimeters and comparable devices up to original specs all the time. Take advantage of best short term specs for critical situations.

The low cost Fluke 515A offers a basic $\pm 0.001\%$ accuracy per month ($\pm 0.003\%$ per year) over a wide temperature range, 18°C to 28°C . It weighs a scant 13 pounds (5.9 Kg). For complete portability, the self-contained rechargeable battery gives you up to 8 hours off-line operation.

Color coded functional controls are coherently organized and human engineered. To simplify operation, there is only one set of output terminals for all functions. All specifications are summarized on a decal so the user can conveniently determine the absolute accuracies of a given measurement.

Do all these things with the cal lab in a box. Use it as a basic ac/dc reference standard. At receiving, check all your incoming ac/dc and



resistance devices. Take it wherever you are using digital multimeters and voltmeters so you can take advantage of a given instrument's best short term specs.

Calibrate accuracy, linearity, stability, ac response, offsets, residuals and ranging.

Super specs and only \$1995. DC output is 0 to 999 μV continuous with 0.2 μV resolution, 0 to 1.0 V in 0.1 V steps, 0 to 10 V in 1 V steps and a precise 100 V cardinal point.

AC outputs are offered at three frequencies, 400 Hz, 4 kHz and 50 kHz. 1 V, 10 V and 100 V rms sine wave outputs are available at 400 Hz. 10 V rms is also provided at 4 kHz and 50 kHz. Basic ac accuracy is $\pm 0.04\%$. Resistance ranges are 10 ohms through 10 megohms in decade steps with a mid-range accuracy of $\pm 0.015\%$.

Get all the details. Call your Fluke sales engineer or dial our toll free hotline.

John Fluke Mfg. Co., Inc., P. O. Box 7428, Seattle, WA 98133

For data out today dial our toll free hotline 800-426-0361

For a demo circle 68. For literature only, circle 69.

For info on the rest of the Fluke line see our ad in EEM or the Gold Book.

Giving you a little more to believe in.



Probing the news

Analysis of technology and business developments

IEDM aims at speed, power, density

Electron Devices Meeting features developments in digital processing and microwave parts in its sessions

Digital processing devices are denser and faster than ever, and microwave parts have increased power at higher frequencies. Those were the two main thrusts of this year's International Electron Devices Meeting in Washington, Dec. 9-11.

Digital

A principal aim of today's device research is to extend the limits of bipolar technology in the direction of smaller circuits that operate faster at lower power than ever. An example is injection logic, the LSI bipolar technology invented three years ago that promises 1,000 gates on a single digital chip with a speed-power product of less than 1 picojoule. Already, digital and analog-to-digital linear circuits for television and audio applications, watch circuits, and memory and microprocessor chips for data-processing systems are emerging.

Among them is a new form of injection logic, called substrate-fed logic (SFL), which pushes still further the limits of conventional integrated injection logic to provide higher device packing densities and lower speed-power products, and ultimately faster speeds in optimized devices. Indeed, SFL structures already built by researchers at Plessey Co.'s Allen Clark Research Center, near Towcester in Northamptonshire, England, have three times the packing density and half the speed-power product of conventional I²L structures.

The smaller device sizes result directly from a clever arrangement of the key npn transistor in the injection-logic gate structure. It's put vertically above the injector in contrast to their lateral arrangement in conventional injection logic.

While such new bipolar forms as injection logic are already being revised, innovations are also being made in conventional bipolar logic structures. The bulk of the work is mainly concerned with speeding up the operation of devices while reducing the size of emitters, decreasing depth of bases, and narrowing the isolation regions.

From the East. Three key developments in fast LSI are coming out of Japan. Workers at the semiconductor division of Fujitsu are building transistors with operating frequencies (F_t) as high as 8 gigahertz and with sub-micrometer emitter formations. Researchers at Nippon Electric Co. achieve similar results using a low-emitter-doping concentration (LEC) for their emitter geometries, and a different team at

Nippon is using a new isolation technique to achieve very-low-noise operation at low frequencies.

In the Fujitsu work, which has the advantage of being a self-aligned process for LSI applications, a silicon-nitride etching process reduces the emitter geometry and with it the transistor size. The process provides an outer base layer that is slightly deeper than the base layer itself so that the base resistance (with high F_t) can be reduced an order of magnitude—usually a decrease in emitter size results from high base resistance, which cuts speed. Thus, with an easily manufacturable 3- μm mask, emitter widths as small as 0.5 μm and base depths as small as 0.3 μm are achieved. What's more, these transistors have been built into IC gate structures that have a propagation delay of only 0.25 nanosecond in a standard common-mode logic format. This outperforms any of today's emitter-coupled-logic circuits.

The new isolation technique being applied to linear ICs can pro-

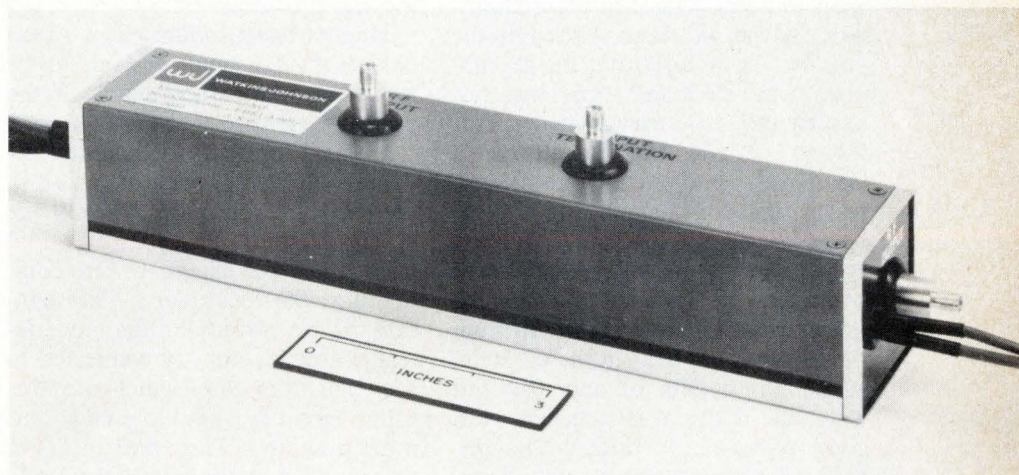

Passing through. This is Watkins-Johnson's WJ 3650 low-pass amplifier. It operates in a frequency range of 0 to 150 MHz; its power rating is 100 W at 4% duty cycle.

Probing the news

duce an ultra-low-noise amplifier (only 3 decibels) at frequencies as high as 10 hertz. The technique is highly reliable because it's done at unusually low temperature.

In the past, the major cause of inferior noise performance of a transistor in linear circuits has been caused by contaminants associated with the high-temperature (1,250°C) of the impurity diffusion used for isolation. The new "cold" process is made possible by conversion of silicon into porous silicon. Usually, this requires masking of the chip with nitrides, which increases the process complexity and cost. In the Nippon Electric approach, the extra process steps are eliminated by a proprietary bath that permits the conversion process to be masked by photoresist in the conventional way.

As a sidelight to bipolar development, a new amorphous emitter structure clearly shows electronic switching properties and potential usefulness for semiconductor applications. David Adler and Kurt E. Peterson of the Massachusetts Institute of Technology have fabricated and operated an amorphous emitter transistor that proves that the amorphous switching mechanism is electronic rather than thermal—a process nearly impossible to control. Since the device works with 1-ns pulses, too fast for heating, it seems clear that the switching mechanism is electronic.

Using glass/pn-silicon devices, Adler and Peterson have shown that electrons are the majority carrier in the on state, while holes predominate in the off state. Although the researchers thought that the mechanism was electronic, this was not exactly the result they expected. Adler notes, "You don't usually get a large injection of electrons out of intrinsic semiconductors, and the reverse injection of holes to the amorphous material should have swamped the forward injection so there would be no gain." Indeed, that is what happens in the off state, which has a gain of only 0.1, but when the material is switched, gain goes up by nearly 2 orders of magnitude—to between 4 and 6. The thresh-

hold voltage of the device is 20 volts.

Much criticism of earlier work in amorphous semiconductors has been centered around their reliability and reproducibility. However, Adler says he has switched one device 10^7 times without failure, and his devices are reproducible.

Charge coupling. In its first detailed public disclosure of three years of work in charge-coupled devices, Hughes Aircraft Co. discussed a CCD memory and imagers related to infrared systems. One of the basic developments is a new type of input and output structure that permits merging of serial input or output signals into or out of a fast "racetrack" configuration without loss of charge-transfer efficiency. It is analogous to a fast-moving sidewalk that has an ancillary ramp to bring pedestrians up to speed before they get on the walk.

Both structures prevent loss of speed, permitting the racetrack to operate at frequencies higher than 1 megahertz with high transfer efficiency, measured at 0.99986 after 4,800 transfers. The CCD chip measures 150 by 200 mils, and the racetrack contains 150 bits. It is used as a line converter, a slowly scanning infrared-system input, and a much faster output.

Hughes has also developed a non-recursive CCD filter that uses single-phase devices rather than the multiphase versions now in use. The single phase could make the system easier to adapt to other systems. The filters also permit matching to both the desired signal spectrum and mismatching to the noise spectrum encountered, which would improve the signal-to-noise ratio.

Hughes has also fabricated a CCD device that is small enough to be mounted at the focal plane of the optical system so that the IR signals can be multiplexed for remote time delay. The CCD, which is cooled to very low temperatures, makes the system more flexible than it would be if all of this circuitry were combined at the focal plane. The separate 32-bit indium-antimonide detector array is directly connected to a silicon CCD chip, which contains input circuitry, antiblooming, and multiplexing. The multiplexing greatly reduces the number of leads

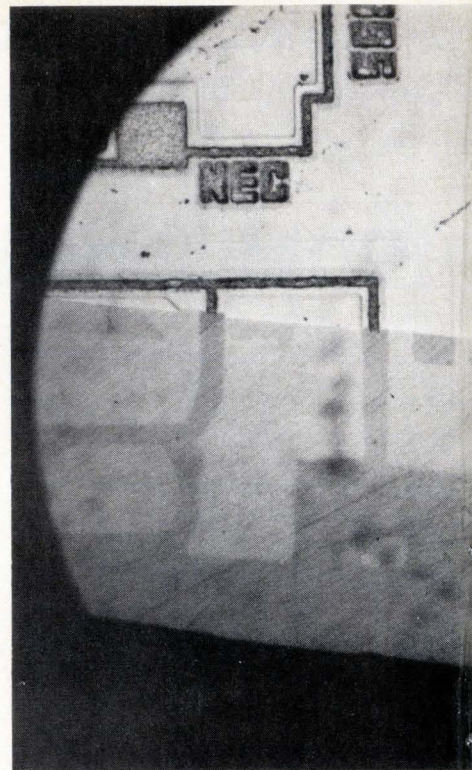

required, which reduces heat leaks.

The final Hughes device is a CCD chip used for detection of infrared light. For this application, three detector arrays, of 8, 16, and 32 bits, are combined with CCD registers and signal processors of similar capacities, plus background correction and antiblooming overload protection to permit the output register to carry only the relevant IR signal.

Digital capacitor. Traditionally, a capacitor is an analog component. Its value is either fixed or continuously variable, as for a trimmer capacitor. But now, at the R&D center of General Electric Co. in Schenectady, N.Y., a digitally programmable capacitor has been developed.

The new device is made up of a parallel combination of metal-oxide-semiconductor capacitors and MOS field-effect-transistor switches—all fabricated on a single chip. Each MOS capacitor can be individually switched and maintained at two distinct radio-frequency capacitance values—one high and the other low. The maximum-capacitance binary state is that of an inverted MOS device at high frequencies, while the minimum-capacitance state is that of a fully depleted MOS device. High-Q operation in the vhf and uhf regions is possible.

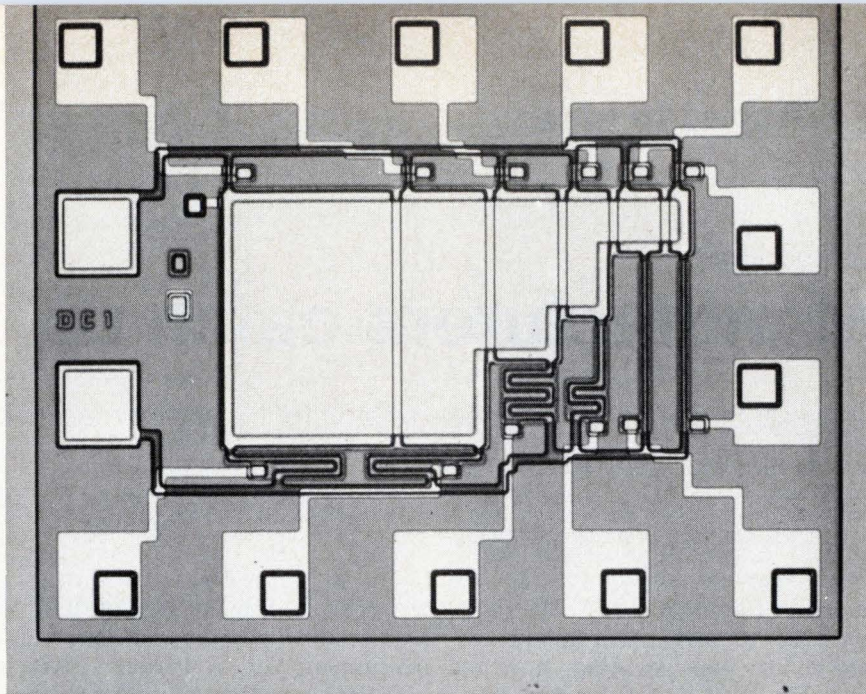
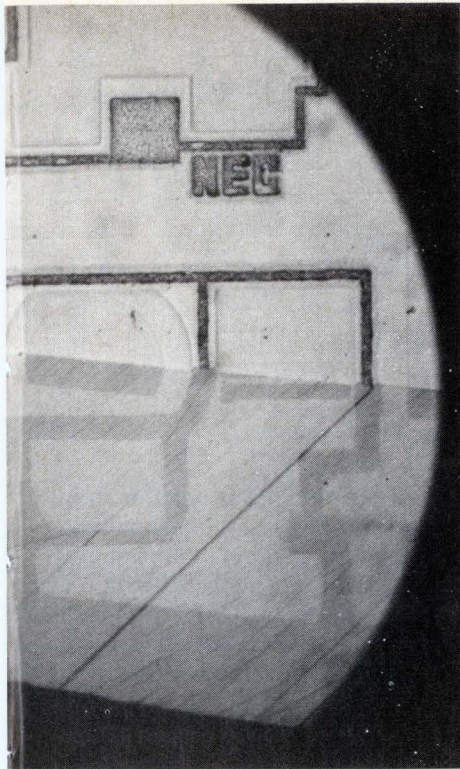

Digital. General Electric has developed the digitally programmable MOS capacitor shown above. Its parallel combination of capacitors and FETs is fabricated on a single chip.

From Japan. Nippon Electric's researchers have developed a low-emitter-doping concentration for their emitter geometries, left. Nippon also reported on a new isolation technique.

Microwave

Microwave devices—semiconductors, vacuum tubes, and a combination of the two—came in for major attention at six sessions. Among the papers drawing the most interest were those on new electron-bombarded semiconductor (EBS) devices, which consist of an electron gun, modulated by an rf input signal, which bombards a semiconductor-diode target. This modulates the diode's current to provide an amplified output signal [*Electronics*, July 25, p. 85].

An exploratory program has been in progress for the last two years at Watkins-Johnson Co., Palo Alto, Calif., to develop EBS amplifiers that surpass the performance available from either transistors or traveling-wave tubes. Performance to date, says Watkins-Johnson's James A. Long, includes a pulsed 500-watt L-band amplifier that operates from 1 to 2 GHz. Maximum output power was 520 w at 0.1% duty cycle at 1.5 GHz and 250 w at 1%. At the 500-w level, saturated gain is about 23 dB, and small-signal gain is 29 dB. The 3-dB bandwidth is 106 MHz (6.8%). Voltage-reset time is 6 ns at 200 A, and at 400 A, rise time is 10 ns.

Another EBS device may help

solve a problem that has held back full use of millimeter-wave systems. Millimeter waves offer the prospect of heavy data handling, but in practice, multiplexing and data-input equipment has been limited in data rate. An EBS device developed at the Northrop Research and Technology Center permits multiplexing eight data-input lines to a single output (parallel-to-serial conversion) at a data output rate as high as several gigabits per second. The output power is sufficient to drive a p-i-n diode phase-shift modulator at 2 gigabits a second for a millimeter-wave carrier.

Diode-target construction is critical to performance of the device, researchers say, and its design must permit it to operate in the electron-beam environment without degradation. This is accomplished by using a polysilicon beam shield, layer, and guard ring, which moves the periphery of the junction to a protected region under the polysilicon. The researchers have been able to fabricate diodes that exhibit little or no breakdown in voltage with a 10-kilovolt electron beam. Voltage breakdown has been a problem with semiconductor targets in the past. Cooling remains a problem. High temperatures cause device failure

because silicon diffuses out into the aluminum contact films. Adding a thin chromium layer appears to prevent this, and devices with this construction are currently under life test at a power density of 30 w per square millimeter—thus far without degradation.

Northrop's work is being done for the Air Force Avionics Laboratory, which will use the device in millimeter-wave systems, but a researcher says it could also be useful for waveguide telephone systems.

Engineers at Hewlett-Packard Co.'s Microwave Technology Center in Palo Alto, Calif., are working on an experimental 6-GHz silicon bipolar power transistor that shows promising performance, gain, and efficiency. Chip size is 620 by 500 micrometers (about 24 by 20 mils), and the base is divided into four separate areas, or cells, for better heat dissipation and ballasting.

Although still far from the production stage, the 6-GHz device shows considerable promise for dependability. About 40 devices have been tested for an equivalent operation time of 12 years without a single failure. In addition, 50 transistors were held at 150°C for 96 hours with their collector bases reverse-biased at 30 v. □

Components

Manufacturers catch up

Now that demand has dropped, resistor and capacitor makers can spare production capacity for their delayed new-product lines

by Lucinda Mattered, Components Editor

Only a year ago, resistor and capacitor manufacturers had all they could do to keep up with the demand for their existing product lines. Lead times were stretching to a year in some cases. However, the general business slowdown that hit components this past summer freed production capacity for new products that manufacturers had been forced to sideline during those hectic times. Now, product lines are being expanded, new materials are being tried, and new markets are being sought through new designs.

One such area, very much in vogue these days, is IC-compatible packaged networks. Most of the major resistor and capacitor suppliers now offer a selection of dual in-line, as well as single in-line, networks.

This year saw Bourns Inc. of Riverside, Calif., and Stackpole Carbon

Co. of St. Marys, Pa., follow the success of such suppliers as Allen-Bradley Co. of Milwaukee and Beckman Instruments of Fullerton, Calif., with their own lines of thick-film resistor networks. And Sprague Electric Co. of North Adams, Mass., noting the popularity of its packaged ceramic capacitor chips, is now putting tantalum chips in dual in-line and single in-line packages.

Early in 1975, Sprague will be selling DIP networks containing a combination of ceramic and tantalum chips. The new networks are intended for decoupling applications for transistor-transistor logic and MOS systems. The DIPs can have from two to 16 pins and can accommodate up to eight ceramic chips, four tantalum chips, or a combination of the two. For these networks, Sprague has maximized the CV product of the tantalum chips; it ranges from 238 to 330 volt-microfarads.

Stackpole's DIP and SIP thick-film resistor networks are made up of resistive elements that are shaped like top hats, quite different from the usually rectangular competitive devices. Because of their top-hat design, the resistors can be laser-trimmed without appreciably decreasing their current path and creating unwanted hot spots. Furthermore, the resistive material is intended for laser trimming. All this adds up to better power performance.

Bourns will shortly introduce a complete standard line of DIP and

SIP cermet thick-film resistor networks and is also coming out with an economy line of conformally coated SIP resistor networks within a couple of months. (Pricing is still uncertain at this time). The company will also be announcing a new family of resistor-capacitor networks for use with emitter-coupled-logic systems.

Beckman Instruments has just augmented its family of DIP thick-film cermet resistor networks with a complementary line of SIPs. Unlike a dual in-line package, a single in-line package offers the advantage of being directly accessible from either one of its sides.

Some variable resistors are being designed as modules for greater flexibility of application. A single line of these modular controls is made up of hundreds of standard and optional selections, so that there are literally millions of possible combinations, and the user can tailor his control to satisfy his exact needs. Actually, the modular-control concept originated with Allen-Bradley, which introduced it about four years ago in its series 70 MOD POT line of potentiometers and switches.

Within a few months, Bourns will be second-sourcing this Allen-Bradley line with its own model 80 modular control series. At first, just the potentiometer sections will be available, with the switch sections to follow by the end of 1975. The potentiometers are $\frac{3}{8}$ -inch-square units containing either a conductive-plastic or cermet resistive element. Up to four sections can be ganged for a single control. The total torque force can be closely adjusted so that it

Kitted. Allen-Bradley has put its series 70 MOD POT line into this kit. It can be used to assemble up to 20 prototype controls.



Proven Ideal for Instrumentation Manufacturers!

High Frequency Counters from PLESSEY.

Most leading manufacturers of 512 MHz counters have one great thing in common: Plessey high-speed divider circuits in the front end of their instruments. The reason for their unanimous choice? Plessey makes the best possible device for their application. Yours, too.

In fact, Plessey Semiconductors offers a comprehensive line of high-frequency dividers up to 1.2 GHz... all state-of-the-art... all ideal for virtually every counter application.

Divide by 2, 4, 5 or 10

You can specify Plessey counter IC's to divide by 2, 4, 5 or 10. With some decade devices, you get BCD outputs, too. And you get guaranteed frequency of operation over the entire temperature range of 0°C to +70°C on commercial grades, -55°C to +125°C on MIL Grades.

Higher Frequency, Lower Power Consumption

You've probably heard this statement from Plessey before. As usual, nobody even comes close to our input frequencies of up to 1,200 MHz. With an incredibly low power drain, as you can see from the tables.

Plessey offers Custom Counters, too

Send for our data sheet with all the facts. Whatever your counter application, we bet you'll find Plessey has the best approach. And, in the rare case where we don't have a standard counter for your exact requirements, let us quote on a custom. For more information, write or call today. **You'll find it pays to specify Plessey.**

YOUR CHOICE OF HIGH FREQUENCY COUNTERS

Type*	Modulus	Speed (MHz)**	Power Drain (mA typ)
SP8600A & B	+4	250	16
SP8601A & B	+4	150	16
SP8602A & B	+2	500	12
SP8603A & B	+2	400	12
SP8604A & B	+2	300	12
SP8607B	+2	600	12
SP8613B	+4	700	60
SP8614B	+4	800	60
SP8615B	+4	900	60
SP8616B	+4	1,000	60
SP8621B	+5	300	55
SP8622B	+5	200	55
SP8630B	+10	600	70
SP8631B	+10	500	70
SP8632B	+10	400	70
SP8635B	+10	600	80
SP8636B	w/BCD outputs	500	80
SP8637B	w/BCD outputs	400	80
SP8665B	+10	1,000	80
SP8667B	+10	1,200	80

*Guaranteed operating temperature for "A" types: -55°C to +125°C, "B" types: 0°C to +70°C.

**Guaranteed input frequency range (sine wave).

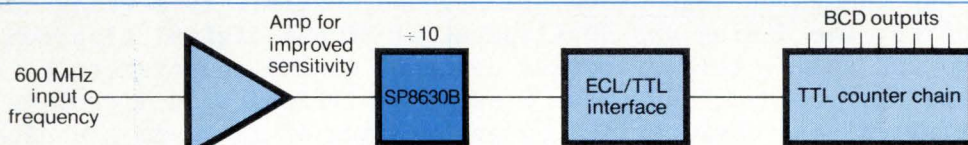

TYPICAL APPLICATION OF SP8630B FOR FREQUENCY MEASUREMENT

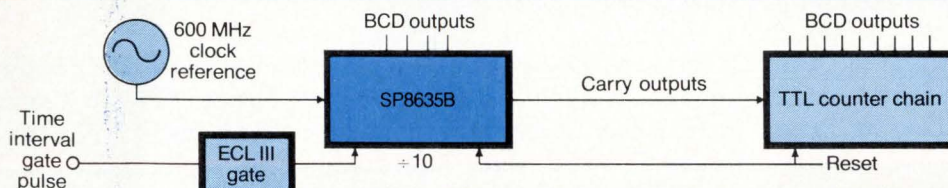

TYPICAL APPLICATION OF SP8635B FOR TIME MEASUREMENT



PLESSEY SEMICONDUCTORS

1674 McGaw Avenue, Santa Ana, California 92705 • Tel: (714) 540-9945, TWX: 910-595-1930
Cheney Manor, Swindon Wiltshire, England • Tel: (0793) 6251, Telex: 449637

West Germany - Tel: 811 3516021, Telex: 5215322 • France - Tel: 727-4349, Telex: 62789 • Italy - Tel: 3491741, Telex: 34347 • Sweden - Tel: (08) 23 55 40, Telex: 10558

SCIENCE / SCOPE

How a communications satellite can serve isolated areas was demonstrated to delegates at the first International Congress of Electrical and Electronic Communications in Mexico recently. A clear voice link was immediately established with people on Isla de Cedros, an island off the west coast of Baja California, via Western Union's Westar I and a portable earth station, both built by Hughes. In another experiment, three Canadian oil companies successfully completed similar demonstrations, using the same earth station with the Hughes-built Anik satellite to relay voice communications from remote arctic sites to company headquarters in Calgary.

A hologram lens system for a pilot's "head-up" display, currently being developed by Hughes research scientists, uses holography to produce the optical properties of a lens on a transparent plate in the pilot's line of sight. Projecting information via this plate does not block his vision outside the cockpit. The new technique has a larger field of view and lighter weight than display systems using conventional lenses and promises to be highly cost-effective.

The first mosaic map of the continental U.S. ever assembled from satellite photos taken from the same altitude and lighting angle was completed recently by the U.S. Department of Agriculture, which combined 595 photos taken by the Hughes-built multispectral scanner system (MSS) aboard NASA's Earth Resources Technology Satellite (ERTS). The map will aid in assessing the nation's surface water, drainage network, land use, and vegetation. Though NASA originally predicted a lifetime of only one year for ERTS, it began its third year July 23. Its still functioning MSS has now sent more than 200,000 photos back to earth.

A space-qualified three-stage cryogenic refrigerator, designed for super-cooling infrared sensors to increase their sensitivity, has been developed for the U.S. Air Force by Hughes. It is the first three-stage refrigerator of the Vuilleumier type ever built and cools down to -439°F . (absolute zero is -459.6°F .). Because it operates at slow speed and low pressure, it provides high reliability and a long, maintenance-free life. It has already operated for 2,000 hours and will be delivered to the Air Force Flight Dynamics Laboratory at Wright-Patterson Air Force Base for a 5,000-hour operating-life test.

Hughes Space and Communications Group, El Segundo, Calif., is seeking engineering managers to direct the design and development of RF and digital electronics circuits and subsystems and solid-state microwave devices, including parametric, tunnel diode, low-noise transistor, linear and class C power amplifiers, and microwave integrated circuits. Requirements: engineering degree, minimum of 10 years technical experience, U.S. citizenship. Write: Mr. A. St. Jacques, P.O. Box 92919, Los Angeles, CA 90009. An equal opportunity M/F employer.

Two weather-mapping instruments will be built by Santa Barbara Research Center, a Hughes subsidiary, under contract with NASA's Goddard Space Flight Center. The VISSRs (Visible/Infrared Spin-Scan Radiometer) will be the major payload aboard the second and third Geostationary Operational Environmental Satellites, scheduled for launch in 1976 and 1977. A VISSR aboard the first Synchronous Meteorological Satellite is providing excellent day-night weather photos of the entire earth's disc every 30 minutes from a stationary position 22,300 miles above the Amazon.

Creating a new world with electronics

HUGHES
HUGHES AIRCRAFT COMPANY

Probing the news

does not become prohibitively large.

Meanwhile, Allen-Bradley has not been standing still. This month, the company is adding another series to its MOD POT line. These series 72 units have plastic shafts and bushings for electrical isolation in high-voltage applications. The potentiometers contain carbon-composition resistive elements. Up to two sections can be ganged for a single control.

Resistance values range from 50 ohms to 10 megohms, with standard tolerances of $\pm 10\%$ and $\pm 20\%$. The power rating is 0.5 w per section at 70°C , and the operating temperature range is -55°C to $+100^\circ\text{C}$.

Additionally, the older series 70 MOD POT line will soon be available in kit form. The kit, which is packaged in a desktop container, includes a selection of components for assembling up to 20 prototype controls. An instruction manual, tools, fixtures, and lubricants are supplied.

Allen-Bradley is also extending the maximum resistance range of its type CC cermet-film resistor line from 1 megohm to 10 megohms. The higher resistivity, without a sacrifice in performance, is made possible by an improved resistive ink.

Improved materials are also making a difference in capacitors. For example, Erie Technological Corp. of Erie, Pa., will soon be offering its high-K ceramic dielectric in tubular capacitors. For some time now, the company has been selling ceramic disk capacitors made with the material, which has a dielectric constant of about 50,000.

Another capacitor manufacturer, Vitramon Inc. of Bridgeport, Conn. also has developed an improved dielectric for its multilayer ceramic chip capacitors. The new material provides twice as much capacitance for a given chip size.

After one and a half years of development, Sprague is about to announce its model 135 all-tantalum electrolytic capacitor—even the case is made of tantalum. The unit, which has an all-welded construction, can take reverse voltages of 2 v. It is intended for military and aerospace applications.

A logical test for Digital Logic Test Systems.

1. Can response be measured 100 nanoseconds after simultaneous applications of stimulus?

Yes **No**

2. Are clocks programmable for frequency, pulse width and number of pulses?

Yes **No**

3. Is it economically expandable to three work stations with 1024 two-way interface lines in each station?

Yes **No**

4. Does the system software provide a debug feature which allows the operator to monitor and control the test?

Yes **No**

5. Does it provide File Management, guided-probe fault isolation and complete self-test to the card level?

Yes **No**

Hughes 1024 Digital Logic Test System.



Hughes 1024 Digital Logic Test System answers yes to all the questions above. It also provides an optional simulation system, Digital Fault Analysis (DFA), which generates a logic model; simulates the unit under test; verifies using fault insertion techniques; and generates fault isolation data for the automatic guided probe. Time independent gate level simulation identifies "race" conditions and traces them to their origin.

Write for our new brochure: Hughes Automation Analysis, 2020 Oceanside Boulevard, Oceanside, CA 92054. Or call (714) 757-1200, Extension 336.

HUGHES
HUGHES AIRCRAFT COMPANY
INDUSTRIAL PRODUCTS DIVISION

Circle 75 on reader service card

Communications

AT&T suit: spur to competition

Acceleration in new services and hardware predicted regardless of outcome of U.S. action; FCC overload a factor in filing

by Ray Connolly, Washington bureau manager

"This is a conspiracy to obstruct competition. That is the issue here; not the costs or the efficiency of Western Electric," says one government attorney specializing in communications law. "That's what AT&T is going to have to address itself to in court." That view was expressed shortly after the Justice Department's late November filing of the largest antitrust suit in U.S. history—against American Telephone & Telegraph Co., its manufacturing subsidiary Western Electric Co. Inc., and Bell Telephone Laboratories Inc., its R&D arm. It's the nub of the government case as initially

presented in its 15-page charge.

The allegations of illegal monopoly and conspiracy by the three corporate defendants and the 23 operating telephone companies of the Bell System named as co-conspirators contend that they have not only conspired "to prevent, restrict and eliminate competition" by other competing carriers by denying them interconnection with the Bell System, but the Government also charges the companies with doing the same "to other manufacturers and suppliers of telecommunications equipment."

First response from AT&T chair-

man John B. deButts was predictable. Vowing to "fight to the end," deButts was adamant that "there will be no consent agreement" such as the one that AT&T negotiated in 1956 to terminate an earlier government antitrust action that had been hanging fire for nearly seven years. But deButts left the door open with a later observation to the effect that he did not know how much room there was to maneuver because he had yet to talk to the Justice Department.

Not only is AT&T being pressed to divest and subdivide Western Electric, whose 1973 sales of \$7 billion represented nearly one third of AT&T's revenues, but the government wants to split off either the Long Lines department or some or all of the operating companies. The government is less certain about Bell Labs, with its \$500 million R&D budget supporting some 17,000 workers at three main laboratories in New Jersey, another in Illinois, plus facilities in seven other states. Its future is left to the court in the Justice filing.

Timetable. Unlike the government's antitrust action against International Business Machines Corp., now expected to come to trial in early 1975 after six years of preparation, the AT&T suit could be ready for court in no more than three years, perhaps two, by most legal estimates in Washington. As Edward Spivak, counsel for the North American Telephone Association explains, "this is not like IBM. With AT&T, most of the discovery process has already been done. It is a matter of knowing where to look" for the documentation. Attorney Spivak be-

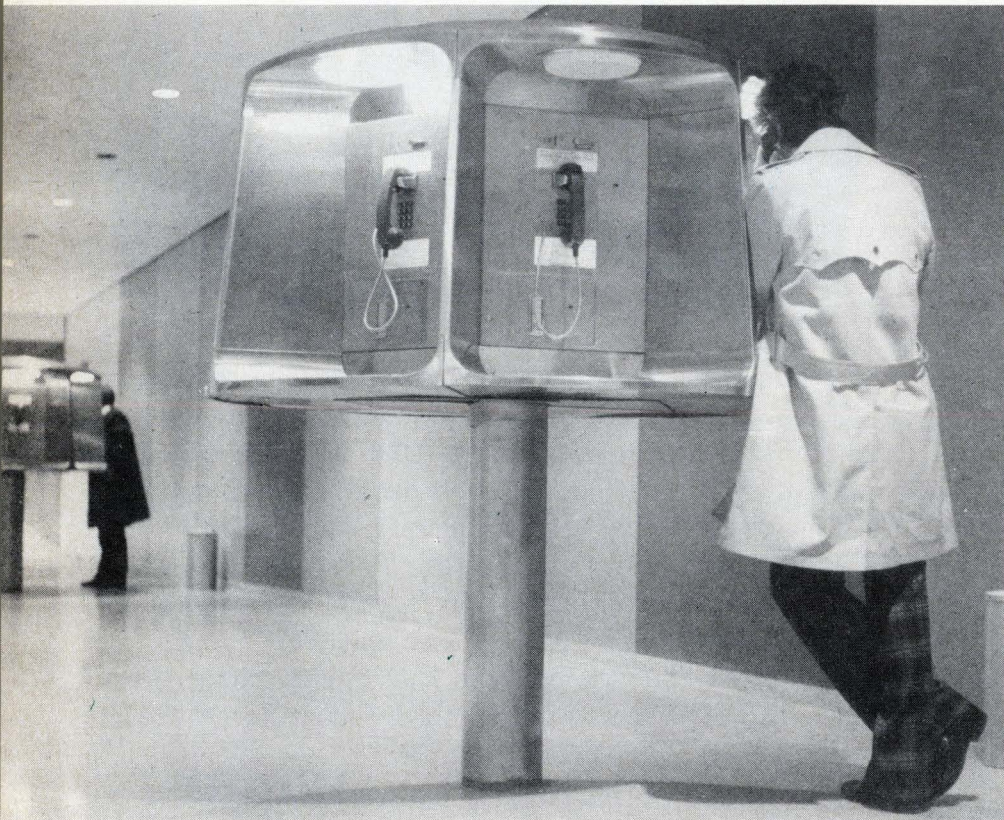

Careful there . . .
you're likely
to start
something.



Just a
"flutter" of pressure
. . . and SNAP!

Less than 2 grams of force actuates this Cherry snap-action miniature switch. Outside, the external aluminum actuator is purposely $2\frac{3}{8}$ " long to provide this unusually low operating force. Inside, an extra internal actuator further reduces operating force while maintaining solid contact mating pressure for reliable performance.

The "flutter force" switch is only one of Cherry's E22 series of unique miniatures. All are rated 3 amps, 125 VAC. All are also available in gold "crosspoint" configuration for low energy solid state circuits.

A switch in your hand is worth two in the tree, so . . . SNAP UP A FREE SNAP-ACTION SAMPLE.

Just TWX 910-235-1572 . . . or PHONE 312/689-7700 and ask Frank to give you facts on miniature switches . . . or circle appropriate reader service number.

E22-75HX
5 grams LIGHT
FORCE actuation
Circle No. 76 for
Free Sample

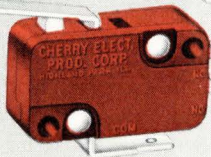

E22-55HX
3.5 grams LIGHTER
FORCE actuation
Circle No. 77 for
Free Sample



E22-85HX
Less than 2 grams
"FLUTTER
FORCE" actuation
Circle No. 78 for Free Sample



CHERRY

CHERRY ELECTRICAL PRODUCTS CORP.
3608 Sunset Avenue, Waukegan, Illinois 60085



Cherry affiliates worldwide • Hirose Cherry Precision Co., Ltd., Tokyo • G. W. Engineering Pty. Ltd., Sydney
Cherry Electrical Products (U.K.) Ltd., St. Albans, Herts • Cherry Mikroschalter GmbH, Bayreuth, Germany

Probing the news

believes he knows. His law firm, Cohn & Marks, filed a \$900 million private antitrust action against AT&T on behalf of nine small NATA member companies just two days before the government acted on its own [*Electronics*, Nov. 28, p. 46].

Because AT&T, unlike IBM, is subject to Federal and state regulation, there are massive amounts of documentation already available. Prime source is the Federal Communications Commission, which announced plans for its first major investigation of AT&T, its structure, and its determination of costs, nearly a decade ago. That investigation continues.

Though the court battle in the antitrust suit is at least two years away, there is already much informed speculation as to the impact

on technology of what one market research firm calls "the unbundling of AT&T." William McGowan, president of MCI Communications Corp., the first of the special common carriers to get FCC blessing to compete, says the Government "recognizes that there is a public benefit to having alternative suppliers of communications equipment."

By the Electronic Industries Association's estimate, the 1973 U.S. market for common-carrier electronics totaled \$3.36 billion, including nearly \$2.7 billion for central office hardware. Station equipment, including small private branch (PBX) units, accounted for another \$412 million, while large PBX units designed to accommodate 100 or more lines generated nearly \$260 million in sales.

Overall, the U.S. telecommunications industry runs to \$16 billion annually, exclusive of the Bell System, according to The Yankee Group, a Cambridge, Mass., market researcher in telecommunications and one of several organizations that is rushing to analyze the impact of the antitrust action. Howard M. Anderson of the company believes not only that the suit will be successful in the long run, but that ultimate beneficiaries in the interconnect industry will include such diverse makers of key systems, PBX and automated (PABX) exchanges, and electronic switching gear as ITT, General Telephone & Electronics, Nippon Electric, North American Phillips, North Electric, and General Dynamics Inc.'s Stromberg Carlson.

Other smaller potential beneficiaries of an open competitive market embrace a multitude typified by such companies as Wescom Inc., Voycall Inc., and Jarvis Inc., of Richmond, Va.

Jarvis, the prime plaintiff in the \$900 million private antitrust suit that preceded the Federal filing, looks favorably on the government action. So does ITT, which sees a divested Western Electric as a "very formidable competitor." Nevertheless, "we would expect to in-

Is regulation good?

Despite the claim by AT&T's chairman, John B. deButts, that the Federal suit "increases the problem of inflation by guaranteeing higher prices for telephone service," assistant attorney general Thomas E. Kauper, chief of the antitrust division, believes otherwise and sees flaws in the Federal regulatory process. "Much of this regulation, frequently justified by reference to natural monopoly and 'ruinous' competition, has contributed substantially to the pressures of inflation. Heavily regulated industries are relatively unresponsive to consumer needs, which must be translated through a bureaucratic intermediary. Some of the problem rests with the regulators, in some cases untrained in the industry or in economics, and thus ignorant of the harm they do to the efficiency of a free market economy."

crease our share of the market," says an official for ITT, itself the protagonist in a 1967 private antitrust suit that seeks to get General Telephone & Electronics Corp. to divest itself of Automatic Electric, the GTE counterpart to Western Electric. Successful in a lower court, that suit is now on appeal by GTE, which stands in sharp opposition to the Government's AT&T antitrust suit as well.

Dissenter. Though the communications industry envisions GTE as a beneficiary in the equipment marketplace, Leslie H. Warner, company chairman and chief executive, says he is "shocked and appalled" at Washington's timing in "this precipitous action" when the nation "is in the midst of a recession, the stock market is in a shambles, and AT&T and other telephone companies are already finding it almost impossible to raise the enormous amount of capital required" to grow.

Thus the division of views on technology comes not on the issue of innovation and continued growth in telecommunications, but on the point of where the growth shall come—within the established structure of AT&T or outside of it. □



Embattled. A serious John deButts is shown left above. AT&T's general counsel, F. M. Garlinghouse, is in the picture at left.

A STAR IS BORN TO SAVE SPACE

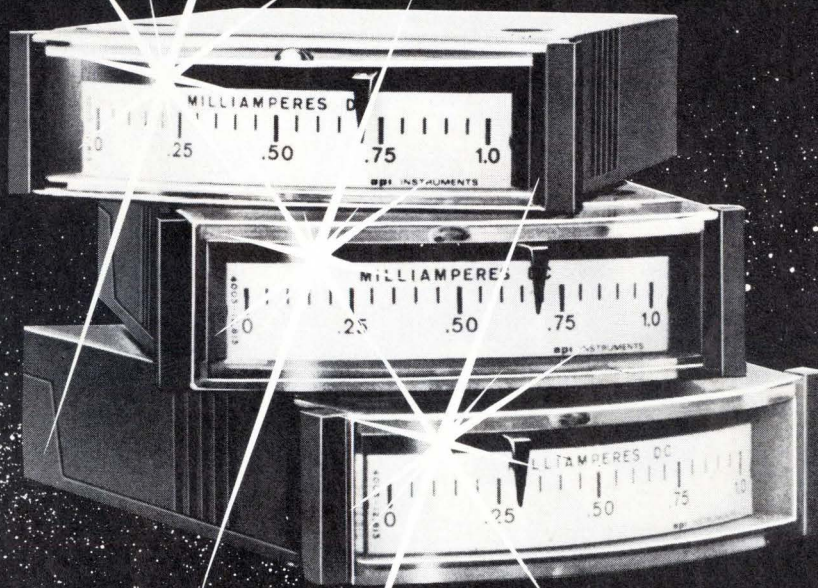

api Series 1000 Edgewise Meters

Save space and money, too. The api 1015 (1.5") and 1025 (2.5") stackable edgewise meters were created to provide attractive, economical, and accurate analog display in a minimum of panel space. Because they're new, these meters provide a number of user benefits available nowhere else.

STYLE—Sculptured, crystal-clear window and molded black flange crisply define the dial for an appearance of modern engineered precision. No separate bezel is required.

MOUNTING—Both the 1015 and 1025 fit standard

panel cutouts, yet the snap-in mounting is simpler than any other edgewise mounting method, saving you time and money.

ACCURACY—The unique flat d'Arsonval pivot-and-jewel mechanism provides 2% accuracy for vertical or horizontal scale orientations; and complies with ANSI C39.1 performance and C39.5 safety standards.

AVAILABILITY—Standard ranges are stocked by a distributor near you. Authorized modification centers can provide special ranges and dials fast. Quantity

OEM requirements are handled with traditional quick response and high quality.

ETCETERA—Frankly, we think you'll be surprised how much the Series 1000 beats inflation. Bulletin 0540-PB has detailed photos, drawings, specs and prices. Please write or call today for your free copy. LFE Corporation, Process Control Division, 1601 Trapelo Road, Waltham, MA 02154, (617) 890-2000.

LFE
CORPORATION

Process Control Division

RCA announces
a major breakthrough
in the world of op amps.

MOS/FET, CMOS on the

It's the low cost CA3130 from RCA. The people who first combined PMOS and bipolar technologies in the CA3100T. A simple, accurate and easy-to-work-with op amp at a price you can afford, it's the result of combining PMOS/FET, bipolar and CMOS technologies on a single chip.

It's simple to apply. Simple to design. Simple to manufacture.

And simplicity is why you get a lot of op amp for a little change. \$0.75 at 1K.

Here are some of the principal features you get for your change (values shown are typical):

General Purpose

High open loop voltage gain: 110 dB

Low input offset voltage: 8mV

Low input current: 5 pA

Input offset current: 0.5 pA

FET input

Very high input impedance: 1500 M Ω

Wideband

Unity gain crossover frequency: 15 MHz

High slew rate: 10 V/ μ s

Fast settling time: 1.2 μ s

Micropower

2.5 mW at 5 V supply voltage

High current

22 mA output

A voltage swing to within 10 millivolts of either rail on a single power supply is now possible for the first time because of the CMOS output stage.

These are some of the features that make the CA3130 the op amp you should use in such applications as D to A conversion, voltage follower circuits, fast sample-hold amplifiers. And many more.

Bipolar and same chip.

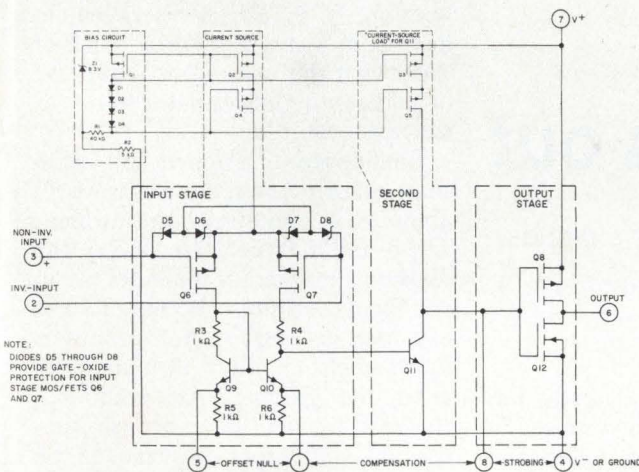

Premium versions of the CA3130 are also available. The CA3130A (\$2.95 at 1K) offers lower input offset voltage (5mV max) and current (20 pA max). You can even get a full military temperature range version, the CA3130B (\$9.95 at 1K).

Available in 8-lead TO-5 ("T") or 8-lead dual in-line ("S") packages off the shelf from your RCA Solid State distributor. For more information, call him or write RCA Solid State, Box 3200, Somerville, N.J. 08876. Phone (201) 722-3200. Ask for Bob Rauth, Marketing Administrator (Ex 3142).

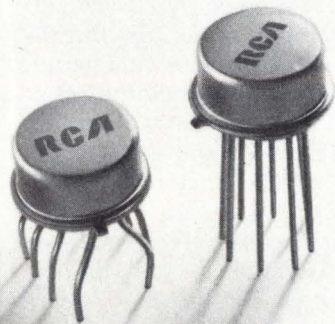

RCA Solid State
A full house in Linear ICs



Probing the news

Avionics

Grumman branches out

Company decides to make simulators for everyone's planes, as well as to expand into nonaircraft business

by Ron Schneiderman, New York bureau manager

Building flight simulators and training systems is nothing new to Grumman Aerospace Corp. But building them for applications other than training for Grumman aircraft is an innovation for the Bethpage, N. Y., airframe and space-systems company.

"We looked at this business about 18 months ago," says Ralph Tripp, a Grumman Aerospace vice-president, "to determine if it could go on its own as a business and not necessarily limit ourselves to aircraft."

What came out of that study was the definition of a market valued at several hundred million dollars and a newly-formed Training Systems division. The division is already out bidding on some \$50 million worth of business.

Initially, says Tripp, who heads the new division, Grumman will be active in five types of simulators: weapons-systems trainers, operations flight trainers (OFT), "suitcase" emergency-procedures trainers (SCEPTRS)—smaller and much

Tally ho! A Grumman employee is about to button down his simulated F-14 canopy for a "flight" while another employee mans the control panel in the foreground.

simpler OFTs—cockpit-procedures trainers, and maintenance trainers. A typical OFT simulator employs multiple minicomputers to drive a variety of cockpit displays for pilot training. Just last month, the Navy signed a \$14,550,000 negotiated fixed-price incentive contract with Grumman Aerospace for two weapon-systems trainers for the A-6E Intruder, an all-weather Navy attack plane. Grumman beat out Goodyear Aerospace Corp.

But Goodyear expects to remain competitive. Richard Roth, the company's training systems' marketing manager, says Goodyear plans to respond to Air Force RFQs—due out within the next few weeks—for a Republic Corp. A-10 fighter flight simulator, a B-52 refueling trainer, and a KC-135 boom operator trainer.

Although the A-6E is Grumman-built, the company is also competing for its first simulator of a non-Grumman aircraft. This, for the first time, pits the new division against the historical leader in training-systems manufacture—Singer Co.'s Simulator Products division in Binghamton, N. Y. The firms expect to hear from NASA next week which of them won the contract to build the orbital aeroflight simulator (OAS) for the Space Shuttle.

Confidence. Designed to train shuttle-flight crews, the OAS is worth about \$12 million to the winner. Tripp and Samuel Greenberg, the division's marketing manager, seem confident, possibly because NASA extended its request for proposals by 45 days to allow Grumman to enter the bidding. An additional contract for an advanced shuttle-mission simulator, expected to be submitted for bids next year, is worth \$20 million. As for Singer's attitude toward its new competitor, the best description would be "non-committal." A Singer spokesman says he remembers the NASA extension, but beyond that he tends to shrug off Grumman.

Grumman also is teamed with Hughes Aircraft Co. to compete against Singer for the F-14 weap-

1975 CERAMIC CAPS...NOW

MONO-KAP™, MONO-GLASS. Radial. Axial. USCC/Centralab has taken the lead for '75. You can be confident now of short delivery, plentiful supply and competitive pricing on reliable ceramic capacitors from the leader in monolithic technology.

DISCRETE ASSEMBLY

MONO-KAP™ radial-leaded epoxy coated capacitors are reliable performers; they're rugged enough to work in MIL environments. 4.7pF to 10Mfd., 50 to 200 WVDC in a variety of dielectrics and case sizes. Immediate delivery from stock; large volume production orders in *eight weeks* . . . and price competitive.

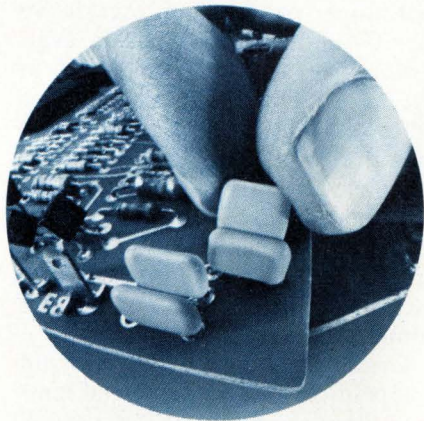

AUTOMATIC HIGH VOLUME INSERTION

MONO-GLASS axials are glass encapsulated, designed for automatic

PCB insertion; furnished reel-packed for high volume applications. They're available in 50 and 100 WVDC from .01 to 1.0Mfd.; three dielectrics: COG, X7R and Y5V.

Our basic materials research gives you the best in monolithic technology; our productivity engineering guarantees competitive prices and best delivery.

You can design confidently with USCC in 1975 for: calculators, computers, business machines, communications or any volume application using discrete or automatic assembly.

Some manufacturers are still solving problems; we can produce 25 million pieces per month and we're still expanding; at USCC we've got 1975's

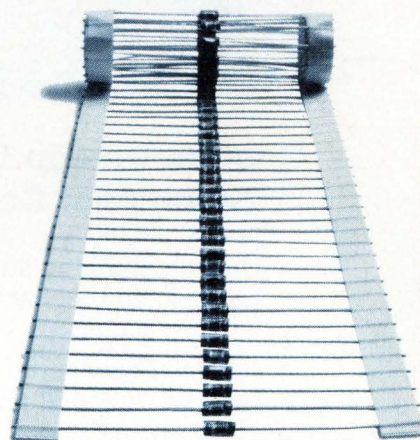

capacitors NOW. Write or call for large quantity quotations or evaluation samples.

Remember, USCC/Centralab.



USCC/Centralab

Electronics Division • Globe-Union, Inc.

2151 North Lincoln Street • Burbank, California 91504
(213) 843-4222 • TWX: 910-498-2222



Probing the news

ons-systems trainer. Hughes is the prime contractor, and Grumman would build the operations-flight-trainer portion of the simulator. The Navy won't announce the winner until at least next spring.

Down to earth. Tripp says Grumman is looking to such nonaircraft-

training applications as operation of nuclear power plants, in which Singer has been active for four years, ground-transportation systems, and operation of mining equipment, among many others. But growth, both in development and marketing, is slow. For instance, Tripp says that Grumman had thought it would get a contract to develop a mining-equipment sim-

ulator, but the deal fell through. "They lost interest. We're really not sure why, but we imagine it was too expensive for them." Adds Greenberg, "When our ability to win and perform the job is well established, we'll look beyond aircraft."

Branching out. One reason behind the decision to branch out in simulator applications, says Greenberg, is the tremendous advances made in the state of the simulator art in the past few years and Grumman's feeling that it has contributed to these changes.

Tripp says that Grumman has improved its chances at winning such major programs as the shuttle-mission simulator through the in-house development of a color-television visual system. Simulator visuals are usually black and white. At this point, Tripp will only state that the unusually high TV resolution—1,000 to 1,500 lines—offers the pilot a more realistic field of view than previous equipment, particularly during simulation of carrier landings and air-combat maneuvers.

Suitcase. The SCEPTR trainer, designed and built by Grumman, is literally a large suitcase that opens into a scaled-down facsimile of the instrument panel of an aircraft. So far, Grumman has sold for evaluation five SCEPTRs configured to the A-6E, but Greenberg says "they're applicable to just about any aircraft. When the evaluation is completed shortly, we'll try to update the system, based on the results of the evaluation and go after follow-on orders, aimed primarily at the A-7, F-14, and E-2 as well as commercial aircraft."

Grumman will also run into stiff competition in the commercial market. One company already there, British-based Redifon Ltd., which built the DC-10 simulators, maintains a low market profile. However, it recently won a \$13 million contract for the visuals portion of the U. S. Air Force undergraduate-pilot-training program through the efforts of American Airlines, which markets Redifon's simulator visuals systems in the U. S. American, in fact, has just entered a bid with Grumman to provide the visuals subsystem for the A-6E weapons-systems trainers. □

PLASMAC™

A *New* DISPLAY OPPORTUNITY



Custom Design Capability Allows Significant Cost Reductions

- Unlimited combinations of fixed messages, numeric and alphanumeric characters in a single panel.
- Minimized drive requirements with internal bussing and multiplexing.
- Large panels with Large Characters.
- High Brightness with Uniformity.
- Superior Readability.
- Low Power Consumption.

Call or write for full details



NATIONAL ELECTRONICS

a varian division
geneva, illinois 60134 (312) 232-4300

What makes Gallium from Arkansas so special?

It's available . . . in quantity . . . now!
Availability you can depend on for a
long time . . . from stock, and as close as your
nearest airport.

The reason: Alcoa has just completed a
new plant in Bauxite, Arkansas. The plant is in
full operation . . . processing large quantities of
gallium from our own gallium-rich reserves of
Arkansas bauxite.

All of it pure. And the known consistency
of our domestic source promises no unexpected
trace elements.

That kind of gallium will be coming out
of Arkansas for a long time.

Alcoa® gallium.

So there's now an ample supply of gal-
lium for optocouplers, LEDS, injection lasers,
magnetic bubble memories or anything else.
So don't hesitate in designing with, specifying
and purchasing devices utilizing gallium.

Alcoa can now supply the gallium needs
for today and tomorrow . . . in million-gram
quantities if required.

Send us your questions about gallium.
Just write Aluminum Company of America,
490-M Alcoa Building, Pittsburgh, PA 15219.

Change for the better with
Alcoa Gallium



Introducing the Brush 2400, the most significant advance in direct writing recorders in the past decade.

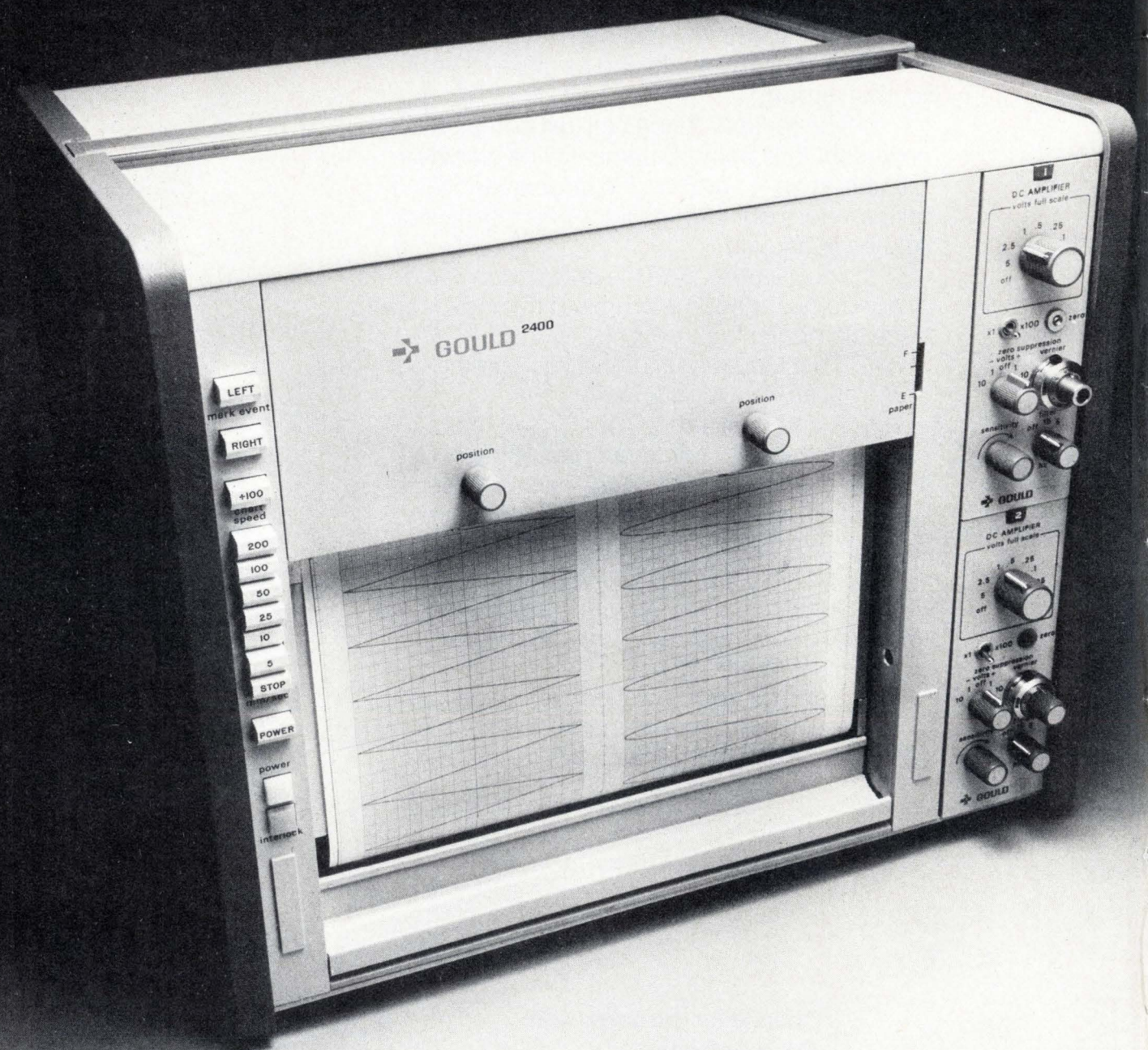

Brush direct writing recorders have been the standard of the industry since the early 1960's. Now we've advanced the state of the art even further. The brand-new Gould 2400 wide channel recorder is being called the best performing, most versatile, most reliable multi-channel analog signal recording system you can buy. Here's why.

The Gould 2400 can fit just about any industrial-scientific-medical application.

The 2400 is available in two, three and four channel configurations utilizing combinations of 50 mm and 100 mm channels totalling 200 mm. Left and right margin event markers are standard and may be activated by remote switch closures or TTL level inputs.

The Gould 2400, with its full 100mm wide channel, has the best resolution of any wide channel recorder on the market.

The heart of the 2400 is a 100 mm high-stiffness servo controlled penmotor with an exceptional frequency response. The high-stiffness servo penmotor enforces 99.65% linearity over the entire channel width. You get high display resolution of wide chart presentations for frequencies that most narrow channel recorders cannot accommodate. It makes your trace analysis easier and more meaningful.

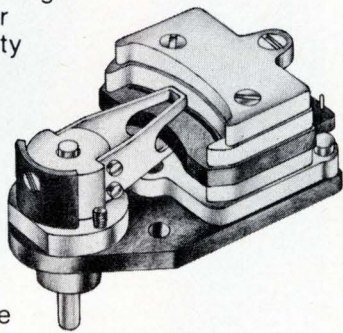

The Gould 2400 has an unequalled frequency response. The 2400's frequency response is an outstanding 30 Hz at 100 mm, 50 Hz at 50 mm and up to 125 Hz less the 3dB down.

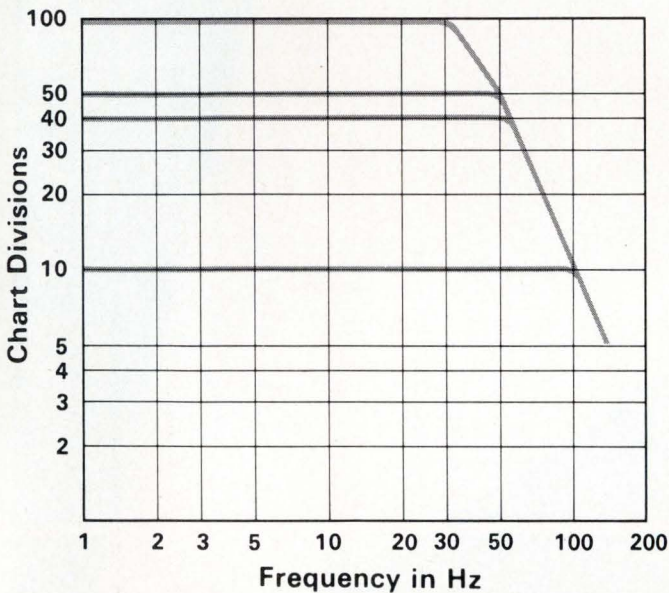

The Gould 2400 has 12 chart speeds.

Twelve chart speeds from 0.05 to 200 mm/sec are pushbutton selected and activated by either front panel or remote controls. A front panel paper supply indicator operates like a fuel gauge and lights up when a new roll is required assuring full usage of the entire paper supply.

The modular design of the Gould 2400 means ease of service and choice of channel combinations.

Plug-in signal conditioners are housed in standardized end caps on the right side of each recorder. Ink shutoff valves, adjustment pots, penmotors and the drive motor and transmission are all readily accessible. Disposable ink cartridges are easily cleaned or replaced in seconds.

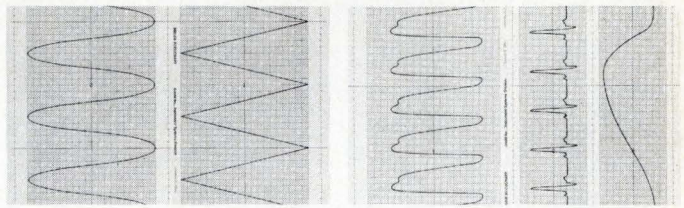

2 Channel Each 100 mm

3 Channel 1-100 mm, 2-50 mm

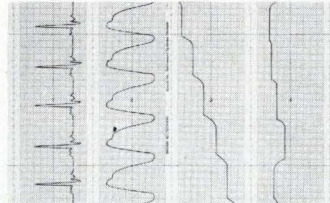

4 Channel Each 50 mm

The Gould 2400 has a full range of plug-in signal conditioners.

These signal conditioners provide a wide measurement range from 0.25 mV/mm to 500 V full scale, calibrated zero suppression to expand desired portions of an input signal, and low pass filtering to reject noise or unwanted signal components.

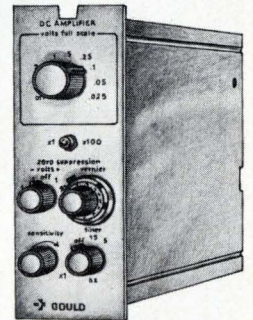

The Gould 2400 comes with all the Brush exclusives.

The Brush pressurized inking system gives you the highest quality traces, with no smudges, smears, skips or puddles. Our Metrisite non-contact servo loop feedback device eliminates slide wires and guarantees a better than 99.65% linearity. Our recorders have a rectilinear presentation rather than a curvilinear one. And all of our recording systems are self-calibrating.

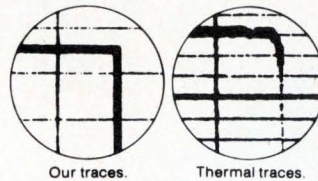

The Gould 2400: the ultimate performer for multichannel analog signal recording.

Take a first hand look at our new 2400 wide channel recorder. See for yourself why we say it's the best performing direct writing recorder on the market today. Call your nearest Gould Sales Engineer to arrange a demonstration. Or write Gould Inc., Instrument Systems Division, 3631 Perkins Avenue, Cleveland, Ohio 44114. Or Kouterveldstraat Z/N, B 1920 Diegem, Belgium.



the monochip:®

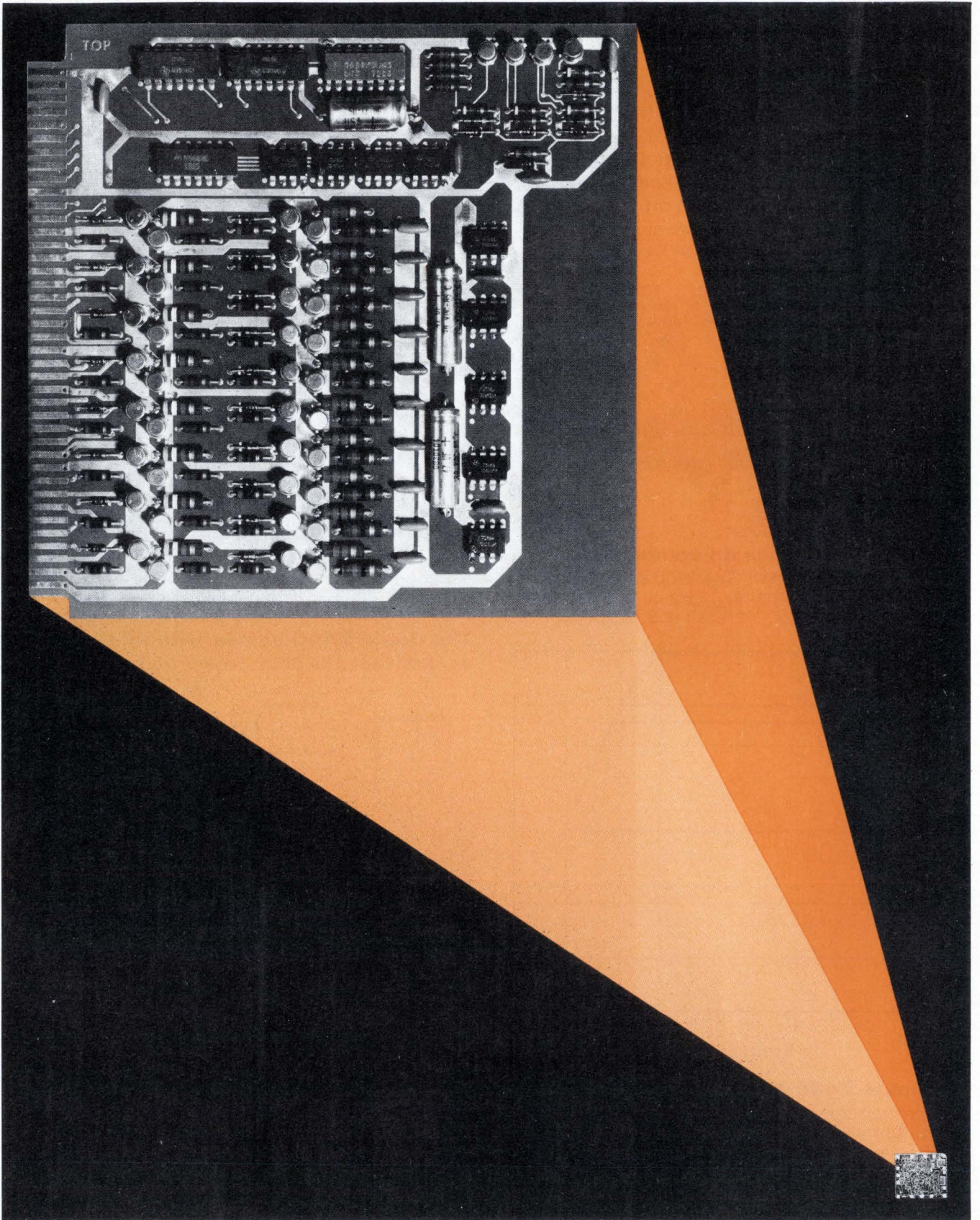

puts your PC board on one chip for \$1,800

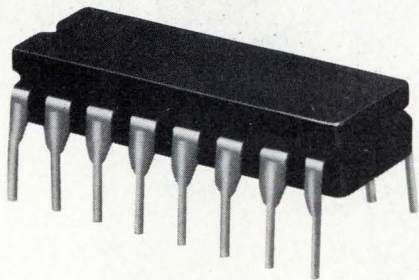

It's a remarkable concept.

A do-it-yourself monolithic IC chip. And it works just like the Erector Set you had as a kid.

We have three basic IC chips carrying up to 300 bipolar components—but none are interconnected yet. You tell us which components you want connected and we perform the integration.

You start by breadboarding your circuit using our \$39 design kit. It contains discretes corresponding to the components on our Monochips plus a complete design handbook.

Then you select one of three Monochips that best fits your design.

Finally, we do the integration for you on the chip by making a mask that connects only those components you want to activate.

In three weeks you have your initial 50 custom IC's.

And for under \$2,000.

The Monochip fills the bill for products that don't call for LSI technology or ultra-high production runs. It is most economical in production runs of 1,000 to 100,000.

Any manufacturer of instrumentation will be interested, for example. (Imagine squeezing a \$30 PC board on a \$3 chip. Or an \$80 hybrid on a \$6 chip!)

The Monochip is also ideal for the first stages of product design. You can do the development right on the chip.

If you don't want to spend \$40,000 and a whole year to get your custom IC, send for our new brochure on Monochip design. See how simple it is to design your own monolithic IC's.

Your note on a company letterhead will also get a free subscription to our quarterly publication on chip design—the "Monochip Technical Journal."

But don't dilly-dally. Your competitor is also reading this ad.

Interdesign, 1255 Reamwood Ave., Sunnyvale, Calif. 94086. Phone (408) 734-8666.

Interdesign™

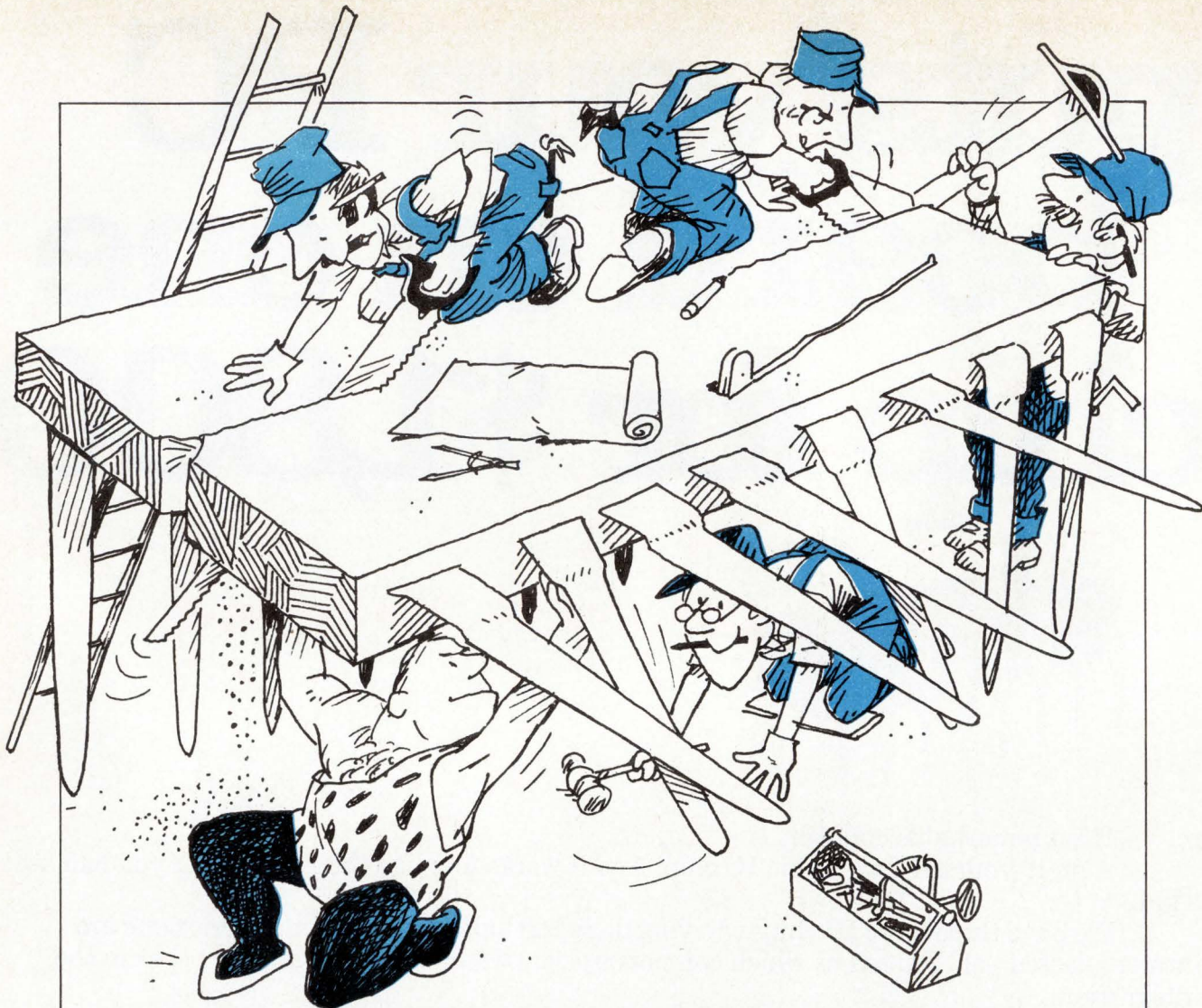

Our DIP crew makes great SIP resistor networks, too.

Leave it to our guys. They know you need a variety of space-stretchers to make your circuit-board packaging easier. And that's why these DIP experts also make Beckman RESNET™ standard SIP networks in 30 popular varieties.

These thick-film, cermet SIPs (.780" wide, .350" high, .090" thick) are standard 8-pin types, dimensionally uniform and ideal for automatic insertion techniques. Laser-tailoring assures precise resistance values, and every part is 100% tested.

Two convenient networks (see schematics)

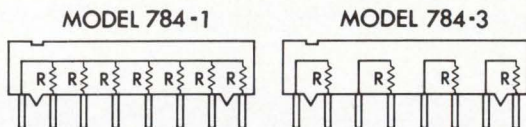

give you a 7-resistor model for applications like pull-up or pull-down networks, and a 4-resistor model for such typical uses as line termination and LED current limiting.

Resistance values available in both versions are 100, 150, 220, 330, 470, 680, 1K, 1.5K, 2.2K, 3.3K, 4.7K, 10K, 15K, and 22K.

And now for more good news. They're all stocked locally by your Beckman/Helipot distributor, ready for immediate delivery.

Cost? Truly competitive, actually giving you cermet quality at plastic prices.

Why wait? Let the new Beckman SIP line start making things a lot easier for you. For immediate literature or the phone number of your Beckman/Helipot representative, call toll-free (800) 437-4677. Right now.

Beckman®
HELIPOT DIVISION

Electronic switching brings efficiency to data networks

First digital-communications switching system uses a central processor and distributed control through the same communications lines as subscriber data; switching is by time-space-time-division method

by Stephen E. Scrupski, *Communications and Microwave Editor*

□ Operators of voice-telephone systems have proved beyond a doubt that the capability to switch subscribers to any other points in a telecommunications network is more efficient and flexible than using private leased lines. In the switched system, customers pay only for the time their equipment is connected, rather than a fixed monthly rate, and the network operator can efficiently allocate his available equipment according to the statistical distribution of calls.

Now, a data-communications network is exploiting the advantages of electronic switching. The first electronic data-communications switch, being installed for Data Transmission Co. in its Brunswick, Ill., office, is to begin operation next January. Datran, a specialized common carrier, is building an all-digital data-communications network to serve several cities between Houston and Chicago, and the system will soon be expanded both eastward and westward. Until now, the company has been able to offer only leased-line services, but when the switch begins operation, subscribers can obtain nearly instant access to points throughout the network.

The system, which uses time-space-time-division switching, takes advantage of many new features, including the capability to control several switching

matrixes from one central processor. Two central processors—one a backup—were built for the center by Comten Corp., St. Paul, Minn. Distributed control is perhaps the greatest benefit that will be derived from the use of computers, but other beneficial concepts are being developed.

Although the computers and the switching matrix—the circuit that actually connects the input lines to the desired output lines—are initially located in the same place, future plans call for computers in the center to control switching centers perhaps more than 1,000 miles away. The system's designers are taking advantage of new electronics technology to separate the processor and the switching matrix to gain several economies. With a centrally located processor, only one group of experienced personnel is required to maintain the equipment, only one inventory of spare parts is required, and, eventually, fewer redundant standby processors will be required.

Distributing control

There has been little need to separate the computer and the switching matrix in previous electronic switching systems because they merely replaced existing electromechanical systems. But to separate the two ele-

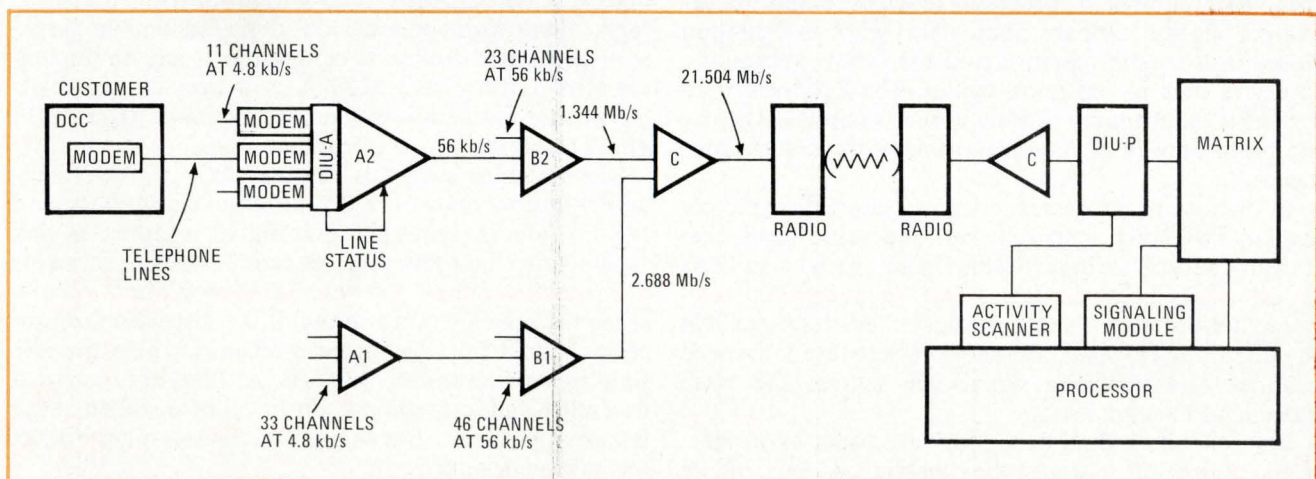

1. **Multiplexer hierarchy.** Customer data signals enter A-level multiplexers and are combined in three multiplexer levels. In the switching system (right), the central processor extracts control signals through the digital interface unit (DIU-P) and controls the switching matrix.

2. B-multiplexer output. Horizontal direction shows bits coming in from each A2 multiplexer—three groups of 11, plus 2 control bits. Each vertical column is order in which bits are transmitted by B-level multiplexer.

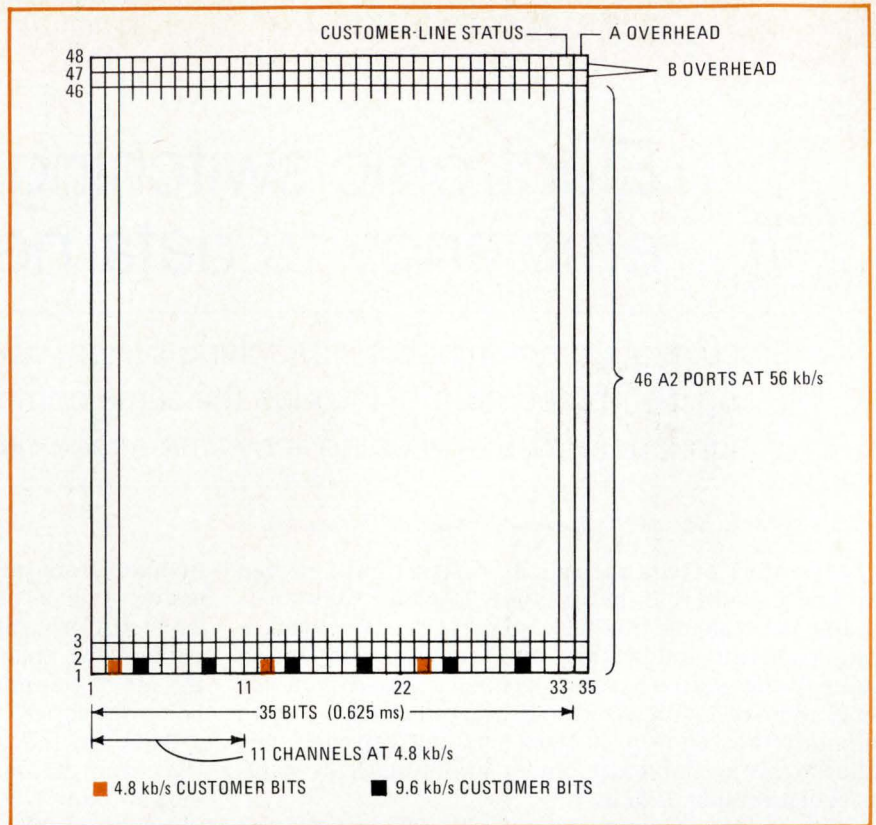

ments, the designers must have confidence in communications links between them, since a failure can close down the entire system. The designers also had to devise reliable techniques for transmitting and decoding such switching signals as the directory number of the called party.

In the same way that the matrix can be located remotely from the processor, other elements can also be decentralized. Another benefit of distributed control is derived from the remote location of the activity scanner, which recognizes when a customer is requesting service. Previous electronic switching systems included the scan command in the processor software. This arrangement was slow and burdensome to the processor because the command requires the processor to scan the status of incoming lines, compare that data with information stored in the main memory, and then use a subroutine to derive data for off-hook signals. The Datran system performs the scanning activity in remote units that communicate only brief messages back to the central processor.

In the system, processors communicate with remotely located switching matrixes over the same lines that transmit subscriber data. Status signals, such as on hook or off hook, holdover terms from conventional telephony that specify whether the customer's terminal is in the idle or active state, are sent in a separate low-speed channel, and switching signals are sent in the same channel as the data itself.

For reliability, dual processors are used, as in electronic switching systems for telephones. But unlike some systems, one processor is only an idle standby, rather than a full partner participating, in synchronism,

in every switching operation. The active unit periodically updates the standby so that it will be prepared when it must step in and take over control. But the standby, while it is waiting for the update information, can perform such other tasks as maintenance and trouble-shooting.

Taking advantage of redundancy

The switching matrix, built by Stromberg-Carlson Corp., Rochester, N.Y., is also redundant—two sections, called lays, connect alternate calls. If one lay fails, the other can take over the full load. The matrix is non-blocking, which means there is a path through the switch for every call that is made. The switching matrixes use standard 7400-series transistor-transistor logic, along with some custom-designed bipolar large-scale-integrated counters, comparators, and multiplexers. MOS shift registers, 512 bits long, provide recirculating memories to address standard Fairchild type 93410 dual 512-bit random-access memories.

The switching system is designed as a two-level hierarchy. District offices are connected to subscribers, and regional offices connect district offices together, as well as supervise fault-recovery operations in the processors at the district offices. Every call is logged into a processor at the regional office so that if the district-office processor should fail, the regional office can help the idle standby unit reconnect the calls. At first, only one district office and one regional office will be installed in the Brunswick location, but as traffic increases, other district offices may be added.

A district office can handle as many as 78,000 calls per hour, and 99% of the time, the system responds to a

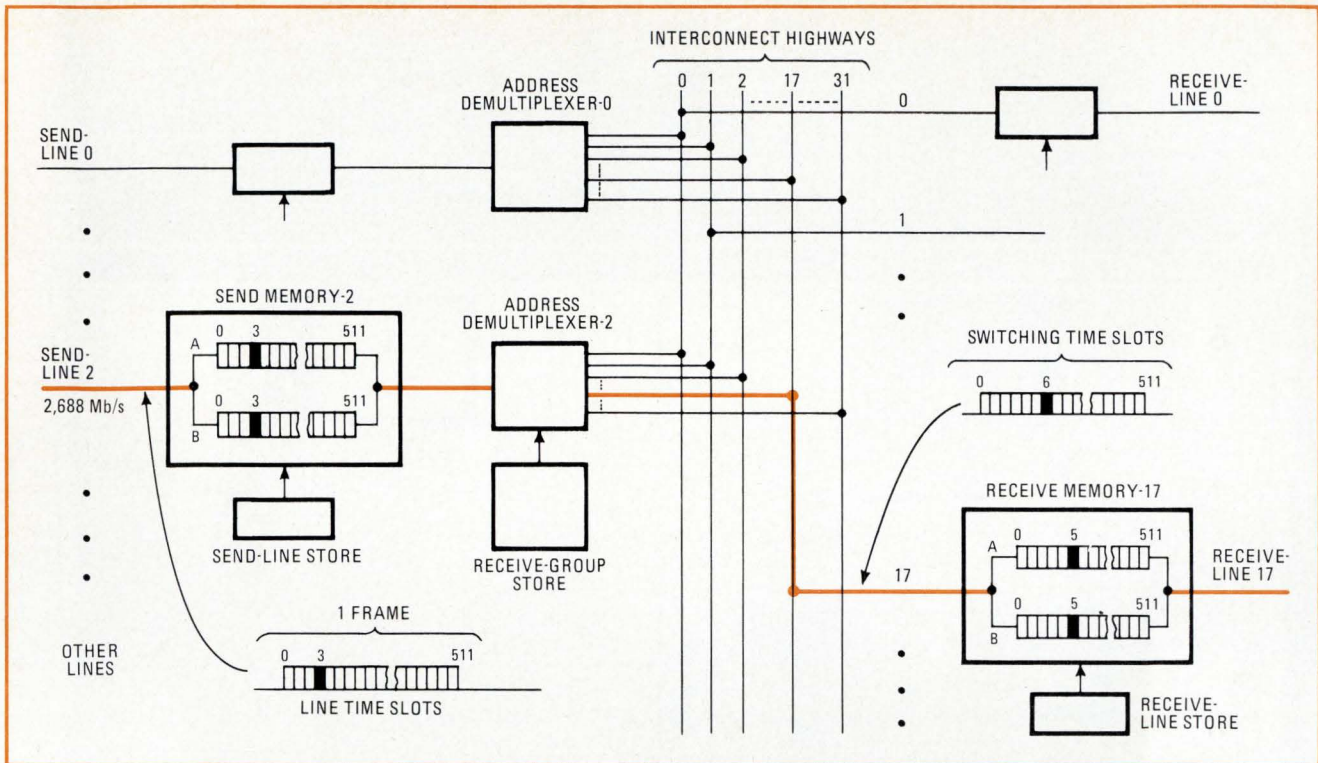

3. Time-space-time. Data signals are stored in send memory and read out by random-access. Address-demultiplexer connects signals to interconnect highway and receive memory. Example shows line-time slot 3 switched to highway 17 and stored in receive-memory slot 5.

customer's request for service—either with a ring or busy signal—in three seconds or less.

The organization of the transmission system (Fig. 1) shows how local lines from customers first are fed into A-level multiplexers, of which there are two types: an A1 multiplexer combines 33 channels at 4.8 kilobits per second, adding extra bits for framing and line status, into one stream at 168 kb/s and an A2 multiplexer combines 11 4.8-kb/s channels into a 56-kb/s stream.

At the next-higher level, a B1 multiplexer accepts 46 signals at 56 kb/s and sends them out, after adding "overhead" or control bits, at 2.688 megabits per second. Thus, at the B level, the transmission line carries 560 bit positions per frame at a rate of 4,800 frames per second, but, of the 560 bit positions, only 506 are actually used for subscriber messages; the remainder are used for control, framing, and status information. A B2 multiplexer combines 23 56-kb/s channels to attain a speed of 1.344 Mb/s (extra bits can be added, or "stuffed," to make this compatible with the Bell System's T1 line rate of 1.544 Mb/s.). C-level multiplexers group the B-level outputs for transmission over digital microwave-radio channels at 21.504 Mb/s.

Individual bits from each subscriber are interleaved by the A-level multiplexers, and each bit occupies a time slot in the output of the A multiplexer (Fig. 2). Thus, when transmitting at 9.6 kb/s, two time slots are used within the basic 4.8-kb/s frame, and 19.2 kb/s uses four time slots.

To set up a call, the subscriber first keys in the address of the message through a data-channel controller (DCC). This information is stored in a semiconductor memory within the DCC until the subscriber presses a

request-service key. The digits will be sent to the processor as a unit in 11-bit Ascii stop-start format. This avoids the problem of forcing the processor to wait until the subscriber completes his manual keying.

The DCC, which is the interface device between the switched network and the customer's equipment, is based on a Burroughs Corp. Mini-D microprocessor. Two 256-bit programmable read-only memories are used to control the line protocol for call setup and special services. The DCC also contains other control logic and the line-interface electronics.

An activity scanner in the district office notes the subscriber's request for service and passes it on to the computer. The computer first looks up such information in its own disk file as the data speed of the subscriber's line and its location in the line time-slot sequence. The processor then sets up the connection through the switch to a digit receiver (the processor communicates with the matrix through a standard EIA RS-232-C interface), which accepts the dialed numbers that are coming in from the DCC.

Test character checks connection

The computer studies this information for errors and special-service requests, determines the location of the destination, and then sends a test character through the matrix to check the connection. The destination DCC then sends its own address back to the switch. Once the processor is satisfied that the proper destination is ready to receive data, the computer disconnects the digit receivers and connects the two lines, allowing the data to flow between them.

A maximum of 506 time-division-multiplexed 4.8-

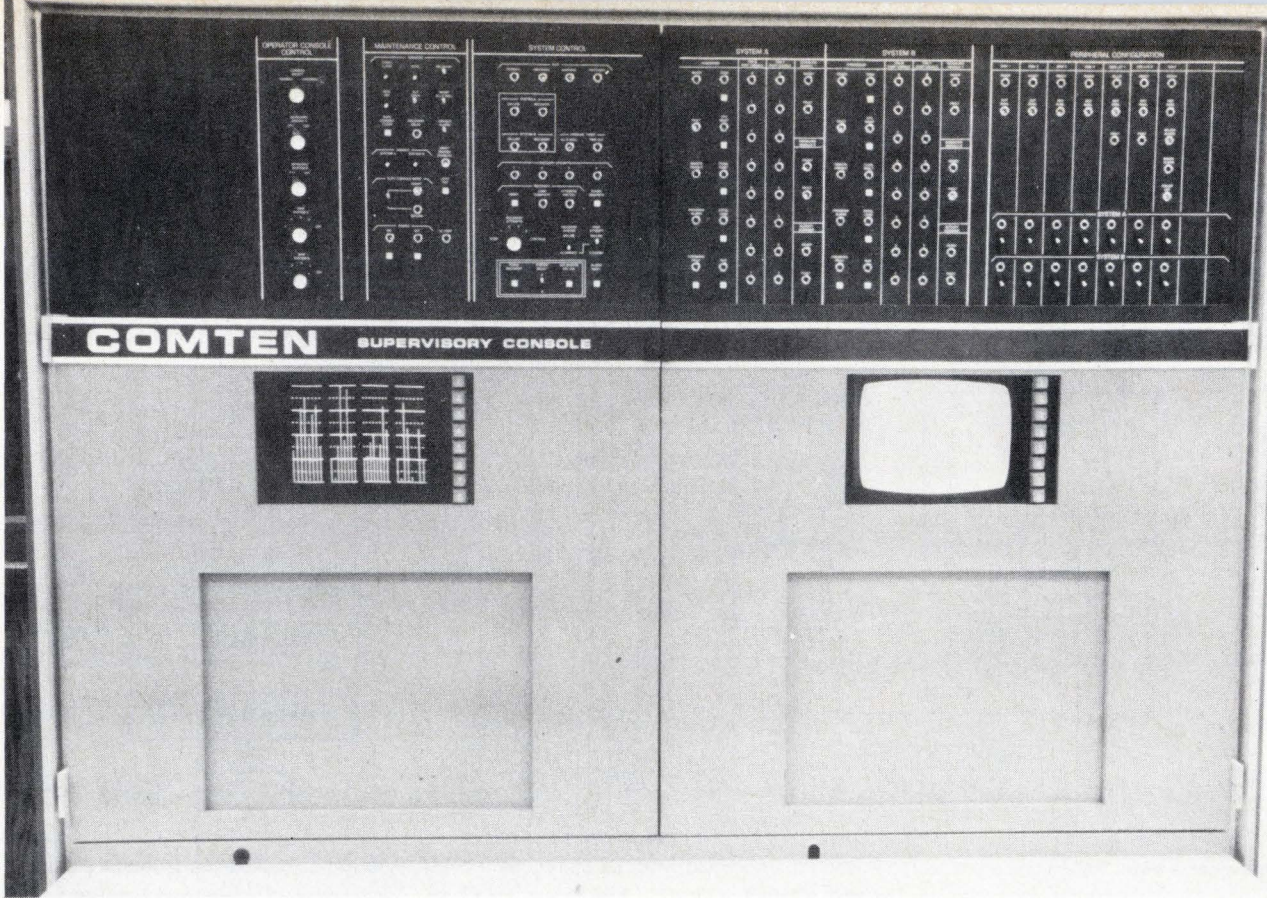

4. Activity monitor. Processor's supervisory console houses displays that can be switched to show activity, or traffic levels through various parts of switch. Close-up (below) shows bar chart, which could, for example, represent calls handled by digit receivers. The push buttons at the right are used to select the measure of activity that will be displayed.

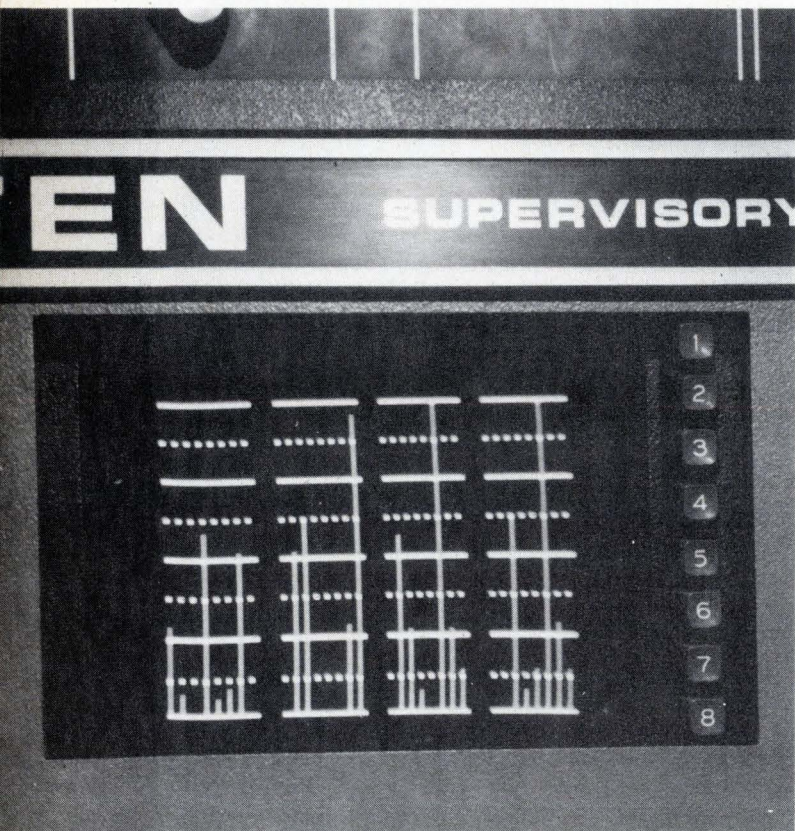

kb/s subscriber calls from each of several B-level multiplexers enter the switching system at 2.688 Mb/s. The switching system is shown in Fig. 3. Data entering the switch is temporarily stored in the send memory, whose outputs are controlled by send-line stores. An address-demultiplexer acts under control of a receive-group store to gate the data onto interconnect highways, which are 32 buses that connect to the receive memory. After the connections, the receive memory and receive-line stores take the data from the interconnect highways and send it on its way through multiplexers.

To illustrate how the time-space-time-division switch operates, assume that the subscriber line in send-line 2 is using line-time slot 3 and is sending data to a subscriber on line 17, using time slot 5. One frame of the incoming-data stream, carried in line-time slots 0 to 511 (506 data bits plus six control bits) is first stored in the send memory; each incoming bit is sequentially stored according to its line-time slot. However, the order in which bits are read out of the memory differs from their order of entry. In setting up the connection between line-time slots 3 and 5, the send-line store and the receive-line store collaborate to find a switching-time slot, which differs from the line-time slot, so that the send and receive memories can be connected together.

Assume that they find that switching-time slot 6 is not being used. As data enters, one 512-bit frame is stored in one half of the send memory (side A) and the next frame is stored in side B of the send memory. While data is being stored in side B, the data previously stored in A is being transferred out in a random-access fashion under control of the send-line store. After the address demultiplexer switches it to one of the interconnection highways, the data is stored in one half of the receive

memory in a position that will allow it to be read out, sequentially, during the next frame, in the proper time slot—receive-time slot 5, in this case.

Thus, a given bit of data is read out of the correct slot of the send memory (time division), applied to the proper interconnect highway (space division), and stored in the correct slot of the receive memory (time division), all during the same switching-time slot. Finally, the processor breaks the connection by clearing the control stores without disturbing any other connection.

Activity scanning

Activity scanning, which recognizes when a subscriber is requesting service, operates this way: A separate channel in the multiplexer stream is used for DCC status information, and, when a DCC is on-hook, it sends a 1-bit signal to the activity-scanner unit, which stores this signal in a particular location of its internal memory. When the DCC goes off-hook, the bit changes state. If it stays in the new state for two successive time slots (two bits are needed to avoid possible errors from transient system faults), then the memory in the activity-scanner unit automatically changes the state of another bit. The master unit of the activity scanner then uses this bit to indicate that the DCC has gone off-hook.

Periodically, the main processor issues a command to the master activity scanner to find the next five communications lines that have changed state. The activity-scanner unit then searches for a change in the memory and, after resetting the bit to indicate that it has noted the change, transmits the location back to the processor. A similar process applies to lines that complete their calls and go on-hook.

The designers have given a great deal of autonomy to the digit-receiver circuit, a full-duplex circuit that can communicate between district offices and either subscriber DCCs or regional offices. This circuit can take simple commands from the processor and reconfigure itself to carry out the commands, reporting back only the results to the processor. The circuit can, in fact, be either a digit receiver or a transmitter, according to instructions from the processor.

For example, some of the checkout routines between the switching system and the DCC require that the system ask the DCC to send a certain character that subsequently will be checked against the original command. To do this, the digit-receiver circuit accepts the command from the processor, performs whatever translations are necessary, and sends the request over the lines to the DCC. When the DCC responds, the same circuit rearranges itself to act as a receiver.

The system also takes many steps to ensure reliable connections. On every call, it sends a test signal through the matrix before completing the connection. It also uses parity bits and redundant bits in the signal that represents the destination of the call.

When a 4.8-kb/s customer places a call, the bits that represent the called number are sent twice, in two time slots, and the digit receiver ensures that both bits are the same before completing the call (the effective signaling rate is thus 2.4 kb/s). If the customer transmits data at 9.6 kb/s, then the signaling bits are sent with

Datran to go West

Datran, a specialized common carrier that links seven Midwest cities, will begin in January to serve subscribers on the West Coast. This service was brought about by an interconnect agreement with another specialized common carrier, Southern Pacific Communications Co., that will link San Francisco and Los Angeles through a connection in Houston to the Datran network. Datran also has an "overbuild" agreement to share the nonelectronic facilities, such as microwave towers, of the SPCC network when it is extended to the East Coast in 1975. When Datran's switching system begins operation, it will provide dial-up connections between any two of the cities served. Datran's network now consists of Houston, Dallas, Oklahoma City, Tulsa, St. Louis, Kansas City, and Chicago.

four-fold redundancy (again, a 2.4-kb/s signaling rate). These signals are sent in the same line-time slots as the subsequent messages, and thus the system also verifies the quality of the data path before making the connection.

The performance of the system can be monitored at the central processor's supervisory console, which has a cathode-ray-tube display called the system-activity monitor (Fig. 4). This real-time display presents information in bar-graph form for such measures of system activity as numbers of calls started, answered, and disconnected.

Furnishing subscriber conveniences

Datran offers several optional network conveniences. A subscriber can control which other subscriber lines are allowed to call him. To do this, a privacy table is maintained on a disk memory for each subscriber that desires it, and the switching system rejects all excluded calls. An addressing-error indication is returned to the rejected caller.

The call-back option enables any subscriber to get in line to place a call to a busy party. The network will complete the call in its turn when the line becomes available. The subscriber must request call-back prior to sending the destination address and must remain off-hook until the call can be completed. If the subscriber returns on-hook before completion of a call-back call, it is canceled by the switching system. The system is able to queue a maximum of six call-back requests for each called number. When the queue is full, additional callers receive a simple busy response.

Abbreviated addressing allows a subscriber to send fewer than seven digits to identify the addresses. Two types of abbreviated addressing are offered. If the subscriber normally sends seven-digit addresses, he must send an escape digit at the beginning of the addressing sequence, followed by an abbreviated code of zero, one, two, or three digits. If the subscriber is set up to send an address code of one, two, or three digits, he must send an escape digit at the beginning of the address sequence, followed by seven-digit address code. Such features were easy to build into the system because of the flexibility offered by computer controls. □

For solid-state watches the time is at hand

Momentum builds surely as traditional firms seek to maintain market positions against semiconductor firms; Integrated injection logic is brightest frontier yet

by Gerald M. Walker, *Consumer Editor*,
and Laurence Altman, *Solid State Editor*

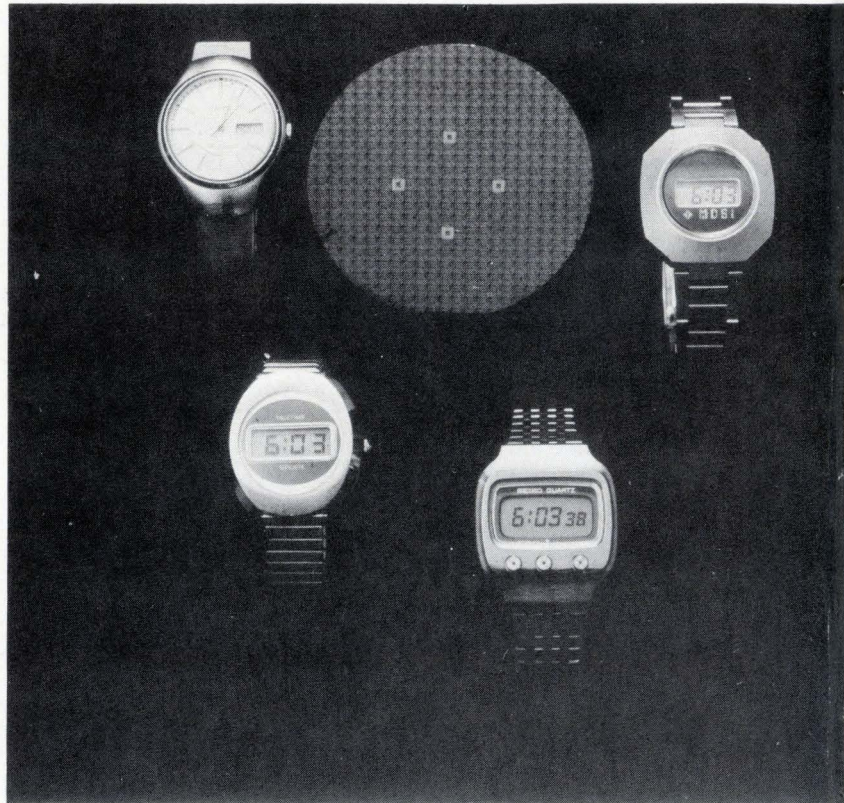

□ Time is money, as the old saying goes, and a raft of entrants into the electronic digital watch market is all abustle in an effort to prove it. Thus far, the protagonists have been running slow, hampered by high production costs, a relatively bulky product, and less-than-sensational reliability of the early liquid crystal displays. And some traditional watchmakers, who see their mechanical-timepiece domain seriously challenged, have been reluctant to accept the digital electronics touted by the upstart semiconductor industry. Nevertheless, this new and potentially lucrative field has attracted several competitors, many traditionalists included.

Right now there are about 15 companies trying to sell liquid crystal display watches at retail prices of \$125 to \$300. Another 20 offer light-emitting-diode display watches at anywhere from \$125 to \$2,500, depending on one's penchant for luxury. So far, each company has generally been confining itself to one type of display, but some will eventually offer both.

A matter of record that causes concern among these competitors is the boom-or-bust character that befell another glamor electronics product, the pocket calculator. Some similarities are obvious: large scale integration technology, the advantage of few parts, a heavy influx of new firms into the market, and, most telling, the

possibility of rapidly falling prices. But the parallel is not perfect. The pocket calculator came along to fill a relatively empty void; a large portion of the demand was induced by the sheer novelty of the product and its extraordinary convenience. Then, for many calculator firms, the bust came as prices fell and a few companies, capitalizing on their vertical integration, began to dominate the market.

By comparison, the watch industry is one of the oldest and most well established in the consumer market. Worldwide sales have increased at a stable, healthy 6% to 10% each year over the past 20 years. Now at about \$4 billion, sales are expected to reach \$7 billion by 1980. In 1974, worldwide sales will amount to between 210 and 225 million units. Fifty-five percent of these units, representing 61% of dollar value, are priced between \$10 and \$50. The digital watch will be available in this price range within a couple of years.

Coming down to earth

Also, if the history of electronics innovation holds true, it's not unlikely that wrist devices will offer more data than merely the time. There is, therefore, the marketability of potential new features to be considered, besides the obvious potential of one-to-one consumer re-

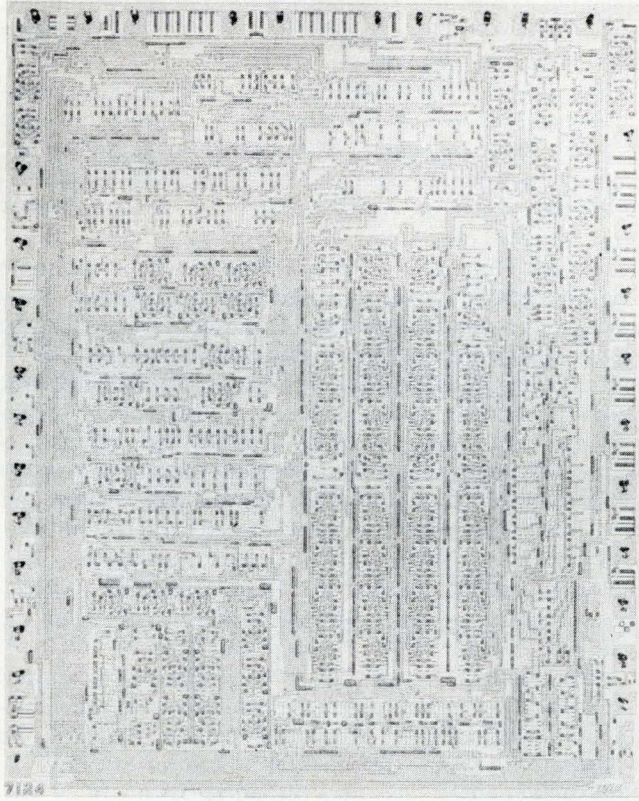

The scheme of things. A number of distinct corporate structures now operate in the electronic watch business. Some companies produce finished products (opposite page) with digital LCD or LED displays, and analog dials; others are module makers who supply internal packages to the traditional and newly formed companies; then there are the semiconductor firms producing the components; and there are the "hybrid" companies trying to get it all under one roof.

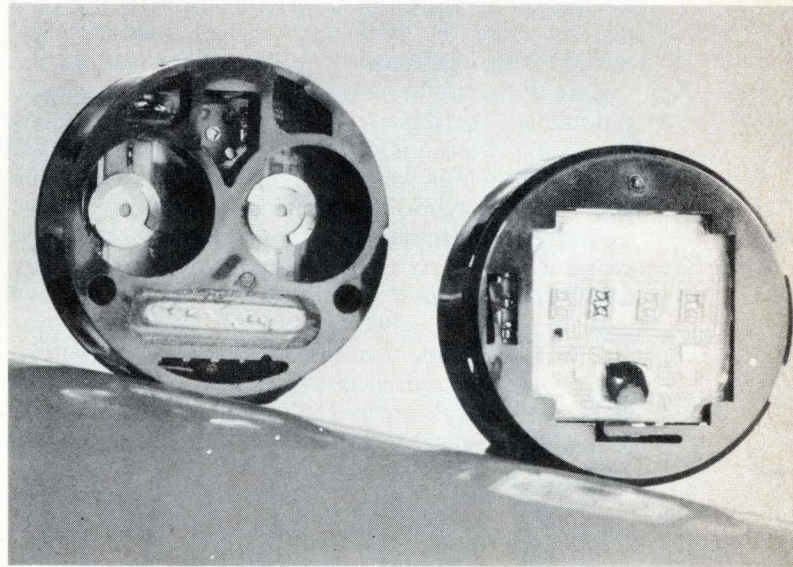

placement of mechanical watches. But today, at any rate, the electronic watch market, in an over-all sense, is anything but lucrative.

It's doubtful that any of the current entries are yet paying propositions. Several firms have sunk fortunes into trying to improve the displays, compress the internal components, and make styling attractive. The number of digital watches actually sold remains a trickle at about 100,000 to 150,000 this year. Styling has been an especially nagging concern; digitals tend to be big and heavy, which explains the dearth of women's models until very recently. LED displays are difficult to read in bright sunlight, and most LCD displays are impossible to read in the dark. LED types require the user to press a switch to read the time. Both types are difficult to set. Some models require the user to visit a jeweler just to replace the power cell. And finally there have been some reliability problems. But high rollers in the market expect these handicaps to be overcome. They're reminded of how the first color TV receivers looked and performed at a price of \$1,000.

Currently the solid state watch market is being pursued by four types of companies. The established watch companies are one; practically all of these are either Swiss, Japanese, Russian, or American. Initially, (and in

some cases even now) many established companies looked upon the electronic watch with some disdain. After all, they have large investments in the manufacture and marketing of mechanical and electromechanical timepieces, and little, so far, in solid state electronics. Also, traditional watches are sold through jewelers in a closely controlled environment characterized by 100% markups all along the line.

Shape of the future

The solid state watch threatens all of this. It is a case where highly refined manufacturing is replaced with semiconductor processing, where intricate assembly is replaced with simple interconnects, and precise maintenance with replaceable modules. Reluctantly at first, but now aggressively, many traditional watch makers are buying into the new technology.

Then there are the youngsters who came in owning the new technology. At first the semiconductor companies were content to develop the necessary ICs and displays and supply them to watch companies. But some have now moved into position to assemble and market timepieces under their own labels. So far, Novus, the consumer products division of National Semiconductor Corp., is the only one to take the plunge

this fall with a line of six LED display watches.

The third type of company is that which manufactures the complete internal modules of a digital watch and sells them to an assembler who puts together and markets the final product. Into this class fall such companies as Hughes, National, Rockwell, American Microsystems, Optel, Texas Instruments, and RCA. Recently, Motorola got out of the module business before delivering a single module.

There is a fourth class that might be called "hybrid." These are firms like Pulsar, a subsidiary of HMW Industries Inc., formerly the Hamilton Watch Co., and Microma, a subsidiary of Intel, that are neither traditional watch companies, nor operating semiconductor companies, nor assemblers. They are electronic watch companies attempting to bring technology, manufacturing and marketing knowhow under one roof. They may, in fact, represent the prototype of the entire industry's transition into electronics.

None of these different companies is yet in a position to dominate the digital watch market. The traditional firms lack the technology base, the semiconductor firms and the module-makers fall short on styling and sales savvy, and the hybrid firms are too weak.

Until now consumers have not beaten a path to anyone's door, and part of the reason may be the lackluster promotion the digital watch has received. Be that as it may, the drift of technology portends a traumatic period for an industry that has been orderly and predictable for a few hundred years. It appears that over the long haul, vertical integration, a process already underway, will be critical in establishing the successful competitors in the market.

What's in a watch

Since their first appearance in 1953, electronic watches have been built with a variety of techniques. There have been electronically driven balance wheels, tuning-fork references to operate analog displays, and tuning-fork or quartz-crystal references to drive digital displays. Of all the possibilities, the technique almost universally accepted for today's watches is one that uses some form of quartz crystal.

The simplest circuit required to achieve the crystal-referenced readout is shown in Fig. 1. All that's needed is a crystal input stage, a divider chain to step down the crystal frequency to the required 1 Hz, and logic configurations to properly sequence the drive circuit to power the numerical display.

These elements have been within reach of the same technology that served the hand-held calculator. They include the divider registers, the pointing and timing logic, and the light-emitting diode or liquid crystal readouts. Complementary metal oxide semiconductor ICs, already part of a well-developed micropower technology, were a natural choice to build the divider networks and control logic. High-current bipolar transistors were used for the digit and segment display drivers and a 32-kilohertz quartz crystal was used as the reference. These parts, together with the already-available 300-milliamper LED digits or the 10-volt liquid-crystal displays, made up the first generation of electronic watches.

The success of this borrowed technology spurred semiconductor manufacturers into tailoring these elements specifically for the time-keeping function. To make the C-MOS circuits operate at still lower power on still smaller chips, designers turned to silicon gates, ion-implanted structures and two-level metalization. They abandoned the early nematic liquid crystal displays requiring 10-volt operation in favor of the newer 3-volt field effect crystals, so that output drive circuits could be smaller and less power consuming. This grouping, together with better quartz crystals and longer lasting batteries, formed the next generation of watch technology.

Figure 2 shows a block diagram for a typical LED watch chip and module. The timing circuit (a), a single chip supplied by National Semiconductor and using a low-threshold ion-implanted C-MOS metal gate process, facilitates all the signaling required for a 3½ digit watch. The same chip interfaces with separate bipolar digit and segment drivers (b). As in most watch circuits, the circuit time base is a 32,768-Hz crystal-controlled oscillator attached to the diode input stage. This time-based frequency is successively divided through a 15-stage divider to provide drive signals for the multiplex 7-segment LED display. The output of the multiplexer provides hours, minutes, or seconds upon demand. These outputs can interface with any currently available standard bipolar segment and digit-driver IC. The chip is organized in a standard 12-hour display format and operates from a single 2.4 to 5 v supply.

While 2 chips, and in many cases 3 chips, are required in an LED watch, a single chip can provide all the

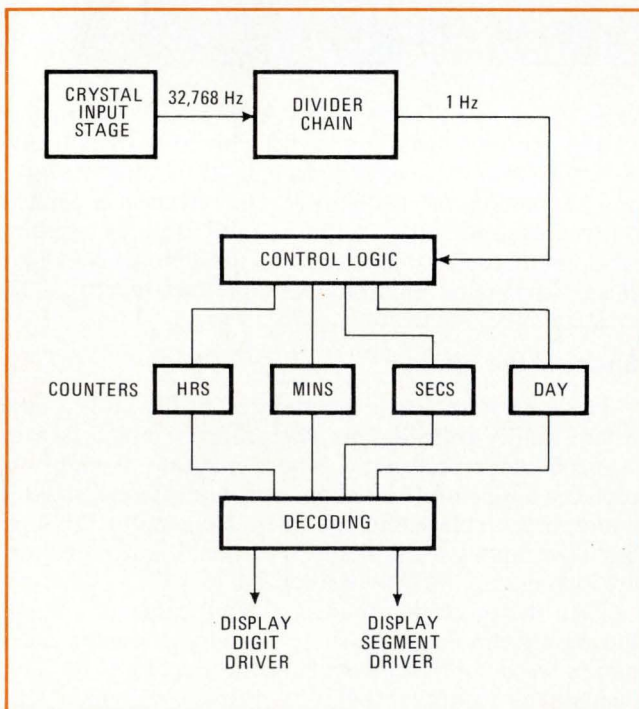

1. Easy does it. Functionally the watch chip is not complicated. A crystal-reference input signal is divided down to a 1-Hz timing signal which is then appropriately divided for second, minute, and hour readings. Separate digital and segment drivers power the display.

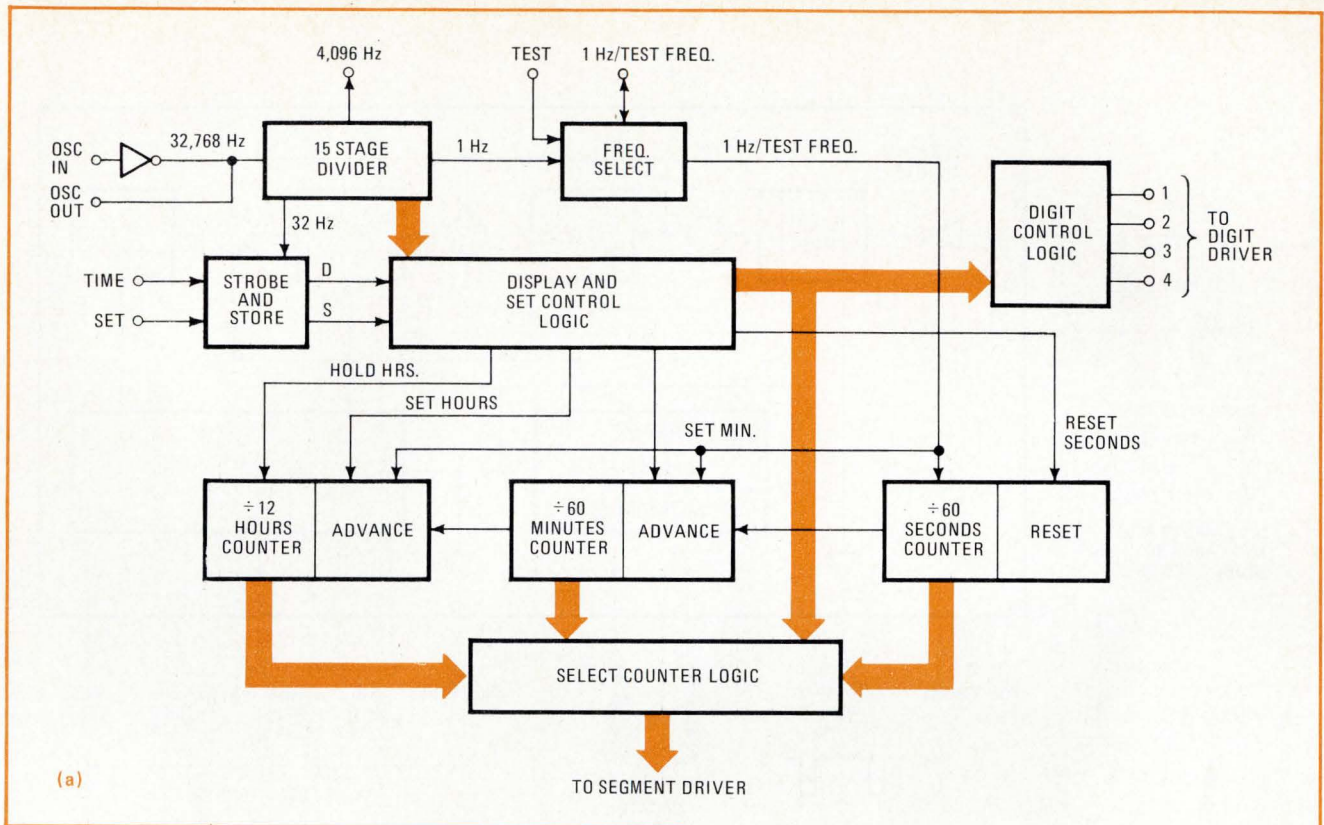

timing and drive functions needed for an LCD watch (Fig. 3). The problem with LCDs is that they cannot be multiplexed (they switch too slowly). The advantage of fewer ICs is paid for with more external connections in the module assembly. Indeed, developing an LCD material system that is fast enough to be multiplexed is a principle R&D effort at IC laboratories.

In any case, the LCD watch chip operates pretty much like the LED. In the circuit shown in Fig. 3, (this one developed by RCA), a self-biased input amplifier takes the 32,768-Hz crystal oscillator signal, divides it through the standard 15-stage divider, and feeds it to the control logic, that provides the second-minute-hour output signals sufficient to drive a 3½-character, 12-hour field-effect liquid-crystal display. In this design, typical of many LCD chips, a 30-microsecond 250 Hz output (labeled DDG in the figure) is provided as an input signal to a flyback-type up-converter to furnish the needed 3 to 6 V for the LCD. And, as in the LED chip, all power, both to the chip itself and to the up-converter, can be supplied from a standard single silver oxide battery cell of 1.6 v.

Another requirement in all watch circuits is some way to update and set the time. Display updating and time setting are done by two single-pole single-throw switches whose inputs are protected against switch bounce for periods up to 30 milliseconds. As shown in the figure, updating is accomplished by applying voltage V_{DD} through switches S_1 and S_2 while internal pull-down resistors set the proper voltage V_{SS} input levels when switches S_1 and S_2 are open. This input voltage can be extremely low and thus avoids excessive loading of the battery supply during time setting.

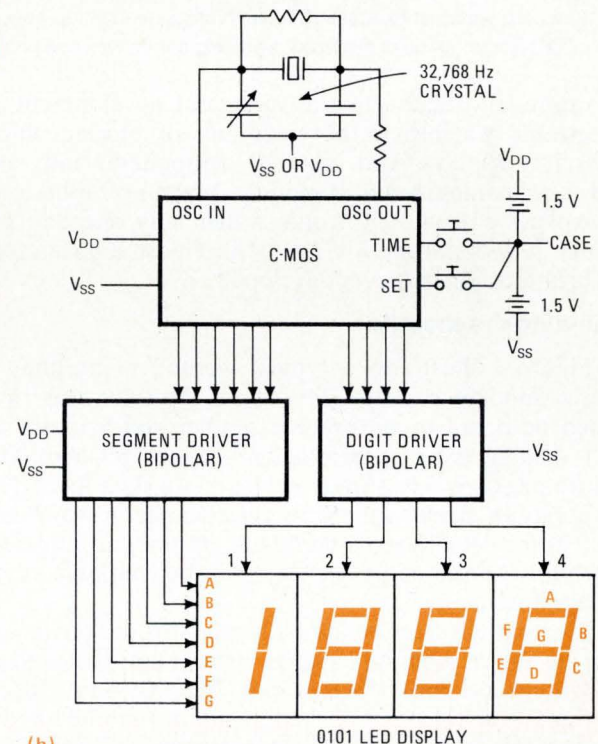

2. Making up time. In the National C-MOS watch chip layout (a), a 15-stage divider chain provides the 1-Hz signal from a 32-KHz quartz crystal reference. Two divide-by-60 and one divide-by-12 registers provide the proper second, minute, and hour signals. In the watch system layout (b) separate segment and digit driver chips operate the LED display. A date display signal can also be included.

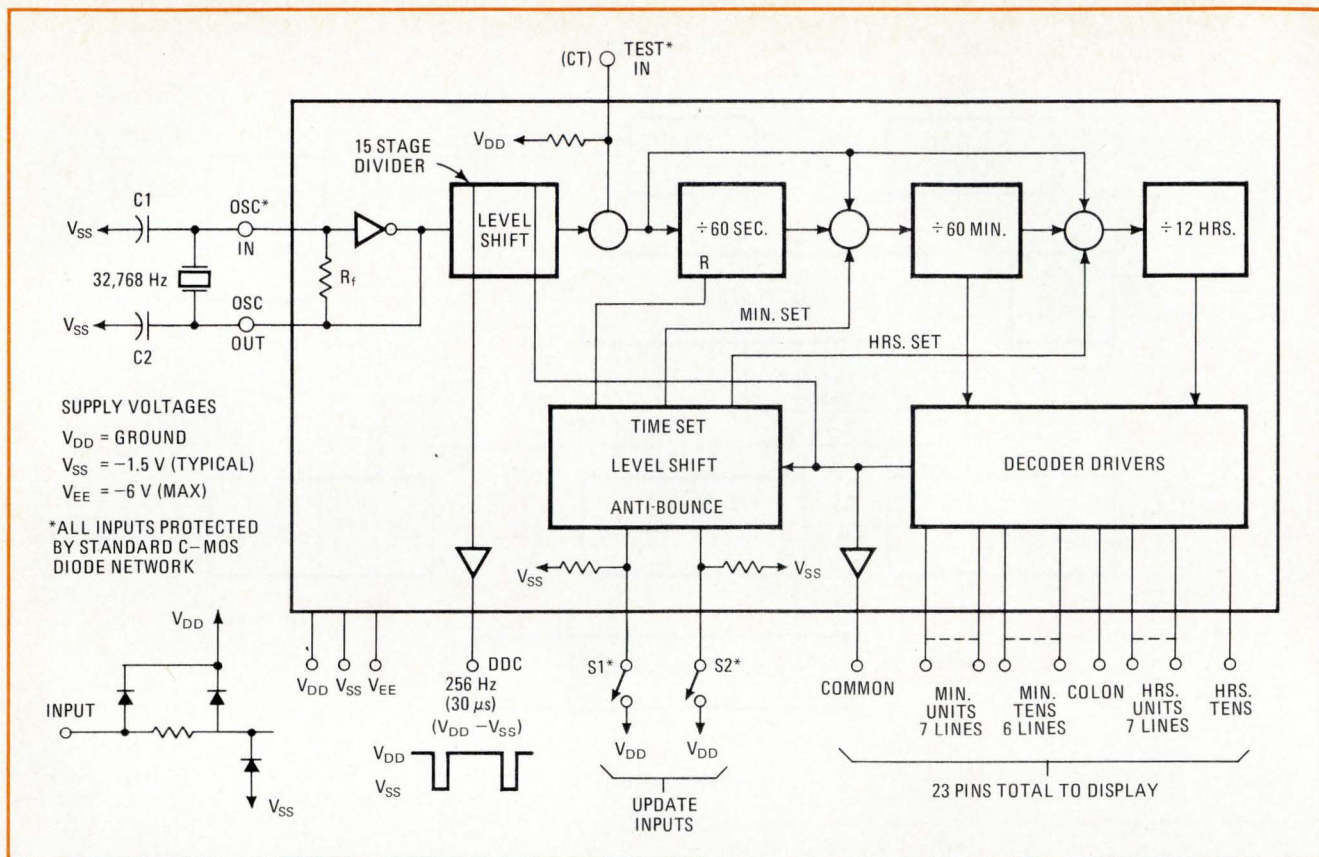

3. The LCD watch chip. Most LCD watch chips need an up-converter to boost battery voltage into the 3-volt LCD drive range. And because an LCD digit cannot be multiplexed, each segment needs a separate driver for a total of 23 pins to the display, as in this RCA design.

Intimately related to the successful development of electronic watches is the feasibility of putting chips, crystals, displays, and external components into one low-cost, compact hybrid module. Make no mistake: as inexpensive as the electronic watch may one day become, it will still require one of the most sophisticated hybrid technologies ever developed.

Building the module

Figure 4 illustrates a typical method of building a watch module package. Developed by RCA, this two-sided pc board or substrate is sandwiched between an LCD display and a 32-terminal flat pack watch chip. The entire package is less than a third of an inch high. The photograph shows a more recent package in which the LCD and C-MOS IC are mounted on an integral substrate assembly so the entire package will be available as an integral unit.

Progress has been made with modular designs in reducing the number of separate components required in a watch assembly. American Microsystem International's first-generation hours/minutes module had a total of 45 components, 51 interconnects, consumed 12 microamps of power, required 7 V to drive the LCD, was more than a third of an inch thick, and could be switched by a stem method only. By comparison, the company's new watch module consists of only 23 components, 21 interconnects, uses only 7 microamps and 3-V LCDs, is one-quarter inch thick, and has three switching options. It is with this kind of innovation that to-

day's module manufacturers hope to make the mechanical watch as obsolete as the sun dial by 1976.

Again, this reduction in complexity requires a sophisticated hybrid technology. For example, a National Semiconductor watch module is assembled on 96% alumina ceramic substrate, double-sided, rectangular, and only 30 mils thick. All conductors are made with a lead/gold printed process using a minimum of 10 mil lines and spaces. The backside resistors are fabricated using films of 300,000 ohms per square resistivity and can be laser trimmed to any desired value. What's more, all dice are attached to the substrate using conductive epoxy similar to the material developed for aerospace applications. The 70-lead bonds are made with the same thermal compression gold ball bonding used in today's high reliability hybrid assemblies.

The ceramic substrate is completed by soldering the end clips needed for front-to-back connections, switch and battery contacts, and quartz-crystal and trim capacitor. The ceramic is then clipped into a plastic holder and a shock-dampening material is molded around the quartz crystal. Finally, the topside junctions are coated to give humidity, thermal cycling, and thermal shock protection equal to or better than that provided by standard molded epoxy packages.

The watch of tomorrow

Semiconductor firms are busy developing less expensive, more accurate, easier to manufacture watch parts and modules. Two technologies are being considered to

Time marches on—slowly

From about the time of their invention in Germany in the 16th century until the early 1900s, mechanical watches relied on energy stored in a spring that was manually wound, usually with a stem or a key. The spring acted to power gears which activated hands which pointed to the time. Self-winding mechanical watches, which relied on an inertial swivel arrangement, became available some time in the 1920s but were never widely used until after World War II. This watch got its appeal from seemingly automatic operation, but the power was still furnished by a main-spring.

Things remained pretty much as they were until the early 1950s when the first battery-powered watch made its appearance. This and other early designs, however, were something less than what is now thought of as electronic. The battery simply powered an oscillating motor which drove mechanical contacts which drove the gears which ran the hands which told the time. But the age of electric watches had dawned.

It was in the mid-50s that discrete semiconductors—diodes and transistors—were used in place of mechanical contacts. And all at once the handwriting was on the wall for the eventual end of the mechanical watch. In 1960 a battery-powered tuning fork replaced the balance wheel. A few years later, a quartz crystal was used as a frequency reference, and watches were built that were all electrical-electronic, except for a few mechanical linkages to the hands. It was these first electronic watches, with accuracies better than 2 seconds per month, that launched a new era.

Soon there followed the development of the light-emitting diode display, complementary MOS micro-power technology, availability of inexpensive, highly accurate quartz crystals, and, with batteries borrowed from the hearing-aid industry, the all-electronic-digital watch became a reality.

boost performance and lower costs. C-MOS on sapphire substrates, and the new bipolar technique of integrated injection logic. (I²L).

Putting complementary MOS on sapphire substrates accomplishes three things. First, it provides smaller circuits that can operate at high frequencies and lower power than C-MOS circuits on bulk silicon. And because sapphire circuits are faster, they can accommodate higher frequency crystals such as the 4-megahertz standard—a crystal that is cheaper, more accurate, and smaller than today's 32-kilohertz quartz. Finally, because circuits built on insulating substrates such as sapphire can be smaller, the extra divider stages required to reduce the frequency to the standard 1-Hz level can be easily accommodated.

A photograph of the first available SOS C-MOS watch chip is shown in Fig. 5 where a 23-stage ripple counter divider is provided instead of the standard 15-stage divider, so that a 4-megahertz crystal input can be accommodated.

Perhaps most exciting for watch circuit manufacturers is the new technique of integrated injection logic whose low power, high speed properties, many feel, are

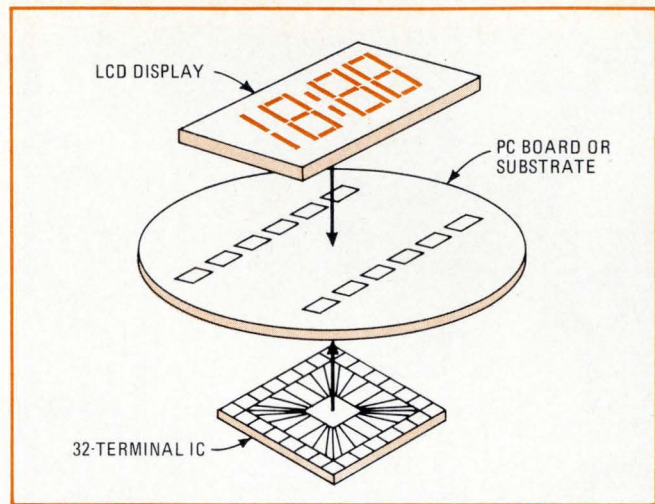

4. Assembly line. Watch module assembly requires a compact chip carrier and display package. This RCA technique puts the LCD display and IC on opposite sides of the printed circuit board. The assembly illustrated above is about 1/8-inch thick.

perfectly matched to watch applications. In a comparison of the speed-power relationships of the three competing technologies—regular C-MOS, C-MOS on sapphire, and injection logic—at low input frequencies, say below 1 MHz, all three offer similar low power dissipations. But, as the frequency is increased, standard C-MOS begins to show large power dissipation, while sapphire-based circuits and those built with I²L offer considerably lower power operation, with I²L showing the best overall performance. But I²L has other significant advantages over SOS technology. First of all, I²L, being a simplification of standard bipolar circuit techniques, can be built with today's standard bipolar processing techniques; no new materials or processing system need be developed as is the case with sapphire. Being a bipolar technique, I²L structures can also be easily built alongside the standard high-current TTL structures required to power the watch's digital displays. Therefore, the entire watch timing and drive function—divider chain, logic, and display driver—can be accommodated on a single bipolar chip, a prospect well beyond the range of today's C-MOS technology. It offers the prospect of a single IC built with a single bipolar technology that, at the inputs, can handle signals in the nanoamp current range, and, at the output, provide digit drive signals in the one-half amp range.

Injection logic has another property that makes it even more adaptable to watch circuits. By simple geometric changes in a single mask step, the speed and power dissipation of an I²L transistor can be tailored to operate at any point on its speed-power curve by simply adjusting the voltage supplied to the element. This has enormous implications for watch-circuit operation. It means that, now, only those transistors operating at the high-speed input portion of the circuit need be used as high-frequency transistors consuming moderately high amounts of power. Circuit elements at the slower portion of the circuit can be used as low-frequency, low-power transistors. Thus, by simply tailoring the geometry of the circuit elements, the optimum speed-power

Looking like a bandwagon

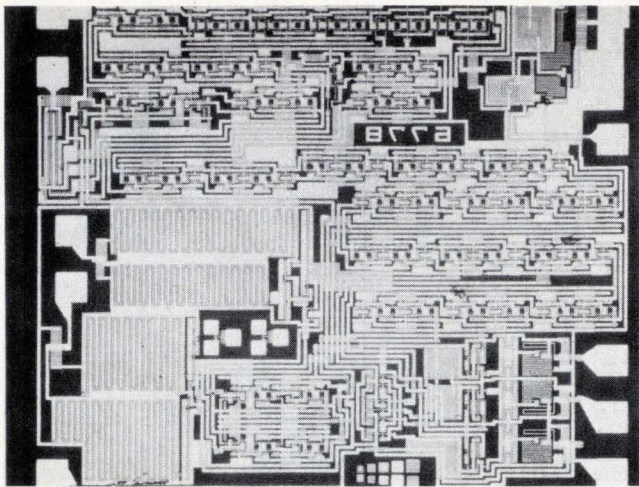

5. Sapphire makes time. The first commercially available silicon-on-sapphire C-MOS timing chip has a 23-stage divider chain to handle a 4-MHz crystal reference input. This chip, from RCA, is designed for analog, motor-driven watch dials.

relationship of the circuit can be accomplished. No other known technology offers this flexibility.

In a typical high-frequency watch circuit design, I^2L could be used as follows: say there are 25 divider elements in the divider chain needed to reduce a 4-MHz crystal input frequency to the required 1-Hz signal. With I^2L this could be done in three circuit blocks, each block designed to operate at a correspondingly lower frequency with a correspondingly lower power dissipation. The first block could, for example, reduce the frequency from 4 MHz down to below 100 kHz. The next block could be used to reduce the frequency to below 1 kHz, while the remaining stages could be used to bring the frequency the rest of the way to 1 Hz. Thus only a small fraction of the divider stages are operating at the high-frequency high-power-consuming portion of the circuit. With this technique, the power requirements of a typical watch circuit operation can be reduced by as much as a factor of 10.

Intensive study

Because of this ability, injection logic for watch-circuit application is under intensive study at most major semiconductor laboratories. I^2L circuits should have immediate application for watches using LED displays because of its advantage of requiring no external bipolar drive circuits. Indeed, I^2L could well become the next generation of watch circuit technology regardless of the type of display used. National, Hughes, TI and others are all known to be actively developing I^2L watches.

In fact the first application of TI's I^2L LSI chip in an LED display module has been announced by Benrus Watch Co. The logic, timing, and display drivers are on a single chip that is 25% smaller than the typical C-MOS type used in LED display watches. Texas Instruments is building the I^2L chip into a module that also contains the quartz crystal oscillator, frequency adjust capacitor, a single substrate, and the LED display. Module connections have been reduced 33%. The watch will run on two 1.5 v batteries and display hours, minutes, and seconds.

Clearly, the technology for reliable, well-styled digital watches is at hand. So much so that, after some early soul-searching, such venerable names as Benrus, Bulova, Longines, Elgin, Gruen, Waltham, and others, have decided to cover their bets. All have LCD or LED devices now on the market or in the planning stage. Even Speidel—until now only known as a maker of wrist bands for watches—has introduced a line of LCD time-pieces. The modules were developed for Speidel by Electronic Research Corp.; both firms are subsidiaries of Textron Co.

Speidel's new product director, William Slattery, says the company had been interested in starting its own watch line for the past 10 years, but did not see an opening until the advent of the new technology. "The solid state watch gave us an opportunity to enter the market in an equal position with the other watch companies," he says.

In Japan, companies like Seiko, Citizen, and Orient have LCD models either on sale now or announced for later availability. In Switzerland, one of the smaller companies, Nepro, has pushed passed its more cautious brethren to come up with an LCD watch.

John W. Rutledge, president of Bulova, while admitting that his company started with "a little prejudice" against digital watches, now says the digital "is a trend that can't be denied, especially in the youth market."

Bulova has an LED watch, and is introducing a LCD type next year. And to provide more leeway in design, as well as to protect its supply line, Bulova has taken the unusual step of integrating into C-MOS processing. It

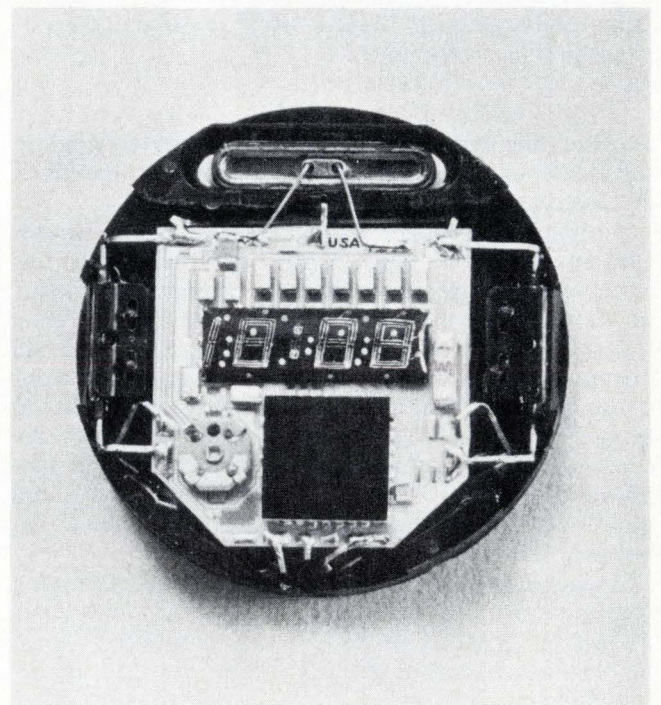

6. Early entry. One of the first into the digital display competition was Pulsar, a subsidiary of Hamilton. Its latest LED module is supplied from RCA and HMW for both man's and woman's models.

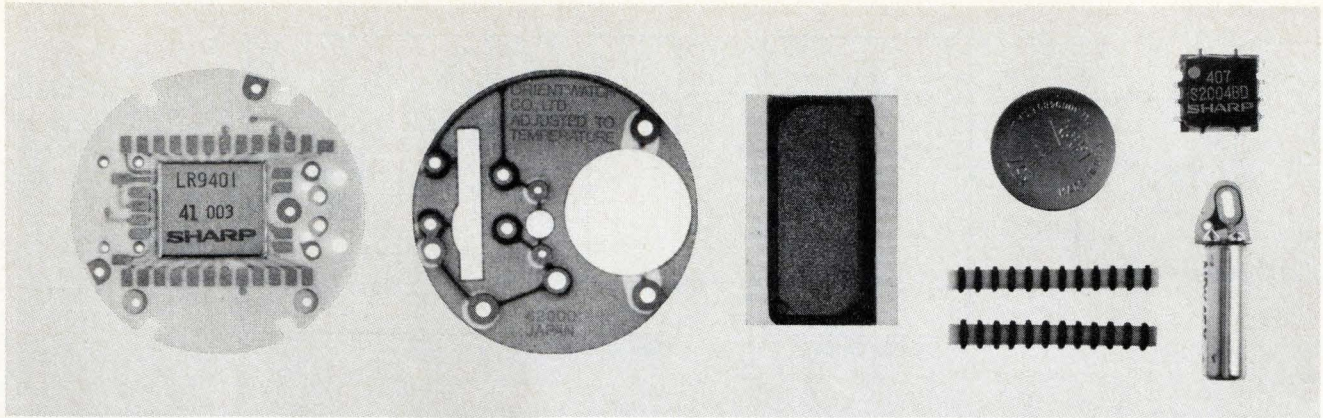

7. Orient express. The C-MOS chip and other components for Sharp Corp.'s liquid crystal display module manufactured for Orient Watch Co. require two substrates that hold the single LSI chip and connect with a light-weight contact pad to the display.

and three other nonconflicting manufacturers each have assumed 15% ownership in Synertek, a newly formed IC producer in Santa Clara, Calif. specializing in C-MOS technology.

Benrus, another old company, is also responding to the changes. Reflecting the general industry-wide viewpoint, Benrus Corp. president Victor Kiam foresees a challenging year ahead, and adds that, "Benrus is geared for it. We will continue to hold down our inventory of mechanical watches in order to adopt to changing circumstances."

Kiam acknowledges that one reason the established companies have been slow in introducing digital watches is the desire to protect large inventories of standard timepieces.

He makes note of an important point, however—it will probably be late next year before the digital watch begins to make an impact because of a severe bottleneck in the supply of cases. Without cases, no new entries will get very far, and there's a six to nine month lead time now. This restriction may spur the use of plastic cases for electronic watches, if consumers will accept them.

"If a company is going to put out only 100,000 units, that's peanuts; one style will do," Kiam observes. "But when you reach one million units, you need many styles. Even Timex has over a hundred different styles. You've got to have style."

Today's digital watches are still a long way from the potential as seen by John B. Bergey, president of Pulsar Time Computer Inc., Lancaster, Pa. Bergey expects the industry to go in two directions—one taken by those companies dedicated to increasing volume by lowering the cost, and the other taken by producers concerned with adding new features to high priced products.

Aside from the obvious garnishes—calendar and chronograph—the new features could exploit micro-computer technology to bring consumers additional information, like weather and body temperature.

However, Bergey warns, "The future of the solid state watch is in jeopardy because of the quality slippage. A house cleaning is in order, because some of the products have been a disappointment. We have a great opportunity as an industry to give the consumer something he has not had before. Our future is on the line."

Richard Boucher, president of Microma, Cupertino, Calif., believes the electronic watch companies have to do a better job of merchandising. Though a wholly-owned subsidiary of Intel, Microma has followed the established watch distribution pattern rather than attempt a new route as the calculator companies did. Yet Boucher is enthusiastic over the prospect of semiconductor companies selling digital watches in any location. Microma, one of the first electronic watch companies, has three new models due in 1975. All three use MOS time circuits from the parent company, Intel.

Japanese in the fray

Sieko, the largest watch company in Japan, utilizes MOS circuits in both analog and digital solid state watches. The company uses a variety of sources, including those made in its own plant, those purchased from domestic manufacturers, and others imported from America. Echoing U.S. watchmakers, Seiko engineers point out that the future design of C-MOS will be based more on considerations that improve the convenience of using the watch—such as setting the time—rather than technical tradeoffs like smaller chips. As in the U.S., however, the trend is toward a single chip for timing and driving.

Citizen Watch Co. is buying three types of MOS chips from Mitsubishi Electric Corp., two for a digital watch and one for an analog model. The digital model features a field effect LCD that shows hours, minutes, seconds, day, date, and a-m or p-m. It is also possible to turn off the display, a characteristic designed for shipping from the factory with the battery installed. The company does not urge users to turn off the display under normal operation. It uses two ICs—one a 10-pin flat pack with oscillator and divide circuits, and the other a 58-pin flat pack with the counter, decoder, and driver.

The analog model has a single chip measuring 3 mm by 4 mm, 1.8 mm thick. The complete movement module is even bigger at 26.4 mm in diameter.

Like others, this watch divides down crystal frequency to 1 Hz to drive a motor. Unlike others, the 1-Hz output also drives a scale-of-60 counter. There is also a 5-bit latch with internal reset so it can store numbers from 1 to 30 and a tap at the 32 Hz output of the frequency divider that can be connected to the scale-of-60 counter

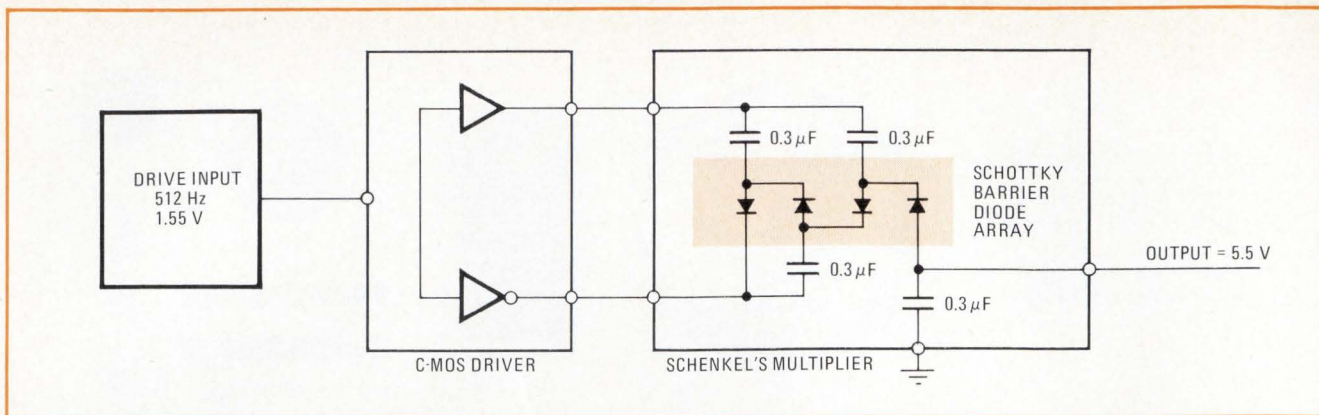

8. Step right up. Sharp's C-MOS-Schenkel's multiplier type dc to dc converter for the Orient liquid crystal watch has a conversion efficiency of 85% on input voltage of 1.55 V for an output voltage of 5.5 V. This makes it possible to use a different voltage for divider and display.

to drive it at 32 times the normal speed.

Normally the scale-of-60 counter synchronizes with the second hand. But if the watch should be, say, 10 seconds fast when setting it with a radio signal, operating the time-setting switch attached to the stem causes the latch to retain the 10 and the counter is reset to zero. The watch hands stop while the counter runs out the 10 seconds, then the watch hands resume operation with the second hand at the correct time. If the watch is 15 seconds slow, the latch is at zero and the counter is at 45. This time operation of the switch causes 32 Hz pulses to be fed to the counter until it advances to zero and agrees with the latch. The second hand also advances to zero. It's also got a light emitting diode that flashes on every time the second hand passes zero.

Another feature consists of four correction terminals on the chip. This permits both a 15-step coarse correction for oscillator frequency by changing the counter ratio and a fine adjustment with variable capacitor.

The 15-step adjustment means that the crystal need not initially be cut to close tolerance and thus reduces the cost of the crystal. The tradeoff is an increase in the cost of the chip.

Sharp Corp. has taken a unique approach in a chip developed for the Orient Watch Co. (Fig. 7). It's a single C-MOS LSI chip that operates from two separate power supply voltages. Battery voltage of 1.55 v is used to power the oscillator and divider portion.

Stepped up voltage of 5.5 v is used to power that portion of the chip used for driver functions. Square wave output of 512 Hz drives an array of Schottky barrier diodes, and four capacitors arranged in a Schenkel-type voltage multiplier rectifier circuit (Fig. 8) to provide higher voltage needed to drive the field effect LCD.

Power drain of the circuits operated at battery voltage is 4 microwatts; power drain of circuits operated at the stepped up voltage is 1 μ W, and power drain of the display is 1 to 2 μ W. It's designed to run on one battery for two years.

The unpunctual Swiss?

While the major Swiss companies are sitting on their hands, Nepro has scheduled production of up to 5,000 digital display watches by next year. Using American made C-MOS circuits and a Swiss-devised display (Fig.

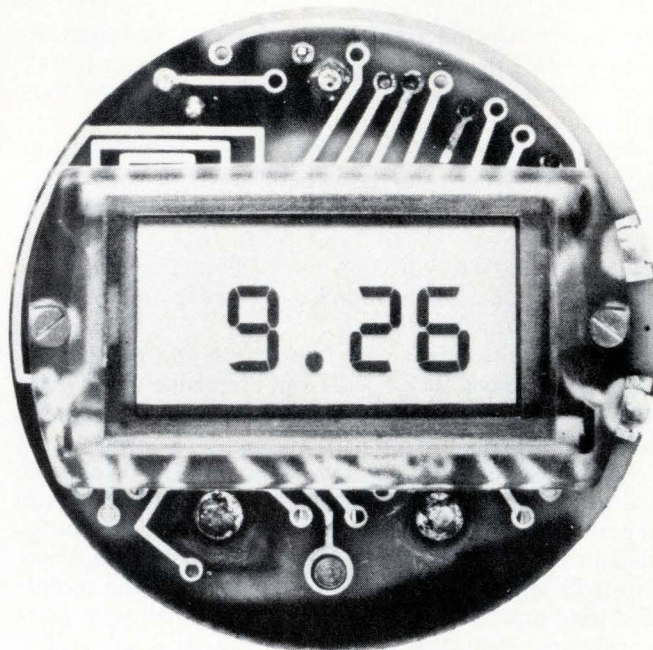

9. Swiss movement. The Nepro digital display module is one of the few Swiss electronic watches. It's got U.S.-made C-MOS ICs and a Swiss-made field effect LCD, lighted for visibility in the dark.

9), the watch is expected to sell for about \$300.

Nepro's field effect LCD was developed by Brown, Boveri & Cie AG. It has internal illumination for reading in the dark and lenses that enlarge the numerals for easier reading.

Nepro plans to bring out another model with seconds and date display soon, also using the Brown, Boveri display. In a case of understatement, Nepro president Paolo Spadini says, "It's no secret that the Swiss are very conservative." Indeed, it is wondered if the beginning of a turbulent decline for the Swiss watch industry is at hand.

For those who want to ponder yet another factor, the Russians have disclosed to Japanese sources that the manufacture of digital electronic watches is on their priority list. The Soviet Union may skip the calculator era, but solid state watches apparently are on the way. Thus the electronic watch competition is shaping up to be quite a global affair. □

Solitron delivers high power, high current 2N 6258 2N 6259 transistors from stock

If you're looking for these homogeneous base Silicon NPN power transistors for commercial and industrial applications, look no further. Solitron has them... packaged in a JEDEC TO-3 case.

Features include:

- VCEO greater than 150 Volts
- hFE @ 30 Amps
- .284" X .284" single-diffused chip
- IS/B greater than 250 Watts seconds (typical)
- $\theta_{J-C} = 0.5^{\circ}$ C/W (typical)

All it takes is a phone call to us.
What are you waiting for?

Solitron
DEVICES, INC.

1177 BLUE HERON BLVD./RIVIERA BEACH, FLORIDA 33404
(305) 848-4311 / TWX: (510) 952-7610

SCHADOW

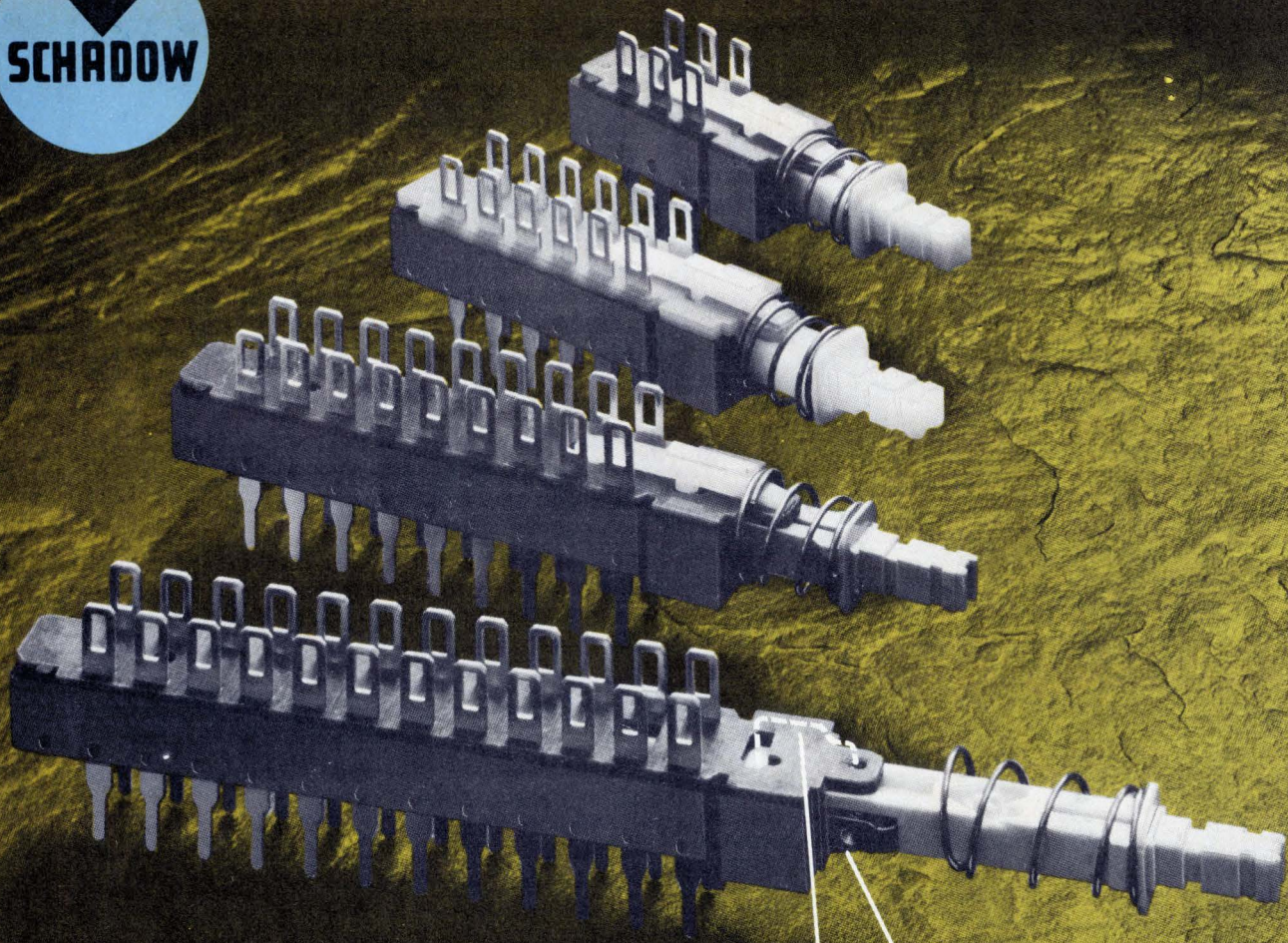

better switch...here's why...

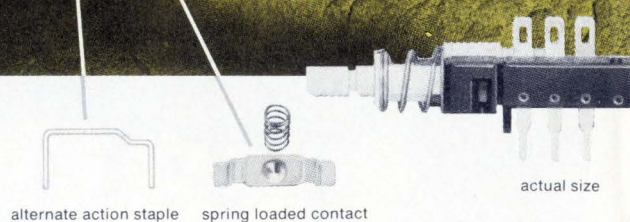

Yes, IEE/Schadow offers an outstanding array of functional push buttons including mechanical reflector indicators... and behind each one of them is the best engineered switch mechanism available today.

Individual Coil Spring Loaded Moving Contacts

- The coil spring-loaded contoured moving contacts have been designed to provide balanced contact pressure for optimum surface to surface interface with the fixed contacts... assuring reliable performance in low voltage (dry circuit) applications
- Long term low contact resistance
- Constant coil spring tension at the contact points provides positive self-cleaning action

Hand Wiring and Flo-Soldering Connections are Standard

- Solder lugs on top for hand wiring
- PC spikes at bottom for flo-soldering

Superior Modular Construction

- Ease of maintenance... switch plunger with slicing contacts is removable from the front without disturbing electrical connections

Circle 106 on reader service card

- Enclosed housing protects inner contact area from dust and foreign intrusions
- Fixed terminals are "staked" in position, providing an extra seal to help prevent wicking of solder or flux
- Molded PC Board Standoffs, front and back, on bottom side, assure parallel mounting

Technical Data

Contact Resistance 4-6 mOhms
... after 25,000 cycles 6-20 mOhms
Lifetime Expectation Interlocked	(50,000)
Momentary, Push Push	(100,000) cycles
Material Of Construction	
Fixed contact Brass/Silver Plated .0002"
Moving contact Bimetal Brass/Silver .0004"
Plunger Material Delrin
Contacts Non-shorting

Housing Material Glass Reinforced Nylon/or Poly Carbonate

Terminal Board

Material . . . High Grade Paper Phenolic

NOTE: In circuits imposing unusual demands for insulation resistance and dielectric strength, we offer these alternatives: Housing Material:

Makrolon (Polycarbonate)

Terminal Board Material: Hard paper grade IV

If it's a better switch you need... better switch to Schadow.

Full color switch selection guide available free when requested on your business letterhead.



IEE/SCHADOW inc

8081 Wallace Road, Eden Prairie, Minn. 55343
612/944-1820 • TWX 910-576-2469

Manufacturing facilities in Minneapolis, Minnesota, Einbeck, W. Germany and W. Berlin

Rectifying wide-range signals with precision, variable gain

by Jerald Graeme
Burr-Brown Research Corp., Tucson, Ariz.

Millivolt-level signals cannot be rectified directly because they are smaller than the typical 0.7-volt drop across a forward-biased diode. An operational amplifier can reduce this loss to around 10 microvolts. But such circuits have a fixed gain when designed straightforwardly, whereas variable gain is needed for range control in many applications—amplitude detection in ac voltmeters, for example.

Varying the gain has usually required either the adjustment of more than one resistor or, in very complex circuits, the use of a separate input amplifier. With the precision rectifier shown in the diagram, however, variable gain is achieved without a gain-control amplifier.

Gain is controlled by a single variable resistor, which can be a potentiometer or a multiple-tap resistor. In addition, this circuit has a high input impedance without an input buffer and requires only one resistance match. It has a gain range from unity to several thousand, for signals from 1 millivolt to 10 v.

Rectification results when the feedback diodes are switched by a reversal of the signal polarity, which in turn reverses the circuit gain polarity. With the diodes in one orientation, the signal path to the output is a noninverting amplifier; when they switch, it becomes a voltage follower and an inverting amplifier.

An input of positive signals produces a positive current i_1 that turns diodes D_2 and D_3 on and D_1 and D_4 off. This connects the noninverting amplifier A_1 to the output with a gain of $1/x$, where x is a fraction representing the potentiometer setting. In this mode A_2 is merely a ground return for the resistance xR_1 ; its output is disconnected from the circuit output by the reverse-biased diode D_4 . Thus the circuit output, controlled by A_1 alone, is $e_o = e_i/x$.

When the input signal swings negative, so does the current i_1 . It switches off D_2 and D_3 and turns on D_1 and D_4 . Now the output of A_2 is connected to the circuit output, and A_1 merely maintains a signal equal to e_i at its own inverting input. In doing so it also develops this signal across the resistance xR_1 . That resistance acts as the input resistor to A_2 , connected as an inverting amplifier. With a gain of $-1/x$, this inverting amplifier develops $e_o = -e_i/x$, the negative of that produced by positive signals. Since the polarity of the gain switches with that of the input signals, the output signal is always positive, and $e_o = |e_i/x|$.

Gain can be varied from unity to several thousand to accommodate a wide range of signal levels. To insure

continually equal gain for positive and negative signals, it is only necessary to match the resistor R_2 to the total potentiometer resistance R_1 . Op amp gain error directly affects circuit gain, but identically for both positive and negative signals.

Otherwise, circuit accuracy depends upon the noises, dc errors, and ac responses of the op amps. Noise isn't generally a major source of error in the practical signal range of 1 mV to 10 v, as long as the resistance levels are low enough to limit the effects of noise currents at the amplifier inputs.

Ideally, the diodes would switch just as the input signal crosses zero, but the op amps' dc offset voltages—the input levels below which the amplifiers produce no outputs, as a result of mismatched transistors in the amplifiers—cause the circuit to depart from this ideal. The error currents are:

$$(V_{os1} - V_{os2})/xR_1 + I_{B1}$$

and

$$(V_{os1} - V_{os2})/xR_2 - I_{B2}$$

This switching-point offset limits the circuit's operation with very small signals. To extend it, the amplifiers are chosen for low bias currents, and the op-amp offset voltages are nulled. Matched op amps insure low initial dc errors and thermal drifts.

Another output offset is produced by input currents flowing through the feedback resistances. This offset cannot be removed by the op-amp null controls without again offsetting the diode switching, but it is minimized

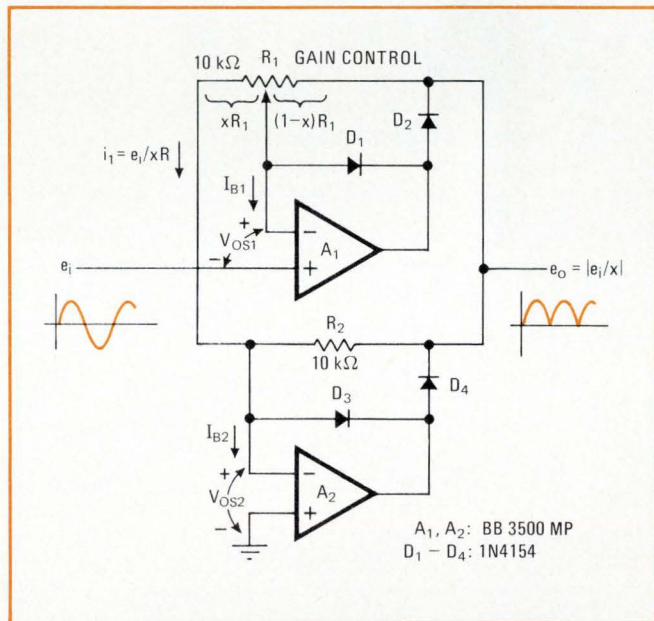

Precision rectifier. Variable gain is achieved without a separate gain-control amplifier, since the control potentiometer varies the gains of both amplifiers identically. Circuit gain ranges from unity to several thousand. Forward or reverse biasing of diodes make the circuit either an inverting or noninverting amplifier.

ALTERNATE SOURCE FOR HP SCHOTTKY BARRIER HOT CARRIER DIODES

AERTECH A2S800 SERIES

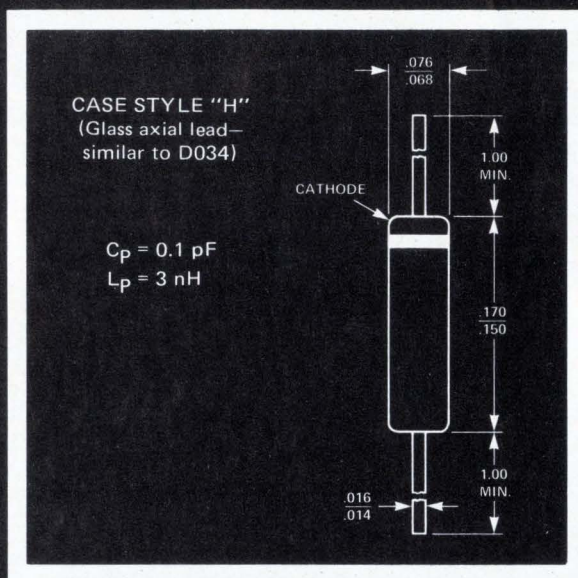

HP	AERTECH
5082-2800	A2S800
5082-2804	A2S804
5082-2805	A2S805
5082-2810	A2S810
5082-2811	A2S811
5082-2814	A2S814
5082-2815	A2S815
5082-2826	A2S826
5082-2835	A2S835

Now In Distributor Stock

AERTECH AUTHORIZED DISTRIBUTORS*

Century Aero Corp.
Hawthorne, California
Phone: (213)772-1166

Intermark Electronics
Sunnyvale, California
Phone: (408)738-1111

Intermark Electronics
Denver, Colorado
Phone: (303)936-8284

Microwave Distributors Co.
Jericho, New York
Phone: (516)433-7448

Intermark Electronics
San Diego, California
Phone: (714)279-5200

Intermark Electronics
Salt Lake City, Utah
Phone: (801)486-3411

E.G. Lomas LTD
Ottawa, Ontario, Canada
Phone: (613)725-2177

Intermark Electronics
Seattle, Washington
Phone: (206)767-3160

Treeco Sales, Inc.
Beltsville, Maryland
Phone: (301)967-8260

*Distributor areas still available for: Florida, Pennsylvania, Boston, and Illinois-Indiana. Interested distributors please contact H. Crittenden for details.

Aertech is a volume producer of Schottky, PIN, Step Recovery, Tunnel, Backward, and Tuning Varactor Diodes.

Aertech
INDUSTRIES

825 STEWART DR., SUNNYVALE, CALIF. 94086 • (408)732-0880 • TWX 910-339-9207

by the choice of suitable op amps and resistances.

High-frequency performance is limited by the speed with which the op-amp outputs can turn off one rectifying diode and turn on the other. While the first diode is being turned off, the signal with the wrong polarity passes, and while the second diode is turning on, no signal passes. Ideally, this transition should be instantaneous, but in practice it always takes a finite time, limited by the operational amplifiers' slewing rates and their bandwidths, which are expressed by the speed with which the amplifiers can swing their outputs

through two diode voltage drops, $2V_f$.

If the input signal is small, the rate of change of the amplifier output voltages equals the rate of change of the input signal multiplied by the open-loop gain of the amplifier at the signal frequency, $A(f_i)$, and therefore the transition time is the time required for the input signal to change by $2V_f/A(f_i)$. For larger signals the rate of change of the amplifier output voltage can be no more than its slewing rate limit S_r , so that the transition time is $2V_f/S_r$. These considerations limit the usable bandwidth of the precision rectifier to about 1 kilohertz. □

Power-failure detector is good for short lapses

by K.C. Seino,
Fermi National Accelerator Laboratory, Batavia, Ill.

A power-failure-detection circuit for a digital system should be reliable for any interruption, whether it lasts for milliseconds or hours. It should also produce reset and restart timing pulses. The conventional power-clear circuit, which consists of a gate with an RC delaying network at its input, works well for power failures of long duration, but not after a momentary failure. Nevertheless, the system must still be reset and checked before it is restarted.

Two voltage comparators and an open-collector gate

can be the basis of such a circuit as shown in Fig. 1. The diagram shows the LM 311, which can be operated with only a +5-volt power supply, and the peripheral driver SN 75451 B, useful because of its small physical size. But any comparator or open-collector gate with the proper specifications can be used.

When power is present, the (+) input of comparator A_1 stays higher than the (-) side, and the output is high. The NAND gate inverts the level, cutting off the transistor. As soon as power starts to go down, the (+) input, nominally at 3.3 v, quickly drops below the 3.1-v level on the (-) input, which is maintained briefly by capacitor C_1 . This reversal of the input levels causes the output of A_1 to become low; capacitor C_2 , which is normally fully charged, discharges through the transistor, which turns on when the output of A_1 drops.

While the power-supply voltage is less than about 2 v, the output of both amplifiers simply follows whatever may be available on the supply line. But when full

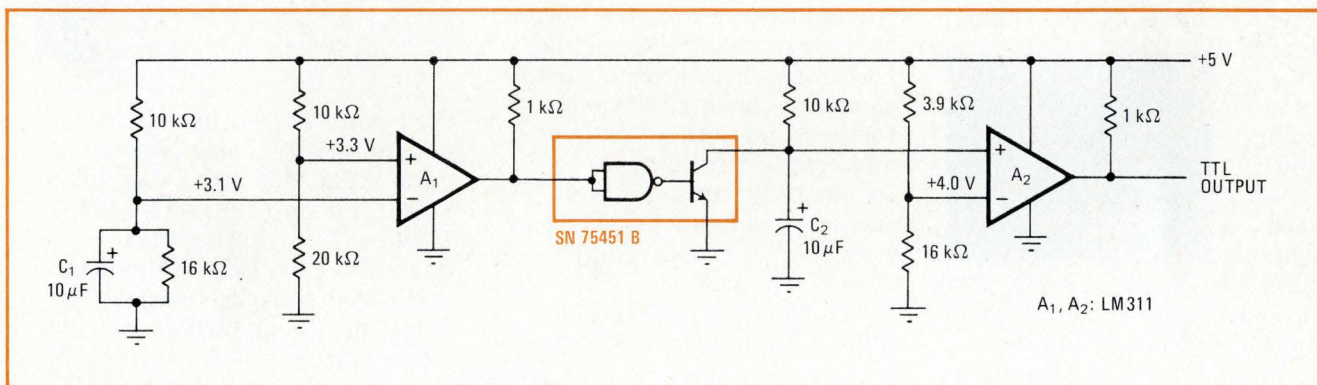

1. Reset and restart. Two voltage comparators and a gate can reset a digital system and restart it after any power interruption, be it a glitch or a complete blackout. Wide variety of ICs can be used. Key components are the RC network at the input of A_2 .

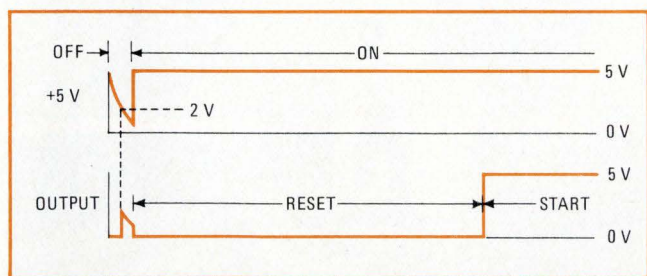

2. Short failure. Even a momentary failure that falls below 2 volts can cause problems. Reset begins the moment power is restored; start pulse is generated after restored power recharges capacitor.

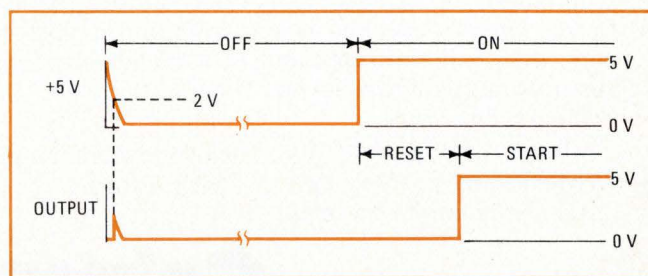

3. Long failure. In the event of a total power failure, the output stays down after power is restored, again until capacitor has been recharged. Duration of reset depends on RC time constant.

Calma presents Norman's latest napkin masterpiece.

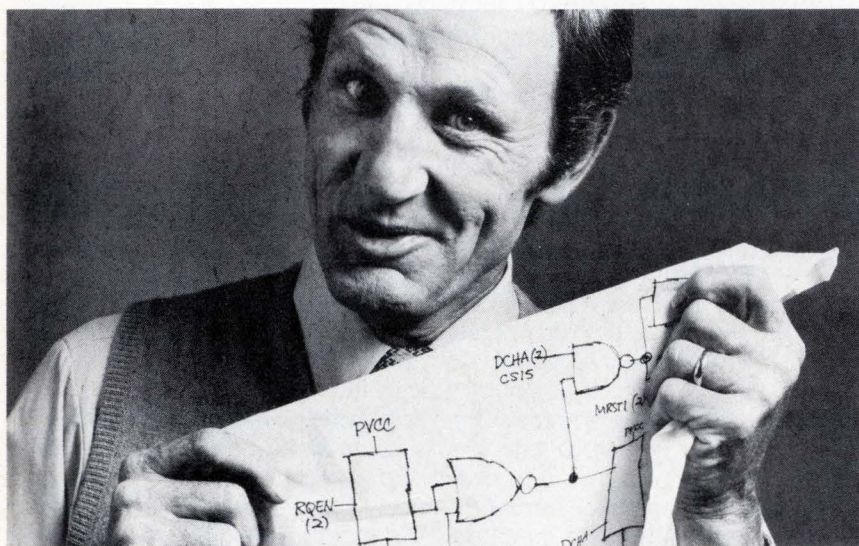

A report on circuit art production. Norman is a conceptual genius. A little sloppy perhaps, but a genius nonetheless. His greatest idea was conceived halfway through an anchovie and pepperoni pizza at Bruno's last Wednesday. After lunch, a young lady earning \$8400 per year turned Norman's napkin into flawless circuit art in just 54 minutes. She did it on a Calma interactive graphics system. She did it one hundred times faster than a speeding draftsman, about twice as fast as she could on any other system. The Calma system checked her accuracy, drew all the lines and symbols automatically, relieved her of the drudge work.

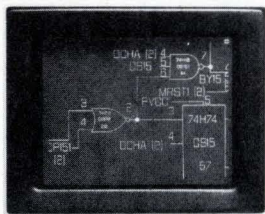

Changes made lightning fast. While eating pretzels two days later, Norman had a brain-

storm. A way to get even hotter performance out of the same circuit concept. Presto. In microseconds, the original design was retrieved from storage and displayed on the CRT at Norman's own interactive work station. In about three minutes Norman himself modified the original. Electronically. Just that fast the company benefited from his fertile mind with a totally new and competitive circuit. Incidentally, up to six work stations can be included in one system with no degradation of performance.

The fast generation.

Where Calma really makes tracks is the transition from art to production. Each Calma system drives up to three high speed plotters in the background mode. All operate at full rated speeds, never interfering with design

or drafting at the system's six work stations. The secret of Calma's non-stop productivity is that no function ever interferes with another.

Reliable sophistication!

For all its sophistication a Calma system is incredibly reliable. More than 100 have been installed and almost all were up and operating the day they were delivered. Learn how this powerful computer-based graphics system can speed your circuits from conception to production. For literature or to arrange a demonstration, phone or write Calma Company,

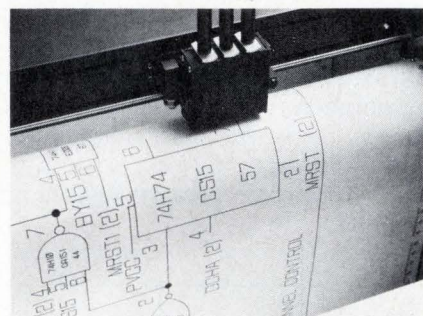

Corporate Marketing Headquarters, 1930 Isaac Newton Square East, Reston, Virginia 20090. Phone (703) 471-1450. European Marketing Headquarters, P.O. Box 6, Marlborough, Wiltshire, SN8 4EW, England. Phone 067286 (Lockeridge) 658.

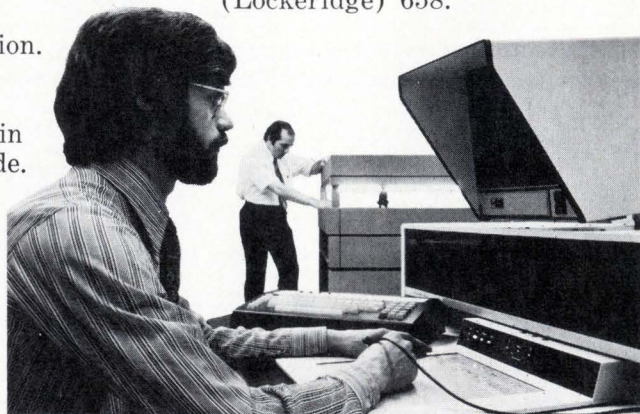

Calma Interactive Graphics Systems.

power is restored, the capacitor C_2 begins to recharge. This takes time—the recharge path is through the 10-kilohm resistor, and the time constant is 100 milliseconds. The output of A_2 stays low until the capacitor voltage reaches 4.0 v, as shown in Figs. 2 and 3. This

condition can be used as a reset pulse, and the transition to the high level when the capacitor voltage passes 4 v can generate a start pulse.

For a longer or shorter reset time, the 10-kilohm and 10-microfarad values can be changed. □

Complementary lighting control uses few parts

by Mark E. Anglin
Novar Electronics Corp., Barberton, Ohio

A very useful tool for stage lighting, light shows, or even home movies is a complementary lighting-control unit that will fade out one lamp while simultaneously increasing the light output of another. The usual design for such a control unit is rather complicated, relying on dual potentiometers, two fader circuits, and two of everything else. But the circuit in the diagram can perform this function with a minimum of parts, and the two loads track each other accurately without adjustments.

The gate of SCR_1 , a silicon-controlled rectifier, is driven from a standard phase-control circuit, based, for example, on a unijunction transistor or a diac. It controls the brightness of lamp L_1 directly. Whenever SCR_1 is not on, a small current flows through L_1 , D_1 and R_1 , permitting SCR_2 to fire. When SCR_1 turns on, current

flow ceases through D_1 and R_1 ; the energy stored in C_1 produces a negative spike that turns SCR_2 off.

In this circuit, the peak current through the diode bridge never exceeds the peak current through either SCR, because the two SCRs can never be conducting at the same time. This is an advantage over the conventional circuit, in which each SCR would be fired at a 45° phase angle to produce half brilliance from the lamps. This represents the worst case of simultaneous conduction and draws a peak current from the bridge that is twice the magnitude of the current of a single 150-watt lamp.

If this control circuit is to be used with lamps rated at more than 150 watts, the value of C_1 should be increased. The value of C_1 , in microfarads, equals or exceeds:

$$(1.5 t_{off} I) / E$$

where t_{off} is the turn-off time of the SCR in microseconds, I is the maximum load current, and E is the voltage at this maximum load current. □

Designer's casebook is a regular feature in Electronics. We invite readers to submit original and unpublished circuit ideas and solutions to design problems. Explain briefly but thoroughly the circuit's operating principle and purpose. We'll pay \$50 for each item published.

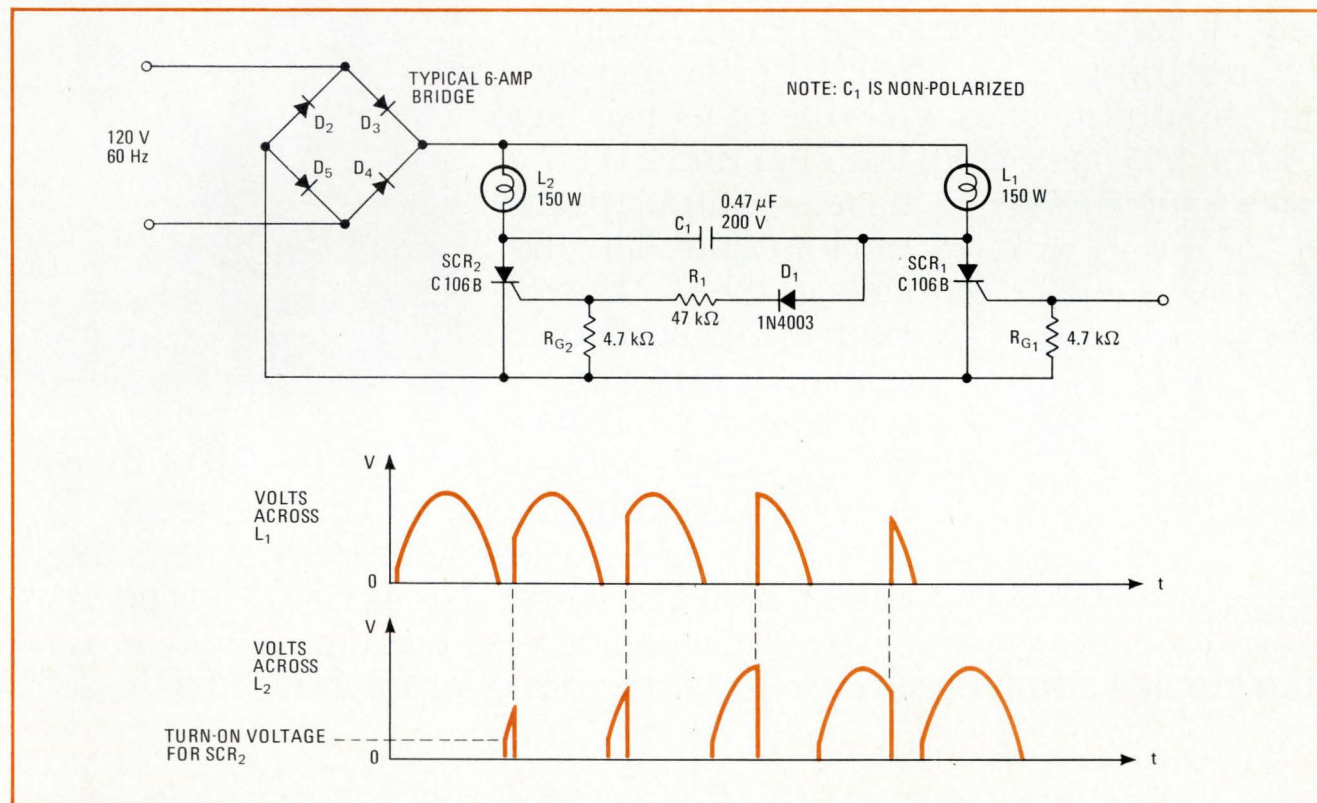

Parts miser. Complementary lighting control fades one lamp out while bringing up the other one, with fewer parts than conventional controls use. Waveforms are segments of successive half-cycles of a full-rectified sine wave as control signal varies.

Choose any speed from Intel's new colle

We have expanded the 2102 series into a first-class family of versatile, easy to use, n-channel static RAMs. These new 1024-bit RAMs add very high speed and 256x4 modularity to the family. Our advanced 2102A series delivers a variety of very fast military and industrial RAMs. The 2101, 2111 and 2112 RAMs save packages in small, expandable memory systems.

The 256x4 organization is available in three package options: 22-pin 2101, 18-pin 2111 and 16-pin 2112. The 2101 has separate input and output lines while the other two have common I/O lines. Both the 2101 and 2111

INTEL'S 1K STATIC RAM FAMILY			
PART	WORST-CASE SPEED*	SIZE	PINS
2102A-2	250 ns	1024x1	16
2102A	350 ns	1024x1	16
2102A-4	450 ns	1024x1	16
MC2102A-4	450 ns	1024x1	16
2101-1	500 ns	256x4	22
2102-1	500 ns	1024x1	16
2111-1	500 ns	256x4	18
2101-2	650 ns	256x4	22
2102-2	650 ns	1024x1	16
2111-2	650 ns	256x4	18
2112-2	650 ns	256x4	16
MC2102A-6	650 ns	1024x1	16
2101	1 μ s	256x4	22
2102	1 μ s	1024x1	16
2111	1 μ s	256x4	18
2112	1 μ s	256x4	16

*Worst case access time and minimum cycle times are guaranteed over full operating temperature range (-55 to +125°C for MC2102A-4 and MC2102A-6; 0 to 70°C for all other types).

have an output disable pin for controlling the state of the I/O bus. Both also have two chip enable inputs, whereas the 2112 has a single chip enable input. Like the 2102, these new RAMs dissipate only 150 mW, typically.

The world's fastest static RAMs are in Intel's 2102A series of 16-pin, 1024x1 RAMs. The 2102A-2's worst case access time is 250 ns. Like all the family's commercial RAMs, its speed is guaranteed from 0 to 70°C.



and configuration tion of static RAMs.

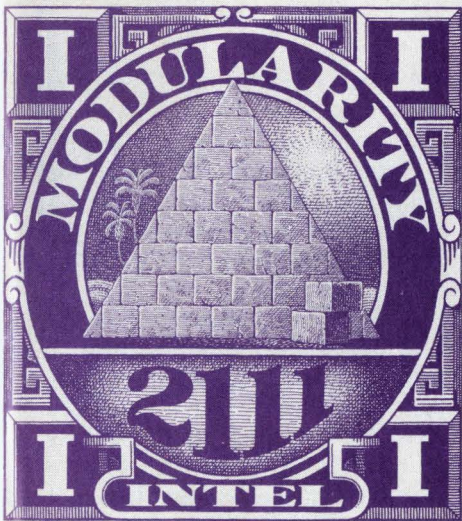

For military temperature range operation, two worst case speed options are offered, 450 ns for the MC2102A-4 and 650 ns for the MC2102A-6.

Every member of the family is as easy to use as the 2102. They operate on a single +5V supply at TTL logic levels and have three-state outputs for easy OR-tying. They need absolutely no MOS/TTL interface circuitry. And all are fully static — no clocks or refresh.

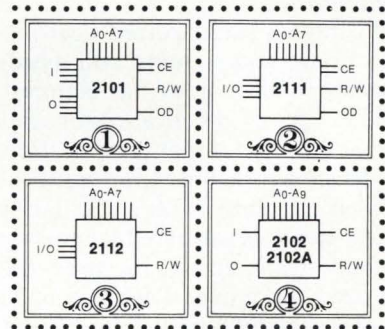

The new series are as easy to get, from stock at your local distributor, as the 2102. See him now and choose these first-class RAMs in whatever variety you need to optimize system cost, performance, and modularity.

All of Intel's static RAMs are available now from Almac/Stroum, Cramer, Hamilton/Avnet, Sheridan Sales, Industrial Components, and L.A. Varah. Or write Intel for the n-channel static RAM information package.

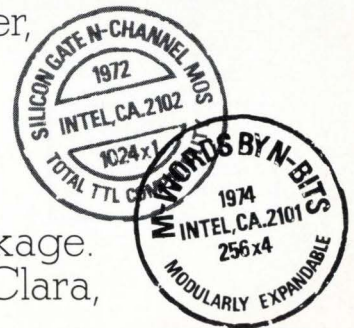

Intel Corporation, 3065 Bowers Avenue, Santa Clara, California 95051 (408) 246-7501.

intel® delivers.

Heat pipes cool gear in restricted spaces

Fluid that cycles in tubes through evaporation and condensation process reduces temperatures around even high-power electronic subassemblies

by Alan J. Streb, *Dynatherm Corp., Cockeysville, Md.*

□ Convective cooling of electronic components—even when heat sinks are used to increase the heat-radiating area—is not always enough to keep operating temperatures within limits. A simple alternative is the heat pipe, which uses fluids cycling through liquid and vapor phases to conduct heat away from temperature-sensitive components.

Although standardized heat-pipe cooling systems for electronic components and systems do not yet exist, heat-pipe technology has matured to the point where a wide range of practical configurations can be produced economically for many applications.

As shown in Fig. 1, a typical heat pipe consists of a sealed tube lined with a capillary pumping structure, or wick, which is saturated with a working fluid. As heat is added at one end of the tube, the working fluid is vaporized and moves down the tube until it condenses at a cooler site and reverts to the liquid state. As liquid is returned to the heat source via capillary action in the wick, heat is continuously transferred from one region

to another through the nearly isothermal process of evaporation and condensation.

The efficiency of transferring heat energy is largely determined by the heat pipe's capability to conduct the vapor from the heat source to the heat sink and to return liquid from the condenser to the evaporator. Capabilities depend on fluid properties, wick configuration, and heat-pipe geometry and orientation.

Heat pipes have been successfully operated over the range from cryogenic to liquid-metal temperatures to convey heat from equipment dissipating power ranging from a few watts to thousands of watts. For any desired temperature range, a number of appropriate working fluids, containment-vessel materials, and wick designs are available. For cooling of electronic components, fluids such as water or organic fluids, contained in pipes made of such materials as aluminum, copper, or stainless steel, can dissipate as much as a kilowatt.

Water has proved to be the most desirable heat-pipe fluid for the temperature range of electronic compo-

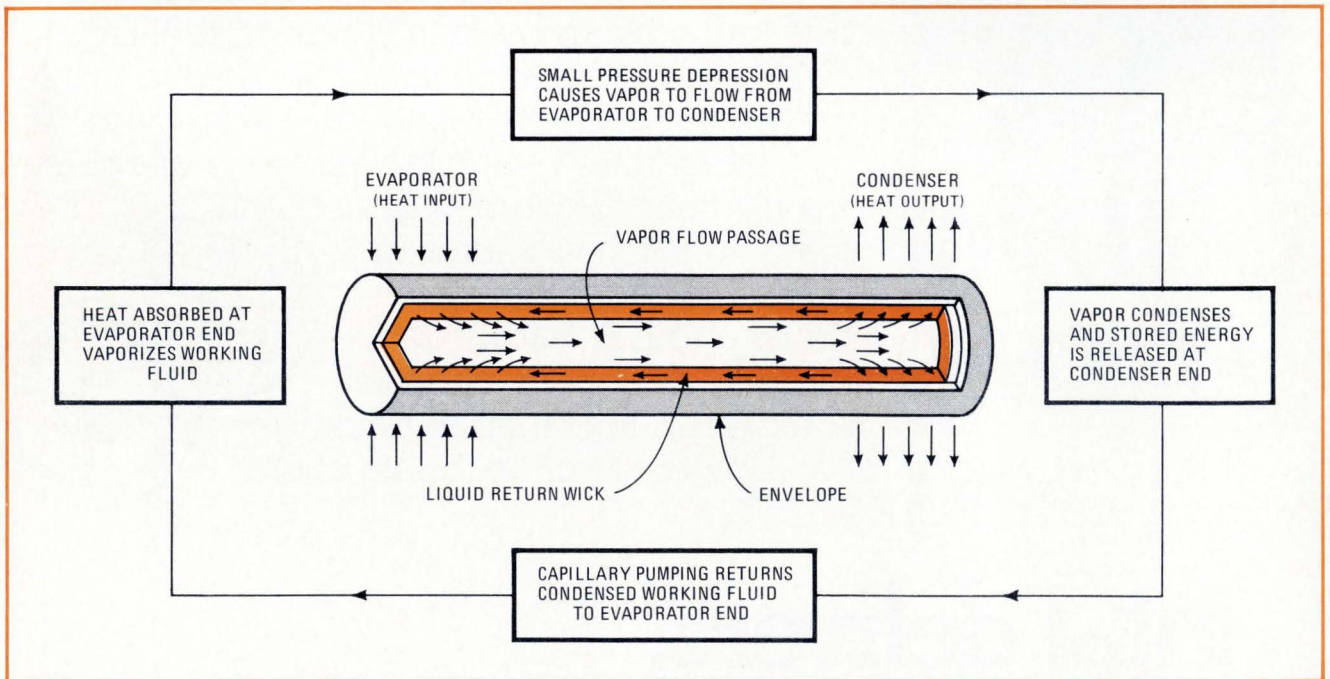

1. Heat Pipe. Using the properties of a fluid as it cycles between the liquid and vapor states, a heat pipe can cool the environment of temperature-sensitive components in enclosed spaces. Water in copper has proved the most desirable combination for electronic parts.

nents, 50°C to 200°C. Figure 2 shows the relative heat-transport capability of a number of fluids for this range. Since water is compatible with copper and copper alloys, but few other containment materials, copper is most widely used in the construction of heat pipes for cooling electronic components and packages.

The physical properties of the heat-pipe working fluid—especially heat of vaporization, surface tension, liquid density, and liquid viscosity—establish the heat-transport capability of the heat pipe. Since these properties are temperature-dependent, the performance of the heat pipe operating with a given fluid is temperature-dependent. One fluid will, therefore, function most effectively over any particular temperature range.

Although the temperature of the vapor within the heat pipe is nearly constant over the length of the device, the temperature varies at the evaporator and condenser regions, where heat is conducted through the walls and the liquid film that lines the walls. This results from the thermal resistance of the container and the working fluid. However, proper design of the containment vessel and the wick can minimize this resistance.

Designing a heat pipe

For a given heat-pipe geometry, the maximum heat-transport capability may be estimated by:

$$Q_{\max} = ad^2/l$$

where Q_{\max} is the maximum heat-pipe heat-transport capability in watts, d the inside diameter of the heat pipe in inches, l the heat-pipe length from midpoint of evaporator to midpoint of condenser in inches, and a is a constant.

The value of the constant is determined by the geometry of the heat-pipe wick, working fluid, and orientation. Values of this constant for a typical copper-water heat pipe configuration are presented in Fig. 3.

The maximum temperature gradient across a heat pipe can be estimated for a given heat pipe geometry from:

$$\Delta T = (Q/b)(1/A_{\text{evap}} + 1/A_{\text{cond}})$$

where ΔT is the over-all temperature drop in degrees fahrenheit, Q the heat transport in watts, A_{evap} the total area of the evaporator in square inches, A_{cond} the total area of the condenser in square inches, and b is a constant.

The constant in this equation has a value determined by the heat pipe's configuration. For a typical copper-water heat pipe,

$$b = 3 \text{ W/in.}^2\text{F}$$

A first-cut selection of the size of heat pipe required for a particular application can be determined from these equations. But to optimize the heat pipe, the designer must also consider such other factors as the relative position of the evaporator and condenser, both with respect to each other and to the horizontal plane.

The pressure developed by capillary pumping within the heat pipe must balance the losses in viscous pressure within the system, as well as differences in elevation pressure that may be caused by locating the heat source

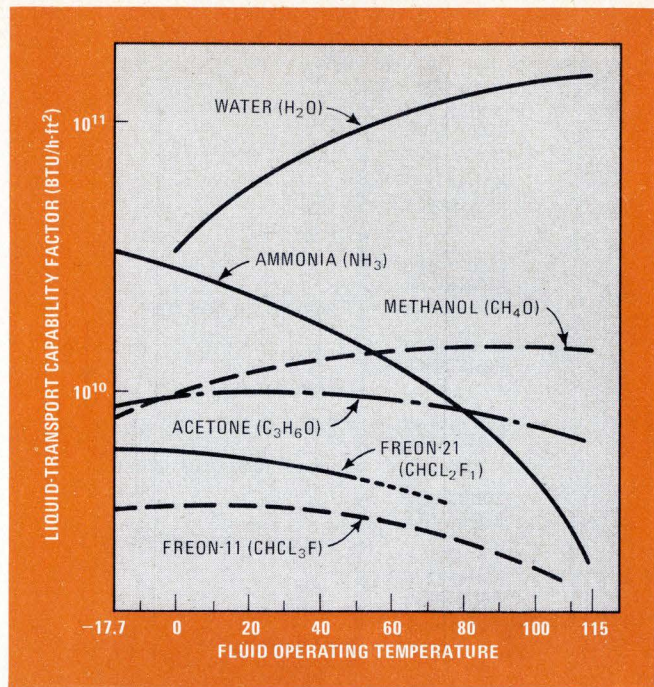

2. Working Fluids. Over a wide temperature range, water has a higher heat-transport capability than other fluids for heat pipes.

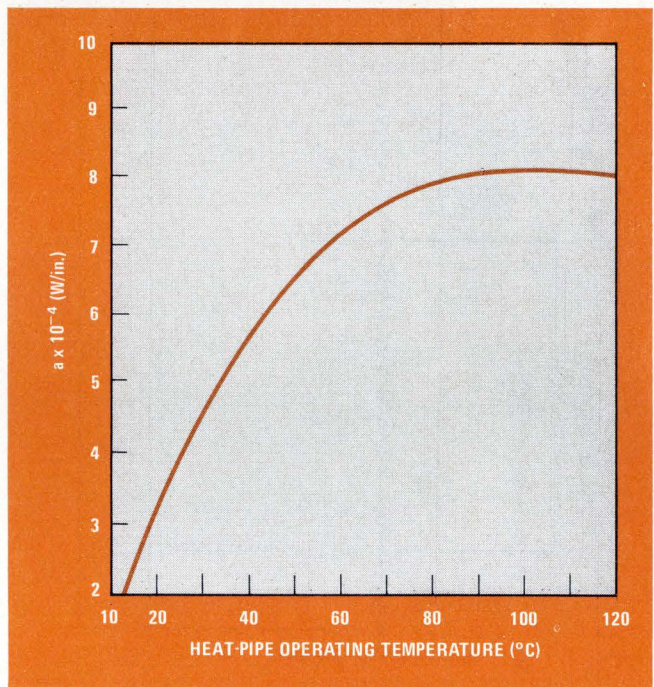

3. Heat transport. For a copper heat pipe using water as the working fluid, the heat-transport constant varies with temperature.

above the heat sink. Because the capillary-wick structure is only capable of a limited rise in liquid-pumping pressure, adverse orientation of the heat pipe can degrade its performance.

Calculating heat flow

Lowering the condenser end will degrade the steady-state heat-transporting capability of the heat pipe, and that capability will go to zero if the condenser end is lower than the evaporator by an amount in excess of a

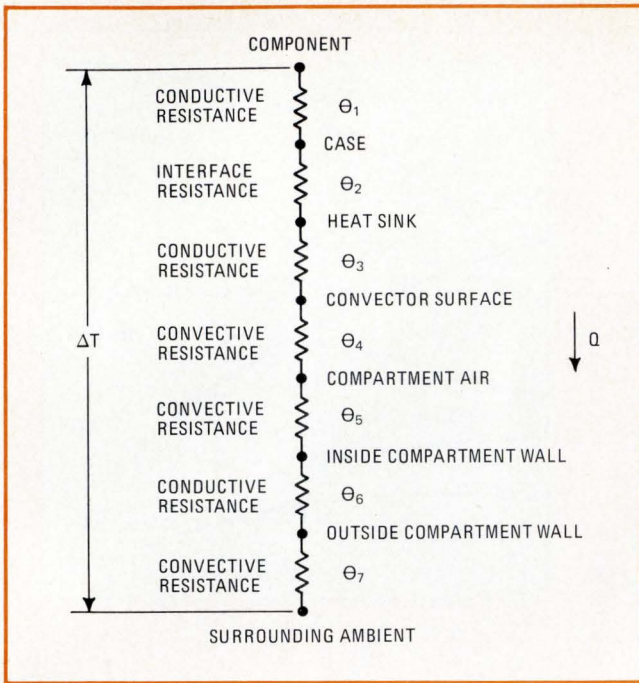

4. Analogy. Thermal resistances met by heat as it flows from a component to its surroundings are analogous to electrical resistances.

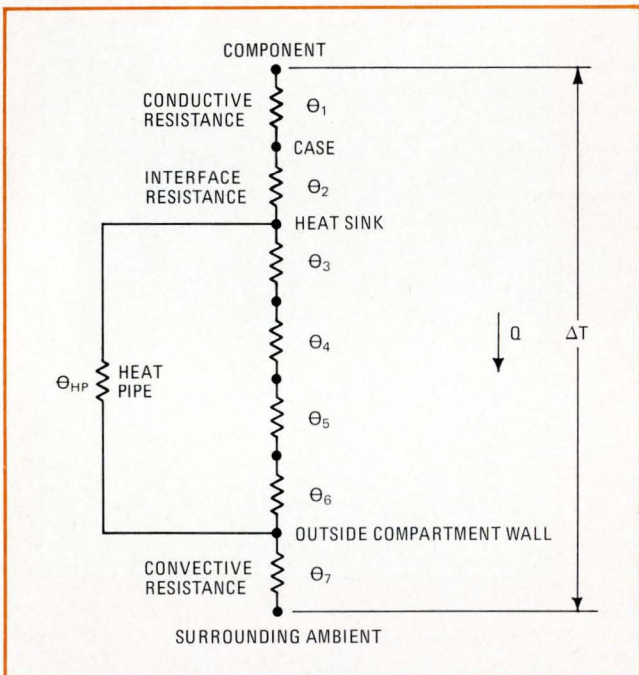

5. Short-circuit. A heat pipe can act as a thermal short-circuit to help heat flow to the surrounding ambient.

dimension called the static-wicking height. The static-wicking height, which is a function of the working fluid, the temperature, and the capillary size, ranges from eight to 16 inches for a typical water-filled heat pipe.

In an electronic system, heat flows from a source through a series of thermal resistances to the surroundings. The rate of heat flow depends on the total effective thermal resistance of the path and the total temperature difference between the source and the surroundings. This is similar, of course, to an electrical circuit, since

voltage difference is analogous to temperature difference, current to heat flow, and electrical resistance to thermal resistance.

In Fig. 4, the "circuit" for heat flow from a heat-producing component, through thermal resistances, to the surrounding ambient is shown. Heat (Q) is driven through thermal resistances (Θ) by a temperature difference (ΔT) so that

$$Q = \Delta T / \Sigma \Theta$$

The series-thermal-resistance path shown in Fig. 4 is idealized. In most practical situations, parallel paths are also present, but these resistances may be combined to an equivalent thermal resistance through an analog of Kirchoff's Law. The major contributors to the total effective thermal resistance in a system like that of Fig. 4 are usually those resistances external to the component itself, i.e., Θ_2 through Θ_7 ; therefore, techniques to improve heat transfer are often sought in these areas.

Because of its inherently low thermal resistance and the relative insensitivity of resistance to length, a heat pipe is an efficient conductor of heat. All of the resistances Θ_3 through Θ_6 can be bypassed by interposing a heat-pipe shunt between the component case and the compartment wall, as shown in Fig. 5.

If all the convective resistances (Θ_4 , Θ_5 , and Θ_7) are approximately equal, all the conductive resistances (Θ_1 , Θ_3 , and Θ_6) are approximately equal, and all of these thermal resistances are much larger than the thermal resistance of the heat pipe, Θ_{HP} , the total thermal resistance of the circuit with the heat pipe is approximately one third of the total circuit resistance without the heat pipe. The heat pipe acts as a thermal short-circuit.

Beating the heat

Heat pipes can substantially reduce the thermal resistance between the heat source and the heat sink in a wide variety of applications. They are especially valuable in cooling systems that have confined spaces, as well as in enclosed products. In one computer system, conduction had to be used to remove heat generated by large numbers of densely mounted components on a printed-circuit board. The glass-epoxy board itself did not have sufficient thermal conductivity, even when augmented with heavy layers of copper.

To solve the problem, a flat-plate heat-pipe panel (Fig. 6a) was designed to serve as a structure/thermal base for two board assemblies—one on each side. Heat absorbed by the panel surface from the card-mounted components is transferred to the two edges of the heat-pipe panel, where the panel interfaces with its mounting rails. The heat absorbed at the rails is conducted through the enclosure and dissipated to an external air or liquid cooling system. The effective over-all thermal conductivity of the panel is eight times that of copper.

Another difficulty arose when a high-density solid-state microwave amplifier for military applications had to be cooled by natural convection only, yet the circuitry had to be enclosed and sealed within an existing package designed for outdoor use. The ambient temperature extremes were therefore substantial, and the internal and external heat sinks were limited.

DESIGNING HEAT PIPES TO FIT THE JOB

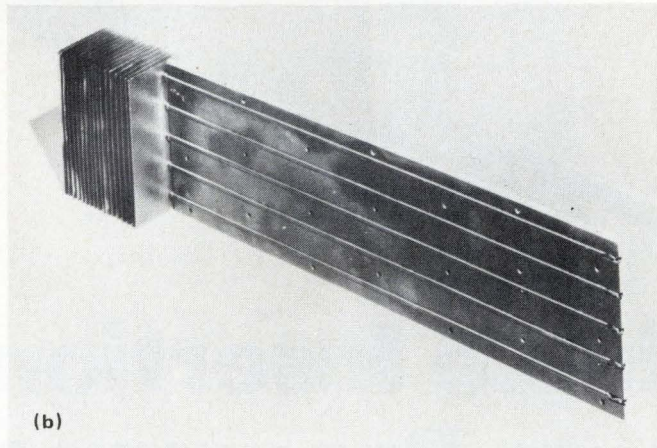
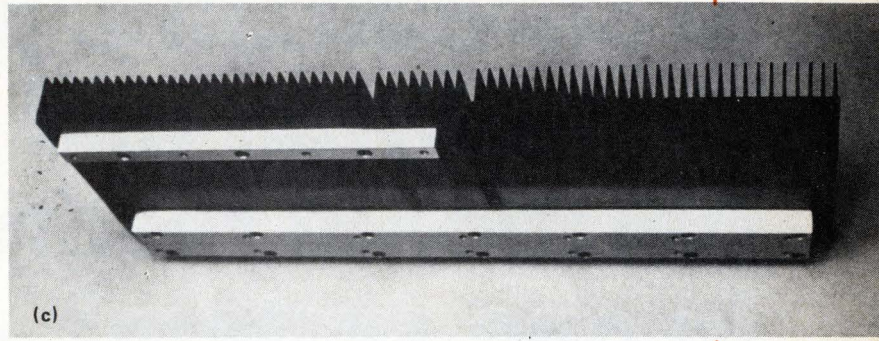
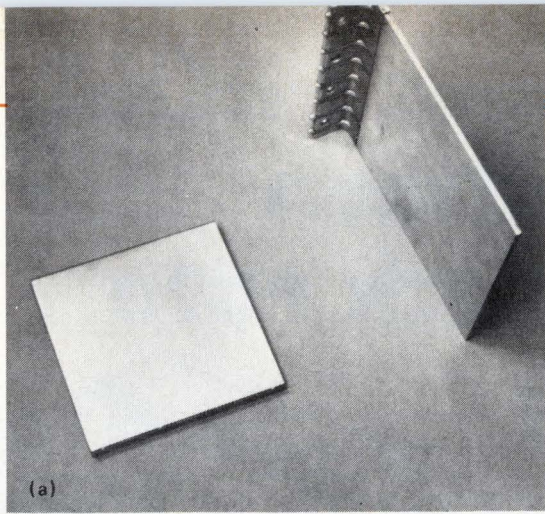

6. Configuring coolers. A flat-pole heat pipe (a) conducts heat away from printed-circuit boards in a computer system. Five heat pipes were brazed onto an aluminum baseplate to cool a microwave amplifier in an enclosed assembly (b). The entire rear wall of the enclosure in a sealed numerical-control system forms a heat pipe (c) to distribute the heat, and fins on the outer surface dissipate it. A heat pipe serves both as drive shaft and heat sink with integral fins for heat dissipation in a motor for a servo-control drive in an airborne system (d).

A heat pipe with integral fins (Fig. 6b) was devised to cool the amplifier assembly. The heat sink consists of an aluminum baseplate to which five heat pipes are brazed at equal intervals. Heat is transported by the heat pipes to copper fin plates outside of the sealed enclosure. Between a component mounted at any location along the 23-inch-long mounting plane and the ambient air near the fins, the thermal resistance totals $0.66^{\circ}\text{C}/\text{w}$. The unit is designed for a nominal heat throughput of 85 w.

Cooling a sealed enclosure

At another installation, a numerical-control system for a machine tool required a sealed enclosure to prevent contamination from dirt and oil vapor. As a result, heat removal became a problem. The conventional solutions were found to be either thermally inadequate or too complex and costly.

A large heat-pipe assembly was developed to serve as the entire rear wall of the enclosure (Fig. 6c). The outward-facing surface of the heat sink includes sufficient finned surface to dissipate the entire thermal load by natural convection. A single flat-cross-section heat pipe applied across the interior surface of the heat sink distributes the heat uniformly over the large panel area.

Heat-generation is predominantly associated with a

power supply that is conductively coupled directly to the interior of the heat-sink panel. Over-all effective resistance of the heat sink from the subsystem mounting pad to the environment is $0.25^{\circ}\text{C}/\text{w}$. The unit is rated for a maximum heat input of 150 w.

To achieve the required performance in a compact drive motor for a servo control in an airborne system, efficient removal of a substantial heat load generated in the rotating armature was necessary. Circulation of a fluid through the armature would have necessitated the use of rotating seals and added undesirable volume and weight to the assembly.

A heat pipe was designed to serve both as a drive shaft and heat sink (Fig. 6d). The end external to the motor frame contains integral fins for heat dissipation. The armature winding is pressed onto the heat-pipe shaft. Heat generated within the armature winding is conducted through the armature to the evaporator end.

Heat is transported isothermally down the length of the shaft and delivered to the finned convector by the heat-pipe operating cycle. The heat is dissipated from the fins by convection and radiation. A thermal resistance of less than $5^{\circ}\text{C}/\text{w}$ is achieved between the armature shaft interface and cooling air. The assembly is designed for a nominal rating of 15 w. □

NOW! Simultaneous PROM programming, pattern verification and clock rate functional testing in one system!

PROM's must be tested for pattern sensitivity

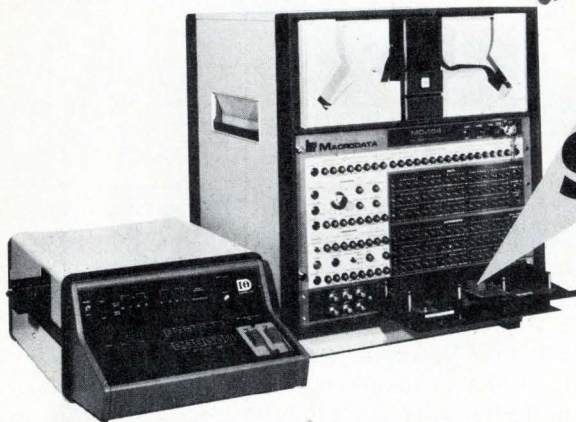
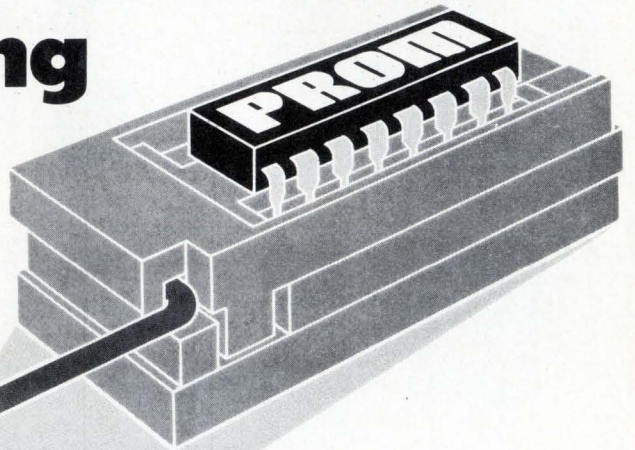

Single Insertion Single Program = Big Savings

**Works on all PROM technologies:
Avalanche Induced Migration (AIM), Fusible Link, MOS, MNOS**

SYSTEM USE Macrodata, and Data I/O Corporation have just introduced the first integrated system for PROM programming, pattern verification and functional clock rate testing. Using Macrodata's MD-100 or MD-104 programmable microprocessor and Data I/O's Model III, it is now possible to program and test PROMS up to 2K x 16 organization made by any manufacturer using a paper tape input or standard PROM.

The Macrodata MD-100/104 and Data I/O Model III contain personality card interfaces to the PROM-AIM, fusible link, MOS, MNOS, and bipolar PROMS. The bit pattern is loaded into the MD-100/104 and Model III RAM buffers via a high speed paper tape reader or standard PROM. Bit pattern input can be ASCII/P-N, ASCII/H-L, ASCII/HEX, Octal or BCD. A system translator converts your input to machine code.

A single "START" switch on the personality card activates the complete "program-verify-test" cycle. The Data I/O Model III controls bit pattern programming and static DC parameter verification, ensuring that each bit has been programmed to spec. Programming, timing, and voltage parameters per manufacturer's spec are preset and adjustable to suit your particular requirements.

Following successful programming of the PROM, the MD-100/104 executes a functional clock rate test on the PROM using field-proven worst case addressing patterns. These patterns are run at minimum and maximum bias voltages and input/output levels per manufacturer's spec — all under system program control. End of test is

indicated by a "PASS" or "FAIL" lamp. Total program-verify-test time for an 8K PROM organized as 1K x 8 is less than 2 seconds.

PATTERN SENSITIVITY Experience has shown that PROMS are pattern sensitive to address and data iteration sequences in much the same way as are RAMS.

"ROM SCAN" is a sequential addressing pattern which runs through all addresses at device clock rate, checking the entire bit pattern at each address. Dual limit comparators are used to check for "0" and "1" level at each bit of each address.

"ROM RUN" is a GALPAT type program that is an excellent PROM functional test. It simulates actual use of a PROM in a system by checking address stable to data out access time from each address to every other address. It is very common for a PROM to have the correct bit pattern of "1" and "0" in each location, yet, due to circuit faults, be unable to meet its access time spec under particular addressing sequences. Testing the PROM functionally at programming time saves the cost of trying to locate the error once the PROM is installed on the PC board and the manufacturer's warranty is void. The system can be used with single PROM's and can also be used for programming, verifying and testing PC board with multiple PROM's having the same or different bit patterns.

For more information, use the reader service number or contact Macrodata or Data I/O directly at the phone numbers below.

MACRODATA 

Macrodata Corporation, 6203 Variel Avenue, Woodland Hills, California 91364,
Phone: (213) 887-5550



Data I/O, P.O. Box 1603, Bellevue, Washington 98009, Phone: (206) 455-3990.

Rare-earth permanent magnets move into new applications

Lower costs of raw materials and improved manufacturing technology enlarge the applications base for these devices, especially those of samarium-cobalt, whose characteristics permit smaller, simpler designs

by R.J. Parker, Hitachi Magnetics Corp., Edmore, Mich.

□ The growing practicality of rare-earth permanent magnets requires the prospective user to reconsider many long-standing design relationships in order to capitalize on their true potential. Weight and energy differentials between rare-earth and other permanent magnets are usually too great to allow simple interchangeability. It is often necessary to rearrange magnetic circuits, restructure devices, and rethink many fundamental relationships when a rare-earth magnet is to be substituted for a conventional magnet.

Rare-earth magnets enjoyed only limited acceptance until recently because of their comparative high cost. Not that the supply of rare-earth elements was ever really a problem, but the expense of separating one element from another was, and to a lesser degree still is. But the costs of rare-earth elements have dropped dramatically in the past five years. Samarium, which has proved to be the most effective rare-earth element for permanent-magnet applications, now costs about one-fifth of what it did five years ago. Manufacturing pro-

cesses, too, have greatly improved so as to lower magnet cost.

In fact, the cumulative developments have been such that Hitachi Magnetics has switched from pilot production to full production of samarium-cobalt compound at its magnet plant in Edmore, Mich. Calling it by the trade name Hicorex, Hitachi uses a reduction-diffusion process that permits the samarium-cobalt compound to be made directly, without having to make pure samarium first. It's a process developed by General Electric's R&D Center, Schenectady, N.Y.

Making rare-earth magnets

To obtain a good permanent magnet, the magnetic material must be ground into small particles having a high intrinsic magnetization, as well as some kind of energy barrier that makes the reversal of magnetization difficult. Compounds of cobalt and the rare-earth elements have both a high intrinsic magnetization with high curie temperatures and a remarkable energy bar-

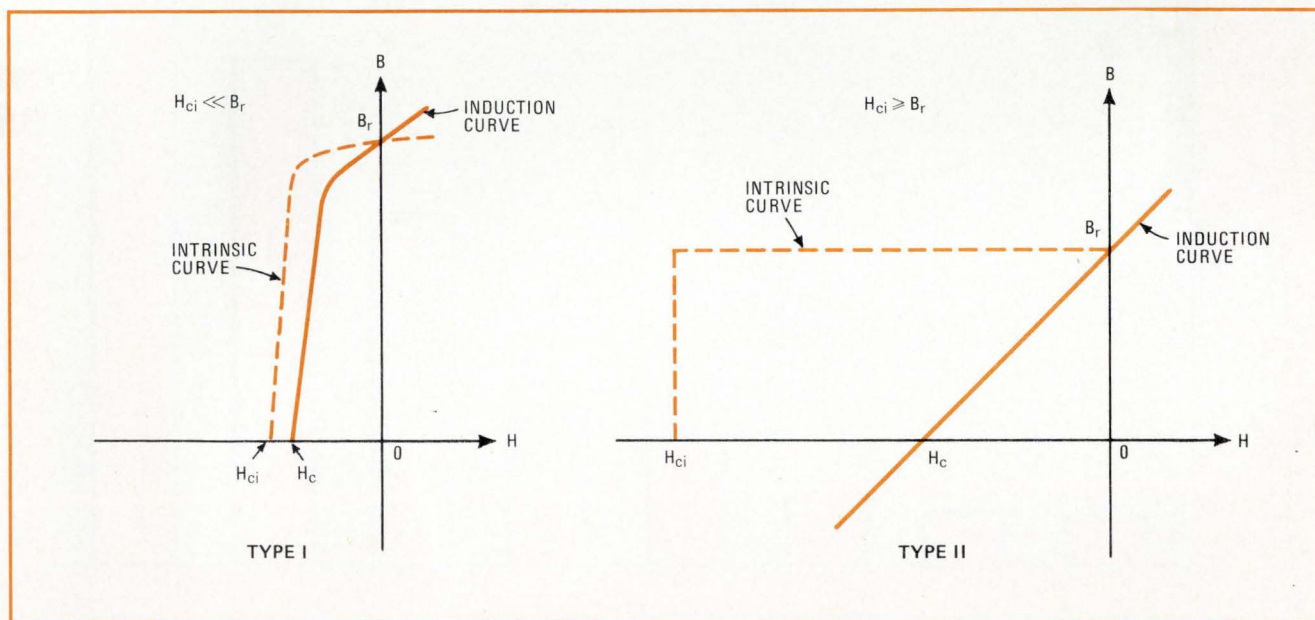

1. Demagnetization curves. Essentially, permanent magnets can be divided into two types by considering their resistance to demagnetization, known as intrinsic coercive force (H_{ci}). For Type I magnets, H_{ci} is much smaller than the residual magnetization (B_r), making the intrinsic and induction curves nearly the same. For Type II magnets, H_{ci} is greater than or equal to B_r , so that there is a large difference between these curves. Rare-earth magnets, which exhibit a high resistance to demagnetization, are in the Type II class.

rier because of the strong attachment of the magnetization to a particular crystal axis.

Generally, rare-earth magnets are formed from compounds of cobalt and one or two of the following: yttrium, cerium, lanthanum, praseodymium, samarium, or mischmetal. The latter is a combination of rare-earth elements occurring in natural deposits.

To process rare-earth magnets, first the intermetallic compound is formed by melting the elements together in the desired ratio in a vacuum, or protective atmosphere. This cast compound is next ground into fine particles on the order of a few micrometers in diameter. These particles are then reassembled and ordered in a magnetic field, then densified by sintering them in a protective atmosphere.

At the present time, only samarium cobalt, or samarium in combination with other rare-earth elements, exhibits properties close to theoretical predictions. Much research remains to be done to identify what is unique about samarium, because, in terms of their identifiable properties, other rare-earth elements should, in theory, also give comparable results. There is much to be learned about the role played by particle surface conditions, crystal imperfections, domain walls, and nucleation sites for magnetization reversal.

Today, mischmetal may be substituted in part for samarium to obtain a more attractive property-to-cost relationship. With mischmetal, the expensive process of separating the rare-earth elements can be eliminated. It is possible, for example, to replace half the samarium in samarium-cobalt with mischmetal, while reducing the

material's energy product by only 10%. For large magnets, an appreciable cost savings can be realized.

Samarium-cobalt exhibits sharply improved properties over more popular types of permanent magnets, like those made from Alnico (aluminum-nickel-cobalt-copper-titanium-iron) or ceramic materials. The samarium-cobalt devices are more efficient, have lower leakage and greater resistance to demagnetization, and can be magnetized to higher levels.

Electromechanical devices made with samarium-cobalt magnets can be smaller and lighter. Servo motors, gyros, aircraft alternators, linear actuators, moving-magnet meters, loudspeakers, phonograph pickups—all represent some of the possible applications. Magnetic circuits that take advantage of the high performance of samarium-cobalt magnets can be built more compactly, opening up application possibilities ranging from microwave tubes to moving-coil meters to electronic watches.

Looking at the differences

Permanent magnets can be divided into two basic types with respect to their resistance to demagnetization (coercive force, H_c) and their level of residual magnetization (B_r). Figure 1 shows this property relationship for both Type I and Type II magnets.

For the Type I magnets, the intrinsic coercive force (H_{ci}) is much less than the residual magnetization, B_r . On the other hand, for the Type II magnets, H_{ci} is equal to or greater than B_r . Rare-earth permanent magnets are Type II components. This substantial dissimilarity

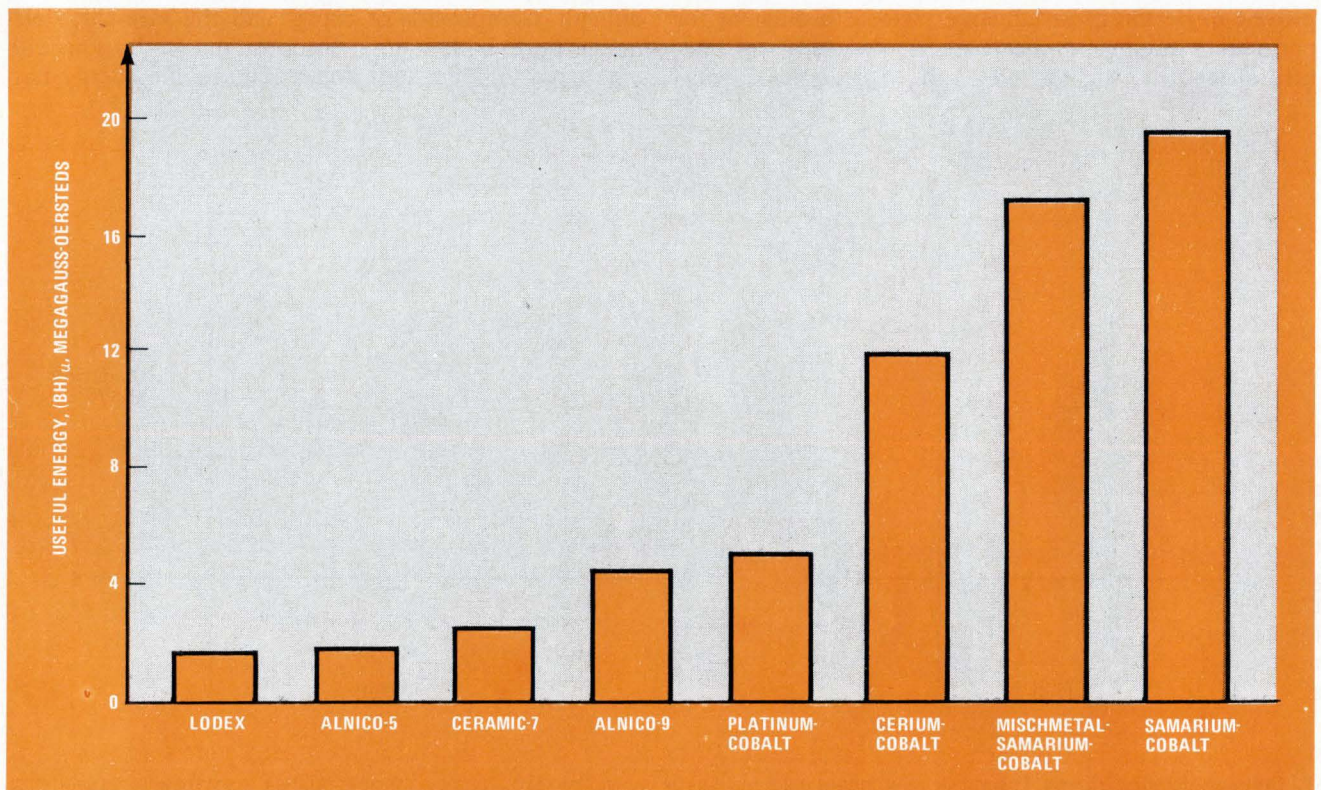

2. Energy comparison. Permanent magnets made from compounds of cobalt and the rare-earth elements produce more useful energy than those made from conventional magnetic materials, like Alnico or ceramic. Because of this property difference, rare-earth magnets provide greater efficiency for applications involving dynamic loading, as in a torque motor or a latching magnet.

About permanent magnets . . .

Basic relationships among the key properties of a permanent magnet can be observed from a plot of flux density versus field strength. Such a plot, as shown here, reflects the intrinsic properties of the material being used, and its normal induction properties.

The rectangular hysteresis loop (dashed color lines) represents the relationship between the magnetic potential or field strength (H) and the resulting intrinsic magnetization or flux density (B). The other hysteresis loop (solid color lines) is the material's normal induction curve. It is obtained by adding the value of the magnetic potential to the value of the intrinsic magnetization at every point.

When a permanent magnet must establish a field in an air gap, the induction curve is used to determine the volume and geometry of the magnet. In this case, the magnet usually operates in the second quadrant of the induction hysteresis loop. When a permanent magnet must react with an external field, the intrinsic magnetization curve is used to calculate the force or torque on the magnet, since the force results from the interaction between the magnetization and the external field.

The most important material properties are its residual magnetization (B_r), which is the magnetization level at zero applied field; its intrinsic level of resistance to complete demagnetization, which is called its intrinsic coercive force (H_{ci}); and its induction level of resistance to complete demagnetization, which is called its coercive force (H_c).

Another important property is the maximum available energy product, $(BH)_{max}$, which is also known as the material's volumetric figure of merit. This represents the point on the induction curve where B and H values are such that their product is a maximum. This means that the magnet's volume can be minimized for a given external energy requirement. The magnet can be designed to operate with this B -to- H ratio by controlling its geometry and its associated magnetic circuit.

For rare-earth materials, the intrinsic coercive force is greater than the intrinsic magnetization (B_i), creating a

large difference between the intrinsic and induction curves. However, for many other types of magnetic materials, the H_{ci} value is much less than the B_i value, making the intrinsic and induction curves nearly the same.

The level of the intrinsic saturation magnetization (B_{is}) establishes the material's basic boundaries. The coercive force can approach the residual magnetization as a limit, since the material's intrinsic magnetization cannot increase along with increasingly negative values of magnetizing force.

In a bulk magnet the level of intrinsic saturation is the composite contribution of all the domains or crystal sites in the material. Therefore, it is important to pack together as many sites as possible, and each must be aligned so that it makes a maximum contribution. Ideally, the ratio of B_r/B_{is} should be unity.

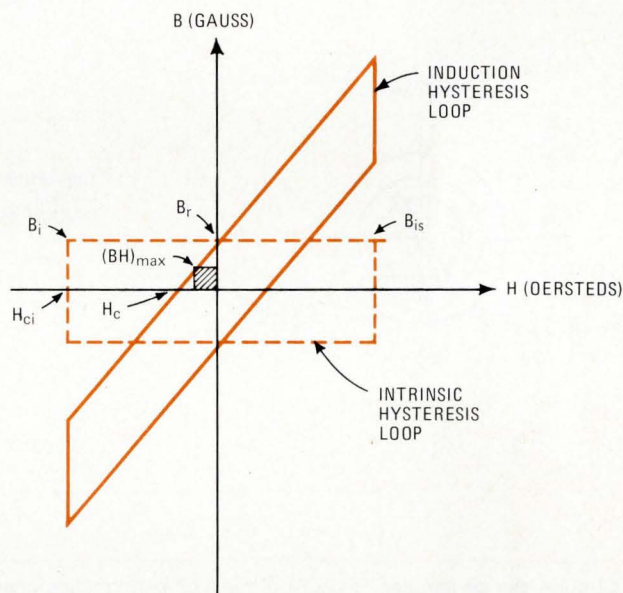

of the two characteristics means that the behavior of the two classes of magnets will be significantly different, and they cannot be used interchangeably in the same application.

The first distinction between the two classes concerns their resistance to demagnetization. For the Type II magnets, the point of irreversibility of induction is moved from the second quadrant of the induction hysteresis loop to the third quadrant. This class of magnets, therefore, can encounter levels of demagnetization greater than its own maximum self-demagnetizing influence without the need for remagnetization. Also, their reversible permeability is close to unity, and the major and minor hysteresis loops tend to have the same slope.

As the Type II magnet is loaded and unloaded over a dynamic work cycle, as would happen in a torque drive or a latching magnet, it transforms energy very efficiently. The magnet will store potential energy within its volume, and this energy can be converted back into mechanical work. However, with a Type I magnet, such

as Alnico-5, most of the potential energy is stored in the leakage field external to the magnet's volume, and only a small portion of this energy can be converted back into mechanical work.

For the dynamic-work-cycle sort of service, the significant property of the magnet is its useful energy, $(BH)_u$, as opposed to its total available energy, $(BH)_{max}$.

Figure 2 shows a comparison of the useful energy level of several popular types of permanent magnets. As can be seen, rare-earth magnets are eight to 10 times more efficient than Alnico or ceramic magnets.

A second point of distinction between the two classes is the greater disparity among the Type II magnets between the intrinsic and normal demagnetization curves. This means that a heavily self-demagnetized Type II magnet can be placed in an external field, and yet very large forces or torques per unit mass may still be obtained. The torque is directly proportional to the intrinsic magnetization of the magnet and the field into which it is placed. Rare-earth magnets have high levels of intrinsic magnetization, making them practically immune

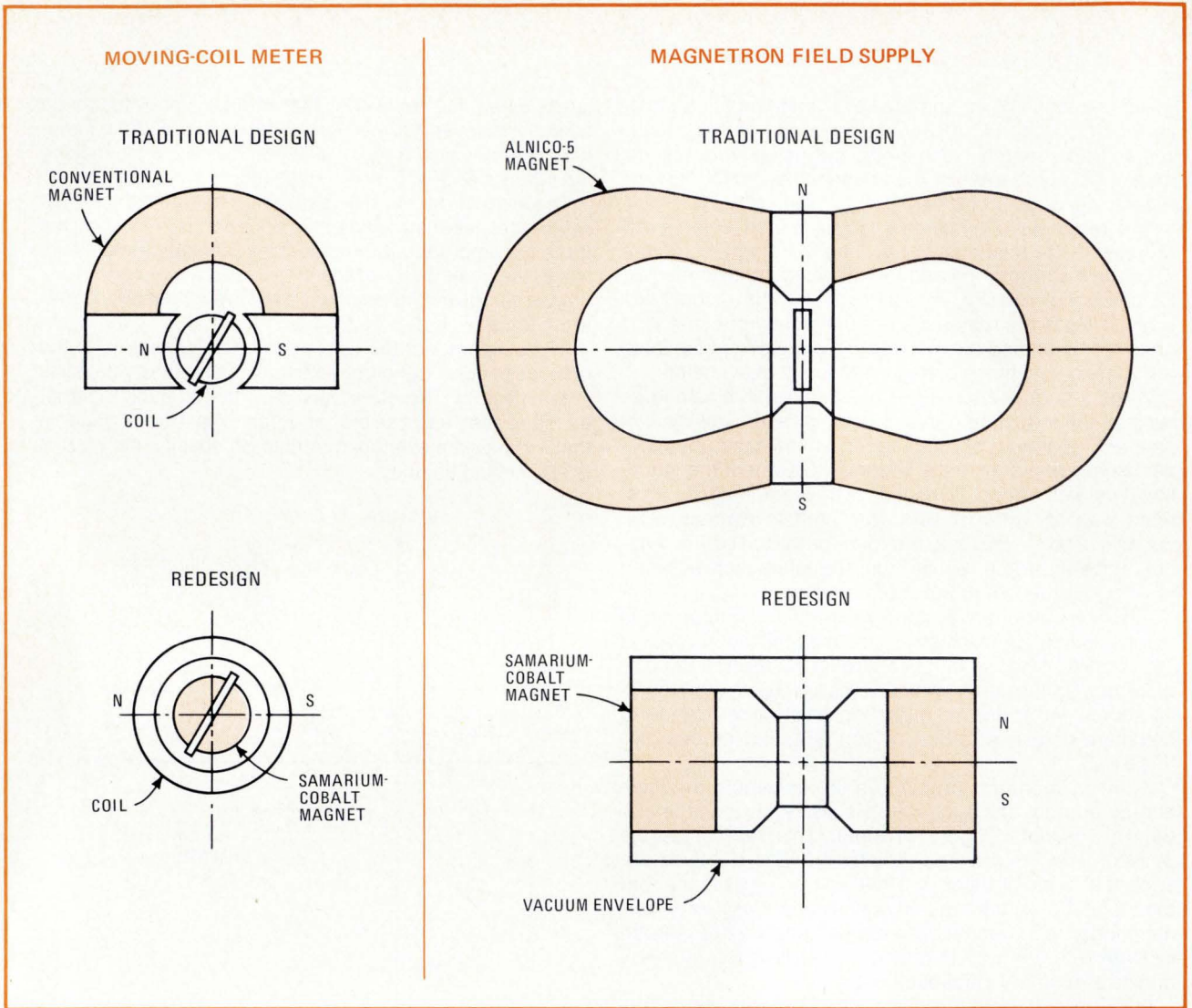

3. Circuits can be smaller. Because of the high-performance characteristics of samarium-cobalt magnets, magnetic circuits can be designed to occupy less space than is traditionally required. Not only can the samarium-cobalt magnets be smaller themselves, but they also can be moved into the reaction space for a more compact circuit, as shown here for a moving-coil meter and a magnetron field supply.

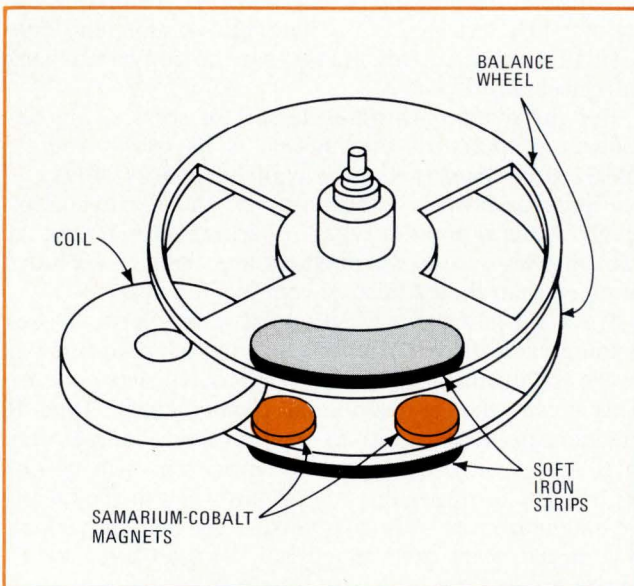

4. For electronic watches, too. When samarium-cobalt magnets are used in an electronic watch, as shown here for a spring-balance resonator design, the watch can be smaller and more efficient.

to magnetization reversal when placed in very high fields. This should have great impact on electromechanical devices.

In traditional electromechanical design, a permanent magnet is the massive static member, while a low-inertia coil is the moving member. With a rare-earth magnet, especially samarium-cobalt, it becomes possible to invert this design approach, giving birth to a whole new breed of moving-magnet meters, motors, loudspeakers, linear actuators, and so forth.

Designs can be better

Torque in electric servo motors is vastly improved with samarium-cobalt magnets. Their large coercive force means higher levels of armature flux can be achieved, as well as better stability, so that motor per-

formance and efficiency are both upgraded. In gyros, samarium-cobalt can increase sensitivity significantly and reduce power consumption. Phonograph pickups with samarium-cobalt magnets have lower mass and improved dynamic characteristics.

In aircraft alternators, samarium-cobalt magnets allow higher speeds than possible with a wound type of excitation. Higher speed means improved power density per unit of weight, a factor of vital importance in aerospace applications.

In linear actuators, moving-magnet meters, and loudspeakers, samarium-cobalt magnets permit better dynamic and thermal characteristics, in addition to facilitating designs that are more easily manufactured because wide tolerances can be used.

The third important distinction between the two classes concerns leakage. For the Type II magnets, the permeability of the magnetic materials is high, making it essentially the same as the permeability of the surrounding space. When a magnet's permeability is high, the lines of flux leaving the magnet's pole are practically perpendicular to the surface of the pole. Leakage, then, is almost nil, and all of the flux at the pole can be used.

The performance of samarium-cobalt magnets allows many magnetic circuits to be designed more compactly. In the case of the moving-coil meter and the magnetron field supply, for instance, the very large magneto-motive force available from samarium-cobalt permits the magnet to be moved toward the reaction space for a very compact circuit, as shown in Fig. 3.

The samarium-cobalt circuit designs are also free of flux leakage, and all the useful magnetic energy is delivered to the terminals of the magnet. In the magnetron circuit, a short samarium-cobalt magnet can be moved inside the vacuum envelope to replace the usual long Alnico-5 structure. The redesign provides an over-all volume reduction on the order of 10:1.

Samarium-cobalt magnets have also influenced the performance and size of traveling-wave tubes. To focus the beam of these tubes, the most efficient type of magnetic circuit is a periodic reversing structure—the focusing cells are in repulsion, and the peak field seen by the beam is limited by the coercive force of the magnet. The large coercive force of samarium-cobalt means that the fields can be very high, producing a high-power and efficient tube.

For a given power level, drastic reductions can be made in the size of the tube and its focusing structure. Both the length and diameter of the focusing assembly in a redesigned tube, for example, can be reduced by a factor of three in comparison with an Alnico-8-focused tube. Many cross-field electron tubes can also be redesigned to capitalize on the weight and volume savings.

Electronic watches represent yet another application area. Watch size can be reduced, and motor efficiency can also be improved. Figure 4 shows a watch design that uses the basic spring-balance resonator. Here the magnetic circuit permits interaction with the coil. Other types of watches that can make use of samarium-cobalt magnets are those that employ a tuning-fork or a step-motor drive.

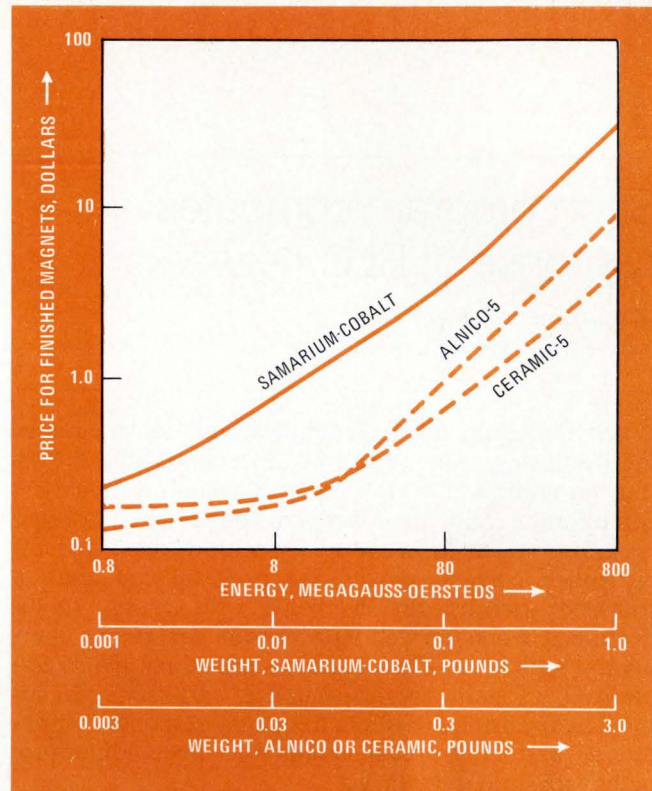

5. Cost projection. For small magnet sizes, there is little cost difference between rare-earth magnets and other types, especially when bought in volume. Rare-earth magnets are relatively expensive for bigger sizes, but they may provide cost savings in areas such as manufacturing and design because of their better performance. To determine true cost-effectiveness, a complete system study should be done.

The cost of rare-earth permanent magnets continues to drop as over-all volume production increases. For samarium-cobalt magnets, the cost of raw materials should be down to around \$5 per pound by 1976. (Pure samarium is now around \$65 per pound.)

Economic considerations

Figure 5 is a projection of what finished rare-earth magnets might cost compared to other types of finished magnets under volume-production conditions. The common horizontal axes indicate the magnet energy and weight for the various materials.

For very small magnets, the curves converge, and the high cost of rare-earth materials is of little significance in the cost of the finished magnet. As the magnets get larger, however, the graph shows that the rare-earth types tend to be increasingly more expensive than Alnico or ceramic magnets to produce the same energy. But this observation can be misleading because the cost of the finished magnet is only part of the story.

The real advantages of rare-earth magnets lie in the impact their properties can have on the total system or device. Permanent magnets are components that often influence the size, efficiency, and stability of the equipment of which they are part. A complete system study is needed to see how an improved magnetic circuit can possibly enhance product value and reduce costs in manufacturing. □

Short program computes response of RLC networks

by Werner A. Schnider
Swiss Federal Institute of Technology, Zurich

When designing filters, amplifiers, and other circuits, the frequency response can be determined with a Fortran program that is very short and requires much less computation time than many common circuit-design programs such as ECAP-1. By introducing current-controlled current sources, the program can analyze transistor circuits directly, while with a little modification it works as well with circuits containing operational amplifiers. The program stores three matrixes—basically of resistance, capacitance, and reciprocal inductance—during the whole frequency-response computation, and from them builds the node-admittance matrix for each frequency.

The computational procedure for each frequency requires the set-up of a node-admittance matrix, $[H]$, and the computation of two determinants, $|H_{10}|$ and $|H_{ii}|$ and the gain V_o/V_i . The gain is the quotient of the two determinants—a consequence of the equivalent current vector having only one non-zero element, corresponding to the input node. In the abstract, each of the two voltages that determine gain is the matrix product of the current vector and the inverse of the node-admittance matrix. Computing that inverse usually involves a great many determinants. But when the current vector has only one non-zero element, the matrix product becomes a scalar product, and, because the gain is a quotient of two such products, everything cancels out

INPUT DATA CARDS

```
5,
AR,1,2,1.E3
AR,2,3,60.,
AR,3,0,3.75E3,
AC,3,0,90.E-12,
AC,3,4,3.E-12,
AR,4,0,1.E3,
AC,4,0,50.E-12,
AR,4,5,10.E3,
AL,5,2,0.56E-3,
AB,3,6,150.,
A ,,,,
1,4,
2.E5,7.E6,35,
```

PROGRAM

```
PROGRAM AC(INPUT,OUTPUT)
DIMENSION DC(20,20),BC(20,20),GM(30),NKA(30),NKB(30),EC(20,20)
COMPLEX CD,CE,(20,20)
DIMENSION A(100),O(100)
INTEGER P,C,R,BLANK,TYPE
DATA R,C,B,BLANK,L0/1HR,1HC,1HB,1H ,1HL/
C INPUT-ROUTINE.
PRINT 7
FORMAT(1H1,10(1H*),20H FREQUENCY RESPONSE ,10(1H*),/)
DO 8 I=1,20
DO 8 J=1,20
8 DC(I,J)=9C(I,J)=EC(I,J)=0.
NZ=0
CALL NREAD(NK)
2 CALL NREAD(TYPE,K1,K2,WERT)
IF(TYPE.EQ,BLANK) GOTO 6
PRINT 10,TYPE,K1,K2,WERT
10 FORMAT(1H ,A1,2I3),4X,E12.4)
IF(TYPE.NE,R) GOT 3
WERT=WERT*GM(K1)
NA=NKA(K1)
NB=NKB(K1)
NBA=NKB(K2)
NAA=NKA(K2)
IF(NA.NE,J.AND,NAA.NE,J) BC(NA,NAA)=BC(NA,NAA)+WERT
IF(NA.NE,0.AND,NB1.NE,J) BC(NA,NB1)=BC(NA,NB1)-WERT
IF(NB.NE,J.AND,NB1.NE,J) BC(NB,NB1)=BC(NB,NB1)+WERT
IF(NB.NE,0.AND,NAA.NE,0) BC(NB,NAA)=BC(NB,NAA)-WERT
GOTO 2
3 CONTINUE
NZ=NZ+1
NKA(NZ)=K1
NKB(NZ)=K2
IF(TYPE.EQ,R) GM(NZ)=1./WERT
IF(TYPE.EQ,F) CALL MATR(K1,K2,BC,GM(NZ))
IF(TYPE.EQ,C) CALL MATR(K1,K2,DC,WERT)
IF(TYPE.EQ,L0) H=1./WERT
IF(TYPE.EQ,L0) CALL MATR(K1,K2,EC,H)
GOTO 2
6 CALL NREAD(KA,KR)
CALL NREAD(F1,F2,N)
PRINT 20,KA,KR,F1,F2,N
20 FORMAT(/,11H I/O-PORTS:1,2I4,/,1H ,8HF1-F2-N=,2E14.4,I8)
PRINT 11,4Z,*K
11 FORMAT(/ ,1H ,I4,9H BRANCHES,10X,I4,6H NODES,/)
C COMPUTATION OF FREQUENCY RESPONSE.
DEL=(F2-F1)/(N-1)
DO 50 I=1,N
FREQ=F1+(I-1)*DEL
OMEGA=6.2831852*FREQ
DO 51 K=1,NK
DO 51 L=1,NK
51 Q(K,L)=CMPLX(BC(K,L),OMEGA*DC(K,L))-EC(K,L)/OMEGA
CALL CDDET(Q,KA,KA,NK,CD)
CALL CDDET(Q,KR,KA,NK,CE)
CD=CE/CD
AMPL=CABS(CD)
IF(REAL(CD).EQ,0.) CD=CD+1.E-16
PHASE=ATAN2(AIMAG(CD),REAL(CD))
PHASE=PHASE*180./3.1415926
PRINT 60,FREQ,AMPL,PHASE
60 FORMAT(6H FREQ=,E10.3,5X,5HAMPL=,E12.4,5X,6HPHASE=,E12.4)
A(I)=AMPL
P(I)=PHASE
50 CONTINUE
CALL PLOT(A,P,N,F1,DEL)
END

SUBROUTINE MATR(K1,K2,DC,WERT)
DIMENSION DC(20,20)
IF(K1.NE,0) DC(K1,K1)=DC(K1,K1)+WERT
IF(K2.NE,0) DC(K2,K2)=DC(K2,K2)+WERT
IF(K1.EC,0.OR,K2.EC,0) GOTO 9
DC(K1,K2)=DC(K1,K2)-WERT
DC(K2,K1)=DC(K2,K1)-WERT
9 RETURN
END

SUBROUTINE CDDET(Q,IZ,IS,NK,VALUE)
COMPLEX Q(20,20),GA(20,20),VALUE
NKM=NK-1
DO 10 K=1,NK
DO 10 L=1,NK
10 CA(K,L)=Q(K,L)
IF(IZ.EC,NK) GOTO 3
DO 2 K=IZ,NKM
DO 2 L=1,NK
2 CA(K,L)=Q(K+1,L)
3 IF(IS.EC,NK) GOTO 5
DO 4 K=1,NK
DO 4 L=IS,NKM
4 CA(K,L)=CA(K,L+1)
5 CONTINUE
CALL CDDET(CA,NKM,VALUE)
VALUE=VALUE*(-1.)**(IZ+IS)
RETURN
END
```

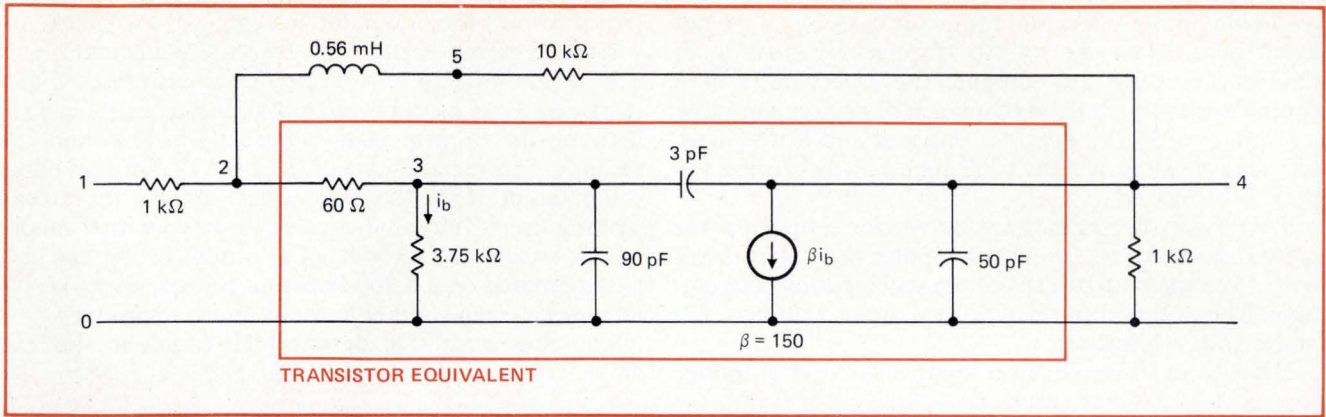

OUTPUT LISTING

***** FREQUENCY RESPONSE *****

R	1	2	1.0000E+03
R	2	3	6.0640E+01
R	3	0	3.7500E+03
C	3	0	9.0000E-11
C	3	4	3.0000E-12
R	4	0	1.0000E+03
C	4	0	5.6000E-11
R	4	5	1.0000E+04
L	5	2	5.6000E-04
B	3	6	1.5000E+02

I/O-PORTS: 1 4
F1-F2-N= 2.0000E+05 7.0000E+06 35

9 BRANCHES		5 NODES			
FREQ=	2.000E+05	AMPL=	7.2734E+00	PHASE=	1.7963E+02
FREQ=	4.000E+05	AMPL=	7.3804E+00	PHASE=	1.7795E+02
FREQ=	6.000E+05	AMPL=	7.5599E+00	PHASE=	1.7664E+02
FREQ=	8.000E+05	AMPL=	7.8091E+00	PHASE=	1.7499E+02
FREQ=	1.000E+06	AMPL=	8.1295E+00	PHASE=	1.7247E+02
FREQ=	1.200E+06	AMPL=	8.5163E+00	PHASE=	1.7017E+02
FREQ=	1.400E+06	AMPL=	8.9594E+00	PHASE=	1.6677E+02
FREQ=	1.600E+06	AMPL=	9.4415E+00	PHASE=	1.6256E+02
FREQ=	1.800E+06	AMPL=	9.9313E+00	PHASE=	1.5748E+02
FREQ=	2.000E+06	AMPL=	1.0382E+01	PHASE=	1.5148E+02
FREQ=	2.200E+06	AMPL=	1.0732E+01	PHASE=	1.4464E+02
FREQ=	2.400E+06	AMPL=	1.0920E+01	PHASE=	1.3713E+02
FREQ=	2.600E+06	AMPL=	1.0899E+01	PHASE=	1.2925E+02
FREQ=	2.800E+06	AMPL=	1.0658E+01	PHASE=	1.2135E+02
FREQ=	3.000E+06	AMPL=	1.0231E+01	PHASE=	1.1378E+02
FREQ=	3.200E+06	AMPL=	9.6741E+00	PHASE=	1.0677E+02
FREQ=	3.400E+06	AMPL=	9.0501E+00	PHASE=	1.0047E+02
FREQ=	3.600E+06	AMPL=	8.4410E+00	PHASE=	9.4893E+01
FREQ=	3.800E+06	AMPL=	7.7895E+00	PHASE=	8.9997E+01
FREQ=	4.000E+06	AMPL=	7.2076E+00	PHASE=	8.5714E+01
FREQ=	4.200E+06	AMPL=	6.6730E+00	PHASE=	8.1960E+01
FREQ=	4.400E+06	AMPL=	6.1879E+00	PHASE=	7.8653E+01
FREQ=	4.600E+06	AMPL=	5.7533E+00	PHASE=	7.5721E+01
FREQ=	4.800E+06	AMPL=	5.3567E+00	PHASE=	7.3104E+01
FREQ=	5.000E+06	AMPL=	5.0026E+00	PHASE=	7.0749E+01
FREQ=	5.200E+06	AMPL=	4.6837E+00	PHASE=	6.8614E+01
FREQ=	5.400E+06	AMPL=	4.3958E+00	PHASE=	6.6666E+01
FREQ=	5.600E+06	AMPL=	4.1325E+00	PHASE=	6.4876E+01
FREQ=	5.800E+06	AMPL=	3.896E+00	PHASE=	6.3221E+01
FREQ=	6.000E+06	AMPL=	3.6831E+00	PHASE=	6.1683E+01
FREQ=	6.200E+06	AMPL=	3.4363E+00	PHASE=	6.0245E+01
FREQ=	6.400E+06	AMPL=	3.1059E+00	PHASE=	5.8896E+01
FREQ=	6.600E+06	AMPL=	2.7141E+00	PHASE=	5.7624E+01
FREQ=	6.800E+06	AMPL=	2.2874E+00	PHASE=	5.6421E+01
FREQ=	7.000E+06	AMPL=	2.8462E+00	PHASE=	5.5283E+01

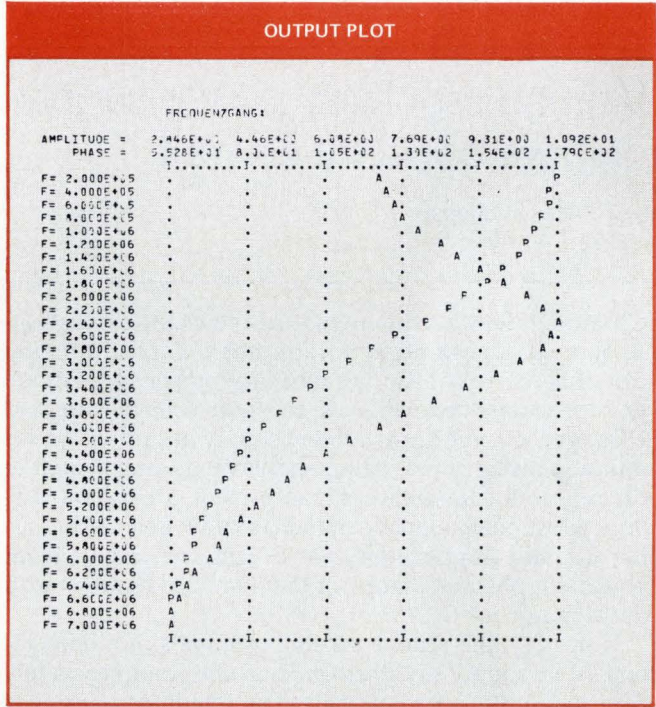

except the two determinants mentioned.

So, to establish the node-admittance matrix, number all the nodes, beginning with zero for the common-input-output port. Place the data cards—either punched cards or an equivalent data-entry medium—at the beginning of the program. The program includes a subroutine, NREAD, that eliminates all requirements for specific formats. All data elements are separated by commas.

The first data card specifies the number of nodes minus 1. It is followed by cards listing the branches with their elements. The first two characters on each branch card are alphabetic that specify the type of the passive element in that branch: AR for a resistor, AC for a capacitor, AL for an inductor. These are followed by two

integers that denote the beginning and ending nodes of this branch, and a floating-point number that gives the value of the element in ohms, farads, or henries. The program numbers the branches automatically in the sequence the cards are read.

The branch cards are followed by cards giving the current-controlled sources with their amplification factors. Each of these begins with the letters AB, which identify this type of card. Then two integers specify the number of the controlling branch and the number of the controlled branch, and a floating-point number denotes the amplification factor. This is followed by the end card, which has only the letter A, one blank, and a series of commas, to signify that all the branches and sources have been listed.

Next comes an input/output card, with two integers that denote the numbers of the input and output nodes. The last data card carries two floating-point numbers that specify the frequency range and an integer that denotes the number of frequency steps—up to 100—to be calculated within the specified range.

The program uses five subroutines, three of which are

available in most scientific computer centers, so are not listed here. They are NREAD (format-free reading of data cards), CDET (to compute the determinant of a complex matrix), and FPLOT (which plots the amplitude and phase of V_o/V_i . FPLOT is optional and if it is used, two arrays called A and R are required for storing the data to be plotted.

Two other subroutines are MATR, for setting up the matrixes, and CCDET, which computes the determinant $|H_{kj}|$ from the matrix [H] and the specified row and column. The program can handle any circuit with up to 20 nodes and 30 branches.

Here is an example. In a compensated rf amplifier

(see drawing) the transistor is replaced by a current-controlled current source and by passive elements. The new program computes the frequency response of this circuit in 35 steps between 200 kilohertz and 7 megahertz on the Control Data 6400/6500 in less than 1.4 seconds. This includes use of the FPLOT subroutine and computation of the plotting values, but not the actual plotting itself. The same circuit computed with a modified ECAP took 3.4 seconds. (The output listing and the plot, prepared on a 1,200-line/min printer, comprise 94 lines, which take another 5 seconds or so to produce.)

The data cards that describe the circuit in this example are listed in the table. □

Voltage-regulated power supply delivers constant current

by Thomas E. Skopal
Acopian Corp., Easton, Pa.

Obtaining a power supply that has constant-current operation or is susceptible to adjustable current-limiting can often be a problem because such power supplies are not as readily available as constant-voltage supplies. However, if a voltage-regulated supply has provision for remote sensing and a voltage-adjustment range equal to the required compliance, it can provide a constant current. Most power-supply engineers know how to do this, but judging from the number of calls we receive from power-supply users, many of them are not familiar with the technique.

Normally, the remote-sensing terminals of a voltage-regulated supply are connected to the load separately from the output-current leads. The regulator senses the load voltage and varies the output voltage of the supply. By this means, it compensates for the voltage drops in the load lines, which vary with output current; thus, it maintains a constant voltage across the load. If the sensed load has a constant impedance, the supply's output current remains constant, even when compensation for impedance variations outside the sensing loop causes the supply's output voltage to vary.

Therefore, a constant current can be maintained through a circuit by sensing the voltage across a resistor and connecting the circuit requiring the constant current in series with the resistor, but outside the sensing loop. The current may be set to any desired amplitude within the rating of the supply by adjusting the supply's output voltage setting.

The power supply must have range of output-voltage adjustment at least as great as the required voltage-compliance range (the range of voltages needed to sustain a given value of constant current over a range of load resistances). In addition, the voltage across the resistor must be set no greater than the difference between the supply's maximum output voltage rating minus the compliance range. For example, a 1-ampere constant current with a compliance range of 1 to 5 volts may be obtained from a 0-to-7-v supply and a resistor no greater than 2 ohms. A "slot" adjust supply—one not adjustable down to 0 v—may also be used if its slot range equals or exceeds the necessary voltage compliance, and if the voltage maintained across the resistor equals or exceeds the minimum limit of the slot range.

Most power supplies provide for external voltage adjustment by means of a potentiometer wired in series with one of the sense lines. The load is connected between this sense line and its respective output terminal. On some supplies, the other set of output/sense terminals has a smaller compliance. □

Engineer's Notebook is a regular feature in Electronics. We invite readers to submit original design shortcuts, calculation aids, measurement and test techniques, and other ideas for saving engineering time or cost. We'll pay \$50 for each item published.

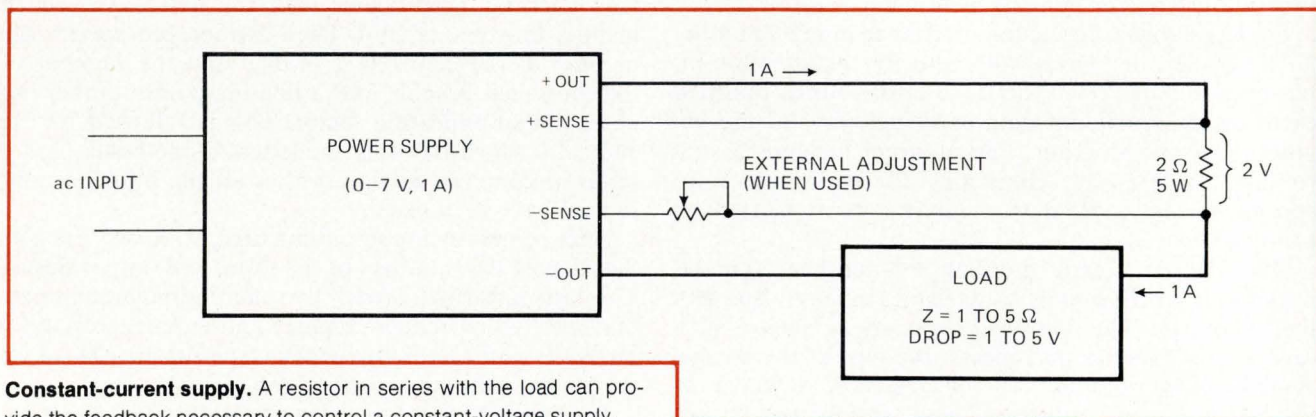

Constant-current supply. A resistor in series with the load can provide the feedback necessary to control a constant-voltage supply.

The new Keithley Model 168 autoranging DMM... ...vive la différence!

There really is a difference in Digital Multimeters, and once you've experienced Keithley's 168 you'll know why we say *vive*! If you're tired of "general-purpose" promises that turn into run-of-the-mill

performances; if you want that bit extra that'll make your job easier, then *vive la différence*... here's the DMM for you! Send for our DMM Selector Guide or call us for demo now. **Phone (216) 248-0400.**

**AC VOLTS
DC AMPS
OHMS**

5 functions

100 μ V to 1000 V dc
100 μ V to 500 V ac
0.1 μ A to 1 A dc
0.1 μ A to 1 A ac
100 m Ω to 20 M Ω

price

Enough said? Order one... or two... or three now!

\$299⁰⁰

two-terminal input

Simple to connect. You can't get it wrong. Eliminates the word "whoops" from your vocabulary. Saves temper, too.

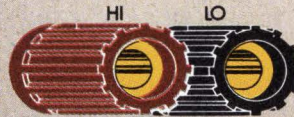

options & accessories

Rechargeable batteries that you can install anytime. An RF probe for high frequencies. Test leads. A 50-amp current shunt too.



hi-lo ohms

Select either of two voltage levels, 1 V or 100 mV, for ohms measurements. You can have your PN junctions either way you want 'em... on or off.



automatic ranging

You just connect the signal and push the function. The decimal point pops into position automatically and the display is direct reading. That does save time!

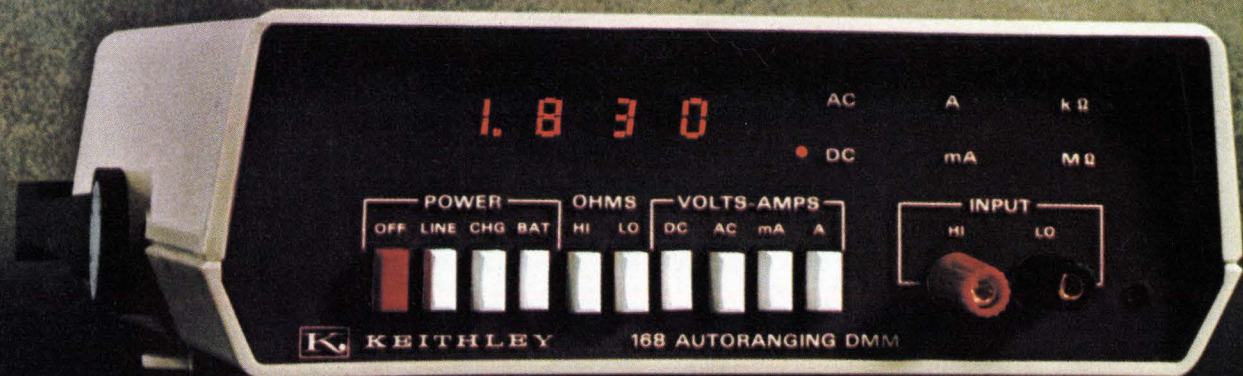

**KEITHLEY
INSTRUMENTS**
U. S. A.: 28775 AURORA ROAD, CLEVELAND, OHIO 44139
EUROPE: 14, AVENUE VILLARDIN, 1009 PULLY, SUISSE

Customize your own voltage regulator

Fixed-voltage regulators in simple, three-lead integrated-circuit form have proved a real blessing in building power supplies. But what do you do if the dc voltage you need isn't covered by a standard unit? James E. Trulove, Phoenix, Ariz., says you can **add a zener diode between the IC ground-reference pin and the actual power-supply ground**, or a couple of forward-biased silicon or germanium diodes will do instead of the zener if the voltage adjustment you need is less than, say, 3 volts. The ground-terminal current is usually less than 10 milliamperes for most IC, so you can get away with a low-wattage zener.

For example, he says, **you can develop a regulated output of 13.6 volts by using a type 7808 (8-v) voltage regulator and a 5.6-v zener.** The zener power is $5.6 \text{ V} \times 10 \text{ mA}$, or 56 milliwatts, well below the $\frac{1}{4}$ -watt level of economy zeners. **Alternatively, you could use a type 7812 12-v regulator and combine it with three silicon diodes with forward drops of 0.5 v each.**

Carbon-comp resistors are not all the same

You get what you pay for in carbon-composition resistors—sometimes, says Dale Hileman of Sphygmometrics Inc., Woodland Hills, Calif. He tells a long tale of woe about **carbon-comp resistors ostensibly built to RC07 military specifications, costing as much as any other quality resistor on the market, but which turned out to be noisy and likely to change their nominal resistance values when soldered.** For example, allegedly 180-kilohms, $\frac{1}{4}$ -watt resistors increased to 300 kilohms after they were soldered.

Where to learn about microprocessors

If you're considering using microprocessors, it may be worth your while enrolling in one of the many short courses now being offered by consultant houses, semiconductor manufacturers, and universities. For instance, Integrated Computer Systems, 12561 Appleton Way, Los Angeles, Calif. 90066, **is taking a three-day course on the road in January for \$375** (group rates available), stopping at Washington, D.C., on Jan. 7-9, Salt Lake City on Jan. 15-17, San Diego, Calif., on Jan. 22-24, and Ottawa on Jan. 28-30. **In the Phoenix area three-day courses costing \$375 are run every month** by Motorola Semiconductor, 5005 East McDowell Rd., Phoenix, Ariz. 85008. Next summer, the University of Pennsylvania will hold a five-day course from July 14 through 18, for \$390.

Addenda

If you can satisfy the ILC Data Device Corp., that you're "a qualified engineer," you can get a free copy of the company's new **Synchro Conversion Handbook**, a 108-page paperback. Write to them at Airport International Plaza, Bohemia, N.Y. 11716, for a copy of the qualifying form. Otherwise, you'll have to pay \$3.95. . . . And Swani Publishing Co., 1021 Rockton Rd., South Beloit, Ill., 61080, is charging \$4 a copy for its "Preparing Now to Go Metric." The company describes it as "a practical, hard-headed, face-the-facts set of suggestions for establishing a conversion program."

—Stephen E. Scrupski

HP 3000CX Mini DataCenters



**A big idea doesn't
have to be big.**

What's the big idea? HP 3000CX Mini DataCenters. Distributed power for your department, region or division. Power previously available only at your large EDP Center. Power you can afford.

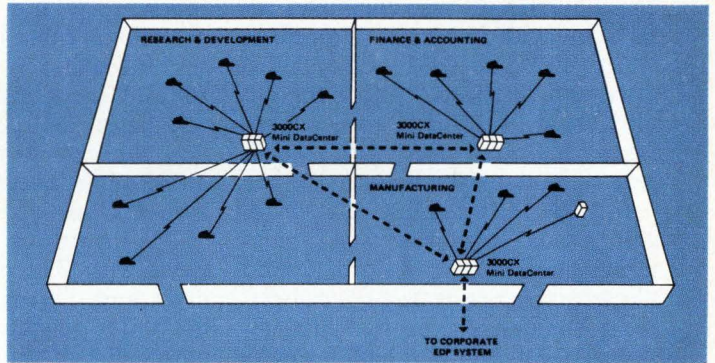

The world's most powerful minicomputer system.

Designed to run interactive terminals, do real-time data acquisition in a multi-programmed environment and terminal and batch jobs at the same time. The 3000CX brings computer power to the people who need it. Several users can run their own programs concurrently using BASIC, RPG, COBOL, FORTRAN, or HP's SPL.

Input-output spooling from terminals or batch devices. Virtual memory. Automatic re-entrant programming. Mini DataCenters have them all, and then some. They even communicate with the big systems or other Mini DataCenters at the same time they perform the other jobs.

How come we thought of it first? If there is a message here it's that we thought small. We're not locked into big machines that can break the bank. We'd rather deliver you a dozen utility Mini DataCenters, so you can expand your computer power as you need to. Choose from four models, from \$99,500 to \$203,500 in the USA. And all it takes is a staff of one to run them.

Isn't it time you started thinking big by thinking small?

**HP minicomputers.
They work for a living.**

HEWLETT  PACKARD

Sales and service from 172 offices in 65 countries.
1501 Page Mill Road, Palo Alto, California 94304

22508

Chip contains 16-bit microprocessor

General-purpose processing and control IC from National, an industry first, is built with p-channel MOS silicon-gate technology, needs only two supplies

by Stephen E. Scrupski, Senior Editor

A **16-bit microprocessor** is admirably suited for applications that require high accuracy, such as numerical control and process control. The data length also facilitates interfacing with 16-bit minicomputers, which increases efficiency of hardware and software. Putting the device on a single chip adds advantages of lower cost with higher reliability and system density.

First on the market with a single-chip 16-bit microprocessor is National Semiconductor Corp. Called PACE for processing and control element, the device processes either 8-bit or 16-bit data and handles tasks that require 16-bit instructions and addresses. The device is built with p-channel MOS silicon-gate technology because, the company says, this well established process is predictable and has been used in numerous products of comparable complexity.

PACE, a general-purpose microprocessor has integrated on a single chip control logic, a stack, four accumulators and interrupt-control circuitry.

Because PACE can operate on either 8- or 16-bit data, the designer avoids the double-precision software operations and extra hardware required when an 8-

bit processor is used in 16-bit applications. He also avoids the byte-packing required when a 16-bit processor is used in an 8-bit application.

National chose the p-channel process because, it says, p-channel allowed the designers to meet the two basic goals: instruction-execution time of 10-microseconds and fitting all the needed components on a single chip.

The instruction set consists of 45 types with 337 individual instructions, and the company claims that the unit is powerful enough to allow more efficient program-coding than most microprocessors and also compares favorably with many minicomputers. National says it will offer an extensive array of software

and hardware products to support systems designed with PACE. Software support includes assemblers, loaders, a debug program, an editor, diagnostics, and software for programming programmable read-only memories.

A prototyping system also aids in development and debugging of both software and hardware. Built in an instrument-size case, the system has a front control panel that allows the engineer to examine or alter the contents of any register, the stack, or memory location. The prototyper, which provides single-instruction execution and bootstrap-loading, also interfaces to a card reader, line printer, or tape reader for high-speed input and output.

PACE is being marketed as a single component in a 40-pin package that sells for \$141 each in quantities of 100 and also on a printed-circuit card of 4.5 by 4.5 inches, along with enough other components to form a complete data-processing controller. Other circuits on the card include four hex MOS sense amplifiers and three hex buffers as well as a crystal oscillator and several clock drivers.

National Semiconductor Corp., 2900 Semiconductor Dr., Santa Clara, Calif. 95051 [338]

Data-processing controller. Heart of the system is the microprocessor (largest ceramic IC package, center left). Board also contains buffer and clock circuits.

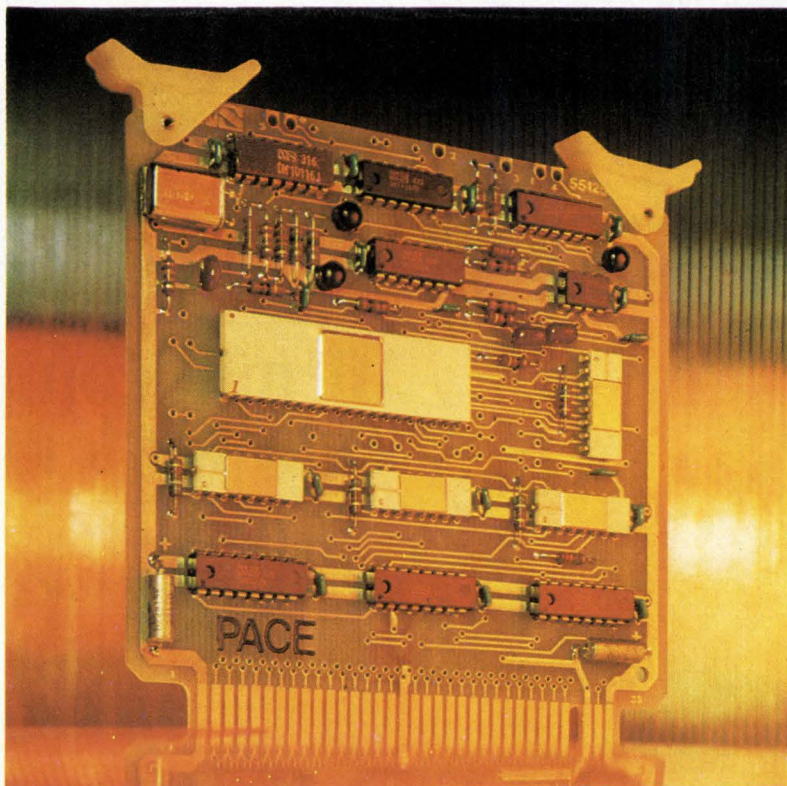

CONVERT 8 BITS IN 6 MICROSECONDS FOR \$25.....

it's easy!

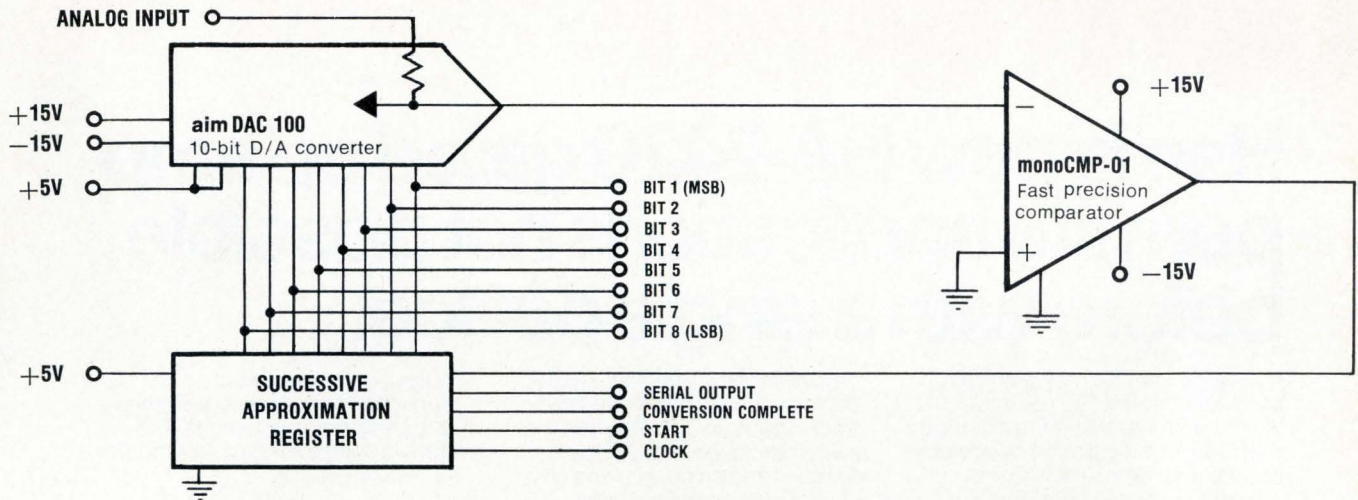

THREE IC'S BUILD A FAST A/D CONVERTER - FOR UNDER \$25!

It's easy with high performance analog components from Precision Monolithics—start with PMI's aimDAC100 Low Cost D/A Converter—with its internal precision reference voltage, 10-bit resolution, choice of linearities and high speed current output, it's ideal for all D/A and A/D applications. Next, add the PMI monoCMP-01 Precision Comparator with its fast 90ns response, low Vos, drift and superior stability—complete your converter with a

successive approximation logic chip and that's it! Sound easy? You bet—and 10-bit versions can be built for under \$40! Circuit construction and performance are fully detailed in our new Application Note: pre-drilled demonstration circuit cards are available free by contacting your local PMI rep or stocking distributor—call him today and find out how easy A/D conversion can be!

SPECIFICATIONS		PRICES
aimDAC 100 DDT1*	0.30% Linearity Max-0/70°C	\$ 9.95 @ 100 pcs.
aimDAC 100 CCT1*	0.20% Linearity Max-0/70°C	\$12.00 @ 100 pcs.
aimDAC 100 BCT1*	0.10% Linearity Max-0/70°C	\$17.00 @ 100 pcs.
aimDAC 100 ACT1*	0.05% Linearity Max-0/70°C	\$26.00 @ 100 pcs.
*Specify T1 for 0 to 10 Volt usage; T2 for 0 to 5 Volt usage.		
monoCMP-01CJ	Vos 2.8 mV Max	\$3.25 @ 100 pcs.
monoCMP-01EJ	Vos 0.8 mV Max	\$7.50 @ 100 pcs.

PRECISION MONOLITHICS REPRESENTATIVES

Alabama (205) 539-4411
 Arizona (602) 992-9884
 California, North (415) 948-6533
 California, Los Angeles (213) 340-1745
 California, South (714) 830-3939
 Colorado (303) 771-4920
 Connecticut (203) 269-7964
 Florida, Ft. Lauderdale (305) 776-4800
 Florida, Orlando (305) 425-5505
 Illinois, North (312) 774-3535
 Indiana (317) 783-7630
 Maryland (301) 944-8262

Massachusetts (617) 890-0011
 Michigan (313) 557-1934
 Minnesota (612) 646-7217
 Missouri, St. Louis (314) 731-5799
 Missouri, Kansas City (816) 761-6543
 New Jersey, North (516) 567-5900
 New Jersey, South (609) 966-4070
 New Mexico (505) 265-5655
 New York, New York City (516) 567-5900
 New York, Upstate (716) 464-8636
 North Carolina (919) 725-5384
 Ohio, North (216) 461-8333

Ohio, South (513) 293-3145
 Pennsylvania, East (215) 644-3477
 Texas, Dallas (214) 234-6334
 Texas, Houston (713) 772-0730
 Virginia (703) 548-7818
 Washington (206) 624-9020
 Wisconsin (414) 933-2733
 Canada, Montreal (514) 626-8324
 Canada, Toronto (416) 625-8874
 Canada, Vancouver (714) 752-1760

AUTHORIZED DISTRIBUTORS

NEW YORK METROPOLITAN AREA Harvey Radio, Westbury, N.Y.: (516) 921-8700 • NEW ENGLAND AREA Gerber Electronics, Dedham, Mass.: (617) 329-2400 • UPSTATE NEW YORK Harvey Federal Electronics, Binghamton, N.Y.: (607) 748-8211 • NORTHEAST Newark Electronics, Woburn, Mass.: (617) 935-8350 • BALTIMORE-WASHINGTON Whitney Distributors, Baltimore, Md.: (301) 944-8080 • PENNSYLVANIA Hallmark Electronics, Huntingdon Valley, Pa.: (215) 355-7300 • Pioneer/Pittsburgh: (412) 391-4846 • MICHIGAN RS Electronics, Detroit, Mich.: (313) 491-1000 • SOUTHEAST Kirkman Electronics, Winston-Salem, N.C.: (919) 724-0541 • EAST CENTRAL Pioneer/Cleveland, Cleveland, Ohio: (216) 587-3600 • Pioneer/Dayton, Dayton, Ohio: (513) 236-9900 • CENTRAL Hallmark Electronics, Elk Grove Village, Ill.: (312) 437-8800 • Minneapolis, Minn.: (612) 884-9056 • St. Louis, Mo.: (314) 291-5350 • TEXAS-OKLAHOMA Sterling Electronics, Houston, Texas: (713) 623-6600 • Dallas, Texas: (214) 357-9131 • SOUTHWEST Sterling Electronics, Albuquerque, N.M.: (505) 345-6601 • Phoenix, Ariz.: (602) 256-4531 • WEST Westates Electronics Corp., Chatsworth, Calif.: (213) 341-4411 • Sunnyvale, Calif.: (408) 733-8383 • Intermark Electronics, Sunnyvale, Calif.: (408) 738-1111 • Denver, Colo.: (303) 936-8284 • Salt Lake City, Utah: (801) 486-3411 • San Diego, Calif.: (714) 279-5200 • Santa Ana, Calif.: (714) 540-1322 • Almac-Stroum, Seattle, Wash.: (206) 763-2300 • Portland, Ore. (503) 292-3534 • CANADA Intek Electronics, Vancouver, B.C.: (604) 324-6831.

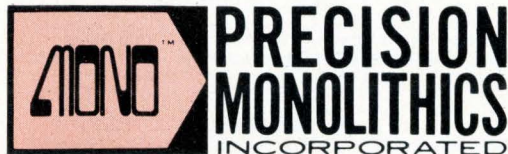

1500 SPACE PARK DRIVE, SANTA CLARA, CALIF. 95050
 TEL. (408) 246-9222 • TWX 910-338-0528 • CABLE MONO

Sample and hold on a chip!

Harris' new HA-2420 gated op amp permits applications not possible before with a single device.

It heralds a whole new generation of linear IC's. It is the result of Harris' advanced linear technology that will permit creation of devices unavailable before in IC form.

Basically, the HA-2420 is a monolithic circuit consisting of a high performance op amp with its output in series with an ultra low leakage switch and a MOSFET input unity gain amplifier.

With an external holding capacitor connected to the switch

output it forms a versatile high performance sample-and-hold or track-and-hold circuit. When the switch is closed, the device functions as an op amp and any standard op amp feedback network may be connected around it to control gain, frequency response and the like. When the switch is opened, the output remains at its last level.

Without a holding capacitor the device serves as a versatile gated

output op amp for such applications as analog switches and peak holding circuits. For details see your Harris distributor or representative.

Features: (+25°C unless specified)

Input Offset Voltage	4mV (MAX)
Input Bias Current	200nA (MAX)
Slew Rate (C_H = 1000pF)	5V/μs (TYP)
Open Loop Gain	50K (TYP)
Input Voltage Range	±10V (MIN)
Output Voltage Swing	±10V (MIN)
Output Impedance	5ohms (TYP)
Drift Current on C_H (+125°C)	.5nA (TYP)
Acquisition time (C_H = 1000pF)	4 μs (TYP) to 0.1% of final value
Control Input	TTL Compatible: [L sample [H hold
Aperture time	50 ns (TYP)
	100-999 units
HA-2425 0°C to +75°C	\$14.85
HA-2420 -55°C to +125°C	\$29.70
Hermetic 14 pin DIP package	

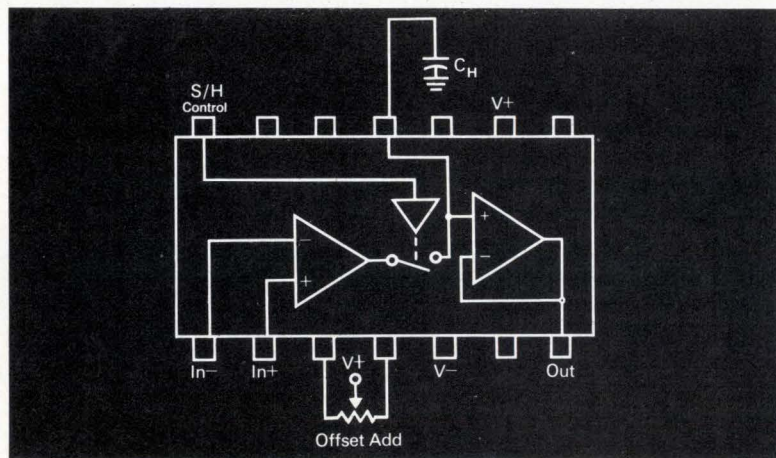

P.O. Box 883, Melbourne, Florida 32901 (305) 727-5430

WHERE TO BUY THEM: OEM SALES OFFICES: ARIZONA: Scottsdale, (602) 946-3556 **CALIFORNIA:** Long Beach, (213) 426-7687; Palo Alto, (415) 964-6443 **FLORIDA:** Melbourne, (305) 727-5826 **ILLINOIS:** Schaumburg, (312) 894-8824 **MASSACHUSETTS:** Wellesley Hills, (617) 237-5430 **MINNESOTA:** Burnsville, (612) 432-6111 **NEW YORK:** Endwell, (607) 754-5464; Melville, L.I., (516) 249-4500 **OHIO:** Dayton, (513) 226-0636 **PENNSYLVANIA:** Wayne, (215) 687-6680 **TEXAS:** Richardson, (214) 231-9031.

SALES REPRESENTATIVES: CALIFORNIA: San Diego, (714) 279-7961 **COLORADO:** Denver, (303) 771-4920 **KANSAS:** Olathe, (913) 782-1177 **MARYLAND:** Randallstown, (301) 922-1248 **NORTH CAROLINA:** Raleigh, (919) 828-0575 **NEW YORK:** Buffalo, (716) 633-7970 **OREGON:** Beaverton, (503) 643-1644 **TENNESSEE:** Shelbyville, (615) 684-4544 **VIRGINIA:** Falls Church, (703) 534-1673; Troutville, (703) 345-3283; Virginia Beach, (804) 481-7200 **WASHINGTON:** Bellevue, (206) 454-0300.

New products

Components

Film capacitors go beyond 1 μF

Metalized-carrier

polystyrene units offer small size, high values

Stability usually makes polystyrene-film capacitors the designer's choice when capacitance value is critical in a particular circuit. But because polystyrene has a lower voltage breakdown strength than other dielectrics, polystyrene capacitors generally have to be larger to attain the same capacitance value and voltage rating as other capacitors—a tradeoff between size and voltage rating that has more or less restricted them to values below 1 microfarad.

However, a new line of polystyrene capacitors from TRW Capacitors comes in standard values up to 1 μF and special values up to 4

μF . The type X1263 units are also smaller than earlier counterparts, and over-all they perform better.

Instead of conventional foil electrodes or a directly metalized dielectric, the new capacitors make use of a metalized-carrier electrode. Layers of polystyrene film are sandwiched between layers of a plastic film that is metalized on both sides, as shown in sketch. This construction more than triples voltage-breakdown strength over conventional foil designs, according to Joseph Toro, chief engineer, who says the breakdown of a metalized-carrier unit is greater than 1,200 v per mil.

Also, the polystyrene film itself can be thinner, giving it greater integrity. For instance, the new capacitors are self-healing, yet they maintain a high insulation resistance of typically 500,000 megohms and a low dissipation factor of typically 0.03. Their temperature coefficient is good, too—for standard units, it's -50 ± 50 ppm/ $^{\circ}\text{C}$ from 0°C to 70°C .

The capacitors come in five sizes, ranging from 0.175 inch in diameter by 0.58 in. long to 0.643 in. in diameter by 1.5 in. long. There are seven capacitance values available, from 0.001 to 1.0 μF , with tolerances of $\pm 0.5\%$ to $\pm 20\%$. All standard units are rated at 100 v, but higher ratings up to 600 v can be obtained.

In production quantities, a 0.001- μF 100-v device having a $\pm 20\%$ tolerance costs \$0.35 each, while a similar 1- μF device costs \$1.75 each. Delivery time is 8 weeks.

TRW Capacitors, 301 West O St., Ogallala, Neb. 69153 [341]

Solid-state relays built for heavy-duty jobs

As its first product line in the solid-state power-switching field, C. P. Clare & Co. has developed a family of four 10- and 25-ampere relays designed for heavy-duty applications such as switching of solenoids, motors, heaters, and lamps.

Rated at 140 or 250 volts ac, all four models are configured as



single-pole, single-throw, normally open devices. They are optically isolated for complete input/output isolation; dielectric withstanding voltage is 1,500 v ac (rms). Zero-crossing synchronous switching gives the relays a one-cycle surge current rating of 1,000%, and the devices are compatible with diode-transistor-logic and transistor-transistor-logic inputs.

Transient dv/dt output protection is built in and will accommodate both resistive and inductive loads. The series 212 relays are packaged in self-extinguishing plastic housings on an aluminum base plate, and measure 2.8 by 1.75 by 1.2 inches. Combination terminals accept lugs, bare wires, or quick-connects, and they are recessed to reduce the possibility of externally caused short circuits.

Available now from stock, the series 212 relays are priced at \$25 each.

C.P. Clare & Co., a subsidiary of General Instrument Corp., 3101 W. Pratt Ave., Chicago, Ill. 60645 [342]

Miniature reed relay switches 20 watts

A miniature Form C reed relay, said to be the smallest reed relay in the world with a latching option, can switch up to 20 watts at rates as high as 500 hertz. Measuring 0.394 inch wide by 0.394 in. high by 0.787 in.

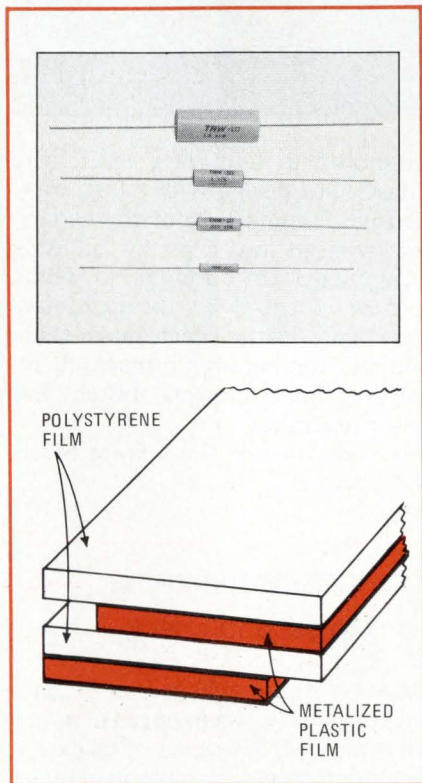

**We just expanded
the dynamic range
of your tape recorder.
By three orders of
magnitude.**

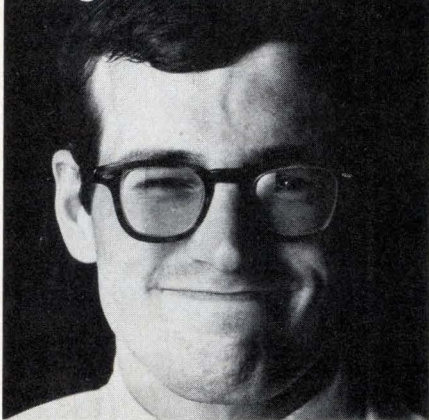

We put our heads together, and based on technology we've long had, designed a compression/expansion system to end all compression/expansion systems.

By handling over 100 dB signal range, it enlarges the dynamic range of tape recorders by three orders of magnitude. Without distortion.

You can analyze compressed data with conventional spectrum analysis equipment.

Or, you can restore the original dynamic range prior to analysis.

And (as a concession to my fat fingers) the system eliminates data loss due to improperly set gain controls.

Arrange a demonstration or request the specs by contacting your Ithaco sales rep, or write to Ithaco, Box 818-CE, Ithaca, N.Y. 14850. Call (607) 272-7640 or TWX 510-255-9307.

ITHACO



New products

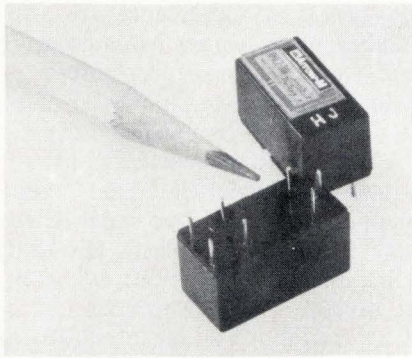

long, the device is sealed in plastic, rather than in the usual glass package, and has an insulation resistance of more than 1,000 megohms at 500 volts dc. Twelve variations on the relay are available: it can be hermetically sealed or magnetically shielded; it can be a dry-circuit or a power type; and it can be a polar single-side stable device, a bistable single-coil latching device, or a bistable double-coil latching relay. The price is \$2.35 each in quantities of 1,000. Delivery is from stock.

Arrow-M Corp., 250 Sheffield St., Mountainside, N. J. 07092 [343]

Tantalum capacitor has reliable elastomer seal

A series of miniature tantalum capacitors with reliable elastomer seals is especially suited for use on printed-circuit boards and in com-

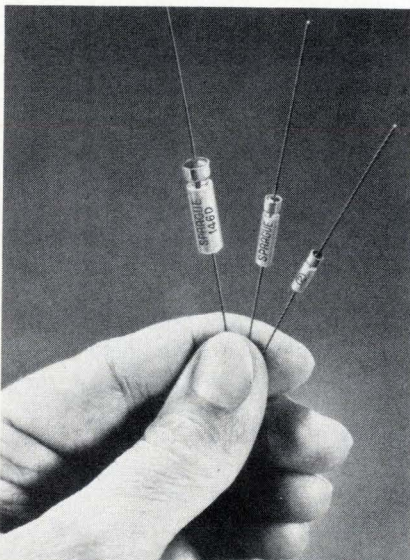

mercial and industrial applications where space is at a premium. The type 146D sintered-anode Tantalex capacitors are available with capacitances from 1.0 to 470 microfarads, and with voltage ratings from 6 to 60 working volts. The TFE-fluorocarbon elastomer seal is said to be extremely resistant to temperature cycling, and to eliminate many of the temperature-induced problems that occur when capacitors are flow-soldered to pc boards.

Sprague Electric Co., 35 Marshall St., North Adams, Mass. 01247 [344]

Ceramic chip capacitor is packaged in glass

The GlasGuard line of ceramic chip capacitors is a family of multilayer devices encapsulated in glass packages. Whilst providing the advan-

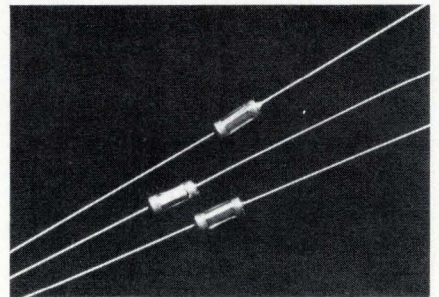

tages of a hermetic seal, the GlasGuard design allows fast, inexpensive manufacture of the capacitors without any need for molding equipment. In addition to being low-cost themselves, the capacitors have axial leads, which make them suitable for automatic machine insertion, thus allowing faster, less costly assembly.

AVX Corp., 19 Ave. South, Myrtle Beach, S. C. [345]

See-through trimmer is easy to set and check

Because it is packaged in a one-piece, partly transparent nylon housing, the 3810 series of trimming potentiometers can have its contact



Debug Your System Design Before You Build It.

Stable? Oscillatory? Unstable? With an HP 9830 Calculator, you'll know exactly how your control system will perform — long before you've committed to an expensive prototype.

The secret to this cost-saving performance is our new State-Variable Dynamic Analysis Software. It's a carefully developed set of programs that can ensure you a stable system — often in less time than it takes to evaluate one or two computations by other methods.

Consider the benefits! No more struggling with Laplace transforms. No hassling with computer programming and interfacing. You just key in system component values directly from your block diagram, and the 9830 does the rest, automatically.

In ten minutes or less, you get a high resolution plot of transient response and printed documentation of system parameters. And if your

design needs adjustment, the handy post-modification routine lets you change components or parameters with a few keystrokes.

Electronic, hydraulic, mechanical, optical or hybrid controls: The HP 9830 Dynamic Analysis System can quickly save you enough on design costs to repay its \$435* per month lease price. And through our extensive software library, you can compound its profitability with savings on the whole spectrum of engineering tasks.

But why not see for yourself. For complete details, or a hands-on demonstration, call your local HP Sales Office. Or send us the coupon below:

*Domestic U. S. A. price only. Lease, where available, includes service contract.



Sales and service from 172 offices in 65 countries.
P.O. Box 301, Loveland, Colorado 80537

Please tell me more about your Dynamic Analysis System.

Hands-on demonstration Information only.

I analyze these kinds of systems _____

Name _____

Firm _____

Address _____

Telephone _____ Zip _____

Hewlett-Packard Co.
P.O. Box 301, Loveland, Colorado 80537

816G



0.1 Hz to 1 MHz for only \$140.00*

This new function generator from Heath offers sine, square & triangle waveforms, wide frequency range, 10 V output, 70 dB attenuation for only \$99.95* kit, \$140* assembled

Every lab needs a good function generator. And now Heath offers a true function generator at a price everyone can afford. Our 1271 provides sine, square or triangle waveforms from 0.1 Hz to 1 MHz with a 10 volt peak-to-peak output into a 50-ohm load. The calibrated attenuator provides 0 to 50 dB attenuation in 10 dB steps with up to 20 dB additional variable attenuation for each step, for a total of 70 dB. Triangle waveform nonlinearity is 5% maximum, with waveform symmetry within 10%. Sine wave harmonic distortion is 3% maximum from 5 Hz to 100 kHz. Square wave rise and fall times are 100 ns max. Its light weight and small size allow it to be placed almost anywhere. The adjustable tilting handle provides easy carrying and positioning for best access to the front panel controls. For \$140*, you can have the SG-1271, completely factory assembled and calibrated. Or buy the kit-form IG-1271 for only \$99.95* and save by building it yourself — a triggered scope is all that's needed for alignment.



Our latest catalogs contain complete description & specs for the 1271 and many other high-performance, low cost instrument values from Heath. Send for your free copies and see how you can get more value for your instrument dollar.

HEATH COMPANY
Dept. 531-282
Benton Harbor, Michigan 49022

- Please send the 1975 Heathkit Catalog.
 Please send the latest Assembled Instruments Catalog.

Name _____

Company/Institution _____

Address _____

City _____ State _____ Zip _____

*Mail order prices; F.O.B. factory. Prices & specifications subject to change without notice.

EK-445

HEATH

Schlumberger

New products

carrier easily set and inspected visually, thus reducing calibration and production trimming costs. The 0.75-inch trimmer has epoxy-encapsulated terminals and a seal between the lead screw and the housing to protect it against moisture, solder fluxes, and cleaning solvents. Available with both the P and K printed-circuit pin terminal spacings, the 3810 comes in a range of resistance values from 10 to 20,000 ohms. The wirewound devices have a temperature coefficient of 20 ppm/°C and can dissipate 1 watt at 40°C. Minimum rotational life is 200 cycles.

Amphenol Sales Division, Bunker Ramo Corp., 2875 South 25 Ave., Broadview, Ill. 60153 [346]

Brushless dc servo motor uses capacitive sensing

A size 15 (1.437 inches in diameter by 2.5 in. long) brushless dc servo motor uses a capacitive transducer to sense rotor position and drive the power amplifiers. The BDCM-1500 has a stall torque of 10 ounce-inches and a no-load speed of 5,000 rpm. The motor's cylindrical Alnico 9 permanent-magnet rotor practically eliminates cogging torque, while generated torque ripple is removed by matching the distribution of the two stator windings to the electronic drive system. The resultant torque ripple is less than 1% of peak torque. Amplifier power requirements are 3 amperes at ±15 volts.

MacBar Mechanisms Inc., 11 West Mall, Plainview, N. Y. 11803 [348]

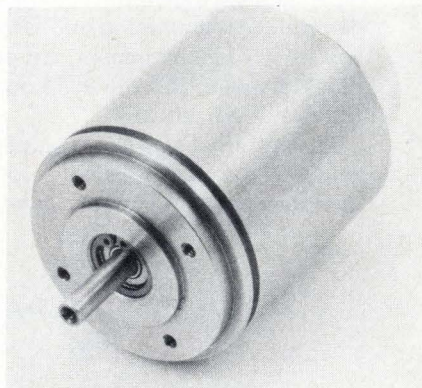



**there's a solution to
your most demanding
fabricating needs
in soft magnetic alloys**

The performance you demand. Uniform quality. Consistent mechanical properties for best fabrication. Complete selection. Yours, in Carpenter soft magnetic alloys . . . whether your job calls for stamping, etching, deep drawing, spinning, hydroforming, machining, forging, cold heading, blanking or forming. Consistency that keeps productivity up, costs down. Full range of grades. High permeability nickel-iron alloys, silicon core irons, ferritic stainless, high flux density cobalt-iron alloys, purest available commercial iron. The best choice for every application, such as Hipernom® for shielding, and many more. Our products, people and capabilities can supply the answer to every fabricating need in soft magnetic alloys. Call your nearest Carpenter Service Center for proof. Carpenter Steel Division, Carpenter Technology Corporation, Reading, Pa. 19603. European Office: 51, Square Vergote, 1040 Brussels, Belgium.

Yours for the asking:
helpful new booklet
on Carpenter soft
magnetic alloys.

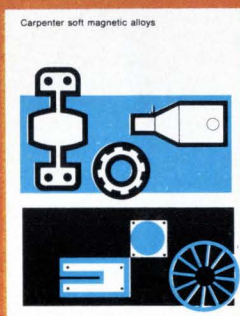

CARTECH CARPENTER
TECHNOLOGY
CARPENTER STEEL DIVISION

**Carpenter
For Sure**

Our ADAPT Aerospace Digital Computer.

Tough enough for a Tomcat,



versatile enough for a missile.

Garrett developed the ADAPT series of digital computers to position the wings and control the supersonic air inlets of the F-14 Tomcat fleet superiority fighter. So it had to be rugged. As well as reliable, compact, and light weight.

The things that make the versatile ADAPT series the ideal computer for advanced aircraft make the new ADAPT RF-20 the optimum computer for missile and launch vehicle applications, too.

More computational power per unit cost. Multi-sourced TTL integrated circuits. 20-bit parallel operation. Bus-organized. Micro-program control. 16 general registers. Over 100 instructions. Up to 64K words of core or solid state memory. Mil-E-5400 Class II. And Garrett quality throughout.

Send the coupon today. We'll rush you the full ADAPT story.

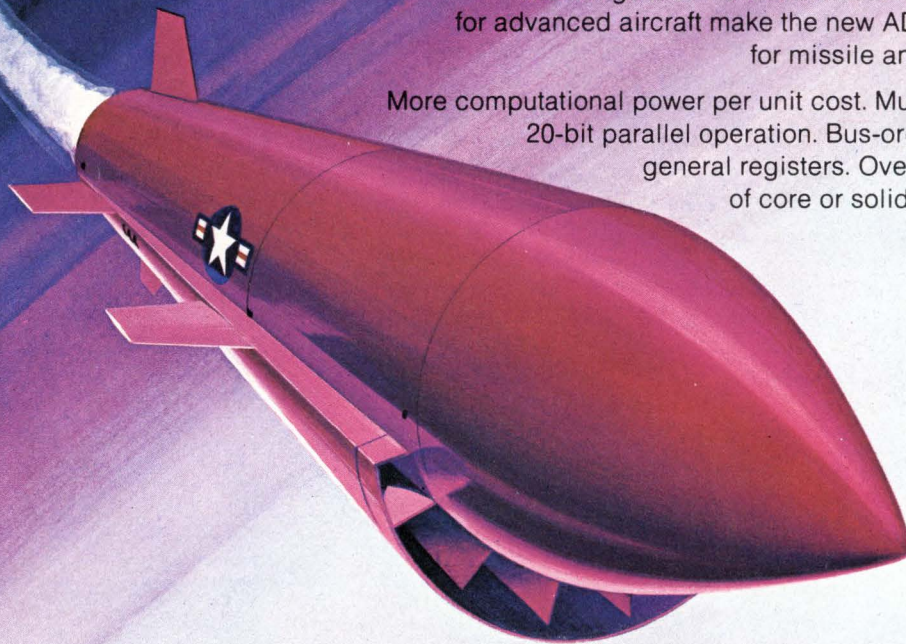

The Garrett Corporation One of The Signal Companies

Sales Manager,
Electronic Systems
AiResearch Manufacturing Company
of California,
2525 W. 190th St., Torrance,
CA 90509.

NAME

TITLE

COMPANY

ADDRESS

ZIP

PHONE

GARRETT ELECTRONICS

Adds up to value.

Circle 138 on reader service card

New products

Instruments

DMM resolves 1 μ V, 10 pA

3½-digit (2,000-count)
meter has 10-megohm input
resistance, costs \$525



While low-cost, general-purpose digital multimeters keep getting lower in price and more widely accepted, the increasing use of micro-power circuitry has made them inadequate for an increasing number of laboratory applications. Typically, these instruments can resolve something like 100 microvolts and 100 nanoamperes on their most sensitive scales. By contrast, Keithley's latest meter is a 3½-digit (2,000-count) machine that can resolve one microvolt, 10 picoamperes, and one milliohm on its most sensitive ranges. At the same time, it has top ranges of 1,200 v, 2 A, and 2,000 M Ω . The only bad news is that the model 160B is a dc-only instrument—it has no ac voltage or current ranges. The price is \$525—more, of course, than that of less-sensitive, general-purpose 3½-digit instruments, but considerably less than the cost of the 5½-digit machines to which one typically has to resort to get the kind of sensitivity it provides.

The 160B has seven voltage ranges, starting at 1 mv full-scale, and going up to 1,000 v. All have a 10-M Ω input resistance, and all but the top range have 100% over-ranging. The bottom three ranges are protected up to 600 v (dc plus

peak ac), continuous; the rest of the ranges can take up to 1,200 v. Actually, even the lower ranges can take 1,200 for a short period. The maximum error on all dc ranges is $\pm(0.1\%$ of reading + 1 digit).

The meter has nine current ranges, going from 10 nA full-scale up to 1 A. All of the ranges have 100% overrange, and the top seven can take overloads up to 3 A at which point a fuse blows. The two lowest ranges have maximum allowable currents of 0.25 mA and 2.5 mA.

For measuring resistance, the 160B has 10 ranges; the lowest measures 1 Ω full-scale, and the highest goes up to 1,000 M Ω . All have 100% over-ranging, and all are protected up to 250 v.

The basic instrument is a line-powered meter which pulls 5 watts at one of the four following, switch-selectable voltage ranges: 90-110, 105-125, 195-235, or 210-250; all at 50 to 60 hertz. Extra-cost options include a rechargeable battery pack which adds \$75 to the basic price of \$525, and a BCD output at \$195. Keithley's traditional analog output is standard. Delivery time is 30 days.

Keithley Instruments, Inc., 28775 Aurora Rd., Cleveland, Ohio 44139 [351]

Digital delay generator has 10-ns resolution

Designed for such applications as radar simulation, pulsed laser work, automatic test systems, and precision calibration of test instruments, the model 7055 programmable digital delay generator produces low-jitter time delays from 10 nanoseconds to 10 milliseconds, selectable in 10-ns increments. An option that extends the delay to 1 second with the same



resolution is available. The delay time can be set manually using front-panel thumbwheel switches, or it can be remotely programmed with BCD inputs. The output pulses have 5-ns rise times and are produced in both polarities simultaneously. A separate gate output is also provided. A repetitive operating mode generates digitally selectable periods. Price of the 7055 is \$1,725; delivery time is 30 to 45 days.

Berkeley Nucleonics Corp., 1198 Tenth St., Berkeley, Calif. 94710 [353]

Portable system analyzes environmental noise

A portable instrumentation system for the measurement and analysis of industrial and community noise consists of a self-contained data-acquisition system, a reader/converter, and proprietary computer software. The data-acquisition system records noise information in 10 octave-bands across the audible range. Sampling intervals

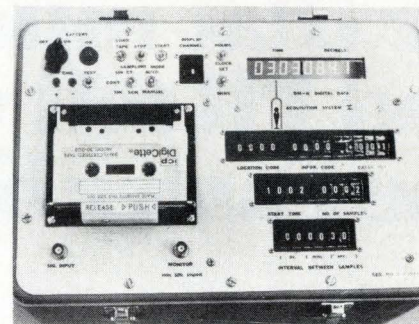

are selectable from 4-second to 24-hour periods. Standard digital tape cassettes can record 7 hours of information at the shortest sampling rate. The reader/converter provides the interface between the field recording unit and a computer system or a programmable calculator. The proprietary software package generates the printout of a hazard profile study which can be presented in several formats, depending upon the application. For instance, community noise levels are evaluated on the basis of Housing and Urban Development or Environmental Pro-

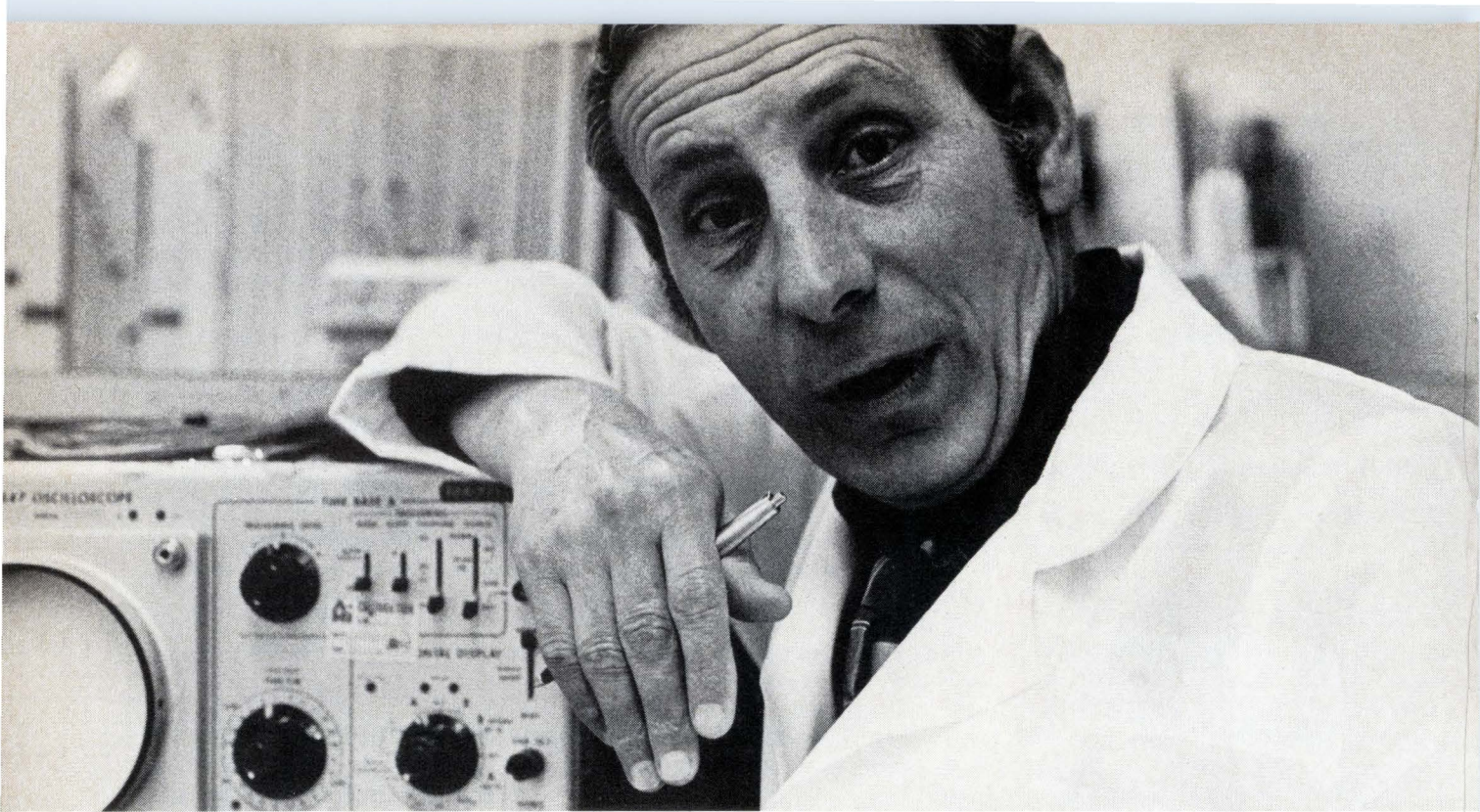

**“Okay, okay.
You tell me where we can find
twenty thousand RAMs a week
for that much less than the 2102
and I’ll tell you where to find
the Easter bunny.”**

*New low price —
\$3 each!
(quantities over 1000)*

**Give him
the good news:**

You can find all the 1K RAMs you need right now—right here at AMI. We have 4006, 4008 and 4008-9 RAMs ready for immediate delivery. They’re pin-for-pin with Mostek’s. But you can get more of ours—faster. (Stands to reason that when you have larger production facilities you can produce more.) The price is right, too. For example, the 4008-9 is yours for just \$3.50 in quantities over 1000. You get the advantages of a 2102 system, while saving a bundle with our 4006 family. You can get an application note on how to do it, and a free sample, by writing to

Frank Rittiman, AMI, 3800 Homestead Road, Santa Clara,
CA 95051. Phone: (408) 255-3651. Or ask your distributor.

AMI
AMERICAN MICROSYSTEMS, INC.

The charge of the 1K RAMs.

No more waiting for your 4006 family.

You have a perfect combination of price/performance for your 1024 bit MOS RAM applications. Use them for buffer or scratch pad memories. Or for peripherals, terminals, displays, programmable calculators, cash registers, optical scanners, spectro-analyzers.

And we give you more than fast deliveries. We give you specs like these:

P/N	S4006	S4008	S4008-9
No. of Bits	1024x1	1024x1	1024x1
Access Time	400 ns	500 ns	800 ns
Cycle Time	650 ns	900 ns	1000 ns
Power Supply	+5V, -12V	+5V, -12V	+5V, -12V

And this is how the S4006/8/8-9 looks on paper:

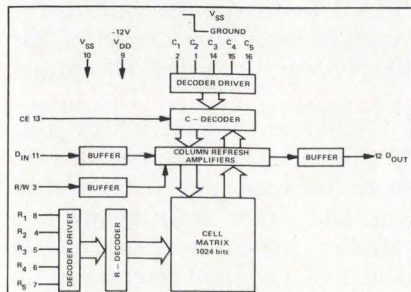

AMI
AMERICAN MICROSYSTEMS, INC.

Circle 141 on reader service card

New products

tection agency criteria, while industrial noise is evaluated in terms of the requirements of the Occupational Safety and Health Act.

Donley, Miller & Nowikas Inc., 56 Route 10, East Hanover, N.J. 07936 [354]

Sweep/signal generators span 0.5 to 500 MHz

Two general-purpose types of sweep/signal generator cover the frequency range from 0.5 to 500 megahertz. The model 1001A spans the range from 0.5 to 300 MHz and the model 1002 covers 1.0 to 500 MHz. Maximum sweep nonlinearity is 2%. Flatness of ± 0.25 dB is accomplished with pin-diode leveling.

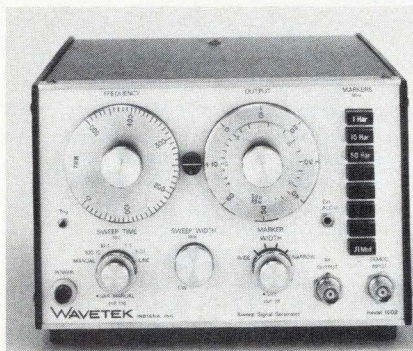

Output amplitude is +60 dBmV maximum with total attenuation range of 90 dB. Attenuation accuracy is ± 0.5 dB. Both 1000-series units have a-m and fm capability. The price of the 1001A is \$1,100; the 1002 costs \$1,150. Delivery is from stock.

Wavetek Indiana Inc., 66 North 1st Ave., Beech Grove, Ind. 46107 [355]

50-MHz scope works from almost any voltage

Designed to compete on a convenience and price basis for the medium-performance segment of the international oscilloscope market, Philips' PM3240 is a 50-MHz, dual-trace instrument that weighs 18.5 lb, costs \$1,470, and can operate on any ac voltage from 90 to 270 v, at any

The pollution problem. Maybe your engineers deserve a little help.

The engineers' will be the ones to find the technical solutions to pollution problems. There's no doubt about it.

But pollution is a people problem, too. And the engineers' technological approach to pollution isn't going to solve people problems.

Maybe this booklet can help. It lists some of the things all people can do to fight pollution. And with all the people supporting your engineers we'll have a better chance of winning the fight.

For a free copy or a list of bulk rates write to Keep America Beautiful, Inc., Box 1771, Radio City Station, New York, New York 10020.

Keep America Beautiful

Advertising contributed for the public good



People start pollution. People can stop it.

**This Christmas give your car
a Mark Ten B Capacitive
Discharge Ignition. You and
your car will enjoy it all year.**



The Mark Ten B keeps your car in tune. That means increased mileage, less maintenance and a better running car. A well-tuned car also decreases emission contaminants. All this adds up to more driving enjoyment for you. Mark Ten B, the perfect gift—for cars—and their owners.



DELTA PRODUCTS, INC.

P.O. Box 1147, Dept. E
Grand Junction, Colo. 81501
(303) 242-9000

Here's my Christmas order. Please rush!

Please send me free literature.

Enclosed is \$ _____ Ship ppd. Ship C.O.D.

Please send: _____ Mark Ten B assembled @ \$64.95 ppd. _____ Mark Ten B Kit @ \$49.95

ppd. 12 volt negative ground only • _____ Standard Mark Ten, assembled, @ \$49.95 ppd.

_____ 6 Volt: Neg. Ground Only _____ 12 Volt: Specify _____ Pos. Ground _____ Neg.

Ground • _____ Standard Mark Ten Deltakit" @ \$34.95 ppd. (12 Volt Positive or Negative

Ground Only)

Car Year _____ Make _____

Name _____

Address _____

City/State _____

Zip _____

Circle 142 on reader service card

**Fight
Them All**

Heart Attack, Stroke
High Blood Pressure
Rheumatic Fever

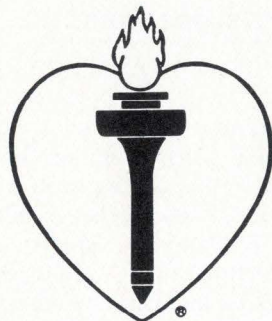

Help your Heart... Help your Heart Fund

New products

line frequency from 46 to 440 hertz, or from dc voltages of 90 to 200 v—all without switching. The oscilloscope has a full-bandwidth sensitivity of 5 millivolts per division on both channels and has two independent time bases for delayed-sweep operation. The front-panel controls are "cold switches"—that is, they control logic circuits, which, in turn, control the actual input signals—so that front-panel layout can be based entirely on human-engineering considerations. For example, the cable connections are all placed along the bottom of the scope without regard for their proximity to the various controls. Adding a pair of PM9350 probes raises the price of the oscilloscope to \$1,560.

Philips Test & Measuring Instruments Inc.,
400 Crossways Park Drive, Woodbury, N. Y.
11797 [359]

Hewlett-Packard expands 'snap-on' instrument line

Hewlett-Packard's 5300 line of digital multimeters and counters has been expanded by the addition of four high-performance modules. The new devices are a high-resolution (8-digit) mainframe, a 1.1-gigahertz frequency-counter snap-on measuring unit, an H-P bus interfacing unit that snaps between a system mainframe and a snap-on measurement module, and an improved "snap-between" digital-to-analog converter which is compatible with both the new 8-digit mainframe and the older 6-digit unit. The model 5300B 8-digit mainframe costs \$460 and is available with a \$180 option that adds a temperature-compensated crystal oscillator. The model 5305A 1.1-GHz counter extends the frequency-measuring range of the 5300 system up from 525 megahertz. It costs \$1,100. The model 5312A output module, which costs \$350, provides an Ascii-encoded interface between any 5300 instrument and other instruments and controllers (such as programable calculators and minicomputers) so that the individual instrument can become part of a larger measuring



You already have everything you need to keep our keyboards clean.

Getting any keyboard dirty is easy.

From that point on, things become more difficult. Because the contacts on mechanical keyboards are very sensitive to contamination. And, if the dirt hasn't already gotten to them, the cleaning process might.

MICRO SWITCH makes the cleaning process easy. All it takes is a bucket of hot, sudsy water. And maybe a brush.

Because MICRO SWITCH has solid-state keyboards. Designed around Hall effect chips that are completely encapsulated, they're impervious to just about any contaminant you can name.

So things like dirt and coffee can't get in. And neither can a bath in hot, sudsy water.

It makes your equipment maintenance a lot easier. And, in the long run, can substantially reduce service costs. Besides giving you a keyboard with all the built-in reliability of a solid-state design in the process.

If you'd like more information on MICRO SWITCH keyboards, call, toll-free, 800/645-9200 (in N.Y., call 516/294-0990, collect) for the location and telephone number of your nearest MICRO SWITCH Branch Office.

You'll see a line of keyboards that work like a dream. And wash like a coffee cup.

Circle 143 on reader service card

MICRO SWITCH

FREEPORT ILLINOIS 61032

A DIVISION OF HONEYWELL

MICRO SWITCH products are available worldwide through Honeywell International.

New products

system. The model 5311B d-a converter, at \$350, is expected to replace its predecessor for such tasks as the driving of analog chart recorders. Estimated delivery time for all modules is less than 30 days.

Inquiries Manager, Hewlett-Packard Co., 1501 Page Mill Rd., Palo Alto, Calif. 94304 [357]

Constant-current source puts out up to 1.1 amperes

A constant-current source with a maximum output current of 1.1 amperes at a compliance voltage of 50 volts and a lower-current compliance voltage of 300 volts spans the current range from 1 microampere to 1.1 A in four decade ranges. Its output current level is selected by means of three front-panel switches. The compliance voltage limit (the maximum voltage the source will develop across a load) is also selected via a front-panel control. It can range from 3 v to the maximum. This allows the user to protect voltage-sensitive loads (such as semiconductor junctions) by limiting the maximum voltage to which the load will be exposed. If the load changes and the model 227 reaches the compliance limit, a front-panel light indicates that the output is being limited. The output current of the model 227 can be modulated or programed by applying a voltage with the desired modulation characteristic to rear-panel terminals. The modulation can be virtually any percent of full range and can be on top of any dc level. A programing option (the model 2271) permits the current source to be programed even beyond the modulation capability. It allows remote selection of range and compliance limit while providing for both voltage and resistance programing of the exact current level. The model 227 sells for \$925, and the 227/2271 combination is priced at \$1,155. Delivery time is within 30 days.

Keithley Instruments, Inc., 28775 Aurora Road, Cleveland, Ohio 44139 [356]



Some Delevan designs are very special...

THEY'RE NOT MADE YET.

Applications for inductive devices are virtually unlimited . . . and not even Delevan's broad line of *standard* designs can fit every requirement. That's where Delevan's Application-Engineering capability comes in! No matter how unusual or highly-specialized your application may be . . . Delevan can provide a custom-engineered design to meet the most demanding specifications, the most unique applications.

At Delevan, the design of inductive devices is far more than an art . . . it is a highly-sophisticated science. State-of-the-art techniques in winding and molding, the instant availability of computerized data, and utilization of new materials and procedures . . . combined with the proven expertise of Delevan engineers . . . equals unmatched capabilities. If you have the application, Delevan can provide the design.

Delevan
Division



AMERICAN
PRECISION
INDUSTRIES INC.

270 QUAKER RD. / EAST AURORA, N. Y. 14052
TELEPHONE 716/652-3600 TELEX 091-293

OTHER DIVISIONS OF AMERICAN PRECISION INDUSTRIES INC. :
BASCO • DUSTEX

VACTEC Couplers

**For putting it together, VACTEC
is second only to RODIN*.**

Vactec Optical Couplers (T.M. Vactrols) put together incandescent lamps, neon lamps or LEDs with photoconductors or phototransistors in a wide variety of packages and capabilities.

Couplers using photoconductive cells are useful for isolation where speed requirements are in the order of milliseconds. Applications include noiseless switching, noiseless potentiometers, signal modulators for audio, triac firing, and low cost RMS regulators.

Couplers using LEDs and phototransistors or photodarlington provide higher speed for output sensing, input driving, interfacing and coupling, solid state relays, and switching.

VACTEC really does put them together—we make our own photoconductive cells, phototransistors and photodarlington and do the assembly at our only factory near St. Louis. Write for all Vactrol bulletins.

*Reproduction of The Kiss by Rodin.

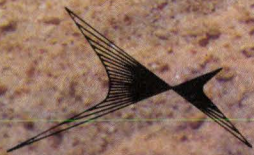

Vactec, Inc.
2423 Northline Industrial Blvd.
Maryland Heights, Mo. 63043 U.S.A.
(314) 872-8300

Circle 145 on reader service card.

Now Corning can meet your complete precision metal film resistor needs.

And you can quote us.

You can quote us on our new RN55, RN60, and RN65 "E" characteristic 25ppm precision metal film resistors in 0.1, 0.25, 0.5 and 1% tolerances, in addition to our full line of RL, RLR, and RN (C and D) characteristic resistors.

They're available now directly from us or through your Corning distributor.

Even before we put our new 25ppm precision metal film resistors on the market, Corning was manufacturing more metal film resistors than anyone else in the United States. There's a reason. Our multi-million dollar investment in high-speed automated equipment and improved techniques assures prompt delivery of volume orders. Our

distribution supply center maintains a stock of Corning components in anticipation of future distributor needs.

The best distributor network in the country is ready to service your metal film resistor needs. Give them a call. For additional information, contact your nearest Corning Electronics sales office or Corning Glass Works, Electronic Products Division, HPA2, Corning, New York 14830, (607) 974-8652.

CORNING
ELECTRONICS

Request
For Quotation

GLASS WORKS
ELECTRONIC PRODUCTS DIV.
CORNING, N.Y. 14830

REQUEST
FOR QUOTATION



CORNING GLASS WORKS
ELECTRONIC PRODUCTS DIVISION
CORNING, N.Y. 14830

REQUEST
FOR QUOTATION

Request
For Quotation



Request
For Quotation

Call your Corning distributor.

ALABAMA: Huntsville
Cramer/EW (205)539-5722

ARIZONA: Phoenix
Liberty Electronics (602)257-1272

CALIFORNIA: Gardena
Bell Industries Electronics (213)321-5802

CALIFORNIA: Los Angeles
Liberty Electronics (213)322-8100

CALIFORNIA: Mountainview
Elmar Electronics (415)961-3611

CALIFORNIA: San Diego
Liberty Electronics (714)565-9171

COLORADO: Commerce City
Elmar Electronics (303)287-9611

COLORADO: Denver
Cramer Electronics (303)758-2100

CONNECTICUT: North Haven
Cramer Electronics (203)239-5641

FLORIDA: Hollywood
Cramer/EW (305)923-8181
Hamilton/Avnet Electronics (305)925-5401

FLORIDA: Orlando
Cramer/EW (305)894-1511

ILLINOIS: Chicago
Bell Industries (312)282-5400
Schweber Electronics (312)593-2740

INDIANA: Indianapolis
Graham Electronics Supply (317)634-8202

MARYLAND: Baltimore
Radio Electric Service Co. (301)823-0070

MASSACHUSETTS: Watertown
Sterling Electronics (617)926-9720

MASSACHUSETTS: Newton Centre
Cramer Electronics (617)969-7700

MINNESOTA: St. Paul
Ragon Electronics (612)488-0201

NEW JERSEY: Cherry Hill
Cramer Electronics (609)424-5993

NEW JERSEY: Somerset
Schweber Electronics (201)469-6008

NEW MEXICO: Albuquerque
Cramer Electronics (505)265-5767

NEW YORK: Freeport
Milgray Electronics (516)546-6000

NEW YORK: Hauppauge
Cramer/Long Island (516)231-5600

NEW YORK: Rochester
Cramer/Rochester (716)275-0300

NEW YORK: Syracuse
Cramer/Eastern (315)437-6671

NEW YORK: Westbury
Schweber Electronics (516)334-7474

NEW YORK: Woodbury
Harvey Electronics (516)921-8700

NORTH CAROLINA: Raleigh
Radio Electric Service Co. (919)832-2077

NORTH CAROLINA: Winston-Salem
Cramer/EW (919)725-8711

OHIO: Cincinnati
Sheridan Sales Co. (513)761-5432

OHIO: Cleveland
Schweber Electronics (216)464-2970

OHIO: Columbus
Hughes-Peters (614)294-5351

PENNSYLVANIA: Philadelphia
Almo Electronics (215)676-6000

TEXAS: Dallas
Solid State Electronics (214)352-2601

TEXAS: Houston
Hamilton/Avnet Electronics (713)526-4661

UTAH: Salt Lake City
Cramer Electronics (801)487-4131

WASHINGTON, D.C.
Cramer/EW (301)948-0110
Milgray/Washington (301)864-1111

WASHINGTON: Seattle
Liberty Electronics/NW (206)763-8200

CANADA: Montreal
Cesco Electronics, Ltd. (514)735-5511

CANADA: Toronto
Cesco Electronics, Ltd. (416)661-0220

New products

Semiconductors

Power transistor speeds switching

100-ampere, 120-volt unit
combines with ICs for
industrial applications

Progress in integrated circuits is overshadowing progress in discretes, but some advances in discrete semiconductors are also helping to make IC applications more widespread. An example is silicon power transis-

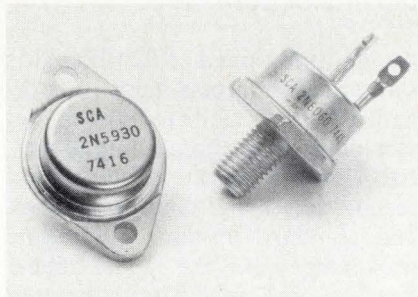

tors, where fast, high-power transistors are combined with ICs in fast-switching applications. A new family of high power transistors made by Semicoa seems likely to be used in this way, and to open new industrial and military applications or simplify existing ones. The 100-ampere, 120-volt SCA100-120 has a minimum common-emitter current-gain cutoff frequency of 30 megahertz (typical 60 to 80) and this permits it to handle fast-switching applications that had previously required multiple parts. Mark Kalatsky, president of Semicoa, expects the device to find use in inverters, power switches, motor control, display systems, pulse modulation equipment, servos and process control. "The 100-120," he says, "can replace up to 10 smaller devices, giving higher reliability, lower cost and faster assembly."

Kalatsky says the 250-mil-square device has a typical 40-A second-breakdown current, with a 100-miljoule second-breakdown energy,

compared to the 0.4 mJ of a device it will replace. Peak power capability is 6 kilowatts, with device dissipation of 200 watts at an ambient temperature of 25°C. The part is offered in the TO-63 stud-mounted package (at right in photo) at \$50, or in a TO-3 case (left) for \$5 less, both prices applying to quantities of 100 parts.

The npn planar transistor has a collector-emitter breakdown voltage of 120 v, emitter-base breakdown of 8 v, and collector-base breakdown of 140 v. Collector-emitter saturation voltage at 100-A collector current and 20-A base current is only 1.7 v.

Common-emitter current gain is a minimum of 10 at a collector current of 70 A. Output capacitance is 450 picofarads.

In addition to the model 100-120, Semicoa can supply a 100-A 80-v version for \$30 in quantities of 1,000. A higher-voltage part is also made, and this model is rated at 250 v at 30 A.

Semicoa, 3333 McCormick Avenue, Costa Mesa, Calif. 92626 [411]

Analog function array comes in 16-pin DIP

A multifunction building block consisting of two precision comparators, two analog samplers, and two current sources replaces at least two standard integrated circuits and a few transistors with a single 16-pin dual in-line package. The model ER201M is expected to be especially useful to instrument designers in need of logarithmic converters, ramp generators, capacitance meters, multipliers, and phase comparators—to mention just a few of the functions that can be performed

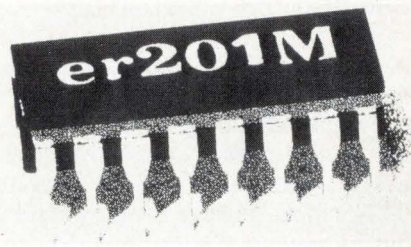

New products

by suitable interconnections of the ER201M's functional blocks (and some additional passive components). The analog function array has an operating temperature range of -55° to $+125^{\circ}\text{C}$ and costs \$15 when bought in hundreds.

Electronics Research Group, 22 Mill St., Arlington, Mass. 02174 [413]

Multiplier-divider
has 1% maximum error

Laser-trimmed and needing no adjustments or external components to achieve its rated accuracy, the model 4205K multiplier-divider is priced at \$36 in small quantities. A similar unit, the model 4205J, with a maximum error rating of 2%, costs \$26. Both monolithic devices have differential inputs for flexibility in

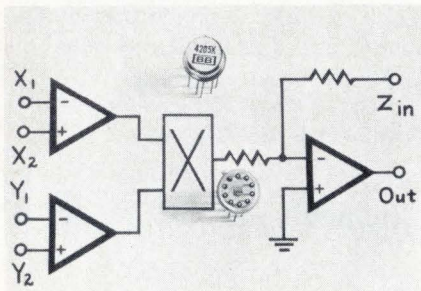

choosing the algebraic sign when performing four-quadrant multiplying, dividing, and square-rooting. Hermetically sealed in a TO-100 package, the 4205 has a 25-volt-per-microsecond slew rate and a 1-megahertz bandwidth.

Burr-Brown Research Corp., International Airport Industrial Park, Tucson, Ariz. 85734 [414]

Sample-and-hold amplifier
can grab 20-V step in 5 μs

A hybrid sample-and-hold amplifier—the model LH0053G—is fast enough to acquire a 20-volt step signal in less than 5 microseconds. It has a maximum sampling error of 0.2% which, however, can be nulled out by means of a trimming poten-

tiometer in the device's external feedback loop. The amplifier has a maximum aperture time of 25 nanoseconds, a minimum analog input range of $\pm 10\text{V}$, and an output that's proof against short circuits. The LH0053G has an operating temperature range of -55° to $+125^{\circ}\text{C}$ and costs \$35.30 in hundreds. A similar device, the LH0053CG, operates between -25° and $+85^{\circ}\text{C}$ and costs \$18.15 in similar quantities. Delivery of both units is from stock.

National Semiconductor Corp., 2900 Semiconductor Drive, Santa Clara, Calif. [416]

1-k static RAM has
500-ns access time

A medium-speed 1,024-bit MOS static random-access memory is organized as a 256-byte-by-4-bit device with shared input-output pins. Its 4-bit organization, 500-nanosecond access and read cycle times, and standard 16-pin dual in-line packaging make the model 2606-1 suitable for small, bus-structured data systems. Examples of these include computer peripheral equipment and scientific calculators. The n-channel, ion-implanted memory operates from a single 5-volt supply and dissipates about 200 milliwatts. Its price, in hundreds, is \$11.65,

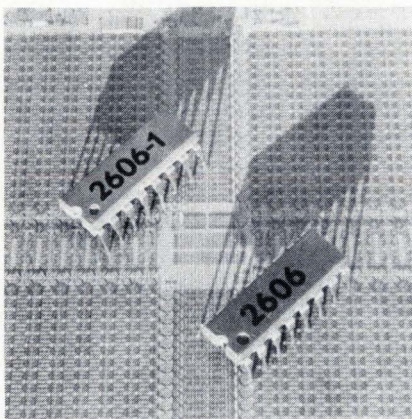

while the older, slower (750-ns), but otherwise similar model 2606 costs \$10.40, when purchased in the same quantities. Samples are available immediately; large-quantity orders will have a delivery time of eight

GIANT II

GENERAL INSTRUMENT ADVANCED N-CHANNEL ION IMPLANT TECHNOLOGY

16K x 5 VOLTS*

HERE'S WHERE TO CALL...

GENERAL INSTRUMENT SALES REPRESENTATIVES

ALABAMA, Huntsville 20th Century Mktg.	(205) 772-9237
ARIZONA, Scottsdale Mercury Engineering Sales Inc.	(602) 945-1927
CALIFORNIA, El Segundo Varigon Assoc.	(213) 644-3611
Los Altos P.M. Sales	(415) 941-4444
COLORADO, Littleton Goynes Assoc. Inc.	(303) 798-8955
CONNECTICUT, Stratford Gerald Rosen Co., Inc.	(203) 375-5456
FLORIDA, Hollywood Component Engineering Sales Corp.	(305) 922-8917
ILLINOIS, Park Ridge Metcom Assoc.	(312) 696-1490
INDIANA, Greenwood Valentine, Schillinger & Assoc.	(317) 888-2260
South Bend Valentine, Schillinger & Assoc.	(219) 291-6258
IOWA, Cedar Rapids J. R. Sales Engineering, Inc.	(319) 377-8211
KANSAS, Wichita Dy-Tronix, Inc.	(316) 943-6221
MARYLAND, Baltimore Component Sales, Inc.	(301) 484-3647
MASSACHUSETTS, Framingham Gerald Rosen Co. Inc.	(617) 879-5505
MINNESOTA, Minneapolis Nortec Inc.	(612) 835-7414
MISSOURI, Hazelwood Dy-Tronix, Inc.	(314) 731-5799
Kansas City Dy-Tronix, Inc.	(816) 761-6543
NEW JERSEY, Teaneck R. T. Reid Assoc.	(201) 692-0200
NEW MEXICO, Albuquerque Goynes Assoc. Inc.	(505) 265-6794
Buffalo Quality Components, Inc.	(716) 839-2044
NEW YORK, Manlius Quality Components, Inc.	(315) 682-8885
Rochester Quality Components, Inc.	(716) 889-1919
NORTH CAROLINA, Raleigh Component Sales, Inc.	(919) 782-8433
OHIO, Cincinnati G & H Sales	(513) 771-8231
Grove City G & H Sales	(614) 878-1128
OREGON, Portland Jas. J. Backer	(503) 297-3776
PENNSYLVANIA, Narberth Jerry Bresson Assoc.	(215) 839-6770
WASHINGTON, Seattle Jas. J. Backer	(206) 285-1300

GENERAL INSTRUMENT SALES HEADQUARTERS

DOMESTIC

EASTERN AREA SALES HEADQUARTERS
600 W. John St., Hicksville, N.Y. 11802, (516) 733-3107
CENTRAL AREA SALES HEADQUARTERS
3101 West Pratt Blvd., Chicago, Ill. 60645, (312) 388-9200
WESTERN AREA SALES HEADQUARTERS
7120 Hayvenhurst Ave., Van Nuys, Calif. 91406, (213) 781-0489

INTERNATIONAL

GENERAL INSTRUMENT CANADA LTD.
61 Industry St., Toronto 337, Ontario, Canada, Tel: (416) 763-4133
GENERAL INSTRUMENT MICROELECTRONICS LTD.
57/61 Mortimer St., London, W1N 7TD, England, Tel: 01-636-7022
GENERAL INSTRUMENT INTERNATIONAL CORP.
Fukide Building, 17 Fukide-cho, Minato-ku, Tokyo 105, Japan,
Tel: (03) 437-0281-5



GIANTII™

GENERAL INSTRUMENT ADVANCED N-CANNEL ION IMPLANT TECHNOLOGY

16K x 5 VOLTS*

DECEMBER
monday **2** 1974

4K x 4
STATIC ROM
(R0-3-16384)

* *Single +5V Supply*
TTL Compatible
Address/Chip
Select Latch
1 μsec maximum
Access Time

AND MORE GIANTII's COMING ...

NEXT. 1024 BIT S/R DC-2MHz

NEXT. 16K ROM STATIC 2K x 8

NEXT. UAR/T- 60 kbaud

NEXT. 5 x 7 x 64 HIGH SPEED CHAR. GEN.

NOW AVAILABLE

For complete information call toll-free 800-645-9247 (In New York State call 516-733-3107) or write, General Instrument Corporation, Microelectronics, 600 W. John St., Hicksville, N.Y. 11802

SEPTEMBER 30 1974
monday
STATIC ROMS
5K (R0-3-5120) 512 x 10
Single +5V supply
4K (R0-3-4096) 512 x 8
Single +5V supply

**GENERAL INSTRUMENT CORPORATION
MICROELECTRONICS**



DIB*

DUAL IN-LINE BRIDGE

An integrated bridge rectifier in a miniature dual in-line package

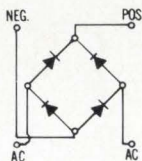

- 4-pin, low-profile DIP
- Leads on standard .10" (2,54 mm) grid
- Compatible with automatic testing, handling and inserting.
- Greatly reduces labor & material costs.
- 100% surge tested at 25A.
- Meets moisture resistant requirements of MIL-STD 202, method 106C.
- Two Series: 1 Amp (I_o) at 40°C; ½ Amp (I_o) at 55°C
- 25 to 1000V (V_{RRM})

* TM-Varo Semiconductor, Inc.



Write for free sample

Design us in . . . we'll stay there

VARO SEMICONDUCTOR, INC.

P.O. BOX 676, 1000 N. SHILOH, GARLAND, TEX. 75040 (214) 272-4551 TWX 910-860-5178
Circle 150 on reader service card

Metal Core Circuit Boards handle circuits 4 to 13 times too hot for G-10

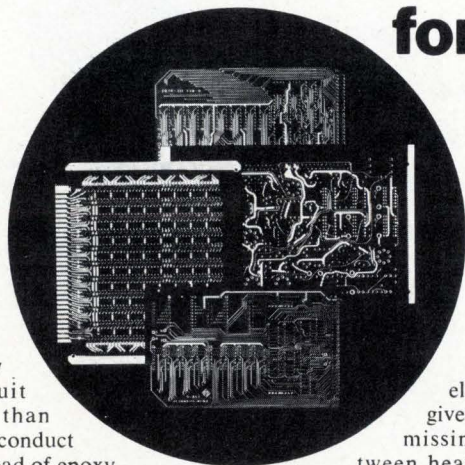

No. 20 of a Series

You can load a lot more hot components on our new Metal Core Circuit Boards (MCCB) than G-10 because they conduct heat like metal instead of epoxy.

Here's what you can expect over G-10:

Environment	Power Density Increase
Still air	Four times
Forced air	Eight times
Thermally grounded system	Thirteen times

MCCB's spread the heat around for efficient convection, eliminate hot spots and give you the heretofore missing thermal link between heat producing device and the outside world. If your circuits are too hot to handle, write to IERC, a subsidiary of Dynamics Corporation of America, 135 West Magnolia Boulevard, Burbank, California 91502.



Heat Sinks

New products

weeks after receipt of order.
Signetics, 811 East Arques Ave., Sunnyvale, Calif. 94086

3-ampere rectifier
can take 200-A peaks

A line of 32 diffused silicon rectifiers is rated at 3 amperes continuous current (at an ambient temperature of 40°C) and comes in versions with peak surge ratings of up to 200 A. The line includes controlled avalanche devices with avalanche ratings of 250, 450, 650, and 850 volts minimum; non-controlled rectifiers with repetitive reverse voltage ratings from 50 to 1,000 v; and fast-recovery diodes with reverse recovery times of 200 nanoseconds. The normal-speed devices are available with 100- and 200-A surge ratings, while the fast-recovery diodes have ratings of 75 and 150 A. Prices start at 22¢ (for the model V330 which is a 50-v unit with a 100-A surge rating).

Varo Semiconductor Inc., P. O. Box 676, Garland, Texas 75040 [417]

Two 0.5-in. LED displays
combined in one package

Following the lead of some makers of planar gas-discharge devices, Litronix has introduced the first 0.5-inch light emitting diode displays in which more than one digit is put into a single package. Two types are available: the model DL-727 with two seven-segment digits plus decimal points, and the model DL-721 with a plus or minus sign and a "1" preceding one seven-segment digit. The digits use the light-pipe packaging technique to spread light evenly over broad segments to achieve a luminous intensity of 5.0 millicandelas at a drive current of 20 milliamperes per segment. Pricing for both devices is \$4.70 per two-digit package in quantities of 1,000.

Litronix Inc., 19000 Homestead Rd., Cupertino, Calif. 95014 [420]

INNOVATIVE SWITCHES by CDI

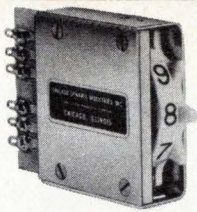

Sealed Switch Module. Completely sealed and/or RFI shielded.

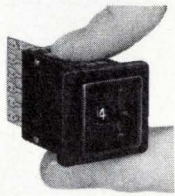

Series TSM Mini Thumb-wheel switch mounts on 1/2" centers. Retrofits most miniature thumb-wheel switch panel openings.

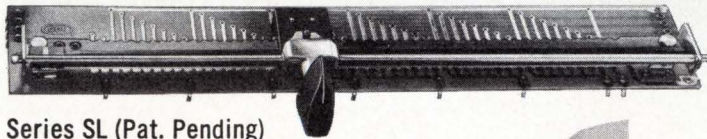

Series SL (Pat. Pending) Linear Slide Switch. Up to 100 or more positions. Mounts EITHER left/right OR up/down. Single or multiple position selectors.

No Down-Time Rotary Switch. 5-Second wafer replacement. Mfd. under Tabet U.S. Patent 2,956,131 & others.

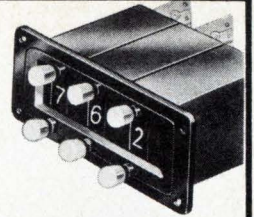
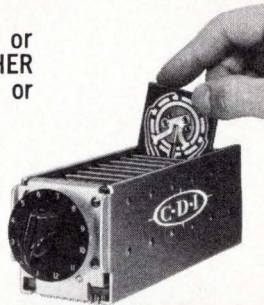

Miniature Add/Subtract Pushbutton units retrofit most mini-thumb-wheel switch panel openings. Pat. #3,435,167.

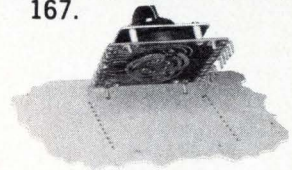

Series SP Rotary Switch. Economical, flexible, compact. More options on one wafer than previously available.

CDI earns its reputation every day for Consistently High Quality, Consistently Good Delivery. Request catalog.



CHICAGO DYNAMIC INDUSTRIES, INC.

PRECISION PRODUCTS DIVISION

1725 Diversey Blvd., Chicago, Illinois 60614 Phone (312) 935-4600, TELEX 25-4689

Circle 151 on reader service card

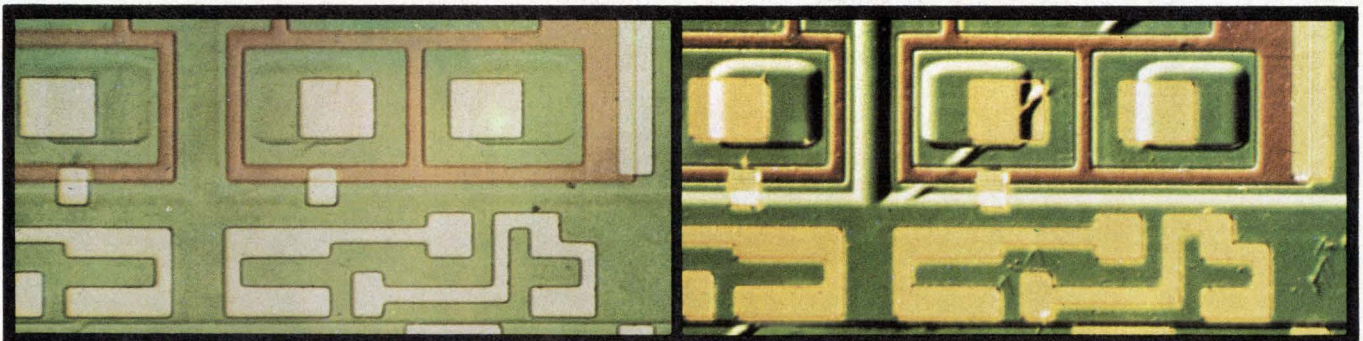

If this is all you're seeing, this is what you're missing.

The AO DICV Series 10 Differential Interference Contrast Microscope can make a big difference. A standard brightfield microscope reveals only what is shown in the specimen on the left.

Now look at the specimen on the right. With this ability to reveal significant detail in outstanding relief in black and white or color, the AO DICV Series 10 can help you spot surface irregularities, inclusions and faults.

By using incident light, after Nomarski, it provides contrast enhancement of opaque

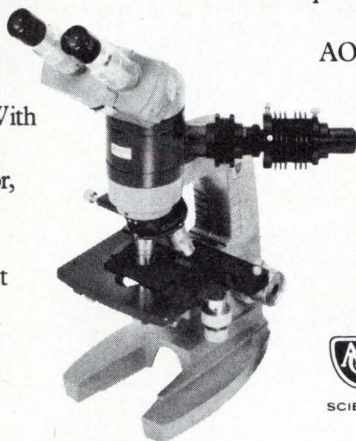

and semi-opaque materials. Helps you make critical quality control checks of semi-conductors, integrated circuits and metallurgical samples.

AO DICV Microscopes convert quickly from interference contrast to brightfield.

So if you can't afford to miss something, you can't afford to overlook the AO

DICV Microscope. For details, write American Optical Corporation, Scientific Instrument Division, Buffalo, N.Y. 14215.



AMERICAN OPTICAL CORPORATION

SCIENTIFIC INSTRUMENT DIVISION • BUFFALO, N.Y. 14215

**Today the "hot-spot" temperature
will approach 200 C, with a
90% chance of moisture, and
contamination could be severe.**

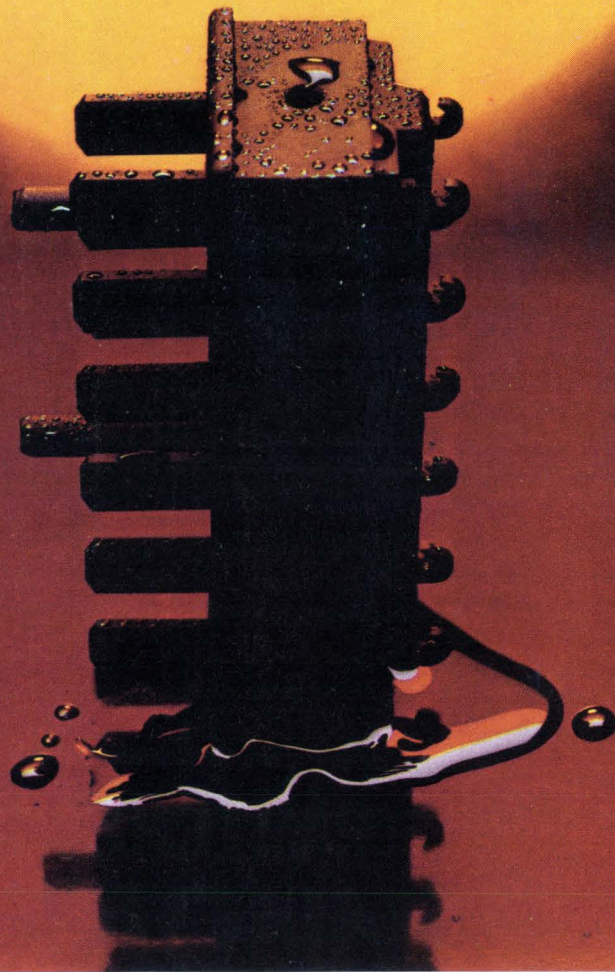

Protect your systems with silicone compounds.



Sooner or later, the electronic devices you design will have to stand up to persistent and inherent problems: corrosion, high heat, water, chemicals, oils, salts. Anything but rosy.

But think about this. Dow Corning dielectric compounds handle harsh environments, and retain excellent electrical properties from -40 to 200 C. They're ideal for high voltages, and a wide range of frequencies. Won't dry out, bleed, or melt; are oxidation resistant, odorless, and practically nonvolatile. And they fill several functions at the same time.

For instance, Dow Corning[®] 2 compound is a dielectric sealer that prevents copper corrosion. Use it on connectors or communications cables. If you need a good lubricant, a water repellent, and a corrosion preventive for switches or terminals, try Dow Corning[®] 3 compound. And Dow Corning[®] 4 compound, a moistureproof dielectric sealer, is great for high-altitude ignition systems.

We have a heat-sink system, too. Pot diodes and transistors for excellent thermal conduction. Then, for maximum protection, apply our heat-sink compound between the device and chassis.

Versatility, economy, performance, and easy application. Good reasons why silicone compounds should be your design tools. Write for full information to Dow Corning Corporation, Dept. C-3335, Midland, Michigan 48640.

Silicones; simply the best way to protect electronic circuits.

DOW CORNING

DOW CORNING

Circle 152 on reader service card

New products

Subassemblies

DEC 'unbundles' acquisition board

Data conversion module for low end of PDP-11 computer line is marketed separately

As data-acquisition modules continue to proliferate in a variety of applications and prices, Digital Equipment Corp. has decided to take aim at users of the low end of its PDP-11 computer line and offer a \$1,500 module on a single board.

The data module, called the AR11, can be used to link the PDP-11 with analytic instruments in chemical, biomedical and other applications in the physical sciences, as well as in industrial process control and in digitizing signals for spectrum analysis.

Initially a part of the Declab 11/10 computer systems announced earlier this year, the AR11 is not meant as a replacement for the LPS11 laboratory peripheral system, which is $5\frac{1}{2}$ inches high, has 12-bit capability, is priced at \$5,050, and is intended for more demanding laboratory applications. The new AR11 has only 10-bit capability, but DEC thinks it will open up new markets in low-priced systems where the company's data-acquisition capabilities haven't competed before.

The AR11 is a real-time module that includes a 10-bit auto-zeroing analog-to-digital converter, a 16-channel multiplexer with a sample-and-hold, a crystal-controlled programmable clock, and two 10-bit digital-to-analog converters for scope display and control. No analog voltage supply is required because a dc-dc converter draws 5 volts from the mainframe. Most dc-dc converters use transformers, but DEC designed its AR11 with diodes and capacitors to reduce costs. The unit is operated under software control and is program-compatible with the

larger LPS11, the company points out.

Product engineer Jesse Lipcon says the successive-approximation a-d converter uses a novel design in which auto-zeroing is inherent. One inexpensive amplifier is shared between the comparator of the converter and the sample-and-hold; the offset of one function subtracts the offset of the other, so it zeros out.

Since the unit includes both a-d and d-a converters, they can test each other. Wraparound testing, as this is called, is not novel, but Lipcon says DEC has made two innovations. The voltage from the d-a converter is divided by a factor of 100 with a pair of resistors, allowing the AR11 to test noise levels of less than half the least significant bit, so analog specifications can be tested at better-than-usual system resolution.

Maximum throughput rate of the AR11 is 35 kilohertz for a single channel, and 30 kHz for 2 to 16 channels. The input voltage range can be unipolar (0 v to +5 v) or bipolar (-2.5 v to +2.5 v). Conversion time is 22 to 24 microseconds, with accuracy to within $\pm 0.1\%$ of full scale at 25° C and linearity of half a LSB. Input impedance is a minimum of 10 megohms. Settling time is 8 μ s.

The clock can operate with single or repeated intervals and at five programmable rates between 1 MHz and 100 Hz as well as from an external input and an auxiliary input. Both external input and auxiliary frequency input are TTL. Counter size

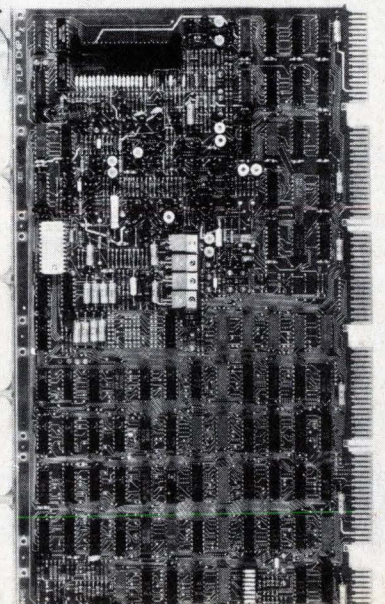



FREON* **(BLACO-TRON**)**
**A rose by any other name
 will clean as well.**

Why shouldn't BLACO-TRON precision cleaning solvent clean the same as FREON: Their chemical formulas are identical.

DuPont calls their trichlorotrifluoroethane "FREON" TF. We call ours "BLACO-TRON" TF. So now you have a choice.

If they're identical, why should you try BLACO-TRON? Service. The

service you get only from Baron-Blakeslee—for 38 years the accepted leader in advanced design precision cleaning equipment and the solvents to go in them.

Many types of BLACO-TRON are available for immediate delivery.

BLACO-TRON
 FLUORINATED SOLVENTS—NOW THERE IS A CHOICE

NEW Precision Cleaning Solvent

REFERENCE GUIDE

Covers the full line of BLACO-TRON fluorinated solvents—with complete specifications on each solvent.

WRITE FOR YOUR COPY TODAY.



Baron-Blakeslee

1620 South Laramie Ave., Chicago, Ill. 60650—Offices in All Principal Cities.

Circle 154 on reader service card

*FREON is DuPont's registered trademark for its fluorocarbon cleaning agents.

**BLACO-TRON is Baron-Blakeslee's registered trademark for its fluorocarbon cleaning agent



**Call your nearest
Baron-Blakeslee "BLACO"
SERVICE CENTER
for prompt Solvent Service**

- New England**
General Chemical Corp., Boston, Mass.
(617) 872-1202
The Hubbard-Hall Chemical Co.
Waterbury, Connecticut
(203) 756-5521
- Metro New York City, Northern New Jersey,
Long Island**
Baron-Blakeslee, Garden City, N.Y.
(212) LE9-8680
(201) 687-7383
(516) 747-8460
- South New Jersey, Eastern Pennsylvania,
Maryland, Delaware**
Tri-State Chemicals, Inc.
Blackwood, N.J.
(609) 228-0272
Baltimore, Md.
(301) 685-5423
- Southeastern United States**
MORELAND CHEMICAL CO. INC.
Spartanburg, S.C.
(803) 583-8481
Greenville, S.C.
(803) 242-3727
Florence, S.C.
(803) 662-5246
Augusta, Ga.
(404) 722-3751
Atlanta, Ga.
(404) 457-4485
Kingsport, Tenn.
(615) 247-7149
Chattanooga, Tenn.
(615) 894-8700
Charlotte, N.C.
(704) 392-4301
Greensboro, N.C.
(919) 292-0624
Tampa, Fla.
(813) 685-5874
- Upstate New York, Northwest Pennsylvania**
Inland Chemical Corp., Syracuse, N.Y.
(800) 348-4661
- Indiana, Ohio, Michigan**
Inland Chemical Corp.
Ft. Wayne, Indiana
(800) 552-4605
Inland Chemical Corp., Toledo, Ohio
(800) 348-3621
Inland Chemical Corp.
South Bend, Indiana
(800) 552-4605
Inland Chemical Corp., Cleveland, Ohio
(800) 348-3621
Inland Chemical Corp., Lima, Ohio
(800) 348-3621
- Illinois, Wisconsin, Minnesota, Iowa,
Missouri, Nebraska**
Baron-Blakeslee, Chicago, Illinois
(312) 656-7300
Baron-Blakeslee, Milwaukee, Wisc.
(414) 762-6850
- No. California, Nevada**
Baron-Blakeslee, San Francisco, Calif.
(415) 591-8237
- Oregon, Washington**
Baron-Blakeslee, Portland, Oregon
(503) 252-3468
- Southern California, Arizona**
Baron-Blakeslee, Los Angeles, Calif.
(213) 532-0730
- San Diego Area**
Baron-Blakeslee, San Diego, Calif.
(714) 295-0041

New products

and preset register size are both 8 bits, and they are accurate to within 0.005%.

The d-a output voltage range of the scope control is -5 v to +5 v or -0.5 v to +0.5 v, jumper-selectable. Accuracy at 25° C is within ±0.1% of 10 v full scale, or ±2% of 1 v full scale. It is intended primarily for DEC's VR14 scope, but can also be used with Tektronix scopes, or it can drive an X-Y analog recorder.

Digital Equipment Corp., 146 Main St., Maynard, Mass. 01754 [381]

**Thermal barrier gives
5-V supply a 2-A rating**

With a thermal barrier between its heat-generating and heat-sensitive components, the model 922 5-volt power supply is able to achieve a 2-ampere rating while measuring only 3.5 by 2.5 by 1.62 inches. To make sure that the plastic-foam barrier is able to do its job, the manufacturer has provided a gap in the supply's metal case so heat cannot find an alternative path across the foam. Epoxy resin is used to bond together the two metal portions of the supply. The model 922 provides line regulation to within 0.02% and load regulation to within 0.05%, making it suitable for use with IC logic systems. Ripple and noise have maximum root-mean-square values of 0.5 millivolt, ensuring high performance for sensitive amplifiers and

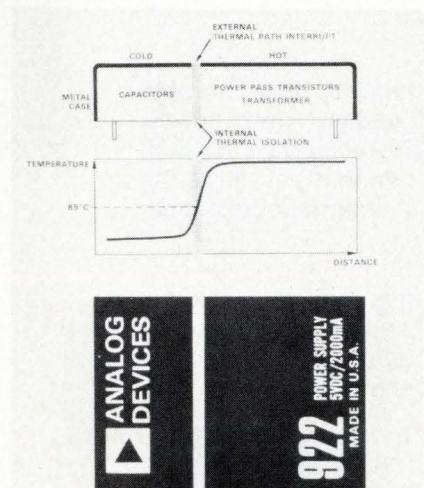

other low-noise circuitry. The supply will accept input voltages from 105 to 125 v at 50 to 400 Hz. Single-quantity price is \$89.

Analog Devices, Inc., P. O. Box 280, Norwood, Mass. 02062 [383]

**Switching power supply
generates 150 watts**

A family of five 150-watt switching-type power supplies range from 30 amperes at five volts to 7 A at 24 v. Operating at a switching frequency of 20 kilohertz, the supplies have efficiencies in the range of 70 to 80%, and maintain output regulation to



within 0.1%. Weighing only 8 pounds and occupying about 0.1 cubic foot, the supplies are modular in construction, with all transistors and associated circuitry mounted on plug-in modules that are interchangeable with other supplies of the same model.

Accc Electronics Inc., Oceanside Industrial Center, Oceanside, Calif. 92054 [385]

**Hybrid op amps
put out 100 watts**

A series of high-reliability hybrid operational amplifiers is intended for use in aerospace, military, and demanding industrial applications. Rated at 100 watts and seven amperes, the RCA HC2000H/1-to-4 are similar devices screened to four different levels of reliability. All of the units are completely solid-state and incorporate quasi-complementary Class B output circuits with home-

Team up with PERMAG MAGNETS

The Permag team's a winner. Permanent magnets, assemblies, Alnico, ceramics, and beryllia. What a lineup! 24 hour off-the-shelf delivery. Design and engineering assistance. Complete magnetizing, grinding and cutting facilities. Call or write for our new catalogs. Permag . . . worth cheering for.

YOUR NO. 1 SOURCE FOR ALL MAGNETIC MATERIALS

Consult your Yellow Pages for address and telephone number of Permag near you.

Cable Address: MAGNETS NEWYORK

San Francisco
Los Angeles
Dallas
Boston
New York
Chicago
Toledo
Atlanta

ALL ACROSS THE COUNTRY

Circle 156 on reader service card

GAUSSMETERS

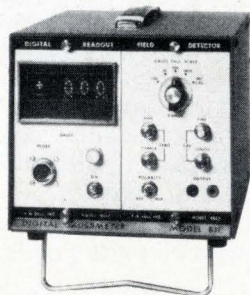

model 811

high accuracy
excellent repeatability
rugged

Bell gaussmeters measure magnetic field strength from .0001 gauss to 100,000 gauss. There are six gaussmeter models and 110 probe models for each gaussmeter. The resulting combinations meet the challenging requirements of all magnetic field measurement applications.

F. W. Bell has the experience and know-how to offer you the best instruments that are available. Your local representative is equipped to give you a demonstration. Use the inquiry card to find out how these instruments can benefit you.

4949 Freeway Drive East
Columbus, Ohio 43229
Phone: 614/888-7501
TWX: 810-337-2851



a subsidiary of Arnold Engineering

156 Circle 205 on reader service card

New products

taxial output transistors and built-in load-fault protection. They are supplied in hermetic metal packages and cost from \$125 to \$300 each in quantities of 15 to 24, depending upon reliability level.

RCA Solid State Division, Box 3200, Somerville, N. J. 08876 [387]

16-channel multiplexer uses C-MOS FET switches

The model MM-16 analog multiplexer consists of 16 complementary-symmetry MOS FET switches with an address decoder and an output buffer amplifier. The output of the break-before-make switches and the input of the buffer amplifier are brought out on separate pins so the analog switches and the output amplifier can be used separately. Using the buffer amplifier, the MM-16 has a maximum transfer error of 0.01% and a settling time of three microseconds. Without the amplifier, the switching time is typically 500 nanoseconds. The multiplexer has a current requirement of six milliamperes at ± 15 volts. Single-quantity price is \$129; delivery is stock to five weeks.

Datel Systems, Inc., 1020 Turnpike St., Canton, Mass. 02021 [388]

Allen-Bradley extends logic control line

Allen-Bradley's Cardlok line of solid-state logic modules for industrial control applications has been expanded by eight units ranging from a three-decade presettable digital timer to a thumbwheel switch

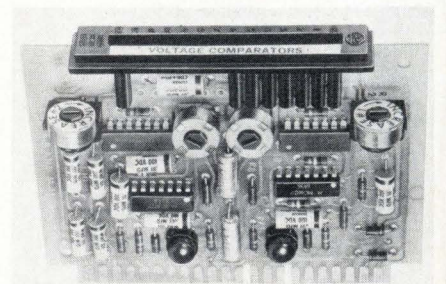

Electronics/December 12, 1974

Grayhill introduces

the different DIP switch

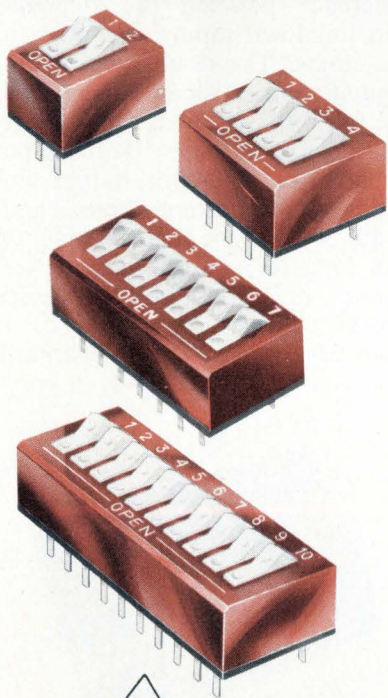

different contact system

This exclusive Grayhill technique provides positive contact with wiping action and tease-proof reliability. The spring-loaded sliding ball contact insures that the switch is either in the open or closed position, and can't be "hung-up" at some point which could produce an intermittent effect. High resistance to shock or vibration.

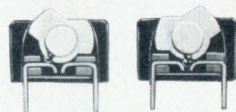

different life span

Tested to 50,000 mechanical operations, with commensurate electrical life, far in excess of what is required for the typical logic application... a performance standard provided without price premium over other brands.

different sizes, from 2 to 10 poles

Available in 9 sizes, even a hard-to-find 2-rocker version, on up to 10 rockers. All SPST, each switch independent, rocker actuated.

different color

The most visible difference... the red housing is only important because it tells you it's made by Grayhill, a name synonymous with precision and quality in miniature switches! (Also offered in black.)

Of course, the different DIP Switch—Grayhill's Series 76—also offers the standard DIP benefits: easy PC board mounting, compact high density design, cost savings from use of industry-accepted package dimensions, multi-function programmable PC boards, and elimination of mounting hardware or hand wiring interconnections. Get the full story, including detailed specifications and prices, in Grayhill Engineering Bulletin #238, available free on request, from Grayhill, 561 Hillgrove Avenue, La Grange, Illinois 60525, Phone (312) 354-1040.

"WE PUT PLENCO UP IN LIGHTS."

—McGraw-Edison's
Halo Lighting Division

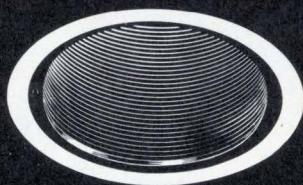
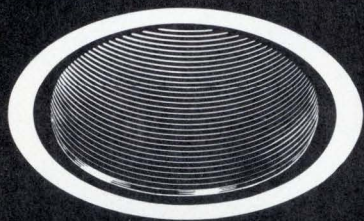

An innovator of sophisticated lighting systems, Halo Lighting, a McGraw-Edison Company Division, Rosemont, Ill., provides them for commercial/industrial/residential installations.

Built into many of their recessed downlight fixtures are Plenco 349 Heat-Resistant Black phenolic-molded "Coilex" light baffles. Matte finish, the grooved cylinders absorb spill or stray light, eliminate glare and unwanted reflection, and provide low aperture brightness.

Reports Halo and the molder, Van Norman Molding Co., Bridgeview, Ill.: "Basically our need was for a black material that was highly heat-resistant, not brittle, able to hold a sharp edge and keep up a good appearance. Your Plenco 349 H.R. compound gave us that."

Versatile, the compound is also used for decorative accents on the sphere lamp-holders of Halo's "Power-Trac" residential line. Whatever your own product design or thermojet molding requirement... see the light. Plug in on Plenco.

PLENCO
THERMOSET PLASTICS

PLASTICS ENGINEERING COMPANY
Sheboygan, Wis. 53081

Through Plenco research... a wide range of ready-made or custom-formulated phenolic, melamine and alkyd thermojet molding compounds, and industrial resins.

New products

and cable assembly. Among the other modules is the completely isolated model 1720-P3 power supply which can operate as either a positive or negative supply, delivering 0.5 ampere at 14.5 v dc. There is also a three-decade LED display module, a triple BCD-to-seven-segment decoder driver module, a dual voltage comparator, and a null detector. Finally, there is an octal two-input latching AND module which is similar to an older quad four-input device.

Allen-Bradley, 1201 S. Second St., Milwaukee, Wisc. 53204 [389]

Tiny phase comparators span 1 to 160 MHz

Measuring 0.52 by 1.48 by 2.05 inches and weighing 2.5 ounces, the PCS-3 series of phase comparators is available in four standard models with center frequencies of 21.4, 30, 60, and 160 megahertz. Other models with center frequencies in the range from 1 to 160 MHz can be made on special order. The comparators provide two outputs—one proportional to the sine of the phase difference between the reference and unknown inputs, the other to the cosine. The result is an unambiguous phase measurement over the full 0 to 360° phase-shift range. The devices all have 50-ohm input impedances, 150-ohm output impedances, an instantaneous bandwidth of 5% of the center frequency, and a maximum error, at center frequency, of 3°. Small-quantity price is \$250; delivery time is 45 days.

Merrimac Industries, Inc., 41 Fairfield Place, West Caldwell, N. J. 07006 [390]

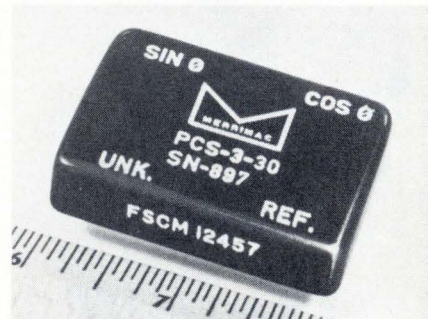

There's no RF energy crisis with RCA power tubes.

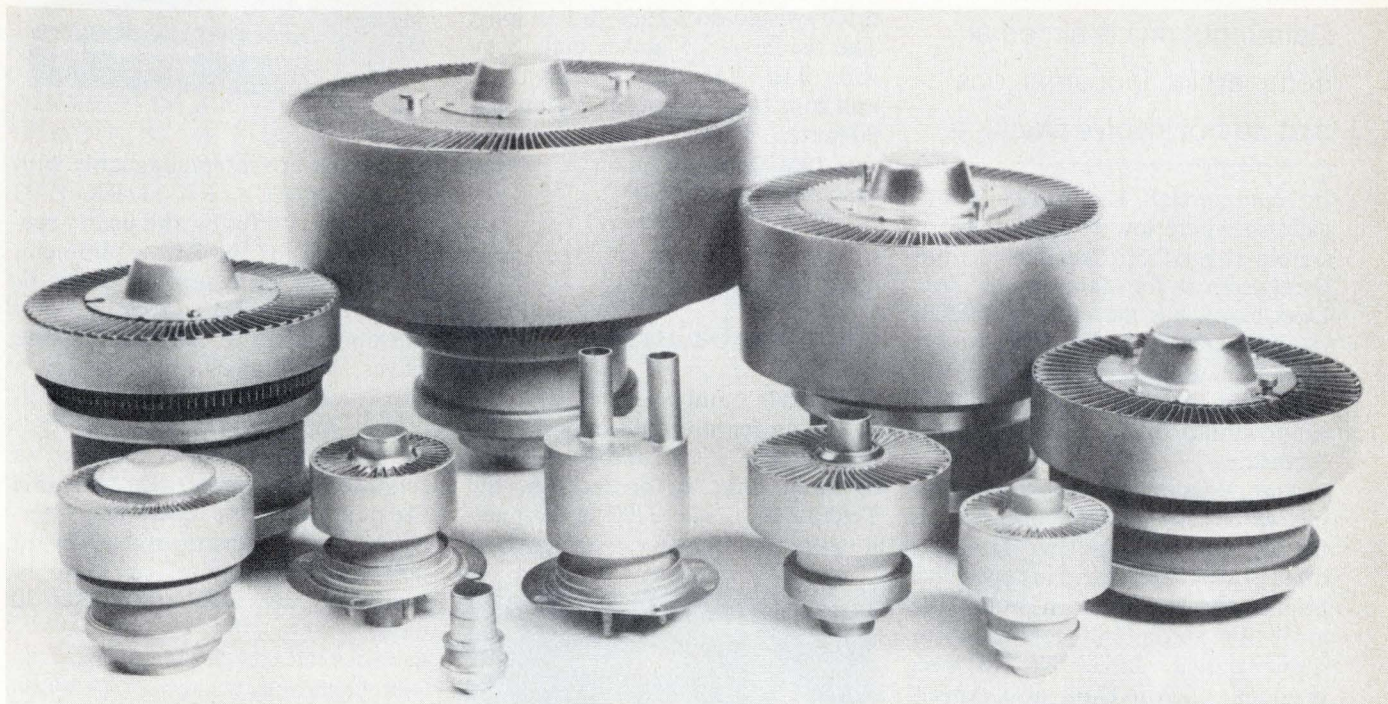

RCA's combined families of regular and large power tubes not only comprise the broadest line of such tubes in the industry, but they range in power all the way up to 250 kW . . . and in frequency to 1450 MHz.

Covering almost every major power tube application area, the RCA line also includes a comprehensive array of cavities and circuits. These cavities and circuits are specifically designed to enhance the advantages of RCA's power tubes. Together, they achieve a total power package unmatched for reliable high performance.

For more information on the entire RCA power tube line,

call your RCA Representative or RCA Industrial Tube Distributor, or fill out and return the reply coupon.

Manager, Power Devices Marketing
RCA, New Holland Avenue
Lancaster, PA 17604
 Please send me the new RCA Power, Frequency and Application Chart.
 Please have an RCA Representative call me. Telephone _____
Name _____
Company _____
Street _____
City/State/Zip _____
----- 70L-12

RCA Power and Microwave Devices

New products

Data handling

Low-cost reader for single cards

Data-input unit is aimed at commercial, industrial jobs that do not involve stacking

In commercial and retail applications, where low cost is critical, a simple rugged card reader still has great appeal for data input. True Data Corp. has therefore simplified its high-speed reader [*Electronics*, May 2, p. 149] to produce a single-card reader priced at only \$1,000 in single units or about \$600 in OEM quantities.

The new device is convenient for use with hand-marked order cards for inventory and pricing data at a restaurant, or with inexpensive punched cards used in automatic gates for automobile toll roads or rapid transit. James W. McKee, president of True Data, also expects the reader to be attractive in the low-cost minicomputer and microcomputer markets, where prices of peripherals may determine the practicality of some systems.

The reader's main difference from True Data's earlier high-speed unit is the elimination of the pickup and stacking mechanism. Otherwise, almost all electrical and mechanical parts are identical, including transport and read head, and the same mechanical simplicity and ruggedness is featured—for example, the use of only one moving part and two bearings. This commonality helps reduce inventory for users who need both single-card and high-speed readers.

The basic reader accepts mark/sense cards, with optional capability for punched cards or for both. The pickup is optical. Like the high-speed reader, it is designed to handle damaged and dirty cards with minimal errors. True Data claims a normal operating life of the reader to be five years or 15,000 op-

erating hours, with a mean time between failure of 3,000 hours and a mean time to repair of under 45 minutes.

Output levels are standard transistor-transistor-logic signals, with others optional. The output will drive twisted-pair lines 20 feet long. The reader is 7.5 inches high, 8 in. wide, and 15 in. deep, weighs 12 lb, and runs on 115 volts at 2 amperes, 60 hertz.

True Data Corp., 12701 South Halladay, Santa Ana, Calif. 92705 [361]

CRT terminal offers adjustable baud rates

Adjustable baud rates and a space-over-data feature are standard with the Teleray 3700 cathode-ray-tube terminal. Like its predecessor, the Teleray 3300, the 3700 is designed for easy maintenance, with socketed

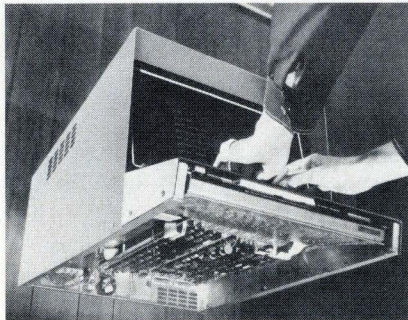

rather than wired-in integrated circuits and with all logic circuitry on one plug-in board. The terminal can handle dual data rates to 9,600 baud and is compatible with RS-232, current-loop, and TTL interfaces.

Research Inc., P. O. Box 24064, Minneapolis, Minn. 55424 [364]

Disk system works with all PDP-11 minicomputers

A cartridge disk system that's fully compatible with Digital Equipment Corp. PDP-11 minicomputers can be freely intermixed with other cartridge disk hardware. The AED 2200 hardware, software, and stor-

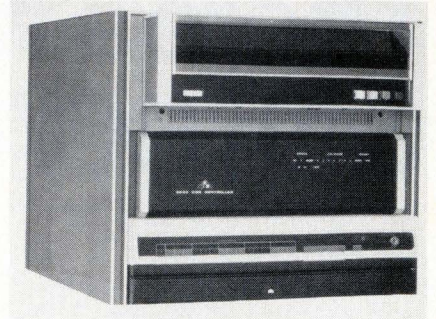

age media are interchangeable with those in DEC's RK-11/RK-05,03 system, thus offering the user a second source for the DEC equipment. The AED 2200 controller plugs directly onto the PDP-11 Unibus and can operate up to four Diablo disk drives, in any combination, for a maximum capacity of almost 5 million 16-bit words. Price of a basic AED 2200 system, including a single spindle drive, a removable cartridge, and the necessary interconnecting hardware, is \$5,500 for delivery schedules of at least 10 units per year. Delivery time is 30 days.

Advanced Electronics Design Inc., 754 North Pastoria St., Sunnyvale, Calif. 94086 [363]

Management card expands PDP-11 memories

A memory-management card that permits Digital Equipment Corp. PDP-11/35 and 11/40 processor memories to hold up to 128 kilowords instead of their normal 28 kilowords, the Plessey PM-11D is

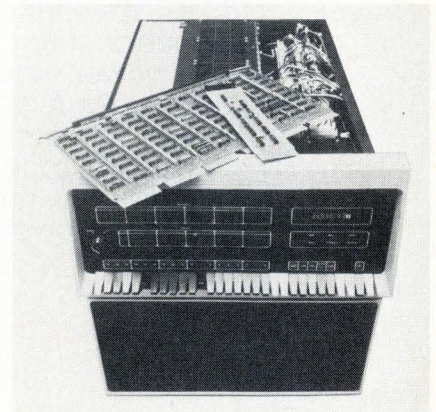

Some of the best things about our new Digivac[®] 1000 are what you can't see.

When you look at our vacuum fluorescent readout, you won't see the low voltage requirements making it directly compatible with available MOS IC logic packages.

You won't see the exclusive mica substrate which supplies mechanical strength and helps emphasize lighted segments through a desirable halo effect.

You won't see the low cost, lower than competing readouts with fewer customer advantages.

Of course, there are things about our Tung-Sol[®] Digivac 1000 you can see.

Like the Digivac 1000's brightness. 50% more brightness and greater uniformity than ever before.

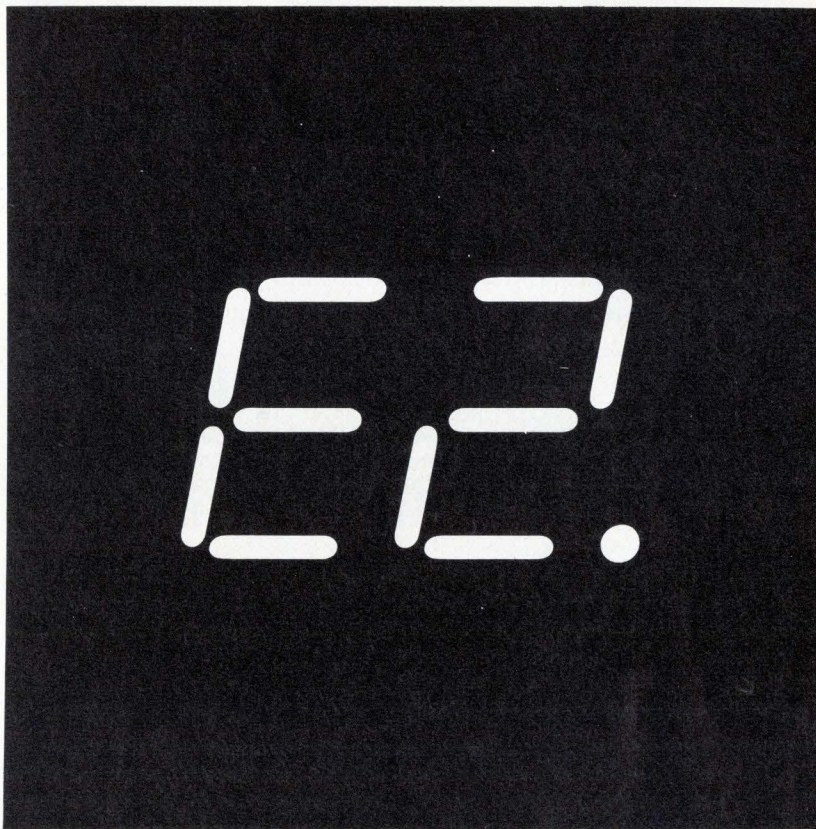
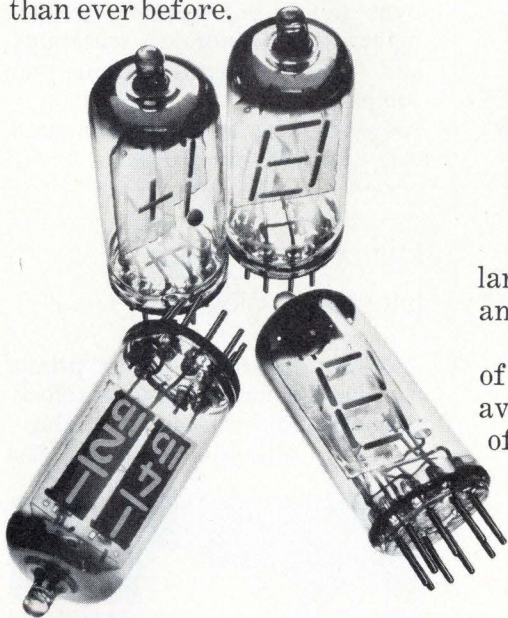

You can see the flexible language with alpha, numerical and symbolic figures.

You can see the wide range of colors, including white, available with common types of filters.

And because of the unique construction, you can see the accurate viewing assured from virtually any angle.

With the Digivac 1000 readout, whether you see it or you don't... it's still nice to know it's all there.

For additional information on the Digivac 1000, write to: Tung-Sol Division, Wagner Electric Corporation, 630 W. Mt. Pleasant Avenue, Livingston, New Jersey 07039.

Wagner makes other quality products in volume for the electronics industry, including bridges, power supplies and subsystems, silicon rectifiers, resistors, miniature lamps and status indicators. And Wagner offers contract manufacturing.

WAGNER[®]

We've got a lot more riding for you.

®Trademarks Wagner, Tung-Sol and Digivac, Reg. U.S. Pat. Off. and Marcas Registradas

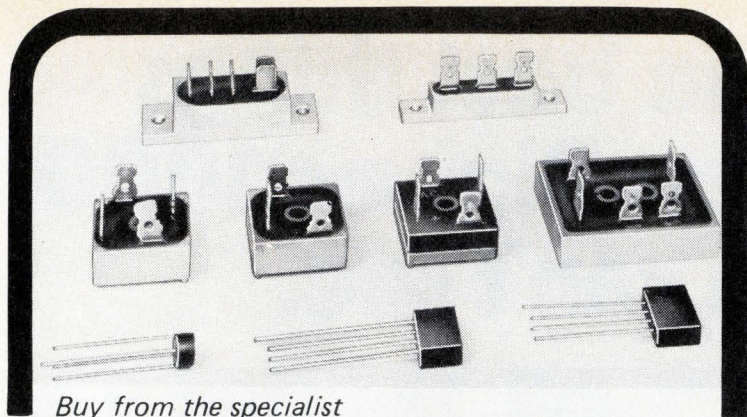

Buy from the specialist

Rectifier Bridges

Peak Reverse Voltages from 50 to 12,000 • Currents from 1 to 30 Amp • For P.C. and power terminal mounting • For Heat Sink and Chassis Mounting • Single and 3-phase. Center Tapped and Doubler • Standard and U.L. Component Recognition Types Standard and Fast Recovery • Many unique features Attractive Prices



Free Samples

Write for catalog. Describe application and we will provide free samples and our best low prices.

electronic devices inc.

21 GRAY OAKS AVE., YONKERS, N.Y. 10710
 (914) 965-4400 TWX (710) 560-0021 TELEX 13-1580
 Circle 162 on reader service card

Audio Indicator "Systems"

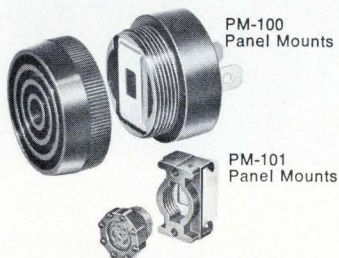

PM-100 Panel Mounts

PM-101 Panel Mounts

Speed Up Installation...

add versatility, too!

AI-100 series Audio Indicators



Take your choice. Components... or systems.

AI-100 Series Audio Indicators: Rugged, reliable, steel encased. Rated at a very noticeable 76 dB at 400 Hz. Four models: AI-101 (3 VDC); AI-103w (3 VDC with third wire collector); AI-105 (5 VDC); AI-112 (12 VDC). Use panel mounts for added versatility. **PM-100:** fits 1 1/8" opening in 1/8" panel. Terminals accept .250" female disconnects, screws, or solder. **PM-101:** for 1/2" openings in 1/8" panels. Bezel, self tap screws, or adhesive mounting. Special mounts made for OEM. What are your needs?



projects unlimited

3680 Wyse Road
 Dayton, Ohio 45414
 Tel. 513-890-1918
 TWX 810-450-2523

IN EUROPE
 projects unlimited/
 Europe B.P. 15;
 6100 Mont Sur
 Marchienne
 Belgium, Telex 51-390
 Tel (07) 36.84.86

D.I.A.L. 800-645-9200 for the name of your nearest representative. In New York call 516-294-0990 collect.

162 Circle 206 on reader service card

New products

claimed to be a less expensive replacement for the DEC KT11-D memory management option. Providing complete memory management and protection, the PM-11D plugs directly into a pre-wired slot in the minicomputer mainframe. It may be used with Plessey PM-1105 and PM-1116 card memories, and with DEC MM11L, MM11S, and MM11U memories.

Plessey Memories Inc., 1674 McGaw Ave., Santa Ana, Calif. 92705 [365]

Magnetic data recorder replaces paper-tape system

The model PG2100 magnetic-tape system is a compact, low-cost replacement for paper-tape systems like those used with ASR33 and similar teletypewriters. Based on the existing PG204 series of cartridge drives, which use the 3M DC300A data cartridge, the PG2100 is completely hardware- and software-compatible with the paper-tape stores it aims to replace. Advantages over the paper systems include higher-density storage, reusability, and faster program-loading, the company says.

Penny & Giles Ltd., Mudeford, Christchurch, Dorset, BH23 4AT, England [366]

Matrix printer keeps latest line visible

A front-impacting matrix printer eliminates hammer-framing (blocking) and adjacent-character ghosting while always keeping the last

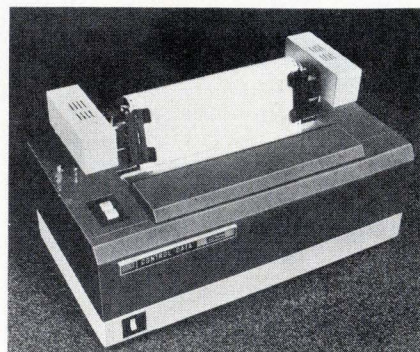

Electronics/December 12, 1974

When a life depends on the display you choose...

depend on HP's new 1332A. This improved display gives you the superior picture quality you must have when life is in the balance. It answers your need for higher resolution, better stability, more uniform light-output. And it meets the stringent UL Listing for electronic equipment used in patient care. The 1332A provides a combination of high performance and easy system integration to give OEMs a better display solution for demanding medical-instrument applications. For example:

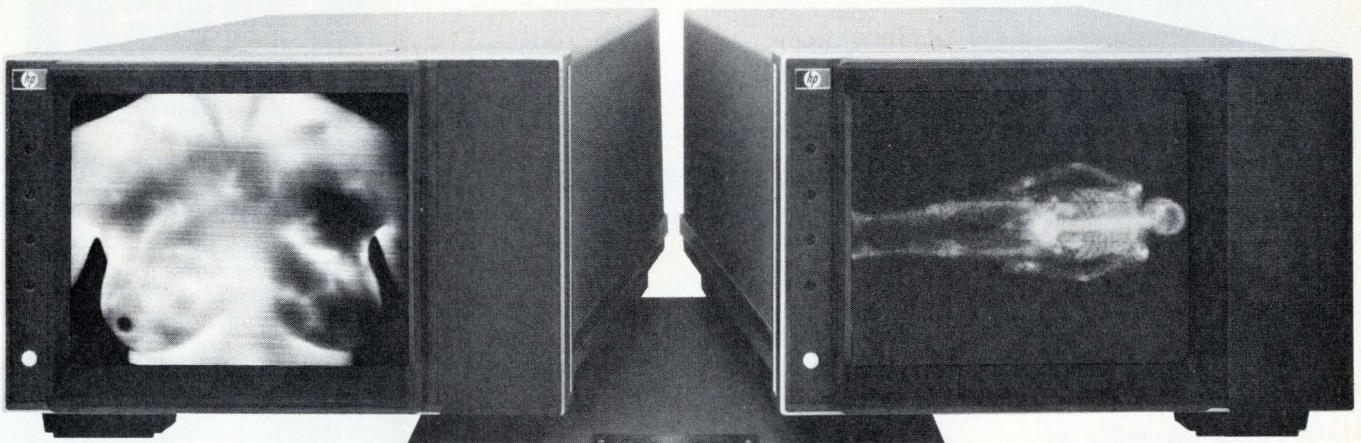

Thermographic breast scan for cancer. Courtesy of Dorex Inc., Los Angeles, CA.

Gamma camera provides full body bone scan for early detection of cancer. Courtesy of Penrose Cancer Hospital, Colorado Springs, CO.

Ultrasound determines dynamic blood flow through the heart. Courtesy of Metrix, Denver, CO.

In Thermography Equipment, HP's 1332A delivers the stable light-output required for making long scans or taking display photographs. Regulated CRT filaments prevent power-line surges from interfering with picture quality. And the 22.5 kV CRT allows more grey shades and assures a bright picture, even at low refresh rates typical in this application.

For Radioisotope Cameras, the 1332A provides superior light-output uniformity for more accurate analysis. Exceptional CRT design maintains the unit's extremely high resolution regardless of intensity level or beam deflection. This, combined with a fast z-axis rise-time means you get sharp pictures that reflect your system's true performance capability.

In Medical Ultrasound Units, where crisp, clear pictures are essential, the 1332A gives sharp focus at all

intensity levels, with any degree of beam deflection. As a result, you get the sharp, high-resolution pictures you need — at high or low intensity, over the entire viewing area. With this display, you get the picture quality needed for accurate diagnoses.

In addition to high performance, the 1332A offers easy system integration. Over 40 standard options, such as phosphor selection, digital blanking, gamma correction, choice of z-axis rise-time, x- and y-axis deflection factor, control location and more, let you tailor the display to your system's needs. You also get the quality, product safety and after-sales support you expect from a leader in CRT technology. To get more information about the new 1332A Display, just contact your local HP field engineer. Or, write to Hewlett-Packard.

084/7

HEWLETT  PACKARD

Sales and service from 172 offices in 65 countries.
1501 Page Mill Road, Palo Alto, California 94304

Actual photos taken from these systems in use.

Electronics/December 12, 1974

Circle 163 on reader service card 163

X-Y RECORDERS

**BIG
SPECS
AT SMALL PRICES**

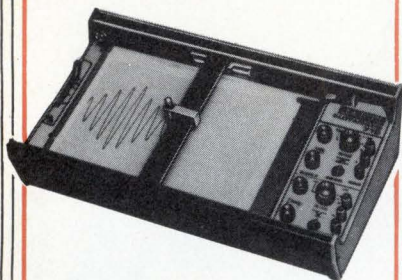

MFE's 715A offers:

- Pad/load[®], 8½ x 11" recorder
- 5 ranges 1MV/in - 10V/in or .5MV/cm - 5V/cm
- Disposable fibre tip pen
- 50-400 hz, 115/230V switchable
- Electronic overdrive protection
- Zero check pushbutton
- > 140 db CMR at line
- Constant 1MΩ impedance
- Slew speed 20 ips
- Plug-in timebase optional
- GSA schedule GS-00S-27790

Call or write Ron Gosk to discuss specific requirements.

MFE

MFE CORPORATION

Keewaydin Drive, Salem, N.H. 03079
Tel. 603-893-1921 • TWX 710-366-1887
TELEX 94-7477

New products

printed line visible to the operator. The model 9316 handles one- to five-part forms measuring 4 to 16.75 inches wide and is intended for minicomputer and terminal manufacturers. Each of the printer's character sets (a standard set of 64 or optional sets of 96 and 128 characters) is encoded on a single read-only memory, so the user can change the sets simply by unplugging and replacing a single integrated-circuit package. Production shipments of the 9316 are scheduled to begin next February. Single-unit price is \$2,350.

Control Data Corp., Box 0, Minneapolis, Minn. 55440 [367]

Reader handles
200 cards per minute

In line with its stated policy of emulating the Burroughs TC 700 terminal, Bunker-Ramo has developed the model 2092 punched-card reader to work with its model 2001 universal teller terminal in savings-bank systems. The 2092, which can read 200 cards per minute under control of the 2001, enables a branch office to process payments directly into the user's central computer as they are received, operating through an on-line terminal. It can also operate off line, with the card data being stored locally by a model 2094 tape cassette. Price of the 2092 is \$3,850; deliveries are scheduled for the first quarter of 1975.

Bunker Ramo Corp., Information Systems Division, 35 Nutmeg Drive, Trumbull, Conn. 06609 [368]

Magnetic-tape cleaner
locates defects easily

The model 101 magnetic-tape cleaner/re-winder offers an optional defective-area locator which enables the operator to find errors on the tape easily and precisely. Simplified cutting and stripping procedures make repairs fairly straightforward, whenever they are feasible. The

**MORE
for LESS**



Here's a low-cost sweep/function generator that doesn't act like one. The Exact Model 196 has an internal sweep generator, a 20-volt p-p output, 0.1 Hz to 1 MHz frequency range, VCF input, DC offset and variable output amplitude. A great signal source for sine, square, triangle, ramp, pulse and swept waveforms, all for just . . .

\$350

f.o.b. Hillsboro, Oregon

DANA EXACT
electronics, inc.

(A Subsidiary of Danalab, Inc.)

BOX 160, HILLSBORO, OREGON 97123
(503) 648-6661 TWX 910-460-8811

Circle 207 on reader service card

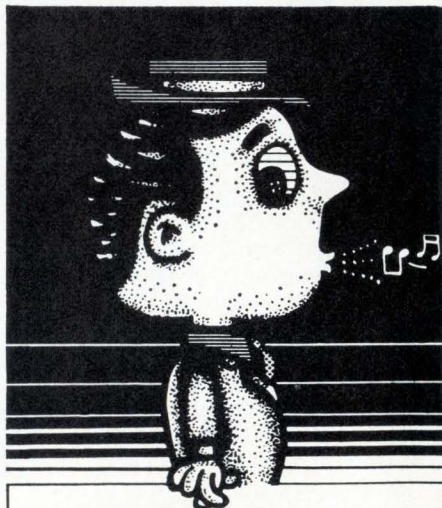

**you're whistling
in the dark.**

. . . if you haven't had your blood pressure checked lately. You could have high blood pressure and not know it. It can lead to stroke, heart and kidney failure. See your doctor—only he can tell.

Give Heart Fund
American Heart Association



You know TRW for chassis and engine parts.

But do you know our resistor capability?



While you no doubt know TRW Automotive Worldwide, you may *not* know TRW/IRC—the resistor branch of the family.

TRW/IRC offers the broadest line of fixed resistors in the business—used by the *billions* in consumer, industrial, and military applications. This is a total resistor technology: carbon comp.'s, Metal Glaze™, wirewound, thin-film, networks, strips, and resistive functions for specific applications. We can give you *any* of the proven technologies, at reliability levels to meet automotive demands.

In fact, our resistors are already designed into automotive safety devices, electronic controls, ignition systems, fuel injection, adaptive brake systems and, of course, AM and FM radios, and mobile communications equipment.

TRW/IRC offers a high-volume, multi-source (four domestic plants) production capability. *Plus*

the packaging know-how for cost-effective interfacing with your assembly equipment. So get to know us. Send for the TRW/IRC Resistors Catalog. TRW/IRC Resistors, an Electronic Components Division of TRW, Inc., Greenway Road, Boone, N.C. 28607. (704) 264-8861.

**TRW/IRC Fixed Resistors
Greenway Rd., Boone, N.C. 28607**

**Please send your latest catalog
on TRW/IRC Resistors for
Automotive Applications**



Name _____ Title _____
Company _____
Address _____
City _____ State _____ Zip _____

TRW[®] IRC RESISTORS

Fluxless soldering easy with Ultrasound

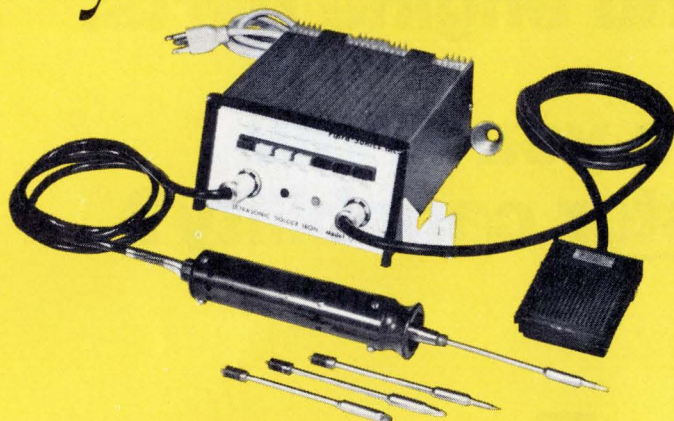

Ultrasonic soldering system handles fluxless soldering of regular metals, exotics, glass and ceramics.

G-35 generator delivers 35 watts of ultrasonic heated power into soldering iron. Push button controlled power levels of heat and sound energy. All solid state circuitry. Auto-feedback, power tracking.



The T-35

ULTRASONIC
Tool Head

T-35 tool has titanium driver/coupler and 400°C piezocrystal vibrating elements to eliminate mechanical or heat failure.

Complete unit weighs only 2.7 kgs. (six lbs.). Iron weighs less than 340 gms. (12 oz.). "Metricized" design. All parts except threads at tool end are metric measurements. Small welding tip also available.

For a free confidential evaluation, send samples of your materials and description of your requirements to Fibra-Sonics. They will be returned at no cost or obligation.

FIBRA-SONICS®, INC.

4626 N. Lamon Avenue / Chicago, Illinois 60630 / (312) 286-7377
to have representative call circle no. 240

For more information circle no. 239

Own your own holder to hold your own!

Hold your own copies of Electronics in specially designed slipcase holders. They'll keep your Electronics library neat and handy—a permanent information file, issue by issue.

Just complete the coupon and mail to Jesse Jones. He'll process your order upon receipt, postpaid.

ELECTRONICS BOXER
Jesse Jones Box Corporation
2250 E. Butler St., Philadelphia, Pa. 19137

Please send me: boxes @ \$4.25 each; 3 boxes @ \$12.00; 6 boxes @ \$22.00.
My check or money order is enclosed.

Name: _____

Address: _____

City: _____ State: _____ Zip: _____

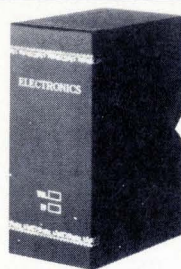

New products



cleaner/rewinder is a double-pass machine with dual capstans for independent tension control during both cleaning and winding modes. Speed is 180 inches per second. Price is \$2,200; delivery time is two to three weeks.

Computer-Link Corp., 14 Cambridge St., Burlington, Mass. 01803 [369]

Tab-card reader offers custom-wired plate

A line of static tab-card readers is available with custom-wired connector plates at economical prices when ordered in large quantities. The custom-wired plates, which are equipped with harnessing and fully mounted connectors, make installation and servicing of the Sealectrocard tab reader quick and easy. The reader's static output can be

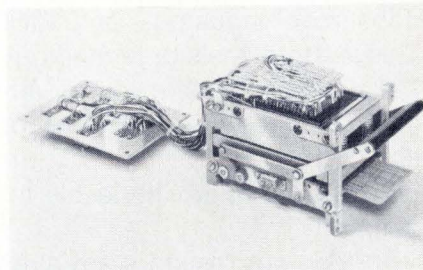

serialized and read out at high speed. Tab-card punched holes are sensed mechanically by normally open single-pole single-throw contacts in a remote location—away from card-carried dust and grease. The reader is so designed that its sensing probes will not engage unless the card is of the proper type and is fully inserted, so accuracy

When you need a motor that doesn't exist, make sure it's the best in the world.

Synchron motors are made in five major styles. Speeds from 900 rpms to one revolution per week. Torque from 8 thru 98 oz-in at one rpm. Hundreds of output options.



Odds are about 1,000 to 1 that you won't find a ready-made synchronous motor that meets your exact specifications. On anyone's shelves. Anywhere.

In that case, what do you do?

You look for a company with a track record you can depend on. A company that has demonstrated its capability time after time after time. That has built a solid reputation for delivering a product of unsurpassed quality. That keeps its promises. That company is Hansen . . . manufacturers of the Synchron motor.

We custom-make every Synchron motor because it's the only way to guarantee that its design, torque, speed and output option *exactly* meet customer requirements. Sure, it takes a little longer, but it's how we know our motors will do what we say they will do. Every motor. Every-time. And we can still deliver in about the same time as off-the-shelf suppliers.

So next time you need a quality synchronous motor, specify one that doesn't exist. Specify a genuine Synchron motor.

MALLORY



HANSEN MANUFACTURING CO.
a division of P. R. MALLORY & CO. INC.
Princeton, Indiana 47670

We make every Synchron motor as if *our* name were on *your* product.

A CAMBION® Double "QQ" Product Line

As often as you want, too. The design of the jack and the materials from which it is produced give it the strength to be cycled more than 50,000 times (we've done it) without appreciable change in contact resistance.

And we didn't just do it once "in the lab."

We have tens of millions of these jacks out, in use by customers. ID's range from .016" to .080". And are available in different shapes and types for mounting components, patching, plugging, or whatever you have in mind.

All CAMBION cage connectors are standard, immediate delivery items. You can have them fast in whatever number you want. That's the CAMBION Double "QQ" approach, the quality stands up as the quantity goes on. Ask for a sales engineer or a catalog. Cambridge Thermionic Corporation, 445 Concord Avenue, Cambridge, Mass. 02138. In Los Angeles, 8703 La Tijera Blvd. 90045.

This cage jack was built for recycling!



Circle 168 on reader service card

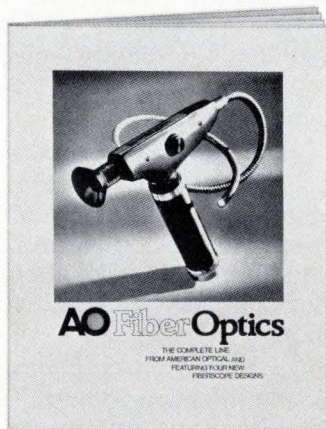

FREE Fiber Optics Catalog

Features the complete AO line of fiber optics products—from Inspection Fiberscopes and Light Guides to Illuminators, Image Conduits, Faceplates and Custom Components. Includes the four newest remote inspection fiberscopes now available.

Describes the principle, technology and techniques used to make flexible light and image transmissions a proven, practical fact. Write today for your FREE copy of the AO Fiber Optics catalog to American Optical Corporation, Fiber Optics Division, Southbridge, Mass. 01550.

AO
American
Optical

168

Circle 208 on reader service card

New products

is assured, the company says. Seaelectro Corp., Programming Devices Division, 225 Hoyt St., Mamaroneck, N. Y. 10543 [370]

Nova 840 is replaced by less expensive model

The low end of Data General Corp.'s new Eclipse line of small computers [*Electronics*, Oct. 17, p. 32] overlaps the top of the company's minicomputer line, the Nova 840, in both price and performance. But the 840 is now being replaced by the Nova 830, which has most of the features of the 840 but costs about 30% less. With 65,536 words of main memory, power supply and console panel, plus 10 slots available for system memory and input/output interfaces, the Nova 830 costs \$23,150 compared to \$35,730 for a similarly equipped 840.

The principal reason for the price difference is the use of 16 kilowords of core memory on a board, until now a feature only of the Nova 2 line. A denser memory has fewer elements, is cheaper to manufacture, and—for any given memory configuration—doubles the capacity of the machine. With the 840, an expansion chassis was needed to handle 131 kilowords of memory, while in the 830 there is still room left for adding input/output ports. The use of 16-kiloword boards does, however, reduce system speed: the 840 has a cycle time of 800 nanoseconds, while the 830 has a cycle time of 1 microsecond. But the company points out that, if a user really needs the extra 200 ns, he can get it from the 840 or the Eclipse 100.

The 830 is a number-cruncher and includes such features as dual operations, memory-mapping, and operations by dual processors that share a disk. Data General also sees markets in industrial process control, data communications such as front-end network management processing for a large computer, and on-line interactive processing.

Data General Corp., Southboro, Mass. 01772 [362]

Electronics/December 12, 1974

HERMES LOOP ANTENNA

THREE SAMPLE SITES
ON THE NORTH AMERICAN
CONTINENT —

DIFFERENT LATITUDES
DIFFERENT CLIMATE

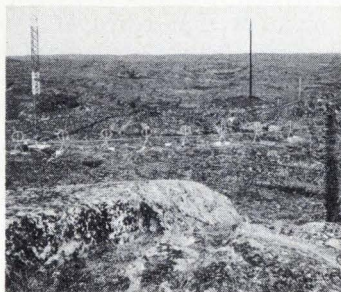

FROBISHER BAY, CANADA

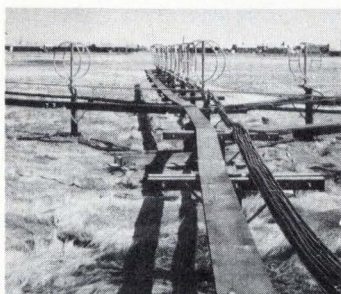

MARSHFIELD, MASS.

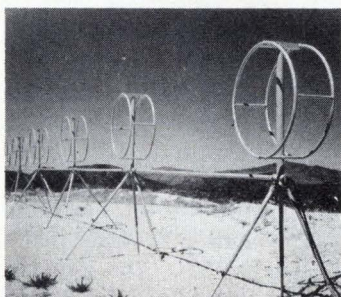

NEAR SAN DIEGO, CALIF.

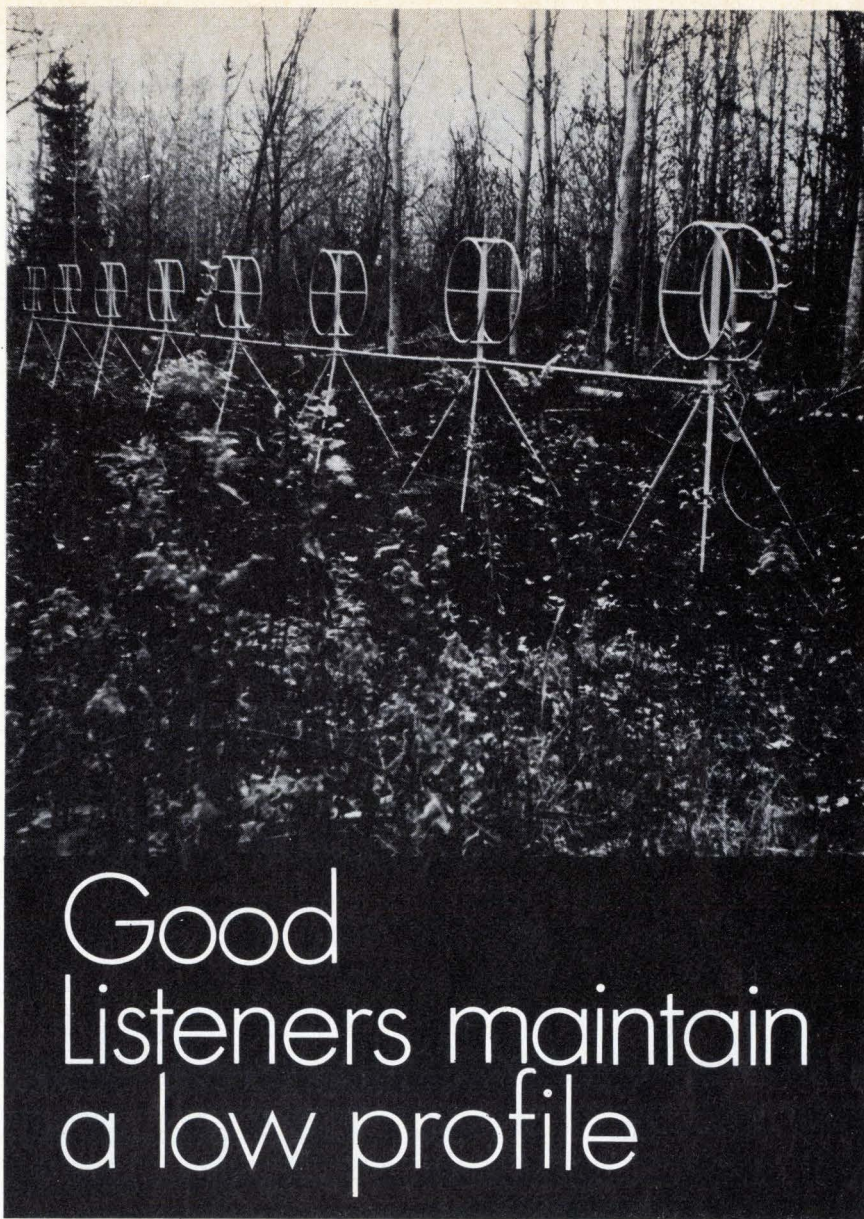

Good Listeners maintain a low profile

Even in the solitude of the forest depths, from rooftops, arctic tundra, swamps to sweltering tropics, 'neath snow, sand or ice, the Hermes Loop antenna keeps an ear to the sky. The amazing aperiodic antenna does away with vast log periodic and rhombic arrays - those towering antenna farms.

Excellent directional characteristics in rosette configuration, the Hermes loop antenna provides an omnidirectional broadband receiving array in space merely 1/100th that of the traditional antenna farm.

More than 53 government agencies around the world have pressed the loop antenna into service.

A new, even more compact version is available. Only Hermes Electronics makes it.

**2-32MHz
BROADBAND**

ASK US Send for our Brochure

Hermes Electronics Limited
Suite 315
2020 F Street NW
Washington, DC 20006 USA
202-296 2978
TWX 710 822 1106



from SPECTRUM.... for emi CONTROL. The 1 MF. FEED-THRU CAPACITOR.



SHOWN
ACTUAL
SIZE

The combined technologies of SPECTRUM CONTROL, INC. and ALLEN-BRADLEY CO. have produced this exciting line of multi-layer feed-thru capacitors. Their tubular design and coaxial construction gives low inductance with capacitance values to 1 MF. The operating temperature range is -55°C to +125°C at 10 amps and 50 VDC. They are ideally suited for bypassing, filtering and coupling applications. Write today for our complete catalog.

Part No. (Threaded)	54-785-005	54-786-013	54-786-021	54-786-014
Part No. (Solder-In)	54-785-006	54-786-015	54-786-019	54-786-016
DC Working Voltage	100	50	50	50
Capacitance, MF. at 0.1 VRMS, 25°C, 1 KHz	0.05 GMV	0.3 GMV	0.5 GMV	1.0±20%
Insertion Loss (db)	16	32	35	40
	1 Mhz	50	70	80
1 GHz				
Thread Size - Bolt	8-32	10-32	10-32	10-32
Mounting Hole Size (Solder-In)	.140 ±.015	.171 ±.015	.171 ±.015	.171 ±.015

Available now from these authorized distributors:

HALL-MARK ELECTRONICS	215-355-7300
METUCHEN CAPACITOR	201-442-0500
MIRCO ELECTRONICS	602-944-2281
ROSE ELECTRONICS	415-697-0224

SPECTRUM CONTROL INC.

152 EAST MAIN ST. • FAIRVIEW, PENNSYLVANIA 16415
PH. 814-474-5593 TWX 510-699-6848



Circle 170 on reader service card

New products/materials

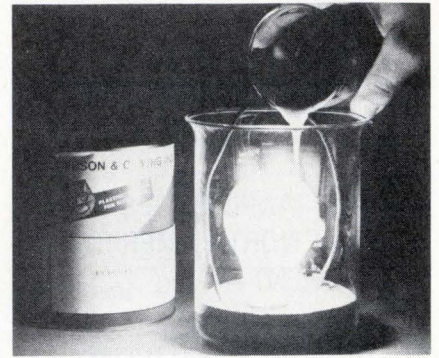

A **conductive epoxy casting resin** called Stycast 1970 is a two-component material that cures at room temperatures. The gray material obtains its volume resistivity of 0.01 ohm-centimeter from the metallic particles with which it is loaded. Intended as a replacement for metal conductors where current-density requirements are not too stringent, the material is said to be superior to metallic solders in adhesive and flexural strengths.

Emerson & Cuming Inc., Dielectric Materials Division, Canton, Mass. 02021 [476]

Glass-free gold conductor paste is a thick-film material which does not use glass frit to bond to the substrate. Microbond Gold #8880 adheres to the substrate by forming microscopic reactive bonding sites at the ceramic interface with the metalization. The glassless material can be fired at temperatures as low as 900°C.

Electro-Science Laboratories Inc., 1601 Sherman Ave., Pennsauken, N. J. [477]

An injection-molding compound made of fiberglass-reinforced rubber is a thermoplastic material based on a polyolefin elastomer. Available in three grades containing 17%, 20%, and 30% intermediate-length glass fibers, the reinforced material is much stronger than the unreinforced rubber. The plain rubber has a flexural modulus of 1,500 to 20,000 psi, while the reinforced versions have moduli of 85,000, 200,000, and 300,000 psi for the 10%, 20%, and 30% grades.

Fiberfil Division, Dart Industries Inc., 1701 North Heidelberg Avenue, Evansville, Ind. 47717 [479]

With *Vector* Cards, It's Easy To

PICK A WINNER!

FROM OVER 100
"Off-the-Shelf"
MODELS
Plus Matching
Terminals

LIKE OUR

NEW



Model 4066-4, 4 1/2" x 6 1/2"
For Wire Wrapping
Has 3 Bus Planes
Holds Up to 34 DIPS

Send For New Data Sheets NOW

FOR
MORE
VECTOR
EEM
Vol. 3,
pp. 722-726

GOLD
BOOK
Vol. 3,
pp. 227, 269

SPECIALS
AVAILABLE



ELECTRONIC COMPANY, INC.
12460 Gladstone Avenue, Sylmar CA 91342
(213) 365-9661 TWX 910-496-1539

37974

170 Circle 209 on reader service card

IF WE CAN'T MAKE YOUR MINICOMPUTER SYSTEM DO MORE WORK FOR LESS MONEY, NOBODY CAN.

When we introduced the SPC-16, we promised it would be the world's most powerful, versatile, cost-effective family of minicomputers.

It was. It still is.

The SPC-16 isn't the lowest priced hardware you can buy. But it will give you the lowest cost solution.

Through advanced systems architecture, simplified interfacing and a powerful instruction repertoire, the SPC-16 allows you to minimize programming, interfacing and memory costs no matter what size your system is.

Six mighty minis.

The SPC-16 family consists of six minicomputers offering a choice of three memory cycle times (800ns, 960ns and 1440ns), memory expansion to 128K using efficient 16K boards, and two different packaging configurations.

If you build a system around the SPC-16, it will do more work for less money than any other system you could build.

And that translates into more profits.

We know it for a fact. In the past few years, we helped a lot of OEMs get the edge on their competition by designing our product into their products. We helped a lot of end users solve a lot of tough, tight-budget applications. And, we produced some cost-effective systems of our own.

Two hard working systems.

Take RTOS II for example. It's a multi-programming system offering real-time event driven foreground processing concurrent with background job development and computation.

You couldn't buy a better price/performance solution for applications such as process control, data acquisition, laboratory research, material handling, communications or overall manufacturing automation.

We also built a powerful disk-based general purpose system around the SPC-16. DBOS II lets you do more computation with less memory, in far less time, at a lower price than any system on the market. It offers both scientific and commercial languages and a combination of interactive and batch operation.

This system is perfect for service centers, research and development groups and system house dedicated applications.

That's the short form.

To really appreciate how much power we can deliver for your money, write for our book

"The Value of Power." It will give you the facts to back up our claim: If General Automation can't make your system do more work for less money, nobody can.

Write General Automation, 1055 South East Street, Anaheim, California 92803. Or call (714) 778-4800. In Europe, write General Automation, S.A., 24 rue du Sergent Bauchat, 75012 Paris, France. Telephone (1) 346/7973. In Canada, write G.A. Computer Ltd., 880 Lady Ellen Place, Ottawa K1Z5L9, Ontario. Telephone (613) 725-3626.

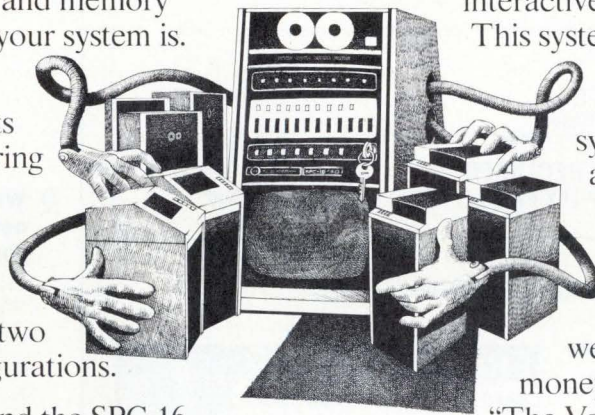

POWERFUL MINICOMPUTERS BY GENERAL AUTOMATION



EMPLOYMENT OPPORTUNITIES

Send New Ads to:
Electronics
Class. Adv. Dept.
P.O. Box 900, N.Y., N.Y. 10020

TECHNICAL DIRECTOR

AIR FORCE

FOREIGN TECHNOLOGY DIVISION

The United States Air Force is searching for a technical manager with a broad engineering background to fill the top technical position in the Directorate of Engineering of the Air Force Systems Command's Foreign Technology Division at Wright-Patterson AFB, Ohio. A leader in the assessment of foreign technology, the mission of the Foreign Technology Division is to acquire, analyze, evaluate and report on foreign aerospace related scientific and technical information. The incumbent for this position is required to provide technical leadership to a professional workforce representing a wide variety of disciplines; including aerospace, electronic, mechanical and photogrammetric engineering; astronautics; physics; mathematics and digital computer programming.

The Technical Director:

- Is the senior technical advisor to the Director of Engineering.
- Provides technical leadership to all elements of the Directorate of Engineering.
- Guides Directorate plans, programs and operations.
- Formulates and develops advanced engineering and analytic techniques necessary to support the organization's continually developing mission.
- Represents the Foreign Technology Division at the national level.

The incumbent will have established a national reputation in either aerospace research and development or scientific and technical intelligence. Although preference will be given the applicant possessing the earned Doctoral degree in a directly relevant field, exceptionally well-qualified applicants with the Masters degree are encouraged to apply.

Salary ranges from \$32,806 to \$36,000, depending on qualifications. Please send detailed resume* or Standard Form 171, specifying this position to:

ASD/DPCE
ATTN: Mr. Lowell Wagner
Wright-Patterson AFB, Ohio 45433



- U.S. CITIZENSHIP REQUIRED
- AN EQUAL OPPORTUNITY EMPLOYER

SEARCHLIGHT SECTION

FIBERCOM

FIBER OPTIC
COMMUNICATION LINKS
Analog - Digital
Bandwidths To 50MHz

RADIATION DEVICES CO. PO BOX 8450
BALTIMORE, MD. 21234, 301-665-2764

CIRCLE 951 ON READER SERVICE CARD

free catalog

POTTING APPLICATORS
MANUAL OR AIR OPERATED
2 1/2cc 6cc 12cc 30cc
FOR POTTING, ENCAPSULATING ETC.

PHILIP FISHMAN CO., INC.
7 CAMERON ST WELLESLEY, MASS. 02181

CIRCLE 952 ON READER SERVICE CARD

FREE CATALOG

HARD-TO-FIND PRECISION TOOLS

Lists more than 2000 items—pliers, tweezers, wire strippers, vacuum systems, relay tools, optical equipment, tool kits and cases. Also includes ten pages of useful "Tool Tips" to aid in tool selection.

JENSEN TOOLS
4117 N. 44th Street, Phoenix, Ariz. 85018

CIRCLE 953 ON READER SERVICE CARD

RADAR SYSTEMS

TRACKING ANTENNA SYSTEMS

Nike Hercules, Nike Ajax, M-33, MPS-9, SCR-584, TPS-1E, TPS-28, FPS-6, FPS-14, FPS-18, FPS-75, UPX-6, MPQ-10A, IBM 705 Computers, HUNDREDS MORE. LARGEST INVENTORY OF RADAR AND MICROWAVE EQUIPMENT IN THE WORLD.



RADIO RESEARCH INSTRUMENT CO.

3 QUINCY ST., NORWALK, CONN. (203) 853-2600

CIRCLE 954 ON READER SERVICE CARD

NEW SURPLUS—FREE CATALOG

INTEL 8008: \$79.45; MCM7001, 1K RAM: \$10.25
MM5203Q-1, 2048 BIT RE-PROM: \$19.50
1101A RAM: \$2.50; MC4024 V.CON.M.V.: \$2.25
XR2240, PROG.TIMER: \$5.95; 8038, VCO: \$5.25
AYS-1008 & 1010, TTY RX & TX: \$6.50
LASCR, I.R.: \$1.55; 2N5942, 2N6166: \$16.00

ELECTRONIC DISCOUNT SALES
138 N. 81st St., Mesa, Arizona 85207

CIRCLE 956 ON READER SERVICE CARD

SAME DAY SHIPMENT
Minis & Peripherals

PRINTERS

Some "BRAND NEW"

DATA PRODUCTS

2440—700 LPM
2470—1250 LPM. \$9500
MOHAWK DATA SCIENCES

4320—300 LPM
4330—380LPM

CONTROL DATA CORP.

9322—200 LPM. \$2500
9352—600 LPM

ALSO

CENTRONICS, POTTER, CDC
A. B. DICK, IBM, HIS, UNIVAC
(617) 261-1100

Send for Free Report "Maintenance of Computers"
AMERICAN USED COMPUTER CORP.
P.O. Box 68, Kenmore Sta., Boston, MA 02215
member COMPUTER DEALERS ASSOCIATION

CIRCLE 957 ON READER SERVICE CARD

Q. Whom do I contact or call to re-
new my classified ad or make
corrections?

A. Write Electronics, Class. Adv.
Dept., P.O. Box 900, NY, NY
10020 or call: (212) 997-6585
or 6586. Give full company
name, size of ad, & date or dates
it is scheduled to appear.

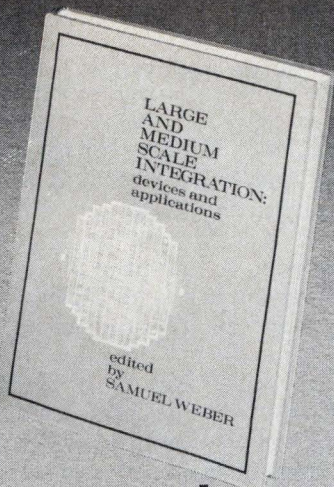

Large and medium scale integration: Keep up with this fast changing technology

Now, in one comprehensive volume, a complete working grasp at large and medium scale integration for electronics engineers engaged in the design of electronic systems, equipment and products.

A wealth of practical working data on large and medium scale integration has been culled from the most important articles in Electronics magazine by Samuel Weber, Executive Editor. Emphasis is on design problems at the system or subsystem level, as well as on the economics of today's design.

Whatever the design problem — from partitioning a digital system to working with a semiconductor company in producing the best LSI design, this book covers the full range of today's important technologies on a practical, rather than a theoretical, level.

It's yours for \$15.00. Keep up.

FREE 10-DAY EXAMINATION

McGraw-Hill Book Company
1221 Ave. of the Americas,
New York, N.Y. 10020



Send me a copy of Large and Medium Scale Integration (068815-X) for 10 days on approval. At the end of that time, I will either remit \$15.00, plus tax, postage, and handling, or return book without further obligation. (Remit in full with this coupon, plus any tax, and McGraw-Hill pays all postage and handling costs.)

Name _____

Address _____

City _____

State _____ Zip _____

Offer good only in the U.S. and subject to acceptance by McGraw-Hill. For prices outside U.S., contact McGraw-Hill Book Co.

23 K138-4018-3

New literature

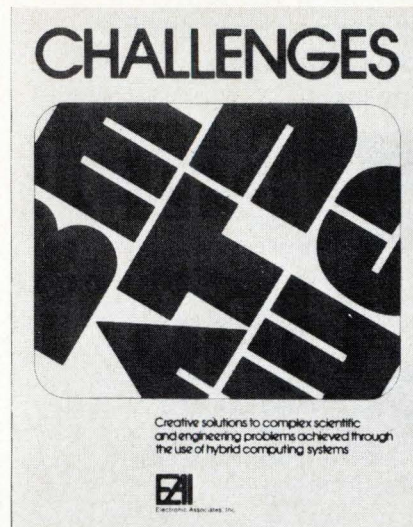

Hybrid computers. Applications of high-speed hybrid computers for solving complex scientific and engineering problems is described in a publication called "Challenges" and produced by Electronic Associates Inc, 185 Monmouth Parkway, West Long Beach, N.J. 07762. Circle 421 on reader service card.

Microwave power amplifiers. A data sheet on Class A linear high-power amplifiers includes applications in general rf and microwave laboratory tests. The 22 amplifiers provide frequency coverage from 5 megahertz to 4,200 MHz in octave and decade bandwidths at lower levels up to 20 watts. Microwave Power Devices Inc., Adams Ct., Plainview, N.Y. 11803 [422]

Plastics tests. An updated edition of "Standard Tests on Plastics" has been published by Celanese Plastics Co., 550 Broad St., Newark, N.J. 07102. The 32-page publication contains more than 30 ASTM tests commonly used to describe the characteristics of plastics. [423]

Multimeter. Dranetz Engineering Laboratories Inc., 2385 South Clinton Ave., South Plainfield, N.J. 07080, offers a six-page bulletin describing its model 325 digital power-system instrument, the Polymeter. It is a portable, direct-reading voltage-current-time-frequency meter for simultaneous measurement of two ac

THE NEW DIGITAL MULTI-METER DESIGNED FOR FIELD SERVICE

with laboratory accuracy

.02%

LM-4



\$227

- One year guarantee.
- Full four digits
- 100 microvolt resolution
- Automatic zeroing.
- Automatic polarity.
- Self-contained batteries and battery charger included.
- 1.9" H. x 2.7" W. x 3.9" D.

For immediate delivery fill in below.

Special offer of \$217 with coupon.

LM-4

Send more information.

Name _____

Company _____

Address _____

City _____ State _____ Zip _____

Check enclosed C.O.D.

THE NEW NON-LINEAR SYSTEMS, INC.
Box N, Del Mar, Calif. 92014
(714) 755-1134

The high performance photoreader family

With an eye focused on giving you top price/performance, Tally brings you a family of photoreaders loaded with features.

Here's the line-up.

Model R-2050

The new Tally R-2050 delivers 250 characters per second for only \$275. Or \$375 with com-

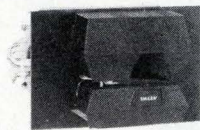

plete electronics. The compact, super reliable unit features easy, adjustment-free operation.

Model R-2000

For added performance power, the R-2000 comes complete with power supply and bi-directional drive elec-

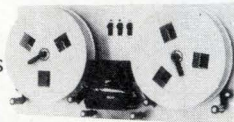

tronics. Prices start at \$546. Numerous options can be added. Speed is 300 cps continuous and 200 cps asynchronous.

Model R-5000

For those applications that demand the very best, the top of the line R-5000 has

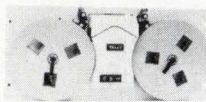

speeds of 500 cps continuous and 1200 cps search. It's the reader with all the extras built-in.

TALLY®

Get the full story. Write or call Tally Corporation, 8301 So. 180th St., Kent, Washington 98031. Phone (206) 251-6771. Circle 174 on reader service card

Countdown Free!



Interstate Pulse Generators have Constant Duty Cycle

Interstate's exclusive Constant Duty Cycle mode automatically controls pulse width as a percentage of the period, so when you're varying the rep rate, the generator can't possibly skip a pulse or two and give you an invalid output.

Constant Duty Cycle is only one of many innovative Series 20 features you've never seen in a pulse generator before. Call John Norburg collect and he'll send you the new Interstate Series 20 Pulse Generator catalog — it's free, too!

Phone (714) 772-2811

IEC INTERSTATE ELECTRONICS CORPORATION
Subsidiary of A-T-O Inc.

Dept. 7000, Box 3117, Anaheim, California 92803
TWX U.S.A. 910-591-1197 TELEX U.S.A. 655443 & 655419.

Circle 210 on reader service card

New literature

voltages, two currents, voltage and current, and voltage or current vs time or frequency. [424]

Tape system. A four-page brochure describing a tape system for Honeywell 200 and 2000 series computers is available from Formation Inc., One Computer Dr., Cherry Hill, N.J. 08003. The system's features and options are described, its eight Honeywell-equivalent operating modes are summarized, and its software compatibility is outlined. [425]

Delay lines. Two acoustic delay lines providing brief delays (1.5 to 10 microseconds) at 60 megahertz are described in a catalog sheet issued by Walther M.A. Anderson & Associates Inc., 4 Main St., Ext., Tariffville, Conn. 06081. The sheet offers complete specifications covering delay, delay-tolerance, and drift, center frequency, bandwidth, insertion loss, spurious signals, input and output impedance, size, and terminals. [426]

Ceramic parts. An engineering bulletin from Pekay Industries Inc., P.O. Box 559, Farmingdale, N.J. 07727 contains specifications, dimensions, and other information on metalized ceramic parts, including terminals, end seals, capacitor and resistor housings, and coil forms. [427]

Time indicators. General Time Corp., Space and System Division, 1200 Hicks Rd., Rolling Meadows, Ill. 60008, offers a catalog containing information about a series of subminiature elapsed-time indicators. [428]

Catalog 136B
SUPPLEMENT A

MODEL 16B-Y
MODEL 16B
MODEL 95G
MODEL 25G

GENERAL TIME
ELAPSED TIME
INDICATORS

GENERAL TIME
A TALLY INDUSTRIES COMPANY
SPACE AND SYSTEMS DIVISION

NEED A 1/4" x 1-1/4" TIME-DELAY FUSE OR QUICK-ACTING FUSE?

BUSS HAS IT!

Time-current characteristics of FUSETRON® dual-element time-delay fuses

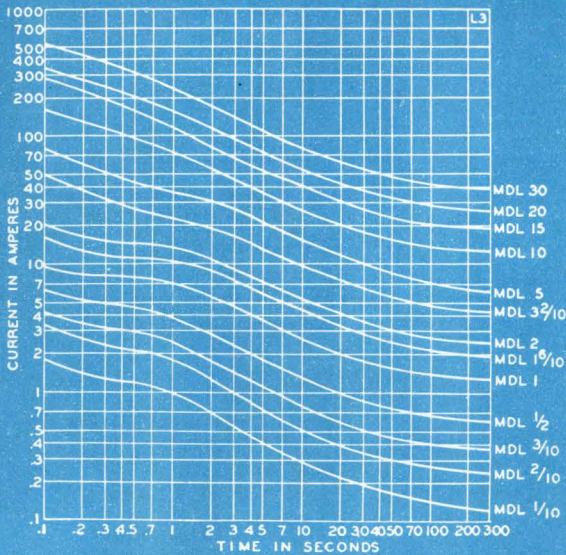

Time-current characteristics of BUSS® fast-acting fuses

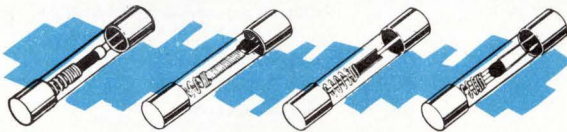
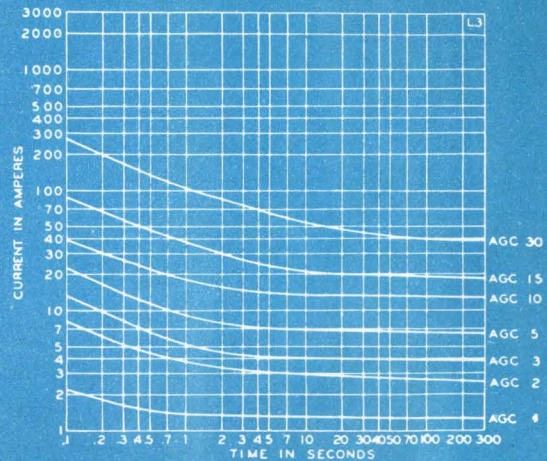

FUSETRON® dual-element fuses

Time-delay characteristics avoid nuisance openings from starting currents or surges—yet, give full protection from short-circuits or dangerous overloads.

Voltage	Symbol	Amperes
250 or less	MDL	1/100, 1/32, 1/16, 1/10, 1/8, 15/100, 175/1000, 3/16, 2/10, 1/4, 3/10, 3/8, 4/10, 1/2, 6/10, 7/10, 3/4, 8/10 or 1
250 or less	MDX	1-1/4, 1-1/2, 1-6/10, 1-8/10 or 2
125 or less	MDL	1-2/10, 1-1/4, 1-1/2, 1-6/10, 2, 2-1/2, or 2-8/10
125 or less	MDX	3, 3-2/10, 4, 5, 6-1/4 or 7
32 or less	MDL	3, 3-2/10, 4, 5, 6-1/4, 8, 10, 15, 20, 25 or 30

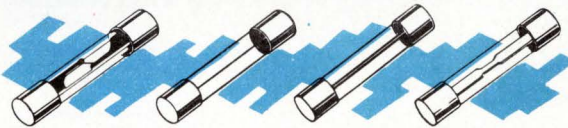

BUSS® fast-acting fuses

Fast-acting characteristics provide the instantaneous high speed opening necessary to protect sensitive instruments or delicate apparatus.

Voltage	Symbol	Amperes
250 or less	AGC	1/500, 1/200, 1/100, 1/32, 1/16, 1/10, 1/8, 15/100, 175/1000, 3/16, 2/10, 1/4, 3/10, 3/8, 45/100, 1/2, 6/10, 3/4, 1, 1-1/4, 1-1/2, 1-6/10, 2
250 or less	MGB	1/16 or 1/8
MBW & MBB fuses now called AGC.		
250 or less	AGC	2-1/2, 3
250 or less	MTH	4, 5 or 6
For 250 volt fuses above 6 amperes—See ABC fuses.		
125 or less	GLH	7, 8 or 10
32 or less	AGC	4, 5, 6, 7, 7-1/2, 8, 10, 15, 20, 25 or 30

For a complete selection of BUSS fuses and fuseholders ask for bulletin SFB.



BUSS In-the-Line Fuseholders

HKP Fuseholder

BUSS Panel Mounted Fuseholders Lamp Indicating

BUSS HGB-C Fuseholder Military Type FHL11U

BUSS Space Saver Panel Mounted Fuseholders

BUSS HMR Shielded Panel Mounted Fuseholders

BUSS Snap-Lock Rear Panel Mounted Fuseholders

BUSS Panel Mounted Fuseholder

Fuse Blocks For 1/4 x 1 1/4 Inch Fuses No. 4408 2 pole



BUSSMANN MANUFACTURING
a McGraw-Edison Company Division
St. Louis, Missouri 63107



Electronics advertisers

December 12, 1974

* AEG-Telefunken Wergeagentur Dr. Kahl GmbH	154	Digital Equipment Corp.— Components Group Schneider Parker, Inc.	64-65	‡ Interdesign, Inc. Bonfield Associates	88-89
Aertech	108	‡ Doric Scientific Noonan Public Relations and Advertising	61	International Electronic Research Corp. McCarron, Kane, Inc.	150
Allen Bradley Company Hoffman, York, Baker & Johnson, Inc.	28	Dow Corning Corp.—Fluids, Emulsions, Compounds Division Ketchum, MacLeod & Grove, Inc.	152-153	■ Interstate Electronics Corp. Chris Art Studio, Inc.	174
Aluminum Company of America Ketchum, MacLeod & Grove, Inc.	85	Eastman Chemical Products, Inc., Industrial Chemicals J. Walter Thompson Company	6	■ Ithaco, Inc. Webb & Athey, Inc.	134
American Microsystems, Inc. Wilton Coombs & Colnett Inc., Advertising	140-141	‡ Eastman Kodak Co. Business Systems Markets Division Engineering Data System Micrographics J. Walter Thompson Company	45	Keithley Instruments, Inc. Chagrin Valley Marketing Associates	127
American Optical Scientific Instrument Division Wilson, Haight & Welch, Inc.	151	Electronic Arrays, Inc. Bonfield Associates	43	Krohn-Hite Corp. Impact Advertising, Inc.	5
American Optical Corp. Fiber Optics & Industrial Product Division Wilson, Haight & Welch, Inc., Advertising	168	Electronic Navigation Industries Hart/Conway Advertising—Public Relations	14	LFE Corp., Process Control Division LFE Advertising	79
■ AMP Incorporated Aitkin-Kynett Co., Inc.	17-20	■ Electronic Devices, Inc. McAndrew Advertising	162	Litronix, Inc. Bonfield Associates	12-13
* Ampex Cassey and Hull Limited	45, 7E	Electronic Measurements, Inc. Hill Advertising Agency	44	* LTT	13E
■ Augat Creamer, Trowbridge, Case & Basford, Inc.	3rd Cover	* Electronics Circulation	16E ABCD	Macrodata Company JMR Advertising	118
‡ Baron Blakeslee Kolb/Tookey & Associates, Inc.	154-155	■ Erie Technological Products Co., Inc. Altman Hall Associates Advertising	25	■ MFE Corporation Brightman Company, Inc.	164
Bausch & Lomb, Inc. Wolff Assoc., Inc.	16	Exact Electronics Hugh Dwight Advertising	164	■ Micro Switch Division of Honeywell N.W. Ayer & Son, Inc.	143
■‡ Beckman Instruments, Inc., Helipot Division N.W. Ayer/Jorgensen/MacDonald, Inc.	90	Fibra Sónics, Inc., Division of C.E. Niehoff The Griswold + Eshleman Company	166	Molex Incorporated Howard H. Monk and Associates, Inc.	180
Bell, F.W. Technical Marketing Services, Inc.	156	■ Fluke Manufacturing Co., John Bonfield Associates	68	Mostek Corporation David W. Evans, Inc./Texas	15
Brand-Rex Creamer, Trowbridge, Case & Basford, Inc.	66-67	FMC Corporation—Semiconductor Products Operation DeSales Advertising, Inc.	179	* Motorola Semiconductor Graham & Gillies Limited	89
■‡ Bussmann Mfg. Division of McGraw-Edison Company Henderson Advertising Company	175	* Gardner-Denver Co. Buchen Advertising, Inc.	131	Motorola Semiconductor Products, Inc. E.B. Lane & Associates, Inc.	26-27, 55
Calma Company William Cain, Inc., Advertising	110	Garrett Corp. J. Walter Thompson Company	138	National Electronics Lea Advertising	84
■ Cambridge Thermionic Corporation Chirurg & Cairns, Inc.	168	General Automation Albert, Newhoff & Burr	171	Non-Linear Systems A & J Associates, Inc.	173
Carpenter Technology Corporation Quest, Inc.	137	■ General Instrument Corporation, Microelectronics Division Norman Allen Associates, Inc.	148-149	■ Permag Corporation Schneider, Allen, Walsh, Inc.	156
* Centre Engineering Williams & Associates	16E	■ Gould, Inc./Instrument Systems Division Carr Liggett Advertising, Inc.	86-87	* Philips N.V. P1/T & M Division Broekies Communications Systems SA	58
Cherry Electrical Products Corporation Kolb/Tookey and Associates, Inc.	77	■ Grayhill, Inc. Stral Advertising Company, Inc.	157	* Philips Elcoma Intermarco nederland	2E
■ Chicago Dynamic Industries Burton Browne Advertising	151	Harris Semiconductor Tucker Wayne & Company	132	* Phillips Industries Vaz Dias	62-63
■‡ Corning Glass Works, Electronics Products Division Warner, Bicking & Fenwick, Inc.	146-147	Hansen Mfg. Co. Keller-Crescent Co.	167	Plastics Engineering Company Kuttner & Kuttner, Inc.	158
■ Dale Electronics, Inc., A Sub. of the Lionel Corporation Swanson, Sinkey, Ellis, Inc., Advertising	4th Cover	■ Heath/Schlumberger Scientific Instruments Advance Advertising Services	136	‡ Plessey Semiconductors Basso/Boatman, Inc.	73
Data General Corporation Scali, McCabe, Sloves, Inc.	48-49	Hermes Electronics, Ltd. Public & Industrial Relations Limited	169	‡ Precision Monolithics, Inc. Marlborough Associates, Inc.	131
Data Industri Holter, Young & Rubicam AS	21	■ Hewlett-Packard Tallant/Yates Advertising, Inc.	2, 163	Projects Unlimited Inc., Dayton, Ohio The Parker Advertising Company	162
Datatron, Inc. Larry Courtney Company	50-51	■ Hewlett-Packard Richardson, Seigle, Rolfs & McCoy, Inc.	127	Raytheon Company, Production Equipment Department Provandie Eastwood & Lombardi, Inc.	6
■ Delevan Division, American Precision Industries, Inc. Comstock Advertising, Inc.	144	■ Hewlett-Packard Tallant/Yates Advertising, Inc.	1	* RCA Electronic Components Al Paul Lefton Company, Inc.	90
Delta Air Lines Burke Dowling Adams, Inc.	42	■ Hewlett-Packard Tallant/Yates Advertising, Inc.	135	RCA Electronic Components Al Paul Lefton Company	159
Delta Products, Inc. The William Loughran Company	142	Hughes Aircraft Company Foote, Cone & Belding	74-75	* RCA Ltd. Marsteller Ltd.	73
■ Dialight Corporation Michel-Cather, Inc.	2nd Cover	* Industrie Bitossi s.a.s. Studio Ruini	14E	RCA—Solid State Division Marsteller, Inc.	80-81
		IEE Shadow Inc. Fischbein Advertising, Inc.	106	■‡ Rental Electronics, Inc. Humphrey Browning MacDougall, Inc.	58
		Intel Corp. Regis McKenna, Inc.	112-113	Robinson Nugent, Inc. Kolb/Tookey & Associates Inc., Advertising	22-23
				* Rohde & Schwarz	1E
				Rotron, Incorporated Black-Russell-Morris	47

Introducing the V-71. 32K for 8 grand.

Incredible. Getting 32K out of an off-the-shelf mini. Plus the option of a power fail/restart, teletype controller, automatic bootstrap loader for TTY's and real-time clock for only \$800 more*.

It gives us the distinction of being the cheapest computer in the world delivering 32K. And gives you the chance to get a lot more power for your money.

But the V-71 is more than just another piece of bare metal selling at a rock-bottom price (we leave that specialty to others). It—like the entire Varian V-70 family—has been elegantly designed by Varian engineers who think in terms of systems and total concepts.

With additions, the V-71 is capable of a powerful blend of hardware, systems software (the VORTEX operating system), and extensive peripherals. And Writable Control Store if that's what you need.

How much of a system you want to make out of the V-71 is up to you. The raw power is there. And Varian's open-ended architecture makes it easy to add whatever building blocks you need.

If you want more power for less money, check out the new V-71. For further information, write Varian Data Machines, 2722 Michelson Drive, Irvine, CA 92664. Or call 833-2400.

*V-71 price and options based on orders of a dozen.

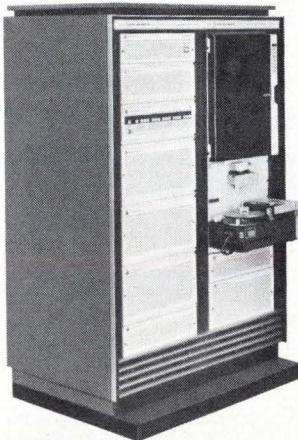

 **varian
data machines**

A little simple arithmetic about a Math major.

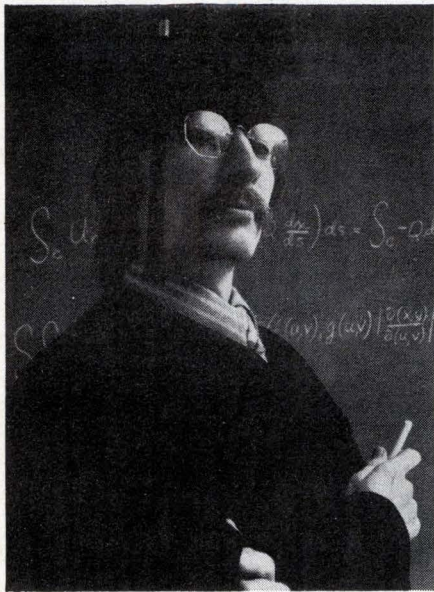

The cost of a higher education is getting higher. In fact, you could end up spending close to \$20,000 to put your child through college.

So maybe you should consider U.S. Savings Bonds. They're one of the most dependable ways to build funds for an education.

All you have to do is join the Payroll Savings Plan where you work. Then an amount you specify is set aside from your paycheck and used to buy Bonds.

Say your child is 3 years old now. If you buy a \$75 Bond a month through Payroll Savings, by the time he's 18, you'll have \$16,048 tucked away. A solid sum to get him started. See? A little simple arithmetic can add up to a lot.

Make the chances of your child's college education more secure. Join the Payroll Savings Plan now.

Now E Bonds pay 6% interest when held to maturity of 5 years (4% the first year). Bonds are replaced if lost, stolen or destroyed. When needed, they can be cashed at your bank. Interest is not subject to state or local income taxes, and federal tax may be deferred until redemption.



Take stock in America.

Join the Payroll Savings Plan.

Ad Council A public service of this publication and The Advertising Council.

* RTC Feldman Callex Associates	9E
Schauer Manufacturing Corp. Nolan, Keelor & Stites	40
‡ Siemens Corporation Stiefel/Raymond Advertising, Inc.	62-63
* Silec	12E
* Sescosem Bazaine Publicite	5E, 52
* Siemens A.G. Munich Linder Presse Union GmbH	56
Sodeco—SAIA PR Service	106
Solltron Devices, Inc., Transistor Division William E. Haselmire Advertising, Inc.	105
■ Spectrum Control, Inc. Egon Jackson Advertising	170
Sprague Electric Company Harry P. Bridge Company	8, 32
Systron Donner Concord Instruments Fred Schott & Associates	9
Tally Corporation Bonfield Associates	174
■ Tektronix, Inc. Tektronix, Advertising	37, 39, 41
* Teledyne Relays S. Michelson Advertising	146
Teledyne Semiconductor Regis McKenna, Inc.	7
Teradyne, Inc. Quinn & Johnson, Inc.	10-11
■ TRW /IRC Resistors Gray & Rogers, Inc.	165
* Ultra Electronics Components Ltd. Dennis Dolling Limited	15E
■ Unitrode Corporation Culver Advertising, Inc.	31
U.S. Capacitor Corp. S. Michelson Advertising	83
■ Vactec, Inc. Coleman & Associates Advertising	145
Varian Data Machines Durel Advertising	177
Varo Semiconductor, Inc. Warren-Guild	150
Vector Electronic Company, Inc. Communications Management Company	170
■ Wagner Electric Corporation Coordinated Communications, Inc.	161
‡ Weston Instruments, Inc. APCL & K, Inc.	52
■ Woven Electronics Prentiss Court Advertising	24

Classified & Employment Advertising

F. J. Eberle, Manager 212-997-2557

EQUIPMENT (Used or Surplus New) For Sale	
American Used Computer Corp.	172
Electronics Discount Sales	172
Fishman, Philip Co.	172
Jensen Tool & Alloys	172
Radiation Devices	172
Radio Research Instrument Co., Inc.	172
Wright Patterson Airforce Base	172

■ For more information on complete product line see advertisement in the latest Electronics Buyer's Guide
* Advertisers in Electronics International
‡ Advertisers in Electronics domestic edition

Advertising Sales Staff

Pierre J. Braudé New York [212] 997-3468
Director of Marketing

Atlanta, Ga. 30309: Joseph Lane
100 Colony Square, 1175 Peachtree St., N.E.
[404] 892-2868

Boston, Mass. 02116: James R. Pierce
607 Boylston St. [617] 262-1160

Chicago, Ill. 60611:
645 North Michigan Avenue
Robert W. Bartlett (312) 751-3739
Paul W. Reiss (312) 751-3738

Cleveland, Ohio 44113: William J. Boyle
[716] 586-5040

Dallas, Texas 75201: Charles G. Hubbard
2001 Bryant Tower, Suite 1070
[214] 742-1747

Denver, Colo. 80202: Harry B. Doyle, Jr.
Tower Bldg., 1700 Broadway
[303] 266-3863

Detroit, Michigan 48202: Robert W. Bartlett
1400 Fisher Bldg.
[313] 873-7410

Houston, Texas 77002: Charles G. Hubbard
Dresser Tower, 601 Jefferson St., [713] 224-8381

Los Angeles, Calif. 90010: Robert J. Rielly
Bradley K. Jones, 3200 Wilshire Blvd., South Tower
[213] 487-1160

New York, N.Y. 10020
1221 Avenue of the Americas
Warren H. Gardner [212] 997-3617
Michael J. Stoller [212] 997-3616

Philadelphia, Pa. 19102: Warren H. Gardner
Three Parkway,
[215] 997-3617

Pittsburgh, Pa. 15222: Warren H. Gardner
4 Gateway Center, [212] 997-3617

Rochester, N.Y. 14534: William J. Boyle
9 Greylock Ridge, Pittsford, N.Y.
[716] 586-5040

San Francisco, Calif. 94111: Don Farris
Robert J. Rielly, 425 Battery Street,
[415] 362-4600

Paris: Alain Offergeld
17 Rue-Georges Bizet, 75 Paris 16, France
Tel: 720-73-01

Geneva: Alain Offergeld
1 rue du Temple, Geneva, Switzerland
Tel: 32-35-63

United Kingdom & Scandinavia: Keith Mantle
Tel: 01-493-1451, 34 Dover Street, London W1

Milan: Robert Saidel
1 via Baracchini, Italy Phone 86-90-656

Brussels: Alain Offergeld
23 Chaussee de Wavre
Brussels 1040, Belgium
Tel: 13-73-95

Frankfurt/Main: Fritz Krusebecker
Liebigstrasse 27c, Germany
Phone 72 01 81

Tokyo: Tatsumi Katagiri, McGraw-Hill
Publications Overseas Corporation,
Kasumigaseki Building 2-5, 3-chome,
Kasumigaseki, Chiyoda-Ku, Tokyo, Japan
[581] 9811

Australasia: Warren E. Ball, IPO Box 5106,
Tokyo, Japan

Business Department

Stephen R. Weiss, Manager
[212] 997-2044

Thomas M. Egan,
Production Manager [212] 997-3140

Carol Gallagher
Assistant Production Manager [212] 997-2045

Dorothy Carter, Contracts and Billings
[212] 997-2908

Frances Vallone, Reader Service Manager
[212] 997-6057

Electronics Buyers' Guide

George F. Werner, Associate Publisher
[212] 997-3139

Regina Hera, Directory Manager
[212] 997-2544

FMC

Syntron Semiconductor Sales Organization

ARIZONA

Fryco, Engineering Reps.
Scottsdale
(602) 945-3281

CALIFORNIA

Carl E. Holmes Co.
Los Angeles
(213) 256-2255

COLORADO

Gossard & Associates
Denver
(303) 985-0602

FLORIDA

L. Haas Co., Inc.
North Miami Beach
(305) 949-9143
(305) 949-5157

ILLINOIS

Syntron Chicago Sales Co.
Hinsdale
(312) 325-3250

INDIANA

Seawood Sales, Inc.
Montgomery
(513) 793-6702

MARYLAND

Callas Electronics, Inc.
Baltimore
(301) 744-7711

MASSACHUSETTS

Garrettson Co., Inc.
Needham
(617) 449-2640

MICHIGAN

L. H. Dickelman
Detroit
(313) 255-3300

MINNESOTA

Northport Engineering Inc.
St. Paul
(612) 698-3841

MISSOURI

Harlan J. Weisler & Associates
St. Louis
(314) 428-3934

NEW JERSEY

Syntron Newark Sales Co.
Hasbrouck Heights
(201) 288-1845

NEW YORK

J. Lazor Associates
Penfield
(716) 473-8337

NORTH CAROLINA

Jake Rudisill Associates, Inc.
Charlotte
(704) 377-6901

OHIO

Allen Nace Co., Inc.
Brecksville
(216) 526-4323

PENNSYLVANIA

W. Reeves Associates, Inc.
Media
(215) 566-6709

TEXAS

Palatine Sales, Inc.
Richardson
(214) 231-9489

WASHINGTON

Bergford & Associates
Olympia
(206) 866-2001

WISCONSIN

Syntron Semiconductor Sales Co.
Milwaukee
(414) 273-6773

Syntron Power Thyristors

Syntron Thyristors (SCRs) are diffused, three junction, semiconductor units designed for medium and high power solid state control applications.

Available in the popular standard JEDEC configurations from 25 amps rms to 850 amps rms with V_{BO} ratings to 1600 volts and transient ratings to 2000 volts, these Thyristors exhibit the same reverse voltage avalanche characteristics found in all Syntron silicon diodes.

In a single element application, they can be used for direct conversion and continuous control of AC to DC power requirements or they can be used as a DC switch to initiate current flow.

Rigid quality control and years of field testing have made Syntron Thyristors among the most reliable devices available for solid state power control.

For detailed information, contact:

FMC Corporation
Semiconductor Products
Operation
Homer City, Penna. 15748
(412) 479-8011

**FMC Special
Products**

introducing: the BOSS™ switch

new Molex Binary Option Selection Switch

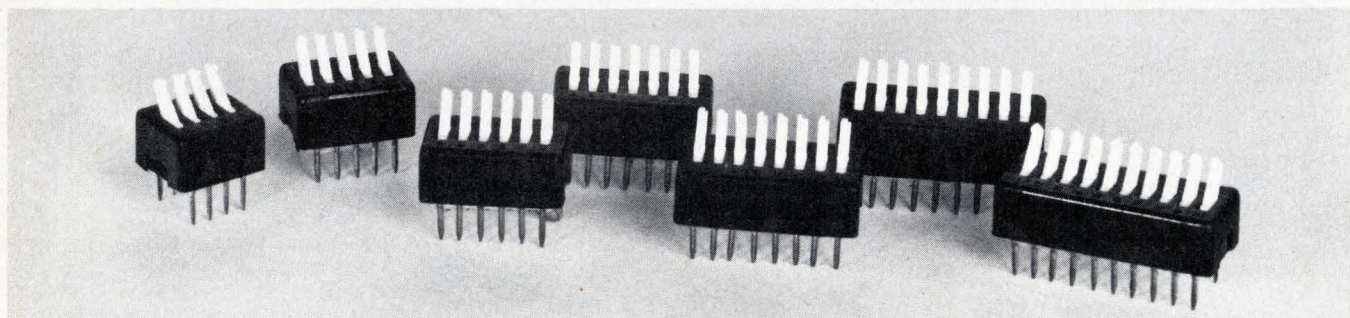
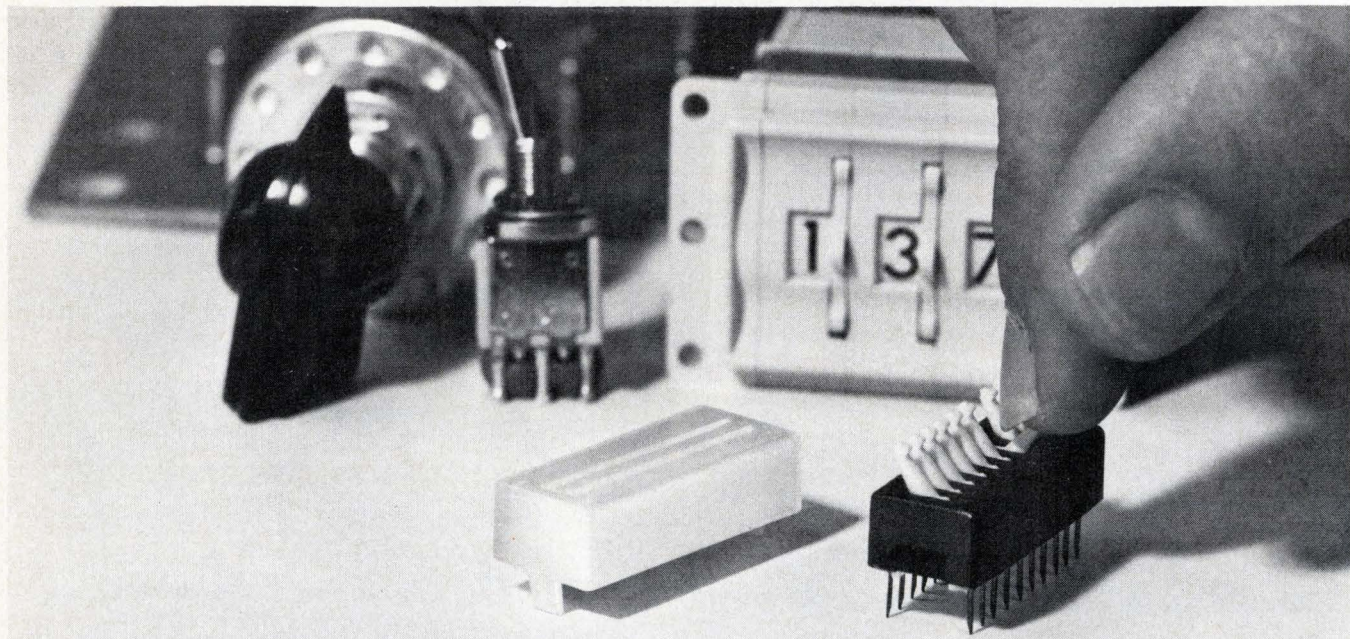

It's the BOSS because butting and wiping contacts make it better.

You need both butting *and* wiping contacts for *positive* logic function programming. The new BOSS switch gives you both—plus gold-over-phosphor bronze contacts for reliable “dry circuit” applications. And easy manual operation means you don't need special tools to program the BOSS.

We make the BOSS in a choice of four to 10 single-throw, single-pole switches with a polyester housing. Enclosed design protects against dust, dirt, and other environ-

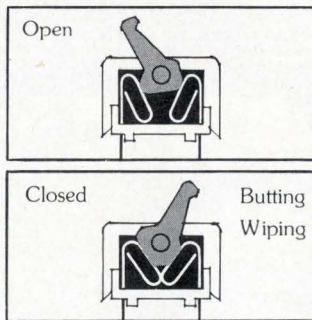

mental hazards and makes the BOSS fully cleanable after soldering.

Solder-tail leads on .100 x .300 centers let you mount the BOSS through a DIP header or directly to the P.C. board eliminating the cost of interconnection wiring to perform the switching function.

BOSS is rated for 50 ma at 30 v, d-c and it programs savings up to 50% into computer, computer peripheral, communications, testing equipment, and related applications.

molex ... Affordable Technology

Molex Incorporated, Dept. E1274, 2222 Wellington Court, Lisle, Illinois 60532