

SEPTEMBER 5, 1974

Designing low-cost Omega receivers/98

Data acquisition under microcomputer control/107

Minis in action: automated component insertion/117

FOUR DOLLARS A MCGRAW-HILL PUBLICATION

Electronics®

**Bipolar
LSI
computing
elements
add designer
options**



1420 TCH590 MCSA9 JUN75
STATE TECHNICAL INSTITUTE
MS NF WALKER
5963 MACON COVE
MEMPHIS TN 38134

LIBRARY
STATE TECHNICAL INSTITUTE
AT MEMPHIS

Royer Reviews.

Where are the A/D's?



Computer memory speeds are up. Access time is down. DMA (direct memory access) is now a reality on most minicomputers. Multi-channel data acquisition at megahertz channel rates now demands very fast, highly-accurate, moderately-priced A/D converters. In a new compact size occupying a single card-slot width.

If you had the money and the time and the space, you could always get the speeds you were reaching for. But . . . it was a matter of compromise.

If you wanted speed (e.g. 10-bits in 1μ sec) you had to sacrifice stability. If you were looking for stability you had to be satisfied with slower speeds (e.g. 10-bits in 5μ sec).

Living with the limitations.

So, in the past, high conversion speeds (>1 MHz), high resolution and low TC's (20 ppm/ $^{\circ}$ C) were considered fundamentally divergent specs for A/D converters.

For the simple reason that the high currents required in current mode switches coupled with the resulting high power dissipation of the entire converter resulted in thermal instabilities which limited TC's to approximately 50 ppm/ $^{\circ}$ C or worse. The resulting speed/accuracy/stability limitations centered mainly around high-speed current-mode switches required to implement the DAC in the ADC.

Until now the monolithic NPN Quad Switches available were an order of magnitude too slow for the kind of conversion speeds we're talking about.

We did it our way.

We set out to design our own version of the monolithic quad switch. It's a dielectrically isolated PNP switch that will handle MSB currents up to 5 or 6 mA with tracking TC's of less than 1 ppm!
Not bad, eh!

Couple this with a proprietary comparator that can resolve a millivolt or so in less than 10 nanoseconds and you have the ingredients for a family of very-high-speed ADC's.

Meet the family.

First of all we have a *complete* family of very high speed A/D converters: Model 4130— 750 nsec max. for 8-bits; Model 4131— 1μ sec max. for 10-bits; and Model 4132— 3.5μ sec max. for 12-bits. Each of them boasts TC's of ± 10 ppm/ $^{\circ}$ C max. Each of them is unusually compact— $5.08 \times 10.16 \times 1.02$ cm (or $2 \times 4 \times .4$ inches). So they're perfect for all tightly-spaced analog interfaces that are popular in today's minis. Pretty good for starters!

There's more, much more.

But we're not stopping here. We're already looking at a high-resolution, high-speed family—from 12-bits in 1μ sec out to 15-bits in 10μ sec.

What's it all about?

Leading the way in a state-of-the-art technology like this, we know that the application potential in high-speed data acquisition is extended dramatically. This applies to such areas as FFT processing, real-time vibration analysis, radar return analysis, etc., etc., etc.

If you're as fascinated as we are by the implications of our new family of very-high-speed A/D converters and would like to explore their possibilities with us, give us a call. Telephone (617) 329-1600. Or write us, Dedham, Mass. 02026. In Europe, Tel. 73.99.88, Telex: 25881. Or write, 181 Chaussee De La Hulpe, 1170 Brussels.

James Royer
Marketing Manager

 **TELEDYNE
PHILBRICK**

Circle 900 on reader service card

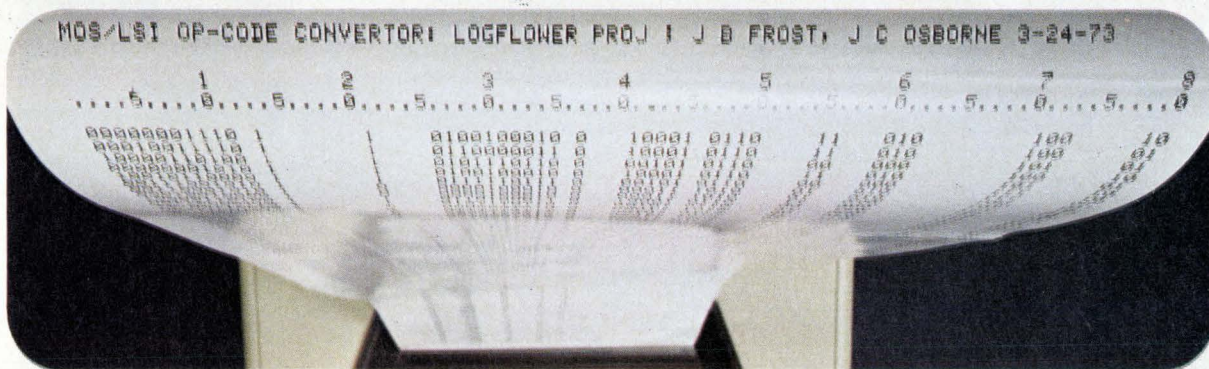
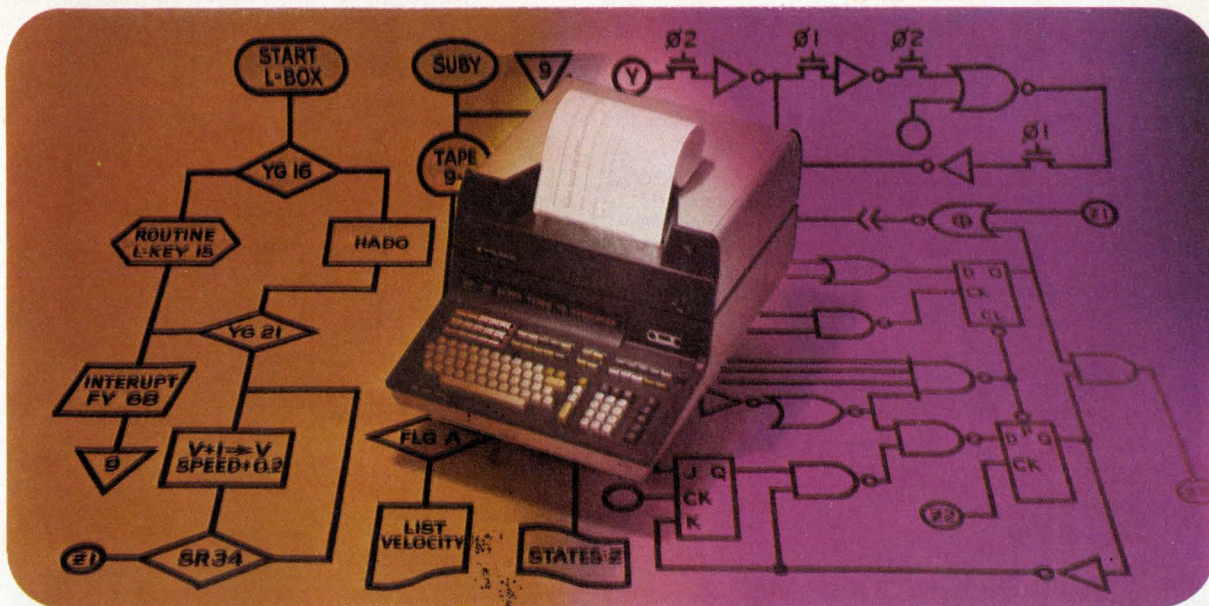

Simulate Logic Designs Directly From Your Schematic...

And slash your digital development and leadtime costs with the HP 9830 Programmable Calculator. Team the 9830 up with our new Logic Simulation Software and you'll have a potent calculator-aided design system that will verify your digital designs—long before you've spent a nickel on a prototype.

With incredible speed and precision, the 9830 runs through all possible input conditions and associated bit streams, generates the state/time map, then complete logic documentation. Interconnect lists. Truth tables. Timing.

And since the 9830 sits right on your desk, you can interact with your design. Use your experience and training to guide the model to its optimum configuration in a fraction of the time required by other methods.

Combinational or sequential circuits. MOS logic. TTL/DTL logic. No matter what circuit type,

digital simulation with the 9830 adds up to more professional satisfaction for you; more profit for your firm. Not only does it eliminate the drudgery of hand-generated timing diagrams, it also lets you neatly sidestep the slow turnaround time of outside services. Most importantly, it means an end to costly prototype reworks.

You can reap the benefits of an HP 9830 with Logic Simulation Software for just \$332* per month. For complete details or a demonstration, call your local HP Sales Office, or send us the coupon. We think you'll agree, it's the logical solution to your digital design problems.

*Domestic U.S.A. price only. Lease, where available, includes service contract.



Sales and service from 172 offices in 65 countries.
P.O. Box 301, Loveland, Colorado 80537

094110

Tell me more about your HP 9830 CAD Logic Simulation System.

Information only. Hands-on demonstration.

I work with these families of circuits: TTL _____

MOS _____ DTL _____ Other _____

Name _____

Title _____

Company _____

Address _____

City _____ State _____

Zip _____ Phone _____

Hewlett-Packard Co. P.O. Box 301; Loveland, CO 80537

816D

FOR NEW STANDARDS IN SIGNAL GENERATORS, THINK HP



“A good general purpose signal generator should handle most of your bench needs and be cheap enough to fit every budget. That’s why we designed the HP 8654A”

Frequency range: 10-520 MHz
Calibrated
output level: +10 to -130 dBm, leveled
Modulation: AM & FM,
internal & external
Stability: 20 ppm/5min
Price: \$1700. Domestic USA price only.

But you'll want to evaluate the 8654A for yourself. A call to your local HP field engineer will put one in your hands. Or for more information just write.

HEWLETT  PACKARD

Sales and service from 172 offices in 65 countries.
1501 Page Mill Road, Palo Alto, California 94304

04406A

- 29 **Electronics Review**
MEDICAL: Bedside processors handle intensive care in hospitals, 29
MILITARY: Night recon gets lift from large-diameter intensifier, 30
SOLID STATE: CCDs loom large in mass-memory future, 31
PERIPHERALS: Terminal's flashing LEDs catch the eye, 31
INDEX OF ACTIVITY: 32
COMMUNICATIONS: Skynet II: UK to try another launch, 32
Interconnection eased for answering devices, 34
CONSUMER: Satellites may beam soothing music, 36
NEWS BRIEFS, 36
INDUSTRIAL: Infrared instrument measures angles, 38
- 53 **Electronics International**
JAPAN: Erase-mode innovation gives dense RAM, ROM, 53
AROUND THE WORLD: 53
- 65 **Probing the News**
MEDICAL ELECTRONICS: Pacemakers quicken beat, 65
COMPANIES: Sun peeks through Pertec's clouds, 68
THE ECONOMY: Hittinger calls productivity deflation key, 76
AUTOMOTIVE ELECTRONICS: After the interconnect, 79
- 89 **Technical Articles**
MICROCOMPUTERS: Bipolar LSI chip set is fast and flexible, 89
NAVIGATION: Phase difference is key to low-cost receivers, 98
MICROPROCESSORS: Expanding data-acquisition applications, 107
DESIGNER'S CASEBOOK: Phase-locked loop includes indicator, 112
Window comparator needs only one op amp, 113
MINICOMPUTERS: Automating component insertion in pc boards, 117
ENGINEER'S NOTEBOOK: Checking capacitors with a voltmeter, 125
Economical approaches to 16-bit d-a conversion, 126
Listening to magnetic fields can be useful, 127
- 131 **New Products**
IN THE SPOTLIGHT: IC-memory tester is interactive, 131
SEMICONDUCTORS: Signetics' first microprocessor, 133
PACKAGING & PRODUCTION: Deposition unit is modular, 138
DATA HANDLING: ROM programmer is fast, low-priced, 146
INSTRUMENTS: Meter displays any engineering units, 154
MATERIALS: 158
- Departments**
Publishers letter, 4
Readers comment, 6
40 years ago, 8
People, 14
Meetings, 20
Electronics newsletter, 25
News update, 42
Washington newsletter, 49
Washington commentary, 50
International newsletter, 55
Engineer's newsletter, 128
New literature, 162
New books, 172

Highlights

The cover: At last, a really fast microcomputer, 89

A microcomputer chip set that exploits Schottky bipolar LSI technology has other advantages besides better-than-MOS performance: its elements can be arranged into a wide variety of control and computation systems; the user microprograms it himself, and it is compatible with off-the-shelf memories. Cover is by illustrator Steve Osborn.

Pacemakers do well and get better, 65

The market for electronic pacemakers is growing at an annual rate of maybe 25%, and manufacturers here and in Europe are using diverse technological advances to increase the versatility and lifetime of their products.

Omega receivers need not cost much, 98

A NASA grant is financing a project aimed at making it possible for private pilots and boatmen to afford accurate position-finders. The Omega navigational system, which goes into operation shortly, emits vlf signals that could be picked up by a novel IC-based receiver costing less than \$1,000.

Microprocessors upgrade industrial control, 107

The computerization of industrial control and measurement systems will proceed at a much faster rate, now that microprocessors provide a physically small, low-cost, and flexible means of running data-acquisition systems. A demonstration system illustrates how they operate.

And in the next issue . . .

Special report on automatic testing . . . start of a series on bipolar transistor models for computer-aided design . . . conductive elastomers.

EDITOR-IN-CHIEF: Kemp Anderson

EXECUTIVE EDITOR: Samuel Weber

MANAGING EDITORS: Lawrence Curran, *News*;
Arthur Erikson, *International*

SENIOR EDITORS: John Johnsrud,
H. Thomas Maguire, Laurence Altman,
Ray Connolly, Stephen E. Scrupski

ART DIRECTOR: Fred Sklenar

ASSOCIATE EDITORS: Howard Wolff,
Gerald M. Walker, Alfred Rosenblatt

DEPARTMENT EDITORS
Aerospace / Military: Ray Connolly
Circuit Design: Lucinda Matterna
Communications & Microwave:

Stephen E. Scrupski
Computers: Wallace B. Riley
Consumer: Gerald M. Walker
Industrial: Michael J. Riezenman
Instrumentation: Stephen E. Grossman
New Products: H. Thomas Maguire
Packaging & Production: Andy Santoni
Solid State: Laurence Altman

COPY EDITORS: Margaret Eastman,
Everett C. Terry, Bill Dunne

ASSISTANT EDITOR: Marilyn Offenheiser

ART: Charles D. Ciatto, *Associate Director*
Patricia Cybulski, *Assistant Director*

PRODUCTION EDITOR: Arthur C. Miller

EDITORIAL SECRETARIES: Janet Noto,
Julie Gorgoglione, Penny Roberts

FIELD EDITORS

Boston: Gail Farrell
Los Angeles: Paul Franson (Mgr.)
Midwest: Larry Armstrong (Mgr.)
San Francisco: Bernard Cole (Mgr.)
Judith Curtis
Washington: Ray Connolly (Mgr.)
Larry Marion
Frankfurt: John Gosch
London: William F. Arnold
Paris: Arthur Erikson
Tokyo: Charles Cohen

McGRAW-HILL WORLD NEWS

Director: Ralph R. Schulz
Bonn: Robert Ingersoll
Brussels: James Smith
London: Marvin Petal
Milan: Peter Hoffmann, Andrew Heath
Moscow: Peter Gall
Paris: Michael Johnson, Richard Shepherd
Stockholm: Robert Skole
Tokyo: Mike Mealey

PUBLISHER: Dan McMillan

DIRECTOR OF MARKETING: Pierre J. Braudé

ADVERTISING SALES SERVICE MANAGER:
Wallis Clarke

BUSINESS MANAGER: Stephen R. Weiss

CIRCULATION MANAGER: Nancy L. Merritt

MARKETING SERVICES MANAGER:
Tomlinson Howland

RESEARCH MANAGER: Margery D. Sholes

In our issue of October 17, *Electronics* will announce the recipient of the first annual *Electronics* Achievement Award. The award will be made to the person who, in the opinion of the editors, has made the most important contribution to the progress of electronics over the past year.

The contributions that will be considered fall under two main headings: outstanding technological achievements that significantly affect the direction or scope of electronic applications, and accomplishment or leadership in education, government, or industry that enhances the prestige and well-being of the electronic industries. Anyone in the world is eligible to receive the award.

The task of choosing the award recipient is by no means an easy one. We know there are thousands of men and women at all levels of industry, government, and academe whose accomplishments are worthy of consideration.

And we know that we can't pick them all. The fact that we have established the award is, in a way, a tribute to all the pioneers, innovators, movers, and shakers who make electronics the exciting and challenging field it is.

The issue in which we will announce the Achievement Award winner is a special one for us. We are calling it "Technology Update" and plan to detail the impact of today's technological trends on the major industry sectors—from computers to components from mi-

croprocessors to microwaves—both right now and in the next year or two.

The emphasis is on where technology has brought us and how it is being harnessed—right now—to meet mankind's social and personal needs. Indeed, with all the activity going on, the story of electronics technology today is a fascinating one.

We are going to home in on the practical applications the engineers are working on now. And, although we are taking a look at what's still in the labs and the directions in which technology is moving, there's little of the blue-sky to be found in our special issue.

Besides the Achievement Award winner, the issue will have some other special features, including a chronological chart of technological trends and a look at how companies around the world organize their research and development.

We think that, by presenting this "snapshot" of technology as it speeds along, we are rendering an important service. So be sure to watch for our special October 17 "Technology Update" issue.

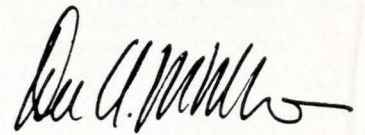

September 5, 1974 Volume 47, Number 18
94,602 copies of this issue printed

Published every other Thursday by McGraw-Hill, Inc. Founder: James H. McGraw 1860-1948. Publication office 1221 Avenue of the Americas, N.Y., N.Y. 10020; second class postage paid at New York, N.Y., and additional mailing offices.

Executive, editorial, circulation and advertising addresses: Electronics, McGraw-Hill Building, 1221 Avenue of the Americas, New York, N.Y. 10020. Telephone (212) 997-1221. Teletype TWX N.Y. 710-581-5234. Cable address: MCGRAWHILL N.Y.

Subscriptions limited to persons with active, professional, functional responsibility in electronics technology. Publisher reserves the right to reject non-qualified requests. No subscriptions accepted without complete identification of subscriber name, title, or job function, company or organization, including product manufactured or services performed. Subscription rates: qualified subscribers in the United States and possessions, Canada, and Mexico \$12.00 one year, \$24.00 three years; all other countries \$25.00 per year, except Japan \$50.00 per year, Brazil \$40.00 per year, Australia and New Zealand \$90 per year, including air freight. Limited quota of subscriptions available at higher-than-basic rate for persons outside of field served, as follows: U.S. and possessions and Canada, \$25.00 one year; all other countries \$50.00. Single copies: \$4.00.

Officers of the McGraw-Hill Publications Company: John R. Emery, President; J. Elton Tuohig, Executive Vice President-Administration; Gene W. Simpson, Group Publisher-Vice President; Senior Vice Presidents: Ralph Blackburn, Circulation; Walter A. Starbury, Editorial; John D. Hoglund, Controller; David G. Jensen, Manufacturing; Gordon L. Jones, Marketing; Jerome D. Luntz, Planning & Development.

Officers of the Corporation: Shelton Fisher, Chairman of the Board and Chief Executive Officer; Harold W. McGraw, Jr., President and Chief Operating Officer; Wallace F. Trendly, Group President, McGraw-Hill Publications Company and McGraw-Hill Information Systems Company; Robert N. Landes, Senior Vice President and Secretary; Ralph J. Webb, Treasurer.

Title registered in U.S. Patent Office; Copyright ©1974 by McGraw-Hill, Inc. All rights reserved. The contents of this publication may not be reproduced in whole or in part without the consent of copyright owner.

Subscribers: The publisher, upon written request to our New York office from any subscriber, agrees to refund that part of the subscription price applying to copies not yet mailed. Please send change of address notices or complaints to Fulfillment Manager; subscription orders to Circulation Manager, Electronics, at address below. Change of address notices should provide old as well as new address, including postal zip code number. If possible, attach address label from recent issue. Allow one month for change to become effective.

Postmaster: Please send form 3579 to Fulfillment Manager, Electronics, P. O. Box 430, Hightstown, N. J. 08520.

theKEPCO PTR

is an OEM modular power supply *with a difference!*

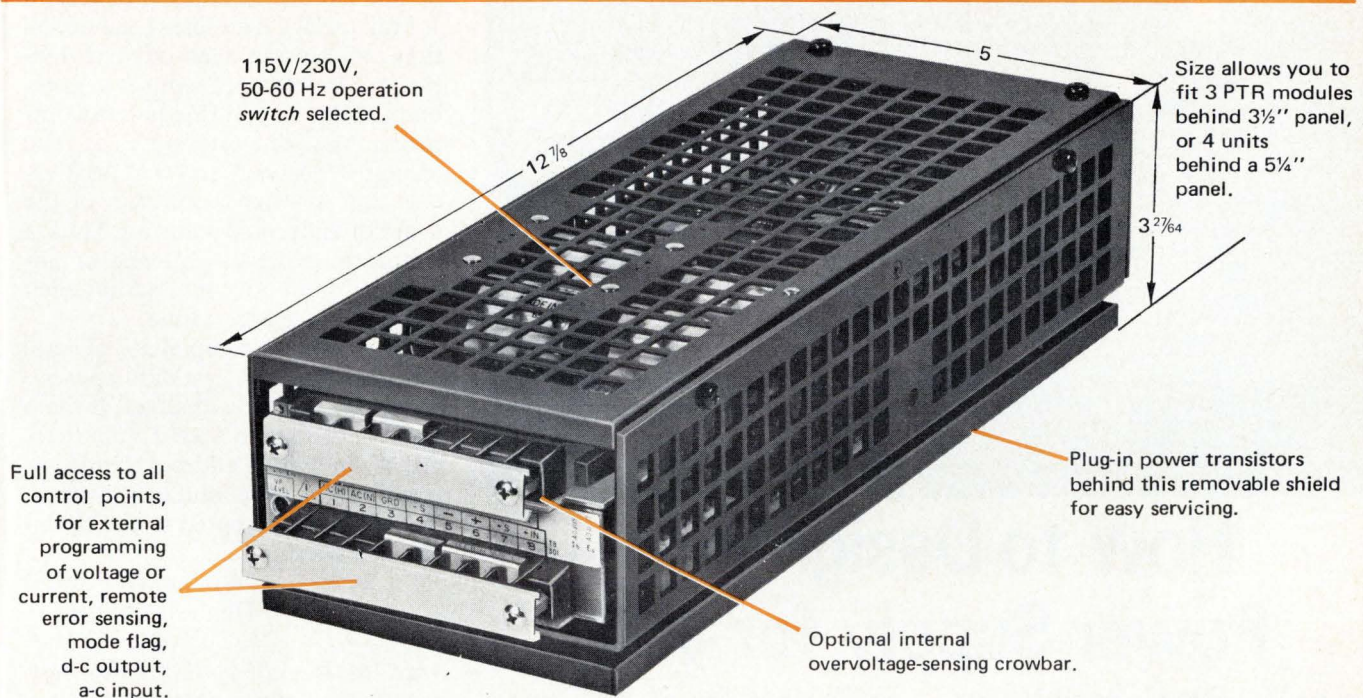

The Kepco PTR is an OEM modular power supply . . . with a difference.

The difference is that for \$273.00 you **don't** get a stripped-down, open-frame module with external heat sink fins, skimpy capacitors and a tricky derating chart versus ambient temperature—nor do you get a limited-range voltage stabilizer with fold back over-current protection.

For \$273.00, you get a Kepco PTR . . . a fully programmable, automatic crossover voltage and current stabilizer that functions with its self-contained, convection-cooled heat sink to produce *full output* to +71°C with *no derating*.

PTR's produce from 0–7 volts at 5.5 amperes to 0–100 volts at 0.6 amperes in six different models. All units have two control channels with plug-in I-C control amplifiers for excellent stabilization (0.005%) and temperature immunity (0.01%/°C).

For an extra \$25.00, you can get a built-in overvoltage-sensing crowbar.

The PTR is a truly remarkable value—the features and performance of lab and systems-type power supplies in an inexpensive, value packed OEM module. Write for Catalog 146-1278 for the full details.



KEPCO®

For complete specifications, write Dept. EL-14

*with KEPCO
you're in control!*

KEPCO, INC. • 131-38 SANFORD AVENUE • FLUSHING, N.Y. 11352 • (212) 461-7000 • TWX #710-582-2631 • Cable: KEPCOPOWER NEWYORK

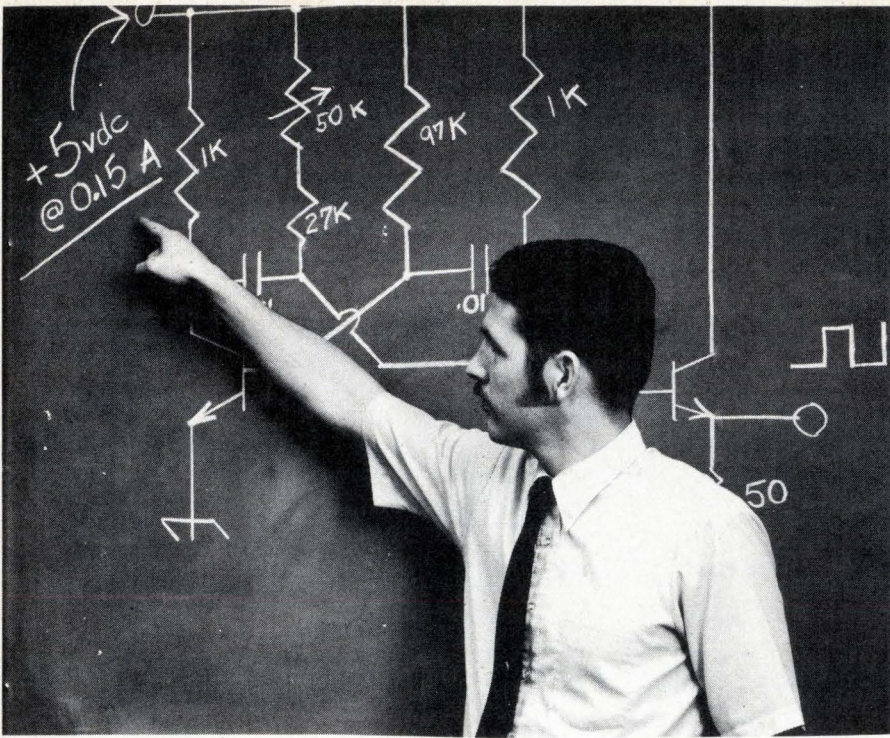

How to Design Your Power Supply for \$66

You get the **complete schematic diagram, and parts list** with operating and installation instructions when you spend \$66 for an Abbott Model "RN" power supply. Two years in development, this model represents the latest state of the art in power module design. It features close regulation (0.1%), low ripple (0.02%), automatic short circuit and complimentary overvoltage protection and continuous operation in a 160°F ambient.

Abbott Engineers followed specific design criteria in engineering these modules. First, the electrical design was carefully engineered to insure that all components operate well within their limits, under "worst case" operating conditions. Second, the thermal design, including case construction, was carefully made to insure that the maximum temperature limits of all components are never exceeded. Then the size and weight of these modules were controlled to a minimum, without sacrificing reliability. Finally these units were thoroughly tested to make certain that all design and performance specifications were met.

So, you can build your own power supply using our schematic diagram if you want to—but we think we can build it more

reliably and for less cost, simply because we have been doing it for ten years. Put our power supply in your system first and try it. Examine its performance. We think you will be pleasantly surprised at the quality, adherence to specifications, and the reliability you find in the Abbott Model "RN".

Any output voltage from 5 to 100 volts DC with current from 0.15 to 20 amperes is available. **Many of the popular voltages are carried in stock for immediate delivery.** Please call us for attractive O.E.M. discount prices.

Abbott also manufactures 3,000 other models of power supplies with output voltages from 5.0 to 3,650 volts DC and with output currents from 2 milliamperes to 20 amperes. They are all listed **with prices** in the new Abbott catalog with various inputs:

- 60 A to DC, Hermetically Sealed
- 400 A to DC, Regulated
- 28 VDC to DC, Regulated
- 28 VDC to 400 A, 1 ϕ or 3 ϕ
- 24 VDC to 60 A, 1 ϕ

Please see pages 581-593 of your 1973-74 EEM (ELECTRONIC ENGINEERS MASTER Catalog) for complete information on Abbott Modules.

Send for our new 56 page FREE catalog.

abbott transistor

LABORATORIES, INCORPORATED

general offices

eastern office

5200 W. Jefferson Blvd./Los Angeles 90016
(213) 936-8185 Telex: 69-1398

1224 Anderson Ave./Fort Lee, N.J. 07024
(201) 224-6900 Telex: 13-5332

Readers comment

Testing bipolar ROMs

To the Editor: A modification can be made to the ROM tester of Joseph J. McDowell ["Measuring the access time of bipolar read-only memories," *Electronics Engineer's notebook*, May 2, p. 115] that can improve the thoroughness of the testing. We have found that ROM access time is often a function of the order of address sequencing. Thus, a simple monotonic sequence of addresses does not necessarily elicit the worst-case access time.

To make a completely general test, the ROM tester should exercise all possible address changes. If there are n addresses to a ROM then there are $n^2 - n$ unique address transitions possible. Some redundancy of transitions can be accepted so the circuit can be kept simple.

William D. Farwell
Hughes Aircraft Co.
Culver City, Calif.

■**Mr. McDowell replies:** *Your addition of the "all-possible-jumps" logic is worthwhile. We incorporated it into our system about a year ago and found that most ROMs were slower in the all-possible-jumps mode. In the short space available, I did not go into the details of this addition.*

Martin pages an error

To the Editor: An error was made in the article, "Germans to start nationwide paging," [July 11, p. 69], with regard to capacity of the Martin Marietta Hicap paging system. It has a single-channel coding capacity of 2.1 million individual addresses. Our standard package uses a subset of the Bose-Chaudhuri code, which has a capacity of 65,000 independent addresses. However, the equipment is capable of extension to the full 2.1 million capacity for any application where it is needed.

Swedish authorities are developing a system to operate from their standard fm broadcast system, and they have declined to accept proposals from any manufacturer whose system is not compatible with their multifrequency-broadcast concept.

J. Douglas Wells
Martin Marietta Aerospace
Orlando, Fla.

TRW power Schottky SD-51

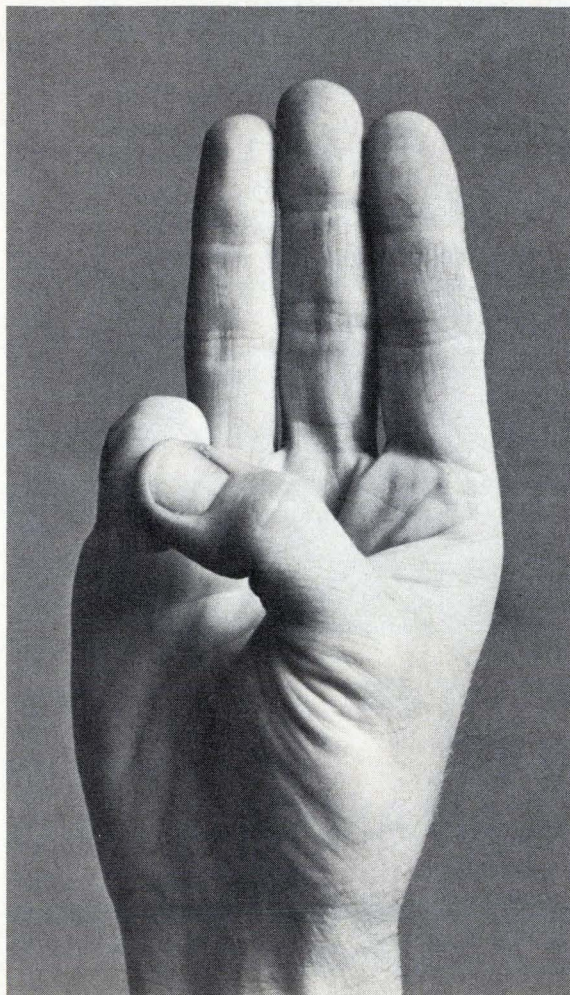

0.6V forward drop at 60 amps WITH a T_j of 125°C

On our honor. This power Schottky was developed with improved barrier formation techniques that make it possible to maintain 60 amp—0.6V forward drop at a T_j of 125°C.

We know there have been problems with power Schottkys when the T_j approached 100°C. This is simply not true with the TRW SD-51. Even at 125°C, the SD-51 has a 35V reverse leakage of 200mA, and a reverse recovery time

of less than 10Ns in inverter circuits.

If you're into low voltage, high current power supplies, you owe it to your design to test TRW's SD-51. They're drop-in. And they keep right on working at high temperatures!

For proof, see your distributor or call (213) 679-4561, TRW Power Semiconductors, an Electronics Components Division of TRW, Inc., 14520 Aviation Blvd., Lawndale, California 90260.

TRW® POWER SEMICONDUCTORS

These products are available through the following authorized distributors:

Almo Electronics
Bell Industries
Cramer Electronics Inc.
De Mambro Electronics

Electronics Marketing Corp.
Elmar Electronics Inc.
Hall-Mark Electronics Corp.
Harvey-Michigan Inc.

Lake Engineering, Ltd.
Liberty Electronics
Pyttronic Industries Inc.
Rochester Radio

Semiconductor Concepts Inc.
Summit Distributor
R. V. Weatherford Co.
Westates Electronics Corp.
Wilshire Electronics

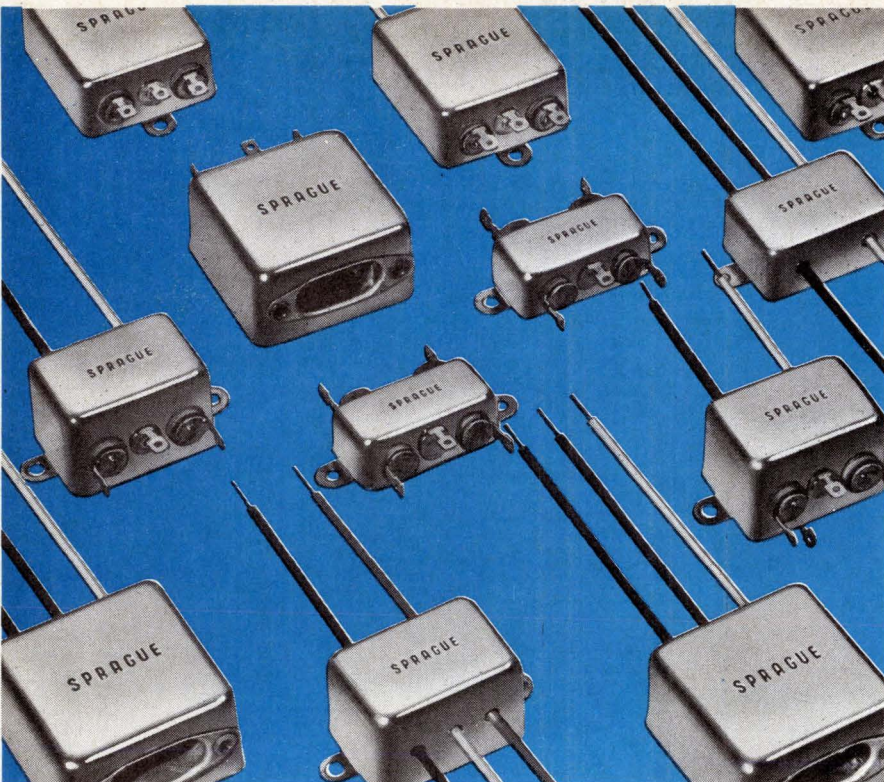

**FILTERS THAT WORK.
FILTERS THAT FIT.
FILTERS YOU CAN AFFORD.**

**Sprague JX5100 Series EMI Powerline Filters
give you the right blend of efficiency/size/cost.**

The lower cost of these general-purpose filters makes them especially suitable for higher-volume production-assembled equipment such as computer peripherals, cash registers, credit card verifiers, electronic service instruments, etc.

Series JX5100 Filters are designed to protect equipment from line noise as well as to protect the line from equipment noise, particularly equipment with high impedance loads. Smaller in size than many filters with comparable performance, they control line-to-ground interference with a high degree of efficiency. Filtering both sides of the line, the need for two filters is eliminated.

Available in a wide variety of current ratings (1 to 30 amps) and several different terminal configurations, Series JX5100 Filters withstand a test voltage of 2100 VDC, assuring protection against high-voltage transients. Line-to-ground capacitance is only .01 μ F, and maximum leakage current (each line to ground, @115V, 60Hz) is 0.5mA.

Sprague maintains complete testing facilities for all commercial, industrial, and government interference specifications.

For complete technical data, write for Engineering Bulletin 8210.11 to: Technical Literature Service, Sprague Electric Company, 35 Marshall Street, North Adams, Mass. 01247.



THE BROAD-LINE PRODUCER OF ELECTRONIC PARTS

40 years ago

From the pages of Electronics, September, 1934

Commercial facsimile

The facsimile transmission of photographs is being made ready on a large scale for several nation-wide newspaper groups. Early in the year the Associated Press announced that the Western Electric Co. would build for it twenty-six photo-transmitting and receiving units, to be installed at twenty-six principal cities, each unit capable of transmitting to the rest of the system, a picture 12 by 17 inches, the picture detail to be 100 lines to the inch. It is understood that a considerable part of this apparatus is now ready for installation and will be in regular service by the end of the year.

The receiving equipment is understood to be of the daylight type, so that the machines operate in an ordinary room. Standard photocells are modulated by the reflected recording light beam, through light choppers. Synchronization is effected by tuning forks in fixed-temperature containers at each point. At the receiving end, light-gates of the motion-picture type in turn modulate the light-beam projected on the sensitized paper. A full 17-by-12-inch picture can be sent in 17 minutes, with a picture rate of one inch per minute, and a top frequency of 2400 cycles per second.

New things for radio

At present it seems that high fidelity will not create much of a stir. 1934-1935 will be "all-wave" years in the chronology of the industry. High fidelity must take its winnings later, if ever. The chances are that high fidelity will be a slow process creeping into all phases of the industry. As soon as some really high class sets come on the market, others will try to get sufficient fidelity into cheaper sets to create competition—and all this will serve to better the general run of receivers, now admittedly poor. This fall many receivers will mark new low-water marks in freedom from harmonic distortion, in power output, and in wide range of tone. The higher frequencies will be improved somewhat—but probably not much.

How to multiply your draftsmen's time.

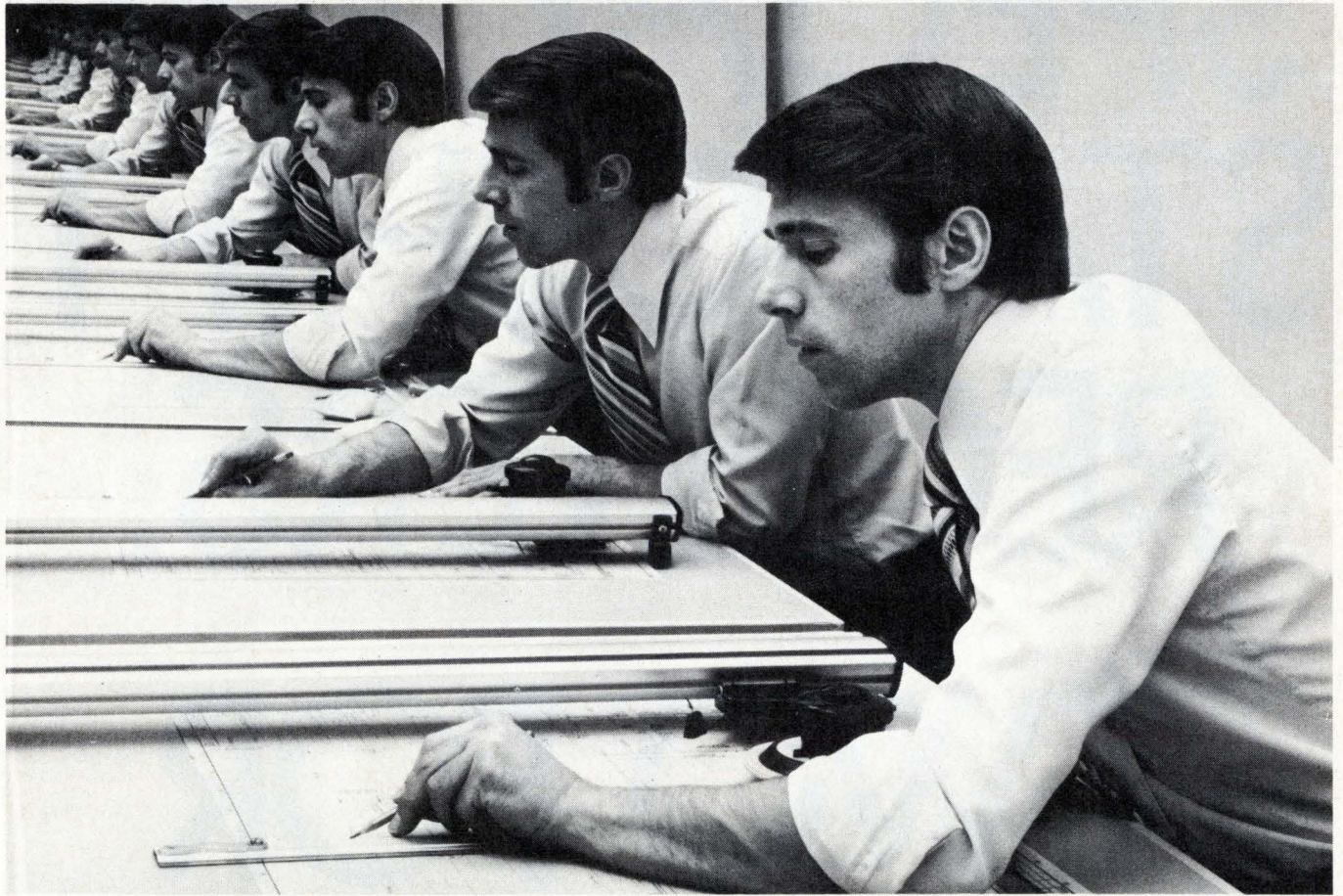

Shortcuts from Kodak turn drafting hours into minutes—on job after job.

Routine redrawing chores take a lot of valuable board time. Kodak can show your draftsmen how to restore drawings, make revisions, and handle repetitive elements—without redrawing. You'll save hours of drafting time and save money, too.

It's easy, because it's done photographically! We'll explain how to do it and help you select the proper Kodagraph films and papers for your particular work. And we can show you how, with an automated Kodak

processor, you can get reproductions back to your draftsmen faster, to save even more time.

There are other ways that Kodak can help multiply your draftsmen's efficiency. Microfilming your drawings will make them more accessible, save filing space, provide security, and give you other benefits, too.

Get the details.

For additional information write: Eastman Kodak Company, Business Systems Markets Division, Dept. DP792, Rochester, N.Y. 14650.

Kodak products for drawing reproduction.



**SPECIAL ON
STATIC SHIFT
REGISTERS:**

**TWO FOR
THE PRICE OF
NONE.**

We really want to sell you our MOS static shift registers. They're AMD-approved, alternate-source versions of many of the best parts now on the market. Each is processed to MIL-STD-883. Each is available for immediate delivery.

We know how much better our static shift registers are. And now we've come up with a no-cost way for you to know too.

Here's the deal: Check out our new family of MOS static shift registers. Then,

check off any two devices and we'll send you a free sample of each to have, hold and test for yourself. (If you'd prefer, we'll send you two free samples of any single device.)

If you don't need any samples, if you're ready to buy now, do it. But if you'd like a free look, just fill out the coupon and mail it to Advanced Micro Devices, the next giant.

AMD People: Why should I take your word for it when I can take my word for it instead? Please rush me free samples of the following:

(Instructions: Check any two boxes for a free sample of each. If you prefer two samples of any single device, write "2" in the box.)

Dual 128-Bit Static Shift Register

- Am2814 (TMS3114)
Data Rate 2.5 MHz
- Am2810 (MK1002)
Data Rate 2.0 MHz

Quad 128-Bit Static Shift Register

- Am2855 (MM4055/5055)
Data Rate 2.5 MHz

Dual 256-Bit Static Shift Register

- Am2856 (MM4056/5056)
Data Rate 2.5 MHz

512-Bit Static Shift Register

- Am2857 (MM4057/5057)
Data Rate 2.5 MHz

1024-Bit Static Shift Register

- Am2833 (2533, TMS3133, MM5058)
Data Rate 2 MHz

Name _____ Company _____

Address _____

City _____ State _____ Zip _____

Mail To:

Advanced Micro Devices 

**MOS
MAINSTREAM**

Corporate offices are at 901 Thompson Place, Sunnyvale, California 94086. Telephone (408) 732-2400 or toll free from outside California (800) 538-7904/Southern California office: Beverly Hills (213) 278-9700/Mid-America: Oak Brook, Illinois (312) 323-9600/Edina, Minnesota (612) 835-4445/Eastern United States: Roslyn Heights, New York (516) 484-4990/6806 Newbrook Ave., E. Syracuse, New York (315) 437-7546/Baltimore, Maryland (301) 744-8233/Lexington, Massachusetts (617) 861-0606/Britain: Advanced Micro Devices, Telephone Maidstone 52004/West Germany: Advanced Micro Devices, Munich, Telephone (089) 53 95 88. Southern Europe: Advanced Micro Devices, S.A., Neuilly, France, Telephone: 747-4194. Distributed nationally by Hamilton/Avnet, Cramer and Schweber Electronics.

Ride down faster with Intel's

Intel's 2107A n-channel 4K RAM family is your ticket to the fastest, smoothest ride down the cost curve for dynamic MOS memories. You can start right now for a mere \$12.

2107A 4K RAM FAMILY				
PART NO.	ACCESS (ns MAX)	READ CYCLE (ns MIN)	WRITE CYCLE (ns MIN)	AVAILABILITY
2107A-8	420	690	970	Now
2107A-4	350	570	840	Now
2107A	300	500	700	Now
2107A-1	280	450	550	Oct.

At only \$12 in 100-up quantities, the new 2107A-8

has already set a new low in 4K RAM prices. It's available now from stock at Intel distributors and in OEM volumes direct from Intel. But if you prefer to begin with only one at \$12, use the ticket.

Your system overhead costs will plunge, too. The 2107A family cuts system overhead costs in half, compared with 1K RAMs.

Furthermore, your system design will stay on the right track — with standard 22-pin packages and standard supplies. The industry has already accepted the 2107A's pin configuration and +5, -5 and +12V supply levels.

That's understandable. The 2107A provides all the system economies of a fully decoded, single clock, TTL compatible, standard voltage 4K RAM. A designer who detours to a 16-pin package to save a little board area, for example, runs into double clocks, extra logic and other drawbacks.

The 2107A allows 32 kilobytes to be stored on one small card which dissipates barely 4 watts.

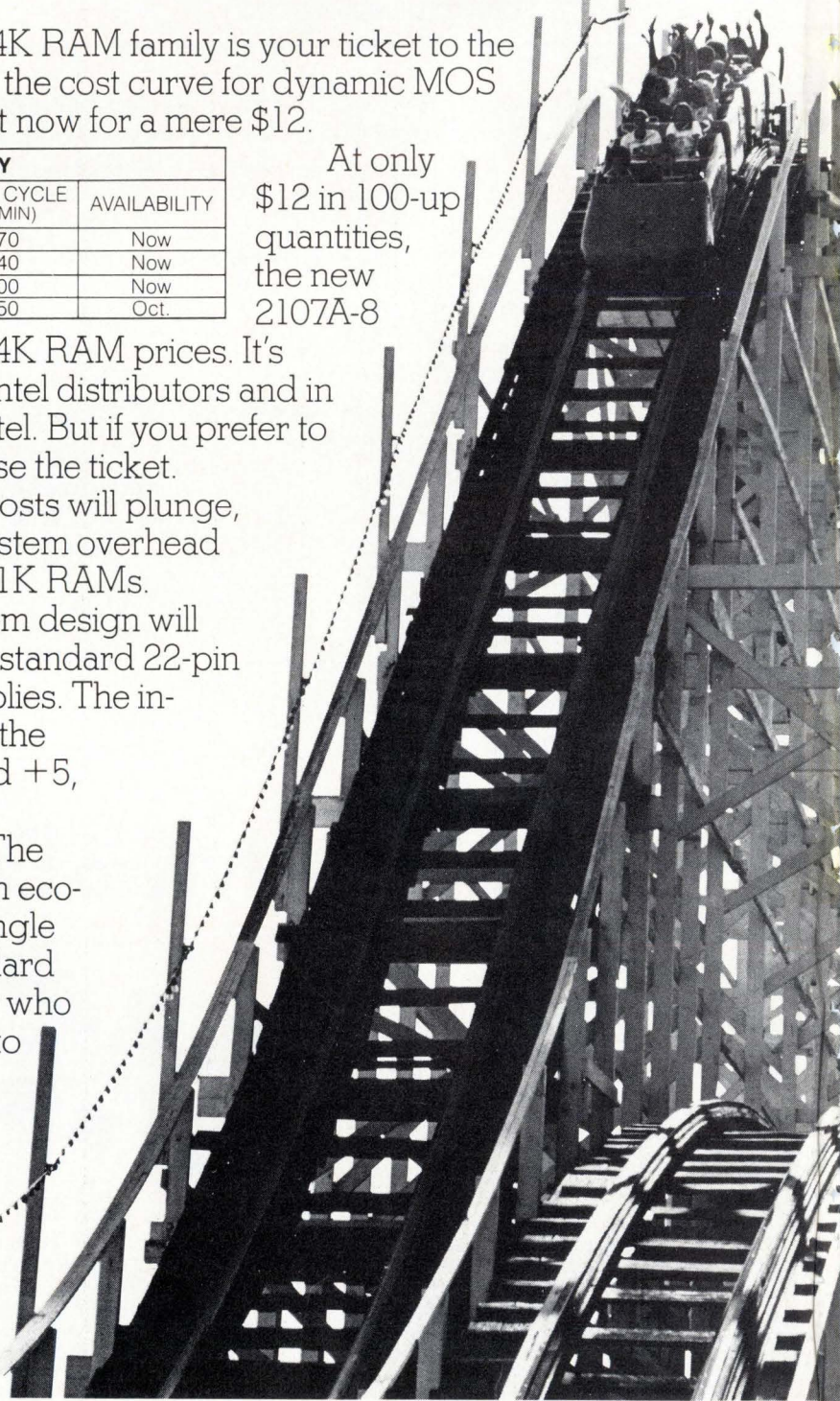

the 4K cost curve \$12 RAM.

In addition this new 4K RAM has been specifically designed for ease of use with battery backup. For systems that require maximum battery life, all versions of the 2107A may be ordered with a special low power data retention option.

Other exciting advantages of the 2107A include a choice of the right speeds, extremely low input capacitance, very comfortable $\pm 1V$ clock margins, readily available support components and, of course, Intel's n-channel production power.

For economical support, Intel's 3210 provides four address drivers and one clock driver in a single package, while Intel's 3404 buffers six output data bits.

Nobody is further along the n-channel production curve than Intel, and nobody makes a smaller 4K RAM chip (which assures you competitive pricing for years to come).

So start off by taking the 2107A-8 ticket to the nearest Intel distributor. It's good for one 4K RAM at \$12. Plus a free 3210 driver as a bonus if you act right now. And write us for the new 2107A application note that shows how to cut system overhead in half. Then, when you're ready to move faster down the memory cost curve, we'll ship you all the 4K RAMs you want at whatever speed you need. Now.

LOW POWER DATA RETENTION OPTIONS		
PART NO.	ACCESS (ns MAX)	STANDBY PLUS REFRESH POWER
2107AL-8	420	1 μ W/bit MAX
2107AL-4	350	1 μ W/bit MAX
2107AL	300	1 μ W/bit MAX
2107AL-1	280	1 μ W/bit MAX

Intel Corporation, 3065 Bowers Avenue, Santa Clara, California 95051 (408) 246-7501. Distributors: Almac/Stroum, Cramer, Hamilton/Avnet, Sheridan Sales.

intel® delivers.

NO DELAY IN SUPPLYING DELAYS!

New, increased production capacity now permits greatly improved shipping schedules on any ELECTROMAGNETIC DELAY LINE in our catalog...including modifications of standard items!

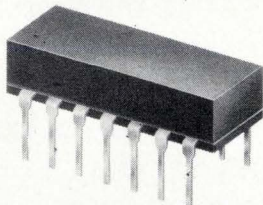

- DIPS (12-16-24 pin)
- LUMPED CONSTANT
- DISTRIBUTED CONSTANT
- VARIABLE
- MINIATURE
- SUBMINIATURE
- MODULAR

Prototype
2-3 week delivery

•

Production Orders
6-8 week delivery

*Complete engineering
handbook available.*

Call our hotline for prompt
service and delivery.
(201) 374-3311

RCL

ELECTRONICS, Inc.

General Sales Office:
700 So. 21st Street
Irvington, N. J. 07111

People

World standards
his special mission



Standards bearer. Podolsky wants more Federal support for standards.

Leon Podolsky has a complaint. He says the U.S. is one of the few countries in the world in which the Government does not appropriate funds for work aimed at establishing national engineering standards. Podolsky is in a better position than most of us to appreciate that. He is the new, unsalaried head of the U.S. National Committee of the International Electro-technical Committee, the organization that tries to set international standards for electronics.

Lately, however, Podolsky has been looking forward to a change in the situation. Provisions of the International Voluntary Standards Cooperation Act (HR 7506), now before Congress, would allow the Department of Commerce to provide up to \$1 million in subsidies to international standards bodies, including IEC.

Electronics man. The 63-year-old Podolsky is the first president in the 70-year history of the National Committee to have spent his career in electronics. Associated with the committee for 24 years, he was with Sprague Electric Co. of North Adams, Mass. for 29 years. He started as a consultant in the Resistor division, became its research director, and moved on to a variety of assignments before becoming assistant to the president. This posi-

tion gave him "an opportunity to look into everything, he recalls, including national and international standards." He left Sprague in 1967 to form an independent consulting firm.

Partly as a result of Podolsky's urging, the IEC meeting this month in Bucharest, Rumania, will consider a method for certifying the quality of electronics components. All passive and active components would be covered. If manufactured to this standard, they could move freely from one country to another without the need for additional testing and inspection. But Podolsky is also concerned about what he feels are protectionist standards. In particular, he cites a proposal introduced to the IEC by a Western European group. The group itself would certify parts and manufacturers within its geographic area. If adopted, Podolsky says this proposal might act as a nontariff barrier against U.S. and other companies. Fostering greater awareness of such developments is the chief role Podolsky sees for the U.S. National Committee of IEC. "Soundly based engineering standards," he argues, "should open the marketplace to participation by everyone."

Micro chief sits
atop growth surge

The newly appointed general manager of the Microelectronics division of Hybrid Systems Corp., Alan S. Esbitt, is confident about his job. "I can work well in the area of expansion," he says. And Hybrid is certainly expanding. Last October the company, located in Burlington, Mass., bought Sprague Electric's thin-film division in Worcester, Mass., which at that time had an annual volume of about \$3 million. Now, almost a year after the acquisition, Esbitt has been installed at the helm and the division is said to account for a volume of \$5 million to \$6 million—at least half of Hybrid's total sales.

To encourage and direct this growth, Hybrid wanted someone

BURROUGHS DISPLAYS

CAN TAKE IT!

Burroughs gas discharge display panels are designed to stand up under the toughest operating conditions of shock, vibration, humidity, and temperature extremes ranging from -40° to over $+185^{\circ}$ F. Burroughs display panels are capable of withstanding the real-world conditions so often encountered in automotive, aircraft, instrumentation, consumer, and industrial applications.

SELF-SCAN[®], PANAPLEX[®], and SELF-SCAN BAR GRAPH displays have no moving parts, no internal welds, and require a minimum of external connections (only 8 connections for a dual SELF-SCAN BAR GRAPH, 16 connections for a 16- or 32-character SELF-SCAN display, and 17 connections for a full 9-digit PANAPLEX display). Gas-discharge technology has proven long life through years of rugged use.

These bright, sharp, clear, high-contrast displays are a pleasing neon-orange color, making them a comfortable display to read, even for extended periods of time.

SELF-SCAN display panels are the ideal man-machine links for displaying 16 to 256 alphanumeric characters for information display systems.

PANAPLEX display panels are for 4 to 16 numeric character applications, and can include arithmetic symbols and alphanumeric characters for systems requiring constant or intermittent display of data, such as calculators, clocks, and recording instruments.

SELF-SCAN BAR GRAPH analog displays present information in analog form with digital accuracy for the measurement and display of speed, torque, temperature, pressure, force, acceleration, and other control or information parameters.

SELF-SCAN, PANAPLEX, and BAR GRAPH display components are attractive, easy to read, compact, versatile, and are ideally suited to the new generation of information display requirements.

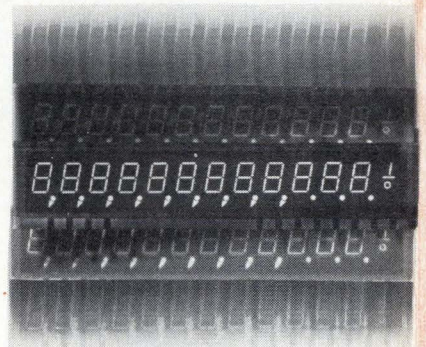

For complete technical details and applications engineering recommendations, write or call Burroughs Corporation, Electronic Components Division, P.O. Box 1226, Plainfield, N.J. 07061 or call (201) 757-3400 or (714) 835-7335 in California.

Burroughs



Circle 15 on reader service card

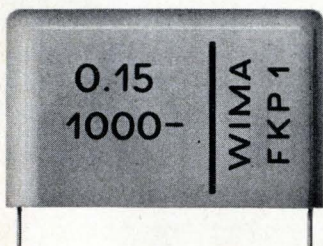
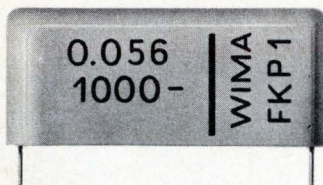
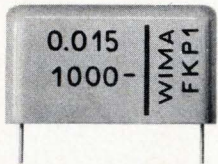
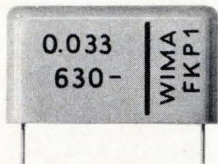
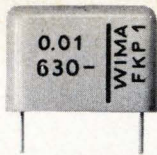

WIMA FKP 1

**Self healing
polypropylene
capacitors
with the
lowest losses
for high
current duties**

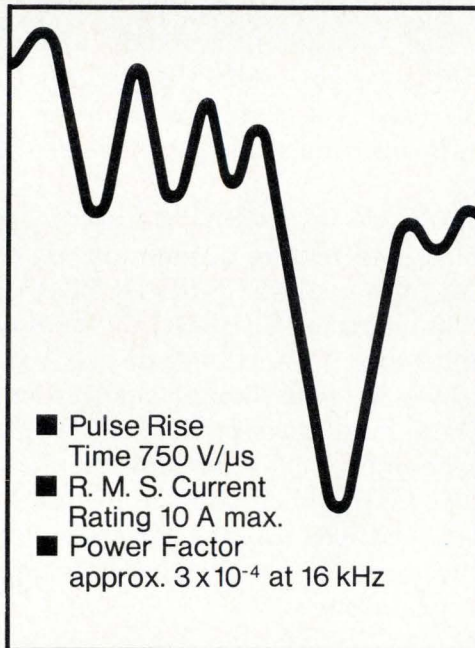

The unique capacitor designed for thyristor deflection circuits in colour television sets. Proven in leading TV models and in solid state equipment.

Write for our new catalogue!

WILHELM WESTERMANN

Spezialvertrieb
elektronischer Bauelemente
D-68 Mannheim · Fed. Rep. of Germany
Augusta-Anlage 56 · P.O. Box 2345
Tel.: (06 21) 40 80 12

People

with broad experience in research and production and a strong background in integrated circuit technology. Esbitt, a 38-year-old Ph.D. in physical chemistry from Harvard, has spent most of his career in the semiconductor field and seemed to fill the bill. For 10 years he was engineering director for the Component division and later operations manager of the MOS division at General Instrument Corp. For the past three years he was general manager of the Components division, Transitron Electronics Corp.

Esbitt seems to like the challenge of a small but growing company. He thinks the Microelectronics division at Hybrid Systems will continue to grow fast, noting that while semiconductor chips are becoming more complex the end user wants more complex systems. The market for hybrid circuits is in the gap between chips and systems.

Esbitt's division makes high reliability thin film circuits, resistor chips and networks. And it recently introduced what it claims is the first 12-bit IC digital-to-analog converter. More 'symbiotic' products, combining the circuit design capability of hybrid systems and the thin film processes of the microelectronics division, are on the drawing board—the result of a centralized engineering department, Esbitt says.

Materials are another area of major interest. The company is investigating new thin-film materials that can provide higher resistivity than heretofore available. Esbitt is also looking at the idea of developing a process to deposit thin films on new substrate materials. The combination could lead to hybrid circuits in other frequency ranges, particularly in applications to cable television. New materials could also lead to more complex resistor networks, as well as to lower-cost resistors.

As the division expands, Esbitt says he would prefer to bring in experts in particular technologies rather than starting in new areas from scratch. Otherwise he is satisfied with the basic organization, saying he wants to make each department manager totally responsible for the operation of his department.

The first modular instrumentation calculator.

Just \$5945 as shown.

It's our 31/53 Data Acquisition System with DM 501 and DC 503.

A powerful, yet inexpensive calculator combined with our 153 Instrumentation Interface and system software. You add the instrumentation modules you need. It's all there and it's portable. Now that's versatility!

With our 31 Calculator, you can read input from our DM 501 and/or DC 501, 502, 503 counters. You can log data selectively, calculate results and output data or trigger signals.

Programming? Little more than natural math. Go ahead, write your own. Also, our standard software gives you data logging (on the optional alphanumeric printer) and data capture on the 31 at operator selected intervals.

Dealing with complex variables? Then label 24 keys with personal functions on the user-definable overlay.

Energy monitoring. Quality control testing. Laboratory and production instrumentation. The applications go on, and so does our system's potential. Just add the main-

frames and modules you need. We have a graphic calculator system, too. Let our sales engineer fill you in. Pick up your phone and call our nearest center. Or write: IDD Calculators, P.O. Box 500, Beaverton, Oregon 97077.

Our programmable calculators. Natural. Powerful. Significantly less expensive.



For a demonstration circle 187 on reader service card

Circle 17 on reader service card



Your problem is data input and storage. The answer is ready to ship.

The TU60 cassette mag tape system. Proven. Reliable. Priced at \$1600 in quantities of a hundred.

Maybe you're storing numerical control data, communications messages, or data logged from instruments.

Maybe you're involved with program development, file searching, or remote control storage.

Or maybe you want to store your data in small, rugged, portable packages.

The TU60 cassette mag tape system is the answer.

We designed the TU60 specially for accuracy and reliability.

The mechanics are simple and sturdy: the TU60 is tough. Its extra-heavy 1 mil tape resists stretching and edge wear; it's spec'd at 1000 passes, with a typical life of 6000. Reel-to-reel drive and servo-controlled motors give smooth, easy starts and stops, with no capstans, pulleys or pinch rollers that could damage tape.

Power variation or mechanical difficulty won't cause mistakes either: the read electronics adapt to tape speed. Each data record is terminated with 16 bits of cyclic redundancy checking. The machine reads even very low data levels, yet rides right over any noise between the data blocks. Other error reducing features include automatic leader detection and single-track low-density recording.

With an error rate ten times lower than that of most other systems, the TU60 is a machine you can count on.

Maintenance is rarely necessary. When it is, it's no problem. The top flips open, everything is acces-

sible, and the two main modules can be replaced in minutes.

The TU60 is easy to interface to any major minicomputer — if you want, we'll even design and manufacture the interface for you.

And compared to paper tape, the TU60 is easier to handle, less messy, and a lot more versatile. (Ever try to erase a hole?)

Look at the price: \$1600 each in quantities of a hundred. Low? Low.

So pick up the phone and dial 800-225-9480. Toll-free from 8:30 AM to 5:00 PM your time.

(US only. Massachusetts residents, please dial (617) 481-7400, extension 6653.)

We're the Components Group of Digital Equipment Corporation, One Iron Way, Marlborough, Massachusetts 01752.

In Canada: Digital Equipment of Canada Limited, P.O. Box 11500, Ottawa, Ontario, K2H8K8. (613) 592-5111, extension 154.

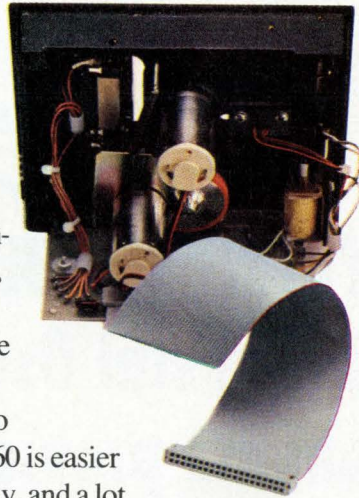

digital
COMPONENTS
GROUP

**Unbundling the world's most
popular minicomputer systems.**

NEW!

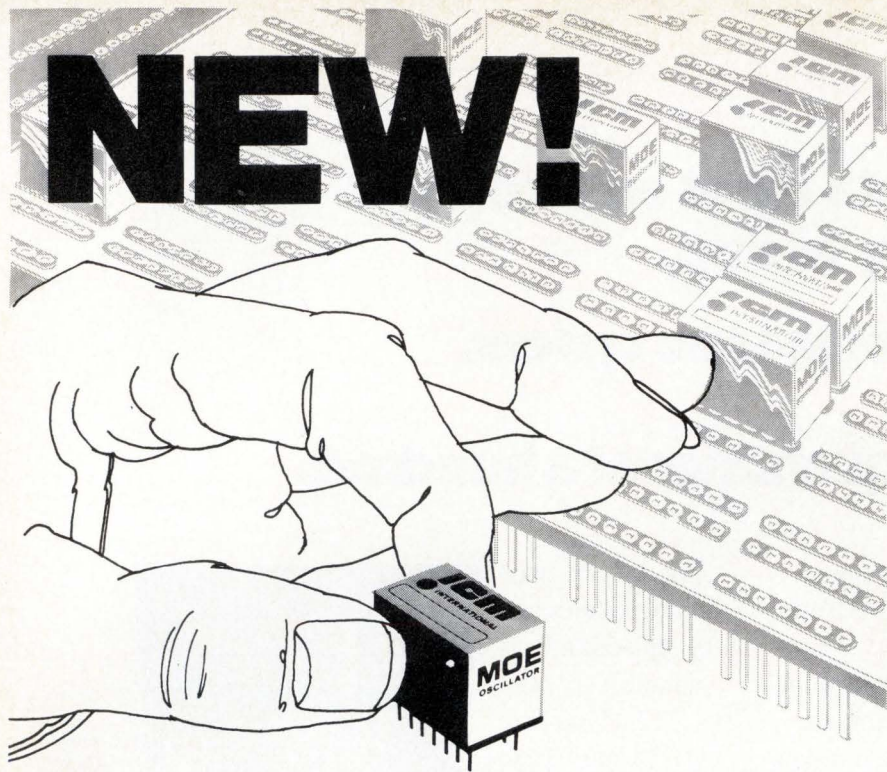

INTERNATIONAL'S MOE Crystal Oscillator Elements provide a complete controlled signal source from 6000 KHz to 60 MHz

The MOE series is designed for direct plug-in to a standard dip socket. The miniature oscillator element is a complete source, crystal controlled, in an integrated circuit 14 pin dual-in-line package with a height of 1/2 inch. Oscillators are grouped by frequency and temperature stability thus giving the user a selection of the overall accuracy desired. Operating voltage 3 vdc to 9 vdc.



TYPE	CRYSTAL RANGE	OVERALL ACCURACY	25°C TOLERANCE	PRICE
MOE-5	6000KHz to 60MHz	+ .002% -10° to +60°C	Zero Trimmer	\$35.00
MOE-10	6000KHz to 60MHz	+ .0005% -10° to +60°C	Zero Trimmer	\$50.00

Meetings

Western Electronic Show and Convention (Wescon), IEEE, Los Angeles, Sept. 10-13.

Broadcast Symposium, IEEE, Washington Hotel, Washington, D.C., Sept. 19-20.

International Broadcasting Convention, IEEE et al., Grosvenor House, London, Sept. 23-27.

International Conference on the Technology and Applications of Charge-Coupled Devices, University of Edinburgh, Centre for Industrial Consultancy and Liaison, et al., Edinburgh, Sept. 25-27.

Minicomputers in the Factory, New York Management Center, Delmonico's Hotel, New York, Oct. 7-8.

Eascon '74, Electronics and Aerospace Systems Conference, IEEE, Marriott Twin Bridges Motor Hotel, Washington, D.C., Oct. 7-9.

Tenth Annual International Telemetry Conference, EIA et al., International Hotel, Los Angeles, Oct. 15-17.

National Electronics Conference, sponsored by the National Electronics Conference Inc., Oak Brook, Ill., Hyatt Regency O'Hare Hotel, Chicago, Oct. 16-18.

1974 Symposium of the International Society for Hybrid Microelectronics, Montgomery, Ala., to be held at the Sheraton-Boston Hotel, Boston, Oct. 21-23.

ISA Conference and Exhibit, Instrument Society of America, Pittsburgh, Pa., to be held at New York Sheraton Hotel and New York Coliseum, Oct. 28-31.

Nerem-74, Northeast Electronics Research and Engineering Meeting, IEEE, John B. Hynes Veterans Auditorium, Boston, Oct. 29-31.

International Symposium on Information Theory, IEEE, Notre Dame, Ind., Oct. 27-31.

HD/CMOS
is a proprietary
process which made
CMOS practical
for custom
large-scale integration.
We invented it.

**We sell more than circuits.
We sell solutions.**

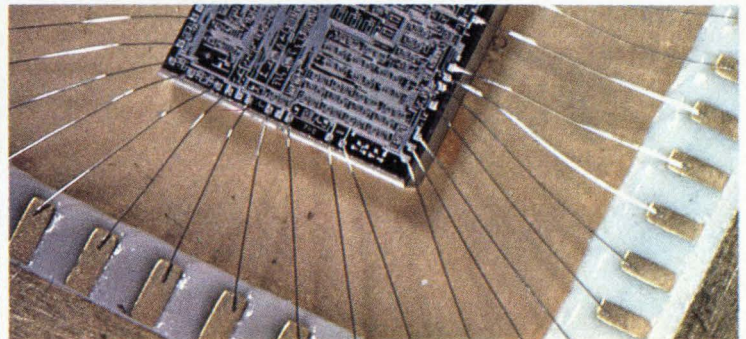
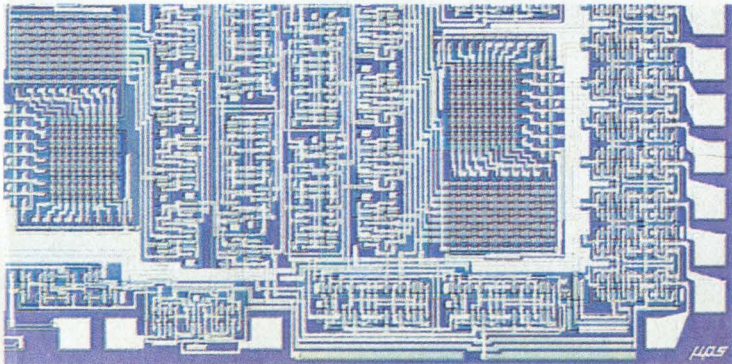

MICRO POWER SYSTEMS

3100 Alfred Street, Santa Clara, CA 95050
Telephone (408) 247-5350

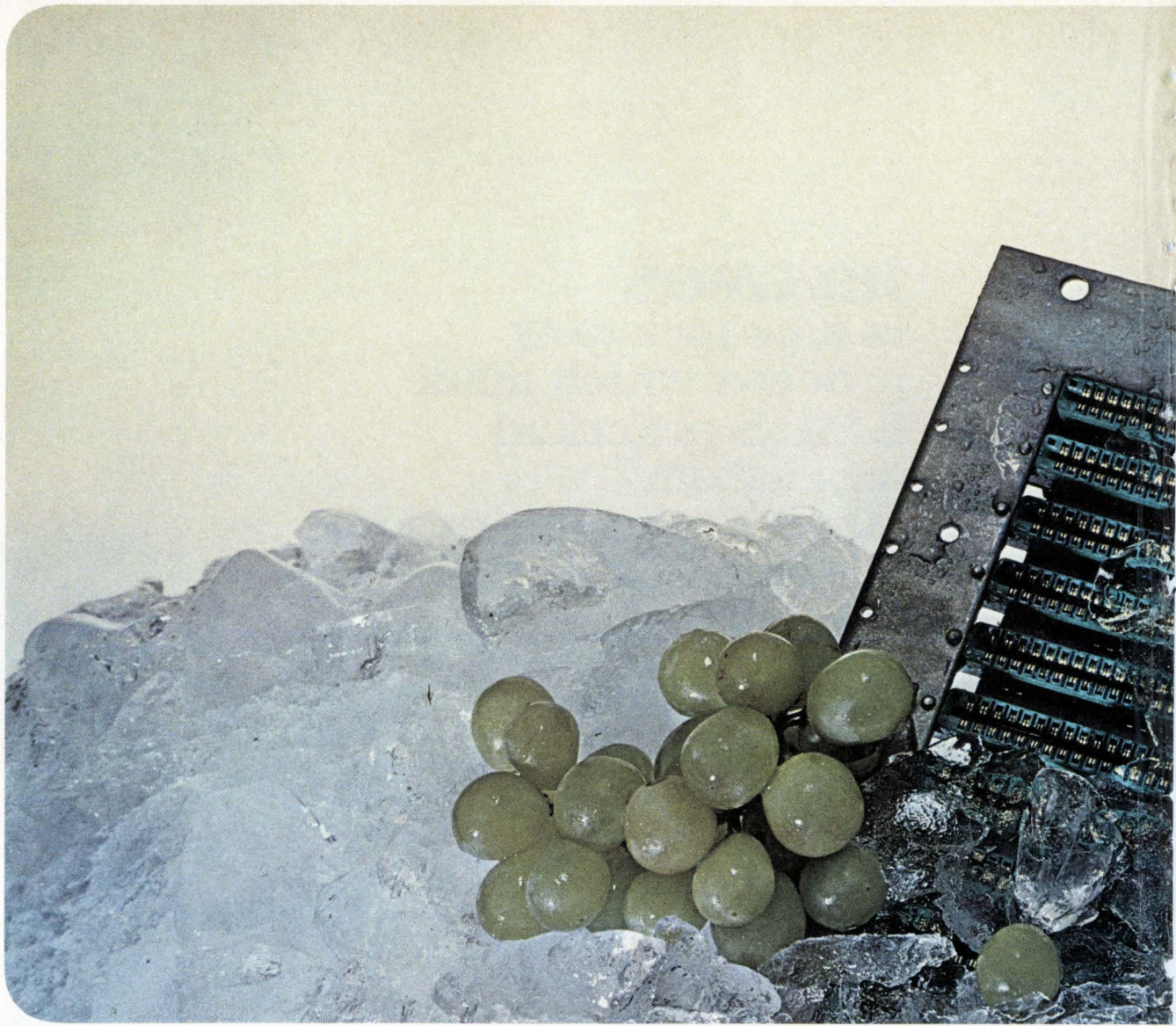

The fresh, new approach to Advanced System Design...

**Winchester Electronics
Back Panel Packaging**



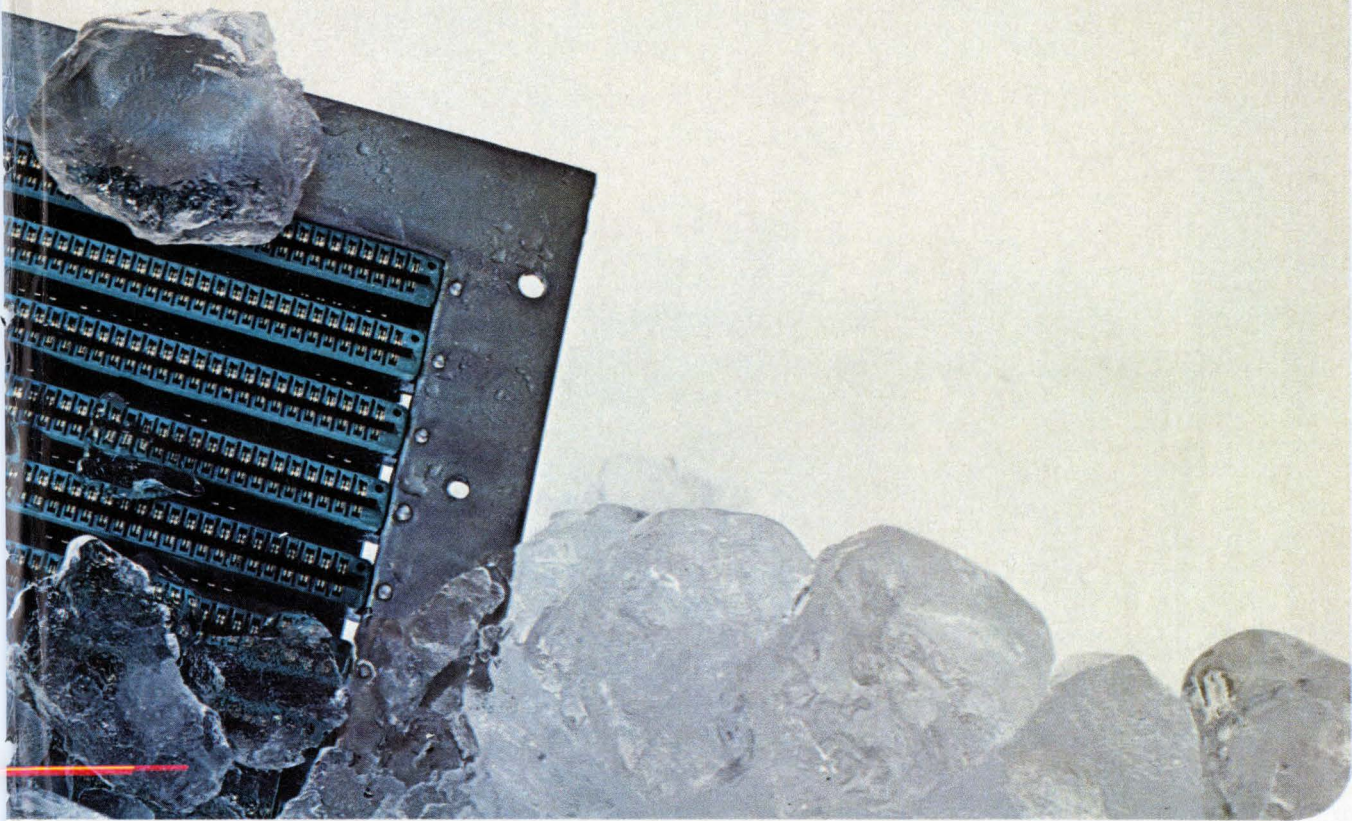

You can turn a trickle of an idea into a cool, fresh achievement. You can do it in not just one, but in 3 basic ways to suit your design, production and applications needs.

That's Winchester Electronics Back Panel Packaging . . . the fresh, new approach to advanced system design.

Above is Winchester Electronics Metal Frame Back Panel Packaging. The way to go when production runs are limited, when design changes, circuit modifications, additions or function variations are in the cards. To help, you'll find an abundant compatible array of printed circuit, input/output and other discrete connectors available off-the-shelf. With the contact termination and grid spacing requirements you want.

The same scope holds true for Winchester Electronics Metal Plate and Printed Circuit Back Panel Packaging, too.

To all these elements, add the comprehensive, in-depth experience of Winchester Electronics itself. Applications-oriented engineering . . . ideas, capabilities, production know-how and facilities to help you *design-by-specifying*. From custom back panels to complete packaged systems. Assembled panels, interconnections, components, wiring, card cages . . . exactly what you specify to meet the cost/performance requirements you want.

Winchester Electronics Back Panel Packaging. It will speed your designs, production capabilities and competitive success. Write now for our new Winchester Electronics Back Panel Packaging Handbook. You'll like the story it tells. Winchester Electronics Division, Main Street & Hillside Avenue, Oakville, Connecticut 06779 (203) 274-8891.



WINCHESTER ELECTRONICS

Litton

You don't have
to give up
carbon composition
performance to
save space.

If you're really
serious about cost,
be serious about quality.

Are you cramped for board space but not in power handling capabilities? Is reliable performance vital? Then use Allen-Bradley 1/8 watt carbon composition resistors. Get the pulse handling and overload capabilities that are superior to resistors manufactured by other technologies. Exclusive hot molded construction for a

dense resistance element which reduces noise, and results in a consistent performance. Most importantly, our 1/8 watt resistors have all of the quality and reliability common to our larger sizes. Quality that really can cut your fixed resistor costs. If you think resistors are identical, write for "7 Ways to Tell the Difference in

Fixed Resistors." Available from your Allen-Bradley Electronic Distributor, or: Allen-Bradley Electronics Division, 1201 South Second Street, Milwaukee, Wisconsin 53204. Export: Bloomfield, N.J. 07003. Canada: Allen-Bradley Canada Limited, Cambridge, Ontario. United Kingdom: Jarrow, Co. Durham NE32 3EN.

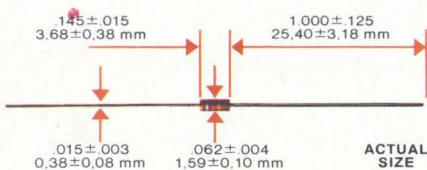

ALLEN-BRADLEY
Milwaukee, Wisconsin 53204

Circle 24 on reader service card

Harris to show remote processor

In its first major hardware announcement since it was acquired by Harris Corp. two years ago, **Harris Data Communications division will unveil next week a remote communications processor** that it hopes will expand its business substantially beyond the remote-batch-terminal market it now serves. Dubbed the Cope 1600, the system's mainframe architecture—which includes a 104-instruction set—allows remote-job-entry configurations, as well as data collection, inquiry response, and satellite-communications tasks. In addition, it's designed to interface with two or more host processors simultaneously.

Besides being a powerful mini built for distributive-data-processing applications, the modular system appears to be **the first terminal system built with SDLC-compatible hardware**; software will be incorporated when IBM defines its synchronous data link control (SDLC) software in mid-1975.

AMI to make Motorola processor

Motorola's microprocessor family, due for formal introduction and volume production in early November, should get a substantial boost as **the first microprocessor to have a second source**. American Microsystems Inc. will get masks for the parts from Motorola; it already uses the same n-channel process, since the Motorola processor uses a jointly developed 4,096-bit random-access memory. Motorola is now delivering the first production sample parts; earlier samples were from preproduction lines and had minor problems. The first parts available will be the microprocessor itself, a peripheral interface adapter, a synchronous interface adapter, and a 1,024-bit RAM and a 1k ROM.

H-P scope houses microprocessor

Hewlett-Packard is about to introduce a 275-megahertz dual-channel oscilloscope **with a built-in microprocessor**. The instrument, called the model 1722A, also boasts a 3½-digit light-emitting diode display. This will give direct digital readout of interval, frequency, dc voltage, instantaneous voltage, and relative amplitude expressed in percent. Use of a microprocessor, says H-P, will mean accurate measurements on narrow time intervals, particularly on low-repetition-rate signals. And, the company adds, at a price of \$4,500, the new scope **will cost about \$2,000 less than comparable models**.

4-k RAMs are on schedule

Cutting through the claims and confusion surrounding the 4,096-bit RAM is the simple fact that production levels of the high-performing part are pretty much what experienced observers had predicted all along: low production (under 1 million units) at high prices (\$15 to \$20) in 1974; moderate levels (10 million) at more attractive prices (\$10) from an assortment of manufacturers in 1975; **building to very high volume (over 25 million) at low prices (\$6 to \$8) from a few surviving manufacturers in 1976**. Indeed, it's at the \$6 to \$8 level that mainframe makers will finally give up core, and then volume will soar; until then, the part will mostly be a micro- and minicomputer component.

As for volume production levels, TI, Intel, and Mostek lead the suppliers. After some well-publicized yield problems TI is back onstream with its 300-nanosecond product. TI won't release production numbers,

but Ed Huber, market manager of the 4-k RAM, flatly states that it's largest volume producer of the 4-k RAM, "and we've read all the estimates." In July, TI began shipping to distributors, as well as major OEMs, so **the part is now available to the small users as well as large ones.** Berry Cash, Mostek vice president, says that his company is shipping at a steady monthly level of 20,000 pieces, while Intel expects to ship about 400,000 units by the end of the year, mostly the slower and cheaper 2107A version. The faster Intel 2107B will grow in volume toward the end of this year, replacing the A version during the first half of 1975, say Intel spokesmen.

Silicon Valley layoff impact still light . . .

Layoffs in the semiconductor industry have thus far ranged between 1% and 10% and have generated rumors in Silicon Valley of more to come. However, the facts are that there have been no massive furloughs, and that **in most cases the personnel affected are "overhead"**—technicians, R&D engineers, clerical workers, supervisors, and middle-level managers. In a few cases, there have been reduced R&D efforts or selective layoffs of production workers. Experts stress that this comes after two years of unprecedented growth.

Memory makers seem to be in the best condition. Where the market for digital ICs seems to be declining, says Edward Gelbach, marketing vice president at Intel, the growth of memory sales is receding **from "fantastic" to just above average.** "Instead of growth rates that will double each year," he says, "most companies in the memory business, ourselves included, will have to settle for 20% or 30%." He sees the first quarter of 1975 as the turnaround period as 4,096-bit RAMs and microprocessors reach volume production, with the rest of the semiconductor industry turning around a quarter later.

. . . as firms follow government rules and list totals

Nervous employees of semiconductor companies are having their heads filled these days with "inside" stories about unreported layoffs. But the Securities and Exchange Commission, which regulates the securities industry, has strict rules **forcing firms whose stock is traded publicly to report any significant change** in labor supply, turnover, or cost. Failure to report on a special form provided for the purpose within 30 days can result in a company's stock being suspended from trading.

With both Hewlett-Packard Co. and American Microsystems Inc. reporting no layoffs—H-P is doing replacement hiring only, while AMI has a hiring freeze on—and TI refusing to comment on rumors that it will furlough 1,700, here are layoff figures as given to *Electronics*:

Advanced Micro Devices, 50 out of 1,100 total; no production workers.

Fairchild Semiconductor, 200 to 400 out of 27,000; domestic cutbacks, primarily overhead; overseas cutbacks, primarily production.

Intel, 100 to 200 out of 2,200; no production workers.

Intersil, 50 to 80 out of 1,100, mostly nonproduction; will reassess at end of September.

Electronic Arrays, 35 to 40 out of 420 across the board.

National Semiconductor, domestic hiring freeze; 500 to 700 laid off overseas.

Signetics, 160 out of 8,000, 25 of them production workers.

We'll deliver 10,000 SCR's in three weeks.

Choose the plastic 2N5060 Series, or IP100 Series now available to 300V. Or the hermetically-sealed ID100 Series now available to 400V. Both with typical dv/dt capability of 75V/ μ sec.

Unitrode also offers many other low-level SCR's. The widest choice in the industry. The right SCR for your specific environmental requirements, at the right price. All part of a growing family of Unitrode plastic or hermetic SCR's designed for a wide range of sensing and control applications.

Place an order. We'll deliver 10,000 of any of the SCR's listed — in three weeks or sooner.

Write for our latest data sheets. Or for faster action, call Vin Savoie at (617) 926-0404.

Unitrode plastic or hermetic SCR's



Type			Blocking Voltage	Maximum Current, RMS	Gate Trigger Current I_{GT}	Gate Trigger Voltage V_{GT}	Holding Current I_{HX}
TO-92	TO-92	TO-18					
2N5060	IP100	ID100	30V	0.8A	200 μ A Maximum	0.8V Maximum	5mA Maximum at $R_{GK}=1K$
2N5061	IP101	ID101	60V				
2N5062	IP102	ID102	100V				
2N5063	IP103	ID103	150V				
2N5064	IP104	ID104	200V				
	IP105	ID105	300V				
		ID106	400V				

See Electronics Buyers' Guide Semiconductors Section for more complete product listing.

Circle 27 on reader service card

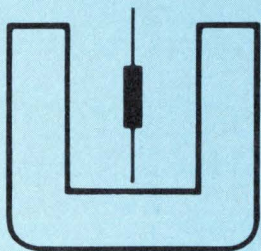

UNITRODE

580 PLEASANT STREET, WATERTOWN, MA 02172

We can't make supply problems go away. We can make them less of a burden to our customers.



closing the door on some attractive new business, we're willing to pay that price to preserve what we feel are our most important business relationships.

Called on our engineers to design around shortages wherever possible and to suggest acceptable alternatives wherever practical.

Asked our purchasing department to

search out new materials and new vendors, from around the world if necessary. And to work closely with long-term vendors in meeting our requested deliveries.

Instructed our salesmen to keep customers up-to-date on the copper/plastics picture, and insisted on complete honesty in their relaying information both ways.

We're realistic. We don't expect these steps to solve every material shortage. But they should help ease customer procurement problems.

At Brand-Rex, we're committed to filling every order we take. On time, or as close as it is humanly possible to be. Any time we do have a problem, we'll let you know what it is and what it's going to mean to you. And we'll do everything we can to make it less of a burden.

That's our pledge. It's a lot to live up to, but we think it's the least we can do. As time goes by, we'll try to find even better ways to serve you. And if I'm sure of anything, it's this: We can do it.

If ever there was a time for positive thinking about wire and cable availability, this is it. We all know the material problem. It's up to all of us to work around it. At Brand-Rex, anything we *can* do, we *will*.

Here are some of the things we've already done:

Organized a company-wide program to promote a "Yes We Can" attitude — asking all our employees to do everything possible to minimize customer inconvenience.

Set up systems which uncover customer purchase patterns. Purpose: Allow us to project future material needs. Result: the best possible service to existing customers, given the circumstances. While it may mean



Harry Wasiele, Jr.

Harry Wasiele, Jr.
President, Brand-Rex Company

Brand-Rex

Willimantic, Conn. 06226

Circle 28 on reader service card

Bedside processors handle intensive care in hospitals

Lower cost than mini-based systems is promised for patient-monitoring units with hard-wired, LSI controllers

Automatic, around-the-clock monitoring of patients' life functions by computerized systems has been a dream of the future to most hospitals. But centralized, minicomputer-based systems cost too much, and their failure could be catastrophic—it could shut down an entire intensive-care facility. But a new distributed-intelligence system, based on low-cost LSI microprocessors and hard-wired controllers, puts independent control elements at each patient's bedside.

Developed by Spacelabs Inc., Chatsworth, Calif., the Alpha Sys-

tem is already being installed at St. Joseph Medical Center in Burbank, Calif. It's also on order at the Mayo Clinic, Rochester, Minn., Massachusetts General Hospital, Boston, and Miami Heart Institute, says Spacelabs' vice president of product development, Donald J. Valiquette. He estimates it has a per-bed cost of \$6,000 to \$8,000 as against the \$12,000 to \$16,000 typical of mini-computer-based systems.

Medical bus. The Alpha system has a bus-oriented architecture. The independent system elements communicate through a parallel data bus—in this case, a 48-parameter time-division-multiplexed "medi-bus." Attached to it are a central monitoring unit, slave monitors, hard-copy displays, and the bedside units with their cathode-ray-tube displays. These last can function either on their own or as slaves to the

central monitoring unit in the hospital.

Into each bedside unit are plugged modules, called source cardules, which pick up analog data from the patient and digitize it. One monitors blood pressure, a second monitors heart-rate and performs electrocardiographs (ECGs). Other special plug-in cardules for tracking the parameters of respiration and temperature will become available next year. The cardule system uses hard-wired processors with programmable read-only memories and, in some cases, random-access memories needed to display alphanumeric symbols and waveforms.

In addition, two derived-param-

Monitor. Smallest of the bedside processors accepts four functional plug-ins. It's 21 inches wide, 7 inches high, with a 9-inch CRT.

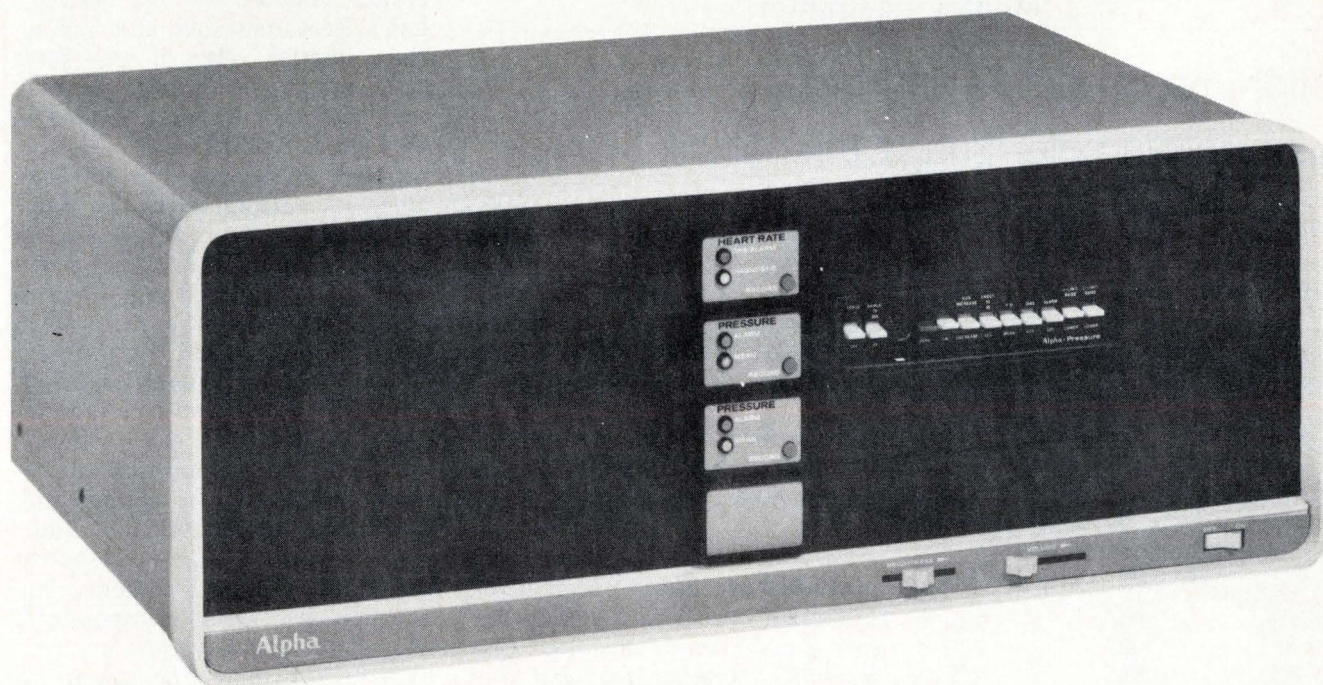

ter cardules are available, both of which use National Semiconductor Corp.'s IMP-16 microprocessors to interpret vital data right at the patient's bedside. One is the trend/graphics cardule, which uses the CRT to display trends in data it accumulates over periods of four, eight, or 24 hours. The other is the arrhythmia cardule, which analyzes a patient's ECG for irregularities that could precede heart failure.

Up to six traces can be shown on the displays. A 9-inch CRT comes with the smallest bedside unit, the one that accommodates four plug-ins. A larger unit that accepts eight plug-ins has a 14-in. CRT.

All cardules contain alarms that can be set to notify nurses if any bodily functions fail or change significantly. The alarms can also trigger remote hard-copy recording units to record a waveform for future analysis.

The bedside display, even when operating independently, can also communicate through the medi-bus with remote slave units or with displays at a central location. The central display enables nurses on the ward to watch traces and rates, plus receive alarms if anything unusual occurs. For fast identification, patients' names are read out on the

screen next to their traces. It's possible by flipping a switch to operate the bedside unit as a slave under central control.

Easy does it. Valiquette says that one of the major goals of the development was to make the equipment easy for nurses to use, since they cannot be expected to be programmers or electronic technicians. For that reason, the equipment has minimal controls—simple on-off toggle switches, for example, rather than more complicated potentiometers. "The users don't even know they are sophisticated instruments. They just turn them on," Valiquette says.

Spacelabs, which has been a manufacturer of patient monitors for a number of years, took as much advantage as possible of large-scale integration in developing the Alpha System. LSI microprocessors are used in the trend and arrhythmia cardules, and 1,024-bit and 4,096-bit random-access memories are used for such purposes as storing data so that adequate trace length—up to 16 seconds—can be presented. Although National microprocessors have been used in the first designs, others are also under consideration. Valiquette notes that the speed of the microprocessor is adequate since "most medical rates are slow." □

tested with conventional daylight cameras. And now ITT Electro-Optical Products division, Ft. Wayne, Ind., has developed the type of image intensifier the Air Force wants to reduce the size of the flash units and raise the altitudes at which the reconnaissance aircraft can fly. An electromagnetic image-amplifier tube with a diameter of 6.4 inches, it yields the resolution and contrast in the near-infrared 700-900-nanometer region needed for medium- to high-altitude night flights. And while some of the tube specifications—such as cathode sensitivity and gating times—have been achieved before, they have not been available in a tube large enough to completely fill the standard Air Force 4½-by-4½-inch film format.

The larger format is needed to retain a wide field of view with long-focal-length lenses required for image details at the medium and high altitudes. ITT's tube has a diameter of 162 millimeters. Earlier image intensifiers of this quality, usually electrostatically focussed types, have been 80 mm across or less. The present image amplifier is the last in a series of developments by ITT and upgrades a 144-mm version "that had gating problems, uniformity problems, and a relatively insensitive cathode," says Fred Farinet, project engineer at the Avionics Lab's Reconnaissance and Surveillance division. "But it was flown with enough success that we were convinced that we were headed in the right direction."

Better processing. For its large tube, ITT extrapolated the same techniques it had developed for smaller units. In particular, it developed methods for laying down a heavier but uniform multi-alkali photocathode needed for the near infrared. This incorporates a metallic antimony doped with cesium, sodium, and potassium.

Techniques also had to be developed for making a gating grid, mounting it, and holding it taut during the various bake-in steps required for the photocathode. The new tube, which also incorporates a fiber-optic faceplate, has a sensitivity of 25 milliamperes/watt at

Military electronics

Night recon gets a lift from a large-diameter image intensifier

Pilots in fast-flying aircraft on night-reconnaissance missions often hesitate to take more than three or four

passes at a target because the bright flares they use can turn their own aircraft into a target. To get around this, the Air Force Avionics Laboratory at Wright-Patterson Air Force Base, Ohio, is trying to develop a covert night reconnaissance system that combines invisible near-infrared flash modules with a camera containing a built-in image intensifier.

Filtered, electronic xenon flash modules have already been flight-

Point of pride. Avionics Labs' Fred Farinet holds image amplifier for night recon.



850 nm. Tube gain is 15, considered large for near-IR wavelengths.

Shuttering, or gating the system is extremely important, Farinet notes, to reduce backscatter and raise resolution and contrast. The amount of light reflected back from the atmosphere when the xenon flash is fired is reduced by waiting to turn on the tube after the light has left the plane but before it reaches the ground. ITT uses a metal grid or mesh behind the cathode and pulses it just positive of the photocathode's -16,000 volts to bring the amplifier to an on, in-focus condition. Gating electronics, which will turn the tube on or off in less than 0.2 microsecond, were developed by Venus Scientific Inc., Farmingdale, N.Y. Other electronics, including an image-motion compensation deflection yoke to allow longer exposure without blurring, were built by ITT's Aerospace Optical division.

ITT will deliver three image-amplifier tubes to the Avionics Laboratory next month, and the Air Force plans to start building a camera system based on the tube later this year. Night missions would probably be flown on aircraft such as the reconnaissance version of the McDonnell-Douglas F-4.

The high cost of the tube—about \$20,000 in quantity—should limit its nonmilitary applications. "Without the mesh gating, it would be useful for large-area astronomical work, or direct photography on a telescope," says Donald Ceckowski, project engineer at ITT. "Coupled with a fiber-optic input window and an X-ray scintillation screen on that window, there are industrial and medical X-ray applications." □

Peripherals

Terminal's flashing LEDs catch the eye

The design of most entry terminals for batch-processing information systems ignores the human key-punch operator. Or so thinks a London designer who says that most

CCDs loom large in mass-memory future

Hopeful that charge-coupled memory chips containing 16,000 and 32,000 bits will be available from semiconductor manufacturers by the end of the year [*Electronics*, Aug. 22, p. 128], builders of auxiliary memories and rotating mass-memory systems are eyeing them as replacements for drums and disks in military and commercial gear.

RCA's Government and Commercial Systems division, Van Nuys, Calif., is working with a CCD equivalent of an 8-million-bit drum memory. It is only a tenth the size of the drum, weighs an eighth as much, operates four to eight times faster, and consumes 1/60th the power (see table).

Donald J. Sauer, project engineer on the CCD-memory program, mentions Intel and Fairchild as possible

chip sources. At present, RCA is working with home-grown 16-kilobit chips that use a two-phase double-level-gate CCD technology [*Electronics*, Aug. 8, p. 95].

Each chip measures 224 by 240 mils and contains two 8,192-bit CCD shift registers. Each register consists of a C-MOS input translator, four cells in a series-parallel-series format, and a series-connected C-MOS output translator. Since the cell size on these developmental CCD chips is a comfortable 1.8 mil², plenty of room is left for size reduction in production-optimization programs.

A second C-MOS support chip provides the clock drive and logic necessary to convert the 16-kilobit memory chip into a two-loop recirculating drum-type memory. □

DRUM AND CCD EQUIVALENT CHARACTERISTICS

	Drum	CCD Equivalent
Tracks (loops)	256	1,024
Bits per track (net)	32,768	8,192
Data rate	2 MHz	2 MHz
Access time (max), (average)	16 ms, 8 ms	4 ms, 2 ms
Usable capacity	8,388,608	8,388,608
Volume	3 cubic feet	1/3 cubic foot
Weight	125 pounds	15 pounds
Power	300 W	5 W operating, 2 W standby

cathode-ray-tube terminals display the wrong information in the wrong place and make the operator perform so many time-wasting eye and hand motions that data is transcribed from forms into data storage only at about 50% efficiency.

To remedy this, Bernard A. Soloway has human-engineered a terminal by means of light-emitting diodes and programable magnetic cards and predicts it will increase throughput about 20%. Basically, his terminal reduces an operator's

frustration by presenting him with the feedback he needs only when he needs it.

Soloway uses a row of LEDs to guide the operator's eye to the right information block a line at a time. The front panel, containing these LEDs and an alphanumeric display indicating what the operator has punched, is positioned just above the area where the document is read. As an operator inputs the data from each information block the LEDs go out one by one and his eye

Electronics review

is drawn to the next block while the display shows what has just been punched. When a line is finished the document is automatically moved to the next line, and the LEDs light up again over the appropriate blocks.

To plug the document into the system, the operator slides it along a guide into a slot in the front panel. Sensors detect its presence, and a belt-driven roller driven by a stepping motor moves it into the first reading position. Since the document is rolled around the roller while being processed, it finishes upside down in a stack of other documents under the terminal after it is read.

A programed magnetic card masterminds the whole process, and the terminal itself can be used to program its own instructions. The card can in turn become a master program for making other cards for a whole bank of terminals. If a company has many different forms to be read, it can build up a library of master cards so that each terminal can handle different documents.

Another asset is that the keyboard is movable and can be placed wherever it is most convenient.

The document display unit is Soloway's second system design aimed at increasing processing efficiency. His Soval error-checking terminal, currently being sold by British Equipment Co., requires an operator to key in a number twice. The machine's electronics compares the two numbers, accepts the data only if the two numbers match. Soloway is negotiating to license his document display unit with several companies through his design consulting firm, Soval Ltd. □

Communications

Skynet II: UK to try another launch

The U.S. and the U.S.S.R. may soon lose the monopoly they have on communications satellite systems. The first operational system to be built by a third country is scheduled

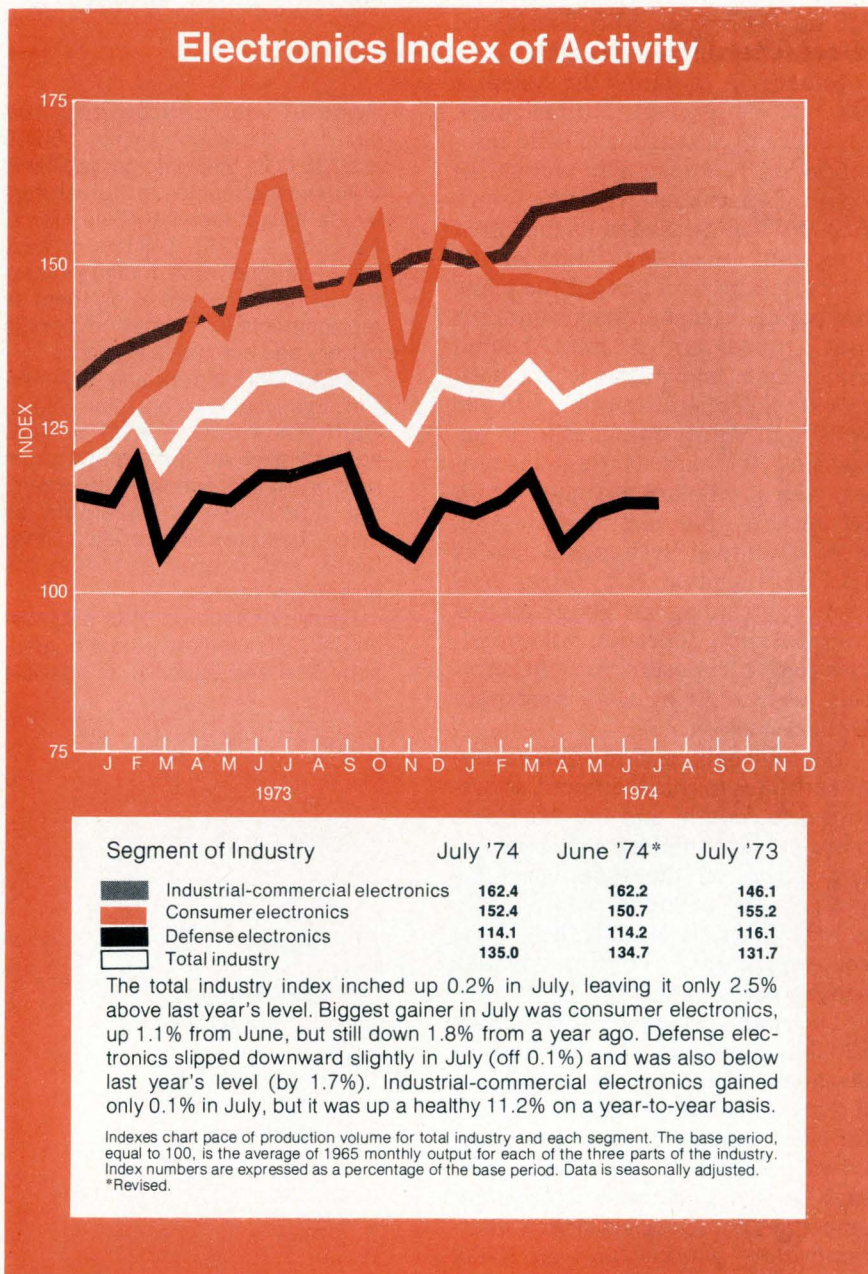

to go up in November when the United Kingdom will make its second attempt to launch Skynet II. It's designed to provide worldwide coverage for British military forces.

Skynet II's liftoff will follow a scheduled launch this month of UK 5, an X-ray astronomy satellite, in what is planned as a British one-two punch into space and a lucrative double play by spacecraft builder, Marconi Space and Defence Systems Ltd.

Mostly British-built, Skynet II will replace a smaller U.S.-built

Skynet I satellite. When the first Skynet II satellite launch was unsuccessful in January because of failure of the U.S. Thor-Delta launch vehicle at Cape Kennedy, the mishap was widely reported in the British press as a failure of British technology. But sensitive Marconi executives were quick to point to U.S. reports that the satellite worked until it burned up in the atmosphere because of a bad orbit.

Skynet III? For Marconi, the second-generation system might lead to a Skynet III system. The com-

The Easy, Low Cost Way to Display Difficult Signals

Slowly scanned, gray scale images, low repetition rate signals, and single-shot waveforms. All of these hard-to-view signals are easily displayed on the new TEKTRONIX 605 Variable Persistence Display Monitor—at normal intensity and without flicker. At the same time the 605 combines faster writing speed and wider bandwidth with low cost (\$1675) to provide more value for your display dollar.

Simply turning a dial varies the length of time a display is held on the 605 from a fraction of a second to more than 5 minutes. In the save mode viewing time is even longer.

Faster spot response time results from the 3 MHz bandwidth of the X and Y channels (3 times the bandwidth of comparable crt displays).

With the fast (1 div/ μ s) writing speed of the 605, even single-shot events are displayed as bright, easily viewed waveforms. The 605 has front panel controls and TTL compatible remote control inputs, a combination unique at such a low price. Real time monitoring applications are easy with the optional low cost time base (\$125), another feature not offered on other variable persistence displays.

Applications for the 605 are many and varied. Bright, gray scale raster scan plots are obtained for ultrasound, thermographic, and nuclear scanning and for viewing scanning electron microscope images. Resolution is improved in spectrum analysis. Valuable trajectory information is provided for radar

and sonar displays. With the time base option slow biophysical signals are easily monitored. In mechanical measurements flicker-free engine pressure/volume curves are readily plotted with no smear due to cycle-to-cycle variations. Uncluttered, single-shot vibration waveforms are easily displayed using the 1 div/ μ s writing speed.

For further information on how the 605 Variable Persistence Storage Monitor provides extra value in your display application contact your local Tektronix Field Engineer or write Tektronix, Inc., P. O. Box 500, Beaverton, Oregon 97005. In Europe write Tektronix, Ltd., P. O. Box 36, Guernsey, Channel Islands, U. K.



TEKTRONIX®
committed to
technical excellence

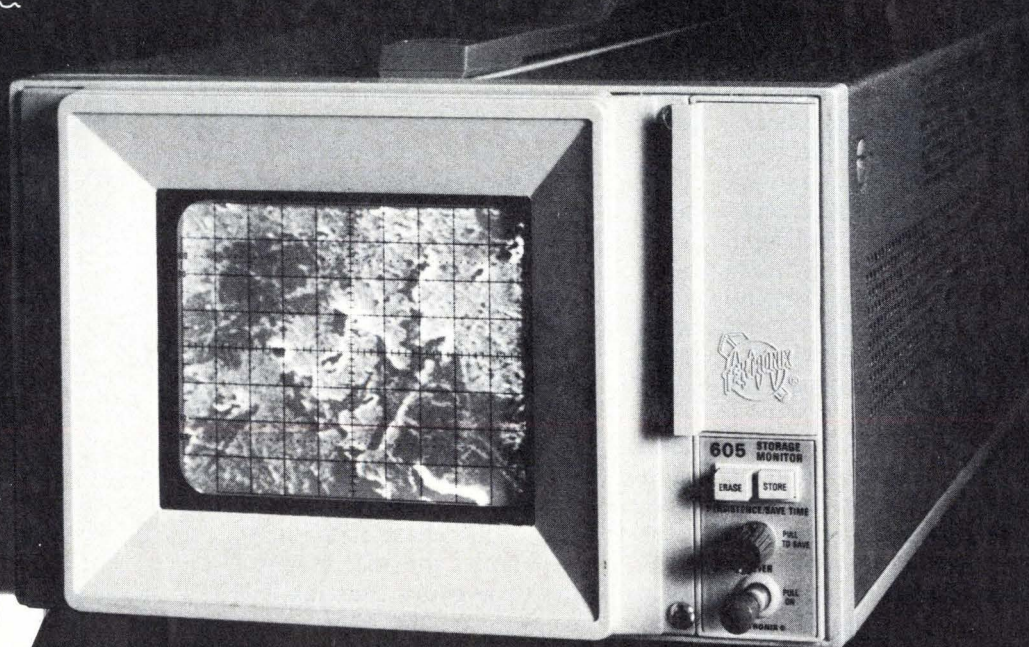
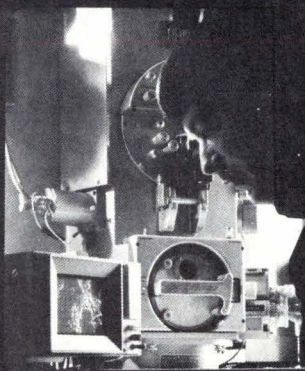
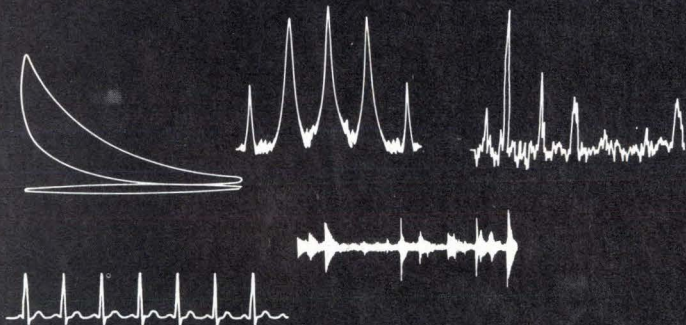

Gray scale capability and variable persistence storage of the 605 are used with a scanning electron microscope to study metal samples in a dental research laboratory.

For a demonstration circle 32 on reader service card

Circle 33 on reader service card

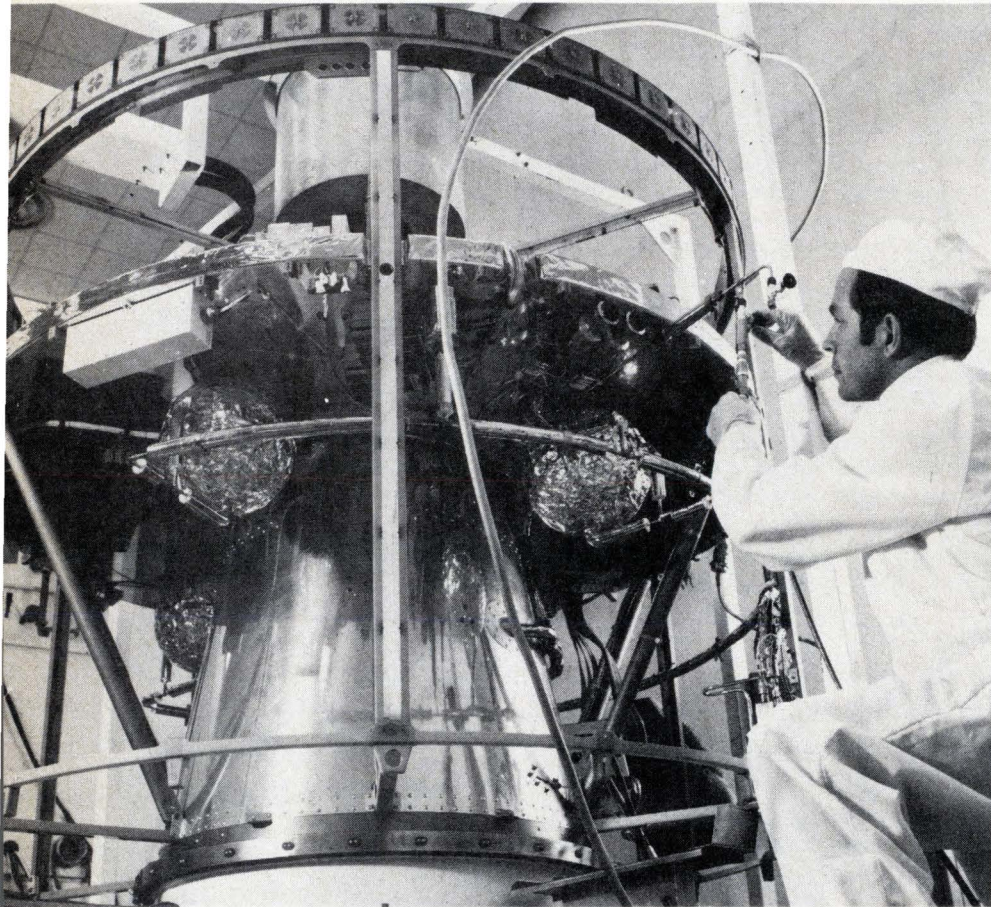

Second. Skynet II, Britain's military communications satellite, is being readied at the Portsmouth facility of prime contractor, Marconi Space and Defence Systems Ltd.

pany is now preparing studies for Britain's Ministry of Defence for various follow-on systems, says W. Martin Lovell, deputy technical director. The company also might receive an add-on contract to refurbish the qualification model originally intended for system evaluation into a backup satellite.

Importantly for Marconi, the contract also calls for development of a wide range of ground terminals for future military and civilian uses, according to Robert C. Chapman, marketing director. These include a 42-foot-diameter master communications terminal, 40-ft semi-static terminals, 21-foot air-transportable terminals, and a new 3½-foot shipboard terminal for the Royal Navy. Furthermore, the company is developing six-foot terminals for land or vehicle operation and a three-man-pack infantry terminal.

The S-band satellite will weigh about 960 pounds at launch, but

that is just about all company officials will make known because of Ministry of Defence security. The spacecraft is presumed to be able to handle both voice and digital traffic. The public estimates of the program's cost have varied between \$15 million and \$35 million. Philco-Ford division, Ford Motor Co., of the U.S. provided subcontracted work for some antennas, motors, and traveling-wave tubes, and Britain's Ferranti supplied the silicon cells that power the craft.

Dipole array. The spin-stabilized craft uses an omnidirectional-antenna system consisting of an array of cavity-backed dipoles mounted in a single band around the circumference as it maneuvers to synchronous orbit. Once it is orbited, a single-horn antenna mounted on top of the craft's spinning axis will be used for the main communications link. The horn antenna will be mechanically despun to keep it

pointed at the earth.

The UK 5 scientific satellite is a \$7 million project to probe X-ray sources in deep space, including the mysterious black holes. On board the cylindrical, 300-pound satellite are five UK experiments and one from NASA's Goddard Space Flight Center in the U.S. Among its British tricks, it will carry a magnetic-core storage system for processing the experimental data and use pulse-code modulation for the telemetry link. The experiments use collimated photomultipliers, proportional counters, Bragg crystal spectrometers, and cesium-iodine scintillators, among other gear. Launched by a U.S. Scout rocket from the Italian San Marco platform off the coast of Kenya, the satellite will orbit the earth every 90 minutes. □

Interconnect eased for answering units

The Bell System appears to have eased up on its dogged insistence that all "foreign" electronics gear attached to its telephone lines make the connection through a Bell-supplied protective interconnect device. But don't interpret the move as a forerunner of further interconnection policy changes, says a spokesman for American Telephone and Telegraph Co., New York.

Specifically, Bell is now permitting telephone-answering sets—and telephone-answering sets only—to be connected to its lines without the interconnect device—which Bell installs and leases for a relatively substantial fee. Instead, the company will permit the answering sets to have a "protective connecting module" incorporated within internal circuitry. This new module has been designed by Bell engineers, and its manufacture will be licensed for a fee to manufacturers of the telephone answering sets and modules.

The move by AT&T was prompted by a complaint filed last year with the Federal Communications Commission by Phone-Mate Corp., Torrance, Calif. Phone-Mate, which

THE ODD COUPLER.

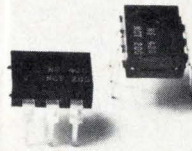

If you get a kick out of interfacing between two voltage levels, you're gonna *love* these.

The new NCT 200 and NCT 260 opto couplers from National Semiconductor provide isolation voltages of 2 KV to 3.5 KV (don't you find such a high isolation voltage odd?).

You might also be tickled to learn that the isolation capacitance is 0.5pF... and the typical current transfer ratios 80% (NCT200).

And more couplers are coming in our ever-expanding new opto-electronics line.

Speaking of opto-electronics...

Our name up in lights.

We knew we could make it in the big time of LEDs and lamps if we just kept plugging away.

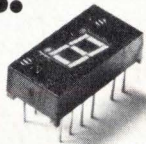

Current highlights include our new NSA series arrays that meet



your 6, 7, 8, 9 (up to 14) digit needs, with or without minus sign, floating decimal and fixed decimal in all the popular combinations.

And a range of new individual single digit LEDs.

And more...with even more coming soon.

For more electrifying details give us a call or write National Semiconductor Corporation, 2900 Semiconductor Drive, Santa Clara, California 95051.

Inquiries will be processed without regard to race, creed or color.

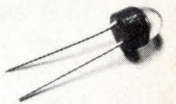

NATIONAL

claims to have sold half of the estimated 500,000 answering systems now in use, complained about AT&T's insistence on the separate interfacing device. With an installation charge of up to \$40, plus a monthly service charge of as much as \$4.50, the customer paid as much for the interconnect in three years as he did for the answering device itself, according to Phone-Mate's chief executive officer, William Shaphren. Most telephone-answering devices sell for \$150 or less, he says.

AT&T negotiated an agreement with Phone-Mate that will apply to the approximately two dozen manufacturers of telephone-answering equipment. However, an AT&T spokesman says interconnect devices will still be required for other types of non-AT&T attachments, the proliferation of which was spawned by the FCC's Carterfone decision of 1968 that allowed foreign equipment to be connected to the telephone lines.

The answering device appears to be a special case for AT&T—it is essentially a receive-only device not designed to send dial signals on the lines. The telephone company has consistently maintained it feared foreign interconnects could affect its phone lines in any of four ways. The equipment could put out improper dial pulses that would interfere with switching or it could put out excess signal levels. It could set up a longitudinal imbalance on the line which, like excessive signal level, could cause cross talk. Or, finally, the equipment could cause a 110-volt power-line short across the telephone line.

Unimportant. Some industry sources actually pooh-pooh the AT&T move. It isn't really important, says John Sodolski, vice president of the Electronic Industries Association, Washington. The policy towards interconnects on private branch exchanges (PBXs) and key telephone systems is much more important, he says. These areas represent more than \$200 million in annual sales.

Telephone-answering devices account for about \$20 million, and,

with the interconnect installation and lease charges removed, sales should increase even faster than they have been. Phone-Mate says it doubled sales last year and did about \$13 million in business.

Although AT&T would not make public the full technical details of the new connecting arrangement, companies applying for a license to use it will receive details, possibly later this month. An AT&T spokesman did say that the new circuits are composed of several components, including a couple of transistors with associated resistors and capacitors, some limiting diodes, a line seizure relay, and a three-winding transformer.

Besides protecting the network, the circuit prevents the answering device from either making outgoing calls or stimulating false "off-the-hook" seizures of the line. It also limits abnormally high levels of voice signals emanating from the recording device. Shaphren and others estimate its cost at under \$20. □

Satellites may beam soothing music

When they first appeared practical more than a decade ago, broadcast satellites seemed, among other things, ideal for beaming reading lessons, health-care lectures, and the like down to poor and remote areas of the world. Probably no one at the time would have thought of using the satellites to beam soothing, recorded music to some of the world's most populated cities.

This is exactly what is being contemplated now, and if tests under way prove successful, it could result in the first large-scale deployment of thousands of small earth stations to receive broadcast satellite signals.

Behind the plan is Muzak Corp., New York, the well-known supplier of recorded background music to in-

News briefs

Control Data building Air Force radar

Control Data Corp., Minneapolis, Minn., has won a \$1.3 million contract to build a special-purpose synthetic-aperture radar system for the Air Force Avionics Laboratory, Wright-Patterson Air Force Base, Ohio. The system will be delivered in 16 months and tested for 15. Called Imfrac, for Integrated Multi-Frequency Radar, the system differs from other radars in that radar returns from several frequencies are processed digitally in real time and displayed on a TV screen for inspection by the airborne operator. Data is also recorded simultaneously on magnetic tape.

The radar concept was invented by the Air Force's Cambridge Research Laboratories and the experimental model was tested and evaluated jointly with the Avionics Laboratory's Reconnaissance and Surveillance division.

Bowmar to move calculator production

The calculator-assembly operations of Bowmar Instrument Corp. will be moved from Acton, Mass., this month and consolidated with the Sonora, Mexico, facility. Bowmar president and chairman, Edward White, says the move should be a major savings to the corporation and will improve working capital. Engineering and warehousing will be located in Bowmar facilities at Nogales and Tucson, Ariz., but calculator marketing operations will remain in Acton.

Store "gives away" calculators

Electronic calculators may be becoming what drinking glass give-aways used to be to gas stations. In its back-to-school promotion, an Illinois supermarket chain is selling the National Semiconductor Corp.'s Novus 650 calculator for \$14.98 with one other purchase.

From the
voltmeter
house...

Here's how we tested our 42,386th multimeter.

The world's best-selling 3½ digit multimeter is virtually indestructible.

Recently, two Fluke quality control engineers wanted to know if our 8000A 3½ digit multimeter would survive a fall from a 24-foot rack. We were shipping several to a phone company.

So they tossed one out the window. Two stories up. It still worked.

But 9944/100% of these out-of-the-ordinary tests we **don't** instigate.

They just seem to happen.

Our president talks about the time he picked up an 8000A at a trade show without knowing it was ready for case removal. The works crashed to the floor but it still played perfectly . . . to everyone's delight and the president's relief.

One reason why our DMM is so tough: it only has 99 parts. Major analog and digital circuitry are on LSI chips.

It's also flexible. This DMM has 26 ranges, including five ranges of ac and dc volts, five ranges of ac and dc current, and six ranges of resistance. And it's the only DMM using an A-to-D converter with inherent self-zeroing to completely eliminate offset uncertainty.

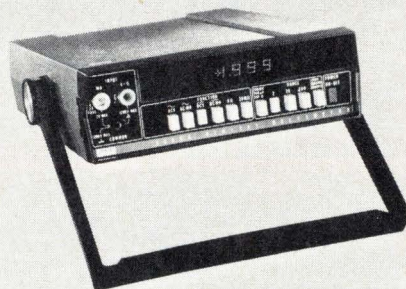

But it's the ruggedness that really makes the 8000A a conversation piece. Our sales force still laughs about the Fluke salesman who was so hot to make a sale that he took his Fluke multimeter and brought it down—crash!—right on his prospect's desk.

"See," he said, "it's really tough."

And so it was, but the op amp that was hidden under a pile of papers wasn't. P. S.—our salesman didn't make the sale.

On a more positive note, a UPS truck accidentally backed over an 8000A not long ago . . . without ill effect.

So there you are. The world's largest selling 3½ digit DMM. And the toughest. And for \$299 it could be yours.

For data out today, dial our toll-free number, 800-426-0361

In the continental U.S., dial our toll free number 800-426-0361 for the name and address of your nearest local source. Abroad and in Canada, call or write the office nearest you listed below, John Fluke Mfg. Co., Inc., P.O. Box 7428, Seattle, Washington 98133. Phone (206) 774-2211. TWX: 910-449-2850. In Europe, address Fluke Nederland (B.V.), P.O. Box 5053 Ledeborstraat 27, Tilburg, The Netherlands. Phone 013-67-3973. Telex: 844-52237. In the U.K., address Fluke International Corp., Garnett Close, Watford, WD2 4TT, England. Phone 0923-33066. Telex: 934583. In Canada, address ACA, Ltd., 6427 Northam Drive, Mississauga, Ontario. Phone 416-678-1500. TWX: 610-492-2119.



For information, circle # 37 For demonstration, circle # 244

MINI- AND MICROCOMPUTERS SEMINAR

Seminar Chairman: A. C. Knowles, Digital Equipment Corp., Maynard, MA

Monday and Tuesday, October 28 and 29

Commonwealth Ballroom of the Sheraton-Boston Hotel

9:30 am, Monday

S-1 DEVICE TECHNOLOGY

Chairman: W. H. Roberts, Western Digital Corp., Newport Beach, CA

LSI-16/THE WORLD'S FIRST 16 BIT SOS MINICOMPUTER — L. E. Taylor, General Automation, Inc., Anaheim, CA

A HIGH PERFORMANCE, MICROPROGRAMMED, NMOS-LSI PROCESSOR FOR 8- AND 16-BIT APPLICATIONS — Z. Soha and W. B. Pohlman, Western Digital Corp., Newport Beach, CA

MOTOROLA M6800 MICROCOMPUTER/AN ARCHITECTURE DESIGNED FOR EASE OF USE — T. H. Bennett, Motorola Semiconductor Products, Inc., Phoenix, AZ

4K RAM SYSTEM DESIGN CONSIDERATIONS — J. E. Coe, Mostek Corp., Carrollton, TX

2:00 pm, Monday

S-2 MAIN FRAME AND COMPUTER TECHNOLOGY

Chairman: E. D. Crockett, Hewlett-Packard Co., Cupertino, CA

THE TECHNOLOGY OF THE COMPUTER — C. G. Bell, Digital Equipment Corp., Maynard, MA

AN OVERVIEW OF MAJOR MINICOMPUTER PERIPHERALS — R. J. Daniel, Hewlett-Packard Co., Cupertino, CA

GOING REAL-TIME WITH PEOPLE/TERMINAL TRENDS AND PRODUCTS — J. A. Wolaver, Digital Equipment Corp., Maynard, MA

TRENDS IN MINICOMPUTER SYSTEMS AND SYSTEMS SOFTWARE — E. D. Crockett, Hewlett-Packard Co., Cupertino, CA

9:30 am, Tuesday

S-3 INDUSTRIAL APPLICATIONS

Chairman: A. T. Devault, General Automation, Inc., Anaheim, CA

BUILDING MANAGEMENT SYSTEMS — J. H. O'Connell and D. M. Priestley, RCA, Burlington, MA

A PROCESS CONTROL LANGUAGE FOR MICROPROCESSORS — L. H. Anderson, COMSTAR, Edina, MN

PRACTICAL CONTROL APPLICATIONS FOR MICROCOMPUTERS — A. Raynaud, R2E Microcomputers, Orsay, France

MULTI-TASK EXECUTIVES/AN APPROACH TO MICROPROCESSOR APPLICATION SOFTWARE — P. Roybal, National Semiconductor Corp., Santa Clara, CA

2:00 pm, Tuesday

S-4 SCIENTIFIC APPLICATIONS

Chairmen: E. Kramer, Digital Equipment Corp., Maynard, MA

LABORATORY AUTOMATION — D. Glover, Digital Equipment Corp., Maynard, MA

MINICOMPUTER APPLICATIONS IN CHEMISTRY/THE PRESENT AND A LOOK INTO THE FUTURE — D. Dix, Dow Chemical, Wayland, MA

THE NORTHEASTERN UNIVERSITY HIGH ENERGY PHYSICS DATA ACQUISITION SYSTEM — W. Faissler, Northeastern Univ., Boston, MA

MICRO- AND MINICOMPUTER APPLICATIONS IN BIOMEDICINE — A. Gottmann, MD, Metropolitan Labs, Denver, CO

REGISTRATIONS REC'D BY OCT. 15TH

IEEE Members \$80 Non-Members \$99

REGISTRATIONS REC'D AFTER OCT. 15TH

IEEE Members \$95 Non-Members \$125

Registration fee includes one copy of the Seminar Proceedings and free registration to general program and exhibits.

Mini-Micro

Name _____

Address _____

Checks payable to: NEREM-74

31 Channing St. Newton, MA 02158

Circle 38 on reader service card

Electronics review

dustrial and commercial buildings. It will use facilities leased by RCA Global Communications Inc. on the Canadian Anik II satellite, now in stationary orbit. And according to Muzak vice president and product division general manager Paul Warner, if the earth stations could come in at less than \$1,000 each, the company would be interested in buying and installing a staggering 75,000 of them.

Economics. The situation hinges on the economics of the satellite system, Warner is quick to point out. But with \$1,000 ground stations, the satellite-based transmission scheme has a good chance of being competitive with what Muzak now uses. The company transmits its music in two ways—via leased telephone lines or leased subchannels on frequency-modulated radio stations.

The proposed Muzak system was demonstrated last month in New York at the company's 40th anniversary convention. A four-foot-diameter antenna, low-noise receiver, and down converter, assembled by AII Systems, Moorestown, N.J., were mounted on a balcony of the Waldorf-Astoria in New York. A signal was beamed to the satellite from RCA's ground station in Valley Forge, Pa.

In the Muzak plan, four channels, one for each continental U.S. time zone, will be sent to the satellite for broadcast across the country. Receivers atop subscriber buildings will be tuned to one of the channels. Since only four channels will be used, the satellite transponder's power can be concentrated in each channel (the transponder power normally is spread over as many as 1,000 voice channels), and the re-

Music maker. Equipment for Muzak satellite test includes four-foot dish, low-noise amplifier on tripod leg, and an fm receiver.

ceiver will not need either a large dish or a very-low-noise amplifier. The dish could be about 2.5 feet in diameter, and the receiver noise temperature could be about 170 kelvin. This corresponds to a noise figure of about 2 decibels, which could be obtained with an uncooled parametric amplifier.

Problems. If the satellite should fail and a nearby back-up satellite have to be put into operation, the receiving antenna might not be properly pointed. The job of re-aligning 75,000 antennas across the country could be formidable. Moreover, if the satellite transponder failed and it became necessary to switch to another frequency, then all the receivers would have to be retuned, also a difficult task.

Another potential problem lies in interference from terrestrial microwave links, which operate in the same frequency band—about 4 gigahertz. The antenna could simply be repositioned on the rooftop, or, if this fails, Warner says the antenna could be located nearby and linked to the customer building by a laser communications system. Warner says that Muzak already has about 10 or 12 low-cost laser systems in operation, at sites where fm reception is poor. □

Industrial electronics

IR instrument measures angles

Ever since people began surveying, or laying out buildings, they've been using tape measures for getting distances. In recent years, highly sophisticated instruments have replaced the conventional surveyor's transit. But for short-range, on-site



Another technical knockout

the first reliable 60 W gold UHF amplifier

J. R. Black did the first aluminum metallization research at Motorola in 1967¹...Louis Terry did the first gold metallization at Motorola in 1969²...now Motorola announces the first reliable, producible gold metallization system for RF power with the MRF306.

The process features ultra-accurate metal pattern delineation by ion beam etching ensuring correct finger widths and vertical finger walls... thick oxide step coverage... oxide-passivation... and very high figure-of-merit geometric design allowing rugged structuring without sacrifice of power gain.

It's a totally new, engineered system involving the latest equipment designed for the process — rather than process designed for available equipment.

Theoretical device metallization MTBF is 10⁷ hrs. @ 200°C.

The MRF306 is a Controlled Q* unit with 2-stage internal matching maximizing bandwidth due to lower input Q, ensuring easier circuit design. Typical G_{PE} is 10dB at 400 MHz.

*Trademark Motorola, Inc.

1. Proceedings of 1967 Annual Symposium, Reliability Physics, IEEE, Cat. #7-15C50, Nov. 1967.
2. IEEE Proceedings, Sept. 1969, "Metallization Systems for ICs."

The particulars are available in a new Engineering Bulletin, EB-26. Send for it and data sheets: Box 20912, Phoenix, AZ 85036.

Design UHF with the best products you can possibly get — and be first with the first...

ONE OF THE 48 INDIVIDUAL CELLS ON THE 60 x 165 MIL MRF306 CHIP

BASE BONDING PAD

12,000 Å OXIDE STEP

BASE FEED BAR

NICHROME RESISTORS

EMITTER FEED BAR

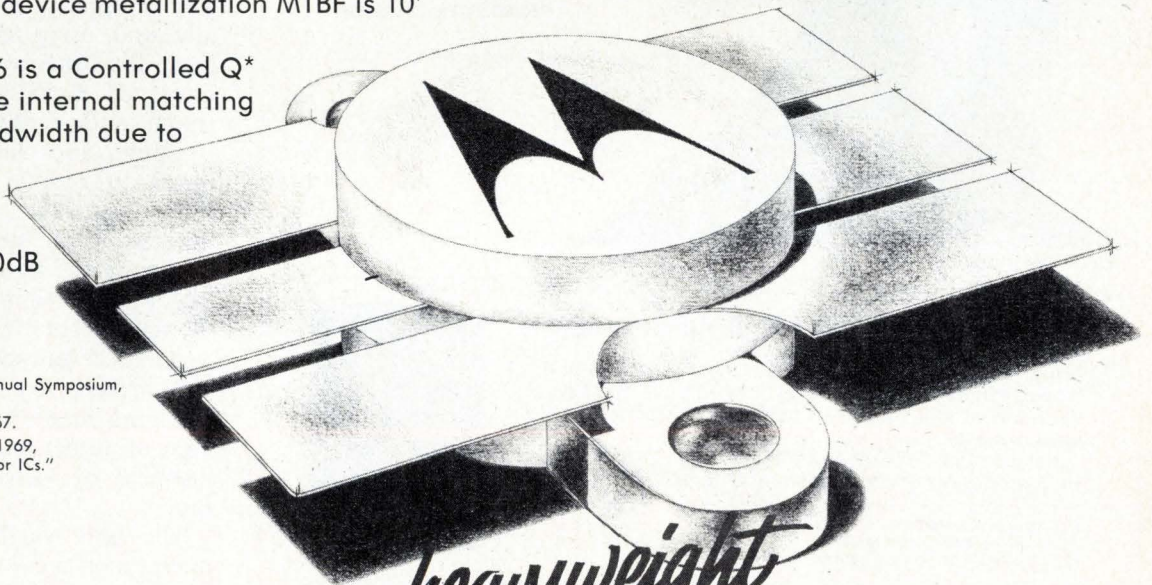
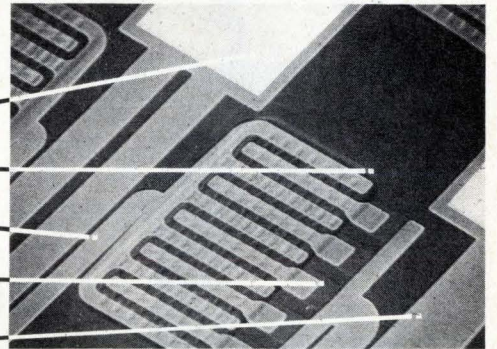

heavyweight

from Motorola, the RF producer.

Visual images are fleeting—so, for the record, ... you need pictures. No telling when or how often they can prove invaluable.

THE CHAMP

...PICTURE TAKER



Circle 40 on reader service card

That's why so many of your peers are routinely snapping pictures while looking at specimens and samples with Bausch & Lomb's StereoZoom 7 visual-photographic system. The Champ's superb optical system which gives unbeatable visuals will put the images on film right while you're looking. And they will be available as often as you want to refresh your memory, make comparisons, prove points.

There's a choice of most camera formats with the new Integrated Cameras, Series II with optional exposure meter. They're integral, but do not interfere with the optical system and interchange to fit varying needs.

Be ready. Write for our new Stereomicroscope catalog 31-15 and our free demonstration offer.

BAUSCH & LOMB 
SCIENTIFIC OPTICAL
PRODUCTS DIVISION

62309 Bausch Street, Rochester, N.Y. 14602

StereoZoom, Reg. T.M.
Bausch & Lomb.

Electronics review

layout, tapes are still used, mainly steel tapes 50 meters long.

Now, the Swedish electronics firm of AGA Geotronics AB has developed a small, simple, electronic infrared instrument that it claims can compete against a tape measure. The Geodimeter 12, about the size of a cigar box, can be mounted on any standard theodolite, transit, or tripod to measure angles.

AGA says the major applications will be in setting out construction sites, street layout, mining, erecting power lines, surveying, and wherever tapes are ordinarily used—particularly where there is heavy or constant traffic or where terrain is rough. AGA says that 80% of all distances that are surveyed and measured are less than 100 meters. The Geodimeter 12 has a maximum range of 1,700 meters when using a three-prism reflector or 700 meters when using a one-prism reflector. Accuracy is within ± 5 millimeters at 1,700 meters.

The device uses an infrared gallium-arsenide light-emitting diode, working at a wavelength of 0.91 micrometer, as a light source. The light is reflected from the target, a retro-reflector prism, back to the device, where it is received by an avalanche diode and modulated at frequencies of 15 megahertz and 150 kilohertz. The two phases are compared digitally, and, using transistor-transistor logic, the distance is computed and displayed digitally on RCA Numitron incandescent tubes.

Signal. The Geodimeter 12 produces an audible signal when the light is on target. Since the light is invisible, this could cause problems in aiming the light onto the target. The audible signal is heard when the light nears the target at a divergence of 25 centimeters at a range of 100 meters. By listening to the changing tone, the user brings the light on target and makes final adjustment by viewing a needle display.

The unit weighs 2.8 kilograms, operates off a 6-volt battery, carried in a separate pack, and uses a maximum of 24 watts of power. In Sweden, AGA Geotronics prices the Geodimeter at about \$7,000.

Own your own holder to hold your own!

Hold your own copies of Electronics in specially designed slipcase holders. They'll keep your Electronics library neat and handy—a permanent information file, issue by issue.

Just complete the coupon and mail to Jesse Jones. He'll process your order upon receipt, postpaid.

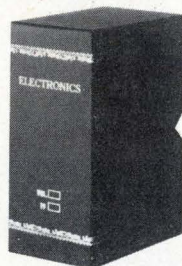

ELECTRONICS BOXER
Jesse Jones Box Corporation
2250 E. Butler St., Philadelphia, Pa. 19137

Please send me: boxes @ \$4.25 each; 3 boxes @ \$12.00; 6 boxes @ \$22.00.
My check or money order is enclosed.

Name: _____

Address: _____

City: _____ State: _____ Zip: _____

Watts New



Sorensen introduces the new, higher power density DCR-B series lab/system dc power supplies. Designed specifically as an extension of the popular single-phase DCR-A series. Minimum panel height is 3½". Power output is up to 2700 watts. Noise and ripple are 50% lower than in previous models.

Other DCR-B advantages: low cost-per-watt; fast response time; choice of 32 new versatile models to cover a broad range of applications; exceptional efficiency and dependability; and new, less expensive overvoltage protection option that can be installed at the factory or in the field. For complete data, contact the Marketing Manager at Sorensen Company, a unit of Raytheon Company, Manchester, N.H. 03103. (603) 668-4500.

Representative Specifications – DCR-B

Voltage Ranges: 0-10, 20, 40, 60, 80, 150, 300, 600 volts DC			
Efficiency: Up to 86% typical			
Panel Height	Cooling	Nominal Output Power (watts)	Price Range
3½"	convection	500	\$400-475
5¼"	convection	1000	575-690
7"	convection	1800	775-975
7"	fan	2700	1075-1150

Sorensen
POWER SUPPLIES

News update

IBM looking for more than meets the eye Will memory makers some day be able to fabricate devices smaller than the wavelength of light? Don't look for such devices right away, but keep your eyes on work now going on at IBM's Thomas J. Watson Research Center in Yorktown Heights, N.Y. That's where the developers of a technique based on scanning-electron microscopy [Oct. 11, 1973, p. 52] are busily trying to improve resolution obtained by electron back-scattering. No commercial applications are in sight, but the technique is being used in the lab "to see things that we couldn't see before," as an IBM spokesman puts it. What are the researchers aiming at? Why, things that they can't see yet.

LCD business sounds good to reed maker Almost two years ago, Hamlin Inc., the oldest and largest reed-switch manufacturer in the country, figured that it just naturally belonged in the liquid-crystal-display business. The Lake Mills, Wis., company reasoned that its experience in the high-volume production of glass parts could be applied easily to making LCDs [Oct. 25, 1973, p. 34]. Now, it looks as though Hamlin had a point. It boasts about a half-dozen high-volume customers and estimates that 60% to 70% of its business is in custom products. And Hamlin is broadening its line. Additions are a field-effect watch display—all previous displays were dynamic scattering—as well as an eight-digit, 0.47-inch-high calculator display and a 3½-digit (0.6-in.) instrument display with legends for ac, dc, and ohms. Later this fall, Hamlin will introduce a 16-segment alphanumeric display, supplied in modules with the LCD connector, aimed at designers for prototyping.

Radiation detector getting hotter After more than a year on automobile production lines, says Vanzetti Infrared & Computer Systems Inc. of Canton, Mass., the reliability of its infrared radiation-detection systems [April 12, 1973, p. 35] has been proved. At General Motors' Cadillac division, it is used to check induction heat-treated valve seats in engines, and at Chevrolet's Vega assembly plant, it monitors induction-heating of camshafts. Interest in infrared detection on the part of automobile manufacturers is growing more slowly than expected, but new applications are being found, and now support plants are getting onto the bandwagon—one, Camcar Screw & Manufacturing Co., a Ford plant, is using a system to control induction-hardening of bolts used to hold seat belts. Now Vanzetti is working with GM on using systems for spot-welding and to measure the temperatures of metal cutting surfaces. And with more and more metal parts being replaced by

plastics, there is interest in putting the fiberoptics used to sense infrared into an injection machine to measure temperature.

Stitch-welding system leads to acquisition Accra-Point Arrays (APAC) of Santa Ana, Calif., is being acquired by Varian Data Machines. And the reason is a planar stitch-welding process developed by APAC [April 12, 1973, p. 47] that Varian wants to use to make its own mini-computers and other equipment. APAC will continue to operate autonomously, however, and will serve customers other than Varian. The stitch-welding is viewed as an alternative to wire-wrap and etched circuit boards, especially for complex but relatively low-volume boards. APAC's process, which, says marketing vice president Michael Beck, has been gaining acceptance, "particularly in the last six months," avoids the need for special terminals that made stitch-welding too expensive for most commercial use.

Word processing making it in land of the giant The number of companies that have tried to chop off a piece of IBM's market share in one of the many areas of the data-processing business it dominates are legion. But not so numerous are those that have succeeded; Lexitron Corp. of Chatsworth, Calif., appears to be one of those. The vehicle is a word-processing system, the Lexitron Model 91, and the company says it's selling well. A recently introduced version, the Model 92, is monospaced and uses a Diablo printer, while the original model uses an IBM proportional-spacing typewriter for output. The new system also is faster, operating at 30 characters per second—rather than the 11 turned out by IBM's competitive system.

Exxon fax passing its Florida tests Is the world ready for an almost throwaway facsimile machine? Well, ready or not, world, here comes Exxon Enterprises with Qwip. Exxon Enterprises is the venture-capital arm of the giant oil company. Qwip is its fax machine that leases for \$29 a month. And the "throwaway" feature works this way: "If you call for repairs," says Richard Nelson, manager of Qwip Systems division, "the repairman is apt to arrive with a new unit under his arm" so that on-site repairs won't disturb the customer's routine. The machine, being made in Altamonte Springs, Fla., for the Florida market, will be tried out soon in New York. It was announced about 18 months ago [April 12, 1973, p. 48]. And if you're wondering about the name "Qwip," don't bother to check the dictionary. It's a coined word—which is what you might expect from a company called Exxon. —Howard Wolff

Intended to bring *Electronics* readers up to date on news stories of the past months.

SIEMENS

IC's – Semiconductor Memories – Core Memory Systems tested expediently

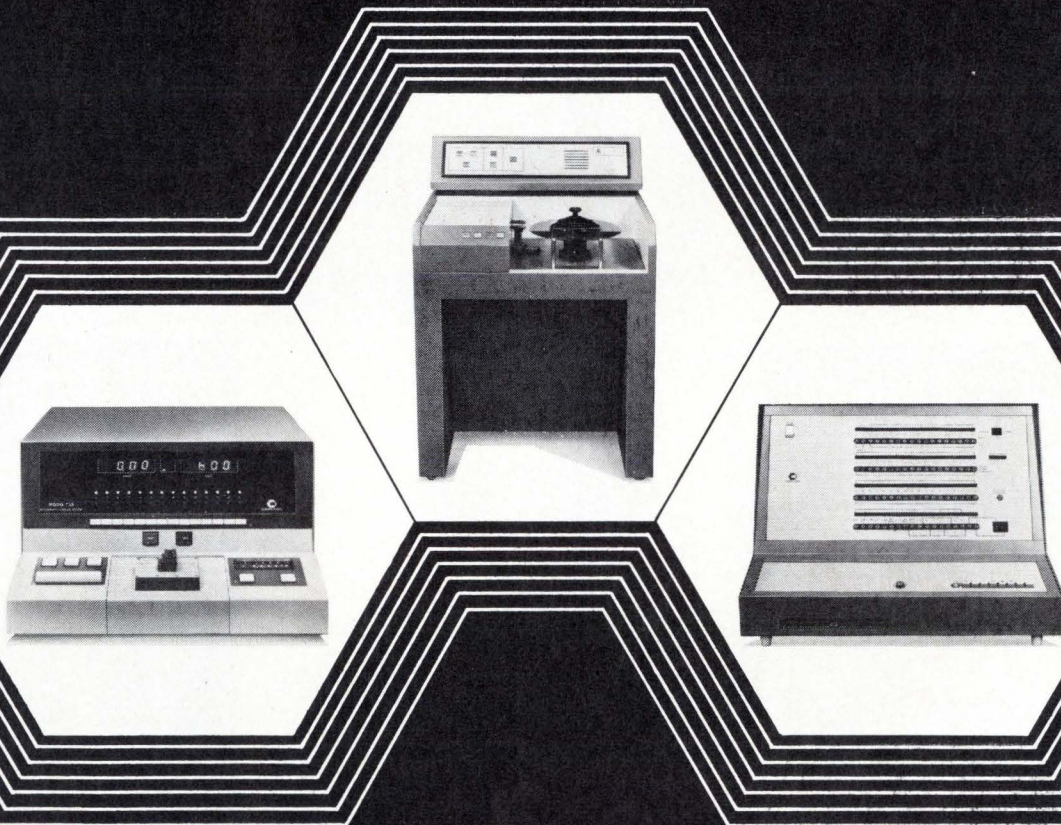

Do you work with electronic modules or memory systems? Then you should know COMPUTEST. COMPUTEST is a proven equipment series for testing of IC's, complete semiconductor memories as well as core – and disc memories.

The system COMPUTEST contains:
IC-testers-universal test equipment

and automatic test systems for digital and linear circuits. Semiconductor memory test systems for fast functional control of RAMs, ROMs and shift registers. Or for testing on chips and at the system level.

Test systems for automatic checking of production phases in the manufacture of core and disc memory.

Should you be interested in the system COMPUTEST within the extensive test- and check-out-program of Siemens?

Write to
Siemens Aktiengesellschaft,
ZVW 133/Ce
7500 Karlsruhe 21,
Postfach 21 1080.

COMPUTEST

Test- and Check-out System by Siemens

Circle 43 on reader service card

Beckman Instruments

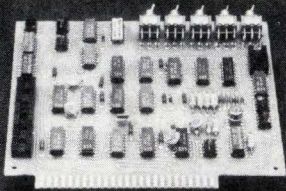

CalComp/Century Data Division

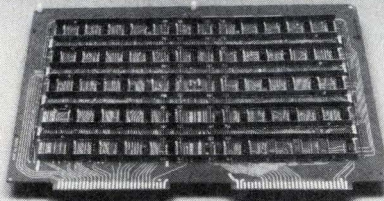

Litton Digital Data Systems

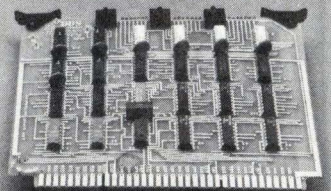

Lexitron

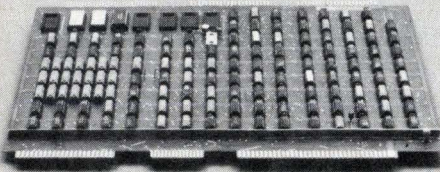

North Electric Company

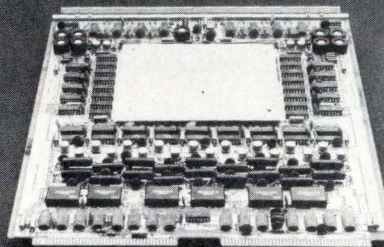

Western Electric Company

(Board not released for photography.)

Econolite

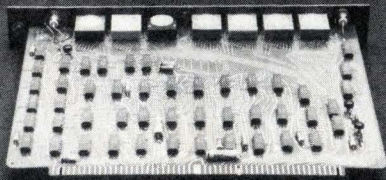

Data Source

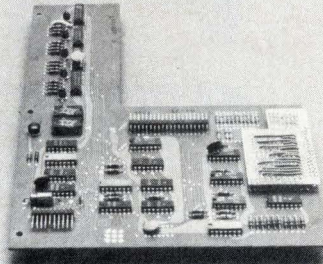

Diablo Systems Incorporated
A Xerox Company

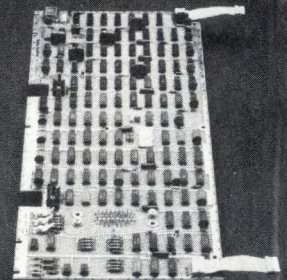

COMPUTER AUTOMATION'S AUTOMATIC TESTER HAS

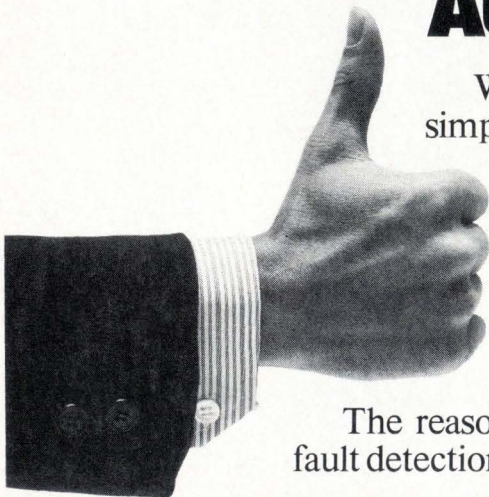

We've listed a few of our CAPABLE tester customers simply to point out something obvious. Companies like these don't buy sophisticated hardware just on the name. Which is a good thing because how many people have ever heard of the CAPABLE tester, anyway?

The fact is, you can't solve testing problems with a name - big or otherwise. So these companies did just what you would do. They looked at all the automatic board testers available. And then they picked our CAPABLE.

The reason is faster board throughput. High-speed, high-volume fault detection and isolation across the entire board range. From simple

Collins Radio Company

(Board not released for photography.)

TRW Data Systems

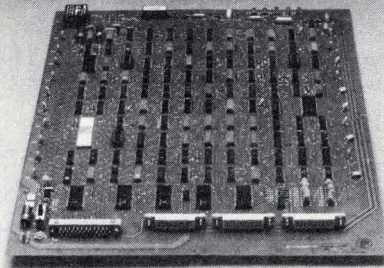

Rockwell International

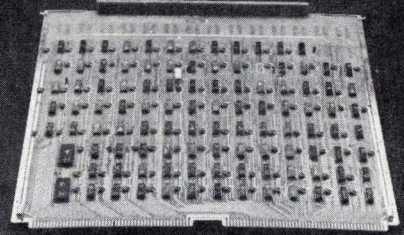

Diebold, Inc.

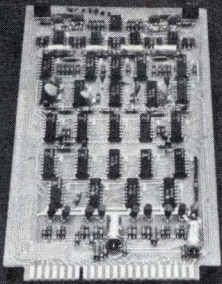

Tally Corporation

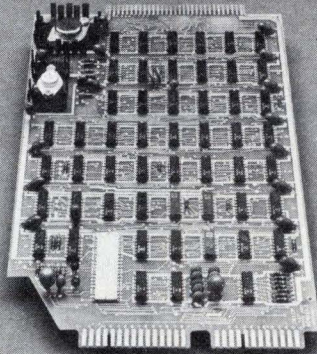

Computer Machinery

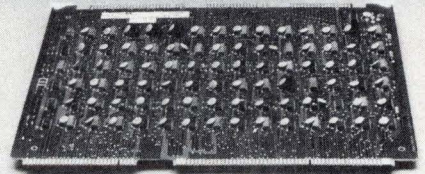

Ampex Corporation

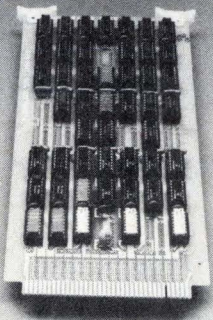

GTE/Information Systems

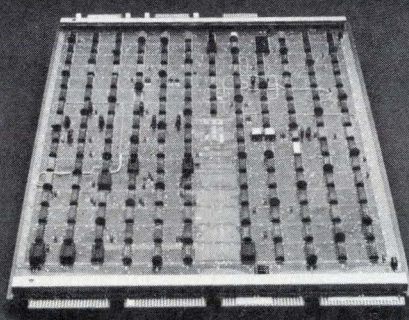

National Cash Register

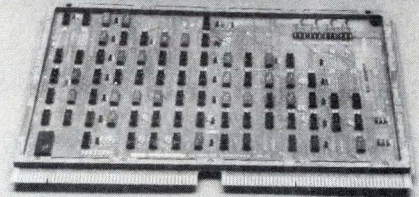

ACROSS THE BOARD APPROVAL.

to complex modules. Digitals to hybrids. With incredible ease of operation.

And here's the payoff. Actual in-use figures show that CAPABLE can pay for itself in as little as 12 months. Even less in some cases.

If you're more interested in profits than prominence, we can help you now. Later on we'll throw in a big reputation.

18651 Von Karman, Irvine, California 92664, (714) 833-8830



CA ComputerAutomation
Industrial Products Division

Bellevue, Washington, (206) 455-9650 / San Jose, California, (408) 247-2026 / Broomfield, Colorado, (303) 466-1749 / Orlando, Florida, (305) 857-0100 / Elk Grove Village, Illinois, (312) 956-6400 / Cleveland, Ohio, (216) 692-1965 / Massapequa, New York, (201) 825-0990 / Watford, England, Watford (0923) 39627

Circle 45 on reader service card

COORS CERAMICS MAKE

Easy to say, you say, but is it true?

We honestly think it is. Consider these facts: We're one of the world's largest producers of technical ceramics for industry. We've been making high-alumina and beryllia ceramics for electronics for over 30 years. During this time we've manufactured millions of parts and components for thousands of applications and hundreds of customers — most of whom are still our customers. We think this proves something. We hope you agree and will read on. You may discover a way Coors ceramics can make your electronics better.

PACKAGES

Circuit packages—for discrete devices, hybrid circuits, IC chips—all available from Coors. Types include power transistor headers, DIPs, cerpacs, and specials made specially for you. Ceramics include beryllia or black or white alumina. Noble-metal coatings and low-temp sealing glasses are standard, as are moly-manganese metallization and all popular plating processes. Our usual fine ceramics with controlled densities, dimensions, and finishes ensure highest hermeticity when vacuum-tightness is demanded. We have the facilities and experience for continuous, high-volume production runs, plus the flexibility for speedy preproduction development.

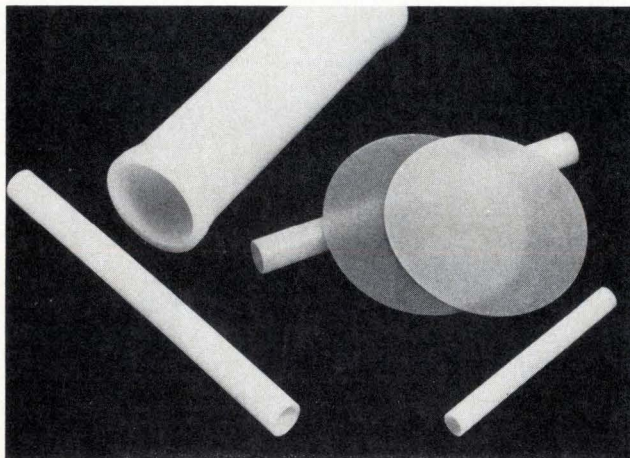
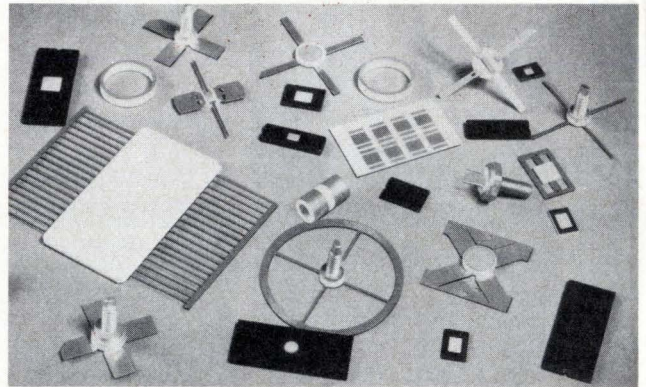

VISTAL®

A *translucent* high-alumina ceramic, Vistal has excellent transmittance values in the visible and IR regions of the spectrum. This plus high dielectric, electrical-insulation, strength and temperature properties makes Vistal an outstanding material choice for demanding optical applications. Available in disc and tube form.

TUBES

Our ceramic tubes are used for furnace linings, thermocouple-lead and -sensor protection, gas sampling, target and sight envelopes, combustion experiments, and undoubtedly a number of other things we know nothing about. Available in mul-lite, silicon-carbide*, or high-alumina ceramic, they are strong, straight, refractory, dimensionally precise (stay with us), gas-tight, noncontaminating, corrosion-proof, and resistant to thermal shock. We stock many popular shapes and sizes for fast delivery. Others quickly made to order.

*Crystar® brand

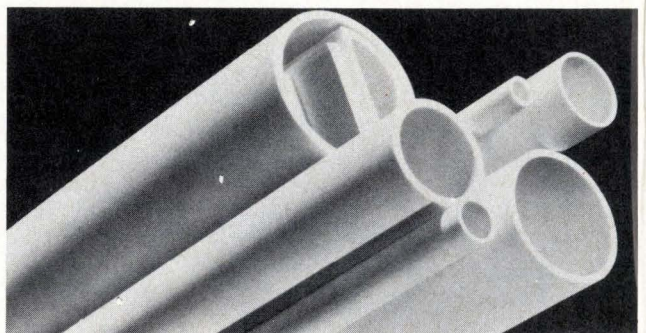

BETTER ELECTRONICS

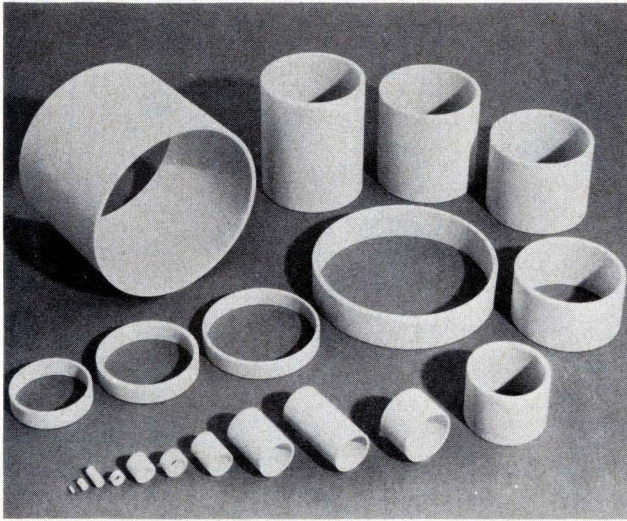

HOUSINGS

Many leading manufacturers of electron tubes specify Coors ceramic housings for their klystrons, thyratrons, TWTs, magnetrons, and other high-power devices. Have for years. The reason, we've found, is they like the consistently high quality of our alumina and beryllia ceramics. Particularly pleasing properties: excellent dielectric characteristics, uniformly high densities, good mechanical strengths, good thermal conductivity, high temperature capability, easy metallization. What's not to like?

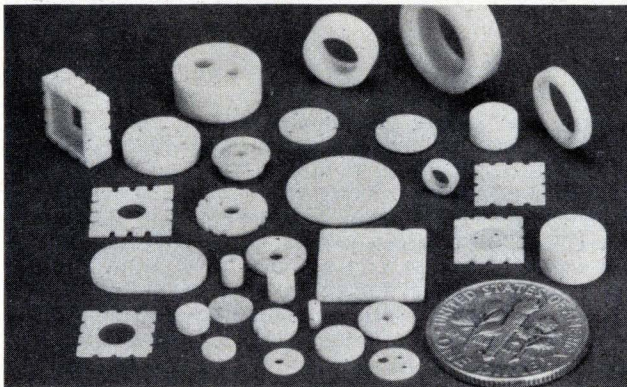

MICROCERAMICS

Microceramics is a term coined a few years ago to describe a very large variety of very small ceramic components for microelectronic applications. Spacers, headers, supports, insulators, standoffs, frames, mounting pads—you name it, we probably produce it... in alumina or beryllia ceramic... and large volumes. If you use microceramics but don't buy them from us, it would probably be worth your while to find out why not. To coin a phrase, we could both be losing money.

SUBSTRATES

Substrates for thick- and thin-film circuit bases are something of a specialty at Coors. As one of the industry's largest producers we make all practical shapes and sizes in practically any volume. For thick-film work we offer a widely used, economical 96% alumina ceramic; for thin-film, a well-established 99.5%. For circuits that lend themselves to gang-type processing we point with pride to our Strate-Breaks®, prescored substrates which, after processing, break into smaller individual units. And for small orders and quick deliveries, we have a special prototype service, including laser-scribing equipment. With all this capability we're sure we can handle your substrate requirements too. Give us a chance.

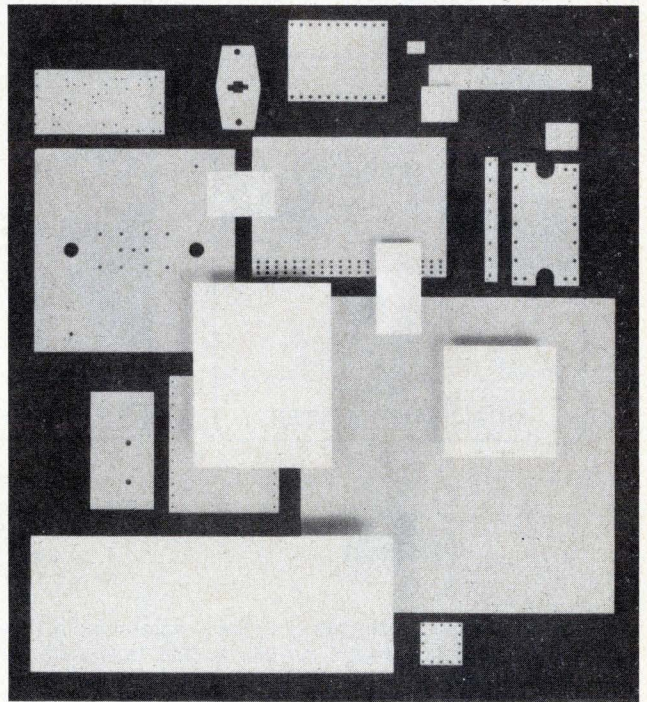

SEND FOR MORE INFORMATION using this magazine's information-request card. For faster service, write or phone:

COORS PORCELAIN COMPANY

Sales Dept., 600 Ninth St.,
Golden, CO 80401
(303) 279-6565. Telex 45593.



FOR BETTER ELECTRONICS

THE FIRST OF THE BIG COUNT TIMERS

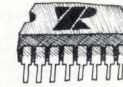
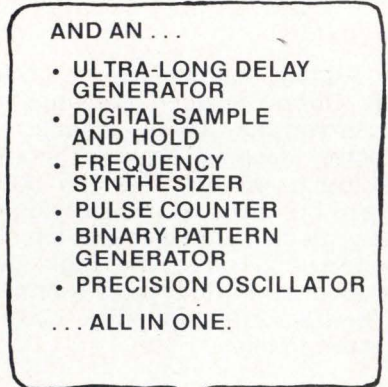
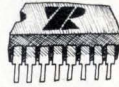
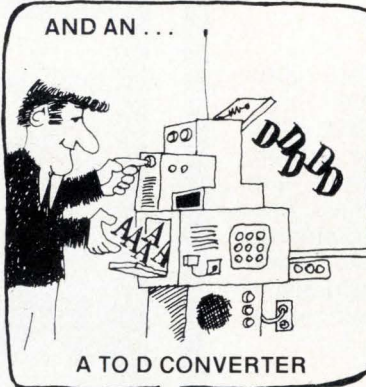
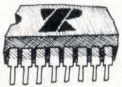
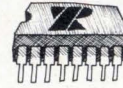
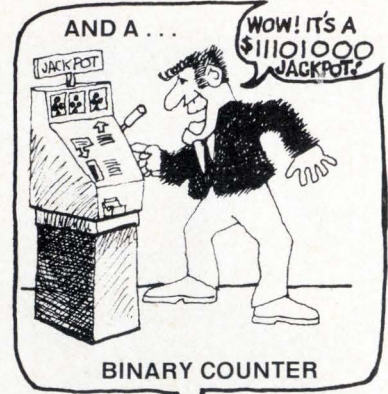
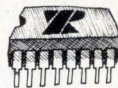
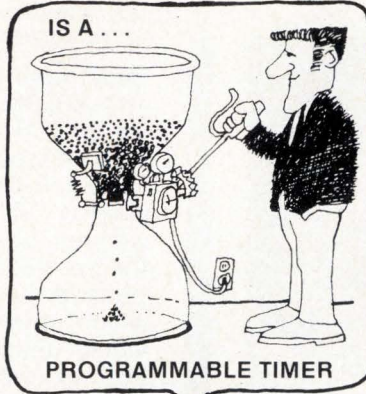
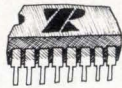
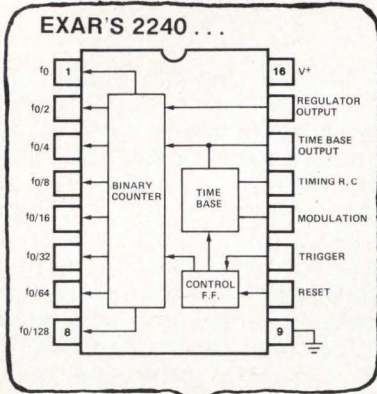

Exar's new XR-2240 counter/programmable timer solves so many tough problems that designers will unanimously agree that it's really the universal timer.

With its unique combination of analog and digital timing methods, you can now replace inadequate and complex assemblages of monolithic and electromechanical timers with the much simpler XR-2240. As a bonus, you get greater flexibility, precision operation, and a reduction in components and costs for most applications.

Because of built-in programmability, you can also use the XR-2240 for frequency synthesis, electronic music synthesis, digital sample and hold, A to D conversion, binary counting and pattern generation, and more.

With a single XR-2240 you can now generate

precision time delays programmable from $1RC$ to $255RC$, a range of microseconds to 5 days. By cascading only two XR-2240 timers, you can extend the maximum delay by a factor of 2^N , where $N = 16$ bits, resulting in a total delay of 3 years!

The XR-2240 operates over a 4V to 15V supply range with an accuracy of 0.5% and an 80 ppm/°C temperature stability. It's available in either a 16-pin ceramic or plastic dual-in-line package for military or commercial applications. Prices start at \$4.50 in 100 piece quantities.

For the more conventional timing applications, look to our other timers: the XR-320 timing circuit and the XR-2556 dual timers. Call or write Exar, the timer leader, for complete information.

EXAR SPEAKS YOUR LANGUAGE

R-OHM CORPORATION
EXAR INTEGRATED SYSTEMS
P.O. BOX 4455, IRVINE CA 92664
TELEPHONE: (714) 546-8780
TWX: 910-595-1721

Rohm
QUALITY RELIABILITY

R-OHM ELECTRONICS GMBH
EXAR INTEGRATED SYSTEMS
MÜHLENSTRASSE 70
4051 KORSCHENBROICH
FEDERAL REPUBLIC OF WEST GERMANY

Members of the International R-OHM Group

Washington newsletter

FCC likely to reject AT&T's satellite interconnect tariffs

Proposed American Telephone & Telegraph tariffs on the interconnection of AT&T land lines with domestic satellite communications **will be rejected by the Federal Communications Commission if it follows the recent recommendation to this effect by its Common Carrier Bureau**, say industry sources. The FCC decision on the proposals, which would prohibit certain interconnections without which specialized common carriers could not exist, is expected within the next few weeks. Meanwhile, **the FCC has suspended the AT&T tariffs, which were scheduled to go into effect on Aug. 31**, until other companies and the agency staff can complete their reviews.

Western Union, which runs the only U.S. satellite system at present in operation for domestic communications, has **claimed that the AT&T tariffs "would make a mockery of the FCC's satellite policy and stifle competition."** Other specialized common carriers backing WU include American Satellite Corp. and MCI Corp.

Army to seek improved radar, optics technology

Research aimed at advancing state-of-the-art radar and optical sensor technology will be funded out of the approximately \$90 million earmarked in the fiscal 1975 budget for advanced technology research by the Army's Ballistic Missile Defense System Command, headquartered in Huntsville, Ala. Military spokesmen say the radar research will include work on power amplifier tubes and the use of **LSI technology to "reduce the size of radar units by up to 90%."** **The use of charge-coupled devices as optical sensors is to be explored to improve on present sensor performance**—heat radiation is now detectable from 1,000 miles away, and objects a fraction of a radian apart can be differentiated.

Air Force to automate coding, distribution of messages

Thousands of digital electronic packages for coding and decoding military messages will be built for the Air Force and perhaps the other armed services, too, **if prototype testing of a minicomputer-based message-switching system comes to a successful conclusion** later this year at Randolph AF Base, Texas. The Air Force developed the system jointly with General Dynamics' Electronics division, San Diego, Calif., which built four prototype systems under a \$500,000 contract.

Each encoding/decoding package consists of a typewriter, a cassette recorder player, and a specially developed cryptographic device. Numbers of these packages, located at offices scattered throughout a military base, will channel messages to each other and to offices in other bases through the minicomputer. **The minicomputer functions as an automatic switch** and will be linked to minicomputers at other bases.

Satellite-borne social services could be \$1 billion market

Hopeful that Congress will approve pending legislation, officials from **the National Aeronautics and Space Administration and the Department of Health, Education and Welfare promoted the medical and educational uses of communications satellites** at an Aug. 28 conference attended by representatives from more than a dozen companies. Industry representatives, though impressed by a potentially \$1 billion market for ground terminals and other equipment, are wary of development problems. HEW officials, however, say **Congress is expected to supply guarantee financing.**

Technology transfer and Comecon, Part 2

Fairchild Camera & Instruments' C. Lester Hogan advocates commercial semiconductor technology transfer to the East European bloc of Communist nations known as Comecon in order to share in that developing market. Excerpts of Hogan's views as presented to the Senate late this summer follow. The opposing views of Texas Instruments' J. Fred Bucy appeared in this space on Aug. 22.

—Ray Connolly

Low prices are essential in protecting the U.S. semiconductor industry's competitive position in the world. To the degree our industry can sell its older technologies in a way which will not undercut that position, we can also derive income outside of product sales for the research needed to develop new technologies, permitting even further reductions in unit prices.

The semiconductor industry's overseas sales and operations have contributed a substantial net surplus to this country's balance of trade during the past decade. In 1973, this surplus amounted to \$500 million.

Eastern Europe is the last sizable, commercial market which has not been tapped by the U.S. or its Japanese or European competitors. This [commercial] market, we estimate, will provide billions of dollars of semiconductor sales over the next decade. Consumption of devices in Eastern Europe was about \$400 million last year and is expected to increase to \$1 billion annually by 1980.

The \$2.6 billion stakes

If we assume that U.S.-owned companies could capture 50% of the 1980 market, the East European sales that year could be \$500 million. This level can be realistically attained in the socialist countries by carefully negotiating agreements which specify a market share in return for products and technologies. Cumulative sales for the U.S. during the 1974-80 time span would then be \$2.6 billion. If the U.S. is denied access to this market, we believe it likely that its foreign competitors will quickly move in to dominate it.

Fairchild also felt encouraged to enter negotiations as a result of the Administration's widely publicized policy of détente. During these lengthy negotiations [beginning in 1972] with Unitra, the Polish state organization charged with semiconductor sales and production, Fairchild had no clear idea as to the kind of agreement that would be acceptable to the U.S. Government. Clearly, Fairchild knew that technology which conferred significant military advantage could not be transferred; it also

knew that the sale of integrated circuits for use in calculators was entirely permissible. The line between, however, was not known, [and] there were simply no guidelines available. So, too, today, the present policy remains, one of ad hoc approval of particular export licenses.

Fairchild submitted an export license application for its Unitra contract to the Commerce Department on March 30, 1973. On June 28, 1974—15 months and several extensions of its Unitra contract later—the Government made a decision to deny the license application [without ever giving Fairchild] a clear explanation of any particular objections which Government officials had to its contract.

This lack of feedback and this sense of frustration is particularly troubling when viewed against the expense for any company participating in this "system." Fairchild spent approximately \$400,000 on attempting to obtain Government approval for this agreement. Such costs will probably deter smaller companies from embarking upon major foreign agreements—a result which is both unfair and anti-competitive.

Suggested reforms

Fairchild recommends specific reforms of the export license control process in order to make it more open, fair and efficient, both for the Government and the private sector. These are:

- Decision-making committees or boards of experts would be created by the Government to consider and promulgate guidelines for the transfer of sensitive technology to Eastern European countries. These committees should be comprised of independent, technical personnel. Guidelines approved by the President or the appropriate cabinet members should represent binding Government policy.
- Each of these committees should seek [confidential] input from companies to insure that industry perspectives are fully considered.
- Guidelines should be reviewed periodically.
- Individual companies interested in negotiating agreements with East European countries should be [enabled] to confer privately with the appropriate committee in advance.
- Precedents created by [individual export decisions] could be made public in abstract form without the mention of names or other confidential information.
- Upon denial of an export control application, the applying party should have an opportunity to appeal to a special appeals board.
- Any system of license application review and decision-making should include time limits.

Don't worry about systems compatibility.

S-D already has.

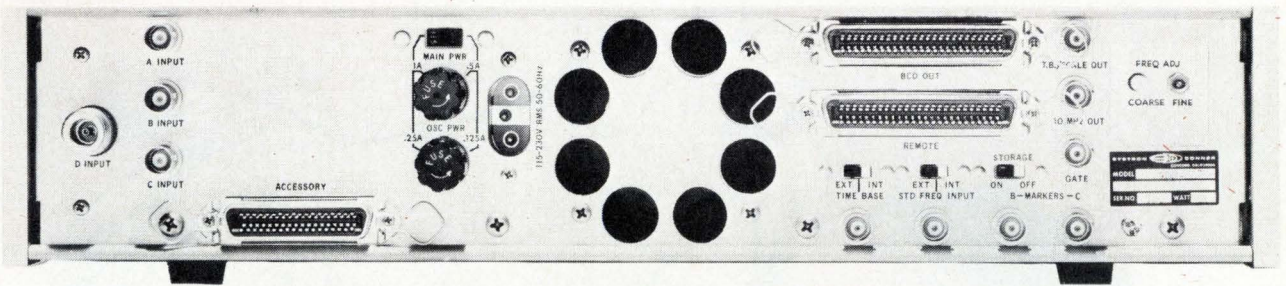

Systron-Donner manufactures a complete line of programmable instruments for systems applications. They were **meant** to be programmable right

from the start. Here are but three of S-D's many easy-to-interface instruments:

Waveform Analyzers

- Fully programmable
- Single transient to 1 GHz
- 0.1% accuracy
- 1 mv to 2 v voltage measurement
- Search mode and programmable delay

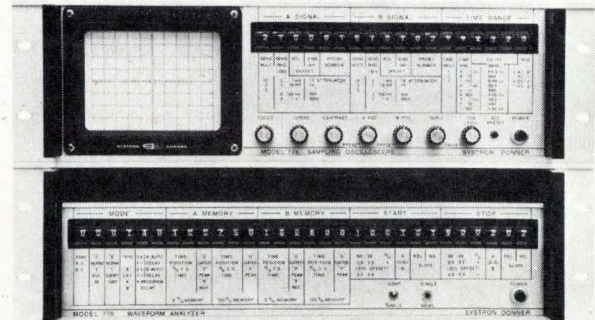

Counters

- Completely programmable including trigger levels
- 50, 200, 512 MHz or 3 GHz models
- 10 ns one shot T.I.M./period



Pulse Generators

- All pulse parameters programmable
- 50 MHz repetition rate
- Current sink capability

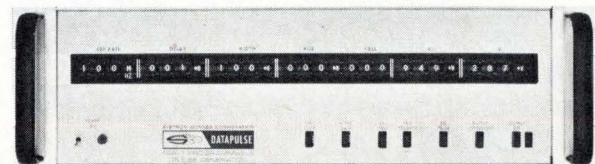

For immediate information on Systron-Donner's broad line of instruments for systems, call us collect on our Quick Reaction line: (415) 682-6471. Or you may contact your Scientific Devices office or S-D Concord Instruments Division, 10 Systron Drive, Concord, CA 94518. Europe: Systron-Donner GmbH, Munich, W. Germany; Systron-Donner Ltd., Leamington Spa, U.K.; Systron-Donner S.A., Paris (Le Port Marly) France. Australia: Systron-Donner Pty. Ltd., Melbourne.

SYSTRON  **DONNER**



Just arrived! Our 12-bit CMOS DAC.

Our new baby's a beauty. With 12-bit resolution and *guaranteed* linearity of $\pm\frac{1}{2}$ LSB in 10 bits over -55° to $+125^{\circ}\text{C}$.

We've christened it Model 872, and it's a *complete* DAC. CMOS input logic, R-2R ladder, micropower output amp, internal reference—even preset zero offset and gain—are all inside.

And all of this comes in one neat package just 1" by 1.5". Price is \$49.50 to \$66 in 200-piece quantity, depending on linearity and internal reference specs.

You might have expected it, considering that we're one of the country's major suppliers of DACs...and among the leading hybrid manufacturers, too. We make a lot of standard hybrids, but we're also great problem-solvers in custom situations.

If you need immediate technical literature or the telephone number of your local Beckman/Helipot representative, call toll-free (800) 437-4677.

Beckman®
HELIPOT DIVISION

Erase-mode innovation gives fast, dense RAM, electrically alterable ROM

A **nonvolatile** semiconductor memory with a new type of erase mode can be used as a random-access memory—with an access time of 500 nanoseconds and an erase time of 1 millisecond, or less. It can also be used as an electrically alterable read-only memory with the same fast access time. When used as a RAM, the memory retains information during power interruption and uses no power to maintain memory information.

The 1-kilobit developmental device, which uses MNOS technology, was developed at the Toshiba R&D center by a group headed by Yoshio Nishi and Keikichi Tamaru. It is organized as 1,024 words by one bit. The memory includes full decoding on the chip for writing, reading, and selective erasing—which is the key improvement that makes it possible to use the new memory for RAM applications.

A major barrier to selective erasing of individual bits in memories of this type is the need for reverse polarity—opposite that used in the write operation—during the erase operation. This may require electrical isolation of individual bits, which greatly reduces the number of bits that can be put on a single chip.

Toshiba engineers eliminated the need for reverse polarity in the new memory by using different physical mechanisms for writing and erasing. Writing a 1 into the device utilizes a tunneling mechanism similar to that used with other MNOS devices. A -30-volt pulse is applied to the memory transistor gate, with the source, drain, and substrate at ground potential.

However, a 0 is written into the new memory by a combined avalanche-tunnel mechanism. The only disadvantage is that a somewhat larger voltage pulse is required—about 40 v.

In the actual array, each cell consists of one p-channel MNOS transis-

tor for memory and two enhancement-type p-channel MOS transistors for cell selection. Coincident selection is used to select cells for writing and reading.

In some respects, the operation of MNOS transistors is intrinsically analog, and so the voltage values are not absolute. The magnitude of the pulses and their duration will affect both memory retention characteristics and operating margin. In any case, the voltages cited and pulses of not more than 1-millisecond duration will provide essentially

permanent writing. Where this is not necessary, shorter pulses can be used.

Fabrication of these memories is more complex than for usual MOS circuits because both the MNOS transistors for data storage and silicon-gate transistors for bit selection and peripheral circuits are fabricated in the same device. Furthermore, the depletion-type transistors require boron channel doping, and phosphorous-ion implantation is required to cut the channels of parasitic transistors. □

Around the world

1d holograms for dense data storage

Through a bit of manipulation of light paths, a new approach eases the storing and reproduction of optical signals on tape or disks. Using coherent optical means—or holograms—the method offers high bit densities while eliminating the mechanical tolerance problems associated with other optical recording and readout methods. The technique, developed at the Munich labs of Siemens AG, uses one-dimensional holograms that are projected by laser beams onto an erasable recording medium—a thermoplastic, for example. For reading out the information contained in the holograms, the tape or disk is moved past a constant reference beam.

In experiments performed so far, the Siemens approach has yielded a linear storage density of 1,000 bits per millimeter along a 3-micrometer-wide track. "But that," says Hartwig Rüll, who developed the technique, "is far from what's achievable." With a refined lens system, it will be possible to produce 1.5–2-micrometer tracks, and that will push the packing density to 10^5 bits per square millimeter and beyond, Rüll says.

Color synthesizer animates TV screen

Heard of switched-on Bach? How about switched-on Fellini? Production will begin soon on a color-video synthesizer, which may do for TV pictures what the audio synthesizer does for sound. Developed by Electronic Music Studios Ltd., the synthesizer, called Spectre, allows the user to generate a wide variety of moving or static patterns and shapes on a TV screen.

The intended market encompasses visual artists and designers involved in commercial graphics, and the special effects departments of television or movie studios. Or it could function as home entertainment for the visually oriented person who can afford the \$10,000 price tag. Digitally-based, Spectre can show self-generated images in up to 64 colors or play upon images in 16 levels of brightness, from a variety of sources, including monochrome-TV cameras, still-life pictures, and film.

And, to give a graphics designer a wide electronic palette, the system can be adapted to record new images or designs on previously recorded tapes in what becomes a form of video multitrack recording similar to what is done in recording studios. Moreover, sound can be plugged into the unit so the images, or sequences, respond by color, shape or pulsing to music, at the discretion of the user. The basic system consists of the valise-sized synthesizer, a small monochrome-TV camera, and a color-TV set.



The world's leading manufacturer of miniature aluminum electrolytics wants to show you their etchings.

**Come visit us at the Wescon Show
Booth 4024 • Los Angeles • Sept. 10-13**

In the production process of electrolytic capacitors, the etching and forming of the foil is one of the most critical processes. The design of the foil directly affects performance and life.

This is why United Chemicon designs, etches and forms all its own foil and achieves complete quality control of every one of the over 60 million miniatures we sell each month. We know that we must use exactly the right type of foil to meet our customers' specific performance characteristics. That's why we welcome special, tough applications.

Now that you know more about our etchings, you should also know that our special machinery division designs, develops and builds all our machinery. Every capacitor is automatically aged and 100% tested.

This control guarantees an unparalleled degree of product uniformity, predictability and reliability of supply.

Shouldn't you know us?

Write, call 315/474-2954
or wire for full information
and latest technical bulletins.

6.3 to 500 WV, op temps from -40° to $+85^{\circ}$ C.
We solicit inquiries to your specs, as broader temperature ranges and performance characteristics are available.



United Chemicon.

World's leading manufacturer of miniature aluminum electrolytics. You should know us.

©1974 United Chemicon, Inc. 731 James Street Syracuse, New York 13203 315/474-2954 TELEX 937439

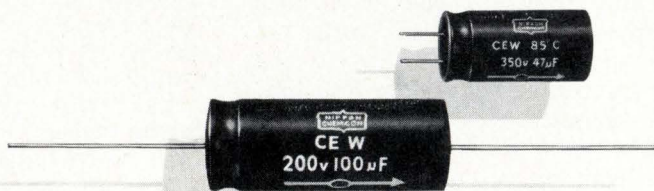

German company develops 90-minute video cassette

West Germany's BASF has developed a magnetic-tape cassette system that could eventually become the key item in small hand-held consumer-type video cameras. Called LVR, for longitudinal video recording, the system features a playback time of 90 minutes—half an hour more than that of the longest-playing video cassettes now on the market.

In a radical departure from conventional techniques, which record with rotating heads along slanted tracks, **the LVR uses a fixed head and longitudinal tracks.** Recording and playback, either in black and white or color, are with a 580-meter-long, 0.25-inch-wide chromium dioxide magnetic tape containing 28 parallel tracks. The tape moves at 3 meters per second and reverses its direction of movement at each track end. With this reversal taking only 80 milliseconds, the track change is hardly perceivable by the eye. The cassette measures 118 by 110 by 16 mm and is thus no larger than a pack of five cigars.

Now under development at BASF is a suitable playback system for home applications as well as a 2-hour tape to hit the market not before 1976. **The playback system will sell for less than \$1,150, BASF says. The cassette price will be about \$35 for the 90-version and roughly \$46 for the 2-hour version.** Use of the cassette in a consumer-type video camera depends on how soon electronics producers come up with a relatively inexpensive and compact camera with a semiconductor or charge-coupled-device pickup system to replace the vidicon tube.

MRCA still limping, as Lucas meets with delay on engine unit

Development of the pan-European Multi-Role Combat Aircraft, which has been limping along from assorted ills, has picked up another nail in its shoe: **delay in the delivery of the production versions of electronic engine-control units.** Lucas Aerospace, which is in charge of that phase, confirms that it will take at least until next February to work out the bugs and deliver the production units. Lucas is sub-contractor to engine-builder Rolls-Royce. The MRCA, a joint effort by the UK, Germany, and Italy, now costs an estimated \$10 million per plane.

Meanwhile, interim units, mainly built by Rolls with aid from Lucas, have been used to help get first versions of the plane flying. However, these units reportedly don't have the reliability that the production units are designed to achieve. **The control units, which suffer from overheating problems because of their close proximity to the engines, have been plagued from the start,** partially due to last-minute design changes and conflicts between the analog Rolls design and Lucas' digital experience during the two-and-a-half year effort.

Siemens, Hungarian company set up joint consulting firm

By setting up a joint company in Budapest, West Germany's Siemens AG and the Hungarian firm Intercooperation have begun a venture that is something of a novelty in East-West economic relations. **It's the first time, Siemens says, that a western electronics/electrical producer has become part owner of a company in Eastern Europe,** where capitalist ownership is generally considered anathema. The new venture, in which Siemens has a 49% share is called Sicontact GmbH and is run by a Hungarian-German management team. Sicontact will act primarily as a consulting firm. Among its tasks will be helping to solve problems in automation and control engineering, giving technical advice to the

Hungarian industry in devising production programs and assisting in the planning and developing of large electro-technical systems. Sicon-tact will also perform systems service and train Hungarian technicians.

Marconi, Philco-Ford team to battle for satcom market

The impending Brazilian domestic satellite system is the biggest target for Marconi Space and Defence Systems and Philco-Ford. They have informally joined forces **to compete for a worldwide market in communications satellite systems, which is estimated to be many billions of dollars in the next 10 years by one Marconi executive.** Since each considerably-experienced company has the capability to build complete systems from ground terminals to space craft, the UK-U.S. team has a "gentlemen's agreement" on a number of things. For one, the prime contractor will be from the country most favorable to the areas wanting systems. For another, subsystems will be apportioned commensurate with each company's capability and expertise. Though no joint company will be formed, apparently, the team based on a decades experience as subcontractors to each other in specific programs, also seeks possible sales in India, the Arabian states, and Australia among others.

Meanwhile, Marconi is seeking to enter the U.S. domestic satellite market as a subsystem supplier. The British company is in earnest talks with RCA Globcom, American Satellite Corp. and TRW Systems about supplying such things as transponders and spacecraft propulsion control units.

Sharp to build color-TV sets in Australia

Large-screen PAL color-TV sets in console cabinets will start coming off the lines next January at a Sharp Corp. subsidiary plant in the suburbs of Sydney, Australia. The rented plant will start with 22-inch sets and then add 26-in. models. Initial production will be 1,500 sets a month, increasing to 3,000 by the end of the first year. The workforce is expected to be stable at about 200, though. Cabinets and other suitable components will be produced locally—including the 26-in. tubes, which are not available in Japan. Complete 18-in. sets and smaller models will continue to be supplied from Japan. Sharp says **the cost of shipping large sets, for which there is demand in Australia, together with a limited market for large sets at home, is behind the move.**

Addenda

A fully decoded 2,304-bit MNOS electrically alterable ROM has been developed at Toshiba's research and development center. Contents of the 256-word-by-9-bit memory can be electrically erased and rewritten at least 1 million times and retained in excess of 10 years. Electrical isolation between the memory circuits in the center of the chip and the decoder circuits around the periphery facilitates application of opposite polarity write and erase voltages. . . . Sharp Corp. has developed **a silicon photovoltaic cell with good sensitivity to ultraviolet** and is pushing it for use in test and measuring equipment. Each cell costs about \$20, but it is cheaper than a photo multiplier plus power supply. One job for the cell will be to monitor chemical processes and pollution. . . . San-ken has started production of **a large numerical LED with the digit measuring about 0.6 by 0.4 inch.** It will sell for about \$1.33 in quantity.

New snap-in rockers with Cutler-Hammer reliability.

Here's a completely new line of snap-ins, each engineered with the kind of solid dependability you expect in Cutler-Hammer Rockette® switches. Bright metal bezels, illuminated and non-illuminated, A-c and D-c capabilities up to 20 amps.

Sub-panel rockers in a variety of colors, rocker or paddle designs in standard, special, or proprietary models.

Switches snap in and stay in permanently. Speed up assembly time, cut costs.

Flush-mounted rockers in the same wide range of designer-oriented colors and styles. One- and two-pole models.

Illuminated single-pole rockers. Choice of red, green, amber, white, or clear. Hot-stamped legends indicate switch functions.

For more information, call your Cutler-Hammer Sales Office or Switch Distributor.

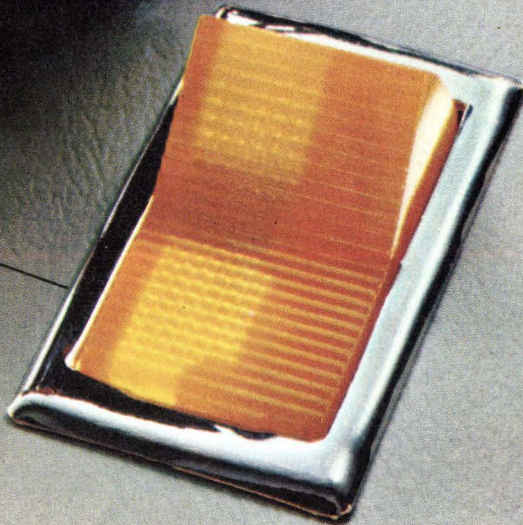
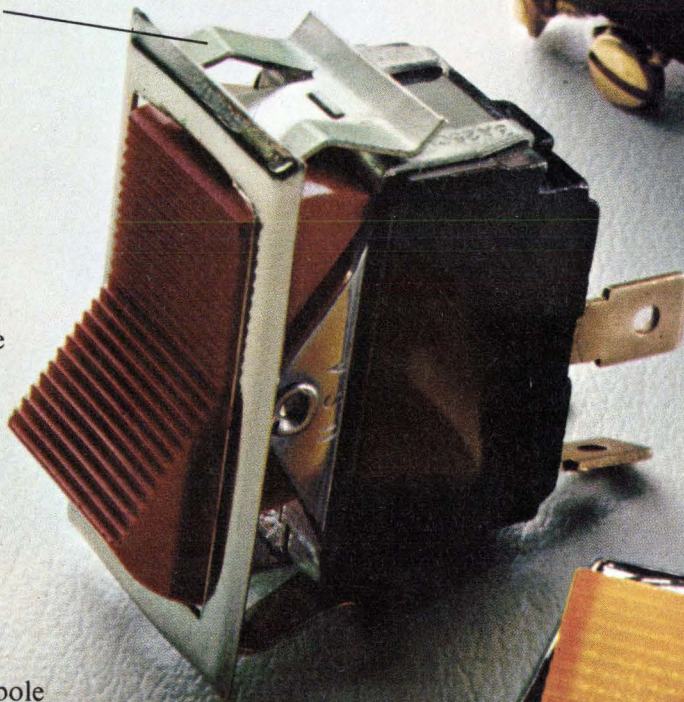

CUTLER-HAMMER
SPECIALTY PRODUCTS DIVISION, Milwaukee, Wis. 53201

 **Switch to No.1**

INTRODUCING LITTELITES FROM LITTELFUSE



SNAP-MOUNT PLASTIC LITES

For rectangular, $\frac{5}{16}$ " and $\frac{1}{2}$ " diameter mounting holes. Flex arms insure positive retention and protection against shock and vibration.



SUBMINIATURE LAMP HOLDERS

Eight series of holders for front or rear mounting into $\frac{3}{8}$ ", $\frac{15}{32}$ ", or $\frac{17}{32}$ " clearance holes. For use with replaceable neon or incandescent midget flanged base lamps.



CARTRIDGE LAMPS AND LAMP HOLDERS

Available with solid state, incandescent, and neon lamps. Mating holders mount into $\frac{3}{8}$ " clearance holes.



MINIATURE LAMP HOLDERS

For front mounting into $\frac{11}{16}$ " clearance holes. Designed to accept replaceable bayonet based neon and incandescent lamps.

**The most unique indicator light
and service program ever offered
to manufacturers**

We're out to win you over to Littelfuses with top quality, fast service, and hard facts. Judge for yourself:

FACT 1. Littelfuse is the only manufacturer that offers all four types of indicator lights, saving you time, paperwork, and money.

FACT 2. Littelfuse has all new tooling and total in-house production capabilities for top quality, better control, and faster processing.

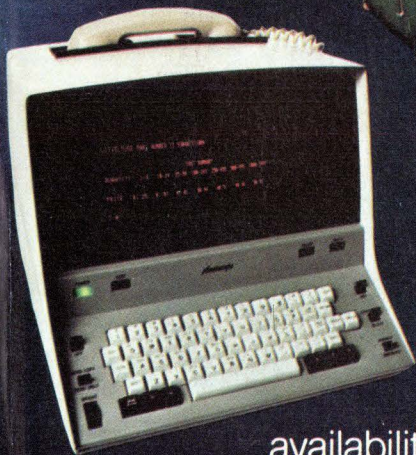
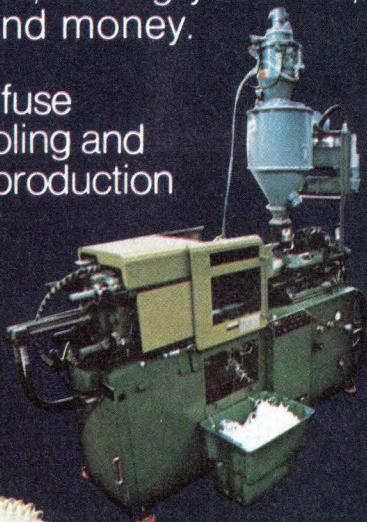

FACT 3. Littelfuse has a computerized service center that can cross reference, price, and provide availability information . . . all within seconds.

FACT 4. Littelfuse means fast, prompt delivery.

FACT 5. Littelfuse has a Littelfuses team of R & D and sales engineers to assist you.



FACT 6. Littelfuse offers the widest selection of packaging available.

FACT 7. Littelfuse offers one-stop shopping for your additional circuit protection and control device needs.

FOR MORE INFORMATION

Contact Littelfuse or your local Littelfuse representative and ask for our Littelfuses Product Guide or individual product catalogs:

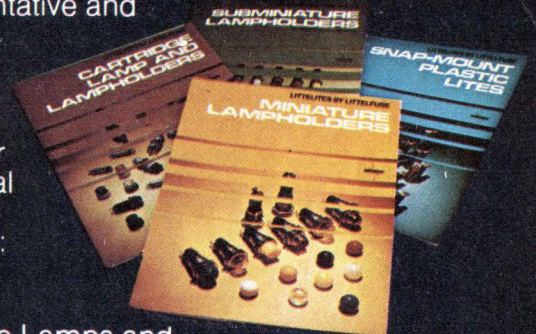

Cartridge Lamps and Lampholders	Cat. No. LL-C574
Subminiature Lampholders	Cat. No. LL-S574
Miniature Lampholders	Cat. No. LL-M574
Snap-Mount Plastic Lites	Cat. No. LL-P574

LITTELFUSE

LITTELITES

Your indication of quality and service

800 E. Northwest Highway
Des Plaines, Illinois 60016
(312) 824-1188

Subsidiary of Tracor

Circle 59 on reader service card

Only TRW/IRC offers you complete resistor choice.



You get exactly the resistor you need for your application.

No compromises. No "favorites." Just quality.

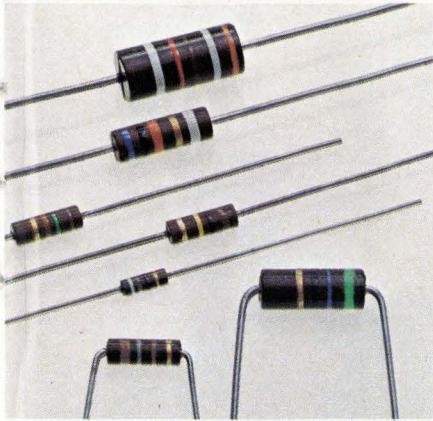

Carbon comp.

Billions used in consumer, industrial, military applications. TRW/IRC carbon comp. capability ranges from standard commercial types through established reliability RCR's, to ultra-high range (10^{11} ohms). Where you're using carbon comp.'s in automated assembly, TRW/IRC packaging options can help cut the cost of interfacing with your machines. Card packs, lead tape reels, cut and formed leads... we'll be glad to explore the potential economies with you.

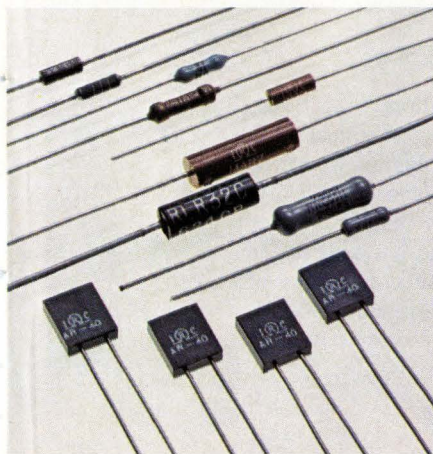

Metal Film

TRW/IRC has brought the state of the art in thin-film to a performance level equaling high-stability wirewounds. Capabilities include resistors with tolerances to $\pm 0.01\%$ and ± 3 PPM T.C. ...high-rel units... precision subminiatures...and, of course

the popular RN's. You can also look at alloy films offering high-temperature and high-voltage capability at low cost.

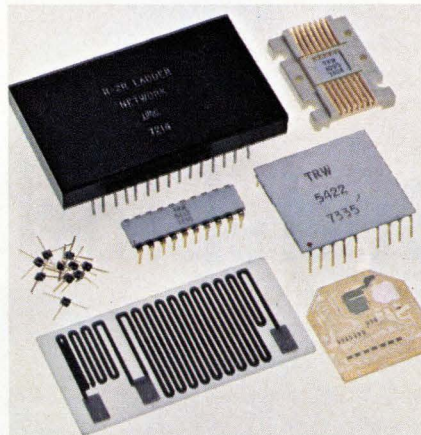

Resistive Networks

Advanced resistor technology here. These IC compatible, precision tantalum-film circuits provide inherent low noise, excellent stability, and hermetic performance without hermetic cost. Tolerances from 5% to 0.05% available in custom designs. TRW/IRC also offers the industry's most complete line of discrete fixed resistors.

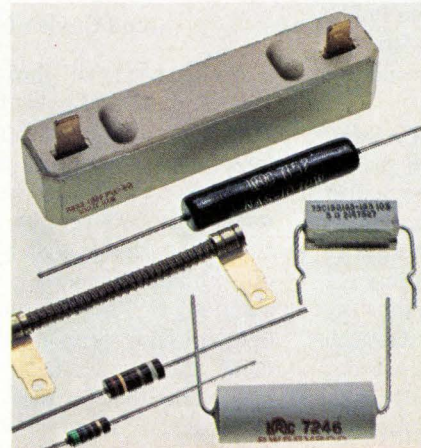

Wirewound

The line starts with molded wirewound resistors—"space-savers" that bridge the cost-performance gap between composition resistors and precision wirewounds. It proceeds to standard, non-insulated types

for appliance/automotive use...to precision subminiatures offering high power density... to low cost fusible, flameproof units for consumer and industrial applications... to tubular and flat power wirewounds with ratings to 250 W.

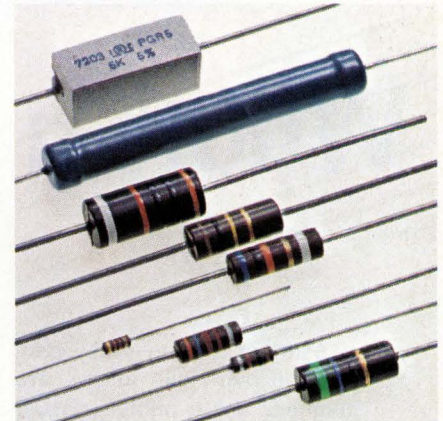

Metal Glaze™

This is TRW/IRC's thick-film technology—for all types of low power resistor applications. Metal Glaze is widely accepted for its built-in power handling reliability, resistance range, and cost effectiveness. Numerous standard and special designs—precision, semi-precision, flameproof, high-rel, high-voltage.

All types...all technologies... one source

To wrap it up, TRW/IRC offers you the most complete line of fixed resistors in the business, with many of the popular types available from one source—your local TRW/IRC distributor. Having a direct pipeline to each of our plants, he can give you fast delivery.

Contact your local TRW sales office for application assistance, custom designs, and special engineering help when you need it. TRW/IRC Resistors, an Electronic Components Division of TRW, Inc. Plants at Boone, N.C., Burlington, Iowa, and Philadelphia, Pa. Write TRW/IRC Resistors, 401 N. Broad St., Philadelphia, Pa. 19108. Or call (215) 923-8230.

TRW[®] IRC RESISTORS

Circle 61 on reader service card

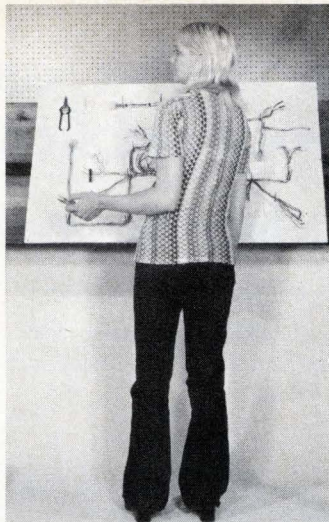
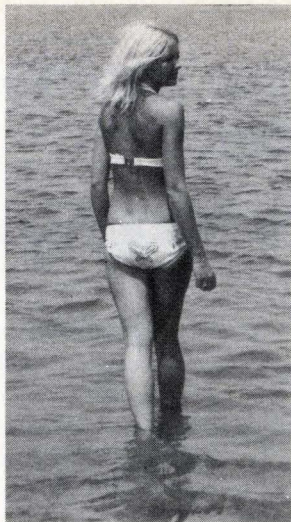

What's a Gudebrod?

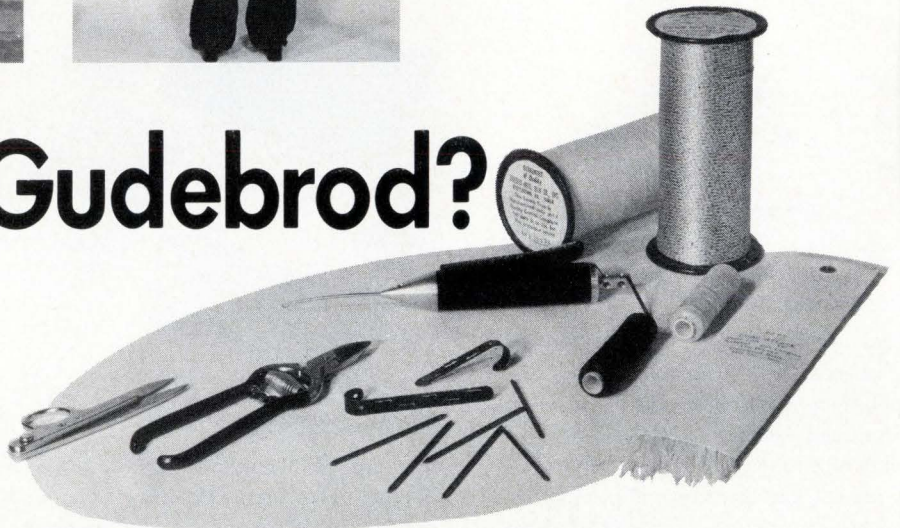

Many of the new-today company names and images are dreamed up in public relations and advertising agency offices. The company and its product names will have an interesting ring to them, will be catchy, quick on the tongue and easy to remember, which in turn helps to sell the product.

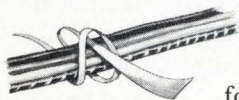

The Gudebrod Brothers formed this company in 1870 B.P.R.H. (Before Public Relations Hoopla!). But even with this time honored image . . . our name sure takes a beating!

Chances are, one of our **GOOD BOARD** Salesman is teaching a young apprentice in the harness room, the proper way to tie the no-lost motion knot . . . we *often do that* you know! Chances are somewhere in the world, there is an electronics show where the **GUDIE BROD** (as they say in Denmark) products such as lacing tapes, cable lacers, harness pins, WHO clips, swivel tilt board mounts, snips and cutters are on display.

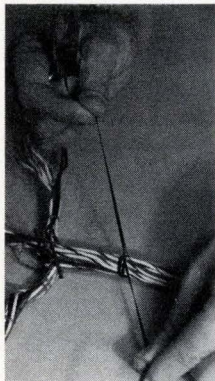

As for the **GOOD BROAD** lacing tapes . . .

Why, they're of the highest quality and we

offer you a complete range from which to choose. Nylon*, Dacron*, Teflon*, Nomex*, Glass. All have a definite purpose. Many meet and exceed military specifications, and if none meet your requirements . . . we'll research for one that does.

Good Guide's been thru it!

We've been all through those vibrations, extreme heat and cold, fungus, chemical reactions and self-extinguishing problems. We know how to tie it up, hold it down or cut it off! Knots won't slip, harnesses stay tied, assemblies remain firm and secure . . . and it's a lot faster and less expensive than you think. Give one of our 6 branch offices a call today and we'll talk about it. Don't be alarmed if our switchboard operator also pronounces the name wrong . . . she's been doing that for the better part of the last 103 successful years!



By the way . . . **GUDEBROD** is pronounced **GOOD BROD** but of course, those of you buying our products may continue to call us whatever you like!

Send for the Gudebrod Facts today!

Burbank, Cal. Chicago, Ill. Charlotte, N. C. New York, N. Y. Boston, Mass.
(213) 848-3962 (312) 337-3025 (704) 333-9591 (212) 524-5858 (617) 426-5347

*DuPont Trademark



Gudebrod Executive Office
Dept. 193, 12 South 12th Street
Philadelphia, Pa. 19107 (215) 922-1122

SIX NEW SWITCHERS. LET US SHIP YOU SOME.

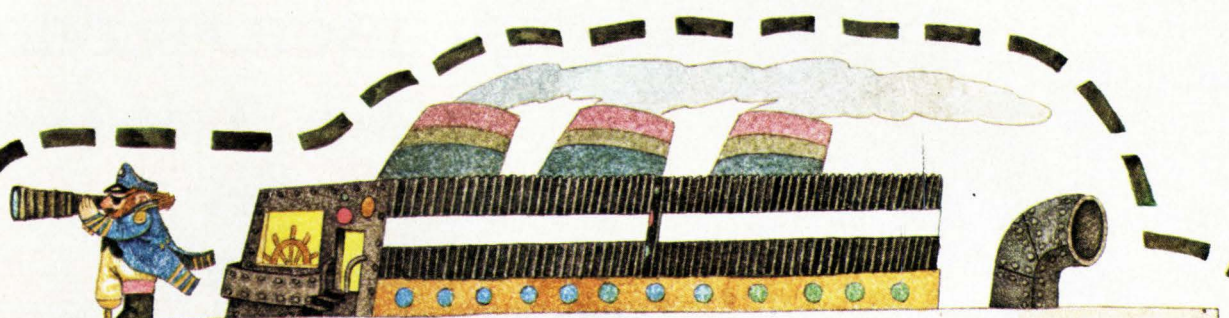

It's a small celebration to launch six new models in our switching power supply series: five 150 watt units and a 750 watt unit. From us: ACDC Electronics, Inc. Manufacturers of proven, reliable DC power supplies. The new JP switchers offer the latest in technology. Small, cool and efficient, they pack more watts per cubic inch than conventional pass-type supplies. These 20 KHz inaudible switching power supplies operate from a selectable input of 115/220-230 VAC 47-63Hz (100 VAC also available). Overvoltage and overload protection is standard. EMI is minimized by shielding and filtering. Low inrush turn-on for soft start. Units can be paralleled for higher current requirements. Don't miss the boat. Just circle the reader service number. Or if you'd like information on ACDC's complete line of DC power supplies, fill out the coupon or write to us on your company letterhead. We'll send you our 1974 product and application guide.

ACDC

Name

Company Name

Address

City State Zip Code

acdc electronics inc.

Oceanside Industrial Center, Oceanside, CA 92054
(714) 757-1880



To locate your nearest ACDC representative call toll-free (800) 645-9200 (In New York State, Call Collect (516) 294-0990).



BOURNS®
New, Low-Cost
Cermet
Trimming
Potentiometer
outperforms
the other
"small-change"
models!

Bourns super cermet performance delivers again. Our new Model 3352 trimming potentiometer handles more power . . . takes more shock and vibration . . . has a lower CRV . . . and is easier to set than, for example, the "Model 91". Naturally, Bourns super cermet performance is comparably priced. You can depend on it.

The 3352 is a 3/8" diameter, single-turn device with an easy (but stable) three-way thumbwheel adjust. It can be wave-soldered, and withstands board washing processes with minimal (1%) TR shift. The 3352 is available TODAY in a variety of pin styles to suit your requirements.

Compare performance . . . specify Bourns Model 3352. For complete details, contact your local Bourns representative . . . or the factory direct.

COMPARE PERFORMANCE

	Model 3352	Beckman Model 91
Power	.75 watts at 40°C	.5 watts at 40°C
Electrical Angle	230°	180°
Adjustability	±0.05%	±0.05%
Torque	5 oz.-in. max.	6 oz.-in.
Shock	100G's max. ±2% VRS	50G's no VRS spec.
Vibration	30G's max. ±2% VRS	10G's no VRS spec.
Contact Resistance Var.	1%	2%
Rotational Life	200 cycles	200 cycles
Temp. Range	-55°C to +125°C	-55°C to +125°C



*Nobody knows more about
trimming potentiometers than we do*



TRIMPOT PRODUCTS DIVISION • 1200 COLUMBIA AVE., RIVERSIDE, CALIF. 92507

Circle 64 on reader service card

Probing the news

Analysis of technology and business developments

Pacemakers quicken their market beat

New technologies, wider applications, auger 25% sales hike even though makers plan new models to last longer

by William F. Arnold, London bureau manager

A particularly vital offshoot of the electronics industries—the manufacture of heart pacemakers—is picking its way through a sizeable stack of state-of-the-art advances and could be facing a prolonged upsurge in growth. Some companies are predicting a growth rate of 25% per year for the next five or six years.

Technical improvements, actual or feasible, that have entered the pacemaker field in recent years have had, or are expected to have, a number of effects, including:

- Programable pacemakers that can be adjusted externally.
- Greater use of hybrid circuitry in place of discrete components.
- Use of C-MOS circuitry to lengthen battery life and improve electrode performance.
- Longer-life power sources, including lithium, nickel-cadmium and sodium-bromine approaches. (Interest in nuclear power seems to be declining because of Government regulations and medical reasons).
- Improved geometric design and surface coating of electrodes to decrease current drain.
- Newer hermetic seals and coatings to better insulate the electronic circuitry against damage from body fluids and batteries.
- More units that are rechargeable and more that are “bifocal,” i.e., they stimulate two heart chambers instead of one.

But as much as new electronics technology promises to benefit patients, doctors must first be sold on new technology. Here companies differ over how receptive physicians might be.

Donald E. Battles, pacemaker marketing director for General Electric's Medical Systems division, presents one view. “Pacemakers are now the treatment of choice for heart block,” he says, “but several physicians are considering them the treatment of choice for many cardiac deficiencies,” a task now confined primarily to drugs.

But surgeons like to use a unit with which they are familiar. They are reluctant to try something new, since they don't want to have to learn new techniques and performance quirks. Thus, some physicians aver that new devices might have tough going.

Batteries. Another of the major questions in pacemaker technology, according to A. G. Blankenstijn, marketing manager for Vitatron Medical of the Netherlands, is the pacemaker power supply. Vitatron, for example, is moving into lithium-iodine batteries, which it thinks will last 5 to 10 years, depending on circuitry design. Vitatron now gets about three years of life out of mercury-oxide-zinc units. GE uses a mercury-zinc battery in its newest line, which is expected to have an implanted life of more than five years, says P. Richard Kelly, GE director of pacemaker engineering.

“Circuitry advances, like C-MOS, will help improve battery life, as will electrode improvements that might lower packing thresholds by an order of magnitude in terms of power delivered to the patient,” Kelly says. “But barring electrode development, we'll probably need a different power cell to increase pace-

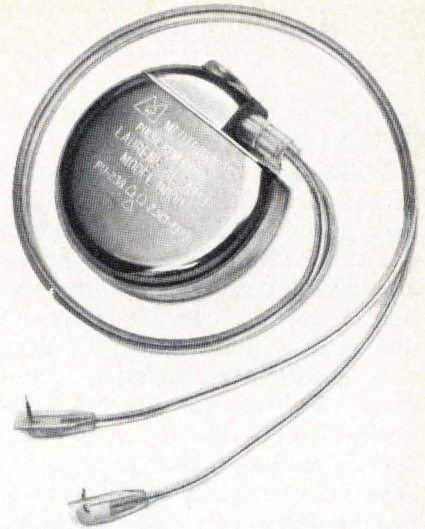

Steady beat. Medtronic is licensed in U.S. to make nuclear-powered pacemaker (above) developed in France. Pictured below is a conventional model manufactured by the Minneapolis, Minn., company.



maker longevity to more than five years,” he says. There's some hope for lithium power cells, and GE is also looking at sodium-bromine sources.

Medtronic Inc. of Minneapolis, Minn., is using a mercury cell that will make its pacemakers run three times as long as previous ones, up to seven or more years, according to Dr. Alan R. Kahn, vice president for research and engineering. But the company also is intrigued with lithium power cells. “Theoretically, we can predict a very long life, but the world just doesn't have enough ex-

Probing the news

perience to predict the problems of lithium batteries," he says.

While agreeing on the importance of batteries, Dr. Herbert E. Goldberg, general manager for American Optical, Bedford, Mass., thinks the emphasis should be more on reliability than longevity. He points out that most batteries last four years, new solid-state batteries about seven, and nuclear sources practically forever. But, he says, pacemaker patients (average age 67) have an average life expectancy of five to seven years. More reliable batteries are necessary because most pacemaker failures are battery failures, Goldberg says. His company is looking at nuclear sources but hasn't produced any. Most other companies are lukewarm, at best, about nuclear sources.

Companies pushing longevity gains have been concentrating on two other areas besides better batteries: Lowering the threshold of electrical stimulation of the heart, and designing circuitry that draws less power to drive the heart.

Current drains have been cut in half in the last two years—from 25 or 30 microamperes down to 13, 14, or 15, says Kahn. "As we learn more about the energy required to stimulate the heart, we find we've overdone it. So we've titrated it down—the pulses now deliver less energy to the heart, but are still effective," he says.

Whither C-MOS? While most pacemakers today use discrete components, "there is little doubt that as the state of the art moves forward, more and more will take advantage of things like C-MOS circuitry," notes Kelly. With the exception of the output (stimulation) pulse, all pacemaker circuitry could be C-MOS, once its reliability is proven, he says. Though C-MOS has been around more than five years, it's only been recently that any pacemaker has used it, he points out. Kelly says the industry is just now moving toward increasing use of hybrid circuitry, and 100% hermetically sealed packages.

Will all this lead to pacemakers on a single chip? "I doubt it," replies Medtronics' Kahn. "As long as the

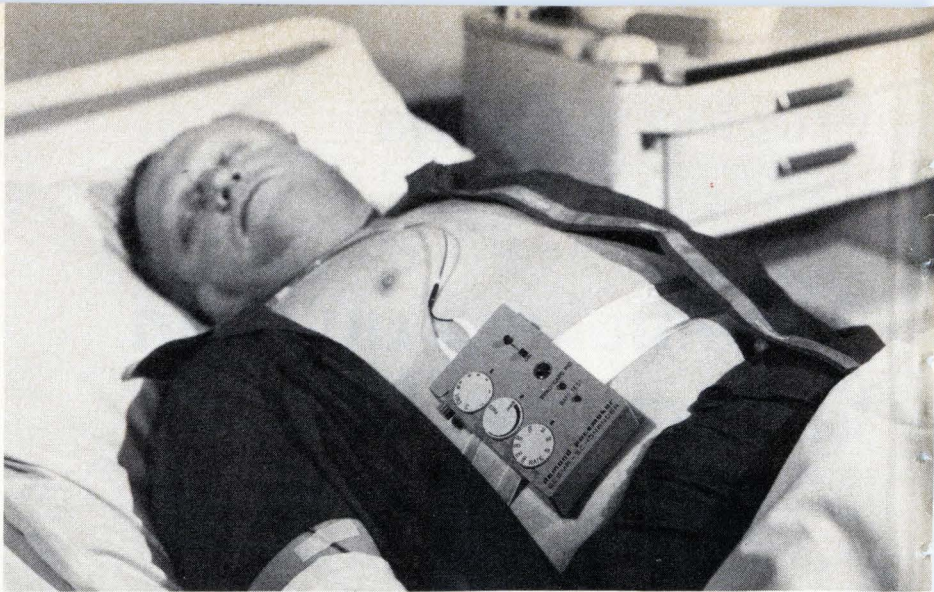

On the Job. Patient is shown wearing a demand pacemaker control unit. The Swedish device also can operate at a fixed rate. At right is a version from Siemens of West Germany, the model EM152.

field keeps changing as fast as it does, we'll keep the components hybridized."

Impatient. Some industry sources, however, are impatient with the preoccupation with more sophisticated circuitry. They say it has tended to eclipse another, more mundane, but important concern of pacemaker manufacturers: electromagnetic interference.

Interference became a problem with the advent of so-called demand units—ones that monitor the heartbeat and kick in when the beat falls below a certain rate; and with rechargeable units, which must be sensitive to outside signals (ideally only that one that performs the recharging.)

Pacemakers now sell for about \$1,000; improvements are expected to push up the price. Longer-lived units that would last six to eight years could command about \$2,000, estimates Robert Gaertner, director of investor relations for Medtronic, which claims to make 60% of the units sold worldwide.

Industry consensus is that sales will total about \$60 million this year, peaking to perhaps \$500 million in 1980. But who sells how much remains closely guarded information.

"This is a very competitive business," observes Allan Smale, managing director of Great Britain's Devices Implants Ltd., which was recently acquired by the U.S. John-



son and Johnson group. Smale declined to pinpoint his company's sales figures. He's echoed by Joel Bernstein, corporate attorney for Cordis Corp., Miami, Fla. "We don't want to tip off our competitors," Bernstein says.

But the apparent industry leader is Medtronic, followed by Cordis, which has a programable pacemaker on the market. Also in the running are CPI in Minneapolis, American Optical, and Pacesetter Systems Inc., of Sylmar, Calif., which produces the nickel-cadmium-powered rechargeable unit developed at Johns Hopkins University [*Electronics*, Aug. 16, 1973, p. 35].

Other important contenders are Siemens AG and Biotronix in West Germany, and Siemens-Elema in Sweden, which with 20% of the world market has one unit that lets a doctor externally monitor performance. □

WHY DESIGNERS PREFER VALOX[®] THERMOPLASTIC POLYESTER OVER PHENOLIC, ALKYD AND DAP.

WHY MOLDERS PREFER VALOX[®] THERMOPLASTIC POLYESTER OVER PHENOLIC, ALKYD AND DAP.

Dielectrics. Takes 10,000 more volts.

A 35,000-volt dielectric strength requirement is just one reason why VALOX 420 thermoplastic polyester was specified over phenolic in this revolutionary multi-component automotive high energy ignition system. Besides resisting creep, heat, chemicals and impact, VALOX resin resists wet and dry arc 10 times better than phenolic.



Moldability. New freedoms.

In this automotive ignition system, VALOX 420 thermoplastic polyester does what phenolic can't. It easily fills deep, complex parts with walls as thin as .080". Without breaking. What's more, it generally molds 70% faster than phenolic, eliminates secondary steps and permits use of regrind.

Dimensional stability.

Holds critical tolerances.

With glass-reinforced VALOX 420-SEO resin, the 16 critical mating surfaces of this support insulator keep their shapes better than with alkyd. They're tougher too. And more resistant to chemicals and vibrations, yet cost less per finished part, while meeting UL requirements.

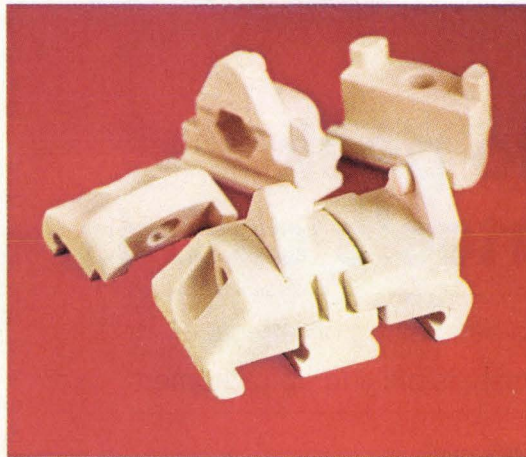

Molding time. 20 seconds flat.

This support insulator of VALOX 420-SEO resin cycles 3 times faster than alkyd, without alkyd's surface problem. Fact is, VALOX resin cycles faster than most other engineering thermoplastics, even in thick sections, without sinks. And up to 25% regrind nets even lower costs.

Heat resistance. Up to 420°F.

VALOX resin withstands up to 100°F more than Diallyl Phthalate (DAP) in connectors, yet provides more toughness and lower current leakage in 80% humidity, at lower cost.

Its moisture absorption is very low; its chemical resistance is very high. And VALOX resin withstands 650V tests while meeting UL and military specs.

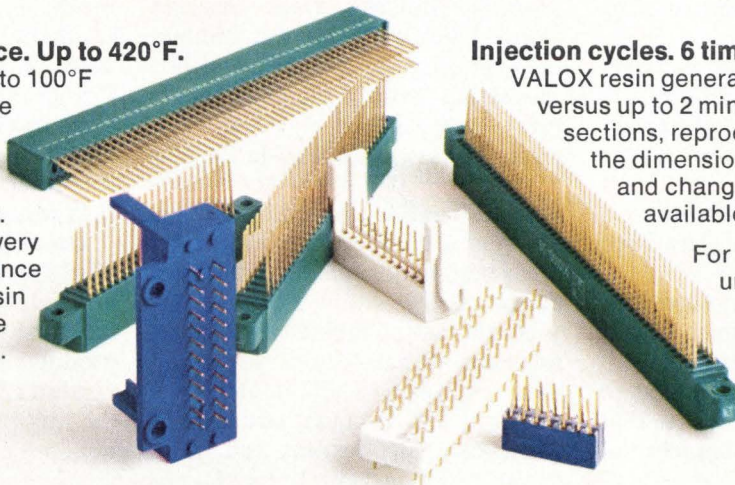

Injection cycles. 6 times faster.

In connectors, VALOX resin generally cycles in 15-25 seconds versus up to 2 minutes for DAP. It easily fills thin sections, reproduces the finest detail and has the dimensional stability to prevent warpage and changing tolerances. Eight colors available as standard.

For full details on all four unreinforced and reinforced grades, write Section 228, Engineering Polymers Product Dept., General Electric Company, One Plastics Ave., Pittsfield, Mass. 01201.



Ready to take off. Ryal Poppa, president of Pertec Corp., says his peripherals firm has trimmed sails for a smooth trip.

dent Harold Kurth was deposed, a number of managers left, and the company operated under interim management until Poppa was brought in as president in April 1973. A number of legacies from the previous management have haunted him. One was a computer-output-microfilm (COM) operation that didn't dovetail with the rest of the firm's business and has since been sold. Another was a partially developed line printer acquired with Eikon Data Systems Inc., in January 1972, and now shelved.

It would seem that the line printer complements the rest of the company's products. Pertec, which has headquarters in El Segundo, Calif., and peripherals-manufacturing facilities in Chatsworth, is best known for its minicomputer tape drive, but its claim that it's No. 1 is disputed by fast-growing Wangco. Pertec also makes minicomputer disk drives, and is now starting production of flexible, or "floppy," disk drives.

The tape drives alone accounted for about \$20 million of Pertec's \$33 million in sales during fiscal 1974 and disks for \$3.5 million. But even after two year's work the new printer was not easily manufacturable. "It was an acceptable and solid product, but the cost of goods was too high," says Poppa, "and changes would be too expensive." So in December, he announced that January shipments of the printer would be delayed. Then financial results in January indicated that the company would have a good cash flow, making money available for further development. This was duly announced. But that decision, too, had to be changed when a big order for other products meant that the cash would be needed elsewhere.

Developments. Summing up the whole printer affair, Poppa says that not only was it the least advanced and most expensive of the potential products in the back room, but he wouldn't have gone along with it in the first place if he hadn't inherited it. The other legacy from earlier

Companies

Sun starts to peek through Pertec's clouds

Peripherals maker appears to be shaking off effects of management struggle, has cash, is picking up customers

by Paul Franson, Los Angeles bureau manager

At first glance, things might not appear to be going well at Pertec Corp. For example:

- A major product line is being phased out by a major customer.
- Some of the firm's best customers are becoming competitors.
- A new line has been dropped as a bad risk after two years of work.
- A major product line has been sold.
- The firm is slipping into competition with IBM Corp., which it has scrupulously avoided in the past.

Yet the future looks bright to president Ryal Poppa, an IBM alumnus who has headed several

peripherals companies, most recently Mohawk Data Sciences Corp., Utica, N.Y. He was brought in to stabilize the company, which is recovering from a fierce management struggle that was tearing it apart. It has cash available for new acquisitions at a time when cash-flow problems are common, and it is entering a number of new business areas with major commitments from customers.

As the list of problems indicates, however, all hasn't been rosy in the past few years. The company was wracked by a court struggle in which company founder and presi-

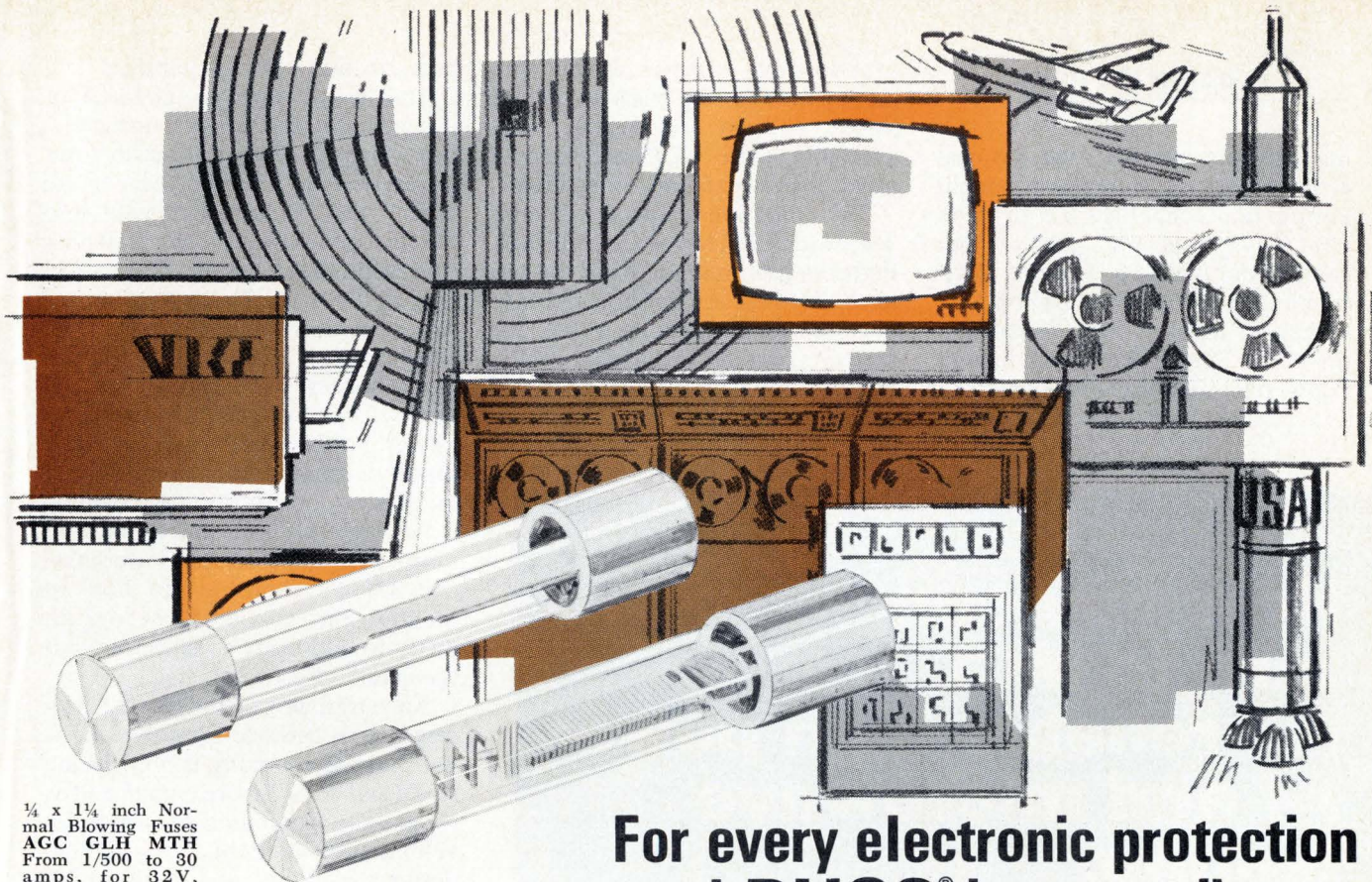

$\frac{1}{4}$ x $1\frac{1}{4}$ inch Normal Blowing Fuses AGC GLH MTH From 1/500 to 80 amps, for 32V, 125V, or 250V

$\frac{1}{4}$ x $1\frac{1}{4}$ inch Time Delay Fuses — From 1/100 to 30 amps, MDL MDX for 32V, 125V, or 250V

For every electronic protection need **BUSS**[®] has a quality Fuse and Fuseholder

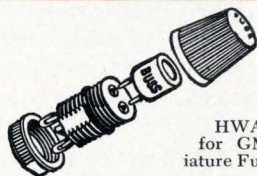

HWA Fuseholder for GMW Subminiature Fuses

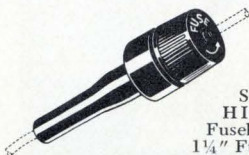

Series HH and HI In-the-Line Fuseholder for $\frac{1}{4}$ x $1\frac{1}{4}$ " Fuses



HTA Space-Saver Panel-Mounted Fuseholder for $\frac{1}{4}$ x $1\frac{1}{4}$ " Fuses (solder terminals) also HTA-DD, $\frac{3}{16}$ " Quick-Connect Terminals and HTA-HH, $\frac{1}{4}$ " Quick-Connect Terminals



HKL Lamp Indicating - Panel - mounted Fuseholder for $\frac{1}{4}$ x $1\frac{1}{4}$ " Fuses

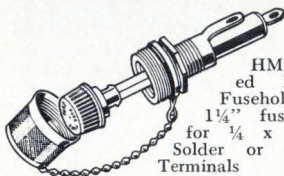

HMR RF-Shielded Panel-Mounted Fuseholder for $\frac{1}{4}$ x $1\frac{1}{4}$ " fuses and HMS for $\frac{1}{4}$ x 1" fuses — Solder or Quick-Connect Terminals

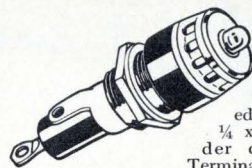

HLD Visual-Indicating Panel-Mounted Fuseholder — for $\frac{1}{4}$ x $1\frac{1}{4}$ " Fuses — Solder or Quick-Connect Terminals

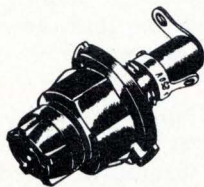

NEW: BUSS SNAP-LOCK rear panel mounted fuseholder for $\frac{1}{4}$ x $1\frac{1}{4}$ " fuses — a "snap" to install Ask for BUSS Bulletin SFH-14

The BUSS line of fuseholders is as complete as the BUSS line of fuses, covering all applications.

If you've got a circuit to protect, BUSS has the fuseholder as well as the fuse to protect it.

For more information on the complete line of BUSS fuses, fuseholders, fuseblocks, and fuse clips, write for a free copy of BUSS Bulletin SFB.



BUSSMANN MANUFACTURING
a McGraw-Edison Company Division
St. Louis, Missouri 63107



Probing the news

management was the COM business acquired when the company bought Peripheral Technology Inc. in 1970. COM equipment was part of that company's Business Systems division in Santa Ana, Calif., along with a key-to-tape system manufactured for Singer. But even though Poppa once said that Pertec was one

of the few companies making money in COM, the business was for leased, end-user equipment, while everything else at Pertec favored original-equipment manufacturers.

The operation was sold early this year to Bell & Howell Co., Chicago. Pertec is continuing to build the systems, but Bell & Howell could take over the manufacturing if the line really takes off. The result is that Pertec is now out of the end-user

business, and Poppa is happy.

That would seem to take care of things in the business-systems area—but it doesn't. Singer is phasing out its key-to-tape line this year, as are other firms. Pertec is moving into the next generation, however, with a shared-processor system that should take up the slack. It acts as a key-to-disk system in the first applications. The company has a "very significant contract" with Univac, and will also sell the systems to other companies. Poppa says the sales are on a rapidly rising ramp, and should quickly pay off development costs.

However, sitting squarely on that ramp is IBM, which has introduced the 3790 system in the last 18 months. Pertec won't be selling directly to end users as IBM does, but the giant's effect will be felt.

An outgrowth of the shared processor is a cathode-ray-tube terminal that the company is now selling to OEMs. Even more significantly, Poppa says the shared-processor development gives Pertec the ability to design, program, and build mini-computer systems.

A prime candidate is a smaller-business version, a highly intelligent terminal that Poppa says will compete with such products as the Datapoint 2200. "The intelligent-terminal market is growing very rapidly and has the potential of great success for us." In the CRT terminal, Pertec makes "everything but the tube," an approach it also espouses in other equipment. The company is highly integrated vertically for margin. This is exemplified in its new flexible-disk drive, for which Pertec makes even the heads and motors.

"The secret to success is minimizing labor and materials cost—for example, the drive uses stamped, rather than cast, chassis. It is much smaller than other floppy drives," he claims, so that four can fit in the same space occupied by two others. Poppa says the company recently shipped its first production models, but hasn't yet committed to a major OEM. "We wanted to wait until we could deliver in volume."

Trend. The flexible-disk drives, like cassettes, are part of the major industry trend toward micro-processors, which require low-cost peripherals, but he thinks the

Now you can turn to MCL for reliable high power r-f and microwave testing.

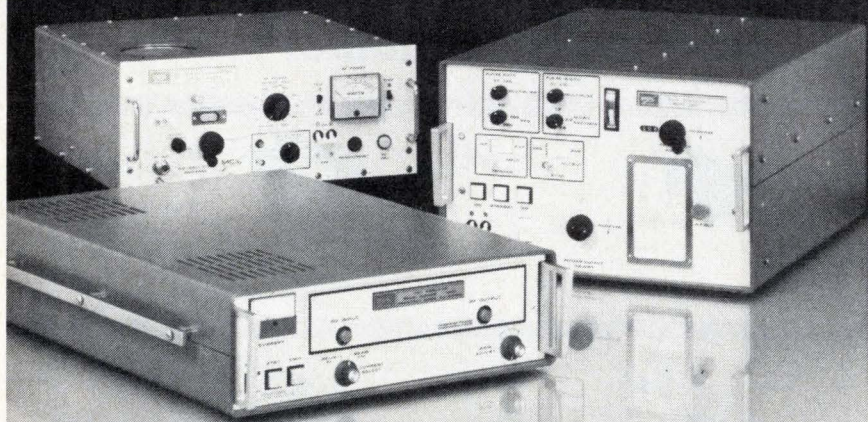

Many customers remember us for the "extras" engineered and built into our microwave cavities, e.g., our potted anode bypass assembly.

But some may not be aware that today MCL also offers one of the industry's largest and most diverse power oscillator, amplifier and systems lines.

The same extra margin of reliability and performance customers have learned to expect from our cavities is also a feature of our instrumentation products.

For a recommended solution to your high power testing problem—without obligation—write us today.

MCL, Inc., 10 North Beach Avenue,
La Grange, Illinois 60525.
Or call (312) 354-4350.

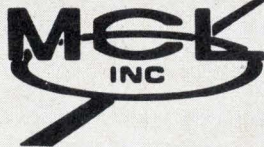

Now on GSA contract GSOOS-27086 See us in EEM-Vol. 1 pp. 284-291

We got computers and terminals talking (...and listening)!

In fact, EVERYBODY'S talking about our line-up of data com sub-systems! Western Digital - the first to introduce the Universal Asynchronous Transmitter/Receiver to the world - gives you a world of MOS/LSI silicon gate data communication devices to choose from! What's more, because Western Digital has more data com devices in more applications, there's a world of experience behind each and every data com circuit - experience that means quality and reliability that no one else can offer.

The Industry Standard - Still the Industry Leader

We've taken our TR1402 Asynchronous Transmitter/Receiver and improved it! Our TR1602 has all the features of the TR1402 but is Baudot Code compatible, too! (5 level code with 1.5 stop bits). It's fully programmable and is available in hermetic plastic or ceramic DIP package.

Get in Synch with Our P/SAT and P/SAR

Our two programmable transmitting and receiving sub-systems give you synchronous and asynchronous capability in a single package! The PT1482B (Programmable Transmitter) and PR1472B (Programmable Receiver) communicate your data at speeds to 640K bps!

Our Shift Register Eliminator - FIFO

Our FR1502E FIFO (First-in First-out) Buffer Memory is 9 bits wide to match your data and 40 characters deep for elastic storage. Plus you can order the asynchronous I/O data rate you need - 250 KHz, 500 KHz or 1 MHz. It's even expandable without external hardware!

For more information on how we can help you get your message across, just write, call or twx Data Com Headquarters - Western Digital Corp.!

smarter mos/lsi

WESTERN DIGITAL

C O R P O R A T I O N

3128 RED HILL AVENUE P.O. BOX 2180
NEWPORT BEACH, CALIFORNIA 92663
TELEPHONE: 714-557-3550
TWX: 910-595-1139

STANDOFFS AND SPACERS

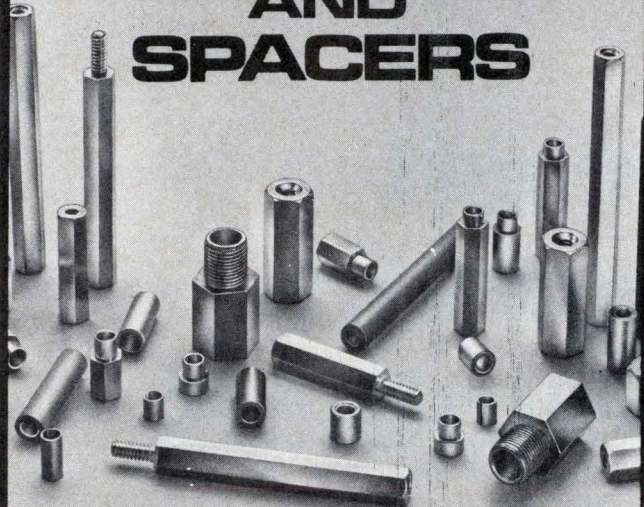

Over 200 assorted sizes and styles cataloged for you to choose from. Available in Aluminum, Brass and Phenolic, tapped or thru-hole. Immediate delivery from stock. Free engineering service for your special requirements.

NEW FREE CATALOG ON REQUEST



Manufacturers of Standardized Hardware for Electronics

KEYSTONE

ELECTRONICS CORP.

49 Bleecker Street • New York, N.Y. 10012

Circle 72 on reader service card

FINALLY. A LOW NOISE GUARANTEE COMES TO IC FET OP AMPS.

The Analog Devices AD514 FET-input op amp.

The AD514 gives you an input noise voltage below $5\mu\text{V}$ (p-p) max. Guaranteed. Because every one is tested for noise parameters.

You also get a low bias current of 10pA max and a low V_{os} drift of $25\mu\text{V}/^\circ\text{C}$. All for the price of only \$9.90 in hundreds for the AD514L, with other versions of the AD514 starting as low as \$5.90.

For more information, send for the data sheets. Or call Analog Devices Semiconductor, Norwood, Mass. 02062. East Coast, (617) 329-4700. Midwest, (312) 297-8710.

West Coast, (213) 595-1783.



 **ANALOG
DEVICES**

Probing the news

diskettes will severely erode the market for cassettes. Another sign of interest in lower-cost peripherals is that a fixed-disk drive has high priority at Pertec, which has been making the more expensive removable-cartridge types.

Not all the effort is in the direction of lower cost, however. The company is fleshing out its already wide tape-drive by the introduction in October of a vacuum-column tape drive. Though entering the market late, Pertec hopes that its recent design will prove attractive to the market; the company expects it to be highly competitive for OEMs.

The OEM peripherals marketplace, however, has been churning in the last few years as mini-computer companies such as Digital Equipment Corp. and Data General Co. have started making some of their own peripherals. Lately, DEC has even started to aggressively market the peripherals separately. Poppa says Pertec doesn't supply large volumes to them, but does expect such moves to affect Pertec to some degree. He points out, however, that the company's major customers, Burroughs and NCR, build many tape drives, but when they want a specialty drive or low volume, they go outside. He thinks this thinking will continue, with mini-computer companies making only their high-volume products.

Matchmakers. Poppa thinks the first companies to be affected by minicomputer-company-made peripherals will be companies marrying computers and peripherals and supplying them as special-purpose systems; Pertec obviously expects to hop in here with its systems.

Poppa looks to the worldwide inflation to continue the move to minicomputers as labor costs rise, and that should be good for Pertec. "We're being careful not to be mousetrapped by the economy. We've made a tremendous financial recovery in the past year, and we aren't going to be caught expanding too fast. We're not high rollers. I was with a high roller—Mohawk Data Sciences—and felt very uncomfortable there. Now look where they are." □

Monsanto introduces its HT SERIES *(a breakthrough in High Technology)* with four Universal Counter/Timers

Monsanto's new HT Series (High Technology) of frequency and time instruments designed to meet the rigid requirements of laboratory and field use, is the 8500 family of Universal Counter/Timers. They constitute another major achievement in our continuing R & D program to produce digital instrumentation of ultimate reliability and performance. These demanding standards have been realized by using field proven technology, unique designs

and state-of-the-art components and circuitry. The application of human engineering principles enables simple and self-evident use of the instrument. Our proudest achievements, these HT Series instruments are housed in attractive, designer-styled, diecast aluminum enclosures that provide an outward appearance as advanced as the technological innovations they contain.



8500 Series
prices range from
\$650.

The 8500 Series of Universal Counter/Timers consists of four separate models with ranges of 50 MHz, 150 MHz, 550 MHz and 1 GHz.

All models feature: Complete Counter-Timer functions of Frequency, Period, Period Average, Time Interval, Time Interval A to B, Ratio and Totalize/Full 9 digit, Monsanto, easy-to-read amber LED display/Opti-ranging for optimum display resolution/10 mV rms sensitivity with AGC for VHF & UHF measurements/High stability, oven controlled, crystal oscillator/Optional parallel BCD output/Optional higher stability TCXO oscillator/Available from stock/Generous OEM quantity discounts.

UNITED SYSTEMS CORPORATION
918 Woodley Road, Dayton, Ohio 45403
Ph: (513) 254-6251 Twx: (810) 459-1728
a subsidiary of

Monsanto

Information only circle 73 on reader service card.

Monsanto

Demonstration wanted circle 201 on readers service card.

the biomated scope

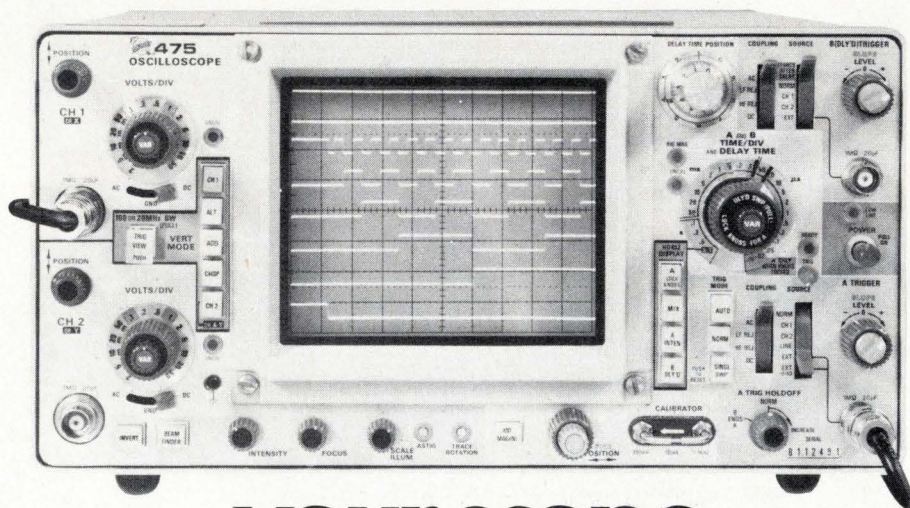

your scope

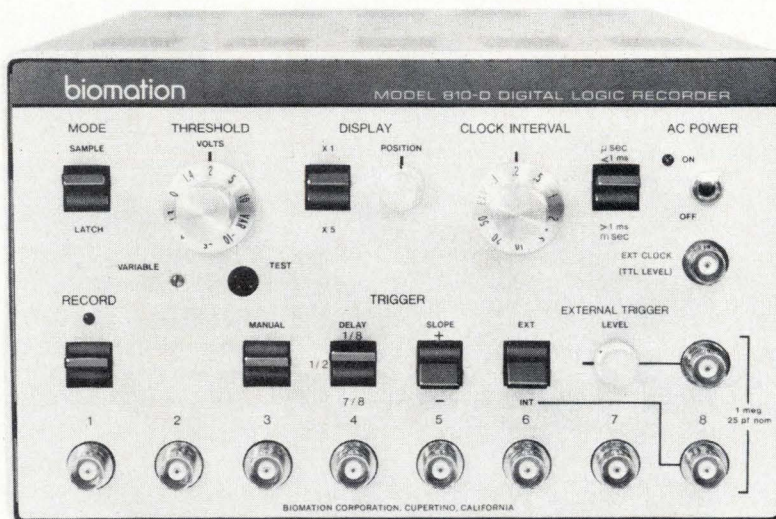

our glitch fixer™

8 traces of digital logic!

If your world is digital, Biomation's 810-D Glitch Fixer can help you. Mate it to your scope and it captures and displays complex timing events on 8 channels at once. At speeds to 10 MHz. *On your bench scope.*

Too many guys have had to sweat out a deglitching problem one line at a time. They asked us to help, and we answered with the 810-D.

The unit contains 256 bits of memory per channel—producing a continuous 8-trace timing diagram display on your scope from just one logic stimulus combination of your device.

The memory, in conjunction with a novel trigger delay and record control feature also gives you the ability to store a selected amount of the signals which occurred *prior* to the time of the detected trigger.

Add to this the unit's 10ns glitch-catching mode and you will know why the 810-D has become a new basic diagnostic tool for designing and debugging digital circuits.

Features:

Eight logic signal channels with 1M Ω inputs.

Presents 8 x 256 bits of recorded data on scope in easily-interpreted timing-diagram form.

Input latch mode selection provides detection of random pulses—as narrow as 10ns.

Selectable logic thresholds include TTL and EIA levels.

Synchronous clock input to 10MHz.

Or internal clock selection 20Hz to 10MHz.

Saves selectable amount of prior-trigger data, provides pre-trigger lookback.

Display expansion gives precise time analysis of data.

Digital output allows computer analysis or mass storage.

Price: \$1950

So if you've got a single trace scope and an 8-trace problem, Biomate it with a Glitch Fixer. Get all the glorious details by calling, writing or circling the reader service number. Biomation, 10411 Bubb Road, Cupertino, CA 95014. (408) 255-9500. TWX 910 338 0226.

biomation

The economy

Hittinger calls productivity deflation key

RCA executive sees it as solution to problem over the long run, but advocates price rises now; supports free East-West trade and export of U.S. technology and know-how to East bloc

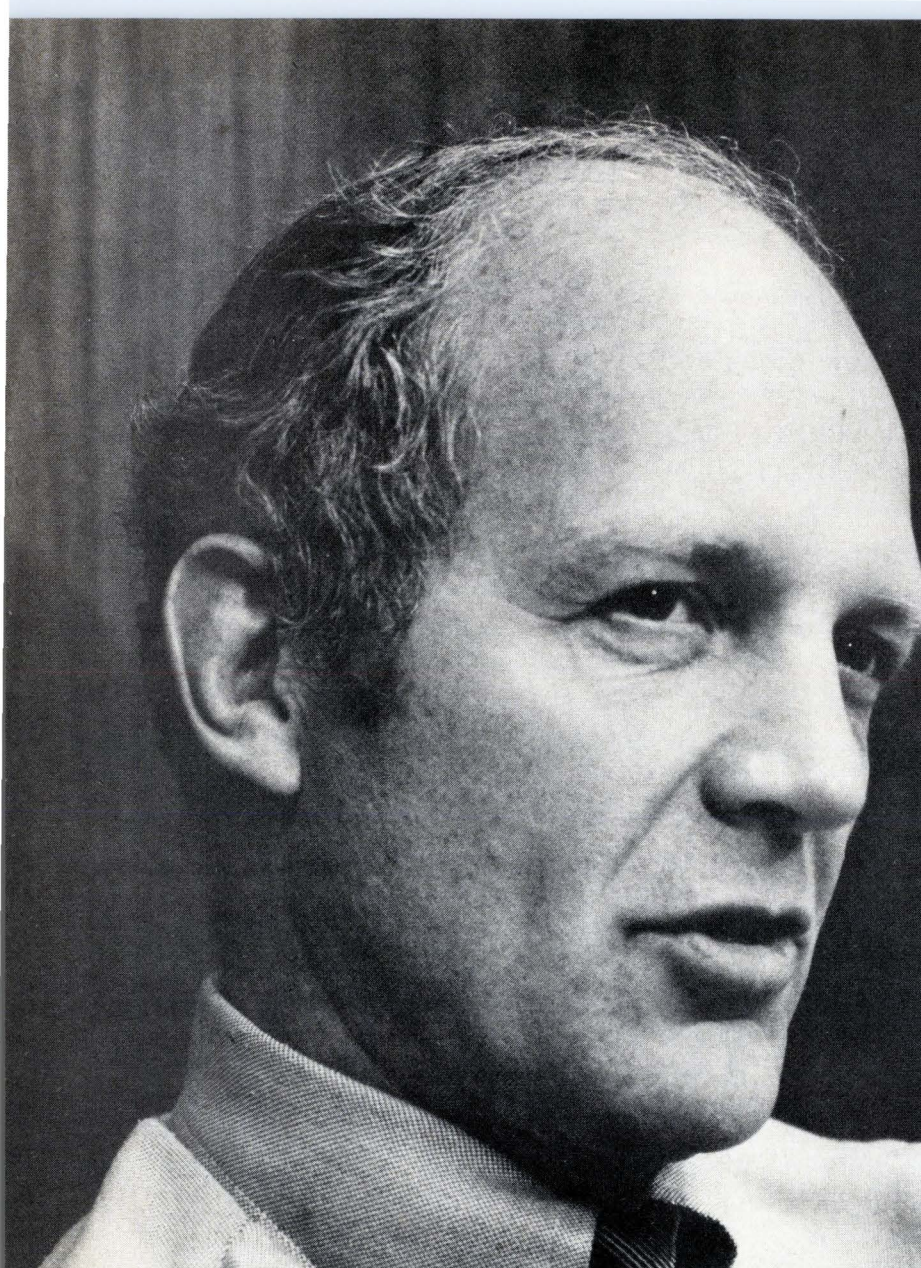

As general manager of three of the RCA Corp. divisions most concerned with exploiting technology, William C. Hittinger occupies an unusual position in that his responsibilities extend to both the component and equipment builder. Hittinger's divisions—Consumer Products, Solid State, and Electronic Components—accounted for aggregate sales last year totaling more than \$1 billion of RCA's \$4.3 billion.

He is thus qualified to discuss virtually all aspects of the electronics industry, particularly those affected by inflation, materials shortages, and East-West trade. Hittinger, who is also an executive vice president of RCA, talked with *Electronics* editors on Aug. 12. The following questions and replies are adapted from a transcript of that meeting.

Q: As you are well aware, your business is a worldwide one, and you've just been abroad. How's the economic situation there?

A: I find the short-term outlook very mixed—component activity still going strong, inflation cutting into equipment sales. But there is a long-term feeling of optimism: there's no question that both here and abroad, there's an upbeat feeling about our industry's future, in such areas as telephony, consumer electronics, and industrial applications—these markets are going to grow rapidly.

Q: What of the immediate economic problems facing all industry, including electronics, such as the rising costs of materials?

A: You can't overemphasize the deep concern we all have about the impact of inflation. It's surpassing

40% annually for some materials. The problem is that it's a worldwide phenomenon, not just confined to England or France or anywhere else. In the U.S., of course, we're all feeling inflation in a way that few of us can remember.

Q: How about this year—how does it look for equipment?

A: Very strange. Mixed. Sales may be good, but profits will be squeezed. This will be the second best year in terms of TV sets sold, for example. In excess of 9 million units. On the other hand, you're aware of the profit squeeze that's hitting everyone. It's serious. Our company needs increased revenue if we're going to afford the R&D and the mechanization needed for continued growth. Here the whole industry's in a tight spot. Witness the

acquisition of Motorola by Matsushita and Admiral by Rockwell; Philco-Ford will need to do something about its situation. And lots of rumors persist about others, mostly because of inflation.

Q: Is there anything you—RCA—can do to check it?

A: Like any other company, RCA has been working strenuously in areas of cost reduction—production innovations, automation, better personnel training. In the long run, inflation must be controlled by increasing productivity. It's as basic and fundamental as that. The trouble is, not even the toughest cost-reduction program can recover some of the material-cost inflation we've been seeing.

Q: How do you deal with short-term cost inflation?

A: By getting a better price for our product, it's as simple as that. Passing along some of these inflationary costs—that's a responsibility we have. But it's not the easiest thing to do in the case of, say, TV sets and TV products.

Q: Because of competition?

A: Well, yes. Last year, we at RCA decided to broadcast our feeling that our industry needed price increases for black-and-white sets. But we were relatively unsuccessful in getting our point across because certain segments of the industry felt it was not timely to go along. And black and white sets are in a very competitive situation. But we're working on it and we're encouraged by the support that others are expressing for better pricing.

Q: What about materials?

A: The single most important factor in the higher costs of making our product is materials. Consider such mundane things as cardboard and other packing materials. We've seen increases of 50% to 60% this year. A host of raw materials—copper, zinc, and gold, which is used heavily in solid-state technology—is going up at double-digit inflationary rates. These costs are staggering. But another overriding problem is the cost of money. Every business today is struggling with trying to obtain money for plant expansion—and the electronics industry is based on expansion. So it's the cost of materials, first, and the cost of money that is making managers groggy.

Q: How about automating TV assembly? We've heard equipment automation is still lagging.

A: RCA has mechanized to some extent, but TV manufacture is basically still not subject to great degrees of immediate automation. But in recent times, we have been spending money in that area as well as time in testing both at the board level and at the final instrument level. This will need to accelerate as our products become more sophisticated.

Q: How does the move to all-solid-state sets effect testing?

A: Well, for better performance and increased reliability, we decided to go 100% solid state. But this means using more and more sophisticated devices, ICs in particular, that gets you into an all new ball game in terms of component-handling and testing. The whole industry needs to make strides.

Q: With respect to your competition, is there an advantage in a set manufacturer also being his own circuit maker?

A: Yes, I think there is. If you look at an instrument today and look at where it's likely to go, it's more and more of a total system, rather than one in which the instrument maker operates at arm's length from his component suppliers. Again it's a reflection of the trend toward integration. The tradeoff between using complex IC chips or discrete components has become much harder to define. The day has long since gone when the television designer works from a catalog.

Q: How do East-West trade opportunities effect the picture?

A: Our posture is to engage in trade wherever it's commercially sensible to do it and where it's agreed to by the U.S. government. We believe in worldwide trade and always have. Indeed, we're now negotiating with China for a turnkey color-TV tube operation on the mainland. [*Electronics*, Aug. 22, p. 25] and we'll take advantage of other East-West trade deals as they become attractive.

Q: As you know, there has been some controversy within the semiconductor industry on turnkey operations. We've already published conflicting points of view by Fairchild's

Lester Hogan and TI's Fred Bucy on technology, knowhow, payoffs and the turnkey deals that companies have been making. What is your feeling, from a commercial point of view, and is there a problem of national security?

A: Our guidance on national security would come from the U.S. government. From a commercial sense, I believe that our markets in electronics are worldwide. I am a strong believer in free trade. RCA has always supported this concept. In fact, many of the problems of inflation and productivity can be alleviated by free trade in both directions. We support the idea of competition from overseas companies. As for the controversy, I think the positions of Bucy and Hogan are coming together. There was a time when TI said it was wrong to pass any technology behind the Iron Curtain. I don't think they're saying that today.

Q: TI makes a distinction between selling products and selling technology. It favors the former, but it's against the technology deals. On the other hand, Hogan says we're not giving away state-of-the art technology or production techniques. The problem is to stay ahead.

A: I happen to think that's true. The great strength of U.S. electronics is the fact that we have not been a highly secretive industry. Quite the contrary. The reason the U.S. is so strong all over the world is that we have had a free exchange of ideas. People publish freely, talk freely, and move freely from one company to another—we have been an open industry. We won't lose our shirts by dealing with people behind the Iron Curtain. Our great strength has been that we are aggressive, we do exchange ideas, we are motivated to continue to evolve and improve.

Q: One of the arguments for turnkey operations is that if we don't do it, the Japanese will. Do you agree?

A: Yes, I do. From our point of view, selling turnkey plants to Eastern Bloc countries is no guarantee they're going to beat you. It depends on many other things—awareness to investments resources in people, management skills and the rest—these are the U.S.'s greatest resources. □

Big new .3" GaAsLITE[®] displays: Low voltage. Low cost.



MAN 51
Common Anode;
Right Hand
Decimal



MAN 52
Common Anode;
Left Hand
Decimal



MAN 53
Common Anode;
Overflow (± 1)



MAN 54
Common Cathode;
Right Hand
Decimal



MAN 71
Common Anode;
Right Hand
Decimal



MAN 72
Common Anode;
Left Hand
Decimal



MAN 73
Common Anode;
Overflow (± 1)



MAN 74
Common Cathode;
Right Hand
Decimal



MAN 81
Common Anode;
Right Hand
Decimal



MAN 82
Common Anode;
Left Hand
Decimal



MAN 83
Common Anode;
Overflow (± 1)



MAN 84
Common Cathode;
Right Hand
Decimal

Our new green, red and yellow displays, the MAN 50, 70 & 80 series, give the readout designer a whole new set of options. You get not only the good looks, easy readability and proven quality of Monsanto's solid-state displays, but also important savings in cost, power and voltage.

The cost? Suggested retail prices start at \$2.20 each in 1000-lot orders. Any color! Larger volumes yield lower suggested prices.

And voltage? Directly compatible with IC levels. No

need for an extra power supply. Low power drain too. Plus, you get the reliability of solid-state—no filament, no glass, no vacuum—and a delivery schedule you can rely on. The quantities you need for instruments, P.O.S. terminals, or digital clocks *when you need them.*

So when you're specifying displays, specify Monsanto's MAN 50, 70 or 80 series. For a closer look at all the specs, call your distributor or **Monsanto Commercial Products Company**, Electronics Division, 3400 Hillview Avenue, Palo Alto, CA 94304 (415) 493-3300.

Putting innovation to work

Monsanto

Automotive electronics

Expected loss of interlock is hedged

Semiconductor suppliers concede there will be some slackening in market, but look to other auto applications to make up the difference

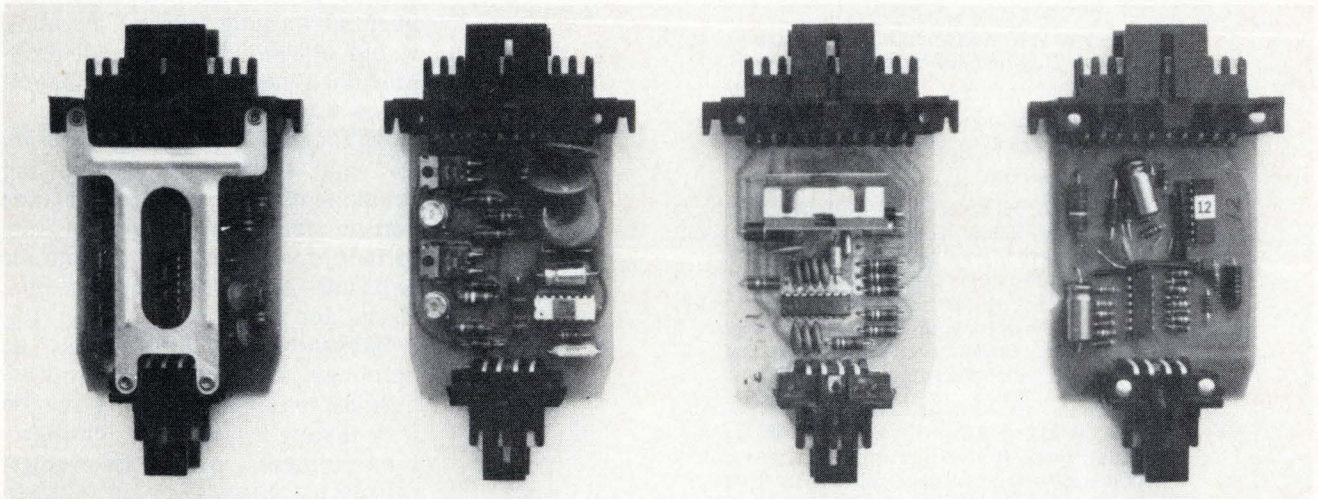

To be changed? Logic modules for GM's 1974 seatbelt interlock system would have to be redesigned if law is changed.

Now that Congress has all but killed the requirement that automobile seat-belt-ignition interlocks be installed as standard equipment, semiconductor suppliers find themselves looking to other automotive applications to take up the slack.

Although all insist they're not losing any sleep over the change, National Semiconductor's Joseph Obot, consumer-marketing manager, best expresses the mood by saying, "We will be adversely affected on the money end, but not in volume."

The reason is obvious. Even a watered-down National Traffic and Motor Vehicle Safety Act of 1966—the House has already acted [*Electronics*, Aug. 22, p. 38] and the Senate is expected to go along—would probably call for a dashboard light or buzzer to indicate unfastened seat belts. However, the end of the ignition interlock would require less complex electronics for the surviving system. Thus, the market, estimated now at \$15 million to \$20

million annually, is expected to slacken. Obot says that when the House voted, "my initial reaction was concern, since we've been building up lots of capacity in that area."

But Obot says that talks with two Detroit auto makers have calmed him. One told him it will simply go back to the seat-belt configuration of last year, which uses a smaller and cheaper chip. "The only difference between the old and the new chips is that the new one cuts out the interlock to the ignition," says Obot.

The other manufacturer has told National that it would go with the same circuit into the first half of 1976. The seat-belt sensing mechanism will still be used, but it will be less complicated, says Obot. He notes, "it would require some redesign on our part."

Incredulous. At Motorola's Semiconductor Products division in Phoenix, Ariz., Douglas W. Taylor was incredulous at first. "It's hard to

believe that there will be utter abandonment of electronics' potential for saving lives," says the automotive-marketing manager. "We recognize that the interlock aspect of the system is unpopular, especially due to all the possibilities for failures that would keep a car from starting, but I've seen figures that indicate a 60% increase in seat-belt use in 1974 model cars, and that must translate into fewer injuries and fatalities."

But Taylor, like his marketing counterparts at other semiconductor houses, has recovered from the initial shock and anticipates the retention of some form of warning system. If such a buzzer or light is kept, the logic part of the system will still be needed, he says, adding, "But this may be whistling in the dark."

Texas Instruments, which supplies interlock modules to General Motors, both ICs and power devices to Ford and Ford suppliers, and discrete devices to Chrysler, is maintaining its institutional cool. If Congress legislates an optional seat-belt

A message for Nova users.

Wait just a darn minute.

If you think you need to add all the good things to upgrade your Nova/Fortran IV system to Fortran 5 speed . . .

Or if you are thinking about buying a Nova/Fortran 5 system in the first place . . .

Wait just a minute.

Consider first our faster Fortran IV hardware/software package at only \$5000. This system, with its FP-09 64-bit fully parallel floating-point processor with Fortran IV stack-oriented command set, will give your Nova/Fortran IV all the compute speed of Fortran 5 at one fifth the cost—half the cost if you're buying from scratch. The two circuit cards are fully compatible with any Nova CPU; installation is a plug-in proposition.

Of course, if you really need all the frills of Fortran 5 (and are willing to pay for them) that's something else again. But if simply faster Fortran IV—problem execution in seconds rather than minutes—will fill your bill, think Floating Point Systems. We are the largest independent producers of peripheral floating-point processors, and we service what we make. If you have a mini problem, we may have a major solution.

Faster Fortran IV

A matter of arithmetic.



**floating
point
systems**

3160 S.W. 87th Ave., Portland, Oregon 97225
Phone: (503) 297-3318 TELEX: 36-0470

Probing the news

interlock, says Robert Silco, automotive marketing manager at TI's Semiconductor Group, "it wouldn't cause a ripple for us in components. We'd see a dip in modules, but not anything like the in-house suppliers would see."

As at other companies, TI's auto eggs are in more than one basket. "We have other automotive programs that we'll be building up for," says Silco, "and they'll offset any decline in interlock business." Sequential warning systems, he adds, would still require an IC, but probably not as complex as those Detroit is now using.

Although Silco declines to specify for what systems TI is supplying components, they probably include voltage regulators and ignition, and, further down the road, electronic exhaust-recirculation systems, clocks, and gage alerts.

Substitute. At Motorola, too, the emphasis is on new automotive business to replace whatever may be lost through Congress' changes. First on the list in Phoenix is entertainment. Says Taylor, "Auto makers are very interested in electronically tuned or digital de luxe car radios; they would help keep the average selling price up as consumers buy smaller cars." These radios would also gain in compactness and be redesigned to fit the small cars. Also, if the Moss bill is enacted into law, all car radios would have to be am-fm, and hence would have more electronics. "It would have an enormous effect on the semiconductor complement and sales," says Taylor. However, the bill's future is still up in the air.

The other application expected to require increased new electronics is digital instrumentation and perhaps digital control of major automotive subsystems. At least one instrumentation program is scheduled for the 1977 model year, but Taylor expects it to slip a year. And, of course, antiskid controls for trucks will take up a good amount of electronics—"unless someone slips us a Mickey," says Taylor, referring to trucking-industry opposition. The present standards are for air brakes, but hydraulic standards are coming. □

CHOPPER AMP PERFORMANCE AT BIPOLAR PRICES... *it's easy!*

$V_{OS} - 10 \mu V$
 $TC V_{OS} - 0.2 \mu V/^{\circ}C$
 $V_{OS}/Time - 0.2 \mu V/Month$
 $e_n - 0.35 \mu V p-p$



NO EXTERNAL COMPONENTS - NO CHOPPER PROBLEMS!

Freedom at last! Freedom from zeroing potentiometers and periodic system recalibrations. Freedom from noisy, expensive chopper amplifiers. Freedom from bulky external components.

New monoOP-07 Ultra-Low Offset Voltage Op Amps combine ultra-low noise, ultra-stable performance

with applications ease and flexibility — at unbelievably low prices. Upgrade system performance, reduce design time, improve MTBF while saving money. The monoOP-07 is a direct replacement for 725, 108A/308A, 741 and most other op amps — they're off-the-shelf at your Precision Monolithics distributor now!

GUARANTEED MIN/MAX SPECIFICATIONS

	monoOP-07AJ	monoOP-07J	monoOP-07EJ	monoOP-07CJ	
Temp. Range	-55/ +125	-55/ +125	0/ +70	0/ +70	$^{\circ}C$
V_{OS} @ 25 $^{\circ}C$	25	75	75	150	μV
V_{OS} @ Full Temp.	60	200	130	250	μV
TCV_{OS}	0.6	1.3	1.3	1.8	$\mu V/^{\circ}C$
Long Term Drift	1.0	1.0	1.5	2.0	$\mu V/Month$
Noise Voltage (.1 to 10 Hz)	0.6	0.6	0.6	0.65	$\mu Vp-p$
CMRR ($V_{IN} = \pm 13V$)	110	110	106	100	dB
Price @ 100 Pcs. (TO-99)	\$60.00	\$25.00	\$15.00	\$9.95	•

AUTHORIZED DISTRIBUTORS:

NEW YORK METROPOLITAN AREA Harvey Radio, Woodbury, N.Y.: (516) 921-8700 • **NEW ENGLAND AREA** Gerber Electronics, Dedham, Mass.: (617) 329-2400 • **UPSTATE NEW YORK** Harvey Federal Electronics, Binghamton, N.Y.: (607) 748-8211 • **NORTHEAST** Newark Electronics, Woburn, Mass.: (617) 935-8350 • **BALTIMORE-WASHINGTON** Whitney Distributors, Baltimore, Md.: (301) 944-8080 • **PENNSYLVANIA** Hallmark Electronics, Huntingdon Valley, Pa.: (215) 355-7300 • **Pioneer/Pittsburgh**: (412) 391-4846 • **MICHIGAN** RS Electronics, Detroit, Mich.: (313) 491-1000 • **SOUTHEAST** Kirkman Electronics, Winston-Salem, N.C.: (919) 724-0541 • **EAST CENTRAL** Pioneer/Cleveland, Cleveland, Ohio: (216) 587-3600 • **Pioneer/Dayton**, Dayton, Ohio: (513) 236-9900 • **CENTRAL** Hallmark Electronics, Elk Grove Village, Ill.: (312) 437-8800 • **Minneapolis**, Minn.: (612) 884-9056 • **St. Louis**, Mo.: (314) 521-3800 • **TEXAS-OKLAHOMA** Sterling Electronics, Houston, Texas: (713) 627-9800 • **Dallas**, Texas: (214) 357-931 • **SOUTHWEST** Sterling Electronics, Albuquerque, N.M.: (505) 345-6601 • **Phoenix**, Ariz.: (602) 258-4531 • **WEST** Westates Electronics Corp., Chatsworth, Calif.: (213) 341-4411 • **Sunnyvale**, Calif.: (408) 733-8383 • **Intermark Electronics**, Sunnyvale, Calif.: (408) 738-1111 • **Denver**, Colo.: (303) 936-8284 • **Salt Lake City**, Utah: (801) 486-3411 • **San Diego**, Calif.: (714) 279-5200 • **Santa Ana**, Calif.: (714) 540-1322 • **Almac-Stroum**, Seattle, Wash.: (206) 763-2300 • **Portland**, Ore.: (503) 292-3534 • **CANADA** Intek Electronics, Vancouver, B.C.: (604) 324-6831.

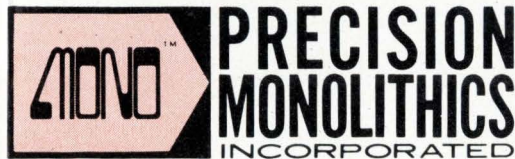

1500 SPACE PARK DRIVE, SANTA CLARA, CALIFORNIA 95050
 TEL. (408) 246-9222 • TWX 910-338-0528 • CABLE MONO

**Announcing
the most logical
result of the
overwhelming
acceptance of the
RCA CD4000 series.**

**Lower-cost
COS/MOS.**

The learning curve tells the whole story. The more COS/MOS we make, the greater our COS/MOS experience, the lower the cost.

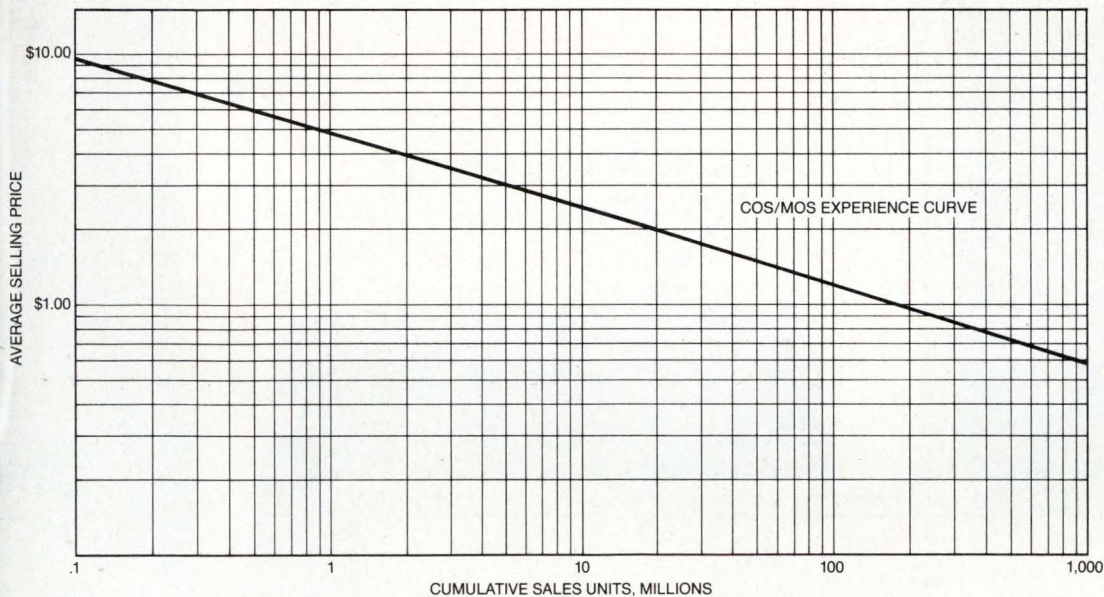

But there are more benefits from the RCA learning curve than volume and price. There's advanced circuit design, meticulous control of quality, the offering of the broadest choice of functions and in-depth applications support.

Should your projects, present and future, demand the design advantages of CMOS; i.e. ultra-low power consumption, high noise immunity, toleration of wide voltage swings—lower cost should make RCA COS/MOS more tempting than ever.

For example, we've recently reduced prices of plastic, commercial ceramic and chip versions of standard COS/MOS by an average of 15%. Popular MSI types have been reduced by as much as 20%.

And we look for this trend to continue as we perfect technologies and production facilities even further.

For a free COS/MOS brochure write RCA Solid State, Section 7015, Box 3200, Somerville, N.J. 08876. For complete pricing information contact your local RCA Solid State distributor or phone RCA (201) 722-3200 Ext. 2355.

RCA Solid State
The first house in CMOS

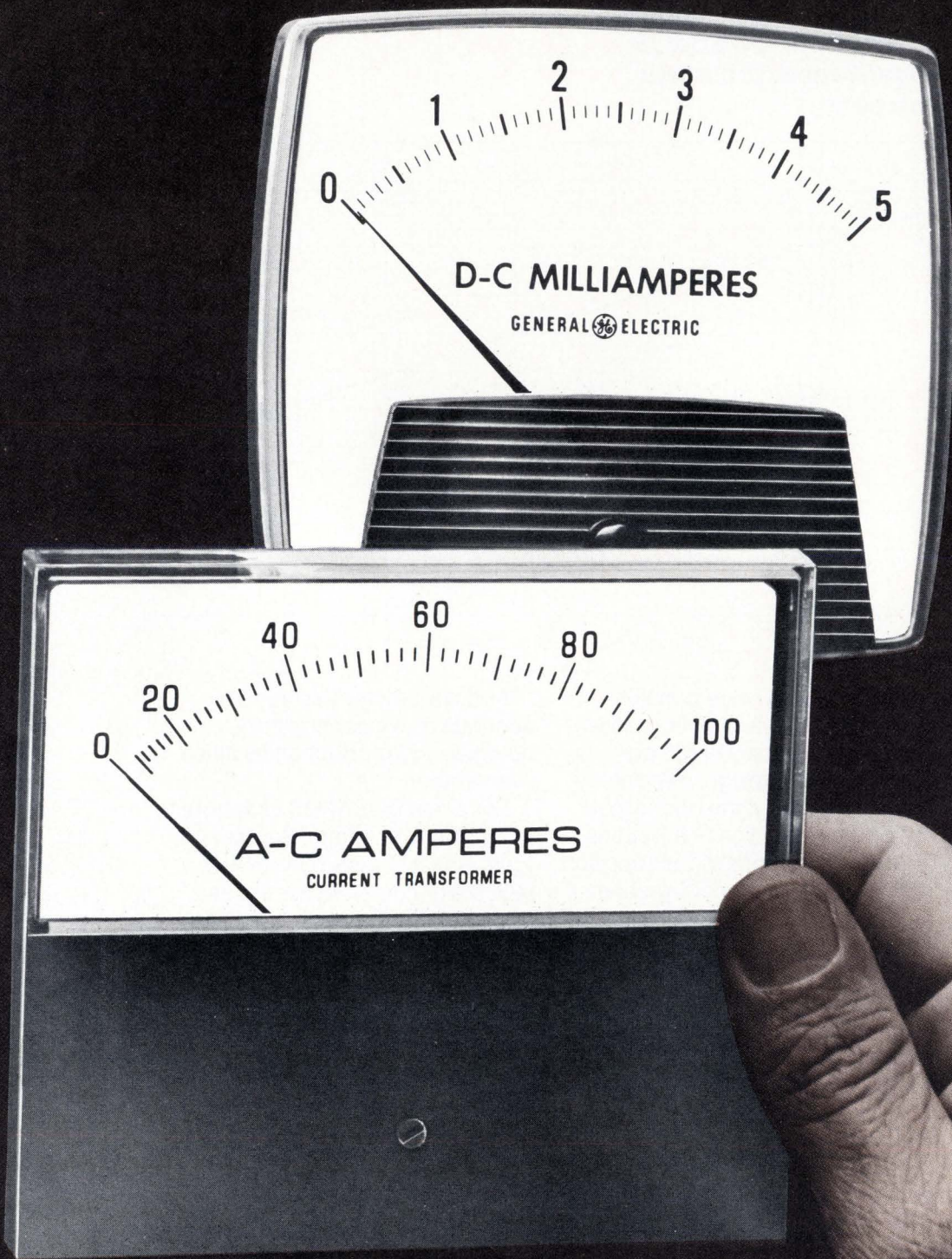

GENERAL  ELECTRIC

All Panel Meters are not created equal.

General Electric puts in more . . .
just for good measure.

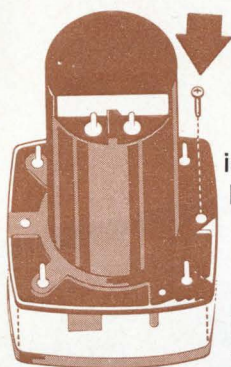

For example, if you must remove the cover, it's a lot safer with a GE panel meter. The lucite cover is held in place by a safety screw behind the meter face. Before taking off the cover, you must first remove *the instrument itself* from the panel to reach the screw. This prevents shock hazard and helps you meet national safety requirements. It's standard on our Series

200 BIG LOOK® and HORIZON LINE® panel meters.

GE solves your replacement-instrument problems.

The mounting studs on GE's new Series 200 panel meters can be ordered to fit existing panel openings. At no extra cost. There's a BIG LOOK or HORIZON LINE instrument in a-c or d-c, from 1½ to 4½ inch, in the range and rating you need. When it's replacement time, think of GE.

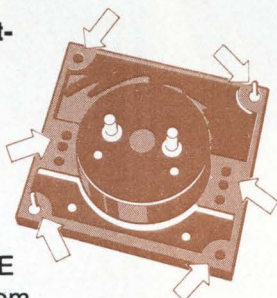

GE panel meters are quick-change artists.

Mount your square-shouldered HORIZON LINE panel meter *either behind the panel . . . or in front. It's your choice.* Just remove the snap-off mask to mount behind-panel. What's more, you don't have to buy a bezel, *and* you'll get a better-looking panel installation.

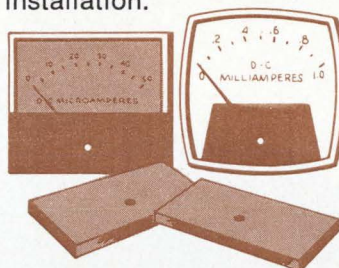

For front-mounting, you can order masks in six available colors. Or choose the wide-eyed BIG LOOK style for unmatched readability and unique impact.

General Electric handles a full line.

GE makes panel meters with taut-band or pivot-and-jewel movements. Slim edgewise meters for vertical, horizontal, or stacked mounting. Motor load indicators. Self-contained frequency meters. Elapsed-time meters. Meter relays and pyrometers. Come to GE to find it . . . and get GE quality and dependability.

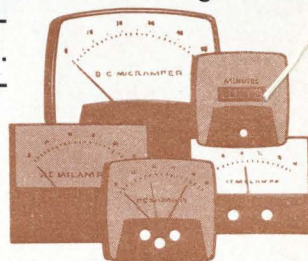

For a complete catalog of competitively priced and readily available GE panel meters, see your nearby authorized GE Distributor, Modification Center, or GE Sales Office.

Or write to General Electric Company,
Section 592-45, One River Road,
Schenectady, N. Y. 12345.

**Specify
General Electric...
just for good measure.**

**OUR POWER
SEMICONDUCTORS
ARE SO GOOD
WE USE THEM OURSELVES.**

20,000 TIMES A DAY.



That's the rate at which Delco Electronics supplies a variety of products for GM cars.

Under one roof we design and manufacture complete systems, including the power semiconductors that help make those systems work. This can mean a lot to you. Here's why:

We know the requirements and standards that must be met to produce over 20,000 systems a day. We know what it means to deliver on time, to meet our own production schedules. And we know the importance of component quality in assuring reliability of the end product.

Our semiconductor devices are used

in the Delco AM radios, AM/FM radios and stereo tape systems we produce for GM cars. They are also used in the GM High Energy Ignition systems, I.C. voltage regulators, alternators, and in the new combination front seat/shoulder belt interlock systems you find in all the 1975 GM cars.

And all the capabilities that go into Delco semiconductors can work for you, too.

There are select distributors with stock on hand strategically located coast to coast. For the distributor nearest you, phone

your closest Delco Electronic regional sales office: Kokomo, Ind. (317) 459-2175, Van Nuys, Calif. (213) 988-7550, Union, N.J. (201) 687-3770.

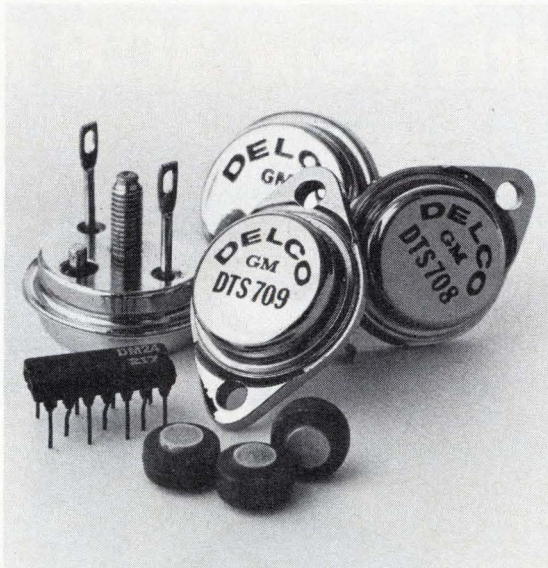

DELCO ELECTRONICS



Circle 87 on reader service card



Dramatic new product opportunities ... yours with new 3C8 ferrites



The market is ripe for product breakthroughs. Just look, for example, at the growth of such items as the hand-held calculator, small camera flashguns, ultra-mini portable radios and recorders. The key to these tremendous sales successes is high frequency power conversion circuits.

And the key to still *more* efficient, high-frequency power conversion is Ferroxcube's new 3C8!

This important new ferrite material gives significantly higher flux densities at higher temperatures, and lower losses at high excitation levels than any other magnetic core material. It is available in practical size cores for use up to kilowatt power levels.

3C8 is already being used with great success in: inverters, battery chargers, fluorescent lamp ballasts,

strobe light devices for highway markers and harbor buoys, power oscillators, power amplifiers, ultrasonic generators.

In all of these circuits Ferroxcube's 3C8 material has led to greater efficiency, lower cost, less weight, and smaller sized units. In one power supply, for example, the size of the core was reduced from 13 lbs. at 60Hz to 4 lbs. at 20,000 Hz and the volume from 35 to 9 cu. inches—savings of 70 to 75%!

Can 3C8 improve your present products or suggest new products and markets for your company? If you've got the imagination, we've got the core! Call 914•246-2811, TWX 510-247-5410 or write today.

Ferroxcube linear ferrites—made in Saugerties, N. Y. and stocked in seven U. S. locations.



FERROXCUBE CORPORATION, SAUGERTIES, N. Y. 12477 • 914•246-2811
A NORTH AMERICAN PHILIPS COMPANY

Distributed through North American Philips Electronic Components Corporation with warehouses in Boston, 617 • 899-7100; New York, 516•538-2300; Saugerties, 914•246-5861; Philadelphia, 215•836-1616; Chicago, 312•593-8220; San Diego, 714 • 453-5440

16404

Bipolar LSI computing elements usher in new era of digital design

Schottky bipolar chip set that is compatible with standard memories outdoes MOS microprocessors in performance and flexibility—the user microprograms it, and it can be configured to fit many computation and control functions

by Justin Rattner, Jean-Claude Cornet, and M.E. Hoff, Jr., Intel Corp., Santa Clara, Calif.

Microprocessors have popularized programable LSI technology as a replacement for discrete logic and custom ICs¹—at least, in the lower-speed applications for which the performance of metal-oxide-semiconductor technology is suited.

But high-performance applications are no longer beyond the reach of the microprocessor revolution. A family of computing elements has been developed using Schottky bipolar LSI technology, and it is not only faster but also far more flexible than its MOS predecessors. The new bipolar chips can be arranged in a number of different system organizations, and they are also microprogrammed by the system designer to perform a number

of different processing functions.^{2,3}

Furthermore, systems built with this large-scale integrated circuitry are much smaller and less costly and consume less energy than equivalent designs using lower levels of transistor-transistor-logic integration. Even allowing for ancillary logic circuits, the new bipolar computing elements cut 60% to 80% off the package count in realizing most of today's designs made with small- or medium-scale-integrated TTL.

For example, an entire 16-bit processor (Fig. 1) can be assembled on one six-inch-square printed-circuit board. Such a processor is capable of typical register-to-register add cycle times of less than 125 nanoseconds. In

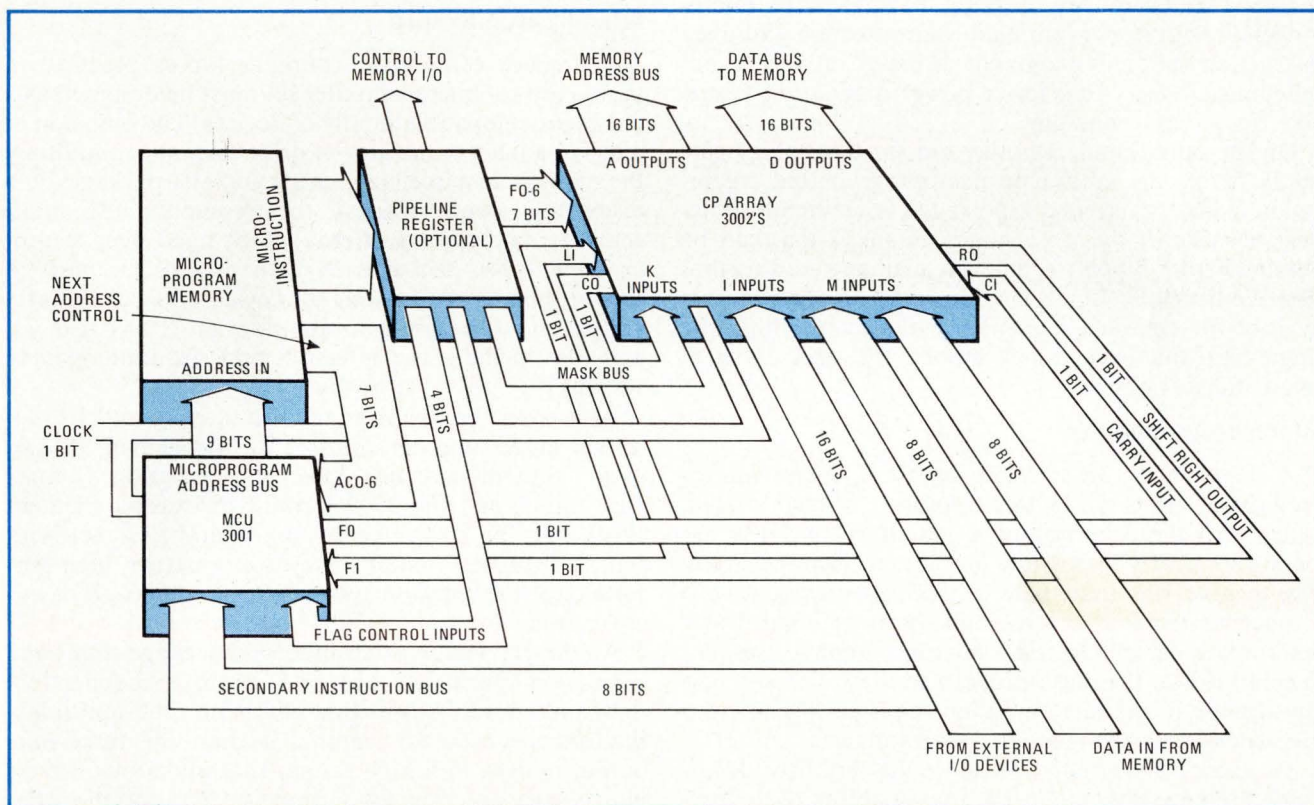

1. Bipolar microcomputer. Block diagram shows how to implement a typical 16-bit controller-processor with new family of bipolar computer elements. An array of eight central processing elements (CPEs) is governed by a microprogram control unit (MCU) through a separate read-only memory that carries the microinstructions for the various processing elements. This ROM may be a fast, off-the-shelf unit.

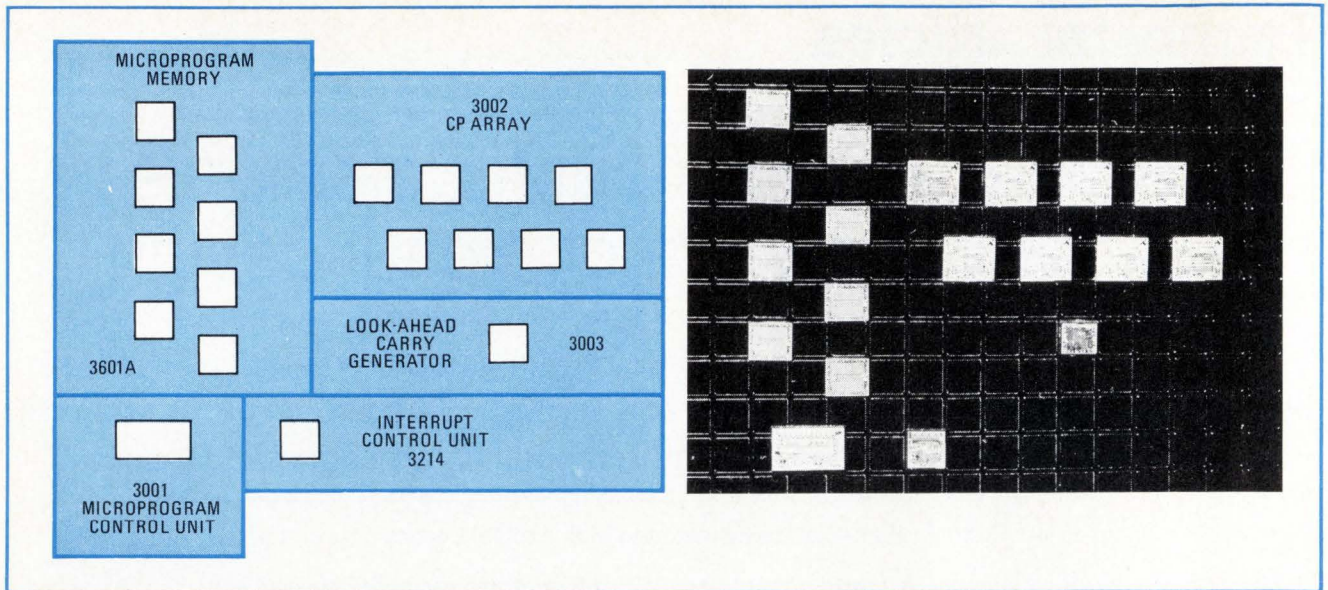

2. Family portrait. Four members of the Intel 3000 Schottky bipolar microcomputer chip set are shown here on an old transistor wafer. Interconnecting them in different combinations results in a wide range of low-cost, high-performance control and computation systems.

terms of raw computing power, that's over 15 times faster than Intel's 8080, the fastest n-channel MOS microprocessor,⁴ and at double the word size.

Every LSI circuit technology confronts the chip architect and the device engineer with an assortment of design and manufacturing tradeoffs. Such factors as gate complexity, power dissipation, and propagation delay must all enter into the selection of a suitable component organization.

MOS LSI technology favors the single-chip microprocessor with its conventional control section and fixed instruction set. This judgment is based on the higher functional density and lower power dissipation realizable from MOS technology.

On the other hand, Schottky bipolar technology currently favors the multi-chip microprogramable organization. Microprogramed bipolar LSI is eminently practical because of the close match in speed that can be obtained from bipolar computing elements and memories. Additionally, since microprogramming circumvents most of the complex sequential logic found within the single-chip microprocessors, bipolar die sizes are kept small and economical.

Microprogramability

A few early MOS LSI processors were microprogramed. But, while this approach offered certain benefits to the semiconductor manufacturer,⁵ the devices were nearly impossible for users to microprogram. The trouble was that these processors utilized a non-standard integrated control unit for their control and read-only memory. To test a microprogram, a user had to commit it to the mask-programmed ROM element, and any change in the microprogram required a costly and time-consuming change to the program mask.

To avoid this pitfall, which would seriously downgrade the versatility and user programability of the new microcomputer set, the decision was made to utilize standard bipolar LSI memories—electrically programmable and mask-programable read-only memories, as

well as random-access memories, as options for storing the micro-instructions for the LSI computing elements. RAMs can hold the microprograms in developmental systems to simplify debugging. PROMs can be used to build and test prototypes or even in the production of low-volume systems. High-volume applications can commit their microprograms to compatible mask-programmed ROMs. In every case the use of standard off-the-shelf components minimizes memory costs.

A family architecture

To reduce component count as far as practical, a multi-chip LSI microcomputer set must be designed as a complete, compatible family of devices. The omission of a bus or a latch or the lack of drive current can multiply the number of miscellaneous SSI and MSI packages to a dismaying extent—witness the reputedly LSI mini-computers now being offered which need over a hundred extra TTL packages on their processor boards to support one or two custom LSI devices. Successful integration should result in a minimum of extra packages, and that includes the interrupt and the input/output systems.

With this objective in mind, the Intel Schottky bipolar LSI microcomputer chip set was developed. Its two major components, the 3001 Microprogram Control Unit (MCU) and the 3002 Central Processing Element (CPE), may be combined by the digital designer with standard bipolar LSI memory to construct high-performance controller-processors with a minimum of ancillary logic.

Among the features that minimize package count and improve performance are: the multiple independent data and address buses that eliminate time multiplexing and the need for external latches; the three-state output buffers with high fanout that make bus drivers unnecessary except in the largest systems, and the separate output-enable logic that permits bidirectional buses to be formed simply by connecting inputs and outputs together.

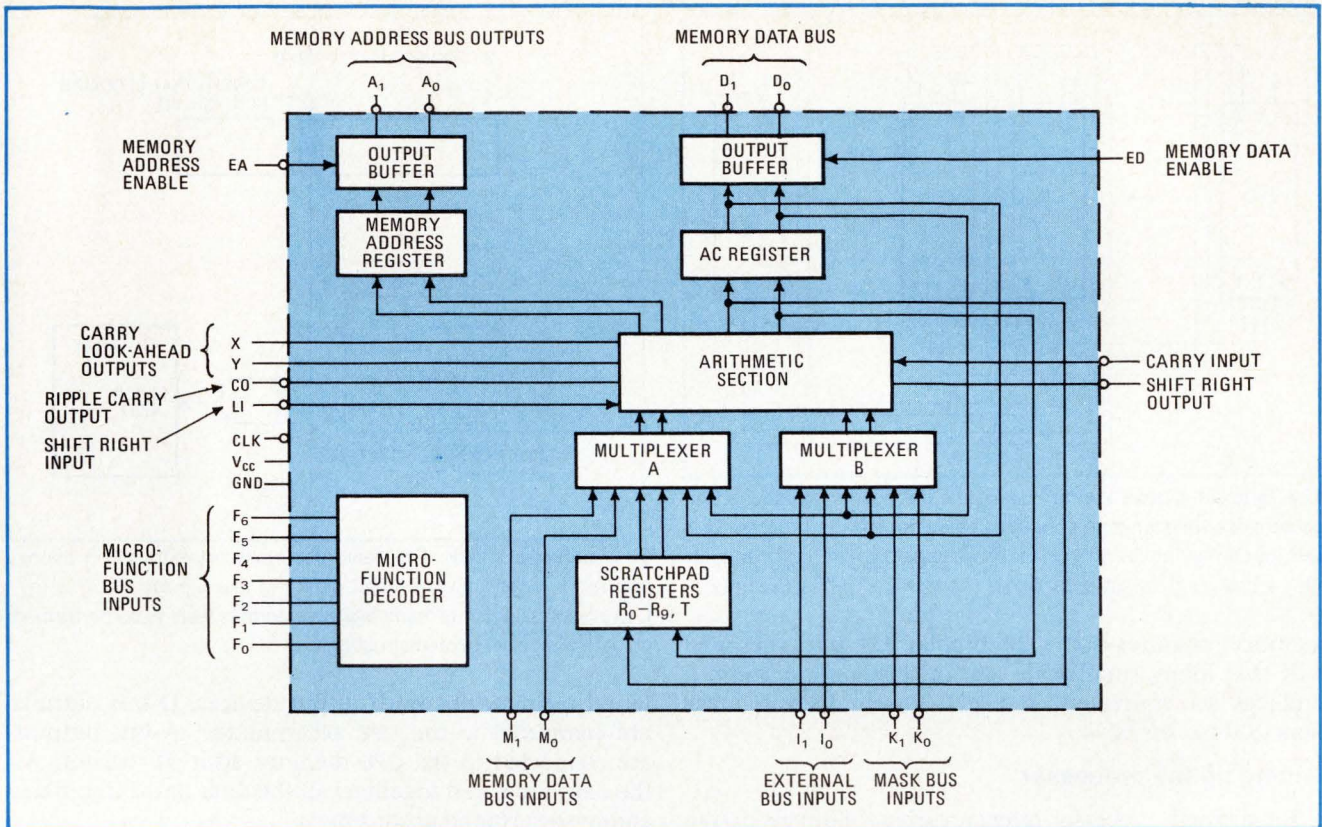

3. Central processing element. This element contains all the circuits representing a two-bit-wide slice through a small computer's central processor. To build a processor of word width N, all that's necessary is to connect an array of N/2 CPEs together.

Each CPE represents a complete two-bit slice through the data-processing section of a computer. Several CPEs may be arrayed in parallel to form a processor of any desired word length. The MCU, which together with the microprogram memory, controls the step-by-step operation of the processor, is itself a powerful microprogrammed state sequencer.

Enhancing the performance and capabilities of these two components are a number of compatible computing elements. These include a fast look-ahead carry generator, a priority interrupt unit, and a multimode latch buffer (Fig. 2). A complete summary of the first available members of this family of LSI computing elements and memories is given in the table on this page.

The cost/performance spectrum

The total flexibility of the Intel LSI computing elements is demonstrated by the broad cost/performance spectrum of the controllers and processors that can be constructed with them. These include:

- High-speed controllers, built with a stand-alone ROM-MCU combination that sequences at up to 10 megahertz; it can be used without any CPEs as a system state controller.
- Pipelined look-ahead carry controller-processors, where the overlapped microinstruction fetch/execute cycles and fast-carry logic reduce the 16-bit add time to less than 125 nanoseconds.
- Ripple-carry controller processors (a 16-bit design adds the contents of two registers in 300 nanoseconds).
- Multiprocessors, or networks of any of the above controllers and processors, to provide computation, inter-

rupt supervision, and peripheral control.

These configurations represent a range of microinstruction execution rates of from 3 million to 10 million instructions per second, or up to two orders of magnitude faster, for example, than p-channel microprocessors. Moreover, the increases in processor performance are achieved with relative simplicity. A ripple-carry 16-bit processor uses one MCU, eight CPEs, plus microprogram memory. One extra computing element, the 3003 Look-ahead Carry Generator, enhances the processor with fast carry. Increasing speed further by pipelining, the overlap of microinstruction fetch and execute cycles, requires a few D-type MSI flip-flops.

At the multiprocessor level, the microprogram memory, MCU, or CPE devices can be shared. A 16-bit processor, complete with bus control and microprogram

THE 3000 BIPOLAR LSI FAMILY	
3001	Microprogram control unit
3002	Central processing element
3003	Look-ahead carry generator
3212	Multimode latch buffer
3214	Priority interrupt unit
3216	Noninverting bidirectional bus driver
3226	Inverting bidirectional bus driver
3601	256-by-4-bit programmable read-only memory
3604	512-by-8-bit programmable read-only memory
3301	256-by-4-bit read-only memory
3304	512-by-8-bit read-only memory

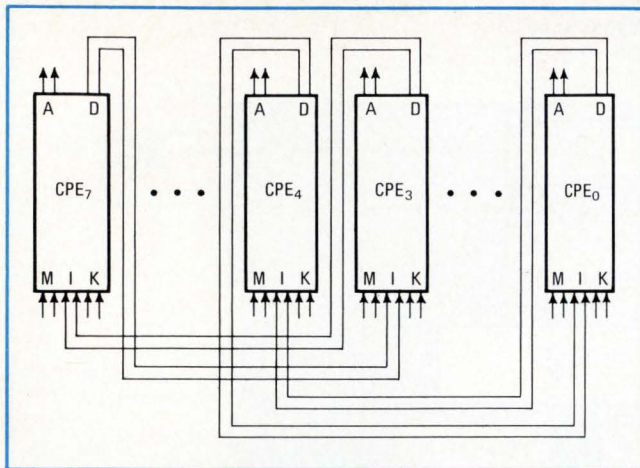

4. A byte for a byte. Used frequently in data-communications processors, a byte exchange connection exchanges high-order outputs and low-order inputs. In connection illustrated here, exchange of two highest- and lowest-order bits is shown for a 16-bit CPE array.

memory, requires some 20 bipolar LSI packages and half that many small-scale ICs. In this configuration, it replaces an equivalent MSI TTL system having more than 200 packages.

Slicing up the processor

Bit slicing a processor offers a variety of device design alternatives. On the one hand, die size restrictions and pin limitations may force a slice to get by with fewer external input and output busses, and as a result, fewer independent data paths than is desirable. This has two unfortunate results.

First, the paucity of data paths causes a proliferation of external latches and multiplexers to create the address, data, and control busses found in a typical processor. Second, the inability of operands, including bit masks, to enter the slice in parallel, severely degrades performance. Multiple microcycles are required to load and operate on data in addition to the overhead cycles needed to multiplex addresses with data on a single output bus.

On the other hand, attempting to put too much logic on a single chip can also seriously degrade performance. For a given amount of power dissipation, which is determined by the selected package and limited by its cost and mechanical intricacy, the functional complexity of a device establishes its power dissipation per function ratio. As a device becomes more complex, the available power per function decreases, and the propagation delay per function increases. Clearly, longer propagation delays mean lower performance.

The organization of the 3002 CPE is a result of balancing the need for a certain number of independent busses and data paths against the current limits on die size and power dissipation.

CPEs form a processor

Each CPE (Fig. 3) carries two bits of five independent busses. The three input busses can be used in several different ways. Typically, the K-bus is used for microprogram mask or literal (constant) value input, while the other two input busses, M and I, carry data from ex-

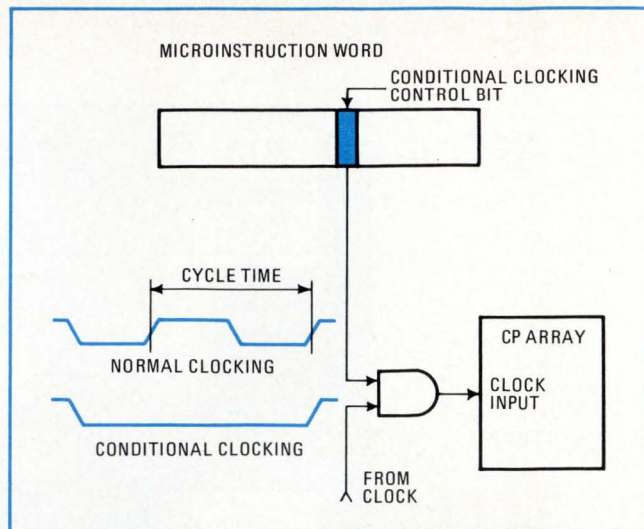

5. Conditional clock. This feature permits an extra bit in microinstruction to selectively control gating of clock pulse to CP array. Carry or shift data thus made available permits tests to be performed on data with fewer microinstructions.

ternal memory or input/output devices. D-bus outputs are connected to the CPE accumulator; A-bus outputs are connected to the CPE memory address register. As the CPEs are wired together, all the data paths, registers, and busses expand accordingly.

Certain data operations can be performed simply by connecting the busses in a particular fashion. For example, a byte exchange operation, often used in data-communications processors, may be carried out by wiring the D-bus outputs back to the I-bus inputs, exchanging the high-order outputs and low-order inputs as shown in Fig. 4. Several other discretionary shifts and rotates can be accomplished in this manner.

A sixth CPE bus, the seven-line microfunction bus, controls the internal operation of the CPE by selecting the operands and the operation to be performed. The arithmetic function section, under control of the microfunction bus decoder, performs over 40 Boolean and binary functions, including 2's complement arithmetic and logical AND, OR, NOT, and exclusive-NOR. It increments, decrements, shifts left or right, and tests for zero.

Unlike earlier MSI arithmetic-logic units, which contain many functions that are rarely used, the microfunction decoder selects only useful CPE operations. Standard carry look-ahead outputs, X and Y, are generated by the CPE for use with available look-ahead devices or the Intel 3003 Look-ahead Carry Generator. Independent carry input, carry output, shift input, and shift output lines are also available.

What's more, since the K-bus inputs are always ANDed with the B-multiplexer outputs into the arithmetic function section, a number of useful functions that in conventional MSI ALUs would require several cycles are generated in a single CPE microcycle. The type of bit masking frequently done in computer control systems can be performed with the mask supplied to the K-bus directly from the microinstruction.

Placing the K-bus in either the all-one or all-zero state will, in most cases, select or deselect the accumulator in the operation, respectively. This toggling effect of

the K-bus on the accumulator nearly doubles the CPE's repertoire of microfunctions. For instance, with the K-bus in the all-zero state, the data on the M-bus may be complemented and loaded into the CPE's accumulator. The same function selected with the K-bus in the all-one state will exclusive-NOR the data on the M-bus with the accumulator contents.

Three innovations

The power and versatility of the CPE are increased by three rather novel techniques. The first of these is the use of the carry lines and logic during non-arithmetic operations for bit testing and zero detection. The carry circuits during these operations perform a word-wide logical OR (ORing adjacent bits) of a selected result from the arithmetic section. The value of the OR, called the carry OR, is passed along the carry lines to be ORed with the result of an identical operation taking place simultaneously in the adjacent higher-order CPE.

Obviously, the presence of at least one bit in the logical 1 state will result in a true carry output from the highest-order CPE. This output, as explained later, can be used by the MCU to determine which microprogram sequence to follow. With the ability to mask any desired bit, or set of bits, via the K-bus inputs included in the carry OR, a powerful bit-testing and zero-detection facility is realized.

The second novel CPE feature is the use of three-state outputs on the shift right output (RO) and carry output (CO) lines. During a right shift operation, the CO line is placed in the high-impedance (Z) state, and the shift data is active on the RO line. In all other CPE operations, the RO line is placed in the Z state, and the carry data is active on the CO line. This permits the CO and RO lines to be tied together and sent as a single rail input to the MCU for testing and branching. Left shift operations utilize the carry lines, rather than the shift lines, to propagate data.

The third novel CPE capability, called conditional clocking, saves microcode and microcycles by reducing the number of microinstructions required to perform a given test. One extra bit is used in the microinstruction to selectively control the gating of the clock pulse to the central processor (CP) array. Momentarily freezing the clock (Fig. 5) permits the CPE microfunction to be performed, but stops the results from being clocked into the specified registers. The carry or shift data that results from the operation is available because the arithmetic section is combinatorial, rather than sequential. The data can be used as a jump condition by the MCU and in this way permits a variety of nondestructive tests to be performed on register data.

A good example of the over-all capability of the CPE is stack pointer or program counter maintenance. Usually this operation requires four microprocessor cycles: fetch the register data, send it to the memory address register, increment the value, and store the result back in the specified register. But the CPE can do it in one microcycle, using any one of its 11 scratchpad registers as the stack pointer or program counter. The desired address is gated through the arithmetic section to the memory address register, and the memory cycle is initiated. Simultaneously, over a separate data path, the

Microprogramming technology

- **Microprogram:** A type of program that directly controls the operation of each functional element in a microprocessor.
- **Microinstruction:** A bit pattern that is stored in a microprogram memory word and specifies the operation of the individual LSI computing elements and related subunits, such as main memory and input/output interfaces.
- **Microinstruction sequence:** The series of microinstructions that the microprogram control unit (MCU) selects from the microprogram to execute a single macroinstruction or control command. Microinstruction sequences can be shared by several macroinstructions.
- **Macroinstruction:** Either a conventional computer instruction (e.g. ADD MEMORY TO REGISTER, INCREMENT, and SKIP, etc.) or device controller command (e.g., SEEK, READ, etc.).

address value is incremented by the arithmetic section and sent back to the scratchpad.

By itself the CP array is incomplete as a microprocessor. The arithmetic, logic, and register functions need to be controlled in some orderly fashion, and this is the function of the MCU.

Microprogram control

The classic form of microprogram control incorporates a next-address field in each microinstruction—any other approach would require some type of program counter. To simplify its logic, the MCU (Fig. 6) uses the classic approach and requires address control information from each microinstruction. This information is not, however, simply the next microprogram address. Rather, it is a highly encoded specification of the next address and one of a set of conditional tests on the MCU bus inputs and registers.

The next-address logic and address control functions of the MCU are based on a unique scheme of memory addressing. Microprogram addresses are organized as a two-dimensional array or matrix, as shown in Fig. 7. Unlike in ordinary memory, which has linearly sequenced addresses, each microinstruction is pinpointed by its row and column address in the matrix. The 9-bit microprogram address specifies the row address in the upper 5 bits and the column address in the lower 4 bits. The matrix can therefore contain up to 32 row addresses and 16 column addresses for a total of 512 microinstruction addresses.

The next-address logic of the MCU makes extensive use of this addressing scheme. For example, from a particular row or column address, it is possible to jump either unconditionally to any other location in that row or column or conditionally to other specified locations, all in one operation. For a given location in the matrix there is a fixed subset of microprogram addresses that may be selected as the next address. These are referred to as a jump set, and each type of MCU address control jump function has a jump set associated with it.

Incorporating a jump operation in every microinstruction improves performance by allowing process-

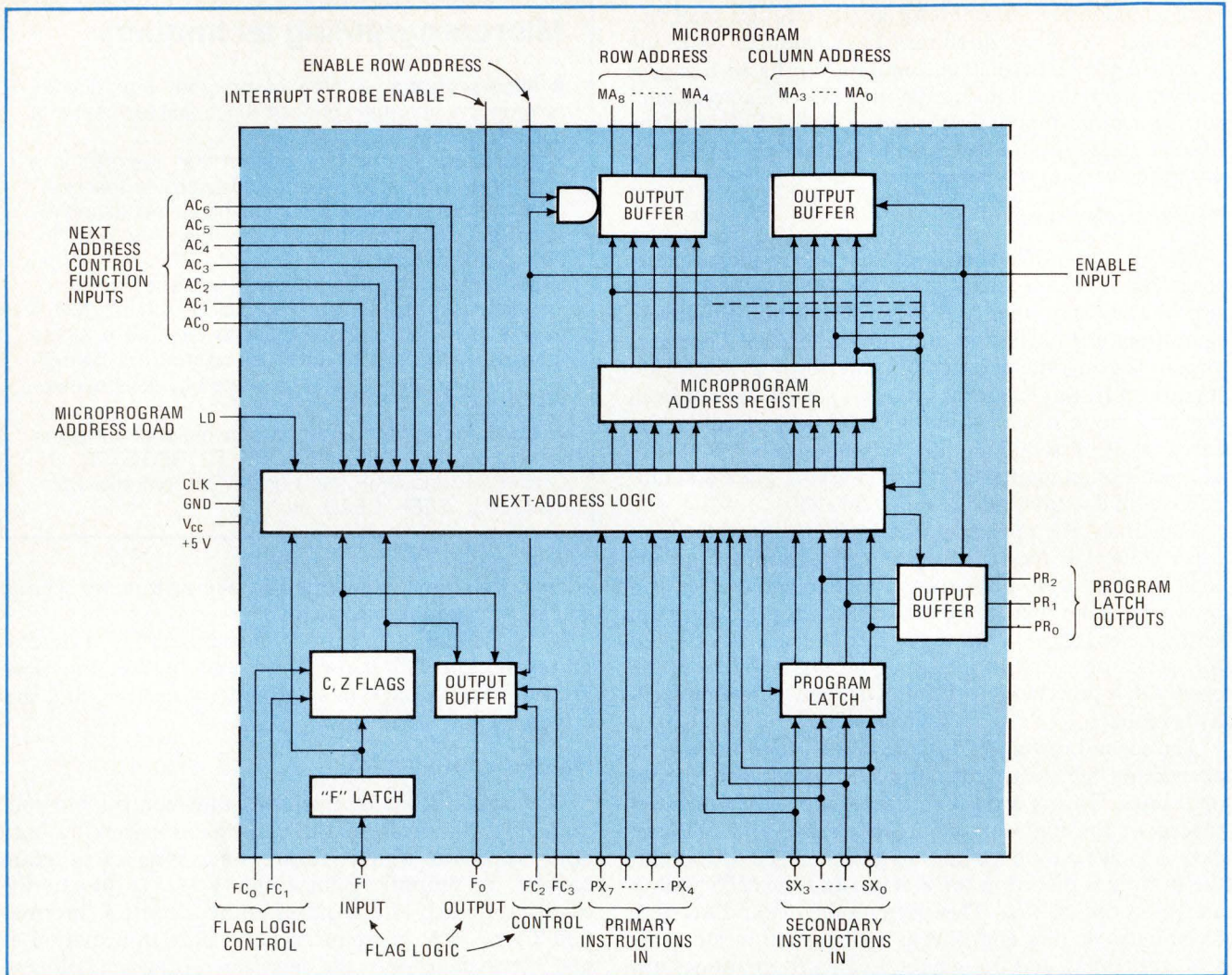

6. Microprogram control unit. The MCU's two major control functions include controlling the sequence of microprograms fetched from the microprogram memory, and keeping track of the carry inputs and outputs of the CP array by means of the flag logic control.

ing functions to be executed in parallel with program branches. Reductions in microcode are also obtained because common microprogram sequences can be shared without the time-space penalty usually incurred by conditional branching.

Independently controlled flag logic in the MCU is available for latching and controlling the value of the carry and shift inputs to the CP array. Two flags, called C and Z, are used to save the state of the flag input line. Under microprogram control, the flag logic simultaneously sets the state of the flag output line, forcing the line to logical 0, logical 1, or the value of the C or Z flag.

The jump decisions are made by the next-address logic on the basis of: the MCU's current microprogram address; the address control function on the accumulator inputs; and the data that's on the macroinstruction (X) bus or in the program latch or in the flags. Jump decisions may also be based on the instantaneous state of the flag input line without loading the value in one of the flags. This feature eliminates many extra microinstructions that would be required if only the flag flip-flop could be tested.

Microinstruction sequences are normally selected by the operation codes (op codes) supplied by the micro-

instructions, such as control commands or user instructions in main memory. The MCU decodes these commands by using their bit patterns to determine which is to be the next microprogram address. Each decoding results in a 16-way program branch to the desired microinstruction sequence.

Cracking the op codes

For instance, the MCU can be microprogrammed to directly decode conventional 8-bit op codes. In these op codes the upper 4 bits specify one of up to 16 instruction classes or address modes, such as register, indirect, or indexed. The remaining bits specify the particular subclass such as ADD, SKIP IF ZERO, and so on. If a set of op codes is required to be in a different format, as may occur in a full emulation, an external pre-decoder, such as ROM, can be used in series with the X-bus to reformat the data for the MCU.

In rigorous decoding situations where speed or space is critical, the full 8-bit macroinstruction bus can be used for a single 256-way branch. Pulling down the load line of the MCU forces the 8 bits of data on the X-bus (typically generated by a predecoder) directly into the microprogram address register.

The data thus directly determines the next microprogram address which should be the start of the desired microprogram sequence. The load line may also be used by external logic to force the MCU, at power-up, into the system re-initialization sequence.

From time to time, a microprocessor must examine the state of its interrupt system to determine whether an interrupt is pending. If one is, the processor must suspend its normal execution sequence and enter an interrupt sequence in the microprogram. This requirement is handled by the MCU in a simple but elegant manner.

When the microprogram flows through address row 0 and column 15, the interrupt strobe enable line of the MCU is raised. The interrupt system, an Intel 3214 Interrupt Control Unit, responds by disabling the row address outputs of the MCU via the enable row address line, and by forcing the row entry address of the microprogram interrupt sequence onto the row address bus. The operation is normally performed just before the macroinstruction fetch cycle, so that a macroprogram is interrupted between, not during, macroinstructions.

The 9-bit microprogram address register and address bus of the MCU directly address 512 microinstructions. This is about twice as many as required by the typical 16-bit disk-controller or central processor.

Moreover, multiple 512 microinstruction memory planes can easily be implemented simply by adding an extra address bit to the microinstruction each time the number of extra planes is doubled. Incidentally, as the number of bits in the microinstruction is increased, speed is not reduced. The additional planes also permit program jumps to take place in three address dimensions (Fig. 8) instead of two.

Because of the tremendous design flexibility offered by the Intel computing elements, it is impossible to describe every microinstruction format exactly. But generally speaking, the formats all derive from the one in Fig. 9. The minimum width is 18 bits: 7 bits for the address control functions, plus 4 bits for the flag logic control; plus 7 bits for the CPE microfunction control.

More bits can be added to the microinstruction format to provide such functions as mask field input to the CP array, external memory control, conditional clocking, and so on. Allocation of these bits is left to the designer who organizes the system. He is free to trade off memory costs, support logic, and microinstruction cycles to meet his cost/performance objectives.

Configuring a processor

The processor organization of Fig. 1 may be varied to enhance speed, reduce component count, or increase data-processing capability. As mentioned earlier, one widely applicable technique for maximizing a processor's performance is called pipelining. To pipeline a microprocessor, a group of D-type flip-flops is hung on the microprogram memory outputs (excluding the address control field) to buffer the current microinstruction and so allow the MCU to overlap the fetch of the next microinstruction with the execution of the current one. If fast carry logic is also used, the microinstruction cycle time is typically less than 125 nanoseconds.

Although almost any number of CPEs may be arrayed (up to 320 bits without buffering, to be exact), a system

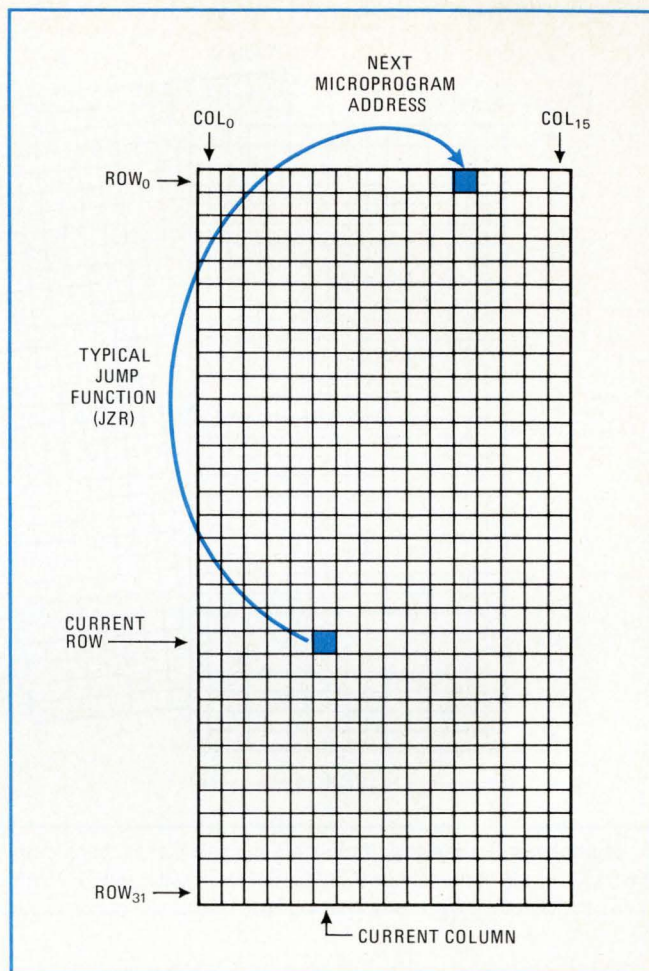

7. Jump function. Microprogram addresses, represented here by boxes, are organized as a two-dimensional array or matrix. Each microinstruction contains a jump operation field that specifies the next microprogram address. Shown here is a typical jump operation from location (row 20-column 5) to (row 0-column 11).

using only a few CPEs may not have a CP array address bus wide enough for the size of main memory required. A good example is the 8-bit processor that needs a 16-bit address bus. Such problems are easily solved. In this case the CP array delivers one byte of the address on its memory address bus outputs and the other byte on its data bus outputs. The tradeoff is that two microcycles are required to send the address to memory.

Another configuration insures rapid servicing of interrupts by combining two CP arrays with one MCU. All of the register contents associated with the interrupted routine are held in one array, while the interrupt service routine is executed on the second CP array. Normal program execution resumes when the MCU regains control of the first CP array.

Multiprocessing is another way to obtaining high performance. Several satellite MCU-CP arrays can share a common main memory—an arrangement that could be used quite effectively in a multi-terminal information system. In a busy system, memory bus conflicts might increase the average processor cycle time, but the speed of the Schottky bipolar computing elements is so great that such delays would be invisible to the users.

As a final example, consider the costly and complex

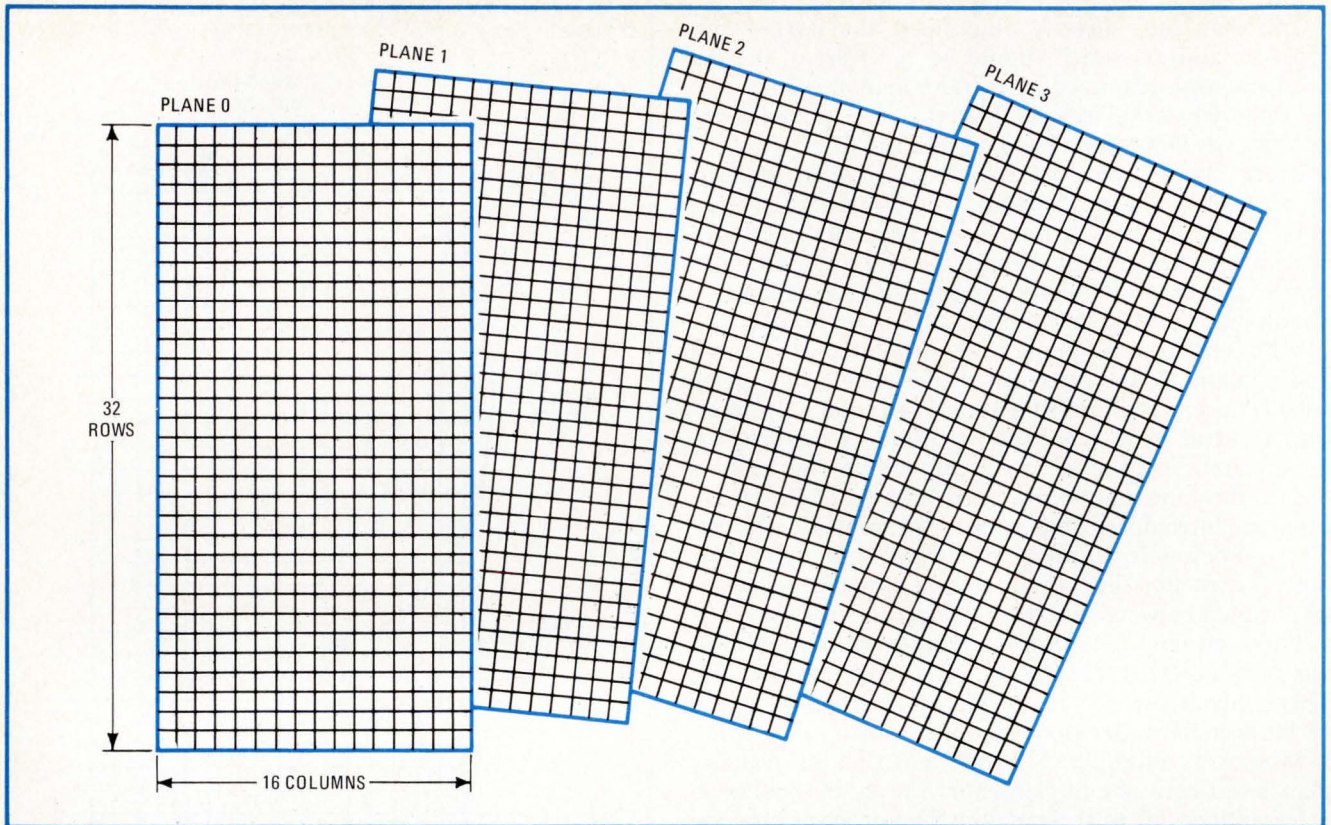

8. Multiplanar addressing. If required, multiple planes, each carrying 512 microinstructions, can be implemented without any sacrifice in the speed of the system. Moreover, jumping is possible in three address dimensions with such a configuration.

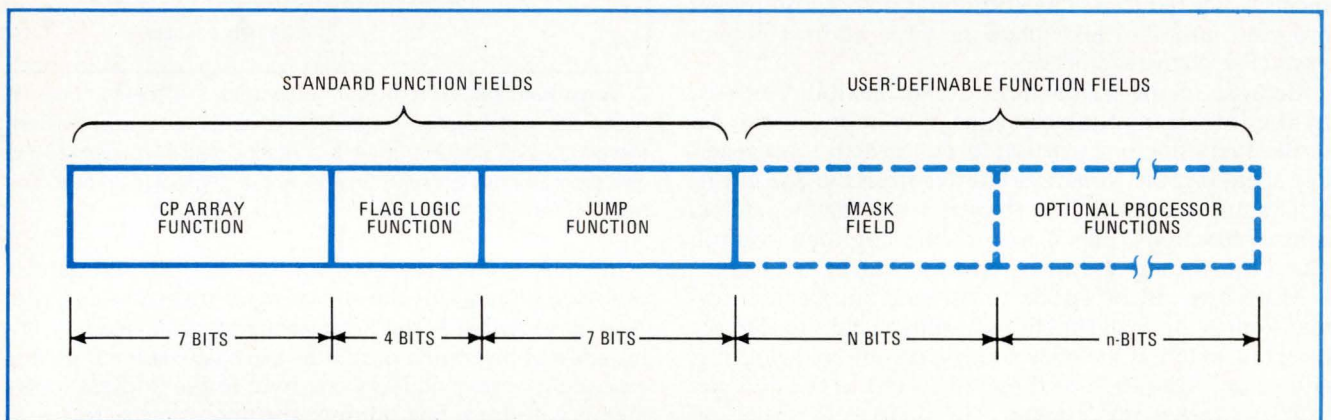

9. Microinstruction format. Only a generalized microinstruction format can be shown since allocation of bits for the mask field and optional processor functions depends on the wishes of the designer and the tradeoffs he decides to make.

controllers available for the inexpensive diskette or floppy disk. The relatively high data-transfer rates and the processing demands of the soft-sectored diskette put this application just beyond the reach of the fastest MOS microprocessors. Existing controllers contain upwards of 250 TTL packages and can only work with one type of media-formatting scheme.

In contrast, a universal diskette controller, adaptable to a variety of formatting schemes through microprogramming, requires less than 20 bipolar LSI components, including the MCU, CPES, and memories. The over-all diskette controller package count is reduced by two thirds.

Intel's Schottky bipolar computing elements are the first LSI technique endowed with the computing and

control power of discrete high-speed TTL circuits. In addition, they give the digital designer a degree of flexibility, simplicity, and economy never before available to him. By all indications, bipolar LSI computing elements are destined to become the standard for high-speed design in the next generation of computation and control systems. □

REFERENCES

1. M.E. Hoff, Jr., "New LSI Components," 8th IEEE Computer Society International Conference Digest, 1972, pp. 141-143.
2. S.S. Husson, "Microprogramming: Principles and Practice," Prentice Hall Inc., 1970.
3. P.M. Davies, "Readings in Microprogramming," IBM Systems Journal, Vol. 11, 1972, pp. 16-40.
4. M. Shima and F. Faggin, "In switching to n-MOS microprocessor gets 2-microsecond cycle time," *Electronics*, April 18, 1974, pp. 95-100.
5. G. Reyling, Jr., "Considerations in Choosing a Microprogrammable Bit-Slice Architecture," *Computer*, July, 1974, pp. 26-29.

The most efficient combination for 200-watt TV translators

CAVITIES

TH 18122 175.225 MHz

TH 18152 470.860 MHz

+

TRIODE TH 338

THOMSON-CSF offers a complete range of tubes and cavities from 20W up to 2 kW for TV equipment with common amplification of video and sound signals.

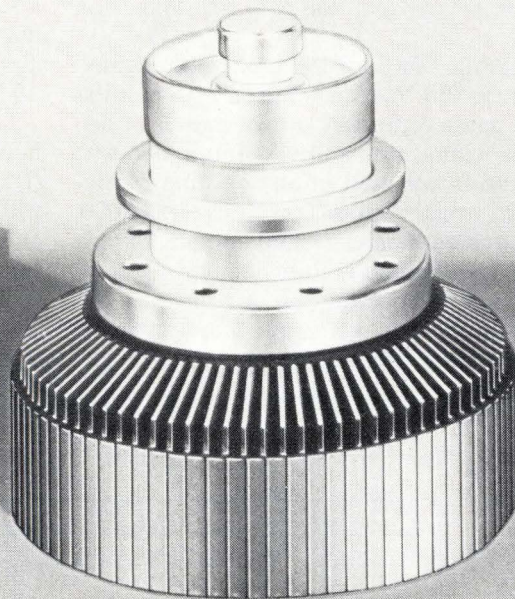

THOMSON-CSF

THOMSON-CSF ELECTRON TUBES, INC./ 750 Bloomfield Avenue CLIFTON NJ 07015 / Tel. (201) 779 1004 / TWX : 710 989 7149

France - THOMSON-CSF Groupement Tubes Electroniques / 8, rue Chasseloup-Laubat / 75737 PARIS CEDEX 15 / Tel. (1) 566 70.04

Germany - THOMSON-CSF Elektronenröhren GmbH / Am Leonhardsbrunn 10 / 6 FRANKFURT / MAIN / Tel. (0611) 70 20.99

Italy - THOMSON-CSF Tubi Elettronici SRL / Viale degli Ammiragli 71 / ROMA / Tel. (6) 38 14.58

Japan - THOMSON-CSF Japan K.K. / Kyosho Building / 1.9.3. Hirakawa-cho / Chiyoda-ku / TOKYO / F 102 / Tel. (03) 264.6341

Sweden - THOMSON-CSF Elektronrör AB / Box 27080 / S 10251 STOCKHOLM 27 / Tel. (08) 22 58.15

United Kingdom - THOMSON-CSF Electronic Tubes Ltd / Bilton House, Uxbridge Road, Ealing / LONDON W 5 2TT / Tel. (01) 579 55.11 / Telex : 26 659

Circle 97 on reader service card

Phase-difference method offers low-cost navigation receivers

Circuitry and techniques being developed under a NASA grant may bring the benefits of accurate Omega position-finding to private pilots and boatmen through simplified receivers that cost less than \$1,000 each

by Ralph W. Burhans, *Ohio University, Athens, Ohio*

□ The Omega very-low-frequency navigational system will soon begin providing the Northern Hemisphere with precise positioning data derived from phase-measurement techniques. When international agreements are completed within a few years, the system will span the globe. Based on accurate synchronization of transmitting stations to provide time or phase data to ships and planes, Omega is already guiding military and commercial transport vehicles.

But if the cost and complexity of the method were significantly reduced, Omega could also be made available to the public—the general-aviation pilot, the small-boat operator, and perhaps even the balloonist or the backpacking explorer. With these objectives in mind, the Avionics Engineering Center of Ohio University has undertaken a study for NASA to develop the necessary concepts and low-cost circuits that would make possible receivers of less complexity than today's color-television sets.

None of the methods now in use can be implemented by low-cost circuitry. But ICs can be used in a method that measures the phase difference of two signals of different frequencies being transmitted simultaneously. Though this method is not used in any existing receivers, which range in price from \$4,000 to over \$50,000, it's the basis for a breadboard system for an Omega processor that has been built at the university.

Use of the phase difference and other principles developed in the study could make simple Omega receivers feasible, even without further development of large-

scale integrated circuits and relying instead on the analog ICs, transistor-transistor logic, or complementary-metal-oxide-semiconductor circuits already available. But with the new 4- and 8-bit microprocessors in single-chip form, these receivers will be even more attractive for the future.

Fortunately, under the Omega system, direct binary processing and display need only a minimum of decimal conversion. Portable devices operating on a single-voltage low-drain battery pack are possible with C-MOS processors or more conventional systems that use a single 5-v power supply.

Some longer-range plans for the program include investigation of simplified methods of using loop antennas, noise-canceling antenna systems for aircraft, system studies of the software data-reduction problem, 4-bit binary processors for Omega map conversion, and a 3.4-kHz difference-frequency processor for long-range navigation.

The Omega concept

Omega transmitting stations are already in operation in Norway (A), Trinidad (B), Hawaii (C), North Dakota (D), and Japan (H). Soon to join the worldwide network will be stations near Madagascar (E), in Argentina (F), and Australia (G). The stations transmit a synchronized format on 10.2 kHz, 11.3 kHz, and 13.6 kHz (Fig. 1).

The transmitters are clocked so that, although all eight are transmitting the same frequencies, each station transmits a given frequency in a separate time slot,

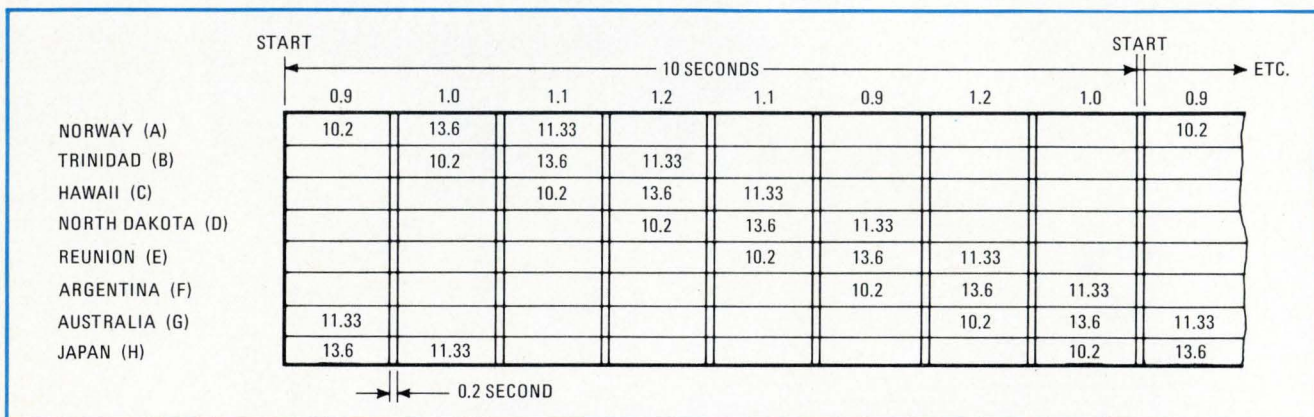

1. **Omega line-up.** When completed, the Omega system will have eight stations, each transmitting three frequencies in sequence for about 3 seconds and then remaining silent for about 7 seconds. At no time are two stations operating on the same frequency.

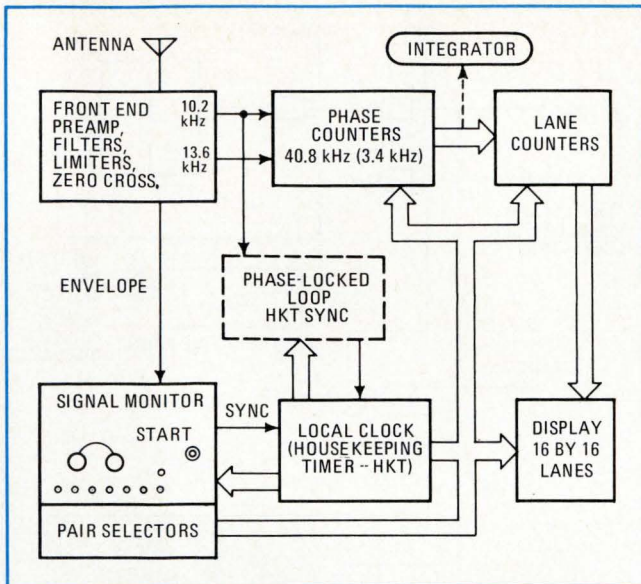

2. Basic receiver. A simplified Omega receiver consists of a front end, phase and lane counters (either at 40.8 kilohertz or 3.4 kHz), and display-control circuits. The front end receives, filters, and converts signals to zero-crossings, and counters generate phase data.

and no two stations are transmitting the same frequency at the same instant. It takes 10 seconds for all eight stations to complete their transmissions on the three Omega frequencies. Each station transmits its three frequencies in sequence for about three seconds and then remains silent for about seven seconds until its turn comes up again.

The Omega system is somewhat similar to Loran, but it has longer range, providing hyperbolic isophase contours, or lines of position (LOP) between stations. Because of the wide separation of transmitting stations on the spherical earth, the resulting grid appears to be nearly straight-line segments for a hundred miles or so on a typical local navigation chart.

The spaces between the LOPs are called lanes, and anyone using the system must know which lane he is in before he can accurately determine his position. For the 10.2-kHz frequency, the lanes are about eight miles wide on the station-pair baseline.

In principle, LOPs are determined by measuring and temporarily storing phase information from each station and comparing their difference through analog or digital loop systems with a local reference. An integra-

tion time as long as two minutes, or long-term correlation-detector filtering, smooths the data readout for use with low navigational velocities. Either differential corrections, applied from a nearby ground monitor to the user via a radio link, or correction tables are used to compensate for the diurnal changes in propagation velocity.

Propagation changes can vary as much as a full LOP or about eight miles at the 10.2-kHz frequency over a 24-hour period. At any given time, the isophase grid is changing quite slowly with respect to the velocity vehicle. The grid may be thought of as a rubberlike map stretching slowly over the earth's surface back and forth as the earth rotates every 24 hours.

The stretch or change in the grid structure is predictable, and tables are published for areas covered by the Omega system. However, minor problems are created at local sunrise and sunset, when somewhat more rapid phase changes occur. Solar flares also sometimes produce SIDs (sudden ionospheric disturbances) which may distort the grid by many miles for a short period of time. In general, users can anticipate a worst-case error of ± 2 nautical miles at night and usually can do better when good correction data is available from tables or ground-based monitors.

Navigating

All Omega receivers require some form of internal clocks to determine which station is being measured at a particular time. A variety of methods are used, and most of them also obtain internal housekeeping and phase-measurement references from the same clocks. The more sophisticated processors use cycle-matching systems with a single reference oscillator operating at a high enough bit rate to generate all possible signals of interest from 0.1 hertz, the time interval of a complete Omega sequence, to 10.448 MHz, which is a 10-bit clock rate for a 10.2-kHz signal.

Several methods are available to determine position from the transmissions. One method employs simultaneous transmissions from different station pairs in each time slot. Some existing digital-processing Omega receivers use cumulative differences with the internal clock as a reference.

A receiver could operate on only one frequency, say, 10.2 kHz, and store the phase of the receiver signal with respect to an internal reference so that it might be compared with a 10.2-kHz signal from another station. The

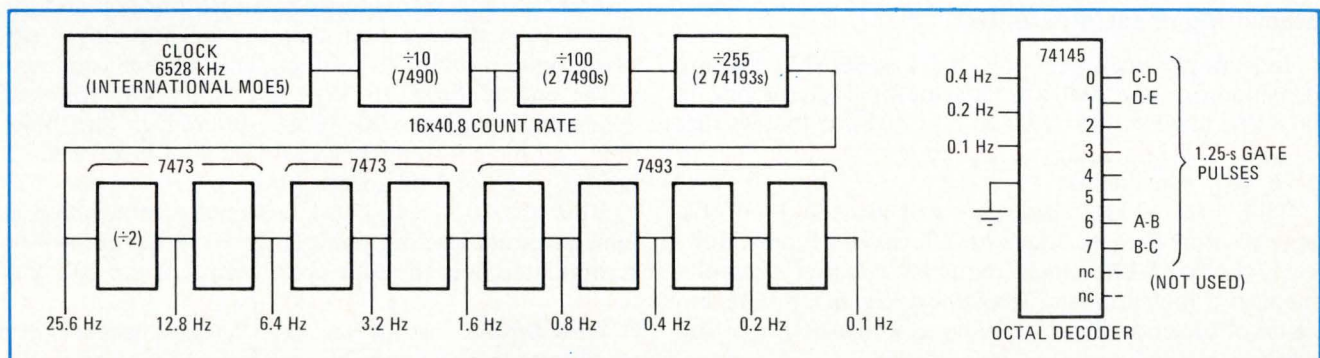

3. Housekeeper. In the basic timer, a commercial 6.528-kHz crystal oscillator drives dividers, which generate pulses at all frequencies of interest in the Omega sequence. The octal decoder generates pulses while the stations are transmitting.

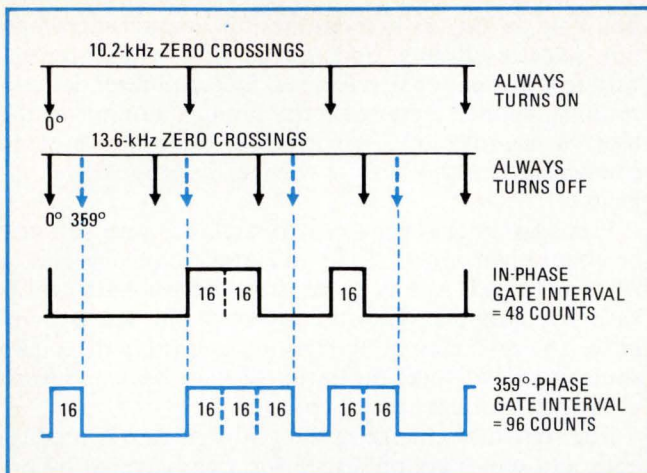

4. Phase gate. In the 40.8-kHz, least-common-multiple method of phase measurement, the 10.2-kHz zero crossings turn an RS flip-flop on, and the 13.6-kHz crossings turn it off. The flip-flop's on time, which gates pulses into a register, represents the phase difference.

receiver would require transmissions from a minimum of three stations to form two pairs—A-B and B-C, for example. Another method is to use a highly stable clock as a reference, matching the phases of the two stations directly to the reference, and calculating the phase difference from this data.

Although these two methods are not adaptable to operation with low-cost circuitry, another technique does offer that promise. That is measuring the phase difference of two signals of different frequencies that are being transmitted simultaneously—say, station A at 13.6 kHz and station B at 10.2 kHz. Phase would not have to be stored for each station—only differences are stored—and the internal clock need not be of atomic quality.

Of course, the phase of two signals of different frequencies cannot be compared directly, but the two signals can be converted to a common frequency, either by using a multiplier with a factor equal to the least common multiple or by using a divider with the greatest common divisor. This would maintain the respective phases and allow generation of the needed phase difference.

The receiver (Fig. 2) first amplifies and filters the signals and then applies them to limiters and zero-crossing detectors to develop pulses related in time to the original phases of the signals. These pulses are processed in phase-measurement circuits based on digital methods.

Measuring phase differences

In a simple receiver, if only 10.2 kHz and 13.6 kHz are considered, the least-common-multiple frequency is 40.8 kHz ($10.2 \times 4 = 13.6 \times 3 = 40.8$). It follows that a 4-bit 40.8-kHz signal would require a clock rate of $2^4 \times 40.8 = 652.8$ kHz.

This 4-bit 40-kHz clock rate will provide 1/64 of a lane resolution at 10.2 kHz or, effectively, 6 bits. However, the 652.8-kHz clock frequency is easier to implement at a higher crystal frequency, say, 6.528 MHz, because of better oscillator stability as well as lower crystal costs.

A basic clock, or housekeeping-timer system (HKT) (Fig. 3), starts out with a standard commercial crystal

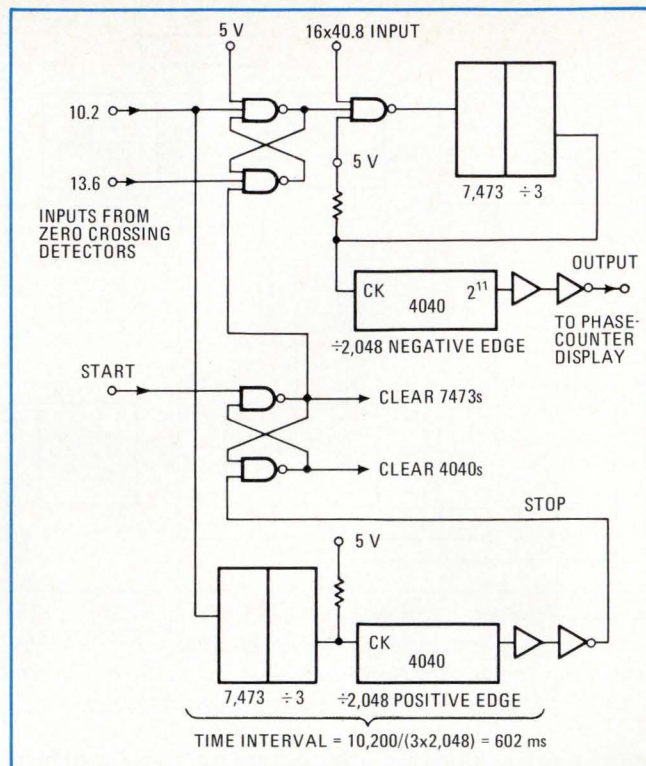

5. Phase detector. In the circuit for Fig. 4, the RS flip-flop operates on the start pulse from the housekeeping timer. After $3 \times 2,048$ of the 10.2-kHz edges, the counter stops and is reset. Output to the display is a 4-bit serial count between 0 and 15.

oscillator operating at 6.528 MHz, which has a short-term aging rate of less than 1×10^{-9} and is trimmable to within 1×10^{-7} .

Direct division by 10 supplies the basic counting rate of 16×40.8 kHz, which will be used in the later phase-detector circuits. Division by other combinations of integers provide other frequencies down to 0.1 Hz (the basic Omega sequence rate), which are used for various gating functions.

An octal decoder, driven by the 0.4-, 0.2-, and 0.1-Hz signals, generates gating intervals at each time-slot position of the Omega sequence. To start the circuit in synchronism with the Omega sequence, a delay of 312 milliseconds is used after the station selected for startup. All uniform sampling intervals then occur when the stations shown are transmitting simultaneously on 10.2 and 13.6 kHz.

If the 10.2-kHz signal turns on an RS flip-flop and the 13.6-kHz signal turns it off, then the flip-flop output can gate a pulse train into a counter. The counter's contents at the end of three 10.2-kHz cycles or four 13.6-kHz cycles will represent the phase difference. The pulse train will have a frequency of 16×40.8 kHz, or 652.8 kHz ($16 = 2^4$ for 4-bit accuracy).

When the 10.2- and 13.6-kHz signals are in phase at some arbitrary starting point (Fig. 4), 48 counts will be accumulated over the four-cycle period of the 10.2-kHz

7. Three displays. The 4-bit output from the phase detectors could be displayed in binary form (opposite page, bottom) on a strip-recorder driven by a d-a converter or on a directional display where LEDs light up in sequence as the vehicle proceeds.

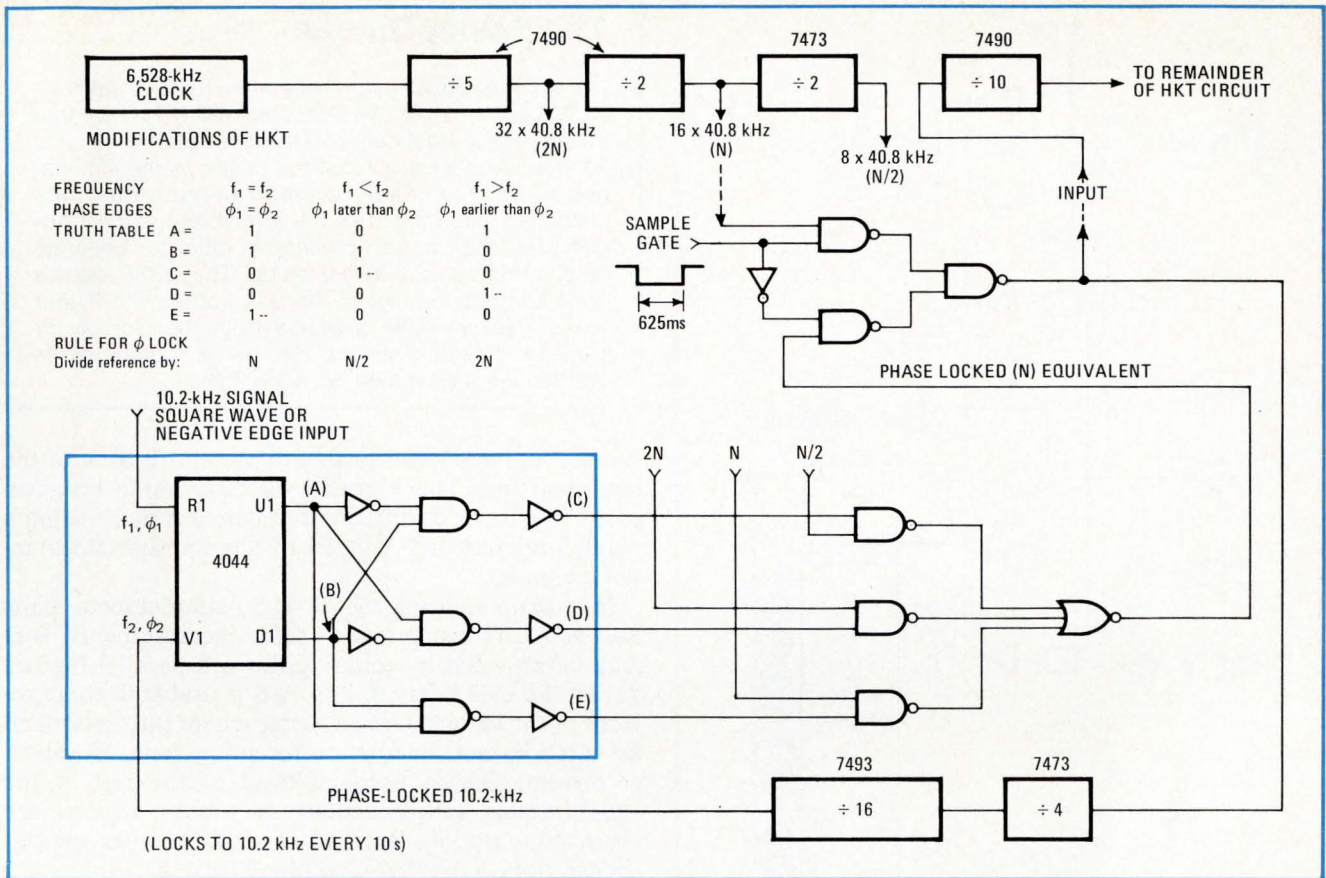

6. Phase-locked loop. In the 3.4-kHz, greatest-common-divisor method of phase measurement, a type 4044 IC is used as a phase detector, with the truth table shown, to phase-lock the local clock to the transmitted 10.2-kHz signal.

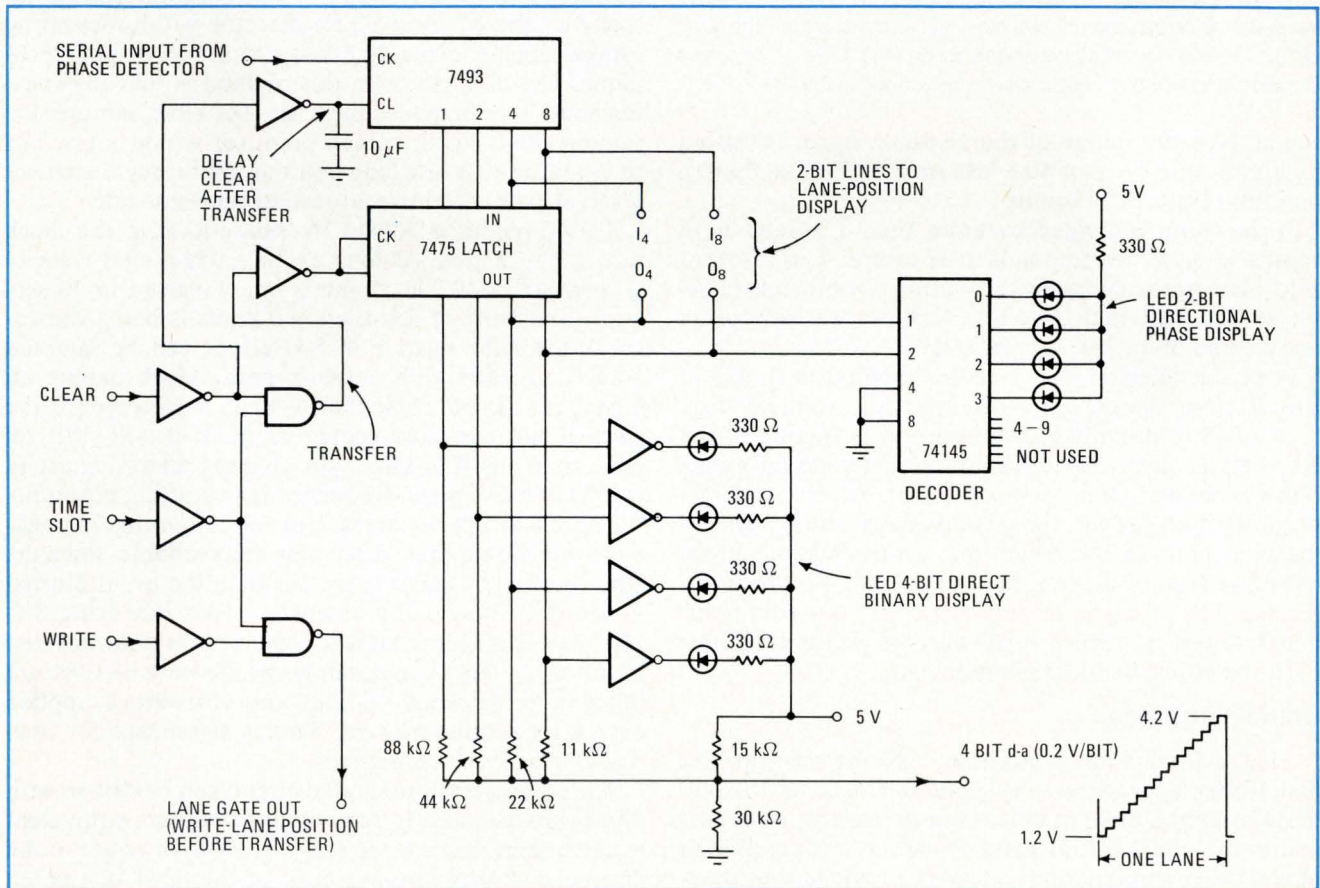

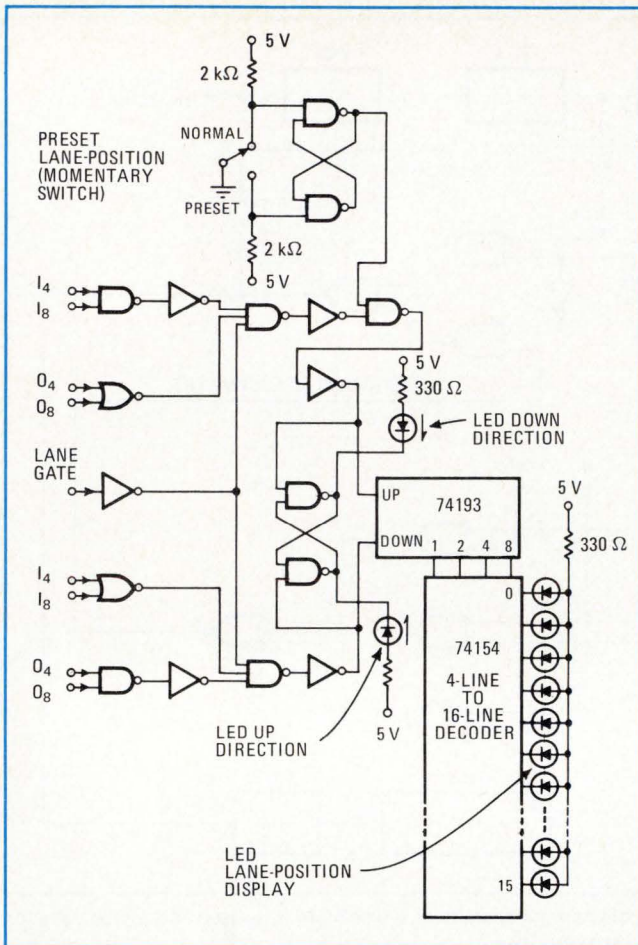

8. Lane-positioning. The unit keeps track of the number of lanes traversed by comparing the two most significant bits from the latch of Fig. 7 to find when lane transitions occur. One of two LEDs shows direction, and one of 16 LEDs shows position within the lane.

signal. Now the phase of the 13.6-kHz signal is shifted by almost one cycle of 40.8 kHz (say, 359° of 40.8 kHz), and this results in 96 counts.

If the count is divided by three, then 0° results in 16 counts, and 359° corresponds to 32 counts. The 16-count zero-bias can be suppressed by using a 4-bit shift register, so that the initial 16-count overflows and disappears out the end of the last counter stage.

A phase detector that uses this method is shown in Fig. 5. Here, the output width intervals are divided by $3 \times 2,048$ to provide 602-millisecond averaging of the 10.2-kHz frequency. The RS flip-flop operates on a start pulse generated from the HKT circuit. After $3 \times 2,048$ of the 10.2-kHz edges, the counter stops and is reset for the next pair. In the meantime, a serial-count output has flowed out of the output terminal to a 4-bit counter-display. The serial-count output in Fig. 5 is a 4-bit number from 0 to 15, which is the average phase difference of the resulting 40.8-kHz phantom lane.

Combining lanes

This method is not used in any existing receivers. At first, it may appear too simple and restricted by the fact that the combination of lanes used for navigation is limited to the simultaneous pairs. However, it is possible to obtain other combinations of lanes, provided that mea-

The Soviet Omega

The USSR has an Omega-like system that transmits on 11.905 kilohertz, 12.649 kHz, and 14.881 kHz (so that the respective least common multiples are 16, 17, and 20 kHz). A receiver/processor similar to the simultaneous-pair or least-common-divisor methods presented here might use the lowest and highest frequencies with a 4:5 processor ratio to generate 59.525-kHz and 2.976-kHz lanes. The USSR signals are receivable in most of the U.S.—often with higher levels than presently available from the Norway or Trinidad Omega stations. The power output of its transmitters is estimated to be 30 kilowatts.

asurable simultaneous signals are present in each of the time slots used. This is done by subtraction in up-down counters after or during the simultaneous pairs, using a parallel register that is gated by the appropriate time-slot intervals.

In a major portion of the U.S., simultaneous pairs B-C and C-D can provide usable measurements. B-D may be provided by counting down a parallel register during the C-D interval. Pair A-B is usable in some regions of the eastern United States where the Greenland ice cap does not shadow the reception zone. However, at present, Omega users in most of the rest of the United States, and particularly in western regions, are restricted to stations B, C, and D because of excess signal loss from A over the Greenland ice cap.

The incoming 10.2-kHz signal can also be divided by 3, and the 13.6-kHz signal by 4 during simultaneous transmissions. The resulting 3.4-kHz signals can be directly compared by a phase-detector width-measuring system similar to the 40.8-kHz simultaneous-pair technique. The difficulty with this method is that the starting point is ambiguous unless the HKT clock samples the same relative 40.8-kHz lane point (or within a few bits of the same 40.8-kHz lane point at a 4-bit measurement level) at each successive 10-second time-slot gate.

This problem is solved by phase-locking the clock rate to one station. As long as the navigational velocity is such that a 40.8-kHz lane is not traversed in 10 seconds (a velocity of less than 360 knots is being considered), the same relative 40.8-kHz lane can be sampled 10 seconds later with a free-running clock having an offset that can be worse than 1×10^{-6} . However, if the clock is not corrected sooner or later, it will drift off more than one 40.8-kHz cycle, creating an ambiguity in the 3.4-kHz difference-frequency lane-starting position.

The 3.4-kHz lanes are useful for long-range navigation when no diurnal corrections are available, since the lane width of 24 miles is greater than the usual diurnal variations. Thus, if the navigator starts out using 3.4-kHz LOPs from some known position and does not lose count of the lanes traversed, he would only be off eight miles or so at worst without any corrections applied over a long-range mission. This is significant for low-cost Omega receiver methods.

A phase-detector integrated circuit can be driven with digital input signals to provide logic outputs equivalent to clock rates that are too fast, too slow, or equal to the desired rate. The internal logic of the 4044 integrated

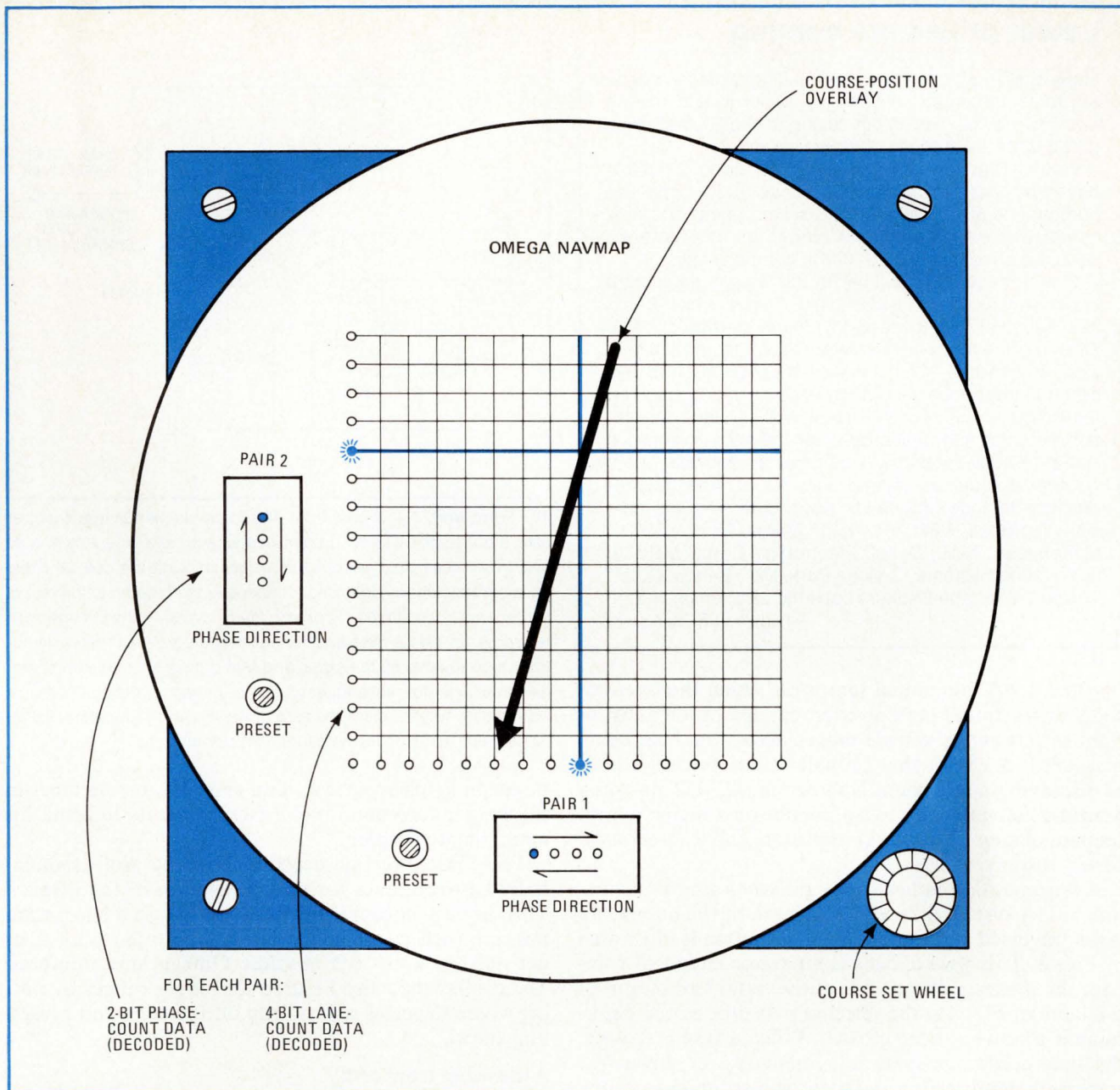

9. Mapper. One proposed navigation aid is a map display, which shows the lanes lighting up as edge-lit lines and LEDs lighting in sequence to indicate direction and also position between lines. This display would only suffice for a short-term flight.

circuit, for example, will sense phase and frequency according to the truth table in Fig. 6. This circuit may be used for a binary phase-locked loop that controls the count-down rates from the receiver's internal clock. A complete loop circuit can be built (Fig. 6) to periodically correct the internal clock phase with respect to a common-station phase every 10 seconds. The count-down chain operates most of the time at the normal division rate of 40.8×16 , but it is speeded up or slowed down according to the error observed every 10 seconds during the 625-millisecond sampling interval.

The noisiness of the Omega raw data generally makes it undesirable to present information to the pilot at a centilane (1/100 of a 10.2-kHz lane). Some commercial Omega receivers use a final-output display precision of 1/10 of a 10.2-kHz lane—each output increment of

phase represents slightly less than a mile on the pair baseline. Centilane data, even when averaged over a few time slots, will fluctuate too much, particularly if one of the signals from the pair is weak. Thus, 0.5- to 1-mile output increments of phase are desirable for navigational use to aid in smoothing the information display for a pilot or navigator.

The 4-bit binary information output from Fig. 6 can be displayed at the output of a four-stage counter directly in binary format. Unfortunately, most potential users of Omega equipment are not happy with raw binary information, and a conversion to a more familiar, easier-to-read, format is desirable. A 4-bit d-a converter used with a meter-type indicator or a pen recorder is one possibility.

Another simple method would be to decode the out-

Lower prices are coming

Many manufacturers are now making Omega receivers for commercial and military airborne and marine use, but no receiver is yet selling in the \$1,000 price range targeted in the accompanying article.

One of the lowest-price units will soon be introduced by Micro Instrument Co., Escondido, Calif. The company is aiming at a \$2,595 selling price for a new model, and even the optional strip-chart recorders will keep the price below \$3,000, the company says.

One of the first companies in the Omega equipment business was Tracor Inc., Austin, Texas, which has a new receiver that uses C-MOS and carries a basic \$2,975 price tag. The Northrop Corp. Electronics division, Hawthorne, Calif., makes the AN/ARN-99 airborne Omega receiver, which is being widely used by the military. This receiver uses sophisticated correlation-detector and phase-detector methods to improve signal-to-noise ratios by as much as 30 decibels.

Other companies making units for commercial marine use include Magnavox Advanced Products division, Torrance, Calif., Raytheon Marine Products Co., Manchester, N.H., Dynell Electronics Corp., Melville, N.Y., Litton Systems, College Park, Md., Bendix Corp., Towson, Md., and Beukers Labs Inc., Bohemia, N.Y.

—Stephen E. Scrupski

put to a set of individual lamps on which the operator watches fractional lane position change up or down or right or left as the vehicle moves across the lane being measured. A circuit that provides these three methods of displaying phase count is shown in Fig. 7. This uses a 4-bit d-a converter to drive a pointer on a meter, a 2-bit sequential step (four steps) indicator, and a direct 4-bit binary display.

A lane-position indicator is similarly a useful navigation aid. A system that will keep track of the number of lanes traversed and the direction of motion is illustrated in Fig. 8. This uses a 2-bit comparator circuit to compare the most significant bits at the input and output of the latch of Fig. 7 at the selected pair time slot to determine if a lane has been crossed. When a lane is crossed, the lane-position display increments up or down one step, and the direction indicator shows which way the lane change is going. A momentary preset lane-position button may be operated to step the output lane-position display to any desired point, going from position 0 to 15 and starting over again on the 16th step. A 16-step lane-position indicator will cover about a 32-mile range for 40.8-kHz lanes and a 128-mile range for 10.2 kHz on the station-pair base line. This would be useful for local-area aircraft navigation aids or coastal-area navigation for boats.

A possible method of combining two lane-pair indicators into a compact Omega navigation map is illustrated in Fig. 9. The pilot or navigator first presets his course with respect to Omega coordinates on the course-overlay cursor. The operator then increments his preset known position to the desired starting point on the display and moves in the chosen direction with the aid of an independent direction indicator, such as a compass or direction gyro, to maintain approximate course heading correctly. He then observes the indicator

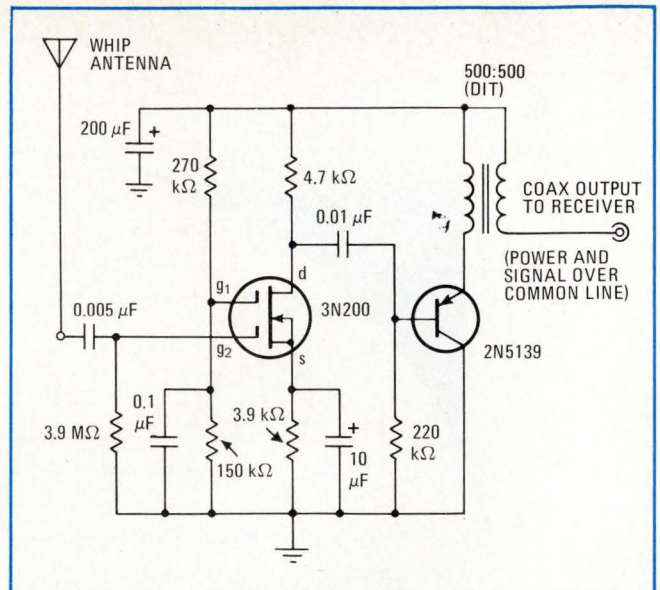

10. Front end. A low-cost front end for a simple Omega receiver uses a dual-gate MOSFET preamplifier located at a whip antenna as here. The preamplifier receives its power through the coaxial cable up to several hundred feet long, connecting the preamp to the rest of the receiver. Two stages of ceramic filters turned to the Omega center frequency set up the signal for an integrated-circuit limiter-detector, which squares off the signal and also provides a measure of signal amplitude for subsequent use in gating circuits. Finally, a comparator circuit senses the zero crossings and provides pulses to be decoded in the phase-measurement circuits.

direction lights operate as long as he is crossing lanes in the proper direction, and the cross points indicate his approximate position.

The phase-direction decoder shows positions sequentially between lanes for finer resolution of the display. This display concept is intended for use on a short-term mission, such as an hour's flight, where the pilot does not need to know the absolute Omega lane numbers. The display may also be used for longer ranges by noting where the cross points drop off the edge and presetting ahead.

A low-cost front end

If the eventual goal is a receiver-processor system with a total cost of less than \$1,000, a short whip or blade type of receiving antenna will suffice for the input. Ten-kilowatt transmitting systems with large antennas typically provide signal levels of several hundred microvolts at 1,000 nautical miles across the input to a high-impedance preamplifier with a 20-foot whip antenna. The atmospheric noise level at 10.2 kHz on a short-wire antenna is typically quite high—1 μV per hertz of receiver bandwidth.

The preamplifier (Fig. 10) should have high input impedance and sufficient gain to overcome the noise introduced by the common operational amplifiers that are used with ceramic or mechanical high-Q bandpass filters. A voltage gain of 10 (20 dB) is desirable with an input noise factor less than 0.1 $\mu\text{V}/\text{Hz}$. A low-cost amplifier can be obtained from a diode-protected dual-gate MOS field-effect transistor.

The whip antenna is coupled through an isolating ca-

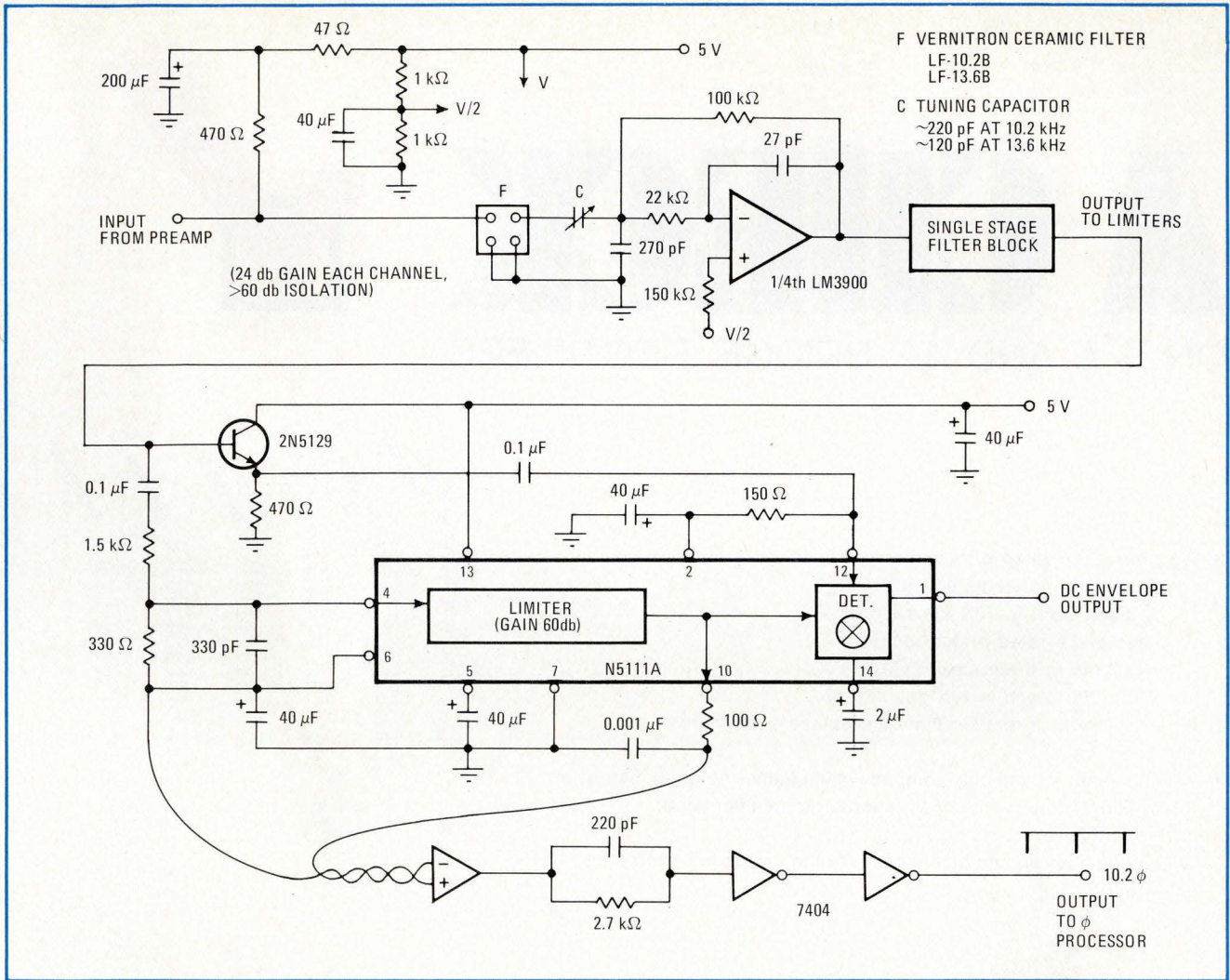

capacitor to the control gate, and the preamplifier is physically located at the antenna. The MOSFET drives a bipolar transistor amplifier, which has its output coupled to the filters through a wide-band transformer. The low-impedance output line from the transformer also carries the 5-v power for the preamplifier. Thus, a single coaxial cable with a length of several hundred feet can be used to separate the main receiver from the antenna-preamplifier.

The low-impedance output line of the preamplifier directly drives split-ring ceramic bandpass filters, which can become available at quite low cost if sufficient demand for them in the very-low-frequency-Omega market can be created. A single filter unit, followed by a gain block of about 10dB, gives a 3-dB bandwidth of about 35 Hz. These filter units have small spurious high-frequency responses, which are removed with an active low-pass filter network. The low-pass filter is designed with a cut-off of four to five times the operating frequency, based on an output impedance of about 25 kilohms for the ceramic filter as the input source to the filter. The ceramic filters are tuned to the exact Omega center frequency with series capacitors, and they have a low sensitivity factor—about 0.1 Hz/pF.

A second filter stage, nearly identical to the first, further reduces the bandwidth to about 15 Hz. The two-

stage filter is designed for an over-all gain of slightly greater than 20 dB for whip-antenna usage. For navigation with a ship antenna, measurable signal levels from at least 10 μV to 1,000 μV in a 15-Hz bandwidth are needed.

The two-stage filter drives the limiter. A standard fm limiter-detector integrated-circuit package (N5111A), normally used at 10.7 MHz, provides good limiting properties with no phase error, as well as a means of measuring signal amplitude. Although Omega measurements are based on phase, some amplitude information is desirable. Using the strongest burst for lock-up when the receiver is first turned on makes it easy to synchronize the local receiver clock with the transmitted Omega format.

The multiplier allows synchronous product detection by using the unlimited filter output to drive an emitter follower and thus isolate the filter's relatively high output impedance—1,000 ohms or so—from the multiplier input terminal.

Still more system gain is needed to provide clean square-wave edges for further use. The limiter-output signal drives the comparator, which, in turn, drives the edge-detector differentiator. This provides a simple means of generating pulse trains for the leading-edge zero crossings of the original signal. □

A CHECK



ON 3/4A AND 4A BRIDGE RECTIFIERS

	GENERAL INSTRUMENT	MOTOROLA	VARO	UNITRODE	SEMTECH	DIODES INC.
1—Who has a 4A rated bridge rectifier?	<input checked="" type="checkbox"/>	<input checked="" type="checkbox"/>	<input type="checkbox"/>	<input type="checkbox"/>	<input type="checkbox"/>	<input type="checkbox"/>
That does not require heatsinking?	<input checked="" type="checkbox"/>	<input type="checkbox"/>	<input type="checkbox"/>	<input type="checkbox"/>	<input type="checkbox"/>	<input type="checkbox"/>
At 85¢* each in 10K quantities?	<input checked="" type="checkbox"/>	<input type="checkbox"/>	<input type="checkbox"/>	<input type="checkbox"/>	<input type="checkbox"/>	<input type="checkbox"/>
2—Who has a 3/4A rated bridge rectifier?	<input checked="" type="checkbox"/>	<input type="checkbox"/>	<input checked="" type="checkbox"/>	<input type="checkbox"/>	<input type="checkbox"/>	<input type="checkbox"/>
Available in three case styles?	<input checked="" type="checkbox"/>	<input type="checkbox"/>	<input type="checkbox"/>	<input type="checkbox"/>	<input type="checkbox"/>	<input type="checkbox"/>
All at 20¢* each in 10K quantities?	<input checked="" type="checkbox"/>	<input type="checkbox"/>	<input type="checkbox"/>	<input type="checkbox"/>	<input type="checkbox"/>	<input type="checkbox"/>
3—Who has a bridge rectifier that can replace 4 rectifiers at no additional cost?	<input checked="" type="checkbox"/>	<input type="checkbox"/>	<input checked="" type="checkbox"/>	<input type="checkbox"/>	<input type="checkbox"/>	<input type="checkbox"/>
4—Which is the first and only company using flame-retarding materials (classified 94V-0) in the construction of its rectifiers and bridge rectifiers?	<input checked="" type="checkbox"/>	<input type="checkbox"/>	<input type="checkbox"/>	<input type="checkbox"/>	<input type="checkbox"/>	<input type="checkbox"/>
5—Which company should be checked for the lowest priced bridges, anywhere?	<input checked="" type="checkbox"/>	<input type="checkbox"/>	<input type="checkbox"/>	<input type="checkbox"/>	<input type="checkbox"/>	<input type="checkbox"/>

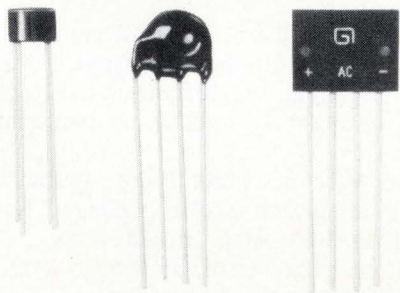

75WOM 75A 20¢*
WOM 1.5A 25¢*

75KBD 75A 20¢*
KBD 1.5A 25¢*

75KBP 75A 20¢*
KBP 1.5A 25¢*
KBL 4.0A 85¢*

*PRV @ 400V or lower, 10,000 units scheduled within 60 days.

G^I'S GOT IT!

For complete information on G^I's bridge rectifiers, call toll-free 800-645-1247 (In New York State call 516-733-3235) or write, General Instrument Corporation, Semiconductor Components Division, 600 W. John St., Hicksville, N.Y. 11802.

**GENERAL INSTRUMENT CORPORATION
SEMICONDUCTOR COMPONENTS**



Microprocessors expand industry applications of data acquisition

More flexible than hard-wired logic, less costly than minicomputers, microprocessors promise a new wave in industrial measurement and control; their smallness and reliability open up new uses

by Alan J. Weissberger,
National Semiconductor Corp., Santa Clara, Calif.

□ Industrial applications of computerized data-acquisition systems have grown less rapidly than many people expected, despite great advances in computer and measuring-instrument technology. Minicomputer-controlled systems that might be perfectly acceptable in physics laboratories require just too much in the way of space and dollars, and their maintenance also is often too demanding in such applications as operating traffic light systems, keeping tabs on pipelines, or testing automobile engines.

For applications like these, however, a microcomputer-controlled data-acquisition system is almost ideal. It is smaller, cheaper, and more reliable than alternative, functionally equivalent systems.

Cutting size

The size reductions made possible by microcomputers are dramatically illustrated in a demonstration system made by National Semiconductor Corp. (Fig. 1). This 16-channel system, which performs both control and data-acquisition functions, is built around a microcomputer, consisting of a 16-bit microprocessor, 256 words of random-access memory, 512 words of read-only memory, data buffers, and some auxiliary logic circuitry. It also includes analog-to-digital and digital-to-analog converters, analog multiplexers, analog scaling circuitry, and a pair of high-power transistors for amplifying the d-a converter outputs.

All these elements are contained on two 8.5-by-11-inch printed-circuit boards. One board contains the complete microprocessor, and the other—called the data-acquisition interface (DAI) board—contains the rest of the analog and digital circuitry.

In fact, the only components not on the two boards are the power supply and the transducers used to mea-

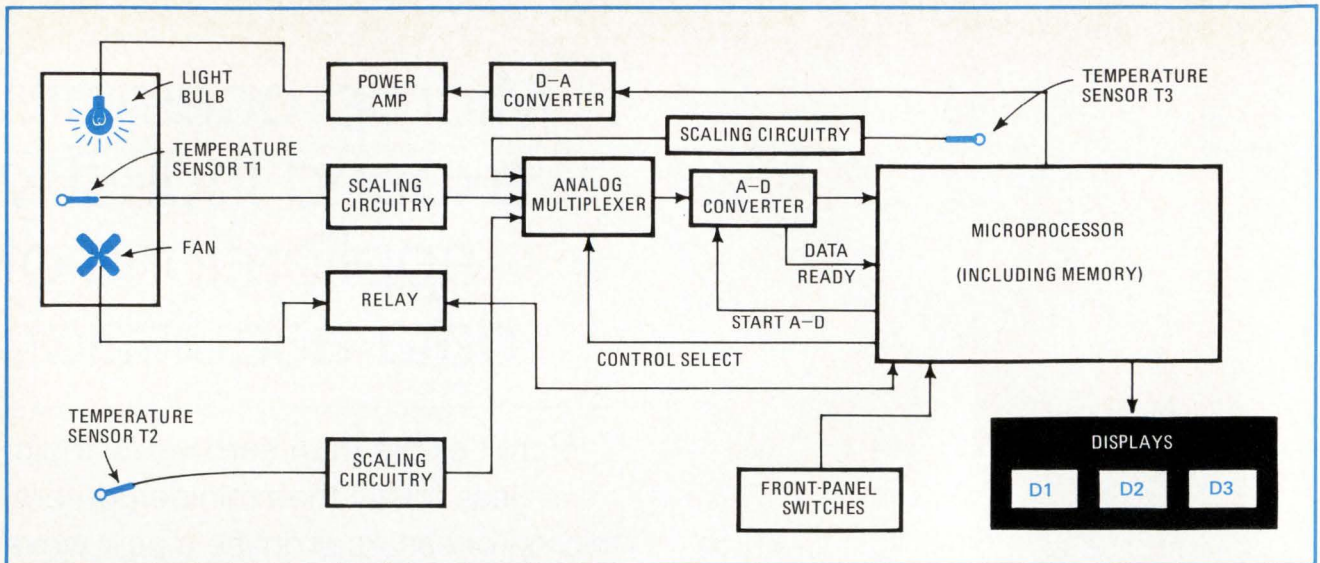

1. Feasible. Demonstration system proves feasibility of combining LSI microprocessor with hybrid circuitry into a compact, complete data-acquisition system. Temperature transducer T_1 is part of control loop for temperature-controlled chamber at upper left. Probe T_2 monitors and displays ambient temperature, while a third transducer, T_3 , measures and displays the temperature in the microprocessor compartment.

sure whatever is being monitored or controlled.

This remarkable compactness results mainly from the use of large-scale integration in the microcomputer chip set. Further space and money is saved by the elimination of various connectors, line drivers, line receivers, and cables. And eliminating components, as is well known, also increases reliability.

Increasing reliability

Further improvements in hardware reliability stem from the fact that microcomputers are supplied, not as complete chassis, but as sets of LSI devices—including microprocessor, memory, and input/output function chips. Thus the user is free to package them in a way that maximizes system reliability for his application.

But the reliability of a data-acquisition system depends not just on the reliability of its hardware but on how it handles temporary power failures, failures of interconnections between the system elements, and failures of the system's central computer, if any.

Typically, a microcomputer is programmed in firmware—that is, the control program for the microprocessor chip is contained in a read-only memory and cannot be lost because of a temporary power failure.

A completely centralized data-acquisition system consists of a central computer and a lot of remote sensors. All data gathering stops if the central computer fails. But with a microprocessor-based system, there is a local, dedicated microcomputer at each remote site. For most routine tasks, the central computer isn't needed at all, and even during a failure, data continues to be gathered and stored in the local processor.

From a systems viewpoint, a failure of the communications system connecting the remote sites with the central computer is the same as a failure of the central computer. Again, because it can function without being connected with the central computer, the microprocessor-based system is less susceptible to breakdowns in the communications system.

Moreover, with microcomputers at each remote site,

raw data and status signals need not be sent from the site to the central computer, and commands need not be sent so often to the remote sites. With less data being exchanged, the communications bandwidth requirements, and hence the costs, of the system are reduced.

In fact, in some applications, microcomputers can make electronic communications unnecessary altogether. Data could be stored for days or weeks on a tape cassette or a floppy disk memory, to be picked up at intervals by service personnel.

In addition, with less data being exchanged, there is less opportunity for transmission errors to creep into the system to reduce its over-all operational reliability.

Even if a central computer is still deemed necessary, a less expensive unit would be required than in the situation without remote microcomputers. So by acting, at least in part, as a communications pre-processor, the microcomputer can greatly reduce the costs of both the central computer and the communications links connecting it with the remote sites.

A typical system

The workings of a typical microcomputer-controlled data-acquisition system can be understood from Fig. 1. In this setup, an incandescent lamp and a fan are used, respectively, to heat and cool an enclosed volume (upper left-hand corner) whose temperature is monitored by a temperature transducer. Under control of a microcomputer, the fan is turned on and off, and the lamp intensity is varied, so as to maintain a pre-set temperature in the enclosed volume. Two additional transducers are included in the system—one to monitor the temperature of the microprocessor board, the other to monitor room temperature.

The pre-set temperature, the initial value of which is set by the control program in the read-only memories, can be changed by means of thumbwheel switches on the front of the demonstration panel, as can the scan periods for each of the temperature sensors. The scan period for an input channel (sometimes called an input

point) of a data-acquisition system is the inverse of the frequency with which it is interrogated by the microprocessor.

The partial block diagram of Fig. 2 illustrates the operation of the system. Analog signals from the temperature transducers are scaled by individual signal-conditioning amplifiers (or attenuators) to voltage levels compatible with the input analog multiplexers. The demonstration unit contains two multiplexers, each of which can handle eight single-ended inputs or four differential inputs.

No change of address

When the microprocessor's arithmetic logic unit (ALU) wants to determine the temperature at a particular point, it first instructs the analog multiplexer to look at the desired input channel. Since the address data fed to the multiplexer must, of course, not change during the period required by the a-d converter to digitize the input signal, it is latched in to a pair of quad D flip-flop packages. There it remains unchanged until a Start Convert signal has been sent to the converter and a Strobe Output (data-ready) signal from the converter indicates that conversion is complete. The timing diagram of Fig. 3 shows how conversion time varies with precision. Since conversion time is 1.4 microseconds per bit, 8-bit resolution leads to a total conversion time of 11.2 μ s, while 12 bits takes 16.8 μ s.

When a-d conversion is complete, the converted data is read into the ALU where it is processed as required. If it is to be displayed, it is converted to a BCD code and fed to a light-emitting-diode decoder/driver. If the variable is to be used in the feedback control loop, it is compared against a setpoint plus or minus a specified dead-

band. If the variable is out of limits, a command is sent to actuate a control point (output channel).

For applications in which processing time must be minimized, very efficient real-time computation is possible if a very fast a-d converter is used. In particular, if the converter's settling time is 6.5 microseconds or less, the IMP-16C microcomputer can address the converter's output as a ROM location. This output may be loaded, added, subtracted, or multiplied with one of four general-purpose registers during the same instruction cycle as it is read. This technique eliminates the instructions used to sense the a-d converter's strobe output signal and to read its output word. Signal averaging, digital filtering, and the calculation of voltage amplitude distributions and correlation functions are some of the normally time-consuming operations that may then be carried out in a reasonable length of time.

Flexible control

The demonstration setup has both simple digital (on/off) and analog (proportional) control points. The digital control points are connected to relay drivers, which, in turn, can actuate motors, valves, pumps, etc. In this case, a digital point controls the cooling fan.

The analog control points are digital representations of analog voltages. These values are computed and sent in parallel to a d-a converter in order to produce the desired voltages. There are two d-a converters in the demonstration system.

Power transistors may be used to boost the current available from the d-a converters. National was able to mount two such transistors in the system to provide up to 1.8 amperes to the 20-watt heat lamp.

One great advantage of computerized systems over

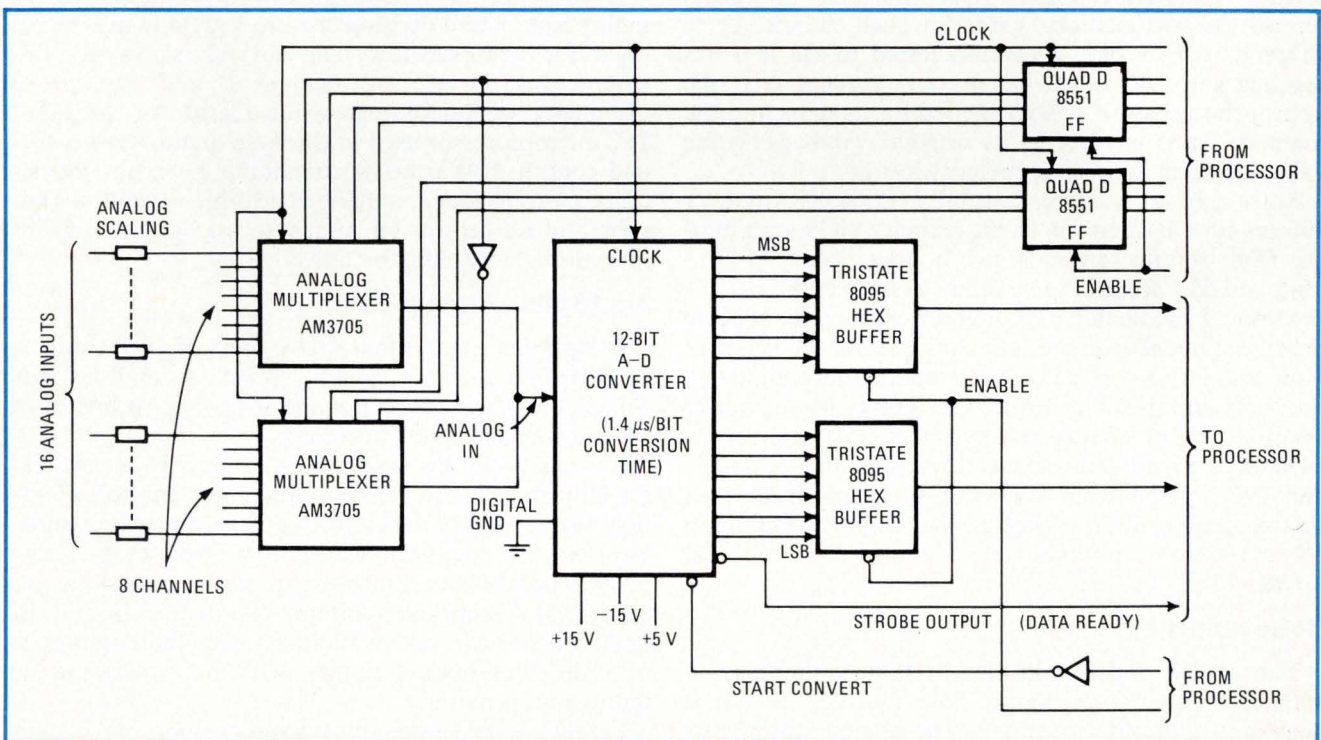

2. Input. Front end of data-acquisition system employs two analog multiplexers to handle either 16 single-ended inputs or eight differential inputs. Successive-approximation a-d converter has a maximum resolution of 12 bits. However, it can operate at reduced resolution, for increased speed, when it receives instructions to do so from the microprocessor.

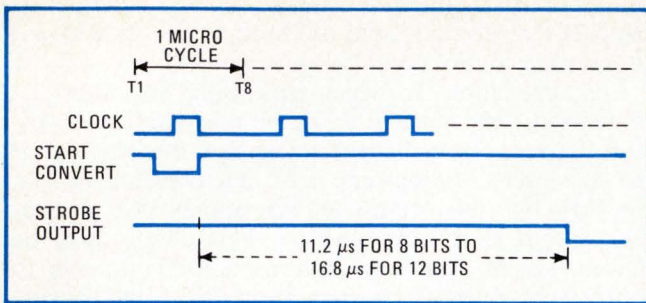

3. Timing. Analog-to-digital conversion is initiated by start-convert pulse from microprocessor. When conversion is complete, strobe output signal from converter indicates that data is ready.

their hard-wired counterparts is their flexibility. Control setpoints and scan rates, for example, can easily be changed. And it is not necessary for all of the input channels to be scanned at the same rate. Further, resistance to obsolescence is improved. Functional changes—new analog or digital points and new processing, control or data-collection requirements—can be accommodated simply by changing the program. In a hard-wired setup it would be necessary to rebuild practically the entire system.

For most systems, including the one being described, initial values for scan rates and control setpoints are assigned by the firmware. These values, however, may be easily changed by the operator.

The microprocessor makes extremely efficient use of its memory to provide a wide range of scan times for each input channel. Two 16-bit memory words are used to determine the scan time for each channel. A master oscillator provides a minimum basic scan period of 100 milliseconds. Every 100 ms this oscillator causes an interrupt request to be generated. The interrupt causes one of the two memory words for each channel to be decremented by one count and tested to see if it has reached zero. When the timer count reaches zero, the appropriate channel is interrogated for its data, and the memory word is reset to its original value using the value stored in the second memory location.

Since a 16-bit word can assume over 64,000 values, a 100-ms time base and a 16-bit memory yield scan periods from 100 ms to almost two hours (1 hour, 49 minutes, and 53.6 seconds to be exact) in steps of 0.1 s.

Merging the analog and digital worlds on a single pc board created some special requirements. Power supplies for +15 v and -15 v were needed in addition to the +5-v supply for TTL and -12 v supply for the power required by the analog and hybrid ICs. A total supply current of 37 milliamperes at 15 v, 59.5 mA at -15 v, and 1.43 A at 5 v were worst-case specs for all ICs used in the demonstration system. The high-current lamp driver required approximately 3 A at +15 v and 200 mA at -15 v.

Noise reduction

The analog and hybrid circuits that communicated with each other were placed close together to reduce noise and undesired coupling. The analog scaling circuitry, multiplexers, and a-d and d-a converters fall into this category. Analog input and output components were placed near edge connectors, and the power tran-

sistors were put in a remote corner of the board to minimize interference with, and to prevent heating of, other components.

For additional noise protection, two 33-microfarad decoupling capacitors were placed across the dc power supplies. Further, an analog reference ground was provided by mounting a small copper-plated board onto the board containing the analog circuitry. The analog and digital grounds were then interconnected at a single point to prevent ground loops.

Ordinarily, the system's transducers must not be more than 50 feet from the receiving circuits. Noise pickup, and the distortion caused by line capacitance tend to degrade signals at much greater distances.

If, however, a system has most of its transducers located close to the receiving circuitry, and an additional one or two are at distances greater than 50 feet, it may make economic sense to use a two-wire current transmitter (such as National's LH0045) to convert the signal voltage to a current for transmission over a twisted pair. The same twisted pair carries the required supply voltage from the data-acquisition system to the two-wire transmitter. The current is converted back to an appropriate input voltage by passing it through a precision resistor at the input to the system.

The memory needed to count, collect, process and display data for up to 16 analog points is self-contained on the microcomputer board. The program of 512 words is in four programmable read-only memories while the counters and data are in 16 metal-oxide-semiconductor static random-access memory chips. When functional requirements change, the program is changed by replacing PROMs. Programs stored in the PROMs are nonvolatile and need not be loaded by the operator.

Normally, even such simple arithmetic operations as multiplication and division require a great many microcycles for their execution. This not only slows up a microprocessor but uses up memory as well. Because of the microprogrammable expansion feature of the IMP-16C microprocessor used in this system, however, a second control ROM (CROM) containing 17 extra instructions could be added, making it possible to multiply, divide, and do certain bit and byte manipulations with special single-word instructions.

Are 16 bits really needed?

It has been argued that many users of 16-bit microprocessors could have gotten by with 4- or 8-bit machines. But a case can be made for using 16 bits even when it isn't absolutely necessary.

For one thing, it's easier to program a 16-bit processor chip than a smaller one—an important consideration, since software-development costs can swamp hardware costs in some applications. A 16-bit chip is also much more flexible. Since it can easily work with a-d converters of varying resolution (8, 10, 12, 14 and 16 bits), the user can take a standard part and combine it with different hybrid circuits with no processing or throughput penalties.

Finally, a processor that handles more bits than strictly necessary can improve system reliability by having parity checks and other error-detecting and error-correcting codes incorporated in its control program. □

It takes more

than a neon lamp to solve circuit problems like these...

VOLTAGE REGULATOR: 1% ACCURACY



Copy machine voltage can be regulated within $\pm 1V$ over a current range of $400\mu a$ to $15ma$ using a Signalite Subminiature voltage regulator. Other applications inc: reg. power supplies, photomultiplier regulators, scopes, calibrators, reference sources.

SEQUENTIAL SWITCH FOR TV TUNER

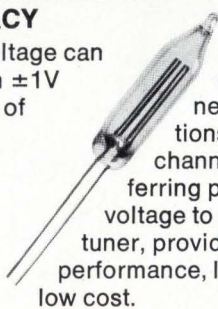

Varactor tuning systems for color TV sets use Signalite neons to perform two functions — illuminating the channel selector and transferring precise, regulated voltage to a Solid State tuner, providing reliable performance, long life and low cost.

TV VOLTAGE MONITOR/PROTECTOR



Federal x-ray emission safety regulations require control of TV picture tube voltage. Signalite's economical multi-function neon circuit components accurately detect precise voltage levels and provide the necessary signals to activate high-voltage shutdown circuitry.

It takes application help from a group of circuit specialists...
...yours for the asking.



SIGNALITE APPLICATION NEWS — is used to communicate new and proven techniques and applications of Signalite's neon lamps and gas discharge tubes. Signalite Application News provides a forum for an exchange of ideas to keep the design engineer aware of the versatility of neon lamps and their many applications. Copies are available from your Signalite representative or contact Signalite, 1933 Heck Ave., Neptune, N. J. 07753, (201) 775-2490.

Circle 111 on reader service card

**SIGNALITE DIVISION
GENERAL INSTRUMENT CORP.**



Phase-locked loop includes lock indicator

by J.A. Connelly and G.E. Prescott
Georgia Institute of Technology, Atlanta, Ga.

One problem with phase-locked loops is that it's often hard to tell exactly when the loop is locked to the input signal. In many applications, it would be very useful to include a lock indicator in a phase-locked loop to display the state of the loop.

For example, in automatic test equipment, the lock indicator would afford a simple, yet efficient, way to measure the tracking and capture ranges of a phase-locked loop. Also, various low-pass filter configurations could be evaluated easily by sweeping the loop's input frequency range. A straightforward implementation for a phase-locked loop with lock indication is shown in the figure.

A phase-locked loop can be in its locked state over a range of input frequencies. The center frequency of this range occurs when the frequency of the input signal (f_n) is identical to the free-running frequency of the loop's controlled oscillator (CO). At the center frequency, the

output of the CO will be shifted by 90° with respect to f_n . The CO frequency will track variations in f_n until the phase error of the feedback signal with respect to f_n reaches a limit set by the loop gain. For input-frequency variations beyond this limit, the loop reverts to its unlocked mode of operation, and the CO output returns to its free-running frequency.

In the circuit drawn here, the loop's feedback path is altered by breaking the normal feedback loop and inserting a divide-by-2 network. Since this network halves the CO output frequency, the CO free-running frequency must be doubled to achieve normal loop operation.

Both the output of the CO ($2f_n$) and the output of the divide-by-2 network feed a phase shifter, which produces a signal that lags the output from the divide-by-2 network by exactly 90° . The signal from the phase shifter is then compared with the input frequency, after this latter signal has been squared up by a wave shaper.

Whenever the input frequency is half the free-running frequency of the CO, the output of the CO will be shifted by 90° with respect to the input. The phase shifter introduces an additional 90° shift, causing the inputs to the phase comparator to be 180° out of phase with each other. Comparing two signals that have the same frequency but that are 180° out of phase produces a constant zero-level output.

However, if the input frequency changes, the inputs

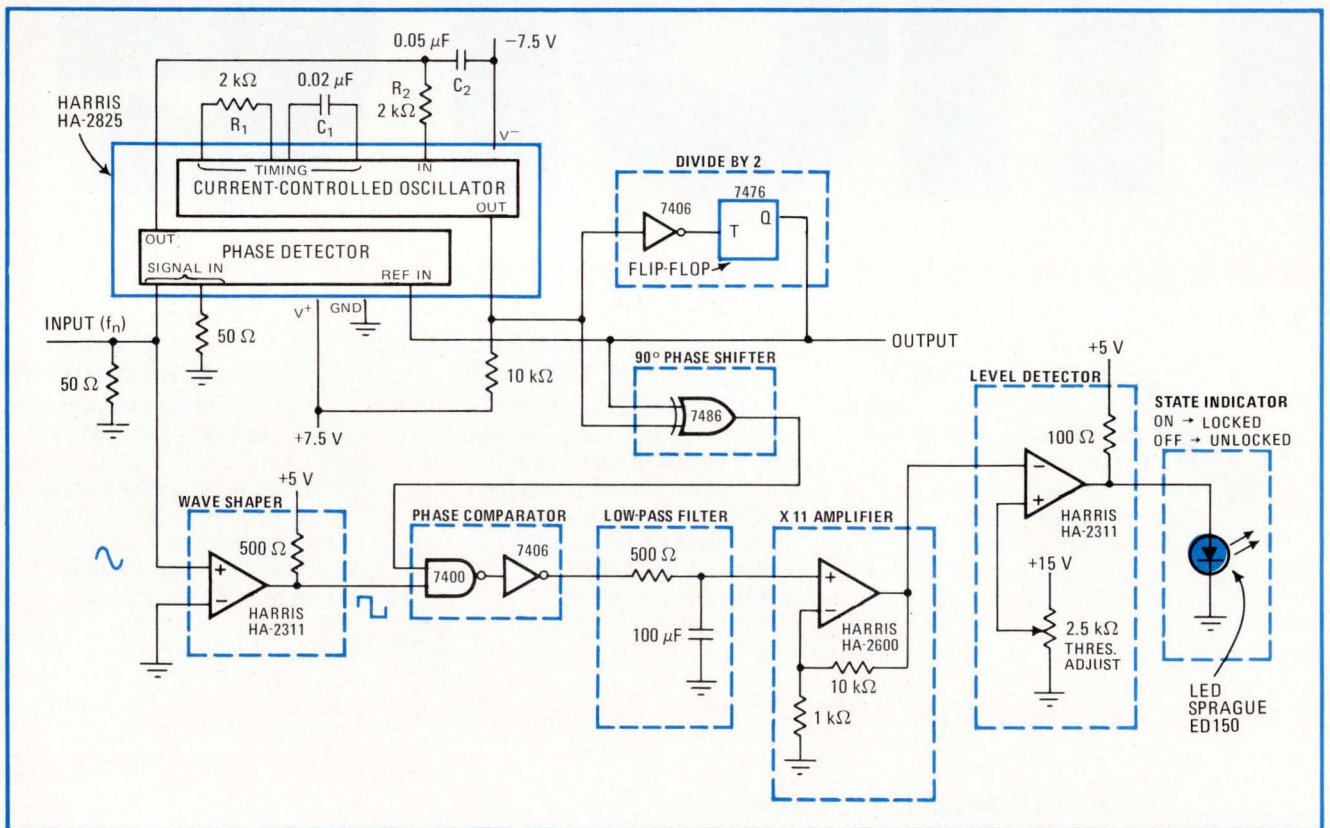

Monitoring loop state. This phase-locked loop has an LED indicator that lights when the loop is locked and goes off when the loop is unlocked. The loop's normal feedback path is opened to accommodate the lock-indicator circuitry. And the free-running frequency of the loop's controlled oscillator must be doubled because of the divide-by-2 network. The circuit's output frequency characteristic is also shown.

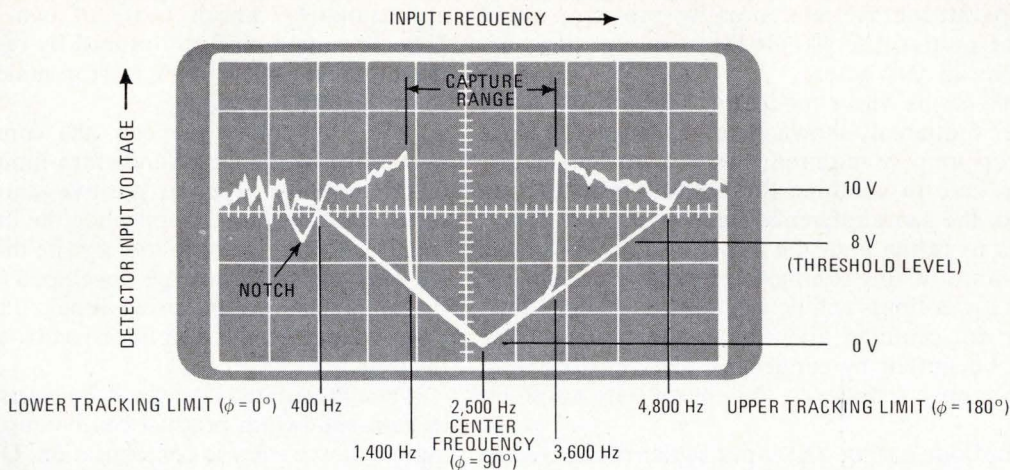

to the phase comparator will no longer be exactly 180° out of phase. Instead, they will be skewed somewhat, depending on the phase error between the feedback signal and f_n . Variations in the input frequency cause a series of narrow pulses to be fed into the low-pass filter, which attenuates high frequencies and applies a dc voltage to the level detector.

As the input-frequency deviations from the free-running CO frequency become larger, the phase comparator and low-pass filter produce correspondingly larger dc voltages for the level detector. For a locked loop, the output of the level detector is high, and the LED lock indicator is turned on. When the loop is unlocked, the detector's output goes low, turning off the LED.

For the components shown here, resistor R_1 and capacitor C_1 set the CO free-running frequency at 5,000 hertz, making the input center frequency equal to 2,500 Hz. Resistor R_2 and capacitor C_2 serve as the conventional low-pass filter for the loop. The loop's capture range can be expressed as:

$$\text{capture range} = \pm(8\pi^2)/[2\pi C_2(R_2 + R_{in})]^{1/2} \text{ Hz}$$

where R_{in} is the CO input impedance, which is approximately 500 ohms for the part used here.

The actual output frequency characteristic of the entire loop is also shown in the figure. This waveform is obtained by slowly sweeping the loop's input-frequency range, while monitoring the input voltage to the loop's level detector. The minimum voltage is developed when the loop is locked—the input frequency and the CO out-

put are 90° out of phase. Any input-frequency deviation from this null point will result in a positive dc voltage. The steep edges within the V portion of the characteristic define the capture range of the loop. These abrupt transitions are created as the loop suddenly enters the locked mode from the unlocked condition.

When the input and CO output signals are either 0° or 180° out of phase, the inputs to the phase comparator will be in phase, and the voltage to the detector will be at its maximum level. At this point, the loop becomes unlocked, and the CO and input frequencies are no longer related. The notch appearing at the left end of the V trough is caused by beat frequencies that occur as the loop attempts to capture the input signal. For proper circuit operation over a wide frequency range, the threshold voltage of the level detector should be set lower than the minimum amplitude of this notch.

Through the threshold adjustment, the reference voltage for the level detector can be set as close as is practical to the maximum input detector voltage, without tripping the detector for the unlocked condition. When the input detector voltage drops below this reference level, the output from the detector goes high, lighting the LED to indicate that the loop is locked. In this circuit, the reference voltage is set at approximately 8 v.

If a bank of switchable active filters is used as the loop's normal filter, the lock indicator can serve as a control circuit for changing the tracking and capture ranges of the loop automatically. It does this by switching the loop filter upon loss of track. □

Window comparator needs only one op amp

by Jerald Graeme
Burr-Brown Research Corp., Tucson, Ariz.

Diode gating can considerably simplify the circuitry for a window comparator, reducing it to just one oper-

ational amplifier, a single voltage reference element, and a diode bridge. A window comparator indicates whether or not a signal is within a given voltage range for applications such as go/no-go testing. Normally, it requires two op amps and two voltage references, as well as an AND gate.

A signal within the comparator's defined range produces a low output state, while a signal above or below that range produces a high output state. In the conventional window comparator, one op amp detects signals above the acceptable range, and the other op amp de-

tests signals below the range,¹ by comparing the signal against separate voltage references. To provide a single comparator output, the signals from the op amps are combined by an AND gate.

For applications where moderate accuracy, say 1%, is acceptable, the circuit shown here can be used. Since only one op amp is required, there is no longer any need for a gate to combine the outputs from two op amps. Also, the same reference element, a zener diode, now serves to define both the upper and lower voltage limits. Because of this common reference element, the upper and lower limits will be well-matched about zero. For limits not centered about zero, the center of the range can be shifted by connecting bias resistors from the power-supply voltages to the appropriate amplifier input.

Through diode gating, the input signal is directed to the proper amplifier input. Input signals above the positive limit forward-bias diode D_1 , pulling the zener voltage upward so that diode D_2 is also forward-biased. A positive voltage is now applied to the noninverting input of the amplifier, causing this device's output to swing to its positive state. The upper range limit, therefore, is the zener voltage plus two forward diode drops ($V_Z + 2V_F$).

A positive output swing is also produced by negative input signals that exceed $-V_Z - 2V_F$. These negative signals will forward-bias diodes D_3 and D_4 so that a negative signal appears at the amplifier's inverting input. Signals within the range defined by the positive and negative voltage limits are not passed by the diode bridge to the amplifier, and the amplifier's output is negative because of the bias voltage from resistor R_1 .

The accuracy of this comparator is controlled by the diode voltages at low input frequencies and by the amplifier's gain-bandwidth limit at high input frequencies. Since both the zener and diode voltages are subject to tolerance and temperature variations, the range limits can be in error by several percent. To reduce the temperature sensitivity of the range limits, resistors R_2 and

R_3 bias the zener so that its thermal voltage variation approximately cancels those of two junction diodes. (The dc voltage shift introduced by resistor R_1 adds to the amplifier's offset voltage error, making this offset error comparatively small.)

At high input frequencies, the comparator error is dominated by the gain-bandwidth-limited output swing of the amplifier from its positive state to its negative state. This transition occurs when the input signal is disconnected from the amplifier by the diode bridge, leaving only the small voltage developed by resistor R_1 at the amplifier's noninverting input. The limited input drive voltage to the amplifier results in a slow output fall time.

If a compensated op amp is being used in the circuit, its gain-bandwidth product can be improved by removing the device's phase compensation. Or, an uncompensated op amp can be used instead, as is done here. With the uncompensated op amp shown, the window comparator will have a bandwidth of 2 kilohertz and an ac error of only 1%.

There are a couple of other response limitations that should be considered. They are the amplifier's overload recovery delay and the discharging time of the diode capacitances. In order to switch, the amplifier must first recover from its saturated condition—this introduces a time delay. Fortunately, removing the phase compensation from most op amps shortens their overload recovery time.

Another switching delay can be produced by the capacitance discharging time of diodes D_2 and D_4 through resistors R_4 and R_5 , respectively. This factor, along with the input resistance, is determined by one of these resistors shunted by either resistor R_2 or R_3 . □

REFERENCE

1. "Applications of Operational Amplifiers—Third-Generation Techniques," J. Graeme, McGraw-Hill Inc., 1973.

Designer's casebook is a regular feature in Electronics. We invite readers to submit original and unpublished circuit ideas and solutions to design problems. Explain briefly but thoroughly the circuit's operating principle and purpose. We'll pay \$50 for each item published.

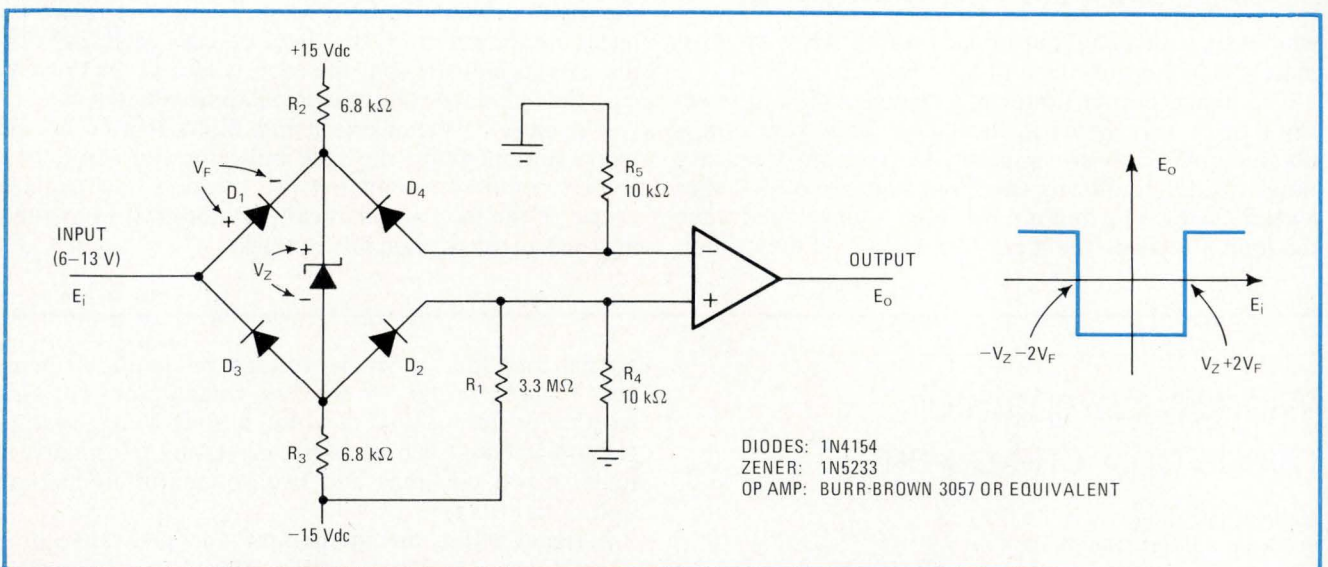

Saving an op amp. Window comparator for moderate-accuracy applications can be built with only one op amp. The zener diode and the diode bridge determine the circuit's voltage limits, directing positive and negative signals to the appropriate amplifier input. The circuit's output is low for signals within the defined range. D_1 and D_2 conduct for positive signals, while D_3 and D_4 conduct for negative signals.

updating from

SGS  **ATES**

PENTAWATT[®]

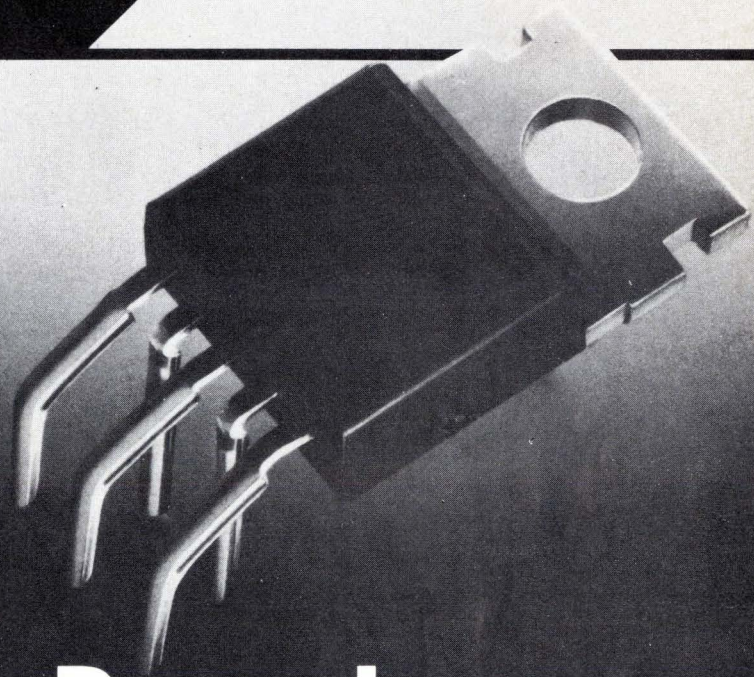

**Rugged, compact,
5 legged,**



hatched for a hot life

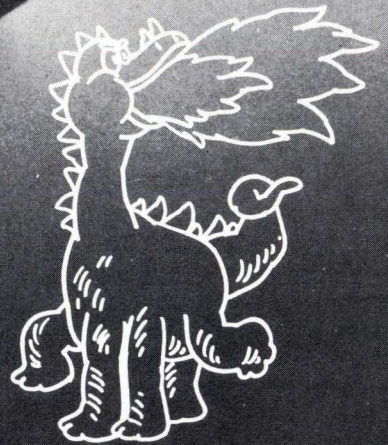

PENTAWATT® **The 5-lead plastic power package**

We designed a 5-lead power plastic package for linear ICs. We saw fit to patent our assembly, calling it Pentawatt®, because we know it is going to become an industry standard, as have all the power packages introduced by SGS-ATES to date. And we want to protect our customers against poor imitations.

Pentawatt® is designed for automotive and industrial applications. It is compact and rugged. It has the power dissipation capability of a TO-3 metal can. And, being plastic with 5 leads, it offers the most economic and versatile solution

to power IC applications in adverse environments. And we're putting lots of applications into the Pentawatt®. I.e., a 50W amplifier, voltage regulators, other special devices for the automotive industry, regulated power

supplies, boosters and actuators, and a fully protected monolithic complementary Darlington transistor pair. All very soon. So, look out for devices in Pentawatt®, the 5-lead plastic power package. They're bound to change your world.

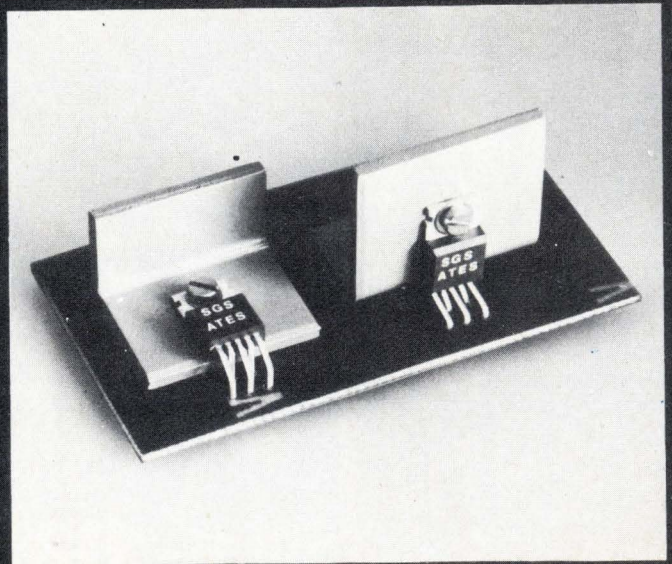

SGS-ATES

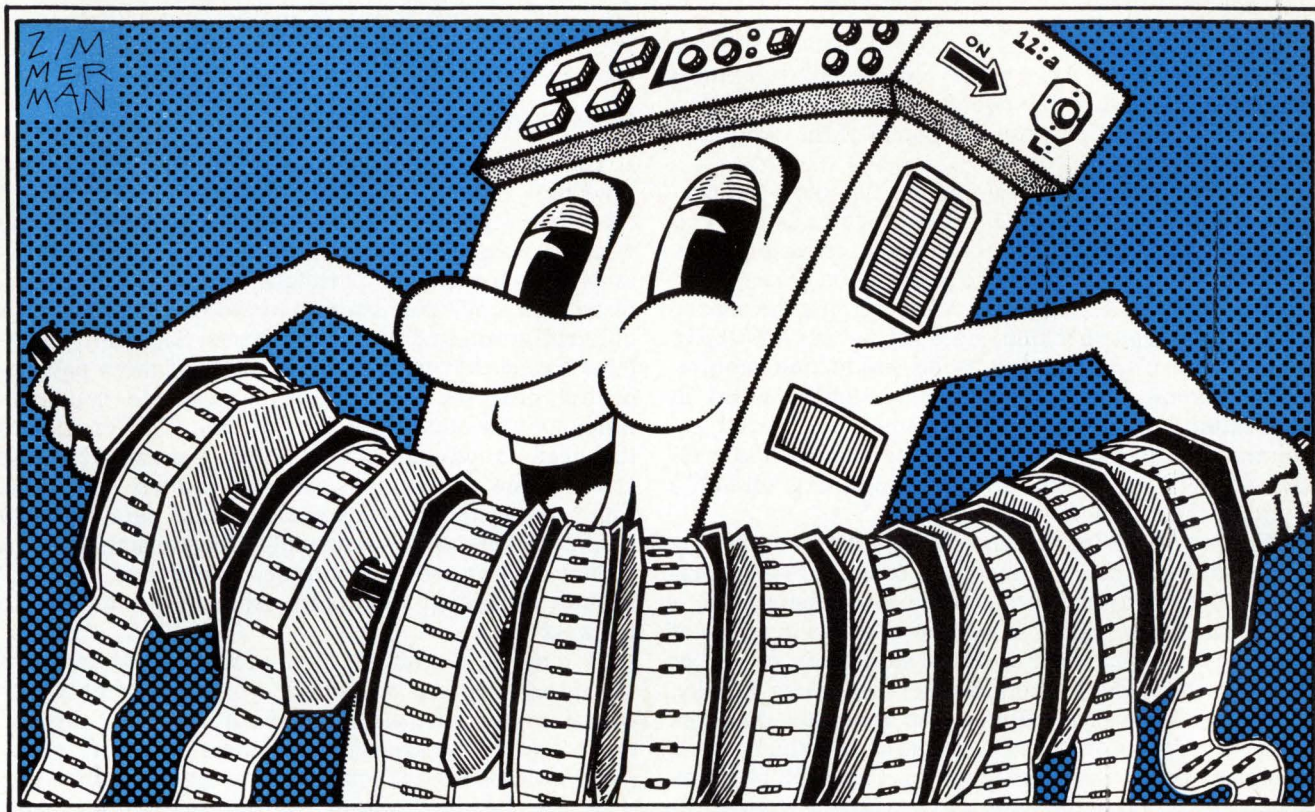

Streamlining insertion of components in pc boards

Hierarchical arrangement of assembly line makes control of runs efficient and simple, either by in-line or presequenced techniques; minicomputer controls board positioning, component selection, testing, and checking

by Donald R. Freese,
Universal Instruments Corp., Binghamton, N.Y.

□ It is common knowledge that continual streamlining and automation of manufacturing processes have been contributing to the decreasing costs of electronic components. It is less well known that the basic assembly of these components on printed-circuit boards—commonly called board stuffing—is at the same time becoming cheaper and faster than ever before. Minicomputers are responsible for these increases in efficiency on the assembly line, and the chief reasons are hardware advances and new concepts of utilization. Minicomputers also lend themselves to on-line checking and testing, which simplifies and speeds up the manufacture of electronic equipment.

But minicomputers are not resting on their laurels. Not yet. Methods of pc-board verification at the end of the assembly line are being refined. And prospects are excellent for adding various types of components to the automatic-assembly process, including thin films and programmable read-only memories. What's more, it's been proposed that the same input data could be used to control a combination programmer, tester, and inserter. However, the triumph of minicomputers for some applications may be fleeting. They may be replaced eventually by microprocessors, which cost even less, for such tasks as controlling inserter machines.

Advances in minicomputer hardware include longer words and larger memories at the same or lower prices than the earlier models. As a result, minicomputer control is not only cost-justified, but the computer itself has acquired enough capability to handle the application easily with some reserve.

At the same time, shorter machine cycles, which have

fallen from 2 microseconds or more in the late 1960s to about 0.5 μ s now, have given today's minicomputers processing capability that equals or exceeds that of even the largest general-purpose computers of the 1950s and early 1960s.

Coupled with these developments has been the concept of a computer hierarchy that provides as many as four complete and independent levels of automation. While not unique to pc-board automation [*Electronics*, March 29, 1971, p. 56], this concept permits the user to start with a single machine and build up step-by-step to a high level of automation as his production requirements increase. It also permits maximum flexibility in application, reconfiguring the system for special requirements and permitting continued operation at a reduced level (sometimes called "graceful degradation") if part of the system fails.

The first of the four levels of automation adopted by Universal Instruments is merely a controller—one computer for each assembly machine. At the next level, a single computer, called a worker, controls a series of machines. At the third level, a supervisor computer monitors the work of several worker computers. Finally, at the fourth level, a management computer monitors multiple supervisory computers, each of which has a group of worker computers under it. The level for a particular application depends on production configurations and annual output.

At level 1, the individual machines may be independent sequencers, inserters, and other standard or specially designed assembly machines, each controlled by its own independently programmed minicomputer. When the capability of any minicomputer is expanded to permit it to control several machines, the system advances to level 2. A series of such systems appears along the lower edge of the block diagram (Fig. 1). As shown,

the level-2 machines are among as many as 32 subsystems in a level-3 system, in which the minicomputers are interconnected with one another and with a supervisory computer. Each worker simultaneously controls its machines and gathers management data.

Supervising the system

The supervisory computer at level 3 performs three functions. First, it monitors the production of each of the worker computers and loads new programs in the workers when job requirements change—as, for example, when a run of a particular kind of board is completed and a new run is set up to produce boards with a different arrangement of components. Second, it maintains a collection of as many as 1,000 of these pattern-control programs on a directly accessible magnetic-drum unit or other bulk-storage unit. This eliminates the need to program the workers individually from cumbersome paper tapes, as was formerly required. Third, the system displays management data gathered by the workers, makes it available for transmission to a distant data-processing computer as required, and distributes occasional commands from that computer to the workers.

So long as this remote data-processing computer is concerned only in a minor way with the assembly process, it is not a level 4 system. But it has been proposed that top-level management computers be integrated directly with the worker computers on the production line (Fig. 2). In this system, automatic computer-to-computer communications would permit any management computer to back up any failed supervisory computer, permitting the system to continue in operation at a reduced level, instead of shutting down altogether.

Although Universal Instruments markets machine-control systems at all four levels, it specializes in those at the two lowest levels. These utilize either the General Automation SPC-12/10, an 8-bit computer operated in double-precision mode (two computer words for each

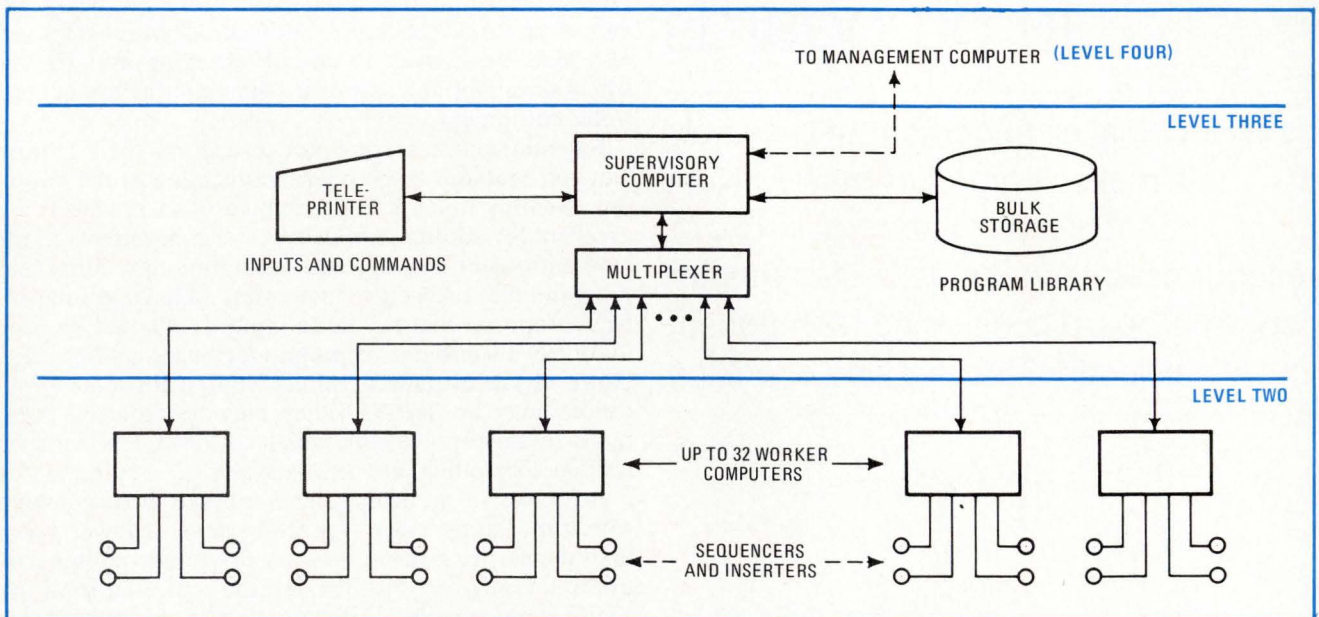

1. Four levels. Minicomputer power in printed-circuit-board automation is extended by using it in layers. Lowest level is individual machine control (not shown), then groups of machines controlled by a "worker," then supervisory control, and finally, management.

word of control information), or the Digital Equipment Corp. PDP-11/05, a 16-bit computer that, because of its longer words, can run in single precision. Universal builds both automatic printed-circuit-board assembly systems and automatic back-plane-wiring systems. The two are similar, except for the attachments on the machines themselves.

Two approaches to insertion

The assembly systems can be built in either of two common configurations: in-line and presequenced. In the presequenced configuration, better for low-volume production, two kinds of machines are needed. The first machine is a sequencer. It uses components with axial leads, which the parts manufacturer supplies in reels. These reels, a couple of feet in diameter, contain large quantities of components supported between two strips of pressure-sensitive tape. A large number of these input reels is loaded on the sequencer—up to 95 reels can be loaded on Universal's largest sequencer. The sequencer winds as many as 15,000 parts per hour in the desired sequence on a single output reel.

The sequenced reel is then loaded onto a single insertion machine, which places all the components on a single board and releases the board for soldering. A single-headed inserter can handle typically 7,500 insertions per hour; the rate goes up to 12,000 in a two-headed model.

Machines that insert dual in-line packages or transistors combine sequencing and insertion in one unit. These machines are fed from a magazine that can handle a maximum of 24 types, but they cannot also handle axial-lead devices, which require a separate pass through another machine. Radial-lead components—notably disk capacitors—remain a problem; some experimental inserters have been built, but none has yet become a standard product. (These components can be handled on standard machines if their leads are performed to the axial direction.)

The in-line method, suitable for high-volume production, uses a large number of essentially identical machines, each of which inserts a single kind of component at a particular spot on a board. Components can be of any type, fed by reels, tubes, vibrating bowls, or any other suitable method. The machines are placed side by side in a long row, linked by a transfer mechanism.

A "naked" board, placed at the start of the conveyor, works its way down the line, pausing at each machine, which mounts its one component in the designated place. When the board comes off the end of the line, it is checked to ensure that it is fully populated with components and sent on to be soldered.

An in-line system handles 600 to 1,200 boards per hour. If a typical board contains 30 components, the corresponding insertion rate can be as high as 36,000 per hour. Furthermore, every machine in the line can be set up at the beginning of the run to insert its component at one particular place on every board that comes to it; unlike the presequenced inserter, it does not require a pattern-control program, which would tell it what the whole board looks like.

What the computer does

The computer requirements for the two configurations are quite different. In the sequencer, the computer places each component on a moving band at the right time so that it is the right distance behind the previous component, which at that moment may not yet have been placed. The computer, with the aid of a mechanical switch, also detects when a component is missing just before it should be taped into place on the output reel. The switch stops the machine and flashes a warning to the operator to replace the part manually.

When the sequenced components are inserted, the computer controls the horizontal movements of the board in two dimensions to bring the proper insertion points under the head. The two steps are relatively complex, but the sequencing equipment is much more com-

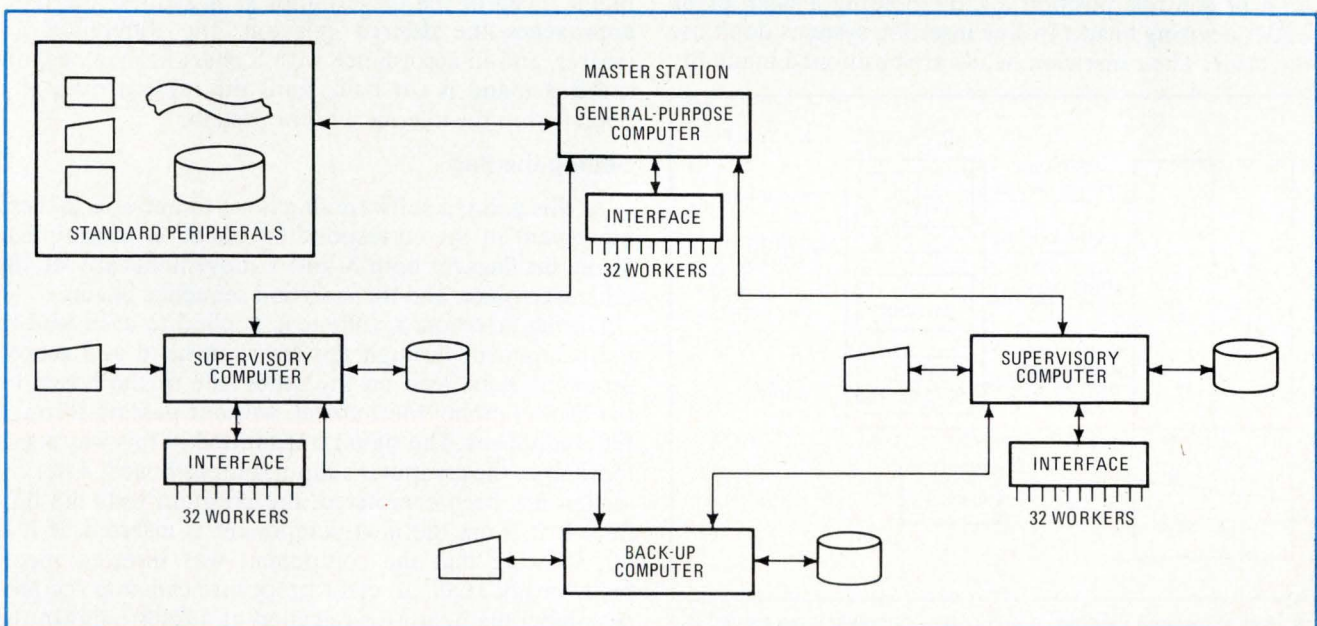

2. Direct Integration. This proposed level 4 system not only gathers management data from the individual worker and supervisory computers, but permits management and supervisory roles to be interchanged if one of the computers should fail.

fact than the equipment for in-line insertion.

On the other hand, the in-line method requires the computer to simultaneously control a maximum of 32 insertion heads, as well as feed empty boards from an input stock onto the conveyor, check that a board was fed, verify that the board was moved into position at each station, and check after the last station for the presence of all components.

However, the in-line system displays the mini-computer's flexibility particularly well in that it can be programed to let a malfunction pass, when letting the error get by would be more economical than stopping the line. When this happens, the faulty board is ejected automatically at the end of the assembly process so that the insertion can be made manually. This capability is controlled by software that presets the maximum number of consecutive errors that can be accepted—without stopping the line. This number can be changed at any time by entering a command through a teleprinter. Only when consecutive errors exceed the preset number does the line stop.

This error level can be programed fairly high—a maximum of 255—when setting up the line. It can be reduced when all or most of the “bugs” have been removed. One, two, or three consecutive errors are normally considered permissible.

The allowance for permissible errors is part of an on-line diagnostic system, which also measures the time required to complete each operation and signals that something is amiss if the elapsed time is too great. In an emergency, the control can shut down the whole line.

Positioning the table

The key to presequenced insertion is the control by a computer (Fig. 3) of a two-axis table that positions the board under the component-insertion head. (The same kind of controls position a table holding a back plane under a wiring head.) In-line insertion systems don't use the table. Their insertion heads are positioned manually

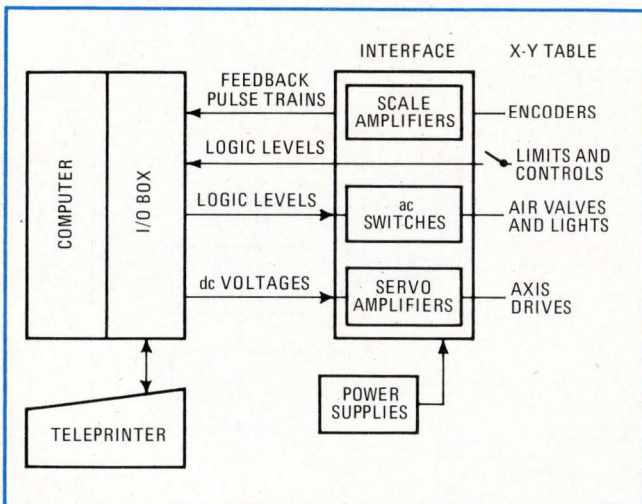

3. Key to presequencing. A computer-controlled table moved in X or Y directions by a digital servo can position a pc board under the insertion head or a backplane under an automatic wire-wrapper.

at the start of the run; each head inserts a component at the same spot on each board that passes.

In a presequenced system, when the table is in position and a component is in place in the head, the computer initiates a sequence that includes inserting the component, cutting and crimping the leads, and repositioning the board for the next component. For each axis of the table, the controller contains a position register with 12 bits—11 for position and one for sign. The least-significant bit represents a movement of 0.0005 inch; the total range of the 11 bits is 1.0235 inch.

As the table moves in either the X or Y direction, the drive motors, through a digital feedback encoder, generate two pairs of square waves of the same frequency but 90° out of phase (Fig. 4). The sign of the phase difference of these waves defines the direction of table movement in the corresponding coordinate direction, and each zero-crossing of either wave generates a pulse that steps the corresponding position register up or down. Since the table's maximum speed is 600 inches per minute, or 10 inches per second, the 0.0005-inch resolution thus requires a position register step every 50 μs, corresponding to a maximum square-wave period of 200 μs and a frequency of 5 kilohertz.

From time to time, the computer adds the accumulated total in the two position registers to the contents of an absolute-position buffer in memory and resets the registers, which start anew to record the distance moved by the table until they are sampled again. At maximum speed, the table moves an inch in about 100 ms, shortly after which the registers would overflow. For servo stability, updating is required at least once every 10 ms and, in fact, updates are usually considerably more frequent than that—every 2 ms in the SPC-12 computer and every 0.5 ms in the PDP-11.

After updating, the contents of the absolute-position buffer are compared with the desired position of the table for the next insertion. If the difference between the two is sufficiently great, a signal calling for maximum speed of the drive motor is issued. As the table approaches the desired position, the difference decreases, and in accordance with a chart in memory, the speed demand is cut back until the table arrives at a point within the tolerance of the system.

Setting the flag

At this point, a software flag is set to indicate that the movement in the corresponding direction is complete. When the flags for both X and Y movements are set, the table is in place, and the insertion sequence begins.

During insertion, a voltage is applied to each lead of the component through the insertion head and picked up in the same lead on the other side of the board by the lead-crimping mechanism, without passing through the component. The signal transmitted in this way sets a flip-flop in the computer's input/output board. After insertion has been completed, the program tests the flip-flop. If it is on, the next component is inserted. If it is off, showing that the component was inserted incorrectly or not at all, an error procedure can stop the process, label the board for rejection at a later point in the process, or merely turn on a light to call the operator's attention to the mis-insertion.

The control procedure ensures that a new board is in place before the start of every insertion sequence and that the sequence control and the sequence of components are not out of step with each other. The table is first positioned in a spot where no component is to be inserted—a "check gap" is designed specifically for this purpose. The sequence of components includes a blank space, so that the inserter goes through its cycle without receiving a component to insert. If, at the end of this first cycle, the board contains a component, signaled by the on state of the flip-flop, the system stops and alerts the operator.

Minicomputer requirements

Stuffing pc boards requires three key minicomputer capabilities—the right word length, the right speed in terms of raw cycle time, and the provision for generating management data.

The word length of the minicomputer must be long enough to position an X-Y table 36 inches square so that any point on it can be brought under a component mounting head with no more deviation than ± 0.0005 inch. This requires the computer to count 2,000 increments per inch of table position as the table moves, or a total of 72,000 counts.

A 16-bit buffer containing the incremental count can go to 65,535, less than 10% short of the required total. The overflow, which occurs only when the table moves into its extreme positions for small portions of the largest boards it can carry, is handled by software. Within this limitation, a 16-bit computer can handle the job with single precision, or a single word. An 8-bit double-precision machine, which requires two words, can be used, but it's likely to be slower.

The speed of the computer must be great enough to permit all necessary processing to take place while also frequently sampling the digital servomechanisms that drive the X-Y table—that is, the position register. Servo stability requires a sampling rate of 100 per second, or one sample pulse every 10 milliseconds. When working with 8-bit words in double precision, the computer may have to execute as many as 4,000 instructions during this 10-ms interval. Therefore, the average instruction cycle must be no more than 2.5 μ s.

But that's a worst-case figure. In most installations, the SPC-12, which has a cycle time of 2.16 μ s, can service the servos at a 2-ms rate—five times the minimum required. At this rate, it can easily control four different machines in a level-2 environment and still have time left over to receive and transmit teleprinter data, which moves at 9.09 ms per bit.

Likewise, the cycle time of the PDP-11 is less than 1 μ s, and its 16-bit word permits it to work in single precision. This, plus its more extensive instruction set, means its heaviest load requires many fewer instructions to be executed between servo samplings. These combined characteristics let it sample as often as once every 0.5 millisecond, four times the rate of the SPC-12 and 20 times the minimum required rate. For most jobs, the PDP-11 could control a dozen or more insertion machines simultaneously without degrading the performance of the system.

The third requirement for the minicomputer in this

application is the ability to generate management data. Because such data, in general, is character-oriented, in contrast to the binary orientation of the control system, the minicomputer must have the capability to generate, process, and transmit character-oriented data—a rather simple requirement in either 8- or 16-bit machines, but nevertheless not automatically available unless specifically called for. As the advantages of computer-controlled insertion become more and more evident, customers are increasingly asking for software with their insertion systems that can gather this data for management, as well as edit pattern programs on line. Data-gathering software monitors the performance of the system, maintains continuous records, and displays the accumulated data upon command from a teleprinter, or automatically, at preset intervals—say, hourly or at the end of the shift.

Software for on-line editing enables machine operators to make small alterations in pattern-control programs directly in the minicomputer when a program bug becomes evident. Without such software, they may have to punch new program tapes to correct errors or even go back to a central data-processing system, which may be in a remote location and may not belong to the owner of the insertion system.

What's to come

Future developments of automatic computer-controlled component-insertion equipment will probably be primarily aimed at improving on-line testing and verification of assembled boards. The more testing that can be carried out during the assembly period itself, the more quickly the assembled boards can move through the rest of the production process and reach either the hands of the customer or a final assembly stage where they themselves become system components.

The components to be inserted are well standardized and are unlikely to undergo substantial configuration changes that would affect automatic assembly or require improvements in the insertion machines. However, new kinds of components that previously haven't benefited from high-volume insertion techniques may

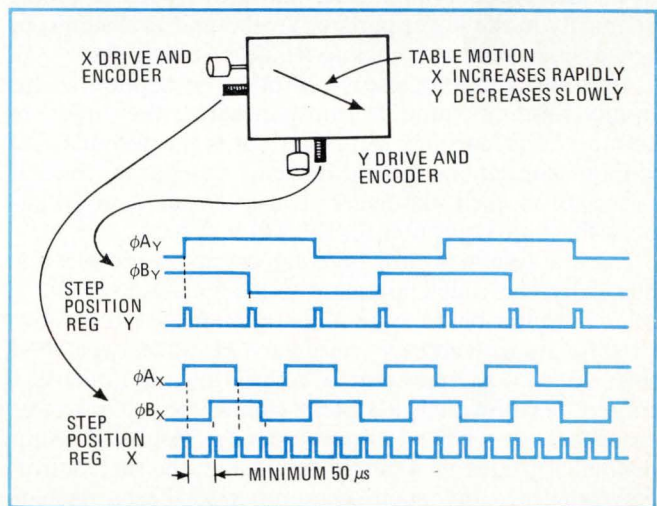

4. Table-control feedback. Two square-wave pairs, for X and Y, show direction of motion by their phase difference, while the count of pulses generated by their zero-crossings shows distance moved.

trigger new developments. Among these are placement and testing of thick-film components, such as resistor networks, and selective mounting of programmable read-only memories (PROMs).

PROMs of various types are finding increasing use in various applications, replacing the classic ROM as a control memory in computers, storing programs in dedicated-application systems, and especially in conjunction with the burgeoning microprocessor market. They are principally of value in applications where the volume isn't great enough to justify the production of mask-programmed ROMs.

But an application-oriented PROM is usually put together as a network of individually programmed PROM integrated circuits. This points the way to a combined programmer, tester, and inserter, all operated by the same input data. It would be like the machine that inserts standard dual in-line packages, but would include a PROM programmer and tester in the path between the supply of PROM blanks and the insertion head.

In today's machines, DIPs always pause at one or more points in this path while the DIPs preceding them are inserted; the proposed machine would simply capitalize on this pause. Under control of a computer program, the inserter would select the desired DIPs, program them for a certain application, test them, and assemble them on a pc board. As many as several hundred such boards could be produced as needed, then new computer instructions would program the same PROMs differently and assemble them into pc boards for a different application.

Microprocessors themselves show some promise as a means of controlling insertion machines. However, microprocessors that depend on semiconductor memories, which lose their programs when power fails, would be restricted to systems that included a means for reloading the memory quickly—say, from a supervisory computer with a nonvolatile memory or from a magnetic-tape cassette. The somewhat limited capability of today's microprocessors implies that they would be useful primarily in the lower parts of level-3 and -4 systems, in any case, so that such backup would be available.

Because microprocessors can often be applied where minicomputers would be too expensive, they may be suitable in a level-3 system that omits the second-level worker computers, using instead a separate microprocessor in each sequencer or inserter and a single supervisory minicomputer for the whole system.

Such a system would be a far cry from the old numerically controlled insertion machine because, like a minicomputer-based system, its functions are separated by software instead of by hardware. However, in a way, this would also represent a return toward numerical control because such a system would use separate microprocessors for the different functions instead of using distinct routines in a single minicomputer for control. Nevertheless, any such microprocessor-based system would probably need a minicomputer to assist in developing and refining its control program, which could then be committed to a PROM and a microprocessor. □

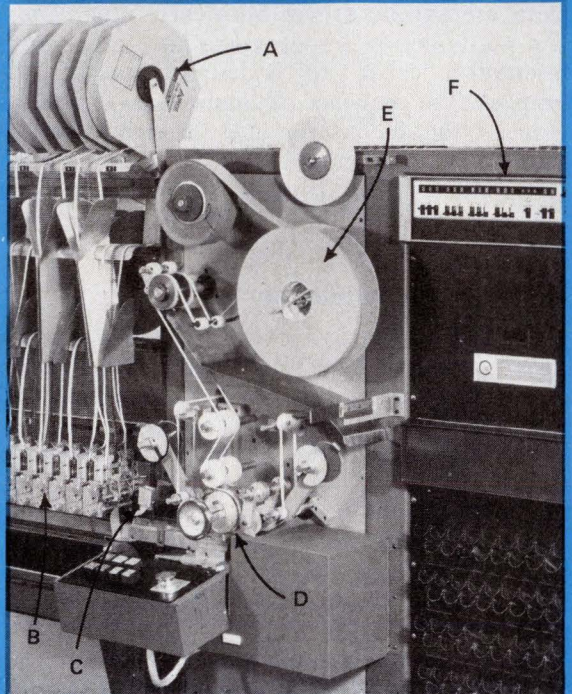

Sequencer. Components from up to 95 reels (A) are fed through heads (B), sensor (C), and taping station (D) onto output reel (E), all under control of computer (F).

In-line assembly. New reel of axial-lead components (top of photo) is loaded at insertion station. Note partly stuffed cards below girl's left hand and at next station.

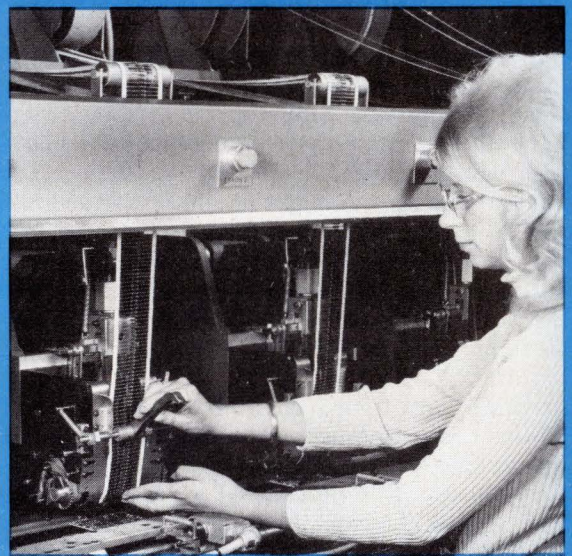

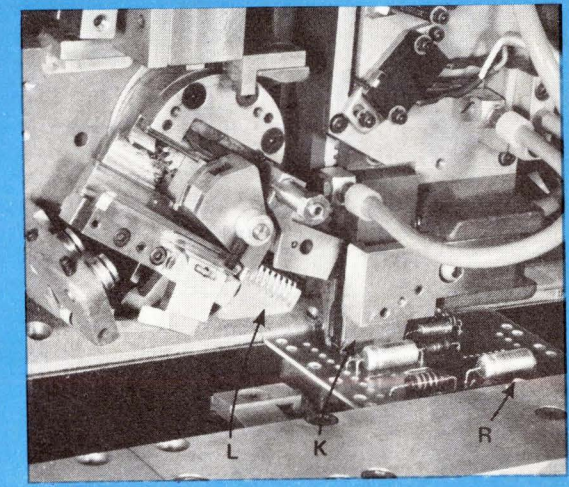
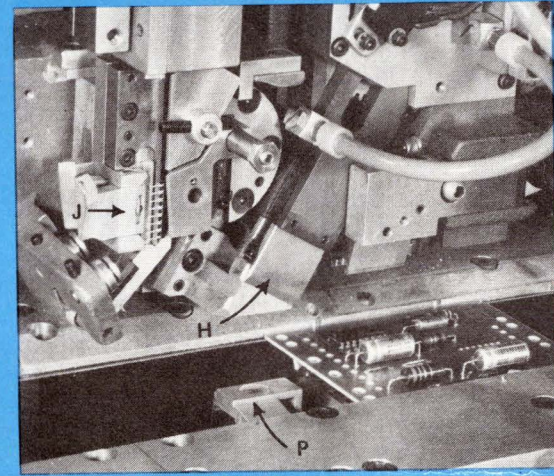
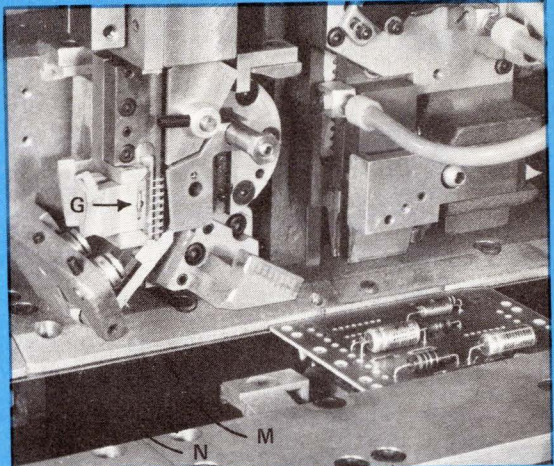
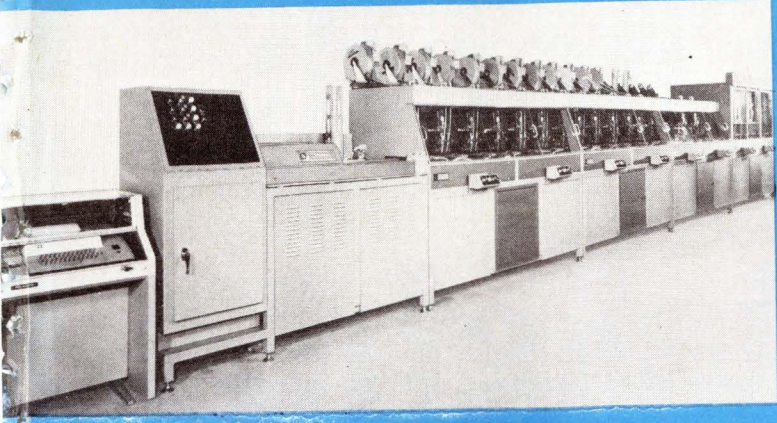

Step by step. Entire in-line insertion system is controlled by one computer, at left in photo above. Photo shows magazine for blank cards, inserters for axial-lead components, jumper wires, and DIPs. Close-up at near right shows capacitors being fed to insertion head at one stage of in-line system. At far right, step-by-step photos show DIP arriving at transfer point (G), where its pins are straightened, then being picked up by swing arm (H) while next part (J) follows into transfer. Finally, as the slide housing inserts the DIP into the printed-circuit card (K), the next part moves from the transfer point onto the vacuum block (L), which holds it until the swing arm can pick it up. The printed-circuit card slides along two rails (M), (N), from one insertion station to the next, propelled by a transfer finger (P) and held by a locator finger (R), barely visible in these views, which fits into a notch in the side of the card.

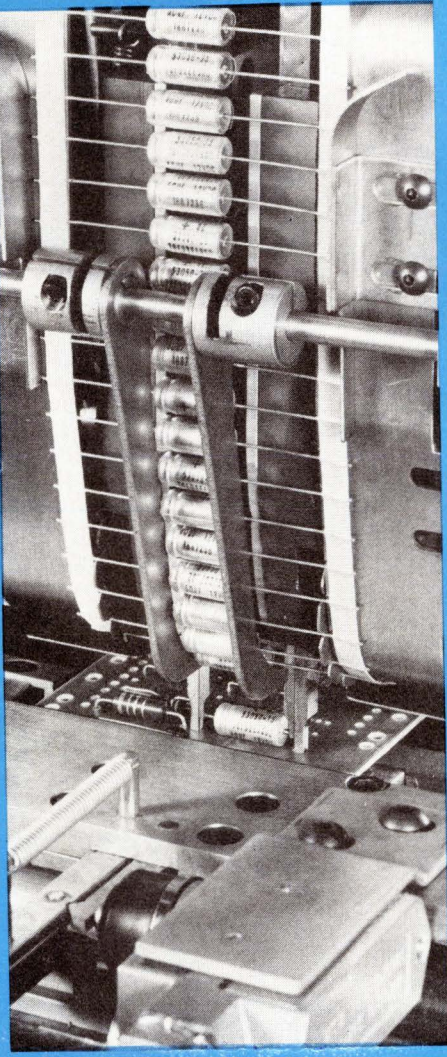

Dialight sees a need:

(Need: Single source supply for all indicator lights.)

See Dialight.

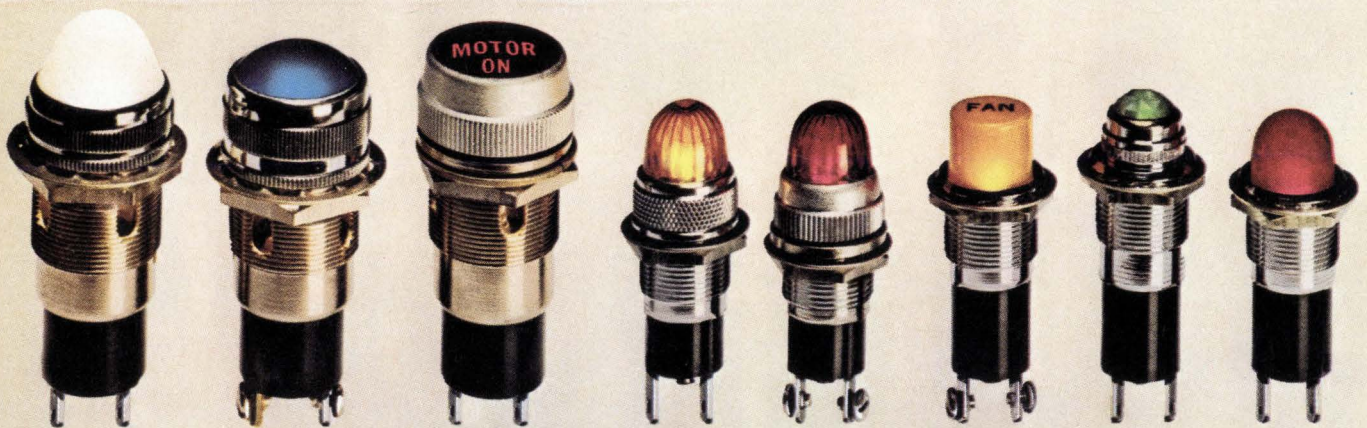

INCANDESCENT OR NEON MINIATURE AND LARGE INDICATORS

Designed to accommodate either incandescent (2-250V) or neon (105-250V) lamps for panel mounting in 11/16" or 1" clearance holes. Units meet or exceed MIL-L-3661 requirements; all are listed in Underwriter's Recognized Components Index. Wide selection of lens shapes, colors,

finishes and terminations. Many lenses may be hot stamped, engraved or offered with film legend discs. Oil-tight units with unique "O" ring construction make them oil, water and dust tight on the face of the panel. Available off the shelf for prompt delivery.

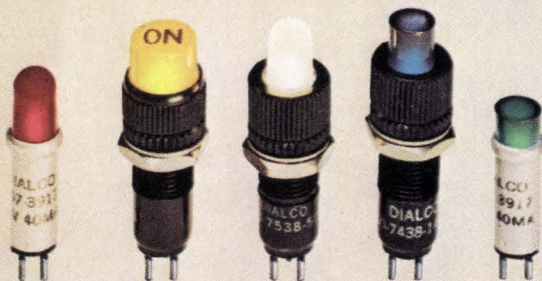

LED, INCANDESCENT OR NEON ULTRA-MINIATURE DATALITES®

Meet or exceed MIL-L-3661. Replaceable plug-in cartridges for 1.35-125V operation. Indicators mount as close as 1/2" centers; available with red, green, amber, blue, white translucent, light yellow or colorless lenses in wide range of lens shapes, legends and finishes. Off-the-shelf.

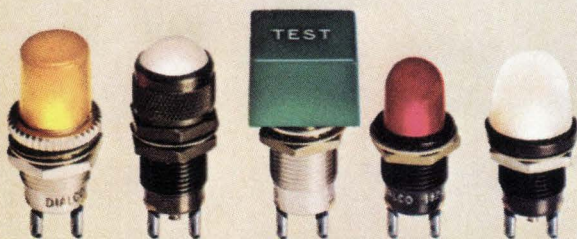

INCANDESCENT OR NEON SUB-MINIATURE INDICATORS

Meet or exceed MIL-L-3661. Mounts in 15/32", 1/2" or 17/32" clearance holes. Incandescent for 1.35-28V; neon has patented built-in current limiting resistor. Choice of cylindrical, faceted, convex, flat, square and round lens shapes, colors, finishes, legends. Off-the-shelf.

DIALIGHT

Dialight, A North American Philips Company
203 Harrison Place, Brooklyn, N. Y. 11237 (212) 497-7600

SEND ME FREE INDICATOR LIGHT PRODUCT SELECTOR GUIDE.



Test circuit enables voltmeter to check electrolytic capacitors

by Mark Anglin
Novar Electronics Corp., Barberton, Ohio

Aluminum electrolytic capacitors are excellent low-cost components for noncritical timing applications. But, before they can be inserted in a timing network, their actual values must be checked because they typically have capacitance tolerances like +100% and -20%.

Though a capacitance bridge can be used to make these checks, it is sensitive to hum, requires attention to capacitor polarity, and is too slow for high-volume selection. The simple capacitance checker drawn in the figure overcomes these problems, permitting fast and efficient determination of capacitance value. Furthermore, it is accurate to within $\pm 2\%$ for capacitors having tolerances of +80% and -20%, it costs only around \$5 to build, and it works in conjunction with a standard analog or digital ac voltmeter.

Circuit operation is based on capacitive reactance. If two capacitors are connected in series across a 1.2-volt ac source, the voltage across the lower capacitor (C_1) can be written as:

$$V_{C1} = \frac{(1/\omega C_1)1.2}{(1/\omega C_1) + (1/\omega C_2)}$$

where ω is the frequency of the ac source, and C_2 is the upper capacitor. If the reactance of C_2 is much greater

than the reactance of C_1 , this equation reduces to:

$$V_{C1} = (1.2/C_1)C_2$$

And, if the values of the applied voltage and capacitor C_1 are kept constant during the measurement, then:

$$K = 1.2/C_1$$

So that the voltage across C_1 can be regarded as being directly proportional to the value of capacitor C_2 :

$$V_{C1} = K C_2$$

In the test circuit, transformers T_1 and T_2 are used to derive the 1.2-v ac source voltage. Such a low driving voltage permits aluminum electrolytics and most solid-tantalum electrolytics to be measured without regard to their circuit polarity. The low impedance of the voltage source and the large 4,000-microfarad capacitor make the test capacitor virtually immune to hum.

Variations in the constant K , which here equals $(1.2 \text{ v})/(4,000 \mu\text{F})$, can be adjusted for by using the 50-kilohm potentiometer. This trimmer also allows the circuit's output voltage to be scaled so that the test capacitor's value can be read directly from the voltmeter's display.

The circuit, as shown, is set up for selecting 150- μF capacitors, but other component values can be substituted to select other capacitor values. To calibrate the circuit, the switch is flipped to its CALIBRATE position, and the potentiometer is adjusted until the ac voltmeter reads 15 millivolts, which corresponds to the 150- μF value of the standard capacitor. With the switch in its TEST position, the voltmeter will read 21.8 mV if the test capacitor's value is 218 μF . □

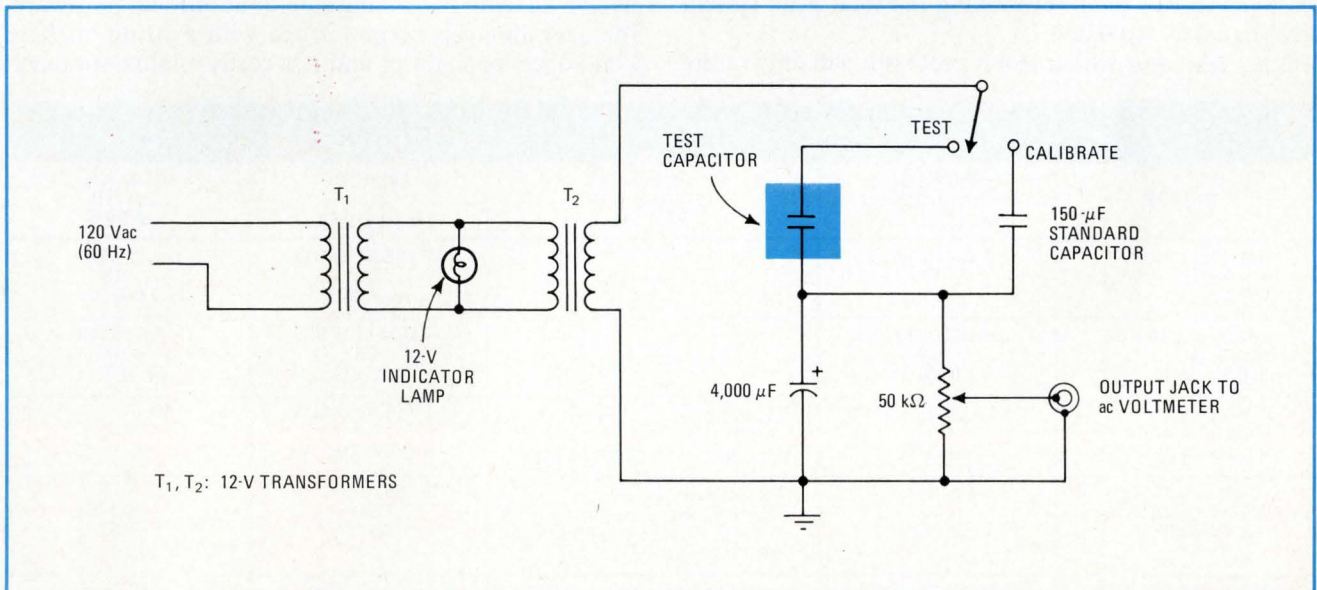

Fast and easy. The value of an electrolytic capacitor can be determined rapidly with this capacitance checker working in conjunction with an ordinary ac voltmeter. The capacitance value is read directly from the voltmeter's display. Because a low 1.2-V ac driving source is used, the test capacitor can be inserted without regard to its polarity. This particular circuit measures a capacitance of 150 microfarads.

Economical approaches to 16-bit d-a conversion

by David Atkins

Hybrid Systems Corp., Burlington, Mass.

Though modular digital-to-analog converters (DACs), are constantly improving in performance, they have not been able to keep up with digital processors in providing extended resolution and accuracy at a reasonable price. In some applications, users are forced to spend \$400 to \$500 for high-resolution DACs with an accuracy good enough for 16-bit computers. However, in many other applications, users can take advantage of lower-priced, less sophisticated converters, which are not only readily available, but also can be made compatible with 16-bit machines.

The ultimate in modular DAC accuracy is represented by the large, slow, and expensive 16-bit converter having a relative accuracy of $\pm\frac{1}{2}$ to ± 1 least significant bit (LSB). A converter's relative accuracy is the total error produced by the unit after its offset and scale factors have been adjusted perfectly. Relative accuracy may also be thought of as end-point linearity, since this linearity represents the deviation of the DAC's transfer function from an ideal straight line drawn through the zero and full-scale end points of the converter's analog output.

When mated with a 16-bit digital processor, a high-accuracy 16-bit DAC will contribute an error to the system equal to its relative accuracy. However, this error is not the only one that exists in the system, since there must also be a quantization error of $\pm\frac{1}{2}$ LSB (in 16 bits) inherent in the digital word supplied to the converter. The total error in converting to an analog voltage, then, is the sum of the $\pm\frac{1}{2}$ -LSB quantization error and the relative error of the DAC, making the total peak system error equal to $\pm 0.0015\%$.

But a DAC user with a 16-bit processor will only rarely

need this kind of accuracy at a price of \$500. He can get adequate accuracy by going to alternate, less expensive approaches. The table summarizes four other methods of converting digital information from a 16-bit source into an analog signal with good accuracy and at relatively low cost.

The first method involves a simple, but cost-effective, modification to the high-performance approach just described—buy a 16-bit DAC with a poorer accuracy specification. Most manufacturers of high-performance 16-bit d-a converters offer the identical model with a relative accuracy of 14 or 15 bits (an error of ± 2 LSBs in 16 bits) at a price reduction of 15% to 25%. The resulting system error will then be a $\pm\frac{1}{2}$ -LSB quantization error plus a ± 2 -LSB analog error, or a peak output error of $\pm 2\frac{1}{2}$ LSBs (in 16 bits). Of course, the other disadvantages of the high-performance DAC, namely slow speed and large size, still remain.

A second, more drastic, alternative is to change the very nature of the DAC. Just because the digital word is 16 bits is no reason to force the DAC to be 16 bits. A 12-bit DAC, which is both small and fast, can be used instead, but the user must then decide what to do with the four LSBs that have no connection to the 12-bit DAC. One possible solution is to simply drop them (this is called truncation). A second solution is to use the 4 LSBs to correct the digital number to the nearest 12 bits (this is called rounding off).

Rounding off to 12 bits is equivalent to quantizing to 12 bits, so that the digital quantization error becomes $\pm\frac{1}{2}$ LSB in 16 bits plus $\pm\frac{1}{2}$ LSB in 12 bits, or $\pm 0.00075\% + \pm 0.012\%$. In addition, a typical 12-bit DAC has a relative accuracy of $\pm\frac{1}{2}$ LSB in 12 bits, or $\pm 0.012\%$. Therefore, when a 12-bit DAC is used with round off, the total output error for the system becomes $\pm\frac{1}{2}$ LSB in 16 bits plus $\pm\frac{1}{2}$ LSB in 12 bits plus $\pm\frac{1}{2}$ LSB in 12 bits, or $\pm 0.00075\% + \pm 0.012\% + \pm 0.012\% = \pm 0.025\%$.

This approach produces more error than the previous two methods, but it costs much less, even though it does involve an extra processing step or additional hardware. The operation can be performed with a string of three 4-bit adders or a slower and less costly analog approach

ERROR COMPARISON FOR 16-BIT D-A CONVERSION

METHOD	ERROR OF DIGITAL PROCESS (FROM COMPUTER)	ERROR OF INTERMEDIATE PROCESS	ERROR OF D-A CONVERTER	TOTAL PEAK SYSTEM ERROR
HIGH-ACCURACY 16-BIT DAC (COST \approx \$500)	$\pm\frac{1}{2}$ LSB IN 16 BITS OR $\pm 0.00075\%$	—	$\pm\frac{1}{2}$ LSB IN 16 BITS OR $\pm 0.00075\%$	± 1 LSB OR $\pm 0.0015\%$
LOWER-ACCURACY 16-BIT DAC (COST \approx \$400)	$\pm\frac{1}{2}$ LSB IN 16 BITS OR $\pm 0.00075\%$	—	± 2 LSBs IN 16 BITS OR $\pm 0.003\%$	$\pm 2\frac{1}{2}$ LSBs OR $\pm 0.00375\%$
12-BIT DAC WITH ROUND OFF (COST \approx \$75)	$\pm\frac{1}{2}$ LSB IN 16 BITS OR $\pm 0.00075\%$	ROUND OFF (FROM 16 TO 12 BITS) $\pm\frac{1}{2}$ LSB IN 12 BITS OR $\pm 0.012\%$	$\pm\frac{1}{2}$ LSB IN 12 BITS OR $\pm 0.012\%$	$\pm 0.025\%$
12-BIT DAC WITH TRUNCATION (COST \approx \$75)	$\pm\frac{1}{2}$ LSB IN 16 BITS OR $\pm 0.00075\%$	TRUNCATION (DROP 4 LSBs) + 0 LSB, - 1 LSB IN 12 BITS OR + 0%, - 0.012%	$\pm\frac{1}{2}$ LSB IN 12 BITS OR $\pm 0.012\%$	+ 0.013%, - 0.037%
16-BIT DAC WITH 12-BIT ACCURACY (COST \approx \$75)	$\pm\frac{1}{2}$ LSB IN 16 BITS OR $\pm 0.00075\%$	—	$\pm 0.01\%$	$\pm 0.01075\%$

DAC = DIGITAL-TO-ANALOG CONVERTER LSB = LEAST SIGNIFICANT BIT

can be used instead. Since rounding off requires that 1 LSB (in 12 bits) be added to the DAC input any time the 2^{-13} th bit is true, an analog voltage equivalent to 1 LSB can be added to the DAC output each time the 2^{-13} th bit is logic 1.

Truncation is similar to rounding off, but it has a somewhat different error pattern. Since the unused bits are simply dropped in truncation, no additional hardware is involved. However, truncation also means that the 12-bit representation of a 16-bit quantity may be in error by -1 LSB (in 12 bits), or -0.024% . If the error were centered by adding $\frac{1}{2}$ LSB (in 12 bits) and then truncating, the resulting error would be $\pm 0.012\%$, which is equivalent to the error obtained when round off is used. However, this addition would force the DAC's zero and

full-scale end points to be in error, and the converter would be difficult to calibrate.

The fourth method of mating a d-a converter to a 16-bit processor at reasonable cost lies somewhere between the other approaches. This method makes use of a DAC having a relative accuracy of 12 bits but a resolution of 16 bits, like the model DAC328 made by Hybrid Systems Corp. With such a converter, the user can preserve the low digital error from the computer, while obtaining an analog accuracy of $\pm 0.01\%$, which is consistent with the accuracy of a regular 12-bit DAC. The system error again is the sum of the digital error ($\pm 0.00075\%$) and the converter error ($\pm 0.01\%$), for a total peak error of $\pm 0.01075\%$. Further, it costs no more to use this higher-accuracy approach than to use a regular 12-bit DAC. □

Listening to magnetic fields can be useful, as well as fun

by Calvin R. Graf
Kelly Air Force Base, San Antonio, Texas

Magnetic fields created by an alternating current are radiated by many electrical and electronic devices, including power transformers, motors, electronic wristwatches, pocket calculators, lamp dimmers, and electric clocks. Listening to what these various devices sound like in the audio-frequency range can be not only interesting, but also quite useful.

With the simple sensing circuit drawn in the figure, you can detect changing magnetic fields—even the field created by the tuning-fork oscillations of an electronic wristwatch powered by as little as 8 microwatts. The telephone pickup coil functions as the circuit's antenna, the loudspeaker as its transducer, and the audio amplifier, which can be of the transistor-radio variety (for strong magnetic fields), as its receiver. The circuit's audio response for magnetic fields ranges from 40 hertz to 10 kilohertz. All the parts are readily available and will easily fit into a small hand-held case, loudspeaker and all. And parts cost is low—only about \$10.

What can you do with this magnetic-field sounder? Well, in your home, you can locate electrical wiring in walls to within a fraction of an inch. Or, you can find buried water pipes, either copper or iron ones, to within a few inches because there is a 60-hertz power frequency induced into a buried water-pipe system.

You can also enjoy the musical sounds made by your pocket calculator as you press its keys or when the unit is computing, but you'll find it far more informative to tune in your automobile. You can listen to: the high-frequency whine of the alternator, the low-frequency hum of the alternator field, the voltage regulator, the distributor timing, the firing of an individual spark plug, the click-click of the fuel gage and gas tank sensor, the engine starter, the windshield-wiper motor, the air-conditioner's magnetic clutch or blower motor, and the

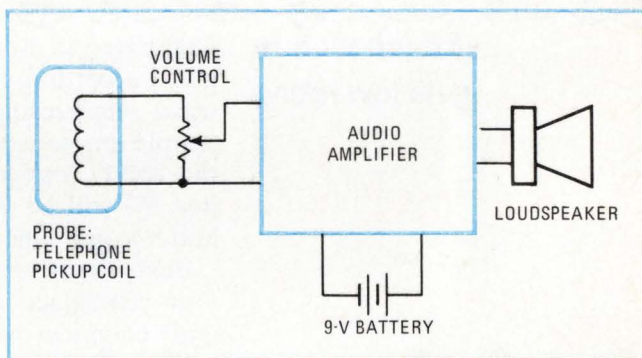

Sounding out magnetic fields. Simple sensing circuit enables you to eavesdrop on the interesting world of magnetic fields. An ordinary telephone pickup coil acts as the circuit's probe, serving as the antenna for the audio amplifier, which can be a garden-variety transistor radio. You can listen to the sounds created by an automobile, the ac line in your home, and many other sources.

left-turn/right-turn directional signal flashers.

Here are a few more ideas. You can check the 30-pulse-per-second vertical synchronization signal in your television set, as well as locate and isolate fluorescent light ballasts. And natural very-low-frequency emissions caused by lightning and other phenomena make for interesting listening, too—you'll be able to hear all sorts of clicks, pops, and tweets.

The magnetic field created by a small permanent magnet can also be detected (heard) as the field is moved back and forth across the sensor's probe. Additionally, the circuit can be used to amplify both ends of a telephone conversation by placing its probe near the induction coil of the telephone receiver. Radiation from nearby radar sets and microwave ovens can also be picked up.

The magnetic-field sounder can even aid in determining the operating condition of an implanted cardiac pacemaker. Better yet, it could prove very useful to the wearer of a pacemaker by alerting him to the presence of electromagnetic interference that might affect the implanted device adversely. □

Engineer's Notebook is a regular feature in Electronics. We invite readers to submit original design shortcuts, calculation aids, measurement and test techniques, and other ideas for saving engineering time or cost. We'll pay \$50 for each item published.

How to cost avionics: by the pound

If you're bidding on a military avionics system, chances are your bid will work out at about \$1,000 per pound, says Harry Davis, former deputy undersecretary of the Air Force and now a consultant with the firm of Davis, Fubini, and Simon in Arlington, Va. Davis, who also teaches a course in avionics at UCLA, says that the \$1,000 figure is an average—**electronic countermeasures equipment, which is primarily a transmitter, could work out as low as \$300 per pound, while high-density computers bring inertial navigation systems up to the \$2,000-per-pound level.** Also, if the equipment is to be space-qualified, multiply the cost figures by 5. Davis adds another rule of thumb—avionic equipment usually has a weight density half that of water, or about 30 lb/ft³.

EE job picture gets low rating

Compared to other engineering specialties, the EE job situation isn't too good, according to an Engineers Joint Council report. As of April, electrical engineering was near the bottom in openings per number of people employed and in prospects for the following 12 months. **Out of the 20,517 jobs for EEs surveyed, only 4% were openings this year and just 5% will be in 1975.** Also, the 2,290 electronics companies polled had 8% openings per number employed and 12% for next year.

Just about every other specialty—mining/petroleum, nuclear, and even aerospace engineering—had better job opportunities than EEs. Only chemical and industrial engineers were worse off.

Better ways of protecting zener diodes

Recently, this page discussed the possibility of getting fast protection for a zener diode by simply placing a junction diode in series with it [*Electronics*, May 2, p. 118]. But things are not so simple, warns Lawrence W. Johnson of Hewlett-Packard Laboratories in Palo Alto, Calif. He points out that **the low capacitance of the junction diode will not take care of the switching delay of the zener caused by this device's large junction capacitance.** This occurs whether the series diode is a discrete device, external to the zener, or whether it's built into a temperature-compensated reference zener.

According to Johnson, there are really only two effective solutions to the problem. **One is to buy a truly low-capacitance zener—**except that the few makers of this device don't like to guarantee its capacitance value, and the capacitance limits are not too good in any case.

Less elegant but more practical, the other solution is to **connect a series-dropping resistor to the supply voltage to keep the zener turned on and its capacitance charged up all the time.** The series diode is still necessary, the resistor being tied between its anode and the zener's cathode as well as to the supply. The protected node is the one at the cathode of the series diode. And remember, for best results, **the anode of the zener should be grounded.**

Transducer tracks pressure in trucks with accuracy

Looking for a cheap but accurate pressure transducer that covers the range of 50–1,000 psi full scale and can also survive a really rugged environment? The TO and ITQ series units, priced at about \$50 each from Kulite Semiconductor Products Inc., Richfield, N.J., have been monitoring air and oil pressure in diesel truck engines. Truckers report only one failure in 310,000 miles.

—Laurence Altman

Shouldn't a CRT display reflect your system's true performance?

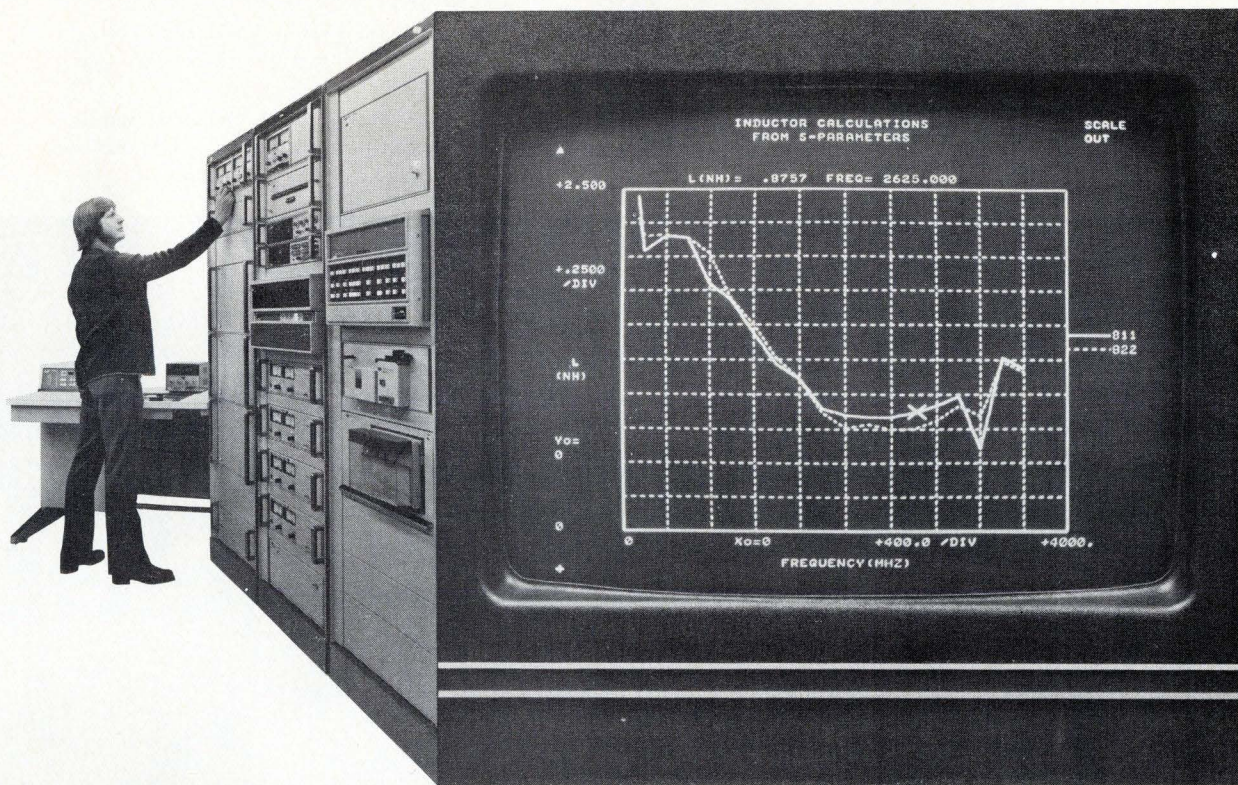

(Model 1317, 17" Diagonal Display)

Count on it with an HP display... including new large-screen models with improved performance your OEM systems demand. The high writing speed and fast settling time of our 14- through 21-inch displays means simplified output programming and greater information density in computer graphics, analytical research, radar and other display applications. Yokeless electrostatic deflection simplifies operation, eliminates geometric correction circuitry and unnecessary delay lines, and reduces required power by a factor of 5 or more. Bright, easy-to-read displays result from the 28.5 kV accelerating potential. And dy-

amic focusing assures a sharp trace at any screen location, over a wide range of intensities.

You also get versatility in HP displays. A variety of standard options allow you to tailor a display to your system's needs. Our rugged new 1317A and 1321A models give you options of TTL blanking input, differential inputs and gamma correction to match your system design and simplify interface problems. You have a choice of CRT sizes and shapes for stand-alone or rack-mounted applications. And you can get various phosphors that range from slow P7 and P39 to fast P31

In addition to top performance

and versatility, you get the quality, reliability, and product safety you expect from a leader in CRT technology. Optional UL listing is available. Plug-in board construction simplifies servicing...and HP's worldwide support means rapid parts replacement and service—an important consideration when you're designing a display into your system. So, for a display that reflects your system's true performance, look into HP's large-screen display family. For more information, contact your local HP field engineer. Or, write Hewlett-Packard.

084/6A

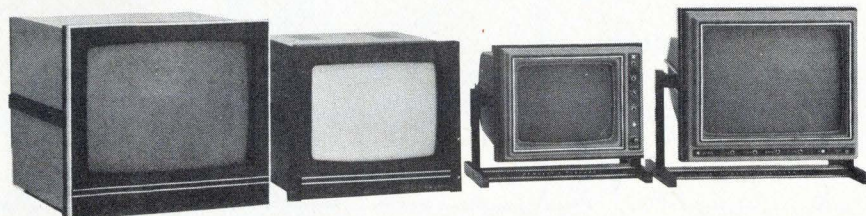

HEWLETT  PACKARD

Sales and service from 172 offices in 65 countries.
1501 Page Mill Road, Palo Alto, California 94306

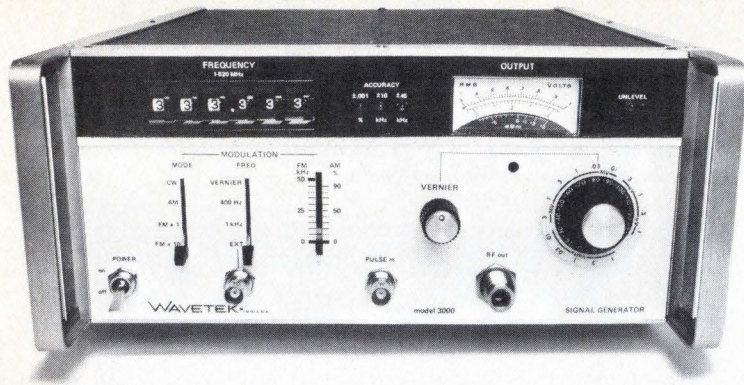

SPECIFICATIONS

- Frequency Range: 1 - 520 MHz
- Frequency Accuracy: $\pm 0.001\%$
- Resolution: 1 kHz
- Stability: Less than 0.2 ppm per hour
- Output Range: +13 dBm to -137 dBm
- Flatness: ± 0.75 dB
- AM Modulation Range: 0 - 90%
- FM Deviation: 0 - 50 kHz and 0 - 500 kHz
- Internal Modulation Rates: 400 Hz and 1 kHz
- Dimensions: 12" wide x 5 1/2" high x 13 3/4" deep
- Price: \$1,975

Note: In addition, the entire frequency range is remotely programmable in 1 kHz steps using six lines of BCD programming.

We'll remember your impressive bulk, your incredible weight, the glow of your vacuum tubes burning into the night. Whenever anyone said "signal generator" we thought of you.

But someone new has come along—from Wavetek. Slim, attractive, a mere twenty-five

pounds of solid state ingenuity. Yet the phase-locked Wavetek 3000 can do everything you used to do. (Some things a little better.) All the while consuming less than a tenth the power and a fraction the bench space. Even the price is a little lower.

We could go on, but that

would be cruel. So we'll just print the Wavetek 3000's specifications for you to read . . . and weep.

WAVETEK®

INDIANA INCORPORATED
 P.O. Box 190, 66 North First Avenue
 Beech Grove, Indiana 46107
 Tel. (317) 783-3221 TWX 810-341-3226
 Circle 130 on reader service card

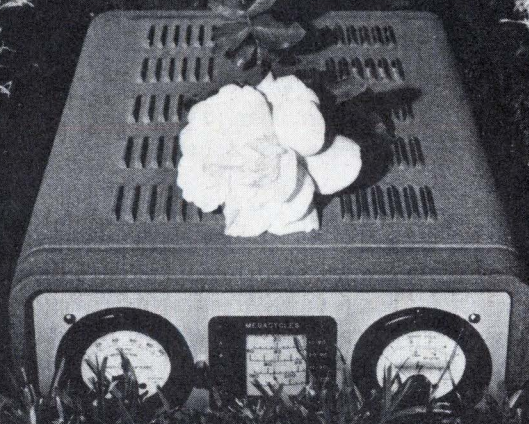

So long, fatso.

New products

IC-memory tester is interactive

Built for device characterization and evaluation, system can also be used for production checkout; CRT display helps monitor single cells

by Paul Franson, Los Angeles bureau manager

For engineering design or evaluation, some semiconductor-memory test systems on the market are not exactly ideal. Designed for production testing, they compel users to become programmers or to work through a programmer—not an efficient procedure for those who are primarily process or design engineers.

Xincom Corp. has a solution for these people, as well as for large users who must rigorously evaluate prospective parts. It's the model 5560 memory test system, in which the interactive controls and unique X-Y display were designed for device characterization.

The design team of a large semiconductor manufacturer shared in the development of the system, says marketing vice president John W. Coons. He expects it to sell to large semiconductor makers and users.

Look and adjust. The 5560 system can function as a conventional production tester of memories. But it has added controls and buffering that permit all functions, voltage levels, and timing to be adjusted while the operator watches the display to determine how the changes affect the memory.

The cathode-ray tube displays up to 4,096 bits of storage, with a small dot indicating the status of each cell. An intensified spot indicates that the individual memory cell is failing. The same display can show test patterns of 1s and 0s as bright and light spots and can be stepped through slowly to show the arrangement of such patterns as checkerboard or Galpat. It can also be arranged to correspond to the topography of the chip, so that marginal areas are easy to locate.

The standard Xincom system tests

dynamic and static random-access memories plus shift registers, in ECL, TTL, and MOS families. Programmable read-only memories, as well as straight ROMs, can be tested by the addition of plug-in modules.

As a memory tester, the system includes a 12-megahertz micro-programmable pattern generator that generates standard programs. Random data generation is added with an optional truth-table RAM of up to 512 16-bit words.

Programmability. The timing system is crystal-controlled and programmable from 100 hertz to 100 megahertz, and three programmable test periods of 10 bits each—selected on the fly—are provided. Ten independent clock phases have start and

stop ranges from 30 nanoseconds to 10.23 seconds, with resolution as tight as 1 ns. Refresh is separately programmable, permitting dynamic memories to maintain storage even if test patterns are being run slowly.

The interactive control system allows the user to adjust all the variable levels and timing. Digital meters indicate the state of existing signals and enable them to be read as they are varied. Initial values and test patterns are normally entered with a high-speed tape reader, as in production systems.

The standard model 5560 is priced at about \$88,000 and includes test head.

Xincom Corp., 8944 Mason Ave., P.O. Box 648, Chatsworth, Calif. 91311 [338]

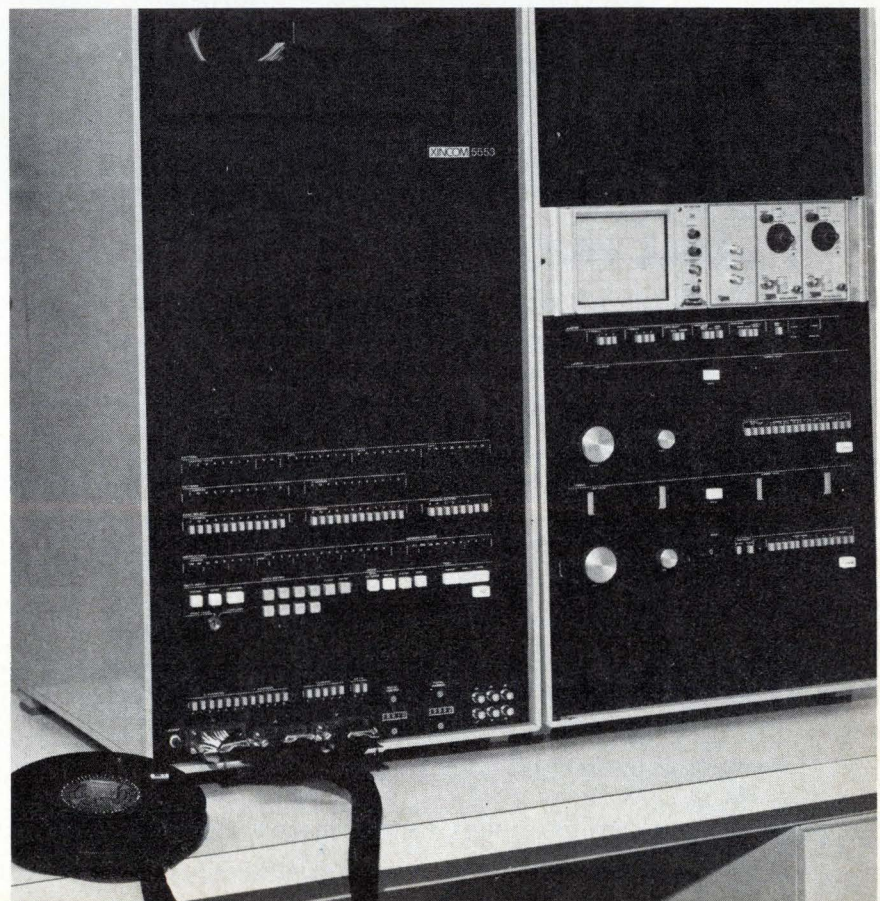

There's a little tiger in every Cherry switch

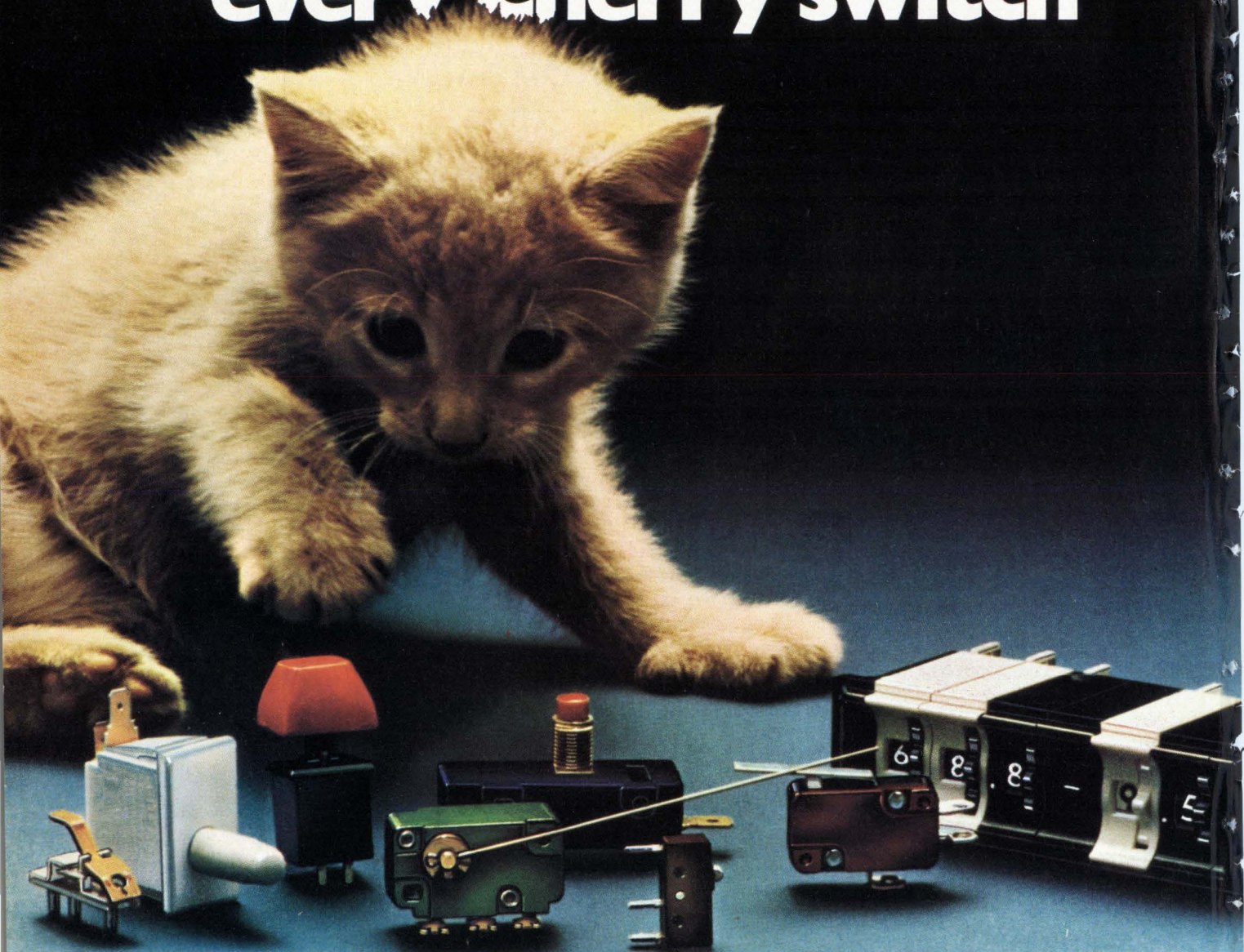

...but we're pussycats to do business with

Our products are tough, but our people aren't... and that's the beauty of dealing with Cherry.

You see, we can control the quality of our switches because we fabricate most of our own parts (moldings, stampings, springs, printed circuits, etc.) And we can keep the price down because we're loaded with automatic equipment to handle high volume.

But the real difference is in the *people* you work with at Cherry...from your first contact with a technically trained sales representative...through careful analysis and recommendations by engineers

who are really concerned about *your* problem... to production scheduling and customer service men who follow-up and expedite to make sure we keep our delivery promise to you.

Of course we're proud of our modern facilities and equipment...but what we're proudest of is our reputation for customer service. Try some.



Test a free sample "tiger" from the pussycats at Cherry. Ask for our latest catalog which contains complete information on all our switches and keyboards, and we'll include a free sample switch. Just TWX 910-235-1572...or PHONE 312-689-7700... or circle the reader service number below.

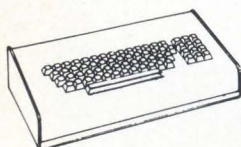

CHERRY



CHERRY ELECTRICAL PRODUCTS CORP. • 3608 Sunset Avenue, Waukegan, Illinois 60085
ELECTRONIC DATA ENTRY KEYBOARDS • ELECTRONIC DESK TOP CALCULATORS



Circle 132 on reader service card

Semiconductors

Signetics' first microprocessor

8-bit general-purpose unit to be followed next year by more sophisticated devices

In a first step toward establishing itself as a supplier of single-chip microprocessors, Signetics Corp. will begin shipping samples of a general-purpose parallel 8-bit binary processor in November. According to Joseph Kroeger, microprocessor marketing manager, the model 2650 PIP (programable integrated processor) will be followed late in 1975 by special-purpose processors aimed at both the low-cost and high-speed ends of the market.

"Admittedly, it is a little late to get into the market with a general-purpose processor," he says, "but not too late. If we are to gain a significant foothold, it behooves us to establish ourselves with a general-purpose device before going to anything more sophisticated."

Kroeger readily admits that Intel's 8080 is what the Signetics 2650 must in some measure displace, and he believes that it can. Both microprocessors offer about the same number of instructions—78 for the 8080 and 75 for the 2650—with about the same performance.

Built on a single chip with n-channel ion-implanted silicon-gate MOS technology, the 2650 can address 32,768 bytes of any kind of semiconductor memory in any combination. Instructions can be implemented in one-, two-, or three-byte lengths with execution times ranging from 5 to 10 microseconds, depending on the length of instruction, the nature of the operation, and the addressing mode specified.

Kroeger emphasizes that the Signetics 40-pin DIP 2650 has a lot of "little things" that make it attractive to certain kinds of customers. Two of those things are the power supply and timing. Like Motorola's 6800

[*Electronics*, March 7, p. 29], the 2650 needs only a single 5-volt power supply and one external clock. Because the chip is implemented with static logic, this allows the use of a single-phase, TTL-level clock. And with only one power supply, two additional interface pins are available for use with control signals, he points out.

The 2650 is fully TTL-compatible, without the addition of external peripheral interface circuits, not only at the inputs and outputs but also for the 5-v power supply. The bus outputs are tri-state, and all will drive a standard 7400-series TTL load.

All external operations—memory, input/output, and interrupt—are handled asynchronously by the operation control signals. The address, data, and control lines are static during external operations, so that no internal demultiplexing or latching logic is required.

Conventional computer-oriented explicit operand addressing was chosen as the basic instruction mode. Explicit addresses are carried out in the instructions, as opposed to implicit addressing where instructions refer to addresses located elsewhere in the processor.

Although pricing details are not set, Kroeger expects the 2650 will sell at about \$100 to \$130 each in 100-lots.

Signetics Inc., 811 E. Argues Ave., Sunnyvale, Calif. 94086

Memory circuit offers access time of 6.5 ns

A very fast read-write memory circuit, the model 10142, is an emitter-coupled random-access memory that is organized into 64 words of 1 bit each. It features a typical address access time of 6.5 nanoseconds and a chip-select access time of 5.5 ns. This ECL 10,000 series memory is pin-for-pin and functionally equivalent to the model 10148 RAM, which has a typical access time of 8.5 ns. In addition to the high-speed read capability, the 10142 has a write pulse width of less than 5 ns, and adding

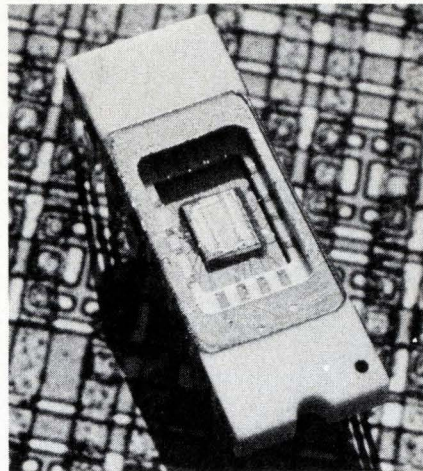

the minimum set-up and hold times, provides a total write cycle that is less than 10 ns. Since the read and write cycles each take 10 nanoseconds or less, the memory can operate at data rates up to 100 megahertz.

Signetics, 811 East Arques Ave., Sunnyvale, Calif. 94086

Memory is designed for harsh environments

Called Semistore III, a semiconductor memory for OEM and end users is designed for use in extreme environments. The rack-mounted system is based on a 1,024-by-1 p-MOS dynamic RAM and meets military specifications. Applications include buffering, data acquisition, display refresh, and main memory. Access time is 385 nanoseconds, and cycle time is 500 ns.

Monolithic Systems Corp., 14 Inverness Dr. East, Englewood, Colo. 80110 [404]

Quad NAND gate has Schmitt-trigger action

A C-MOS quad two-input NAND gate with Schmitt trigger, called the CD-4093AE, consists of four identical Schmitt trigger circuits with each circuit functioning as a two-input NAND gate. Schmitt trigger action occurs on each input without requiring external components, and the gate switches at different points for

**Cut your
hot design problems
down to size.**

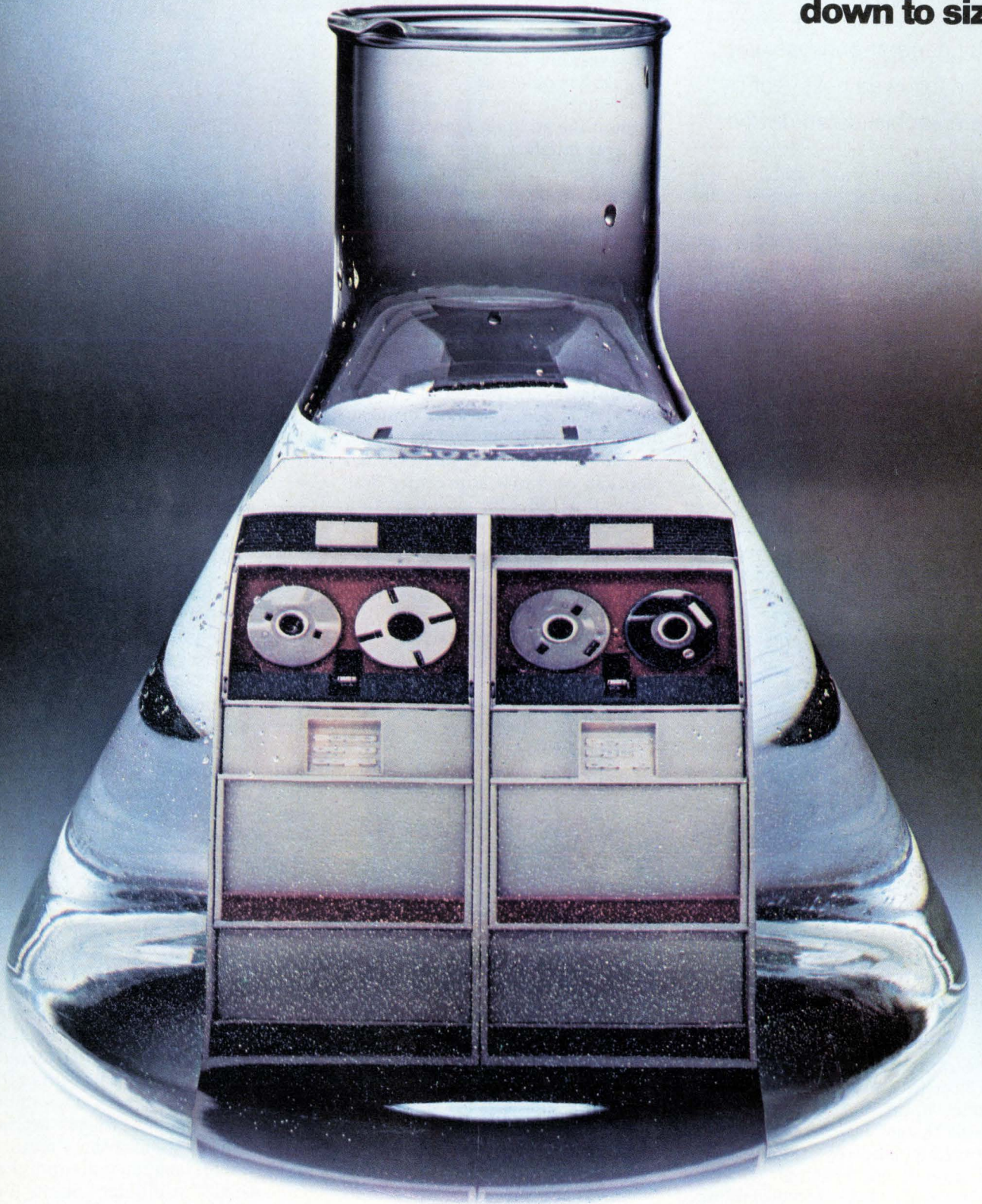

New products

Use Dow Corning dielectric coolants.

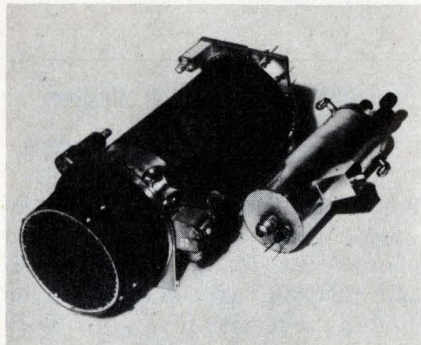

A UHF amplifier, for airborne equipment (right), was reduced in size and weight by using Dow Corning® 200 fluid. Only this unit produced full power over full frequency at an altitude of 100,000 ft.

If you're stuck with a hot electronic apparatus that you want to pack away in a snug place somewhere, relax. Silicone dielectric fluids from Dow Corning could be your answer.

The thermal stability of silicone fluids, combined with excellent physical and dielectric properties, solves the critical problem of high performance in smaller equipment. Specifically, rapid heat dissipation, superior dielectric strength, and low losses over the temperature range -40 to 200 C are primary reasons why closer spacing or size reductions in electronic apparatus are possible. Available in a wide viscosity range, they can be used for cooling power tubes, damping meter indicators, insulating high-voltage power supplies, or filling dashpots.

Nonsludging and essentially non-toxic, silicone fluids deliver long life at a competitive price where conventional organic liquids fail rapidly.

For specific information on our complete line of fluids, write Dow Corning Corporation, Dept. C-3336, Midland, Michigan 48640.

Silicones; simply the best way to protect electronic equipment

DOW CORNING

DOW CORNING

positive- and negative-going signals. Special features include noise immunity greater than 50%, typical hysteresis voltage of 0.6 volt at a supply voltage of 5 v and 1.7 v at a supply voltage of 10 v, no limit on input rise and fall times, and equal source- and sink-drive-current capability. Typical applications include wave-shapers and pulse-shapers, monostable and astable multivibrators, high-noise-environment systems, and NAND functional logic. Price in 1,000-lots is \$2.25.

RCA, Solid State Division, Box 3200, Somerville, N.J. 08876 [414]

LED display uses molded bubble lenses

A gallium-arsenide-phosphide three-digit numeric display, the model GL-930 AR, is packaged as a standard 12-pin DIP with integrally molded bubble lenses. This provides a magnified digit height of 2.55 mil-

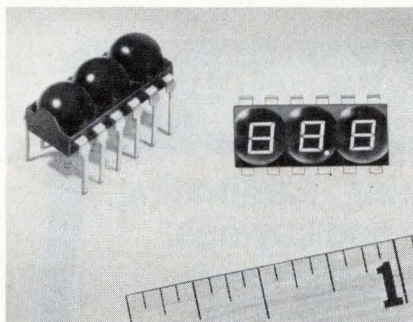

limeters and a wide viewing angle $\pm 30^\circ$ from the center line of the digit. Brightness is rated at 200 foot-lamberts at a current of 5 milliamperes. The display is 15.24 mm wide and can be end-stacked for multiple-unit arrays.

Shigoto Industries Ltd., Empire State Building, 350 Fifth Ave., New York, N.Y. 10001 [416]

Four hybrids handle most modem functions

Four thick-film hybrid devices, which together can handle more than 90% of a modem's functions in

300-baud frequency-shift-keyed applications, are designated mini-Modem. The devices require few additional components to create a type 103/113 compatible model within six square inches of circuit board at a cost of less than \$62. In addition, by using switched active resonator techniques, the mini-

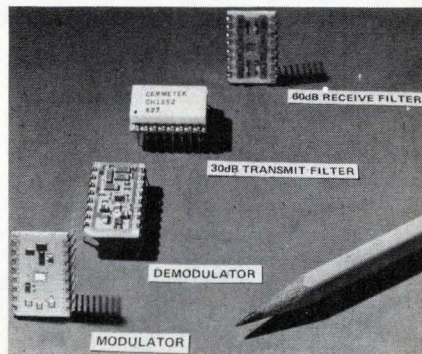

Modem eliminates many of the problems associated with phase-locked-loop circuits. The four devices, also available in CCITT versions, are housed in 16-pin double DIPS.

Cermetek Inc., 660 National Ave., Mountain View, Calif. 94043 [415]

Power transistors deliver 6 watts at 3 gigahertz

A family of 3-gigahertz rf power transistors are gold-metalized and emitter-ballasted. Included in the family are a 6-watt, 4-w and 1-w types housed in hermetic ceramic-to-metal packages, flange, stud or pill packages. At 3 gigahertz, the PH 3006 typically produces 6 watts of rf power with 5.2 dB of gain and 33% efficiency at 28 volts. At 2.3 GHz

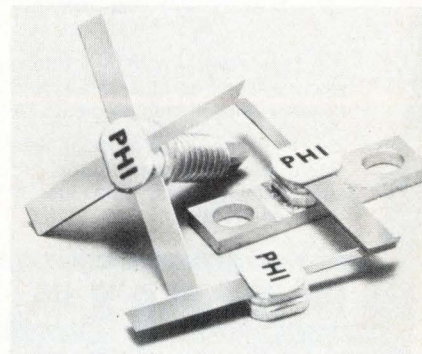

BODINE TRAN-BAL®

Fluorescent Lighting From D.C. Power

- Transistorized inverter ballast for operating fluorescent lamps from low voltage D.C. current.
- Designed for applications requiring long life, reliability and efficiency.
- Models can be synchronized to prevent beat notes between lamps in multiple lamp installation.
- Rapid start and instant start models from 4 to 40 watts.
- Eliminate lamp flicker with high frequency operation.
- Protection against reverse polarity available.
- Replaceable transistors and in line fuses.
- Solves many photo electric problems.

BODINE CO.

MANUFACTURERS OF ELECTRONIC EQUIPMENT

236 MT. PLEASANT ROAD • COLLIERVILLE TENNESSEE 38017

Area Code 901/853-7211

Circle 136 on reader service card

RELEASE AGENTS

for Potting, Encapsulating, Laminating,
Filament Windings, and Lay-ups.

- Save money by reducing rejects and increase speed.
- Increase production output.
- No cleaning prior to painting or bonding.
- Dependable multiple releases.
- No mold build-up.
- Retention of details.
- Use with all epoxies.

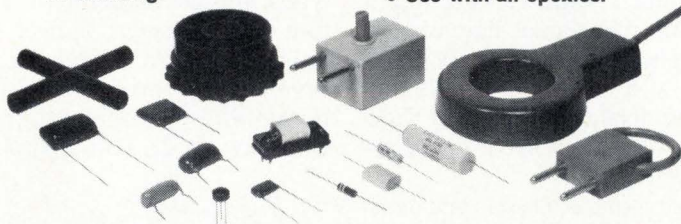

We have several standard release agents (both silicone and non-silicone types) to meet most needs. We also make custom solutions to meet unusual requirements. Aerosol spray cans or bulk.

Please tell us what your application is and we will send you by return mail complete information and prices on the proper release agent plus a FREE 16-ounce SAMPLE. Or else call us for even faster answers.

Have a nice day!

CONTOUR
chemical company

3 draper street • woburn, mass. 01801 • tel: (617) 935-5910

136 Circle 206 on reader service card

New products

and 22 volts, the PH3006 will typically produce 8 watts with 7 dB of gain. In quantities of 1 to 99, the PH3006, PH3004 and PH3001 are priced at \$95, \$75, and \$51, respectively.

Power Hybrids Inc., 1742 Crenshaw Blvd., Torrance, Calif. 90501 [418]

Blue-violet sensitive diodes
have wide spectral response

Providing up to twice as much response in the blue region as most photodiodes, the models PDO50F and PDO50L are designed to be used in the reverse-bias mode. They have a guaranteed minimum spectral response of 0.5 ampere/watt maintained from wavelengths of 0.85 through .62 micrometer. The photodiodes have an essentially flat response through more than seven decades—right through the visible region and well into the blue-violet region. The current output is linear with light. The photodiodes are suitable for near-infrared, visible, and blue-violet wavelength measurement. Sample quantities of the PDO50F and PDO50L are priced at \$25 each; and in 25-49 quantities, at \$17 each.

Innotech Corp., 181 Main St., Norwalk, Conn. 06851 [417]

IC drives liquid-crystal
display in watches

For applications in watches, a monolithic C-MOS IC called the NEC-5015, drives a 3½ digit, 7-segment field-effect liquid-crystal display directly without external components. The decoder/driver handles an LCD of hours and minutes from 23 outputs and a common line with a 32-hertz ac signal. Seconds are displayed with a flashing colon, and two time-setting inputs are provided for hours and minutes. The circuit also features built-in switch debounce. Price is \$17.50 each for 100 to 999.

Nortec Electronics Corp., 3697 Tahoe Way, Santa Clara, Calif. 95051 [419]

Electronics/September 5, 1974



You can kluge up a mag tape compression/expansion system if you like. I'd rather use Ithaco's 3170.

We sometimes develop new products at Ithaco by solving our own problems. That's what happened with this new compression expansion system of ours.

My analog instrumentation tape recorder couldn't handle the wide dynamic range data I was feeding it. I needed a compression system. There were none commercially available. So we checked into how other guys were solving the problem. You wouldn't believe it.

Oh, it wasn't that the systems they had cobbled together didn't work, it was just that none of them worked very well. So we put our heads together and, based on technology we've long had, designed a compression/expansion system to end all compression/expansion systems. By handling over 100dB signal range, it

enlarges the dynamic range of recorders by three orders of magnitude. Without distortion.

Then you can analyze the compressed data with conventional spectrum analysis equipment. Or, you can restore the original dynamic range prior to analysis.

And, as a concession to my fat fingers, the system eliminates data loss due to improperly set gain controls.

Arrange a demonstration or request the specs by contacting an Ithaco sales rep or write to Ithaco, Box 818—CE, Ithaca, N.Y. 14850. Call (607) 272-7640 or TWX 510-255-9307.

If you need to compress data, use our model 3170. Believe me, it's better than homemade.



ITHACO

You can see the model 3170 at Wescon, booth 2730.

Circle 137 on reader service card

Packaging & production

Vapor deposition unit is modular

Design of low-cost system for 2- and 3-inch wafers reduces cleaning downtime

One of the more irritating drawbacks to many vapor deposition systems is the cleaning time.

Often this takes as much as half a day, since it involves taking the machine apart piece by piece. The result is profit-consuming downtime that the semiconductor manufacturer can ill afford.

A new vapor deposition system—the model 2000—will be introduced next week at Wescon by Pacific Western Systems Inc., and its modular construction reduces cleaning time to about five minutes, the company says.

Measuring 52 by 23 inches and weighing 250 pounds, the instrument can be cleaned by the operator, who simply swings open the front panels and removes the modules inside.

Priced between \$8,800 and \$14,000, depending on options, the PWS model 2000 is about one-third as expensive as comparable systems, according to Len Gilmore, marketing manager at PWS.

The system has a capacity of 21 two-inch wafers or 10 three-inch wafers and a deposition rate of 1 micron at 2½ inches per minute.

Deposition is accomplished by placing the wafers on a heated plate which traverses beneath a laminar-flow gas nozzle atop the compact unit. Oxygen and silane are introduced from the nozzle about 100 mils above the wafers into a reaction zone. The gases combine, and deposition of silicon dioxide occurs on the surface of the wafers.

The gas system contains five flowmeters controlling the flow of oxygen, silane, dopant, and nitrogen carrier gas for both oxygen and silane.

Gas and water ducting consists of nylon tubing and fittings. Valves and flowmeters are stainless steel, and all tubing is O-ring-sealed for easy maintenance.

The plate temperature is controlled by a proportional controller with a power consumption of 3,500 watts at 220 volts. A selectable trip-point discontinues heating of the wafers if a preselected temperature limit is exceeded.

The system provides a uniformity of within $\pm 5\%$ for 1-micron depositions, Gilmore says. It can be programmed for multilayer depositions, and it fits the standard six-foot laminar-flow hood.

Options include programable mass-flow controllers, stainless steel gas plumbing, an electronic tachometer, an exhaust pressure indicator, and a double-width laminar-flow nozzle.

Pacific Western Systems Inc., 855 Maude Ave., Mountain View, Calif. 94040 [391]

IC-insertion/extraction tool protects leads

Molded of reinforced nylon, IC-insertion/extraction tools protect leads while providing quick positioning for IC insertion into pc boards or sockets. The model 870 Insertic is used by pressing the IC into the tool jaws, lining up the lead pins on one side with the circuit-board holes, rolling the remaining leads into place, and pressing the ejector button to snap the IC into place. The 875 Pul-N-Sertic operates similarly, except it also extracts ICs. Price of the Insertic is \$2.95, and of the Pul-N-Sertic, \$4.95. De-

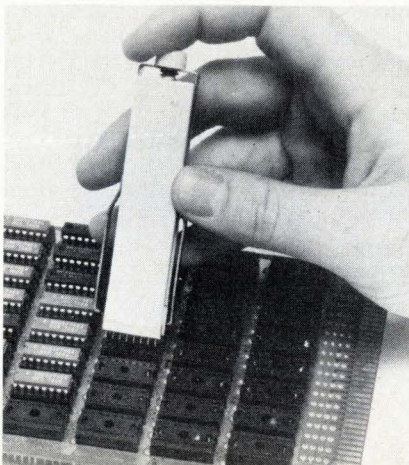

livery of the tools is from stock. Solder Removal Co., 1077 E. Edna Pl., Box 1678 Covina, Calif. 91724 [394]

Cine tape bonder handles 1,000 chips per hour

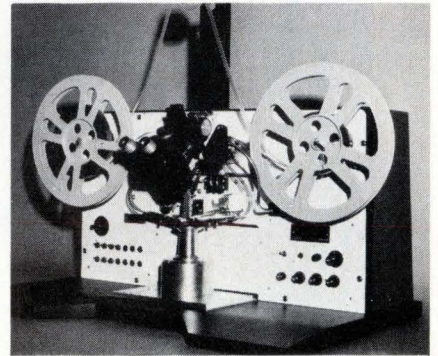

A bonder that simultaneously gang-bonds the leads of a flexible printed-circuit cine tape to all the bonding pads of an IC chip in one operation is designed to operate at 1,000 chips per hour nominal, independently of the number of leads. The model ECTA 205 can be supplied in any standard cine film format such as 8-, 16-, 35- or 70-millimeter and is available with either of two chip-handling systems: A 1:1 manual chessman or an automatic X-Y stepping table.

International Micro Industries., P.O. Box 604, Cherry Hill, N.Y. 08034 [393]

Two-film coated substrates offer high stability

Two-film coated substrates, designated the AD1900 series, are available with sheet resistivities from 50 to 500 ohms/square, noise rating to -50 decibels, power densities to 50 watts per square inch, long-term stability within 0.005% per year at 25°C, and sizes from 0.025 in. square to 3.50 in. square. The two-film system consists of a nichrome resistive coating covered by a 150-microinch gold conductive layer. Surface finishes of either 304 or 5-10 microinches are available. A back-side gold conductive coating is optional. The line of substrates in-

A new autoranging multi-function counter using LSI/MOS from the "Counter House" the 1900A

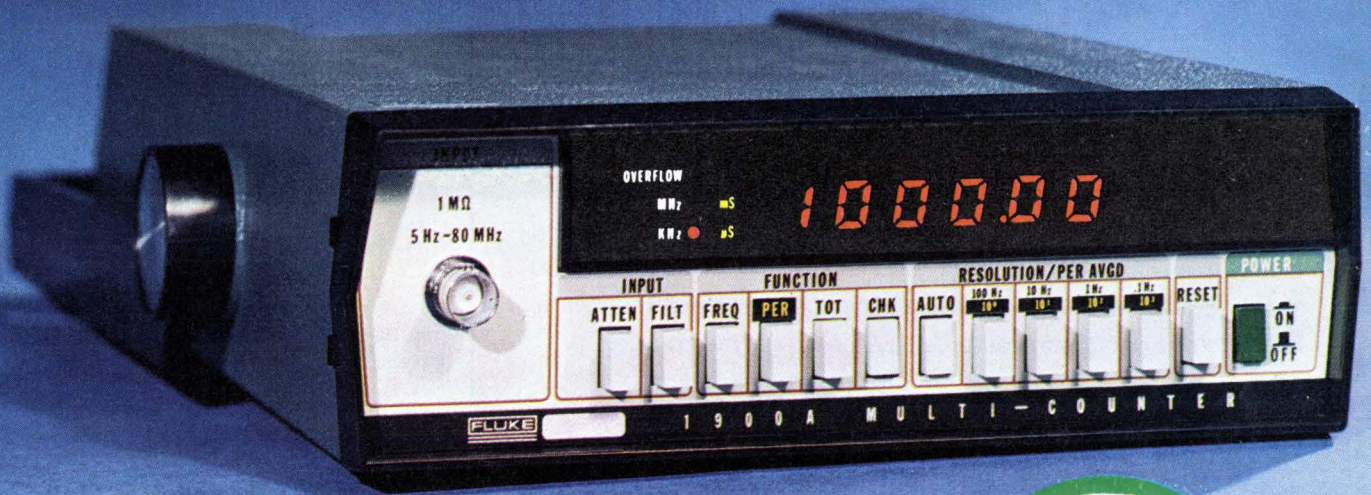

Fluke's new 1900A multi-counter offers you...

\$
349

... a superb autoranging counter with outstanding features ... like leading zero suppression to end confusion ... autoreset, so your first reading is always correct no matter how often you change the function ... 5 Hz to 80 MHz dynamic range ... autoranging in both frequency and period measurement modes ... signal input conditioning ... 25 mV sensitivity, typically 15 mV ... event counting to 10^6 with overflow indication ... six digit LED display ... automatic annunciation ... and 20% hysteresis on autoranging to eliminate bothersome range switching. All this and more for \$349.

With the 1900A you get a rugged, compact and reliable instrument with all the performance and quality that Fluke is famous for. Including Fluke's full 12-month guarantee.

If you want battery operation we'll install an optional internal battery pack that gives you five hours of continuous operation between charges. Or if you need a data output we can provide it.

For fast, fast delivery order your 1900A from your local Fluke distributor - he has them in stock. Or write or phone us direct.

FLUKE
COUNTER DIVISION

John Fluke Mfg. Co. Ltd.,
Counter Division
P.O. Box 1094, Station "D"
Buffalo, N.Y. 14210
Phone (716) 842-0311
TWX 610-492-3214

Circle 139 on reader service card

New Card-Pak

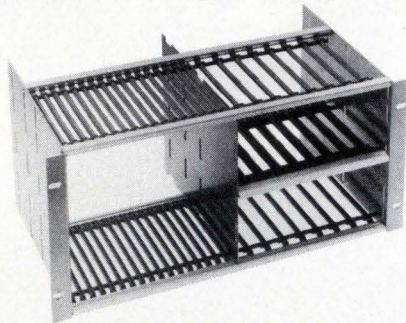

Introducing a new design in card files. Accepts all circuit or socket cards between 2 x 4 inches and 8 x 9 1/4 inches. Any card spacing (from 0.3 in. up) in 0.05 in. increments. Single and/or double tiers in three file sizes. With a complete assortment of catalogued hardware. Ready to ship as soon as you order. Send for our free catalog.

Also available from G.S. Marshall Co. nationwide.

EECO

1441 East Chestnut Avenue/Santa Ana, California 92701/Phone 714/835-6000
Circle 140 on reader service card

When you're looking for reliability,
performance and economy in **BRIDGE RECTIFIERS**

IBR®

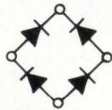

**SILICON
CONTROLLED
AVALANCHE
INTEGRATED
BRIDGE
RECTIFIERS**



**TO-3 outline
mounting flange**

- 10A and 25A (I_o), single phase full-wave bridges
- 15A & 36A (I_o), 3 ϕ full-wave bridges
- 100V, 200V, 400V, 600V (V_{RRM})
- 250V, 450V, 650V and 850V min avalanche voltages (V_{BR}) permit lower (V_{RRM}) safety factors in design considerations
- Fast recovery series, 200 nsec. (t_r)
- Low junction-to-case thermal resistance (R θ_{j-c}), 1°C/W or less allows operation at full rated load to 100°C, T_c
- 2000V minimum circuit-to-case insulation
- Three mounting options: Press-fit, Stud Mount, and TO-3 outline mounting flange.
- 187" or 250" flag terminals available

EBR

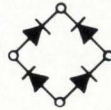

**EPOXY
BRIDGE
RECTIFIERS**

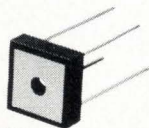

10A



2A and 6A

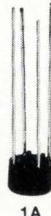

1A

- 1A, 2A, 6A and 10A (I_o)
- Controlled avalanche series with 250V, 450V, 650V and 850V minimum avalanche voltages (V_{BR})
- 50V, 100V, 200V, 400V, 600V and 800V (V_{RRM})
- Fast recovery time series, 200 nsec., (t_r) available
- 10A series has bonded ceramic-to-copper mounting pad for low circuit-junction-to-heat sink thermal resistance

*Design us in;
we'll stay there*



**VARO
SEMICONDUCTOR, INC.**

P.O. BOX 676, 1000 N. SHILOH, GARLAND, TEX. 75040, 214/272-4551, TWX 910-860-5178

New products

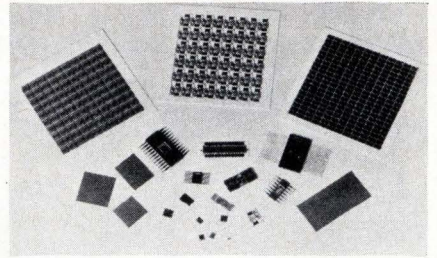

cludes 1,200 standard variations. The AD1922, for example, has a sheet resistivity of 250 ohms per square, substrate thickness of 25 \pm 2 mils, 5-10 microinches of surface finish, and a gold back-side coating. It is priced at \$3.60 per square inch in 100-square-in. quantities.

Analog Devices Inc., Box 280, Rte. 1 Industrial Park, Norwood, Mass. 02062 [395]

Resistor networks
are in chip form

Thin-film precision-resistor networks in chip form are designed as custom hybrid substrates. The substrate contains bonding pads for chip capacitors and integrated circuit dice, as well as passive resistors. Metal-film interconnections, rather than soldered or welded joints, are used, and the networks consist of integrated films of chromium cobalt vacuum deposited on special glass substrates, providing low tolerance. They are suited for many types of precision applications, including use in instrumentation and communications systems.

Allen-Bradley, 1201 S. Second St., Milwaukee, Wis. 52304 [396]

Terminator attaches coax
cables to pc boards

Terminating miniature coaxial cables to printed circuit boards can be done with a one-piece, shielded terminator. Each terminator consists of a solder-sleeve terminating device attached to a tin-plated copper body. The solder-sleeve device is a prefluxed solder preform contained in a heat-shrinkable insulating sleeve. When heated, the solder pre-

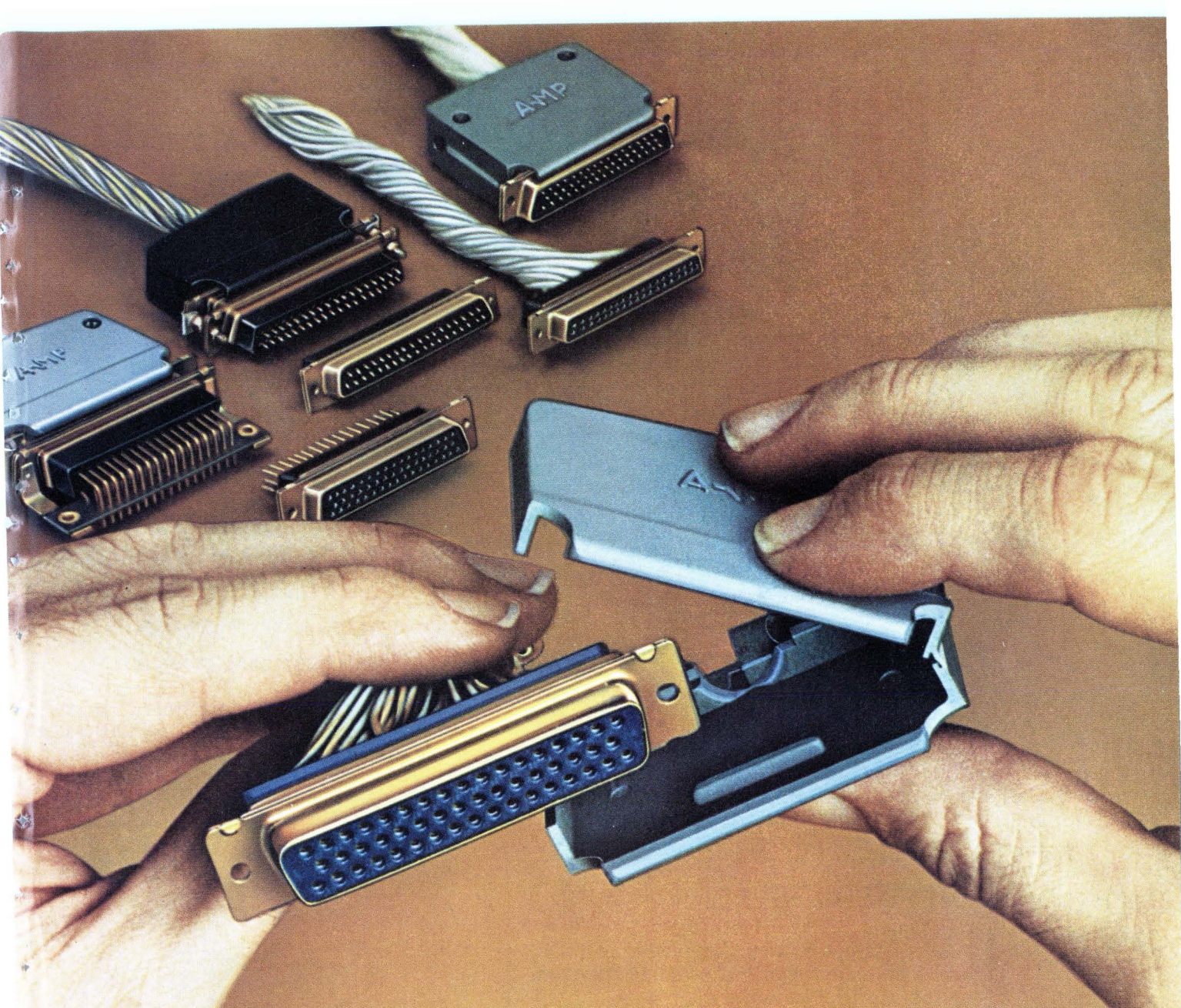

**Because
you
only have
two hands.**

AMPLIMITE high-density connectors

come with our exclusive, one-piece plastic strain relief/shield. You can't get one that's easier or less complicated to put on.

Hold the joined "clam-shell" in one hand. Turn the screw with the other. It's that simple to cut into your handling costs. In addition, you have a highly versatile line of reliable and economical AMP high-density connectors.

With rack and panel interconnections as well as posted configurations. Straight as well as right-angle post contacts. And a variety of contact styles including some with insulation support features. Sizes are 9, 15, 25, 26, 37, 44, 50, 62, 78 and 104 positions.

Of course AMPLIMITE connectors are intermateable with existing high-density types.

For immediate information, call (717) 564-0101. Or write AMP Incorporated, Harrisburg, Pa. 17105.

AMP and AMPLIMITE are trademarks of AMP Incorporated.

AMP
INCORPORATED

Circle 141 on reader service card

A snappingly simple small super switch.

Snap, it's in. Push, it's on. It's that simple to install C&K's new Momentary, Bezel-Mounted, Snap-In Pushbutton Switches. Super-dependable (100,000 make/break cycles, at least) and surprisingly competitive, they're yours in SPDT and DPDT subminiature models in 81 different cap-and-bezel color combinations. Snap in. Push on. Save time. Save money. Specify C&K **C&K Components, Inc.**
103 Morse Street, Watertown, MA 02172
Tel: (617) 926-0800
TWX: 710-327-0460

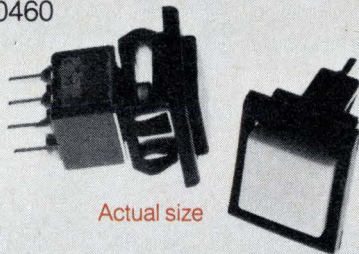

Free Engineering Samples On Request

"Visit C&K at *Wescon '74* (Sept. 10-13) Booth # 2910; and at *Nepcon* (Oct. 1-3) Booth # 445."

Circle 142 on reader service card

mi·cro·temp (mī'krō tēmp')

A patented, positive safety thermal cutoff.

It will interrupt a circuit when the operating temperature exceeds the rated temperature of the cutoff. Normally employed as a back-up safety protector to cut off power to electronic circuits or components that develop abnormal temperature build-up, this device is fast, reliable and accurate to $\pm 3^\circ\text{F}$.

MICROTEMPS are CSA listed and insure product safety. Costing as little as 7.5¢ each, MICROTEMPS are available in a wide range of configurations, ratings and terminations to suit your individual applications. MICROTEMPS are hermetically sealed; unaffected by vibration, shock, aging or positioning, and meet UL standard 1020. For specific details, call or write:

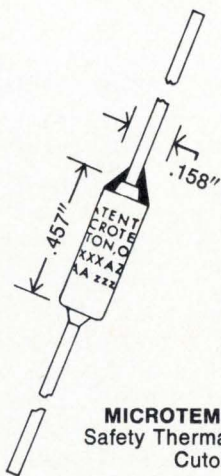

MICROTEMP
Safety Thermal
Cutoff

MICRO DEVICES CORP.
1881 Southtown Blvd. Dayton, Ohio 45439
Ph. (513) 294-0581 Telex: 28-8087

142 Circle 208 on reader service card

New products

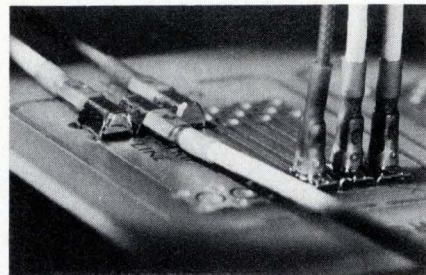

form melts, connecting the cable's shield to the body of the terminator. The shrinkable sleeve provides insulation, strain relief, and environmental protection.

Raychem Corp., Devices Division, 300 Constitution Dr., Menlo Park, Calif. 94025 [397]

Three-level circuit board reduces noise, crosstalk

A three-level metal-core circuit board handles very high thermal density and is said to reduce noise and crosstalk. With a metal substrate between dielectric coatings, the board has a built-in ground plane, allowing the elimination of ground lines on the board along

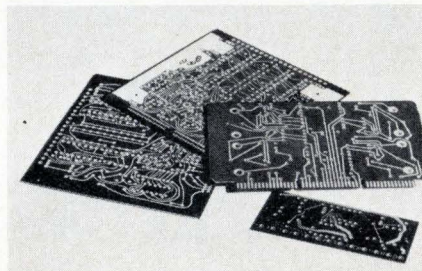

with their associated noise. And while the substrate is distributing heat over the entire board, it also shields against crosstalk from one side to the other.

International Electronic Research Corp., 135 W. Magnolia Blvd., Burbank, Calif. 91502 [398]

Terminal strip conforms to curved surfaces

A molded thermoplastic polyvinylchloride body, with flexibility to conform to curved surfaces or be cut by a sharp pocket knife to required

Electronics/September 5, 1974

The standard power supply is a minor consideration... until it fails.



One little power supply can put a big piece of equipment out of commission. And, that's when "bargain-level power" can get very expensive.

Besides downtime and repairs, the cost of 'unreliability' may also include some loss of reputation.

That's why it will pay you to take a good look at North. We've been the leading producer of custom power units for over 40 years. And our standard modules get the same reliability treatment—including rugged life tests, EMI analysis plus shock, vibration and humidity tests.

If reliability is worth more to you, send for a bulletin, or call your North Standard Power Manager at 419/468-8874.

Listed here are the more popular models—many other voltages are available.

MODEL	11000	12000	13000	14000	15000	16000	17000	18000
VDC	AMPERES							
5.0	3.9	5.3	11.3	13.0	20.0	32.5	49.0	82.0
12.0	2.8	4.2	8.0	10.5	15.0	23.0	36.0	58.0
15.0	2.4	3.7	7.5	9.5	14.0	20.5	27.0	47.0
18.0	2.1	3.3	6.0	8.0	13.0	18.0	26.0	40.0
24.0	1.5	2.8	4.2	7.0	11.0	15.0	21.0	33.0
28.0	1.4	2.4	4.0	6.3	9.0	14.0	20.0	29.0
36.0	1.2	2.2	3.1	5.6	8.0	11.0	14.0	23.0
48.0	.95	1.8	2.6	4.2	6.0	8.0	10.0	18.0

MODEL	10000
VDC	AMPS
0-7.5	2.10
0-16	1.25
0-25	0.85
0-33	0.68

DUAL OUTPUT SUPPLIES	
MODEL	N03052
VDC	AMPS
+15-12	400MA
MODEL	N60052
VDC	AMPS
+15-12	1.0A

SP-20

NORTH 
ELECTRIC COMPANY

North Electric Company / Galion, Ohio 44833 / A United Telecom Co.

Circle 143 on reader service card

General Controls' versatile family of printers

Fast Printouts from 1 to 20 digits on tickets or tapes—ink or pressure-sensitive printing!

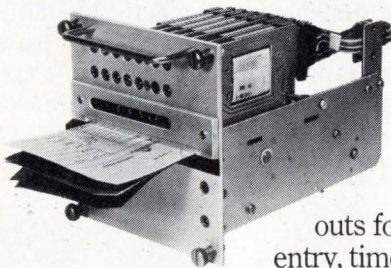

Versatility... Models are available that offer functions and printouts for totalizing, parallel entry, time/date indication,

BCD input, subtractive predetermining and additive predetermining which facilitate data monitoring functions beyond the scope that's been available.

Models offer anywhere from 1 to 20 digits in standard and custom frames. Each decade can be customized for you with

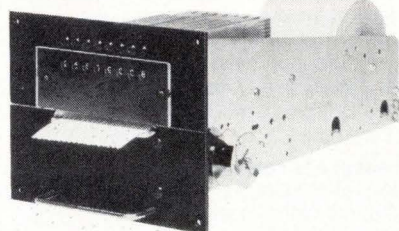

up to 12 letters or numbers to meet your particular read-out requirement.

Find out more about this advanced line of printers. For full information and

free catalogs, write or call

Manager, Printers/Counters, ITT General Controls, International Telephone and Telegraph Corporation, 801 Allen Avenue, Glendale, Calif. 91201. Telephone (213) 842-6131.



GENERAL CONTROLS 

Electronics for the 1980's.

At Lockheed we are embarked on one of the largest and most far-reaching R&D programs ever mounted. Our projects range from unique deep-sea vehicles to advanced spacecraft. From fleet ballistic missiles to new approaches in laser communications.

Our work spans the state-of-the-art in many disciplines and offers advanced assignments in telemetry, circuit design, microelectronics, environmental testing, microwave sub-systems and a wide variety of other activities. We need innovators, not imitators.

Thus our criteria for engineers and scientists is not only competence but imagination.

If you're an electronics engineer who wants to test the limits of his imagination, let's talk. Write the Professional Placement Manager, P.O. Box 504, Sunnyvale, CA 94088.

Lockheed is an equal opportunity F/M employer.

LOCKHEED

Missiles & Space Company, Inc.

Circle 144 on reader service card

New products

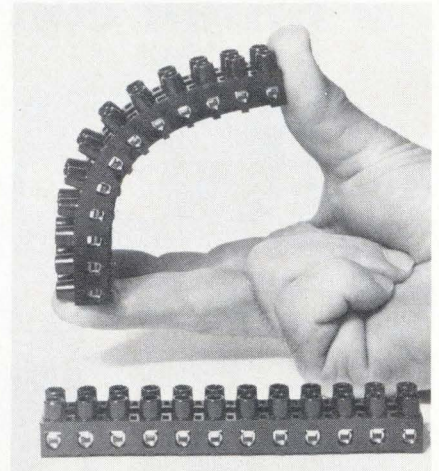

number of terminals, is called the EK series. It is suitable for use at temperatures up to 212°F and is rated at 20 amperes, 300 volts. The series is available in three types of 12-pole terminals—screw/screw, screw/solder lug, and screw/plug. The latter can be used for a plug and socket arrangement with the others. Length of the 12-pole terminal strip is 5 inches. Price is \$203.66 for 100 pieces.

Electrovert Inc., 86 Hartford Ave., Mount Vernon, N.Y. 10553 [399]

Tandem fastener strips
eliminate parts handling

Miniature tandem-type fasteners are designed to eliminate handling small loose parts and to limit parts loss. Produced in standard 35-piece tandem lengths, the strips serve as a handle for each individual fastener since they can be guided into an as-

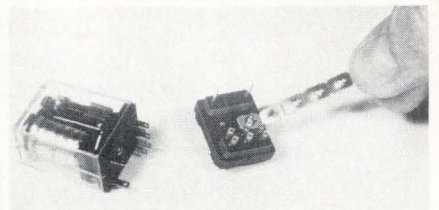

sembly location. The miniature tandems are available in low-carbon steel, with cadmium-electroplated finish as standard, also available in spring steel and stainless steel.

Eaton Corp., P.O. Box 6688, Cleveland, Ohio 44101 [400]

**CONNECTORS/
P.C.**

**JACKS &
PINS**

BERYLLIUM
COPPER
CAGES

CONCORD ELECTRONICS CORPORATION

37 GREAT JONES STREET NEW YORK, N.Y. 10012 (212) 777-8571 • TWX 710-581-4930

and
TEFLON*
**AND SOLDER
TERMINALS**

*DUPONT T.M.

SEND FOR CATALOG

Exclusive Economic and Industry Studies

**For Financial Analysts,
Corporate Planners,
Business Economists,
Marketing Executives**

Geared directly to the future, our Department of Economics offers more than 40 forecasting tools to help project the general economy and industrial growth over the short and long run.

EXAMPLES: Do you know that the current operating rate for the chemical industry is 86%? For synthetic materials, the utilization rate is 93%? That construction and mining machinery new orders are expected to be 8% higher in 1974 than in '73? That steel expects a 3% decline in physical volume of sales in 1974? That consumer income after taxes will increase 8% in 1975?

At a modest cost, our various services covering most industrial segments of the economy are available to you.

For more information write for our booklet, "Exclusive Economic Studies," or phone Douglas Greenwald, Chief Economist, (212) 997-2216.

Department of Economics
McGraw-Hill Publications Company
1221 Avenue of the Americas
New York, N.Y. 10020



GATES - INS4000, INS4001, INS4002, INS4011, INS4012,
INS4019, INS4023, INS4025

BUFFERS - INS4007, INS4009, INS4010, INS4049, INS4050

FLIP FLOPS - INS4013, INS4027

COUNTERS - INS4017, INS4018, INS4020, INS4022, INS4024,
INS4029, INS4040, INS14510, INS14516

REGISTERS - INS4035, INS4042

SWITCHES - INS4016, INS4051, INS4052, INS4201

MEMORIES - INS4061, INS4200

**ARITHMETIC
FUNCTIONS** - INS4008, INS4030, INS14581, INS14582

DECODER - INS4028

Our 4000 series SOS/CMOS are pin-for-pin compatible with the CD-4000 series, but ours are different. Different in that our 4000 series offer you the optimum balance between higher speed (three times faster than monolithic CMOS) and lower power dissipation (typically less than 10nW) than any other logic family. Different in eliminating SCR latch-up problems while the noise immunity remains 45% of supply voltage (3 to 15 volts).

Our INS4000 series is available in both military (-55°C to +125°C) and commercial (-40°C to +85°C) grades. Inselek also offers the INS4200

series of proprietary devices, including the INS4200 --- a 256 x 1 SOS/CMOS RAM, and the INS4201 --- a 4 x 4 cross point

switch. Check the devices you want above and then contact one of our authorized sales representatives or distributors below.

Sometimes being different is better!

HIGH SPEED CMOS



SALES OFFICES IN:
CONCORD, MASS. (617) 369-5298
LOS ANGELES, CALIF. (213) 889-2788
AUTHORIZED SALES REPRESENTATIVES
COAST TO COAST

Circle 145 on reader service card

DISTRIBUTORS:

CALIFORNIA, Westates Electronics, Chatsworth, (213) 341-4411 ● COLORADO, Electronic Parts Co., Denver, (303) 744-1992 ●
MASSACHUSETTS, Greene Shaw Co., Newtonville, (617) 969-8900 ● NEW JERSEY, Wilshire Electronics, Cinnaminson, (609) 786-8990
● NEW YORK, Summit Dist. Inc., Buffalo, (716) 884-3450 ● WASHINGTON, Sterling Electronics, Seattle, (206) 762-9100

1%
AMERICAN MADE
Tolerance
SCHAUER
1-Watt
ZENERS

**Immediate Shipment
Low Prices**

ANY voltage from 2.0 to 16.0

Quantity	Price each
1-99	\$1.07
100-499	.97
500-999	.91
1000-4999	.86
5000 up	.82



All welded and brazed assembly

No fragile nail heads

Gold plated leads

Write for complete rating data and other tolerance prices.

**Buy the kit-
Save a lot**



Kit contains a 51-piece assortment of SCHAUER 1% tolerance 1-watt zeners covering the voltage range of 2.7 to 16.0. Three diodes of each voltage packaged in reusable poly bags. Stored in a handy file box. Contact your distributor or order direct.

A \$54.57 value for
ONLY \$24⁵⁰

Semiconductor Division

SCHAUER
Manufacturing Corp.

4514 Alpine Ave. Cincinnati, Ohio 45242
Telephone: 513/791-3030

New products

Data handling

**Programing
PROMs fast**

Card for microprocessor user handles 8-by-256-bit unit in less than 5 minutes

Two things that make the life of a microprocessor user a lot happier are ease of programing and low cost.

For users of National Semiconductor Corp.'s IMP-16P, IMP-16L, or IMP-8P prototyping systems, the company is offering a PROM programmer card for use with its 8-by-256 and 8-by-512-bit PROMs that is said to provide both these features.

For example, the high-speed programing techniques inherent in the PROM programmer unit allow an 8-by-256-bit PROM to be programed, typically, in less than five minutes.

And, according to Phil Roybal, National's semiconductor marketing manager, this option—at \$750 each—costs less than 25% of the price of equivalent stand-alone PROM programers.

Contained on an 11-by-3-inch card, the programer plugs directly into a connector in the prototyping system, as shown in the photo at right above. No special wiring or power supplies are required.

Input power for the programer is supplied via its edge-connector pins from the +5 and -12-volt supplies of the prototyping system.

PROMs to be programed are easily connected into the programing circuits via low-insertion-force 24-pin PROM sockets, which are readily accessible on the exposed upper part of the programer.

In conjunction with National's prototyping systems the programer allows the user to:

- Edit and assemble the application program, using software which runs on the prototyping system (large-scale computers or time-sharing facilities may also be used).
- Debug the application program.



■ Load the application program into the system memory from paper tape or card reader, depending on the form of the program to be read into the PROM and on the type of peripheral devices available.

■ Program the PROM with the application program.

Also, the contents of an existing PROM or ROM may be read into the system memory and then copied into the PROM to be programed.

The input connector on the card contains 144 pins with 0.125-inch spacing.

National Semiconductor Corp., 2900 Semiconductor Dr., Santa Clara, Calif. 95051

**Data system transmits
at 2,400 bits a second**

A CRT data-entry and retrieval system permits stand-alone order entry, updating of customer files, and on-site storage of data at local offices. The System/500 batches data and, when polled by a central computer, automatically transmits the information over standard dial-up telephone facilities at speeds up to 2,400 bits per second. System/500 components include the Wiltek magnetic-card reader/recorder, the model 500 data-communications terminal, and a choice of three printers that operate at 10, 30, or 120 characters per second.

Wiltek Inc., Glover Ave., Norwalk, Conn. 06850 [363]

**Interface module links
PDP-11 with peripherals**

Designated the MDB-11C, a general-purpose interface module provides linkage between any DEC



**there's a way to be sure
of controlled-expansion
alloys that meet your
fabricating requirements**

Uniform quality, time after time. Optimum fabricability in every production process. Full range for every application. Yours with Carpenter controlled-expansion alloys. Complete selection of low and high expansion, as well as glass- or ceramic-sealing grades for stamping, deep-drawing, etching, forming or coining. Excellent fabricability, high quality surfaces, uniform temper, minimum orange peel and camber in every grade. Like Kovar®, the most widely used glass-sealing alloy, and more. Result: predictable production on every job.

To put it all together, call your nearest Carpenter Service Center. Carpenter Steel Division, Carpenter Technology Corporation, Reading, Pa. 19603. European Office: 51, Square Vergote, 1040 Brussels, Belgium.

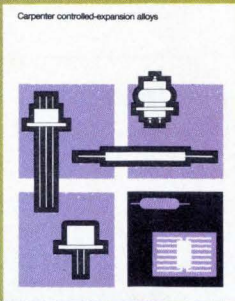

For more details, ask for this helpful new booklet on Carpenter controlled-expansion alloys.

CARTECH CARPENTER
TECHNOLOGY
CARPENTER STEEL DIVISION

**Carpenter
For Sure**



A LOT OF I-C HANDLER FOR \$1200

The Ramsey Model RH-202 Manual I-C Handler provides an easy, inexpensive way to automate your I-C testing. It's completely self-contained... requires no air or power. It's versatile... accommodates a variety of different package configurations, 6-through 18-pin, or 24-through 40-pin. It's dependable... the design is simple, straightforward and rugged. Precious metal contacts are individually replaceable. It incorporates a performance board for bypassing and decoupling for device compensation. As we said before, it's a lot of I-C Handler for the money. For information, write or call Ramsey Engineering Company, Electromechanical Products.

RAMSEY 
ENGINEERING COMPANY
ELECTRO-MECHANICAL PRODUCTS

1853 W. County Rd. C, St. Paul, Mn. 55113 • Phone: (612) 633-5150
 Cable: RAMCO TWX: 910-563-3553 TELEX: 29-7001

Circle 148 on reader service card

ECONOMICAL PROGRAMMING IS HERE

A 10 x 10 MATRIX BOARD
FOR UNDER \$15.00, SINGLE QTY.

AVAILABLE FROM STOCK

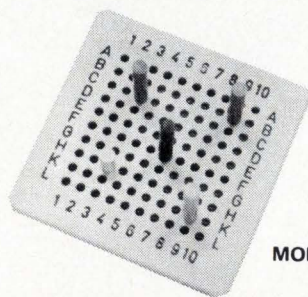

MONOMATRIX



ONE OF THE PURDY GROUP OF COMPANIES

770 Airport Blvd • Burlingame, Ca 94010 (415)347-8217

148 Circle 211 on reader service card

New products

PDP-11 series Unibus and almost any peripheral. The MDB-11C requires a single quad mount and draws its power directly from the central processing unit (550 milliamperes at +5 volts). In addition, it adds only one bus load per Unibus signal. Device-addressing logic (up to 16 sequential addresses), interrupt-control logic (two separate control and vector addresses), and separate 16-bit input and 16-bit output registers are offered. There are

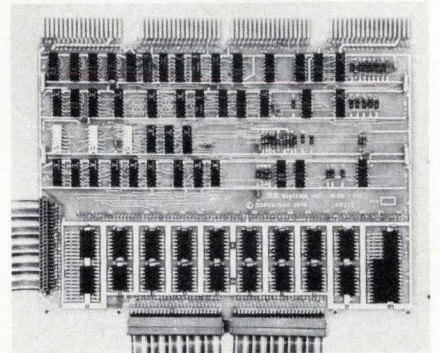

also 20 wire-wrap positions provided for 14- or 16-pin sockets or ICs or 18-, 22-, 24-, 24-, or 40-pin MSI/LSI chips. All wire-wrap is on the component side, allowing standard board-spacing. Basic price is \$390.

MDB Systems Inc., 981 N. Main Street, Orange, Calif. 92667 [365]

Graphics interface plots
from 256 to 1,024 points

A graphics interface, called the BP-734 timeshare serial graphics interface, plots from 256 to 1,024 points and/or vectors on any oscilloscope or larger X-Y display. No mechanical or electrical modifications are required on either the time-sharing terminal or the oscilloscope. To use, the engineer applies RS-232-compatible serial data to the data-set connector, switches to the desired



Electronics/September 5, 1974

SIEMENS

Brushless DC Motors: Make reliable products more reliable.

Because they're *brushless*, Siemens DC motors last as long as their bearings. Bearings last much longer, too, because there's no brush carbon dust.

Because they're *brushless*, Siemens DC motors can run for 20,000 hours and never cause any trouble. Even if the motors lay idle for a year, they'll start immediately, because no oxidation can take place. Periodic service and replacement is eliminated.

Because they're *brushless*, Siemens DC motors can be used in explosive atmospheres. There's no arcing or sparking.

Because they're *Siemens*, these brushless DC motors are the highest quality and come in the most complete range of power sizes available from stock. Siemens pioneered brushless DC motors. And Siemens will give you the benefit of years of application experience, by advising and assisting you with electronic circuit design for your individual needs.

Your high-quality electronic equipment will benefit from Siemens brushless DC motors. Siemens will show you how. Call or write Siemens Corporation, Power Engineering Division.



Siemens Corporation
Power Engineering Division

186 Wood Avenue South, Iselin, New Jersey 08830 (201) 494-1000

We built 100 of these

Computer peripheral
equipment circuit.

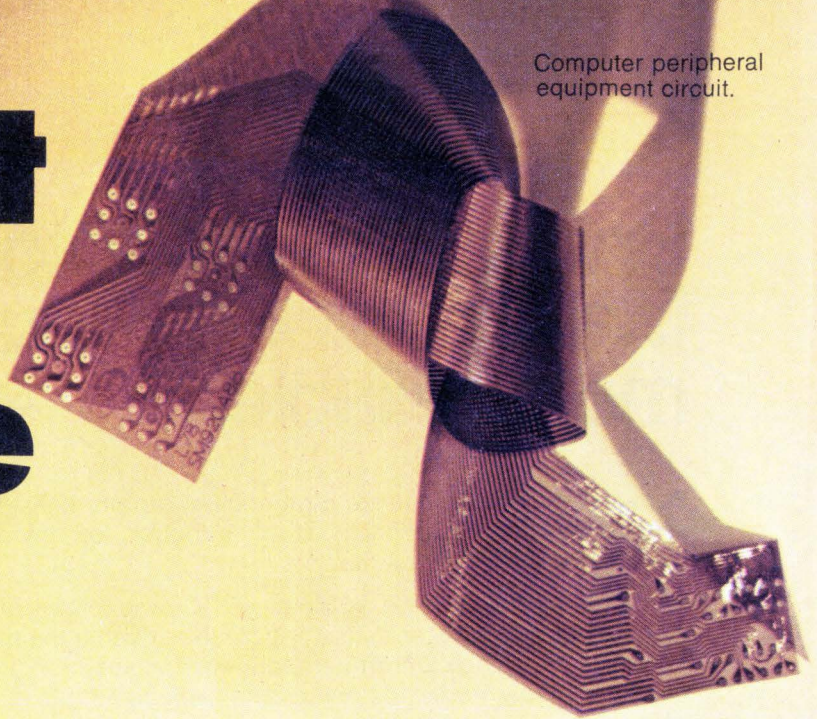

We're known for building flex-circuits for high volume users. Ford Motor Company, Kodak, Texas Instruments.

But you probably didn't know we have an excellent new, short run facility too. A separate and specialized facility designed specifically to handle smaller quantity orders economically.

You don't have to be a big name or pay a big price to put Sheldahl's technology and experience to work for you.

We offer all the same capabilities on short runs — single or double sided circuits, plated-thru holes, reflow coated circuits, solder plated conductors, solder fused pads, film or epoxy cover coated circuits, back-bared pads, flexcircuit-hard-board hybrids.

If you are designing a new product, revising an old one, building a series of prototypes or have any application where your flexcircuit quality and tech-

nology needs are high but your volume requirement is low, give us a call. Our new short run manufacturing facility is made to order for you.

Low volume, flexcircuits fast, economical, and with the Sheldahl name behind them. What more could you ask for?



Sheldahl

Electrical Products Division
Northfield, Minnesota 55057
Phone: (507) 645-5633

The state of the art people in flexible circuits.

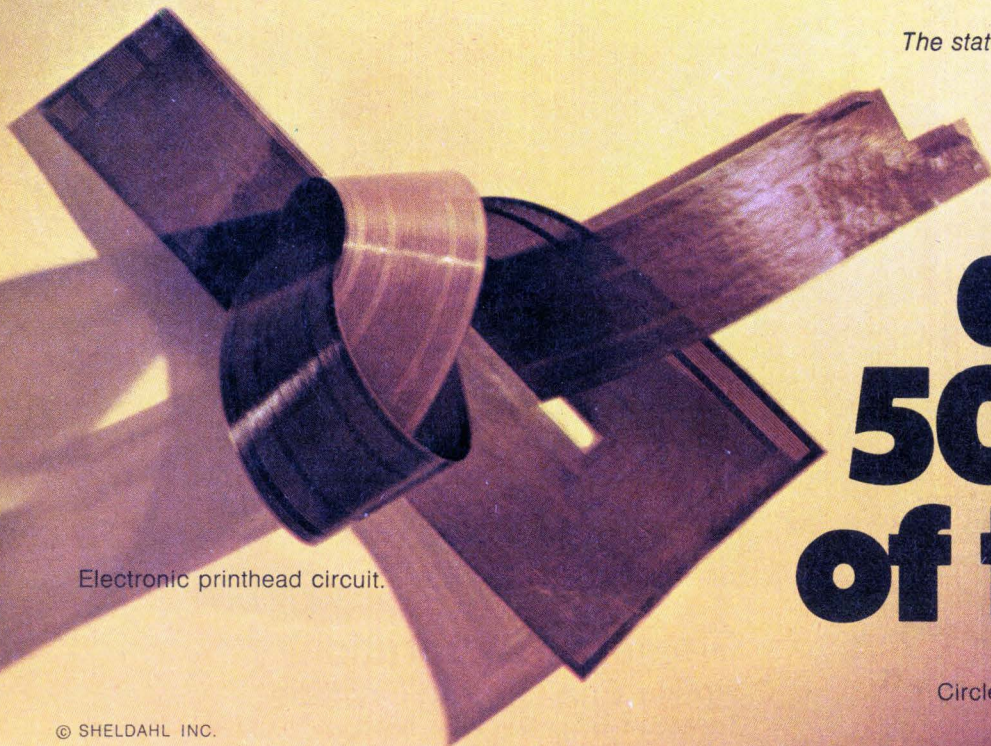

Electronic printhead circuit.

and 50,000 of these.

Circle 150 on reader service card

New products

baud rate (10 or 30 characters per second) and connects to the display unit. Additional switch-selectable rates to 2,400 b/s are available for direct serial connection to a local computer. Prices range from \$1,595 for the 8-bit model, with 256-vector capacity, to \$2,495 for the 10-bit model, with 1,024-vector capacity.

Megatek Corp., 1055 Shafter St., San Diego, Calif. 92106 [367]

Microprocessor systems are intended for custom designs

The models DL-8 and DL-16, 8-and 16-bit microprocessor computer systems are designed for building customized systems. The DL-8 and DL-16 each consists of four major

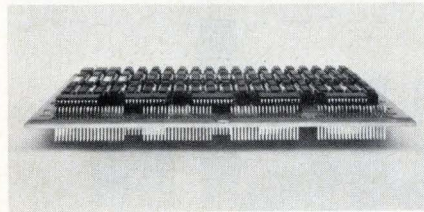

elements: a central processor, power supply, control panels with displays, and finished cabinet. Both systems can be ordered without microprocessors, chips or other IC elements, but are wired and tested so that customers can insert their own ICs. The units provide I/O channels of up to 128 input and output ports of 4, 8, or 16 bits. Prices start at \$395 for a completely wired central processor.

Data Numerics Inc. 141-A Central Ave., Farmingdale, N.Y. 11735 [368]

Printer operates at 100 characters/second

Called the Sidewriter, the model PR1021 printer produces characters sideways at a throughput of 100 characters per second. The company claims the unit has 50% fewer parts than equivalent printers, which yields cost-savings. Adaptable for broad applications, the Sidewriter is particularly designed for use with

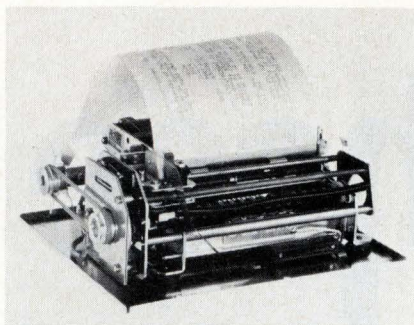

80-column CRT-display terminals, communications printers, instrumentation, and computer terminals. Price ranges from \$287 to \$128, depending on quantity.

Elec-Trol Inc., 26477 N. Golden Valley Rd., Saugus, Calif. [369]

Tape-cartridge system uses 3M drive, controls

The WL300A tape-cartridge formatter that is contained inside the 3M DCD-3 door-loaded cartridge drive, is also offered with interfaces to the PDP-11 or Nova computers or to an RS232 interface. The formatter is located on two modules that replace the usual data electronics and direction control modules supplied by 3M; one set of modules controls up to four DCD-3 drives. The formatter automatically inserts the preambles, postamble, and cyclic redundancy check according to the proposed ANSI X3BI/626 cartridge specification. All timing is crystal controlled so that no one-shots are used. The complete system for the PDP-11 or Nova, including an embedded computer interface, is priced at \$2,712.

Wilson Laboratories Inc., 2536-D East Fender Ave., Fullerton, Calif. 92631 [370]



NEREM 74 SEMINARS IN BOSTON

COMPUTERS AND COMMUNICATIONS SEMINAR

Seminar Chairman: J. Prendiville, New England Telephone Co., Boston, MA

Wednesday and Thursday, October 30 and 31

Commonwealth Ballroom of the Sheraton-Boston Hotel

9:30 am, Wednesday

S-9 COMPUTER CONTROL IN SUPERVISION IN COMMUNICATIONS

Chairman: W. B. Groth, IBM Corp., White Plains, NY

A COMPUTERIZED TOLL TICKETING SYSTEM — J. R. McHugh, IBM Corp., Boca Raton, FL

STORED PROGRAM CONTROL OF A KEY/PABX BUSINESS COMMUNICATION SYSTEM — J. G. Miacak, Bell Northern Research, Ottawa, Ontario

ROLE OF COMPUTERS IN MOBILE DATA COMMUNICATION SYSTEMS — A. M. Goldstein, Motorola, Inc., Schaumburg, IL

INTERNATIONAL DIGITAL DATA SERVICE/COMPUTER APPLICATION — K. M. Jockers, Western Union International, Inc., New York, NY

2:00 pm, Wednesday

S-10 COMPUTERS/HELPING THE COMMUNICATIONS INDUSTRY DO A BETTER JOB

Chairman: R. C. Cady, Digital Equipment Corp., Maynard, MA

MINICOMPUTER AIDED TRAFFIC MEASUREMENT AND ANALYSIS — J. Mannino, Applied Data Research, Inc., Princeton, NJ

MINICOMPUTERS IN A TELEPHONE OPERATING COMPANY/THE IMPACT ON MANAGEMENT AND ORGANIZATION — G. A. Barletta, New York Telephone, New York, NY

MINICOMPUTERS ENHANCEMENT TO TELEPHONE SWITCHING MAINTENANCE SYSTEMS — C. J. Many, Bell Telephone Labs, Holmdel, NJ

MINICOMPUTER CONTROLLED MEASUREMENT OF VOICE BANDWIDTH TRANSMISSION CIRCUIT PARAMETERS — I. E. Hardt, Collins Radio Co., Cedar Rapids, IA

9:30 am, Thursday

S-11 NEW COMMUNICATIONS SERVICES

Chairman: R. Alter, Packet Communications Inc., Waltham, MA

DATAPHONE DIGITAL SERVICE — C. F. Stuehr, AT&T Co., New York, NY

DATRAN'S SWITCHED DIGITAL NETWORK — E. V. Farinolt, Data Transmission Co., Vienna, VA

PACKET-SWITCHED DATA COMMUNICATIONS SERVICES — L. R. Talbert, Packet Communications Inc., Waltham, MA

PANEL DISCUSSION

2:00 pm, Thursday

S-12 PRACTICAL ASPECTS OF COMPUTER COMMUNICATIONS SYSTEMS

Chairman: S. M. Isaacs, State Street Bank and Trust Co., Boston, MA

REAL TIME AND BATCH TRANSMISSION SYSTEMS PROJECT MANAGEMENT/ARE THEY REALLY DIFFICULT? — I. H. Derman, National BankAmericard, Inc., San Mateo, CA

SWITCHING, PATCHING, MONITORING AND TESTING AT THE EIA DATA INTERFACE — R. B. Sepe, A. Lucci and R. A. D'Antonio, International Data Sciences, Inc., Providence, RI

WHEN TO USE PABX'S IN DATA NETWORKS — M. F. Roetter, A. D. Little, Inc., Cambridge, MA

THE COST OF SECURITY IN COMPUTER-COMMUNICATIONS SYSTEMS — D. W. Lambert, MITRE Corp., Bedford, MA

REGISTRATIONS REC'D BY OCT. 15TH

IEEE Members \$80 Non-Members \$99

REGISTRATIONS REC'D AFTER OCT. 15TH

IEEE Members \$95 Non-Members \$125

Registration fee includes one copy of the Seminar Proceedings and free registration to general program and exhibits.

Comp-Com

Name _____

Address _____

Checks payable to: NEREM-74

31 Channing St. Newton, MA 02158

**All those little
wires have been
pushed around
long enough.**

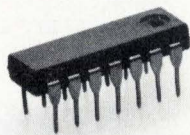

Until now, all those wires have been at the mercy of packaging materials that expand when things get hot.

So we developed new Dow Corning® 480 semiconductor molding compound.

Dow Corning 480 has a low coefficient of thermal expansion.

So it virtually eliminates the hot intermittent open. And moisture penetration.

Which means that an integrated circuit stays integrated. Through all sorts of temperature and atmospheric extremes.

But that's not all that's different about 480 molding compound.

Its resistance to salt spray is excellent.

And it reduces your packaging costs because it saves time. Molding times are short—less than one minute for some components. Post curing is unnecessary.

Of course, Dow Corning 480 molding compound also has the advantages of our other silicones. Consistency. Long shelf life. Less cleaning downtime because there's no buildup. Non-flammability. And, because it doesn't irritate skin, there's no need for special handling.

Dow Corning 480 semiconductor molding compound is the kind of improved product you can expect to keep getting from Dow Corning. Our Technical Service and Development Department has more manpower and greater technical facilities than any other in the industry.

If you want to know more about 480, call us at 517 636-8000, or write Dow Corning Corporation, Dept. B-4334, Midland, Michigan 48640.

DOW CORNING



New products

Instruments

Meter displays engineering units

Process indicator converts analog voltages into 4-digit readout of chosen units

Although some process-control display systems read out directly in engineering units, Schneider Electronics Inc. has found that many users still have to measure and display a transducer's output voltage instead of the variable they really want to study. Therefore, the company will introduce at Wescon, Sept. 10-13 in Los Angeles, a process indicator—the ic 400—which can measure any variable represented by an analog voltage and display it digitally in any chosen units.

This capability is provided by a scaling factor that is continuously adjustable from 0.5 to 2, and by a strap-selectable decimal-point position for the four-digit display. The adjustable scale factor is set by an easily accessible potentiometer. The user can set it himself or, if he knows what factor he will use in advance, it can be set at the factory. For instance, if input voltage is between 0 and 2 volts and the scale factor is 0.5, the unit displays digits from 0 to 1,000 with resolution of 2 millivolts. Full-scale length of the ic 400 is 2,000 digits. The standard input range is from 0 to 2 v, with resolution between 500 microvolts and 2 mV. Resolution of the optional 0-

0.2-v range is specified at 50 to 200 μ V.

The ic 400 has a built-in constant current source for exciting external sensors, and it provides an analog current output proportional to the input signal. This is used for either recording or regulating since much regulation equipment, for instance in the petrochemical and oil industries, measures in current. Parallel binary-coded decimal output is optional. Two measurements can be made per second. Input impedance is 10 megohms, offset current is 10 nanoamperes.

Temperature coefficient is less than 150 ppm/°C between 0° and 50°C, the operating temperature range.

The unit is protected against surges as great as ± 100 v for 1 minute without damage. Accuracy is within $\pm 0.2\%$ of reading $\pm 2\%$ of range. Zero drift is 1 mV for $\pm 25^\circ$ C variation in relation to ambient temperature. A zero-shift capability allows the user to displace the origin of a signal by ± 500 mV.

The ic 400 sells for \$450. Delivery time is 8 days.

Schneider Electronics Inc., 11 Riverside Ave., Medford, Mass. [351]

Events-delay counter views pulse trains without jitter

For troubleshooting asynchronous logic systems, a delay-by-events counter is a particularly useful instrument. Though time may be difficult to predict precisely, the number of "clocking" events in a pulse train is usually known and can easily be set on the counter's thumb-wheel switches.

Tektronix Inc. has added such a counter to its TM 500 line of modular test instruments. The company says that jitter is not a problem because the plug-in unit, called the DD 501 digital delay, creates delay by counting pulses rather than by timing an interval. In normal operation, an independent trigger signal is used to initiate a count. Events can be counted at frequencies up to 65 megahertz. The unit can also



serve as a divide-by-n counter; response extends to 40 MHz in this mode.

Using five thumbwheels on the control panel, the operator can set the delay for any digital count from 0 through 99,999. When the number of input pulses reaches the preset count, the DD 501 will deliver a pulse that can trigger an oscilloscope. Meaningful measurements can be made on data trains up to 100,000 bits long.

Together with a TM 501 power module, the digital-delay module forms a portable means of providing a scope with delay-by-event capability in any application where long trains of serial data are handled. Examples include viewing selected information in data communications, examining data transfer from peripherals to a central processor, and studying individual indexing pulses or data segments in disk, drum, or tape memory systems. In rotating memory systems, the company points out, the jitter cause by mechanical speed variations is eliminated. Price of the DD 501 is \$495.

Delivery time is two weeks.

Tektronix Inc., P.O. Box 500, Beaverton, Ore. 97005 [352]

Signal generators' range extended to 1,024 megahertz

Hewlett-Packard 8640 a-m/fm signal generators are now optionally available with an internal extension band of 512 to 1,024 megahertz (with overrange to 1,100 MHz). When the high band (512 to 1,024 MHz) is included, the generators are



designated HP 8640A Option 002 (dial readout of frequency) or HP 8640B Option 002 (digital readout).

The digital-readout version contains a built-in 550-MHz counter, plus internal synchronization to phase-lock the carrier frequency to a crystal reference. Output in the range of 512 to 1,024 MHz is +13 to -145 dBm into 50 ohms and is leveled to ± 1.5 dB.

Amplitude modulation is possible to 100% with a modulating signal up to 50 kHz. Frequency modulation is provided with calibrated peak deviation to 5.12 MHz and rates to 250 kHz. Externally pulsed outputs offer less than 1-microsecond rise and fall times and a 60-dB on-off ratio. Price of the 8640A (dial readout) with Option 002 is \$4,950 and the 9640B (digital readout) with Option 002 is \$6,450. The model 11698A field-modification kit costs \$750.

Hewlett-Packard Co., 1501 Page Mill Rd., Palo Alto, Calif. 94304 [353]

Voltage standard is also a precision source

The TB100 voltage standard provides dc voltage in three ranges: 1, 10, and 100 volts full scale. Calibrated voltages are set and displayed by four decades of thumb-wheel switches. The unit also provides up to 10 mA of output current at less than 50 milliohms output im-



pedence with accuracy to within $\pm 0.01\%$ of range $\pm 0.02\%$ of setting, based on a precision zener reference. If excessive output current is taken, an overload indicator lights up. The output is isolated from the case, and polarity can be reversed by a front-panel switch with a short-

There's a world of difference between Dow Corning and the other semiconductor packaging-materials suppliers.

The difference is that only Dow Corning has available worldwide a complete line of silicone molding compounds, an accomplished technical service and development team, the advantage of a completely compatible product line, and the convenience of worldwide delivery and service. If you want to give your packaging operation a competitive advantage, just call or write. One of our representatives is nearby.

J. Guillot
DOW CORNING S.A.R.L.
140, Avenue Paul Doumer
92500 Rueil Malmaison
France
Telephone: 977.00.40

M. Tedone
DOW CORNING SpA
Viale Restelli 3/7
20124 Milan, Italy
Telephone: 688.2458

ASIA

H. Takahashi
DOW CORNING ASIA LTD.
P&O Building, 9th Floor
21 Des Voeux Road, C.
Hong Kong
Telephone: 5-258035

H. Hotta
DOW CORNING ASIA LTD.
Room 803, Cathay Building
Mount Sophia
Singapore - 9
Republic of Singapore
Telephone: 321213-5

AUSTRALASIA

H. Tuynman
DOW CORNING AUSTRALIA PTY. LTD.
36 O'Dea Avenue
Waterloo, N.S.W. 2017
Sydney
Telephone: 699 8055

P. Winter
DOW CORNING AUSTRALIA PTY. LTD.
103 High Street
Prahran, Vic. 3181
Telephone: 51 5450

Dow Corning semiconductor molding compounds...quality and dependability worldwide.

B-4335

NORTH & SOUTH AMERICA

Resins and Chemicals Marketing
DOW CORNING CORPORATION
Midland, MI 48640
Telephone: 517 636-8682

EUROPE

R. Hediger
DOW CORNING INTERNATIONAL LTD.
Chaussée de La Hulpe 177
1170 Brussels, Belgium
Telephone: 73.80.60

B. Sneddon
DOW CORNING LTD.
Reading Bridge House
Reading RG1 8PW
Berkshire, England
Telephone: Reading 57251

R. Jones
DOW CORNING GmbH
1150 Vienna
Mariahilferstrasse 180/4
Austria
Telephone: 83.85.38

S. Haberer
DOW CORNING GmbH
8000 Munchen 50
Pelkovenstrasse 152
West Germany
Telephone: 14.861

DOW CORNING

DOW CORNING

New products

ing off-position. Price of the TB100 is \$395.

Zi-Tech Division, Aikenwood Co., 223 Forest Ave., Palo Alto, Calif. 94301 [357]

Sweep/function generator covers 0.1 Hz to 1 MHz

The model 196 sweep/function generator produces sine, square, triangle, ramp, pulse and swept waveforms, as well as a ramp sync output and a separate transistor-transistor logic pulse output. Its fre-



quency range is 0.1 Hz to 1 MHz in seven ranges with 20-volt peak-to-peak output amplitude. The unit has an internal sweep generator, which will sweep from zero to 1,000:1 (3 decades) width at rates adjustable from 1 millisecond to 10 seconds. The operator can sweep either narrow or wide band. Price of the generator is \$350.

Exact Electronics Inc., Box 160, Hillsboro, Ore. 97123 [355]

Multimeter has five dB measurement ranges

Offering five standard multimeter functions, plus five decibel-measurement ranges extending from -60dB to +56dB, the model 2180 digital multimeter has an accuracy to within 0.1% and resolution of 100



microvolts. Button-selected functions include ac volts, dc volts, ac current, dc current, resistance, and decibel. The 31 measuring ranges are selected by rotary switch, with an additional battery-check position that allows the internal battery condition to be monitored. The integral automatic battery-charging circuit will maintain a full charge as long as the instrument is connected to the ac line. Price is \$395.

United Systems Corp., 918 Woodley Rd., Dayton, Ohio [358]



Patent Pending.

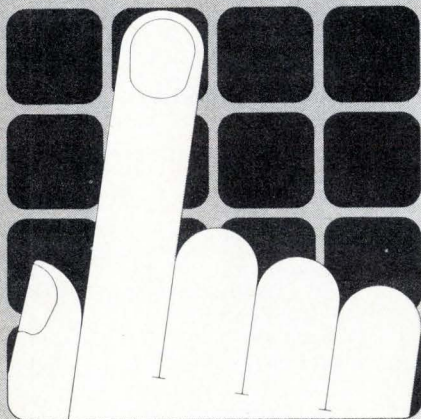

it's what's under the cap that counts

Stackpole economical Lo-Pro™ keyswitches are setting a new standard of value in cost-conscious applications like desk top calculators, data terminals, and communications equipment.

- completely enclosed switch with only 6 parts.
- coil spring cross point contacting with controlled wipe.
- specially designed terminal, base and housing protect against flux contamination.
- less than 7/16" body profile, .160" or optional .100" total stroke, latch or momentary.

Check under the Stackpole cap. You'll find pace-setting low initial cost, functional long life, and operating accuracy. Write for Bulletin No. 77-103. Stackpole Components Company, P.O. Box 14466, Raleigh, N.C. 27610. Phone: 919-828-6201.



STACKPOLE
COMPONENTS COMPANY

Instrumentation recorder
gives choice of five speeds

A laboratory instrumentation recorder designated the series 120A recorder/reproducer offers a choice of five tape speeds and two reel sizes. It operates at standard speeds



from 15 to 15/16 inches per second and uses either 7-inch or 10½-inch NAB reels of quarter-inch tape. Almost all the switching circuitry is solid-state in plug-in modules. Inputs may be either direct or fm; any arrangement of four input channels may be made. Bandwidths are 70 hertz to 64 kHz (direct) and dc to 5 kHz (fm) at 15 in. One option includes voice input for annotation on one direct channel.

3M Co., P.O. Box 33600, St. Paul, Minn. 55133 [359]

Strip-chart recorder
offers linearity within 2%

A servo-operated strip-chart voltage recorder, with a sensitivity of 100,000 ohms per volt, called the model CR-500, has five ranges, from

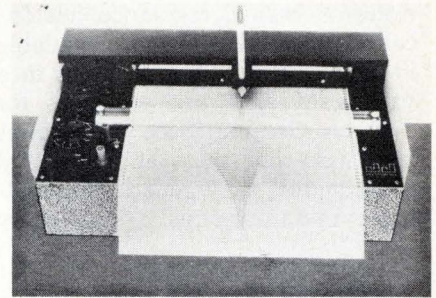

10 millivolts to 100 volts, accuracy to within 1.0%, and linearity within 2.0%. The chart paper, 270 millimeters wide, is driven at any of nine electronically controlled speeds, from 1 mm per minute to 10 mm per second, and the marking device can be a standard felt-tip pen. Other features include zero shift control and remote-operated event marker. Hampden Engineering Corp., East Longmeadow, Mass. 01028 [360]

new...



...square subminiature rotary switch

Here's a new subminiature rotary switch design with all the reliability and flexibility of Stackpole's larger rotaries . . . for logic circuitry where space is at a premium and quality is of prime importance.

- only 9/16" across the body, 13/16" maximum width across terminals.
- square design provides maximum support of solder lugs or optional P.C. pins.
- fully enclosed Stackpole environment-proof package with rugged coil spring, dual ball index mechanism.
- shorting and non-shortng, articulated contacts in silver or gold plated brass or silver alloy.
- 30°, 60°, and 90° index angles, up to 9 decks with 2 modules per deck.
- BCD or special encoding available.
- priced under \$2.00 per switch in 1000 quantities.

Write on your letterhead for a sample of this revolutionary new switch which will be available in late 1974. Stackpole Components Company, P.O. Box 14466, Raleigh, NC 27610. Phone: (919) 828-6201.

 **STACKPOLE**
COMPONENTS COMPANY

New products/materials

Adhesive-backed resistance heaters, called Stik-on Heaters, are available in square and ribbon versions in a variety of sizes and wattages for 115-volt circuits. Since the heaters have very low mass and offer foil construction, they generate heat almost instantaneously, uniformly

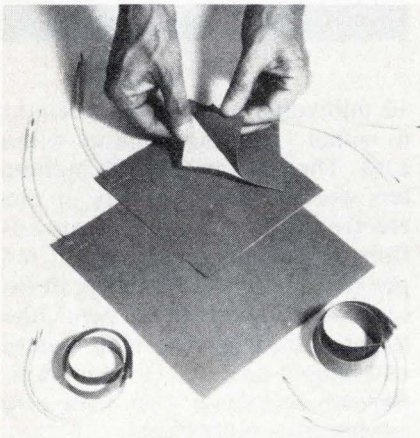

over the entire surface. Applications are in consumer electronics, aerospace, and industrial areas.

Sierracin/Thermal, 13920 South Broadway, Los Angeles, Calif. 90061 [476]

Eccosorb CR and **Eccosorb CR-S** are magnetically loaded casting resins for producing microwave-absorbing components in place in waveguides, coaxial lines and strip-lines. The materials can therefore make shapes that are difficult to machine from solid stock, and provide electromagnetic isolation between enclosed closely packed components. Specific resins are available for different values of impedance and attenuation at various frequency bands that range from below 100 megahertz to above 10 gigahertz.

Emerson and Cuming Inc., Canton, Mass. 02021 [477]

Called **Sermabond HCG**, a process for metalizing ceramic and glass electronic components uses an inorganic coating containing aluminum microspheres as the filler in a conductive ceramic matrix. The coating bonds to glass or ceramics for electroding and assembling applications. It can also be used to make hermetic glass-to-metal seals and to make thick-film printed circuits.

Teleflex Inc., Box 187, North Wales, Pa. 19454 [478]

A mildly activated resin-core solder, designed for high-speed soldering of electronic assemblies, is called material 381 RMA. The solder leaves a nonconductive and insulating flux residue and has wetting properties almost equal to those of type RA activated core solders. The material is good for all metallic surfaces that are clean and oxide-free. Moreover,

need an inductor? check these facts about ferrites

FACT 1: cost of ceramic ferrites is 1/10 of steel alloys for low frequency applications, yet ferrites offer extremely high resistivity and low coercive force.

FACT 2: for power applications, ferrite cores can operate at higher frequencies than laminated steel with better permeability and higher Q.

FACT 3: higher perm ceramic ferrite inductors require fewer turns, resulting in lower distributed capacity, material savings, and improved performance.

FACT 4: as the country's largest producer of ceramic ferrite material, Stackpole offers unique mold-to-size capability, numerous tooled shapes, and its Ceramag® family of materials for frequencies from 1.0 KHz to 400.0 MHz and permeabilities from 7.5 to 7500.

Call for help. Stackpole Carbon Company, Electronic Components Div., St. Marys, Pa. 15857. Phone: 814-781-1234. TWX: 510-693-4511.



STACKPOLE
ELECTRONIC COMPONENTS DIV.

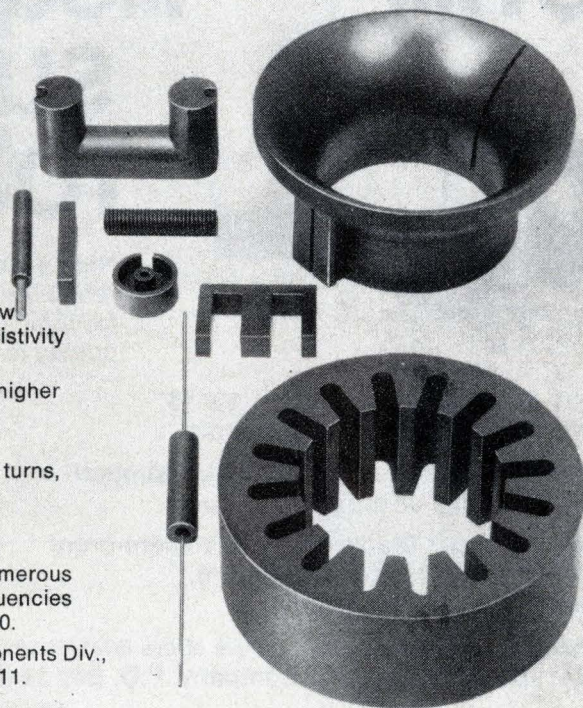

the flux residues are nonhygroscopic and offer high resistance, so they do not have to be removed from most assemblies.

Multicore Solders, Westbury, N.Y. 11590 [479]

Available in nominal 25°F increments, surface temperature standards are calibrated to a specific temperature near the nominal to an accuracy within $\pm 1^\circ\text{F}$. Applications include calibration of hot-stage and gradient-bar melting-point apparatus, ovens, thermocouples, and a variety of instruments and other devices where accurate knowledge of surface temperature is necessary. The materials, which are traceable to the National Bureau of Standards, are all stable, low-vapor-pressure compounds, available in granular and liquid forms. They are supplied in kits of 10 standards,

having a range of from -25 to 350°F and 375 to 600°F . Price is \$49.50 per kit.

Omega Engineering Inc., Box 4047, Stamford, Conn. 06907 [480]

Zinc single crystals of 99.999% purity are grown in crucibles and are available in rods ranging in diameter from $\frac{1}{4}$ to 2 inches and in lengths of 1, 2, 4 or 6 in. The crystals are supplied with random orientation, but specific orientations within 1° of major axis 100, 110, and 111 are also available. A typical 1-in. crystal with a $\frac{1}{4}$ -in. diameter is priced at \$175. One 2-in. in diameter and 6-in. long is priced at \$1,200.

Aremco Products Inc., Box 429, Ossining, N.Y. 10562 [401]

A filler metal intended as a silver-brazing paste contains 30% silver and is suitable for applications

where joint material cost is the prime consideration, since the percentage of silver in this filler reduces the cost of the paste. The material is a powdered type mixed in a flux-binder combination and is adaptable to all heating methods.

Fusion Inc., Willoughby, Ohio [402]

A diffusant source of boron and phosphorus is supplied in the form of thin-film wafer preforms in sizes to conform with the diameters of silicon wafers. These diffusant preforms act as an infinite diffusant source that yields more than 10^{20} surface concentration of boron and phosphorus atoms. Offered are boron-1020B, p-type and phosphorus-1020N, n-type in all sizes up to 4 inches in diameter. The 2-inch-diameter preforms are priced at 8 cents each in production quantities.

Transene Co., Rte. 1, Rowley, Mass. [403]

low cost circuit protection against high voltage/high energy surges

Stackpole Special Purpose Resistors (SPRs) help protect systems where high energy surges and high voltages would destroy valuable equipment. Check these characteristics:

- Best solution for protecting against high voltages in limited space.
- Unlike wire-wound resistors, SPRs are non-inductive, can be made in rods, rings, discs, or sleeves with wire leads or metal contacts.
- SPRs do not fuse out; they return to nominal value after absorbing the energy surge.
- Maximum voltage gradient 10 kilovolts/in., resistivity range from 2 ohm-cm. to 10,000 ohm-cm.

Write on your letterhead for samples to test in your next system design. Stackpole Carbon Co., Electronic Components Div., St. Marys, Pa. 15857. Phone: 814-781-1234. TWX: 517-693-4511.



Bulletin No. 83/84-101 gives full specification data, size ranges and application guidance. Ask for it.

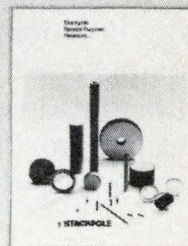

GEORGIA. THE LOW-RISK STATE FOR ELECTRONICS.



Selecting a new plant site can be a highly speculative venture. Particularly in an unsure economy.

In Georgia, we're organized to lower your risks. Working with all other state-wide developers, we'll thoroughly review your company's individual needs. And conduct research based on those needs.

If worldwide shipping is crucial to your business, we'll include information on our international air terminal. And on our deep water

ports, which are efficiently operated by Georgia Ports Authority.

We'll give you an honest analysis of all pertinent information. Then, using computers, we'll match available plant sites and buildings with your requirements.

You'll have all the facts. Up front. So that when you make your decision, there'll be little room for doubt. Want to know more about our confidential site selection program? Mail in the coupon today.

Georgia Department of Community Development
Industry & Trade Division, Dept. EL-52
Box 38097
Atlanta, Georgia 30334



Name _____

Title _____

Company _____

Street _____

City _____ State _____ Zip _____

GEORGIA.
WE MEAN BUSINESS.

Our new Series-500 Logic-Circuit Testers say so. Loud and clear. They are: fully portable, fully automatic, with both random and programmable patterns, at quantity prices as low as \$5,950!

Correct. The whole bag. In a "suitcase."
For tens of thousands of dollars less than previous production test systems.

There's more.
Program compatibility with most other test systems. Superior fault-isolation techniques. Unusually high test rates and dynamic resolution.
Low cost program preparation.

Questions? Fire away. Need literature? Just write. Trial sales? We have those too. It's a whole new way to look at logic circuit testing!

From this moment on you will have to look at logic circuit testing in a totally different way.

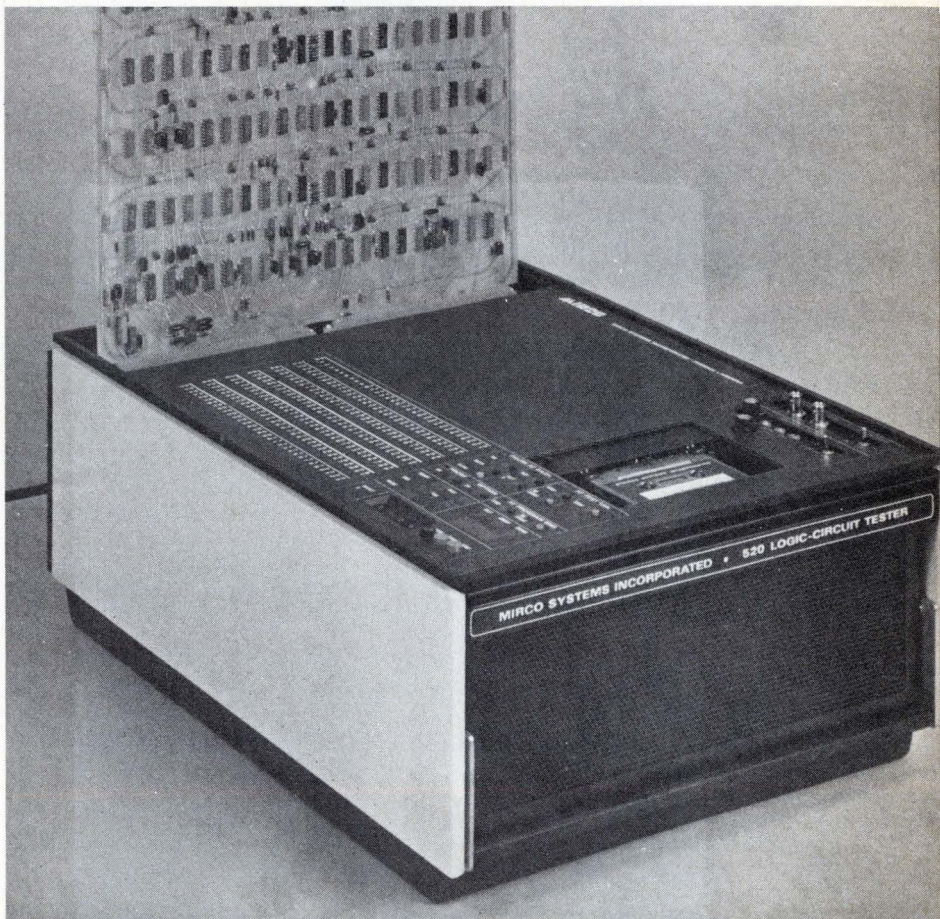
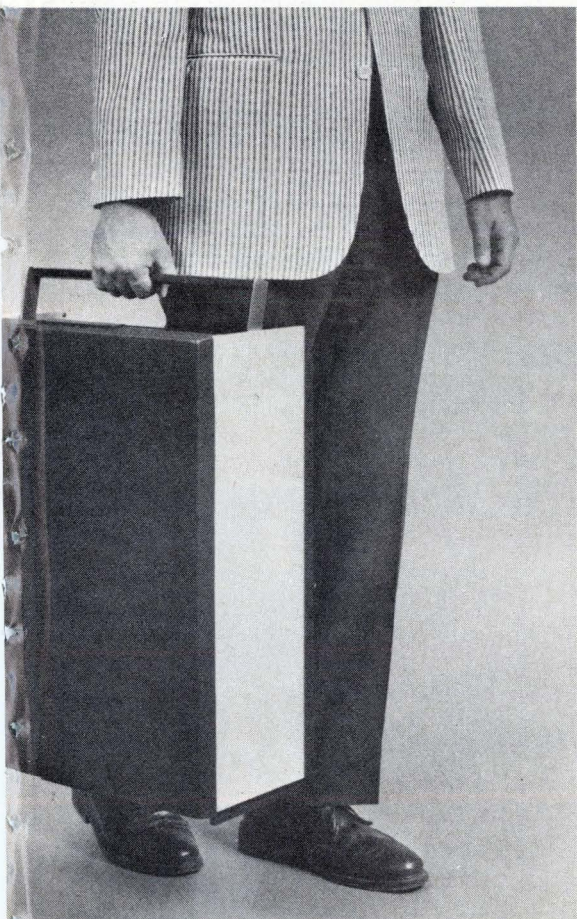

MIRCO 500-Series Portable Full-Capability Logic-Circuit Testers

MIRCO MIRCO SYSTEMS
INCORPORATED

See us at Booth 327
NEPCON/CENTRAL

2106 WEST PEORIA AVENUE • PHOENIX, ARIZONA 85029 • (602) 944-4691 • TELEX 668-403

Circle 161 on reader service card

R_x

For Reed Relay Applications

We can prescribe over 6,000 different ways to cure small logic system problems using a Reed Relay.

We manufacture the complete relay including the switches and run over 3 billion test cycles per day so we know precisely what each relay prescription will do.

Our specialists are on constant call to consult, diagnose and prescribe for you. Delivery is fast—3 to 4 weeks. Write or call us now. If it's a logic problem, we can cure it . . . and fast!

*Wabash Relay & Electronics, Inc.
First & Webster Streets
Wabash, IN 46992
(219) 563-2191*



wabash

WITH OVER 6,000 REED RELAY PRESCRIPTIONS.

Circle 162 on reader service card

The Brush recorder module. It gives your system the competitive edge.

OEM recorder modules give you design flexibility along with all the Brush exclusives.

Choose single or dual channel, low profile or vertical models. There's a wide range of chart speed options.

Plus Brush exclusives like pressurized ink writing and Metrisite® servo loop feedback system that assures 99.5% linearity.

Write Gould Inc., Instrument Systems Division, 3631 Perkins Avenue, Cleveland, Ohio 44114. Or Kouterveldstraat Z/N, B 1920 Diegem, Belgium.

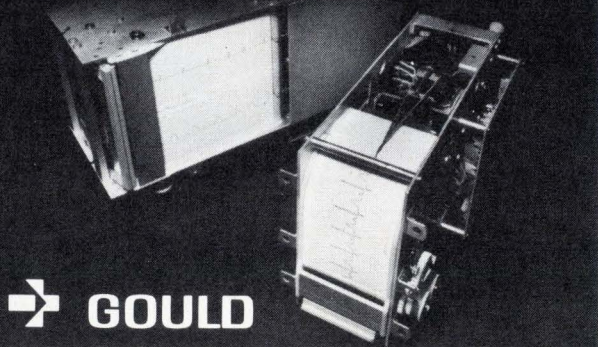

 **GOULD**

162 Circle 212 on reader service card

New literature

Voltage regulators. A cross-reference brochure from International Rectifier, Semiconductor division, 233 Kansas St., El Segundo, Calif. 90245, lists more than 1,800 zener voltage regulators, showing competitive and in-house part numbers. The eight-page guide also provides power ratings, zener voltages, tolerance ranges, and key characteristics of each series. Military specifications are discussed. Circle 421 on reader service card.

Components. A series of one-page application notes is available from Frequency Devices Inc., 25 Locust St., Haverhill, Mass. 01830. Initial topics are tuning filters and oscillators with multiganged pots, programable active filters, voltage tuning and bandpass filters, filters and oscillators with single-ended supplies, and programing and range-switching the company's 440 series of oscillators. [422]

Microwave components. A catalog containing data on a line of dc to 18-gigahertz passive microwave components is available from Midwest Microwave, 3800 Packard Rd., Ann Arbor, Mich. 48104 [423]

Power supplies. Kepco Inc., 131-38 Sanford Ave., Flushing, N.Y. 11352, has published its 1974 catalog and handbook on stabilized power sup-



KEPCO
POWER SUPPLIES

Electronics/September 5, 1974

"We figure payback at 18 months – even with our extremely low usage rate of 1 hour a day, 70,000 units a year."

We gave the Qualifier 901 a big build-up because we know it is the surest, least expensive way to avoid faulty IC's in your finished product.

But we had to know how the industry felt about our new system. When the phones

"From what I've seen, the 901 and its Qual Card programming works beautifully regardless of staff."

"I have technical people, but I need a test unit where I can utilize non-technical people... say someone that knows the difference between AC and DC!"

We just introduced the Fairchild Qualifier 901™

It's our new logic IC tester for incoming inspection of CMOS, DTL and TTL. We told you about unique Qual Card™ programming. We pointed out its simplicity of operation. Foolproof. There's only two things to remember: insert the Qual Card and IC — and read the results.



started ringing, we got nosy. A sampling of the most common responses is here.

The comments we received convinced us we had satisfied our design concept: "Make it easy for the user."

For example, take a look at Qualifier 901 programming. The durable plastic

"Why a 901? It's simple. We'll reduce our 1½-2% IC failure, 50% board rework to an acceptable ½% IC failure, 10% board rework."

cards verify the accuracy of the drive and measurement circuits.

And the Qualifier 901 is under \$8000 for the basic 16-pin test unit. For another \$2500 you can expand that capability to a 24-pin field. The Qual Card costs from \$20 to \$60 each.

If you'd like more information on the Qualifier 901, we'll send you a brochure, a list of representatives and a growing library catalog of 400 Qual Cards now available. Call collect or write today.

Fairchild Systems Technology, A Division of Fairchild Camera and Instrument Corporation, 1725 Technology Drive, San Jose, California 95110. (408) 998-0123, TWX: 910-338-0558.

Qual Card, verified by us, is immediately available from our library. When it comes back by return mail, all you do is put it in the machine. Everything is in the card. It's unbreakable. Slide the

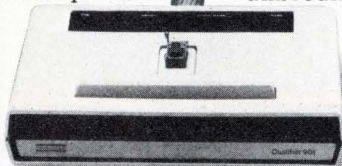

"We need a unit for incoming inspection with minimally qualified people at \$2.50-\$3.00 an hour."

FAIRCHILD

SYSTEMS TECHNOLOGY
A DIVISION OF FAIRCHILD CAMERA AND INSTRUMENT CORPORATION

DiaPak

Sealing at 300°C
Doesn't Have
to be Expensive

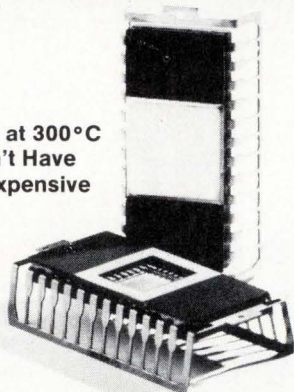

If you're tired of the high cost of hermetic MOS packaging but can't stand the sealing temperature of CER-DIP, the DiaPak is for you. You can seal DiaPak in your current furnaces with no sacrifice in yield or quality and the price will put profit into your MOS operation... 1 million pcs, 24 lead \$.555 ea. no surcharge

DiaPak comes in 8 to 28 lead configurations

DIACON

4812 Kearny Mesa Road, San Diego, Ca. 92111, (714) 279-6996

Circle 164 on reader service card

The Quick Way

New Electronics Buyers' Guide
Easy-to-use, single volume source for:

- Information on 4,000 products
- Over 6,000 company listings and phone numbers
- **EBG EXCLUSIVE:** quick access to over 800 catalogs through a Direct Inquiry Service

Here is the international world of electronics at your fingertips. Find suppliers... fast... accurately... and locally! If you don't have your own copy, send \$15.00 (USA and Canada only; elsewhere send \$25.00) to address shown below.

Electronics Buyers' Guide

A McGraw-Hill Publication • 1221 Ave. of the Americas • New York, N.Y. 10020

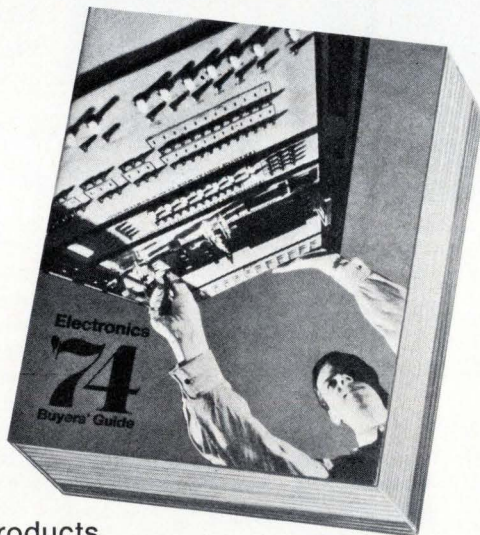

New literature

plies. A power-supply glossary is included. [424]

Computing calculators. A 16-page booklet from Hewlett-Packard Co., 1501 Page Mill Rd., Palo Alto, Calif. 94304, describes the computing alternatives offered by sophisticated calculators, and more specifically discusses those types of calculators having capabilities between those of adding machines and large computers. [425]

Push-button switches. Control Switch Inc., 1420 Delmar Dr., Folcroft, Pa. 19032. A two-page technical bulletin describes the B8000 series subminiature push-button switches for printed-circuit boards. The switches are intended for sub-chassis checkout and interlock circuits, as well as for front panels where space is limited. [426]

One-shot. Teledyne Semiconductor, 1300 Terra Bella Ave., Mountain View, Calif. 94043, is offering an application note on a dual one-shot with high noise immunity. The note discusses timing networks for this high-noise-immunity-logic monolithic circuit. Applications are given for various pulse generating designs, coincidence detectors, voltage-to-frequency converters, and frequency dividers, among others. [427]

Impulse generator. The model IG-115 impulse generator is described in a brochure available from Singer Instrumentation, 5340 Alla Rd., Los Angeles, Calif. 90066. Applications for the instrument are in receiver alignment, bandwidth determination, transient-response studies, and signal-sourcing. [428]

Waveguides. Technicraft division, Tech Systems Corp., 401 Watertown Rd., Thomaston, Conn. 06787, has published a 12-page brochure that describes flexible and rigid waveguides and components. [429]

Cermet trimmers. A catalog from CTS Corp., 406 Parr Rd., Berne, Ind. 46711, describes nine single-turn cermet-trimmer configurations. Catalog 3360F also includes electri-

If your printed wiring can't stand the heat, switch to Norplex G-30.

Ordinary laminates just can't take the extreme temperatures generated by high density electronic systems.

But Norplex G-30 is no ordinary copper-clad laminate/prepreg material. It's a woven glass impregnated with polyimide resin, which assures you an outstanding combination of processing and operating characteristics.

For example, its exceptional heat resistance permits continuous operating temperatures in the 400°-500° F. range. G-30 gives you unexcelled dimen-

sional stability, flexural strength and processability. In multilayer applications, it also eliminates the smearing of resin during hole drilling, and minimizes cracking of plated-through holes.

Thus, Norplex G-30 performs with unequalled excellence in such demanding applications as aerospace electronics, computers, and com-

munications equipment.

Send coupon for our brochure on G-30 glass-polyimide, a new breakthrough in circuit technology. Or phone: 608/784-6070.

Norplex[®] laminates
by **UOP**

Circle 165 on reader service card

© 1974 UOP

Norplex Division, UOP
(Universal Oil Products Company)
Norplex Drive,
La Crosse, Wis. 54601

Please send me your brochure on
G-30 glass-polyimide.

Name _____

Title _____

Company _____

Address _____

City _____ State _____ Zip _____

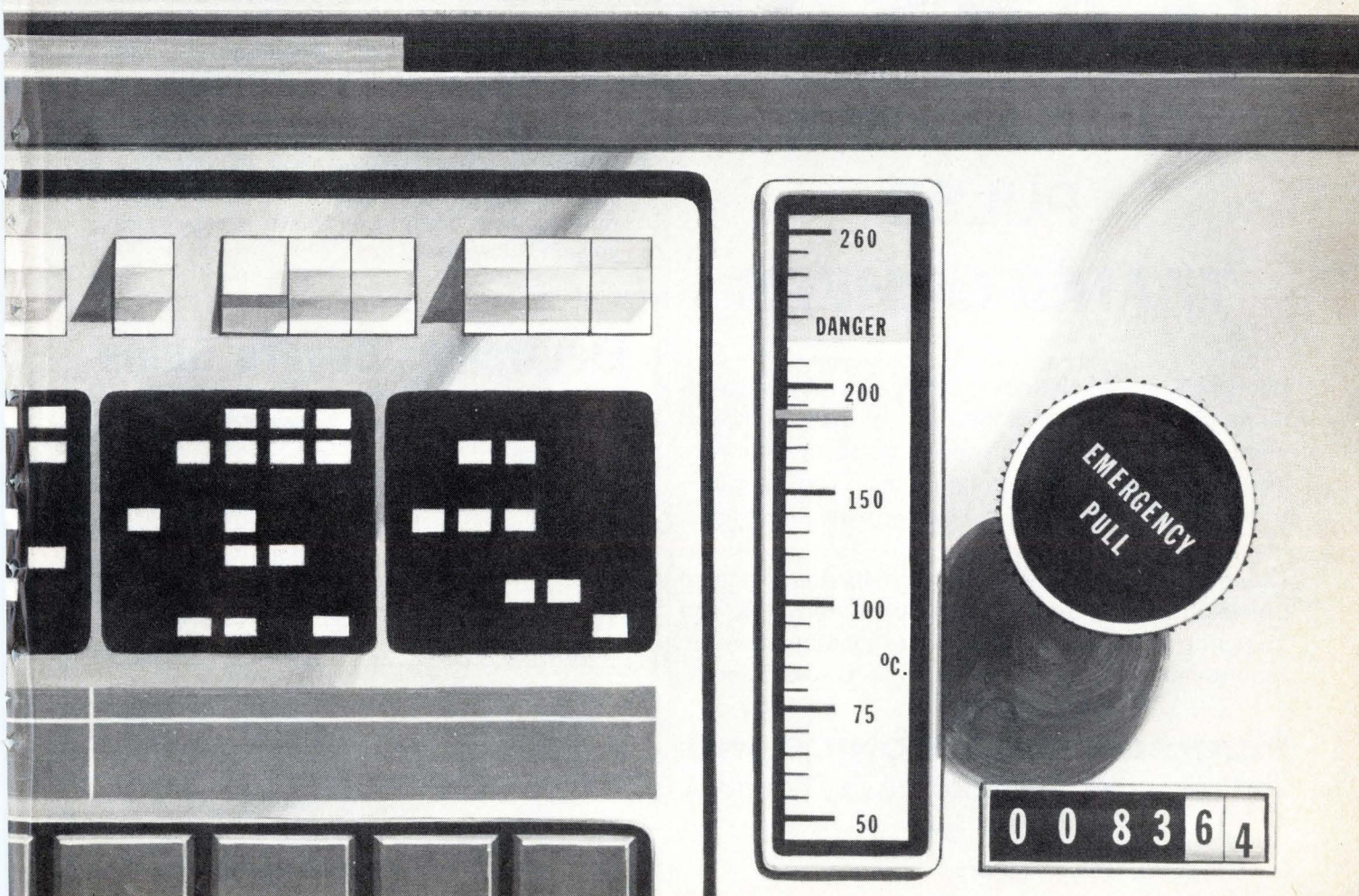

Keithley's new DMM really does have a difference!

That's the best way to describe the auto-ranging Model 168 Digital Multimeter. It's got the sensitivity (100 microvolts) and full function capability (ac/dc volts, amps, ohms) needed for bench work, plus the carrying ease and optional battery operation needed for portability. And more. Only \$299. Send for data now.

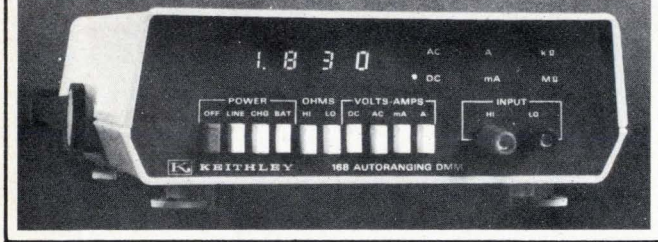

KEITHLEY INSTRUMENTS
U. S. A. : 28775 AURORA ROAD, CLEVELAND, OHIO 44139
EUROPE: 14, AVENUE VILLARDIN, 1009 PULLY, SUISSE

Circle 240 on reader service card

PEARSON

Very High Voltage

PULSE

TRANSFORMERS

Pearson Electronics, Inc. specializes in the development, design, and manufacture of very-high and super-high-voltage, high-power pulse transformers and related modulator components. Typical pulse transformers manufactured by Pearson Electronics, Inc. range in output voltage from 40 kV to 600 kV. Other Pearson pulse-modulator components include precision current transformers, voltage dividers, and charging inductors. Inquiries regarding specific requirements for these components are welcomed.

PEARSON ELECTRONICS, INC.

4007 Transport St., Palo Alto, California 94303, U. S. A.
Telephone (415) 326-7285

166 Circle 166 on reader service card

Energy Saver

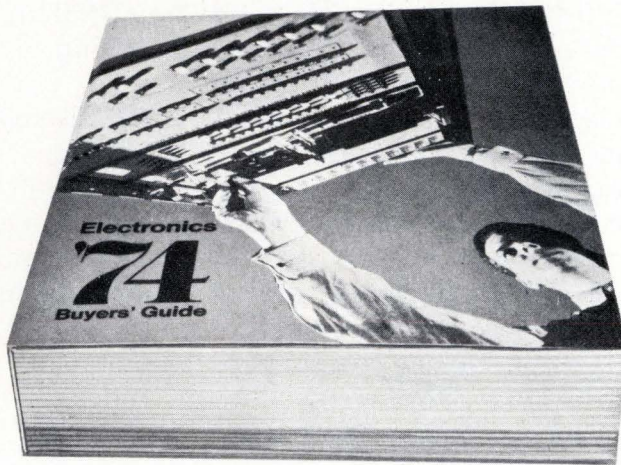

NEW ELECTRONICS BUYERS' GUIDE . . . EASY-TO-USE, SINGLE VOLUME SOURCE FOR:

- Information on over 4,000 products.
- Over 6,000 company listings and phone numbers — both home and field offices.
- **EBG EXCLUSIVE:** quick access to over 800 helpful catalogs through a timesaving Direct Inquiry service.
- More than 1,400 pages of data.

Here is the international world of electronics at your fingertips. Find suppliers . . . fast . . . accurately . . . and locally! Don't have a copy? Use coupon below, today.

Electronics Buyers' Guide

A McGraw-Hill Publication
1221 Ave. of the Americas, New York, N. Y. 10020

Yes, send me _____ copies (copy) of the energy saving Electronics Buyers' Guide. I've enclosed \$15.00 (USA and Canada only; elsewhere send \$25.00). Full money back guarantee if not satisfied.

NAME _____

COMPANY _____

STREET _____

CITY _____

STATE _____ ZIP _____

You'll Get the Reed Relays You Need.

MICRO-MINIATURE AXIAL

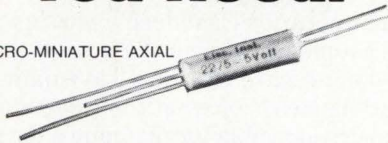

ULTRA-MINIATURE
PICO SERIES

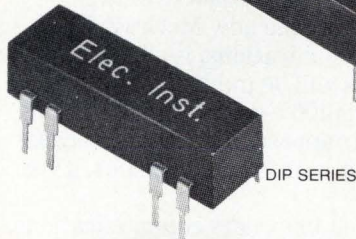

DIP SERIES

Instead of the Run-Around.

We know that often the reed relay you need isn't *exactly* like a catalog item. Which often leads to compromises or special runs, both of which can cost far more than anticipated. We also know that many other manufacturers won't even consider your special requirements unless it's a high-volume order.

Cheer up, get our **Miniature Reed Relay Catalog** (it's free). And don't worry if what you need isn't quite like the catalog item. Just ask us—we'll take care of you—without the run-around or high cost.

ELECTRONIC INSTRUMENT & SPECIALTY CORP.

42 Pleasant Street
Stoneham, Massachusetts 02180

Telephone (617) 438-5300

New literature

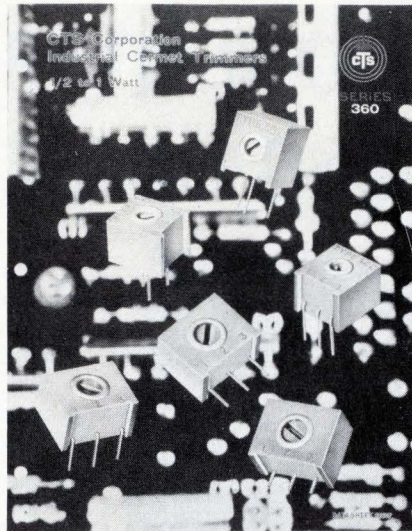

cal, mechanical, and environmental specifications. [430]

Interface equipment. Computer Products, 1400 N.W. 70th St., Box 23849, Fort Lauderdale, Fla. 33307 has published a four-page brochure that describes a family of analog and digital interface equipment compatible with minicomputers. [431]

IC sockets. A 68-page product catalog is available from Robinson-Nugent Inc., 800 East Eighth St., Box 470, New Albany, Ind. 47150. The catalog (IC-1075) discusses a line of circuit sockets and interconnect accessories, giving specifications and charts. [432]

Die-stamped pc boards. A four-page brochure describes low-cost circuit boards stamped from dies made by a photo-etching process. The brochure is available from Industrial and Environmental Products Operation, Philco Ford Corp., Aeronautics division, Newport Beach, Calif. 92663 [433]

Power devices. A 32-page catalog from Solid Power Corp., Farmingdale, N.Y. 11735, gives information on silicon power transistors, high-voltage transistors and power Darlingtons. Input/output and operating data is included. [434]

Panel meters. Tekelec Inc., 31829 La Tienda, Westlake Village, Calif.

WHO CAN MAKE ANY GLASS MATERIAL FOR FLAT PANEL DISPLAYS?

Need flat glasses for windows and backplates in thicknesses from .010" to .090"? Corning makes them. We also make glass ceramic materials for backplates. And black glass ceramic cell sheets chemically machined with any pattern or hole size. You can even put your displays together with Corning glasses. We make devitrifying powdered glasses, and vitreous sealing glasses in rectangular shapes. Preformed beads for tubulation seals. Hard glass rods to space front and backplates. Even the mercury capsules used for dispersion in gas displays. Corning makes them all! Want more information? Write or call:

CORNING MAKES IT!

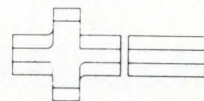

Electronic Materials Department

CORNING

CORNING GLASS WORKS

Corning, New York 14830

(607) 974-8866

Data Communications—the new business every business must have.



We're
putting it
all together
for you.



Data communications is indeed a puzzle to most of the people working in the market. In fact, many don't realize that they have data communications needs or what their needs are.

The people responsible for planning a data communications system for their company must decide alternative systems approaches, carriers, hardware, and vendors—all in the context of economics, government regulation, and future technology development.

Putting together all the pieces of this puzzle—that's what the new McGraw-Hill magazine, **Data Communications**, is all about. **Data Communications** will be published bi-monthly.

Our editorial is 100% data communications and we know our approach is correct because we have tested it with two pilot issues, a year apart.

Our audience is 100% data communications because to qualify, they must have responsibility to buy, specify, recommend or approve the purchase or lease of products associated with data communications.

Our subscribers are 100% request verified—not only are they qualified but each one of the 25,000 has individually requested **Data Communications**.

If you want to cover the fastest-growing market in our economy, take a full-year's schedule of full pages in **Data Communications** for only \$7,800, which includes color, bleed and special positions. We'll even do your color separations at minimal cost.

For complete advertising information, contact your nearest McGraw-Hill office.

data **McGraw-Hill**
COMMUNICATIONS
A McGraw-Hill Publication

the magazine and the market.



General Electric's New
PowerUp-15* Battery

**RECHARGES
IN 15 MINUTES**



**THINK
OF THE
POSSIBILITIES**

When charged at room temperature for 15 minutes with an approved charger, General Electric's new PowerUp-15* battery delivers 90 percent of its rated capacity.

The battery is charged with a unique Voltage/Temperature Cutoff system which features straight forward charger control circuitry.

Ideal for portable industrial power tools, photographic equipment, portable communications devices... anywhere portable electric power is needed fast. And you get all the advantages of time-proved GE nickel-cadmium rechargeable batteries.

For more information, write General Electric Company, Section 452-04, Schenectady, N. Y. 12345, or circle reader service card.

*Trademark of General Electric Company

GENERAL  ELECTRIC

New literature

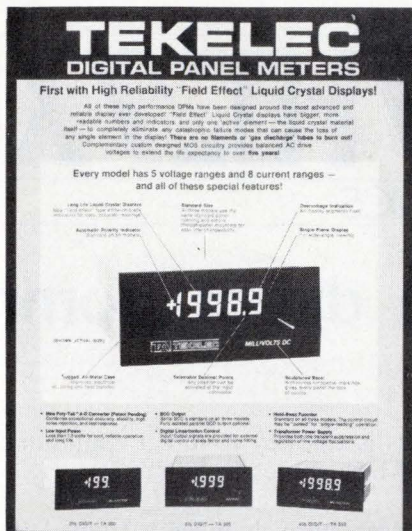

91361. A four-page brochure gives information on the model TA305 3½ digit and model TA310 4½ digit panel meters. Electrical and mechanical specifications are presented along with pricing information. [435]

Logic recorder. Designed for analysis and troubleshooting, the model 810-D digital logic recorder from Biomation Corp., 10411 Bubb Rd., Cupertino, Calif. 95014, is described in a brochure that gives general information and specifications. [436]

Tape readers. The Fly Reader 45 photoelectric paper-tape reader is described in a bulletin published by Teleterminal Corp., 12 Cambridge St., Burlington, Mass. 01803. Diagrams, specifications, and illustrations are included. [437]

Diodes. Codi Semiconductor, Pollitt Dr., Fair Lawn, N.J. 07410. A four-page guide of Jedec reference diodes is available with detailed specifications of several series. [438]

Fiber optics. A "General Introduction to Fiber Optics" has been prepared by Valtec Corp., West Boylston, Mass. 01587. The six-page illustrated brochure describes how light is transmitted through fibers of glass or plastics, and covers a number of applications of fiber optics, including data processing, instrumentation, and medical equipment. [439]

**WHO
CAN
MAKE A
PHOTOMASK
FROM
SCRATCH?**

Corning can! We start from scratch—we make two glass compositions for substrates and DUR-COR™ photoplates. Through an integrated process the sheet glass is finished and cleaned to flatnesses down to 50 microinches per inch in either .060" or .090" thicknesses and that includes the new 4" squares. We can offer you the products, and we can deliver because we've increased our capacity 50%. Our DUR-COR photoplates are made with an incredibly durable iron oxide layer coated on either of these substrate compositions. And, we can also give you advice. Because of our integrated process, we are technically competent in all aspects of mask production. For more information on our products, or processing help, write or call:

**CORNING
MAKES
IT!**

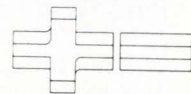

Electronic Materials Department
CORNING
CORNING GLASS WORKS
Corning, New York 14830
(607) 974-8866



Number One in Japan

The key to direct communication in Japan

In Japan, Nikkei Electronics is the key to direct communication between electronic engineers and advertisers of electronics products.

The world's leading enterprises, with their sights trained on the Japanese electronics market, accept Nikkei Electronics as the most reliable medium of its kind in Japan.

In 1973, 316 advertisers placed a total of 2,511 pages of Nikkei Electronics, out of which 15 international advertisers occupied 115 pages. Nikkei Electronics is the only magazine devoted exclusively to electronics in Japan that has attained such distinguished reliability among so many international firms.

Leading international advertisers in 1973 were:

	36 pages
 TEXAS INSTRUMENTS	30 pages
	8 pages

Editorial

Nikkei Electronics is associated with McGraw-Hill's Electronics, offers high level, world-wide technical articles for professional and executive subscribers who need and demand the latest "hot" news on electronics.

Circulation

Nikkei Electronics is the only Japanese electronics magazine authoritatively audited by the Japan Audit Bureau of Circulation, which reported that the number of Nikkei Electronics subscribers in 1973 was 24,678. The latest circulation figures have risen over 15% and have reached the total of 28,710 (May-25, 1974 issue).

For more information, please contact with McGraw-Hill's Electronics sales offices or Advertising Dept. NIKKEI-McGRAW-HILL, INC., Nikkei Annex Bldg., 2-1-2, Uchikanda, Chiyoda-ku, Tokyo, Japan.

our 1975 economy compact models

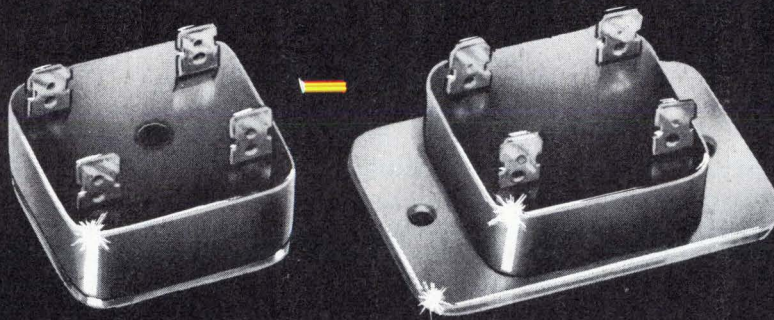

It's the year of the compact and our 25 amp ELF Bridge packs all the power of more bulky encapsulated assemblies. Our double diffused diode is available with ratings up to 1200 PRV. Designed to be an economical bridge, it meets NEMA creepage clearances and Hi-pot standards. Suitable for extreme temperature conditions to -55°C , it is available in single hole (Series EMF) or flange mounting (Series ELF). Our 32 amp assembly (HELF or HEMF) facilitates even higher demands.

For detailed information, contact:
FMC Corporation
Semiconductor Products Operation
Homer City, Penna. 15748
(412) 479-8011

FMC Special
Products

Circle 171 on reader service card

FROM BREADBOARD TO FINAL PACKAGING HARDWARE...

ALL AVAILABLE FROM ONE SOURCE

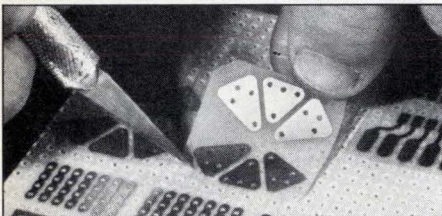

★ **ADHESIVE BACKED CIRCUIT SUB-ELEMENTS**
(Over 200 Pre-Drilled component mounting patterns available "off-the-shelf.")

★ **EPOXY GLASS BOARD MATERIALS**

- 76 Standard "Off-the-Shelf" Boards.
- Including Unclad, Copper Clad, Cut & Peel Copper Clad, Pre-etched "X-Y" Pattern and Plated thru Hole Copper Clad.
- .100" Grid Hole Pattern or Undrilled.

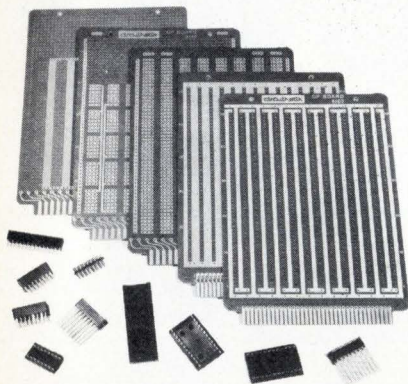

★ **GP CIRCUIT BOARDS and ACCESSORIES**

- Highest Quality — Choose from 74 "Off-the-Shelf" Boards.
- Sockets — Low & Standard Profile, P.C. and Wire Wrap. • Highest Quality Gold Contacts.
- Adapter plugs • Connectors
- Card Pull Handles.

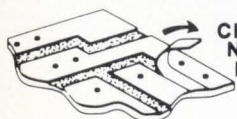

CIRCUIT-STIK'S
NEW CUT &
PEEL BOARDS

SEND FOR OUR NEW CATALOGS #502 & #801

circu-it-stik®

P.O. BOX 3396 • Torrance, California 90510
Phone (213) 530-5530

New books

Large and Medium Scale Integration: Devices and Applications, Samuel Weber, editor, McGraw-Hill Book Co., 320 pp., \$15.

As an anthology of articles that have appeared in *Electronics* during the past few years, this book is a source of a broad range of information on new technology that would normally not be available in book form for several years. Covered are such subjects as metal-oxide semiconductors, including silicon-gate MOS, ion-implantation, silicon-on-sapphire, charge-coupled and bipolar devices.

The earliest article, by a group of system designers from IBM in 1967, covers system partitioning. This is followed by "What level of LSI is best for you?" by Gordon Moore of Intel Corp.

Having thus set the stage with economic considerations, Weber, who is Executive Editor of *Electronics*, arranges the material in the following six chapters: "MOS Processes and Technology" (11 articles), "Bipolar Processes and Technology" (five articles), "Miscellaneous Technologies" (four articles covering CCDs and amorphous semiconductor memories), "LSI and MSI Memories" (11 articles), "LSI and MSI in Computer Design" (nine articles), and "Miscellaneous applications of LSI and MSI" (13 articles covering such applications as electronic watches, solid-state imagers, a-d converters, and the HP-35 scientific calculator).

The book also is full of circuit diagrams, processing sketches of device cross-sections, performance curves, operational waveforms, technology-comparison charts, and side discussions in boxed-off panels of much of the basic information needed to fully appreciate the developments discussed in the articles.

Recently published

Manual of Linear Integrated Circuits: Operational Amplifiers, and Analog ICs, Sol D. Prenskey, Reston Publishing Co., 289 pp., \$16.95.

Telecommunications, second edition, J. Brown and E. V. D. Blazier, Halsted Press, 382 pp., \$9.50 (paper), \$17.50 (cloth).

High-Q Tunable Filter



The EDMAC Hi-Q Tunable Filters are general purpose active two pole filters which can be used in either a bandpass or a bandreject mode of operation.

FEATURES

- ≡ Tunable bandwidths corresponding to circuit Q's of 1000.
- ≡ Tunable frequencies from 1 Hz. to 30,000 Hz.
- ≡ Independent controls for bandwidth and center frequency.
- ≡ Simultaneous bandpass and bandreject filter functions.
- ≡ Controlled input-output phase relationship.
- ≡ Zero phase shift at center frequency.
- ≡ Selectable automatic tracking.
- ≡ Circuit overdrive indication.
- ≡ Selectable calibration mode.

WRITE FOR COMPLETE SPECIFICATIONS

EDMAC Associates Inc.

333 West Commercial Street,
East Rochester, New York 14445
(716) 385-1440

Uninterrupted storage

Signals for storage are usually single shot or random, they need to be studied in detail and referenced in time to a second, related signal. Therefore two input channels are necessary and the displays should be continuous if the details are not to be missed.

This is exactly what our new 10 MHz instrument provides.

By eliminating beam switching we not only make the display detail easier to examine, but also ensure that the signal is not missed. (This can happen if the beam switches just as the signal appears).

This new oscilloscope is of the 'half tone' storage type,

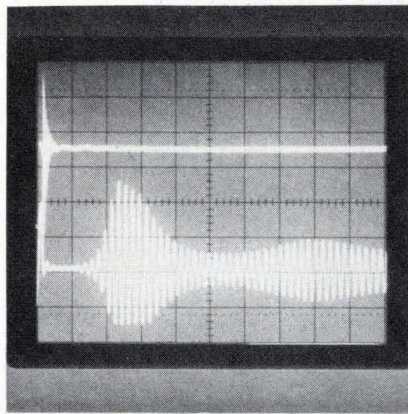

All Philips 10 MHz : 2 mV oscilloscopes feature true dual beam operation. This technique eliminates beam switching and gives a continuous display.

which gives the additional benefits of variable persistence. Adjustment is from 0.3 seconds to 1.5 minutes and hence ideal for difficult-to-see signals like low frequency signals suffering from flicker or high frequency, fast rise time pulses with low repetition rates.

Continuous, bright displays plus storage plus variable persistence therefore adds up to a lot of new display possibilities. For more details contact your local Philips organisation or write to : Philips Test and Measuring Instruments Inc., (A North American Philips Company), 400 Crossways Park Drive, Woodbury, N.Y.

**BOOTH
No. 2203/04**

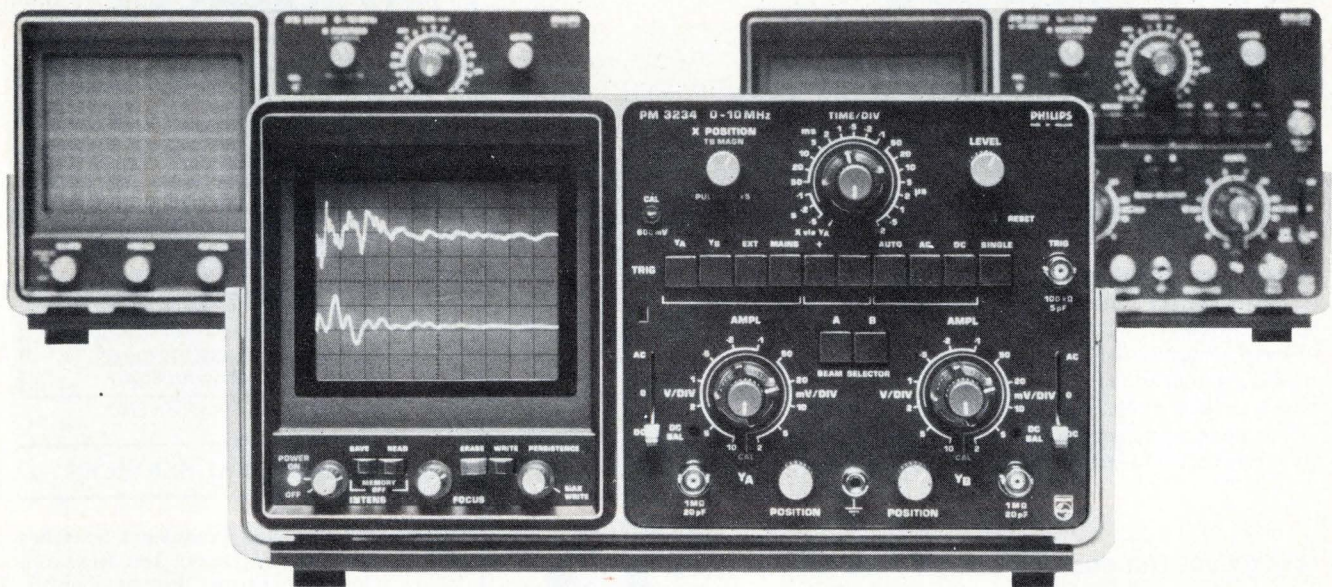

PHILIPS

SEARCHLIGHT SECTION

RF-PACKAGES—MICROWAVE SYSTEMS
WORLD'S LARGEST RADAR & MICROWAVE INVENTORY

**AUTOTRACK ANTENNA
SCR-584 RADAR SYSTEM**

360 deg azi 210 deg ele. Better than 1 mil. accuracy. Missile vel. accel. and slew. rates. Amplidyne servo control. Handle up to 20 ft. dish. Compl. with control chassis. ALSO in stock 10 cm. van mounted rad. system. Conical scan. PPI. 6 ft. dish. Ideal telemetry, balloon missile rocket trk, ECM range. 600 pg. instr. bk. on compl. radar avail. \$25 ea.



1 MEV LINEAR ACCELERATOR

Dual Mode, Ion or Electron. RF Drive, 300 KHZ at 45 KW. Includes control console, RF unit, accelerator, etc.

MOD IV HI-RES MONOPULSE TRACKER

Instrumentation radar; freq. 8.5-9.6 GHz, Pwr: 250 KW, 1 mil tracking accuracy. 6' Fresnel lens antenna with 4 horn monopulse feed. Trk. Rng. 50 or 200 mi.

PULSE MODULATORS + H.V.P.S.

- 245 KW LINE PULSER Output 16 KV at 16 amp. .25 μ s at 4000 PPS.
- 405 KW FLOATING DECK PULSER Output 20 KV at 20 amp. 1 μ s to 10 milisecond pulse.
- 500 KW LINE PULSER Output 22 KV at 28 amp. .4/1.75/2.25 μ s at 2500/550/300 PPS.
- 1 MW HARDTUBE MIT MODEL 9 Output 25 KV at 40 amp. .25 2 μ s at .002 D.C.
- 2.0 MW LINE PULSER Output 30 KV at 70 amp. 1/2 μ s at 600/300 PPS.
- 3 MW LINE PULSER Output 39 KV at 75 amp. .25/1 μ s at 500 PPS.
- 10 MW LINE PULSER Output 76 KV at 135 amp. 2.5 μ s at 350 PPS.
- 17 MW LINE PULSER Output 17 KV at 1000 amp. 2-5 μ s a 150-2000 PPS.

RECON DRONE CONTROL RADARS

X Band systems autotrack and search complete with plotting boards. Fully mobile van mounted. Gnd to air links and beacons also in stock.

MICROWAVE LINK EQUIPMENT

Freq. 7.1-7.9 GHz, Pwr. 100 mw., 4 channels. Transmits video, pulse, synchro, and voice information. Mfr: Motorola. Others in stock.

SEND FOR FREE 24 PG. CATALOG ON YOUR LETTERHEAD

SPARE PARTS IN STOCK

Nike Ajax, Nike Hercules, M-33, MPS-19, TPS-ID, TPS-10D, FPS-6, SPS8, SCR-584, HIPAR. Many more, write.

RADAR & RF PKGS.

- 34ghz 40 kw Pulse RF pkg
- 24ghz 40 kw Pulse bomb toss system
- 16ghz 130 kw Pulse B-58 search radar system
- X BAND SEARCH 40 KW PULSE WEATHER RADAR
- X BAND AUTOTRACK 250KW PULSE M-33 compl w/plor boards
- X BAND BEACON 400 W PULSE AN/DPN-62
- X BAND AUTOTRACK 50KW PULSE B-47 fire control complete
- C BAND WEATHER RADAR 250 KW PULSE
- C BAND HEIGHT FINDER AN/FPS-26, 5 megawatt output. AN/TPS-37, 1 megawatt output.
- C BAND 285 KW PULSE Search AN/SPS-5
- S BAND AUTOTRACK 500 KW PULSE 10' DISH
- S BAND 1 MEGAWATT COHERENT AN/FPS-18
- S BAND 1 MEGAWATT PULSE NIKE ACQ.
- S BAND 5 MEGAWATT HEIGHT FINDER AN/FPS-6
- S BAND AUTOTRACK 250KW 6ft dish mortar locator MPQ-10A
- L BAND 500KW PULSE AN/TPS-1D/E
- L BAND 5 to 20KW PULSE 400 mhz 1KW CW AN/FPS-23 225mhz 1 MEGAWATT PULSE AN/TPS 28 CW 4.4-5ghz 1 KW CW 950-5ghz 150 WATTS CW 1.5 mhz-10.5ghz 5 WATTS CW 1.7-2.4ghz 10 KW

AN/GPG-1 SKYSWEEP TRACKER

3 cm. auto. tracking radar system. Comp. pkg. w/indicator sys. Full target acquisition & auto. tracking. Input 115v 60 cy. new. In stock for imm. del. Entire sys. 6' X 3' X 9'.



Radio Research Instrument Co., Inc.
3 QUINCY ST., NORWALK, CONN. 06850
(203) 853-2600

CIRCLE 951 ON READER SERVICE CARD

**Job-seekers...
be the first to know
with McGraw-Hill's
Advance Job Listings**

By having our new weekly ADVANCE JOB LISTINGS sent First-Class (or by Air Mail, if you prefer) to your home every Monday you can be the first to know about nation-wide openings you qualify for both in and out of your field.

This preprint of scheduled employment ads will enable you to contact anxious domestic and overseas recruitment managers BEFORE their advertisements appear in upcoming issues of 22 McGraw-Hill publications.

To receive a free sample copy, plus information about our low subscription rates (from one month to 12), fill out and return the coupon below.

ADVANCE JOB LISTINGS / P.O. BOX 900 / NEW YORK NY 10020

PLEASE SEND A SAMPLE COPY OF ADVANCE JOB LISTINGS TO:



NAME _____ ADDRESS _____
STATE _____ ZIP _____
CITY _____ STATE _____ ZIP _____
9/5/74

**SAME DAY SHIPMENT
Minis & Peripherals**

**PRINTERS
"BRAND NEW"**

DATA PRODUCTS

2440— 700 LPM

2470— 1250 LPM

MDS 4320— 300 LPM

ALSO
CENTRONICS, POTTER, CDC
A. B. DICK, IBM, HIS, UNIVAC

Send for Free Report "Maintenance of Computers"

AMERICAN USED COMPUTER CORP.
P.O. Box 68, Kenmore Sta., Boston, MA 02215
member COMPUTER DEALERS ASSOCIATION

CIRCLE 952 ON READER SERVICE CARD

free catalog
POTTING APPLICATORS
MANUAL OR AIR OPERATED
2 1/2cc 6cc 12cc 30cc
FOR POTTING, ENCAPSULATING ETC.
PHILIP FISHMAN CO., INC.
7 CAMERON ST. WELLESLEY, MASS. 02181

CIRCLE 953 ON READER SERVICE CARD

FREE CATALOG
HARD-TO-FIND PRECISION TOOLS
Lists more than 2000 items—pliers, tweezers, wire strippers, vacuum systems, relay tools, optical equipment, tool kits and cases. Also includes ten pages of useful "Tool Tips" to aid in tool selection.
JENSEN TOOLS
4117 N. 44th Street, Phoenix, Ariz. 85018

CIRCLE 954 ON READER SERVICE CARD

FREE ALARM CATALOG
Full line of professional burglar and fire alarm systems and supplies. 96 pages, 450 items. Off the shelf delivery, quantity prices.
mountain west alarm
4215 n. 16th st., phoenix, az. 85016

CIRCLE 956 ON READER SERVICE CARD

—NEW SURPLUS—FREE CATALOG—
Laser Diode, 6W, 25A, GaAs: \$10.75;
8038 VCO: \$5.95; NE555V: \$1.00
1101 RAM: \$2.25; 1103 RAM: \$4.50
Nixie B585351, .5": \$2.50; DL707: \$2.50
Liq. xtal, 3 1/2 digit, .4x.22" char: \$9.75
2513, 2516: char. gen. roms: \$12.75
ELECTRONIC DISCOUNT SALES
138 N. 81st St., Mesa, Az., 85207

CIRCLE 957 ON READER SERVICE CARD

PROFESSIONAL SERVICES

Thorough Patent and Trademark Searches for Professional Engineers and Research & Development Firms. Patent Consultants, 422E Washington Building, Washington, D.C. 20005. (202) 638-1666.

EMPLOYMENT SERVICES

Growth Positions, \$14-30,000. Fees Paid. Nationwide. Longberry of Pittsburgh. Suite 962-G, Two Gateway Center, Pittsburgh, Pa. 15222.

IR's new glass passivated, high voltage Power Transistors and Darlington...

Better performance where it really counts.*

The three other largest selling high voltage power transistor lines of today offer you good characteristics. But while a specific device may excel in specs for one parameter, it may be marginal in other equally important characteristics. Not so with IR's new high voltage power transistors. They easily meet or exceed all established specifications. Now you can design a better, more efficient circuit without compromising.

*** High Voltage and High Gain in the same transistor.**

Most others offer you either high voltage or high gain. They can't give you both in the same device. We can. For example: rated to 700V_{CBO} with an I_C from 7 to 10 Amps (pulse), we provide a gain of 30-90 at 1 Amp.

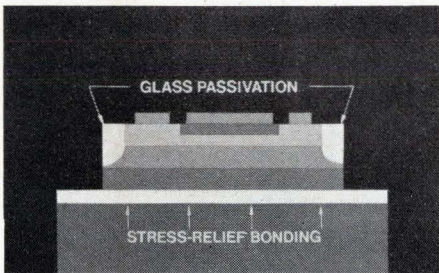

*** Glass Passivation for longer life, better stability.**

IR triple-diffused, NPN mesa structures are the first and only high voltage power transistors with glass passivated

junctions. You'll get longer life and a stability unequalled by the other brands.

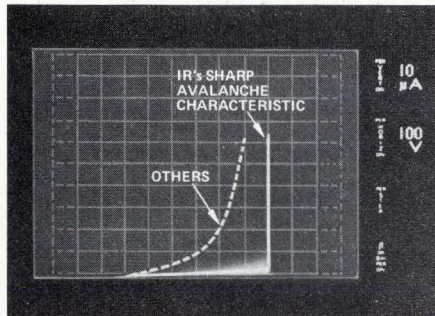

The avalanche curve pictured shows our "sharp" curve and the "soft" curve of the others. Convincing evidence of better junctions that you can operate at full rated specs without a worry.

*** Lower Saturation Voltage for better efficiency.**

IR saturation voltage is lower than the others. Higher efficiency, less power loss, reduced power consumption and system operation at lower power levels are your new advantages. And you won't have to sacrifice switching speeds or voltage capability.

*** "Stress-Relief" Bonding for better resistance to temperature cycling.**

IR's "Stress-Relief" bonding between the chip and mounting surface gives better protection from thermal cycling, gives you an extra margin of safety in thermal design considerations, with a broad safe-area that is more than adequate for any application.

Competitively Priced and Cross-Referenced to the 3 major lines.

IR high voltage power transistors are available in 12 models rated from 300 to 700V_{CBO} with an I_C from 7 to 10 Amps (pulse). Monolithic Darlington in 15 models are rated to 600V_{CBO} with an I_C from 15 to 25 Amps (pulse). All are in the standard TO-3 package.

Find IR's equivalent to the devices you're now using, then ask your local IR salesman, Rep or Distributor for complete specs and a test evaluation sample. When you've put it to the test, we think you'll agree. It's better — everywhere that counts.

IR P/N	Delco P/N	RCA P/N	Motorola P/N
IR401	DTS 401		MJ3026 MJ3027
IR402	DTS 402 2N3902		MJ3028 MJ3030 2N3788 2N3902
IR403	DTS 403		
IR409	DTS 409		
IR410	DTS 410	RCA410	MJ410
IR411	DTS 411	RCA411 2N5838 2N5839	MJ411 MJ1800 MJ3029 MJ3430
IR413	DTS 413	RCA413 2N5840	MJ413
IR423	DTS 423	RCA423	MJ423
IR424	DTS 424		MJ424
IR425	DTS 425		MJ425
IR430	DTS 430	2N5239 2N5240	MJ430
IR431	DTS 431	RCA431 2N5240	MJ431 2N5241

Monolithic Power Darlington

IR4040	DTS 4040	Ask for data on IR's 11 additional types.
IR4045	DTS 4045	
IR4060	DTS 4060	
IR4065	DTS 4065	

Prove our point on your curve tracer...

Get your test sample today.



International Rectifier

...the innovative power people **IOR**

Electronics advertisers

September 5, 1974

Abbott Transistor Labs, Inc. Technical Advertising Agency	6	EDMAC Associates J.L. Newman & Associates, Inc.	172	Keithley Instruments, Inc. Chagrin Valley Marketing Associates	166
‡ ACDC Electronics, Inc. Rose Associates Advertising & Public Relations	63	EECO The Greer Agency	140	■ Kepeco Inc. Weiss Advertising	5
* Advanced Micro Devices Keye Donna Pearlstein	18E	* Electro Scientific Industries Commark Group, Inc.	21E	Keystone Electronics Lawrence Nelson Advertising	72
Advanced Micro Devices Keye Donna Pearlstein	10-11	Electronics Instrument & Specialty Corp. The Drumbeater Co.	167	‡ Littelfuse, Inc. LF Advertising, Inc.	58-59
Allen Bradley Company Hoffman, York, Baker & Johnson, Inc.	24	* English Electric Valve Co., Ltd. The London Advertising Partnership	8E-9E	Lockhead Missiles & Space Co. McCann-Erickson, Inc.	144
■ AMP Incorporated Aitkin-Kynett Co., Inc.	141	Fairchild Camera & Instrument (Systems Technology Div.) Rose Associates Advertising and Public Relations	163	M C L, Inc. Huwen & Davies, Inc.	70
■ Analog Devices, Inc. Schneider Parker, Inc.	72	Faultfinders Inc. D.J. Moore Advertising, Inc.	180	* Metrimplex Hungexpo	24E
Bausch & Lomb, Inc. Wolff Assoc., Inc.	40	‡ Ferroxcube Black-Russell-Morris	88	■ Micro Devices Advertising & Merchandising, Inc.	142
‡ Beckman Instruments, Inc., Helipot Div. N.W. Ayer/Jorgensen/MacDonald, Inc.	52	Floating Point Systems Commark Group	80	Micro Power Systems Associated Ad Ventures, Inc.	21
Blomation Paul Pease Advertising	74-75	■ John Fluke Mfg. Co., Ltd. Lennox Marketing Limited	139	Mirco Systems, Inc. McAward Associates	161
The Bodline Company Tech-Nik	136	■ Fluke Manufacturing Co., John Bonfield Associates	37	Molex Incorporated Howard H. Monk and Associates, Inc.	177
‡ Bourns, Inc. Marlborough Assoc., Inc.	64	FMC Corporation— Semiconductor Products Operation DeSales Advertising Inc.	171	Monsanto Commercial Products Co., Electronic Special Products Advertising Promotion Services	78
Brand-Rex Creamer, Trowbridge, Case & Basford, Inc.	28	* Function Modules, Inc. Leon Richman Design, Inc.	22E	* Motorola Semiconductor Graham & Gillies Limited	57
Burroughs Corporation Conti Advertising	15	* Ganz Measuring Instruments Hungexpo, Varosliget	22E	Motorola Semiconductor Products, Inc. E.B. Lane & Associates, Inc.	39
‡ Bussmann Mfg. Division of McGraw-Edison Co. Henderson Advertising Company	69	* Gardner-Denver Co. Buchen Advertising, Inc.	88	■ National Semiconductor Corp. Chiat/Day, Inc. Advertising	35
Carpenter Technology Corp. Beaumont, Heller & Sperling, Inc.	147	■ General Electric Company, Battery Products Dept. Robert S. Cragin, Inc.	169	NEREM Drumbeater	38, 151
* Centre Engineering Williams & Associates	23E	■ General Electric Company, Plastics Dept.—Valox Resin Ross Roy of New York, Inc.	67	Nikkel-Electronics	170
Cherry Electrical Products, Corp. Kolb/Tookey and Assoc., Inc.	132	■ General Electric Company, Utility & Process Automation Products, Dept. Robert S. Cragin, Inc.	84-85	North Electric Co.— Electronics Div. Marc Associates	143
Circuit-Stik, Inc. Haaga Advertising	172	■ General Instrument Corporation, Semiconductor Comp. Div. Norman Allen Associates, Inc.	106	* Oscilloquartz SA, Neuchatel	52
■ C & K Components Van Christo, Inc.	142	General Magnetics McCarthy, Scelba, DeBiasi Advertising Agency, Inc.	3rd Cover	■ Pearson Electronics Williams E. Clayton & Associates, Inc.	166
* C.P. Clare International N.V.	10E-11E	* General Radio Grad Associates	7E	* Phillips Elcoma Brockies Communications	17E
■ Clairex Corporation Black-Russell-Morris	4th Cover	Georgia Department of Community Development Gerald Ratshoon Advertising, Inc.	160	* Phillips Elcoma Intermarco Nederland	41
Computer Automation Cochrane Chase & Company, Inc.	44-45	■ Gould, Inc./Instrument Systems Division Carr Liggett Advertising, Inc.	162	* Phillips Electrologica Intermarco Nederland	4E
■ Concord Electronics Corp. Sound Advertising	144	Gudebrand Bros. Silk Co. Electronics Division Coastline Advertising	62	* Phillips Industries Vaz Dias	2E-3E
Contour Chemical Co. Engineered Advertising, Inc.	136	■ Hewlett-Packard Tallant/Yates Advertising, Inc.	129	* Phillips N.V. Pit/T & M Division Brockies Communications Systems SA	173
Coors Porcelain Co. Business Mail & Media Service Co.	46-47	■ Hewlett-Packard Tallant/Yates Advertising, Inc.	1	* Phillips TMI Brockies Communications Systems SA	54
■ Corning Glass Works, Electronic Materials Dept. Pierce Brown Associates, Inc.	167-169	■ Hewlett-Packard Bozell & Jacobs/Pacific	2	‡ Precision Monolithics, Inc. Marlborough Associates, Inc.	81
‡ Cutler-Hammer, Inc. Campbell-Mithun, Inc.	57	* I L C Data Device B. Hodes Advertising, Inc.	23E	Ramsey Engineering Co. Midland Associates, Inc.	148
■ Dale Electronics, Inc. Swanson, Sinkey, Ellis, Inc.	58-59	Inselek Ambrose & Borrie Advertising	145	‡ Raytheon Company, Sorensen Department Provandie Eastwood & Lombardi, Inc.	41
‡ Delco Electronics Division, General Motors Corp. Campbell-Ewald Company	86-87	Intel Corp. Regis McKenna, Inc.	12-13	* RCA Electronic Components Al Paul Lefton Company, Inc.	9
Diacon Rogondino Advertising and Marketing	164	International Crystal Mfg., Co Robert V. Freeland & Associates	20	RCA—Solid State Division Marsteller, Inc.	82-83
■ Dialight Corporation Michel-Cather, Inc.	124	International Rectifier Corp., Semiconductor Division William E. Wilson Company	175	■ RCL Electronics, Inc. Morvay Advertising Agency	14
Digital Equipment Corp.— Components Group Schneider Parker, Inc.	18-19	Interswitch William J. Purdy Promotions, Inc.	148	* Rhone Progil	15E
Dow Corning Corp.— Fluids, Emulsion, Compounds Division Ketchum, MacLeod & Grove, Inc.	134-135	■ Ithaco, Inc. Webb & Athey, Inc.	137	* Rohde & Schwarz	1E
Dow Corning Corp. —Resins & Chemical Ketchum, MacLeod & Grove, Inc.	152-153, 155	ITT General Controls D'Arcy-MacManus & Masius	143	R-OHM Corp. Diversified Corporate Services, Inc.	48
‡ Eastman Kodak Co. Business Systems Markets Division— Engineering Data System Micrographics J. Walter Thompson Company	9			Schauer Manufacturing Corp. Nolan, Keelor & Stites	146

introducing: the BOSS™ switch

new Molex Binary Option Selection Switch

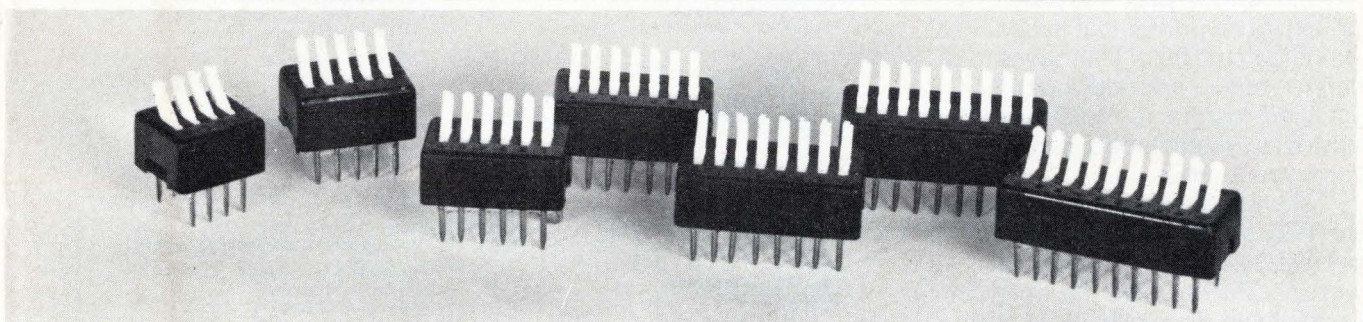
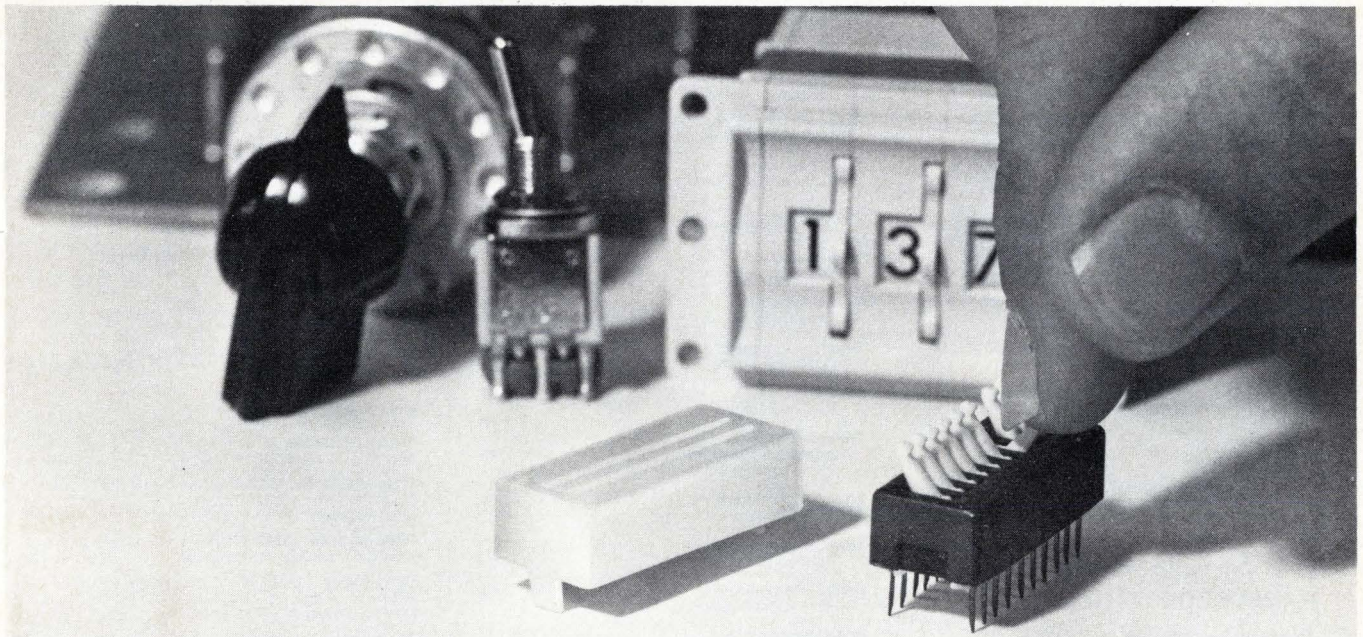

It's the BOSS because butting and wiping contacts make it better.

You need both butting *and* wiping contacts for *positive* logic function programming. The new BOSS switch gives you both—plus gold-over-phosphor bronze contacts for reliable “dry circuit” applications. And easy manual operation means you don't need special tools to program the BOSS.

We make the BOSS in a choice of four to 10 single-throw, single-pole switches with a polyester housing. Enclosed design protects against dust, dirt, and other environ-

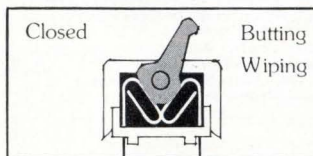
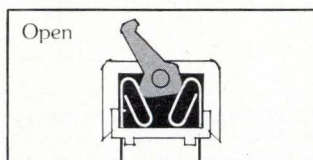

mental hazards and makes the BOSS fully cleanable after soldering.

Solder-tail leads on .100 x .300 centers let you mount the BOSS through a DIP header or directly to the P.C. board eliminating the cost of interconnection wiring to perform the switching function.

BOSS is rated for 50 ma at 30 v, d-c and it programs savings up to 50% into computer, computer peripheral, communications, testing equipment, and related applications.

molex ... *Affordable Technology*

Molex Incorporated, Dept. E974, 2222 Wellington Court, Lisle, Illinois 60532

THE QUIET ONE



So reliable you never hear from it.

Not only a quiet running printer, but a printer that keeps running in the field. That saves service calls... and adds up to satisfied customers. Makes your business system look smart. And more profitable.

No matter how hard you drive the Tally printer, you'll be hard pressed to break it. That's why we're confident in giving a one year warranty on our mechanism. Without any duty cycle limitations.

Reliability isn't the only reason why users prefer Tally. There's much more. It's a data processing printer. For print runs measured in hours rather than minutes. Multiple copies. 200 lines per minute. 132 columns. 64 character set. Straight line print registration. Numerous options. Numerous interfaces.

Write or call Tally Corporation, 8301 South 180th Street, Kent, Washington 98031.

Phone (206) 251-5647.

TALLY®

The Line Printer
For The Long Run.

Siemens AG Linder Presse Union GmbH	43
Siemens Corporation Stiefel/Raymond Advertising, Inc.	149
Signalite, Inc. McCarthy, Scelba, DeBiasi Advertising Agency, Inc.	111
* Spectrol Reliance Limited J M R Advertising	12E-13E
Sprague Electric Company Harry P. Bridge Company	8
Stackpole Carbon Company, Electronic Components Division Ira Thomas Associates, Inc.	156-159
Systron Donner Concord Instruments Fred Schott & Associates	51
Tally Corporation Bonfield Associates	178
■ Tektronix Inc. McCann-Erickson, Inc.	33
■ Tektronix-IDD Young & Roehr, Inc.	17
* Telcon Metals Ltd. Oliver Dawkins Ltd.	18E
Teledyne Philbrick Ingalls Associates	2nd Cover
Thomson CSF Bazine Publicite	97
Trinidad & Tobago Industrial Development Corp. Development Counsellors International, Ltd.	179
■ TRW/IRC Resistors Gray & Rogers, Inc.	60-61
■ TRW Semiconductors The Bowes Company	7
‡ United Chemicon, Inc. Spitz Advertising Agency, Inc.	54
United Systems Corp., A sub. of Monsanto Co. Advertising & Merchandising, Inc.	73
■ Unitrode Corporation Culver Advertising, Inc.	27
Universal Oil Products, Norplex Division Campbell Mithun, Inc.	165
Varo Semiconductor, Inc. Warren-Guild	140
■ Wabash	162
■ Wavetek Indiana Chapman Michetti Advertising	130
Western Digital Corporation W D C Advertising	71
Wima, Westermann Oliver-Beckmann GmbH	16
Winchester Electronics Renaccio Advertising & Marketing, Inc.	22-23
* Yokogawa Electric Works, Ltd. General Advertising Agency, Inc.	81

Classified & Employment Advertising

F. J. Eberle, Manager 212-997-2557

EQUIPMENT (Used or Surplus New) For Sale	
American Used Computer Corporation	174
Electronic Discount Sales	174
P. Fishman Company, Inc.	174
Jensen Tools and Alloys	174
Mountain West Alarm Supply Company	174
Radio Research Instrument Company	174

■ For more information on complete product line see advertisement in the latest Electronics Buyer's Guide
* Advertisers in Electronics International
‡ Advertisers in Electronics domestic edition

Advertising Sales Staff

Pierre J. Braudé New York [212] 997-3468
London 01-493-1451
Director of Marketing

Atlanta, Ga. 30309: Joseph Lane
100 Colony Square, 1175 Peachtree St., N.E.
[404] 892-2868

Boston, Mass. 02116: James R. Pierce
607 Boylston St. [617] 262-1160

Chicago, Ill. 60611:
645 North Michigan Avenue
Robert W. Bartlett (312) 751-3739
Paul W. Reiss (312) 751-3738

Cleveland, Ohio 44113: William J. Boyle
[716] 586-5040

Dallas, Texas 75201: Charles G. Hubbard
2001 Bryant Tower, Suite 1070
[214] 742-1747

Denver, Colo. 80202: Harry B. Doyle, Jr.
Tower Bldg., 1700 Broadway
[303] 266-3863

Detroit, Michigan 48202: Robert W. Bartlett
1400 Fisher Bldg.
[313] 873-7410

Houston, Texas 77002: Charles G. Hubbard
2270 Humble Bldg. [713] CA 4-8381

Los Angeles, Calif. 90010: Robert J. Rielly
Bradley K. Jones, 3200 Wilshire Blvd., South Tower
[213] 487-1160

New York, N.Y. 10020
1221 Avenue of the Americas
Warren H. Gardner [212] 997-3617
Michael J. Stoller [212] 997-3616

Philadelphia, Pa. 19102: Warren H. Gardner
Three Parkway,
[212] 997-3617

Pittsburgh, Pa. 15222: Warren H. Gardner
4 Gateway Center, [212] 997-3617

Rochester, N.Y. 14534: William J. Boyle
9 Greylock Ridge, Pittsford, N.Y.
[716] 586-5040

San Francisco, Calif. 94111: Don Farris
Robert J. Rielly, 425 Battery Street,
[415] 362-4600

Paris: Alain Offergeld
17 Rue-Georges Bizet, 75 Paris 16, France
Tel: 720-73-01

Geneva: Alain Offergeld
1 rue du Temple, Geneva, Switzerland
Tel: 32-35-63

United Kingdom & Scandinavia: Keith Mantle
Tel: 01-493-1451, 34 Dover Street, London W1

Milan: Robert Saidel
1 via Baracchini, Italy Phone 87-90-656

Brussels: Alain Offergeld
23 Chaussee de Wavre
Brussels 1040, Belgium
Tel: 13-73-95

Frankfurt/Main: Fritz Krusebecker
Liebigstrasse 27c, Germany
Phone 72 01 81

Tokyo: Tatsumi Katagiri, McGraw-Hill
Publications Overseas Corporation,
Kasumigaseki Building 2-5, 3-chome,
Kasumigaseki, Chiyoda-Ku, Tokyo, Japan
[581] 9811

Osaka: Ryji Kobayashi, McGraw-Hill
Publications Overseas Corporation, Kondo
Bldg., 163, Umegae-cho Kita-ku, Japan [362] 8771

Australasia: Warren E. Ball, IPO Box 5106,
Tokyo, Japan

Business Department

Stephen R. Weiss, Manager
[212] 997-2044

Thomas M. Egan,
Production Manager [212] 997-3140

Carol Gallagher
Assistant Production Manager [212] 997-2045

Dorothy Carter, Contracts and Billings
[212] 997-2908

Frances Vallone, Reader Service Manager
[212] 997-6057

Electronics Buyers' Guide

George F. Werner, Associate Publisher
[212] 997-3139

Regina Hera, Directory Manager
[212] 997-2544

YOU CAN GET EXPERT ELECTRONICS CONTRACT WORK FOR UNDER \$250 PER HOUR!

(including Labor, Profit and Overhead, F.O.B. Trinidad)

And just as important as price is quality. In the Caribbean nation of Trinidad & Tobago trained, willing hands have been producing for U.S. companies some of the most sophisticated electronic components anywhere. Examples: two-way mobile radio harnesses, memory core assemblies, advanced micro-electronic relays, and printed circuit boards.

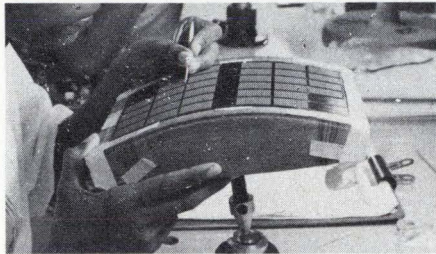

Ask such companies as Westinghouse, Sylvania, Bunker-Ramo, General Electric or Fifth Dimension Inc. about Trinidad & Tobago. Or ask us...by filling in and returning to us the coupon below.

**TRINIDAD &
TOBAGO**

Trinidad & Tobago
Industrial Development Corporation
400 Madison Avenue, New York, N.Y. 10017
Clyde S. Namsoo, U.S. Director
I'd like you to give me 15 reasons why electrical and electronics manufacturers are making or contracting their products in Trinidad & Tobago.
Name & Title _____
Company _____
Address _____
City, State, Zip _____
Telephone No. _____
Product Line _____

See us at
WESCON
Booth 1132

Circuit board yield improved to 98% with FAULTFINDER™



FF101 combines production line in-circuit component testing with fully automatic fault isolation

Circuit manufacturers attain near 100% yield with our FAULTFINDER in-circuit component test system. One manufacturer's yield is now 98%, 40% better than they were able to achieve with functional testing alone.

The reason for the improved yield? More thorough testing, fault isolation and board repair. Our FAULTFINDER accurately checks individual components against specified values. Any test failure indicates a circuit fault. Automatic printout supplies explicit data to allow rework personnel to make complete circuit repairs, quickly and economically.

Faultfinder engineers conceived the basic reason for in-circuit component testing 20 years ago. This idea remains unchanged; a board that is built right will work right. It will also be more reliable. Only thorough testing, fault isolation and repair will produce a board that is built right. We start by detecting shorts, opens and poor connections. After this continuity test we check for incorrectly-oriented and out-of-tolerance parts and

inoperative semiconductors. Fault detection is instantaneous and automatic.

Functional testing equipment also can detect certain component faults. However it must use involved sub-routines in the test program or interrupt automatic operation to allow for CRT-assisted manual probing of the circuit board. Many component faults cannot be detected by functional tests. Those in redundant circuits, decoupling networks and compensating circuits will pass functional tests undetected, yet our Faultfinder will isolate each of these faults, automatically, during the test cycle.

Our highly efficient FF101 increases production, improves product quality and lowers production costs for all types of circuit manufacturing. The FAULTFINDER test system can serve you on your own production line or on a contract basis at one of our Service Centers. Call us, we can help you determine which is more suitable or convenient.

WE HELP MANUFACTURERS MAKE BETTER ELECTRONIC PRODUCTS

FF FAULTFINDERS Inc.

A807428

24 Wade Road, Latham, N.Y. 12110 (518) 783-7786
646 N. Busse Hwy., Park Ridge, ILL. 60068 (312) 696-0335
525B Del Rey Ave., Sunnyvale, CA. 94086 (408) 732-9020
17971 Suite E, Sky Park Circle, Irvine, CA. 92707 (714) 549-4901