

- 109 Reducing component count with prograded logic arrays
- 115 How to design the optimum class A bipolar amplifier
- 120 Technology update: color-television tubes

LIBRARY
 STATE TECHNICAL INSTITUTE
 AT MEMPHIS

Electronics®

PUTTING CHARGE-COUPLED DEVICES TO WORK

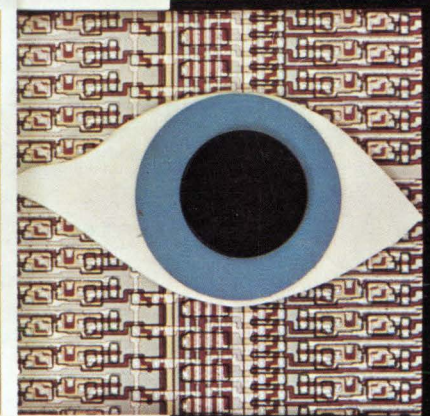
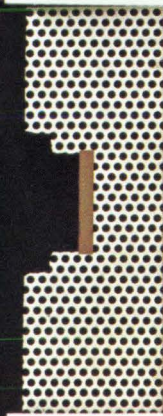
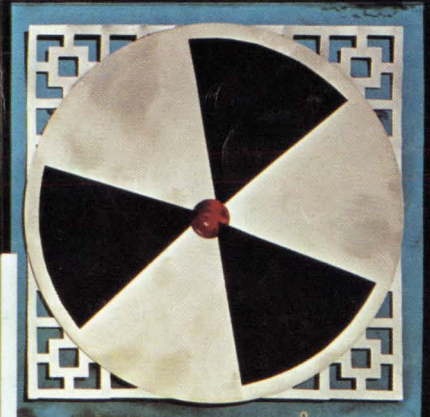
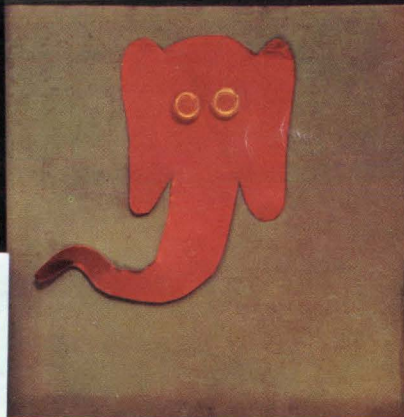
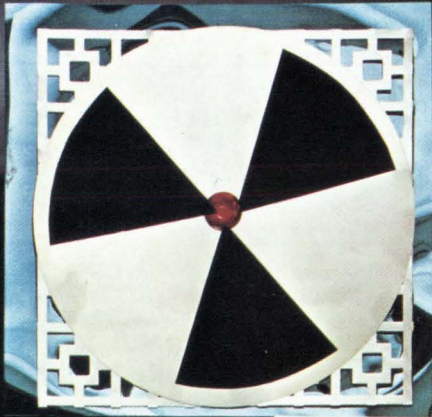

STATE TECHNICAL INSTITUTE
 MS NF WALKER
 5983 MACON COVE
 MEMPHIS TN
 38134

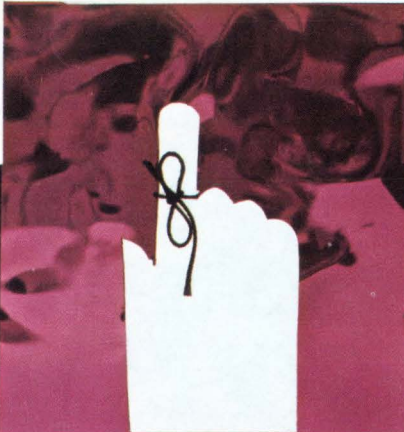
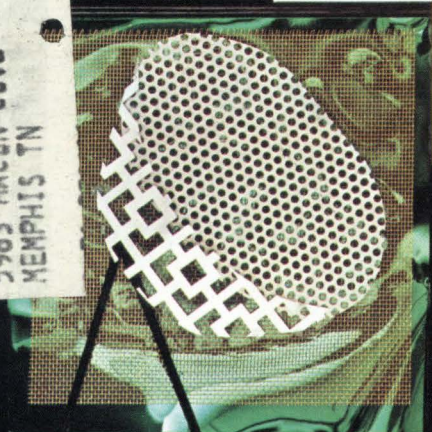

Maddox Speaks.

DAC's make the difference in displays.

Some really *clear, sharp* pictures are being generated for demanding computer CRT Display jobs like Air Traffic Control, Avionic Heads-Up, and others.

To get sharp, clean output on high speed X-Y deflection displays you have to start with good spot definition and intensity and then drive it with a clean deflection signal. And that's where high-speed display DAC's come in.

Here's how.

Display DAC's convert digital position commands to analog voltage levels which will position the spot on the CRT face. New commands are usually clocked in at a steady update rate. The spot is positioned to the start of a line or character and then moved by progressive commands to draw the line.

If the DAC's behave, all is well, but often lines wiggle, and show intensity variations.

Who's the culprit?

Glitch, (transient *spike* or bump in the DAC output) and *differential non-linearity*, (a wrong size step in a series of steps).

Display DAC's are "de-glitched" to achieve very low output glitch values, and are designed to have damn good differential linearity.

How to define spec limits?

First, determine maximum allowable glitch voltage as measured through a test filter which simulates your deflection circuit's passband. The test filter is the key. You can even lump together the effects of glitch and differential non-linearity. Then, ramping the DAC and comparing its band-limited output to an

ideal ramp, you can check the errors. And after limits are set for intensity variation and wiggle, you can graphically arrive at ramp error limits for the DAC's.

Among other things.

You can also have an inherent lack of line fidelity due to the staircase-like DAC output. Smaller steps through greater DAC resolution will help. But beware, for the limits of maximum available update rate and minimum picture refresh rate set a resolution limit for line drawing. We can show you some filter techniques that can improve ramp fidelity by 10 to 1 or more, solving this staircase problem.

Settling is really important, too, and long settling tails must be absent so that line starting points will land where you planned.

Things like large-signal settling time, slew rate, zero offset, large scale linearity, and scale factor can normally be obtained much better than available deflection circuits, so use care; don't over-specify the DAC's. Save yourself some money.

Talk to the experts.

There are a lot more parameters to be considered in specifying high-speed display DAC's, so if you are into this, or going to be, probably the best approach is to consult us. After all, we have standard products such as our 12 or 13 bit DAC's (Models 4014 and 4017), and a lot of display knowledge and real experience. We've built and shipped more high-speed display DAC's than anybody else in the world.

Telephone, toll-free (800) 225-7883, in Mass. (617) 329-1600. Or write us, Dedham, Mass. 02026. In Europe, Tel. 73.99.88, Telex: 25881. Or write, 1170 Brussels, Belgium.

 **TELEDYNE
PHILBRICK**

Circle 900 on reader service card

Ed Maddox, Sr. Engineer

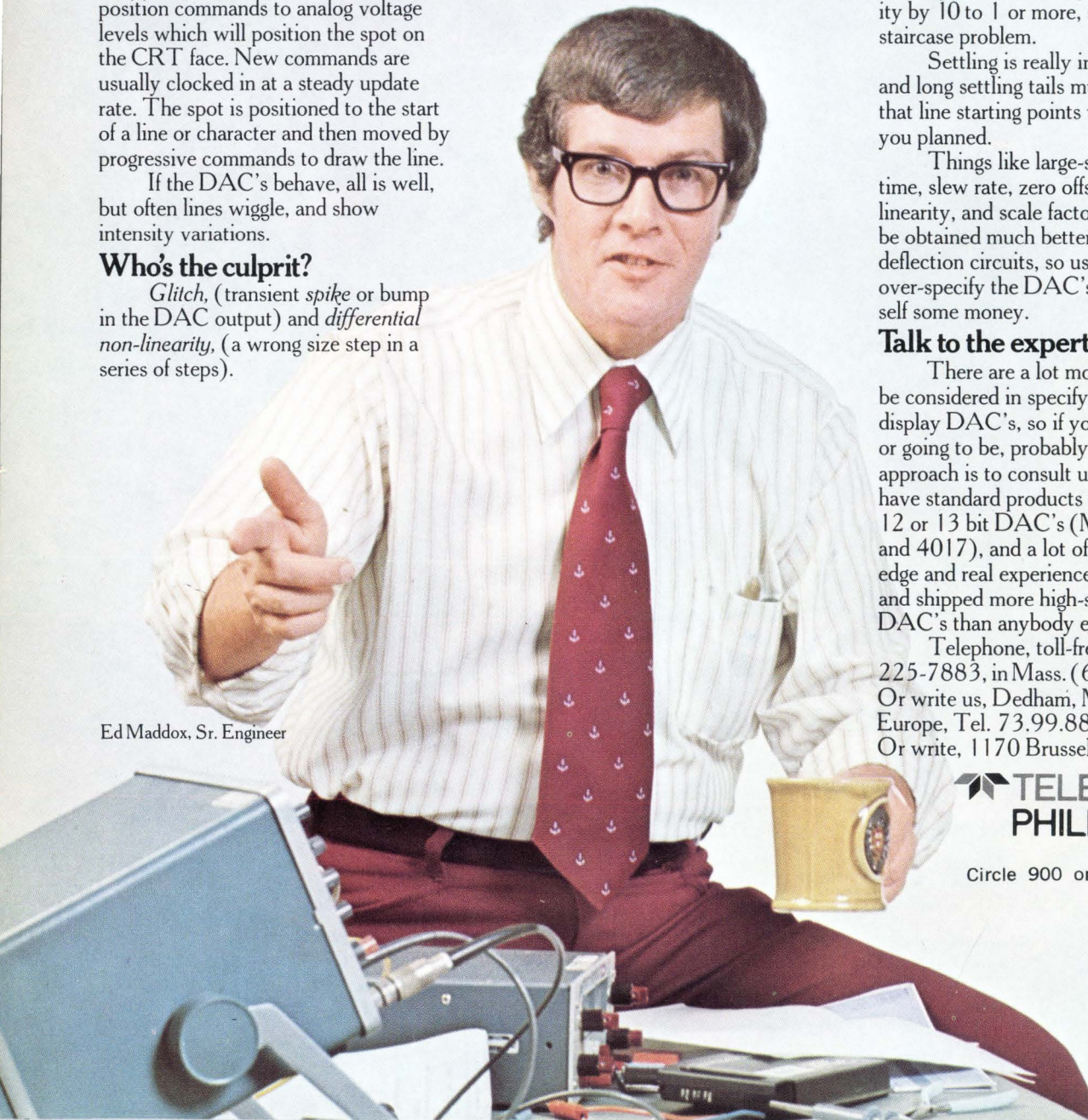

Send for your IDIOM button today!
Wear it proudly!

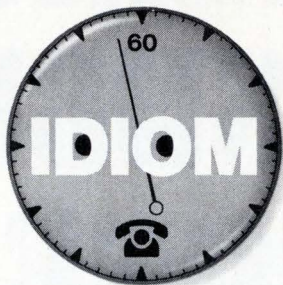

**But read this first and
see what you're getting into.**

IDIOM stands for Inventory and Delivery Information in One Minute. It is the rental industry's first and only nationwide real time computer system. What does it do for you? Just dial our number and tell us your rental requirements. Instantly, the computer queries all warehouses and gives you a firm commitment on availability, delivery and rental rate. No more runaround, delays or broken promises. Just a quick, accurate response.

IDIOM is a service of U.S. Instrument Rentals, Inc., a brand new company that was born well established, thanks to the resources of one of the country's leading financial institutions and the experience of the world's oldest and largest leasing organization, United States Leasing International.

We offer the largest on-the-shelf inventory of new, up-to-date instruments in the industry. And **IDIOM** and inventory are just the beginning. USIR has developed a number of unique programs tailored specifically with your needs in mind. Things like our *automatic return reminders*, to help you save money by terminating the rental when the job is over.

... our *New Product Evaluation Program*, under which you can get your hands on

selected newly introduced instruments at greatly reduced rental rates.

... the industry's only *service claims with teeth*: a money penalty if a unit fails in operation and we don't turn it around or ship a suitable replacement within 48 hours.

In all there are eight sound reasons why it makes more sense to rent from us than from someone else. There are also ten excellent reasons why you should consider renting in the first place. Not as an expedient, but as a prudent money management tool.

If you use (note: we didn't say "own") electronic instruments, send us this coupon or the reply card in the back and we will send you 1) your **IDIOM** button and 2) our catalog (including the rest of USIR's new rental ideas).

U.S. Instrument Rentals, Inc.
951 Industrial Road, San Carlos, CA 94070
Please send my button and your catalog.
Name _____
Title _____
Company _____
Address _____
City _____ State (Zip) _____

US
INSTRUMENT RENTALS, INC.

☎ (415) 592-9230

☎ (213) 849-5861

☎ (201) 381-3500

THE ALTERNATIVE TO TONE DIALING...

ANNOUNCING...THE MOS PUSHBUTTON TELEPHONE DIALER CIRCUIT

NOW. ALL THE CIRCUITRY NEEDED
TO CONVERT PUSHBUTTON CLOSURES
TO ROTARY DIAL PULSES...

... IN THIS
ACTUAL SIZE
PACKAGE

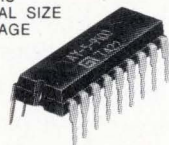

Finally... the answer to low-cost pushbutton dialing is here. General Instrument's new MOS Telephone Dialer Circuit (AY-5-9100) converts pushbutton closures to rotary dial pulses directly compatible with all existing standard telephone systems. Pulse rate, mark to space ratio, and interdigital pause can all be easily adjusted by you to suit your requirements.

Dynamic circuitry is employed to reduce power requirements to less than 2 mW, making possible battery or, where applicable, line powered operation. In addition, the last number dialed is stored, allowing for automatic re-dial when desired. Access pause capability is also provided to simplify operation in a PABX or WATS system.

The AY-5-9100 is available now in production quantities. For the answer to how you can convert to low-cost pushbutton dialing, dial toll-free 800-645-9247 (In New York State dial 516-733-3107) or write, General Instrument Corporation, Microelectronics, 600 W. John St., Hicksville, N.Y. 11802

GI'S GOT IT!

GENERAL INSTRUMENT CORPORATION
MICROELECTRONICS



39 Electronics Review

COMPUTERS: Computer alters its architecture fast, 39
MATERIALS: New alloy may cut phone-gear costs, 40
TRANSPORTATION: DOT perks up fast rail systems, 41
COMMERCIAL: Tampering is out with C-MOS lock, 42
INSTRUMENTS: CRT design is key to improving scope, 42
CONSUMER: Four-channel fm test goes over cable, 43
NEWS BRIEFS: 44
RADAR: TI to develop Coast Guard radar, 46
COMPONENTS: Pressure sensor relies on frequency, 46

62 Electronics International

GREAT BRITAIN: MOS LSI gamble pays off in three phone systems, 62
INTERNATIONAL: CAI glow brightens in Paris, London, 63
AROUND THE WORLD, 63

75 Probing the News

CONSUMER ELECTRONICS: Shakeout seen among calculator makers, 75
AVIONICS: Big market beckons for NATO's F-104 replacement, 78
COMPONENTS: Distributors nervous about parts glut, 82
COMPANIES: Draper Lab: a successful spin-off, 86

91 Technical Articles

SOLID STATE: CCDs move in on memories and analog processing, 91
DESIGNER'S CASEBOOK: Full-wave rectifier eases matching, 104
Providing a decimal output for a calculator chip, 105
Broadband p-i-n attenuator has wide input dynamic range, 106
COMPUTERS: PLAs enhance digital processor speed, 109
CIRCUIT DESIGN: Class A amplifiers meet specified tolerances, 115
TECHNOLOGY UPDATE: Color television picture tubes, 120
ENGINEER'S NOTEBOOK: C-MOS Schmitt trigger is versatile, 124

131 New Products

IN THE SPOTLIGHT: Self-latching relays offer six poles, 131
Calculator turns into data terminal, 133
COMPONENTS: Binary-coded-decimal switches are compact, 135
INSTRUMENTS: Test oscillator is clean and fast, 141
COMMUNICATIONS: IC links push-button, dial phones, 146
INDUSTRIAL: Monitor senses faults in power line, 152
MATERIALS: 157

Departments

Publisher's letter, 4
Readers comment, 6
40 years ago, 8
People, 14
Meetings, 20
Electronics newsletter, 35
Washington newsletter, 51
Washington commentary, 52
International newsletter, 65
Engineer's newsletter, 126
New literature, 158

Highlights

Cover: More jobs for charge-coupled devices, 91

Well-established by now in electro-optical equipment, charge-coupled devices are making a bid for even stronger positions among digital memories and in analog signal processing. Large CCD serial shift registers will cost very little per bit, and CCD delay lines, filters, and multiplexers extend the reach of monolithic integrated circuitry. Cover by designer Ann Dalton symbolizes the three CCD application areas.

Shakeout starts in consumer calculators, 75

The seasonal nature of consumer calculator sales, combined with the low margin of the cutthroat retail prices, means that only the larger and more efficient suppliers can hope to survive. The odds are on the vertically integrated semiconductor manufacturers.

PLA makes microprogramming simpler, 109

The programmed logic array (PLA) is basically a read-only memory with programmable addresses. Because it contains fewer bits and fewer addresses than standard ROMs, it also operates faster and has a smaller component count.

Technology update: color-TV tubes, 120

Steady improvements in the design of color-television tubes over the past few years have focussed partly on the consumer appeal of enhanced brightness and fast warm-up and partly on the set-manufacturing economies provided by the self-convergence in-line-gun tube.

And in the next issue . . .

Wescon preview . . . high-speed speech playback without distortion . . . how to load and schedule a semiconductor test system.

EDITOR-IN-CHIEF: Kemp Anderson

EXECUTIVE EDITOR: Samuel Weber

MANAGING EDITORS: Lawrence Curran, *News*;
Arthur Erikson, *International*

SENIOR EDITORS: John Johnsrud,
H. Thomas Maguire, Laurence Altman,
Ray Connolly, Stephen E. Scrupski

ART DIRECTOR: Fred Sklenar

ASSOCIATE EDITORS: John N. Kessler,
Howard Wolff, Gerald M. Walker,
Alfred Rosenblatt

DEPARTMENT EDITORS

Circuit Design: Lucinda Matterna
Communications & Microwave:

Stephen E. Scrupski
Computers: Wallace B. Riley
Consumer: Gerald M. Walker
Industrial: Michael J. Riezenman
Instrumentation: Stephen E. Grossman
Aerospace/Military: Ray Connolly
New Products: H. Thomas Maguire
Solid State: Laurence Altman

COPY EDITORS: Margaret Eastman,
Everett C. Terry

ASSISTANT EDITOR: Marilyn Offenheiser

ART: Charles D. Ciatto, *Associate Director*
Patricia Cybulski, *Assistant Director*

PRODUCTION EDITOR: Arthur C. Miller

EDITORIAL SECRETARIES: Janet Annunziata,
Julie Gorgoglione, Penny Roberts

FIELD EDITORS

Boston: Gail Farrell
Los Angeles: Paul Franson (Mgr.)
Midwest: Larry Armstrong (Mgr.)
New York: John N. Kessler (Mgr.)
San Francisco: Bernard Cole (Mgr.)
Judith Curtis
Washington: Ray Connolly (Mgr.)
Larry Marion
Frankfurt: John Gosch
London: William F. Arnold
Paris: Arthur Erikson
Tokyo: Charles Cohen

McGRAW-HILL WORLD NEWS

Director: Ralph R. Schulz
Bonn: Robert Ingersoll
Brussels: James Smith
London: Marvin Petal
Milan: Peter Hoffmann, Andrew Heath
Moscow: Axel Krause
Paris: Michael Johnson, Richard Shepherd
Stockholm: Robert Skole
Tokyo: Mike Mealey

PUBLISHER: Dan McMillan

DIRECTOR OF MARKETING: Pierre J. Braudé

ADVERTISING SALES SERVICE MANAGER:
Wallis Clarke

BUSINESS MANAGER: Stephen R. Weiss

CIRCULATION MANAGER: Nancy L. Merritt

MARKETING SERVICES MANAGER:
Tomlinson Howland

RESEARCH MANAGER: Margery D. Sholes

Charge-coupled technology is moving in on a wide range of data-processing applications. The technology, barely four years old, is getting strong support in areas far removed from the imaging applications that were its first claim to fame.

Larry Altman, our solid state editor, put together an in-depth report on CCD and data processing (see p. 91). You'll find in this report details about the spectacular impact of CCD technology on military analog-signal processing, where for the first time the full force of monolithic IC technology has been brought to bear on sophisticated analog communications systems. Then, too, there are the benefits that CCD will bring to commercial communications systems. Finally, we review the commercially most significant development: CCD memories.

We're sure you'll find the 11-page report an invaluable guide to what can be expected as CCD meets data processing.

The latest installment in our Technology Update series covers a vacuum tube—the color-TV picture tube. It's the one tube still under intensive development all around the world. And, as Jerry Walker, our consumer electronics editor, points out in the article on page 120, color tubes are being churned out at the rate of 24 million a year—and are supplied in a wide range of picture sizes, deflection angles, shadow masks, and materials. There are even some fast-warmup models.

The one big common denominator, though, is the in-line arrangement of electron guns. But even here there are significant differences and innovations. So, for what's new in the design of color-TV tubes, from work on display brightness to the tradeoffs involved in fast-warmup tubes, turn to page 120 for Technology Update.

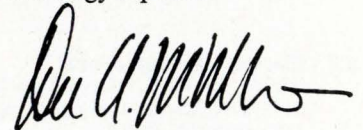

We're looking for a computer editor

The ideal candidate for this position will have an engineering degree, as well as extensive experience in the design of computers, or computer-based systems and components. The candidate must, of course, have writing ability.

In covering the stimulating new developments in technology our editors travel extensively, interview the people who make electronics the dynamic field it is, and write and edit technical articles.

As part of McGraw-Hill, one of the world's leading publishing companies, we offer excellent working conditions and fringe benefits. And, the salary level is as good as or better than industry rates for engineers.

If you are interested and have the necessary qualifications, send your résumé with salary requirements to: The Executive Editor, ELECTRONICS Magazine, 1221 Avenue of the Americas, New York, N.Y. 10020.

August 8, 1974 Volume 47, Number 16
93,769 copies of this issue printed

Published every other Thursday by McGraw-Hill, Inc. Founder: James H. McGraw 1860-1948. Publication office 1221 Avenue of the Americas, N.Y., N.Y. 10020; second class postage paid at New York, N.Y. and additional mailing offices.

Executive, editorial, circulation and advertising addresses: Electronics, McGraw-Hill Building, 1221 Avenue of the Americas, New York, N.Y. 10020. Telephone (212) 997-1221. Teletype TWX N.Y. 710-581-5234. Cable address: MCGRAWHILL N.Y.

Subscriptions limited to persons with active, professional, functional responsibility in electronics technology. Publisher reserves the right to reject non-qualified requests. No subscriptions accepted without complete identification of subscriber name, title, or job function, company or organization, including product manufactured or services performed. Subscription rates: qualified subscribers in the United States and possessions, Canada, and Mexico \$12.00 one year, \$24.00 three years; all other countries \$25.00 per year, except Japan \$50.00 per year, Brazil \$40.00 per year, Australia and New Zealand \$60 per year, including air freight. Limited quota of subscriptions available at higher-than-basic rate for persons outside of field served, as follows: U.S. and possessions and Canada, \$25.00 one year; all other countries \$50.00. Single copies: \$4.00.

Officers of the McGraw-Hill Publications Company: John R. Emery, President; J. Elton Tuohig, Executive Vice President-Administration; Gene W. Simpson, Group Publisher-Vice President; Senior Vice Presidents: Ralph Blackburn, Circulation; Walter A. Stanbury, Editorial; John D. Hoglund, Controller; David G. Jensen, Manufacturing; Gordon L. Jones, Marketing; Jerome D. Luntz, Planning & Development.

Officers of the Corporation: Shelton Fisher, Chairman of the Board and Chief Executive Officer; Harold W. McGraw, Jr., President and Chief Operating Officer; Wallace F. Trendly, Group President; McGraw-Hill Publications Company and McGraw-Hill Information Systems Company: Robert N. Landes, Senior Vice President and Secretary; Ralph J. Webb, Treasurer.

Title registered in U.S. Patent Office; Copyright ©1974 by McGraw-Hill, Inc. All rights reserved. The contents of this publication may not be reproduced in whole or in part without the consent of copyright owner.

Subscribers: The publisher, upon written request to our New York office from any subscriber, agrees to refund that part of the subscription price applying to copies not yet mailed. Please send change of address notices or complaints to Fulfillment Manager; subscription orders to Circulation Manager, Electronics, at address below. Change of address notices should provide old as well as new address, including postal zip code number. If possible, attach address label from recent issue. Allow one month for change to become effective.

Postmaster: Please send form 3579 to Fulfillment Manager, Electronics, P.O. Box 430, Hightstown, N.J. 08520.

If you want a power supply
that's as fast
as the rest of your system
look into

KEPCO

OPS

Operational power supplies,
the fast programmable voltage stabilizers
that you can program with a computer.
There are ten different OPS Groups
ranging from
10 watt modules to a kilowatt

OPS groups VI, VII & VIII are comprised of 31 separate models ranging from 0-6 volts to 0-150 volts, in 100 watt, 250 watt, 500 watt and 1000 watt power classes. High open loop gain, superb comparators and stable references permit them to function with better than 0.005% stabilization. A unique "no-filter-capacitor" output circuit allows them to follow rapid fire programming instructions. Their entirely linear design generates no hard-to-suppress transients.

Ask your Kepco man for details about the Kepco OPS. If you don't know who he is, call (212) 461-7000 collect, or write Dept. EQ-14 and we'll be glad to direct you to the most exciting power supplies on the scene.



Half-Rack: 250-500W

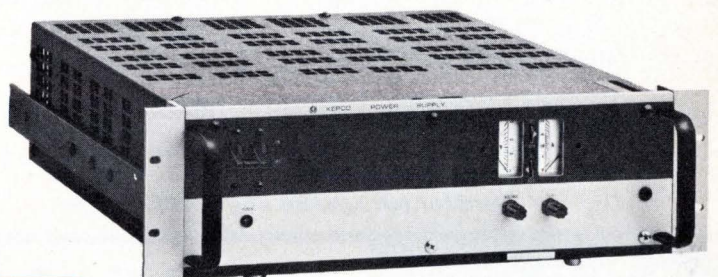

Full-Rack: 1000W+

KEPCO®

KEPCO, INC. • 131-38 SANFORD AVENUE • FLUSHING, N.Y. 11352 • (212) 461-7000 • TWX #710-582-2631 • Cable: KEPCOPOWER NEWYORK

When You Buy a Power Supply, Why Not Get the Best?

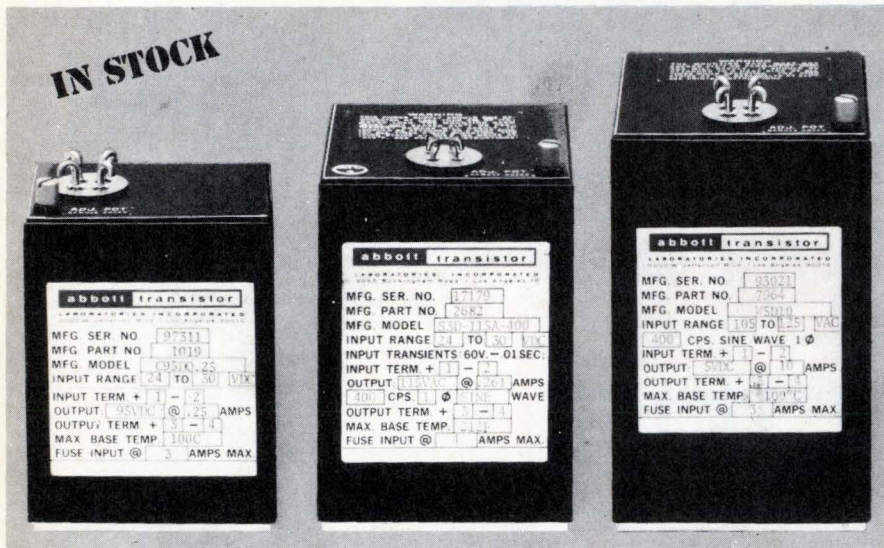

28 VDC to DC
(55,463 Hrs.)
Model C95D

28 VDC to 400 A
(61,387 Hrs.)
Model S3D

400 A to DC
(56,148 Hrs.)
Model W5D

Abbott's New Hi-Performance Modules

are designed to operate in the stringent environment required by aerospace systems — (per MIL-E-5400K or MIL-E-5272C) and MIL-STD-461 for electromagnetic interference.

RELIABILITY — MTBF (mean time between failures) as calculated in the MIL-HDBK-217 handbook can be expected in excess of 50,000 hours at 100°C for all of these power modules. The hours listed under the photos above are the MTBF figures for each of the models shown. Additional information on typical MTBF's for our other models can be obtained by phoning or writing to us at the address below.

QUALITY CONTROL — High reliability can only be obtained through high quality control. Only the highest quality components are used in the construction of the Abbott power module. Each unit is tested no less than **41 times** as it passes through our factory during fabrication — tests which include the scru-

tinizing of the power module and all of its component parts by our experienced inspectors.

NEW CATALOG—Useful data is contained in the new Abbott Catalog. It includes a discussion of thermal considerations using heat sinks and air convection, a description of optional features, a discussion of environmental testing, electromagnetic interference and operating hints.

WIDE RANGE OF OUTPUTS — The Abbott line of power modules includes output voltages from 5.0 volts DC to 3,650 volts DC with output currents from 2 milliamperes to 20 amperes. Over 3000 models are listed **with prices** in the new Abbott Catalog with various inputs:

- 60A to DC, Regulated
- 400A to DC, Regulated
- 28 VDC to DC, Regulated
- 28 VDC to 400A, 1 ϕ or 3 ϕ
- 24 VDC to 60A, 1 ϕ

Please see pages 581 to 593 of your 1973-74 EEM (ELECTRONIC ENGINEERS MASTER Catalog) for complete information on Abbott modules.

Send for our new 56 page FREE catalog.

abbott transistor

LABORATORIES, INCORPORATED
5200 W. Jefferson Blvd./Los Angeles 90016 (213) 936-8185
1224 Anderson Ave./Fort Lee, N.J. 07024 (201) 224-6900

Readers comment

Limiting engine rpm

To The Editor: There is an error in "Sure-fire ignition system safely limits engine rpm" [*Electronics*, April 4, p. 121]. In Mr. [L.G.] Smeins's Designer's casebook on a CDI system for autos, he states that to limit an auto engine to 6,000 revolutions per minute, the spark must be limited to 6,000 pulses per minute. That's untrue.

If the sparking rate of a normal engine is limited to 6,000 rpm, the engine would rev to 12,000 rpm because the four-cycle engines fire every other revolution. I'll bet not many auto engines would make it to 12,000. Mine wouldn't.

Tom Swanson
ITT

Cape Sarichef, Alaska

■ *Mr. Smeins replies:* Mr. Swanson is correct in pointing out an error. The original draft stated that capacitor C₁ charges to 4.55 volts at a repetition rate equivalent to 6,000 rpm. I apologize for missing the deletion of "equivalent" in the rewritten manuscript.

On the other hand, Mr. Swanson is incorrect in his analysis of the correct charging rate. Since the trigger operates on all cylinders, the repetition rate depends on the number of cylinders in the engine considered. For the example of an eight-cylinder, four-cycle engine, 6,000 rpm is equivalent to 400 pulses per second or 24,000 pulses per minute—higher, not lower, than shown. A universal expression for the pulse rate is:

$$PPM = (\text{No. cylinders})(rpm)/2$$

for a four-cycle engine

Qs should be flip-flopped

To the Editor: I wish to point out a small error in notation in the drawing for my Engineer's notebook, "Another way to build a two-gate flip-flop" [June 13, p.124].

The NOR gate flip-flop in Fig. 2 should have the upper output labeled \bar{Q} and the lower output labeled Q, instead of the other way around.

Donald P. Martin
Martin Research Ltd.
Chicago, Ill.

Now you have an alternate source for 2GHz & 3GHz microwave transistors



TRW's new 2GHz & 3GHz microwave amplifier parts are available right now, off-the-shelf, from any authorized TRW distributor. So, soon as you qualify these parts, you are no longer at the mercy of a single-source manufacturer!

And here's some more news: our transistors are not simply "just as good" as the originals; they're better! Gold metallized to last longer, Metal migration failure is virtually non-existent. The 2GHz parts can also withstand infinite VSWR and overdrive. Yet TRW's gold metallized parts cost the same as ordinary aluminum ones (maybe less!).

These are practically drop-in parts. You can use them right now, in your present amplifiers—and, of course, in future designs. That means instant

improvement in the reliability of your amplifiers. Part for part:

3GHz PART NUMBERS			
Aluminum		Gold	
1W	MSC2001	TRW2001	MSC3001
3W	MSC2003	TRW2003	MSC3003
5W	MSC2005	TRW2005	MSC3005
10W	MSC2010	TRW2010	—

For details, call Don Comm. (213) 679-4561. Or write TRW Semiconductors, an Electronic Components Division of TRW Inc., 14520 Aviation Blvd., Lawndale, California 90260.

TRW RF SEMICONDUCTORS

These products are available through the following authorized distributors:

- | | | | |
|-------------------------|-----------------------------|-----------------------------|----------------------------|
| Almo Electronics | Electronics Marketing Corp. | Pytronic Industries Inc. | R. V. Weatherford Co. |
| Bell Industries | Elmar Electronics Inc. | Rochester Radio | Westates Electronics Corp. |
| Cramer Electronics Inc. | Hall-Mark Electronics Corp. | Semiconductor Concepts Inc. | Wilshire Electronics |

What's more, ours are better!

TRW's new gold-metallized 2GHz and 3GHz microwave amplifier transistors mean metal migration is virtually a thing of the past. The 2GHz parts can also withstand infinite VSWR and overdrive. That means longer life and greater reliability for your present and future designs. Yet TRW's gold-metallized parts cost the same as aluminum parts—maybe even less!

Once you qualify our parts, you no longer have to worry about being dependent on a single supplier. Our microwave transistors are available immediately—right off the shelf—from any authorized TRW distributor.

And you have complete choice, part for part:

	2GHz PART NUMBERS				3GHz	
	Aluminum		Gold		Aluminum	Gold
1W	MSC2001	TRW2001	MSC3001	TRW3001		
3W	MSC2003	TRW2003	MSC3003	TRW3003		
5W	MSC2005	TRW2005	MSC3005	TRW3005		
10W	MSC2010	TRW2010	—	—		

See for yourself how good these new transistors are. Send the coupon for complete details.



TRW RF Semiconductors
 An Electronic Components Division of TRW Inc.
 14520 Aviation Boulevard
 Lawndale, California 90260

Send me data sheets on your 2GHz and 3GHz gold-metallized microwave amplifier transistors.

name _____

company name _____

address _____

city _____ state _____ zip _____

Mail in coupon or call Don Comm (213) 679-4561.

TRW RF SEMICONDUCTORS

These products are available through the following authorized distributors:

- Almo Electronics
- Bell Industries
- Cramer Electronics Inc.

- Electronics Marketing Corp.
- Elmar Electronics Inc.
- Hall-Mark Electronics Corp.

- Pytronic Industries Inc.
- Rochester Radio
- Semiconductor Concepts Inc.

- R. V. Weatherford Co.
- Westates Electronics Corp.
- Wilshire Electronics

40 years ago

From the pages of *Electronics*, August, 1934

Electronic resistor sorter

By a series of bridge measurements, made automatically, resistors of the type used by the million in the annual production of home and audio radio receiving sets, are tested and sorted by this machine developed by Rex D. McDill, of Cleveland.

The machine will test in production 80 resistors per minute and reject those not within plus or minus 0.5 per cent. In one installation the device, controlled by electron tubes, saved \$1 per 1,000 units and therefore paid for itself very quickly.

Hoppers feed the resistors to notched discs rotated by a motor. The resistors are picked up and brought past a pair of contacts which connect them individually into a Wheatstone Bridge. If the bridge indicates that the resistor is below a certain value, an air jet led to the machine through a hose rejects the resistor by forcing it into the first of the three chutes.

If the resistor is above this value of resistance but below some other value, the resistor gets past the first but not the second air gun. If the resistor is still higher in value, the unit is either shot down the third chute, or is carried clear around to fall through the hole in the bottom of the table and is thereby rejected completely.

Daily notes for engineers

Dr. C.F. Burgess, chairman of the board of the Burgess Battery Company, requires his key men to keep daily diaries recording observations, actual happenings, new ideas, and facts pertinent to their work. Such notebooks often become of great usefulness in patent cases, in dating inventions, etc.

"There is no more difficult rule to enforce than that pertaining to daily notes," says Dr. Burgess, "But once a man sees the value of recording his accomplishments and plans, he becomes equally enthusiastic. An employee whose daily work does not uncover something of interest to himself and his company which is worthy of writing about should look for another job."



No Offense

Non-PCB (polychlorinated biphenyl) . . . non-toxic . . . non-polluting. That's new Sprague ECCOL® A-C Capacitors . . . developed for today's ecology-conscious world.

Equipment manufacturers using capacitors with polychlorinated biphenyl impregnants are finding that some nations have prohibited the import of products containing PCB.

ECCOL® capacitors have been designed to meet industry needs for PCB-free capacitors. They exhibit essentially identical electrical performance characteristics to those of long-used askarel capacitors. Their operating life and reliability are also equivalent. Even the size of ECCOL® Capacitors is similar to previous designs, except for a slight increase in case height.

Drawn-case ECCOL® Capacitors are available in a wide range of capacitance values from 1 to 55µF, with four voltage ratings from 300 to 660 VAC.

For complete technical data, write for Engineering Bulletin 4550 to:
Technical Literature Service
Sprague Electric Company
35 Marshall Street
North Adams, Mass. 01247

45P-4113

SPRAGUE®

THE MARK OF RELIABILITY

THE BROAD-LINE PRODUCER OF ELECTRONIC PARTS

a SELF-SCAN[®] PANEL

says it all...

**ENGLISH • FRENCH • GERMAN • HEBREW • RUSSIAN
JAPANESE • SYMBOLS • GRAPHICS • and other languages**

No matter what you have to say or how you say it, a SELF-SCAN panel display provides the economical and practical solution to your readout problem. The only commercially available dot matrix pattern with five years of proven customer performance plus the following features:

- Low Cost
- Compact Packaging
- Few Connections
- Distinctive Appearance

The 5 x 7 dot matrix format of SELF-SCAN panels and our variety of MOS character generators allow you to communicate with maximum legibility and flexibility. Simultaneous bi-lingual display is also possible on certain models. SELF-SCAN panels are simple to interface to computers.

Single register displays of 16, 32, and 80 characters, and multi-register displays of 256 (8 x 32) characters are available. 0.2", 0.3", 0.4" characters with soft neon-orange glow are visible up to 25 feet.

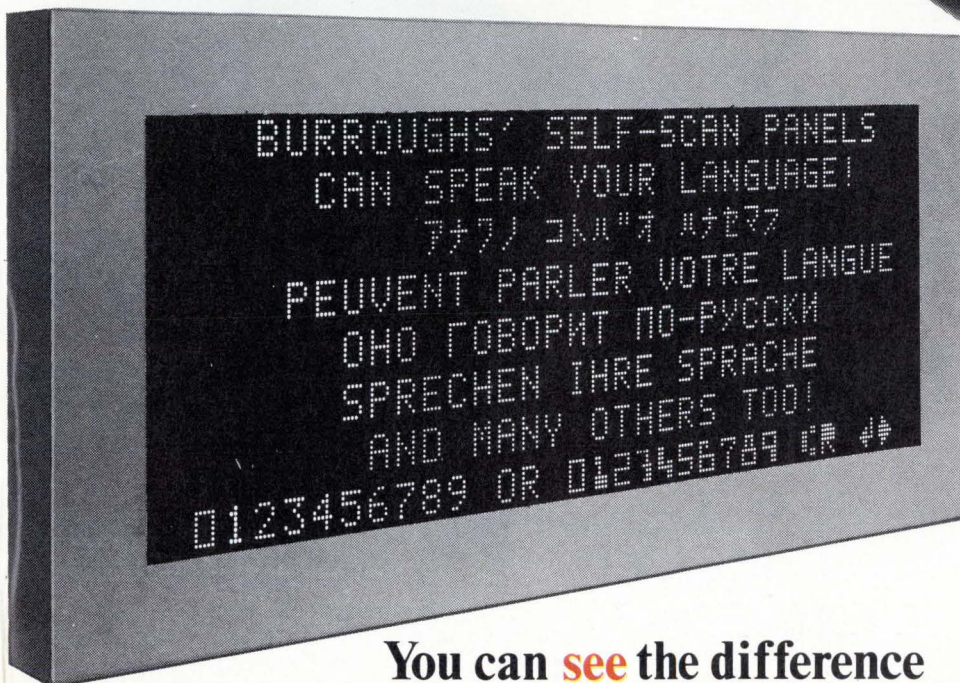

Call your Burroughs representative for a "briefcase" demonstration, or get in touch with Burroughs Corporation, Electronic Components Division, P.O. Box 1226, Plainfield, New Jersey 07061, Tel. (201) 757-3400 or (714) 835-7335.

You can see the difference

Burroughs



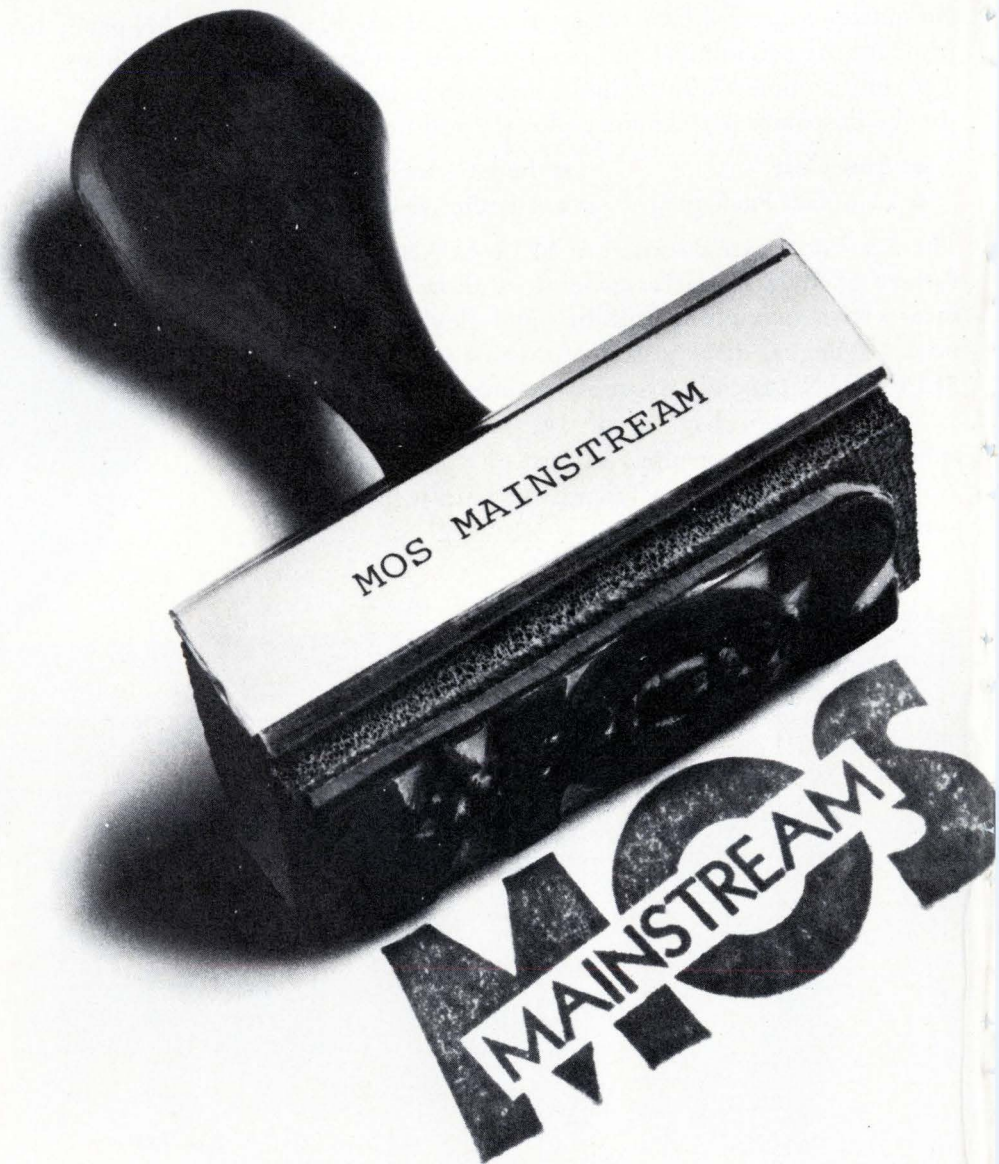

AMD/MOS/AUGUST ONE

More than 40 mainstream MOS memories, all in one place: Advanced Micro Devices.

More than a dozen new devices since May.

Every one is silicon gate. (Five are N-channel.) Every one is available in military temperature range. Every one is built to MIL-STD-883 at no extra charge. Every one is tested over 100 percent of its power supply range.

Every alternate source MOS part we make is guaranteed to be as good or better than the original. Our proprietary products are in a class by themselves. Every part is available for immediate delivery.

If you're getting into MOS, if you want spec sheets or app notes or a thousand parts, talk to Advanced Micro Devices, the next giant.

Am1002 Dual 128-Bit Static Shift Register	Am2533 1024-Bit Static Shift Register	Am2841 64x4-Bit FIFO Memory
Am1101A 256-Bit Random Access Memory	Am2602 1024-Bit N-Channel Static Random Access Memory	Am2855 Quad 128-Bit Static Shift Register
Am1402A Quad 256-Bit Dynamic Shift Register	Am2802 10MHz Quad 256-Bit Dynamics Shift Register	Am2856 Dual 256-Bit Static Shift Register
Am1403A Dual 512-Bit Dynamic Shift Register	Am2803 10MHz Dual 512-Bit Dynamic Shift Register	Am2857 512-Bit Static Shift Register
Am1404A 1024-Bit Dynamic Shift Register	Am2804 10MHz 1024-Bit Dynamic Shift Register	Am3114 Dual 128-Bit Static Shift Register
Am1405A 512-Bit Dynamic Recirculating Shift Register	Am2805 512-Bit Dynamic Recirculating Shift Register	Am3133 1024-Bit Static Shift Register
Am1406/1506 Dual 100-Bit Dynamic Shift Register	Am2806 1024-Bit Dynamic Recirculating Shift Register	Am3341 64x4-Bit FIFO Memory
Am1407/1507 Dual 100-Bit Dynamic Shift Register	Am2807 512-Bit Dynamic Recirculating Shift Register	Am4055/5055 Quad 128-Bit Static Shift Register
Am2102 1024-Bit N-Channel Static Random Access Memory	Am2808 1024-Bit Dynamic Recirculating Shift Register	Am4056/5056 Dual 256-Bit Static Shift Register
Am2505 512-Bit Dynamic Recirculating Shift Register	Am2809 Dual 128-Bit Static Shift Register	Am4057/5057 512-Bit Static Shift Register
Am2512 1024-Bit Dynamic Recirculating Shift Register	Am2810 Dual 128-Bit Static Shift Register	Am4102 1024-Bit N-Channel Static Random Access Memory
Am2521 Dual 128-Bit Static Shift Register	Am2812/2812A 32x8-Bit FIFO Memory	Am5058 1024-Bit Static Shift Register
Am2524 512-Bit Dynamic Recirculating Shift Register	Am2813/2813A 32x9-Bit FIFO Memory	Am7552 1024-Bit N-Channel Static Random Access Memory
Am2525 1024-Bit Dynamic Recirculating Shift Register	Am2814 Dual 128-Bit Static Shift Register	Am9102 1024-Bit N-Channel Static Random Access Memory
	Am2833 1024-Bit Static Shift Register	(To be continued...)

Advanced Micro Devices

Corporate offices are at 901 Thompson Place, Sunnyvale, California 94086. Telephone (408) 732-2400 or toll free from outside California (800) 538-7904/Southern California office: Beverly Hills (213) 278-9700/Mid-America: Oak Brook, Illinois (312) 323-6900/Edina, Minnesota (612) 835-4445/Eastern United States: Roslyn Heights, New York (516) 484-4990/Baltimore, Maryland (301) 744-8233/Lexington, Massachusetts (617) 861-0606/Britain: Advanced Micro Devices, Telephone Maidstone 52004/West Germany: Advanced Micro Devices, Munich, Telephone (089) 53 95 88. Southern Europe: Advanced Micro Devices, S.A., Neuilly, France, Telephone: 747-4194. Distributed nationally by Hamilton/Avnet, Cramer and Schweber Electronics.

The 2401 overhead in half.

Intel's 2401 n-channel 2048-bit shift register does much more than chop register board area and assembly cost in half.

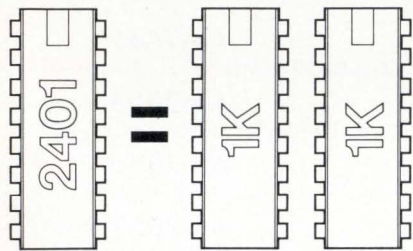

It is also a remarkably efficient, easy to drive, TTL compatible register

that cuts all your other overhead costs in half, too. Maybe more.

All inputs and outputs operate at TTL logic levels, including the single clock input and the single +5 volts V_{CC} supply pin on the corner of the 16-pin plastic DIP. That lets you trim off the high voltage sections of your power

supply and eliminate MOS/TTL interfaces.

The maximum capacitance of all inputs, including the single-phase clock input, is only 7 pF and the outputs only 14 pF. Clock capacitance is about 1/80th of the total presented by a pair of two-phase 1K p-channel regis-

ters. Other capacitances are reduced about 50%. So, remove drivers, simplify the clocking logic, and pare down the power supply some more.

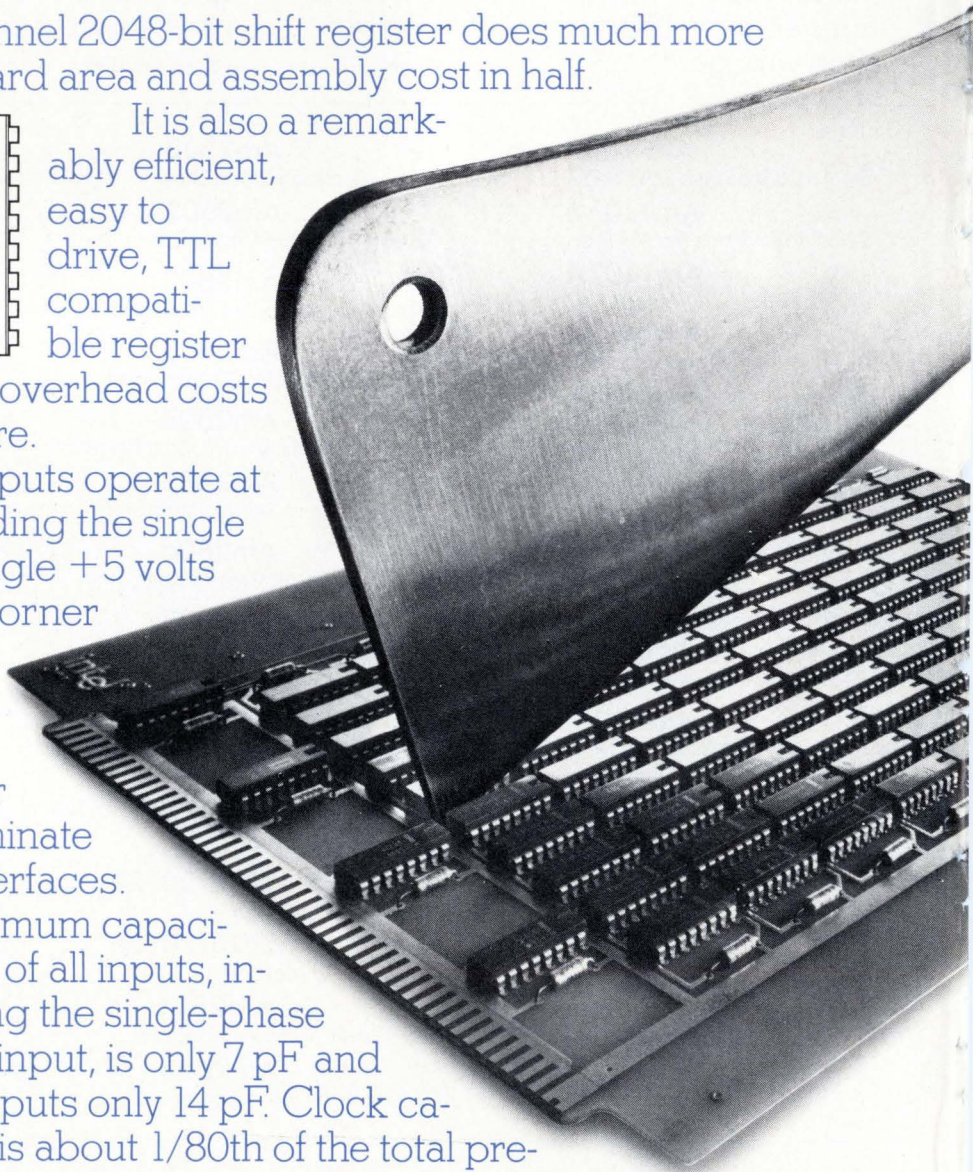
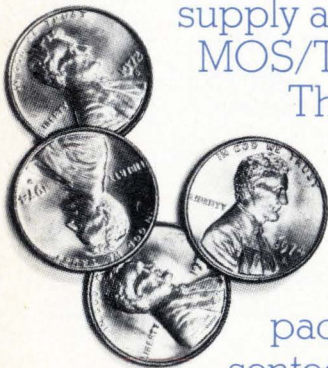

cuts shift register Maybe more.

Furthermore, the 2401 has on-chip X-Y chip select controls

and separate write/recirculate controls in each 1024-bit section. That minimizes external logic for OR-tied arrays and gives you the flexibility of single 2K or dual 1K operation.

In other words, the 2401 has advantages in serial storage designs like the 2102 (the world's most

popular static 1K RAM) has in random access designs. And the 2401 is as easy to buy as the 2102 because both are made with the same high volume, silicon gate n-channel technology.

We hope all this makes you think twice about

using expensive static registers or lesser dynamic registers in buffer, CRT refresh, key to tape, signal sampler and other serial memories.

Think instead about cutting system overhead in half (maybe more) with our big, efficient, completely TTL compatible 2401.

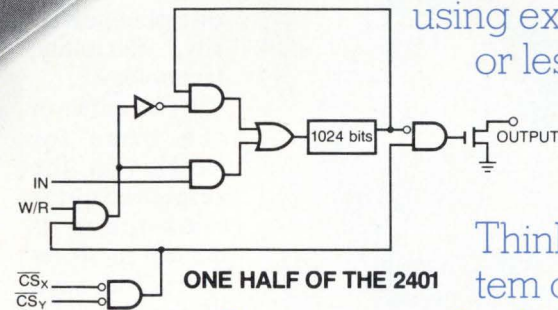

ONE HALF OF THE 2401



MSI DATA CORP.
PORTABLE TERMINAL

Intel Corporation, 3065 Bowers Avenue, Santa Clara, California 95051.
(408) 246-7501.

intel® delivers.



**AT YOUR
FINGERTIPS**

*Industry's
Best Delivery
On Every*

MINIATURE ROTARY SWITCH

In Our Catalog

Call our hotline for prompt
service and delivery.
(201) 374-3311

RCL
ELECTRONICS, Inc.
General Sales Office:
700 So. 21st Street
Irvington, N. J. 07111

People

All he wants is for Fairchild
to be number one

The newest topic of conversation in "Silicon Valley" near San Francisco is trying to figure out what makes Wilfred J. Corrigan tick. This is like trying to come up with the right answer to a complicated multiple-choice question. Is the new 36-year-old president and chief executive officer of Fairchild Camera & Instrument Corp. [*Electronics*, July 25, p. 35] tough or easy-going; conservative or risk-taking; pragmatic or dogmatic; product- or people-oriented; hard-nosed or understanding; practical or blue-sky; an engineer, a manager or a production man; a knuckle-busting in-fighter or a sophisticated executive skilled in corporate maneuvering?

The answer is probably all of these, as it is for any ambitious man dedicated to getting things done, no matter what it takes. And Corrigan, born and educated in England with a degree in chemical engineering, is results-oriented.

"I'm easy to work for," he says. "All that I want from the people working for me is that they do what needs to be done to get results, and are willing to take responsibility for their decisions."

This tough stance may be what Fairchild needs in its next step to full recovery from the depths of 1968. On the surface, the company has never looked in better shape, with first quarter sales this year of \$103.8 million and a net operating income of \$10.4 million.

But sales appear to be leveling, with the first quarter's in-

crease in shipments dipping to less than 3% over that of the previous quarter and the downtrend continuing in the second quarter. Sales of about \$105.8 million yielded net income of \$10.5 million. But it is Corrigan's belief that this softening of Fairchild's position reflects no corporate weaknesses, but rather a toughening marketplace.

"Although it will be nothing like 1970, the second half of this year will be an interesting and unsettling period for the electronics industry," he says. "Supplies are catching up with demand, and the growth rate is flattening slightly. This doesn't mean a downturn or anything of the sort. But it does mean a shift from a period of fantastic growth to a period of somewhat more normal growth rates."

"The growth rates and the health of the industry in general will still be much better than the rest of the economy, but it will be a buyers' and not a sellers' market."

The companies that will weather this new, tougher environment the best, he says, will be the ones who took the lessons of the 1970 recession to heart. And what did Fairchild in general and Corrigan, in particular, learn from that experi-

Corrigan: The new president at Fairchild looks for results and responsibility.



ence? Corrigan sums it up in one short, staccato series of words: "Control, discipline, diversity, flexibility, technology."

"The name of the game for success in the semiconductor marketplace is control in all respects," he says. "Control of logistics, control of marketing, control of finances, control of production, and control of technology. And Fairchild is a strong company in all these as-

Blowbacks. Another good reason for microfilm.

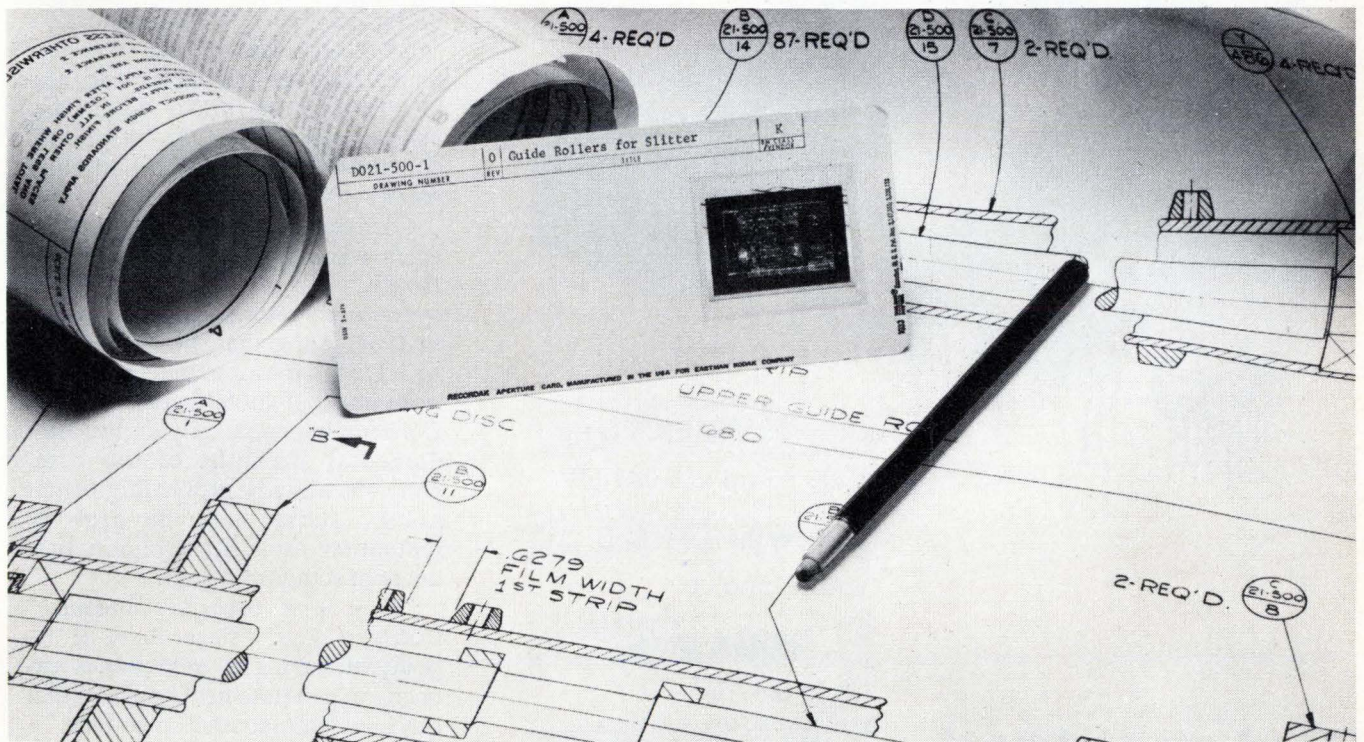

Put the flexibility of Kodak microfilm into your engineering program.

There are many advantages to microfilming your drawings. It saves space, it provides security, and it's one of the most efficient methods of filing and retrieving engineering data. And now, you can make high-quality enlargements directly from the sharp, crisp microfilm images that Kodak products have produced.

Blowing back onto Kodagraph films or papers from microfilm is a fast, easy way to make second originals. And you not only eliminate the need to use original drawings; you also save material because you can

produce the exact size reproductions you require.

You'll find that you save in other ways, too! Whether the job is revising drawings or restoring them, or even making distribution prints, blowbacks from Kodak microfilm can save you time and money.

Get the details.

Find out how Kodak microfilm and drawing reproduction products can benefit your department. Write for our booklet on Engineering Document Control or ask for a sales representative to call. Eastman Kodak Company, Business Systems Markets Division, Dept. DP786, Rochester, N.Y. 14650.

Kodak products for engineering data systems.



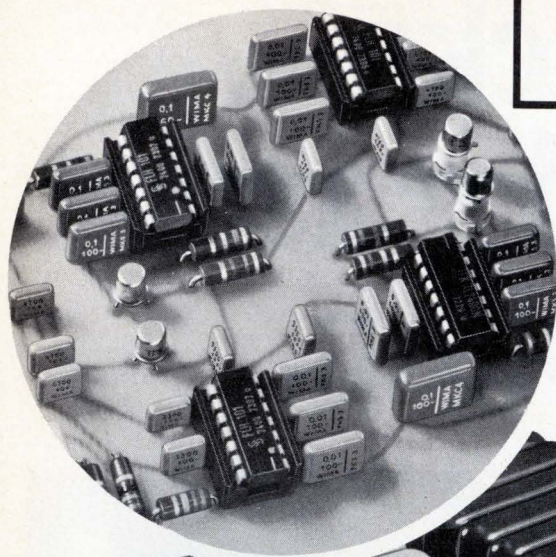

IC's
require
small
C's

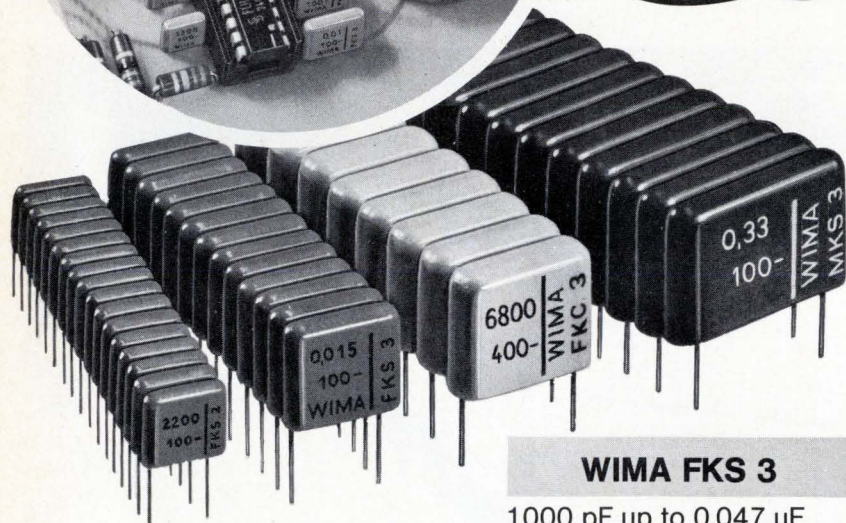

WIMA FKS 3

1000 pF up to 0.047 μ F

WIMA FKC 3

100 pF and up

WIMA MKS 3

Up to 0.47 μ F

WIMA FKS 2 min

P.C.M. 5 mm
1000 pF to 0.047 μ F

Cast-moulded capacitors

are an excellent aid in designing your IC-equipped printed boards. Use the new plug-in WIMA[®] capacitors which are smaller and have regular dimensions.

Write for our new catalogue.



WILHELM WESTERMANN

Spezialfabrik
für Kondensatoren
D-68 Mannheim 1
Fed. Rep. of Germany
Augusta-Anlage 56
P. O. Box 2345
Tel.: (0621) 40 80 12

People

pects—and will remain so.”

In six years under Corrigan's predecessor, 54-year-old C. Lester Hogan (recently promoted to vice chairman of the board), the company has increased its customer base from 600 to 5,000 and expanded its product lines to include linear, memory and discrete, as well as digital devices. At the same time, the company was decentralized into 11 separate divisions.

Flexibility. All this, explains Corrigan, gives the company the flexibility and innovative capability of a smaller organization and the economic leverage of a larger one, and “I intend to use this to make Fairchild number one in the integrated-circuit business,” he says flatly and matter-of-factly.

Corrigan was one of seven managers who came to Fairchild with Hogan when the older man moved over from Motorola Semiconductor in 1968. Altogether, he has worked with Hogan for more than 14 years.

To make Fairchild number one, Corrigan intends to rely on two fundamental strengths of the company—its already proven high-technology status, and its growing reputation as a high-volume producer of standard circuits.

“This is a necessary balance,” Corrigan says, “since there is no point in having a tremendous capacity to generate new products that can't be manufactured in volume.”

He is pinning a lot of his hopes for increased sales and profits on recent developments in MOS devices, an area in which Fairchild has been regarded as weak. Included among the new Fairchild products are a 4,096-bit random-access memory, a high-speed, high-density 8-bit microprocessor, and a family of one-chip calculators. In addition, Fairchild will apply such advanced manufacturing techniques as its Isoplanar process which improves the speed and performance of bipolar, emitter-coupled logic, metal-oxide-semiconductor, and complementary-MOS circuits.

“Ultimately, we want to be able to offer our customers one-stop shopping,” says Corrigan, “as well as some high-technology buys they couldn't get elsewhere.”

Our Graphics.

Now they lend an even bigger hand.

Present graphic and alphanumeric information the fastest way possible.

Our 4010 Graphic Display Terminal gives you the power. With 11 inches of pure screen readability. Team it with our 4610 Hard Copy Unit and copy your ideas as quickly as you get them. Change them, and then work with them some more.

A graphic presentation gives you your ideas in pictures, designs, graphs, and procedures. All in sharp high-resolution display. Flicker-free.

Instantaneously. Just the way you think. Analyzing is faster. Decision making, more profitable.

Add our Flexible Disc Memory. That's convenient, user-controlled storage for off-line or auxiliary use. With dual disc capacity of 524K bytes. Our Graphic Tablet for fast, freehand digitizing and menu picking. Whatever you need in a big way, our graphics give you. At a price that's just as realistic. Graphic terminals from \$3995, to the big 19-inch terminal for \$9995.

Graphic Tablet, \$4995.
And Dual Disc Memory, \$5750.

Ready for a big hand? Give your local Tektronix Applications

Engineer a call. And for a bigger picture of the graphics story, write for our new publication, The Computer Graphics Handbook. It's free and it's information you can use, from:

Tektronix, Inc.
Information Display Division
P.O. Box 500
Beaverton, Oregon 97005.



Circle 17 on reader service card



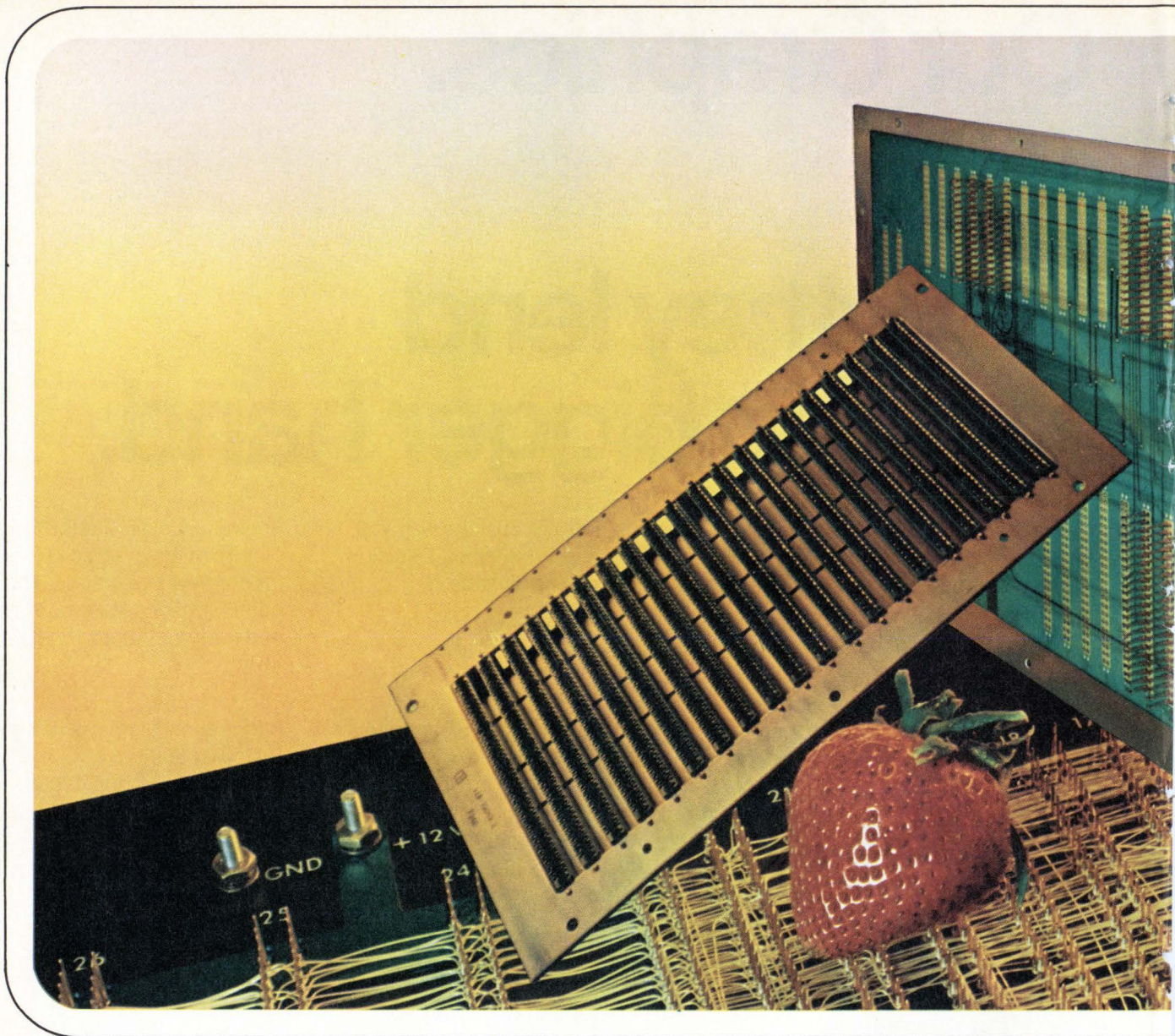

The fresh, new approach to Advanced System Design...

**Winchester Electronics
Back Panel Packaging**



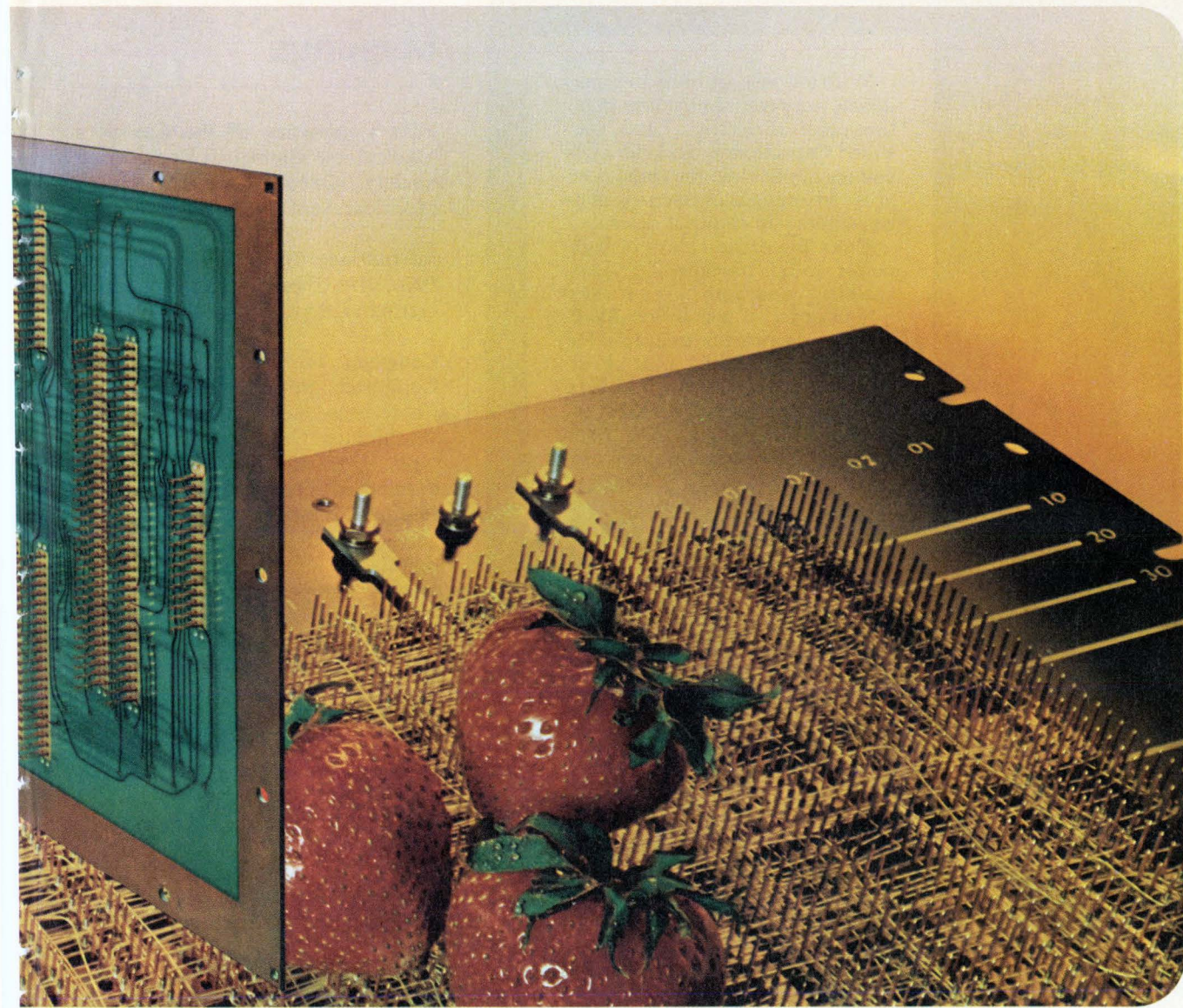

Now you've got a better way to make those ideas bud, blossom and bear fruit. It's Winchester Electronics Back Panel Packaging . . . the fresh, new approach to advanced system design. Right now, it's capturing the imaginations — and appreciation — of electronics packaging engineers everywhere. And for good reason.

With Winchester Electronics Back Panel Packaging, you can carry your design into any dimensions you want. Freely. Without compromising performance or straining the budget.

The fresh, new approach anticipates the multitude of choices and pin-point decisions you have to make. And simplifies your task with a logic you must see to believe. It puts you in command of not one, but 3 basic systems. Metal Frame, Metal Plate and Printed Circuit Back Panel Packaging. So you choose the one that fits best and then spring forward from there. Using any of an abundant, compatible crop of printed circuit, input/output and other discrete connectors.

Using any of many types of contacts, grid spacing or terminations you prefer. All this and more because . . .

Winchester Electronics Back Panel Packaging turns on comprehensive, in-depth experience for you, too. Applications-oriented engineering . . . fueled with ideas, capabilities, production savvy and facilities to help you *design-by-specifying*. So you get what you need. From custom back panels to complete, packaged systems. Assembled panels, interconnections, components, wiring, card cages . . . exactly what you specify to suit the cost/performance requirement you face.

Winchester Electronics Back Panel Packaging. To speed your design, production capabilities and competitive success — it's the berries! Write now for our new Winchester Electronics Back Panel Packaging Handbook. You'll like the story it tells. Winchester Electronics Division, Main Street & Hillside Avenue, Oakville, Connecticut 06779 (203) 274-8891.



WINCHESTER ELECTRONICS

Litton

**For Capacitance
at High Voltage
and
High Current**

With low loss, stability of capacitance, easy variability and puncture-proof dielectric, Lapp Gas-Filled Capacitors provide for high-voltage application the same operating advantages as open-air plate capacitors—in compact design.

From the earliest days of high-power radio transmission, Lapp gas-filled capacitors have provided a high order of reliability. Available for broadcast or industrial RF generator use to 85kv peak, at current ratings to 390 amps at 1 MHz, and capacitances to 22,000 pf.

Write for Bulletin 302. Lapp Insulator Division, Interpace Corporation, LeRoy, N.Y. 14482.



**Gas-filled
Capacitors** by

Lapp

INTERPACE
CORPORATION

Meetings

Fifth Conference of the Canadian Medical and Biological Engineering Society, Queen Elizabeth Hotel, Montreal, Sept. 3-6.

International Switching Symposium 1974, VDE, Sheraton Hotel, Munich, Germany, Sept. 9-13.

Comcon 74, Ninth Annual IEEE Computer Society International Conference, IEEE, Mayflower Hotel, Washington, D. C., Sept. 10-12.

Western Electronic Show and Convention (Wescon), IEEE, Los Angeles, Sept. 10-13.

Fourth European Microwave Conference, Microwave Exhibitions and Publishers Ltd., Maison des Congrès, Montreux, Switzerland, Sept. 10-13.

European Solid State Devices Research Conference, Institute of Physics, IEEE, University of Nottingham, Nottingham, England, Sept. 16-19.

Broadcast Symposium, IEEE, Washington Hotel, Washington, D.C., Sept. 19-20.

International Broadcasting Convention, IEEE et al., Grosvenor House, London, Sept. 23-27.

International Conference on the Technology and Applications of Charge Coupled Devices, University of Edinburgh, Centre for Industrial Consultancy and Liaison, et al., Edinburgh, Sept. 25-27.

Minicomputers in the Factory, New York Management Center, Delmonico's Hotel, New York, Oct. 7-8.

Tenth Annual International Telemetering Conference, EIA et al., International Hotel, Los Angeles, Oct. 15-17.

National Electronics Conference, National Electronics Conference Inc., Oak Brook, Ill., Hyatt Regency O'Hare Hotel, Chicago, Oct. 16-18.



MEASUREMENT COMPUTATION

innovations from Hewlett-Packard

NEWS

AUGUST, 1974

in this issue

They're here!
Green and yellow LEDs

Take a new look
inside your circuits

New high-frequency
scope for fast logic

New minicomputers combine
MOS memory with user
microprogrammability

This enlarged mask shows all the circuitry
packed into HP's tiny 4K memory module, only
1 in. by 0.5 in.

HP introduces a totally new mini-computer family, 21MX, featuring MOS semiconductor memory systems and user-microprogrammability. Using 4K random access memory (RAM) components, up to 16K words of memory are provided on a single 8 in. (20 cm) square module. When combined into memory systems, these modules are faster, cost less, weigh less, consume less power, and are more reliable. For example, the mean time between failures is estimated to be 2 to 15 times better than that of conventional core memories.

Transcending the limitations of conventional hardware logic, the 21MX is fully microprogrammable, giving you greater control over the processor and

(continued on page 3)

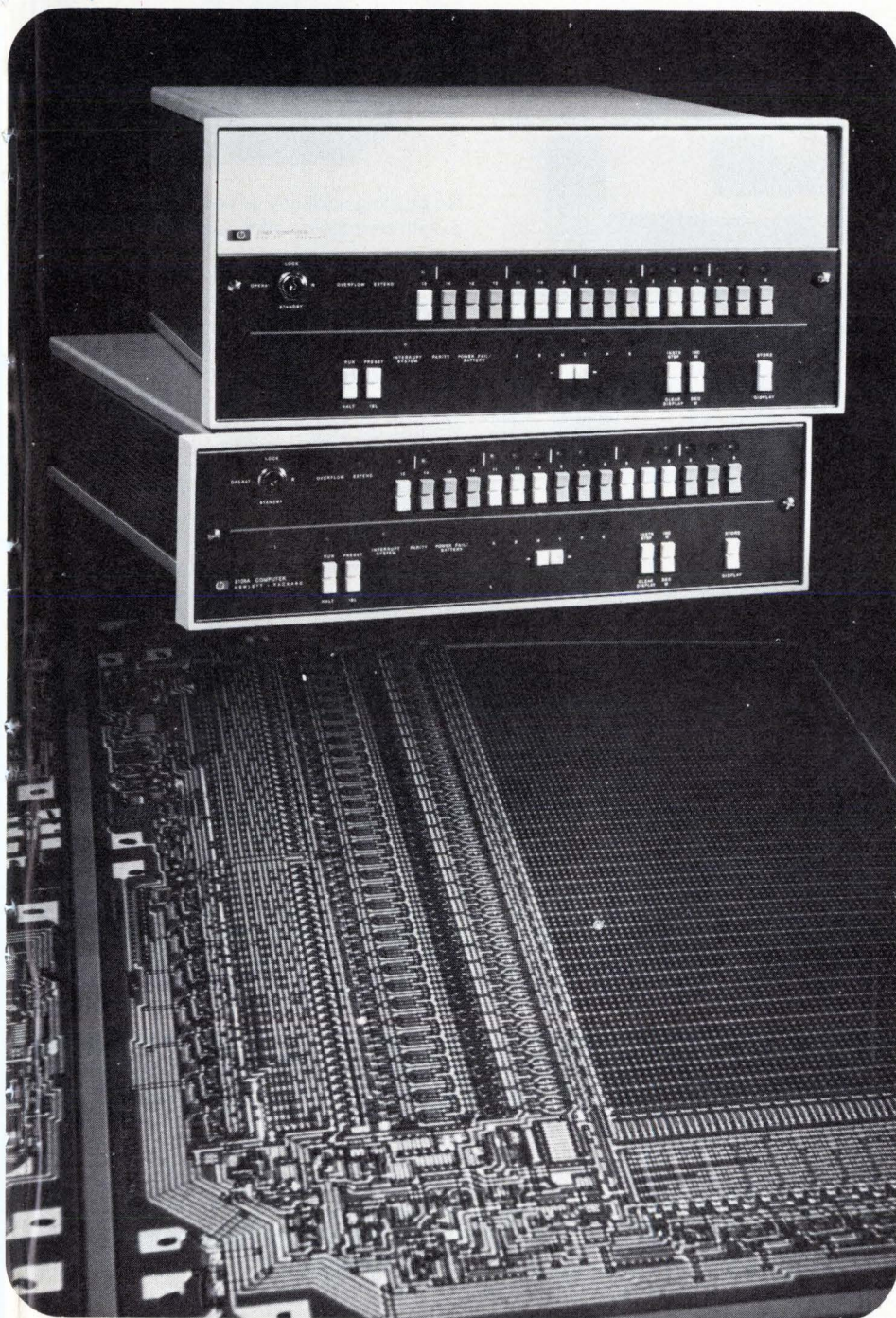

Compact bench x-ray finds "hidden" circuit defects

Now, you can look inside circuits to detect problems such as registration, porosity, broken wire, and weak welds. HP's automatic, compact 43805A x-ray unit fits right on your workbench and makes these problems immediately visible. It's radiation-shielded for operation in populated areas.

This test device is easy to use. The machine itself tells you what voltage to set and shuts itself off automatically. The unit has an adjustable output voltage from 10 to 110 kVp with 3 mA current, ensuring good contrast over a range of object thicknesses and densities. High definition prints can be

produced in seconds using Polaroid or standard wet film.

Use x-rays to pinpoint defects in welds, castings, and small intricate devices. You can quickly view misalignment, inclusions, missing elements and poor fabrication in printed circuits, micro-logic elements, contacts, relays, resistors, encapsulated components and connectors. Quality control, batch inspection and production studies are available from HP.

To learn more, check the HP Reply Card.

Smaller than .001 in., these broken wires (upper corner) in an integrated circuit are shown by x-rays.

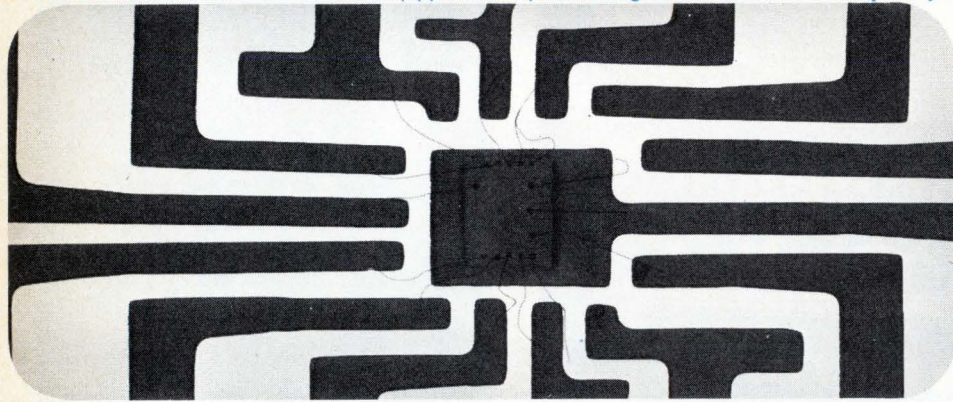

Train and gain with HP's logic lab

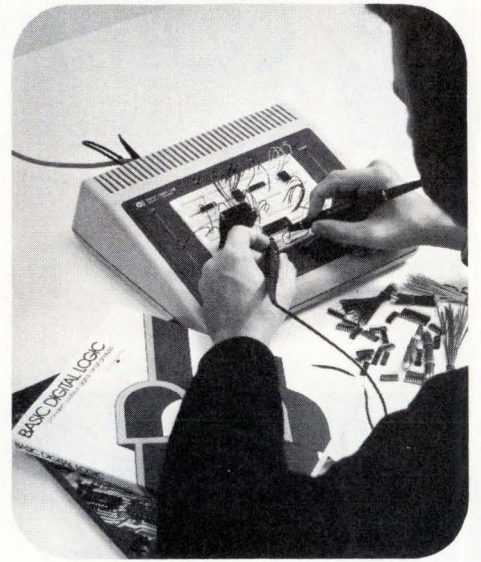

No grueling soldering or unsoldering—the plug-in breadboard uses solderless connection techniques.

Here's a simple way to upgrade yourself or your technicians to the new digital technology. Designed for hands-on learning, the 5035T logic lab is a complete self-paced or classroom course in digital electronics with a textbook, lab workbook, fully equipped portable laboratory, and proven digital test instruments. You learn to assemble functioning digital circuits using the breadboard, components, and interconnecting wiring—all supplied with the logic lab.

Simply place the breadboard in the lab station mainframe. All essentials needed to stimulate the circuits are built-in: power supply, logic state indicators and programmers, and pulse sources. You can verify circuit operation using professional digital test instruments—the HP logic probe, logic pulser and logic clip. You not only learn how to troubleshoot, but also see visual evidence of circuit behavior so that you can make sense of interactions. If you stop in the middle of assembling or testing, the logic lab is always ready for the next user. You can easily remove a breadboard and replace it with another without disturbing the circuits.

Simply check the HP Reply Card for more information.

New low-cost card reader enhances HP calculators

Need a low-cost card reader for your HP 9800 series calculator? The new compact, hand-fed 9870A card reader

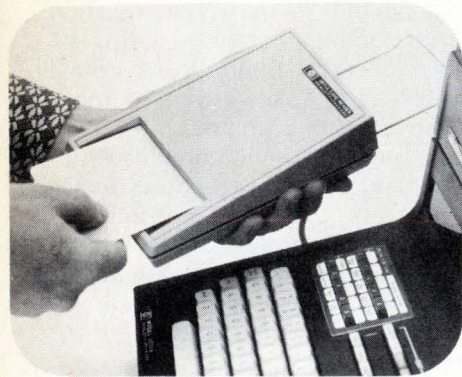

The 9870A is a simple, inexpensive way to add card-reading capability to your HP desktop calculator.

is designed specifically for such data or program input. It reads standard 96-character Hollerith code on either pencil-marked or punched cards. Cards may also be custom-designed to suit various applications.

The 9870A weighs just 18 oz. (0.5 kg). It's small and quiet enough for desktop use in any business environment. The power required for operation is supplied from the calculator.

Cards may be used to input patient histories, shipping and receiving orders, field research data, and any statistical analysis.

For details, check the HP Reply Card.

Three new sensors increase RF power level measurements

Three new thermocouple power sensors extend the capability of HP's precision 435A microwave power meter to higher power levels, lower frequency ranges, and 75Ω system measurements.

- For higher power levels in the 10 MHz—18 GHz frequency range, use the new 8481A opt H01 sensor whose power range is 30 μW to 3W. Its SWR is impressive: <1.2 to 8 GHz, <1.3 for 8 to 12.4 GHz, and <1.5 over 12.4 to 18 GHz.

- For power measurements at lower frequencies, the new 8482A sensor covers 100 kHz to 4 GHz. SWR is <1.18 from 300 kHz to 2 GHz, and <1.3 from 2 to 4 GHz. Power range is 0.3 μW to 100 mW (-35 to +20 dBm).

- Measurements in 75Ω systems are no problem for the new 8483A sensor. Power range is -35 to +20 dBm, over a frequency range of 100 kHz to 2 GHz. Above 600 kHz, SWR is <1.18.

- For general purpose use, the popular 8481A sensor covers 10 MHz to 18 GHz in frequency, and 0.3 μW to 100 mW (-35 to +20 dBm) in power. Its SWR is <1.18 at 30 MHz to 12.4 GHz, and <1.28 from 12.4 to 18 GHz.

Need a power meter for field tests? The 435A options include an internal rechargeable battery pack and long cables to operate any of the above sensors up to 200 feet from the meter.

For details, check the HP Reply Card.

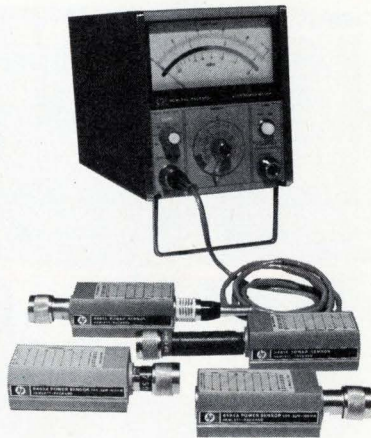

Each sensor has very low SWR which means reduced mismatch error—hence, better overall measurement accuracy.

New amplitude/delay distortion analyzer meets CCITT specs



With increasing use of audio channels for transmission of non-voice traffic (such as data or facsimile), parameters like attenuation and delay distortion acquire a new significance. While voice traffic is relatively immune to these distortions, they can cause errors in data transmission.

The International Telegraph and Telephone Consultative Committee (CCITT) has specified an instrument for

the measurement of envelope delay distortion and attenuation distortion on audio channels, and HP's new 3770A portable amplitude/delay distortion analyzer meets these requirements.

The 3770A measures envelope delay distortion (± 10 mS), attenuation distortion (± 40 dB), and absolute level (+10 dBm to -50 dBm) over the frequency range 200 Hz to 20 kHz. It's easy to use, highly accurate, and ensures repeatability of results. The sender and receiver are contained in a single portable unit. The sender provides both manual adjustment of the measurement frequency and single or continuous sweep, within digitally set sweep limits. The sender output level is calibrated to permit measurements of channel loss. A telephone/monitor facility is provided to allow communication in 2 or 4 wire modes over the channel under test.

For more information, check the HP Reply Card.

(continued from page 1)

processing speeds. Firmware microprograms such as HP's Fast FORTRAN Processor enable programs to run 2 to 30 times faster than possible with conventional programming techniques.

The new minicomputer family is modular so you can design a system to fit your needs. Choose one of two HP 21-M microprogrammable processors, then select from two HP 21-X memory systems:

- The M/10 processor is only 5¼ in. (13.3 cm) high, can contain 32K 17-bit words of memory, and has 4 powered I/O channels within its mainframe.

- The M/20 processor is 8¾ in. (22.2 cm) high, will be expandable to 64K later this year, and has 9 powered I/O channels in the mainframe.

Floating point firmware, memory parity, extended arithmetic unit (EAU), and power fail detection are standard. Both processors have control store addressing space for 4096 24-bit words, four times greater than the 1024 of earlier core units. As for compatibility, any program written for the earlier HP 2100 systems will run on the new HP 21MX series. All 2100 peripherals and

interfaces are compatible as well.

MOS memory technology enables HP to offer semiconductor memories with 650 ns cycle time:

- The HP 21-X/1 is a high-density memory that comes in 8K and 16K 17-bit word modules.

- The HP 21-X/2 is a medium-density memory system that you can purchase in 4K and 8K 17-bit word modules.

The unique 21MX power system functions even in substandard electrical conditions. Line voltage can fluctuate up or down 20% without danger. In the event of a total line failure, the power fail recovery system will sustain the integrity of a 32K memory system for at least two hours.

At the moment, availability is restricted to purchasers ordering 5 or more processors.

To learn more, check the HP Reply Card.

New high-speed plotter augments HP time-share systems

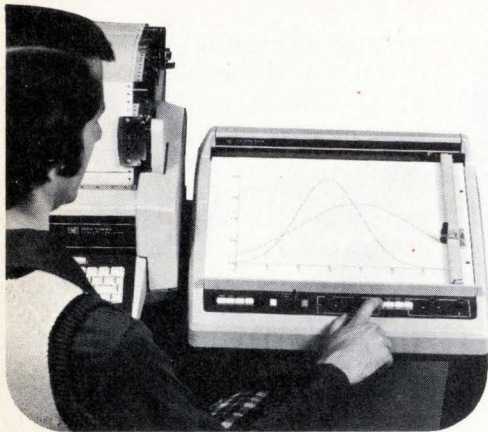

Now, you can plot up to 7 vectors per second in any direction with HP's new high-speed digital plotter. This new 7203A x-y plotter works with an HP 2000C or 2000F time-share system and operates in parallel with your terminal so you get both graphs and printouts. The new plotter accepts bit-serial ASCII data at the rate of 10 or 30 characters per second.

You can plot graphs on any size paper up to 11 by 17 in. (28 by 43 cm). Unlike the "staircase" drawings from incremental plotters, the 7203A draws a

clean, smooth, continuous line. If there is an error in data transmission, that point is omitted and the next correct point is plotted. Four colors of ink are available, and the pens are disposable for convenience. Simply snap out an empty pen, and snap in a new one.

A picture may well be worth a thousand numbers.

To learn more, check the HP Reply Card.

New super-fast CRTs increase display area

Two new large-screen CRT displays maintain crisp, sharp traces regardless of position on the screen, changes in writing speed, or z-axis modulation. Linear writing speed is a super-fast 10 in/ μ s (25.5 cm/ μ s). More than 4096

characters can be refreshed on the screen in less than 5 ms. Yet power consumption is extremely low—only 100 W, compared to 500 W or more on older style displays.

Model 1317A is the largest CRT display that can be mounted horizontally in a standard 19 in. (48.3 cm) equipment rack. Ideal for instrument systems, it fits flush with the front panel yet gives you up to 65% more display area than commonly used CRTs. The other new model, 1321A, is even larger, a 21 in. (53.3 cm) diagonal display that's especially useful for highly detailed computer graphics. Several options, including different phosphors and contrast filters, are available.

Simply check the HP Reply Card for more information.

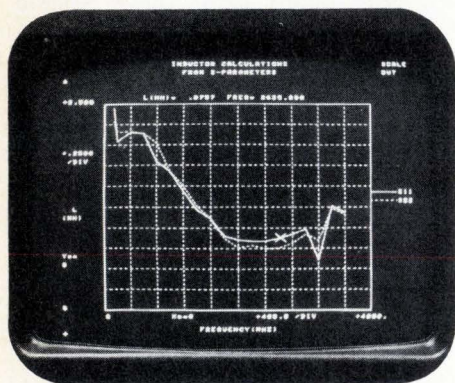

With point plotting time of <200 ns per point, the new 1317A produces a graph like this, in sharp focus, within milliseconds.

Now, measure microwave pulses automatically

The new 5354A automatic frequency converter for HP's 5345A counter brings innovations to pulsed carrier frequency measurements in DME and ATC navigation and identification systems, surveillance radar, ECM and even microwave ovens. It's accurate and automatic; no external equipment is needed. For example, measure a clean 1 μ s wide pulse to 4 digits simply by applying the signal to the input.

External gating helps position the measurement so that you can measure the entire pulse except leading and trailing edges that may contain anomalies. Thus, maximum useful resolution is achieved. Or, the external gate can be narrowed to 20 ns and positioned within the pulse to measure frequency profiles, such as within a chirp radar signal.

Another innovation, frequency averaging, increases resolution for repetitive pulse trains by averaging separate measurements made over many pulses. Blind spots are eliminated, and true averages are guaranteed.

You can also obtain external gating and frequency averaging above 4 GHz with the 5345A counter by using the 10590 plug-in adapter and existing HP 5245L counter plug-ins.

For details, check the HP Reply Card.

The 5354A frequency converter brings the accuracy and convenience of automation to microwave pulse measurements.

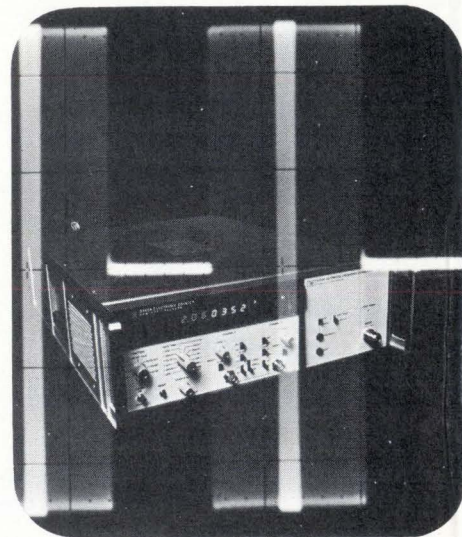

Two new options extend pulse generator applications



By adding the output of the pulse generator and output of the function generator in A+B mode, you can generate very complex waveforms.

Two new options expand use of the versatile 8015A pulse generator: one option lets you use the 8015A with another generator to achieve higher output voltages, and the other option provides a third output that delivers TTL-compatible pulses.

The 8015A is a dual-output generator capable of testing CMOS, low-threshold MOS and most high-threshold MOS logic, as well as TTL, HTL and discrete circuits. Each output produces pulses as strong as 16V, or you can combine outputs for a 30V range, from -15 to +15V.

Option H01 lets the 8015A outputs be used as linear amplifiers, from dc

to 60 MHz (+1 to -3 dB). With separate access to each output amplifier, you can use one as the normal pulse generator output and connect the other to any external signal generator.

Option H04 provides a third output that delivers fixed TTL-compatible 4.6V pulses while you can vary all other pulse parameters from the front panel controls. This option adds greater operating convenience and prevents TTL circuit damage by accidental changes of output amplitude.

For more information, check the HP Reply Card.

New meter measures high capacitance automatically

Measuring high capacitances of electrolytics and tantalum capacitors is faster and easier with the new 4282A digital high capacitance meter. Ideal for inspection and manufacturing, it measures capacitance from 10 nF to 1 F, dissipation from 1.0 to 10 with 0.001 resolution, and the product of capacitance and equivalent series resistance (ohm-farads). Reading rate varies from 0.3 to 2 seconds. You can even use the 4282A as a 3-digit voltmeter to 600 V.

Measurements appear on the LED display. Capacitance and dissipation factors are displayed alternately—you don't have to reset the panel switches or use two different instruments. Four test frequencies are available: 50, 60, 100 and 120 Hz. The 4282A is remotely programmable, and you can attach a printer to document results.

To learn more, check the HP Reply Card.



Here, the 4282A digital meter checks some tantalum capacitors.

Precision power supply doubles as a DVM

DC calibrators, reference sources, and high performance lab supplies are just a few traditional uses for HP's 6114A/6115A precision power supplies. Here's a little trick that lets you convert these supplies into nulling digital voltmeters with accuracy better than 0.025% + 1 mV. The setup includes a galvanometer, like so:

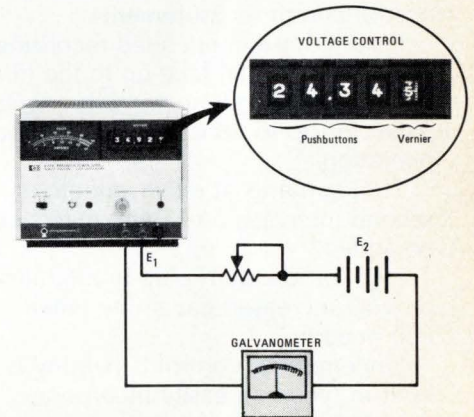

When the galvanometer reads 0, then unknown voltage $E_2 = E_1$. Just read the unknown voltage off the 4-digit pushbutton switch and fifth-digit vernier control.

These 40W supplies feature output voltage accuracy of 0.025% + 1 mV, with 5-minute cold-start warmup. Both models use four-digit pushbutton switches for fast, accurate voltage setting, with a fifth-digit vernier providing 200 μ V resolution. Model 6114A provides 0-20V at 0-2A and 20-40V at 0-1A. Model 6115A provides 0-50V at 0-0.8A and 50-100V at 0-0.4A. These supplies also have constant voltage/constant current operation, front-panel mode indicator, built-in overvoltage protection, high speed, and remote programming capability.

For details, check the HP Reply Card.

Make faster, error-free voice and data measurements

Now, you can reduce telephone test time with two new HP digital test sets. The 3551A transmission test set complies with Bell System requirements; model 3552A, with CCITT requirements. Frequency range is 40 Hz to 60 kHz. Both test sets are lightweight (13 lb/6 kg) and portable—ideal for field as well as bench use.

Suddenly all other methods are old-fashioned. Now, you can make voice, program or data circuit measurements with just one instrument. Check tone level, noise level and frequency at the same time you send tone. Autoranging speeds your measurements; you know immediately if your levels are too high or too low, insuring correct readings every time. And you can measure amplitude and frequency directly into the impedances with which you work.

The digital LED readout displays level or frequency of either the input



or output. Either test set can be powered from an ac line or rechargeable batteries.

For more information, check the HP Reply Card.

Now you can record weeks of data continuously and unattended

The two-channel 7402A oscillographic recorder is a low-cost proven instrument with dual 50 mm channels, stainless-steel pens, and a new instant dry ink system. Now, several new options customize the 7402A for continuous long-term measurements.

For all those unattended recordings, attach an optional take-up to the front of your recorder. It neatly rolls enough paper for up to 58 days of continuous operation.

Timing marks at either minute or second intervals, and event marks can be added.

High or low gain plug-in modules provide increased capability when you need it.

Since remote control capability is built-in, you can easily incorporate the 7402A in a computerized data system.

For details, check the HP Reply Card.

Simply slip the option module into the main frame—it's that easy to adapt your 7402A to long-term measurements.

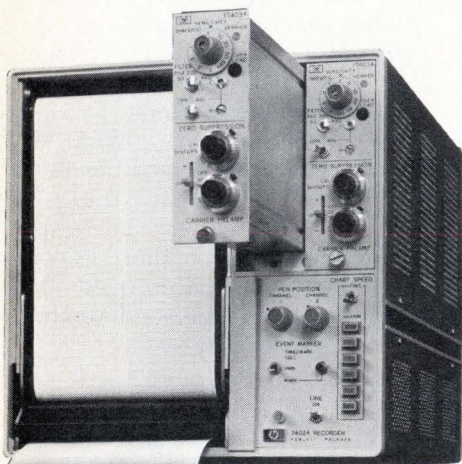

New D/A converter and remote digital display for HP counters



Two new accessories provide analog output or an extra digital display.

Even in this digital world, analog records are useful to show trends. HP's new 59303A digital-to-analog converter lets you make a strip chart from HP 5345A or 5340A counter outputs or other ASCII-output devices. It operates directly with the new super-fast 5345A counter and any compatible logging device such as the 7155A portable recorder or a CRT. This fast DAC outputs a voltage accurate to 0.1% in 30 μ s, from your selection of any three consecutive digits in an ASCII data string.

It's convenient to use, too. Hook up the recorder, and calibrate it simply by turning the DAC's concentric knob to "calibrate." Then select the digit trio.

There's no need for auxiliary equipment to shift zero or change the polarity. If you have an HP 9820A/21A calculator, you can operate the DAC under remote control as all functions are programmable.

Another useful counter accessory is the new 59304A display that shows 12 digits in scientific notation or fixed point. Use it anytime you want the counter display reported at another location on the interface bus.

To learn more, check the HP Reply Card.

High-value signal generator for every bench

Although it's usually thought of in terms of receiver testing, the venerable HP 608 VHF signal generator has also enjoyed widespread use as a bench delivering good quality, calibrated-level test signals. This same order of signal quality for general purpose applications can now be obtained with the all solid-state HP 8654A which is 1/5 the 608's size, 1/4 its weight, and priced considerably lower.

The 8654A covers 10-520 MHz with +10 to -130 dBm output power (automatically leveled to ± 1 dB over its en-

tire frequency range). Internal modulation tones (400/1000 Hz) are included for calibrated AM as well as simple FM. The unit can also be externally modulated.

The 8654A's carrier stability is comparable to that of the older 608—typically <20 ppm/5 minute period after warm-up. And the other facets of signal purity are compatible with most general-purpose applications.

For more information, check the HP Reply Card.



The 8654A offers high value for general purpose bench use.

HEWLETT-PACKARD COMPONENT NEWS



Green: 2½ times brighter than our standard T-1 red LED.

Yellow: 6 times brighter

The new red: 6 times brighter

Brighten your displays with new red, yellow and green LEDs

Three new LEDs give you an interesting choice of colors and luminous intensity many times brighter than our standard T-1 red lamp. All have a 180° viewing angle, good on-off contrast ratio, and a low price tag.

The new green lamp (5082-4984) uses gallium phosphide to generate a typical luminous intensity of 2 mcd at 20 mA.

Our new yellow lamp is *really* yellow. The 5082-4584 offers 2.5 mcd typical at 10 mA.

Red has an output 6 times brighter, thanks to non-saturating gallium arsenide phosphide. With intensity of 2.5

mcd at 10 mA, the new 5082-4684 red LED is unbeatable.

With these new LEDs, Hewlett-Packard has significantly advanced the state-of-the-art. The design achieves maximum light output by minimizing absorption losses. By using a transparent substrate chip instead of an absorbing substrate, HP has increased coupling efficiency by as much as a factor of 18. Light rays directed downward or rays reflected from the top surface are not absorbed; they are reflected back to the top surface, increasing light output.

Compare these new LEDs with other

GaP and Ga(As,P) devices. At 10 mA, the red and yellow lamps emit approximately 10 times more light than conventional red Ga(As,P) devices. At this same drive current, they generate about 4 times as much light as typical red GaP (Zn,O) LEDs. At 10 mA, the new green lamp produces over 3 times the luminous flux of standard Ga(As,P) red devices.

To learn more, check the HP Reply Card.

New high-frequency scope brings new accuracy to fast digital measurements

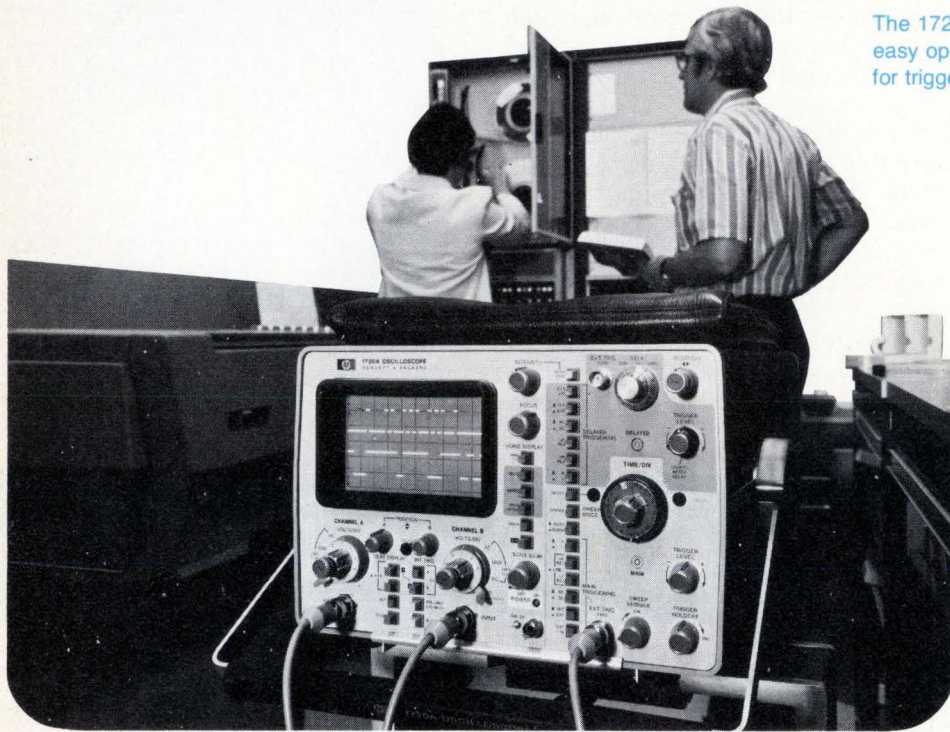

The 1720A uses color-coded pushbuttons for easy operation—blue for display modes, green for triggering, and gray for secondary features.

Our new high-frequency oscilloscope is designed especially for systems using fast logic—computers, peripherals, and high-speed digital communications equipment, as well as high-frequency RF applications. The new 1720A has two channels with 10 mV/cm deflection factors, sweep speeds

to 1 ns/cm, frequency response to 275 MHz, and a practical price to fit your budget.

Accuracy specs are unequalled in its class: calibrated sweeps are accurate to $\pm 3\%$ from 0° to 55°C (only 2% in the 100 ns/cm to 20 ms/cm range)—specified over the full 10 cm of horizontal

deflection. Differential time measurements are within 1% for most applications.

Switch-selectable 50Ω or $1\text{ M}\Omega$ inputs offer maximum flexibility. The 275-MHz bandwidth is maintained in both impedance modes from 0° to 55°C and when the amplitude verniers are in use. The 1720A requires only 1 cm of vertical deflection for stable triggering to 300 MHz (only 0.5 cm to 100 MHz). The internal trigger sync take-off point is immediately after the attenuator which maintains a stable display regardless of changes in position, vernier or polarity controls. The $\times 10$ magnifier offers increased measurement flexibility in all sweep speeds by letting you expand any portion of the waveform without using the delayed sweep.

For more information, check the HP Reply Card.

HEWLETT  **PACKARD**

East-20010 Century Blvd., Germantown, MD 20767, Ph. (301) 428-0700.

South-P.O. Box 2834, Atlanta, Ga. 30328, Ph. (404) 436-6181.

Midwest-5500 Howard Street, Skokie, Ill. 60076, Ph. (312) 677-0400.

West-3939 Lankershim Boulevard, North Hollywood, Calif. 91604, Ph. (213) 877-1282.

Europe-Post Office Box 85, CH-1217 Meyrin 2, Geneva, Switzerland, Ph. (022) 41 54 00.

Canada-6877 Goreway Drive, Mississauga, Toronto, L4V 1L9, Ph. (416) 678-9430.

Japan-Yokogawa-Hewlett-Packard, 1-59-1, Yoyogi, Shibuya-ku, Tokyo, 151.

Here's Ramtek's new color graphic display system, the FS 2000, for the manager who has nothing—but gauges, strip charts, plot boards and so forth.

Who needs it?

Anyone responsible for process supervision, power utility control or financial management information processing.

Ramtek introduces the FS 2000 System for the manager who is involved in monitoring the flow of raw materials through his industrial process to a profitable conclusion.

We've utilized the design experience of our highly successful GX 100 Series System and applied it to the development of the FS 2000 System. Here's what the new system offers:

- The ability to address a character to any location on a 256 x 256 grid.
- Four character sizes, the smallest of which allows 85 characters per line.
- Graphic line generation of any thickness or length with four bytes—only one byte required to modify either.
- Automatic overwrite of a character on a graphic entity—no erase step necessary.
- Ability to overlay or completely overwrite characters non-destructively allowing convenient combinations.
- Two byte relocation of any display block—allowing convenient "visual subroutines."
- Dual intensity available on each of seven colors.
- Ability to blink any entity from full brightness to half brightness or off.

Need more information? Contact:
Ramtek Corporation, 292 Commercial Street, Sunnyvale, California 94086. Telephone (408) 735-8400

RAMTEK CORPORATION
THE GRAPHIC DISPLAY COMPANY

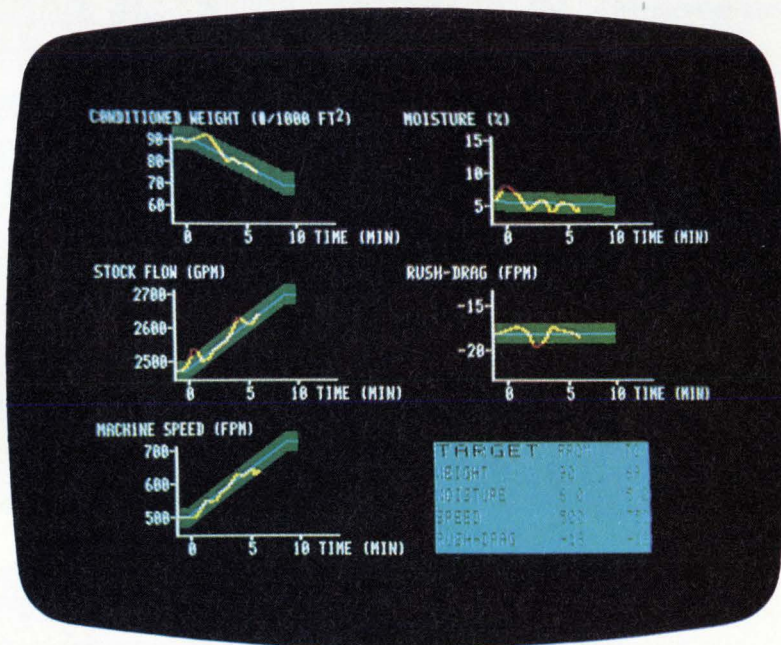

Beckman Instruments

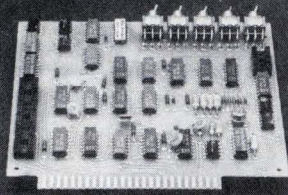

CalComp/Century Data Division

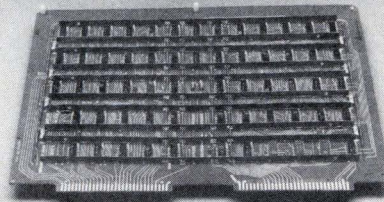

Litton Digital Data Systems

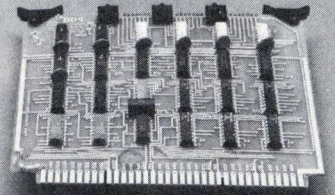

Lexitron

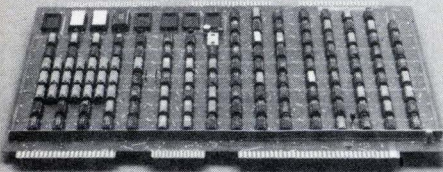

North Electric Company

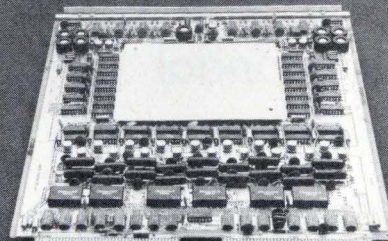

Western Electric Company

(Board not released for photography.)

Econolite

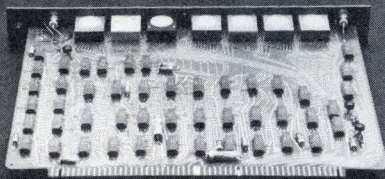

Data Source

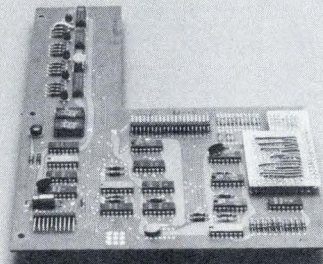

Diablo Systems Incorporated
A Xerox Company

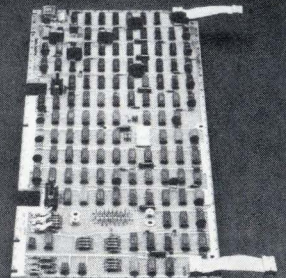

COMPUTER AUTOMATION'S AUTOMATIC TESTER HAS

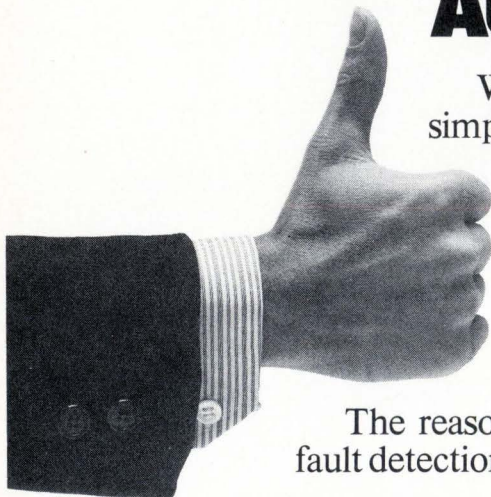

We've listed a few of our CAPABLE tester customers simply to point out something obvious. Companies like these don't buy sophisticated hardware just on the name. Which is a good thing because how many people have ever heard of the CAPABLE tester, anyway?

The fact is, you can't solve testing problems with a name - big or otherwise. So these companies did just what you would do. They looked at all the automatic board testers available. And then they picked our CAPABLE.

The reason is faster board throughput. High-speed, high-volume fault detection and isolation across the entire board range. From simple

Collins Radio Company

(Board not released for photography.)

TRW Data Systems

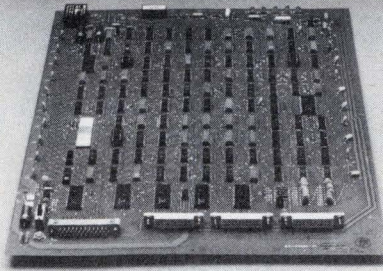

Rockwell International

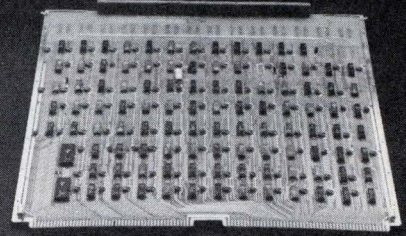

Diebold, Inc.

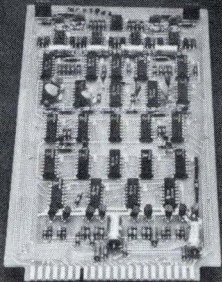

Tally Corporation

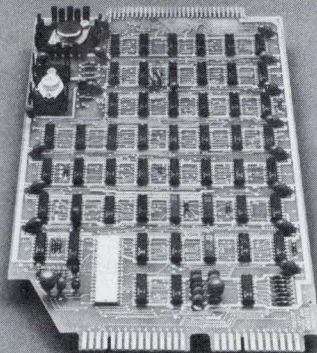

Computer Machinery

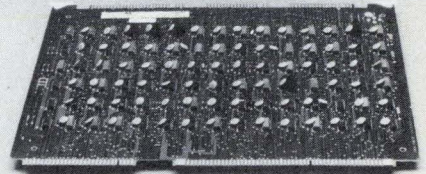

Ampex Corporation

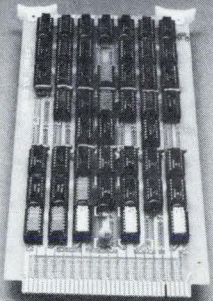

GTE/Information Systems

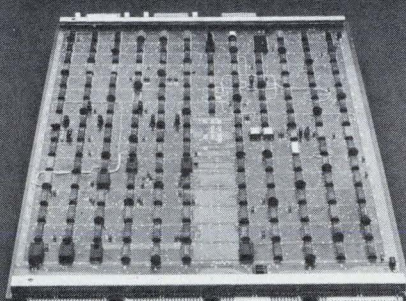

National Cash Register

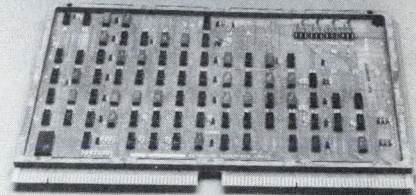

ACROSS THE BOARD APPROVAL.

to complex modules. Digitals to hybrids. With incredible ease of operation.

And here's the payoff. Actual in-use figures show that CAPABLE can pay for itself in as little as 12 months. Even less in some cases.

If you're more interested in profits than prominence, we can help you now. Later on we'll throw in a big reputation.

18651 Von Karman, Irvine, California 92664

Telephone (714) 833-8830

Industrial Products Division
Computer Automation, Inc.



There's only one cermet film resistor with enough design improvements to set a new standard of quality.

Ultra thick solder coated wire leads are both weldable and solderable.

Capless design does away with problems associated with end cap construction.

Conformal coating provides outstanding insulation properties.

Alumina core is physically and thermally strong to resist fractures.

Crisp, clear, dual markings for easy identification.

We blended our extensive fixed resistor knowhow with 15 years of cermet experience to produce an outstanding cermet film resistor. And we've developed unique manufacturing techniques that let us provide consistent quality.

Available in preferred resistance values (E96 Series) from 10 ohm to 1 meg; higher values available on special order. 1/4 watt at 70°C; 1/8 watt at 125°C; 1% tolerance; 100 PPM. Size 0.250 L. by 0.090 D.

Available in tape reels if you prefer.

Approved to MIL-R-10509 for Style RN55, Characteristic D. Write Allen-Bradley Electronics Division, 1201 South Second Street, Milwaukee, Wisconsin 53204 for complete technical details on Type CC. International Division, Milwaukee, Wisconsin 53204. Canada: Allen-Bradley Canada Limited, Cambridge, Ontario. United Kingdom: Allen-Bradley Electronics, Limited, Jarrow, County Durham NE32 3EN.

If you're really serious about cost, be serious about quality.

Circle 34 on reader service card



ALLEN-BRADLEY

Milwaukee, Wisconsin 53204

EC69

China rejects U.S. trade mission, cites export barriers

The People's Republic of China says it cannot give "sincere consideration" to a proposed U.S. trade mission of electronics and telecommunications equipment makers **because U.S. export controls prevent shipment of most electronic products to China.** The China National Machinery Import and Export Corp., the state trading agency, rejects the proposal in a recent letter to the Electronic Industries Association, which first proposed the visit on Nov. 4, 1972. The letter to EIA's John Sodolski, staff vice president of the communications division, who visited the 1973 Kwangchow Trade Fair, **is being read by industry as the first formal sign that China is in no hurry to open its market to outside technology** [*Electronics*, July 5, 1973, p. 73].

Nevertheless, the Peoples' Republic **did not close the door completely on trade with the U.S.**, but solicited EIA's views on the "artificial barriers" of America export controls, asking for an "explanation and scope of such 'control,' so that we may reply about your again proposed visit."

Rockwell enters 1103A memory race

Rockwell International Corp.'s Microelectronic Device division, has samples of an 1103A random-access memory part in the hands of major computer makers for evaluation. **The 1,024-bit part is the Anaheim, Calif., division's first true standard memory part,** and should be on the market in the fourth quarter. Price hasn't been established, but the device will have an access time comparable with many of the other entries coming to market—less than 200 nanoseconds. The move is significant because **it underscores the Rockwell division's intention of competing in the standard parts business,** a departure from its posture as a custom supplier that has been predicted by division officials. Until now, though, it hadn't been clear what device type would be used as the first vehicle.

Die-stamped circuit boards make comeback

Die-stamped circuit boards, a manufacturing method that appeared moribund a decade ago, have been made practical by new technology and appear to be on the comeback trail. The latest indication of this is given by Philco-Ford's recent move into production. **The technique, most applicable to high-volume, low-cost boards for automotive, appliance, and toy applications, can save up to 50% of the cost of conventional boards,** according to the firm's Newport Beach, Calif., Aeronutronic division.

The boards offer fast turnaround, short lead times, the possibility of flush dielectric, wide choice of substrate, and high bond strength. **Registration between boards is excellent, but resolution is not as high** as for conventional etched boards—minimum circuit and space width is 10-20 mils for light three-ounce foil, 25-60 mils for heavier 4-10-ounce sheets. Other firms reportedly are also going into production of the parts.

Cigar-sized chemical laser has megawatt output

A cigar-sized chemical laser with 1 megawatt peak output has been developed at the Aerospace Corp.—**an output which developers of the device believe can be scaled up 250 times by just a fivefold increase in linear dimensions** as a result of the doubled efficiency of the larger part. **Volumetric efficiency appears competitive with that of huge state-of-**

Electronics newsletter

the-art carbon-dioxide lasers. Electrical gain of the pulsed laser is 1.48, claimed to be dramatically higher than existing lasers, and **chemical efficiency is 6.3%, also the highest yet publicly claimed.**

Key to the high performance, which includes uniform ignition without arc or streamer formation, appears to be **pre-ionization of the fluorine and hydrogen or deuterium mixture (diluted by a noble gas)** instead of simple flash photolysis or straight electron beam initiation. The research carried out at the El Segundo, Calif. company was sponsored by the Air Force and the Defense Department's Advanced Research Projects Agency.

FAA rule change could eliminate \$14 million market

A general-aviation market for approximately 20,000 beacon transponders costing \$700 or more per plane could be wiped out this fall if the Federal Aviation Administration **drops its proposed rule that aircraft have automatic altitude-reporting equipment in addition to identity transponders** whenever they are operating out of Cleveland, Denver, Detroit, Houston, Philadelphia and the six other group II cities. **What's more, aircraft operating under instrument flight rules that pass through the control area—that is, within 20 to 25 miles and 7,000 feet of the airport—would not even be required to have the identity transponders.**

Transponders and automatic altitude-reporting equipment will be required at the larger Group I airports, such as Boston, Atlanta, Chicago, and Dallas-Ft. Worth, beginning next January. The General Aviation Manufacturers Association had opposed the Group II requirement and in addition had advocated moving back the equipment-requirement deadline for Group I from the original target of July 1974.

Will Semicon go to Europe?

Watch for an announcement soon by the Semiconductor Equipment and Materials Institute that it will hold a Semicon show in Europe for the first time next year. The institute is made up of some 120 member companies that supply fabrication equipment and materials to semiconductor manufacturers. Headquartered in Mountain View, Calif., the organization is **desirous of enlarging its horizons beyond its twice-yearly exhibits and technical sessions, which have been held in San Mateo, Calif., and on New York's Long Island.**

Meanwhile, **booth space for Semicon East '74 is about 90% committed,** says a SEMI spokesman. The show will be held Oct. 1-3 at the Nassau County Coliseum, Uniondale, N. Y.

NBS develops new microwave measuring system

A new and less expensive way to measure power output of microwave equipment has been opened by the National Bureau of Standards. Scientists there have developed a design based on **adapting an automatic network analyzer with new broadband directional couplers, say NBS officials at its Boulder, Colo., office.** The system can measure 20 frequencies from 2 to 12 gigahertz at a cost of about \$700, **almost half the old manual-test cost of about \$1,200 for three frequencies.** NBS officials say the new system can save money for microwave users by **assuring greater accuracy over a wider frequency range, which in turn reduces the need to overdesign to compensate for interpolated manual measurements.** Widespread use of the system is expected, an NBS man says, because the frequency range covered by the new system is "the largest in demand."

We'll deliver 10,000 SCR's in three weeks.

Choose the plastic 2N5060 Series, or IP100 Series now available to 300V. Or the hermetically-sealed ID100 Series now available to 400V. Both with typical dv/dt capability of $75V/\mu\text{sec}$.

Unitrode also offers many other low-level SCR's. The widest choice in the industry. The right SCR for your specific environmental requirements, at the right price. All part of a growing family of Unitrode plastic or hermetic SCR's designed for a wide range of sensing and control applications.

Place an order. We'll deliver 10,000 of any of the SCR's listed — in three weeks or sooner.

Write for our latest data sheets. Or for faster action, call Vin Savoie at (617) 926-0404.



**Unitrode plastic
or hermetic SCR's**

Type			Blocking Voltage	Maximum Current, RMS	Gate Trigger Current I_{GT}	Gate Trigger Voltage V_{GT}	Holding Current I_{HX}
TO-92	TO-92	TO-18	30V 60V 100V 150V 200V 300V 400V	0.8A	200 μ A Maximum	0.8V Maximum	5mA Maximum at $R_{GK}=1K$
2N5060	IP100	ID100					
2N5061	IP101	ID101					
2N5062	IP102	ID102					
2N5063	IP103	ID103					
2N5064	IP104	ID104					
	IP105	ID105					
		ID106					

See Electronics Buyers' Guide Semiconductors Section for more complete product listing.

Circle 37 on reader service card

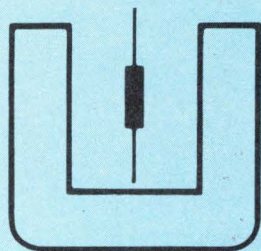

UNITRODE

580 PLEASANT STREET, WATERTOWN, MA 02172

D-LASAR is quick to point out your faults.

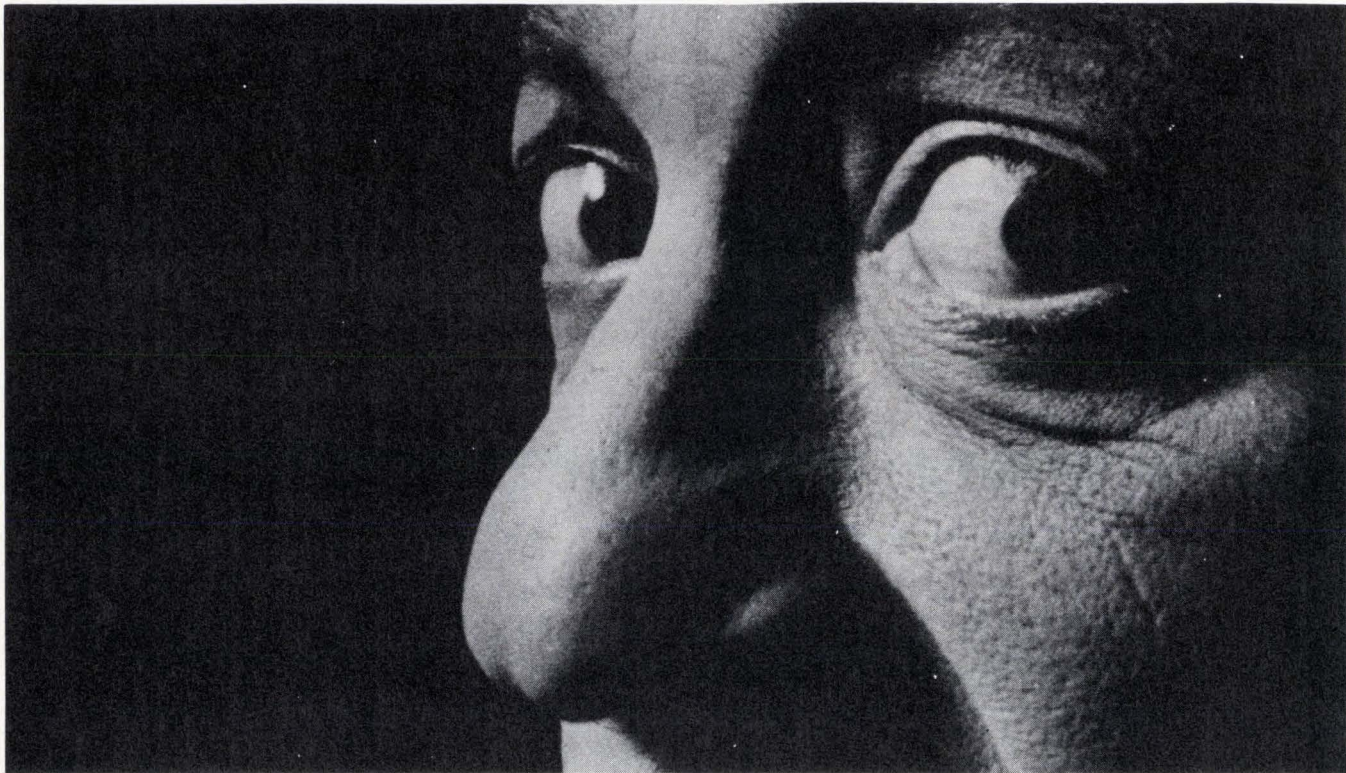

UCC introduces D-LASAR, a revolutionary new automated test generator and response analyzer for complex sequential digital networks. With amazing speed, D-LASAR automatically generates test patterns. Then it analyzes responses to produce complete fault isolation data.

How fast is D-LASAR? Its fault dictionary generation on a 200-IC circuit typically takes one hour. Compare that to the various conventional fault simulation techniques, which require hundreds of hours of computer time to achieve similar results.

D-LASAR detects 98% of all faults in digital circuits of up to 400 IC's. Faults are isolated so precisely that resolution is an excellent 1.2 replacements/fault. The common "probing" method is no longer needed.

The advanced D-LASAR program is exclusively available on the UCC network via remote terminals.

D-LASAR, another example of what the right people can do with a computer.

For details, call the Scientific & Engineering Division, (214) 741-5781. Ask for Paul Newton. Or mail this coupon.

Please send me more information on D-LASAR.

Please have someone call me.

Name _____

Title _____

Company _____

Address _____

City/State/Zip _____

Telephone _____

Mail to UCC, Scientific & Engineering Division,
P.O. Box 6171, Dallas, Texas 75222.

**When you have the best people,
you have the best product.**

UCC
UNIVERSITY COMPUTING COMPANY
7200 Stemmons Freeway • P.O. Box 47911 • Dallas, Texas 75247
A Wyly Company

Electronics review

Significant developments in technology and business

Computer alters its architecture fast via new control

QM-1 emulates mainframes in milliseconds with programs that change paths among functional subassemblies

By carrying programability deeper than ever before into the heart of processor architecture, a small Williamsville, N.Y., company, Nanodata Corp., has built a machine capable of switching from one computer mode to another in a matter of milliseconds.

Though many computers can emulate other computers, they don't do so easily. Emulation requires rewriting a machine's control program or microprogram—the collection of instructions that determines whether the machine behaves like, say, a PDP-11 or an IBM 370. And the rewriting will usually take weeks or months.

Then, engineers must spend either hours installing a new read-only memory or minutes off line reloading a writable control memory containing the new emulator.

Nanoprograms. The new machine is called the QM-1, and its unparalleled facility at emulating other computers, including ones not yet built, depends on what are described as "nanoprograms." Nanoprograms rearrange the machine so that it responds differently to the programs in the control memory. The net result is great flexibility.

Nanoprograms are not to be confused with either machine-level programs or microprograms (see chart on p. 40). Instructions at the machine level tell the hardware what to

do externally—to add, multiply, perform this or that logical operation, or fetch or store data.

In some of these conventional computers, the minute details of how to execute individual machine-level instructions are specified by a microprogram made up of microinstructions. Microinstructions tell the computer hardware to move data, say, from one register to another via a functional subassembly such as an adder or a shifter.

Modifying the microprogram changes the way the machine executes machine-level instructions, and thus changes the nature of the machine. In this way it can be made to emulate a different machine.

Herein lies the novelty of the QM-1. Unlike in conventional computers, the paths between the functional subassemblies of the QM-1 are programable, and these paths are specified by the nanoprogram. Thus, not only can the QM-1 emulate many other machines, but it can change what it's emulating more readily than is possible with an ordinary microprogram. The rearrangement is carried out through programable interconnections among 12 buses, three register banks, a three-level storage hierarchy, and an arithmetic/logic unit and shifter.

Evidence of the QM-1's talent for emulation is impressive. In one case, it took only 30 man-days of effort to emulate Control Data Corp.'s model 160A, a second-generation transistorized machine, says Nanodata's engineering vice president, John Hale. Ordinarily, such a task takes maybe five times as long, depending on the microinstruction set.

Furthermore, a large aerospace

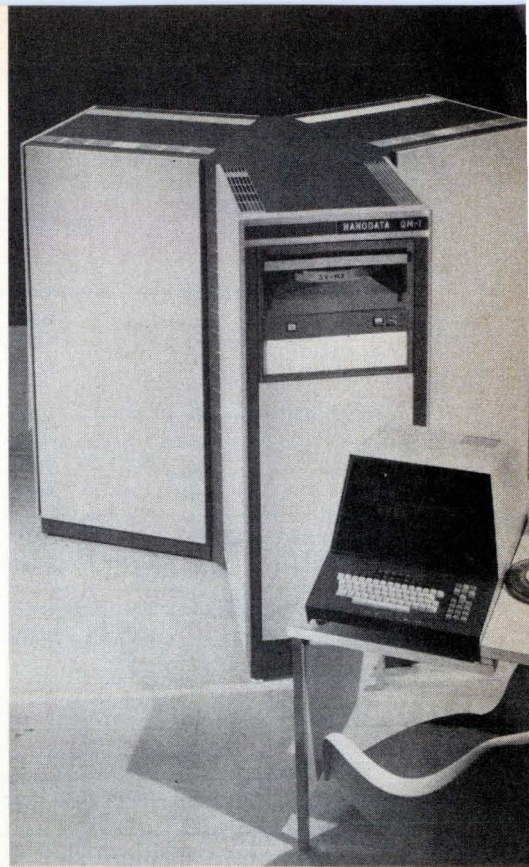

Emulator. Architecture of computer designed by Nanodata can be changed in milliseconds with new type of program control.

company is reportedly considering using a QM-1 in its development of a spacecraft for a deep-space mission. The on-board computer hasn't been built yet—for that matter, its specifications haven't even been established—but the company will use the Nanodata machine to emulate it as the design progresses on paper.

Fast switch. The emulation can be dynamic—changing from, say, IBM 370 mode to Honeywell 6000 mode in as little as a few milliseconds. Thus, the QM-1 would be useful as a front-end processor in a mixed multiprocessor installation.

The first production machine has already been shipped to a large computer manufacturer. This company indicates that it plans to use the QM-1 in advanced research—for instance, to emulate various repertoires of instructions and microinstructions that might be used on its future machines.

Nanodata's second machine is going to the computer sciences department of a Canadian university for research in programming languages.

Stripped, the machine sells for \$68,000. In a more typical configuration, with a memory of reasonable size and a collection of standard in-

LEVELS OF LANGUAGE

PROBLEM-ORIENTED	MACHINE-INDEPENDENT. MOST USERS WORK AT THIS LEVEL, THEIR PROGRAMS BEING TRANSLATED INTO MACHINE-LEVEL LANGUAGE BY COMPILER.
SYMBOLIC	MACHINE-DEPENDENT. GENERALLY USED ONLY FOR SMALL PROGRAMS. TRANSLATED INTO MACHINE-LEVEL BY ASSEMBLER.
MACHINE-LEVEL	PURE BINARY CODE THAT MACHINE CAN EXECUTE.
MICROPROGRAM	SPECIFIES STEPS NECESSARY TO EXECUTE MACHINE-LEVEL PROGRAM.
NANOPROGRAM	SPECIFIES INTERNAL CONFIGURATION NECESSARY TO EXECUTE MICROPROGRAM.

put/output devices, it goes for \$150,000 to \$250,000.

The main core memory, up to 262,144 words, has a cycle time of 750 nanoseconds and comes in modules of 16,384 words. Both the microstore and the nanostore are reloadable semiconductor memories with 75-nanosecond cycle times. The microstore's word length is 18 bits and it has a maximum capacity of 32,768 words in 1,024-word increments; the nanostore is 360 bits wide and is available with capacities of 256 to 1,024 words. □

Materials

New alloy may cut phone-gear costs

Studying the properties of a gold-platinum alloy might not sound like a very promising way of cutting the cost of telephone equipment, but that's just what a Bell Laboratories scientist has done—and with notable success.

The idea was to use the alloy as a metallurgical model from which to develop an improved copper-based alloy for springs. Such copper-based spring materials as phosphor-bronze and copper-beryllium are used by the thousands of tons in relays, stepping switches, and connector clips. And they're used in other appli-

cations in which high strength and ductility must be combined with good electrical conductivity and low susceptibility to stress-corrosion cracking, and/or good plating characteristics.

John T. Plewes, a research metallurgist in Bell's Materials Research Laboratory, studied specially treated gold-platinum mixtures. He wanted to know why they did not live up to their theoretical promise of high yield strength (resistance to deformation) and good ductility (formability). Often, alloys treated to increase their yield strengths lose ductility and become brittle. This makes them both hard to form and, when overloaded, subject to catastrophic failure.

Brittleness. Finding a way to avoid brittleness in his gold-platinum model, Plewes searched for the appropriate copper-based metallurgical analog and applied essentially the same techniques to it. The result is a family of copper-nickel-tin alloys that are stronger, more ductile, and cheaper than the existing copper-based spring materials. The new material, depending upon its exact composition, offers up to a 50% increase in strength over phosphor-bronze at no increase in cost, or a 100% increase in strength at a small price increase.

The strength of the new alloy is about the same as that of copper-2% beryllium, but formability of the copper-nickel-tin alloy is far supe-

rior. More dramatically, the cost of the raw materials for the new alloy should be only one third that of copper-beryllium because of the very high price of beryllium.

Laboratory results have turned out so well that Plewes is now working with Western Electric and with materials suppliers. He wants to determine how the new alloys perform when they are produced in commercial quantities under production, rather than laboratory, conditions.

Uniform. Just about all methods for increasing the yield strength of metal involve the distribution of a second material within the primary metal. Roughly, the idea is that these second-phase particles impede the movement of crystal dislocations in the primary material, making the mixture stronger than it is in its unworked or unalloyed state. The effectiveness of this approach strongly depends upon the fineness and uniformity with which the second-phase material is distributed. In general, the finer the particles and the more uniformly they are distributed, the stronger the final alloy becomes.

Unfortunately, most precipitated alloys are formed by a process of nucleation and growth. This tends to cause the second-phase material to occur in fairly large, non-uniformly distributed clumps.

One important exception to this rule is found in materials that have undergone a process called spinodal decomposition. These materials are characterized by a very fine, uniform distribution of the second-phase particles.

Gold-platinum is the archetypical spinodal material. In studying it, Plewes found that the thermo-mechanical treatment causing the desired spinodal decomposition also causes an undesirable grain-boundary transformation. This is responsible for the material's brittleness. To reduce brittleness, he manipulated the kinetics of the two transformations by mechanically working and aging the alloy for various lengths of time at various temperatures. The result was spinodal materials with only a minimum amount of grain-boundary transformation.

One copper-based alloy that behaves in much the same way as platinum-gold is a cupro-nickel in which perturbations in tin composition are used for the second-phase distribution. Depending upon its exact composition, the material can be optimized for such parameters as electrical conductivity, strength, low cost, corrosion resistance, and strength, says Plewes. □

Transportation

DOT perks up fast rail systems

Obligated to play catch-up with the high-speed ground programs of France, Germany, Canada, and Japan, the U.S. Department of Transportation is pushing several multi-million dollar schemes for short-haul rail systems that suspend trains with electromagnets and propel them with linear induction motors.

Latest of these is a \$2.1 million contract in late July to Ford Motor Co., Dearborn, Mich., to build and test a vehicle simulating a system using levitation by magnetic repulsion on an aluminum guideway.

Whichever high-speed-system approach—electromagnetic repulsion, electromagnetic attractive, or even the suspension of the rail cars on a cushion of air—is ultimately blessed by DOT after an estimated five years of prototyping and testing, it could lead to a U.S. capital investment of more than \$3 billion in 1972 dollars to put together a Northeast Corridor system between Boston and Washington. Makers of electronic controls employing sensors, switches, and computer hardware can expect to get an estimated 10% of that outlay for the 300 mile-per-hour system—roughly \$1 million for each mph.

That first installation could also be the beginning of a major new electronics market as high-speed regional ground systems are put in place to relieve the air-traffic saturation predicted for several areas by the end of the decade. Though other

countries have already begun prototyping high-speed ground systems, DOT officials say, somewhat hopefully, that U.S. funding is beginning to close the developmental gap.

Better ideas? The 16-month Ford contract includes funds for building an aluminum guideway for magnetic levitation at the Naval Weapons Center, China Lake, Calif. Ford will test and evaluate guideway construction parameters and operational problems of magnetic levitation on the 1-mile track. Future vehicles would be propelled by linear induction motors now being developed by General Motors.

As a repulsion vehicle moves over an aluminum guideway on retractable rubber wheels, it will produce a magnetic field in the road bed that pushes up against the vehicle's electromagnets. As vehicle speed increases, the magnetic field becomes stronger and supports the vehicle against gravity as the wheels retract. Without gravity or friction, such a magnetically suspended vehicle can

travel faster than a conventional train's theoretical top speed of 150 to 200 miles per hour.

Another form of magnetic levitation, using magnets attracted to a steel guideway, will be tested after another contract from DOT is issued later this summer. Competition for the "attractive" research grant includes international partnerships among Germany's MBB and ITT's Krauss-Maffei and American companies.

After two years of testing, DOT will determine which of the two techniques deserves a full prototype test. It estimates that prototype development could cost more than \$20 million.

Thyristors. Operating at up to 300 mph, magnetic levitation systems would glide approximately six to eight inches above the guideway. The Ford test model, designed merely to accumulate data, will only reach half that speed, though. Electronic controls using thyristors will be needed to maintain gap spacing, explains Ford scientist Robert H.

Speeder. Magnetically suspended, high-speed transit vehicle is envisioned that will carry 150 passengers at 300-plus miles per hour between cities 300 to 500 miles apart.

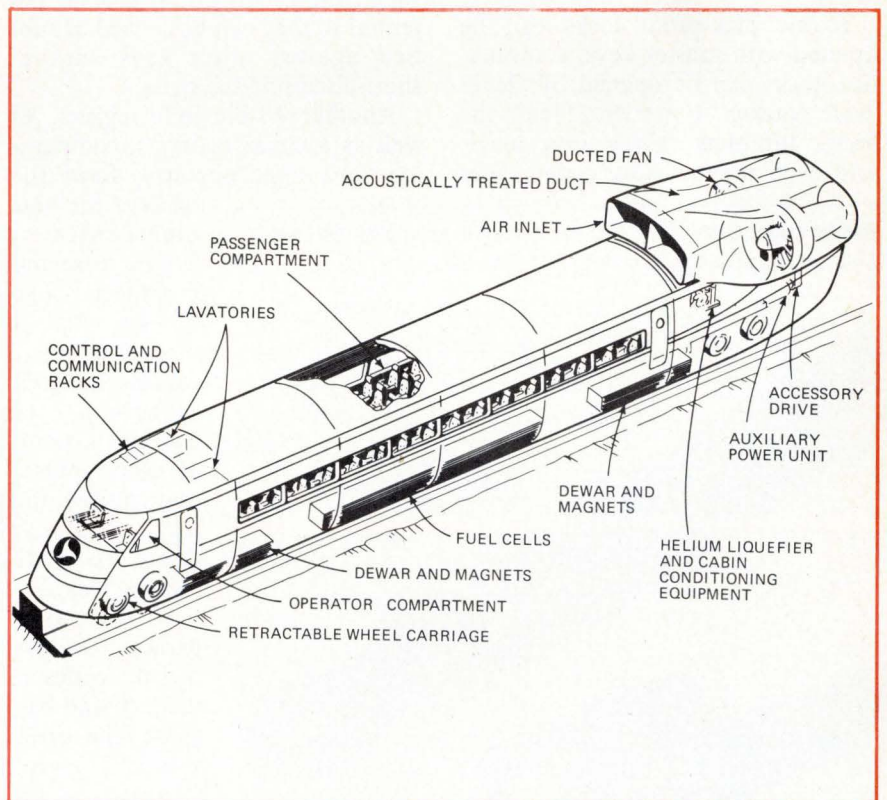

Borcherts. Relying on magnetic repulsion, the system will be inherently unstable without such controls, says Borcherts, Ford's deputy project manager. Ford has been working on repulsion, along with Stanford Research Institute, for the past four or five years. The Europeans, on the other hand, have concentrated on attractive systems.

Repulsion has the advantages of better dynamics and less magnetic drag, Borcherts says. Attractive systems, which would require a much smaller gap and greater instrument precision, he says, are also more difficult to construct. □

Commercial electronics

Tampering is out with C-MOS lock

How secure is a locked door? Not nearly secure enough if you're anxious to prevent determined and technically sophisticated persons from entering, say designers at Arthur D. Little Inc., Cambridge, Mass.

Exotic pick-proof locks can be opened with master keys, combination locks can be opened by clever "safe-cracker" types who "feel" the lock's tumblers falling into place, and even magnetically coded locks

Secret code. C-MOS shift register hidden in key holds the code for pick-proof lock designed by Arthur D. Little Inc.

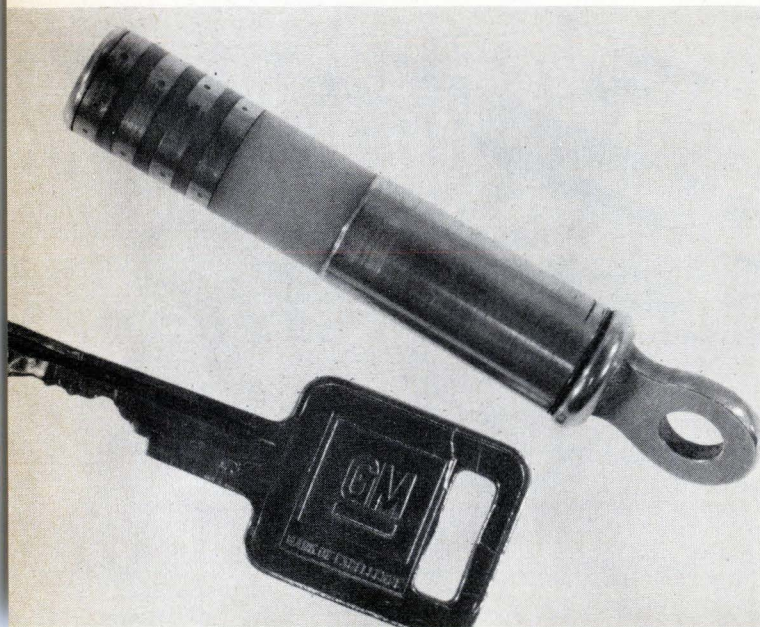

require entry cards whose data key can be read out and duplicated.

The answer to real security, say the ADL people, is an electronic lock they've just developed that stores its code in a complementary-MOS shift-register memory. The lock itself interrogates another shift register in the key. If the two codes match, the lock will pop open.

Information in the key cannot be altered or erased by electromagnetic or electrostatic fields, nor can either key or lock code be read out, says Robert R. Perron of ADL. Perron and John T. Fowler are project engineers for the new lock system.

Cigarette. The prototype key, the size of a thick cigarette, contains an 18-bit complementary-MOS shift register—the RCA CD4006A. In production, the key would use a 32-bit device, which could provide more than 4 billion combinations. The register is powered by three small mercury cells. A small capacitor across the input terminal provides enough energy for the circuitry when the batteries are replaced.

Four contacts at the end of the key provide leads for ground potential, clock input, signal output, and signal input. All are at ground potential so they can be carried or rubbed against other keys without short-circuiting the signal.

Another 18-bit shift register, as well as a clock, counters, comparator, and logic circuitry, form the

basis of the lock electronics. When inserted in a special hole, the key flips a microswitch, causing the lock circuitry to transmit a series of clock pulses that makes the key register dump its code into the lock.

If the comparator decides that the codes in the lock and key agree, the open signal is given. Otherwise, an

alarm signal is generated. And as clock pulses extract the combination from the key, the time code in the lock reprograms the key.

The lock itself is programed by a special code-card programmer that inserts a code into the lock register. The key can be programed at the same time, or the key and lock can be programed separately.

Lock company. ADL developed the new system for Eastern Co. of Naugatuck, Conn., which has a lock-making subsidiary. Eastern has not yet decided whether to manufacture it or license it to another company. However, a study done at ADL shows the lock electronics could be manufactured for perhaps \$10 with the circuitry on an LSI chip. The key could be made for \$3 to \$4.

Perron says it would be impossible to make a duplicate key—the code is pulsed in such a way that it is impossible to tell where the beginning and end are. And since the key emits neither sonic nor electromagnetic radiation, it is almost impossible to read the key combination.

Neither can the lock be interrogated to determine its code. Any electronic exploratory signals applied to the lock would most likely destroy its memory. And the interrogation rate of the lock, while functionally fast, is slow enough at 100 codes per second to require about 400 days to run through the code permutations of a 32-bit register.

The only weak link in the system is that it requires a keyhole. Perron says that any opening can be tampered with. However, for exceptional security, contact between key and keyhole could be eliminated by such techniques as inductive coupling or optical transmission. □

Instrumentation

CRT design is key to improving scope

Cynics may claim that vacuum-tube technology is dead, but oscilloscope designers at Tektronix Inc., Beaverton, Ore., have achieved a new

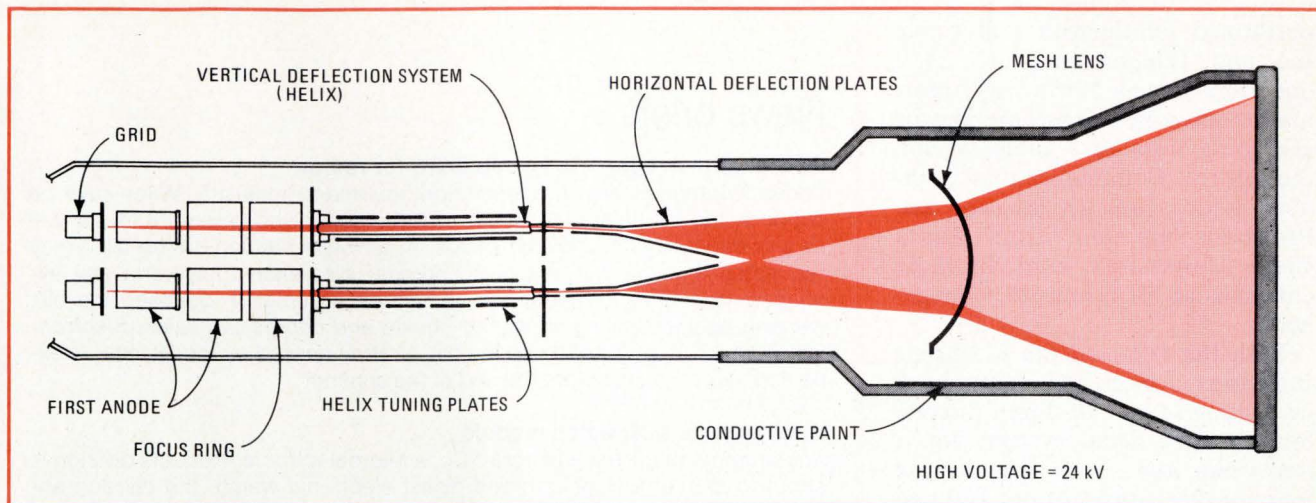

Grand design. Closely spaced electron guns team with mesh lens to enable full scan overlap in dual-beam scope from Tektronix. Transmission-line characteristics of helical vertical-beam-deflection structure helps CRT attain bandwidth of 2 GHz.

plateau of performance largely through further development of a cathode-ray tube. The new Tektronix model 7844 dual-beam scope [*Electronics*, June 27, p. 161] boasts both 400-megahertz bandwidth—an eightfold improvement—and full-scan overlap. Bandwidth of the tube alone is 2 gigahertz.

“A dual-beam scope is truly effective when it becomes two distinct scopes with a common display,” says Conrad Odenthal, project engineer for the CRT. “Both traces must cover the entire display area, rather than only the two thirds of the display that the beams in our earlier scope covered.”

Dual-trace scopes, on the other hand, use a single beam to deliver two traces, and each of them covers the entire display. But the trace is time-shared, which means it cannot effectively deliver an image in single-shot mode or when the repetition rate is low.

“We also wanted to boost bandwidth from 50 MHz, the limit of our earlier dual-beam scope, to 400 MHz.” To obtain full-scan overlap, Odenthal’s group mounted the guns side by side, instead of mounting them under and over as in their earlier models. The designers also spaced the guns closer together than before.

Lens. Then, a lens was built in the form of a very fine mesh, which provides the scan expansion necessary to bend the trace to fill the display

region of 8 by 10 cm on the screen. Explains Odenthal: “The scan-expansion mesh enables a high potential to be applied to the conductive coating in the tube. This potential accelerates the beam and enhances the writing rate—crucial to high-frequency real-time scopes.”

Also, use of the mesh enables the CRT designer to shorten the tube and lower the deflection factor, measured in volts per centimeter, thereby easing the task for the circuit designer who must design the deflection circuits to drive the CRT, he adds.

Helix. To obtain vertical deflection with more than 400-MHz capability, Odenthal used a helical structure, similar to that used in microwave traveling-wave tubes, instead of conventional flat deflection plates. Such flat plates just can’t provide accurate deflection at extremely high frequencies, Odenthal points out.

When the signal-impression time becomes shorter than the transit time of each electron speeding through the CRT gun, deflection becomes “mushy.” However, the helical structure chops up the deflection field into many short segments so that the transit time for any beam electron passing any gap segment becomes very short, compared with the period of a changing signal.

Each helix consists of 25 box-shaped turns. This configuration enables tuning plates to be positioned

alongside it to “unlump” what is actually a lumped-parameter delay line. The helix becomes a matched transmission line. As a result, there is virtually no reflection of high-frequency components which would otherwise degrade the fidelity of the trace. □

Consumer electronics

4-channel fm test goes over cable

A California cable-TV equipment maker has sidestepped the lack of Federal Communications Commission standards to regulate discrete quadraphonic “surround sound” broadcasting by going over a cable television net. A month-long feasibility test has shown that the system is fully compatible with cable operations and could be easily converted to on-the-air broadcast equipment.

The tests showed “no insurmountable problems,” says Frank A. Genochio, president of Catel Corp. in Sunnyvale, Calif. But further studies are needed, he admits, to determine how a market for the four-channel system could be developed.

Catel has been using the Dorren discrete four-channel fm system developed by Quadracast Systems Inc. of San Mateo, Calif. The test was

performed jointly with Gill Cable Inc. and Teleprompter, two CATV operators serving Northern California communities. Since the signals are going through a cable system, the Federal Communications Commission does not get into the act. Programs emanate from Santa Clara University's local fm-radio channels at 91.1 and 89.1 megahertz.

Both the FCC and the Electronic Industries Association have been evaluating some half-dozen discrete four-channel signal systems for a few years now. Such systems use four speakers—two in front and two in the rear. Eventually, they hope to develop national standards similar to those now regulating two-channel stereo broadcasts.

Testing. During the test period, the four-channel signals at the university's studio were generated by commercially available Panasonic discrete four-channel audio equipment and fed into the CATV systems through the Dorren discrete fm four-channel generator. Technics (Panasonic) receivers with conventional stereo fm front ends and four-channel amplifiers in conjunction with prototype Dorren fm four-channel demodulators are at the receiving end.

The demodulators, not currently available, are connected to the multiplex output of any existing fm receiver to decode discrete four-channel audio output from the Dorren fm four-channel composite signal. Quadracast had previously experimented with Dorren fm broadcast over the air in 1970-71 under FCC temporary approval granted for San Francisco's KIOI. General Electric Co., another contender, has also had test broadcasts, as have others.

In the meantime, the EIA's National Quadracast Radio Committee has been attempting to work out a recommendation for a single standard for the FCC to promulgate. At the same time, fm stations across the country have begun limited broadcast of matrix four-channel—referred to as four-two-four. Such broadcast is permissible because this coding and decoding approach does not require any change in the

News briefs

FCC chairman supports fm capability for radios

Federal Communications Commission chairman Richard E. Wiley says he supports the bill before the House of Representatives to require fm as well as a-m capability in consumer radios. At a House hearing on the bill, Wiley requested that the FCC be given broader discretion to enforce any all-channel law. Only the Electronic Industries Association opposed the bill, warning against limiting consumer choice and depressing sales [*Electronics*, June 27, p. 53]. Action on the bill, already passed by the Senate, is expected in the House before the end of the summer.

Hughes adds LCD watch module . . .

Amid rumors that Hughes Aircraft Co.'s Microelectronic Products division is about to market a Hughes-brand digital electronic watch, the division announced production of a liquid-crystal-display watch module. The new module will use the same complementary-MOS chip and battery circuitry that Hughes fabricates for its line of light-emitting-diode modules. Price of the new module is the same as for the LED version, which is aimed at watches selling for \$150 to \$300.

. . . while Seiko pushes analog electronic watches

While others expect great things soon from the digital watch market, Seiko Time Corp. predicts it will be a long time before the new timepieces make a significant dent in the analog market. Seiko itself expects to sell one million electronic quartz watches with analog faces in 1974, double the number it sold last year. However, industry sources say Seiko does have a substantial investment in electronic digitals, and the company will market a liquid-crystal-display model in 1975.

Computer tracks inventory for test-equipment rentals

U.S. Instrument Rental Inc., San Francisco, an electronic test-equipment rental house, is copying auto-rental agencies and airlines by using a computer-based inventory-control system to pinpoint equipment availability and location at a moment's notice. Equipment can be committed to a customer within minutes. And the company guarantees to ship a replacement for a malfunctioning instrument in 48 hours.

DEC may be close to semiconductor manufacture

Discussions underway between Digital Equipment Corp. and Mostek Inc. reportedly are aimed at preparations for DEC to crank up a semiconductor-manufacturing operation for itself. Neither DEC nor Mostek would officially confirm the scope of the discussions. However, an insider at DEC suggests that the minicomputer maker may be interested in manufacturing special integrated circuits available from regular sources only in limited quantities. "None of our suppliers will be impacted," he adds.

System tracks nuclear materials

With funds from the Atomic Energy Commission, Government-sponsored Sandia Laboratories, Albuquerque, N.M. is developing a communications system that will track trucks transporting nuclear materials. The system, which will go into operation next year, places a transmitter-receiver in each truck and five relay stations in various locations in the U.S. A central terminal receives each truck's location which is then relayed to the trucker's home office.

TRW resumes production of HEOS

TRW Inc. has resumed development of HEOS, the High Energy Astronomy Observatory Spacecraft scheduled for launch in 1977. TRW was awarded a \$71.1 million contract by NASA in 1971, but production was held up last year while NASA explored cost reductions.

Fingertip signal averaging... ...and a lot more

Any signal that can be displayed can be digitized, stored, and processed by the TEKTRONIX Digital Processing Oscilloscope.

A noisy signal . . .

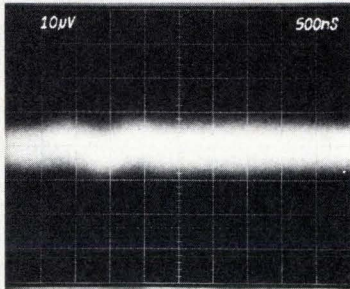

. . . is made useful by signal averaging with the DPO.

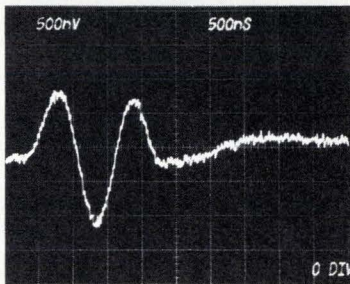

Over 30 TEKTRONIX 7000-Series oscilloscope plug-ins give the DPO unmatched acquisition flexibility. Signals from microvolts to kilovolts in amplitude, from picoseconds to seconds in duration, and from dc to 14 GHz are now available for computer analysis.

The range of possible measurements is almost unlimited. Program call buttons on the DPO give you fingertip access to waveform processing from simple multiplication, addition, and subtraction to integration, differentiation, Fourier transforms, and correlation.

Get all the details from your local Tektronix Digital Applications Engineer. For your copy of the "Digital Processing Oscilloscope" brochure, contact: Tektronix, Inc., P.O. Box 500A, Beaverton, OR 97005. Phone: (503) 644-0161. In Europe: Tektronix Ltd., Guernsey, C.I., U.K.

For a demonstration circle 44
on reader service card

Circle 45 on reader service card

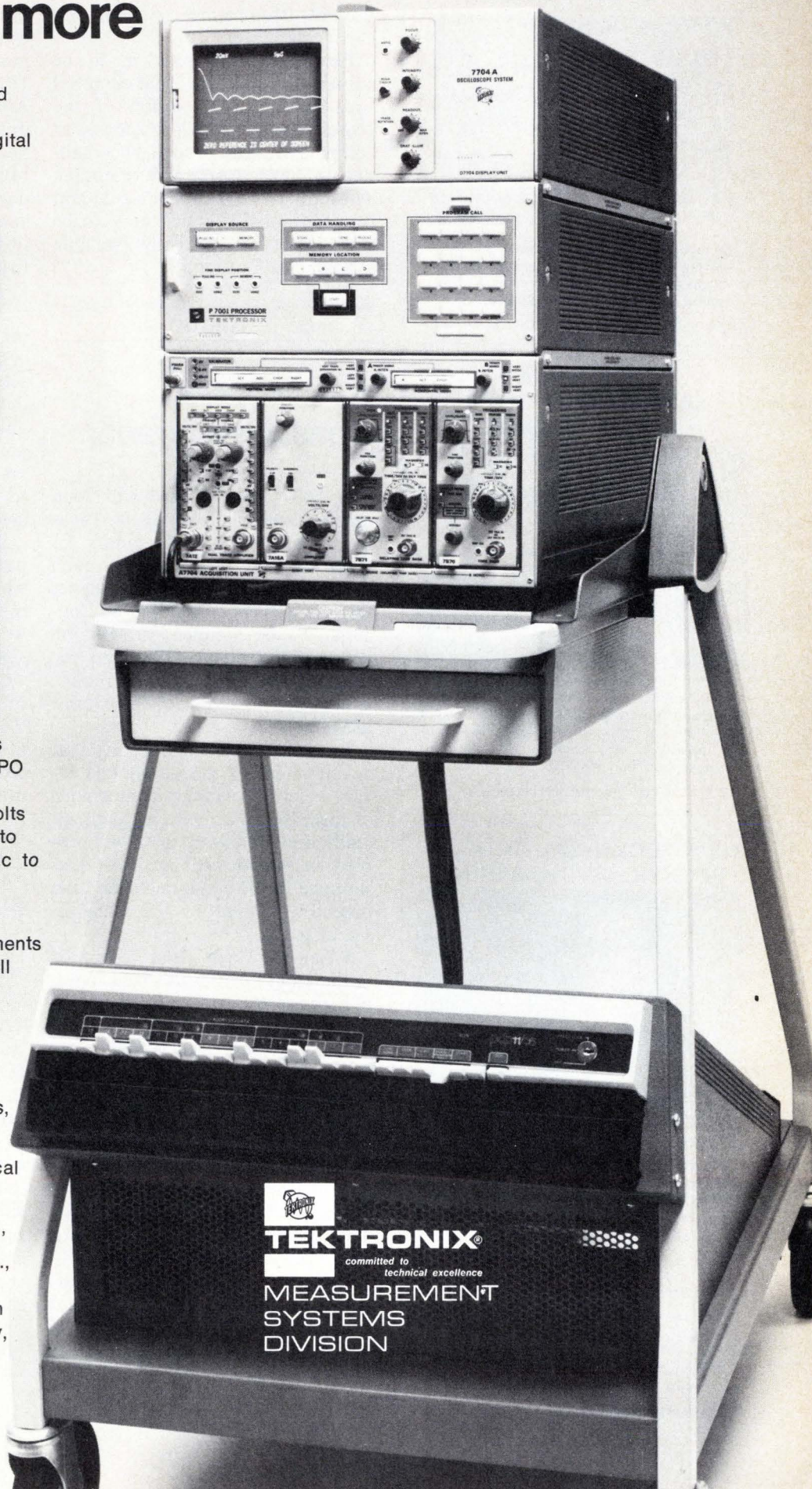

TEKTRONIX
committed to technical excellence
**MEASUREMENT
SYSTEMS
DIVISION**

ECCOMOLD® EPOXY MOLDING COMPOUNDS



Comparative physical, electrical and processing properties of Eccomold transfer molding compounds are in colorful chart. Typical applications are indicated.

Circle 46 on reader service card

NEW DATA APPLICATION GUIDE EMI/RFI GASKETS

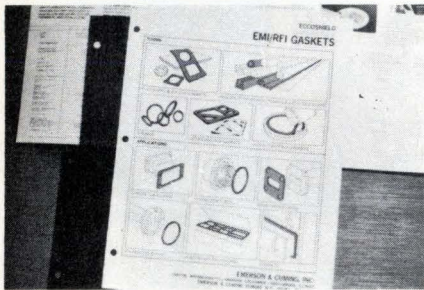

ECCOSHIELD® folder describes the broadest line of conductive plastic gaskets, including forms and applications. All materials feature high insertion loss, hermetic seal, low closing pressures, low compression set, low maintenance. Send for FREE copy.

Circle 200 on reader service card

NEW TECHNICAL DATA ON EPOXY CASTING RESINS



STYCAST® Casting Resins are described and properties tabulated in this new folder/wall chart. Includes all significant properties of 24 high-performance resins plus notes on curing agents, cure procedures and use. Valuable reference.

Circle 201 on reader service card

Emerson & Cuming, Inc.



CANTON, MASS.
GARDENA, CALIF.
NORTHBROOK, ILL.
Sales Offices
in Principal Cities

EMERSON & CUMING EUROPE N.V., Oevel, Belgium

Electronics review

present two-channel (stereo), fm-carrier standards.

Essentially, the problem to be solved in discrete four-channel broadcasting is allocation of the present fm band, while keeping it compatible with present two-channel fm transmission and reception. Thus, an additional pilot signal and two additional channels have to be shoehorned into currently available frequency allocation. □

Radar

TI to develop Coast Guard radar

The U.S. Coast Guard will soon make public its selection of Texas Instruments to provide radars for airborne sea surveillance, even though procurement of the planes they fly in has been slowed by Congress. To be handled through the Naval Air Systems Command the contract, for an estimated 50 radars, is expected to produce a unit price of \$110,000.

Coast Guard officials observe that development of the dual-mode radar, which will contain components of three Navy airborne systems already under contract to TI, will proceed despite an estimated two-year slippage in the program's operation timetable caused by the Congressional action.

When the Coast Guard disclosed to the House earlier this year that it planned to sole-source Rockwell International for 41 North American T-39 Sabreliner business jets, Congress urged it adopt a two-step competitive procurement. That competition, now expected to include Lear Jet and Falcon entries, will preclude an operational sea surveillance system before fiscal 1979. But the avionics is being pushed because its development is still "not fat for time," says a program source.

Parts. The new radar—selected after the service looked at 12 different available models—will draw most of its parts from the APS-115 search radar now used by the Navy on the

land-based P-3C antisubmarine-warfare aircraft. However, it will be modified to include the small IP1131 lightweight display from the APS-124 radar used on the Navy's destroyer-helicopter program, known as Lamps (Light Airborne Multi-Purpose System). The new radar will also include some cockpit components from the APQ-122 used in the Adverse Weather Aerial Delivery System aboard the Lockheed C-130 Hercules transport.

Melding. Successful melding of the three radars should produce a system that "will operate in higher sea states" than other available radars, making it possible to distinguish small boats and other targets amid sea clutter. Proponents of the system contend it has the potential to "open up a whole new product area" for search on the sea surface.

The Coast Guard is following its pattern of procuring Navy systems where possible because its requirements for only small quantities would "escalate unit costs out of sight," if any sizable development were required, one official pointed out. Moreover, maintenance of Coast Guard systems is performed at Naval bases, making hardware commonality with Navy systems a must. □

Components

Pressure sensor relies on frequency

With Detroit voicing its need for cheap and reliable pressure sensors for emission control and electronic fuel-injection systems, many firms are scrambling to strip the cost out of present pressure transducers without sacrificing performance.

But Amphenol Connector division's Controls operation is taking a different tack: it has designed from scratch an unusual capacitive pressure sensor that could be quite inexpensive. However, declining to name a specific price target, an Amphenol spokesman says only that it will sell for "less than competitive

SCIENCE/SCOPE

The F-14 Tomcat's AWG-9 system and Phoenix missile were praised in a recent report of the House Armed Services Committee for having demonstrated capabilities "unprecedented in the annals of aviation." Major accomplishments cited in the report: longest-range fighter detection of fighter-size targets; longest-range fighter-launched air-to-air missile firing; first fighter to demonstrate automatic detection and tracking of multiple targets; and first fighter to demonstrate multiple, near-simultaneous firing of missiles against multiple airborne targets. The AWG-9 weapon control system and the Phoenix missile are built by Hughes for the U.S. Navy.

The National Society of Professional Engineers has chosen ERTS (Earth Resources Technology Satellite) as one of the top ten engineering achievements of 1973, based on benefit to mankind, creative significance, and contribution to technology. The multispectral scanner system aboard ERTS, developed for NASA by Hughes and its subsidiary, Santa Barbara Research Center, records solar energy reflected from Earth to produce photos which indicate the health of fields, forests, rivers, and lakes. ERTS was launched in 1972 by NASA's Goddard Space Flight Center and is still operating. It circles Earth every 103 minutes in a polar orbit.

A fiber optic data link carrying aircraft flight control signals from cockpit to controls was successfully flight tested for the first time by the U.S. Air Force recently. The test was part of a program to evaluate various electromagnetic-integration-resistant transmission media for carrying multiplexed signals in a fly-by-wire flight control system. Of particular concern was the potentially catastrophic effect of lightning and other forms of electromagnetic interference on the conventional twisted-pair-wire bus now used to carry primary flight control signals. The two-way multi-port fiber optic data bus was integrated with F-DADS (fault-tolerant digital airborne data system) equipment. Both were developed by Hughes.

39 scientists will provide the experiments aboard the two Pioneer spacecraft NASA will send to Venus in 1978. They were selected from among the 162 who submitted proposals. Primary objective of the twin missions is a detailed investigation of Venus's atmosphere and clouds. One of the spacecraft will orbit Venus in a highly elliptical trajectory, transmitting data for a full Venus year (eight Earth months). The other will launch one large and three small probes before it enters Venus's hot, dense atmosphere. The probes will transmit data to Earth during their hour-long descent to the planet's surface. Hughes will build the two spacecraft.

Laser communications specialists: our Space & Communications Group has immediate openings for well-qualified professionals with experience in: systems analysis/systems engineering (PhD in engineering, 10 years experience); control system design (BS or MS in engineering, 5 years experience); or optical systems design (BS or MS in engineering physics or physics, 5 years experience). U.S. citizenship required. Please send your resume to: D.T. Stewart, Hughes Aircraft Co., P.O. Box 92919, Los Angeles, CA 90009. An equal opportunity M/F employer.

Commercial products from Hughes: a high-power X-band multipactor for high-resolution radar systems; it provides front-end protection for radar receivers and is capable of RF pulse forming and switching....a new version of the Conographic(tm) graphic display terminal, featuring desk-top packaging with integrated keyboard and CRT screen; it displays curvilinear information from significantly less data than required with x-y plotting....three new series of waveguide components for the 26.5 to 110 GHz range -- E- and H-plane bends, tapered transitions, and 45° and 90° bends -- designed for transmission lines and waveguide assemblies.

Creating a new world with electronics

HUGHES

HUGHES AIRCRAFT COMPANY

Liquid Rivets, Bolts, Nails, Staples, Etc.

One drop goes a long way in fastening almost anything to almost anything.

Metals, for instance. And plastics. And ceramics. And rubber.

Eastman 910[®] adhesive bonds fast, too. Almost instantaneously. With only contact pressure.

Tensile strength? Up to 5,000 psi at room temperature.

New Eastman 910 MHT and THT grades hold when the heat is on. Even over 400°F.

For further data and technical literature, write: Eastman Chemical Products, Inc., Kingsport, Tennessee 37662.



Electronics review

products." Conventional pressure-sensing devices now cost automakers upwards of \$15, he points out.

Unlike competing devices that mechanically link the pressure sensor to a potentiometer or transformer to give voltage differences, the Amphenol unit produces frequency variations. The sensing device is incorporated as the plates of a variable capacitor in an oscillator circuit. Thus, changes in pressure are reflected as changes in output frequency. In a prototype sensor, the frequency decreases linearly as pressure increases over a range of six to 16 pounds per square inch.

The variable frequency output of the new transducer, unlike voltage outputs, "lends itself to digitizing," points out Raymond M. Fields, industrial marketing manager for the Broadview, Ill., division of Bunker-Ramo Corp. The frequency signal can be passed either through a counter to obtain a digital output or through a discriminator to get an analog equivalent.

Capacitors. The Amphenol system is actually two capacitors wired in parallel. Both sides of a ceramic substrate are screened with a silver-palladium layer to form the fixed plates, and each side is capped with a movable plate, or diaphragm, that is sealed to the substrate. The dual-capacitor arrangement gives the unit greater sensitivity, Fields says, and compensates for any possible flexure of the ceramic substrate. Diaphragms are stamped from Ni-Span-C, an alloy developed for watch mainsprings.

The sealed substrate/capsule assembly is evacuated to form a vacuum reference. As variation in pressure changes the distance between the diaphragm or capsule and the metalized substrate, the capacitance of the circuit changes. "The external plates also can be at ground potential," Fields points out. "That, in effect, forms a shield to protect the capacitor from any ambient electrical interference that might yield spurious signals."

Connection. In its present form, the sensor is packaged in a plastic housing that can be connected by tube to the pressure source. Elec-

tronics to complete the oscillator circuit are mounted on a printed-circuit board atop the package, 2.25 inches square by 1.25 inches high. Price for the sensor—being sampled by Detroit—is now \$50 to \$75 in quantities of 1,000 to 5,000, according to Amphenol.

But to drive the price down, the sensor's electronics will be integrated onto the periphery of the substrate, outside the sealed capsule, as a hybrid circuit of chip ICs and capacitors, with screened-on resistors and conductors. Sub-

Sensor. Discrete components are mounted above evacuated chamber in prototype pressure sensor from Amphenol. Prime customer is the auto industry.

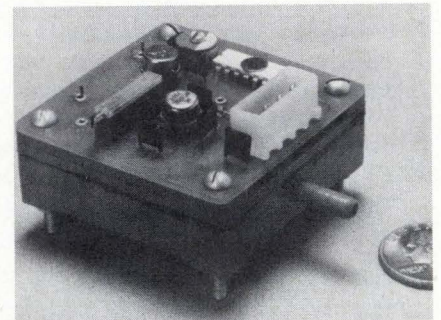

sequently, Amphenol may try to move the electronics into the capsule, between substrate and diaphragm, to take advantage of the more benign sealed environment. The company received a patent for a capacitive pressure sensor fabricated in such a manner earlier this summer.

Bridge circuit. Amphenol has also been experimenting with placing the variable capacitor of the pressure sensor in a bridge circuit. The result of this arrangement is a varying voltage output rather than a varying frequency.

Applications are not limited to the auto industry's needs, Fields says, although he notes that the sensor was designed with those primary requirements in mind. Since the device boasts repeatability of better than $\pm 1\%$ of full scale, it can be used for most any general industrial or process-control use. There is also potential for meteorological and medical-electronics applications. □

Another technical knockout

the first 900 MHz, 50 W RF chain

900 MHz radio is here now and Motorola is first with broadband devices for the entire range.

900 MHz TYPE	P _{out} W	G _{PE} (G _{PB})* dB Min	V _{cc} V
MRF816	0.75	10.0	12.5
MRF817	2.5	6.2	13.6
MRF818	8.0	5.05	13.6
MRF823	5.0	8.0	12.5
MRF824	12.0	5.0	12.5
MRF825	25.0	4.0	12.5

*Common Base

Controlled Q[†] and mesh-overlay technologies are what did it. We combined all the best of land-mobile technology to develop the first lineup of common-emitter/common-base devices that meet the criteria of performance and cost.

†Trademark Motorola Inc.

A complete line of 50 ohm PC board demonstration amplifiers to aid you in building your radio is available through your Motorola representative. And a new Engineering Bulletin, EB-23, is waiting to start you in

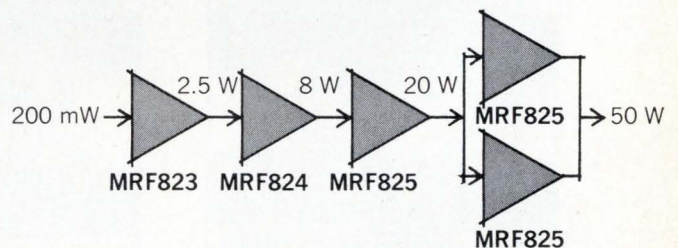

12.5 V, 806-821 MHz

the right design direction. Box 20912, Phoenix, AZ 85036. Be first with the first...



heavyweight
from Motorola, the RF producer.

YOU HUM THE TUNE, EXAR PLL WILL SING IT

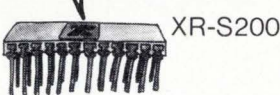
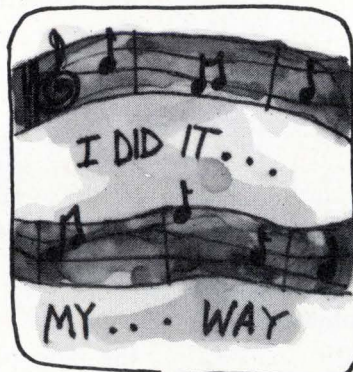
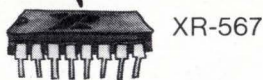
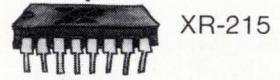
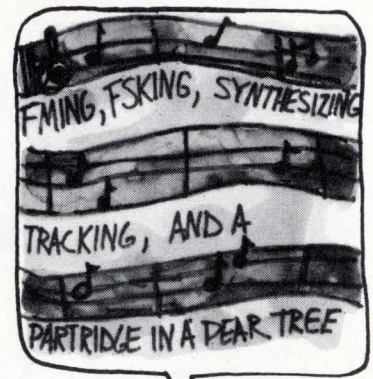
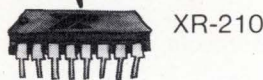

We have the broadest chorus line of Phase Lock Loop circuits available today. Take a brief look at our ever-expanding PLL line:

The XR-210 is designed for FSK Modulation and Demodulation and features a self-contained output logic driver, compatible with RS-232C requirements.

Use the XR-215 for FM or FSK demodulation, frequency synthesis and filter tracking. It has a 5V to 26V supply range and 0.5 Hz to 35 MHz frequency bandwidth. What's more, it's bipolar logic compatible.

The XR-S200 is a do-it-yourself building block. With this you design your own PLL circuits by selecting external connections and components. You get instant pro-

totypes with minimum fuss and costs.

Moving right along . . . the XR-567 PLL is designed for tone and frequency decoding. It has a bandwidth adjustable from 0 to 14%, sinks up to 100 mA of load current and has a logic compatible output. Our dual version, the XR-2567, is a real hummer with even better temperature tracking and matching characteristics. Power supply rejection is improved by an order of magnitude over the single version. The dual outputs can switch up to 100 mA at 26 volts.

All together now. We would like to send you the complete musical score on our PLL products. Our data sheets are good and they're filled with applications data. Write now, write.

EXAR SPEAKS YOUR LANGUAGE

EXAR INTEGRATED SYSTEMS

R-OHM CORPORATION
EXAR INTEGRATED SYSTEMS

P.O. Box 4455
Irvine, CA 92664
Telephone: (714) 546-8780
TWX: 910-595-1721

Rohm
QUALITY · RELIABILITY

R-OHM ELECTRONICS GMBH
EXAR INTEGRATED SYSTEMS

Mühlenstraße 70
4051 Korschenbroich
Telefon (02161) 298 05
Telex 852330 rohm d

MEMBERS OF THE INTERNATIONAL R-OHM GROUP

First opposition develops to IBM satellite entry

A Senate subcommittee has been told that **International Business Machines Corp. will eventually dominate the developing U.S. market for high-speed, wide-bandwidth communications and distributed data processing if it is allowed to enter the domestic-satellite business.** The warning was delivered by Royden C. Sanders, Jr., president of Sanders Associates Inc., Nashua, N.H., a CRT computer terminal maker and IBM competitor, in testimony before the judiciary subcommittee on antitrust and monopoly chaired by Sen. Philip A. Hart (D., Mich.). IBM has proposed the acquisition of 55% of CML Satellite Corp. with Comsat General Corp. holding the remainder [*Electronics*, July 11, p. 26].

Federal Communications Commission approval of the IBM proposal, which Sanders opposes, would lead to **"a division of the market along noncompeting service lines" between AT&T and IBM.** Most of AT&T's capacity, Sanders said, "is geared for slow-speed, low-bandwidth communications. The new information-handling market will be most efficiently and economically serviced by high-speed, high-bandwidth communications; IBM will make that market by forcing its business and data-processing product lines." Although IBM's would not be the only domestic satellite, Sanders noted, the combination of the system with the company's financial resources **"will give IBM the missing ingredients—low-cost communications and the means to absolute market control" of distributed data processing.**

Soft economy makes a buyer's market, says NASA . . .

In the buyer's market of a soft economy, NASA procurement officers find component companies are beating a path to their doors. **Before the energy crisis, companies used to turn away the space agency's high-technology, low-volume orders in favor of more profitable high-volume commercial orders without NASA's stringent quality control. Components deliveries, too, were taking months instead of weeks.**

But the picture changed radically early in 1974. Components manufacturers, hurting from slumping orders by automakers and others, began approaching the agency, lead times began to shrink, and **upcoming increases in production capacity are making firms seek high-volume Government orders for standardized components.** Fairchild is cited as one semiconductor maker newly eager for NASA's custom.

. . . but inflation slows hardware standardization

Nevertheless, **inflation and the fears it breeds about program cutbacks are slowing NASA's efforts to implement the hardware standardization policy it began in May, say agency officials.** They report reluctance among design engineers to **diminish their workloads by adopting standard systems** and, in fact, only one—a spaceborne data tape recorder from California's Odetics Inc.—has been contracted for since May.

However, components standardization is progressing at some NASA centers. **Goddard Space Flight Center recently submitted eight standardized C-MOS specifications** for assimilation to Defense Department standardized specs, and **Marshall Space Flight Center is assembling a component standardization staff that will handle transistors, diodes, resistors, and capacitors, in that order.** When product lists are completed, NASA centers will reference standard components at expected annual savings of 20% of buying price, 25% of testing costs. **The \$32 million saved will go on more hardware buys, unless eaten up by inflation.**

The search for a U.S. export policy

Where it was once only very difficult to find a domestic economic or political issue that had been well handled by the Administration of Richard Nixon, it is now impossible. And the widespread acclaim by the President's advocates for his successes in foreign affairs seems overblown as well.

In the two years since the President's mission to Peking, little of substance has followed to mark any broadening of relations between the United States and the People's Republic of China. To the contrary, the PRC has effectively rejected an Electronic Industries Association proposal to send a U.S. delegation of electronics manufacturers to explore possible trade opportunities (see p. 35).

China's polite but firm rejection of the EIA offer cited the "artificial barriers" of U.S. export controls that it says would preclude American manufacturers from obtaining licenses for shipment of most electronic products to the PRC. Therefore, concluded the Chinese, any trade mission would be a waste of time.

While it could be argued that China misread American policy on the granting of export licenses, and that the U.S. Department of Commerce will license the export of electronic products more readily than it does the export of manufacturing technology, that argument will not be advanced here. The fact is that American manufacturers do not know and cannot find out what U.S. export policy is when it comes to high technology. And some, like Fairchild Camera & Instrument Corp.'s C. Lester Hogan, who have sought to determine the U.S. policy, now wonder if one exists at all.

Fairchild's frustration

Hogan recently complained bitterly about the problem before the Senate Foreign Relations subcommittee on multinational corporations which was taking testimony on the 1969 Export Administration Act. Describing Fairchild's meetings with Commerce in seeking export guidelines while the company was negotiating with Unitra of Poland to build a plant that would make p-channel MOS integrated circuits for calculators, Hogan called the experience "quite frustrating." It was also expensive. Fairchild spent more than \$400,000 in the U.S. alone in shuttling executives between California and Washington, only to have the deal rejected on the ground that it was "not in the interests of the United States."

More frustrating to Hogan is the fact that Fairchild was never able to learn what kind of deal might be acceptable to the U.S. The re-

sponse of Commerce, he said, was to tell the company to negotiate another agreement and submit it for Government consideration.

Hogan indicated Fairchild had heard that the Department of Defense was behind the rejection of the deal with Poland, but was unable to get an official statement. But now the Pentagon willingly confirms that it recommended against giving Poland p-channel MOS production capability and says it would be happy to let Fairchild see its position paper.

Credibility for DOD?

Moreover, the Pentagon is moving to "try to improve its credibility" in the area of high-technology exports by developing advisory guidelines for a wide range of product areas, including semiconductors, computers and peripherals, and electronic instrumentation. This was disclosed before the Senate subcommittee by J. Fred Bucy, executive vice president of Texas Instruments, who will head a new industry and Government advisory committee to develop guidelines for the Defense Science Board. Bucy, whose appearance before the Senate preceded Hogan's by several days, opposes the export of high-technology manufacturing knowhow to Communist nations. As a general rule, however, he believes the U.S. should not restrict export of finished products to the Soviets and their allies.

The opposing views heard by the committee from Hogan and Bucy on the potential of the East European market proved no more than an elaboration of the positions first presented by both men in *Electronics* last fall [Sept. 24, 1973, p. 42; Oct. 11, 1973, p. 41]. And many listeners thought Bucy developed the stronger case.

Where Hogan produced strong documentation of his charge that there is no effective U.S. export policy for high technologies such as electronics, his presentation stopped short of proposing corrective action. The TI position, on the other hand, was replete with recommendations. Bucy called for rejection of trade agreements that whipsaw competitors with the offer of exclusive entry into the market, as well as for a strengthening of the rules of Cocom—the coordinating committee of NATO allies and Japan—so that another nation's manufacturers cannot benefit from export opportunities now denied U.S. firms on national security grounds.

In testimony before the U.S. Senate, where the membership is more interested in having problems answered than listed, it must be said that the man from Dallas made the more effective presentation.

—Ray Connolly

Don't worry about systems compatibility.

S-D already has.

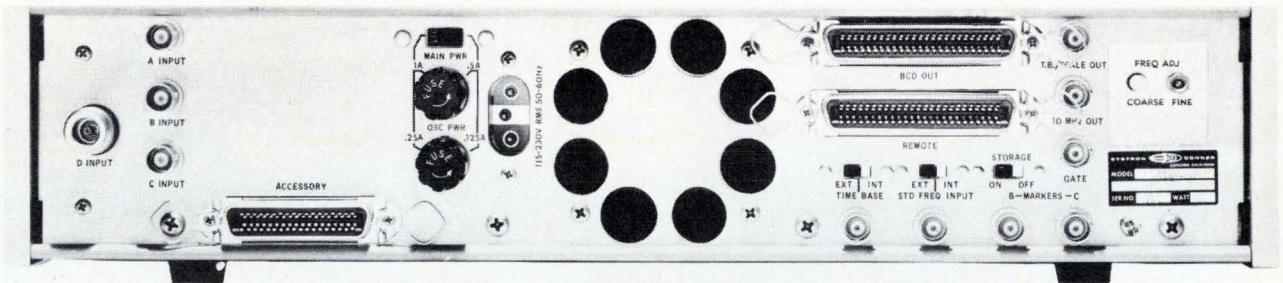

Systron-Donner manufactures a complete line of programmable instruments for systems applications. They were **meant** to be programmable right

from the start. Here are but three of S-D's many easy-to-interface instruments:

Waveform Analyzers

- Fully programmable
- Single transient to 1 GHz
- 0.1% accuracy
- 1 mv to 2 v voltage measurement
- Search mode and programmable delay

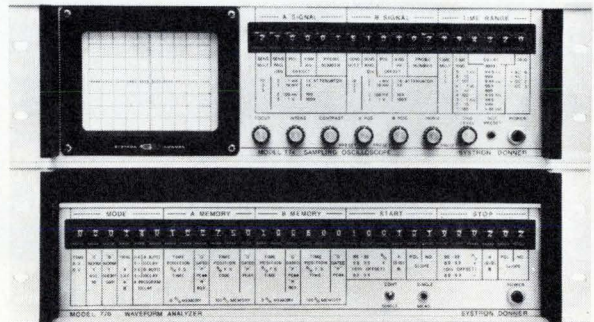

Counters

- Completely programmable including trigger levels
- 50, 200, 512 MHz or 3 GHz models
- 10 ns one shot T.I.M./period

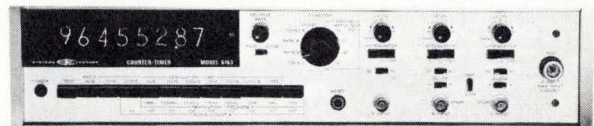

Pulse Generators

- All pulse parameters programmable
- 50 MHz repetition rate
- Current sink capability

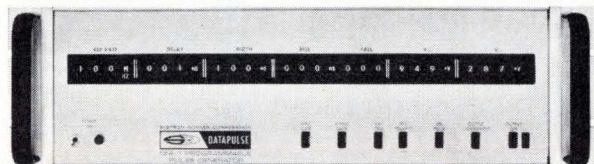

For immediate information on Systron-Donner's broad line of instruments for systems, call us collect on our Quick Reaction line: (415) 682-6471. Or you may contact your Scientific Devices office or S-D Concord Instruments Division, 10 Systron Drive, Concord, CA 94518. Europe: Systron-Donner GmbH, Munich, W. Germany; Systron-Donner Ltd., Leamington Spa, U.K.; Systron-Donner S.A., Paris (Le Port Marly) France. Australia: Systron-Donner Pty. Ltd., Melbourne.

SYSTRON  DONNER

GEORGIA. THE LOW-RISK STATE FOR ELECTRONICS.



Selecting a new plant site can be a highly speculative venture. Particularly in an unsure economy.

In Georgia, we're organized to lower your risks. Working with all other state-wide developers, we'll thoroughly review your company's individual needs. And conduct research based on those needs.

If worldwide shipping is crucial to your business, we'll include information on our international air terminal. And on our deep water

ports, which are efficiently operated by Georgia Ports Authority.

We'll give you an honest analysis of all pertinent information. Then, using computers, we'll match available plant sites and buildings with your requirements.

You'll have all the facts. Up front. So that when you make your decision, there'll be little room for doubt. Want to know more about our confidential site selection program? Mail in the coupon today.

Georgia Department of Community Development
Industry & Trade Division, Dept. EL-51
Box 38097
Atlanta, Georgia 30334

DIVISION OF
it
INDUSTRY AND TRADE

Name _____
Title _____
Company _____
Street _____
City _____ State _____ Zip _____

GEORGIA.
WE MEAN BUSINESS.

JAPAN ELECTRONICS SHOW '74



September 18-24 1974 Tokyo

THIS ONE IS JUST TOO BIG TO MISS!

The '74 Japan Electronics Show will be held at the Harumi International Fairgrounds in Tokyo from September 18 to 24. More than 320,000 square feet of exhibit space will be given over to displays of industrial and consumer products, electronic components and related electronic equipment. Over 400 lead-

ing Japanese and foreign manufacturers will be represented. Thousands of buyers and engineers from over 60 countries will be in attendance. If you want to understand the Asian electronics market you've simply got to be at the '74 JES. See you at the show.

For details of the '74 JES (13th), please write to

JAPAN ELECTRONICS SHOW ASSOCIATION

(Show management for the Electronic Industries Association of Japan) 2-2, Marunouchi 3-chome, Chiyoda-ku, Tokyo, Japan

GOOD-FEELING LOW-NOISE PUSH-SWITCHES

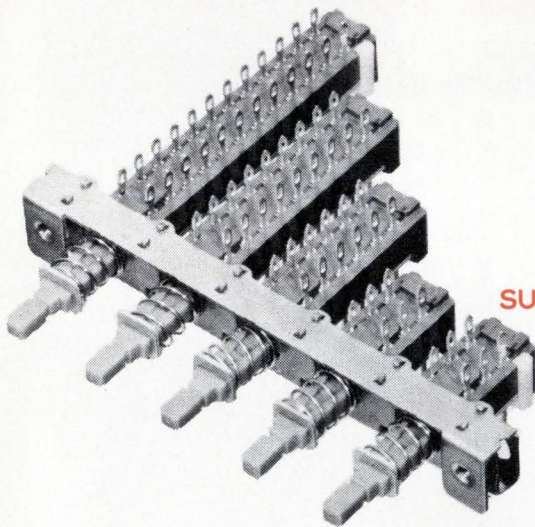

SUD-SERIES

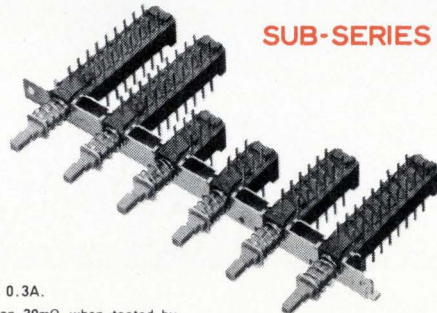

SUB-SERIES

Dimensions

	SUDtype	SUBtype
A	59.45	57.00
B	47.55	45.10
C	35.76	33.20
D	23.75	21.30
E	15.25	12.80
F	17.55	20.00
G	4.00	3.00
H	9.05	11.50
I	11.40	10.00
J	3.60	5.00
K	19.80	19.60
L	10.00	7.55
M	10.00	9.00
N	5.20	5.00
O	6.40	5.00

Rating 45VDC, 0.3A.
 Contact Resistance Less than 30mΩ when tested by volt-ammeter method at 5VDC, 1A.
 Insulation Resistance Greater than 100MΩ when measured by 500VDC insulation resistance meter.
 Dielectric Strength 500V AC (50-60Hz) for one minute.
 Inter-Terminal Capacitance Terminal to terminal less than 2pF.
 Terminal to ground less than 3pF, measured at 1kHz

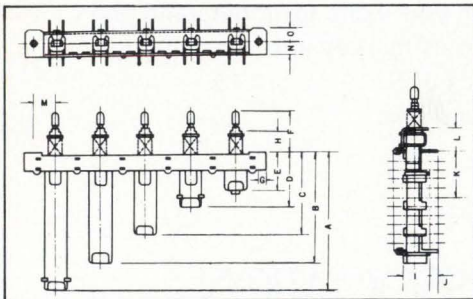

ALPS PUSH SWITCHES

ALPS ELECTRIC CO., LTD.

HEAD OFFICE: 247, YUKAWA-CHO, OHTA-KU, TOKYO, JAPAN.
 YUKAWA FACTORY: 12F, SHIWA-CHO, KOBURU-KU, YOKOHAMA, JAPAN.
 OSAKA BRANCH: 212, CHOMEI-AWAZANAKAHO, NISHI-KU, OSAKA, JAPAN.
 NEW YORK OFFICE: ONE WHITEHALL ST. NEW YORK, N. Y., 10004, U. S. A.

CONTROL—precise SIZE—fits SUPPLY—fast PRICE—fine

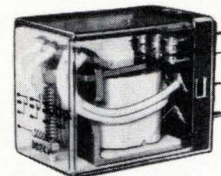

Miniature Relay Type MPM-100

- Available for various voltages AC & DC.
- Both 4PDT and DPDT contact switching requiring minimum driving power is available.
- Highly economical.
- Incorporates anti insulation fatigue device which prevents short-circuits.
- Uses UL-approved resin bobbin.

Digital Line Printer LP-108

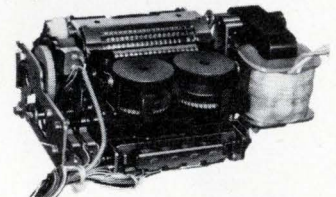

- Compact size with simplified mechanism.
- Up to 18 columns.
- 13 characters per column.
- High reliability.
- Red/black printing.
- Print rate of 2.5 to 3.0 lines/sec.
- Low cost

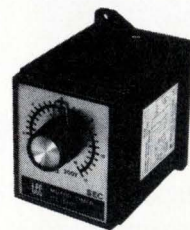

Miniature Motor Timer Type UT-500

- Smart surface design. Plug-in type terminal.
- Economical due to simplified pointerless mechanism.
- Available in a variety of types ranging from 10 seconds to 24 hours, surface-mounted or flush-mounted.

Whichever way you take the measure of TEC control instruments you're getting top value. They work longer; give you more reliable performance for your money.



TOKYO ELECTRIC CO., LTD.

14-10, 1-chome, Uchi-Kanda, Chiyoda-ku, Tokyo, Japan



Investigate New Sources of Quality Products at . . .

JAPAN ELECTRONICS SHOW '74

Tokyo
Sept.
18-24

NOBLE

CONTROLS FOR AUDIO DEVICES

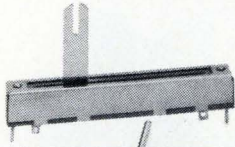

SLIDE VARIABLE RESISTOR
Stroke sizes available are 25, 30, 45 and 60mm, each available in the gang type. Various shapes of lever are prepared.

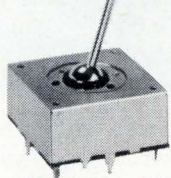

BALANCE VOLUME
This is a volume which is able to one-touch control four sound sources. The maximum manipulation angle of the lever is 60°. Each of the built-in volumes can be manipulated freely over the full stroke. Measuring 60x60mm in outside diameter and 50mm in depth.

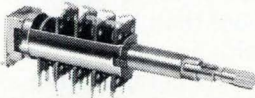

V16L5TGR
This series is a multiple section variable resistor provided with a variety of functions on a single axis specially designed for use in audio equipment for cars. Various switching functions can be integrated such as: vol., tone, bal., prog., eject., and power switch on the control shaft side and band switch, reverse switch and circuit switch on the tuning shaft side.

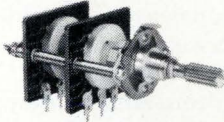

AP351
AP351 is the high-grade step-type variable resistor that has been newly designed to meet the growing requirements for higher performance and better feeling of the audio industries.

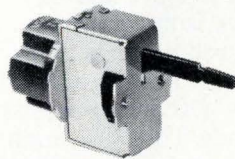

SY02
A new lever-type power switch developed by combining the pull-push switch with satisfactory results as the power switch for color TV, and the lever system with excellent switching feeling. (Utility model pending)

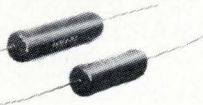

METAL OXIDE FILM RESISTOR
These have been designed for use in TVs, radios, instruments, computers, and other electronic equipment. These resistors have excellent moisture resistance and superior overload capacity to give satisfactory performance characteristics.

MAIN PRODUCTS

Variable Resistor, Electronic Switch, Capacitor Fixed Resistor, Power Resistor, etc.



ALL ROUND ELECTRONIC COMPONENTS MANUFACTURER
TEIKOKU TSUSHIN KOGYO CO., LTD.

335 Kariyado, Nakahara-ku, Kawasaki, Kanagawa, Japan
Tel: (044) 422-3171 Cable: TEITSU-KAWASAKI Telex: 3842-155

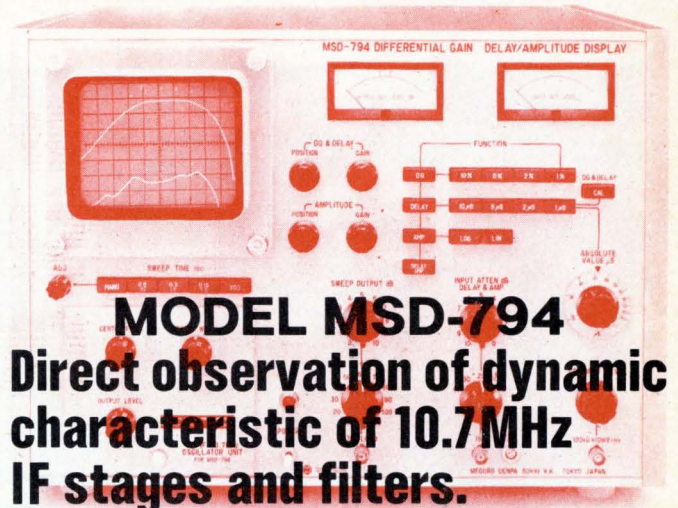

MODEL MSD-794

Direct observation of dynamic characteristic of 10.7MHz IF stages and filters.

Differential Gain, Delay/Amplitude Display

- Distortion characteristic of FM detectors can be directly observed.
- Since delay and amplitude can be simultaneously observed, circuits can be adjusted while observing the relative characteristic.
- Rough value of absolute delay can be read from a dial.
- CRT graticule (%/10mm, μ s/10mm) can be freely calibrated for easy reading of differential gain and delay time.
- Manual recording at X-Y recorder. Automatic recording at 50 times the sweep time.
- Active probe is available (Option) to view IF inter-stage characteristic.



MEGURO DENPA SOKKI K.K.

No.5, 1, 2-chome, Chuo-cho, Meguro-ku, Tokyo, Japan TEL: 715-1211
Cables: MEGURODENPA TOKYO TELEX-02468206 MEGURO J
Circle 57 on reader service card

Cost Cutter



New Electronics Buyers' Guide . . . Easy-to-use, single volume source for:

- Data on over 4,000 products
- Over 6,000 company listings and phone numbers
- **EBG EXCLUSIVE:** quick access to over 800 catalogs through a Direct Inquiry Service.

The international world of electronics at your fingertips. Find suppliers . . . fast . . . accurately . . . and locally! For your copy send \$15.00 (USA and Canada only; elsewhere send \$25.00) to address shown below.

Electronics Buyers' Guide

A McGraw-Hill Publication
1221 Ave. of the Americas, New York, N.Y. 10020



Investigate New Sources of Quality Products at . . .

JAPAN ELECTRONICS SHOW '74

Tokyo
Sept.
18-24

Primo

—Leader in the Microphone Field—



Uni-directional
Dynamic Microphone

UD-959

The UD-959 cardioid dynamic microphone has been designed to provide bright, crisp clear sound in a rugged, attractive satin chrome metal housing. The newly designed dynamic cardioid element offers great presence in vocal use where its multistage ball type wind screen eliminates breath blast and wind noises. Professional 3 pin type audio connector provides maximum utility and reliable operation. The UD-959 is an attractive, rugged professional microphone which will give outstanding performance for many years.



UD-876M

The UD-876M microphone is a uni-directional cardioid dynamic microphone intended for the most demanding needs of professional musicians. The dynamic cartridge used in this microphone has been designed with the needs of the performer on stage in mind. The wind screen provides exceptional rejection of both breath blast and wind sound.

• For catalog, write to:

PRIMO MICROPHONE, INC.

SUITE 2207, 111 EAST WACKER DRIVE, CHICAGO, ILLINOIS 60601, U.S.A. TEL: (312) 565-0220, 0221
TELEX: 25 4225 PRIMO MUS CGO

PRIMO COMPANY LIMITED

6-25-1, MURE, MITAKA-SHI, TOKYO, JAPAN
TEL: 0422-43-3121-9
TELEX: 2822 326 PRIMO J

Circle 58 on reader service card

Different hopes for different folks.

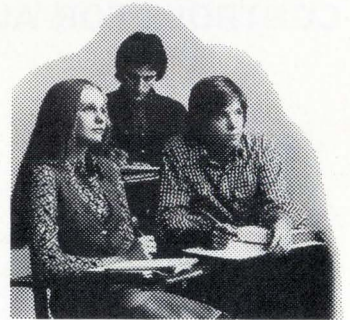

People want different things from a college education.

But they all agree on one thing. It takes more than brains to get a diploma.

Why not make the burden a little easier? Start buying U.S. Savings Bonds now.

Bonds are a dependable way to build a college fund for your children. And an easy way to start saving them is by joining the Payroll Savings Plan.

Start a college fund now with U.S. Savings Bonds. They just might let your kids spend more time studying and less time working to stay in school—whatever they hope to be.



Take stock in America.

Buy U. S. Savings Bonds

Now E Bonds pay 5½% interest when held to maturity of 5 years, 10 months (4% the first year). Bonds are replaced if lost, stolen, or destroyed. When needed they can be cashed at your bank. Interest is not subject to state or local income taxes, and federal tax may be deferred until redemption.

The U. S. Government does not pay for this advertisement. It is presented as a public service in cooperation with The Department of the Treasury and The Advertising Council.

Electronics/August 8, 1974

1/4W
RESISTOR

FIXED COMPOSITION
FIXED CARBON FILM
SEMI-FIXED (1/8W)

TAIYO DENKI CO., LTD.
225-3, 7-cho, Nakamachi, Ohtori, Sakai City, Japan 593 Phone: 0722 (62) 8281

58 Circle 173 on reader service card

NEW! **18-Pin Printed Circuit Connector AK-M18**

...Over 10 million units in use!

AK-M18 for color television, computer peripherals, and related equipment and terminal medical instruments. Low-low cost; 40¢ each.

*Main Products:

- High-fidelity, low frequency circuit connectors.
- High-fidelity printed circuit connectors.
- High frequency coaxial cable connectors.
- Plugs and jacks for telecommunication equipment.

(P.A.T. pending)

AK-M18

—Manufacturers of a wide variety of CONNECTORS—
HONDA TSUSHIN KOGYO CO., LTD.
18-12 Megurohoncho, 6-chome Meguro-ku, Tokyo, Japan
Tel: 03-714-1151
Telegrams & Cables: Hondaconnector Tokyo
Telex No.: 2466785 HTKCON J

Circle 174 on reader service card

Everything you need in ferrites

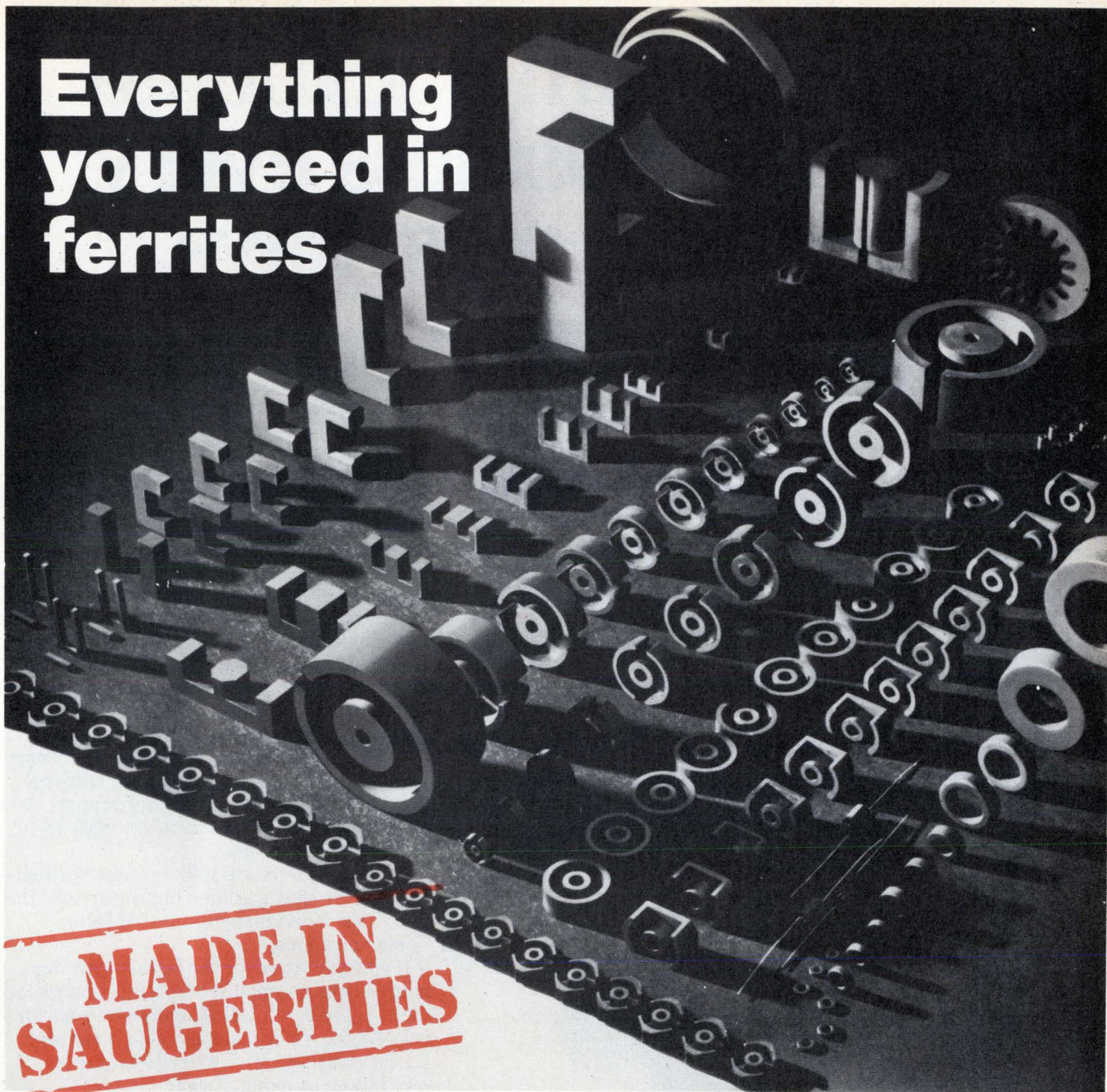

Broad Product Line: Ferroxcube offers a complete array of sizes and shapes of ferrite cores. They're made in Saugerties, N.Y. and stocked throughout the U.S.A. Toroids for pulse transformers, pot cores or square cores for precision filters, transformer cores in all sizes and shapes— E, U, I, specials and read-only memory cores—you can trust Ferroxcube to provide the optimum core for your inductors.

Unsurpassed Materials Technology: Ferroxcube, the acknowledged U.S. leader in ferrite technology, offers a wide range of standard materials for your cores. Chances are that one of them has exactly the *right combination of characteristics* for your application. And, you can depend on Ferroxcube to deliver the same uniform,

product characteristics year after year for consistent, optimum circuit performance in your designs.

24-hour Availability: Standard components are available for 24-hour delivery from any of seven warehouses conveniently located in Boston, New York, Saugerties, Philadelphia, Chicago, Santa Clara and San Diego.

If you're up on the advantages of ferrites, discover the added values of dealing with Ferroxcube. Ask for the new 1973 catalog. If you're new to ferrites and the design possibilities they open up, talk to one of our applications engineers. Call 914•246-2811, TWX 510-247-5410 or write Ferroxcube, Saugerties, N.Y. 12477.

Ferroxcube linear ferrites—made in Saugerties, N.Y. and stocked in seven U.S. locations.



FERROXCUBE CORPORATION, SAUGERTIES, N.Y. 12477 • 914•246-2811
A NORTH AMERICAN PHILIPS COMPANY

Distributed through North American Philips Electronic Components Corporation with warehouses in Boston, 617 • 899-7100, New York, 516•538-2300; Saugerties, 914•246-5861; Philadelphia, 215•836-1616, Chicago, 312•593-8220; San Diego, 714 • 453-5440

16404

Data Communications— the new business every business must have.

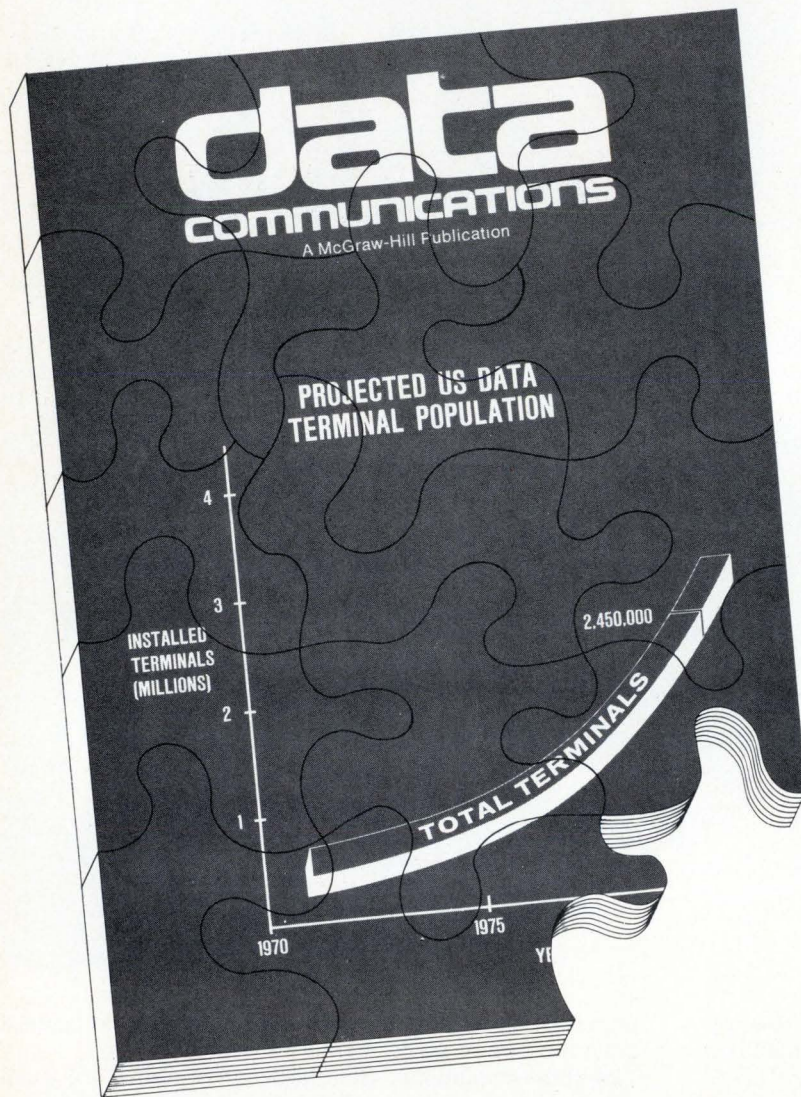

We're
putting it
all together
for you.



Data communications is indeed a puzzle to most of the people working in the market. In fact, many don't realize that they have data communications needs or what their needs are.

The people responsible for planning a data communications system for their company must decide alternative systems approaches, carriers, hardware, and vendors—all in the context of economics, government regulation, and future technology development.

Putting together all the pieces of this puzzle—that's what the new McGraw-Hill magazine, **Data Communications**, is all about. **Data Communications** will be published bi-monthly.

Our editorial is 100% data communications and we know our approach is correct because we have tested it with two pilot issues, a year apart.

Our audience is 100% data communications because to qualify, they must have responsibility to buy, specify, recommend or approve the purchase or lease of products associated with data communications.

Our subscribers are 100% request verified—not only are they qualified but each one of the 25,000 has individually requested **Data Communications**.

If you want to cover the fastest-growing market in our economy, take a full-year's schedule of full pages in **Data Communications** for only \$7,800, which includes color, bleed and special positions. We'll even do your color separations at minimal cost.

For complete advertising information, contact your nearest McGraw-Hill office.

data **McGraw-Hill**
COMMUNICATIONS
A McGraw-Hill Publication
the magazine and the market.

IS ONE BRAND OF FUSE
AND FUSEHOLDER AS
GOOD AS ANOTHER?

DON'T BET ON IT.

BET ON BUSS®

There are some good reasons for being brand-conscious. Here are three of them:

1. **ACCEPTANCE** — Without question, BUSS® is the best known and most widely accepted name in fuses and fuseholders of all types. There's no need for introductions or explanations. When it's BUSS, no questions are asked.
2. **QUALITY** — You can take BUSS quality for granted, because BUSS doesn't. Not only are BUSS fuses manufactured to exacting quality control standards, but **every one** is electronically tested.
3. **SPECIALIZATION** — All BUSS resources are focused solely on manufacturing quality fuses and fuse mounting hardware. Such a concentration of undivided attention automatically results in a superior product.

So be brand-conscious —

YOU'LL ALWAYS BE AHEAD WITH BUSS.

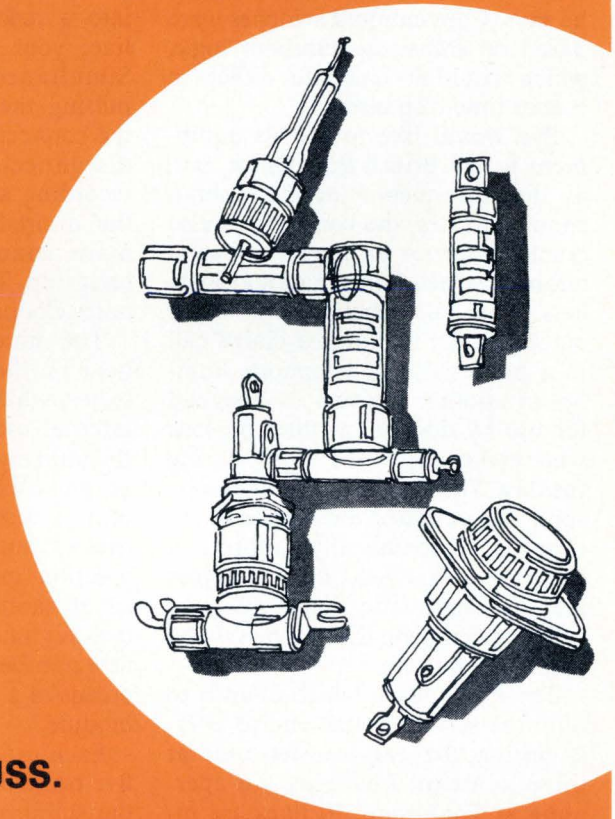

BUSSMANN MANUFACTURING
a McGraw-Edison Company Division
St. Louis, Missouri 63107



Pye's MOS LSI gamble pays off in three new telephone systems

Six years ago, Pye TMC Ltd., seeking to enlarge its share of the telephone-equipment market, gambled on the then uncertain large-scale integration of metal-oxide semiconductors. Next month, Pye will show three new products based on MOS LSI at the Tehran International Trade Fair. They are a call-transfer unit, a changed-number intercept device, and a 32-address automatic dialer.

The company, which designs its own circuits, chose MOS at the time because it promised economy with low power, says M.D. Cooper, manager for special products. MOS could be used for relays at similar or lower costs in similar and smaller space, he says. Conventional switches were based on transistor-transistor logic, which couldn't compete either in cost or time response.

Pye would like to sell its equipment to the British Post Office, but, as the introduction at the Tehran show indicates, the company is also cranking up for an aggressive sales effort in selected international markets. The call-transfer unit, which automatically forwards a dialed call to a predesignated telephone number at another location, is designed for use by doctors or other persons who make scheduled stops during the day. The changed-number intercept, also designed for telephone exchanges, automatically informs a caller of a changed phone number, and the automatic dialer allows a caller to complete the call merely by pressing a button.

The Post Office, which intends to offer the service by the end of 1975, is testing the call-transfer unit at three locations. Five lines are operating at Tonbridge, 10 lines are installed at Warrington, and five are to be installed at Cambridge.

Operation. Each call-transfer unit, which handles two lines, sells for about \$900. The Post Office plans to charge the user for rental, installation, and usage.

Unlike call diverters used in the United States, which need a separate line back to the exchange, the call-transfer unit requires no additional line because it is located at the exchange. To operate it, a subscriber uses a key on his telephone. With handset at rest, he dials a single digit from one of nine possible transfer numbers. The unit returns a 2-second burst of ringing to inform the subscriber that his transfer has been made.

The call-transfer unit, connected between the subscriber's final-selector output and his line circuit, will intercept the ringing at a subscriber's number and plug the caller into a recording, "Please hold the line; your call is being diverted." Simultaneously, the unit begins pulsing the second number. When the connection is complete, the unit disconnects the caller from the recording and puts him through to the desired phone, which will remain connected until the caller hangs up. There is only a 1-dB loss, notes Cooper.

The nine transfer numbers are held in the MOS LSI shift register stores, which are maintained by an internal nickel-cadmium battery in the unlikely event of a power failure at the exchange. To program the unit, a technician at the exchange uses a number-allocation and inspection module. By plugging the small hand-held unit into the call-transfer unit, he can punch in the new numbers and check his entry by means of a numerical display of the module.

Each call-transfer unit consists of five-printed circuit boards—one for the stabilized power-supply circuits and the master oscillator, and four containing the four MOS circuits and their interface components. Two MOS circuits are for address-select and control, and two are for address-store and send circuits, and all meet Post Office specifications.

Pye says that the units can be electrically modified to meet most needs, but, for the moment, their use is restricted to local exchange areas because of network-transmission restrictions. The devices could be used internationally if the telephone networks could handle them, Pye says. That way, a subscriber would be able to leave as his next number a number in another country.

Changed-number intercept. Development of the changed-number intercept unit is almost completed, and Pye expects to go into production next year. A prototype was shown at the October 1973 meeting of the U.S. Independent Telephone Association in Miami, Fla., and at a private Pye exhibition. The unit, designed for urban exchanges of 2,000 to 10,000 lines, will cost from about \$3,750 for a four-line unit to \$12,500 for one capable of handling 200 lines.

Cooper explains that, instead of separate announcing devices, the company designed a common announcing unit containing exchange names, decimal numbers, and a standard message.

Each name, number, and message is continuously played on its own dedicated audio channel. Each is stored in delta-modulated digital form on MOS LSI shift registers. An MOS-LSI audio switch taps the appropriate channels to create the right message so that a caller will hear the old standby, "The number you have called has been changed to [the new number]."

Each old number is linked to the system through a line-terminating unit, containing the audio switch. An MOS LSI word-pattern store, programmed with the new number, controls the audio switch so that the correct number is extracted from the contents of the audio channels, the company says. The line-terminating units operate independently of each

other, and subscriber calls are not queued. Pye says the unit is economical and easy to maintain, operate, and program.

Pye is mum about the 32-address automatic dialer, except to say that it will be available next year. It is known that a built-in loudspeaker in the dialer allows the caller to monitor the progress of his call without lifting the handset until the other party answers. □

International

CAI glow brightens in Paris, London

In France and England, the proponents of computer-aided instruction figure that the only way to big progress is by starting fairly small. There is plenty of progress at the Universities of London and Paris, where research teams have CAI systems in service and are building up libraries of teaching sequences.

Next month, the University of Paris VII will try out a terminal linked to its "Ordinateur Pour Etudiants" (OPE) outside Academe. Electronics technicians at a Philips Industries plant on the outskirts of Paris will get a 30-hour course in quadripole analysis of circuits. At London's Chelsea College, the CAI people are getting ready to tack their minicomputer-based system onto the university's large Elliott computer, but the Digital Equipment Corp. PDP-11 minicomputer will be kept as a multiplexer.

Although its geographical reach isn't much—20 terminals at Paris VII's skyscraper campus flanking the Halle aux Vins, plus a half-dozen others in the Paris area—OPE nonetheless boasts a high student throughput. "We have run 20,000 students and some 1,500 *lycées* through programs," says Romain Jacoud, who is codirector of the OPE laboratory, along with Yves Le Corre. OPE has in its library more than 120 dialogs (lesson segments). Most are in natural sciences like physics and biology, but there are

Around the World

IC transistors can drive plasma panel

Two new plasma display panels, developed by Nippon Electric Co., need so little voltage for switching that their driver transistors are contained in integrated circuits. Displays requiring driver-output voltage swings of 30 V and 40 V will both be marketed. The panels will be manufactured both in multi-digit seven-segment format for simple calculators and multidigit five-by-seven dot-matrix format for more sophisticated applications requiring alphanumeric readout. The matrix display will have 32 digits. The low drive-voltage requirement is achieved by adding an extra set of control electrodes in the panels. The key is to keep the breakdown voltage of the control cells smaller than that of the display cells.

Monitor filters out power transients

Surges and other transients in power lines can play havoc with computers and other sensitive electronic equipment. The British Admiralty was so concerned about this hazard that it underwrote development of a monitor to detect the disturbances. Now, Data Laboratories Ltd., Mitcham, Surrey, having developed the prototype the Admiralty is now testing at sea, is about to begin marketing a commercial version of the power-line-disturbance monitor. Called the DL019, the device "is basically an attenuator," explains a spokesman. Attached to the power line, "it filters out the basic frequencies of the main and leaves behind all the harmonics, plus any disturbances."

Court in Italy reinstates cable-TV relays

Italians will soon be able once again to watch television broadcasts relayed from France, Switzerland, Yugoslavia, and Austria. The Italian Constitutional Court, in two decisions of potentially great importance, has ruled that the government has no right to ban private relay stations of foreign television programs, that cable television is legal, and that, although the state radio and television monopoly is legal, it should guarantee greater impartiality and greater freedom of information. A national uproar was created last month when private repeater stations, which have sprung up over the years to relay foreign programs, were shut down just before the start of the world soccer championship series in Germany.

also dialogs for English, computer programming, and pedagogy.

The OPE hardware, which was put into operation early in 1968, remains about the same today, except for a fourfold expansion of its original 16-kilobyte core memory. The system is built around an IBM system 360/30 computer. It's paired with four disk units, a punch-reader, a fast printer, and 20 teletypewriter terminals. Each terminal has alongside it a remote-controlled carousel-type slide projector.

In London. Meanwhile, a CAI group at Chelsea College's electronics department in London was pushing on with its electronic-aided instruction (EAI), based on small computers and monochrome television terminals. The EAI research unit believes that only by standardizing the systems around off-the-shelf hardware can the concept be

come economically feasible.

The group is about to upgrade its basic research system for further student-testing. The computer generates only the alphanumeric information while relaying the teaching material from a lesson-sequence store to inexpensive television-receiver/terminals via alphanumeric TV converters.

Development is also starting on the required rapid random-access library, from which a student would call up the desired lesson as well as the necessary audio and video buffer stores to "hold" the images for the TV terminals. The library would be based on the research unit's Animated Audio Strip-Film Presentation. Audio cassettes provide narration and key appropriate slides from a 16-millimeter film strip to a non-electric terminal. A 100-terminal system would cost about \$75,000. □

Good news for MOS-LSI users.

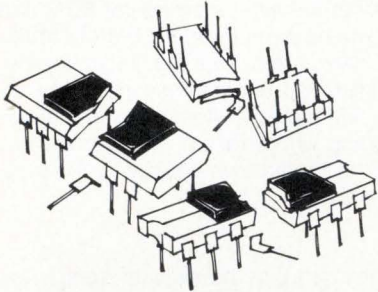

No breaks

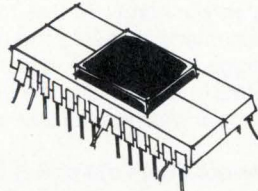

No bends

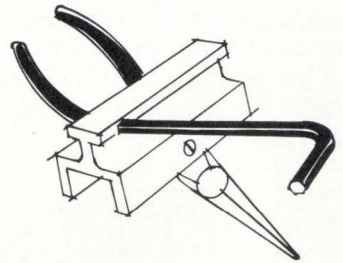

No tooling

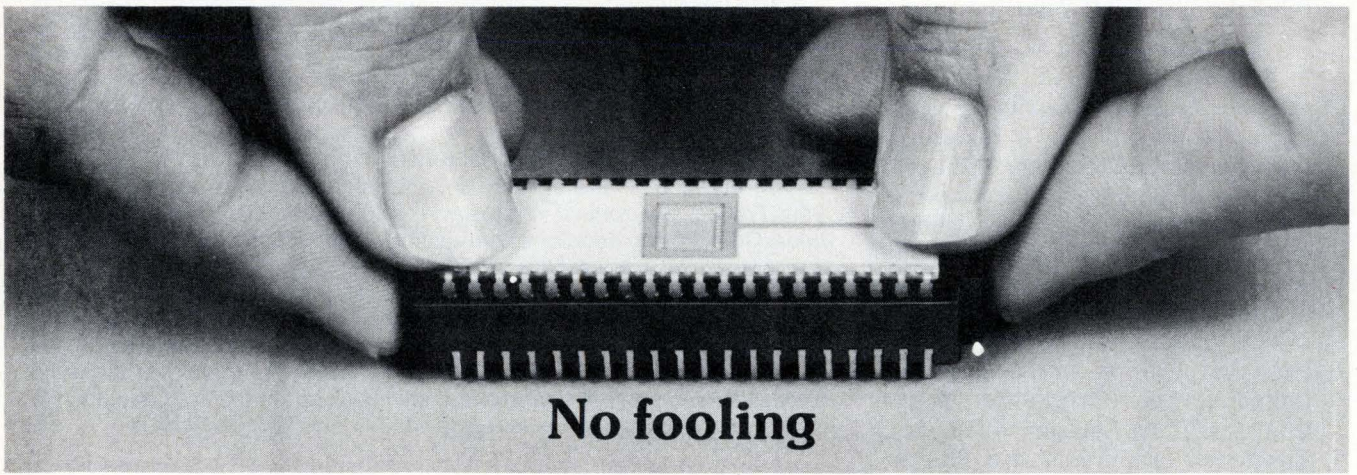

No fooling

Molex new "Zero Force" sockets take you away from all this.

Molex announces a major breakthrough in MOS-LSI socket design that lets you insert and withdraw fragile ceramic or plastic MOS-LSIs with no damage, breakage, or loss of hermeticity.

Our secret is a new patented locking principle that exerts zero force on the LSI leads until the instant the package is locked in position.

Here's how: Just as the MOS-LSI package is pressed into position (and two fingers are the only tools you need), a special contact wedge moves the spring contacts against the leads, creating a wiping action. A soft "click" tells you the package is securely seated.

Result: A securely locked, gastight connection wiped clean of resistant film. To remove the MOS-LSI, you release the locking tabs on the contact wedge and lift the package out.

The Molex Zero Force Socket has a low profile (.4 with LSI seated) and we offer it in 24, 26, 28, 36, and 40-position models.

Our price is another breakthrough. If you're paying more than 1¢ per line in OEM quantities, let Molex take you away from all that, too.

Get more facts! Read all about the Zero Force Socket in our new Idea File. For your copy, write to the address below.

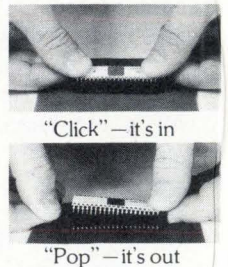

molex ... Affordable Technology

Molex Incorporated, Dept. E874, 2222 Wellington Court, Lisle, Illinois 60532

Election worries telecommunications suppliers in Britain

The almost certain general election this fall is causing jitters among the major British telecommunications suppliers, who **fear that a solid Labour Party majority would increase prospects of nationalization.** Those worries have been heightened by the sympathetic reception by the minister for industry to recent suggestions that parts of Plessey's Telecommunications division be nationalized. Thus, Plessey, the largest supplier in the UK—with an annual turnover of about \$355 million—joins GEC and ITT's Standard Telephone and Cables as possible candidates for nationalization expected to be announced shortly in a paper by the takeover-minded minister.

The suggestion was brought by a delegation from the Association of Scientific, Technical and Managerial Staffs, which singled out Plessey but generally is **concerned about the long-term harm that recent cut-backs in the British Post Office budget might have on suppliers production, sales and employment.** Another union complaint—and one receiving some industry support—is how the post office can contemplate ordering \$25 million worth of new telephone exchange equipment, which would be built in Sweden, from Thorn-Ericsson, even though British Thorn owns 51% of the combine. Moreover, Sweden prohibits sales by UK suppliers.

Siemens buys up Telefunken Computer and its big TR 440

West Germany's Siemens AG and its Unidata partners, Philips of the Netherlands and Compagnie Internationale pour l'Informatique of France, are in position to round out the upper end of their computer line. Putting an end to speculation [*Electronics*, May 30, p. 55], Siemens has taken over Telefunken Computer GmbH, developer and manufacturer of the TR440, which is larger than any models in the Unidata assortment. **Though now a strictly Siemens property, the new acquisition will likely be integrated into Unidata later.**

Siemens has redubbed the company Computergesellschaft Konstanz mbH. Former owners AEG-Telefunken and Nixdorf Computer AG threw in the towel for an undisclosed sum. They had teamed up two and a half years ago hoping to mount a breakthrough for the big computer with Nixdorf marketing skill. **But success proved elusive. The company chalked up losses of \$36 million in its first two years,** and installed and ordered computers were pegged at only \$170 million when Siemens moved in.

Siemens made the move after getting the go-ahead from its Unidata partners. It says it will drop the older TR4 from the product line-up, but will have to deal with the 35 already installed in West Germany. This leaves the TR440 and its now-in-development successor, the TR550, which Siemens says it will continue pushing.

New coastal limits may spur radar markets

The growing number of nations claiming 200-mile "economic" coastal boundaries is seen as spurring a lucrative market in sea surveillance radars to watch for smugglers, fishing boats, and other intruders. The market is part of "an enormous demand for a poor man's Nimrod," cheaper editions of coastal patrol aircraft, say officials of Ferranti Ltd. **They say they already have identified a market for 100 units among Brazil, Canada, and India, and indicate pursuit of several hot prospects.** Competing against such U.S. companies as AIL, Bendix and Texas In-

struments, Ferranti will offer its new Stalker system, a less-sophisticated version of the Seaspray units designed for the Westland Lynx helicopters. Prices vary, though, from about \$10,000 for simple radars to about \$100,000 for the Ferranti unit.

Sharp plans to market a 1-hour VTR

Sharp Corp. intends to burst into the video tape-recorder business next year by producing cartridge-type recorders that can record and play back either 30-minute or 1-hour programs in half-hour-size cartridges. Laboratory development of the new recorder is now nearing completion and the company expects to have the product on the market in the second half of next year. Sharp men say that because it is entering the field late, it must offer new and different features.

Sharp uses cartridges of the type developed by Matsushita and recommended by EIA-J. But by using high-energy chrome dioxide or cobalt-doped tape and halving both tape speed and rotating head speed, tape consumption is cut in half for a playing time of 1 hour. **In this mode of operation, both fields of one frame are recorded on the same track.** The Sharp recorder also has a switch that allows it to play back or record on standard tape with the standard 30-minute playing time. At least one competitor, which does not want to be identified at the moment, says that it has **an even better trick up its sleeve that it plans to reveal in the near future.**

West Germany pumps more money into computer R&D

The West German parliament's \$1.4 billion 1974 budget for the research and technology ministry contains a sharp increase for computer projects. Funding for EDP and documentation development work jumped from \$148.9 million last year to \$180 million. The biggest chunk of this—\$133 million—is ticketed for basic R&D. Smaller amounts are planned for specific projects, such as new industrial applications.

In other areas, the ministry's nearly stable aerospace budget of \$228.5 million **reflects the continuing trend in West Germany to stress joint European projects.** Some \$75 million is planned for such cooperative projects, compared to \$49.2 million for German-only aerospace research and testing. Another \$38.3 million is slated for cooperative ventures with NASA, including the Helios research satellite. For basic R&D to improve electronic components, optics, and measuring and analysis technology, the government has earmarked \$47.5 million.

AEI and Cameca pool scientific instrument R&D

A cross-Channel pact to pool research and development activities while retaining corporate independence has been agreed to by Britain's AEI Scientific Apparatus, a GEC-Marconi Electronics company, and France's Cameca, a Thomson-CSF subsidiary. The joint move was made to save on development, production, and marketing of scientific instruments. The companies seek to avoid duplicating research, to jointly investigate new developments, and to streamline their respective production facilities. They also carve up international marketing territories between them and will sell each other's products. **The pact is seen as a more viable way to achieve cooperation across frontiers than going the merger route, which often fails.**

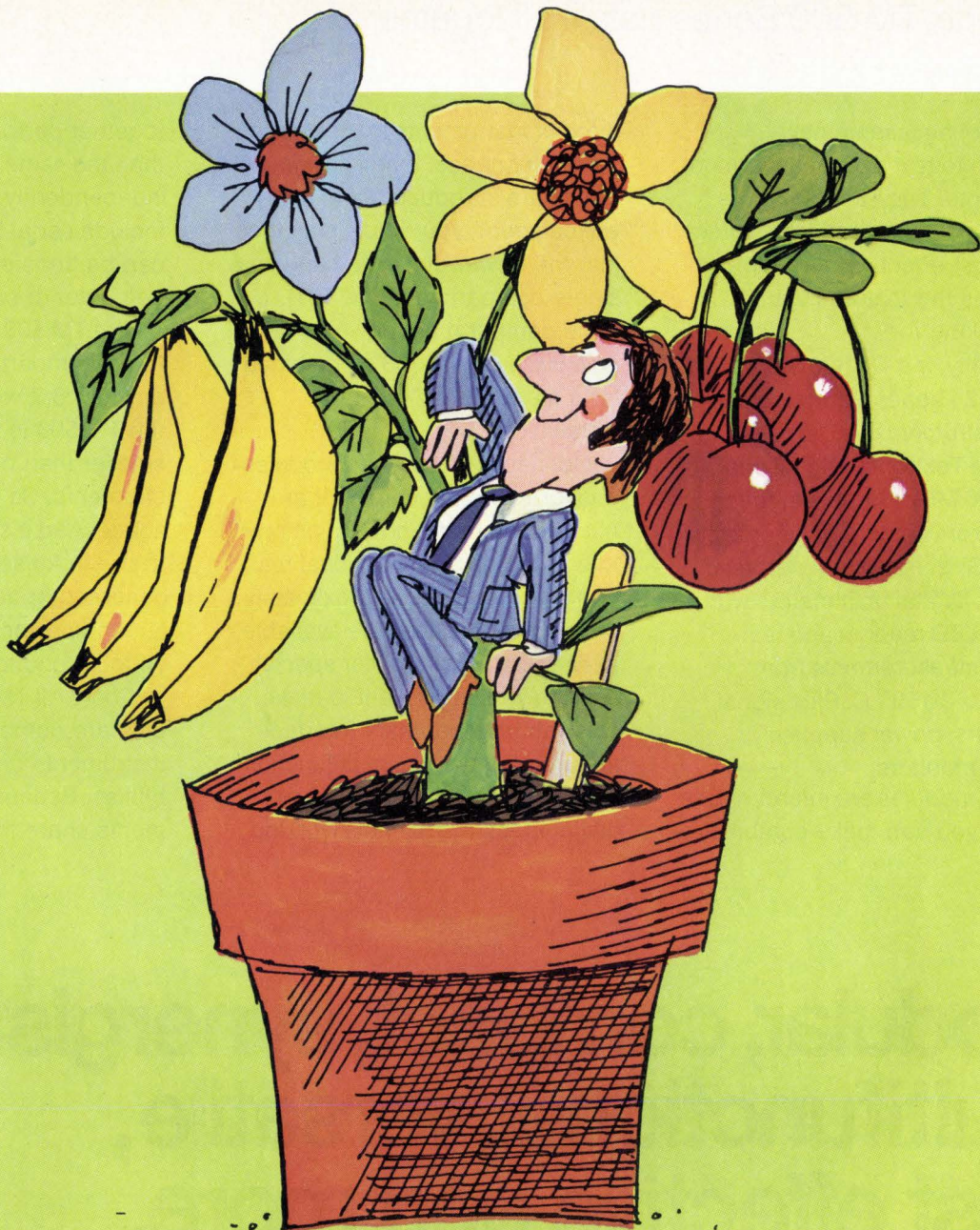

Unusual hybrids don't stump us at all.

One of our strong suits is solving tough performance/packaging problems by creating great hybrid microcircuits. We've been doing it for years.

Remember that. Because chances are you'll bump into occasional design problems standard products just can't handle.

Then talk to us. Because we're really into hybrid technology. Not only with applications and design assistance, but also with one of the finest manufacturing facilities in the nation. Which lets us turn out highest-quality volume production, to time schedules few others can meet. And all at competitive prices.

Remember, too, hybrids don't have to be

super-exotic circuits. Typical custom units we make are modem and tone frequency filters. Entertainment system DACs and equalization filters. Custom display substrates. MIL-performance log amps, regulators, DACs, ADCs, and many others.

So next time you're stumped by a sticky problem, think "custom hybrid." And think "Beckman" for quick response, high quality, and fast delivery.

If you need immediate technical literature or the phone number of your local Beckman/Helipot representative, call toll-free (800) 437-4677.

Beckman[®]
HELIPOT DIVISION

Tektronix TM 500 Series puts it all together

Tektronix has taken a new approach to test and measurement instruments. The TM 500 Series is modular, multifunctional, synergistic, cost effective, and more. It includes the features you've been looking for.

Presently, the TM 500 Series includes 24 general purpose plug-in test instruments. All new ways to think of Tektronix. Digital counters to 550 MHz. Signal sources ranging from below 1 millihertz to above 1 GHz. Pulse generators to 250 MHz. Digital multimeters with 4½ digit LED readout and temperature measurements from -55° C to +150° C. Plus signal processors, power supplies, and CRT monitors.

All the modules are interchangeable. So you can make combina-

tions of instruments to meet your particular needs. When new instruments are introduced (and many will be soon), you simply plug them into the power unit. You can use a single compartment (TM 501), a triple compartment power unit (TM 503), or two 503's combined for a standard rackmount installation.

Connections between modules and/or external equipment are made through the power unit rear interface board and optional rear panel connectors. Approximately 30 input-output lines are available in each compartment for special set-ups you might want to make. This intracompartiment interface feature also permits multifunction applications resulting in a synergistic effect. Instruments working

together perform more functions than the same instruments working independently. Many modules include serial BCD so information can be transferred directly to a computer or calculator.

The TM 500 is compact too. A three-compartment power unit is only 6"x8.7"x15.3". That means the TM 500 is two to six times smaller than comparable instruments. So you save bench space. And it's light weight, easy to carry. A package including a general purpose counter, multimeter, and power supply weighs 14 to 18 pounds!

Cost? All TM 500 plug-in modules are competitively priced with instruments of comparable capabilities. Because TM 500 instruments share the fixed costs of

Modular, compact, synergistic, multifunctional, versatile, cost effective and more.

Circle 68 on reader service card

For a demonstration circle 69 on reader service card

power supplies, cabinets, etc., they consistently provide the lowest cost per test/measurement function. And, because the instruments are modular, cost of maintenance is lower too.

For complete details, contact your Tektronix Field Engineer. Or write or phone for our new 12 page, full color brochure and 24 data sheets. They show why the TM 500 is the finest test and measurement series available today. Tektronix, Inc. P.O. Box 500, Beaverton, Oregon 97005. In Europe, write Tektronix Ltd., Guernsey, C. I., U.K.

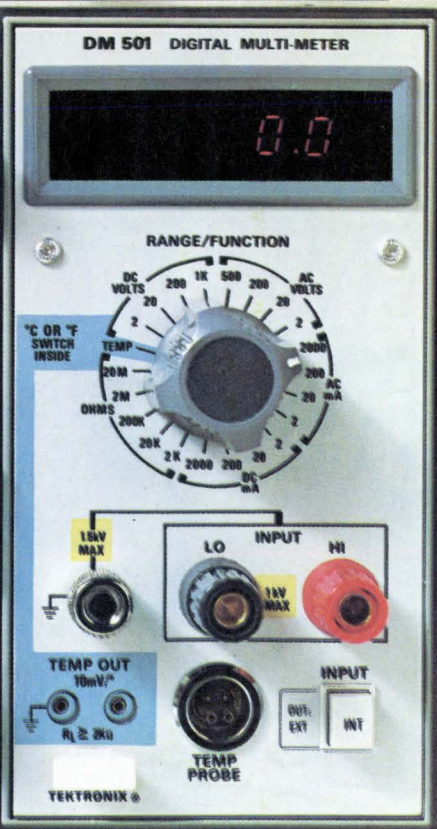
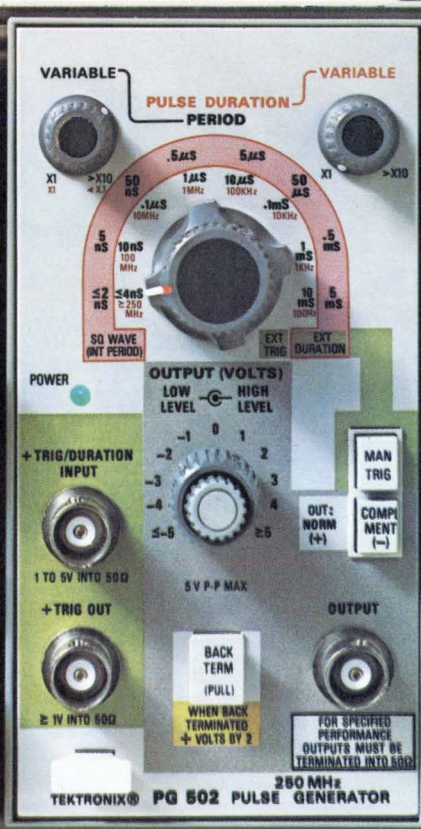
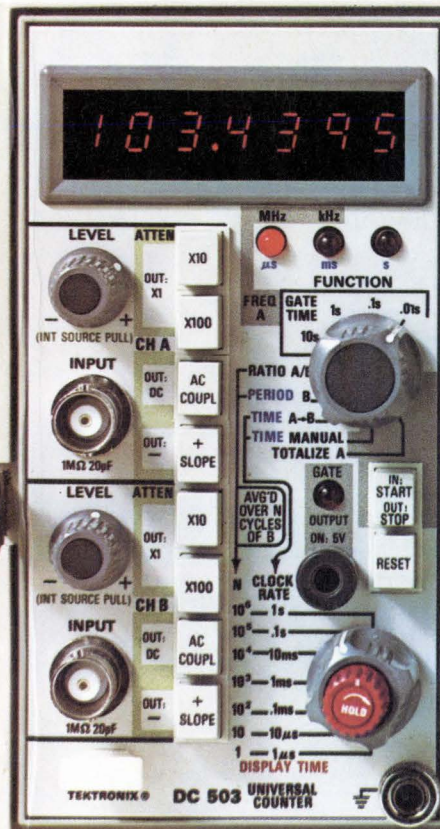
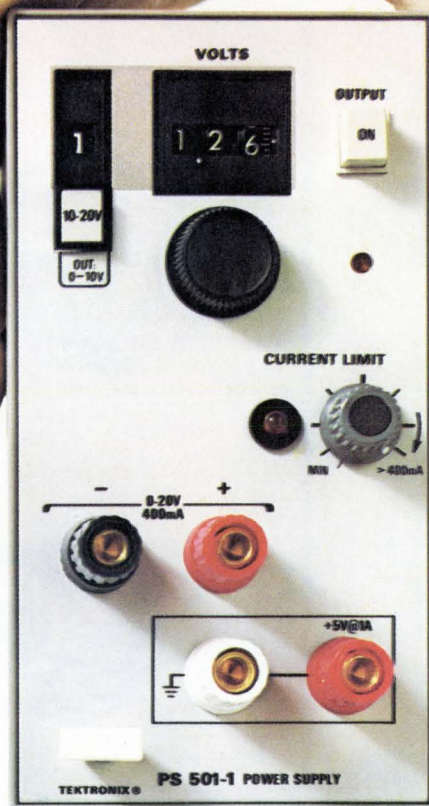



BOURNS[®]
PANEL
POWER

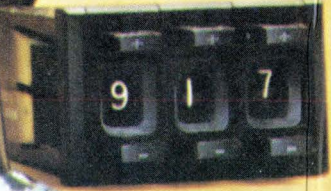

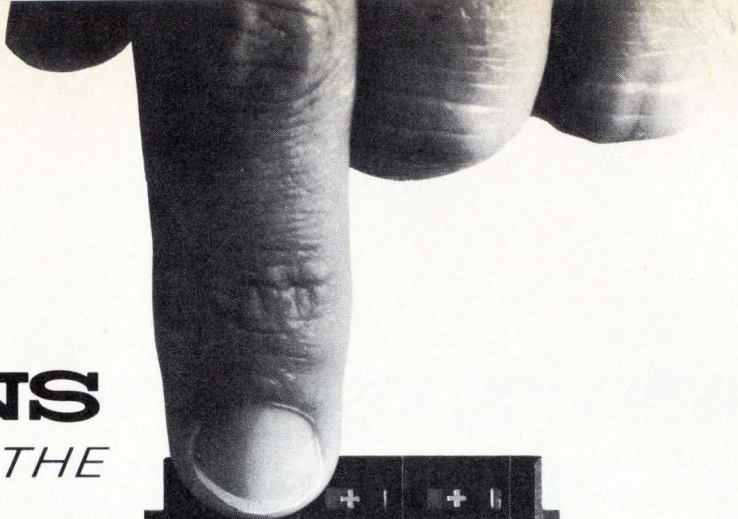

BOURNS
INTRODUCES THE

FIRST INTEGRAL PUSHBUTTON POTENTIOMETER



If you're designing panels with precision data entry or set-point controls, consider the BOURNS Model 3680 KNOBPOT® Digital Potentiometer . . . another innovative idea from Bourns. The 3680 integrates a precision incremental decade potentiometer with an easy-to-read digital display, AND a speedy pushbutton control action. It is handsome, extremely accurate, and a "snap" to install. Everything is INSIDE the Model 3680 . . . no resistors or mini-PC boards are required . . . nothing clutters the back of the unit to steal precious space.

PUSHBUTTON ACTION

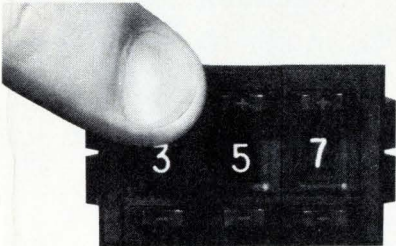

Simple, fast, precise. Push the PLUS button to increase; the MINUS to decrease. Rated life is 100,000 operations per decade.

IN-LINE DIGITAL READOUT

Large, easy-to-read numbers enable fast, "squint-free" data entry and information readout.



ACCURATE

You get what you set with the 3680 . . . every time. The unique Bourns design integrates precision laser-trimmed cermet resistor technology with a positive pushbutton detent action. The result is resolution of output of 1 part in 1000 discrete steps, and dependable repeatability of $\pm 0.1\%$.

COSTS LESS TO INSTALL

Snap-in mounting cuts installation time, eliminates mounting hardware. Integral bezel covers irregular panel cut outs and minor edge blemishes. Terminals match the AMP Series 110 receptacle . . . or can be soldered in the standard fashion.

FEATURES AND SPECIFICATIONS

- stable built-in cermet resistance elements
- 100 PPM/°C tempco • 2 watts power rating
- standard resistance range (3 decade unit) 5K ohms to 1 megohm • $\pm 1.0\%$ resistance tolerance • resolution 0.1%.

COMPACT SIZE

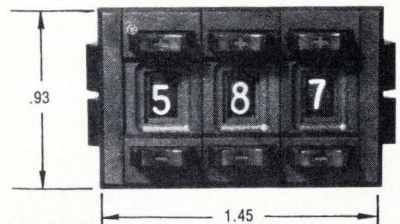
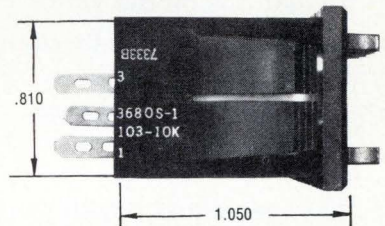

For the name and number of your nearest Bourns representative, dial EEM toll-free 800-645-9200.

when innovation counts, count on...



TRIMPOT PRODUCTS DIVISION • 1200 COLUMBIA AVE., RIVERSIDE, CALIF. 92507

Circle 71 on reader service card

SIEMENS

The unvarying ingredient in every Siemens component: batch-to-batch quality.

Even though Siemens makes 50,000 different shapes and sizes of components, to meet virtually any need *and* the reality of your economics, we're best known for the efforts we devote to quality. Year after year, batch after batch. (We've made 500 million pot cores in the last 5 years alone.)

One of the reasons for our high level of quality and reliability is the two million dollars we invest every working day in research and development. Our R&D program has paid off well—90% of the components we offer today were not available 10 years ago.

R&D has also enabled Siemens to pioneer metallized polyester-film (MYLAR*) capacitors, tuning-diodes, gas-filled SVP's® and cradle relays. And there are more innovations on the way.

If you depend on electronic components, you can depend on Siemens. Batch after batch, the quality never varies.

*DuPont registered trademark.

For details, get in touch with your local Siemens specialist, or fill in the coupon below.

Please indicate your specific area of interest and mail to:

Siemens Corporation, Components Division
186 Wood Avenue South, Iselin, N.J. 08830

- | | | |
|--|---|---|
| <input type="checkbox"/> BWO's | <input type="checkbox"/> LCD's | <input type="checkbox"/> Semiconductors |
| <input type="checkbox"/> Capacitors | <input type="checkbox"/> LED's | <input type="checkbox"/> Opto-Electronics |
| <input type="checkbox"/> Ferrites | <input type="checkbox"/> Planar Triodes | |
| <input type="checkbox"/> Gas-Filled Surge
Voltage Protectors (SVP®) | <input type="checkbox"/> Relays | |

Name _____ Title _____

Company _____ Tel. _____

Address _____

City _____ State _____ Zip _____

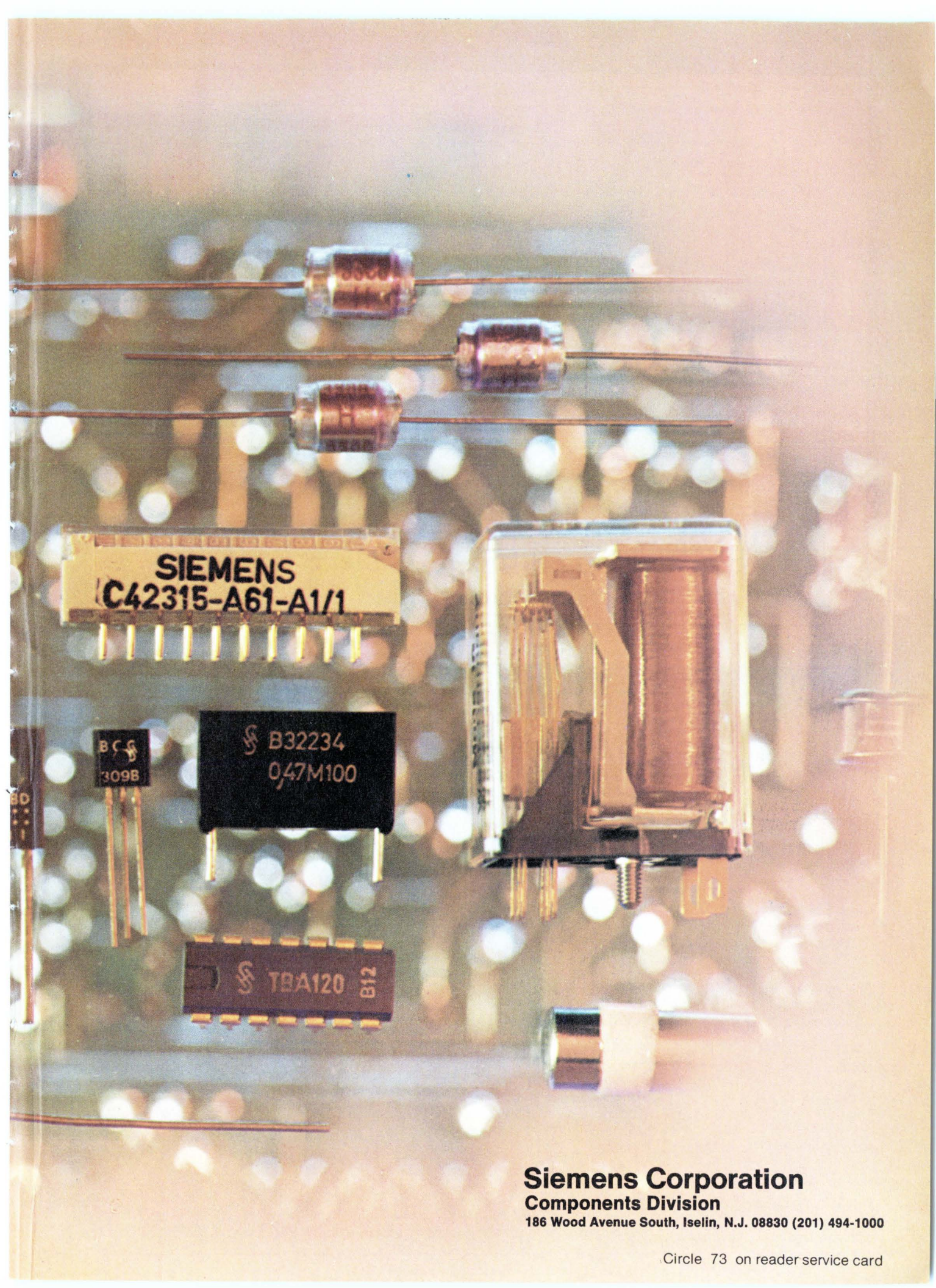

Siemens Corporation
Components Division

186 Wood Avenue South, Iselin, N.J. 08830 (201) 494-1000

Circle 73 on reader service card

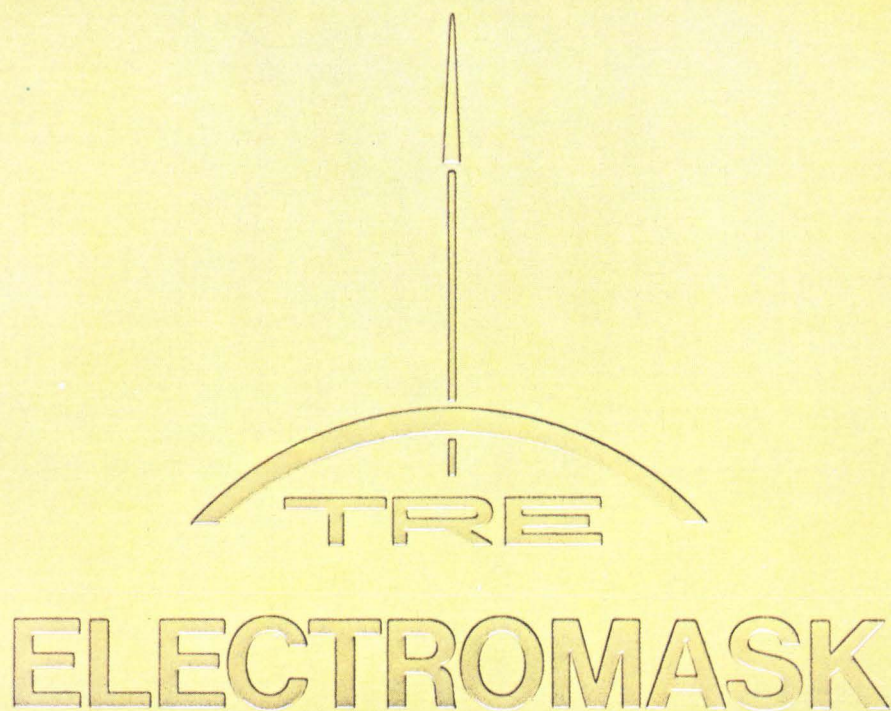

*and its TRE
"Arrow of Excellence!"*

Once Electromask was a little company with big ideas. It's still a company with big ideas, but it's not so little any more. It has now been awarded the TRE "Arrow of Excellence." It belongs to a great and growing family.

To earn its new symbol, Electromask had to epitomize the three things TRE stands for: "technology, research, and excellence." But then, few companies are better qualified.

Electromask has been in the forefront of its technology since it first threw the nuts and bolts away and produced the world's only photomasking equipment utilizing lasers for measurement and air-bearings for frictionless staging. That's why today, many major semiconductor and computer manufacturers will produce their most critical masks only on Electromask equipment.

This equipment is so reliable that the original models

have been running for nine years in our own Photomasking Division with non-degradable accuracy even though tolerances are held to millionths of an inch. And now, in our new 65,000 square-foot facility we are continuing to offer precision photomasking services and to produce this same kind of high-reliability state-of-the-art equipment for the most dynamic segments of the electronics industry.

But then that's what the TRE "Arrow of Excellence" is all about. Today, wherever the Arrow flies, you'll find a dynamic company employing the most advanced technology, based on solid research, and converted into concrete accomplishment through practical engineering. You'll find companies like Electromask.

For more information on Electromask services, pattern generators, or image repeaters, use the reader service card or contact the factory directly.

ELECTROMASK, INC.

A subsidiary of TRE Corporation, 6109 De Soto Ave., Woodland Hills, California 91364, Phone: (213) 884-5050, Telex 67-7143

Circle 74 on reader service card

Probing the news

Analysis of technology and business developments

Consumer calculator shakeout seen

Marginal assemblers expected to fall by the wayside as semiconductor giants marshal forces; mid-year business slump leads to excess inventories

Major forces afoot in the consumer-calculator business are converging to make a shakeout of marginal suppliers imminent. At least two manufacturers, Cal-Tex and Rapid Data have already dropped out. However, there is some argument as to which types of manufacturers will prevail—the vertically integrated semiconductor manufacturers, the companies with the most experience in retail marketing and promotion, or companies that haven't even plunged into the business yet. The heavy vote for survival goes to the vertically integrated calculator manufacturers.

One blow to the market is the aggressive marketing of consumer machines by semiconductor manufacturers who now make all the critical components of the hand-helds: MOS chip, display, and keyboard. Another is the true emergence of small calculators as low-price retail items on which there's not enough profit margin to support multistep distribution.

Combine these with the highly seasonal nature of the business aimed at the Christmas, income-tax, and graduation-time rushes, and the shakeout begins to mature. The first casualties are expected to be assemblers at the mercy of outside suppliers of the three key components, especially the MOS circuit.

Also in trouble, according to some competitors, are calculator makers whose distribution lines are too long—those that don't sell directly to mass retailers in one step. The reason is that prices won't sustain the take of the distributor.

Scenario. These pressures, together with strong evidence of a spring sales and order slowdown



Indicator. Sign in Manhattan store window touting 40% reduction on calculators is a symptom of the excess inventories dealers found as demand has slowed, causing talk of a shakeout among suppliers.

that extended partially into the summer, are inspiring the semiconductor manufacturers who have made it big in consumer calculators to spin the scenario that they will remain as the dominant forces in the hand-held business after the demise

of many of the more than 50 suppliers now competing.

The semiconductor makers who have integrated vertically argue that, to be successful, a company must make all three key parts. Among those that do are Texas Instruments, now considered No. 1 in sales; Rockwell International, thus far a brand labeler; National Semiconductor's Novus division, which touts a \$19.95 six-digit model; Mostek Corp.'s subsidiary, Corvus Corp.; and Bowmar/ALI. Of these, all but Bowmar have established histories as semiconductor makers, and Bowmar is scrambling to get into production with a new MOS facility it acquired near Phoenix.

Significantly, when the semiconductor firms first entered the rough-and-tumble consumer field, many scoffed that they couldn't handle the pricing, distribution, and marketing necessary to make a profit. Now it appears that they have not only learned those disciplines well, but are calling the shots in consumer calculators.

At variance, however, with the view that the big semiconductor houses will also dominate the consumer-calculator business is the Keystone division of Berkey Photos Inc., Paramus, N. J., a consumer-calculator assembler. There, Stuart Better, general manager of consumer electronics, admits to having a "modest" share of the market. He maintains that marketing expertise and a strong sales force will be the pivotal ingredients in surviving a shakeout—which he says is imminent—and will weed out garage shops.

Better concedes that the semiconductor-makers-turned-calculator-

Probing the news

builders will be a major factor through 1975, but he contends that those suppliers that will ultimately dominate the hand-held market aren't even in it yet. He suggests RCA and Gillette as the kinds of firms with the proper retail marketing approach and sales forces to compete effectively in supermarkets and large chain stores, which will be the principal sales outlets.

Big three. But Donn Williams, president of Rockwell International's electronics operations, is a firm subscriber to the premise that the vertical integrators will rule the hand-held business. In fact, he says that three companies will dominate: Texas Instruments, National's Novus, and Rockwell's own Microelectronics group. All three make the critical MOS circuits, displays, and keyboards. Williams says the three eventually will each command about 25% of the market, and the remaining 25% will be split among survivors of the shakeout, which he says is taking place now.

A TI spokesman says only that, to survive a shakeout, "companies will require lower manufacturing costs, innovative distribution, advertising, and a strong technological base." The lack of this base could prove to

Slashed. Competition has driven prices \$10 under the \$29.95 model featured.



be the telling vulnerability of many assemblers.

"Vertically integrated companies that have the ability to lower costs and have the available money for marketing, plus the promotional experience that assemblers don't" will edge out the smaller, more specialized calculator firms, asserts Russell Stewart, director of marketing at Litronix Inc.'s Consumer Products division, Cupertino, Calif. "Anybody buying something has to pay more than if he made it himself," he adds. Litronix, for example, combines its MOS, display, and IC sections in one division to "give us better coordination through manufacture and design of the unit," he says.

R. Scott Brown, director of marketing at National's Novus division, concurs: "As prices go down, the vertically integrated people are the ones who will stay" in the business. Partially integrated firms that make one or two components such as display and keyboards, but have no MOS chip capability, have a smaller chance of survival, says Brown, "I don't know if they'll make it or not."

One company that has decided to get out of the low-end calculator market while the going is still good is Cal-Tex Semiconductor Inc., Santa Clara, Calif. Mel Snyder, director of marketing, says that, even though the calculator market is increasing, the availability of chips is decreasing. Cal-Tex plans to concentrate on the watch market. "The price of the four-function calculator is down in the mud, and it's impossible" for companies that didn't start building total capacity early in the game to catch up with the likes of Litronix, National, and Rockwell, he says.

The price decreases affected Cal-Tex's decision to move out of calculators, he says. "If you're vertically integrated, you can produce at a lower cost. We were too far behind in making a finished calculator to catch up, and Cal-Tex, which made only the calculator chips, found some customers, like Rapid Data, the Canadian assembler, failing.

Sales slump. Litronix' calculator-sales forecasts for 1974 are on the mark, though during late spring, especially after Father's Day, there was "a major decline in consumer

demand." Despite the decreased demand, the company has only eight days' inventory, Stewart says.

One of the big early winners in consumer calculators was Bowmar, but the Acton, Mass., firm obviously lost momentum in its recent third quarter, which ended June 30. The company admittedly felt the pinch caused by the excess of supply over demand, as reflected in a loss of \$143,000. That compares with earnings of almost \$2.2 million for the comparable period last year. Edward A. White, Bowmar president and chairman, blamed the loss on a sudden drop in retail sales of all calculators, which began in April.

Like everyone else, Corvus Corp., Dallas, is beginning to experience seasonality, especially in under-\$50 machines. Marketing manager George Miller ranks those peaks—in descending order—as Christmas, back-to-school, tax season, and "grads and dads."

"To smooth out those peaks, we're beginning to look harder at sectors of the market that aren't seasonal," he says, "such as private label, premium and incentive, and mail-order businesses." Miller, though, doesn't agree wholly with the shakeout scenario. "Six months ago, I'd have said that the small calculator manufacturers without vertical integration would be most likely to drop out of the market," he notes. "But now, with the cost of money what it is, even some of the largest ones are suspect."

Corvus is manufacturing at its highest level, and "our inventories are big, like everyone else's," he says. "But we have a backlog that runs through Christmas, and by Dec. 25, we expect to have no inventory at all." He agrees that April and May were bad months, but Corvus' business picked up in June, and "Our incoming order rate for July was fantastic," Miller says.

Brown of National's Novus believes the supermarket is the place where a leveling out of the market's seasonality will occur. "At our price (the lowest is \$19.95), the best retail channel of distribution" is the grocery store, he says. But as Novus gets into new markets "where the calculator has not been sold," he adds, "it will even out these seasonal fluctuations." □

Seven ways to tell a Darlington that's great from a Darlington that's merely good.

Monolithic rather than two-chip offers greater reliability

Device geometry eliminates the possibility of interconnect failures

Clip lead construction improves thermal and mechanical ruggedness

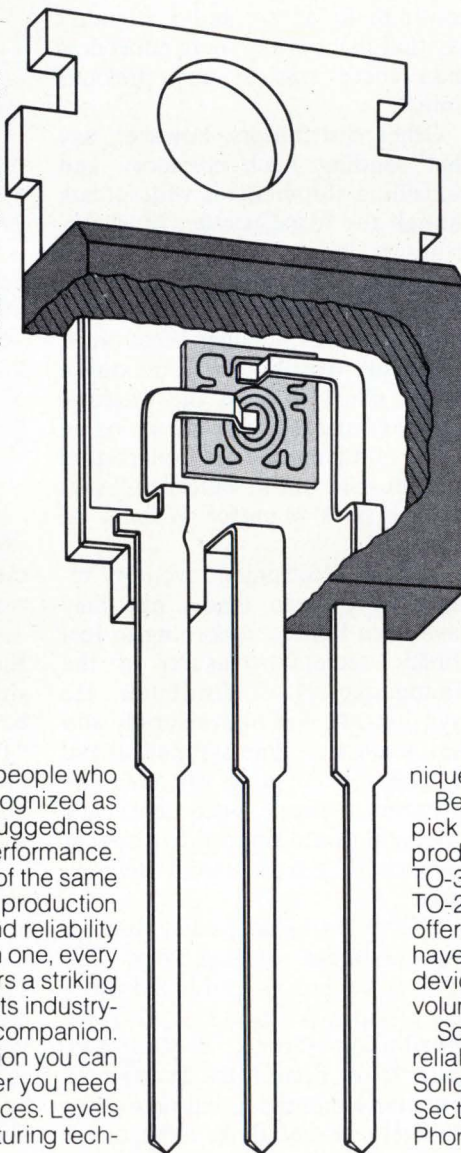

Process Controls and thermal fatigue characterization result in high I_{SB} capabilities

Built-in protective diode shunts reverse current for added circuit protection

Exclusive thermal fatigue ratings enable safe full-capability operation

Real-time testing improves quality levels over traditional testing

It's what you'd expect from the people who brought you the 2N3055 — long recognized as the industry leader for ruggedness and performance.

Our Darlington transistors are made of the same construction system, on the same production facility, with the same process and reliability controls. So, in more ways than one, every RCA Darlington transistor bears a striking resemblance to its industry-workhorse companion.

Another RCA power transistor tradition you can look for is high quality levels whether you need a hundred, a thousand, or a million pieces. Levels achieved through modern manufacturing tech-

niques combined with real-time product control.

Because RCA offers a wide variety, you can pick the Darlington package that best suits your product needs. Including the hermetic steel TO-3. The TO-5. The TO-66. Plus the RCA TO-220 VERSAWATT — the plastic package that offers reliability at low cost. Soon, you'll also have the RAP series, a new generation of devices designed for low power, high volume applications.

So if you want RCA performance and reliability in a Darlington, contact your RCA Solid State distributor or write: RCA Solid State, Section 70H8, Box 3200, Somerville, N.J. 08876. Phone (201) 722-3200 Ext. 2129.

RCA Solid State

International: RCA, Sunbury-on-Thames, U.K., or Fuji Building, 7-4 Kasumigaseki, 3-Chome, Chiyoda-Ku, Tokyo, Japan.
In Canada: RCA Limited, Ste. Anne de Bellevue 810, Canada.

Components

The big squeeze on distributors

With manufacturers flooding them with products and customers holding back on bill payments, distributors face cash-flow headaches

by Larry Armstrong, Chicago bureau manager

Distributors—the middlemen of electronics—have really been caught in the middle lately. They have been squeezed from one side by a deluge of inventory from components manufacturers with new-found capacity and from the other by customers sitting a little longer on their now-expensive money.

That one-two punch has caused cash-flow problems for some distributors, problems serious enough in some cases for suppliers to put them on credit hold. Now, most of the majors are beginning to see the end of the troubles of the past several months. But the change has come about through adjusting to conditions at hand, not because of any real, fundamental change in those conditions.

Top heavy. Inventory imbalances hit distributors and users alike. "During last year's shortages, some manufacturers unfortunately told distributors that allocation was based on backlog," says Peary A. Nelson, marketing vice president at Semiconductor Specialists Inc., Elmhurst, Ill. "Well, we all played along to some extent."

Semiconductor Specialists, according to Nelson, was a bit cautious and did not fall completely into the trap of placing huge orders for inventory it knew it would never use. The company first started to notice slight inventory increases in March. In April, it put definite schedules on shipments, and effected some cancellations and a few returns, "but no more than under normal formulas set down with suppliers," he says.

"We always exercise our stock-rotation rights under our contracts with suppliers to the maximum—to

keep our inventory fresh and viable," says Ed Stimer, financial vice president at Hamilton/Avnet. "We continue to do so, and I wouldn't say that there is any more effort now than there was at any previous time."

Other distributors, however, say that sending back inventory and cancelling shipments is widespread, though the worst is over. Most distributors, however, have cancelled or rescheduled orders, but have not returned inventory.

For example, Cramer Electronics, like many distributors, is making a strong effort to keep the products that have arrived. "We are sitting on a lot of inventory for orders that were pushed out or cancelled," says outside sales manager William A. Connolly.

At Jaco Electronics, inventory returns have been made, but they have been limited, according to Joel Girsky, secretary-treasurer of the Hauppauge, N. Y. distributor. He says that TTL was in oversupply and that some suppliers shipped ahead of schedule. To keep an adequate inventory balance, Jaco sent back orders that were shipped to it well in advance of the requested delivery dates.

"We've probably passed through the maximum of inventory. The worst is behind us," adds Sid Spiegel, group vice president at Wyle Distribution Group, El Segundo, Calif. "Now there is the question of how many months it will take us to get where we would like to be, to get to realistic levels."

Some suppliers are beginning to lay off people and halt product lines, indicates Homer Nielsen, executive vice president at Kierulff

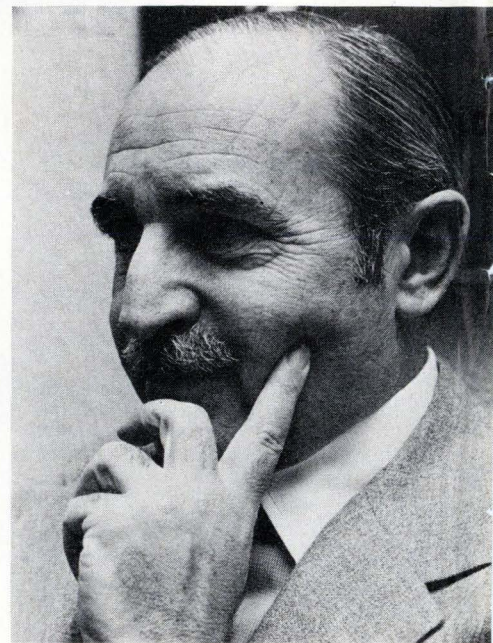

Critical look. Seymour Schweber's firm is being more selective about customers.

Electronics, Inc. "The only way this situation will ease is if suppliers cut back on their production," he says. "They're not making a big noise about it, but they are cutting back on production lines, shutting off the spigot."

Payments. Accounts receivable continue to stretch, and now average somewhere over 50 days for the industry, most distributors agree. That's a disturbing 10% to 15% increase over the level of a year ago. With skyrocketing interest rates, its cheaper to delay paying bills than to borrow to pay them off. As a result, distributors are policing their accounts more carefully.

"Most distributors are putting more effort into the collection area—making more calls, dunning more people," says Kierulff's Nielsen.

Linear COS/MOS... RCA's CA3600E premieres

CA3600E schematic diagram

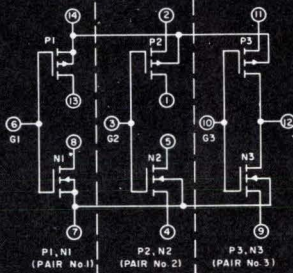

CA3600E transistor pair biased for linear-mode operation

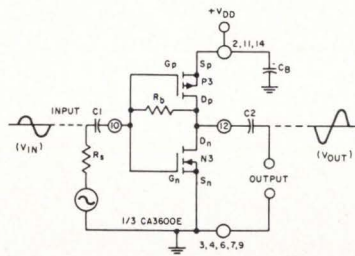

Analog timer using CA3600E

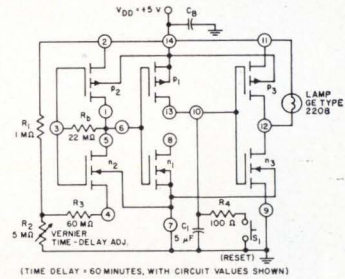

Meet the linear IC with the advantages of COS/MOS. The new RCA CA3600E Transistor Array... three pairs of complementary enhancement-type MOS (p-channel/n-channel) transistors on a single chip.

The CA3600E is designed for a great variety of applications requiring virtually infinite input impedance, wide bandwidth, matched characteristics, lower power consumption and general purpose circuitry.

And that's not all. With the new CA3600E you get performance advantages that include square-law characteristics, superior cross-modulation performance, and a greater dynamic range than bipolar transistors.

Whether you're working in timing, sensing and measuring or any other applications, or if you're tired of fighting beta variation in your bipolar circuit, let your "linear" imagination run wild. The features offered in the new CA3600E COS/MOS Linear IC

are too good to pass up.

- Virtually infinite input resistance/ 100 gigohms
- Each transistor rated for operation up to 15V and 10 mA
- Low gate-terminal current/ 10 picoamps
- No "popcorn" (burst) noise
- Matched p-channel pair/gate-voltage differential ($I_D = -100\mu A$) ... $\pm 20mV$ (max)
- Stable transfer characteristics over a temperature range of $-55^\circ C$ to $+125^\circ C$
- High voltage gain/up to 53dB per COS/MOS pair.

Supplied in the 14-lead dual-in-line plastic package, the CA3600E is available in production quantities from your local distributor or direct from RCA.

For complete data sheet/application note write: RCA Solid State, Section 70H8, Box 3200, Somerville, N.J. 08876. Or phone: (201) 722-3200.

RCA Solid State
products that make products pay off

International: RCA, Sunbury on Thames, U.K., or Fuji Building, 7-4 Kasumigaseki, 3-Chome, Chiyoda-Ku, Tokyo, Japan. In Canada: RCA Limited, Ste. Anne de Bellevue 810, Canada.

**Today the "hot-spot" temperature
will approach 200 C, with a
90% chance of moisture, and
contamination could be severe.**

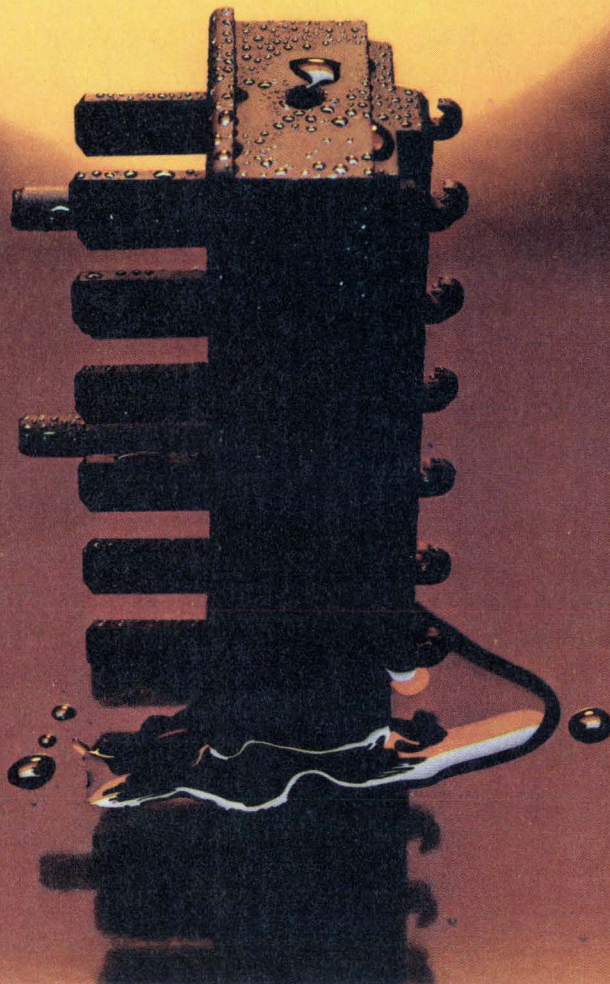

Protect your systems with silicone compounds.

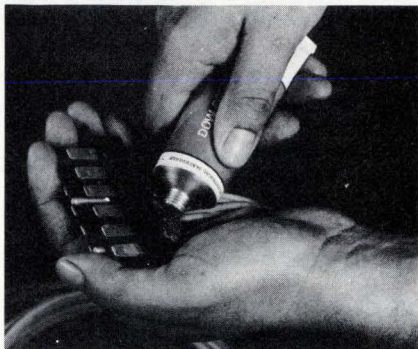

Sooner or later, the electronic devices you design will have to stand up to persistent and inherent problems: corrosion, high heat, water, chemicals, oils, salts. Anything but rosy.

But think about this. Dow Corning dielectric compounds handle harsh environments, and retain excellent electrical properties from -40 to 200 C. They're ideal for high voltages, and a wide range of frequencies. Won't dry out, bleed, or melt; are oxidation resistant, odorless, and practically nonvolatile. And they fill several functions at the same time.

For instance, Dow Corning® 2 compound is a dielectric sealer that prevents copper corrosion. Use it on connectors or communications cables. If you need a good lubricant, a water repellent, and a corrosion preventive for switches or terminals, try Dow Corning® 3 compound. And Dow Corning® 4 compound, a moistureproof dielectric sealer, is great for high-altitude ignition systems.

We have a heat-sink system, too. Pot diodes and transistors for excellent thermal conduction. Then, for maximum protection, apply our heat-sink compound between the device and chassis.

Versatility, economy, performance, and easy application. Good reasons why silicone compounds should be your design tools. Write for full information to Dow Corning Corporation, Dept. C-3335, Midland, Michigan 48640.

Silicones; simply the best way to protect electronic circuits.

DOW CORNING

DOW CORNING

Probing the news

"And along with that, we're being a little more selective on some of our credit limits. We're being more discreet about who we extend credit to."

In some cases, this critical look at marginal customers prevails even when it might lead to a sacrifice in volume. "We are weighing sales more carefully with an eye toward profitability as well as volume. We're being more selective in the customers we sell," says Seymour Schweber, president of Schweber Electronics, Westbury, N. Y.

Most distributors are now pretty much holding the line on receivables, but they don't expect to see them starting to come in again until the cost of money drops. Distributors' customers are paying at least 3/4 of a point above the prime interest rate, and some smaller ones are paying 14% to 16%.

"The financial world has been telling us for the last two or three months that the high prime rate is going to come down, and when it does it will fall rather rapidly," says Kierulff's Nielsen. "But, of course, they were saying that when it hit 10%."

It's not going to drop significantly—to under 10%—before 1975, distributors agree, but it's not

going to go above its current peak, either. "I think banks will keep the prime at 12%, but they're beginning to hit in other areas, such as requiring more cash on deposit," says Nelson. "Rather than raise the prime, many banks have zipped up the minimum balance."

No one expects to see a big shake-out among the smaller distributors. The ones with problems are weathering pretty well, although the going might be awfully rough. Indeed, "two distributors are on my desks as acquisitions," says Jaco Electronics' Girsky.

Besides, the problems are not necessarily characteristic of small competitors, "but of who has the biggest control problems," points out Wyle's Spiegel. Girsky agrees with him on the fundamental importance of inventory control: "That's the secret of the business."

Jaco controls inventory with a three-point program that includes a monthly review of inventory, monthly returns of inventory to suppliers, and an "open-to-buy" program that limits purchases if present inventory does not move.

The "open-to-buy" program, Girsky says, was initiated by department stores many years ago. Basically, it limits the proportion of orders Jaco buyers can place until present inventory is proportionately decreased. □

The worrisome inventory items

Optoelectronics, TTL, and linear devices are all in good supply on distributors' shelves, C-MOS is easing although it's still tight in large quantities, and "diodes haven't improved one damn bit," says one distributor, reflecting the view of most.

Many, in fact, consider TTL in oversupply, although not to the point where price erosion has started at the distributor level. "No one is scalping anymore. They are holding prices," says Cramer's Connolly, "and I think it will get back to extreme price competition." The oversupply headache has been a problem principally in simple functions, he adds. Semiconductor Specialists' Nelson agrees: "TTL prices are reasonably stable on the distributor level, but I have heard fairly aggressive prices on large bids to the factory."

"It's the big names in TTL that are faced with oversupplies," he continues, "but it's the secondary manufacturer that's going to get hurt. He secured market position during the tight market, and the majors are beginning to want it back."

But fast replacing TTL as the product that most semiconductor manufacturers are trying to get rid of may be analog and linear devices. "I can generally tell which products the manufacturers have overstocked by the number of contests we have going for competing manufacturers' lines," Nelson says. "And analog is No. 1 in the hit parade of our manufacturers requiring contests."

Avionics

Plane makers tangle in European dogfight

American, British, Swedish, French craft compete as F-104 replacement; avionics makers maneuver for share

by James Smith, McGraw-Hill World News

Avionics manufacturers in the U.S. and Western Europe are vying for a multibillion-dollar market as the free world begins a new round of replacing fighter aircraft. At the head of the line are four NATO countries—Belgium, Holland, Norway, and Denmark—that must phase out some 350 obsolete F-104 Starfighters beginning in 1978. Their orders are expected to total a neat \$2 billion, of which about one sixth, or \$330 million, will probably be spent on electronic equipment.

But even more important, the four are probably the key to even larger purchases by other NATO partners and third-world countries in Latin America and the Near and Far East, as well as the U.S. itself. Together, these nations will probably need some 1,500 aircraft by 1980 and could buy as many as 4,000 over the next 15 years, a \$20 billion to \$30 billion dollar jackpot, of which at least \$3.5 billion, and perhaps up to \$6 billion, goes for avionics.

The importance of their choice has not been lost on the four countries. They are playing off manufacturers and governments against each other in order to channel some of the business to their own industries—the so-called offset package—and cash in on third-country sales.

As the situation comes to a head, behind-the-scenes maneuvering is building to a frenzy. In the past few weeks the Belgians and Dutch have received over-the-transom offers from Britain's Hawker-Siddeley to

deliver Harriers off the assembly line with no offset package involved. British Aircraft Corp., which previously had its Jaguar ruled out by the Dutch air force, came up with a last-minute proposal to the Belgians involving 100 improved Jaguars similar to those being delivered to the French and U.S.

Viggen bids. But one of the most lavish propositions came from producers of Sweden's Viggen, determined to overcome objections that the country's neutrality would handicap NATO in wartime. In a totally revamped offer, the Swedes proposed to manufacture the entire Viggen within NATO countries through a consortium mainly of Swedish and Benelux firms and to call the airplane the Eurofighter.

Saab, LM Ericsson, and Volvo propose to give Dutch and Belgian industry 85% of production of the airframe, 60% of the engine, and all of the electronics, to be divided 50-50 between the two countries. Bel-

gium's MBLE, which is a Philips subsidiary, Ateliers de Constructions Electriques de Charleroi, ITT's Bell Telephone Manufacturing Co., and Sait would produce the complete advanced cockpit display system, except for the head-up display, plus half of each radar set.

Dutch firms Hollandse Signaale Apparaten, also a Philips company, and PTI would have production responsibility for the radar and would handle the remaining 50%, in addition to producing the major U.S. electronic equipment aboard the aircraft. As a further attraction, Sweden promises to line up non-aviation projects for the two countries—ranging from a Saab car factory and a Volvo truck plant to electronic-components facilities for computers.

Despite the fierce bidding by the British and Swedes, the main contenders for the business are France and the U.S. The French propose an improved version of the Mirage



HOW TWO MOS RAMS STACK UP AGAINST EIGHT.

It's a rout: compare two 256 x 4, five-volt ion-implanted, N-channel silicon gate static MOS RAMS. With 16 pins and bus-structuring. Against eight 1024 x 1's. It's no contest, no two ways about it. The 256 x 4 is the greatest savings device to come across the board in read/write organization. And here's the byte. You get an eight-bit word with only two IC's instead of eight. Why pay for more than you need? The 256 x 4 organization gives you no wasted bits. And an industry standard package saves you board space, design time and money.

Presenting the 2606 static MOS RAM. The first one out had to be fast. The 2606 gets it done in 750 ns access time. Its bus structuring means simpler input/outputs, and no interface and support logic. And this RAM fits right into the scheme of new bus-oriented systems to come. Throw in total TTL compatibility with no clocks required, and your 256 x 4 package is complete.

The 2606. Your distributor has inventory now. Buy some today. And while you're at it, send us the coupon. We'll get you more information on our new 256 x 4's—and other MOS memories. From Signetics, first again.

**ADD IT UP.
NOW TWO IS MORE
THAN EIGHT.**



signetics

Signetics MOS P.O. Box 3004-38
Menlo Park, California 94025 (408) 739-7700

Let's have the complete specs and technical data on your new 256 x 4 N-channel: The 2606.

Name _____

Title _____

Company _____

Address _____

City _____ State _____ Zip _____

Telephone _____

Signetics Corporation, a subsidiary of Corning Glass Works, 811 East Arques Avenue Sunnyvale, California 94086 (408) 739-7700.

Probing the news

F-1—with a new engine, the M53, not yet in the testing stage. The two U.S. airplanes are the General Dynamics 402 and the Northrop Cobra. The 402 is a variation of the YF-16, and the Cobra is based on the YF-17. Both are being tested by the U.S. Air Force.

The hard sell. Both sides are selling hard. Northrop, working with countries such as Holland and Norway, which were already flying Northrop F-5s, began designing the Cobra as an all-European replacement for the Starfighter as far back as 1967—before there was any interest in the concept in the U.S. The company, which claims to have spent \$30 million on the project, had worked out a comprehensive offset package with the four European countries. The deal involves production of about 50% of the value of the airplanes ordered, participation in sales to third countries, and half the electronics.

Discussions are now being held with European firms, primarily concerning components of the radar and inertial navigation systems. At the same time, the French have put together what U.S. officials concede is "an interesting offset deal," reported to involve as much as 60% to 80% of the value of the aircraft orders, plus participation in planes sold to third countries—estimated to be potentially around 1,200 aircraft. More important, the French, desperate from failures of the Concorde and Airbus, are considered likely to

offer the plane at a loss in order to win business for their own badly mauled aircraft industry.

The likelihood that the U.S. Air Force will buy one of the American prototypes for its own use has radically changed the picture in Europe. First, it has made General Dynamics a viable last-minute contender, since early this year, for the European business. Second, it has opened the possibility that the Air Force itself may share development costs for the airplane with the Europeans and provide necessary spare parts and logistical backup.

Standardization. In addition, the likelihood that the U.S. may deploy the plane in its own NATO forces opens interesting possibilities for NATO standardization—something the Dutch insist on. To try to clinch matters, when the Europeans visited the U.S. in June, Government officials offered to push up the Air Force decision date from next spring to December so that the five countries together could define the role of the airplane and phase in offset plans. Moreover, they promised the Dutch and Belgians, not only 50% offset on their own orders, but—for the first time—10% on lucrative third-country business.

To counterbalance this, the French have stepped up pressure on their Common Market colleagues to buy European in order to preserve the EEC's ailing aircraft industry. They have continued to bear down on the Belgians, who have already purchased four types of French airplanes, including 100 F-5 Mirages and are considered again to favor

the French. In addition, it now appears that the French Air Force will pick up development costs of the M53 engine. Then the French may adapt the revamped aircraft for their own air force, to avoid objections—mainly from the British—that it is not being used in France. There are also rumors that France might rejoin the NATO Group of Eight, a military planning association of European members, as a political maneuver to sell aircraft.

Significantly for the U.S., though European countries are keenly interested in maintaining employment in their own industries, they also have their eyes on long-range technological transfer and related third-country sales potential. Most aircraft companies have been quick to respond. BAC, for example, is offering Belgian firms the possibility of joint cooperation in research and development on electronics and new materials in the highly advanced, expensive Multirole Combat Aircraft.

And besides making Belgian firms exclusive suppliers of components for the British navigation and attack system, which is considered fairly sophisticated, British GEC-Marconi has suggested cooperation on equipment extending beyond the Jaguar, including advanced displays, computer, radars, and systems electronics.

The U.S. pitch. U.S. specialists are also touting technical superiority of the General Dynamics and Northrop fighters as 1970-generation craft with a market into the 1990s, whereas competing planes date from the 1960s and may even be end-of-series models.

Much of the U.S. technical edge stems from highly sophisticated electronic equipment that is embargoed from the French. Northrop, for one, has been careful to spread much of this to electronics companies in all four countries—including Kongsberg Vappenfabrik and Gustav Ring in Norway, Terma in Denmark, HSA in the Netherlands, and ACEC, MBLE, Siemens, and Bell Telephone in Belgium. ACEC and MBLE are expected to handle part of the radar system, for which three companies—Westinghouse, Hughes, and Rockwell—are bidding in the U.S. □

Some U.S. companies win either way

U.S. electronics superiority may guarantee American companies a share of the European F-104 replacement business—no matter who gets the order. Much of the avionics on the Viggen, for example, is licensed by U.S. firms, including a central digital computer and inertial platform designed by Singer-Kearfott, a Honeywell automatic flight-control system, and an air-data computer designed by Garrett AiResearch.

American companies could also benefit even from choice of the Jaguar or Mirage through equity interests in Benelux aircraft producers, particularly electronics firms. Northrop, for example, shares 20% of Dutch-German airplane builder Fokker-vfw, which will get a major share of Dutch offset orders no matter which plane is selected.

Fokker, in turn, owns nearly 50% of Belgian aircraft builder Sabca; the remainder is controlled by the French company Dassault, which makes the Mirage. Large portions of Belgium's electronics industry are also in U.S. hands, including ITT's Bell Telephone Manufacturing; ACEC, controlled by Westinghouse; and Sait, in which Lockheed has a major holding.

Your personal data acquisition system.

Analyzing's just a keystroke away.

Our 31/53 Data Acquisition System has the processing power of most minis.

A powerful, versatile and modular calculator you can talk to. At a cost much less than a mini.

Define 24 keys with your functions. The user-definable keyboard and overlay means you can really customize the 31/53. So when dealing with complex variables, a single keystroke gives your results. And our statistical and mathematical

libraries give you further support.

The 31/53's convenience beats a mini, too. Read input from the DC501, 502 and 503 counters. They're digital, modular and compact. Just like the DM501 multimeter. Both plug into the mainframe, along with the interface. And together, they make a lot of comparisons. Time, temperature and measurement of electrical signals.

Work with data in your own language. Program with little more than natural math. That's a truly personal

test and measurement system.

Your local Tektronix representative has the full story. And he's just a phone call away. Or write us:

Tektronix, Inc.,
Information Display Division,
P. O. Box 500,
Beaverton, Oregon 97005.



Companies

Draper Lab: a successful spin-off

After a year as an independent R&D company, MIT's 35-year-old Instrumentation Laboratory has more funding than ever before

by Gail Farrell, Boston bureau

One near-casualty of the student protests of the 1960s was MIT's Instrumentation Laboratory. Faced with student demands, the Massachusetts Institute of Technology had the choice of drastically changing the lab's base of expertise—operational weapons systems—or spinning off the lab entirely.

The school took the latter course, and now, after a year as an independent, not-for-profit R&D company, Charles Stark Draper Laboratory Inc. is doing better financially than it ever did under MIT's wing. Estimated expenditures for 1974 are \$90 million, much of it due to an increase in subcontracting. That funding is up from \$71 million in 1973.

Beginnings. For 35 years, the laboratory, founded by Charles Stark Draper, was a part of the department of aeronautics and astronautics. When protests against defense work mounted at MIT, the school decided not to accept any more work in operational weapons systems, which had comprised a large part of the lab's work. In 1970, the lab was made a separate division of MIT, and on July 1, 1973, all legal ties with the university were cut.

"If we had stayed at MIT, we would have been governed by their policies, such as accepting no research going to operational weapon systems," notes lab president Robert A. Duffy, a retired Air Force brigadier general and former vice commander of the Space and Missile Systems Organization. "We would have had to change our direction, and we would have been lost."

As it is, the Draper Lab has assumed liability for all contracts that were being performed by it as a division of MIT, including guidance

system work on the Apollo, Skylab, and Space Shuttle programs for NASA and work on the Polaris and Poseidon missiles. In addition, the lab just signed a \$120 million contract, which will extend over four years, for work on the Trident ballistic-missile guidance system.

Duffy thinks the lab has "gained a little more elbow room financially," as a result of its independence. Since procurement regulations differ for universities and other organizations, the lab for the first time is allowed independent R&D costs. "This means we can do research not directly related to current projects, and the expense is a legitimate charge to the Government contract," Duffy explains.

Expertise. The lab still revolves around its main strength of "dynamic geometry," broadly characterized as vehicle control and including everything from fire control and gun aiming to controls for space craft. While it is perhaps best known for its work with inertial components and systems, Duffy says "we want to be thought of as an instrument lab, not just a gyro lab. Some 10% of our in-house money is spent on the instrument shops."

The work in controls has led to development of information-handling technology. The lab has developed computers for the Apollo missions and for missile-guidance schemes, and Duffy expects it will continue to find new ways to use information theory and computers.

The vast majority of Draper's work is federally funded, with 85% coming from the Department of Defense, 10% from NASA, and 3% from other agencies, such as the National Science Foundation and the De-

partment of Commerce. About 2%, or \$1.5 million, is commercially-funded work in industrial research, mostly automation. The lab has adapted its control theory and technology to production-line automation problems at Fiat and Olivetti.

Duffy would like to see 10% of the lab's work in the industrial sector. Says Duffy, with an eye to the U.S.-Russian strategic-arms limitation talks: "We are looking at different alternatives so that if there is a major change in national policy we are not cancelled out."

He feels strongly that the 1,800-person work force, almost 700 of whom are professionals, is a national resource. A major concern is keeping this work force stable and intact, avoiding the ups and downs in employment that are typical of defense work. As a result, about 45% of the dollar flow to the lab last year was spent on subcontracting cyclical work.

Education. Although the legal and administrative ties with MIT are now severed, Draper Lab still regards education as one of its major functions. MIT accepts student work at Draper as part of a degree, and 25 to 30 MIT graduate students are in residence as Draper fellows. Some members of the Draper staff hold appointments as MIT lecturers, and some of the MIT faculty are supported by the lab.

The lab is also revitalizing a program that provides postgraduate training for military officers and civilian employees of the military. And, companies that will be follow-on producers of the equipment developed at Draper have about 200 representatives in residence to ease technology transfer. □

MONO-GLASS... A JEWEL OF A CAPACITOR

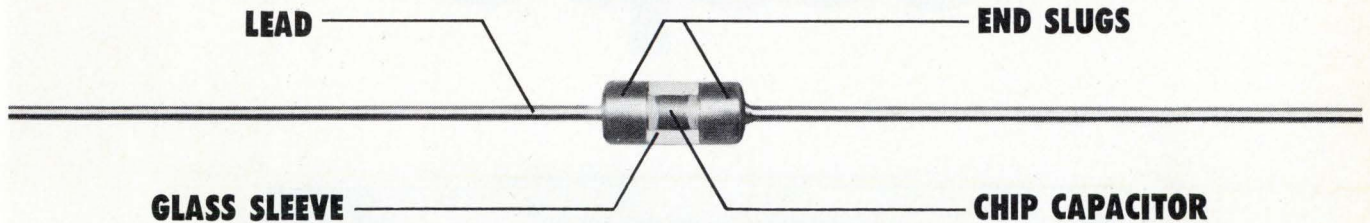

U.S. Capacitor Corp. has done something elegant for high volume capacitor users . . . MONO-GLASS.

This glass encapsulated monolithic ceramic capacitor offers something special: for the Design Engineer looking for cost reduction and dependability; for the purchasing agent looking for low price with fast delivery; for the incoming Q.C. inspector who is looking for reliability.

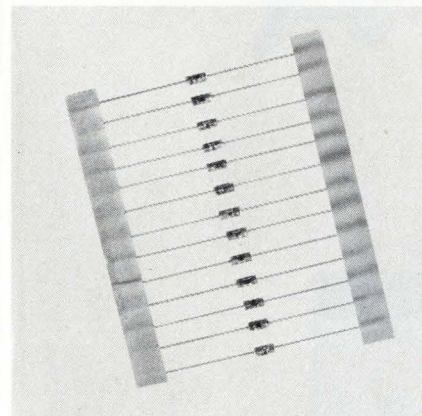

AUTOMATIC INSERTION:

If you use it, you know the substantial savings in time and cost. MONO-GLASS is designed for automatic insertion with the same equipment used for diodes and resistors. Reel packed and ready for your machines.

DURABILITY:

Our hermetically sealed, glass-to-metal construction offers these advantages: solderless internal contacts that won't reflow in your wave-soldering process; no glass fracturing during lead forming—stress is transferred to the end slugs rather than the glass sleeve.

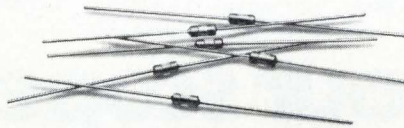

HIGH VOLUME; LOW PRICE

USCC's production capability for chip capacitors is second to none. MONO-GLASS is produced by a simple assembly technique. Combine these two and you get the best possible delivery for high quantity requirements, at a budget price.

WIDE SELECTION:

Four case sizes are available200 x 100; .250 x .100; .300 x .150 and .400 x .150. The 50 and 100 WVDC units offer up to .01 mfd in COG dielectric, to .18 in X7R and up to 1.0 mfd in the Y5V dielectric.

RELIABILITY:

USCC is the proven leader in state-of-the-art, demonstrated on N.A.S.A. life support and guidance systems. Commercial as well as military aerospace applications benefit from the high reliability features of our products—the best available.

MONO-GLASS is our lowest priced ceramic axial lead capacitor, offering a new quality capability for communications, navigation and guidance, computer business machines or anywhere that high volume, low price is required.

Write or call for an evaluation sample, more technical data or applications help for your special requirements. Remember, USCC-Centralab.



USCC

USCC/Centralab



Electronics Division • Globe-Union, Inc.

2151 North Lincoln Street ■ Burbank, California 91504

(213) 843-4222 ■ TWX: 910-498-2222

the biomated scope

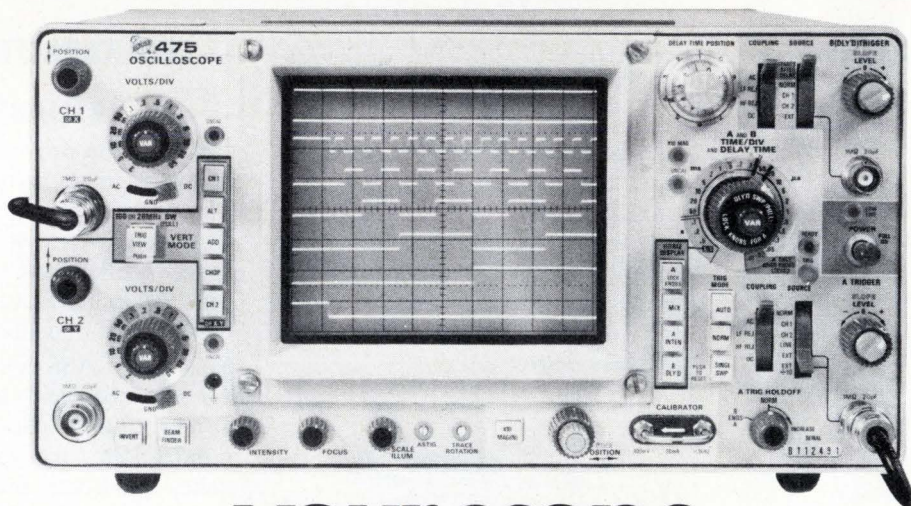

your scope

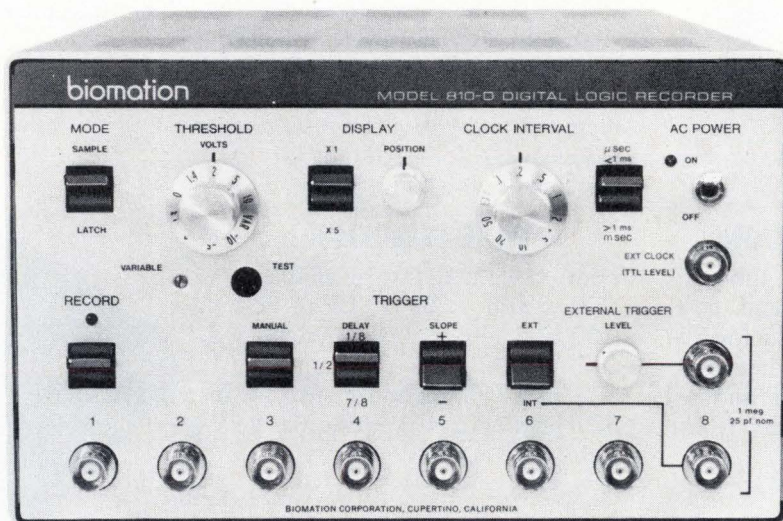

our glitch fixer™

8 traces of digital logic!

If your world is digital, Biomation's 810-D Glitch Fixer can help you. Mate it to your scope and it captures and displays complex timing events on 8 channels at once. At speeds to 10 MHz. *On your bench scope.*

Too many guys have had to sweat out a deglitching problem one line at a time. They asked us to help, and we answered with the 810-D.

The unit contains 256 bits of memory per channel—producing a continuous 8-trace timing diagram display on your scope from just one logic stimulus combination of your device.

The memory, in conjunction with a novel trigger delay and record control feature also gives you the ability to store a selected amount of the signals which occurred *prior* to the time of the detected trigger.

Add to this the unit's 10ns glitch-catching mode and you will know why the 810-D has become a new basic diagnostic tool for designing and debugging digital circuits.

Features:

Eight logic signal channels with 1M Ω inputs.

Presents 8 x 256 bits of recorded data on scope in easily-interpreted timing-diagram form.

Input latch mode selection provides detection of random pulses—as narrow as 10ns.

Selectable logic thresholds include TTL and EIA levels.

Synchronous clock input to 10MHz.

Or internal clock selection 20Hz to 10MHz.

Saves selectable amount of prior-trigger data, provides pre-trigger lookback.

Display expansion gives precise time analysis of data.

Digital output allows computer analysis or mass storage.

Price: \$1950

So if you've got a single trace scope and an 8-trace problem, Biomate it with a Glitch Fixer. Get all the glorious details by calling, writing or circling the reader service number. Biomation, 10411 Bubb Road, Cupertino, CA 95014. (408) 255-9500. TWX 910 338 0226.

biomation

Hybrid microcircuit designers are watching us...

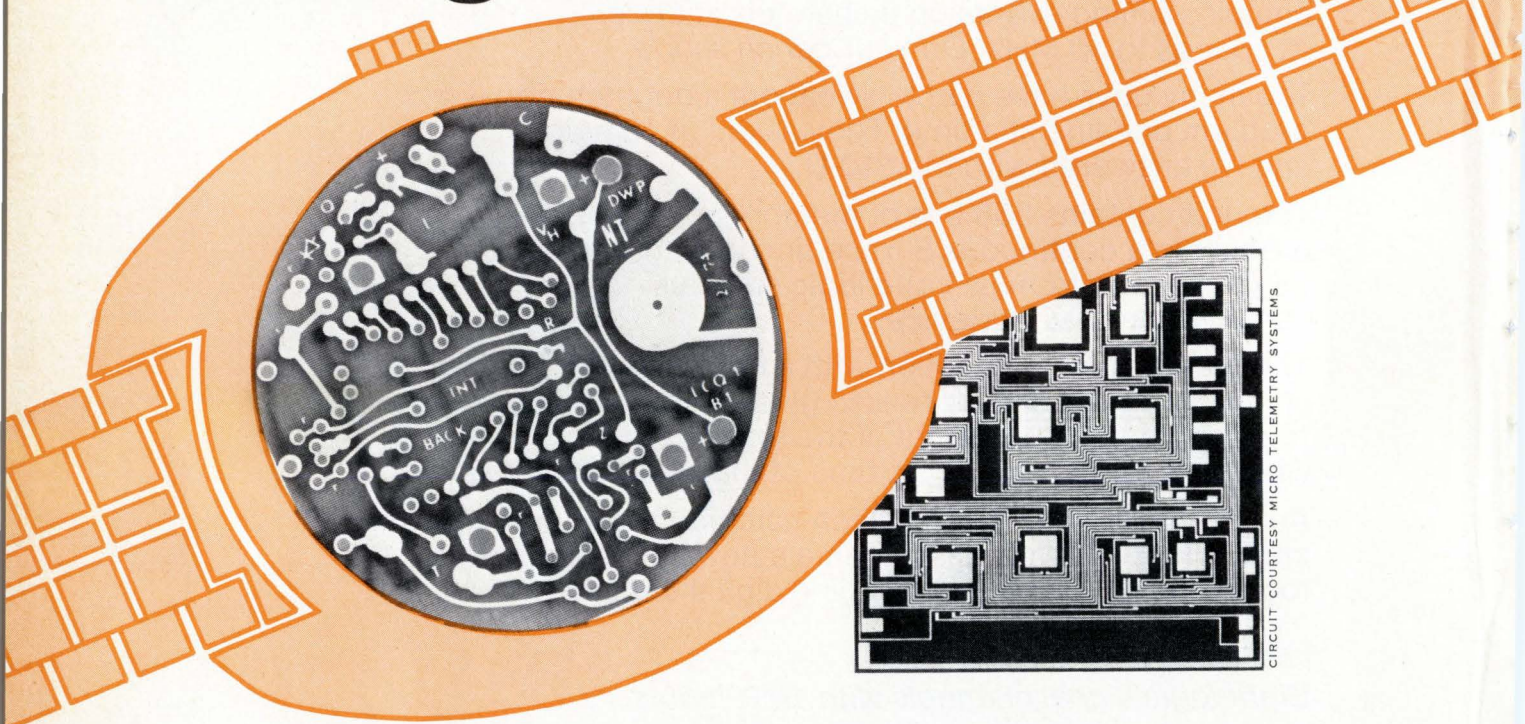

CIRCUIT COURTESY MICRO TELEMETRY SYSTEMS

...because we have a proven microcircuit substrate that costs much less than ceramic and offers important design and production advantages.

The two microcircuits shown are dramatic proof of the advantages of Micaply® Hybrid Microcircuit Substrate.

The electronic watch circuit, made by a major watch manufacturer, was produced on 10" x 12" sheets, drilled, then die cut into a circular shape. Substrate cost for a 1" x 1" square, metalized both sides, is 10¢!!

The microcircuit at the right has 2 mil lines and spaces and was also produced on large sheets of substrate at a fraction of the material cost of ceramic.

Micaply® Hybrid Microcircuit Substrate is epoxy glass, metalized on one or both sides with 100 microinches of copper. Standard printed circuit etching techniques produce line and spaces as fine

as 2 mils without the need of expensive screening, firing or vacuum equipment.

Other advantages include:

- The copper metalization acts as a plating electrode.
- It can be easily drilled, cut and shaped.
- Multilayering for higher density can be done with ease and at low cost.
- Simple processing results in faster throughput and higher yields.
- Active and passive chips are easily bonded.

Complete design assistance and prototype service is available. Contact us for an evaluation of your requirement or comprehensive technical literature. Find out how Micaply® Hybrid Microcircuit Substrate can reduce your microcircuit costs.

The **Mica** Corporation

10900 Washington Boulevard, Culver City, California 90230, (213) 559-4223, TWX: 910-340-6365; Telex: 674999

Micaply International, Ltd. Silloth, Cumbria, England, Silloth 571, Telex: 64120, Cable: Micaply, Silloth

Technical articles



Promises kept. Symbols allude to charge-coupled technology's achievements to date—low-resolution cameras for video systems, emergent 16- and 32-kilobit auxiliary computer memories, and high-resolution analog processors for telecommunications systems.

Charge-coupled devices move in on memories and analog signal processing

The structural simplicity of the charge-coupled device (CCD) lowers memory chip costs, while the analog nature of CCD operation is exploited in delay lines, filters, and multiplexers

by Laurence Altman, *Solid State Editor*

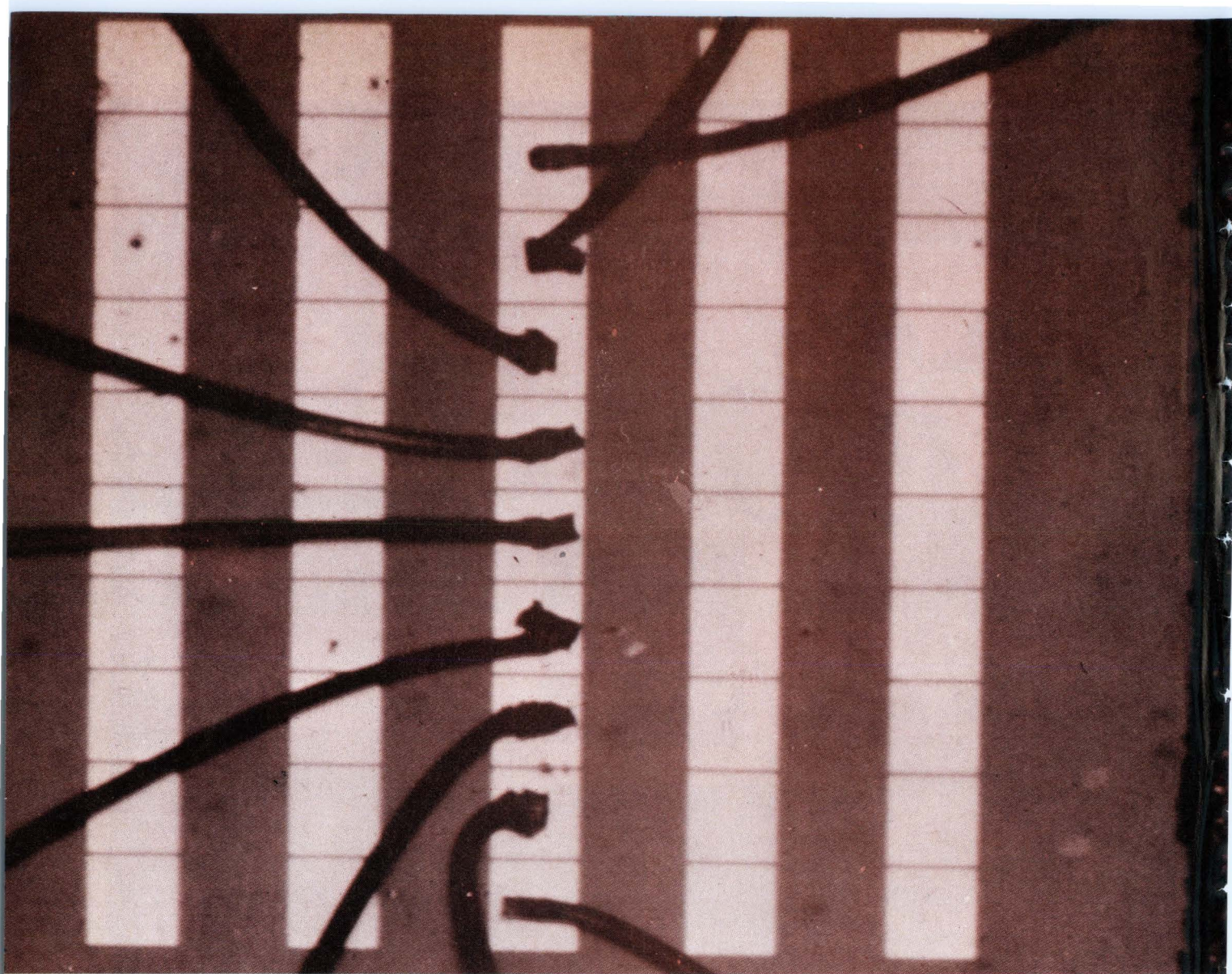

"What good is charge-coupled technology?" That question is often asked by systems engineers who've heard of charge-coupled devices only in the context of solid-state imaging. But while CCDs have undoubtedly enlarged the horizons of electro-optical equipment design, their effect on a wide range of data-processing systems—from mass memories in computers to signal-processing applications in complex communications systems—will be still more profound and far-reaching.

It's time to measure how far CCD technology has progressed in these other areas since its inception about four years ago. Then, it was hailed as a fundamental advance in metal-oxide semiconductor technology [*Electronics*, May 1970, p. 112]. Today, advanced analog-signal-processing and digital-memory designs have cleared the research laboratories and are entering that phase of intense engineering and manufacturing activity that precedes product introduction.

Stimulated by large military contracts, analog-signal-processing developments in CCDs have been spectacular, for the first time bringing the full impact of monolithic integrated-circuit technology to bear on sophisticated analog communications systems. CCD delay-line, multiplexing, and filtering components are by now operating in developmental systems, where they

provide such complex and vital signal-processing operations as matched filtering in spread-spectrum communication, bandpass and low-pass filtering, Hilbert and Fourier transforms for single-sideband modulation, complex coding for military communications, and adaptive equalization for modems.

But designers of commercial communications systems, too, are benefiting from charge-coupled technology. In filtering alone, CCD will bring an entirely novel simplicity to the building of time-delay and equalization networks for standard-band video communications. Some TV sets for the European PAL TV system already employ CCD delay lines, while U.S. television makers have developmental TVs with CCD delay lines in operation. Telephone transmission has an urgent need for bandwidth-compression components, and these are mostly easily implemented with CCDs. Bell Laboratories, whose scientists invented the CCD, as well as communications-systems manufacturers throughout the world, are all making intensive efforts to realize CCD versions of transmission-line equalization gear, video bandpass and delay compression components for high-density data and video phone transmission, in addition to tapped-delay-line CCD transversal filtering for secure digital signal processing.

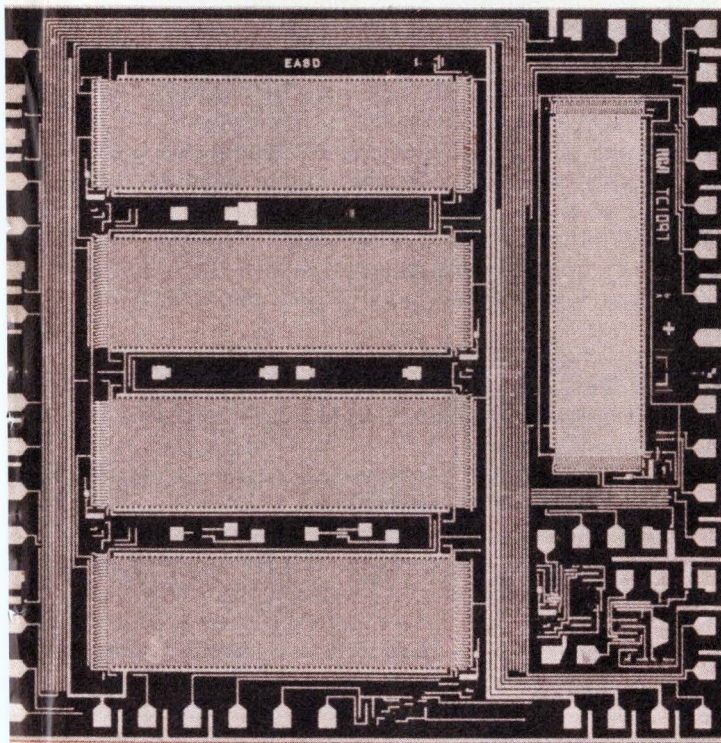
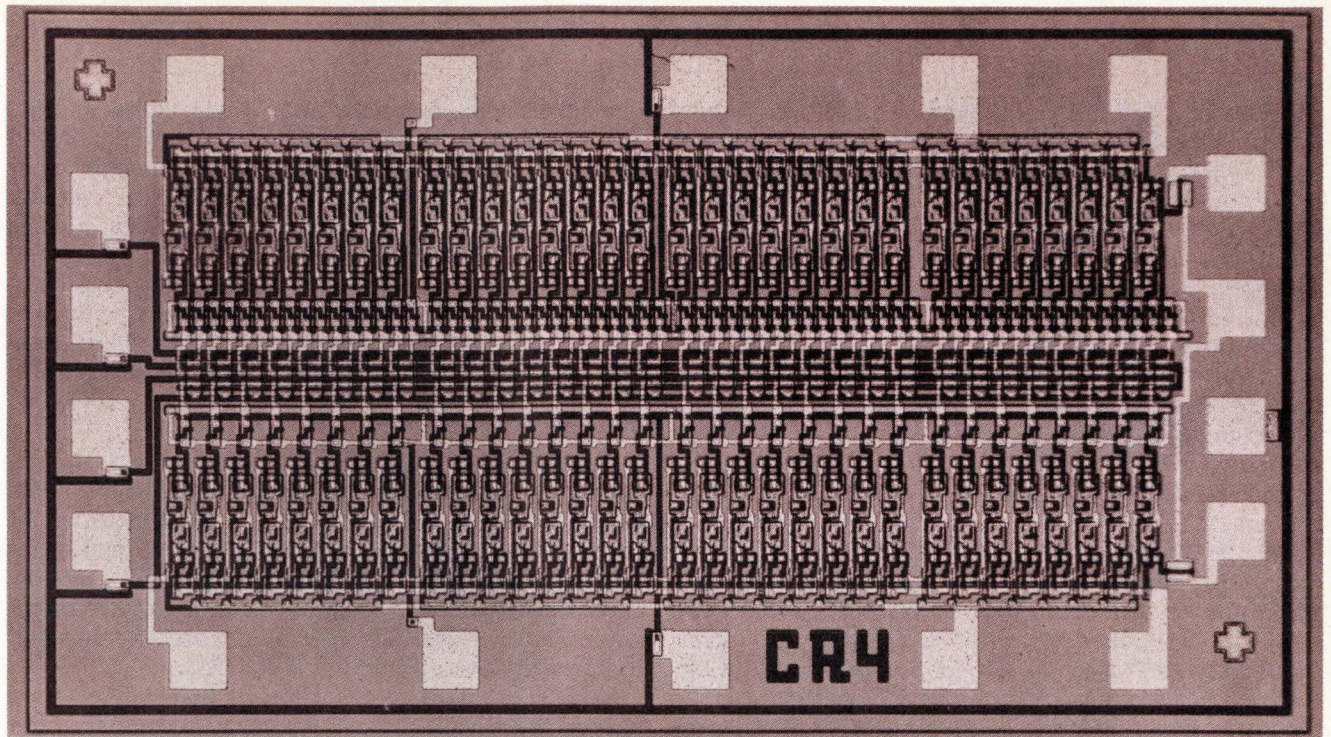

Then and now. From modest beginnings at Bell Labs four years ago—the first CCD structure, a $3\frac{1}{2}$ -bit shift register, is shown opposite—has sprung a powerful semiconductor technique that raises the performance levels of imaging, memory, and signal-processing semiconductor devices. The GE surface charge correlator for analog signal processing (above) contains 32 stages on a 115-by-66-mil chip. The developmental memory chip (left), built by RCA Laboratories, Princeton, contains over 5,000 bits of memory in a series-parallel-series format. Serial- and block-accessed auxiliary CCD memory chips with 16 and 32 kilobits, operating at better than 1 MHz, will be available by year end.

But perhaps most significant of all in their commercial implications are CCD memory systems. Here progress has been slower, mostly due to the already high level of bipolar and MOS memory technology and the fact that CCD memories, owing to their charge-transfer process, are basically serial (see "How charge-coupling works," p. 95). Nevertheless, CCD memories have been gaining momentum. From being designs on paper just two short years ago, today they are about to emerge as commercial products.

The first to arrive will be 16,000- to 32,000-bit serial CCD memory elements capable of operating at respectable 1- to 5-megahertz data rates. These serial memories are expected to grow to 64 and 128 kilobits on a chip in the next two years, at last ushering in the age of mass-memory chip technology.

More revolutionary will be the CCD versions of block-oriented disk-file and tape-type memories. Computer manufacturers are developing stacked CCD memory chips at the 10-megabyte level with data rates of 32 megabits per second and access times of 250 microseconds to a block of 256 words (or $512 \mu\text{s}$ to a word). Dissipating less than 3 microwatts of power per bit, these chips will radically change the way in which computer memories are made and used.

Mass memories and the CCD

The idea of a half-million-bit memory chip costing only thousandths of a cent per bit is heady stuff to computer-memory designers—but that's just the prospect offered by charge-coupled devices. This is shown in Fig. 1, which plots the speed-cost relationship of a variety of either available or developmental memories. So far as cost goes, CCD memories clearly will be well below the expensive, fast semiconductor random-access memories, which today cost between 0.3 and 1 cent per bit, and much closer to the very slow but very cheap magnetic disk and tape memories, which today sell for somewhere under 10 millicents per bit. A CCD memory can be designed in either a fast- or slow-access format to provide an access time ranging from 1 to 1,000 microseconds, at a cost of 10 to 50 millicents per bit, depending on the speed and bit density desired.

High bit density is the other characteristic that will give CCDs an important place in memory module design. The table on p. 95, which is based on CCD data supplied by TRW Systems Group, lists cell sizes and bit densities both for proposed CCD chips and for available MOS and bipolar memories. (The dimensions of CCD circuit features, like line widths, lengths and electrode gaps, used in this comparison are the same as those current in standard MOS memory production.)

The table shows that today's bipolar memory cell usually occupies 10 to 20 square mils, the equivalent MOS structure needs 5 mils², but in the highest-density CCD format envisioned, the memory bit takes up hardly more than 0.1 mil². (Such a chip is under development at, for example, TRW.) This figure translates into a density of better than six bits to the square mil, so that it should be possible to fit 128,000 bits on a standard 200-by-200-mil chip.

To cap it all, because CCD fabrication techniques re-

quire the fewest diffusions and contact holes through the oxide into the silicon substrate, basic processing will be easier and yields much higher than with either bipolar or MOS memories. This means that larger memory chips become feasible, pointing to 300-by-300-mil chips containing almost 400,000 bits of serial memory.

The conclusion is clear. CCD serial and block memories, with 10 to 100 times more memory per chip yet costing 10 to 100 times less than today's random-access memories, will become available in the next few years.

Who wants them?

The question is, who needs such a memory? The parameters seem formidable since no such memory exists today or was envisioned when today's generation of computers was designed, and it may at first be difficult to imagine how best to exploit it. Nevertheless, by now every major computer manufacturer has under intensive study what tradeoffs in computer architectures will be necessary to make best use of the CCD.

Some indications of the strategy that will be used have become available. In a typical 1974 computer, fast block-oriented memories store about two bytes for every one byte stored in the computer's main memory. For example, in a 15-megabyte computer hierarchy (120 megabits), about 10 megabytes are in block-oriented magnetic disk, accessible in 4 milliseconds and transferring data at 3 megabytes per second, while the remainder are in the computer's main memory (not counting what's on tape or stored in a vault.) There are also slow random-access block-oriented memories with two orders of magnitude larger capacity, one order of magnitude longer access, and maybe about half the transfer rate.

Clearly, the CCD will move in first on the fast block-orientations (the slow memories cost too little per bit to be threatened in the near future). In fact CCDs may well replace a major portion of this memory type—some say as much as 80%—leaving the present disk types to handle the slowest (millisecond) applications.

What's more, since CCD memories in the fast-access format are capable of speeds that fall just below those of present-day semiconductor memories, they may well prove able to handle some of today's typical RAM and ROM functions such as control stores, look-up tables, random logic functions, and the rest. This of course would require a new computer architecture to handle the CCDs' serial format, but the savings in cost and power have computer system analysts engaged in a thorough exploration of the idea.

Finally, there's the small to medium (1 megabit) memory application that does not require high speeds. Examples are microprocessor-control data stores, electronic switching systems in data communications networks, and medium-speed memories in smart terminals. At present, these functions are generally performed by a relatively high-priced semiconductor RAM or ROM that is too fast for the job, or by the often too slow but more economical magnetic core memory. Here, again, the CCD memory should find a warm welcome.

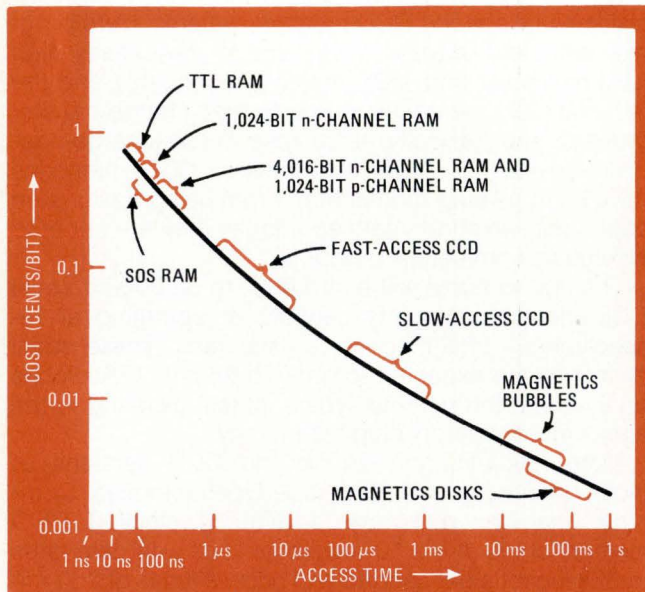

1. No more memory gap. CCD memories are destined to cover the range of medium-speed low-cost storage that falls between the fast but expensive random access memory and the cheap, slow magnetic disk. Bubble memories will impact low end of the range.

How charge-coupling works

The charge-coupling principle basic to CCDs is very simple. Carriers are stored in the inversion regions (or potential wells) under depletion-biased electrodes and moved from under one electrode to under the next by appropriate pulsing of the electrode potentials. The neighboring electrodes must be close enough to allow the potential wells under them to couple and the charges to move smoothly from one well to the next.

In imaging, charges are introduced into the device when light from a scene is focused onto the device's surface. As in all semiconductors, the absorption of light quanta creates hole-electron pairs which, under the influence of the potential beneath each storage electrode, are collected as a charge packet. The quantity of charge stored is proportional to the intensity of the image.

In this manner, a spatial charge representation of the scene is stored in the device. It is transferred off the device when clock voltages are applied to the electrodes, moving each charge packet serially from storage site to site until all charges reach the output diode.

In signal-processing and memory devices, the signal is not light-induced but is simply introduced into the device by a standard MOS element and then passed along by pulsing the appropriate electrodes sequentially. In conventional memory applications only a 1 and 0 threshold detection is required, but the analog-signal-processing devices must rely on the CCD structure's ability to pre-

serve the quantitative as well as the spatial characteristics of the charge packet. This makes a much bigger demand on the CCD processing technology, especially since there can never be 100% charge transfer efficiency between stages, and signals inevitably deteriorate.

Another problem, both for memory and signal-processing applications, is the junction leakage inherent in all CCD structures. This leakage, together with errors due to the trapping of surface charge, sets unavoidable limits to transfer speed and element density.

Devices are under development to keep both charge-transfer inefficiency and junction-leakage loss as low as possible. In the buried-channel transfer structures being developed at Fairchild, for instance, the charge actually moves along a shallow channel beneath the oxide, while RCA, IBM, and Bell Northern are working on structures that employ overlap silicon-gate mechanisms. All point to higher speed over greater numbers of charge-coupled elements.

FOR MORE READING

Begin with two early *Electronics* articles on CCDs, both by Laurence Altman, called "CCD techniques point to junctionless devices" (May 11, 1970, p.112) and "The new concept for memory and imaging: charge coupling" (June 21, 1971, p.50). Then go on to "Charge coupling improves its image, challenging video camera tubes," by M. F. Tompsett and colleagues (*Electronics*, Jan. 18, 1973, p.136). This year, CCDs for both memories and analog signal processing were the subject of Session 9 of the IEEE Intercon 74 Technical Papers, and in the National Computer Conference Proceedings, 1974, p.828, J. E. Carnes and W.F. Kosonocky describe "Charge-coupled Devices for Computer Memories."

The various memory organizations being considered for CCDs share a single goal—they all aim at exploiting the low-cost serial nature of charge-coupled technology while increasing its inherently slow access time.

According to researchers at RCA Laboratories, where a large memory program is under way, two of the most common types under evaluation throughout the industry are the serpentine loop structure (Fig. 2a), where bits of memory are passed along a winding series of memory loops, and the series-parallel (SPS) format (Fig. 2b), where data enters an input serial register and then is shifted in parallel to an output shift register. Each offers a different set of parameter tradeoffs.

With the serpentine type, the signal passes along a short segment of memory loop, is refreshed by a signal

regeneration stage at the end of the segment, and then moves on to the next segment. With charge-transfer techniques, the efficiency of transferring charge from one element to the next depends in part on the drive frequency. Since the number of elements in each segment of the serpentine system can be kept low, say, around 100, each bit will pass only 100 transfers before being refreshed, and transfer speed can be quite high.

Also, with charge-transfer inefficiency rates (the fraction of charge lost in one transfer) as low as 0.00009, it's possible to achieve bit rates as high as 20 megahertz, which results in an access time to any bit of about 10 μ s. This is the so-called fast-access CCD memory.

However, this respectable access time is attained only at the expense of increased chip complexity and in-

HOW MEMORY TECHNOLOGIES COMPARE FOR BIT DENSITY AND SPEED

Technology	Cell size (mil ²)	Bit density (bits/mil ²)	Number of kilobits per:		Relative maximum operating frequency (f _{max})*
			200-by-200-mil chip	300-by-300-mil chip	
Future high-density CCD	0.16	6.25	128	384	4
Serial CCD (parallel flow)	0.32	3.125	64	192	1
Serial CCD (serpentine flow)	0.64	1.56	32	96	1
MOS RAM (p-channel, n-channel, and silicon-on-sapphire)	1 - 6	1 - 0.15	4	16	10
Bipolar RAM (TTL and I ² L)	2 - 12	0.5 - 0.07	1	4	20

*Figures in this column express ratio of each technology's f_{max} to the serial CCD f_{max}

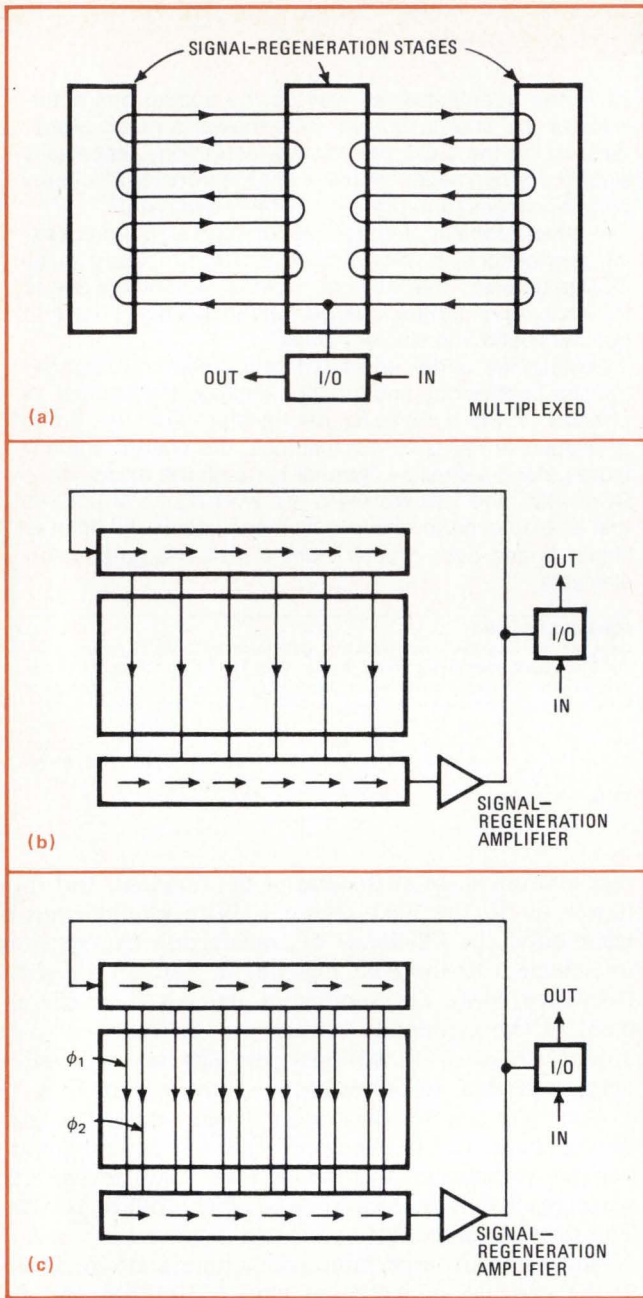

2. Layouts. The organization of a CCD memory is determined by the access time, operating speed, and bit density desired. The serpentine organization (a) is fast but requires more complex processing and more space. In RCA's slower but denser series-parallel-series arrangement (b), the bits travel in parallel between an input and output register. RCA's multiplexed setup (c) has greatest bit density.

creased power dissipation. The regeneration stage in each loop is composed of a standard MOS diffused detector and amplifier stage, and this in many cases may increase processing complexity enough to seriously offset a basic advantage of the CCD transfer process—a total lack of pn junctions. Space, too, is lost—it's estimated that the regenerating circuit may occupy as much as 25% of the total chip area. The implication is that the fast-access serpentine memory may be useful only in relatively small memory modules where microsecond access times are the major consideration.

Keeping power consumption down

The series-parallel-series structure being developed at RCA Laboratories takes the form of two serial and one large multichannel parallel shift register. The data stream is introduced serially into the upper high-speed input register and, once loaded, transferred in parallel into a slower middle register. All of the vertical parallel channels in the middle area are clocked together at a lower frequency. At the output, the process is reversed.

The power-saving feature of the series-parallel-series structure now becomes evident. Whereas in the serpentine scheme each bit passes through every storage site in one trip around the loop at the same frequency (which for good access time must be as high as possible), in the SPS system the bulk of the data transfer takes place in the lower-frequency central parallel register.

This lower frequency of operation means greatly reduced power consumption, a factor that grows steadily more important as more bits are packed on a single chip. It is estimated that the SPS type of memory structure can yield devices in the upper ranges of the CCD memory potential—in the region of 300,000 to 400,000 bits—while consuming little more energy than today's fast 1,024-bit semiconductor memory.

For even greater densities, the SPS system could be

3. Hardware. On Bell Northern's 4,096- and 8,192-bit CCD memories, this decode logic can handle 4- or 5-digit addresses. It reads out nondestructively, unless the input terminal is enabled. At right is 8,192-bit chip.

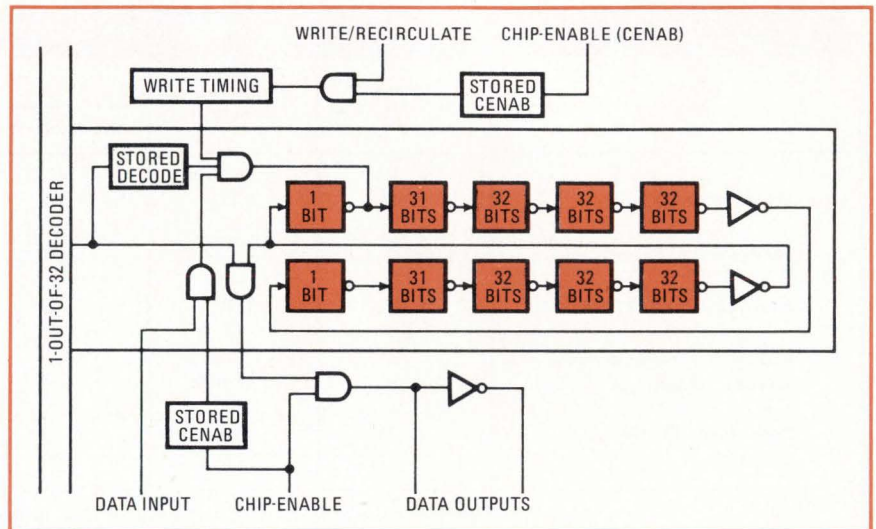
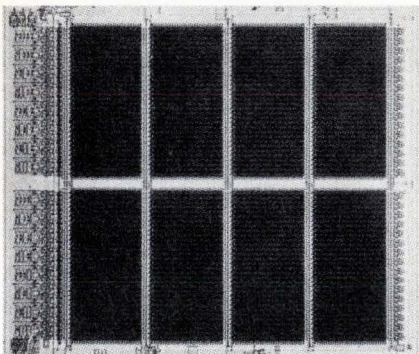

built with a vertical channel for each phase of the horizontal serial register, with every other vertical channel being loaded during alternate read-ins of the serial register (Fig. 2c). CCDs can be operated with two-, three- or four-phase clock action. For a two-phase system, the first horizontal line would be entered under phase-1 electrodes in the input registers (two elements are shown) and transferred into every other vertical channel. The second line would be entered under phase-2 electrodes and transferred into the remaining vertical channels. The full line would then be moved down one stage and the procedure repeated. This "interlace" mode would double the packing density possible with a standard SPS structure, which has only one vertical channel per horizontal stage.

Multiplexing techniques can also be used to maximize the high bit-packing potential of CCDs. In a conventional CCD shift register one bit of storage in a two-phase system requires two storage wells for each bit, and half the potential storage wells are unoccupied at all times. But all storage sites except one could be occupied if each site were provided with its own clock and, starting at the output, each bit were transferred sequentially into the empty slot. The empty slot would appear to move from the output toward the input.

Under development at Texas Instruments, this structure is called the electrode-per-bit or E/B scheme. A similar structure, called the multiplexed-electrode-per-bit, or ME/B, reduces the number of clocks needed (each vertical row requires a clock) and increases the data rate up to a respectable megabit level.

Fast- and slow-access CCD memories of various chip densities up to 32,000 bits have been developed by the laboratories of many companies, among them IBM, Fairchild, Intel, RCA, Bell Laboratories, Signetics, Honeywell, Bell Northern, Texas Instruments, and Philips. Typical examples are Bell Northern's 4,096-bit and 8,192-bit arrays, intended principally for computing systems requiring auxiliary memory with a data rate of 1 to 2MHz and a slow access time of about 100 μ s.

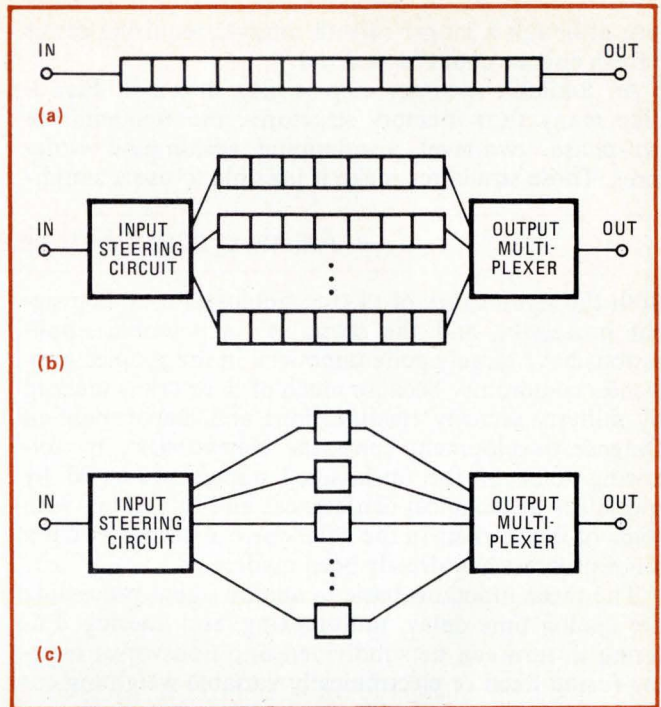

4. Signal processing variety. The simplest analog delay line (a) is a single line, where transfers are made serially from input to output. The parallel lines in (b) and (c) reduce dispersion with multiplexing techniques but require more complex structures.

This access time is obtained by organizing each array as a recirculating serial shift register that acts as if it were made up of 256-bit serial memory blocks. Random access to any track is provided by on-chip decoding of four- or five-digit addresses (Fig. 3). Data is read out nondestructively except while the input terminal is enabled, in which case each input bit replaces the bit that was read out during the previous clock period. End-of-row refresh amplifiers recirculate the data by driving return lines back to the input side of the array. In-row or end-of-row refresh is carried out after every 32 storage

The value of CCD memories

The main reason for all the interest in CCD memories is that they promise a lower cost per bit. Manufacturers expect to be able to maintain reasonable yields of CCD chips containing an unprecedented number of bits.

The CCD memory's increased storage capacity is due to two separate factors. First, it requires a smaller area for each bit. Second, the number of contact openings or diffusions is not large, simplifying processing to the point where it should produce acceptable yields on larger chips than can be used with conventional MOS LSI.

CCD memory cells are small because only a few MOS capacitors are required to store one bit. For example, if two-phase polysilicon-aluminum gate structures, such as those developed at RCA Laboratories, are used with standard layout rules (a 1.2-mil gap, 0.1-mil alignment and 1.0-mil-wide channels), each bit need occupy an area of only 1.2 mil². This is two to four times as good as in present dynamic MOS memories.

Moreover, even smaller cell areas are achievable. Assuming 0.5-mil-wide channels and line widths of 0.2 mil,

gaps of 0.2 mil and an alignment of 0.05 mil, bit areas can range between 0.3 and 0.8 mil², depending upon the technology used—an average of 0.5 mil²/bit is achievable with at least four different CCD technologies.

These predictions all assume conventional photolithographic processing, which is the factor that limits cell size. However, even smaller CCD cells appear capable of operating without signal-to-noise ratios being reduced beyond the point of practical operation. Consequently, the exploitation of high-resolution electron-beam definition in CCD fabrication appears likely.

The feasibility of going to larger chip sizes because of simpler CCD processing is difficult to assess. At present, CCD memories can probably be manufactured for about 0.01¢/bit. To achieve 0.001¢/bit or less, the full potential of CCD memories for high packing density and large chips must be demonstrated and combined with high yield. The goal is a chip approaching 500 mils on a side and containing almost half a million bits, and an industry-wide effort is being directed to this end.

bits, although a longer refresh interval requiring fewer refresh circuits could be realized.

An 8-kilobit memory chip is also shown in Fig. 3. Like many CCD memory structures, the elements are two-phase, two-level, overlapping silicon-gate structures. These structures make it possible to use a simpli-

fied electrode layout that automatically transfers charge in one direction and eliminates the need for special implanted devices to provide the required directionality. The active area per bit is typically 1.4 mil², and most important, the decoding adds only about 8% to the total chip area.

Analog signal processing and the CCD

Both the significance of CCD technology for analog signal processing and the scope of its potential applications have largely gone unnoticed in the general electronics community because much of the work is masked by military security classifications and Department of Defense development contracts. Nevertheless, by following some of the unclassified papers presented by specialists at technical conferences and by talking with some of the workers in the field, one can glimpse what a lot of progress has already been made.

The three functions basic to analog signal processing are analog time delay, multiplexing, and filtering. Filtering in turn can be subdivided into transversal filtering (using fixed or electronically variable weighting coefficients) and recursive filtering.

Perhaps most interesting to the nonmilitary communications engineer is the work done with simple time delay—a function that is found throughout commercial telecommunications and video broadcast equipment.

The most straightforward configuration for realizing analog time delay is the single CCD delay line (Fig. 4a). Here, a series of CCD transfer elements is put down on a silicon substrate between an input and an output MOS-diffusion stage. The analog signal enters the device, is transferred from element to element, and is taken out at the end of the line. If there were no loss in the transfer process, the output signal would be an exact replica of the input signal.

The time delay is simply the time taken by the signal to travel between two elements multiplied by the number of elements. But the time between elements is proportional to the clock frequency used to drive the CCD delay line. It follows immediately that the delay for a line with a fixed number of elements depends solely on the clock frequency.

This is one beauty of CCD delay lines. No other technology can provide a delay ranging across several octaves, from microseconds to milliseconds, in such a simple manner.

Another asset is the ease with which a CCD tapped delay line can be built. It's done by adding a conventional MOS pn junction alongside any designated CCD element or elements in the line, so that the charge can be sensed at any desired place along the line and at as many places as desired. Signals can then be pulled out at any specified point along the line, processed, compared to other independent signals or to signals tapped off further down the line, fed back into the line or other lines, multiplexed, added, subtracted, and manipulated in various manners, while all the time maintaining their analog nature (assuming no dispersive loss) at time intervals that are simply controlled by a clock frequency. In fact, this relatively uncomplicated structure, with taps of fixed or variable weights, forms the basic build-

ing block for the other two fundamental analog-signal-processing functions, too.

There are, however, practical problems. For one thing, the transfer process between CCD elements is not completely lossless, although the transfer inefficiency between adjacent elements can be as low as one part in 10,000. However, because analog signals are involved and delay lines are long, the errors accumulate and even the lowest transfer inefficiency will result in dispersive losses which limit performance.

Compensating for loss

To be more explicit, a dispersive loss in a CCD occurs when charge is lost during a one transfer and shows up at a later transfer, adding to or subtracting from the signal in such a way as to cause errors in both its magnitude and time interval. This loss adds up at each transfer stage and can be considerable over a long, many-element delay line.

Researchers, such as Dennis Buss and Walt Bailey at TI, who are well advanced in understanding how CCDs handle analog signal processing, have studied the dispersive losses characteristic of various device structures. They say that the dispersion due to imperfect charge transfer can be reduced by using a multiplexed CCD configuration (Fig. 4b). In this configuration several shift registers operate in parallel, and the total delay is divided among them. Adjacent segments of the signal are multiplexed in turn onto the various parallel lines by an input steering circuit and then collected in turn at the output demultiplexer circuit.

The dispersion is reduced significantly because now each part of the signal travels over a shorter delay line and consequently makes fewer transfers. On the other hand, the demultiplexing and multiplexing circuitry adds complexity and, perhaps more serious, the leakage and gain must be very nearly identical in each of the parallel channels, or else a periodic fixed pattern of noise will result that cannot be filtered.

The logical step is to take the parallel sequence to its extreme by having each parallel channel contain only a single stage of delay (Fig. 4c). This makes charge-transfer loss of no practical consequence because only one low-loss transfer occurs with any signal pass. The problem here is that charge leakage from the CCD electrodes themselves limits the achievable time delay to less than 10 milliseconds—if the delay time is longer, too much charge leaks off. Consequently, the desired large number (say, 10⁶) of parallel single-element delays requires an unreasonably ambitious transfer frequency (say, greater than 100 megahertz).

The effects that leakage current has on limiting frequency of operation and on signal dispersion are not the same for all delay-line configurations. In the serial

CCD format of Fig. 4a, each charge packet spends an equal amount of time in each storage location, so that the leakage charge appearing at the output is the exact average of the leakage contribution from each cell. This means the leakage charge as a function of time is uniform and can be eliminated by adding an ac coupling circuit at the output—a fortunate circumstance that makes the serial CCD delay line tolerant of large leakage-current values before the dynamic range begins to degrade.

In the parallel arrays of Figs. 4b and c, however, the leakage current is different for every storage location and gives rise to fixed-pattern noise that cannot be filtered. In these configurations, even small leakage values have serious dynamic-range limitations. For instance, a 60-decibel dynamic range requires charge leakage to be kept below $10^{-3}n$.

Multiplexing with CCDs

A CCD analog multiplexer consists of an array of parallel delay lines, into which information is loaded from a number of parallel inputs and from which the data is then shifted out in serial form. A demultiplexer can be constructed by the reverse procedure. Such a multiplexing scheme would be good at providing video delay for TV receivers (required for Europe's PAL system), video frame storage for scan conversion, and beam steering for commercial sonar systems.

In military applications, CCDs are especially useful for multiplexing detector arrays in radar receivers, for a couple of reasons. First, they can operate with very low signal levels, owing to the sensitivity that can be achieved with CCD amplifier techniques. Second, they can be operated at low temperatures, where, because of decreased charge mobility, the leakage problem is minimized and the dynamic range maximized. Moreover, the cost, power, size, weight, and reliability of CCD demultiplexers will give them significant advantages over the conventional digital implementations of radar-range gate filters that use TTL circuits.

Still in the developmental stage, CCD multiplexer/demultiplexer devices suffer from two problems unique to the technology: charge-transfer loss introduces crosstalk between adjacent input/output channels, and nonuniformities in the gain or offset level of the input/output amplifier give rise to fixed-pattern noise, which limits the dynamic range.

A solution to the first problem is to insert one or more isolation elements between the information storage elements. This step reduces crosstalk to a second- or higher-order effect.

Fixed-pattern noise, however, is a more bothersome problem, particularly when the low-signal levels often encountered in radar must be multiplexed. Nevertheless, input techniques (which are still classified) have been devised that are independent of variations in the MOS threshold voltage of the output amplifier and therefore provide stable, uniform operation with acceptably low fixed-pattern noise.

A CCD transversal filter operates by sampling each node voltage in a CCD delay line, multiplying each of these samples by the weighting coefficient on its tap, and summing the results. Thus, enormously compli-

cated analog transform functions like the Hilbert and Fourier transforms can be implemented in real time with a relatively simple structure.

A transversal filter

One such filter is shown schematically in Fig. 5. This device has fixed weighting coefficients, and the circuitry for performing the sampling, weighting, and summing functions is integrated with the CCD in a single integrated-circuit chip. The weight of each tap is determined at the factory mask stage—each electrode in the metalization layer is given a particular conductivity profile by having its size and shape adjusted appropriately. The code or impulse response is determined by the same photo-mask.

The advantage of fixed weighting is that it requires a less complicated IC structure than any of the variable-weighting schemes so far proposed. Its disadvantage is that each filtering application requires a custom mask design. A corollary is that changes in tap weights cannot be made in the field to conform to changes in a particular application.

Obviously, fixed-tap-weight filters will be practical only when volume is high enough. They should therefore show up in such applications as matched filtering in communications systems (in other words, spread-spectrum communication), pulse compression of radar signals, discrete Fourier transforms for bandwidth compression, target recognition, radar pulsed-doppler processing, and bandpass filtering.

The attraction of the filter with fixed weighting coefficients, in contrast with conventional digital filters, lies in its ability to process extremely complex signals despite a relatively simple structure. The filter in Fig. 5, for instance, is made up of n parallel CCD transversal filters and is not much more complex than the basic CCD. In the near future the fixed-weighting-coefficient CCD filter will surely become a standard component in analog microprocessor design—and so cheap and small a component, too, that it will open up new applications in areas where transversal filtering is not now feasible.

A cost comparison

Just how cost-effective CCD filtering techniques can be when compared to conventional digital techniques can best be realized by analysing a typical filtering function. Take, for instance, a 100-point convolution fil-

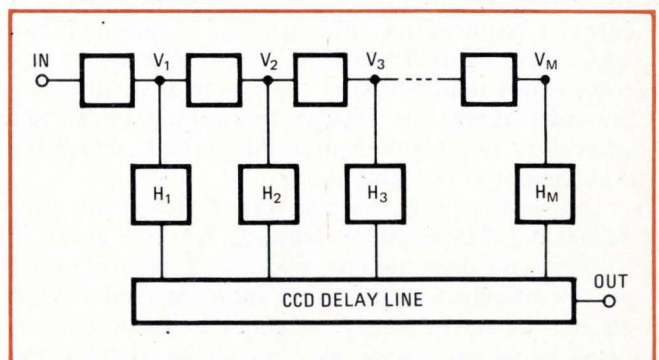

5. Transversal filtering. CCD transversal filters have taps with weighted coefficients corresponding to the character of the analog signal. In TI's filter, the weight of each tap (H_i) is fixed into the mask.

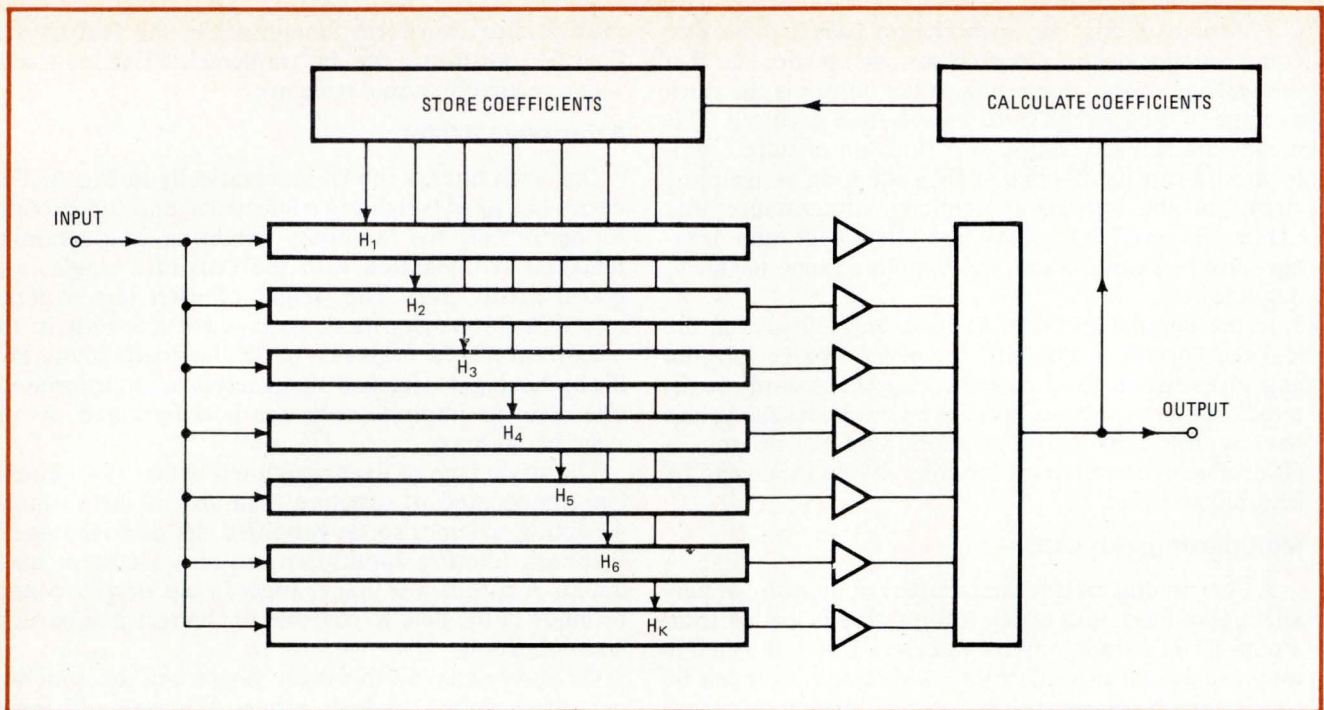

6. Programmable. For adaptive filtering, electrically programmable CCD delay lines can be built with their weighting tailored for a particular or changing code. MNOS transistors can be used to weight the taps, or the programmability can be built into the CCD structure itself.

ter with a dynamic 80-dB range requiring 8-bit resolution. Further assume that an analog signal must be sampled at 100 kHz, filtered, and then presented at the output in analog form.

According to TI estimates, when this filtering operation is implemented with TTL, the cost and power consumption are determined primarily by the 8-bit a-d converter (\$2,000 and 5 watt) and the digital filter (\$2,000 and 4 w, or approximately 400 TTL networks costing \$5 each and dissipating 100 mw apiece).

In costing comparable CCD implementation, volume is an important factor. For, whereas the digital filter can be implemented with standard catalog items, the CCD is a custom IC whose unit cost varies inversely with the number of units required. A reasonable basis for estimating the CCD's price is to assume \$8,000 basic cost plus \$5 per copy. Then the price per copy (P) for a given number of units required (N) works out at:

$$P = \$5 + (\$8 \times 10^4)/N$$

If $N = 80,000$, then $P = \$6$. Along with the CCD, circuitry is required for clock drivers, output amplifiers, and output sample-and-hold. The total cost for these parts is less than \$50, and the power dissipation is on the order of 600 mw. (Integration of these circuit functions is in development and will further reduce both cost and power consumption.)

To summarize, the digital version of the filter costs \$4,000 and dissipate 45 w, whereas the CCD version will cost \$56 and dissipate only 600 mw. True, this may be an oversimplification of a real situation—and the situation is already heavily weighted in favor of CCDs, being based upon a simple convolution filtering operation for which CCDs are ideally suited. Nevertheless, it does illustrate the saving in cost and power which is such an attractive feature of charge-coupled devices.

While fixed-weighting-coefficient filters are useful for many signal-processing applications, there are many others where it is desirable to tailor the weighting functions to a particular code. An example is the adaptive matched filtering setup shown in Fig. 6.

The electrically programmable CCD filter

Two variable-weight tap methods appear most promising: the nitride MOS weighting method being developed by workers at Westinghouse Space and Defense Laboratory, and the charge-transfer "sloshing" techniques being developed at General Electric's Technology Center.

The Westinghouse approach is simple enough in concept. MNOS transistors are built alongside the CCD delay line at the points to be tapped, and the conductivity of each tap is adjusted by changing the charge stored on the nitride transistor.

Essentially, the weighting is accomplished by electrically programing the threshold voltage of the MNOS transistor to correspond to the quantity of charge to be drawn off at each CCD tap. This is done by altering the MNOS conductance in a closed feedback loop. The approach makes nondestructive sensing and electrical reprogramming of the device possible.

In the GE method, only normal CCD processing is required. The variable weighting is achieved by allowing the charge in each packet under the tapped CCD element to slosh back and forth between the electrode pair comprising the element. The sloshing frequency determines the transfer efficiency between the pairs and hence the amount of charge that is detected at each element. Therefore, tap weights in this structure depend solely on the frequency of operation, and binary values of 0 and 1 are readily obtained.

The basic GE structure is shown schematically in Fig.

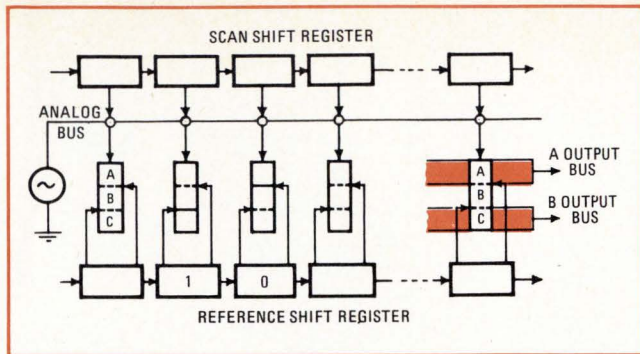

7. Sloshing charge. In GE's method of tap-weight control, charge in a pair of elements is moved back and forth so that the output signal is proportional to the total charge moved.

7. The key idea is that the direction of charge transfer can be controlled electrically. A single analog-signal bus serves all of the charge-transfer elements in the system, and the insertion of charge from this bus into the storage regions is controlled by a shift register. Thus, whenever a single binary 1 is sent down the register, charge packets representing successive time samples of the signal are inserted into adjacent storage elements.

Charge in a paired storage element is moved back and forth within it by three electrodes, which also serve all the other storage cells in the system. As in serial transfer structures, the loading of the drivers for these electrodes produces an output signal proportional to the total charge being moved.

Multiplication of the signal charges by a binary tap weight is achieved by selectively controlling the direction of the transfer in each of the cells. What happens is that transfer gates either block or permit the flow of charge between the center and the outer regions of the individual cell.

To implement variable-weight tap applications like adaptive transversal filtering, a precession of the signal versus the tap weights is necessary and is accomplished by moving the binary control signals in a second reference shift register. Note that if both of these shift registers are fed back to their respective inputs so that the scan bit and the reference word continuously recirculate, the structure will function in precisely the same way as a serial-transfer transversal filter.

While the GE structure performs the convolution of the analog signal against only a binary-valued tap-weight function, the resolution of the reference signal (tap-weight function) could easily be increased by adding extra channels for extra binary bits, say GE researchers Jerry Tiemann, Bill Engeler, and Dick Baertsch. The outputs of these separate channels would be weighted to correspond to the weight of their respective digits and summed externally to form the desired output signal.

Since these signals are regenerated to fixed levels at each stage, they are not subject to degradation. Since only digital samples are passed between chips, it is possible to cascade any number of modules without degrading the accuracy of the signals. And since the charges representing the analog signal move back and forth within a single region, charge-transfer losses are not cumulative.

The programability of the GE device is immensely

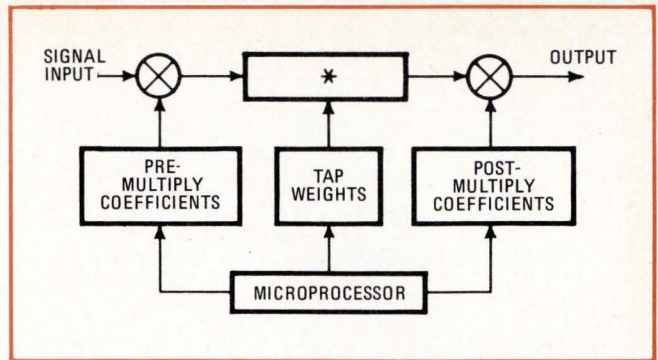

8. Fourier transforms. CCDs can handle complex bandwidth reduction for video image transmission needing Fourier-transformed data. This GE system could be controlled by a microprocessor.

valuable in the design stages of a new signal-processing system. It permits implementation to begin before procurement of special devices, and it provides a flexibility that would otherwise be prohibitively expensive.

It is also useful in systems where a number of different processes must be performed on an input signal. This is the case in adaptive systems, where the results of a previous process determine the parameters of subsequent actions, and it is also the case in secure systems, where the coding applied to a channel changes from time to time.

Finally, programability, combined with the ability to store the signal for times longer than the processing delay, make the charge-sloshing approach suitable for character-recognition systems or in beam forming, where a large number of different linear processes are sequentially performed on each input signal.

In applications like ultrasonic imaging, where reverberations from previous pulses can confuse the signals, programability again can help. In these cases, different orthogonal pn sequences can be used to encode successive pulses so the reverberations from one pulse have essentially no effect on later ones.

Other uses

In addition to the matched-filter applications, spectrum analysis yields another group of linear-signal-processing applications. Though many of them are now being done digitally with the complicated FFT, the algorithm is often performing only simple convolutions. In these cases, a variable-weight-tap CCD would be more efficient.

Other, more complex, applications for CCDs include bandwidth reduction for video image transmission, when the desired output is the Fourier transform of the data. The architecture required for the implementation of this Fourier transform function is shown in Fig. 8, where a microprocessor is included to control the system. The implication is that much more complicated algorithms could be implemented if a repertoire of processes were available in the form of prestored tap functions, the means for selecting one of them, and the means for deciding which process is appropriate. Additionally, in cases such as character recognition, where a decision tree is involved, it is much easier to implement the decisions in a programming language than to do so in hardwired logic. □

McMOS is the MSI supply...with

Logic functions with three-state outputs have achieved popularity because they permit multiplexing schemes which use a single element to drive a common bus line, while disabling all other drivers on that line.

Because the need is there, Motorola's MC14500 Series MSI offers more CMOS three-state logic functions, covering a wider range of system requirements, than you can find anywhere else.

From the beginning, Motorola's commitment has been to build the most useful CMOS logic family in the industry, based on the needs of the systems being designed for the marketplace. And, as the opportunity for new standard three-state functions arises, we will add them to the line. Several are in planning or under consideration at this time.

The broad McMOS* line does offer more, and not only in three-state. MSI functions serve logic system needs with shift registers, timers, counters, decoders, latches, buffers, data routers, arithmetic functions,

and analog multiplexers. There are ROMs and RAMs, and specialized functions such as the dual schmitt trigger, priority encoder, and parity tree. Since the world still needs simple gates and flip flops, the McMOS line includes them, too.

were reduced significantly in May, with the biggest savings showing up on the MC14500 MSI Series. Naturally, the three-state logic types featured here are included. Don't take our word for it, though. Ask someone who's tried us recently.

McMOS Three-State Logic Functions

MC14502	Strobed Hex Inverter/Buffer
MC14506	Dual Expandable AND-OR-INVERT Gate
MC14508	Dual 4-Bit Latch
MC14512	8-Channel Data Selector
MC14534	Real Time 5-Decade Counter
MC14580	4 X 4 Multiport Register
MC14583	Dual Schmitt Trigger
MC14034	8-Bit Universal Bus Register

McMOS RAMs With Three-State Outputs

MCM14505	64-Bit Random Access Read-Write Memory
MCM14537	256-Bit Static Random Access Memory

Excellent availability... and the lowest prices ever

Availability is now excellent across the entire line, including the broad range of MC14500 Series MSI functions. Many types are available off-the-shelf, and we are quoting short 6 week delivery on most others. That's CMOS availability! And don't forget, McMOS prices

For applications information on three-state CMOS, respond to Motorola Semiconductor Products Inc., P. O. Box 20912, Phoenix, AZ 85036, or circle the reader service number. We'll send you AN715, "Introduction to CMOS Integrated Circuits With Three-State Outputs," and a McMOS selector guide for reference.



more three-state CMOS.

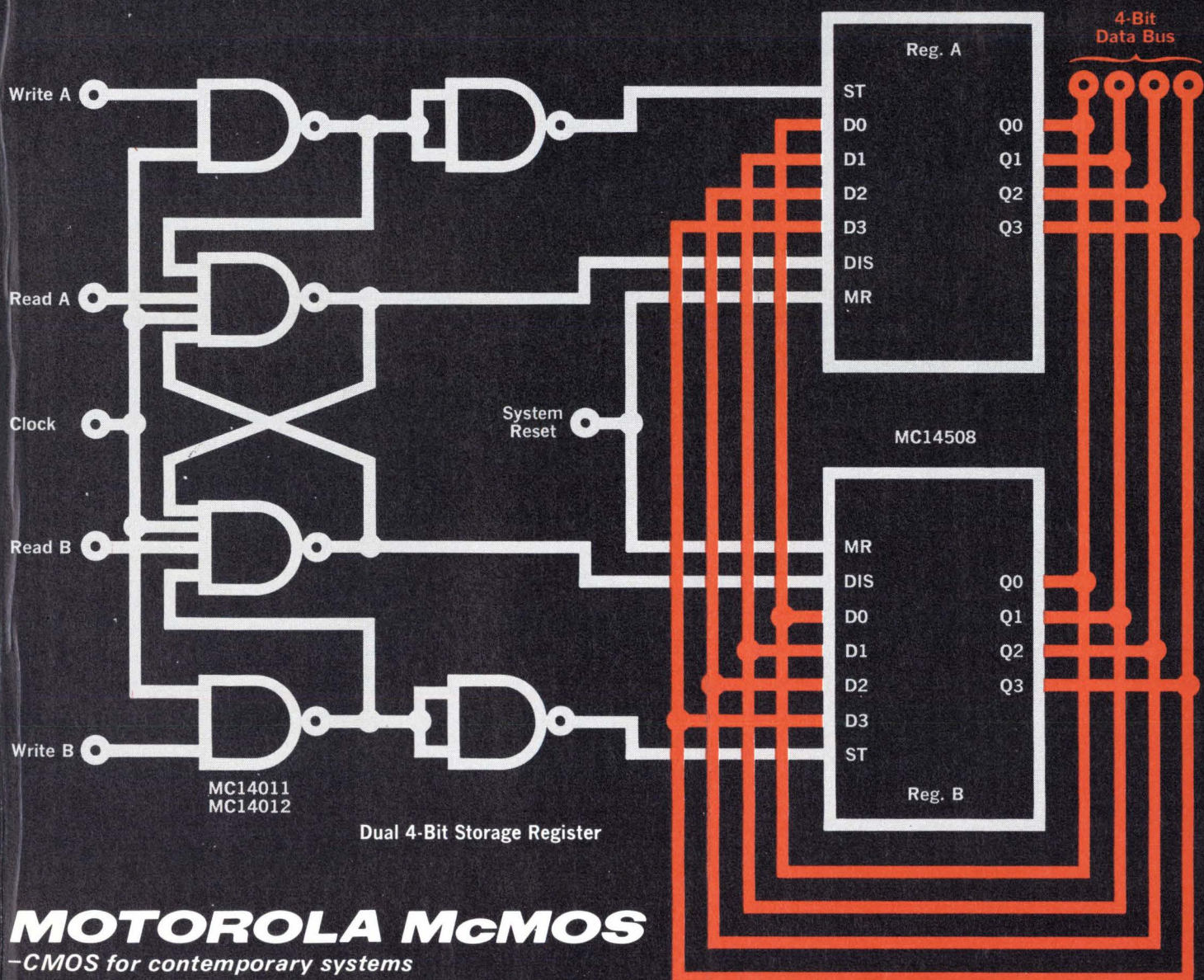

MOTOROLA McMOS
-CMOS for contemporary systems

Full-wave rectifier needs only three matched resistors

by Jerald Graeme
Burr-Brown Research Corp., Tucson, Ariz.

Precision rectifiers or absolute-value circuits will accurately rectify even a millivolt-level signal for applications requiring precise magnitude detection. But because of their low input resistance, most of these circuits require many resistors to be matched. With the precision rectifier drawn in the figure, however, a high input impedance can be achieved without the addition of a buffer amplifier—and only three resistors have to be matched.

In an absolute-value conversion, the input signal is converted from a bipolar form to a unipolar form, a standard requirement for magnitude detection in many average-reading measuring instruments. There are several absolute-value circuits that can be built with an operational amplifier to obtain the desired high accuracy for full-wave rectification.

In these circuits, rectification is carried out without sacrificing a significant portion of the input signal to forward-bias the rectifying diodes. These diodes are placed in the op-amp's feedback loop so that the high gain of the op amp reduces signal loss. This means that only very small signal changes are needed to drive the diodes into and out of conduction, and millivolt-level signals can be rectified.

Most precision rectifier circuits have a low input impedance, which is set by input summing resistors, so that a buffer amplifier must often be added. However, the need for an additional op amp is avoided by the circuit shown because its input impedance is the common-mode input impedance of an op amp, and the usual in-

put summing resistors are eliminated. This results in a typical input resistance either of 25 megohms for an op amp having a bipolar-transistor input or of 10^{12} ohms for an op amp having a FET input.

Full-wave rectification is produced by diode switching that reverses the polarity of the net circuit gain when the polarity of the input signal reverses. The polarity of the output signal is therefore prevented from changing. This feature, coupled with the circuit's equal-gain magnitude for input signals of either polarity, results in an absolute-value conversion.

Gain polarity is switched by the diodes as they alternate the connection of the output of amplifier A_1 between the two inputs of amplifier A_2 . Positive input signals cause the output of A_1 to become positive, reverse-biasing diode D_1 and forward-biasing diode D_2 . Since the output of A_1 is now connected to the noninverting input of A_2 , amplifier A_2 provides a gain having a positive polarity.

Gain magnitude is controlled by three feedback resistors that are designated as multiples of R_1 in the diagram. Feedback forces the output of amplifier A_2 to the level that develops a voltage equal to E_i across the $R_1(n+1)/(n-1)$ resistor. For the positive-signal case, the associated gain (E_o/E_i) is n . Since both amplifiers are connected in a common feedback loop for the positive-signal mode, additional phase compensation may be required with the capacitor shown.

Negative input signals are amplified by a gain of opposite polarity. They cause the output of amplifier A_1 to swing negative, forward-biasing diode D_1 and reverse-biasing diode D_2 . Now amplifier A_1 drives the inverting, rather than the noninverting, input of amplifier A_2 . Because the noninverting input of A_2 is connected to ground through resistor R_2 , A_2 acts as an inverting amplifier, providing a negative gain for the signal supplied by A_1 .

With its feedback shorted by diode D_1 , amplifier A_1 performs as a voltage follower, supplying inverting am-

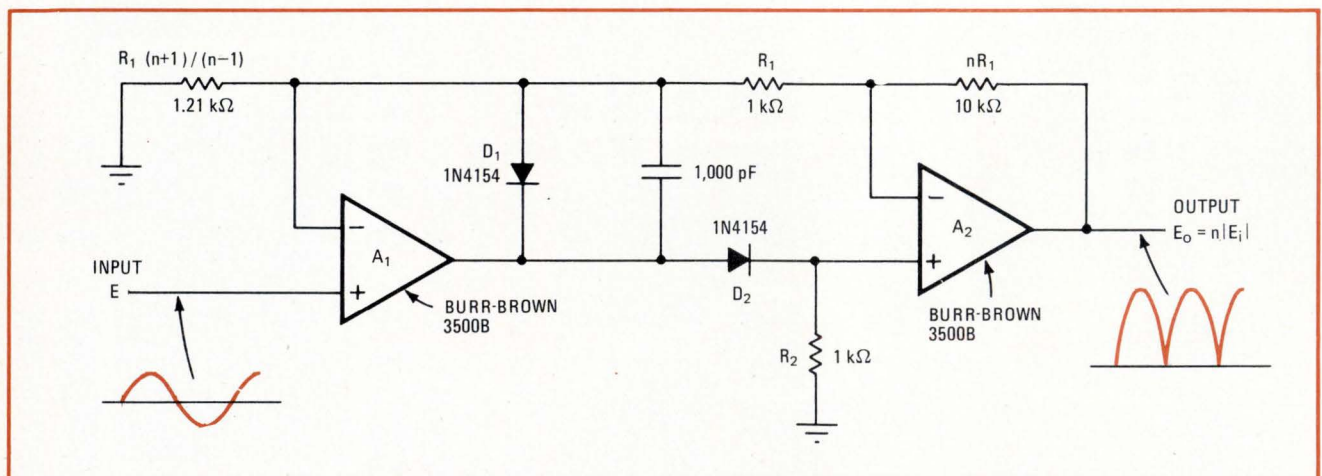

Improved rectifier circuit. High-accuracy full-wave rectifier requires matching only three resistors. The circuit has a high input impedance, without an extra buffer amplifier, because the common-mode input impedance of amplifier A_1 faces the circuit's input. For positive signals, amplifier A_2 is noninverting so that circuit gain is $+n$. For negative signals, A_2 becomes inverting, and circuit gain is $-n$.

plifier A_2 with a signal that equals input voltage E_1 . The over-all circuit gain is now $-n$. Circuit gain, therefore, is switched from $+n$ for positive signals to $-n$ for negative signals.

The performance of the circuit is limited by a number of factors, including resistor matching, as well as the amplifiers' input offset voltages, input bias currents, fastest slewing rates, and maximum gains.

The input offset voltages and input bias currents introduce a deadband around zero, in addition to an output offset. These two errors are removed by first nulling the offset voltage of amplifier A_1 to eliminate the deadband, and then nulling the offset voltage of amplifier A_2 to get rid of the output offset. Because of the interaction of these two nulls, this procedure must generally be repeated. The slewing rate and gain of amplifier A_1 and the diode capacitances also create a deadband around zero that limits the upper rectification frequency.

Any deviation from the resistor-matching ratios indi-

cated here will produce a gain error that, in some cases, will make the gain magnitudes different for the two input signal polarities. This gain error can be removed by first adjusting the circuit's gain for negative signals through trimming resistor R_1 or resistor nR_1 . Circuit gain for positive signals can then be matched to the negative-signal gain by adjusting resistor $R_1(n+1)/(n-1)$. Prior to these gain trims, it may be necessary to null out any existing deadband error since this error can also produce unequal outputs for equal positive and negative input signals.

With the component values shown, the circuit can accept a maximum input voltage of 2 V peak-to-peak and produce a maximum output voltage of 10 V. Circuit gain is 10. □

BIBLIOGRAPHY

- J. Graeme, "Applications of Operational Amplifiers—Third Generation Techniques," McGraw-Hill, 1973.
 G. Tobey, J. Graeme, L. Huelsman, "Operational Amplifiers—Design and Applications," McGraw-Hill, 1971.

Providing a decimal output for a calculator chip

by Jack Lambert

Lambert Associates, Lexington, Mass.

Calculator chips, which are becoming readily available, can be used to advantage in applications other than

pocket calculators. However, these chips usually have an output that drives a multiplexed seven-segment display. This is not really convenient for performing subsequent operations or even for interfacing with Nixie-type readouts.

With the circuit shown here, the output of a calculator chip can be converted to the more convenient decimal form. If desired, this decimal output can also be converted, for example, to a binary-coded-decimal form. A calculator chip having a decimal output can be used as an input to another calculator, to operate a

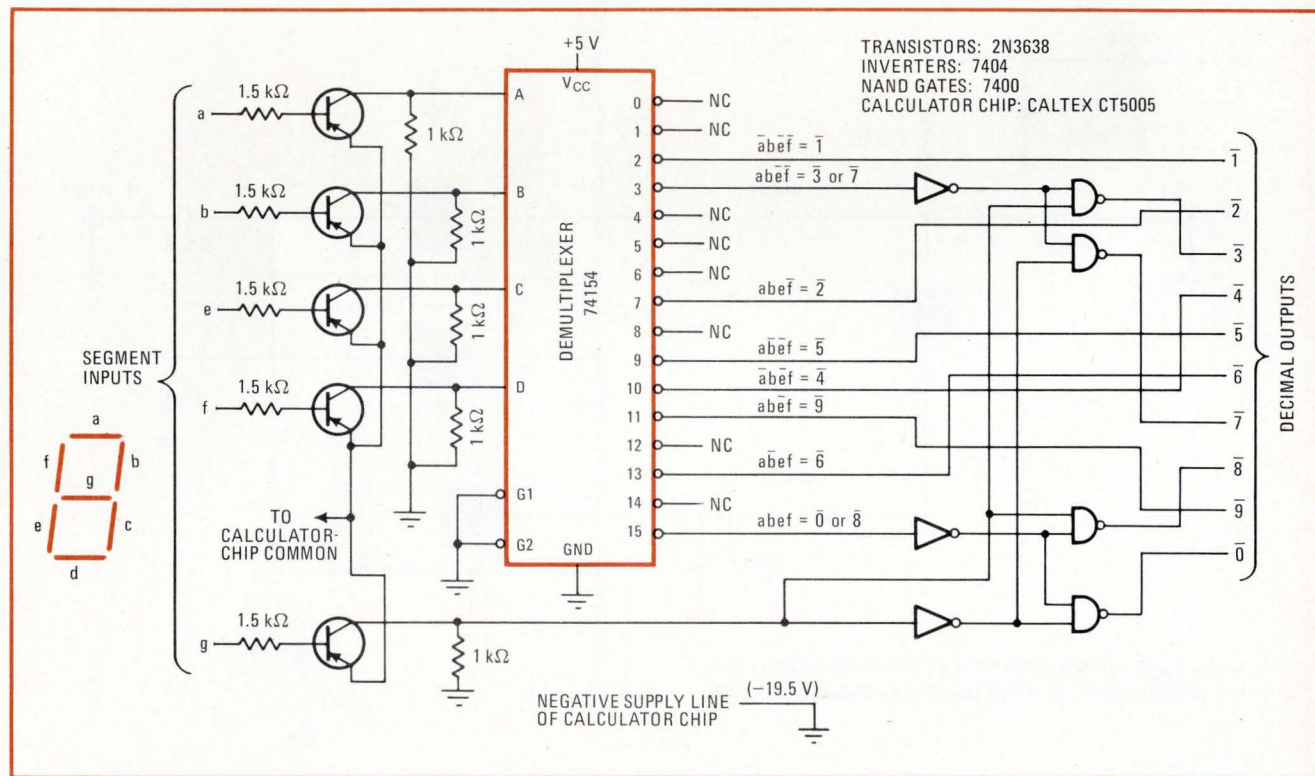

More applications. Decoder circuit converts the seven-segment-display outputs of a calculator chip to decimal form, greatly increasing the application versatility of the chip. All 10 of the decimal outputs can be derived from only five of the segment inputs. The same power supply is used for both the chip and the decoder's TTL circuitry. The chip's negative supply line acts as ground for the TTL supply.

large dot-matrix display, to feed a printer, or to drive a digital controller or computer.

Although the conversion circuit is not necessarily the simplest logic scheme, it is easy to set up and to wire. Only three TTL IC packages are required—they are a four-line-to-16-line demultiplexer, a hex inverter, and a quad two-input NAND gate.

The lower-case letters in the diagram correspond to the display segments used to set up the logic for the conversion circuit. Only five of the seven possible segment inputs are needed to develop all of the decimal outputs; the other two segments are redundant. The seven-segment logic inputs are high, while the decimal outputs are low. The gate inputs (G1 and G2) to the demultiplexer may be used if desired, otherwise they should be tied low, as shown.

This particular conversion circuit is intended for the

Caltex type CT5005 calculator chip. A separate 5-volt supply is used for the TTL ICs, but the negative line (-19.5 V) of the chip supply is made the ground line of the TTL supply. This allows a single supply, one having the proper dropping resistors and regulation, to be used for both the chip and the conversion circuit.

The discrete transistors serve as a simple interface between the chip and TTL devices. This means that the display outputs of the chip can directly drive the conversion circuit. Of course, a chip other than the type CT5005 device may require other interfacing.

The use of the type 74154 demultiplexer results in a certain amount of redundancy in the circuit's decoding process. However, the demultiplexer does keep the wiring simple, and it also conserves board space without increasing parts cost significantly. The entire circuit costs about \$3.50 to build. □

Broadband p-i-n attenuator has wide input dynamic range

by Roland J. Turner
American Electronic Labs, Colmar, Pa.

A low-loss broadband attenuator that is built with p-i-n diodes offers an exceptionally flat response over a wide input dynamic range. The circuit, which employs the p-i-n diodes in a π configuration, is useful for automatic-gain-control applications over the frequency range of 50 to 300 megahertz. Its response remains flat to within ± 0.10 decibel over the full 11-dB input control range. Insertion loss is less than 0.50 dB, and the input/output return loss exceeds 20 dB over the entire op-

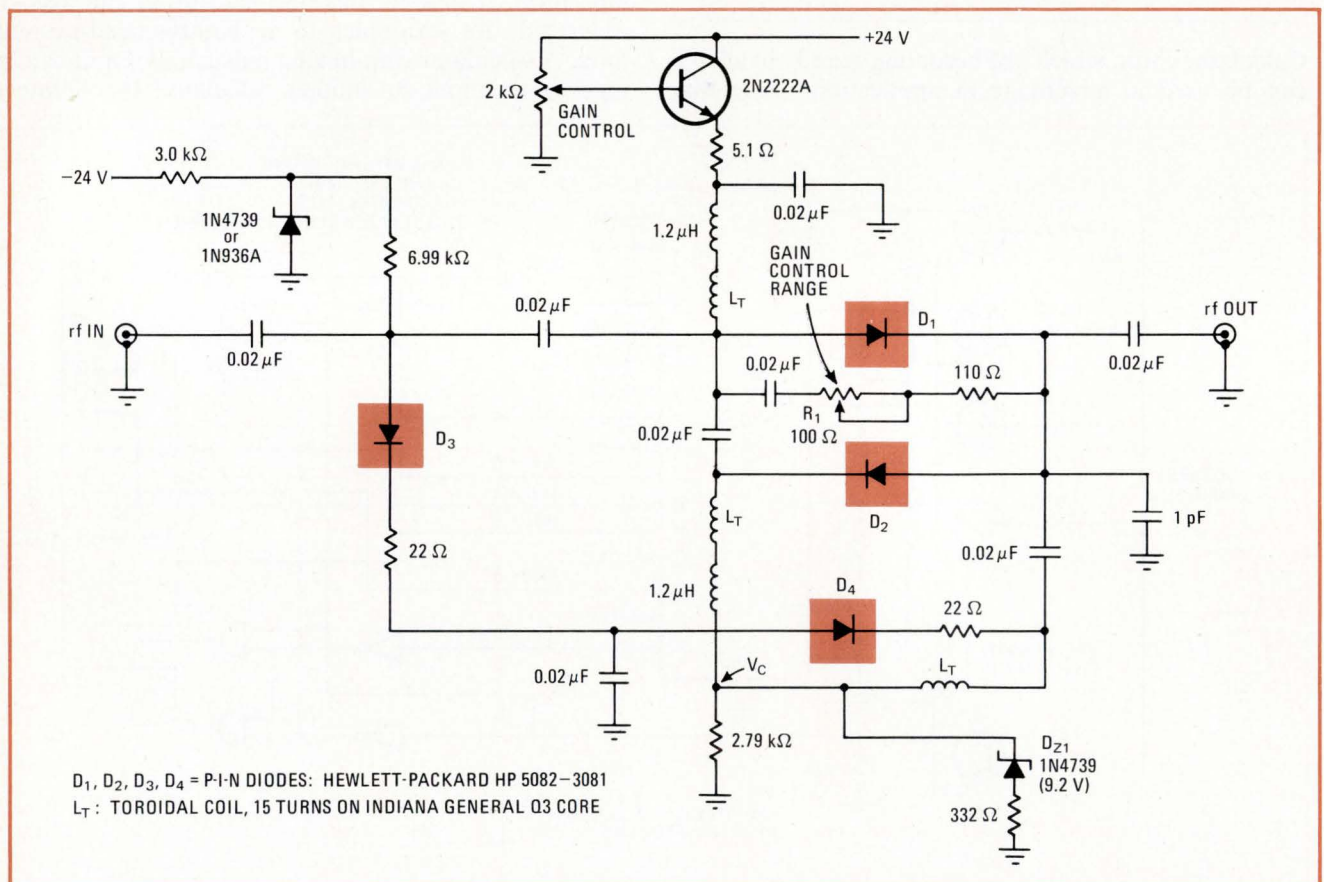

High performer. This rf attenuator provides exceptional response flatness over a wide input dynamic range from 50 to 300 megahertz. High-quality p-i-n diodes connected in a π configuration minimize the circuit's intermodulation distortion. Diodes D₁ and D₂ form the series arm of the π network, while diodes D₃ and D₄ form the shunt arm. Graphs 1 and 2 show the attenuator's primary characteristics.

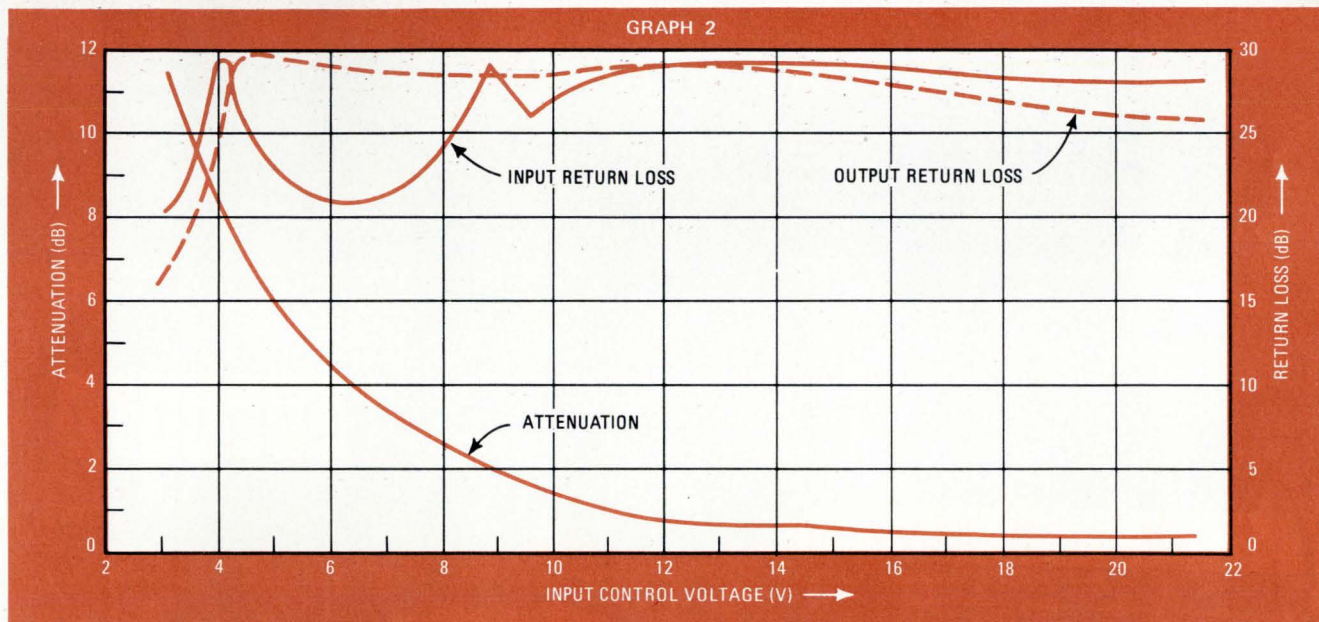
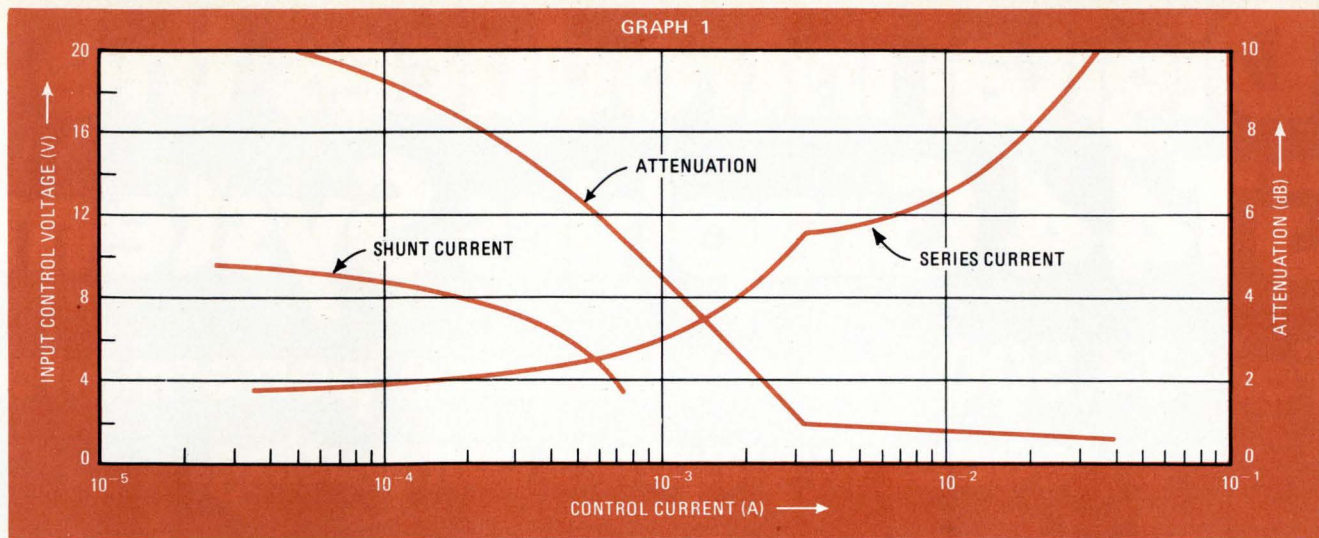

erating frequency range and gain-control range.

A π configuration, as opposed to a bridged-T network, is used here because of its superior performance. The π attenuator requires less current-drive shaping, and it reduces the effect of parasitic inductances on input/output return losses, since stabilizing resistors can be used in its shunt arm. The bridged-T attenuator, on the other hand, requires low resistance values in its shunt arm so that stabilizing resistors cannot be used. Therefore, the input return loss and response flatness of the bridged-T attenuator are seriously affected by reactive current at high attenuation levels.

The high-performance π attenuator shown in the figure uses p-i-n diodes that exhibit very low intermodulation distortion across the circuit's full operating band. P-i-n diodes D_1 and D_2 form the series arm of the π -configuration attenuator—they are connected in parallel for signal transfer and in series for the control bias.

When low attenuator loss is desired (for control voltages of more than 10 v), zener diode D_{Z1} conducts and forces the series control bias current to exceed 35 milliamperes. For an attenuation level of greater than

1.5 dB, D_{Z1} is nonconducting, and the series control current in diodes D_1 and D_2 is less than 5 mA. Series resistor R_1 is used to set the gain control range between 8 and 13 dB.

The attenuator's control circuit is quite simple. The control bias voltage, V_C , which governs the turn-on of shunt diodes D_3 and D_4 , is determined by the amount of series control current that flows. Consequently, when the series control current decreases, the shunt control current automatically increases.

Graph 1 shows the series and shunt control currents, as well as the attenuation level, produced at various input control voltages. The gain-control characteristic and the input/output return loss generated by this current profile are plotted in Graph 2.

The operating frequency range of the attenuator is limited by the p-i-n diodes used. With the ones called for here, the attenuator should provide similar performance characteristics down to 5 MHz. □

Designer's casebook is a regular feature in Electronics. We invite readers to submit original and unpublished circuit ideas and solutions to design problems. Explain briefly but thoroughly the circuit's operating principle and purpose. We'll pay \$50 for each item published.

Digital introduces the GT44 Graphics System.

For \$34,500 you get the price/performance leader in graphics computing.

There's nothing comparable for the price.

Complete with hardware and software. Including our advanced 16-bit PDP-11/40 CPU, 16K words of 980 nano-second internal memory, two 1.2-million word removable cartridge disks, new 17-inch CRT display, display processor (complete with character and vector generation) and light pen, Digital's own 30 cps console

terminal, and our graphics-supported disk operating system with BASIC.

And it's a totally flexible system. Add peripherals. Develop new software using the CRT. Monitor and direct experiments, design interactively. In fact, do any of the things you wanted a graphic computer capability for and couldn't afford till now. But don't take our word. Come to

Digital and see for yourself. Draw your own conclusions.

Contact your local Digital office, or write: Digital Equipment Corporation, Maynard, Mass. 01754. European headquarters: 81 route de l'Aire, 1211 Geneva 26. Digital Equipment of Canada Ltd., P.O. Box 11500, Ottawa, Ontario K2H 8K8.

digital



PLAs enhance digital processor speed and cut component count

Programed logic arrays, which are simplified read-only memories, offer benefits of microprogramming, but avoid some of its pitfalls; the advantage comes through programming addresses as well as data

by George Reyling, *National Semiconductor Corp., Santa Clara, Calif.*

□ Engineers faced with the problem of designing digital processors and control units may use programed logic arrays, or PLAs, to get faster operation than is feasible with large-scale MOS integrated circuits, while at the same time reducing the component count below that of traditional random logic. A PLA is a read-only memory with programmable addresses; when used in place of a conventional ROM, it provides the major advantages of microprogramming while avoiding many of its problems.

Several vendors offer PLA products now or are expected to offer them soon. These products suggest several applications in computer design. PLAs have been used in microprogramed microprocessors and single-chip calculators made with MOS technology, where space is at a premium and the number of functions is limited. In the same way, TTL microprogramed processors may also benefit from PLAs.

And, in addition to their potential use as control memories, one of the most straightforward applications of PLAs is in address transformation in conventional control memories. They may also be used with registers directly in peripheral-device controllers to implement the flow charts of state diagrams. This reduces design time and permits fewer errors.

Other applications include code converters, implementing decision tables, and, where only one task is required for any given set of input conditions, a single PLA may be used as a condition-driven lookup table or code converter, giving the address of the program to be executed directly.

The anatomy of the PLA

Like a conventional read-only memory, a PLA is a matrix of crosspoints; a mask superimposed on the matrix during its manufacture establishes connections at some crosspoints and leaves other crosspoints open. Each connection is usually a transistor or a diode, so that energy can flow in only one direction through the connection, eliminating spurious "sneak paths" through the array.

The matrix of a PLA is divided into two parts (Fig. 1). In the first part, input signals (and their complements, usually internally generated) are selectively connected to product-term lines in such a way that certain combinations of inputs produce a logically true signal on one or more of the product-term lines. These lines are inputs

to the second part of the matrix, where other selective connections transfer the true state from each product-term line to one or more output lines.

In fact, the only difference between the PLA and the ROM is that, in the ROM, *all* combinations of inputs cause an output to appear—whereas in a PLA some combinations may have no effect, and some groups of combinations may be indistinguishable, as described later.

Effectively, the second part of the matrix is pro-

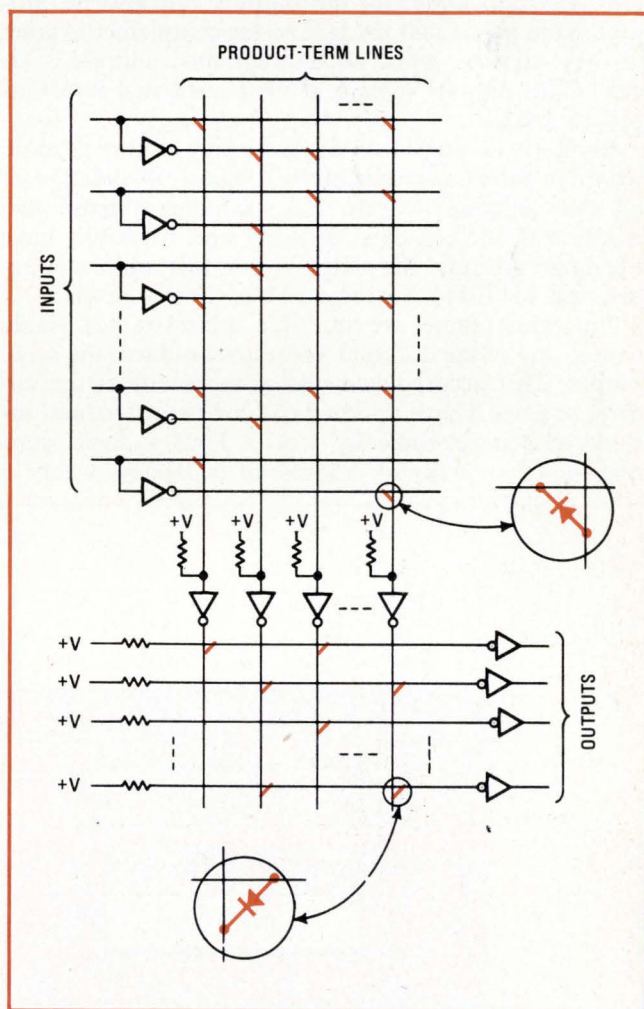

1. **Programed logic array.** Like a ROM, a PLA is a matrix, but addresses are programmed, as well as data. Using optional bits in an address permits two or more addresses to point to one word.

Don't be confused

Programmable logic arrays now offer many advantages in microprogramming digital processors and control units. But storing a microprogram in a PLA is not the same as using a PLA as a collection of programmable AND and OR gates to construct a random-logic controller. The latter is a valid alternative to the use of read-only memories as truth tables, and it may be a quicker way to complete a design. The use of both ROMs and PLAs in random-logic design is already well documented.

gramed at the time of manufacture with the PLA's data, while the first part contains its programmed addresses, also specified during manufacture. Because the addresses are programmed, the PLA can cope with certain special address conditions more easily than a ROM can. These special cases include unprogrammed addresses, single addresses for multiple words, and multiple addresses for single words.

An unprogrammed address input doesn't read any word of the PLA, so that all bits of the output, in general, remain at 0. (In some PLAs, such as National's parts DM7575 and DM7576, the outputs can also be programmed to give either the true or the complement value; in these devices, when an unprogrammed address is received, all outputs remain at their unexcited levels, as programmed.)

Similarly, a single address can apply to two or more words in the PLA, producing the logical OR function of all the addressed words. For example, suppose two words with the contents 01010011 and 10100101, have the same address; the output when this address is received is 11110111, the logical OR of the two words.

But when there are multiple addresses for single words, any of the different addresses produces the same output. This occurs when one or more bits of the address of a word have optional or "don't-care" values; instead of being specifically 1 or 0. Thus a single word may be given a binary address of 00010 $\phi\phi\phi$, where ϕ

represents an optional value; this word appears at the PLA output when any address in the decimal range 16 through 23 inclusive (binary 00010000 through 00010111) is sent to the PLA input.

Optional values are supplied to the address of a word in the PLA simply by leaving both the true and complement input lines unconnected to the product-term lines in the address part of the PLA matrix. The ϕ symbol is used because it resembles a 1 superimposed on a 0.

This use of optional address bits is the basis of the PLA's advantage over the ROM, which requires exhaustive decoding to achieve the same results. For the three special cases mentioned, the ROM must respond to every address. It must produce an all-0s word for a meaningless address, corresponding to the PLA's unprogrammed address; a word specifically programmed with the logical OR of two or more other words, corresponding to the single address for multiple words; and separate identical words for nearly identical addresses, which can't contain optional bits.

Furthermore, the PLA can implement several simple functions by using only part of the structure for each function; or complex functions can be implemented by connecting several PLAs in series or parallel.

Microprogrammed processors

Most microprogrammed computers and processors have two levels of programming: the microinstruction level and the external instruction level. External instructions are stored in the main memory (Fig. 2), and microinstructions, which direct the basic functions of the processor, are stored in the control memory.

Microprograms may be "horizontal," that is, have instructions with many bits that individually control all parts of a processor in a single cycle at relatively high speed; or they may be "vertical," with fewer bits encoded in groups to specify different kinds of processor controls, requiring several cycles per instruction. Vertical microprograms run more slowly, but they are easier to write and to modify.

Control memories are often implemented with read-only memories; but in some instances, a read-only

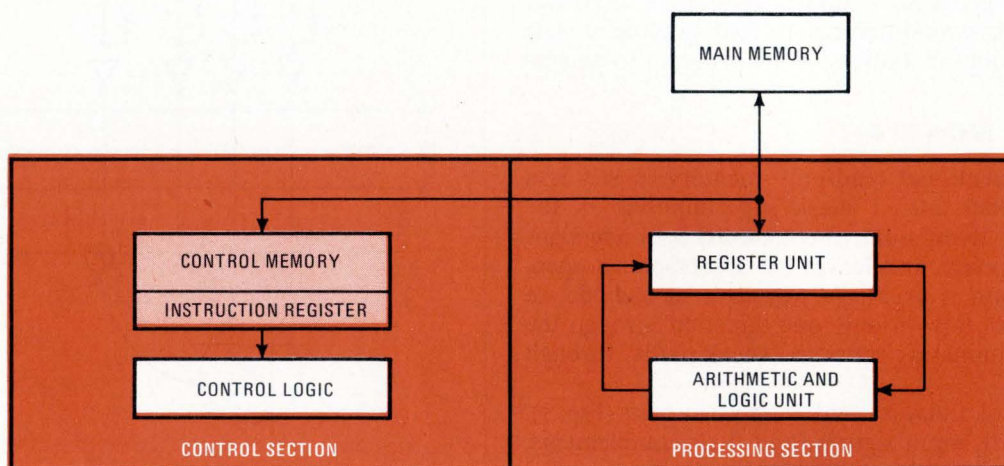

2. Microinstruction control. Basically, the operation code of an instruction in the user's program (external) is interpreted as an address specifying, in the microprogram (internal), the beginning of the routine that executes the external instruction.

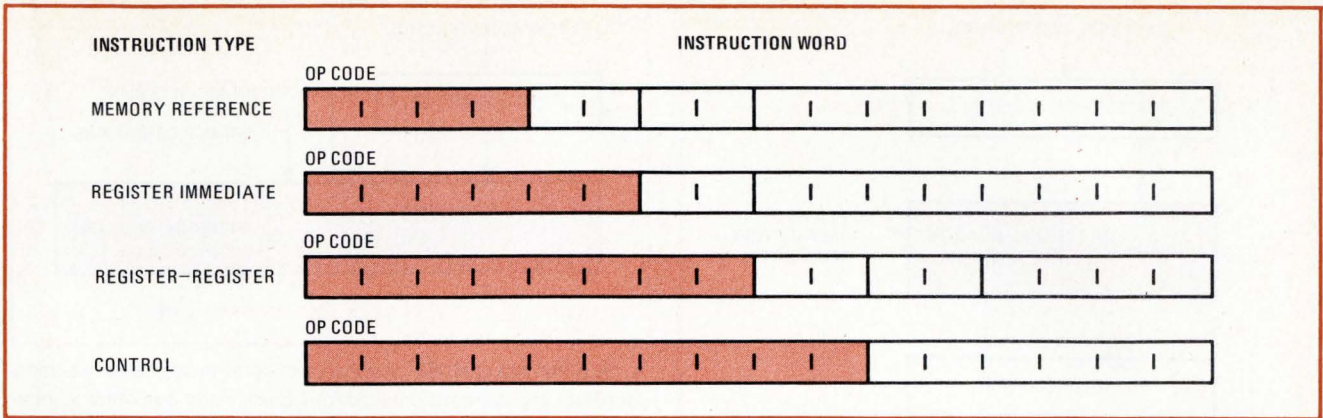

3. Complicating factor. Long operation codes (color) at user's level may address nonexistent control-store locations. Short ones may not address all of a store. Other instruction-word parts (black) specify such locations as main-memory address and internal register.

memory requires more complex control logic that can be simplified with a PLA. The need for address transformation in control memories is also shown by a consideration of how the microprogram is brought into the operation of the processor.

Problems with variable formats

The microprogram is a collection of microroutines, each one a series of microinstructions corresponding to a particular external instruction. For example, the microroutine for a REGISTER ADD instruction would obtain data from two appropriate registers, route them through the adder, and store the result in a designated register.

The address of the microroutine in the control memory is, most simply, the operation code of the external instruction. The code is interpreted as an address after the entire instruction is fetched from main memory and placed in the instruction register by a separate microroutine. As such, it points only to the first word of the microroutine; successive words, if any, are taken in the proper order as the microroutine is executed, under direction either of external logic or of certain bits fed back from the control memory output.

But this simple approach presents a considerable problem when the operation code for various instructions in a particular processor are of different lengths. Some of them may have more bits than are necessary to address the control store—which implies that some operation codes, interpreted as binary addresses, may point to nonexistent control locations.

Choice, not coercion

For example, consider the instruction format for a hypothetical but typical computer using 16-bit instructions (Fig. 3). The operation code varies from 4 to 10 bits in length. The control store may contain only a few hundred words, but the 10-bit operation code can address a maximum of 1,024 locations. Thus it should not specify the address of the microroutine directly because the address would sometimes exceed the storage capacity. Furthermore, even if the control store contains more than 1,024 words, the microprogrammer should have the choice of starting addresses for his microroutines, rather than having them specified directly by the operation code, so that he can avoid awkward problems that can

arise, for example, from almost identical operation codes.

Suppose the ADD and SUBTRACT codes are almost identical. This is not unreasonable because both call for two operands to be put through the adder, and they differ only in that one of the operands in SUBTRACT is complemented (all 1s replaced by 0s and vice versa) before adding. Both operations, therefore, would be controlled by almost identical microroutines, and their operation codes might differ in only one bit. If that bit is in or near the least-significant-bit position of the code (the right end), the two microroutines would begin in consecutive or nearby locations in the control store, and they may therefore overlap. On the other hand, if the bit that distinguishes ADD from SUBTRACT is in or near the most-significant-bit position of the operation (the left end) the two microroutines would begin in locations far removed from one another in the control store, and may overlap wholly unrelated microroutines.

Thus, an arbitrary operation code should be transformed into a convenient control store address (Fig. 4). Past designs have performed this function with logic

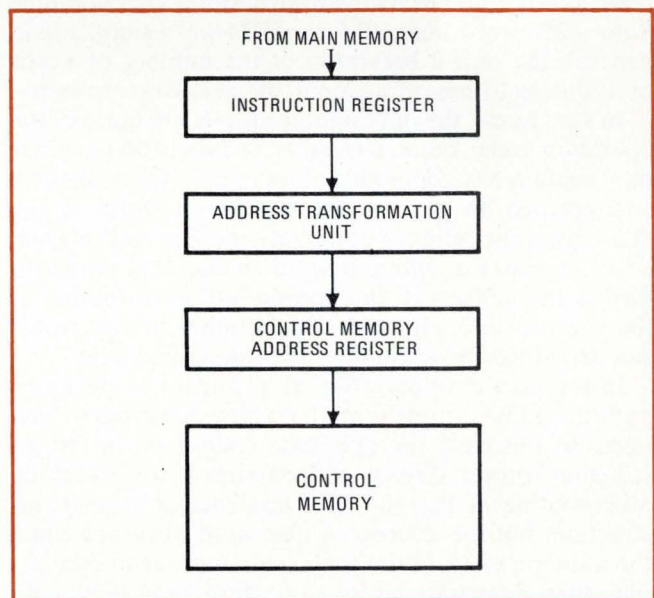

4. Address transformation. Having operation code generate a control store address overcomes difficulties of addressing the store directly and permits efficient microprogram organization.

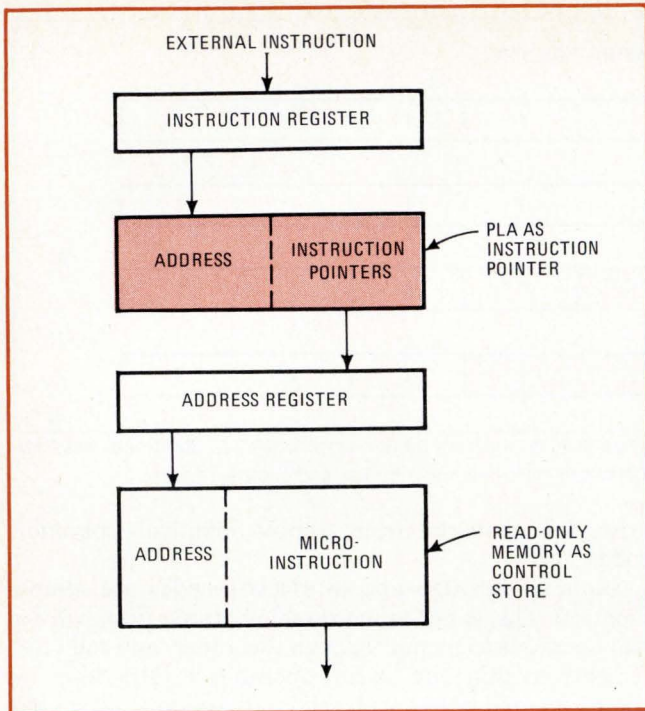

5. PLA plus ROM. Simplest address-transformation technique uses PLA in path between instruction register and conventional ROM. Longest operation code defines number of PLA inputs.

gates and multiplexers, but the choice of operation codes and starting addresses has been limited by the need to minimize the logic complexity.

Alternatively, the address transformation may be implemented with a PLA in any of three ways, shown by the following examples:

The first case (Fig. 5) combines a PLA for address transformation with a conventional read-only memory for a microprogram. The number of PLA-address inputs equals the number of bits in the longest operation code, while the number of PLA outputs equals the number of address bits required by the control store. This would be 8 for a 256-word store, 10 for a 1,024-word store, and in general, the base-2 logarithm of the number of words or, if the logarithm is fractional, the next larger integer.

In PLA access, the only significant bits are those of the operation code; other bits that the instruction register may contain have optional values of ϕ , so far as the PLA is concerned. In general, the number of words in the PLA equals the number of operation codes so that each code addresses a different word of the PLA, which in turn is the address of the appropriate microroutine in the control store. However, this number of PLA words can be reduced by techniques to be described later.

In the next example, (Fig. 6), a single PLA performs both the address-transformation and control-store functions. In this case, the operation code, held in the instruction register, directly addresses the first word of the microroutine in the PLA that implements a given instruction, but the address of that word need not equal the numeric value of the code. This approach takes less time than a separate address-transformation step, as in the previous example.

A significant advantage of this PLA application is that it can eliminate explicit testing for microinstruction

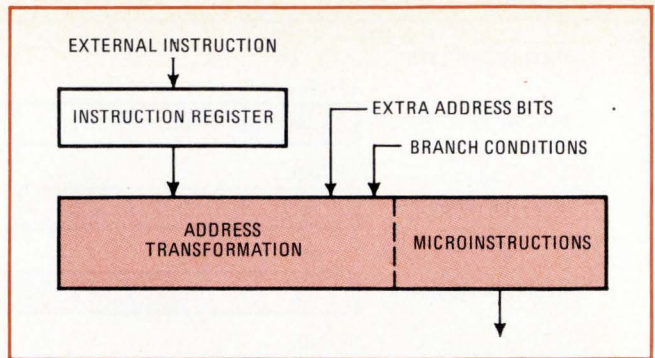

6. PLA instead of ROM. One PLA can perform both address-transformation and control-store functions quickly and can react to interrupts directly. But, since it has many inputs, it is quite large.

branching by using the conditions that might be tested as address inputs to the PLA instead. With this technique, the arrival of an interrupt triggers the appropriate microroutine immediately so that the interrupt is processed quickly. On the other hand, every input, including the extra condition inputs, must be made available to the address-programming lines in both true and complement form, requiring an inverter on the PLA chip for each of them. This requirement for inverters means that the PLA must be very large in physical area—even for a relatively small number of words.

The third example uses separate PLAs for address-transformation and control-store functions (Fig. 7). When used in minicomputers, this approach often has the smallest number of bits of any of the three examples—for two reasons. First, the main PLA as a control store is smaller than the read-only memory of the first example and has fewer inputs than the combined PLAs of the second example. Second, the address-transforming PLA contains only one word for each different external instruction format, in contrast to one for each different external instruction, and this PLA is therefore likely to contain less than a dozen words.

The outputs of the address-transforming PLA drive an array of AND gates through which the operation code passes to the input of the main PLA. Because of these gates, all bits that are not part of the operation code in that particular format appear as 0 to the main PLA. Since the second PLA input must accept the operation code with the longest format, the unused bit positions in shorter formats, assumed to be the least-significant bits, are available for incrementing from word to word in a microroutine, or for bringing in such special lines as interrupts or feedback lines from the PLA output. These lines must be properly multiplexed to prevent their interference with long-format operation codes.

Extensions to microprogramming

PLAs can be applied not only to conventional single-level microprogramming, as demonstrated by the preceding examples, but also to modifications of the microprogramming concept. One modification is to divide the PLA into several parallel parts for functionally separate portions of the processor—such as control of the arithmetic/logic unit, register control, interrupt control, and input/output control. This "horizontal" approach has fewer bits and simpler interconnections in certain appli-

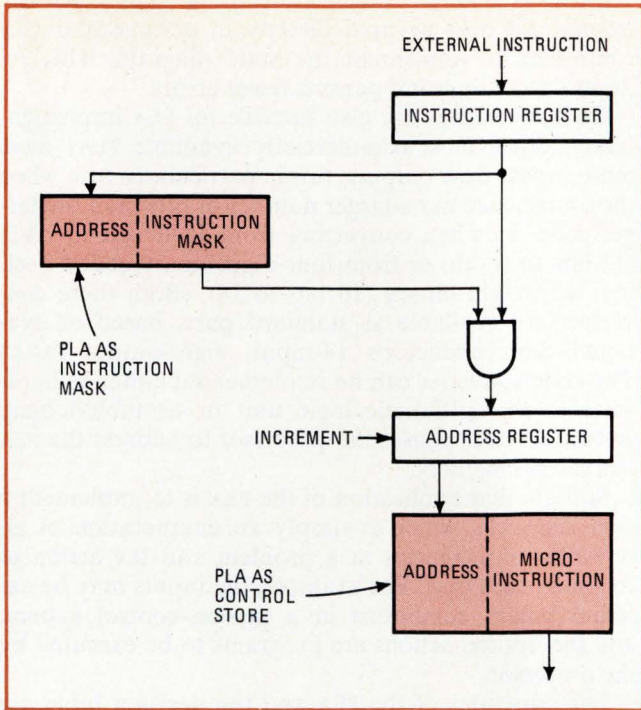

7. Two PLAs. Division of labor between two PLAs reduces total number of bits in control logic and simplifies interrupt-processing and ordinary word-to-word microroutine-incrementing.

cations, but is more difficult to program than the traditional microprogram structure.

Another modification is to use two or more levels of control store. This "vertical" approach may be used in combination with parallel partitioning. Thus, a microinstruction may cause the execution of a sequence of control instructions at an even lower level. "Vertical" and "horizontal" partitioning affect system speed somewhat analogously to the speed trade-offs of vertical and horizontal microprogramming.

Partitioning in TTL designs is somewhat limited by the PLA configurations available, but may become more commonplace as new products are announced.

Minimization

Using "don't-care" bits in the PLA address reduces the number of words required. Logic designers are familiar with standard minimization techniques for multiple-output combinational networks, which can be applied as well to the PLA, considered as an array of AND and OR gates. These techniques can also be applied by computer programs—probably the most valuable general-purpose way to reduce a PLA, except that minimizing a network with 14 inputs and eight outputs sometimes requires a lot of computer time.

Minimizing PLAs for microprogram storage can often be done manually or with simplified computer assistance. The most significant reduction in microprograms can be made by combining identical microinstructions at different addresses into a single term. This requires the addresses to differ by 2, 4, 8, 16, and so on—that is, in one bit position, which is programmed as ϕ .

A substantial further reduction can sometimes be made at the assembly-language level, looking for microinstructions that perform the same function but have different bit patterns. These can be detected much more easily at the assembly-language level than at the bit level. For example, ADD R2, R1, R1, which means "add the contents of register 2 to the contents of register 1 and store the result in register 1," is functionally the same as ADD R1, R2, R1, but it has a slightly different bit pattern. Computerized text-manipulation systems are very useful for finding these assembly-language equivalences.

Another simple trick combines two or more microinstructions into one by the use of optional bit values. For example, a microprogram might contain two instructions, "OR, 0, R2, R3," and "OR, R1, 0, R3." Both

CONVENTIONAL MICROPROGRAM		MICROPROGRAM IN PLA USING ϕ BITS	
ADDRESSES	MICROINSTRUCTIONS	ADDRESSES	MICROINSTRUCTIONS
100101	INSTRUCTION	100101	INSTRUCTION
100110	INSTRUCTION	100110	INSTRUCTION
100111	SET COUNTER = 8	100111	INSTRUCTION
101000	SHIFT ONE POSITION *	101000	} 101 $\phi\phi\phi$ SHIFT ONE POSITION **
101001	DECREMENT COUNTER *	101001	
101010	RETURN TO SHIFT IF COUNTER \neq 0 *	101010	
101011	IF COUNTER = 0 TAKE NEXT STEP	101011	
101100	INSTRUCTION	101100	
101101	INSTRUCTION	101101	
		101110	
		101111	
		110000	INSTRUCTION
		110001	INSTRUCTION

* THESE THREE MICROINSTRUCTIONS ARE EXECUTED A TOTAL OF 24 TIMES

** THIS MICROINSTRUCTION HAS 8 SUCCESSIVE ADDRESSES BECAUSE ϕ IS USED IN DEFINING ITS LOCATION IN PLA

8. Simplifying a microroutine. With optional bits in the address of a word in a PLA, several different input addresses can point to that word, and thus cause the microinstruction to be repeatedly executed. Here, address ending in $\phi\phi\phi$ can repeat one step eight times.

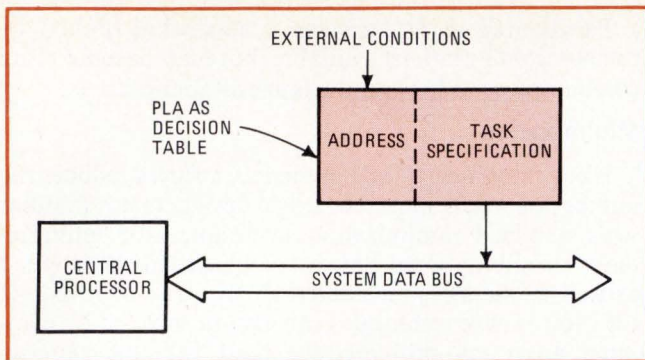

9. PLA as decision table. When it's convenient to specify the response to all contingencies by looking them up in a table listing, the table can easily be made of a PLA. It's used as if it were a peripheral device connected to a computer's data bus.

instructions effectively call for a 1 to be inserted in a register called R3 in each position where either or both of two other registers contain a 1. However, both instructions, by the designation 0, fail to specify one of the source registers, so that the other source works with what is assumed to contain only 0s. As a result, both instructions effectively move the contents of one other register into R3.

Meanwhile, a third microinstruction might legitimately perform the OR function on the contents of registers R1 and R2. But if the two data-move microinstructions have addresses differing in only one bit, then replacing that bit with an optional value calls for the full OR microinstruction without using up an extra word to hold it.

One word for three

Still another use of optional values permits some program loops to be replaced with single short routines that are executed repetitively by the judicious use of addressing. For example, a conventional microprogram might be required to shift an 8-bit byte from one end of a 16-bit word to the other, perhaps to execute an arithmetic operation on only the high-order byte (arithmetic operations are ordinarily executed, beginning on the low-order, or least significant, bits of a word).

This would require three microinstructions in a loop that would be executed eight times for a total of 24 microinstruction cycles. One of the three microinstructions would shift all eight bits of the byte one bit position; the next would decrement a counter and the third would conditionally return the microprogram to make another shift if the counter had not reached 0.

But in a PLA, only the shift microinstruction would be required (Fig 8). If the microinstruction has an address programmed to end in $\phi\phi\phi$ (that is, with the three least significant bits optional), and if the input address ends in 000, it can be incremented eight times and the shift executed eight times before the three low-order bits generate a carry into the fourth position and thus address a new microinstruction. The result of this arrangement would be the same as with the conventional microprogram, but only eight cycles would be required, instead of 24.

The PLA may be used for numerous functions in a processor system other than microprogram control. For

example, it may be used directly in peripheral-device controllers to implement the state diagram. This reduces design time and permits fewer errors.

Code converters are also suitable for PLA implementation. Since most commercially available PLAs have more inputs than outputs, this is particularly true when the source code has a larger number of bits than the target code—as when converting from Hollerith to Ascii (12 bits to seven) or from four-digit binary-coded decimal to straight binary (16 bits to 14). (Both these converters are available as standard parts based on National Semiconductor's 14-input, eight-output PLAs.) The code converter can be implemented either as hardware in the arithmetic/logic unit or as table-lookup software, which causes the processor to address the PLA as external memory.

Still another application of the PLA is to implement a decision table, which is simply an enumeration of all possible contingencies in a problem and the action to follow in each case. For example, the inputs may be external binary conditions in a process-control system, and the desired actions are programs to be executed by the processor.

The structures of the PLA and the decision table are exactly analogous—the condition entries drive the address inputs, and the data-output bits represent the desired actions. The PLA is connected as a peripheral device to the system's data bus (Fig. 9). When the processor reads the PLA, it executes the tasks specified by true bits. Decision tables are often implemented in software, but considerable time and program storage can be saved by using PLAs because decoding the tasks specified by a PLA's output-bit pattern is much easier than the full software approach. Furthermore, even this task of scanning the bits and sequentially generating the addresses of the routines to be executed can be implemented with a PLA to give even higher speed.

Where only one task is required for any given set of input conditions, a single PLA may be used as a condition-driven lookup table or code converter, giving the address of the program to be executed directly.

Future products

Future PLA products will probably include variations in the number of inputs, outputs, and words, and there will possibly be variations in the basic logic structure to make the PLAs cost-effective in many more applications. The devices may also be available with edge-triggered latches on the chip for direct feedback to the inputs via external connections. Sequential logic designs require this feedback, but depend today on external latches. Some bits could be fed back internally from the output to the input as well.

Perhaps the most important advance will be the implementation of field-programable PLAs using the same technologies as field-programable ROMs. These field-programable versions will probably have mask-programable pin-for-pin replacements. With these, new PLA applications can be put together on a breadboard instead of using PROMs, gates, or plugboards—today's usual practice. Field-programable PLAs will also allow their use in low-volume applications, where the cost of mask-programing is not justified. □

Designing class A amplifiers to meet specified tolerances

Easy-to-follow method, which can be quickly carried out on a pocket calculator, takes the worry out of designing an optimized bipolar-transistor amplifier to specifications

by Ward J. Helms, *University of Washington, Seattle, Wash.*

□ At first thought, designing a class A amplifier stage may seem to be a simple, easy problem that is also well documented. But this is not true. Although nearly all electronics textbooks cover the selection of biasing components for a bipolar-transistor class A amplifier, no textbook presents a clear-cut method to design an optimum stage.

Instead, these texts often define various individual stability parameters, which are essentially partial derivatives of the amplifier's idling current with respect to some transistor parameter. A good design minimizes these partial derivatives, the reader is told, but no general technique is ever given to achieve this goal.

A design procedure that delivers

However, a simple, direct design procedure can be followed when specific design objectives must be met. The technique guarantees that the quiescent current of a class A amplifier will lie within a specified range for any given temperature environment and any type (number) of bipolar transistor. Furthermore, with this method, only the transistor specifications normally given on a data sheet need be known. There is also another advantage—the procedure is organized so that desired design values be computed on a calculator.

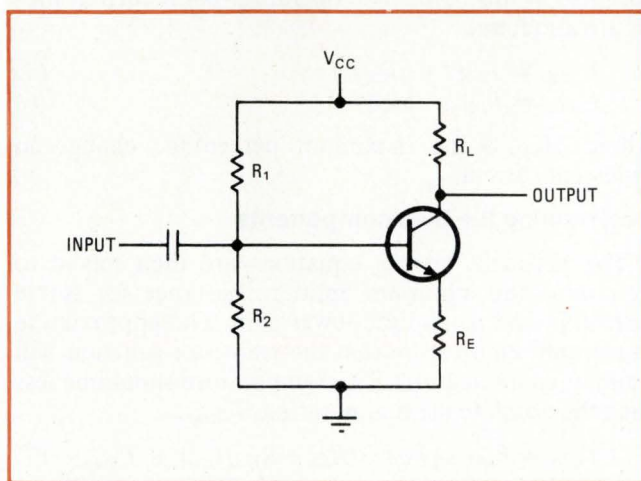

1. Standard stage. Location of the quiescent operating point of this class A power amplifier is critical. The design technique developed in this article takes worst-case operating conditions into consideration, as well as variations between devices in transistor parameters and the self-heating effects of a transistor junction.

The standard configuration for a class A transistor stage is shown in Fig. 1. The power gain of this stage will be optimized, while restricting the shift in the operating point to a specified value for a given temperature range and set of transistor parameters.

If the emitter resistor is bypassed by a large electrolytic capacitor, the gain of the amplifier can be increased significantly without sacrificing bias stability. However, such a capacitor is expensive, and the optimization of a bypassed stage requires complex procedures, as well as careful selection of the parameter to be optimized.

This design technique takes into account the variation of the transistor's base-emitter voltage (V_{BE}) and forward current-transfer ratio (h_{FE}) with junction temperature and collector current. The statistical spread between devices in the values of a transistor parameter is also taken into consideration.

Since the computation is carried out on a worst-case basis, the actual operating-point shift should be considerably smaller than the maximum allowed in the design. Under no condition, within design limits, will the transistor's collector current exceed its specified maximum allowable value (I_{Cmax}) or be less than its specified minimum value (I_{Cmin}). All other important transistor factors are also accounted for, including the self-heating of the junction.

The complete design procedure is summarized for easy reference in "Calculating a class A amplifier design," p. 117. To begin with, a suitable power-supply voltage (V_{CC}) must be chosen so that V_{CC} is regulated within reasonable limits, say $\pm 5\%$. This is particularly important for a class A amplifier because the quiescent transistor collector current (I_{CQ}) does not vary with signal level. The maximum allowable collector-current variation is selected at this point. If this current limit is set tighter than $\pm 10\%$, the amplifier's output power is generally reduced because the value of the emitter resistor (R_E) must be greatly increased.

Figure 2 shows the variation in amplifier power output and power gain versus the percentage of shift in quiescent collector current (ΔI_{CQ}) for a small-signal transistor. The power gain increases monotonically as ΔI_{CQ} becomes larger, but the maximum power output decreases because the output voltage swing becomes smaller. A reasonable choice for ΔI_{CQ} is $\pm 20\%$. Clearly, output voltage swing may be traded for power gain.

The next step in the design procedure is to determine

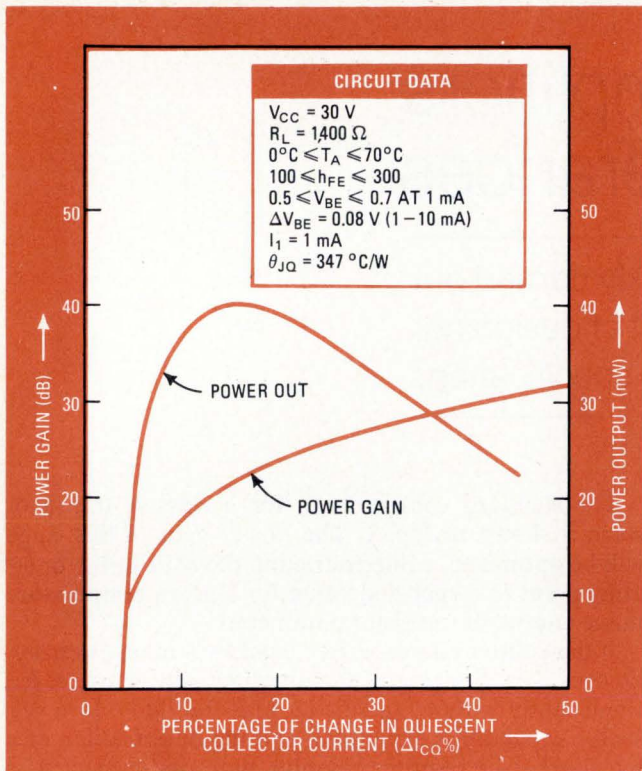

2. Trading off gain and swing. For large variations in quiescent collector current, power gain increases, but power output decreases because the output-voltage swing becomes smaller. The change in collector current should be some reasonable value like $\pm 20\%$.

several key parameters from the transistor's data sheet. Figure 3 shows how to find the typical base-emitter voltage change (ΔV_{BE}) from the device's plot of V_{BE} versus I_C . A convenient decade of collector current, which should bracket the desired operating point, is selected to establish currents I_1 and $10I_1$.

This information is used to predict the variation of V_{BE} with collector current. The base-emitter voltage is assumed to be proportional to the logarithm of the collector current. For an ideal transistor junction at room temperature, the proportion coefficient is 60 millivolts per decade of change in the collector current. Real devices deviate from this value, particularly at high currents. Under very-high-current conditions, the logarithmic assumption also breaks down. However, by careful selection of the I_1 current point, the error may be made quite small, as illustrated in Fig. 3.

The unit-to-unit statistical variation of V_{BE} at current I_1 is accounted for by determining two additional parameters: V_{BE1min} , the minimum base-emitter voltage at current I_1 and at a junction temperature of 25°C ; and V_{BE1max} , the maximum base-emitter voltage at 25°C .

The transistor's thermal resistance (θ_{JA}) also must be computed:

$$\theta_{JA} = (T_{Jmax} - 25^\circ\text{C})/P_D \quad (1)$$

where T_{Jmax} is the maximum junction temperature rating, and P_D is the maximum rated transistor power dissipation at 25°C . If the transistor is mounted on a heat sink, the ambient temperature is taken to be the transistor's case temperature.

With the next step, the actual design procedure be-

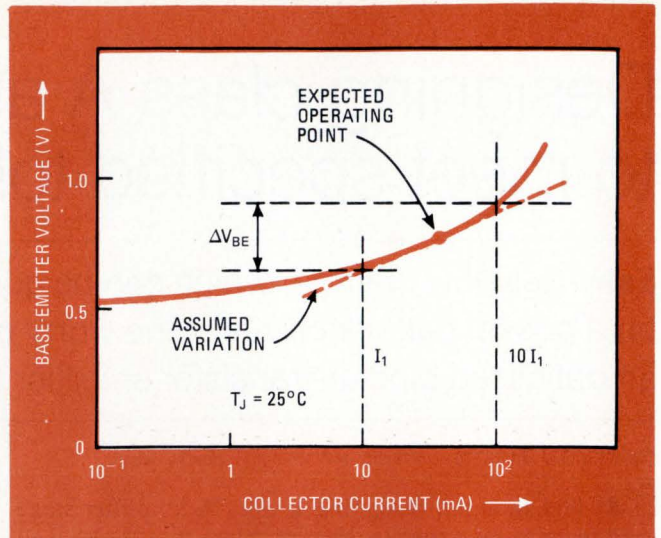

3. A reasonable assumption. The change in transistor base-emitter voltage can be regarded as constant over a (log) decade variation in collector current, so long as the current is not too large.

gins. Initially, the emitter resistance is assumed to be 10% of the collector load resistance. This assumption is merely a convenient starting point and does not prejudice the final value of R_E . The minimum load resistance (R_L) that the transistor can drive within its thermal limits is determined first:

$$R_{L1} = \theta_{JA} V_{CC}^2 / [4.4(T_{Jmax} - T_{Amax})] = R_{Ln} \quad (2)$$

where T_{Amax} is the maximum ambient temperature. A larger value of R_L may be employed and, if desired, should be specified at this point in the procedure. The emitter resistance is computed next:

$$R_{E1} = R_{L1} \times 10\% = R_{En} \quad (3)$$

Now find the operating point for the maximum output voltage swing:

$$I_{CQ} = V_{CC} / [2(R_{Ln} + R_{En})] \quad (4)$$

If a different quiescent current is desired, it should be specified at this point. The operating-point current limits are also found:

$$I_{Cmax} = I_{CQ}(1 + \Delta I_{CQ}) \quad (5)$$

$$I_{Cmin} = I_{CQ}(1 - \Delta I_{CQ}) \quad (6)$$

where ΔI_{CQ} is the maximum percentage change in quiescent current.

Determining the bias components

The pertinent biasing equations are then solved to determine the minimum emitter resistance for stable operation and maximum power gain. The approximate maximum temperature that the transistor junction will attain is computed first. This temperature should be less than the absolute maximum rating, T_{Jmax} :

$$T_{max} = \theta_{JA} I_{CQ} [V_{CC} - (R_{Ln} + R_{En}) I_{CQ}] + T_{Amax} \quad (7)$$

The actual V_{BE} voltage at T_{max} is then determined:

$$V_{BEX} = V_{BE1min} + \Delta V_{BE} \log(I_{Cmax}/I_1) - 0.0022(T_{max} - 25^\circ\text{C}) \quad (8)$$

Next, the minimum junction temperature of the tran-

Calculating a class A amplifier design

A class A amplifier stage built with a bipolar transistor can be designed by means of these fairly simple computations on a pocket calculator.

■ Set design objectives. Choose a suitable bipolar transistor type and the regulated power-supply voltage (V_{CC}). Establish:

ΔI_{CQ} = maximum desired percentage variation of quiescent current

T_{Amax} = maximum ambient temperature (use the maximum case temperature for a transistor mounted on a heat sink)

■ From the transistor's data sheet, determine:

T_{Jmax} = maximum junction temperature rating

P_D = maximum rated power dissipation at 25°C

I_1 = collector current, usually selected for convenience so that I_1 and $10I_1$ bracket the expected operating point

ΔV_{BE} = typical base-emitter voltage change over the range of I_1 to $10I_1$ at 25°C

V_{BE1min} = minimum base-emitter voltage at I_1 , 25°C

V_{BE1max} = maximum base-emitter voltage at I_1 , 25°C

■ Calculate the transistor's thermal resistance:

$$\theta_{JA} = (T_{Jmax} - 25^\circ C) / P_D$$

■ Estimate the minimum load resistance (R_{L1}) and the emitter resistance (R_{E1}):

$$R_{L1} = \theta_{JA} V_{CC}^2 / [4.4(T_{Jmax} - T_{Amax})] = R_{Ln}$$

$$R_{E1} = R_{L1} \times 10\% = R_{En}$$

■ Calculate the quiescent current and its limits:

$$I_{CQ} = V_{CC} / [2(R_{Ln} + R_{En})]$$

$$I_{Cmax} = I_{CQ}(1 + \Delta I_{CQ})$$

$$I_{Cmin} = I_{CQ}(1 - \Delta I_{CQ})$$

■ Calculate the base-emitter voltage (V_{BEX}) under hot, high-current conditions:

$$T_{max} = \theta_{JA} I_{CQ} [V_{CC} - (R_{Ln} + R_{En}) I_{CQ}] + T_{Amax}$$

$$V_{BEX} = V_{BE1min} + \Delta V_{BE} \log(I_{Cmax} / I_1) - 0.0022(T_{max} - 25^\circ C)$$

■ Calculate the base-emitter voltage (V_{BEN}) under cold, low-current conditions:

$$T_{min} = \theta_{JA} I_{Cmin} [V_{CC} - (R_{Ln} + R_{En}) I_{Cmin}] + T_{Amin}$$

$$V_{BEN} = V_{BE1max} + \Delta V_{BE} \log(I_{Cmin} / I_1) - 0.0022(T_{min} - 25^\circ C)$$

■ Make a better estimate for the emitter resistance:

$$R_{E(n+1)} = [-2(V_{BEX} - V_{BEN})] / [I_{Cmax} - I_{Cmin}]$$

If V_{BEX} is greater than V_{BEN} , R_E may be set to zero, and the value for R_L increased by 10%. Then repeat the design procedure with the new resistance values. The design procedure must also be repeated if $R_{E(n+1)}$ differs from R_{En} by more than 5%, or if T_{max} is more than T_{Jmax} . In the case of the latter condition, the value of R_L must be increased slightly.

■ From the transistor's data sheet, determine:

h_{FEmax} = maximum worst-case current gain at T_{max} or T_{min} and I_{Cmax} or I_{Cmin}

h_{FEmin} = minimum worst-case current gain at T_{max} or T_{min} and I_{Cmax} or I_{Cmin}

■ Calculate the Thevenin-equivalent resistance (R_B) and voltage (V_{BB}) for the amplifier's bias network:

$$R_B = [h_{FEmax} h_{FEmin} R_{E(n+1)} (I_{Cmax} - I_{Cmin}) + V_{BEX} - V_{BEN}] / [h_{FEmax} I_{Cmin} - h_{FEmin} I_{Cmax}]$$

$$V_{BB} = V_{BEN} + I_{Cmin} [(R_B / h_{FEmin}) + R_{E(n+1)}]$$

■ Calculate the values of resistors R_1 and R_2 :

$$R_1 = R_B V_{CC} / V_{BB}$$

$$R_2 = R_B V_{CC} / (V_{CC} - V_{BB})$$

■ Check the minimum power gain of the stage:

$$A_P = [R_B R_L h_{FEmin}] / [R_E (R_B + h_{FEmin} R_E)]$$

■ Check the minimum signal power of the stage:

$$P_s = (1 - \Delta I_{CQ})^2 [V_{CC}^2 R_L / 8(R_L + R_E)^2]$$

If the minimum power gain is not large enough, another transistor type should be selected— one whose h_{FEmin} value is higher.

sistor is found, with junction self-heating effects taken into consideration:

$$T_{min} = \theta_{JA} I_{Cmin} [V_{CC} - (R_{Ln} + R_{En}) I_{Cmin}] + T_{Amin} \quad (9)$$

And the base-emitter voltage at T_{min} is calculated:

$$V_{BEN} = V_{BE1max} + \Delta V_{BE} \log(I_{Cmin} / I_1) - 0.0022(T_{min} - 25^\circ C) \quad (10)$$

Normally, V_{BEX} is less than V_{BEN} , making it necessary to include an emitter resistor. But if V_{BEX} is greater than V_{BEN} , R_E can be eliminated ($R_E = 0$), and the load resistance (R_L) increased by 10%. Then repeat the design procedure, using the new values for R_E and R_L .

Now a better estimate can be obtained for R_E :

$$R_{E(n+1)} = [-2(V_{BEX} - V_{BEN})] / [I_{Cmax} - I_{Cmin}] \quad (11)$$

If $R_{E(n+1)}$ is not within $\pm 5\%$ of the R_{En} value, the design procedure must be repeated to this point. Moreover, when T_{max} exceeds T_{Jmax} , R_L must be made slightly larger. This process converges rapidly and seldom re-

quires more than two iterations. If $R_{E(n+1)}$ should continue to increase and approach the value of R_L , then ΔI_{CQ} is too small and cannot be realized with the transistor type selected while retaining reasonable power gain. Possibly, an emitter-follower should be used instead of a common-emitter amplifier.

The transistor's data sheet is now consulted again to find the maximum and minimum values of current gain (h_{FE}). These two values are determined by using the worst-case combination between T_{max} or T_{min} and I_{Cmax} or I_{Cmin} . The h_{FEmax} and h_{FEmin} values must be known accurately in order to predict the minimum power gain of the stage.

Next, the Thevenin-equivalent circuit values are found for the amplifier's biasing network:

$$R_B = [h_{FEmax} h_{FEmin} R_{E(n+1)} (I_{Cmax} - I_{Cmin}) + V_{BEX} - V_{BEN}] / [h_{FEmax} I_{Cmin} - h_{FEmin} I_{Cmax}] \quad (12)$$

$$V_{BB} = V_{BEN} + I_{Cmin} [(R_B / h_{FEmin}) + R_{E(n+1)}] \quad (13)$$

Resistors R_1 and R_2 are now easily computed:

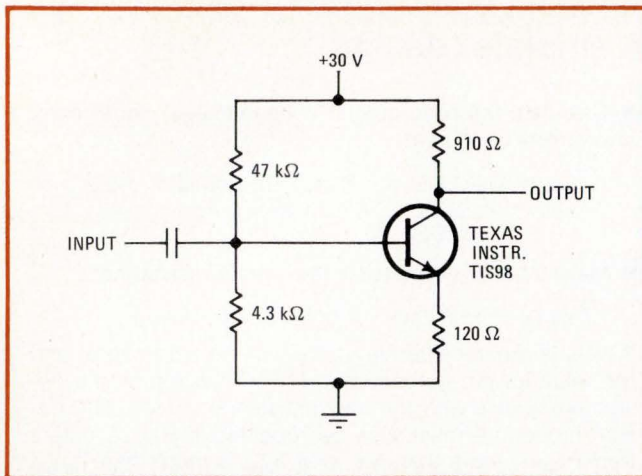

4. For instance. Amplifier stage, designed with the procedure described here, is optimized for maximum power output (22.8 decibels) and maximum power gain (61.8 milliwatts) from 0°C to 70°C.

$$R_1 = R_B V_{CC} / V_{BB} \quad (14)$$

$$R_2 = R_B V_{CC} / (V_{CC} - V_{BB}) \quad (15)$$

The closest standard-value resistances are usually good enough to use for R_1 and R_2 . These last equations are valid provided that:

$$(h_{FE_{max}}/h_{FE_{min}}) \text{ is greater than } (I_{C_{max}}/I_{C_{min}})$$

which is a condition that is generally satisfied because most transistors have a large spread of h_{FE} values.

To check the usefulness of the stage, its minimum power gain must be calculated:

$$A_P = [R_B R_L h_{FE_{min}}] / [R_E (R_B + h_{FE_{min}} R_E)] \quad (16)$$

The stage's minimum signal gain must also be checked:

$$P_S = (1 - \Delta I_{CQ})^2 [V_{CC}^2 R_L / 8(R_L + R_E)^2] \quad (17)$$

If either A_P or P_S is insufficient, a heat sink can be added to the transistor, or a transistor type having a higher $h_{FE_{min}}$ can be substituted. In the equations for A_P and P_S , the static forward-current transfer ratio is used instead of the more correct dynamic $h_{FE_{min}}$ value. Since the static $h_{FE_{min}}$ is a worst-case minimum value, the minimum power gain computed with it is a bit lower than the gain actually will be.

The entire design procedure, which may appear to be somewhat complicated, is really quite simple and rapid when done on a pocket calculator, especially one like the HP-35 or the HP-45. A programable calculator makes the procedure even easier to run through. The technique, of course, also can be written as a Basic or Fortran program.

Solving a practical problem

A design example will help to clarify the procedure. A single-stage class A amplifier is needed to operate from a 30-v power supply. The maximum power output and maximum power gain must be obtained from a Texas Instruments type TIS98 transistor over an ambient temperature range of 0°C to 70°C, with a maximum quiescent-current variation of $\pm 20\%$.

From the transistor's data sheet, determine:

$$T_{J_{max}} = 150^\circ C$$

$$P_D = 0.36 W$$

$$\Delta V_{BE} = 0.10 V \text{ from } 3 \text{ to } 30 mA$$

$$V_{BE1_{min}} = 0.54 V \text{ at } 3 mA \text{ at } 25^\circ C$$

$$V_{BE1_{max}} = 0.74 V \text{ at } 3 mA \text{ at } 25^\circ C$$

$$I_1 = 0.001 A$$

Now the transistor's thermal resistance can be computed from Eq. 1:

$$\theta_{JA} = (150 - 25) / 0.36 = 347^\circ C/W$$

The load and emitter resistances are found next from Eqs. 2 and 3:

$$R_{L1} = (347)(30^2) / 4.4(150 - 70) = 888 \text{ ohms}$$

$$R_{E1} = 888 \times 10\% = 89 \text{ ohms}$$

Three iterations of the design procedure are needed to produce a better estimate for the emitter resistance: Equations 4 through 11 are used to do this:

PARAMETER	ITERATION		
	1	2	3
R_L (ohms)	888	910	910
I_{CQ} (mA)	15.4	14.7	14.6
$I_{C_{max}}$ (mA)	18.4	17.7	17.5
$I_{C_{min}}$ (mA)	12.3	11.8	11.7
T_{max} (°C)	150	146.5	146.1
$V_{BE_{X}}$ (V)	0.344	0.350	0.351
T_{min} (°C)	77	73.6	73.1
$V_{BE_{N}}$ (V)	0.687	0.693	0.694
$R_{E(n+1)}$ (ohms)	112.4	116.1	118.3
% change	26%	3.3%	1.8%

The nearest standard-value resistor—120 ohms—is chosen for R_E .

Once again, the transistor's data sheet is read to obtain the properly and carefully scaled values needed for transistor current gain:

$$h_{FE_{max}} = 600 \text{ at } 150^\circ C \text{ at } 18 mA$$

$$h_{FE_{min}} = 100 \text{ at } 80^\circ C \text{ at } 12 mA$$

These gain values are then used to find the Thevenin-equivalent circuit values for the amplifier's biasing network. The nearest standard resistance value should be substituted for R_E (120 ohms) and R_L (910 ohms). From Eq. 12:

$$R_B = \frac{600(100)[120(0.0175 - 0.0117) + 0.351 - 0.694]}{600(0.0117) - 100(0.0175)}$$

$$R_B = 4,019 \text{ ohms}$$

And from Eq. 13:

$$V_{BB} = 0.694 + 0.0117 [(4,019/100) + 120]$$

$$V_{BB} = 2.568 V$$

The values of biasing resistors R_1 and R_2 can now be calculated by using Eqs. 14 and 15:

$$R_1 = 4,019(30) / 2.568 = 47 \text{ kilohms}$$

$$R_2 = 4,019(30) / (30 - 2.568) = 4.3 \text{ kilohms}$$

The power gain of the stage (Eq. 16) will be:

$$A_P = \frac{4,019(910)(100)}{120[4,019 + 100(120)]} = 190 = 22.8 \text{ dB}$$

And the stage's signal power (Eq. 17) will be:

$$P_S = (1 - 0.20)^2 [(30^2)(910) / 8(850 + 120)^2]$$

$$P_S = 61.8 \text{ mW}$$

Figure 4 shows the final, complete amplifier design. □

OUR DAMN FAST BUFFER CAN BE USED AS A DIDDLE YOKE DRIVER

Presenting some really wild, far-out stuff from National Semiconductor.

For solving some really strange, unusual problems.

Like where you need a diddle yoke driver for your high resolution CRT displays... or something to continuously drive 50 ohm coaxial cables.

That'd be our LH0063 FET-input "Damn Fast Buffer" (that's its name, honest)... which is a whole order of magnitude faster than any other buffer on the market... slew rates up to $6000V/\mu s$.

Some other hot special function goodies.

The products we're talking about are hybrids. Special function analog and digital circuits that do things that can't be done with a monolithic chip.

A FET input op amp with very low offset voltage and $5\mu V/^{\circ}C$ max drift. LH0052.

A high speed sample and hold circuit capable of acquiring a 20V step signal in under $5.0\mu s$. LH0053.

An ultra fast FET op amp with slew rates over $500 V/\mu sec$. LH0032.

A high current op amp capable of delivering over one ampere of output current. LH0021.

Or just maybe you're looking for some kind of a thingamajig off the shelf that'll transmit sensor signals without line drops or voltage noise. (LH0045).

Damn good reading.

We've rounded up all our way-out special function devices and put 'em in a catalog.

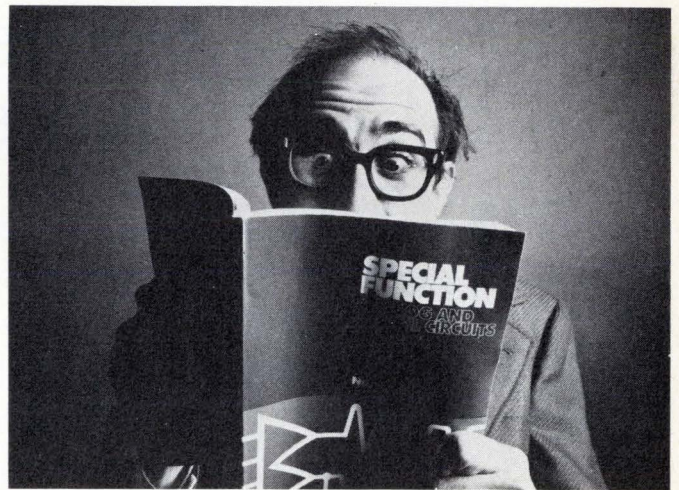

Which, happily, is yours for the asking. Call your friendly neighborhood National distributor, our office nearest you listed below, or use this coupon.

You need never again be without a diddle yoke driver.

Gentlemen,

I think your Damn Fast Buffer is a damn good idea. I'd like to receive your Special Function catalog... and be damn fast about it.

Name _____ Title _____

Company _____

Address _____

City _____ State _____ Zip _____

Mail to: National Semiconductor Corporation,
2900 Semiconductor Drive, Santa Clara, California 95051.

NATIONAL

National Semiconductor Corp., 2900 Semiconductor Drive, Santa Clara, Calif. 95051; Scottsdale, Ariz. (602) 945-8473; Mountain View, Calif. (415) 961-4740; Sherman Oaks, Calif. (213) 783-8272; Tustin, Calif. (714) 832-8113; Miami, Fla. (305) 446-8309; Chicago, Ill. (312) 693-2660; Indianapolis, Ind. (317) 255-5822; Lenexa, Kan. (816) 358-8102; Glen Burnie, Md. (301) 760-5220; Burlington, Mass. (617) 273-1350; Farmington, Mich. (313) 477-0400; Minneapolis, Minn. (612) 888-4666; Englewood Cliffs, N.J. (201) 871-4410; Syracuse, N.Y. (315) 455-5658; Dayton, Ohio (513) 434-0097; Dallas, Tex. (214) 233-6801.

Color television picture tubes

The new in-line, self-convergence television CRTs have gained wide acceptance, but enhanced brightness and wide-angle deflection are key developments, too

by Gerald M. Walker, *Consumer Editor*

□ In this age of all-solid-state design, there's still one type of tube under intensive development: the color-television cathode-ray tube being manufactured worldwide at a rate of about 24 million units a year. With a total international market of about \$2 billion in 1974—almost equal to worldwide integrated-circuit sales—it's easily the best-selling tube today.

As a result of the marketing pressure on TV-set manufacturers to have something just a bit different virtually every year, the dozen-plus color-tube makers around the world have in the last few years provided a wide range of picture sizes, deflection angles, shadow masks, materials, and fast-warmup models. Not every innovation has met with equal enthusiasm among tube designers.

But one development that has captured general support from tube manufacturers and set makers alike is the in-line-gun system. In the in-line arrangement the red, green, and blue color guns are aligned in a horizontal row instead of the conventional pyramid delta formation (Fig. 1). There are slight variations in the execution of this concept: neck sizes differ, toroidal or saddle yokes or combinations of the two are used, and over-all tube length may vary depending on convergence-circuit design and deflection angle.

But the prime objective is the same for all types: ease of use and resultant cost reductions by the set manufacturers. The in-line-gun concept has been around for some time. Philips in Europe demonstrated its superior-

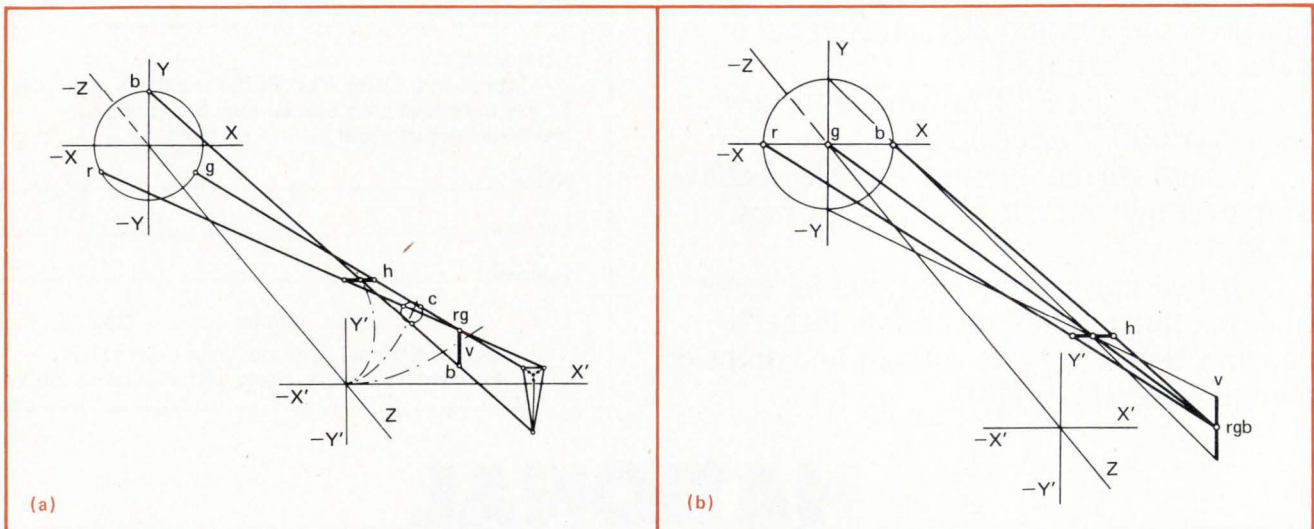

1. Guns. To make the beams converge on one point, convergence of conventional shadow-mask delta-gun tube (a) needs more corrections than that of in-line tube (b). If aligned at center screen for in-line, the beams will be correct for every point on the screen.

ity in simplifying convergence circuits some 20 years ago, and General Electric has been making in-line models for about 10 years. However, much of the new enthusiasm comes from the perfection of self-convergence in-line tubes.

The in-line may need only half the tolerance-compensating corrections required with dynamic-convergence delta-gun types. In addition, the dynamic-convergence tubes, while highly accurate immediately after assembly, drift into misalignment with age. Also, though adjustment may correct convergence errors, it's often at the expense of other picture qualities such as color purity and beam-to-phosphor register.

Carrying out the in-line theme

The most significant and most recent European innovation for in-line-gun systems has come from Philips Gloeilampenfabrieken's Elcoma division, the 20AX system for 110° tubes in 18-inch, 22-in.-, and 26-in.-diagonal models. It's actually the mass-produced realization of Philips' 20-year-old concept. The hang-up had been the manufacturing accuracy required for the tube and coil.

With today's 20AX, the gun's precision is improved by a more rigid construction and a better mounting technique, while the deflection coil's precision was increased by the introduction of a multisection pin-indexed winding technique. Philips also improved the accuracy of the deflection coil's position relative to the tube axis by incorporating a circular centering ridge on the cone of the tube. The only remaining errors are minor and can be corrected by a simple convergence corrector circuit (Fig. 2). As a result, Philips has cut dynamic tolerance compensations from 15 to seven, done away with dynamic-convergence units on the tube neck, and eliminated three other adjustments because north-south raster corrections are not required.

RCA's precision in-line tubes also feature self-convergence. The salient portion of this development is the precision static toroid yoke. Each turn of wire is precisely placed in the winding grooves of molded plastic rings that are cemented to each end of the core. According to RCA, the yoke weighs one and a quarter pounds and uses only 20% of the copper needed in a comparable saddle yoke.

This self-convergence system, too, cuts set-manufacturing costs. Since convergence and purity are independent of the driving circuit, the yoke and neck components can be set up, adjusted and permanently attached to the tube at the tube-manufacturing plant.

In Japan, Tokyo Shibaura Electric Co. (Toshiba) has two types of in-line-gun tubes, both different from either the RCA or Philips models. The 110° Rectangular Cone In-line Gun Slotted Mask (RIS) tube has a 35.6-mm-wide neck compared with 29.11 mm for the RCA model. According to Toshiba, the rectangular cone places the rectangular horizontal-deflection yoke as close to the beam as it would be on a narrow neck, thus reducing the required deflection power. This tube has what the Japanese call a semitoroidal yoke—that is, a saddle-type horizontal yoke and a toroidal-type vertical yoke—which is supposed to use less power than an all-toroidal yoke. The Simplified Dynamic Convergence Slotted Mask In-Line Gun (SSI) 90° deflection model has a narrow neck with simplified dynamic convergence circuits requiring just two adjustments.

Bright, brighter, brightest

Since the introduction in the early 1960s of new phosphor systems like the RCA all-sulfide screens and the later introduction of rare-earth reds by GTE-Sylvania, brightness has been almost an obsession with TV-set makers and their picture-tube suppliers. Besides new phosphors, other factors affecting tube brightness are the glass transmittance of the face panel, mask aperture size and gradient, and matrix window size and gradient. Tube engineers have changed all of these factors during the brightness race, increasing the transmittance and the size of the mask aperture and matrix window.

Power into the screen (anode voltage and current), amount of overscan or raster size, quality and color of white setup, and yoke convergence assemblies—all external brightness factors—have also been refined or changed. Now many feel that the brightness race has come to an end, partly because it has become expensive and partly because all the "classical" engineering techniques for boosting brightness have been pretty well exhausted. It will take a radical breakthrough to push brightness a great deal beyond present levels.

Probably the most significant advancement in brightness after the new phosphors were developed was the negative-guard-band concept, often referred to as the black-surround picture and heavily played up in many TV-receiver advertisements. Introduced by Zenith in 1969, the negative-guard-band tube is now in its fourth generation.

Briefly, in the negative-guard-band tube the electron beam is larger than the phosphor dot it's aimed at so that the beam cross-section covers the entire dot and

overlaps onto the black "surround" between dots. If the beam is slightly misaligned, it still lights the entire dot without illuminating an adjacent dot of another color. The black area absorbs ambient light without reducing the light output of the dots.

Along with the matrix design have come slit masks and striped phosphor deposits, replacing the dots to gain improved contrast. By now, both General Electric in the U.S. and Matsushita in Japan are marketing new slotted-black-matrix tubes with horizontal- and vertical-matrix construction intended to provide greater contrast than the vertical-stripe-only construction.

A source of controversy among tube users these days is the fast-warm-up tube intended to provide a quick picture without the need for a continuously hot instant-on circuit to keep the chassis warmed up. The tradeoff is roughly zero seconds to picture ignition with instant-on, five seconds with fast-warm-up tubes, and 15 seconds with a standard tube in an all-solid-state chassis. These contrast with 20 to 25 seconds for the pre-solid-state "hybrid" chassis. Consequently, if the instant-on circuit is to be eliminated, but an all-solid-state chassis used, the difference comes down to a matter of 10 seconds.

One problem with the fast-warm-up tubes is that they are not compatible with older chassis. In Japan, only Sony is making its fast-warm-up tubes interchangeable

with older models to make tube replacements easier in the field. Other firms are providing additional components with which servicemen can modify old sets to accept new tubes.

As for future color-picture-tube developments, the most-discussed effort these days is the flat-screen or wall-screen TV, based on semiconductor displays. U.S. tube manufacturers say simply that the flat screen will be ready in the 1980s. A practical consumer flat-screen TV will probably require a complete redesign of the receiver, a move that set makers will not undertake overnight.

Meanwhile, tube manufacturers will concentrate on more immediate goals such as a new unitized gun for the in-line tube, a more efficient means of depositing color phosphors, improvements in screening technology to mechanize production further, and perhaps tubes with higher resolution than present models. □

SOME MORE READING

If you want to know more about in-line-gun tubes, read "New RCA Color Picture Tube System for Portable TV Receivers," presented by RCA's R.L. Barbin and R.H. Hughes at the June 1972, IEEE Chicago Spring Conference, and "The 20AX System and Picture Tube," read by P.G.J. Barten of Philips to the June 1974, IEEE Chicago Spring Conference. Barten's paper also covers fast warm-up. Details of the brightness race can be found in "Color Television Brightness—Yesterday, Today and Tomorrow," R.Q. Vogel, Electronic Tube division, Electronic Components Group, GTE-Sylvania Inc., Seneca Falls, N.Y., and self-convergence is covered in "An Improved Convergence System for In-line Gun Color Picture Tubes," by R.A. Budd, Electronic Tube division, Sylvania Electric Products Inc., Seneca Falls, N.Y. Finally Susumu Yoshida, Akio Ohkoshi, and Senri Mayaoka of Sony Corp. discussed "A Wide-Deflection Angle (114°) Trinitron Color Picture Tube," at the June 1973 IEEE Chicago Spring Conference.

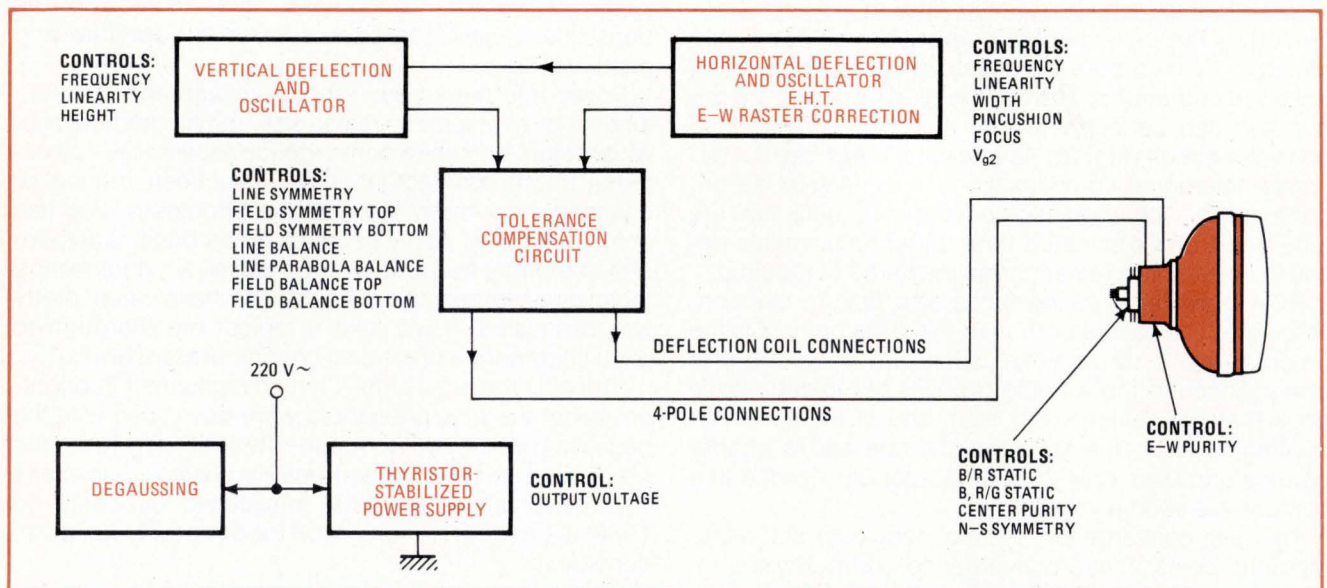

2. Decontrol. A block diagram of the Philips in-line, self-convergence tube deflection system shows the convergence settings that can readily be achieved with seven simple dynamic tolerance compensations. Note, too, that no north-south raster correction is required.

A flexcircuit for low-light home movies.

We did it for Kodak.

In turning the idea of low-light home movie making into the reality of the KODAK XL-55 Movie Camera, Kodak engineers solved tough design problems at every step. Among these problems, the design of a circuitry system of minimal bulk and maximum reliability.

They accomplished this with a Schjeldahl flexcircuit.

Flexing in four planes, this Schjeldahl flexcircuit has two 180 degree fold-over sections. This provides circuit reversal, transfers conductors to opposite sides of the circuit without the expense of plated-through holes and permits placement of seven conductors in a five conductor space — all without two-sided circuitry.

This Schjeldahl flexcircuit makes all electrical connections in the camera and carries all electronic components. For manufacturing efficiency, a hardboard back-up section permits auto insertion of components and continuous process wave soldering.

The flexcircuit fits available space and is designed for volume production. It does for Kodak what flexcircuitry does best.

Perhaps Schjeldahl flexcircuitry advantages can help in your design problems. It only takes a call to Schjeldahl to find out.

Schjeldahl did it for Kodak.

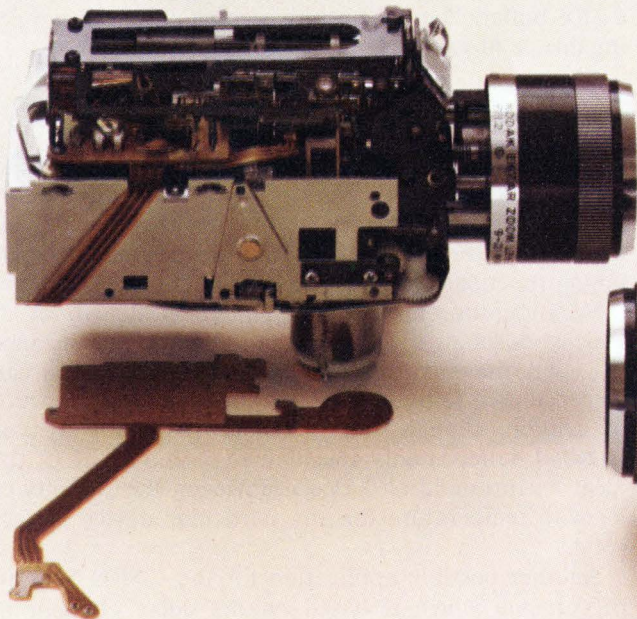

 **Schjeldahl Company**

Electrical Products Division
Northfield, Minnesota 55057
Phone: (507) 645-5633

The state of the art people in volume flexible circuits



And we can do it for you.

C-MOS Schmitt trigger can be more than an interface

by R.L. Morris
Audichron Co., Atlanta, Ga.

A Schmitt trigger makes a convenient interface between any type of logic family and signals that have slow transition times and possibly contain some noise component. When complementary-MOS circuits are being used to take advantage of their high input impedance and convenient switching threshold level, it is particularly necessary to employ an interface circuit that provides sufficient hysteresis.

A versatile C-MOS Schmitt trigger can be built with a minimum of parts—with only a couple of resistors and a conventional C-MOS noninverting buffer, such as the type CD4050 device. The circuit, which is drawn in Fig. 1, is actually quite similar to a standard comparator circuit having hysteresis. Unlike a comparator, however, the source impedance required to drive the C-MOS Schmitt trigger can be considerably lower than the value of its input resistor (R_1). If the source resistance is a relatively fixed value, it can even be added to R_1 for calculation purposes.

To see how the C-MOS Schmitt trigger operates, first let output voltage V_3 be at ground level. As input voltage V_1 increases from below the circuit's positive-going threshold point, voltage V_2 is divided by resistors R_1 and R_2 . When the threshold point of the C-MOS buffer is reached, the output of the buffer will begin to increase, producing positive feedback through resistor R_2 . This causes a fast transition at the circuit's output and latches the circuit into its other state.

Now, let output voltage V_3 be at the V_{DD} supply level. The same circuit action takes place, but it occurs in the opposite direction. The scope display in Fig. 1 shows the superimposed waveforms for V_1 , V_2 , and V_3 for typical values of these voltages. The total circuit hysteresis, in this case, is approximately 2.3 volts.

Only a few circuit equations are needed to describe circuit behavior with reasonable accuracy. The feedback factor can be expressed as a resistance ratio:

$$K = (R_1 + R_2) / R_2$$

The circuit's positive-going threshold voltage is then given by:

$$V_{T+} = V_T K$$

where V_T is the threshold voltage of the C-MOS buffer being used. The negative-going threshold voltage can be written as:

$$V_{T-} = K(V_T - V_{DD}) + V_{DD}$$

And the total hysteresis of the circuit is the difference between the two threshold voltage levels:

$$V_H = V_{T+} - V_{T-} = (K - 1)V_{DD}$$

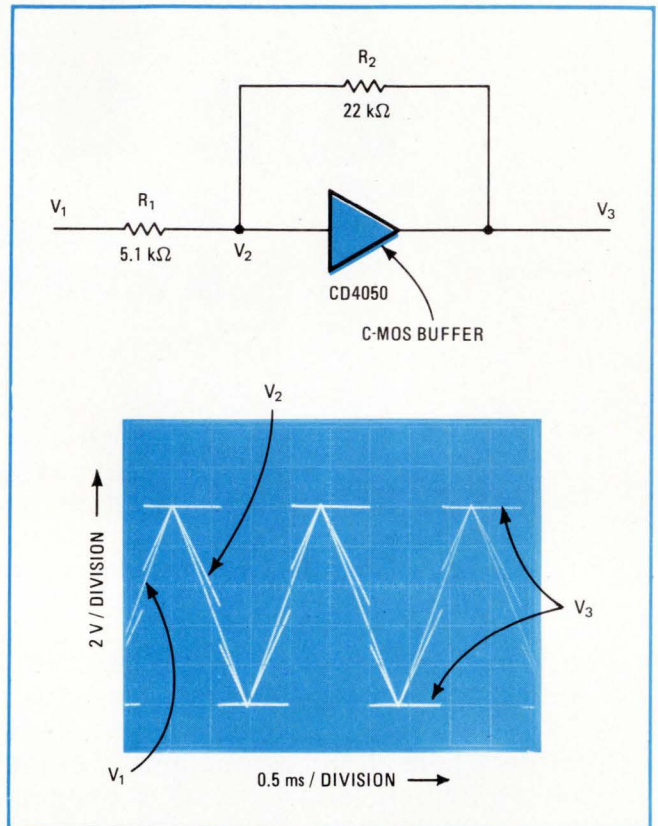

1. Simple circuit. C-MOS buffer and two resistors form a Schmitt trigger circuit that provides a high input impedance, fast output transitions, and a wide range of hysteresis voltage. The scope display illustrates the circuit voltages when the input is a triangular wave.

These equations can be further simplified by assuming that $V_T = 0.5V_{DD}$, which is a good approximation for a C-MOS buffer. Then, the positive-going and negative-going threshold voltages can be expressed as:

$$V_{T+} = 0.5V_{DD}K$$

$$V_{T-} = (1 - 0.5K)V_{DD}$$

Of course, there are a number of ready applications for the C-MOS Schmitt trigger of Fig. 1. One is as a delay element to generate time delays with a simple RC integrator network. The delay may be desired for logic timing functions or for filtering noise. Figure 2a shows the configuration for a delay element. In this circuit, as long as resistance $10R_3$ is less than or equal to resistance $(R_1 + R_2)$, the circuit's hysteresis and time constant can be considered to be independent of each other. A word of caution, though—the threshold point for a type CD4050 buffer is only specified to within $\pm 40\%$ of the ideal V_T threshold of $0.5V_{DD}$. However, the stability of V_T with temperature for any particular device is very good.

Another possible application for the C-MOS Schmitt trigger, one which is based on the delay element of Fig. 2a, is as an edge detector or differentiator (Fig. 2b). Three different outputs can be obtained from this circuit. With a NAND gate at the output, the circuit detects only the leading edge of the positive input pulse.

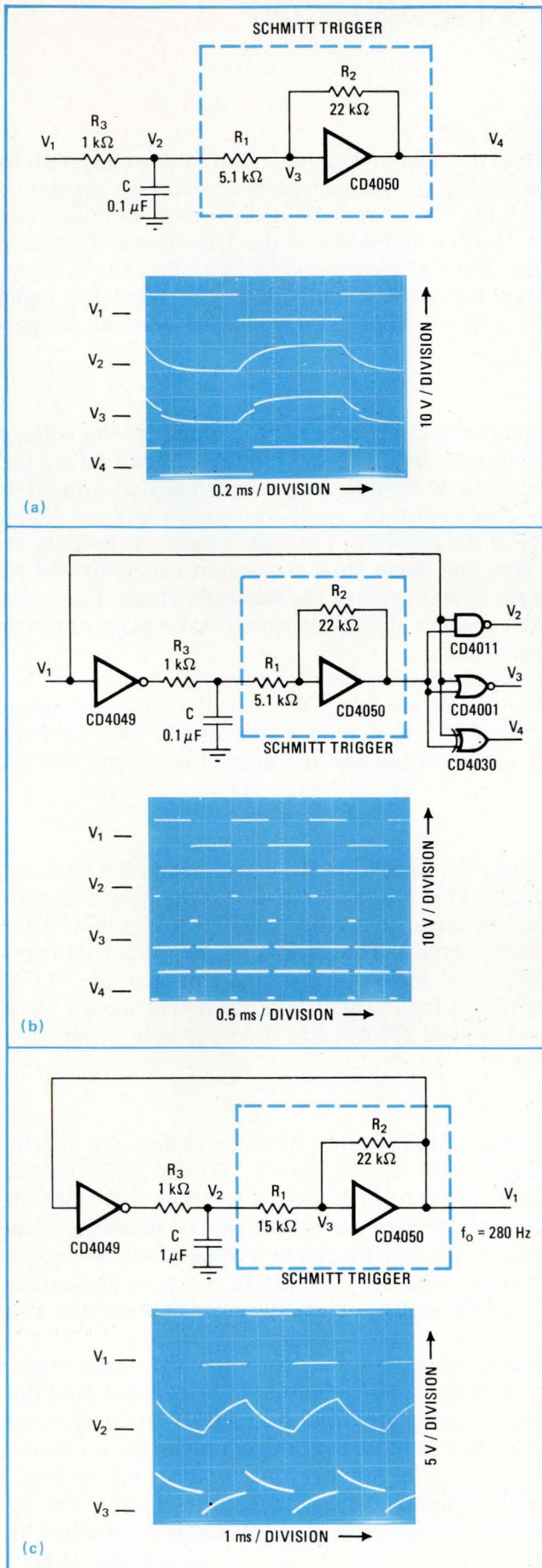

2. Applications. With an RC network at its input, the C-MOS Schmitt trigger can operate as a delay element (a), an edge detector (b), or an oscillator (c). Depending on the output gate employed, the edge detector will mark leading and/or trailing pulse edges.

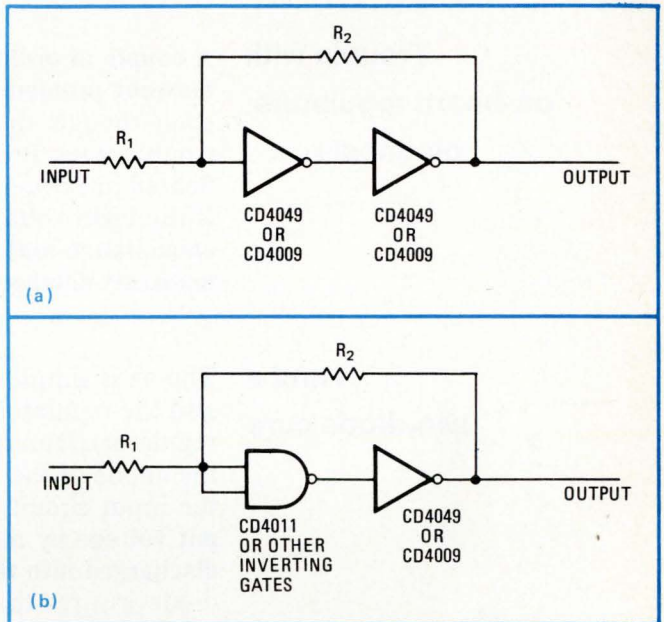

3. Alternate implementations. Instead of a buffer, two inverting-type C-MOS gates can be used to obtain a Schmitt trigger, as long as very fast output transitions are not needed. Two inverters can be substituted, as in (a), or, as in (b), a gate and an inverter.

With a NOR gate at the output, the circuit detects only the trailing edge of the positive input pulse. And with an exclusive-OR gate at its output, the circuit will detect both edges of the input pulse, as well as doubling the input pulse frequency. Output pulse width for this edge detector is controlled by the delay introduced by the RC network.

The delay element can also be used to construct a simple RC oscillator, as shown in Fig. 2c. Because of the Schmitt trigger circuit, the slow transition from the RC network is never applied directly to the device being driven by the oscillator. In this circuit, the hysteresis range of the C-MOS Schmitt trigger is expanded to make use of the RC time constant. By increasing the value of resistor R_1 , the hysteresis voltage of the Schmitt-trigger portion of the oscillator is raised to 6.4 V.

For designs where only one or a few Schmitt triggers are needed, it may be desirable to use some other C-MOS device, rather than the CD4050 buffer. Any two inverting-type gates can be substituted, as indicated in Fig. 3. Although a buffer is preferable for driving resistor R_2 , a gate-type device, which has a lower output drive, will do, provided that the proper values are selected for resistors R_1 and R_2 . The lower-gain gate-type device will result in slower output transition times.

If several Schmitt triggers are needed for a design project, dual-in-line packaged resistor networks, instead of discrete resistors, can be used to help conserve circuit board space. □

Engineer's Notebook is a regular feature in Electronics. We invite readers to submit original design shortcuts, calculation aids, measurement and test techniques, and other ideas for saving engineering time or cost. We'll pay \$50 for each item published.

Trouble with on-board regulators: diagnosis . . .

A couple of ordinary junction diodes can put a stop to those mysterious blowout problems that sometimes plague on-board voltage regulators even though their outputs are protected against short circuits. The trouble, says Brother Thomas McGahee of the Don Bosco Technical School in Boston, Mass., is not at the regulator's output, but at its input. **If the input voltage drops below the output voltage, the regulator, being capacitance-loaded, in effect becomes reverse-biased and can be permanently damaged.**

. . . and a two-diode cure

The fix is simple. Connect one diode between the input driving voltage and the regulator's input terminal (with the diode's cathode facing the regulator). Run a second diode from the regulator's output terminal to the anode of the input diode (with the feedback diode's cathode facing the input circuit). **Now if the regulator's output voltage exceeds its input voltage by more than one diode drop, the output capacitor will be discharged into the input circuit through the feedback diode.** The input diode assures that the capacitor discharge cannot take place through the regulator's pass transistor.

During normal operation, the feedback diode will remain off because it is reverse-biased, and the input diode will reduce the input voltage by one diode drop. Of course, both diodes should be capable of withstanding the peak input voltage and the normal operating current of the regulator.

Faster 1103s stay in the race

Memory system designers are benefiting from semiconductor makers' efforts to keep the popular 1103-type random-access memory competitive (it's being buffeted by cheaper-per-bit 4,096-bit RAMs and faster but costlier 7001 n-channel types). The trick is to keep the 1103 inexpensive but make it faster, and one of the fastest to emerge is the 1103X from American Microsystems Inc., Santa Clara, Calif. The device has a **120-nanosecond access time and 270-ns cycle time** and is in production for delivery this quarter.

Optical couplers are good for analog signals, too

Although generally used in digital systems, optical couplers can also be used for coupling analog signals, notes O'Dale K. Griffith, Jr., who's at the Microelectronic Device division of Rockwell International Corp. in Anaheim, Calif. **For analog applications, the inherent nonlinearity of an optical coupler's transfer characteristic can be compensated for by using a second optical coupler** of the same type. In this way, the nonlinearity error can be reduced to just a **tracking error between the two couplers.**

The LED inputs of the couplers are wired in series with each other, with the output of one coupler facing the circuit to be isolated, and the output of the other coupler facing the driving circuit. If an operational amplifier is used to drive the input LEDs of both couplers, the output of the second coupler will be feeding the inverting input of the op amp. **Since this second optical coupler is inside the feedback loop of the op amp, any nonlinearities will be reduced by a factor that is determined by the loop gain.**

—Laurence Altman

**We have a half
million ways to
solve your card
packaging problems...**

**We
do it
better**

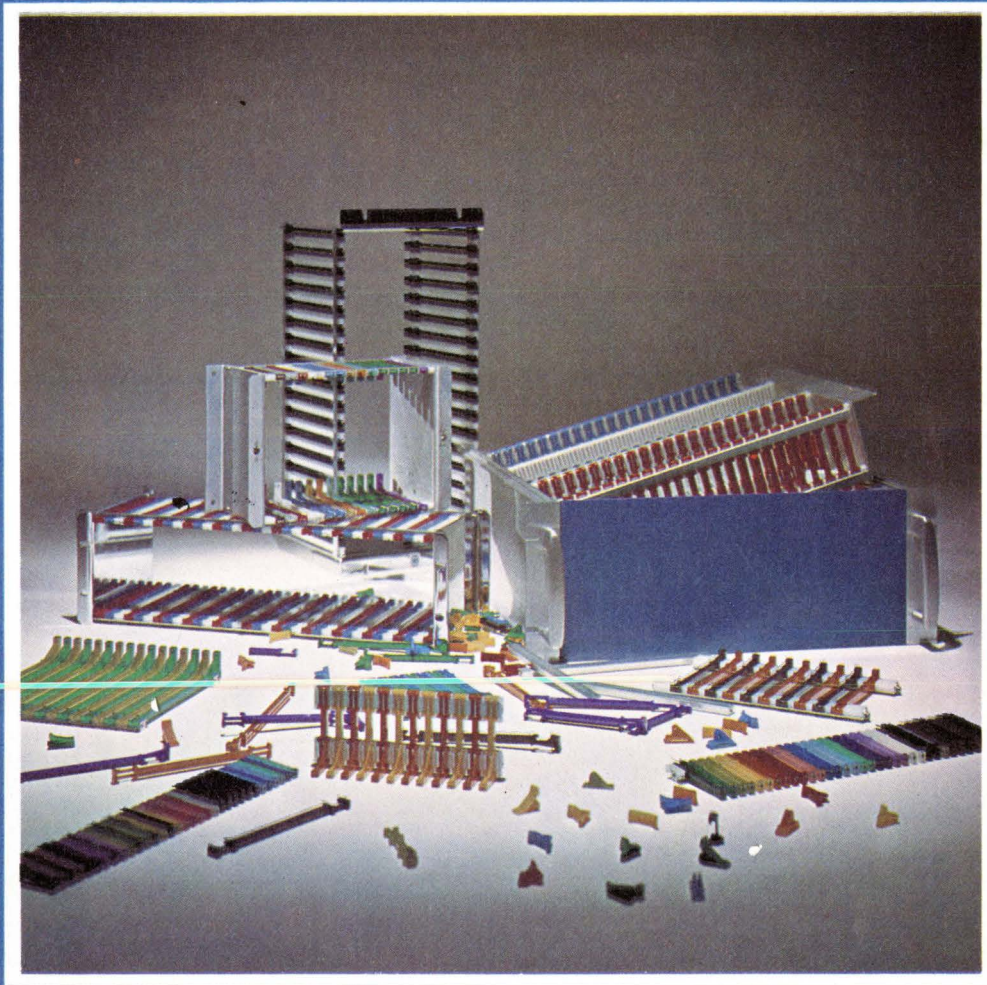

Configurations are virtually unlimited . . . bulk components, subassemblies, files, kits, drawers—horizontal or vertical.

We do it by offering nylon guides with integral connector mounting feet. This insures precise card/connector alignment while permitting complete card length and spacing flexibility.

We do it with guides that snap-on to strong extruded aluminum bars between end plates or drawer frames. This provides an exceptionally rugged, lightweight package perfectly suited to your particular card file needs . . . when it's put together, it stays together.

We do it by mounting mother boards and back planes in single or multiple row files. We do it by

mounting large or small cards with any connector arrangement.

We do it by really solving packaging problems . . . yours, his and theirs. So give Scanbe a call or send us your requirements. Either way, we can help you do it better.

Scanbe Manufacturing Corporation
3445 Fletcher Avenue
El Monte, California 91731
(213) 579-2300/686-1202 TWX: 910-587-3437

 **SCANBE**
CANOGA INDUSTRIES

Circle 127 on reader service card

The 80 MHz universal counter/timer that measures time interval...and a lot more too for only \$749

Now you can measure frequency, frequency ratio, single period, multiple period averages, and time interval, as well as totalize and gateable totalize - all with the 1952A universal counter/timer - a real bargain at only \$749.

Plus you get many other features, such as a dc to 80 MHz range that can be expanded, in the field, to 515 MHz, 50 mV sensitivity, and matched input channels with full control of coupling, slope and trigger level.

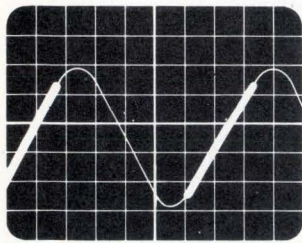

It's this trigger level control, when used in conjunction with the oscilloscope marker output which lets you easily position start and stop trigger points in time interval measurements.

The model 1952A has a seven-digit LED display incorporating leading-zero suppression and units annunciation... plus overflow, gate and trigger level status

lamps. And if you need more digits, 8 and 9 digit displays are available.

No wonder the 1952A is called "The Versatile One". And of course you get traditional Fluke quality and a full 12-month guarantee.

Phone or write today for complete details on "The Versatile One" at \$749 from Fluke.



John Fluke Mfg. Co., Ltd.
Counter Division
P.O. Box 1094, Station "D"
Buffalo, N.Y. 14210
Phone (716) 842-0311
TWX 610-492-3214

Circle 128 on reader service card

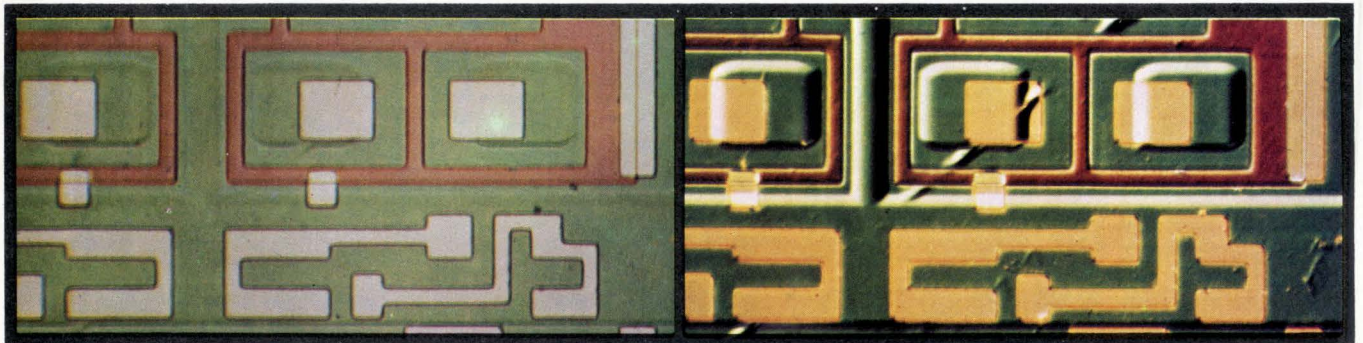

If this is all you're seeing, this is what you're missing.

The AO DICV Series 10 Differential Interference Contrast Microscope can make a big difference. A standard brightfield microscope reveals only what is shown in the specimen on the left.

Now look at the specimen on the right. With this ability to reveal significant detail in outstanding relief in black and white or color, the AO DICV Series 10 can help you spot surface irregularities, inclusions and faults.

By using incident light, after Nomarski, it provides contrast enhancement of opaque

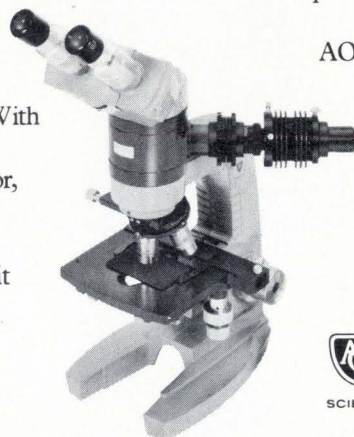

and semi-opaque materials. Helps you make critical quality control checks of semi-conductors, integrated circuits and metallurgical samples.

AO DICV Microscopes convert quickly from interference contrast to brightfield.

So if you can't afford to miss something, you can't afford to overlook the AO DICV Microscope.

For details, write American Optical Corporation, Scientific Instrument Division, Buffalo, N.Y. 14215.

 **AMERICAN OPTICAL CORPORATION**
SCIENTIFIC INSTRUMENT DIVISION • BUFFALO, N.Y. 14215

HOW VALOX[®] SOLVED THERMOPLASTIC POLYESTER THE DESIGN PROBLEMS OF NYLON AND METAL.

HOW VALOX[®] SOLVED THE THERMOPLASTIC POLYESTER PRODUCTION PROBLEMS OF NYLON AND METAL.

Dielectrics. Double insulation.

In this vacuum cleaner motor housing, VALOX 420-SEO thermoplastic polyester replaced diecast aluminum because of its unique property profile. It combines extraordinary high-temperature dielectric strength and arc resistance with excellent dimensional stability, toughness and all other needed mechanicals. So even heat-retaining, molded-in metal inserts caused no warpage.

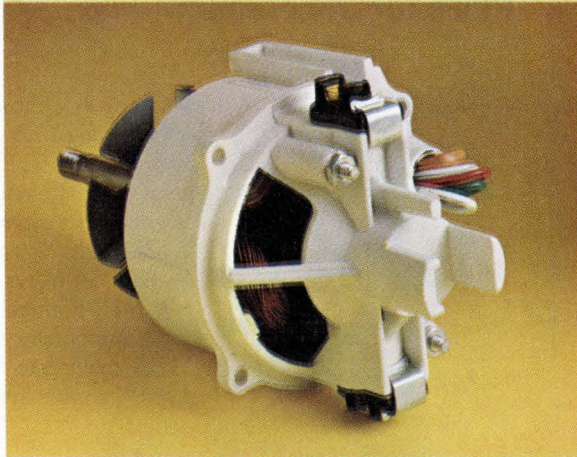

Materials costs. More stability.

Motor housings cast in aluminum are especially vulnerable to soaring materials costs. (Last year alone, aluminum prices jumped 60% while VALOX thermoplastic polyester remained relatively stable.) And compared to other engineering plastics, VALOX resin's easier molding characteristics permit more latitude in mold design without compromising finished part quality.

Solvents. Withstood corrosive flux.

Unlike nylon or ABS, VALOX 310-SEO and 420-SEO resins offered the chemical resistance, low moisture absorption, lubricity and wear characteristics these switches required. Available in colors, they also withstood the 120°C and 130°C continuous-use temperatures UL required, facilitated ultrasonic welding and survived wave soldering.



Cycling. Up to 50% faster.

In replacing nylon switches, VALOX resin injection cycled as much as six seconds faster; in replacing ABS switches, it cycled twice as fast.

Fact is, VALOX resin cycles faster than most other engineering thermoplastics. And it molds smooth and glossy without warping or crazing, without deposits, etching or noxious fumes.

Heat. Survived 550°F soldering.

Besides providing phenolic-like heat resistance, lower moisture absorption and better rigidity-to-flexural-strength ratios, VALOX resin held this zero force connector's alignment better than nylon. Which protected fragile terminals from damage during assembly.

Also, the resin survived critical electrical, shock and vibration tests.

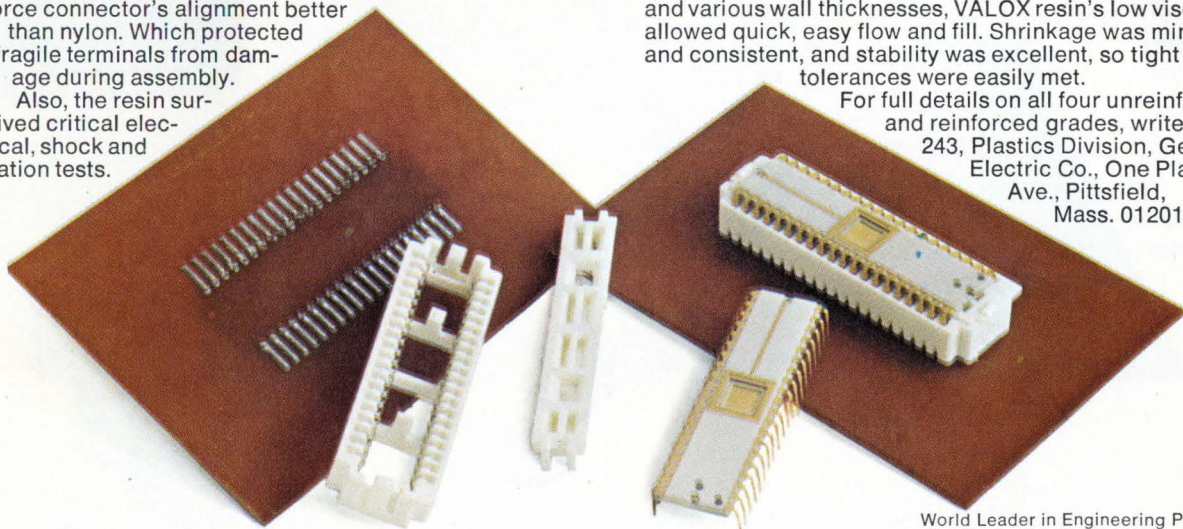

Productivity. 20% higher.

In connectors, VALOX 420-SEO resin offered faster injection cycles than nylon, with less flash and exceptional ductility. And despite the connectors' complexity and various wall thicknesses, VALOX resin's low viscosity allowed quick, easy flow and fill. Shrinkage was minimal and consistent, and stability was excellent, so tight tolerances were easily met.

For full details on all four unreinforced and reinforced grades, write Sect. 243, Plastics Division, General Electric Co., One Plastics Ave., Pittsfield, Mass. 01201.

World Leader in Engineering Plastics
LEXAN[®] NORYL[®] GENAL[®] VALOX[®]

GENERAL  ELECTRIC

GREATEST YIELD IN THE ELECTRICAL FIELD

**Allegheny Ludlum gives designers
more for their money.**

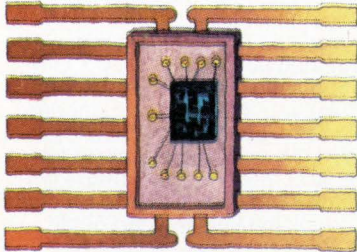

Critical demands for leadframes in semiconductors are more than semifilled by Allegheny Ludlum. Our product range and consistently high quality fill numerous needs.



Wider strip? In widths up to 25 inches, our electrical alloy strip yields more good parts faster to cut costs. Sheet? Plate? Bar? Get the best... for laminations and shavings. Motors. Transformers. Generators. Relays. Solenoids. Vibrators. Cores. Check our Sealmet alloys. Or Ohmaloy. Mumetal. Moly Permalloy, etc.: all products of strict A-L quality control... from computerized melting to final shipment... for consistently superior characteristics.



We can earn your seal of approval... with special steels for glass-to-metal seals: AL 42 and 4750. Sealmet 1 and 4. AL 430Ti. And others. All meet tightest tolerance requirements... for sealed-beam headlights, fluorescent lights, electronic tubes.

A pioneer in developing magnetic shielding materials, we stock Mumetal and Moly Permalloy for prompt delivery. Our Research Center, most elaborate in stainless and specialty alloys, helps solve special shielding problems.

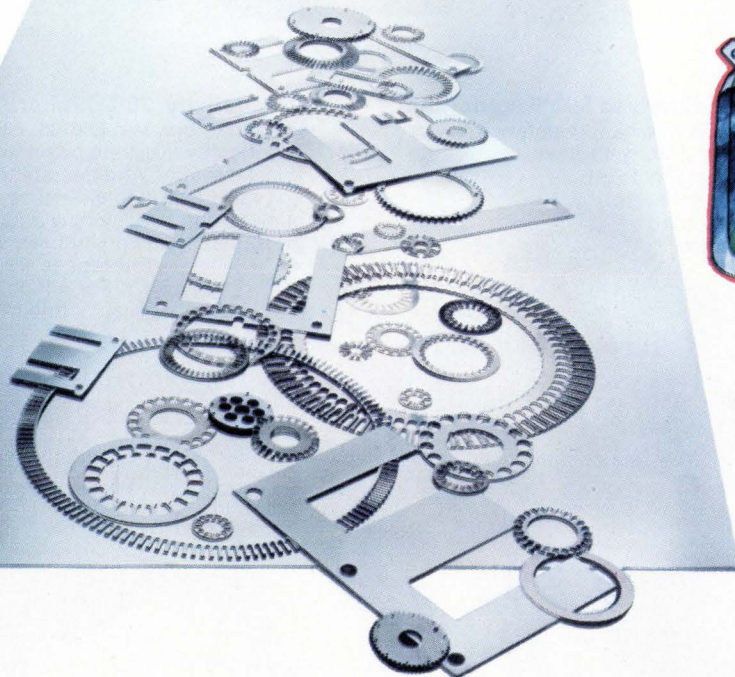
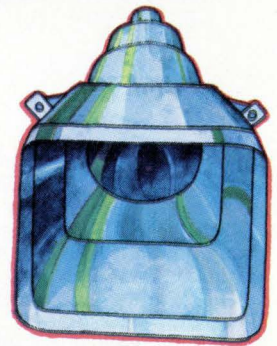

For more on how America's leading producer of stainless and specialty alloys can help you in the electrical field, write: Allegheny Ludlum Steel, Dept. 432, Oliver Building, Pittsburgh, Pa. 15222.



Allegheny Ludlum Steel
Division of Allegheny Ludlum Industries

New products

Self-latching relays offer 6 poles

Special material with magnetic memory makes it possible to build device that latches without need for permanent magnets

by Larry Armstrong, Midwest bureau manager, and Lucinda Mattered, Circuit Design Editor

In the telephone company's new electronic switching systems, a key component is the self-latching reed relay. Adapting the Bell System technology, C.P. Clare & Co. has developed a family of devices that is expected to find applications, not only in the phone industry, but in automated video and rf switching equipment, automatic test systems and computer interfaces.

The new series 961 relays save power since coil voltage does not have to be applied continuously, and they are not bothered by power interruptions. They can also save money and board space because up to six poles can be built into a single relay package.

A self-latching relay differs from a latching relay in that the contact blades themselves are magnetized to get the latching function. In contrast, permanent magnets are used in the latching type of relay.

Greater relay complexity is another benefit. A latching relay is limited to two-pole configurations because of the interaction between its permanent magnets. Three latching relays must be connected in parallel if six poles are needed.

Furthermore, explains Wyman L. Deeg, Clare's engineering manager for special products, each magnet in a latching relay must be individually adjusted—it must be strong enough to hold the contacts closed, but not so strong that it can close the contacts itself. Driving currents are also critical. If the current through the reset coil to open the contacts is too large, they will open and then close again. A self-latching relay, however, can be overdriven as long as the coil heat generated is not excessive.

A simple three-coil arrangement is used for each pair of contacts in a self-latching relay. One contact blade has a dual concentric winding surrounding it. Each of these windings is wired in series with the single common winding associated with the other contact blade. The blades are made up of a material that has inherent magnetic memory.

When the set coil, which is one of the concentric windings, is energized, the blades are magnetized with opposing polarities so that they attract and close. If the reset coil, which is the other concentric winding, is energized, the blades are given the same polarity and, therefore, they repel and open.

The self-latching relays can be bought as one- to six-pole units. A one-pole package measures 1.96 by 0.50 by 0.46 inches, while a six-pole

package is 1.96 by 1.25 by 0.46 in. Nominal coil voltages are 6, 12, or 24 v dc. Maximum contact rating is 1.0 ampere continuous and 5 VA switched, while contact resistance is 100 milliohms maximum. Set time for the devices is 1.5 milliseconds maximum, including contact bounce time, and maximum reset time is 0.1 ms. The set/reset pulse duration can be as short as 0.5 ms at the nominal coil voltage.

The units will be available in September. The cost of a one-pole self-latching relay is competitive with the price of a one-pole latching relay. But, as the number of poles increases, the self-latching relay will cost less than an equivalent configuration built with latching relays.

C.P. Clare & Co., a General Instrument Company, 3101 W. Pratt Ave., Chicago, Ill. 60645 [338]

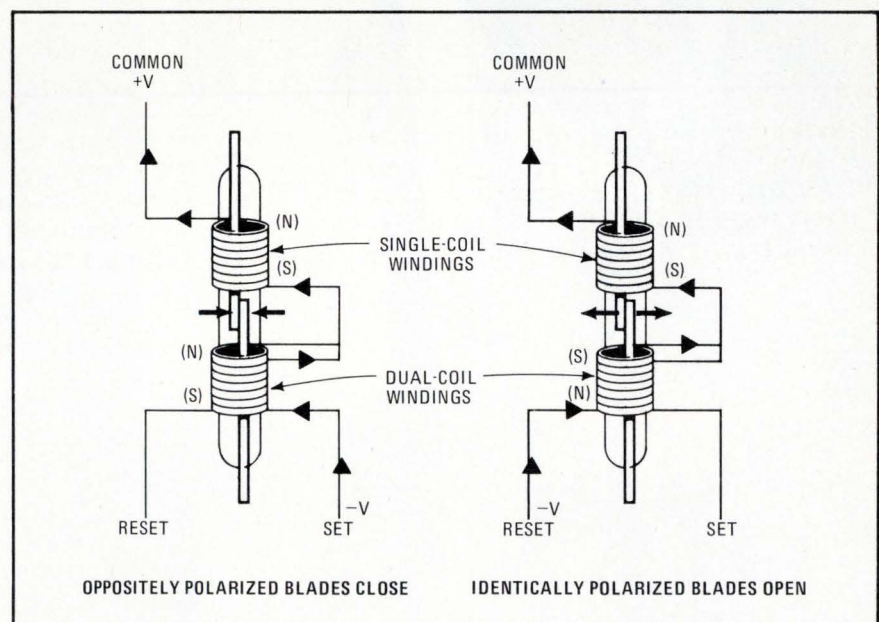

Inside story. A three-coil arrangement is used for each contact pair of a self-latching relay. The contacts are polarized oppositely or identically to close or open them.

Crank up this high-performance machine and you'll have 30 MHz at your command. Enough frequency for about any test situation you can name.

Of course top end isn't everything. The Wavetek 164 has the sophistication to maneuver smoothly on anybody's test bench.

You can shift to any of nine

different waveforms in continuous, triggered or gated modes. Drop to 3 μ Hz and then run up the entire range in 1000 to 1 sweeps or discrete 10% steps. You can even adjust rise-and-fall times with the unique trapezoidal waveform.

The price is \$995*. A bit more than average. But a few minutes at the controls will convince you that

the Model 164 is no average function generator.

*F.O.B. San Diego, wheels optional at extra cost.

WAVETEK®

P.O. Box 651
San Diego, California 92112
Tel. (714) 279-2200, TWX 910-335-2007

Circle 132 on reader service card

Thirty million Hertz puts you in the driver's seat.

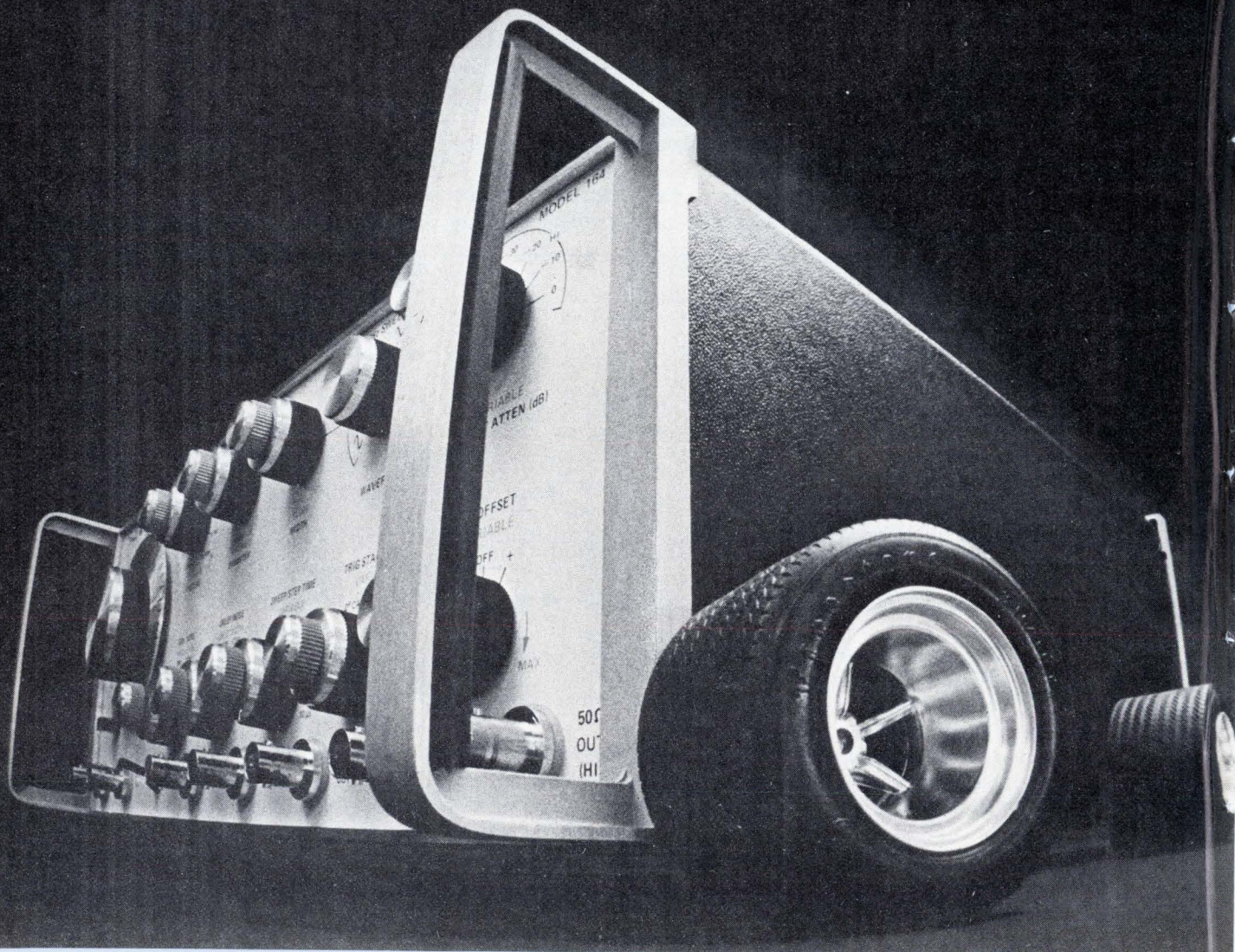

Calculator turns into data terminal

Interface cables and read-only memory plug-ins permit desktop unit to communicate with computers, time-shared systems, other terminals

by Stephen E. Scrupski, Communications and Microwave Editor

Owners of the Hewlett-Packard model 9830A desktop calculator can now turn it into a programmable data terminal by purchasing a set of interface cables and read-only-memory plug-ins. With the additional equipment, a user can communicate with other terminals or with a large computer for batch processing or for time-sharing applications. The interface setup, called the model 11285A, sells for \$1,500 (the basic 9830A sells for \$6,475) and allows the 9830A to communicate in synchronous or asynchronous mode at data rates that can range from 110 to 9,600 bits per second.

The company says that about 2,000 9830As have been sold since the calculator's introduction in late 1972. Since the introduction, the company has added several optional peripherals: a card reader, a line printer, and a disk-storage unit. The calculator itself uses a tape cassette for storage, but the system has grown steadily to the point where, now, it is almost a small processing system. However, one need that hadn't been met was full communications ability, now supplied by the interface and the ROM, the company points out.

In strings. The ROM enables the calculator to interface with any modem that conforms to EIA specification RS-232-C and with automatic dialers that meet EIA spec RS-366. Two new Basic statements (the 9830A is programmed with the Basic language) are defined by the control ROM to allow the user to write or read messages in strings from a remote terminal or a computer via telephone lines. Other features include programmable parity, auto-

matic answering, programmable end-of-transmission character, and either half- or full-duplex modes.

Still other features can be added with two additional ROMs. The 11297B ROM allows the terminal to operate with a binary-synchronous protocol. It also adds error detection and ASCII-to-EBCDIC conversion so that the user can connect the 9830A as a remote-batch terminal without modifying software drivers at the computer. One other significant feature is programmable error recovery. In a data-communications mode, errors (incorrect commands or codes, for example) can often be automatically remedied. The 11297B ROM, therefore, includes the ability to take different actions for different types of errors.

The main storage in the 9830A is programmed with the actions to be taken, and the ROM includes the commands to jump to this area of storage after identifying the type of error. The ROM also allows use of transparent text in the binary synchronous protocol, so that special characters can be used, with appropriate coding that warns the receiving end of their presence.

The second additional ROM, the 11298B, allows the calculator, when operating in an

asynchronous mode, to function as an interactive teleprinter to a time-shared computer. The calculator can transmit and receive Basic programs or free text, which can include programs written in other languages, such as Fortran. Two of the 9830's 10 special-function keys are defined to correspond to teleprinter SHIFT and CTRL keys. Two other keys are defined to send a line from a 9830A display, and to receive program lines into the 9830A calculator memory.

Price of the two additional ROMs is \$500 each. Delivery time is eight weeks.

Inquiries Manager, Hewlett-Packard Co., 1501 Page Mill Rd., Palo Alto, Calif. 94304 [339]



30 AMP CENTER TAPPED Silicon Integrated Rectifiers



Three new series in TO-3 cases

Three New Series:

A controlled avalanche (R702, 704, 706); non-controlled avalanche (R711, 712, 714, 716) and a fast recovery time series (R711X, 712X, 714X, 716X).

Advanced Rectifier Technology:

All series feature a low (0.5°C/W) maximum thermal resistance, ($R_{\theta J-C}$). This results in greater operational reliability and longer life. The hermetically sealed TO-3 case offers ease of handling and mounting.

Specifications for a variety of applications:

Controlled avalanche versions have 200V, 400V and 600V Peak Repetitive Reverse Voltages (V_{RRM}) with 250V, 450V and 650V min. avalanche voltages (V_{BR}). The non-controlled avalanche and fast recovery (200 nsec., t_r) series have 100V, 200V, 400V and 600V (V_{RRM}). All units are rated at 15 Amps per diode (I_o) at 100°C , (T_c). Peak $\frac{1}{2}$ cycle surge current, per diode (I_{FSM}), 250A (150A for fast recovery series).

Typical applications are: Power supplies, inverters, ultrasonic systems, choppers and low RFI systems.

Three Circuit Configurations:

Center tapped common cathode, case positive; common anode, case negative and a doubler circuit.

Typical low pricing: R711, **\$0.93** ea., 1000 quantity.

AVAILABLE CIRCUITS

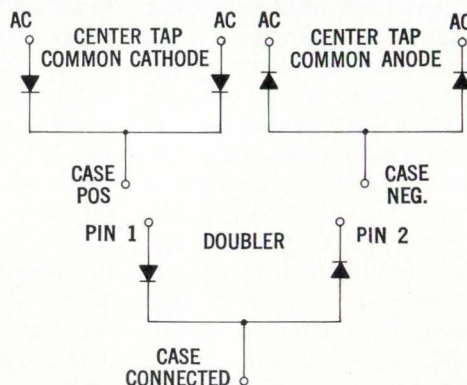

Design us in . . . we'll stay there

VARO SEMICONDUCTOR, INC.

P.O. BOX 676, 1000 N. SHILOH, GARLAND, TEX. 75040 (214) 272-4551 TWX 910-860-5178

Varo Sales Representatives

AL Buchanan & Abrams Assoc. 305-898-7444 • AZ W. W. Posey Co. 602-949-5873 • AR Whiteside Sales 214-231-9771 • CA (NO) W. W. Posey Co. 415-948-7771 • CA (SO) Corcoran Assoc. 213-823-4589 • CT Comp Rep Assoc., Inc. 203-239-9762 • DE Tom Davis Marketers 302-998-0123 • FL Buchanan & Abrams Assoc. 305-898-7444 • GA Buchanan & Abrams Assoc. 305-898-7444 • IL (NO) Varo Semiconductor Inc. 312-627-3802 • IL (SO) Beneke & McCaul 314-567-3399 • IN Technical Reps, Inc. 317-546-4967 • KS Beneke & McCaul 314-567-3399 • KY Technical Reps, Inc. 317-849-6454 • LA Whiteside Sales Co. 214-231-9771 • ME Comp Rep Assoc., Inc. 617-444-2484 • MD Tom Davis Marketers 703-591-7390 • MA Comp Rep Assoc., Inc. 617-444-2484 • MI Davis-Martensen Co. 313-474-8300 • MN Loren F. Green Assoc. 612-781-1611 • MS Buchanan & Abrams 305-898-7444 • MO Beneke & Caul, Inc. 314-567-3399 • NJ (NO) Cooper-Simon & Co. 516-487-1142 • NJ (SO) Tom Davis Marketers 302-998-0123 • NM W. W. Posey Co. 302-998-0123 • NY (METRO) Cooper-Simon & Co. 516-487-1142 • NY (UPST) Bob Dean, Inc. 607-272-2187 • NC Buchanan & Abrams Assoc. 704-332-4974 • OH (NO) J. C. Hofstetter Co. 216-241-4880 & 216-725-4477 • OH (SO) J. C. Hofstetter Co. 513-296-1010 • OK Whiteside Sales Co. 214-231-9771 • OR C. K. Shanks & Assoc. 503-292-5656 • PA (E) Tom Davis Marketers 302-998-0123 • PA (W) J. C. Hofstetter Co. 412-561-5454 • RI Comp Rep Assoc., Inc. 617-444-2484 • SC Buchanan & Abrams Assoc. 704-332-4974 • TX Whiteside Sales Co. 214-231-9771 • VA Tom Davis Marketers 703-591-7390 • WA C. K. Shanks & Assoc. 206-632-4290 • WI Varo Semiconductor, Inc. 312-627-3802 • CANADA • ONT Cantronics, Ltd. 416-661-2494 • QUE Cantronics, Inc. 514-733-0749

New products

Components

BCD switches are compact

Enclosed single-deck rotary units for industrial use are $\frac{3}{4}$ -inch in diameter, depth

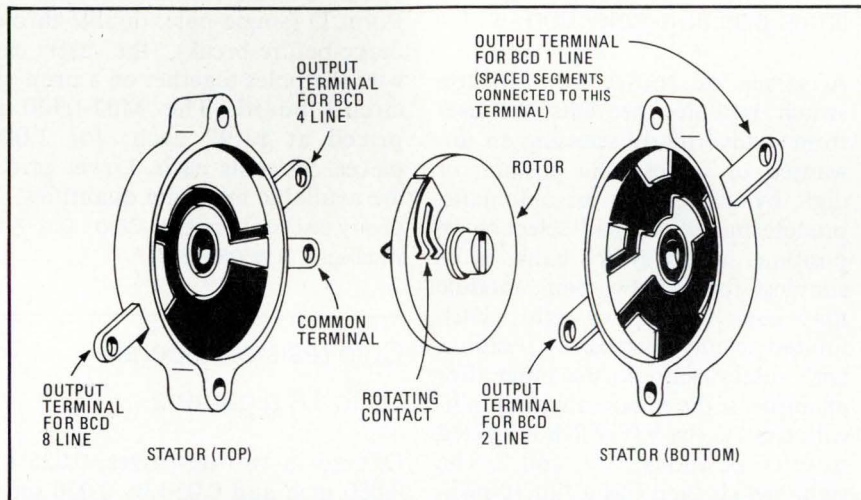

Single-deck construction. The bifurcated contact of this enclosed rotary switch completes the circuit between the device's two stators, which carry the BCD output terminals.

Most rotary switches providing a binary-coded decimal output are either enclosed multi-deck units or open-wafer single-deck units. But Grayhill Inc. of La Grange, Ill., now has available a series of rotary BCD switches that are enclosed, as well as being built with a single deck. Additionally, the series 71 switches, which have a $\frac{3}{4}$ -inch diameter and a $\frac{3}{4}$ -in. rear-panel depth, occupy only a quarter of the area of the open-wafer models. The new units are intended for use in industrial applications like counters, machine tool control, and process control.

The BCD switch output is developed by a bifurcated contact that rotates between two stators, as shown by the drawing above. One stator contains the common ring and the output terminals for the 8 and 4 BCD lines. The other stator provides the output terminals for the 2 and 1 BCD lines. The one-piece rotating contact completes the cir-

switch is wired into a system by tying its common line to the logic-level supply voltage and by using its BCD output lines to bias an associated external counting circuit.

The gold-plated contact system is rated to make and break 125 milliamperes at 30 volts dc for at least 25,000 operating cycles. The rotary construction, says Bruce E. Vinckel, sales vice president at Grayhill, avoids the tracking problems sometimes found in BCD

cuit between the two stators. The thumbwheel switches. These units, which often incorporate the BCD switching pattern on a small printed-circuit board, are susceptible to shock and vibration because contact pressure must be kept low to avoid dragging metal particles across the insulation between stator segments.

Series 71 switches use diallyl phthalate insulation, and they have molded-in terminals to guard against flux contamination. The units cost \$5 each in 100-lots.

Grayhill Inc., 561 Hillgrove Ave., La Grange, Ill. 60525 [341]

Synchronous relays have I/O isolation of 1,500 V

The series GB 15000 synchronous relays in molded epoxy packages feature an input-to-output isolation

of 1,500 volts ac. Optically coupled input zero-voltage switching, minimizing electromechanical interference, is also offered along with a 3-32 v dc input, TTL compatibility, and 5-10-A switching capabilities at 24-240 v ac. Applications include traffic controls, machine-tool controls, office equipment, computer and peripheral equipment, and process controllers. For a 120-v, 5-A version, price in 100-lots is \$11.40.

Grigsby-Barton Inc., 3800 Industrial Dr., Rolling Meadows, Ill. 60008 [344]

Miniature LED warns of battery failure

A miniature LED lamp that acts as a self-contained battery-status indicator for portable equipment, is designed for cameras, tape recorders, calculators, and similar equipment. The lamp gives users an early warning of imminent battery failure. It lights at 3 volts and is dark when battery voltage has declined to 2 v. The model RLC-400 lamp combines a voltage-sensing integrated circuit and a GaAsP light-emitting diode in a conventional T-1 size lamp package. Price is 60 cents in volume.

Litronix Inc., 19000 Homestead Road, Cupertino, Calif. 95014 [342]

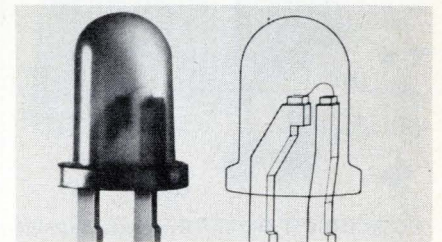

Time delays operate from 1 to 511 seconds

Programmable precision time delays, designated the 295 series, are accurate to within $\pm 0.0016\%$ and may be programmed from 1 second to 511 seconds in 1-second intervals. The units use an integrated circuit to perform all the timing functions and a relay as an output device. They are designed for use with a wide va-

**FROM
BREADBOARD
TO FINAL
PACKAGING
HARDWARE...**

**ALL AVAILABLE
FROM ONE SOURCE**

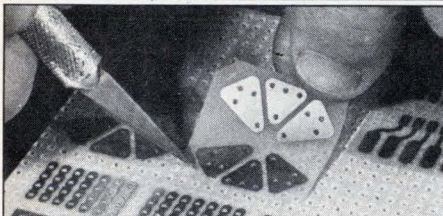

**★ ADHESIVE BACKED
CIRCUIT SUB-ELEMENTS**

(Over 200 Pre-Drilled component mounting patterns available "off-the-shelf.")

**★ EPOXY GLASS BOARD
MATERIALS**

- 76 Standard "Off-the-Shelf" Boards.
- Including Unclad, Copper Clad, Cut & Peel Copper Clad, Pre-etched "X-Y" Pattern and Plated thru Hole Copper Clad.
- .100" Grid Hole Pattern or Undrilled.

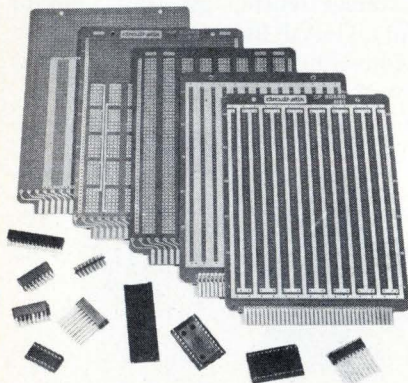

★ GP CIRCUIT BOARDS and ACCESSORIES

- Highest Quality — Choose from 74 "Off-the-Shelf" Boards.
- Sockets — Low & Standard Profile, P.C. and Wire Wrap. • Highest Quality Gold Contacts.
- Adapter plugs • Connectors
- Card Pull Handles.

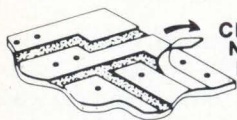

**CIRCUIT-STIK'S
NEW CUT &
PEEL BOARDS**

SEND FOR OUR NEW CATALOGS #502 & #801

circuit-stik®

P.O. BOX 3396 • Torrance, California 90510
Phone (213) 530-5530

New products

riety of input voltages and may be set as either a time delay on pickup or drop-out, one-shot or oscillating. Specifications include: resolution of 1 second; input voltage of 12 to 240 v at 60 Hz, and output-contact rating through 10 A, 120 v ac, 1/3 horse-power.

Essex International Inc., Controls Division, 131 Godfrey St., Logansport, Ind. [347]

**Rotary-switch module
limits position-selection**

A series of rotary push-button switch modules prevents the user from inadvertently selecting an unwanted or undesirable position or digit by giving him an automatic, predetermined, limited selection of positions in any switch bank. In its simplest form, a two-bank module may have the left or right switch limited to any number of positions with relationship to the other. For example, if the maximum digit indication is 26, the left switch is limited to three positions: 0, 1, and 2. The right switch then has a full 10-position capability only when the left switch is in position 0 or 1. When the left switch is in position 2, the module automatically limits the right switch to positions 0 through 6. Conversely, should the right switch be in a position other than 0 through 6, the left switch cannot be moved to position 2 from position 1. International Precision Products B. V., Box 47, Bloemendaal, the Netherlands [343]

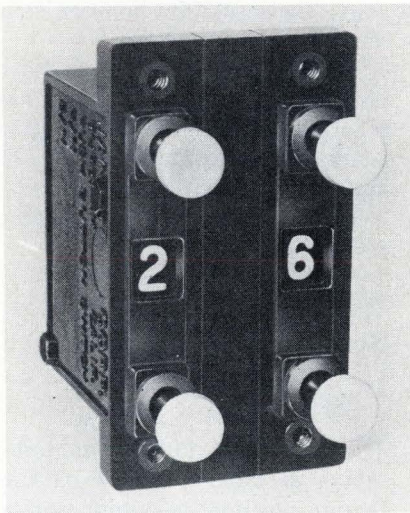

**Keyboard switch offers
two sets of contacts**

A keyboard switch has two sets of contacts: one single-pole, single-throw, normally open, and the other SPST, normally closed. When the switch button is depressed, it causes the first (normally open) operation to close. When the button is further depressed, the normally closed one opens. To convert the switch into a Form D (single-pole, double-throw, make-before-break), the user can wire the poles together on a printed-circuit board. The M62-0900 is priced at \$1.97 each; for 2,000 pieces, 99 cents each. Lower prices are available for larger quantities.

Cherry Electrical Products Corp., Box 718, Waukegan, Ill. 60085 [346]

**Chip resistors operate
up to 18 gigahertz**

Offered in two new sizes, 0.025 by 0.050 inch and 0.050 by 0.050 inch, a series of chip resistors provides stable performance up to 18 GHz and exhibits no adverse characteristics due to skin effect, even in the 18-GHz region. Their small size helps keep resistive areas to the minimum length needed for stable operation at higher frequencies. The resistors are suitable for a variety of microwave integrated-circuit applications, including microstrip and stripline terminations, isolated combiner/dividers, and bias networks for active devices.

Tek-wave Inc., Somerville, N.J. [348]

**Stripswitch built for
computer programing**

Providing a small and inexpensive method for programing computers and using computer-type logic where 16-bit words are the basic logic information unit, a stripswitch mounts directly on printed-circuit boards, vertically or horizontally on either side of the board by wave-sol-

dering. This eliminates rivets, eyelets, mounting hardware, and switch-to-board wiring. The switches are one-piece molded units with up to six switch stations per strip. Models are available for screwdriver, fingertip, or knob set-

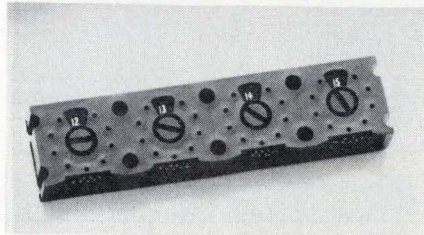

ting. Price is under \$1 each in production quantities.

Electronic Engineering Co. of California,
1441 E. Chestnut Ave., Santa Ana, Calif.
[345]

Integrated rectifiers come in a variety of configurations

Two series of 30-ampere, center-tapped, silicon integrated rectifiers in TO-3 cases are available: a controlled-avalanche series and a non-controlled avalanche series with or without fast recovery time. The controlled-avalanche series, designated R702, 704, and 706, has 200-v, 400-v, and 600-v peak repetitive reverse voltages with 250-v, 450-v, and 650-v minimum avalanche voltages. The non-controlled avalanche series, R711, 712, 714 and 716, with suffix "X" for fast-recovery-time models, have 100-v, 200-v, and 600-v repetitive peak reverse voltages, with 200-nanoseconds recovery time for the fast-recovery versions. All devices are rated at 15 A per diode at a temperature coefficient of 100°C. Typical price is 93 cents.

Varo Semiconductor Inc., Box 676, 1000 N. Shiloh, Garland, Texas 75040 [349]

Potentiometers offer high resolution

A line of miniature precision wirewound potentiometers now includes three- and five-turn Pixiepots

that are 3/4 inch in length and 7/8 inch in diameter. The units feature a mechanical life of 500,000 shaft revolutions, slotted stainless-steel shafts and C-rings, and resolution that is said to be better than wirewound pots twice their size. The devices are also available with metric shafts and

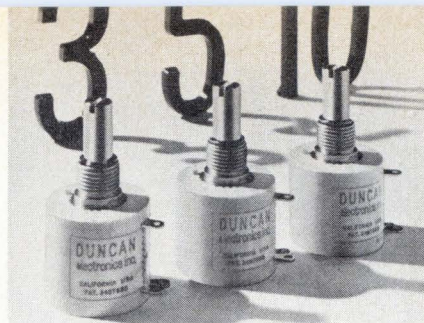

bushings, at no extra charge.

Duncan Electronics, 2865 Fairview Road,
Costa Mesa, Calif. 92626 [350]

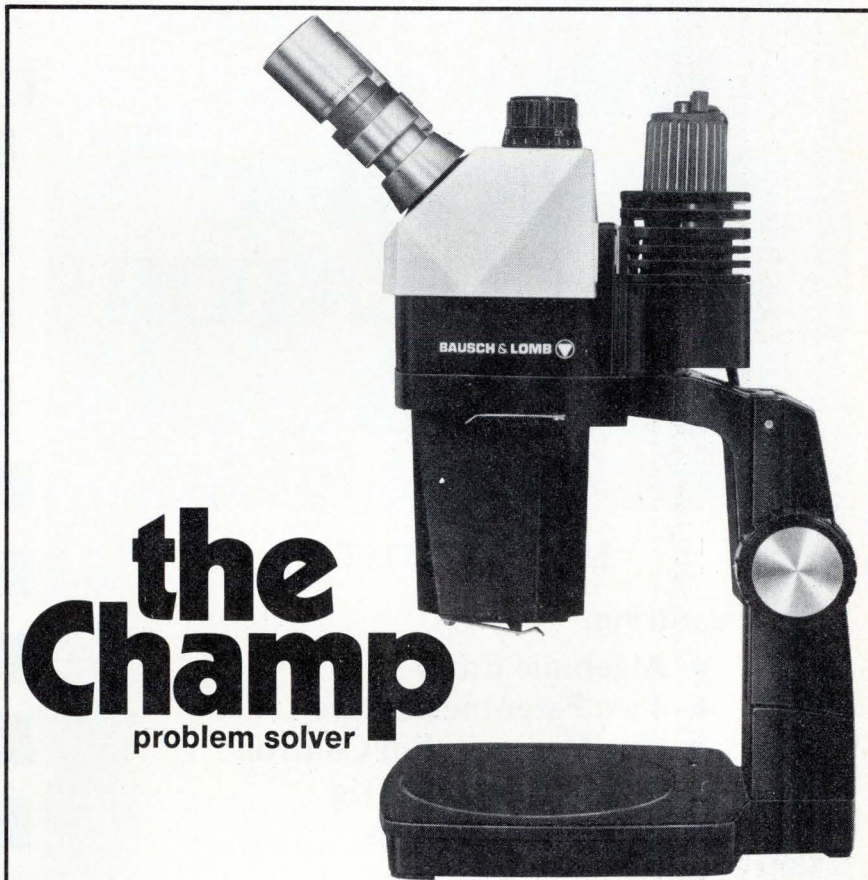

the Champ

problem solver

Bausch & Lomb StereoZoom 7 Microscope with Coaxial Illuminator is the answer to your need for full field, full aperture illumination; full color, high contrast imaging and better resolution.

This unique form of incident illumination eliminates surface glare from highly reflective surfaces and also effectively illuminates low contrast objects.

You zoom over a magnification range of 15X through 280X. Field diameter ranges from 0.55 in. through 0.03 in. Working distance is 3.0 in.—0.56 in.

**Send today for our catalog 31-15
and our FREE DEMONSTRATION offer.**

BAUSCH & LOMB 

SCIENTIFIC OPTICAL
PRODUCTS DIVISION

StereoZoom. Reg. T.M.
Bausch & Lomb

62308 Bausch Street, Rochester, N. Y. 14602

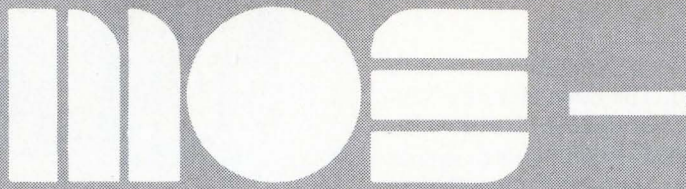

THE NEW GENERATION FOR SCIENTIFIC CALCULATOR ARRAYS

THE SCIENTIST

Featuring:

- Algebraic Entry
- Two Parentheses Levels
- One Memory, Full Control
- Trig and Inverse Trig
- Logs and Anti-logs
- Exponentiation
- Full 40 Key Control
- Deg. or Rad. Trig
- 10 Digit Mantissa
- Full Scientific Notation

And

- Direct LED Segment Drive
- Low Power (< 200 MW Avg.)
- Minimum External Components

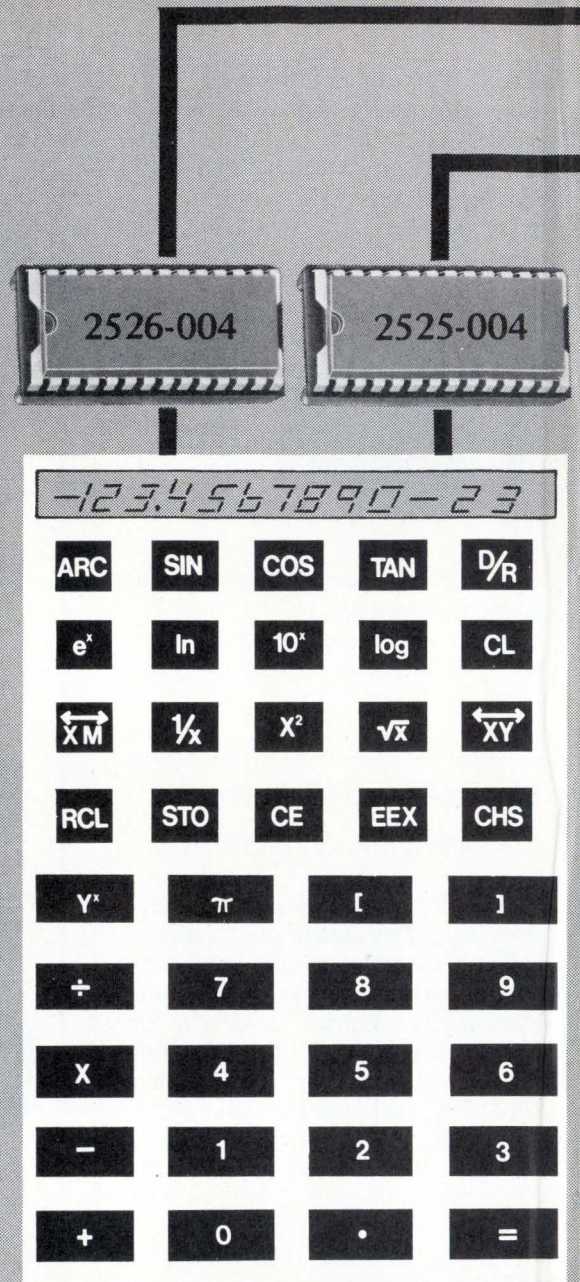

HEADQUARTERS—

Applications Mgr.: Mr. Julius Hertsch;
MOS Technology, Inc., Norristown, Pa. 19401

CENTRAL REGION—

MOS Technology, Inc., 838 S. Des Plaines St.
Chicago, Illinois 60607 (312) 922-0288

EASTERN REGION—

Mr. William Whitehead, Suite 307—
88 Sunnyside Blvd., Plainview, N.Y. 11803 (506) 822-4240

WESTERN REGION—

MOS Technology, Inc., 2172 Dupont Dr., Suite 221
Patio Bldg., Newport Beach, Calif. 92660 (714) 833-1608

a proud affiliate of ALLEN-BRADLEY



... OR ADD ONE ARRAY AND GET ALL THIS!

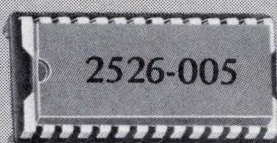
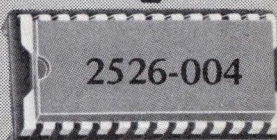
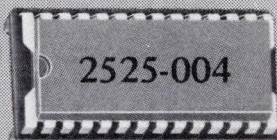

THE **SENIOR** SCIENTIST

Now Work With:

- Three User Memories
- Full Group Control

-for-

Advanced Math:

- Binomial Coefficients
- Factorials
- Combinational Math
- Coordinate Conversions
- Vectors

Statistics:

- σ and \bar{X}
- $Pr(x) = \frac{1}{\sqrt{2\pi}} \int_{-\infty}^0 e^{-\frac{t^2}{2}} dt$
- $\Gamma(x) = \int_0^{\infty} t^{x-1} e^{-t} dt$
- $\|X\| = \sqrt{SOS}$

-123.4567890-23

	SIN ⁻¹	COS ⁻¹	TAN ⁻¹	CF
F	SIN		TAN	D/R
n!	$\Gamma(x)$	$\binom{n}{k}$	$\binom{n}{k}$	GRP
e ^x	ln	10 ^x	log	CL
Σ^-	Pr(x)	σ	\bar{x}	$\ X\ $
Σ^+	1/x	x ²	\sqrt{x}	\overleftrightarrow{XY}
RCL Σ	STO Σ	\overleftrightarrow{XM}	RCL k	STO k
RCL	STO	CE	EEX	CHS
Y ^x	π	[]	
÷	7	8	9	
X	4	5	6	
-	1	2	3	
+	0	.	=	

WE'VE TURNED
A TECHNOLOGY
INTO A COMPANY

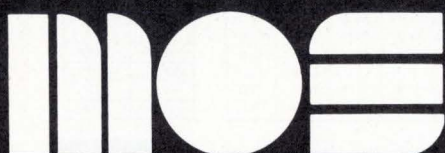

MOS TECHNOLOGY, INC.
VALLEY FORGE CORPORATE CENTER, NORRISTOWN, PA. 19401 (215) 666-7950

We take your reputation seriously.



That's why we build and test our Standard Power Modules so carefully.

The fact is, the basic power supply can put an expensive business machine out of business. And, while the shutdown may only be temporary—the possible loss of reputation and customer confidence may be permanent. This is why many O.E.M.'s are taking another look at their power supply "economies". When they do, North Electric looks better and better.

This is because our line of Standard Power Modules offers the highest levels of engineering skill, production line care and quality control in the industry—the same standards that have made North Electric the leading custom power source for more than 40 years. The point is—when North delivers power, you can bet your reputation on it.

Send for a complete product catalog today, or call your North Standard Power Product Manager at 419/468-8874.



Listed here are the more popular models—many other voltages are available.

MODEL	11000	12000	13000	14000	15000	16000	17000	18000
VDC	AMPERES							
5.0	3.9	5.3	11.3	13.0	20.0	32.5	49.0	82.0
12.0	2.8	4.2	8.0	10.5	15.0	23.0	36.0	58.0
15.0	2.4	3.7	7.5	9.5	14.0	20.5	27.0	47.0
18.0	2.1	3.3	6.0	8.0	13.0	18.0	26.0	40.0
24.0	1.5	2.8	4.2	7.0	11.0	15.0	21.0	33.0
28.0	1.4	2.4	4.0	6.3	9.0	14.0	20.0	29.0
36.0	1.2	2.2	3.1	5.6	8.0	11.0	14.0	23.0
48.0	.95	1.8	2.6	4.2	6.0	8.0	10.0	18.0

MODEL	10000
VDC	AMPS
0-7.5	2.10
0-16	1.25
0-25	0.85
0-33	0.68

DUAL OUTPUT SUPPLIES	
MODEL	N03052
VDC	AMPS
+15-12	400MA
MODEL	N60052
VDC	AMPS
+15-12	1.0A

NORTH 
ELECTRIC COMPANY

New products

Instruments

Test oscillator is clean, fast

Distortion level is below 0.002%, 10 Hz to 20 kHz; unit settles in 6 seconds

In pushing amplifier performance to new standards of excellence, designers of high-fidelity equipment are challenging designers of test equipment to provide heretofore unobtainable linearity—well beyond the

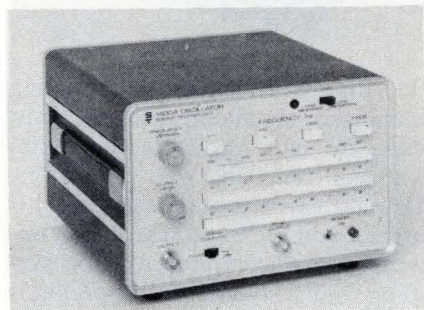

performance of the product to be tested. An oscillator developed by Sound Technology promises to fill this requirement.

Designated the model 1400A, the oscillator is an extraordinarily clean signal source. It boasts a level of total harmonic distortion (THD) that is below 0.002% over the range from 10 hertz to 20 kilohertz.

Today, engineers want to measure total harmonic distortion below 0.1%, so they require a signal source that has a total harmonic distortion about five times better, or 0.02%. Thus the model 1400A's THD of less than 0.002% can serve successfully as a source for THD measurements down to 0.01%.

The 1400A is efficient at measuring distortion because of its rapid settling time. Often, low-distortion oscillators require long settling times before their output level stabilizes following each new frequency setting. This can hinder the engineer bent on rapid distortion tests at a number of discrete points. However, the 1400A settles to each new fre-

quency in a maximum of 6 seconds.

Flipping the slide switch on the front panel changes the output from a grounded to a floating signal source, valuable because it enables the user to avoid ground loops which often introduce 60-Hz components and impair the accuracy of distortion measurements. Push-button frequency selection provides the user with 3-digit resolution over the range of 10 Hz to 110 kHz. A frequency vernier knob shifts the output plus or minus three least significant digits.

The model 1400A is 6 inches high by 9½ in. wide by 9¾ in. deep and weighs 9½ lb. Price is \$570.

Sound Technology, 1400 Dell Ave., Campbell, Calif. 95008 [351]

Oscillator plug-in covers 2 to 18 gigahertz range

A 2-to-18-gigahertz plug-in for Hewlett-Packard's solid-state sweep oscillator uses microelectronic technology. It measures 5¼ inches high, 16¾ in. wide, and 11¾ in. deep, and it weighs 33 pounds. Microelectronic elements of the model 86290A are: a YIG-tuned 2-to-6.2-GHz fundamental transistor oscillator (oscillator with 3:1 tuning range); a 2-to-6.2-GHz wideband amplifier delivering more than 100 milliwatts of power; and a high-efficiency multiplier integrated with a tracking YIG filter. Price of the 86290A is \$13,250; the 8620A sweeper mainframe is priced at \$1,750, and a modification kit for 8620A mainframes costs \$300.

Hewlett-Packard Co., 1501 Page Mill Road, Palo Alto, Calif. 94304 [352]

Pulse generator offers 11 programable parameters

A general-purpose pulse generator has 11 programable parameters controlled by serial or parallel BCD inputs. Pulse amplitude of the model PX-30/31 is 0 to 10 volts into 50 ohms from a 50-ohm source, and repetition rate range is zero to 9.99

megahertz. Other features include a dc-offset range of 0 to ±9.9 volts, independent of amplitude; less than 2% nonlinearity of pulse rise and fall; and less than 5% preshoot, overshoot, undershoot, droop, ringing and other anomalies combined. In addition, pulse rise and fall times can be independently programmed. Price is \$3,750 for the PX-30 and \$4,500 for the PX-31.

Phenix Electronics, 13724 Prairie, Hawthorne, Calif. 90250 [354]

Rotary pair selector can be used with test equipment

Designed for rapid pair selection when used with front-tap shoes on a main distribution frame, a rotary pair selector can also be used with various testing equipment such as volt-ohm-milliammeters, tone generators, scopes, and meters to test

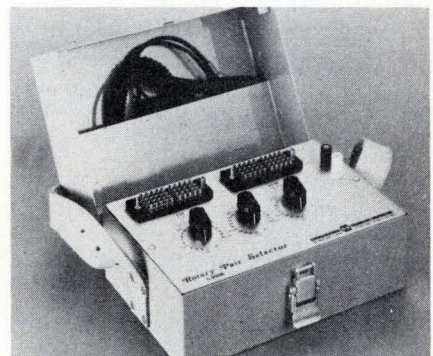

cable pairs. The rotary pair selector is self-powered and portable for use in any location in the central office. The unit selects one out of 50 pairs and when used with specific front-tap shoes, will isolate special circuits, buck pairs, and locate them for pair reclamation.

Communications Technology Corp., 2237 Colby Ave., Los Angeles, Calif. 90064 [355]

Inexpensive pulse generator simplifies component design

A pulse generator, the model 1101, sells for \$159 in single quantities. Two or more are priced at \$149 each, and five or more pulse gener-

New products

ators sell at \$139 each. The low cost of this general benchtop instrument is attributed to placing 85% of all the components in a single custom IC. The pulse generator is battery-operated so that it can be isolated from ground. The batteries provide 40 hours of operating time and are rechargeable in 10 hours. The fre-



quency range is more than seven decades, from 0.1 hertz to 2 megahertz. Fall time is 10 nanoseconds, and rise time is 40 ns. In addition, the pulse width is continuously variable from 0 to 100% of the period, output voltage is adjustable from 0 to 5 volts, and the pulse output sinks 50 milliamperes and sources 5 mA.

Interdesign Inc., 1255 Reamwood Ave., Sunnyvale, Calif. 94086 [356]

Transistor-test set

handles voltages to 2,500 V

For testing npn transistors at voltages up to 2,500 v, the T397 high-voltage transistor tester can function as an independent test instrument or in conjunction with the T347 computer-operated transistor test system. The T397 tests breakdown voltage and leakage current at up to 2,500 v and 1 milliamperes. Latching voltage and current gain can be

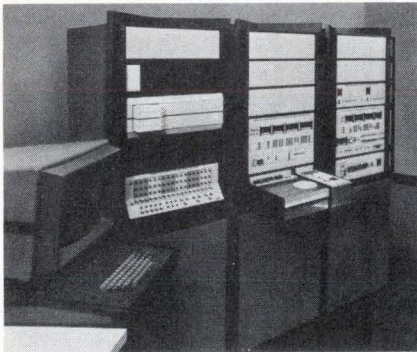

tested at up to 1,000 v and 100 mA. The internal memory of the instrument has a basic capacity for 32 tests. Using a magnetic card loader, the tester can also store established job plans on magnetic cards for future use. The job plans direct the test sequence and binning of each device. Price of the T397 is \$15,000.

Teradyne Inc., 183 Essex St., Boston, Mass. 02111 [357]

High-voltage meter measures to 30 kV

The model 88M high-voltage meter directly measures dc voltages up to 30 kilovolts with an error at less than 1% of full-scale deflection. The instrument has greater than a 30,000-megohm input impedance and the maximum test current taken is less than 1 microampere, which means it can replace electrostatic voltmeters in many applications. The instrument, which weighs less than five pounds, can be supplied with a probe especially designed for

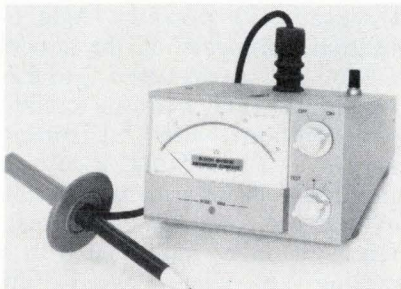

high voltages. The meter also features a recorder output for checking long-term high-voltage stability. Power is provided by internal 9-volt batteries. Price is \$295.

Zi-Tech division, Aikenwood Co., 223 Forest Ave., Palo Alto, Calif. [359]

Microprocessor-chip tester

checks individual instructions

A microprocessor-chip tester checks the individual instructions on a chip in varying sequences to ascertain worst-case testing. Intended for probing and receiving inspection,

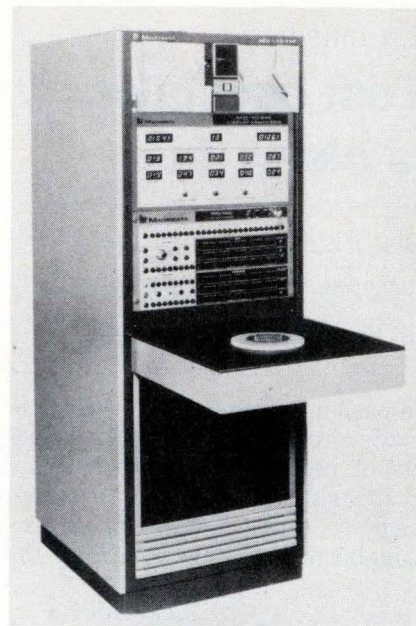

the Big M is suitable for testing memories or microprocessor chips used in such products as digital watches, seat belts, and calculators. Dc-parametric-testing capability is included in the basic system. An optional supervisory processor for handling four test systems in parallel is available, providing data-logging and test control of up to eight test heads. The unit is priced at less than \$50,000.

Macrodata Co. Inc., 6203 Variel Ave., Woodland Hills, Calif. 91634 [358]

Transistor-noise tester

offers two bandwidths

The model 512 B transistor-noise test set reads noise figures directly and includes two noise bandwidths, 10 to 50 hertz and 10 Hz to 10 kilohertz. Noise figures are read directly from 0 to 62 dB, collector currents are adjustable from 10 to 1,000 microamperes, and collector voltages can be set from 3 to 30 volts. Four internal or external base resistors are selectable by panel switch. The instrument measures popcorn, burst, flicker, or broadband noise and requires no adjustments or calculations for operation.

Quan-Tech Division, Scientific-Atlanta Inc., Randolph Park West, Route # 10, Randolph Township, N.J. 07801 [360]

From the voltmeter house...



Discover how these auto-multimeters keep you out of trouble.

On the surface they may look like any well-designed digital multimeters.

Now look closer. What else do you see?

There... the Fluke name!

That indicates unusual performance.

We designed both the Fluke 8600A and the 8800A with auto range, auto zero, and auto polarity. **And every parameter is fully protected.** This means you can accidentally overload the instrument with too much current... too much voltage... or too much resistance!!... and you're still okay.

Another way you stay out of trouble: MTBF on each instrument is a minimum of 10,000 hours.

Now, the specs.

The 26-range Fluke 8600A, \$599. We packed this 20,000 count multimeter with five

ranges of volts from 200 mV through 1200 V ac and dc. Five ranges of current, 200 μ A to 2 A ac and dc. And six ranges of resistance from 200 ohms to 20 megohms.

Basic dc accuracy is a fully credible 0.02%. Options include built-in automatic rechargeable battery pack for up to 8 hours off-line operation. Digital output is also offered.

The 0.005% Fluke 8800A, \$1099.

This digital multimeter features five ranges of dc volts from ± 200 mV

to ± 1200 V. Four ranges ac from 2 V to 1200 V. And six ranges of four terminal resistance from 200 ohms to 20 megohms. For complete isolation the input resistance is better than 1,000 megohms on lower ranges and 10 megohms on the higher ranges.

For critical resistance measurements the instrument provides completely isolated four terminal ohms with less than 4 volts open circuit from 200 ohms through 20 megohms.

So there are the specs.

Impressive? We think so. But remember—specs are one thing. That name on the panel, however... It's what makes a Cadillac a Cadillac.

And a Fluke a Fluke.

For details, call your nearest Fluke sales engineer. Or simply dial our hot line.



For data out today, dial our toll-free hotline, 800-426-0361

In the continental U.S., dial our toll free number 800-426-0361 for the name and address of your nearest local source. Abroad and in Canada, call or write the office nearest you listed below, John Fluke Mfg. Co., Inc., P.O. Box 7428, Seattle, Washington 98133. Phone (206) 774-2211, TWX: 910-449-2850. In Europe, address Fluke Nederland (B.V.), P.O. Box 5053 Ledeborstraat 27, Tilburg, The Netherlands. Phone 013-67-3973. Telex: 844-52237. In the U.K., address Fluke International Corp., Garnett Close, Watford, WD2 4TT, England. Phone 0923-33066. Telex: 934583. In Canada, address ACA, Ltd., 6427 Northam Drive, Mississauga, Ontario. Phone 416-678-1500. TWX: 610-492-2119.



For Information circle 142 on reader service card.

For Demonstration circle 143 on reader service card.

This chip
is the world's first
SOS processor.



It makes all the
stuff on the next page
possible.

Silicon-on-sapphire isn't new. The aerospace industry and the military have recognized its high-speed, high-density and high-reliability characteristics for years.

But no one was ever able to use it in a computer processor.

Until now.

Now General Automation designers have built the world's first commercial processor using SOS technology.

always meant you had to make major concessions in performance.

With SOS you make none.

The LSI-12/16 has an instruction execution cycle time of 2.64 microseconds.

It's faster than any microprocessor on the market.

unique built-in ROM patch that lets the user retrofit new instructions to any ROM.

Custom tailoring.

There's one more advantage the LSI-12/16 has that no other microproduct can offer.

It's the systems backup and application expertise that General Automation gives you. Helping solve customer problems has always been our long suit. It still is.

We can customize I/O boards and match the LSI-12/16 exactly to your requirement.

Our microcomputer is available in one of two different configurations:

As a board-only system, packaged with memory, control console and processor on a single 7-3/4 by 10 inch printed circuit board.

Or the same board packaged in an enclosure with power supply, battery backup for semiconductor memory and card slots for additional I/O boards.

For more information, write

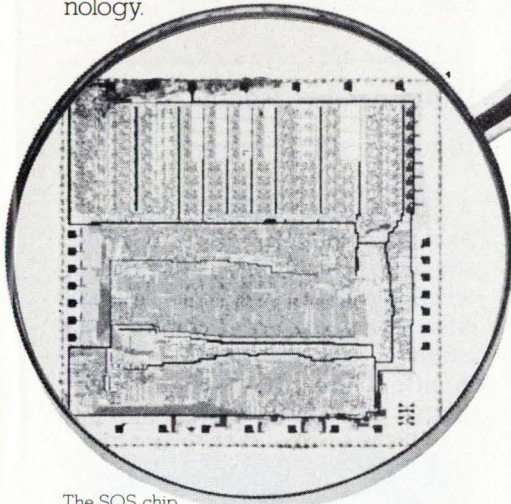

The SOS chip magnified 16 times.

They've placed 2000 gates or the equivalent of 4000 to 5000 transistors on a single semiconductor chip.

An 800 times size reduction from its predecessor product, the SPC-12.

The world's first microcomputer.

That tiny SOS chip has made it possible to bring you the LSI-12/16. A complete digital automation microcomputer with from 1K to 32K bytes of semiconductor memory.

We call it the world's first microcomputer because it's the only

restart, remote cold start, 16 bit parallel I/O interface and up to 2K bytes of semiconductor memory.

But we didn't stop there.

GA engineering has also overcome the problems associated with semiconductor memory. Like loss of data in the event of power failure.

We handled that by developing an auxiliary battery backup system that will activate immediately upon loss of power and will retain the contents of memory for up to 15 hours.

In case you're interested in more memory, we've designed a piggyback board that will give you an additional 2K of RAM or 8K of ROM.

And if there's ever an error in ROM programming, it can be corrected. The LSI-12/16 has a

It's more powerful. And lower in cost. In board-only configuration with 1K memory, it costs only \$495 in minimum OEM quantities of 1000 per year. In short, we offer all the performance of a minicomputer at microprocessor prices.

Breakthroughs across the board.

The LSI-12/16 is the first microproduct to successfully put all of the following on a single board: A processor, power fail/auto

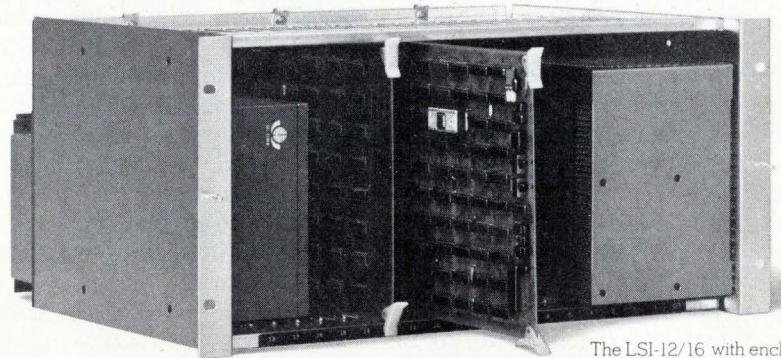

The LSI-12/16 with enclosure.

General Automation, 1055 South East Street, Anaheim, California 92805. Or call us at (714) 778-4800.

Our European headquarters is at Centre Silic, Cidex L242, 94533 Rungis, Paris, France. Call 686-7431.

GENERAL AUTOMATION

A new generation of computer processors is beginning. All because of this.

The board-only system.

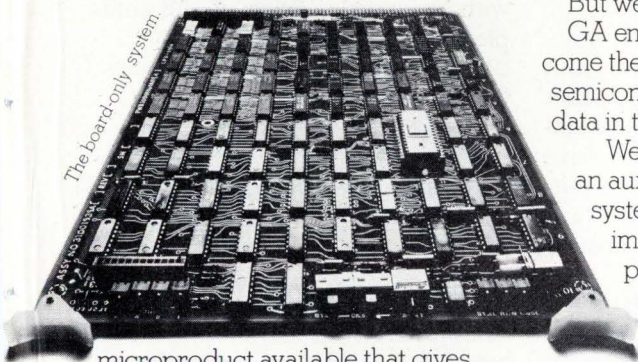

microproduct available that gives you the performance, the systems features, the reliability and the applications support you would normally expect from a minicomputer.

More work, less money.

In the past this kind of size reduction

Communications

Push-button, dial phones linked

IC permits push-button calls to go through PABX, central office without Touch Tone

In a push to become a new power in telecommunications components, General Instrument Corp. of Hicksville, N.Y., has developed an integrated-circuit push-button dialer for telephones—the first of what will become a standard U.S. product line. While once the sole domain of the Bell System and one or two of the larger independent phone companies, the telephone interconnect market is growing at the rate of 50% to 60% a year, says Brian Cayton, marketing manager for telecommunication products at GI.

Previously, push-button calls could not be processed through a standard private branch exchange or through a central office handling rotary-dialed calls. But the new GI circuit, designated the AY-5-9100, converts push-button closures to a series of pulses compatible with all dial-telephone systems. Thus, the circuit bypasses the need to go to Touch Tone.

The AY-5-9100 also includes a memory that enables a caller to press a button if a line is busy, then hang up and re-dial the call later by simply pressing another button.

GI will market a more sophisticated memory for rotary dialers, the AY-5-9200, later this year. That unit will store as many as 10 20-digit phone numbers and be activated by a button switch. The third product in this line will be the AY-5-9400, a tone-generator circuit for Touch Tone phones.

GI's Glenrothes, Scotland, facility has been heavily involved in telephone components for the European market for several years. But Cayton believes the 25 million independent phones (there are 140 million Bell System phones in the U.S.)

in the country form a separate market that will include manufacturers of private and public branch exchange equipment, telephones, dial-up data terminals, tone-to-pulse conversion, and other equipment for connection to phone systems.

The AY-5-9100, with operating requirements of less than 2 milliwatts, can operate off the line current or from two small dry cells. The unit comes in an 18-lead dual in-line package and is available for immediate delivery at \$15 in 100-piece quantities.

General Instrument Corp., Microelectronics Division, 600 W. John St., Hicksville, N.Y. 11802 [401]

Amplifier delivers 100 watts over 1,600–1,700 MHz

The model PWA1617-12 continuous-wave solid-state class C amplifier delivers 100 watts saturated power over the frequency range from 1,600 to 1,700 megahertz. The unit also features a 50-decibel gain, output circulator for protection against load mismatches, strip technique, and microwave-integrated-circuit construction. Applications include satellite communications and radar systems.

Microwave Power Devices Inc., Adams Ct., Plainview, N.Y. 11803 [404]

Limiting i-f amplifiers shift less than 5°

Offering less than 5° phase shift over a 65-dB dynamic range, a series of integrated-circuit limiting i-f amplifiers work with continuous-wave or pulsed signals and have an output buffer stage to eliminate load variation errors. The units operate

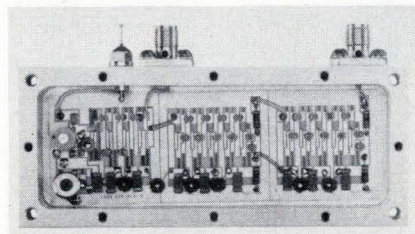

from -40°C to $+70^{\circ}\text{C}$. The ICSL series is also available with center frequencies from 30 to 160 megahertz and bandwidths to 20 MHz. Dynamic range is from -70 to -5 dBm, and VSWR is less than 1.5:1. Prices start at \$675.

RHG Electronics Laboratory Inc., 161 E. Industry Ct., Deer Park, N.Y. 11729 [405]

Video system transmits, receives still pictures

A video communications system capable of transmitting and receiving still television images over dial-up telephone lines or other voice grade circuits includes a closed-circuit TV camera, camera stand, 12-inch monitor, and Colorado Video's models 260 video compressor and



261 video expander for two-way operation. Sixty seconds are required to transmit a single medium-resolution image, while a magnetic disk is used in the receiver memory to allow indefinite image storage time with gray scale. Price of the complete basic system is \$9,000.

Colorado Video Inc., Box 928, Boulder, Colo. 80302 [406]

Traveling-wave tubes cover 5.9 to 14.5 GHz

A family of periodic high-power communications traveling-wave tubes, focused by permanent magnets, is said to provide higher output power, as well as improvements over other models in gain variation, phase linearity, and cooling. Applications are in microwave and satel-

85 amp DO-5



The ratings are back and even we're a little amazed at the fantastic results. We knew our upgraded DO-5 was a honey, but an 85 amp rating is (to say the least) a major breakthrough in power semiconductors.

Here's how it tested:

- Dimensions as per JEDEC DO-5 outline.
- Maximum Recurrent Peak Reverse Voltage . . . 100-1600 volts.
- Maximum Average Forward Current, Single Phase Half Wave Rating at 115°C. Case Temperature 85 amps.
- Maximum Surge Current (One Cycle) 1500 amps.
- Θ_{JC} 0.6

For detailed information, contact:
FMC Corporation
Semiconductor Products Operation
Homer City, Penna. 15748
(412) 479-8011

FMC Special
Products

decassette
tuo
digital equipment corporation

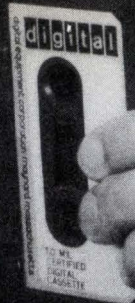

digital digital equipment corporation · maynard, mass.

Wherever Digital computers are, Digital cassettes are going.

Digital's dual magnetic tape cassettes aren't everywhere yet. But wherever Digital PDP-8 and PDP-11's are used, DECcassettes are rolling.

That's because DECcassettes are the first truly reliable alternative to paper tape. Digital's own 1 mil tape with heavy mylar backing guards against tape failure. A special reel-to-reel drive design extends the life of tape performance. And single track recording coupled with error checking circuits protects against intrusion of noisy external signals.

Yet, with all these features, a DECcassette costs less than paper tape. And 15% less than other cassette-type systems. The single-unit price before liberal OEM quantity discounts is only \$2990.

Every DECcassette is also supported with the diagnostics and systems software you need to

get your research, development, monitoring, data communications and other applications running in a minimum amount of time.

For stand-alone systems, CAPS-8 and CAPS-11 give you the convenience of a magnetic tape resident programming system and the adaptability of a paper tape system.

Editor, relocating assembler, linker, debugger and file utility routines, combined with a concise, easy-to-use command language and a standard cassette file structure, enables easy extension of the system, too.

Operating systems software such as DOS/BATCH-11, RT-11 and OS-8 come complete with handlers that support the DECcassette. COMTEX-11 communications executive and other types of applications software are available on cassettes, thus elim-

inating the need for other more costly input devices.

Now you know why wherever Digital computers are, Digital cassettes are going.

Check into one yourself, whether you need a total system or just the drive itself.

Once you do, you'll be rolling, too. Delivery 30 days after receipt of order.

Call or write for complete information, Digital Equipment Corporation, Maynard, Mass. 01754. (617) 897-5111, Ext. 2949. European headquarters: 81 route de l'Aire, 1211 Geneva 26. Tel: 42 79 50. Digital Equipment of Canada Ltd., P.O. Box 11500 Ottawa, Ontario, K2H 8K8 (613) 592-5111.

digital

New products

lite systems. Specifications include: a frequency ranging from 5.9 to 14.5 gigahertz, power from 150 to 600 w, and gain of 45 db for all four models.

Teledyne MEC, 3165 Porter Drive, Palo Alto, Calif. 94304 [407]

Decommutator handles PCM signals in high-quality links

Using the model 500-480 decommutator with the integral bit synchronizer, pulse-code-modulated signals can be directly decommuted from medium- or high-quality links without the need for a coherent clock signal. This simplifies testing of PCM modules and is said to offer an economical way to accomplish the decommutation func-



tion in industrial systems using direct wire links or tape-stored data. Front-panel toggle switches set up main- and subframe synchronizing words, and thumbwheel switches select the desired word for display. Either percent-of-full-scale (model 500-480-1) or binary-weight (model 500-480-2) can be displayed on a 4-digit planar gas-discharge display. The model 500-480 sells for \$3,450.

Base Ten Systems Inc., 3828 Quakerbridge Rd., Trenton, N.J. 08619 [408]

Receiver-transmitter is for asynchronous uses

A universal asynchronous receiver-transmitter, called the COM 2017, performs all receiving and transmitting functions associated with asynchronous data communications. The MOS LSI circuit is made with p-channel low-voltage oxide-nitride

technology, and the duplex mode, baud rate, data-word length, parity mode, and number of stop bits are independently programable through the use of external controls. Moreover, there may be 5, 6, 7, or 8 data bits, odd/even or no parity, and 1, 1.5, or 2 stop bits when utilizing a 5-bit code from the COM 2017.

SMC Microsystems Corp., 35 Marcus Blvd., Hauppauge, New York 11787 [409]

Dual-tone detector signals dial tone, numerals

A series of dual-tone or coincidence detectors, for use in any communications system that must identify the arrival of simultaneous tones, includes the model DTMF-0350-0440, which handles simultaneous 350- and 400-hertz tone signals. Other models are based on the combinations dialed on civilian and military phones, including 941, 852, 770, and 607 Hz, and 1,209, 1,477, 1,336, and 1,633 Hz as standard Touch Tone frequency combinations. Applications for the Touch Tone detector cards are in the telephone-switching and identification requirements of communications lines. Other applications are in transmission of digital numbers using the same code as the Touch Tone dial systems, and in remote control via the telephone network. Standard frequency combinations are available from \$90 to \$150 each in small quantities.

OPT Industries Inc., 300 Red School Lane, Phillipsburg, N.J. 08865 [410]

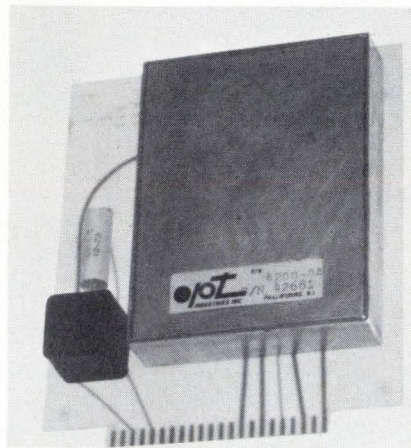

1 %
AMERICAN MADE

Tolerance SCHAUER 1-Watt ZENERS

Immediate Shipment Low Prices

ANY voltage from 2.0 to 16.0

Quantity	Price each
1-99	\$1.07
100-499	.97
500-999	.91
1000-4999	.86
5000 up	.82



All welded and brazed assembly

No fragile nail heads

Write for complete rating data and other tolerance prices.

Buy the kit- Save a lot

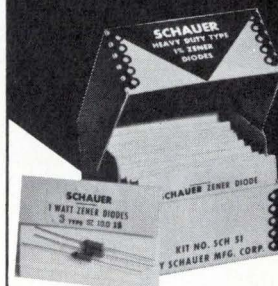

Kit contains a 51-piece assortment of SCHAUER 1% tolerance 1-watt zeners covering the voltage range of 2.7 to 16.0. Three diodes of each voltage packaged in reusable poly bags. Stored in a handy file box. Contact your distributor or order direct.

A \$54.57 value for
ONLY **\$24⁵⁰**

Semiconductor Division

SCHAUER
Manufacturing Corp.

4514 Alpine Ave. Cincinnati, Ohio 45242
Telephone: 513/791-3030

Only the Gould 6000 gives you 128 floating and integrating inputs, real time monitoring, 200 points/sec. and a 3M computer grade tape cartridge in a Data Acquisition System.

The Gould 6000 is an analog to digital data logger-reader that's the best way we know of to monitor and record low frequency data. It scans up to 128 input channels, converts the data to digital form, displays the data for real-time monitoring and stores the results on 3M 1/4" computer grade magnetic tape.

High performance, high or low scanning speed.

Our full-floating integrating front end minimizes signal noise and eliminates sampling errors inherent with other data collecting systems. Each analog input is fully floating with respect to the chassis ground and continuously integrated during the entire scanning period.

The Gould 6000's 128 inputs may be all analog or up to 48 digital

and 80 analog. There are four full scale programmable gain sensitivity ranges: $\pm 10\text{mV}$, $\pm 100\text{mV}$, $\pm 1\text{V}$ and $\pm 10\text{V}$.

To select the scanning rate, push one of the six buttons on the front. The rate can be varied from 200 points per second to 1 scan every ten minutes. In an external record mode, a scan can be triggered by an external clock or an event.

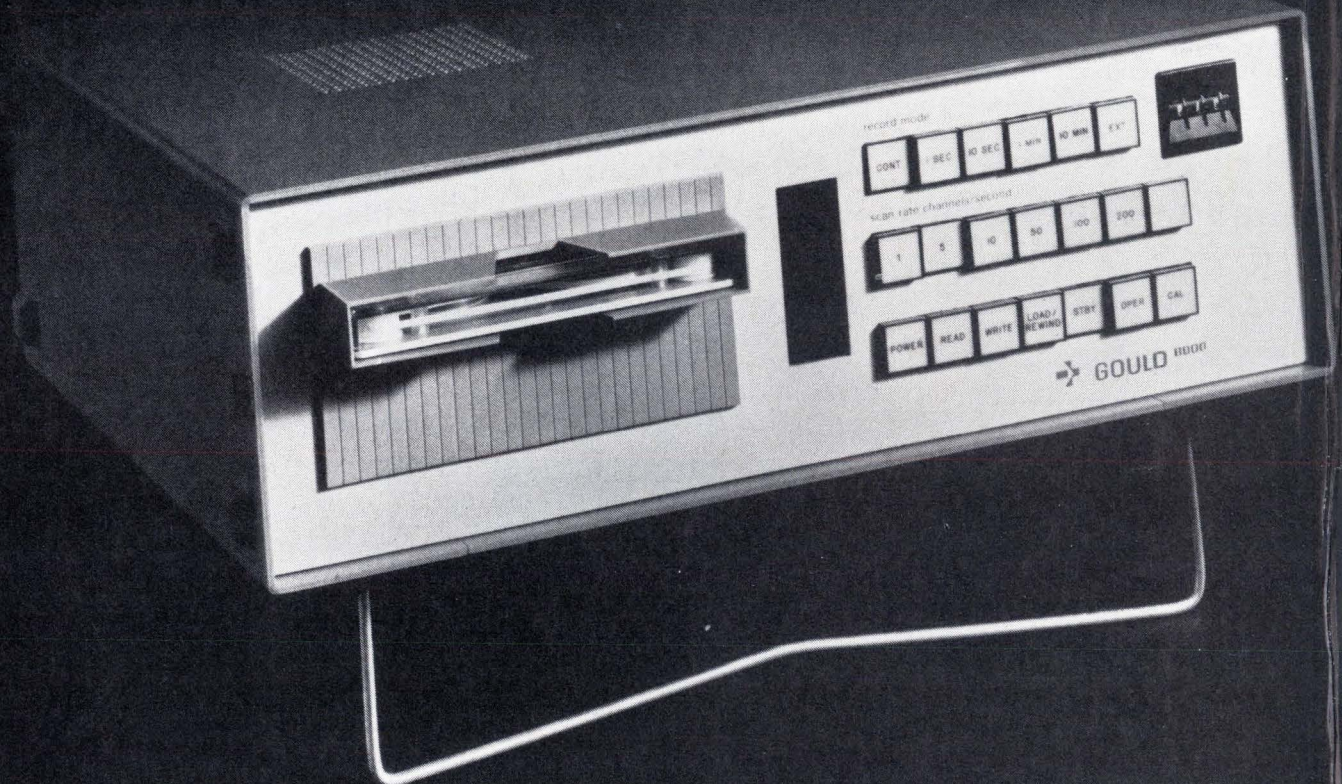

A significant advance in tape handling.

The 1/4" computer grade magnetic tape in a front loading reel-to-reel cartridge represents a significant improvement in tape handling. The 3M cartridge has 8 times the storage capacity of a cassette while eliminating tape handling problems frequently associated with large, expensive 1/2" reel-to-reel transports.

In addition, the cartridge combines plug-in convenience, foolproof operation with a single

motor drive, a built-in File Protect, 4-track read-write capability.

A typical writing error rate approaching one part in 100 million.

The Gould 6000's typical error rate which approaches 1 part per 10⁸ translates to only one writing error for every 12 tape cartridges used.

Connect up to 128 inputs to the Gould 6000 and you won't miss a thing.

The Gould 6000 can be used just about anywhere to monitor just about anything. It's being used for pollution monitoring, chemical processing and refining, weather and seismic recording, product testing, and applied research in various fields.

The Gould 6000's light-weight (under 36 pounds), easy to use controls and rugged construction make it a natural for portable, as well as on-site data acquisition jobs.

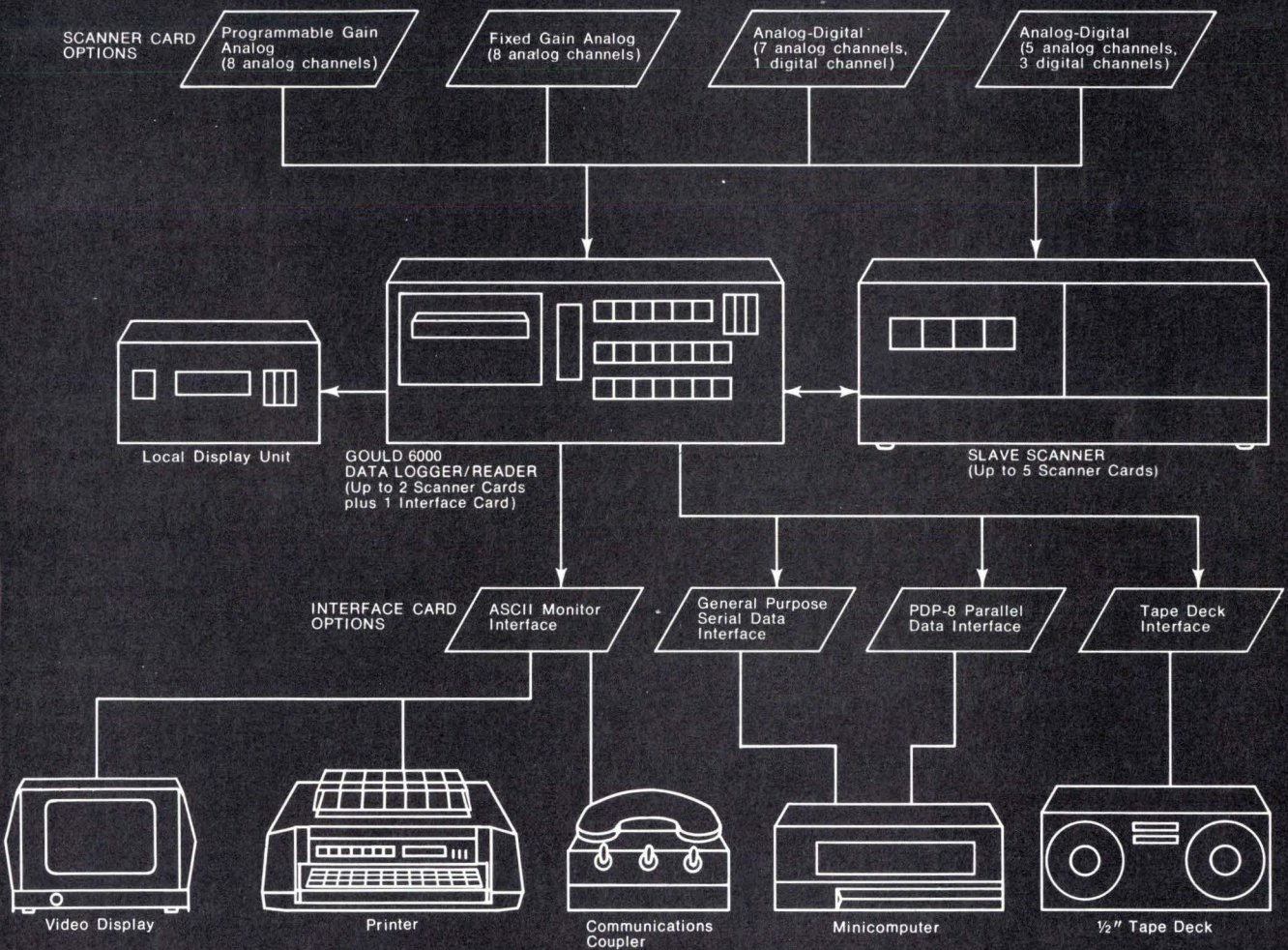

The complete data acquisition system.

The Gould 6000 is truly an operational definition of what a high performance data logger-reader should be. If your research requires an instrument of this quality, contact your nearest Gould

Sales Engineer or Representative. Or write us for detailed performance information and specifications. Gould Inc., Instrument Systems Division, 3631 Perkins Avenue, Cleveland, Ohio 44114 or Kouterveldstraat Z/N, B 1920, Diegem, Belgium.



Industrial

Monitor senses faults in line

Low-cost device detects outages down to 1 cycle, transients down to 100 μ s

When its computerized pay-TV systems for hotels failed intermittently for no apparent reason, Data Architects Inc. turned to commercially available power-line equipment like meters and strip-chart recorders to see if power-line faults were responsible. Finding none of the equipment adequate for its needs, the Waltham, Mass. company built its own device and is now preparing to produce it in quantity.

Called Linealert, the device is a low-cost, high-speed ac power-line fault detector that can detect outages down to one cycle. The company says electromechanical detectors are not sensitive to outages from one to 10 cycles that can cause a computer memory to stop or a power supply to drop out.

Linealert also can detect high-voltage transients exceeding 270 volts for at least 100 microseconds. Strip-chart recorders can detect transients, but, according to Data Architects, even the fastest can't detect events less than 1 millisecond long. The new device can also detect line voltages that drop below 100 v for at least 100 ms.

Finally, prices for electromechanical types start at \$1,000, while the Linealert costs under \$100.

The company says Linealert's capabilities cover most line faults that can cause malfunctions in data processing, telecommunications, and other equipment dependent upon clean, pure 60-hertz power. High-voltage transients appear to be the most common problem, but with the energy crisis the low-voltage problem is getting worse. "We have found that subtle power problems are very common and troublesome," says chief engineer Thomas Geh-

man, of Data Architects Inc.

The Linealert uses conventional bipolar transistor technology, with flip-flops to actuate the indicator lamps. The high-voltage transient detector has a proprietary voltage-threshold detection scheme, and the low-voltage detector operates by performing a voltage division with resistors and comparing it against an internal reference. The pocket-sized device plugs into the ac outlet to be monitored, and three lamps (for out, 270 v, and 100 v) light to show the unit is working. The user depresses the reset button to turn them off. The lamps then signal line faults when they occur and remain lit until manually reset.

Gehman says the Linealert "can narrow down the range of things to look at when a malfunction occurs." The user determines if equipment malfunctions when transients occur and takes corrective action. If his power is unstable he might purchase a filter, or if it is subject to outages he may need a standby power supply. The Linealert can then be used to determine if the corrective action was effective.

Units will be available in quantity in four weeks.

Data Architects Inc., 460 Totten Pond Rd., Waltham, Mass. 02154 [371]

Digital manometer measures 0 to 3,000 psi

An industrial digital manometer, the DM100, is designed to provide the same function as oil- or mercury-filled manometers and gives pressure measurement, with digital readout, in rugged industrial environments. Full-scale pressure ranges of 0 to 0.1 pound per square inch to 0 to 3,000 psi, static or bidirectional differential, are available with readout in such engineering units as psi, inches of water or mercury, or millimeters of mercury and centimeters of water. A high/low-range switch allows the operator to expand the readout by a factor of 10 for close observation of small pressure measurements. Pressure ranges below 0.1 and above 3,000 psi are avail-

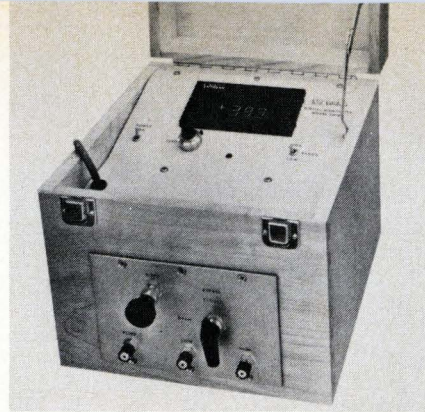

able on special order. No leveling procedures or other mounting precautions are required.

Validyne Engineering Corp., 19414 Londelius St., Northridge, Calif. 91324 [373]

SCR control provides transient voltage protection

A 1/8- to 1-horsepower single-phase SCR control that meets NEMA-4 and -12 requirements for applications requiring protection from water, dust, and oil, includes a 90-volt-dc, enclosed, nonventilated, permanent-magnet motor in foot mount or 56C

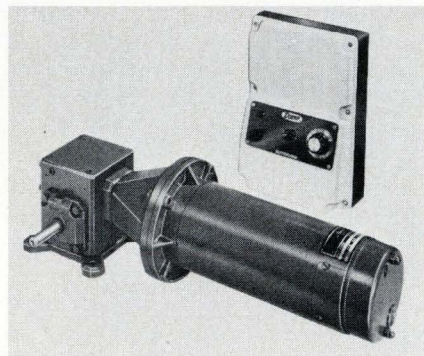

face version. Standard control features of the Stedi-Drive are: full-wave bridge, current limit, voltage-drop compensation, dynamic braking, transient voltage protection, and fuse-overload protection. No-load to full-load speed regulation is 3% over a 30:1 speed range.

Doerr Electric Corp., 1201 Doerr Way, Cedarburg, Wis. 53012 [376]

Preset indexer drives bifilar stepping motors

The model C73123 Index-A-Matic III preset indexer is specifically designed for driving bifilar stepping



STRIKE GOLD

**... every time you
actuate a
Cherry
Keyboard Switch**

Cherry's unique gold "crosspoint" contacts eliminate the two main causes of contact failure—(1) formation of insulating chemical film on contact surfaces, (2) mechanical interference of foreign particles on contacts.

This proven design concept (gold prisms at right angles to each other) provides high force per unit of contact area to enhance reliability. Tested to 50,000,000 operations and beyond, the gold crosspoint contact keyboard switch is available individually, with or without two-shot molded keycaps, or as part of a fully encoded electronic data entry keyboard.

FOR A FREE SAMPLE SWITCH and all the facts on Cherry keyboard switches, plus standard and custom keyboards, PHONE 312-689-7700 . . . or circle reader service number below.

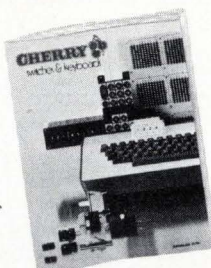

Model B70-54AA Keyboard
53-Key Special Quad Mode

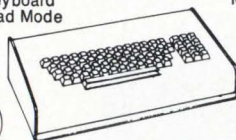

Model B65-1712 Keyboard
12-Key Numeric

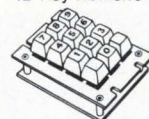

Electronic Desk Top
Calculators



CHERRY



CHERRY ELECTRICAL PRODUCTS CORP.
3608 Sunset Avenue, Waukegan, Illinois 60085

Cherry Worldwide: (Subsidiaries) Hirose Cherry Precision Co., Ltd., Tokyo • Cherry Mikroschalter GmbH, Bayreuth, Germany
• Cherry Electrical Products (U.K.) Ltd., St. Albans, Herts • (Licensee) G.W. Engineering Pty. Ltd., Sydney



Cover 2-18 GHz with only 2 swr bridges

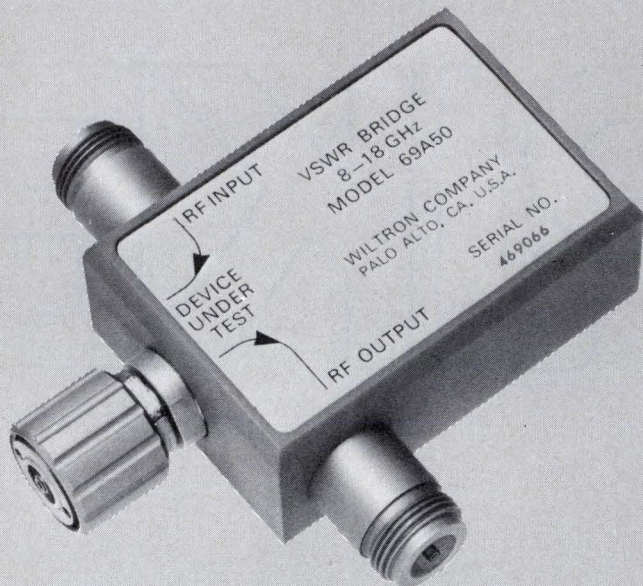

You can now measure swr and return loss over the entire 2 to 18 GHz range with only two WILTRON swr bridges.

Besides wide frequency coverage these new bridges also give you high directivity — at least 35 dB. That's very important to you when you need to measure low swr.

WILTRON swr bridges are the simple, fast and economical way to measure swr and return loss. The new 69A50 (8-18 GHz) is only \$725; the 64A50-2 (2-8 GHz) only \$670. They replace a lot of reflectometer hassle.

Call Walt Baxter at WILTRON today for more information about these bridges. Or about other WILTRON bridges down to 50 kHz.



Read the technical details
in our 8-page
"WILTRON Technical Review."
Ask for Vol. 1, No. 1.



930 E. Meadow Drive • Palo Alto, Ca. 94303 • (415) 321-7428

New products

motors in applications requiring precise motion control. The number of steps in an index is selected by a four-decade thumbwheel switch arrangement on the front panel. The action of the indexer is controlled by eight signals applied to TTL-compatible inputs via an interface

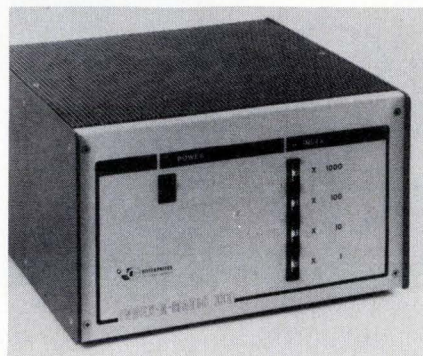

socket located on the rear panel. These are index clockwise, index reverse, jog forward, jog reverse, run forward, run reverse, inhibit index (without losing count), and counter reset. Price is \$1,125.

J.C. Enterprises, P.O. Box 23445, San Diego, Calif. 92123 [377]

Set-point controller

holds error to 1%

The West 622B two-mode controller features digital thumbwheel set-point selection, solid-state output, and LED indicator lights. The digital set-point indicator compensates for the nonlinearity of the thermocouple curve so that control is accurate over the entire span. This eliminates the need to consult calibration



Our 4203 four-quadrant monolithic IC Analog Multiplier is not only tiny and priced to sell, but it is completely self-contained. It needs no external components to deliver a guaranteed untrimmed accuracy of up to 1%. And, if you need even less total error, it can be trimmed to just 0.6%.

What does it mean to you that it is self-contained? Less design time, and a lower installed cost, that's what. Also, because it doesn't need trim pots to adjust offset voltage and gain errors or external amplifiers, there are less circuit components to drift with time

and temperature, and less space needed. This hermetically sealed TO-100 unit is versatile, too. Its internal op amp allows you to use it as a highly accurate two-quadrant divider. Add a simple diode, and you have a neat little square rooter. You get high reliability, fully monolithic construction, versatility, and performance that equals some of the high cost modular units. You get a 25V/ μ sec slew rate, a 1 MHz bandwidth, and a settling time to 2% of final value of just 1 μ sec. And, you get a unit that is ideal for hundreds of medical, industrial, and

commercial applications. **The best part is that prices start at only \$17.00 in 100's. Write or call us for complete details.**

Burr-Brown, International Airport Industrial Park, Tucson, Arizona 85734. Telephone (602) 294-1431.



Need a MONOLITHIC 4 Quadrant Analog Multiplier that shrinks your circuit size and your cost?

We have it.

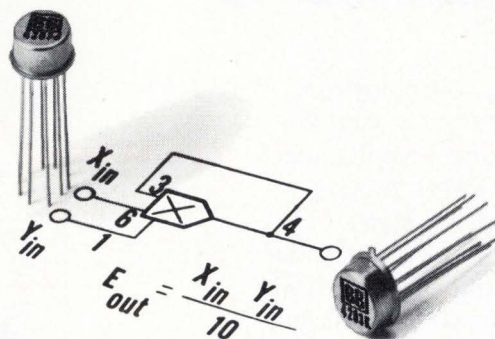

Another IC
from Burr-Brown!

Solid State, Miniature ATTENUATORS

Telonic attenuators are available in rotary and toggle switch types. Rotary units incorporate solid state components to provide new levels of accuracy and power handling capabilities. Write for the complete Attenuator Catalog.

ROTARY TYPES

Attenuation Ranges 0 to 110 dB
Steps .1 to 10 dB
Power Rating 3 watts, average
Frequency DC to 2 GHz
Dimensions 1 1/4" D x 3" to 1 1/4" D x 6"

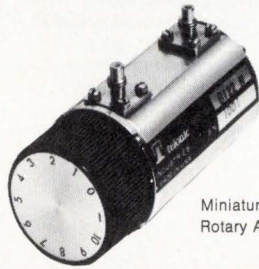

Miniature Rotary Attenuator

TOGGLE TYPES

Attenuation Ranges 0 to 102 dB
Steps .5 to 20 dB
Frequency DC to 300 MHz

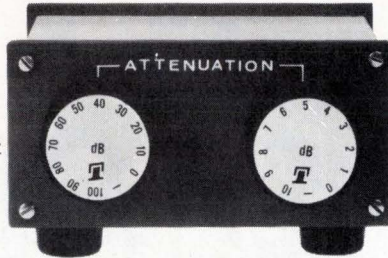

Bench Mounted Attenuator



TELONIC INDUSTRIES, INC.
Box 277 • Laguna Beach, California 92652
Tel: 714 494-9401 • TWX: 910 596-1320

Circle 154 on reader service card

HARD FIRED GOLD.

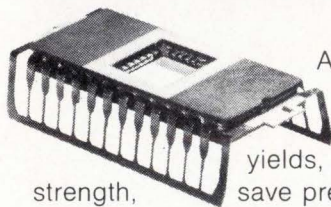

A new innovation from Diacon to improve die attach yields, increase bond strength, save preform costs. Available in 14, 16, 18 and 24 lead DiaPak. The slight premium "Hard Fired" costs will be a money-saving trade-off for consistent yield improvements. **DIACON, INC.**

4812 Kearny Mesa Road, San Diego, California 92111
(714) 279-6992

154 Circle 182 on reader service card

New products

charts in order to adjust the controller or to interpret deviation indication. Set-point error is 1% over the central 80% of span. Time proportioning, rate, manual reset, and adjustable proportional band and cycle time are also standard features.

Measurement & Control Systems Division, Gulton Industries Inc., East Greenwich, R.I. 02818 [379]

Temperature controller helps improve efficiency

The series 800 proportional temperature controllers are designed to evaluate the effectiveness of closer temperature control in plant equipment or processes. The portable units can be plugged into line and load. Each series 800 controller consists of controller and a control box, with power input cable, on/off switch, load-output socket, sensor jack, power-level indicator lamp, and set-point potentiometer and dial. Maximum load is 1,725 watts at 115 volts and 3,450 w at 230 v, with accuracies to within $\pm 0.05^\circ\text{C}$. Temperature control extends from -90°C to $+500^\circ\text{C}$, and units are available with phase firing and zero-voltage firing for minimal radio-frequency interference. Prices start at \$110, less probe.

RFL Industries Inc., Boonton, N.J. 07005 [380]



Electronics/August 8, 1974

You won't find a Synchron[®] Motor that meets your specifications.

But we'll build one (or 100,000) that matches your specifications. Exactly.

Synchron motors are made in five major styles. Speeds from 900 rpms to one revolution per week. Torque from 8 through 98 oz-in at one rpm. Hundreds of output options.



And we'll build it at a competitive price.

And we'll deliver it on time.

And we'll make sure it will perform in accordance with your specs. (Every motor we make is tested before it leaves the factory.)

But most of all, we'll be sure *you* are completely satisfied. It may be a strange way to do business, but we've been doing it for so long we don't know any other way.

Call or write for complete Synchron motor specifications and the name of your Hansen representative.

MALLORY



HANSEN MANUFACTURING CO.
a division of P. R. MALLORY & CO. INC.
Princeton, Indiana 47870

We make every Synchron motor as if *our* name were on *your* product.

RF-PACKAGES—MICROWAVE SYSTEMS

WORLD'S LARGEST RADAR & MICROWAVE INVENTORY

AUTOTRACK ANTENNA SCR-584 RADAR SYSTEM

360 deg azi 210 deg ele. Better than 1 mil. accuracy. Missile vel. accel. and slew. rates. Amplidyne servo control. Handle up to 20 ft. dish. Compl. with control chassis. ALSO in stock 10 cm. van mounted radar system. Conical scan. PPI. 6 ft. dish. Ideal telemetry, balloon missile rocket trk, ECM range. 600 pg. instr. bk. on compl. radar avail. \$25 ca.



1 MEV LINEAR ACCELERATOR

Dual Mode, Ion or Electron. RF Drive, 300 KHZ at 45 KW. Includes control console, RF unit, accelerator, etc.

MOD IV HI-RES MONOPULSE TRACKER

Instrumentation radar, freq. 8.5-9.6 GHz, Pwr: 250 KW, 1 mil tracking accuracy. 6' Fresnel lens antenna with 4 horn monopulse feed. Trk. Rng. 50 or 200 mi.

PULSE MODULATORS + H.V.P.S.

245 KW LINE PULSER Output 16 KV at 16 amp. .25 μ s at 4000 PPS.

405 KW FLOATING DECK PULSER Output 20 KV at 20 amp. 1 μ s to 10 milisecond pulse.

500 KW LINE PULSER Output 22 KV at 28 amp. 4/1.75/2.25 μ s at 2500/550/300 PPS.

1 MW HARDTUBE MIT MODEL 9 Output 25 KV at 40 amp. .25 2 μ s at .002 D.C.

2.0 MW LINE PULSER Output 30 KV at 70 amp. 1/2 μ s at 600/300 PPS.

3 MW LINE PULSER Output 39 KV at 75 amp. .25/1 μ s at 500 PPS.

10 MW LINE PULSER Output 76 KV at 135 amp. 2.5 μ s at 350 PPS.

17 MW LINE PULSER Output 17 KV at 1000 amp. 2-5 μ s at 150-2000 PPS.

RECON DRONE CONTROL RADARS

X Band systems autotrack and search complete with plotting boards. Fully mobile van mounted. Gnd to air links and beacons also in stock.

MICROWAVE LINK EQUIPMENT

Freq. 7.1-7.9 GHz, Pwr. 100 mw., 4 channels. Transmits video, pulse, synchro, and voice information. Mfr: Motorola. Others in stock.

SEND FOR FREE 24 PG. CATALOG
ON YOUR LETTERHEAD

SPARE PARTS IN STOCK

Nike Ajax, Nike Hercules, M-33, MPS-19. TPS-ID. TPS-10D. FPS-6, SPS8, SCR-584, HIPAR. Many more, write.

RADAR & RF PKGS.

34ghz 40 kw Pulse RF pkg
24ghz 40 kw Pulse bomb toss system
16ghz 130 kw Pulse B-58 search radar system
X BAND SEARCH 40 KW PULSE WEATHER RADAR
X BAND AUTOTRACK 250KW PULSE M-33
compl w/plor boards

X BAND BEACON 400 W PULSE AN/DPN-62
X BAND AUTOTRACK 50KW PULSE B-47
fire control complete

C BAND WEATHER RADAR 250 KW PULSE
C BAND HEIGHT FINDER

AN/FPS-26, 5 megawatt output.
AN/TPS-37, 1 megawatt output.

C BAND 285 KW PULSE Search AN/SPS-5
S BAND AUTOTRACK 500 KW PULSE 10' DISH
S BAND 1 MEGAWATT COHERENT AN/FPS-18
S BAND 1 MEGAWATT PULSE NIKE AQO.
S BAND 5 MEGAWATT HEIGHT FINDER AN/FPS-6
S BAND AUTOTRACK 250KW

6ft dish mortar locator MPQ-10A
L BAND 500KW PULSE AN/TPS-ID/E
L BAND 5 to 20KW PULSE

400 mhz 1KW CW AN/FPS-23
225mhz 1 MEGAWATT PULSE AN/TPS 28
CW 4.4-5ghz 1 KW

CW .950-5ghz 150 WATTS
CW 1.5 mhz-10.5ghz 5 WATTS
CW 1.7-2.4ghz 10 KW

AN/GPG-1 SKYSWEEP TRACKER

3 cm. auto. tracking radar system. Comp. pkg. w/indicator sys. Full target acquisition & auto. tracking. Input 115v
60 cy. new. In stock for imm. del. Entire sys. 6' X 3' X 9'



**Radio
Research
Instrument
Co., Inc.**

3 QUINCY ST., NORWALK, CONN. 06850
(203) 853-2600

CIRCLE 951 ON READER SERVICE CARD

**SAME DAY SHIPMENT
Minis & Peripherals**

**PRINTERS
"BRAND NEW"**

DATA PRODUCTS

2440—700 LPM

2470—1250 LPM

MDS 4320—300 LPM

ALSO
CENTRONICS, POTTER, CDC
A. B. DICK, IBM, HIS, UNIVAC

Send for Free Report "Maintenance of Computers"
AMERICAN USED COMPUTER CORP.
P.O. Box 68, Kenmore Sta., Boston, MA 02215
member COMPUTER DEALERS ASSOCIATION

CIRCLE 952 ON READER SERVICE CARD

HERMETIC SEALING

GLASS/CERAMIC TO METAL
CONNECTORS • HEADERS
CUSTOM SEALS

1 C FLAT PACKS • RELAY BASE
FEED THRU TERMINALS
TESTING SERVICES

Hermetic Sealing Since 1959

DETORONICS Corporation
10660 E. Rush, S. El Monte, CA. 91733
(213) 579-7130—TWX 910 587-3436

CIRCLE 953 ON READER SERVICE CARD

free catalog

**POTTING APPLICATORS
MANUAL OR AIR OPERATED**
2 $\frac{1}{2}$ cc 6cc 12cc 30cc
FOR POTTING, ENCAPSULATING ETC.

PHILIP FISHMAN CO., INC.
7 CAMERON ST. WELLESLEY, MASS. 02181

CIRCLE 954 ON READER SERVICE CARD

FREE CATALOG

HARD-TO-FIND PRECISION TOOLS
Lists more than 2000 items—pliers, tweezers, wire strippers, vacuum systems, relay tools, optical equipment, tool kits and cases. Also includes ten pages of useful "Tool Tips" to aid in tool selection.

JENSEN TOOLS
4117 N. 44th Street, Phoenix, Ariz. 85018

CIRCLE 956 ON READER SERVICE CARD

FREE ALARM CATALOG

Full line of professional burglar and fire alarm systems and supplies. 96 pages, 450 items. Off the shelf delivery, quantity prices.

mountain west alarm
4215 n. 16th st., phoenix, az. 85016

CIRCLE 957 ON READER SERVICE CARD

**REMEMBER
TO USE
ZIP CODE**

EMPLOYMENT OPPORTUNITIES

Send New Ads to:
Electronics
Class. Adv. Dept.
P.O. Box 900, N.Y., N.Y. 10020

SPANISH FIRM NEAR MADRID

is looking for design and development engineers with a minimum of three years of experience in the field of P.C.M. equipment to be used by the telephone industry. Areas of interest are encoders and decoders, P.C.M. multiplexers and R.F. equipment to transmit P.C.M. data. Salary open.

Send resumé to:

NORTRON
Fernando el Católico, 63
Madrid 15
SPAIN

EMPLOYMENT SERVICES

Growth Positions, \$14-30,000. Fees Paid.
Nationwide. Longberry of Pittsburgh. Suite 962-G, Two Gateway Center, Pittsburgh, Pa. 15222.

Q. Whom do I contact or call to re-new my classified ad or make corrections?

A. Write Electronics, Class. Adv. Dept., P.O. Box 900, NY, NY 10020 or call: (212) 997-6585 or 6586. Give full company name, size of ad. & date or dates it is scheduled to appear.

New products/materials

Developed for use in the manufacture of printed circuits and other applications, photoresist type GP contains a blue coloring that allows the board to be inspected for coating uniformity and, since it remains after developing, permits positive inspection of the image. The viscosity and solids content of the material permit application by flow-, dip-, or whirl-coating techniques. Drying time is 10 minutes, after which the photoresist is cooled and then exposed with a high-intensity ultraviolet source. The solvent-soluble material can be developed either in a trichloroethylene spray vapor degreaser or in a Chemco liquid developer.

Chemco Photoproducts Co. Inc., Division of Powers Chemco Inc., Glen Cove, N. Y. 11542 [476]

A general-purpose epoxy is for potting and encapsulation applications. Called Uniset G-508, it is a single-component, oxide-filled, Class H material that has good resistance to thermal shock, chemicals, and moisture. The epoxy may be preheated to 140°F for pouring, and best results are obtained, says the company, when the component is preheated above 220°F to remove moisture.

Amicon Corp., Polymer Products Division, 25 Hartwell Ave., Lexington, Mass. 02173 [478]

Two screen-printable silver pastes are formulated to produce fine lines of 3 to 5 mils and a uniform thickness. Conductrox 3303 contains silver flake to provide a dense fired film, and Conductrox 3306 contains size-controlled silver particles. Partlok, a screening vehicle used in both pastes, prevents settling of particles, and the low evaporation rate of the vehicle permits paste exposure on the screen for extended periods. The formulas are fireable at 475°C to 550°C for optoelectronic applications and work on glass substrates, and up to 950°C for thick-film applications on ceramic substrates. The pastes are priced below \$10 per ounce in quantity.

Thick Film Systems Inc., 324 Palm Ave., Santa Barbara, Calif. 93101 [479]

You say you want a

low-profile snap-in-mounting push button switch or matching indicator that is interchangeable with most 4-lamp displays... available in a full range of cap colors... with a choice of bezels in black, gray, dark gray or white.

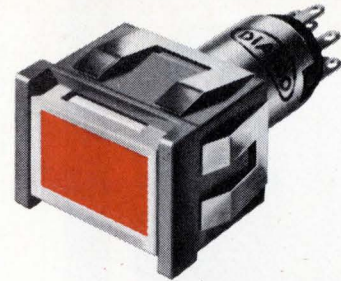

and a

legend presentation that's positive (like this one) or negative (like the one below) or just plain (like the one above)... one that's white when "off" and red, green, yellow (amber), blue or light yellow when "on"... or colored both "on" and "off."

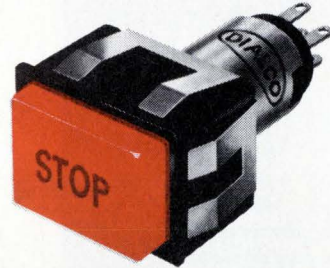

and a

highly reliable switch proven in thousands of installations... available in momentary or alternate action... N.O., N.C. or two circuit (one N.O., one N.C.)... that accommodates a T-1 1/4 bulb with midget flanged base, incandescent, in a range of voltages from 6-28V.

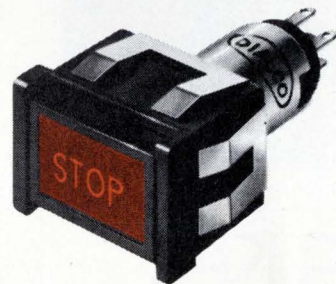

*etc.
etc.
etc.*

**Now, for the first time
Dialight gives you
custom panel designing
with a standard line of
push-button switches and
matching indicators**

Dialight offers a broader range of switch and indicator possibilities than you'll find anywhere in a standard single-lamp line. Sizes: 3/4" x 1", 5/8" and 3/4" square and round. Send today for our new full-color catalog.

DIALIGHT

A North American Phillips Company
Dialight, 203 Harrison Place, Brooklyn, N. Y. 11237

NO MORE BROWN-OUT



with ultra high efficient
AC LINE REGULATORS
for
BROWN-OUT and POWER ECOLOGY

NO DISTORTION OR SPIKES
½ CYCLE STEP RESPONSE
45-70 Hz OPERATION
98-99% EFFICIENCY
ALL SOLID STATE
250VA - 150KVA
SMALL SIZE
LOW COST

Power-Matic, Inc.
8057 RAYTHEON ROAD SAN DIEGO, CA 92111
PHONE (714) 292-4422

Circle 158 on reader service card

NEUSES

COMPLETE RELAY SERVICE TOOL-KIT

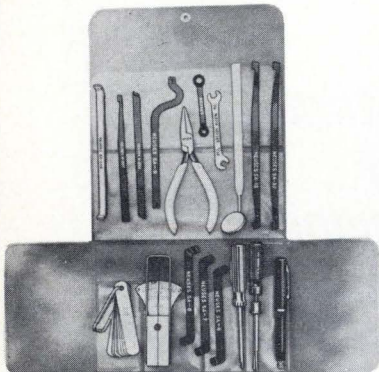

18-piece tool set includes everything needed to service, align, check and maintain relays. Includes: Contact Burnisher with extra blades, Spring Tension Gauge, Wrenches, Thickness Gauge Set, Inspection Mirror, etc. All in handy Vinyl Case; with Instruction booklet.
No. TK-18 Kit.....\$38.60

P. K. NEUSES, INC.
Box 100 - Arlington Heights, Ill. 60006

PRECISION TELE-COMMUNICATION TOOLS

158 Circle 184 on reader service card

New literature

Program cards. Owners of HP-35 or HP-45 pocket calculators can buy packets of program cards that extend the computing power of their machines. These instructions give the keying sequences for handling such operations as quadratic and cubic roots, complex numbers, polynomials, and hyperbolic and transfer functions. The programs are written on both sides of cards that are the size of business cards. A complete program package, which costs \$3.95, is available from FOS-RCH/Programs, 3120 Castle Oak Ave., Orlando, Fla. 32808. Circle 421 on reader service card.

Filters. Estep Enterprises, 5217 Cangas Dr., Agoura, Calif. 91301, is offering a handbook priced at \$5.95, which provides the designer with various configurations for state-variable active filters. In tabular form, the handbook lists the practical transfer functions for primary state-variable forms. [422]

Power supply. Abbott Transistor Laboratories Inc., 5200 W. Jefferson Blvd., Los Angeles, Calif. 90016, has published its 1974 power-supply catalog describing more than 2,616 models, complete with electrical specifications, operating parameters, and dimension charts. [423]

Digital cassettes. The advantages of incremental recording on magnetic-tape cassettes are discussed in a handbook available from Memydyne Corp., 369 Elliot St., Newton Upper Falls, Mass. 02164. [426]

Ceramics. Pekay Industries Inc., Box 559, Farmingdale, N.J. 07724, has put out a bulletin containing information on metalized ceramics. The brochure discusses custom-shaped parts and gives specifications and dimensions. [424]

Logic types. A comparison study of MECL 10,000 and Schottky TTL circuits has been published by Motorola Semiconductor Products Inc., Box 20912, Phoenix, Ariz. 85036. Key performance points are discussed, including power consumption and toggle rates. [425]

CONNECTORS/
P.C.

JACKS & PINS

BERYLLIUM
COPPER
CAGES

CONCORD ELECTRONICS CORPORATION
37 GREAT JONES STREET NEW YORK, N.Y. 10012 (212) 777-6571 • TWX 710-581-4930

and
**TEFLON*
AND SOLDER
TERMINALS**

*DUPONT T.M.

SEND FOR CATALOG

Circle 185 on reader service card

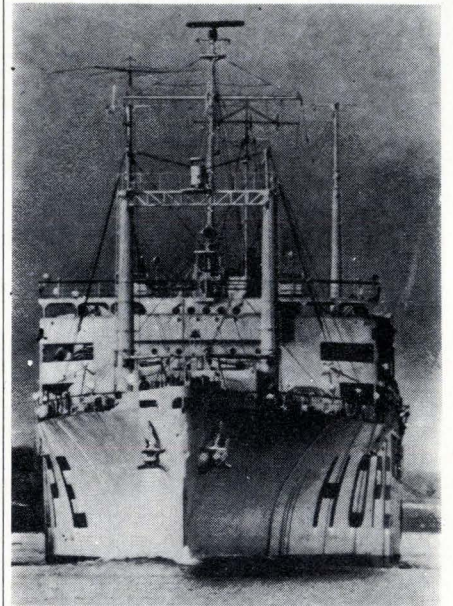

S.S. HOPE, M.D.

Doctor . . . teacher . . . friend to millions on four continents—this floating hospital is a symbol of America's concern for the world's disadvantaged. Keep HOPE sailing.

**PROJECT
HOPE**

Dept. A, Washington, D.C. 20007

Electronics/August 8, 1974

"We subjected the Augat plug-in socket panel to an accelerated-life test in order to induce contact failure.

"We failed."

Dave Fillio
Principal Engineer, Component & Materials Engineering
Honeywell Information Systems

"We needed an interconnection system for controllers on the H716 mini-computer that could help us meet four basic requirements:

"High density to get as much as possible into a small package and still meet the increasing customer demand for a broad range of peripherals, each requiring a separate controller.

"The capability of automatically wiring, with a minimum of two-levels.

"Flexibility to permit anticipated design changes and still allow us to meet a very tight schedule.

"And finally, all these features had to be available in a standard product.

"The most logical approach seemed to be printed wiring boards. But to accommodate all our controllers could have required as many as eight boards. And we couldn't afford the room. Also, when recycling changes are taken into consideration, the design cycle of printed wiring boards becomes too long and, consequently, too costly.

"Multi-layering offered a minimum of flexibility, and it, too, was rejected.

"The only practical solution was the plug-in socket panel. And of all the vendors, Augat was the only manufacturer that could provide a completely uniform, broad range of standardized products, the lowest possible profile and maximum reliability.

"The reliability tests we

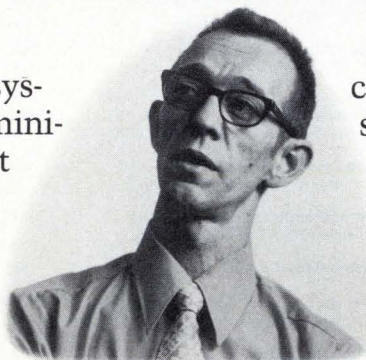

Dave Fillio

conducted on the Augat machined sockets included environmental exposures, accelerated-life, vibration, thermal shock, and durability. All tests with the Augat system were positive.

"From a field service standpoint, a key consideration with increasingly complex and flexible systems like the H716 is keeping them on the air at all times. Because of the reliability of the Augat interconnection system, we've had no reports of machine down-time associated with the Augat product since the introduction of the H716 eight months ago."

More and more companies like Honeywell are realizing that Augat socket-panels are an economical, reliable and totally flexible solution to interconnection problems, including development, production and field service requirements.

Augat's precision-machined tapered entry contact has made Augat the reliability standard for the industry. As the world's leading manufacturer of socket panels and other IC interconnection products, Augat is ready to help you solve your interconnection problems.

Call or write today for a free brochure and complete product information. Augat, Inc., 33 Perry Avenue, Attleboro, Massachusetts 02703. Represented and distributed internationally.



The H716

AUGAT

See us at the WESCON Show Booth #1216-1217

Circle 159 on reader service card

Europe—Augat International, Inc., Boulevard A. Reyers, 103, 1040 Brussels, Belgium, Tel. (02) 36-93-99.

Japan—Kyokuto Roeki Kaisha Ltd., New Otomachi Bldg., 2-1-2, Chome Otomachi, Chiyoda-Ku, Tokyo 100, 01-1111, Tel. (03) 556-2700.

Electronics advertisers

August 8, 1974

Abbott Transistor Labs Inc. Technical Adv. Agency	6	General Automation Chiat-Day, Inc. Advertising	144-145	Schauer Manufacturing Corp. Nolan, Keelor & Stites	147
Advanced Micro Devices Keye/Donna/Pearlstein	10-11	General Electric Company, Plastics Dept.—Valox Resin Ross Roy of New York, Inc.	129	Sheldahl Inc. Chuck Ruhr Assoc. Advertising, Inc.	123
Advanced Micro Devices Keye Donna Pearlstein	67	General Instrument Corporation, Semiconductor Comp. Div. Norman Allen Associates, Inc.	2	Siemens Corporation Stiefel/Raymond Advertising Inc.	72-73
Allegheny Ludlum Steel Corporation Vansant Dugdale Advertising	130	General Magnetics McCarthy/Scelba/DeBiasi Adv. Agcy., Inc.	3rd Cover	Signetics Corp., Sub. of Corning Glass Works Hall Butler Blatherwick, Inc.	83
Allen Bradley Company Hoffman, York, Baker & Johnson Inc.	34	General Radio Grad Associates	5E	Spectrol Reliance Limited JMR Advertising	6E-7E
Alps Electric Co. Ltd. Nihon Keizaisha Advertising Ltd.	56	Georgia Department of Community Development Gerald Rafshoon Advertising, Inc.	54	Sprague Electric Company Harry P. Bridge Company	8
American Optical Scientific Instrument Division Wilson, Haight & Welch, Inc.	128	Gould, Inc./Instrument Systems Div. Carr Liggett Adv., Inc.	148-149	Syston Donner Concord Instruments Fred Schott & Associates	53
Augat Creamer, Trowbridge, Case & Basford Inc.	159	Hansen Mfg. Co. Keller-Crescent Co.	155	Taiyo Denki Co., Ltd. Daipro Inc.	58
Bausch & Lomb, Inc. Wolff Assoc., Inc.	137	Hewlett-Packard, Electronics Products Group Corporate Marketing Communications	21-30	Tally Corporation Bonfield Associates	162
Beckman Instruments, Inc., Heliport Div. N.W. Ayer/Jorgensen/MacDonald, Inc.	67	Honda Tsushin Kogyo Co., Ltd. General Advertising Agency, Inc.	58	Telkoku Tsushin Kogyo Co., Ltd. Diamond Agency Co., Ltd.	57
Blomation Paul Pease Advertising	88-89	Hughes Aircraft Company Foote, Cone & Belding	47	Tektronix Inc. McCann Erickson, Inc.	45, 68-69
Bourns, Inc. Marlborough Assoc., Inc.	70-71	Industrie Bitossi s.a.s.	8E	Tektronix-IDD Young & Roehr, Inc.	17-85
Burr-Brown Research Corp. N.A. Winter Advertising Agency	153	Intel Corp. Regis McKenna, Inc.	12-13	Teledyne Philbrick Ingalls Associates	2nd Cover
Burroughs Corporation Conti Advertising	9	ITT General Controls D'Arcy-MacManus & Masius	162	Telonic Altair Jansen Associates, Inc. Marketing Services	154
Busmann Mfg. Division Of McGraw-Edison Co. Henderson Advertising Company	61	Japan Electronics Show Association Asian Advertising, Inc.	55	Thomson CSF/Dumont Raniere, Saslaw, Mohr and Associates, Inc.	1
Cherry Electrical Products, Corp. Kolb/Tookey and Assoc., Inc.	151	Kennedy Co. R. L. Thompson Advertising	62	Tokyo Electric Co., Ltd. PAL, Inc./Export Advertising	56
Circuit-Stik, Inc. Haaga Advertising	136	Kepeco Inc. Weiss Advertising	5	Tokyo Sokuhan Co., Ltd. Showa Advertising Service, Inc.	60
Clairex Corporation Black-Russell-Morris	4th Cover	Lapp Insulator Div., Interpace Corp. Wolff Associates, Inc.	20	TRW Semiconductors The Bowes Company	7
Computer Automation Cochrane Chase & Company, Inc.	32-33	Meguro Denpa Sokki K.K. General Advertising Agency, Inc.	57	Tucker Electronics Company Taurus Marketing Agency	161
Concord Electronics Corp. Sound Advertising	158	The Mica Corporation Robert A. White Advertising	90	Unitrode Corporation Culver Advertising, Inc.	37
Dale Electronics, Inc. Swanson, Sinkey, Ellis, Inc.	72-73	Micro Devices Advertising & Merchandising, Inc.	162	University Computing Company (S.E.D.) Gannett Incorporated Advertising—New Production Development	38
Diacon Rogondino Advertising and Marketing	154	Molex Incorporated Howard H. Monk and Associates, Inc.	64	U.S. Capacitor Corp. S. Michelson Advertising	89
Dialight Corporation Michel-Cather, Inc.	157	MOS Technology, Inc. Henry S. Goodsett Advertising, Inc.	138-139	U.S. Instrument Rentals, Inc. Kickback Corporation Division of Intrinsic, Inc.	1
Digital Equipment Corporation Creamer, Trowbridge, Case & Basford, Inc.	146B, 108	Motorola Semiconductor Products, Inc. EB Lane & Associates, Inc.	49, 102-103	Varo Semiconductor, Inc. Warren-Guild	134
Dow Corning Corp.—Fluids, Emulsions, Compounds Division Ketchum, MacLeod & Grove, Inc.	80-81	National Semiconductor Corp. Chiat/Day, Inc. Advertising	119	Wavetek San Diego Chapman Michetti Advertising	132
Eastman Chemical Products, Inc., Industrial Chemicals J. Walter Thompson Company	48	North Electric Co.—Electronics Div. Marc Associates	140	White Instruments, Inc. Wilson & Associates, The Art Studio, A Division of Graphic Studios	161
Eastman Kodak Co. Business Division—Engineering Data System Micrographics J. Walter Thompson Company	15	P.K. Neuses, Inc. J.J. Carroll & Associates/Advertising	158	Wiltron Company Frank Burkhard Company	152
Electromask, Inc. JMR Advertising	74	Philips N.V. Pit/T & M Division Brookies Communications Systems SA	64	Wima, Westermann Oliver-Beckmann GmbH	16
Emerson & Cuming, Inc. Edwin F. Hall	46	Powermatic Manning/Bowen and Associates	158	Winchester Electronics Renaccio Advertising & Marketing, Inc.	18-19
English Electric Valve Co., Ltd. The London Advertising Partnership	10E, 11E	Primo Co., Ltd. General Advertising Agency, Inc.	58	Yokogawa Electric Works., Ltd. General Advertising Agency, Inc.	59
Ferroxcube Black-Russell-Morris	59	Ramtek Corp. McDonough Communications	31		
John Fluke Mfg., Co., Ltd. Lennox Marketing Limited	128	RCA—Solid State Division Marsteller, Inc.	77-79		
Fluke Manufacturing Co., John Bonfield Associates	143	RCL Electronics, Inc. Morvay Advertising Agency	14		
FMC Corporation—Semiconductor Products Operation De Sales Advertising Inc.	146A	R-OHM Corp. Diversified Corporate Services, Inc.	50		
Gardner-Denver	15	Rohde & Schwarz	1E		
		Scanbe Manufacturing Corp. Warren C. Wilson & Associates	127		

Classified & Employment Advertising

F. J. Eberle, Manager 212-971-2557

EQUIPMENT (Used or Surplus New) For Sale	
American Used Computer	156
Detronics Corp.	156
Philip Fishman Inc.	156
Jensen Tool	156
Mountain West Alarm	156
Nortron	156
Radio Research Instrument Inc.	156

- For more information on complete product line see advertisement in the latest Electronics Buyer's Guide
- Advertisers in Electronics International
- ‡ Advertisers in Electronics domestic edition

Advertising Sales Staff

Pierre J. Braudé New York [212] 997-3468
London 01-493-1451
Director of Marketing

Atlanta, Ga. 30309: Joseph Lane
100 Colony Square, 1175 Peachtree St., N.E.
[404] 892-2868

Boston, Mass. 02116: James R. Pierce
607 Boylston St. [617] 262-1160

Chicago, Ill. 60611:
645 North Michigan Avenue
Robert W. Bartlett (312) 751-3739
Paul W. Reiss (312) 751-3738

Cleveland, Ohio 44113: William J. Boyle
[716] 586-5040

Dallas, Texas 75201: Charles G. Hubbard
2001 Bryant Tower, Suite 1070
[214] 742-1747

Denver, Colo. 80202: Harry B. Doyle, Jr.
Tower Bldg., 1700 Broadway
[303] 266-3863

Detroit, Michigan 48202: Robert W. Bartlett
1400 Fisher Bldg.
[313] 873-7410

Houston, Texas 77002: Charles G. Hubbard
2270 Humble Bldg. [713] CA 4-8381

Los Angeles, Calif. 90010: Robert J. Rielly
Bradley K. Jones, 3200 Wilshire Blvd., South Tower
[213] 487-1160

New York, N.Y. 10020
1221 Avenue of the Americas
Warren H. Gardner [212] 997-3617
Michael J. Stoller [212] 997-3616

Philadelphia, Pa. 19102: Warren H. Gardner
Three Parkway,
[212] 997-3617

Pittsburgh, Pa. 15222: Warren H. Gardner
4 Gateway Center, [212] 997-3617

Rochester, N.Y. 14534: William J. Boyle
9 Greylock Ridge, Pittsford, N.Y.
[716] 586-5040

San Francisco, Calif. 94111: Don Farris
Robert J. Rielly, 425 Battery Street,
[415] 362-4600

Paris: Alain Offergeld
17 Rue-Georges Bizet, 75 Paris 16, France
Tel: 720-73-01

Geneva: Alain Offergeld
1 rue du Temple, Geneva, Switzerland
Tel: 32-35-63

United Kingdom & Scandinavia: Keith Mantle
Tel: 01-493-1451, 34 Dover Street, London W1

Milan: Robert Saidel
1 via Baracchini, Italy Phone 87-90-656

Brussels: Alain Offergeld
23 Chaussee de Wavre
Brussels 1040, Belgium
Tel: 13-73-95

Frankfurt/Main: Fritz Krusebecker
Liebigstrasse 27c, Germany
Phone 72 01 81

Tokyo: Tatsumi Katagiri, McGraw-Hill
Publications Overseas Corporation,
Kasumigaseki Building 2-5, 3-chome,
Kasumigaseki, Chiyoda-Ku, Tokyo, Japan
[581] 9811

Osaka: Ryji Kobayashi, McGraw-Hill
Publications Overseas Corporation, Kondo
Bldg., 163, Umegae-cho Kita-ku, Japan [362] 8771

Australasia: Warren E. Ball, IPO Box 5106,
Tokyo, Japan

Business Department

Stephen R. Weiss, Manager
[212] 997-2044

Thomas M. Egan,
Production Manager [212] 997-3140

Carol Gallagher
Assistant Production Manager [212] 997-2045

Dorothy Carter, Contracts and Billings
[212] 997-2908

Frances Vallone, Reader Service Manager
[212] 997-6057

Electronics Buyers' Guide

George F. Werner, Associate Publisher
[212] 997-3139

Regina Hera, Directory Manager
[212] 997-2544

USING ACTIVE FILTERS OR PASSIVE FILTERS ?

**Are size, shape or weight considerations important?
Special mechanical configurations offered—Her-
metically sealed or encapsulations for pcb installa-
tions**

**Low, high, band pass and reject designs—Butter-
worth, Chebishev, Bessel or elliptic response char-
acteristics—wide range of source and load impe-
dances**

**Low frequency actives, stable toroidal LC's, RC
twin-T's**

No EXTERNAL components required

**Unbiased recommendations on active or passive
filter selections for maximum economy**



instruments, incorporated

PHONE AREA 512/892-0752 • P.O. Box 698 AUSTIN TEXAS 78767

Circle 187 on reader service card

ANOTHER SUPER SALE FROM TUCKER

SINGER-GERTSCH MODEL RLF-1 LOW FREQUENCY STANDARDS RECEIVER



All solid state receiver and comparator for calibrating 1 MHz standards and receivers. 60 KHz input from WWVB is magnified 5 times to produce a shaped 300 KHz signal which is compared to a 1 MHz shaped input from local standard. Comparison is made on meter and through DC recorder output. Loop Antenna and 100 foot cable supplied. Many other features.

**NEW UNITS - 90 DAY WARRANTY
30 DAY MONEY-BACK GUARANTEE
List Price: \$795.00**

**SALE PRICE: \$349.50
(While they last)**

FOR RUSH ORDERS OR INFORMATION CALL TOLL-FREE 800-527-4642.

CLIP COUPON AND MAIL WITH YOUR PAYMENT TO ADDRESS BELOW: ALLOW \$5.00 FOR FREIGHT. NJ, TX, & IL RESIDENTS ADD 5%. CA RESIDENTS ADD 6% TAX.

CHECK OR MONEY ORDER ENCLOSED. SHIP COD.

CHARGE MY ACCOUNT BELOW: BANK AMERICARD

MASTER CHARGE

AMERICAN EXPRESS

SHIP TO:

CARD NO. _____

EXP. DATE _____

NAME _____

ADDRESS _____

CITY _____

STATE _____

ZIP _____



TUCKER

**P.O. Box No. 1050
Garland, Texas 75040**

Do your own thing...

Customize a counter to fit your exact needs—with our decade modules.

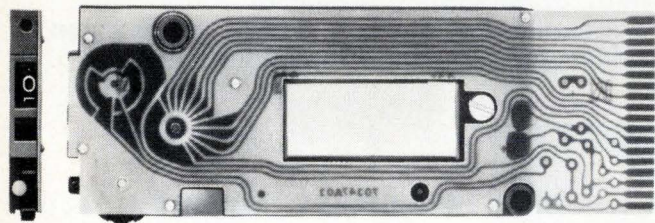
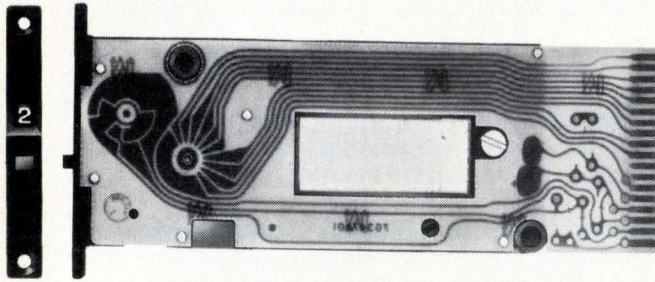

Compact, narrow profile modules with any combination of numbers and letters (from 10 to 12) for each decade • Stack up as many decades as you need (.350" column to column) • Flange or panel back mounting configurations • Visual indication, reset capability, isolated readout/in circuitry, arc suppression, high counting speed and 50×10^6 counts minimum life • Options include pushbutton set means, BCD input interface circuitry, and raised character printout wheel for use in printer. *Functions:* predetermining; batch counting; serial totalizing; visual and electrical readout; data storage; time/date indication.

For full applications information and free catalogs contact Manager, Printers/Counters, ITT General Controls, International Telephone and Telegraph Corporation, 801 Allen Ave., Glendale, CA 91201. (213) 842-6131.

GENERAL CONTROLS **ITT**

Circle 162 on reader service card

The high performance photoreader family

With an eye focused on giving you top price/performance, Tally brings you a family of photoreaders loaded with features. Here's the line-up.

Model R-2050

The new Tally R-2050 delivers 250 characters per second for only \$275. Or \$375 with com-

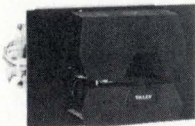

plete electronics. The compact, super reliable unit features easy, adjustment-free operation.

Model R-2000

For added performance power, the R-2000 comes complete with power supply and bi-directional drive elec-

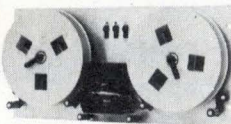

tronics. Prices start at \$546. Numerous options can be added. Speed is 300 cps continuous and 200 cps asynchronous.

Model R-5000

For those applications that demand the very best, the top of the line R-5000 has

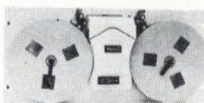

speeds of 500 cps continuous and 1200 cps search. It's the reader with all the extras built-in.

TALLY®

Get the full story. Write or call Tally Corporation, 8301 So. 180th St., Kent, Washington 98031. Phone (206) 251-6771.

162 Circle 186 on reader service card

mi·cro·temp (mī'krō tēmp')

A patented, positive safety thermal cutoff. It will interrupt a circuit when the operating temperature exceeds the rated temperature of the cutoff. Normally employed as a back-up safety protector to cut off power to electronic circuits or components that develop abnormal temperature build-up, this device is fast, reliable and accurate to $\pm 3^\circ\text{F}$. MICROTEMPS are CSA listed and insure product safety. Costing as little as 7.5¢ each, MICROTEMPS are available in a wide range of configurations, ratings and terminations to suit your individual applications. MICROTEMPS are hermetically sealed; unaffected by vibration, shock, aging or positioning, and meet UL standard 1020. For specific details, call or write:

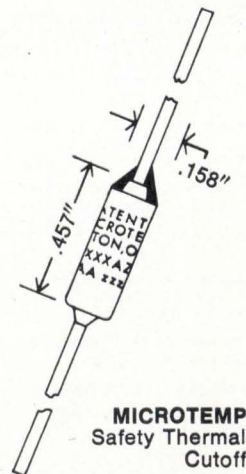

MICRO DEVICES CORP.
1881 Southtown Blvd. Dayton, Ohio 45439
Ph. (513) 294-0581 Telex: 28-8087

Circle 163 on reader service card