

A guide to digital range tracker design 86

Wideband receiver uses sampled-data techniques 106

A new regular feature: Engineer's notebook 113

29 MAR 1972

Electronics®

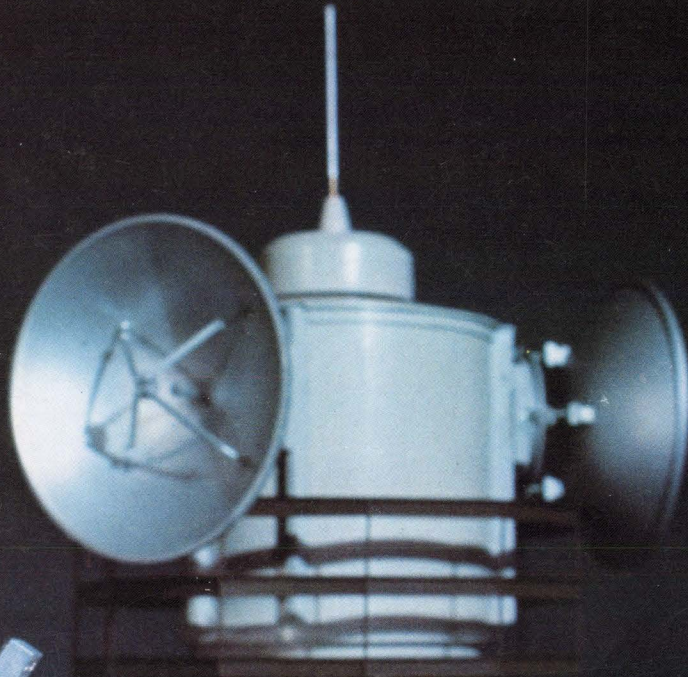

**Meeting digital
traffic demand with
20-GHz systems**

14ZA NVA999 99U40 MAR73
US NAVAL AIR DEV CTR
CSD LIBRARY
N62269-72-M-2160
WARMINGSTER PA
18974

CSB
LIBRARY



FIRST AT VALLEY FORGE!... NOW ACROSS THE COUNTRY!... THE MOS TECHNOLOGY TROOPS STAND READY TO SERVE!

PART NUMBER	CAPACITY (ORGANIZATION)	SPEED	COMPATIBILITY		NUMBER OF CLOCKS	TYPE		PACKAGE & NO. LEADS	MOS PROCESS
			TTL	MOS		STATIC	DYNAMIC		
SHIFT REGISTERS									
MTS1001	2X100	10KHz+2MHz	NO	YES	2		X	TO	Standard H.V.
MTS1002	2X32	DC+1MHz	NO	YES	1	X		TO	Standard H.V.
MTS1016	3X66	10KHz+2MHz	NO	YES	2		X	TO	Standard H.V.
MTS1100	2X50	10KHz+2MHz	NO	YES	2		X	TO	Standard H.V.
MTS2013	2X100	10KHz+3MHz	YES	YES	2		X	TO	Low Voltage
MTS2100	1X512	10KHz+5MHz	YES	YES	2		X	TO	Low Voltage
MCS2102	2X100	DC+2MHz	YES	YES	1	X		DIP/16	Low Voltage
MTS2103	2X32	DC+1MHz	YES	YES	1	X		TO	Low Voltage
MCS2104	4X25	DC+2MHz	YES	YES	1	X		DIP/14	Low Voltage
MTS2105	2X64	DC+2MHz	YES	YES	1	X		TO	Low Voltage
MTS2107	2X128	DC+1MHz	YES	YES	1	X		TO	Low Voltage
MTS2108	2X128	DC+2MHz	YES	YES	1	X		TO	Low Voltage
MTS3100	1X1024	10KHz+2MHz	YES	YES	2		X	TO	Low Voltage
READ ONLY MEMORIES									
MCS1004	2240(7X5X64)	700ns, Char., 350ns, Col.	NO	YES	0	X		DIP/28	Standard H.V. (28V)
MCS1004A	2240(7X5X64)	700ns, Char., 350ns, Col.	NO	YES	0	X		DIP/28	Standard H.V. (24V)
MCS2000	2240(5X7X64)	800ns	YES	YES	0	X		DIP/24	Low Voltage
MCS2001	2240(7X5X64)	800ns	YES	YES	0	X		DIP/24	Low Voltage
MCS2002	256X10	800ns	YES	YES	0	X		DIP/24	Low Voltage
MCS2003	320X8	800ns	YES	YES	0	X		DIP/24	Low Voltage
MCS2004	512X5	800ns	YES	YES	0	X		DIP/24	Low Voltage
MCS2005	640X4	800ns	YES	YES	0	X		DIP/24	Low Voltage
MCS2006	1280X2	800ns	YES	YES	0	X		DIP/24	Low Voltage
MCS2007	256X9	800ns	YES	YES	0	X		DIP/24	Low Voltage
MCS2008	2560X1	800ns	YES	YES	0	X		DIP/24	Low Voltage
MCS2009	2048X1	800ns	YES	YES	0	X		DIP/24	Low Voltage
MCS2010	1024X2	800ns	YES	YES	0	X		DIP/24	Low Voltage
MCS2011	512X4	800ns	YES	YES	0	X		DIP/24	Low Voltage
MCS2012	256X8	800ns	YES	YES	0	X		DIP/24	Low Voltage
MCS2014	768X3	800ns	YES	YES	0	X		DIP/24	Low Voltage
MCS2015	384X6	800ns	YES	YES	0	X		DIP/24	Low Voltage
MCS2017	4032(7X9X64)	400ns	YES	YES	2		X	DIP/24	Low Voltage
MCS2018	3840(10X12X32)	400ns	YES	YES	2		X	DIP/24	Low Voltage
MCS2020	2240(7X10X32)	400ns	YES	YES	2		X	DIP/24	Low Voltage
RANDOM ACCESS MEMORIES									
MCS2050	256X1	800ns	YES	YES	0	X		DIP/16	Low Voltage
UNIVERSAL COUNTER TIMERS									
MCS1003-001	Decade	DC+500KHz	NO	YES	1	X		DIP/24	Standard H.V.
MCS1003-002	Decade	DC+500KHz	NO	YES	1	X		DIP/24	Standard H.V.

STANDARD PRODUCT LISTING

We've Turned
A Technology
Into A Company

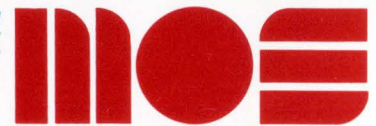

MOS TECHNOLOGY, INC.

VALLEY FORGE INDUSTRIAL PARK, VALLEY FORGE, PENNA. 19481
215-666-7950 • TWX: 510-660-4033

A Proud Affiliate of Allen-Bradley Co.

NOW QUARTERED IN DEPTH AT:

NEWARK ELECTRONICS

East

BOSTON AREA

561 Main Street, Malden, Massachusetts 02148

(617) 321-3930

NEW YORK CITY-NEW JERSEY AREA

303 Monroe Avenue, Kenilworth, New Jersey 07033

(201) 272-8410

LONG ISLAND AREA

80 Express Street, Plainview, New York 11803

(516) 822-5000

ROCHESTER

30 Allens Creek Road, Rochester, New York 14618

(716) 473-6600

BALTIMORE-WASHINGTON AREA

P.O. Box 618, Bowie, Maryland 20715

(800) 621-2604

NEWARK ELECTRONICS

Central

CHICAGO

500 North Pulaski Road, Chicago, Illinois 60624

(312) 638-4411/TWX: 910-221-0268

TELEX: 25-3218

DETROIT

20700 Hubbell Avenue, Oak Park, Michigan 48237

(313) 548-0250

GRAND RAPIDS

2114 South Division, Grand Rapids, Michigan 49507

(616) 452-1411/TWX: 810-273-6904

MINNEAPOLIS

336 Hoover Street, Minneapolis, Minnesota 55413

(612) 331-6350

CINCINNATI

112 East Liberty Street, Cincinnati, Ohio 45210

(513) 421-5282/TWX: 810-461-2662

CLEVELAND

4506 Chester Avenue, Cleveland, Ohio 44103

(216) 431-4340

COLUMBUS

1153 Northridge Road, Columbus, Ohio 43224

(614) 267-9474

DAYTON

3427 Linden Avenue, Dayton, Ohio 45410

(513) 253-9197

INTERMARK ELECTRONICS

West

SANTA ANA

17192 Gillete Street, Santa Ana, California 92705

(714) 540-1322/(213) 860-8589

TWX: 910-595-1583

SAN CARLOS

100 Industrial Road, San Carlos, California 94070

(415) 592-1641/TWX: 910-376-4899

SAN DIEGO

7933 Clairemont Mesa Blvd., San Diego, Cal. 92111

(714) 279-5200/TWX: 910-335-1238

VAN NUYS

7110 Gerald Avenue, Van Nuys, California 91406

(213) 782-0362/TWX: 910-495-2005

SEATTLE

621 South Michigan Street, Seattle, Wash. 98108

(206) 767-3160/TWX: 910-444-2054

DENVER

2600 West Second Street, Denver, Colorado 80219

(303) 936-8284/TWX: 910-931-0501

TEMPE

1318 East Princess Road, Tempe, Arizona 85257

(602) 968-3489

OR CONTACT MOS REGIONAL HEADQUARTERS DIRECT:

EASTERN REGIONAL SALES DIRECTOR — Mr. William Whitehead, MOS TECHNOLOGY, INCORPORATED, 88 Sunnyside Blvd., Suite 307, Plainview, New York 11803 • Phone: (516) 822-4240

CENTRAL REGIONAL SALES DIRECTOR — Mr. Alan Mattal, MOS TECHNOLOGY, INCORPORATED, 10400 W. Higgins Rd., Suite 631, Rosemont, Illinois 60018 • Phone: (312) 298-2035

WESTERN REGIONAL SALES DIRECTOR — Mr. Jack Turk, MOS TECHNOLOGY, INCORPORATED, 2172 Dupont Drive, Patio Bldg., Suite 221, Newport Beach, California 92660 • Phone: (714) 833-1600

Circle 900 on Reader service card

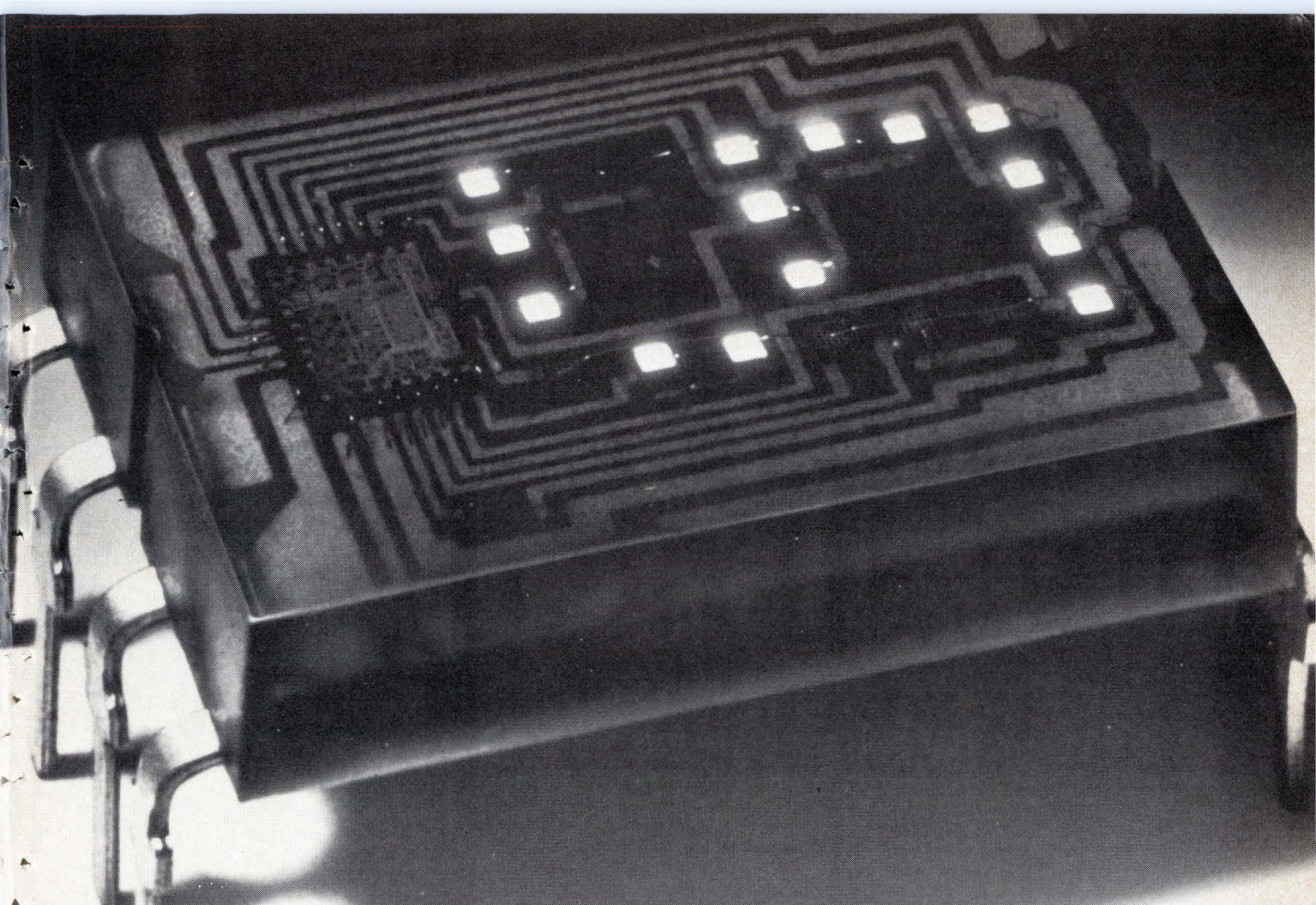

We built in the decoder/driver so you don't have to.

Not only the decoder/driver but the memory too! Now available for *immediate* delivery is the HP 5082-7300 series solid state display.

It's completely TTL compatible. All you do is address it directly with four-line BCD input. The on-board IC allows for either the storage of input data or real-time display. You save design time, space and money, and get a completely reliable integrated display system.

A bright .290 inch high, shaped character gives

excellent readability over a wide viewing angle in a compact .600 inch by .400 inch package.

So why wait? For *immediate* delivery on the HP 5082-7300 call your local HP sales office, or Hewlett-Packard, Palo Alto, Calif. 94304. In Europe: 1217 Meyrin-Geneva, Switzerland.

HEWLETT  PACKARD

COMPONENTS

Circle 1 on reader service card

01202A

Why the best high frequency transistors cost less than the second best.

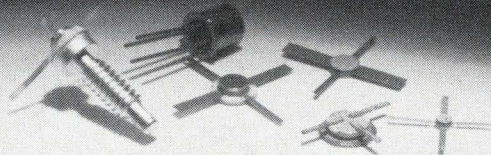

It doesn't happen often. But in the case of microwave transistors, you don't have to trade off performance to get the lowest price. That's because we've combined advances in silicon semiconductor technology with efficient mass-production. The result to date has been:

The workhorse: HP 21.

This small signal transistor is the backbone of any RF/microwave amplifier design. It has a 12 dB gain at 2 GHz (useable to 5 GHz), a noise figure of 4.2 dB at 2 GHz and a price of only \$19 each in small quantities. So you won't be making tradeoffs in your design.

Really low noise.

The HP 22, a significant new high frequency device, has a maximum

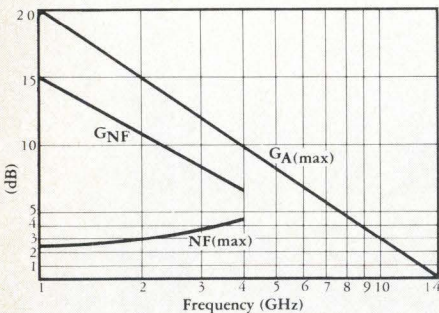

guaranteed noise figure of 4.5 dB at 4 GHz with 6.5 dB gain when biased for optimum NF (10 V, 5 mA). With 3 dB more gain across the band than the HP 21, the HP 22 is useable to 8 GHz

in its stripline packages. All for just \$75 each. No other transistor can make that statement.

More power out.

That's the function of the new HP 11. It fills the power gap between the HP 21 and high power devices. As a preamp

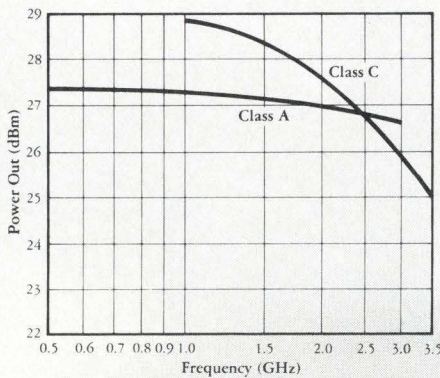

output or linear driver, it offers low distortion from 2 to 4 GHz. Yet it costs the same as the small signal HP 21.

The low price of success.

You've seen the kind of performance our transistors offer. Now let's get down to the cost factor.

Quantity	HP 21	HP 22	HP 11
1-99	\$19	\$75	\$19
100+	15	65	15

(Domestic USA prices for stripline packages.)

Can you afford not to use them?

Firm delivery and great reliability.

We can deliver most orders from stock. And you can count on device reliability. Our proven manufacturing process not only provides excellent parameter stability from batch to batch but insures healthy devices. Like 10 million hours MTBF for the HP 21.

An HP field engineer is nearby to answer your questions and handle your orders promptly. Why not give him a call for complete information about our transistors. Or write Hewlett-Packard, Palo Alto, California 94304. Europe: 1217 Meyrin-Geneva, Switzerland.

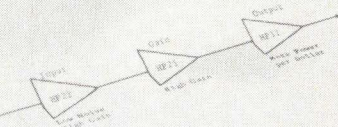

HP transistors: a small price to pay for performance.

HEWLETT  PACKARD
COMPONENTS

29 Electronics Review

INTEGRATED ELECTRONICS: First CCD vidicon built, 29
COMMERCIAL ELECTRONICS: Frame grabbers big market? 30
MILITARY ELECTRONICS: Pentagon looking to European arms, 31
COMPANIES: Educational VTR a lucrative sideline, 31
GOVERNMENT: Computer to sense mine gases, 32
COMMUNICATIONS: Suppliers win domsat contest, 34
INSTRUMENTATION: Six-port coupler simplifies job, 36
LOGIC: Raytheon offers power-compensated ECL, 36
DISPLAYS: Planar processing yields big figures, 38
SOLID STATE: Correlators that solve problems, 38
AVIONICS: NASA test advances VTOL, 40
FOR THE RECORD: 42
ELECTRONICS INTERNATIONAL: Gloom in Paris, 53

59 Probing the News

SOLID STATE: Japanese target: MOS markets, 59
COMPONENTS: X-band amplifiers go solid-state, 62
COMMERCIAL ELECTRONICS: Unmanned banks—a new investment, 65
COMMUNICATIONS: Ship-satellite system sought, 68
COMPUTERS: IBM threat to hold back service vexes industry, 70

81 Technical Articles

COMMUNICATIONS: Data to speed over 20-GHz radio relay, 81
CIRCUIT DESIGN: Building a range tracker with digital circuits, 86
DESIGNER'S CASEBOOK: Series-tied op amps null offset voltage, 92
Linear signal limiting with feedback amplifier, 93
Simple logic circuits compare binary numbers, 94
COMPONENTS: New applications open for the isolation amplifier, 96
CIRCUIT DESIGN: One-shot timing: don't take it for granted, 101
COMMUNICATIONS: Digitizing rf signals requires optimum sampling, 106
ENGINEER'S NOTEBOOK: Finding loop gain without opening loop, 113
Coaxial buses help suppress power supply transients, 113
A quick solution to conductive heat transfer problems, 114

119 New Products

IN THE SPOTLIGHT: Side-brazed LSI packages make room at the top, 119; Software cuts sensitivity-analysis cost, 123
COMPONENTS: A-d converter is ratiometric, 125
INSTRUMENTS: Amplifier is monolithic, 128
MICROWAVE: One-port counter covers 18 GHz, 133
SEMICONDUCTORS: MOS RAM offers 100-nanosecond access, 136
MATERIALS: 138

Departments

Publisher's letter, 4
Readers comment, 6
40 years ago, 8
People, 14
Meetings, 20
Electronics Newsletter, 25
Washington Newsletter, 47
Washington Commentary, 48
International Newsletter, 55
Engineer's Newsletter, 117
New Books, 138
Personal Business, PBI

Title R registered U.S. Patent Office; Copyright 1972 McGraw-Hill Inc.
All rights reserved, including the right to reproduce the contents of this publication in whole or in part.
Volume No. 45, Number 7

Highlights

Automated banking systems gain a foothold, 65

Teller stations built around minicomputers perform 80% of all banking functions without human help. Staffer Marilyn Offenheiser reviews their present status and the prospects for a \$1 million-a-year market.

Japanese to test 2-GHz radio-relay system, 81

All-digital 13-hop trial link will use phase-shift keying with four-phase modulation to speed data at 4,000 Mb/s. Author Yasuaki Ninomiya discusses criteria considered by Nippon Telegraph & Telephone Corp. in designing the system, and he outlines concepts still to be tested.

Engineer's Notebook, 113

A new regular department debuts with useful tips on an easy way to measure loop gain, suppressing power supply transients, using do-it-yourself coaxial tubes, and a nomogram for solving heat transfer problems.

Program checks out dc sensitivity, 123

Software packages, till now discussed only in the "Technical Articles" section, will now be covered in "New Products." This innovation underlines the growing importance of programed aids for the circuit designer.

And in the next issue . . .

Functional trimming of hybrid circuits . . . a solid-state direct replacement for vacuum tubes . . . a microelectronic watch with liquid crystal display.

The cover:

Intermediate-frequency amplifier is shown in front of Japanese quasimillimeter-wave radio relay tower.

Electronics

EDITOR-IN-CHIEF: Kemp Anderson

EXECUTIVE EDITOR: Samuel Weber

MANAGING EDITORS: Lawrence Curran, *News*;
Arthur Erikson, *International*

SENIOR EDITORS: John Johnsrud,
H. Thomas Maguire, Stephen E. Scrupski

ART DIRECTOR: Fred Sklenar

ASSOCIATE EDITORS: Richard Gundlach,
John N. Kessler, Howard Wolff

DEPARTMENT EDITORS

Aerospace: William F. Arnold

Circuit Design: Lucinda Mattern

Communications & Microwave:

Lyman J. Hardeman

Computers: Wallace B. Riley

Consumer: Gerald M. Walker

Industrial: Alfred Rosenblatt

Instrumentation: Michael J. Riezenman

Military: Ray Connolly

New Products: H. Thomas Maguire

Packaging & Production:

Stephen E. Scrupski

Solid State: Laurence Altman

Special Issues: Harry R. Karp

COPY EDITORS: Margaret Eastman,
Everett C. Terry

ART: Charles D. Ciatto, *Associate Director*

PRODUCTION EDITORS:
Patricia Cybulski, Arthur C. Miller

EDITORIAL ASSISTANT: Marilyn Offenheiser

EDITORIAL SECRETARIES: Vickie Green,
Nancy Baldasare, Julie Gorgoglione

FIELD EDITORS

Boston: James Brinton (Mgr.), Gail Farrell

Dallas: Larry Armstrong (Mgr.)

Los Angeles: Paul Franson (Mgr.)

New York: Alfred Rosenblatt (Mgr.)

San Francisco: Stephen Wm. Fields (Mgr.),

Roberta Schwartz

Washington: Ray Connolly (Mgr.),

William F. Arnold

Frankfurt: John Gosch

London: Michael Payne

Paris: Arthur Erikson

Tokyo: Charles Cohen

McGraw-Hill World News

Director: Walter A. Stanbury; *Atlanta*: Stan Fisher; *Chicago*: Mike Sheldrick; *Cleveland*: Arthur Zimmerman; *Detroit*: James Wargo; *Houston*: Robert E. Lee; *Los Angeles*: Michael Murphy; *Gerald Parkinson*; *San Francisco*: Margaret Drossel; *Seattle*: Ray Bloomberg; *Washington*: James Canan, Herbert W. Cheshire, Seth Payne, Warren Burkett, William D. Hickman; *Bonn*: Robert Ingersoll; *Brussels*: James Smith; *London*: Marvin Petal; *Milan*: Peter Hoffmann, Andrew Heath; *Moscow*: Axel Krause; *Paris*: Stewart Toy, Michael Johnson; *Stockholm*: Robert Skole; *Tokyo*: Mike Mealey

PUBLISHER: Dan McMillan

ADVERTISING SALES MANAGER: Pierre J. Braudé

ADVERTISING SALES SERVICE MANAGER:
Wallis Clarke

BUSINESS MANAGER: Stephen R. Weiss

CIRCULATION MANAGER: George F. Werner

RESEARCH MANAGER: David Strassler

MARKETING SERVICES MANAGER:
Tomlinson Howland

Publisher's letter

During the more than 42 years that *Electronics* has been published, there have been a great many changes in its format. Some were revolutionary, some evolutionary—but all were designed to help the magazine keep pace with our readers' changing expectations and changing information needs.

We've just completed another redesign, one that has—among other things—added two new sections to the mixture of news, analysis, technical articles, and new products information that we bring you every two weeks. This redesign is an evolutionary one; therefore, many of the changes may not be apparent at first glance. But we're sure you won't want to miss the two new sections—Engineer's Notebook and Engineer's Newsletter. You will find them on pages 113 and 117, respectively.

These departments add a whole new dimension to *Electronics*. The material in both departments will deal with various everyday problems that continually frustrate engineers. The emphasis is on the engineering tradeoffs involved in solving design problems, as well as insights and tips on applications, novel designs, and engineering shortcuts.

The best examples of what you'll be finding in the new sections are the headlines of the stories in the first Engineer's Notebook:

- A quick solution to conductive heat treatment problems.
- Coaxial buses help suppress power supply transients.
- Finding open-loop gain without opening the loop.

And we'd like this to be a two-way street. If you have any ideas

that you think would be of interest to your fellow readers, send them to us, addressed to Dick Gundlach.

The rest of the changes include a Highlights section added to our Contents page (see page 3). We've done that to speed you on your way to the most important and timely stories in the magazine.

Then we've added some new types of headlines in the *Electronics Review* section (see page 29). We designed these to make it easier for you to find the stories that interest you most.

From now on, you'll find our Probing the News section immediately following *Electronics Review*. We made this change so that all news stories will be near the front of the magazine for your convenience. Now, you'll be able to find all of *Electronics'* up-to-the-minute stories of technology and business that are covered in the newsletters and *Electronics Review* right beside the in-depth analyses of industry trends that are the specialty of Probing the News.

Also, don't look for the old, yellow newsletter pages. From now on, the *Electronics*, *Washington*, and *International Newsletters* will be printed on a crisp white stock that's easier to read.

All these changes add up to a better way to meet your changing expectations and information needs. I would welcome your comments and suggestions.



March 27, 1972 Volume 45, Number 7
90,260 copies of this issue printed

Published every other Monday by McGraw-Hill, Inc. Founder: James H. McGraw, 1860-1948. Publication office, 330 West 42nd Street, N.Y., N.Y. 10036; second class postage paid at New York, N.Y., and additional mailing offices.

Executive, editorial, circulation and advertising addresses: *Electronics*, McGraw-Hill Building, 330 West 42nd Street, New York, N.Y. 10036. Telephone (212) 971-3333. Teletype TWX N.Y. 710-581-4235. Cable address: MCGRAW HILL N.Y.

Subscriptions limited to persons with active, professional, functional responsibility in electronics technology. Publisher reserves the right to reject non-qualified requests. No subscriptions accepted without complete identification of subscriber name, title, or job function, company or organization, including product manufactured or services performed. Subscription rates: qualified subscribers in the United States and possessions and Canada, \$8.00 one year, \$12.00 two years, \$16.00 three years; all other countries \$25.00 one year except Japan \$50.00 per year including air freight. Limited quota of subscriptions available at higher-than-basic rate for persons outside of field served, as follows: U.S. and possessions and Canada, \$25.00 one year; all other countries \$50.00. Single copies: United States and possessions and Canada, \$1.00; all other countries, \$1.75.

Officers of the McGraw-Hill Publications Company: John R. Emery, President; J. Elton Tuohig, Senior Vice President—Services; Donald B. Gridley, Group Vice President; Vice Presidents: Ralph Blackburn, Circulation; John R. Callahan, Editorial; John B. Hoglund, Controller; David G. Jensen, Manufacturing; Jerome D. Luntz, Planning & Development; Joseph C. Page, Marketing.

Officers of the Corporation: Shelton Fisher, President; Joseph H. Allen, President, Publications and Business Services Group; John J. Cooke, Senior Vice President and Secretary; Ralph J. Webb, Treasurer.

Title registered in U.S. Patent Office; Copyright 1972 by McGraw-Hill, Inc. All rights reserved. The contents of this publication may not be reproduced either in whole or in part without the consent of copyright owner.

Subscribers: The publisher, upon written request to our New York office from any subscriber, agrees to refund that part of the subscription price applying to copies not yet mailed. Please send change of address notices or complaints to Fulfillment Manager; subscription orders to Circulation Manager, *Electronics*, at address below. Change of address notices should provide old as well as new address, including postal zip code number. If possible, attach address label from recent issue. Allow one month for change to become effective.

Postmaster: Please send form 3579 to Fulfillment Manager, *Electronics*, P.O. Box 430, Hightstown, N.J. 08520.

A more functional generator for \$495.

The new Krohn-Hite Model 5200 linear sweep/function generator gives you more versatility and performance for your money. If that's a sweeping statement, we stand ready to prove it! Model 5200 generates basic sine, square, triangle and ramp waveforms that you can manipulate with sweeps and triggers from 0.00003Hz to 3MHz. For even more versatility, the new Model 5300 adds an exponential ramp for logarithmic sweeping at only \$695. For fast action, call the Wavemakers at (617) 491-3211, TWX 710-320-6583, Krohn-Hite Corporation, 580 Massachusetts Ave., Cambridge, Mass. 02139.

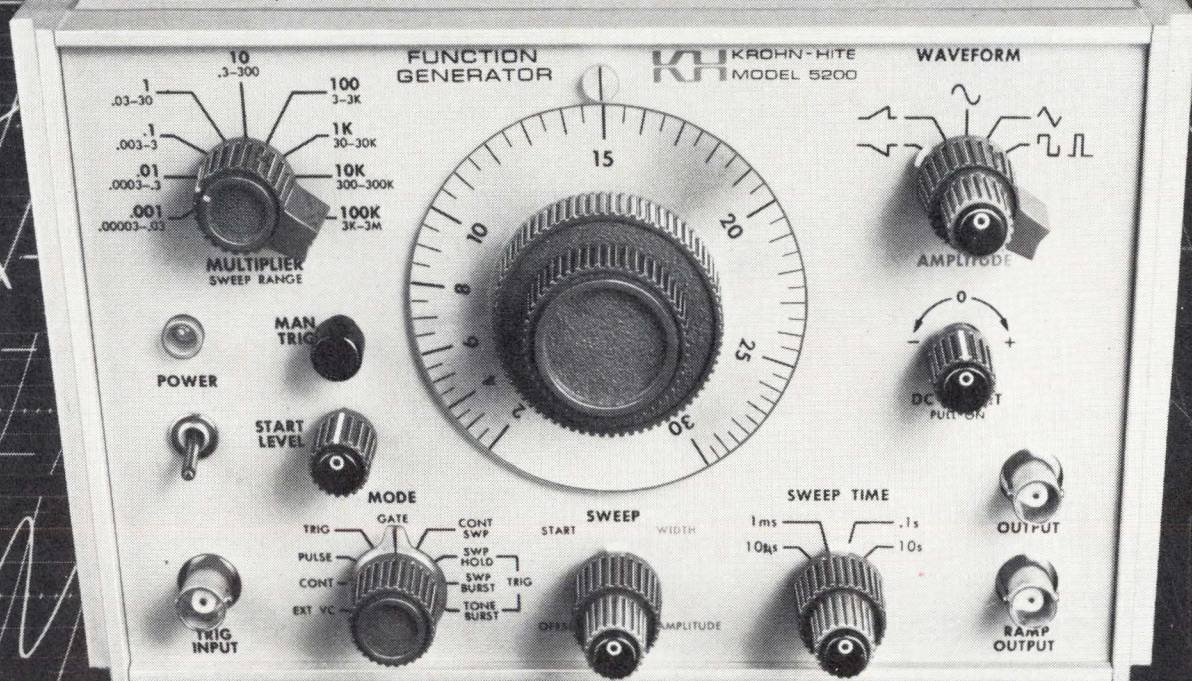

KH KROHN-HITE CORPORATION

OVERSEAS SALES OFFICES: AUSTRIA, Universal Elektronik Import; AUSTRALIA, Warburton O'Donnell Limited; BELGIUM, C. N. Rood s. a.; DENMARK, SC Metric A/S; ENGLAND, Allied International Limited; FINLAND, INTO O/Y; FRANCE, Antares; GERMANY, Nucletron Vertriebs-GMBH; HOLLAND, C. N. Rood n. v.; INDIA, Bali International Agencies; ISRAEL, R.D.T. Electronics Engineering, Ltd.; ITALY, Vianello S.P.A.; JAPAN, Shoshin Shoji Kaisha, Ltd.; NEW ZEALAND, H.M.Z. Ltd.; SOUTH AFRICA, Protea Physical; SPAIN, Rema Leo Haag, S.A.; SWEDEN, Teletinstrument; SWITZERLAND, Megax Zurich GMBH.

Eight rays of hope for the incurably trigger-happy.

You know how it is with conventional dual-channel scopes. You reposition a trace and you have to re-adjust the trigger. A man can get trigger-happy.

Well, Dumont's 1050/1060 scope series puts an end to all that. All eight models have trigger systems that bypass the positioning circuits. Result: No loss of trigger (in either channel, in any position), no trace flicker in dual trace, and no re-adjusting the trigger level after trace positioning.

Ask us about our 1050/1060 Series. About the easy operation, about the tremendous sensitivity, about the excellent wide-band operation.

At prices that begin at \$1845, they should shed a little glow in the budget department too.

Write or call for details.

DUMONT OSCILLOSCOPE LABORATORIES, INC.

40 Fairfield Pl., W. Caldwell, N.J. 07006
(201) 575-8666 TWX (710) 734-4308

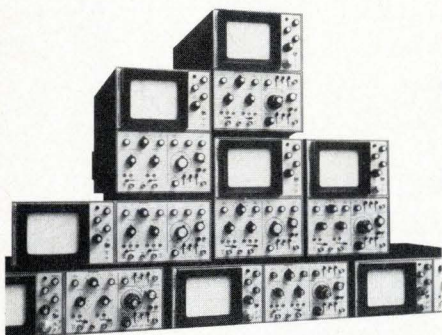

Readers comment

Decoding tree

To the Editor: Louis E. Frenzel Jr.'s decoding trees described in "Positive and negative gates trim package count" [*Electronics*, Oct. 25, 1971, p. 78] can be rearranged by using 7408 quad AND gates throughout, but using 7408 or 7400 at the output

whereas it should be connected to the non-inverting (+) input. The drain of the FET goes to the inverting input. In other words, reverse the plus and minus symbols on the 741 inputs.

Thomas D. Price Jr.
Saundersstown, R. I.

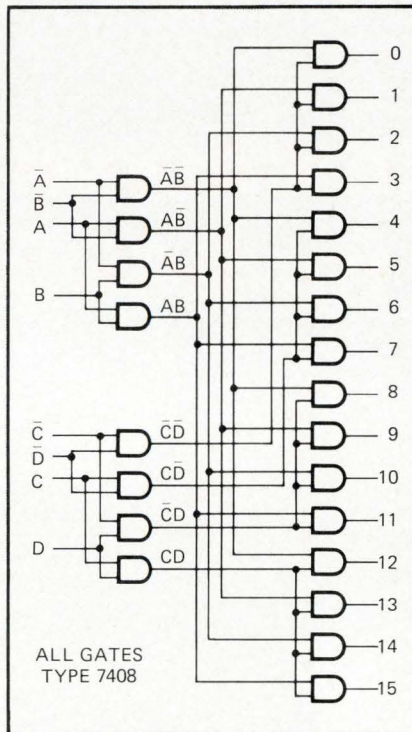

side to give N or \bar{N} decodes, as required. The package count is identical, but the circuit is quicker to check over.

Bernard Jones
Crossfield Electronics Ltd.
London, England

FET current source

To the Editor: Two errors somehow escaped the scrutiny of your proof readers in my Designer's casebook article, "FET current source gives stable, precise ramp," [*Electronics*, Nov. 8, 1971, p. 81]. First, in the text, the last sentence in the next-to-last paragraph should read, "Once FF_1 is reset, its \bar{Q} output goes high, C_1 discharges fast through D_1 , terminating the ramp." Please note that the bar was left off the \bar{Q} in the text as published.

The second error occurred in the schematic. The Q output of flip-flop is shown connected to the inverting (-) input of the 741 op amp,

Revised version

To the Editor: In Max Artusy's article, "Tunable active filter has controllable high Q" [*Electronics*, Jan. 31, p. 57], I fail to agree with the equation for resonant frequency— $f_0 = \frac{1}{2\pi}(\frac{R_1 R_2 C_1 C_2}{R_1 R_2 C_1 C_2})^{1/2}$ —and results based on the values shown in the schematic.

Where have I made an error? Has the author erred?

Leonard E. Herzmarsh
Biomedical Instrument Systems
Prairie Village, Kan.

Other readers who raised this point include Alexander Bell, of Xan Instrumentics, Beaufort, N.C.; Joseph S. Laughter, of the University of Tennessee's division of biomedical instrumentation; Harry G. Newman, of Sangamo Electric Co., Springfield, Ill.; and William S. Wagner, of the University of Cincinnati's department of electrical engineering.

The author replies: there are several points that require clarification concerning the circuit, which is perhaps better described as a tunable active bandpass filter. The floating junction of R_1 and C_1 should have been grounded (see corrected schematic below). Resonant frequency is $f_0 = 1/[2\pi(R_1 R_2 C_1 C_2)^{1/2}]$, where $R_1 = R_2$ and $C_1 = C_2$. To prevent oscillation, the following condition must be met: $1 + R_4/(R_s + R_3)$ must be less than 3. The op amp is, of course, made by Fairchild and many others.

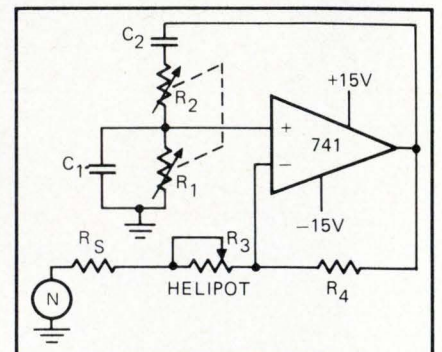

ANOTHER MYTH DESTROYED.

Myth: National doesn't make FET op amps. And, even if they did, they probably wouldn't be as good as bipolar devices. And, besides, everybody knows that FET op amps have lousy offset voltage and drift specs. And, FET op amps are too expensive. And, anyway, why not just go to a module house in the first place...

Fact: National does make FET op amps. A "family" of five devices, to be exact. Including the super precise new LH0052 (with an offset voltage of 0.1mV, an offset voltage drift of just $5\mu\text{V}/^\circ\text{C}$, and bias current of less than 1pA); the LH0022 (high performance good general purpose FET op amp); the LH0042 (lowest cost FET op amp on the market with even better performance than cheap module designs); the LH0033 (at $1500\text{V}/\mu\text{S}$, the fastest voltage follower available anywhere); the LH0032 (a $500\text{V}/\mu\text{S}$ device); and coming soon: The precise-and-speedy new LH0062 (slew rate, $80\text{V}/\mu\text{S}$; bandwidth, 15MHz; settling rate, 800nS). Significantly, each of the above was designed and manufactured completely in-house using a special chip construction technique combining the best of J-FET and bipolar technologies. All of which goes to show that FET op amps are, indeed, alive and well at National Semiconductor Corporation, 2900 Semiconductor Drive, Santa Clara, California 95051. Phone (408) 732-5000. TWX: (910) 339-9240. Cable: NATSEMICON.

NATIONAL.

RANGE CHANGE



Extralytic® Aluminum 'Lytic Capacitors give you extended temperature range without sacrifice in life or leakage current.

Type 601D Tubular Case	Type 602D Cylindrical Case
-55C to +105C	-55C to +85C
Superior performance over entire temperature range, unlike conventional 'lytics that do not operate satisfactorily at low temperatures. High volumetric efficiency, long shelf life, low leakage current. Withstand high ripple current. Write for Engineering Bulletin 3456A or; CIRCLE 240 ON READER SERVICE CARD.	Power supply filter capacitors specifically designed for maximum efficiency. Offer the power supply design engineer the lowest ESR and the highest ripple current capability per case size available today for long, trouble-free life. Write for Engineering Bulletin 3457 or; CIRCLE 241 ON READER SERVICE CARD.

MORE FROM SPRAGUE . . . THE BROAD-LINE PRODUCER OF ELECTRONIC PARTS

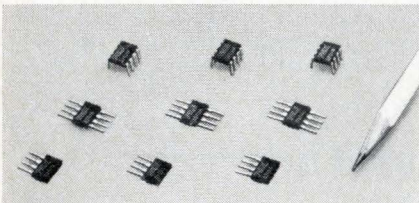

HALL EFFECT SWITCH ICs. Actuated magnetically, not mechanically or optically. Hall generator trigger circuit and signal amplification circuit on single silicon chip. Reliable (no moving parts). Easy interfacing with DTL/TTL/MOS logic. High speed. Low cost. Write for Engineering Bulletin 27,402A or;

CIRCLE 242 ON READER SERVICE CARD.



U.L. LISTED FILTERS. Series JX5000 for EDP equipment and general-purpose use. Rated 125/250 VAC, 0-60 Hz, 1 thru 50 amps. 60 db @ 150 kHz, 80 db from .5 MHz thru 1 GHz. Special designs and rectangular multi-circuit units also available. Write for Engineering Bulletin 8210 or;

CIRCLE 243 ON READER SERVICE CARD.

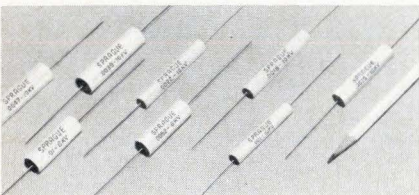

TYPE 430P METFILM® 'E' CAPACITORS. High-Voltage metallized polyester-film capacitors designed for voltage multiplier circuits used in electrostatic copiers, TV power supplies, etc. Working voltages from 4,000 to 15,000 V. Capacitance is stable with time, temperature, voltage. Write for Engineering Bulletin 2445.1 or;

CIRCLE 244 ON READER SERVICE CARD.

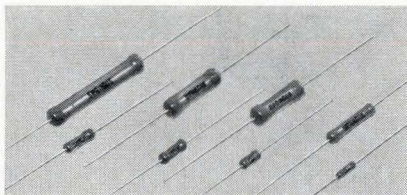

BLUE JACKET® RESISTORS. Vitreous-enamel power wirewound. Unique all-welded end-cap construction eliminates moisture paths along leads, anchors leads securely to resistor body. Expansion coefficients of vitreous enamel, ceramic body, and end caps are closely matched. Write for Engineering Bulletin 7410E or;

CIRCLE 245 ON READER SERVICE CARD.



TECHNICAL LITERATURE SERVICE, SPRAGUE ELECTRIC CO., 35 MARSHALL ST., NORTH ADAMS, MASS. 01247

45-2101

40 years ago

From the pages of Electronics, March 1932

Harmfulness of city smoke, less because of smoke particles breathed into the lungs than because smoke decreases the transparency of the air and shuts out part of the health-giving rays of sunlight, was emphasized by an exhibit on clean air and clean streets arranged recently by the committee on public health relations of the New York Academy of Medicine. One new instrument shown was a portable meter and recorder for ultraviolet rays. Two such meters, one inside the smoky area of a city and another somewhere outside the smoke zone, provide a continuous record of the percentage decrease of the solar rays by smoke.

Springfield, Mass., makes use of a new application of carrier currents or high-frequency impulses on the power wires, to control 800 local street lights. The regular power service is 60 cycles, while the control impulses for the street lights are 480 cycles, and those for turning on and off the water heaters are 720 cycles. Use of carrier currents, of course, eliminates the necessity of a separate circuit for the control mechanism, hence making possible a pronounced saving. The double-control method, employing currents of two frequencies, is already so practical that it is suitable for general utility purposes.

Groszkowski, writing in L'Onde Electrique, Paris, describes use of the new Lange-Schottky photocell, Cu₂O-Cu, specially sensitive to the ultrared radiations. A quartz lens forms the image of part of the anode of the tube under test on the sensitive surface of the cell, thus eliminating the effect of the glass bulb, of daylight, and of the cathode luminosity.

Dr. Karl T. Compton, president of the Massachusetts Institute of Technology, has announced that construction will shortly begin on a 15,000,000-volt X-ray tube, to be operated by a Van de Graaff electrostatic generator. The tube will be of the double-acceleration type.

This new "See-Through" mask will more than double your present production yields of usable semiconductor devices.

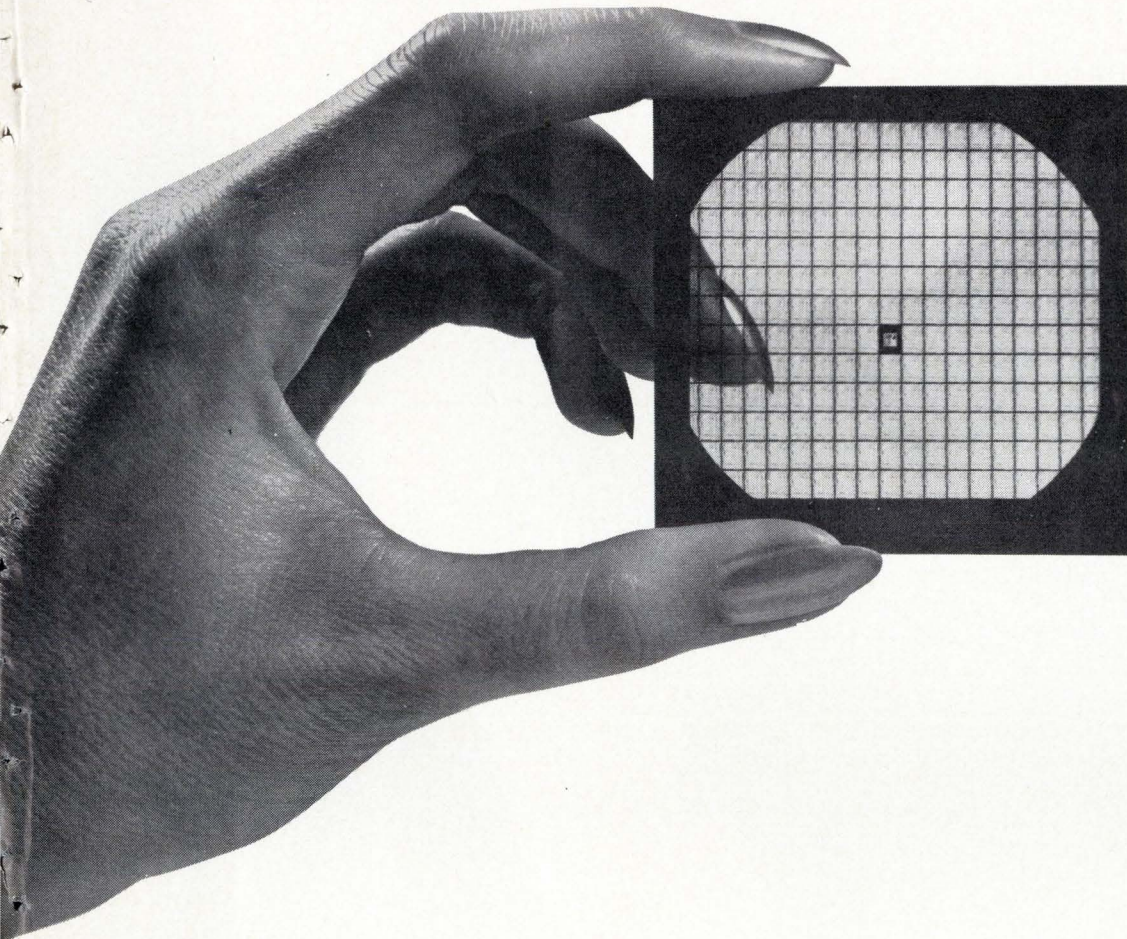

Your yields will increase.

Dry processing eliminates residue, swelling and contamination which account for most rejects in finished chips. Also, GAF® Microline® "See-Through" Plates eliminate rejects due to misalignment.

Your production costs will decrease.

Photomasks are made right "on-site" on low-cost equipment thereby saving you time and outside costs. Also, these masks last about 10 times longer than conventional emulsion photomasks.

The resolution characteristics of new GAF®

Microline® Plate are without match. Micron line-widths are easily obtained.

(Manufacturers in commercial production have resolved 2000 lines/mm using the United States Air Force resolution target in the photorepeater.)

New wafer photofabrication system.

The processing of silicon wafers using GAF® Microline® positive-working photoresists and GAF® Microline® plates results in a simplified, positive high yield system for producing usable semiconductor devices.

If high reject rates are the problem in your com-

pany, just fill out the coupon. We'll gladly send you full technical data on these new products and/or phone for an appointment to demonstrate just how great the savings can be in your own plant.

Available Plate Sizes:
 2"x2"x0.060"
 2½"x2½"x0.060"
 3"x3"x0.060"
 3½"x3½"x0.060"



383A-2100

GAF Corporation
 Commercial Development Dept. 606-032
 140 West 51 Street, New York, New York 10020

Gentlemen:

- Please send complete technical information on GAF® Microline® High-Resolution Plate.
- Please send complete technical information on GAF® Microline® positive-working photoresists.
- Have a representative phone for an appointment to demonstrate this new product in my plant.

Name _____ Title _____
 Company _____ Phone _____
 Address _____
 City _____ State _____ Zip _____

Help save inner space.

New Burndy High-Density Connector

We've been busy winning another space race. Our new 145-position, high-density connector takes less space, but still offers several distinct advantages. The nylon hood with a unique molded hinge permits it to be opened without removal from the connector. This simplifies wiring inspection and correction and protects the wires.

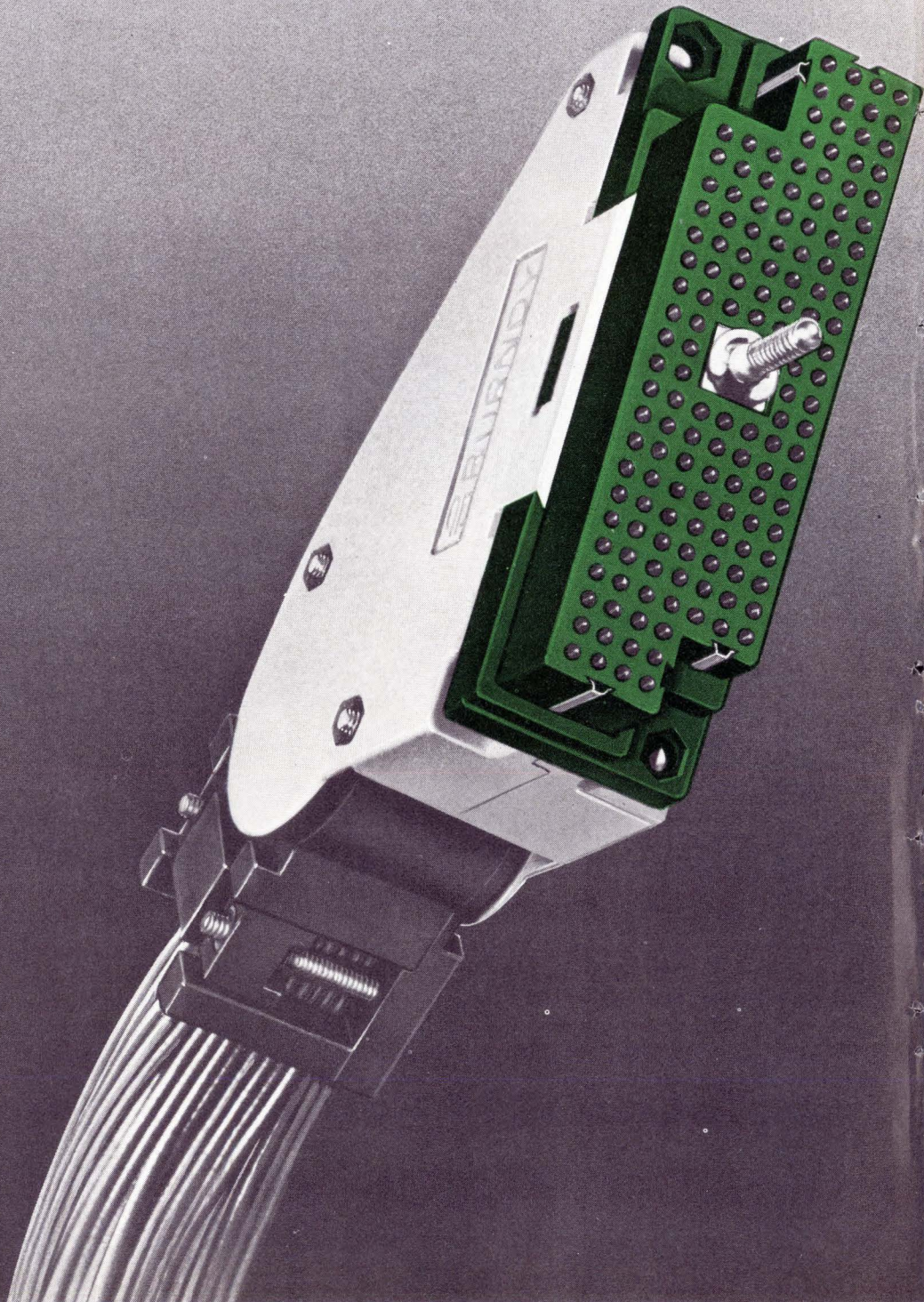
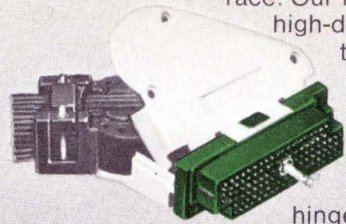

An original, five-position, strain-relief-cable clamp of molded nylon allows you to choose from straight through to a 90° takeoff by simply turning the cable to the desired position and locking the clamp.

Contact spacing is .100" center-to-center (shown at right actual size) in a square grid arrangement which permits adapting the connector for automatic or semi-automatic solderless wrap.

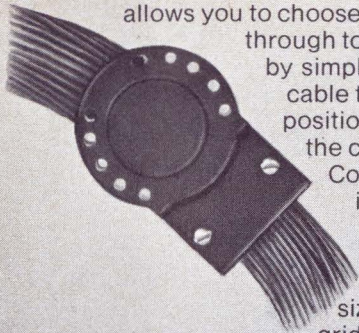

The contacts are standard #22D rear-release type qualified to MIL-C-38999 and accommodate wire sizes 22-28.

These contacts can also be used with the miniature round Compact Bantam™ connectors, available in 9

configurations. Another Burndy first—3 discriminating keys in a rectangular connector which prevents inappropriate mating of like connectors on the panel. By inserting the keys in the molded keyways, 18 different discriminations can be made. Use this new high-density connector for mother board or I/O. It's ideal for computer mainframe and peripheral applications. So make things better for yourself—specify the new HD145 connector. And get more out of inner space.

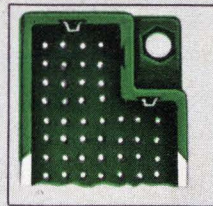

 **BURNDY**
Norwalk, Connecticut 06856

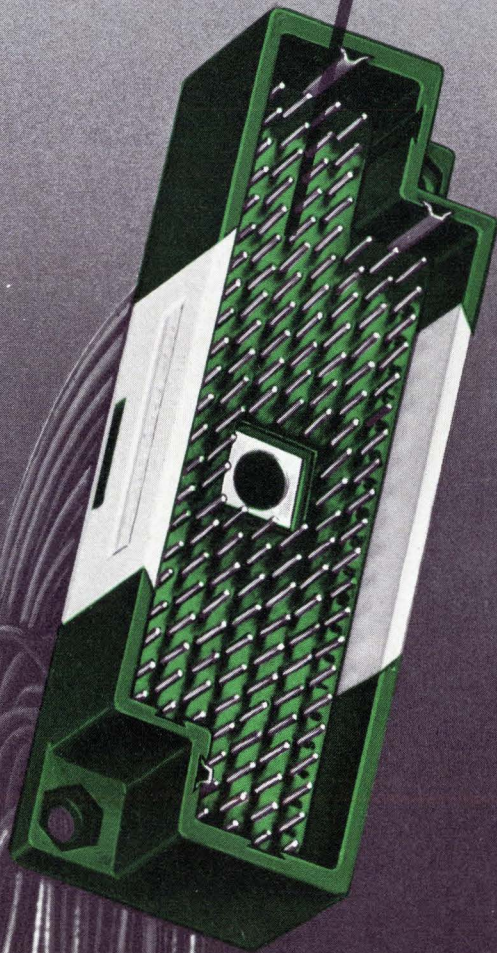

BURNDY  CONNECTS

Circle 11 on reader service card

**SCHOTTKY
TTL DEVICES
DELIVERABLE
IMMEDIATELY**



Our TTL Family Tree has a vigorous new Schottky branch: SSI devices now. Proprietary MSI (and more SSI) devices soon.

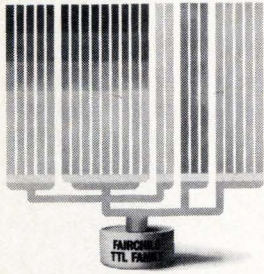

Our TTL Family Tree continues to grow. Now a new Schottky branch: SSI in volume now. MSI coming up. To give you new ways to solve your very-high-speed digital systems design problems.

Schottky TTL Devices are pin-for-pin replacements for slower, functionally

equivalent elements in existing TTL systems. An example of the speed improvement achieved is shown in the table below. These Schottky functions can be used to selectively replace devices in critical speed limiting paths within the system.

**TTL SWITCHING TIME COMPARISON
EXAMPLE: HEX INVERTER**

	T _{PLH} (turn-off delay)		T _{PHL} (turn-on delay)	
	Typ.	Max.	Typ.	Max.
9N04/7404	12.0	22.0	8.0	15.0
9H04/74H04	6.5	10.0	9.0	13.0
9S04/74S04	3.0	4.5	3.0	5.0
9S04A/74S04A	2.5	4.0	2.5	3.5

Note: All speeds listed in nanoseconds.

Important areas where speed limiting occurs are: decoder and multiplexer expansion; memory addressing and selection; general arithmetic and control functions; prescalers and counters; and elimination of skew problems in clock distribution. System speed improvements of 20 to 50% can be expected in these situations without any major redesign. Power requirements, logic levels and noise margins remain compatible with the slower, lower cost standard TTL devices which can be retained when speed is not important.

For your Schottky needs we now have 13 TTL/SSI functions, making us the only major supplier to second source these devices. And we can deliver them immediately. Our 9S and 93S series are completely interchangeable with the 54/74S series.

Just as important, these are but the first of the new Fairchild Schottky TTL family. Soon other SSI elements. Soon also, our first 93S series of proprietary MSI functions.

FAIRCHILD TTL/SSI DEVICES AND AVAILABILITY

Device	Description	Available
9S00/54S00, 74S00	Quad 2-Input NAND Gate	Now
9S03/54S03, 74S03	Quad 2-Input NAND (O.C.) Gate	Now
9S04/54S04, 74S04	Hex Inverter	Now
9S05/54S05, 74S05	Hex Inverter (O.C.)	Now
9S20/54S20, 74S20	Dual 4-Input NAND Gate	Now
9S22/54S22, 74S22	Dual 4-Input NAND (O.C.) Gate	Now
9S40/54S40, 74S40	Dual 4-Input NAND Buffer	Now
9S74/54S74, 74S74	Dual D Flip-Flop	Now
9S04A	Fast Hex Inverter	Now
9S05A	Fast Hex Inverter (O.C.)	Now
9S64/54S64, 74S64	AND-OR-Invert	Now
9S65/54S65, 74S65	AND-OR-Invert (O.C.)	Now
9S140/54S140, 74S140	Dual 4-Input NAND Line Driver	Now
9S109	Dual J-K Flip-Flop	2nd Qtr.
9S112/54S112, 74S112	Dual J-K Flip-Flop	2nd Qtr.
9S113/54S113, 74S113	Dual J-K Flip-Flop	2nd Qtr.
9S114/54S114, 74S114	Dual J-K Flip-Flop	2nd Qtr.

FAIRCHILD TTL/MSI FUNCTIONS AND AVAILABILITY

Device	Description	Available
93S41	4 Bit ALU/Function Generator	2nd Qtr.
93S05	Variable Modulo Counter	2nd Qtr.
93S39	Multiple Port Register	3rd Qtr.
93S10	Synchronous Decade Counter	3rd Qtr.
93S16	Synchronous Hexadecimal Counter	3rd Qtr.
93S12	Eight Input Multiplexer	3rd Qtr.
93S42	Carry Look Ahead Unit	3rd Qtr.
93S00	4 Bit Universal Shift Register	3rd Qtr.

Other MSI functions in development include high speed decoders and parity checkers.

Whatever your High Speed needs we have the answer. Schottky TTL for retrofitting existing systems, or our temperature compensated Easy ECL 9500 family for new high-speed systems.

Your Friendly Fairchild distributor has both our Schottky TTL and Easy ECL devices in stock, deliverable immediately. Or for more information, we have data sheets and application notes on both.

**MADE IN
FAIRCHILD**

More power to you!

AND BANDWIDTH TOO . . .

Our Model 406L is an ultra-wideband RF power amplifier whose wide range of frequency coverage and power output provides the user with the ultimate in flexibility and versatility in a laboratory instrument. Easily mated with a wide variety of signal sources, this completely solid state unit amplifies AM, FM, SSB, TV pulse and other complex modulation with minimum distortion.

Constant forward power is continuously available regardless of the output load impedance match, making the 406L ideal for driving highly reactive loads.

Unconditional stability and instantaneous failsafe provisions in the unit provide absolute protection from damage due to transients and overloads. Complete with power supplies and output meter, this low cost instrument provides over 5 watts of power from 100 KHz to over 250 MHz. . . and there's no tuning.

Applications include:

- RFI/EMI testing
- Laser modulation
- Communication systems
- Ultrasonics
- Laboratory instrumentation
- Spectroscopy

For complete information write or call

Electronic Navigation Industries,
3000 Winton Road South,
Rochester, New York 14623.
(716) 473-6900

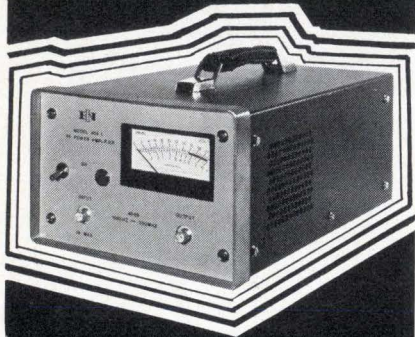

EN ELECTRONIC
NAVIGATION
INDUSTRIES

People

Dresselhaus scores an MIT first

MIT has just appointed the only tenured woman professor in its school of engineering, Mildred S. Dresselhaus, an associate head of the EE department. The first woman to be named to a major academic post in the engineering school, in her new position Dresselhaus is responsible for electrical science and engineering, which includes about half of the 1,100 students and 110 faculty members in the department. The other half are in the computer science and engineering section.

In her new role, Dresselhaus has a hand in shaping curriculum policies. "A department is always building up things," she says, "but with a constant budget some things are left slide; they get out of date. I have to see that everything goes together, to see to the natural changes."

One change she hopes to make in her new post is to increase the attention paid to junior faculty members. Dresselhaus feels they shouldn't be overburdened with courses and committees, and should be given "every chance to shine as researchers." It is also important to inform them of their chances for promotion and tenure, especially since tenure is no longer automatic. "Junior faculty should be alerted to their chances so they don't fizzle away."

Physicist. Dresselhaus was a solid state physicist at MIT's Lincoln Lab until 1967, when she was appointed to the Abby Rockefeller Mauze pro-

fessorship, established to bring distinguished women scholars to MIT. She believes it is important for women students in the sciences to have a role model, and so has been active in several women's programs at MIT. She has conducted a seminar on women in science and engineering, and more recently helped organize a forum to explore women's roles at MIT.

While national figures show a decline in the number of engineering students [*Electronics*, Feb. 28, p. 42], Dresselhaus says "there is no erosion in enrollment in my section". The computer science section is also attracting an increasing number of students. MIT may be running counter to the trend, she thinks, "because distribution of students is so largely in math, science, and engineering areas."

She has noted certain trends in student interest. "Computers are very high on the list," she says, "and job opportunities, at least for the near future, seem very good. This is one area where we have to turn down students because the size of the department is limited." On the electrical sciences side, she says, "We are going into bioelectric engineering on a much larger scale, and student interest is high in controls."

Staudte and Statek: parlaying a layoff

The heads of most successful small companies seem to be entrepreneurs who chafed under the restraints im-



Town and gown. Mildred Dresselhaus is MIT's associate EE department head. Jurgen Staudte gained by layoff.



0.25 pA I_b (max)

AD523. This one has the lowest bias current of all high performance I.C. operational amplifiers. Even ours. Especially theirs.

The AD523 is our new series of J-FET input operational amplifiers. It's the first linear I.C. to guarantee 0.25 pico-amp of bias current under operating conditions. At either input terminal. And in a low leakage case.

And you know what that means.

This amplifier is more charge-sensitive and an

order of magnitude more current-sensitive than other linear I.C.'s. And with $15 \mu\text{V}/^\circ\text{C}$ of offset voltage drift, 90 dB of CMR, and a slew rate of $5 \text{ V}/\mu\text{sec}$.

We did a number of important things to give you this performance.

Like combining matched small geometry FET chips with a

specially designed monolithic thin-film chip. And mounting them in TO-99 can with high resistivity glass insulation and a guard pin connected to it. So you can minimize surface leakage currents, power supply induced input noise, and capacitive pickup.

You can evaluate a package of five AD523's at the hundred piece

price if you order right now.

You can see all the things we make to solve more of your problems better than anyone else by sending for our 1972 Product Guide.

Analog Devices, Inc.,
Norwood, Mass. 02062.
Tel. (617) 329-4700.

 **ANALOG
DEVICES**

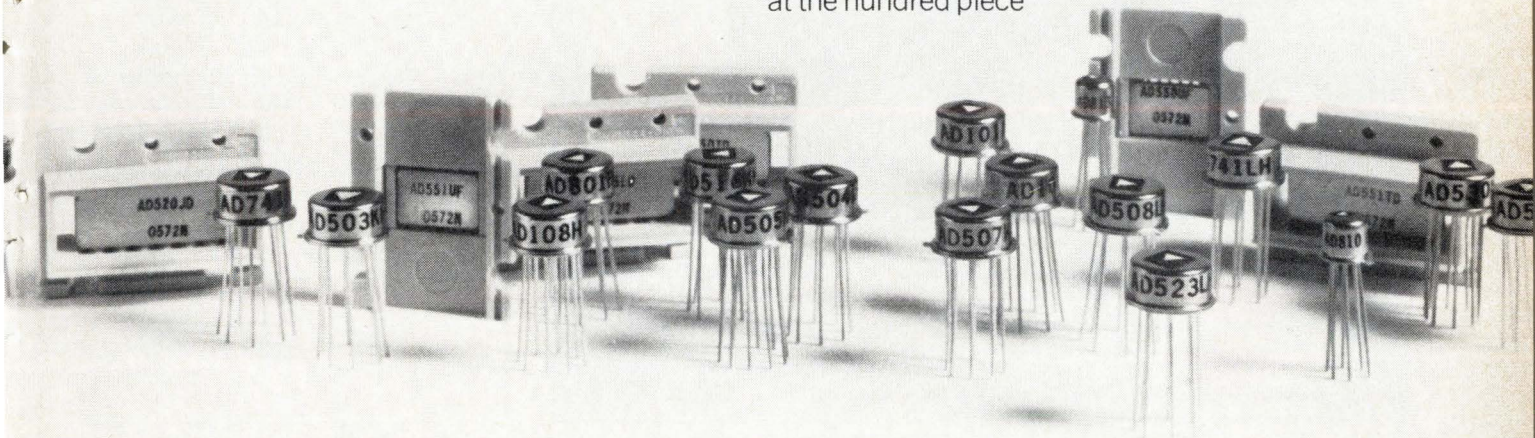

the original ME-2 Socket only from Scanbe

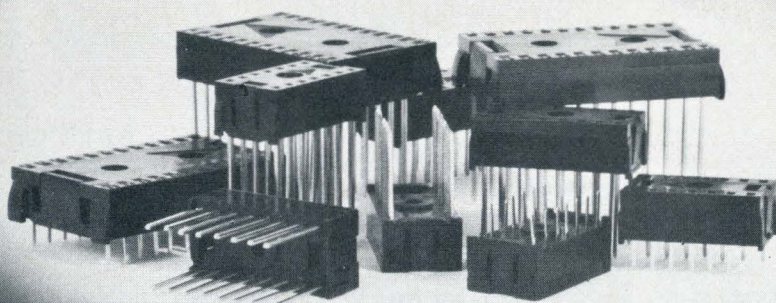

a dozen configurations...

with exclusive features from Scanbe's dual inline ME-2 Sockets. Four pin lengths, solder tail, one, two and three level solderless wrap in 14, 16 or 24 pin models.

Exclusive features include:

- Closed entry design means precision alignment for DIP leads
- Side gripping contacts means 80% more contact pressure
- Low insertion force means no damage to DIP's
- Highest reliability means Scanbe

Solder relief, replaceable pins, optional screw mountings and U.L. approved molded nylon for caps and bodies are other customer benefits along with Scanbe's quality and experience. The best contact your DIP can make is a Scanbe ME-2 Socket.

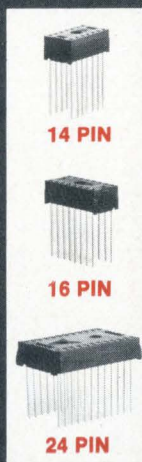

SCANBE MANUFACTURING CORP.
"The Packaging People"

3445 Fletcher Ave • El Monte, Calif. 91731
Telephone: (213) 579-2300

People

posed on them by large organizations. But not Juergen H. Staudte (pronounced Jurgen Stout), 34, president of Statek Corp., in Orange, Calif. "I was happy at Autonetics, and in the Air Force before that. I didn't mind working for a big organization. You might even say," the German-born Staudte adds with a smile, "I enjoy being regimented."

But Autonetics laid him off, and he turned the misfortune into an opportunity to found a company to develop an idea he had been considering since college—subminiature quartz frequency-determining crystals processed by the photolithographic batch techniques that have made transistors and ICs practical.

Staudte was born in East Germany, and had almost completed chemical engineering school when his father was arrested for "war-mongering" and sentenced to five years. Staudte and the rest of the family then escaped to Hamburg (his father made it out later), where he went to work as a junior chemical engineer in the oil industry. However, the inflexible West German educational system didn't recognize his East German studies, so he came to the U.S. in October 1956.

No wild blue. He had been in the country only a month when he received a draft call, so he "volunteered" for the Air Force. Plans to become a pilot fizzled because he wasn't a citizen, so he got out. After working at Hallicrafters, in Illinois, he realized that he had to get a degree, and worked at Elgin National Watch Co. in the calibration laboratory while he attended Aurora College. He received his bachelor's in physics after three years, then joined a midwest firm as an engineer in crystal manufacturing.

"But it was a little limiting," he says, "so I went to Michigan State to study acoustics under a graduate assistantship." He got an MS in physics. While at Michigan State, an ad for 1-mil-thick quartz blanks in a Swedish magazine gave him the idea for making crystals.

Then he got a job at Autonetics, got caught in the layoff flood, took the chance to apply his ideas, and started Statek.

NEW

5th edition from the leading SCR and triac supplier incorporates 15 years of application experience.

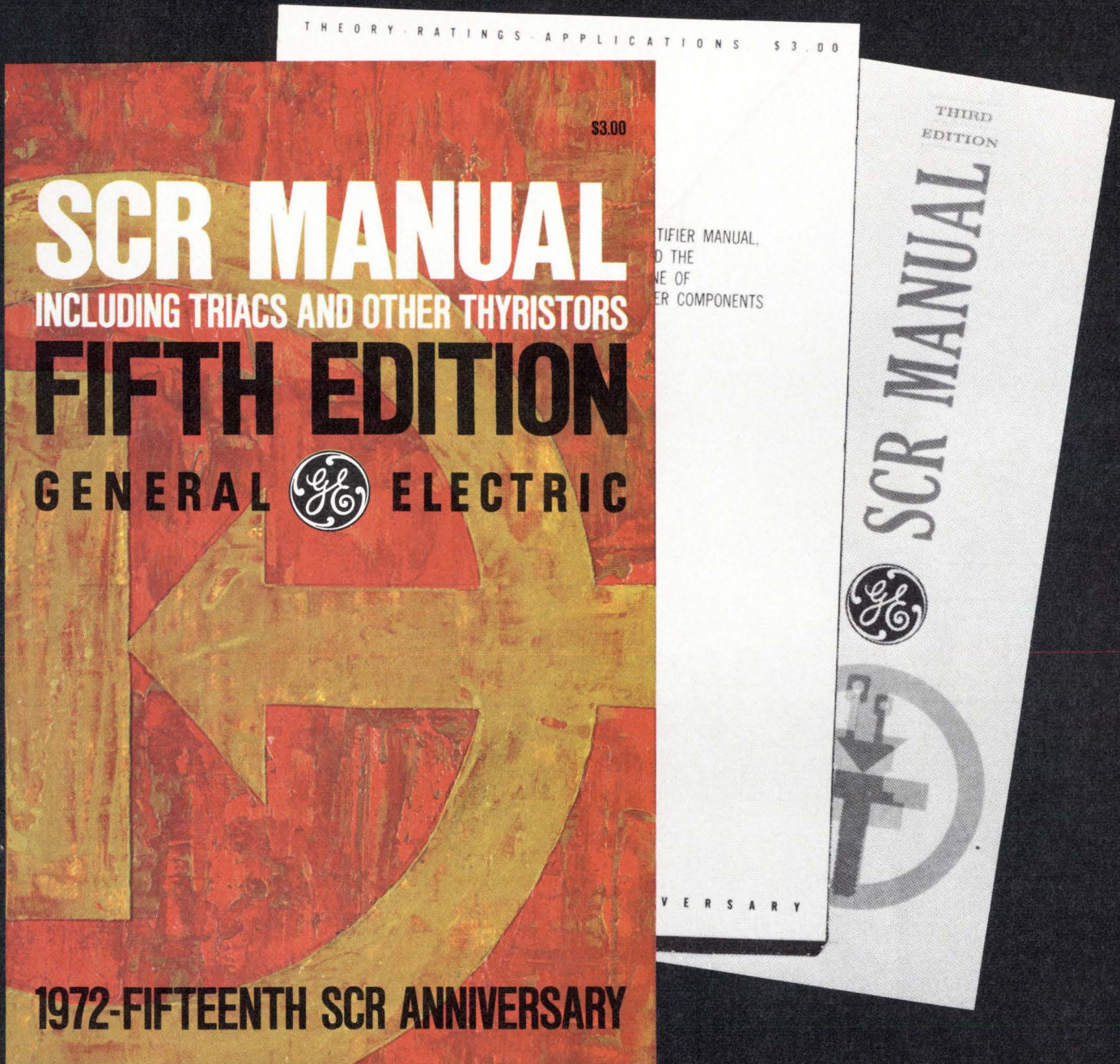

To get your copy, contact any authorized General Electric distributor or any General Electric Electronic Component Sales office.

GENERAL  ELECTRIC

Semiconductor Products Department
Electronics Park, Syracuse, New York
13201

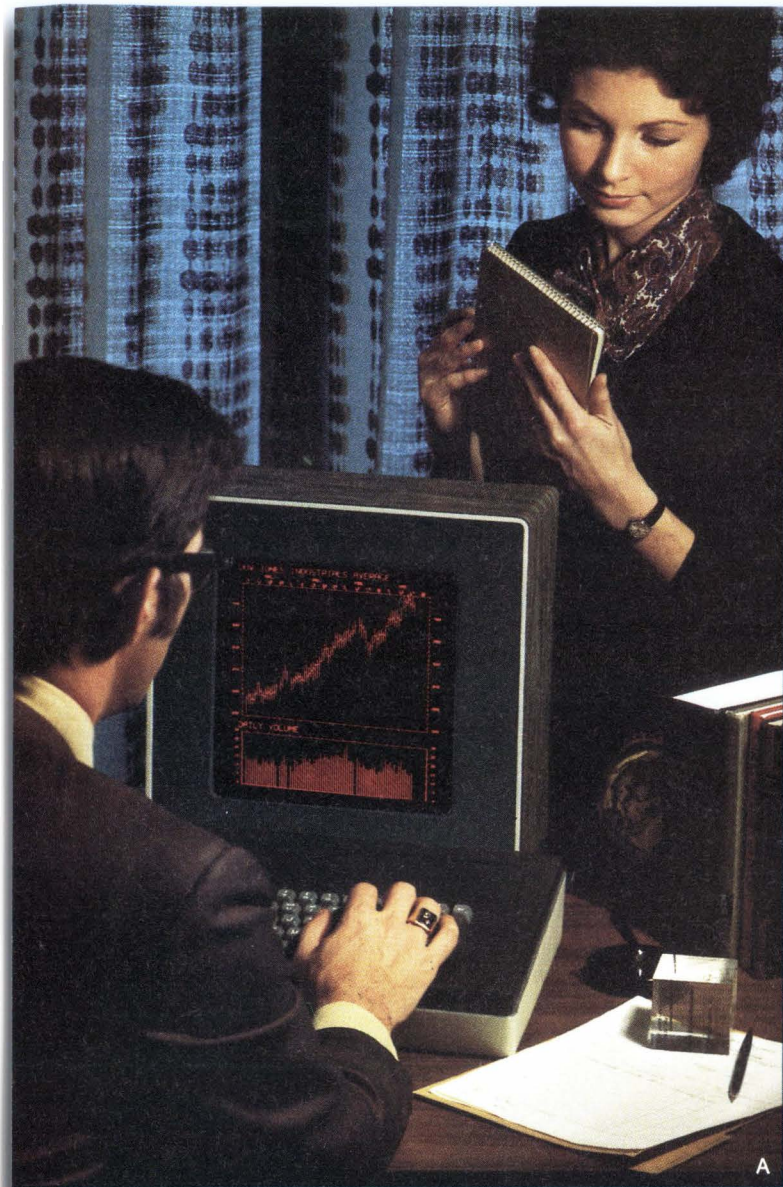

A

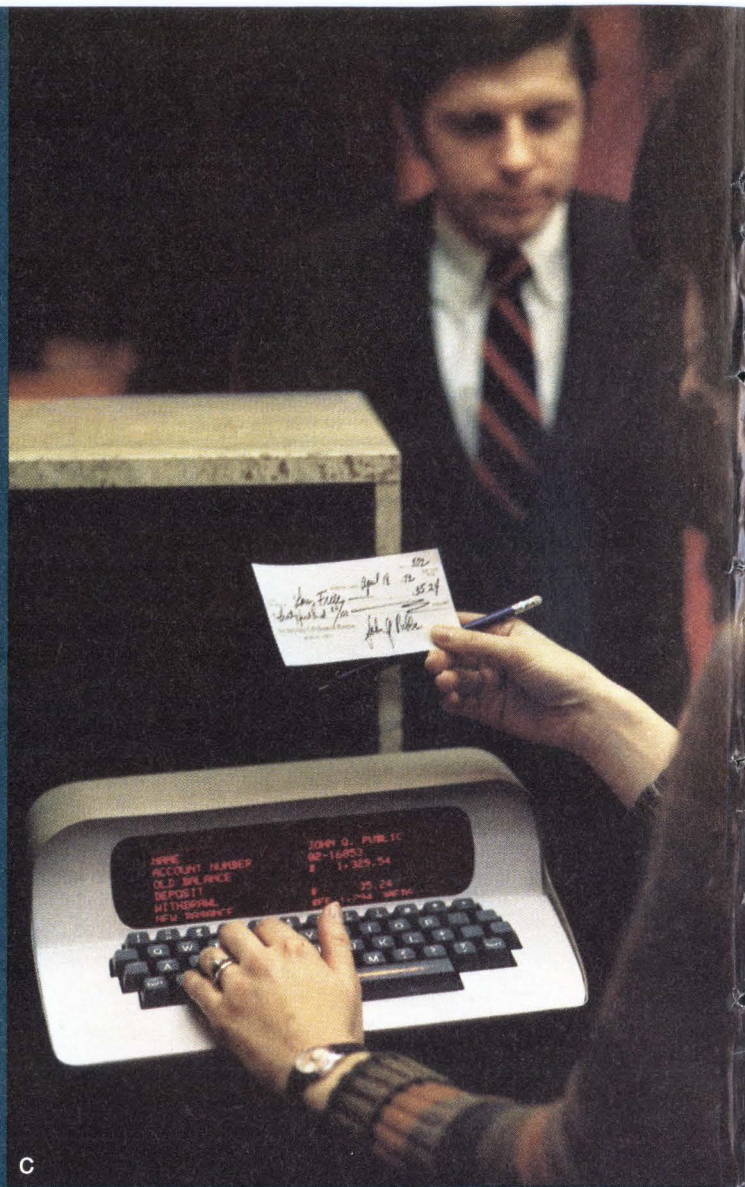

C



A

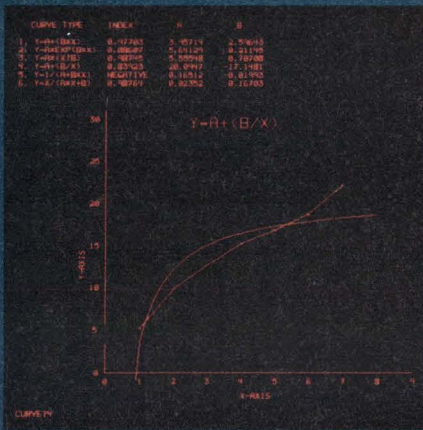

A

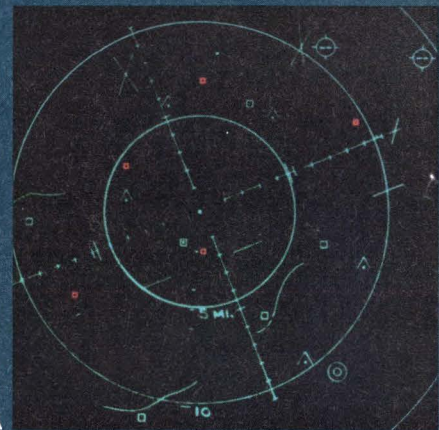

A



A

DEPARTURES

FLT. NO.	SCHED. DEPART.	GATE NO.	DESTINATION	RE MARKS
388	8:00	C5	WASHINGTON	DEPARTED
535	8:12	C2	BOSTON	DEPARTED
43	8:35	B8	MIAMI NON-STOP	BOARDING
5L212	8:42	B9	LACUARDIA	BOARDING
485	9:05	C3	BOSTON	AREA OPEN

B

STK	OPEN	HI	LO	CLOSE
OWEN-ILL	47-1/2	47-7/8	47-1/2	47-3/4
GEN MGT	82-3/4	83-1/2	82-3/4	83-1/2
AM T & T	47-3/8	47-3/4	47-1/4	47-3/4

C

A. Digivue 512-60 Display/Memory Unit. An 8 1/2" x 8 1/2" square panel of 512 x 512 lines at 50 lines per inch resolution.

B. Digivue 256-50 Display/Memory Unit. A 5 1/2" x 10 1/4" panel of 256 x 512 lines at 50 lines per inch resolution.

C. Digivue 64-33 Display/Memory Unit. A 2" x 8" panel of 64 x 256 lines at 33.3 lines per inch resolution.

Digivue[®] Display/Memory Units.

Take a look at tomorrow. You can have it today.

Take a look at Digivue display/memory units from Owens-Illinois. With the kind of visual impact needed in the new age of communication. And then consider this combination of features never before available in any other single display panel:

Inherent Memory—Flicker-free display without refresh requirements. Your computer is, in effect, free to perform other operations after addressing Digivue display/memory units.

Selective Write/Erase—Digivue display/memory units are digital display devices, with no digital-to-analog conversion necessary. You directly address Digivue display/memory units at individual display points on the panel matrix for selective write or erase at micro-second speeds.

Drift-Free Images—The intersections of thin, narrow electrodes imbedded in the panel positively define all elements of the images.

Rear-Projection—Because Digivue display/memory units are transparent they are ideally suited for rear-projection. You have drift-free registration between computer-generated displays and optically-projected images.

Design Adaptability—Digivue display/memory units are flat, not curved. As a result, information at the edges is just as sharp and accurate as in the center. And a Digivue display/memory unit is uncommonly slim—regardless of display area—allowing for a variety of installation possibilities . . . in desks, walls, drawers, consoles.

Hard-Copy Potential—The resolution of a Digivue display/memory panel allows for integration with standard office duplicating processes to produce page at a time hard-copy printouts of excellent quality.

Digivue display/memory units are available from Owens-Illinois in sizes ranging from 80 by 256 display lines at a resolution of 33 electrode lines per

inch to a 512 by 512 display lines panel with a resolution of 60 lines per inch and a display capability of up to 4000 characters. One of them just has to be right for your system.

Think what these Digivue display/memory units can do for time-sharing applications, management information systems, computer-aided instruction . . . and dozens more including airline reservations displays, aircraft cockpit displays, financial data terminals . . . in fact any display terminal for direct readout from digital computers or data systems.

WHO IS OWENS-ILLINOIS? O-I is a multi-product, multi-national manufacturing and marketing organization with 140 major facilities and sales in excess of \$1.5 billion a year. You may think of us as a packaging products company, but we also manufacture and market a diversified product line that includes everything from laboratory glassware to inertial guidance test systems for deep-space vehicles.

AND WHY ARE WE MAKING DISPLAY UNITS? As a natural extension of our already broad-based capabilities—in television bulbs, microelectronic products, ground glasses, new generation materials for technical, commercial and industrial use, and elements necessary for laser technology. We're committed to change, to the future, and to Digivue display/memory units.

If you and your organization are also committed to the future and to opening new and more effective communications systems, we'd like to hear from you. We'll send you technical data on Digivue display/memory units and a copy of our new full-color brochure.

Call or write: Jon Klotz, Marketing Manager, Electro/Optical Display Business Operations B, Owens-Illinois, Inc., P. O. Box 1035 Toledo, Ohio 43601 • (419) 242-6543.

OWENS-ILLINOIS

Toledo, Ohio 43601



Flat-Pack RF/Pulse

Low Cost

Low Loss

Transformers

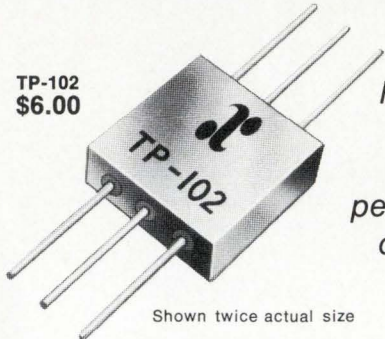

TP-102
\$6.00

Five new ANZAC flat-pack transformers are ready to help you improve performance and packaging of your solid-state circuits.

Shown twice actual size

MODEL	BANDWIDTH (MHz)	IMPEDANCE (Ohms)	INSERTION LOSS (db max)
TP-100	5 - 1000	50 unbal / 12.5 unbal	0.4
TP-101	5 - 1000	50 unbal / 50 unbal	0.4
TP-102	5 - 500	50 unbal / 200 unbal	0.5
TP-103	5 - 1500	50 unbal / 200 bal	0.4
TP-104	.05 - 100	50 unbal / 600 bal (DC isolated)	0.5

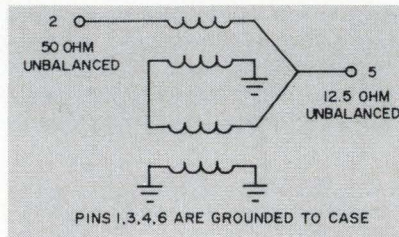

TP-100

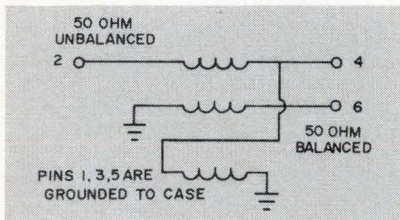

TP-101

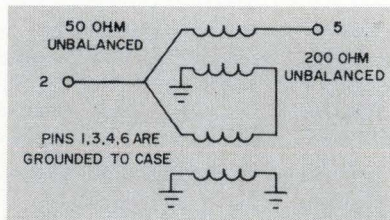

TP-102

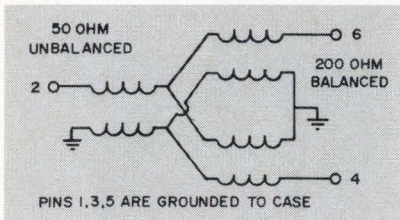

TP-103

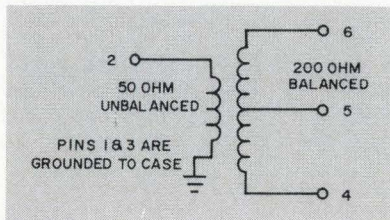

TP-104



39 Green Street • Waltham, Mass. 02154
(617) 899-1900 TWX (710) 324-6484

Meetings

International Electronic Components Exhibition: FNIE, Parc des Expositions, Porte de Versailles, Paris, April 6-11.

International Conf. on Magnetics (INTERMAG): IEE, Kyoto International Conference Hall, Kyoto, Japan, April 19-21.

International Symposium on Circuit Theory: IEEE, Sheraton-University Hotel, Universal City, Calif., April 19-21.

Southwestern IEEE Conf. & Exhibition (SWIEEEO): IEEE, Baker Hotel & Dallas Mem. Aud., Dallas, Texas, April 19-21.

Conf. on Computer Aided Design: IEEE, IEE, University of Southampton, Southampton, England, April 25-28.

National Telemetry Conf.: IEEE, Houston Shamrock Hilton Hotel, Houston, Texas, May 1-5.

Electrochemical Society Spring Meeting: Electrochem. Soc., Shamrock Hilton, Houston, Texas, May 5-12.

International Electronics Conf.: IEEE, AIP, OSA, APA, Queen Elizabeth Hotel, Montreal, Canada, May 7-11.

International Semiconductor Power Converter Conf.: IEEE, Lord Baltimore Hotel, Baltimore, Md., May 7-10.

Spring Joint Computer Conf.: IEEE, Convention Center, Atlantic City, N.J., May 15-18.

Aerospace Electronics Conf.: IEEE, Sheraton Dayton Hotel, Dayton, Ohio, May 15-17.

Electronic Components Conference: Electronic Industries Assn., IEEE, Statler-Hilton Hotel, Washington, D.C., May 15-17.

International Microwave Symposium: IEEE, Arlington Park Towers Hotel, Chicago, May 22-25.



If you'd rather be sailing

Let SAE solve your packaging problems.

Surely there's something you'd rather do than hassle with component selection, packaging and assembly. So let us handle all that. You take a few moments to day-dream about that 100' schooner.

Only SAE offers you three choices in packaging systems: Plug-in, Planer, and Dipstik™.

We make all the hardware for plug-in systems, including PC cards, card guides, card files, enclosures, connectors, sockets, mounting, and bussing.

Go planer, and we'll provide logic panels, mounting hardware, sockets, all peripheral items.

Or consider unique Dipstik. It gives twice the IC density as PC methods, and eliminates lots of hardware.

Whichever method you choose, we can supply the components you need to do the assembly yourself. Or, we'll pick the parts, do the assembly, and let you do the wiring. Or we'll provide everything: components, assembly, and Wire-wrap®. So, just call us in . . . and you can go sailing!

Free bumper sticker for your desk. Display your "druthers"! If sailing isn't your thing, tell us what is. Maybe we have a bumper sticker for that, too. We'll also send a new brochure on how we can free you from packaging problems and drudgery. Write us:

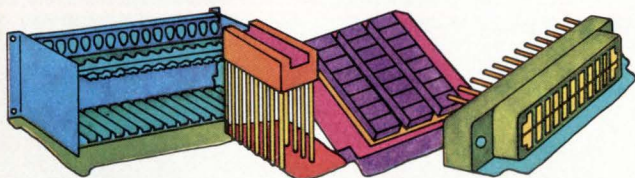

I'd rather be sailing

Stanford Applied Engineering Inc.

340 Martin Avenue, Santa Clara, California 95050 Telephone (408) 243-9200 — (714) 540-9256 — TWX 910-338-0132



Think Twice:

How will you choose your next portable scope ...on faith, or on fact?

Forget everything you ever knew about portable scopes; today's portables are something else entirely. In the last year, both major scope manufacturers have brought out completely new lines. So, choosing a new portable on "blind faith" in your old make is about as sensible as marrying a girl you've never met, just because her second cousin was Miss America in 1967.

The only rational way to choose a new portable today is to make a head-on comparison between our scopes and our competitor's. And this means more than just a quick look at price tags and specs. It means a thorough investigation of total acquisition cost. Be sure you check these specific points:

Initial purchase price. Are you getting the best price available? HP's Portables are priced as much as \$200 below the competition, with special purchase agreements available.

Ease of Use. Are the controls simple and logical? Or are they a jungle of tightly packed knobs. Ten minutes a day, spent in needless tinkering, can add up to hundreds of

dollars a year in wasted man-hours.

Fieldworthiness. Some scopes have such high power requirements that battery operation is impossible. HP feels that a portable scope should have "go-anywhere" capabilities, so our Portables all use low-power-requirement designs which permit battery operation. Low power requirements also mean lower heat, which prolongs component life. As a result, only HP's Portables eliminate the need for fans, or dust-admitting vent holes.

Calibration and Service. Have you considered how much your scope will cost you *after* you've purchased it? For example, HP Portables are quickly calibrated — requiring approximately half the time required to calibrate our competitor's portable scope. This could save you hundreds of dollars over the life of your scope. And are you going to have to deal with one manufacturer for scope service, and another for your voltmeters, signal sources, etc.? Or can you save time and money by limiting your dealings to one company? And don't forget training aids; HP offers live

demonstrations, video tapes and literature to simplify conversion problems.

Look into all these points, and we think you'll find that you'll save a lot of time, effort, and money — and avoid a lot of frustration — by choosing HP's Portables. But don't take our word for it; make the comparisons yourself.

For a revealing package of information on HP's new Portables, send for a free copy of our "No-Nonsense Guide to Oscilloscope Selection." Or contact your local HP field engineer for a demonstration. Check before you choose. Hewlett-Packard, Palo Alto, California 94304. In Europe: 1217 Meyrin-Geneva, Switzerland.

**Scopes Are Changing;
Think Twice.**

082/2

HEWLETT  PACKARD

O S C I L L O S C O P E S

You can assemble our SMA connectors

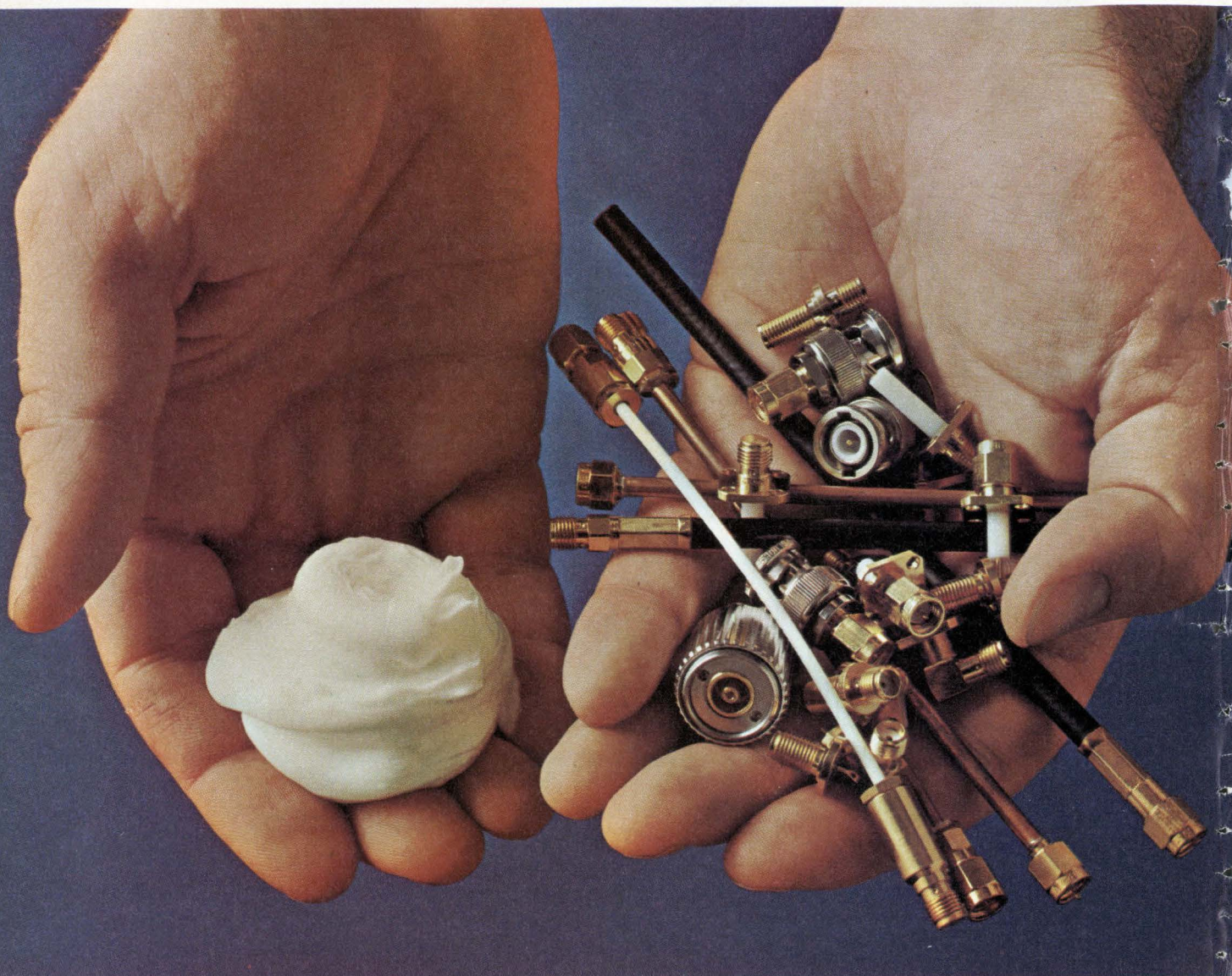

in less time than it takes to shave.

Five minutes. That's all it takes to assemble our SMA connectors for subminiature coax cables. A significant savings in production time.

You get your Amphenol SMA connectors factory preassembled, thus keeping loose parts at a minimum. And by using an inexpensive tool kit to prepare the cable, putting them all together is a snap. Parts loss is virtually eliminated.

Amphenol set the trend by making its SMA connectors of high-strength, heat-treated beryllium copper material, which is three times stronger than stainless steel. These superior connectors are, of course, completely intermatable and interchange-

able with existing stainless steel designs. Amphenol was the first source qualified for MIL-C-39012 SMA connectors.

Available in a wide variety of flexible and semi-rigid cable connectors; receptacles for strip-line, MIC packages, and numerous other microwave components. And if you need SMA specials or complete cable assemblies, come to the world's largest manufacturer of coaxial connectors.

See your authorized Amphenol distributor or write Amphenol RF Division, Bunker Ramo Corporation, 33 East Franklin Street, Danbury, Connecticut 06810.



AMPHENOL

March 27, 1972

Universal IC timer, by Signetics to sell for 75 cents

Signetics Corp. is reversing common semiconductor pricing practices in a marketing gamble that could have a big payoff. The Sunnyvale, Calif., semiconductor house has developed a **universal IC timer and priced it at 75 cents in lots of 100**. Instead of hoping that appliance makers will design the new circuit into their washers, dryers, and the like so that prices can come down as volume goes up, **Signetics is making the price so low to start with that designers will almost be forced to use the part.**

The circuit is capable of **time delays from 1 microsecond to 1 hour with a stability of 50 parts per million per degree centigrade**. It contains a comparator, a flip-flop, and a buffered output stage; timing is controlled by an external resistor and capacitor. Also, the circuit can work in or out of TTL levels, can supply up to 200 milliamperes of output drive, can be configured as a highly stable one-shot timer, or an ultra-stable oscillator in which the duty cycle can be adjusted independent of frequency.

Laser standard set at 1 mw/cm² level

The latest draft standard by the American National Standards Institute for the safe use of lasers specifies a maximum permissible exposure of continuous radiation on the eye of **1 milliwatt per square centimeter—still not what laser manufacturers were hoping for.**

This "safe" level, which increases in steps as exposure time on the 7-millimeter-diameter eye decreases, is well above the 40 microwatts/cm²-level regarded by manufacturers as so disastrously low when it was proposed last autumn **but below the 5 to 10 mW/cm² they regard as safe.**

"There are still many objections but it will in all probability go through," comments C. Harry Knowles, who vociferously opposed the 40 μ w level. He is a member of the ANSI laser committee and president of laser producer Metrologic Instruments Inc. of Bellmawr, N.J. Weighing in favor of approval is the desire to provide a national consensus on safety **that would prevent states from coming up with different standards of their own.**

List grows for 2-way television experiments

More cable television operators and hardware manufacturers are getting together in bidirectional cable TV experiments to find out if interactive programming using the bands below 50 megahertz is feasible. **A neck-and-neck race to be first with 25 home subscriber terminals linked to minicomputers is on** between Hughes-supported Theta-Com, Los Angeles, and RCA's new cable acquisition, EIE Inc. of North Hollywood, Calif. EIE is set to try 25 connections—24 homes and one gasoline station—in Orlando, Fla., together with operator ATC Corp. of Denver, Colo. Theta-Com's partner for a similar hookup in El Segundo, Calif., is TelePrompTer, New York, the largest CATV operator in the U.S.

Meanwhile, Tocom Inc. of Irving, Tex., is clearing the red tape to set up a **two-way experiment in a section of Irving that eventually will cover some 2,400 homes, apartments, and businesses.** All the trials will concentrate on digital return of information from subscribers via computer interrogation of home terminals.

Memorex enters computer field

Memorex Corp., the Santa Clara, Calif., maker of magnetic tape, disks, and computer peripheral products, **has brought out its first mainframes.** The two compatible machines, MRX 40 and MRX 50, are manufactured by Midwest Systems Inc., the company's wholly owned subsidiary in Minneapolis [*Electronics*, June 25, 1971, p. 25].

The machines are aimed at a market defined by the company as "below the IBM system 360 model 30." **Architecturally, they are virtual multiprocessing systems.** In each, eight processors, a memory, and an arithmetic and logic unit (ALU) share a common bus. Four of the processors actually process data, and the rest, being dedicated to input-output functions, are termed virtual processors. **To the user they look like one black box**—he need not distinguish between them in his programming. They share the ALU and the memory. **The combination, the company says, produces a task switching time of essentially zero.**

The memory is a high-speed semiconductor array. The MRX 40 can hold up to 64 kilobytes of MOS main memory (1.6-microseconds total cycle time). The MRX 50's main memory capacity is 128 kilobytes, and main memory cycle time is only 800 nanoseconds. Monthly system rental ranges from \$2,500 to \$8,500; shipments begin in September.

Sears to sell \$100 NR calculator

North American Rockwell will begin delivering in June electronic calculators that are expected to sell to the consumer for about \$100. **Among the customers is Sears Roebuck.** The calculators, which will have unique features and case designs for individual customers, will use liquid crystal displays and MOS ICs manufactured by NRMEC—North American Rockwell Microelectronics Co.

NR has contracts for more than 150,000 machines with Sears, Lloyds of California, Logic Data of Chicago, and others to be announced. And Donn L. Williams, president of NR's Electronics group, says that **worldwide sales are expected to total at least a million units a year.**

Sperry to market liquid crystal displays in fall

Sperry Information Displays in Scottsdale, Ariz., best known for its inexpensive seven-segment gaseous displays, **will start pilot production of liquid crystal this September**—a year ahead of schedule. The displays use packaging technology similar to the firm's present planar displays, and prototypes are operating from -26 to $+77^{\circ}$ C with no degradation after 5,000 hours of dc operation.

Autonetics readies small version of D 216 computer

Now that its D216 military computer using large-scale MOS plus plated-wired memory is nearing qualification and first deliveries in June, North American Rockwell's Autonetics division in Anaheim, Calif., is working on a **miniature, lower-cost version called the DM216.** It will be preceded in December by the DI216, a twin of the D216 except for a new CPU that features higher throughput and microprogram control. Then, late in '73, the DM216, **using beam-lead versions of the chips plus a new 2-mil plated wire memory,** will be ready.

The 16-bit, 8,192-word machine will have 2-microseconds add time, weigh only 4.5 pounds (as against 15 lb for the D version), require 30 rather than 48 watts, and have a volume—including the power supply—of 0.07 instead of 0.26 cubic feet. Autonetics projects its price as about half the D216's \$30,000 in quantities of 100.

Introducing the OEM Yardsticks

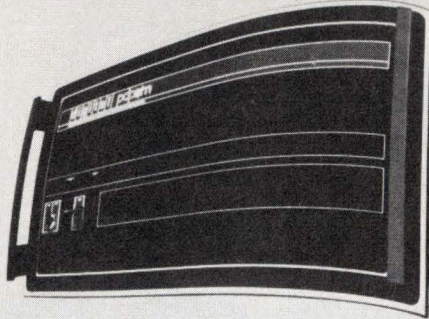

On your left, the 12-bit PDP-11/05. On your right, the 16-bit PDP-11/05. Our brand new additions to the world's most popular families of minicomputers.

Complete computers — at incredibly low prices. Like \$3,069 for the 11/05, and \$2,962 for the 8/M in quantities of 100. Even the dis-

count schedule is new. Very attractive.

In addition, they're compatible with the rest of the family members. Their options. Their peripherals.

They have the features of their bigger brothers. And a full instruction set, OEM-oriented architecture. Both

the UNIBUS™ architecture of the 11/05 and the OEM B/M permit easy, flexible configuring and interfacing. Real pluses for the OEM.

They're built with the kind of reliability that comes easy after delivering over 77,000 minicomputers,

and they're supported with more field back-up than you can get anywhere else worldwide.

PDP-11/05, PDP-11/05, Dec approved for the OEM. Proven for the OEM. Choice for the OEM. From the leader in OEM computer applications.

Now there's a whole new set of standards to measure up to.

Write for more information: Digital Equipment Corporation, Main Street, Maynard, Massachusetts 01754. (617) 897-5111.

digital

INFORMATION RETRIEVAL NUMBER 14

nuts

Yardsticks named do not yardsticks make. And while their minicomputers may be good, they're not good enough to be OEM yardsticks.

They're not even close. Large gaps stand between their definition of an OEM yardstick and that of GRI's Functional Process Minicomputers*, the computers with the original Universal Bus System. Gaps consisting of the dramatic simplicity, ease and efficiency with which you integrate a GRI computer into your systems environment.

GRI's yardsticks: the cost of writing real-time software, of designing hardware interfaces, of debugging both the hardware and the software—the cost and effort it takes to get the total system actually up and running. Yardsticks!

*Patented

GRI computers' unique combination of functional programming languages and software, sets them apart as standards of efficiency for the real-time applications of today's minicomputers.

It all comes down to accommodating your system to THEIR computer or using a GRI computer designed to accommodate YOUR system.

Yardsticks? Decide for yourself. Write for the GRI story and see if we're not talking your language about yardsticks.

Write to: GRI Computer Corporation
320 Needham Street, Newton, Mass. 02164
Phone: (617) 969-0800. Cable: GRICOMP

Go ahead and crack a nut.

gri
GRI Computer
CORPORATION

Ion Implant Sparks Tidy Front-End Business

By NAT SNYDERMAN

NEW YORK — Ion implantation is gaining favor in semiconductor factories and is generating a tidy little business for a handful of equipment suppliers virtually unknown a few years ago.

Considered a laboratory maverick until recently, ion implanters have evolved into sophisticated front-end production equipment which may one day compete with diffusion in microcircuit processing, notably in MOS.

National Semiconductor, Intersil and American Micro-systems are among the major IC

producers which have installed ion implanters. Fairchild, Mostek and Hewlett-Packard have units on order.

A solid endorsement of the ion bombarding art will soon be given by IBM which has placed orders for three machines — two for East Fishkill and one for Manassas, Va. — reported to be a prelude to a push in MOS circuits. Made by the Ortec division of EG&G, the units will be delivered in April.

Equipment manufacturers estimate the total cost of the three systems IBM will buy from Ortec at \$250,000 to \$300,000.

Ion implantation has technique for doping semiconductor wafers — generally thin-films — uniformly over each wafer. The process, in this technology, is accelerated to high energies and is implanted onto the surface of the wafer. They penetrate and then

Device engineers have found that ion implantation permits them to dope semiconductor wafers with fine adjustments of dopant concentration.

Electronic News, 1/24/72

Ion-Implant Production Accelerating at Mostek

DALLAS (FNS) — Mostek Corp., here, has ion-implanted more than 100,000 wafers of MOS/LSI circuits during the past 15 months, according to Bob Palmer, vice-president of the firm's Worcester, Mass., processing operation.

All of the wafers were implanted with a single machine purchased from "Accelerators, Inc., Austin, Tex. Another machine is on order from the same firm. The new unit will offer both higher currents, and will

Electronic News, 2/21/72

Technology

The HP-35 employs MOS/LSI circuits using ion-implant processes.

Hewlett-Packard thinks they are the largest presently in volume production. Each circuit is equivalent to 6,000 transistors — a total of 30,000 devices. They are made by Mostek especially for Hewlett-Packard (Dallas) and American Microsystems (Santa Clara, Calif.).

The HP-35 may well be one of the major developments of the current decade and the harbinger of things to come.

Electronic Buyers' News, 2/7/72

Hewlett-Packard Introduces Electronic Pocket Calculator

PALO ALTO, Calif. — Hewlett-Packard Co. said it has introduced a new electronic pocket calculator called the HP-35.

William R. Hewlett, president, compared the nine-ounce battery-powered calculator to a "fast, extremely accurate electronic slide rule, with a solid-state memory similar to those used in computers." The HP-35 is approximately three inches wide, six inches long and one inch high and will sell for \$895, according to Mr. Hewlett.

Major Business Publication, 1/5/72

Ion implantation as a processing tool will be used in one way or another by all manufacturers within a few years. Equipment will be refined and become less costly as more suppliers move into this market. Because of its ability to adjust thresholds, make depletion devices, make CMOS devices, etc., it is too useful a tool to ignore. Circuits made by ion implantation will be cost-competitive with most other technologies and offer some perform-

EDN/EEE, 9/15/71

Ion-Implantation Moves Ahead

Ion implantation technology continues to advance. This was borne out at the recent International Electron Devices Meeting in Washington, D. C. where, of the twelve papers presented on the subject, nine described applications other than the most commonly known ones.

EDN/EEE, 12/15/71

Today ion implantation is big news.

Look what we started!

Two years ago you probably never heard of ion implantation. Today it's big news—helping turn bright ideas into profitable products.

MOSTEK was the first to use ion implantation in the volume manufacture of MOS/LSI, beginning in 1970. Since then we have made process and product innovations that have initiated an industry-wide movement towards ion implantation. Today you will find our implanted MOS circuits in an ever widening range of applications including: business and scientific calculators; electronic organs; credit verification terminals; industrial timers; computer

peripherals; medical electronics; avionics; portable measuring instruments and modems. Looking ahead, implanted MOS is ideal for such new and exciting areas as utility meter reading, time keeping, and automotive electronics.

If you are considering using MOS in your products, check what implanted circuits can do for you, both technically — (lower power, higher speed, and operation over broad supply voltages)—and economically. Let MOSTEK recommend a custom approach or one of its standard implanted MOS circuits to meet your needs.

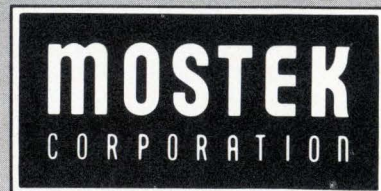

1400 Upfield Drive
Carrollton, Texas 75006
(214) 242-1494

Regional Sales Offices: West: 11222 La Cienega Boulevard, Inglewood, Calif. 90304 (213) 649-2600 East: 60 Turner Street, Waltham, Mass. 02154 (617) 899-9107

Midwest/Southeast: 515 S. W. Avenue, Jackson, Michigan 49203 (517) 787-0508

International: MOSTEK GmbH, 7 Stuttgart 80, Waldburgstrasse 79, West Germany 0711-731305; System Marketing Inc., Center News Bldg. 1-3-11 Sotokanda, Chiyoda-ku, Tokyo, Japan; W. G. Booth Pty., Ltd., 39 Church Street, Hawthorn, Victoria 3122, Australia.

Circle 28 on reader service card

First CCD vidicon, for Picturephone, built by Bell

Developmental array contains 128 by 106 elements, but denser versions are coming for commercial application

Bell Laboratories has built the first solid-state vidicon using charge-coupled technology. It promises better performance and reliability, at a lower cost, than conventional camera tubes. Unlike recently announced solid-state imagers, such as RCA's [*Electronics*, Feb. 28, p. 72], the Bell device approaches the resolution required by many video transmission applications. In fact, it was the need for a cheap, reliable, and small camera for Picturephone that spurred Bell's work.

The Bell camera can be used for Picturephone by scaling of the element array by a factor of 2 in both directions—from 128 by 106 elements to, say, a 210-by-210 array. That prospect is not distant, since researchers there already have built

500-element linear arrays and are working on charge-coupled structures that minimize element spacing for the high-density arrays required in vidicons.

Bell Labs executives are enthusiastic about CCDs for vidicons, having all but abandoned the alternate, bucket brigade approach as an immediate imaging technique. Eugene I. Gordon, director of Bell's optoelectronic department, general director of the work, says:

"The CCD camera is the next generation of vidicons. We frankly are surprised at the speed at which the CCD effort has progressed. Two years ago no one had heard of a CCD; nine months ago we had the bare bones of 8-by-8-element imagers; now we have something approaching a camera target. And although the device is still in a developmental stage, the speed of CCD implementation is so far ahead of the development rate of the silicon-diode tube in a comparable period of time in its history, that problems of CCD vidicon fabrication pale

compared to those encountered with silicon-diode targets."

The Bell device has its 128-by-106 array arranged on a 192-by-240-mil chip, large by IC standards. But since diffusions are required only at the outputs and fabrication involves metalization only, chip size is not the critical factor in yield.

However, as pointed out by H.A. Watson, head of device development, Bell's CCD chip requires highly sophisticated metalization

Whole picture. Bell Labs' Carlo Sequin, a key developer of CCD vidicon, adjusts display on Picturephone in lab demonstration.

CCD vs silicon

One major advantage charge-coupled-device vidicons have over silicon-diode versions is ease of manufacture. For one thing, a CCD vidicon requires no diffusions in the silicon to form image elements; the diode vidicon requires several hundred thousand diffusions. CCD vidicons are scanned with conventional MOS shift-register circuits—small, low-power, inexpensive, and available. The diode vidicon is a vacuum tube requiring a high-voltage, high-power magnetic-field electron-beam scan, which often burns in and degrades performance. Nor are CCDs subject to lag—or smearing.

Most important, CCD cameras, since they are built with standard semiconductor technology and require conventional low-cost scanning circuits, will be cheap and small compared to today's vidicons. Since this year's camera tube market is expected to reach \$50 million, it's no wonder that commercial camera makers (GE, RCA, Fairchild, TI) are racing to build CCD vidicon versions. □

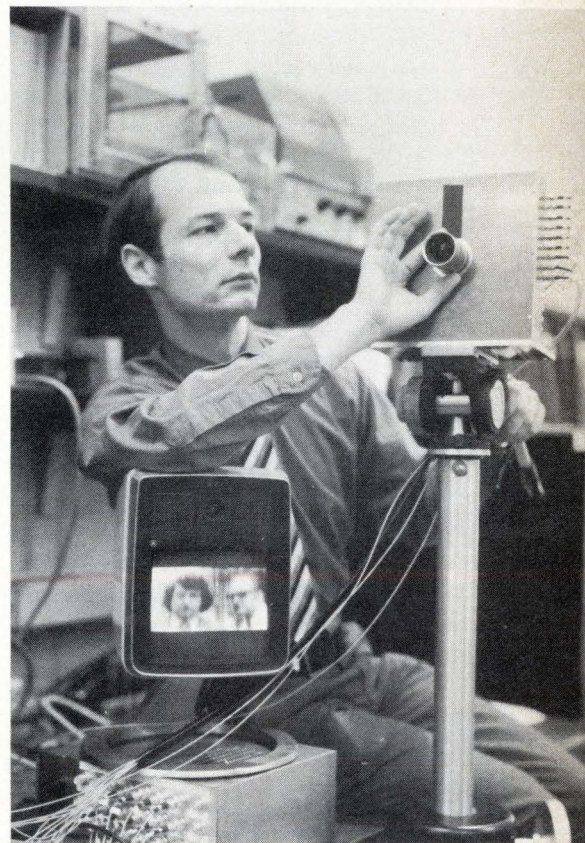

techniques—many parallel electrodes, each 9 micrometers wide, with 2- μ m gaps. Since 10- μ m fabrication rules are standard in the IC business, Bell's 2- μ m gaps may indeed become a difficult standard to achieve in production, especially when larger arrays are built. To avoid the metalization strictures, Bell is looking at other structures, using double metalizations, overlapping electrodes, buried channels, and the like. □

Commercial electronics

Frame grabbers: a big market?

When the Telebeam Corp. demonstrates its new system for bringing pay television and other services into hotel rooms next month, it will also be spotlighting a piece of electronic gear that in years to come could have sales in the millions of units. The device, dubbed a frame snatcher, or grabber, is designed to display still pictures on a TV set. Its sales potential is judged not by its use in Telebeam-type systems alone, but in its usefulness in two-way educational television and information retrieval and display systems.

Telebeam's frame grabber, developed by a Plainview, N.Y., company, Systems Resources Corp., stores a frame of information in a

Time frame. Airline schedule is stored in frame grabber from Systems Resources.

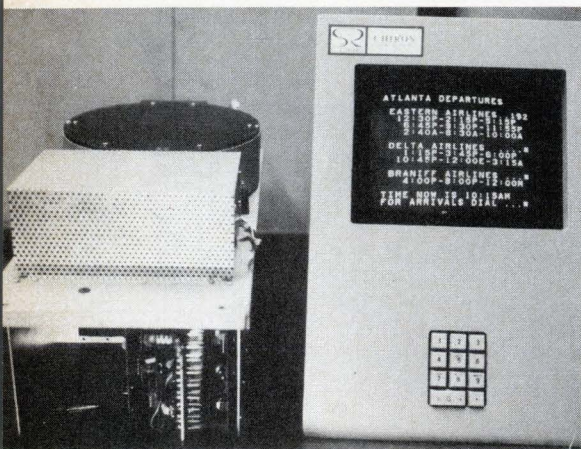

single track around a rotating disk of ordinary video tape. The device is critical to the operation of the Telebeam system because it will eventually be the relatively low-cost means by which a company will provide a whole range of free information services in addition to the movies, plays, and sporting events usually associated with pay TV.

These hotel-room services will include information about the hotel itself, about restaurants in the neighborhood and their menus, and about such things as plays, concerts, and other events taking place throughout the city.

Telebeam is also considering tying into airline and theater ticket reservation systems. By presenting airline schedules and prices at the request of the guest, the system would enable him to book space and order tickets from his room.

Operation. The frame grabber plucks the desired frame of information from those stored in a mini-computer system located in the hotel and deposits it in a rotating disk on a turntable beside each TV set. The disk continually refreshes the television picture, while the central computer is free to handle other requests.

Several companies have been developing frame grabbing devices (see panel). Price is paramount: Systems Resources' unit is now in the \$600-to-\$700 range, but once it is tooled for large-scale production, this figure could readily drop to \$150, says Eugene Leonard, the president. Leonard's device relies on a circular disk of magnetic material cut from ordinary video tape. This is fastened at its center on a machined aluminum turntable having a 1/4-inch-wide circular groove cut about an inch from its circumference. Early units relied on an 8-inch-diameter disk, but now Leonard is moving to a 10-inch-diameter disk for "better resolution."

Drilled into the bottom of the groove and through the outer edge of the turntable are tiny holes, spaced at about 90°. As the turntable spins, air suction from its spinning outer edge creates a vacuum that sucks the magnetic tape down

Grab bag

While the Telebeam pay-TV system relies on a frame grabber made by Standard Resources Corp. of Plainview, N.Y., other companies are also in this potentially lucrative market. Systems Resources and Sony Corp. store frames magnetically, while systems made by Hughes Aircraft Co. and Princeton Electronic Products rely on silicon tubes.

The hope now is that big orders could get the price down to about \$50, according to William F. Mason, technical director of Mitre Corp.'s Systems Development division in McLean, Va. Mitre is setting up a prototype two-way cable TV education system; McLean bases his \$50 on a system serving 10,000.

Mason plans to use electronic storage tubes—Mitre now feels that the VTR cassette and reel-to-reel approaches are too expensive. However, Mason says that prototype tubes of 1 or 1.5 in. cost \$500 each. □

into the groove. The effect is enough to produce a circular trough in the spinning magnetic disk. One frame of information is produced with each revolution. The speed of the driving motor is controlled by the TV synchronizer.

A magnetic read/write head, positioned over the groove, actually rides on an air cushion over the groove in the tape. "The tape bends out of the way of the head and into the groove," Leonard explains. Thus, the head experiences next to no wear.

Infinite. Each 7-in.-diameter track can store elements with 70 nanoseconds of resolution, and a display can have infinite starting point resolution. This translates to 70 characters on 30 lines in a standard 525-line system using an 8-in. disk at 1,800 revolutions per minute, according to Leonard. With the 10-in.-diameter disk spinning at 3,600 rpm, he hopes to get 120 characters on 60 lines by using two tracks and a 1,100-line TV monitor.

Either unit will weigh under 15

pounds and stand about 8 inches high. In addition to discrete power supply and motor drive, the electronic components will take up a minimum of space because they are packaged on one LSI and three hybrid circuits. The LSI chip contains circuitry for decoding the address of the room guest, conditioning the signal for recording, decoding the read-back signal, and deriving the motor-drive signal. The hybrids consist of a read/write preamplifier, a composite video output module, and a video input and sync stripping function. □

Military electronics

Pentagon looking to European arms

The Pentagon's global view of defense is being expanded to include a worldwide view of weapons procurement in a drive to achieve technical compatibility and lower costs.

As Assistant Defense Secretary Eberhardt Rechtin put it to a small group of Electronics Industries Association members in Washington recently: "Here's a tough one. U.S. systems are going to have to be compatible with—or at least adaptive to—systems of other free-world countries. We cannot write the interface specifications. Those systems which are not adaptable," Rechtin declared, "are going to have a hard time of it."

Inevitable. "Foreign systems are going to appear in U.S. inventories," Rechtin says. "The best bet is that we will make these foreign systems under license to them."

"But there is really not much choice as to whether or not some of them are going to appear in our inventory. Costs for U.S. systems are going to have to be brought down if we are going to afford adequate quantities to compete with the free world in the selection of systems for our mutual defense. After all, if the British, French, or Germans can offer us a product to do almost the same job at a tenth of the cost,

Companies find educational VTR a growing and lucrative sideline

Electronics firms have been flirting with the education field for years—by conducting seminars and selling handbooks, reference books, and design aids—but generally as an adjunct to regular sales efforts. Now, however, several of the best-known names in electronics have committed themselves to the business.

The latest is Texas Instruments, which has set up an independent profit entity, called the Learning Center, devoted to the manufacture and marketing of video tape courses and technical books. It's a big market, considering the number of vocational schools, colleges, junior colleges, and graduate programs. But, says Donald C. Scharringhausen, Components group market communications manager, "We don't have enough history of education VTR [video tape recording] to know how big it really is."

More to come. The learning center's initial three offerings are a 12-hour, 12-set VTR on basic solid state, selling for \$2,580; a more specialized 11-hour set on metal oxide semiconductors selling for \$3,575; and a \$2.95 textbook on general electronics. TI plans to add a semiconductor memory course by midsummer, and courses on linear and digital circuits are planned.

Because of the cost of the tapes, they're obviously aimed at corporate and college users. In fact, William N. Carr, a professor at Southern Methodist University and one of the authors of the MOS course, is using the TI tapes in a graduate class studying MOS ICs.

In the business longer has been Hewlett-Packard Co., Palo Alto, Calif., which got into it by producing

training tapes for instrument calibration and maintenance. Jim Taylor says that H-P soon found out there was a need for tapes explaining basic concepts.

There are three types of tapes: tutorial, which come with questions and answers in a complete training package; operation of equipment which includes applications data; and maintenance "we tear down a scope," says Taylor, "and show where R-23 is and what happens if you adjust it."

Full library. H-P has a library of some 77 video programs on 100 reels. One of the best, Taylor says, is a nine-hour 15-tape series on transistors. This series, complete with textbook and assignments, sells for \$1,350. Typical customers include the Navy and junior colleges; Stanford University will present the course over a closed-circuit TV net.

As far as H-P is concerned, Taylor says, "the business grew like Topsy. After we introduced some of the calibration and maintenance tapes, we found that others that contained basic information (such as the transistor one) were needed." Next on the H-P production schedule is a series on troubleshooting of transistor circuits; this will be out in about a year.

Taylor points out that the H-P tapes are not made merely by aiming a camera at a man standing up in front of a room, reading a script. "We have trained professional producers, writers, directors, and equipment. This includes 11 studios. All we lack to be a commercial TV station is an FCC license and a transmitter." □

TI's Scharringhausen: A big market, "but we don't know how big it really is."



there's not much choice as to what most of the free world will do," Rehtin warned. "And so, we might as well."

Trend. The first significant U.S. move toward broadening its procurement perspective to include foreign systems developed by allies was made by David Packard when he was deputy defense secretary. Packard pushed the Army to buy and test models of the French Ratac field artillery radar, as well as low-altitude field air-defense missiles, including the French Crotale [*Electronics*, Dec. 21, 1970, P.39], British Aircraft Corp.'s Rapier and the West German Nord combine's Roland [*Electronics*, March 29, 1971, p.31]. Crotale has completed preliminary tests successfully, with Rapier tests tentatively set for spring, and Roland for this fall. "Selection of one of these systems would eliminate the need for a U.S. development," says John S. Foster, director of defense research and engineering. Foster, when outlining his fiscal 1973 research and development program to Congress, identified 10 other foreign systems under U.S. scrutiny.

Those with heavy electronics content include: the French Exocet

ship-to-ship missile under Navy tests, joint service tests of the British-French WG-13 helicopter for possible application in the Navy's Lamps program, a joint U.S.-British sonar for surface ships, and the joint U.S.-French sonar development program called RAP for Reliable Acoustic Path.

Both Foster and Rehtin say that about one-third of Europe's annual outlay of roughly \$3 billion for nonstrategic R&D can be duplicated (see table) and that savings can be achieved through increased joint efforts or assignment of a given weapons area to the country or countries that have demonstrated expertise. This approach, it is said, could provide one way of getting around growing constraints on R&D budgets.

Jobs. Rehtin visualizes U.S. licensing of production of foreign systems as a way around congressional criticisms of defense industry unemployment—what he calls "the belly-to-the-bench problem"—while holding down overall DOD budget increases. Congressional approval of systems "depends on how much it costs, also," he explained.

Rehtin's view is that "we may not have much choice if trends keep going the way they are. The effective

U.S. productivity is half that of most of Europe. I don't see how we stay in business." □

Government

Computer to sense gas in mines

Present sensing of poisonous or explosive fumes in coal mines isn't precise, fast, or comprehensive enough to suit the U.S. Bureau of Mines. To remedy the problem, the bureau will begin operating an experimental computerized sensing system in June that will probably yield enough data from which it could require similar systems throughout the coal industry, say sources close to the program. The bureau's effort is likely to generate a good market, adds A.C. McInnes, supervisor of instruments and communications for the Mine Safety Appliance Co., Pittsburgh, Pa., which is developing and installing the experimental system in the bureau's Bruceton, Pa., test mine under a \$606,000 contract.

Warning. The experimental off-the-shelf system will use a General Electric PAC-30-2 computer with 32,768 words of core storage. The topside computer will analyze sensor inputs from 10 areas deep in the mine and display new readings on a operator control console every minute. If any element of the system malfunctions, or if the concentration of methane in a shaft approaches explosive limits, the computer will automatically warn the operator and the mine by flashing lights and buzzers.

Besides methane, the sensors will measure carbon monoxide, hydrogen, air temperature, rate of temperature change, air velocity, noise and smoke. The carbon monoxide and hydrogen sensors, for example, pull the sampled air through chemically-treated cells. An excessive concentration of either gas triggers a chemical reaction, the heat of which energizes a thyristor. Currently, most such measurements are taken

ALLIES' ANNUAL MILITARY R&D OUTLAYS

	Helicopters	Light aircraft	Jet aircraft	Trucks	Tanks	Tactical missiles	Tactical nuclear	Guns and artillery	Ground Radar	Avionics	ASW equipment	Computers	Ships	Submarines	Sub-launched missiles	RDT & E budget*
U.K.	●	●	●	●	●	●	●	●	●	●	●	●	●	●	●	\$614
France	●	●	●	●	●	●	●	●	●	●	●	●	●	●	●	980
Germany		●	●	●	●	●		●	●	●		●	●	●		470
Holland									●	●	●	●	●			12
Italy	●	●	●	●		●		●		●			●	●	●	37
Canada		●							●	●	●		●			130
Japan	●	●	●	●	●	●	●	●	●	●	●	●	●	●		300
Australia		●		●		●			●	●		●	●		●	71
Total equivalent budget																\$2,614

*In millions at standard rates of exchange. Source: Pentagon estimates.

Over there. About \$1 billion of Allies' military R&D annually duplicates U.S. efforts.

In Answer To Your Gripes About Every Other Portable Recorder

The no jazz CPR 4010. A 7 speed, 1/2" or 1" tape, 10 1/2" reel portable recorder/reproducer.

Old Clichés Revisited

What's so great about it? Mainly, it's the easiest machine around to use, maintain and service. (We know you've heard that before, but bear with us for a minute.)

Operation

We've got a single knob for transport speed and electronics equalization. Automatic. Other transport functions are push-button controlled including our proprietary AUTOLOAD automatic, mistake proof tape loader that works precisely. Every time. All the electronics are in one housing. Even monitor meters, voice logger, 7 speed servo card, and all 14 record and reproduce modules. It's easy to add options because it's pre-wired. All you do is plug in.

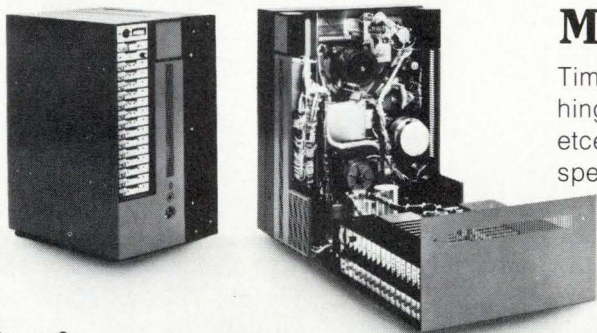
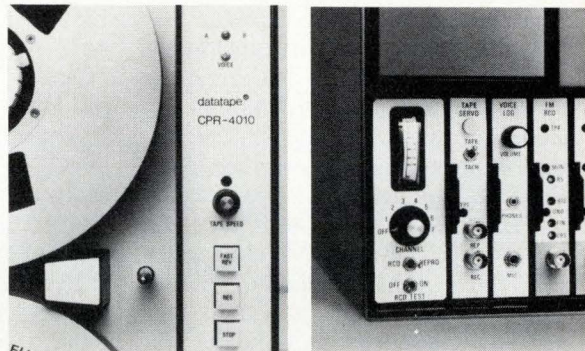

Maintenance and Servicing

Time for the annual P.M.? It's no big deal. The back panel's hinged. Just flip it down. All motors, power supplies, electronics, etcetera, are right there. (It even runs in this position.) Nothing special needed. How's that for simplicity?

Performance

Briefly, from the top: 7 speed transport, 15/16 to 60 ips; 7 speed direct, all automatically switched, 300 kHz at 60 ips; 7 speed FM record; 40/20 kHz, automatically switched. Any 2 speeds of FM reproduce; low tape flutter and TBE; isolation from reel perturbation via dual capstans and tension sensors. Low mass, closed loop IRIG servo system. The same electronics design as our top-of-the-line VR-3700B.

Bell & Howell & the CPR 4010

Get all the specs. Just ask Bell & Howell, CEC/Instruments Division, 360 Sierra Madre Villa, Pasadena, California 91109.



CEC/INSTRUMENTS DIVISION

 **BELL & HOWELL**

©Copyright 1971 Bell & Howell

manually, says Thomas N. Nasiatka, staff engineer for the bureau. Voice communications between the control room and each station, as well as between stations, will be handled by the experimental system. The computer also will check continuously to make sure that the data and voice lines are working. Each sensor will have a gage so that underground workers can check air conditions at their stations.

Going to work. "The purpose of the experiment," says Nasiatka, "is to demonstrate that technology exists to do this kind of job." The bureau's mine doesn't produce coal, but "we can simulate various kinds of environments to test out the equipment," he says. "We're pretty sure the system is going to work," Nasiatka adds, and it will help "develop better sensors to make the sys-

tem we will be testing more economical."

Computer sensing systems would be valuable because "it's helpful to the operator to pick up these conditions in advance," Nasiatka says. And continuous operation is an advantage also. In addition, a future system might automatically condition the air, as well as monitor it. The bureau's work, spurred by the 1969 Coal Mine Health and Safety Act, is part of an over-all research program [*Electronics*, Sept. 13, 1971, p. 103].

A commercial system wouldn't need to be as elaborate, says McInnes. "You could use an inexpensive computer—maybe a mini—and telemetry systems," he estimates. "You wouldn't need the CRT display, hard copy, or redundant power capability either." □

Communications

Suppliers are winners, no matter which way FCC goes on domsat

Communications equipment makers will be the ultimate winners in the domestic satellite system competition, no matter which proposals now pending before the Federal Communications Commission are approved. That's the reaction of manufacturers and the Electronic Industries Association to an FCC staff recommendation that narrows the field for the commission. A final decision is expected this year.

Potential. "Whoever wins—we still make the equipment," observes EIA vice president John Sodolski. He adds that domestic satellite systems offer immeasurable potential for producers of ground stations; so do the microwave links and other hardware to interconnect users.

In addition to the business potential for satellites and ground interconnection hardware, Sodolski points out that the domestic satellite market should markedly expand the cable television and special-service common carrier industry.

Though the Common Carrier Bu-

reau, headed by Bernard Strassburg, hinged its recommendation on technological considerations, the seven commissioners must still assess the politics of the matter when the full FCC begins oral arguments on the report on May 1.

Four main groups of applicants were chosen because the FCC staff says it wanted to team those with existing customers and proved technology, and combine those with "novel" technology and no customers. Group 1 is composed of West-

ern Union Telegraph Co., Hughes Aircraft Co. with General Telephone & Electronics, RCA Corp., and tiny Western Tele-Communications Inc., all arrayed around Hughes or similar satellites. Group 2 consists of Communications Satellite Corp. and AT&T. In the two "novel" groups are MCI-Lockheed with their proposed 48-transponder spacecraft, and Fairchild Industries with its craft based on Applied Technology Satellite F.

Two paths. The staff offered an option of whether to join or go it alone to Western Tele-Communications, RCA, and Comsat-AT&T. Industry observers conjecture that Western can't go independent and might not be included in the first group, either. RCA, which reportedly hasn't solidified its proposed system, was given some restrictions if it went along, which might induce it to stay in Group 1. Comsat-AT&T is seen as a profitable and efficient team, but there is some speculation that AT&T, which has wanted its own system, might pull out after an operational system got saturated, leaving Comsat high and dry.

The staff's plan "makes it all pretty even," says one industry insider. Members of the first group can get together to share risks and costs while the "novel" companies have been told "to go do whatever you want to," he says. Grouping Comsat with AT&T and restricting AT&T to only long lines and WATS service recognizes a "political and practical situation," the spokesman says.

Concerned. One interested party—the White House Office of Telecommunications Policy, which says

Mid-May decision?

A final domestic satellite decision by mid-May is the new goal of FCC chairman Dean Burch, commission sources report. Burch wants to wrap up the program "two weeks after completion" of three days of hearings on the staff report scheduled to begin May 1. Though industry skeptics question whether Burch

can get his six fellow commissioners to move that quickly, sources say Burch is determined to get the domsat question on the agenda for the week of May 15. Speculation is that Burch also may face some foot-dragging, though, by the White House Office of Telecommunications Policy. □

There's more to ESP rectifiers than you might think.

Customers have already perceived at least two additional features that provide more reasons to go ESP — low leakage, especially at high temperatures and operation over the full military range of -65°C to $+175^{\circ}\text{C}$.

Now Unitrode has added three more reasons. The voltage range has been increased to 150V. The three UES series are now available as 1N5802 through 1N5816. And you can get them in high efficiency assemblies as center tap rectifiers, bridges, and higher current modules.

Of course, you already know about the 15nsec typical recovery time in any circuit — forward voltage drop as low as 0.8V at 20A — continuous ratings of 2.5A to 20A — very low diode losses and low cost — and off-the-shelf delivery from local Unitrode distributors. These features alone added up to the best in Efficiency, Speed and Power.

And now there are five additional features that make very good sense. Maybe there's even a sixth one.

Unitrode Corporation, 580 Pleasant Street,
Watertown, Mass. 02172 (617) 926-0404.



UNITRODE

Call your local franchised Kierulff or Schweber distributor
for your ESP Rectifier "free sample card."

it wants an "open skies" approach—apparently is concerned about the staff's recommendation and is likely to have further words about any domsat decision.

Three posers. When the May arguments begin, the staff has urged the commission to seek opinions on three questions: should domsat be open to everyone or restricted, as the staff suggests? Should AT&T be limited just to phone service? Should Comsat have to choose between AT&T or a separate system?

Cable television backers seem to have gotten strong support from the recommendations. Particularly pleasing was the staff's urging that cable users be allowed to use low-cost receive-only earth stations. "They did us a good turn there," says a National Cable Television Association spokesman. "We have leverage in our favor" against costs of long-lines or microwave connections, such as those by AT&T. □

Instrumentation

6-port coupler simplifies job

A six-port coupler developed at the National Bureau of Standards in Boulder, Colo., promises to enable engineers to use three inexpensive off-the-shelf hybrid junctions to measure transmission-line voltage, current, power, complex impedance, and phase angle. Present methods are complex and require expensive components.

The device, developed by Cletus A. Hoer, consists basically of a pair of directional couplers, in addition to the junctions. It has four side arms and two main-line ports. By measuring only the magnitudes of the voltages at each of the side arms, one can calculate all the other desired data.

Actually, only three of the magnitudes are needed to determine the system completely, but the fourth enhances the accuracy of the phase-angle calculations and provides an estimate of the accuracy of all of the

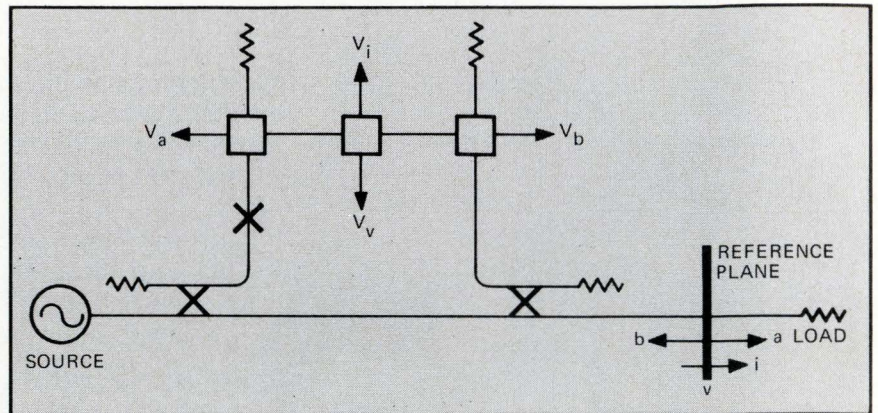

Poor man's lab. Three hybrid junctions and a pair of directional couplers make this precision measurement setup. Adjustable impedance at the heavy cross allows nullification of some system errors by setting $V_v = 0$ when a short is placed at the reference plane.

measurements. In the diagram, v and i are the voltage and current at the reference plane, while a and b are the amplitudes of the forward and reflected voltage waves, respectively. The side-arm outputs are voltages proportional to the subscripted quantities.

Good sweeper. Instead of measuring voltage, one could use power detectors on the side arms and still calculate all of the quantities of interest. As Hoer will explain when he describes the coupler at the Conference on Precision Electromagnetic Measurements this June in Boulder, the device is made entirely of broadband components, hence it is well suited to making measurements on a swept-frequency basis.

An important feature of the new device is that it does not require high-quality junctions and couplers to yield accurate results. So long as the components are stable, their imperfections can be nulled or included in the calibration of the output detectors. □

Logic

Raytheon offers power ECL

Large-mainframe computer builders, taking their cue from the rest of the industry, now seem willing to consider standard logic families. Texas Instruments' 5400/7400 series

TTL has become the standard in electronics circles, and it appears that Motorola's MECL 10,000 series will become the standard ECL family in computer circles.

Fairchild Semiconductor has brought out a line [*Electronics*, March 13, p. 41], and the latest company to announce MECL 10,000-type parts is Raytheon Semiconductor.

The Mountain View, Calif., firm is actively soliciting development contracts for what it calls TPECL (temperature and power supply compensated ECL), which the company will make in either MECL 10,000 pinouts or Fairchild 9500 pinouts.

Fast. Speed is one of the most important specs in an ECL circuit, and Walter Seelbach, manager for advanced development at Raytheon, says that because TPECL is made with Raytheon's V-ATE process [*Electronics*, June 7, 1971, p. 35] it is faster than the others. For the Raytheon equivalent of the 10109 and 95102 dual OR-NOR gate, the spec is 1.5 nanoseconds typical propagation delay versus 2 ns for the Fairchild and Motorola parts.

The big advantage, however, is that the user doesn't have to worry about power-supply fluctuations—a built-in voltage regulator keeps the high and low logic levels within a few millivolts of the nominal value, even over wide fluctuations. For TPECL, with a V_{ee} of 5 volts at 25°C and all outputs loaded with 50 ohms to -2 v, high-level output is 915 mV ±45 mV. This is guaranteed not to

Harris' Family of Op Amps. They're a different breed. By design.

Harris op amps have always been a little bit different ever since we introduced the industry's first internally compensated op amp back in 1966.

Today, we still make our op amps a little different. For example, our PNP's, or better put, our P_NP are vertical instead of lateral to give you superior AC performance without sacrificing DC characteristics.

Then take our designs. We employ a single gain stage to provide better behaved frequency response. Our bias networks are a bit more complex for uniform performance over a wide range of supply voltages and temperature ranges, and our output stages have better output current capabilities. In testing we're different too—more thorough. In fact, we were guaranteeing slew rates and rise times long before other manufacturers did. Consider just two examples:

Harris wide band general purpose op amps offer:

- Close loop bandwidth up to 100 times greater at the same gain or 100 times greater gain capability for the same bandwidth than the common 741 types.
- Much lower closed loop phase shift, lower gain error, and lower distortion at all frequencies.
- Superior response at higher gains.
- Hundreds of times better DC performance (for example, the HA-2600/2620 has a 5nA bias current, 300M Ω input resistance, and 100K minimum open loop gain).

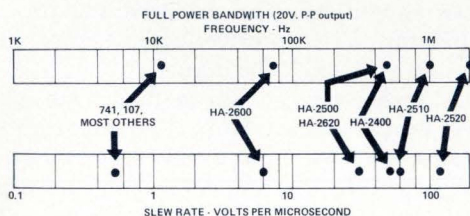
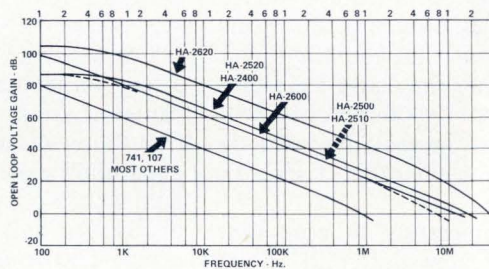

Harris high slew rate series offer:

- The only monolithic high slew rate amplifiers that are true operational amplifiers. They can be operated inverting, non-inverting, or balanced with fast settling times. In fact, they provide improved performance in virtually any standard hookup.
- The fastest settling time of any monolithic op amp. (For example, the HA-2520 settles in 250 ns to 0.1%.)
- Higher output voltage swing at high frequencies. (If you have ever tried to put a 10V peak 1MHz sine wave through a 741 type, you know what we mean.)

In summary, Harris makes a difference... our family of proprietary devices and popular alternate source devices can offer you the best price/performance op amp package for your system.

Full military temperature range (-55°C to +125°C):

HA-2101A	HA-2600	HA-2620	HA-2500	HA-2520	HA-2909
HA-2101	HA-2602	HA-2622	HA-2502	HA-2522	HA-2700
HA-2107			HA-2510		HA-2400
HA-2107-3			HA-2512		

Commercial/Industrial (0°C to +70°C):

HA-2301A	HA-2207	HA-2505	HA-2525	HA-2704	HA-2404
HA-2201A	HA-2605	HA-2515	HA-2911	HA-2705	HA-2405
HA-2307					

All in standard 741 pin-compatible configuration. (Except HA-2400/2404/2405 4-channel op amp.) For details see your Harris distributor, representative, or contact us direct.



HARRIS
SEMICONDUCTOR
A DIVISION OF HARRIS-INTERTYPE CORPORATION

P.O. Box 883, Melbourne, Florida 32901
(305) 727-5430

DISTRIBUTORS: Schweber Electronics; Westbury, New York (516) 334-7474; Rockville, Maryland (301) 881-2970; Hollywood, Florida (305) 927-0511 / Harvey/R & D Electronics; Lexington, Massachusetts (617) 861-9200 / Semiconductor Specialists, Inc.; Chicago (312) 279-1000; Detroit (313) 255-0300; Minneapolis (612) 884-8132; Kansas City (816) 452-3900; St. Louis (314) 428-6100; Dallas (214) 358-5211; Indianapolis (317) 243-8271; Pittsburgh (412) 781-8120; Dayton (513) 278-9455 / R.V. Weatherford Co.; Albuquerque (505) 265-5671; Anaheim (714) 547-0891; Austin (512) Enterprise 1443; Dallas (214) 231-6051; Denver (303) 427-3736; Glendale (213) 849-3451; Houston (713) Enterprise 1443; Palo Alto (415) 321-5373; Phoenix (602) 272-7144; Pomona (714) 623-1261; San Diego (714) 278-7400; Seattle (206) 762-4200. **HARRIS SALES OFFICES:** Wellesley, Massachusetts (617) 237-5430; Wayne, Pennsylvania (215) 687-6680; Palos Heights, Illinois (312) 597-7510; Melbourne, Florida (305) 727-5430; Palo Alto, California (415) 321-2280; Melville, New York (516) 249-4500; Syracuse, New York (315) 463-3373; Washington, D.C. (202) 337-4914; Dallas, Texas (214) 231-9031; Scottsdale, Arizona (602) 946-3556; Long Beach, California (213) 426-7687.

vary more than 1.3 mV per volt of power supply deviation, and not more than 10 μV per degree centigrade of temperature deviation. For Fairchild's 95102, the deviation is 9 mV per volt of power supply deviation and 60 $\mu\text{V}/^\circ\text{C}$ of temperature change.

Besides the difference in specs, the two new ECL circuits are being marketed differently. Fairchild will come out with standard circuits, while Raytheon will work with customers in developing a line of products. The primary reason for this is money—Raytheon, smaller than Fairchild, can not spend in-house dollars to develop circuits. But Seelbach points out that the Raytheon circuits, whether they have Fairchild 9500 or MECL 10,000 pinouts, will be "standards" in that they will be compatible with the other devices in the family.

It's also interesting to note that many of the new Fairchild 95100 parts are pin-compatible with 10,000 parts, and so it appears that for the mainframe business, the standard family will be MECL 10,000, even when it is called 95100.

Seelbach says samples will be available next month in the form of a dual OR-NOR gate with either Fairchild 9500 or MECL 10,000 pinouts; the price for the Raytheon parts will be about \$5. □

Displays

Planar processing yields big figures

Workers in fast-moving technologies have a way of abandoning relatively fresh developments before all their potential has been realized. A new type of display developed by Antex Corp., Palo Alto, Calif., is a good example of that. Antex was formed a year ago by Ken T. Chow, founder of Electro Nuclear Labs, and has been developing light-emitting-diode displays for calculators. The company is now supplying them for several Japanese calculator makers.

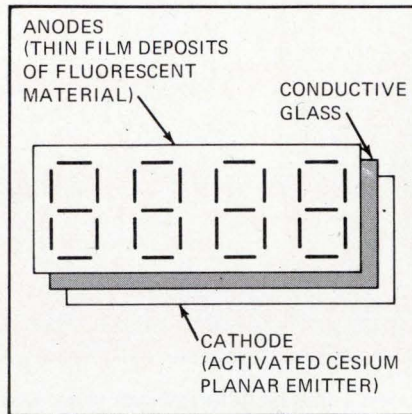

Number game. Panarray display, made by planar process, features half-inch to 2-inch figures and needs low voltages.

Chow, aware that most of the talk about large displays these days is centered around liquid crystals, felt that there was much to be gained by expanding existing technology. The goal was to come up with a low-cost display for half-inch to 2-inch characters. The result is Panarray.

Low voltage. The biggest advantage over other planar panel arrays is that Panarray is a low-voltage display (Burroughs' Panaplex requires upwards of 200 volts) and thus it can be driven directly by MOS circuits. While Panarray is only in the developmental stages now, William S. Routh, engineering vice president, says that samples should be available in about six months.

Panarray combines an excited phosphor digit, similar to what can be found in RCA's Numitron and several Japanese display digits, with planar processing techniques. In a three-layer sandwich, a seven-segment pattern of phosphor material is deposited on the back of a glass plate, and electrodes are attached to each segment. This is backed up by a conducting glass plate which acts as a control grid. Next comes a cathode, which is a plate coated with a cesium oxide, producing what Routh calls an active emitter.

Using digit multiplexing, the middle layer, or grid, controls which digit in an array is on. Total drive current of a display in on the order of "tens of microamps at 20 volts," according to Routh, and the display is available in most colors. □

Solid state

Correlators offer cheap solutions

A pair of digital LSI correlators developed at TRW Systems, Redondo Beach, Calif., promise an economical solution to important problems in bit synchronization, bit detection, error correction, and pulse compression. Furthermore, they achieve high yields on chips as large as, or larger than, any others made to date—and one of them uses a fabrication technique that some people think is largely obsolete in today's world.

Digital correlation requires a binary word to be delayed by a time increment, multiplied bit for bit by another underlaid word, and the products then added. Both new TRW circuits use exclusive-OR gates to do the multiplying. Ordinarily, exclusive-OR gates are used for binary addition, but here analog summing does that chore.

Respective bits of the two words to be correlated, as inputs to the exclusive-ORs, are interpreted as ± 1 rather than 1 and 0; in this context the exclusive-OR output, inverted, correctly represents the product of the inputs.

Epi method. One of the two correlators is made with conventional epitaxial techniques, but interconnections on the chip require two levels of metalization. The chip also has a cermet film to form stable resistors and to inhibit a chemical reaction between aluminum and silicon, which tends to reduce the yield.

The other correlator is made by a triple-diffusion process, using arsenic instead of phosphorus as a collector dopant, a technique some consider obsolete. Arsenic diffuses more slowly, and therefore the diffusion is harder to control than when phosphorus is used; also, devices made with diffused arsenic have a relatively low unity-gain crossover frequency. These factors hastened the general acceptance of the epitaxial deposition process for

A pair of glasses is positioned at the top of the page, and a rotary telephone is shown in the lower-left quadrant. The main headline is written in a large, bold, sans-serif font across the center of the page.

While you're reading about our new X-band solid-state communications amplifiers, your competitor may be ordering them.

Quick reactions have never hurt anybody. Especially in the microwave amplifier field, where there's a crying need for advanced designs. Because until now, all that's been available has been tubes.

And tubes, you know, can burn-out. And they're expensive.

So now, Hughes announces its new solid-state avalanche diode amplifiers.

System-proven in the F-14, F-15, and Phoenix programs.

Superior quality. Low voltage power supply. Less system down time for your customer.

And very, very inexpensive.

Right now, we're delivering our solid-state ADAs for 1W systems in C, X, and Ku bands. And for millimeter-wave systems through V-band.

All you have to do is stop reading and write us at: Electron Dynamics Division, 3100 W. Lomita Blvd., Torrance, CA 90509.

Or better still, in case your competition has ordered some, call: (213) 534-2121.

HUGHES

HUGHES AIRCRAFT COMPANY
ELECTRON DYNAMICS DIVISION

Best Buy

in 1% Tolerance
1-Watt Zeners
SCHAUER
Immediate Shipment



Low Prices

ANY voltage from 2.0
to 18.0

Quantity	Price each
1-99	\$1.07
100-499	.97
500-999	.91
1000-4999	.86
5000 up	.82

Write for complete rating data and other tolerance prices.

Buy The Kit!

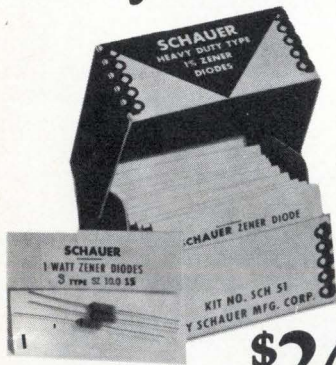

A
\$54.57
value for
only

\$24.50

Kit contains a 51-piece assortment of SCHAUER 1% 1-watt zeners covering the voltage range of 2.7 to 16.0. Three diodes of each voltage in reusable poly bags. Stored in a handy file box. Contact your distributor or order direct.

Semiconductor Division

SCHAUER

Manufacturing Corp.

4514 Alpine Ave. Cincinnati, Ohio 45242

Telephone: 513/791-3030

Electronics review

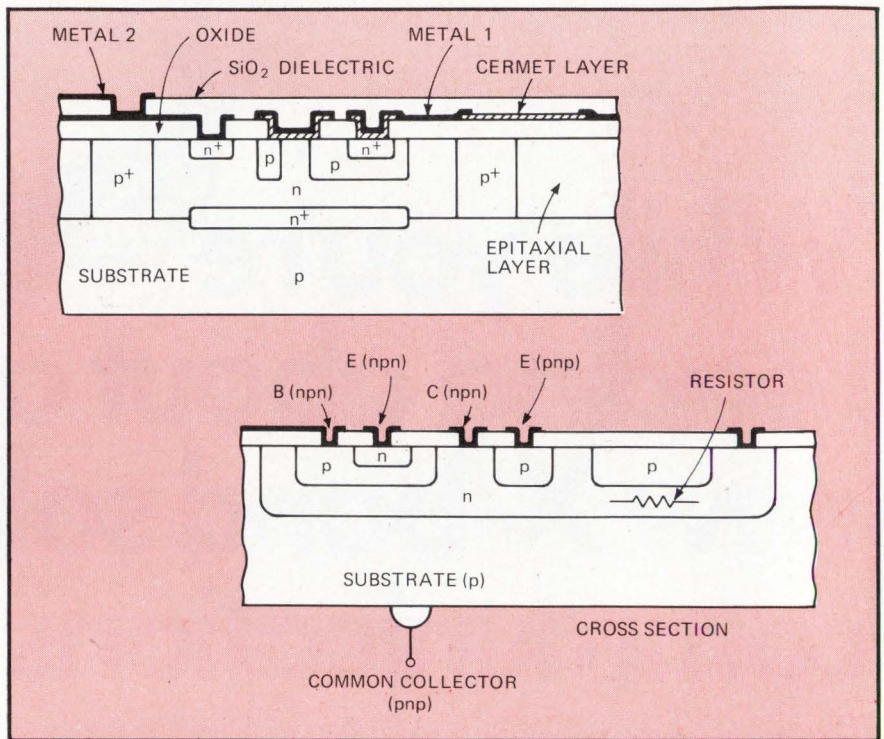

Together. Pair of LSI digital correlators from TRW. Top device is made by conventional epitaxial fabrication; bottom one by triple-diffusion method using arsenic as a collector dopant.

IC manufacture. And where diffusion is still in use, arsenic is the dopant for the buried layer, not the collector. But using arsenic for the collector in the correlator results in a simpler process that requires only one level of metalization.

Yields with the epitaxial method are similar to those obtained with conventional integrated circuits, such as p-channel MOS devices. This is remarkably good because the epitaxial chip measures a whopping 214 by 236 mils. The epitaxial correlator is good for data rates of 25 to 200 megahertz and up.

On the other hand, although the triple-diffusion method is basically inferior in some ways—its maximum data rate, for example, is only 30 MHz—it reaches yields much higher than those of the epitaxial method, and the maximum data rate is good over the entire military environmental specifications of temperature, humidity, and so on. The triple-diffused correlator is on a 220-by-230-mil chip—about the same area as the epitaxial one but a different shape.

Getting good yields on such enormous chips is remarkable in its own right. If chips of a more pedestrian size—say, 100 to 125 mils

square—were used, the yield at the chip level would probably be several times higher; but then, of course, interconnection problems would arise, limiting the yield and the reliability at the system level. □

Avionics

NASA test advances VTOL

Vertical takeoff and landing (VTOL) aircraft look ideal for short-haul commuter traffic in built-up urban areas, but two technological problem areas have been dimming that promise—noise and uneconomical operation. The aircraft must operate under all weather conditions on flight paths that will lessen their perceived noise, keep them safe, and minimize their hover time so that they won't burn up too much fuel. Until now, VTOL advocates have had to rely too much on the pilot.

But researchers at NASA's Langley, Va., Research Center claim a major milestone in VTOL avionics development with the first fully

Call RCA if you want to talk about **MIL-M-38510** COS/MOS

Now, for high-reliability types in COS/MOS ICs — for full MIL-STD-883 — call RCA.* And let's talk about advanced MIL-M-38510 techniques. In RCA's rapidly evolving 38510 program, high-reliability type product becomes not just the result of screening, it will be built in, through procedures being developed to the specification:

- Scanning electron microscope (SEM)
- Radiographic inspection
- Product traceability for permanent product control
- Rigorous operator training to maintain high quality-control standards

The COS/MOS CD4000A series is available in high-reliability types now being produced under MIL-STD-883, with SEM inspection specified in NASA-Goddard Space Flight Center specification GFSC-311-P12A, on special order.

And, since RCA's COS/MOS production is a single, integrated process, process advances that are developed for high-reliability product are automatically reflected in the commercial type you specify.

If you want the leader's standard of quality plus volume capability and systems cost effectiveness, go COS/MOS. See your RCA Representative or your RCA Distributor. Or write, RCA Solid State, Section 70C-27, Box 3200, Somerville, N.J. 08876. International: RCA, Sunbury-on-Thames, U.K., or P.O. Box 112, Hong Kong. In Canada: RCA Limited, Ste. Anne-de-Bellevue 810, Quebec.

**For information on high-reliability COS/MOS and our MIL-M-38510 progress, call RCA's high-reliability marketing specialist, Garry Miller (201) 722-3200 Ext. 2805.*

RCA Solid State
products that make products pay off

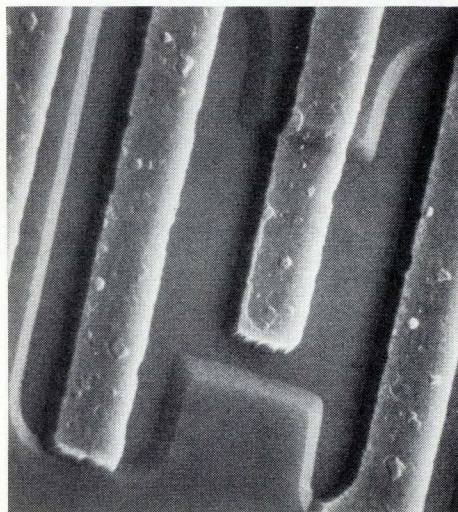

RCA's scanning electron microscope at 1000 X magnification shows excellent conformity of conductors over wafer contours, assuring continuity and reliability of metal interconnects. This is a dramatic example of process refinements achieved under the RCA high-reliability program which are automatically applied to commercial products.

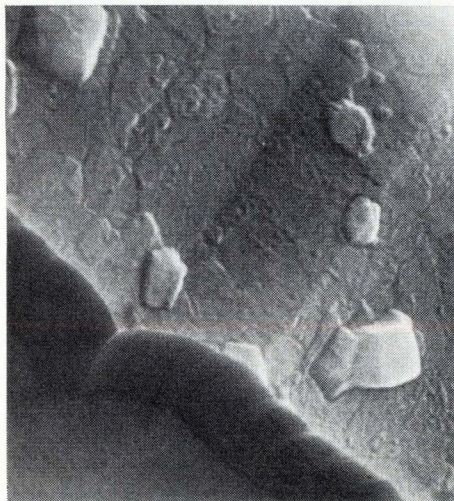

6000 X magnification shows excellent metal coverage over an oxide step, eliminating intermittent opens, thereby enhancing reliability. The scanning electron microscope has become a major tool in RCA's diagnostic and high-reliability procedures.

for
**rapid
reaction**

INQUIRY > QUOTE
ORDER > DELIVERY

Specify



Mica Capacitors



CMR Type

For hermetically sealed or potted in applications.



CER Type

For specialized mounting arrangements and operation under selected environmental parameters.



CEM Type

For specialized form factors and operation under environmental extremes.

Custom Electronics can fill your mica capacitor requirements in minimum reaction time (inquiry; to quote-order-to delivery). Meet your design engineer's requirements for higher voltage, higher temperature and greater reliability by calling on Custom Electronics for Mica Capacitors. The greatest single cause for capacitor failure is a short in the dielectric material. Consequently, we precisely inspect and grade all of our dielectric material **before** production. The result is the finest quality capacitors of their kind available today.

Write or call on your application today!



CUSTOM ELECTRONICS, Inc.
Browne St., Oneonta, N. Y. 13820
PH: 607-432-3880 TWX 510-241-8292

Electronics review

automatic landings by a manned CH-46 tandem-rotor helicopter. Using a NASA-developed experimental landing system, the helicopter flew automatically two to three miles to the intended spot at speeds of 60 miles per hour at an altitude of 800 feet. At 1,500 feet from touchdown, the helicopter automatically decelerated until it was hovering 50 feet over the touchdown point and then landed. The pilot monitoring the operation had to intercede once each flight to flick on the descent mode, reports John F. Garren, program manager.

Signal smooth. The Langley-developed guidance equipment included a Bell Aerospace GSN-5 ground-based tracking radar, linked by fm multiplex to onboard equipment: an Electronic Associates analog computer, and a special inertial signal-smoothing device with a fixed-gain common filter. The last device, by coordinating radar signals with the aircraft's instruments, provides control signals to a four-axis servo-control system.

NASA considers the tests significant, Garren explains, because it freed the pilot from actual flying so he could judge the flight better. Commercial VTOL craft will need guidance and avionics systems that select each landing profile for optimum noise, safety, and fuel requirements—a task no pilot can perform now, he says. "Conventional aircraft find a landing speed and hold it until touchdown," he explains, "but with VTOL you keep the speed as high as possible for as long as possible because low-speed flight burns up fuel at a high rate."

The tests indicate that, besides special avionics, VTOL-based transit will need ground-based radar equipment at each landing pad. "You need good range information and good ground-speed information," which is best provided by such equipment, Garren says. □

For the record

Site. The world's largest planned radio telescope finally has a home—Datil, N.M. And electronic subsystem makers are getting ready to

compete for chunks of an anticipated \$20 million in contracts. The telescope, which will operate at microwave frequencies of 2,695 and 8,085 megahertz, is an array of 27

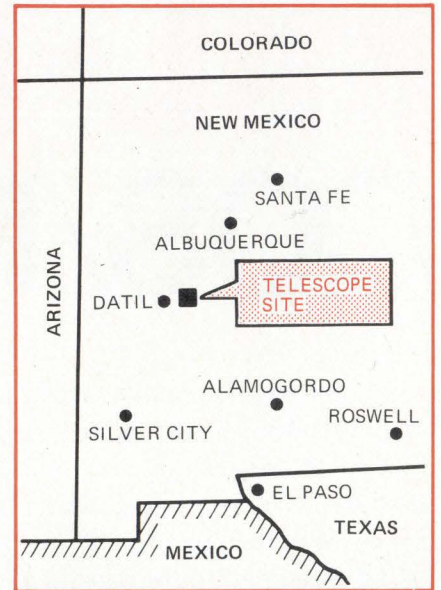

dish antennas arranged in a Y with each arm about 13 miles long. Each dish will be 82 meters in diameter. The project, called VLA for very large array, will be managed by the National Radio Astronomy Laboratory. Completion is scheduled in 5 years; total cost is estimated at \$76 million. The fiscal 1973 budget contains \$3 million [*Electronics*, Jan. 31, p. 75], and Congress has still to approve the program.

The message. Only one new element, although an important one, turned up in President Richard Nixon's unexpectedly brief special message to Congress on expanding civilian research and development through new technological opportunities [*Electronics*, Sept. 27, 1971, p. 33, and Jan. 31, p. 76]. The new proposal calls for creating a larger role for state and local participation in the effort under a three-part program.

Nixon said he wants science adviser Edward David to develop broader ties with state and local groups through discussions aimed at developing: (1) systematic means for communication of local groups' R&D priorities to appropriate Fed-

3146

3146

3146

3146

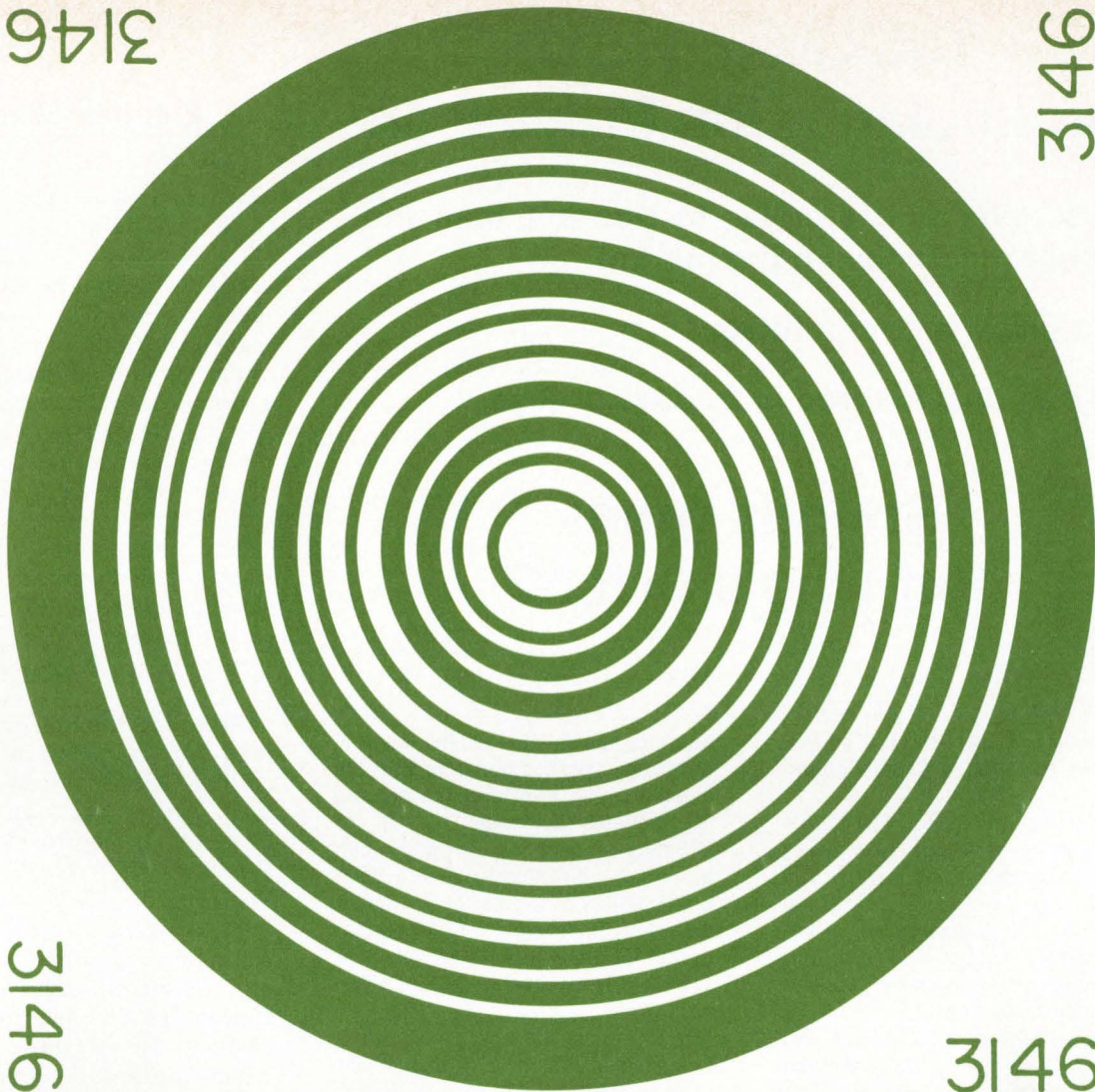

The laser label reader converts the varying reflections from the box label to binary coded pulses. A He-Ne laser is the ideal illumination source because it needs no complex focusing optics. Furthermore, the precise beam is collimated all along its length, making the system largely independent of the box position.

Boxes, boxes, and more boxes. Hundreds of them, zipping along an automated conveyor-belt. In some are motors for air conditioners; in others, hinges for freezer doors, agitators for washing machines, blades for electric carving knives.

Each box is destined for a particular assembly line, and somehow, miraculously, it arrives at the right time, in the right order, with the right parts. Yet no one seems to be keeping track of things; how does it happen?

The secret is a binary coded label on each box, and a laser beam that knows how to read. Regardless of the position of the box or the label, it can't get by the laser scanning station without revealing its identity, contents, and destination to

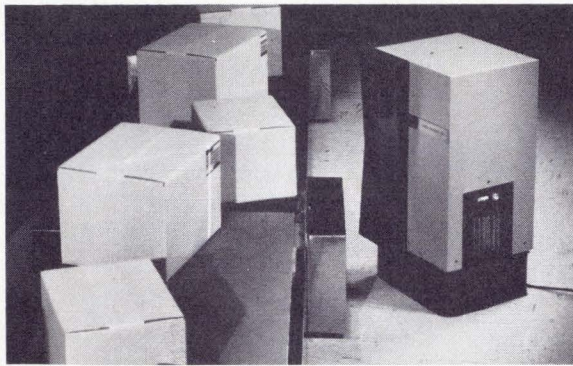

Label-reading Laser helps get it all together

research, you name it.

Perhaps you have a problem one of our lasers could illuminate. Write the #1 laser people today at 1250 West Middlefield Road, Mountain View, California 94040, 415/961-2550.

the computer-controlled system.

It used to be done with mirrors, and a touchy optical system with an unreliable tungsten light source. And it made mistakes. But the new laser system* stays right on the beam—regardless of variations in ambient light intensity and color—and the only down-time on the assembly lines is over the weekend.

Spectra-Physics OEM lasers are shedding new light on a lot of old problems, in manufacturing, communications, transportation,

*made by Bendix Recognition Systems, Southfield, Michigan



Spectra-Physics

Circle 43 on reader service card

The Ortec P-554 Ion Implantation Processor:

- It's safer and simpler to operate than the other machines on the market.
- Its price is competitive.
- It can be delivered in 90 days or less.

Sounds great. But who's Ortec?

The question is justified. For all you know, we could be a garage operation.

Truth is, we were once just that—about twelve years ago. Now we're one of the leading producers of ion sources, semiconductor detectors, and electronic instrumentation for nuclear physics research. We're into life-sciences instrumentation, too, and x-ray analysis systems.

We're no strangers to vacuum and accelerator technology, for sure. Both are in our normal line of work. And as for semiconductor technology—well, we're the world's largest manufacturer of precision silicon and germanium radiation detectors.

In other words, although you may not have heard of us, we've been toiling in your back yard for quite some time.

And our Ion Implantation Processor shows it. The P-554 is a very practical production machine. Take, for example, its extraordinary simplicity: the

operator has only to load the tray with wafers and push a button to start the implant cycle. After that, the process is completely automatic.

Safety precautions—for both operator and the wafer load—are elaborate. With our system of interlocks, it's nearly impossible for an operator to foul up the works. Or expose himself to high-voltage or radiation hazard.

But perhaps the best proof of performance is for us to implant a few of your wafers. Which we'll be glad to do. Or, if you prefer, we'll send you a copy of our P-554 brochure. Either way, you have only to call or write our systems specialist, George Thoeming. The phone number: (615) 482-4411. The address: Ortec Incorporated, 110 Midland Road, Oak Ridge, Tenn. 37830. In Europe: Ortec Ltd., Dallow Road, Luton, Bedfordshire, England. Phone: LUton 27557. Ortec GmbH, 8 München 13, Frankfurter Ring 81, West Germany. Phone: (0811) 359-1001. In Japan: Toyo Trading Co., Tokyo. Phone: 279-0771.



ORTEC[®]
AN  **EG&G** COMPANY

5296

Electronics review

eral agencies so they can be incorporated into Federal planning; (2) ways of assuring state and local access to Federal R&D centers' technical resources in such areas as transportation, the environment, and energy programs, and (3) aggregation of state and local markets for specific products so industries can give government purchasers benefit of innovation and economies of scale.

That final point, say industry officials, could accelerate and expand sales of such items as communications equipment for law enforcement to state and local markets.

Univac spectrum. Computer facilities for the Federal Communications Commission's spectrum management task force operating in Chicago will be provided by Sperry Rand Corp.'s Univac division, Washington, D.C., under a 40-month contract for \$870,000. The computer will assemble information on land mobile radio service in the Chicago area to determine the most efficient use of those frequencies. Losers in the competition were IBM, Control Data, and Honeywell.

China flap. RCA Global Communications, Inc.'s \$2.9 million communications satellite earth station which it sold in January in Shanghai to the People's Republic of China and which went on the air in February [*Electronics*, Feb. 28, p. 44] got its permanent export license from the U.S. Department of Commerce. And that action has generated a disapproving uproar among members of Cocom, the committee that coordinates allied controls on the sale of high-technology equipment to Communist powers.

However, Washington could hardly take back the ground station now. RCA says it is in operation, with Intelsat 4 over the Pacific carrying telephone, leased-channel, telegraph, and facsimile communications between the U.S. and China. Upset nations such as Japan and Britain contend that Cocom rules have barred them from sale of comparable high-technology equipment to the mainland Chinese. □

Meet Trinidad electronics specialist Derrick Govia... he speaks your language!

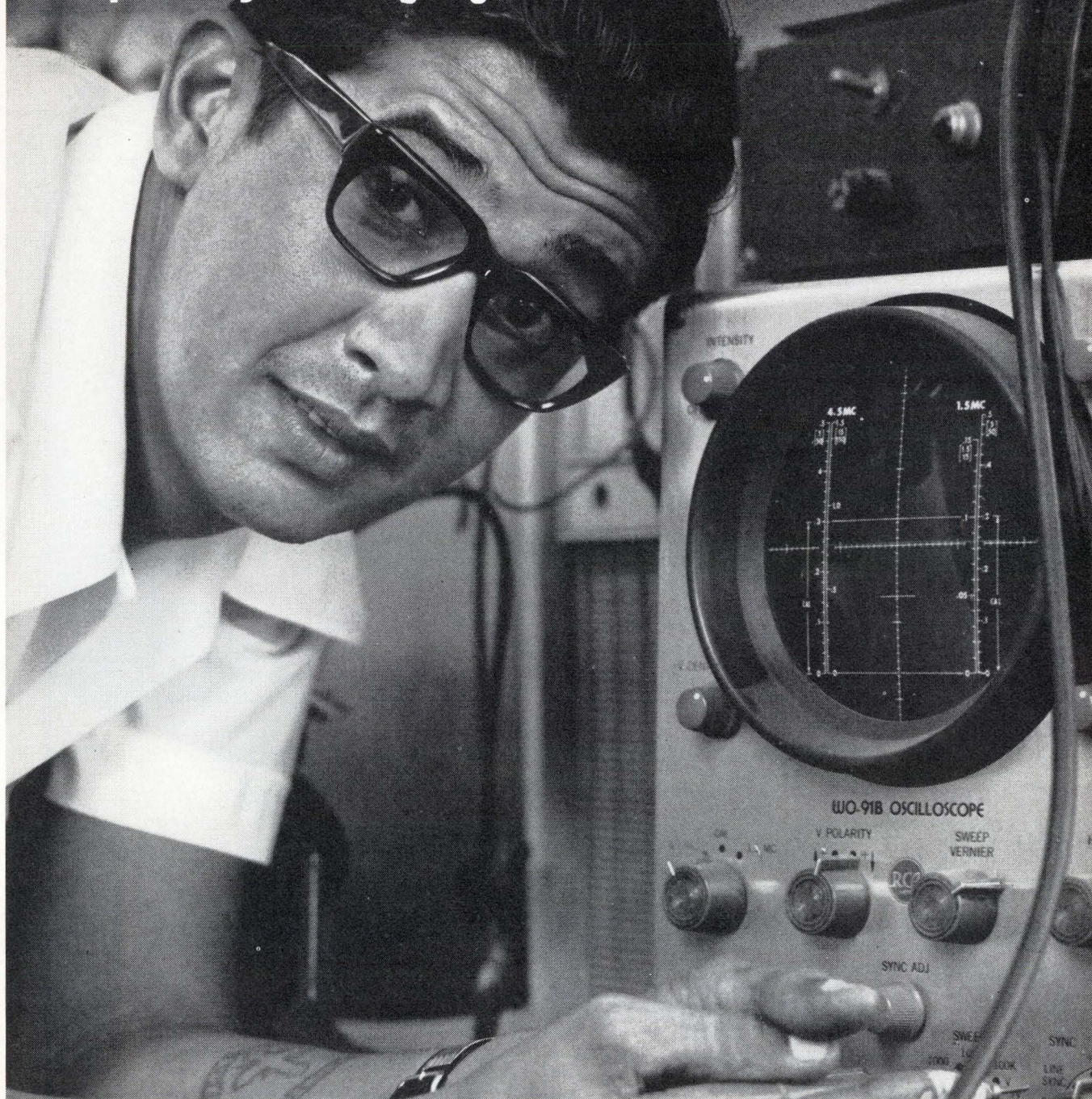

You need people who understand and respect expensive electronic equipment, right? Well, you're looking at one of them, Derrick Govia, Service Manager for one of Trinidad & Tobago's leading electronic companies.

He's got good fingers and a good head and he believes that "Trinidad & Tobago has great potential for foreign investment in any field."

If that's the kind of talk you like, you'll hear plenty of it in our 10-year old nation, from young, highly trained people like Derrick Govia, from older successful businessmen who might serve as your partners, help introduce you to new sales areas like the new CARIFTA market that spans the Caribbean.

Think about it. Then contact us, or fill in and send this coupon.



Trinidad & Tobago Industrial Development Corp.

400 Madison Avenue, New York, N. Y. 10017
(212) PLaza 5-9360
Clyde S. Namsoo: North American Director

Please send me factual information on Trinidad & Tobago as an investment location.

Name & Title _____

Company _____

Address _____ Zip _____

City & State _____ Tel. No. _____

Product Line _____

SUE: THE FIRST GIRL MINICOMPUTER.

It's a woman's right to change her mind.

SUE is as different from other minicomputers as women are from men. And for the same reason. It's the way she's built.

SUE is the System User Engineered mini-computer.

From the beginning, the first principle in her make up was flexibility. In that she's unmatched.

Look at her main frame. The wide bandwidth Infibus you see there has plugs for up to 24 cards. Memory cards. Logic cards. Arithmetic cards. Input/Output cards. Special interface cards. Even multiprocessors on a common Infibus. So there are literally hundreds of SUEs. What she can do depends on the number and combination of cards chosen for a particular application.

In short,

whatever kind of minicomputer you want her to be, she is. And that's all you pay for. Exactly the minicomputer you need.

As your needs change, you can change SUE. Simply by changing cards. You can expand her memory to 32K. You can mix core and semiconductor memories, and memories of different speeds, in the same system. She'll give you a throughput of 80 million bits a second.

If you've got a system that's looking for a mini-computer, have we got a beauty for you.

Call SUE for her vital statistics. (213)

722-6810 or write: 6201 E.
Randolph St., Los Angeles,
California 90040



Lockheed Electronics

Data Products Division.
A Subsidiary of Lockheed Aircraft Corporation.

Visit SUE on the COMPUTER CARAVAN in a city near you.

Washington newsletter

March 27, 1972

EIA turns around on export trade legislation . . .

Pressured by what it calls a changed "climate of opinion," the **Electronic Industries Association** says it now favors extension of the **Export Administration Act of 1969**. It is urging the Government to remove those export controls found to be "unnecessary burdens on the U.S. export industry."

This position differs from its recommendation of eight months ago that Congress "take no action" on extending act. **Nevertheless, EIA's governors for second time deferred development of an international trade position paper** (*Electronics*, Nov. 22, 1971, p. 45).

. . . seeing threat in Burke-Hartke bill

The change in EIA's attitude stems from the introduction of the Foreign Trade and Investment Act of 1972 by Rep. James Burke (D., Mass.) and Sen. Vance Hartke (D., Ind.), **which EIA and other groups contend is strongly protectionist and certain to produce international trade wars**. At the same time, EIA's governors have formed a committee to monitor the nine-part bill to thwart possible efforts of organized labor to get sections passed as riders to other laws.

The AFL-CIO's reported withdrawal of the bill from its "must pass" list indicates to industry leaders that **labor has given up on getting it through Congress as a package**. The legislation would amend tariff and trade laws to "promote full employment and restore a diversified production base," would exact penalties on companies with foreign plants, and would eliminate foreign tax credits.

Airlines may use X-ray units for tighter security . . .

Besides making the airlines buy about 400 more magnetometers, the Government's speedup of anti-skyjacking precautions is expected to result in the purchase of **short-pulsed, low-dose-X-ray equipment for baggage inspection**. Moreover, some FAA staff members are saying privately that **X-ray machines to screen passengers will eventually replace the magnetometers**. For baggage inspection, one expert's guess is that **one or two X-ray snoopers, costing \$27-\$45 thousand each, might be installed at about 100 likely airports to be used in case of a threat**.

. . . as may Customs in war on dope

As part of a phased experimental program to help crack down on dope smuggling, the U.S. Customs Bureau is expected shortly to announce purchase of two second-generation X-ray devices from American Science and Engineering Inc., Cambridge, Mass., for evaluation in New York City. **The two units, at a total cost of \$120,000, will test the usefulness of X-rays in spotting contraband in high-volume mail**.

Addenda

A two-week trade mission to explore communications and industrial electronics sales to the Soviet Union, Poland and Czechoslovakia is set for September by the Government and the Electronic Industries Association, which expects to sign 12 corporations for the trip. The seven signed up so far include GE, GTE-Sylvania, Magnavox and RCA. . . . The Army's \$171 million request to continue FY 1973 advanced development on SAM-D, successor to the improved Hawk, is seen vulnerable in Congress in view of speculation it will not go to production.

Defense procurement policy and practice: the case of the F-14

By October the Navy must exercise its option to buy 48 more F-14 fleet defense fighters from Grumman Aircraft. And insiders on both sides of the project agree that, when it does so, the price will be higher. Renegotiation of the Grumman contract is starting, despite public pronouncements by high defense officials about holding Grumman's feet to the fire.

Defense Secretary Melvin Laird, for example, told Congress not long ago that "while the contractor has indicated that he is unwilling to accept this option, we retain the position that we have a valid and legal contract with Grumman." Yet Laird nimbly sidestepped the issue of specific prices when he added, "I want to reassure the Congress that the option will be exercised only if I am convinced that the F-14 will provide the capability the Navy needs and at a realistic cost." What is realistic? Laird didn't say.

The money in the till

The current fiscal year budget of the Pentagon comptroller has the Navy down for 48 planes at nearly \$1,031 million, including initial spares, RDT&E, and a small amount for related military construction. That works out to a bit more than \$21.4 million a plane without Government-furnished weapons. On the same basis, the Navy wants to commit itself to 48 more planes in fiscal 1973 for \$734.8 million, or an outlay of roughly \$15.3 million a plane.

If that price is renegotiated upward—and industry sources, including some subcontractors, believe it will be—it will make a joke of former Deputy Defense Secretary David Packard's effort to give credibility to the concept of "fixed price" contracts. A new F-14 contract will also give a very hollow sound to the ringing statements of such dedicated persons as assistant secretary of defense Eberhardt Rechtin, who recently told electronics manufacturers that contractors' price must contain "numbers which really mean something and which Defense must enforce."

The Grumman side

The other side of the coin, the Grumman side in the case of the F-14, is that some unrealistic economic estimates were inserted in the proposals of F-14 bidders by the Pentagon. For example, bidders were required to premise their costs on an estimated inflation rate of less than 4% when it has proven to be more like three times that figure. Moreover, individual contractors' overhead escalated sharply as eco-

nomie recession set in and contracts were cut back. Thus were first estimates of overhead charges found to be low. Now Grumman is trying to convince the Pentagon that the company should not be held responsible for a price built around faulty Federal economics.

But Congress is unlikely to buy those arguments in this election year. Viewing the problem in the simplest terms, the public is going to be left with the impression that the F-14 is but one more mucked-up military program to be recited with the litany of Lockheed's C-5A Supertransport, General Dynamics' F-111 swing-wing fighter, and their predecessors.

A way out?

Is there a way out? Solutions are being sought by the commission on Government procurement, which has been at work more than a year. Ironically, however, that body's effort has slipped to the point that its report, expected at the end of last year, will not come out now until the end of 1972, after the election.

Apart from the prospect of canceling the F-14 program and substituting the Air Force's F-15 now under development by McDonnell Douglas, an unlikely prospect at this point, it seems there is little that can be done to hold down the cost of the Grumman plane. But there may be an answer for future contractors if the Defense Department will eliminate the requirement that bidders accept its economic forecasts and permit them to substitute their own estimates predicated on Federal statistics plus any other private intelligence they may want to factor in. Then at least they would be responsible for their own pricing policies and be better held accountable.

The Pentagon's comptroller, Robert Moot, says his office has found that there are techniques available which can determine "the final actual cost of a system within 10% to 20%," compared to the spread of up to 200% or more that has resulted from some major buys in the past. If so, these techniques need to be made available to industries such as aerospace and defense electronics whose technological expertise far exceeds their capability in Federal procurement economics.

That contractors need such information quickly is demonstrated not only by the immediate problem of Grumman but also by the broader observation of assistant secretary Rechtin when he commented that, in defense procurement generally, the United States "has run out of price."

—Ray Connolly

Cal-Tex: we do MOS

e.g.

**FOUR-FUNCTION 12-DIGIT
DISPLAY CALCULATOR
CHIP CT5001**

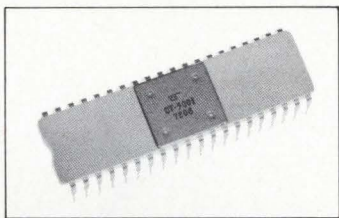

\$800
in 50,000
quantities.
Other quantity
prices on
request.

Coming: In April, CT5003/4, 2-chip multi-function printing calculator set with memory — programmable for 8-16 digits; in May, CT5005 12-digit display calculator chip with memory; in June, CT5006 printing circuit to match the CT5005.

And what can we do for you?

Custom MOS is our offering.

Custom MOS starts with custom design.

We have a team of system and circuit designers who have worked together on major products for major names like Canon, Olympia, Omron, Olivetti, Lagomarsino, IBM, SCM, and Eiko.

Custom MOS requires computer-aided design and artwork generation.

We're equipped to do it all in-house on our Calma/Calcomp computer/plotter system. No waiting.

Custom MOS is done best when the guys who do the system development, design and artwork also oversee production.

We've got the newest production, test, and packaging equipment available. It's all in place. Operating. Delivering. And growing.

If custom MOS is what you need for computers, terminals, industrial controls, instrumentation, timing circuits, or whathaveyou — and if speed is of the essence — give us a call.

We do MOS. Fast.



CAL-TEX SEMICONDUCTOR, INC.

3090 Alfred Street, Santa Clara, California 95050
(408) 247-7660

In the grand tradition

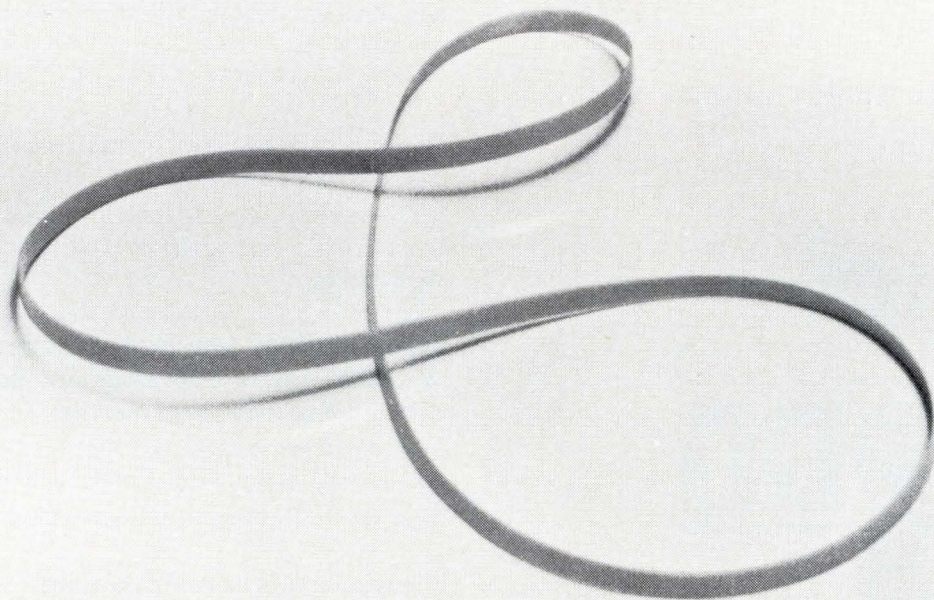

The 3M drive band. A new concept in tape handling.

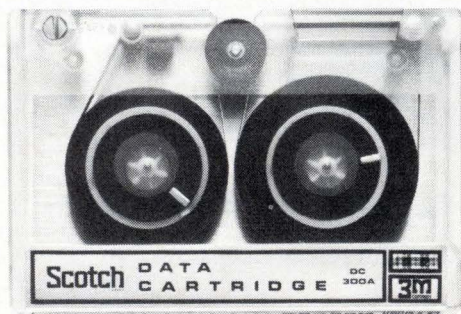

Based on an entirely different, elegantly simple drive technique, the new Scotch[®] Brand Data Cartridge combines reel-to-reel performance with cassette convenience and price.

The Data Cartridge functions as its own transport and needs to be driven at only a single point. There are no pressure pads, no pinch rollers, no capstans — tape handling is fast, accurate and precise with *no* external tape guidance.

With our new technique, tape is handled — not just driven — in the Data Cartridge. The drive band travels around three tension rollers and is wrapped partially around the tape on both hubs, making

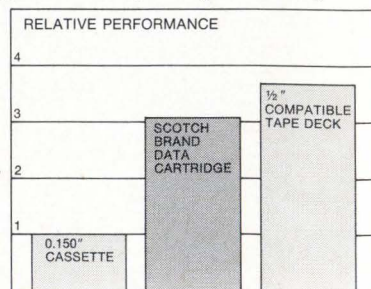

on of the paper clip:

"rolling" contact with the tape. Tape wear is extremely low since the tape oxide touches nothing else except the head. Compliance in the band provides controlled tape tension at all times. No machine operation can cinch, spill, stretch or break the tape.

A single external motor powers the drive band through contact with extended hubs on one of the tension rollers. Tape motion is easily controlled by starting, stopping or reversing this motor.

Since no external guidance is required, tape/head alignment is simplified and a variety of head and data configurations may be used with consistently high data reliability.

The end result is low cost digital data storage like nothing you've ever seen before. The Data Cartridge starts and stops

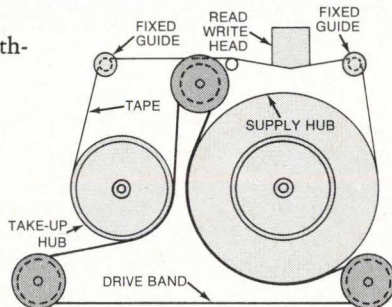

within 25 ms at any operating speed, shuttles at up to 180 ips, stores up to 8 times as much data as the 0.150" cassette and has an expected lifetime in excess of 5000 passes.

Add to this a cost comparable to cassettes and only one quarter that of 1/2" compatible tape decks, and you have a breakthrough in digital tape handling for any application.

Need more data? Simple.

Contact Data Products, 3M Company, 300 S. Lewis Road, Camarillo, California 93010,

Tel. (805) 482-1911. TWX 910-336-1676.

Data Products **3M**
COMPANY

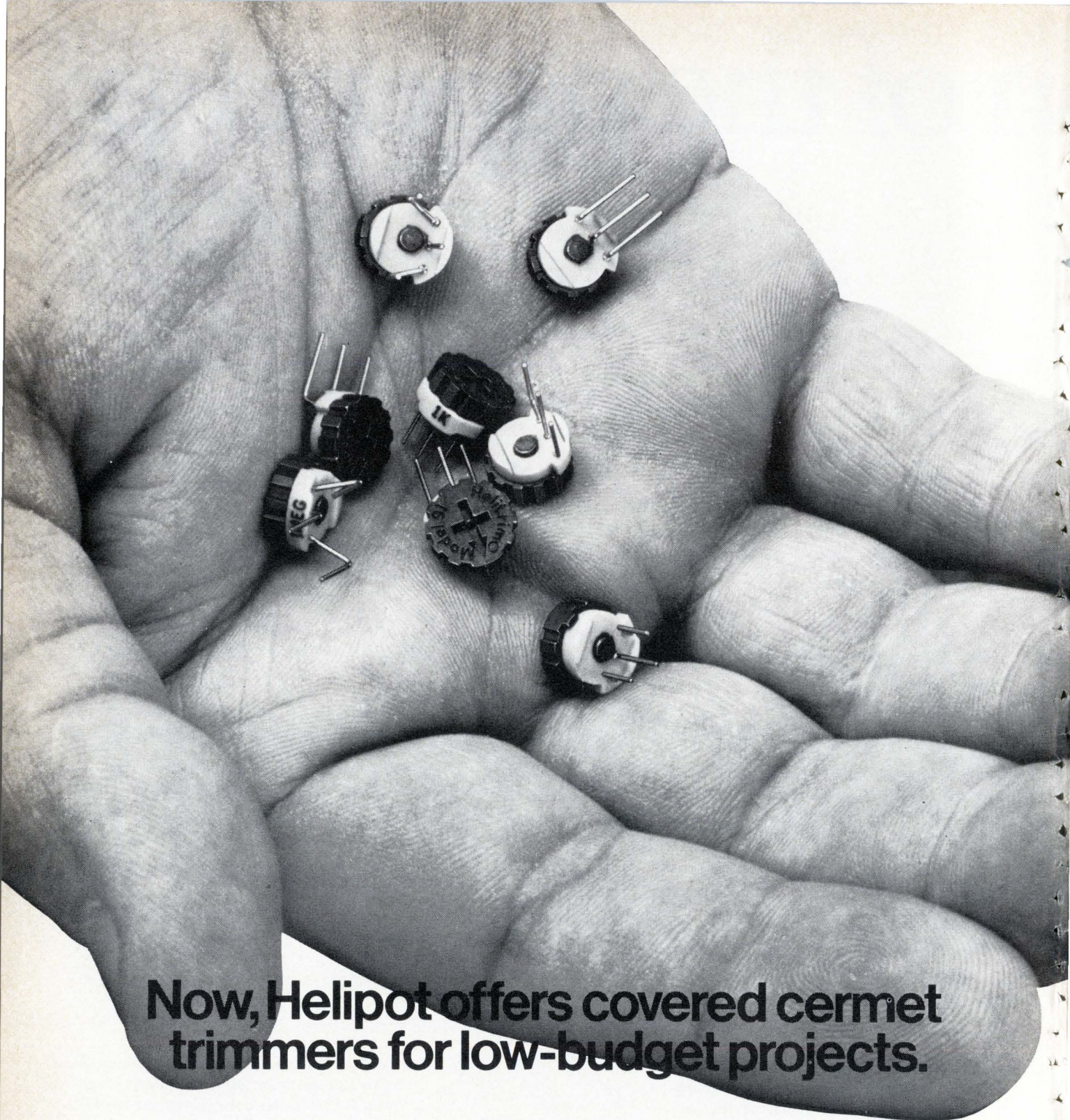

Now, Helipot offers covered cermet trimmers for low-budget projects.

There's not much sense in using cheap wirewound or carbon trimmers anymore. Not when the new Helipot Series 91 Cermet Trimmers are available *off-the-shelf* for a few cents more.

These single-turn, $\frac{3}{8}$ " , covered trimmers come in 10 different mounting styles and 19 standard resistance values from 10 ohms to 2 megohms. Covered construction helps protect against moisture, corrosive atmospheres, dust, oil and other

contamination. Which means, in addition to cermet stability and better resolution, you get long-term dependable performance.

The breakthrough price is just 35¢ each in the 50,000 piece quantity, and they're equally well-priced in other quantities.

Send now for complete data on the Series 91 Trimmers... the finest of their class. We've made them for your projects where the budget may be tight, but you don't want to compromise performance.

Beckman®
INSTRUMENTS, INC.
HELIPOT DIVISION
Fullerton, California

HELPING SCIENCE AND INDUSTRY IMPROVE THE QUALITY OF LIFE

INTERNATIONAL SUBSIDIARIES: AMSTERDAM; CAPE TOWN; GENEVA; GLENROTHES, SCOTLAND; MEXICO CITY; MUNICH; PARIS; STOCKHOLM; TOKYO; VIENNA

Circle 52 on reader service card

Flowering of MOS, displays brighten cloudy view at Paris Components Show

April in Paris is usually a lot gloomier than the song suggests, so it may well be suitably cloudy from April 6 through 11 during the Paris Components Show, Europe's largest international electronic products exhibition.

The show at the giant Porte de Versailles exposition hall will have just over 1,000 exhibitors from 25 countries—down about 100 from last year because of what show managers call "economic constraints." For the first time, however, there will be large block exhibits sponsored by the United States, Japan, and Spain, showing products made by smaller companies from those nations. The new American exhibit represents 48 companies—most of them seeking sales representatives for their products in Europe.

Despite a continuation of the generally sluggish markets that characterized European electronics in 1971, there are enough bright spots to generate optimism among component makers that 1972 will end up better than last year. French manufacturers underscore this optimism with plans to introduce important new products, including integrated circuits for watch markets and other applications, liquid crystal displays, diversified instruments, and electronic components for automotive use.

British instrument makers are focusing special attention at the burgeoning market in vhf/uhf mobile radio systems and in communications generally. German companies, although not optimistic about the near-term prospects of the semiconductor and component market, view 1972 as the year for metal-oxide semiconductor devices to take off in terms of applications and production. The Germans also point out that the semiconductor price decline has been arrested, and that de-

mand for TV components continues strong.

French exhibits. Among French exhibits—which represent about 40% of the total—one highlight will be the introduction of Thomson-CSF's liquid-crystal display that changes color as voltage is raised and lowered. The firm will demonstrate it in a system with brilliant, solid, uniform colors that can be used on an X-Y grill to create images of alphanumeric. The formula for the crystals includes a proprietary additive, Thomson says, and this formula enables a relatively large surface to react uniformly to a given voltage. Also, the parallel alignment of the crystal's molecules is achieved by electrically controlled birefringence, a method which Thomson says has significant advantages over the more generally used dynamic scattering mode.

Sescosem, France's only native broad-line semiconductor supplier, will feature a 100-product line of temperature-compensated zener diodes, infrared emitters and couplers, an automotive IC that combines amplifier and oscillator functions, a complementary-MOS circuit for electronic watches, low- and medium-power thyristors, and power transistors.

British exhibits will spotlight new instruments, many of them aimed at makers and users of mobile radio systems. Two new instruments mark the debut of light-emitting diodes in British-made units. Both instruments are portable, taking full advantage of the low-voltage characteristics of LEDs. Marconi Instruments Ltd. will show a 6½-pound frequency counter intended for field-checking of mobile radio transceivers. It uses Hewlett-Packard's seven-by-four gallium arsenide phosphide diode matrices in a four-digit readout.

Also using LEDs is a 2½-pound multimeter from Solartron Electronics group. The four-digit readout uses seven-segment numerals, all on the same substrate, from Monsanto and Bowmar. Counters will be exhibited by Advance Electronics Ltd., SE Laboratories Ltd., and G. and E. Bradley Ltd. Among component features will be Plessey Company's lines of emitter-coupled-logic frequency dividers, integrated circuits for TV, and a variety of calculator chips.

West German MOS. In West Germany, volume delivery of MOS devices will get underway in 1972. Marketing officials at Siemens AG predict that the MOS market will double to about \$6 million. During the past year, Siemens has readied for mass production more than 20 MOS circuits of varying degrees of complexity, and for 1972 another 50 are planned. Besides using conventional manufacturing technologies such as high-voltage p-channel and nitride techniques, the company is increasingly concentrating on ion-implantation methods to come up with circuits capable of operating with less-than-10-volt supplies.

MOS components on the Siemens stands at Paris will range from low-complexity circuits with 20 to 40 gates per chip to devices with more than 600 gates on a chip smaller than 18 square millimeters. Applications are in telephone communications equipment, computer peripherals, and entertainment products.

Siemens will also show ICs for sensor-type channel selection in radio and TV sets, and low-speed logic ICs. AEG-Telefunken will exhibit a new delay line for TV receivers, using the French Secam color transmission standard, and a cathode-ray tube designed for transistorized broadband oscillographs. □

In telephone companies around the world, inclusion-free copper-clad laminates from Norplex provide the extra measure of dependability demanded by sophisticated communications systems. They are without equal for stress-free uniform quality and reliability.

The Lint-Pickers take such infinite pains in manufacturing a superior product, they have had to design much of their own quality-control

equipment. This way they can guarantee it will meet or exceed NEMA, MIL-P and customer specifications.

This careful attention to detail continues even after the sale. Your account is in the hands of an in-depth service organization, headed by your Norplex representative. He is an experienced laminate engineer, and a qualified problem-solving consultant in his own right. He is supported by a customer-service team on the "inside" and a technical service depart-

ment "outside" in the field. Together they offer readily available expertise second to none.

For the most complete line of laminates in the industry, call on the Lint-Pickers from Norplex Division, UOP (Universal Oil Products Company).

Main Office and Plant
Norplex Drive
LaCrosse, Wisconsin
54601
608/784-6070

Franklin Office and Plant
P.O. Box 186—
Route 31 North
Franklin, Indiana 46131
317/736-6106

How the Lint-Pickers keep the conversation clear.

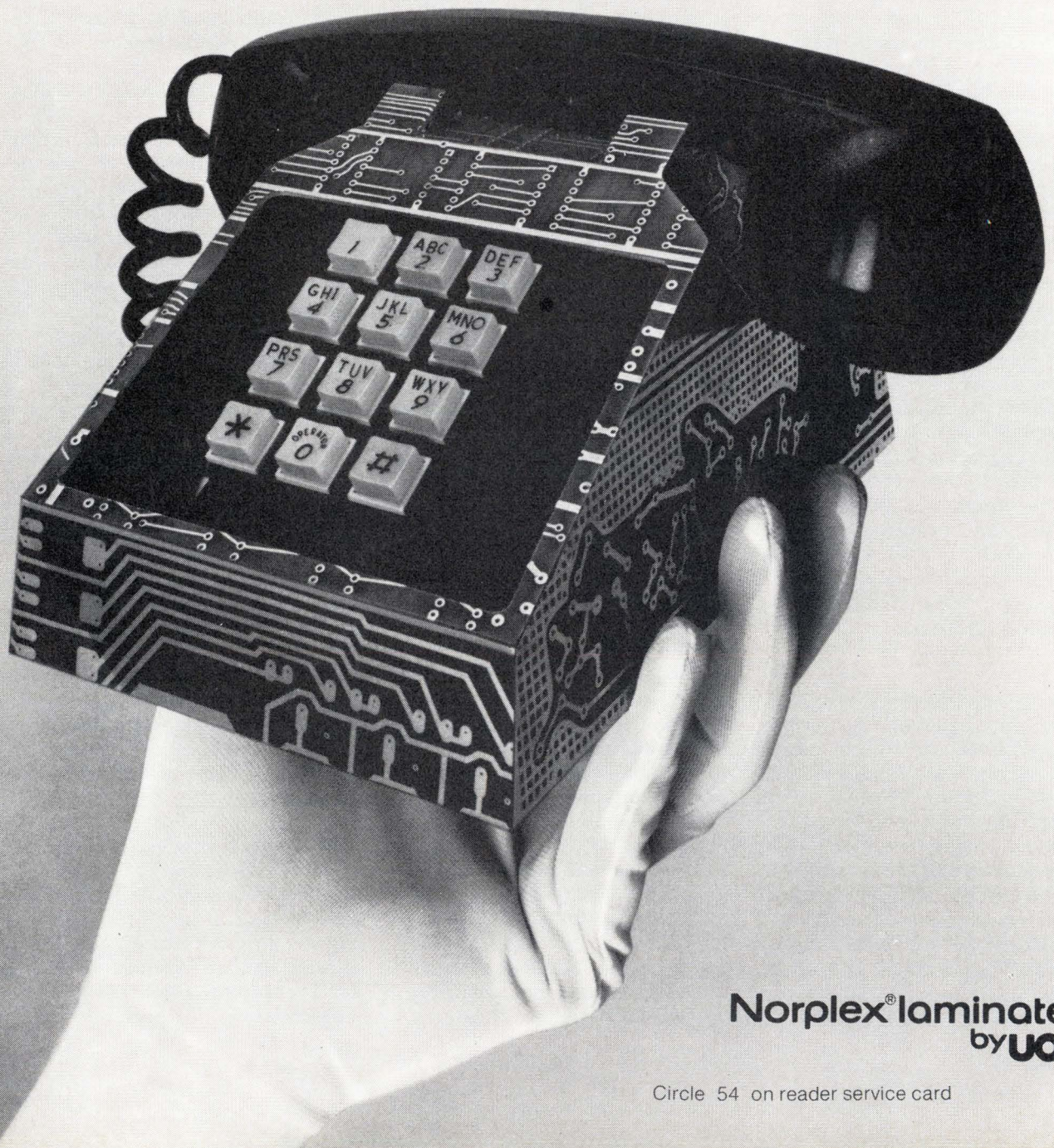

Norplex® laminates
by UOP

Circle 54 on reader service card

March 27, 1972

Russians and U.S. companies push to open Soviet market

The Soviet Union's drive to obtain high-level Western computer and data processing know-how for its economy is accelerating. Three groups—including banking, planning, and scientific research leaders—are to be sent to the U.S. soon to study American advances. It would be Russia's highest-level computer-related industrial delegation to have toured the U.S.

And the potential of the Russian market is a two-way street. American companies are eager to cash in—when export controls on many strategic items, such as large computers, are eased. Many observers expect an easing to be announced around May 22, when President Nixon is due in Moscow for summit talks. **Control Data Corp., for one, is reported to be near a sale of a CDC 6200 for use at the Dubna nuclear research institute.** And Russian sources say that Roy Ash, Litton Industries' chairman, is due to visit Moscow to promote Litton's sales prospects. An ITT team is planning a similar trip in early April. What's more, IBM is still awaiting U.S. Government approval for the sale of a System 360/50 brought to last fall's Leningrad computer show and then delivered to the chemical industry ministry. It won't be hooked up, Moscow sources say, until final approval of the deal.

Philips aims \$870 video cassette unit at consumer market

Starting in April, Philips will hit the market with video cassette recorders for consumer uses. **They will initially be distributed in several West European countries—including Belgium, Denmark, Luxembourg, the Netherlands and West Germany—with sales elsewhere following later.** The VCR equipment, for magnetic recording and playback of black and white and color tv programs, operates with 30-, 45-, or 60-minute cassettes. The price for a record/playback system incorporating a clock and a built-in color tv receiving section will be around \$870 on the German market. **A 60-minute cassette will sell for about \$43.**

East Germans show off liquid crystals at Leipzig Fair

East Germany's electronics industry, though generally lagging behind Western technology, is apparently doing well in some specific areas. At the Leipzig Spring Fair this month, East German component makers showed for the first time liquid crystal display elements for applications in desk calculators, measuring equipment, and other electronic indicating systems. The prototype devices, shown operating in time-indicating equipment, are now being offered to prospective customers, according to East German experts on the stands.

The seven-segment digit elements displayed in Leipzig are IC-compatible and consume less than 100 microwatts per digit. Designed for an ambient temperature range from 10° to 60°C, the new liquid crystal devices come in two sizes and feature response and decay times of about 100 and 200 milliseconds, respectively. The current requirements are from 1 to 2 microamperes.

Laser to read current flow in electric lines

An experimental laser-based instrument for measuring current flow may soon go to work on transmission lines of the Central Electricity Generating Board, Britain's national electricity utility. **Emission from a helium-neon laser at ground level is polarized and split into two beams**

directed at the end faces of two flint-glass rods, fixed one on each side of the conductor. The polarization angles rotate in the glass in proportion to the magnetic field induced by the current flow, but in opposite directions. The angle is measured on the ground in a double detector, which receives the beams reflected from the back faces of the rods. Two contrarotating beams enable common interference from adjacent lines to be detected easily. **CEGB men say the system offers, compared with the conventional technique, vastly improved bandwidth—30 to 50,000 amperes compared with 100 to 4,000 amperes—** better sensitivity to transients, 50% cost savings, and no effective limit on line voltage because no insulation is required.

Swedish defense budget leans toward unsophisticated gear

The Swedish government has proposed that about \$2.6 billion be appropriated over the next five years for defense material purchases and research and development. The sum was much less than the military had hoped for, even though it does constitute a slight increase over current appropriations. In presenting the proposal to parliament, defense minister Sven Andersson outlined **new Swedish thinking in the type of armaments this neutral nation will need in the future.** Defense will be aimed at preventing an aggressor from securing a fast footing in the nation, which in turn means creating deep defenses as well as forces in strength on coasts and the borders. **For electronics companies, that means a greater amount of less sophisticated weapons systems, rather than a few highly sophisticated ones, will be called on to do the job.**

Ion implantation scheme cuts uhf transistor noise

Mullard Ltd. reckons to halve noise in its microwave transistors by using ion implantation to implement an idea proposed by Shockley 25 years ago but not practicable until now. Using electron beam lithography, a fine nichrome-gold grid is built over the transistor surface, roughly at right angles to the emitter and base contact fingers. Boron implanted between the grid bars creates low resistance paths from the base contacts under the emitters to active base areas. Further, the grid bars are narrow compared to the emitter stripes, reducing base resistance into active base areas. **The combined effect on some test uhf transistors is to cut noise from 8 decibels to under 4 dB at 2 gigahertz,** mostly from a drop in base resistance from 56 to 14 ohms. The price is a sacrifice of about 15% in F_t . **The researchers believe the technique will provide 4-gigahertz devices with a noise figure of 2 dB, about half of what is quoted for the best devices presently available.**

Color TV cassette uses 8-mm film

A new color video cassette system that uses conventional 8-millimeter film has been developed by Vidicord Ltd. of Britain. **The Vidicord OR-1 will sell for about \$1,000 and will hit the teaching and training market early next year.** A home-market version is planned for 1975-76. The first prototype, introduced this month at the Vidca video cassette show in Cannes, France, uses a new EMI improved phosphor CRT with a 0.1 microsecond decay time and a 1.5-square-inch raster. Lawrence V. Mayhead, designer of the OR-1, says the new CRT uses less expensive photomultiplier tubes and eliminates the need for corrective electronics called for in slow-phosphor tubes. He claims the system's **main advantage is the wide availability and low price of compatible software.**

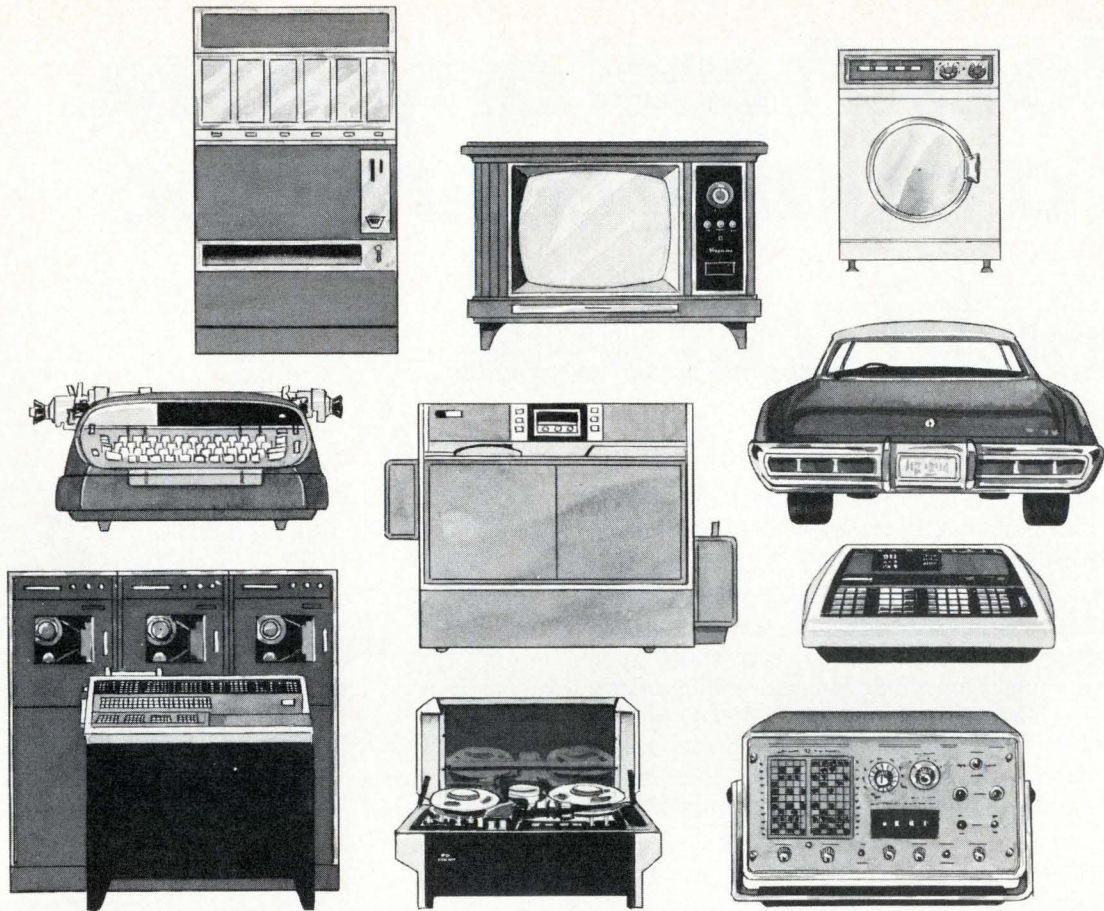

How many Cherry Switches can you find in these products?

HINT: Think big. Think of 97,650 switch configurations that let products like those above use mostly stock switches like those below. Think of Cherry's modern new facilities . . . with staffs of electrical, mechanical, tooling, industrial and manufacturing engineers guiding every phase of design and production. Think of 160 million switches produced during 19 solid growth years. And 104,000 more new switches passing through Quality Control every day, keeping our volume high . . . and our prices low.

How many Cherry switches can you put in your products? Find out: Check Cherry's latest big catalog. Send for your free copy today.



T20-01A Thumbwheel



261-0100 Key Module



E69-20A Panel Mount



E62-00A Subminiature



S31-20P "Goldie"

CHERRY

CHERRY ELECTRICAL PRODUCTS CORP.

3608 Sunset Avenue, Waukegan, Illinois 60085

Makers of patented Leverwheel/Thumbwheel Switches, Matrix Selector Switches, Snap-Action Switches and Keyboards.

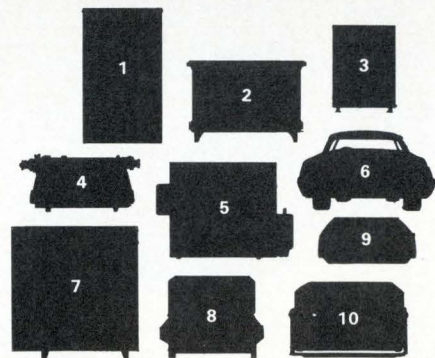

1. Vending machine, up to 10 Cherry switches.
2. A TV tunes with 2 Cherry switches.
3. Washer-dryer combination, at least 3, up to 7.
4. Electric typewriter, 1 or 2 Cherry switches.
5. Photocopy machine, a surprising 55!
6. An auto, 1 to 6 Cherry switches.
7. A computer has 2 Cherry switches.
8. Electronic video recorder, 5 Cherry switches.
9. Electronic calculator—63 Cherry "Goldies."
10. Digital data generator, 4 Cherry thumbwheels.

IT ADDS UP TO AT LEAST 146 CHERRY SWITCHES!

It doesn't cost any more for a quality connector. It could cost less.

How do we do it?

Well, first we design a totally new miniature rectangular connector that practices economy without losing sight of reliability. After all, you need both.

That's good, but we go beyond that. We offer you AMPECONOMATION—fast working automated application machinery in your own plant for high speed application of contacts. Depending on your requirements, machine capacities range from 2,000 to 12,000 finished terminations per hour with single applicator. So, whichever machine you choose, you're assured the greatest number of reliable contacts at the lowest applied cost.

Put them together—quality, low initial cost and lowest applied cost, and you've got a miniature rectangular connector that's hard to beat. Which is exactly as we planned.

Sound reasonable? It's more than that. It's downright economical, and the facts to prove it are available now. Just write **AMP Incorporated, Harrisburg, Pa. 17105**

AMP
 INCORPORATED

Manufacturing and direct sales facilities worldwide: Barcelona, Brussels, Buenos Aires, Frankfurt, London, Mexico City, Paris, Puerto Rico, Sao Paulo, s'Hertogenbosch (Holland), Sydney, Stockholm, Tokyo, Toronto, Turin, Vienna.

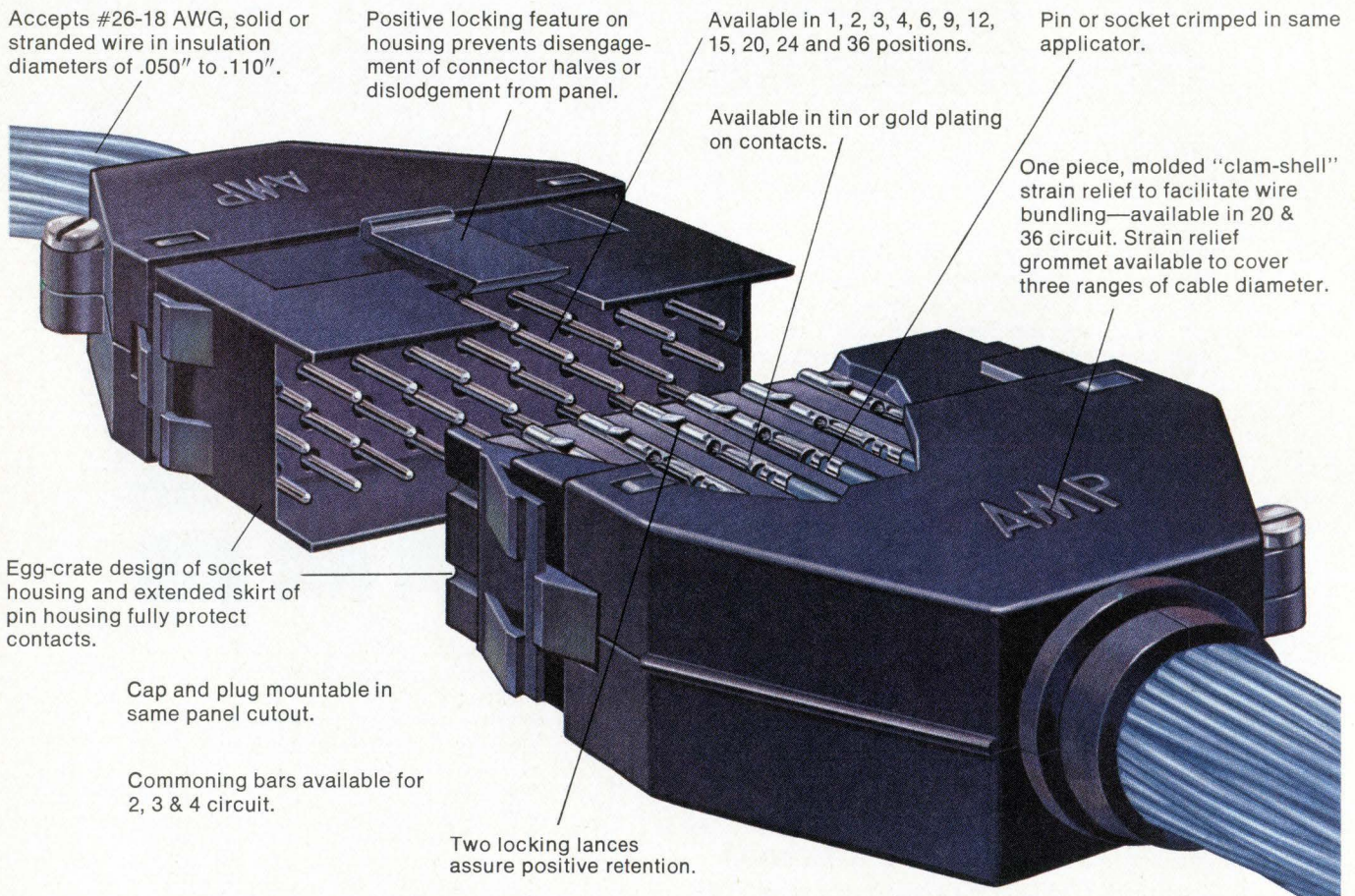

Accepts #26-18 AWG, solid or stranded wire in insulation diameters of .050" to .110".

Positive locking feature on housing prevents disengagement of connector halves or dislodgement from panel.

Available in 1, 2, 3, 4, 6, 9, 12, 15, 20, 24 and 36 positions.

Pin or socket crimped in same applicator.

Available in tin or gold plating on contacts.

One piece, molded "clam-shell" strain relief to facilitate wire bundling—available in 20 & 36 circuit. Strain relief grommet available to cover three ranges of cable diameter.

Egg-crate design of socket housing and extended skirt of pin housing fully protect contacts.

Cap and plug mountable in same panel cutout.

Commoning bars available for 2, 3 & 4 circuit.

Two locking lances assure positive retention.

Probing the news

Analysis of technology and business developments

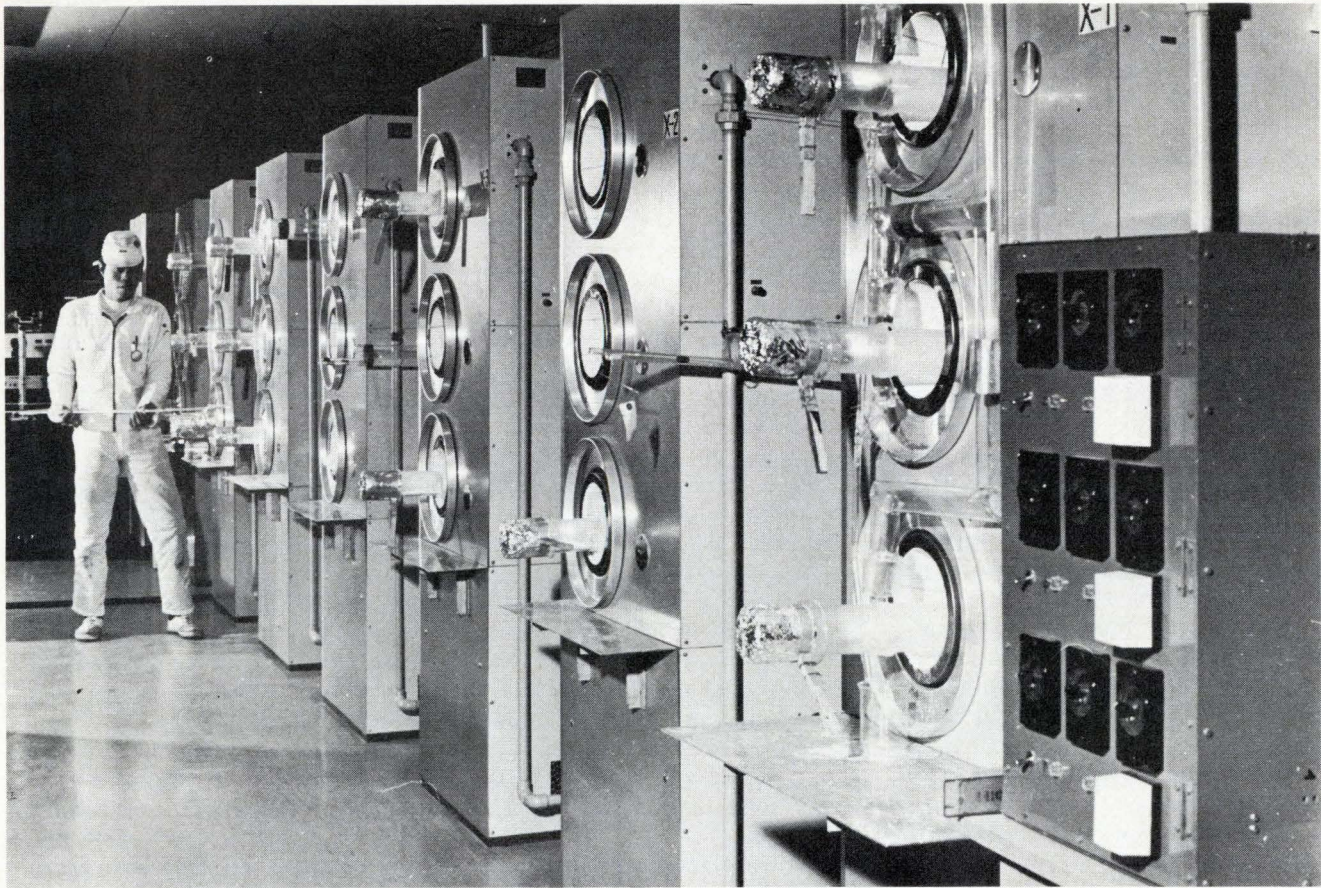

Japanese target: MOS markets

Manufacturers, taking dead aim at the computer memory potential, make determined effort to catch up in semiconductor technology

by Charles Cohen, Tokyo bureau manager

Japanese digital integrated circuit manufacturers are out to capture the fastest-growing IC market of them all—the metal oxide semiconductor memory market. By 1975, that market is expected to grow to \$400 million, an increase of 90% over today's figure. This added to the expected growth in calculators, business equipment, and consumer and government sectors will bring the estimated MOS market up to \$700 million by 1975.

Although the Japanese are aiming their heavy guns at memories, they will participate in all sectors of the MOS market—for example, in calculators, where they already have a beachhead in equipment and assembly. Only two years ago, 100%

of the calculator chips sold in Japan came from the U.S. By midyear the Japanese are expected to take over 45% of that market.

Competing with U.S. Using the most advanced n-channel silicon gate technology, Nippon Electric Co. is building random access memories that compete with the best that U.S. manufacturers are offering. For example, 1,024-bit RAMs with 220-nanosecond access times—for mainframe, buffer, and scratchpad memory—are already in production; units of 2,048, 4,096, and even 8,192 bits are goals, offering LSI circuit users speed-power products unheard of a year ago.

Like semiconductor manufacturers everywhere, Japanese com-

panies are relying heavily on new MOS technology to accomplish their aims in the digital IC market. Right now, production of digital ICs in Japan is about evenly divided between MOS and bipolar. In the next year or so, MOS production is expected to rise to about 60% of the total, but the ratio will not become more lopsided than that. Hiroe Osafune, general manager of the Semiconductor division at Nippon Electric Co. thinks MOS will overshadow bipolar because of its increasing use in computer peripherals and terminal equipment.

One of the most advanced memo-

On the way to MOS/LSI. At Toshiba, a thermal diffusion furnace is being loaded.

Probing the news

ries in production in Japan is a 1,024-bit memory using n-channel technology. Seitaro Tsuneki, assistant general manager of Nippon Electric's IC division, says his company's 1,024-bit n-channel memory now on the market outperforms Intel's 1103 in every specification, including compatibility with transistor-transistor logic for some types. Chip size is about 130 by 138 mils—slightly larger than Intel's chip.

N-channel in production. NEC's n-channel line includes a 512-bit dynamic memory, a 256-bit static memory (both available immediately), a 1,024-bit dynamic memory, to become available in April, and a 1,024-bit dynamic memory for TTL without drive or sense circuits, to become available in June.

Toshiba says that it is by-passing n-channel technology altogether and concentrating on development of complementary MOS. Mitsubishi claims to have developed n-channel MOS in its laboratory, but says it has no orders.

Hitachi Ltd. says it now can make MOS memories with 1,024-bits and bipolar with 256 bits. Ion implantation is under development, and Hitachi expects a product within a year.

Another general-purpose LSI

memory being built by NEC is a programmable metal aluminum semiconductor array [*Electronics*, Electronics International, Feb. 28]. Osafune says demand for that unit now exceeds supply. By the end of the year, he expects the company's memory business to total half of its LSI business. He adds that, in addition to the general-purpose LSI memories, NEC will also build devices for buffer memories, main memories, and read-only memories for microprogramming.

Hitachi, the largest producer of MOS in Japan, is now shipping samples of 100-bit and 1,000-bit Intel-compatible shift registers with silicon gates. The registers are aimed for use in terminals, such as teletypewriters and line printers.

In April, Hitachi plans to ship samples of 1103-type high-speed RAMs. And by the end of the year, Hitachi predicts that its non-calculator LSI business will reach about 10% of its total sales.

Who's making MOS. Other Japanese entries in MOS include Mitsubishi Electric Corp. and Toshiba Corp. Sony Corp. has produced some chips, and Matsushita Electronics Corp. expects to start production this summer, with Sharp Corp. beginning production units by fall. Fujitsu Ltd. has begun production of n-channel memories for its computers. Oki Electric Industry

Ltd. and the Seiko group of companies are expected to begin manufacture of logic chips for calculators and electronic watches.

So far, NEC has sold about 1.5 million bits of its 144-bit MOS memory chip, used in cache memories of Japan's Electro-technical Laboratories large-scale project computer, and in Nippon Telegraph and Telephone Public Corp. DIPS communications computer. NEC is also working on high-speed bipolar memories for internal use. But because all Japanese computer manufacturers make semiconductors, NEC doesn't feel there is a general market for bipolars in Japan.

Sueo Hattori, senior vice president and director, says NEC is producing 5 million bits of memory per month. And, when NEC completes its new production line at the company's plant in Kumamoto City in Kyushu this summer, it will add another 20 million bits to its monthly capacity.

Hattori says there is a good chance that NEC can compete with U.S. firms because costs are falling rapidly. Initially, NEC's price will be about 5 cents a bit for standard (64,000-bit) memory subsystems consisting of 1,024-bit devices mounted on printed circuit boards. But when demand begins to approach capacity, the price may go to 1 cent a bit, says Hattori.

Sacrifice now to gain later. The Japanese are dead serious about taking over the MOS market even if it means financial sacrifice at first. Osafune says NEC is willing to take a loss on its MOS so that it can keep production lines going and develop economical and reliable production technology. When the scene shifts to computer components, where NEC expects to be able to operate profitably, the company will be all set to go.

The effect of technical assistance agreements, such as between Texas Instruments and TI-Sony and North American Rockwell Micro-electronics Co. and Sharp, is difficult to gauge. The U.S. production know-how being transferred to Japan is probably at least two years old and confined to relatively unsophisticated devices. If the Japanese catch up with U.S. manufacturers, it will be on their own. □

A U.S. view of Japanese MOS/LSI technology

Hitachi, Nippon Electric, and Mitsubishi are recognized by U.S. Semiconductor makers as the main Japanese producers of MOS. But even these companies are considered to be at least a year behind the U.S. One American firm cites two limitations of Japanese MOS makers: "Their chips are relatively small, under 150 mils," and their computer-aided design for custom parts is "very limited," as regards both software and equipment.

Another source, James Imai, president of Imai Marketing Associates Inc., Sunnyvale, Calif., says that the Japanese are on the right track and that they will be successful in MOS "as long as no new technology comes along." In other words, it took them years to develop an MOS capability and if something new came along, it would take them years to shift their technology and build that up, too.

Imai believes this is a basic difference between U.S. and Japanese planning: in the U.S., many companies are working on many things at the same time, but in Japan the companies tend to work on one thing at a time and expect it won't be the wrong one.

At Texas Instruments, Eugene R. McFarland, semiconductor circuits marketing manager for the Dallas-based Components group, says that TI-Sony—a Japanese-manned and -managed company wholly owned by Texas Instruments—has the potential to pull alongside the U.S. in MOS/LSI capability. "They have assembly and test technology that's technically equivalent to that in the U.S.," he says.

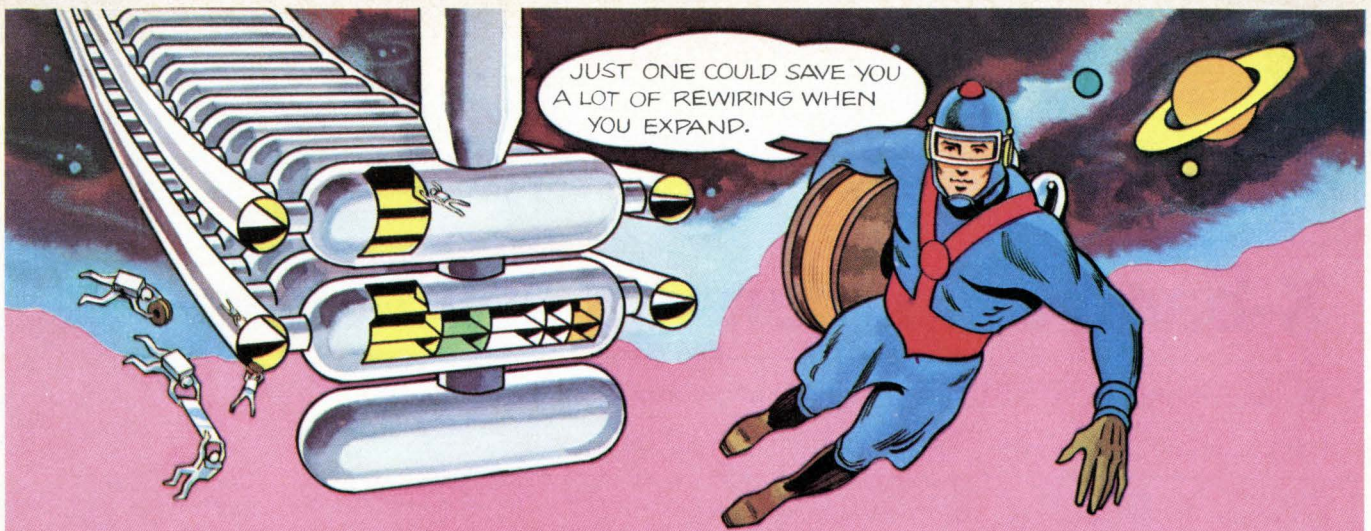

Brand-Rex produces over 3,000 new designs every year.

Every year we design over 3,000 new wire and cable configurations... because your needs constantly change. Each new design must be as sophisticated as the equipment it connects... so it's as right for tomorrow's applications as it is for today's.

That's why Brand-Rex products are designed into the first stages of so many of today's advanced systems, in the telephone/

communications; computer/peripheral; commercial/appliance; industrial/utility; and military fields. Even our tubing and sleeving and microwave dielectrics are made with the future in mind.

For our comprehensive All-Products Brochure, write to Buck Rogers, Brand-Rex Company, Willimantic, Conn. 06226. Or call (203) 423-7771.

BRAND-REX...WAY AHEAD IN WIRE AND CABLE



Components

X-band amplifiers go solid-state

By stacking up to five stages, designers at several companies have built amplifiers with 1-W output and 30-dB gain

by Lyman J. Hardeman, *Communications & Microwave Editor*

The high-gain solid-state X-band amplifier is about to poke through a number of technological barriers and emerge as a practical component in microwave relay systems. Because of greater reliability, lower power requirements, and potentially lower costs of solid-state amplifiers, the day of the travelling-wave-tube amplifier for systems requiring 1- to 2-watt output with 30-decibel gain is ending.

Design engineers at several microwave houses have recently overcome the major problems in achieving stable amplifiers with high gain over bandwidths of several hundred megahertz. In every case, multistage amplifiers are proposed—but that's about all the designs have in common. Numerous combinations of negative-resistance amplifiers and injection-locked oscillators are being used, with both Gunn and Impatt diodes as the active elements.

As frequency allocations at the lower end of the microwave spectrum become saturated, the market for solid-state X-band amplifiers, industry spokesmen predict, will call for at least several hundred units a year for the next few years.

Companies in the race include Hewlett-Packard, Hughes, Raytheon, Microwave Associates, and Watkins-Johnson.

The engineers at Hewlett-Packard Co., Palo Alto, Calif., have changed over from conventional amplifier designs to a two-stage injection-locked oscillator that achieves 1-W output with 30-dB gain. Over-all efficiency is about 4.5%. The amplifier consists of a varactor-tuned Gunn-diode first stage, followed by a fixed-tuned Impatt diode output stage.

H-P feels its approach is the most economically viable in the commercial market. "We will soon be able to sell this amplifier for under \$800 in quantities of 100," predicts Del Hanson, project manager responsible for the amplifier's development.

ILOS. The advantages of an injection-locked oscillator over reflection-diode amplifiers are, according to H-P: greater gain per stage over the desired bandwidth, higher efficiency, less sensitivity to temperature, and lower cost.

Hughes Aircraft's Electron Dynamics division of Torrance, Calif., makes a commercial amplifier that operates in the 7-to-11-gigahertz band. The two-stage silicon Impatt unit yields 10-dB gain with 1-W minimum output. Single diodes power each stage. The amplifier sells for under \$1,000 each in lots of 100.

According to Richard Johnson, marketing manager for solid-state devices at Hughes, the company is presently developing injection-locked oscillators to give greater than 20-dB gain to drive its commercial unit. "Adding a high-gain unit like this would just about double the sale price," says Johnson.

A third manufacturer developing injection-locked oscillators is Raytheon's MicroState division, Waltham, Mass. Its 30-dB gain design comprises three stages—all powered by GaAs Impatts, a company specialty.

The first stage gives about 10-dB gain with a broadband amplifier for operation at all X-band frequencies. An injection-locked Impatt-diode second stage yields some 17-dB gain with up to 300-MHz bandwidth. Finally, a single Impatt diode adds

about 4-dB gain to give 1-W output.

The noise added in the last two stages of the amplifier is 50 to 75 picowatts in a 3-kilohertz bandwidth 5.5 MHz away from the carrier. Since the amplifier is being developed for digitally modulated systems, lower noise was not a goal. The company feels that, if necessary, this noise added figure can be reduced to under 20 pW.

Microwave Associates, Burlington, Mass., puts four cascaded Gunn-diode stages together to obtain 30 dB of gain and a 1-W output. Says Allen A. Sweet, who engineered the design, "Trying to get that gain with fewer stages makes the amplifier susceptible to spurious oscillation."

Staging. With a 1-mw input, the gain of the first stage is 10 dB. The second and third stages add 10 dB and 5 dB of amplification. Two parallel diodes in the output stage boost the signal level by 5 dB to the 1-W output. The four-stage amplifier operates at an efficiency of 2% with a noise figure of 16 dB.

An amplifier built by Watkins-Johnson Co., Palo Alto, Calif., achieves 30-dB gain at X-band, but uses Impatt diodes in the last three of five stages. Gunn devices power the first two stages, and were chosen over Impatts to get lower noise.

"An important advantage in these amplifiers over the traveling wave tube," says Keith Kennedy, head of W-J's solid-state research and development, "is that stages can be added almost indefinitely. Each stage contributes up to ± 0.2 -dB additional gain across a typical 5% band, but compensation can be made in higher-gain units to flatten the over-all response." □

Bendix printed circuit board connectors put an end to close order drilling.

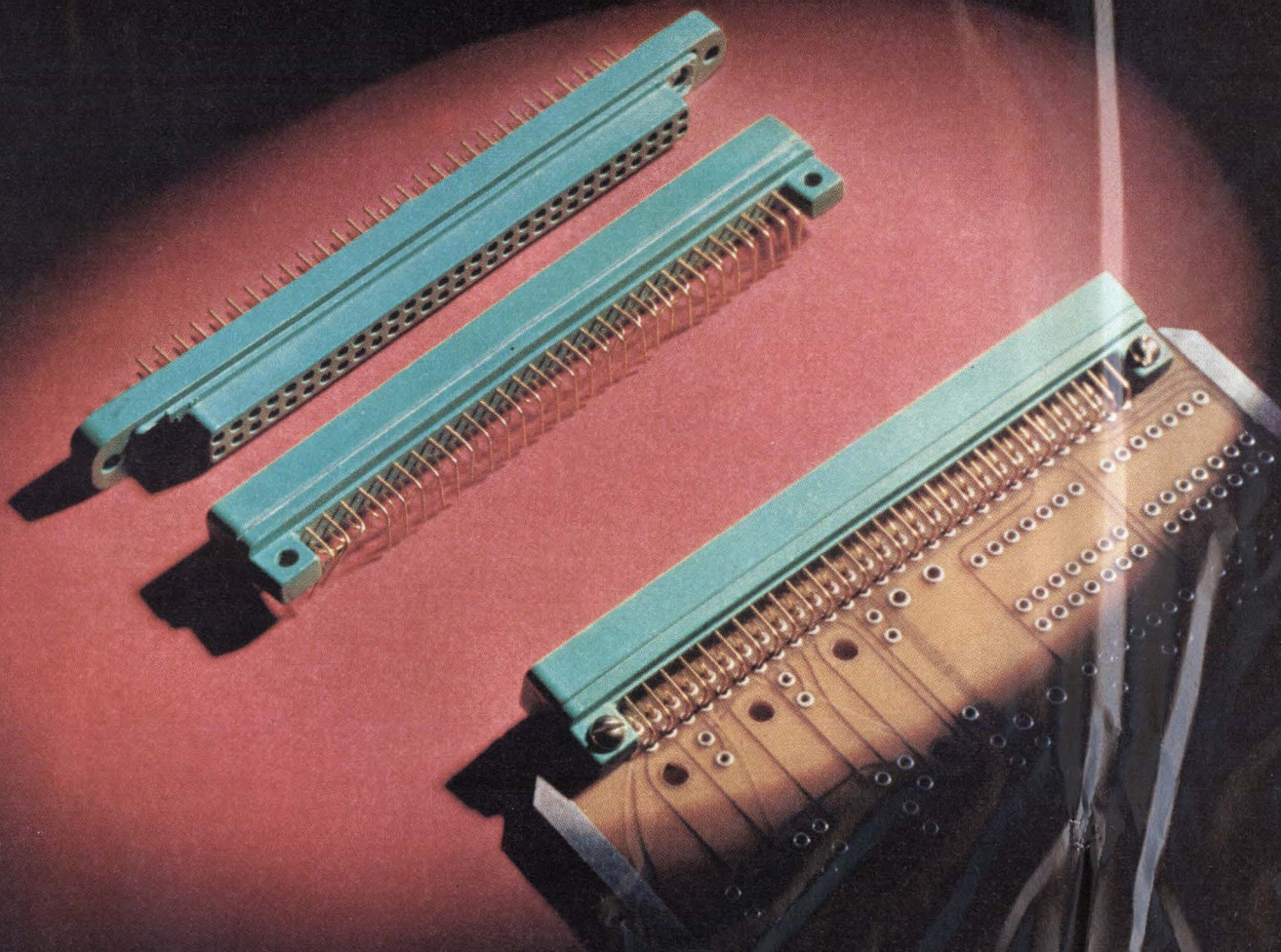

You know close order drilling. It's what's called for to produce ultraprecise hole locations in printed circuit boards. Eliminate this need and you'll cut costs for sure. Bendix P.C.B. connectors help you do precisely that. Their optional floating pin terminations "give" enough to make it easier to align pins with the printed circuit board holes.

Bendix boasts other features, too. Options like wire wrap or solder termina-

tions. Straight or right angle. Insertable crimp contacts.

Applications? Wherever printed circuit boards are used, such as switching circuits, computers, business machines, process controls, etc.

Chances are, Bendix Printed Circuit Board connectors can help you. Why not find out. The Bendix Corporation, Electrical Components Division, Sidney, New York 13838.



Signetics chooses 10,000

Two years from now you'll wonder why you waited.



Take the time for a good hard look into ECL 10,000's high speed/performance advantages. And engineer your own head-start into tomorrow's optimized logic. Available today—and tomorrow—from the major new source for ECL series 10,000. Signetics.

Because Signetics never settles for less than total IC capability, we researched your future requirements in high speed logic. And cut through the claims of existing ECL alternatives without mercy. All the know-how, the back-up, the all-out commitment you expect in Signetics linear, digital and MOS, stands behind our development and production of proven, line-ready ECL 10,000 devices.

What's in it for you? A constant reliable supply of the best high speed/low power trade-off yet. Typical speed level: 2.0 ns propagation delay per gate. Low power dissipation of 25mW—with no special cooling required in any environment, still air or forced. Switching rise and fall times compatible with conventional system layouts (3.0 ns edge speed).

ECL 10,000 delivers outstanding design/function flexibility. Multi-

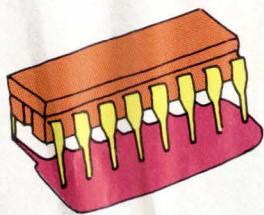

level gating on a single chip, through open emitter outputs and high impedance inputs, means a significant savings in gate and package count. Plus a free choice of terminating schemes and logic interconnects.

Packaged in plastic Silicone DIP or Cerdip, Signetics ECL 10,000 line will provide a complete high speed logic family—some already on-shelf in factory or distributor stock, the remainder due by summer.

Signetics DUAL 3-INPUT 1 OR/2 NOR OUTPUT GATE 10112
10112 B-E - 25 to 100°C

DIGITAL 10000 SERIES ECL

DESCRIPTION
The 10112 is a dual in-line package 3-input 1 OR/2 NOR output gate. The 10112 is designed to be used in either common-emitter or common-collector. The output modes of this device are either the open-emitter or the open-collector mode.

PACKAGE TYPES
P - 16 Pin Plastic DIP
F - 16 Pin CERDIP

TEMPERATURE RANGE
10°C to 100°C (Standard)

RECOMMENDED OPERATING VOLTAGE
*V_{CC} = 5.0V to 10.0V

CIRCUIT SCHEMATIC

Contact your Signetics salesman, rep or distributor for availability information. He will also rush you our informative ECL 10,000 booklet, free upon request. Or write Signetics/ECL directly, 811 E. Arques Avenue, Sunnyvale, California 94086.

SIGNETICS ECL 10,000 SERIES

- | | | |
|--------------------------------------------|---------------------------------------------------|-------------------------------------------------|
| 10101 Quad 1-Input OR/NOR Gate | 10112 Dual 3-Input 1-OR/2-NOR Gate | 10130 Dual D-Type Clocked Latch |
| 10102 Quad 2-Input NOR Gate | 10113* Quad Exclusive-OR Gate/Comparator | 10131* Dual D-Type Master-Slave Flip-Flop |
| 10105* Triple 2,3,2-Input OR/NOR Gate | 10115* Quad Differential Line Receiver | 10161 1 of 8 Demultiplexer/Decoder (Low) |
| 10106* Triple 4,3,3-Input NOR Gate | 10116 Triple Differential OR/NOR Line Receiver | 10162 1 of 8 Demultiplexer/Decoder (High) |
| 10107 Triple 2-Input Exclusive OR/NOR Gate | 10117 Dual 2-wide 2,3-Input OR-AND/OA Invert Gate | 10170* 9 + 2-Input Parity Circuit |
| 10109 Dual 4,5-Input OR/NOR Gate | 10118 Dual 2-wide 3,3-Input OR-AND Gate | 10171* Dual 1 of 4 Demultiplexer/Decoder (Low) |
| 10110 Dual 3-Input 3-Output OR Gate | 10119* 4-wide 4,3,3,3-Input OR-AND Gate | 10172* Dual 1 of 4 Demultiplexer/Decoder (High) |
| 10111 Dual 3-Input 3-Output NOR Gate | 10121* 4-wide 3,3,3,3-Input OR-AND/OA Invert Gate | |

*Coming soon.

Signetics

Commercial electronics

Unmanned banks—a new investment

Automatic teller stations offering up to 80% of banking functions promise to generate a billion-dollar market in next few years

by Marilyn Offenheiser, New York Staff

Any investment-minded banker with an extra \$12,000 to \$50,000 can cash in with a new automated banking machine. An automated teller can handle 80% of the bank's functions—including withdrawals, deposits and transfers—and save a bank about \$10,000 a year, according to a cost study done by Payment Systems Inc., New York City, for the Mosler Safe Co.

The market is just opening up. Already 350 automatic tellers have been installed, and 300 more are on order for the 75,000 banks in the United States. "We expect a market in the billions [of dollars] over the next few years," says Justin Guidi, president of Digital Security Systems, a leading manufacturer of automated banking equipment.

In addition to Digital Security Systems, Natick, Mass., other automatic teller makers include Docutel, Irving, Texas; Mosler Safe Co., Hamilton, Ohio; Diebold Inc., Canton, Ohio; and Burroughs Corp., Detroit, Mich. As the market grows, however, other companies providing equipment to banks now—including IBM, Poughkeepsie, N.Y. and Optel Corp., Princeton, N.J.—can be expected to expand further into the automatic banking market. "Right now," says Earl Ward, Mosler's marketing manager of automated products, "the market is much greater than we can supply."

Europeans were among the first to install cash-dispensing systems in their banks, but have been slow on the uptake with automatic teller stations. Leading makers for the laggardly market are England's Smiths' Industries Ltd. and Chubb & Son Ltd., France's CIT, Germany's Siemens AG, and Sweden's Metior AB.

In Japan, the front runners are Fujitsu Ltd., Oki Electric Industry Co. Ltd., and Omron Tateisi Electronics Ltd.

'Mini' heart. The automated bank teller, with a minicomputer as its heart, uses printers, card readers, and optical and magnetic sensing equipment. To activate the machine, a user inserts a credit card encoded with a magnetic stripe and then punches his account number on a keyboard. The computer is programmed to "capture" stolen cards, but if the card is good, the user pushes the proper button to complete his transaction, and a printer delivers a receipt.

None of the teller stations on the market is compatible with each other and "won't be, since none wants to change," according to Ward. But the American Banking Association has set up a standard

for the magnetic stripe, which must be encoded at 75 bits per inch, 40 characters on a single track. A problem is that the magnetic stripe can be rubbed, scratched off, or altered. A Diebold spokesman says that the company is now embedding the stripe into the card. The magnetic stripe approach is not mandatory, however—Digital Security Systems offers an automated teller that uses a punched plastic card.

Mechanics to electronics. "On the whole, teller systems still have a lot of mechanical parts, but we are converting to total electronics as fast as we can," states Robert Faught, marketing manager at Docutel. The Docutel teller uses a core memory in the minicomputer and MOS circuitry. "But the closest thing to optoelectronics right now is the photocells we use to check for error," continues Faught.

Automatic teller Units offer 24-hour banking and provide 80% of services. There are 350 units in operation in the U.S., 300 more on order.



NEW



COMPONENTS BENDING TOOL

Bending Length: min. mm. 12 max mm. 50

CUT AND BEND TOOL

NEW



Cuts lead wires from \varnothing 0,3 to 1,5 mm.

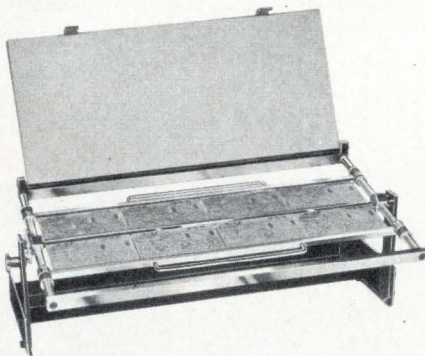
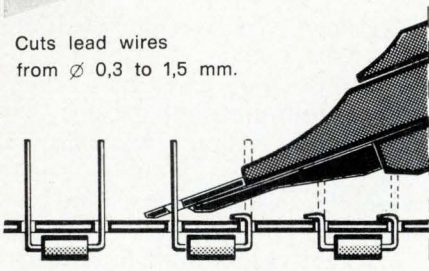

HOLDER FOR PRINTED CIRCUITS

PCS/2M for printed circuits 200x250 mm.
PCS/3G for printed circuits 200x450 mm.

ELMEC SASSO MARCONI - (Italy)
P.O. BOX N. 1750
40100 BOLOGNA

AGENTS AND DEALERS REQUIRED.

**SALON
DES
COMPOSANTS ELECTRONIQUES
PARIS 6 - 11 AVRIL 1972
ALLEE 13 - STAND 114**

Probing the news

Burroughs is upgrading its model RT2000 automated teller, which has been marketed in the United Kingdom for the past year. The Burroughs teller uses a controller to check the reliability of the logic circuitry. Although Burroughs is using diode transistor logic now, the company says MOS/LSI will be introduced soon. The system operates from a microprogramed head-per-track disk memory that completes a transaction in 7 seconds. "Other systems have 30-second transaction times," says Burroughs' John Healy, corporate production manager, "and that can be an eternity for the user."

Going on-line. None of the tellers is on-line to a central computer now, although each company claims to have that capability. Data is stored mainly on punched paper tape, but other options are available. "Now, someone has to collect the information periodically from the teller," says Ward. "But when we are on-line, the information will go directly into the bank's central processor." However, Digital Security's Guidi predicts that developing on-line software programs will deter conservative bankers. "It takes time to set up special software programs

that have to be incorporated in the bank's central computer," he says.

Another problem is created by the banks themselves: because it's a legal hassle to get a branch charter, most bankers are opting for terminal installations in their bank lobbies or vestibules to reduce operational costs and provide 24-hour service. So far, only one bank, the Huntington National Bank of Columbus, Ohio, has installed an automatic teller as a branch. However, Columbus City National bank, says vice president John Fisher, "will eventually open an unmanned branch bank for drive-in customers, as well as pedestrians."

Eliminate money? The Hempstead Bank of Syosset, N.Y., is taking another route. Point-of-sale terminals, installed by participating local merchants, have been hooked up on-line to the bank's central processor. Besides dispensing cash, purchases made in the stores are automatically transferred from the customer's checking account to the merchant's. The bank's aim is to eliminate both checks and credit cards—perhaps even money itself.

Eventually," says Michael Shade, vice president, "the bank will be authorized to pay a customers' bills—such as utilities—directly. This will eliminate paperwork, and eliminate the branch bank altogether." □

Banking on electronics

How does a business like banking become technologically oriented? The routes to automation are various: the progressiveness of a technically oriented bank chairman, close association with a bank supplier, and employing men from other fields.

Six years ago, Bruce Wood Hall, chairman of the Hempstead Bank, Syosset, N.Y. found himself unable to get a check cashed on a trip. Hall, trained in construction engineering, got together with the bank's executives, drew up a plan in laymen's terms, and began knocking on doors. Two years ago, the bank hired an engineering consultant after the initial terminal contract was farmed out. "We should have hired him five years ago," says vice president Michael Shade. "We were like fish out of water. This has been a real learning experience."

The Huntington Bank, Columbus, Ohio, has had a long association with the Mosler Safe Company, a supplier of bank vaults and safes. When Mosler decided to expand its services, the Huntington Bank naturally went along with the tide, relying on the technical expertise at Mosler. "But a bank does need someone who is technically inclined," says David Cottie, vice president, who himself has a background in engineering.

John Fisher, vice president at Columbus' City National Bank came out of the radio business. Says Fisher: "A bank today has to import and attract men from other industries. Our data processing group is from the computer field. It's the job of these men to keep abreast of technology and develop relationships in the field."

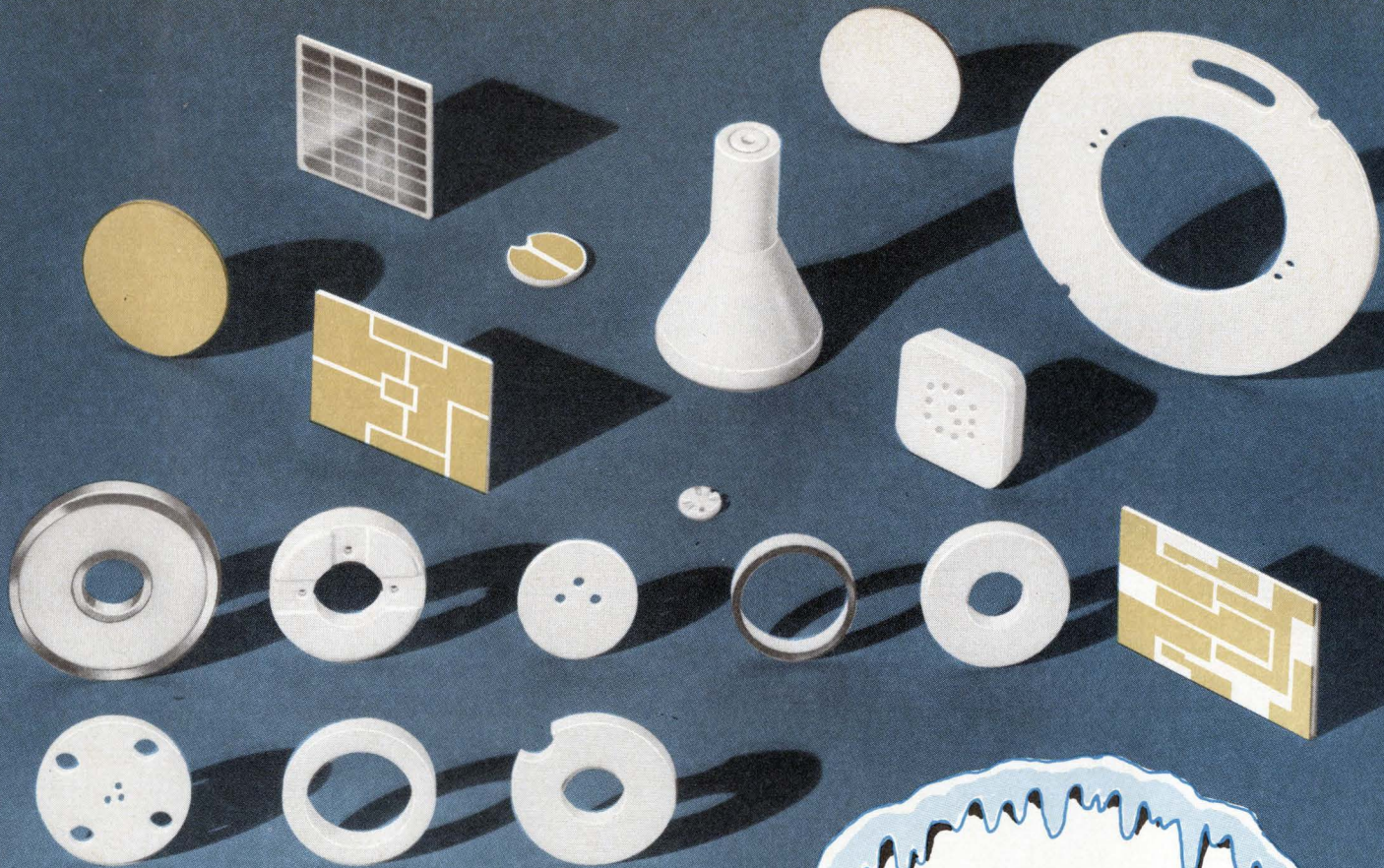

ALL PARTS
APPROXIMATELY
ACTUAL SIZE

 Precision insulators: .089" triangle, .060" thick with hole .024".

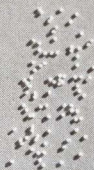
 These parts are .020" x .012". A lady's thimble will hold more than 10,000.

COOL IT!

COOL IT WITH

AlSiMag[®]
BRAND

BERYLLIA[®]

The electrical insulator that conducts heat

Get rid of fans, blowers, conduits . . . save space, cost, time . . . improve performance and reliability with this superior electrical insulator that **conducts** heat!

Widely used as substrates and heat sinks. Can be produced in complex shapes to close tolerances. Custom metallization. Thick film precision pattern generation. Molybdenum plus nickel base for direct soldering. 100 microinch gold also available. Stock items or prototypes permit you to evaluate.

Bulletins 703 and 693 on request.

American Lava Corporation



PHONE 615/265-3411 • CHATTANOOGA, TENN. 37405, U. S. A.

A SUBSIDIARY OF

Circle 67 on reader service card

Communications

Ship-satellite system sought

Proposed network, to be operational by 1980, would provide navigation and communications for ships on Atlantic, Pacific, and Indian Oceans

by William F. Arnold, Aerospace Editor

A worldwide satellite communications and navigation network to connect 4,460 large vessels with computerized data links is being jointly advanced by planners in the U.S. Maritime Administration and the shipping industry. Still in the planning stage, the network would cost at least \$256 million over a seven-year installation period, including satellites, ground terminals, shipboard terminals, and land-leased circuits, according to industry estimates.

The proposed Maritime Satellite System (Marsat), to begin operation by 1980, would cover the Atlantic, Pacific and Indian Oceans. Each satellite would use global coverage antennas; four large-antenna ground stations would reduce satellite power requirements; and a network control center would use large computers to direct communications traffic. Shipboard terminals would include automatic-pointing antennas and computers to process communications data. Ship-to-satellite links would use the L band, and satellite-to-shore communications would use the C band. The network would use existing technology, say its backers.

The system most likely would be privately run. Possible operators would be an Intelsat-like group, the Communications Satellite Corp. (Comsat), private companies, or a consortium of maritime interests. A network that would combine Marsat and the proposed Aeronautical Services Satellite (Aerosat) looks favorable.

Brass key. "Satellite communications and navigation capability will be the greatest thing to ever hit the U.S. maritime community," says

Edward P. Fitzgerald, chairman of the advisory telecommunications special committee for the American Institute of Merchant Shipping (AIMS), an industry trade group promoting the system. He points out that 93% of the messages aboard ship today are sent by "brass key" telegraphy in Morse code at a slow rate and require six hours delivery

time. The new network would "give 1-minute access time to any ship in the world" with "land-line quality" facsimile, digital, and real-time communications, Fitzgerald says. "It costs 38 cents a word today," he adds. "You could send it for about 6 cents with satellites."

The Maritime Administration also considers such a network long

All the ships at sea. The proposed maritime satellite system would use C-band ship-to-shore, L-band ship-to-satellite links for fast global communications and navigation.

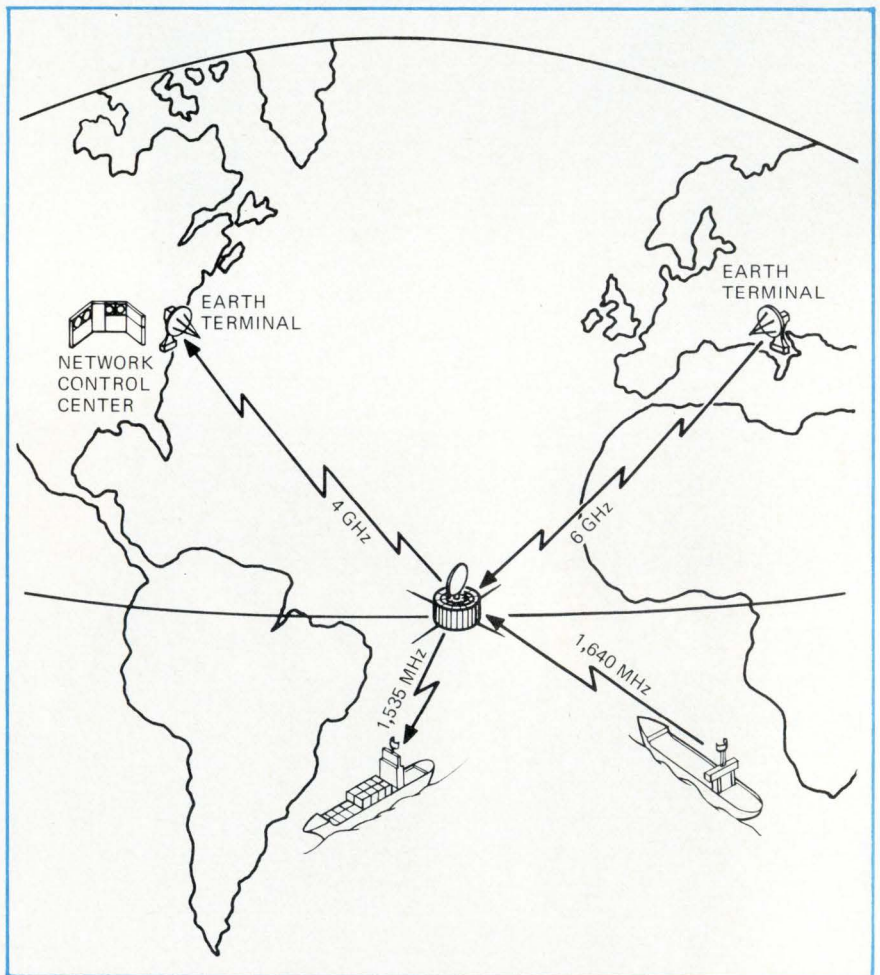

overdue. "We have a tremendous asset in space technology that heretofore hasn't been used in the merchant marine," says Stanley D. Wheatley, chief of the Office of Advanced Ship Operations, who adds that the system is an effective way for fleet owners to keep competitive. Ship size and costs are increasing, and, even though they handle more cargo, vessels have to be kept at sea longer to recover the huge investments by their owners.

Phase two of a four-phase experimental program leading to an operational domestic system is being started by the Maritime Administration, says Harry A. Feigleson, program manager. Nine merchant ships will be selected, along with a Maritime Administration ship, for a test of shipboard terminals late this year. The five-month test will use NASA's Applications Technology Satellites (ATS) 3 and 5.

Unfortunately, says Feigleson, the ship-to-satellite test will use C-band, the Intelsat frequencies of 4 and 6 gigahertz. "They're the wrong frequencies, but we can get the systems techniques checked out." Maritime is dickering with NASA for L-band space—either on the upcoming ATS F or G—to test the system pre-operationally as phase three.

Operational. A prototype system should begin operating in 1975, about the same time the Aerosat is to be ready, Feigleson says. The prototype system would use four satellites—two over the Atlantic and two over the Pacific—and existing earth stations. He estimates the cost at about \$150 million.

But, "you may need more than six satellites in a worldwide operational system," he says. "It depends on whether or not you have navigational services in the satellite."

S-cubed. Also as part of the \$3 million phase-two effort, the Maritime Administration is gaining experience with ground station technology at the National Maritime Research Center, Kings Point, N.Y. Here, the new Maritime Data Coordination Center will spearhead antenna tracking and control center research, Wheatley says. The satellite project is part of a program, called S-cubed (for Ship/Shore/Satellite), that is designed to spur shipboard automation and comput-

erization, he says.

The comparatively low initial investment should attract users, says the Initial Maritime Satellite Consortium (Imasco), composed of large corporate fleet owners. Officials estimate that a shipboard terminal would cost about \$22,000, including about \$9,000 for installation. Deck and mast-mounted equipment would include a high-gain antenna, automatic tracking unit, duplexer and rf lines, preamplifier and preselector, totaling about \$7,000. Below-deck gear, costing about \$6,100, would include up/down converters, voice, data, and access control modems and a 100-watt power amplifier.

By 1980, Imasco officials foresee Marsat accommodating simultaneously as many as 1,500 vessels in the Atlantic. Each ocean would be served by a maximum of 10 equivalent voice channels, of which teletypewriter traffic would require only one-quarter the effective satellite power of voice circuits. Small, simple satellites—requiring less than 500 watts of dc power—would be used. Ships would be polled for messages. Estimated traffic per ship per day would be about 2.5 minutes each of business and crew personal radio-telephone and 200 words of radio-teletypewriter traffic.

Easy money. The network would return its investment in a relatively short time, according to a confidential Imasco study. With the 4,460 potential subscribers, which comprise only 30% of the projected world's large vessel fleet, the network would completely pay for itself in seven years. "The system is not only self-supporting, it is profitable," the AIMS-backed study says.

Several additional factors are propelling Marsat. In addition to proven satellite technology, a mandate was given the Maritime Administration by the 1970 Merchant Marine Act to upgrade the Merchant Marine. The strong interest by oil companies is indicated by Imasco, composed of representatives of British Petroleum Tanker Co., Shell International Marine Ltd., Sea Land Services S.S. Co., the Standard Oil Companies of New Jersey and California, and their affiliates, Esso International, Humble Oil Co., and Chevron Shipping. □

So you want to handle everyone's DIPs...

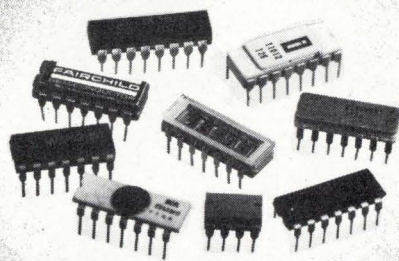

You can, with our new test handler. It handles 8 to 18 lead packages.

For more information on how you can save money in your test area, contact:

**International
Production Technology**

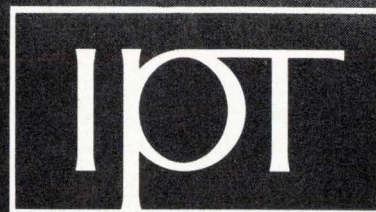

185 Evelyn Avenue
Mountain View, CA 94040
• (415) 961-9521 •
HOT LINE (415) 961-2458

Computers

IBM threat to hold back service vexes industry

Computer giant has refused to service some machines with enhanced memories; are the changes that drastic?

by Wallace B. Riley, Computers Editor

Some users of International Business Machines Corp.'s System 360 are finding that IBM won't maintain their machines because they've enhanced the main memory beyond the IBM-specified maximum capacity. A maker of these memories, Advanced Memory Systems, Inc., got so worried at the turn of events that it haled IBM into court. The legal hassle hangs on the changes required for expanding IBM computer memories.

Memory enhancement (as distinguished from memory add-on, which does not exceed IBM's maximum) requires some internal changes to the central processor. IBM says these changes render the machine unfamiliar to its servicemen, and therefore unserviceable.

Thus far only users of System 360 model 30 with enhancements from Data Recall Corp., El Segundo, Calif., have received these notices. But the development worries at least four other leading companies—Advanced Memory Systems Inc., Sunnyvale, Calif.; Ampex Corp., Marina del Rey, Calif.; Fabri-Tek Inc., Minneapolis, Minn.; and Electronic Memories & Magnetics Corp., Los Angeles, Calif.—as well as users of larger models of the 360 where enhancement requires fewer changes than on the model 30.

The 360/30's specified memory capacity ranges from 8,192 to 65,536 bytes. Data Recall has enhanced some of them to 131,072 bytes.

Complicating the situation is the slack in IBM's revenues from System 370 sales, because customers are trading in their 360s for 370s at

nearly a one-for-one rate. Says Frederick G. Withington, a computer-industry analyst at Arthur D. Little Inc., Cambridge, Mass., "This cuts sharply into IBM's income and for multiple trade-ins may even represent negative income."

Worse yet for IBM, many customers who previously replaced their IBM peripheral equipment with compatible gear from independent makers at lower prices are now trading in their 360s for new 370s, but keeping the old non-IBM peripherals. Thus IBM is getting hit twice by the same competition.

Modifications. What are these changes that IBM says cause so much difficulty for its servicemen? "The biggest one is an extra bit position in each of the five address registers in the model 30," says Edward V. Garcia, vice president, technical operations, at Comma Corp., a large independent maintenance firm.

Doubling the memory size requires an increase in the address length from 16 to 17 bits. In addition, the "wrap-around" detection logic, which warns that a program has called for a memory location beyond the maximum, must be modified, as does the address decoder, which now must decode 17 bits instead of 16. Finally, the microprogram must be changed.

Architecturally, all models of the 360 are geared to a 24-bit address, capable of directly addressing over 16 million bytes. But physically the smaller models, like the 360/30, are restricted to much lower capacities. Modifications in the 360/30 are more extensive for memory en-

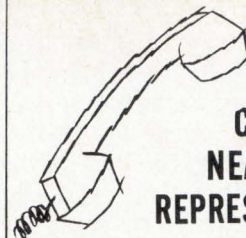

**CALL YOUR
NEARBY ERIE
REPRESENTATIVE**

CALIFORNIA

Palo Alto • 415-327-1520
Santa Ana • 714-835-4822

FLORIDA

Winter Park • 305-644-0954

ILLINOIS

Des Plaines • 312-297-5560

INDIANA

Fort Wayne • 219-743-4418

MASSACHUSETTS

Wakefield • 617-245-7880

MINNESOTA

Minneapolis • 612-545-2526

NEW JERSEY

Montvale • 201-391-3403
Pennsauken
(New Jersey) • 609-665-4787
(Philadelphia) • 215-925-9228

NEW YORK

Liverpool • 315-457-5935

NORTH CAROLINA

Greensboro • 919-299-1905

OHIO

Dayton • 513-293-6959

TEXAS

Dallas • 214-827-4401

**WASHINGTON, D.C./BALTIMORE,
MARYLAND**

Ellicott City • 301-465-8450

EXPORT SALES

PENNSYLVANIA

Erie • 814-453-5611

CANADA

Trenton, Ont. • 613-392-2581

ENGLAND

Erie Electronics Ltd.
S. Denes,
Great Yarmouth, Norfolk

GERMANY

Erie Elektronik GmbH.
8500 Nurnberg,
Kreuzsteinstrasse 1A

ITALY

Erie Elettronica Spa
Via Melchiorre Gioia 66,
Milano



ERIE TECHNOLOGICAL PRODUCTS, INC.
ERIE, PENNSYLVANIA 16512

Not New...Just the Best



ERIE RED CAP

Miniature Ceramic Capacitors

WIDEST SELECTION OF MINIATURIZED CERAMIC CAPACITORS IN THE INDUSTRY!

Erie is in the Red Cap winner's circle because of a well engineered component that's backed by a unique process control system. Combine this with talented, motivated people and you have Erie as the leader in its field. These tiny high quality capacitors are not new . . . but they are the best. Our customers attest to it. Our test laboratories prove it.

Red Cap dielectrics are manufactured by Erie's exclusive Monobloc Process® . . . a modern, time-proven ceramic film technology. And tough environmental extremes routinely are endured by our own Jet-Seal, a hard, bright red polymeric protective coating. (The superior aesthetic appearance of Jet-Seal comes to you at no charge.)

Erie Red Caps have it all. 21 temperature characteristics. 1pF to 10uF capacitance range. Ratings from 25 to 500 Vdc. You name the application . . . we've got a Red Cap for the job. All this is due to Erie's total in-house capability . . . from exclusive ceramic formulations to unique packaging. So on your very next buy of ceramic capacitors, do it the easy way . . . specify Erie Red Caps.

Write TODAY for Red Cap brochure 8000 . . . or call our nearby factory representative.

CAPACITANCE
RANGE
1pF to 10uF

21
TEMPERATURE
Characteristics

Voltage Range
25 to 500 Vdc

Encapsulated
by
"JET-SEAL"

Meet or Exceed
Requirements
of MIL-C-20
MIL-C-11015
As applicable

ERIE TECHNOLOGICAL PRODUCTS, INC.
Erie, Pennsylvania 16512

ERIE

Circle 71 on reader service card

at Circuit Technology we make our customers smile



We have the know how to miniaturize complex circuit functions and subsystems without compromise in performance. We combine creative circuit design, extensive thick film hybrid manufacturing experience and unique mechanical packaging to produce quality custom devices in compliance with MIL-M-38510 and MIL-STD-883.

Illustrated below are just a few of the custom hybrid circuits we have supplied, over the years, to our satisfied customers.

- | | |
|--------------------------------------------------------------------|---------------------------------------------------------------------------------|
| A High Speed A/D Converter | E Voltage Regulator (3/8" x 3/8" Flatpack) |
| B 100 MHz Bandwidth Video Amplifier (1.25" x 1.25" plug-in) | F Active Filter (SHP) NAFI Module |
| C Two Watt Servo Amplifier (1" x 1" Flatpack) | G FET Input Operational Amplifier (Triple Deck TO5) and many, many more. |
| D Analog Multiplier (5/8" x 5/8" Flatpack) | |

Our credits include: F14 • F15 • S3A • E2C • A6E • F4 • ATS
• Apollo • Pioneer • Sea Sparrow • SRAM

For a complete description of our capabilities send for our custom hybrid circuit listing, you may find something very close to what you need. Better yet, send us your circuit requirements and we will send you a quote to make you smile.



Circuit Technology Incorporated

160 Smith Street, Farmingdale, N.Y. 11735 • (516) 293-8686

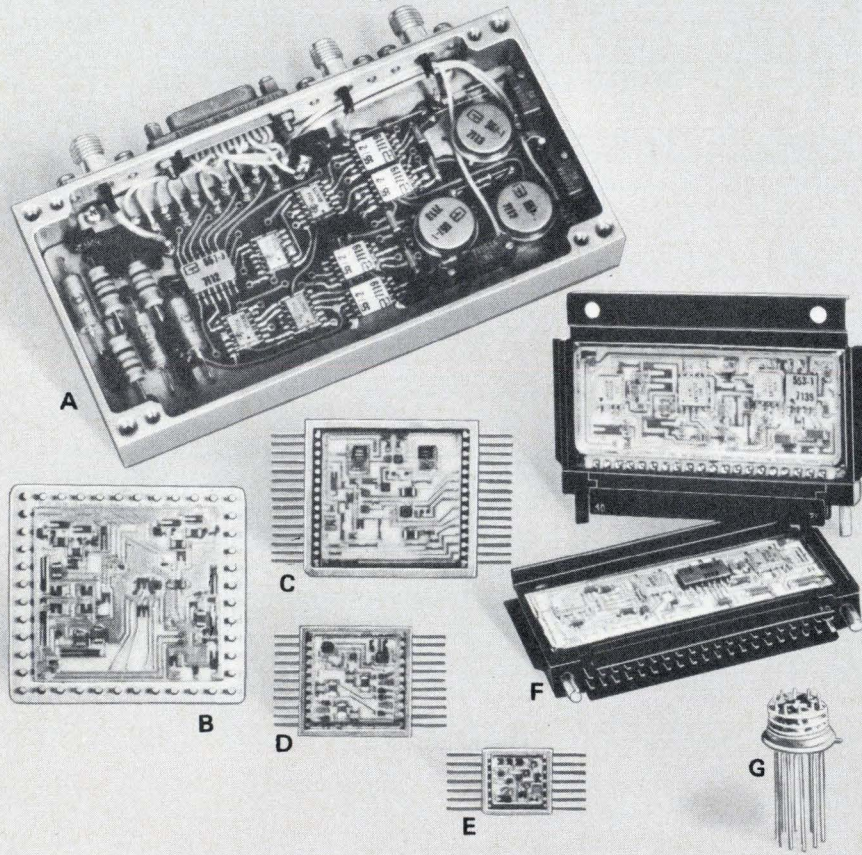

Probing the news

enhancement than are those in larger models, because they involve the input/output channels and because the 360/30's data path is 8 bits wide—just right to handle an unenhanced memory address in two machine cycles. That 17th bit requires more machine time, obtained through microprogram changes. Larger machines have external I/O channels, wider data paths, and higher specified memory capacities, making the changes simpler.

Changing words. The microprogram for the 360/30 contains just over 3,000 words, of some 70-odd bits each; 500 of these are changed when the memory is enhanced. "But the most extensive changes involve only five or six bits per word, and most of them are only a bit or two," says Garcia. And actually making the change, after its correctness has been checked, is very easy; it involves only punching a few holes in a Mylar card similar to a conventional paper punched card. Conductive spots on the Mylar make one plate of an array of capacitors; the other plate is a permanent part of the machine. Changing the microprogram involves only punching a new 12-word Mylar card and installing it in place of the original. "These changes to the microprogram, together with the new printed circuit cards and some new wires, are rather ordinary when compared with the total number of cards and wires in the machine, and with changes that are routinely made to correct 'bugs' and improve performance," says Garcia—speaking, of course, from the serviceman's point of view.

Pull cards. But a supplier of enhanced memories has a different view. "We feel safer from errors by pulling all the cards and replacing them with our own," says H. Frederick Koehler, chief engineer for core and semiconductor memories at Ampex Corp.'s Computer Products division. Koehler also feels that the changes of enhancement are bigger than routine changes. "But we follow IBM's standards, so it's only a problem of magnitude," he hastens to add. "I'm not sure other makers follow them." □

our OEM power supplies made it big at UL



All 51 models in our OEM series qualified for UL listing. Every one: from 4 to 32 volts, from 0.9 to 36 amps. That's another big bonus to boost your confidence in our OEM power supplies. Proven in actual use, now they're proven through UL's exhaustive testing for cool operation and safety requirements.

Yes, these are our low-priced units. But you still get 0.1% regulation, reliable overload protection, stability, versatile mounting, off-the-shelf delivery, and our "guaranteed forever" performance. All the dependability you always get with any ACDC power supply. So follow UL's lead and make us big on your list.

acdc electronics inc.

Oceanside Industrial Center, Oceanside, California 92054, (714) 757-1880

Circle 73 on reader service card

**If TRW can design
a 700-volt, 10-amp, 200nsec
power switching transistor**

**...think what TRW can do for you
in precision motor systems,
resistive networks
and back plane connectors.**

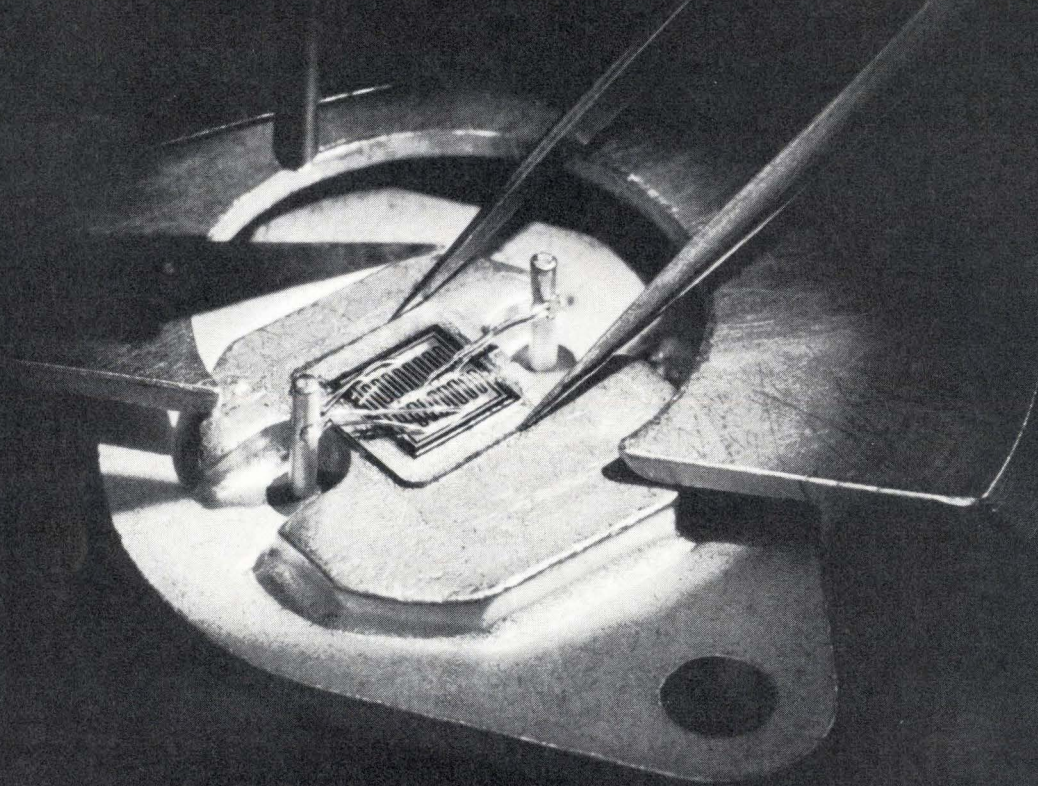

TRW's SVT 7000 Series power switching transistors

have a pulse energy rating of 4.5 KW for 100 μ sec. They make significant size, weight and cost savings possible in such designs as off-line power supplies and power modulators. Microwave and mobile transistors, hybrids, high speed diodes and microelectronic power amplifiers are some other areas of TRW's advanced semiconductor technology. (For more information, circle 216 on the reader service card.)



TRW/Globe precision fractional horsepower motors

operate everything from sophisticated space and missile systems to high-volume industrial applications. Globe precision miniature motors are available from 1/1000 to 1/6 hp, AC, DC or wound field, in over 40 types, with integral gear trains and a choice of ratios. Also as blowers, fans, timers, actuators, motor switches, tachs, pumps and "next assemblies." And these are just examples of the hundreds of AC and DC motors and motor systems we offer. (For more information, circle 217 on the reader service card.)

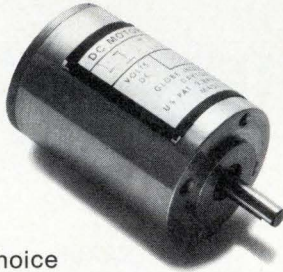

TaNFilm™ resistive networks are an excellent example of TRW/IRC advanced resistor technology.

These subminiature precision thin-film devices offer inherent low noise, excellent stability, and hermetic performance without hermetic cost. Tolerances of $\pm 0.03\%$ are quite feasible. TRW also makes the industry's most complete line of discrete fixed resistors. (For more information, circle 218 on the reader service card.)

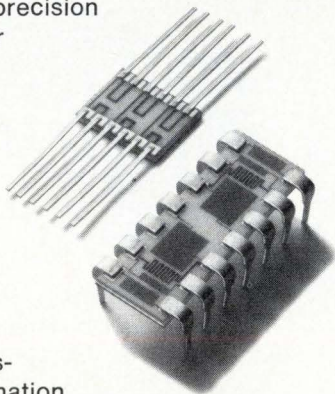

TRW/Cinch back plane connector systems solve the

high density inter-connection problem characteristic of computers and related equipment. They consist, basically, of a series of PC board edge connectors mounted on a precision punched aluminum plate, with voltage and distribution capabilities. Other Cinch connectors meet the precise needs of every segment of today's electronic industry. (For more information, circle 219 on the reader service card.)

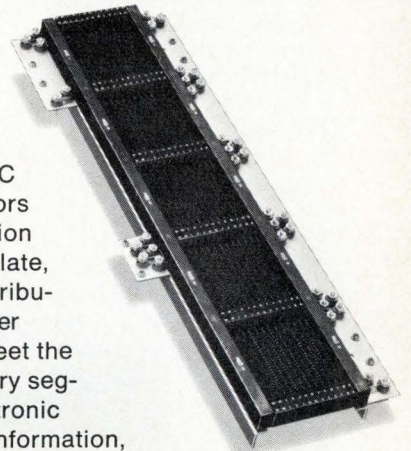

What else do we make? Just about every type of electronic component in the books from actuators to zeners. Plus amplifiers, cable, capacitors, chokes, diodes, filters, gearmotors, power hybrids, inductors, RF modules, potentiometers, printed circuits, rectifiers, resistors, transformers, tuners, wiring harnesses, color convergence yokes...and more.

One source — your local TRW representative — offers you all of these product lines and can supply almost all of your component needs. With a direct pipeline to all of our plants, he can assure you fast delivery, applications assistance, custom designs and special engineering help whenever you want it.

Think what TRW can do for you. Then call or write TRW Electronic Components, 10880 Wilshire Blvd., Suite 1700, Los Angeles, CA 90024. Phone (213) 475-6777.

TRW[®]
ELECTRONIC COMPONENTS

WHAT'S OURS IS YOURS. FREE FOR 30 DAYS.

STATE-OF-THE-ART

ELECTRONICS: Longer life, higher noise immunity and higher accuracy because of the LED's, photo-transistors and fiber optics used in all our readers. (TRS9300BD with 7½" reels shown.)

SPEED: Stop-on-character at up to 750 ch/s with our 8000 Series, up to 300 ch/s with our 9000 Series, and no overshoot — ever. (TS-8000 with 10½" reels shown.)

GENTLE TAPE HANDLING: Noiseless, fully-proportional reel servos and a sprocket drive virtually eliminate tape wear and tear at any speed. (TRS9300B with 5¼" reels shown.)

HIGH RELIABILITY: No lamps to replace, all solid-state electronics and only one moving part (the sprocket drive) with an MTBF of over 10,000 hours. (TR-9300B shown.)

ERROR-FREE TAPE READING: Self-cleaning, easy access heads read all standard tapes with up to 60% transmissivity. (TRF9300B fan-fold reader shown.)

MINI-READER: Reads bidirectionally at the same 300 ch/s speed and uses the same state-of-the-art electronics as all our other 9000 Series readers. (TRM9300B shown.)

HOW TO GET YOURS:

If you need versatile, reliable, state-of-the-art readers, they're yours for the asking.

Just write or call our tape reader department and get what you need.
Free for 30 days.

Electronic Engineering Company of
California, 1441 East Chestnut Avenue,
Santa Ana, Calif. 92701.
Telephone (714) 547-5651.



EECO OEM readers and spoolers: what more could you ask for?



RT-01. The data entry terminal you didn't think there was the remotest chance you could afford.

An RT-01 with a 16-character keyboard, numeric Nixie* read-out, four status indicators to display non-numeric information from your computer, Teletype and EIA serial line compatibility will only run you from \$600 to \$1000.

Or as little as \$500 without the Nixie display. Chickenfeed.

So now, if you're a big opera-

tion, you can have an RT-01 here, an RT-01 there, an RT-01 everywhere you've ever wanted one.

If you're little, you can have one at last.

We've got a booklet that'll tell you all about it that you can write for.

Or, if you're in as big a hurry as we hope you are, we've got a

good egg who'll be happy to run right over and explain it to you.

We're the Logic Products Group, Digital Equipment Corporation, Maynard, Massachusetts 01754. (617) 897-5111.

digital

*Registered trademark of Burroughs Corporation
Circle 77 on reader service card

NOW YOUR MOS/LSI BUILDING BLOCKS CAN LAST FOR GENERATIONS.



When you know about our advances in the state of the art, you're able to get a continuing return on your design investment in our MOS/LSI electronics.

Over and over again.

Since MOS/LSI circuits embrace so many functions, it's just good business to think of using them in different systems. And, with our unique custom-layout computer-aided design, we give those circuits versatile building-block capabilities.

In a single basic design, for instance, we provide MOS/LSI building blocks for several model generations of calculators, accounting machines, cash registers, appliance timers, automotive controls, or for modem and multiplexing subsystems of data transmission and telecommunication equipment.

MOS/LSI beats the high cost of product development.

Our MOS/LSI building-block circuits can be adapted quickly and inexpensively for use in a succession of different models. You can produce a new model before your salesmen can say "competition"—and go to Petty Cash instead of your Board of Directors to finance the changes.

We can even make it possible to produce a number of different

models of a machine from exactly the same circuits.

Wiring changes, that's all. And, of course, circuit costs drop. Because you buy in

quantity for a number of models, instead of buying a few circuits for each model.

Lower costs elsewhere, too.

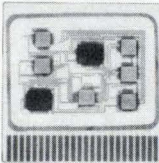

Mastery of MOS/LSI design and of high-volume production has enabled us to produce commercial electronic systems at an all-time low cost. As much as 50% the cost of conventional systems—electromechanical or electronic.

And, our MOS/LSI systems can be packaged so that non-electronic manufacturers can assemble them into their equipment without teaching employees new trades.

For many of the functions performed today by little black boxes selling for around \$20,000, you can buy our MOS/LSI digital filter circuits (in

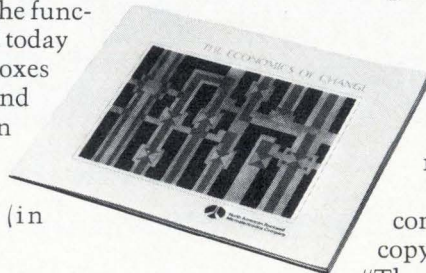

small quantities) and fabricate a plug-in digital filter for less than \$1,000. Or, you can buy our MOS/LSI modem circuits and save substantially.

We've MOS/LSI memory systems and circuits that cost less per bit than conventional devices—and we're ready with other processes, too. For example, silicon-on-sapphire (SOS) diode arrays that make beautiful ROMS (3,000-plus bits) with 20 ns maximum access times. Within 24 hours we'll custom encode them with our special laser and sell them to you one by one for \$64. Less, much less, in quantity of course.

Collaboration made easy.

As part of NR's Electronics Group, we're ready to share with you the long-term commitment required for new product design, testing and development.

Even more.

We'll join you in product planning, so that you may share in the progress of current research.

Drop us a line on your company letterhead for a copy of our new brochure, "The Economics of Change!"

Write A.B. Chambers, P.O. Box 3669, Anaheim, California 92803.



**North American Rockwell
Microelectronics Company**

Centralab Technical Ceramics... in line with your design requirements

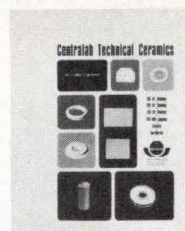

Write
Centralab
for
Bulletin
No. 1117TC2

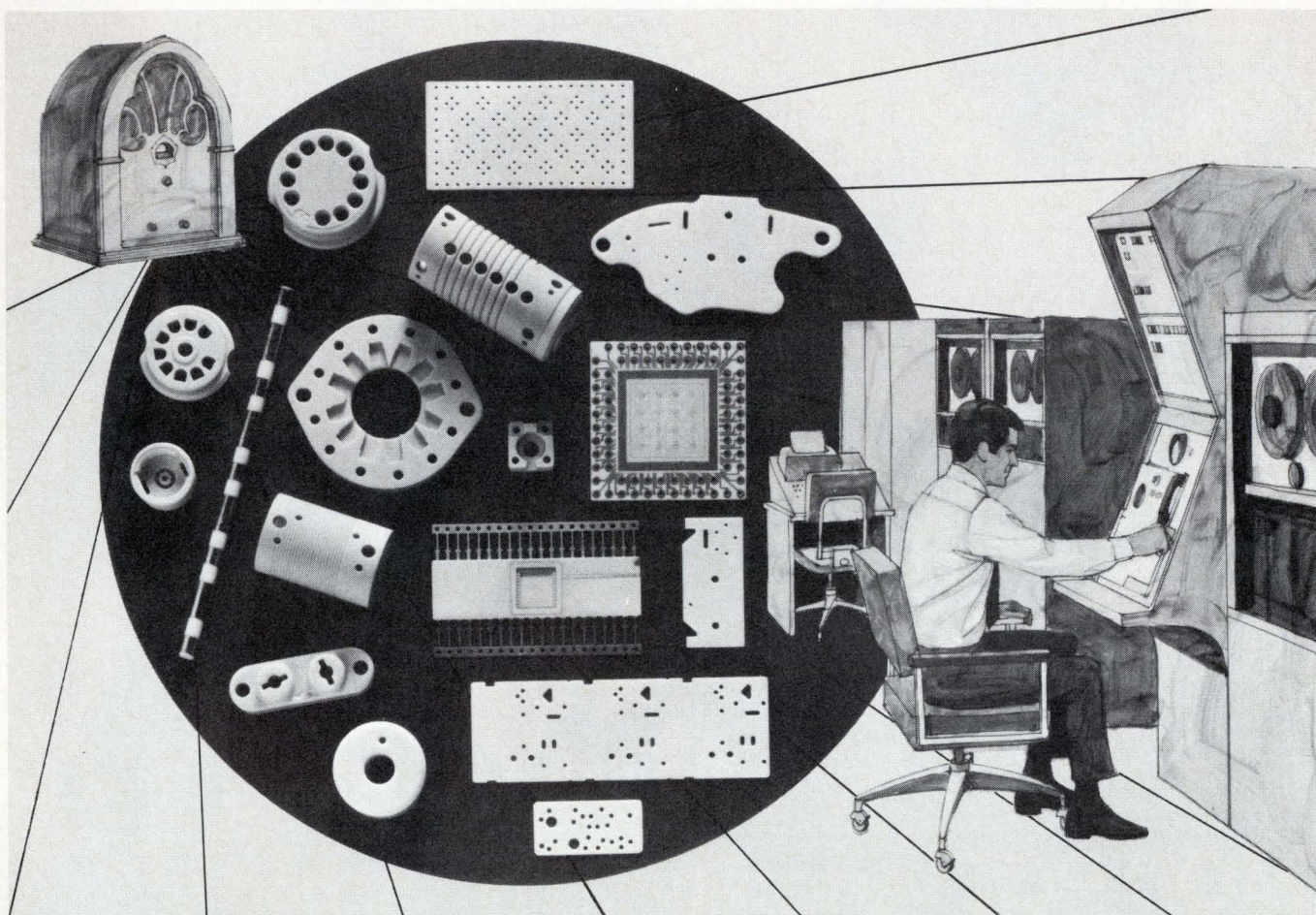

What's next for our ceramics?

We've been involved since 1928 when we built vacuum tube bases for six-tube radios.

Since then new-idea ceramics for electronics have put us in such varied applications as medical and scientific equipment, instrumentation, home and portable appliances, communications, office machines, computers and peripheral equipment. Our ceramics have found use as hybrid circuit and thin-film substrates, VHF tuner parts, LED substrates, MOS packages, LSI multilayer interconnections, SCR housings and vacuum tube parts.

So, what's next for our ceramics? Only your new design requirements will tell. You can specify aluminas, steatites, cordierites, or metallized ceramics in the configurations you need. A variety of metallizing systems is

available to insure satisfaction in your particular application. We also offer full capabilities in ceramic-to-metal assemblies and engineering service to aid you in design.

It's this kind of involvement that allows Centralab to be one of the largest manufacturers of technical ceramics. And, because we're also our own largest customer, it's important that we produce only the finest ceramics available. To us, developing better and more reliable ceramic materials for electronics means higher quality electronic components. It will mean the same to your products.

What's next for our ceramics? Whatever you need. For the complete capability story, call Centralab Technical Ceramic Sales at (414) 228-2942.

GET CENTRALAB THE "IN LINE" FOR YOUR DESIGN

Hybrid Microcircuits
Pushbutton & Rotary Switches
Capacitors
Potentiometers
Technical Ceramics
Ceramic Packages
Semiconductor Devices



CENTRALAB

Electronics Division
GLOBE-UNION INC.

5757 NORTH GREEN BAY AVENUE
MILWAUKEE, WISCONSIN 53201

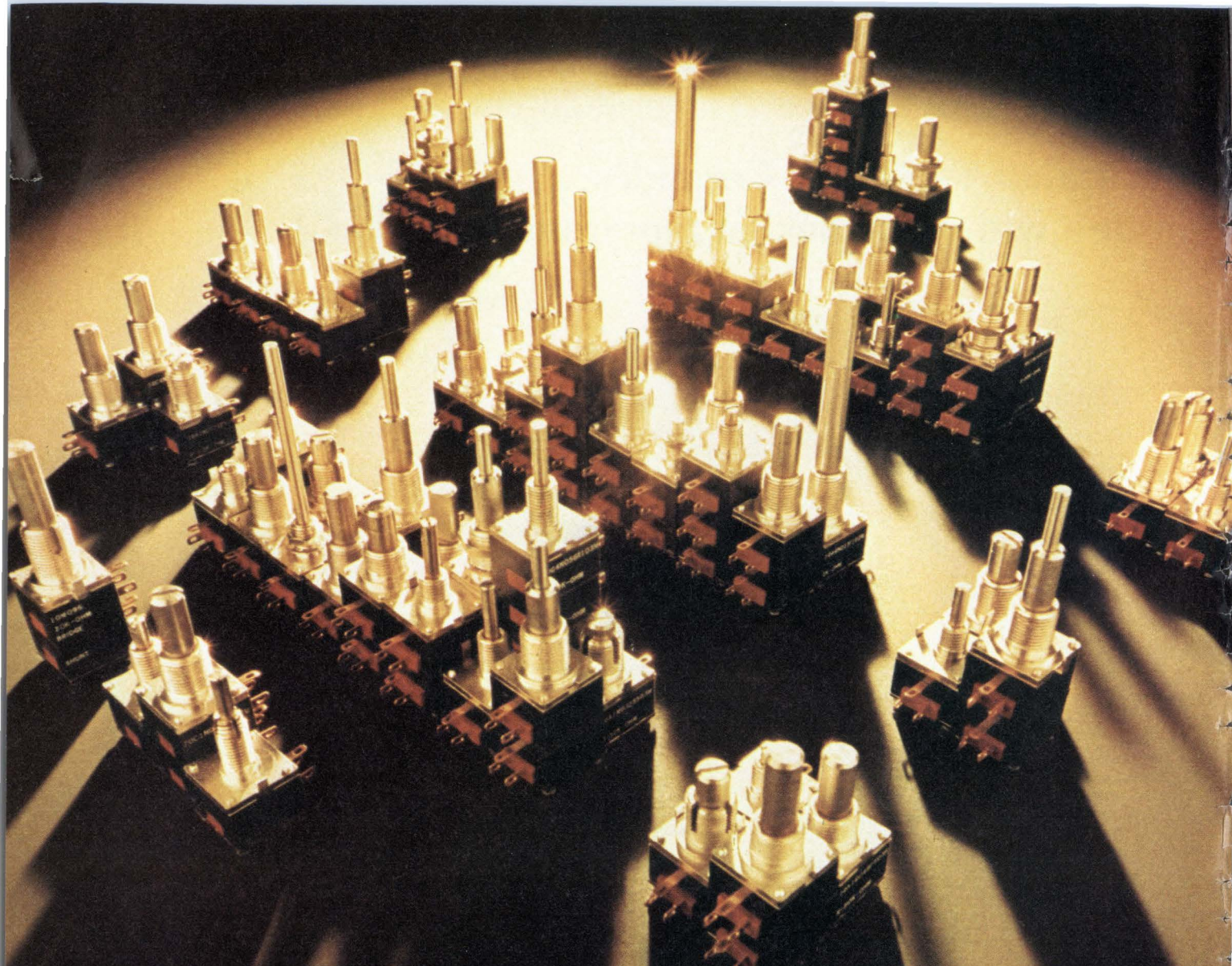

MOD POT™ versatility is unmatched. Hundreds of standard modules give you millions of options.

MOD POT is the most versatile $\frac{5}{8}$ " square potentiometer available today. A whole family of cermet or hot-molded composition resistive

modules, switch options and vernier drives with single or concentric shafts. These pre-engineered, pre-tested modules form single, dual, triple or quadruple section controls. Millions of possible combinations to solve your unique control problems. Cermet elements are rated at 2 watts (70°C) with resistances from 100 ohms to 5 megs. Composition elements rated at 1 watt (70°C) with

resistances from 50 ohms to 10 megohms, five standard tapers. And if you need something truly special we're equipped to handle that too. Call your appointed A-B distributor for details, or write: Allen-Bradley Electronics Division, 1201 South Second Street, Milwaukee, WI 53204. Export: Bloomfield, N. J. 07003. Canada: Galt, Ontario. United Kingdom: Bletchley, Bucks.

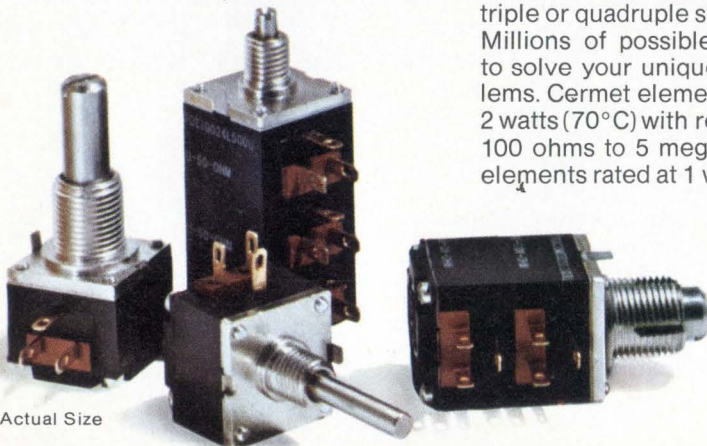

Actual Size

NEW DIMENSION ELECTRONICS
ALLEN-BRADLEY



Circle 80 on reader service card

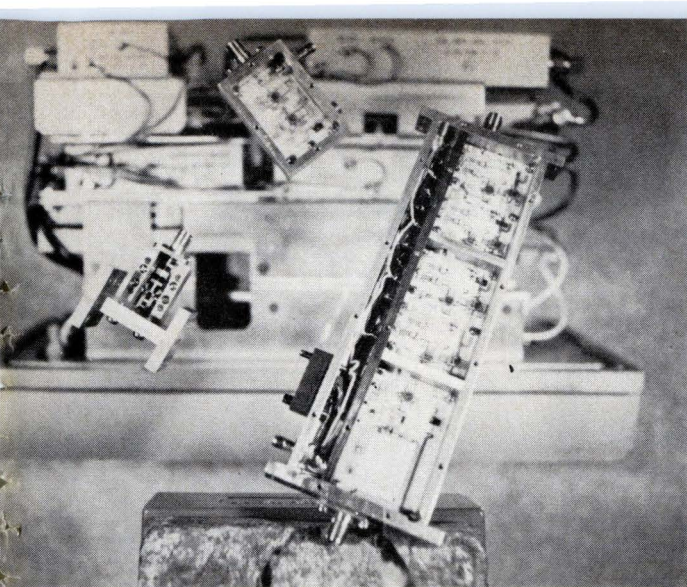

Data to speed over 20-GHz radio relay

Japanese to install an all-digital 13-hop trial link, using phase-shift keying with four-phase modulation

by Yasuaki Ninomiya,

Nippon Telegraph and Telephone Public Corp., Tokyo, Japan

□ Until recently, the increasing demand for communications has not forced the use of frequencies above 15 gigahertz. But with anticipated demand for new communications services and saturation of transmissions at presently used frequencies, digital techniques are being developed to overcome the less desirable propagation characteristics that must be tolerated at the higher frequencies.

This advancing technology has made feasible for the first time a multihop radio relay link operating in the quasimillimeter band at about 20 GHz. Such a system is being developed in a large project at the Musashino Electrical Communications Laboratory of the Nippon Telegraph & Telephone Public Corp.

NTT now operates a commercial digital radio relay system in the 2-GHz band, with a capacity of 240 telephone channels per radio carrier. The highest frequency fm radio relay operates at 15 GHz and has a hop distance of about 13 kilometers. It is designed as a local system, however, with maximum length of about 200 kilometers and a capacity of 960 telephone channels. Bell Laboratories in the United States is presently testing a digital system at 20 GHz, but only a single-hop link is being evaluated.

The experimental 13-hop system, planned for the near future, will span approximately 60 km between two of the company's laboratories. An experimental single-hop system was constructed last month to study the various interference characteristics and problems of pole-mounted stations.

The goal of the current experimental effort is to achieve a transmission capacity of 4,000 megabits per second, which is equivalent to about 57,000 two-way voice telephone channels.

To achieve this, a maximum of 20 transponders will be used in each repeater station—10 in each direction (Fig. 1). The 3.5-GHz total bandwidth is centered near 20 GHz.

The relatively high tolerance to interference achieved by using digital modulation allows two carriers of the same frequency (one horizontally polarized and one vertically polarized) to be used as two separate radio channels under normal propagation conditions. However, heavy rainfall degrades the polarization of the radio waves. This may make it necessary to stagger horizontally and vertically polarized channels, which will

not permit the entire two-fold capacity increase potentially available.

The 13-hop circuit will initially have only two channels in each direction. This long system is intended to study transmission characteristics of multistation relays and characteristics of simultaneous transmission of several kinds of information, including voice, picture telephone, and data.

The choice of 20 GHz results from a tradeoff between the crowded frequency spectrum at low frequencies and higher attenuation losses, together with difficulty in building hardware at high frequencies.

Prototype receivers and transmitters were completed in 1970, and tests have shown that they should be suitable for practical use. Improved units have been manufactured, and further development is continuing on a commercial system.

Each transmitter and receiver (Fig. 2) will have a capacity of 400 megabits per second and utilize four-level phase-shift-keyed (PSK) modulation and coherent phase detection.

The 60-km system, a first at 20 GHz, will have a hop distance between repeaters of about 5 km, a little longer than the hop lengths planned for commercial links in the future (these commercial circuits will be designed for a total length of 2,500 km). Longer hop distances increase outage caused by heavy rainfall, but because the experimental circuit is relatively short, the 5-km hop distance is considered satisfactory.

Commercial systems probably will be mounted on steel pipe poles about one meter in diameter at a height 20 meters above ground level. The experimental installation will be mounted on towers to facilitate frequent adjustment and changing of equipment for tests.

Digital system improves quality

In existing frequency-modulated analog systems, the noise on each span adds, and the total circuit noise thus increases approximately in direct proportion to the number of repeaters. However, with digital repeaters, the transmitted pulses are regenerated in each repeater to eliminate distortion caused by noise. Thus, network quality remains relatively high, regardless of the number of repeaters.

When it rains, the noise on an fm system increases in direct proportion to the additional attenuation caused

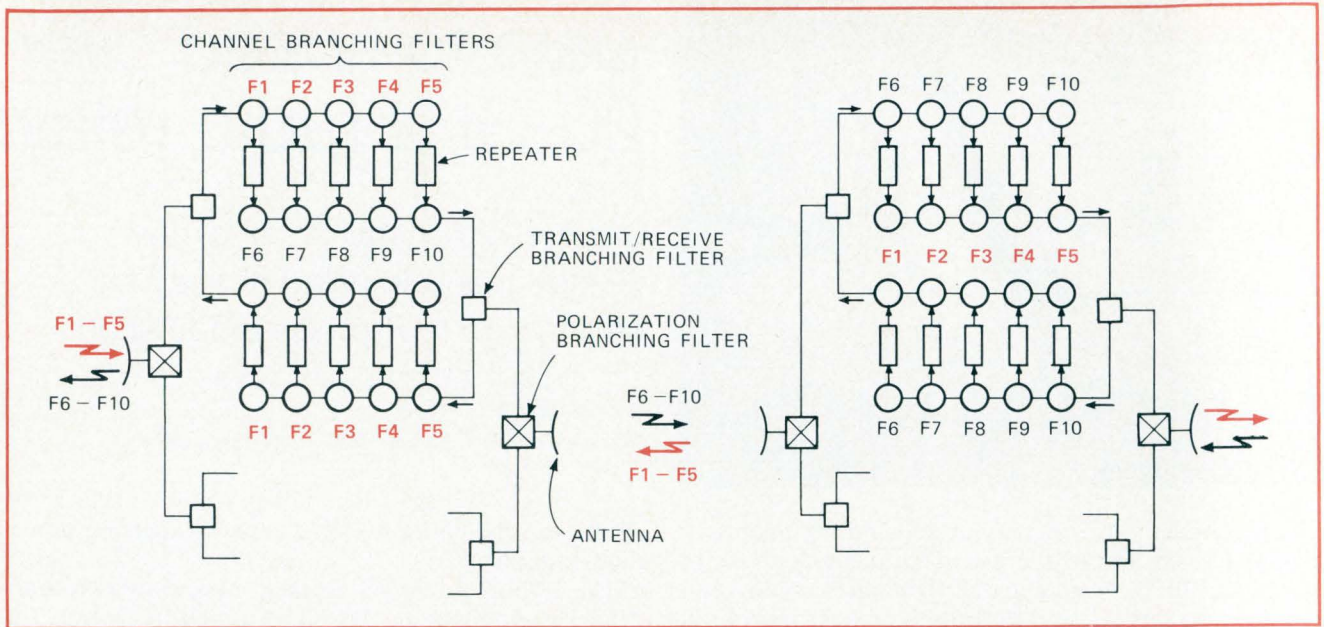

1. Using full bandwidth. In full operational system, twenty 400-Mb/s transponders (ten in each direction) are accommodated in a 3.5-GHz bandwidth with a complex network of polarization and channel branching filters. Notice alternate use of transmitting bands.

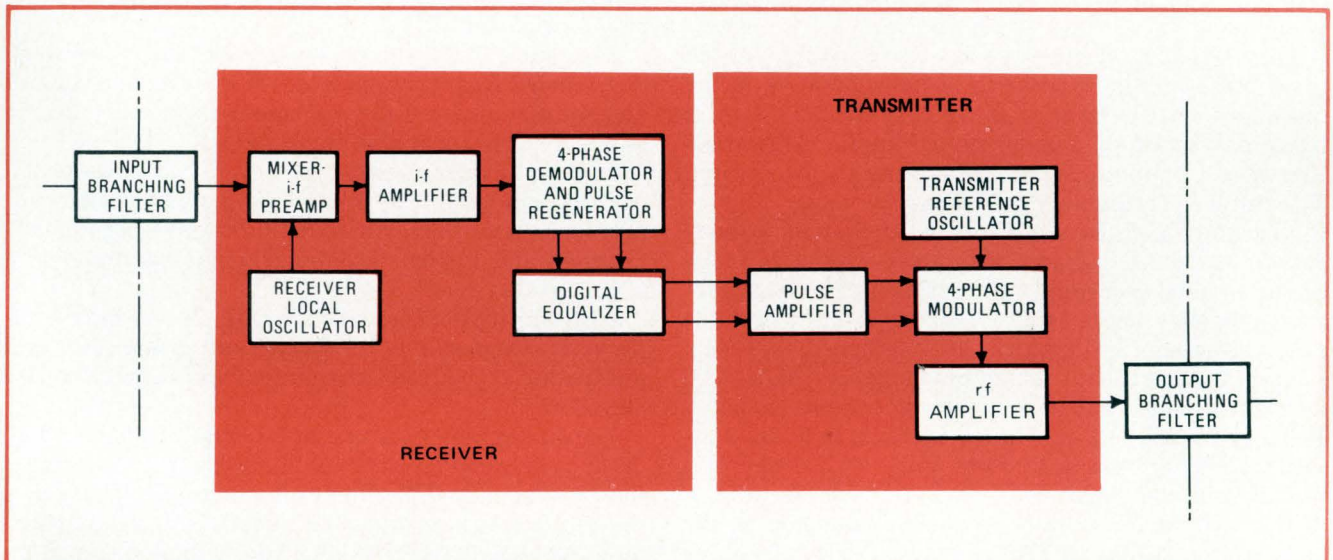

2. Repeater. Each 400-Mb/s repeater utilizes coherent phase detection in the receiver and four-level phase-shift-keyed transmitters.

by the rain. The regeneration of the signal in digital links, however, maintains the transmission quality without degradation so long as the signal level does not decrease below a threshold.

Because of the large number of repeaters needed at 20 GHz, digital transmission is the only type that can be used because it is the only kind of system that can maintain a satisfactory s/n ratio under adverse conditions. Spacing for the individual spans is determined by the probability of circuit outage that can be tolerated over the total route length.

At lower microwave frequencies, another important factor helps determine the choice between analog and digital systems. The PCM-encoded voice signal generally occupies a bandwidth several times that of the frequency-modulated signals commonly used for microwave telephone repeaters. But there are many ways of increasing the efficiency of spectrum utilization of the

digital signal until it approaches that of the frequency-division-multiplexed fm type.

Phase-shift keying is more efficient than conventional frequency-modulated systems for the transmission of data and video signals. A typical FDM fm system with a capacity of 1,800 voice channels is capable of a data transmission rate of 4,800 bits per channel, or about 8.6 megabits per second over a single rf carrier.

The information capacity of the phase-shift-keyed radio carrier can be increased by dividing the available 360° into smaller increments. In this system, four-phase modulation has been chosen, a tradeoff between increased capacity and the lower tolerance to interfering signals encountered at more than four-phase levels.

A digital system using four-level phase-shift keying could transmit about 60 Mb/s using the same rf spectrum, or about seven times the information capacity of the analog circuit. The relatively high tolerance to inter-

ference achieved by using the digital modulation also allows a frequency to be assigned to more than one link in the same geographic area.

With the requirement for many repeaters separated by short hop lengths, it is necessary to design repeaters carefully to reduce costs and increase reliability, as well as to provide a modulation system to reduce the effects of cumulative noise and distortion.

Repeater gets cost-cutting design

Costs will be lowered and reliability increased by use of semiconductor devices—both microwave integrated circuits at rf and high-speed monolithic logic circuits at baseband. With these general requirements as guidelines, the repeater configuration was determined.

A 1.8-meter Cassegrain antenna, which is limited in size for aesthetic reasons, gives the repeater a gain of 49.6 dB at 21 GHz. The receiver noise figure is slightly lower than 10 dB. These parameters, together with a design objective allowing a 50-dB margin for rainfall fading, require a transmitter power of 200 mW, a value which is achievable at reasonable costs for a solid-state power source.

Relay station equipment consists of two antennas, the FDM repeaters and three levels of branching filters. These filters separate vertically and horizontally polarized waves, receiving and transmitting signal bands, and the individual channels.

While the vertical/horizontal and receive/transmit branching filters use conventional designs, the channel branching filter design is new. The technique was developed for millimeter-wave systems. Again, the main requirement was cost, since each repeater will contain dozens of these filters.

Channel-branching filters must maintain a balance between interference due to coupling between adjacent channels caused by a wide passband and distortion of transmitted pulses by an excessively narrow passband. A bandwidth of approximately 300 MHz appears best.

The channel-branching filters (Fig. 3) consist of an input waveguide, multiple ring resonators, and output waveguide. The ring resonators are bent along the H-plane with coupling to apertures in that plane.

The output of a two-ring filter contains the desired frequency attenuated by about 0.3 dB. Attenuation at frequencies 300 MHz on either side of center frequency is at least 15 dB. Similar performance for a three-ring filter is shown. The two-ring resonator design has been adapted.

Quasimillimeter wave oscillators are used in two places in each repeater—one as a receiver local oscillator and one as a reference oscillator in the transmitter. Gunn devices are used in both.

Recently developed Gunn oscillators have a power output of 40 milliwatts with a frequency stability within $\pm 5 \times 10^{-5}$ over the operating temperature range of -10

3. Three-ring filter. These channel-branching filters were designed for millimeter-wave systems. Resonators are coupled to each other by multihole directional couplers and to waveguide via slots in the H-plane. Curves show transmission loss for typical 3-ring resonator centered at 19.9 GHz. However, 2-ring resonators give adequate performance and were adopted for the 20-GHz link.

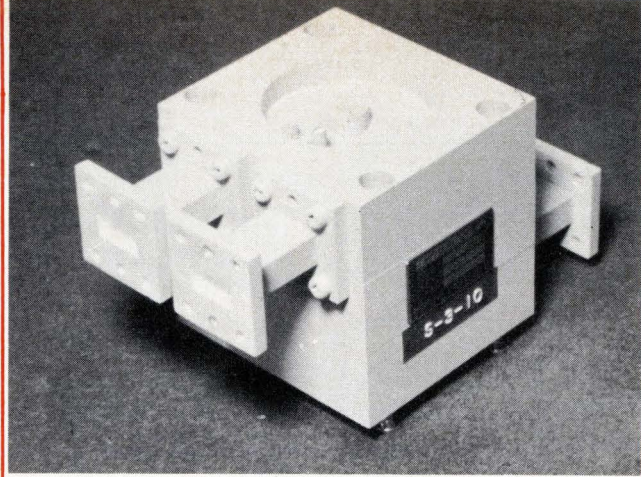

(a)

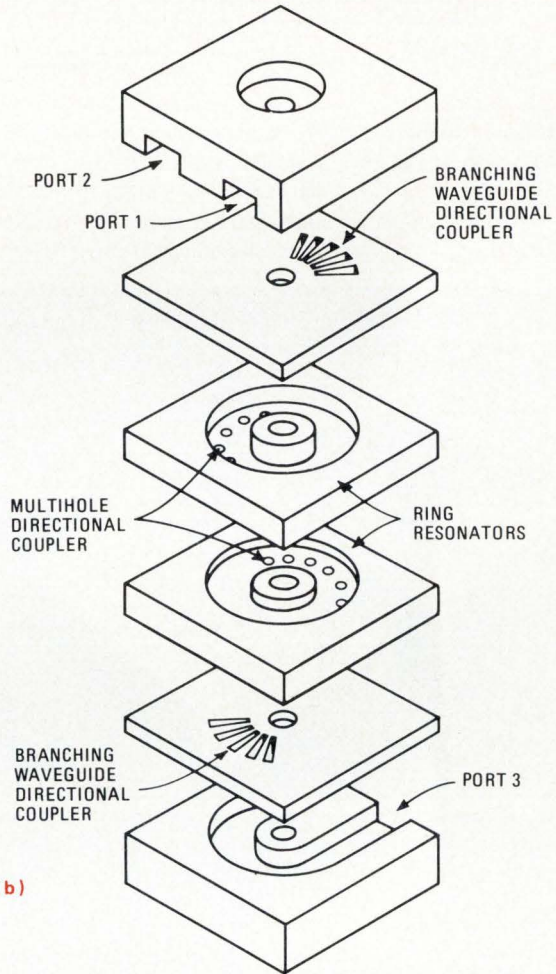

(b)

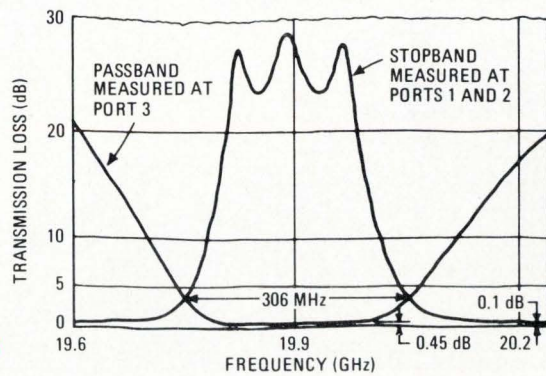

(c)

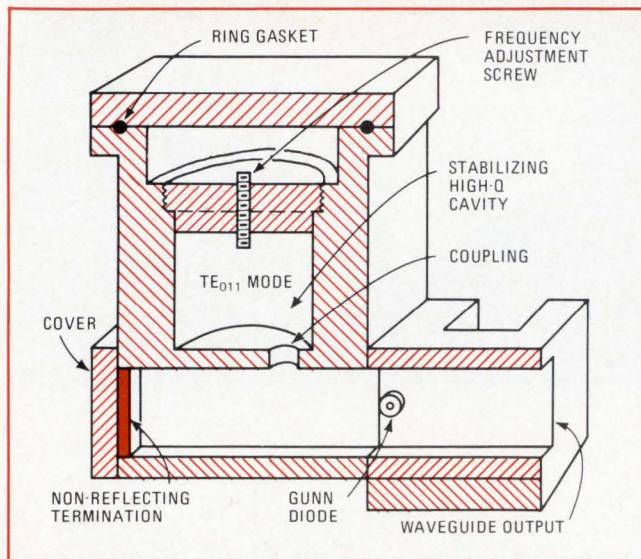

4. Steady Gunn. Oscillator incorporates a non-reflecting termination at the end of the stub which couples the Gunn diode to stabilizing cavity. Thus, unwanted oscillating modes, which can be generated during turn-on, are suppressed. Output is 40 mW. Invar cavity yields an output with a frequency stability within $\pm 5 \times 10^{-5}$.

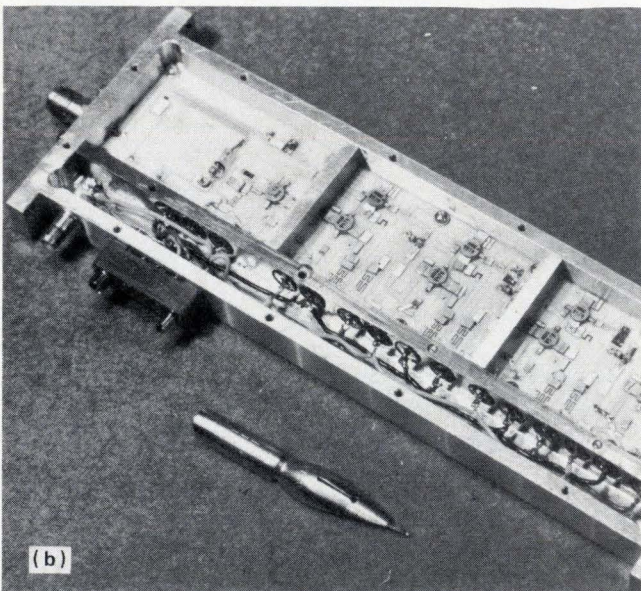
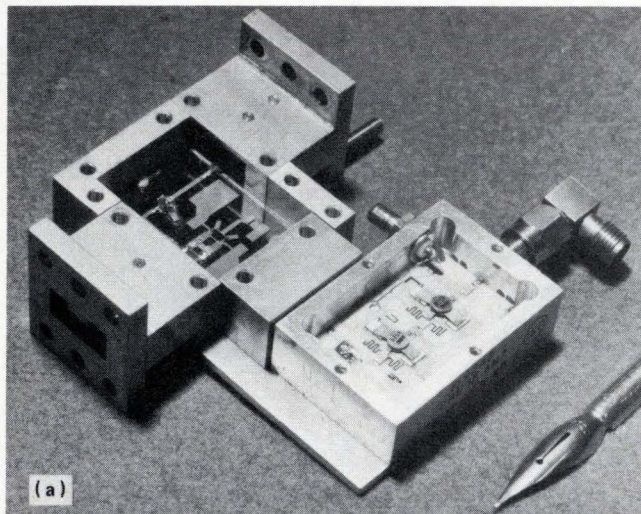

to $+60^\circ\text{C}$. Output power over the same temperature range varies less than ± 0.5 dB.

In the receiver, the oscillator output exceeds the excitation requirements of the mixer, so a 3-dB attenuator is used between the oscillator and the mixer. The transmitter oscillator has a varactor diode connected in parallel with it for narrow-band frequency modulation for transmission of supervisory signals.

The oscillator is reflection-stabilized by a high-Q Invar cavity. It differs from other stabilized oscillators in that it has only a single tuned circuit. In other oscillators, the Gunn diode is coupled to the stabilizing cavity through a stub that resonates between the discontinuity at the diode and the short circuit at its far end. The presence of these two heavily coupled cavities causes the resonant frequency to split into two modes, either of which may start when the oscillator is started. This greatly complicates maintenance.

Termination prevents resonance

In the new Gunn oscillator, the short circuit at the end of the stub is replaced by a non-reflecting termination (Fig. 4), which prevents the stub's operation as a resonant cavity. Thus, the oscillator diode is effectively coupled into the stabilizing cavity, and unwanted modes are suppressed.

A microstrip mixer is used in the receiver to down-convert the incoming signal to an intermediate frequency of 1.7 GHz (Fig. 5a). The circuit is fabricated on a substrate of fused quartz. Schottky barrier diodes are used in the balanced mixer circuit to give a bandwidth of 600 MHz and a conversion loss of about 5 dB. Noise figure is 10 dB. A two-stage i-f preamplifier follows the mixer, giving the 1.7-GHz signal an extra 16-dB gain.

The main i-f amplifier is of stripline construction on alumina substrates (Fig. 5b). Ten microwave transistors give the amplifier a gain of 70 dB at the center frequency of 1.7 GHz. Amplifier bandwidth is 800 MHz, but a two-stage filter at one interstage coupling limits frequency response to 400 MHz. P-i-n diodes automatically control intermediate-frequency gain over a dynamic range of about 56 dB.

The demodulator, designed for phase-coherent detection of PSK signals (Fig. 6), is implemented with microwave IC in the 1.7-GHz i-f portion and monolithic logic circuitry in the baseband portion.

A key feature of the carrier regenerator is the use of a four-phase reverse modulator. As shown in the diagram, the incoming signal is divided in a 3-dB coupler. The signal on one path is detected to form two separate 200 Mb/s pulse streams, each of which is amplified. The signal on the second path is fed into a reverse modulator with the appropriate time delay so that it arrives at the same time as the detected pulses.

The amplified pulses reverse-modulate the modulated i-f carrier, cancelling the phase modulation produced at the transmitter to give an unmodulated signal. This unmodulated 1.7-GHz signal is then amplified and

5. Up front. A microstrip balanced mixer (a) converts down to an i-f of 1.7 GHz with a noise figure of 10 dB. A two-stage preamplifier boosts the signal 16 dB; main i-f amplifier (b) provides 70-dB gain with automatic level control over a range of about 56 dB.

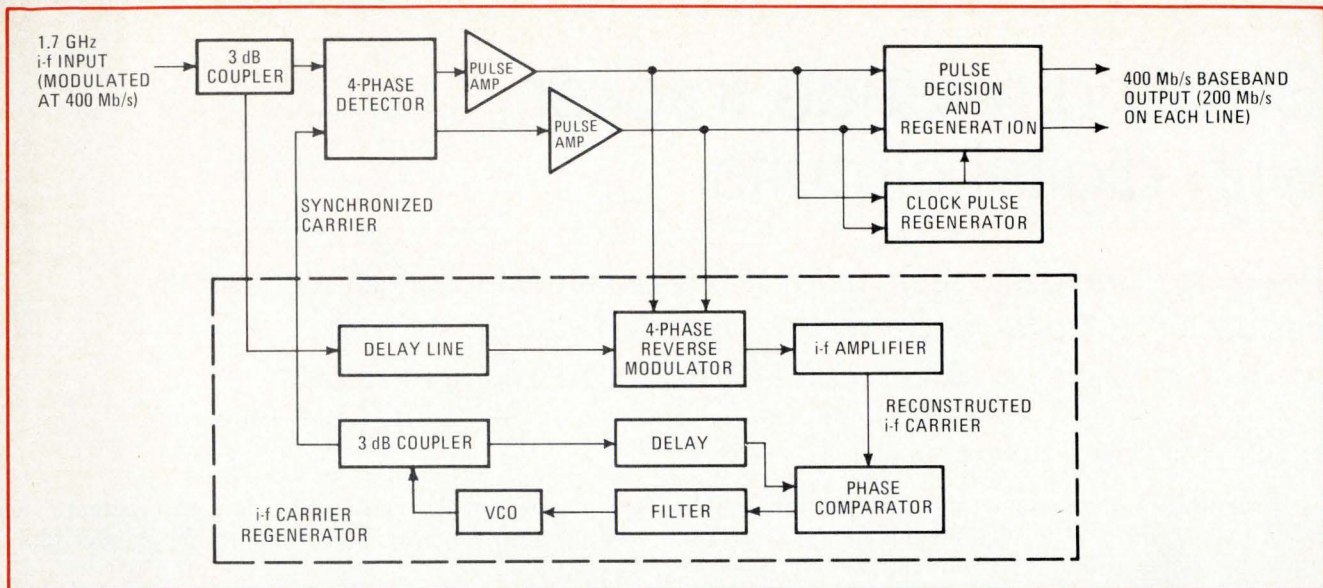

6. Four-phase demodulator. The 400-Mb/s demodulator uses MIC construction at the i-f frequency and monolithic logic circuitry at baseband. Block diagram shows how reverse modulator regenerates i-f carrier. Four-phase detector drives pulse regeneration circuitry.

fed into a phase comparator, the output of which determines the phase of the voltage-controlled oscillator that is the reference for the four-level phase detector.

The clock-pulse regenerator is conceptually similar to the carrier regenerator. The four-phase demodulator of Fig. 6 is followed by a digital equalizer. This configuration was chosen over a more conventional phase delay equalizer between the i-f preamplifier and the main i-f amplifier because improving the phase response with an equalizer does little to improve the pulse waveform.

Because of distortion in the amplitude response, a given pulse in the received pulse train will cause, not only a large output at its own sampling time, but also a small output at the sampling time of the next pulse. A feedback loop, consisting of a delay line (equivalent to one clock interval), a variable attenuator, and a subtracting circuit, cancels the output from a given pulse at the sampling time for the next pulse. This does not provide true pulse shape equalization, but it does provide the required reduction in intersymbol interference. The reconstructed baseband pulse stream now modulates the transmitter.

The transmitter reference oscillator operates with about 40-mW output, a comfortable operating level for the Gunn device.

A transmitter amplifier boosts the output to the higher level required by the system. An injection phase-locked Gunn diode amplifier serves this function. Amplifier gain is about 10 dB, and output power is greater than 200 mW over the operating temperature range from -10 to $+60^{\circ}\text{C}$.

The four-phase modulator (Fig. 7) is driven by two separate 200 Mb/s streams, giving an output modulation rate of 400 Mb/s. In the modulator, two Schottky barrier diode switches control the phase by adding and subtracting rf line segments in increments of π and $\pi/2$ radians. This control is accomplished by switching shorted transmission lines of lengths $\lambda/4$ and $\lambda/8$, respectively, in and out of the circuit. Power loss between the modulator input and output terminals is about 2 dB. A

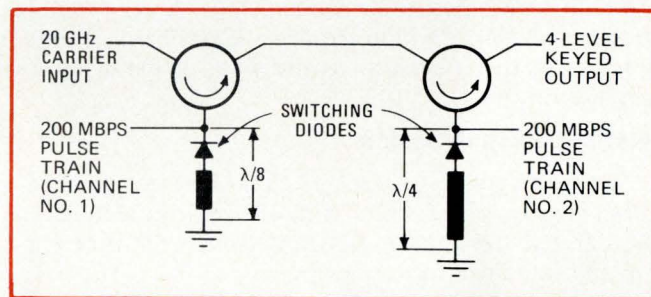

7. Modulating at 500 Mb/s. Four-level phase-shift keying is achieved with two 200-Mb/s pulse trains driving switching diodes to alter rf transmission path lengths. Rf transmission loss is about 2 dB.

similar modulator technique developed several years ago is now operating in phase-shift-keyed repeaters at 2 GHz. [See *Electronics*, May 25, 1970, p. 91.]

The future holds no limit

Operation of both the single-hop test link and the 13-hop 60-kilometer link will provide additional data on degradation of cross-polarization by rainfall, variations in rainfall fading with direction, and other types of interference and signal degradation.

These data will be used in the design of a commercial 20-GHz digital radio-relay system. Testing of such a system is expected to begin in a few years.

The Nippon Telegraph and Telephone Public Corp. is continually evaluating broadband communications systems. Components for a 40–80-GHz circular waveguide system are also being developed.

Tentative features of such a system include gallium arsenide Schottky diode up- and down-converters, a 1.7-GHz thin-film i-f amplifier and Impatt diodes for use in the local oscillator. The most recent laboratory measurements show Impatt power outputs of 91 milliwatts at 82 GHz.

Twenty-six channels in each direction will each have a transmission capacity of 800 Mb/ using four-level phase-shift keying. □

Building a range tracker with digital circuits

Breaking down basic servo loop into its fundamental components simplifies design of digital range tracker; optional features, such as an excess-range computer, can also be added with relative ease

by Edwin Drogin, AIL, a division of Cutler-Hammer, Deer Park, N.Y.

□ Designing a radar system, even a simple one, usually takes up a good deal of engineering time and creates many problems in hardware implementation. But digital design techniques and the availability of sophisticated large-scale ICs are simplifying the whole business. A complete digital range tracker, for example, can be built with only one or two LSI chips. A very complex tracker, of course, would require a larger bank of digital circuits, perhaps even an entire small general-purpose digital computer.

Getting down to basics

Most digital range trackers cannot be designed in a strict step-by-step fashion. Still, the basic guidelines can be derived from the fundamental elements that make up any standard tracking loop.

In its digital form, such a loop is commonly built around a binary counter that starts when a radar pulse is transmitted and stops when a reply (echo) pulse is received. The number left in the counter represents the range (distance) of the target from the radar system.

This sort of measurement is an open-loop technique that is feasible for a single target and a high signal-to-noise ratio, provided the reply pulse either has a fast rise time compared to the range accuracy desired or has a relatively constant amplitude.

Unfortunately, few of these conditions are met in the real world. It is usually necessary to construct a tracking loop that follows the target's range. The loop must be unaffected by the presence of other possible targets occurring either earlier or later than the target of interest. And noise effects, pulse rise time, and variations in target amplitude should also be minimized.

The analog-to-digital converter

A block diagram (Fig. 1) of a digital range tracking loop shows the three key loop elements: an analog-to-digital error converter, a tracking gate generator, and a range register (integrator). There may also be several auxiliary subsystems, such as a display interface and manual or automatic range position and slew systems for target acquisition. Further, it may be necessary to add circuitry to prevent a transmitter pulse from interfering destructively with a target reply pulse.

One popular technique for implementing the first main element—the a-d error converter—is illustrated in Fig. 2. Here, the video reply pulse is applied to two elec-

tronic switches. An early and a late gate actuate the switches to isolate the target from earlier or later reply pulses.

When the reply pulse is centered between the gates, equal energy is passed by both switches, and the voltage outputs from the two RC integrators become equal. As the target moves from the center position, the voltage difference between the two integrators varies monotonically, as the range error graph shows.

To cover the full range of possible error outputs, the early and late gates must be at least as wide as the expected target reply pulse, and in practice are made very wide to ease the problem of acquiring a high-velocity target. Such gates also help the system stay in track during rapid target maneuvers or bad signal fades.

A voltage-controlled oscillator converts the error voltage to digital form. The VCO is driven by a single-pole double-throw electronic switch, which is connected to the error voltage for half a computation cycle and to a reference voltage for the other half. A square wave oscillating at or less than the radar pulse repetition fre-

1. Digital range tracker. Block diagram of basic tracking loop comprises three fundamental subsystems. Analog-to-digital converter follows range error, gate generator isolates target's reply pulse, and range register stores ultimate target range information.

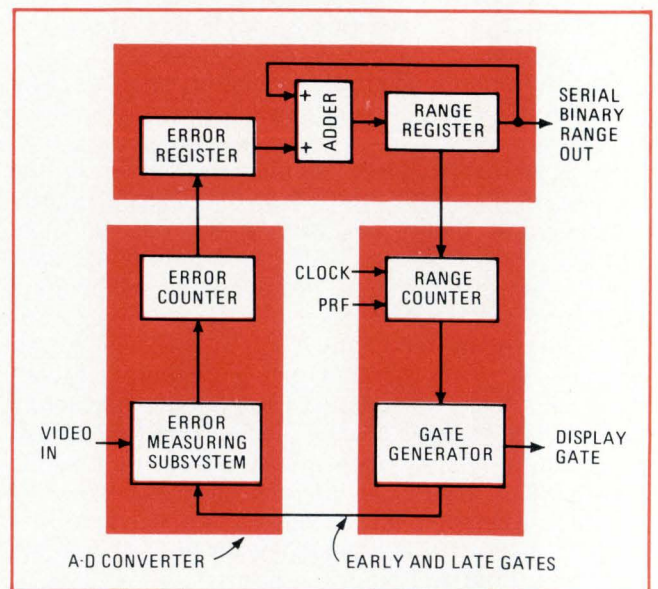

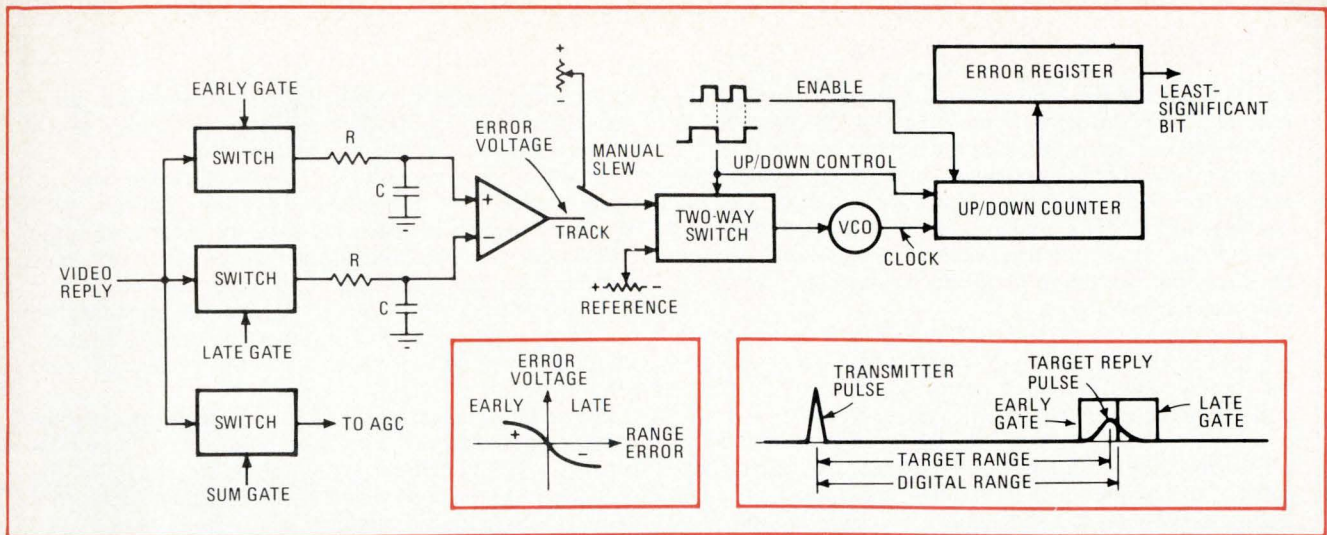

2. From analog to digital. Error measuring circuitry and error counter make up analog-to-digital converter. When video reply pulse is centered between early and late gates, outputs of RC integrators are equal. Error voltage is created as target shifts from center position. Range error graph shows gate tracking characteristic. Voltage-controlled oscillator converts error voltage to digital output for up/down counter. If error voltage is greater than reference voltage, net count after one up/down cycle is positive. If it is smaller, net count is negative.

quency (PRF) is applied to the switch input. (The square-wave frequency should be high compared to the time constant of the RC integrators.)

The output of the VCO is a digital clock, which feeds an up/down counter. While the VCO is connected to the error voltage, the counter counts up. It counts down when the VCO is connected to the reference voltage. If the error is higher than the reference, which is nominally 0 volts, there will be a net positive number in the counter at the end of one up/down cycle. The reason is that the VCO frequency output is higher when the counter is counting up than when it is counting down. Conversely, if the error voltage is lower, the counter will contain a net negative number.

In actual practice, the up/down counter is enabled for only part of the square-wave period, as indicated in Fig. 2, to allow time for transients in the VCO output to settle after switching. Also, there must be enough time to load counter contents into the error register and to clear the counter before the next cycle. With this enabling scheme, the square-wave frequency need not be precise. For example, it could be the PRF of a variable-PRF radar. Only the two enable intervals must be precisely matched.

Tweaking the converter

A relatively inexpensive VCO is allowable, since its center frequency is not critical and can drift slowly without affecting circuit operation. (The residual count error accumulated in the counter depends only on the stability of the VCO's frequency-versus-voltage characteristic.) Also, the tracking point can be made to compensate for switch offsets and dc voltage drifts by adjustment of the reference voltage, since the loop automatically makes the error and reference voltages equal.

If the design allows switching from the error voltage output to a potentiometer, it becomes possible to slew the early and late gates in or out manually with respect to range. To provide a very fast slew capability, the bi-

nary error count from the counter can be loaded into higher-bit positions in the error register.

As the amplitude of the target reply pulse fluctuates, the gain of the error-measuring system also fluctuates and may lead to under- or over-damping of the tracking loop—or even to instability in more complex loops. To avoid this, the integrator outputs can be summed and the resultant voltage used in an automatic gain control circuit. The over-all gain is usually set so that a motion of the target reply by E feet from the center position will result in a digital error count equivalent to E feet.

The gate generator

The second key loop element for a digital range tracker is the early-late gate generator. This consists of a range counter and associated logic.

At the start of the transmitter pulse, the one's complement of the expected binary digital range is loaded into the range counter, which then moves in the up direction. The time it takes for all counter flip-flops to reach logic 1 is equivalent to the time it takes for the target reply pulse to be received—that is, if the target is at the exact digital range expected.

Because this all-logic-1 state detects target range, an ordinary ripple-carry counter can be used instead of a synchronous binary counter. Specifically, the first counter flip-flop is the last to go to logic 1 once all other counter flip-flops have arrived there. Consequently, the delay in reaching an all-logic-1 state is the necessary number of clock periods plus the delay of the first flip-flop after clock actuation. This being identical to the delay of a fully synchronous counter, a ripple-carry counter is quite adequate.

Figure 3a illustrates a gate-generating technique with a simple counter chain of flip-flops A through J. NAND gate G_1 is enabled when the outputs of all the flip-flops become logic 1. This resets the early-gate flip-flop (G_2 and G_3), and sets the late-gate flip-flop (G_4 and G_5). The former is set at some count less than the all-logic-1 state, the latter reset at some count past this state. These

Analyzing tracking loops

The input variable to a digital range tracker may be a quantity like shaft position, the phase of some sine wave or other waveform with respect to a reference, or the time of occurrence of some pulse with respect to a reference pulse. The output of the tracking loop is simply a digital representation of the analog quantity. It is compared with the input variable, and any discrepancies result in a digital error that is used to drive the digital output closer to equivalence with the input.

If the computation (sample) rate is high compared to the loop noise bandwidth, the loop transfer function can be approximated with Laplace transforms:

$$E_o/E_i = G/(1+G) = \alpha K/(s^2 + \alpha s + \alpha K)$$

where G is the open-loop transfer function, s is the Laplace operator, and α is the low-pass cutoff radian frequency of the integrator in the error measuring circuit. If a simple RC filter is used, then $\alpha = 1/RC$. Variable K is called the velocity constant—this is simply the update rate that achieves unity gain in the error subsystem. For example, if the range register is updated 50 times a second, then a 1-foot error will result in a range rate of 50 feet per second in the register.

The denominator of the loop transfer function is the characteristic equation, and can be written as:

$$s^2 + \alpha s + \alpha K = s^2 + 2F\omega_0 s + \omega_0^2$$

where ω_0 is the undamped natural frequency of the loop in radians per second, and F is the damping constant. For this loop:

$$\alpha = 2F\omega_0 \text{ and } K = \omega_0^2/2F$$

When F is unity, the loop is critically damped. If F is less than unity, the loop is underdamped and will overshoot and/or oscillate before settling to some final value after a step input. For $F = 1$:

$$\alpha = 2\omega_0 \text{ and } K = \omega_0^2/2$$

Manipulating the values of K and α , therefore, allows the setting of noise bandwidth and the lag or lead error

for a constant-velocity target. Usually K is limited to some submultiple of the radar pulse repetition frequency, and α is then established for best damping.

Higher-order loops can be implemented by adding velocity, acceleration, and even higher-order registers. With a velocity register installed between the error and range registers in the loop, the characteristic equation becomes a cubic equation. And there is no lag or lead error for a constant-velocity target, since the velocity register, after an initial transient interval, stores the target velocity, causing the range register to follow the target with zero error in the error register.

Besides eliminating lead or lag error problems, higher-order loops can have narrower bandwidths than first-order loops. And since the integrators are all digital, the drift or gain-stability problems that complicate high-order analog loops are nonexistent.

Loop analysis with Laplace transforms may be inaccurate for high-order loops, because the higher the order of the loop, the higher the data sampling rate must be as compared to loop noise bandwidth: For an exact analysis of a digital range tracker, z-transforms or finite difference equations must be used for characterization, since a tracker is a sampled-data system.

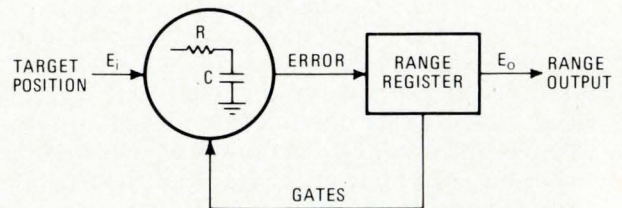

gate edges do not have to be accurate; therefore the counter propagation delays do not matter. But the edge of the pulse derived from the all-logic-1 state is critical, because it corresponds to the tracking point.

In practice, there may be several available counts for setting and resetting the two gates so as to provide a variety of gate widths for a variety of situations. For instance, a wide gate could be used for target acquisition and a narrow gate for tracking. For a narrow gate, signals B and \bar{C} of Fig. 3a are fed to NAND gate G_6 to generate the early-gate set pulse. Signal \bar{C} prevents additional set pulses from falsely restarting the early gate or interfering with the reset pulse. Similarly, the load command to the range counter resets the late gate, preventing a hangup if that gate is run into the next transmitter pulse for maximum range.

Delays in the transmitter and/or the radar beacon (if the target carries one) can distort range. To compensate for them, the width of the load command pulse can be varied. Alternatively the position of this pulse with respect to the transmitter pulse may be varied to obtain the same result.

A sum gate is provided for age circuitry and an absolute-range gate for a digital display. The second gate starts when the flip-flop chain starts counting and ends at the tracking point (beginning of the late gate). It is

used to gate clocks to a binary-coded-decimal counter that drives a decimal display system. By selecting the appropriate clock rate to the BCD counter, the same display can read out in miles, feet, kilometers, or any other desired system of units.

Interpolation boosts resolution

For the digital range tracker of Fig. 1, range resolution depends on the clock rate to the range counter. However, by adding the three-bit interpolation network shown in Fig. 3b to the gate generator of Fig. 3a, the resolution of the entire tracker can be improved without increasing the clock rate. For instance, a 6.2-megahertz clock rate allows a tracker resolution of about 80 feet. Adding three delay lines will improve the resolution to 10 feet—the equivalent of a 49.6-MHz clock.

The path of the tracking pulse through or around each delay line is controlled by the three lowest-order bits of the tracker loop—for this example, represented by 40, 20, and 10 feet, respectively. The range counter receives the highest-order bits (80 feet and up). There is a fixed delay, even with all delay lines bypassed. But it is easily calibrated out of the system by adjusting the range counter load point or the tracking point on the reply pulse.

Although this interpolation technique is relatively

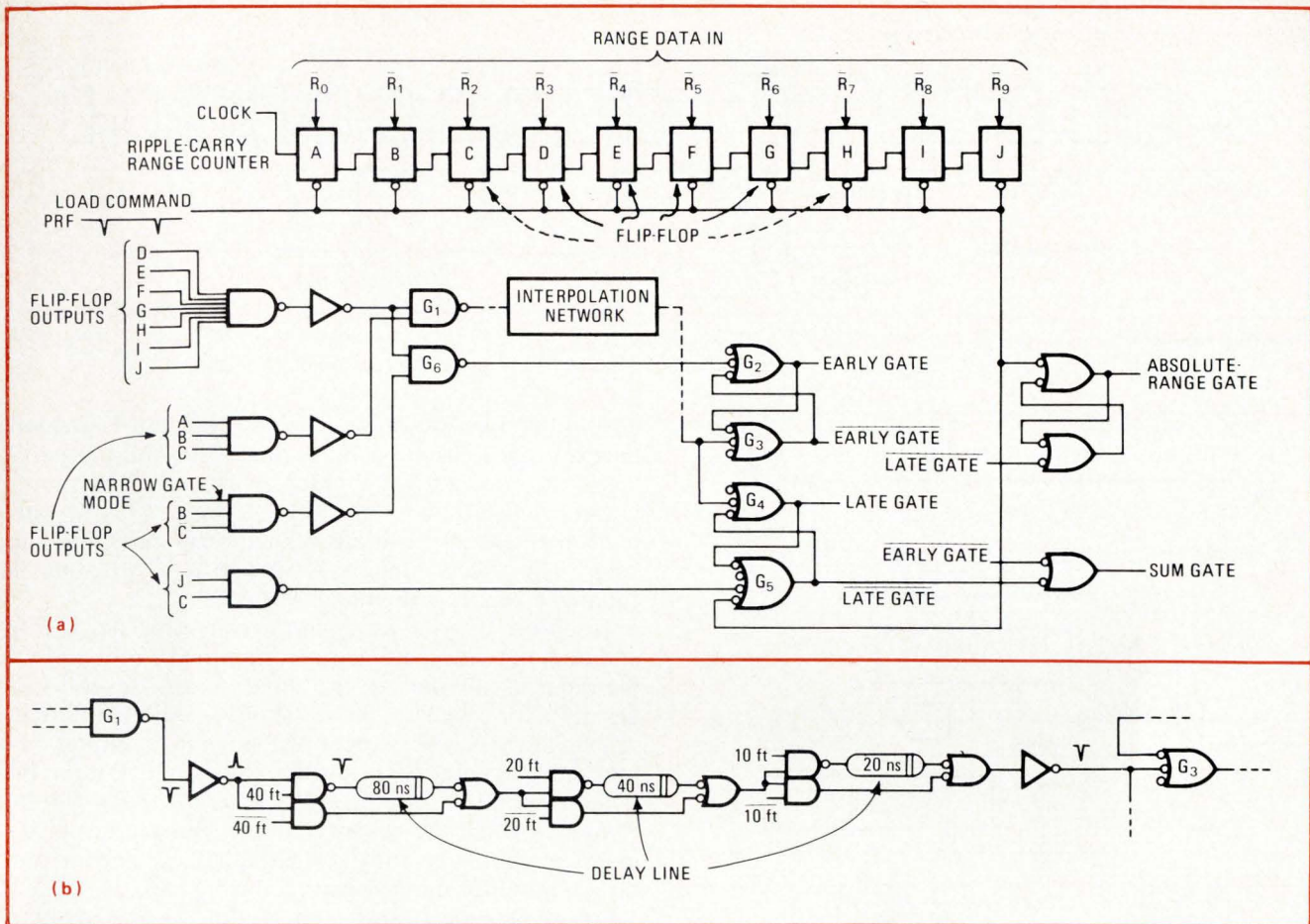

3. Counting and gating. Time required for every flip-flop in range counter (a) to go to logic 1 is time needed to receive target reply pulse. Early gate is enabled at some count lower than all-logic-1 state, late gate is reset at higher count. Sum gate output is for automatic gain control circuitry, and absolute-range gate output allows incorporation of digital display. Inserting interpolation network (b) improves resolution without increasing clock rate. Number of interpolator delay lines corresponds to number of lowest-order tracker-loop bits needed.

easy to implement, it does not allow the range to be displayed to full system resolution; for it doesn't make use of the absolute-range gate or the clock to the range counter. A way to avoid using a higher-frequency clock and yet improve display resolution is to set up a separate range counter that employs all the range bits.

If this counter is driven by the same clock that drives the gate-generating counter, the range gate produced will be eight times wider than true range, when interpolating over three bits. But now the range gate and system clock can directly drive a BCD counter to produce a range display with full system resolution. The maximum update rate for the display will be restricted to one-eighth the radar PRF because of the interpolation scale factor introduced.

The range register

The third and last key loop element is the range register. It's shown in Fig. 4 with its associated error register and adder.

The error signal (represented by inputs E_1 through E_5) from the up/down counter of the a-d converter subsystem is transferred, in parallel, to the error register. Then it is shifted out serially to an adder, where it is summed with the range information stored in the range shift register. Serial arithmetic is used to save parts, and

also because the required shift rates are usually low compared with the capability of standard ICs.

The error register need not have as many bits as the range register, since the error requires fewer significant bits than the range. Instead, the sign bit is fed to the input of the error register, and is used to fill the higher-order error bits. This can be done when the same number of clocks drives the error and range registers.

A positive error has a sign bit of logic 0, so that zero is added to the higher-order range bits. A negative error is converted into two's complement form with a sign bit of logic 1 and added to the range. In effect, a negative error automatically subtracts from the range since all higher-order error bits are also logic 1. For the two registers in the figure, a burst of 10 shift clocks circulates the range through the adder to complete one cycle.

Adding excess-range computation

Sometimes, high-PRF radars are used, because they reduce the peak power required in tracking long-range targets, yet maintain adequate average power on the target. Figure 5a shows the echo pattern in relation to the transmitter pulses for such a radar. The true range of the target is R_T and the apparent range is R_E (also called the excess range):

$$R_E = R_T - nP$$

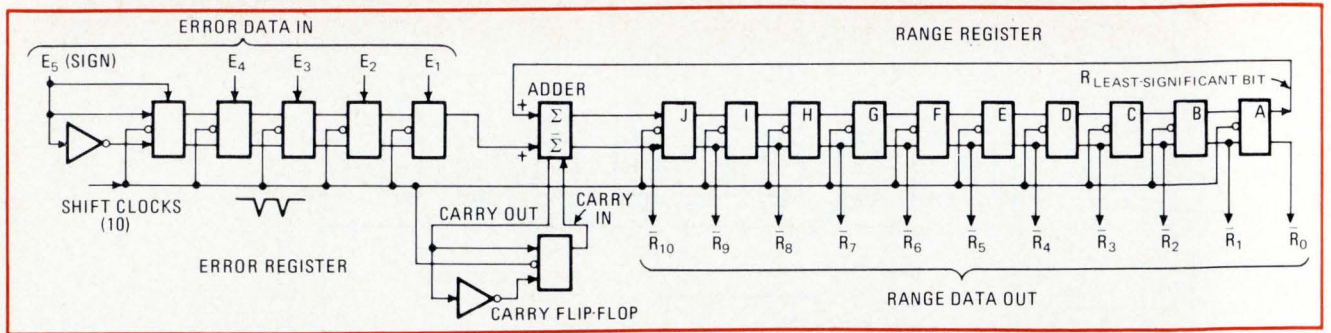

4. Storing range data. Error signal from error counter is fed to error register. Error is then shifted to adder and summed with existing range data in range register. Since serial arithmetic is used, only a few parts are needed, and these can be operated at low shift rates.

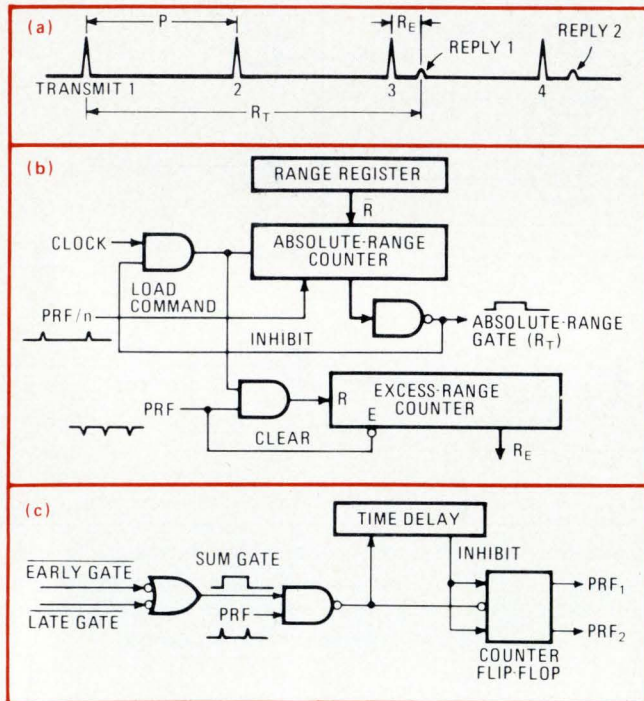

5. Worthwhile additions. Tracking long-range target requires high-frequency radar that causes multiple-pulse echo pattern (a). To find true range (R_T) of target, an excess-range (R_E) computer (b) is needed. Absolute-range counter provides gate proportional to width of R_T . Excess-range counter is only on during absolute-range gate, making its count the desired R_E for generating proper early and late gates. Anti-eclipsing circuit (c) prevents transmitter pulse of ambiguous-range radar from eclipsing target reply. If early or late gate runs into transmitter pulse, NAND gate is enabled, and radar jumps to new PRF so that new R_E can be found without loss of track.

where P is the radar interpulse period and n is the integer number of echos.

To track the target and utilize all the transmitter energy efficiently, a set of early and late gates is needed at a range R_E from each transmitter pulse. At the same time, the range in the range register should be true range, R_T . Both requirements can be met by including an excess-range computer, like the one in Fig. 5b, between the range register and a range counter that cycles at the radar PRF.

This "computer" is merely an additional pair of range counters. One of them generates an absolute-range gate that is proportional to R_T in width and that is essential for displaying range in any radar. The other operates

during the absolute-range gate interval, but is cleared during every transmitter pulse time. The count remaining in the excess-range counter at the end of the absolute-range gate is the desired excess range. This R_E output is then used to generate the necessary early and late gates. The excess range is updated at a rate that is counted down from the radar PRF.

To ensure that the range in the range register is true and does not reflect an incorrect number of echo pulses, the radar usually has several PRFs—that is, several values of P . For each PRF, the value of R_E will be different, so long as the various values of P have no common factors and true range R_T is less than the product of the P s. If these conditions are met, a new value of R_E will be computed when the PRF is changed. But the target remains in the early and late gates if, and only if, the range register contains the correct value of R_T .

For acquisition purposes, it is unnecessary to jump back and forth between different PRFs to make sure that the range register is slewed to the correct range. Rather, target returns can be shown on a display that has a wide enough sweep to cover the full range. And every n th transmitter pulse must be jittered. Then, when the display sweep is synchronized to the jittered pulse, the true target echo appears to be steady. The approximate true range can now be measured off the display to check that the range register is slewed to near the correct value.

Anti-eclipsing circuitry

With an ambiguous-range radar, a tracked target may run into a transmitter pulse, forcing R_E to go to zero since $R_T = nP$. Because the receiver cannot usually be on during the transmitter pulse time, there is also the possible danger of loss of track. To avoid these problems, the position of the early-late gates in relation to the transmitter pulse can be monitored by an anti-eclipsing circuit (Fig. 5c).

Both gate signals drive a NOR gate, forming a sum gate that is applied to a NAND gate along with the radar PRF. Whenever an early or late gate bumps into a transmitter pulse, the NAND gate is enabled, and the radar PRF is jumped, causing the radar to operate at a new PRF. The time constant of the anti-eclipsing circuit is long enough to hold the radar at the new PRF, so that a new R_E can be calculated and tracking can be resumed.

Many other features can easily be added to a digital tracking loop. These include automatic search and acquisition logic, anti-jamming circuitry, self-test logic, and self-calibration logic. □

Theirs.

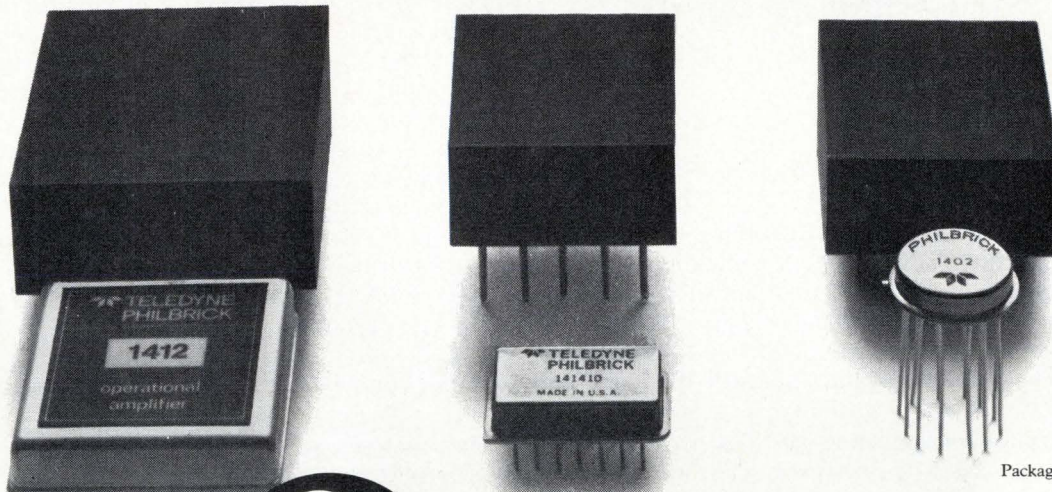

Packages shown actual size.

Ours.

Small. Very small. In fact, the smallest.

We call them our Series 1400. They're hermetically sealed and have better specs. Ideal for HI-REL military/aerospace applications. Ask about our MIL STD 883 capability.

MODEL 1412 mini-chopper. Unique. Gives you unbelievable flexibility in solving critical packaging problems. High performance. Like, $\pm 25 \mu\text{V}$ max initial offset, $0.25 \mu\text{V}/^\circ\text{C}$ drift, and 30 pA bias current, $2 \text{ pA}/^\circ\text{C}$ drift. Price: \$104 in 100's.

MODEL 1414/10. Fastest FET op-amp in a DIP package. $65 \text{ V}/\mu\text{sec}$ slew rate. Settles to .01% in 800 nsec. 20 pA bias current, 25 mA output current. Price: \$45.50 in 100's.

MODEL 1402 micro power FET op-amp with 0.5 mA quiescent current, $\pm 4 \text{ V}$ to $\pm 24 \text{ V}$ supply range, 15 pA typ bias current, and $10 \mu\text{V}/^\circ\text{C}$ drift. All this, and more, in a TO-8 case. Ideal for pollution-monitoring devices, oceanography, and portable test equipment. Price: \$44 in 100's.

A small price to pay for the best. And we can prove it, with evaluation samples. Off the shelf shipment from the industry's largest selection of linear circuit modules.

Get full details from your local Philbrick representative or Teledyne Philbrick, Allied Drive at Route 128, Dedham, Massachusetts 02026. For toll-free ready data dial (800) 225-7883. In Massachusetts, (617) 329-1600.

Philbrick Linear Microcircuits. The good ones.

Designer's casebook

Series-connected op amps null offset voltage

by Lawrence Choice
Burr-Brown Research Corp., Tucson, Ariz.

The input offset voltage and offset voltage drift of a differential operational amplifier can be held essentially to zero by connecting a second amplifier at the inverting input of the first. This auxiliary op amp must have an offset voltage and drift that are matched to the primary op amp. The additional amplifier will then act as a

floating voltage source, canceling any offset voltage.

As shown in (a), unity-feedback amplifier A_1 is connected to the inverting input of amplifier A_2 , providing a floating offset voltage source between A_2 's non-inverting input and its output. (If A_1 's offset characteristics were matched with opposite polarity to those of A_2 , then A_1 could be placed at A_2 's non-inverting input.) Letting V_{os} represent the input offset voltage of A_2 , V_{A1} the voltage across A_1 , A_o the open-loop gain of A_2 , and E_1 and E_2 the two input signals, then output voltage E_o can be written as:

$$E_o = -A_o(E_1 - E_2) - A_o(V_{A1} - V_{os})$$

If $V_{A1} = V_{os}$, then:

$$E_o = -A_o(E_1 - E_2)$$

The composite amplifier consisting of A_1 and A_2 can

Getting rid of offset voltage. Letting amplifier A_1 act as floating voltage source (a) effectively eliminates offset voltage and offset voltage drift of amplifier A_2 . As long as A_1 and A_2 are matched, their offset voltages cancel, keeping offset of composite amplifier at zero. Composite amplifier of (a) can be used as conventional single operational amplifier for either inverting (b) or non-inverting (c) applications.

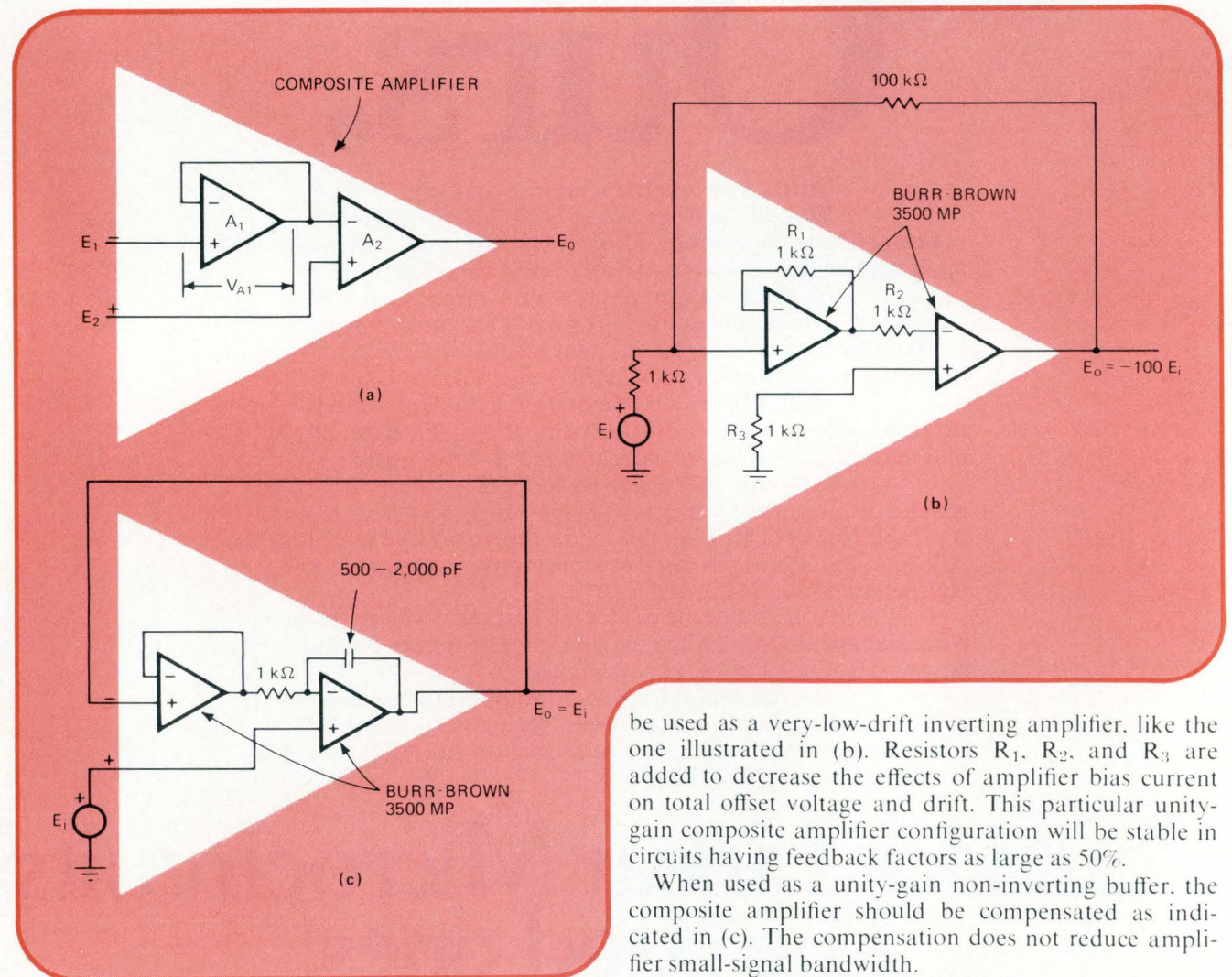

be used as a very-low-drift inverting amplifier, like the one illustrated in (b). Resistors R_1 , R_2 , and R_3 are added to decrease the effects of amplifier bias current on total offset voltage and drift. This particular unity-gain composite amplifier configuration will be stable in circuits having feedback factors as large as 50%.

When used as a unity-gain non-inverting buffer, the composite amplifier should be compensated as indicated in (c). The compensation does not reduce amplifier small-signal bandwidth.

Linear signal limiting with feedback multiplier

by R.J. Karwoski
Raytheon Co., Equipment division, Sudbury, Mass

A signal can be linearly compressed or limited over a wide dynamic range by using a four-quadrant analog multiplier as a feedback element. Particularly useful for audio applications, this linear limiting technique does away with the signal distortion that occurs with nonlinear methods. Also, the linear limiter does not require the careful calibration and many trial-and-error adjustments needed for a nonlinear limiter.

The control section of the linear limiter consists of three operational amplifiers and a multiplier. Op amp A_1 is the throughput amplifier with local feedback through resistors R_F , R_1 , and R_2 . When R_F is shorted, the control circuitry is bypassed, and the circuit becomes a linear voltage-follower:

$$e_o = e_i(1 + R_F/[R_1 R_2/(R_1 + R_2)])$$

The fundamental feedback equation for the limiter is based on amplifier A_1 :

$$e_o = A_o e_i / (1 + A_o \beta)$$

where gain A_o is determined by A_1 's local feedback arrangement of R_F and R_1 in parallel with R_2 . Feedback factor β depends on the control section, whose operating function resembles the basic feedback equation. The relationship between multiplier input e_Y and multiplier input e_X becomes:

$$e_Y = e_X / (1 + e_X)$$

For small values of e_X , this equation degenerates to:

$$e_Y = e_X$$

which is a linear function representing a 1:1 compression ratio between e_o and e_i . For large values of e_X , the function becomes asymptotically limiting:

$$e_Y = e_X / e_X = 1$$

Over-all limiter transfer function can be written as:

$$\frac{e_o}{e_i} = \frac{1 + R_F/[R_1 R_2/(R_1 + R_2)]}{1 + 410 R_F (e_i)_{pk} / R_2}$$

Multiplier output $e_X e_Y / 10$ and the product of gains of amplifiers A_2 , A_3 , and A_4 are represented by the factor $410(e_i)_{pk}$, where $(e_i)_{pk}$ is the peak input signal amplitude. Resistor R_F controls both circuit gain and compression. However, for any single value of e_i , the limiter can be set to provide a gain of unity, regardless of R_F 's resistance and how much or how little limiting is needed. Additional over-all gain adjustments are then unnecessary, even if the compression ratio must be changed.

With a 100-millivolt input, the circuit illustrated supplies a 100-mV output, no matter what the setting of R_F . For any value of R_F , resistor R_1 is selected to keep:

$$1 + R_F/[R_1 R_2/(R_1 + R_2)] = 1 + 410 R_F (100 \text{ mV}) / R_2$$

Circuit compression ratio can be varied by changing the value of R_F , but circuit gain remains unity for $e_i = e_o = 100 \text{ mV}$.

The performance curves show the limiter's transfer function for three compression ratios with circuit unity-gain point at 100 mV—1:1 (no compression, $R_F = 0$), 8:1 (maximum compression, $R_F = 25 \text{ kilohms}$), and 3:1 (midrange compression).

Variable linear limiter. Compression ratio can be varied by adjusting resistor R_F without changing circuit gain—limiter's unity-gain point remains $e_i = e_o = 100 \text{ millivolts}$. Amplifier A_1 is controlled by local feedback through resistors R_F , R_1 , and R_2 and by additional feedback from multiplier and amplifiers A_2 , A_3 , and A_4 . When $R_F = 0$, compression ratio is 1:1, when $R_F = 25 \text{ kilohms}$, compression is 8:1.

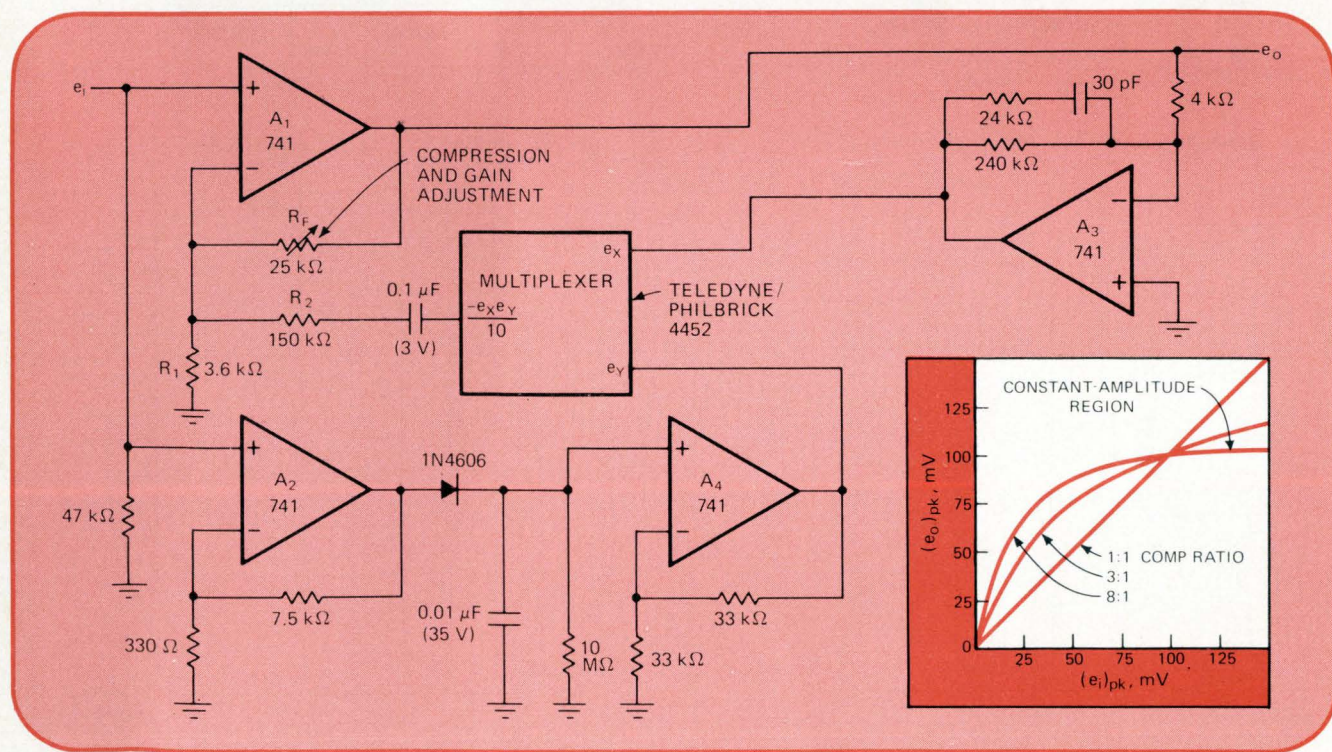

Simple logic circuits compare binary numbers

by Edward J. Murray
Inter-Computer Electronics Inc., Lansdale, Pa.

In real-time data acquisition applications, determining the relative magnitude of two binary numbers with hardware, rather than software, now requires only three logic modules if data is being transferred serially. Previously, rather complex circuitry was needed.

Only the most-significant difference between two coincident serial data streams defines their relative magnitude. If the least-significant bit is transmitted first, the last difference between coincident word bits determines which is the largest word. When the most-significant bit is the first transmitted, the first difference establishes relative magnitude, and all other differences can be ignored.

Six logic gates (a) can compare two words when the least-significant bit is the initial input. Eight logic gates (b) are needed when the most-significant bit arrives first. The heart of both schemes is a three-state latch that provides three comparisons for input words A and B: A is greater than B, A equals B, and A is less than B.

The timing diagrams in (a) and (b) illustrate circuit operation when input A is octal number 25 (binary 010101) and input B is octal number 15 (binary 001101). Signals A and B are not limited to a fixed number of bits per word. Any variable word size can be used if the results are interrogated after the word has been transmitted and a reset pulse precedes the word being interrogated.

This type of binary comparator is useful in preliminary data sorting and number ranging prior to software processing for multi-channel data acquisition. In the timing diagram, the "result available" waveform indicates the best interrogation periods.

Designer's casebook is a regular feature in Electronics. We invite readers to submit original and unpublished circuit ideas and solutions to design problems. Explain briefly but thoroughly the circuit's operating principle and purpose. We'll pay \$50 for each item published.

Checking number size. To find relative magnitude of serial words A and B, only most-significant differences between coincident data bits must be considered. Transmitting least-significant bit first (a) requires six gates for comparison. Two additional gates are needed (b) if most-significant bit is transmitted first. In timing diagrams, octal 25 (binary 010101) is compared to octal 15 (binary 001101).

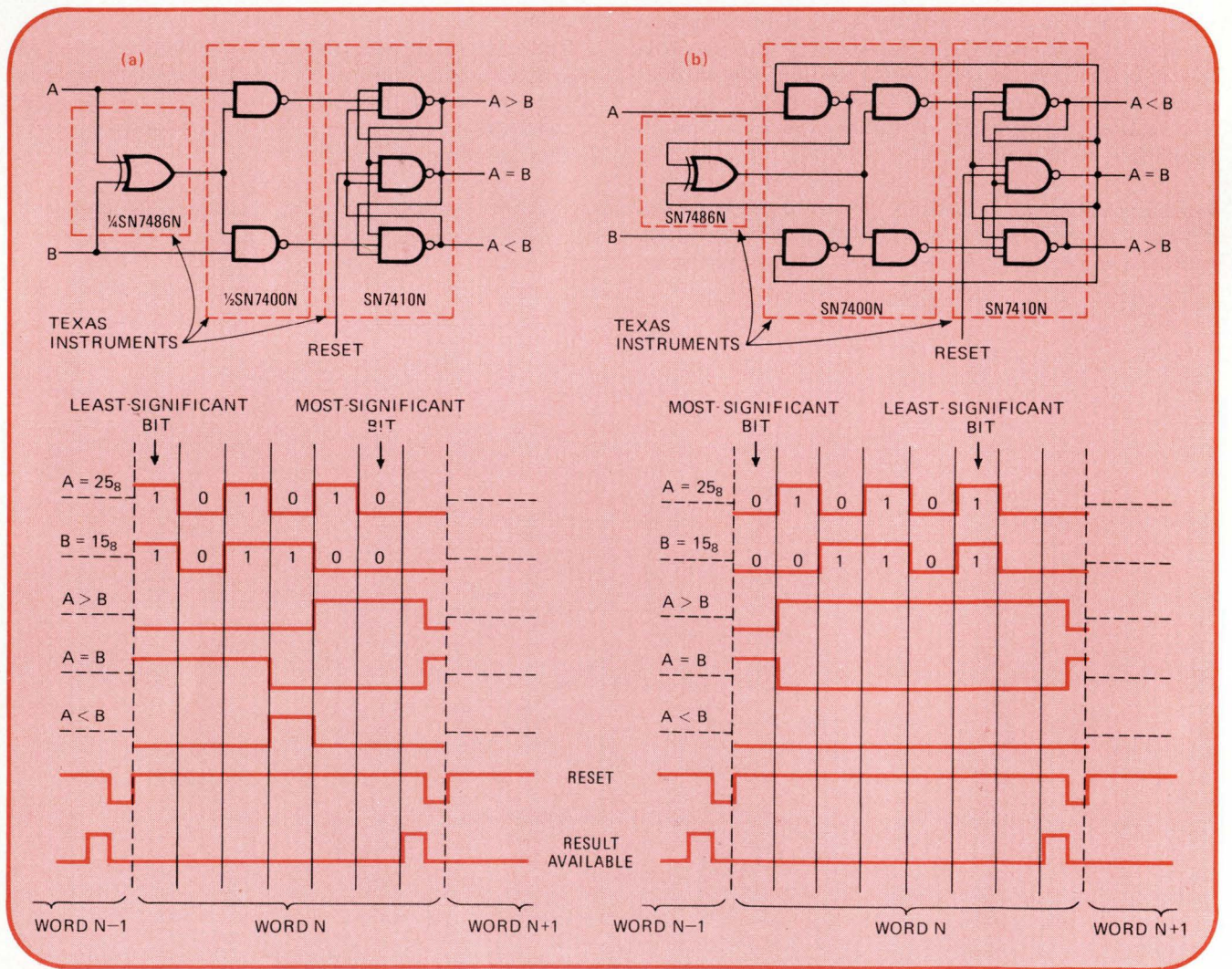

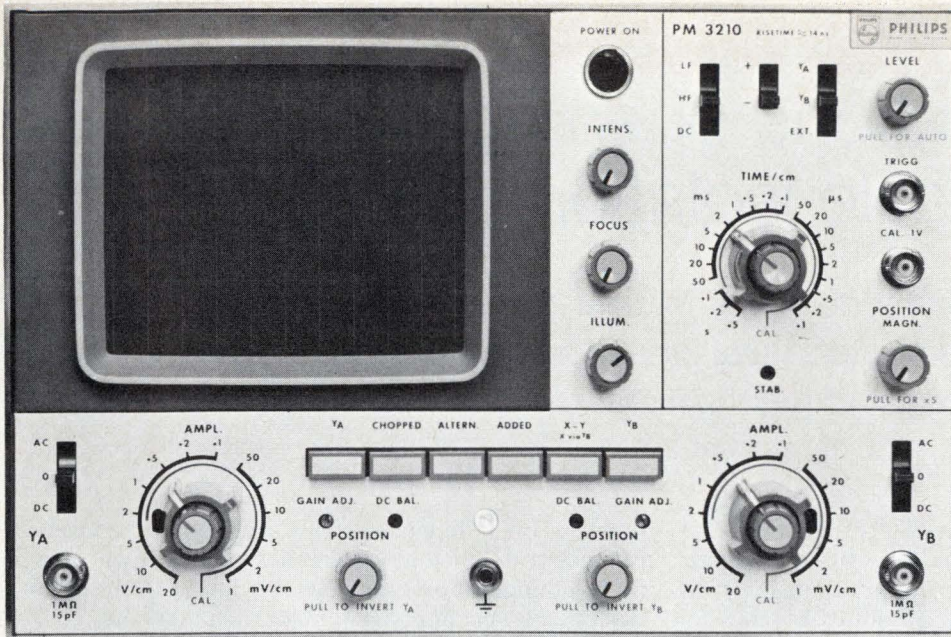

PM 3210
\$1350

easy

**Best
price/
performance
ratio**

**25 MHz/1mV
15 pf input capacitance
No dc drift***

For service application in production testing, quality control, medical research and computer servicing, Philips' new PM 3210 easily gives you the best all around price/performance ratio of any scope in its field: dual trace 25 MHz at 1 mV sensitivity per channel ... dual delay lines ... input impedance 1M Ω /15pf ... X-Y displays with only 2° phase shift from 0 to 5 MHz ... 16 combinations of vertical display modes

Easy to use

*No correction needed for dc drift, self-correcting ... push button mode selection ... automatic triggering, 10 Hz to 25 MHz

Easy to read

10kV acceleration and 8 × 10 cm screen produce clear, unambiguous displays

Easy to service

Plug-in circuit boards throughout

Easy to buy

Call Dick Rude, Sales Manager, Test & Measuring Instruments today (914-664-4500). He's holding a demonstrator for you.

**PHILIPS
ELECTRONIC
INSTRUMENTS**

750 S. FULTON AVE., MT. VERNON, N.Y. 10550
A DIVISION OF PEPI, INC.

New applications open up for the versatile isolation amplifier

Extremely high common-mode rejection ratios and common-mode voltage ratings make isolation amplifiers ideal for a wide variety of tasks—from preventing the electrocution of heart patients to measuring off-ground signals

by C. Peter Zicko, *Analog Devices Inc., Norwood, Mass.*

□ For measuring off-ground signals, protecting delicate circuitry against high common-mode voltages, or interrupting leakage paths in medical applications such as cardiac monitoring, an isolation amplifier is often an economical solution to an otherwise costly problem. At first glance it looks much like an instrumentation amplifier, but is distinguished by its extremely high common-mode rejection (even with high source-resistance unbalance), high common-mode and differential-voltage rating, high common-mode and differential-input resistance, and low leakage capacitance between input circuit and ground (see table).

Unfortunately, an isolation amplifier has less gain, less bandwidth, greater temperature sensitivity, and greater noise than an instrumentation amplifier. This performance degradation arises from the signal modulation circuits used to achieve isolation.

Many applications

From these general characteristics, it is clear that the most obvious application for isolation amplifiers is in data-acquisition systems. Here, off-ground current or voltage readings must be transferred to levels about ground so they can be fed to computers, recorders, and

other data-handling equipment. In general, the low cost of modern isolation amplifiers has created a whole new range of applications, much as the development of low-cost operational amplifiers did for linear circuits.

For example, the isolation amplifier not only is useful for measuring signals that are floating hundreds of volts above ground, it can also reverse the signal flow, and actually feed control signals from information sources at ground level to circuitry that is floating at some high voltage level (Fig. 1).

In the illustration, a dc power supply is controlled by digital commands that are fed to the digital-to-analog converter. The power supply is designed so that either output terminal can be grounded for a choice of positive or negative output polarity. In one instance, consequently, the regulating circuitry will be off-ground to the tune of the full-scale output voltage. Coupling problems are solved, of course, by interposing the isolation amplifier between the regulating signal source (d-a converter) and the actual voltage-regulating circuits. Conversely, but not shown, feedback signals for closed-loop voltage control may be brought down to ground level by an isolation amplifier working in the conventional way.

1. Reversed operation. Isolation amplifier works backwards in power-supply application, converts grounded input to floating output. Caution: this mode requires an isolated power supply that can float at the same potential as the amplifier's output.

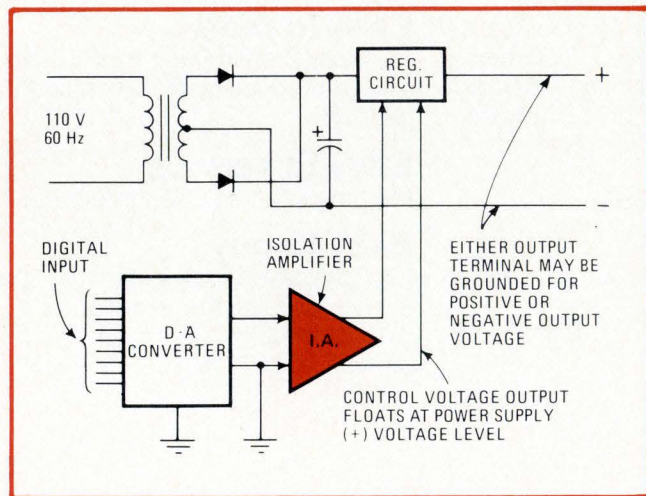

Monitoring motor current

An isolation amplifier's excellent 60-hertz common-mode performance is brought to bear on the motor load indicator of Fig 2a. Because of its up to 115-decibel common-mode rejection (CMR) from dc to 100 Hz, the amplifier can handle high-voltage ac measurements, as well as dc. In this instance, where the delta connection eliminates any neutral line at or near ground potential, the current shunt is inserted directly into one of the three-phase lines, and readings are transferred to ground by the amplifier. A unit's 1,000-volt common-mode-voltage (CMV) rating enables applications of this type to handle motors operating from 1,000-v peak supplies (600 v rms), or dc supplies in the 1,000-v region.

If isolation amplifiers with high CMV ratings were not available, it would be necessary to use a pair of matched voltage dividers to reduce the CMV (Fig. 2b). But because the pair cannot be matched perfectly, the dividers would degrade the temperature stability of the circuit and reduce its CMR.

An important class of applications for isolation amplifiers—one that has nothing to do with the dangers or

How it works

The remarkable specifications summarized in the table derive from the carrier system, which is used to transfer both signals and power between the amplifier's shielded input stage and the rest of its circuitry. Because a high carrier frequency (150 kilohertz) is used, the amplifier is able to provide a small-signal bandwidth of 2 kHz and a full-power response up to 200 Hz.

The high-value resistor, R_L , limits the differential fault current in case one of the input FETs fails. It also keeps the differential input resistance high during periods of input-amplifier saturation. This series resistor gives the amplifier its 5,000-volt differential input rating, making it independent of linear operation of the input circuitry.

Because the FET input preamplifier operates single-ended (non-inverting), only a difference input current

flows; no net bias current flows under these conditions. Normally, a differential amplifier has two independent bias currents, one each at the inverting and non-inverting inputs, and requires a return path for these currents.

Unlike the ordinary instrumentation amplifier, which depends upon precise component matching for its common-mode rejection, the isolation amplifier exploits its low-leakage transformer coupling to obtain a distinct interruption in the common-mode circuit. This makes it inherently immune to common-mode signals and highly insensitive to input imbalances.

In point of fact, only the unavoidable leakage capacitance between the shielded input section and the rest of the circuitry keeps the common-mode rejection ratio from being infinite. The reason is that the leakage paths are the only mechanism through which the common-mode input can affect the amplifier's output.

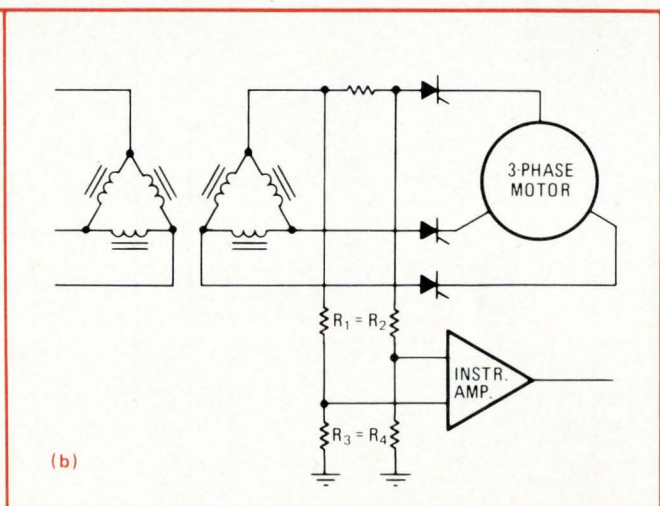
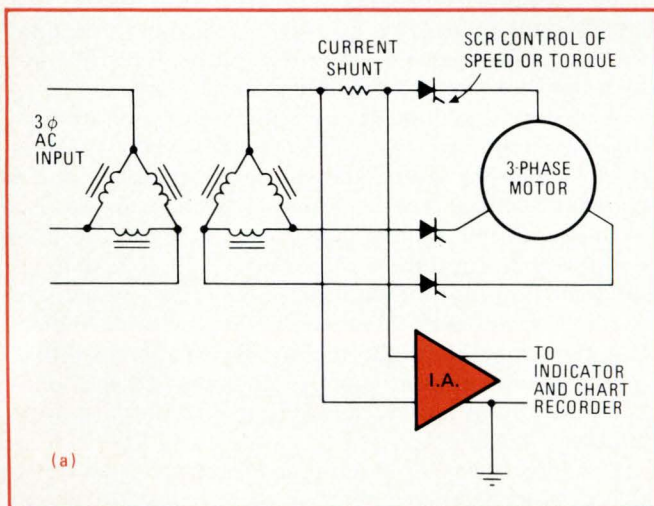
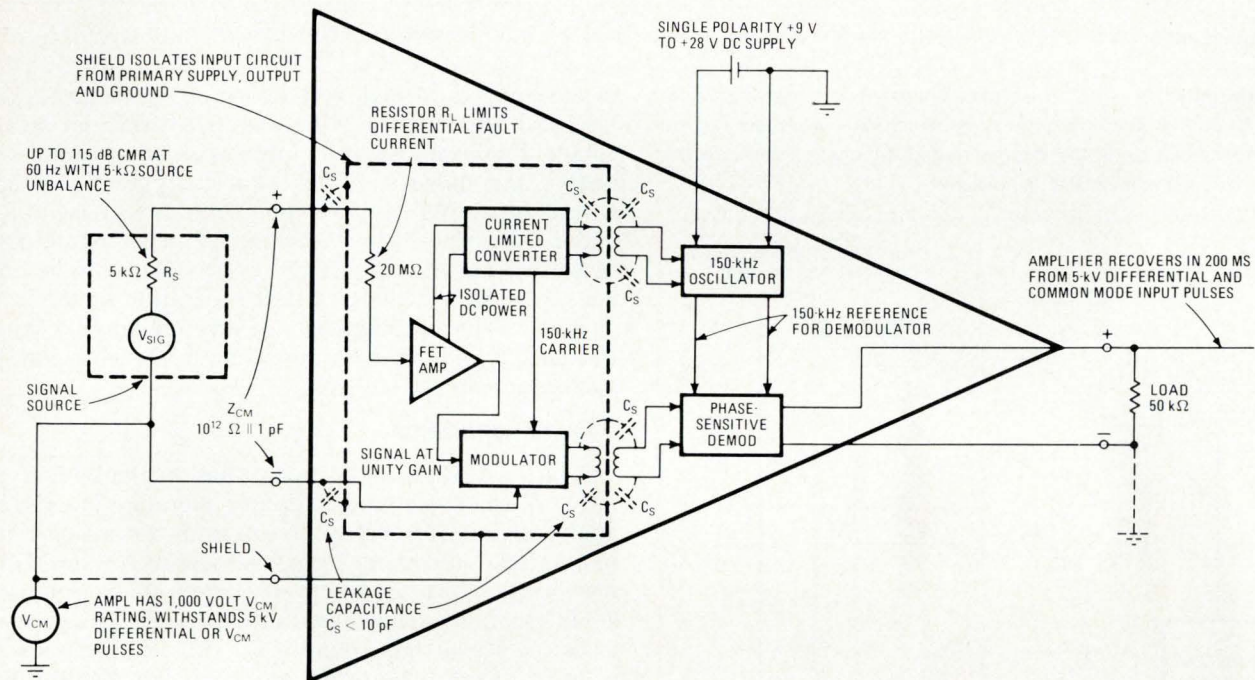

2. Motor monitor. Excellent common-mode rejection of isolation amplifier allows measurement of ac motor current (a). Amplifier has useful gain to 10 kHz, permitting observation of steep-fronted SCR waveforms on oscilloscope. With ordinary low-CMV instrumentation amplifier, voltage divider network is required (b). This reduces CMR because of imperfect matching of resistors.

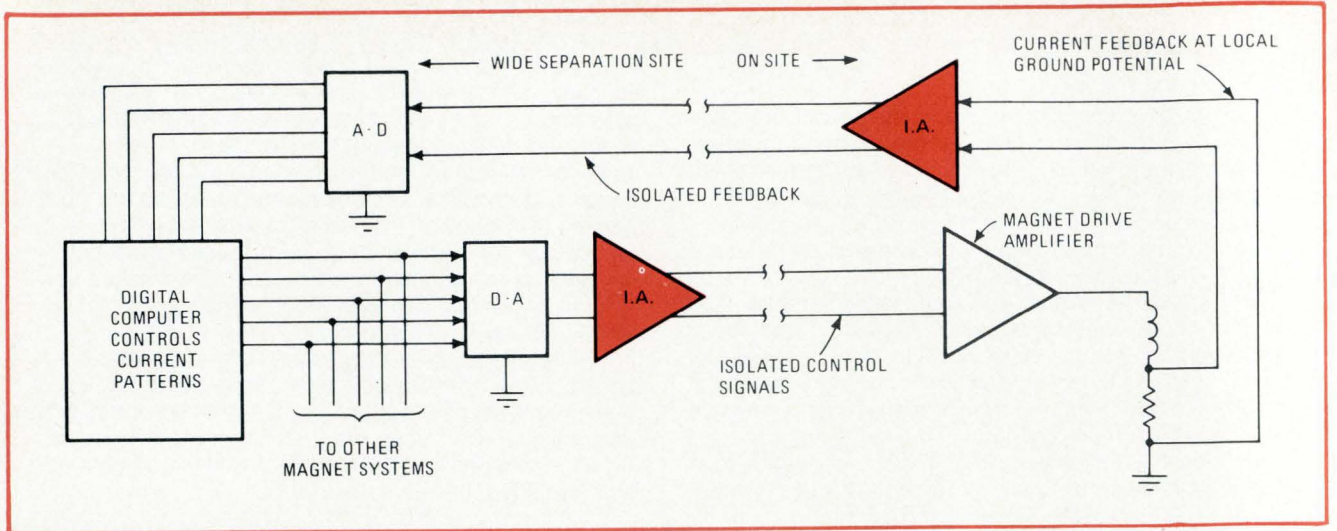

3. Ground separation. Isolation amplifiers keep analog and digital signals separated in this digitally controlled magnet system.

4. Uniformity. Driving all strain gauges in series from a single constant-current source ensures uniform excitation. It also ensures the occurrence of a high CMV at top of transducer chain; this situation is easily resolved with isolation amplifiers.

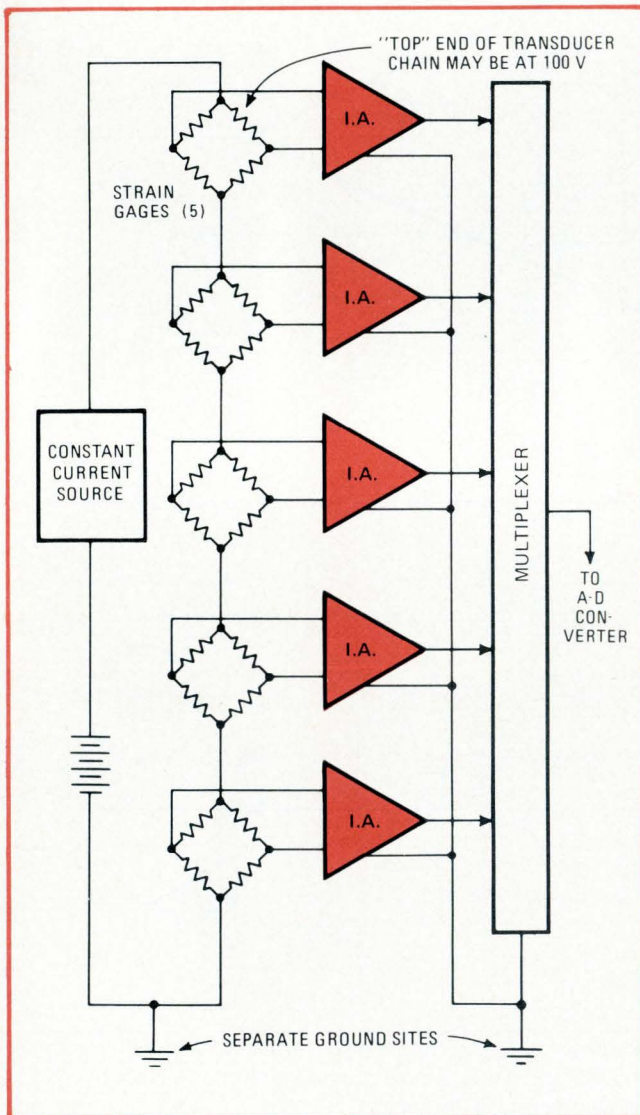

inconveniences of high common-mode voltages—is the electrical separation of different parts of an electronic circuit. For example, it is often wise to separate the analog and digital portions of a computer-controlled hybrid circuit. When this is done, interface errors in a-d and d-a converters can be eliminated, and ground loops between different components in the system can be broken. In addition, true electrical separation of different circuits can prevent digital pulses from riding on sensitive analog lines, thereby obscuring least-significant-bit analog increments.

Ground separation

A representative application of this technique is given in Fig. 3, where a digital computer operating in a closed analog-digital loop sets up precise time-varying currents in a nuclear accelerator's magnet system. Although just one loop is shown, a particle accelerator may often have 20 different magnet coils, with total power consumption in the megawatt region and total area in the hundreds of square yards. The technique of analog-digital isolation not only keeps digital pulses out of analog signal lines, but provides benefits in reverse; for it allows each analog load to operate at whatever ground potential prevails at the load site, without imposing difficult common-mode problems at the a-d and d-a interfaces.

A modern technique for ensuring uniformity of transducer excitation is to use current forcing (Fig. 4) rather than to energize several transducers in parallel from a common voltage source. This approach overcomes problems arising from voltage drops in the lines feeding the different transducers and ensures tighter reading of different pressure, temperature, and other values. For example, in agricultural research, it is necessary to measure the temperature differential of a sun-warmed field to a resolution exceeding 0.1°C , and this becomes difficult if line drops introduce uncertainty in thermistor excitation voltage.

If a large string of strain-gauge or thermistor transducers is to be driven from a single constant-current source, then appreciable common-mode voltage will appear at the upper end of the transducer chain (Fig. 4). Here, then, is an example of the need for an amplifier

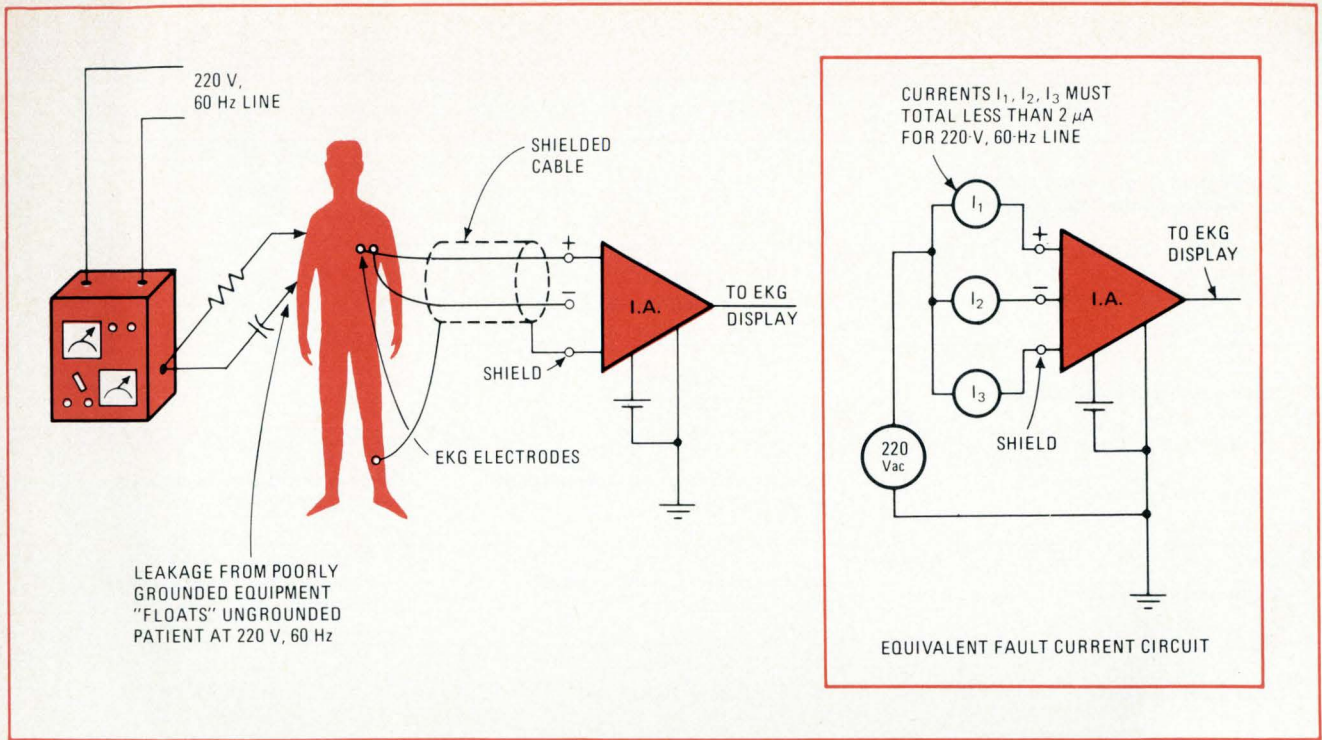

5. Life and death. In medical applications, where patients may be in contact with poorly grounded equipment, isolation amplifier breaks leakage-to-ground path, thus prevents electrocution of the patient. The fatal current need be only a few microamperes in many cases.

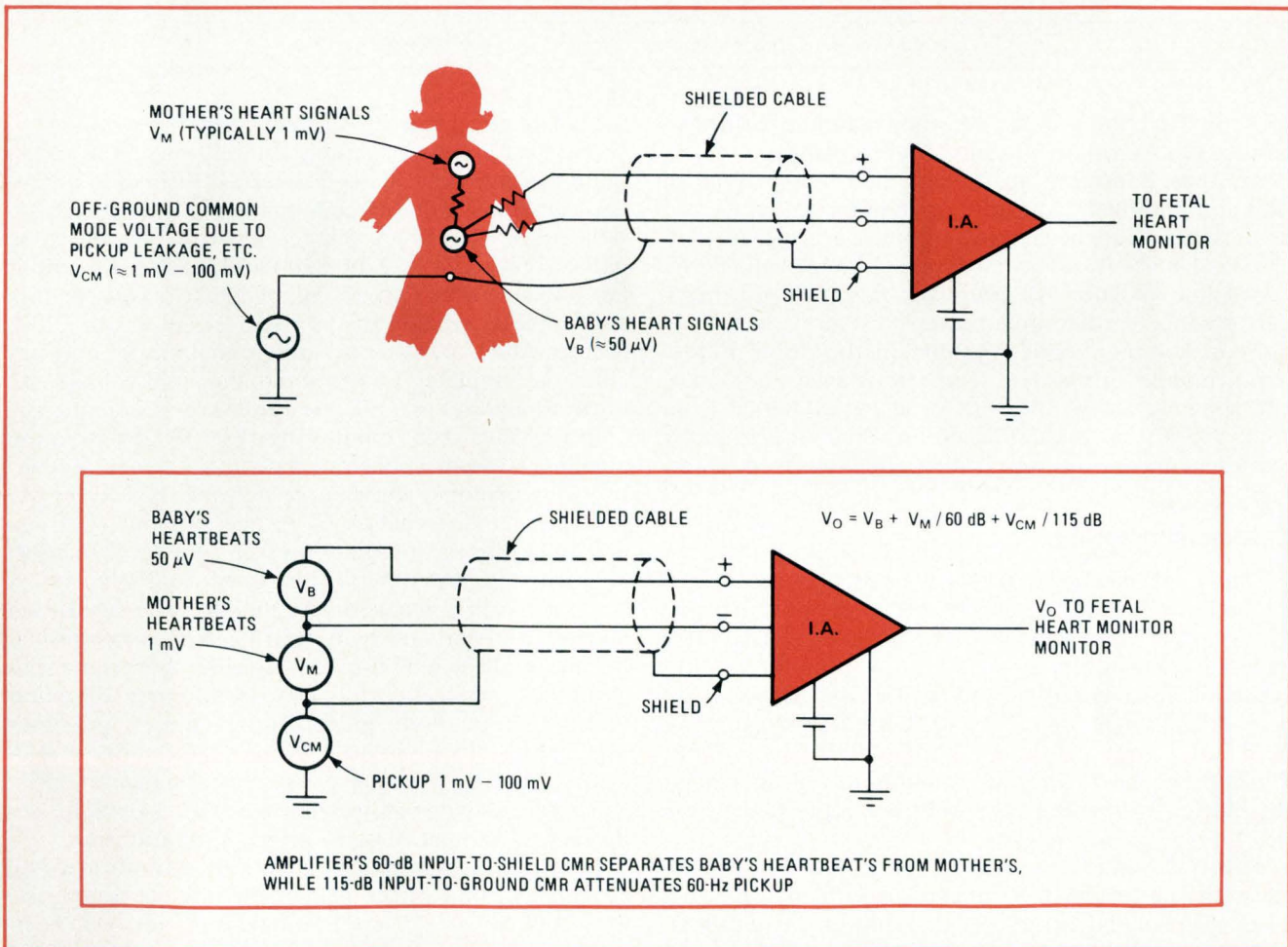

6. Fetal heartbeat monitoring. Here the problem is not only to reject any muscle noise, but to detect weak signal from baby's heart in presence of strong cardiac signal from the mother. Solution is high common-mode rejection of isolation amplifier.

TABLE: ISOLATION AMPLIFIER vs INSTRUMENTATION AMPLIFIER

KEY SPECIFICATIONS	ISOLATION AMPLIFIER *	TYPICAL INSTRUMENTATION AMPLIFIER
CMRR for unity gain with 5,000 ohms of source unbalance from dc to 100 Hz	115 dB	80 dB
Common-mode voltage range	$\pm 1,000$ V (5,000 V, peak)	± 10 V
Differential input voltage range	$\pm 1,000$ V (5,000 V, peak)	± 10 V
Input-to-ground leakage	Transformer isolated; 10^{11} ohms shunted by less than 10 pF.	Feedback generated depends upon linear circuit operation.
Bias current configuration	Single bias current; amplifier needs only 2 input conductors.	Two bias current; third wire is needed for bias return.
Small-signal passband	dc to 2 kHz	dc to 1.5 MHz
Price (1-9) (100-999)	\$ 109 \$ 67	\$ 30 to \$ 150 \$ 25 to \$ 35

* The isolation amplifier described in this table is the Analog Devices' Models 272 - 275.

with high common-mode rejection and the ability to handle 100 v or more of common-mode voltage.

Another important instrumentation application of isolation amplifiers is in cardiac monitoring, where the heart signals can be masked by muscle noise, electrochemical noise, residual electrode voltages, and 60-Hz power-line pickup. An amplifier designed for high-performance cardiac monitoring must provide the utmost in common-mode rejection in the dc to 100-Hz band, handle substantial source resistance unbalance, and separate a few millivolts of heartbeat signal from 50 to 500 mV of residual electrode potential created by electrochemical processes at the patient-electrode interface.

Cardiac monitoring

Safety specifications skyrocket when it comes to cardiac monitoring during open-heart surgery or intensive care of patients. In these cases, because the resistance of exposed organs drops to the fractional-ohm level, millivolts of inadvertently applied leakage voltage can create the 20 microamps of body current now known to be lethal. Consequently, an electrically isolated amplifier must be used to avoid grounding of the patient as the electrocardiograph electrodes are connected to the heart.

This isolation is an important safety requirement because the patient may be in contact with such hazards as poorly isolated or grounded respiratory equipment, heart-lung machines, and bed-moving servomotors (Fig. 5). If so, electrical connection to grounded EKG displays would complete the leakage-to-ground path for

the potentially dangerous currents from these sources.

The transformer isolation and 10-picofarad maximum leakage capacitance between the isolation amplifier's input and other circuits limits the fault current to well below the 20- μ A danger level, even when the patient is exposed to a full 220-v, 60-Hz line. An amplifier with a 1,000-v CMV rating, of course, easily handles accidental connection of the input electrodes to 220-v sources. And a 5,000-v peak differential input rating enables the amplifier to withstand the high-voltage defibrillation pulses that may be applied in an emergency.

In fetal heartbeat monitoring (Fig. 6), the isolation amplifier's specifications can be exploited even further. In this demanding application, not only is it necessary to reject muscle voltages, 60-Hz pickup, and electrode potentials, but the amplifier must be able to distinguish between the weak fetal heartbeat and the much stronger cardiac signals of the mother. The separation between parental and baby heartbeats is accomplished by the 60-dB common-mode rejection between input electrodes and shield, while the 115-dB input-to-ground CMR screens out 60-Hz pickup, muscle noises, and other interference. In addition, because the amplifier can achieve its high common-mode performance at unity gain, 500 millivolts of residual electrode potential can be handled without its being driven into saturation.

Since isolation amplifiers have only recently become available at unit prices below \$70 in OEM quantities, their full range of applications has not yet been scratched. In the next 10 years, like the op amp over the past decade, they are certain to turn up with increasing frequency and in the most unexpected situations. \square

One-shot timing performance: don't take it for granted

Study of industry standard monostable multivibrator—the 9601-type of one-shot—reveals that vendor-to-vendor variations in timing accuracy are wide enough to prevent device interchangeability

by David E. Green, *Honeywell Information Systems Inc., Billerica, Mass.*

□ All too often, designers presume that a component's data sheet is precise. Inaccurate performance specifications are not intentional misrepresentations on the part of the manufacturer. Instead, they result from problems inherent in processing techniques, device geometries, or packaging effects. But, no matter what its cause, excessive performance variations—particularly those of so-called building blocks that can be used in a number of applications and that are readily available off-the-shelf from several manufacturers—must be brought to the designer's attention.

Consider, for example, the industry standard retriggerable monostable multivibrator, typified by the 9601. A recent study of a dozen sample lots of these one-shots from several different companies shows that the variations in output pulse width are so severe—sometimes approaching 60%—that some manufacturers are re-evaluating their current designs, whereas others are already in the process of redesign.

Timing errors become especially significant for small values of timing capacitance. For instance, the one-shot's minimum true output pulse is specified to have a maximum value of 65 nanoseconds, but approximate extremes of 30 and 92 ns were observed.

Examining the problem

Pulse width variation for the monostable is specified at a minimum of 3.08 microseconds and a maximum of 3.76 μs about a nominal output of 3.42 μs . Or, in-specification variations of timing accuracy can be thought of as $\pm 10\%$. Therefore, after accounting for timing resistor and timing capacitor tolerances, as well as supply voltage variations, the designer must deal with an overall timing limit tolerance of $\pm 15\%$ to $\pm 20\%$, making any additional one-shot timing inaccuracies difficult to handle.

Adding a trimmer potentiometer is the simplest way to compensate for this wide tolerance spread, or even poor one-shot timing—but an acceptable trimmer is

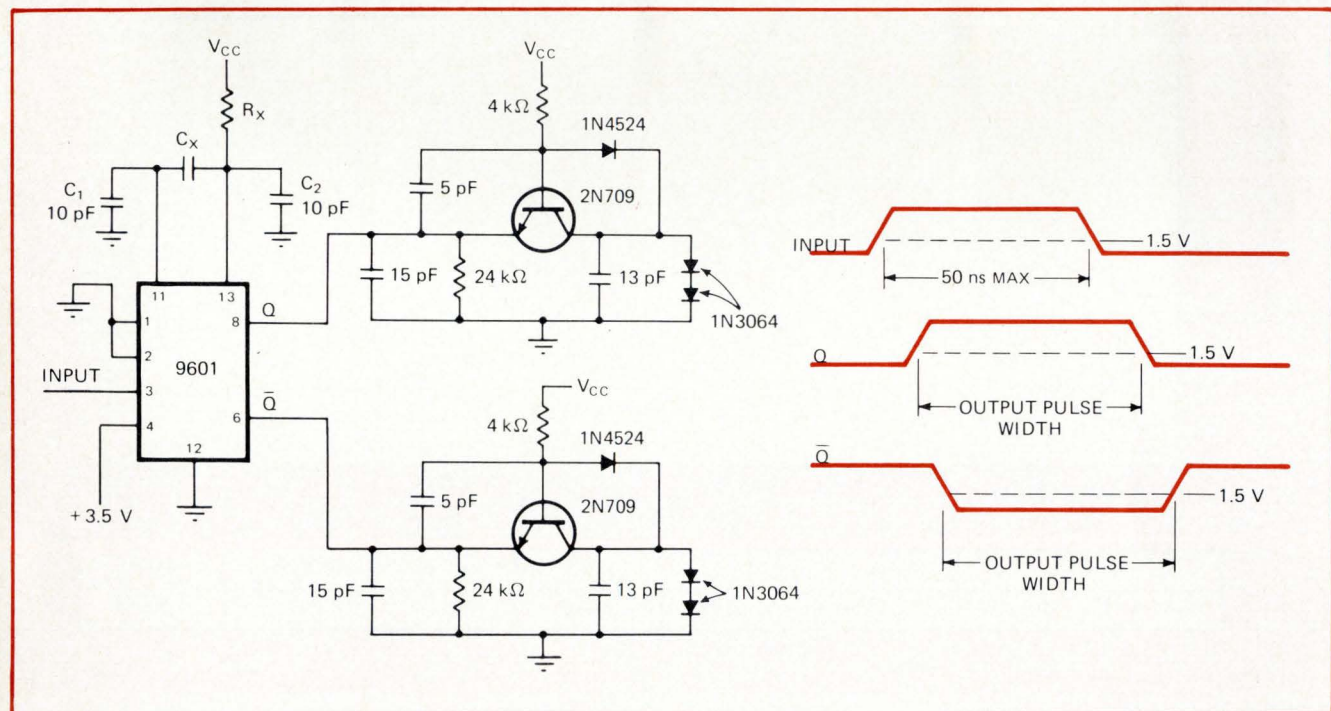

1. Testing the one-shot. Test circuit for retriggerable monostable multivibrator employs unit TTL load on each output. Timing network formed by R_x and C_x determines output pulse width at Q and \bar{Q} . Capacitors C_1 and C_2 are fixed at 10 picofarads (including stray capacitance and fixture capacitance), and minimum C_x is held to 5 pF. Output pulse width is measured at device's low-level logic threshold.

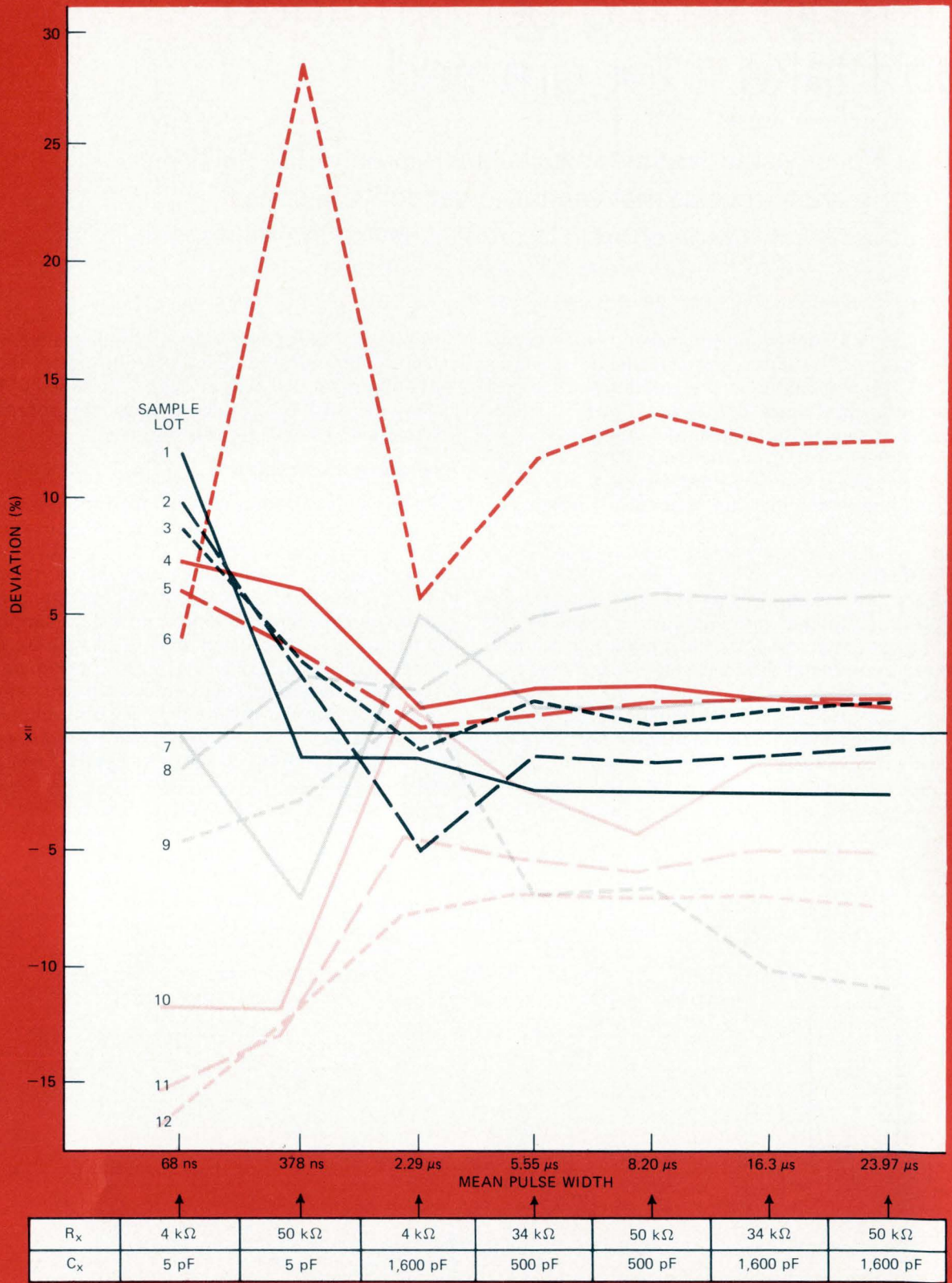

2. Plotting the results. Pulse width variations of over 500 9601-type one-shots are shown as percentage deviation from mean pulse width (\bar{x}) for entire group. Test points for 12 sample lots are plotted individually. Values noted for R_x and C_x are those used to obtain indicated mean pulse widths from 68 ns to 24 μ s. Scattered distribution of results indicates significant discrepancy between actual and specified timing performance. Also, output pulse variations from one vendor to next are so great that parts cannot be used interchangeably.

generally more expensive than the multivibrator itself. And for most printed circuit boards, no provision is made for adding a trimmer at some later date if a problem arises.

Specified one-shot timing accuracy implies that the part holds pulse-width variations to $\pm 10\%$ for outputs above and below the nominal $3.4\text{-}\mu\text{s}$ value. However, extensive testing of over 500 of these multivibrators shows that this is not true. The study notes the variation in output pulse width for 12 sample lots of 9601-type one-shots from a number of different vendors.

The test circuit used is illustrated in Fig. 1. Stray capacitance and capacitance from the test fixture are represented by capacitors C_1 and C_2 . The total value for each of these capacitors is fixed at 10 picofarads to permit the use of a variety of test fixtures. Timing capacitance C_X is held to a minimum value of 5 pF since the minimum data sheet value of 0 pF is not really achievable in practice.

Both Q and \bar{Q} outputs are terminated with a unit transistor-transistor logic load and a 15-pF load capacitor that includes probe capacitance. (In this case, a unit load is the equivalent of a standard TTL gate that requires the one-shot to supply 60 microamperes for its high output and to sink 1.4 milliamperes for its low output.)

All pulse widths for the study were measured at the low-level logic threshold of the Q output.

The graph of Fig. 2 summarizes test results by comparing the mean pulse width for each sample lot (\bar{x}) to the mean pulse width for all the units tested ($\bar{\bar{x}}$). Final values of $\bar{\bar{x}}$ are indicated along the horizontal axis, showing the mean pulse width obtained for the timing components used. For every combination of timing component values, there is a set of 12 data points, each point representing the percentage deviation of mean pulse width \bar{x} for a given vendor from the group mean width of $\bar{\bar{x}}$, which ranges from 68 ns to 24 μs .

Analyzing test results

Several observations can be made from the graph. For instance, the data point at 2.29 μs , near the standard test point of 3.4 μs , suggests that the number of units meeting specification is not very high since deviations from $\bar{\bar{x}}$ are significant. Also the $\pm 10\%$ tolerance band is drastically exceeded for several pulse widths, indicating a serious discrepancy from predicted performance.

For some sample lots, output pulse width diverges from its specified value as pulse width increases, even though published timing data states that the output width should be linearly related to timing component values when C_X is greater than 1,000 pF.

In addition, for narrow output pulses, performance tracking from vendor to vendor is particularly poor, with a highly undesirable broad distribution of data points. A user changing vendors would encounter significant timing performance differences, especially since the plot deals only with deviation from a mean, and does not show worst-case errors. For example, when $R_X = 50$ kilohms and $C_X = 5$ pF, supposedly identical devices from vendor 6 and vendor 12 can generate pulses ranging from 237 to 732 ns in width.

Published timing data

The expected output pulse width of the widely used 9601 type of monostable multivibrator is easily determined from its data sheet. Generally, how the unit's timing is computed depends on the value of timing capacitance C_X . When C_X is greater than 1,000 picofarads, output pulse width can be computed:

$$T = 0.32R_X C_X (1 + 0.7/R_X)$$

where T is in nanoseconds, timing resistance R_X in kilohms, and C_X in picofarads. For C_X values of less than 1,000 pF, manufacturer's timing curves, like those shown, must be used.

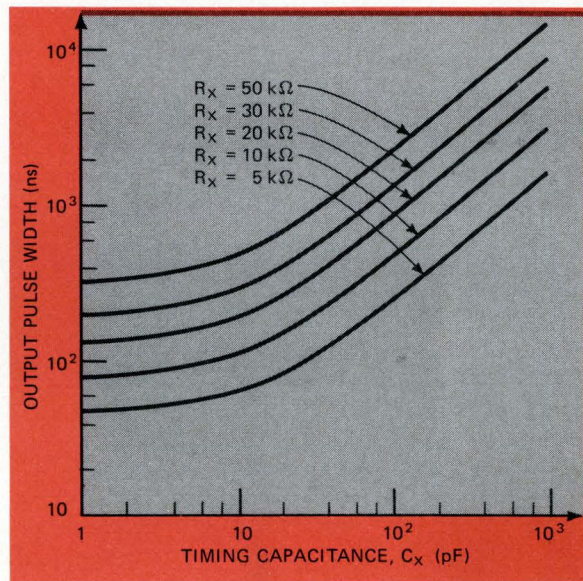

A singular advantage to testing pulse width is the ability to select those vendors whose products fall within the desired tolerance of $\pm 10\%$ over the full timing range. One-shot timing should be monitored for all pulse widths of interest by using permissible combinations of R_X , between 5 and 50 kilohms, and C_X , up to 1,000 pF.

As this study decidedly points out, in-spec performance at one pulse width does not imply across-the-board in-spec performance. One vendor's products, for instance, exhibited unorthodox characteristics even though the one-shots passed the standard $3.4\text{-}\mu\text{s} \pm 10\%$ pulse width test for $R_X = 10$ kilohms and $C_X = 1,000$ pF. Some devices displayed a variation of $\pm 40\%$ around a 68-ns mean pulse width, while others could not generate pulses wider than 3.5 μs under any conditions.

Once the vendors whose products track together are selected, additional testing should still be done for absolute certainty of timing performance. To virtually eliminate any excessively inaccurate one-shots, the tests should fix the allowable $\pm 10\%$ timing tolerance as the 3 σ limit of a Gaussian distribution of test results. Based on the graph of Fig. 2, the recommended pulse widths and timing networks are: 85 ns $\pm 10\%$, 5 kilohms and 5 pF; 380 ns $\pm 10\%$, 50 kilohms and 5 pF; 3.4 $\mu\text{s} \pm 10\%$, 10 kilohms and 1,000 pF; and 17 $\mu\text{s} \pm 10\%$, 50 kilohms and 1,000 pF. □

**In 1971 RCA Solid State introduced
448 new products...now**

**The RCA
hot line
gets
hotter
in 1972!**

Last year RCA's tremendous surge in solid state capability erupted in an outpouring of 448 new devices—new products, new packaging, improved performance—for expanded coverage to meet the demands of today's market.

Here's the 1971 record for new commercial and developmental types:

Linear IC's 93

Single and dual op amps, triple programmable op amps, transistor and Zener diode arrays, analog multiplier, sense amplifier, power control circuits, low-noise op amps, AM/FM communications circuits, and stereo multiplex decoder, in packaged, chip, and beam lead versions.

COS/MOS IC's.

3 to 15 Volt Circuits 151

Gates, gate arrays, buffers, complementary pairs, flip/flops, latches, adders, decoders, multiplexers, counters, shift registers, timing circuits, memories and chip versions.

Power Transistors 76

Hometaxial II, high-power n-p-n, high-voltage n-p-n, medium- and

high-power p-n-p, VERSAWATT n-p-n and p-n-p types, and n-p-n power amplifiers.

Thyristors and Rectifiers ... 72

High-current 80-A triacs, ISOWATT ceramic isolated plastic triacs, 400 Hz high-commutating dv/dt triacs, glass passivated-plastic triacs and SCR's, fast-switching SCR's and rectifiers, SCR/rectifier arrays, and fast-recovery power type rectifiers.

Power Hybrid Circuits 37

Amplifiers, series regulators, arrays, building blocks and chips.

RF Power Transistors 13

Types for microwave, broadband, mobile-radio, and single-sideband applications.

Liquid Crystals 6

Single-digit and four-digit transmissive and reflective seven-segment readouts.

The momentum is continuing in 1972. New products, new technological advances, new application aids will be introduced throughout the year. For 1972, RCA's goal—616 man-years of solid state technology at Somerville, N.J. and at the David Sarnoff Research Center at Princeton, N.J. Here's how RCA developments in 1971 and 1972 will influence the directions of solid state in the remainder of the seventies:

Linear IC's

RCA, a leader in consumer linear IC's, recently made one of the largest single product introductions ever to come from a solid state supplier: 21 new types for the communications, controls and instrumentation markets. The pace continues in 1972, with many other new types—including op amps, A/D converters, control circuits, transistor arrays. The total line of 175 types represents one of the industry's broadest-coverage sources.

COS/MOS IC's

RCA pioneered complementary-symmetry MOS, and now has more design, engineering, technological and manufacturing background than anyone in the industry. RCA shipped 7 out of 10 of all C/MOS devices delivered in 1971. Besides the 3- to 15-volt commercial types announced in 1971, RCA initiated and completed numerous custom LSI devices. Coming in 1972—additional functions including three-level registers, triple AND/OR pairs, word-organized memories, counters, buffers, latches, multivibrators, multiplexers.

Power Transistors

In 1971 RCA led the industry with: the concept of thermal-cycling ratings to extend equipment life; cost-effective high-voltage devices to make off-line switching economically feasible; and delivery of cost-effective reliable plastic packages. In 1972 RCA is extending its low-cost packaging (plastic and metal) technology to all the power transistor manu-

facturing approaches—hometaxial chips for linear operations, multi-epitaxial design for fast switching, and a wide range of Darlington's, both n-p-n and p-n-p. Perhaps this capability is why RCA is filling 39% of the industry's power sockets (November, 1971 EIA figures., U.S. factory sales).

Thyristors and Rectifiers

To the industry's broadest line of triacs, RCA added the first 80-A device last year, and continued to lead the way in plastic/glass passivated chip technology. RCA remains the world technology center for TV horizontal deflection devices. The 1971 sales record: industry thyristor sales down about 10%, RCA up about 10% (U.S. factory sales).

Power Hybrid Circuits

RCA now offers the industry's broadest commercial line for use in servo amplifier, audio amplifier, deflection amplifier, power supply, hammer driver, stepper motor, high-current dc motor control and many more applications. And it's still expanding.

RF Power Devices

In 1971, the RCA-originated overlay technology was expanded in a rapidly developing line of emitter-ballasted high-output microwave devices. A broad new line of emitter-ballasted microwave power transistors already announced in 1972 is providing 10 W at 2 GHz and 6.5 W at 2.3 GHz — in both stripline and coaxial.

New products announced at the rate of more than one a day.

What does this mean to you?

First, a major source of supply, broad product range (10,000 devices)...ability to deliver products in volume with competitive pricing.

Second, a worldwide sales organization with in-depth applications back-up and a strong network of distributors to serve you.

Plus, a total capability of people, products and technology that brings an applications-oriented approach to your requirements...and results in reliable systems cost effectiveness with RCA products.

And now RCA has expanded technical and applications information to bring you up to date on all existing and new RCA types in the 3000-page, six-volume SSD-200 DATABOOK series. Updating service will keep you posted on 1972 developments.

Before you make any commitments for solid state devices, check RCA—the hot line that's getting hotter all the time. See your RCA Distributor or Sales Representative about any of the product lines listed here. Or call Dan Del Frate, Marketing Manager, about your special requirements. RCA Solid State Division, Box 3200, Somerville, N.J. 08876; (201) 722-3200. International: RCA, Sunbury, on-Thames, U.K., or P.O. Box 112, Hong Kong. In Canada: RCA Limited, Ste. Anne de Bellevue 810, Quebec.

RCA Solid State
products that make products pay off

Digitizing multiple rf signals requires an optimum sampling rate

Based on an advanced radio using an analog-to-digital converter to process a selected signal, design rules relate lowest a-d conversion rate to rf passband width, not carrier frequency

by Arthur G. Stephenson, TRW Systems Group, Redondo Beach, Calif.

□ Sampled-data techniques have recently been combined with analog-to-digital conversion in an experimental wideband high-frequency radio receiver (Fig. 1), proving the practicability of on-line real-time digital reception of a transmitted signal. If multiple tunable digital filters and fast digital conversion are used, and the cost of analog-to-digital converters and large-scale integration continues to drop, such a digital receiver could be designed to do the job of multiple conventional receivers. For example, a single digital receiver could very likely handle signals from 16 stations at a time.

Commands from a digital computer can instantaneously set the digital filter to the desired center frequency. As a result, the receiver's output, suitably demodulated but in digital format, is ready for data processing. The computer processing analyzes the signal, and through feedback to the receiver, provides automatic tuning for optimum signal-to-noise ratio.

Key to the receiver's versatility is the analog-to-digital converter that rapidly samples and digitizes a pre selected rf passband. Sampling creates multiple image spectra of the original band, each of which—also digitized, but centered at lower (and higher) frequencies—contains the same information as the band. Any digitized spectrum can act as input to the digital filter.

Functionally, each spectrum is analogous to an intermediate-frequency passband obtained by heterodyning. Consequently, creating spectra by sampling and a-d conversion can be thought of as digital heterodyning, similar to the analog heterodyning of conventional receivers. Sampling, though, creates many "intermediate frequencies" at the same time.

The digital receiver (Fig. 2) can be tuned to within 100 hertz anywhere in the radio-frequency band of 2 to 30 megahertz. The varactor-tuned presampling analog filter selects any 1.5-MHz portion of that band, and its output is then digitized by the a-d converter into 8-bit-plus-sign data words at any of four sampling rates up to 14 million times a second.

Filter action

In accordance with command signals, the tunable digital filter momentarily looks at any selected frequency in the rf passband. The corresponding stream of digital words represents the modulated signal of the selected transmitter. Also on command, this filter can be set to any one of eight bandwidths ranging from 250

hertz to 6 kilohertz. The demodulator contains logic to process a-m, fm, pm, and pulsed cw signals.

Because of the samplings and digital conversion processes, the design of a digital receiver has to take into account considerations that are foreign to the superheterodyne receiver. The most critical is the selection of the a-d converter's sampling frequency. If this is not done properly, particularly with respect to the bandwidth and roll-off characteristics of the analog pre-sampling filter, the sampling process will generate spurious signals in the spectrum of interest.

Known as aliasing signals, they can crowd this spectrum, defeating the selectivity of the pre-sampling filter and negating the benefits of digital heterodyning and processing. During the development of this receiver, criteria for the optimum sampling frequency have evolved which can be applied to the design of other bandpass sampling systems. And, because practical system constraints may prevent use of an optimum sampling frequency, additional information for non-optimum sampling frequencies has also been worked out.

The a-d converter, when digitizing an analog signal, samples the input for a very short time, called the aper-



1. Digital receiver. Experimental radio uses sampling and digital filtering techniques to permit signal processing for optimum tuning.

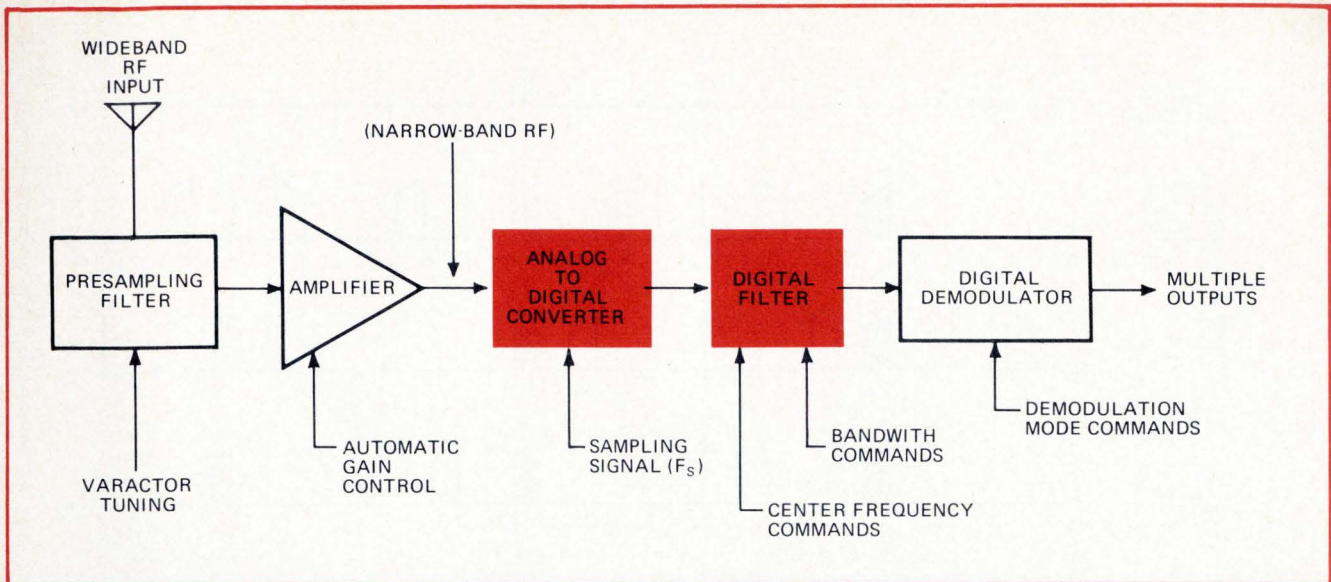

2. Digital heterodyning. In the experimental radio, the analog-to-digital filter supplies multiple information spectra, one of which feeds into a remotely tunable digital filter. The filter's output is demodulated in digital format for signal-to-noise analysis by a computer.

ture time. Then, during a longer hold time, it digitizes the analog signal. It repeats this operation periodically, depending on the sampling frequency, F_s .

According to sampled-data theory for the low-pass case, the sampling frequency must be at least twice as great as the highest frequency of interest (F_H) in the sampled time-varying signal if it is to preserve the information content. In practice, to minimize aliasing, the sampling frequency must be even greater.

In the present context, the optimum sampling frequency is one that in combination with a suitable pre-sampling filter is high enough to attenuate aliasing to some satisfactory value. On the other hand, choosing too high a sampling frequency puts a burden on the specifications of the analog-to-digital converter, to the point that, even with the best a-d converters now available, digital heterodyning would be difficult in the rf spectrum. Also, high sampling rates mean high data processing rates, and thus more cost for equipment.

Although sampling actually occurs on time-varying signals, the consequences are easier to understand if they are represented in the frequency domain. Fig. 3a shows the frequency spectrum envelope for a time-varying signal containing frequencies starting at zero (F_0 or dc) and going up through F_H . (In this ideal band-limited spectrum, the solid sloping line does not indicate actual spectral characteristics, but is an artifice to distinguish the original spectrum from its mirror-image.)

The sampling process repeats or images the original spectrum at harmonics of the sampling frequency F_s , where each image spectrum is located in frequency with respect to its harmonic as the original spectrum is with respect to F_s . In Fig. 3b the repeated spectra also slope down to the right. However, the sampling process also "folds" each imaged spectrum, including the original one, around F_0 and F_s and its harmonics, creating a series of mirror-image spectra, shown here as sloping down to the left. In Fig. 3b, the sampling frequency has been chosen as exactly twice the highest frequency, F_H , and because of the sharp cutoff characteristics of the

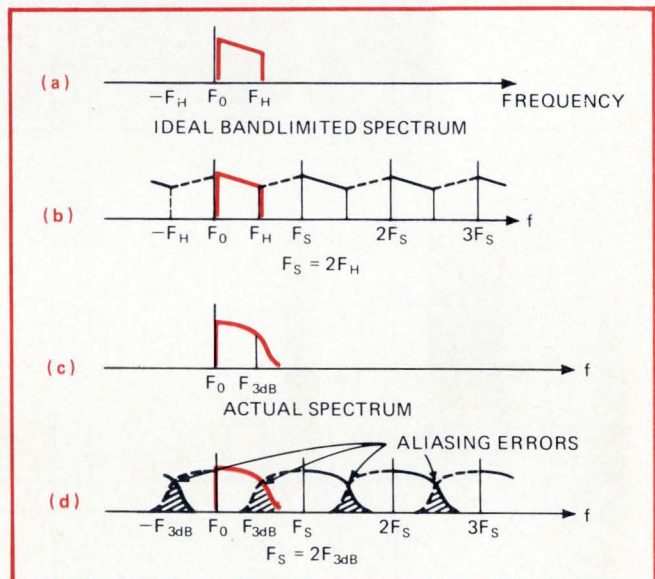

3. Sampled data. In digitizing a low-pass band, an actual spectrum with roll-off (c) creates more aliasing (d) than ideal spectrum (a)

original none of the spectra overlap to create aliasing frequencies that intrude into any other spectrum.

A more typical case, however, is a low-pass filter with a gradual roll-off characteristic (Fig. 3c). Here, F_{3dB} is the same as F_H , and F_s is twice this frequency. In this case, when the sampling process creates its repeated and image spectra (Fig. 3d), the portion of the original spectrum above the 3-dB frequency repeats and folds into all spectra, creating aliasing. The figure implies the cure—increasing F_s for a given roll-off characteristic will separate the spectra and reduce aliasing.

Consider now an rf bandpass spectrum with ideal cutoff frequencies at the filter's 3-dB points (Fig. 4a). This spectrum contains many carrier frequencies, each modulated with an information-bearing signal. Assume that only one carrier frequency exists, centered between F_H and F_L , the lower edge of the spectrum, and that this

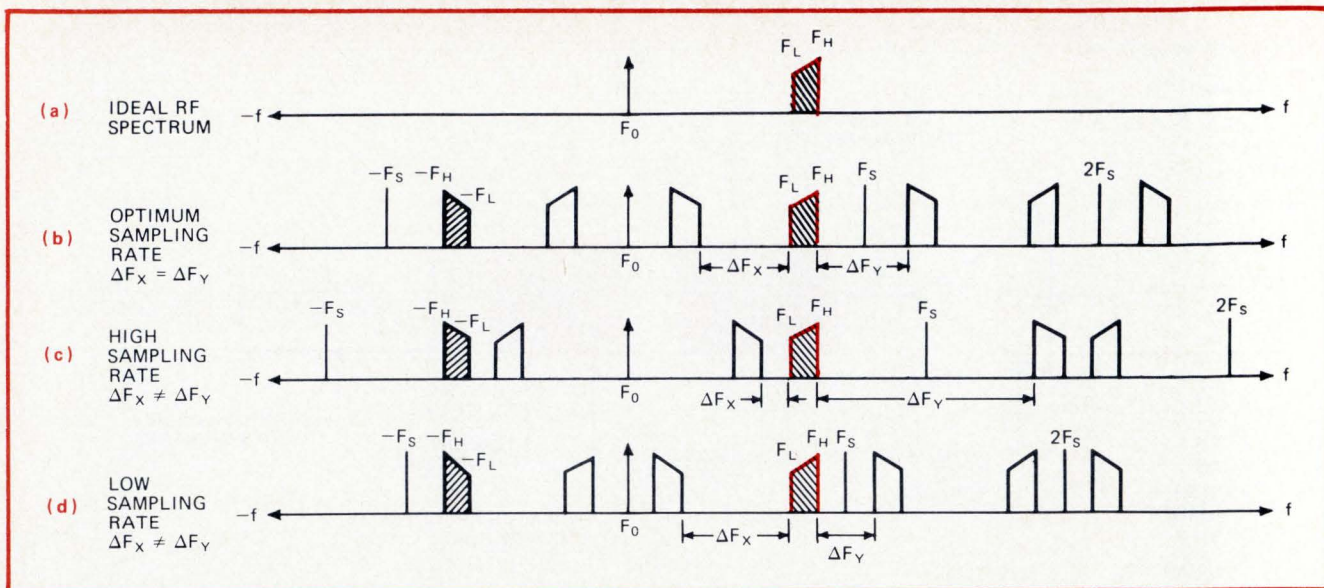

4. Optimum sampling rate. Digitizing an rf passband (a) creates multiple image spectra (b), (c), and (d), the separation of which depends on the sampling frequency F_s . Optimum sampling is shown in (b), in which the selected F_s causes ΔF_x to equal ΔF_y .

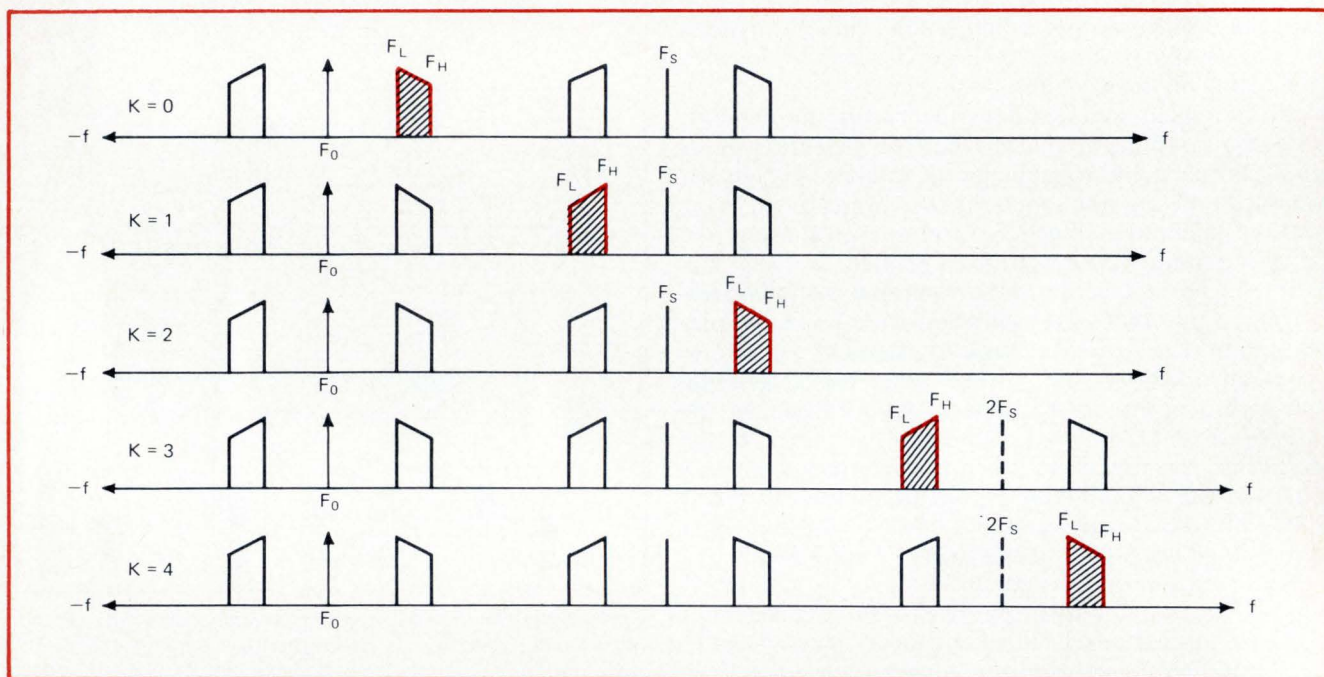

5. Spectral density. The sampling frequency depends on the width of the passband, shown here as the same for five different cases. Computation of the actual sampling frequency for a given case depends on the spectral density, K , the number of spectra below the original band.

is modulated by only one signal with a bandwidth $B = (F_H - F_L)$. Because the sampling process must preserve only the integrity of the information signal, the required sampling frequency depends on the width of the band, which is much less than the carrier frequency.

The optimum sampling frequency, or rate for digitizing a bandpass signal, is the lowest one that produces an acceptable signal distortion from aliasing. The occurrence of aliasing also depends on the presampling filter's selectivity and on the symmetry of the roll-off characteristic on each side of the filter's center frequency. Since roll-off in practical filters is usually nonsymmetrical, distortion due to aliasing is minimized when each spectrum is separated by the same amount, in fre-

quency, from its neighboring spectra. Optimum sampling frequency, then, occurs when $\Delta F_x = \Delta F_y$, as shown in Fig. 4b. The effects of non-optimum sampling rates are shown in Figs. 4c and 4d.

The optimum sampling frequency depends not only on equal separation but also on the bandwidth and where the bandpass center frequency falls in relation to the total frequency spectrum. Figure 5 contains representations of the same-bandwidth original spectrum at five different center frequencies in the total 2- to 30-MHz range. In each case, the optimum sampling frequency is the same and, as shown, may be lower than the original spectrum. The five cases differ in spectral density, which is defined as the number of spectra, K , between zero

frequency and the original bandpass spectrum.

Figure 6 defines the spectral edges of passbands for odd and even spectral-density numbers. With these edge definitions, the optimum sampling frequency for each K value can be determined by setting $\Delta F_Y = \Delta F_X$, where ΔF_Y is the frequency separation between the original and the next higher spectrum, and ΔF_X is the separation between the original and next lower band.

For K = 1

$$\begin{aligned} (2F_S - F_H) - F_H &= F_L - (F_S - F_L) \\ 2F_S - 2F_H &= 2F_L - F_S \\ F_S &= \frac{2(F_L + F_H)}{3} \end{aligned}$$

For K = 2

$$\begin{aligned} F_L - (2F_S - F_L) &= (2F_S - F_H) - (F_H - F_S) \\ 2F_L - 2F_S &= 3F_S - 2F_H \\ F_S &= \frac{2(F_L + F_H)}{5} \end{aligned}$$

For K = 2n

$$\begin{aligned} (2n+1)F_S - 2F_H &= 2F_L - 2nF_S \\ 4nF_S + F_S &= 2F_L + 2F_H \\ F_S &= \frac{2(F_L + F_H)}{4n+1} \end{aligned}$$

For K = 2n + 1

$$\begin{aligned} (2n+2)F_S - 2F_H &= 2F_L - (2n+1)F_S \\ 4nF_S + 3F_S &= 2F_L + 2F_H \\ F_S &= \frac{2(F_L + F_H)}{4n+3} \end{aligned}$$

For the general case, including K=0, the optimum sampling frequency is

$$F_S = \frac{2(F_L + F_H)}{2K + 1} \quad (1)$$

The preceding relationships do not give the actual frequency width of the separations which are needed to evaluate aliasing effects. Using the edge definitions in Fig. 6 and only integer values of K, the separations are:

$$\Delta F_X = 2F_L - KF_S \quad (2)$$

$$\Delta F_Y = (K+1)F_S - 2F_H \quad (3)$$

Equations 2 and 3 apply to both optimum and non-optimum sampling.

In practice, the sampling frequency may have to be derived from the system's clock. Then, more than likely, the separations will be unequal, or non-optimum. To determine the separations with non-optimum sampling, the value of K is first determined from Equation 1, rewritten

The fractional part of the K value obtained from Equation 4 is dropped, and the remaining integer-value of K is inserted into Equations 2 and 3. The answers provide basic information about the non-optimum separation of neighboring spectra. However, the fractional value actually obtained from Equation 4 provides additional insight into aliasing. For example, if the computed value of K contains a fractional value of exactly one-half ($K + 1/2$), the sampling frequency is a submultiple of the center frequency of the spectrum being sampled, and there is a direct overlap of 3-dB points of the spectra. That is, aliasing will occur regardless of the pre-sampling filter's characteristics.

Spectra positions

If the fractional portion of the value of K computed in Equation 4 is less than one-half, the nearest aliased spectrum centers above the center of the original spec-

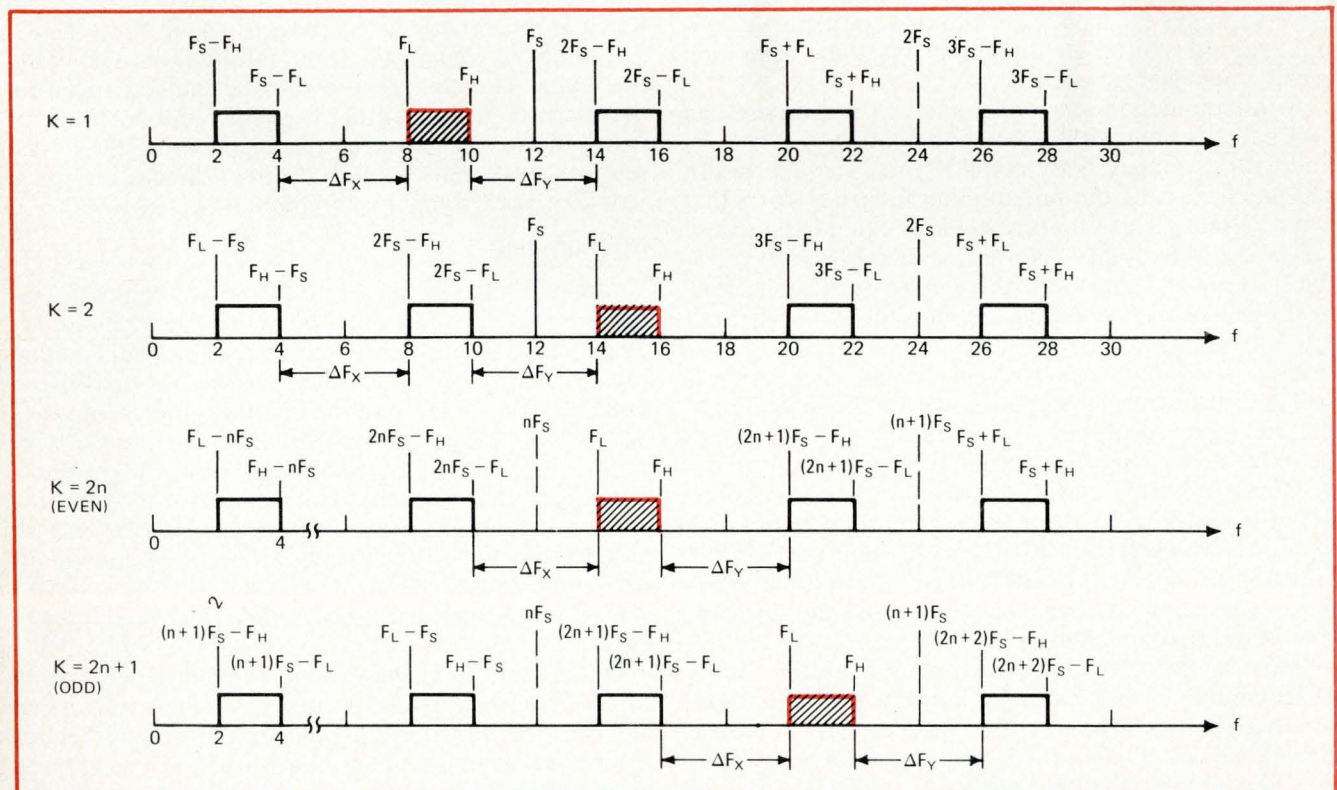

6. Edge definitions. With these spectral edge definitions of multiple spectra resulting in either odd or even values of K, the actual values of separation between neighboring spectra can be computed for both optimum and non-optimum sampling frequencies.

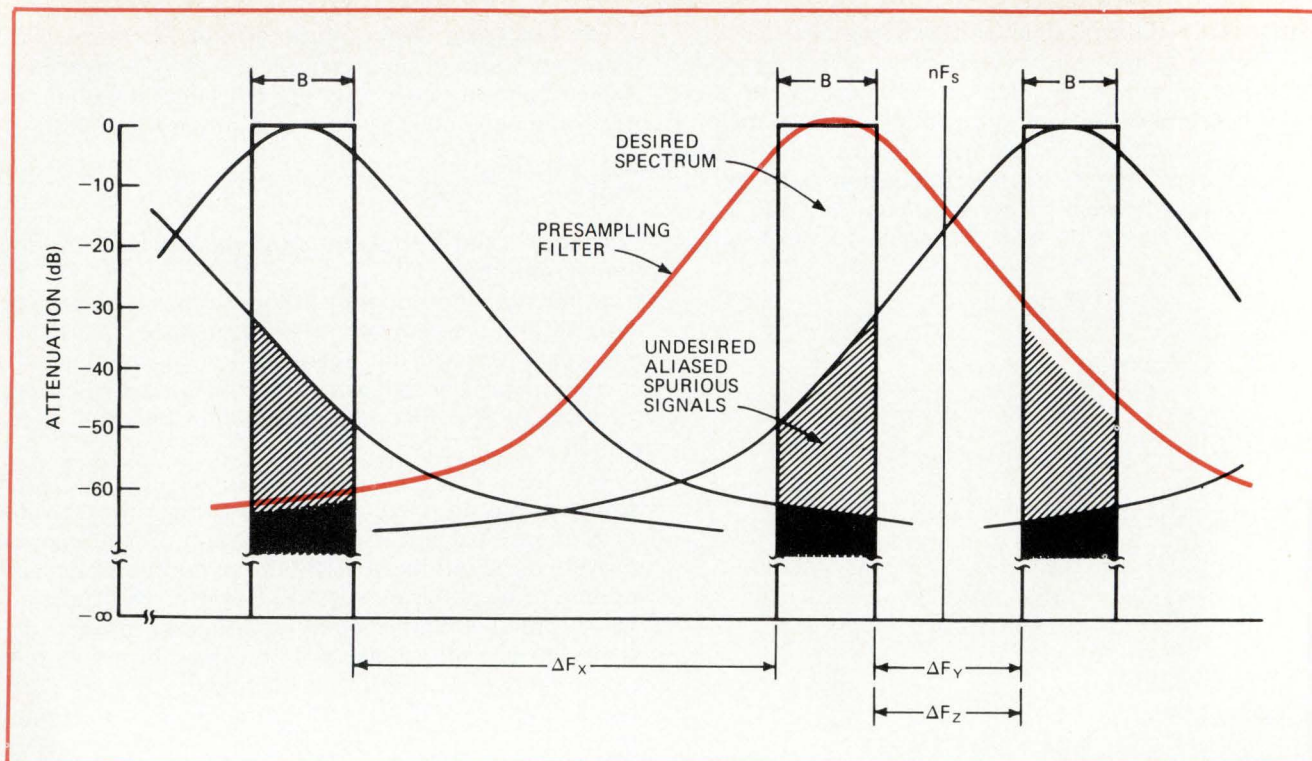

7. Final evaluation. Even with an optimum sampling frequency to reduce aliasing, some further aliasing can occur; for the skirts of the pre-sampling filter may generate frequencies that intrude into the selected imaged spectrum that is fed into the tunable digital filter.

trum. If the fraction is greater than one-half, the nearest aliased spectrum centers below the center of the original spectrum.

If either solution to Equation 2 or Equation 3 results in a negative number, the spectra overlap. With no negative solution, the smaller of the two spectrum-separation values is used to determine whether separation meets aliasing requirements.

As mentioned, the foregoing analysis presupposed an original spectrum with 3-dB-down points at F_L and F_H and with extremely sharp cutoff at these frequencies. In the practical case, the presampling filter has skirts that roll off gradually, so that frequencies extend above and below the 3-dB points. As Fig. 7 shows, the skirts introduce spurious signals into the desired spectrum. Here, in the worst-case condition, the unwanted alias signals are down 30 dB in the spectrum.

If the sampling frequency is fixed, but attenuation is still not satisfactory, the filter's order can be increased to provide sharper roll-off. A convenient way to specify the filter's selectivity for this kind of application is to determine acceptable aliased spurious content at a specified frequency away from the spectrum's center frequency. This frequency is $(\Delta F_z + \frac{1}{2}B)$, where ΔF_z is the lesser of ΔF_x or ΔF_y , as shown in Fig. 7. The attenuation vs frequency parameter then specifies the rejection requirements of the filter.

If the sampling frequency can be altered, the results of Equations 2 and 3 can be examined to determine whether F_s should be increased or decreased to reduce aliased signals. If ΔF_x is less than ΔF_y , then the optimum F_s is higher than the one postulated, which should therefore be increased. If ΔF_x is greater than ΔF_y , F_s should be reduced.

Once the correct sampling frequency has been determined to provide adequate spectra separation, and the filter's selectivity has been adjusted if necessary to minimize spurious signals, any one of the image spectra below the frequency of the original spectrum can be selected as the input to a succeeding stage in the system—since they all contain the same information. Generally the digital filter is locked-on to the imaged spectrum that is closest to F_0 and that is a direct and not a mirror image of the original spectrum. By choosing the lowest possible spectrum, the digital filter's processing-speed requirements are kept to a minimum.

Aperture time

Although the sampling rate of the a-d converter depends on the rf bandwidth, and not on the much higher carrier frequency, the maximum carrier frequency that can be digitized is determined by the a-d converter's aperture time. In general, the aperture time is inversely proportional to the carrier frequency and the a-d converter's bit length. For example, a 7-bit a-d converter (128 quantization levels) with an aperture time of 1 nanosecond can digitize a 100-megahertz carrier with an error less than 1 quantization level. Some commercial sample-and-hold circuits that are used for a-d conversion have aperture times of less than 100 picoseconds.

In the high-frequency range, digital heterodyning avoids requirements for analog frequency conversion and thus the need for a synthesizer, or analog heterodyning. But even for higher frequencies such as vhf and uhf bands, a digitizable intermediate frequency can be obtained using an analog synthesizer stepped in increments as large as 50 MHz. □

It took us years to develop the best stereo microscope.

Now give us a few minutes to prove it.

Let us compare our StereoStar/ZOOM to any stereoscopic microscope in your lab.

Our microscope offers high resolution, larger fields of view, greater working distance. We have as wide a magnification range as you're likely to need: a full 6 to 1 zoom range with magnifications from 3.5 X through 210 X. The zoom control knob is coupled—so that it's conveniently located on both sides, for either left or right-hand operation. And the entire head is easily rotatable through 360°.

135 years of optical excellence went into the AO StereoStar/ZOOM. Let us compare it to any stereo microscope in your lab. After all, if it's worth your money, it's worth your time.

Call your AO Representative. Or write for our convincing 24-page brochure.



**AMERICAN OPTICAL
CORPORATION**

SCIENTIFIC INSTRUMENT DIVISION • BUFFALO, N.Y. 14215

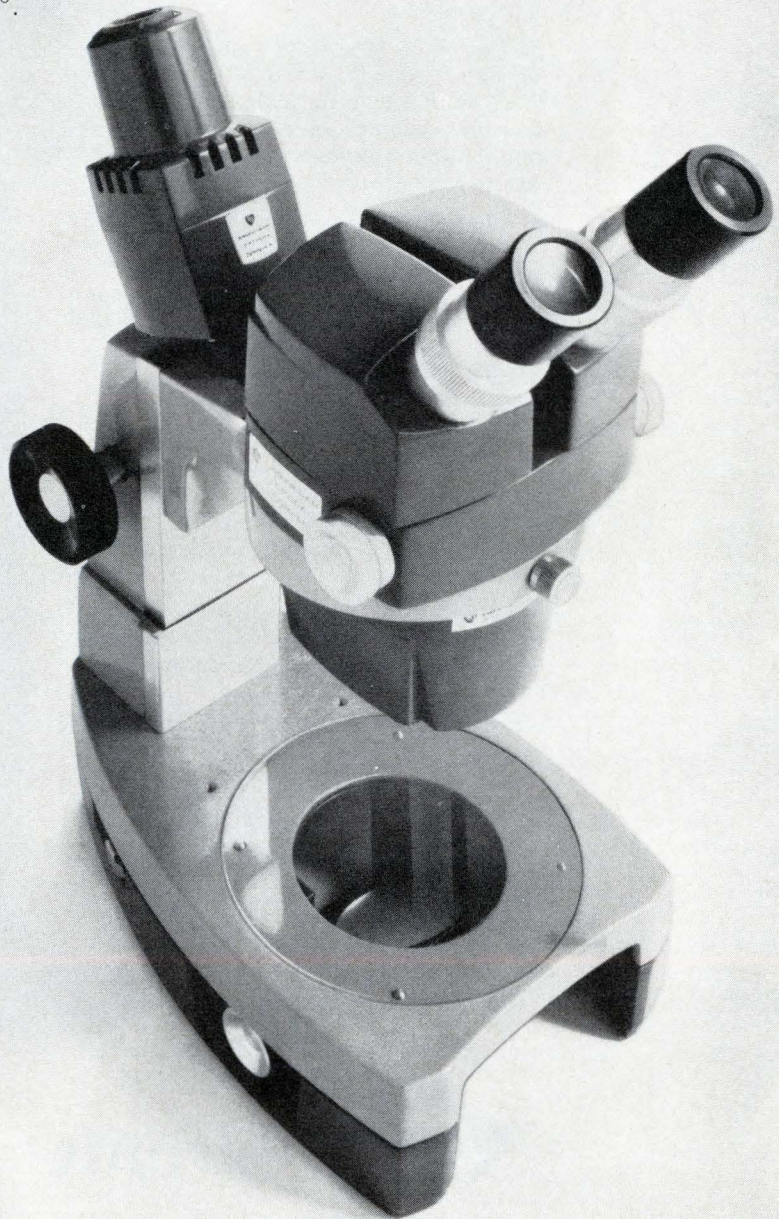

Representatives

Arizona: Erskine Assoc.
Scottsdale (602) 263-7654
California:
Bertrand-Zoolalian,
Downey (213) 927-4406
Celtec, San Diego,
(714) 279-7961
Trident Assoc., Mountain
View (415) 967-7031
Colorado: R. G. Enterprises,
Denver (303) 744-2464
Florida: WMM Assoc.,
Altamonte Springs,
(305) 831-4645
WMM Assoc., Clearwater,
(813) 446-0075
WMM Assoc., Pompano
Beach (305) 943-3091
WMM Assoc., West Palm
Beach (305) 848-9042
Illinois: Compar,
Des Plaines (312) 824-0104
Indiana: Compar, Fort
Wayne (219) 747-0402
Kansas: Compar, Wichita,
(316) 722-6341
Maryland: Micro-Comp,
Towson (301) 823-3603
Massachusetts: Contact
Sales, Lexington,
(617) 861-1550
Michigan: Greiner Assoc.,
Grosse Point Park,
(313) 499-0188
Minnesota: Comstrand,
Minneapolis (612) 560-5300
Missouri: Compar,
St. Louis (314) 567-3399
New Jersey: P.A.L.
Components, Englewood
Cliffs (201) 871-4020
TAI (Thomas Assoc.)
Haddonfield (609) 854-3011
New Mexico: Electronic
Marketing, Albuquerque
(505) 265-7837
New York:
P.A.L. Components
Greenvale, L.I.
(516) 484-4900
Tritech, DeWitt
(315) 446-2881
Ohio: Compar, Fairview
Park (216) 333-4120
Compar, Dayton
(513) 435-1301
Texas: Carter,
Garland (214) 276-7151
Virginia: Micro-Comp,
Lynchburg (703) 239-1003
Washington: Compar
Kirkland (206) 822-4191
Canada: Cantronics,
Downsview (416) 636-8311
Cantronics,
Montreal (514) 733-0749

International Distributors

Australia: CEMA Pty Ltd.
Crows Nest, N.S.W. 2065
439-4655
Austria: Bacher
Elektronische, 1070 Vienna
Denmark: Tage Olsen A/S
DK-2100 Copenhagen
(01) 294800
England: Guest Int., Ltd.
Surrey (01)-689-2121
Finland: SW-Instruments
00530 Helsinki 53, 738-265
France: ALMEX
92-Chatillon-Sous-Bagneux
Quatrelec S.A.
92-Levallois-Perret
270-7174 or 270-03-81
Germany: Omni-Ray GmbH
6700 Ludwigshafen/Rhein
513055-56
Omni-Ray GmbH
D-8 München 19
(0811) 5132059
Omni-Ray GmbH, Breyell,
(02153) 3261
Holland: Klaasing
Electronics NV,
Amsterdam-C
928444 or 928445
Israel: Rapac
Electronics Ltd.
Tel Aviv 77 71 15-6-7
Italy: Eledra 35, Milano
86.03.07
Japan: Electro Marketing
Tokyo 359-4521
Internix, Inc., Tokyo
3633649
Riker Corporation, Tokyo
591-5241
Norway: Nordisk Elektronik
Majorstua-Oslo 3, 602590
So. Africa: Liberty
Electronics, Boksburg
527637-8
Sweden: Stenhardt
Komponentbolag N.
161 56 Bromma, 08/37-29-45
Switzerland: Dimos AG
CH 8048 Zurich (051) 626140

Field Sales Offices

Atlantic States: New York
(516) 421-0162 or 692-4861
Midwest States:
Creve Coeur (314) 872-8511
New England
Up-State N.Y.:
Andover (617) 536-3366
Southwestern States:
Palos Verdes (213) 377-7871

IF YOUR DISPLAY STILL COMES IN A BOTTLE, DROP IT.

Here are six good reasons to go solid state with Litronix LEDs:

1. They last and last. Solid state LEDs have an anticipated life span far, far greater than their fragile bottled ancestors, as long as 20 to 30 years. They can take vibration and they don't break.

2. And they are quiet. Solid state LEDs produce no electrical noises, that's no RF interference. That's a cost savings on fancy shielding.

3. They love IC's. Solid state LEDs operate at low voltage and low power. They are directly compatible with IC's and that makes them ideal for hand-held battery operated things. No voltage converter needed and you save again!

4. Small, medium and large. Solid state LEDs come in all sizes. To name but a few: Our DL-62 has a 6/10 inch character in a DIP. Our DL-34 has four, 1/8-inch digits set on 187 mil centers for end-to-end stacking. (Calculator people love it.) And there's the DL-10A. It's a high efficiency, high brightness, low cost, 1/4-inch display. (Purchasing agents love it.)

5. No hidden costs. If you buy a glass tube display, it may cost you more than you bargained for. Add up the cost of a socket, a voltage converter or a transformer, a high voltage rectifier, additional assembly time and costs—then compare.

6. Litronix. We have a broad range of LEDs in the shape, size and cost range to compete with bottle displays. Write for our opto guide—it's free.

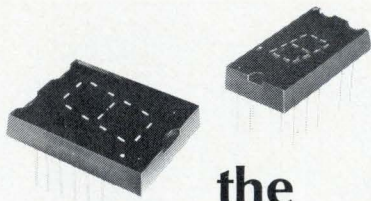

the
bright
guys



litronix

Litronix, Inc. • 19000 Homestead Road • Cupertino, California 95014 • (408) 257-7910 TWX: 910-338-0022

Finding open-loop gain without opening the loop

by David Luttrupp
Hewlett-Packard Co., Loveland, Colo.

Measuring the closed-loop response of regulated power supplies can be a tricky problem, particularly when operational amplifiers are used. Even though IC makers supply frequency-response plots for their devices, closed-loop response problems always pop up when an additional pole or zero is picked up from the pass transistor and filter. The total loop response now depends on both the op amp and the additional circuitry.

Unfortunately, measuring open-loop response requires breaking into a high-gain loop, which isn't very practical. It is much better to determine the open-loop response with the loop closed.

Circuitry can be designed and built to do the job, but with Hewlett-Packard gain phase meter model 3575 handy, you're already halfway there. Simply add an ac voltage source, dc-coupled and floating in series with the feedback path, and determining open-loop gain is almost reduced to reading a meter.

Although the oscillator's signal isn't critical, it should be low enough for the amplifier to remain linear. An oscilloscope can be used to monitor the signal.

The open-loop response of an amplifier with gain A

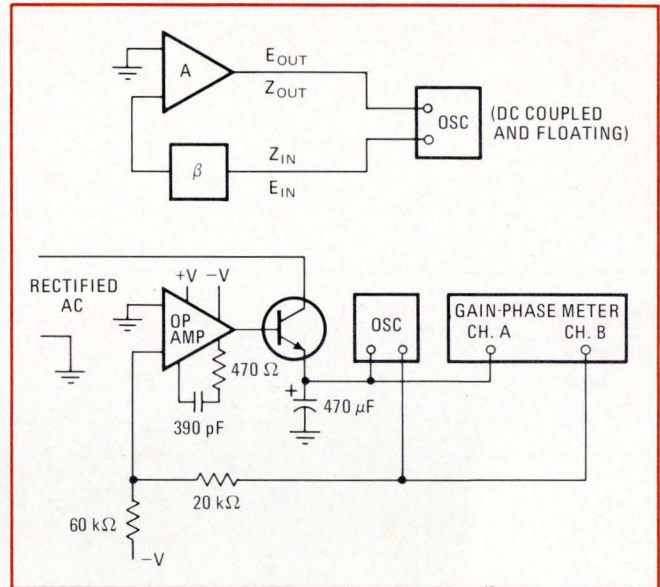

Typical test setup needs floating direct-coupled oscillator

and feedback function can be expressed as:

$$A\beta = \frac{E_{OUT}}{E_{IN}} \left(1 + \frac{Z_{OUT}}{Z_{IN}} \right)$$

If Z_{out} is much less than Z_{in} , then the expression reduces to E_{out}/E_{in} . The gain and phase plot of E_{out}/E_{in} is a simple Bode plot, but the 3575 is well suited for this role because it measures the log ratio of E_{out} and E_{in} and the phase between them.

Coaxial buses help suppress power supply transients

by Herman Levin, Jeffrey O'Neil, and William Lord,
Colorado State University, Fort Collins, Colo.

The engineer using today's faster logic circuits may face the problem of power supply switching transients that have frequency components in excess of 1 gigahertz. Adding suppression networks to an adequately designed power supply will have little effect, but suppressing these transients along the power-supply feeder lines proves a viable technique.

Instead of using large parallel tubes just to satisfy the system's current requirements, try them in a coaxial configuration, and thus attenuate those transients, as well. A practical approach is to use copper tubes co-

axially configured with polyvinylchloride tubing slipped over the inner tube and heat-shrunk tightly to it.

An experimental feeder-line section can be made easily by using copper tubing in sizes readily available from a hardware store. Connections to the section are

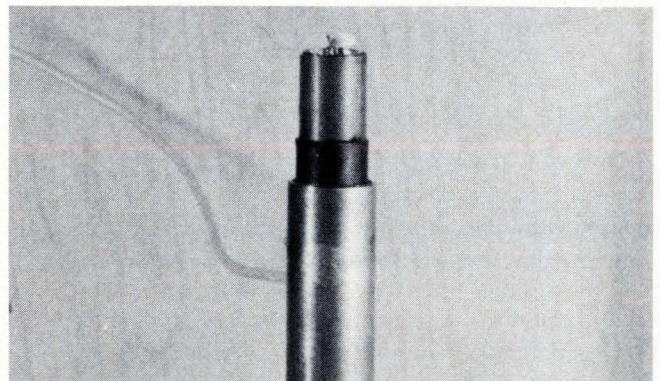

Experimental coaxial section uses standard copper tubes

made at the ends of the inner and outer tubes. For convenience, holes can be drilled prior to assembly in the outer tube at regular intervals, and connections to the inner tube can be made by drilling small holes through

the sleeve and inner tube and using blind pop-type rivets to attach the leads. Connections to the outer tube can be made with clamps or presoldered connectors.

When production quantities are involved, most of the parameters can be optimized: the dielectric material and ratio of tube diameters can be chosen to increase the attenuation, and the inner tube connectors can be made with special feedthrough components for ease of fabrication.

Standard coaxial cable can be substituted for the copper tubes and sleeving. However, an excessively large cable would be needed to equal the current-carrying capacity of the tubes, and making connections to the inner conductor of standard coax isn't simple. Moreover, the ratio of the tube diameters can be adjusted to provide greater attenuation per unit length of the power supply feeder line.

TRANSIENT SUPPRESSION IN DECIBELS FOR A 3-FOOT SECTION (SOURCE RESISTANCE 50 Ω)

Bus No.	Frequency equivalent of transient		
	1 GHz	100 MHz	10 MHz
1	38	23	3.5
2	41	27	7.5
3	43	30	10
4	45	32	12
5	41	22	2

TYPICAL BUS CONFIGURATIONS

Bus No.	Outer tube nominal	Inner tube nominal	PVC tubing nominal
1	3/8 in.	1/4 in.	3/8 in.
2	1/2	3/8	1/2
3	5/8	1/2	3/4
4	3/4	5/8	3/4
5	1	3/4	1

TYPE L RIGID COPPER TUBES

Nominal size	Outside diameter	Inside diameter	Equivalent B & S wire size
1/4 in.	.375 in.	.315 in.	4
3/8	.500	.430	2
1/2	.625	.545	1
5/8	.750	.666	0
3/4	.875	.785	00
1	1.125	1.025	0000

A quick solution to conductive heat transfer problems

by International Electronic Research Corp. staff, Burbank, Calif.

Anyone looking for a shortcut to solving the conductive heat transfer equation should find this nomograph very useful. It is based on the more familiar units of watts and inches, and can help solve for any unknown within the equation. The accuracy of the result depends on how careful you are in plotting the points.

For example, suppose you wished to find the temperature drop across each segment of a one-inch-square sandwich of beryllium oxide and aluminum, separated by a 0.001-in. layer of air, that must conduct 30 watts.

The nomograph can be used to solve for ΔT across the 0.12-in. BeO layer once the heat conductivity, k , is found (table lists typical values).

- Draw a line from 30 on Q scale to 0.12 on L scale, and note the point where it crosses reference line 1.
- Draw another line from this reference point to 80 on k scale (exact value depends on the particular type of BeO). Note where this line crosses reference line 2.
- Draw a third line from this point through 1 on the left side of A scale—and read 0.78°C on the left of the ΔT

THERMAL-CONDUCTION DATA FOR VARIOUS MATERIALS AT APPROXIMATELY 65°C

Material	Density (lb/in. ³)	Thermal conductivity, k (W/in. ² °C)	(Btu/hr-ft. ² °F)
Silver	0.380	10.6	241
Copper	0.322	9.7	220
Gold	0.696	7.5	171
Aluminum, pure	0.098	5.5	125
Aluminum, 63S	0.100	5.1	116
Magnesium	0.063	4.0	91
Beryllium oxides	0.109 to 0.136	1.7 to 3.9	38.7 to 88.7
Red brass	0.316	2.8	63.7
Yellow brass	0.310	2.4	54.6
Beryllium copper	0.297	2.1	47.8
Pure iron	0.284	1.9	43.2
Phosphor bronze	0.318	1.3	29.6
Soft steel	0.284	1.18	26.8
Monel	0.318	0.9	20.5
Lead	0.409	0.83	18.9
Hard steel	0.284	0.65	14.8
Steatite	0.094	0.06	13.6
Pyrex	0.094	0.032	0.728
Grade A Lava	0.085	0.03	0.683
Soft glass	0.094	0.025	0.569
Water	0.0361	0.0167	0.380
Mica	0.101	0.015	0.341
Paper-base phenolic	0.0497	0.007	0.159
Plexiglas	0.043	0.0047	0.107
P-43 casting resin	0.045	0.0046	0.105
Maple	0.025	0.0042	0.096
Pine	0.018	0.003	0.067
Polystyrene	0.038	0.0027	0.061
Glass wool	0.001	0.001	0.023
Air	0.000043	0.0007	0.016

scale. (If the right side of the A scale were used, then the right of the ΔT scale would also have to be used).

The ΔT across the 0.09-in. thick piece of aluminum and the ΔT across the 0.001-in. air gap are found in similar fashion. But there is one correction that must be made for the air gap case: since the L scale does not extend to 0.001, a factor of 10 must be used and the line

drawn from 30 on the Q scale to 0.01 on the L scale. The remaining steps are performed in the same way, except for the last. When the line is extended and intersects the ΔT scale at 430°C , a correction factor of 10 must again be applied. The correct ΔT is 43°C .

Engineer's Notebook is a regular feature in Electronics. We invite readers to submit original and unpublished design, applications, and measurement ideas.

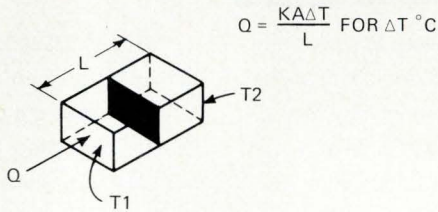
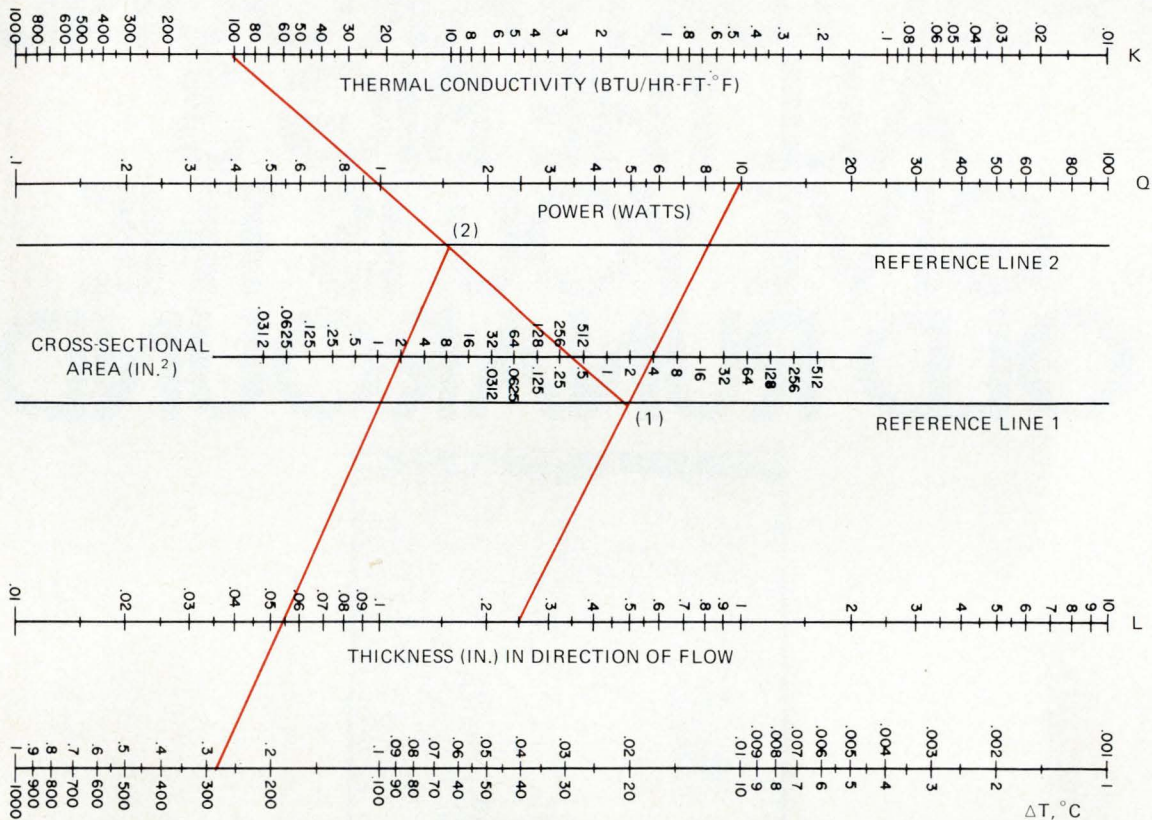

$$Q = \frac{KA\Delta T}{L} \text{ FOR } \Delta T \text{ } ^\circ\text{C}$$

SAMPLE SOLUTION
 Q = 10 W
 L = .25 IN.
 K = 100
 A = 2
 $\Delta T = 0.28409$

FINDING ΔT

- STEP 1: DETERMINE POWER Q (WATTS).
- STEP 2: DETERMINE THICKNESS L (INCHES).
- STEP 3: CONNECT POINTS OF STEPS 1 & 2. THIS FIXES REFERENCE POINT (1) ON REFERENCE LINE 1.
- STEP 4: DETERMINE THERMAL CONDUCTIVITY K (BTU/HR-FT- $^\circ\text{F}$).
- STEP 5: CONNECT REFERENCE POINT (1) WITH POINT DETERMINED IN STEP 4. THIS FIXES REFERENCE POINT (2) ON REFERENCE LINE 2.
- STEP 6: DETERMINE CROSS-SECTIONAL AREA (SQUARE INCHES).
- STEP 7: CONNECT REFERENCE POINT (2) AND AREA, AND EXTEND LINE TILL IT CROSSES THE ΔT $^\circ\text{C}$ SCALE.

NOTES

1. NOMOGRAPH INCORPORATES CONVERSION OF (BTU-FT- $^\circ\text{F}$) UNITS TO WATTS IN $^\circ\text{C}$. (BTU-FT- $^\circ\text{F}$ UNITS MUST BE USED WHEN EQUATION IS USED IN PLACE OF NOMOGRAPH).
2. WHEN $\Delta T < 1^\circ\text{C}$, USE AREA AND ΔT NUMBER ON LEFT SIDE OF AREA AND ΔT LINES. WHEN $\Delta T > 1^\circ\text{C}$, USE AREA & ΔT NUMBER ON RIGHT SIDE OF AREA AND ΔT LINES.
3. FOR VALUES NOT SHOWN ON Q, L, K, & A LINES, A MULTIPLICATION FACTOR MAY BE EMPLOYED. INCREASING Q OR L BY A FACTOR OF 10 INCREASES ΔT 10 TIMES; INCREASING K OR A BY A FACTOR OF 10 DECREASES ΔT BY AN ORDER OF MAGNITUDE.

YOU HAVE A SPECIAL NEED FOR FAST TURNAROUND. ALL THE BIG 3 GIVE YOU IS THE OLD RUNAROUND.

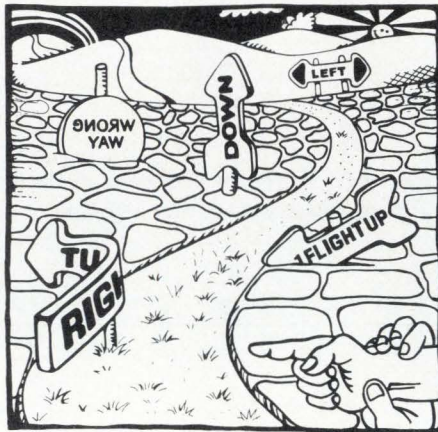

It's sad but true. The giant semiconductor manufacturers are geared to meet mass demands. They are not geared to meet anybody's special needs.

Raytheon Semiconductor is. We're organized to handle unusual requirements. We even have a new Quick Reaction Capability program designed for superfast turnaround on hot projects. We're small and agile enough to deal effectively with your special problems. We have the technical know-how and state-of-the-art

manufacturing processes to solve them.

Raytheon Semiconductor is on the leading edge of our technology with such processes as beam-lead and V-ATE, such facilities as computer aided design and testing, such products as bi-polar memories, the Beyond Super Beta op amp, and high-speed ECL and TTL devices.

Raytheon Semiconductor is small enough to offer you personal attention from engineering, manufacturing, product applications, and top management.

And, small as we are, we're backed by a billion-dollar corporation. Which gives us the strength to offer you volume production, the highest quality products at reasonable prices, and absolute reliability.

If you have a special need, we'll meet it.

Call up our Director of Marketing or nearest regional sales manager and talk to him about it. Or stop by Raytheon Semiconductor, 350 Ellis Street, Mountain View, California 94040. (415) 968-9211.



**Come to
Raytheon Semiconductor.
We're ready to go with you all the way.**

Engineer's newsletter

March 27, 1972

Try compatibility for instruments until standards set

Got any thoughts on how programable test equipment should be standardized for timing, coding, connectors, and other interface factors? **The Scientific Apparatus Makers Association, 1140 Connecticut Ave., N.W., Washington, D.C. 20036, has put out a questionnaire** on the subject in preparation for upcoming standardization meetings of the International Electrotechnical Committee meetings in Germany. You can get a copy of the questionnaire from James E. French at SAMA. Meanwhile, if you're designing a programable instrument and haven't set your own standards yet, **make it compatible with existing equipment** if at all possible. The easiest way to do this, says Robert Fulks, engineering vice president at General Radio, West Concord, Mass., is simply to look at the catalogs of other instrument makers. The GR 1682 and 1683 automatic bridges are examples of his own company's standards, says Fulks, who heads the IEC working committee.

Check specs for DIP lead lengths

If you're using sockets for dual in-line packaged integrated circuits, you'd do well to keep an eye on your IC supplier's specs on DIP lead lengths. Dick Grubb, marketing manager for Augat, Inc., Attleboro, Mass., says that **tolerances on DIP lead lengths are so wide** that some IC makers have tooled up for leads at the shorter end of the tolerance band, and some users are having difficulty with leads that aren't fully gripped by the socket contacts.

N-channel MOS has advantages for logic circuits

Look for n-channel MOS to make its mark in MSI AND LSI logic circuits—perhaps even before it succeeds in memories; it's as fast as TTL, and its logic levels, reference levels, and other specs are compatible with TTL. Thus, you will be able **to breadboard a circuit with TTL logic cells and then have it translated directly into n-channel MOS**, where you'll get the benefit of lower costs because of higher densities.

Hot pencils— \$10 a dozen

Ten bucks for a dozen pencils? Try that on your purchasing department. But if you're trying to figure out **how to mark ceramic substrates before firing** with something that doesn't vaporize at temperatures as high as 1,500°C in the furnace, such pencils may be the only way to do it, says George Lane, president of Electro Materials Corp. of America, Mamaroneck, N.Y. EMCA, a maker of thick-film paste, has been making and using the pencils in the lab, and now is going to sell them. The per-dozen price drops to \$6 at the 10-dozen level, Lane adds.

Addenda

Need a simple but accurate analog squaring circuit? Connect the voltage to be squared to the input of an analog-to-digital converter and also to the reference input of a multiplying digital-to-analog converter. Let the a-d output be the other input to the d-a; output of the d-a then is the square of the input. (From Bruce Smith, Micro Networks Corp., Worcester, Mass) . . . **"Understanding Solid-State Electronics,"** a 12-chapter self-teaching book from the Texas Instruments Learning Center, Dallas, is as good a basic book as we've seen. For \$2.95, it will take a novice from basic electricity through MOS and linear ICs.

the window is optional

in Microsystems International's new monolithic 2048 bit MOS ROM family

A choice of five ROM's and PROM's that meet just about every application need.

There are MF1701 and 1702, both recognisable by their quartz window. Unique because you can erase a program on the spot, simply, with high intensity ultra violet light. Then electrically program it again, and again.

That is why these PROM's are being widely used for system prototypes and in low volume applications requiring a frequent reprogramming capability.

MF1601 and MF1602 primarily for the lower volume applications, use the same 256 word by 8 bit chip and are electrically programmable by you or us.

When you need high volume, lower cost ROM's, our mask programmed MF1301 is unbeatable.

There are many options on product, but none on quality. Its the best. With our guarantee that all 2048 bits are programmable, and 100% factory tested for performance, plus immediate delivery. All good reasons for you to contact Microsystems International. Now.



MF 1701, 1702
MF 1601, 1602
& MF 1301

silicon gate MOS LSI from the performance leader

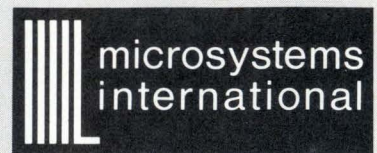

microsystems international limited, box 3529 station c, ottawa, canada — montreal, ottawa, toronto, brussels, stuttgart, london, palo alto, union.

For further information — call or write your nearest Microsystems sales office or distributor.

U.S.A. MICROSYSTEMS INTERNATIONAL SALES OFFICES: CALIFORNIA — Palo Alto, Phone 415—493—0848 ILLINOIS — Schaumburg, Phone 312—894—7660. NEW JERSEY — Union, Phone 201—964—3131.
SALES REPRESENTATIVES: ARIZONA — Scottsdale, Erskin Associates, Phone 602—263—7654. CALIFORNIA — Los Altos, W.W. Posey, Phone 415—948—7771. Santa Ana, Rical Associates, Phone 714—557—6453. CONNECTICUT — New Canaan, Stan Pierce Inc., Phone 203—966—4630. FLORIDA — Indiantonic, Tech—Rep Associates, Phone 305—723—9140. Largo, Tech—Rep Associates, Phone 813—595—2834. GEORGIA — Chamblee, Tech—Rep Associates, Phone 404—939—8339. ILLINOIS — Itasca, Lou Bacher & Associates, Phone 312—773—1810. INDIANA — Indianapolis, R.E. Marquart & Associates, Phone 317—253—3997. MARYLAND — Baltimore, L.H. Kolman Co., Phone 301—752—8756. MASSACHUSETTS — Norwood, Stan Pierce Inc., Phone 617—762—3164. MISSOURI — St. Louis Pem Sales Co., Phone 314—427—7200. NEW YORK — Ciero, Advanced Components Inc., Phone 315—699—2671. New York, ABC Electronics Sales, Phone 516—747—6610. OHIO — Columbus, Tom Mulligan & Associates, Phone 614—457—2242. PENNSYLVANIA — Philadelphia, ABC Electronics Sales, Phone 215—464—2275. TEXAS — Addison, Campion Sales, Phone 214—239—9196.
DISTRIBUTORS: ARIZONA — Phoenix, Kierulff Electronics, Phone 602—273—7331. CALIFORNIA — Gardena, Santa Monica Bell, Phone 213—321—5802. Los Angeles, Wesco, Phone 213—685—9525. Menlo Park, Bell Electronics, Phone 415—323—8431. San Carlos, Sterling Electronics, Phone 415—592—2353. San Diego, Kierulff Electronics, Phone 714—278—2112. COLORADO — Denver, Kierulff Electronics, Phone 303—343—7090. LONG ISLAND — Freeport, Milgray Electronics Inc., Phone 516—546—6000. MARYLAND — Baltimore, Arrow Electronics Inc., Phone 301—247—5200. MASSACHUSETTS — Dedham, Gerber Electronics, Phone 617—329—2400. Watertown, Sterling Electronics, Phone 617—962—9720. MINNESOTA — Minneapolis, Hall Mark Electronics Corp., Phone 612—925—2944. NEW YORK — Buffalo, Genesee Radio & Parts Co. Inc., Phone 716—573—9661. Rochester, Simcona Electronics, Phone 716—328—3230. NEW MEXICO — Albuquerque, Kierulff Electronics, Phone 505—247—1055. TEXAS — Dallas, Semiconductor Specialists Inc., Phone 214—358—5211. WASHINGTON — Seattle, Kierulff Electronics, Phone 206—763—1550.
CANADA — MICROSYSTEMS INTERNATIONAL SALES OFFICES: ONTARIO — Ottawa, Phone 613—828—9191, Toronto, Phone 416—366—7721. QUEBEC — Montreal, Phone 514—875—2814.
SALES REPRESENTATIVES: BRITISH COLUMBIA — Vancouver, A.W. Bleue, Phone 604—685—7914.
DISTRIBUTORS: BRITISH COLUMBIA — Vancouver, R.A.E. Industrial Electronics Ltd., Phone 604—687—2621. ONTARIO — Malton, Semiconductor Specialists (Canada) Ltd., Phone 416—678—1444. QUEBEC — Montreal, Cesco Electronics Limited, Phone 514—735—5511.

New Products

LSI packages make room at the top

Ceramics manufacturers to market side-brazed types that provide a variety of cavity sizes for big MOS chips

by Stephen E. Scrupski, Packaging & Production Editor

MOS chips are getting larger, and it's not just because more functions are being put on them. In addition, computer-aided design increasingly is being used to lay out the chips and, though it is much faster and makes fewer errors, the computer just isn't as efficient as a human in making use of available space.

So semiconductor makers are looking for packages with larger cavities to accommodate the bigger chips designed by computers. Packages with lead frames brazed to pads on the top surface are limited in cavity sizes by the space needed for the pads. When lead frames are brazed to the underside of the package, some users fear short circuits to the printed circuit board. The third approach is to braze the leads to the sides of the package, and the increasing popularity of this design is indicated by a series of new LSI packages to be announced in the next month or two.

Kyocera International Inc., Sunnyvale, Calif., which last August introduced the first 40-lead side-brazed package—with a 250-mils-square cavity—is ready to announce a 40-lead side-brazed package with a 310-mils-square cavity. The earlier package has since been made the standard at Fairchild Semiconductor division for all its custom-designed MOS chips.

American Lava Corp., Chattanooga, Tenn, a subsidiary of 3M Co.; Metalized Ceramics Corp., Providence, R.I.; and Semiconductor Component Substrates Corp., Garland, Texas, will also be marketing side-brazed LSI packages during the next month.

However, not all ceramics makers are ready to jump on the band-

wagon. Centralab Electronics division of Globe Union Inc., Milwaukee, has had a 40-lead DIP with a 250-mils-square cavity on the market for more than a year, and one with a 315-mils-square cavity was introduced late in 1971.

Centralab brazes leads to the underside of the top substrate, but another layer of ceramic—slightly narrower—raises the bonding pads away from the printed circuit conductors and thus prevents shorting. J. C. "Chuck" Thompson, Centralab sales manager, points out that his package preserves the planar packaging format, whereby the lead frames come out in the same plane as the package and are bent down in the last phases of production.

Retooling is required for the side-brazed package, but a bending step is not required. And one ceramic package maker views retooling for the side-brazed package as the

"dues" that a semiconductor maker must pay for wide cavity sizes.

Kyocera offers a full line of side-brazed packages—from eight to 40 leads—both in white and black ceramic, used for light-sensitive chips. In the 24-, 28-, and 40-lead packages, maximum cavity size of the first packages was 250 mils square. Now, the 310-mils-square cavity "is about the maximum you can get with the side-brazed package," says Arthur Jonichi, Kyocera vice president. Typical price for the new 40-lead unit will be less than 90 cents in quantity, he adds.

One interesting offshoot of the Kyocera package is the receptacle recently introduced by Amp Inc., Harrisburg, Pa., which handles a leadless side-brazed package. Contacts in the socket simply press against the bonding pads along the sides of the package. The receptacles are zero-insertion-force type—

Versatile. Receptacle from Amp Inc. handles leadless ceramic package that is designed for side-brazed lead frame, as well as packages with pads on top.

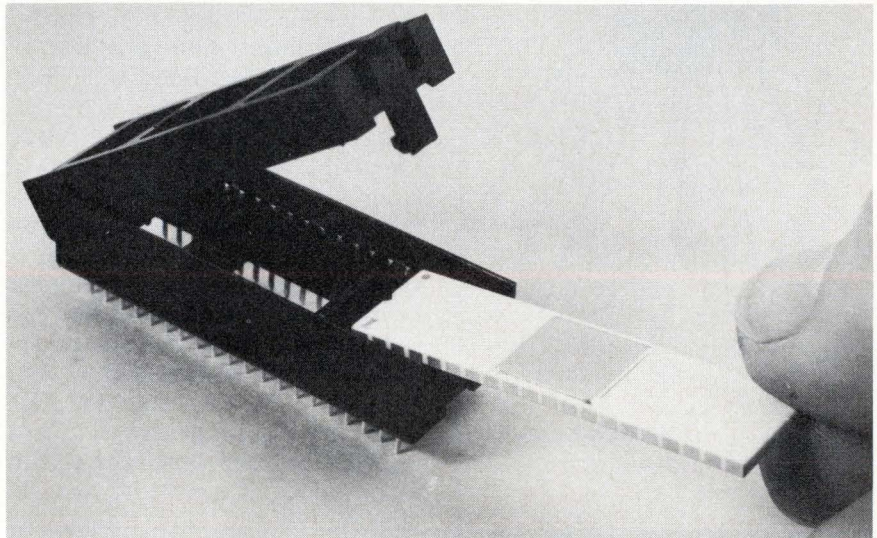

Procond is young (electronics too)

Plastic film
and electrolytic capacitors
for entertainment
and professional
field.

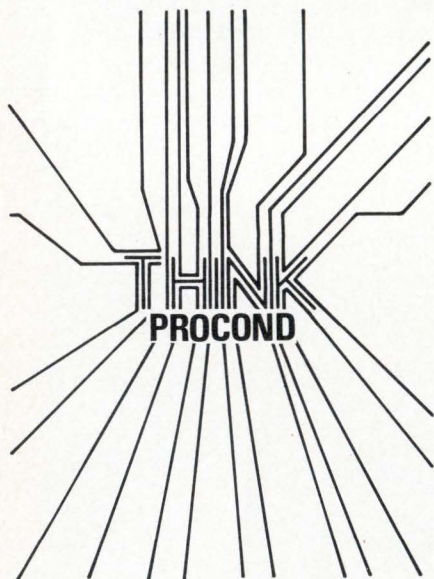

PROCOND S.p.A. - 32013 Longarone, Italy.

New products

the contacts are actuated when the cover is pivoted into place. In its present form, the receptacle handles a 40-lead package and provides contacts to the printed circuit board on the same 600-mil spacing as packages with leads.

Another version of the Amp receptacle will handle the ceramic package introduced last year by the Electronic Products division of E.I. DuPont deNemours & Co., Wilmington, Del. The DuPont package normally uses a lead frame with a C-clamp structure that grips the edges of the substrate and is soldered to bonding pads on the top and bottom of the substrate. For use with the Amp receptacle, the lead frames would be eliminated, and contacts in the receptacle would contact the pads on the top.

DuPont also is working on a "simulated" side-brazed package, which should be ready in about three months, reports John J. Cox, division manager for packages. The C-clamp lead frame in this package is used on pads that are remote from the cavity; but near the center of the package edge—where the cavity is—the top arm of the C is removed so that contact is made only to the side and bottom of the ceramic.

Only four of the 20 leads along one side of the 40-lead package would have to be modified in this way, says Cox, in order to reach cavity sizes of 310 mils square or even larger. Structural integrity would be maintained because the lead frame is held together by the shorting strip until the final stages of the process, when it's clipped off for final test.

The Fairchild custom-MOS operation has standardized on side-brazed packages for all devices. Fairchild has had to re-tool to handle the vertical leads on the package, but Tom Dyer, program manager, points out that the use of standard seal rings and the savings in elimination of the lead-bending step, together with improvements in packaging, more than pay for any redesign of test jigs and the like. Dyer sees the Amp receptacle as a useful approach in reducing cost of maintenance and board rework. By eliminating the lead frame, the

package cost may drop to less than 20 cents, assuming high-volume usage, Dyer predicts.

"Side-brazed packages will take the major portion of LSIs," says Robert Applewhite of American Lava. Right now, his company has packages of this type with up to 22 leads, and it is tooling up for 24-, 28-, and 40-lead units.

Metceram has a 22-lead unit, and Frank Rydwansky, applications manager, says the 40-lead housing will be available within a few weeks, followed soon thereafter by 24- and 28-lead versions.

At SCS, tooling was begun in the third quarter of last year for side-brazed packages, marketing manager Don Fleming says, and units with 28 and 40 leads are now being released in evaluation quantities. Prices could drop to 80 cents each in

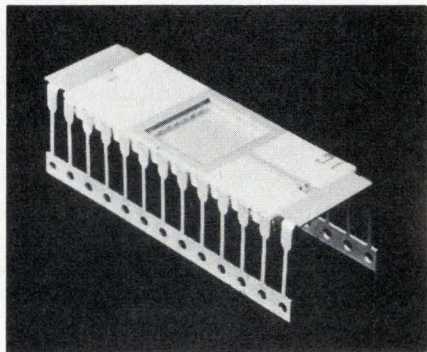

For memory chips. Side-brazed LSI package with 22 leads is made by Metceram.

large quantities, Fleming says.

Texas Instruments' Hermetic Seals department, Dallas, is providing sample lots of 22-lead side-brazed packages, but hasn't yet made a full commitment because TI officials are not convinced that it's the way to go, says Richard Presby, marketing manager.

Another approach to wide-cavity packages is being taken by Space Ordnance Systems, Saugus, Calif., which is offering a 40-lead glass-ceramic package with a die-bond area measuring 280 by 350 mils at about 90 cents in large quantities. For smaller packages with leads on 300-mil spacing, the company recently introduced a unit in which the Kovar lead frames are bent before the glass-ceramic is fused to the metal.

1,577,703 Photodiodes

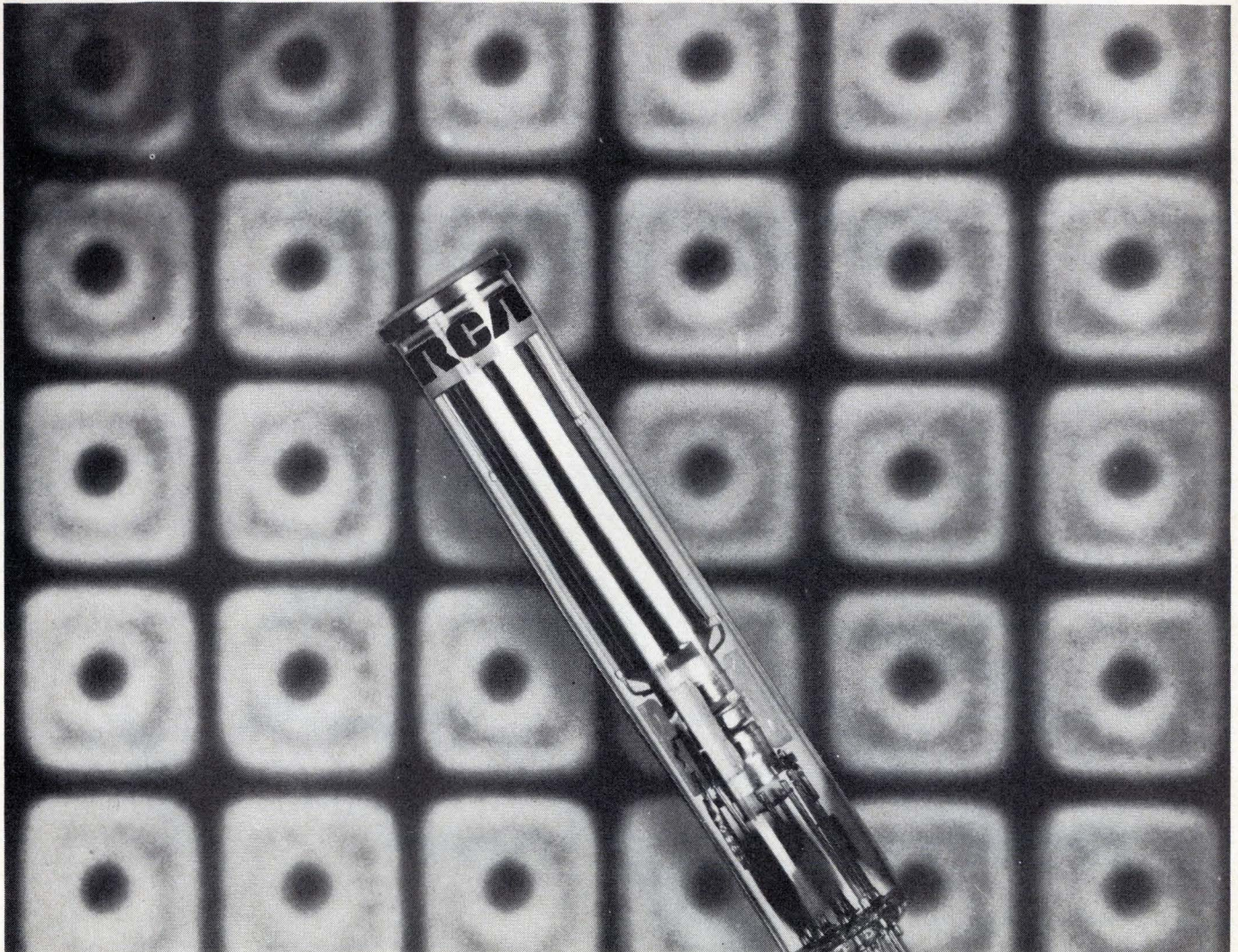

Typical ST-Vidicon shown with greatly enlarged portion of silicon target. Thirty photodiodes of the 613,346 covered by the standard 4:3 raster are shown.

... make one silicon target that takes the compromise out of vidicon performance.

It took a technological breakthrough to produce RCA's unique silicon target structure. RCA conceived a way to achieve the excellent performance of which silicon targets are inherently capable. Then one of the industry's most talented teams went to work. The no-compromise performance was well worth the wait. Now available from stock are silicon target vidicons with outstanding resolution, as well as low dark-current and low lag.

The RCA-4532A is the outstanding example of this unique photodiode target technology and is intended for high-quality TV pickup. The RCA-

4532 is ideal where quality criteria are less stringent.

RCA ST-Vidicons have the sensitivity needed for security and surveillance. Quantum efficiency of at least 60% through the visible range provides pictures at as low as 0.1 lux (0.01 footcandle) on the faceplate. Covert systems using infrared are made possible through the ST-Vidicon's 30% QE at 900 nanometers.

Use the ST-Vidicon wherever you now use a conventional vidicon. Get low lag, low dark-current, immunity to highlight burn, and high sensitivity. Use it in broadcasting, education, security, and surveillance.

Ask your RCA Representative or RCA Industrial Tube Distributor for more information on these and other RCA ST-Vidicons. For technical data, write: RCA, Commercial Engineering, Section 70C-27/ZC13, Harrison, N.J. 07029. International: RCA, 2-4 rue du Lièvre, 1227 Geneva, Switzerland, or Sunbury-on-Thames, U.K., or P.O. Box 112 Hong Kong.

RCA Electro Optics

Stop wasting matches— TRW power resistors won't burn!

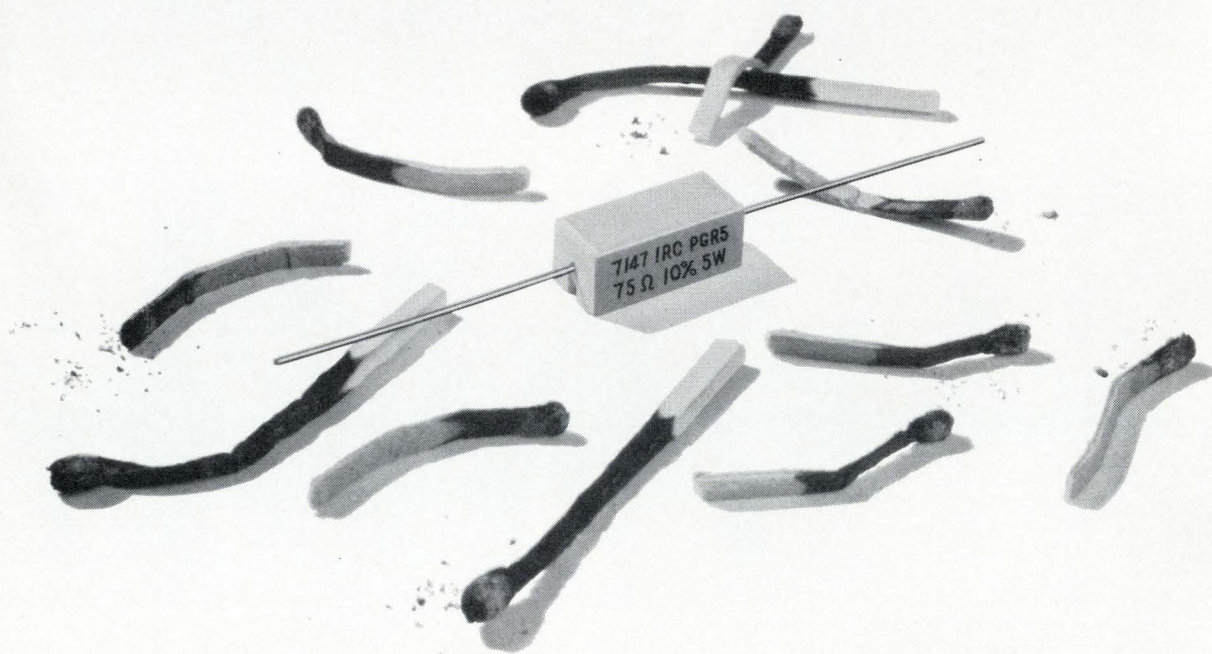

PGR power resistors are flameproof, not just flame retardant. You can't beat them for economy and reliability. Available in IRC's famous Metal Glaze™ thick film construction, PGR's come in 1 to 5 watt sizes, values to 100K, $\pm 2, 5$ and 10% tolerances.

PGR resistors are tough enough to withstand transients, even continuous power overloads without failure. Under severe fault conditions, these units open without flame or sufficient heat to ignite adjacent components. If your product must be certified for fire safety, it will pay you to investigate.

If non-flammability isn't enough benefit, compare the price with other power resistors — even those not designed to be flameproof! The PGR is less

than 6¢ in quantity. That's why so many appliance, TV, and industrial users specify TRW.

PGR joins IRC's type PW wirewound series which for many years has been the price and performance leader in consumer electronics. PW's are available in equivalent sizes to PGR and serve those applications where lower resistance values down to .1 ohm are required. In addition, specific fusing characteristics and positive temperature coefficients are available where the resistor is used for component or circuit protection. 2 to 50 watts.

Call us about your application. TRW/IRC Fixed Resistors, an Operation of TRW Electronic Components, Boone, N.C. 28607. (704) 264-8861.

TRW
IRC RESISTORS

Software cuts sensitivity-analysis cost

Easy-to-use computer program checks hundreds of parameters in seconds, determining their effect on circuit-output functions

by Lucinda Mattera, Circuit Design Editor

Running through a sensitivity analysis with most computer programs can be time-consuming and very expensive. But a software system called Aedcap (Automated engineering design circuit analysis program) can now reduce the cost of sensitivity analysis to a matter of a few seconds and a few pennies. Besides dc and ac sensitivity analysis, new features include worst-case analysis and finding the square root of the sum of the squares.

Aedcap, which was developed by SofTech Inc., Waltham, Mass., allows the user to treat his design as though it were breadboarded or being checked with an oscilloscope. He can vary the dc bias conditions and then perform ac analysis, all with the same conversational language that is used to create models,

subcircuits, and circuits.

Sensitivity analysis with a computer allows the user to vary each design parameter individually by the same or different amounts and determine the effect each change has on circuit performance.

The illustration is an example of a dc sensitivity analysis printout for the amplifier shown. The sensitivity of the voltage, V(14,0), across resistor R₁₂ (from node 14 to node 0 [ground] in the circuit) is found. For example, resistor R₅, which is nominally 811 ohms, has a sensitivity of 1.3×10^{-3} volts per unit, and causes about a 10-millivolt change in V(14,0) when varied by 1%. All the figures in the normalized column represent a 1% parameter change. To find the effect of larger or smaller percentage changes, the

normalized 1% figure is simply multiplied by the desired factor. Transistors, as usual, are represented by the desired computer models.

A sensitivity analysis usually involves many circuit parameters—102 for the amplifier shown. But Aedcap performs sensitivity analysis in a single mathematical step—by transposing a matrix (interchanging rows and columns) that represents the circuit being analyzed. For a 55-node circuit, Aedcap will hold computer costs to a little more than \$40 for both an initial dc analysis and a 100-parameter sensitivity analysis.

The program is available for in-house installations or on a time-shared basis through National CSS of Stamford, Conn.

SofTech Inc., 391 Totten Pond Rd., Waltham, Mass. 02154 [339]

Analyzing dc sensitivity. In a second, Aedcap program checks 102 parameters of amplifier circuit, at right. Printout shows results.

SENSITIVITIES FOR V(14,0)				
ELEMENT	ATTRIBUTE	VALUE UNITS	SENSITIVITY VOLTS/UNIT	(NORMALIZED) VOLTS/%
R1	RESISTANCE	1.00000E+02	2.37239E-07	2.37239E-07
R2	RESISTANCE	1.00000E+02	-2.15445E-07	-2.15445E-07
R3	RESISTANCE	4.80000E+03	3.25505E-08	1.56242E-06
R4	RESISTANCE	4.80000E+03	-3.09637E-08	-1.48625E-06
R5	RESISTANCE	8.11000E+02	1.30346E-03	1.05710E-02
R6	RESISTANCE	2.17000E+03	-1.45855E-04	-3.16505E-03
R7	RESISTANCE	8.20000E+02	4.04530E-04	3.31715E-03
R8	RESISTANCE	1.32000E+03	-9.45963E-04	-1.24867E-02
R9	RESISTANCE	4.50000E+03	-1.63411E-05	-7.35350E-04
R10	RESISTANCE	1.32000E+03	-7.30131E-15	-9.63773E-14
R11	RESISTANCE	5.25000E+03	1.78757E-15	9.38475E-14
R12	RESISTANCE	5.25000E+03	4.58711E-06	2.40823E-04
Q1	RC	4.00000E+01	-1.29860E-14	-5.19440E-15
	RB	7.00000E+01	-2.15445E-07	-1.50812E-07
	IES	1.00000E-14	1.19616E+10	1.19616E-06
	ICS	1.10000E-14	1.87225E-01	2.05947E-17
	NBE	9.99999E-01	-3.13231E-03	-3.13231E-05
	NBC	9.99999E-01	0.00000E+00	0.00000E+00
	BF	5.00000E+01	7.18141E-07	3.59070E-07
	BR	5.00000E+00	-2.21779E-16	-1.10889E-17
Q2	RC	4.00000E+01	1.40075E-15	5.80305E-15
	RB	7.00000E+01	2.15445E-07	1.50812E-07

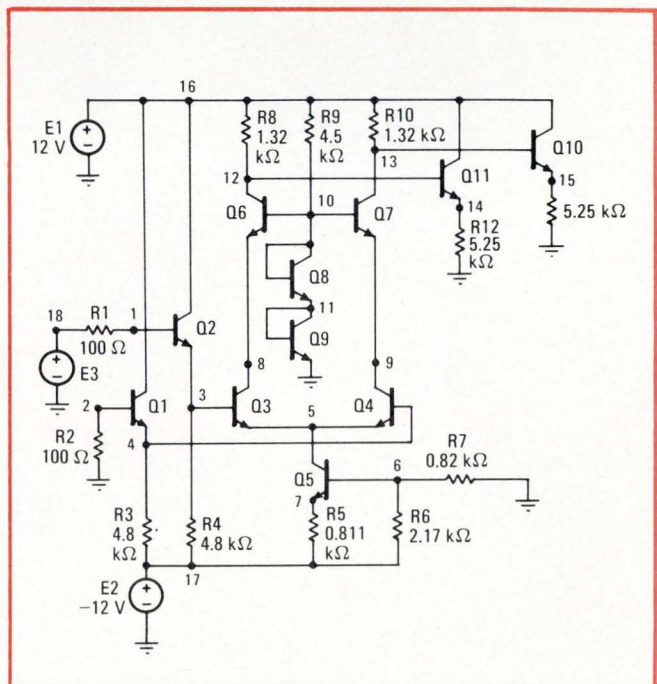

Now that we're in your systems, we're looking for a place in your hearts.

It's not that we're unhappy.

Our instrumentation recorders are the finest made...they're proving it in systems around the world.

But we would like to remind you that we can make life even easier for you.

We have a complete line of easy-to-use, versatile test and calibration equipment. Lab-type and portable. Flutter meters and test sets. A sweep generator that shows you the response of your recorder across its full frequency range at a glance.

A tape care package that cleans, winds, bur-nishes and certifies your tapes in minutes with the push of a button.

Just about everything you'll ever need for trouble-shooting your systems and taking care of your tapes faster, with a lot less grief.

So why not get all the details on all our instru-ments today.

To know them is to love them.



INSTRUMENTATION PRODUCTS **3M**
Mincom Division COMPANY
300 S. Lewis Rd., Camarillo, Calif. 93010. Tel: (805) 482-1911.

TLC for your tapes and systems.

Components

A-d converter measures ratio

12-bit unit based on successive approximation technique sells for \$150

Analog-to-digital converters that can produce a digital value from the multiplication (or division) of two analog inputs simplify the data acquisition problems for subsequent signal processing. Now, such a ratio-metric ADC can be obtained for between \$150 and \$180, depending on required accuracy. The new line from Hybrid Systems, called the ADC560 series, yields a 12-bit output and is based on the successive approximation technique.

The ratiometric ADC operates in two modes. In one case, one input is the supplied reference voltage and the other is an external measured variable. Here, the digital output represents the product (or ratio) of a variable multiplied by a constant. In the other case, the reference is disconnected and another external variable is connected, so that the digital output represents the product of two input variables. These input signals can be between 0 and 10 volts or -5 to +5 volts. For a measuring transducer requiring an external reference voltage, that voltage can be the same as the ADC reference, thus reducing the effect of reference voltage fluctuations and

the effect of common mode noise.

The four units in the series offer different accuracies. The ADC560-10 is accurate to within 0.05% and is priced at \$150. For \$175, the ADC560-11 offers accuracy to within 0.025%; and the ADC560-12, priced at \$180, is accurate to within 0.0125%. All provide two's-complement output. The ADC560-3-BCD produces three-decade binary-coded-decimal output, has an accuracy within 0.05%, and costs \$150.

The ADC560 line uses all hermetic components and thin-film resistors for long-term accuracy. Conversion time is 20 microseconds.

The modules measure 2 by 2 by 0.4 inches for card mounting, and they require ± 15 -volt and 5-volt power supplies.

Hybrid Systems Corp., 87 Second Ave., Northwest Park, Burlington, Mass. [341]

12-bit d-a converter is housed in a DIP

Functional trimming—adjusting film resistors according to their effects on circuit operation rather than on resistance value alone—is the key to high accuracy of a 12-bit digital-to-analog converter built by Micro Networks Corp. and housed in a hermetically-sealed 16-lead dual in-line package. With a laser, thin-film Nichrome resistors on silicon substrates as small as 40 mils square can be trimmed to within 0.01% of absolute value, and ratio can be trimmed to within 0.003% of desired value.

The trimming operation takes 2 to 3 minutes per circuit, says Bruce Smith, product marketing manager at Micro Networks. For a converter with 1-volt full-scale output, for example, all digital inputs are turned on, and resistors are trimmed until the output voltage falls within the specified accuracy limits. Then the input is changed, and the next resistor is trimmed until that output voltage is reached, and so on until all the resistors are trimmed.

The 12-bit unit offers linearity within one-half of the least significant bit over the operating range of

0°C to 70°C. Settling time to 0.01% of its final value is under 500 nanoseconds and, more typically, 300 ns, according to Smith; although, since it requires an external operational amplifier for output, settling time will be controlled by the amplifier.

Micro Networks Corp., 5 Barbara Lane, Worcester, Mass. 01604 [342]

Time-delay relays offered in 60 models

A line of time-delay relays is designed for use in timing and input-power applications. The line consists of four families: delay-on-make, delay-on-break, single-shot, and flip-flop configurations. There are about

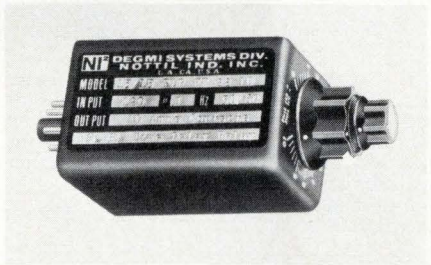

15 models in each family. Input is 120 volts ac and 24 v dc, and output is double-pole double-throw, 10-ampere resistive. Repeat accuracy is to within $\pm 2\%$, and life is rated at 5 million operations. Price starts at \$14.75.

Degmi Systems Div., Nottil Industries Inc., 7648 San Fernando Rd., Sun Valley, Calif. 91352 [343]

Mercury-wetted reed switch is only 1.5 inches long

A double-throw form C mercury-wetted reed switch is 1.5 inches long, with a 0.214-in.-maximum glass diameter and 0.805-in.-maximum glass length. Switching voltage of the model MRC-DT is 28 volts dc at up to 0.5 ampere, and breakdown voltage is 1,000 v dc minimum. The device is designed for applications where contact bounce cannot be tolerated, for dry-circuit applications, and for high inrush



If your catalog data is over 7 months old, it's probably out of date. Send for the latest GE catalogs...they're free.

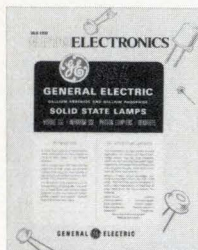

Solid State Lamps: 4 pages. Data covers 11 infrared and 4 visible Solid State Lamps, previously called Light Emitting Diodes, plus 2 SSL Numeric Readout displays. Diameter range, 0.080" to 0.230".

Circle Product Card #160

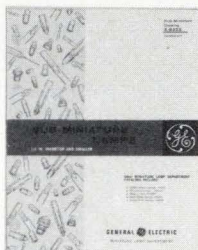

Sub-Miniature Lamps: 24 pages. Data covers over 200 sub-miniature lamps. Lamp life up to 60,000 hours. Diameters 1/4" and smaller.

Circle Product Card #161

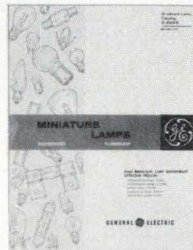

Miniature Lamps: 40 pages of data covering over 500 miniature lamps ranging from 3 to 20,000 hours average rated life. With a design voltage range of from 1.2 to 125, and candle-power range from .02 to 250. Diameter range from 1/32" to 2 1/16".

Circle Product Card #162

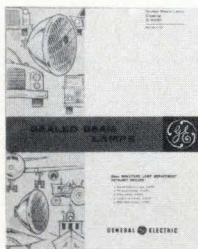

Sealed Beam Lamps: 16 pages. Data covers over 180 Sealed Beam lamps, ranging from 4 1/2" to 8" in diameter, with a design voltage range of from 4.0 to 115 and initial candle-power of from 150 to 600,000.

Circle Product Card #163

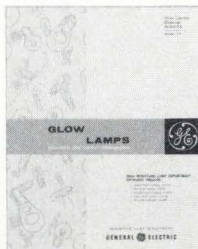

Glow Lamp: 8 pages. Data covers 77 Neon Glow Indicator and Circuit Component lamps. Diameters ranging from 1/4" to 1 3/4".

Circle Product Card #164

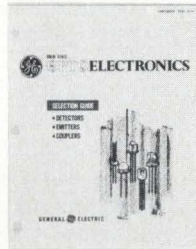

Solid State Optoelectronics Selection Guide: 4 pages. Data covering SS Emitters, Photon Couplers, 18 Detectors, Photo Transistors Arrays, Programmable Unijunctions Transistors, Selecon Controlled Switches and Rectifiers (SCS's and SCR's).

Circle Product Card #165

All of the above catalogs have been revised or updated in the past 7 months. To get the catalog(s) you need, free of charge, circle the product card number shown under each catalog or write, General Electric Company, Miniature Lamp Department, Nela Park, Cleveland, Ohio 44112.

GENERAL  ELECTRIC

New products

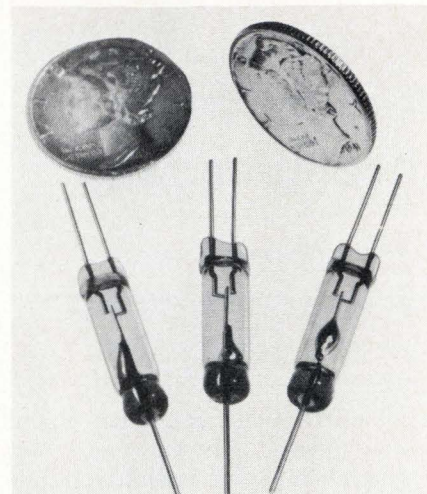

loads. Price is \$4.50 in quantities of 1,000, delivery from stock.

Hamlin Inc., Lake Mills, Wisc. 53551 [345]

Rf detector has flatness of 0.1 dB per octave

An rf detector for use in the range of 1 to 500 megahertz has a flatness of 0.1 decibel per octave. Called the model 450A, the unit uses low-threshold, hermetically sealed silicon diodes instead of temperature-sensitive germanium diodes. The internal components are potted in a silicon compound and the detector will withstand a 500-milliwatt rf in-

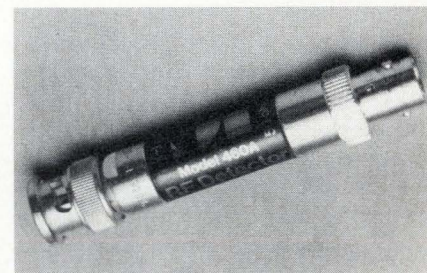

put overload indefinitely. Price is \$35 each for one to nine.

Synergex Inc., 459 E. Main St., Denville, N.J. 07834 [344]

Voltage-controlled crystal oscillator consumes 20 mW

A voltage-controlled crystal oscillator uses only 20 milliwatts, and is aimed at applications in radio communications equipment where

space, weight, and power requirements are critical. The unit is housed in a hermetically sealed container measuring 0.75 cubic inch. The model JKTO-85 is designed for any center frequency between 17.5 and 22.5 megahertz. Price in 100-lots is \$200 each.

CTS Knights Inc., Sandwich, Ill. 60548 [346]

Zero-crossover switch isolates load from input

A zero-crossover switch assures zero-volt switching by forming an electrical cushion between the signal input and load power. The output switching circuit is isolated from the

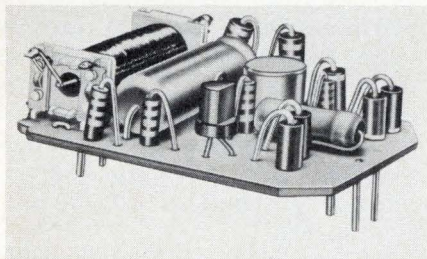

input signal through a reed relay. The series 6500 module is suitable for switching solenoid and high-intensity lamp loads. Contact termination is single-pole single-throw with contact rating of 1.0 ampere at 120 V ac, 50/60 hertz. Minimum life is 10^7 operations.

Guardian Electric Mfg. Co., 1550 W. Carroll Ave., Chicago, Ill. 60607 [347]

Glass delay lines attenuate over 14-megahertz band

Glass delay lines offer 30-decibel main signal attenuation, 14-megahertz bandwidth, and less than 50-dB spurious levels. They are aimed at applications in broadcast and studio equipment. The units measure 2.64 by 1.39 by 0.57 inches, and have nominal delay time values of 64 microseconds. Added benefits are low insertion loss and wide noise margins. Price is \$245.

Corning Memory Products, Electronic Products Div., Corning Glass Works, Raleigh, N.C. 27609 [348]

Talk to Gudebrod

...about tying wire bundles
Lacing Tapes
Dial Cords
and Systems

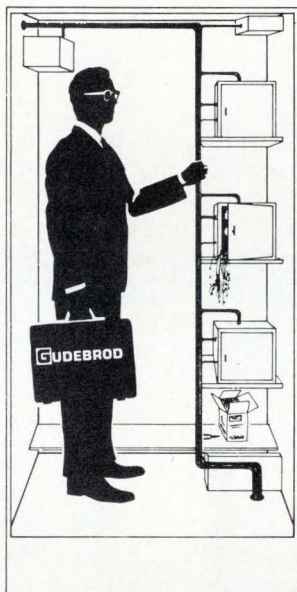

...about harness rooms

Speed
Economy
Lab Control
Vibration
Temperature

...about Quality

...and about our
quarter of a century
of experience with *tough*
problems like yours!

Gudebrod is known around the world as the "Quality House" for Lacing Tapes and Harness systems. We use knowledgeable company men and have five branch offices in the United States to serve you. Write to this address for prompt return of our **Product Data Catalog**. Should you be well into a project that needs immediate attention—phone the nearest office . . . Ask for the Electronics Division. *Then we can really do some talking!*

Philadelphia	215-WA 2-1122	Chicago	312-DE 7-3025
New York	212-LA 4-5858	Burbank	213-848-3962
Boston	617-HA 6-5347	Charlotte	704-333-9591

Export Division Office in New York

Gudebrod Bros. Silk Co., Inc.

FOUNDED IN 1870

Electronics Division

Dept. 813

12 SOUTH 12th STREET, PHILADELPHIA, PENNSYLVANIA 19107

Instruments

Amplifier is on a chip

Device offers high common mode rejection, slews at 8 volts/microsecond

For signal acquisition, signal processing, recorder front-end, and other applications, designers often need so-called instrumentation amplifiers: specialized linear circuits with high common mode rejection, high input impedance, good linearity, and a small temperature coefficient. Analog Devices Inc., has developed what it says is the first monolithic device that fills the definition. It's called the AD520.

The usual approach to low-cost design combines a number of IC op amps and a closely matched network of resistors in a package or on a board. This costs money in chips, in resistors, and—perhaps even more—in the packaging, which can range from module size to a printed circuit board or more. But at \$18 each, Analog says, the AD520 is a half to a third the price of discrete-component amps.

Competing devices use external feedback stabilization and outboard resistor networks to improve common-mode rejection. Analog has switched to internal current feedback, and, instead of outboard resistors, uses direct-coupled Darlington-paired input transistors in each channel, not only to get more than 100 decibels CMR through tight transistor beta and breakdown matching, but also to obtain an input impedance of 2×10^9 ohms. The only outboard resistance needed is a single gain-controlled trim pot, and the unit allows practically constant input impedance over a gain range of 1 to 1,000.

Unlike input impedance, CMR does vary with gain—but not so much as to hamper the user. At a gain of 1, CMR already is 70 dB, even with a 1,000-ohm imbalance

between the two inputs—and generally, input loads are matched as closely as possible when an instrumentation amp is installed. Between dc and 100 hertz, CMR rises to 90 dB at a gain of 10, to 106 dB at a gain of 100, and to more than 110 dB at a gain of 1,000. And though a dc low-frequency amp, the AD520's CMR at 1,000 Hz still is 86 dB.

Input bias is only 30 nanoamperes while offset is 10 nanoamperes and trims to zero. Analog spokesmen say they are trying to lower the latter specification even further.

To avoid matching and temperature tracking problems, Analog's designers have placed many resistors on a thin film overlying the chip. The thin film resistors are not only more accurate than diffused resistors but also have a common heat sink in the chip itself. Thus Analog

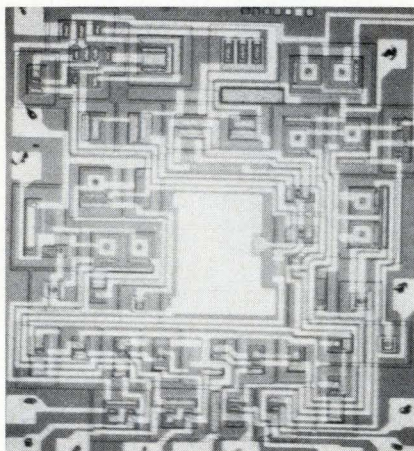

claims a voltage drift at unity gain of only 0.01% per degree centigrade, and at a gain of 1,000, a maximum drift of 0.05%/°C. Maximum non-linearity for the circuit is 0.02%.

Although designed to work at low frequencies, the AD520 slews at 8 volts per microsecond. This is very fast for any linear IC, according to Analog spokesmen, and fits it for applications like electrocardiography or electroencephalography, where the average wave is a low-frequency one, but where high-frequency information often is contained in abrupt level changes. The ac performance of the device is such that its full ± 10 -V, 5-mA output is available over a 150-kHz bandwidth. The AD520 is packaged in a 14-lead plastic DIP.

The \$18 unit price drops to \$12 in lots of 100. Delivery of the AD520 is from stock.

Analog Devices Inc., 420 Turnpike St., Canton, Mass. 02021 [351]

Portable scope has 350 MHz bandwidth at 5 mV/division

The highest gain-bandwidth product available in an oscilloscope is combined with easy-to-use features and portability in the model 485 developed by Tektronix Inc. It is a 350-MHz, 1-nanosecond-per-division, dual-trace scope that weighs 20.5 pounds.

The user has a choice of switching to 50 ohms or 1 megohm input impedance. Other features include trigger holdoff, trace separation, external trigger display, alternate delayed sweep, automatic vertical scale-factor readout, auto-focus, and B-sweep intensity control. Single-function pushbuttons add to user convenience.

At 5-millivolts-per-division sensitivity, selection of the high impedance limits the full-sensitivity bandwidth to 250 MHz, but the 50-ohm impedance permits a 350-MHz display. A separate signal path for the 50-ohm input gives a VSWR of 1:1.2, and an automatic internal detection circuit protects the 50-ohm input by disconnecting the amplifier whenever the signal exceeds 5 V rms or 0.5 watt and 0.1 watt-second.

Automatic vertical scale-factor readout for attenuating probes is provided by three light-emitting diodes located around the edge of each input attenuator knob. A

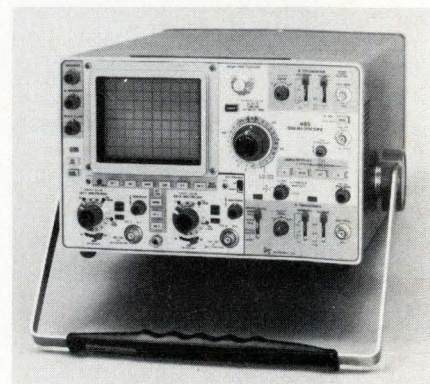

glance at the LEDs assures the user of the correct volts/division on the screen.

To complement the higher bandwidth, the 485 has 1 nano-second/division without magnifier, and this is believed to be the fastest sweep available on any portable oscilloscope.

An auto-focus circuit makes it unnecessary to readjust the focus each time the intensity is changed. This means that the focus will always be correct in single-shot photography. A beam-limit circuit protects the CRT phosphor from high-intensity burns.

Overall dimensions of the 485 are 20% by 12 by 6 9/16 inches. Price is \$4,200. Delivery time is 90 days.

Tektronix Inc., P.O. Box 500, Beaverton, Oregon 97005 [352]

Frequency counter covers
20 Hz to 18 GHz range

A frequency counter designated the model 6057, offers continuous-wave, frequency-modulated, and pulse-modulated measuring capabilities of input signals from 20 hertz to 18 gigahertz. The unit combines an automatic computing transfer oscillator for cw measurements with an advanced manual transfer oscillator



measuring technique for fm and pulsed rf, all within a portable bench instrument. Full digit readout is to nine places, with automatic decimal point and annunciator. Pulse widths can be as short as 100 nanoseconds, and resolution is selectable in decade steps down to 1 Hz. Price is \$5,450.

Options include binary-coded-decimal output, remote programing, and a choice of high-stability oscillators to tailor a model 6057 to

So you're looking for low frequency filters...

Like 10.2 kHz
11.3 kHz
13.6 kHz

Very Small

but High Performance

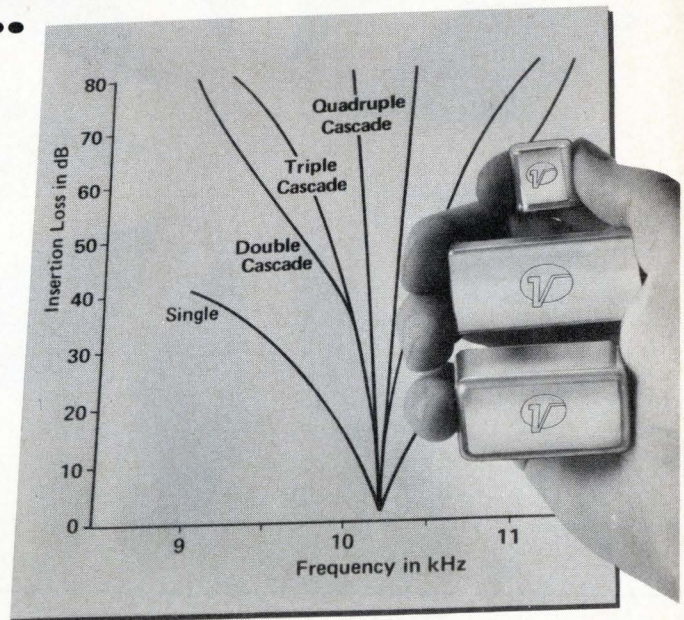

better check Vernitron... (the filters people)

For VLF receivers, Mil-Nav systems, Omega systems, command-destruct systems, underwater sound — these miniature ceramic LF filters are about one-tenth the size and weight of comparable low-frequency types, yet have narrower bandwidths, lower insertion loss and greater stability. This means you can pack more performance into one-tenth the space — and have no worries about shock, vibration, thermal drift. Available in any discrete operating frequency from 7.5 kHz to 50 kHz — including the Omega f_o 's of 10.2, 11.3 and 13.6 kHz. They're fixed-tuned, so you have no installation adjustments to make. Hermetically-sealed, immune to environments... and there's no need for shielding.

Performance? Just the single-resonator models have 20 dB/3 dB bandwidth ratios less than 13, stopband attenuation to beyond 30 dB from dc to above 100 kHz. Less than 5 dB insertion loss. And that's not all!

Cascaded Models for Higher Selectivity, Higher Rejections

Great thing about ceramic LF filters — they can be cascaded together in the same package, for quantum jumps in selectivity and rejection — with minimum sacrifice to volume and weight. Vernitron supplies them in 2-, 3- and 4-resonator models. Some examples:

2-resonator Models—40 dB/3 dB ratios of 10; stopbands to above 60 dB.

3-resonator Models—60 dB/3 dB ratios of 10; stopbands to above 80 dB.

4-resonator Models—80 dB/3 dB ratios of 13.5; stopbands to above 90 dB.

Both Mil-spec and commercial models. Prices will surprise you. They're at least competitive with conventional types, and often considerably less. If it's in the 7.5 kHz to 50 kHz range, it will pay you to check Vernitron. Send us your requirements. We'll send complete specs and technical data.



Vernitron Piezoelectric Division

232 Forbes Road / Bedford, Ohio 44146 / (216) 232-8600

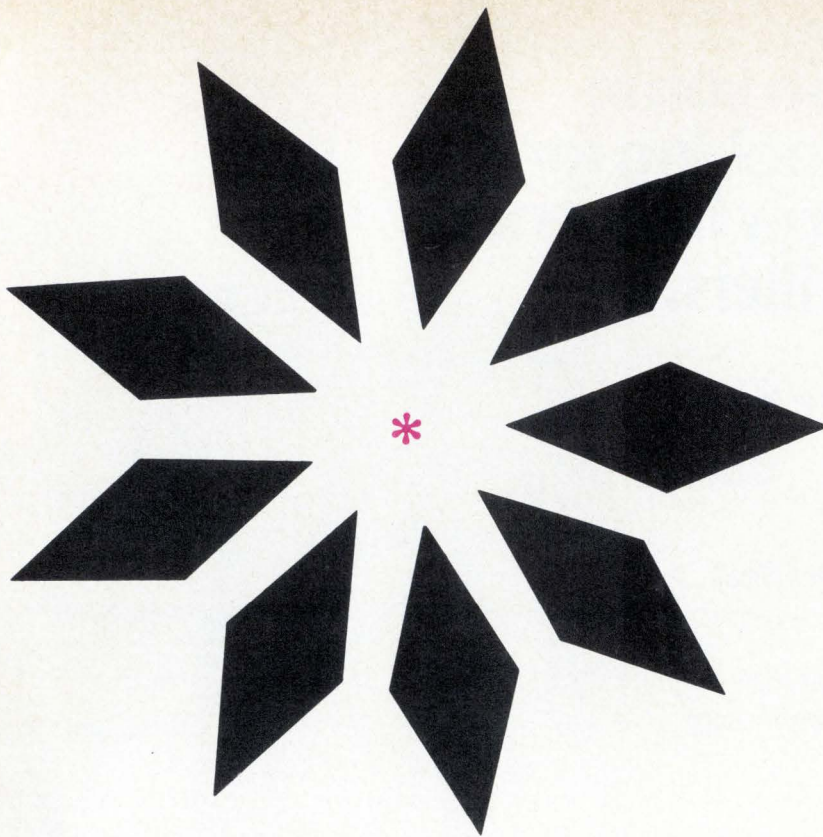

Complete HF Receive Antenna capability in a 50 meter circle

How Hermes did away with vast rhombic or log-periodic antenna farms. Shoed away by a shrewd array:

Take 1 meter diameter loops, 4 meters apart, and get an omni directional broad-band receiving array.

Covers 2 - 32 MHz.

Optimum beam characteristics for both long and short range communications.

Rosette configuration of linear arrays gives a number of overlapping high gain beams - all available simultaneously.

*** Using less than one hundredth of traditional real estate.**

Aperiodic Loop Systems are shrewd enough for restricted space, quick set up, roof mountable, or just below ground level. And portable version now available.

From polar icecap to sweltering tropics.

Installed in more than 52 locations for more than ten governments and more than 32 of their agencies.

Give up the antenna farm. ASK US

Hermes Electronics Limited

Suite 315

2020 F Street N. W.

WASHINGTON

D.C., 20006

Telephone 202 296-2978

TWX 710-822-1106

New products

special requirements and to systems. Delivery time is 30 days after receipt of order.

Systron-Donner Corp., Instruments Div., 888 Galindo St., Concord, Calif. 94520 [354]

Spectrum analysis system tests ssb, a-m, fm units

Providing rapid tests for calibration and troubleshooting of single-side-band, a-m, and fm transmitters and receivers, the CSA-290 system consists of a spectrum analyzer, a two-tone audio generator, and a high-

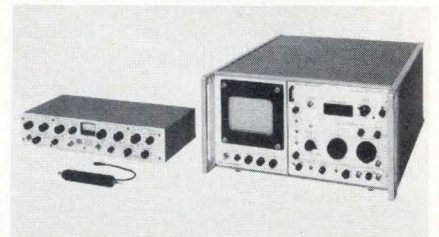

impedance probe. Signals from 10 hertz to above 40 megahertz are displayed with 10-Hz resolution and 70-decibel distortion-free dynamic range. Price is \$4,950.

Nelson-Ross Electronics, 5 Delaware Dr., Lake Success, N.Y. [356]

Generator puts out 26-kilowatt pulses

Designed for semiconductor testing, modulating microwave tubes, laser pulsing, and other applications, a pulse generator designated the model 350A provides 10%-duty-factor output pulses. Peak power output varies from 26 kilowatts for a single pulse to 2.1 kw at 10% duty. A plug-in feature allows good impedance matching between the pulse generator and load for any impedance between 0.1 ohm and 20,000 ohms. Continuously variable output pulses from 0 to 2,100 volts are available, and pulse width may be varied from 0.1 microsecond to 300 μ s. Pulse rise and fall times are 30 to 50 nanoseconds respectively. Price is \$4,490.

Velonex, Div. of Varian, 560 Robert Ave., Santa Clara, Calif. 95050 [357]

**If your IC Logic
doesn't give you
a guaranteed 3.5 volt
noise immunity...**



Fire yours and hire ours.

HiNIL, High Noise Immunity Logic

Teledyne's Series 300 HiNIL has a 3.5 volt worst-case noise immunity spec. But that's just one reason for designing with HiNIL. Here are a few more that take the sweat out of industrial logic design.

HiNIL offers MSI. Included in the Series 300 are such complex functions as BCD to decade decoders and drivers, Nixie[®]* drivers, decade and hexadecimal counters, a quad latch and a 4-bit comparator.

HiNIL is slow. HiNIL is one of the slowest logic families since relays. It has a nice 100-nanosecond propagation delay, so it is unperturbed by high voltage transient noise. HiNIL won't switch falsely when a fork lift rolls by or a lathe turns over.

HiNIL is easy to use. There are very few system interfaces that cannot be handled simply with HiNIL devices. The open-collector devices

in the family, including the simple gates, have ample output sink and drive currents to operate a small lamp or relay.

For *output* interfaces to TTL, DTL or MOS—you simply connect an open collector output through a pullup resistor to the desired high logic level.

HiNIL is versatile. Every IC in the Series 300 family comes in a 16 pin dual-in-line package, providing better than 10% more functional utility than you get with most standard TTL circuits. Vcc and Ground take up two of the pins, leaving 14 for functional use compared with 12 for TTL. You can do more with HiNIL.

HiNIL is priced right. It's priced competitive with TTL. Need we say more?

Write for a free copy of our 64 page HiNIL handbook. Save yourself from those embarrassing noise problems—use Series 300 HiNIL.

 **TELEDYNE SEMICONDUCTOR**

1300 Terra Bella Avenue Mountain View, California 94040 (415) 968-9241 TWX: 910-379-6494 Telex: 34-8416

*Nixie is a registered trademark of Burroughs Corp.

The mini-maxi machine. Kearfott SKC-2000 Airborne Digital Computer has a new number—AN/YUK-13.

Floating point arithmetic eliminates scaling problems and permits use of Fortran IV compiler.

Existing, working hardware designed to accommodate tomorrow's technology, today.

Large machine architecture used in compact airborne digital computer is readily expandable.

True modularity. Machine architecture and mechanical design permit virtually unlimited addition of CPU and memory modules.

Unique mechanical design provides for adequate cooling of MSI/LSI devices used.

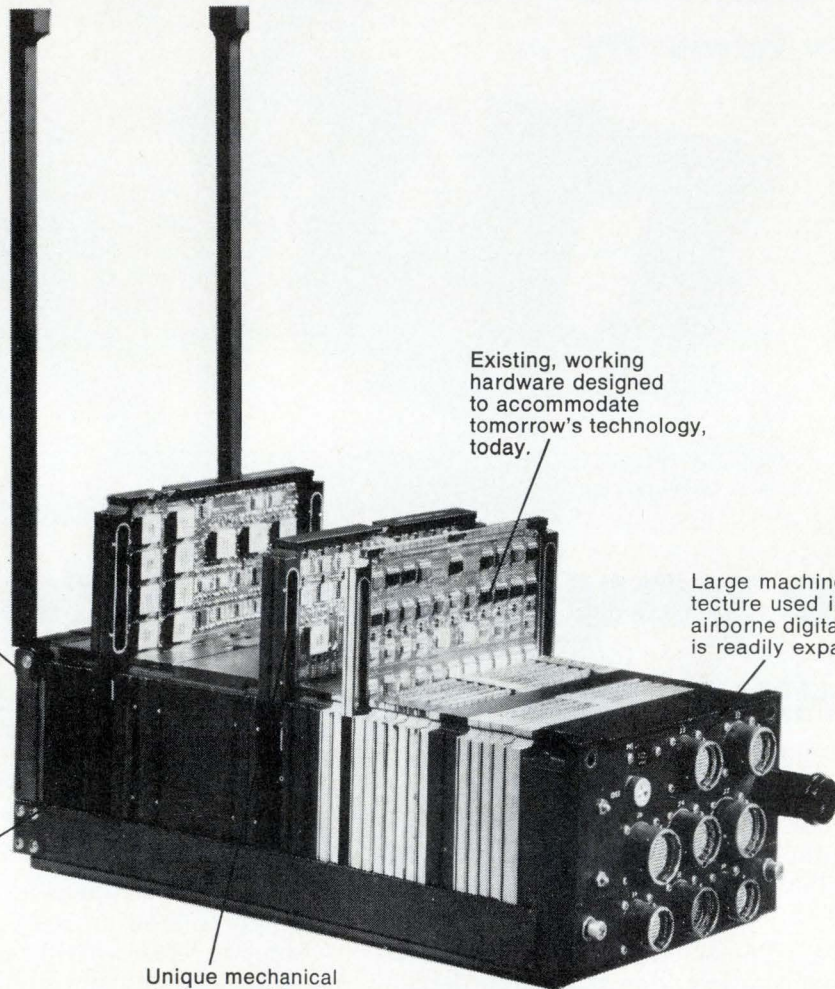

Here's a general purpose, high performance digital computer based on a single data and control bus, and an interconnecting series of modules. Modules that can be combined to form a simplex central computer, a multi-computer or a multi-processor—simply, quickly, efficiently.

But there's more. Through the use of asynchronous module operation, a complete spectrum of input/output capabilities is made possible. Because the SKC-2000 modules can be mixed and matched, and even replaced as new technological advancements are made.

We can provide you with a whole family of compatible modules for our SKC-2000. And one of our experts can help you put together a winning combination, from a mini-machine all the way up to a maxi-machine.

For more information, and a detailed new brochure, write The Singer Company, Kearfott Division, 1150 McBride Ave., Little Falls, N.J. 07424. Or call (201) 256-4000.

SINGER
AEROSPACE & MARINE SYSTEMS

Typical Characteristics (CPU)	
Number Systems	Binary, floating point and two's complement fixed point
Data words, Floating Point	24 bit mantissa, 8 bit exponents
Data words, Fixed Point	32 bits including sign
Instruction Words	16 bits short, 32 bits long
Instructions	99 total long & short
Address Modes	Direct, indirect, relative, immediate
Average Execution Times For	Add-2.125 μ sec, multiply -5.875 μ sec Divide -5.875 μ sec
1.9 μ sec memory (LSI)	
Memory words directly addressable	131,072

Microwave

One-port counter covers 18 GHz

Instrument has—35-dBm sensitivity to 12.4 GHz, —25 dBm up to 18 GHz

It's not usual to measure X-band signals and signals in the 1-Hz region through the same input port. Neither is it usual to make microwave frequency measurements without changing plug-ins, switching ranges, or tuning a transfer oscillator. However, if this versatility is desired, Hewlett-Packard's Model 5340A microwave frequency counter is the instrument to do it.

H-P says that this is the first microwave counter that can trigger reliably on signals as small as -35 dBm (up to 12.4 GHz) and -25 dBm (up to 18 GHz). The counter displays eight digits with both the decimal-point position and the correct units automatically selected. The counter is actually two instruments in one. For frequencies to 250 MHz, it acts as a direct counter. Above this frequency, it changes into an automatic transfer oscillator system. To prevent incorrect measurements and confusing displays, the instrument's circuits are disabled while it decides how it's going to operate.

In addition to its full-range 50-ohm input port, the 5340A has a 1-megohm input that can be used over the frequency range from 10 Hz to 250 MHz. This second port has a sensitivity of 50 mV rms for a sine wave. A front-panel slide switch selects either of the two ports.

The counter's resolution can be varied from 1 Hz to 1 MHz in seven decade steps. Since the unit can only display eight digits at a time, it is necessary to overflow the most significant digit of the display to increase the obtainable resolution at the higher frequencies. When in this mode, the instrument energizes an OFLO lamp to remind the user of the invisible digits.

The standard instrument, which has a time base with an aging rate of less than 3 parts in 10^7 per month, is priced at \$5,300. For an additional \$400, the counter comes with a special high-stability time base with an aging rate of less than 5 parts in 10^{10} per day. The standard time base changes by less than 2 parts in 10^6 over the range from -20 to +65°C. The high-stability time base cuts the temperature drift to less than 1 part in 10^8 .

Inquiries Manager, Hewlett-Packard Co., 1601 California Ave., Palo Alto, Calif. [401]

4-GHz transistors put out 5 watts at 30% efficiency

Five watts of output power at 4 gigahertz can now be extracted from a commercial transistor. Its performance gives the circuit designer new options in developing C-band communications gear and for applications in S-band telemetry, electronic countermeasures, and phased-array radar. The devices can also be used as driver circuits for X-band radar and communications.

The 5-watt device is one of the new series MSC4000 transistors developed by Microwave Semiconductor Corp., Somerset, N.J. Typical saturated power output versus frequency for units in this series is shown in the graph.

"Efficiency for the 5-w, 4-GHz device is above 30%," says Ron Rosensweig, the company's president, "and 25% efficiencies are achieved

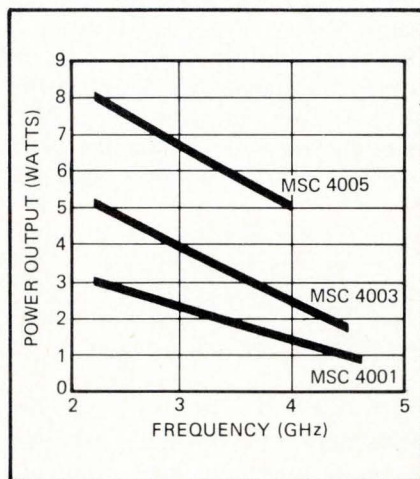

at 4.5 GHz with 1-w output." Power gain at 4.5 GHz is about 5 dB, increasing to 10 dB at 2.3 GHz, with 50% efficiency.

Key to the transistor's performance is an interdigitated structure that yields an unusually high ratio of emitter periphery-to-base area. With emitter fingers of 1-micrometer width aligned to within 1.5 μ m of the base, the company claims an emitter periphery-to-base area ratio of eight can be achieved. Thermal resistance is less than 7.5°C/watt for model MSC4005 and 30°C/W for model MSC4001.

Projected mean-time-to-failure is greater than 20 years when the device is operated at a junction temperature of 140°C. This is achieved with bandwidths greater than 10% in the 2- to-4-GHz range.

Prices are: MSC4005, \$400; MSC4003, \$250; and MSC4001, \$175. Microwave Semiconductor Corp., 100 School House Rd., Somerset, N.J. [402]

Shutter coaxial switches offer low insertion loss

A remote shutter coaxial switch is designed for applications including protection of components from rf overload in receiver circuits. Frequency range is from dc to 12.4 gigahertz, and isolation is 60 decibels minimum. Insertion loss from dc to 7 GHz is 0.3 dB maximum, and from 7 to 12.4 GHz it is 0.6 dB maximum. Price is \$90 for dc-control units and \$105 for ac-control types. Delivery is from stock.

RLC Electronics Inc., 83 Radio Circle, Mt. Kisco, N.Y. 10549 [405]

Harmonic absorption filter passes 8 GHz, stops 16 GHz

A harmonic absorption filter, designated model 2748, passes 18 gigahertz and absorbs 16 GHz. Passband loss is 0.2 decibel, and voltage standing wave ratio is 1.10 maximum. The 16-GHz absorption of 30 dB is achieved with virtually no reflected power, and the unit



EMPLOYMENT OPPORTUNITIES

POSITIONS VACANT

Electronic Technicians, Relay Technicians

—Rapidly growing southwestern utility has immediate openings for qualified electronic and relay technicians. Electronic technicians must have a minimum of three years experience in installation, testing and troubleshooting all types of telemetering, supervisory, load control, power line carrier, microwave and mobile radio systems. First or second class F.C.C. license is required. Relay technicians must have a minimum of three years experience in installation, testing and troubleshooting all types of protective relaying, plant and substation control equipment. Experience with solid state relays desirable. Starting rate of both positions is \$5.49 per hour with excellent fringe benefits. Address complete resume of experience and education in confidence to: P-7004, Electronics. An Equal Opportunity Employer.

CLASSIFIED ADVERTISING

SEARCHLIGHT SECTION

BUSINESS OPPORTUNITIES
USED OR SURPLUS EQUIPMENT

ELECTRONIC CALCULATORS Wanted On O.E.M. Basis

A major company with national and international distribution network is interested in marketing a line of office and/or portable electronic calculators. Our client may consider providing assistance after prototypes have been reviewed and approved. Quantity deliveries must begin no later than 120 days after signing of agreement. All replies will be acknowledged. Forward specs, photos and proposals in confidence to:

Institute of Consumer Research
P.O. Box 3131, Grand Cen. Sta., N.Y.C., N.Y. 10017

CIRCLE 952 ON READER SERVICE CARD

RADAR SYSTEMS GROUND AND AIRBORNE. AUTOMATIC TRACKING ANTENNA SYSTEMS. NIKE AJAX. NIKE HERCULES. M-33. MSQ-1A. MPS-19. MPS-9. SCR 584. TPS-1D. TPS-28. FAA-ASR-2. AIRBORNE SYSTEMS. APN-84. APN-102. APS-20. APS-27. APS-45. DPN-19. DIGITAL COMPUTERS. IBM 650. IBM 704.



LARGEST INVENTORY OF RADAR AND MICROWAVE EQUIPMENT IN THE WORLD.
RADIO RESEARCH INSTRUMENT CO.
3 QUINCY ST., NORWALK, CONN. 06850 (203) 853-2600

CIRCLE 953 ON READER SERVICE CARD

Don't forget the

BOX NUMBER

... when answering the classified advertisements in this magazine. It's our only means of identifying the advertisement you are answering.

New products

mates with WR112 waveguide flanges. The 2748 measures 1.93 by 4.50 by 6.87 inches. Price of the filter is \$575 and delivery time is six weeks.

Microwave Filter Co. Inc., 135 W. Manilus St., E. Syracuse, N.Y. 13057 [404]

Transistor delivers 20 W at 400 MHz to 1.2 GHz

A power transistor, designated model D20-28, offers 20 watts available power from a 24- to 28-volt supply over the range of 400 megahertz to 1.2 gigahertz. The device features single-chip construction and the ability to withstand an infinite voltage standing wave ratio at all phase angles when operated at rated output power from a 24-volt supply. Price is \$70.

Communications Transistor Corp., 301 Industrial Way, San Carlos, Calif. 74070 [406]

Miniature attenuator operates over dc to 2 GHz

A miniature, continuously variable attenuator with flat frequency response measures 1.3 inches long by 1.62 in. in diameter, making the device suitable for applications in rf-level control where panel space is limited. The model 907 offers attenuation ranges of either 0 to 10 decibels or 0 to 20 dB. Both versions operate over the frequency range of dc to 2 gigahertz. Incremental phase shift of the rf signal as a function of the attenuation setting is 1°/dB times the frequency. The model 907 with 10-dB range is priced at \$300, and the unit with 20-dB range, \$325.

Weinschel Engineering, Gaithersburg, Maryland [403]

YIG-tuned transistor oscillator covers 4-8 GHz

Series AV-7400 YIG-tuned transistor oscillators are operable over the range of 4 to 8 gigahertz. The units

are built on sapphire substrates, and use thin-film integrated circuits. Applications are in wideband military and commercial fields requiring high linearity. Three versions are

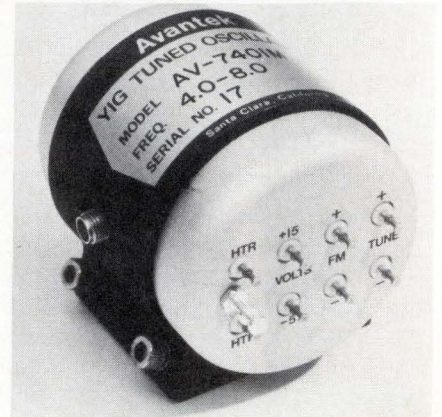

available. Power output is 10 milliwatts for two types and 5 mW for the third. Linear tuning accuracy is to within $\pm 0.1\%$. Prices start at less than \$1,000 in production quantities.

Avantek Inc., 2981 Copper Rd., Santa Clara, Calif. 95051 [407]

Miniature choke is useful from 300 MHz to 12 GHz

Exceptionally high self-resonant frequency, coupled with broadband characteristics, makes the M series miniature microwave choke useful for a variety of applications in oscillators, frequency multipliers, mixers, and some radio-frequency interference equipment. The choke,

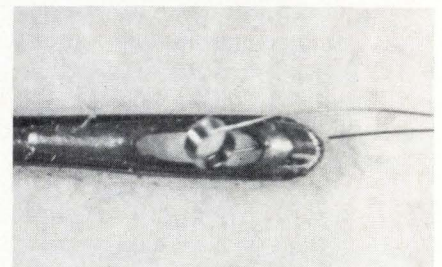

useful over the range from 300 MHz to 12 GHz, is suited for broadband modulators and power supply filtering. Price is under 50 cents each in small quantities.

Piconics Inc., Cummings Rd., Tyngsboro, Mass. 01879 [408]

New: I.C. Burn-In System

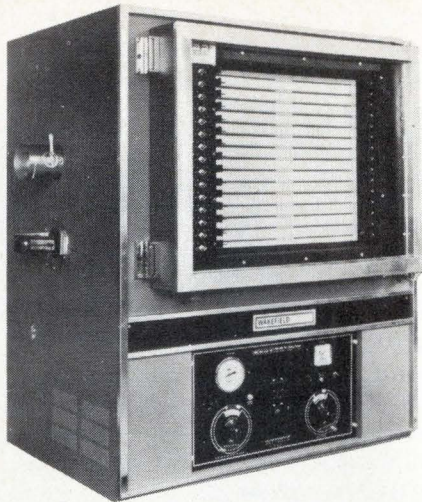

Front and rear doors, allowing programming of power supplies and stimuli on either or both doors, are features of a new oven system for aging IC's and power devices. This standard system permits configurations of 30, 58 or 74 board positions and is designed for either maximum pin usage, maximum density or a mixture of both. The oven system is versatile, so that regardless of the original configuration systems are easily changed over. Send for Bulletin OV-62.

WAKEFIELD ENGINEERING INCORPORATED
 AUDUBON ROAD, WAKEFIELD MASSACHUSETTS 01880
 TELEPHONE (617) 245-5900

Circle 214 on reader service card

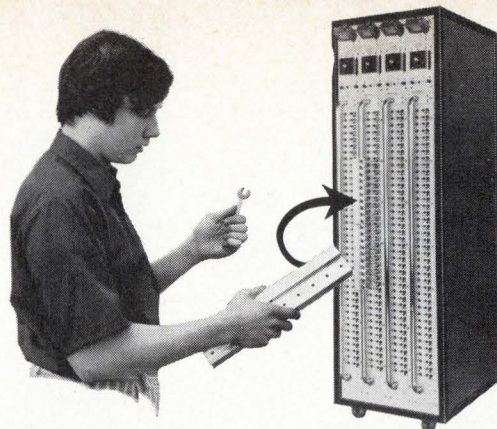

Power Burn-In System with Heat Sinks interchangeable to any case style in 30 minutes!

- ✓ Demountable heat sink bars hold constant temperature for Burn-Ins, HTRB, Life Testing, Product Evaluation.
- ✓ Versatile System never becomes obsolete.
- ✓ Complete System or Modules available.

Write or call for Standard Burn-In Literature.

WAKEFIELD ENGINEERING, INC.

Systems Div. Wakefield, Mass. 01880 • Phone: 617-245-5900

Circle 135 on reader service card

MULTIPLE APPLICATION LED/PHOTOCELL MODULES

5S series light coupled LED/Photocell Modules are comprised of a Gallium Phosphide light emitting diode with fast-response Cadmium Selenide photoconductive detector. Optical coupling is enhanced by a clear epoxy encapsulant without degrading high emitter-to-detector isolation voltage. Solid-state; hermetically sealed package for high reliability; directly compatible with AC circuitry; ideally suited for switching triacs or feedback.

NSL options: Silicon photodetector, neon or incandescent lamp Optically Coupled Isolators.

Let us look at your applications. Technical literature on request.



NATIONAL SEMICONDUCTORS LIMITED

331 Cornelia St., Plattsburgh, N.Y. 12901, (518) 561-3160
 2150 Ward St., Montreal 378, Que., (514) 744-5507

Circle 148 on reader service card

Push ON Push OFF

Exceptionally high current. 6A @ 125 VAC. Snap-action — with fast make & break contacts. SPDT, DPDT & 4PDT — useable either as Norm. Open, or Norm. Closed switch. Silver contacts & terminals. Also available as momentary.

ALTERNATE ACTION



Shown with optional switch guards

ALCOSWITCH®

DIV. OF ALCO ELECTRONIC PRODUCTS, INC., LAWRENCE, MASS.

Circle 149 on reader service card

ROTARY SWITCH MINIATURES

Two series: MRA Series with adjustable stop & in 1-2-3-4 poles on a single deck with max. of 10 or 12 positions. MSRE waterproof series meet high reliability standards; non-adj. 1 to 4 poles. 500 mA @ 125 VAC.



ALCOSWITCH®

DIV. OF ALCO ELECTRONIC PRODUCTS, INC., LAWRENCE, MASS.

Circle 150 on reader service card 135

New products

Semiconductors

MOS RAM offers 100-ns access

'Invisible' refresh mode allows 1,024-bit n-channel unit to simulate cores

The availability of a 100-nano-second 1,024-bit metal oxide semiconductor random-access memory has put MOS back at the leading edge of memory technology. The EA1500, a 1,024-bit n-channel RAM, is being marketed by Electronic Arrays Inc. Besides being the fastest MOS RAM available, it has other unusual features, such as invisible refresh. This is a technique that allows direct simulation of core memories, and means that the memory can be refreshed with a single pulse without interruption of the normal cycle.

Conventional RAMs cannot be refreshed by a single pulse because they require a refresh buffer for each column in the 32-by-32 array of storage cells. The n-channel silicon-gate process permits buffering to be incorporated in each cell. Consequently, it is not necessary to determine logically which columns are scheduled for refresh and then address pulses to those columns. The EA1500 cells are arranged so that any "write" pulse is bussed to all write data in all cells. However, only the addressed cell will accept the new data input.

Refresh intervals of most RAMs depend on charge-storage time in the storage field effect transistors—normally 2 milliseconds. But the EA1500 has slow charge leakage, extending the storage time to 5 to 10 ms, depending on operating temperature.

If desired, modules of a memory system built with EA1500s can be refreshed only on demand. One technique is to place a timing circuit in each memory module and refresh that module whenever 5 to 10 ms have elapsed without a write into that module. If write accesses are

made randomly throughout the memory, this mode may eliminate any busy time. "Invisible" refresh is an alternative mode, requiring a write pulse in every regular memory cycle, following chip-enable time during a read operation.

Memory configuration, which is easily expandable, is 1,024 by one.

The new memory is available in two versions. The EA1500 offers a maximum access of 85 ns at 70°C and operates from ± 15 -V supplies. Power dissipation is 185 milliwatts. The EA1501 operates from ± 12 V and has a 150-ns access time. Power dissipation is 89 mW. The EA1500 is priced at \$25 each in quantities of 100; the 1501 sells for \$10.50. Delivery is from stock.

Electronic Arrays Inc., 501 Ellis Street, Mountain View, Calif., 94040 [411]

Dual in-line oscillators are for data applications

A series of miniature dual in-line clock oscillators is designed to meet the requirements of medium and high speed digital applications. Designated XO-300, the series features outputs directly compatible with DTL and TTL digital integrated circuits through the use of ICs in the oscillator output stage. Frequency ranges from 1 megahertz to 4 MHz in some models and from 4 MHz to 25 MHz in other versions. Delivery is from stock.

Bulova Watch Co. Inc., Electronics Div., 61-20 Woodside Ave., Woodside, N.Y. 11377 [414]

Miniature DIP relays aimed at commercial applications

A miniature relay with dual in-line terminals measures 0.020 by 0.020 by 0.210 inch long, arranged on a 0.200 by 0.300 inch grid. The double-pole double-throw relays are encased in black nylon dust covers and are intended for applications in commercial areas such as television cameras, dictating machines, desktop computers, copying machines,

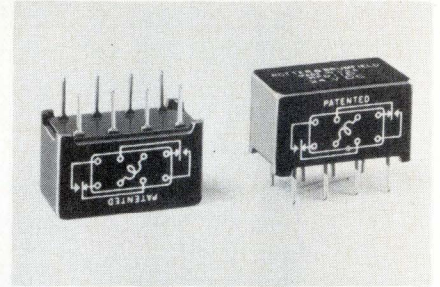

and other products using high density circuits. Single lot price is \$8.35 for a DPDT model with a 24-volt coil. The 48-volt version is priced at \$8.90.

Potter & Brumfield, a Div. of AMF, 1200 E. Broadway, Princeton, Indiana 47670 [415]

FET features 0.6 μ V noise over 10 Hz to 20 kHz range

A field effect transistor called the C813N is designed for low level amplifier use in applications such as

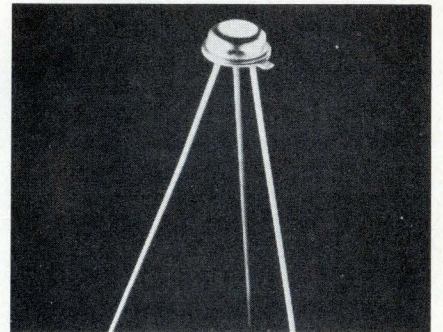

professional microphone amplifiers, instrumentation inputs, and phono-graph and tape playback amplifiers. Input noise voltage is six microvolts rms over the frequency range from 10 hertz to 20 kilohertz. Other characteristics include a gate leakage of 3.0 nanoamperes and a pinch-off of 1.5 volts. Price is \$35 in small quantities.

Teledyne Crystalonics, 147 Sherman St., Cambridge, Mass. 02140 [416]

IC stereo decoder uses phase lock loop technique

A monolithic integrated circuit, capable of decoding multiplexed frequency modulated signals in radios and tuners, operates without using

tuning inductors. The device, designated the MC1310, uses phase lock loop technology to lock onto the 19-kilohertz pilot signal provided by

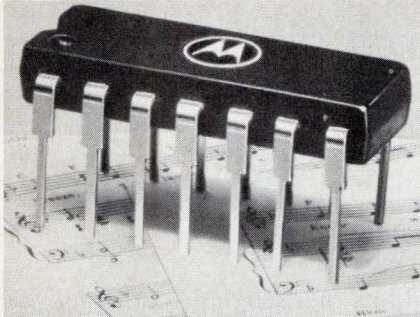

the stereo broadcaster, and to create a signal which is in phase with the pilot signal and double the frequency. This 38-kHz subcarrier is then used to demodulate the stereo information. Price in 100 lots is \$4.35.

Motorola Inc., Semiconductor Products Div., P.O. Box 20924, Phoenix, Arizona 85036 [417]

Reference diode chips are packaged as LIDs

Channel-mounted temperature compensated reference diode chips are part of a line of zener regulators and rectifier chips. The units are packaged as leadless inverted devices and may be mounted either in the inverted position by epoxy or



solder reflow, or in an upright position by wire leads bonded to the gold metalized legs. The units can be used in hybrid circuit applications and measure 0.080 inch long by 0.082 inch wide by 0.040 inch high.

Centralab Semiconductor, 4501 N. Arden Dr., El Monte, Calif. 91734 [418]

Mini Mitter Size

5watt
Model T-1014D-5



Mighty Mitter Power

Ground/data Corporation has taken full advantage of recent linear integrated circuit developments by solid-state component manufacturers, to provide a very small crystal-controlled transmitter for voice operation in the 136 to 175 MHz portion of the RF spectrum. The Model T-1014D-5 features small size and exceptional battery life for unattended use.

A VOICE-OPERATED SWITCH turns the output stages off and reduces battery drain by more than 90% when no audio is present.

The unit operates with any 50-ohm antenna
Microphone, antenna, and battery not included.

Ground/data
CORPORATION

4014 N. E. 5th Terrace
Fort Lauderdale, Florida 33308 phone: (305) 563-2527

Circle 151 on reader service card

If you read the May 31 issue of TIME, you won't want to miss the 1971 issue of Georgia's Industrial Survey.

If you caught the cover story of the May 31 issue of TIME, you read that "the Southern boom has urbanized and industrialized Georgia more quickly and completely than the rest of the Deep South.

"Georgia leads the region's indexes of growth and change."

Of course, you don't have to take TIME's



word for what's happening in Georgia.

You can send for your free copy of our 1971 Industrial Survey and get it straight from the source.

Georgia Department of Industry & Trade
Industry Division, Dept. EL-10, P.O. Box 38097,
Atlanta, Georgia 30334.

Please send me a copy of your 1971 Industrial Survey.

Name _____ Title _____

Company _____

Address _____

City _____ State _____ Zip _____

Georgia, the unspoiled.

**BECOME THE
WORLD'S TALLEST
ELECTRONICS
COMPANY...
IN LEADVILLE,
COLORADO.**

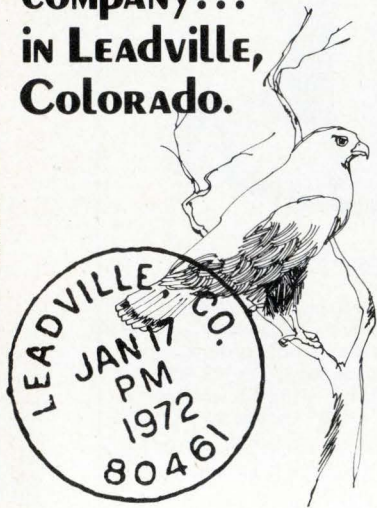

Follow on the heels of the gold rush, the silver, lead and zinc strikes, and the molybdenum boom. At an elevation of 10,152 feet, you'll be situated at the entrance to our nation's finest ski country. Yet commercial property can be obtained at uninflated prices, and several liberal loan programs are available to keep your immediate site and construction costs at a minimum.

Leadville and many other Colorado cities also have the transportation and the natural resources you require. Not the least of the latter are the educated, talented people who live here, love it, and will never leave it.

Learn about 127 Colorado communities — including Leadville — that have prime industrial sites to suit your business. Send for our free, 83-page Executive Portfolio. Write William C. Hacker, Colorado Division of Commerce and Development, 1252 State Capitol Annex, Denver, Colorado 80203.

COLORADO
where there's room to live and breathe

New Products/materials

Cure coating, manufactured in powder form, is designated Eccocoat 721. The material is applied to a component that has been preheated to 180°F. A post-cure of several hours at 180°F or one hour at 250°F will develop electrical properties and chemical resistance. Price is about \$2 or \$3 per pound.

Emerson & Cuming Inc., Canton, Mass. 02021 [476]

Electroless gold bath will plate uniformly (regardless of loading) thick, nonporous deposits of 24-karat gold directly on many metal and seeded surfaces with good adhesion and solderability. The bath is autocatalytic and deposits the gold to any desired thickness. One-gallon samples are available at \$30.

Kollmorgen Corp., Photocircuits Div., 31 Sea Cliff Ave., Glen Cove, N.Y. 11542 [477]

Protective coating, called Anti-Heat, acts as a heat sink in welding, brazing, and soldering operations. The material confines heat to the area being worked on and prevents

the adjacent areas from becoming hot. Application is by spreading or brushing and is effective on metals.

Big Three Industries Inc., Hamilton Blvd., S. Plainfield, N. J. [478]

Anaerobic sealant, which cures within 5 to 10 minutes, is called Arontite. The material is a single-component liquid compound, and 14 types are available to prevent loosening, leakage, and wear.

Vigor Co., Div. of B. Jadow & Sons Inc., 53 W. 23rd St., New York, N.Y. 10010 [479]

Black devitrifying solder-sealing glass for alumina integrated circuit packages features a melting point of 355°C. Sealing temperature and time of Code 7587 material ranges from 10 minutes at 470°C to 3 minutes at 510°C. Price depends on quantity and type of mesh ordered. Four thousand pounds or more, for example, in the 100/400 mesh range is \$2.75 per pound. Delivery is from stock.

Corning Glass Works, Electronic Materials Dept., Corning, N.Y. 14830 [481]

New books

Physical Design of Electronic Systems, Volume IV: Design Process, Staff, Bell Telephone Laboratories, Inc., Prentice-Hall, Inc., pp. 595, \$19.95.

This is the last volume in a series published during the last year dealing with all aspects of the design of electronic systems. Previous books presented an over-all look at the design process itself and considered physical and mechanical design, engineering materials, and new semiconductor devices. This volume covers logical and functional aids to design, computer aids to design, system reliability, and the system approach to physical design.

Particularly good is a discussion of "decision trees" in the first chapter. Using the design of a reed relay as the example, the authors show how to arrive at the proper choices for the reed material, the contact plating, and the gas inside the envelope. With a decision tree, the designer can at least bound the prob-

lem, making a first cut at the design of a complex system, or in simpler cases, arrive at the proper decisions.

Variations in design tolerances are also discussed, although details are left to the referenced texts. Computer-aided design gets extensive treatment, with emphasis on programing. Reliability, although it's been well-covered in many texts and journal articles, is made more meaningful in this book because of the communications outlook of the authors, in which system reliability is heavily dependent on so many factors.

The sections on partitioning should find immediate interest among many engineers because of the ever-changing cost tradeoffs involved, as integrated circuits become more complex. The book closes with a case history of an advanced data processing system design. This makes interesting reading in itself, since it touches every base of the design process.

Electronics advertisers

March 27, 1972

ACDC Electronics, Inc. Rose Associates Advertising & Public Relations	73	General Electric Co., Semiconductor Products Dept. Advertising & Sales Promotion Syracuse Operation Studio Hedy	17 48E	Powercube Corporation, Div. of Unitrode Advertising Assistance, Inc.	3rd cover
# Adret	7E	# General Instrument Europe S. P. A.	48E	PROCOND S. P. A. QUADRAGONO	120
Alco Electronic Products, Inc. Marketronics Advertising	135	Georgia Department of Industry & Trade Cargill, Wilson & Acree, Inc. Adv.	137	Raytheon Semiconductor Durel Advertising	116
Allen-Bradley Company Hoffman-York, Inc.	80	GRI Computer Allied Advertising Agency, Inc.	27	# RCA Ltd. Marsteller Ltd.	14E-15E
# American Lava Corporation, Sub. of Minnesota Mining & Mfg. Co. Designers, Inc.	67	Ground/Data Corp. Glenn Willis Advertising	137	RCA Solid State Division Al Paul Lefton Company, Inc.	41, 104-105
American Motors, Javelin Wells, Rich, Greene, Inc.	PB7	Gudebrod Bros. Silk Co., Electronics Division Coastline Advertising	127	RCA Electronic Components Al Paul Lefton Company	121
American Optical Corporation, Scientific Instrument Div. Fuller & Smith & Ross, Inc.	111	Harris Semiconductor Tucker Wayne & Company	37	# Rohde & Schwarz	33E, 35E
AMP, Inc. Aitkin-Kynett Co., Inc.	58	# Heinzinger Technik Marketing	32E	Scanbe Manufacturing Corp. Warren Co. Wilson & Associates	16
# Amphenol RF Division, Bunker Ramo Corporation Marsteller, Inc.	24	Hermes Electronics Ltd. Public & Industrial Relations Limited	130	# Schaffner	40E
Analog Devices, Inc. Kalb & Schneider, Inc.	15	# Hewlett-Packard Dorland Advertising Ltd.	9E, 11E, 12E-13E	Schauer Manufacturing Corp. Nolan, Keelor & Slices	40
Anzac Electronics Robert J. Allen Marketing & Public Relations	20	# Hewlett-Packard Richardson, Seigle, Rolfs & McCoy, Inc.	1	# Selenia Tilligraf	43E
# Beckman Instruments, Inc., Helipot Div. N. W. Ayer/Jorgensen/MacDonald, Inc.	52	# Hewlett-Packard Tallant Yates Adv., Inc.	22-23	# Sescosem Pérez Publicite	27E
Bell & Howell-Electronics & Instruments Group Coordinated Communications, Inc.	33	# Hewlett-Packard Richardson, Seigle, Rolfs & McCoy, Inc.	2	Sheraton Park Hotel and Motor Inn, Washington, D. C. Needham & Grohmann, Inc.	PB8
# Bendix Corporation, Electrical Components Div. D Arcy-MacManus-Intermarco, Inc.	63	Hughes Aircraft Company Foote, Cone & Belding	39	# Siemens Aktiengesellschaft Linder Presse Union GmbH	52
Brand-Rex Creamer, Trowbridge, Case & Basford, Inc.	61	# Hughes International Service Company/I. E. G. Foote, Cone & Belding	1E-4E	Signetics Corp., Sub. of Corning Glass Works Hall Butler Blatherwick, Inc.	64
Burdyn Components Ketchum, MacLeod & Grove, Inc.	10-11	IPT Corporation ROY MINOR/Graphic Arts	69	# Silec Electronique Pema	24E
Cal-Tex Semiconductor Paul Pease Advertising	49	# Kokusai Electric Co., Ltd. Asian Advertisers, Inc.	47E	Singer Company, Kearfott Div. Gaynor & Ducas, Inc.	132
# Carlo Erba Orma	45	Krohn-Hite Corporation Impact Advertising, Inc.	5	Snelling & Snelling, Inc. Evo & Mattern Advertising	PB11
# Celduc Fontvieille	22E	Litronix, Inc. Regis McKenna, Inc.	112	# Sodeco PR Service	18E
Centralab, Div. of Globe Union, Inc. The Brady Co.	79	Lockheed Electronics Company McCann-Erickson, Inc.	46	# Sorel Gerard Micaud	30E
Champion Spark Plug Co. J. Walter Thompson Co.	PB3	# LTT Publibel	37E	# Souriau & Cie Ariane Publicite	28E
# Chauvin Arnoux Edition et Publicite	31E	Microsystems International Ltd. Media Advertising Ltd.	118	Spectra-Physics, Inc. Hal Lawrence, Inc.	43
# Cherry Electrical Products Corp. Kolb/Tookey and Assoc., Inc.	57	# Microtecnica	42E	Sprague Electric Company Harry P. Bridge Company	8
# Circuit Technology, Inc. Litek Corp.	72	# Miller Stephenson Chemical Co., Inc. A. B. W. Toft and Co.	47E	Stanford Applied Engineering Rose Associates Advertising & Public Relations	21
Colorado, State of Commerce and Development Division Frye-Sillis, Inc.	138	# 3M Company—Mincom Division D Arcy-MacManus—Intermarco, Inc.	50-51, 124	# Systron Donner Concord Bonfield Associates	36E
Combustion Engineering Basford, Inc.	PB5	# The Morgan Group InterAd, Ltd.	17E	# Teledyne Philbrick Ingalls Associates, Inc. Advertising	91
# Custom Electronics, Inc. Laux Advertising, Inc.	42	MOS Technology, Inc. Henry S. Goodsett Advertising, Inc.	2nd cover	# Teledyne Relays S. Michelson Advertising	57
Dale Electronics, Inc., A Sub. of The Lionel Corporation Swanson, Sinkey, Ellis, Inc. Advertising	4th cover	Mostek Corporation Continental Communications, Inc.	28	Teledyne Semiconductor Regis McKenna, Inc.	131
# Digital Equipment Corporation Kalb & Schneider, Inc.	77	# National Semiconductor Corp. Chiat/Day, Inc. Advertising	7	# Thompson CSF Bazaine Publicite	41E
# Ducati Electrotecnica Microfarad Studio Busoli Gastone	26E	# National Semiconductors, Ltd. Knox Advertising, Ltd.	135	# Tokyo Sokuhan Co., Ltd. Showa Advertising Service, Inc.	44E
Dumont Oscilloscope Laboratories, Inc. Barbetta Miller Advertising, Inc.	6	# Nippon Kogaku K.K. K & L Advertising Agency	34E	Trinidad & Tobago Industrial Development Corp. Development Counsellors International, Ltd.	45
Electronic Engineering R & H Marketing Communications	76	North American Rockwell, Microelectronics Co. Campbell-Ewald Company	78	TRW, Electronic Components Division The Bowes Company	74-75
# Electronic Navigation Industries Hart Conway Co., Inc.	14	# D. Olivetti & C. Spa Studio ECO	21E, 23E	TRW Electronics, IRC Boone Division Odiorne Industrial Advertising, Inc.	122
ELMEC s.n.c. TECNOSTAMPA	66	Ortec, Inc. Thomas R. Sundheim, Inc.	44	# Unitrode Corporation Impact Advertising	35
# Erie Technological Products Co., Inc. Altman Hall Associates Advertising	70-71	# Oscilloquartz SA, Neuchatel M. R. Hofer Werbeagentur BSR/EAAA Bern	45E	Universal Oil Products, Norplex Div. Campbell Mithun, Inc.	54
Fairchild Semiconductor, Inc. Carson/Roberts, Inc. Adv.	12-13	Owens-Illinois, Inc.—Digivue Howard Swink Advertising	18-19	# Vernitron Piezoelectric Division Cross & Associates, Inc.	129
Florists' Transworld Delivery Post Keyes Gardner, Inc.	PB10	Pascoe Steel Corporation Boylhart, Lovett & Dean	PB9	Wakelield Engineering, Inc. Robert Robotham Advertising	135
# GAF Corporation Michel-Cather, Inc.	9	# Philips Electronics Instruments J + M Condon, Inc.	95	Watkins-Johnson Company William C. Estler—Public Relations	140
General Electric Co., Miniature Lamp Div. Batten, Barton, Durstine & Osborn, Inc.	126	# Philips Gad Elcoma Tag-Intermarco delaMar	38E		
		# Philips N. V. Pit/T & M Division Marsteller International S. A.	54		
		# Pignone Sud Linea Spn	25E		

Classified & Employment Advertising

F. J. Eberle, Manager 212-971-2557

EQUIPMENT (Used or Surplus New) For Sale	
Institute of Consumer Research	134
Radio Research Corp.	134

For more information on complete product line see advertisement in the latest Electronics Buyer's Guide
Advertisers in Electronics International

A Fine Pair of Medium Power TWTs for Advanced Systems Applications

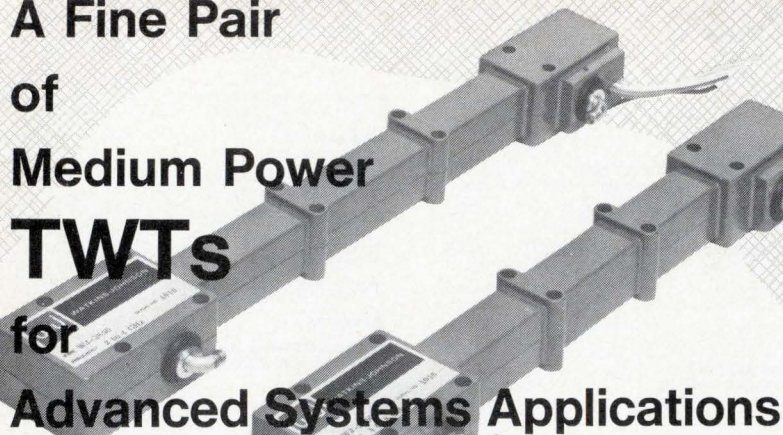

With hundreds of hours of environmental testing on record, the WJ-3850 and WJ-3860 TWTs are ready for CW operation in the most demanding environments.

Designed for stringent airborne applications, these second generation TWTs are ready to serve as high gain drivers/transmitters for ECM equipment, as transmitters for radar transponders, and as amplifiers for AM and FM communications systems.

The WJ-3850 and WJ-3860 TWTs employ switching grids for fast blanking or for pulsed-only operation. Users can expect the same long life and high reliability found in all W-J tubes, plus full performance in 100°C operating temperature, small size and weight, and conduction cooling.

WJ-3850

Frequency Range: 2 to 4 GHz
Saturated Power Output: 25 W
CW
Gain at Rated Power Output:
30 dB

WJ-3851

Frequency Range: 2 to 4 GHz
Saturated Power Output: 50 W
CW
Gain at Rated Power Output:
30 dB

WJ-3860

Frequency Range: 4 to 8 GHz
Saturated Power Output: 25 W
CW
Gain at Rated Power Output:
30 dB

WJ-3861

Frequency Range: 4 to 8 GHz
Saturated Power Output: 50 W
CW
Gain at Rated Power Output:
30 dB

Weight, Any Unit: 2.5 Pounds Maximum

UNITED KINGDOM: Shirley Ave., Windsor, Berkshire, England
Tel: Windsor 69241 • Cable: WJUKW-WINDSOR • Telex: 84578
WEST GERMANY: 8 Muenchen 2, Maximiliansplatz 12A
Tel: (0811) 29 33 30 • Cable: WJDBM-MUENCHEN • Telex: 528401
ITALY: Piazza G. Marconi, 25
00144 Roma-EUR
Tel: 59 45 54 • Cable: WJROM-ROMA • Telex: 60117



3333 HILLVIEW AVE., STANFORD INDUSTRIAL PARK, PALO ALTO, CALIF. 94304 (415) 493-4141

Advertising Sales Staff

Pierre J. Braudé [212] 971-3485
Advertising Sales Manager

Atlanta, Ga. 30309: Joseph Lane
100 Colony Square, 1175 Peachtree St., N.E.
[404] 892-2868

Boston, Mass. 02116: James R. Pierce
607 Boylston St. [617] 262-1160

Chicago, Ill. 60611: Robert W. Bartlett
Kenneth E. Nicklas, 645 North Michigan
Avenue, [312] MO 4-5800

Cleveland, Ohio 44113: William J. Boyle
[716] 586-5040

Dallas, Texas 75201: Richard P. Poole
1340 Republic National Bank Building
[214] RI 7-9721

Denver, Colo. 80202: Harry B. Doyle, Jr.
Tower Bldg., 1700 Broadway
[303] 265-3863

Detroit, Michigan 48226: Robert W. Bartlett
2600 Penobscot Building
[313] 962-1733

Houston, Texas 77002: Richard P. Poole
2270 Humble Bldg. [713] CA 4-8381

Los Angeles, Calif. 90017: Robert J. Rielly
Bradley K. Jones, 1125 W. 6th St.,
[213] HU 2-5450

Minneapolis, Minn. 55402: Kenneth E. Nicklas
1104 Northstar Center [612] 332-7425

New York, N.Y. 10036
330 W. 42nd St.
Warren H. Gardner [212] 971-3617
Michael J. Stoller [212] 971-3616

Philadelphia, Pa. 19103: Warren H. Gardner
6 Penn Center Plaza,
[212] 971-3617

Pittsburgh, Pa. 15222: Warren H. Gardner
4 Gateway Center, [212-971-3617

Rochester, N.Y. 14534: William J. Boyle
9 Greylock Ridge, Pittsford, N.Y.
[716] 586-5040

St. Louis, Mo. 63105: Kenneth E. Nicklas
The Clayton Tower, 7751 Carondelet Ave.
[314] PA 5-7285

San Francisco, Calif. 94111: Don Farris
Robert J. Rielly, 425 Battery Street,
[415] 362-4600

Paris: Alain Offergeld
17 Rue-Georges Bizet, 75 Paris 16, France
Tel: 720-73-01

Geneva: Alain Offergeld
1 rue du Temple, Geneva, Switzerland
Tel: 32-35-63

United Kingdom: Keith Mantle
Tel: 01-493-1451, 34 Dover Street, London W1

Milan: Robert Saidel, Roberto Laureri
1 via Baracchini Phone 86-90-656

Brussels: Alain Offergeld
23 Chaussee de Wavre
Brussels 1040, Belgium
Tel: 13-65-03

Stockholm: Brian Bowes
Office 17, Kontor-Center AB, Hagagarten 29,
113 47 Stockholm. Tel: 24 72 00

Frankfurt/Main: Fritz Krusebecker
Liebigstrasse 27c
Phone 72 01 81

Tokyo: Masaru Wakeshima, McGraw-Hill
Publications Overseas Corporation,
Kasumigaseki Building 2-5, 3-chome,
Kasumigaseki, Chiyoda-Ku, Tokyo, Japan
[581] 9611

Osaka: Ryji Kobayashi, McGraw-Hill
Publications Overseas Corporation, Kondo
Bldg., 163, Umegae-cho Kita-ku [362] 8771

Australasia: Warren E. Ball, IPO Box 5106,
Tokyo, Japan

Business Department

Stephen R. Weiss, Manager
[212] 971-2044

Thomas M. Egan,
Production Manager [212] 971-3140

Carol Gallagher
Assistant Production Manager [212] 971-2045

Dorothy Carter, Contracts and Billings
[212] 971-2908

Frances Vallone, Reader Service Manager
[212] 971-6057

Electronics Buyers' Guide

George F. Werner, Associate Publisher
[212] 971-3139

Regina Hera, Directory Manager
[212] 971-2544

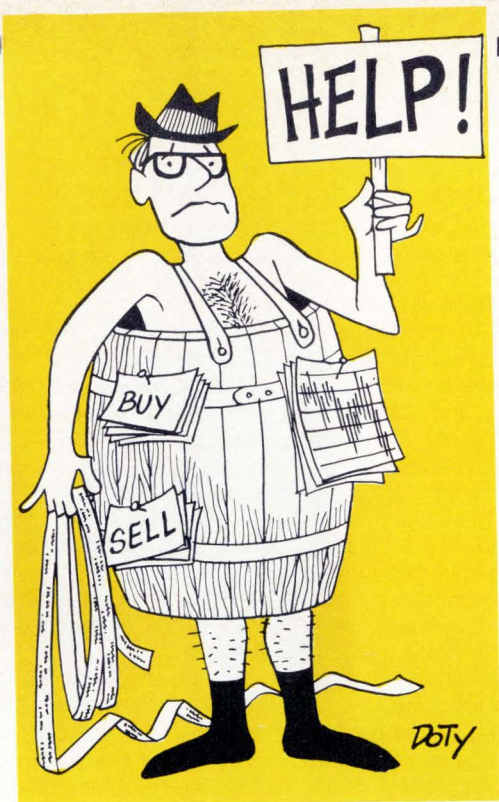

MARCH 1972

INVESTMENTS

What to do when your broker lets you down

TAXES

Investment costs that trim your taxes
Tax tips in the news

REAL ESTATE

Mixing pleasure and profits in resort condominiums

THE GOOD LIFE

Coffee is a many-splendored thing

BOOKS

HEALTHY, WEALTHY AND WISE

INVESTMENTS

Where do you turn when your broker lets you down?

One year ago, as Wall Street was emerging from its most tumultuous period since the 1930s, the investing public was presented with an extraordinary legislative package. Called the Securities Investor Protection Act, the law created a new government corporation—quickly acronymed SIPC by the Street—to guard the average investor against the failure of a brokerage firm. At least, it protected him up to \$50,000 in losses of cash or securities if his broker went broke.

It did nothing, however, for the investor whose broker manages to stay solvent but does a shabby or even fraudulent job with the investor's resources. Today this is a bone of investor-broker contention. It is gnawed

from time to time, but particularly in times like these, when the going gets tricky in the market. "The first thing an aggrieved investor should do," says the sales manager of a leading New York brokerage, "is to try to distinguish between the vagaries of the stock market itself and the possibility—and I repeat, possibility—that his broker just isn't cutting it. A sliding market can make even the most honest broker look bad."

Once the investor has made up his mind that it's the broker, not the market, who's at fault, he has a number of avenues of recourse open to him. Depending on the severity of his grievances, he can trade his customer's man for a new one within the same house, take his business elsewhere, or—if he has suspicions of chicanery backed by solid evidence—refer the matter to arbitration procedures offered by the major stock

markets, or even haul the rascals into court. None of these, however, can be done without some wear and tear.

Even if it's simply a matter of distaste for a particular customer's man ("I can't seem to get through to that idiot," is the way it is sometimes expressed), the move may not be easy. Brokerage houses do not like shifting accounts around in-house. It's bad for morale. It makes it look as though the house is impugning the skills of one broker against another. And it pricks at the heart of a universal brokerage commandment: Thou shalt not steal a customer from thy fellow broker—in this house, anyway. The new man, in other words, may feel slightly soiled, at least in the eyes of his brethren. Brokerage houses prefer conciliation. If that fails, and the account is big enough, they will probably make the change, however.

Breaking off with the firm altogether is simplified if the investor has personal possession of his securities. Otherwise, he must go to his new brokerage house, fill out a form authorizing transfer of the securities, sign it, and generally wait several days for the switch to occur.

All this presumes that the investor is simply displeased with the way his port-

PERSONAL BUSINESS, like all McGraw-Hill publications, is written for a select audience. Prepared each month by the Personal Business staff, it is devoted entirely to your own interests and activities. Its theme: Better management of your time and money. Personal Business reaches a limited audience and there is no separate subscription list, or rate.

folio has been performing and wants to try his luck elsewhere. Unfortunately there are times, too, when an investor feels he has actually been victimized. He may feel, for instance, that his account has been "churned"—that shares were bought and sold merely to generate commissions for the broker. He is likely to get that feeling when he balances the market value of his portfolio, say, six months ago against what it is today, and finds that the broker has done appreciably better than he has in the interim.

But that tabulation alone will get him nowhere in court or in arbitration before the New York Stock Exchange, although "churning" is a violation of Rule 405 of the NYSE constitution.

Complaints of "churning" largely apply to discretionary accounts, and Rule 405 specifies that a broker must have a firm knowledge of his customer's investment objectives. For the protection of all concerned, *this is best stated in writing*. But even then, an unhappy investor must produce solid evidence that the broker not only violated the understanding, but did so in bad faith. And that takes meticulous evidence, hard to get. Proof of loss—the basis of any suit—is also difficult, since hindsight or "what might have been" doesn't count.

A case of "bad faith" might be made of the following ingredients: A novice investor inherits \$20,000, and a broker is told in writing to invest it conservatively, for income. But the broker has an allotment of Hot Shot Software, a new underwriting, and is having trouble getting rid of it. So he buys 500 shares for the investor. Hot Shot not only produces no income, it bombs altogether before the broker can shuffle the customer into something more substantial. In court, he should be a sitting duck.

Another case in which an investor has hopes of collecting is when he can prove his broker is buying stock for him that he is actively selling off for other accounts. This is a violation of the Securities & Exchange Act (Rule 10-B 5). In the most notable recent case, Merrill Lynch settled up with retail customers who charged that Merrill knew that Douglas Aircraft was about to report large quarterly losses, tipped off its institutional customers (who began to sell) and let the retail customers go right on buying Douglas.

For the investor with a legitimate complaint, the least costly recourse is the arbitration route set up by the stock exchanges. The Big Board's cost structure for arbitration varies with the extent of the claim, but even at its most expensive, the procedure is no more than \$120 per hearing—and often, one hearing will be enough. Here's how it works:

First, any investor who wants to recover damages from a broker is wise to have a lawyer, one familiar with securities law. Claims are initiated by filing

with the NYSE's Arbitration Director three copies of a typewritten statement, which must include the name of the investor's attorney, a chronology of facts upon which the claim is based, and the exact amount of damages claimed. When received, the arbitration director sends it to the opposing party, which generally has 10 days to reply with its own statement.

When he has all statements, the arbitration director will set up an arbitration panel—it may vary in size and makeup, depending on the size of claim and wishes of the investor—and schedule a hearing. (New York isn't the only place arbitration will be scheduled by the exchange. They may be held in 12 other cities as well). Prior to the hearing, attorneys for either party or the arbitrators themselves may use subpoena power to extract testimony or summon witnesses. If for some reason the investor is pressing his case without a lawyer's help, the Big Board's arbitration director will arrange for issuance of subpoenas.

Hopefully, the hearing will be held on its scheduled date. It begins with opening statements by each party (usually the attorneys); then, the investor's case is presented, complete with witnesses, presentation of documentary evidence and cross-examination. Closing statements are made, and the parties are dismissed. The arbitrators then meet privately, reach their decision and sign an award—if the investor has made his case. Their decision is final, and the Big Board member firm is bound by Exchange law to pay off.

The major problem with the arbitration procedure is that it is prolonged, often taking as much as one year to complete. But an investor has other options.

For instance, he can always carry his troubles to the SEC, whose new chairman, William J. Casey, seems intent on policing Wall Street. While the SEC is chronically handicapped by overwork and under-financing, a legitimate complaining letter to the chairman (with a copy to the offending brokerage) has been known to work wonders. Writers of such letters, of course, should check them with their lawyers beforehand to avoid the risk of libel.

"An investor's best bet," says the branch manager of a major brokerage, "is to check out the brokerage and his customer's man very carefully before he allows either of them to execute a trade." In any book of investor-broker relations, this might well stand as Rule 1.

—PETER F. EGAN

BOOKS

WALL STREET:
SECURITY RISK
BY HURD BARUCH
ACROPOLIS, \$8.95



Sometime within the next year or so, Congress is expected to pass what may well be the most sweeping legislation for Wall Street since the Securities Exchange Act of 1934. Among other things, it will impose more rigorous control on the New York Stock Exchange by the Securities & Exchange Commission, and thus give Chairman William J. Casey's activist SEC a stronger hand in dealing with practices that have scarred the financial community in recent years.

An indicator of the SEC's tougher stance is *Wall Street: Security Risk*, by Hurd Baruch, special counsel for the commission. While both Baruch and the SEC insist that the commission is not responsible for its contents, the book obviously has Casey's blessing. More important, *Wall Street: Security Risk* is a skillful and authoritative account of the weaknesses of the self-regulatory mechanism so cherished by the Big Board. Says Baruch: "The securities industry has a long tradition of opposing every constructive change in the markets, and such is its power that it may again prevail, unless the public understands and actively supports proposed reforms."

So, Baruch's editorial exercise is as much a plea for greater investor awareness as it is an indictment of Wall Street. But as an indictment, the book serves its purpose. In his discussion of the 1968-70 back-office crisis, for example, Baruch notes that Goodbody & Co. once showed differences of \$43-million between actual securities on hand and the amount the company's books said should be on hand. Yet, Goodbody's reserve against such differences was a scant \$1.5-million.

Baruch also delves into the brokerage community's capitalization structure that—although toughened by the Big Board not long ago—once allowed almost instant withdrawal of funds by a firm's partners. And he castigates the non-competitiveness of Wall Street's commission rate structure—suggesting that while the securities industry extols competitive capitalism, it rarely practices what it preaches. Concludes Baruch: "With 'friends' such as it has had at the head of the securities industry in the past, capitalism has had no need of enemies."



"You name it and I've put Champion Spark Plugs in it."

"I'll tell you this. For 24 years I've put Champions in every single car we tune up at my service station . . . from Caddys to Fords and Chevys to these new

Japanese machines.

"They're the best darn plug you can put in any engine or my name isn't Robert Tank, Omaha, Nebraska."



Toledo, Ohio 43601

20 million people have switched to Champion Spark Plugs.

Investment costs that trim taxes, increase profits

"Tax deductions for investment expenses is a muddled proposition," says a tax lawyer with one of New York's leading firms. "A lot of people don't know how far they can go—and others go too far." All of this is, in itself, quite a reasonable proposition, considering the ambiguity of the rules.

The investor who pays out sizable amounts for investment-related services, or who travels widely to manage his investments, knows how fast these costs can add up—sometimes they can even make the difference between a modest profit and a loss on an investment. Unhappily, though, there are no clear, specific tests for determining when a particular expense is deductible. There is a general rule that allows an investor to deduct costs incurred to produce or collect investment income, or for the management of property held for investment. But application of the rule breaks down into several trouble areas.

In most cases, the key issue is whether there is a direct connection between the expense and the investment. For example, in a situation where an investor travels out of town to see his investment counselor for portfolio review, there is no argument—the travel costs, as well as the counselor's fees, are deductible. But what if the investor travels to a stockholders' meeting? Here the line is much finer. If he is a major owner of the company trying to safeguard his investment, the trip costs might be deductible; but where he is simply one of hundreds or thousands of shareholders, the trip would not be considered by Internal Revenue to be essential to the investment. In another situation, a stock market amateur made daily lunchtime visits to his broker's office; he watched the ticker tape to get the "feel" of the market. IRS disallowed his travel expense deductions—the connection between merely pondering the tape and managing an investment portfolio was too tenuous.

For a deduction, the expenses must be related to *current* investments and merely looking at prospects won't do. In one case, an investor traveled widely to inspect possible investments for diversifying his portfolio. He also hired an investment service that reported on the companies he was investigating. All re-

lated deductions were denied because the investments weren't *owned* at the time. Turning the coin, an investor who travels to check on income property, such as a rental building, can deduct his travel costs. In a recent case, an investor's travel expenses were deductible even though the property was not actually producing income. He owned a Florida orange grove which was not yet yielding fruit. Still, he was permitted to deduct the cost of long trips to the grove to supervise the installation of tree heaters, and such. But his wife's travel expenses weren't deductible, even though she was a part owner—it simply wasn't necessary for her to accompany her husband, said the court.

Legal fees in connection with investment property may or may not be deductible. The lawyer should be asked to bill separately for services related to capital outlays (such as property purchase or long-term leases) which do not give rise to deductions, and *income* items (such as collection of rents, preparation of tax returns, tax audits, and such)—which produce deductions.

Legal fees in connection with property purchase are non-deductible capital expenses. But what if an investor buys property as part of a tax-saving plan? Here the fee should be split—allocated between tax advice and purchase expense. A carefully itemized bill will help the investor who is trying to convince Internal Revenue that at least part of the fee is legitimately deductible.

If an investor has an office-at-home for working on his investments, he may have a tax deduction.

In a new case, Internal Revenue conceded that maintenance and depreciation attributable to such an office can be deducted. A retired investor claimed that he used about 50% of his large residence in his investment activities. Internal Revenue, however, estimated that he used only about 900 sq. ft. of a total of 1,500 sq. ft. So based on this ratio, it allowed a deduction for maintenance, expenses, and depreciation of 6%. The Tax Court accepted the allocation of footage, but the court estimated that the square footage total was 9,000, not 15,000. Based on a ratio of 900 to 9,000, the allowable deduction was raised to 10%.

In this case, the result for the taxpayer amounted to a considerable reduction of his original claim. Still, the decision is favorable. It is of considerable importance to the highly active investor as well as the man who looks after his investment portfolio in retirement.

One clear-cut rule: The cost of a safe deposit holding securities is deductible.

—BERNARD GREISMAN

Tax scene: dollar items in the news

FRIGID LOSSES. In one of its unnerving generalizations, Internal Revenue says that a casualty loss is the "complete or partial destruction of property resulting from an identifiable event of a sudden, unexpected, or *unusual* nature." Putting this rule to practice has confounded some taxpayers, and snow-and-ice casualties are atop the slippery list. People tend to overlook some less obvious write-offs. For instance, such items as a car motor that froze solid, a garage wall that caved in due to freeze-and-thaw, and the killing of tropical plants by "chill" have produced dollar-saving deductions. . . . In a current Tax Court case, seeping water had caused a house to settle. Stopped up drains caused snow to crack the garage floor and undermine walls. IRS denied the deduction, but the Tax Court sided with taxpayer despite possible negligence on his part. The case becomes an arguing point—in a common situation.

SAVINGS POSTPONED. "Deferred" interest earned on a long-term savings deposit over a span of more than a year is taxable on a monthly pro-rata basis. New rules provided by the Tax Reform Act of 1969 apply to certificates of deposit, beginning January 1, 1971. For example, say that on June 1, 1971, a taxpayer bought a \$10,000 certificate of deposit with a three-year redemption value of \$11,941. Thus original issue discount is \$1,941, and the ratable monthly portion includable in taxable income is \$53.92—\$1,941 divided by 36 (months). Taxable income for 1971 is \$377.44 (7 months x \$53.92); for 1972 and 1973 it comes to \$647.04 a year (12 months each), and for 1974, \$269.60 (5 months). . . . Banks and S & Ls must file information returns with IRS.

CHILDREN'S GIFTS. Shares of stock may be given to minors with the much publicized custodian account used as a vehicle for transferring the property. If the donor dies before the child is 21, the value of the stock is normally not included in the donor's taxable estate. There may be a hitch, though, when the donor has named *himself* as custodian. In a new federal court case, the estate of a donor-custodian was liable for the added estate tax. A father-donor might wisely name someone else as custodian—friend, relative, family lawyer, or such. This will take the onus off.



We're trying to keep gas companies from running out of gas.

If they run out of gas, you run out of gas. Gas to boil water for your morning coffee, gas to heat your home, gas to power your manufacturing plant.

One of our subsidiaries, C-E Lummus, is working to prevent this by offering gas companies new processes that make natural gas out of ingredients found in ordinary oil, to assure you of a hot cup of coffee before work . . . or an operating plant when you

get there. We're building three of the first plants to manufacture Synthetic Natural Gas in the U.S. to keep you supplied.

And we're also working with the federal government on the next step: designing and building one of the country's first pilot plants to create clean-burning natural gas out of coal. Which will help cut down on one of the nation's pollution problems, too.

So until gas companies find additional natural sources of natural gas, we're one of their most promising resources. And as one short-term solution to the fuel crisis, we think Synthetic Natural Gas is a natural.



COMBUSTION ENGINEERING, INC.
277 Park Avenue, New York, N.Y. 10017

Our name in the process industries...C-E Lummus.

Other C-E names: C-E Combustion Division • C-E Industrial Group • C-E Natco • C-E Tyler • C-E Cermatec • C-E Canada.

Mixing profits with pleasure in condominiums

FROM PALM SPRINGS TO MAJORCA, THE IDEA'S CATCHING ON

A case of March doldrums—that guaranteed annual state of mid-winter blues—can persuade even the thriftiest traveler to fork over \$100 a day for a double room near a beach, a golf course or a ski slope. In the past few years, however, penny-wise vacationers have discovered the resort condominium, and developers from the Mediterranean to the Rockies are rushing to accommodate a demand that shows no sign of abating.

For many, the resort condominium is a dandy way to enjoy a place in the sun when they want it—and at the same time, pocket a tax shelter, an appreciating asset, and a potential profit. "Many of our buyers consider it an investment alternative," says Roy D. Chapin, III, marketing vice president of John's Island, a posh ocean-front golf resort north of Vero Beach, Fla.

Indeed, the investment motive is so strong that many developers have had to alter their plans to accommodate it. "We expected a significant number of sales to people who would not rent their units on a transient basis," admits David Warner, vice president for land development of Rockresorts, Inc. (1290 Avenue of the Americas, New York, N.Y. 10019), which is currently building luxurious condominium units along a fairway at Puerto Rico's Dorado Beach. "We have discovered that the bulk of our market is people interested in investment."

From the sandy beaches of Majorca to the glistening slopes of Aspen and the desert mecca of Palm Springs, real estate developers are tuning in to this burgeoning new market. The economics of an affluent society with its many three-day weekends and increasingly common four-week vacations has spawned a new breed of tax-conscious, leisure-minded investors. Buyers range all the way from well-heeled globe-trotters who have long



Ultra-private Village Two, New Hope, Pa., offers sports unlimited.

eschewed the burdens and responsibilities of a second home to young "swingers" who probably could not buy a primary home at today's prices.

Typically, the condominium developer organizes or contracts with a management company, which services the community and rents out the units when owners are not in residence. The management company charges a fee for protecting and maintaining the unit, plus a percentage of the gross income earned from rentals.

This income can be substantial. At Mission Hills Golf & Country Club in

Palm Springs, Calif., for example, a luxuriously-appointed \$50,000 unit will bring as much as \$3,000 a month. At Villa Dorado in Puerto Rico, a one-bedroom condominium rents for \$125 a day during the winter season when Dorado Beach Hotel charges \$105 for a double room. Both are offered on a modified American plan.

The management's share of this rental income represents a significant bit of recurring income to the developer. For this reason, many developers require that the unit be made available for rent during specified periods of the year. At Es-

Condominium resort on St. John's Island (Fla.) is golfer's dream.



WHEN YOU BUY A JAVELIN YOU GET SOMETHING YOU CAN'T GET WITH A MUSTANG, CAMARO OR FIREBIRD.



You get a lot more than a good-looking sporty car when you buy a Javelin.

You get a car that's been road-tested and checked over so thoroughly, we make this promise: If anything goes wrong and it's our fault, we'll fix it. Free.

And, if we have to keep your car overnight to fix it, over 1900



When you buy a new 1972 car from an American Motors dealer, American Motors Corporation guarantees to you that, except for tires, it will pay for the repair or replacement of any part it supplies that is defective in material or workmanship.

This guarantee is good for 12 months from the date the car is first used or 12,000 miles, whichever comes first.

All we require is that the car be properly maintained and cared for under normal use and service in the fifty United States or Canada and that guaranteed repairs or replacements be made by an American Motors dealer.

**AMERICAN MOTORS
BUYER PROTECTION PLAN**

dealers will loan you a car. Free. Finally, you get a name and toll-free number to call in Detroit if you have a problem. And you'll get action, not a runaround.

Nobody in the business does all this for you after you buy a car.

Which is probably why people who've never bought a car from us before are buying one now.



The Sheraton-Park in Washington, D.C.

Where a little meeting goes a long way.

Lecture rooms. Conference rooms. Reception rooms. Rooms for meetings of 20 or 200. Spacious suites in our Congressional Wing for all-day sessions in complete privacy. At your disposal after your meeting, all the superb facilities of the Sheraton-Park, including luxuriously refurbished accommodations at moderate rates. Write for our conference brochure or call our sales office collect at 202-265-2000.



Sheraton-Park Hotel & Motor Inn

2660 WOODLEY ROAD, N.W.
SHERATON HOTELS AND MOTOR INNS.
A WORLDWIDE SERVICE OF I.T.T.

Director of Sales
Sheraton-Park Hotel & Motor Inn
2660 Woodley Road, N.W.
Washington, D.C. 20008

Please send me your conference brochure, including complete information on smaller meeting facilities.

Name _____
Title _____
Organization _____
Address _____
City _____ State _____
Zip _____

tate Questa Verde in St. Croix, for example, a condominium owner has the use of his apartment for two weeks in the winter season and four weeks in the summer. (Vice President Spiro Agnew was among the early purchasers of these units.)

Many of the ski-resort condominium developers exact similar agreements so that they, too, may get a piece of the high-rent action in peak season. Increasingly, though, ski resort developers are installing year-around facilities such as tennis courts, golf courses, and artificial lakes for boating and swimming to attract the non-skiing market during other periods of the year. At Breckenridge, Colo., for example, Four Seasons Village, now under construction, will feature bowling, golf, tennis, sailing, horseback riding and skeet shooting as well as live theater and concerts. And Village Two, a condominium resort at New Hope, Pa., even offers year-round skiing and swimming—courtesy of plastic snow and an enclosed pool.

International travelers who prefer their pleasures urban-style are also getting a crack at the investment condominium. The Melia Organization of Spain (its U. S. address: 30 East 42nd St., New York, N. Y. 10017) is finding a ready market for the "Apartotels" it is developing in major cities around the world. Its \$23-million, 1,000-unit Melia Castilla in Madrid, the largest hotel in Western Europe, has sold all but a handful of its apartments to investors at prices ranging from \$21,000 for a studio to \$53,000 for larger suites. In addition to occasional use of the apartment and the income

earned by it in his absence, a buyer also gets a 20% discount in all other hotels in the Melia chain, 20% off on car rentals, 10% on Melia tours, and 5% on investments in all future Melia real estate developments.

Melia buyers pay 20% down, the rest in five to 20 years, at 8%. Melia charges 5% of gross rentals to cover operating costs and promotion expenses, and 15% of the net rental income as a commission. It has land and plans for additional urban hotels in London, Paris, Brussels, Rome, and Mexico City. Beach resorts include the Magaluf in Majorca, which is nearly sold out, and the Alicante, now under construction on the eastern coast of Spain. A third is planned for Puerto Rico.

The condominium hotel has caught on in many other areas, too. Many of Hawaii's hotel units are individually-owned and rented out. Developers of John's Island are building a 108-room ocean-front hotel, all of whose rooms will be sold to members of its property owners' association and run as an investment for them. Chapin estimates a relatively-low break-even occupancy rate of 30%.

Beachfront property has almost a built-in appreciation factor for investors. So does property bordering a well-planned championship golf course by a "name" designer. Buyers of golf course condominiums at Sea Pines Plantation on Hilton Head Island off the coast of North Carolina have seen their units appreciate from less than \$20,000 to well over \$45,000 in a few years. Resales at John's Island have been even more heady: A golf cottage that sold for \$48,500 one and a half years ago is now selling at \$70,000. "And we never have

Mission Hills Golf and Country Club spreads over 680 acres outside Palm Springs, Calif.



one on the market more than three hours," says Chapin.

Golf course architect and planner Desmond Muirhead usually aims to combine the appeal of both water and golf course views in his condominium communities. At Mission Hills, for example, the \$44,000 to \$95,000 condominium units are on an island in a lake in the middle of the golf course—safely out of range of errant golf balls.

Nothing must detract from the course's appeal to the golfer, Muirhead says. "At the same time, the course's main function is to help sell houses. The trick is to balance these two factors."

As in any other types of real estate investment, however, the resort condominium is only as good as its location, its design, and its management. An investor may, of course, depreciate the unit, write off an occasional trip to inspect his investment, and deduct management fees for the period during which he makes the unit available for rental—even if there are no takers. He may even clear enough this way to cover the cost of amortizing the investment. But a poor rental record won't make the unit very appealing when he tries to re-sell it. So if capital gains figure in his reckoning, he had best do some preliminary research before he takes the plunge. One of the best ways to evaluate a unit from a tenant's point of view is to rent one like it from another owner.

Despite the caveats, however, the condominium boom continues to spread. It has even reached the boating market. A new wrinkle dubbed "Aquaminium," dreamed up by a houseboat dealer in St. Thomas, Virgin Islands, is a floating version of the condominium housing concept.

The buyer purchases a fully-equipped, 46-ft. houseboat for \$50,000 through the Compass Point Club in St. Thomas. If he makes the boat available for charter at least 26 weeks out of the year, Aquaminiums, Inc., says his net return over a five-year period will be \$45,500. A five-year franchise fee of \$3,000 is paid to Aquaminiums out of the first year's rentals, but all charges for mooring, maintenance, insurance and such are absorbed by the company. The owner gets four weeks free use of the boat a year. If he uses it more than that, however, he must pay the management company its share of potential income it lost while he was aboard.

—RESA W. KING

If you are planning to build any type of industrial, commercial, or institutional building, this *free* guide is a "must" regardless of how much you intend to spend.

It tells how to avoid costly mistakes in planning. And covers the numerous questions that should be answered before construction begins... such as engineering, zoning, soil tests, drainage, access roads, rail spurs, expansion potential.

It also explains the advantages of Pascoe metal building systems.

There is no obligation. And additional copies are available upon request.

Pascoe builds them better.

PASCOE STEEL CORPORATION
SUBSIDIARY OF AMERICAN CEMENT CORPORATION
Plants in Columbus, Georgia and Pomona, California

Your free building construction guide is out. We suggest you read it before you're in.

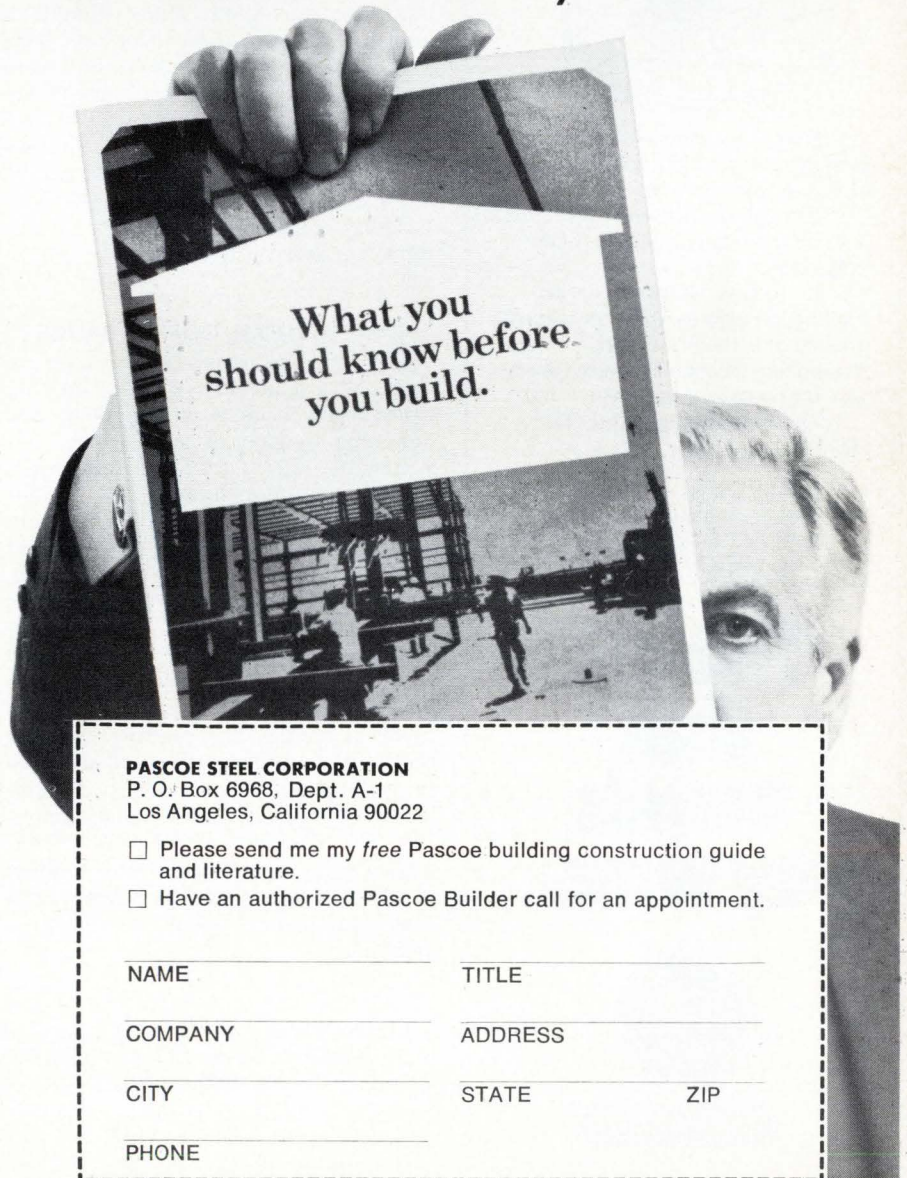

PASCOE STEEL CORPORATION

P. O. Box 6968, Dept. A-1
Los Angeles, California 90022

- Please send me my *free* Pascoe building construction guide and literature.
- Have an authorized Pascoe Builder call for an appointment.

NAME _____ TITLE _____

COMPANY _____ ADDRESS _____

CITY _____ STATE _____ ZIP _____

PHONE _____

FTD Speed-A-Gift

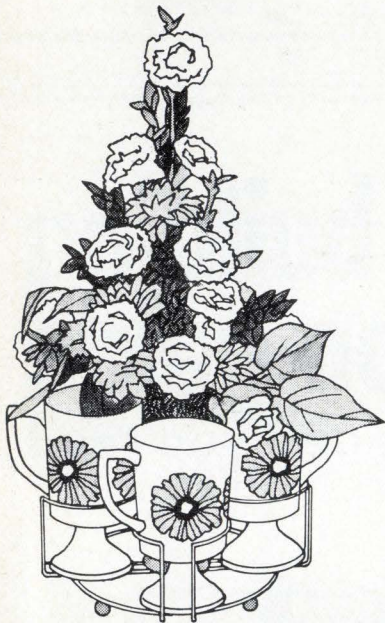

Now you can wire a beautiful, fresh flowers and gift combination almost anywhere in the country.

Just call or visit your FTD florist and choose from his Speed-A-Gift collection.

It's so easy. No wrapping, no mailing, no worries. Why not surprise a loved one, thank a friend... or just remember someone in a very special way for no special reason?

Available through your FTD Florist.

Pictured above is SG-17, Cups and Caddy. Colorful, footed mugs designed for display on functional see-through caddy. Has easy-carry handle for no-spill service.

The gift that travels by wire.



Speed-A-Gift
DELIVERY SERVICE

THE GOOD LIFE

Ways with coffee: In a cup or cake, or even on meat

THE BEAN IN CUISINE FROM RED-EYE GRAVY TO TALLEYRAND'S CUP

Americans consume better than 30 pounds of coffee per person each year, one way or another. Most of it is sipped from that favorite cup, but a good deal reaches the American palate through candy, ice cream, baked goods and other culinary efforts. Next to chocolate and vanilla, coffee is our favorite flavor. It can be bitter or sweet (but never cloying), and it is great drunk straight or wedded to such lovely things as thick cream, Cognac or chocolate. And, as a flavoring for cuisine, it is a many-splendored thing.

One of the most unusual recipes among the manifold ways coffee can be used in cooking comes to us from Mrs. Joseph Martinson, wife of the noted coffee taster and roaster. Here it is:

BAKED STEAK, COFFEE SAUCE

Take a thick steak—at least 2½ in. thick. Sear it quickly in butter on both sides. Place it in a baking dish. Add generous dollops of chili sauce, A-1 Sauce, a cup of canned mushroom pieces, a generous handful of tiny button onions (or a cut-up larger one), salt, pepper, and a pinch of paprika. Bake at 325 degrees for about two hours, basting now and then. Twenty minutes before the end, pour a cup of very strong coffee into the pan. Continue basting. When you serve, use the pan juices as gravy. As a matter of fact, a favorite recipe for "country" ham in the South calls for coffee added to the fry pan in which a thick slice of ham has been cooked. That is the famous "Red Eye" gravy of Kentucky, Tennessee and points South. But the coffee yen knows no regional boundaries, and Mrs. Martinson's steak is a success anywhere.

Coffee in its non-beverage form is more usually a dessert component. For instance, there's coffee gelatin: Soak 2

tsps. unflavored gelatin in ½ cup water for five minutes; boil a cup of water and add to the gelatin; then add two very strong cups of coffee, ½ cup sugar and 3 cloves, and pour into mold. Better yet, try this:

COFFEE SOUFFLE

¾ cup hot, strong coffee
2 tbsps. flour
½ cup sugar
½ tsp. vanilla
3 tbsps. butter
¼ cup cream
4 eggs, separated
pinch of salt

In the top of a double boiler, melt the butter and add the flour. Pour the coffee in slowly. Bring it just to the boiling point, then add the sugar and salt, then stir until smooth. Add the egg yolks, and keep beating until the mixture is thick. Fold in the egg whites (well beaten, of course) and the vanilla. (It may be wise to have an extra egg white or two—it can only help assure a nice rise). Pour into a soufflé dish and bake at 400 degrees for 25 minutes, or until nicely risen. Serve it with whipped cream, and discover why coffee soufflé is considered a dessert par excellence.

It is as a beverage, of course, that coffee is most popularly known. Everyone has his own favorite method of making it— Joseph Martinson, for instance, used to boil his in an ordinary saucepan with just coffee, water and an egg shell, without percolator, drip pot, pressure or other gadgetry. So telling anyone how to make coffee is about as productive as telling a confirmed martini man how to mix his next one. Possibly the best tip for making good coffee is *use enough coffee*. Remember this before all: Coffee cannot be too strong!

There are ways, however, to add variety to your coffee drinking. Cappuccino, an Italian coffee, is a favorite, but it is best made with an Italian pressure coffee-maker. Unless you have one, relegate Cappuccino drinking to restaurant visits.

But anyone can easily make *Café Brûlot*. It is nicest when made at table in a chafing dish, but it can be made in a small saucepan on the stove just as well. To make enough flavoring for six small cups of coffee, use 1 cup of Cognac, 10 lumps of sugar, six or eight whole cloves, the rinds of half an orange and a quarter of a lemon. Heat almost to a boil, then touch a match to the Cognac and flame it—but don't let it burn too long. Pour a good teaspoonful into each demitasse of strong coffee.

Another interesting version of our favorite beverage is *Cuban Coffee*, a much richer drink than good old café au lait. Instead of using water, simmer (but do

not boil) ½ cup of ground coffee in two cups of milk and 1 cup of cream for five minutes. Strain. Serve with sugar and whipped cream.

For a change from regulation iced coffee, there is the Italian invention, *Coffee Granito*—a sophisticated version of a drink often made with fruit juices. To make it, dissolve ½ cup of sugar in a pint of very strong, hot coffee. Let it cool, then put it in a bottle and set it in the freezer compartment of the refrigerator or a pot of cracked ice. Turn it from time to time. It must be half frozen, about the consistency of mush, and it is usually served in sherbet glasses.

Indeed, when it comes to being imaginative with coffee, there are even ways for the coffee-lover literally to have his cake and eat it, too. The most obvious way is to bake a coffee-flavored cake like this:

COFFEE CAKE, MOCHA ICING

To make the cake, beat together ½ cup of butter and 1 cup of brown sugar. Add two eggs, ½ cup of molasses, ½ cup of strong coffee, and 2 cups of flour sifted with 3 tsps. of baking powder. Add ¼ tsp. of ground cloves, ¼ tsp. of cinnamon, ½ tsp. of salt. Divide the mix in half, and bake as two layers for about 25 minutes in a moderate oven.

Now for the icing. Cream ½ of a cup of sweet butter, 1 cup of confectioner's sugar, and 1 tbsp. of cocoa. Mix thoroughly. Add 3 tsps. of strong, hot coffee and enough more sugar to make the icing thick enough—but not too thick—to spread easily. Beat well, and coat both layers and sides while the layers are still warm.

These, of course, are only a few of the ways that man has devised to enjoy the savory pleasures of coffee, for which we owe a debt (according to legend) to an anonymous goat-herd of ancient Arabia. One day, the story goes, he noticed that his goats were behaving with unusual liveliness after nibbling some berries growing on a glossy-leaved bush. He tried some, and found them awful. With a little experimenting, however, he found that when roasted they weren't bad, and brewed they were even better.

However it came into being, coffee has been captivating palates throughout history. Among its most devoted admirers was the famous Talleyrand, who is reputed by some biographers to have sipped up to 40 cups of the brew a day. And, in Talleyrand's immortal words, there was only one way to make it: "Black as the Devil, hot as Hades, pure as an angel, sweet as love."

—ROBERT J. MISCH

Just one thing has made us the leader.

Performance.

Consistently, Snelling & Snelling—the world's largest employment service—has performed for many of this nation's largest and smallest employers.

And they have learned if we don't have immediately available the people they need—we find them.

Quickly. Efficiently.

And with measurable savings in time, aggravation and in another vital area—money.

Look us up in the White Pages. And watch us perform. Consistently.



Snelling AND Snelling®

The World's Largest Employment Service
with 540 offices coast to coast



**American antiques:
where tastes and
values aim high**

Antique shows and auctions this winter make the point that more buyers with more money are seeking Americana than ever before in history. Values are up 5% to 10% over last year, and the trend is to more of the same. High-styled 18th century furniture—the prime buy—has tripled in value in 10 years. Limited supply in the face of rising demand is fundamental. So is the current trend in taste toward the simplicity of the past, and away from disappointing machine-made products. . . . Pre-1830 antiques are most coveted, and today the market is bullish for the works of leading 18th century cabinetmakers such as Goddard, Townsend and Chapin. A Goddard Queen Anne chair recently brought \$15,000. Works of lesser known men of the period fall into the \$2,000-\$10,000 range. Federal period pieces (circa 1800) by such cabinetmakers as Seymour, Duncan Phyfe and Shaw are priced from \$150 for small chairs up to \$1,500 for sofas and highboys. A boom is also on for Empire furniture (1800-1820), with a current range of \$100 to \$700.

Museums such as New York's Metropolitan (American wing) and the Boston Museum of Arts are excellent places to learn about antiques. Auctions conducted by leading houses are good, too (though country "barn" sales may be wisely avoided). Top dealers are well known at local museums. Characteristically, the better dealers stick to prices, and offer little chance for dickering. . . . Must reading: *American Furniture, the Queen Anne and Chippendale Period 1725-1788*, by Joseph Downs; *American Furniture of the Federal Period 1788-1825*, by Charles F. Montgomery; and *Fine Points of Furniture: Early America*, by Albert Sack. The magazine, *Antiques*, will give you the feel of the market with its deceptions and vagaries.

**"Retirement"—or
graceful layoff?**

"Pretty soon it'll be like the military," says a Chicago management consultant. "You'll be 'retired' young enough to start a second career." . . . His view is held by a growing number of specialists. A report by J. K. Lasser, for example, indicates that early retirement is being used by more companies as a way to replace older men with younger ones. Lasser points to IBM with its pensioned retirement at age 55, and notes that the company is now offering added early-retirement inducements to 25-year men. IBM's action still isn't common, but it's being adopted by more corporations. . . . A Boston consultant notes: "What this does for many people is to move up their normal retirement planning by quite a few years. A middle manager, especially, will want to keep on top of this trend—and plan accordingly." (*Personal Business* will review early-retirement, and add practical tips, in a future series on career-planning.)

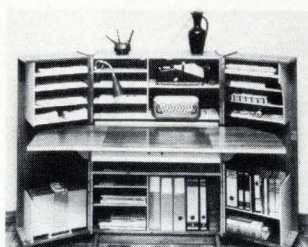

If you work at home amid cluttered surroundings, consider tidying up operations with the aid of an ingenious piece of Norwegian-made furniture called The Home Office. It's a cleverly integrated and unobtrusive version of the old giant-size roll-top desk that held everything from a 30-lb. typewriter to fishing tackle. The Home Office has ample cubbyhole space for the usual gadgetry, folds into a sleek cabinet (Greatwood Products, 290 Madison Ave., New York 10017; \$370). . . . Real estate scene: Find a good buy in a townhouse? H. Dickson McKenna's *A House in the City* piles up ideas on renovation of the classic row house; it's an A-1 review, beautifully illustrated (Van Nostrand, \$12.95). . . . Good life: PB's

restaurant-of-the-month is Chicago's Blackhawk where on St. Patrick's Day the Irish coffee is strong pub-style. Mix was created by barman Joe Sheridan at Shannon airport: Heat a tumbler with hot water, then fill $\frac{3}{4}$ up with strong piping hot coffee. Put in 3 small sugar cubes and add 2 oz. Irish whiskey. Top with 1 tsp. whipped cream. . . . PB's hotel-of-the-month: the new Innisbrook Resort & Golf Club, near Tarpon Springs, Fla.; with two 18-hole courses and golf pro Mike Souchak.