

Summing with op amps simplified 73
 Superintegration with bipolar technology 82
 Electro-optics focuses on trillion-bit memories 91

LIBRARY
 STATE TECHNICAL INSTITUTE
 AT MEMPHIS

Electronics®

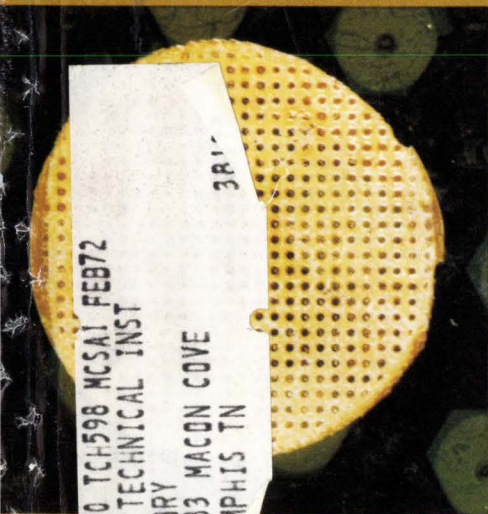
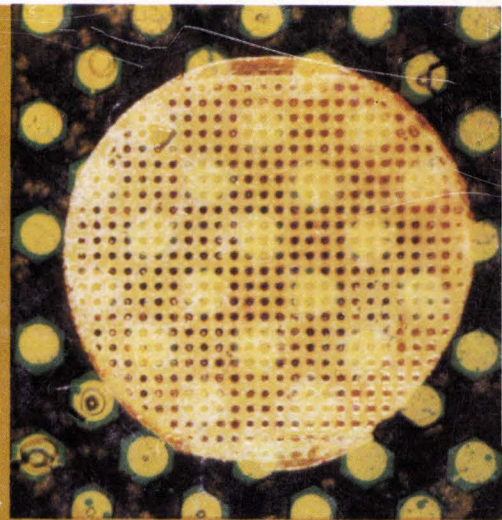

STEPS
 TOWARD
 OPTOELECTRONIC
 STORAGE
 AND
 DISPLAY

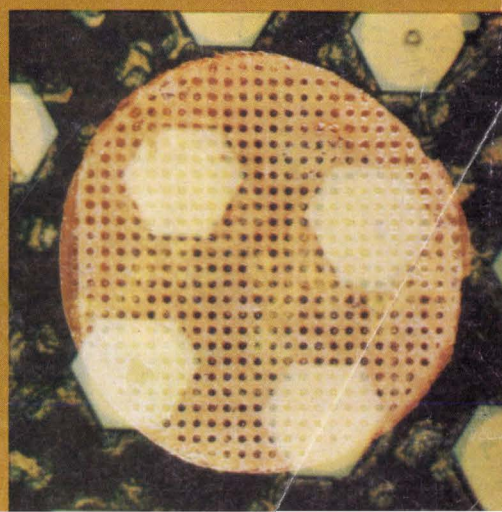
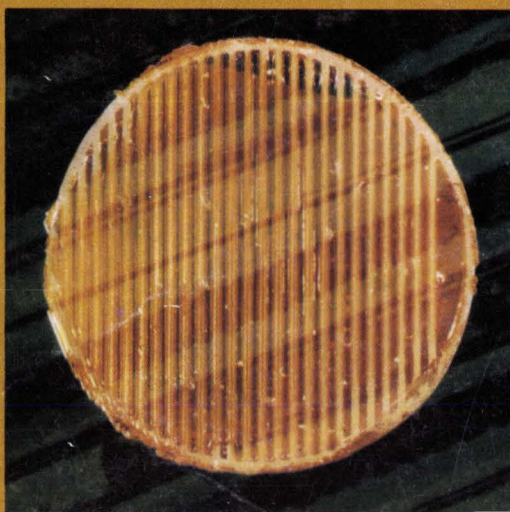
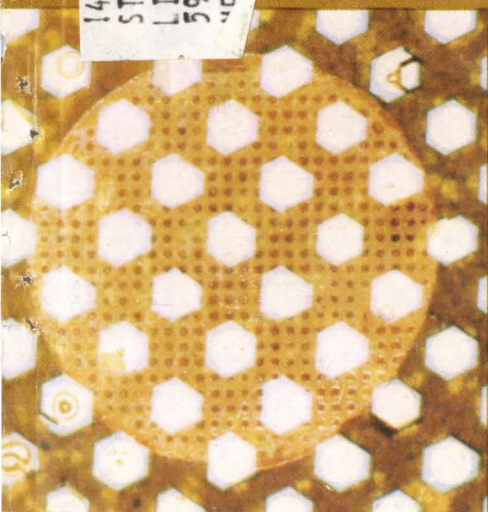
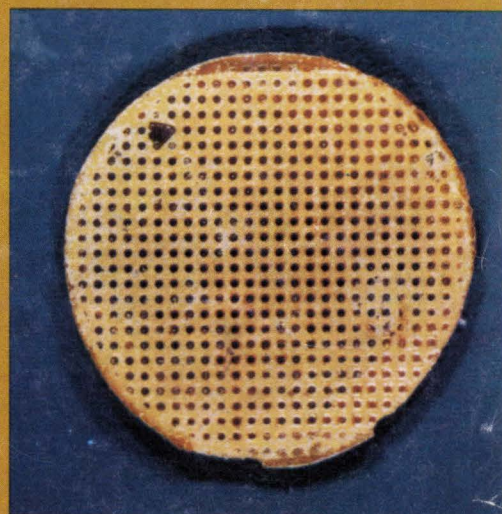

RCL MINIATURE ROTARY SWITCHES

MINI MIDI MAXI



1/2" OD
Up to 12 positions
Up to 6 poles/deck
PC or solder terminals



3/4" OD
Up to 12 positions
Up to 6 poles/deck
Multi-deck models available

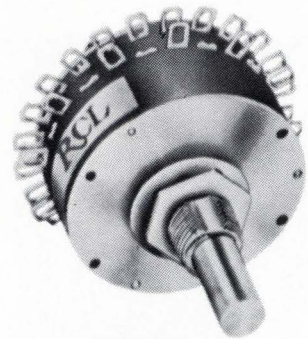

1 3/8" OD
Up to 24 positions
Up to 12 poles/deck
Multi-deck models available

- Totally enclosed. Low contact resistance. Long life — up to 200,000 mechanical operations. Intermix of shorting and non-shorting action available on same deck.
- Explosion and contamination proof. Rugged terminals integrally molded into switch body.
- Priced comparable to open deck wafer-type switches.

Completely automated facilities enable RCL to offer low cost commercial versions at competitive prices for use in commercial applications.

(1,000 piece quantities cost just \$1.96 each)

DELIVERY FROM STOCK

Write for complete technical information

RCL ELECTRONICS, INC.

700 South 21st Street, Irvington, New Jersey 07111.

REG U.S. PAT. OFF. #3352979

Why the best high frequency transistors cost less than the second best.

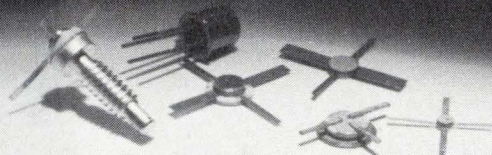

It doesn't happen often. But in the case of microwave transistors, you don't have to trade off performance to get the lowest price. That's because we've combined advances in silicon semiconductor technology with efficient mass-production. The result to date has been:

The workhorse: HP 21.

This small signal transistor is the backbone of any RF/microwave amplifier design. It has a 12 dB gain at 2 GHz (useable to 5 GHz), a noise figure of 4.2 dB at 2 GHz and a price of only \$19 each in small quantities. So you won't be making tradeoffs in your design.

Really low noise.

The HP 22, a significant new high frequency device, has a maximum

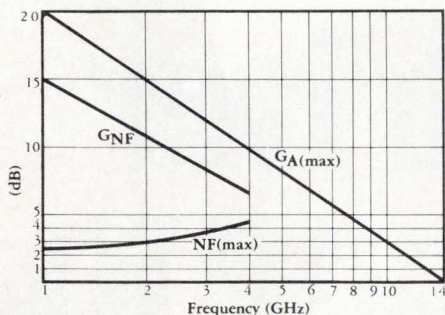

guaranteed noise figure of 4.5 dB at 4 GHz with 6.5 dB gain when biased for optimum NF (10 V, 5 mA). With 3 dB more gain across the band than the HP 21, the HP 22 is useable to 8 GHz

in its stripline packages. All for just \$75 each. No other transistor can make that statement.

More power out.

That's the function of the new HP 11. It fills the power gap between the HP 21 and high power devices. As a preamp

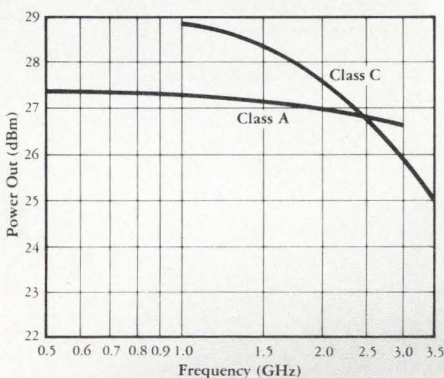

output or linear driver, it offers low distortion from 2 to 4 GHz. Yet it costs the same as the small signal HP 21.

The low price of success.

You've seen the kind of performance our transistors offer. Now let's get down to the cost factor.

Quantity	HP 21	HP 22	HP 11
1-99	\$19	\$75	\$19
100+	15	65	15

(Domestic USA prices for stripline packages.)

Can you afford not to use them?

Firm delivery and great reliability.

We can deliver most orders from stock. And you can count on device reliability. Our proven manufacturing process not only provides excellent parameter stability from batch to batch but insures healthy devices. Like 10 million hours MTBF for the HP 21.

An HP field engineer is nearby to answer your questions and handle your orders promptly. Why not give him a call for complete information about our transistors. Or write Hewlett-Packard, Palo Alto, California 94304. Europe: 1217 Meyrin-Geneva, Switzerland.

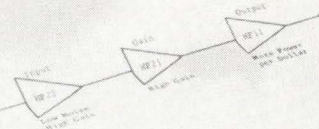

HP transistors: a small price to pay for performance.

HEWLETT  PACKARD

COMPONENTS
Circle 1 on reader service card

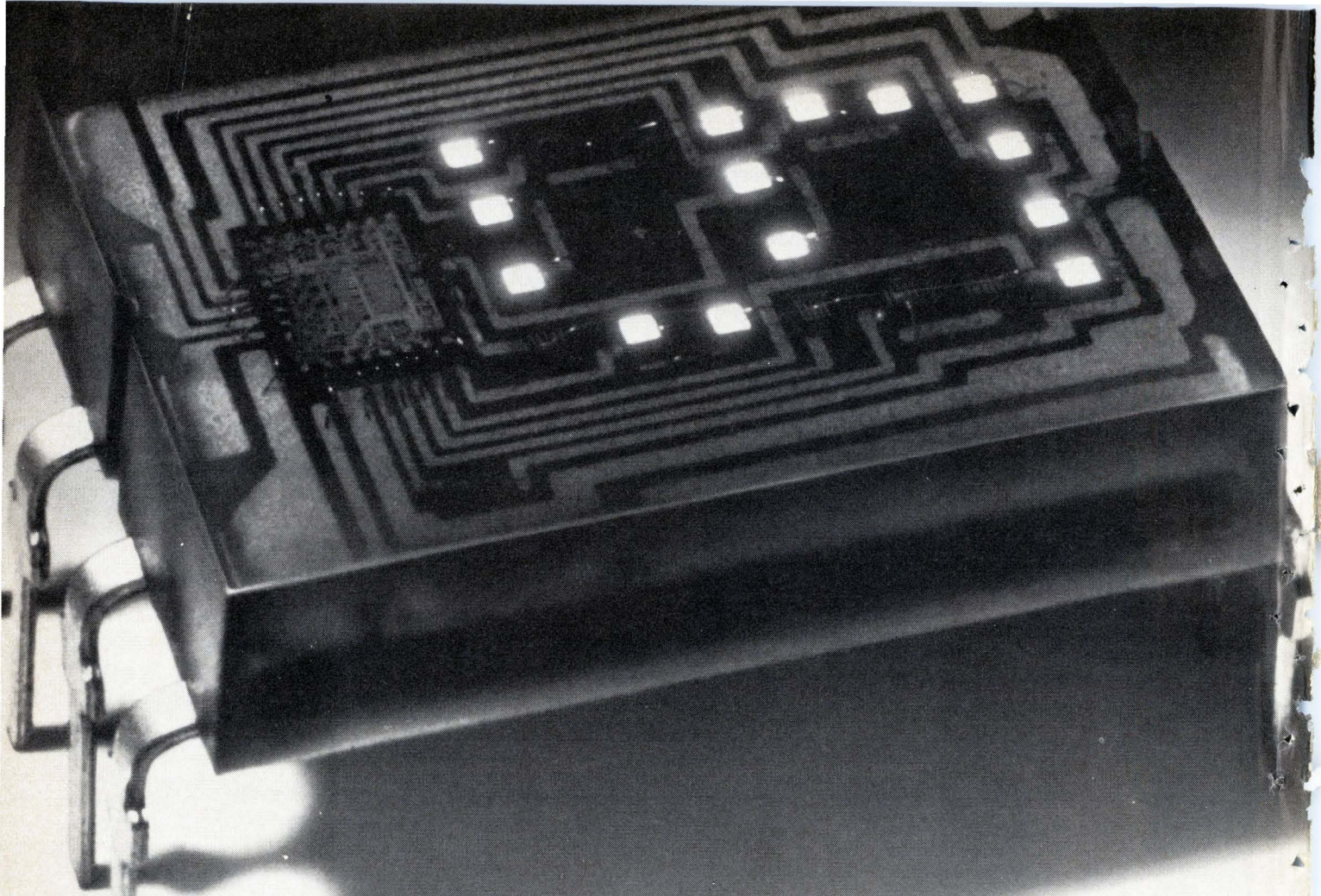

We built in the decoder/driver so you don't have to.

Not only the decoder/driver but the memory too! Now available for *immediate* delivery is the HP 5082-7300 series solid state display.

It's completely TTL compatible. All you do is address it directly with four-line BCD input. The on-board IC allows for either the storage of input data or real-time display. You save design time, space, and money, and get a completely reliable integrated display system.

A bright .290 inch high, shaped character gives

excellent readability over a wide viewing angle in a compact .600 inch by .400 inch package.

Best of all is the price: \$10.00 each in 1K quantities. So why wait? Order now! For *immediate* delivery on the HP 5082-7300 call your local HP sales office, or Hewlett-Packard, Palo Alto, Calif. 94304. In Europe: 1217 Meyrin-Geneva, Switzerland.

01202

HEWLETT  PACKARD

COMPONENTS

33 Electronics Review

CONSUMER ELECTRONICS: New 'fair-trade' committee draws cheers and boos, 33
MILITARY ELECTRONICS: Weapon woes overshadow first S-3A flight, 34
COMPUTERS: The NCR-CDC deal: adding up strengths, 34
INDEX OF ACTIVITY: 35
LASERS: Experiment aims at quake prediction, 36; Measuring nitrogen dioxide, 38
SOLID STATE: Westinghouse speeds delivery of high-power semiconductors, 41
COMMUNICATIONS: On-line protection scheme ends switchover data loss, 42; FCC shops for experts to resume Bell probe, 42
INSTRUMENTATION: H-P moves to standardize programable test gear, 45
FOR THE RECORD: 46

59 Technical Articles

SPECIAL REPORT, Part 3: The medium of the message will soon be optoelectronic, 60 (cover)
CIRCUIT DESIGN: Doubling operational amplifier summing power, 73
CIRCUIT DESIGN: Designer's casebook, 77
SOLID STATE: Bipolar catches up with MOS, 82; Superintegrated memory, 83; Collector coupling minimizes interconnections, 87

91 Probing the News

COMPUTERS: How to miniaturize mass memories, 91
GOVERNMENT: U. S. agencies spur avionics sales abroad, 94
MATERIALS: Coming attractions in magnetic tape, 97
MANAGEMENT: New CBS pilot maps his own course, 100
MARKETING: LSI buyers must learn to think subsystems, 104

109 New Products

IN THE SPOTLIGHT: Circuit analyzer does factory-type tests in the field, 109
COMPONENTS: A-d converter puts out 16 bits, 111
INSTRUMENTS: Pulsar family reaches 50 MHz, 113
SUBASSEMBLIES: Voltage tripler is compact, 119
INDUSTRIAL: H-P enters OEM-supply race, 123
SEMICONDUCTORS: Waveform generator is monolithic, 127

137 Electronics International

JAPAN: Monolithic op amp operates at very low power levels, 137
GREAT BRITAIN: Phase-locked loop IC designed for modems, 137
JAPAN: Color TV projector replaces home movies, 138
JAPAN: Unijunction transistor leads to low-power shift register, 139
THE NETHERLANDS: Bucket brigades speed optical character reading, 139
WEST GERMANY: Piezoelectric plate feeds hand-writing to computer, 140

Departments

Publisher's letter, 4
Readers comment, 6
40 years ago, 8
People, 14
Meetings, 22
Electronics Newsletter, 25
Washington Newsletter, 49
Washington Commentary, 50
New Books, 133
International Newsletter, 135

Electronics

EDITOR-IN-CHIEF: Kemp Anderson

EXECUTIVE EDITOR: Samuel Weber

MANAGING EDITORS: Lawrence Curran, *News*;
Arthur Erikson, *International*

SENIOR EDITORS: John Johnsrud,
H. Thomas Maguire, Stephen E. Scrupski

ART DIRECTOR: Fred Sklenar

ASSOCIATE EDITORS: Richard Gundlach,
John N. Kessler, Howard Wolff

DEPARTMENT EDITORS

Aerospace: William F. Arnold
Circuit Design: Lucinda Mattern
Communications & Microwave:
Lyman J. Hardeman

Computers: Wallace B. Riley
Consumer: Gerald M. Walker
Industrial: Alfred Rosenblatt
Instrumentation: Michael J. Riezenman
Military: Ray Connolly
New Products: H. Thomas Maguire
Packaging & Production:
Stephen E. Scrupski

Solid State: Laurence Altman
Special Issues: Harry R. Karp

COPY EDITORS: Margaret Eastman,
Everett C. Terry

ART: Charles D. Ciatto, *Associate Director*

PRODUCTION EDITORS:
Patricia Cybulski, Arthur C. Miller

EDITORIAL ASSISTANT: Marilyn Offenheiser

EDITORIAL SECRETARIES: Vickie Green,
Nancy Baldasare, Julie Gorgoglione

FIELD EDITORS

Boston: James Brinton (Mgr.), Gail Farrell
Dallas: Larry Armstrong (Mgr.)
Los Angeles: Paul Franson (Mgr.)
New York: Alfred Rosenblatt (Mgr.)
San Francisco: Stephen Wm. Fields (Mgr.),
Roberta Schwartz
Washington: Ray Connolly (Mgr.),
William F. Arnold
Frankfurt: John Gosch
London: Michael Payne
Paris: Arthur Erikson
Tokyo: Charles Cohen

McGRAW-HILL WORLD NEWS

Director: Walter A. Stanbury; *Atlanta*: Stan Fisher; *Chicago*: Mike Sheldrick; *Cleveland*: Arthur Zimmerman; *Detroit*: James Wargo; *Houston*: Robert E. Lee; *Los Angeles*: Michael Murphy; *Gerald Parkinson*; *San Francisco*: Margaret Drossel; *Seattle*: Ray Bloomberg; *Washington*: James Canan, Herbert W. Cheshire, Seth Payne, Warren Burkett, William D. Hickman; *Bonn*: Robert Ingersoll; *Brussels*: James Smith; *London*: Marvin Petal; *Milan*: Peter Hoffmann, Andrew Heath; *Moscow*: Axel Krause; *Paris*: Stewart Toy, Michael Johnson; *Stockholm*: Robert Skole; *Tokyo*: Mike Mealey

PUBLISHER: Dan McMillan

ADVERTISING SALES MANAGER: Pierre J. Braude

ADVERTISING SALES SERVICE MANAGER:
Wallis Clarke

BUSINESS MANAGER: Stephen R. Weiss

CIRCULATION MANAGER: George F. Werner

RESEARCH MANAGER: David Strassler

MARKETING SERVICES MANAGER:
Tomlinson Howland

Publisher's letter

Our wide-ranging three-part series on optoelectronics finishes up this issue with a look at the near future—at ultra high-capacity memories and information retrieval systems (see page 60). Incidentally, the series is available as one reprint. If you want one see the note at the end of the article on page 71.

Speaking of wide-ranging, that's the phrase that our solid state editor, Larry Altman, himself uses to describe the field. Larry, who ranged widely around the country while assembling material for the series, was impressed by the great variety of things that are optical. From tiny light-emitting diodes to giant optical character recognition readers, from eyes for the blind to laser eye welders, from optical isolators to surveying equipment, from light communications gear to sensors against polluters.

"In fact," says Altman, "it's probably the best technology for the small manufacturers to jump into, because a good idea can be quickly translated into a piece of equipment. Most high-technology optical gear can't be mass produced, so a minimum of capital is needed.

"Besides it's one of the new, 'clean' technologies, doing good work. Pollution monitors, blind aids, auto guidance systems, traffic control, library files—all these optical things are people-oriented."

For the golfers among our readers, it may come as a bit of a surprise to know that a remarkable number of top executives in the electronics industries are also sailboat skippers. Captains of industry during the week, captains of rough water on the weekends.

This was one observation made by our consumer editor, Jerry Walker, after a recent assignment to find out what's on the minds of the of the industries' top brass (*Electronics*, Jan. 3, page 95). And, because he is a sailor himself, Jerry had previously discovered a number of boating enthusiasts in the engineering ranks.

On his latest assignment to interview a president—CBS Labs' Renville McMann (see page 94)—Jerry found another sailor. In this case, the exec's fancy was for sailplane flying. And, after all, sailplanes are the airborne analog of sailboats.

"The reason for this interest, apparently, is that sailing requires complete concentration," he concludes. "There's no chance to think about the problems back at the office. And McMann has added a third dimension, so his concentration is even more constant."

Jerry, who has a sailboat ("Not in the executive class, yet"), agrees with the concentration principle. "When you are out there with the sheet straining in one hand, the tiller in the other, and your toes dug into the hiking straps, you just don't worry about unanswered letters."

We'd like to repeat a note we ran last issue in the Readers Comment department, for those of you who missed it. The index of articles published in *Electronics* in 1971 is now available. For a copy, circle number 340 on the reader service card just inside the back cover.



February 14, 1972 Volume 45, Number 4
89,877 copies of this issue printed

Published every other Monday by McGraw-Hill, Inc. Founder: James H. McGraw 1860-1948. Publication office 330 West 42nd Street, N.Y., N.Y. 10036. Second class postage paid at New York, N.Y., and additional mailing offices.

Executive, editorial, circulation and advertising addresses: Electronics, McGraw-Hill Building, 330 West 42nd Street, New York, N.Y. 10036. Telephone (212) 971-3333. Teletype TWX N.Y. 710-581-4235. Cable address: MCGRAW HILL N.Y.

Subscriptions limited to persons with active, professional, functional responsibility in electronics technology. Publisher reserves the right to reject non-qualified requests. No subscriptions accepted without complete identification of subscriber name, title, or job function, company or organization, including product manufactured or services performed. Subscription rates: qualified subscribers in the United States and possessions and Canada, \$8.00 one year, \$12.00 two years, \$16.00 three years; all other countries \$25.00 one year except Japan \$50.00 per year including air freight. Limited quota of subscriptions available at higher-than-basic rate for persons outside of field served, as follows: U.S. and possessions and Canada, \$25.00 one year; all other countries \$50.00. Single copies: United States and possessions and Canada, \$1.00; all other countries, \$1.75.

Officers of the McGraw-Hill Publications Company: John R. Emery, President; J. Elton Tuohig, Senior Vice President—Services; Donald B. Gridley, Group Vice President; Vice Presidents: Ralph Blackburn, Circulation; John R. Callahan, Editorial; David G. Jensen, Manufacturing; Jerome D. Luntz, Planning & Development; Joseph C. Page, Marketing; Robert M. Wilhelm, Finance.

Officers of the Corporation: Shelton Fisher, President; Joseph H. Allen, President, Publications and Business Services Group; John J. Cooke, Senior Vice President and Secretary; Ralph J. Webb, Treasurer.

Title registered in U.S. Patent Office; Copyright 1972 by McGraw-Hill, Inc. All rights reserved. The contents of this publication may not be reproduced either in whole or in part without the consent of copyright owner.

Subscribers: The publisher, upon written request to our New York office from any subscriber, agrees to refund that part of the subscription price applying to copies not yet mailed. Please send change of address notices or complaints to Fulfillment Manager; subscription orders to Circulation Manager, Electronics, at address below. Change of address notices should provide old as well as new address, including postal zip code number. If possible, attach address label from recent issue. Allow one month for change to become effective.

Postmaster: Please send form 3579 to Fulfillment Manager, Electronics, P.O. Box 430, Hightstown, N.J. 08520.

low cost
 add digital control to your **KEPCO POWER SUPPLY***

LINE-POWERED

Plug-in your 115/230V a-c here. The shielded transformer and feedback voltage regulators provide all the power needed.

OPTICALLY ISOLATED

These optical couplers provide a kilovolt of isolation from the digital to the analog.

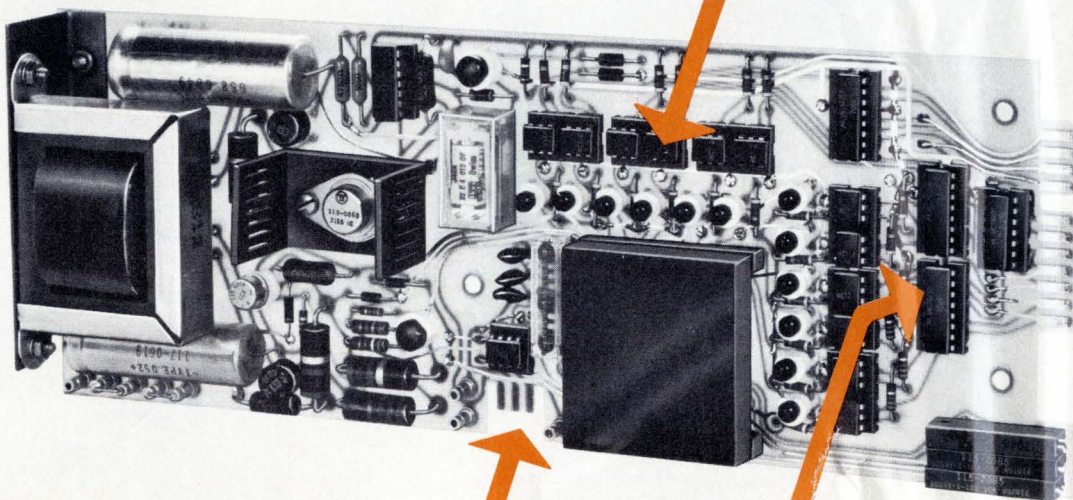

GET YOUR OUTPUT HERE,

a 0-10V (or $\pm 10V$) analog signal that will directly program *any* Kepco operationally controlled power supply.

MEMORY

The buffered storage frees your signal source to do other work.

PUT YOUR DIGITS

IN HERE: 2 digit BCD
 3 digit BCD
 8 bit binary
 10 bit binary
 12 bit binary

IT'S DONE WITH THE KEPCO SN... OPTICALLY ISOLATED, LINE-POWERED, DIGITAL-TO-ANALOG CONVERTERS.

with **KEPCO** *you're in control!*

For complete specifications, write Dept. EH-14

KEPCO, INC. • 131-38 SANFORD AVENUE • FLUSHING, N.Y. 11352 • (212) 461-7000 • TWX # 710-582-2631 • Telex: 12-6055 • Cable: KEPCOPOWER NEWYORK

Electronics/February 14, 1972

* or programmable function generator or VCO
 or active filter (frequency or "Q")
 or d-c amplifier (gain, threshold, offset)
 or comparator
 or calibrator
 or tester
 or anything you control with an analog voltage

Circle 5 on reader service card

A Smart Way to Beat Your Power Supply Size Problem

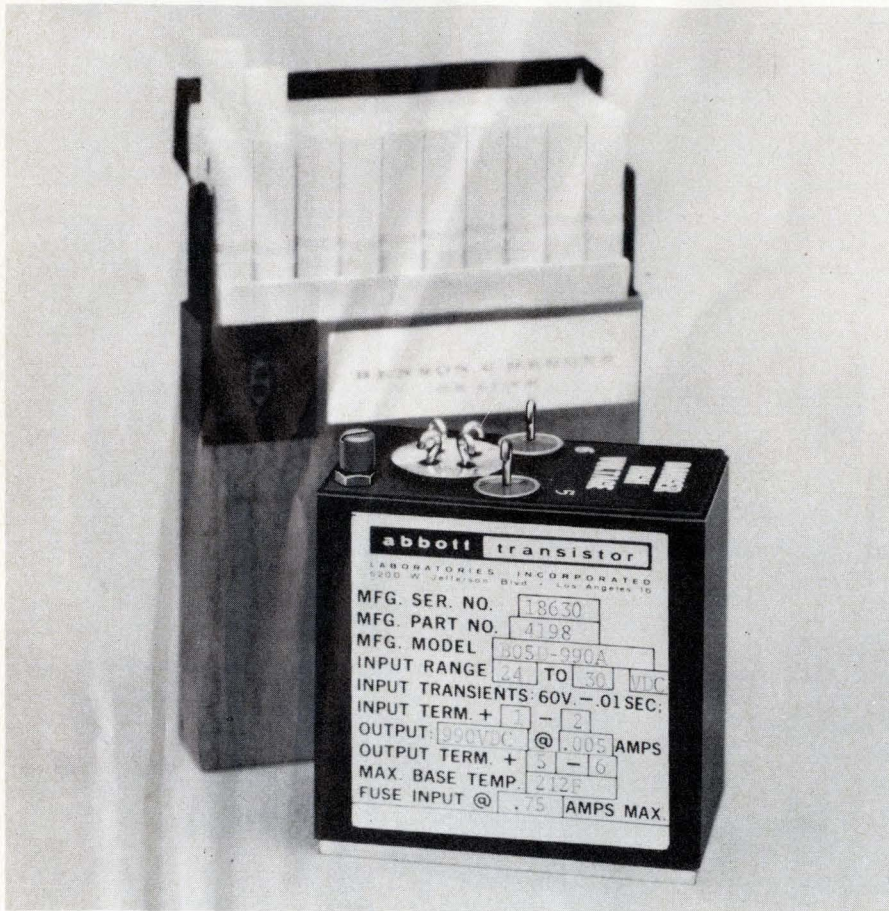

1½" thin, 2¾" narrow, 2¾" short

yet this converter produces 1000 volts DC, regulated, from a battery input of 28 VDC! It weighs less than 15 ounces. This is only one of our wide variety of many small light weight converters, inverters and power supplies — there are over 3000 models listed in our newest catalog, including size, weight and prices. If you have a size problem, why not send for an Abbott catalog?

MIL SPEC ENVIRONMENT — All of the power modules listed in our new catalog have been designed to meet the severe environmental conditions required by modern aerospace systems, including MIL-E-5272C and MIL-E-5400K. They are hermetically sealed and encapsulated in heavy steel containers. New all silicon units will operate at 100°C.

Please see pages 618 to 632 of your 1971-72 EEM (ELECTRONIC ENGINEERS MASTER Catalog) for complete information on Abbott modules

Send for our new 56 page FREE catalog.

abbott transistor

LABORATORIES, INCORPORATED

5200 W. Jefferson Blvd./Los Angeles 90016
(213) 936-8185 Cable ABTLABS

1224 Anderson Ave./Fort Lee, N.J. 07024
(201) 224-6900

Readers Comment

...OR...OR...

To the Editor: Designer's Casebook (Oct. 11, p. 73) shows an eight-bit parity checker-generator. It should be pointed out that an equivalent can be built using two SN7486 Quad "Exclusive OR" packages (see diagram, below). Both the price and the package count are considerably less than Mr. Gordon's design.

His solution and mine, however, are rather academic because the SN74180 contains all the logic necessary in one MSIIC package.

R. W. Anderson
Department of Chemistry and
Chemical Engineering
University of Illinois, Urbana, Ill.

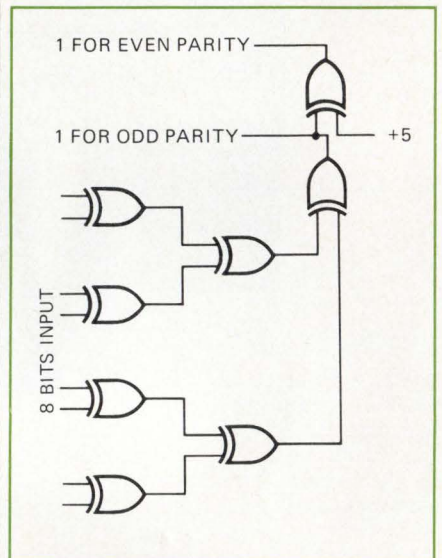

■ The author replies that his circuit is useful in an MOS system, in which a TTL unit would require much MOS/TTL interfacing circuitry.

Index for 1971

To the Editor: I've been a subscriber to *Electronics* for over four years now, and have gotten much use from your circuit design section, technical articles, and newsletters.

Because your magazine has proven so valuable to me, I keep all back issues for future reference. However, I do not see your annual index in either of this year's January issues. Will one be available?

Frank N. Vitaljic
Sedro Woolley, Wa.

■ To obtain the 1971 index, circle 340 on the reader service card.

Go ahead. Its replacement just arrived.

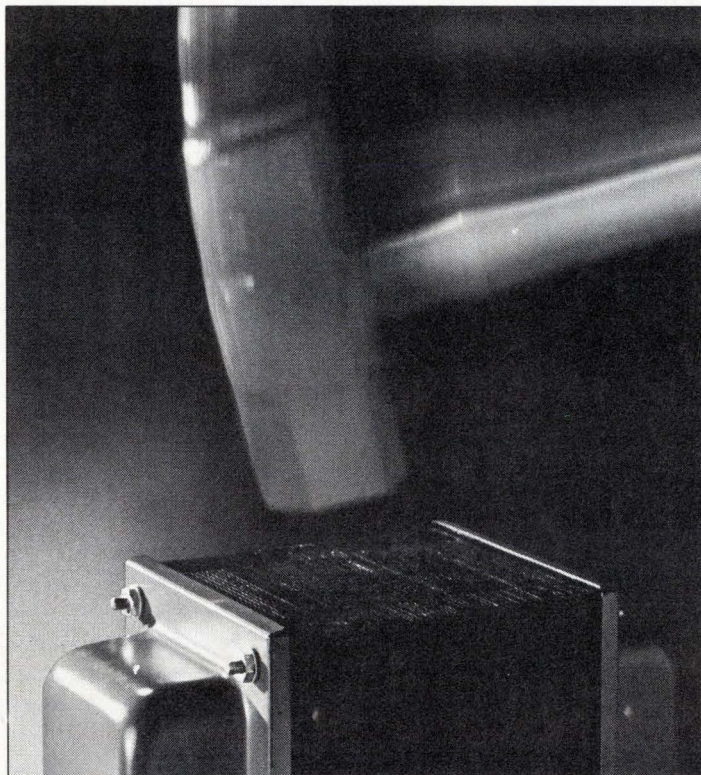

The SVT 6000 Series. TRW's brand new, high-power, high-speed, monolithic Darlington. Available right now—in quantity—for off-line power-supply designs (plus sweep generators and many other uses).

It eliminates 60-cycle transformers and simplifies output magnetics. Added together, it's enough to give your next design an overall 5:1 size reduction. And sizable cost reduction.

SVT 6000 does a much better job, too. Handles up to 650V, switches in 300n sec, has a gain of 300 at 5A ($I_C \text{ max}=15A$), and drops heat dissipation way down.

We don't have to spell out the possibilities for you. Or remind you of the limitations 60-cycle magnetics used to impose on your designs.

But before you take a hammer to the nearest transformer, reflect. It may be a mother. That's what you've called it, often enough.

Now call us—for full information. In California, call (213) 679-4561, collect. Elsewhere, call 800-421-2061, toll-free. Or write TRW Electronic Components, Semiconductor Division, 14520 Aviation Boulevard, Lawndale, California 90260.



LATE NEWS

In electronic automotive ignition systems, the SVT 6000 Series can reduce component count and provide higher voltages and current.

TRW
SEMICONDUCTORS

Did you know... now T-BAR makes switching subsystems like these?

5x20x60 Studio
Switching Matrix

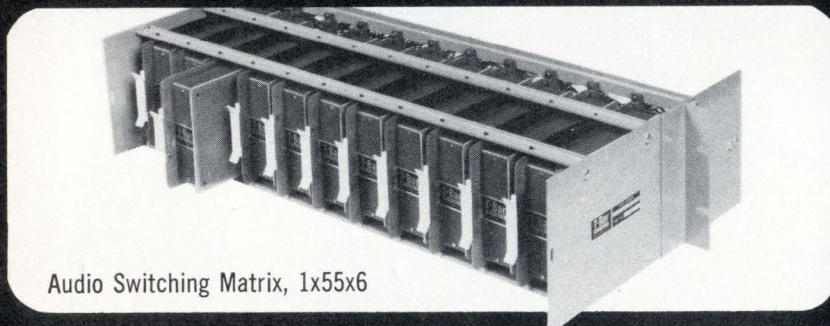
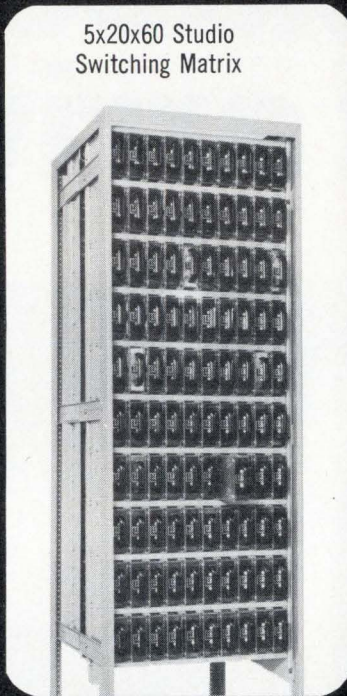

Audio Switching Matrix, 1x55x6

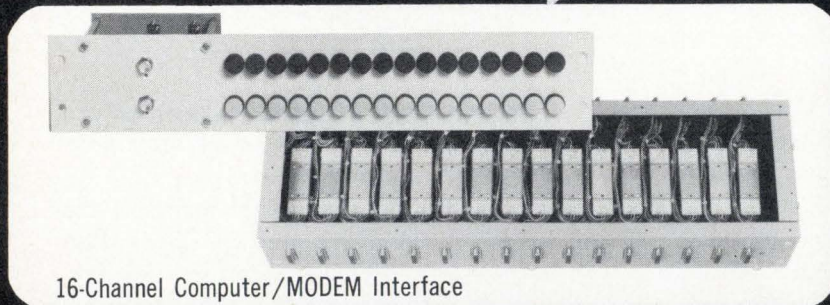

16-Channel Computer/MODEM Interface

Today, T-BAR is the source for switching systems designed and built for

- computer interface
- data communications
- test and instrumentation

Write or phone for information.
We make house calls.

T-Bar
INCORPORATED
SWITCHING TECHNOLOGY

141 Danbury Road, Wilton, CT 06897
phone: 203/762-8351

40 years ago

From the pages of *Electronics*, February 1932

With sixteen million of the homes of America already equipped with radio sets, it is logical that the radio industry next consider the nation's automobiles. For here is the next remaining "frontier" to conquer.

Some 23,000,000 passenger cars are now registered in the 48 states of the Union, and during 1932 at least 2,100,000 more cars will be sold. Looked at from any angle, here is a prodigious potential market for radio sales.

With the introduction of the Senate resolution calling for an investigation of advertising in broadcasting, with the move to take 15% of the wavelengths for "educational institutions," and with the filing of Senator Dill's bill to destroy clear channels, the forces which would tear down our present wonderful radio system begin to get in their work. Where do the attacks come from?

From certain newspaper interests which eye radio as competition.

From "blocs" claiming places in the air to disseminate their own propaganda.

From politicians eager to fix their own political fortunes, by utilizing radio's popularity, and by getting closer control over stations back home through the 15% grab of "educational" wavelengths.

From small stations envious of the greater service and popularity of the successful broadcasters.

The directors of the Institute of Radio Engineers, at its meeting Jan. 6, appointed an emergency employment committee to provide for radio engineers who are in need. Capt. R.H. Marriott is chairman.

A plan has been devised to permit employing a number of engineers in the making of a radio broadcast survey at a wage which will keep them in food and shelter until they get something else. Such a survey will prove of value in the development of radio, which is the objective of the institute. It can also be made of great value to the Federal Radio Commission, Congress, broadcast stations, radio advertisers, radio manufacturers, and the public.

Identical twins.

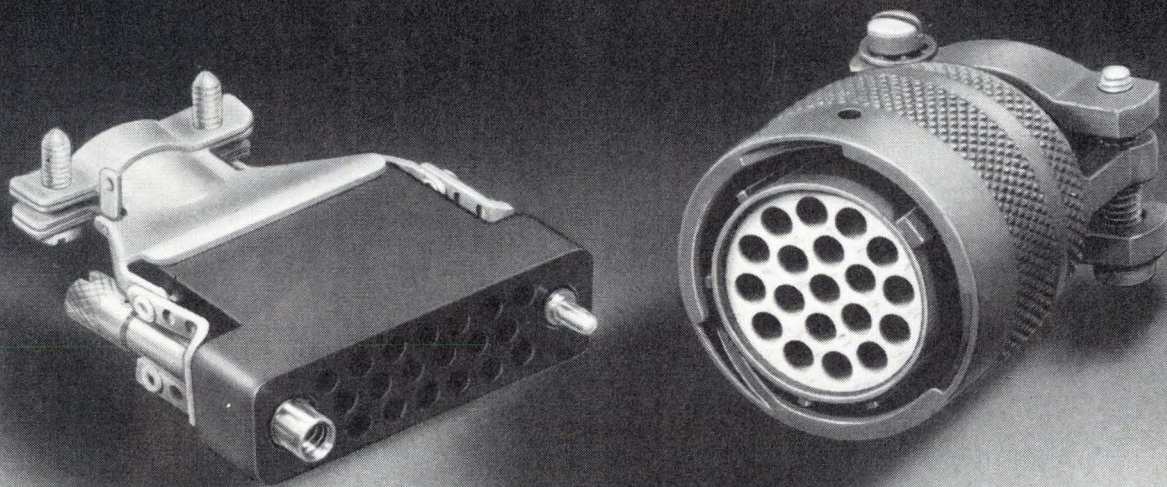

In spite of different designs and different applications, rectangular connectors and miniature round connectors can now use identical Trim Trio contacts. Installed with identical tooling.

You get advantages of standardization where it counts. Think of the reduction in inventory of both parts and tooling. Of the hours saved on operator training. Yet design variations are unlimited and applications cover the spectrum from computers to communications to avionics.

One
contact
system
serves
both.

And the variations increase because—
in the same connector block or shell
—you can intermix submin coax,
mached or strip formed contacts. Which
is what the Trim Trio system is all about.

Burndy installation tooling cuts costs
further. For example, the new Burndy
CATS™ Coaxial Termination System cuts
installation time of submin coax or twisted
pair contacts by 90% over hand installation.

So make things easier for yourself.
Standardize with Trim Trio.

 **BURNDY**
Norwalk, Connecticut 06856



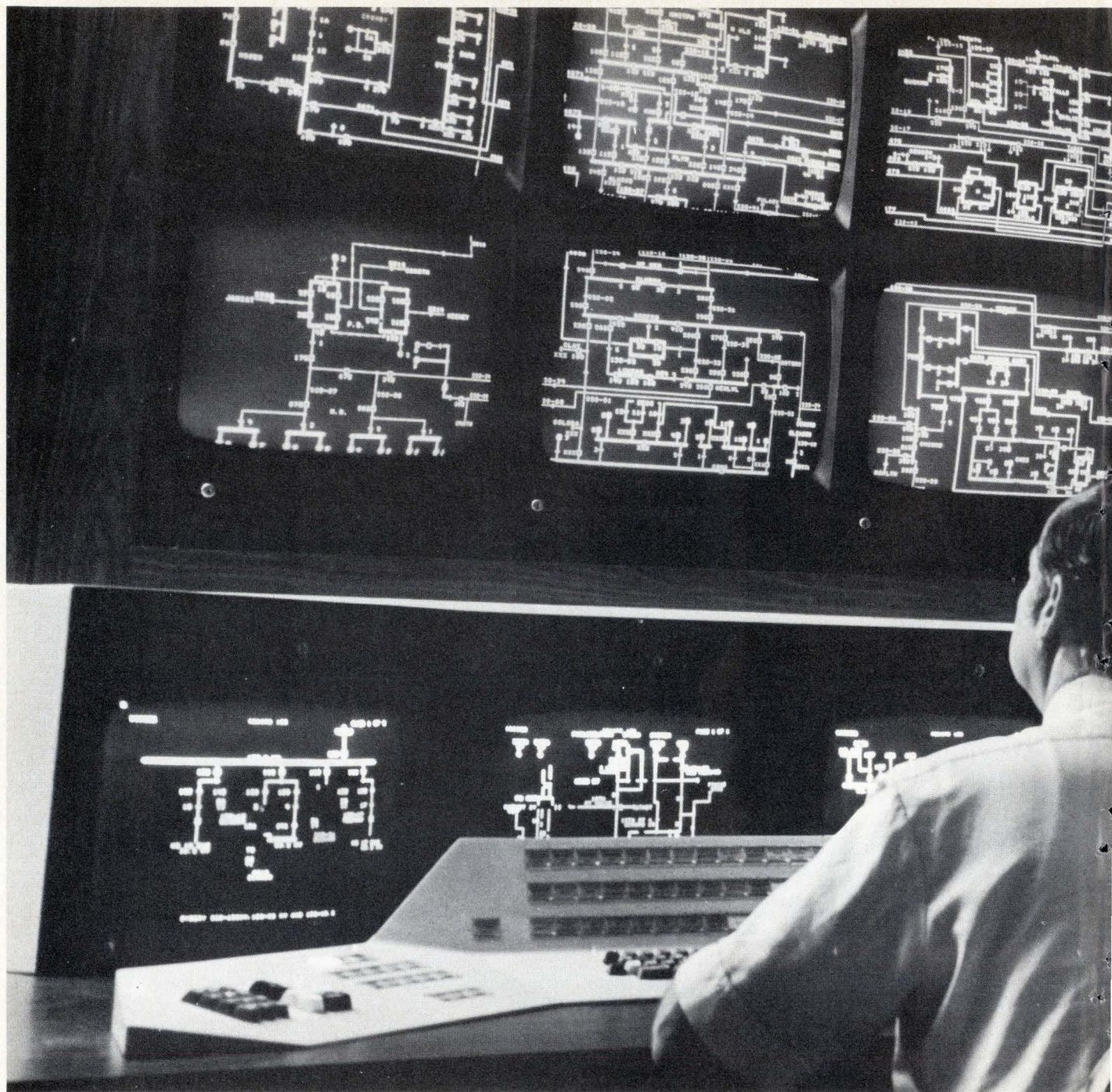

Nobody knows electronics

Strong statement? Maybe. But when it comes to sensing, processing, storing, displaying or transmitting data, nobody can match our experience. Or capabilities. Look at our background in commercial applications alone.

In the utility industry, we're working with the Philadelphia Electric Company to build a complete dispatch control center. (Part of it is shown above.) It will give an operator an instantaneous

look at the entire bulk power complex. Plus projected loads, calculated 15 minutes ahead of time. Automated compensation for actual loads is built right into the system.

We're working with the automotive industry, too. Our Skid-Trol® brake system (complete with onboard mini-computer) electronically monitors and synchronizes wheel deceleration to keep big highway rigs

from jackknifing.

Home entertainment? We're there, too. With the "brain" for an electronic organ. It converts sound waves into digital signals, stores them in memory and recalls them again as sound waves. Beautifully.

You'll also find us in textiles. The computer-controlled knitting machine we helped develop is a good example of our electro-mechanical capabilities.

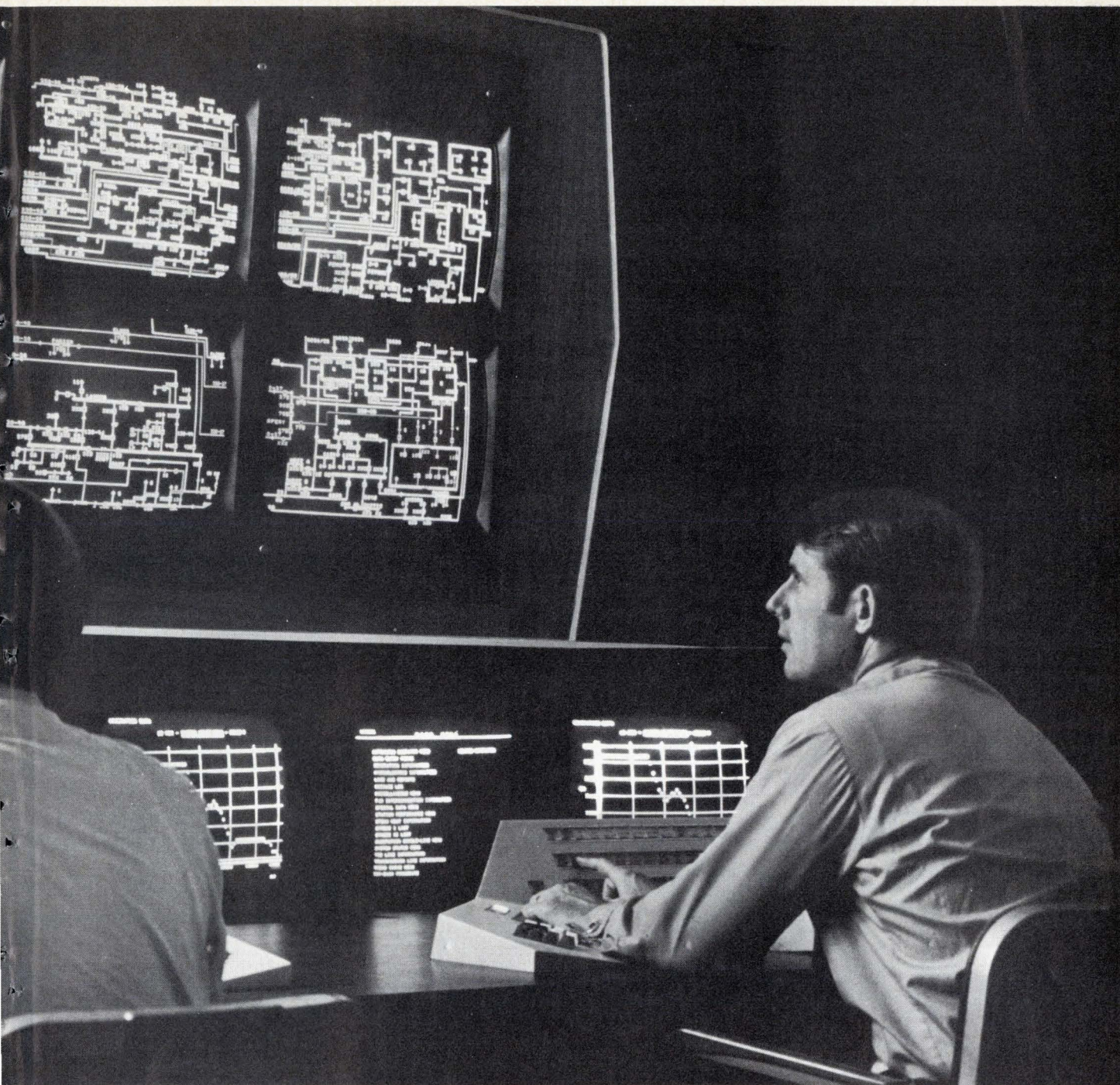

like North American Rockwell.

And of course, we're in business machines. In a big way — we're the world's leading supplier of MOS/LSI devices for electronic calculators.

And that's just the beginning. Electronic cash registers and point-of-sale transaction terminals are a logical next step. We're ready with all the technology that's needed — central processor, liquid crystal displays, output printer, modem communication,

tag readers and even an electronic credit card reader. It reads the embossed numbers on any plastic card and can provide instant credit verification.

There are more examples. Many more. We'd like to tell you all about them. And hear all about

your products and electronic needs. Write us in Anaheim, Calif. 92803. Or phone 714/632-4195.

Nobody can solve your electronic problems like North American Rockwell. We'd like to prove it.



**North American Rockwell
Electronics Group**



PDP-8. PDP-11. For OEM's

A few months ago, we came out with new low cost versions of our PDP-8 and PDP-11 families for the OEM.

With prices as low as \$2436. In quantities of 50.

We made sure they'd have the features, architecture and compatibility that make PDP-11 and PDP-8 the most popular, most imitated minis ever.

We must have hit on the right combination. We've been mixing it up with some of the toughest OEM's around. And coming away with their business.

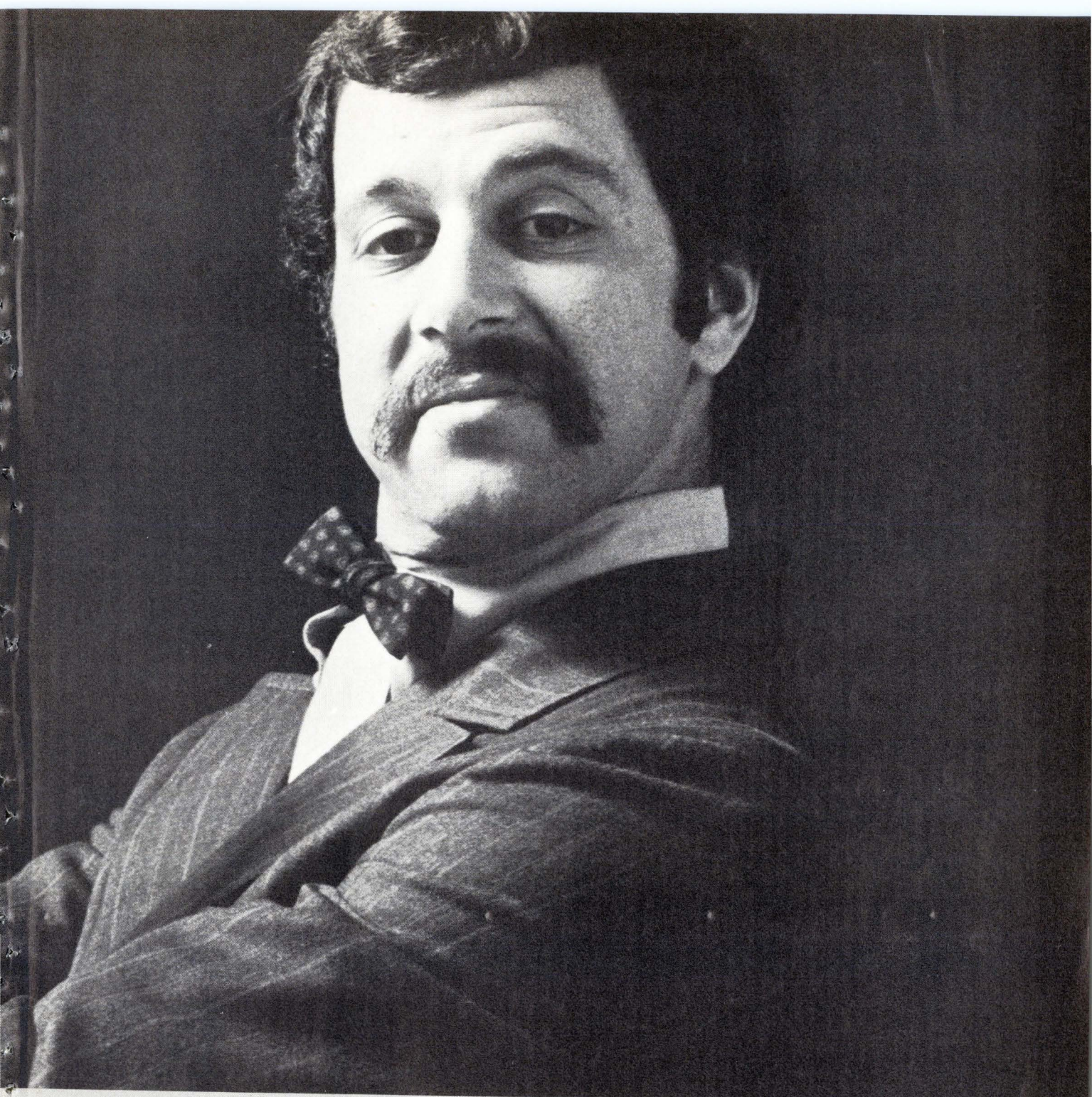

who hate to spend money.

We're after your business, too.
Because now we have the right
computers. At the right prices.
From the right company.
Come and get 'em.

Digital Equipment Corporation,
146 Main Street, Maynard, Mass.
01754. (617) 897-5111.

digital

HOW MANY OP AMPS

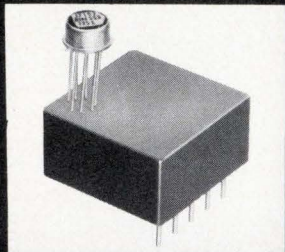

MATCH THESE GUARANTEED SPECS?

- **Vos DRIFT**
0.6 $\mu\text{V}/^\circ\text{C}$ Max.
- **Ios DRIFT**
40 pA/ $^\circ\text{C}$ Max.
- **Vos, 0.5 mV MAX.**
- **INPUT NOISE**
15 nV/ $\sqrt{\text{Hz}}$ Max. @ 10 Hz
(85 nV rms, 0.1 Hz to 10 Hz)
- **GAIN, 1,000,000 Min.**
- **CMRR, 120 dB Min.**
- **\$15.00 @ 250 PIECES**

ONLY ONE!
THE
SSS725EJ
IMMEDIATE DELIVERY
FROM DISTRIBUTOR STOCK

MONO **PRECISION
MONOLITHICS**
INCORPORATED

1500 SPACE PARK DRIVE, SANTA CLARA, CALIFORNIA 95050
TEL. (408) 246-9225 • TWX 910-338-0528 • CABLE MONO

A **BOURNS** Affiliate

People

Wheeler believes it's time
to combine technologies

The usual course of events in the semiconductor industry, and especially in the MOS business, is to "run like hell to develop a new technology, and then run like hell trying to push it down customers' throats." That's how Warren C. Wheeler sees it. And Wheeler, senior vice president and a founder of American Micro-systems Inc., and first president of its recently formed Micro-products division, speaks from experience. He has worked on development of the MOS process, as well as design and application of MOS devices, for the last 12 years—first at Fairchild Camera & Instrument Corp.'s R&D Lab, then at General Microelectronics, now at AMI.

Wheeler says that the time has come "where technology will slip into the background and circuit techniques will come up front." In the past, a new technology might have meant new products or a new market. But, he says, "technology returns are diminishing rapidly."

Use what is here. One way to fill that growing vacuum, Wheeler believes, may be to combine existing technologies. "For example, an 8K random-access memory might be built with an MOS 'core' and bipolar drivers and decoders." While such a product could not be built with today's bipolar or MOS process alone, Wheeler suggests that, instead of trying to invent a new process, designers should apply what exists.

AMI has never pushed a process. While the newcomers were yelling, "Silicon gate is the answer," AMI outshipped them with its standard p-channel devices. Only when a new process had a definite advantage, would AMI put it in production.

Since being named president of the new division, Wheeler says, he has been doing some soul-searching about the future. "When I open a magazine and read that a company plans to put a whole system on a single large MOS chip and sell it for a dollar or two, I feel that I'd rather be in the TTL business. Instead of putting everything on a single chip,



Wheeler: To make a market—but not kill it.

we should be producing smaller functions."

Wheeler points to the extremes of MOS large-scale integration and TTL small-scale integration and says that there is room between them to grow.

"Using an n-channel TTL-compatible MOS process, we can do a very good job in making parallel shift register and multiplier-type circuits—we can replace bipolar medium-scale integration with MOS/MSI and produce a better, less expensive product and still make a good profit." With this approach, Wheeler hopes to avoid doing what he says the semiconductor industry does best—"create a new market and then kill it by driving prices into the ground."

Tarzian sees his people
as part of his family

It isn't difficult to find employees in any large company willing to say nice things about the big boss. But when you talk to the people at Sarnes Tarzian Inc., the television-tuner maker in Bloomington, Ind., the impression is that just about all 1,400 employees think that the 72-year-

Tarzian: Keeping it all in the family.



3146

3146

3146

3146

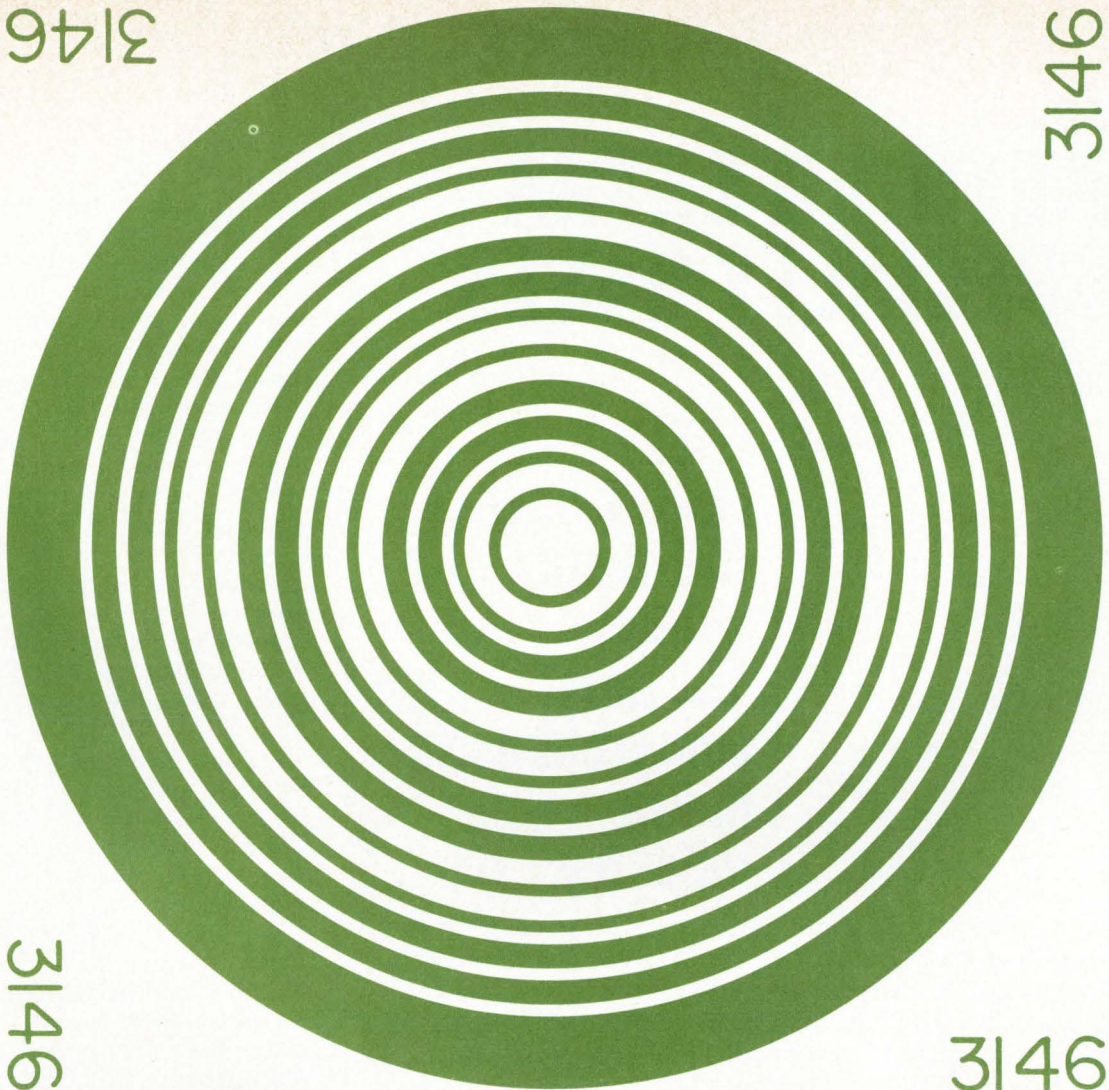

The laser label reader converts the varying reflections from the box label to binary coded pulses. A He-Ne laser is the ideal illumination source because it needs no complex focusing optics. Furthermore, the precise beam is collimated all along its length, making the system largely independent of the box position.

Boxes, boxes, and more boxes. Hundreds of them, zipping along an automated conveyor-belt. In some are motors for air conditioners; in others, hinges for freezer doors, agitators for washing machines, blades for electric carving knives.

Each box is destined for a particular assembly line, and somehow, miraculously, it arrives at the right time, in the right order, with the right parts. Yet no one seems to be keeping track of things; how does it happen?

The secret is a binary coded label on each box, and a laser beam that knows how to read. Regardless of the position of the box or the label, it can't get by the laser scanning station without revealing its identity, contents, and destination to

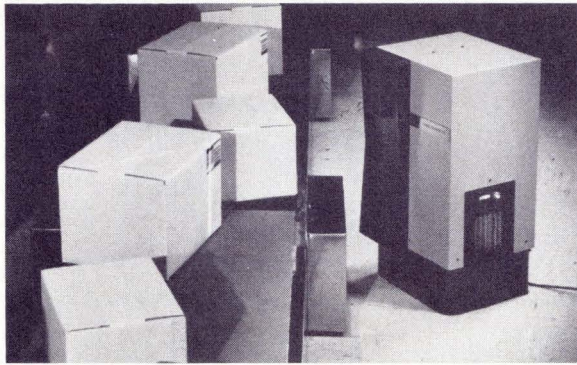

the computer-controlled system. It used to be done with mirrors, and a touchy optical system with an unreliable tungsten light source. And it made mistakes. But the new laser system* stays right on the beam—regardless of variations in ambient light intensity and color—and the only down-time on the assembly lines is over the weekend.

Spectra-Physics OEM lasers are shedding new light on a lot of old problems, in manufacturing, communications, transportation, research, you name it.

Perhaps you have a problem one of our lasers could illuminate. Write the #1 laser people today at 1250 West Middlefield Road, Mountain View, California 94040, 415/961-2550.

*made by Bendix Recognition Systems, Southfield, Michigan

Label-reading Laser helps get it all together



Spectra-Physics

NOW, SOMETHING EXTRA IN SPECIALTY GASES.

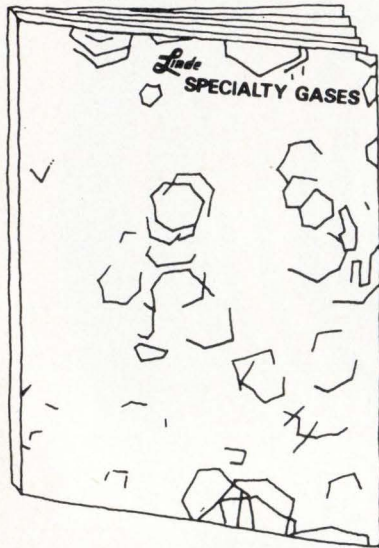

**FREE.
Linde's new
108-page
catalog.
The most
comprehensive
in the
industry.**

Oh sure, we've always made more specialty gases than anyone else.

After all, Linde is a Division of Union Carbide, a corporation that's been making industrial gases for over 50 years.

But for the first time we combined the gases and the equipment and cataloged it all for you. Color-coded the sections, so you quickly get what you want.

And we *supply* what you want quickly too. Five hundred Linde Distributor locations nationwide provide fast service, but we mean really *fast* service. Cost-cutting FOB delivery too, because we have 5 plants across the country.

Linde's product know-how can even help you pinpoint your needs. Not just in specialty gases and types of containers, but in control equipment too.

They're all there in our new catalog. Our little something extra to help make your job easier. Send for your free copy today.



Linde is a registered trademark of Union Carbide Corporation

UNION CARBIDE CORPORATION
LINDE DIVISION, Dept. LB—E
270 Park Avenue
New York, New York 10017

Gentlemen:

Please send me "the something extra" in specialty gases.

NAME _____

TITLE _____

COMPANY _____

ADDRESS _____

CITY _____ STATE _____ ZIP _____

People

old Tarzian himself is the greatest thing that ever happened to them. The question, then, is why?

The answer, says his staff, is that the man thinks of his workers as family—and then treats them that way. Every company has its employee benefits, but to Tarzian those benefits appear to be a way of life. And there's another ingredient. "The main thing about my father," says Thomas Tarzian, a development engineer at the plant, "is he believes in letting people do their own thing. He's canny in hiring and allows autonomy on all levels."

Informality is the rule at the Tarzian plant, which has never been unionized. Tarzian is fond of touring the plant, getting to know his people, and being accessible to all of them. He has not only built a company swimming pool, established recreation programs, and made a policy of paying tuition for continuing job-oriented education, but he moves behind the scenes, too. When a fire wiped out the home of a Tarzian employee not long ago, Tarzian was the "anonymous" donor who contributed the funds to get the family back on its feet.

Pioneer spirit. The senior Tarzian, with a BSEE and an MSEE from the University of Pennsylvania, started out as chief engineer for Atwater Kent Manufacturing Co., and later became chief engineer for RCA, first in Argentina and then in Bloomington. In 1944, Tarzian foresaw the success of television, and began a manufacturing company for what he thought was a set's most important component—the tuner. Since then, the company has grown to include plants in the U.S. and Mexico, as well as television and radio stations in Indiana. Tarzian holds several patents and was instrumental in developing the variable-time fuze while at RCA. The fuze was used during World War II.

But perhaps the truest reading on his personality can be gained from one project that he enjoyed particularly. He was instrumental in bringing a circus to Bloomington—and then got one of the thrills of his life by riding an elephant in the parade.

The Fluke problem solver

The DVM you put together an option at a time, anytime



Because we use single main frame construction with all options field installable, you can configure the Fluke 8200A anyway you want when you buy it or anytime you want to change it. It's Fluke's way of giving you total flexibility for minimum money. It's one of the reasons Fluke has moved to DVM leadership in a scant two years.

Here's what you get for just \$995: 4½ digits with 60% overranging for ±16000 count resolution Auto-ranging and autopolarity on all functions Switched input filter Full 1000 volt guarding ±0.01% accuracy Fluke's unique recirculating remainder* A to D conversion which combines low parts count and low power consumption to provide higher reliability.

To the basic unit you can add: Two ranges of millivolts, giving you autoranging from 1 microvolt resolution up to 1200 volts input Six ranges of ohms measurement, providing autoranging from 10 milliohms to 16 megohms Four ranges of ac volts Four ranges

of true rms ac volts Isolated 4-terminal, real-time ratio measurement.

A real systems DVM too: Speeds up to 400 readings per second with full accuracy after only a 500 micro-second look at the input Isolated and buffered data output for digits, range, functions and polarity—with status flags Isolated remote control for continuous or buffered input commands Isolated and buffered printer output.

Ask for Fluke's 8200A Application Bulletin No. AB-10 for systems designers.

The 8200A's single main frame and field-installed options let you configure the most cost-effective 4½ digit DVM on the market.

To arrange a demonstration or get complete information, call your nearby Fluke Sales Engineer or contact us directly.

*Patent pending

Fluke, Box 7428, Seattle, Washington 98133. Phone: (206) 774-2211. TWX: 910-449-2850/In Europe, address Fluke Nederland (N.V.), P. O. Box 5053, Tilburg, Holland. Phone: (04250) 70130. Telex: 884-52337/In the U. K., address Fluke International Corp., Garnett Close, Watford, WD2, 4TT. Phone: Watford, 33066. Telex: 934583.





Accept No Substitutes!

The New HP Series 9800 is the best programmable calculator system now—and in the foreseeable future. Price. Performance. Simplicity of operation. No matter what criterion you use, there is absolutely no other system on the market that can match the Series 9800.

Only HP Offers You All This For The Low Price Of \$2975

To build your personal desk-top computing system, start with the Series 9800/Model 10 Programmable Calculator. Your basic Model 10 comes with standard equipment that is either not available, or available only as an extra-cost option, on other machines.

If bad experiences have taught you that basic is synonymous with stripped—have no fear. The *basic* Model 10 can perform a complete regression analysis, or solve a system of 10 simultaneous equations.

Only HP Offers You A Fully Modular Calculator

The unique, modular/plug-in architecture of the Model 10 lets you “design” your own problem-solving system. You can expand the memory, add peripherals, or change the keyboard of your existing Model 10, at any time.

Only HP Gives You A Fully Expandable Dual Memory

The Model 10 has a unique dual memory system—one memory for programs and one for data. You can expand from the basic 500 program steps *and* 51 data registers to 2036 program steps *and* 111 data registers.

Beware of simple number comparisons with other calculators. The refinements in the memory design and the keyboard make the Model 10 so efficient that in most cases it requires *fewer steps to execute a given problem.*

Only HP Lets You Design Your Own Keyboard

Interchangeable keyboard plug-in blocks give you a choice of powerful *Statistics* or *Mathematics* functions, complete with their own memories, under single keystroke command. Another option, the *User Definable Function* plug-in, lets *you* customize individual keys with operations uniquely important to *you*.

Only HP Offers An Alphanumeric Printer

By simply inserting the *exclusive HP Alphanumeric Printer Plug-in*, you can automatically generate labels, program instructions, or messages—in English—right on the printer tape.

Only HP Gives You A Wide Choice of Sophisticated Peripherals

The I/O bus of the Model 10 lets you plug-in a Marked Card Reader, Paper Tape Reader, Digitizer, Typewriter, Tape Cassette, or the *exclusive X-Y Plotter* that plots linear, log-log, semi-log, or polar plots, and writes alphanumerics.

Only HP Offers You A Totally New System

The Series 9800 is no paper tiger. It's available now to free you from the drudgery of problem-solving so you can get on with your job of innovative thinking and designing. For more information or a “hands-on demonstration” at your desk, write: Hewlett-Packard, P.O. Box 301, Loveland, Colorado 80537. In Europe: 1217 Meyrin-Geneva Switzerland.

CO91/S

HEWLETT  PACKARD

CALCULATOR PRODUCTS

DIRECTIONS MOS

Putting MOS Circuits To Work

Practical Interface Methods Underlie Burgeoning Success

MOS usage is mushrooming, and the long run usefulness of the various MOS technologies depends strongly on their abilities to interface with each other and with bipolar circuitry. In some cases complete systems will be built exclusively with MOS techniques. More typically, MOS devices will be used for those portions of a system where low power and/or high density are required. In very large systems particularly, the predominant high-speed portions are likely to be implemented with faster MECL or TTL logic, with lower speed storage functions being assigned to MOS memory devices. Interface problems, therefore, take on considerable importance.

Interfacing between different MOS and bipolar circuits varies in complexity. Some low-threshold MOS processing permits MOS and bipolar devices to coexist without any special supplementary circuits. With others (as with some dynamic shift registers) a combination of clock drivers and voltage-level translators is the price of effecting a compatible union.

Two following device discussions represent the extremes of MOS-bipolar circuitry interface requirements. The high threshold, metal-gate, static register demands level translation at the input and output, as well as clock generation. Comparatively, the low-threshold silicon-gate dynamic circuit requires only clock generation. Somewhere between lie most of the possible interfacing combinations.

Interfacing with High-Threshold MOS

The MC1160G dual 100-bit static shift register is a high-threshold device with the negative logic 1 level specified as at least 9 volts below V_{SS} . The clock input voltage is specified as at least 25 volts below V_{SS} . This high clock pulse amplitude is used to achieve the maximum circuit speed.

In a typical interface application, where the shift register is driven with bipolar logic, the required high operating voltages are achieved by setting V_{SS} at +14 V, V_{DD} at ground, and V_{GG} at -14 V. This allows the use of high-voltage, open-collector DTL or TTL gates as input voltage-level translators. In a typical system of this type, the 5-volt signal levels of conventional DTL and TTL integrated circuits are converted into the necessary high-voltage drive signal for the high-threshold MOS shift register by means of an interface inverter. In turn, a line receiver or resistor divider converts the high-voltage output of the shift register to the 5-volt logic range of DTL and TTL designs.

To obtain the 25-volt (or higher) clock signals, $\phi 1$ and $\phi 2$, the clock drivers are required to swing from +14 volts to -14 volts. Any non-overlapping clock generation scheme which assures a clock OFF time of greater than 10 ns but less than 10 μ s is suitable.

Interfacing with Low-Threshold MOS

The MC2380 is a "bipolar compatible" silicon gate dynamic shift register similar in size to the MC1160. The threshold voltage is low enough so that the same operating and signal levels can be used as with bipolar saturating logic. A pull-up resistor should be used with the TTL gate driving the shift register input to insure that the totem pole output of the TTL circuit will be pulled above the MOS threshold level.

The output transistor of the MC2380 shift register is an open drain device, tied to V_{SS} , with sufficient drive capability to interface directly with one TTL load.

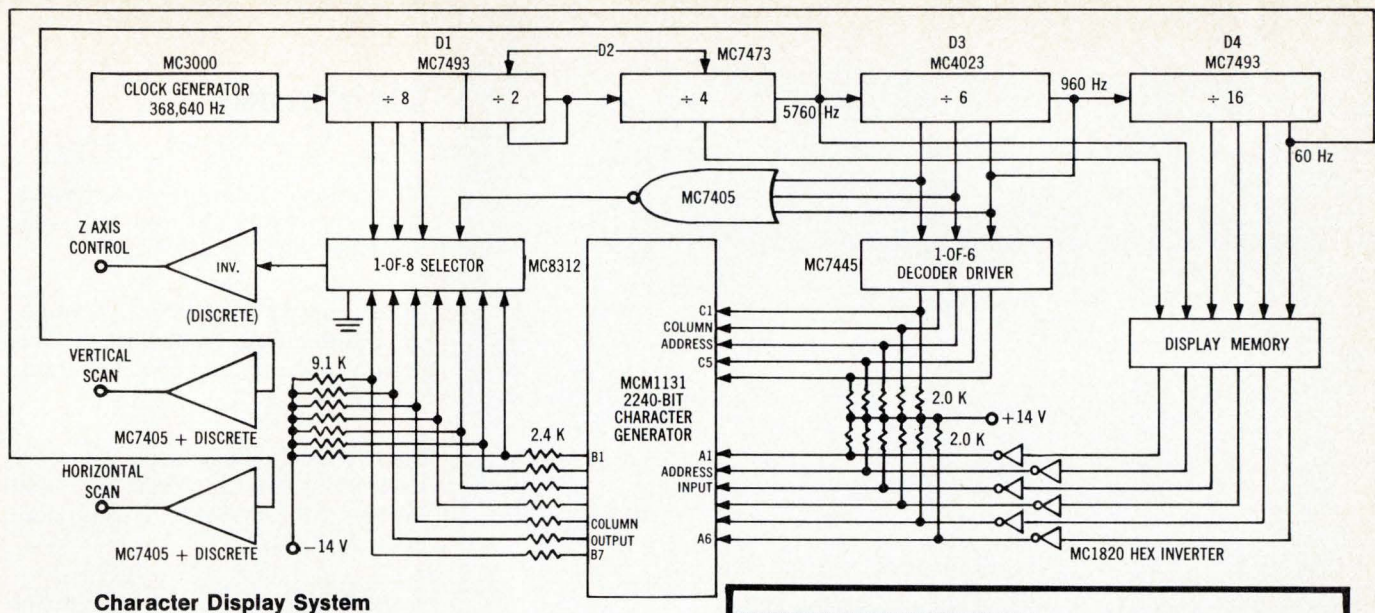

Character Display System

MOS Memories

The unique attributes of the MOS technology lend themselves ideally to semiconductor memories. One of the first major uses of MOS in this category has been in read-only memories (ROMs), which have become available as off-the-shelf products in impressive numbers. Interesting examples of these are the standard Motorola MCM1131 column-select and the MCM1121 row-select 5 x 7 USASCII character generators.

A character generator generates the voltage patterns (of "1's" and "0's") needed to form numbers, letters and symbols to be displayed in a 5 x 7 dot matrix on cathode-ray tubes or 5 x 7 LED arrays. Each of the specific patterns for 64 different characters is stored at specific addresses in a 2240-bit ROM with each character occupying a 35-bit matrix in the memory. When the 6-bit address code associated with a particular character is applied to the six address lines (the 6 bits define 64 USASCII characters) it is decoded by an address decoder that selects the associated 5 x 7 matrix in the memory. Then, when one of the five columns of that matrix (in the "column select" version) is energized, a "word" of seven parallel bits corresponding to that particular column appears at the output. The five columns of the matrix are sequentially energized to provide a five-word sequence of seven parallel bits per word for each character selected by the address inputs.

The Interfacing

Of the various circuits used in the illustrated display system, only the character generator itself is an MOS device. All the others are either TTL or DTL circuits. Voltage-level translation is required at the interface points.

In this system, the first interface requirement is between the character generator, with its zero-to-14 volt output swing, and the 1-of-8 selector with its zero-to-5 volt input requirement. To simplify interfacing, the generator outputs are open drain FETs that permit the use of external pull-down (load) resistors. The pull-down resistor at each output is a pair of series-connected resistors going to the -14 V supply. The inputs of the TTL 1-of-8 selector are connected to the junctions of these series resistors.

The simplified schematic of this arrangement is shown for both MOS to TTL and TTL to MOS interface. In opera-

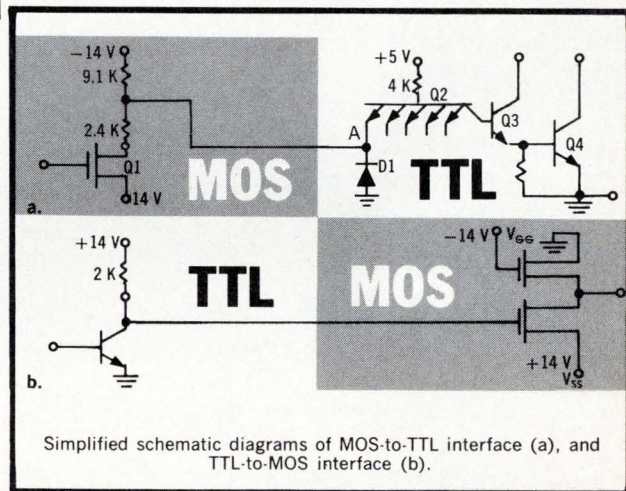

Simplified schematic diagrams of MOS-to-TTL interface (a), and TTL-to-MOS interface (b).

tion, when Q1 is cut off, a negative voltage appears at point A. This causes diode D1 to conduct and clamps the voltage applied to the emitter of the TTL input circuit to one diode drop, or -0.7 V. This is recognized by the TTL gate as a "zero" which defines a space, or "no dot." If the input to Q1 is negative, the FET is turned on. The voltage at A, therefore, increases to a positive (+) value between 2.5 volts and 4 volts, above the TTL input threshold.

The point is, however, that the high-voltage signal at the output of the FET has been translated to the reduced voltage swing needed at the input of the TTL circuit. The COLUMN SELECT inputs to the character generator likewise need level translation — from the low TTL output voltages to the relatively high drive voltages needed by the MOS circuit. This is achieved by the high voltage open collector DTL and TTL circuits mentioned earlier.

This concludes a series designed to present a realistic, objective analysis of MOS technology in a dynamic, competitive industry. Of necessity it is superficial. For a more complete insight to this broad subject, and the scope of Motorola's involvement, circle the reader service number or write to Motorola Semiconductor Products Inc., P.O. Box 20912, Phoenix, AZ 85036.

 **MOTOROLA MOS**
-Directions in digital designs

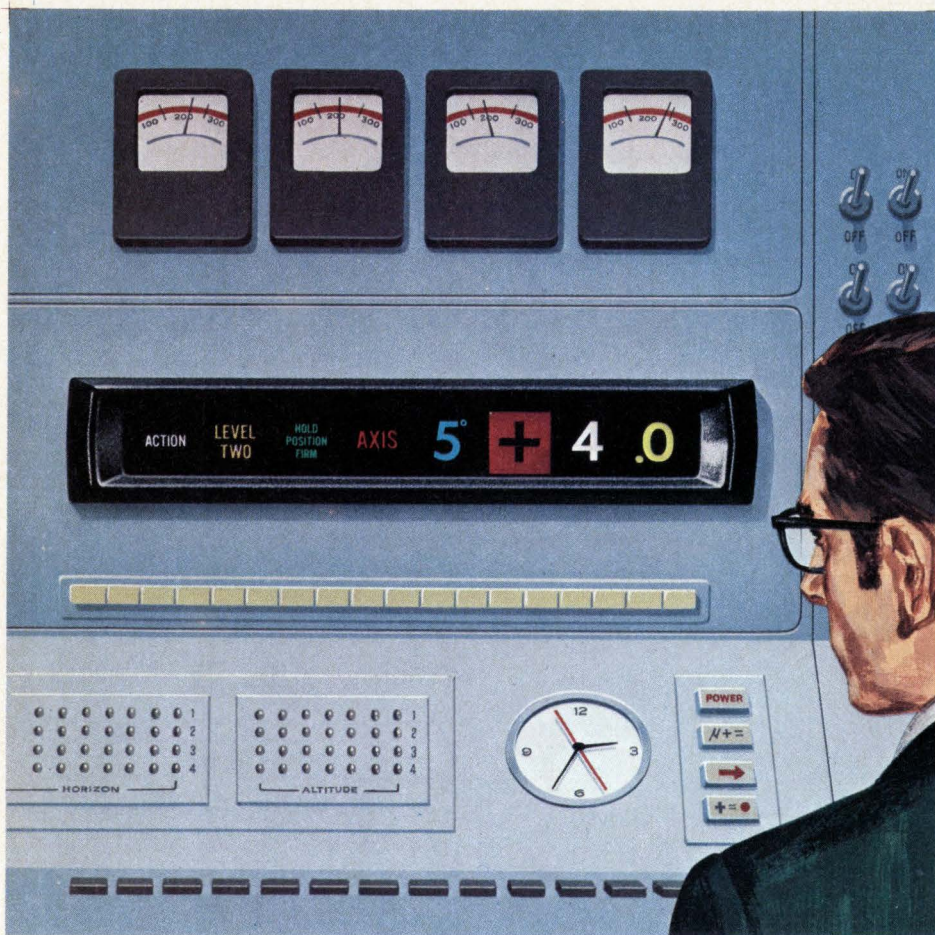

There's more to us
than meets the eye!

and it comes in one package, ready to plug in.

Providing the most versatile, eye appealing displays is our main endeavor—but our concern doesn't end there... not by a long shot. We look beyond to the point of application and how we can save you hours of engineering design time and multi-vendor selection procedures. For instance, we can deliver the complete display package (readouts, drive electronics, switches, bezels, mounting hardware, etc.) ready to

plug in at a price that lets you forget about the preliminaries. Typical, are complete assemblies, from low cost commercial equipment, all the way up to complex RFI/safe military systems. It's a total package concept that makes sense in many ways. Give us a call. IEE,



"the plug-in people." Industrial Electronic Engineers, Inc., 7740 Lemona Avenue, Van Nuys, Calif. 91405. Telephone: (213) 787-0311 • TWX 910-495-1707.

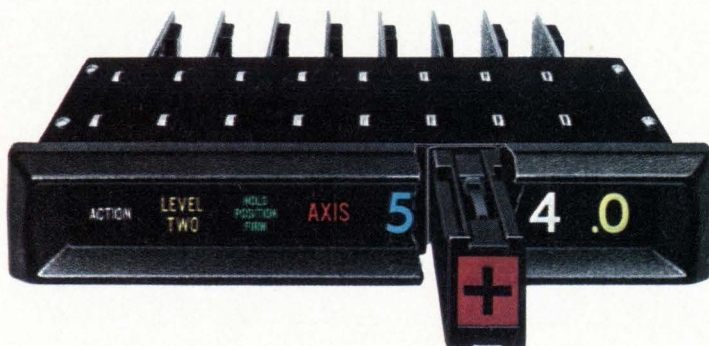

Meetings

International Convention & Exhibition: IEEE, Coliseum and N.Y. Hilton, New York, March 20-23.

International Electronic Components Exhibition: FNIE, Parc des Expositions, Porte de Versailles, Paris, April 6-11.

International Geoscience Electronics Symposium: IEEE, Marriott Twin Bridges Motor Hotel, Washington, D.C., April 9-14.

International Conf. on Magnetics (INTERMAG): IEE, Kyoto International Conference Hall, Kyoto, Japan, April 19-21.

International Symposium on Circuit Theory: IEEE, Sheraton-University Hotel, Universal City, Calif., April 19-21.

Southwestern IEEE Conf. & Exhibition (SWIEEEO): IEEE, Baker Hotel & Dallas Mem. Aud., Dallas, Texas, April 19-21.

Conf. on Computer Aided Design: IEEE, IEE, University of Southampton, Southampton, England, April 25-28.

National Telemetry Conf.: IEEE, Houston Shamrock Hilton Hotel, Houston, Texas, May 1-5.

Electrochemical Society Spring Meeting: Electrochem. Soc., Shamrock Hilton, Houston, Texas, May 5-12.

Quantum Electronics: IEEE, AIP, OSA, APA, Queen Elizabeth Hotel, Montreal, Canada, May 7-11.

International Semiconductor Power Converter Conf.: IEEE, Baltimore Hilton Hotel, Baltimore, Md., May 7-10.

Spring Joint Computer Conf.: IEEE, Convention Center, Atlantic City, N.J., May 15-18.

Aerospace Electronics Conf.: IEEE, Sheraton Dayton Hotel, Dayton, Ohio, May 15-17.

Do you recognize these famous No. 2's?

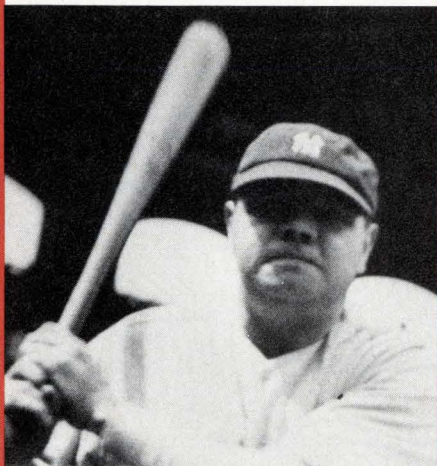

Babe Ruth was No. 1
for single season home runs for 41 years
... then along came Roger Maris.

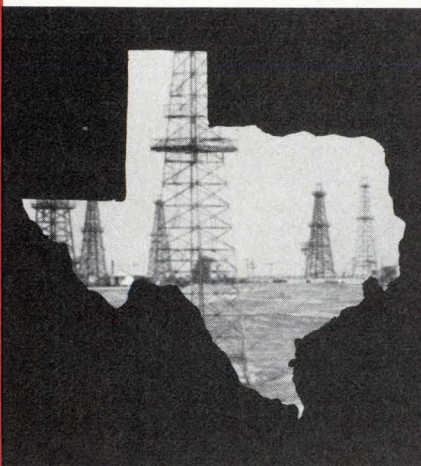

Texas was No. 1
in size for 114 distinguished years ...
then along came Alaska.

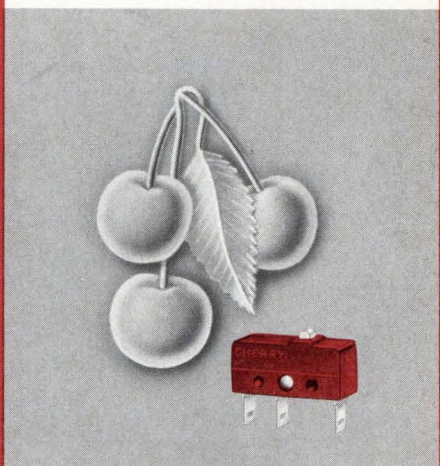

Cherry is No. 2
in the manufacture of precision snap-
action switches. So far.
But remember Roger Maris. And Alaska.

Second place is a far cry from second best. Just ask any Texan. Or, better yet, ask any Cherry customer. There are thousands of them: Savvy, demanding pros who have specified and used 160 million Cherry snap-action switches. Perfectionists who would never settle for anything less than No. 1 quality ... first class dependability ... second-to-none selection ... can't-be-beat delivery and price.

Free: 2 from No. 2. Send for (1) a free sample switch and (2) a complete, 44-page Cherry switch Catalog. You'll see why Cherry has become the 2nd largest supplier of precision snap-action switches. (And why we look to Roger Maris and Alaska for inspiration.)

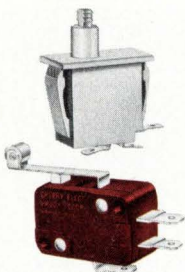

CHERRY

CHERRY ELECTRICAL PRODUCTS CORP.

3608 Sunset Avenue, Waukegan, Illinois 60085



Makers of patented Leverwheel/Thumbwheel Switches, Matrix Selector Switches, Snap-Action Switches and Keyboards.

The CIP/2200 is the newest, most powerful Cincinnati Milacron minicomputer to date. It is a microprogrammable general purpose minicomputer with an amazing list of new features. The CIP/2200 performs decimal arithmetic just like the big computers for handling business data, while retaining all the benefits of

a mini. In addition, the CIP/2200 exercises its new power with such features as RPG compiler, variable length operations, control stack facility for automatic state switching, bi-directional string moves, bit manipulation instructions, translation under mask and editing, plus a user instruction capability.

All these advantages and many more are available right now from Cincinnati Milacron's new, more powerful CIP/2200. Write or call (513) 494-5444, now, for complete details to: MINICOMPUTERS, Process Controls Division, Cincinnati Milacron Lebanon, Ohio 45036.

this year, there's something really new in minicomputers ...Cincinnati Milacron's CIP/2200

CIP/2200 is brand new. It performs functions that heretofore could be done only by larger computers. See copy above.



minicomputers



**CINCINNATI
MILACRON**

Machine Tools
Process Controls
Chemicals
Plastics
Plastics Processing Machinery
Abrasives

Electronics Newsletter

February 14, 1972

Motorola shuffle puts Connors atop semiconductor div.

Motorola Inc. has realigned some of its top management in a surprise move that one insider describes as "a broadening at the top to anticipate future growth." **Probably the biggest surprise is that Stephen L. Levy has been succeeded as vice president and general manager of the Semiconductor Products division in Phoenix by Thomas J. Connors**, who had been corporate vice president for marketing. Connors earlier was marketing manager for the semiconductor products division, and once worked for Texas Instruments. He had a consuming desire while marketing manager in Phoenix to surpass TI in semiconductor sales, and will bring that hard-nosed spirit to his new post.

Levy maintains his corporate vice presidency, **and becomes head of new ventures at the corporate level, working from corporate offices in Scottsdale, Ariz.** In the newly created spot, he'll be responsible for "various research, business opportunity, and acquisition explorations," plus special marketing units.

The corporate-wide realignment created ripples from Phoenix to Chicago. J. Paul Jones, formerly vice president and general manager of the Government Electronics division in Scottsdale, is the new director of corporate staff, and has been succeeded by Ralph W. Elsner, vice president and assistant general manager at the division. Further, another new post—vice president and general manager of all corporate equipment divisions—will be filled by Homer L. Marrs, formerly vice president and general manager of the Communications division in Chicago. He'll have responsibility for automotive, consumer, and communications products, plus the Government Electronics division.

H-P to use distributors for its components

Hewlett-Packard is believed about to market some of its component products through distributors. Traditionally, the company sells through its own sales staff, but while this approach works well for instruments selling for hundreds of thousands of dollars, **it has not worked quite so well for components, such as light-emitting diodes or microwave transistors, selling for \$10 to \$50.** There are many potential customers for, say, LEDs that H-P's sales force doesn't reach, making distributors look to be a better bet. Talks are now believed to be under way with most of the leading distributors.

IEEE constitution may be up for amendment again

Changing the IEEE constitution via petition of members is in the wind again. Victor Galindo of Virginia Polytechnic Institute, who spearheaded an unsuccessful amendment that would have turned the institute toward a career-oriented organization, says that **there will probably be another attempt to revive his controversial proposals and put them to another vote.** The last vote lost because a constitutional amendment requires a two-thirds majority.

Japanese may buy American to fill ATC needs

In a crash program to upgrade their air traffic control system, the Japanese are expected to begin buying an American system—"not copy it, but buy it," emphasizes Federal Aviation Administration head John H. Shaffer. The pressure, he says, stems from last year's disastrous collision between a Japanese F-86 military jet and a 727 jetliner, an event which almost caused the government to fall. **With no modern ATC equipment and no time to develop it, the nation will have to use sophisticated American hardware**, Shaffer points out.

Initial purchases probably will be small, perhaps three or four automated radar systems like ARTS (automated radar terminal system), but larger buys may be in the offing, say industry sources. **A Japanese team recently inspected FAA ATC centers** in Jacksonville, Fla., Chicago, and near Atlantic City, N.J.

Electronics Newsletter

The team, which reportedly also talked with some companies, will study a list of FAA system recommendations before coming back to talk with companies in earnest, says the FAA. **But it's unclear whether the Japanese will negotiate with manufacturers directly or ask the FAA to procure the systems for them and perhaps get a break in price.**

Ubiquitous '10-4' to go digital

Motorola is introducing a mobile communications concept allowing transmission of standard messages simply by pressing buttons. For example, a simple police message such as "10-4," which acknowledges receipt of a transmission, would be sent digitally from police cars. **The technique promises to do much to save operator time and significantly reduce traffic on the already overcrowded frequency spectrum.**

Other components in the system allow automatic vehicle location with no action required by the operator.

Motorola's Communications and Electronics division in Schaumburg, Ill., will aim its new command and control system at police, fire, and other public safety agencies, as well as industrial and commercial users.

Spectroscopy sees NO₂ and SO₂ levels

A Canadian firm, Berringer Research Ltd., Toronto, has developed what it calls **"the first commercial system based on spectroscopy capable of ground-level area surveillance of nitrogen dioxide and sulfur dioxide."** Berringer's system uses a modulated xenon arc as the active source.

What's more, the technique can be extended further into the ultraviolet range to monitor ozone, says A.J. Moffat, director of product engineering, research, and instrumentation. And, with suitable infrared sources and detectors, the Berringer method **could measure the infrared absorption lines resulting from auto exhaust pollution,** Moffat adds.

In yet another approach to measuring NO₂ levels, the Aerospace Corp., El Segundo, Calif., has developed a laser technique that takes advantage of the compound's broad absorption band [see p. 38].

Pentagon to study weapon reliance on foreign parts

American component manufacturers now fulfilling defense contracts with devices manufactured offshore will be the subject of a new Defense Department study this year. Headed by Adm. Eli T. Reich's Office of Production and Engineering, the effort is part of a program to determine how dependent the U.S. has become on foreign supply sources for components of its major weapons systems.

The decision to conduct the vertical analysis in-house came after funds for a study by the Logistics Management Institute were cut from last year's defense budget. **At the moment, DOD estimates that 2% of the dollar value of its weapons consists of foreign-made parts.**

Addenda

NASA could issue requests for proposals as early as this summer for the \$50 million Tiros N weather satellite program—the agency's only new start in the FY 1973 budget—if it decides to go directly into design and development and not take time with an engineering phase. Now under study, the advanced meteorological satellite is scheduled for a 1976 launch. . . . Computer manufacturers will find **a wide-open market for a national computerized stock information network** following the Securities and Exchange Commission's new policy calling for a single securities market system. The SEC's expected rulemaking will spell out system performance standards but not hardware specifications.

New 'fair-trade' committee draws cheers and boos

Japan EIA sees disguised protectionism as consumer electronics group prepares for first general meeting

It's hardly a month old, but the Electronic Industry Committee for Fair International Trade has already attracted its first partisans in the consumer electronics industry and its first blast of criticism. But more important to the committee and its five charter members, its first meeting in Washington later this month is expected to draw some 40 or 50 component suppliers and consumer product manufacturers.

Word of the committee's objectives—to level off trade barriers which discriminate against U.S.-made products overseas [*Electronics*, Jan. 31, p. 39]—had hardly circulated in the industry when the Electronic Industries Association of Japan (EIA-J) challenged the motives and the statistics of the group. EIA-J called the U.S. committee a smoke-screen to hide protectionism in talk of fair trade.

The energetic, 77-year-old chairman of EIC, Robert D. Murphy, denies that the group favors protectionism. "America tried it back in the '30s," the former U.S. diplomat counters, "and it failed. We're going to avoid that cowpath this time."

Friends. Murphy, honorary board chairman of Corning International Corp., has numerous contacts in Washington and in industry that will help the group reach its objectives, but he admits that the job is going to be tough. Other charter members are Robert H. Platt, presi-

dent of Magnavox Co.; Joseph S. Wright, chairman of Zenith Radio Corp.; Amory Houghton Jr., chairman of Corning Glass Works; George E. Ritter, president of Stackpole Carbon Co.; and Merle W. Kremer, president of GTEsylvania, Inc.

Where does this leave America's Electronic Industries Association? That trade group's attitude apparently is one of quiet helpfulness for its potential ally—or rival. In fact, the EIA provided early statistical help for the new organization.

Murphy feels that the need is ripe for his organization. Since the EIA was unable to agree last year on a "white paper" concerning foreign trade, in part due to dissatisfaction from the EIA's Consumer Electronics group, the new fair-trade committee has been careful to provide a broad enough set of goals to please both component firms and OEMs with off-shore facilities. EIC even plans to get

together with union leaders on trade issues and with Japanese firms on investing in U.S.-based plants.

The intention is to restrict membership to top officers as the best strategy for getting the ear of officials in the State, Commerce, and Justice Departments, and on the White House staff. Approaches will also be made to Congress. Total membership of 70 to 80 companies is expected by Murphy.

Eye on Japan. After the organizational meeting, the first task for the committee will be to develop specific examples of the subtle and not-so-subtle restrictions and roadblocks American manufacturers have hit in trying to sell consumer products abroad. The primary focus will be Japan. However, Murphy denies that the intention is to persuade the U.S. Government to throw up retaliatory barriers.

"We're in a struggle for survival, but you can't expect a bureaucrat in

Trader. Ex-diplomat Robert D. Murphy, head of the new fair-trade committee, denies his group is protectionist. "America tried it and failed. We're going to avoid that cowpath."



Washington to take the initiative to help if the industry is mute," says Murphy. "I consider our success will be doing what we can to eliminate obstacles to U.S. imports abroad. We don't intend to be a self-perpetuating group if we can help it."

Pointing to the fact that Corning's television business did not grow in 1971, despite a healthy increase in TV receiver sales, Murphy adds, "I don't see much chance of recouping what's lost to foreign competition. We want to hold what we have, if possible."

Though no one has raised the point yet, the organization of this group holds potential antitrust implications. But Herbert Brownell, legal counsel and a former U.S. attorney general, has assured the group that if it keeps the Government informed of its activities legal questions should not arise.

Military electronics

Weapon woes overshadow Navy's first S-3A flight

Less than a month after the first flight of its S-3A Viking carrier-based sub hunter, the Navy finds itself lodged between a rock and a hard place on the Lockheed Aircraft Corp. program. The rock is the Naval Air Systems Command (Navair) \$627.6 million request to move into its first big production purchase of 42 of the planes from Lockheed in fiscal 1973; the hard place is the performance problem facing the direction-finding and ranging (Difar) detection system, a key antisub weapon in the aircraft.

Part of Navair's 20-piece advanced ASW avionics package (known as A-NEW), the troublesome Difar components include the SSQ-53 passive sonobuoy and its associated airborne processor, the FP-3 version of the AQA-7, both made by Sanders Associates Inc., Nashua, N.H. Pentagon project monitors maintain they are satisfied with the on-time performance of Lockheed's plane thus far, but that they are disturbed with continuing problems

Dicass gaining?

Navy problems with the Sanders Difar sonobuoy performance and the comparatively high costs—about \$450 each vs roughly \$100 for earlier, simpler systems—is increasing speculation that the service may accelerate its development of a series of buoys under its Dicass (directional command activated sonobuoy systems) antisubmarine warfare program. Raytheon Corp. of Lexington, Mass., as well as Difar supplier Sparton Electronics, are leading Dicass contenders. The Navy reportedly wants to escalate its current \$5 million-a-year R&D effort.

with the Difar package after three years in production and six years of development. Of particular concern is the Sanders processor, an advanced version of the unit made by Magnavox Corp., Fort Wayne, Ind., now aboard the Viking's land-based counterpart, the P-3C Orion.

Rejections. Even though the miniaturized sonobuoy is produced by Magnavox and Sparton Corp., Jackson, Mich., as well as by Sanders, Navy officials contend it has been Sanders' comparatively higher rejection rate of sonobuoys that is delaying the program. Moreover, these sources say, Sanders "apparently promised more than it could deliver" with the airborne processor in order to win the contract for that part of the package. The official Navy position is the problems came "in the transition from laboratory production equipment to production line assembly" of the sonobuoy. Sanders buoy contract reportedly has been reduced because 1971 production of about 15,000 buoys yielded only about 1,800 that passed Navy tests. Sanders officials refused to comment.

As for the Sanders FP-3 processor, the Navy now says "the original goal of 300 hours mean-time-between-failures was not realistic in view of the state of the art of microcircuitry at the time of Difar development" in 1966-68. "At present, the average reliability experienced

is approaching 100 hours MTBF."

This permits the P-3C, with two processors, "a 98% probability of completing a 10-hour mission without a critical Difar system failure"—although partial failures are not ruled out. However, the Navair S-3A project office says the Viking's single processor has shown a 95% probability of completing a six-hour mission without critical failure according to laboratory tests. Total system tests against real submerged targets will not come until late this year on the third plane scheduled for July delivery with full avionics.

Red ink? Of the aircraft's economics, the S-3A project manager, Navair's Capt. Fred Baughman, confirms that Lockheed's chances of profitability on the fixed-price contract for the first 55 production models are very slim "unless the economy cools off substantially" over the next two years.

This worries the Navy, which plans to push ahead with its requirement for 136 more planes in 1975 and 1976 to fully equip the fleet, since it raises the specter that the S-3A price could jump in years ahead when a new production contract must be negotiated for the rest.

The Navy's new budget request specifies 42 planes at \$581.1 million plus \$46.5 million more for initial spares, or just under \$15 million per plane. The total is up sharply from this year's \$346.6 million plus \$26 million for spares for a limited first production purchase of 13 planes.

Computers

The NCR-CDC deal: adding up strengths

"At least the Control Data-National Cash Register agreement is different," remarks one marketing man about his rival computer manufacturers. "GE sold its computer operation, and RCA simply closed the doors. NCR and CDC, on the other hand, seem to be planning to stay in the business."

That's exactly what they plan. The deal between the two to cooper-

ate on a broad program to "expand each company's future role" in the general-purpose computer industry is intended to capitalize on their respective strengths while minimizing their weaknesses. And although most industry observers are unsure about the short-term effect of the new working arrangement (see box on p. 36), there is little doubt that both companies will increase their strength in the marketplace.

The two chief executives involved, William C. Norris, chairman and president of CDC, and R. Stanley Laing, president of NCR, point out that the broad and compatible product line that they plan is a prime requirement for success in the general-purpose field. In addition, the two companies expect to be able to reduce costs of computer and peripheral development and engineering, as well as software.

In analyzing the agreement, many

observers foresee immediate advantages for CDC, which is generally believed to be the technological brains of the new association. CDC, which had been supplying NCR all of its tape and some of its card equipment, will pick up more of NCR's OEM peripheral business. It will also get NCR's printers—for which it had been an important customer—on more favorable terms.

At the same time, CDC, whose success has been largely in large-scale scientific and communications systems, seems to be admitting its inability to compete favorably in the business-data processing world. Association with NCR—conceded to have the marketing savvy in this area—should prove valuable.

As to which company instigated the agreement talks, both maintain that negotiations "gradually came about" as a result of the long association the two companies enjoyed in

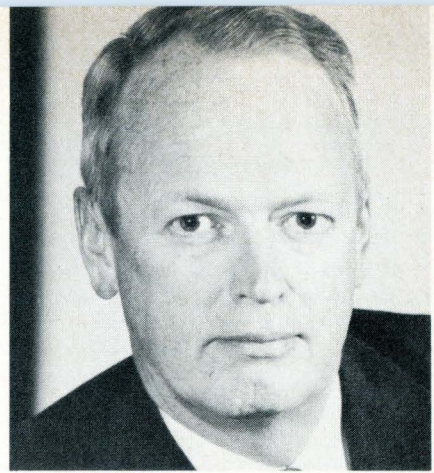

Laing: Were NCR resources too thin?

the peripheral equipment business. However, the consensus in the industry is that NCR may have been the more anxious.

The cost of developing both peripherals and mainframes may have pressed NCR too heavily. Some observers believe NCR is not doing as well as expected in the retailing field, where its cash registers had for so many years produced a major part of its income.

Now, as the new generation of

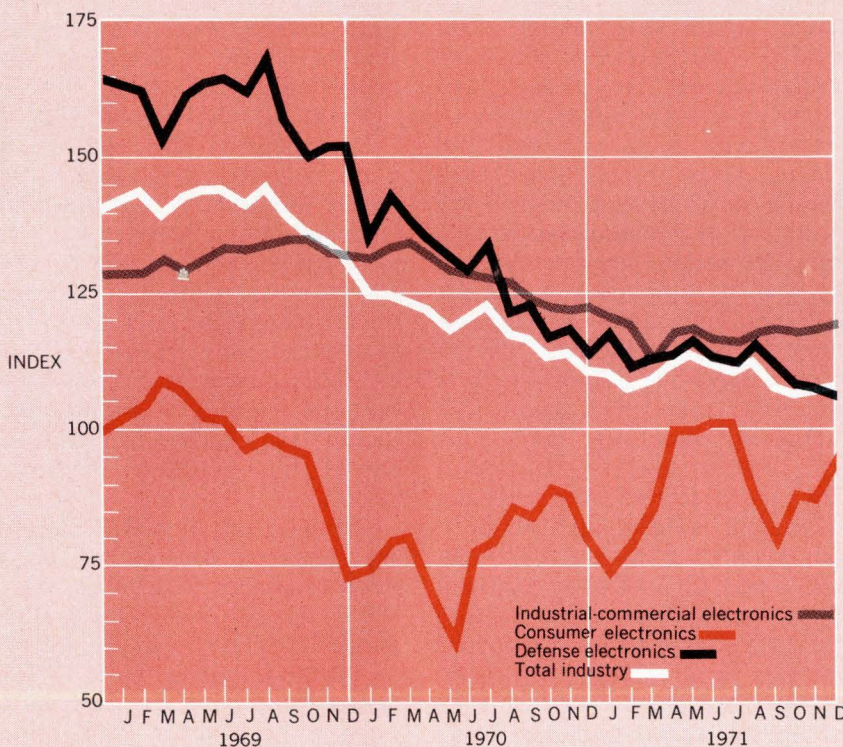

Electronics Index of Activity

Feb. 14, 1972

The total index rose 0.8% in December, the fourth straight monthly increase. However, the figure still was 4.4% below the December 1970 result.

By far the largest increase during the last month of 1971 was in consumer electronics, which soared to almost 9% over its November level and 7% better than its year-ago total. Industrial-commercial electronics rose 0.8%, still off 3% on the year, while defense electronics was the only loser—off 1.3% from November, and down 8.8% from December 1970.

Segment of Industry	Dec. '71	Nov. '71*	Dec. '70
Consumer electronics	95.4	87.6	89.2
Defense electronics	106.2	107.6	116.4
Industrial-commercial electronics	119.3	118.4	123.0
Total industry	108.4	107.5	113.4

Indexes chart pace of production volume for total industry and each segment. The base period, equal to 100, is the average of 1965 monthly output for each of the three parts of the industry. Index numbers are expressed as a percentage of the base period. Data is seasonally adjusted.

* Revised.

point-of-sale terminals is being introduced, NCR seems to be slipping. Companies new to the retailing field—such as Pitney-Bowes Alplex, Friden division of Singer Co., Transaction Systems Inc., and American Regitel—are attracting the attention of retailers and forcing NCR to relinquish its grip on what generally has been estimated to be more than 70% of the market.

Shrinking share? Richard P. Shaffer, a systems consultant to the retail industry and vice president of Gambit Management Strategies, Inc., of New York puts it this way: "By going into computers, in which it has not been too successful, NCR spread its resources too thin. I wouldn't be surprised if, when everything is finally shaken out, NCR drops to only a 50% share of the [point-of-sale] market, or less."

Shaffer may in fact be voicing NCR's concern for continuing strong in its long-time retail and banking industry markets. For in a statement at the time the agreement was announced, NCR's Laing stated that his company would now be able to "devote additional corporate resources to the development of advanced systems for its major markets."

Norris: CDC provides technological brains.



NCR-CDC get-together

With some details still to be worked out, here's what Control Data Corp., and National Cash Register Co. have agreed in principle to do:

- Establish a jointly owned company with net assets of roughly \$50 million. It would engineer and manufacture most of the peripherals used by the two. This includes mainly punched-card and magnetic-tape equipment, and high-speed printers, which will be supplied only to the parent companies.
- Strive for a high degree of compatibility in future mainframes through use of "similar architectural concepts and related software." NCR will develop a "swing" processor to bridge the two lines and will continue to make its small and medium computers. CDC will continue to turn out its more powerful machines.
- Purchase by CDC of NCR's disk file line, which has had mixed commercial success, as well as the disk file plant in Hawthorne, Calif. NCR, in turn, will supply low-speed serial printers for CDC.

NCR had gross sales last year of \$1.4 billion. CDC, which says its 1971 totals are not yet ready, had a 1970 gross of \$539.5 million from computers and \$512.2 million from its Commercial Credit Corp. subsidiary.

Lasers

NASA experiment aims at earthquake prediction

Lasers, which have become common tools for precise underground tunneling, will now focus their beams on another earthly concern—earthquakes. NASA will begin reflecting laser transmissions from passing satellites this summer for triangulation measurements to help scientists unravel the mysteries of the worldwide phenomenon. While scientists know why earthquakes happen, they don't know when—even in areas like California, where tremors are relatively frequent.

Drifting. Essentially, earthquakes are caused by the continual drift of large parts of the earth's surface, called plates, explains David E. Smith, physicist with NASA's Goddard Space Flight Center. The drift causes tremendous pressure beneath the earth's surface; when the force becomes too great, the earth erupts along a fault, which is the fissure between two plates. California's San Andreas Fault, for example, divides the easterly American plate, which is moving south, and the westerly Pacific plate, which is moving north. They move an estimated 3 to 6 centimeters a year.

If the drift of the American and

Pacific plates can be measured accurately, says Smith, then scientists, by computing the two masses involved, can determine the energy stored in the fault system and predict the next quake.

The key to such measurement is that each quake displaces the amount of energy stored up since the last one, Smith says.

NASA, in collaboration with the U.S. Geological Survey, Columbia University, and the National Oceanic & Atmospheric Administration, believes the San Andreas Fault Experiment (SAFE) is just the right system to measure the drift. Scientists will bounce beams from two Q-switched ruby lasers (each with a 1-joule output and 20-to-40-second pulse width) off passing satellites to form a long-sided, highly accurate triangulation measuring system.

One laser will be placed in northern California, near Quincy, on the American plate. The other will be 800 kilometers away in the southern part of the state, near Los Angeles, on the Pacific plate. The two automated tracking stations will be located away from the fault zone itself.

Four orbiting satellites are now equipped with laser reflectors that the experimenters can use, Smith says. A two-month experiment this summer will check out the system. Measuring begins in earnest in the



YOUR KEYS

to more calculator power!

Today, there are only two programmable calculators with mathematical keyboards. Both are TEKTRONIX Calculators.

Our keyboard is uniquely different from keyboards of other programmable calculators. With it you solve even the most complex expressions in a universal language you know and use daily—mathematics. For instance, to solve the expression:

$\ln\left(\frac{\sin x}{x}\right)^2 + x \frac{(x^2 - 1)}{2} \times \sqrt{3^2 + 4^2}$ for $x = 2$ just press the following keys:

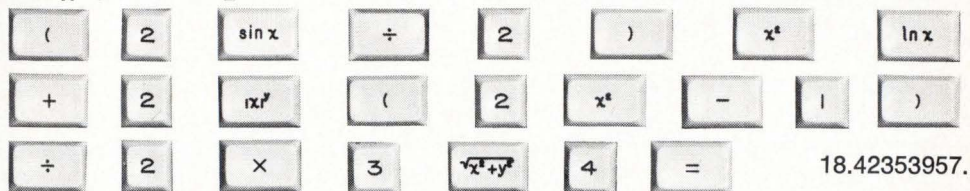

Whatever your discipline, you solve any expression involving as many as 256 programmable keystrokes (5120 with the optional programmer) using the same natural, direct mathematical procedure. You never spend valuable time learning and using an artificial machine language.

Some day all calculators will have mathematical keyboards. User preference demands it.

For complete information or to arrange a demonstration, contact any TEKTRONIX Field Office. Our offices are located in or near major cities and industrial centers—worldwide. If you prefer, write Tektronix, Inc., P. O. Box 500, Beaverton, Oregon 97005.



TEKTRONIX®
committed to
technical excellence

Scientist 909 Calculator \$3200
Statistician 911 Calculator \$3200

U.S. Sales Prices FOB Beaverton, Oregon

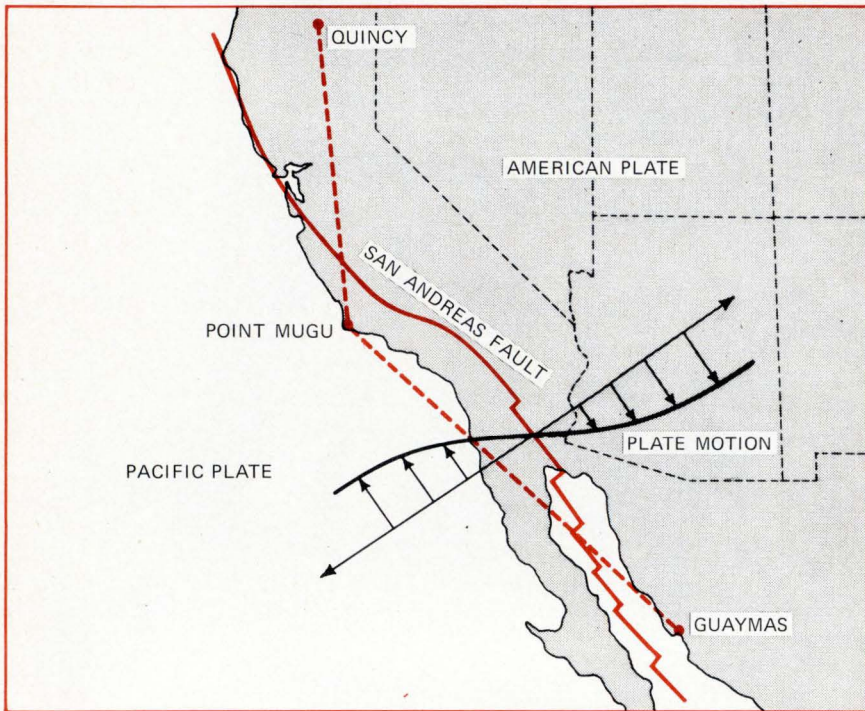

Finding fault. NASA will use laser system to measure shift in San Andreas Fault. Transmissions from Quincy, Point Mugu, Guaymas will be bounced off satellites.

summer of 1973; the project is to last three to 10 years.

By then, system accuracy will have improved from a deviation of 20 to 40 cm to about 10, estimates Thomas S. Johnson, a physicist in the Optical Systems branch at Goddard, meaning a measuring accuracy of about half that, independent of distance. NASA is working on the two improvements needed to get accuracy deviations of 10 cm or less, says Johnson—reducing the laser's transmitted pulse width and improving the receiving signal processing. "You measure not distance, but time, like any radar system," he explains.

Wobbles. NASA proved the accuracy of the laser-satellite system with an earlier experiment between the Goddard center, in Maryland, and a mobile station 408 kilometers away in the Seneca Lake region in upstate New York, Smith says. That experiment was to measure the motion of the earth's poles (the earth wobbles on its axis), but the same principles apply to earthquake measurements, he says.

For the future, NASA is thinking about expanding the SAFE project by adding a station in Mexico to

give a 1,200-kilometer baseline, Smith says, and measure the rest of the fault.

The polar motion studies may prove of further value in the SAFE project because some scientists speculate that the earth's poles might tilt just before an earthquake, Smith says. If SAFE can measure that, too, then people might have warning just before an earthquake.

Laser technique measures nitrogen dioxide in smog

The road to clean air is bumpier than researchers had thought it was. For example, as hydrocarbon emission from auto exhausts decreases, nitrogen dioxide is becoming a serious problem. The reason is that, not only are oxides of nitrogen making up an increasing percentage of the pollution, but techniques that reduce hydrocarbon in car engines increase oxides of nitrogen.

To fill the need for a quick, accurate NO₂ sensor—the present Saltzman wet chemical test is relatively slow and insensitive—the Aerospace Corp., El Segundo, Calif., has devel-

oped a technique that takes advantage of a unique property of the compound that simplifies detection.

Unlike other pollutants, NO₂ has a broad absorption band and fluoresces when excited by any visible laser light. In fact, light sources other than lasers could be used, but more optical filtering would be required. Other pollutants having sharp resonances (spectral lines) require tunable lasers.

Sloppy spectrum. "As far as I know," says Milton Birnbaum, head of the quantum optics department at the Electronic Research Laboratory of Aerospace, "NO₂ is the only pollutant molecule with this sloppy spectrum." In experiments, Birnbaum has excited air samples containing NO₂ with a helium-cadmium laser at 4,416 angstroms and an argon-ion laser at 4,880 Å. A conventional photomultiplier measures fluorescence in the 6,300-to-8,000-angstrom range by counting the number of light quanta generated in a preset period. The strength of the laser beam is also monitored, since it affects the light output.

Extensive tests have determined that normal constituents of the atmosphere do not absorb visible light and fluoresce like NO₂. However, particulate matter is filtered out.

Birnbaum has compared the measurements he makes with those of the County Air Pollution Control District, which has a sampling site about a mile away that uses a modified Saltzman test. He's observed good tracking of levels, though the actual figures still require calibration. Whereas the district makes its tests every hour, the laser measurements are in real time so that Birnbaum can detect many rapid variations. The laser electronic technique is also much more sensitive, detecting parts per billion, while chemical methods are unreliable below a few parts per 100 million.

A major advantage of the laser technique, Birnbaum says, is that it should be readily adaptable to remote control, since it is wholly electronic. The apparatus is conceivably low in cost if made in the reasonably large quantities that would appear desirable for air monitoring in

Bell & Howell & The Do It Itself Transmitter

"Hey, I think I know a way for us to get into a new market." This from one of our new guys.

"How?" we ask.

"Make a transmitter that'll work all by itself. Without adjustments and stuff."

"We've never made transmitters."

"But you've been building transducers for over twenty years.

And if you can transduce, you can transmit."

"All right, but why?"

"Well, there's at least one industry out there with a crying need for help in automated flow and level control."

"For what?"

"Voltage and current pressure transmitters."

"Okay, so where do we start?"

"Well, first off, they ought to be small, easy to carry around and a snap to install."

"That's easy."

"Great. Then it should have useful outputs."

"Okay. 4-20 mA, two wire, 0-5 VDC and 1-5 VDC."

"Then can we make sure we do something about exposed threads and O-rings?"

"Sure. Get rid of them. Figure on an all welded construction."

"How about electrolysis?"

"No problem. Use stainless steel. Won't break down in most corrosive atmospheres."

"Reliability?"

"A two year warranty."

"Ease of adjustment?"

"Why adjust? We'll calibrate at the factory. But for special requirements, we'll supply adjustment capability optional."

"What about shock and vibration problems?"

"No moving parts."

"Wow. Let's see. Very reliable. Accurate. Two year warranty. Practically zero maintenance. That'll save an awful lot of bucks. I think we've got something."

We did, too.

We christened them the 4-400 series pressure transmitters (4-454 differential, 4-403 static). And to make things even sweeter, they're priced competitively with anything you can buy now. And they're backed by a factory direct sales and service organization that can get anywhere in the States within twenty-four hours.

Or the world in forty-eight.

For the whole package, just write Bell & Howell Instruments Division, 360 Sierra Madre Villa, Pasadena, California 91109.

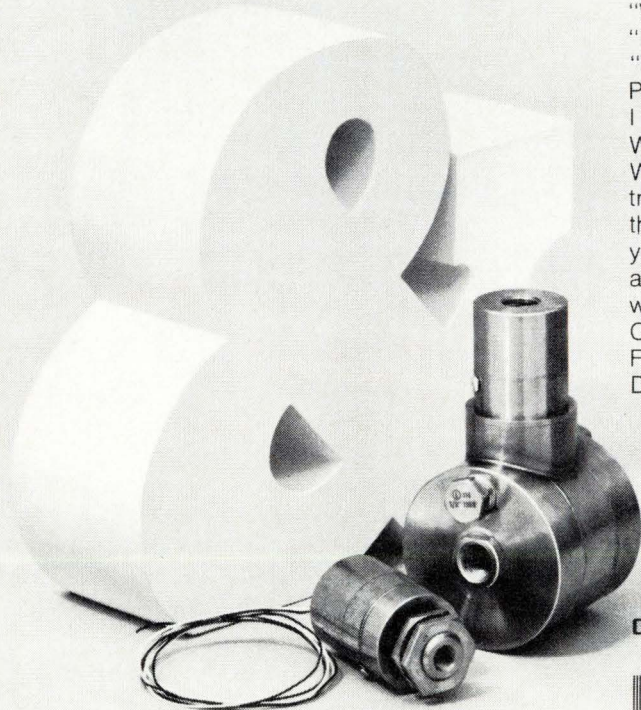

CEC/INSTRUMENTS DIVISION



BELL & HOWELL

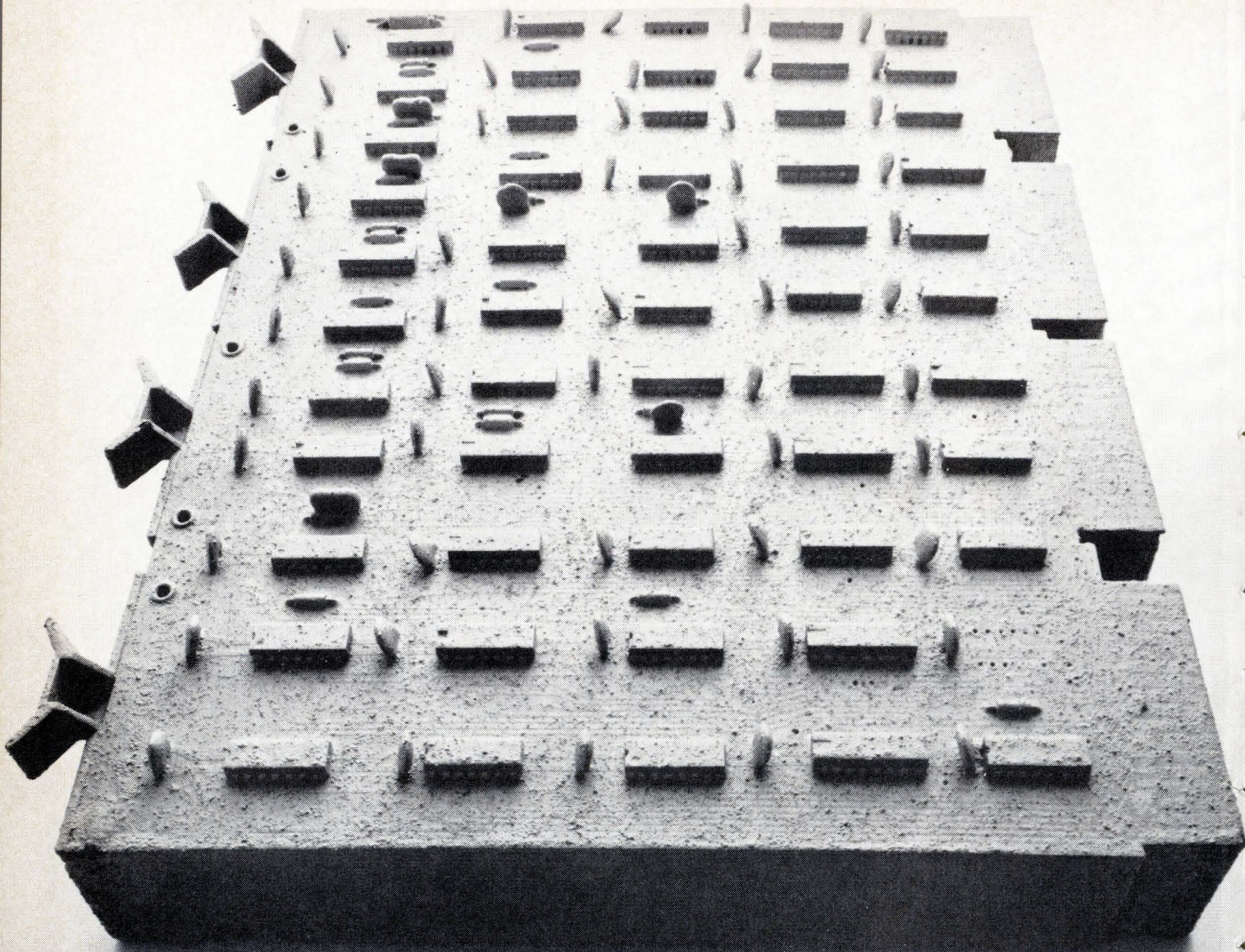

Augat says you can't afford to bury your circuit in a block of cement.

Ever try making production or in-field component changes in a printed circuit board?

Good luck.

Easier to scrap your board and start again. New artwork. New etching. New components.

Now you see why there's a revolution going on to replace printed circuits with flexible, plug-in, wire-wrapped packaging. And Augat's high density dual-in-line panels are leading the way.

The Augat panel is your best guarantee of getting your product on the market fast. Because with Augat you can quickly change your circuits at any time — during breadboarding, prototype or production.

It's the most important and competitive new packaging concept in years. You can have low cost interconnections, high reliability, space saving density . . . all with the flexibility to allow in-production or in-field changes in minutes.

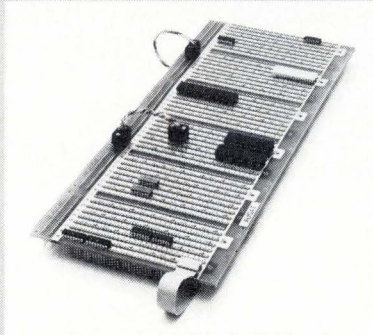

Current sales of thousands of panels a week are proof that the Augat approach is already in orbit. We'll be glad to tell you more. Call us today at (617) 222-2202.

Or write for literature showing our complete product line in panels and accessory equipment. Augat Inc., 30 Perry Avenue, Attleboro, Massachusetts 02703. Our representation and distribution is nationwide and international.

Plug into Augat® instead.

Electronics Review

the future. While the not-for-profit Aerospace doesn't expect to sell its technique, others could find potential customers in government and industry.

Solid State

Westinghouse speeds
high-power devices

A new manufacturing system that guarantees delivery of high-power semiconductor products in as little as 54 hours has been put in operation by the Westinghouse Electric Corp. Semiconductor division, Youngwood, Pa. In contrast, delivery times now typical in the industry range from four to six weeks, according to the company.

A "world bank" at Youngwood stores fully tested and passivated thyristor and rectifier elements, according to customer and application, awaiting assembly. The bank is a single central source of processed semiconductor elements for Westinghouse assembly plants in Guarabo, Puerto Rico, and Le Mans, France.

The company's "bank" eliminates the usual cost of storing the rather expensive devices, points out Paul E. Lego, the division general manager. The user need only enter an agreement describing the type and quantity of high-power devices—including custom-designed units—he will use and the rate at which they will be needed. Space and inventory in the bank are thereby reserved.

Inventory cut. "Until now, users of high-power semiconductors have had to maintain inventories that must cover between four and eight weeks of their production," Lego says. "With the new system, customers need only maintain inventories covering 10 days or less."

A key to the process is Westinghouse's ability to passivate and protect the silicon elements, using silicon nitride and other proprietary materials. Apparently the company is able to passivate and store "indefinitely without deterioration" a broader range of processed semi-

conductor elements than has been possible in the past.

Another feature that assures fast delivery is a highly efficient assembly line that does not need the usual clean-room atmosphere. Instead of the common practice of carrying semiconductors around in batches to different work stations, they are fabricated on a continuous, paced conveyor line, similar to those in the automobile industry. Yields approach 99%, the company says.

This line assembles and fully tests more than 1,500 types of devices rated between 35 and 2,000 amperes and 50 and 3,000 volts. Compression bonding encapsulation is used for attaching leads and fastening individual semiconductor elements within metal housing.

This technique, patented by

Line up. Westinghouse's high-power semiconductor assembly line helps it promise 54-hour delivery of the devices.

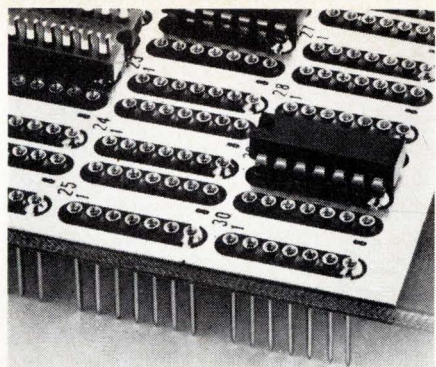
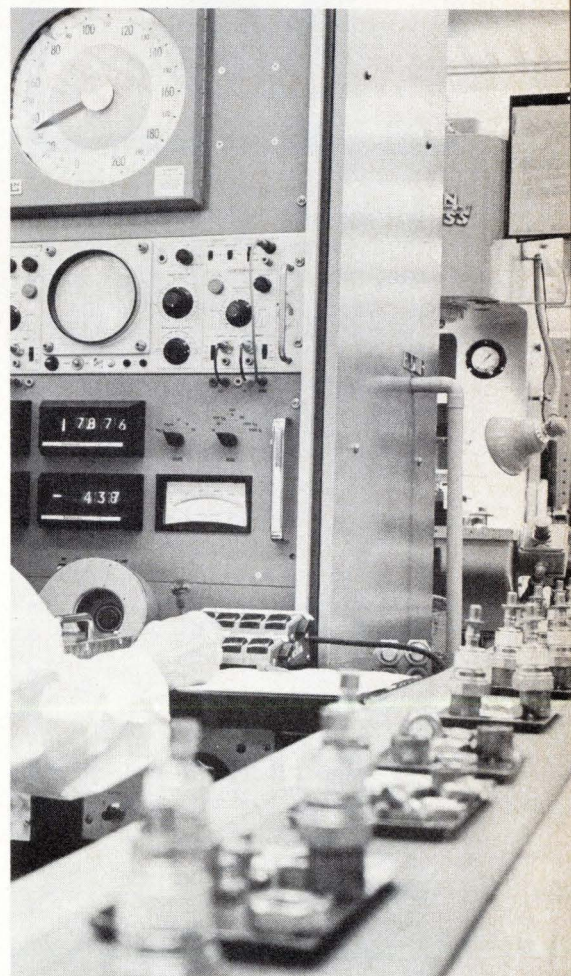

All plug-in panels are not the same.

It's one thing to want plug-in flexibility in your circuit. It's another to get flexibility plus all the other things you'd like in a dependable point-to-point system.

Like easier IC insertion. Precision-machined contacts. Tighter contact retention. Greater reliability (we'll prove it). Unique tapered entry sockets (patent pending). Lower profile. Plus the versatility to accept 14, 16, 18, 24, 28, 36 or 40 pin IC's in a choice of panel sizes.

And we offer virtually any panel you'll need, in any number of patterns, plane-mounted or edge-connected, off the shelf or custom.

We'll also give you single-source supply for sockets, enclosures and accessories—even automatic wire wrapping whenever you need it.

The Augat way? It's a better way. Call us at (617) 222-2202. Or write for our catalog. Augat Inc., 30 Perry Ave., Attleboro, Mass. 02703. Our representation and distribution is nationwide and international.

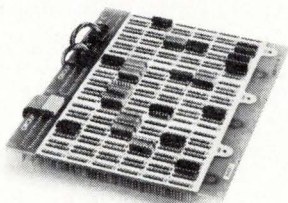

Plug into Augat* instead.

Circle 41 on reader service card

Electronics/February 14, 1972

CONTROL ELECTRICAL LOADS

even under the worst conditions

Jewell GOLD LINE SOLID STATE RELAYS



SUPERIOR FEATURES available nowhere else: Noise immunity. Extremely high inrush capability. Input-output isolation. Fully encapsulated. All solid state. No moving parts for maintenance-free operation.

- ZERO CROSSING TYPES FOR CONTAMINATED, EXPLOSIVE OR CRITICAL APPLICATIONS

8 amp. standard duty. 15 and 30 amp. heavy duty in single, 2 and 3-pole styles. Miniature style—2, 3 and 4 amp.

- PROPORTIONAL CONTROLLER RELAY TYPES

- VARIATIONS TO ORDER

Write or phone for pricing and technical information.

Jewell

JEWELL ELECTRICAL INSTRUMENTS, INC.
Grenier Field, Manchester, NH 03105
Phone: (603) 669-6400 • Telex: 94-3435

Electronics Review

Westinghouse, relies on spring-loaded contacts pressing on the surface of the semiconductor element. The method avoids the main drawback of soldering contacts to the element—heat, which is likely to disturb delicate elements.

Communications

On-line protection scheme ends switchover data loss

A technique developed at Farinon Electric Corp., in San Carlos, Calif., could be the answer to data loss problems caused by switchover in two-transmitter radios.

Since the Federal Communications Commission declared last year that frequency diversity—using a pair of transmitters and receivers operating on different frequencies to transmit the same information—could no longer be used to protect against loss of communications, various techniques have been employed. Most consist of two transmitters—one of which is on standby—operating on the same frequency, with a switch to disconnect a transmitter should it fail and connect the other to the antenna. But while this method works well for voice communications, it wreaks havoc with digital data.

Not only is data lost during the switchover, but if the two transmitters are not on exactly the same frequency, transients also can cause data loss and errors. Attempts have been made at injection-locking the oscillators of two transmitters and then combining the outputs, but this tends to cause distortion when the signal is modulated. However, Farinon has combined outputs of two transmitters, and eliminated data loss in most failures.

Right on. According to Mark W. Wilkens, design engineer at Farinon, the so-called on-line protection scheme employs a phase-locked loop and an output phase detector to assure that the two transmitters are exactly on the same frequency. Both transmitters are modulated by a common baseband input. Their

output signals are compared by the phase detector—a 3-decibel hybrid coupler and two diodes—that controls the frequency on one transmitter through its automatic-frequency-control input. The in-phase carriers are combined in another hybrid circuit, and thus the combined output from the 5-watt, 2-gigahertz transmitters is about 10 watts.

Wilkens says that the output coupler has two parts. The output port has the sum of the two transmitter signals; the other port has a difference signal. If the two transmitters are locked, the difference signal is zero. But, if for some reason the transmitters get out of lock, the difference signal that is produced is detected by the diode. This, in turn, will shut down one transmitter. Several other conditions can cause one transmitter to be shut down.

One possible drawback: when one transmitter is shut, the power of the remaining one is split between the two ports in the detector so that only half the remaining power is sent to the antenna. But, Wilkens points out, this will cause only a 6-dB drop in signal-to-noise ratio.

FCC shops for experts to resume Bell probe

Where do you find 20 communications heavyweights—plus support staff—competent to investigate the operations of the American Telephone & Telegraph Co.? That's the question facing the Federal Communications Commission's Common Carrier Bureau, now that the commission has reinstated its investigation of AT&T.

In the month that followed its pre-Christmas dismissal of the probe for lack of funds and staff [*Electronics*, Jan. 3, p. 44], the commission was deluged by protests from Bell customers ranging from the Defense Department to Ralph Nader. By January's end, the commission had acted with uncharacteristic speed, and reversed itself by a 6-to-0 vote.

The outcry did produce some \$1.2 million of the \$1.8 million in FCC

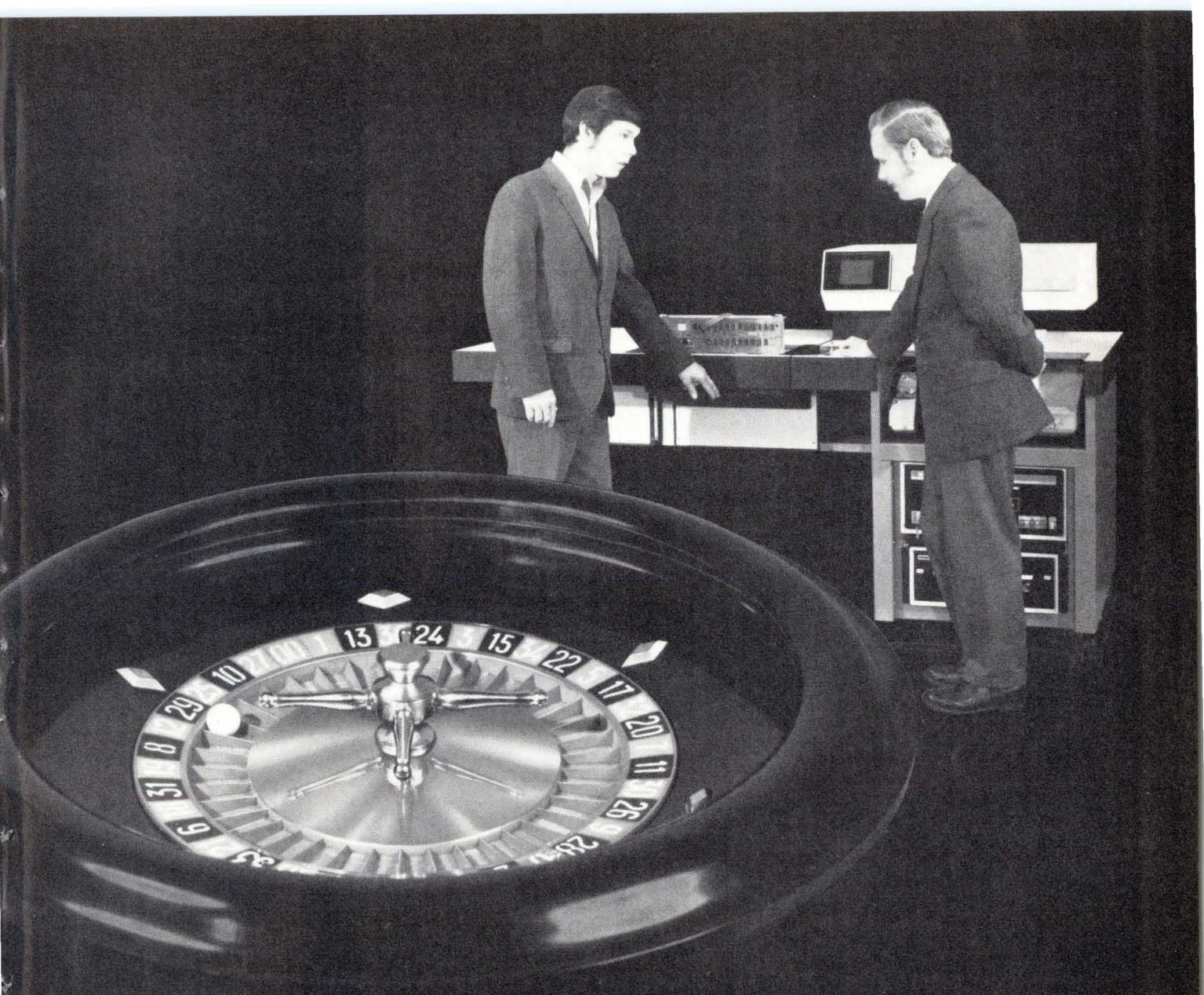

Take the risk out of buying a Logic-Circuit Tester

Buying a tester can be risky. You know it all depends on the supplier, but who can you trust? Your own staff, for one, of course. They know what you need and may find the time to design and build your system. So why not them?

Because General Radio has already done it for you — solved the design and programming problems that your staff has yet to face. In three years, GR has sold twice as many logic-circuit testers as our three closest competitors. Our designs and test programs are proven in 100 years of field operating time, yet you'll pay only a small

fraction of their cost. And, GR assumes full system responsibility. Honestly, now, can you do the job for \$20,000? We can.

Special Needs?

Our modular subsystems and programs are easy to add later as you need them. Let present needs dictate initial specs and cost with the assurance that later expansion will be both possible and economical.

So, who can you count on for a logic-circuit analyzer at least as good as you could make yourself? GR, of course.

Try Us

Our 1790, 1792, or 1793 can do your job. Outline your requirements or ask for a demonstration from the GR office nearest you or from GR in Concord, Mass. In Europe, write Postfach, CH 8034, Zurich, Switzerland.



General Radio

NEW YORK (N.Y.) 212 964-2722 (N.J.) 201 791-8990 • BOSTON 617 646-0550
CHICAGO 312 992-0800 • WASHINGTON, D.C. 301 881-5333 • LOS ANGELES 714 540-9830
TORONTO 416 252-3395 • ZÜRICH (01) 55 24 20
GRASON-STADLER 617 369-3787 • TIME/DATA 415 327-8322

Circle 43 on reader service card

SCIENCE/SCOPE

The U.S. Army's M-60A1 main battle tank will have a new fire-control system built around a ruby laser rangefinder and a solid-state ballistic computer, both developed by Hughes. It will enable the crew to fire its first round more quickly and will greatly increase the probability of scoring a first round hit. The laser rangefinder will utilize hardware assemblies developed earlier for the Army's M60A1E2 tank and M551 Sheridan armored reconnaissance airborne assault vehicle.

A long-life solar cell power supply system for orbiting satellites, now being developed for the U.S. Air Force by Hughes, will be capable of operating at altitudes between 200 and 22,300 nautical miles, or higher, for at least seven years. It will incorporate technology which Hughes developed for USAF's FRUSA (Flexible Rolled-Up Solar Array) program, a system of extendible solar cell panels unfurled like windowshades in space to convert the sun's energy into electrical power.

The first of five U.S. Navy F-14A Tomcat air superiority fighters has been flown to the Pacific Missile Range, Pt. Mugu, Calif. for installation of the AWG-9 weapon-control system and testing of the Phoenix missile, both developed by Hughes. When the twin-engine F-14A becomes operational it will be the Navy's most sophisticated fighter for both offensive and defensive missions. It will carry a 20mm cannon and various combinations of Phoenix, Sidewinder, Sparrow, and Agile missiles.

Two new series of lightweight digital computers have been developed by Hughes for central avionics, ECM, missile guidance, RPV, and other military applications. The HCM-230, latest of a line of Hughes airborne computers spanning 20 years, is a 24-bit, 92-instruction, truly modular computer with a throughput of 400,000 operations per second. The Mini-HDP is a low-cost minimal unit. Though very small (20 cu. in. including 8K of memory), it is a 19-instruction, 16-bit-word-length LSI computer of about 600,000 operations per second.

Hughes needs electro-optical system analysts to work on surveillance and precision tracking systems. Requirements: MS or PhD in Physics or EE and 3-8 years experience with E-O sensor systems, infrared physics, and computer techniques for analysis. Also mechanical engineers for conceptual design of complex E-O systems. Requirements: BS or MS in EE or Physics, 5-10 years experience. Please send your resume to: Mr. Robert A. Martin, Hughes Aerospace Engineering Divisions, 11940 W. Jefferson Blvd., Culver City, CA 90230. An equal opportunity M/F employer.

Digital display systems for the U.S. Navy's future fleet of 30 Spruance-class destroyers are now in production at Hughes under a subcontract from Litton Industries. They will be part of the Naval Tactical Data Systems (NTDS) which provide instantaneous presentation of the action within tactical combat zones. Within seconds, NTDS can evaluate a potential threat, assign and control countering weapons, and perform other command functions. The Spruance class will be the backbone of the Navy's destroyer forces in the mid-1970s and beyond.

Creating a new world with electronics



funds frozen last year by the White House in its push for Federal economies. But commission officials see that as only part of the solution. For now the bureau must locate staff with specialties ranging from economics and law to engineering. And, adds bureau chief Bernard Strassburg, the problem is compounded by the loss of some senior specialists during the past year.

Consequences. For the electronics industries—and particularly communications equipment suppliers, who hope an investigation will open the Bell System to competition—all the preparatory work means it probably will be another year before hearings can take place. The decision-making process that follows could conceivably add a second year.

Indeed, the Common Carrier Bureau's three-man trial staff for the inquiry, headed by deputy chief Asher Ende, has cautioned that if implementation of the proceedings be stalled further, the staff will again request that they be dismissed. However, that appears unlikely in view of Congressional interest in the probe and the White House release of funds that led to the commissioners' reversal. To augment their efforts, Strassburg and Ende will get two extra options: The opportunity to contract for outside studies, if necessary, and freedom to add personnel, regardless of the usual Federal staffing guidelines on "staff averaging."

"As immediate steps," said the commission after its decision, "we are reallocating staff and reprogramming 1972 funds intended for other contractual studies."

Instrumentation

H-P moves to standardize programable test gear

Automatic testing systems are wonderful—once you get them to work. Unfortunately, there are no standards for programable test equipment, so that the task of interfacing such gear is a designer's nightmare.

In an attempt to overcome this

problem, Hewlett-Packard Co. is mounting a corporation-wide effort to standardize the connectors, the cables, timing, voltage levels, and codes on all of its future systems-oriented programable instruments. H-P hopes that other manufacturers will adopt the same ASCII-bus approach as an industry standard.

The new approach, which is incorporated in H-P's new Model 3330A/B automatic frequency synthesizer, uses a bit-parallel, character-serial format for programming test instruments. A small, low-cost, bit-serial to bit-parallel converter is therefore needed to make the new system compatible with standard teleprinters, but this is still a much simpler approach than the elaborate, expensive interfacing gear that is now required.

Simpler. As Larry Holmberg, product manager on the 3330A/B, explains, the new approach will allow a simple card reader or teleprinter to control an automatic test system. Now, a computer is needed to handle just the interfacing problem. With the new system, he says, the computer will be able to dedicate itself to more important tasks, such as the statistical analysis of the data that is being gathered.

An important feature of the approach is its ability to control a large number of different programable instruments connected in parallel on a single ASCII bus because the instruments will not accept any instructions until they have been individually addressed by the controller. Each instrument's address is set at the factory, but the user can change it easily by moving a series of slide switches.

So far, the Model 3320A/B and 3330A/B synthesizers and the Model 9820 algebraic calculator are compatible with the ASCII bus. And Holmberg says that several instruments now in development are also being modified to conform.

The 3330B is a 0.1-hertz-to-13-megahertz synthesizer that features digital sweeping of the output frequency (synthesizer accuracy at every step in the sweep), digital sweeping of the output amplitude, 0.01-decibel amplitude resolution, and

Hughes is in industrial electronics, too: components, equipment and systems.



Microwave diodes (RS 234)

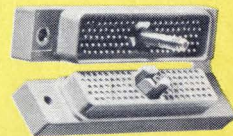

Electrical connectors (RS 235)



Microwave TWTs, TWTAs and solid state products (RS 236)



Direct view and scan converter storage tubes (RS 237)

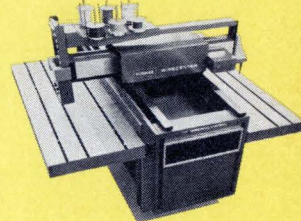

Wire terminating and harness laying systems (RS 238)

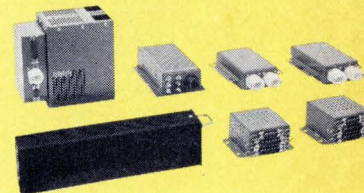

Multiplex systems for remote communications/control (RS 239)

For complete information, write Bldg. 100, Mail Station C-512, Culver City, CA 90230. Or request by Reader Service (RS) numbers.

HUGHES

HUGHES AIRCRAFT COMPANY

Develco superconducting instruments

a first of a kind company and
four first of a kind products

FIRST IN SUPERCONDUCTING PRODUCTS AND SYSTEMS for use in measurements, testing, calibration, and investigations in a multitude of ElectroMAGNETIC areas. Develco's achievements in products and systems during the past 18 months include:

First thin film superconducting magnetometer
First and largest superconducting magnetic shield
First superconducting magnetic test system
 with internal superconducting magnetometer
First superconducting gradiometer

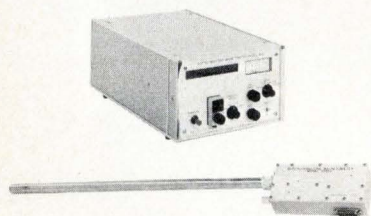

SUPERCONDUCTING MAGNETOMETER uses a thin film sensor to detect changes in magnetic fields of 1×10^{-9} gauss. Can be used as a general purpose, extremely sensitive magnetometer, picovoltmeter, nanoammeter, or as a low impedance bridge for resistance or inductance measurements. Insensitive to shock, vibration, or electrical discharges. Frequency response 0-200 Hz; Dynamic Range 10^{-3} to 10^{-9} gauss.

Circle 216 reader service card

SUPERCONDUCTING MAGNETIC SHIELDS

use unique approach to magnetic shielding to provide ultra-stable test environment with room temperature access and shielding factors exceeding 10^5 . Designed for use in testing magnetometers in low noise environments in the plant, laboratory or operational locations. Remanent magnetic field of a typical shield — less than 1.5×10^{-5} Oe.

Circle 217 reader service card



SUPERCONDUCTING MAGNETIC TEST SYSTEMS are passive, simple and economic systems designed for ultrasensitive measurements of low level magnetic signals. Rugged superconducting shield contains one-, two-, or three-axis superconducting magnetometers for very rapid and accurate measurements of magnetic sensors, solid state samples, magnets, electrical components, biological samples, etc. Digital display of measured values with digital and analog outputs. Test regions available in $2\frac{1}{2}$ to 9 inch diameters. Dynamic ranges of 5×10^{-3} to 5×10^{-8} emu.

Circle 218 reader service card



SUPERCONDUCTING GRADIOMETERS, which use superconducting flux transfer circuits and thin film superconducting magnetometers, provide the capability to make extremely sensitive magnetic field gradient measurements ($\sim 10^{-11}$ gauss/cm noise levels) with short baselines (~ 30 cm). Multi-axis gradiometers can also be used for magnetic surveys, signal studies, magnetocardiograms, etc. in unshielded environments.

Circle 219 reader service card

DEVELCO, INC.
 Superconducting Instrument Division
 530 Logue Avenue, Mountain View, California 94040 • (415) 969-1600

Electronics Review

0.1-Hz frequency resolution all the way up to 13 MHz. The 3330A does not have the output leveling or control features.

For the record

Handling BUEC. Initial tests of the BUEC (back-up emergency communications) portion of the FAA's National Airspace System indicate that alternate transmitter sites will provide adequate aircraft coverage if a primary site goes off the air. The tests were made at the Oakland, Calif., traffic control center.

Robert Crookshank, installation engineer on the project, says, "We are periodically using BUEC to work aircraft to see if we have any holes and to check priorities."

In the system, up to 10 priorities are set up for any given sector; if communication between the air traffic controller and the aircraft is broken, BUEC automatically selects the next best transmitter site and patches the conversation through to it, via radio or landline. If that channel is either out or busy, BUEC will go to choices of lower priority.

Optical wiring. The Du Pont Co. of Wilmington, Del., has demonstrated the feasibility of using a single bundle of fiber-optic light pipes to replace the complicated wiring harness used in an automobile electrical system. Modulated infrared signals from light-emitting diodes were transmitted down a bundle made of Du Pont's Crofon IRX fibers. Receivers at the far end detected the light, decoded the signals, and then energized either a horn or headlight. Quadri Corp., Phoenix, Ariz., designed the transmitting and receiving modules.

Awards. The FAA's award of concept-definition studies totaling \$3 million for a microwave instrument landing system has gone to the six companies expected [*Electronics*, Jan. 3, p. 43]: AIL division of Cutler-Hammer Inc., Bendix Corp., Texas Instruments, Raytheon Co., Hazeltine Corp., and ITT Gilfillan Inc. Amounts ranged from \$463,000 to \$500,000.

NEW DIFFUSING LENS.

Makes the MLED55 appear as a large area light source emitting from the entire lens surface. The emitter appears much larger than the actual chip size and is more easily seen from a distance.

NEW 140° FIELD OF VIEW.

The presence or absence of light is easily detected through a full, 140° viewing angle . . . on/off condition can readily be determined from an "off-axis" viewing angle.

NEW LONG LEADS.

Nearly 7/16"-long leads and a visible difference between anode and cathode make the MLED55 easy to work with and easy to install . . . without polarity error.

HIGH LUMINOUS INTENSITY.

The MLED55 shines at 0.6 millicandellas at a drive current of only 20 mA. Applicable to both diffusing lens and point source light emitting devices, axial luminous intensity in millicandellas is a more explicit and translatable LED visibility measurement.

TURN ON THE REDS

VOLUME AVAILABILITY.

High-speed, low-cost stripline fabrication techniques originally pioneered by Motorola for the plastic transistor have been adapted to MLED55 production. There's immediate availability from your Motorola distributor . . . in our factory warehouse . . . for your prototype/production needs.

LOW FORWARD VOLTAGE.

Low V_f in the "on" condition means the MLED55 is compatible with typical IC voltage and current outputs. No separate power supply is needed.

RELIABILITY.

No filaments to burn out, no parts to shake loose. Operated under forward voltage conditions only so current-steering circuit conditions are realized, the MLED55 has a life expectancy in excess of 100,000 hours.

LOW COST.

Just 57¢ for 100-up quantities of the MLED55 puts solid-state LEDs in reach of designers of circuit/status indicators, fault indicators in systems requiring frequent trouble-shooting, on-off indicators for small, hand-held instruments and linear or large matrix displays.

LIGHT EMITTING DIODES	PLASTIC		HERMETICALLY SEALED					
	ACTUAL SIZE	ACTUAL SIZE	ACTUAL SIZE	ACTUAL SIZE	ACTUAL SIZE	ACTUAL SIZE		
Visible Red 660 nM	LED	Axial Luminous Intensity	LED	Brightness	LED	Brightness	LED	Brightness
	MLED50	1.0 mcd @ 20 mA	MLED600	1100 fl @ 50 mA	MLED610	1100 fl @ 50 mA	MLED630	1100 fl @ 50 mA
	MLED55	0.6 mcd @ 20 mA						
Infra Red 900 nM	LED	Power Output	LED	Power Output	LED	Power Output	LED	Power Output
	MLED60	550 μ W @ 50 mA	MLED900	550 μ W @ 50 mA	MLED910	150 μ W @ 50 mA	MLED930	650 μ W @ 100 mA
	MLED90	350 μ W @ 50 mA						

A LED for every application! Volume-availability on every LED!

. . . an unbeatable combination to fill today's exploding application needs for red and infrared light-emitting diodes in instruments, computers, peripherals, industrial controls, optical communications and entertainment equipment.

And a variety of packaging techniques makes it easy to choose a just-right LED for your design, too: tiny, hermetically-sealed "pill" packages, — large, bright REDHEADS* in the industry-standard, TO-18 — economical, plastic Mini-T* cases.

Motorola has a full complement of photodiodes, phototransistors, photo Darlingtons and PIN diodes to match its capability in LEDs. All available for your needs from distributor or factory.

Write on your company letterhead for a copy of our new, updated Let There Be Light brochure . . . full of specs and applications to turn you on to the world of optoelectronics. Send for it: Box 20912, Phoenix, AZ 85036!

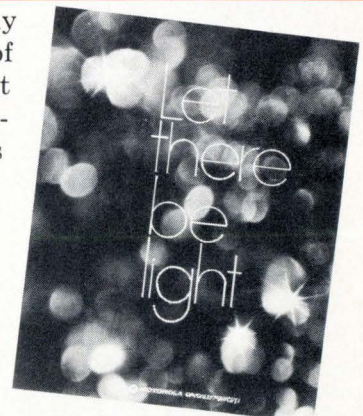

*TRADEMARK MOTOROLA INC.

MOTOROLA OPTO
— let there be light

A 400 pound hammer is a helluva blow to a minicomputer

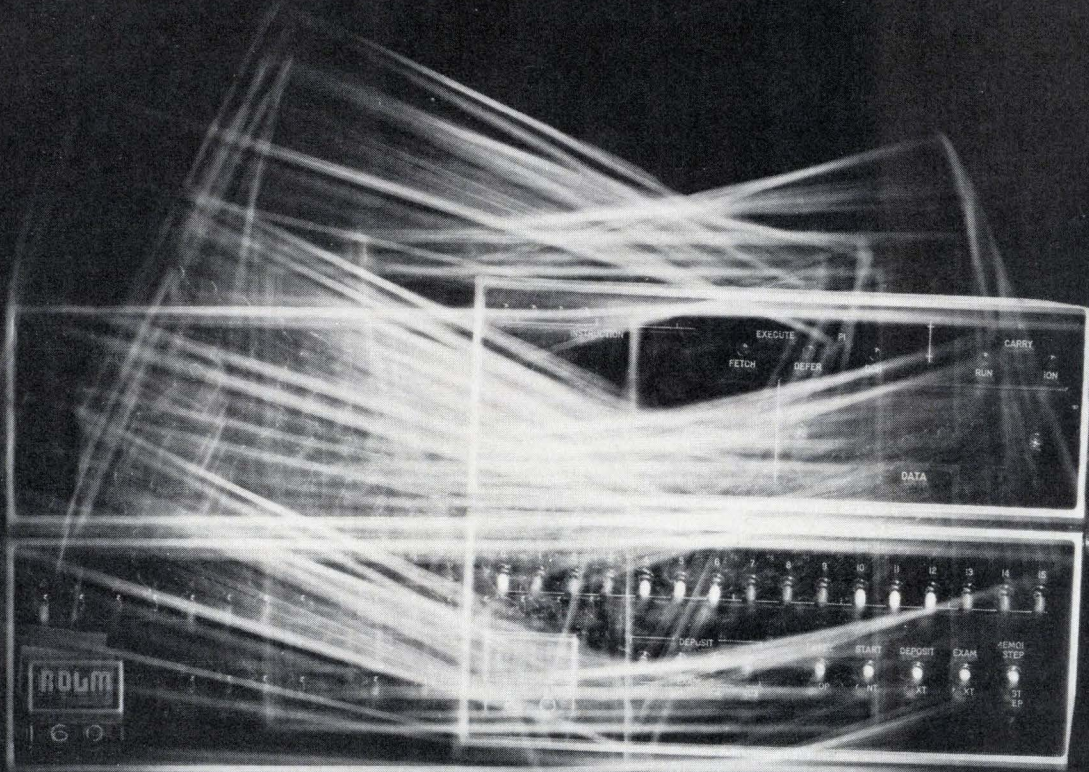

...unless it's a Ruggednova

The U.S. Navy recently bombarded our severe environment minicomputer.

As part of military qualification tests at the Naval Electronics Laboratory Center, our Ruggednova 1601 had to stand up under nine blows of a 400 pound hammer swung through a five foot arc. Hard Mounted!

The 1601 was displaced three inches by the impact, but came through without failure, becoming to the best of our knowledge the first general purpose digital computer to survive this test. It received full qualifications to military specifications Mil E 5400 and Mil E 16400.

The hammering was only part of the test. Other qualifications included operating the Ruggednova throughout a temperature range of -55° to $+71^{\circ}\text{C}$ at altitude levels from sea level to 70,000 feet. Then came salt spray/salt fog test, a five day 95 percent humidity test and stringent electromagnetic interference suppression tests.

Ruggednovas are proving themselves in the field too. They are currently being used in more than 50 severe

environment applications by both military and industry.

This rugged version of Data General's Nova with 4K of memory has been delivered in 30 days for a price of \$13,500. It has a military designation of AN-UYK-12 (V) and is provisioned in Navy and Air Force spares. A full line of peripheral devices and software complete a package that is tough to beat. Write or call Rolm Corporation, 10300 N. Tantau Avenue, Cupertino, Calif. 95014 (408) 257-6440, TWX: 910-338-0247.

ROLM
CORPORATION

In Europe,
contact Rolm at
4 Cours Des Bastions,
1205 Geneva,
Switzerland.
Phone 022/242306.



Washington Newsletter

February 14, 1972

ATS program flies into trouble

"Serious funding problems with the whole program" are likely to stretch out Applied Technology Satellites F and G. According to sources close to the program, **design changes and the addition of extra experiments on board the satellite are running the \$200 million program short of money, and this could throw off next year's launch of F and possibly even scrap the 1975 launch of G.** Even the FY 1973 funding expected in July may not be enough to rescue the program's timetable.

Officially, NASA isn't "prepared to discuss the matter," but agency spokesmen say privately that such problems aren't unusual in large new programs. However, to make up for lost time, **program managers are said to be considering flying the engineering prototype as the F satellite,** instead of building a final model. This is risky business, observers state. And subcontractors, such as Philco-Ford's Space and Re-entry Systems division, which is handling the communications electronics, are falling behind schedule to prime contractor Fairchild Industries. **As for G, one source, who says that there won't be enough money to pay for both the vehicle and its experiments, comments ruefully: "They're loading so many experiments on F, you won't need G anyway."**

LEAA may drop standards effort

The prospect that firm Federal standards may never evolve for local police communications systems and other law enforcement electronics is very likely, say Congressional sources. That is one result predicted for Jerris Leonard's reorganization of the Law Enforcement Assistance Administration since he took over the agency last May. In the face of rising Congressional criticism of LEAA—largely for ignoring minority group rights and for poor fiscal planning—**Leonard continues to push for dropping LEAA's right of prior approval of state programs for spending Federal law enforcement grants.** Instead, states would be given block grants to spend at their discretion, despite protests of some city and county governments.

If LEAA surrenders its jurisdiction over local spending of Federal grants, industry officials also expect that its technical standards efforts will evaporate as well. "If they don't control the purse, they might as well forget everything else," says one industrial official of the agency's long-delayed effort to develop a first standard for police radios.

CATV growth will be affected by new Domsat ruling

With the Federal Communications Commission's compromise ruling on cable television systems scheduled for March 31 implementation, industry officials now want to see how CATV will be permitted to tie in with domestic satellite systems. An FCC decision on these satellites is expected by early spring. "The two decisions must be considered together" in any forecast of the growth rate of the CATV equipment market, say Electronic Industries Association officials. **Interconnection of CATV with such systems would rapidly expand the market for broadcast equipment and receivers.**

Of the CATV rules themselves, equipment makers say they are pleased with **the FCC requirement that systems have a built-in capability for two-way, non-voice communications at the start,** even though subscriber terminals will not immediately be required. Industry officials also favor a separate FCC action establishing a technical advisory group on CATV standards such as signal carriage, two-way systems, and other questions as they arise. Organizations interested in committee participation must communicate by March 15 with the FCC's Sol Schildhause, chief of the Cable Television Bureau.

Washington Commentary

Nixon in trouble with DOD budget in Congress . . .

A year ago Defense Secretary Melvin Laird said the \$505.8 million budgeted for the Air Force's F-111 interceptor represented the last buy in the program. Now his fiscal 1973 program delivered last month to Congress contains a \$160.3 million request for another dozen planes. Why? The unofficial explanation by one Pentagon economic specialist is that "at \$13.3 million apiece those planes represent a good buy." That answer is surprising indeed to anyone remembering the flap over the F-111 cost overrun a few years back and how it brought the Congress down on the head of then Defense Secretary Robert McNamara. **But now, in 1972, the F-111 is in fact less expensive than fighters running to \$15 million and \$18 million a copy.**

There is a message in this for an increasing number of Senators and Congressmen. And when such hardliners on defense spending as Arizona's Barry Goldwater tells his Senate colleagues—as he recently did—that **Pentagon procurement represents "a godawful waste of money,"** then it is apparent the message is being received and the mood of the Congress is changing. This became clear when the President submitted his fiscal 1973 defense request as part of his deficit budget. As one Pentagon lobbyist on Capitol Hill put it: "The lid's finally blown off the pressure cooker. Those people up there are mad as hell."

. . . as deficit turns supporters into sharp critics

More and more members are making it clear to the President that his defense program is in for rougher than usual treatment. Ordinarily that goes without saying in an election year, when control of the White House and the Congress is split between the parties. But **the significant new element is that the criticism is increasingly bipartisan.** Though Secretary Laird proposes to spend only \$75.9 billion of the \$83.4 billion sought, the Nixon request is \$6.3 billion more than last year and represents the largest single increase for any agency.

Stung by three successive Nixon budget deficits, conservatives are telling the President they won't support a fourth. In addition to Goldwater, they also include South Carolina's Strom Thurmond and such powerful committee chairmen as Mississippi's John Stennis of Armed Services, Louisiana's Allen Ellender of Appropriations, who also chairs the defense spending subcommittee, and House Appropriations Committee boss George Mahon of Texas, who heads the lower chamber's defense spending body, too. For each it appears his sense of fiscal economy overrode a strong sense of national security.

Virtually all the President's fiscal critics voice the same complaint: **the budget lacks credibility.** For Goldwater the nation is "continuing down the road to fiscal disaster." Ellender charges the President with "deceiving the American people," while Mahon credits the White House with "a masterful job of putting a rosy image on a near-disastrous financial situation."

Such sharp criticisms guarantee that **defense spending will be a major campaign issue,** and are sure to stall the appropriation in the Congress. That may well be what the President wants to support an attack on a foot-dragging legislature. But **those same assaults from Capitol Hill also seem to have blown the Nixon-Laird strategy to push a big defense appropriation through behind a handful of highly visible, controversial, and, if necessary, expendable program** such as the B-1 bomber and the Airborne Warning and Control System. Now the whole Pentagon program is in for severe scrutiny, and it seems there is little anyone can do to forestall some stiff appropriation cuts. —Ray Connolly

Why pay



for CW only?

You're looking at the only self-contained single instrument capable of measuring virtually any microwave signal from 20 Hz to 18 GHz. It's Systron-Donner's 6057 frequency counter, which combines S-D's Automatic Computing Transfer Oscillator (ACTO®) with an advanced manual T.O. system.

CW and AM measurements are fully automatic from 20 Hz to 18 GHz—simply connect the input and read the final answer. FM and pulse modulated carriers are measured using a simple 3-step operation which yields direct readout answers, even with pulse widths as short as 0.1 μ sec.

A full nine digit readout with automatic decimal point and annunciator is standard. Resolution down to 1 Hz is selectable from front panel pushbuttons. Options include digital outputs, remote programming, and a complete selection of extended stability time base oscillators.

The 6057 is priced at only \$5,450, which is just about what you'd expect to pay for comparable instruments **without** FM and pulsed RF capability. However, with S-D you pay for only what you need. If it's CW only you need to measure, then choose our Model 6016 at \$4,575, or for only \$3,695 you get a Model 6092 manual T.O. measuring system.

Ask your local Scientific Devices offices for technical data or contact: Concord Instruments Division, 888 Galindo St., Concord, CA 94520. Phone (415) 682-6161.



**For only \$5,450
you can get the
one 18GHz box
that measures
everything: FM,
pulsed RF
and CW.**

SYSTRON  DONNER

The Systron-Donner Instruments Group:

Alpha Scientific Computer Systems Concord Instruments Datapulse Kruse Electronics Microwave Trygon Electronics

Computer malfunctions cause incalculable chaos in split seconds. That's why you need multi-layer laminates made by the finicky folks at Norplex Division of UOP.

They're such sticklers for high standards they had to design much of their own quality-control equipment. That's how they can guarantee to meet or exceed NEMA, MIL-P and customer specifications.

And their clean rooms with precisely controlled temperature and humidity provide an extra measure of inclusion-free dependability. Norplex multi-layer laminates are without equal for stress-free uniform quality and dimensional stability.

Your Norplex representative is unique, too. He's a laminate engineer, a problem-solving consultant, offering you the widest line of laminates in the business. And he's backed by a

customer-service team assigned to each account for complete follow-through.

For process predictability in computer laminates, call on the Lint-Pickers. Norplex Division, UOP (Universal Oil Products Company).

Main Office and Plant
Norplex Drive
LaCrosse, Wisconsin
54601
608/784-6070

Franklin Office and Plant
P.O. Box 186—
Route 31 North
Franklin, Indiana 46131
317/736-6106

How the Lint-Pickers keep the numbers game clean.

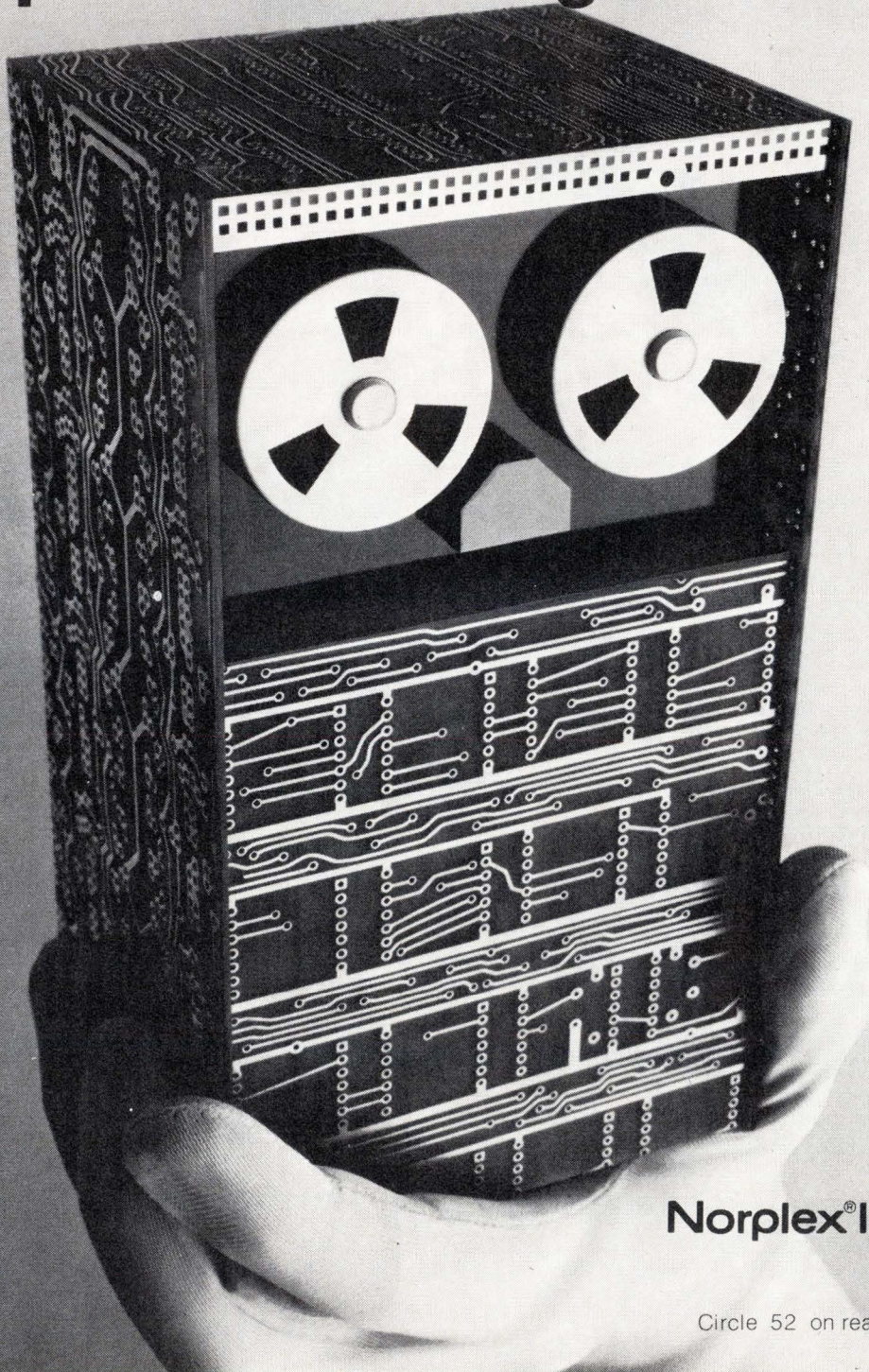

**Norplex[®] laminates
by UOP**

Circle 52 on reader service card

Ring up more savings on keyboard switches.

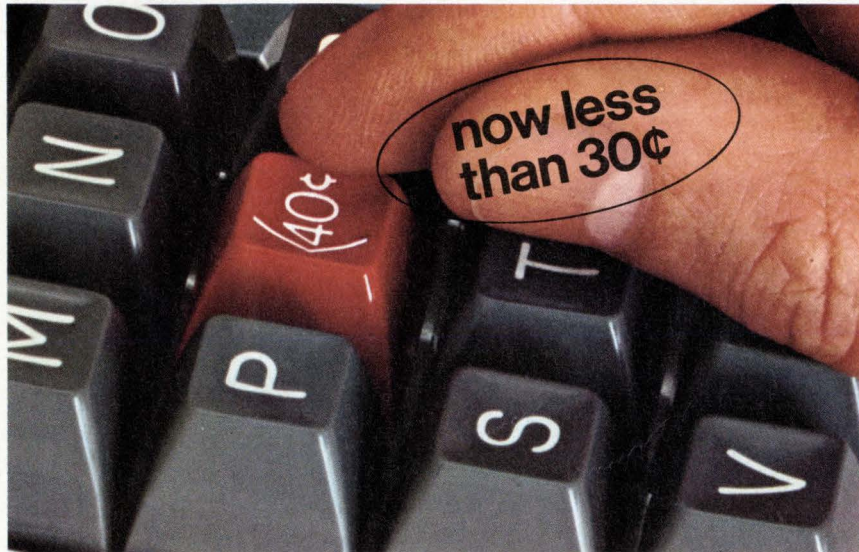

As much as **50%**
(savings per key)

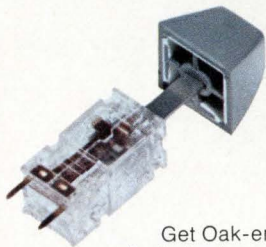

The new Oak Series 400.

Get Oak-engineered quality in keyboard switches with the inherent reliability of electro-mechanical operation. Ideal for peripheral data-processing equipment. Contact bounce is less than 3 milliseconds. Long life, up to 20 million operations per key. Designed with self-cleaning crossbar-wiping contacts.



A feather touch.

We kept the operator in mind. Standard operating force is approximately 85 grams (3 oz.).

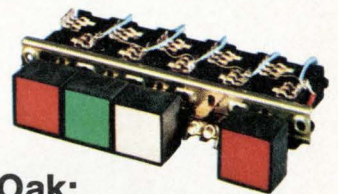

Also from Oak: Series 300 Lighted Pushbutton Switches.

Featuring Oak's exclusive twin-lamp lighting. If one lamp goes out, the other stays on. Double-wiping contact clips. Short stroke. Smooth, quiet operation. Unlimited combinations. Request our Series 300 brochure.

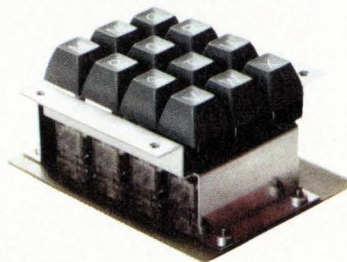

The configurations you want.

The Series 400 is available in limitless arrangements, including standard 10, 12, and 16-button keyboards. And you can specify any of six different contact circuitries. Choose snap-in or plug-in P.C. mounting. Compact—only 1/2" x 1/2" x 1".

Write today for our Series 400 brochure.

Under **30¢** each.

For SPST/NO in production quantities. Other versions comparably priced. Keytop button and snap-in mounting extra.



OAK MANUFACTURING CO.

CRYSTAL LAKE, ILLINOIS 60014 • A DIVISION OF OAK ELECTRO/NETICS CORP

Telephone: 815-459-5000

TWX: 910-634-3353

TELEX: 722-447

Circle 53 on reader service card

THE PRAM.™

The first 4-channel programmable op amp. With more application possibilities than we could possibly list on this page.

HA-2400/2404/2405

Take a good look at this new linear building block. It's unique and so versatile we keep discovering more and more applications for it.

Each PRAM contains four preamplifier sections, one of which is selected through the DTL/TTL compatible inputs and connected to the output amplifier. The selected analog input terminals and the output terminal form a high performance operational amplifier for just about any use you can dream up. And we hope you'll dream up some. If you do, send them along to us and we'll see what we can dream up by way of a reward.

Features.

Offset current 5nA

Voltage gain 150K

Slew rate

$A_v = +1$ $\pm 15V/\mu s$

$A_v = +10$ $\pm 50V/\mu s$

Gain Bandwidth Product

$A_v = +1$ 8MHz

$A_v = +10$ 40MHz

DTL/TTL compatible

100-999 units

0° to +75°C **\$10.45**

-25°C to +85°C **\$15.95**

-55°C to +125°C **\$23.65**

For more details on the PRAM contact your Harris representative or distributor.

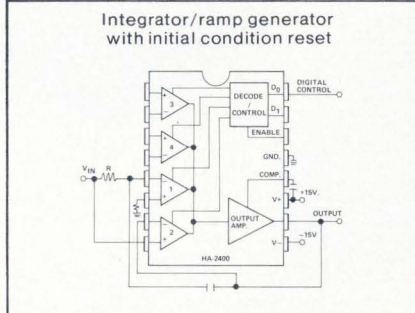
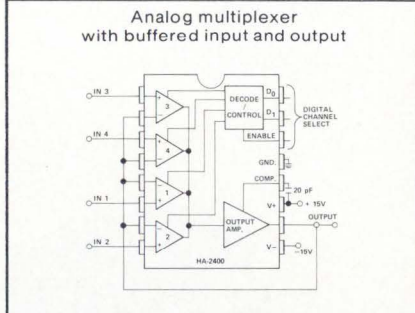
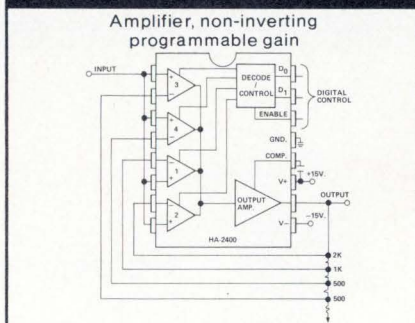
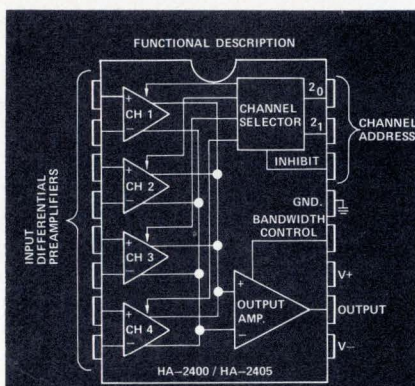

More challenges:

The foregoing diagrams show just three of many applications we've designed using the PRAM. The following lists other possibilities we haven't had time yet to prove out. Why don't you try your hand at designing them or any other ideas you come up with, and send them to:

E. Fernandez
P.O. Box 883
Melbourne, Florida 32901.

A to D converter, Dual Slope Integrating

Active Filter, State Variable Type with Programmable Frequency and/or Programmable "Q"

Amplifier with Programmable D.C. Level Shift

Chopper Amplifiers

Crossbar Switches

Current Source, Programmable

F.M. Stereo Modulator

F.S.K. Modem

Function Generators, Programmable

Gyrator, Programmable

Monostable Multivibrator, Programmable

Multiplier, Pulse Averaging

Peak Detector with Reset

Resistance Bridge Amplifier/Comparator with Programmable Range

Sense Amp/Line Receiver with Programmable Threshold

Spectrum Analyzer, Scanning Type



HARRIS SEMICONDUCTOR
A DIVISION OF HARRIS-INTERTYPE CORPORATION

P.O. Box 883, Melbourne, Florida 32901
(305) 272-5430

DISTRIBUTORS: Schwebel Electronics; Westbury, New York (516) 334-7474; Rockville, Maryland (301) 881-2970; Hollywood, Florida (305) 927-0511 / Harvey/R & D Electronics; Lexington, Massachusetts (617) 861-9200 / Semiconductor Specialists, Inc.; Chicago (312) 279-1000; Detroit (313) 255-0300; Minneapolis (612) 884-8132; Kansas City (816) 452-3900; St. Louis (314) 428-6100; Dallas (214) 358-5211; Indianapolis (317) 243-8271; Pittsburgh (412) 781-8120; Dayton (513) 278-9455 / R.V. Weatherford Co.; Albuquerque (505) 265-5671; Anaheim (714) 547-0891; Austin (512) Enterprise 1443; Dallas (214) 231-6051; Denver (303) 427-3736; Glendale (213) 849-3451; Houston (713) Enterprise 1443; Palo Alto (415) 321-5373; Phoenix (602) 272-7144; Pomona (714) 623-1261; San Diego (714) 279-7400; Seattle (206) 762-4200. **HARRIS SALES OFFICES:** Wellesley, Massachusetts (617) 237-5430; Wayne, Pennsylvania (215) 687-6680; Palos Heights, Illinois (312) 597-7510; Melbourne, Florida (305) 272-5430; Palo Alto, California (415) 321-2280; Norwalk, Connecticut (203) 853-3646; Washington, D.C. (202) 337-4914; Dallas, Texas (214) 231-9031; Scottsdale, Arizona (602) 946-3556; Long Beach, California (213) 426-7687.

Bendix puts an end to the bends.



You know the bends. That's when connector pins are bent or damaged during mating by misaligned plug and receptacle.

The bends just can't happen with Bendix SJT connectors. Pins are recessed. Stronger, too. And that makes them 100% scoop proof. You get positive protection whether the pins are in receptacle or plug.

You get five-key polarization, too. And that makes mismatching a thing of the past.

Consider, too, Bendix SJT connectors meet

the performance and mounting characteristics of MIL-C-38999 and are available with all insert and contact configurations covered by that specification. Lightweight shell sizes from 8 to 24 with from 3 to 128 crimp type contacts accommodating wire gauges from 12 to 28.

Now then. Like to put an end to the bends? Write for our new SJT catalog.

The Bendix Corporation, Electrical Components Division, Sidney, New York 13838.



Complete RF Network Analysis 500 MHz

400 kHz to 500 MHz with 115-dB dynamic range and 0.005-dB resolution. Precise measurements of transmission and reflection properties — magnitude, phase, group delay, and S-parameters — all direct reading and neatly displayed on a built-in scope. Complete characterization of filters, amplifiers, cables, antennas, delay lines, transistors, or almost anything else that comes to mind — all at the push of a button.



500 MHz! A full 400 kHz-to-500 MHz frequency span, automatically swept over the full range or a portion of it — all at the twist of a knob. There's more, of course, including computer-controlled systems or other versions tailored to your needs. Look into it. Better yet, see it — in action — in your application.

For a demonstration of this remarkable system, call your local GR center. The price for the basic 1710 RF Network Analyzer? Only \$6850 (*truly remarkable*).

For High-Frequency Measurements



General Radio

300 BAKER AVENUE, CONCORD, MASSACHUSETTS 01742
 NEW YORK (N.Y.) 212 964-2722 (N.J.) 201 791-8990 • BOSTON 617 646-0550
 CHICAGO 312 992-0800 • WASHINGTON, D.C. 301 881-5333 • LOS ANGELES 714 540-9830
 TORONTO 416 252-3395 • ZURICH (01) 55 24 20
 GRASON-STADLER 617 369-3787 • TIME/DATA 415 327-8322

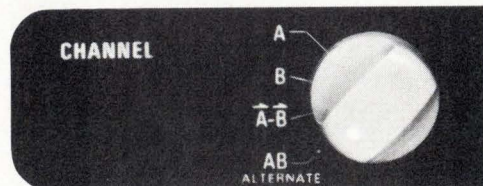
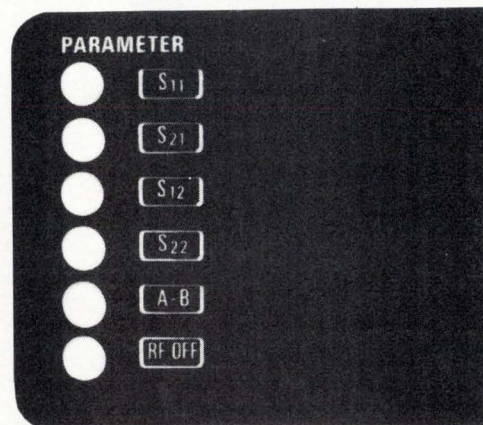
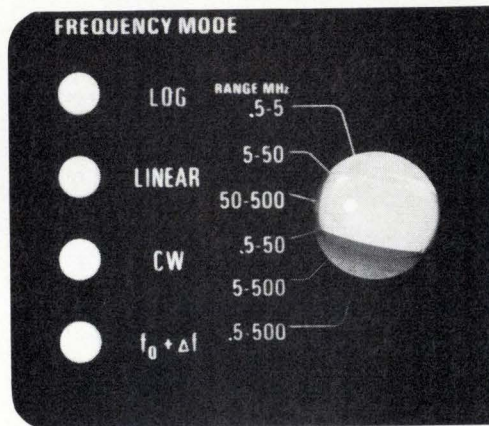
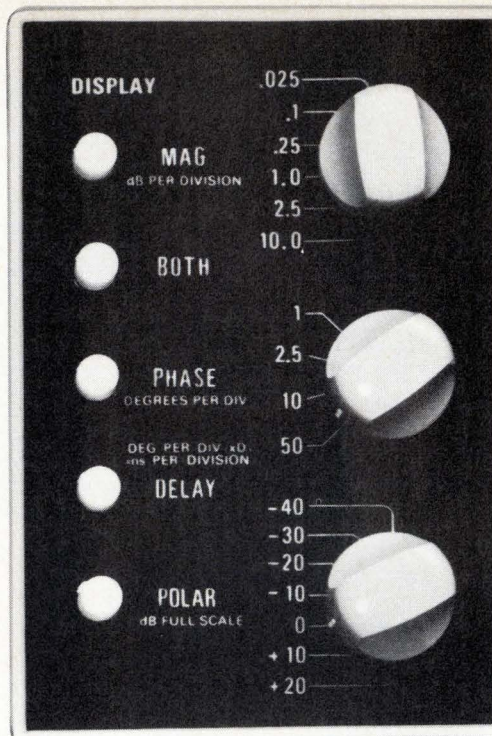

The No. 1 Interface Line is also the No. 1 problem solver.



Find a need and fill it. That's our orders. And now the one and only specifically designated, complete interface line in the field tackles two more stumbling blocks with:

The only bidirectional one-shot in existence, and the first IBM-compatible line driver and receiver. Applications and features below — along with the entire 8T series of exclusive interface devices. Your #1 problem solvers. Offering unique advantages unavailable in any

other ICs on the shelf. All production-proven, in stock now from your Signetics distributor, salesman or rep.

FREE complete handbook of applications for the #1 interface line is yours for the asking. Circle #230 on reader service card, or write Signetics-Interface, 811 E. Arques Avenue, Sunnyvale, California 94086. Or call (408) 739-7700.

Signetics

Find your need. We'll fill it.

APPLICATION	SOLUTION
Precision digitizer for disc, tape and drum systems. Digital communications receiver. Signal conditioner. Bidirectional transition detector. Frequency doubling.	8T20 New Bidirectional One-Shot. Combines linear comparator, one-shot and logic all-in-one. Functions as a zero-crossing detector with an input threshold of $15 \pm 4\text{mV}$ and positive or negative edge triggering, or both.
To meet compatibility requirements of IBM System 360 I/O interface specs, channel to control unit. When tying on any peripheral equipment such as core memory, discs, graphic terminals, etc.	8T23 Dual Line Driver. 8T24 Triple Line Receiver. The first and only interface driver/receiver pair proven totally compatible with IBM 360. Replaces discrete components.
To conform with EIA-Std-RS232, MIL-Std-188 and CC-ITT-V24 specs, when transmitting and receiving digital data.	8T15 Dual Line Driver. 8T16 Dual Line Receiver. EIA/MIL communications devices.
Digital data transmission and receiving, using coaxial cable, twisted-pair, or other low impedance lines. Party-line data transmission. Schmitt trigger. One-shot.	8T13 Dual Line Driver. High current driver with short-circuit protection and DOT-OR capability. 8T14 Triple Line Receiver. High input impedance receiver with Hysteresis.
Data transfer in bus-oriented systems. Modular systems design. Minicomputer design. Multiplexing.	8T09 Quad Bus Driver. Tri-state logic configuration to increase system performance. High speed (10ns) and high current (40mA) capability. 8T10 Quad D-Type Bus Flip-Flop Tri-state outputs with input and output disable. 50MHz typical toggle rate.
Driving seven-segment numerical displays, LEDs or incandescent lamps.	8T04, 8T05, 8T06 BCD-to-Seven Segment Decoder/Drivers. For driving almost any type of display — LEDs, Numitron, etc.
Low voltage (+5V) to high voltage (40V) level translation.	8T80 Quad 2-Input NAND Gate. 8T90 Hex Inverter. Low-to-high voltage interface gates.
High voltage (10V-50V) to TTL (+5V) level translation.	8T18 Dual 2-Input NAND Gate. High-to-low voltage interface gate.

SIGNETICS CORPORATION — A SUBSIDIARY OF CORNING GLASS WORKS



Our filter/capacitor family takes experimentation out of circuit design.

We provide the comprehensive data you need for every one of our filter and capacitor components. Attenuation curves (by current, voltage or in combination at room temperature and maximum). Test procedures. Application aids. Specs. Dimension drawings. That's why the Allen-Bradley family is easier to work with. We also give you high volumetric efficiency and

a wide variety of styles. Backed by our famous track record for quality and improved performance. Request your personal copies of our literature. Call our nearest appointed electronics distributor, or write: Allen-Bradley Electronics Division, 1201 South Second Street, Milwaukee, Wisconsin 53204. Export: Bloomfield, New Jersey 07003. Canada: Galt, Ontario.

Publication 5409: type FA, FB, FW, SB, SS ceramic disc capacitors for VHF/UHF.

Publication 5410: type FCS, SMFB, SMFO filters for the 50 MHz to 10 GHz range.

Publication 5411: type CL multi-layer, coaxial capacitors for connectors.

Publication 5414: type MT, MS by-passing capacitors for 50 KHz to 1 GHz.

Publication 5416, 5417: type BE, SF filters for RF/EMI suppression.

Publication 5418: type AB broad band filters in Pi, T and L configurations.



Actual Size

Circle 58 on reader service card

NEW DIMENSION ELECTRONICS
ALLEN-BRADLEY



Technical articles

Special report, Part 3: Optoelectronics in storage and retrieval: page 60

Storing an encyclopedia on a chip—and retrieving the information in microseconds—is the promise of optical memories. A couple of years ago, it was only a hope. But now advances in holographic recording systems, monolithic displays on light-emitting substrates, and photochromic tubes bring the era of useful ultrahigh-capacity information retrieval extremely close. This third section of our three-part optoelectronic series details just how close that day is.

The cover: One significant advance in optoelectronics is the development of monolithic light-emitting displays. Some of the processing steps in producing such a gallium phosphide display are shown in photos from General Electric.

How to double op amp summing power: 73

When you want to perform algebraic manipulation of several signals, summing them with an operational amplifier is a handy route to go. Indeed, op amps can sum simultaneously on both the inverting and non-inverting inputs. But the calculations for the non-inverting input are tedious, so designers frequently use only the inverting input. Now author Raymond G. Kostantny shows how to simplify these calculations.

Bipolar vs MOS—the battle's far from over: page 82

Researchers are still working on ways to increase the density of bipolar arrays and to cut their power consumption. The goal is to make them competitive with metal oxide semiconductor devices in cost, yet retain their inherent speed advantages. Two groups report some success in extending the life span of bipolar technology.

From IBM's labs in Boeblingen, West Germany, comes the story of a novel bipolar static memory with almost the packing density of dynamic MOS storage devices. Individual cells can be read in less than 10 nanoseconds and written in less than 40 ns. The key to its size is direct injection of minority carriers into inversely operated flip-flop transistors.

And from Philips Research Laboratories in the Netherlands come the details of a large-scale bipolar shift register that has low power dissipation and a high speed/power ratio. Like the IBM device, the Philips register achieves its high density by combining functions on a single island of diffused material.

And in the next issue . . .

A round-up of bucket brigade advances . . . simplified transistor testing . . . pitfalls to avoid in cost estimating.

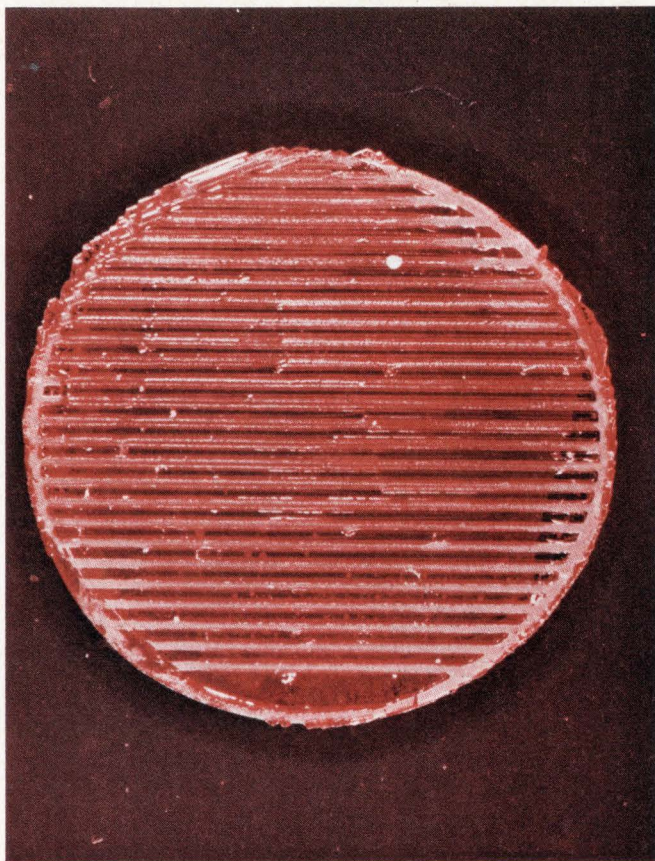

SPECIAL REPORT

The medium of the message will soon be optoelectronic

Part 3 of this Special Report describes optical methods of information handling—LED and holographic memories, monolithic displays, and storage/display tubes

by Laurence Altman, *Solid State Editor*

□ Once, a library on a chip seemed light years away. Even two years ago, when it was obvious that high-capacity optical memories and large-scale monolithic displays were the way to go, the prospects of implementing them seemed dim, since optical storage materials were lacking, light sources were too weak, and methods of light deflection and modulation were too inefficient.

Today, however, holographic storage and retrieval memories with trillion-bit capacities and microsecond accessibility seem almost within reach. So do monolithic displays made on light-emitting substrate material, with a full range of alphanumeric and other characters. And so do photochromic-tube storage systems capable of calling up a central file for a page of a catalog—or a road-map or a patient's medical history—and then displaying it indefinitely in low-cost terminals requiring no storage power.

Research has moved further and faster than could have been anticipated. In storage media, for instance, films of manganese bismuth and europium oxide, and crystals of arsenic trisulfide allow data to be recorded and stored in the form of erasable holograms. Powerful YAG lasers pumped with diode arrays are becoming available to supply the needed watts of optical power. New electro-optical and electro-acoustic modulators, formed from crystals of lanthanum-doped PZT, lithium niobate, and new liquid crystals now make efficient modulation a reality. All the parts of a real system finally are falling into place.

Of the two ways of building an optical memory, the direct employs a one-for-one correspondence between light source and detector, with the presence or absence of a signal forming the data pattern. The other method

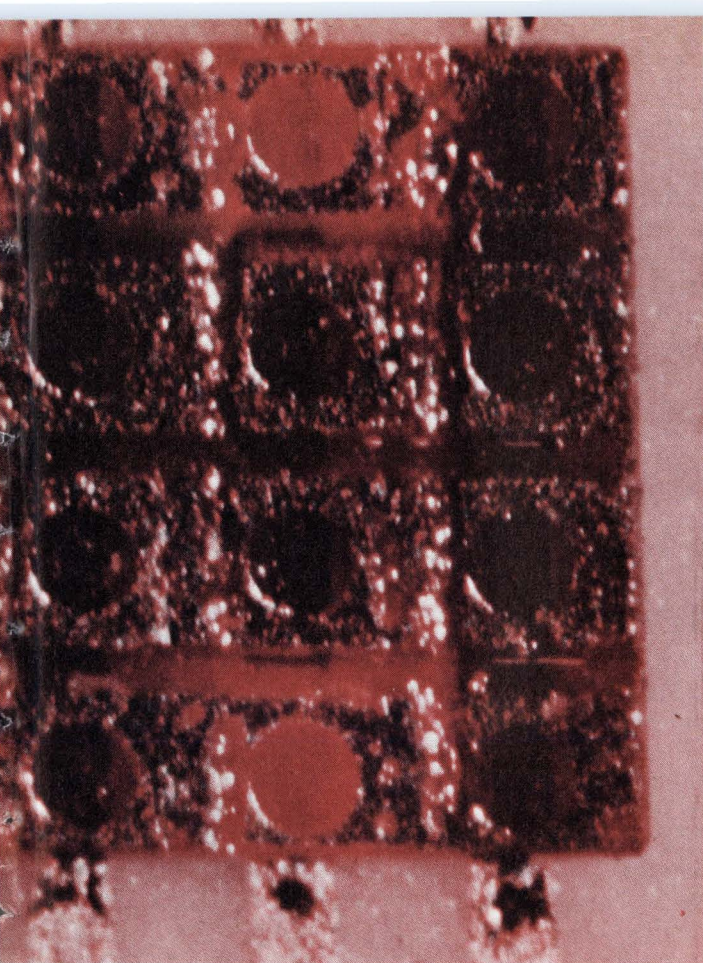

is the holographic approach, which stores information in the shape of holographic dot patterns, and retrieves it by reconstructing the particular hologram containing the desired information.

The two types have elements in common. Both need a coherent source of light, a method of modulation, and a method of detection.

Read-only memories

Figure 1 illustrates the direct approach. In Fig. 1 (a) light source illuminates a pattern of bits permanently stored on a mask. In Fig. 1 (b) the information is retrieved by means of translating optics that energize the appropriate detectors.

Though more limited, this sort of system is clearly the more practical to date, because reliable light sources and detectors have come available in the last several years. The film mask represents no difficulty at the present state of the graphic arts, and the translating and manipulating optics are also available. Although the method has no rewrite capability and offers less capacity than would a hologram system, it does yield useful field-alterable read-only memories.

Quadri Corp., Phoenix, Ariz., has been actively developing one-for-one systems. David LeFebre, Quadri's director of optical development, points out that such systems will differ mainly in the means they adopt for conveying the light to and from the information-carrying film mask. "Three basic methods have been used or proposed," says LeFebre. "One translates and manipulates the energy with the aid of lenses, another with reflectors, and the third, with optical fibers."

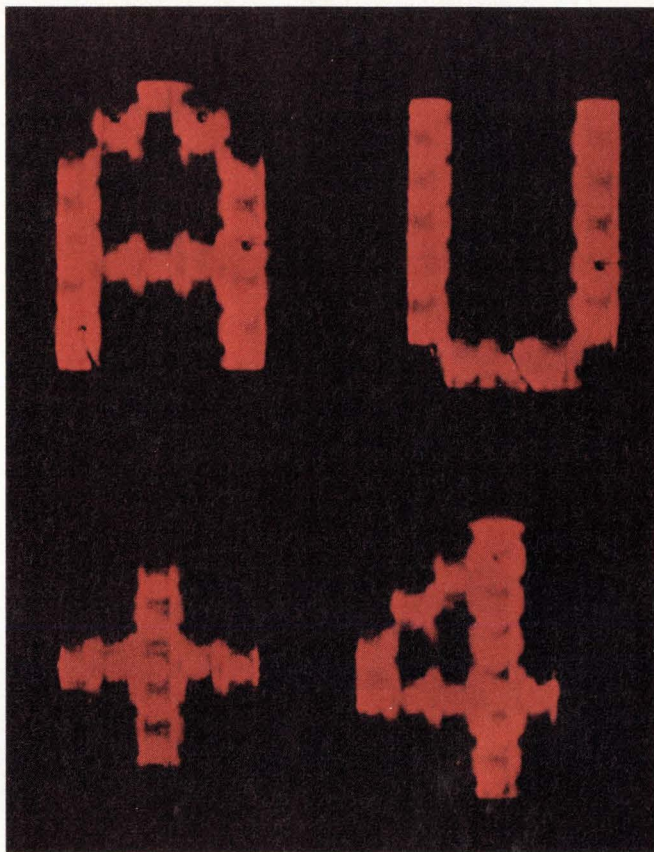

Monolithic. Large area displays built on monolithic GaP substrates represent the goal of many display manufacturers. These elements show a disk of p-strips laid on the GaP, a dot matrix for one character, and the display in action.

He indicates the drawbacks of each method: the first and simplest requires exact alignment and a high-quality lens system; the second suffers from the same alignment problems but not as severely; a fiber system is extremely stable, but is more complex to build. Quadri opted for the last.

In such a system, as Fig. 2 shows, each light emitter is associated with a group of fibers, each of which illuminates a specific site on the film mask. From that site, other fibers conduct the energy to the proper detector. To accomplish this routing, Quadri has developed an optical fiber which is extremely stable and which can transmit light energy while avoiding crosstalk. (The achievement should have significance in other optical systems as well, because Quadri's optical fiber, unlike commercially available fiber, possesses excellent transmission qualities at 900 angstroms—the emission peak of GaAs laser sources.) With this fiber Quadri has built and delivered several 1,024-bit optical memories of the one-to-one type (a cross section is shown in Fig. 3). But LeFebre cautions, that this memory is not an across-the-board competitor for existing electronic memories, but is designed for a special application—one that employs a relatively simple data program but that requires the near-infinite isolation between input and output offered by optical memories. A major guideline in the development of this memory was the requirement for mask replacement in the field by relatively non-

SPECIAL REPORT

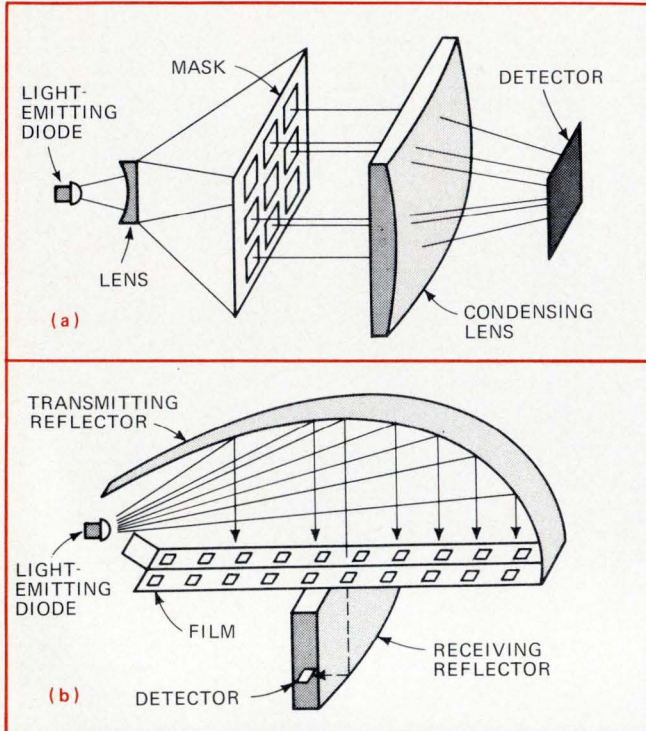

1. Direct. In Quadri Corp's optical memory, a mask containing data is illuminated, and the light pattern detected, as (a) shows. In (b), the detection is done by the translating optics.

technical personnel. Simplicity of mask creation and duplication also were important considerations.

But clearly the simple one-to-one source and receiver memory is not the way to exploit the storage potential of the optical memory to the full. For bulk storage, some form of holographic memory system must be developed, and it's to this end that several major manufacturers are dedicated, including RCA, Harris-Intertype's Radiation subsidiary, Honeywell, IBM, and others.

Memory for the masses

There are two types of optical mass storage: the read-only archival type, and the read/write random access type. Both promise storage densities on the order of 10^{12} bits, and both have intrigued the manufacturers and users of memory equipment for almost a decade. It is generally agreed that by now the simpler archival memory can be built with known techniques and devices, but the read/write mass memory may still require technological innovation.

Traditional methods of storing and retrieving documents are inadequate to cope with the large amount of information generated by modern society. They are both slow and expensive.

An interim solution to this problem is microfilm, but eventually the need for storage at higher density will exceed the limitations of microfilm storage and retrieval devices. The precision of the readout optics can only be improved so far, and use of storage material with virtually no surface defects becomes very expensive—and that's to ignore the fact that even very careful handling

exposes it to dust and scratches that could easily obscure portions of the recording. Furthermore, duplication of high-density microfilms is complex and costly.

Holographic storage and retrieval techniques may be the answer. Potentially, holography makes it possible to miniaturize, index, retrieve and view documents simply and directly, without complex optics. To list the several advantages:

- Lenses are not required to project the image onto a viewing screen, as is the case with microfilm storage. Each hologram stores both data and the optical imaging properties of a lens of high quality.
- With a hologram system, the all-important focusing mechanism need not be adjusted when indexing image to image, as with microfilm systems. Focus is noncritical because of the large depth of field.
- Image resolution can be as good as the diffraction limit imposed by the size of the hologram.
- Aberrations which occur with imaging lenses can be avoided in hologram imaging.
- It is possible to store data with large dynamic range, in fact, continuous-tone photographs can easily be recorded.
- Dissemination copies can be produced from a master hologram with a simple noncontact process, eliminating another microfilm problem—the deterioration of master and submaster that usually occurs with repeated contact printing.

Although the details of a hologram document storage system can vary widely, most systems have a common format by which they store and retrieve data. Generally, the document to be stored is introduced into the holographic system as a photographic transparency—for example, bleached photographic emulsions, or dichromic gelatin. This is done in the usual way: a light wave, modulated by the transparency, interferes with a coherent reference beam, and the resulting pattern is recorded to form a hologram. This hologram is part of a larger array of separate holograms, each of which stores a separate document. The data is retrieved by addressing any particular hologram with a light beam that is a replica of the reference beam. An image of the document is reconstructed and projected onto a viewing screen.

How holograms store data

The essential features of all holographic systems can be understood with the aid of Fig. 4. In the recording arrangement in Fig. 4 (a), the reference beam, which derives from a laser, addresses a specific storage location. At the same time, another beam, derived from the same laser but modulated by the data transparency, is transformed and transferred to the storage location by a lens system. The interference pattern of the signal beam with the reference beam forms a hologram at the storage location, where it is recorded.

The readout arrangement is shown in Fig. 4 (b). When a hologram is addressed by a readout beam, an image of the input data is formed on the readout plane where a viewing screen is located. Information about each part of the document is spread over the entire area of each hologram so that the sensitivity of the system to dust particles and scratches is much reduced. (Dust and

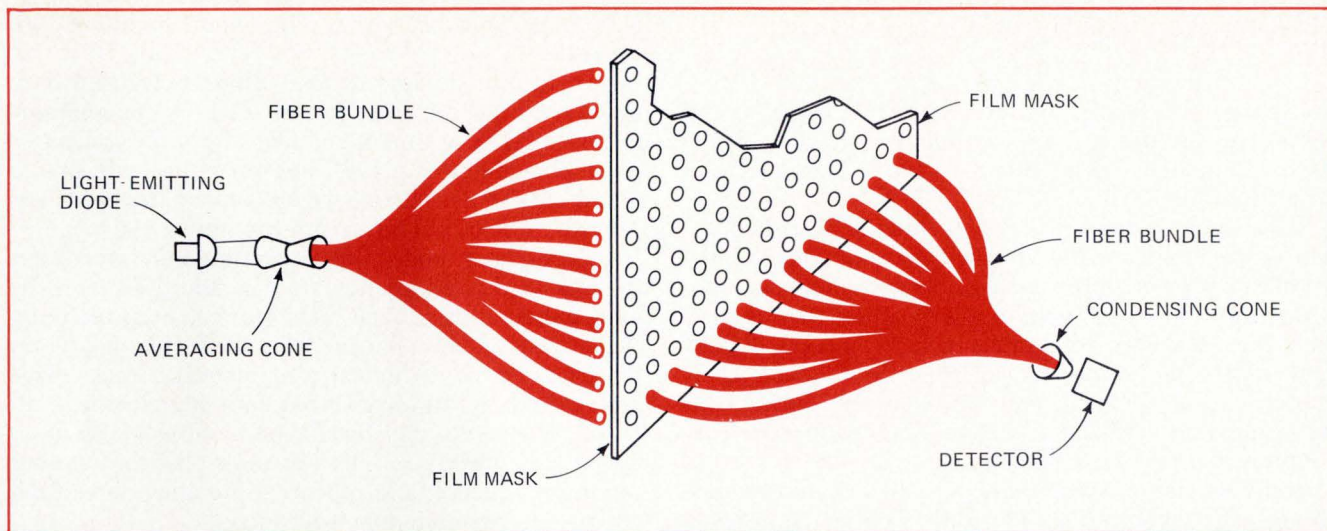

2. By the bundle. To interrogate large memories, Quadri developed a special fiber bundle to transmit light at GaAs emission peak to each bit site. Corresponding bundles pipe the light to the detector. This method eliminates the need for multiple emitters and detectors.

scratches will slightly reduce the signal-to-noise ratio for each portion of the reconstructed document, but none of the information will be completely destroyed.) Furthermore, exact positioning of the individual holograms and the uniformity of illumination at the hologram plane are not very critical.

Radiation Inc., the Ann Arbor, Mich., subsidiary of Harris-Intertype Corp., was one of the earliest facilities to devote its resources to optical storage and retrieval systems, and the systems developed there represent the most advanced in existence. Anthony VanderLugt, research manager at Radiation's Electro-Optics Center, points out that, "of the many different types of holograms that can be used for storing and retrieving information, Fresnel and Fourier transform holograms appear most suitable."

The Fourier approach is particularly attractive because information packing density is highest in the Fourier transform plane (upwards to 10^{12} bits per square centimeter). However, with Fourier transforms, the fluctuation of the light distribution can exceed the dynamic range of conventional recording media, and this results in nonlinear recording and reconstructed imagery, which are not suitable for visual displays. Although a number of techniques are available to overcome the dynamic range problem, a simple solution is to locate the holograms at a plane which is slightly displaced from the Fourier transform plane of the lens.

In one type of Radiation's recording arrangement, illustrated in Fig. 5, this modified near-Fourier transform approach is used. The input data is in the form of a 35-millimeter film strip, obtained by photoreducing the pages of the text to be stored as holograms. The lens shown in the figure serves both as an imaging and as a transform lens. As an imaging lens it projects a full-size image of the original document on a viewing screen. As a transform lens it forms the Fourier transform of the input data in the vicinity of the recording medium. In this application, it's possible to compensate for imaging aberrations, so that the lens used need not be well corrected, and costs relatively little.

The reference beam is a plane wave which impinges

on the hologram plane at an angle relative to the signal beam. After a hologram has been recorded, a different frame of the 35-mm film strip is indexed into position, the recording medium is translated so that a new portion is available, and the next hologram is recorded at this new address. The aperture of each hologram is 1 mm square, and the center spacing between adjacent holograms is 2.5 mm.

The readout configuration is simpler than that shown in Fig. 5, since the input signal path, including transparencies and lens, is eliminated. On being illuminated by a replica of the reference beam, each hologram projects an image onto a 250-mm square screen. The effective reduction factor is therefore 200 to 1, which is comparable to advanced microfilm capabilities.

Although in principle this holographic archival storage system is entirely practical, only parts of small systems have been built. It's still necessary to develop a recording technique for holographic samples that contains the density useful for an archive, and several experimental teams are working in this area.

However, a more limited holographic storage and retrieval setup, in conjunction with a conventional microfilm system, forms a complete human-readable/machine-readable (HRMR) system. This technique is particularly useful with large amounts of human-readable alphanumeric and graphical data recorded on the standard 4- × 6-inch microfiche and stored in a central file. If the same data is also stored in machine-readable form on the microfiche, the digital data can be quickly retrieved and read into a computer for annotation and merging with new data for updating purposes.

In the HRMR system being developed by Radiation, the machine-readable data is conveniently stored in binary form in an unused portion at the top of the microfiche. The area available measures about $\frac{1}{4} \times 4$ in., and the amount of stored data is 2.5×10^6 bits—the ASCII equivalent of 60 pages of the alphanumerics stored on the fiche in human-readable form. This means that the storage density of the digital data is about 2.5×10^6 bits per square inch, or about 4,000 bits/mm.²

HRMR systems of this kind have been extensively

SPECIAL REPORT

studied by the Rome Air Development Center of the Air Force, for use as large central files. In fact, Radiation will be delivering a HRMR system to Rome in June for evaluation.

Since such systems will be eventually operated by semi-skilled personnel in an office environment, it is desirable to protect stored data from accidental damage. Holographic storage provides a way of insuring against data loss, because holograms have a natural coding property that allows the data to be retrieved, even when scratches and disturbances are incurred during the recording and retrieval processes, and surface defects are present on the recording film.

In the Radiation system, digital data is stored as one-dimensional, computer-generated Fourier transform holograms. This information is recorded on the fiche after conversion to an analog signal, which modulates the beam of a laser. After exposure and development of the fiche, the original digital data is retrieved by a hologram reader which consists of: a gallium arsenide laser source; an anamorphic optical system which performs a one-dimensional inverse Fourier transform on the hologram to recover the data; and a linear photodetector array which has the job of converting the data into an electrical bit stream.

Figure 6 is a block diagram of the hologram recording system. In operation, the buffer accepts all the bits of data from the source, and transforms them into a pattern acceptable to the hologram film. There the required ones and zeros holograms of the code are formed. After formatting the data, the transformed bits are applied to a d-a converter which in turn controls an electro-optical modulator which modulates the laser. This operation is illustrated in Fig. 7, which shows the basic laser scanner. The laser records the Fourier transform as an analog one-dimensional hologram that is 3.2 mm long in a track 10 micrometers wide. Two holograms are recorded along one track in the 1/4-in. direction of the available area, and 6,510 tracks are formed

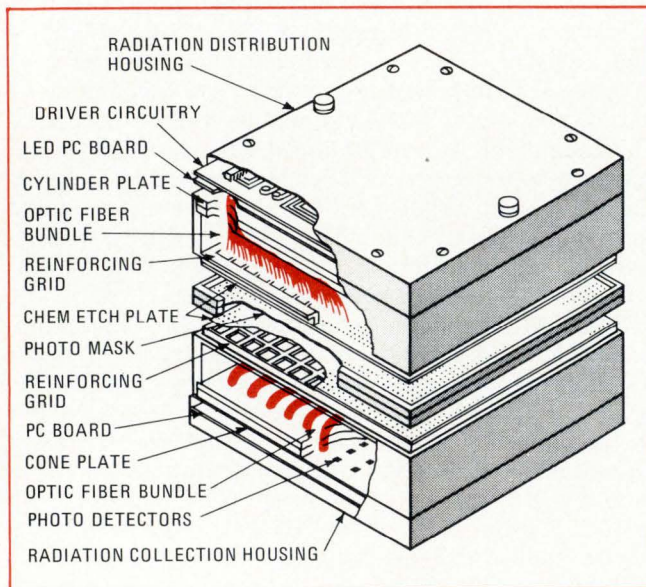

in the 4-in. direction, with a 5- μ m guard band between the tracks.

To read out the data, a laser diode is focused onto one of the holograms in the first track by the anamorphic optics. The reconstructed bit pattern falls onto two linear photodetector arrays, one on either side of the optical axis of the reader, which convert the light pattern into an electrical bit stream containing 192 bits.

A second laser diode, plus associated optics, reads out the data in the second hologram in the data track by being pulsed after the first hologram has been read out. The reconstructed bit pattern from the second hologram falls on the same two linear photodetector arrays. This light pattern is also converted into an electrical bit stream. The rest of the stored data is retrieved by moving the microfiche in a straight path past the readout station in sequence, and repeating the above operation until the entire stored data is recovered.

Unlike the full archival hologram storage and retrieval system, all the components of the HRMR system are well within the state of the art. The most troublesome requirement—the development of a laser powerful enough to record on available materials—is neatly circumvented, since only about 1,300 spots must be recorded across the 1/4-in. dimension, and the data in the hologram can therefore be contained in a spatial frequency bandwidth of only 26 to 102 lines/mm. This gives a data rate of about 1 megabit per second—a modest speed requirement for a laser scanner. Indeed, a low-power gas laser modulated by a standard electro-optical modulator and a low-speed rotating mirror is adequate to record the holograms as shown in Fig. 6.

Standard parts

Available recording materials, such as commercial Kodak films, have adequate signal-to-noise ratios and sensitivities for use in the system. In fact, at the packing density required, several have SNRs in excess of 24 dB—enough to give a system error rate of less than 10^{-7} when about 4% of the hologram is obscured by defects. Even a high-quality, relatively insensitive film such as Kodak 649F, although having a slightly higher SNR, requires a recording laser power of approximately only 2 milliwatts.

The hologram generation unit of Fig. 9, which consists of a counter, a 9-bit adder, a 128-word ROM, an AND gate and an accumulator, can be built entirely from commercially available TTL logic. The cycle time for the device is about 0.1 microsecond. If several of these devices are used in parallel, the holograms can be generated at the rate required for the HRMR system.

The laser source in the reader need not be complicated, either. It needs coherence in only one direction, because the holograms are one-dimensional, and this means that gallium arsenide laser diodes can be used. Such diodes have several advantages over conventional cw lasers: they are low-cost, reliable, small in size, and can be pulsed (that is, the holograms can be read while

3. Memory hardware. This schematic of an optical memory from Quadri shows all the characteristic components—light source, fiber bundles to direct the light to and from the mask plate, and detector and driver circuitry. It's designed for a relatively simple program.

4. Simple Simon. All holographic optical memory systems operate when a reference beam and one modulated with data (a) interface to form a hologram. This interference pattern is read out (b) when the readout beam addresses it and produces an image on a screen.

the fiche is in motion). Also, emission from a standard GaAs injection laser matches the spectral response of silicon phototransistors.

The simplicity of the reader is perhaps the system's most notable advantage. Like the light sources, the detector arrays are commercially available devices, and the optics are made up of simple, easily obtained components. Since the data is stored as Fourier transform holograms that are insensitive to motion along the track, the control of the transverse motion of the fiche-handling device is not critical. Also, a two-barrel reader design allows the fiche to be moved in a straight line along the 4-in. direction while reading out the data. Thus, no precision beam-deflection or beam-scanning devices with their attendant precision servo-control systems are required, as they are in a system which reads out the digital data bit by bit.

Read/write memories

Interesting as these retrieval systems are, they are not easily updated with new information. The ultimate objective is to develop a high-density, random access memory, capable of recording, retrieving, and also updating masses of data at high speed, and combining small size with large capacity.

Scientists at major laboratories around the country—IBM, RCA, Hughes, Honeywell, and others—are using holographic technology to build just such an optical mass memory. The thrust of the work is to develop a holographic read/write memory that could store 10^{12} to 10^{14} bits of information.

Clearly a read/write memory depends on material on which a hologram can be quickly written and quickly erased. One material that has been of particular interest as a storage medium is a thin magnetic film of manganese bismuth. In conjunction with new techniques combining holography and Curie-point heating to write and read the data, it brings the promise of mass memory with the capacity and cost of the large conventional magnetic disks, plus an access time approaching that of core.

This type of memory system is illustrated in Fig. 8. Writing and reading are functions of a laser light beam. The beam first enters a two-dimensional deflector which deflects it to any one of X-Y positions. For each of these positions or addresses, there is an area on the storage medium to which one hologram is allocated. Thus the physical address for each of the pages is determined by the deflector.

The deflected beam is then split into two—a reference beam, which goes directly to the selected page location, and an object beam, which bounces off a two-dimensional array of light modulators before arriving at the same place. The array of light modulators, called a page composer, impresses on the beam the information to be stored; it's essentially a transducer which converts input data in the form of electrical signals to spatial variations

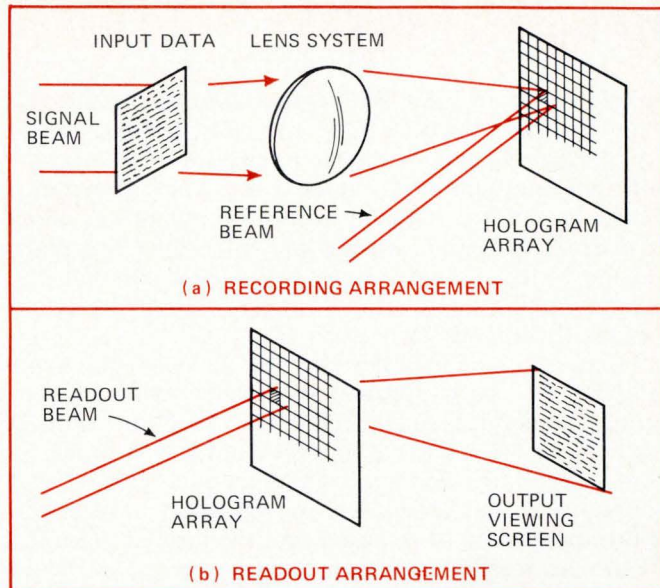

of intensity or phase of the object light beam.

At the selected page location, the reference and object beams form an interference pattern to produce a hologram of the page of information. The hologram is essentially redundant (because light from each modulator position in the page composer covers the entire hologram area), so that the storage medium need not be free from random imperfections, as it has to be if the information is stored as a small direct image.

To read a selected page of the storage medium, only the reference beam is used. When it illuminates the hologram, a real image is produced in the plane of the page composer. There an array of photodetectors, with spatial dimensions identical to those of the page composer, converts the information in the image into electrical signals. These signals, in turn, set the states of transistor flip-flops, one of which is linked with each photodetector. When this integrated array is provided with appropriate addressing circuitry, it can function as the operating memory in the system.

The five functional components of the optical memory are therefore: the laser, the beam deflector, the page composer, the storage medium, and the detector. The external operating memory interfaces with the page composer and the photodetector.

Storage medium

The storage medium is the heart of this system, and although there are several possible candidates, one approach that in principle could satisfy all the requirements is the thin magnetic film of manganese bismuth.

Holograms can be written on MnBi films by Curie-point writing: light incident on the film is absorbed, raising the local temperature over the Curie point and causing the film in that region to become paramagnetic. After the light is removed, that region of the film cools and regains its ferromagnetic state, but with the direction of magnetization reversed.

In the case of holography a roughly periodic light intensity is incident, and a corresponding periodic magnetization pattern results. To preserve the fine detail of the periodic pattern, the light pulse must last only a short

SPECIAL REPORT

time. To attain the Curie temperature of the film, the light intensity must be high. Typically, pulse durations of 20 nanoseconds with peak intensities of 10 kilowatts of light are required for an area of 1 mm². However, it must be pointed out that a laser output power of approximately 100 kw is necessary to produce this power at the MnBi surface because of losses in the deflector, page composer, and various optical components such as lenses, mirrors, etc.

Because of the high power required, Curie-point writing has not been practical with the present commercially available lasers. The only exception is a Q-switched ruby laser, but its repetition rate is much too low to be practical in a memory. However, recent developments in Nd:YAG lasers indicate that a laser with both the desired peak power and the desired pulse rate could be feasible. Of even greater interest is the so-called "doubled" YAG laser which has an output in the green (5,300 angstroms). Since the information packing

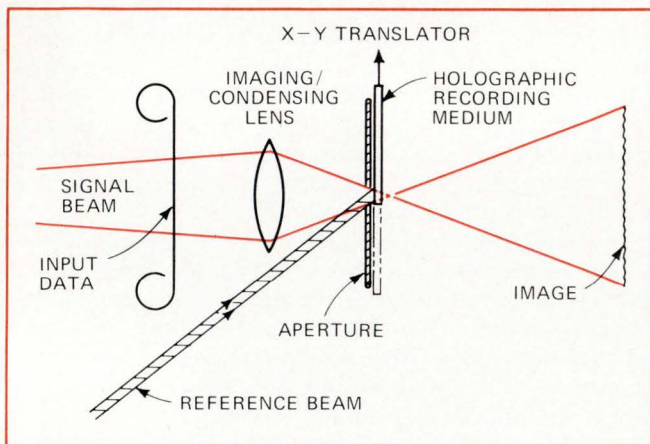

5. Recording. Radiation Inc., an Ann Arbor, Mich., subsidiary of Harris-Intertype, is one of the earliest installations to build complex holographic memories. In one of Radiation's recording arrangements, information from a 35-mm film is made into a hologram.

density which can be achieved varies inversely as the square of the light wavelength, the doubled YAG is the optimum choice for a memory using MnBi as the storage medium.

Instant holography

RCA is one company heavily involved in developing mass storage systems for archival memories. RCA researchers very recently developed a material on which they are able to develop a holographic image immediately, without waiting until the chemical processing required for conventional holographic recording film is over. Recording on thin films of arsenic trisulfide, this real-time hologram technique now puts optical recording in a "whole new light," quips William Webster, vice president of RCA Laboratories in Princeton.

"Although they are simpler to make and easier to control," says Webster, "the new holograms offer all the basic advantages that holograms made with photographic film do. They are scratch- and dust-resistant,

and can store up to 10,000 bits of information in a square millimeter. Furthermore, because they require no chemical processing, they need not be moved after exposure and thus are perfectly positioned for the successive observations required in nondestructive industrial testing."

Low-powered

With the new RCA technique, the holograms are made, or exposed, with a low-powered green laser beam (argon) while their images are simultaneously being projected and read out by an even lower-powered red laser beam (helium-neon).

Figure 9 is a laboratory demonstration of the principle involved. Since the red beam does not affect the exposure, the holographer can watch the image develop, and turn off the green laser when the image reaches the intensity he wants. Alternatively, he can use a light sensitive detector to end the exposure automatically when the image reaches a predetermined brightness. After the green beam is turned off, the hologram is completely developed and now represents a record that is permanent and ready to use.

Another option open with arsenic trisulfide films is the use of the green beam for both writing and readout. Once the desired exposure has been achieved, the holographer merely reduces the intensity of the beam so that there will be no further change in the film. The light is still bright enough for the hologram to be read easily.

"Key to the development," says Scott Keneman, who developed the technique under the direction of Jan A. Rajchman, staff vice president, information sciences, "is the use of a thin film of arsenic trisulfide as the holographic recording medium. Such a film is easily evaporated onto a glass plate with standard techniques, and provides a diffraction efficiency that conventional photographic film holograms can equal only through the use of special processing techniques, such as bleaching."

In operation, the arsenic trisulfide film is exposed in conventional holographic fashion, recording the optical interference pattern created by the interference of an object beam and a reference beam. As it strikes the thin film, the interference pattern of green light causes the absorption edge of the arsenic trisulfide to shift perceptibly. The amount of shift, which is also accompanied by a change in the index of refraction of the material, varies with the varying intensities of light in the interference pattern.

The end result is that the index of refraction of the arsenic trisulfide film is changed to represent the original interference pattern, and a holographic image is subsequently projected whenever a proper laser beam goes through the film.

Although still in the early laboratory stages, already efficiencies of several per cent can be obtained in a square-millimeter hologram stored with approximately 15 mW of laser power in 10 seconds. Significantly, this technique offers very high resolution. Holograms with a resolution of 2,860 lines/mm have been recorded in film 2 μ m thick, with no signs that the resolution limits of the arsenic sulfide have been approached. And most important, RCA is investigating the possibility of devel-

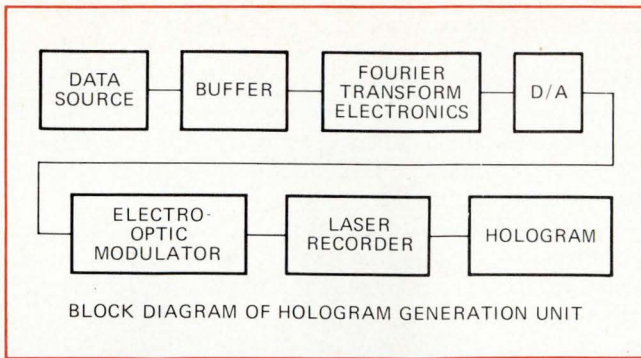

6. Man and machine. In human-readable/machine-readable memory from Harris, a hologram is generated and stored as shown.

oping techniques that would permit the erasure and re-writing of the holograms so that they could be used for read/write as well as for read-only memories.

Displays

Since hologram displays are practically three-dimensional, the prospect of 3-d viewing of objects—land contours, design tools, mechanical surfaces—intrigues equipment manufacturers. But conventional holographic recording and reconstruction is not real-time; it requires a real image in the reconstruction process, and is not suited to dynamic displays.

Bendix, however, has recently developed a concept for a truly dynamic 3-d display system, and has demonstrated the feasibility of its underlying physical principles. The system is based upon holographic principles, which can accept data in coordinate form and synthesize a three-dimensional display in real time.

Its use in topography and map making alone would make a real-time 3-d display an exciting prospect. In fact, the possibility of a true three-dimensional display that could be updated in real time has always been the dream of military display designers ever since it became evident what cathode-ray tubes could accomplish in two dimensions. But an even more important application would be as an industrial design tool, where the contour of a surface, say, the fender of an automobile, could be generated and displayed and changed and regenerated

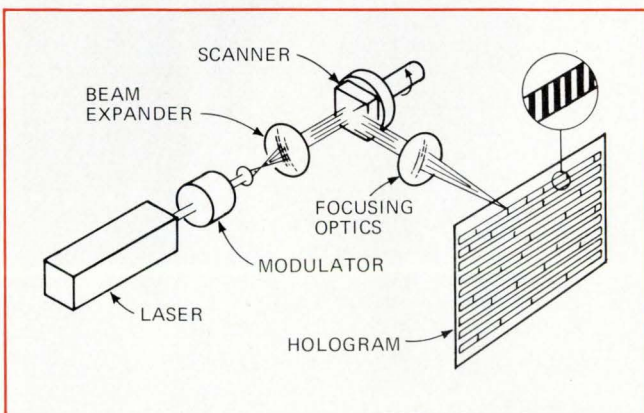

7. Machine reader. For its HRMR development memory, Harris has developed a scan technique in which a laser records a Fourier transform as an analog hologram 3.2 mm long in a track 10 μ m wide. The data is read when a laser is focused onto the hologram.

and redisplayed, the holographic 3-d display concept has considerable potential.

In the Bendix system, the code used is the Fourier transform—mentioned earlier—of the object imagery in the hologram plane. It facilitates reconstruction because it involves an inverse transformation easily accomplished by proper illumination of the hologram.

However, to perform the Fourier transform for even simple surfaces in real time, enormous computational capacity would be required. A large-scale computer would have to be programmed to generate such a hologram, display the computed two-dimensional pattern on a CRT, expose a transparency, and then achieve a reconstructed image.

Sound principle

Fortunately, such a requirement has been eliminated by the development of acousto-optical deflectors, which control the laser beam used for reconstruction. The idea is this: the acousto-optical deflector, on a signal from the contour detector, deflects the laser beam through an angle determined by the frequency at which the acous-

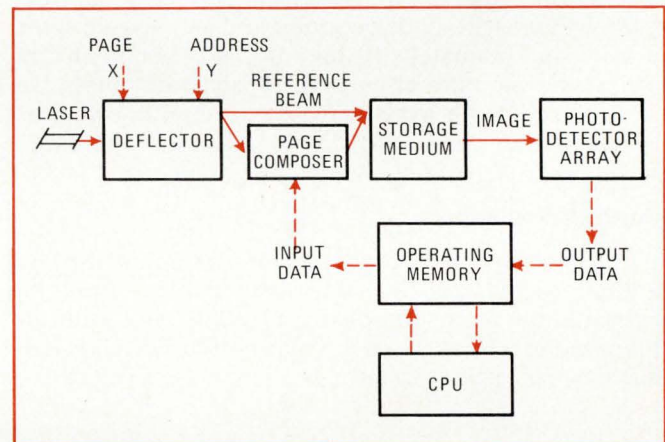

8. Reading and writing. Under development are read/write holographic memories that have storage systems comprising laser, beam deflector, page composer, storage medium and detector. The operating memory interfaces page composer and CPU.

tic transducer is driven, and which has a random access time of the order of microseconds. With two such transducers, the rapid scan of a laser beam in two dimensions is possible, and early models of these devices have achieved excellent television type X-Y displays at normal frame rates. Five hundred spot resolution, using the Rayleigh criterion, is currently realizable in a beam deflector. And it is from this real-time 2-d display that the 3-d holographic display is generated.

The details are shown in the diagram in Fig. 10, and a photograph of the setup is given in Fig. 11. The first step is to form the hologram. The laser beam is passed through an intensity modulator A and then split at B into two beams. The first beam is deflected to a position X', Y' on a diffusing surface G₁ by beam deflectors D₁ and D₂. The second (reference) beam is deflected to position Z' on diffusing surface G₂ by deflectors D₀ and D₃. The holographic recording medium R is illuminated by the two point sources in a succession of steps; the intensity and position at each step is controlled by com-

SPECIAL REPORT

mand computer C, which also performs the required coordinate transformations and corrections.

The second step in the process is to advance the recording medium one frame after developing, and to illuminate the hologram off axis by means of an auxiliary laser. Then the virtual image can be viewed by the observer as shown.

Plain and simple

In this display, the recording medium can be a fast, self-developing photographic film. The film strip is advanced from the recording to the display position frame by frame, as in a motion picture projector. An update time of 1 to 10 seconds and a lag time of 10 seconds appear reasonable.

The components of a feasibility demonstration system of this type are presently being assembled at Bendix. The number of image elements resolvable will be approximately $(300)^3$ or 27×10^6 . For a 2-second total exposure interval, an access time of only approximately 10 microseconds per point and an exposure time of only approximately 10 microseconds per point (all well within the state of the art), 10^5 separate points can be displayed. With some increase in computer complexity, continuous lines could also be generated where useful, without lengthening the updating interval.

Monolithic displays

The most advanced large element arrays under development today are the solid state displays built on monolithic gallium phosphide substrates and with alphanumeric elements that are matrix-addressable. General Electric in Schenectady, N.Y., has been one of the

outstanding pioneers of this type of display.

The advantages of this approach are many. GaP is presently the most efficient light-emitting material that can be easily fabricated. The display can be small, yet contain many light-emitting elements. Matrix-addressing cuts the number of interconnections and external wires to a minimum.

For large displays some form of matrix addressing will probably be essential. As its size increases, an alphanumeric array in which the elements are individually addressed quickly becomes undesirable because it requires such a large number of external leads—a display panel of N elements will require $(N+1)$ external leads. Matrix-addressing reduces this number, cutting it, for example, in a 5×7 array from 36 to 12. A 200-character display, utilizing 7,000 light-emitting elements, can be made with 170 external leads with matrix addressing, instead of the 7,001 leads required for individually addressed devices.

Matrix addressing of individual diodes can be obtained in a hybrid assembly. But fabrication of such a 5×7 array would require 35 die bonds and 35 wire bonds, so that though the external lead complexity is reduced, the number of interconnections on the array increases. The potential unreliability of each interconnection makes the approach impractical for the larger display systems.

A refinement of the hybrid approach is a beam-leaded structure, in which the elements are linked by the beam leads. Though such structures have been described for both gallium arsenide and gallium phosphide, they are fragile and cannot be built to any size.

GE feels that the most promising approach is a planar, monolithic matrix-addressable display. Planar monolithic structures are single semiconductor pieces with surface smoothness on the order of the thickness of



9. Real time. In a technique developed by RCA, a hologram can be developed instantaneously. A green laser is used to expose the hologram, while a red beam is used to read it out. In the setup here, the operator turns off the green beam when he has right exposure.

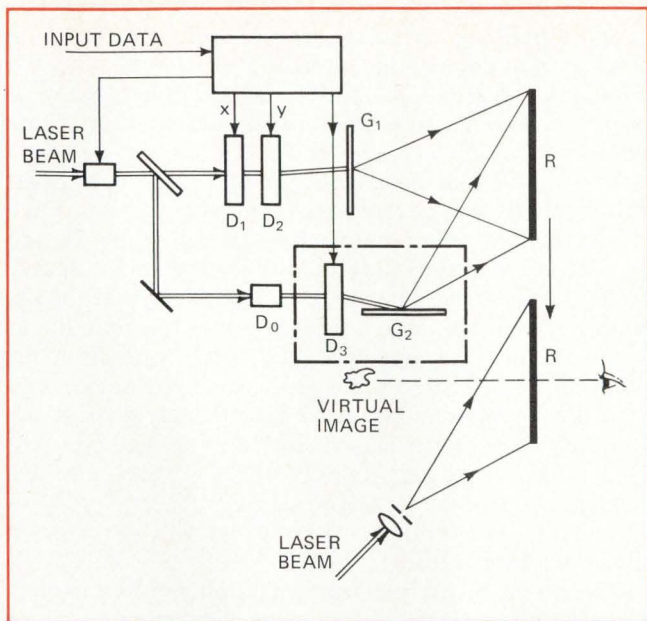

10. Three dimensions. Bendix' dynamic 3-d display system uses holographic methods to accept data in coordinate form and synthesize a display in real time. A computer (c) controls the intensity and position of the light and performs transformations and corrections.

the metalizations and passivations, typically no more than 0.001 in. These monolithic devices typically have a thickness greater than 0.004 in., and are characterized by their ruggedness and the ease with which they may be handled.

A substrate of GaP in a (1-1-1) orientation is either grown by vapor epitaxy, or else cut from an undoped ingot. By means of pyrolytic decomposition, a layer of SiO₂, about 2,500 angstroms thick, is deposited on one face of substrate, and then a stripe pattern is etched

through the SiO₂ film. Stripes of n-type GaP are grown on the unmasked surface of the substrate, after which the surface of the substrate is lapped lightly, leaving parallel n-strips about 4 mils deep. After the top surface has been recoated with SiO₂, and patterned with stripes running orthogonally to the n-strips, stripes of p-type GaP are grown. Zinc and gallium oxide are used as dopants here, so the resulting diodes, which are formed at every intersection of a p-stripe and an n-stripe, will emit red light.

The resulting structure has electrically isolated n-type stripes buried in an insulating GaP substrate, with an orthogonal overlay of p-type stripes which are also electrically isolated from each other.

Next, a 2,000-angstrom layer of gold-zinc is evaporated over the structure, followed by an electroplated nickel layer about half as thick. These layers are then alloyed into the GaP to provide electrical conduction paths for the p-strips and to serve as absorbers for unwanted light. Aqua regia is used to etch 10-mil holes through the metalization over each p-n junction, providing windows for light emission.

Individual 5 × 7 arrays are cut from these wafers and mounted, n-strips down, on a metalized, prepatterned alumina substrate. Ohmic contact to the n-strips is made by alloying to gold-tin stripes included in the metalization pattern on the alumina. Wire bonds from bonding pads to each p-stripe complete the mounting of the array.

Good qualities

Completed, a 5 × 7 element device measures about 0.14 × 0.10 in., about twice the size of typical newtype. A single array, bonded and wired to an alumina substrate, is mounted with one die bond and five wire bonds for a total of six interconnections. Variations of

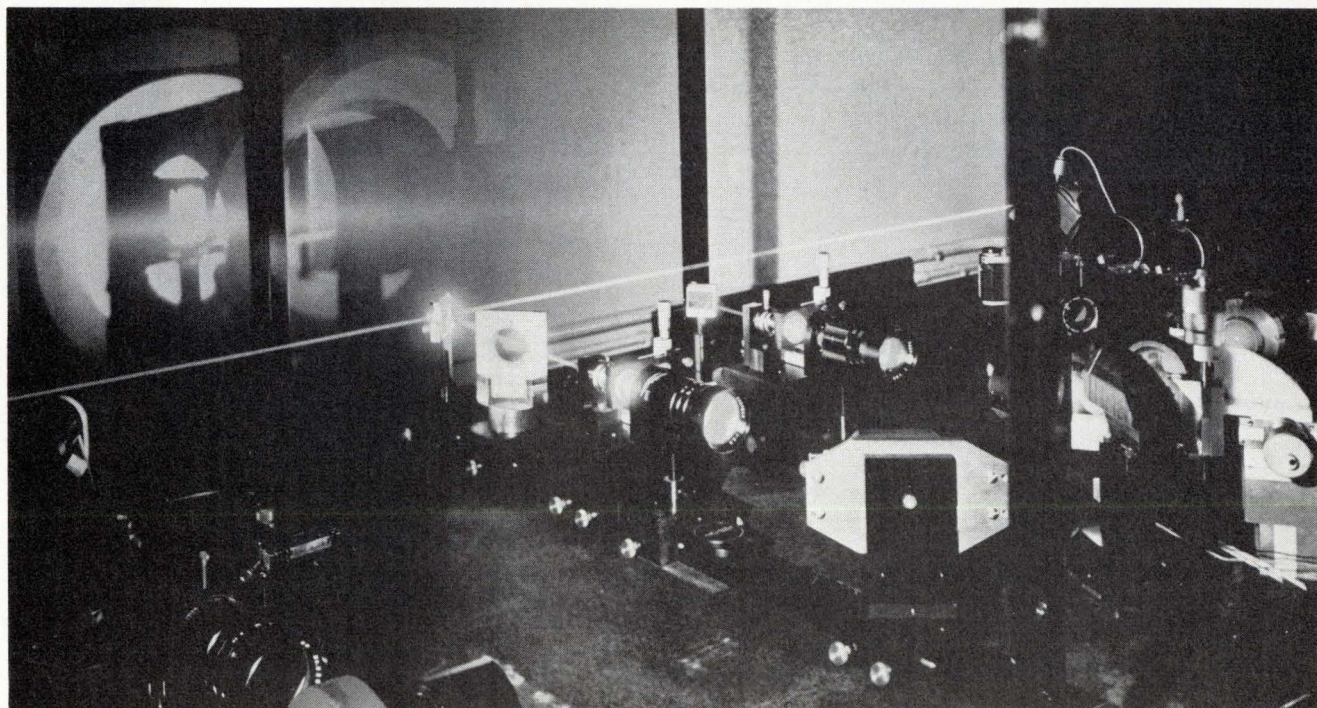

11. Beaming. Bendix' laboratory setup for its quasi-real-time holographic display puts the concept of the real-time holograph through its paces. The setup serves as the basis for the assembly of the components for a feasibility demonstration system with 2-second exposures.

SPECIAL REPORT

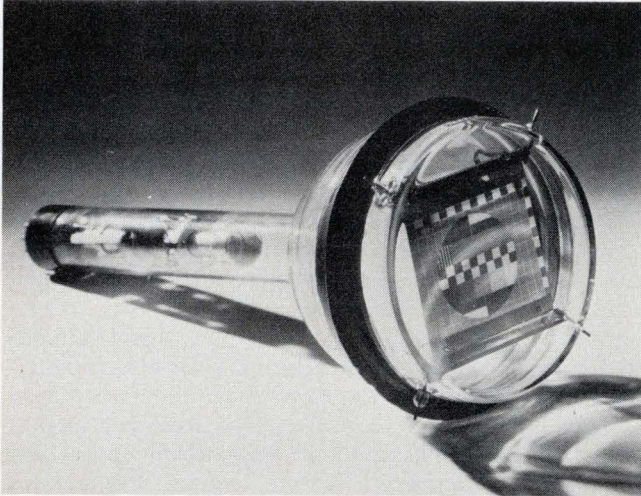

12. Messenger service. RCA Laboratories' cathodochromic storage tube can store and display images of very high quality, as this test pattern shows. Tube is designed for terminal displays.

this design require only one interconnection. This is to be contrasted with the 35 die bonds and 35 wire bonds of the comparable hybrid array.

The planar monolithic array has another feature to distinguish it from hybrid arrays. In addition to radiation from the 10-mil windows in the p-stripes, an element edge emission occurs at the edges of the p-stripes. This gives the appearance of a continuous line when ad-

acent diodes are operating, and is preferable to a line formed from discrete dots of light. At the same time, the array provides enough optical isolation between elements to allow clear, unambiguous presentation of any character.

In a simple matrix-addressable array, the light-emitting elements are operated on a time-shared basis. Each diode is therefore operated in a pulsed mode. In the case of red-emitting GaP, saturation of the radiative centers sets in at rather modest currents, so that for the higher currents the light output becomes less than linear with current. This makes pulsed mode operation far from ideal for red-emitting GaP, yet high device efficiencies are very important. Nevertheless, even at the low duty cycle of one eighth, and at an average current of 1 mA, average brightnesses up to 60 foot-lamberts have been demonstrated. And significantly, the problem of light output sublinear with current will not exist in green-emitting GaP.

There is a broad spectrum of applications for electronic alphanumeric display devices, ranging from small displays measuring less than 6 inches on a side, through medium-size displays up to 2 feet on a side, to large displays covering a whole wall. The required information density may vary from several bits per inch to a few hundred bits per inch.

To date, the cathode ray tube is dominant for small and medium-sized information displays, though it is encountering competition from several newer technologies. For medium-sized, high-bit-density display devices, gas plasma panels may become an alternative, although cathode ray tube will probably remain the

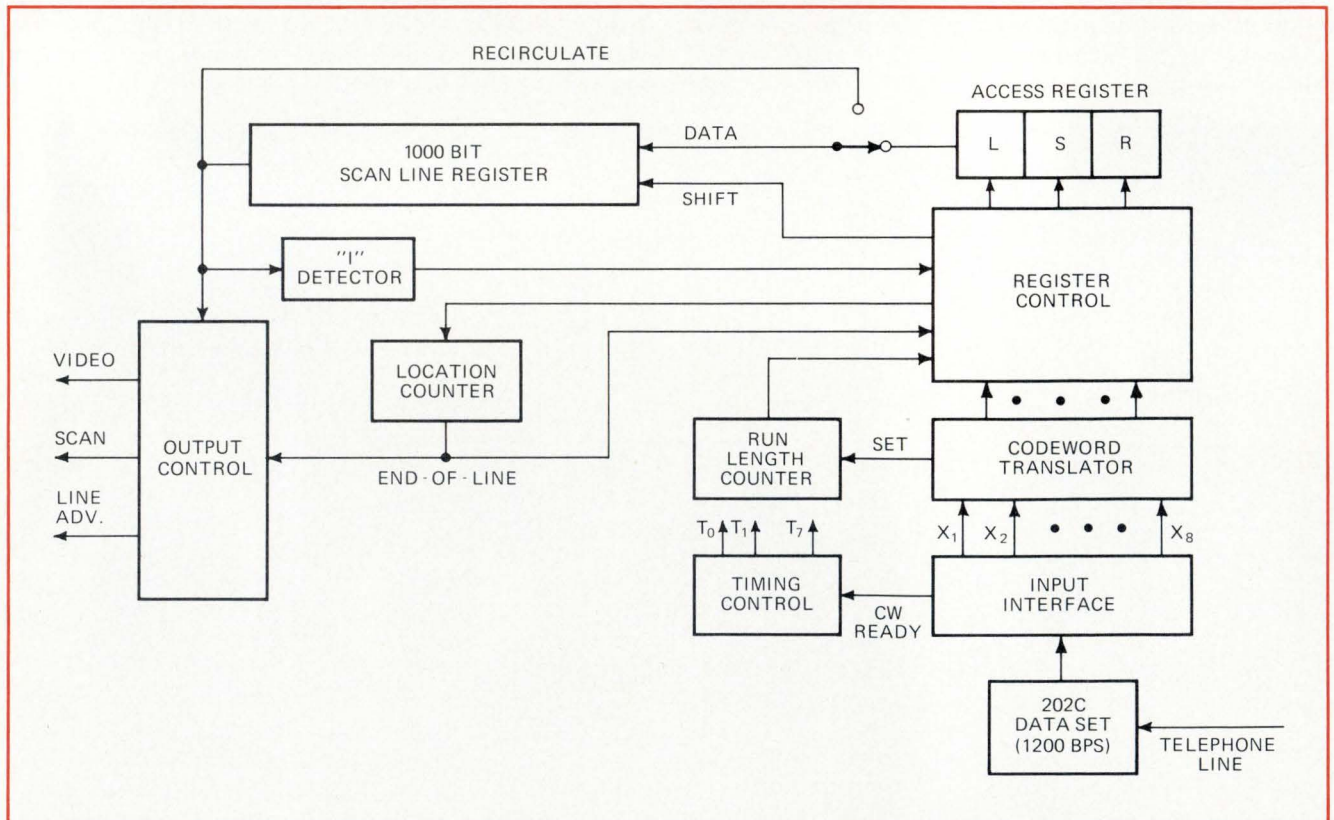

13. Companion. Along with the tube, RCA has developed a decoder system to transmit the image over standard telephone lines, from a central storage bank to remote tube terminals. The reference decoder shown here has actually been used by RCA over telephone lines.

preferred display system for some time. Medium-sized, low-bit-density displays can be served well by liquid crystals. For small displays with low information densities (up to 25 bits per inch), hybrid arrays of light-emitting diodes have been successfully used.

Small desktop display systems that have a high bit density are well suited to monolithic light-emitting diode arrays. For these small systems with up to 1,000 characters, this monolithic matrix-addressable display device approach and its future modifications and variations can be a viable solution to the information display problem.

The storage tube of the future

RCA, recognizing the growing interest in information distribution systems, is in the process of designing a novel graphics display terminal around a recently developed cathodochromic tube that both stores and displays images. This type of display with storage would be particularly useful where a central data bank services many remote terminals, distributing weather map facsimiles, engineering drawings, texts, catalogs, etc.

Clearly, a practical information distribution system must combine low cost with efficient graphics transmission. Since their cost is largely determined by the devices employed for image storage and display, it is desirable to combine the storage and display functions in a single device, and this is a key feature of the RCA tube.

In cathodochromic tubes, information is stored by a reversible electron-beam-induced coloration of the CRT screen material. Since storage is the result of bulk material properties, the tubes are simple and inexpensive. Their address and erase times are longer, but their image retention capabilities are better, than those of storage devices based on surface-charging effects. For this reason, they are well suited for applications where quasi-hard-copy displays are desired.

The RCA tubes have essentially infinite storage time and the displayed image is flicker free. The image quality that is exhibited by these developmental tubes is better than that achieved by any other known frame storage device.

In construction, the storage display screen consists of a thin sheet of mica, a transparent resistive heater, and the settled cathodochromic powder. The heater serves both as the ultor and as the means of thermally erasing the stored image. With this setup, at 25-kilovolt ultor voltage, 4:1 contrast ratio of the stored image is achieved with a 130 microcoulombs/in.², electron beam exposure, while a 10:1 contrast ratio is achieved with 500 microcoulombs/in.² Most important, erasure times of less than 2 seconds have been demonstrated. An example of an image stored on a tube is given in Fig. 12.

Since these storage tubes will be used as terminals for a remote central data bank, data most probably will be transmitted over standard telephone lines. Therefore, it is necessary to employ reference encoding and an efficient graphics data compression technique to reduce transmission time. In addition, inexpensive decoding hardware is a must in information distribution systems where low terminal cost is essential.

Along with their storage tube, the RCA researchers

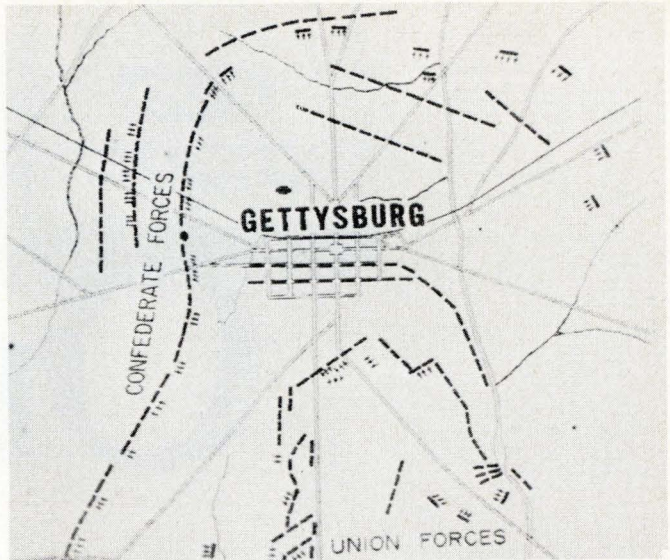

14. Charge. Information such as maps, photographs, catalog pages and stock lists, could all be handled with the RCA storage tube. Data is transmitted at 1,200 baud in an asynchronous character format.

have developed a simple reference decoder, using a single 1,000-bit static MOS shift register, both to store the previous line for use in reference entry decoding, and to accumulate the current scan line as it is decoded. At the start of a new line the scan line register holds the previous line. Code words are received serially, and are accumulated in an input interface. When an 8-bit segment is ready, the timing cycle is initiated and a code word is recognized as either a reference or a run length.

If it is a reference code word, the scan line register shifts until a transition is detected at the output. A transition is then entered through the appropriate access register stage.

Run length code word entries are set into the run length counter. The scan line register is then shifted until this counter counts down to zero, and a transition is entered if the code word represents a terminated run length entry.

As the new line is decoded, it is shifted into the scan line register, displacing that portion of the previous line which is no longer needed. When the present line has been fully decoded, the scan line register is recirculated once at a constant rate for output to the cathodochromic tube. The recirculation is completed before the next 8 bits of encoded data are available.

RCA has operated an experimental terminal to receive encoded image data over voice grade telephone lines from a time-shared RCA Spectra 70/45 computer. Figure 14 shows samples of the data accessed and stored. Data is transmitted at 1,200 baud in an asynchronous character format (two framing plus eight information bits/character). The display tube is addressed on a line-by-line basis: as each scan line is reconstructed by the decoder it is outputted to the CRT. Scan lines composed of 1,000 elements are written in 40 milliseconds. The resulting dot writing time of 40 microseconds is sufficient to produce contrast ratios approaching 10:1. □

This is the third of a three-part series on optoelectronics. Reprints of the entire series are available at \$4.00. Write to Electronics Reprints Department, P.O. Box 669, Hightstown, N.J. 08520. Copyright 1972, Electronics, A McGraw-Hill Publication.

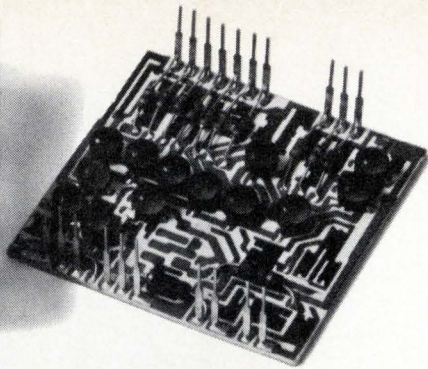
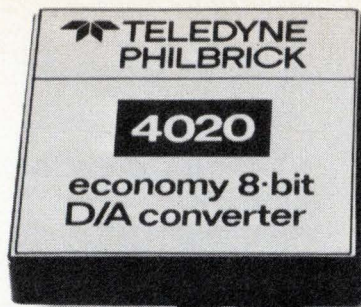

Ours. A bit ahead of theirs.

Another \$19 DAC? But, don't put us down until you've tried it.

Competition gives you exactly what you pay for... a \$19 circuit... no more, no less. Ours is based on Philbrick's famous 4006/4007 digital to analog converters selling originally for \$70 to \$75.

Combined thick-film and re-flow techniques have endowed our 4020/4021 8-bit model with higher performance than you'll get from any competitive unit. Things like — linearity of $\pm 1/2$ LSB with a settling time of 25μ sec and temperature coefficient of 40 ppm/ $^{\circ}$ C.

Match this with any other \$19 DAC and you'll know why we say it's a bit ahead of theirs.

Looking for a 10-bit model?

Then compare our 4022/4023 \$29 version with anybody's. We welcome the comparison. Evaluation samples are yours for the asking. While you're asking, request our new 1972 Product Guide.

Ask your local Philbrick representative or write, Teledyne Philbrick, Allied Drive at Route 128, Dedham, Massachusetts 02026. For toll-free ready data dial (800) 225-7883. In Mass., (617) 329-1600.

Philbrick Data Converters. The good ones.

Doubling op amp summing power

Design equations make calculations for non-inverting amplifier input as simple as those for inverting input so that amplifier efficiency is maximized when several signals are summed at the same time

by Raymond G. Kostanty, Bendix Corp., Navigation and Control division, Los Angeles, Calif.

□ Summation of multiple signals is a useful circuit technique whenever more than one signal must be amplified or attenuated with a single amplifier—for example, in instruments or avionics equipment. And the versatile operational amplifier makes it possible to sum simultaneously on both its inverting and non-inverting inputs.

Unfortunately, designers frequently utilize only the inverting input because calculations for the non-inverting input are usually tedious. A common practice is to use the inverting input of another amplifier, rather than going through the mathematics for the non-inverting input of a single stage.

A new set of equations simplifies summation circuit design by making the resistors for one input as easy to calculate as the resistors for the other. Thus, a single op amp may perform as well as two that use only the inverting input.

Relationships between signal gain, input and feedback resistors, and input and output voltages are uncomplicated for the inverting input, and each can be handled separately. But previously, the non-inverting input required the solution of simultaneous equations—one equation for each applied input. Although these equations were only first-order functions, their solution could become cumbersome for three or more inputs.

The new equations use up to two grounded resistors—one for each side of the amplifier—to control available amplifier gain. This technique permits all signal gains and all input resistors to be calculated without simultaneous equations and with only simple arithmetic.

Circuit functions are elementary

A few basic assumptions are necessary to minimize equation complexity. The amplifier, for example, is assumed to have infinite gain, infinite input resistance, and zero output resistance. Moreover, each of the amplifier's inputs is considered to be directly coupled from a low-impedance source resistance.

The equations set the dc resistance from the amplifier's inverting input to ground equal to the dc resistance from its non-inverting input to ground. This minimizes output null shift with changing temperature.

Output/input relationships for the fundamental amplifier configuration of Fig. 1 are easily defined. Let E_o be output voltage, E_i an input voltage at the inverting terminal, and E_N an input voltage at the non-inverting

terminal. For the inverting amplifier input:

$E_o/E_{I1} = K_{I1}$, $E_o/E_{I2} = K_{I2}$, and $E_o/E_{IN} = K_{IN}$ where K_I represents the desired gain of the signal applied to the inverting input, and subscripts 1 through N designate signal number. For the non-inverting input:

$E_o/E_{N1} = K_{N1}$, $E_o/E_{N2} = K_{N2}$, and $E_o/E_{NN} = K_{NN}$ where K_N is the desired signal gain through the non-inverting input. Once a convenient value for feedback resistor R_F is selected, the input resistors can be found:

$$R_{I1} = R_F/K_{I1}, R_{I2} = R_F/K_{I2}, \text{ and } R_{IN} = R_F/K_{IN} \quad (1)$$

$$R_{N1} = R_F/K_{N1}, R_{N2} = R_F/K_{N2}, \text{ and } R_{NN} = R_F/K_{NN} \quad (2)$$

The values of resistors R_S and R_A depend on the relationship of the sum of the inverting gains to the sum of the non-inverting gains.

Let: $\Sigma K_{IN} = K_{I1} + K_{I2} + \dots + K_{IN}$

and: $\Sigma K_{NN} = K_{N1} + K_{N2} + \dots + K_{NN}$

If: $1 + \Sigma K_{IN}$ is greater than or equal to ΣK_{NN} (3)

then: $R_S = \infty$

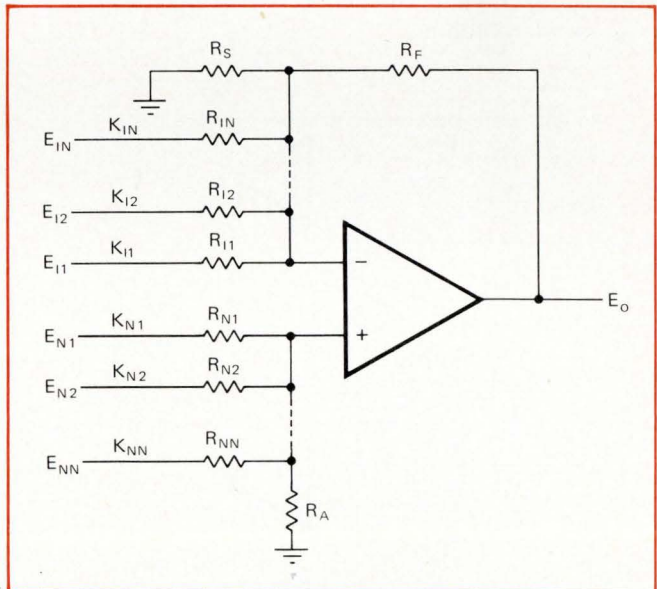

1. Double summation. Finding resistor values when signals are summed at both inverting (I) and non-inverting (N) inputs of op amp can be reduced to elementary calculations. Up to N inputs to either terminal can be accommodated. Simple equations relate input and output voltages to signal gain. Input resistor values depend on R_F and signal gain: $R_{IN} = R_F/K_{IN}$, and $R_{NN} = R_F/K_{NN}$. Resistors R_S and R_A are determined after comparing gain summations.

- and: $R_A = R_F / (1 + \Sigma K_{IN} - \Sigma K_{NN})$ (4)
 If: $1 + \Sigma K_{IN}$ is less than ΣK_{NN} (5)
 then: $R_S = R_F / (K' - \Sigma K_{IN})$ (6)
 and: $R_A = R_F / (1 + K' - \Sigma K_{NN})$ (7)
 where: $K' = R_F / R_S + \Sigma K_{IN}$ (8)
 If Eq. 5 rather than Eq. 3 is satisfied, a minimum value is arbitrarily assigned to K' , which represents the sum of the inverting gains:
 K' must be greater than or equal to $\Sigma K_{NN} - 1$ (9)

Utilizing the results

Using these equations is not difficult and can be illustrated by a few examples. Suppose that an amplifier must be designed for $K_{I1} = 1$, $K_{I2} = 2$, $K_{N1} = 0.5$, and $K_{N2} = 2$; all other inputs are zero. First, a convenient value must be chosen for R_F . (It should be noted that the overall resistance level of the final circuit is proportional to R_F , and that amplifier offset current limits the maximum value of R_F .) Selecting an arbitrary R_F of 50 kilohms allows values of the input resistors to be found with Eqs. 1 and 2:

$$R_{I1} = 50k/1 = 50 \text{ kilohms}$$

$$R_{I2} = 50k/2 = 25 \text{ kilohms}$$

$$R_{N1} = 50k/0.5 = 100 \text{ kilohms}$$

$$R_{N2} = 50k/2 = 25 \text{ kilohms}$$

Since $\Sigma K_{IN} = 3$ and $\Sigma K_{NN} = 2.5$, Eq. 3 is satisfied:

$$1 + 3 \text{ is greater than or equal to } 2.5$$

so that:

$$R_S = \infty$$

and from Eq. 4:

$$R_A = 33.3 \text{ kilohms}$$

The final design is illustrated in Fig. 2(a). If signal conditions remain the same, but another input, $K_{I3} = 3$, is added, input resistor values do not change, and:

$$R_{I3} = 50k/3 = 16.7 \text{ kilohms}$$

Because Eq. 3 is still satisfied, $R_S = \infty$ but:

$$R_A = 11.1 \text{ kilohms}$$

Figure 2(b) shows this completed design.

If a non-inverting, rather than inverting, input is added to the first amplifier example, resistor values, when R_F is 50 kilohms, are unchanged for R_{I1} , R_{I2} , R_{N1} , and R_{N2} . For the new input, $K_{N3} = 3$:

$$R_{N3} = 50k/3 = 16.7 \text{ kilohms}$$

Equation 3 is no longer satisfied, since $\Sigma K_{IN} = 3$ and $\Sigma K_{NN} = 5.5$, but Eq. 5 is:

$$1 + 3 \text{ is less than } 5.5$$

Now, the minimum value of K' is found from Eq. 9:

$$K' \text{ is greater than or equal to } 5.5 - 1 = 4.5$$

Using this value for K' , R_S and R_A can be computed with Eqs. 6 and 7, respectively:

$$R_S = 33.3 \text{ kilohms}$$

$$R_A = \infty$$

The finished circuit is shown in Fig 2(c). If some of the non-inverting gains are expected to increase or some of the inverting gains to decrease, a larger value for K' , such as 8, would be more appropriate. Resistors R_S and R_A then become $R_S = 10$ kilohms and $R_A = 14.3$ kilohms, as indicated in Fig. 2(d).

Modified designs

Given an existing circuit, it is possible to modify it with the design equations. Suppose non-inverting gain must be increased by 20% for the amplifier of Fig. 3(a), in which $R_F = 50$ kilohms, $R_{I1} = 25$ kilohms, $R_{I2} = 50$ kilohms, $R_{N1} = 10$ kilohms, $R_S = 16.7$ kilohms, and $R_A = 25$ kilohms. Existing signal gains must be determined first, using Eqs. 1 and 2:

$$K_{I1} = 50k/25k = 2$$

$$K_{I2} = 50k/50k = 1$$

$$K_{N1} = 50k/10k = 5$$

Next, find K' for $\Sigma K_{IN} = 3$. From Eq. 8:

$$K' = 50k/16.7k + 3 = 6$$

For the modified circuit, K_{N1} must be 20% higher, or:

$$K_{N1} = 5(1.2) = 6$$

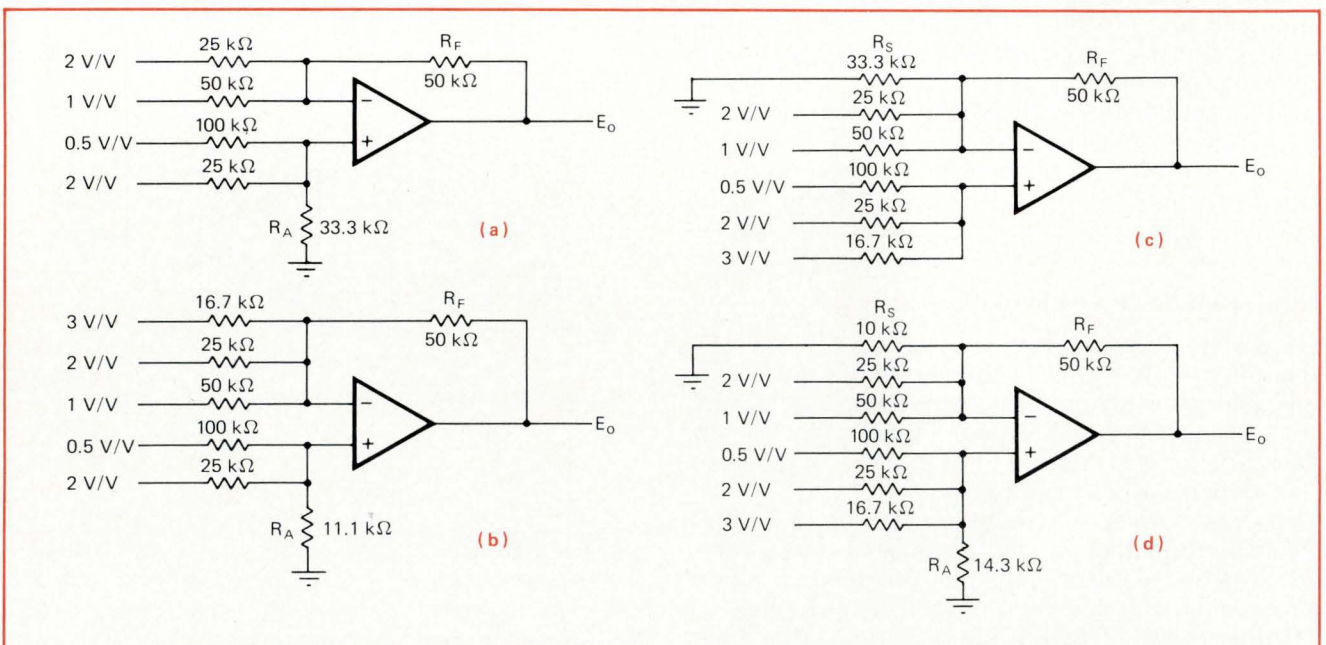

2. Amplifier examples. When another inverting input is added to amplifier (a), as in (b), values of existing input resistors are not affected, but R_A changes value. If non-inverting input is added instead, as in (c), R_S becomes necessary and R_A is eliminated. Amplifier (d) is final design for modified version of (c) that can handle increased non-inverting gains or decreased inverting gains.

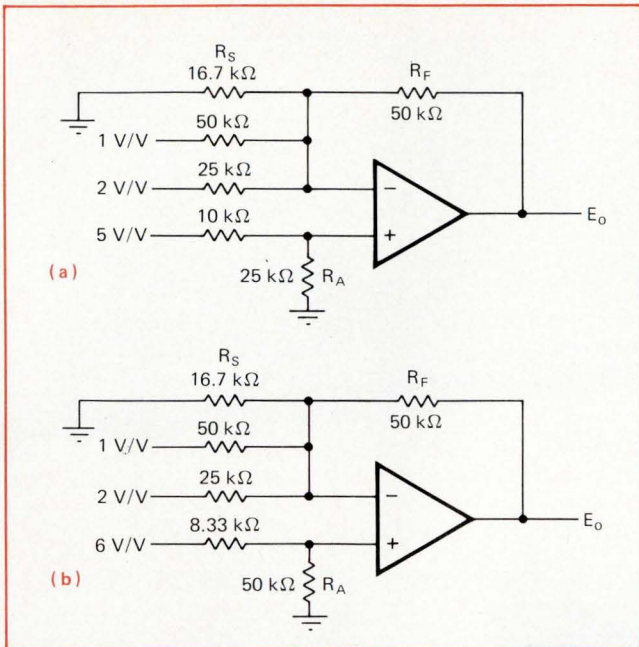

3. Making changes. New design equations are also useful for modifying existing circuits. When non-inverting gain of amplifier (a) is increased by 20%, from 5 to 6, resistors to inverting input are unaffected. As shown in (b), only R_{N1} and R_A must be changed.

Checking the minimum value for K' with Eq. 9:

$K' = 6$ is greater than or equal to $6 - 1$. Since the inequality holds, $K' = 6$ is satisfactory. The value of R_S does not change because K' and the inverting signal gains remain the same, but:

$$R_{N1} = 50k/6 = 8.33 \text{ kilohms}$$

and from Eq. 7:

$$R_A = 50k/(1+6 - 6) = 50 \text{ kilohms}$$

The modified amplifier circuit is drawn in Fig. 3(b). Instead of just a 20% increase, suppose K_{N1} is doubled in value to 10. Since the minimum K' now changes:

K' is greater than or equal to $10 - 1 = 9$

Select $K' = 10$, then:

$$R_{N1} = 50k/10 = 5 \text{ kilohms}$$

$$R_S = 50k/(10 - 3) = 7.13 \text{ kilohms}$$

$$R_A = 50k/(11 - 10) = 50 \text{ kilohms}$$

All the design equations developed assume that the impedance of a source resistance is low and can effectively be neglected. However, this is not always true. If source resistances are some constant known values, the equations are easily modified. Simply subtract a given source resistance from the appropriate calculated input resistor. For example, if R_F is 50 kilohms, K_{I1} is 2, and the source resistance driving E_{I1} is 2 kilohms, then:

$$R_{I1} = 25k - 2k = 23 \text{ kilohms}$$

Ac considerations

Amplifier inputs can also be capacitively coupled. The generalized amplifier configuration of Fig. 4 shows both ac and dc circuit elements and parameters. (Of course, subscript AC denotes an ac element or signal, while subscript DC is for a dc element or signal.)

Although the equations used thus far involve only dc quantities, ac signal analysis parallels the dc. Ac output/input relationships, for instance, are the same as those for a dc signal:

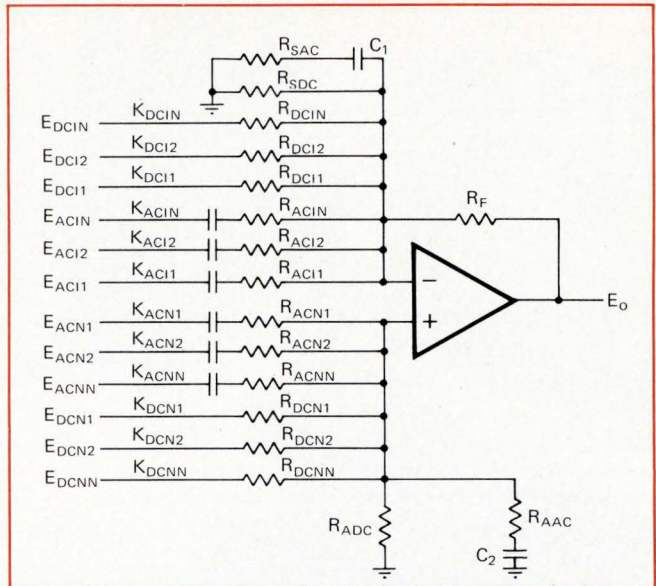

4. Generalized amplifier. For complete design analysis, both ac (AC) and dc (DC) elements and signals must be taken into account. Dc relationships are simply those developed for amplifier of Fig. 1. And ac solutions for signal gain and input resistors are identical, but involve ac quantities. Since computing R_{SAC} and R_{AAC} requires both ac and dc parameters, dc solution should always be found first.

$E_o/E_{ACIN} = K_{ACIN}$ and $E_o/E_{ACNN} = K_{ACNN}$
And input resistor computations are also equivalent:

$R_{ACIN} = R_F/K_{ACIN}$ and $R_{ACNN} = R_F/K_{ACNN}$
The values for resistors R_{SAC} and R_{AAC} , however, depend on both ac and dc signal conditions.

If: $1 + \sum K_{DCIN} + \sum K_{ACIN}$ is greater than or equal to $\sum K_{DCNN} + \sum K_{ACNN}$

then: $R_{SAC} = \infty$

$$\text{and: } (R_{ADC}R_{AAC})/(R_{ADC} + R_{AAC}) = R_F / (1 + \sum K_{DCIN} + \sum K_{ACIN} - \sum K_{DCNN} - \sum K_{ACNN})$$

If: $1 + \sum K_{DCIN} + \sum K_{ACIN}$ is less than $\sum K_{DCNN} + \sum K_{ACNN}$

$$\text{then: } (R_{SAC}R_{SDC})/(R_{SAC} + R_{SDC}) = R_F / (K'_{AC} - \sum K_{DCIN} - \sum K_{ACIN})$$

$$\text{and: } (R_{AAC}R_{ADC})/(R_{AAC} + R_{ADC}) = R_F / [1 + K'_{AC} - (\sum K_{DCNN} + \sum K_{ACNN})]$$

$$\text{where: } K'_{AC} = R_F/R_{SDC} + \sum K_{DCIN} + R_F/R_{SAC} + \sum K_{ACIN}$$

And the minimum value for K'_{AC} becomes:

$$K'_{AC} \text{ is greater than or equal to } \sum K_{DCNN} + \sum K_{ACNN} - 1$$

When using these equations to analyze a circuit, the dc properties must be calculated before tackling any ac problems. Of course, the dc input resistors and R_{SDC} and R_{ADC} are computed with Eqs. 1 through 9.

A few practical circuit considerations should also be remembered. Signal frequencies applied to capacitive inputs should be at least 100 times greater than the maximum frequency on the direct inputs so that capacitors C_1 and C_2 can properly isolate frequency bands. And time constants C_1R_{SAC} and C_2R_{AAC} , as well as the time constant formed by each input capacitor with its input resistor, should be about $0.1/6.28f_{ac}$ seconds, where f_{ac} is the lowest frequency on any of the capacitive inputs. □

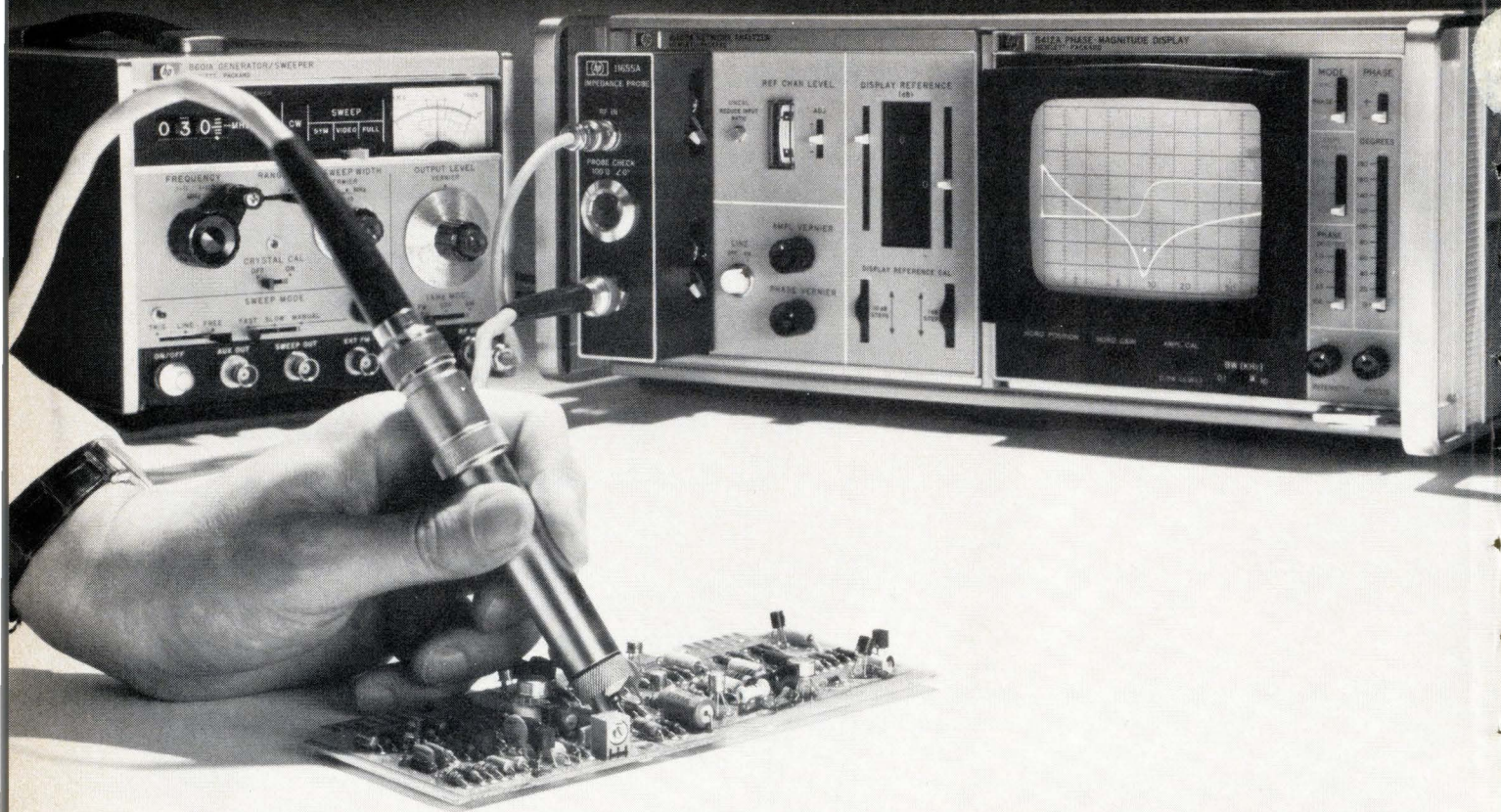

Introducing "touch & see" swept impedance measurement. Now the "do-everything" RF test system does even more.

Just add our new impedance probe to the HP 8407A Network Analyzer, and you can measure complex impedance of circuits, coax systems, discrete components. View impedance excursions over the wide range from 0.1Ω to $10K\Omega$ as you sweep between 500 kHz and 110 MHz.

The HP 8407A Network Analyzer itself makes comprehensive swept RF measurements quickly, and with high accuracy. You see important characteristics like gain/loss, phase shift, voltage and current transfer functions, group delay, impedance, return loss and S-parameters. Dynamic range is greater than 100 dB, yet you can resolve 0.05 dB. It has 360° phase range with 0.2° resolution.

The 8407A Network Analyzer with the 8412A Phase-Magnitude Display costs \$4650. The new impedance probe (Model 11655A) costs \$750. Other accessory kits for circuit probing and for general measurements in coaxial systems are also available, priced from \$325 to \$500.

To learn more about how our "do-everything" network analyzer can help you in design and production test applications, call your field engineer or write Hewlett-Packard, Palo Alto, California 94304; Europe: 1217 Meyrin-Geneva, Switzerland.

HEWLETT  PACKARD

NETWORK ANALYZERS

04112 A

Designer's casebook

Stable square-wave generator provides broad bandwidth

by William Standke

Honeywell Inc., Corporate Research Center, Hopkins, Minn.

A high-speed analog comparator and a linear current source are the key elements in a stable square-wave generator that can oscillate from a few hertz up to several megahertz. The generator circumvents two common sources of stability error—a nonlinear capacitor-charging current and limited op amp bandwidth.

Current source Q_1 linearly charges capacitor C_1 until capacitor voltage exceeds the reference zener voltage on one of the comparator inputs. The normally high output of the NAND gate then goes low, starting the one-shot timing cycle. As the output of the one-shot goes high, Q_2 turns on and sinks the current from Q_1 so that C_1 is quickly discharged. When the one-shot finishes its tim-

ing cycle, its output goes low, Q_2 turns off, and C_1 begins to charge for the next cycle. Circuit oscillation period is approximately:

$$T = 3.3C_1R_1/0.7 + \text{one-shot width}$$

One-shot output pulse width should be as narrow as possible for width stability, but wide enough to discharge fully the timing capacitor. Resistor R_2 slows down this discharge. Although R_2 can be eliminated for small values of capacitance, it must be included for large capacitances to protect Q_2 from excessive currents.

The generator's gate input line allows it to be started and stopped with a digital signal. It should be noted that the generator always starts in the same phase, and its initial cycle has the same period as the subsequent ones. If the gating feature is not wanted, the gate line should be connected to a positive supply voltage (V_{CC}). In addition, the generator can be used as a voltage-controlled oscillator by replacing the zener with a control voltage or by controlling the base voltage of Q_1 .

The silicon transistors and switching diodes selected, as well as capacitor C_1 , depend on the operating frequency desired.

Controlled pulses. Square-wave generator offers stability and wide operating frequency range. C_1 accepts linear charge from Q_1 until its voltage reaches that of zener. Comparator then switches, starting one-shot and turning on Q_2 , which discharges C_1 . When one-shot timing cycle is complete, Q_2 goes off, and C_1 charges again. Gate input permits generator to be controlled digitally.

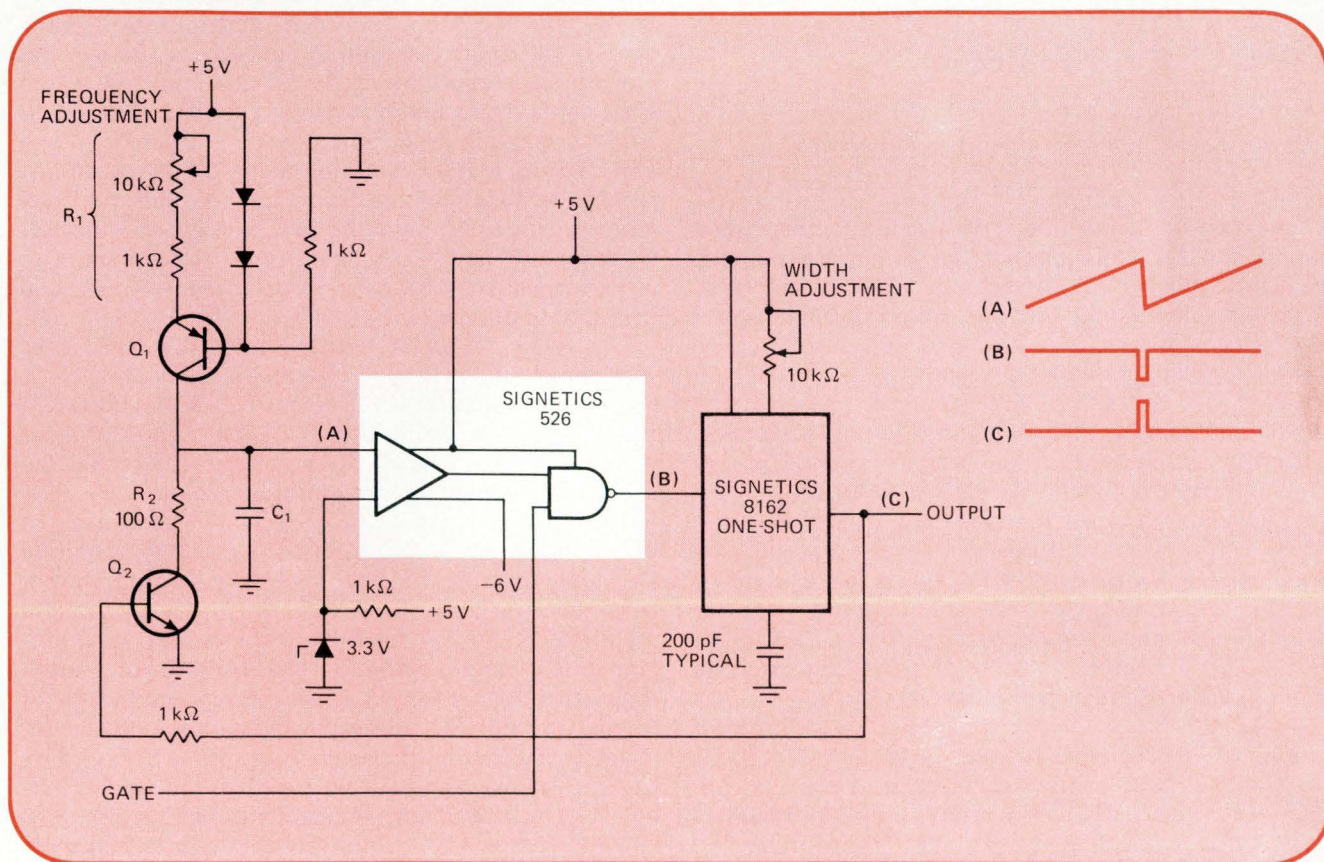

Two adders form BCD subtractor

by Peter K. Bice
Hewlett-Packard Co., Microwave Division, Palo Alto, Calif.

Engineers often avoid using binary-coded-decimal (BCD) designs because the arithmetic involved seems to be formidable. But BCD arithmetic can be almost as simple as binary arithmetic. The circuit shown, for instance, does BCD parallel subtraction. All that is needed for each digit is two four-bit adders and four inverters.

The first adder does the actual arithmetic, subtracting one digit from the other. The second adder converts this difference to BCD form and, if necessary, generates a "borrow" for a subsequent stage. The CARRY OUT is always logic 1 unless a "borrow" is being generated. The last subtractor stage will have a logic 1 CARRY OUT if the difference between the two numbers is positive or if the difference is zero.

The diagram shows one digit of a parallel subtractor. The stages can be cascaded, or one stage can service a serial shift register. BCD addition, it should be noted, cannot be implemented as easily as BCD subtraction since more hardware is required.

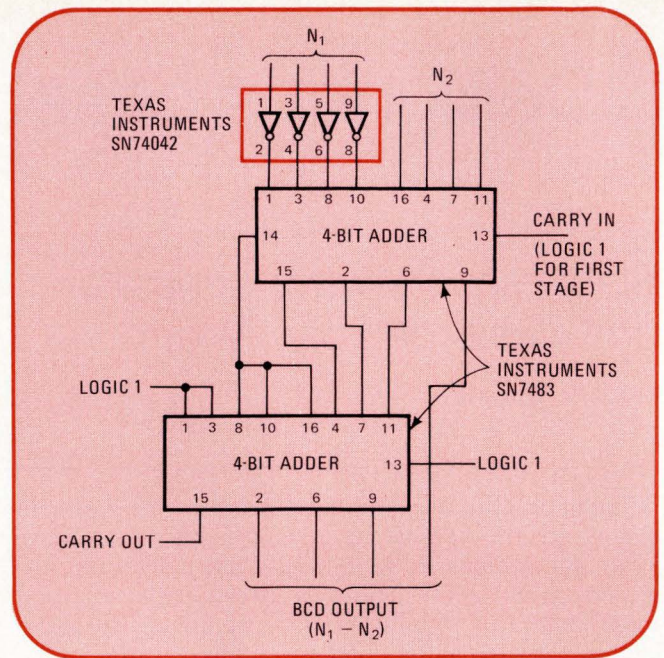

Digital arithmetic. A couple of four-bit adders and four inverters are all of the hardware required to build a BCD parallel subtraction circuit. Top adder takes actual difference between input numbers N_1 and N_2 . Second adder then forms BCD number of this difference. Both "borrow" and CARRY OUT lines are included for use with other stages. Subtractors can be cascaded.

VSWR detector protects class C rf amplifiers

by Frederick A. Warren, Jr.
Harris-Intertype Corp., Radiation Systems division, Melbourne, Fla.

An inexpensive protection circuit against open-circuit damage to class C rf amplifiers senses and detects voltage standing wave ratio with a single-turn transformer. In addition, the circuit removes drive from high-power stages, has low insertion loss, and suppresses second harmonics with a notch filter.

Any class C rf power amplifier must be operated with a load, once supply voltage and an rf signal are applied. If the load is removed, a high VSWR is created, and rf power is reflected back to the output transistor's collector. The resulting rf voltage swing can exceed the transistor's collector-base breakdown voltage, causing collector current to increase in an avalanche manner so that the base-collector or base-emitter junction opens. Risking this destruction is normally unavoidable, unless the designer is willing to accept a significant insertion loss or pay a high price for protection.

Figure (a) shows a block diagram of a high-power class C vhf amplifier—consisting of transistors Q_1 , Q_2 and Q_3 —externally connected to the protection circuit. When the amplifier drives a properly matched load, a quiescent rf voltage develops across transformer T_1 .

This voltage is then rectified by hot-carrier diode D_1 , producing a negative voltage at the junction of resistors R_1 , R_2 , and R_3 . The values of R_2 and R_4 force transistors Q_4 and Q_5 into saturation, creating a short circuit between Q_4 's collector and ground that allows Q_1 to operate normally, relatively insensitive to load phase.

If the amplifier load is removed or shorted, a high VSWR results, and the rf voltage across T_1 increases. The rectified voltage at the resistor junction then becomes more negative and pulls the base voltage of transistor Q_5 down, driving both Q_4 and Q_5 into cutoff. Now, Q_1 's emitter opens, removing the drive to transistor Q_3 and therefore shutting off the amplifier.

For adequate circuit reaction time, the R_1C_1 time constant should be less than one period of the amplifier's operating frequency. Resistor R_3 sets the quiescent base current of Q_5 . And the Q_4 - Q_5 Darlington pair operates with only a small drive voltage differential between transistor cutoff and saturation regions.

The protection circuit also offers the advantage of second harmonic suppression (the second harmonic of an amplifier must be below some maximum power level). Because a class C amplifier is usually operated in a saturated condition, it often generates high-level harmonics that require additional filtering after the output stage, thereby creating undesirable insertion loss or complexity. But the protection circuit provides an integral notch filter whenever its transformer's secondary winding and capacitor C_2 are tuned to the second harmonic of the amplifier's fundamental frequency. And VSWR detection by the protection circuit suffers only

negligible degradation because of the filter.

Graph (b) depicts the voltage levels at the base of transistor Q_5 when the amplifier output is loaded, opened, or shorted. The saturation and cutoff voltages shown are those needed for the Darlington circuit. They must be less than the loaded voltage but greater than the open-circuit and short-circuit voltages. Graph (c), which shows amplitude-versus-frequency curves for the amplifier with and without the protection circuit, reflects the amount of insertion loss. From 170 to 230 megahertz, worst-case insertion loss is 0.15 decibel.

Load watchdog. Output of class C rf amplifier (a) goes to protection circuit that shuts off amplifier when VSWR exceeds safe operating limit. Transformer T_1 performs as VSWR sensing and detection element. Removing or shorting load pulls down Q_5 's base voltage, cutting off Q_4 - Q_5 Darlington pair and opening Q_1 's emitter to turn off amplifier. Plots (b) and (c) illustrate amplifier performance.

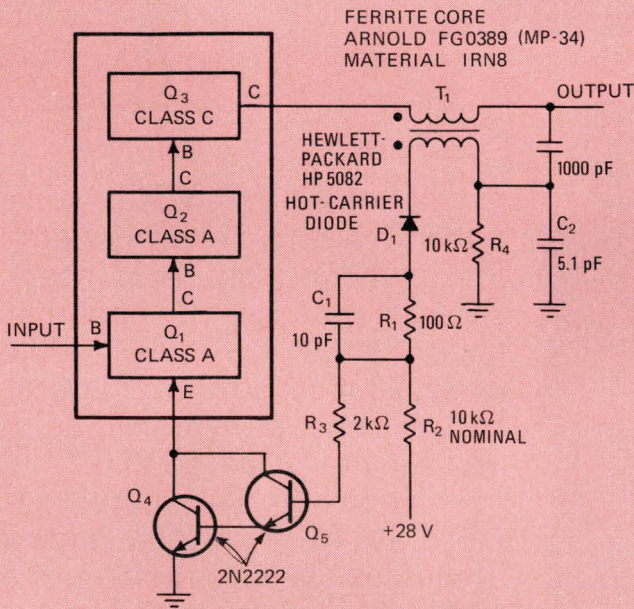

(a)

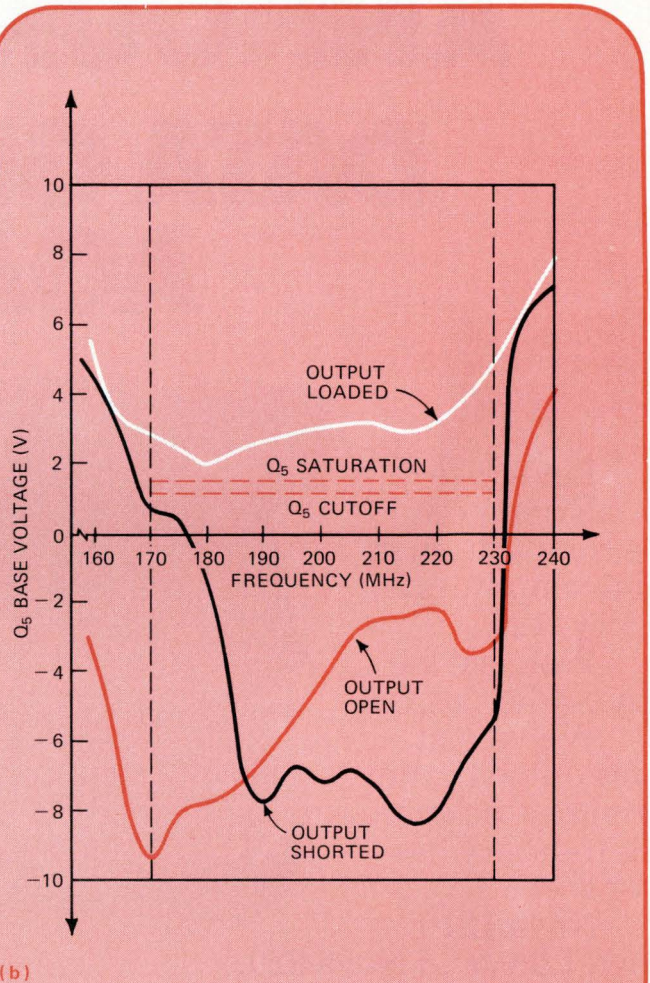

(b)

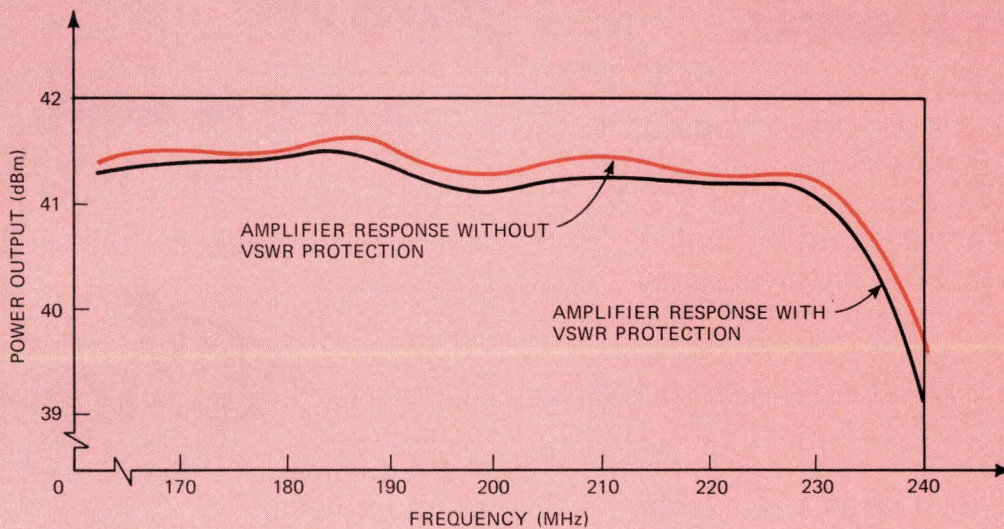

(c)

THE NEW MINICOMPUTER ANNOUNCEMENT. DATA GENERAL AGAIN.

Let's face it. Right now, the competition in minicomputers is pretty stiff.

Well, we've just made it stiffer.

We've just come out with the strongest new line this industry has ever seen.

Nova 1210, Nova 1220, and Nova 820.

THE NEW NOVAS.

Nova 1210. The least expensive Nova. But to get the price, you don't have to sacrifice performance. Nova 1210 has a 1200 nanosecond cycle, and executes arithmetic and logical instructions in 1350 nanoseconds—the same performance as the Nova 1200. In its 5¼-inch high chassis, it has room for 24K of core, or multiple peripheral interfaces. Plenty for most OEM's. \$4,350.*

Nova 1220. The most flexible, expandable, easily interfaced Nova

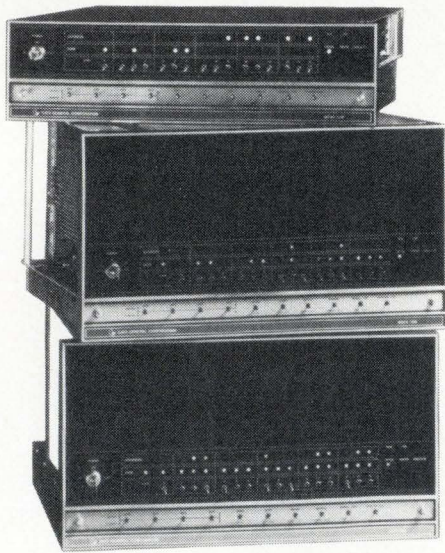

yet. It holds a full 32K of core and still has five chassis slots left over for peripheral interfaces. It matches the performance of the Nova 1200 (1200 ns cycle, 1350 ns add), yet it has 50% more expansion capacity and a lower price. \$5,250.*

Nova 820. The faster Nova. Its fully parallel central processor executes arithmetic and logical instructions in a single 800 ns cycle. And with a full 32K of core, there are still four slots left over for peripheral interfaces. \$6,450.*

A NEW MEMORY.

We've also come up with an 8K x 16-bit core memory board for each of the Nova computers. This reduces costs two ways.

First, you can buy one 8K memory for a lot less than two 4K memories. Second, 8K of core

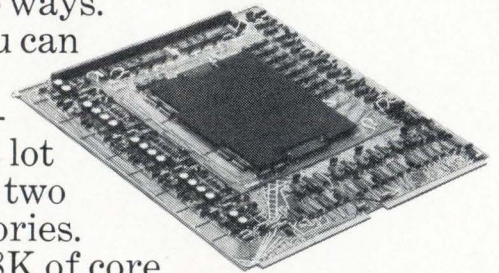

*Price includes central processor, 4K 16-bit words of core memory, programmer's console, Teletype interface, direct memory access (DMA) channel, automatic interrupt source identification, and rack-mount slides or table-top enclosure.

on a single board means you can fit more memory into a smaller, less expensive computer.

A LOW COST CONSOLE.



Our new turnkey console. It costs less than the standard programmer's console, and it's less susceptible to damage or program alteration in severe environments.

And, needless to say, these new computers and options are completely compatible with all the other Nova-line computers, software and peripherals.

Which brings up some important points.

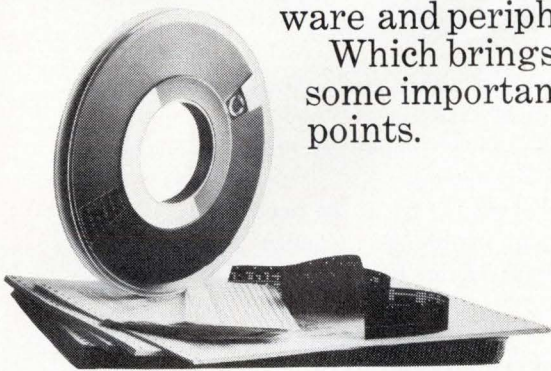

THE SOFTWARE, PERIPHERALS AND SERVICE.

When you buy a minicomputer, you need more than just fancy hardware specs.

You need software. The Nova computers come with the broadest range of software available for any line of 16-bit minicomputers. Extended ALGOL, Extended FORTRAN IV, Time Sharing BASIC, Real Time Operating System, Disc Operating System, and lots more.

You probably also need peripherals. We offer every type of peripheral device commonly used in minicomputer systems. Discs, magnetic tape

units, paper tape equipment, card readers, line printers, real-time clocks, A/D, D/A, and communications equipment. All completely interfaced and supported by us.

And you need solid support after you've bought. We've got field service engineers in major cities all over the U.S., Canada, and Europe, plus a full customer training program for every Nova computer.



A TRACK RECORD.

When you buy a minicomputer you also need some pretty solid assurance that the people you're doing business with can produce what they promise.

Three years ago, we promised we'd build the world's best minicomputers. Since then we've delivered over 2,000 Nova-line minicomputers, to become the world's number 2 minicomputer company.

Now, with these new Novas, we can promise we'll become number 1.

FREE READING MATTER.

What you need most of all when you buy a minicomputer is some reliable information. Like "How to Buy a Minicomputer" and "The Data General Catalog".

NAME _____

COMPANY _____

ADDRESS _____

CITY _____

STATE _____ ZIP _____

 **DATA GENERAL**

Southboro, Massachusetts 01772, Tel. (617) 485-9100

Bipolar techniques approach MOS in density, cost, and power drain, yet retain speed

To achieve small size, the number of interconnections and isolation areas are reduced—in a memory by integrating functions and in a shift register by clever circuit organization and direct collector coupling

□ Until recently, systems designers had a clear choice between bipolar and metal oxide semiconductor technologies—a choice that was decided by system performance requirements. For high performance—that is, speed—bipolar always won out, if the designer were willing to pay a cost premium for the more complex fabrication process and additional interconnections necessitated by lower circuit density per chip.

On the other hand, MOS speed has been increasing steadily, and, although still much slower than bipolar, MOS now qualifies for many applications that fell earlier to bipolar. Considering its higher density and lower cost, MOS has become increasingly attractive.

But don't count out bipolar. For the past couple of years, researchers have been working steadily to increase the density of bipolar arrays and to decrease their power dissipation—in short, to make them competitive with MOS in cost, while retaining their inherent speed advantages.

The major problem in achieving high density in bipolar ICs is the need to isolate the individual transistor structures from one another. Conventional techniques, which use active p-type regions to isolate the transistor collector regions, eat up a lot of chip real estate. One of the most significant advances in overcoming the problem was the Isoplanar process announced by Fairchild Semiconductor division, Mountain View, Calif., last spring [*Electronics*, March 1, 1971, p. 52]. In Isoplanar, a thermally grown oxide region is used for isolation instead of an active diffusion, permitting a 40% saving in chip real estate.

Two more techniques that will make the MOS-bipolar rivalry a horse race again are described in the following articles. In the first, researchers of the IBM World Trade Corp., Boeblingen, West Germany, detail their success in producing what they call "superintegration" by combining functions on single islands of diffused material, greatly reducing the number of isolation walls and interconnections required.

Another approach, taken by Philips Research Laboratories in Eindhoven, the Netherlands, has yielded a 70-MHZ, 256-bit shift register on a chip with an area of only 5.6 square millimeters. The small size was attained by clever organization and direct collector coupling, which again eliminates essentially wasteful isolation and interconnection area.

Both Philips and IBM are represented this week at the International Solid State Circuits Conference in Philadelphia, where further advances are described. Using essentially the same process described here, IBM has designed logic functions and fabricated a half adder and a small shift register. And with a similar principle, Philips has achieved an energy level of only 1 picojoule per logical operation, compared to 20 pJ with conventional ICs. The Philips technique can place over 1,000 gate circuits on a single chip of conventional size by using diodes that are integral with the transistors of the circuit, in place of load resistors.

Superintegrated memory shares functions on diffused islands

Device, made by standard process, achieves small size by injecting minority carriers into inversely operated flip-flop transistors, which replace usual resistive load

by Siegfried K. Wiedmann and Horst H. Berger, IBM World Trade Corp., Boeblingen, West Germany.

□ A novel bipolar static memory device has almost the packing density of dynamic MOS storage devices. Further, it dissipates little power, and it is economical because it can be made by conventional processing.

Individual cells can be read in less than 10 nanoseconds and written in less than 40 ns. In a 2,000-bit array on a 150-mil square chip, taking into account the additional delay of peripheral circuits, these times would be under 60 ns and 150 ns respectively. The key to the device's small size is a direct injection of minority carriers into inversely operated flip-flop transistors, which are used instead of the conventional resistive load.

The bipolar device, diagramed in Fig. 1, and shown in a photomicrograph in Fig. 2, occupies an area of only about 4 square mils per device, including isolation. Two memory devices appear in the photo, but only one of them is wired. This photo clearly demonstrates the reasons for the extremely small size of this static memory cell; the structure is substantially determined by the size of the contact holes—there are only six and a half holes per cell. Furthermore, the device uses no ohmic load resistors and needs no internal isolation. Isolation is re-

quired only between rows in an array, not between devices in a row.

As shown in Fig. 1, a standard n^+ buried layer is diffused into the p^- substrate, the n epitaxial layer is deposited, and the p and n regions are diffused into the n layer. Metalization layers connect p_2 to n_2 , n_1 to p_3 , and p_1 , n_3 , and n_4 to pads for external connections or to adjacent portions of an integrated circuit. This structure forms a transistor at n_1p_2n and n_2p_3n . There are also lateral grounded-base pnp transistors at p_1np_2 and p_1np_3 .

When current is applied to the center p region (p_1), the latter injects holes into the n region. A substantial number of these holes is collected by the adjacent p regions, p_2 and p_3 . Because of the symmetrical structure, both p regions collect equal currents, I_p . These currents—unless withdrawn through the metal lines—forward-bias the base-collector junctions p_2n and p_3n , thus turning on the corresponding transistor n_1p_2n or n_2p_3n in its inverse mode.

Device is flip-flop

Once the right-hand transistor is on, it draws the base current I_p away from the p_2 region of the left-hand transistor through the metallic connection to the n^+ region, provided that the inverse current gain is greater than 1. Of course, the other state with the left-hand transistor on and the right-hand transistor off is also possible. Thus, the structure is a flip-flop. The outer regions n_3 and n_4 couple the flip-flop to the read-write lines in an array organization. This coupling is discussed later in connection with the equivalent circuit.

The structure's bistability depends on the saturation of the "on" transistor, a condition in which the collector-to-emitter voltage is small enough to keep the other transistor off. As the "on" transistor receives equal cur-

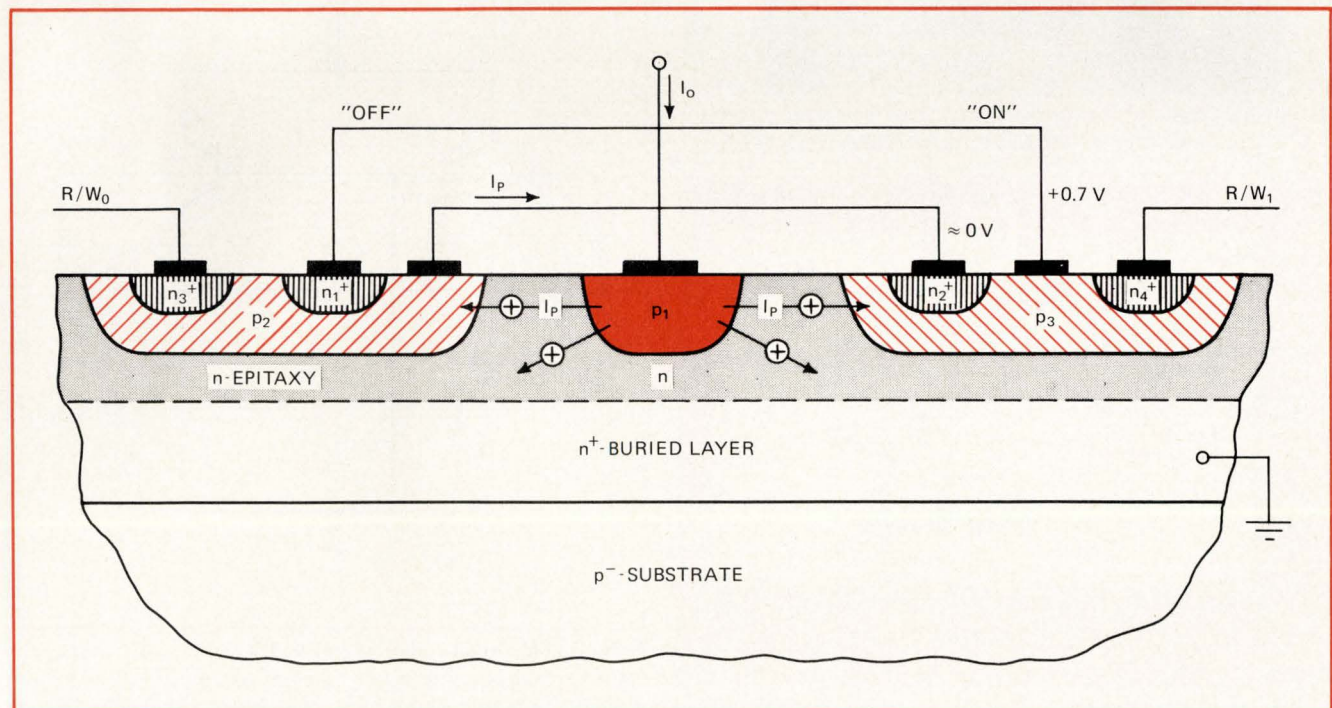

1. Compact memory cell. Standard fabrication techniques are used in the production of this bipolar transistor structure. It stores one bit in only 4 square mils. Key feature is the lateral pnp transistors sharing the region p_1 , which serve in lieu of load resistors.

rents at its base p_3 (or p_2) and its n^{+}_2 (n^{+}_1) region, an inverse current gain larger than unity is sufficient to obtain saturation. The necessary inverse current gain can be attained by conventional processes, since the emitter efficiency depends not only on the doping ratio, but also on the ratio of diffusion length to base width.

Measuring inverse gain

An inverse current gain (β_{inv}) larger than unity is not a very stringent condition. Besides, β_{inv} decreases only slowly as I_o decreases, assuring bistability even with extremely low currents. Its value at various current levels was determined experimentally on devices with special metalization patterns that permitted the component currents to be measured separately; these patterns disrupt the flip-flop cross connections. The current I_p received at the base of one inverse npn transistor (region p_2 in Fig. 1), when divided by half of the supply current

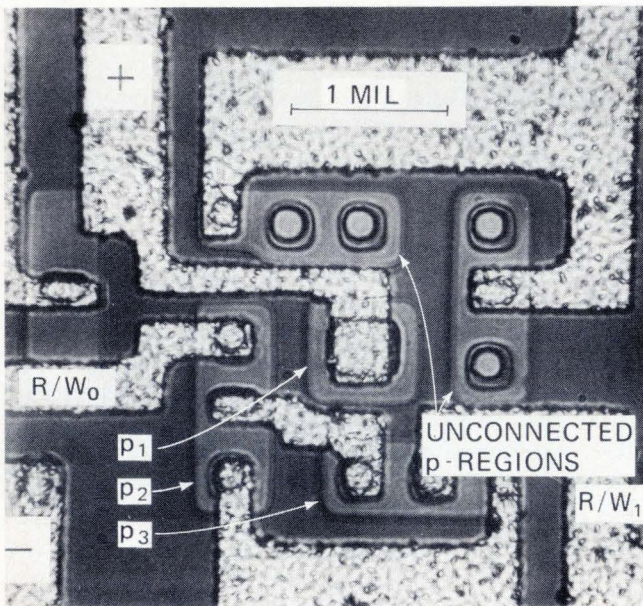

2. Why it's small. In the two cells shown here, the contact holes are the limiting factor in small size. Also no external isolation is needed.

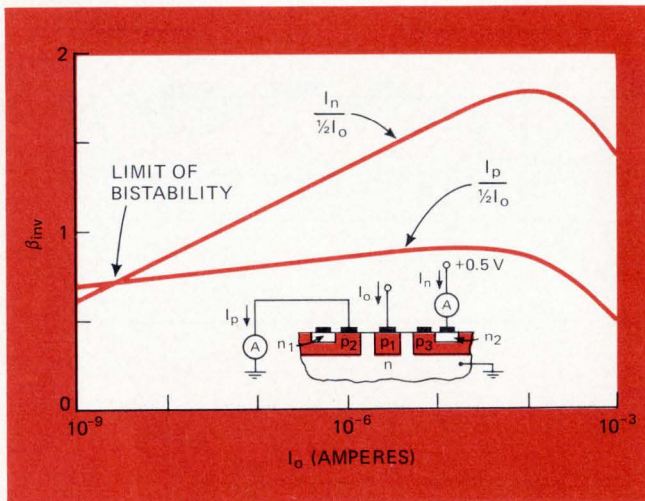

3. Bistability conditions. As long as the I_n curve lies above the I_p curve, the compact memory cell is bistable, even at very low current levels. Ordinarily it would operate in the microampere range.

I_o , indicates the grounded-base current gain α_{npn} of the lateral pnp transistor.

This gain is nearly constant for values of I_o up to about 10 microamperes and decreases for larger currents. Likewise, the collector current I_n of the other inverse npn transistor (region n^{+}_2), also divided by half of the device supply current, represents the product of the pnp transistor's alpha and the npn transistor's inverse beta; it rises to a substantial peak at about 100 μA .

The ratio of these two quantities is the inverse current gain:

$$\beta_{inv} = (\alpha_{pnp} \beta_{nnp}) / (\text{pnp current gain}) = I_n / I_p$$

Bistability is assured as long as this ratio is greater than 1—that is, as long as the I_n -curve in Fig. 3 runs above the I_p -curve.

The plot in Fig. 3 shows that bistability is maintained down to a cell current of about 3 nanoamperes, corresponding to a power dissipation of about 3 nanowatts. In tests, the memory device has been safely operated with a supply current of as little as 10 nA.

This low current level was tried on test devices made by a process not optimized for this purpose. These devices had an inverse current gain of approximately 2; a larger gain is possible with a proper adjustment of the process, thus probably shifting the bistability limit even into the picoampere range.

Equivalent circuit

An equivalent circuit for the superintegrated memory device, shown in Fig. 4, resembles that of a low-power small memory cell described at the 1971 International Solid State Circuits Conference in Philadelphia.² It is distinguished from these earlier circuits only by an additional short-circuit connection indicated by a heavy

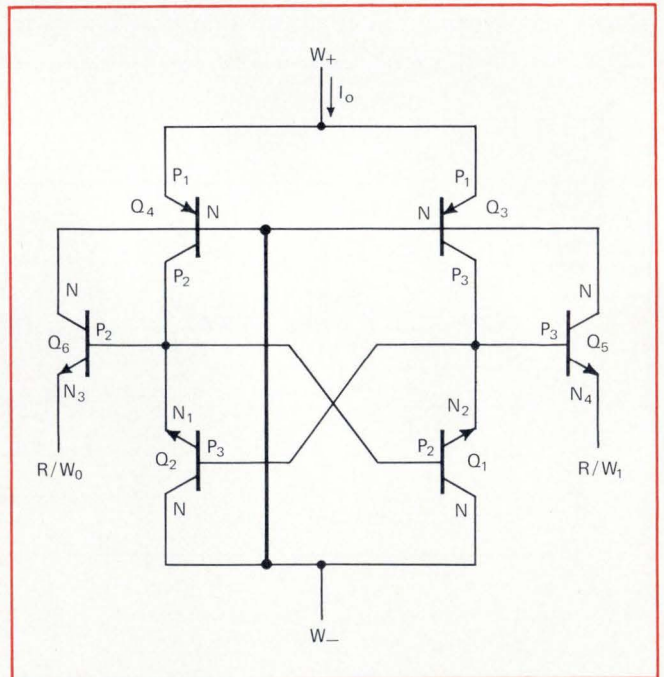

4. Equivalent circuit. Labels correlate this circuit to the structure in Fig. 1. Its distinguishing features are the pnp transistors as current sources and the sharing of single diffusions as regions of different transistors. The short circuit between the current-source bases and the W_- reference point is an important feature of this design.

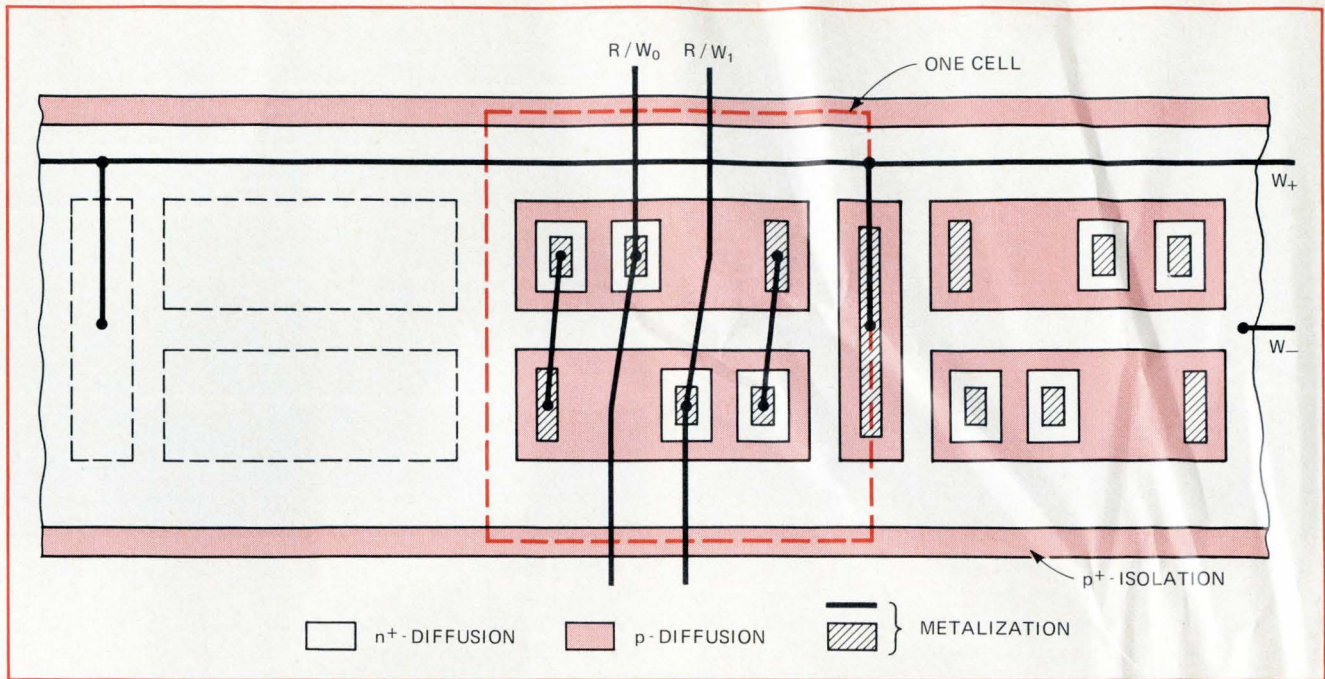

5. Word-organized array. A single n-stripe embeds all cells in a common word-line pair. Pairs of cells share a single p-type emitter. Double-rail read-out lines lie perpendicular to the common n-stripe, interconnecting cells in adjacent n stripes.

line in Fig. 4, between the common n-base of pnp load transistors Q_3 and Q_4 and the common n-collector region of the inversely operated npn flip-flop transistors Q_1 and Q_2 . This connection corresponds to the use of a common n-layer to accommodate all the elements of the superintegrated memory device. The device can also be derived formally by superintegrating a double silicon-controlled rectifier cell,³ but it is not operated in SCR mode.

The labeling of the p and n zones of the six transistors in the equivalent circuit shows how these elements correspond to the p and n regions in the principal structure of Fig. 1. Thus the emitter p_1 is common to both pnp load transistors Q_3 and Q_4 , while the collector p_3 of pnp transistor Q_3 is physically identical with the bases of the inverse transistor Q_2 and of the decoupling transistor Q_5 . Likewise, the p region p_2 serves for the transistors Q_4 , Q_1 , and Q_6 respectively. This extensive merging of separate transistors saves interconnection lines and contact holes, which contributes significantly to the small size attained.

This structure can be laid out in a word-organized array, as shown in Fig. 5. In this layout, all the memory cells belonging to a common word line pair (W_+ and W_-) are embedded in a common isolated n-stripe. The cell structure is essentially the same as shown by the principal structure in Fig. 1, except that a single p_1 emitter serves two memory cells.

The W_- line is simply the common n-stripe between the isolation walls, whereas the W_+ line is a metal strip deposited in a second metalization step; it connects all p emitters of one word. If the series resistance of the W_- line is too high, another metal line can be added parallel to it. The read-write transistors are connected to a read-write metal line pair R/W_0 and R/W_1 , perpendicular to the n-stripes.

With contact holes 0.1 mil wide, this layout requires

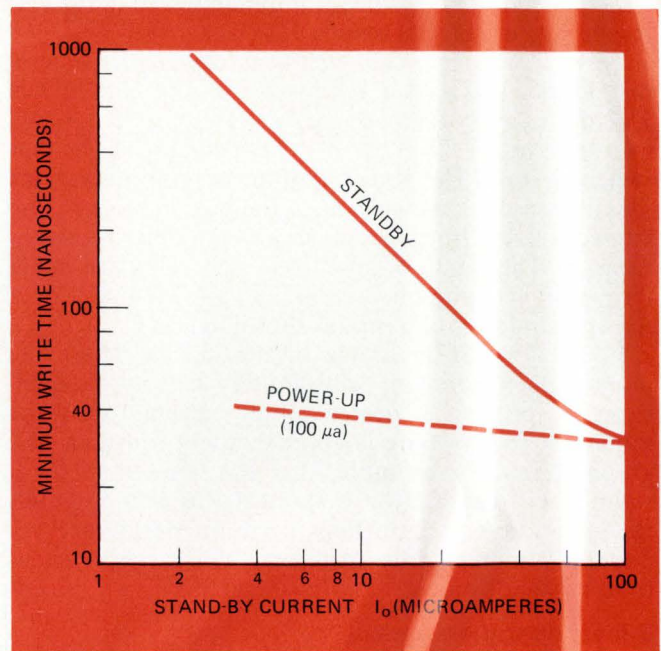

6. Faster writing. Although the compact memory cells' writing time is short, it can be reduced even more without significantly increasing power dissipation by increasing current just before writing.

only about 4 square mils per bit of storage, so that 2,000 bits should fit on a chip about 150 mils square. An oxide isolation would further cut down the size by a factor of about two, permitting 4,000 bits per chip.⁴

Reading and writing

To read a word from this array, the W_+ line serving all devices in a word row is raised by about 0.5 volt. This raises the potential of one line in each read-write line pair—the line that is connected to the “off” side of the corresponding device on the selected word line.

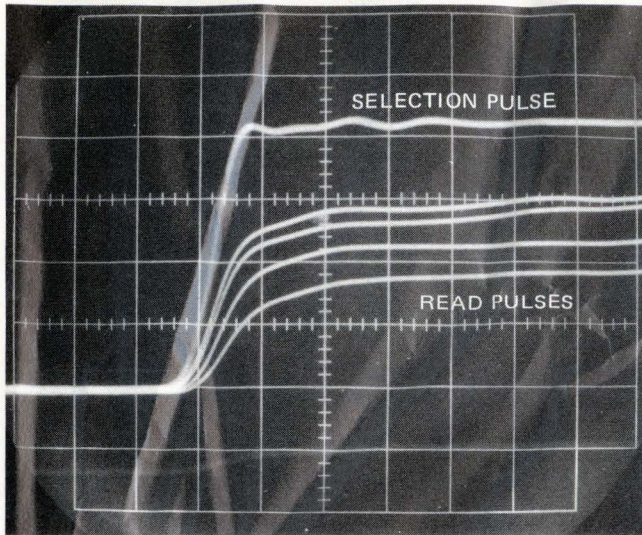

7. Fast reading. Read signals (four lower traces) are differential signals that show less than 10 ns delay even at supply currents as low as 3 microamperes. The four traces are for 100, 30, 10 and 3 μA respectively; the top trace is the 0.4-V selection pulse. Scales are 0.1 V per vertical division and 10 ns per horizontal division.

Thus, the sign of the potential difference on each read-write line pair denotes the information stored in the corresponding cell of that row.

To write a bit in a cell—that is, to change the state of the device—the proper read-write line is held down. This draws away the base current of the corresponding transistor in the flip-flop, if it happens to be on, thus switching it-off. The potential of the other flip-flop node then increases as the current of the pnp transistor is no longer diverted from this point, and the other transistor turns on. The length of time for this charging action determines the minimum write time; it is, of course, longer for smaller device currents, as shown in Fig. 6.

In the low-current range of the device, where the node capacitances are substantially current-independent, the product of device supply current I_0 and the minimum writing time is approximately constant. The graph shows, for example, that the write time for a stand-by current of 20 μA is about 100 ns. Although this time is not unreasonably long, it can be considerably reduced by momentarily increasing the supply current from its standby level.

Bilevel operation is easy

For example, increasing I_0 to 100 μA simultaneously with writing reduces the write time from 100 ns to about 40 ns— as compared to a write time of about 30 ns for a steady supply current of 100 μA , which would increase considerably the circuit's power dissipation. Such a bilevel operation is easy with this device, because the emitter-base junction of the pnp transistor provides a very low external impedance.

As the emitter-follower configuration of the read-write transistors suggests, reading is extremely fast (see Fig. 7). In addition, speed is enhanced because the base-collector junction of this transistor is forward biased in standby, so that the transistor that delivers the read current is already on before the word selection pulse arrives. The oscillograms in Fig. 7 were taken with a simu-

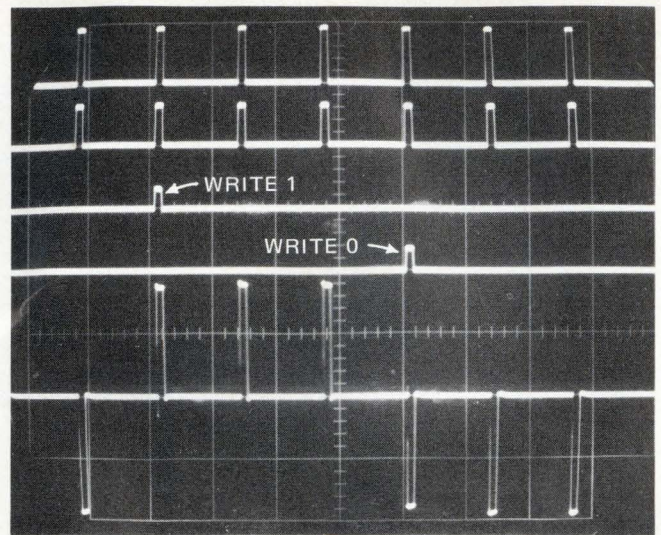

8. Data retention. Memory cell can retain information for quite a long time after current is shut off—here 700 μs . From top, traces are 0.5-V selection pulses, 100 μA power pulses, write 1 and write 0 signals, and read signals of about 0.3 V. Positive pulses on read line are 1s, negative pulses are 0s. Time scale is 500 μs per division.

lated read-line load corresponding to an array of 2,000 to 4,000 bits.

Overcoming drawbacks

In the superintegrated structure, parasitic transistors are present, and their influence must be considered in the operation of an array. For example, in Fig. 5, a parasitic transistor is formed where the underlying n-stripe lies between P_2 and P_3 . The effects are essentially the same as in the low-power small memory cell, described last year at ISSCC. These parasitic effects are not serious, since they can be kept under control by proper design.

But inverse transistor action of the read transistors can be troublesome. In an actual array, the read transistors of non-addressed memory cells draw an inverse current from the read-write line if they are on. This parasitic current decreases the net sense current from the addressed cell.

However, this decrease does not present a severe problem, because of the option to power up the addressed cell during the read or write operation. In fact, the non-selected cells can be switched off during a read operation, because the device can retain the stored information in its internal capacitances.

The oscillogram in Fig. 8 demonstrates this data retention capability. After each write or read operation, the supply current has been completely turned off for about 700 microseconds without destroying the information. Even much longer retention times of about 10 milliseconds have been measured—a much longer time than would be needed in any practical application. \square

REFERENCES

1. S.K. Wiedmann and H.H. Berger, "Superintegrated Bipolar Memory Device for High-density, Low-power Storage," Proceedings, IEEE Electron Devices Meeting, 1971.
2. S.K. Wiedmann and H.H. Berger, "Small Size Low-Power Bipolar Memory Cell," International Solid State Circuits Conference, IEEE Journal of Solid State Circuits, Oct. 1971, p. 283.
3. W. Jutz and C. Schuenemann, "Ein Symmetrisches Bistabiles Thyristor Flip-flop," Mikroelektronik, vol. 3, 1969, p. 277.
4. Doug Peltzer and Bill Herndon, "Isolation method shrinks bipolar cells for fast, dense memory," Electronics, March 1, 1971, p. 52.

Collector coupling minimizes interconnections in chip

Easily made bipolar shift register features extremely high speed, low power dissipation, and packing density approaching MOS devices

by Dieter Kasperkovitz,
Philips Research Laboratories, Eindhoven, The Netherlands

□ One large-scale bipolar IC shift register design offers a good combination of the speed that is bipolar technology's main advantage and the lower power dissipation, high integration density, and simple fabrication of metal-oxide semiconductor technology. The register's low power dissipation and its high speed/power ratio make it potentially valuable in large systems where many long shift registers are employed—for example, in time-division multiplexed telephone systems or in buffers used in computers and bulk storage units.

This register [like the high-density IBM circuit described in the previous article (page 83)] achieves high density by combining functions on a single island of diffused material. Combining these functions reduces the number of isolation walls, as well as the number of contact holes and interconnecting strips that otherwise would be needed if separate islands were used for specific single functions. In addition, reducing the complexity of interconnection contributes to high reliability.

But this circuit [unlike the IBM array of small-area, randomly accessible static flip-flops] is a static shift register; thus it is limited to serial access. Driven by a two-phase clock, the IC stores data current-steered flip-flops that dissipate power only in the master state.

The shift register is capable of operating at clock speeds up to 75 megahertz, yet it dissipates less than 0.2 milliwatt per bit—corresponding to a speed/power ratio of 375 MHz per mW per bit—about two orders of magnitude higher than that of conventional bipolar shift reg-

isters. Each shift register element in the new circuit occupies only about 21 square mils, or 72 elements per square millimeter. A complete shift register with these specifications can be made with only five masking steps, because no buried layer is needed.

Transistors paired

The basic circuit consists of a number of common-emitter transistor pairs, as shown in Fig. 1. The first of these pairs is a high-impedance input stage; the remainder are all memory stages. In each memory stage, the left-hand transistor is referred to here as Q_1 and the right-hand transistor as Q_2 . Within each pair, the base of Q_1 is connected to a -0.25 -volt reference; the collector of Q_1 is connected to the base of Q_2 in the same pair, to the collector of Q_2 in the preceding pair, and through a resistance to ground. The common emitters of each pair are connected through a second resistance to a clock line; alternate pairs are connected in this way to clock signals of opposite phase. To drive the two inverse clock lines, a simple low-power pulse generator can be integrated on the same chip as the shift register proper.

The circuit's small size results from the collector-to-collector coupling, because the collectors of the two transistors in a single pair can be formed from a single island of collector material. In a conventional design, each collector would have its own island of material; each island would be surrounded by an isolation wall, and each would have to be large enough to accommodate a contact hole, through which an overlying metal strip would establish the connection. The holes, the islands, and the walls would all have to include a tolerance in their sizes for possible mask misalignments.

The circuit characteristically inverts data when shifting it from element to element—that is, from transistor pair to transistor pair. Within each pair, a binary 1 is defined as current in the collector resistance, and a binary 0 is the absence of current. When an element's clock line is low, that element is in the master state; otherwise it is in the slave state with no current flowing through the emitter resistance.

An element in the master state storing a 0 shifts that 0

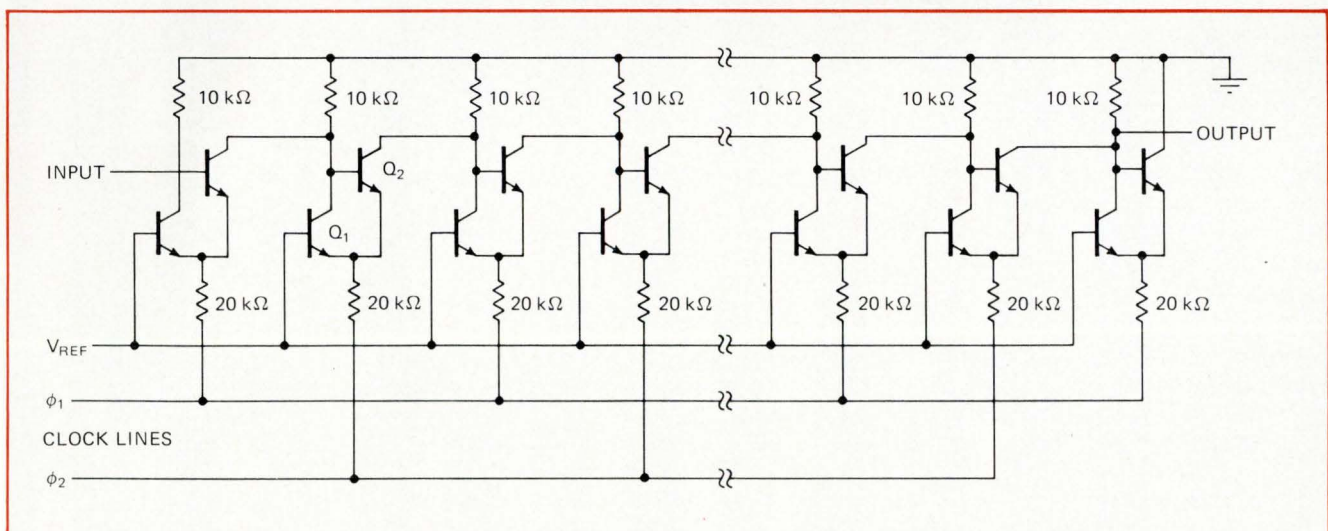

1. Shift register. These two-transistor common-emitter pairs, when integrated into a monolithic chip, form shift register elements occupying only 21 square mils each. Each pair of elements (four transistors) stores one bit, shifting it along the line at up to 70 MHz.

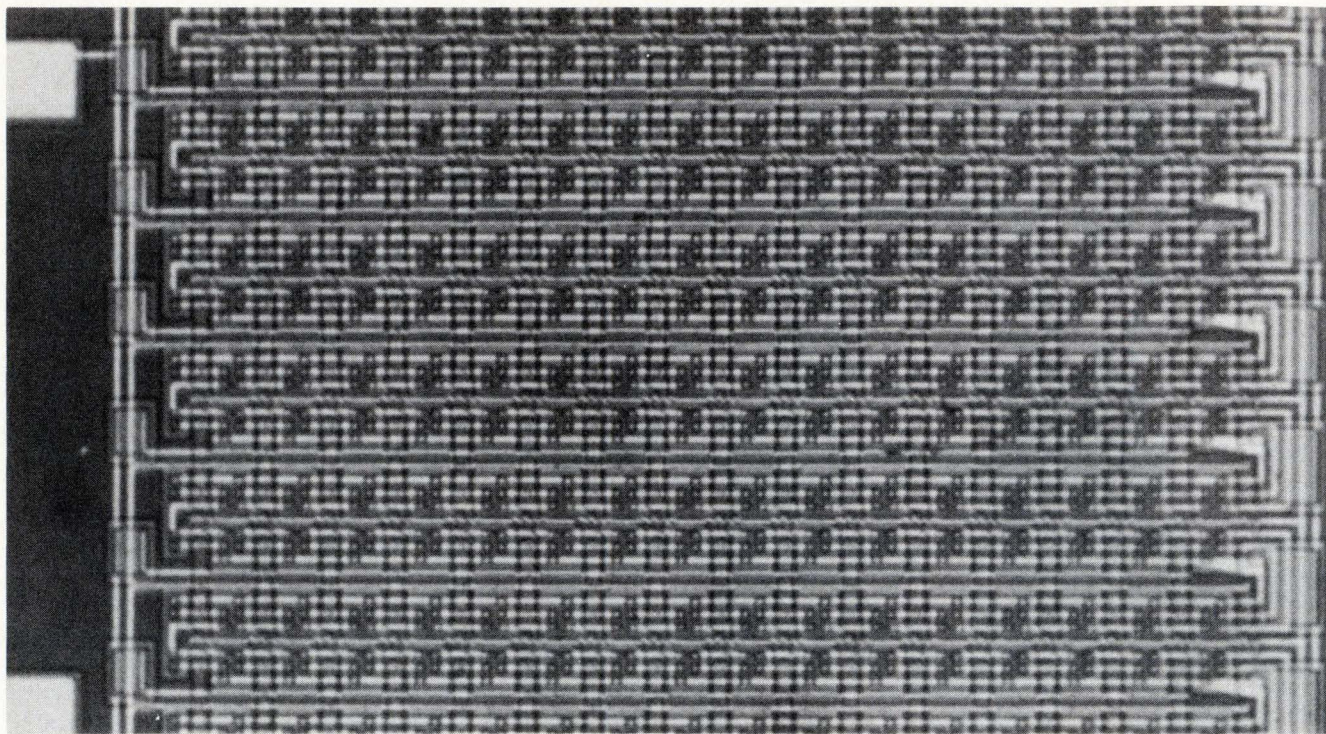

2. Chip section. A 256-bit shift register has been made with the circuit of Fig. 1; part of the chip is shown here. Its high density is made possible by combining functions of two transistors on a single island of semiconductor material, as shown in Fig. 3.

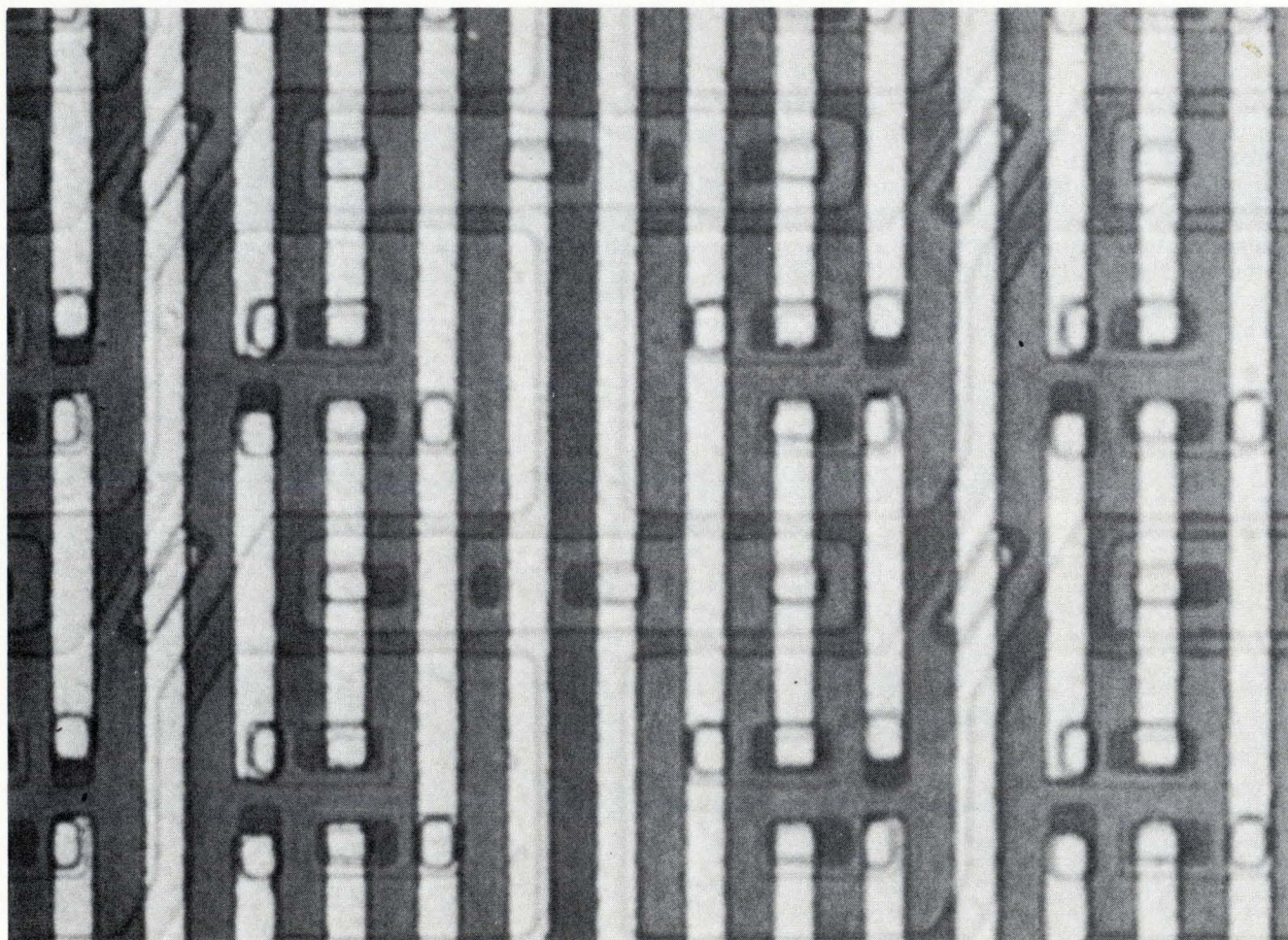

3. Coupling. These few elements of the 256-bit register show how the elements are coupled and how the collector and emitter resistances are integrated into the structure. The light stripes are metal interconnections; the faint shapes beneath them are semiconducting regions.

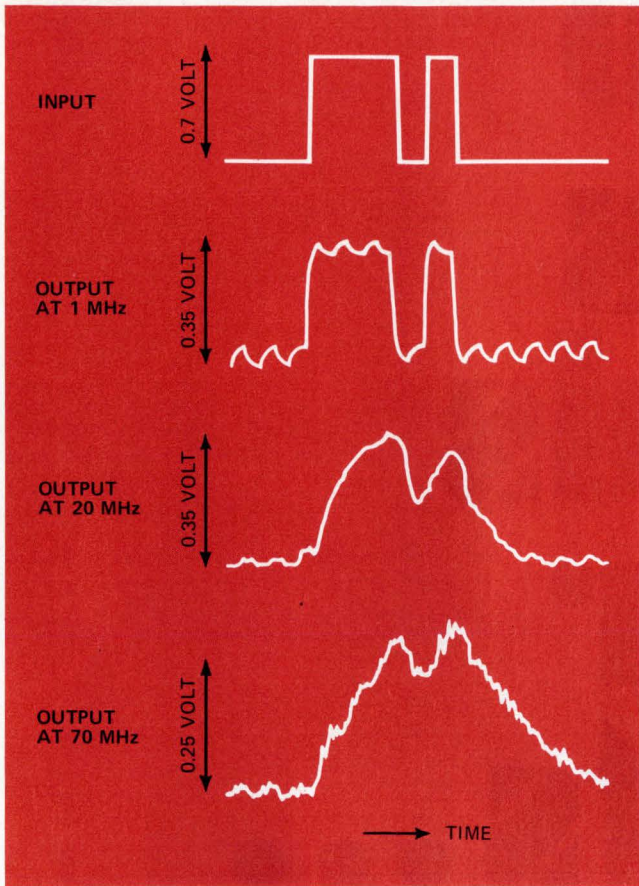

4. Degradation. Although the output of the shift register doesn't look very good at 70 MHz, obviously the register is functioning. Most of the degradation is caused by the measuring apparatus.

to the next element, inverting it to a 1, when the two-phase clock changes state. Before the clock transition, the second element's collector resistor carries current that passes through transistor Q_2 in the first element, through its emitter resistor, and then to the clock line. After the transition, this current passes instead through transistor Q_1 in the second element to the other clock lines.

This second element shifts its 1 to the third element, inverting it again at the next clock transition. Current through the collector resistor of the second element drops the voltage at the base of Q_2 low enough to hold Q_2 off. After the transition, this current either is switched back to the first element or cut off altogether.

Clock controls cutoff

Neither the switching nor the cutoff is instantaneous because the transition of the clock phases is not instantaneous. Thus, the voltage at the base of Q_2 in any given pair follows the clock pulse transition; it tends to increase relatively slowly until it reaches the reference level (assuming the thermal voltage kT/sq is zero).

At that point, Q_1 stops conducting, and if the current through it cannot switch to Q_2 of the preceding pair, it must cut off. This turns on Q_2 of the given pair, and during the remainder of the clock pulse transition, a decreasing current flows from the following pair through Q_2 and the emitter resistor of the given pair.

At the moment Q_1 turns off and Q_2 turns on in the

given pair, a peak current appears at the collector of the following pair. If the parasitic capacitance at this collector were zero, this peak current could create a voltage peak high enough to switch the following pair into the wrong binary state. (The same is true in the opposite situation, when Q_1 turns on and Q_2 turns off during a clock pulse transition; but the voltage peak has the opposite polarity.) But the parasitic capacitance is not zero; it is large enough to create, along with the collector resistor, a time constant approximately equal to the transition time. This delays the moment at which the switching from Q_1 to Q_2 takes place and considerably reduces the amplitude of the peak voltage caused by the switching—to a level well below the critical point that might adversely affect the shift register's operation.

Register illustrated

Parts of a 256-bit shift register are shown in the photos, Figs. 2 and 3. In the larger-scale photo, the collector resistances are visible as enlarged collector islands, connected in pairs by a diagonal channel. This channel is crossed by an aluminum conductor, which is the ground bus, common to all elements in the register; it is connected to the channel by an n^{++} contact.

The long vertical island of collector material forms the emitter resistances, connected to the emitters of the transistors by short aluminum lines that cross the island at each end. Clock pulse signals arrive on the long aluminum lines that cross the emitter resistances near the center of the island.

How the register works in practice is shown for three different clock frequencies in Fig. 4. At the lowest frequency, 1 MHz, small oscillations clearly are visible; these are transitions between master and slave states, which take place at the clock pulse frequency as sequences of identical bits pass the output. At higher frequencies, the output signal deteriorates; but this deterioration is largely due to parasitic capacitances associated with the output and with the oscilloscope probe, which are more than 10 times the internal capacitances. Inside the shift register, the signal is still good. A modified layout could easily be made to present a good external signal also. □

BIBLIOGRAPHY for both preceding articles

- H. H. Berger and S. K. Wiedmann, "Bipolaremonolithische Speicherzellen mit kleiner Verlustleistung," Semiconductor Device Research Conference, Munich, 1969.
- F. Sangster and K. Teer, "Bucket-Brigade Electronics—New Possibilities for Delay, Time Axis Conversion and Scanning," IEEE Journal of Solid-State Circuits, June 1969, p. 131.
- D. A. Hodges et al., "Low-Power Bipolar Transistor Memory Cells," IEEE Journal of Solid-State Circuits, Oct. 1969, p. 280.
- L. Vadasz, D. Grove, T. Rowe and G. Moore, "Silicon-gate Technology," IEEE Spectrum, Oct. 1969, p. 28.
- R. Dunn and G. Hartsell, "At last, a bipolar shift register with the same bit capacity as MOS," Electronics, Dec. 8, 1969, p. 84.
- J. A. Appels et al., "Local Oxidation of Silicon and its Application in Semiconductor-device Technology," Philips Research Reports, Vol. 25, No. 2, April 1970, p. 118.
- L. L. Boysel, W. Chan, and J. Faith, "Random-Access MOS memory packs more bits to the chip," Electronics, Feb. 16, 1970, p. 108.
- "Silicon and sapphire getting together for a comeback," Electronics, June 8, 1970, p. 88.
- E. Boleky, J. Burns, J. Meyer, J. Scott, "MOS memory travels in fast bipolar crowd," Electronics, July 20, 1970, p. 82.
- M. E. Hoff, "Silicon-gate dynamic MOS crams 1,024 bits on a chip," Electronics, Aug. 3, 1970, p. 68.
- "CMOS shift register clocks at 25 MHz," Electronics, Sept. 14, 1970, p. 180.
- S. Waaben and H. A. Waggener, "100-ns Electronically Variable Semiconductor Memory using Two Diodes per Memory Cell," IEEE Journal of Solid-State Circuits, Oct. 1970, p. 192.
- J. Mar, "Two-terminal Transistor Memory Cell Using Breakdown," International Solid State Circuits Conference, Digest of Technical Papers, 1971, p. 10.
- P. T. Panousis, "A Trim Memory Employing both npn and High-gain Unijunction Transistors," International Solid State Circuits Conference, Digest of Technical Papers, 1971, p. 16.
- "Bipolar process promises RAMs with MOS density," Electronics, June 7, 1971, p. 35.

no ifs ands or buts...

General Instrument will deliver, on time, its silicon gate 1024 bit shift registers,
the pin-for-pin replacements for the 1402A's, 1403A's and 1404A's:

DL-9-1402A	(1-99—\$12.00 ea.; 100-999—\$9.00 ea.)
DL-9-1403A	(1-99—\$10.75 ea.; 100-999—\$8.00 ea.)
DL-9-1404A	(1-99—\$10.75 ea.; 100-999—\$8.00 ea.)

In stock and immediately available from authorized General Instrument distributors

For complete information call 516-733-3138 or write: Marketing Services Manager, General Instrument Corporation, 600 West John Street, Hicksville, N.Y. 11802, or call, in New York: 516-733-3333; in Chicago: 312-774-7800; in Los Angeles: 213-641-7411. In Canada, call or write: General Instrument Canada, Ltd., 61 Industry Street, Toronto 337, Ontario, Canada, Tel: 416-763-4133. In Europe, write: General Instrument Europe S.P.A., Piazza Amendola 9, 20149 Milano, Italy. In the U.K., write General Instrument U.K. Ltd., Stonefield Way, Victoria Rd., South Ruislip, Middlesex, England. In the Far East, write General Instrument of Taiwan Ltd., P.O. Box 22226, Taipei, Taiwan.

THE WORLD'S MOS EXPERIENCED COMPANY



GENERAL INSTRUMENT CORPORATION • 600 WEST JOHN STREET, HICKSVILLE, L. I., NEW YORK

Probing the news

Analysis of technology and business developments

How to miniaturize mass memories

Magnetic techniques for storing data may be on top today, but holography holds the promise for smaller trillion-bit memories

by Wallace B. Riley, Computers Editor

A trillion-bit memory the size of a golf ball is on the way with electro-optics. Already storage densities approaching 10^{12} bits per square centimeter have been achieved in experimental systems at Radiation Inc., Melbourne, Fla. And at RCA's David Sarnoff Laboratories in Princeton, N.J., similar densities are obtained with holograms made using manganese bismuth and arsenic trisulfide.

The key to the high storage density is the submicron wavelength of light, since the theoretical limit on the closeness of stored bits to each other is set by the wavelength of the recording energy. The practical limit is set by particle size in the recording medium—and photographic emulsions contain particles a few tens of milimicrons in diameter.

Light waves vs particles. In contrast, magnetic particles are generally about a micron in diameter, and trillion-bit memories based on magnetic recording and readout techniques are therefore physically very large. Examples are Ampex's Terabit, Grumman's Masstape and Precision Instruments' Unicon, which each occupy a large room.

Also, as Bob V. Markevitch, manager of Ampex's optical processing section, points out, conventional magnetic recording is limited to relatively long wavelengths. This length is established by the size of the gap in the recording head.

For these reasons, optical technology will probably take over in the long run. While holograms, except for RCA's, are not yet erasable, they have data accuracy because, as Markevitch says, "A damaged hologram drops out no bits, but only slightly degrades the signal-to-noise

ratio of all bits."

Perhaps the next technology to become commercially practical will be magneto-optic, combining the advantages of optics and magnetics. At Honeywell's Research Center in Hopkins, Minn., Di Chen, a researcher in magneto-optic systems, says his company is also working with MnBi, used as a coating on a 6-inch disk, for "bit-to-bit and holographic recording." The researchers are getting bit spacing "of 3 microns between centers, which works out at a density of 10^7 bits per square centimeter," says Chen, but cautions that the disk "is just a laboratory model—you couldn't even call it a prototype, it's so far from any commercial version."

Like other magneto-optic sys-

tems, the model utilizes the Curie temperature of the recording medium. For MnBi this is $+360^\circ\text{C}$. A laser focused on the tiny spot on the MnBi coating raises its temperature about 360°C , causing the area to lose its magnetic properties. Then the spot is allowed to cool in a magnetic field, and stores data by taking on the field's direction of magnetization.

High power, low power. To read data out of the MnBi film, a second laser beam is focused on the spot, and its plane of polarization is rotated one way or the other, depending on the spot's direction of magnetization. This laser is lower-powered than the first, since if it, too, heated the film to its Curie temperature, it would destroy the stored

Tablon. This system, now in operation and about to be expanded at the U.S. Department of Defense, provides a common data base for several large computers in and near Washington.

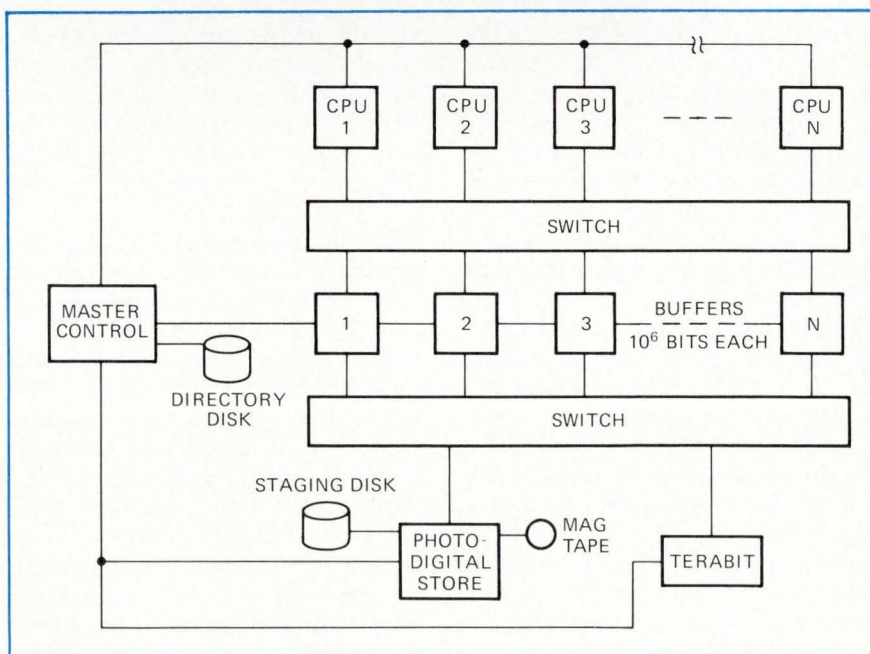

data.

IBM is also involved in magneto-optics. Industry sources indicate that a development project investigating europium sulfide is under way at the company's research laboratories in San Jose, Calif., but IBM's official position is noncommittal. "Everything is proprietary," says an engineer ruefully.

Laser reader. Of the three mass memory systems now on the market Unicon is the only one to use a laser. The memory holds up to a trillion bits, recorded on strips of polyester film coated with a thin film of rhodium. The laser controlled by the binary data to be recorded burns holes about $5\mu\text{m}$ in diameter in the rhodium film. A less powerful laser beam then reads the data, either passing through the holes or being reflected from the unpunctured rhodium.

A single plastic strip in the Unicon system holds 2.5 billion bits. There are 25 strips in a pack and 18 packs in a system. It transfers data at 400,000 bytes per second (1 byte equals 8 bits). The memory was developed and marketed by Precision Instrument Co., Palo Alto, Calif., and costs \$1.6 million.

Terabit is based on Ampex' highly successful videotape recorder. Frequency-modulated digital data is recorded transversely on magnetic tape, along with three longitudinal records of address, control, and tally information. Terabit's use of a magnetic medium for storage makes erasure and rewriting possible, so that active storage is possible. According to the Redwood City, Calif., company, Terabit is also suitable for archival storage, in which data is never erased but may be read many times.

Terabit has a capacity of 43 billion bits per reel of videotape, and has two separate mechanical drives on-line to the computer in each rack, for a total of nearly 100 billion bits per racks. The number of racks depends on the particular installation. Each channel transmits 6 megabits per second to or from the tape, and the Terabit controller can handle four channels at one time.

Automatic loader. Masstape is one

Who needs mass memories?

The U.S. Government—especially the Department of Defense—is a prime customer for mass memories. DOD already has one mass storage network, called Tablon, in operation. Tablon connects several large-scale computers to a single on-line data base, replacing many conventional magnetic tape drives for each computer and eliminating manual loading and unloading of tape reels.

The memory consists of two IBM 1360 photo-digital storage systems, to which an Ampex Terabit memory will be added in a few months. The present system is archival. But when the Terabit is added, Tablon will be capable of active storage, in which data can be written, read, erased and re-written many times. DOD hopes that within the next five to ten years the Tablon concept can be extended to a three- or four-layer hierarchy.

The Defense Department's Advanced Research Projects Agency, the National Security Agency with its cryptographic mission, the Library of Congress, and the Census Bureau still stand as potential customers for mass memory developers. In fact, ARPA recently took delivery on the first Unicon from Precision Instruments Corp., for the Illiac 4 computer, soon to be installed at NASA's Ames Research Center, Mountain View, Calif.

The U.S. Patent Office also was considering automating its vast files and installing a mass memory, but recently cancelled the remainder of its 1972 program for investigating these memories. Among the systems being examined in the Patent Office program were Terabit, Unicon, and Masstape. The agency was also working on holographic memories that could store both digital and image information and that may eventually be best suited to the agency's requirement.

Potential industry users of mass memories include oil companies, insurance firms and banks. The Unicon that went to Ames was originally slated for the Amoco Production Co. (formerly the Pan American Oil Co.) of Tulsa, Okla. Amoco would have used it as a block-oriented random-access memory (Boram) for seismic data, which is accumulating at the rate of several billion bytes per year, and for on-line backup of other vital records, such as oil-well data files. Precision Instruments says the second Unicon is almost ready to go to Amoco, but Amoco spokesmen are noncommittal even though the company is unquestionably interested in obtaining some kind of mass memory in the near future.

solution to the problems of manually loading and unloading conventional magnetic tape drives in large computer centers. It records on $\frac{1}{2}$ -in.-wide instrumentation tape, which comes in cartridges that are automatically loaded and unloaded. Developed by Grumman Data Systems Corp., Garden City, N.Y., Masstape is not expected to be used as an archival system.

The minimum Masstape system contains one storage unit storing 16 billion bytes, and either sells for \$350,000 or rents for \$11,956 a month. A typical large system could hold 128 billion bytes, selling for \$1,239,000 or renting for \$41,300 per month. A single tape cartridge moves data at 150,000 bytes per second; the Masstape controller handles a megabyte per second.

IBM's 1380 Photodigital Storage system records data on small "chips" of photographic film, which it transports mechanically in and

out of small storage bins. Each chip holds rather more than half a million characters; the entire system stores 10^{12} bits. Once a particular chip has had data recorded on it and been developed, it cannot be updated, so that the Photodigital store is truly archival. IBM built several of these machines a few years ago, but found that they were not competitive with other technologies. **Via Video.** International Video Corp. also markets a recorder that uses video techniques, but with a helical rather than transverse scan, like the Sony video recorder.

Magnetic bubble technology is sometimes mentioned as a candidate for mass memory technology. But while bubbles can be packed into thin films at densities of well over a million per square inch, each bubble corresponding to a bit, these do not approach the densities of the advanced electro-optical and magneto-optical techniques. □

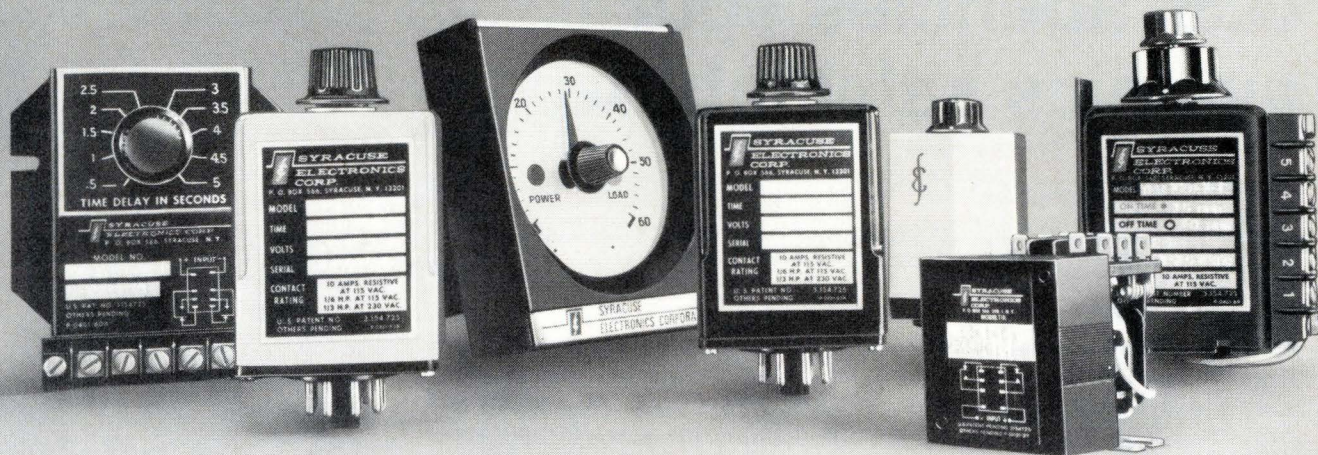

Multiple Problem Solvers!

Broadest Line Of Solid State Timers In The Industry.

Over 30 models to choose from. On delay. Off delay. Single shot. Repeat cycle. More UL approved timers than any other source. Proven accuracy. Top quality. Fast delivery. Competitive prices. For proof that we have the **broadest line**,

write for free catalog now.



syracuse electronics
CORPORATION

Government

U.S. agencies spur avionics sales abroad

Government-industry plan to beat competition overseas includes sales tips, better credit, and company teaming to nail deals.

by William F. Arnold, Aerospace Editor

With the U.S. share of overseas avionics markets declining, three U.S. Government agencies are mounting a coordinated counterattack to help American manufacturers. The Federal Aviation Administration, the Commerce Department, and the U.S. Export-Import Bank have taken aim at the growing need for avionics, communications, and navigational aids in developing countries.

The program was spelled out by officials of the three agencies at a closed meeting with avionics and electronics manufacturers at FAA headquarters in late January, when the South American market was highlighted. Officials were so afraid that details of the program might leak out that they not only barred the public but also kept away representatives of foreign trade missions, embassies, and companies that had heard about the meeting.

How to do it. The plan calls for the FAA to analyze air transportation needs in specific countries and issue these findings to industry. The Commerce Department is to arrange appointments with government officials abroad, organize trade missions, and alert U. S. manufacturers to upcoming "big ticket" projects and what to expect from foreign competitors. The Export-Import Bank will advise and provide financing, including the use of lines of credit with foreign banks.

The plan, initiated by the FAA, represents a significant reversal in U. S. Government policy. Heretofore, U. S. manufacturers have complained that government help abroad—particularly through U. S. embassies—has been lackluster.

Now, closer government-industry relationship must be fostered, Charles O. Cary, FAA assistant administrator for international aviation affairs, told the well-attended meeting. The reason that the U. S. no longer has "a competitive edge," said Cary, is that single U. S. manufacturers often compete against foreign companies that are either government-owned, like France's Aerospatiale; government-coordinated, like Japan's Zaibatsu trading cartels; or government-backed, like the United Kingdom companies. Government participation enables those companies to compete more economically, provide a wider range of products, and offer easier financing than U. S. manufacturers.

All together. FAA administrator John H. Shaffer cited the FAA Act, which calls for that agency to foster air development here and abroad. Export-Import Bank officials outlined how financial arrangements could be made and pledged quick cooperation. Commerce Department administrators explained how trade missions and their foreign representatives function.

At the end of the meeting, attendees submitted their company names and addresses for an information mailing list. They received packages containing the names, addresses, and telephone numbers of officials of the three participating agencies; the FAA's analysis, which included key government officials in each country; and a list of banks in the Western Hemisphere that the Export-Import bank has lined up for credit arrangements.

FAA's Shaffer reminded the audience, "The Europeans sold \$500

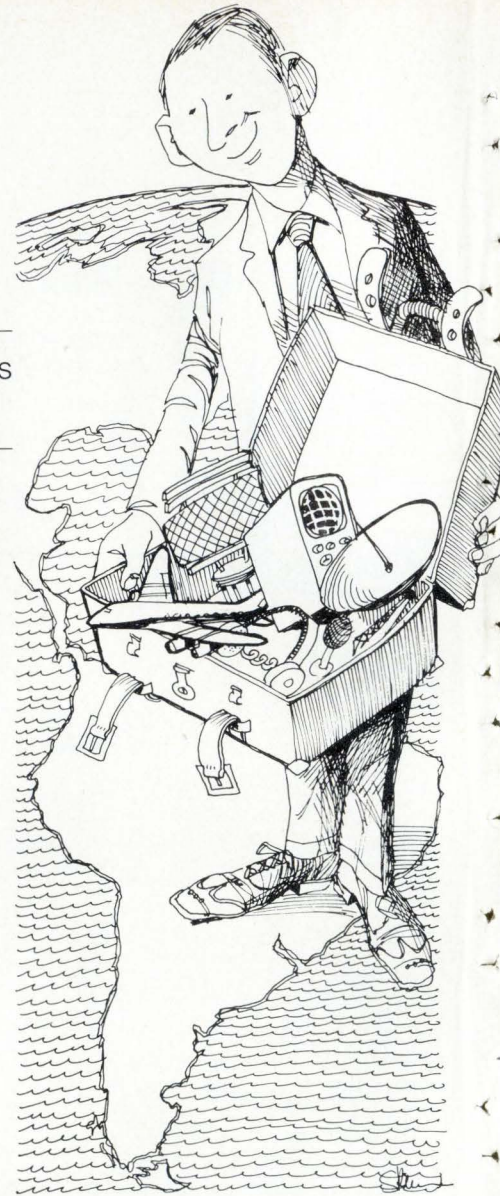

million worth of aeronautical and airport equipment within the last calendar year" to South America alone.

Industry estimates place the total current South American avionics and electronics market at about \$200 million. The toughest competitors there are Thomson-CSF, of France, and Plessey Ltd., of the U. K. Both offer a wider range of services and products than any single U. S. manufacturer.

The meeting on the South American market was the first of a series under the new program. One on the Caribbean market is expected in a few weeks. Pending are other briefings on Europe, Africa, and a Middle East-Southeast Asia combination.

Strauss S. Leon, of Commerce's

new Office of International Business Assistance, explained, "We're a catalyst" to get the other departments to support improved trading efforts. The department will encourage "turn-key" projects," he said. Leon added that the U. S. has "less than half the number of commercial attachés stationed abroad than the British do."

Problems. Both Government and industry acknowledge that the new program has a number of problems. One is antitrust: "We would have to be pretty careful of the nature of the agreement," says Robert J. Shank, vice-president at Cutler-Hammer's AIL division, Deer Park, N.Y. Companies would have to compete if team members offer the same services, he points out. FAA's Cary believes that government industry teams are "a way around antitrust" because of the participation of the Commerce department.

Another consideration is that the agencies are forbidden to aid military aviation needs—a problem in many South American countries where the armed forces operate the civilian airports. Cary says this may be a problem, since "civilian surveillance radar, for example, can be used for military purposes." But he says that the difficulty can be overcome. "The FAA position is that just

to control the civilian traffic in a country, you have to monitor the military, as well," he adds.

Some ask whether anti-U.S. feelings might hamper a trade effort in Latin America. "Civilian aviation officials of the countries generally are all favorable," Cary answers. "We've provided them with technical assistance from time to time," which helps. A problem is that "they tend to buy on a what's-cheapest basis"—that is, least money down and long-term payments.

Quick start. The plan began at the FAA a few months ago as a top priority program, Cary says. Will it work? "I think so," he says. "It's a little bit better than what most other countries are doing." Cary explains, "For the first time, the plan puts all of U.S. industry in the position to form marketing teams so they can compete with whole packages."

A special attraction is that the plan will finance "at reasonable, competitive interest rates" both studies and projects, he says. "It ties together consultants and manufacturers" so that they can sell programs more effectively. "We have a larger industry than most countries," Cary says. "This plan will allow companies to tailor requirements to specific needs." □

What happened when a group of experts teamed up to write this book?

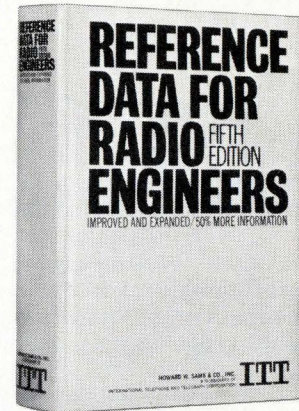

They made it so practical that it's now in its 5th edition!

This completely revised 5th Edition of the world famous Reference Data for Radio Engineers is the result of 5 years work by a broad group of practicing engineers, professors, government experts and the ITT staff. Its 1196 pages and 45 chapters bring you the very latest on transistors, electroacoustics, microminiature electronics, space communication, navigation aids, quantum electronics, reliability and life testing, etc.; information you need in your work. 1350 illustrations, charts, diagrams, tables, etc. Everything cross indexed for ready reference. Practical? Valuable? 400,000 radio engineers think so. Your money back if you don't agree with them.

Reference Data for Radio Engineers
No. 20678 \$20.00



HOWARD W. SAM'S & CO., INC.
4300 West 62nd Street
Indianapolis, Indiana 46268

Please send Reference Data for Radio Engineers. Check/money order enclosed for \$_____ for _____ copies @ \$20.00. (Include sales tax where applicable.) Canadian price slightly higher. **E 022**

Name _____

Address _____

City _____

State _____ Zip _____

Caution tempers industry hopes

While reaction to the Government's proposal to help industry obtain business in developing nations is generally favorable, there are some old scars and lingering cynicism about how helpful the next steps are going to be.

Robert J. Shank, vice-president for plans and business development, AIL division of Cutler-Hammer, Deer Park, N.Y., recalls that a few years ago AIL thought it had sold an instrument landing system to Uruguay. "Then the FAA gave them one." He says that the plan is a "new look in the Government's attitude toward U.S. trading policy." What happens "remains to be seen," Shank says, but "the change from neutrality to a positive attitude, to me, was the real message of the meeting."

Michael S. Kinsey, manager, special product sales, EG&G Inc., electronics systems developers, of Bedford, Mass., says he plans to attend all future meetings. "There's real value there," he says. "If you've got a problem locally with an FAA guy in Brazil, for example, you can tell him that's not what Washington said should be done."

Overall, Kinsey says the meeting was "encouraging," considering "it was the first time they've ever done it." But, he thinks that it was a little superficial. "They should've had department guys from South America actually to tell us what's happening, who to see, and so forth. That's the real stuff." He adds, "All South America is a neglected area."

Charles O. Cary, an assistant FAA administrator, reports that after the meeting, "One guy told me that he had heard a lot of talk about Government-industry cooperation, but this is the first time he had ever seen it."

From Monsanto... something new for people who count.

We build counters for just about every requirement, but a lot of people who count asked for a mix of capabilities we hadn't yet packaged in a single unit. Now, here it is—the Model 113A Counter/Timer, newest addition to the Monsanto line.

Take a quick look at some of its outstanding features... **Frequency range: DC to 80 MHz... 8 operating modes: frequency, totalize, ratio, period, period average, time interval A to B, positive pulse width, negative pulse width... Monsanto LED display.**

The Model 113A gives you automatic selection of slope when measuring positive or negative pulse widths, so you have one less mental calculation to make, one less knob to turn. And you get Monsanto's two-year warranty. What other major instrument manufacturer offers you that? All this versatility, all this four-figure performance, sells for just \$895 for 5-digit display. For complete data or a demonstration, write Monsanto Company, Monsanto Electronic Instruments, West Caldwell, N. J. 07006.

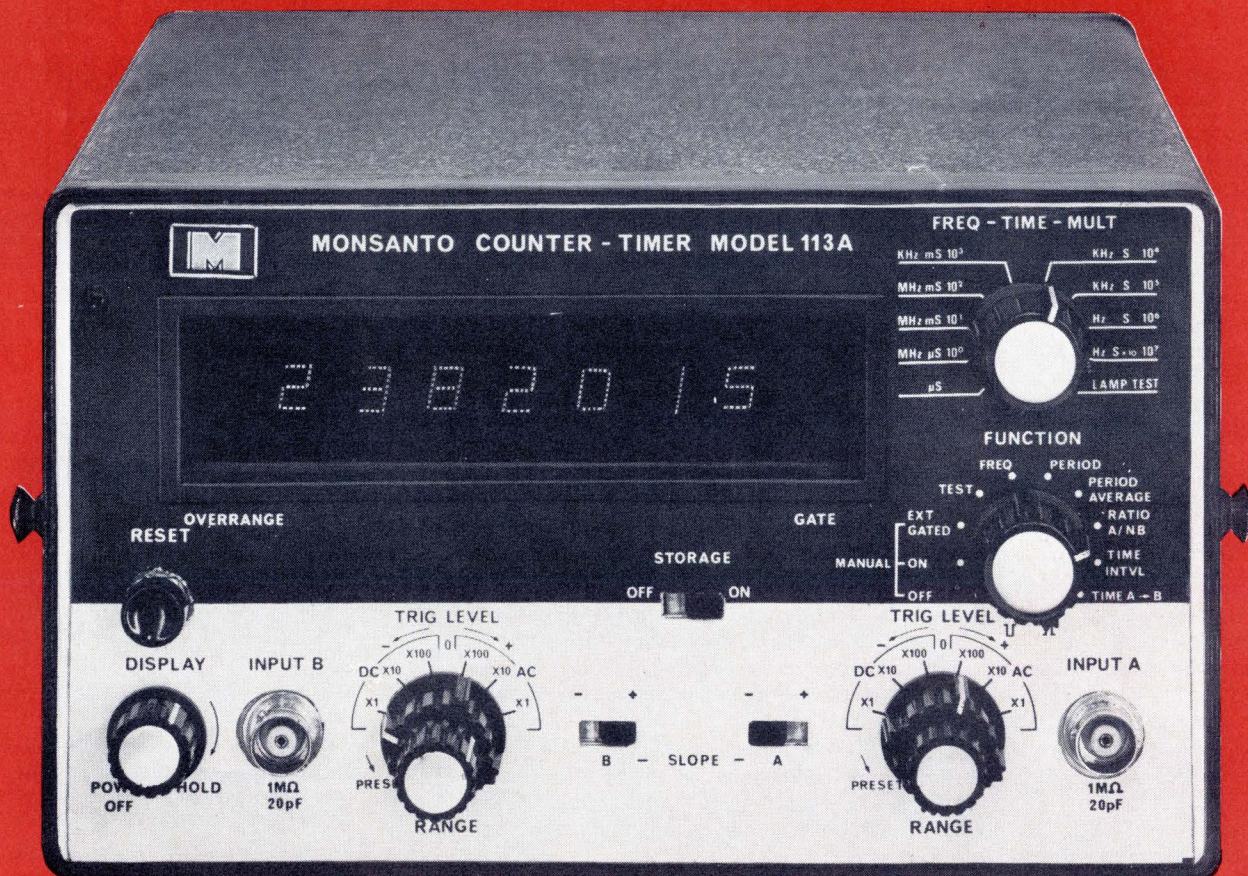

Monsanto

Materials

Coming attractions in magnetic tape

Two new oxides and an alloy with higher coercivities than the iron oxide of today's standard tape promise better performance

by Michael J. Riezenman, Instrumentation Editor

The iron age may be ending for magnetic tape, which until now has been made almost exclusively of gamma iron oxide ($\gamma\text{-Fe}_2\text{O}_3$). While it is still used in over 99% of the tape being made today, three new high-coercivity materials promise a lot of competition:

- A cobalt-doped iron oxide from 3M Co., with a coercivity that varies from about 320 to 1,000 oersteds, depending on the amount of cobalt doping.
- Chromium dioxide, a DuPont product, with a coercivity of about 500 Oe.
- Cobaloy, a product of the Cobaloy division of Graham Magnetics, Graham, Texas, with a coercivity of about 1,000 Oe.

High coercivity makes it possible to pack more information on a given length of tape, because such tape can handle shorter wavelengths (wavelength is the speed that the tape moves past the head divided by the frequency of the signal being recorded).

Small particles needed. Ordinary iron oxide is adequate for wavelengths of about 0.25 mil and greater, according to Delos A. Eilers of the Magnetic Products division of the 3M Co., St. Paul, Minn. Thus, a reel-to-reel audio tape recorder operating at 7.5 inches per second has no need for any other material because, even at 15 kilohertz, its wavelength is 0.5 mil. However, the 1 $\frac{7}{8}$ ips used in a standard audio cassette drops the wavelength to 0.125 mil. The result is degradation of the high-frequency response of the recording and/or degradation of the signal-to-noise ratio.

The reason for this decline in performance is that small magnetic

particles, packed closely together, are needed to record very short wavelengths—just as fine-grained photographic film is necessary for high picture resolution. Unfortunately, when tiny particles are packed closely together and their magnetic polarity is changed quickly as a function of distance (as is the case when dealing with short wavelengths), they tend to demagnetize each other, causing a reduction in signal level.

Eilers points out that this loss of high-frequency response can be reduced by recording at a reduced signal level at which the self-demagnetization effects are negligible. However, this remedy isn't as good as it sounds because lowering the

signal level causes a reduction in the S/N ratio of the recorded signal.

A better solution is to use a magnetic material with a higher coercivity than gamma iron oxide. (A material's coercivity is a measure of its resistance to magnetization or demagnetization).

In describing its line of cobalt-doped iron oxide products, 3M Co. spokesmen emphasize that the coercivity of the material can be tailored to a particular application. For example, the tape for 3M's audio cassettes has a coercivity of 320 Oe, close enough to the 280 Oe of iron oxide to be compatible with standard cassette recorders, while its tape for TV kinescopes has a coercivity of 500 Oe.

Adaptable. This Advent cassette recorder can accommodate either regular iron oxide or chromium dioxide tapes at the throw of a switch.

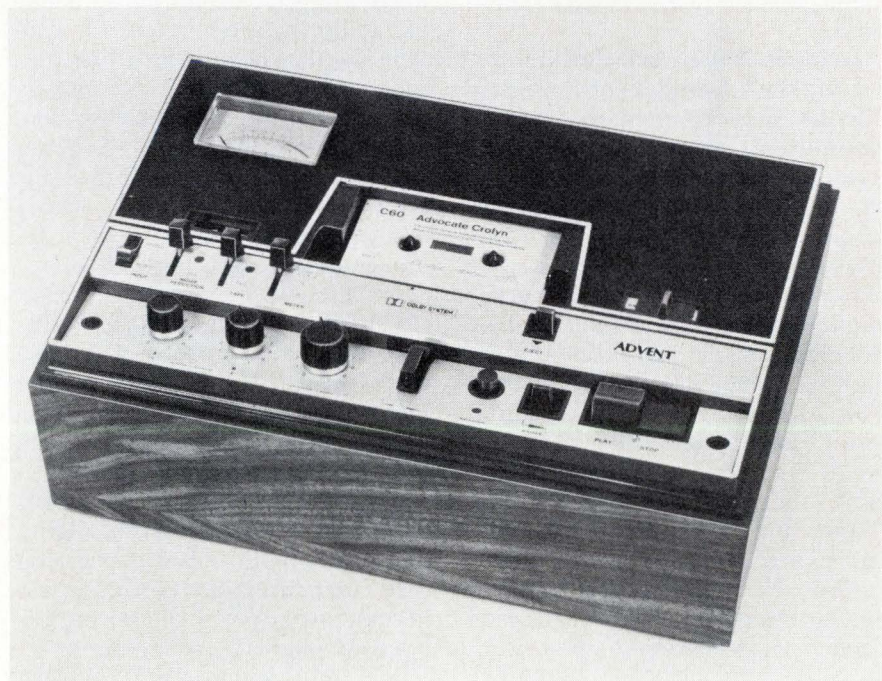

Probing the news

Another advantage claimed for cobalt-doped tapes is that they are no more abrasive than ordinary iron-oxide tapes. In this they are contrasted with chromium dioxide, a very hard material. Though abrasiveness is not much of an issue in audio work, where tapes run at relatively slow speeds, it matters a lot in video, instrumentation, and computer applications, where high tape speeds are the rule.

Paul J. Weber, marketing manager of the Magnetic Tape division at Ampex Corp., Redwood City, Calif., explains that chromium dioxide has not been used in video products at Ampex because of abrasiveness, but he is "not absolutely convinced that abrasivity is inherent in CrO₂."

Spokesmen for DuPont, which has the exclusive rights to CrO₂, minimize the importance of its abrasiveness and claim that how the magnetic coating is applied to the tape's plastic base material is much more crucial than the hardness of the oxide itself. In any event, the recent appearance of extremely hard hot-pressed ferrite tape heads should reduce concern over abrasiveness of tape materials. Even conservative figures indicate that ferrite heads will last at least 10 times longer than standard mu-metal heads under the same conditions.

CrO₂ is highly acicular. In discussing the advantages of chromium dioxide, DuPont engineers emphasize not only its high coercivity, but its high acicularity (needle-like shape), small particle size, and uniformity of particle size, as well. These properties make it possible to maintain excellent uniformity in the alignment of the CrO₂ particles on the tape. This, in turn, increases the high-frequency response of the tape. This advantage is not without serious consequences. The high-frequency response is boosted so much more than the low-frequency response—6 to 12 decibels between 10 and 15 kHz, compared with 1 to 3 dB at the low end—that the standard preemphasis and post-equalization circuits in conventional tape recording equipment must be changed to

MAGNETIC PROPERTIES OF TAPE MATERIALS				
Gamma iron oxide	Cobalt-doped iron oxide	Chromium dioxide	Cobaloy	
280	280 to 1,000	500	500 to 1,150	Coercivity (H _c)* (oersteds)
390	355	490	980	Saturation** magnetization (emu/cc)
4:1	4:1	8:1	—	Shape factor (length/width ratio)

* Coercivity is the magnetic field intensity required to reduce the material's magnetization from saturation to zero.
 ** Saturation magnetization is the maximum magnetization that can be induced in the material by an applied field.

flatten the output power over a wide bandwidth.

Also, the high coercivity of the CrO₂ tape makes it necessary to use bias and input currents that are 4 dB above those used for iron oxide. This is an obvious disadvantage, as Ampex's Weber points out, since instruments then have to be adapted to the new material.

And this raises the issue of compatibility, or the lack of it, and the design of new equipment. Some instrument makers, such as Henry Kloss, president of Advent Corp., Cambridge, Mass., feel that it is worth designing new tape recorders to take advantage of chromium dioxide tapes. Advent makes a line of audio cassette recorders with switches that change their bias current and equalization circuitry so that the machines can handle both conventional and CrO₂ cassettes (see photo). Kloss feels that the slow-playing speeds (short wavelengths) used in audio cassettes make this approach worthwhile.

On the other side of the fence, Robert Peshel, chief engineer of the Instrumentation division of Ampex, comments that "it would require massive redesign of equipment to be able to use a high-energy tape," and that the way Ampex uses tape materials, the advantage of CrO₂ would be limited to 1 to 2dB. But he did indicate that both cobalt-doped iron oxide and chromium dioxide would become attractive if shorter recording wavelengths become a trend.

The third new material, Cobaloy,

is a metal alloy, not an oxide. According to Robert J. Deffeyes, president of the Cobaloy division of Graham Magnetics, Cobaloy particles are less than 0.1 micrometer long (compared with 0.5 to 1.0 μm for CrO₂), and this contributes greatly to its low-noise properties.

Cutting abrasion. Because metals are softer than oxides, Cobaloy is potentially the least abrasive magnetic recording material. Deffeyes emphasizes the word "potentially" because he agrees with Du Pont that the proprietary binder systems used to hold the magnetic material to the tape's polyester backing are as important as the magnetic particles in determining the abrasiveness of the finished tape.

Like cobalt-doped iron oxide, Cobaloy can be made in a variety of formulations, with coercivities ranging from 500 to 1,150 Oe. As with the former material, the coercivity is varied by changing the amount of cobalt in the alloy. But, says Deffeyes, Cobaloy is much less sensitive to temperature than cobalt-doped iron oxide, although it is slightly more sensitive than γ-Fe₂O₃.

Because of its desirable magnetic properties and small particle size, Cobaloy appears promising. So far, however, it is only being produced in small quantities, for users who sign confidential agreements. Thus, no independent verification of the company's claims is possible at present. However, Deffeyes says that Cobaloy tapes will be commercially available early in 1973. □

We put eight IEC F34 Function Generators aboard this 747. Tagged for Paris, France, with one-way tickets.



**IF YOU'D LIKE TO FIND OUT WHY,
CALL JOHN NORBURG AT 714-772-2811 COLLECT**

It's nothing unusual. Our various agents overseas, including Tekelec Airtronic of France, represent a very interesting line of Function Generators. The IEC Series 30. Four of the most advanced-concept test instruments available in the Free World. Designed to fit the exact needs of our customers, whether here or abroad. And priced from \$295 to \$495 to provide the most for the money. Take the IEC F34 (illustrated) for example. At \$495, it does everything an oscillator can do and then some! Square waves and triangles, voltage offset, sweep, trigger, gate and pulse. Plus better sine wave purity than comparably-priced oscillators. The F34, like all Series 30 models, provides extra-special features that make it a

bargain. Together with such inherent quality that we boast one of the industry's lowest "returned for repair" rates.

It may not require a 747 delivery to fulfill your need, but you can depend on IEC to deliver your new Series 30 Function Generator on time. Our John Norburg is ready to answer your questions. Contact him now. Get complete technical data by same-day mail.



IEC F34 Function Generator

SERIES 30 HIGHLIGHTS F34: (\$495) — Frequency Range: 0.03 Hz to 3 MHz. Waveforms: Sine, square, triangle, dc, pulse. Output Amplitude: 10 mv pp to 10 v pp into 50Ω. Sine Distortion: <0.3% up to 30 kHz, <0.5% to 300 kHz, <2% to 3 MHz. Rise/Fall Times: <60 ns. Offset: ±5 v into 50Ω. VCG Range: >1000:1. Operating Modes: Continuous, Triggered, Gated, Tone Burst, Continuous Sweep, Triggered Sweep. Sweep Width: up to 1000:1. Set width directly on tuning dial. Sweep Time: 10μsec to 100 sec. Other Features: Voltage Analog of Frequency, Sync Input, Output Limit Indicator, plug-in IC's. F33: (\$395) — Same as F34, but without Sweep, Tone Burst and Voltage Analog of Frequency. F32: (\$345) — Same as F33, but without Pulse, Trigger and Gate Modes and Sync Input. F31: (\$295) — Same as F32, but without VCG and Output Limit Indicator. Output Amplitude is 100 mv pp to 10 v pp into 50Ω.

IEC GIVES YOU THE MOST FOR YOUR MONEY

INTERSTATE ELECTRONICS CORPORATION A Subsidiary of A-T-O Inc. Dept. 7000, Box 3117, Anaheim, Cal. 92803 (714) 772-2811 TWX 714-776-0280 TELEX 655443 & 655419

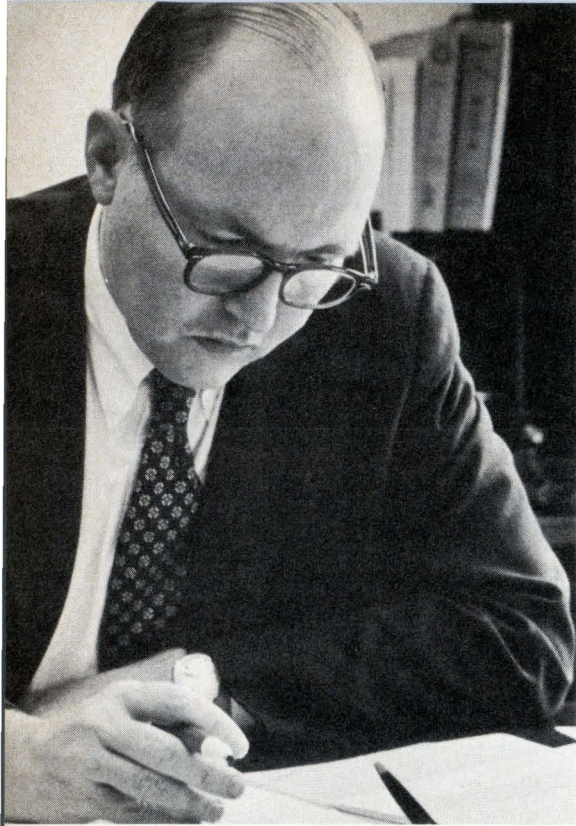

Management

New CBS Labs pilot maps own course

McMann plans to expand electron-beam and laser technology, as well as continue EVR work started by Peter Goldmark

by Gerald M. Walker, Consumer Editor

"A little sheer terror on the weekend is just what's needed to get your mind off other problems," says the new president of CBS Laboratories, 44-year-old Renville H. McMann Jr. about the risks of his hobby, sailplane flying. That argues a certain desirable sangfroid in the successor to the formidable Peter Goldmark, who retired from the Stamford, Conn., firm at the end of last year and who was the prime mover behind the long-playing record, field-sequential color TV, and electronic video recording (EVR).

McMann, however, has already developed his own head of steam for directing the R&D facility. As he puts it, CBS Labs will expand electron-beam and laser technology into applications that directly benefit CBS business interests in electronic typesetting, television broadcasting, and four-channel stereo recordings.

EVR lives. On the subject of EVR, which has had its share of trouble getting started, McMann expresses the tenacity he learned from Goldmark during their 17-year professional relationship. "No, EVR is not dying," he states firmly. "In fact, the lab is continuing work on the next generation that will involve high-resolution film production and eventually lead to EVR cassettes for wall-sized screens." The first step is research into transferring television

productions to film with sufficient resolution to be shown on large theater screens.

McMann also promises new developments in audio recording. Just as the LP record led to the stereo record and stereo led to four-channel, there are new things to come in the consumer record business from CBS Labs.

However, the new president points out, "the next couple of years are going to be tough for us." First, the research firm has had to adjust to reduced Government spending, and drop its personnel from about 700 back to just under 500. At the same time, royalties from previous color tube developments are coming to an end, so that additional royalties from EVR are becoming essential to fill the gap.

In the longer run, however, McMann is optimistic about the expansion of technology in general and CBS in particular. He also sees an end to the popular anti-technology attitude among the young. "People that count in science—those who are going to be outstanding—couldn't be knocked out of the career with anything. We won't lose those with unique contributions to make," he observes.

McMann has made unique contributions of his own during his time at CBS and intends to continue to spend more time in the laboratory than behind his administrator's desk. A holder of some two dozen patents, he has been interested in television and communications since his father brought home a TV set from Westinghouse back in 1938. "I'm proof that watching tele-

vision over a long period can't hurt you," McMann quips. Since getting his BSEE from Yale in 1950, he has been "closely connected with things going to the moon."

Eye saver. Among these things has been what McMann feels is his most satisfying accomplishment. He participated in developing the Apollo color camera, the Minicam, which was based on a revival of Goldmark's field-sequential system. The project required video signals to be sent from the moon in field-sequential mode and converted for broadcasting by magnetic scan techniques to the National Television Standards Committee system.

McMann began work on the camera for a far different purpose, however. He injured his eyes in a laser accident, and got to know many of the problems of ophthalmology at first hand. One was the difficulty of examining the rear of the eye at very low light levels. Recovering from the accident, McMann resolved to do something to meet this requirement. He designed a low-light-level color camera for examining the eye, and later helped persuade NASA to use the device in the Apollo program.

Normal vision has also permitted McMann to return to his two favorite hobbies—soaring and sports cars. The new president, whose quiet, deliberate manner of speech belies his rather hectic mode of relaxation, explains, "Flying totally occupies the pilot with two basic problems—how to find an air current to stay aloft, and failing that, how to get back to the airport without crashing on somebody's farm." As for his



Sperry displays are available in 3 digit, 2 digit, and 1½ (7 segment character and a 1 with + and -) digit models in both ½" and ¼" sizes.

Compare panel meter displays

If you think that Nixie® tubes or LED displays are the only one's you can logically use in your panel meters, you had better take a close comparison look at Sperry. The facts speak for themselves.

COMPARE READABILITY . . . a must requirement. Sperry displays† can be read in direct sunlight with no loss of legibility. And, continuous, "no-gap" Sperry characters make your panel meters a lot more attractive to your customers. Try the others.



COMPARE POWER . . . a very important factor. Under DC operation, LED's require over 500 mW — Nixie® tubes require over 400 mW as compared to Sperry ½" with 200 mW and ¼" with 370 mW. Sperry can go down even further — to 85 mW under pulsed operation using a Sperry decoder/driver, without affecting readability. What about voltage? A simple, inexpensive DC/DC converter takes the battery voltage up to the 170 volts required to operate Sperry displays.

COMPARE RELIABILITY . . . simplicity is the key. Sperry displays have no wirebonds. They are so ruggedly built and reliable that they are used aboard the Boeing 747. Need we say more.

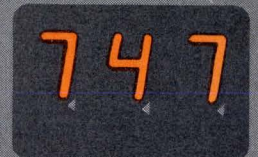

COMPARE SIZE . . . it's the housing to character size ratio that counts. Which display do you want in your equipment?



Add these Sperry advantages to greater clarity and brightness, wider viewing angle and a low cost of \$2.30** per digit for either the ½" and ¼" device and you can end the comparison and specify Sperry — the right displays for your panel meters. Get the whole story on Sperry displays by requesting complete technical information using this publication's reader service card or phone or write: Sperry Information Displays Division, Post Office 3579, Scottsdale, Arizona 85257, Telephone (602) 947-8371

SPERRY
INFORMATION DISPLAYS

It's a whole new ball game in display devices!

SPERRY RAND

†Patent Pending

**NIXIE is the registered trade mark of the Burroughs Corporation.

**Based on 5,000 digit quantity.

Circle 101 on reader service card

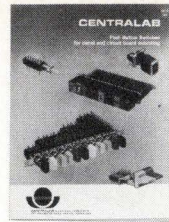

Write
Centralab
for
Bulletin
No. ELC-2

Centralab Push Button Switches... in line with your design requirements

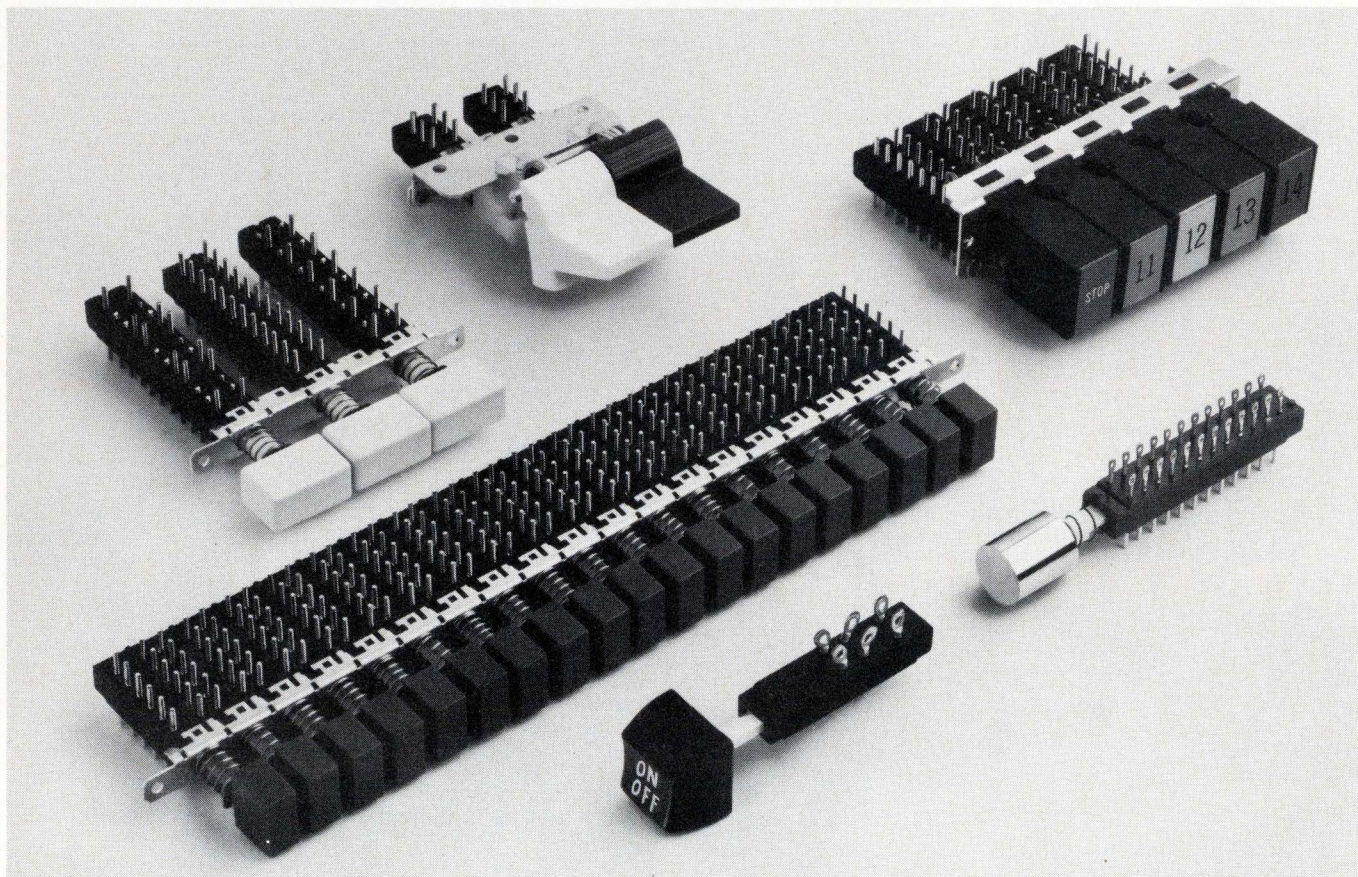

Reasons to switch from the ordinary

Versatile Centralab push button switches* give you more reasons to change from the ones you're using now. Our push button switch conforms to a variety of specifications for consumer products, instrumentation, and industrial applications.

Reasons? Consider these: Centralab is the only manufacturer to offer diallyl phthalate—for highest possible insulation resistance—as well as phenolic or glass alkyd. Our phenolic modules provide greater than 65 db isolation in the voice frequency range. Our modules are available with sealed terminals to avoid flux penetration and we can provide gold contacts and terminals for dry circuit applications.

To conserve space and provide compact stacking in circuit board applications, Centralab modules are adaptable to selective pin cutting or solder lug terminations. We offer three different

lockout devices to match your application. Functions include momentary, interlocking, push-push and push-pull. Up to 29 individual switch modules can be ganged on a common bracket. Other options include keyboard and row-to-row interlock. There are five center-to-center spacings with the widest variety of button colors, sizes and shapes.

Or ask for lighted push button switches that offer all the same features plus interchangeable lenses and filters in a variety of colors to provide maximum utility and appeal.

Our versatile module size line switch rated 3 amps at 120 V AC can be utilized in any position within the switch assembly.

If you need more reasons to switch to Centralab, ask for our bulletin and technical data. Write Switch Sales Manager, Centralab.

* Isostat Licensed

GET CENTRALAB THE "IN" LINE FOR YOUR DESIGN

Hybrid Microcircuits
Pushbutton & Rotary Switches
Capacitors
Potentiometers
Technical Ceramics
Ceramic Packages
Semiconductor Devices



CENTRALAB

Electronics Division
GLOBE-UNION INC.

5757 NORTH GREEN BAY AVENUE
MILWAUKEE, WISCONSIN 53201

Centralab Distributors are another reason to switch

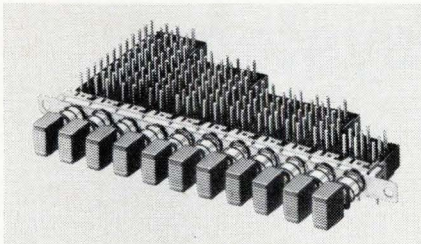

Our field assembly distributors provide a proven capability for immediate delivery of versatile, low-cost push button switches.* These specialists offer a wide variety of lighted and non-lighted switches with custom assembly service to meet your design requirements. Three reasons to contact your Centralab push button field assembly distributor are the right switch, the right price with delivery, right now!

*Isostat Licensed

Almac/Stroum Electronics
Seattle, Washington 98109
Phone: (206) 763-2300

Cameradio Company
Pittsburgh, Pennsylvania 15222
Phone: (412) 391-7400

Kierulff Electronics, Inc.
Los Angeles, California 90022
Phone: (213) 685-5511

Pioneer-Standard Electronics, Inc.
Cleveland, Ohio 44105
Phone: (216) 432-0010

Radio Distributing Company, Inc.
South Bend, Indiana 46624
Phone: (219) 287-2911

Gopher Electronics Company
St. Paul, Minnesota 55113
Phone: (612) 645-0241

Fisher/Brownell
Santa Clara, California 95050
Phone (408) 244-6182

Hammond Electronics
Orlando, Florida 32802
Phone: (305) 241-6601

Herbach & Rademan, Inc.
Philadelphia, Pennsylvania 19134
Phone: (215) 426-1700

Summit Distributors, Inc.
Buffalo, New York 14202
Phone (716) 884-3450

Kirkman Electronics
Winston-Salem, N.C. 27108
Phone (919) 724-0541

DISTRIBUTOR PRODUCTS



CENTRALAB
Electronics Division
GLOBE-UNION INC.

Probing the news

Porsche sports car, he tinkers with the machinery mainly to have something to do with his hands that's entirely different from electronics research. Yet research remains his overriding pleasure.

"I agree with the fellow who said that we are getting paid to do something five days a week that we would probably do for nothing on weekends if we had other, more routine jobs. I like coming to work knowing that there's something new to solve each day," McMann asserts.

He shares the first patents on EVR, invented the CBS electronic image enhancer to improve color broadcast quality, and headed the team that developed a laser color film reproduction system. He has also participated in the design of a color correction device for editing TV tape.

Both the image enhancer and the laser film reproduction unit have direct application to improving broadcasting quality and reducing broadcasting costs, which McMann feels is an important goal for the laboratories. The film reproduction system converts television signals from tape to color film and cuts the cost of

producing film copies for multiple television showings.

"I've always been oriented toward communications and broadcasting," McMann states. "I've gone the ham radio route as a kid and once built my own television receiver at a time when I couldn't afford to buy one." While still at school, he served as a laboratory aide on the staff of the late Major Edwin H. Armstrong, the pioneer in fm broadcasting. After graduation from college he joined the staff of the Hartley Research Laboratory at Columbia University, and later worked at NBC before coming to CBS Laboratories.

Science booster. By assuming a role as a leader in electronics R&D, McMann now feels he has another responsibility to his fellow researchers, similar to the personal commitment he assumed for ophthalmologists. He plans to become active in telling students how science has contributed to the world.

"The anti-technology pendulum will swing," he concludes. "When they (students) get over the fad of damning science, they will realize how important it has been to everyone's life. But leaders of the technological community have to get access to the kids." □

Whither Goldmark?

Though Peter C. Goldmark has retired as president of CBS Laboratories, and though he had previously refused to become a resident deep thinker for CBS—despite a huge salary offer, he's not out of research yet.

He has announced the start of a new company, Goldmark Communications Corp., Norwalk, Conn., to concentrate on the development of systems for cable TV, satellite communications, and the educational use of communications. This new firm, part of Kinney Services Inc., will attempt to mediate between hardware and software in communications.

Goldmark has long had the dream of creating a vast array of communications to bring to the home not only education but enough information to permit people to work at home without commuting. Both CATV and satellite communications play a part in this master plan.

Goldmark, who has been heading a Presidential advisory panel on telecommunications for the National Academy of Engineering, said that a portion of the new company's efforts will go into government work, such as a pilot project to study the use of communications in rural living. Specifically, the study would focus on providing rural areas with the major advantages of living and working in cities, including better health care, improved education, new employment opportunities, and various government services.

This project recently has been funded. Fairfield University and Goldmark's firm will study communications in Connecticut's Windham County region. But Goldmark also expects to research the use of communications for urban areas, including new electronic methods of crime prevention.

"We already have enough inventions through existing technology," he claims. "What is really needed is innovation and the application of existing technology for wider use."

AMERICAN

MADE

1% Tolerance SCHAUER 1-Watt ZENERS

Immediate Shipment Low Prices

ANY voltage from 2.0 to 18.0

Quantity	Price each
1-99	\$1.07
100-499	.97
500-999	.91
1000-4999	.86
5000 up	.82

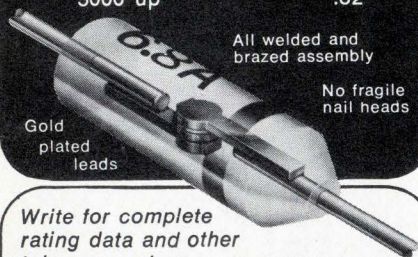

Write for complete
rating data and other
tolerance prices.

Buy the kit— Save a lot

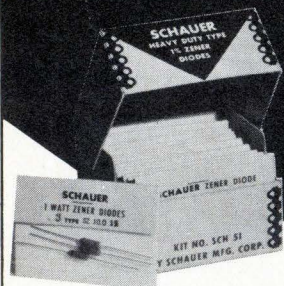

Kit contains a 51-piece assortment of SCHAUER 1% tolerance 1-watt zeners covering the voltage range of 2.7 to 16.0. Three diodes of each voltage packaged in reusable poly bags. Stored in a handy file box. Contact your distributor or order direct.

A \$54.57 value for

ONLY **\$24⁵⁰**

Semiconductor Division

SCHAUER

Manufacturing Corp.

4514 Alpine Ave. Cincinnati, Ohio 45242

Telephone: 513/791-3030

Probing the news

Marketing

LSI buyers must learn to think subsystems

By switching the emphasis to subsystems, LSI is pushing purchasing and engineering into closer cooperation

by Stephen Wm. Fields, San Francisco bureau manager

Large-scale integration is forcing a change in the relationship between design engineer and purchasing agent. As LSI becomes more complex, purchasing agents will no longer buy parts, but subsystems.

That's the view of many semiconductor-house executives, including Floyd Kvamme, vice president for marketing at National Semiconductor Corp. To get his point across, Kvamme divides everything electronic—*from auto radios to computers*—into five subsystems: an input interface, a processor, a memory, an output interface, and a power supply. And LSI, more and more, is wrapping each of those functions in one package.

Shift. Convinced of the importance of this shift toward subsystems, the Santa Clara, Calif., company decided to alter its traditional customer liaison efforts, educating both buyers and engineers about what the new subsystems can do. The first of a series of these seminars was held in December, and future sessions are planned for San Diego, San Francisco, Seattle, and Phoenix.

"Precise system cost evaluation," says Kvamme, "may require purchasing and engineering departments to work together early in the design cycle." Purchasing would provide accurate cost information, while engineering would weigh technical factors in the IC choice.

Even after the basic system is designed, Kvamme says that purchasing officials can look at alternative ways of implementing the overall system. For example, Kvamme tells of the purchasing agent who was

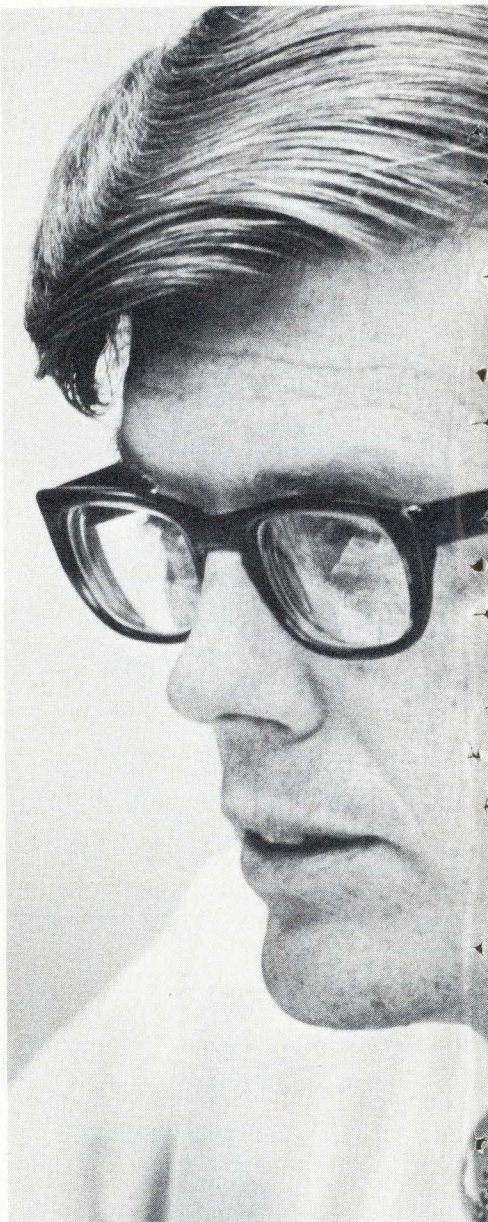

Customer service. National Semiconductor's Kvamme says there are ways to buy LSI economically.

told to cut system cost by \$10. So he went to the IC vendors and told them they had to lower their prices. "We [National Semiconductor] went in and found that because each section had been designed by a separate group, the input signals were being tailored for the processor, but the processor was re-tailoring them anyway. The result was that there were four unneeded ICs. By eliminating these, the buyer saved \$8, and he probably saved the other \$2 because of the reduction in the number of pins on the card."

Blocks. And, as design functions become more generalized, the subsystems performing those functions are becoming highly specialized. The LSI building blocks which form today's systems are often only available from a single supplier, says Kvamme. The buyer must realize that the engineer can configure the same system in several ways, out of different chip sets.

The problem is not just one of interplay between engineering and purchasing, Kvamme explains, but that "many companies are also divided along sharp lines within engineering. No one is looking at the total system, and as a result, there is overdesign, and it all lands in the lap of the purchasing agent."

"Before LSI," says Kvamme, "the processor and the memory made up 90% of the circuitry, but now the input and the output interfaces to the processor make up most of the system." And while this makes some things easier for both purchasing agent and designer, it brings in another complication—custom LSI.

Several semiconductor companies—National, Intel, Fairchild and Varadyne, among them—offer processors that can be employed in a variety of systems, and many companies offer standard memory products. But the input and output interfaces which formerly were relatively simple because the processor was specially designed, now constitute a complex design problem which is being solved through custom LSI.

Here National's seminar points out that "there is custom LSI, and semi-custom LSI," and the buyer must be aware of the tradeoffs. The seminars are aimed at increasing the alertness of the buyer and design engineer to such problems. □

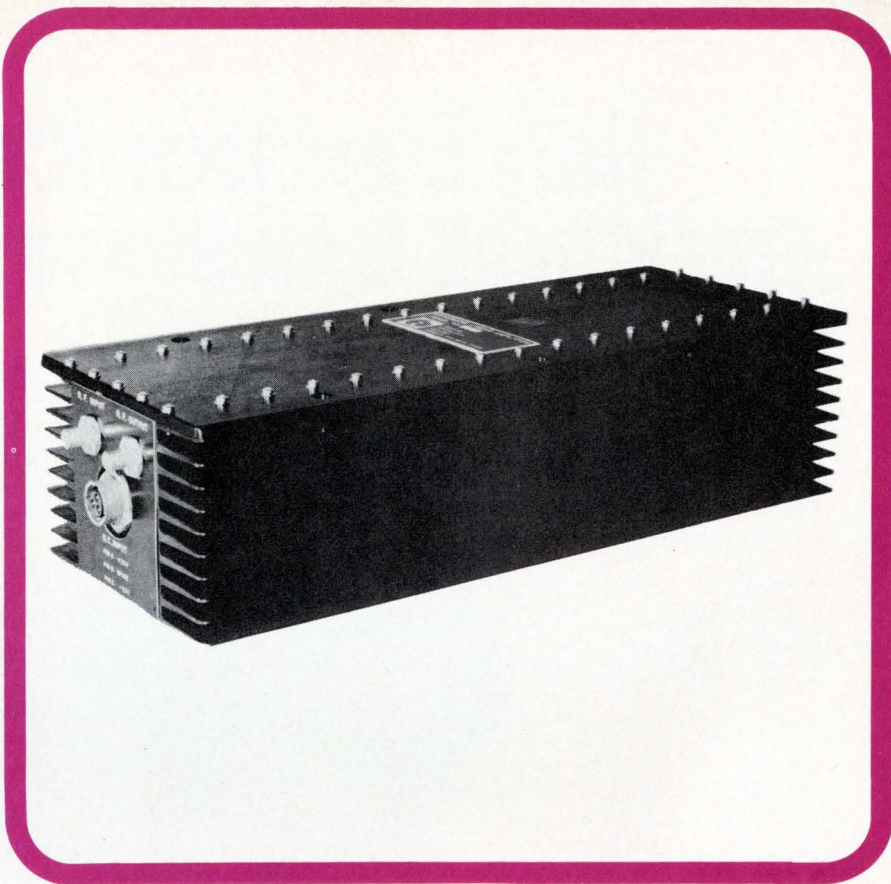

KEEP PLUGGING

A highly reliable solid state high frequency transmitter — 'build it in the field'.

Hermes Electronics Limited manufactures a 100W Broadband linear amplifier which replaces tubes in power output stages.

The 100W modules may be used singly or in groups to provide power output levels from 100 watts to many kilowatts. The amplifier has interface compatibility with the transmitter used in the majority of MANPACK systems, and with most mobile, airborne and fixed ground transmitter excitors.

It covers the frequency range 2MHz to 32 MHz and in combination can achieve power outputs to 5KW.

★ unique cooling system gives high reliability under adverse conditions

★ constructed for vehicular use

★ embodies overload protection

Hermes Electronics Limited can plug you into a wide range of HF equipment.

ASK US



Hermes Electronics Limited

Suite 315

2020 F. St., N.W.

Washington, D.C. 20006

Telephone 202 296 2978

TWX 710 822 1106

Only Electronics takes you into all 5 audience dimensions

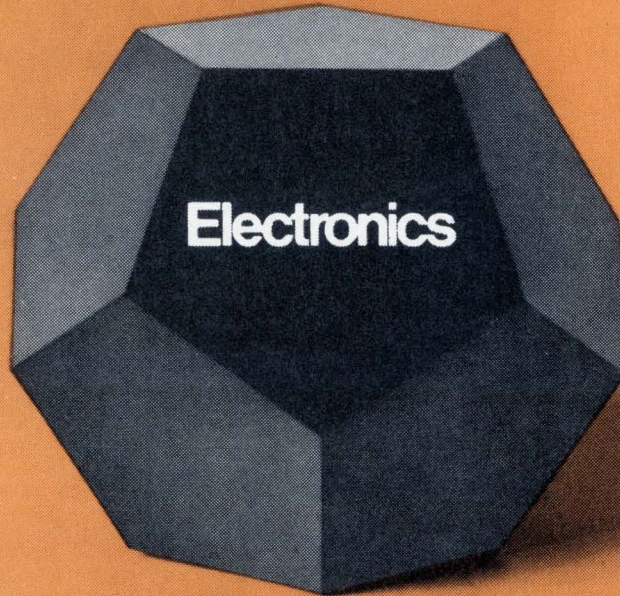

**1. Management Dimension 2. Technical Dimension 3. International Dimension
4. Purchasing Dimension 5. Reader Involvement Dimension**

New reader profile study highlights the power of *Electronics* readers in five key areas. These are the people you must reach to move a product or a service in the worldwide electronics markets today—and tomorrow.

If you want to know just how powerful a magazine is as an advertising medium, ask its readers. We did. Here's what they said.

1. *Electronics* subscribers are vitally important to their companies, and therefore must be important to you: 58,000 (67%) have a management responsibility. 48,000 (56%) are responsible for their companies' profit. 68,000 (79%) travel on business for their companies — 31% make more than 7 trips per year.

2. *Electronics* subscribers are determining the technical and business futures of their companies. They're also determining yours: 70,000 (81%) have engineering job functions. 69,000 (80%) participate in business, product or technology planning.

74,000 (86%) do or supervise design work.

3. *Electronics* subscribers are where you need them: 76,000 (88%) work in the worldwide electronics original equipment market. 7,600 (9%) more, work in vital "user" markets. 44,000 (52%) work in the five major growth markets of the '70's—computers, communications, instrumentation, industrial controls and consumer products.

4. *Electronics* subscribers buy your products: 73,000 (85%) select vendors. 23,000 (26%) recommend, approve or

specify purchases in excess of \$100,000 per year.

70,000 (82%) buy passive components.

71,000 (83%) buy control and display components.

77,000 (90%) buy active components.

75,000 (88%) buy instruments and test equipment.

5. *Electronics* subscribers depend on *Electronics*:

55,000 (64%) read it at home.

41,000 (48%) spend more than one hour reading each issue.

25,000 (29%) do not read *any* of the next six publications in the field.

55,000 (64%) do not read the second publication in the field.

68,000 (79%) do not read the third publication in the field.

It all adds up to this one crucial point—a magazine's power is only as great as the power of its readers. Only *Electronics* takes you into all 5 audience dimensions. For complete details on this new reader profile study, contact your nearest *Electronics* advertising district manager.

Reach the buyers for your product where they're at.

Beginning with the January 3, 1972 issue, *Electronics* offers advertisers four different market-coverage opportunities.

a. Full-Run. Advertisers may reach the *Electronics* worldwide audience of 86,000 with one advertising message. Full-run advertising rates are lowest on a cost-per-thousand basis. Full-run space earns frequency discounts for all other options.

b. Full-Run, Copy Split. Advertisers may reach *Electronics* worldwide audience with two or more advertising messages. Full-run rates apply, plus split-run charge. A standard domestic-overseas split is available at low charge. Full-run split advertising space earns frequency discounts for other options.

c. International Advertising. Advertisers may elect to reach only the *Electronics* overseas audience of 16,000 through the International Advertising Section, which is available in all issues. IAS space earns frequency discounts only for IAS advertising.

d. Domestic Advertising. Advertisers may elect to reach only the *Electronics* U.S. and Canadian audience. This option is available every issue but publisher reserves the right to restrict space to 12 pages per issue. Space units of full page or larger only. Domestic advertising space earns frequency discounts for domestic advertising only.

Electronics offers free proof of advertising effectiveness.

For 1972, *Electronics* offers you a free inquiry follow-up service—Buyer Action Measurement (BAM). It can determine for you just where the buying action is for your product. BAM has a tremendous memory bank which enables you to get unusual and critical information on products you advertise. And, *Electronics* is the only magazine in its field to offer any such service with BAM's capability. Here's how BAM works:

1. When a prospective buyer circles a number on the *Electronics* Reader Service Card, he also checks off his industry classification. When the card is received by BAM, the information is stored in the computer. Questionnaires are then mailed to the requestees to determine the action taken. The response to these questionnaires is also stored in the computer.
2. BAM then produces a printout table

that tells you number of requests for information, number of questionnaires returned from requestees, the percent of response, five types of action taken by respondents, number and percent of sales actions taken—all broken down by *industry classification*.

3. In addition, BAM gives you a comparison report showing the action taken by your customers and prospects on *all similar products* to yours that were advertised in the same issue.

4. And, as a final service, BAM offers a *cumulative comparison report*, by product, of all the issues studied. From this, you can determine where the

sales actions for your type of product come from over a period of time.

Electronics offers AD COM—Advertising Communications Evaluation—the most comprehensive advertising readership service available anywhere. It tells you, through 100 personal interviews, the percent of respondents who remembered seeing your ad and remembered reading it. It also tells you whether your message got through and whether it was believable. Finally, it tells you the percentage of readers who took or plan to take action as a result of reading your advertisement.

1972 ADVERTISING SCHEDULING GUIDE

Use this convenient advertising scheduling guide to take full advantage of special issues and reports, as well as those issues which are scheduled for BAM and

AD COM. You will be notified well in advance of closing dates of the additional special reports and studies as they become scheduled.

ISSUE	CLOSING	CYCLES	SPECIAL REPORTS	AD COM	BAM
Jan 3	Dec 10	A	Annual U.S. Markets Report	✓	
Jan 17	Dec 24	B			✓
Jan 31	Jan 7	A		✓	
Feb 14	Jan 21	B		✓	
Feb 28	Feb 4	A			✓
Mar 13	Feb 18	B	IEEE Preview		
Mar 27	Mar 3	A		✓	
Apr 10	Mar 17	B			✓
Apr 24	Mar 31	A			
May 8	Apr 14	B		✓	
May 22	Apr 28	A			✓
June 5	May 12	B		✓	
June 19	May 26	A			
Jul 3	June 9	B			✓
Jul 17	June 23	A			
Jul 31	Jul 7	B			
Aug 14	Jul 21	A			✓
Aug 28	Aug 4	B			
Sept 11	Aug 18	A	Wescon Preview		
Sept 25	Sept 1	B			
Oct 9	Sept 15	A			
Oct 23	Sept 29	B			
Nov 6	Oct 13	A			
Nov 20	Oct 27	B	Japan Markets Report		
Dec 4	Nov 10	A			
Dec 18	Nov 24	B	European Markets		

TOTAL PAGES SCHEDULED _____

Get the whole picture.

For the total picture of what the five-dimensional audience of *Electronics* can do for you, contact your local *Electronics* district manager.

That's also where you can get a complete copy of our new International Profile Study, as well as the recently-completed European Product Preference Poll and the domestic

Product Preference poll. Plus the 1972 *Electronics* rate card.

You can't sell to the world's electronics markets unless you reach all five audience dimensions.

Electronics
The International Magazine of Electronics Technology

AMS

of the semiconductor
memory systems built
and operating today use the
AMS 6002 MOS RAM.

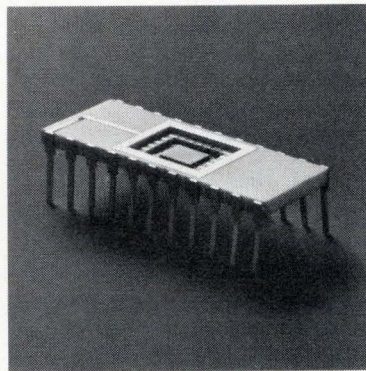

The AMS 6002 MOS RAM has already established more than 16 million hours of field performance in more than 40 installations. Six months after its introduction, the 6002 is still the fastest 1024-bit RAM available with 150 nanosecond access and 250 nanosecond cycle times. It is the only MOS RAM that utilizes field-proven P-channel processing *and* a ceramic package.

That's why most of the systems out there today use the 6002. Shouldn't you?

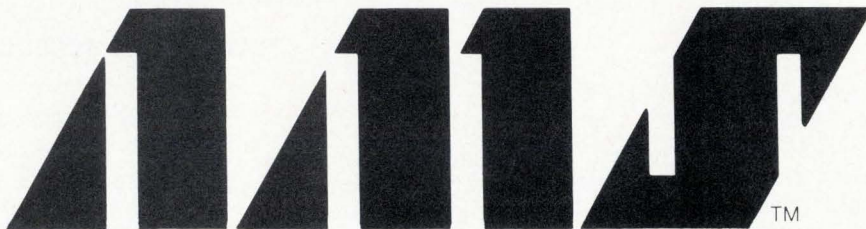

Advanced Memory Systems, 1276 Hammerwood Avenue, Sunnyvale, Ca 94086 (408) 734-4330

Powell/Philadelphia
S. Island Road/Box 8765
Philadelphia, Pa. 19101
(215) 724-1900

Powell/Washington
10728 Hanna Street
Beltsville, Md. 20705
(301) 474-1030

Powell/Huntsville
Box 488, Fayetteville
Tenn. 37334
(615) 433-5737

Powell/Florida
2049 W. Central Blvd.
Orlando, Fla. 32814
(305) 423-8586

Powell/California
411 Fairchild Dr./Box 997
Mountain View, Ca. 94040
(415) 964-0820

Powell/California
Southern California
(213) 988-3330
(213) 873-6431

Apollo Electronics, Inc.
101 Binney Street
Cambridge, Mass. 02115
(617) 868-3120

New products

Circuit analyzer does factory-type tests in the field

by Stephen Wm. Fields, San Francisco bureau manager

Suitcase-size instrument with readout in its probe helps to isolate faults on digital logic boards

Testing digital printed-circuit boards in the field usually means checking the outputs with an oscilloscope or voltmeter, and, if the faults are not found, shipping the boards back to the factory. This method works so long as the factory is still in production on that type of board, and testers can check it out quickly.

But Dan Marshall, marketing manager at Data Test Corp., Concord, Calif., says, "Usually, this is not the case. Either the factory has stopped producing the board, or its testers are so backed up checking production runs that it becomes impractical to test field failures. In one case, we found that 40% of the returned boards were actually good."

Data Test's solution to the problem is its model 2000 portable circuit analyzer.

The tester is packaged in a rugged aluminum case built to airline carry-on specifications (21 by 13 by 7 inches) and weighs only 30 pounds, complete with everything needed to check out and diagnose digital logic boards.

Two runs. The model 2000 operates on the same principle as the company's large semiautomatic and automatic testers such as the 4000 or 4700. [*Electronics*, Oct. 12, 1970, p. 149]. When a sequence of digital events is applied to the inputs of a pc board, each output goes through a certain number of transitions, de-

termined by the logic on the card. To make sure that the board is always at an initial state when the tests are begun, the test sequence is run twice—during the first time, the board is reset, and during the second time, the output transitions are counted. On certain boards, where a reset line is not available at the output connector, a jumper can be connected directly to the integrated circuit on the board to reset it. But, Marshall explains, "Most board designers include a reset line for their own use, and so it is available to us."

Exercise for all. The input signal is a gray code in which only one bit changes at a time. As the code is applied to the inputs, the board is put through every possible state, so that the outputs are all completely exercised.

In testing a board, the number of transitions at an output is noted and compared with those on a board

that is known to be good. If the count is the same for an output on the board under test, that particular output is good; if the counts check out for all of the outputs, the board is good.

Anywhere. In diagnosing circuits, the counts for various points on the board can be used. Thus, if a particular output is faulty, the test probe can be placed at some intermediate point, and the circuit can be checked all the way back to the input. This method works if the correct counts from a good board are known. For checking intermittent failures, the tester has a recycle mode in which the test sequence is repeated over and over indefinitely.

Marshall says that many companies that will be interested in the 2000 already have model 4000 or 4700 automatic testers at their factories; therefore, transition counts used at the factory will apply in the field. However, if counts are un-

On the move. Circuit analyzer in suitcase that's airline carry-on size has four-digit LED display built into test probe. It has everything needed to test logic boards.

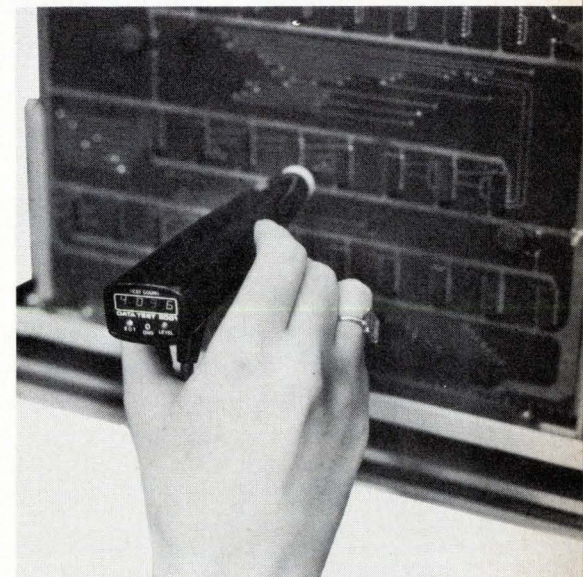
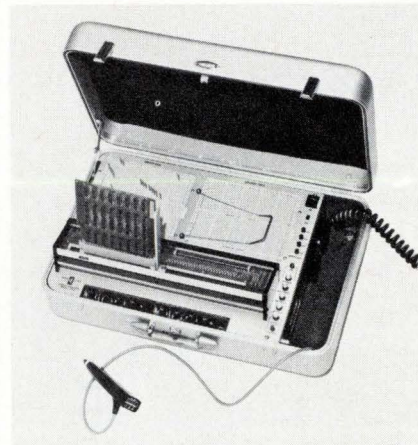

NEW SIMPSON

6-digit frequency counter



model 2726
only \$575

- $\pm 0.001\%$ accuracy
- Direct measurement to 32 MHz
- Period averaging, single or multiple
- Frequency ratio, single or multiple
- Time interval and count totalization
- Switch-selectable sensitivity control
- Solid state . . . integrated circuits
- 7 time bases, crystal controlled
- Automatic overrange indication
- 9 digit resolution
- Also available with 5 digits, Model 2725A, same features as above, \$525

For further information or demonstration see your local instrumentation products distributor or write for bulletin 368C.



SIMPSON ELECTRIC COMPANY
5200 W. Kinzie St., Chicago, Illinois 60644
(312) 379-1121



known, the service man can get them himself from a known good board.

Slipping no problem. The complete 2000 tester consists of four programable power supplies, a test module, a program matrix board for the inputs, and a digital counter with a four-digit light-emitting-diode display built into the test probe. "With the counter and read-out built right into the probe," says Marshall, "the user doesn't have to take his eyes off the board, and thus, the possibility of the probe's slipping is almost eliminated."

The power supplies include one that provides from 3 to 6 volts at 3 amperes and three that can provide from 2 to 30V, either positive or negative, at 1A.

Matrix overlay templates—along with shorting, resistor, or diode pins—are used for input programming. Marshall points out that in companies where many board types have to be field-tested, the overlays for them simply can be prepunched at the factory.

The test module is actually an adapter panel that allows the board under test to be plugged directly into the tester. Only one adapter is needed per board family if the connector is the same for all boards in that family. Up to 100 input pins can be accommodated. The outputs are brought out to a strip on the adapter.

Shifters can be shifted. The 2000 comes equipped to test diode-transistor-logic and transistor-transistor-logic circuits. But because the input buffer boards are readily accessible through a slot in the front of the tester, the TTL boards can be swapped with MOS-level shifters or level shifters for any type of logic.

The Datatest 2000's probe itself contains an adjustment for logic threshold—it can be adjusted from $-10V$ to $+10V$. And because the counter is in the probe, input impedances can be kept high—on the order of 10 megohms—and input capacitances can be kept low—about 20 picofarads.

The model 2000, complete with counter/probe and one test adapter, sells for \$3,800. As of next month, delivery time is 30 days.

Data Test Corp., 822 Challenge Drive, Concord, Calif. 94520 [338]

Components

A-d converter puts out 16 bits

Unit, consisting of two modules on card, offers accuracy to 0.0015%

Resolving an analog signal into a 16-bit digital word means that the least significant bit (LSB) is equal to 15 millionths of the input. Some laboratory and scientific applications need this kind of precision, and then the user must be sure the 16-bit analog-to-digital converter provides accuracy within 1 LSB to be compatible with 16-bit resolution. Analog Devices Inc., is offering this performance in its new 16-bit con-

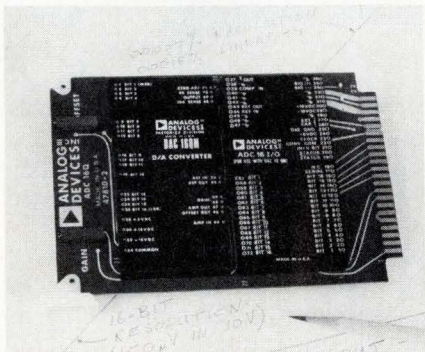

verter, the ADC-16Q, selling for \$1,350.

Prior to the ADC-16Q, such resolution often required a relay-rack full of modules and components, and the error was several times greater than the 1 LSB. The new instrument, however, consists of only two modules mounted on a 4½-by-6-inch card.

The converter is an extension of the company's ADC-12Q, a 12-bit converter. Thus, no new conversion technique has been used. Providing this ultra-resolution is a matter of "painstaking care in selecting components for the ADC and closely controlling the device's manufacture," says Cyril H. Brown, marketing manager for converter products.

Since the ADC-16Q is based on the successive-approximation tech-

nique, it contains a digital-to-analog converter. The accuracy of the a-d converter depends on the accuracy of the d-a converter, which contains 50 to 60 components; about 40 of these, says Brown, must operate with a temperature coefficient of ± 1 part per million per degree centigrade. The internal zener reference is the best available, says Brown.

Data conversion itself takes only 400 microseconds. However, an input buffer amplifier, included to reduce common-mode noise, takes time to settle to within 0.0015% of the input signal—to reach accuracy limits—despite the excellent gain-bandwidth product of the amplifier. Thus, with the amplifier, conversion to stated accuracy takes 4 milliseconds.

For extremely low-noise situations, the buffer amplifier can be bypassed, thus reducing conversion time. However, says Brown, less than 150 microvolts of common-mode noise, equivalent to 1 LSB for this 16-bit converter, would be unusual. The common-mode rejection ratio, using the buffer amplifier, is 100 decibels from dc to 100 hertz.

Linearity error and gain error are each specified as 15 ppm maximum at 25°C $\pm 2^\circ$ C. Maintaining the a-d converter within this temperature range is consistent with the laboratory environment, where the unit will probably be used in scientific applications that need the wide dynamic range of 16-bit resolution. In fact, says Brown, the ADC-16Q is the only 16-bit a-d converter that does not use a programable gain amplifier to provide the 65,536-to-1 dynamic range implicit in 16-bit conversion.

Analog Devices Inc., Rte. 1, Industrial Park, Norwood, Mass. 02062 [341]

Carbon film resistors offer high stability, low noise

New ⅛-, ¼-, and ½-watt carbon film resistors are highly stable under moisture conditions and have low noise-generating levels compared to carbon-composition resistors. Called the Little Rebels, the units have a

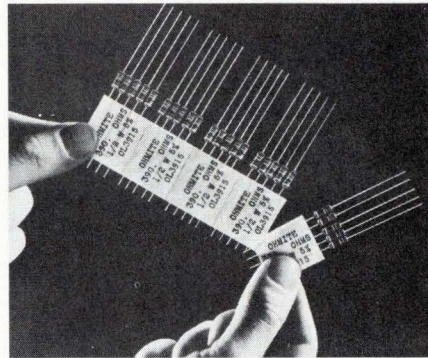

tolerance of $\pm 5\%$ and offer a resistance range from 1 ohm to 1 megohm. OEM quantities of 1,000 or more resistors per value are available in bulk packs. End-tape-reel packaging is also offered.

Ohmite Manufacturing Co., 3601 W. Howard St., Skokie, Ill. 60076 [343]

Thermistor combines bead, heating unit in glass bulb

The model K365 thermistor combines a heating element with a thermistor bead enclosed in a glass bulb. The K365 is unaffected by changes in ambient temperature conditions and when power is applied directly to the bead, the magnitude of the temperature change is based on a temperature increase of 1°C per each 0.015 milliwatt (nominal). Applied power of 0.04 mW (nominal) to the heater element will cause the element to heat the thermistor bead

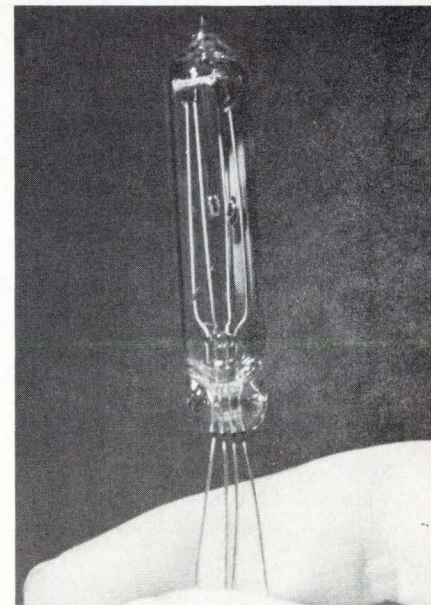

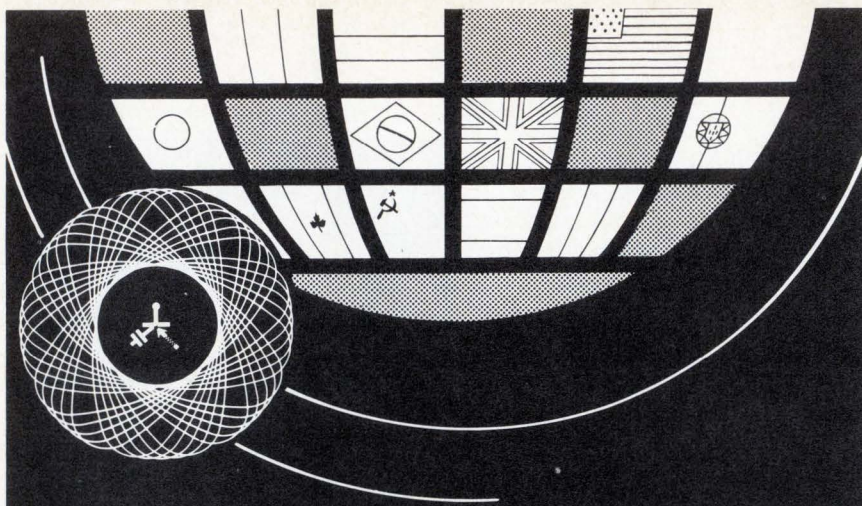

PARIS, APRIL 6, 7, 8, 10 AND 11, 1972
PORTE DE VERSAILLES

15th INTERNATIONAL ELECTRONIC COMPONENTS EXHIBITION

The world's most important event
in the electronic field.

Organized by the S.D.S.A.

For further information and complimentary entrance card please contact :
French Trade Shows, 1350 Avenue of the Americas,
New York, N.Y. 10019. Tel. (212) 582.4960



Detach here

I would like to receive information on the 15th Paris International Electronic Components Exhibition, as well as an entrance card.

Name _____ Title _____

Company _____

Address _____

Zip code _____

Please send this coupon to : FRENCH TRADE SHOWS, 1350 Avenue of the Americas,
New York, N.Y. 10019.

PUBLI-SERVICE

New products

indirectly, resulting in a temperature increase of 1°C. This also changes the resistance on a typical curve of heater power vs. bead resistance from 50,000 ohms to 15,000 ohms.

Fenwal Electronics Inc., 63 Fountain St., Framingham, Mass. 01701 [345]

Keyboard switch rated for 10 million operations

A mechanical keyboard switch with a life in excess of 10 million operations has single-pole, single-throw



contacts enclosed within a housing 0.625 inch square by 0.828 in. high. The moving contacts, of bifurcated gold construction, are arranged to provide self-cleaning wiping action. Operating force is 2.5 ounces, ±0.50 ounces, and price is under 30 cents in large quantities.

Amphenol Controls Div., Switch Operations, 419 South Arch St., Janesville, Wis. 53545 [348]

Chip capacitor provides values up to 1,000 pF

A ceramic capacitor has a capacitance range from 47 to 1,000 picofarads at a working voltage of 50 volts dc. Tolerances available are F (+1%), G (+2%), J (±5%), K (±10%), and M (±20%). The terminations are made from palladium-silver, and the package is approximately 50 mils square. Price of the model ATC 700 starts at 40 cents for the K-tolerance model in 1,000 lots.

American Technical Ceramics, 1 Norden Lane, Huntington Station, N.Y. 11746 [346]

New products

Instruments

Pulser family reaches 50 MHz

Constant-duty-cycle mode, adjustable rise-fall time are featured in top models

Designed for the instrument buyer who wants to pay only for the measurements he needs, a line of 50-megahertz pulse generators developed by Interstate Electronics Corp. offers a wide variety of capabilities

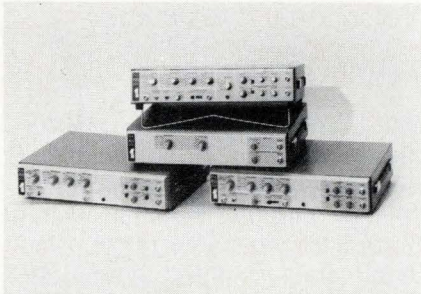

and a price range that runs all the way from \$300 to \$900.

All four pulsers in the series provide repetition rates from 1 hertz to 50 MHz, a pulse-width range of 10 nanoseconds to 1 second, and a continuously adjustable output amplitude of up to 5 volts into 50 ohms.

To be priced at about \$300, the model P21 is the least expensive member of the family. It has two complementary outputs—both with positive polarity—and fixed rise and fall times of 5 ns.

For approximately \$400, the model P22 offers everything the P21 has, plus a delay control (variable from 10 ns to 1 s), dual-polarity outputs, a sync output, a six-position mode-control switch, and a warning light that goes on if the instrument is not being triggered properly.

Models P22, P23, and P24 feature the constant-duty-cycle mode, in which the pulse width automatically changes as the repetition rate is varied to maintain any desired duty cycle from 5% to 95%. Other modes include square-wave, trigger (single pulse), gate (generation of pulses as

long as the gate is open), and a width mode in which the generator acts as a pulse amplifier, producing an output pulse with the same width as the input but with adjustable delay and amplitude.

The model P23, at about \$600, does everything the P22 can do and has a 3.5-ns rise and fall time plus variable dc offsets of both outputs.

The P24, with a price of about \$900, also includes the ability to adjust, independently, the rise and fall times of each output over a range from 5 ns to 500 milliseconds. In addition, this model's warning light will blink if the user asks the instrument to do the impossible: setting the repetition rate to 1 MHz and the pulse width to 100 μ s, for example.

The instruments will not be ready for delivery until June; however, preproduction models will be on display at Interstate's booth at the IEEE show in March.

Interstate Electronics Corp., 707 East Vermont Ave., P.O. Box 3117, Anaheim, Calif. 92805 [351]

Linear amplifier delivers 5 watts over 250 megahertz

Getting 5 watts of power out of a linear amplifier is not exactly an earth-shaking achievement. Neither is a bandwidth that extends from 100 kilohertz to 250 megahertz. But when the user gets both from the same all-solid-state unit, then he has a highly useful instrumentation amplifier at his disposal.

Electronic Navigation Industries' model 406L has a fixed-gain of approximately 40 decibels and a gain variation of less than ± 1.5 dB over the frequency range from 100 kHz to 250 MHz. Harmonic distortion is typically 25 dB down at 5 w, and 30 dB down at 4 w. The third-order intermodulation intercept point is typically +47 dbm.

Selling at \$1,500, the 406L has the ability to work into any load impedance—from an open circuit to a dead short—for an unlimited length of time without sustaining any damage. It is therefore an ideal driver for such variable-impedance devices as ultrasonic transducers.

The amplifier will accept cw, a-m, fm, single sideband, pulse, noise, and other complex modulations, limited only by their bandwidths and peak-power levels.

The unit measures 6 by 8½ by 15 inches and weighs 18 pounds.

Electronic Navigation Industries, Inc. 3000 Winton Road South, Rochester, N.Y. 14623 [352]

Low-priced tester probes individual LSI circuits

Causes of failure in large-scale integrated chips cannot readily be pinpointed unless the troubleshooter can probe inside the individual circuits. But, since the components on the chip are microscopic, troubleshooting is difficult. Comaltest Inc. tackled the problem earlier with a microtest prober called the Mark Ten and now has introduced a low-priced model called the Mark Six that sells for \$4,800.

The probe's needle has a tip that is less than one micrometer in radius, and four high-ratio micro-positioners are provided to allow probing of individual transistors on LSI arrays. Up to 10 micro-positioners can be mounted in the baseplate. Another feature is a fixed-focus camera with a shock-mounted shutter that permits magnification of photos up to 500x.

The price of the Mark Six includes a one-day training program. Delivery from stock takes up to four weeks.

Comaltest Inc., Commerce Dr., Danbury, Conn. 06810 [353]

Picoammeter measures from 1 pA to 30 mA in 18 ranges

A dc picoammeter for measuring currents in such devices as vidicons, photomultiplier tubes, and mass spectrometry equipment is designated the WV-511A. It operates in the range of from 1 pA to 30 mA in 18 overlapping ranges. Accuracy is within $\pm 3\%$ of full-scale reading, and zero drift is less than $\pm 2\%$ each 24-hour period. The design also al-

Rotron's New Vanguard Blowers

*Have a Lot of
GUTS*

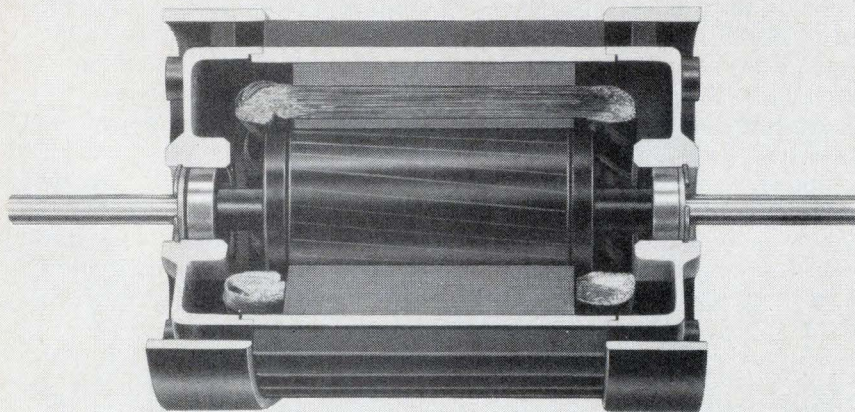

THE ROTRON®-BUILT MULTI-SLOT PSC MOTOR

- PERMANENT SPLIT-CAPACITOR DESIGN
- PERMANENTLY LUBRICATED BALL-BEARINGS
- PRECISION MACHINED ALUMINUM MOTOR HOUSING INSURES LONGER BEARING LIFE
- FINISHED AIR-GAP SURFACES PREVENT CORROSION
- EPOXY GROUND INSULATION

Vanguard blowers provide high volume cooling air for electronic systems and other commercial applications. Their advanced design and rugged construction assure performance and reliability at the lowest noise levels in the industry... at commercial blower prices.

11 models: 5 Simplex, delivering up to 310 cfm; 6 Duplex, delivering over 600 cfm. Configurations and mounting options available to meet a wide variety of installation requirements.

Write today for detailed information. Specify catalog H-3380.

Why settle for less when the best costs no more?



Woodstock, New York 12498 □ Phone 914 • 679-2401 □ TWX 510-247-9033

PACIFIC DIVISION, Burbank, California 91506, Phone 213 • 849-7871
ROTRON N.V., Breda, The Netherlands, Phone: 49550, Telex 844-54074

New products

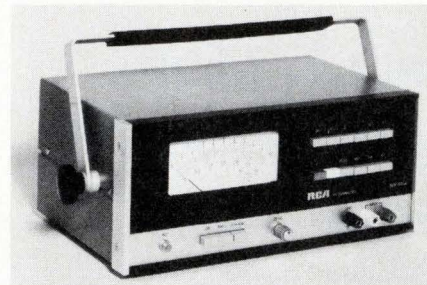

lows the instrument to be used as a high-input-resistance voltmeter in many applications that require an electrometer-type measuring device. Price is about \$250.

RCA Test Equipment and Accessories, Harrison, N.J. 07029 [356]

Directional rf wattmeter covers ranges below 1 W

Most directional rf wattmeters cover from 5 watts to 250 kilowatts, with some exceptions that go down to 1 w. The ThruLine model 4330 milliwattmeter provides a range of non-terminating rf power output measurements below 1 w for signal generators and transceivers. It samples the signal in an integral section of a

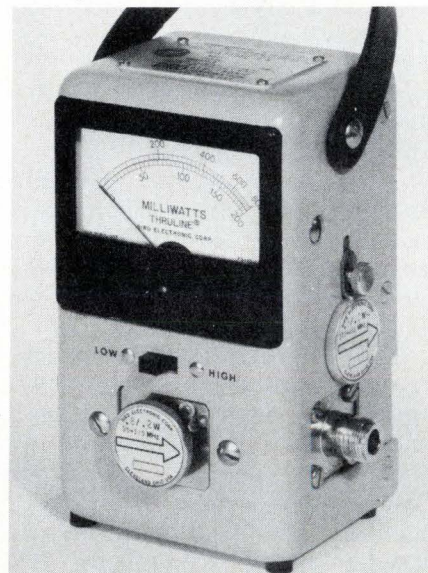

50-ohm precision transmission line with plug-in elements for different frequency bands within the range of 60-2300 MHz. Each element has dual power ranges of 200 mw and 800 mw full scale, which are switchable on the front panel. Price is \$125 for the meter, and the plug-ins sell

for \$60 to \$80.

Bird Electronic Corp., 30303 Aurora Rd.,
Cleveland, Ohio 44139 [355]

Indicator's cold-junction
compensation is automatic

A digital thermocouple indicator
called the ELPH measures 1.68 in. by
3.92 in. (panel cutout dimensions).
Accuracy is 1° for indication of tem-

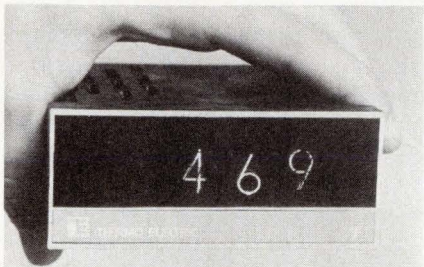

peratures from 0° to 1999° F or C.
Resolution is 1°, one digit repeat-
ability, and approximately five
readings per second. Cold-junction
compensation is automatic and amb-
ient operating range is 40° to
120° F. Temperature indication is
given of reversed thermocouple and
thermocouple burnout.

Thermo Electric, Saddle Brook, N.J. [354]

Trigger generator is for
burst, single shot waves

A voltage controlled function gener-
ator with a trigger and gate capabil-
ity is for single-shot and burst wave-
forms. Frequency range is from
0.0001 Hz to 11 MHz. The model
7050 generates sine, square,
triangle, ramp, pulse, and sync
waveforms: continuous, single-shot,
or burst. Output on all waves is 30 v
peak-to-peak into an open circuit or
15 v peak-to-peak into 50 ohms, ex-
cept in fixed offset operation when

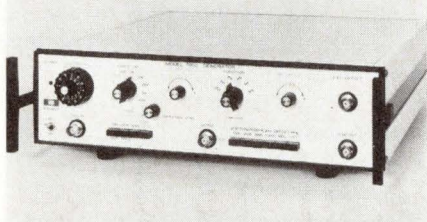

GENTLEMEN,
THESE DDC A-SERIES
MODULES CAN MAKE
EVERYTHING!

WOW! S/D,
D/S, R/D, D/R...IT CAN
BE A 2-SPEED
EVEN A 3-SPEED
CUSTOMIZED
TO OUR
NEEDS!

RIGHT ON! OVER
37 CONFIGURATIONS...
OFF THE SHELF...AND IT'S
MIL SPEC QUALITY. ALL
SOLID STATE.

DOESN'T
PAY TO MAKE
OUR OWN
ANY MORE

FLATTERY WILL GET YOU
EVERYWHERE.

Everybody's talking about DDC's new A-Series synchro or resolver converters. And no wonder: You can assemble *your own* converter in your own way, to your own specifications, using low-cost off-the-shelf modules! And when it's all assembled, you get a lot more:

- Errorless tracking. To 4 RPS as a result of a Type II servo loop.
- Wide range of synchro or resolver conversion. A/D, D/A 60 Hz, 400 Hz, single speed, multispeed, binary, BCD, etc., etc., etc.
- Available for either commercial or military operating temperatures. Each module measures only 1.5 x 2.2 x .61.
- High reliability. Built-in test circuitry. All MIL grade parts, hermetic components. Qualified for airborne applications.
- Immediate availability. The 10 basic modules are available *now*, off the shelf. And they're fully interchangeable: no trimming or adjustment necessary.

When you can assemble your own custom converter at so little cost it doesn't pay to design, breadboard test, de-bug and build, does it? Please let us tell you more about it. And about the rest of our data conversion and signal conditioning devices. Write us. Or phone direct to either Steve Muth or Jim Sheahan. (516) 433-5330.

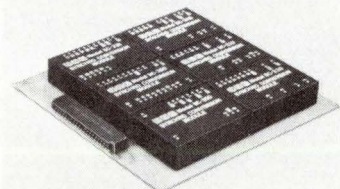

One of 37 possible assemblies of
our multi-module conversion system.

SYNCHRO CONVERTERS

DDC

ILC DATA DEVICE CORPORATION
100 TEC STREET, HICKSVILLE, N.Y. 11801

Megohmmeter and Hipot?

YES! For true integrity in HV bench-testing of electrical or electronic equipment —you need both! Megohmmeter to test insulation resistance (IR) . . . Hipot to test dielectric strength.

HIPOTRONICS OFFERS

a full line of high resistance megohmmeters — sixteen models with ranges to 20,000,000 megohms and high current capability for testing insulation resistance to ASTM specification D-257, MIL, and UL standards.

HIPOTRONICS ALSO OFFERS

a full line of AC/DC hipots — twenty-seven models with ranges to 10KV AC and 25 KV DC for non-destructive measurement of leakage current, corona discharge, AC and DC insulation strength.

HIPOTRONICS GUARANTEES

complete high voltage — high resistance capability for thorough testing of switches . . . motors . . . coils . . . chokes . . . insulation . . . transformers . . . cables . . . electrical/electronic assemblies . . . harnesses . . . and more.

For more information write or call our marketing department for brochures HP7101 and HP7107.

HIPOTRONICS®

BREWSTER, N. Y. 10509
Phone: (914) 279-8091



New products

the output is at half the voltage setting.

Exact Electronics Inc., Box 160, Hillsboro, Ore. 97123 [357]

A-m/fm generator covers range from 0.4 to 484 MHz

An a-m/fm signal generator covers the range of from 0.4 to 484 MHz, and has a guaranteed signal-to-noise ratio of 120 dB/Hz at 20 kHz from the carrier. The type SMDA contains six internal modulating frequencies up to 6 kHz, and external modulation is possible from 40 Hz to 20 kHz. A-m, fm or simultaneous a-m plus fm is provided. The a-m modulation depth is adjustable from 0 to 95% and the fm frequency deviation is adjustable from 0 to 50 kHz. Price is \$5,400.

Rohde & Schwartz Sales Co. (USA) Inc., 111 Lexington Ave., Passaic, N.J. 07055 [358]

Circle 150 on reader service card

Meals in minutes, helped by Hansen

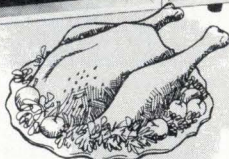
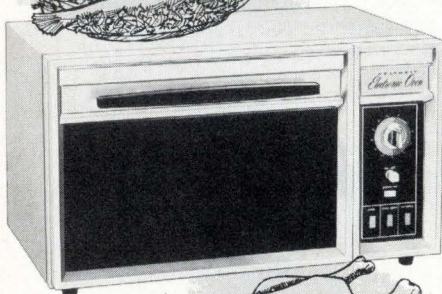
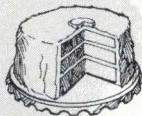

The microwave electronic oven is the newest kitchen miracle. It cooks a cupcake in 15 seconds. A hot dog in 30. This one by the Heath Company is doubly unique. It comes in Heath's famous kit form.

Hansen supplies the Synchron® motor that operates a "stirrer" to keep the electronic cooking molecules evenly distributed throughout the oven. Synchron motors were selected because consumers expect appliances to last up to 20 years. Then, too, Heath has a reputation for top-quality components. Nothing but the finest will do for the sophisticated Heath do-it-yourselfer.

If you also require long life and dependability, specify Hansen Synchron motors.



HANSEN
MFG. CO., INC.
Princeton, Indiana 47670

HANSEN REPRESENTATIVES: Carey & Associates, Houston and Dallas, Texas; R. S. Hopkins Co., Sherman Oaks, Calif.; Melchior Associates, Inc., San Carlos, Calif.; The Fromm Co., River Forest, Ill.; John Orr Associates, Grand Rapids, Mich.; H. C. Johnson Agency, Inc., Rochester, N.Y.; Winslow Electric Co., Essex, Conn.; Kiley Electric Co., Villanova, Pa.; Herbert Rude Associates, Inc., Teaneck, N.J.

Export Department: 2200 Shames Drive, Westbury, N.Y. 11590

Meter can check capacitance at point 25 feet away

A digital capacitance meter called the series 2350 measures continuously and automatically and includes a 3½ digit display. It has both analog and BCD (optional) output.



The meter is unaffected by cable capacitance and stray capacitance to ground, and the point of measurement may be up to 25 feet from the instrument. A bipolar or inverted drive permits capacitance difference or deviation measurements to 0.001 picofarad. Price is \$1,150.

Spearhead Inc., 1401A Cedar Post Lane, Houston, Texas 77055 [359]

"I MUST HAVE DRAWN THIS THING 100 TIMES!"

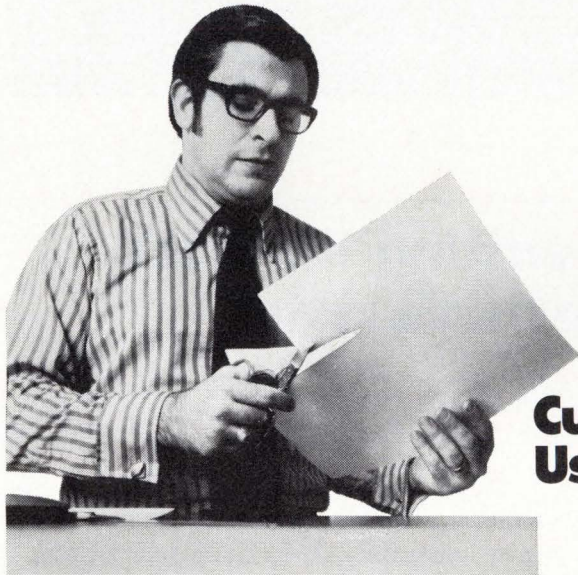

**Cut the detail.
Use KODAGRAPH Films.**

Drawing the same detail over and over is more than tedious—it's a waste of valuable time and money. A far better way is to let Kodagraph film get the job done for you.

That way you draw the detail just once. Make as many photoreproductions as you need. Cut them out, paste them down, then make a Kodagraph film print of the paste-up. And there you have it, a second original for subsequent printmaking.

For a complete rundown on the many shortcuts made possible by using Kodagraph films and papers, just fill out the coupon and send it our way.

Please send me complete details on Kodagraph films and papers and how they can save valuable drafting time.

Name _____

Position _____

Company _____

Address _____

City _____ State _____ Zip _____

Eastman Kodak Company
Business Systems Markets Division
Dept. DP 809, Rochester, N.Y. 14650

ENGINEERING DATA SYSTEMS



\$
1395
00

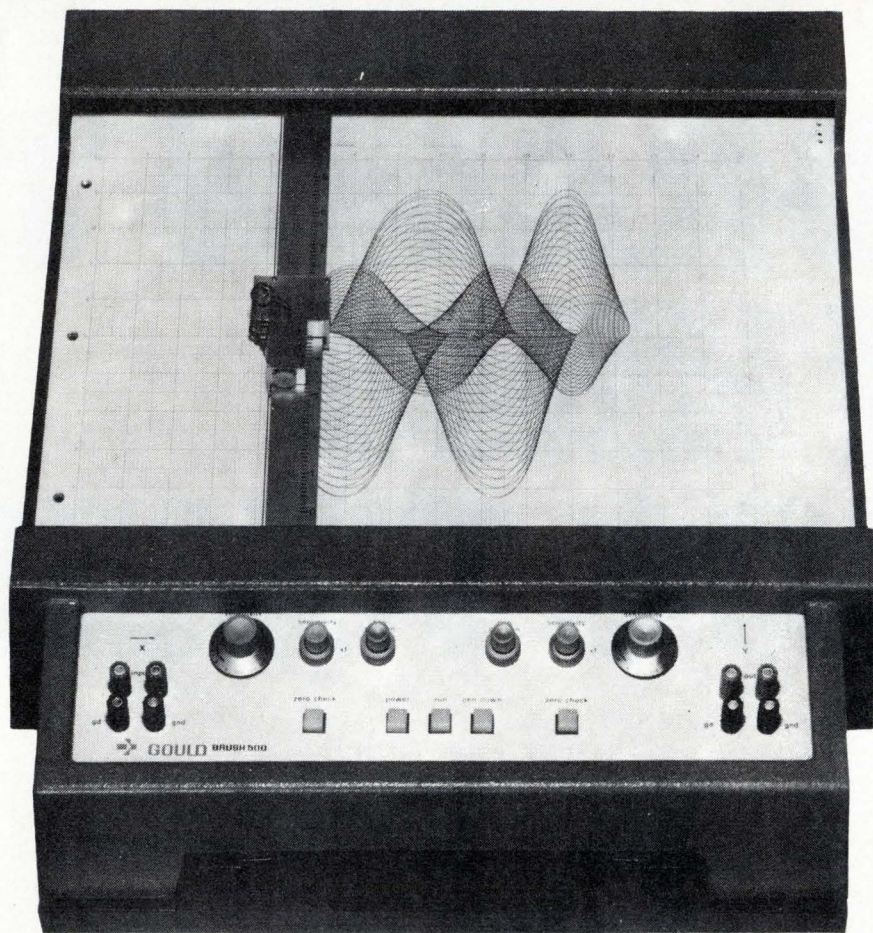

With pressurized ink writing, the price isn't the only thing that's right.

The Brush 500 XY Recorder has a pressurized ink system. And that takes the pressure off you. Stops clogging, skipping, and priming. Because the pen always writes instantly. So even after months of storage, traces are clear, crisp, smudge-proof and uniform. Even at the 500's 40 inches-per-second writing speed. And one disposable plastic ink cartridge holds enough ink for a year's normal use.

And our exclusive Metrisite® non-contact servo-loop feedback system enforces pen positioning at 99.85% linearity.

The Metrisite also solves some other sticky problems. Like noise, slide wire troubles, dirty pots, wear, cleaning and maintenance. Things you've had to contend with in potentiometric feedback systems.

Built-in preamps have sensitivity range from $100\mu\text{V}/\text{div.}$ to $1.0\text{V}/\text{div.}$ As well as balanced, floating, and guarded inputs.

So take a look at the Brush 500 XY Recorder. The price may be low. But the accuracy isn't. Write Brush Division, Gould Inc., 3631 Perkins Avenue, Cleveland, Ohio 44114. Or Rue Van Boeckel 38, Brussels 1140 Belgium.

BRUSH INSTRUMENTS

 **GOULD**

New products

Subassemblies

Voltage tripler is compact

Multiplier in special epoxy case replaces high-voltage section of a TV receiver

Space saving is important, but in high-voltage environments it is even more important to protect against power surges and flashovers that may occur when components are crammed into a small area. So when Sarkes Tarzian's Semiconductor division set out to develop a compact tripler-type voltage multiplier for television receivers, a key consideration was the availability of a special potting epoxy with high dielectric strength.

The multiplier, called the model S6343, measures 2½ by 2½ by 1½ inches and replaces the high-voltage section of a TV receiver, at the same time eliminating X-ray emission.

Though the multiplier is being produced to RCA Corp. standards for use in delivering power to a TV picture tube, TV is not the only application for the S6343, says Walter Petrowski, manager of the Sarkes Tarzian division. The multiplier is also suitable, he points out, for computer displays, oscilloscopes, medical electronic instruments, radar, and electrostatic precipitators.

The epoxy-encapsulated unit contains six ceramic capacitors, six high voltage diodes, and an optional number of internal resistors that can be tailored to meet loading requirements. The diodes are rated at 18 kilovolts at 1-microampere leakage, and the low-loss, 1,000-picofarad ceramic capacitors at 12 kv. Other sizes are available. The high voltage diodes also have a reverse recovery time of less than 1.5 microseconds.

The S6343 typically produces 27 kv, 1½ milliamperes, at 85°C; and maximum output is 35 kv. Input is a maximum 12 kv ac at 15.575 kilohertz. Lifetime is at least 10,000 hours, says Petrowski, adding: "The

multiplier will outlast the receiver." Operating temperature range is from -40°C to +85°C, and a lower-priced unit is specified for a maximum of 65°C.

The S6343, in prototype production now, will be available in quantity in three months at about \$7 each.

Sarkes Tarzian Inc., Semiconductor Div., 415 N. College Ave., Bloomington, Ind. 47401 [381]

D-a converters offer low gain drift, are monotonic

Low-gain-drift 8-, 10-, and 12-bit digital-to-analog converters type DAC-40 are monotonic over a 70°C operating temperature range. Specifications include gain drift of ±10 ppm/°C for 8- and 10-bit models, and ±½ least significant bit or better linearity over the temperature range. Price is from \$115 to \$150 for 8- to 12-bit unbuffered models in 1 to 9 quantities.

Burr-Brown Research Corp., International Airport Industrial Park, Tucson, Ariz. [384]

Sample-and-hold amplifier is accurate to within 0.01%

A sample-and-hold amplifier, an a-d/d-a converter, is for data acquisition applications where sample accuracy, high input impedance, and fast settling time are required. Sample accuracy is within ±0.01% of the full scale range, input impedance is 10¹¹ ohms, and settling time is 7 μs for a 1-to-10-v input step. Other features are user-selectable inverting or non-inverting operation and selectable gain of +1 to +100.

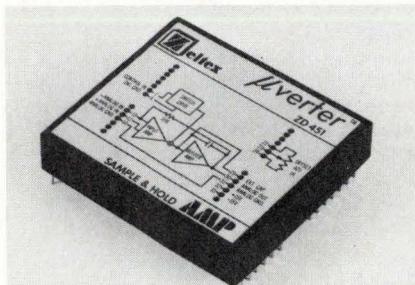

Price in 100 lots is \$39.

Zeltex Inc., 1000 Chalomar Rd., Concord, Calif. 94520 [383]

Amplifier/supply provides variable offset for ac signals

The model 214 power amplifier/supply can be used as a 20 w power amplifier with calibrated voltage gain and a flat power response from dc to 1 MHz, as a stable calibrated dc power supply providing up to 20 v at 1A, or as a programable supply.



Applications are where modulating or biasing signals containing both an ac component and calibrated dc offset are required, or where low impedance circuits must be driven at various frequencies and power levels from a high-impedance source. Princeton Applied Research Corp., P.O. Box 565, Princeton, N.J. 08540 [385]

D-a/a-d power supply puts three outputs in one case

A digital-to-analog/analog-to-digital converter power supply module can also be used to power operational amplifiers when additional logic voltage facilities are required.

think woven

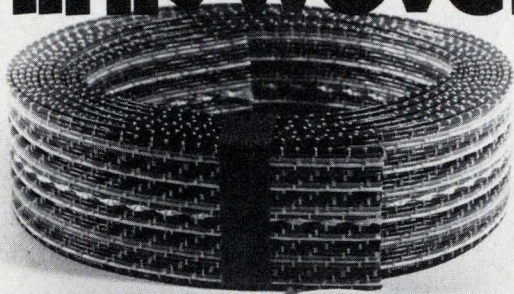

for economy

Save when you buy it. Save when you use it. Today's best flat cable value brings neatness and accuracy to every application. Fast, easy handling cuts your production costs, increases system quality.

WOVEN ELECTRONICS

A DIVISION OF SOUTHERN WEAVING COMPANY

P.O. Box 189, Mauldin, S.C. 29662, (803) 288-4411

Circle 151 on reader service card

Now divide and conquer your sensor's wildest curves.

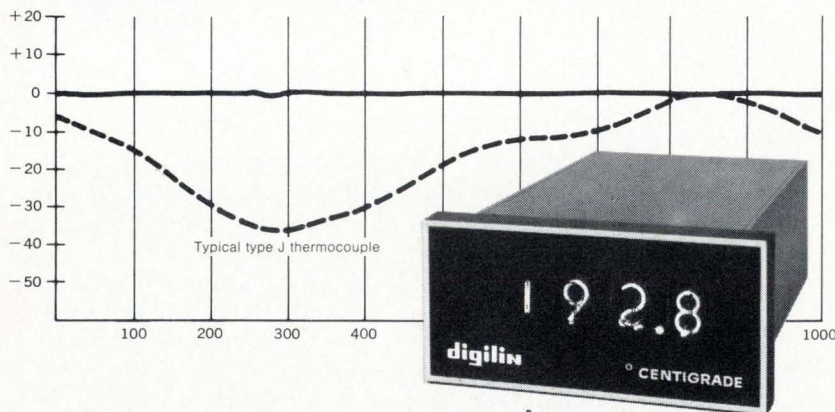

Digilin's linearizing readout breaks up your non-linear sensor information into ten straight-line segments that approximate the most capricious curve with all the accuracy you need for just about any transducer.

And our exclusive piecewise linear approximator works so well with our standard A/D conversion technique that you get the 3½-digit linearizing readout complete in one small panel meter package in

your choice of engineering units with BCD output for as low as \$195 in OEM quantities.

(Which means that now transducer manufacturers can expand their product line with an accurate digital readout and keep prices sharply competitive.)

Be first in your marketplace with Digilin linearizing digital readout. Call Stan Ericsson today. Digilin, Inc., 1007 Air Way, Glendale, Calif. 91201. (213) 240-1200.

digilin
DIGITAL INSTRUMENTS

120 Circle 120 on reader service card

New products

Three outputs are combined into a single miniature package; the outputs are ± 15 v dc at 100 mA and, isolated, 5 v dc at 250 mA. The ± 15 v outputs are dual tracking, and price is \$69.

Shane Industries, Div. of oci, 800 San Antonio Rd., Palo Alto, Calif. 94303 [386]

Log i-f amplifiers use thick-film technology

A matched pair of log i-f amplifiers operate over the temperature range of -20°C to $+65^{\circ}\text{C}$. Designated the model CT724, the unit has an f_0 of

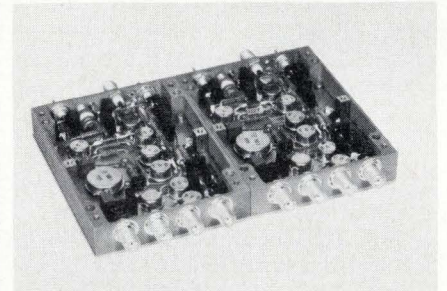

60 MHz and a bandwidth of 12 MHz. Dynamic range is -75 dBm to -5 dBm, and logging accuracy of each amplifier is ± 2.0 dB (1.5 dB over a 50 dB dynamic range). Rise time is a minimum of 60 ns.

Circuit Technology Inc., 160 Smith St., Farmingdale, N.Y. 11735 [388]

Sequencer programs supply for turn-on, shut-off

A power sequencer, the model PM 4600 programs the timing for turning on and shutting off various supplies in equipment such as computer main frames and communications apparatus. The unit eliminates the generation of undesirable transient voltages in any of the devices it controls. Two time-sequenced relays turn the power supplies on and off in time relation to the equipment switch, and the power sequencer is packaged on a pc card measuring 3.7 in. by 2.4 in. by 1.37 in. Price is \$20 in production quantities.

Computer Devices Corp., 63 Austin Blvd., Commack, N.Y. 11725 [387]

Electronics/February 14, 1972

Complete Trimmer Satisfaction

One design...9 pin styles

Still the industry's best trimmer value
... Less than **50¢** each in production quantities



Settability of $\pm .03\%$ and environmental performance requirements of characteristic C of Mil-R-22097

- 1.5% average ENR noise resistance
- 0.5% average CRV
- 1/2 watt @ 70°C

You can choose from an expanded line of compact trimmers. .150" — .125" — .100" in-line terminal spacing and TO-5 pin spacing all available in top and side adjust. Plus .200" delta (.100 grid) in top adjust. All available from your CTS Distributor. **Still the best value in the industry.** CTS of Berne, Inc., Berne, Indiana 46711. Phone: (219) 589-3111.

CTS CORPORATION
Elkhart, Indiana



A world leader in cermet and variable resistor technology

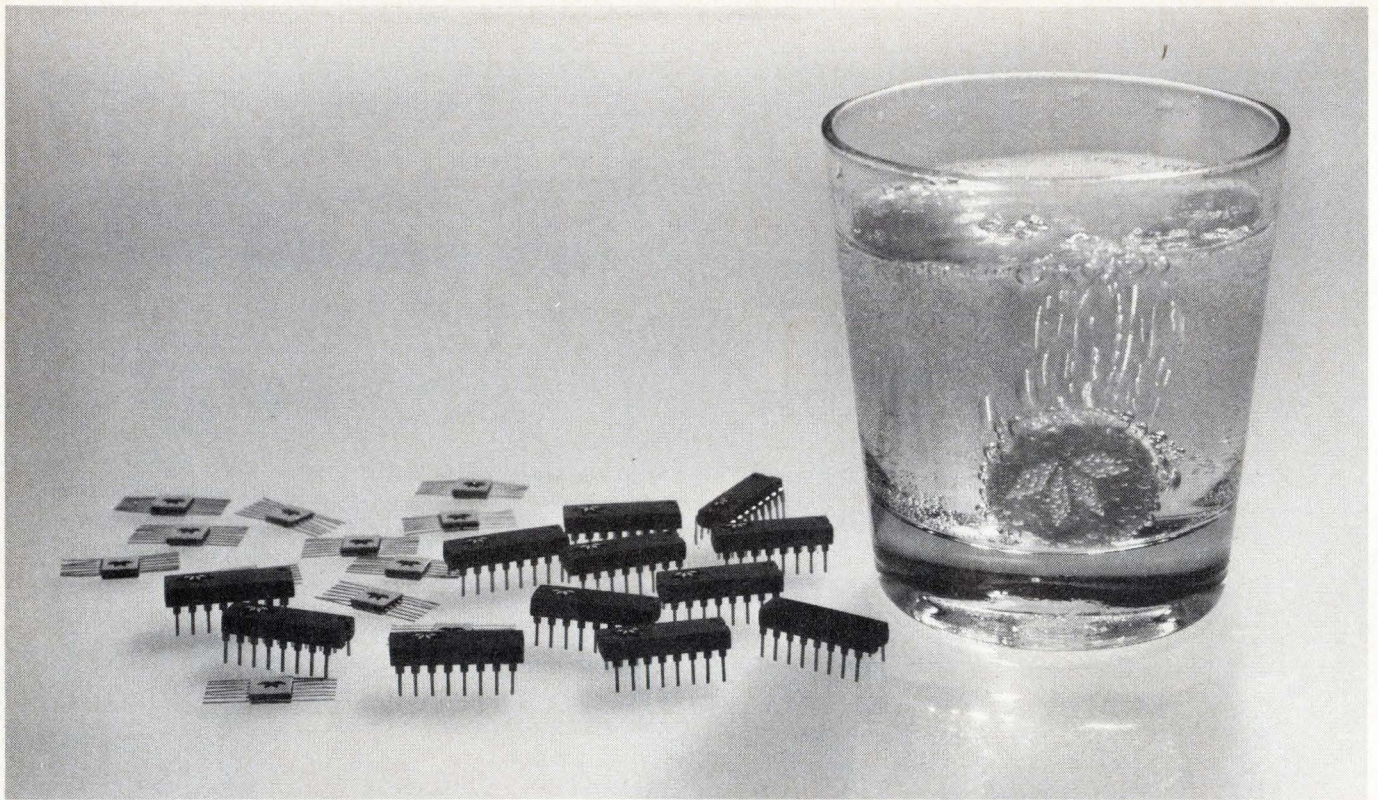

Try it. You'll like it.

HiNIL, High Noise Immunity Logic

Nothing can be more upsetting than trying to design sensitive digital equipment that's headed for a noisy industrial application. Try Series 300 HiNIL, Teledyne's high noise immunity logic.

You can throw away those expensive power supplies, shielding, filtering and other noise stoppers because HiNIL has a 3.5 volt worst case noise immunity spec that lasts all day. And it operates off 12 or 15 volt supplies at a very comfortable ± 1 volt supply tolerance. Power noise immunity is 100 times better than TTL in the "1" state, 23 times better in the "0" state over the entire temperature range (worst case).

HiNIL has a typical propagation delay of 100

nsec. That's slow. Slow enough to ignore a 1 volt ripple caused by a forklift, drill press, power tool or any other nasty noise maker.

HiNIL is easy to use, works in and out of DTL and TTL. It's all monolithic. The whole family of two dozen or more logic circuits comes in DIP or flat pack.

HiNIL will solve those industrial noise logic design headaches simply and economically.

New Low Prices: Now HiNIL is priced competitively with popular TTL units . . . if you've been waiting for low prices, your wait is over.

Write for a free copy of our brand new HiNIL Design and Applications Brochure.

Hi-NIL, High Noise Immunity Logic.
Try it. You'll like it.

 **TELEDYNE SEMICONDUCTOR**

1300 Terra Bella Avenue Mountain View, California 94040 (415) 968-9241 TWX: 910-379-6494 Telex: 34-8416

Industrial

H-P enters OEM-supply race

44 power units are offered initially; computer program ready for custom designs

Suppliers of modular, off-the-shelf power supplies have a new competitor. Hewlett-Packard Co., a giant among instrument manufacturers, has developed a family of 44 supplies—the 62000 series—designed for systems, computer and “buried” original-equipment applications. They join H-P’s line of laboratory power supplies, which the company has been selling for over 10 years.

Initially, the new series-regulated, fixed-voltage supplies will be available in 11 different voltage ratings ranging from 3 to 48 volts dc. (Other outputs are 4, 5, 6, 10, 12, 15, 18, 24, and 28 v). For each voltage, four current ratings—2, 4, 8, and 16 amperes—are available. It’s also possible to adjust the output voltage as much as ± 0.5 v dc, or $\pm 5\%$, whichever is greater. All units deliver full-rated output to 50°C , with derating up to 71°C .

Line and load regulation are within 0.01%, and ripple and noise are less than 1 millivolt rms and less than 3 mV peak-to-peak (dc to 20 megahertz), according to H-P.

Remote sensing is standard on the supplies, and separate sensing terminals are provided. Built-in protection prevents excessive voltages to critical loads should a remote sense terminal be accidentally disconnected. Reverse voltage protection is also built in. And, should the output be shorted, an adjustable cutback-current-limiting circuit holds current to less than 10% of the rated output. Still further protection is provided by a heat-sink-mounted thermostat that opens the fused ac line automatically if the supply overheats.

Solid state components are used throughout the unit, with integrated

circuits used in the voltage-error, overcurrent-limiting, and reference-supply amplifiers.

Several options are available, including an internal crowbar for overvoltage protection, and operation from different line voltages. Standard input voltage is 120 v, 48 to 63 hertz.

H-P has also generated a computer program so that it would be possible to produce custom units fairly quickly, reports Arthur Darbie, engineering manager at H-P’s division in Rockaway, N.J. Using customer requirements, the program would come up with a list showing parts to be used.

The supplies are packaged in three case sizes: the A ($1/8$ -rack-width) module costs \$89, and the G ($1/2$ -rack-width) module costs \$195. In between are two $1/4$ -rack-width modules: the C is priced at \$125, and the E, with roughly twice the current ratings, is \$145.

First delivery will be in April; from stock thereafter.

Inquiries Manager, Hewlett-Packard Co., 1601 California Ave., Palo Alto, Calif. [371]

Controllers offer accuracy within 0.1° or 0.05°C

Two nonindicating proportional controllers called the model 7870 and 7872 are phasefiring and zero-voltage-firing devices respectively. Both work from thermistors operating in the range of from 8,000 to 100 ohms. Temperature range is from -100°C to $+400^\circ\text{C}$. Price of the model 7870 is \$90 and for the model 7872 it is \$105.

RFL Industries Inc., Boonton, N.J. 07005 [372]

Voltage standard guarantees 1 ppm/year stability

A portable ovenized saturated standard cell bank of three cells guarantees a stability to 1 ppm/year and offers front-panel presetting of nominal cell temperatures. Continuous monitoring of temperature set point

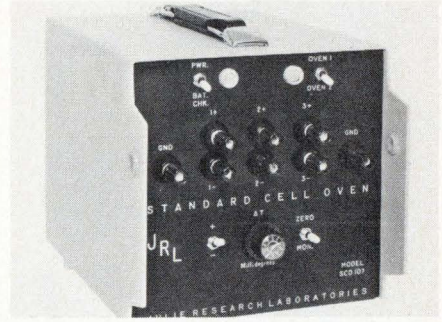

without an external null detector is also offered. Size is $6\frac{3}{4}$ in. by $6\frac{3}{4}$ in. by $8\frac{1}{4}$ in. The model SCO-107 can be preset to temperatures between 28 to 37°C , and the internal temperature will not vary by more than $\pm 0.001^\circ\text{C}$. If line power fails, the unit automatically switches over to battery power. Price is \$1,390 including battery pack and 12 to 15 v dc supply.

Julie Research Laboratories Inc., 211 West 61st St., New York, N.Y. 10023 [374]

Logic modules use optical isolation for noise rejection

Logic modules for process control and monitoring applications are designed to link such devices to DTL and TTL levels. The NJ series use photo isolation to provide high noise rejection and up to 1,500 volts

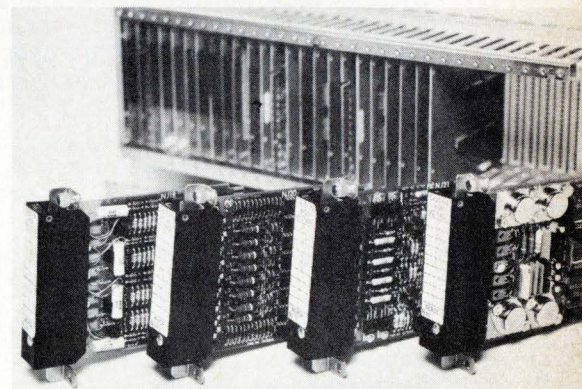

of ground isolation. Four modules in the line consist of a sensor converter, an input detector, an ac switch, and a dc switch. Typical applications include voltage comparison, closing contacts, ac switching, and dc switching. The modules are compatible with the company’s current T and J series line. A barrier strip mounted on each unit provides

Tron Rectifier Fuses

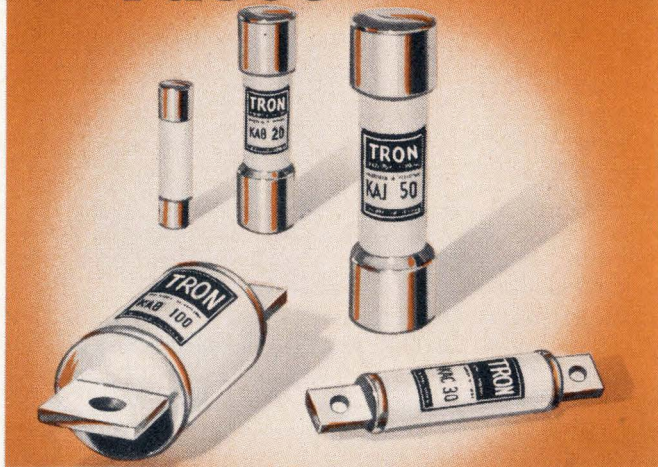

Available in sizes from 1/2 to 1000 amps for voltages up to 1500, TRON Rectifier Fuses are ideal for protecting variable speed drives, inverters, battery chargers, plating power supplies, power controls, and any other application where fast opening and great current limitation are required.

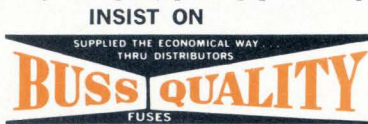

Write for BUSS Form TRFS

Bussmann Mfg. Division, McGraw-Edison Co., St. Louis, Mo. 63107

FUSES

for protection of Electronic Devices

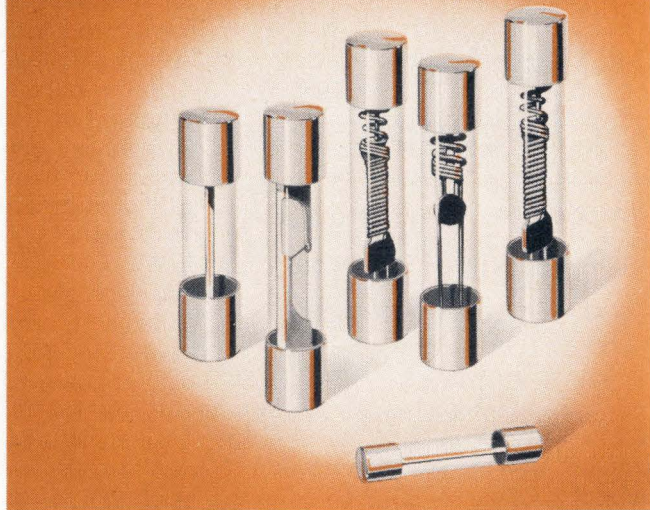

There is a complete line of BUSS Quality fuses in 1/4 x 1 inch, 1/4 x 1 1/4 inch, and miniature sizes, with standard and pigtail types available in quick-acting or dual-element slow blowing varieties.

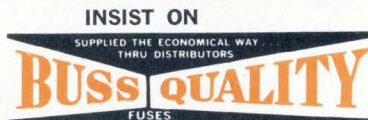

Write for BUSS Form SFB

Bussmann Mfg. Division, McGraw-Edison Co., St. Louis, Mo. 63107

BUSS: The Complete Line of Fuses and . . .

The Heavy-Duty DMM

Take a look at the digital multimeter you can really knock around—and still get 0.1% accuracy for a year. The Hickok 3300A in its tough Cylolac case and with its shock-mounted circuits has enough built-in versatility to take the place of a stack of instruments.

The 3300A measures:

- DC/AC voltage from 100 microvolts to 1.5 kilovolts;
- DC/AC current from 100 nanoamperes to 2 amperes;
- resistance from 100 milliohms to 200 megohms.

To add to your value, the rugged 3300A is truly portable at no extra cost. It operates continuously for 24 hours off its internal rechargeable battery—no other DMM can hold a candle to that performance. You can make measurements while recharging the battery. And the battery's good for 1000 recharges.

This versatility is standard; you get it all in the \$435 price. If you add options and accessories, then the 3300A goes to 30 kilovolts AC/DC. It has a clamp-on current probe good to 100 amperes, DC as well as AC. With an Adapter, the Multimeter becomes a counter up to 20 MHz.

Look for yourself. Call Hickok for a demonstration or complete specifications.



HICKOK

the value innovator Instrumentation and Controls Division 10514 Dupont Avenue • Cleveland, Ohio 44108 (216) 541-8060

New products

easy input-output terminations. Price ranges from \$82 to \$120. Xerox Data Systems, 701 S. Aviation Blvd., El Segundo, Calif. 90245 [373]

Temperature controller measures 1 7/8 in. by 3 3/4 in.

Point 5 series analog temperature controllers measure 1 7/8 in. by 3 3/4 in. The on-off relay output can carry three amperes at 115 v ac, and

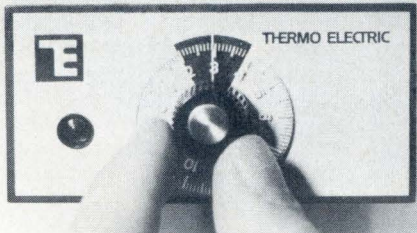

single printed-circuit board construction is used. Fail-safe circuitry de-energizes the relay if the thermocouple circuit opens. The Point 5 controllers are compatible with TE temperature indicators and similar equipment.

Thermo Electric, Saddle Brook, N.J. [377]

Relay test unit has resistive loading feature

A protective relay test unit designated the model PR-71 checks and calibrates relays. The unit has a resistive loading feature in order to avoid current distortion and associated correction factors. This is usually required by other relay testers because of the harmonics developed by inductive loading methods. The



unit is accurate for calibration with instrument error less than 1% of full scale and also can be used as a 3.6 kva power supply. Price is \$2,795.

Instrumentation and Control Services of General Electric Co., 2379 John Glenn Drive, Chamblee, Ga. 30341 [376]

Fuseholders of Unquestioned High Quality

FUSEBLOCKS

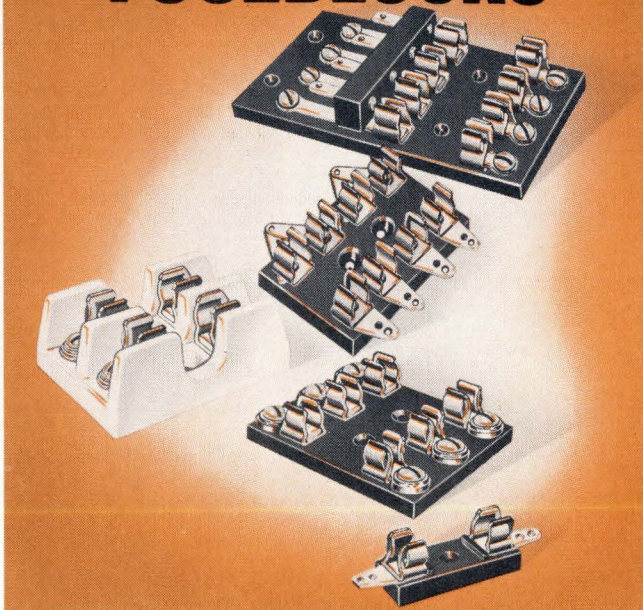

There is a full line of BUSS Quality fuseblocks in bakelite, phenolic, and porcelain, with solder, screw-type, or quick-connect terminals.

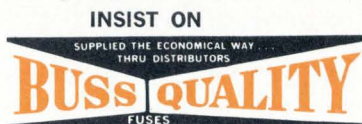

Write for BUSS Form SFB

Bussmann Mfg. Division, McGraw-Edison Co., St. Louis, Mo. 63107

FUSEHOLDERS

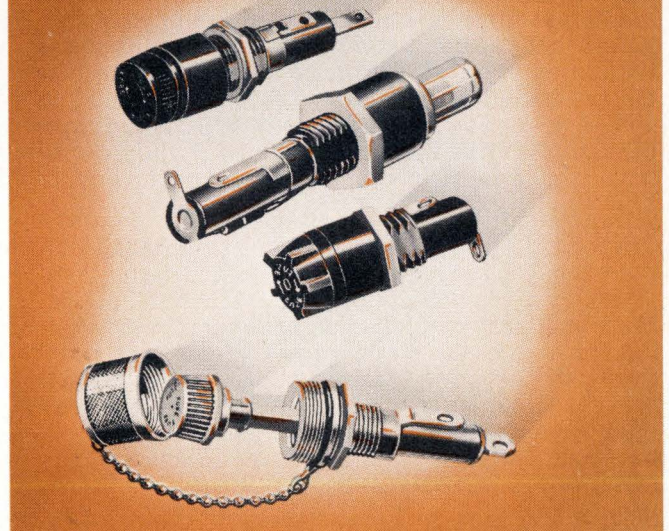

BUSS has a complete line of fuseholders to cover every application. It includes lamp indicating and alarm activating types, space-saving panel mounted types, in-line holders, RFI-shielded types, and a full line of military types. Most are available with quick-connect terminals.

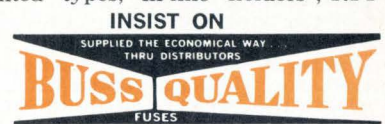

Write for BUSS Form SFB

Bussmann Mfg. Division, McGraw-Edison Co., St. Louis, Mo. 63107

Lean and mean!

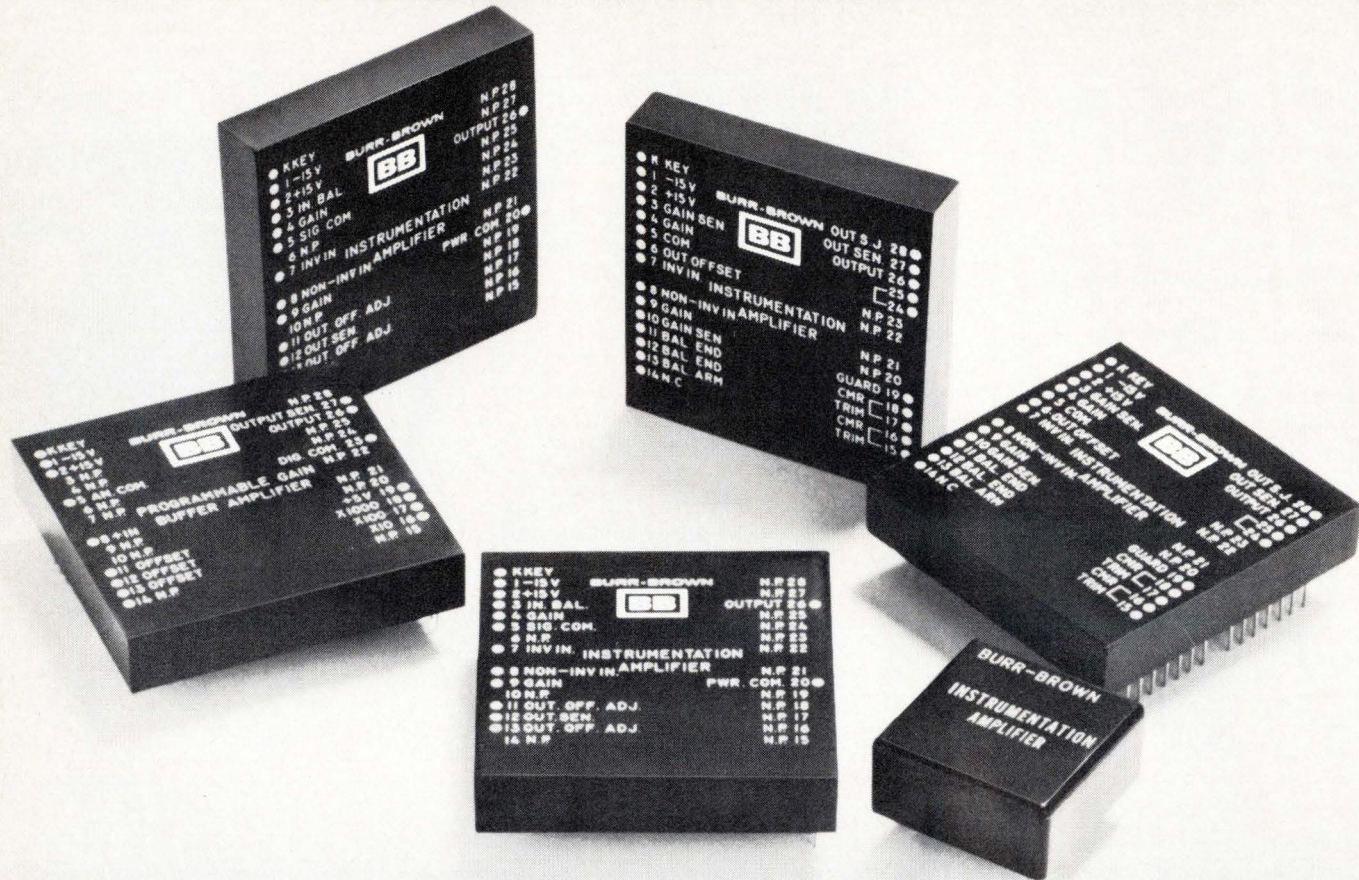

Modular instrumentation amplifiers with rack-mount performance.

Burr-Brown offers over twenty modular instrumentation amplifiers, including programmable gain types, that provide a low-cost approach to systems instrumentation. Performance is equivalent to that of rack-mount units — we've simply removed the frills and packed them into compact, rugged, low-cost, modular packages. Of course, if you have to have rack-mounts, remember, we supply those too.

These versatile amplifiers all feature a wide range of gain, set by a single external resistor. Because of their small size, ruggedness, and low-cost, they lend themselves to a variety of instrumentation applications including amplification of signals from transducers — such as strain gage bridges, load cells, thermistor networks, thermocouples, and biological probes. Other applications include: recorder pre-amplifiers, multiplexer buffers, servo error amplifiers, current sensing, and the measurement of any small differential signal riding on common mode voltages.

A SAMPLE OF THE VARIETY OF PERFORMANCE FEATURES AVAILABLE	
FET INPUT - LOW DRIFT HIGH INPUT IMPEDANCE LOW COST	MODEL 3621 Input drifts as low as $5\mu\text{V}/^\circ\text{C}$, max. Input impedance to 10^{11} ohms. $2\mu\text{V}$ input noise, peak to peak. Single unit price from \$39.00
LOW NOISE - LOW DRIFT	MODEL 3620 Input noise only $1\mu\text{V}$, peak to peak. Gain nonlinearity, .01%. Both $1\mu\text{V}/^\circ\text{C}$ and $3\mu\text{V}/^\circ\text{C}$ max input drifts available. Single unit price from \$85.00
HIGH SPEED WIDE BANDWIDTH	MODEL 3622 $150\text{V}/\mu\text{sec}$ slew rate. Settles to $\pm 0.1\%$ of final value in less than $1\mu\text{sec}$. 3MHz bandwidth at gain of 100. Single unit price from \$79.00
DIGITALLY PROGRAMMABLE GAIN	MODEL 3600 Digitally programmable gain, 46 steps, 0 to 3840. Differential input. $\pm 1\mu\text{V}/^\circ\text{C}$ input voltage drift. Gain nonlinearity .01%. Single unit price: \$245.

PRICES FOB, TUCSON, ARIZONA, USA

For complete technical information and applications suggestions, use this publication's reader service card or contact your Burr-Brown Representative.

NEW BURR-BROWN BOOK

"Operational Amplifiers — Design and Applications", over 470 pages, 300 illustrations. Written by Burr-Brown application-engineering staff, published by McGraw-Hill. U.S. price, 15.00 dollars. Order from Burr-Brown.



BURR-BROWN
RESEARCH CORPORATION
International Airport Industrial Park • Tucson, Arizona 85706
TEL: 602-294-1431 • TWX: 910-952-1111 • CABLE: BBRCORP

New products

Semiconductors

Wave generator is monolithic

Addition of a second chip gives modulated forms with Exar's 16-pin package

Miniaturization has been slow to come to signal-test equipment, primarily because complex waveforms are not easily handled with IC techniques. To bring signal generation into the IC world, Exar Integrated Systems Inc., of Sunnyvale, Calif., has developed a monolithic waveform generator. It can provide almost any wave pattern that large generators can, and a single chip can do the job.

Exar's generator can produce sine, square, triangle, ramp, and sawtooth output waveforms, which can be both amplitude and frequency modulated. What's more, with the addition of a second chip,

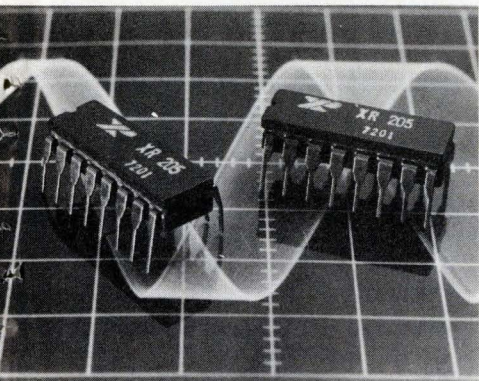

many modulated waveforms can be obtained: sinusoidal a-m output (90% modulation), ramp-modulated a-m output, tone-burst output, swept output, modulated tone burst, and others. With this flexibility, the versatile chip-pair waveform generator can be used as a space-saving component in most communications and telemetry equipment.

Contained in a standard 16-pin dual in-line package labeled the XR-205, the generator is offered in a kit containing the two XR-205 chips, a printed-circuit board that's etched,

drilled, and ready to assemble, a components list with recommended types of external components, and detailed hook-up instructions. The pair operates from a standard 12-volt supply.

The different outputs are obtained by varying pin configurations. For example, a triangle can be converted into a sawtooth configuration by a single pin adjustment; this puts a resistor into the output circuit, which changes the duty cycle of the triangle and makes the conversion. Among other variations, the polarity of the sawtooth can be changed just as easily with another pin configuration.

Price of the XR-205 is \$16.

Exar Integrated Systems Inc., 733 N. Pastoria Ave., Sunnyvale, Calif. 94086

Rf switches operate in 20 to 1,000 MHz range

A series of rf switches have from two to 30 outputs in a single package and measure 1/2 in. thick by 4 in. wide. Length depends on the number of outputs and varies from 2 to 16 in. Frequency range of the switches is from 20 to 1,000 MHz, and they use PIN diodes in a broadband stripline matching structure. Multiple diodes in a series shunt configuration provides an isolation of 70 dB and an insertion loss of 1.0 dB. Amplitude match between outputs is ± 0.2 dB with a VSWR of less than 1.2 to 1.

Integral Data Devices Inc., 46 S. Bayles Ave., Port Washington, N.Y. [415]

Dual line receiver's fanout is 10 DTL or TTL loads

A digital receiver family has a fanout guaranteed to be 10 TTL or DTL loads over the temperature and common mode ranges and supply tolerance. Input threshold guarantees are ± 500 mV and ± 1 V at input voltages of ± 3 V and ± 15 V respectively. Typical thresholds throughout the input range are +60 mV and -80mV. Delays and other criti-

cal specifications are guaranteed. The model DM7820A (-55° to $+125^{\circ}$ C) is priced at \$24 in 100 to 999 quantities, and the model DM8820A (0° to $+70^{\circ}$ C) is \$6.20 in the same quantities.

National Semiconductor Corp., 2900 Semiconductor Dr., Santa Clara, Calif. 95051 [414]

Six-bit monolithic d-a converter settles in 200 ns

A six-bit digital-to-analog converter uses high-yield monolithic fabrication instead of hybrid circuits. The model MC1406 also uses the R-2R resistor ladder network approach. A current steering network controlled by the digital inputs switches this current either to the output or to the positive supply, maintaining a constant current in the ladder resistors. This makes it possible for the converter to settle to within 1/2 of the least significant bit in 200 ns. Price of the device in quantities of 100 is \$3.95 each.

Motorola Semiconductor Products Inc., P.O. Box 20912, Phoenix, Ariz. 85036 [413]

ROM accesses 1.6 million bits in 225 nanoseconds

A read-only memory system is capable of accessing 1.6 million bits of storage (200,000 bits on one board) in 225 nanoseconds. The entire contents of the memory can be unplugged and replaced with a new braid, and individual bits or words may be user-modified in 30 seconds

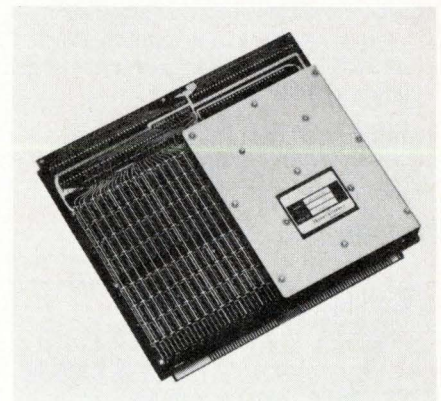

VECO THERMISTORS for MIL. & INDUSTRIAL APPLICATION

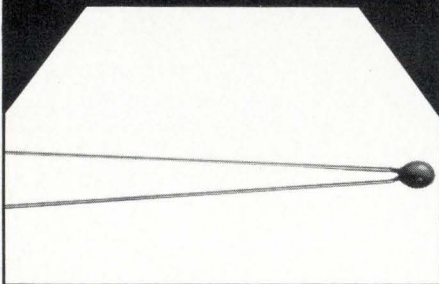

VECO's entire line of thermistor disks and rods for military and industrial use are manufactured to meet MIL-T-23648A. They're suitable for any application in the area of temperature measurement and control (such as transistor circuitry) within a range of -55°C to $+125^{\circ}\text{C}$.

Rugged, insulated design...high reliability...precise accuracy...strength combined with sensitivity...are packed into every thermistor VECO produces.

Whether your application is military or industrial, VECO has a thermistor to fit your application needs.

Complete catalog available from:

VECO
VICTORY ENGINEERING CORPORATION
 VICTORY ROAD, SPRINGFIELD,
 NEW JERSEY 07081
 (201) 379-5900 • TWX 710-983-4430

New products

by disconnecting the appropriate wire and laying a new wire on the braid. Price ranges from $1\frac{1}{2}$ cents per bit in small quantities to $\frac{3}{4}$ cent per bit in large quantities.

Memory Technology Inc., 83 Boston Post Rd., Sudbury, Mass. 01776 [418]

Tiny light-emitting diode is aimed at tape sensing

A light-emitting diode small enough to pass through the eye of a needle, is bonded to a ceramic substrate

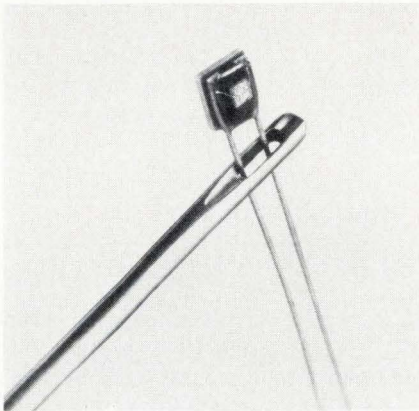

with two attached leads. A typical application is in inserting the device in the guide pin of a cassette tape deck for beginning- and end-of-tape sensing. Price for the He-500 series is \$1.25 in 1,000-lots.

HEI Inc., Jonathan Industrial Center, Chaska, Minn. 55318 [417]

Microampere-gate SCRs feature 600-V ratings

Two series of plastic-packaged microampere-gate silicon controlled rectifiers, called the 106 and 107 series, feature glass junction passivation in place of planar designs. They are intended for power switching and gate-current amplification for driving larger SCRs. The difference in the two series is in gate sensitivity and both have voltage ratings to 600 v. Prices in 1,000 lots range from 34 cents to 97 cents, depending on voltage.

RCA Solid State Div., Box 3200, Somerville, N.J. 08876 [416]

TRY SOME
FREE SAMPLES
OF BY-BUK
PROFESSIONAL
QUALITY
ELECTRONIC
CIRCUITRY
DRAFTING
AIDS.

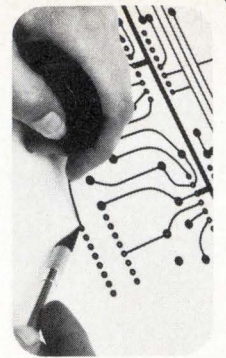

It's our way of proving that artwork layout accuracy can be accomplished in seconds with By-Buk pressure sensitive drafting aids.

We'll also send you our catalog featuring thousands of ideas in individually die cut artwork patterns and conductor line tapes to connect them with.

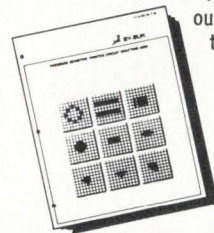

BY-BUK COMPANY
 A SUBSIDIARY OF WEBTEK CORPORATION
 4326 W. Pico Blvd., Los Angeles, CA 90019
 (213) 937-3511

Circle 152 on reader service card

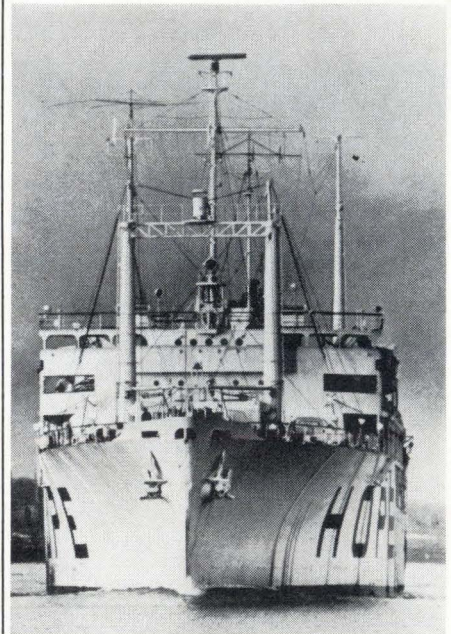

S.S. HOPE, M.D.

Doctor... teacher... friend to millions on four continents—this floating hospital is a symbol of America's concern for the world's disadvantaged. Keep HOPE sailing.

**PROJECT
HOPE**

Dept. A, Washington, D.C. 20007

A kitfull of fastener solutions free

Complimentary contents include: mixed sample bag of Seelscrews[®], Seelbolts[®], Seelrivets[®] and Adjust-A-Seels[®]. Plus detailed catalog. Plus, sheaf of "unexpected" design applications based on our patented positive seal ability. All yours for the asking. Write:

APM **APM-HEXSEAL**
DIVISION OF APM CORPORATION
44 HONECK ST., ENGLEWOOD, N.J. 07631



Circle 153 on reader service card

A ONE SOURCE SUPPLY FOR... TRANSISTOR MOUNTING HARDWARE & SOCKETS

Also mica insulators • Ready to Assemble Kits.

Available from stock

SOCKETS

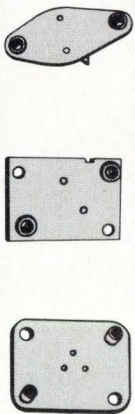

HARDWARE

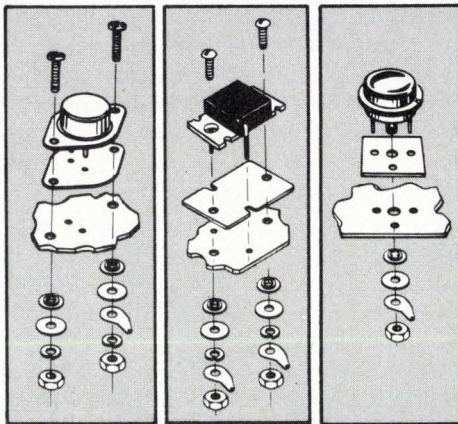

NEW FREE CATALOG ON REQUEST

Manufacturers of Standardized Hardware for Electronics.



KEYSTONE

ELECTRONICS CORP.

49 Bleecker Street • New York, N.Y. 10012

Quality Accuracy Versatility Reliability 1 yr. warranty Low cost

Heath/Schlumberger has them all!

80 MHz Frequency Counter:
10 Hz – 80 MHz range; 100 mV sensitivity; 5-digit LED readout; high stability. Assembled SM-105A, 6 lbs. . . . \$350*

1 MHz Function Generator:
Sine, square, triangle output; 7 decade ranges, 0.1 Hz – 1 MHz; Adjustable DC offset; VCO built-in. Assembled EU-81A, 8 lbs. . . . \$245*

15 MHz Dual Trace Scope:
Complete dual trace capability including X-Y; Triggered sweep; 18 time bases; 50 mV sensitivity. Assembled EU-70A, 35 lbs. . . . \$595*



1 mV 10" Chart Recorder:
23 speeds, 30 in/min to 0.2 in/hr; 18 spans, 1 mV – 500 V full scale; 15 full scales of offset; Fully programmable. Assembled EU-205B, 40 lbs. . . \$675*

HEATH

Schlumberger

Heath/Schlumberger Scientific Instruments

Dept. 520-28

Benton Harbor, Michigan 49022

Please send brochures on following models:

Please send 1972 Electronic Instrumentation Catalog (now in production, available soon).

Name _____

Title _____

Company _____

Address _____

City _____

State _____

Zip _____

*Mail order prices; FOB Benton Harbor, Michigan.

Prices & specifications subject to change without notice. EK-322

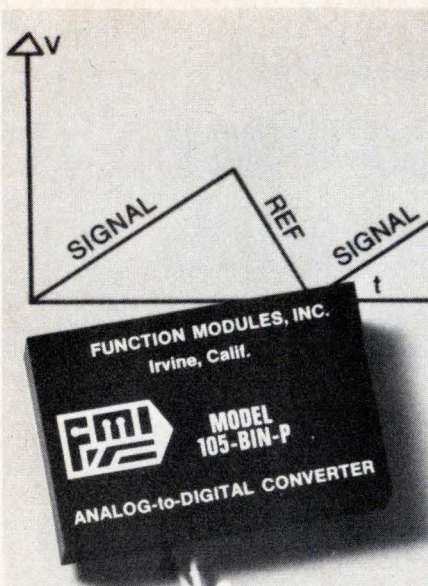

NEW

12 Bit ADC

\$95

(1-9 Quantity)

Model 105 Dual-Slope ADC

- **Resolution of 12-Bits . . .**
Binary or 3½ Digit BCD
- **±0.01% Max Nonlinearity**
- **Low Drift . . .**
±2ppm/°C Offset TC
±10ppm/°C Gain TC
- **Fast Conversion . . .**
2msec for Binary Units
750µsec for BCD Units

And this new analog-to-digital converter is versatile . . . you can connect it to automatically recycle or to convert on external command. We're shipping the 105's from stock, so order several today!



FUNCTION MODULES, INC.
2441 Campus Drive
Irvine, California 92664
(714) 833-8314

New Products / Materials

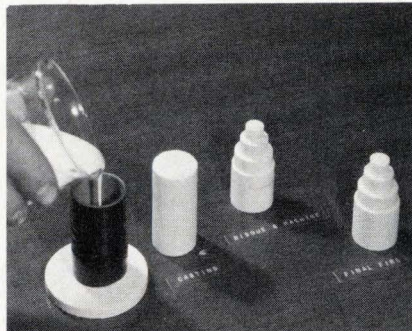

High-temperature machinable-castable ceramic called Cermacast 549 can be cast by the user and then machined into various shapes. The material is available as a two-part system, consisting of a powder base and liquid activator. Setup time is ½ hour, and the final part exhibits a total change of about ¼%. Applications are insulators and components. Price is \$30 for a pint kit and \$50 for a quart kit.

Aremco Products Inc., P.O. Box 145, Briarcliff Manor, N.Y. 10510 [476]

A one-component heat sink and adhesive is designed for use with transistors, SCRs, and other components and can be used for direct bonding to a metal chassis. The material is said to have more thermal conduction than silicone greases, requires no mica and retains high electrical insulation. Measuring, mixing are eliminated.

Standard Patents & Devices Inc., 3000 Marcus Ave., Lake Success, N.Y. 11040 [477]

A high-temperature insulating epoxy called Epo-Tek H55 is designed for microelectronic applications. Specific uses include bonding large capacitor chips where great strength is required and bonding chip resistors over transmission lines. Trial kits are \$15.

Epoxy Technology Inc., 65 Grove St., Watertown, Mass. 02172 [478]

Ferrite absorbers called Eccosorb NZ series are useful over the frequency range from below 50 MHz to above 15 GHz. They are offered in the form of small tiles that can be bonded to flat and curved surfaces. The NZ-31, NZ-41, and NZ-51 types are intended primarily for applications in low frequency ranges. Price is from \$60 to

\$100 per square foot, depending on the type desired.

Emerson & Cuming Inc., Microwave Products Div., Canton, Mass. 02021 [479]

An adhesive for microelectronic fabrication requires no mixing, heating, or measuring. Type S-1098 material produces joints that are transparent, and room temperature cures produce bonds that are resistant to water, most chemicals, and temperature extremes. Price is \$1.80 per two-gram dispensing tube.

Starnetics Co., 10639 Riverside, North Hollywood, Calif. 91602 [480]

A castable microwave absorber material is for fabricating loads, terminations, attenuators, choke rings, rf gasketing, plate line and strip-line structures, and other dissipative parts for microwave frequencies. Casting is void-free, with machinable characteristics. Density is 3.8, distortion temperature is 175°C, and power dissipation is greater than 1 watt per square inch. Price is \$3.75 per pound in quantity.

Transene Co. Inc., Route One, Rowley, Mass. 01969 [403]

A line of flexible copper-clad laminates features no adhesives. Called Micro-Clad, the material is intended for integrated-circuit lead frames, beam-lead substrates, flexible printed circuits, and flexible multi-layer combinations. The material is available in rolls and reels for automatic handling and processing, as well as in sheets.

Fortin Laminating Corp., 1323 Truman St., San Fernando, Calif. 91340 [401]

A dip coating formulated for a variety of electronic components, especially capacitors, is called type 1215. A moderate cure temperature of 125°C makes it specifically suitable for tantalum capacitors, rectifiers, resistors, and ferrite devices. The material, sag-free and non-dripping, is available as a brush or casting system. The coating comes in standard colors of red and black, with other colors available on request. An introductory kit is priced at \$10.

Allaco Products Inc., 130 Wood Rd., Braintree, Mass. 02184 [402]

Compare Mox to whatever resistor you're using now.

Our Metal Oxide Resistors offer you:

- Small Size ■ Maximum Reliability
- 100 ppm TCR ■ High Stability
- High Voltage Capability

Set a comparable MOX Resistor beside the wire wound or metal film resistor you're using now. Chances are you'll find ours smaller, giving you greater design possibilities for ultra-critical applications.

We offer you a complete MOX Series to choose from, and we keep them stocked for prompt delivery.

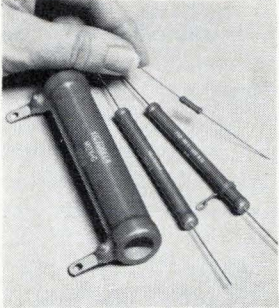

Mini-Mox—Miniature high voltage resistors with ratings as high as 5 KV and dissipations to 1 watt.

Maxi-Mox—Rated at 2.5 watts and 7.5 Kv per lineal inch. Available in 1-5" lengths in 1" increments.

Divider-Mox—Single units with one or more taps. Ratios as high as 10,000:1. Input voltages to 37.5 Kv; .5% output voltage stability.

Power-Mox—High voltage, high power resistors. Voltages to 45 Kv. 45 watts in 70°C air ambient.

MOX FACTS and Technical Data Sheets are available from: Victoreen Instrument Div. of VLN Corp. 10101 Woodland Avenue, Cleveland, Ohio 44104. Telephone: 216/795-8200.

DMA 682

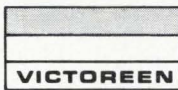

Expertise in high voltage.

Circle 155 on reader service card

DIGITAL TICKET PRINTERS

OEM- RACK- PORTABLE



- BCD INPUTS - PARALLEL ENTRY
- TAB CARD SIZE - 3 COPIES
- INDEXING - 20 CONSECUTIVE LINES
- COLUMN SUPPRESSION - FLOATING DECIMAL
- CONTROLLABLE BY INSTRUMENT OR COMPUTER
- PRINTING MECHANISM AVAILABLE
- 400 MSEC/LINE PRINT RATE
- MANY OPTIONS/ CHARACTER WHEELS

VALUE
PRICED
FROM
\$154

MFE CORPORATION

340 Fordham Rd., Wilmington, Mass. 01887 (617) 658-5500 TWX 710-347-6938

Circle 156 on reader service card

MORE SWITCH FOR LESS MONEY

NEW

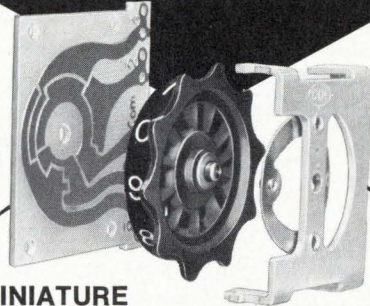

MINIATURE PRECISION THUMBWHEEL SWITCH

1,000,000 Detents (for quality)
Low Cost (for savings)

9 TOP QUALITY FEATURES

1. .05 ohms max. contact resistance.
2. 200 megohms min. insulation.
3. 1,000 volts min. dielectric strength.
4. 2 amps @ 115VAC current carrying capability.
5. 125 ma @ 115VAC current breaking capability.
6. Mounts on 1/2" centers only 1 1/2" behind panel.
7. Glass laminate with precious metal contacts & plating.
8. Multi-applications—you name it.
9. Over 1,000,000 detents.

IMMEDIATE DELIVERY . . . ASK THE PRICE—
BE PLEASANTLY SURPRISED.

CDI Covers The Spectrum of Switches Saves You Space • Effort • Time • Money

THUMBWHEEL SWITCHES

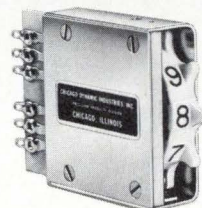

Completely sealed against hostile environments.

ROTARY SWITCHES

Snap-in, snap-out modules in seconds, eliminating downtime.



Tabet Pat.
2841660,
2971066,
3015000,
2956131,
2988607.

PUSHBUTTON SWITCHES



Mounts on 1/2" centers, retrofits most panel openings for miniature thumbwheel switches.

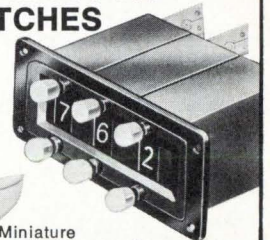

Miniature add/subtract units retrofit most minithumbwheel switch panel openings.

CDI earns its reputation every day for Consistently
High Quality, Consistently Good Delivery.



CHICAGO DYNAMIC INDUSTRIES, INC.

PRECISION PRODUCTS DIVISION
1725 Diversey Blvd., Chicago, Illinois 60614
Phone: 312, 935-4600

Circle 131 on reader service card

131

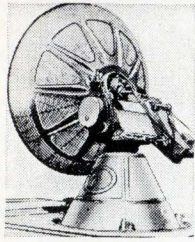
AUTOTRACK MOUNT

AUTOTRACK SCR-584 RADARS
360 degree azimuth, 210 degree elevation sweep with better than 1 mil. accuracy. Missile velocity acceleration and slewing rates. Amplidyne and servo control. Will handle up to 20 ft. dish. Supplied complete with control chassis. **ALSO** in stock—10 cm. van mounted radar system. Conical scan. PPI. 6 ft. dish. Ideal for S band telemetry, weather, balloon trk, missile trk, rocket trk, ECM range. Write for complete data. 600 pg. instr. bk. avail. at \$25 ea.

HAWK MISSILE DOPPLER RADAR

CW low power illuminator. AN / MPQ-33. Dual antenna on single mount. Van mounted. Complete X band doppler tracker.

PATH LOSS MEAS. FACILITY

Mfg. REL For establishing max. xmsn paths for tropo and microwave links. 2 heli-hut vans. Covers 1-2.5ghz bands. 20 to 120 watts CW output.

PHOENIX MISSILE SYSTEM

10" PPI, 5" B and C displays, and complete digital computer consoles.

IBM 704 SCIENTIFIC COMPUTER

w / peripherals & programs. Cost \$2,000,000. Our price \$10,000.

MIT MODEL 9 PULSER 1 MW—HARD TUBE

Output 25kv 40 amp., 30kv 40 amp. max. Duty cy. .002, .25 to 2 microsec. Also 5 to 5 microsec. and 1 to 5 microsec. Uses 5948 hydrogen thyratron. Input 120 / 208 VAC 60 cycle. Mfr. GE. Complete with driver and high voltage power supply. Ref. MIT Rad. Lab. Series, Vol 5, p. 152.

2 MEGAWATT PULSER

Output 30 kv at 70 amp. Duty cycle .001. Rep. rates, 1 microsec. 600 pps. 1 or 2 msec. 300 pps. Uses 5948 hydrogen thyratron. Input 120 / 208 VAC 60 cycle. Mfr. GE. Complete with high voltage power supply.

2 MEGAWATT HARD TUBE PULSER

Output 40kv at 50 Amps. Duty cy. .0038. Var. pulse width. Compl. with driver and HV power supply. Input 208V 60 hz.

RECON DRONE CONTROL RADARS

X Band systems autotrack and search complete with plotting boards. Fully mobile van mounted. Gives PPI, slant range, altitude data. Ground to air control links and beacons also in stock. AN / MPQ-29 & AN / UPW-1

AUTOMATIC TRACKING SYSTEM

SCI. ATL. MOD. 3101-J70 Antenna Pedestal. AZ-EL 15 deg. per second rated speed. 23 inch dia. bearing. Complete w / control console & mag. amplifiers.

SPARE PARTS IN STOCK

Nike Ajax, Nike Hercules, M-33, MPS-19, TPS-1D, TPS-10D, FPS-6, SPS8, SCR-584, HIPAR.

RADAR & RF PKGS.

34ghz 40kw Pulse RF pkg
24ghz 40kw Pulse bomb toss system
16ghz 130 kw Pulse B-58 search radar system
X BAND AUTOTRACK 250KW PULSE M-33 compl w / plot boards
X BAND AUTOTRACK 50KW PULSE B-47 fire control complete

C BAND 5 MEGAWATT PULSED KLYST.

AN / FPS-26 Ht. Finder

C BAND 1 MEGAWATT AUTOTRACK

10ft dish mortar locator MPQ-21

C BAND 285KW PULSE Search AN / SPS-5 / 10

S BAND 1 MEGAWATT COHERENT AN / FPS-18

S BAND 1 MEGAWATT PULSE NIKE ACQ.

L BAND 1 MEGAWATT PULSE AN / UPS-1

L BAND 500KW PULSE AN / TPS-1D / E

L BAND 5 to 20KW PULSE

400mhz 1KW CW AN / FPS-23

225mhz 1 MEGAWATT PULSE AN / SPS-28

2-30mhz 100KW PULSE

CW 950-5ghz 150 WATTS

CW 1.5mhz-10.5ghz 5 WATTS

CW S & X BANDS 300-600WATTS

AN / GPG-1 SKYSWEEP TRACKER

3 cm. auto. tracking radar system. Comp. pkg. w / indicator sys. Full target acquisition & auto. tracking. Input 115v 60 cy. new. In stock for immed. del. Entire sys. 6' x 3' x 10'. Ideal for infrared tracker, drone tracker, missile tracker, R & D.

CATV-COLOR MICROWAVE LINKS

Ratheon type KTR-1000. Fullcolor bandwidth as well as studio audio. Rack mounted. Complete trans-rcvr racks in stock.

HUNDREDS MORE IN STOCK
LARGEST RADAR
INVENTORY
IN WORLD.
WRITE
FOR
CATALOG
ON YOUR
LETTERHEAD

Radio-Research Instrument Co. INC.

3 Quincy St., Norwalk, Conn. 06850 • 203-853-2600

CIRCLE 951 ON READER SERVICE CARD

**DICTIONARIES
WEBSTER**

Library size, 1971 edition, brand new, still in box. Cost new: \$45.00.

Will Sell for \$15

Deduct 10% on orders of 6 or more.

Mail to

**NORTH AMERICAN
LIQUIDATORS**

1450 Niagara Falls Blvd.
Dept. W-394

Tonawanda, New York. 14150

C.O.D orders enclose \$1.00 good will deposit. Pay balance plus C.O.D. shipping on delivery. Be satisfied on inspection or return within 10 days for full refund. No dealers, each volume specifically stamped not for resale. Please add \$1.25 postage and handling. New York State residents add applicable sales tax.

CIRCLE 954 ON READER SERVICE CARD

FREE CATALOG**HARD-TO-FIND PRECISION TOOLS**

Lists more than 1700 items—pliers, tweezers, wire strippers, vacuum systems, relay tools, optical equipment, tool kits and cases. Also includes four pages of useful "Tool Tips" to aid in tool selection.



JENSEN TOOLS and ALLOYS
4117 N. 44th Street, Phoenix, Arizona 85018

CIRCLE 953 ON READER SERVICE CARD

**One Story
83,000 Sq. Ft.
Air Conditioned**

Acreage. Truck. rail.

SOUTH CAROLINA

**BINSWANGER
Company**

Div. of Binswanger/Herman Company

1420 Walnut St., Phila. 19102

215-735-0202

New York, N. Y. • Charlotte, N. C.

CIRCLE 952 ON READER SERVICE CARD

Don't forget the

BOX NUMBER

... when answering the classified advertisements in this magazine. It's our only means of identifying the advertisement you are answering.

New Literature

Frequency synthesizers. RCA Solid State Div., Box 3200, Somerville, N.J. 08876. An applications note reviews low-power digital frequency synthesizers using C/MOS integrated circuits. Discussed are digital phase-locked-loop fundamentals and the use of heterodyne down-conversion. Application to fm receiver synthesizers is also discussed. Circle [421] on reader service card

Digital panel instruments. A guide to digital panel instruments is available from Newport Laboratories Inc., 630 Young St., Santa Ana, Calif. 92705. The 10-page bulletin lists specifications and prices of the company's models. [422]

Keyboard electronics. Cherry Electrical Products Corp., 3600 Sunset Ave., Waukegan, Ill. 60085, has published a brochure with a designer's specification sheet detailing a system of keyboard electronics using a scanning technique. [423]

Optical components. Six data sheets on optical components from Spectra-Physics, Optical Products Div., 1250 W. Middlefield Rd., Mountain View, Calif. 94040, provide technical data, performance characteristics and applications information. [424]

Capacitors. Del Electronics Corp., 250 E. Sandford Blvd., Mt. Vernon, N.Y. 10550. A 20-page catalog of precision and high-voltage capacitors includes performance specifications and engineering applications notes. [425]

Dual in-line panels. Seventy-eight different types of panels are described in a 28-page catalog from Electronic Engineering Co. of Calif., 1601 E. Chestnut Ave., Santa Ana, Calif. 92701. Included are socket boards, connector boards, and special boards. [426]

Component burn-in technology. Wakefield Engineering Inc., Audubon Rd., Wakefield, Mass. 01880, has available a guide to component burn-in technology and life testing of semiconductors. [427]

New books

Value Engineering, Arthur E. Mudge, McGraw-Hill Book Company, 280 pp., \$12.75

Managing in Times of Radical Change, John J. Fendrock, American Management Assoc., 175 pp., \$9.75

Receiving Tube Manual, RCA Technical Series RC-28, RCA/Electronic Components, 784 pp., \$2.50

Communication Circuits: Analysis and Design, Kenneth K. Clarke and Donald T. Hess, Addison-Wesley Pub. Company Inc., 658 pp., \$17.50

FAX—The Principles and Practice of Facsimile Communication, Daniel M. Costigan, Chilton Book Company, 262 pp., \$10.00

Information and Coding Theory, Franklin M. Ingels, Intext Educational Publishers, 229 pp., \$12.50

Semiconductors, Helmut Wolf, Wiley-Interscience, 552 pp., \$22.50

Feedback Systems, Jose B. Cruz Jr., McGraw-Hill Book Company, 324 pp., \$16.50

Semiconductor Circuit Design, J. Watson, John Wiley & Sons Inc., 428 pp., \$22.50

Optimal Control by Mathematical Programming, Daniel Tabak and Benjamin C. Kuo, Prentice-Hall Inc., 237 pp., \$14.95

Rate Distortion Theory, Toby Berger, Prentice-Hall Inc., 311 pp., \$16.95

Signal Processing, Modulation and Noise, J. A. Betts, American Elsevier Publishing Company Inc., 292 pp., \$12.00

Transients in Electronic Engineering, E. E. Zepler and K. G. Nichols, Chapman and Hall Ltd., 358 pp., \$22.50

Auerbach on Optical Character Recognition, Auerbach Publishers, 147 pp., \$12.50

the new Bausch & Lomb StereoZoom 7 Coaxial Illuminator (Patented)

You're looking at a major advancement in microelectronics cost reduction and quality assurance

Now—speedily, surely—you can examine reflective micro-objects for the first time *as they really are*.

Full-color definition. Without flare, glare, shadowy ambiguity. With image quality comparable to the best monobjective microscope . . . and in 3-D.

One-step visual quality control is now possible, for example, in assembling microelectronics. And quality assurance checking of multi-layer elements is swift and conclusive. Results: significant time and cost reductions.

New, unique, vertical illumination is the reason. The Bausch & Lomb StereoZoom 7 Coaxial Illuminator supplies uniform-intensity, full-aperture, on-axis illumination to both sides of the optical system. Better than ring lighting. Better than ordinary vertical and incident light systems.

But words can only hint. See it for yourself. Ask for Catalog 31-2368 and a demonstration of the Bausch & Lomb StereoZoom 7 Microscope with Coaxial Illumination . . . now.

BAUSCH & LOMB 

SCIENTIFIC INSTRUMENT DIVISION

99702 Bausch St., Rochester, N. Y. 14602





Once maps were made by hand.

But why today?

Once, a man told another of what he'd seen and that man drew a map that all others could follow.

All of that was done by hand. That was then.

Today, a man takes a picture from an airplane of what he sees. And a second man prepares a manuscript from these photos. And then, this manuscript is transferred to film.

And then—incredibly—all of the lines that will make up the map (the rivers, the mountains, roads and streets) are *scribed* onto a negative master. By hand.

Finally, a swivel knife is used to cut outlines of specified areas. By hand. In

the seventies of the twentieth century.

Someone doesn't trust someone.

We, CalComp, have told cartographers that our 745 flatbed plotter will scribe lines equal to the tolerances and standards of the most skilled mapmaker's hand.

Cartographers have told us that they tried plotters once. And the lines were not accurate. And they were uneven. And wiggly.

The CalComp 745 Plotter is accurate to a rate of plus or minus .001 inch. The lines it scribes or cuts are smooth and even. (Their step size is only .0001 inch.)

And our 745 plots at a

speed of 4.2 inches per second. No hand alive can do that accurately.

If you make maps by hand, call us. We'll help you get from here to there.

Write us at California Computer Products, Inc., Dept. EM-M2-72, 2411 West La Palma Avenue, Anaheim, California 92801. Or call (714) 821-2011.



CALCOMP

International Newsletter

February 14, 1972

Europeans combine to battle IBM . . .

Three European computer makers have begun weaving a web of interlacing agreements that will expand gradually **to form a powerful new grouping, one powerful enough to be truly competitive with IBM on the Continent and elsewhere.** Two of the companies, Siemens AG of Germany, and Compagnie Internationale de l'Informatique CII of France, signed a 40-page accord to pool their R&D and to establish a joint worldwide marketing effort. **Philips Gloeilampenfabrieken is expected to become a full partner shortly.**

Others likely to join include Britain's International Computers Ltd., as well as the U. S. firms Control Data Corp. and National Cash Register Co., which recently concluded a joint computer production and marketing agreement, and Germany's AEG-Telefunken and Nixdorf AG, a new German computer team [*Electronics*, International Newsletter, Dec. 20, 1971].

. . . and may accept U.S. partners

CDC is already associated with ICL and CII in their joint subsidiary, Multinational Data, which sets compatibility standards for the three companies. Siemens and, possibly, Philips are expected to join Multinational Data within a few months, and CDC reportedly wants NCR to be admitted, as well. CII president Michel Barré says that Multinational Data may become the rallying point for the complex series of agreements—to include U. S. firms, “once we have enough European nucleus to resist domination from our big brothers from America.” ICL is also a probable partner.

Barré says the Siemens-CII accord will permit joint financing of a new generation of computers—an expense none of the companies could afford alone. The contract calls for joint development of product lines, all compatible with machines the companies are already marketing. Each company is to market through a joint organization the other's products in its own country. However, the companies want to maintain their individuality. **But “we are by no means a closed shop,” insists a Siemens spokesman. “We are open to further negotiations on all sides.”**

UK makers see strong nucleonics instrument sales

The boomlet in British nucleonic instruments—at least partially at the expense of U. S. manufacturers—will continue through 1972, industry sources predict confidently. Although domestic sales increased by about \$1 million to total nearly \$11 million, the main reason for success in 1971 was a doubling of export sales to about \$7 million. Most of their overseas business was won from U. S. firms, the British say, **because advances have made their instruments technically superior to those of their U. S. competitors.** The Britons expect the brisk sales pace—in 1971, it was 35% higher than the previous year—to continue.

Italy finances four failing electronics firms

Four Italian electronics companies will stay alive—at least for a while—because of a rescue by a government holding company, Gestioni e Partecipazioni Industriali (GEPI), which has five years to nurse its wards back to economic health. **GEPI has pumped \$5.5 million into Seimart, of Turin, set up a year ago to bolster Magnadyne Radio, a 200-worker company that had gone bankrupt. Seimart late last month took three other troubled companies under its wing—Lesca, Condor, and Dumont Italiana.** The group expects sales of \$35 million this year, mostly in consumer electronics. GEPI, which has a 64% holding in Seimart's capital of \$8.6 million, is not allowed to control the companies it ac-

International Newsletter

quires indefinitely, but must sell or liquidate them after five years. This is a contrast to the power of the older, larger government holding company Istituto per la Ricostruzione Industriale.

H-P opens instrument plant in France

Hewlett-Packard will try to scoop out a larger share of the European instrument market with a plant that has begun production in temporary quarters in Grenoble, France. **H-P has purchased a 42-acre site, where a permanent plant is to be built, possibly starting next year.** The plant, which has a target employment of 3,000 eventually, will be expanded "as business conditions permit." **Officials decline to say what instruments are being produced in Grenoble, but describe the line only as "complementary to our current European production."**

Siemens wins contract from Western Union

The first of seven computer-controlled electronic data switching systems manufactured by West Germany's Siemens AG [Electronics, Electronics International, Sept. 13, 1971] is to begin operation next fall in an American city. Siemens has won a contract from Western Union Telegraph Co., New York, to deliver seven of the systems for installation in six U. S. metropolitan areas. Siemens won't reveal the value of the contract, but says **it is one of the largest single pacts ever received from an American company for telecommunications equipment.** West German observers, however, estimate total value at "well in excess of \$20 million."

Swedish company orders computers from Burroughs

By the end of 1973, Burroughs Corp. computers are to have replaced IBM and Siemens computers at Sweden's largest computer service Bureau, Data-Service AB, owned by three of the country's largest banks. An IBM 360/50, a 360/40, and a 360/30, as well as two Siemens machines based on RCA Spectra/70s, are to be replaced with a B4700 in the Stockholm headquarters and B3500s in Gothenburg, Malmoe, and Norrkoeping. A Data-Service spokesman said the Burroughs machines are better suited for operations with offices of various sizes. The service will retain two GE 425 computers for special work.

SGS phases out plant in West Germany

Italian components maker Societa Generale Semiconduttori (SGS) is continuing its withdrawal from other European markets by phasing out manufacturing operations in Wasserburg, West Germany. **The stoppage comes hard on the heels of an SGS plant shutdown in Sweden, where the company now maintains only regional sales headquarters for the Scandinavian market.** Similarly, activities in Germany will be limited to marketing, directed from offices in Wasserburg. Personnel at the Bavarian plant has been reduced as a result of the tight market and increasing labor costs. **The company decided it had only one option left—look for a buyer of its facilities at Wasserburg. But, with other semiconductor makers in Europe operating below capacity, it is unlikely that anyone will buy the facility.**

When the Wasserburg factory was opened in mid-1968, SGS executives had high hopes of increasing the work force from 300 to about 1,000, but the highest employment ever achieved was less than 600. The decline, which started at the end of 1970, has continued. The main output at the plant consisted of metal-can transistors and custom-tailored devices. **SGS, together with its Italian partner ATES Componenti Elettronici, still maintains production facilities at company headquarters in Agrate, near Milan, as well as in Sicily, France, the United Kingdom, and Singapore.**

Monolithic op amp operates at very low power levels

Nippon Electric's new line of operational amplifiers aims for jobs in battery-run gear: LSI version is next

Micropower operation. built-in signal switching capability, and simplified frequency compensation are among the features of a new monolithic IC operational amplifier developed at Nippon Electric Co. The extremely low power requirements open up many new fields of applications, especially those requiring battery operation.

At the same time, linear large scale integration becomes a possibility. With conventional operational amplifiers, it has been power dissipation and not chip size that has prevented including a number of amplifiers in one package.

Switch. The built-in signal switching function performs by controlling current flowing into all stages of the amplifier, depending on whether the external control terminal is connected to the positive power supply voltage or to ground. When the external control terminal is connected to ground the amplifier is disconnected from its power supply, so that gain becomes zero and output impedance infinite. This enables the amplifier to be switched without introducing into the signal path any devices that might affect normal gain or balance.

In addition to turning the amplifier on and off, the circuit used for switching permits external control of the absolute value of current drain of the amplifier. Amplifier current drain depends on both

power supply voltage and the external resistance connected between the control terminal and positive power supply. With an external resistor in excess of 10 megohms, no-signal power input can be as low as 16 microwatts when the amplifier is operated from a 12-volt power supply, which is the minimum voltage recommended.

Stable gain. Even at very low power input levels, gain of about 110 decibels is maintained, and the Class B output stage enables the amplifier to deliver an output current of 15 milliamperes. Frequency response, though, decreases at these low power levels. More representative operating power levels are 400 μ W, when operated from ± 3 -V power supply and using a 200-kilohm external control resistor, and 2 μ W when operated from ± 15 -V power supply and using a 2-megohm external resistor.

Simplicity of switching and freedom from transient disturbances or unbalance in signal path should make this amplifier attractive for use as a switch even when gain isn't needed. Applications include scanning, multiplexing, and mode control. It may seem extravagant to use a circuit with more than 20 transistors to perform such a simple function, but a single TO-5 package with several external components means that an electronic switch can be implemented with fewer parts than almost any alternative. This technique will become even more attractive when LSI version of the amplifier becomes available.

Loads. The simplified frequency compensation is made possible by the same circuit technique that gives micropower operation. The high

output impedances of transistors are used as active loads, making it possible to achieve typical open loop gain of 110 dB for the amplifier with only two stages of voltage amplification, even though the amplifier operates at extremely low power levels. Because only two stages are used, a single capacitor can control circuit frequency response and give stable operation for any desired amount of feedback.

Market. This op amp will be described in more detail at the International Solid State Circuits Conference by Tokio Furuhashi, who designed it together with Hiroshi Aoyama, Ichiemon Sasaki, and Shuzi Nakazawa. Nippon Electric is now starting production of two commercial operational amplifiers of this type using the same master slice. One of these, UPC 253A, will have the circuit shown in the ISSCC paper. The other, UPC 153A, has a simplified output stage that permits it to deliver about 1 V more peak-to-peak output when operated at a given power supply voltage.

Great Britain

Phase-locked loop IC designed for modems

About a year ago, Signetics Corp. brought out the first of a range of phase-locked loop integrated circuits, with phase comparator and oscillator on a single chip. The loop locks the oscillator frequency to an input signal frequency by comparing the phase of the two frequencies and using the difference signal to shift the oscillator frequency. Thus

any frequency-modulated information in the input signal is demodulated in the difference signal.

Signetics' idea was that the chip—much cheaper than a discrete equivalent could be—would eventually become a widely-used building block in fm demodulators, multipliers, and synthesizers, particularly at lower frequencies. With roughly the same idea in mind, Plessey Co. has developed a similar chip, but more complex and in its initial form specifically designed as a complete modulator and demodulator for frequency shift key modems. Plessey's approach will be explained by Barrie Gilbert, the designer, at the Solid State Circuits Conference this week.

For modems. British Post Office modem specs demand high frequency stability to reduce bias distortion, which means that chip temperature stability has to be very good. Gilbert calculates it must be better than 30 parts per million per °C. He claims he has achieved 20 parts per million per °C up to 100 kilohertz, from -15°C to +85°C. He says this is an order of magnitude improvement over comparable devices made by Signetics and RCA.

He has also put circuitry onto the chip for converting two binary inputs into four precise oscillator frequencies and for converting the demodulated output of the PLL into a binary signal. The frequencies are pre-determined by off-chip resistors, which generate four currents applied to inputs at ground potential, making them easy to program.

Wide range. Gilbert claims a 500:1 frequency range with one capacitor and a linearity of 0.2%. Ground potential input also means that when the oscillator's free-running frequency is the same as the input signal frequency, the loop output is 0, which means that subsequent signal processing is easy. The mark/space ratio can also be varied over a range from 0.001:1 to 1,000:1 by connecting the binary input to the VFO output and using appropriate timing resistors.

The phase comparator block is conventional, except that it is preceded by an amplifier to cut the in-

put level necessary to load the phase comparator to about 1 millivolt rms. And it is followed by a linear multiplier with a connection to one pin so that the loop gain and output current can be externally controlled. There is also a completely separate op amp circuit on the chip with CCITT-compatible output. In a modem this would be used for post-demodulation slicing.

Push-pull. The oscillator is a push-pull emitter timed relaxation type of a new design. Gilbert has achieved good stability by taking care to identify and eliminate drift sources—for instance, emitter current densities at the instant of regeneration have been made as nearly equal as possible. Sensitivity to supply variations is claimed to be down to 50 parts per million for 1% voltage change, and the mark/space ratio accurate to within 0.5%.

Another new Plessey IC, for TV receivers, being described at Philadelphia puts onto one chip the i-f and detection stages for both video and sound. Currently, a set maker has to buy three chips for these functions—i-f amplification; low-level video detection, which may also include automatic gain control and a buffer for automatic frequency control; and fm sound detection. Plessey's 85-mil-square chip contains all these functions. The company says it's cheaper than buying three separate chips, gives a better performance, and does not restrict the set designer's flexibility.

On a chip. Getting it all on one chip with a video gain of 96 dB—rms input to peak-to-peak output—at 40 megahertz and a sound i-f gain of 60 dB without introducing instability involved problems that chip designer Graham Baskerville will describe. One solution has been to include a large substrate contact across the entire chip between the sound and video sections, providing a shunt path of about 10 ohms from the substrate to earth. This reduces the possibility of interference in the video channel from harmonics of the sound i-f. Another technique has been to screen the video i-f amplifier input pads and resistors with buried n⁺ diffusions connected to

the decoupled agc pad, which reduces capacitive coupling to the substrate by 30 dB. Baskerville proves stability by putting his hand on the back of the board holding the demonstration i-f system: it doesn't cause any oscillations.

It's a snag of synchronous detectors that pulse interference can produce white noise on the screen. Baskerville gets rid of this by including a differential Schmitt-trigger noise inverter in the video amplifier. It returns all noise above a white threshold to mid-grey level.

Japan

Color TV projector replaces home movies

Take a 13-inch color picture tube, increase its brightness by a factor of more than three, project its picture by a large lens onto a curved screen, and you have Sony's latest consumer product. Sony's prototype uses a 40-inch-wide screen about 5 feet in front of the projector to give the equivalent of a 50-in. picture. Input to the system can be a magnetic-tape recorder or a TV tuner.

The Sony Video Color Projection System is scheduled to go on sale this fall, with the projection unit selling for about \$2,000 in the U.S. The screen will cost another \$250. The picture tube is similar to those used in regular Sony sets but includes a number of small changes and improvements, including a more transparent faceplate, higher accelerating voltage, and new phosphors.

Lens. The projection lens was designed by Sony and will be fabricated by a contractor. The lens has large glass elements about 5 inches

Project. Sony's home color TV projection system has specially designed screen.

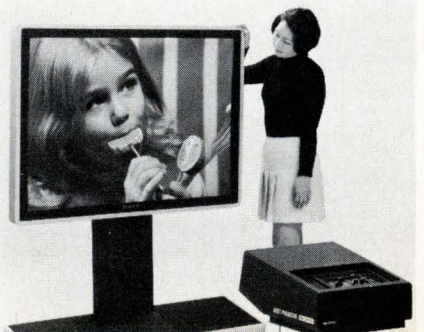

in diameter, because it must have high light transmission. But its resolution can be a controlled low value, not high enough to show horizontal scanning lines or vertical color stripe pattern clearly, yet not seriously degrade the image. Furthermore, the screen is curved to match the curvature of the cylindrical faceplate of the tube. Because of the low resolution requirement and the low magnification, it is possible to design a very inexpensive lens.

The curved screen has a metalized plastic surface, with a fine surface pattern that gives it much higher directivity in the vertical direction than in the horizontal direction. This directivity, which corresponds to high antenna gain in a radio system, greatly increases the brightness of the projected image over that which would be seen on a conventional movie screen.

Bright. The projected picture has a peak white highlight brightness of about 3 foot lamberts, which is similar to that of an 8-millimeter home movie. But it is much more attractive because of higher contrast. Even though picture is more than an order of magnitude darker than the average TV picture, contrast is superior—about 40 decibels for the projected picture compared with about 26 dB for directly viewed color television.

Unijunction transistor leads to low-power shift register

Development of a better unijunction transistor—with small valley current—was the first step in the development of a low-power semiconductor shift register at the Musashino Electrical Communication Laboratory of the Nippon Telegraph and Telephone Public Corp. The device consists of a large number of unijunction transistors on a single chip.

Shift-register operation is possible because the electron-hole plasma that carries current between the emitter and collector of an individual element spreads into the region of adjacent elements, reducing the

peak voltage of these elements.

The most attractive application of the new device will probably be use as a mass memory. Since operation is digital, it can be designed to perform logic—which perhaps will be most advantageous for control of the memory rather than as straight logic device. Logic capability, much more powerful than that of bubble memories, includes ability to perform simultaneous and feedback logic, as well as sequential logic. Another potential application is as an optical imaging device.

Power saving. The new shift register operates on 5 volts. Individual elements have a power consumption of about 0.5 milliwatts in the on state and about 0.2 mW in the off state, for a mean power consumption of about 1 mW per bit. This is approximately the same value required by MOS shift registers. The manufacturing process, though, is essentially the same as for charge coupled devices, because only two diffusions are required. Linear pitch of about 20 microns per bit is also similar to charge coupled devices.

Present transfer speed of experimental devices is up to 10 megahertz. There is no minimum speed, as required in dynamic MOS circuits. The stored signal is regenerated at each bit, which in charge coupled device terminology corresponds to 100% charge transfer. Output voltage is 0.4 V when operated from a 5-v supply with an on state power consumption of 1.5 mW, and is variable up to about 3 V for higher power consumption.

Experimental. Devices fabricated so far show a good yield, indicating that final price will be lower than for MOS devices. Fabrication of devices with 1,000 bits on one chip is expected before the end of the year.

Although a unijunction diode has three terminals, it is operated as a two-terminal element in this device. The base—often called base 2 in American references—merely provides a direct current bias. In its simplest form, this device has a long and narrow base diffusion, a linear array of emitter diffusions equidistant from the base diffusion, and another linear array of collector diffu-

sions on the side of the emitter opposite the base. By making the collectors small and keeping the spacing between them small, plasma coupling is obtained between them. Isolation to prevent coupling to other arrays on the same chip can be had by carrying the base diffusion completely around the array.

Small collectors used in the individual unijunction transistors make for high negative resistance and low valley currents, which together with low voltage levels, keeps the power consumption per bit down to MOS levels. Current flow in these elements produces an electron-hole plasma, in which there is no net surplus or deficiency of either polarity of carrier.

Clocks. Because this device operates in a two-terminal mode, a multiphase clock is needed to obtain unidirectional signal transfer. A three-phase clock is used with experimental symmetrical devices. Asymmetrical devices, in which coupling from a given device is predominately to one of its two neighbors, have also been made. With these devices a two-phase clock has been used. Still further variations in geometry are used to provide logic capabilities.

Optical imaging is obtained very simply. Photoresponse of the individual unijunction transistors causes a decrease in peak voltage when they are illuminated. A pulse of proper amplitude superposed on the clock pulse will cause only illuminated bit positions to turn on. Then ordinary clock pulses can be used to shift the stored information in the usual manner.

The device will be explained in more detail at the International Solid State Circuits Conference by Toshimasa Suzuki and Yoshihiko Mizushima of the Musashino lab.

The Netherlands

Bucket brigades speed optical character reading

For human beings, the admonition against trying to do two things at

once is perhaps best heeded. But when it comes to optical scanning, reading one pattern in while reading another one out has all sorts of advantages. One of the main ones: the photodiodes keep integrating light continuously, meaning there's a higher signal output—all else being equal—than can be had when reading in and reading out sequentially.

The trick, of course, is to find a way to read patterns in and out simultaneously without mixups. Researchers at Philips Gloeilampenfabrieken's laboratories in Eindhoven have found one. They have integrated a row of 64 photodiodes and a bucket-brigade memory into a single metal oxide semiconductor chip. The device holds high promise as the basic building block for optical character readers.

Diodes and bucket pairs. For each of the 64 diodes, there's an associated pair of buckets and an MOS transistor switch. Because of the switches, the diodes are isolated from one another and from the bucket brigade line, except when a switching pulse turns the transistors on. With a clock pulse of 1 megahertz, the pulse lasts only 0.5 microseconds out of a readout cycle lasting 32 microseconds, so the diodes are integrating light practically full time.

When the transistors switch, the charges built up on the diodes are fed into the memory and then the stored pattern is moved along bucket-brigade style to the output, where the signal is picked off by a source follower. "The bucket brigade acts as a buffer memory for each pattern, and the output is a time-multiplexed video signal," says Henk Heyns, the circuit engineer for the development.

Prototypes. For the first versions of the bucket brigade scanner, Philips used p-channel technology. That limits the clock speed to 1 MHz, a trifle slow for some optical character reader applications. "We can get the speed up to between 5 and 10 MHz simply by switching to n-channel MOS," says Joop van Santen, head of microcircuit work at the Eindhoven labs. That would put the scanner well inside the speed range

needed for fast OCR. As for dynamic range, the scanner already has what it takes. The ratio of maximum output signal to illumination noise is 30:1. In other words, a reader based on the scanner could distinguish among 30 shades of gray.

Matrix next. In these first experimental versions, the scanner has a row of 64 diodes with a pitch of 50 microns, flanked by the buckets. Processing of the chip presents no particular problems although extra aluminization is needed over the buckets to keep them in the dark. The transistors in the buckets are also photosensitive, like all semiconductors.

Now that the concept has been proven out with a row of diodes, the next step is a matrix. Van Santen expects a 50-by-50 array will be feasible within a year or so at reasonable chip yields. Philips now can get 400 buckets tucked into an area 1 millimeter square with normal processing.

West Germany

Piezoelectric plate feeds hand-writing to computer

A new graphic computer input device that accepts hand-written data is now being perfected at West Germany's Siemens AG. Developed at the company's Munich laboratories, the device transmits data over regular telephone lines either to a computer for storage or to a terminal where the information is displayed in real time. With that capability the equipment can be used for signature verification in banks or for transmitting hand-drawn charts, sketches, or graphs.

To be sure, electronic equipment for picking up hand-written data and reproducing it at a distant point has been around for quite some time. The new Siemens gear, however, differs in its extreme simplicity and low cost. Yet, it does not sacrifice accuracy.

In any kind of graphic input device, the basic idea is to continuously determine each instan-

taneous position coordinate of a stylus or probe moving across some sort of pad. The coordinate values are then converted into pulses for transmission to a display. The writing pad, the key component in such equipment, is usually made up of vertical and horizontal conductors. The X and Y coordinate values are fixed by pulses that are generated when the stylus causes the conductors to make contact at their intersections.

To the Siemens developers even such straight-forward setups appeared much too complex. Besides, the accuracy of the reproduced data, they contend, is limited by the conductor spacing.

Piezoceramic. They overcame these drawbacks with a simple piezoceramic plate serving as a writing pad. The equipment uses the well-known phenomenon that piezoelectric materials generate a voltage when pressure is applied to their surface. But with this plate, it is not the pressure of the probe itself that's used but the pressure of ultrasound waves within the material. These voltages, indicative of particular coordinate values, are picked up by the probe, processed, and sent to the display.

Attached to two adjacent edges of the piezoceramic plate are silver strips, to which a 500-hertz square-wave signal train is applied. The pulses, 5 volts in amplitude and 0.5 microseconds wide, are fed to the alternate edges and set up the ultrasound waves.

Timing. Absorbent material on the opposite edges prevent reflections of the waves. Since the ceramic material is homogeneous, the waves go through it at a constant velocity and travel parallel with the edges at which they originate.

Since the signals alternate, the sound waves first move from top to bottom and then from left to right. The waves compress the piezoelectric material, producing a precisely-timed voltage wave front that proceeds in the same direction. The material compression is very small. Yet it is sufficient to generate about 0.2 v. The voltages are capacitively picked up by the probe.

Have you heard about Rochester's smaller successes?

Sure, you know about the big ones. In copiers and cameras. In microscopes and men's wear. But a lot of smaller businesses are on their way up in this fertile, dynamic 9-county area of Western New York. Would you like to know who they are, how they're growing... and how to find just the plant space or site where your company can make it big, too? Could you use facts about labor, and educational, recreational and transportation facilities? If so, call collect or write to Bob Hall, Director of Area Development, Rochester Gas & Electric, 89 East Avenue, Rochester, N. Y. 14604 (Telephone: 716-546-2700). Nobody knows more about this area than we do. And because we make money selling energy to industry, we're eager to share our knowledge with you.

R. F. Communications made it here. How about you?

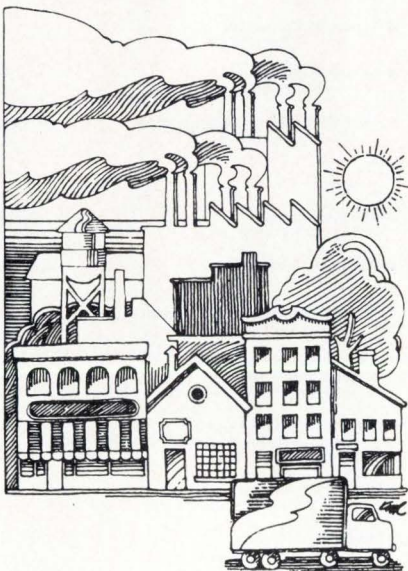

RGE ROCHESTER GAS AND ELECTRIC

Advertising Sales Staff

Pierre J. Braudé [212] 971-3485
Advertising Sales Manager

Atlanta, Ga. 30309: Joseph Lane
1375 Peachtree St., N.E.
[404] 892-2868

Boston, Mass. 02116: James R. Pierce
607 Boylston St. [617] 262-1160

Chicago, Ill. 60611: Robert W. Bartlett
Kenneth E. Nicklas, 645 North Michigan
Avenue, [312] MO 4-5800

Cleveland, Ohio 44113: William J. Boyle
[716] 586-5040

Dallas, Texas 75201: Richard P. Poole
1340 Republic National Bank Building
[214] RI 7-9721

Denver, Colo. 80202: Harry B. Doyle, Jr.
Tower Bldg., 1700 Broadway
[303] 266-3863

Detroit, Michigan 48226: Robert W. Bartlett
2600 Penobscot Building
[313] 962-1793

Houston, Texas 77002: Richard P. Poole
2270 Humble Bldg. [713] CA 4-8381

Los Angeles, Calif. 90017: Robert J. Rielly
Bradley K. Jones, 1125 W. 6th St.,
[213] HU 2-5450

Minneapolis, Minn. 55402: Kenneth E. Nicklas
1104 Northstar Center [612] 332-7425

New York, N.Y. 10036
330 W. 42nd St.
Warren H. Gardner [212] 971-3617
Michael J. Stoller [212] 971-3616

Philadelphia, Pa. 19103: Warren H. Gardner
6 Penn Center Plaza.
[215] 971-3617

Pittsburgh, Pa. 15222: Warren H. Gardner
4 Gateway Center, [212] 971-3617

Rochester, N.Y. 14534: William J. Boyle
9 Greylock Ridge, Pittsford, N.Y.
[716] 586-5040

St. Louis, Mo. 63105: Kenneth E. Nicklas
The Clayton Tower, 7751 Carondelet Ave.
[314] PA 5-7285

San Francisco, Calif. 94111: Don Farris
Robert J. Rielly, 475 Battery Street,
[415] 362-4600

Paris: Alain Offergeld
1 rue-Georges Bizet, 75 Paris 16, France
Tel: 720-73-01

Geneva: Alain Offergeld
1 rue du Temple, Geneva, Switzerland
Tel: 32-35-63

United Kingdom: Keith Mantle
Tel: 01-493-1451, 34 Dover Street, London W1

Milan: Robert Saidel, Roberto Laureri
1 via Baracchini Phone 86-90-656

Brussels: Alain Offergeld
22 Chaussee de Wavre
Brussels 1040, Belgium
Tel: 13-65-03

Stockholm: Brian Bowes
Office 17, Kontor-Center AB, Hagagården 29,
113 47 Stockholm. Tel. 24 72 00

Frankfurt/Main: Fritz Krusebecker
Liebigstrasse 27c
Phone 72 01 81

Tokyo: Masaru Wakeshima, McGraw-Hill
Publications Overseas Corporation,
Kasumigaseki Building 2-5, 3-chome,
Kasumigaseki, Chiyoda-Ku, Tokyo, Japan
[581] 9811

Osaka: Ryji Kobayashi, McGraw-Hill
Publications Overseas Corporation, Kondo
Bldg., 163, Um-gae-cho Kita-ku [362] 8771

Australasia: Warren E. Bail, IPO Box 5106,
Tokyo, Japan

Business Department

Stephen R. Weiss, Manager
[212] 971-2044

Thomas M. Egan,
Production Manager [212] 971-3140

Carol Gallagher
Assistant Production Manager [212] 971-2045

Dorothy Carter, Contracts and Billing,
[212] 971-2908

Frances Vallone, Reader Service Manager
[212] 971-6057

Electronics Buyers' Guide

George F. Werner, Associate Publisher
[212] 971-3139

Regina Hera, Directory Manager
[212] 971-2544

for
**rapid
reaction**

INQUIRY > QUOTE

ORDER > DELIVERY

Specify

CUSTOM

Mica Capacitors



CMR Type

For hermetically sealed or potted in applications.

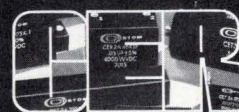

CER Type

For specialized mounting arrangements and operation under selected environmental parameters.



CEM Type

For specialized form factors and operation under environmental extremes.

Custom Electronics can fill your mica capacitor requirements in minimum reaction time (inquiry; to quote order to delivery).

Meet your design engineer's requirements for higher voltage, higher temperature and greater reliability by calling on Custom Electronics for Mica Capacitors.

The greatest single cause for capacitor failure is a short in the dielectric material.

Consequently, we precisely inspect and grade all of our dielectric material before production. The result is the finest quality capacitors of their kind available today.

Write or call on your application today!

CUSTOM
The QC Fanatics

CUSTOM ELECTRONICS, Inc.
Browne St., Oneonta, N. Y. 13820
PH: 607-432-3880 TWX 510-241-8292

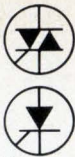

**A TOTAL CAPABILITY
FROM ADVANCED
THYRISTOR TECHNOLOGY**

TRIAC's & SCR's

FOR MOTOR, HEATING,
COOLING AND LIGHTING
CONTROLS AND
SPECIAL APPLICATIONS

ALL POPULAR PACKAGE CONFIGURATIONS WITH VOID-FREE GLASS-PASSIVATED CHIPS

Included are *electrically isolated* 6, 8, 10 & 15 Amp *center-gate* plastic (ISOTAB*) and 30 and 40 Amp *electrically isolated, center-gate* press-fit TRIAC's. All feature improved critical and commutating dv/dt ratings and di/dt capabilities with low switching losses.

Hutson thyristors are available in a wide range of current and voltage ratings from 3A and 4A sensitive-gate to 35 and 40 Amp standard gate devices; and from 30V and 50V to 600V (V_{DROM}).

PATENTED DI-MESA* CONSTRUCTION

This chip construction provides a dual mesa barrier to prevent minute fractures, caused by the dicing operation in glass-passivated chips, from spreading and causing an eventual device failure from repeated operational cycling.



*T.M. HUTSON INDUSTRIES

HUTSON INDUSTRIES

2019 W. VALLEY VIEW LANE
DALLAS, TEXAS 75234 (214) 241-3511
TWX 910-860-5537

Distributed by:

BODELLE COMPANY, Chicago, Ill.
312/468-1016 ■ **NEWARK ELECTRONICS
CORP.**, Inglewood, Cal. 213/678-0441
THOR ELECTRONICS, Elizabeth, N.J.
201/354-2420

Canada: **WEBER-SEMAD ELECTRONICS**, Downsview, Ont.

European Marketing Director:

30 Rue Pierre Semard, Yerres, 91 France
Tel: Paris 925-8258 TELEX 21-311

Distributed in Europe by:

Switzerland: **D. LEITGEB**, Dubendorf
Sweden: **ELEKTROFLEX**, Sundbyberg
Spain: **BELPORT**, Madrid
Holland: **RODELCO**, Den Haag

Electronics advertisers

February 14, 1972

■ Abbott Transistor Labs., Inc. Technical Adv. Agency	6	■ Fluke Manufacturing Co., John Bonfield Associates	17
Advanced Memory Systems Feig and LeBoeuf Adv., Inc.	108	Function Modules, Inc. Leon Richman Design	130
# AEG Telefunken Werbeagentur	25E	General Instrument Corporation, Semiconductor Products Div. Norman Allen Associates	90
Allen-Bradley Company Hoffman-York, Inc.	58	# General Radio Grad Associates	4E-5E
# Anritsu Electric Co. Ltd. Diamond Agency Co. Ltd.	12E	General Radio Co. Grad Associates	43, 56
APM-Hexseal The Sommer Agency, Inc.	129	Gould, Inc./Instrument Systems Div. Carr Liggett Adv., Inc.	118
# Asahi Glass Co., Ltd. Asia Advertising Agency, Inc.	29E	■ Grayhill, Incorporated Carr Liggett Advertising, Inc.	D-4
■ Augat Creamer, Trowbridge, Case & Basford, Inc.	40-41	Guardian Electric Mfg. Co. Kolb/Tookey and Associates, Inc.	28-31
Bausch & Lomb, Inc. Wolf Assoc., Inc.	133	Hansen Mfg. Company Keller-Crescent Co.	116
Bell & Howell- Electronics & Instruments Group Coordinated Communications, Inc.	39	Harris Semiconductor Tucker Wayne & Company	54
Bendix Corporation, Electrical Components Div. D'Arcy-MacManus-Intermarco, Inc.	55	Health/Schlumberger Scientific Instruments	129, D-4 Advance Advertising Services
# Birch Stolec Ltd. Derek R. Miller Advertising Limited	23E	Hermes Electronics Ltd. Public & Industrial Relations Limited	105
Burdny Components Ketchum, MacLeod & Grove, Inc.	9	# Hewlett Packard 11E, 13E, 15E, 17E Dorland Advertising Ltd.	
Burr-Brown Research Corp. N. A. Winter Advertising Agency	126	■ Hewlett Packard Richardson, Seigle, Rolfs & McCoy, Inc.	2
■ Bussmann Mfg. Division of McGraw Edison Co. Henderson Advertising Company	124-125	■ Hewlett-Packard/Loveland Calculator Division	18-19 Tallant/Yates Advertising, Inc.
By-Buk Company, Sub. of Webtek Corp. J. R. Bloomer Company	128	■ Hewlett-Packard Richardson, Seigle, Rolfs & McCoy, Inc.	1, 76
California Computer Products Dailey & Associates Advertising	134	Hickok Electrical Instruments Company Key Marketing Associates	124
Centralab, Div. of Globe Union, Inc. The Brady Co.	102-103	■ Hipotronics, Inc. Kenmarc Advertising, Inc.	116
■ Cherry Electrical Products Corp. Kolb/Tookey and Assoc., Inc.	23	Hughes Aircraft Company Foote, Cone & Belding	44-45
■ Chicago Dynamic Industries, Inc. Burlton Browne Advertising	131	Hutson Industries Warren Associates	D-2
Cincinnati Milacron, Process Controls Division David K. Burnap Advertising	24	ILC Data Device Corporation Marchin Weltman Advertising, Inc.	115
■ Clairex Corporation Michel-Cather, Inc.	4th cover	Industrial Electronics Engineers, Inc. Van Der Boom, McCarron Advertising	22
# Communication Associates, Inc. Caroe Marketing, Inc.	30E	■ Interstate Electronics Corporation Leland Oliver Company, Inc.	99
CTS Corporation Reincke, Meyer & Finn, Inc.	121	Jewell Electrical Instrument, Inc. Amerad Advertising Services, Inc.	42
■ Custom Electronics, Inc. Laux Advertising, Inc.	141	■ Kepeco, Incorporated Weiss Advertising	5
Data General Corp. Quinn & Johnson, Inc.	80-81	■ Keystone Electronics Lawrence Nelson Advertising	129
# Delta Design, Inc. NKS, Ltd.	6E	■ Lambda Electronics Corporation	3rd cover Michel-Cather, Inc.
Develco Paul Pease Advertising	46	# LTT Publibel	26E
Digilin, Inc. Van Der Boom, McCarron, Inc.	120	■ MFE Corporation Scott Advertising, Inc.	131
■ Digital Equipment Corporation Creamer, Trowbridge, Case & Basford, Inc.	12-13	■ Monsanto Company Michel-Cather, Inc.	96
Eastman Kodak Company, Business Systems Markets Div. J. Walter Thompson Co.	117	Motorola Semiconductor Products, Inc. E. B. Lane & Associates, Inc.	20-21, 47
Electronic Engineering Company of California, Electronics Products Div. Marketing Communications Associates	D-3	North American Rockwell, Electronics Group Campbell-Ewald Company	10-11
Electronics	106-107, D4	■ Oak Electro/Netics Corp., Switch Division of Oak Electro/Netics Corp. Buchen Advertising, Inc.	53
■ EMI Electronics Ltd. Bonner Hodgson & Partners Ltd.	28E	# Oscilloquartz SA, Neuchatel M. R. Hofer Werbeagentur BSR/EAAA Bern	24E
Exact Electronics COM/MARK Communications Group	32	# Philips Gad Elcoma	18E-19E, 27E Tag-Intermarco deliaMar
# Ferranti Ltd. - Dundee Rowlinson Broughton Ltd.	16E	Philips N. V. Pit/T & M Division Marsteller International S. A.	24
		Precision Monolithics, Inc. Marlborough Associates, Inc.	14

LOW-COST

# RCA Ltd. Marsteller Ltd.	20E-21E
# RCL Electronics, Inc. Morway Advertising Agency	2nd cover
Rochester Gas & Electric- Advertising Group Hutchins Advertising Company, Inc.	141
# Rohde & Schwarz	3E
Roim Corporation Marmac Advertising	48
Rotron, Incorporated Black-Russell-Morris	114
Howard W. Sams & Co. Aitkin-Kynett Co., Inc.	95
Schauer Manufacturing Corp. Nolan, Keelor & Sittes	104
S. D. S. A. Public Service	112
Signetics Corp., sub. of Corning Glass Works Hall Butler Blatherwick, Inc.	57
Simpson Electric Co. Amerad Advertising Services, Inc.	110
Spectra-Physics, Inc. Hal Lawrence, Inc.	15
# Sperry Information Displays Division N. A. Winter Advertising Agency	101
Syracuse Electronics Corp. Conklin, Labs & Bebee, Inc.	93
# Systron Donner Concord Instruments Bonfield Associates	51
T-Bar, Incorporated The Robert A. Paul Advertising Agency, Inc.	8
# Tektronix, Inc. Dawson, Inc.	37
# Teledyne Philbrick Ingalls Associates, Inc. Advertising	72
# Teledyne Relays S. Michelson Advertising	32E
Teledyne Semiconductor Regis McKenna, Inc.	122
Thomson CSF Bazaine Publicite	27
Toko, Inc. Hakuhodo, Inc.	D-3
# TRW Electronics, Semiconductor Division The Boves Company	7
Union Carbide Corp., Linde Division Young & Rubicam, Inc.	16
Universal Oil Products, Norplex Div. Campbell Mithun, Inc.	52
# V/O Techmasheport V/O Vneshtorgreklama	14E
Victoreen Instrument Division Dix & Eaton, Inc.	131
# Victory Engineering Corporation A. D. Adams Advertising, Inc.	128
Woven Electronics Prentiss Court	120

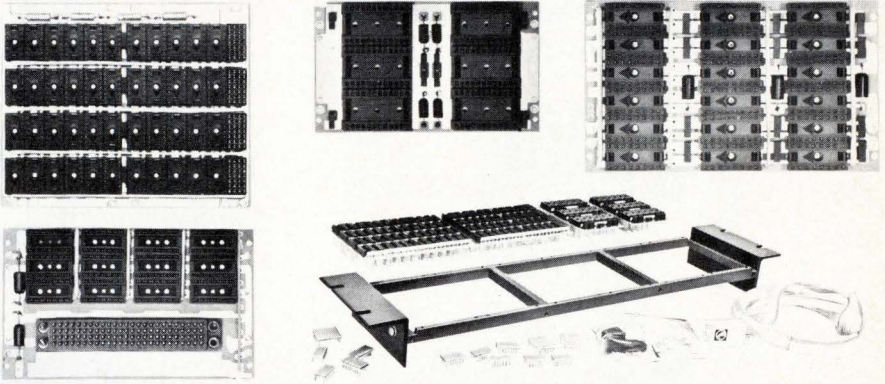

LOGIC PANELS

Now from EECO, logic hardware and low-cost come together, all you need is your design and you've got it made.

KITS... Take advantage of new low-cost (\$186 up) breadboard kits — everything you need including modular socket boards with more location flexibility from 14, 16, and 28 pin IC assemblies. We'll send you frames, boards, plugs, clips, terminals and enough wire to wrap up the job. Even a wire wrapping tool and power supply, if you like. And EECO provides an advanced power distribution system to knock out high speed switching transients, so you maintain full noise immunity.

PANELS... World's largest selection of sockets, panels, drawers and special assemblies — everything to implement your IC logic design. Low-cost, high density, socket modularity and fast delivery, all combined to give the ultimate in design flexibility. If you want more help from us than that, ask about our computer-aided-design and wire wrap service — from logic diagram to wired hardware in 4 weeks. If you're thinking logic design, EECO's thinking of you.



Send for the latest kit information in the new hardware supplement.
ELECTRONIC ENGINEERING COMPANY of California
ELECTRONIC PRODUCTS DIVISION • 1441 E. Chestnut Avenue • Santa Ana, California • Phone: (714) 547-5651
TWX 910-595-1550 Telex 67-8420

Circle 158 on reader service card

Roll Out the Red Carpet — For Toko's New Low Cost High-Speed Memory System

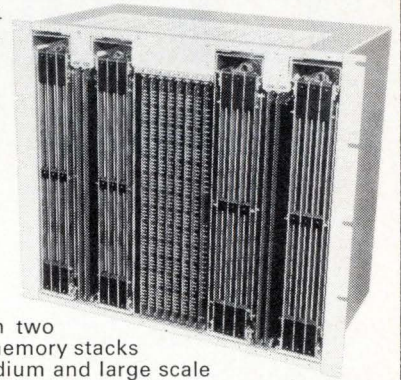

Here's a real eye-opener for computer designers—Toko's new 65K byte memory system, HS-400L. It's constructed with two basic sub-assemblies—woven-plated-wire memory stacks and electronics packages. Designed for medium and large scale computers, the HS-400L offers high reliability, easy maintenance and a flexible arrangement of word lengths.

General Specifications: ● Memory Capacity: 32,768 words—18 bits (Internal Organization is 8K words—72 bits) ● Access Time: 220 ns Random Access ● Cycle Time: Clear/Write 450 ns Read/Restore 450 ns ● Operating Mode: Destructive Read-Out ● Temperature Range: 0° C to 50° C (Operating) ● Measurement: 16.5(H) x 19.0(W) x 10.0(D) ● Interface Level: TTL compatible ● Power Dissipation: 0.3 m W/bit max.

For further information, just call or write

TOKO, INC.

Head Office: 1-17, 2-chome, Higashi-Yukigaya, Ohta-ku, Tokyo, Japan

New York: Toko New York Inc.

350 Fifth Avenue, New York, N.Y. 10001 U.S.A. Tel: 565-3767

Los Angeles: Toko, Inc. Los Angeles Liaison Office

1830 West Olympic Blvd., Los Angeles, 90006 Cal. U.S.A. Tel: 380-0417

Düsseldorf: Toko, Inc. Europe Liaison Office

4 Düsseldorf, Kölner Straße 246, Düsseldorf, W. Germany Tel: 78-7064

Classified & Employment Advertising

F. J. Eberle, Manager 212-971-2557

EQUIPMENT (Used or Surplus New) For Sale

Binswanger	132
North American Liquidators	132
Radio Research Instruments Co.	132
Jensen Tools and Alloys	132

■ For more information on complete product line see advertisement in the latest Electronics Buyer's Guide
Advertisers in Electronics International

What do you want in a rotary switch?

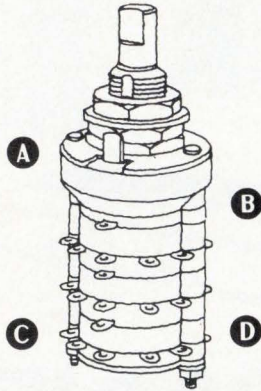

- A** Positive "stall-free" detents with: spring return, isolated position or keylock option.
- B** Circuit versatility 1-12 poles/deck, 2-24 positions/pole.
- C** Solder lug or PC mount terminals.
- D** Molded-in terminals.

These are just a few of the thousand-plus standard design options with Grayhill Rotary Switches.

For our latest Engineering Catalog write or phone: Grayhill, Inc., 523 Hillgrove Ave., La Grange, Illinois 60525. (312) 354-1040.



Circle 159 on reader service card

FREE

'72 HEATHKIT CATALOG

- Now with more than 350 kits to save you money
- See the new Heathkit 3½ digit multimeter for just 229.95*

A kit form multimeter that meets lab specs for about half the cost of comparable wired units . . . has 3½ digits for 100 uV resolution on 200 mV range, 1V on 1000V . . . can be calibrated to 0.2% accuracy VDC with calibrator provided, or lab calibrated to 0.1%. There's also a new 5" triggered sweep scope at a price you can't afford to pass up . . . DC-10 MHz response, 50 ns sweep rate with magnification, AC-DC coupling, 50 mV sensitivity, all for only 229.95*. Not to mention over 350 other fun-to-build, money saving kits for every hobby and professional interest . . . from test instruments, marine and ham radio gear, to stereo-hi-fi and color TV. The Heathkit catalog is bigger & better than ever this year. Order yours now.



HEATHKIT
Schlumberger

HEATH COMPANY, Dept. 53-2
Benton Harbor, Michigan 49022

Please send FREE Heathkit Catalog.

Name _____

Address _____

City _____ State _____ Zip _____

Prices & specifications subject to change without notice.

*Mail order prices; F.O.B. factory.

TE-256

How much free time do you have available for reading?

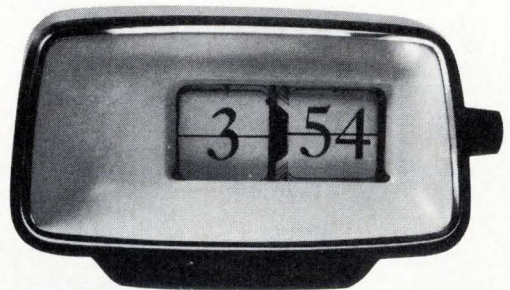

Add up the number of magazines that come across your desk.

Multiply them by an average reading time — minutes to scan, an hour or more to dig in.

Most people can only spend six hours each week on all sources of occupational information.

So how do you fill your professional needs and still keep your reading within reason?

Leaf through this issue again.

Notice how much of its editorial is designed to keep you aware of trends, show you how new technologies are being applied, and give you information on new products.

If you want to keep yourself up to date and cut down on your reading time, do the same thing with every issue of Electronics.

When you make Electronics your regular habit, you'll find you have only occasional need for other electronics magazines.

More information, in less reading time, is one reason it pays you to have your own subscription to Electronics.

Electronics.

It's all you need to read.