

Survey of overseas r-f power transistors 80

\$1.00 A McGraw-Hill Publication

I-r rangefinder focuses camera 102

April 27, 1970

Law enforcement: where does technology fit? 115

Electronics[®]



**CBS's color evr:
The design story**



THE "INTERMEDIATE" SYNTHESIZER

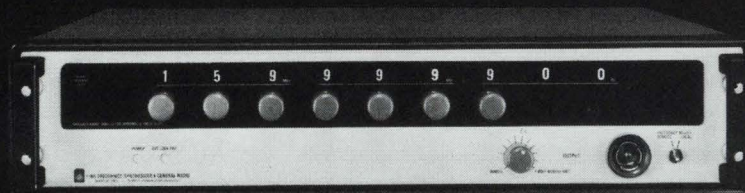

160 MHz for \$5900

Buying a frequency synthesizer has been something like buying a car. There's a confusion of models, options, and price ranges. Except — there has never been a so-called "intermediate"-model synthesizer. That's because price and performance ranges of synthesizers have tended to cluster just at both ends of the spectrum. The choice was between lower-cost, limited-frequency-range models and those with everything, including a sky-high price tag. So, the buying decision was one based on either trade-off or over-capability.

This is not true any longer! GR has filled the price-capability gap with the new 1165 Frequency Synthesizer. Frequency range is wide, 0.01 to 160 MHz in 100-Hz steps. The price is only \$5900, less than half the price it used to cost to get 160 MHz. If you can furnish your own frequency reference signal (5 or 10 MHz), you can get a model for only \$5300. In the \$5900 model, frequency accuracy is maintained either by an internal precision 10-MHz oscillator (1×10^{-9} per day) or by an external drive or lock source. Output is 0.1 to 1 V into 50 ohms. Both frequency and level can be externally programmed; the 1165 is ideal for applications requiring remotely-programmed local oscillators. Harmonics are typically down 30 dB (at maximum output into 50- Ω load); spurious, discrete non-harmonic signals are typically down 60 dB.

For complete information, write General Radio, West Concord, Mass. 01781; telephone (617) 369-4400. In Europe: Postfach 124, CH 8034, Zurich, Switzerland.

GENERAL RADIO



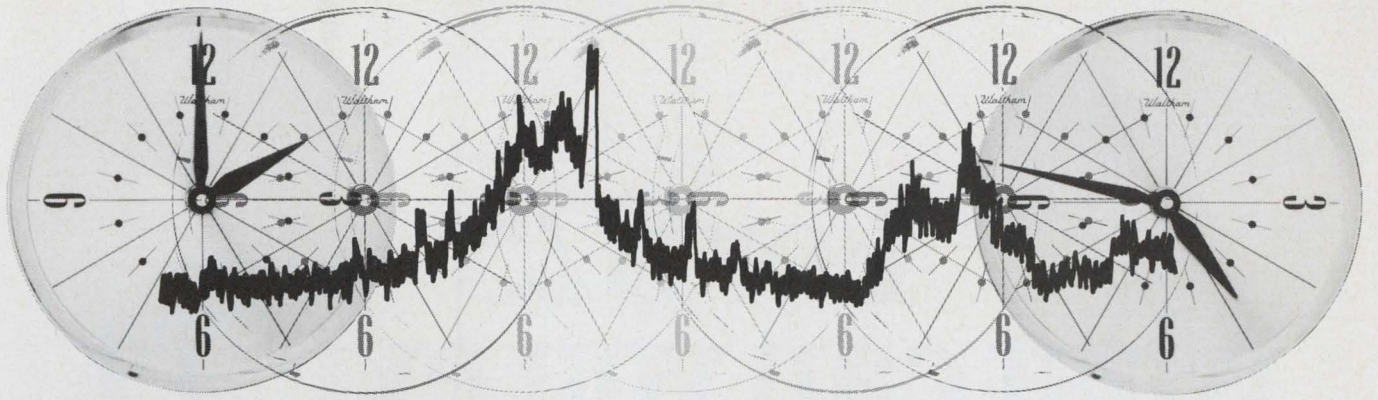

A wave analyzer with a 10,000-second sweep time? Why?

090/6

...because, in low-frequency spectrum analysis work, you need to use a narrow-bandwidth window. The narrower the window you use, the slower you must sweep it across the frequency range to be analyzed. And the slower you sweep, the smaller a frequency range you can cover in any given time. Thus, until now, your choice has been either accuracy or range but not both.

The new HP 3590A/3595A system solves that dilemma. The HP 3595A plug-in is a sweeping local oscillator

with 10,000 seconds of sweep time available. By using it with the HP 3590A Wave Analyzer mainframe, you can scan the entire three-decade audio frequency range at 2 Hz per second, in one sweep. And, by adding an HP X-Y recorder, you can see the results on a single 11 x 17-inch graph.

In addition to extended sweep time, the 3590A/3595A combination also gives you a choice of five sweep rates (from 1 Hz to 1,000 Hz per second) and four filter bandwidths (from 10 Hz to 3,100 Hz), an 85 dB dynamic range

over either of two frequency ranges (20 Hz to 62 kHz and 200 Hz to 620 kHz), 3 μ V to 30 V sensitivity, and built-in autoranging for ease of operation.

The result is a systems-analysis tool ideally suited for work in the lower frequency ranges, with the capability to work in higher frequency ranges as well!

The 3590A Wave Analyzer mainframe is \$3200; the new 3595A plug-in with the 10,000-second sweep time is \$1250. Other plug-ins available for the 3590A are: the 3592A slave and program unit, for use with a second mainframe, \$80; the 3593A with 3-digit mechanical display and 620-second maximum sweep time, \$1100; and the 3594A with 5-digit electronic counter frequency display and 620-second maximum sweep time, \$1600.

To get complete information on the HP 3590A and the various plug-ins, contact your local HP field engineer. Or, write to Hewlett-Packard, Palo Alto, California 94304. In Europe: 1217 Meyrin-Geneva, Switzerland.

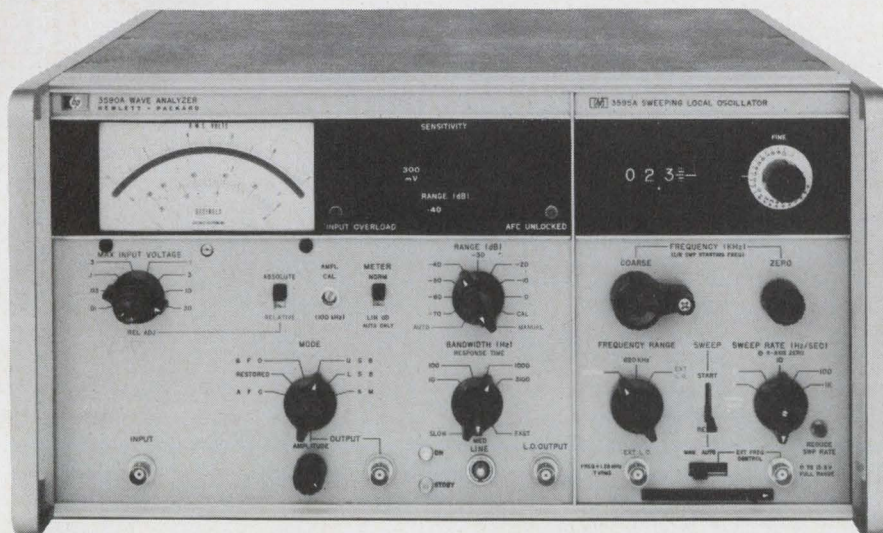

HEWLETT  PACKARD
SIGNAL ANALYZERS

For \$25 what can you expect from a solid-state display? 10 years of brilliant service.

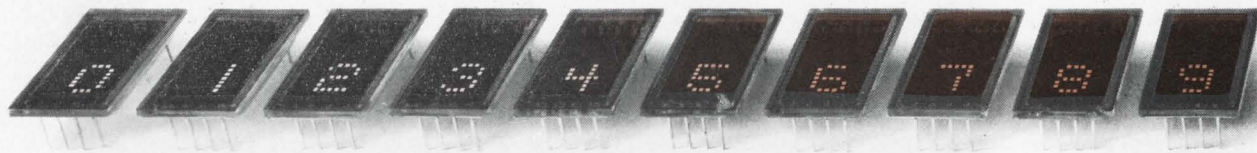

For \$25 each in 1 K lots, HP sells you a hermetically sealed, IC-compatible display with on-board decoder-driver. You just plug the module in; it accepts direct 4-line BCD input. You also get a 5 x 7 dot matrix character that prevents ambiguous readings and a parallax-free design in a package that's one inch high and practically flat. It's the brightest display idea since the tube.

HEWLETT  PACKARD

SOLID STATE DEVICES

Our reliability study shows that the 5082-7000 numeric display glows on for 24 hours a day, 7 days a week for more than 10 years. Ask your HP field engineer for a copy of the study plus volume price quotes on the biggest all-around bargain you can buy in solid-state displays. Or write Hewlett-Packard, Palo Alto, California 94304; Europe 1217 Meyrin-Geneva, Switzerland.

01005

Features

Probing the News

- 115 **Commercial electronics I:** Electronic systems will strengthen the long arm of the law
- 121 **Commercial electronics II:** First police priority is better communications

U.S. Reports

- 41 **Electro-optics:** All-solid-state tv camera
- 42 **Space electronics:** ATS-F and G contracts awarded
- 43 **Space electronics:** How the Apollo 13 affects the program
- 44 **Manufacturing:** Holographic test for honeycomb structure
- 46 **Oceanography:** National Data Buoy competition starts
- 48 **Antennas:** Higher resolution with moderate aperture
- 51 **Government:** Air Force juggles Cambridge lab
- 52 **Communications:** MCI prepares to turn on
- 54 **For the record**

Electronics International

- 65 **Great Britain:** Automatic trouble-shooter for BOAC's 747's
- 66 **Japan:** $\frac{3}{4}$ -watt flip chip; multipurpose coaxial system; more on light diodes
- 68 **Austria:** Push-button exchange
- 68 **West Germany:** AEG-Telefunken and Siemens to join for large computers

New Products

- 131 **In the spotlight**
- 131 Optical character reader for minisystems to bow at SJCC
- 132 Cassette drive for digital jobs
- 136 Controller runs 9 disk drives
- 139 Keyboard has a light touch
- 141 **Components review**
- 141 Circuits assembled from a kit
- 145 **Instruments review**
- 145 Supply has high accuracy
- 146 Synthesizer has low noise level
- 149 **Data handling review**
- 149 Alphanumeric terminal prints all
- 150 ROM expands computer throughput
- 155 **Subassemblies review**
- 155 Low-light tube is supersensitive
- 157 **New materials**

Articles

- Solid state** 80 **Watt-megahertz ratings run second to reliability in foreign r-f power transistors**
A roundup of the technology abroad finds emphasis geared to customer needs
Leon M. Magill,
Electronics' staff

- Circuit design** 90 **Designer's casebook**
- 'Make before break' mode improves FET switch
 - Short-circuit protection for voltage regulators
 - Two op amps simplify design of oscillator

- Consumer electronics** 94 **Looking at color EVR from the inside out**
Electron-beam recording allows use of fine-grain film that has a high data storage capacity
Peter Goldmark,
CBS Laboratories

- Instrumentation** 102 **Camera's i-r eye focuses on new ranging vistas**
New device focuses movie camera by shooting i-r light at an object and controlling position of a detector with the reflected energy
Giovanni Odone,
Paillard S.A.

- Data handling** 107 **A better way to design a character generator**
MOS memories shape characters for crt readout; shift registers handle refreshment chores
Gene Carter and Dale Mrazek,
National Semiconductor Corp.

Departments

- | | | | |
|----|--------------------------|-----|--------------------------|
| 4 | Editorial Comment | 33 | Electronics Newsletter |
| 5 | Readers Comment | 63 | International Newsletter |
| 6 | Who's Who in this issue | 73 | Washington Newsletter |
| 14 | Who's Who in electronics | 158 | New Books |
| 22 | Meetings | 160 | Technical Abstracts |
| | | 161 | New Literature |

Electronics

Editor-in-Chief: Donald Christiansen

Senior staff editors

Technical: Stephen E. Scrupski

News: Robert Henkel

International: Arthur Erikson

Assistant managing editors: H. Thomas

Maguire, Howard Wolff, William Buccu,

Richard Gundlach, Frederick Corey

Special projects editor: Roger Kenneth Field

Senior staff writer: John Johnsrud

Reader Communications manager: John D.

Drummond

Department editors

Senior associate editor: Joseph Mittleman;

Advanced technology: Laurence Altman; Com-

munications: Leon M. Magill; Computers: Wal-

lace B. Riley, George Weiss; Design theory:

Joseph Mittleman; Instrumentation: Owen

Doyle; Military/Aerospace: Alfred Rosenblatt;

New Products: William P. O'Brien; Solid state:

George Watson, Stephen Wm. Fields.

Copy editors: Edward Flinn, William S. Weiss

Assistant art director: Charles Ciatto

Production editors: Susan Hurlburt, Arthur C.

Miller; Editorial research: Virginia Mundt; Edi-

torial secretaries: Claire Goodlin, Bernice

Pawlak, Barbara Razulis, Vickie Green, Terri

O'Neill.

Field bureaus

Boston: James Brinton, manager; Gail Farrell;

Los Angeles: Lawrence Curran, manager; Ralph

Selph; New York: Peter Schuyten; San Fran-

cisco: Stephen Wm. Fields, Marilyn Howey;

Washington: Ray Connolly, manager; Robert

Westgate, Lois Vermillion; Frankfurt: John

Gosch; London: Michael Payne; Paris: Arthur

Erikson; Tokyo: Charles Cohen

Reprints: Virginia Mundt; Circulation: Isaaca

Siegel

Publisher: Dan McMillan

Assistant to the publisher: Wallace C. Carmichael

April 27, 1970

Russia's uphill road to Western markets

● The Russians were at the Paris components show again this year, trying to drum up Western sales for their wares.

Visitors descended upon the Soviet exhibit in large numbers, hovering mostly about the integrated circuit displays, and comparing them with what they saw last year, when the Russians revealed their IC's for the first time. Several things had happened in the interim.

▶ A handful of new devices were added to the IC's already introduced.

▶ Agents had been named to handle sales and market development in some of the Western countries—France and West Germany, for example.

▶ The Russians had provided potential Western customers with sample IC's and are now awaiting responses.

The circuits exhibited in Paris suggest a broad technological capability, ranging from military-grade thin-film hybrids through thick-film hybrids in IBM-type packages. Also shown were monolithic IC's in both flatpacks and dual-in-line plastic packages. Logic schemes comprised DCTL, RTL, DTL, TTL, ECL, and MOS. Included among the linear circuits were operational amplifiers and specialized consumer electronic items. The thin-film hybrids are made using thermo-compression-bonded gold lead wires rather than the more advanced approaches, such as beam leads. Russian materials specialists disclaim the use of any unusual thin-film materials or out-of-the-ordinary ceramic substrates. Critics who examined the Russian IC's said the workmanship was somewhat below par.

Nonetheless, the Soviets speak with pride of their accomplishments, calling attention to a new monolithic MOS

memory matrix with 1,360 MOS transistors on a single chip; ECL with 4-nanosecond delay and 80-milliwatt dissipation; TTL with 60-nsec delay and 3-mw dissipation; and DTL with 90-nsec delay and 23 mw dissipation.

While these specifications clearly indicate that the Russians have no technological advantages over their Western competitors, it is equally clear that they are taking the long-term view. Last year, according to their own estimates, they exported \$150,000 worth of IC's to Eastern Bloc countries. In the future they envision export sales of several million IC's annually—the exact quantity and timing depending on present evaluations by potential customers. But this evaluation phase may stretch out further than the Russians expect. For example, a solid prospect a year ago for Russian-made MOS devices was Italy's Ing. C. Olivetti, for its desk calculators. But at the time of the Paris show, Olivetti still had not decided to buy.

In the meantime, the Russians are not pinning their hopes on IC's alone. During the recent component shortages in West Germany, the Russians enjoyed an upsurge in diode sales and could have sold a lot of transistors, too, except for discrepancies in packages. In still another area, both Kodak and IBM are showing interest in Russian light-emitting diodes, and both companies may test sample lots. The Russians also are hoping to sell power transistors, field effect transistors (both n and p channel), and varicaps. The latter have tuning ratios of up to 1.8 and Q's from 20 to 300.

Not all of the approximately 150 new devices the Russians exhibited in Paris were solid state. Shown for the first time outside the Soviet Union were radar tubes

Published every other Monday by McGraw-Hill, Inc. Founder: James H. McGraw 1860-1948. Publication office 99 North Broadway, Albany, N. Y. 12202; second class postage paid at Albany, N. Y. and additional mailing offices.

Executive, editorial, circulation and advertising addresses: Electronics, McGraw-Hill Building, 330 W. 42nd Street, New York, N. Y. 10036. Telephone (212) 971-3333. Teletype TWX N. Y. 710-581-4235. Cable address: MCGRAWHILLN.Y.

Subscriptions solicited only from those professionally engaged in electronics technology. Subscription rates: qualified subscribers in the United States and possessions and Canada, \$8.00 one year, \$12.00 two years, \$16.00 three years; all other countries \$25.00 one year. Non-qualified subscribers in the U.S. and possessions and Canada, \$25.00 one year; all other countries \$50.00. Air freight service to Japan \$50.00 one year. Single copies: United States and possessions and Canada, \$1.00; all other countries, \$1.75. Officers of McGraw-Hill Publications Company: Joseph H. Allen, President; John R. Emory, J. Elton Tuohig, Senior Vice Presidents; Gordon L. Jones Jr., Group Vice President; Vice Presidents: John R. Callahan, Editorial; John M. Holden, Marketing; David G. Jensen, Manufacturing; Jerome D. Luntz, Planning & Development; Robert F. Marshall, Administration; Robert M. Wilhelmy, Finance; Director of Circulation: Ralph Blackburn.

Officers of the Corporation: Shelton Fisher, President and Chief Executive Officer; John J. Cooke, Senior Vice President and Secretary; Gordon W. McKinley, Vice President and Treasurer. Title © registered in U.S. Patent Office; © Copyright 1970 by McGraw-Hill, Inc. All rights reserved. The contents of this publication may not be reproduced either in whole or in part without the consent of copyright owner.

Subscribers: The publisher, upon written request to our New York office from any subscriber, agrees to refund that part of the subscription price applying to copies not yet mailed. Please send change of address notices or complaints to Fulfillment Manager; subscription orders to Circulation Manager, Electronics at address below. Change of address notices should provide old as well as new address, including postal zip code number. If possible, attach address label from recent issue. Allow one month for change to become effective.

Postmaster: Please send form 3579 to Fulfillment Manager, Electronics, P.O. Box 430, Hightstown, New Jersey 08520.

ГАБАРИТНЫЙ ЧЕРТЕЖ

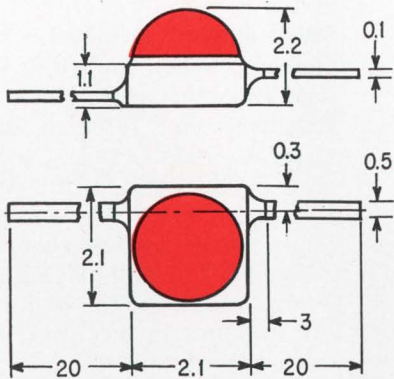

КЛ101А - КЛ101Б
(silicon carbide light source)

capable of displaying character, tv, or radar information simultaneously, as well as optically projected data; a high-resolution crt for photography and xerography applications; and a high-sensitivity oscilloscope tube covering the 0 to 1.5 gigahertz band. A touch of Madison Avenue was evident in the Russians' Western-style marketing demeanor—they touted a line of ceramic capacitors as "the best in the world."

In addition to components, the Russians will sell semiconductor materials, ranging from silicon wafers to such less-utilitarian materials as gallium arsenide, cadmium sulfide and cadmium selenide. But whereas a year ago the Soviets said they had unlimited quantities of high-quality silicon for sale, there is now some question as to whether their domestic market will absorb a good deal of the silicon.

The responsibility for developing markets for Soviet electronic components, including integrated circuits, rests with the trading company Mashpriborintorg. The plan put forth a year ago to market IC's directly to equipment manufacturers, bypassing European distributors, is out; Mashpriborintorg already has assigned distribution rights in France and West Germany. One of the current big problems involves tightening the lines of communication between Russian IC designers and the ultimate customers, particularly during the critical device-evaluation periods.

Russian technologists would have one believe that the devices revealed at Paris represent just the tip of a vast iceberg of electronics products. Even so, the road to marketing such products in the West probably will be more difficult than the Russian marketers expect.—D.C. ●

McGraw-Hill News Service

Director: Arthur L. Moore; Atlanta: Fran Ridgway; Chicago: Robert E. Lee; Cleveland: Arthur Zimmerman; Dallas: Marvin Reid; Detroit: James Wargo; Houston: Barbara LaRoux; Los Angeles: Michael Murphy; San Francisco: Margaret Drossel, Tyler Marshall; Seattle: Ray Bloomberg; Washington: Charles Gardner, James Canan, Herbert W. Cheshire, Seth Payne, Warren Burkett, William D. Hickman; Bonn: Robert F. Ingersoll; Brussels: James Smith; Hong Kong: Kate Mattock; London: John Shinn; Mexico City: Gerald Parkinson; Milan: Jack Star; Moscow: Jack Winkler; Paris: Robert E. Farrell, Stewart Toy; Tokyo: Marvin Petal

To the Editor:

The remarks attributed to Richard H. Stern, chief of the new patent unit in the Justice Department's antitrust division [Feb. 16, p. 14], raise some questions about the nature of patents. How can a patent, as stated in the U.S. Constitution, "secure for limited time to authors and inventors the exclusive right to their respective writings and discoveries" without hampering free enterprise?

Each of the patents that I hold grants to me as well as my successors, heirs or assigns a time limited right to exclude others from making, using or selling the said invention. These rights represent a payment to me in return for my willingness to make my invention known at once.

It would be most interesting to learn from Mr. Stern what kind of limitation of the inventor's rights he has in mind.

Jorgen P. Vinding

Vincomen

Monte Serano, Calif.

Mr. Richard W. McLaren, assistant Attorney General in the antitrust division of the Justice Department, in an address, April 9, to the antitrust section of the American Bar Association said that the patent-antitrust cases filed by the department have been, by and large, challenges to licensing arrangements and practices that law-review articles have questioned and knowledgeable patent-antitrust lawyers have counseled their clients against for a good quarter of a century. The objective of the patent-antitrust program is, according to McLaren, "to honor the patent grant, but to prevent its expansion beyond its intended scope—to protect competition against unreasonable restraints."

Place in the sun

To the Editor:

After reading the article on building low-threshold MOS, [April 13, p. 118], I was somewhat surprised to find that, on page 122, National Semiconductor was left out of the list of companies building low-threshold MOS. You must have a short memory. In your March 16 issue [p. 33] National was recognized as the largest MOS supplier. National announced its first low-threshold, 1-0-0 process in July 1967.

In addition, I must disagree with the "industry spokesman" who says that low-threshold devices can't drive TTL without a sense amplifier. That is completely untrue. Originally, an external resistor was required to handle the TTL sink current in our 1967 product, but recent products interface directly with bipolar at the input or output.

Gene Carter

National Semiconductor Corp.
Santa Clara, Calif.

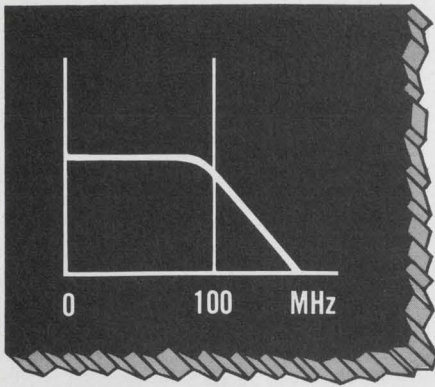

VIDEO SOURCE FOLLOWER

Problem: You want a zero offset source follower, operating from DC to 100 MHz.

Solution: One Siliconix 2N5912 and two matched resistors as shown.

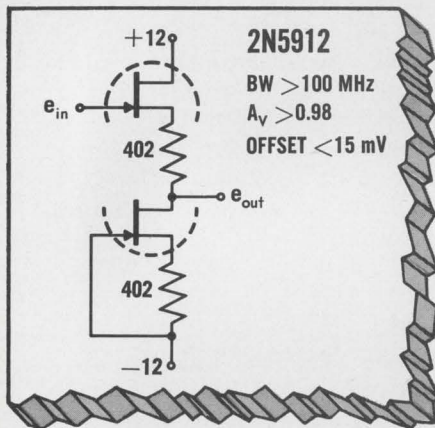

Half the device acts as a current generator for the source follower. Since the FETs are matched to less than 15 mV, $V_{GS1} = I_D R_1 = I_D R_2 = V_{GS2}$ and near zero offset is achieved.

We have more applications information on this and other FETs. Just write or call!

Siliconix
incorporated

2201 Laurelwood Rd. • Santa Clara, Calif. 95054
(408) 246-8000 Ext. 201 • TWX: 910-338-0227
In Europe: Siliconix Limited, Saunders Way, Sketty, Swansea, Great Britain

Who's Who in this issue

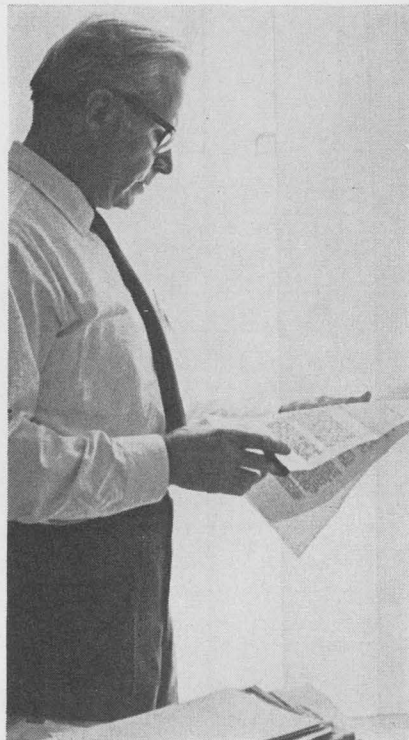

To Leon Magill fell the task of putting together the article on r-f power transistors abroad that starts on page 80. Magill holds a BSEE from the University of Oklahoma and an MSEE from the Columbia University School of Engineering. Communications editor of *Electronics* since September, Magill brought with him a strong background in communications work at Sperry Gyroscope, Radiometrics, and Grumman Aerospace.



Carter

An engineering-marketing team proved to be the right combination for the article that begins on page 107. Author Dale Mrazek is a digital applications engineer at National Semiconductor, while co-author Gene Carter is National's product marketing manager. Mrazek is a BSEE graduate of the University of Denver, and Carter is an alumnus of the Milwaukee School of Engineering.

Goldmark

"Well known" becomes a supreme understatement when applied to Peter Goldmark, who wrote the article that starts on page 94. President and research director of CBS Laboratories, Goldmark, a native of Hungary, holds a Ph.D. in physics from the University of Vienna. Among his many achievements are field sequential color television and the long-playing record. He also is responsible for the high-resolution read-out and ground recording system used in the lunar orbiter.



Odone

Like Hannibal before him, Giovanni Odone, author of the article that starts on page 102, crossed the Alps. But in Odone's case the trip was from the University of Rome to the research department of Switzerland's Paillard S.A. Odone holds a doctorate in physics.



Mrazek

Now...new, lower capacitance values!

Type 192P PACER[®] FILMITE[®] 'E' CAPACITORS

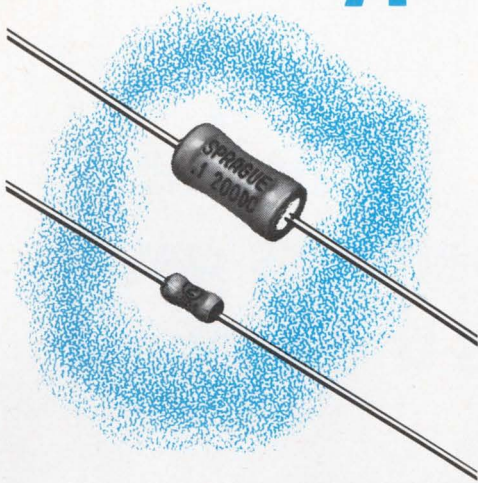

INFORMATION RETRIEVAL NO. 515

- Low-cost film capacitors with one-third the size of conventional tubulars
- Eight new low-capacitance values (100 pF thru 390 pF @ 200V) added to broad range of standard ratings
- Special construction—extended foil sections terminated in metal end caps, assuring positive contact with every turn of the electrodes
- End caps are also effective moisture barriers
- Entire assembly protected by special sleeve of high dielectric strength
- Request Engineering Bulletin 2066B

45C-0105R1

Newly broadened low-cost line!

Type 196D Dipped Solid-Electrolyte Tantalex[®] Capacitors

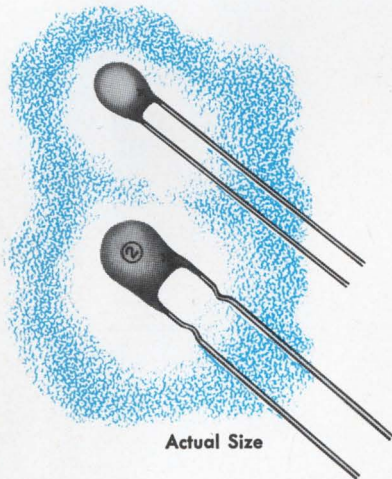

Actual Size

INFORMATION RETRIEVAL NO. 516

- Here's a capacitor design that admirably fills the need for low-cost yet dependable solid tantalum capacitors suitable for printed wiring boards
- Straight leads as well as crimped leads are readily available to meet your manufacturing needs
- Covering a broad range of capacitance values from .1 μ F to 330 μ F, with voltage ratings from 4 to 50 VDC, Type 196D Capacitors are protected by a tough insulating coating which is highly resistant to moisture and mechanical damage
- Request Engineering Bulletin 3545A.

45C-9124R2

For Engineering Bulletins as noted above, write to:
Technical Literature Service, Sprague Electric Co., 35
Marshall Street, North Adams, Massachusetts 01247.



'Sprague' and '®' are registered trademarks of the Sprague Electric Co.

THE BROAD-LINE PRODUCER OF ELECTRONIC PARTS

Why the bankers gave us the money:

From left: W. Jerry Sanders III, President and Chairman of the Board. D. John Carey, Managing Director of Complex Digital Operations. Sven E. Simonsen, Director of Engineering, Complex Digital Operations. Frank T. Botte, Director of Development, Analog Operations. James N. Giles, Director of Engineering, Analog Operations. Edwin J. Turney, Director of Sales and Administration. Jack F. Gifford, Director of Marketing and Business Development. R. Lawrence Stenger, Managing Director, Analog Operations.



At a time when credit couldn't get any tighter without twanging, when the semiconductor industry needed another bunch of hotshots like you need a power failure, a new company got the Bank of America, Schröder Rockefeller, The Capital Group, Inc. and Donaldson, Lufkin & Jenrette to give it enough cash, enough credit, enough commitment to make the new company a serious marketing factor before its first anniversary.

This is what we told them:

1. We are hotshots.

If you have to call us names, that's as good as any other.

As individuals and as a growing team, the members of this company invented circuits, processes and markets. Each has had a serious technical or marketing position with a major semiconductor firm. Each has his own commitment to excellence.

Let's face it: That's why we got together.

2. We know what we're doing.

We're in the large chip MSI and LIC business. Period. No jelly beans. No 10,000-gate freaks. Only the tough-to-make, easy-to-utilize mainstream circuits.

We selected the best people in the business to build (to our specifications) a processing facility that was optimized for the precise, complimentary process control requirements of complex, high performance digital and linear integrated circuits.

We decided to make only one quality of circuit: mil spec reliability or better. By this concentration of technical resources, we're able to get yields that let us sell circuits which meet the most stringent military

reliability requirements and the equally stringent pricing requirements of the commercial market.

And it feels so good, we're going to keep it up.

Oh, yes. Out of our checkered pasts we remembered that there was a kind of annoying difference between employees and owners. So we fixed it. Every employee here is an owner. (As a matter of fact, every owner is an employee except for the bankers.)

3. We know who you are.

You're in the fastest-growing part of the market; probably the computer and peripheral equipment business.

You've been had by experts, so you're ready to listen when we say:

We'll never announce a product that isn't in high volume production, in-house qualified through documented electrical and mechanical life testing, 100% stress tested to MIL STD 883 and in inventory.

The other reason we got the money is that we told the bankers we'd introduce complete product lines—digital and linear—for sale in volume before we are a year old.

And we will.

Advanced Micro Devices Inc.

901 Thompson Place, Sunnyvale, California 94086
Established May 1, 1969

Advanced Micro Devices has perfected the production technology of complex, mainstream digital and linear monolithic circuits. 

If you want
52,593*
 MSI and
 Linear circuits,
 we can ship
 today.

If you need
 another
125,566* - you'll
 have to wait
 a couple
 weeks.

Nine Linears (More to come.)

	Order Number	Package	Temperature Range	Price 100pc Mix
General Purpose Operational Amplifiers				
101A	LM101A	TO-5	-55°C to +125°C	\$30.00
	LM101AD	Dip	-55°C to +125°C	40.00
201A	LM201A	TO-5	-25°C to + 85°C	12.00
	LM201AD	Dip	-25°C to + 85°C	13.00
301A	LM301A	TO-5	0°C to + 70°C	3.45
	LM301AD	Dip	0°C to + 70°C	4.50
748	U5B7748312	TO-5	-55°C to +125°C	5.95
	U6A7748312	Dip	-55°C to +125°C	6.95
748C	U5B7748393	TO-5	0°C to + 70°C	3.25
	U6A7748393	Dip	0°C to + 70°C	3.25
101	LM101	TO-5	-55°C to +125°C	15.00
	LM101D	Dip	-55°C to +125°C	20.00
201	LM201	TO-5	-25°C to + 85°C	7.50
	LM201D	Dip	-25°C to + 85°C	8.80
301	LM301	TO-5	0°C to + 70°C	3.25
Compensated Operational Amplifiers				
107	LM107	TO-5	-55°C to +125°C	33.00
	LM107D	Dip	-55°C to +125°C	40.00
207	LM207	TO-5	-25°C to + 85°C	13.00
	LM207D	Dip	-25°C to + 85°C	14.50
307	LM307	TO-5	0°C to + 70°C	3.95
	LM307D	Dip	0°C to + 70°C	5.00
741	U5B7741312	TO-5	-55°C to +125°C	5.95
	U6A7741312	Dip	-55°C to +125°C	6.95
741C	U5B7741393	TO-5	0°C to + 70°C	3.25
	U6A7741393	Dip	0°C to + 70°C	3.25
Dual Operational Amplifiers				
747	U6W7747312	Dip	-55°C to +125°C	18.00
	U6W7747393	Dip	0°C to + 70°C	7.50
High Speed Operational Amplifiers				
715	U5F7715312	TO-5	-55°C to +125°C	30.00
	U6A7715312	Dip	-55°C to +125°C	36.00
715C	U5F7715393	TO-5	0°C to + 70°C	7.95
	U6A7715393	Dip	0°C to + 70°C	9.55
Video/Sense Amplifiers				
733	U5F7733312	TO-5	-55°C to +125°C	7.95
	U6A7733312	Dip	-55°C to +125°C	15.00
733C	U5F7733393	TO-5	0°C to + 70°C	3.95
	U6A7733393	Dip	0°C to + 70°C	7.10
Voltage Regulators				
723	U5R7723312	TO-5	-55°C to +125°C	5.95
723C	U5R7723393	TO-5	0°C to + 70°C	3.25

Nine MSI (More to come.)

	Order Number	Package	Temperature Range	Price 100pc Mix
Counters				
8284A	N8284A	Dip	0°C to + 75°C	\$ 5.85
	S8284A	Dip	-55°C to +125°C	11.70
8285A	N8285A	Dip	0°C to + 75°C	5.85
	S8285A	Dip	-55°C to +125°C	11.70
9310	U6B931059X	Dip	0°C to + 75°C	11.75
	U6B931051X	Dip	-55°C to +125°C	16.00
9316	U6B931659X	Dip	0°C to + 75°C	11.75
	U6B931651X	Dip	-55°C to +125°C	16.00
Demultiplexers				
9301	U6B930159X	Dip	0°C to + 75°C	6.25
	U6B930151X	Dip	-55°C to +125°C	9.35
Multiplexers				
9309	U6B930959X	Dip	0°C to + 75°C	5.30
	U6B930951X	Dip	-55°C to +125°C	7.95
9312	U6B931259X	Dip	0°C to + 75°C	5.30
	U6B931251X	Dip	-55°C to +125°C	7.95
Registers				
9300	U6B930059X	Dip	0°C to + 75°C	6.50
	U6B930051X	Dip	-55°C to +125°C	9.75
Adders				
9304	U6B930459X	Dip	0°C to + 75°C	7.50
	U6B930451X	Dip	-55°C to +125°C	10.25

1. All units listed here are functionally, electrically and pin-for-pin replacement for the original manufacturers' devices.
2. All units, hermetic DIP and TO-5, are subjected to 100% stress test as outlined in MIL STD 883 Test Method T5004.

MSI & Linear Mixing Discounts!

Only Advanced Micro Devices offers quantity discounts on combined orders for complex digital and linear circuits. A minimum of ten pieces of a single device type can be combined for 100 or 1000 piece mixed quantity pricing.

Here's an example:

Qty.	Device	10-99	100pc Mix price	Savings/ Device
10	101A	\$36.00	\$30.00	\$6.00
15	715C	9.55	7.95	1.60
25	723C	3.90	3.25	0.65
25	9310	14.00	11.75	2.25
25	9300	7.80	6.50	1.30

*Last time we checked (at 5:00PM, April 11, 1970) we had about a third of our product in box stock inventory and the rest in finished dice, two to four weeks away from box stock.

To order, call us at 800-538-7904 toll free or, in California, call 408-732-2400.

For product and quantity pricing information, circle the bingo number.

Advanced Micro Devices has perfected the production technology of complex, mainstream digital and linear monolithic circuits.

**Advanced
Micro
Devices,
Inc.** 

901 Thompson Place, Sunnyvale, California 94086
Established May 1, 1969
TWX 910-339-9280



**“No one made a
small, quiet, medium-speed
chain printer for \$9500.
So Mohawk did.”**

George C. Hohl, OEM Marketing Director, discusses a new product.

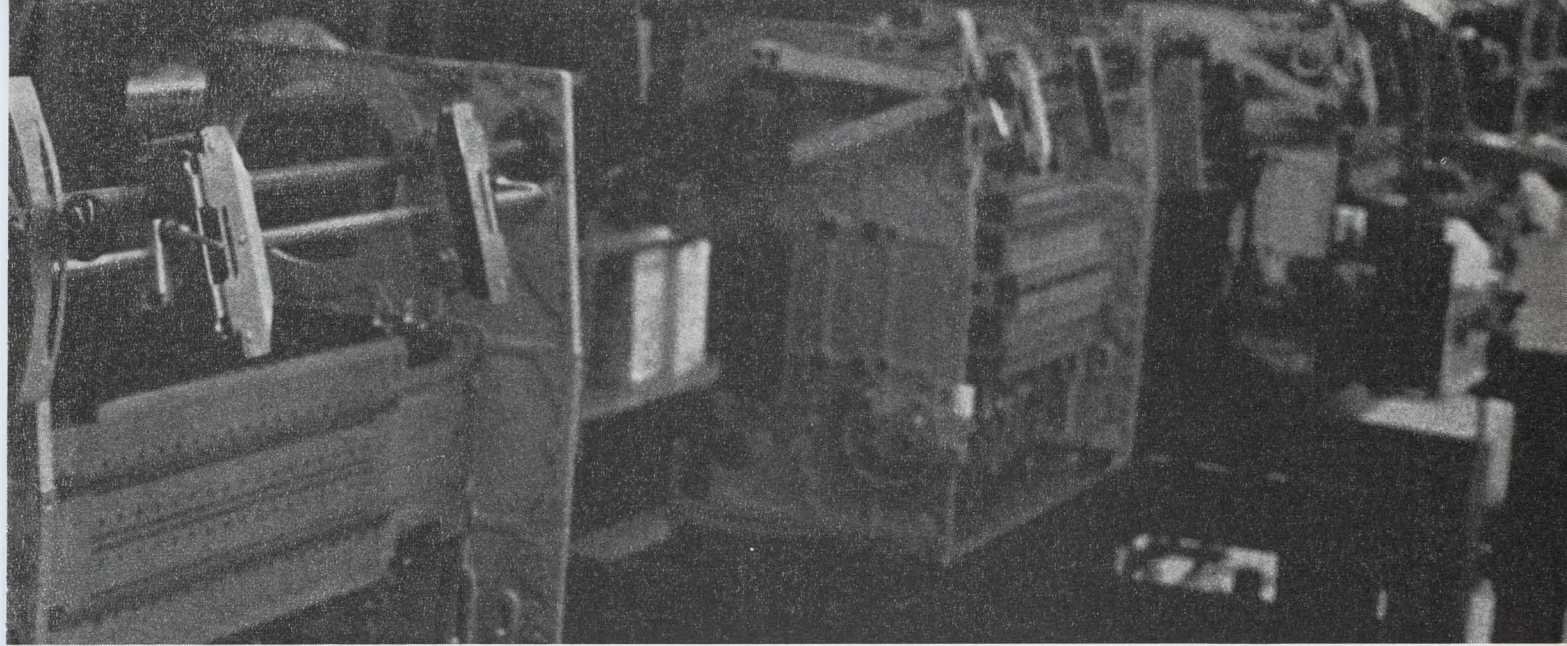

“We saw a gap in the printer field. Either you paid a lot of money to get a lot of speed and sophistication, or you could pay a little and get very little in return. We decided to aim our printer somewhere in between.

“Chain printers are mechanically simpler, easier to maintain, less expensive. Their flat face characters give good print characteristics, too.

“Our design requirements were rough. We wanted 300 lines-per-minute with such niceties as easily changeable fonts, and yet we wanted to sell it for less than \$10K. It had to be small, and yet we couldn't lose accessibility. The design engineers grumbled, but they made it.

“The changeable font cartridge is great—an operator can quickly switch the font chain—and we're offering fonts from 16 to 128 characters.

“We designed a disposable ribbon cartridge to make ribbon

changes quick and clean. Paper handling is enclosed to stay clean, too. And everything that could be modularized, was modularized.

“We considered noise reduction vital—anyone who has worked in a printer room knows why. Well, compared to other printers, you'd hardly know this one was working.

“We're selling the printer for \$9500 in OEM quantities, and some variations cost even less. So you get a lot of performance in a very little printer—for very little money.”

Mohawk Data Sciences Corp.
Herkimer, New York



Being



st

is what you'd expect
of **BALLANTINE**

After all . . . over the past
three decades we've
developed the



Systems Compatible
AC DVM with 10 MHz
Response



True RMS Voltmeter
with 20 MHz Response



Sensitive Wideband
True RMS Voltmeter



Sensitive Ultra-Low
Frequency Voltmeter



Sensitive
AC Voltmeter



AC Voltmeter Utilizing
Logarithmic Indicating
Meter

and during 1970
we will introduce



7 more



Watch for them!

In the meantime, request
a copy of our latest catalog.

Contact us at:

The Singer Company
Ballantine Operation
Boonton, N.J. 07005
201-334-1432

SINGER

INSTRUMENTATION

Who's Who in electronics

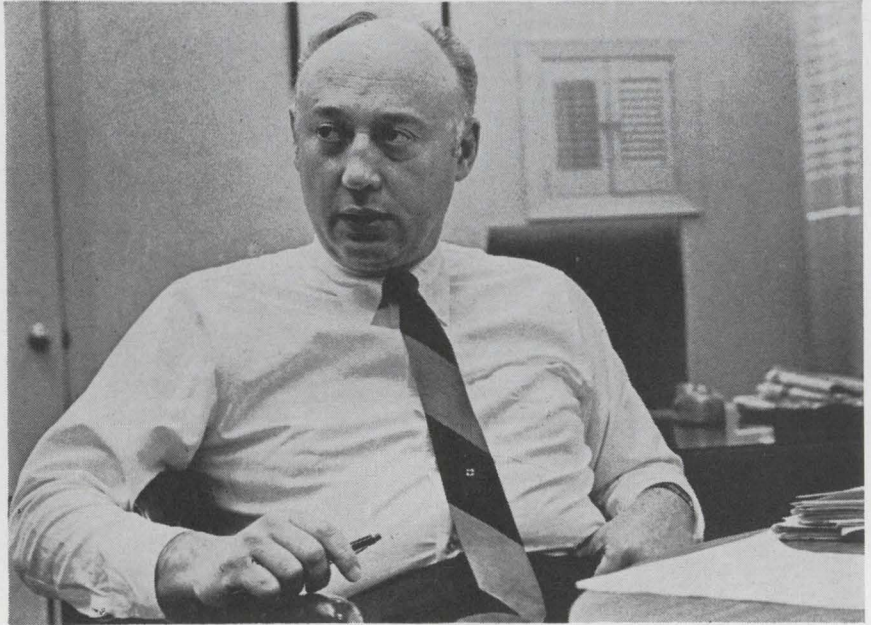

Seelig

For a year now, Gerard L. Seelig has been president of the Lockheed Electronics Co. As such, his main mission there has been to increase the firm's nonmilitary and aerospace business. In other words, he's turning Lockheed Electronics into a commercial electronics company, and judging by the numbers, he's doing a good job. As of this year, nearly 40% of the firm's business is commercial, and in the next few years, he predicts, that figure should rise to at least 50%.

Thus, it's understandable that Gerry Seelig bristles at headlines like the one that appeared earlier this month in the business section of a leading daily newspaper: "Lockheed's Illness Is Contagious." The reference, of course, is to the financially distressed parent company, the Lockheed Aircraft Corp. in Burbank, Calif., and its trouble-plagued C-5 military aircraft program. But publicity like that isn't needed by Lockheed Electronics, a \$100 million company in its own right. "You might almost say that one of our biggest problems right now is getting out from under the wing of the C-5," Seelig complains.

Getting wet. Ten years ago, 90% of Lockheed Electronics' business was military and most of that was performed for the parent organization. And as many other military-

and space-oriented companies have found out, "You can't just wave a magic wand and come up commercial," Seelig explains. "There are one of two ways you can do it, but only one works. You can jump right in—always a risky way of doing things—or you can do it slowly, one toe at a time. Roughly five years ago, we started to make major diversifications into the commercial-industrial sector."

As it is, Lockheed Electronics is now split into three major groups: Military Systems, Technical Services and Support, and Commercial Electronics, which includes both the Industrial Technology and the Data Products divisions.

Not that Lockheed Electronics is in any way getting out of the military business. In fact, the Military Systems division recently won a \$7 million Navy contract for the Mark 86 gunfire control system. And the division is also working on, among other things, follow-on contracts for checkout and test equipment for the Polaris and Poseidon missile programs.

But still, it's his company's growth in the commercial sector that Seelig would rather expound upon, and he points particularly to the Data Products division in Los Angeles—which shouldn't be surprising. Before taking over the

Beckman 136MHz \$1375.*

Universal Counter and Timer
Fully Programmable
Field Replaceable ICs
Signal Level Indicators

Two Counters in One • Burst Mode • Frequency • Period • Single-Channel Pulse Width & Pulse Separation • Two-Channel Time Interval • Multiple Period • Ratio • Multiple Ratio • 25 μ s Recycle Time

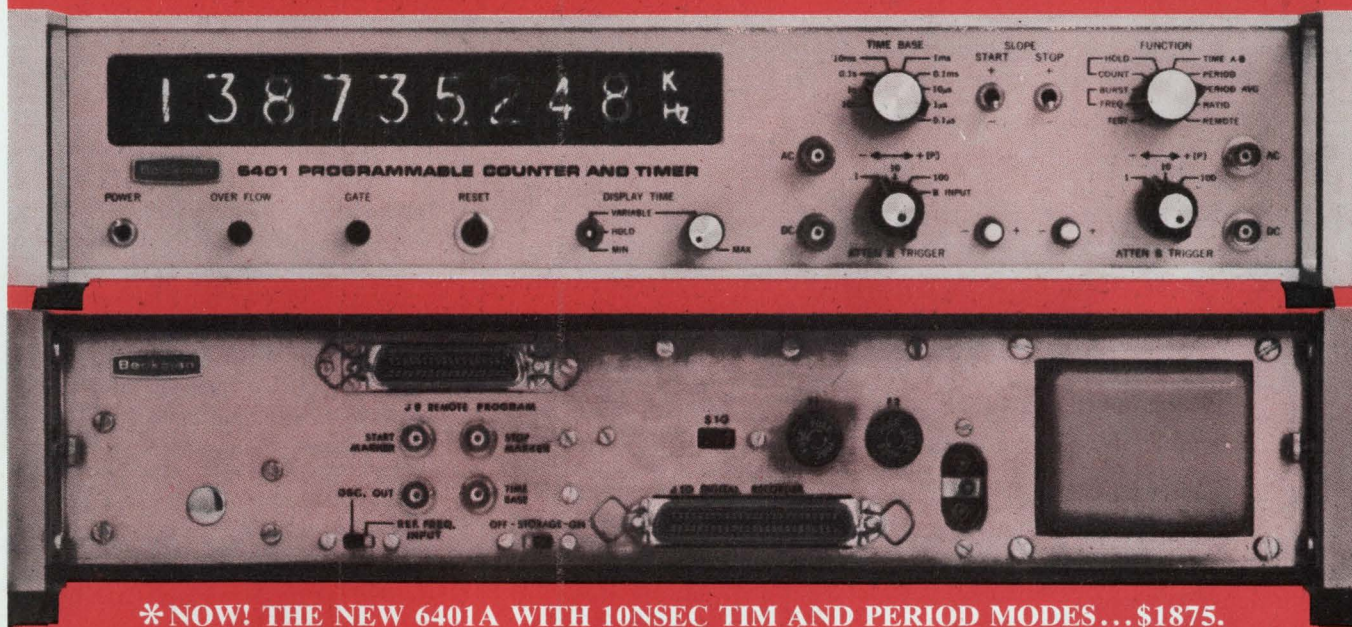

*NOW! THE NEW 6401A WITH 10NSEC TIM AND PERIOD MODES... \$1875.

Beckman

INSTRUMENTS, INC.
ELECTRONIC INSTRUMENTS DIVISION
RICHMOND, CALIFORNIA • 94804

Place your order for the Model 6401 with your local Beckman representative:

Barnhill Associates • Denver, (303) 934-5505 • Albuquerque, (505) 265-7766 • Phoenix, (602) 263-1250 • Houston, (713) 621-0040 • Richardson, (214) 231-2573 • Salt Lake City, (801) 487-1327 • BCS Associates, Inc. • Orlando, (305) 843-1510 • Greensboro, (919) 273-1918 • Huntsville, (205) 881-6220 • Williamsburg, (707) 229-6198 • Plantation, Fla., (305) 584-7556 • Burlingame Associates, Ltd. • Mount Vernon, (914) 664-7530 • New York City area, (212) 933-5555 • Rockville, (301) 427-1255 • Bala Cynwyd, (215) 835-2080 • Syracuse, (315) 454-2408 • New York State, Enterprise 9-6400 • Cozzins and Cudahy, Inc., • Rosemont, Ill., (312) 825-1144 • Cleveland, (216) 725-5660 • Detroit, (313) 585-5159 • Indianapolis, (317) 244-2456 • Minneapolis, (612) 920-1022 • St. Louis, (314) 423-1234 • Instrument Specialists, Inc. • Glendale, Calif., (213) 245-9404 • San Diego, (714) 453-1833 • Santa Clara, (408) 244-1505 • Seatronics, Inc. • Seattle, (206) 767-4330 • Yewell Electronic Sales, Inc. • Lexington, (617) 861-8620 • Easton, (203) 261-2241 • Beckman Instruments, Inc., Electronic Instruments Division, Richmond Operations, (415) 526-7730

INTERNATIONAL SUBSIDIARIES: AMSTERDAM; CAPE TOWN; GENEVA; GLENROTHES, SCOTLAND; LONDON; MEXICO CITY; MUNICH; PARIS; STOCKHOLM; TOKYO; VIENNA

ASK COMPET

Take Compet CS-661 into account. It presents a printed proof of all calculation steps and data at electronic calculator speeds. The paper print-out reads easily due to auto-spacing and auto-punctuation. Feeding is also automatic.

Sharp MOS-IC design provides two working registers plus one full-function memory register for complex mixed calculations up to 16 digits.

Keyboard layout is simple and easy to follow. Sharp's decimal point pre-set system, rounding-off/down selector, and constant switch cut down on calculation time. All keys have double-set protection built in.

This is the Compet to ask if you want the best of both calculation worlds—printed proof at electronic speed.

The stylish, convenient Compet CS-661.



Model CS-661

SHARP
SHARP CORPORATION OSAKA, JAPAN

U.S. Subsidiary: SHARP ELECTRONICS CORP. 178 Commerce Road Carlstadt, New Jersey

Who's Who in electronics

reins at Lockheed Electronics' Plainfield, N.J., headquarters, Seelig was general manager of Data Products. He says: "When I joined that division in 1963, we did less than \$6 million worth of business, 90% of which was military and 90% of which was intercompany. Now, DPD is doing \$50 million, more than eight-fold growth, and 90% of it is commercial business."

Core of the matter. Last year, according to Seelig's estimates, Data Products sold 1.4 billion bits of ferrite-core memories, making it one of the country's largest independent suppliers of core memory. Some of it was sold as just plain cores, some in stacks, but more were sold as memory systems, he explains. The division is also producing plated-wire memories, but that's still a pilot operation—"About two to three million bits per week—just 10% of what we do in cores."

The division, according to Seelig, also ranks as one of the leading independent manufacturers of interconnections for computers—in other words, p-c board.

And, finally, there's the MAC (for multiapplication computer) 16 minicomputer, a 1-microsecond, 16-bit, 4,000-word machine that has been on the market for two years and sells for \$11,500. So far, the venture into computers has been a success. "We've had several million dollars worth of sign-ups for the machine in the first year, and we expect to do three or four times that this year," he says.

MAC son. So successful, in fact, has MAC 16 been, that Lockheed Electronics is now set to announce its second entry in the minicomputer field, the MAC 16J (for junior, as it's jokingly referred to around the plant). This too is a 1- μ sec machine for under \$8,000.

Seelig's faith in computers and computer systems at Lockheed Electronics has a solid basis. Besides being the man who built up the Data Products division, Jerry Seelig feels that his promotion to president of the company was a not-so-subtle way for the parent organization, Lockheed Aircraft, to assure the continued expansion of its Plainfield subsidiary into commercial EDP.

If price and performance are important— here's a 7 MHz value

This is a lab-quality, all-solid-state scope—at a price you'd ordinarily expect to pay for older vacuum-tube models.

Value—DC to 7 MHz bandwidth. This frequency range covers audio, video and most control circuit applications.

Value—5 mV to 20 V per division deflection factor. Here is sufficient capability to pick up most electronic or electro-mechanical system outputs without distortion or need for additional amplifiers.

Value—Rock solid triggering with capabilities ordinarily found only in more expensive lab type oscilloscopes . . . triggered or recurrent sweep, single-sweep, and automatic triggering.

Value—Low drift, long-term stability. Field effect transistors virtually eliminate drift from temperature changes, shock or vibration. Long-term stability means less frequent calibration.

Value—Easy to use. Logical arrangements of controls, beam finder, auto-triggering make operation easy. Interlocking controls on sweep time and magnifier prevent readout errors.

Value—Easy-to-see display. Internal graticule, 8 x 10 cm CRT for measurement accuracy. Bright, small spot-size trace increases visibility and resolution.

Value—Available in single channel cabinet or rack versions (1215A or 1215B), or in dual-channel cabinet or rack versions (1217A or 1217B). Electrical characteristics are identical. Rack version is only 5¼" high. Panel on the cabinet version is about the size of this page.

Value—Price, 1215A/B, \$950; 1217A/B, \$1175. Add up the features, then divide by price and you'll find this is the greatest performance/dollar value ever offered.

080/8

These 7 MHz oscilloscopes are new members of HP's growing family of low- and mid-frequency oscilloscopes. In addition to these new mid-range scopes you have 500 kHz scopes in 14 models with your choice of: Single or dual trace, 100 μ V/cm or 5 mV/cm deflection factors, conventional display or variable persistence and storage, all in cabinet or rack versions.

If you're looking for accurate mid-frequency measurements, ease of use, reliability—all at a low cost—here's a real 7 MHz value!

Call your local HP field engineer. Or, write to Hewlett-Packard, Palo Alto, California 94304. Europe: 1217 Meyrin-Geneva, Switzerland.

HEWLETT  PACKARD
OSCILLOSCOPE SYSTEMS

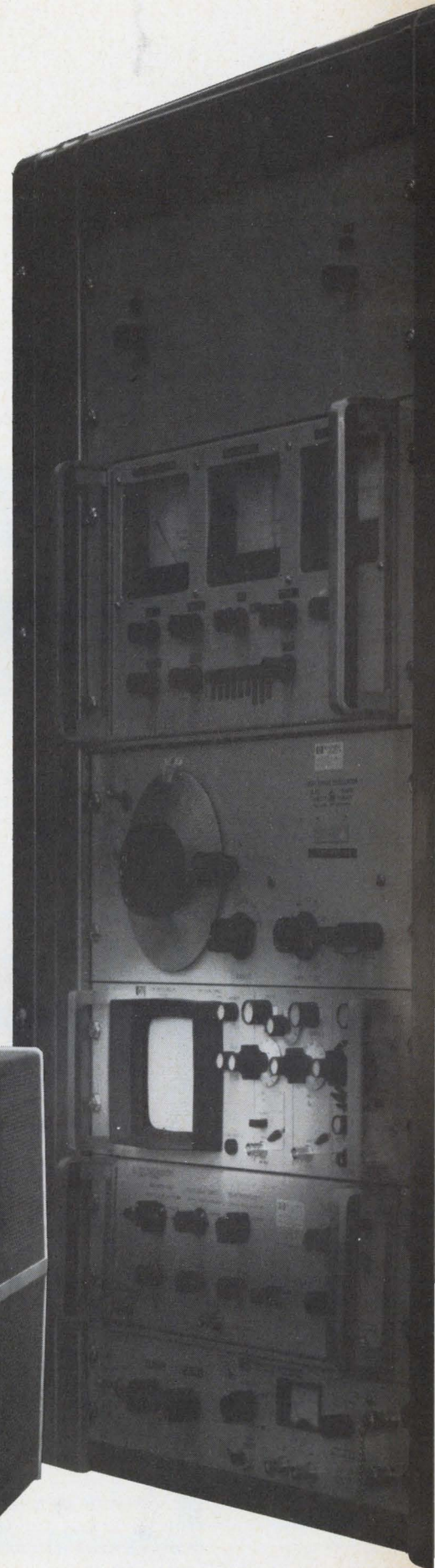
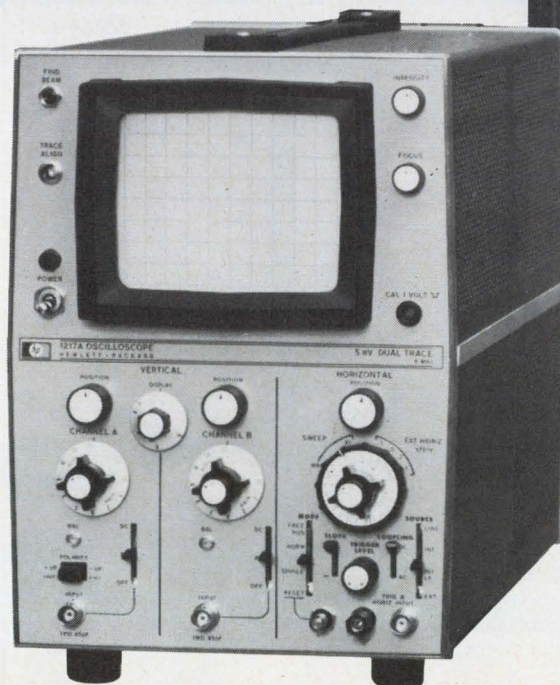



1400V, 5.0A Transistors. Delivering now, in quantity.

The Kokomoans' new DTS 802 and 804 NPN triple diffused silicon high energy transistors are here. You can order them from your Delco Radio distributors now in sample or production quantities. They were specially designed for high voltage inductive switching from rectified 3 phase 220 line, and magnetic deflection circuits in large screen color TV receivers.

They've been application-tested from production lots by

prospective users with stringent reliability requirements. They do the job. And their energy handling capability is verified by Delco Pulse Energy Testing.

The high energy reliability of Delco silicon power transistors has earned them a reputation for survival in the toughest switching jobs. It's a built-in advantage, vitally important where circuits are subject to transients or fault conditions.

Now you can simplify the design of high energy circuits with reduced size, weight, and component cost. Convert HV tube circuits to solid state reliability without the complexity associated with high current, low voltage devices. And fewer components mean higher reliability.

For prices and delivery or additional data on Delco's new DTS 802 and 804 contact us or your nearest Delco Radio distributor.

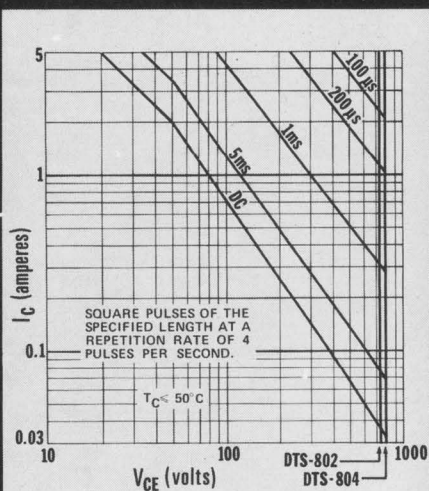

SAFE OPERATING CURVES

PARAMETER	DTS-802	DTS-804
Collector to emitter voltage (V_{CEX})	1200V max.	1400V max.
Collector to emitter voltage (V_{CEO})	1000V max.	1000V max.
Sustaining voltage (V_{CEO} sus)	750V min.	800V min.
Emitter to base voltage (V_{EBO})	5V max.	5V max.
Collector current (I_C) continuous	5A max.	5A max.
h_{FE} , $I_C = 3.5A$, $V_{CE} = 5V$	2.2 min.	2.2 min.
*P.E.T.; $I_C = 7A$, $V_{CE} = 200V$, $t_p = 300 \mu\text{sec}$, duty cycle $< 4\%$	420 mJ min.	420 mJ min.

*Pulse Energy Test

Available in solid copper JEDEC TO-3 package.

From these Delco Semiconductor distributors.

ALA., BIRMINGHAM • Forbes Distributing Co., Inc. (205)-251-4104
 ARIZ., PHOENIX • Sterling Electronics, Inc. (602)-258-4531
 • Hyer/Cramer Electronics, Inc. (602)-263-1112
 CAL., LOS ANGELES • Kierulff Electronics, Inc. (213)-685-5511
 • Radio Products Sales, Inc. (213)-748-1271
 CAL., PALO ALTO • Kierulff Electronics, Inc. (415)-968-6292
 CAL., SAN DIEGO • Milo of California, Inc. (714)-232-8951
 COLO., COLORADO SPRINGS • L. B. Walker Radio Co. (303)-636-1661
 COLO., DENVER • L. B. Walker Radio Co. (303)-935-2406
 • Hyer/Cramer Electronics Inc. (303)-758-2100
 FLA., MIAMI • Mountain Electronics, Subsidiary of Avnet, Inc., (305)-634-4556
 FLA., WEST PALM BEACH • Mountain Electronics, Subsidiary of Avnet, Inc., (305)-833-5701
 ILL., ROSEMONT • F-J-R/Midwest, Inc. (312)-678-8560
 ILL., SKOKIE • Merquip Electronics, Inc. (312)-282-5400
 IND., INDIANAPOLIS • Graham Electronics Supply, Inc. (317)-634-8486
 MD., BALTIMORE • Radio Electric Service Co. (301)-823-0070
 MASS., NEWTON • The Greene Shaw Co., Inc. (617)-969-8900
 MICH., KALAMAZOO • Electronic Supply Corp. (616)-381-4624
 MICH., ROMULUS (Detroit) • Harvey Radio Co. (313)-729-5500
 MINN., MINNEAPOLIS • Stark Electronics Supply Co. (612)-332-1325

MO., KANSAS CITY • Walters Radio Supply, Inc. (816)-531-7015
 MO., NO. KANSAS CITY • ECI Semiconductors, Inc. (816)-221-2400
 MO., ST. LOUIS • Electronic Components for Industry Co. (314)-647-5505
 N.J., CLIFTON • Eastern Radio Corporation (201)-471-6600
 N.M., ALBUQUERQUE • Hyer/Cramer Electronics Inc. (505)-265-5767
 • Sterling Electronics Inc. (505)-247-2486
 N.Y., BINGHAMTON • Federal Electronics, Inc. (607)-748-8211
 N.Y., NEW YORK • Harvey Radio Co., Inc. (212)-582-2590
 N.Y., WOODBURY, L.I. • Harvey Radio Company, Inc. (516)-921-8700
 OHIO, CINCINNATI • United Radio, Inc. (513)-761-4030
 OHIO, CLEVELAND • The W. M. Pattison Supply Co., Industrial Electronics Division (216)-441-3000
 OHIO, DAYTON • F-J-R/Ohio, Inc. (513)-278-9411
 OKLA., OKLAHOMA CITY • Radio, Inc. (405)-235-1551
 OKLA., TULSA • Radio, Inc. (918)-587-9123

PENN., PHILADELPHIA • Almo Electronics, Division of Sterling Electronics (215)-676-6000
 PENN., PITTSBURGH • RPC Electronics (412)-782-3770
 S.C., COLUMBIA • Dixie Radio Supply Co., Inc. (803)-253-5333
 TEXAS, DALLAS • Adleta Electronics Company (214)-742-8257
 TEXAS, FORT WORTH • Adleta Electronics Co. (817)-336-7446
 TEXAS, HOUSTON • Harrison Equipment Co., Inc. (713)-224-9131
 UTAH, SALT LAKE CITY • Hyer/Cramer Electronics Inc. (801)-487-3681
 VA., RICHMOND • Meridian Electronics, Inc., a Sterling Electronics Company (703)-353-6648
 WASH., SEATTLE • Kierulff Electronics, Inc. (206)-763-1550
 WASH., TACOMA • C & G Electronics Co. (206)-272-3181
 CANADA, ONT., SCARBOROUGH • Lake Engineering Co., Ltd. (416)-751-5980

Kokomoan's Regional Headquarters. Union, New Jersey* 07083, Box 1018 Chestnut Station, (201) 687-3770 ■ Santa Monica, Calif.* 90401, 726 Santa Monica Blvd., (213) 870-8807 ■ Chicago, Illinois* 60656, 5151 N. Harlem Avenue, (312) 775-5411 ■ Kokomo, Ind. 46901, 700 E. Firmin, (317) 459-2175 Home Office ■ *Office includes field lab and resident engineer for application assistance.



THE KOKOMOANS ARE IN POWER
DELCO RADIO
 DIVISION OF GENERAL MOTORS
 KOKOMO, INDIANA



ELECTRONIC MATERIALS

DOW CORNING®
3140 RTV
coating

clear, flowable silicone rubber coating;
non-corrosive to copper and other metals
TWO OUNCES

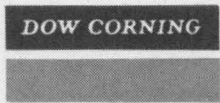

ELECTRONIC MATERIALS

DOW CORNING®
3140 RTV
coating

clear, flowable silicone rubber coating;
non-corrosive to copper and other metals
TWO OUNCES

DOW CORNING®
3141 RTV
coating

WHITE, FLOWABLE SILICONE RUBBER COATING;
NON-CORROSIVE TO COPPER AND OTHER METALS

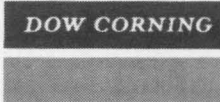

DOW CORNING®
3141 RTV
coating

WHITE, FLOWABLE SILICONE RUBBER COATING;
NON-CORROSIVE TO COPPER AND OTHER METALS
NET WT. 2 oz/57 g

DOW CORNING®
3144 RTV
adhesive/sealant

TRANSLUCENT, ROOM-TEMPERATURE-CURING
SILICONE RUBBER ADHESIVE SEALANT;
NON-CORROSIVE TO COPPER AND OTHER METALS
NET WT. 2 oz/57 g

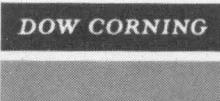

DOW CORNING®
3144 RTV
adhesive/sealant

TRANSLUCENT, ROOM-TEMPERATURE-CURING
SILICONE RUBBER ADHESIVE SEALANT;
NON-CORROSIVE TO COPPER AND OTHER METALS
NET WT. 2 oz/57 g

ELECTRONIC MATERIALS

DOW CORNING®
3145 RTV
adhesive/sealant

grey, non-slump silicone rubber sealant;
non-corrosive to copper and other metals
TWO OUNCES

DOW CORNING®
3145 RTV
adhesive/sealant

grey, non-slump silicone rubber sealant;
non-corrosive to copper and other metals
TWO OUNCES

ELECTRONIC MATERIALS



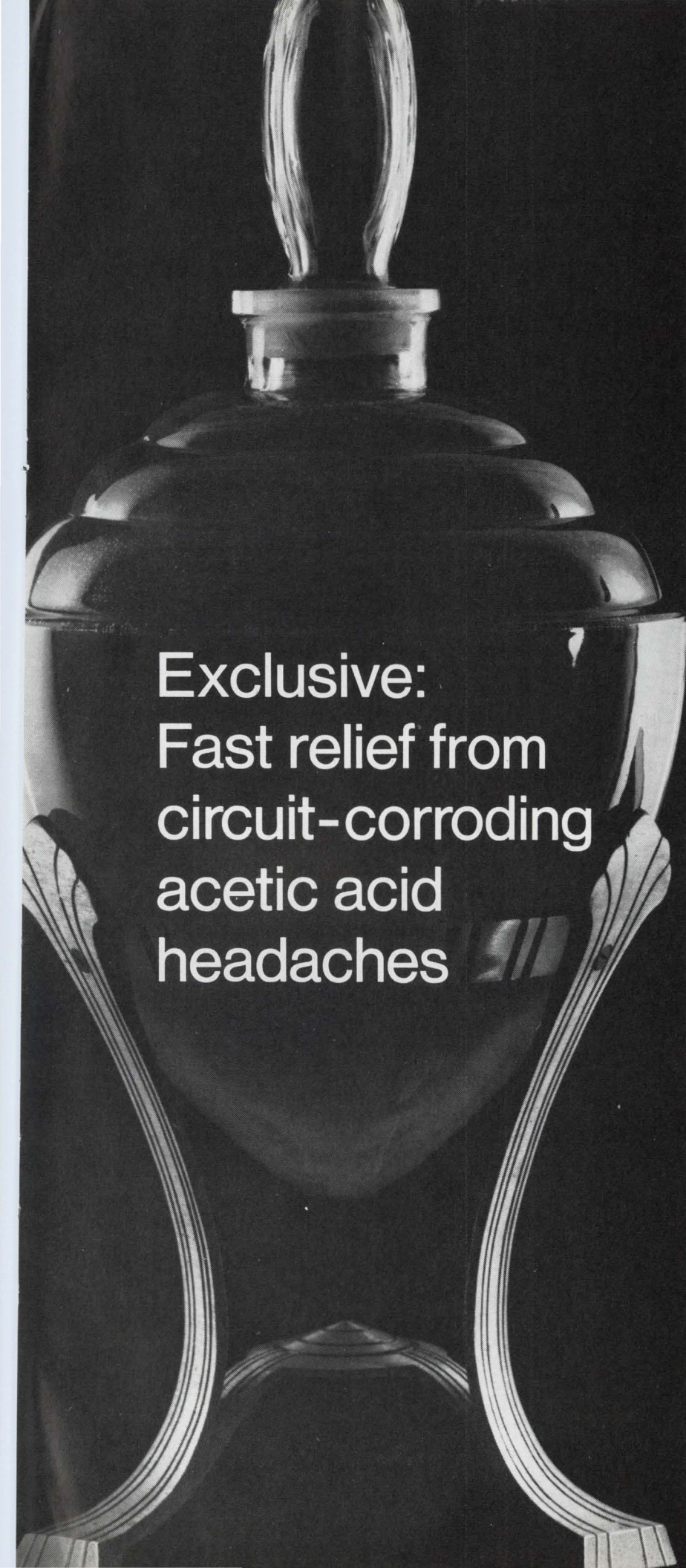

Exclusive:
Fast relief from
circuit-corroding
acetic acid
headaches

Dow Corning® silicone sealants and protective coatings are the only ones that do *not* release acetic acid or other corrosive by-products during cure. They were specifically developed to protect delicate circuit boards and other electronic components from corrosion, dust, dirt, abrasive particles, solvents and chemicals. They are strong, have excellent bond strength, electrical strength; are easy to apply, and cure quickly. There's no "vinegar" smell, either. Dow Corning 3140 (clear) and 3141 (opaque) RTV coatings are ready-to-use silicone rubbers that cure at room temperature. They are ideal for conformal coatings on printed circuit assemblies or for encapsulating small circuits or connectors. Dow Corning 3144 (clear) and 3145 (opaque) RTV adhesive/sealants are high-strength, non-corrosive, nonflowing silicone rubbers used to bond components and seal housings and connectors.

Stop component corrosion with these Dow Corning coatings and sealants. For more information, write Dow Corning Corporation, Dept. D -9342, Midland, Michigan 48640.

*Electrical / Electronic
materials from*

DOW CORNING

DOW CORNING

New low price:

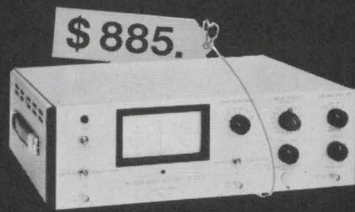

WILTRON PHASE METER

Here's what \$885. buys you —

- MAKE READING WITH 0.1° RESOLUTION at any phase angle over full 360° range at any frequency 10 Hz to 2 MHz.
- METER OFFSET in 10° steps permits the measurement of any phase angle with 0.1° resolution.
- $+180^\circ$ SWITCH permits measurements around 0° or around 180° to solve the problem of the angle of instability.
- VOLTAGE OUT directly proportional to phase permits digital phase readout on an external digital voltmeter.
- ACCURACY of phase output is $0.1^\circ \pm 0.3\%$ of phase angle being measured permits exacting measurements.
- HIGH SENSITIVITY with input range from 1 mV to 100 volts minimizes need for external amplifiers.
- CALIBRATION MAINTAINED even with large amplitude fluctuations of the test signal.

Also available from WILTRON: Digital Readout Phasemeter, a Differential Input version and a lower frequency version going down to 0.5 Hz.

Circle No. below for application data and your copy of WILTRON'S 1970 (36 page) catalog.



930 EAST MEADOW DRIVE
PALO ALTO, CALIFORNIA 94303
(415) 321-7428

W101

Meetings

Cherry blossom time in Dayton

Echoing the nation's concern about the fact that man is rapidly polluting the planet on which he lives, the National Aerospace Electronics Conference is seeking this year to emphasize the "use of aerospace electronics to better our environment, to help solve the problems of the planet on which we live." Good idea, perhaps, but the technical program falls short of this mark. With but a few exceptions, the program deals with what is generally expected at technical conferences—solutions to special engineering problems. And most of them, far from influencing the environment, have yet to operate effectively in the laboratory.

This year's Naecon, the 22nd annual event, takes place from May 18-20 at its usual locale—Dayton, Ohio. The 13 technical sessions and a technical exhibit will be housed at the Sheraton-Dayton Hotel.

In general. The session most nearly coming to grips with the environment is one on general aviation, an unlikely discussion topic in the shadow of the Air Force's giant Dayton-area development and procurement facilities. Wright-Patterson Air Force Base, for example, manages more than half of the Air Force's \$7 billion budget for research, development, test, and evaluation.

Helping the nation's numerous small aircraft navigate more effectively is the theme of the papers in the general aviation session. Michael Brandawie of the Federal Aviation Administration will go into the new area-navigation regulations, and George Cherry of MIT's Instrumentation Laboratory will describe how the FAA has integrated into navigation equipment the microwave scanning-beam instrument-landing system the agency has been testing.

Time-frequency concepts for air traffic control, of the kind used in the Air Transport Association's collision-avoidance system and regarded by many as the potential savior of the air traffic system in

the 1980's, will also have its own session. Robert Buck will present the FAA's viewpoints on the subject, and William Weiss of Autonetics will report on the FAA-sponsored analysis of a national airspace system using the time-frequency concepts. Jack Craigie of TRW will discuss a navigation satellite system, and William Sen of the Air Force's Electronic Systems division will describe his organization's attempts to combine communications and navigation using time-frequency techniques.

Computers. Two computer sessions will deal with parallel processors and software, with Leon Wald of Honeywell talking about an associative memory using large-scale integration, and speakers from the Systems Development Corp., Autonetics and Logicon examining special aerospace-oriented languages. Other sessions will be devoted to microelectronics, with Robert Werner of the Air Force Avionics Laboratory describing high-speed—up to 100 megahertz—metal oxide semiconductor circuitry, and Gordon Rabanus, also of the Avionics Laboratory, digging into the impact of silicon-nitride technology on the memory field. The rest of the technical areas include: bio-cybernetics, airborne reconnaissance and secondary power systems. A classified session will discuss the future of aerospace communications.

For further information, contact Joseph P. Matt, 4130 Linden Ave., Room 750, Dayton, Ohio 45432.

Hybrids bloom in capital

Hybrid microcircuits will dominate this year's Electronic Components Conference to be held May 13-15 at the Statler-Hilton Hotel in Washington. Highlights will be papers on materials selection, interconnection design, and fabrication techniques for hybrids, indicating

(Continued on p. 24)

Now! New automated diagnostic tools for detecting digital faults.

A new service! Mellonics offers three fast, reliable and economical computer programs for detecting functional logic faults in sequential digital circuits. Tested, proven, and in use today they meet your design needs for:

LOGIC SIMULATION

to certify design correctness.

TEST SEQUENCE VALIDATION

to verify that all potential functional faults in a logic design will be detected by your test procedure.

AUTOMATIC TEST SEQUENCE GENERATION

to produce a test procedure assuring that all testable functional faults in a logic design will be detected.

And they're easy to use. A qualified engineer/analyst supervises processing, with full data security. Details promptly on request. Contact Test Systems Marketing.

MELLONICS SYSTEMS DEVELOPMENT DIVISION
LITTON INDUSTRIES
1001 WEST MAUDE AVE., SUNNYVALE, CALIFORNIA 94086 (408) 245-0795



Hybrid thin-film microcircuits to custom specifications

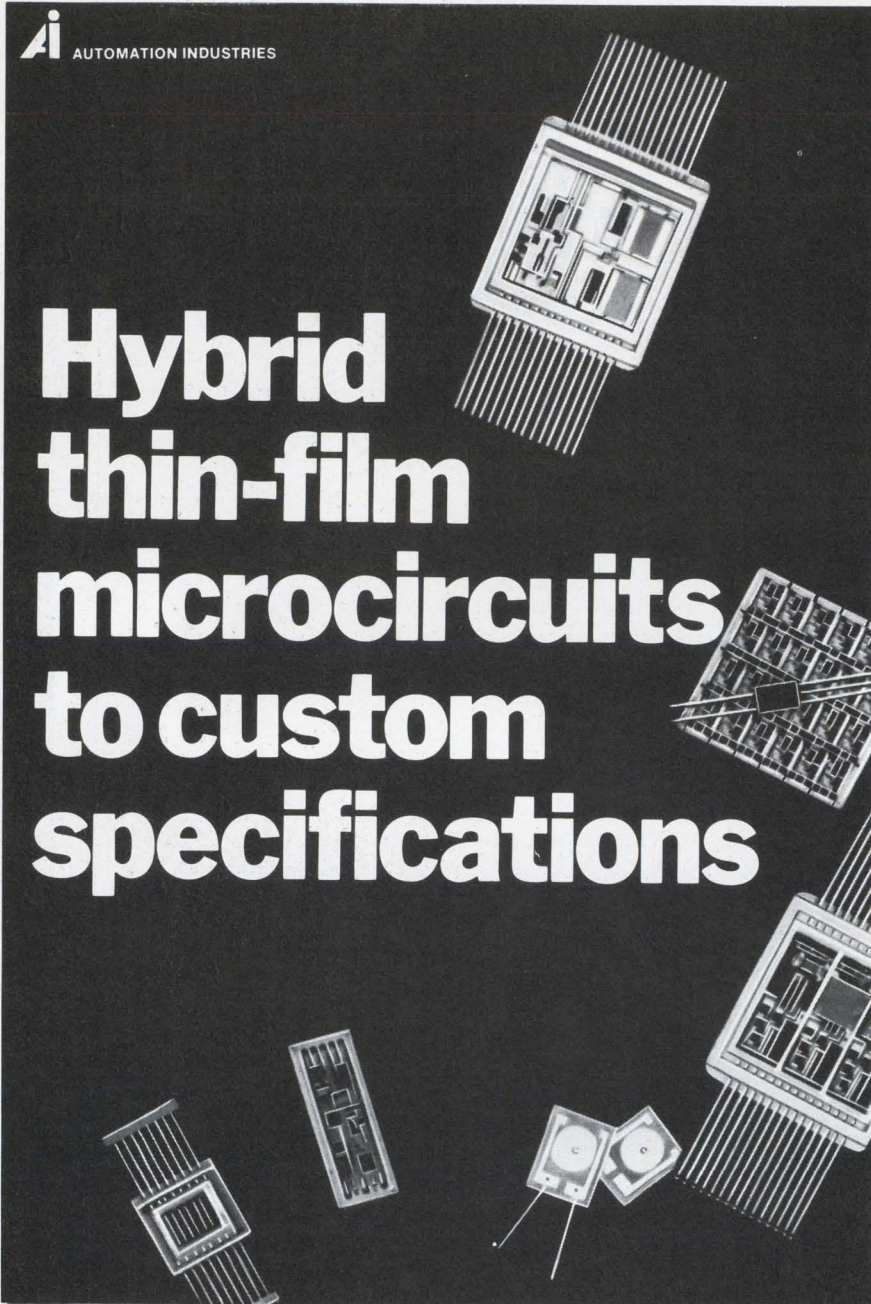

Working from detailed schematics or functional requirements, Vitro contracts for the design, layout, fabrication, packaging, testing and evaluation of microcircuits to customer specifications. Quantity production is not a Vitro requirement.

Our microelectronics staff maintains state-of-the-art capability and continues to develop improved design and fabrication techniques. Of particular interest is the fabrication of hybrid thin-film circuits in which discrete semi-conductor and integrated circuit chips are utilized in back-bonded, flip-chip, or beam-lead form. We can also provide thin-film inductors and resistors to customer requirements.

For a complete file on Vitro capabilities, contact Glenn Franck, Vitro Laboratories, 14000 Georgia Avenue, Silver Spring, Maryland 20910.



Meetings

(Continued from p. 22)

a significant change in emphasis from discrete components to "integrated" units. Sponsors are the Electronic Industries Association and the IEEE.

Two sessions will be devoted to materials, with papers on materials for hybrid resistors and capacitors. For example, A. Feuersanger and M.S. Wasserman of General Telephone and Electronics Laboratories, with I. Pratt of the U.S. Army Electronics Command, will report on the preparation and properties of thin-film capacitors with high capacitance per unit area—an important characteristic in crowded microcircuits. Capacities of 10 microfarads per square inch have been achieved. Metal nitrides as resistor materials will come under the scrutiny of C.Y.D. Huang of TRW. His focus will be on resistive glazes composed of titanium nitride and titanium. And Akio Sato, Y. Oda, and Y. Hishinuma of Nippon Electric, will report on a tantalum nitride thin-film resistor with a low-temperature coefficient of resistance.

Hybrid design is becoming more analytical, judging by the contribution of Jack G. Hewitt of the University of Denver and T.E. Christen of Hewlett-Packard. They'll discuss electrical conduction in cermet films.

In the thick. Thick-film hybrids will be treated in three sessions. Typical entries: "The Effect of Geometry on the Characteristics of Thick-Film Resistors" by Dietrich E. Riemer of EMR Telemetry; "The Influence of Geometry and Conductive Terminations of Thick-Film Resistors" by Sidney J. Stein and J.B. Garvin, Electro-Science Labs; and "The Economics of Thick-Film Hybrid Microcircuit Production" by Donald Hamer of State of the Art Inc.

Face-down bonding and beam-lead bonding of monolithic IC's are increasingly important techniques in hybrid circuit fabrication. This is reflected in a paper from Alexander Coucoulas of Western Electric on beam-lead applications of

(Continued on p. 26)

Testpac® Automatic Tester:

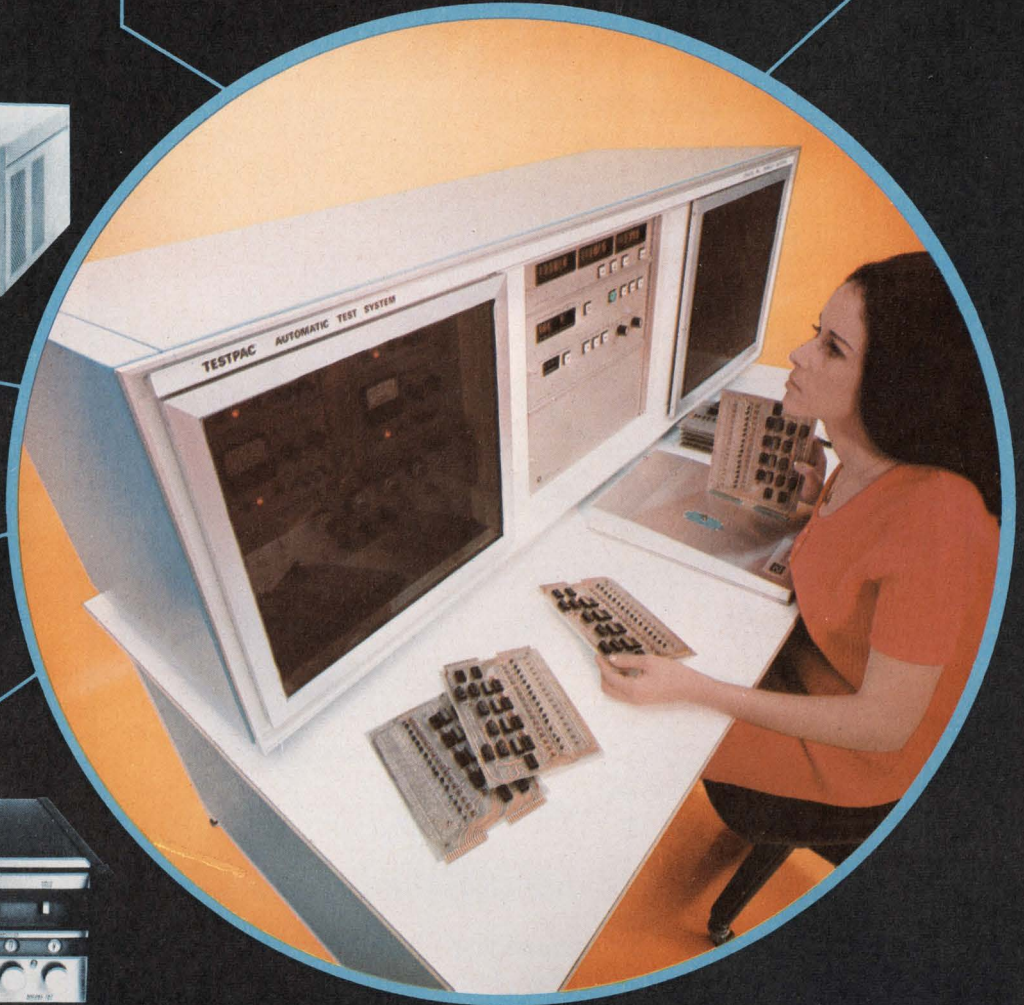

ADAPTABLE because it's COMPATIBLE

(It will test your products automatically.)

This is Testpac—the **only** automatic tester that can offer compatibility with almost any manufacturer's instruments and information sources. Testpac is probably compatible with the instruments you commonly use to stimulate, measure, analyze, and calibrate the devices **you** test. Testpac is easy to program, simple to operate, and can be used with or without a computer. If your testing operations are troubled

with excessive setup or checkout time, lack of accuracy and consistency, or difficulty in adjusting test apparatus to new or redesigned products, you should investigate Testpac. It matches any other automatic tester in versatility and accuracy—and **will save you more**. Zehntel will be happy to provide a presentation and detailed specifications on a Testpac for your instruments and test requirements. Call us.

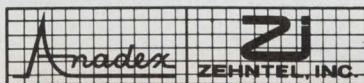

ZEHNTEL, INC.

1450 Sixth Street, Berkeley, Calif. 94710 (415) 527-5440

An affiliate of Electronic Memories & Magnetics Corporation

JOSLYN'S SURE CURE FOR SWELLING CURRENT

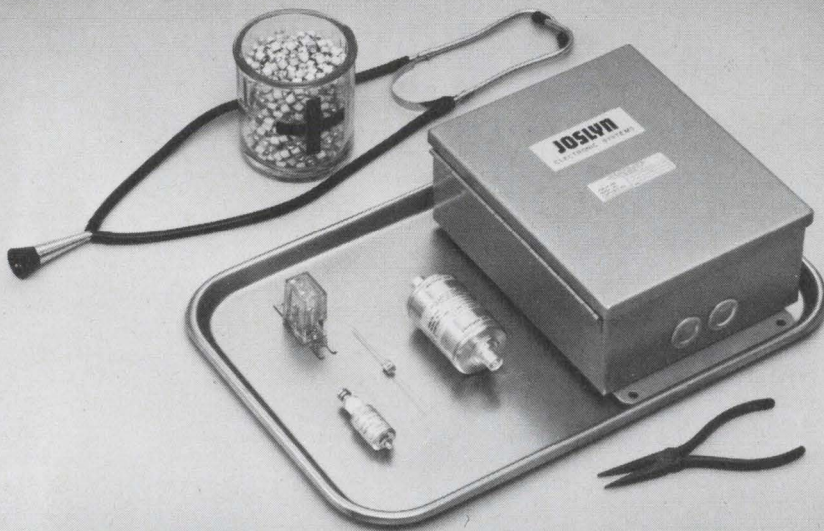

It comes as a single unit (a spark gap) or packaged with other exclusive properties. Either way, Joslyn's cure for swelling current (surge) is nanosecond quick, long lasting, and is sure to work. Again and again and again! True, your more devastating surges might possibly perhaps destroy a Joslyn protector. But your electronics will still go on working*. Over ten years of field use says so.

Don't experiment with other means when you can't afford a failure! For positive protection, Joslyn has the answer. Write or call today for facts on how to solve your protection problem for swelling current.

*when protector is properly selected and connected

When you can't afford a failure . . .



JOSLYN

ELECTRONIC SYSTEMS

Joslyn Electronic Systems Santa Barbara Research Park
P.O. Box 817 Goleta, Calif. 93017 Tel. (805) 968-3551

1906

Meetings

(Continued from p. 24)

compliant bonding, and in one by L.K. Keys, F. Francis, A. Russo, and S. Herring of Magnavox on photoetching and screen printing of conductor patterns for face-down bonded devices. R.J. Clark and J.W. Lunden of General Electric will speak on the use of related technique—semiconductor on thermoplastic on dielectric (STD)—in hybrid circuits.

The session on networks and filters focuses on hybrids, too. Topics include inductorless filters (G.S. Moschytz of Bell Labs), a gyrator suitable for monolithic bipolar construction (Edward L. Renschler and E.H. Allen of Motorola), and principles and design of gyrator filters (J.J. Golembeski and T.N. Rao of Bell Labs).

Although hybrid circuit components are in the spotlight, conventional discrete components aren't neglected. J. Burnham and R.S. Buritz of Hughes, for example, will discuss failure mechanisms in high-voltage mica paper capacitors, and Sam Y.M. Feng will speak on design analysis of toroidal inductors.

For further information contact Roger D. Allan, Electronic Industries Assn., 2001 Eye Street, N.W., Washington, D.C. 20006.

Calendar

Transducer Conference, IEEE;
National Bureau of Standards,
Washington, **May 4-6, 1970.**

Aerospace Power Conditioning Specialists Conference, IEEE; Royal Pines Motel, NASA, Greenbelt, Md., **April 20-21.**

Industrial and Commercial Power Systems and Electric Space Heating & Air Conditioning Joint Technical Conference, IEEE; San Francisco, **May 4-7**

Safety in Research and Development, National Safety Council and the American Society of Safety Engineers; Cambridge, Mass., **May 4-5.**

National Appliance Technical Conference, IEEE; Leland Motor Hotel, Mansfield, Ohio, **May 5-6, 1970.**

(Continued on p. 28)

Is the 901 counter-timer just too good to be true?



NO!

It was...but it's not any more!

Last year, when we introduced the Model 901, we were years ahead of the industry. Here was the first state-of-the-art universal counter-timer that could count directly to 200 MHz without a plug-in, and—with a plug-in—could go right on counting into the gigahertz range. What's more we offered it at the unheard of low price of only \$2475—about \$250 to \$1000 below the nearest competition!

It wasn't long before we knew we had a tiger by the tail. Here was a dream instrument with all the universal counting and measuring functions built into the standard main frame...with gate times of 1 μ s to 100 sec instead of to just 10 sec...with a TIM with a resolution of 10 nsec instead of 100...with an input sensitivity of 10 mV instead of the usual 50 or 100...with 9-decade readout instead of just 8...and with remote control available as an optional extra. With all that going for us we had just one problem: how to get into volume production fast enough to meet demand.

Now cut to 1970. The industry still hasn't caught up with the Model 901, but our production has caught up with demand. You can now buy this state-of-the-art instrument *right off the shelf* for the same low price. What's more, for only \$825 extra, you can also have the Model 931 Heterodyne Converter plug-in that extends the 901 frequency range up to 1.3 GHz.

But why dream on? Why wait to catch up to the times? The 901 is a reality today. For the full facts, circle the reader service card.

COMPUTER MEASUREMENTS



A DIVISION OF NEWELL INDUSTRIES

12970 Bradley/San Fernando, Calif. 91342/(213) 367-2161/TWX 910-496-1487

How to Win the Game

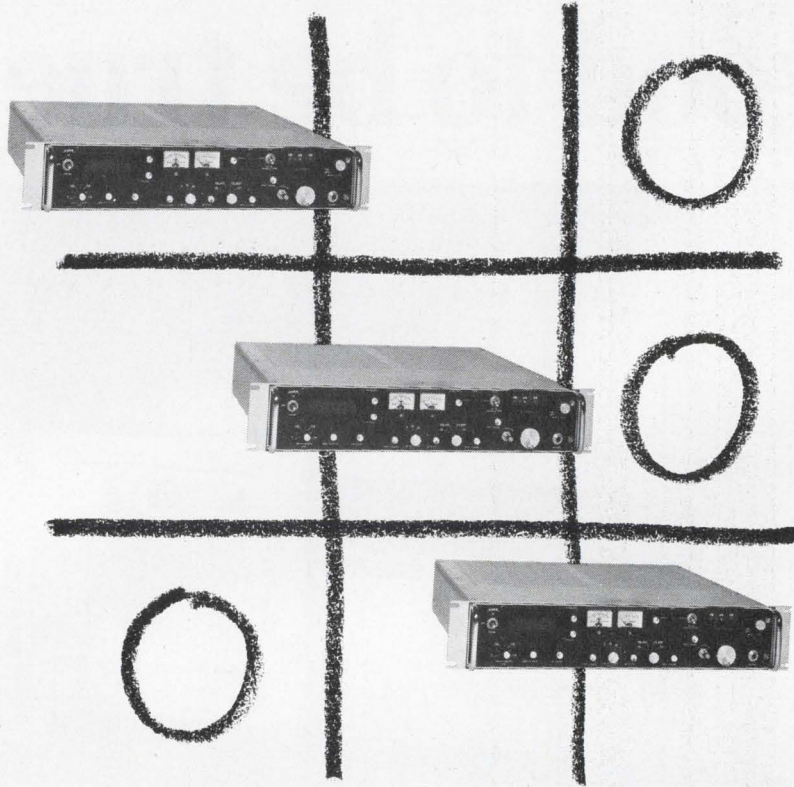

With

W-J HF/VHF/UHF RECEIVERS

This well-established family of W-J receivers offers a wealth of special features in separate units designed for critical surveillance and monitoring applications.

TUNING RANGE

Type 521A	HF Receiver	20-70 MHz
Type 555	VHF Receiver	90-180 MHz
Type 595	UHF Receiver	220-400 MHz

FEATURES:

- Built-In Signal Monitors
- Carrier-Operated Relay (COR)
- Independently variable Beat Frequency Oscillator (BFO)
- Accurate, Readable 26-Inch Steel Tape Dials
- Digital Automatic Frequency Control (DAFC)

World's Largest Selection of Receiving Equipment for Surveillance, Direction-Finding and Countermeasures

CEI DIVISION

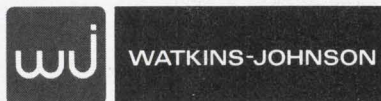

6006 EXECUTIVE BOULEVARD, ROCKVILLE, MARYLAND 20852 • (301) 881-3300

Meetings

(Continued from p. 26)

Spring Joint Computer Conference, IEEE; Convention Hall, Atlantic City, N.J., **May 5-7.**

Midwest Symposium on Circuit Theory, IEEE and the University of Minnesota; University of Minnesota, Minneapolis, **May 7-8.**

Aerospace Instrumentation Symposium, Instrument Society of America; Washington Plaza Hotel, Seattle, **May 11-13.**

International Microwave Symposium, IEEE; Newporter Inn, Newport Beach, Calif., **May 11-14.**

Short courses

Update-Medical Electrical Safety, IEEE Group on Engineering in Medicine and Biology; Marriott Motor Hotel, Philadelphia, **May 15;** \$35 fee.

Systems Evaluation and Measurement Techniques, University of California at Los Angeles, Boelter Hall, **May 18-22;** \$310 fee.

Workshop in Heat Transfer Computer Programs, University of California at Los Angeles, Bel Air Sands Hotel, **May 18-29;** \$420 fee.

Aerospace Vehicle Systems Engineering, University of California at Los Angeles, Boelter Hall, **May 18-29;** \$420 fee.

Call for papers

Environmental Engineering, Society of Engineering Science; George Washington University, Washington, Nov. 2-4. **May 31** is deadline for submission of abstracts to Nozer D. Singpurwalla, School of Engineering and Applied Science, George Washington University, Washington, D.C. 20006.

Photo-Optical Instrumentation for the 70's, Society of Photo-Optical Instrumentation Engineers; Convention Center, Anaheim, Calif., Sept. 14-17. **July 3** is deadline for submission of abstracts to Technical Program Committee, SPIE Symposium, P.O. Box 288, Redondo Beach, Calif. 90277.

Digital Computers in Process Control, Louisiana State University, Baton Rouge, Feb. 17-19, 1971. **July 12** is deadline for submission of abstracts to Dr. Cecil L. Smith, Chemical Engineering Department, Louisiana State University, Baton Rouge, La. 70803.

Need a fast, accurate solution to an IC problem? E-H Research Laboratories, Inc. teams up with Iwatsu Electric Company, Ltd. to offer you the ideal test instrumentation.

E-H breaks through with the **E-H 129 pulser** which is capable of driving the fastest digital logic circuits. Until this compact, all solid-state instrument came along, no practical commercial pulse generator offered repetition frequency capability beyond 200 MHz. The E-H 129 offers 500 MHz, 2-volt pulses with less than 500 ps risetime and such extras as baseline offset, pulse-top/baseline inversion function, and synchronous gating.

And the ideal mate for this instrument is the **Iwatsu 5009B sampling scope** which allows you to observe and control the waveforms you generate. The Iwatsu 5009B with 18GHz bandwidth lets you evaluate fast circuits with high accuracy—in fact, direct measurements on 100 ps edges with less than 2% display error. Features include less than 20 ps risetime, sensitivity from 10mV/cm, dual-trace performance with seven operating modes, separate miniature sampling heads, big CRT and triggering to full bandwidth for extra convenience.

If these two instruments can't solve your problems, E-H can offer you E-H and Iwatsu instrumentation that can. Contact an E-H representative and get a fast solution. Today.

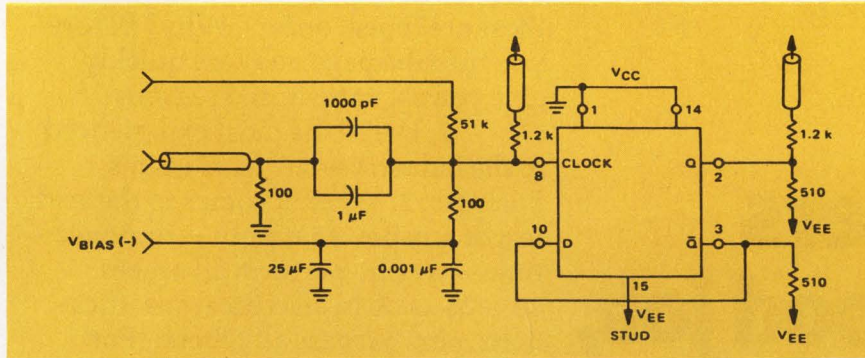

E-H the fast solution

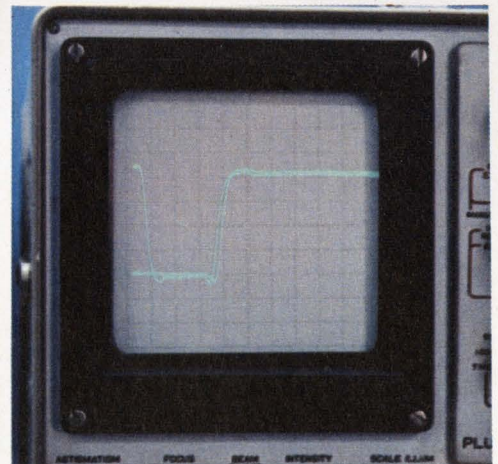
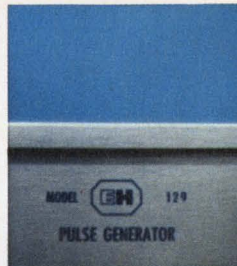

E-H RESEARCH LABORATORIES, INC.

515 Eleventh Street • Box 1289, Oakland, California 94604 • Phone: (415) 834-3030 • TWX 910-366-7258
 In Europe: E-H Research Laboratories (Ned) N.V., Box 1018, Eindhoven, The Netherlands, Telex 51116
 In Japan: Iwatsu Electric Company, Ltd., 7-41, 1-Chome Kugayama Sugunami-Ku, Tokyo 167, Japan

Our engineers have to do a good job, because our salesmen don't.

Now don't get us wrong. Our salesmen are great guys and they've made us the world's largest power supply company. But when it comes to our modular power supplies, they do very little selling. And we don't blame them because they would rather sell \$1,000 instruments than \$89 modular power supplies.

Yet, people have bought over 25,000 of them (ranging from 0 to 330 Vdc—to 300 watts). And 65% of these are repeat orders. Why? Before you turn the page, may we quickly give you six hard-nosed reasons:

1. We're the most experienced in the industry — 26 years in this business.
2. When it comes to the acid test of any power supply — response time — we out-perform all others: 20 — 35 μ s.
3. In all critical specifications, ours surpass all others. (For instance, our regulation is $\pm 0.005\%$ for line and load changes, ripple is 300 μ V rms — 3 mV p-p.)
4. Our supplies require no heat sink in ambients to 71°C.
5. Our modular power supplies and accessories are UL listed.
6. We inventory more power supplies than most manufacturers sell in a year. (And we burn in every one for 48 hours before we ship it.)

Those are the same reasons why the industry has bought over \$150 million worth of Sorensen power supplies.

And those are the same reasons why you may want to consider Sorensen the next time you consider power supplies. For complete information on any of our power supplies (or for our 124-page Power Supply Handbook and Catalog) call our Applications Engineer, Steve Charleston (collect) at (203) 838-6571, or write to him at Sorensen, Richards Ave., Norwalk, Connecticut 06856. Circle 200 on the inquiry card.

Sorensen
POWER SUPPLIES

AN OPERATION OF RAYTHEON CO.



SORENSEN RAYTHEON CO.
MODEL 1000

METER

MULT. 600

OUTPUT

Sorensen
RAYTHEON CO.

SORENSEN
RAYTHEON CO.

INPUT

OUTPUT

INPUT WIRING FOR

OUTPUT

200-240 VAC
210-250 VAC
MAX. 500 VA
X.0 CHOKE
X.0 A. 500 C
X.0 A. 500 C
X.0 A. 500 C
X.0 A. 500 C

MODEL 1000

NOTE: THIS UNIT IS DESIGNED FOR USE WITH A 500 VA CHOKE AND A 500 VA CAPACITOR.

Announcing a new panel savings plan.

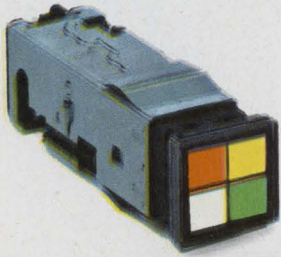

Big dividends from small pushbuttons.

It doesn't take much to reduce the size of your control panels and cabinet fronts.

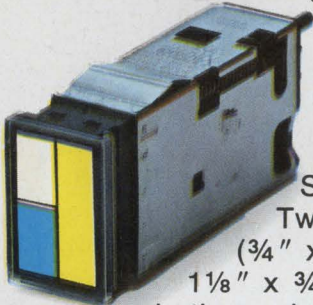

All it takes is compact miniature pushbuttons. Like the new MICRO SWITCH illuminated DS.

Two sizes are available ($\frac{3}{4}$ " x $\frac{3}{4}$ " for our 1-unit and $1\frac{1}{8}$ " x $\frac{3}{4}$ " for our $1\frac{1}{2}$ -unit). And

both can be matrix mounted on $\frac{3}{4}$ " or $1\frac{1}{8}$ " centers. So there's no need for spacers or barriers.

A long-term investment.

A rugged metal housing encloses each switch and protects against the bumps and bangs of military and commercial use.

The housing also helps provide our DS pushbuttons with exceptional RFI attenuation capability. Incorporated into the housing are welded skirts that assure positive metal-to-metal grounding between the switch and adjacent units. And also between the switch and our rigid, box-girder matrix frame.

Your choice of options.

Pick the mounting that best fits your application. Either individually mounted switches (meet the requirements of MIL-S-22885) or custom matrix configurations featuring plug-in switches that are best for remote stations or indicating functions.

You can have up to four lamps in every switch. And either one, two, three or four-way split section screens. (The $1\frac{1}{2}$ -unit provides more than one-third additional legend area.) Full guards are available for single-unit switches.

Then save even more space by combining both 1-unit and $1\frac{1}{2}$ -unit switches in the same matrix. A single frame will handle up to sixteen 1-unit switches or up to ten $1\frac{1}{2}$ -units.

Who can participate in the plan.

MICRO SWITCH DS pushbuttons meet both commercial and military requirements. So they can be used in almost any panel from power plant control to tactical ground support equipment.

For more information, call your MICRO SWITCH Branch Office or Distributor (in the Yellow Pages under "Switches, Electric"). He'll show you how little it takes to participate in our savings plan.

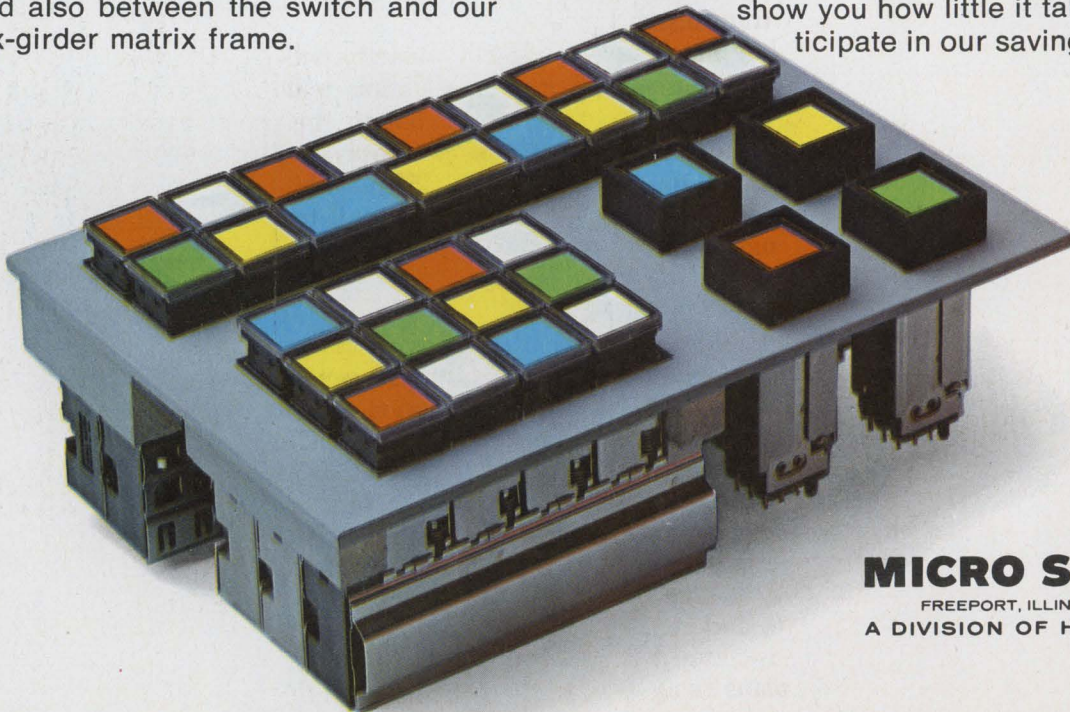

MICRO SWITCH

FREEPORT, ILLINOIS 61032
A DIVISION OF HONEYWELL

Electronics Newsletter

April 27, 1970

Plastic package tests proposed by Air Force

The Rome Air Development Center has proposed tests for plastic-packaged microcircuits. They appear to be the first step toward qualifying plastics for military applications other than the highest reliability uses. The tests, which draw upon methods set forth in Mil-Std-883, don't mean the military is endorsing plastics. As Joseph Brauer, chief of the solid state applications section in RADC's reliability branch, puts it, "The tests mean we've proposed that the services lift the statutory ban on plastics and use those that pass these tests. We haven't qualified anything yet; we've proposed a way for the vendors to qualify."

RADC officials point out, however, that even devices that pass the proposed tests will not be accepted for Class A applications as spelled out in the recently distributed specification, Mil-M-38510. Those are applications in which reliability is "absolutely imperative," RADC officials note.

The proposal includes Group B and C tests and adds 100% screening for devices that might be used in Class B and C applications. Group A tests per Mil-Std-883 will remain the same for plastic or hermetic circuits. Group B spells out tests that must be applied to samples from each lot, including salt-atmosphere tests that aren't applied to hermetically sealed devices in Group B. Also added are biased moisture life tests at 85°C and 85% relative humidity with minimum power bias for 1,000 hours. Then there's another set of tests—Group C—detailing periodic sampling of circuits being considered for Class B and C applications.

Raytheon to build mm-wave system for Air Force

The Raytheon Co. has landed a \$1,743,619 Air Force contract to develop what may become the military's first general-duty millimeter-wave tactical communications system. Designated the AN/GRC-173, the system will operate between 33 and 40 gigahertz as a line-of-sight digital data transmission system.

While much of the system's capacity will be occupied by data transmission, phase-shift-keyed modulation television, voice, and facsimile also will be part of the mix. Though the exact operating bandwidth is not known, it is said to be the equivalent of 6,000 high-grade voice circuits (3 to 4 kilohertz). A 250-megabit-per-second data rate is a contract requirement, but Raytheon will try to achieve 500 megabits.

Range is to be about six miles, with a bit-error rate of 1 in 10^6 . Output is slated at 100 milliwatts.

Viatron OCR features new font

Viatron's just-introduced optical character reader attacks the almost standard optical-character recognition font, OCR-A. Viatron's gear uses its own Vifont. At present, virtually all OCR's can print and use OCR-A and, to a lesser degree, other fonts. Viatron believes that Vifont applications can surpass those of established fonts and convince users that capital investment in OCR-A readers can be written off.

The company plans to accent its reader's low price in its marketing attack. A tape reader will sell for \$2,400 while a card reader will cost \$4,800, and an automatically fed document reader will cost \$7,200—each price is claimed to be less than a tenth that of competing devices. Viatron also plans an aggressive licensing program that would allow OCR makers and users to adapt their equipment on a royalty basis to read Vifont.

Electronics Newsletter

Finally, Viatron claims it can pack six lines of 80 characters each onto a Hollerith-size card, which, if keypunched, is limited to only 80 character positions.

But Viatron's strongest weapon is the potentially vast increase in OCR users. With its prices competing, in some cases, with \$500,000 price tags, Viatron figures other OCR makers will almost be forced to adapt to Viafont.

Low cost is achieved through an easy-to-read font and simple electronics—only three MOS/LSI chips. Viafont is read ignoring all but vertical strokes. These are detected by a silicon-diode detector array fed by a fiber-optic bundle split nine ways to divide letters into nine horizontally scanned stripes. Using the length and position of the vertical lines of each letter, and their order of appearance, the OCR's and System 21 console translate printed word to data in ASCII code at about 80 characters per second.

Tektronix to show display, printer

Tektronix, continuing its advance into the peripheral-equipment market, will introduce a real-time computer display at the Spring Joint Computer Conference to be held in Atlantic City May 5-7. The oscilloscope giant also is expected to unveil a hard-copy printer.

Dubbed the T4005, the display will use an 11-inch diagonal cathode-ray tube similar to the one Tektronix puts in its T4002 terminal. The T4005 will be able to overlay plots and magnify them up to 32 times.

Fairchild delivers Illiac 4 memory

The first of 64 semiconductor memory systems for Illiac 4 has been accepted by Burroughs from Fairchild. The University of Illinois' super-computer, originally designed to execute up to a billion instructions per second, has been running into its share of troubles—like skyrocketing costs and the need to eliminate the medium-scale integrated circuits originally planned in favor of standard IC's [*Electronics*, April 14, 1969, p. 47]. As a result, in an attempt to recoup some of the lost space and speed, contractor Burroughs and the university decided to use semiconductor memories in place of the magnetic thin films initially called for.

The LSI memory system, which Fairchild calls a processor element memory (PEM), consists of four memory boards and a control board and has a total capacity of 131,072 bits. Illiac 4 will have a total memory capacity of 8,388,608 bits.

According to Fairchild, the memory is equal in cost to high-speed core systems—less than 10 cents per bit—and is three times faster—200 nanoseconds for a full operating cycle. The basic memory unit is a 256-bit bipolar chip called the 4100. Off-the-shelf delivery for the 4100 is expected this summer; the company is taking orders for the PEM for delivery in the third or fourth quarter of 1970.

TI: one up, one down

Texas Instruments is having its ups and downs. Growth of its MOS activity has led the company to upgrade its MOS facility in Houston to a full-fledged department. But at the same time, TI has had production woes in Dallas, where diode-transistor-logic production has been cut back to four days a week.

TI will not comment officially about the cutback or talk about the problems that caused it. All that the company will say is that "less than 6% of the total Dallas-based personnel is on a four-day week."



“Sure I know
Allen-Bradley.
They make top
quality resistors
and pots by
the billions,
don't they?”

True. Now take



another look... at **Allen-Bradley** **new/dimension** **electronics**

**New people.
New technologies.
New distribution.**

Volume production of precision components has been our traditional strength. And we're proud of it.

Now there's something new at Allen-Bradley. New people to help speed our reaction time. New research facilities in areas like optoelectronic and microelectronic components. New distribution for prompt delivery. New products. A new dedication for the challenges of this infant decade.

Yet the best of the past remains. Like quality. That's why we have in-house capabilities in mask making, inks and substrates. A Special Machinery Department to create sophisticated mass production tools. And an extensive quality assurance program.

What's new? Cermet network packaging to match your plastic pack IC's. Filter capacitors so small they become an integral part of a connector pin. Cermet trimmers to meet the packaging density demand. Subminiature power line filters. And the familiar hot molded resistor, now qualified to wear the best level (yellow) band of the new military Established Reliability specifications.

New-dimension electronics? A charted growth plan for Allen-Bradley electronic capabilities. A new dimension in people, products and ideas for the Electronic 70's.

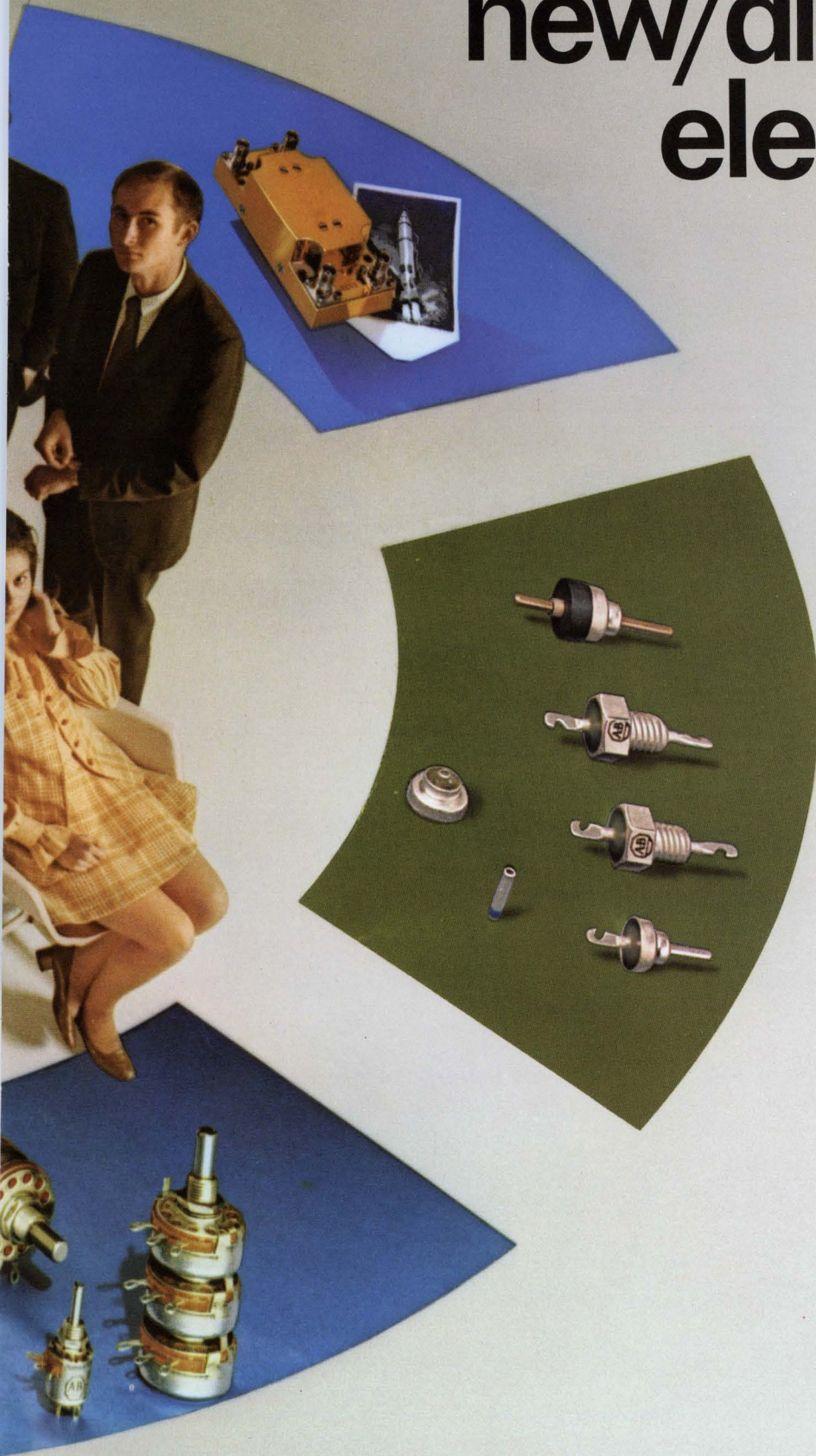

Great ideas demand superb implementation. The complex process where concepts become products. And reliability emerges from the elusive concept of quality.

This traditional Allen-Bradley strength has been preserved and given new significance. New-dimension electronics means not only new ideas and technical excellence, but the ability to produce these ideas more quickly, economically and with great uniformity. Manufacturing facilities have been strengthened. New capabilities added. New machines. New processes. New techniques. Allen-Bradley has the ability to produce, in spades.

Technical excellence is built around sophisticated equipment like the electron microscope (a) and micro-probe (b). Completely automatic equipment helps assure the quality of potentiometers (c) and fixed resistors (d). Specialized tools like the Borrowdale camera (e) give Allen-Bradley complete internal control over production operations.

New-dimension electronics. People. Products. Ideas. Backed by Allen-Bradley's emphasis on quality.

For information, write Marketing Department, Electronics Division, Allen-Bradley Co., 1201 S. Second Street, Milwaukee, Wisconsin 53204, or contact your authorized A-B industrial electronics distributor. Export Office: 1293 Broad Street, Bloomfield, N. J. 07003, U.S.A. In Canada: Allen-Bradley Canada Ltd.

ALLEN-BRADLEY

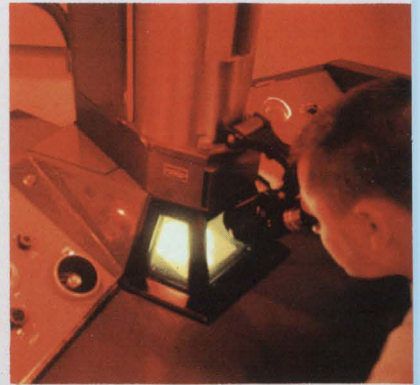

a.



b.

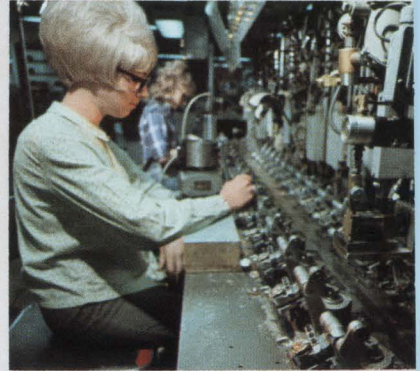

c.

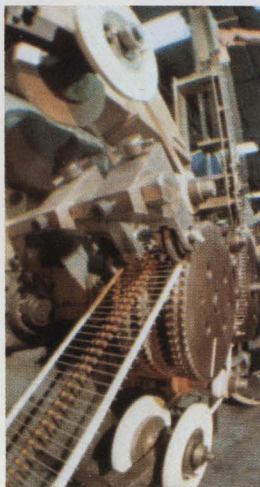

d.

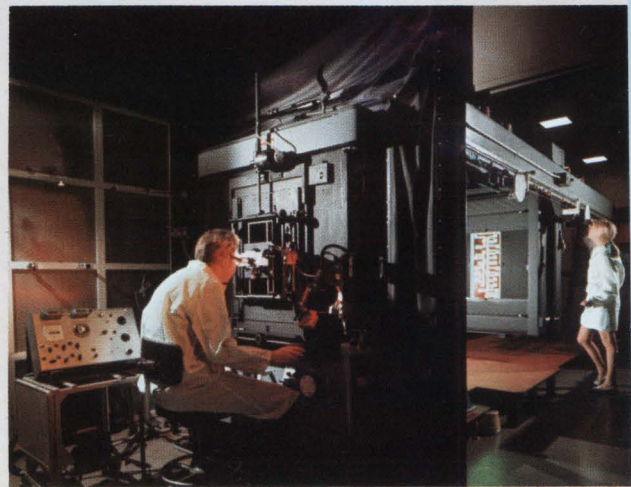

e.

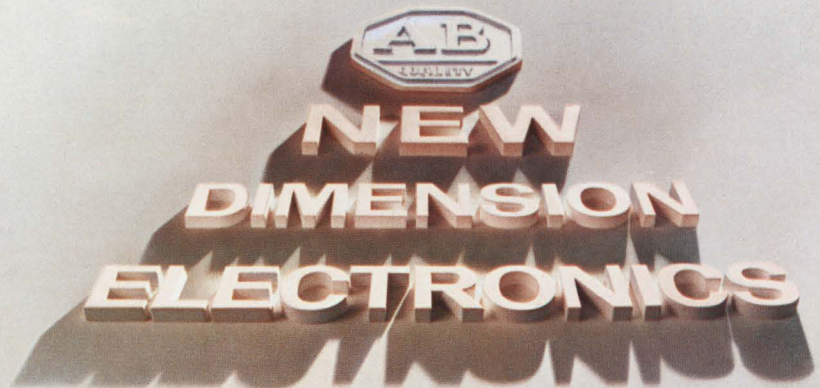

**Introducing
a complex logic
card tester
so simple to operate
you just plug it in,
turn on power
and start testing.**



Sangamo's Comp 200

The Comp-200 uses a new proprietary technique specifically designed to test logic circuits. No programming is required to test any kind of logic card. No programming is required to diagnose and trace a problem right down to a component. You just turn on power and begin testing your logic card. It's that simple.

Each Comp-200 is backed by a full two-year warranty and a team of Sangamo

service specialists. Best of all, the price is just \$7500.00.

Write or call for more information and a demonstration of the Comp-200.

**SANGAMO
ELECTRIC COMPANY**

Data Systems, P.O. Box 3347/Springfield,
Illinois, 62708 Phone: (217) 544-6411
TWX: 910-242-0533 TELEX: 406-421

DS70-1R

Observe Our Zone of Silence

Notice how quiet our new Model 113 Preamplifier is . . .

How quiet? At 10 Hz, with a 2 megohm source resistance, it has a noise figure of less than 0.3 dB. Or at 1 kHz, with a 1 megohm source resistance, its noise figure is only 0.2 dB maximum. Shorted input noise from dc to 100 kHz is typically 1 μ V referred to the input.

Model 113 also offers:

- Switch selectable ac or dc coupling in either single ended or differential input mode
- High rejection of common mode signals
- Low- and high-frequency rolloff controls for attenuation of signals outside the range of interest
- High input impedance: Ac coupled: 100 megohms through 0.1 μ F shunted by 15 pF; Dc coupled: 1 gigohm shunted by 15 pF

- Gain continuously variable from 10 to 25,000
- Battery operation to eliminate 60 Hz pickup. Provides 30 hours of continuous operation between charges. Built-in charger automatically recharges battery when plugged into 110/220 V ac line. Front panel test lamp indicates battery condition.

Ask us to demonstrate our quiet new \$795 Model 113 Preamplifier for you now. Then you'll see why we're making so much noise about it. Contact your local PAR representative or write Princeton Applied Research Corporation, Box 565, Princeton, New Jersey 08540. Telephone: (609) 924-6835.



PRINCETON APPLIED RESEARCH CORPORATION

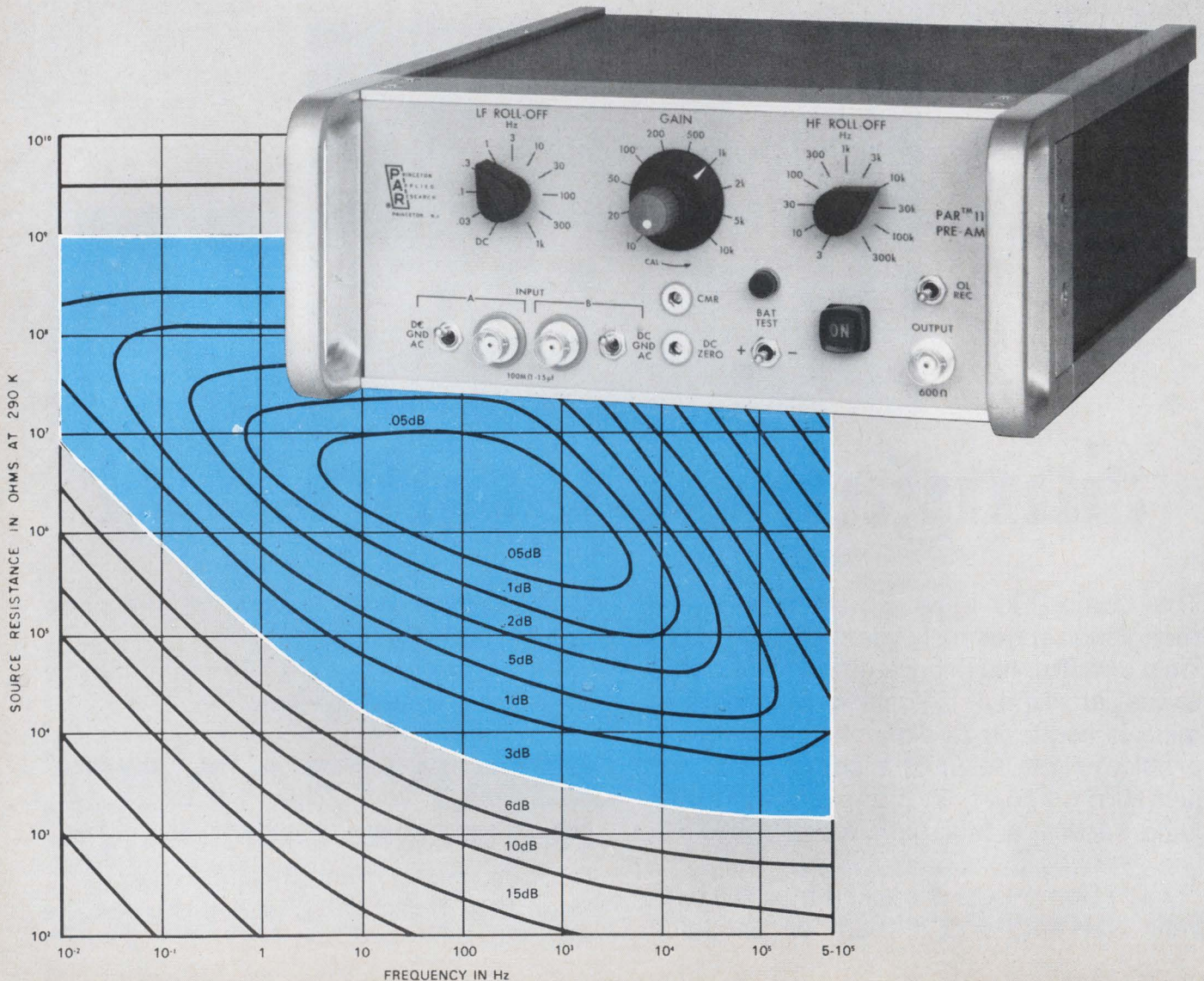

Path open to all-solid tv

Fairchild makes monolithic arrays of photodiodes or phototransistors on chip with scan circuitry

All-solid-state tv cameras—relying on flat arrays of light-sensing semiconductors to image a scene—have received much praise and high billing as the wave of the future. But the wave has been a long time building: no one yet has a solid state light-sensing array that is practical, and which doesn't create more problems than it solves.

However, this may not be the case much longer, for Fairchild Camera & Instrument's R&D division in Palo Alto, Calif., has developed techniques for fabricating monolithic arrays of photodiodes and photo transistors which fit, together with their scanning and accessing electronics, on a single chip of silicon.

Shorter tail. This ability to integrate light-sensing and scanning functions solves a major problem faced by solid state arrays: the signal and scanning wires connecting the light sensors to external circuits have been extremely bulky, resembling an impractically large tail wagging a very small dog.

Fairchild's prize so far is a linear array of 48 junction photodiodes, each 5 mils apart, on a 60-by-30-mil chip of silicon, says the array's designer, Gene P. Weckler. And the chip also contains a 48-bit dynamic shift register, built with silicon gate technology, and field effect transistors that act as accessing switches at each diode. As a pulse ripples through the shift register, the output from each bit turns on the FET's in sequence, allowing the signal on diodes to be read out. The photodiodes operate in a charge-storage mode which sums the light falling on the junction over a period of time and enhances the junction's sensitivity.

The result is an array that needs only six leads, regardless of the number of light-sensing elements, says Weckler. Five leads are on

the input: two two-phase clock signals, and one each for the control pulse that starts the shift register, the pulse that signals the restart of the diode readout cycle, and a common power supply lead. And at the output, there's a single video lead onto which the analog signals from the individual diodes are automatically multiplexed.

Better. The array is designed to operate at scanning frequencies between 10 kilohertz and 1 megahertz, says Weckler, and the array "has exceeded this operation at both ends of the range." Weckler hopes to get 1-mil spacing between the diodes, and to build complete arrays with 100 to 200 detectors on a single chip. Plans are also under way to market the arrays outside Fairchild through the company's Microwave and Optoelectronics division in Mountain View, Calif.

Waiting for the solid state integrated arrays with watering mouths has been another Fairchild division, Space and Defense Systems, in Syosset, N.Y. This division, which does much of Fairchild's film and television camera work, has been developing the camera system concepts for capitalizing on the availability of such arrays, says Thomas J. Palamenghi, director of the advanced reconnaissance systems group. Such a camera would be small and rugged and operate at low semiconductor voltages. And the sensor array wouldn't, of course, need the high-vacuum envelope or high-voltage electron scanning beam required by conventional tv tubes. Westinghouse is also developing such silicon solid state sensor arrays. However, it's been concentrating more on developing dense arrays of photodetectors, rather than on combining the arrays with scanning electronics.

Right now, Palamenghi is decid-

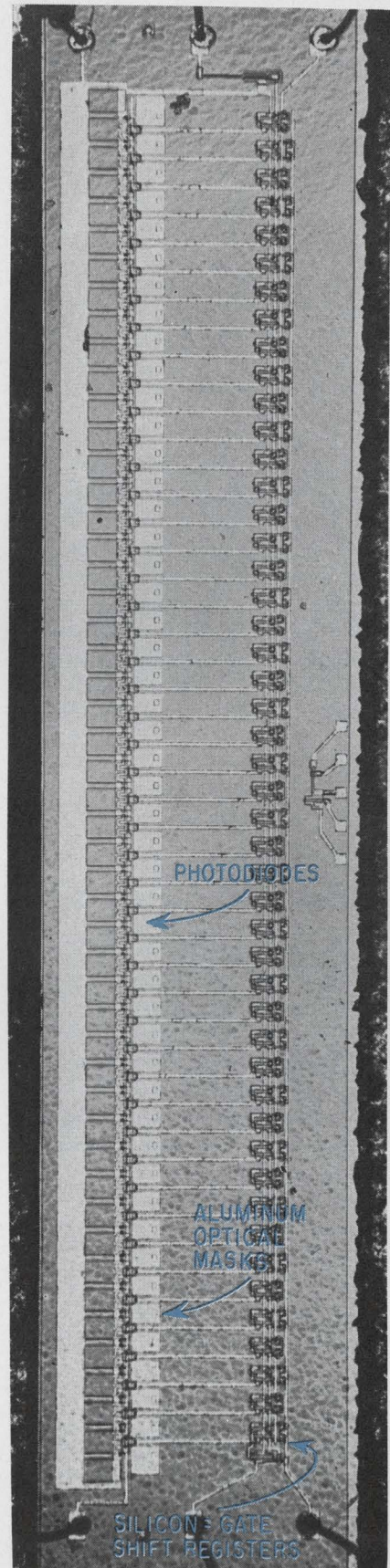

Tube chip. Tv camera tubes could be replaced by a Fairchild array of photodiodes and scanning electronics on a silicon chip.

U.S. Reports

ing which type of array—using photodiodes or phototransistors—to develop into a camera system. Transistors would give the camera sensitivity, he points out, but the diodes could be made to have more uniform response. However, it's possible to overcome the usual nonuniformities among the elements in a solid state array by storing a correction factor for each element in a small semiconductor memory. These factors are then applied as the photodetector signals are read out.

Making it. Linear photodetector arrays are quite suitable for reconnaissance applications, Palamenghi points out. They're also easier to fabricate than two-dimensional arrays. For example, a square array of 100 by 100 elements—which Fairchild has built—requires 10,000 perfect elements. This is much more difficult to accomplish than making the linear array's 100 to 200 elements. Longer arrays—up to 10,000 elements—could be made by putting perfect linear segments end to end, says the Fairchild group director.

Fairchild could have a flight version of a solid state camera ready in about a year and a half, says John Hunt, manager of the electro-optical components and equipment section in Syosset. "There's no reason now, except for straight engineering, why we can't make a variety of cameras," he says. The first one might be a panoramic type which uses a mirror to sweep the scene across the array.

Another important camera application would be in an earth resources satellite in which the linear array is swept over the earth scene by the motion of the satellite. Such a solid state camera would be excellent for taking multispectral pictures of the earth, Hunt continues, resulting in near-perfect registration of the different spectral images in a composite photograph. Such multispectral imaging is being done in the first earth resources satellites (ERTS-A and B) with three separate return-beam vidicon cameras [*Electronics*, May 12, 1969, p. 98].

Knowing less. Perfect registration could be a problem here because

it depends on knowing precisely the position of the scanning electron beam in each of the tubes. With the solid state arrays, however, registration depends only on knowing the position of the individual detector elements. And this is known with extreme precision because of the photolithographic techniques used in the arrays' manufacture. Total number of lines per picture of a silicon array could exceed the nominal 4,500 achievable in present high-performance vacuum tv tubes, according to Hunt.

Hunt also sees the solid state camera being used in covert applications, in which a scene is illuminated by an invisible infrared source. Silicon has much greater sensitivity in the near infrared than conventional vidicons which operate largely in the visible light region.

Space electronics

Off the ground

Now that NASA has awarded its \$50-million-plus contract for Application Technology Satellites F and G to General Electric, the 500-pound satellites can be moved out of the embryonic stage in which they floated during the two-year competitive design study. ATS-F is now scheduled to be fired into synchronous orbit, 22,300 miles up, by a Titan 3C in March 1973; ATS-G is to follow by 1975.

Both craft will have a whopping big antenna, three-axis stabilization, and a pointing accuracy of 0.1°. ATS-F will carry an extensive payload of communications and other experiments.

Some dish. ATS-F's most prominent feature will be a 30-foot parabolic dish, the largest antenna ever deployed in space, made by the Lockheed Missiles and Space Center. This antenna will be used despite GE's commitment, during the early phases of the design completion, to a petaline dish made by Goodyear. An internal NASA Goddard report praises Lockheed's design while criticizing the designs

of Goodyear and Convair. (Losing bidder, Fairchild Hiller, was teamed with Convair before Lockheed came along.) The report notes that Convair's expandable-truss antenna, a complex structure of hinged equilateral triangles, can't be analyzed to determine the distorting effects of solar heating.

Such distortion can severely degrade antenna gain at X band, the frequency of one of ATS-F's communication experiments, by warping the reflector surface more than the specified limit of 0.05 inch from

Package

Here's a list of experiments due to be placed aboard ATS-F, to be launched in March 1973.

► Data relay to and from low-altitude satellites: S and C band.

► Position location and communications for air traffic control: D and C band.

► R-f interference experiment: 4 and 6 gigahertz.

► Direct broadcast of instructional tv to community receivers: 850 megahertz downlink, 6 Ghz uplink.

► Time- and frequency-dispersion experiment: uhf and L band.

► Millimeter-wave experiment to measure atmospheric effects: R band.

► Ionospheric effects experiment: multiband; 20 Mhz to 360 Mhz.

► Laser communications link, spacecraft to spacecraft and spacecraft to ground.

► Infrared and visible spectrum radiometers with five-nautical-mile resolution.

► Integrated Scientific Experiment Package to measure magnetic fields, solar-particle energies and densities, and radiation-induced solar-cell degradation.

► Adaptive precision-attitude-control system.

Aerojet-General's laser experiment may ultimately be used to return real-time tv from space, such as a manned landing on Mars, or for relaying data and tv from one spacecraft to another or from one part of the earth to another.

Also included will be position location and communication tests with aircraft in the 1550 Mhz to 1650 Mhz band, possibly a forerunner of the use of satellites for air traffic control over the oceans.

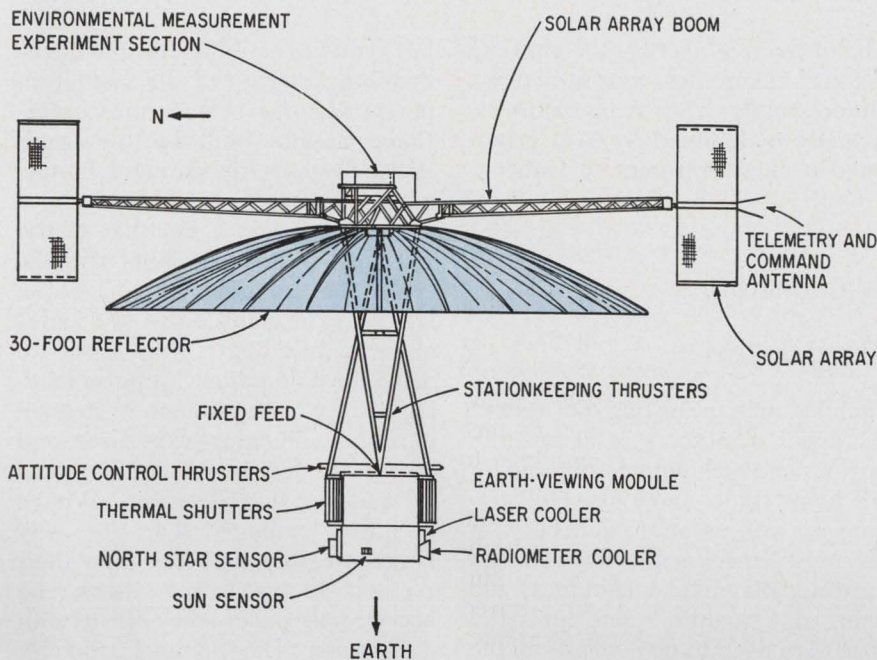

Dishing it out. ATS-F and G will feature 30-foot deployable reflector, largest ever in space. Three-axis stabilization, with beam-pointing accuracy of 0.1° , will depend on east-west solar sensors and a Polaris sensor. Telemetry and command links will be at 136.23/137.11 Mhz and 154.2 Mhz, respectively. The commandable gravity-gradient experiment, dropped from ATS-F, may reappear on the G version in 1975.

a true parabola. A deviation of 0.1 inch, rather than 0.05 inch, would drop the gain by 3.5 db, more than could be made up economically by increasing transmitter size: costs through launch average \$60,000 per pound.

Goodyear's design is faulted for its long, thin shape in the folded launch configuration, a shape very susceptible to vibration and resultant failure under the severe jostling during a launch.

Pinwheel. Lockheed's swirlabola dish is featured on GE's latest scale model of ATS-F. The swirlabola consists of several dozen thin, springy metal ribs that are wrapped, pinwheel-fashion, about an annular hub. On deployment the ribs swirl into their radial configuration, stressing an attached, copper-impregnated nylon mesh to form a precise parabolic reflector.

This antenna should provide a gain of 37 decibels at the 850 megahertz downlink frequency of the direct-broadcast tv experiment. Coupled with the 40-watt uhf transmitter, the gain will yield an effective radiated power of 52.2 dbw, a thousand times stronger than that

provided by Intelsat 3. In addition, this gain will bring the signal level within reach of an inexpensive ground station. The tv experiment is designed primarily to measure ionospheric dispersion effects on wideband signals. However, a further two-year test, one year over India and another over Brazil, will soon lead to permanent satellite tv service for at least the emerging nations, where no organized opposition exists in the form of competing distribution services [*Electronics*, Feb. 2, p. 125].

These nations will also be an enormous market for tv sets once there is something to watch. The Japanese are said to be planning to offer to build and orbit a tv broadcast satellite for Indonesia in exchange for the exclusive right to manufacture and sell tv sets there.

As the world watched

Apollo 13 Commander James A. Lovell probably summed it up best when, while struggling to bring his crippled spacecraft safely back

to earth, he radioed mission control at Houston: "I'm afraid this is going to be the last moon mission for a long time."

The evaluations of just what happened on the aborted Apollo 13 flight are still going on. These, plus any rebuilding of all-but-completed spacecraft that result, could very well postpone the launch of Apollo 14 which is scheduled for next fall.

Almost immediately after the explosion late on April 13 of an oxygen tank in the Apollo 13 service module—which, it later turned out, had blown a 13-foot-long panel from the module and appeared to damage the flaring bell of the propulsion unit—electric power from two of the three hydrogen-oxygen fuel cells dropped to zero, and the power from the third dropped alarmingly. With electrical and oxygen supplies failing fast in the command module, the astronauts began shutting down systems in the command module and moving into the lunar module. And at mission control, the decision was made: terminate the mission and bring the Apollo spacecraft back to earth.

From several options, mission controllers decided to keep the Apollo on its course to the moon; then, as it swung around the moon, they could power it out of a lunar orbit and set in on a course back to earth. All depended on the electrical batteries and life-support systems in the lunar module. It had quickly become the astronauts' life boat while the command module had changed into a cold, dark inhospitable shell. Everything hinged on successful operation of the lunar module's guidance and navigation, and communications systems.

From the start, electrical power and oxygen supplies were low, and had to be carefully husbanded. All unnecessary electronics was shut off. The S-band communications system was operated at reduced power and even the AC Electronics inertial navigation system was eventually replaced by the lower power TRW-Hamilton Standard backup strapdown guidance system for the last two course corrections by the lunar module en-

U.S. Reports

gine. Most of the time, the inertial systems were operated under reduced-power, standby conditions; they were on completely only when midcourse corrections had to be made.

There were five burns during the return flight. The first, occurring soon after it was decided to bring the ship back, returned Apollo 13 to a free-return trajectory to bring the ship back to earth. As the craft came around the moon, there was a second burn, one which simply added velocity and shortened the return by 10 hours. Then followed two more corrections—the trans-earth return trajectory under normal conditions allows for three—and then the final correction on the morning of splashdown, just before the command and service modules separated.

The guidance systems operated near perfectly, although the astronauts could not take star sightings with the alignment optical telescope in the lunar module. This could have been because the spacecraft's attitude prevented the astronauts from recognizing any familiar constellations, or because gaseous debris speeding along with the craft reflected sunlight that showed up as stars, confusing any attempt at taking sightings. Any updating that was done depended on lining up the telescope on the dark-light line along the circumferences of the earth and sun.

Also, early on splashdown day, the lunar module power began charging the recovery batteries in the command module. These batteries normally supply power during the re-entry phase, after the service module has been jettisoned. The inertial guidance system in the command module was also turned on and realigned with the system in the lunar module. Teams at AC Electronics and at the Massachusetts Institute of Technology had earlier, in fact, simulated what would happen in the spacecraft. They first cooled Apollo-type inertial measurement units down and then turned them on and they were certain the precision components in the platforms would operate satisfactorily. And they did.

Cabin temperature in the com-

mand module also began going up as the electronics was turned on. Interestingly, the temperature is usually maintained by heat generated in the electronics systems.

Manufacturing

Bang-up test

Nondestructive testing of aircraft sandwich structures is, at best, an art; no one technique is suitable for all honeycomb materials. Holography as well as static deflection of the test specimen, vibration, r-f heating, magnetic techniques, and thermal, vacuum, and pressure loads are used to detect flaws in the bonding of the honeycomb structure to the aircraft or spacecraft skin.

Scientists at the Hughes Research Laboratories in Malibu, Calif., believe they have a holographic technique that is unique. Compared with commercially used holographic honeycomb testing, the Hughes method is faster and, because it employs a ruby laser, doesn't require the massive stable table usually needed to hold the helium-neon lasers rigid.

Ready to go. George Smith, a vice president and director of the research labs, believes the Hughes method is ready to graduate from

lab status; it could be used to check bonding integrity of the main support structures of the communications satellite built by the firm's Space Systems division with honeycomb material.

Donald Close, a member of the technical staff at the labs, says the technique combines the use of a single-mode giant pulse (10 joules of available light) ruby laser to make the holograms, "impulse loading" of the test specimen to stress it during the hologram exposures, and a series of five to seven holograms all made in 1 millisecond. What's impulse loading? It's the way Hughes researchers describe their method to excite or stress the honeycomb panel—they hit it with a hammer. The hammer, though, while imparting a mechanical rap to start the specimen ringing, also incorporates a Microswitch to trigger the system timing.

About a millisecond after the hammer tap, the laser fires to make a conventional two-beam hologram of the test specimen mounted a short distance from it. Each exposure requires about 30 nanoseconds. The second exposure is made 50 microseconds after the first, and so on until all the holograms have been made.

Loops. The spots on the test panel skin under which there is a poor bond—or where there's no bond of the honeycomb structure

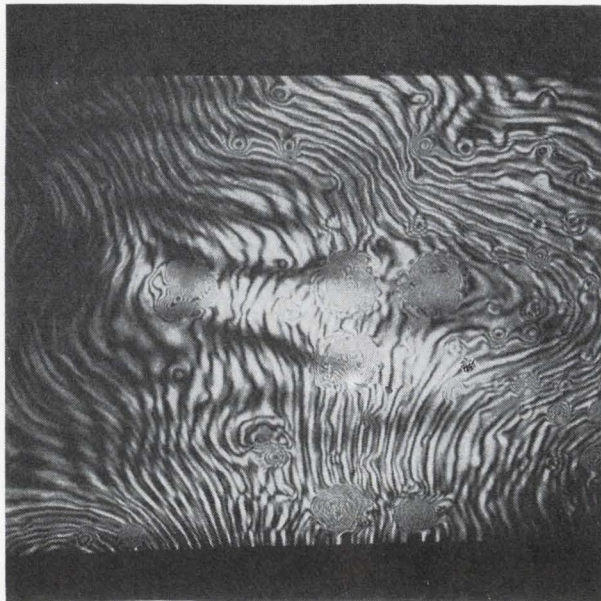

Boing. Fringe patterns indicating unbonded areas appear as knots in a piece of wood in this combination of several holograms of the excited panel.

Why National Semiconductor buys Teradyne J259's by the dozen

National Semiconductor can trace its considerable success as an IC manufacturer to many factors. One of the most important is the productivity of its testing facility, built around a lineup of 12 Teradyne J259 computer-operated test systems. "The Teradyne systems," according to Jeff Kalb, National's TTL product manager, "give us the economy of testing that is so important to profitable high-volume production."

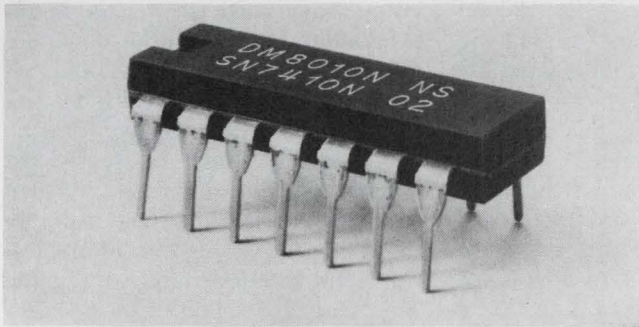

National, along with most other major IC producers, has found that the J259 boosts productivity in many ways. No other test system, for example, gives its user as much multiplexing freedom as does the J259, which lets National leverage its investment by making each J259 support several test stations doing several different jobs.

Reliability is another all-important key to productivity. National experiences minimal downtime with its J259's. This is as it should be; we design and build our equipment to work shift after shift, year after year, in *industrial* use. Teradyne systems are right at home on production lines like National's, where the workload is heavy and continuous. And operation never has to be interrupted for calibration; the J259 has no calibration adjustments.

The J259's great versatility is also put to good use at National. The same systems that test wafers and packages also generate the distribution and end-of-life data that engineers need to control production processes and ensure high device reliability. Production, engineering, QC, and final test—all share simultaneously in the benefits from National's J259's.

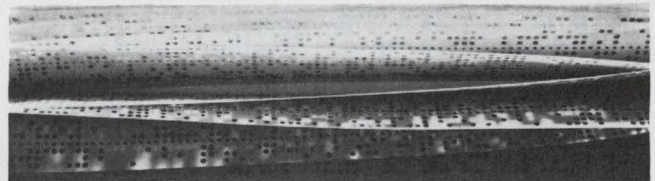

A computer-operated system is only as good as its software, which in the case of the J259 is the best there is. National's J259's are orchestrated by Teradyne-supplied master operating programs for datalogging, classification, and evaluation. As Teradyne updates and improves its software, National is kept fully informed.



National's array of J259's handle the testing of its digital IC's smoothly and economically. For its linear-IC testing, National has turned to Teradyne's J263 computer-operated linear-IC test system.

Teradyne's J259 makes sense to National Semiconductor. If you're in the business of testing circuits—integrated or otherwise—it makes sense to find out more about the J259. Just use reader service card or write to Teradyne, 183 Essex St., Boston, Mass.

Teradyne makes sense.

Circle 45 on reader service card

U.S. Reports

to the skin—appear in the multiple-exposure hologram as fringe patterns that resemble knots in a piece of lumber. Actually, says Close, the holograms can be considered a velocity map of the test panel because no-bond areas resonate faster than good-bond areas.

Hughes takes multiple holographic exposures on one plate because not all the fringe patterns show up on a single hologram, and not all the bad-bond areas would be detected. But by making several holograms with the panel in different states of excitation, combining them on one plate, and then playing them back, all the bonding flaws are revealed.

Alex Jacobson, head of the labs' Unconventional Imaging section, says commercial holographic non-destructive testing using helium-neon lasers require the test specimen to be kept extremely still while holograms are made. Because these are low-power lasers, the exposure takes several seconds vs. Hughes' 1 msec to make several exposures. And with the commercial techniques, two holograms are normally made—one with the specimen unstressed and one with some kind of stress that doesn't cause the specimen to move, such as thermal or magnetic stress. But several two-hologram series may be required.

Tap-tap. Jacobson looks for the Hughes technique to replace ultrasonic and "coin-tapping" methods.

The Hughes way is subject to one limitation researchers hope to change. Jacobson says a minimum of five minutes is required to develop the silver-halide holographic plate. A new photopolymer developed at the labs could provide a film that can be instantly developed, but it hasn't been packaged for commercial use yet.

Oceanography

Keeping afloat

Most engineers working on federal programs these days know of the paucity of new business. But just how tight it's really getting was

graphically demonstrated at an industry briefing in mid-April at which the Coast Guard was to spell out its needs for the National Data Buoy development project: nearly 700 industry representatives turned out.

And this for a program that got its first real money in January—a modest \$6.5 million for fiscal 1970. For a project with an annual budget that wouldn't even buy one F-111 aircraft, the questioning and interest was intense from attendees who represented not only smaller companies but many of the aerospace giants. The battle for business was brought home to one Coast Guard officer in the buoy program who noted his project office recently received an amazing 24 proposals for one \$70,000 study contract.

Cash flow. While the program doesn't look as though it will fulfill the optimistic forecast made in late 1967 that a 10-year effort would run an estimated \$500 million to \$1 billion, the Coast Guard now plans on program costs through fiscal 1977 of \$157 million. Prototype hardware and modifications of sup-

Up and down

Environmental measurements to be made by the high-capability buoy include eight taken to 15 meters altitude, seven down to 10 meters deep, and nine from 10 to 500 meters deep.

Above the sea, the measurements include insolation, precipitation rate, air temperature and pressure, dew point, wind speed and direction, and visibility. Just below the surface, the measurements will include water temperature, wave direction, height and period, salinity, and current speed and direction. Deeper in the sea, the sensors will measure water temperature, salinity, current speed and direction, water pressure, sound speed, ambient light and noise, and transparency.

The low-capability buoy will send back data on air temperature and pressure, water temperature, wind speed and direction, as well as water temperature and pressure from 10 to 200 meters deep.

port equipment would account for about \$67 million. Of course, all this depends on Congress' continuing to appropriate the funds for the buoys.

Money has been, and will continue to be, the pacing factor. One Coast Guard officer admits to "fooling around" for the last two years because "we didn't have the money." Even now, with the formal eight-year, long-range-development plan and concept formulation completed, the Coast Guard could accelerate the program if it gets the cash.

The Coast Guard got in the act early in 1968 after the Interagency Committee on Oceanography and others concluded there was an inordinately large number of independent efforts under way all aimed at the same thing—developing unmanned buoys to collect marine environmental data. So the Coast Guard took on the role of lead agency, its first project management job. And it's proceeding carefully and methodically, to say the least, because, as one Coast Guard officer puts it, "If we don't do a good job on this one, we'll never get another chance." The service is looking past the buoys.

Afloat in '80's. Under current plans, the development project will continue through the 1970's, with deployment of the operational system slated to begin no earlier than 1980. The work breaks down into three parts: advanced development through 1974, engineering development through 1979, and operational system procurement and operation beginning in 1979.

The advanced development phase includes the design, development, and evaluation of a so-called low-capability buoy which will make only a limited amount of meteorological measurements and which might be designed to be air dropped. The design of these buoys is to be completed in fiscal 1971, and procurement and fabrication of about 10 moored and 20 drifting prototypes will begin in fiscal 1972. In 1974, the design of a prototype high-capability buoy will begin. And about 35 prototypes will be built with deployment of this pilot buoy network scheduled for

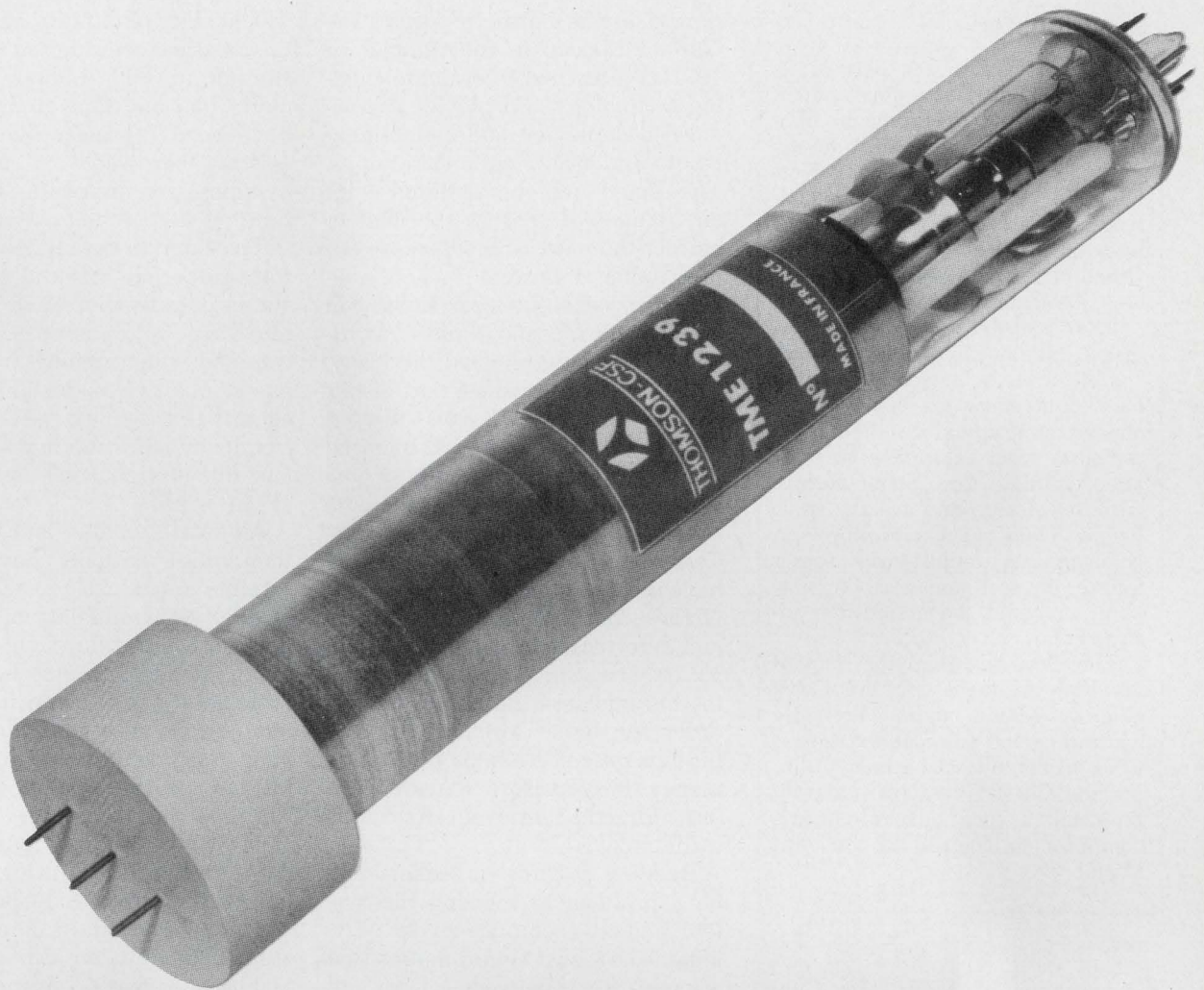

The only miniature storage tube that can hold an image for 1 month...and erase it in one TV frame.

Actually our TME 1239 acts as an electronic buffer memory. It can store a full TV gray-scale image for 15 minutes with constant refreshing, and a black and white image for half an hour. If the power is turned off, storage capability is at least one month.

A unique feature of the TME 1239 is its fast erasing capability: thanks to a specially developed gun*, one TV frame is enough to erase a complete image down to the residual noise level of a good amplifier. Because the display function is separated from the storage system, the user can selectively edit the stored image or, if he is interested in blow-up, zoom-in on any portion of the image.

The 1.5"-diameter structured silicon target of the TME 1239 permits a resolution of 1200 TV lines at a 50% modulation. It also permits operation with standard vidicon hardware, at a voltage level of 750 volts. The resulting flexibility and low cost of associated electronics make the TME 1239 ideal for a number of applications such as TV image storage, bandwidth compression or expansion, scan conversion, peripheral buffer memory, etc.

Also available is the TME 1238: its 1" target permits a resolution of 800 TV lines at 50% modulation.

For specific information, please write or call your nearest Cain & Company representative, or contact us directly.

*Thomson-CSF patent.



THOMSON-CSF

Thomson-CSF Electron Tubes, Inc./50 Rockefeller Plaza/New York, N.Y. 10020/(212) 245-3900

Sea monster

The Coast Guard, as part of its National Data Buoy development project, started operating on February 1 the first environmental reporting buoy off the coast of Norfolk, Va. For this experiment, it borrowed a 100-ton, 40-foot discus buoy developed and built for the Office of Naval Research by General Dynamics' Convair division.

The "monster buoy" was refurbished as an automatic weather station and is presently sending back data every six hours on air and water temperature, barometric pressure, wind velocity, solar radiation, rainfall, dew point, surface current velocity, and average wave height. The Coast Guard, however, is having its troubles with sensor failures in such areas as the dew point unit and the underwater instruments.

The data link from the buoy is via high frequency to the Coast Guard's Miami radio. Presently controlling the automatic station is a Navy computer at La Jolla, Calif., but the Coast Guard plans shortly to install a small general-purpose computer to control the buoy at Miami.

the summer of 1977. The Coast Guard, for planning purposes, is estimating an operational system of 150 buoys.

Industry participation to date has been minimal. Sperry Systems' Management division is the systems support contractor and Texas Instruments is presently surveying oceanographic and meteorological sensors. These contracts carry hardware exclusion clauses, which means that the companies can't bid on hardware until two years after contract work is completed, or July 1972.

Start. But the first big job is coming this summer. In July or August, the Coast Guard expects to issue requests for proposals for two prime contracts on a 10-buoy system, says Cdr. John E. Wesler, deputy manager for the buoy project. One is for a system integrator responsible for the buoy mooring and telemetry, and the other is for a prime contractor to manage the

sensors. These buoys will be deployed in the northern part of the Gulf of Mexico in the summer of 1971 as a testbed to evaluate existing technology and provide experience in deploying and maintaining a network of automatic data buoys. The buoys will be outfitted with environmental sensors specified to correct the most common causes of operational failure.

Sensor reliability, particularly in underwater oceanographic instruments, has long plagued the Navy. "We know the weakest part of our system is sensors," says Wesler. So the Coast Guard in this initial network wants to get the best possible buoy and mooring to eliminate the variables in evaluating sensors. One reason oceanographic sensors have been so deficient, Wesler says, is there has not been enough demand for such instruments. There are only two small companies really in this business, he noted, and an order for 10 sensors at a time is big business. "We hope by putting money into sensors that we can make drastic improvements in the technology."

Random failures in sensors will be a problem in meeting the system objective of once-a-year servicing. The Coast Guard figures that a mean-time-between-failure of more than 15 years will be needed to meet high-capability buoy performance goals. Just how tough a job this will be can be judged from the mtbf of existing sensors, which is typically on the order of a few months, the Coast Guard estimates. What this means is that the emphasis will not be on the development of new sensing techniques or advancing state-of-the-art accuracies, but developments of sensor reliability and calibration stability, according to Wesler.

Computer. One, possibly two, general-purpose digital computers will be needed on the big buoy, and the Coast Guard is counting on large scale integrated circuits to improve reliability and reduce computer size and power demand. It is thinking about a memory capacity of at least 8,192 words of 13 bits each and an add time of 32,000 times a second. State-of-the-art digital magnetic tape records can

meet the requirement of accepting 140,000 bits of data for each synoptic measurement period and total storage of 700 million bits, but more than one tape transport may be needed for each buoy. Again, existing hardware can meet data handling requirements, but reliability is the problem, Wesler says.

The external data link, which will transmit environmental and buoy status data to shore will also need receiving equipment to handle command instructions from shore bases. The two modes of communications that will be used are high-frequency ionospheric propagation, and line-of-sight via satellite relay at vhf or uhf.

All satellite. The data buoy system will eventually have to use satellite relay exclusively because of only 90% reliability of over-the-horizon b-f transmission. This one factor alone consumes half of the 20% data loss allowed in the system performance goal, placing perhaps an impossible reliability burden on the system hardware. The goal for the system is to get at least 80% of the environmental data to the user during at least half of the observation periods.

The Coast Guard hopes to be able to tie into an Environmental Science Services Administration satellite in about 1973. Another satellite that could be used in the aeronautical services satellite in the planning stage for an early 1970's launch.

Antennas

Dishing it out

There's a way to make a higher resolution radar out of a system with only a moderate sized aperture, and scientists at the Air Force Cambridge Research Laboratories are working to improve it.

According to Allen C. Schell, of the center's microwave physics laboratory, a computer-based technique being developed there can often yield a 50% improvement in angular target resolution, and sometimes even up to 100%, a definite plus in situations like those around

NOW

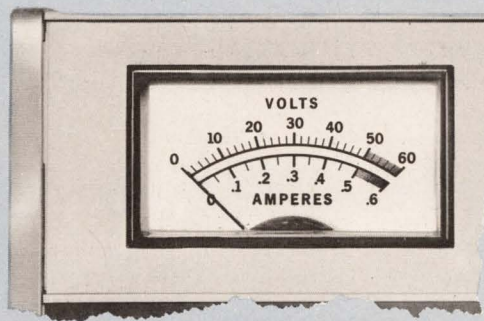

3 MODELS AVAILABLE

Model 6177B
0-500mA, 0-50Vdc

Model 6181B
0-250mA, 0-100Vdc

Model 6186B
0-100mA, 0-300Vdc

THAT'S

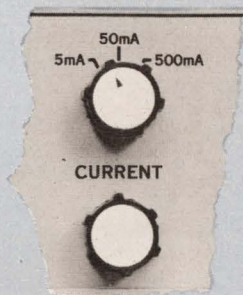

EXCELLENT RESOLUTION
0.02% of range selected

PRECISE REGULATION
25 ppm of output down to 1 μ A using unique guard design.

CONSTANT

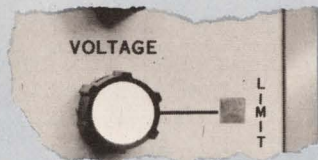

CURRENT

INDEPENDENT VOLTAGE LIMIT

Preset your voltage... light warns when complying voltage limit is reached.



RAPID PROGRAMMING

1ms from 0 to 99% of full range

HIGH OUTPUT IMPEDANCE

100 to 10,000 megohms depending on range

Typical applications for HP Constant Current Sources include: ■ semiconductor testing, e.g., evaluating reverse breakdown and V-I characteristics of p-n junctions ■ measuring dynamic or incremental impedance ■ extremely accurate four-terminal resistance measurements ■ testing and sorting resistors, capacitors, relays, and meters ■ precision electroplating ■ analytical testing ■ operating IMPATT and GUNN Effect diodes ■ supplying accurate currents to Hall Effect devices. Write for Constant Current Application Brochure. Model 6177B and 6181B: \$425. Model 6186B: \$475.

Hewlett-Packard, New Jersey Division, 100 Locust Ave., Berkeley Heights, New Jersey 07922.

HEWLETT  PACKARD
POWER SUPPLIES

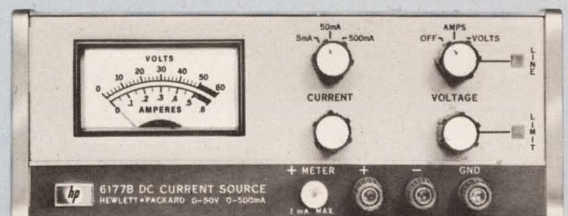

The jackknife with 6 business ends. One unit, many uses.

So when we built the Wirecenter, we built it along the very same lines: A multi-functional tool.

The Wirecenter lays harness. It does back panel wiring. It has NC600 point-to-point controls for absolute and incremental programming; or NC500 contouring numerical control programming. And all commands are on N/C punched tape.

In fact, it's not so much what we say the Wirecenter does, but rather what you'd like it to do. Because you

can configure it to your requirements — both current and future (the Wirecenter can easily be adapted as your production needs change).

You can order it with single or dual heads, one or two tables (on front and back of the machine), or in combination. For wire terminating there's a side loading Wire-Wrap head and a Termi-Point head. For harness assembly, a Harness Laying Head. For field

service, a single source for both the Wirecenter and its Numerical Control.

In short, a specialist machine with generalist functions.

It's the kind of thinking that can lead you to the Wirecenter too. Call or write: Hughes Aircraft Company, Industrial Systems Division, Box 92904, Los Angeles, Calif. 90009.

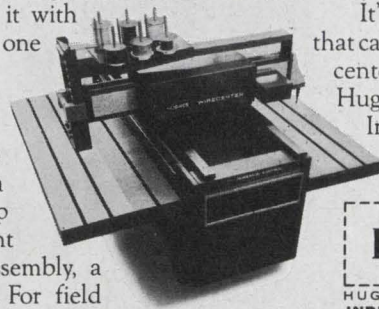

HUGHES

HUGHES AIRCRAFT COMPANY
INDUSTRIAL SYSTEMS DIVISION

It was this kind of thinking that led us to the Wirecenter.

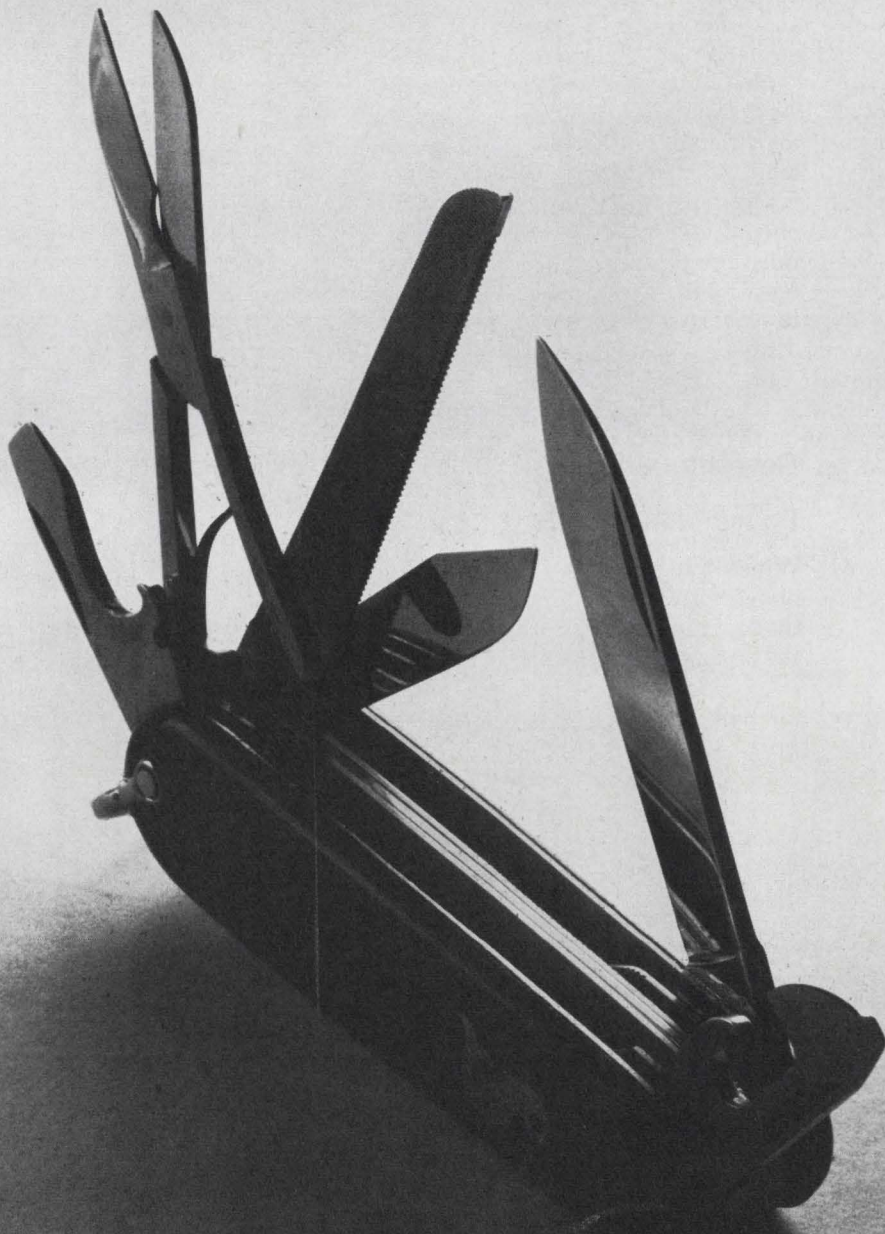

crowded airports where today's broad-beamed FAA radars lack the target discrimination many feel is necessary. Schell also feels the technique could be adapted to radar systems forced to use small diameter antennas like those in aircraft—in effect, simulating a larger dish than would physically fit the plane's nose.

Spots sun. So far, though work on the signal-processing technique has been going for about 18 months, demonstrations have been limited to radiometric work. Using the laboratory's 28-foot antenna in Waltham, Mass., Schell has scanned the surface of the sun at 8-millimeter wavelengths and processed the resulting data in the labs' computer complex.

To see how much improvement in resolution the technique added, Schell arranged for comparison a simultaneous scan by the 120-foot haystack antenna of Lincoln Laboratory. Using this as a standard, Schell was able to arrive at the 50% to 100% improvement figure.

But scanning the sun is a passive application, and the data processing so far isn't done in the real time radar would need—an x-y plot of the sun takes about 45 minutes to compute, according to Schell. Also, the results aren't totally dependable yet; the scheme may be resolving things that aren't really there, he says.

With this in mind Schell is now debugging the program, and in a couple of months he feels that he'll have a much better gauge of the scheme's true performance.

Two parts. The software involves two major phases: first, the spectral components of the source (like the sun) or target (in radar applications) must be restored. The antenna, because its pattern isn't a single perfect beam but rather is divided into lobes and nulls, always gives an incomplete picture of what it views; so by melding the incoming data together with the antenna pattern it's possible to flesh out the picture. The second step is to retrieve and sharpen detail through iterative solution of a complex integral equation.

The accuracy of the technique is only as good as the accuracy of the

antenna pattern; it's here, Schell feels, that some of the suspected errors in the enhancement process may lie. "This technique is only as good as the accuracy of the antenna pattern measurement," he says, "and at Prospect Hill, where the labs' antenna is located, the antenna pattern was measured with the dish pointed at the horizon, while most of our data was taken nearer the sun's zenith. Consequently, gravity probably deformed the dish subtly and so changed the pattern."

But for small dishes whose patterns are easy to gauge, or for larger existing dishes whose characteristics can be measured very accurately—like antennas at major air traffic control centers—the technique could be made to work well.

Heads up. After sharpening up the computer program, Schell hopes to be able to encourage development of a relatively small analog computer module—"one small enough to fit a plane"—which could raise the performance of radar systems with low angular resolution to levels associated with larger dishes.

Government

Penny wise . . .

Without fanfare, and almost without informing the men involved, the Air Force is about to dismantle the Office of Aerospace Research (OAR). Many of its high ranking officials already may quit in disgust.

OAR oversees the activities of the 1,200 personnel at the Air Force Cambridge Research Laboratory, and L. G. Hanscom Field, Mass.; the Aerospace Research Laboratory at Wright Patterson AFB, Ohio, with an estimated 300 to 400; the Office of Scientific Research in Washington with about 150 men; and the office of research analysis in New Mexico with its 60-man staff.

The Air Force appears to be disbanding the headquarters organization of OAR, and directing its laboratories to report to the Air Force Systems Command's director of

A lot of people are saying Hughes is into a lot of things

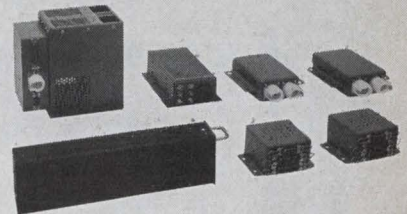
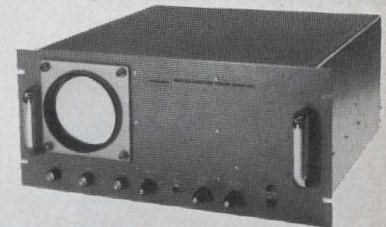
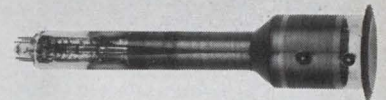
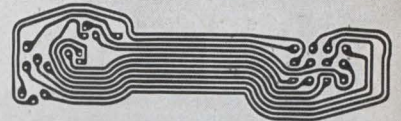
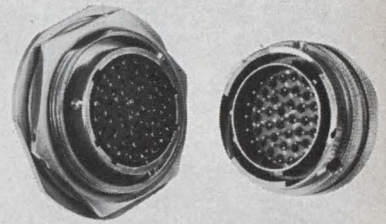

A lot of people are right.

And with good reason. Hughes makes better electrical connectors (RS 287), flat flexible cable and circuit assemblies (RS 288), direct view storage and scan converter tubes (RS 290), display systems (RS 291), and multiplex systems for remote communications/control (RS 292).



NANOPULSER

the fast rise time,
large amplitude, variable
delay pulse generator



Rise/fall time less than 1ns
Amplitude variable up to $\pm 50v$

The Series 2306 NANOPULSER combines extremely fast rise/fall time and large amplitude with other important performance features:

- REP RATES UP TO 1 MHZ
- BIPOLAR OUTPUTS
- GATING CAPABILITY
- SINGLE SHOT OPERATION
- LOW JITTER
- PRE-TRIGGER PULSE
- PROGRAMMING CAPABILITY

TYPICAL APPLICATIONS: Testing high speed switching devices such as semiconductors, IC's, memory elements, etc.; Reflectometer pulse source for discontinuity testing of long or lossy cables via time domain reflectometry. **PRICE:** From \$650

VARIABLE CALIBRATED DELAY UNIT



0 to 60.75ns in
0.25ns increments

Bandpass > 1000 MHz

Series 1200 Delay Units provide discrete values of calibrated delay for applications in RF, pulse and digital systems. Delay steps as small as 0.25ns, continuously variable up to a total of 60.75ns with a built-in 0.3ns vernier. Delay accuracy is better than $\pm 1\%$. Ideal for use with Series 2306 NANOPULSERS to provide calibrated pulse widths. Both manual and remotely programmable models available. **PRICE:** From \$340

GRALEX

INDUSTRIES
155 MARINE ST., FARMINGDALE, N.Y.
516-694-3607
A DIVISION OF
GENERAL MICROWAVE CORPORATION

U.S. Reports

laboratories. On the surface, this looks like just another economy move by simplifying and concentrating the chain of command and responsibility for aerospace research within the Air Force.

Real reason. However, highly placed OAR spokesmen feel that the change may mark the end of one of the most fruitful periods in Air Force research. The reason: the more codified, security-conscious, goal-conscious Systems Command will stifle the research that has led to unexpected breakthroughs in technology, especially at the Cambridge facility. That facility, with its 1,200-man staff, is said to be the largest of the service's true research operations. Now, it's believed, it is to be partly amalgamated with the Electronic Systems division, located at Hanscom field. Although both would have their own commanding offices, the Cambridge lab would find itself depending upon Hanscom field personnel and facilities for much of its service and support activities, and this would be expected to thin the ranks of researchers at the laboratory.

In even longer range terms, the switch would be significant for a different reason. Comments one official there, "We're going to be section 203-ed to death." (Section 203 prohibits research into areas without foreseeable and immediate payoff). "Everything will have to have some kind of mission description to become fundable," he continues, "and there goes the opportunity for the kind of work that has led to unsuspected payoffs in the past."

Remote. The lab does many things which are remote from any war effort: solar mapping, ionospheric measurement, study of the solar corona, brain wave research, and radio astronomy, to name a few.

Thus, staff ranks are expected to thin out because of frustration, and the Systems Command's director of laboratories is expected to use section 203 as a sieve to strain out research funds that would finance any other than tightly goal-oriented research.

Communications

Turning MCI on

The communications industry and its customers are watching closely as Microwave Communications Inc. moves closer to its September 11 start on the first special service common carrier linking Chicago and St. Louis. MCI president John D. Goeken has signed up the Raytheon Co. for the \$3.5 million turnkey installation that will provide the equivalent of 1,800 channels of 4 kilohertz each with 1,600 channel ends. Customers being lined up for the initial installation, says MCI, range from the Continental Can Co. and the Boise Cascade Corp., with Continental Can ready to take the equivalent of 80 voice channels, down through Famous Barr, a time-sharing-service company that will require "only a couple of low-speed data channels."

Between those extremes are organizations like Holiday Inns, MCI says, which will link its Memphis, Tenn., headquarters via the Bell System with MCI's St. Louis terminal on the Laclede Gas Co. building. It then will interconnect with the Chicago terminal being readied at the new John Hancock Tower with its antenna 1,450 feet above street level.

Who does what. Raytheon, says MCI, has subcontracted much of the system, with Canada's Northern Electric providing multiplex equipment; the Rohn Manufacturing Co. is engineering the 12 towers in the loop, while Prodelin is supplying the antennas. Raytheon itself is providing the 20 KTR-3 transmitters, including the two needed for each terminus.

In evaluating suppliers, MCI's Goeken says that ITT's hardware provided the lowest error rates but the fact that it was produced by the company's West German operation raised a question about ability to meet delivery schedules. Raytheon came in next and got the job, while Lenkurt Electric ranked third and Collins Radio last. However, all of the four FCC-approved systems ranked close, and the parent firm, Microwave Communications of America, notes that "we don't

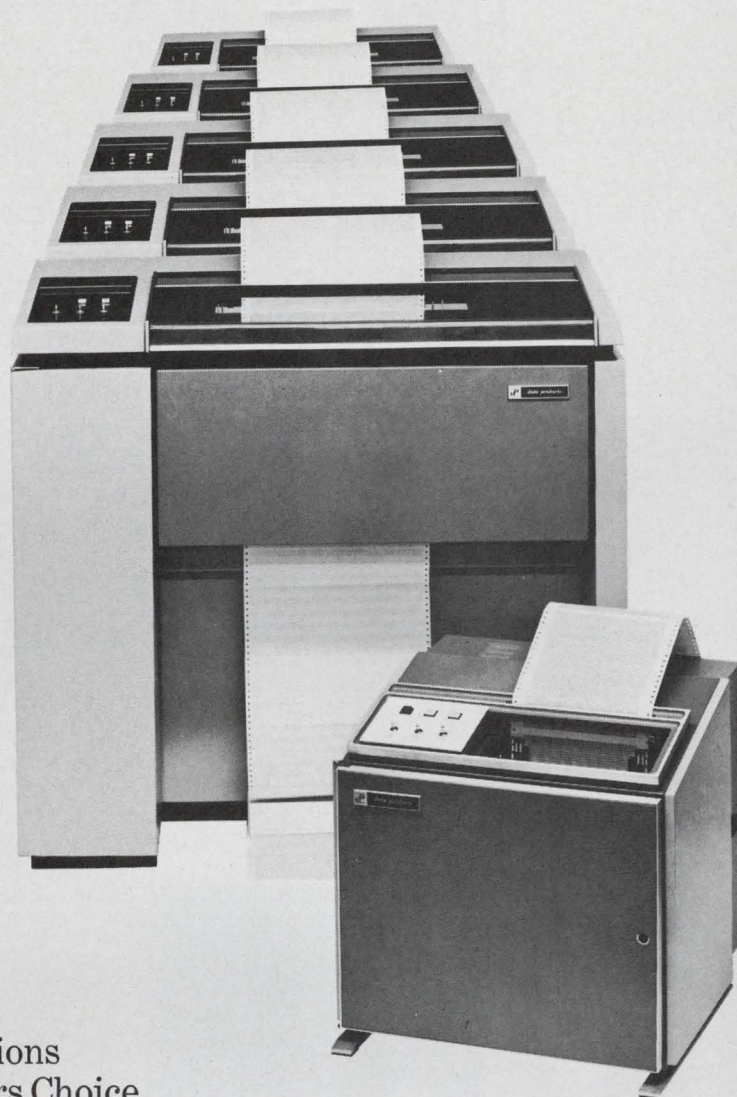

How a Choice of Options
Makes a Line of Printers Choice

First offer the OEM a choice of line printing rates: 245 up through 1200, the highest speed on the market today. Then offer a choice of columns, 80 through 160. Add in interchangeability of spares. Include the unique Mark IV one-piece hammer for extra-crisp printing. You'll have a common-sense approach to a complete line of printers. Family planning you might call it. All that's needed now is the technology, the proprietary components and, of course, Data Products' experience. You've become first choice. (End-users also get a choice through our Systems Division which engineers fully-interfaced systems). Call Bob Englert (213) 981-9600.

DATA PRODUCTS
P technology
gives your
computer
the edge

DATA PRODUCTS

OEM marketing 16055 Ventura Blvd., Suite 419, Encino, Calif. 91316

See us at SJCC Booth 1000

Los Angeles 213/981-9600 Minneapolis 612/927-8747 Dallas 214/239-9641 Acton, Mass. 617/263-3961 Bethesda, Md. 301/652-8120
Melbourne, Fla. 305/723-0720 Chicago 312/325-6630 Amsterdam, The Netherlands 020/156-297 London, England 01-579-3116
Cherry Hill, N.J. 609/667-7555

So what if
H_{beep} P_{beep}
does have
a motor pool

They don't
have an
ac/dc converter
with 70 dB
dynamic range
for \$690.

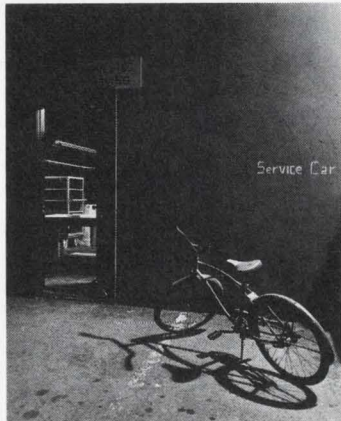

Our Model 1008 is a new type wide range linear detector. As a system building block, it provides more sensitivity (300 microvolt), greater frequency range (5 Hz to 5 MHz) and greater dynamic range (3000 to 1) than any instrument previously available. And for a thousand dollars less. For complete specs on the Model 1008, write Pacific Measurements Inc., 940 Industrial Avenue, Palo Alto, California 94303. We gotta be better.



PACIFIC
MEASUREMENTS

U.S. Reports

expect to lock in with one manufacturer" as it moves to build the more than 12 regional systems planned.

For example, ITT equipment is specified in the filing of Microwave Communications of America's affiliate, Interdata Communications, for a New York-Washington route. Lenkurt gear is specified in two new FCC filings by MCI Mid-Atlantic Communications, running from Washington to Atlanta, and MCI Kentucky Central, linking Atlanta, Chattanooga, and Nashville with major Kentucky cities with an eastern terminus at Cincinnati and a western hookup at St. Louis. Raytheon systems are also specified for the newly filed 64-site system of MCI Texas-Pacific, tying Dallas to Los Angeles at a cost of more than \$8 million. Raytheon is also named in filings of MCI Michigan and MCI New England.

For the record

Pocket model. Japan's Canon Inc. and Texas Instruments have built a calculator that fits into a slim case not much larger than a paperback book. Called Pocketronic, the mini-calculator adds, subtracts, multiplies, and divides; it can also perform repeated multiplications and divisions with a common factor, and its results appear as hard copy printed on a strip of paper. Canon and TI designed the machine around three MOS circuits that contain almost all the machine's circuitry. Not included in the three chips are the system clock, the paper advance controls, the printing mechanism, and the 10-key keyboard. The printing mechanism is based on the thermal printer TI introduced last year [*Electronics*, May 12, 1969, p. 178], and the paper tape, made by the 3M Corp., comes in a cassette. Marketing of the calculator will start in Japan next fall and in the U.S. early in 1971. Price: under \$400.

Satellite snoopers. Sen. Warren G. Magnuson (D., Wash.) is introducing legislation to set up a World Environmental Institute to foster cooperation among nations on both

Programmable Pattern Generator

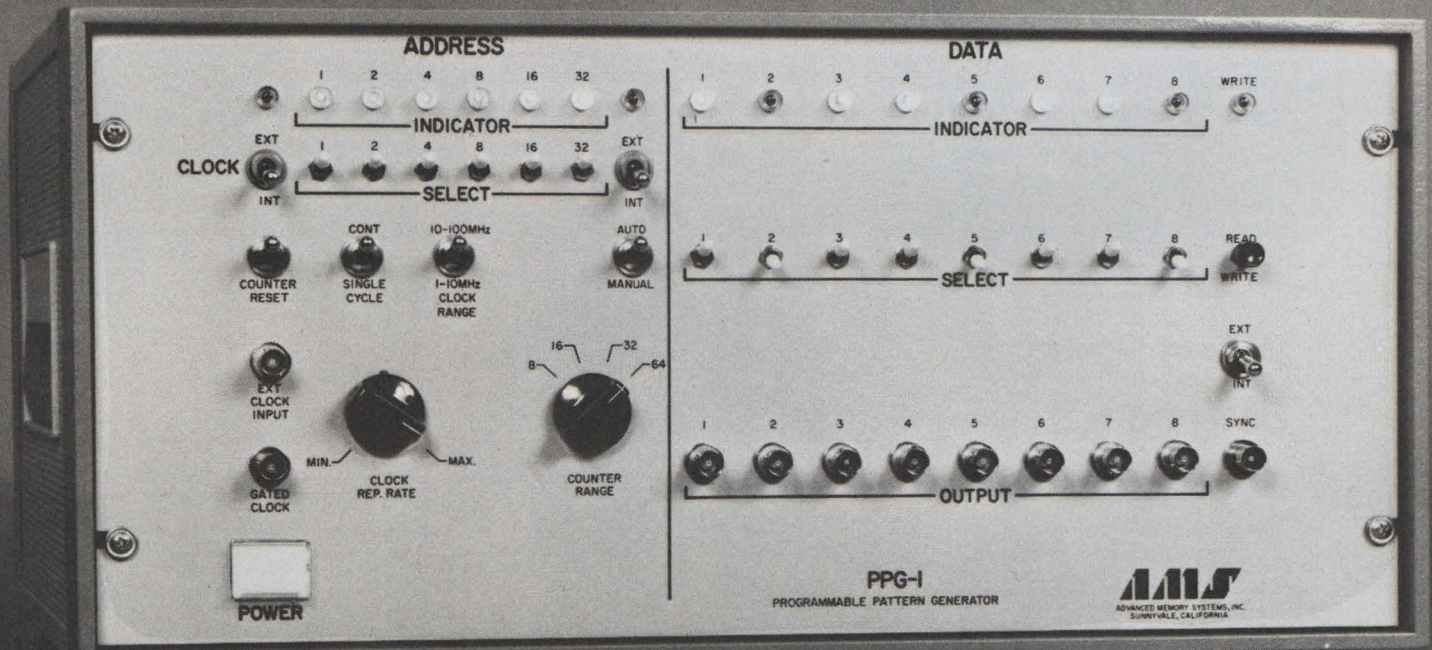

Program pulse position and pulse width from your computer *or* from the front panel. Once the program is set, the PPG-1 can provide data outputs in 10 nanosecond increments. Eight channels, sixty-four bits per channel. DC to 100 MHz clock rate. 1.5 nS rise and fall time.
That's a Pattern Generator:
Advanced Memory System's PPG-1

ADVANCED MEMORY SYSTEMS, INC., 1276 HAMMERWOOD AVENUE
SUNNYVALE, CALIFORNIA 94086 • TELEPHONE (408) 734-4330





Largest selling VOM

now has New
Taut Band
Movement
cannot develop
error-causing
friction.

World Famous
Simpson 260[®]
Millions now
in use!

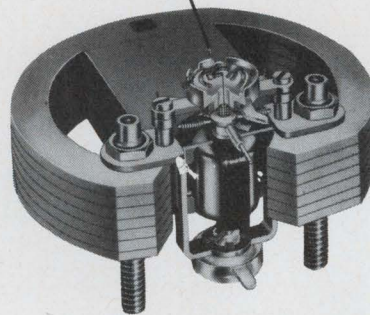

- SELF-SHIELDING, SHOCK PROOF . . . for outstanding accuracy and repeatability.
- VARISTOR PROTECTED against even 200,000% overloads.
- RUGGED DEPENDABILITY that has no equal.

New Taut Band 260[®]-5 complete with test leads, batteries, and 40-page operator's manual . . . \$65.00
 New Taut Band 260[®]-5M with anti-parallax mirror scale and knife-edge pointer . . . \$67.00
 New Taut Band 260[®]-5P with circuit breaker overload protection of VOM circuitry . . . \$97.00

GET "OFF-THE-SHELF" DELIVERY FROM
YOUR LOCAL ELECTRONIC DISTRIBUTOR

Simpson

ELECTRIC COMPANY



5200 W. Kinzie Street, Chicago, Illinois 60644 • Phone (312) 379-1121
 Export Dept: 400 W. Madison Street, Chicago, Illinois 60606. Cable Simelco
 IN CANADA: Bach-Simpson Ltd., London, Ontario • IN INDIA: Ruttonsha-Simpson
 Private Ltd., International House, Bombay-Agra Road, Vikhroli, Bombay

INSTRUMENTS THAT STAY ACCURATE

sides of the Iron Curtain in fighting pollution. Announcing his plans at the International Geoscience Electronics Symposium in Washington earlier this month, Magnuson touched off speculation that the Earth Resources Technology Satellite program might be used in such an international effort. In addition to imaging the earth through remote sensors, the ERTS satellites will be able to interrogate ground-based data buoys and measuring stations. These stations could, for example, be placed to detect pollutants flowing into rivers and streams from industrial plants anywhere in the world. NASA has been trying to acquaint foreign governments with this nation's earth resources survey program working with individual governments, such as Brazil and Mexico, and through the United Nations Outer Space Committee.

Payoff. An in-house R&D program by the Hoffman Electronics Corp. to develop a high-accuracy, solid state, coherent-pulse doppler radar altimeter has paid off with a \$760,000 initial contract award from Lockheed California for development and production of prototype quantities. The instrument is to be used in the Navy's S-3A anti-submarine aircraft. Although the initial contract is small, company officials see several million dollars in potential business from the altimeter, and predict that it will develop into very significant business over the next four or five years.

A watched clock. The Bulova Watch Co. has developed and introduced its version of the quartz crystal wristwatch, and although it's the third to do so, behind Seiko and Longines [*Electronics*, Jan. 19, p. 66 and Sept. 29, 1969, p. 10E], the company claims to be the first of the three to retail them in the U.S. (the first one was sold in New York City earlier this month). The watch is not, however, aimed at a mass market. In the first two men's styles it sells for \$975 and \$1,325. And for the girls, there's a special diamond brooch model for only \$50,000.

Our
 2N5592 JFET
 has
 33% lower
 1/f noise
 than
 our
 2N5593.

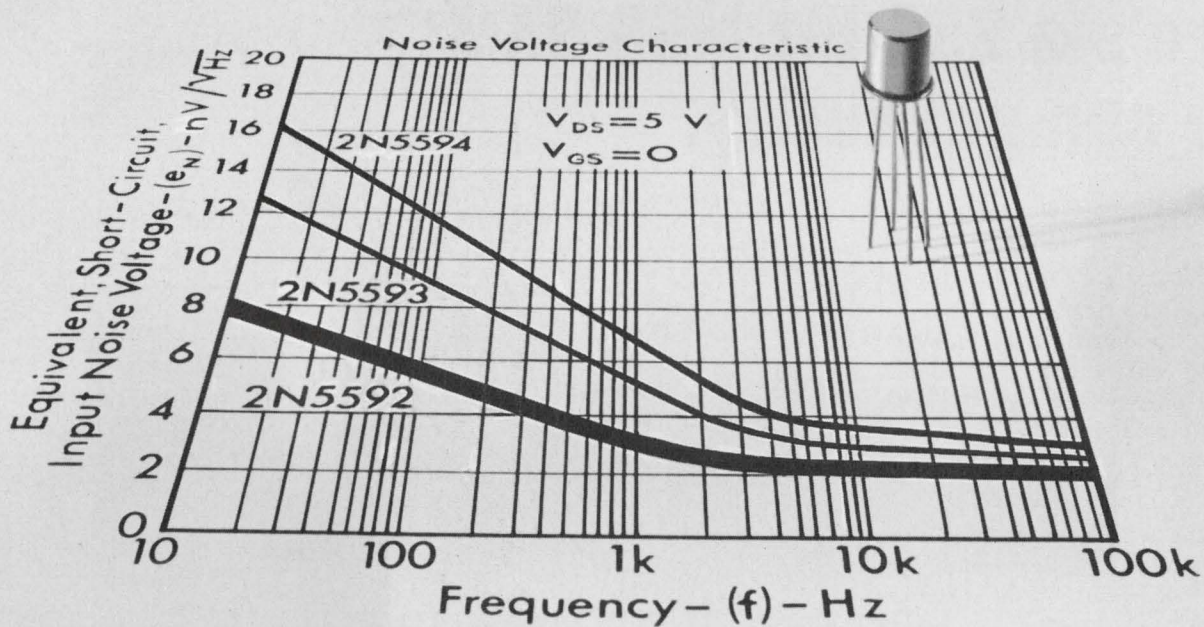

How low can we get?

Only time will tell. Because we're designing an entire family of N-Channel JFET's around a new manufacturing process. And one of the nicest things about this process is that it has low-noise as a natural characteristic. In fact, the 2N5592 is the lowest-noise device of its type. (Maximum noise is $10 \frac{nV}{\sqrt{Hz}}$ at 10 Hz.) Output admittance is also very low, typical γ_{os}

is $1 \mu mho$. And since it's an N-Channel JFET, you know what kind of gain to expect. (Around $4500 \mu mhos$.) What's more, 2N5592 is available right now. Bet you didn't expect that.

Solitron Devices, Inc., P. O. Box 1416,
 San Diego, California 92112.
 Telephone 714/278-8780.
 TWX 910-335-1221.

Solitron DEVICES, INC.

microtopics

If you can wait 10 nanoseconds we can save you a bundle.

If you don't need all the speed of TTL, we can save you money with Philco® DTL. It depends upon whether you can tolerate the extra 10-ns propagation delay.

You save money with DTL because you need fewer types to do the job.

The "totem pole" output of TTL doesn't permit wired-OR connections; therefore you have to buy and stock more types to make up different logic functions. With DTL, however, you buy a few basic types, connect their outputs, and get a variety of functions.

DTL is compatible with all popular MSI as well. But if you *do* need the speed of TTL and the functions of MSI, we've got that too... 9600, 7400, and 9300. Ask the better idea people to analyze *your* logic requirements.

CIRCLE 220 ON READER SERVICE CARD

Here's a 256-bit MOS RAM you can get today.

That's what's different about ours... we can *really* deliver it off the shelf.

It's a *complete* read-write memory system on a chip: 256-bit storage, read-write control logic, sense amplifier, and chip-select logic... with speed and total installed cost comparable to a core memory. And it *needs no peripheral electronics*.

Each bit is a bistable flip-flop that permits nondestructive readout. But pattern is 256 1-bit words—expandable to 4096 bits by stacking. Access time? Typically 1 μ s.

CIRCLE 221 ON READER SERVICE CARD

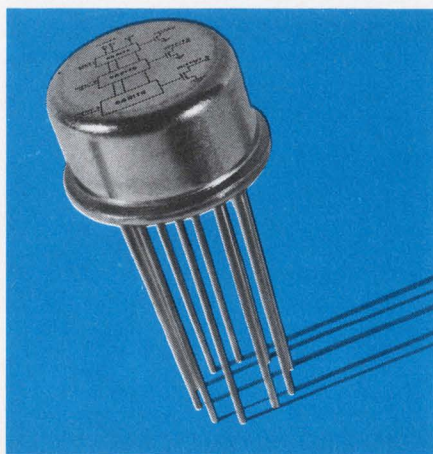
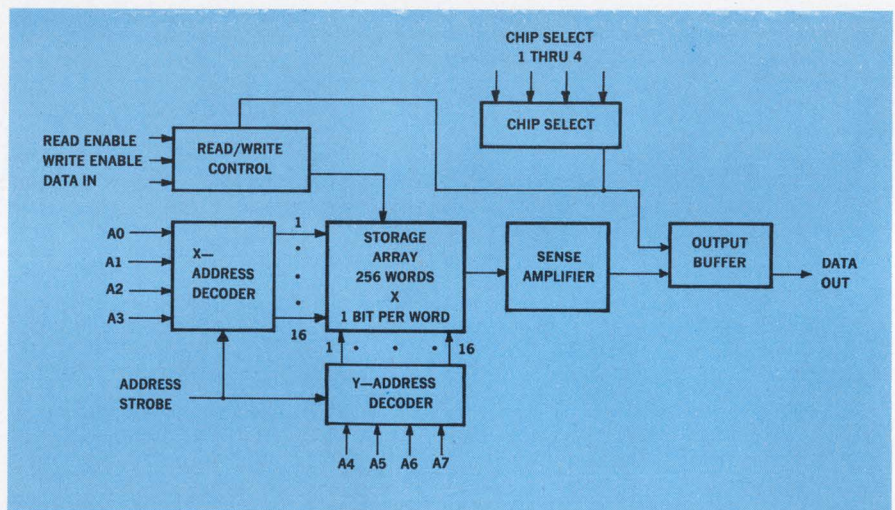

TRIPLE-66 BIT...another MOS shift register from Philco-Ford.

This newest Philco® dynamic shift register is designed to keep your package count down. By using a common power supply, common clock, and common ground, we also minimize the number of wired connections.

This "3-in-1" shift register stores 64 bits of information plus 2 bits of parity on each channel. Shift fre-

quency ranges from 10KHz to 1MHz. Input logic levels are -3 volts for a "0"; -9 volts for a "1." Output capability of each register is 2 ma load current at -3 volts.

Try the pL5R198C for applications like temporary storage, digital rate conversion, precision delays, signal processing correlation.

CIRCLE 222 ON READER SERVICE CARD

The better idea people in microelectronics.

PHILCO 

PHILCO-FORD CORPORATION • MICROELECTRONICS DIVISION • BLUE BELL, PA. 19422

We make an impressive array of silicon photodetectors.

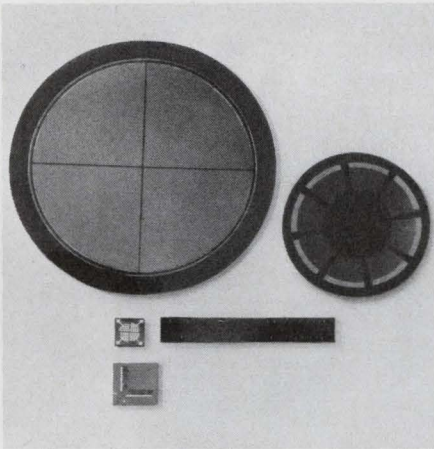

With field-proven performance that's based on 15 years' experience in silicon technology. It all adds up to a broad capability in custom photodiodes, monolithic linear arrays and mosaics—n on p (including guard ring) and p on n structures.

Sophisticated application? We make things like star tracking detectors and sun sensors, high-speed laser detectors and photomixers, flash and explosion detectors, optical fuzes, missile guidance devices, and nuclear radiation monitors.

Want facts and figures? Philco® visible and near-infrared photo devices have specs like these: spectral range of 0.3 to 1.1 microns; responsivities to 0.60 amp/watt @ 0.9 micron; leakage currents as low as 10^{-13} amp; detectivities $> 10^{12}$ cm-Hz^{1/2}/watt; linear arrays of over 150 elements, each as small as 0.001" square; and array cross talk $< 0.01\%$.

Interested in two-color detection? We combine silicon with InSb to achieve visible and far-infrared detection.

CIRCLE 223 ON READER SERVICE CARD

New, high-bit capacity static MOS ROMs:

You can get Philco® 2048-bit static ROMs custom-made for your application in just 6 weeks. For micro-programming, look-up tables, code conversion, control logic... you name it.

Select the bit organization that fits your needs: 8-bit, 4-bit, 2-bit, or 1-bit words. Need a large memory? Just stack these ROMs for any bit capacity, in multiples of 2048.

Because the pMS2048C is a static device, output data remains valid as long as an address is present... and

the output is compatible with both bipolar and MOS circuits.

Some Philco static ROMs are available off the shelf. The pMS2240C, for example, is a 2240-bit MOS device configured as a character generator. It's preprogrammed and, when addressed by the standard ASCII code, generates 64 alphanumeric display symbols... to create all the characters on a conventional teletypewriter. Access time for first-row bits is 1 μ s, 0.7 μ s for successive bits.

CIRCLE 224 ON READER SERVICE CARD

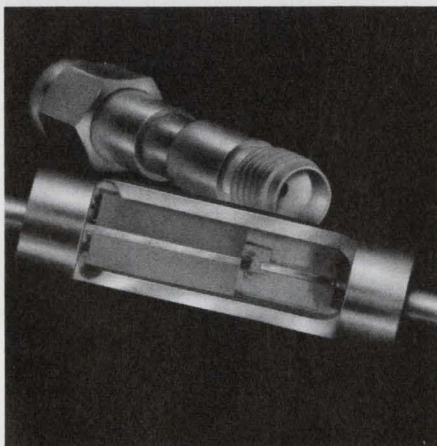
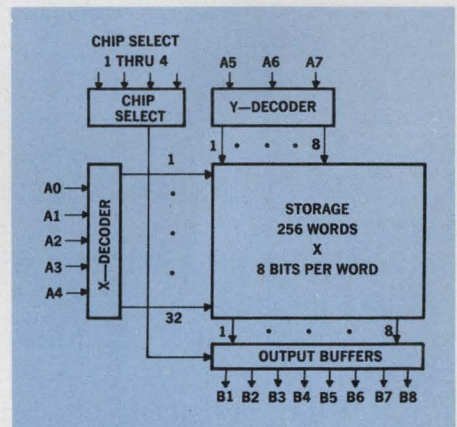

Broadband mixer-detectors... with new mod modules.

Our P5100 Series mixer-detector assemblies are state-of-the-art in the true sense. They're designed with highly efficient Schottky-barrier or backward diode chips in integrated circuit modules for broadband performance from uhf to Ku band.

How? The hermetically sealed module eliminates the package parasitics which limit the broadband per-

formance of conventional semiconductor diodes.

You get performance characteristics like these: 7 db noise figure in mixer applications; 12 db noise figure in Doppler mixers; -55 dbm sensitivity without a requirement for external bias in detector applications.

CIRCLE 225 ON READER SERVICE CARD

Is your IC tester physically fit?



Does your tester test comparators and op amps?

Does your tester test with single card programming?

Is your tester simple to operate and fast?

If not, you should be using our Model 1420 tester. This stout-hearted tester takes ICs through fourteen rigorous tests* as fast as blink, blink, blink. No knobs to fiddle, no dials to twiddle. In fact, it's so easy to operate even your secretary can use it.

And it's the most complete testing system available, with a digital readout meter to indicate to what degree each IC passes

or fails. Plus, all kinds of options like classification, data logging and an accuracy rating from 1% to 5%, your choice.

That's why every major op amp manufacturer owns our 1420 or the 1410.

Check out our low priced line by writing for specs and addendum. Better yet, call marketing, Signetics Measurement Data Division, (415) 961-9384. And see the line for yourself.

Yes, we make house calls.

*The fearsome fourteen...1) power consumption overrange (greater than 200%), 2) power consumption (less than 200%), 3) offset voltage (source resistance zero ohms), 4) offset voltage (source resistance programmed), 5) + supply sensitivity, 6) - supply sensitivity, 7) common mode rejection, 8) bias current, 9) offset current, 10) gain (programmed full load), 11) gain (programmed light load), 12) noise, oscillation, 13) + slew rate, 14) - slew rate.

Signetics

MEASUREMENT/DATA

Signetics, Measurement/Data, 341 Moffett Blvd., Mountain View, Calif. 94040/A subsidiary of Corning Glass Works

Time interval measurements like you've never seen before.

Plug the HP 5379A Time Interval Unit into the HP 5360A Computing Counter and things happen faster than they could ever happen before.

This unique combination resolves time intervals to 100 picoseconds. With absolute accuracy of 1 nanosecond. And you can measure zero, positive and negative intervals, which makes it ideal for checking coincidence.

By adding the HP 5375A Keyboard, you can enter programs to produce instantaneous answers about phenomena that you could never previously measure with a counter. Things like peak-to-peak jitter; rms jitter; phase measurements; duty cycle; and radar ranging in feet,

inches, meters or any other units you want.

Thanks to the 5379A, dozens of jobs can be handled easily and accurately. These include calibration of radar, lasers, and laboratory instruments; testing semi-conductors and computers; cable fault location; delay line adjustment; ballistic and nuclear measurements.

It does all this while saving you the cost of a computer, because the computer's built in. And you're not buying a counter that only measures time interval. You're getting the most advanced frequency measuring system available today, ideal for measuring pulses, pulse trains or any time-based events.

The cost is \$750 for the plug-in and

\$6500 for the mainframe. Your local HP field engineer will be glad to arrange a demonstration. Give him a call. Or write for complete information to Hewlett-Packard, Palo Alto, California 94304; Europe: 1217 Meyrin-Geneva, Switzerland.

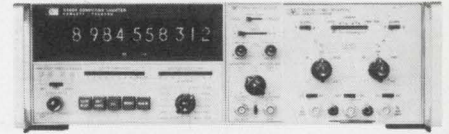

HEWLETT *hp* PACKARD

ELECTRONIC COUNTERS

02920

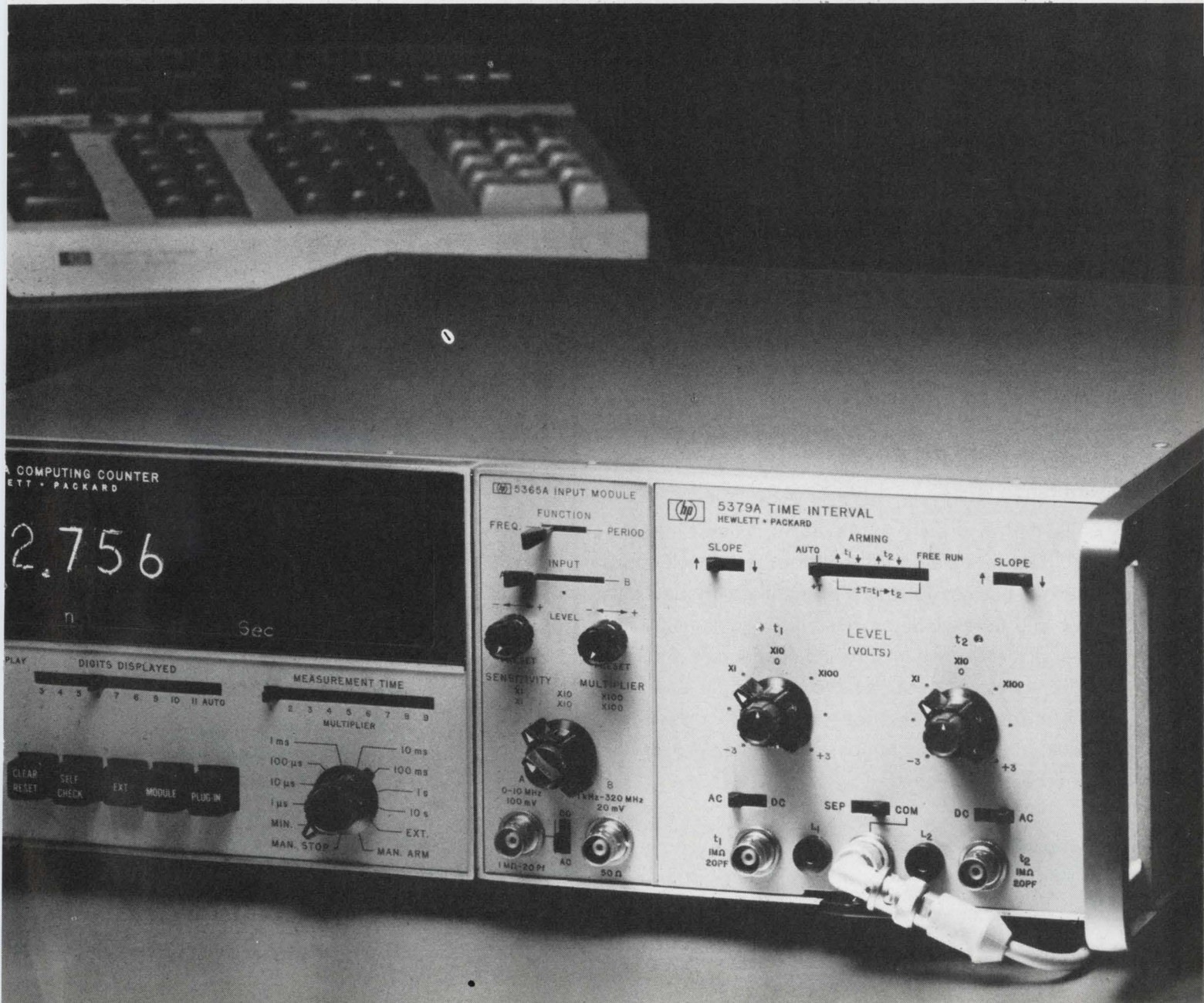



MICROWAVE IC MODULES PROGRESS REPORT #10: RADAR ALTIMETER RECEIVER

When Sperry Rand's PACT (Progress in Advanced Circuit Technology) program addressed itself to radar altimeters, the objective was a receiver module on a single substrate. The objective has been achieved.

Sperry has moved out of the lab and is ready to move into the airplane with a receiver for the 4300 MHz band. It incorporates microstrip technology into a module that includes an oscillator, a switch, a mixer and a filter. The complete receiver function is packaged on a single 3" x 3" x .055" substrate.

The PACT technical development provides substantial improvement in both performance and reliability. The oscillator provides an extremely clean, low-noise input to the mixer. The oscillator-mixer combination has a double sideband noise figure of only 4 db, referenced to a 1.5 db preamplifier. Temperature range is -55 to $+100^{\circ}\text{C}$.

Reliability is greatly improved, of course, by the module's integrated, all-solid-state construction. Sperry's design replaces the customary triode oscillator and its associated reliability problems. Many other discrete components and connectors required by conventional designs have been eliminated. The new module is designed to operate under the shock, vibration and temperature conditions of the airborne environment.

The altimeter receiver again demonstrates Sperry leadership in microwave integrated modules. We would like to apply our capability to your system challenge. To help start our conversation, write or call Sperry Microwave Electronics Division, Sperry Rand Corporation, P. O. Box 4648, Clearwater, Florida 33518. (Phone 813-855-4471).

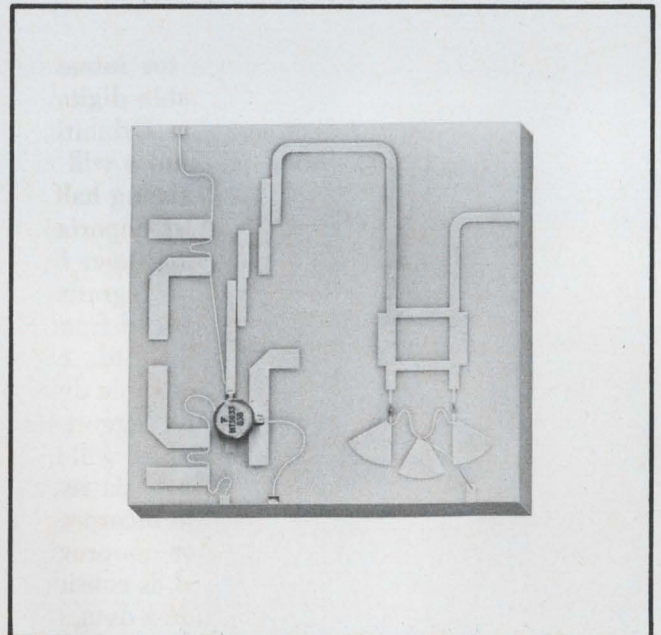

Oscillator-mixer portion of Sperry's radar altimeter receiver module (actual size).

*For faster microwave progress,
make a PACT with people
who know microwaves.*

SPERRY
MICROWAVE ELECTRONICS DIVISION
CLEARWATER, FLORIDA

International Newsletter

April 27, 1970

German government urged to counter Japanese invasion

Japanese competition is beginning to worry the West German electronics industry. In a strong statement, the country's Central Association for the Electrotechnical Industry urges the Bonn government to take measures giving German firms a better competitive edge against the Japanese challenge at home and on world markets.

Among the measures proposed are easing of credit policies for private firms investing abroad, government underwriting of long-term investments, and adapting of national financing and sales conditions to international practices. The association also wants the government to direct, or to participate in, foreign-market research and to disseminate its findings to the industry, as the Japanese government is said to be doing.

Voices of concern are also heard from company officials themselves. They point out that in 1968, the latest year for which official figures are available, imports from Japan were nearly twice as high as West German deliveries there—\$50 million vs. \$26 million. More than 60% of Japanese goods imported were for consumer electronic products, and the rest were for desk calculators, measuring equipment, controls and small tools.

This development is seen as a result of Japanese attempts to become less dependent on U.S. markets alone and to build, as one official puts it, "a strong second leg in Western Europe."

Automatic testing spurs dvm battle

Look for intensifying competition in England between sellers of programmable digital voltmeters. At the Instruments, Electronics and Automation Exhibition in London next month, two established instrument companies will announce their entry into the field, and at least two of the existing half-dozen sellers will show additions to their lines.

Most important new entrant is Racal Instruments Ltd., leader in the counter/timer field, with a range of seven new fully programmable dual-ramp integrating instruments offering accuracies from 0.1% to 0.01% and priced from \$850 to \$1,200. The other new competitor is G. and E. Bradley Ltd., calibration instrument specialists, with a single partially programmable dvm priced at \$820. In addition, Solartron, which currently has the biggest slice of the market, and the EMI subsidiary SE Laboratories Ltd. will introduce new high-precision fully programmable units.

The basic reason for the push is the trend toward instruments that can be incorporated in automatic checking systems. Plus that, the market for nonprogrammable instruments, which can't be automatically controlled, is considered static at best. Because almost all autocheck systems include a dvm, this is where competition will be most intense.

France seeks to sell computers to Cuba

Fidel Castro may plan his sugar production on French computers. France's state-backed computer maker, Compagnie Internationale pour l'Informatique, confirmed that it is negotiating the sale of "one or two" Iris 50 machines, equivalent to the IBM 360-50, to a Cuban planning agency. Press reports that Castro might take five or more machines are untrue, says CII export sales manager Henri Peyroles. He adds, "friendly foreign powers"—meaning the U.S.—were consulted and don't object.

So far, CII has won six export orders for Iris 50, backbone of France's Plan Calcul. Rumania has ordered five machines and the sixth is going to CMM, a private service bureau in Milan.

International Newsletter

Head-up display aimed at Concorde uses paired crt's

Elliott Flight Automation Ltd. hopes to initiate head-up instrument displays in civil aircraft. The company has developed a projector unit about the size of a portable typewriter, containing two 1.7-inch cathode-ray tubes, that attaches to the cockpit roof above the pilot's head. It projects a binocular image onto an integral retractable reflector normally about 7 inches in front of the pilot's eyes. Elliott's main sales prospects will be airlines which will operate the Concorde. Because the Concorde has to be landed in an extreme nose-up attitude, a head-up display would ease the pilot's job.

Military monocular head-up displays, which put the image some distance from the pilot are well developed, but not suitable for civil aircraft because of their bulk. If they are scaled down, their image is too small to see. So far, attempts to provide a large image for the civil pilot have centered around reflectors in contact with the pilot's face, an uncomfortable setup. Elliott's system, in which the two side-by-side images projected by the crt's appear as one, is claimed to solve the size problem and also permit the pilot to move his head from side to side without losing the image. Elliott will start flight trials in a Comet jet transport later this year.

Solar cells to power in-the-air blimp ...

A giant solar-powered blimp to serve as a "space platform" for research and telecommunications is under study by France's space agency. The upper surface of the 900-foot dirigible would be covered from stem to stern with sheets of thin-film cadmium-telluride solar cells, developed under a government contract by RTC la Radiotechnique-Compelec, French subsidiary of Philips' Gloeilampenfabrieken [*Electronics*, Nov. 10, 1969, p. 238]. Standard silicon cells would be too heavy, and RTC engineers figure they will even have to slice in half the 20-micron-thick molybdenum film base on which they deposit CdTe.

Stationed 70,000 feet up, the dirigible would photograph the universe from beyond the earth's atmospheric turbulence, study weather and, possibly, control air traffic and transmit telecommunications. It could be either remotely controlled from the ground or manned by a crew of five to 10 men.

French scientists caution that the idea is only in the brainstorming stage. The space agency is now weighing whether to do a full-scale cost and feasibility study. If they decided to build the blimp, the French would likely seek foreign partners to share costs.

... and recharge down-to-earth radios and meters

Philips, meanwhile, is designing a transistor radio for the consumer market using CdTe solar cells to keep its battery charged. Technical details are secret, but insiders say the Dutch firm has definite plans to market the radio next year.

Three French electronics firms—Schneider Radio-Television, Compagnie des Compteurs, and CRC—are reportedly designing CdTe-powered voltmeters and other measuring instruments. Ambient room light would be enough to keep instrument batteries charged, avoiding the minute changes in a battery's power curve that can falsify precise measurements.

RTC, the world's only CdTe solar-cell producer, is offering cells for 18 cents a square centimeter and predicts greater production will push the price down to 5 cents within a year.

Standard items form troubleshooter for electronic systems on British jets

BOAC and Marconi Instruments teamed up to devise an automatic machine that pinpoints faults in over 130 circuit boards used in Boeing 747's

Airplane builders install electronic systems from many different suppliers. The individual differences in each system force the airline to carry a correspondingly wide—and expensive—range of specialized test gear for troubleshooting.

One way out is to buy specially built comprehensive-test systems such as Hawker Siddeley's Trace, which means test equipment for rapid automatic checkout and evaluation. Both Boeing and Pan Am have bought Trace equipment, as have other airlines. However, because Trace is specially built, it is expensive, restricted to its predetermined function, and, in its most comprehensive form, needs a computer to control it.

Now British Overseas Airways Corp. and Marconi Instruments Ltd. have gotten together and devised a comprehensive troubleshooter based on the Autotest programmed production-checkout gear marketed by MI for the past two years. For a basic cost in the region of \$120,000, BOAC has a machine that will pinpoint faults in over 130 circuit boards used in the non-radio-frequency electronics systems in its new Boeing 747 jumbo jets.

That covers more than 80% of the boards in the central air-data computer, the autothrottle computer, the yaw-damper computer, the inertial-navigation system, the passenger environmental-control system, and many minor systems.

BOAC says the system shows a big cost saving over any alternative way of doing the job. What's more, the airline has been able to specify exactly the generating and measuring instruments incorporated. And they all have a switch-over to manual control, so the instruments can be used for more

than just their programmed function, which increase utilization.

Basically, the system BOAC is buying is a set of standard, programmable generating and measuring instruments which carry out an automatic sequence of measurements on components under central control from a punched tape. The results are printed out in sequence as an absolute value, plus an indication of whether the value is within acceptable limits, too high or too low.

In the aircraft tests set-up, the instruments include digital voltmeter, phasemeter, counter/timer for pulse measurement, and ohms/a-c converter for resistance measurement, plus wave and signal generators. The instruments come from a variety of sources, according to BOAC's requirement. They are contained in two 6-foot and two 3-foot 19-inch racks, together with 400-hertz a-c power supplies,

d-c power supplies, switching logic, reed-relay switching units, interfaces, and the printer.

On tape. The controller is the standard unit, costing about \$14,500, used in production-checkout test applications. The program instructions in standard eight-hole format, are keypunched for each test. The tape code identifies the instruments required, the settings required, the top and bottom limits acceptable, and timing instructions, such as the necessary delays while the instruments settle. The final instruction in a sequence is "digitize"; when the tape is running through the controller, this command starts the test which has just been spelled out. The bottom half of the control unit contains solid state buffer memory, which stores the serial instructions from the tape and holds them until the test is complete.

In BOAC's application, the equip-

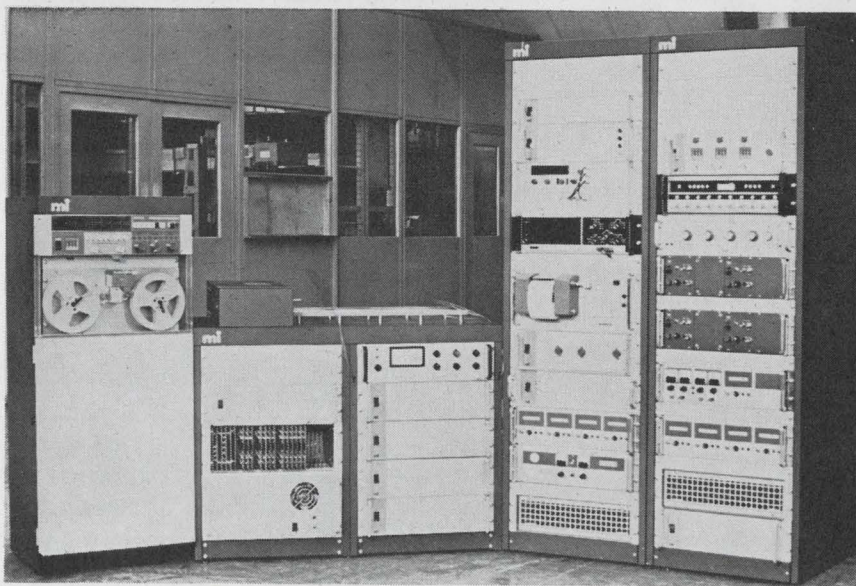

Off-the-shelf. Marconi Instruments used components from its Autotest industrial gear to put together the fault-finding system for BOAC's jumbo jets.

ment will diagnose faults in circuit boards which have already been removed from their black-boxes and labelled "suspect." The board plugs into a slot in a jig which fits on top of the two smaller racks. To keep the jig to a manageable size, the 130 boards are grouped into 11 families. Between jig body and interface block there is a 470-way connector. For any test, all the connections are made, but only some are active. Similarly, a particular board will utilize only some of the paths between this big connector and the slot in the jig. All the signal inputs to the board and outputs to the measuring instruments pass through these connectors.

Because the system is modular, it has considerable potential for expansion. And although it has not yet been delivered, the airline is already working on ways to include more tests.

Japan

Bumpy road to power

A flip-chip transistor with $\frac{3}{4}$ -watt dissipation is claimed by its developer, Sanken Electric Co., to have the highest power rating of such devices now on the market.

The power transistor is one of a line of four flip-chip transistors developed for consumer applications, especially for the hybrid thick-film IC's increasingly being used. The transistors have been designed so they can be sold at prices compatible with this type of application yet have excellent characteristics in audio and other applications.

Sanken's power transistor has the high maximum collector-current rating of 0.5 ampere and good current-amplification-factor linearity. The other three transistors are small signal transistors; two types with power dissipations of 250 and 100 milliwatts, one pnp type with a rating of 200 mw.

The specified $\frac{3}{4}$ -watt rating applies when four solder bumps on the chip are bonded to an alumina substrate measuring 35 by 25 by

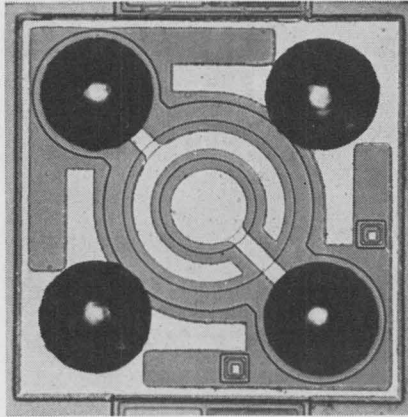

Solder . . . Black dots in corner of Sanken transistor chips are spheres of solder.

0.8 millimeters. The ratings are not the maximum possible for the transistors, though. A coating of heat-conductive material, such as thermal-conductive epoxy, can be applied to increase heat transfer from the back of the chip to the substrate. This trick can raise dissipation of the transistor to about 3 watts.

Strata. The transistors are protected from the environment by two passivation layers. The first layer is thermal silicon dioxide, measuring about 0.7 microns, thick grown during the diffusion processes. The second layer is silicon dioxide, about 2 microns thick, sputtered onto the transistors after metalization. The sputtered silicon dioxide is physically different from the thermal material and does an excellent job of protecting the tran-

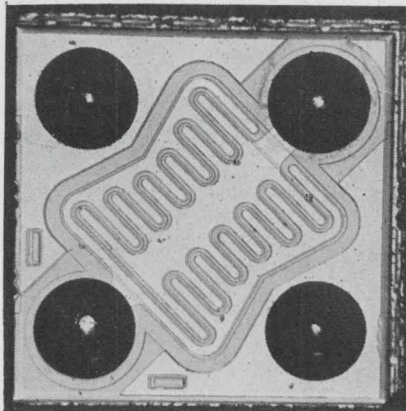

. . . Bumps. The solder is formed on $\frac{3}{4}$ -watt transistor by using coatings of chromium and copper.

sistors, according to Sanken engineers.

Solder bumps are fabricated on aluminum metalization in holes etched in the sputtered silicon dioxide. The aluminum is prepared for the solder by deposited coatings of chromium and copper, and a plated coating of copper. Sanken says that a proprietary process enables it to make all four bumps the same height for trouble-free bonding. Transistors can be easily bonded to the silver palladium wiring that's widely used in thick-film hybrid circuits.

When ordinary transistors are used in hybrid IC's, it is necessary to perform at least four bonding operations per transistor—at least two wires with two ends each. Replacing the precision wire-bonding operations with the one-shot solder-bonding operation both decreases the need for labor and increases the reliability of the finished circuits, Sanken men say.

60 Mhz by cable

To prepare Japan for an era of more talk, pictures and data, the telephone company there has just begun field testing a 60-megahertz coaxial cable transmission system. The C-60M system, developed by the Electrical Communications Laboratory of the Nippon Telegraph and Telephone Public Corp., can transmit 12 super-master groups of 900 voice channels each, or a total of 10,800 voice channels.

Coaxial cables are now made with up to 12 coaxial pairs and production of cables with 18 coaxial pairs is contemplated in the near future. Two coaxial pairs are needed for one system, because a separate coaxial pair is needed for each direction. Thus, a single 12-pair cable can accommodate six coaxial systems, or 64,800 voice channels.

Color, too. One color television channel can be substituted for two super-master groups, enabling a total of up to six television channels to be transmitted. Filters designed for telephone use are retained for this application, and the same pilot frequencies are used.

What's more, television transmission capability can be added to the system merely by adding television converters at terminal stations; the intermediate repeaters are completely unchanged.

Nippon Telephone calls the development the first coaxial transmission system in the world that can be used jointly for voice channels and multiple commercial television channels. For joint use of the cables, non-linear distortion in the repeaters had to be kept to a very low level, because the line spectrum from television can cause serious noise in telephone circuits, and phase distortion must be held to a low level to prevent degradation of the tv signal.

Video. Used for visual phone service the coaxial system will probably be able to accommodate up to 30 or 36 systems. Further evaluation of the frequency response needed for acceptable quality received pictures is necessary before choosing final parameters.

In the future, pcm will probably become the main method of transmitting visual telephone signals, but the new coaxial system can be in service long before the higher-order pcm systems required for this service are developed, and thus will be used initially.

It is the start of visual telephone

service—which will probably begin during the next few years—that makes the new wide-band coaxial system necessary. The present 12-Mhz coaxial system with 2,700 voice channels and the present 4-Mhz coaxial system with 960 voice channels—together with microwave systems including those with 2,700 voice channels, 1,800 voice channels, and 960 voice channels—would probably be sufficient for increases in voice communications for the next seven or eight years.

The large capacity of the new coaxial systems will also provide increased capacity for increasing demands for transmission of data and facsimile.

The new system uses the same coaxial pairs used for the 12-Mhz transmission systems. But attenuation at the higher frequencies is greater, forcing a reduction in repeater spacing to about 1 mile from the 2.8 miles used for the 12-Mhz system.

Design of repeaters with good performance and high reliability is the most important factor in the success of this system. Most of the key components in the repeaters had to be designed specially because they didn't exist when the project was started. Transistors used must have extremely low dis-

tortion. Then, a very large amount of feedback is required to bring the distortion of the amplifiers down to acceptable limits. This meant developing low-distortion transistors that have extremely high cut-off frequencies. Low excess phase and refined feedback techniques enabled use of the very large amount of feedback needed to keep amplifier distortion within acceptable limits.

Gain. Very precise automatic gain control in the repeaters maintains signal level along the transmission line at a constant value. To prevent increase in distortion the transistor bias is kept constant; instead agc is accomplished by a thermistor in the feedback circuit of each repeater. The thermistor corrects for the change in coaxial cable loss over a 27°C operating range, entered on 15°C.

This correction is not perfect, though. To correct for remaining error in gain the 61.16-Mhz pilot frequency—the highest of four pilot frequencies—is rectified at attended repeater stations, which are spaced 62 miles apart. The rectified signal is amplified and fed to series-connected heaters attached to the thermistors in all repeaters between two attended stations. The agc circuit used can adjust the gain by ± 1 decibel.

In another departure from previous practice, a step-recovery diode is used for generation of the carrier frequencies used in the system. A stable-frequency source generates at 2.2 Mhz, and the pulse wave of the signal distorted by the step-recovery diode gives harmonics from which higher frequency carriers are obtained. In previous systems, a coil with a saturating core was used for generating harmonics, but it does not work satisfactorily at the high frequencies used in this system.

Optical couples

Two negative-resistance light-emitting diodes that can act as both emitters and sensors have been developed by researchers at Japan's Oki Electric Industry Co.

Both of the diodes are produced

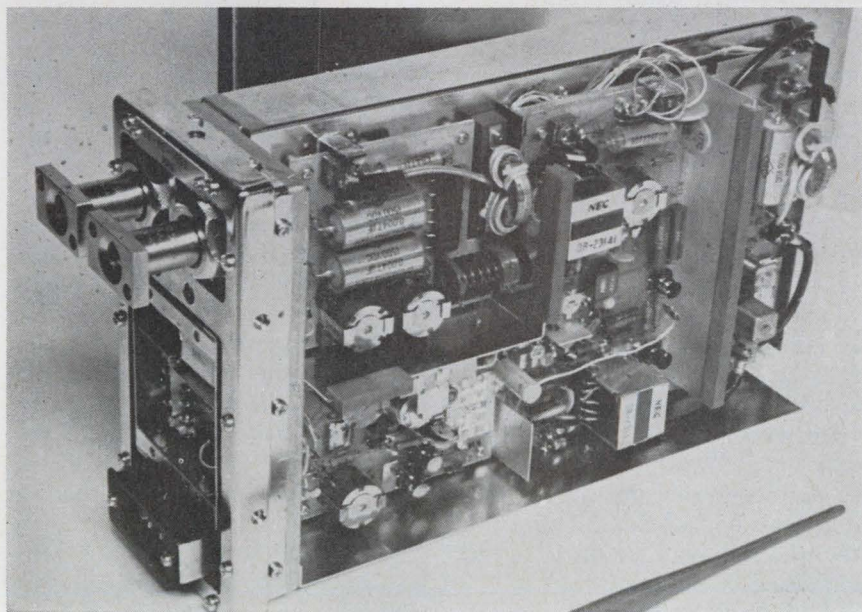

All in one. Repeater used in Nippon Telephones 60-Mhz coaxial cable system is designed for joint transmission of telephone and tv signals.

Self service. Europe's largest push-button telephone exchange, offering a variety of special services and using many semiconductor circuits, is now in service in Vienna. Made by Standard Telephon und Telegraphen AG, the exchange serves the 1,200 extensions of the city's Creditanstalt-Bankverein AG. However, the exchange is capable of handling 10,000 extensions.

Among the special services built into the exchange is call interruption by some high-level extensions; those using the lines are warned of the cutting-in by an audible signal. Some extensions are fitted with automatic tracing of malicious calls both internally and from outside.



in single epitaxial growth. One uses n-type gallium arsenide as the starting material, with pnp layers grown by doping with silicon, which can act as either donor or acceptor in gallium arsenide. This diode emits in the infrared region at 9,300 to 9,500 angstroms. The other diode is similar, but is based on the three-element compound of gallium aluminum arsenide. It emits visible light in the red to green range.

Both diodes exhibit s-type negative resistance. At very low currents, the terminal voltage increases with current, reaches a peak, and then goes through a negative resistance region where voltage falls with increasing current. The diodes also emit light approximately proportional to the current. But if the diodes are externally illuminated, the voltage peak becomes depressed. This change in voltage characteristics can be used to give switching action, which takes place in tens of nanoseconds.

Oki engineers say that a variety of functions can be performed by the diodes, including use in indicators and displays, photoswitching circuits, photocoupling circuits, light pulse-generating circuits, and optical logic, delay and memory circuits, as well as optical amplifier and pulse-regeneration circuits.

Sources at the Sharp Corp., which earlier announced similar infrared and visible-light-emitting di-

odes with negative resistance [*Electronics*, Aug. 4, 1969, p. 229], say that its earliest diodes also showed negative response to incident light. However, they intentionally eliminated that sensitivity in later development models to avoid possible patent problems and, at least for now, any design headaches caused by self-oscillation or other light-induced instabilities.

West Germany

Joint computation

When Siemens AG and AEG-Telefunken pooled resources in turbine and generator engineering about a year ago, there was little doubt that West Germany's two top-ranking electric/electronics producers would some day try the same approach in specific areas of electronics as well.

Last week, both companies let it be known that exploratory talks aimed at some sort of collaboration in data processing have entered a phase where a get-together is seriously contemplated. Discussions are now centering on setting up a jointly-owned subsidiary for computer development, production, and marketing.

Limited. The intended cooperation in computers won't be across-the-board. With its present 4004

models, Siemens has too strong a position in the commercial equipment field to willingly share it. And in the process-control arena both companies compete too fiercely, ruling out a joint venture in this field. Besides, both have know-how exchange agreements with U.S. computer makers—Siemens with RCA, and AEG-Telefunken with General Electric—which may block any cooperative deals involving computers now in production.

The joint venture, instead, is aimed at a large system—the machine costing \$3 million and up, roughly comparable to Remington-Rand's Univac 1108, Control Data's CDC 6600 or the upper end of IBM's Series 360. The Siemens/AEG deal probably will be finalized sometime next year.

Some obvious reasons led to the move. Parallel development is costly. Both firms want to make more efficient use of available computer specialists and of financial resources. Equally important, the firms stress, is that a common initiative will more quickly close the gap that still exists in large-systems development. This, then, would put the two computer makers in a better stance to meet competition from abroad.

Good politics. But aside from all that, insiders say, politics played perhaps the biggest role in getting the two to conduct talks. For years, Bonn government officials have been prodding the computer industry to work together and avoid costly duplication of effort. And some ministries involved are said to have hinged continued financial support to just such joint deals. Although its computer promotion isn't quite like the Plan Calcul mounted by the French Government several years ago, Bonn has recently increased sharply its allocations to the industry. Financial help coming from the Ministry for Science and Education alone this year amounts to roughly \$20 million, which is 90% more than in 1969. There's also more money coming from the Economics Ministry. It's the likelihood of substantially bigger financial help in the future that's bringing the two companies together.

LINEAR

One more time:

Fairchild built a reputation on new products, new technology and new applications. Last month we ran the editorial below. It announced another new step for Fairchild. A commitment to do business wherever there's business. First source. Or second. It was a major policy decision for us. So major, in fact, we're repeating the editorial this month.

EDITORIAL

If We Can't Sell You Ours, We'll Sell You Theirs.

For a long time, Fairchild built only linears designed by Fairchild engineers. We didn't think anything else was worth the effort. People said we had an NIH (Not Invented Here) complex. And, they were right.

However, it's been brought forcefully to our attention that a couple other guys in this business know what they're doing. The competition is coming out with some pretty worthwhile linears. Our customers have noticed too, because they're talking to other manufacturers about linears we don't make. They're even talking to sole sourcers!

To keep things even, we've decided to give our wandering customers something they're going to need if they start dealing with a sole source linear maker: A second source. Us. (Just in case the original supplier's factory blows up or they lose the formula or whatever it is that happens when you can't get delivery.)

Starting now, Fairchild is introducing a new line of linears. We call them IT circuits (Invented There). The first two are available today: The LM101 and the MC1495. Soon we'll add the LM101A, MC1496 and the SN7524. Of course, we've given them Fairchild part numbers. Here's a conversion chart:

μ A795	Analog Multiplier	MC1495
μ A796	Modulator	MC1496
μ A748	Operational Amplifier	LM101
μ A777	Operational Amplifier	LM101A
μ A761	Sense Amplifier	SN7524

There will be other additions to the IT line soon. So be sure you contact your local Fairchild Sales Engineer before you drop a design for lack of a reliable alternate source. Just give him the part number you want and ask him to check the IT line. Farewell NIH.

Application Digest

If you'd like any of the following application literature just write: Fairchild Linear Applications, Box 880A, Mountain View, Calif. 94040. Ask for it by publication number.

Publication Number	Title
138	μ A725 Instrumentation Applications
134	The Frequency Division Multiplex Channel Amp with the μ A748
131	An Arithmetic Analog Computer using μ A735 Logarithmic Amplifier
129	Low-Pass Active Filter for Electronic Imaging using the μ A715
125	Applications of the μ A749 Dual Operational Amplifier
141	μ A742 (TRIGAC) AC Power Control Handbook
164	Applications of the μ A722 10-Bit Current Source
136	Low-Drift, Low-Noise Monolithic Operational Amp for Low Level Signal Processing — μ A725
133	More Voltage Regulator Applications using the μ A723
128	A High Speed Sample and Hold using the μ A715
126	The μ A749 Dual Operational Amplifier
123	A Micropower Monolithic Op Amp — μ A735
99	μ A733 Oscillators
140	μ A731 High Speed Dual Channel Sense Amplifier
130	μ A725 AGC Amplifier
127	A Trapezoidal Deflection Circuit for use with the 3250 Numeric Character Generator using the μ A715
111	A High Speed, Zero Input Current Chopper Amp — μ A715
119	A High Speed Differential Preamp for Thin Film Memories — μ A751
124	The μ A746E Color TV Chroma Demodulator IC
183	A Low-Noise Preamplifier — μ A741
175	The μ A739 — A Low-Noise Dual Operational Amplifier
122	A Monolithic Radiation-Resistant Operational Amp — μ A744
171	Applications of the μ A739 and μ A749 Dual Preamplifier Integrated Circuits in Home Entertainment Equipment

Fairchild Cuts Prices of Ten Popular Linears

Say goodbye to modules. New prices on Fairchild's most popular Linear ICs now make modules expensive as well as bulky.

The Price Story:

DEVICE TYPE	ORDERING CODE	TEMPERATURE RANGE	OLD PRICE 100-999	NEW PRICE* 100-999
μ A715	U5F7715312	-55°C to +125°C	\$48.00	\$30.00
μ A715C	U5F7715393	0°C to +70°C	15.00	7.95
μ A722	U3M7722333	-20°C to +85°C	65.00	37.50
μ A722B	U3M7722334	0°C to +55°C	50.00	22.50
μ A725	U5B7725312	-55°C to +125°C	48.00	37.50
μ A725B	U5B7725333	-20°C to +85°C	37.50	25.00
μ A725C	U5B7725393	0°C to +70°C	—	15.00
μ A735	U5B7735312	-55°C to +125°C	48.00	37.50
μ A735B	U5B7735333	-20°C to +85°C	37.50	25.00
μ A735C	U5B7735393	0°C to +70°C	—	15.00

*Call your local Fairchild distributor or Field Sales office for even lower volume prices.

The Performance Story:

μ A715 — High Speed Op Amp
 100V/ μ S Unity Gain Slew Rate
 300nS Settling Time
 65MHz Bandwidth
 70nA Offset Current
 Reader Service Number 322

μ A722 — 10 Bit D/A Converter
 Current Source
 $\pm 8\frac{1}{2}$ Bit Accuracy
 10 Bit Resolution
 600nS Switching Speed
 Internal Precision Reference
 Reader Service Number 323

μ A725 — Instrumentation Op Amp
 0.5 μ V/ $^{\circ}$ C Voltage Drift
 128dB Voltage Gain
 120dB Common Mode Rejection
 0.6pA $\sqrt{\text{Hz}}$ Input Noise Current
 Reader Service Number 324

μ A735 — Micropower Op Amp
 100 μ W Power Consumption
 0.5nA Offset Current
 10M Ω Input Resistance
 Wide Supply Voltage Range
 Reader Service Number 325

Win \$100

We hope you're getting your entries ready for the contest we announced last month.

Just in case you missed the announcement, here's what you have to do to enter:

1. Get all the facts on a Fairchild Linear IC.
2. Design the world's greatest application for it.
3. Send to: Fairchild Linear Contest, P. O. Box 880A, Mountain View, California 94040.

All entries will be judged by the editors of EEE Magazine. Every month, they will select the most imaginative application and give us the designer's name. We'll publish the winning design and give the winner \$100 upon publication. Ready. Set. Design!

Introducing the World's First Monolithic J-FET Input Op Amp

Punch-through op amps are obsolete.

Fairchild's new μ A740 now offers 150pA (max.) current into either input. While some manufacturers are talking about super beta or punch-through transistors with current gains of 1000, Fairchild technology now makes possible J-FET devices with equivalent betas of over 15,000. And, they're completely compatible with standard monolithic processing.

The μ A740 is a simple two-stage design similar to the μ A741, but employs J-FET input transistors to obtain extremely low input currents.

μ A740 Electrical Performance

Input Current 150pA max.
(either input)
Unity Gain Slew Rate 6V/ μ S
Input Resistance 10^{12} Ohms
Voltage Gain 120dB
Input Offset Current 30pA

The new linear has all the convenience of the μ A741: internal frequency compensation for unity gain, input over-voltage protection to either supply, output short circuit protection to ground or either supply, and the absence of "latch-up."

Balanced offset null is easily obtained with a 10K Ω potentiometer and does not affect other parameters.

Other μ A740 features include a wide common mode range of ± 12 volts, high differential voltage range of ± 30 volts, and wide operating supply range of ± 5 V to ± 22 V.

The μ A740 is directly interchangeable with the μ A741, μ A748 or μ A709.

The new Fairchild device provides circuit designers with superior performance in such

applications as active filters, voltage followers, integrators, summing amplifiers, sample and holds, transducer amplifiers and other general-purpose feedback applications.

The μ A740 is now available in TO-99 packages (both military and industrial temperature ranges) from any Fairchild Distributor.

Reader Service Number 320

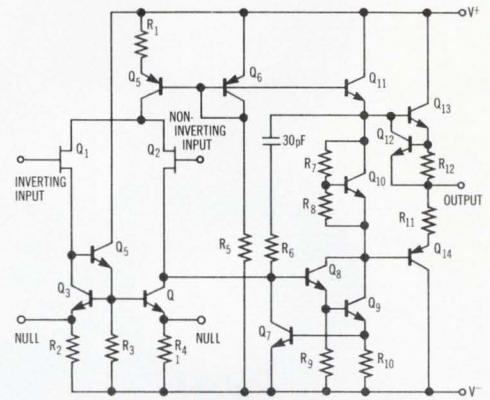

μ A740 FET INPUT OP AMP

μ A757 Ideal Choice for an AGC-Able AM/IF Amplifier

Fairchild's μ A757 can be used very effectively as a high gain, wide AGC range IF amplifier. In this application, the input signal from the generator is matched to the input of the microcircuit with transformer T_1 . The output of the 1st section is taken from Pin 12 across a tank circuit which acts as a load impedance. The signal is coupled through a capacitor to the input of the 2nd section, Pin 10. The output of the 2nd section is taken in a push-pull manner with transformer T_3 . The secondary of T_3 drives the diode detector

from which audio is recovered. Q_1 acts as an AGC signal amplifier to provide gain for the AGC signal from the diode detector.

Voltage gain of the circuit from the input of T_1 to the input of T_3 is typically 80 dB, while the AGC range is typically 70 dB. Input signal handling capability of the microcircuit is typically 300 mV_{RMS} at the input terminals of the microcircuit at full AGC. Stable gain is obtained over a wide temperature range, regardless of AGC setting.

Reader Service Number 321

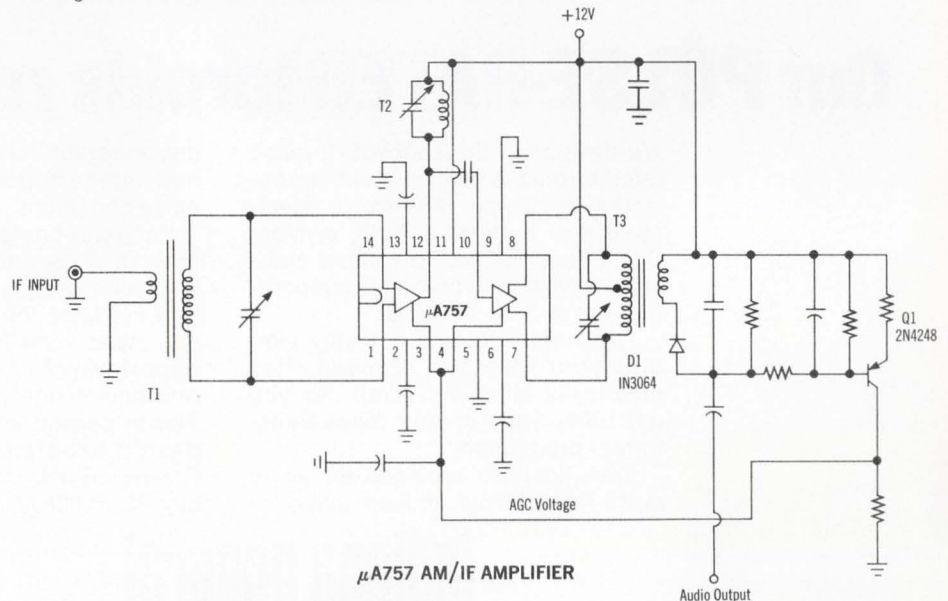

μ A757 AM/IF AMPLIFIER



All toroids look alike.

Our PULSE-RATEDTM toroids really are alike.

We developed the concept of *pulse rated* toroids to eliminate tedious selection problems. Now we've developed new materials. Fully proven. Component tested. So you get guaranteed performance over a temperature range of 0° to 60° C.

Pulse-rated toroids not only simplify your selection process, they practically eliminate scrap. So you get 100% yield in your pulse transformer production.

Specifications provided for every *pulse-rated* toroid include pulse in-

ductance, volt-microsecond product, and temperature behavior under pulse conditions.

Parylene-coated *pulse-rated* toroids in sizes and specifications to suit your design requirements are now available for off-the-shelf delivery. Want some? We welcome the opportunity to send you samples. And hot-off-the-press spec sheets. And to consult with you about your design problems. Write Indiana General, Electronic Products, Keasbey, N. J. 08832.

indiana general 

a division of Electronic Memories & Magnetics Corporation

Washington Newsletter

April 27, 1970

Pentagon would drop foreign partners to save Mallard

Despite top level Defense Department support, the Army is running into difficulty with its effort to save Project Mallard, the controversial plan for a standard multinational tactical-communications system. Although the House Appropriations Committee recommended cancellation of the joint effort with Canada, Britain, and Australia last year [*Electronics*, Dec. 22, 1969, p. 146], the Pentagon has moved to save Mallard and the \$14 million it wants for fiscal 1971 by recommending to Congress that Mallard be made solely a U.S. tri-service effort and earmarking another \$1.6 million in Air Force money for support.

However, some members of Congress are questioning just how genuine the Air Force and Navy support is for a tri-service program initiated by the Army and of limited use to the other two services. So now the Pentagon is thinking about a second option to save the program: make Mallard a North Atlantic Treaty Organization system, where the system will be managed and procured by NATO. The disturbing aspect of this kind of a deal to some U.S. companies is that it would likely increase the amount of hardware bought in other countries.

Congress questions role of Necaf

Though the White House use of an executive order, rather than legislation, has proved successful in creation of a larger and more powerful Office of Telecommunications Policy out of the Office of Telecommunications Management [*Electronics*, Feb. 16, p. 83], it has another problem. That is getting the new National Electromagnetic Compatibility Analysis Facility (Necaf) established in the Department of Commerce.

Necaf is essential to the operation of the new office, but is encountering problems on Capitol Hill where rumblings are that both the Defense Department and NASA are concerned that the facility seeks too much authority. Necaf proponents argue that a strong body is needed to prevent spectrum pollution through development of Government-wide standards for all communications equipment and systems. And, though Congress can't stop establishment of the Office of Telecommunications Policy, it can cripple Necaf by restricting its funding.

Aero services satellite decision unlikely in 1970

There's little hope for a decision this year by the International Civil Aviation Organization on a transoceanic aeronautical services satellite, even though a recent meeting of the ICAO's Astra panel leans toward an L-band system [*Electronics*, March 16, p. 61]. ICAO's Air Navigation Commission, meeting in Montreal late last month, approved six recommendations made by the Astra panel which is defining the system. But the actions only covered more studies.

The next Astra meeting is not expected until November at the earliest, and the U.S. delegation, which has always favored a vhf system, is working on a new position paper answering the Astra report.

An official of the Air Transport Association says the airlines would pay their share for a vhf-only satellite—vhf can provide airlines with earlier access to a satellite. But ATA recently said it would be willing to support a hybrid satellite—four vhf channels, as before, and the addition of an L-band channel. This craft would relay data and voice communications from airliners in addition to providing ranging data.

Comsat, which would put up the Aerosat satellite, is now finishing

Washington Newsletter

work on a proposal for such a hybrid satellite that would be leased to the airlines (through ATA's Arinc) and financed by NASA, FAA, and the airlines. The ATA says it has held high-level discussions with both NASA and FAA on funding the satellite, but it isn't clear at this point where either agency would find the money to support such a plan.

Latest C-5A woe: Avionics system

The Air Force thought at least one portion of the C-5A transport-avionics—was safe from criticism during the months of clashes between Congress and the military over the problems of the giant Lockheed aircraft. But now some House members are concerned over Air Force admissions at recent Congressional hearings that the avionics are not performing as promised and may even require redesign.

The avionics problems could kick off a new round in the controversy, even though the cost of the avionics has not risen as sharply as other C-5A outlays. Cost of avionics per aircraft is now about \$2 million, up from the original estimate of \$1.7 million.

One avionics problem is in the plane's multimode radar developed by United Aircraft's Norden division. The radar was not working in the terrain-following mode; side lobe signal returns from objects directly below the aircraft were limiting its forward-looking function. Lockheed maintains "substantial improvements" have been made in the last 60 days. Air Force sources conceded that some improvements had been made, but stated that the radar is still not acceptable.

Award for route guidance set for June

The Bureau of Public Roads will proceed in about a month with an award for Washington, D.C., demonstration of its Electronic Route Guidance System (ERGS), although budget cutters have sharply scaled down the field tests. Initial plans had called for equipping 100 intersections in the Capital area with electronic gear to direct several hundred specially equipped vehicles [*Electronics*, Aug. 18, 1969, p. 138].

Now, say Department of Transportation sources, the program has been cut by more than half. Though DOT is still juggling funds for its industry spending—and thus won't discuss numbers—agency officials acknowledge they have received favorable final proposals from General Motors, Philco-Ford, and Kollsman Instrument.

Missing fingerprints may hurt criminal record program

Despite the enthusiastic response from local law enforcement officials to the Justice Department's System for Electronic Analysis and Retrieval of Criminal Histories (Search), there's a feeling the real-time system is going to run into problems. Designed to tie state and local law enforcement agencies into a central index file in Michigan, Search will be demonstrated for the first time in July and August (See p. 115).

One basic problem, says a Sperry Rand Corp. official, is that there is no unique characteristic, such as a fingerprint, programed into an offender's Search record. What's needed, he says, is an advanced, accurate fingerprint reader [*Electronics*; March 30, p. 52], but adds that "the technology is not yet here." R&D funds for fingerprint scanning and matching techniques should be included under the project, he feels.

While Search officials do not feel the lack of a unique characteristic will cripple the system, they do plan to run controlled experiments on just how many "misses" are caused by the lack of offenders' fingerprints during this summer's tests.

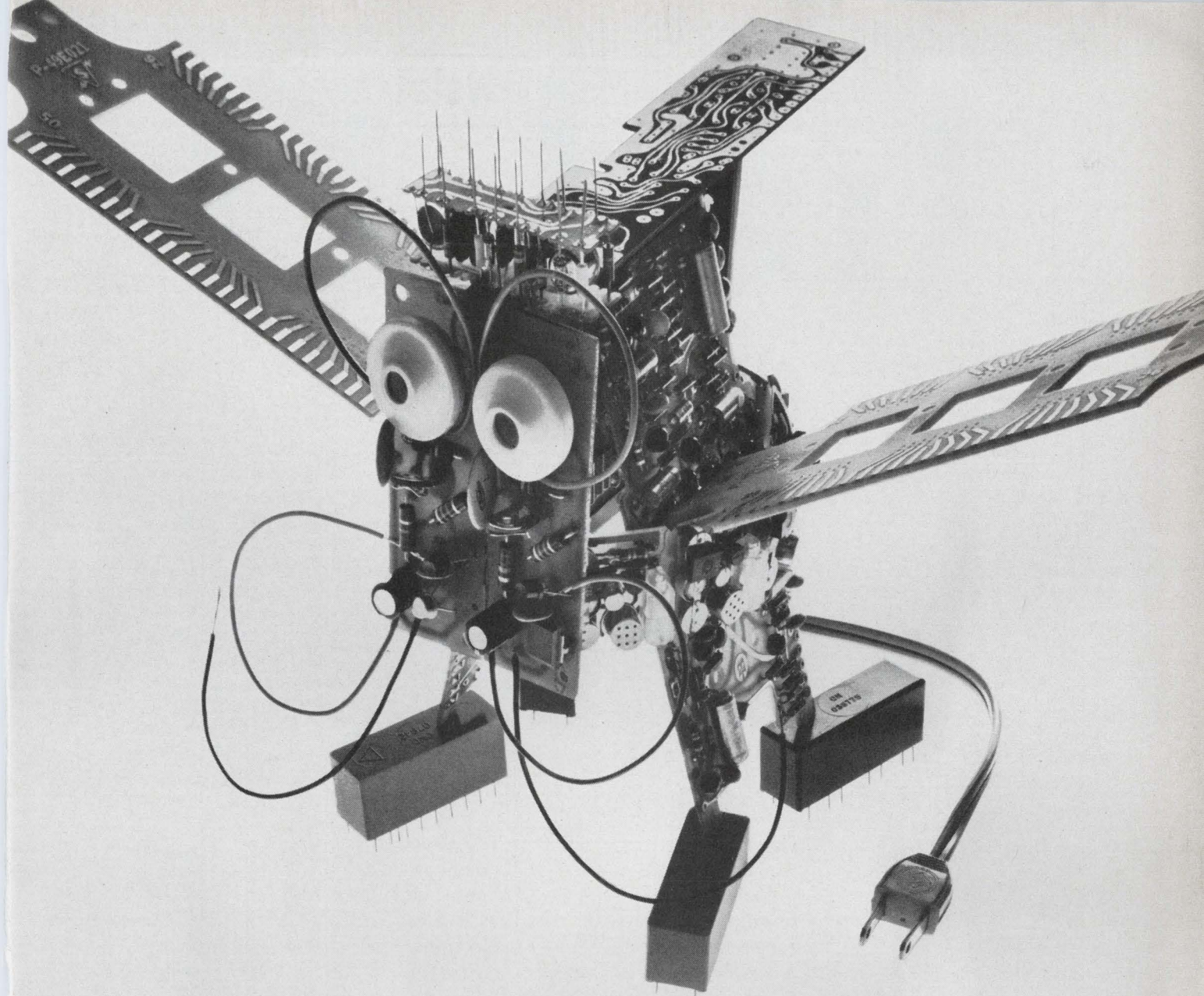

Nobody has asked for this one yet, but if they do we're ready.

We've just given birth to a new operation that's ready for anything.

It's called Sylvania Circuit Modules and it can handle anything in hybrid microelectronics, simple and complex circuit boards, and complete circuit assemblies.

We've always had these capabilities. Now we've put them all into one operation.

To make it easier for you.

Now you don't have to shop around for high volume capabilities in printed circuit boards. And you don't have to

worry about which approach is best for custom assemblies.

We handle them all.

And we can tell you which is the best technique for your application at the best price.

We've designed and assembled everything from low-cost controls for children's toys up to complex precision boards for large-scale computers.

We've designed and built over 80 different types of NAFI modules for the Poseidon missile system.

And if package size is one of your

problems, we have complete facilities for thick-film hybrid microcircuitry.

We've got the production capability and the engineering know-how to solve any circuit module problem.

Even if it's a circuit no one has asked for yet.

Sylvania Electronic Components, Circuit Module Operation, Muncy, Pa.

SYLVANIA
GENERAL TELEPHONE & ELECTRONICS

Circle 75 on reader service card

In TTL

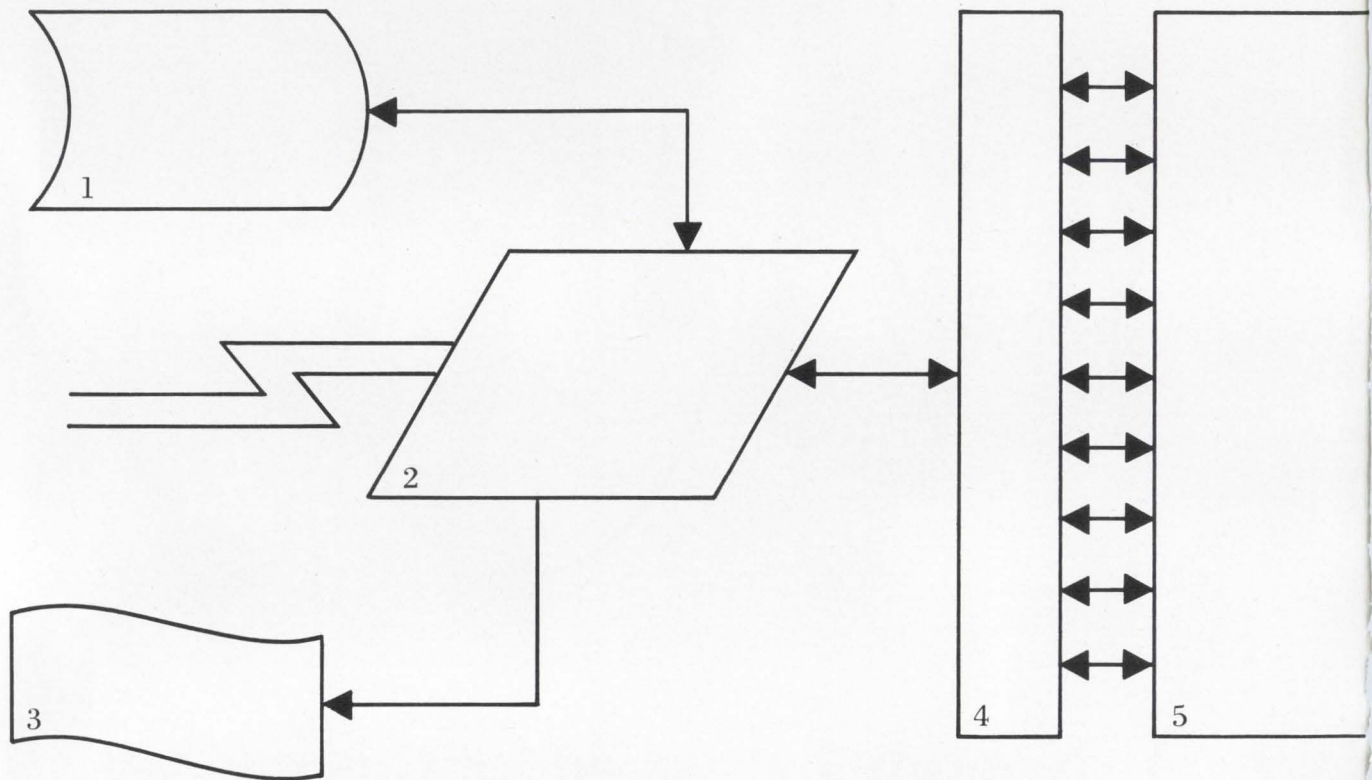

1. Mass Storage

DM8533N Four-bit Binary Counter
 DM8842N BCD to Decimal Decoder
 DM8200N Four-bit Comparator
 DM8210N Eight Channel Digital Switch

2. Modem

DM8210N Eight Channel Digital Switch
 DM8211N Eight Channel Switch (with Strobe)
 DM8220N Parity Generator/Checker
 DM8830N Dual Line Driver
 DM8842N BCD to Decimal Decoder

3. Tape Reader or Punch

DM8550N Quad Latch
 DM8533N Four-bit Binary Counter
 DM8842N BCD to Decimal Decoder

4. Input Interface

DM8220N Parity Generator/Checker

5. CPU

DM8560N Up-Down Decade Counter
 DM8563N Up-Down Binary Counter
 DM8283N Four-bit Binary Adder
 DM8551N Bus-OR'd Quad D
 DM8570N Eight-bit Serial-In Parallel-Out Shift Register
 DM8590N Eight-bit Parallel-In Serial-Out Shift Register
 DM8580N Four-bit Parallel-In Parallel-Out Shift Register

6. Output Interface

DM8210N Eight Channel Digital Switch
 DM8086N Quad Exclusive OR Gate
 DM8220N Parity Generator/Checker

It's MSI

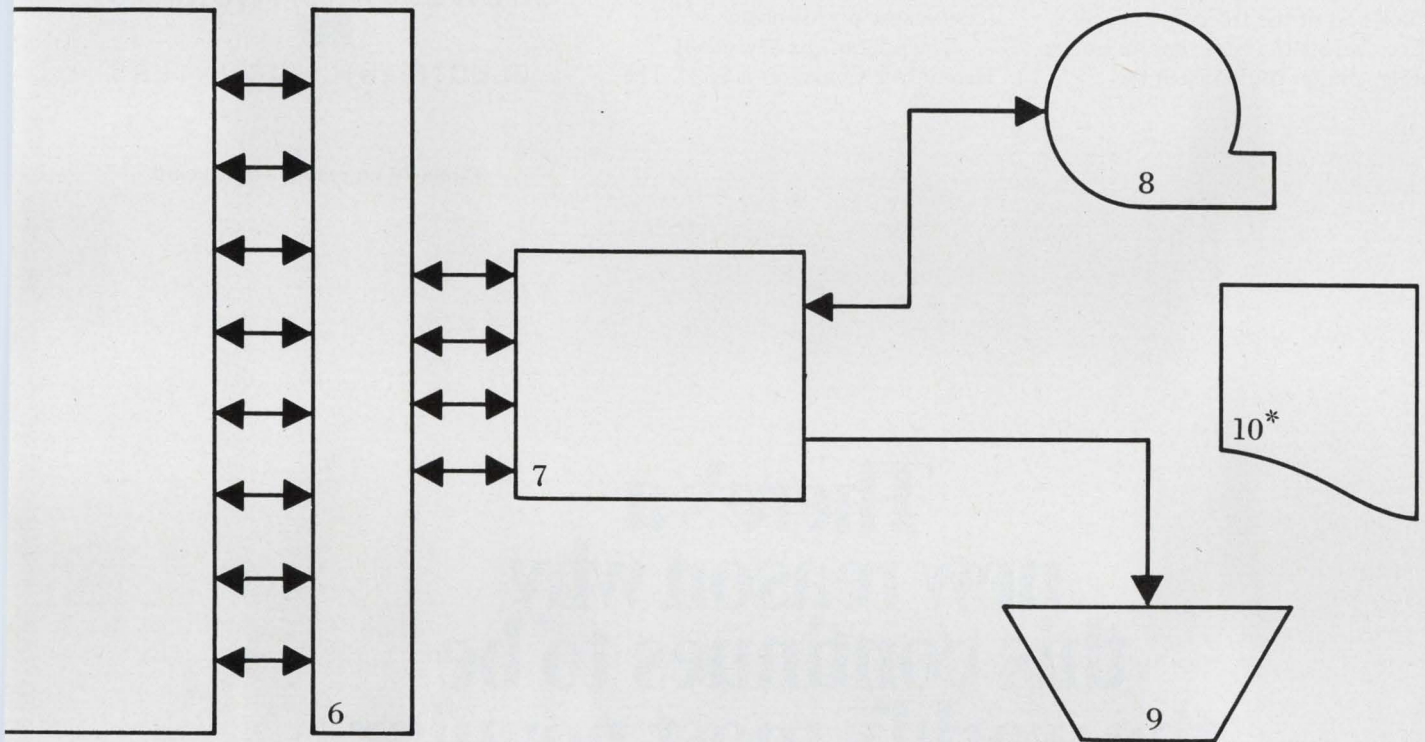

7. Memory

- DM8580N Four-bit Parallel-In Parallel-Out Shift Register
- DM8590N Eight-bit Parallel-In Serial-Out Shift Register
- DM8570N Eight-bit Serial-In Parallel-Out Shift Register

8. Off Line Storage

- DM8200N Four-bit Comparator
- DM8220N Parity Generator/Checker

9. Display

- DM8840N BCD to Decimal Nixie Driver
- DM8842N BCD to Decimal Decoder
- DM8550N Quad Latch

Nixie: Trademark of Burroughs Corporation

*10. Software

Our new 38 page App Note on applications of MSI circuits. Send for it.

(We've got it made)

Shipments from distributor stocks. Plus a complete line of MOS ROMs, shift registers and character generators completing the MSI design package.

National Semiconductor Corporation
 2900 Semiconductor Drive, Santa Clara,
 California 95051 (408) 732-5000 TWX: 910-339-9240
 Cables: NATSEMICON Telex: 346-353

National/TTL MSI

The best gets better.

The HP 5248 General-Purpose Counter can now measure to 3 GHz with a single plug-in — without any gaps. This is made possible by our new 150 MHz to 3 GHz Heterodyne Converter, Model 5254C, and by extending the direct counting range of the 5248 counter mainframe to 150 MHz.

There's another benefit unique to these instruments that's not immediately apparent. Converter and counter ranges actually overlap so you derive the final answer by merely adding the converter dial reading and counter reading. There's no need to remember to subtract readings over any part of the frequency range.

Even before the latest improvements, no other counter could match the

usefulness and flexibility of the 5245 Series. We now offer fourteen different plug-ins to help you make all the measurements you need. These include six frequency converters; transfer oscillator to 18 GHz; two time interval units; two prescalers; video amplifier; DVM; and preset unit.

And you can't beat the 5245 line for reliability either. Its remarkable dependability has made it extremely popular, particularly with rental firms — some of our best customers. When their clients rent an HP counter, rental firms know they won't lose rental fees because of downtime.

The price of the new 5254C Heterodyne Converter is \$825. The

5248L counter is \$2900. You won't find a more economical single-package solution to your dc to 3 GHz counter needs. Your local HP field office has all the details. Give them a call. Or write to Hewlett-Packard, Palo Alto, California 94304; Europe: 1217 Meyrin-Geneva, Switzerland.



HEWLETT *hp* PACKARD
ELECTRONIC COUNTERS

02918

Circle 78 on reader service card

**There's a
new reason why
this continues to be
the world's most popular
counter line.**

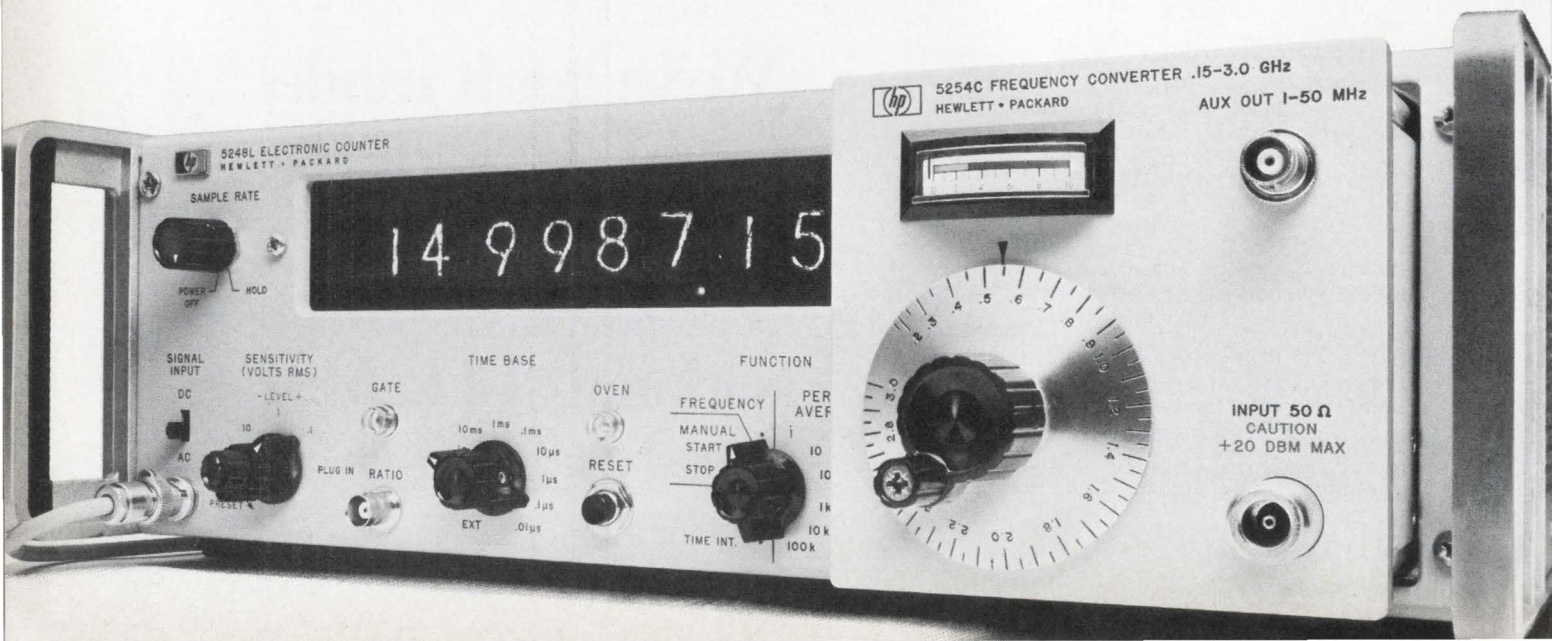

Technical Articles

**R-f power transistors
abroad: Reliability
is the key factor
page 80**

Though most European and Japanese r-f power transistor manufacturers lag behind U.S. firms in the watt-megahertz derby, an *Electronics* roundup finds that the overseas companies are making considerable progress in achieving low collector voltages and high reliability levels. The main technological emphasis at the manufacturing facilities abroad is on fulfilling customer demands, largely for f-m and a-m communications applications.

**Color EVR system
from the inside out
page 94**



In EVR, the CBS approach to video playback, two guns in an electron-beam recorder scan a special silver-halide film, putting monochrome images on one half and coded color data on the other. From this master, copies are made. These are loaded into cartridges, which fit into a playback unit connected to a tv set's antenna terminals. The quality of the regenerated signal is as good as the best broadcast picture, and since an EVR cartridge can hold 100 billion dots of varying shades of gray, it has potential in data-storage work.

**Camera's i-r eye
focuses on new
vistas for ranging
page 102**

A new type of automatic rangefinder focuses a movie camera by shooting pulses of infrared light at an object and controlling a detector's position with reflected energy through a pair of photoresistors and a small motor. Though the first application for the new device is in photography, it could find important uses in a wide variety of portable distance-measuring equipment and other applications.

**A better design for
character generators
page 107**

Character generation in remote computer systems using crt displays can be a costly design problem. One increasingly popular solution to this problem is to include in the circuitry MOS read-only memories and shift registers that produce and refresh alphanumeric characters on the face of the tube. One design approach is simple and inexpensive, and yields drift-free characters.

**A new technology
holds out promise
of junctionless MOS**

Coming

A new, simple MOS device handles data by moving charges, coupled to spatially separated depletion regions, across its surface. The technology can be used in variable delay lines, imaging, and displays, and may not require p-n junctions in many applications.

Watt-megahertz ratings run second to high reliability in foreign r-f power transistors

In a roundup of the technology abroad, *Leon M. Magill* of Electronics' staff finds emphasis geared to customer needs

● Does an r-f power transistor gap exist between Europe, Japan, and the U.S.? The answer is yes—and no; it depends on who you talk to and what aspect of that technology you're talking about. There's no overall agreement on where the gap is and who's ahead.

In Japan, for instance, Nippon Electric engineers feel that their r-f transistor technology lags the U.S. by at least a year or two. On the other hand, engineers at Tokyo Shibaura Electric Co. (Toshiba), Mitsubishi Electric, and Fujitsu claim to be a year ahead of their U.S. competitors. (They do note that although they feel they've reached the U.S. in reliability and low-collector-voltage devices, they lag in producing high-power, high-frequency transistors.)

The situation is no different in Europe. The consensus among the large West German semiconductor manufacturers—AEG Telefunken, Valvo GmbH, and Siemens AG—is that although Germany is not lagging behind the U.S. in basic technology, German firms still have ground to make up in developing specialized circuits for power transistors.

In England, the answers are equally cryptic. Texas Instruments Ltd., for example, claims it leads U.S. manufacturers in interdigitated-device technology, while Mullard Ltd. puts its technology on a par with that of U.S. firms. However, both infer that their emphasis is on reliability rather than high power.

France's Sescosem, the least optimistic of the overseas companies, indicates that its technology lags that of the U.S. by two to three years, while in the Netherlands Philips Gloeilampenfabrieken's Elcoma division estimates its technology is equal to that of U.S. makers.

No matter how the overseas companies rate themselves against U.S. r-f power transistor technology, they feel the U.S. companies mainly are pushing for higher power at higher frequencies. This assessment is correct—to a certain extent. American manufacturers are producing r-f power transistors that operate at 3 gigahertz and put out 2.5 watts, for a watt-megahertz figure of 7,500 [*Electronics*, Nov. 10, 1969, p. 33]. In fact, some American firms are building devices with outputs of 100 watts at 150 Mhz (15,000 watt-Mhz), and some off-the-shelf items produce 20 watts at 1 Ghz and 10 watts at 2 Ghz. Nearly all of these high power r-f transistors operate at collector voltages of 28 volts or higher, and are housed in stripline packages. But despite their emphasis on higher power at higher frequencies, most U.S. transistor manufacturers also are concerned with reliability, bandwidth capability and collector efficiency.

Reliability, both for military and commercial applications, is a prime concern of U.S. manufacturers. They are well aware of the many user applications that place stringent requirements on r-f power devices, and realize that ruggedness is a must. Some devices on the market

Rugged. Philips' interdigitated r-f power transistor, in a stripline-with-stud package, was developed for single-sideband operation.

are rated for all conditions of load impedance—from an open to a short circuit, and for all phases. Heat sinking and package configurations have received considerable attention to insure reliable operation under even the most stringent environmental conditions. And the U.S. firms seem to be doing something about broadening bandwidth capabilities, whereas, the offshore companies at present are confining their work to the narrowband applications of their customers. Most of the U.S. manufacturers provide input impedance and Q data on their devices so the user can estimate their broadband capabilities; most offshore manufacturers cannot or will not provide such information.

The Japanese companies lead the Europeans in the watt-Mhz derby. Although they still lag behind the U.S. they feel that their transistors perform much better at lower collector voltages. Nippon Electric offers a line of r-f power transistors that produce from 35 watts at 50 Mhz at a collector voltage of 13.5 volts, to 3 watts at 2 Ghz at 18 volts. Toshiba offers a 175-Mhz device that puts out 60 watts at 24 volts; Mitsubishi Electric produces a 5 watt-transistor at 1 Ghz; and Fujitsu has a 2-Ghz unit with a 1-watt output.

But the European firms are not too far behind. Philips, for example, has a 50-watt transistor that operates at 175 Mhz. And in England, Texas Instruments Ltd. boasts a 25 watt, 900 Mhz unit, while Mullard's 470-Mhz tran-

sistor delivers 7 watts at a collector voltage of 12 volts. In Germany, Telefunken, and Valvo are marketing lower-frequency devices. Most of them have a 50-watt transistor that operates at 175 Mhz and a 7-watt device at 470 Mhz.

In France, Sescosem at present is marketing only one r-f power transistor—a copy of the 85 watts peak-to-peak 30-Mhz RCA TA-2758. It was originally developed to give its parent company, Thomson-CSF, a second source. However, Sescosem also is producing other power transistors at 200 and 400 Mhz, but these are for internal consumption only.

The future should see a move toward higher power at higher frequencies all around the world. But such a trend will have to take many factors into consideration, including broadband capability, efficiency, power handling capability, and packaging.

In Japan, Toshiaki Irie, manager of the microwave transistor section of Nippon Electric, says the input parasitic impedance will have the largest effect on power output, bandwidth, and power gain of the r-f transistor. Thus he feels a technological thrust to reduce the common-lead impedance of power transistors is perhaps the most important factor. Efficiency, Irie adds, can be improved by better heat removal from the collector-base junction. This could be effected by moving the collector junction closer to the emitter surface than to the rear

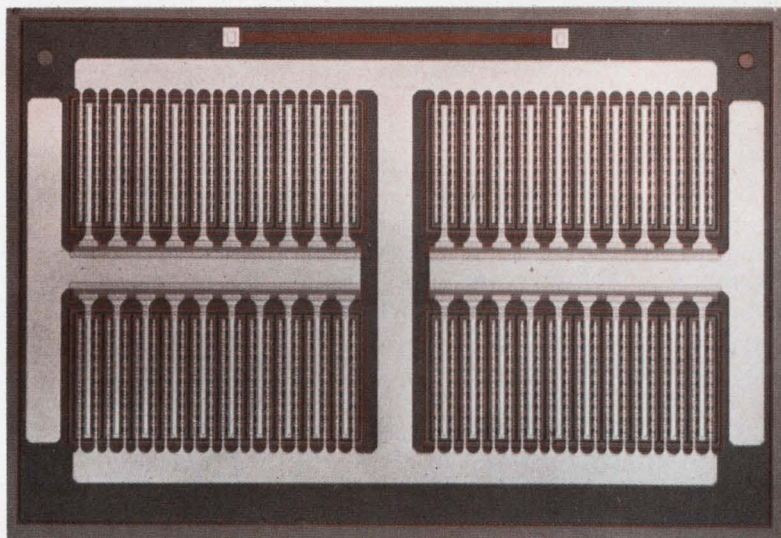
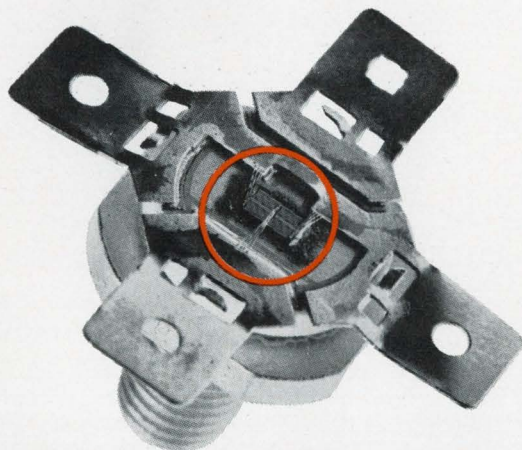

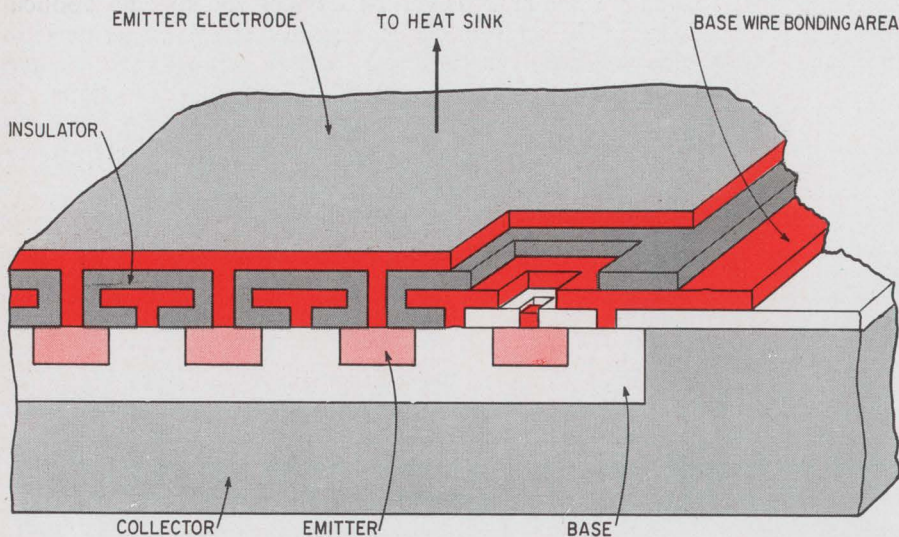

Multilayer metalization. In Fujitsu's technique, emitter metalization completely surrounds the base; it's made possible by bringing out the base lead through an opening etched through the layers of emitter metalization and insulation. In this way base and emitter inductance reductions are effected.

surface of the chip, as Bell Labs does in its flip-chip Impatt diode.

The Japanese predictions seem conservative compared to those emanating from the U.S. Toshiba, perhaps the most optimistic manufacturer, foresees by 1971 a power transistor that puts out 10 watts at 3 Ghz—a watt-Mhz figure of 30,000—which is only 40% of its predicted theoretical limit. And Fujitsu Ltd. predicts 80 watts at 1 Ghz. Mitsubishi and Nippon Electric, however, are less optimistic over their 1971 product line. They see only about 20 watts at 1 Ghz—a figure TRW's Semiconductor division achieved several years ago in its commercial devices.

In Germany, the prognostications are even less optimistic. Valvo engineers see only 6 watts at 1 Ghz for their 1971 line, but do envision higher frequency units, such as 2.5 watts at 2.3 Ghz and 2 watts at 2.7 Ghz, becoming available sometime in the future. Engineers at Telefunken, where broader bandwidths are deemed more important than the quest for higher watt-Mhz figures, claim that 10-watt, 1-Ghz and 5-watt, 2-Ghz power transistors should be ready by 1971. But these devices will be used primarily for in-house microwave communication systems requirements. Siemens sees a 3-watt device operating at 2 Ghz and a 0.4-watt transistor at 5 Ghz by 1971. Hans Hargasser, section head of Siemens' discrete components division, feels that the state of the art in one-micron structures and related masking techniques should produce a 1-watt, 5-Ghz device by 1971.

In France, engineers at Sescosem feel that most theoretical limits on r-f transistor performance are determined by economics rather than technology. In power output, for example, they feel the limit beyond which it becomes cheaper to use two transistors is not far beyond that of RCA's TA2758—an 85-watt peak-to-peak rating of the 30-Mhz power transistor. "We could go up to 500 watts peak-to-peak on a single-sideband transistor," claims Hervé Deroy, manager of the discrete components division, "but it would be much more expensive than using several smaller ones." Deroy, who sees the upper-frequency limit for silicon power transistors at about 10 Ghz, feels that gallium arsenide devices could be pushed up to 20 Ghz. And according to Deroy the present watt-Mhz ratings of 15,000 should double by the end of 1971.

Of theoretical limits, K.W. Hinkel, head of the department of development and fabrication of transmitter semiconductor at Philips says, "The state-of-the-art is so far away from these limits that it's not worthwhile considering." Hinkel, who considers ruggedness one of the major considerations for r-f power devices, claims that "If you drop the ruggedness requirement, a power increase of roughly two times can be expected from existing devices."

There's some disagreement over what factors determine theoretical limits. Some British r-f power transistor manufacturers, Texas Instruments Ltd., for instance, feel that the maximum power and frequency are limited by the device's input resistance. They see 50 watts at 1 Ghz and 20 watts at 2 Ghz as the maximum that should be available, although they don't say when. Engineers at TI think about 20 watts per chip at 2 Ghz is the upper limit. Mullard engineers claim the theoretical limitations of r-f transistors are based on chip size, voltage breakdown limits, and input/output matching. Using these criteria they say 4 Ghz will be the upper frequency limit; they also see a maximum of 500 watts at 2 Mhz, about 200 watts at 30 Mhz, and 25 watts at 3 Ghz. As for actual predictions, Mullard engineers target the following limits for 1971: 120 watts at 200 Mhz; 75 watts at 500 Mhz; and 12 watts at 2 Ghz.

As in the U.S., the overseas transistor manufacturers

tailor their high-power r-f devices for specific applications. The overwhelming majority in Japan are used in f-m communications, such as mobile radio, CATV, and fixed repeaters for point-to-point communications. In Europe, however, the bulk of the applications are for both f-m transmitters and a-m transmitters, mainly for aircraft communications systems.

Mullard has developed a line of r-f power transistors specifically designed to withstand the higher voltage swings required in a-m. Much of Mullard's output is geared for export—about 30% for f-m transmitters and an equally large amount for light aircraft a-m transmitters. These require transistors that operate at 12 volts.

All the overseas manufacturers agree on the single importance of providing for safe operation under severe mismatches. Philips' Hinkel thinks that if power and frequency are the only considerations, you're out of the market. And Mullard's chief of transistor activities, John Culling, observes, "Just getting gain is not the real answer—the difficulty is developing a device that will withstand all likely mismatch conditions at its rated power." And "secondary breakdown characteristics are also of great concern," says Deroy.

Mitsubishi engineers feel that secondary breakdown characteristics of their devices have been greatly improved, so much so that devices don't burn out, even under open or short-circuited loads. Dieter Gerstner, manager of r-f transistor research and development at Telefunken, indicates that overload capacity is important to all users. Good linearity characteristics are significant in a-m operation, while for f-m, efficiency is one of the major considerations.

Sescosem's Deroy feels that a major problem plaguing his users aside from secondary breakdown is maintaining linearity in single-sideband operation. Finding a solution that solves both these problems is almost impossible, he adds, "since relieving one automatically worsens the other."

Although overseas r-f power transistor manufacturers agree that most of their devices are used for narrow band applications at present, they are concerned about bandwidth capability. The amount of broadbanding in r-f power transistors seems to be tied directly to the ability of matching the transistor to the circuit and compensating for its package parasitic inductance. But according to spokesmen at Fujitsu, Telefunken, and TI, the latter is

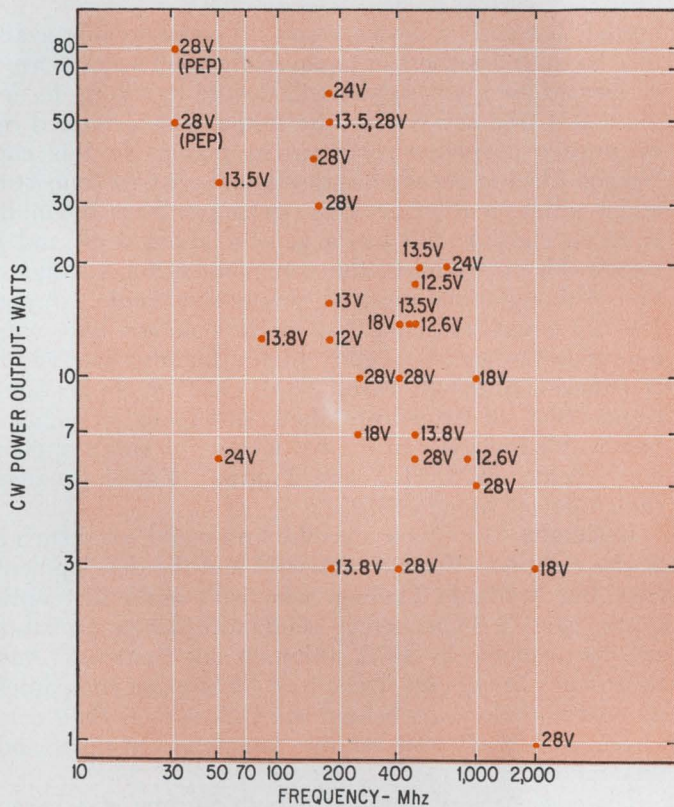

Foreign figures. R-f power transistors available from Europe and Japan show collector voltages ranging from 12 to 28 volts; output power ranges from 1 to 80 watts.

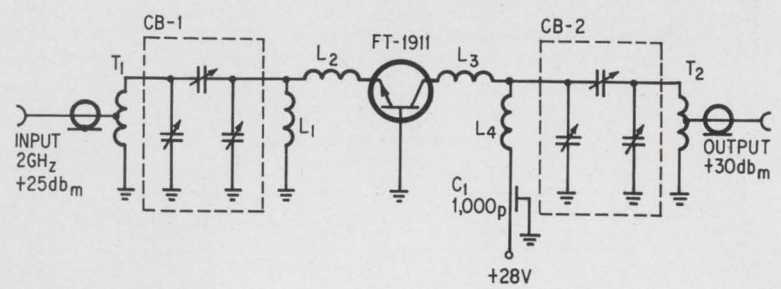
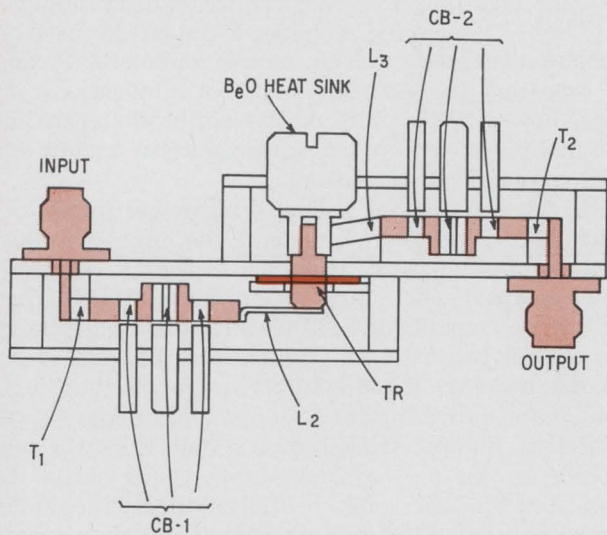

Power amplifier. Fujitsu's 2-GHz amplifier uses a coaxial transistor (FT-1911) to develop an output of 1 watt and a power gain of 5 db.

the major problem in broadbanding.

"We plan to introduce a multilayer lead technique to minimize the parasitic-inductance problem," says Fujitsu's Kaichiro Katori, chief of transistor engineering. Multilayer metalization, which is similar to that used to provide crossovers in integrated circuits, reduces the base-to-emitter inductance. According to Katori, "it would then be possible to have emitter metalization that completely surrounds the base and still bring out the base lead through an opening etched through the layers of emitter metalization and insulation. And the capacitance introduced by this technique will be small compared to the intrinsic base-to-emitter capacitance of the transistor." Although multilayer metalized transistors are not yet part of the Fujitsu line they will be offered shortly, Katori indicates. This technique will be used for future high-power transistors—20 watts or more—under 1 Ghz. The technique needs improvement for use at 2 Ghz and higher because of added stray capacitance.

Package parasitics can be used to advantage in some broadbanding applications. Inductance and capacitance of the package can compensate each other through an arrangement that produces a matched-transmission line, says Telefunken's Gerstner. Mullard engineers share this view. They are aiming at passive matching circuits right on the chip substrate. "The future lies with modules containing transistors with integrated matching networks," asserts Culling. And Mullard is working toward power transistors with matching networks right on the chip that will operate over octave bandwidths with 50-ohm input and output impedances. The multifunction module—a power transistor with other active devices and matching networks—should outsell its discrete competition by 1973, forecasts Derek Crook, power-device marketing manager at TI. And Crook may be right.

On the other side of the Atlantic, however, RCA now has single-stage hybrid-amplifier modules with 20-watt output flat to 1 db in the 225-to-400 Mhz range. Using its transistor chips and batch-fabricated hybrid lumped-constant elements, RCA has had completed amplifiers operating at frequencies from 0.2 to 2 Ghz [*Electronics*, April 14, 1969, p. 100].

But what about octave bandwidth capability in power transistors operating at 3 Ghz? Here, opinions differ considerably. Nippon Electric's Irie, for instance, is con-

vinced that such a device won't be commercially available because designers in Japan really don't seem to need it; instead, he says Nippon will devote its efforts to devices at 4 Ghz and 6 Ghz—the frequencies occupied by microwave telephone repeaters in Japan. To this end Nippon Electric already has developed a 4-GHz transistor and is testing it at 6 Ghz. This device produces 100 milliwatts in class A, and has a gain of about 4 db and a bandwidth of 1 Ghz in the common-emitter configuration. Although data on input Q is not available, Nippon Electric engineers claim that in the common-base configuration the gain is slightly higher but the bandwidth is reduced. Although Yasuo Fujii, chief of applications engineering, of Mitsubishi does anticipate an octave-bandwidth transistor at 3 Ghz, he says it won't appear much before 1974. However, Fujitsu's Katori predicts such a device by mid-1970.

In Europe, TI's Crook feels the firm could build such a device right now if someone would foot the development cost. But Mullard's Culling, who isn't quite that optimistic, says "a 3-GHz octave-bandwidth device probably will be available by 1973, although not from us." And Sescosem's Deroy puts it this way: "European companies are two to three years behind the U.S., just as their customers are. We'll wait for the Americans to do it and then follow."

The consensus of opinion in both Europe and Japan

Electronics' guide

Key specs for r-f power transistors

Transistor type	Mfr.	Freq. (Mhz)	P _o (watts)	P.G. (db)	Efficiency (%)	Package Style	Vcc (volts)	Input Q
SFT 339A	Sesosem	30	80 (PEP)	13	40 (min)	SWS	28	2
BLY 246	Philips	30	50 (PEP)	13	35 (min)	SWS	28	NS
2SC851	NEC	50	35	7.7	70 (typ)	TO-3	13.5	NS
2SC517	Toshiba	50	6	7.8	50 (typ)	TO-8	24	NS
BLY 36	Mullard	80	12	14.2	80 (typ)	TO-60	13.8	NS
2SC690	Mitsubishi	150	40	6.0	60 (min)	SWS	28	NS
2SC1037	NEC	160	30	4.8	70 (typ)	TO-60	28	NS
S1050	Toshiba	175	60	3.0	60 (typ)	SWS	24	NS
BLY 90	Philips	175	50	5	60 (min)	SWS	13.5	NS
BLY 94	Philips	175	50	6.5	60 (min)	SWS	28	NS
BLY 63	TI Ltd.	175	15	4.7	70 (min)	TO-117	13	NS
BLY 81	TFK	175	12	4.5	80 (min)	SL	12	NS
BLY 34	Mullard	175	3.0	8.0	80 (typ)	TO-39	13.8	NS
2N3632	TFK	260	10	6.0	60 (typ)	TO-60	28	NS
2SC636	NEC	260	7	3.7	60 (typ)	TO-60	18	NS
2SC990	NEC	400	13	4.8	60 (typ)	SWS	18	NS
2N3733	TI Ltd.	400	10	4.0	45 (min)	TO-60	28	NS
2N3375	TFK	400	3	5.0	40 (min)	TO-60	28	NS
2SC1015	Mitsubishi	450	13	3.4	50 (min)	LIS (GE)	13.5	NS
BLY 266	Philips	470	18	3.5	60 (typ)	SWS	12.5	NS
2SC1122	Toshiba	470	13	3.3	50 (typ)	SWS	12.6	NS
BLY 53A	Valvo	470	7	6.8	65 (min)	SWS	13.8	2.5
BLY 37	Valvo	470	6	7.8	60 (min)	SWS	28	3
V650B	NEC	500	20	4.0	60 (typ)	SWS (GE)	13.5	NS
2SC1087	Fujitsu	700	20	4.3	65 (typ)	T-33	24	NS
S1080	Toshiba	900	6	3.8	50 (typ)	SWS	12.6	NS
V576	NEC	1,000	10	6.0	60 (typ)	SWS	18	NS
2SC978	Mitsubishi	1,000	5	4.0	30 (min)	LIS	28	NS
V664	NEC	2,000	3	3.0	40 (typ)	SWS	18	NS
FT1911	Fujitsu	2,000	1	5.0	33 (typ)	Coax	28	1.0

Siemens is not selling on the open market as of this date.

NEC — Nippon Electric Corp.
TFK — AEG — Telefunken

SWS — Stripline with stud
GE — Grounded emitter
NS — Not specified on data sheet
LIS — Low inductance stripline
PEP — Peak envelope power

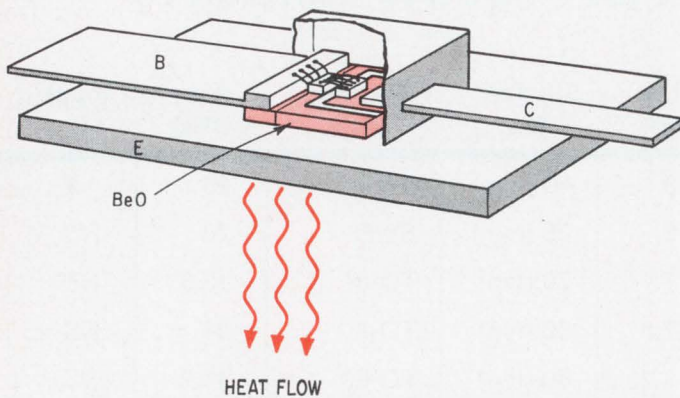

Matched-transmission line. Intended for use with stripline circuits, Telefunken's device removes heat by using a 1-mm beryllium-oxide layer between the emitter on one side and the base and collector on the other. With this package, parasitic inductances are only one-third of those encountered in a TO-60 package.

is that emitter stabilization resistors are essential to the design of rugged, high-power r-f transistors to minimize burnout due to high *vswr*'s. However, exactly where and how they will be incorporated into the structure still isn't certain. Gerstner of Telefunken, who claims he first proposed emitter stabilization several years ago and has several patents pending, says it would be advantageous to have a resistor at each emitter site. But this arrangement requires a large resistor area on the chip which also produces relatively high capacitances, so it's not a practical solution for transistors operating at uhf and microwave frequencies. Gerstner proposes a compromise between the number of emitter sites per cell and the number of cells each having one resistor.

Gerstner's views, however, are not shared by TI's Crook, who advocates putting an emitter stabilization resistor at each emitter site. An extended linear interdigitated array is used as the transistor structure to provide maximum emitter periphery relative to area. This would better distribute the emitter current density over the maximum edge area, minimizing the possibility of local hot spots, hence increasing stability.

The resistor is fabricated by leaving a pad of oxide across the strip at the spine joint so that the metalization over the emitter is broken at that point. The emitter site thus has its own resistor beneath this discontinuity. Crook indicates that this arrangement will enable 25-watt devices to survive all phases of load mismatch at the rated power.

Valvo's attitude is more flexible. The company claims that it uses whatever approach is suitable as long as the transistor can withstand a load *vswr* of 50. Valvo uses an emitter grid structure and stabilizing resistors to prevent hot spots that can cause failures during severe mismatches and secondary breakdown. Using one resistor per emitter cell instead of at each site is the rule at Mullard. This resistor is fabricated via thin-film technology.

Philips emphasizes adequate material specification in addition to emitter stabilizing resistors. It selects the proper thickness and resistivity of the epitaxial layer, as well as using short emitter fingers, to provide equal current distribution in the chip. And the emitter stabilizing resistors are manufactured by either diffusion or evaporation, whichever is more suited to the particular device.

Emitter-stabilization resistors are employed by most

Japanese r-f power transistor makers. These vary from evaporated aluminum layers to silicon bulk resistance, depending on the power and frequency of the device.

Nippon Electric, Fujitsu, and Mitsubishi all agree that emitter-stabilizing resistors are necessary—especially when the device operates in the gigahertz region. Toshiba, however, characterizes them as performance-degrading devices even though they improve secondary breakdown characteristics; Toshiba's solution is to lower the input circuit *Q* with a lossy input choke.

Fujitsu uses resistors at each emitter site. This tends to equalize the current flow to each emitter and thus prevent constriction, as does the multilayer configuration. And the multilayer configuration produces a much more uniform current flow for interdigitated transistors than does the conventional configuration.

In one transistor Nippon Electric uses a separate resistor at each of 400 emitter sites. However, in many of its transistors the resistors are included at each emitter cell.

With stabilizing resistors in series with the emitters, gain decreases at low power levels. And because of a more equal division of current, it's assured that each individual emitter is working at close to 100% of capacity. There is, however, an optimum value of emitter resistor—a value that's too high will reduce output power and one that's too low is useless.

The packaging problems faced by the foreign r-f power transistor manufacturers are no different from those of U.S. firms. Likewise, the approaches taken abroad to increase both operating frequency and output power while maintaining high reliability are quite similar to U.S. methods. Where power dissipation and circuit compatibility are considerations most manufacturers opt for the stripline configuration; for gigahertz frequency operation, coaxial packages get the nod.

Nippon Electric's Irie feels that the stripline pack is the style of the future and is best for circuit compatibility. And although engineers at Toshiba, Fujitsu, and Mitsubishi agree, they differ as to the methods of obtaining the best package. Toshiba's senior specialist, Juzo Yoshida, indicates that the stripline package will have to be modified to reduce ground inductance to obtain higher powers at higher frequencies. However, he declines to reveal the company's method. At Mitsubishi, the basic aim is to reduce chip size and widen the strips to reduce inductance, claims Fujii. "In the future," he asserts, "we will reduce chip size by two-thirds and bond the wide strips directly onto the aluminum pads of the transistor chip to reduce the base and emitter inductances to about 0.6 and 0.3 nanohenrys, respectively." Present values are about 1 nh for both.

Stripline is the number one package choice of Telefunken engineers. "Since this technique is most often

used in r-f circuit design the package should also be compatible with the technique," says Telefunken's Gerstner.

Valvo engineers, like most, agree that stripline is the choice for frequencies below 1 Ghz. But for higher frequencies their approach will be either coaxial or some form of hybrid circuitry. Valvo researchers are investigating the hybrid approach—microstrip and lumped circuits—and most likely will settle on a thin-film hybrid circuit which offers low parasitic inductance making a broadband device possible. Price is also a factor. "Devices shouldn't cost more than \$100 each," adds Frithjof Lampe, who heads Valvo's r-f power transistor production. And Valvo's circuit choice will depend on this factor too.

"The best package style is the coplanar stripline compatible pack," says Mullard's Culling. He indicates that there are definite advantages in hermetically sealed air-space stripline packs, however, they are too costly right now. Culling says that the ultimate package for power dissipation will contain its own heat sink. This is academic, however—in practice the sink must either be a stud or a flange. Although flange packs theoretically offer better heat removal than stud types they are difficult to machine sufficiently flat. The stud package, however, does offer good results when dissipating up to about 100 watts. Culling points out that user convenience is most important, and unless new package styles can be second-sourced, users won't buy them.

"The low-inductance stripline with isolated emitter is, in our opinion, the most suitable package up to 1 Ghz. For higher frequencies, the coaxial package will win," says Philips' Hinkel. And Fujitsu's Katori agrees: "The coaxial package is best at frequencies above 2 Ghz because of lower package parasitic capacitance and superior input-to-output isolation."

Sescosem engineers favor the stripline package over the coaxial unit on virtually every count. "Connector self-inductance characteristics can be just as good with stripline and power dissipation performance is better," says Deroy.

In general, two methods are most often mentioned by overseas manufacturers for efficiently dissipating r-f transistor heat. These are the stripline package with a metal stud that screws into a heat sink, and the use of a beryllium-oxide layer that serves as both an electrical

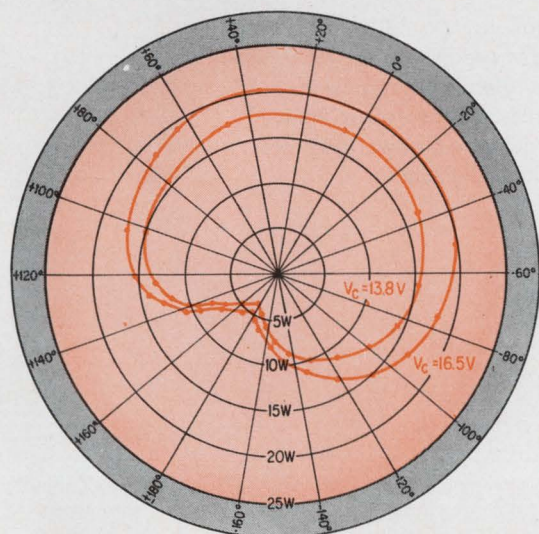

Mismatch data. Dissipation of a power transistor varies with output mismatch phase. Here, a Mullard BLY-53A was measured at 470 Mhz with 2 watts of drive power and the load vswr held at 50.

Foreign registration—better, but . . .

As in the U.S., registration of r-f power transistors in Europe and Japan leaves much to be desired—especially for specifying the r-f parameters. But though most foreign manufacturers and their customers are not completely satisfied with their registration systems, they prefer it to the U.S. version [*Electronics*, May 26, 1969, p. 88].

Under the U.S. EIA registration, a transistor receives a 2N code number followed by a set of numbers that doesn't specify material, frequency range, application, or other useful information. The 2N tells you it's a transistor (1N for diodes) but nothing else.

In Europe, Pro Electron, a Brussels-based agency, assigns designations to new discrete semiconductor devices. The Pro Electron code is based on three letters and two numbers. The first letter identifies the semiconductor material used (A for germanium, B for silicon, C for materials with an energy band gap of 1.3 or more electron-volts such as gallium arsenide, and D stands for materials with a band gap of less than 0.6 such as indium antimonide). The letters A through D indicate one or more junctions; R stands for devices with no junctions and made of materials such as are used in Hall generators and photoconductive cells. The second letter represents the application. For example, L is a high-power r-f device; F means r-f low power; D means low-frequency power; C is a low-frequency preamplifier; P is an optoelectronic device; A is a diode; B is a varicap, U is a power switching transistor, S is a switching transistor, X is a multiplier diode, Y is a rectifying diode, and Z is a zener diode. Devices are characterized as either L or F by their thermal resistance expressed in degrees Centigrade per watt. Anything less than 15°C/watt is considered high power, anything above is low power.

The third letter—if there is one—indicates industrial device and is a Y. If there is no third letter, the device is for consumer or entertainment use.

The digits that follow the letters for industrial units indicate how many devices of that particular type have been registered. The digits start at 10 and go up to 99. When 99 is reached—i.e., after 89 devices—the last letter changes from a Y to an X and the numbering begins anew, working back toward A. There is no Z. For consumer devices the numbers that follow the 2 letters start with 100, allowing registration of 899 similar devices.

The designation BLY 80, for example, means the device uses silicon (B); is for high r-f power use, (L); and is used in industrial applications, (Y); the 80 means that it's the 71st device of its type to be registered with Pro Electron.

Telefunken's Dieter Gerstner says that "good as it is, Pro Electron by no means describes the device completely. Data sheets are necessary to completely describe the device." Valvo considers it superior to the U.S. EIA registration system.

Japan uses a registration code developed by the Electronic Industries Association of Japan; it's similar to the EIA system. And according to most manufacturers and users, it's also inadequate. Nippon Electronic's Toshiaki Irie, microwave transistor manager, indicates the EIAJ system is inadequate because it does not completely describe the device's r-f parameters. Mitsubishi's Yasuo Fujii, chief of applications engineering says, "Circuit designers want to have secondary breakdown characteristics included in the EIAJ registration."

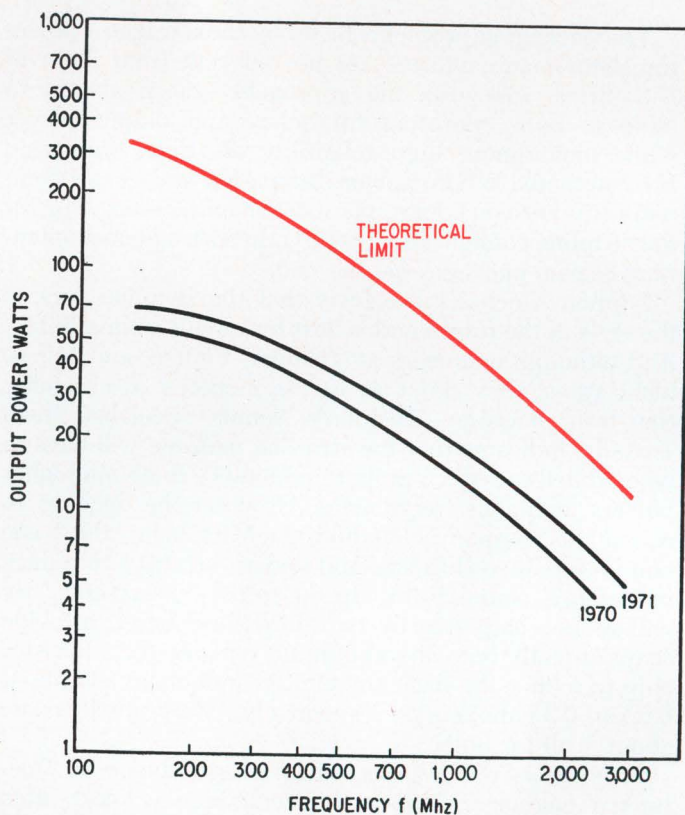

Great expectations. Mitsubishi's r-f power transistor output predictions for 1970 and 1971 are referenced against the company's estimated theoretical limits and were made using a power gain of 3 db as absolute minimum.

insulator and heat conductor. But other approaches aren't ignored. Nippon Electric, for example, uses double heat sinking—on both the emitter and collector sides of the transistor.

Most foreign manufacturers agree with their U.S. counterparts that two or more transistors will provide higher output powers more reliably than a large unit. However, there are differing opinions on optimal maximum power output of a single large transistor. About half the manufacturers cite 50 watts, while the rest see 100 watts as the limit. And in addition, some makers specify a frequency limit. Siemens, for example, thinks that at 30 Mhz approximately 100 watts is the limit for a single transistor. Mullard, however, indicates that above 400 Mhz, the limit should be about 10 watts, a figure set by usable power gain, collector-voltage, and cost considerations.

Opinion on plastic-encapsulated transistors divides foreign manufacturers into two camps—those that say their customers want them and those who say that plastic transistor applications are marginal and unsuited for extreme environmental conditions. Everyone agrees that low cost is the main advantage of the plastic package. However, there's a tradeoff—a poor hermetic seal. And if a silicone encapsulation is added to provide a better hermetic seal it increases the feedback capacity and degrades performance at high frequencies.

Although Nippon Electric does not plan to manufacture plastic transistors at frequencies above 2 Ghz, Irie claims that silicone-molded transistors with platinum-gold metalization have higher reliabilities than can-case transistors with aluminum metalization. "Our customers want plastic transistors because the price is low," says Irie. He claims humidity is no problem; in fact, he says the units can meet very severe specifications. However, he thinks that plastic transistors are not suited for space applications—in such a vacuum environment volatile components can evaporate and be deposited elsewhere. "This doesn't harm the transistors," adds Irie, "but it could degrade the performance of associated equipment."

"Our plastic devices have met full Mil Specs," says TI's Crook. He adds that the devices that were certified by the Royal Aircraft Establishment for use in broadband airborne military transmitters were developmental devices, not production transistors. They were developed by TI under government contract. They operate from 225

to 400 Mhz, and produce 15 watts at 100% amplitude modulation and from 15 to 20 watts in the f-m mode.

In France, the military is accepting Sescosem's SFT-339A plastic-encapsulated power transistor despite possible moisture-leakage problems. The reason, according to Deroy: plastic is the only package available for high power at high frequencies. "They may well reject plastic when other packages are available," adds Deroy. However, in Germany, the military, with its stringent requirements, will not accept plastic transistors even though Valvo engineers consider them acceptable for military use.

Engineers at Mullard are convinced that it's the radial lead layout, made possible at low cost with plastic, that makes this type of encapsulation so popular. According to Mullard's Culling, radial leads are superior to other configurations at frequencies above 175 Mhz because "unwanted inductances go up with frequency, making the shortest leads possible, both inside and outside the package, a necessity."

But low cost isn't everything. Fujitsu's Katori says that low cost cannot compensate for the poor reliability of plastic transistors. Consequently, Fujitsu's customers—manufacturers of high reliability communication equipment—don't want them.

The overwhelming choice of material among all the r-f power transistor manufacturers is silicon—simply because silicon technology is better known and understood even though other materials offer some advantages. Germanium, for example, offers higher frequency performance than Si but runs into problems at about 85° C. Gallium arsenide, which also should provide higher-frequency performance, presently is not economically practical.

In addition, GaAs poses several technical problems. Difficulty in controlling the impurity profile, in the insulating masking process, and low thermal conductivity make it unsuitable for use as an r-f power transistor material at present. However, some foreign transistor manufacturers aren't deterred. Nippon Electric, for example, is doing theoretical and experimental work in GaAs field effect and bipolar transistors. It's also investigating Schottky-gate transistors for high-speed switching. Engineers at Toshiba also are investigating GaAs r-f power FET's and bipolar transistors; they feel that a 10-watt, 2-Ghz FET is not too far off.

Valvo engineers have been working with both Ge and GaAs in the laboratory, but feel that for device development Si is still the best material.

Siemens says silicon's strong point is its ability to perform adequately at higher temperatures. Experiments done with GaAs at Siemens indicate that, as far as Siemens' engineers are concerned, it's not well suited for bipolar transistors—especially power transistors—primarily because of the difficulty in obtaining the required purity levels.

As far as the 1970 market for r-f power transistors goes, it appears to be a fast growing one. In Japan, the people at Mitsubishi see a \$10 million market this year—more than 300% over 1969—while those at Nippon Electric and Toshiba are not quite so optimistic, they see \$6 million and \$3 million, respectively. In Germany, marketers at Siemens forecast \$4 million in sales for West Germany and \$14 million for Western Europe while TI sees the European market at \$9 million. ●

Designer's casebook

Designer's casebook is a regular feature in Electronics. Readers are invited to submit novel circuit ideas and unusual solutions to design problems. Descriptions should be clear. We'll pay \$50 for each item published.

'Make-before-break' mode improves FET switch

By Leonard F. Halio

Digital Equipment Corp., Maynard, Mass.

When field effect transistors are used to switch analog signals spikes often are transmitted with the signals. And a finite resistance associated with the FET varies with temperature changes, introducing further inaccuracies. These problems can be overcome with a circuit scheme using two FET's operating in a make-before-break mode. Here, one of the transistors is switched on prior to gating the analog signal. This provides a low-impedance path to ground which minimizes the spikes.

Since the channel resistance of the FET and its input capacitance are inversely proportional, merely attempting to lower the channel resistance will not eliminate the problem. Input capacitance

would increase when channel resistance is decreased, allowing the gating signal to be coupled through the FET's channel and into the analog system.

In the circuit configuration, a positive gating signal turns on transistor Q_1 while Q_2 remains off, thus allowing the analog signal to be transmitted to the output via the operational amplifier LM 302. Since Q_1 's channel resistance is in series with the 1,000-megohm input impedance of the operational amplifier, variations in the smaller channel resistance over wide temperature ranges can be ignored.

When the analog switch is opened by a negative-gating signal, the time constants of the associated drivers of Q_1 and Q_2 are adjusted to allow Q_2 to turn on before Q_1 turns off—hence, the make-before-break scheme. Any spike coupled through Q_2 sees a low-impedance path through Q_1 , effectively reducing the spike to a negligible value.

This process is repeated when Q_1 turns on and Q_2 turns off. The coupling signal will see a momentary low-impedance path through Q_2 to ground, reducing the spike to a negligible value.

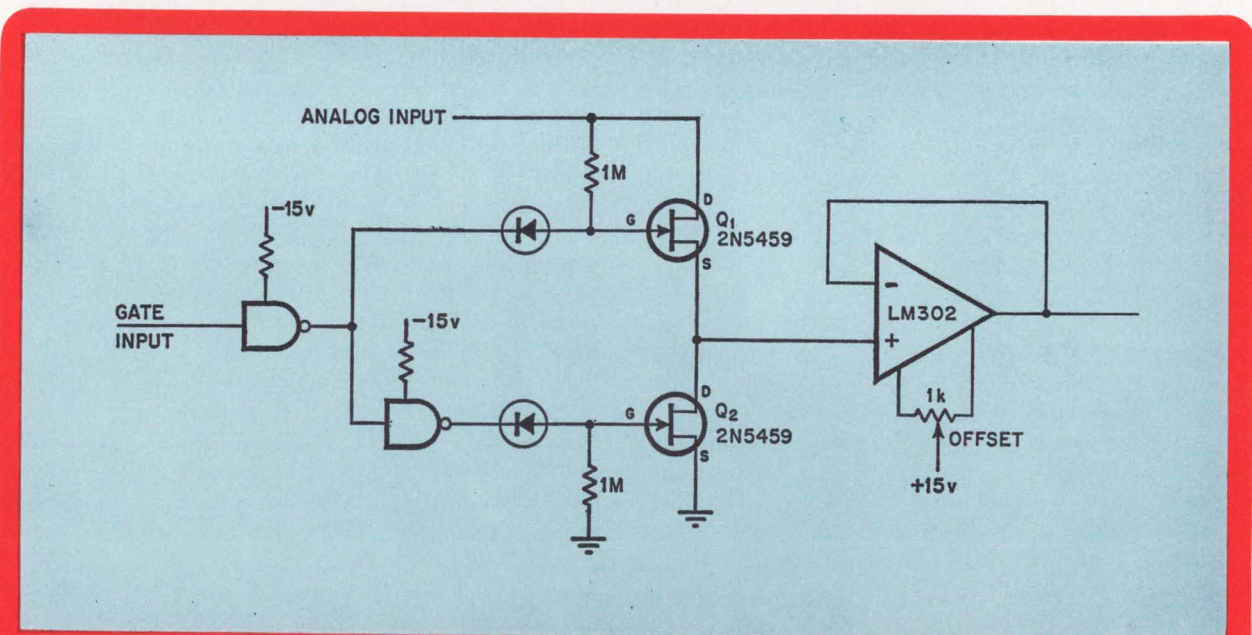

Low impedance. The two FET's acting as a make-before-break switch help reduce troublesome spikes from being gated with signals in an analog switch. The time constants of the associated drives of Q_1 and Q_2 are adjusted to allow Q_2 to turn on before Q_1 goes off, and vice versa, minimizing the gating transients.

Short-circuit protection for voltage regulators

By W. Granter

Central Research Laboratories, Shortland, Australia

A short circuit occurring at a voltage regulator's output could destroy the regulator's series pass transistor. But if a transistor network is added across the series pass transistor terminals the increased current due to a short circuit will be partially drained off by the added transistor. This would hold the power dissipation of the series transistor within acceptable limits.

A typical voltage regulator, the $\mu A 723$, provides a 15-volt output with a load current of 40 milliamperes. If the load terminals of the device (RV_o and ground) are short-circuited, the output voltage adds to the normal voltage drop across the series

pass transistor, Q_1 , in the output stage of the regulator. The new 24-volt supply voltage combined with the 40-ma current increases power dissipation to 960 milliwatts, overloading the regulator by 160 mw.

The modified circuit works as follows. During normal operation, V_o is approximately equal to 15 volts. Transistor Q_2 is biased off by an appropriate selection of values for R_1 and R_2 and has a standby current drain of 10 ma. When RV_o is short-circuited to ground, the voltage across the series pass transistor (V_c to V_o) rises, causing the voltage across R_2 to rise to a voltage exceeding the 0.6-volt turn-on value for Q_2 . Current then is drawn through R_3 , reducing the load carried by Q_1 . R_3 is selected to allow Q_1 to draw 10 ma while 85 ma flows through Q_2 and R_3 . Now the power rating of the series pass transistor is not exceeded and the voltage regulator has a built-in short-circuit protection.

The modification protects any series pass transistor when the values for the resistors and the current limit for Q_2 are calculated to share the load with the transistor to be protected.

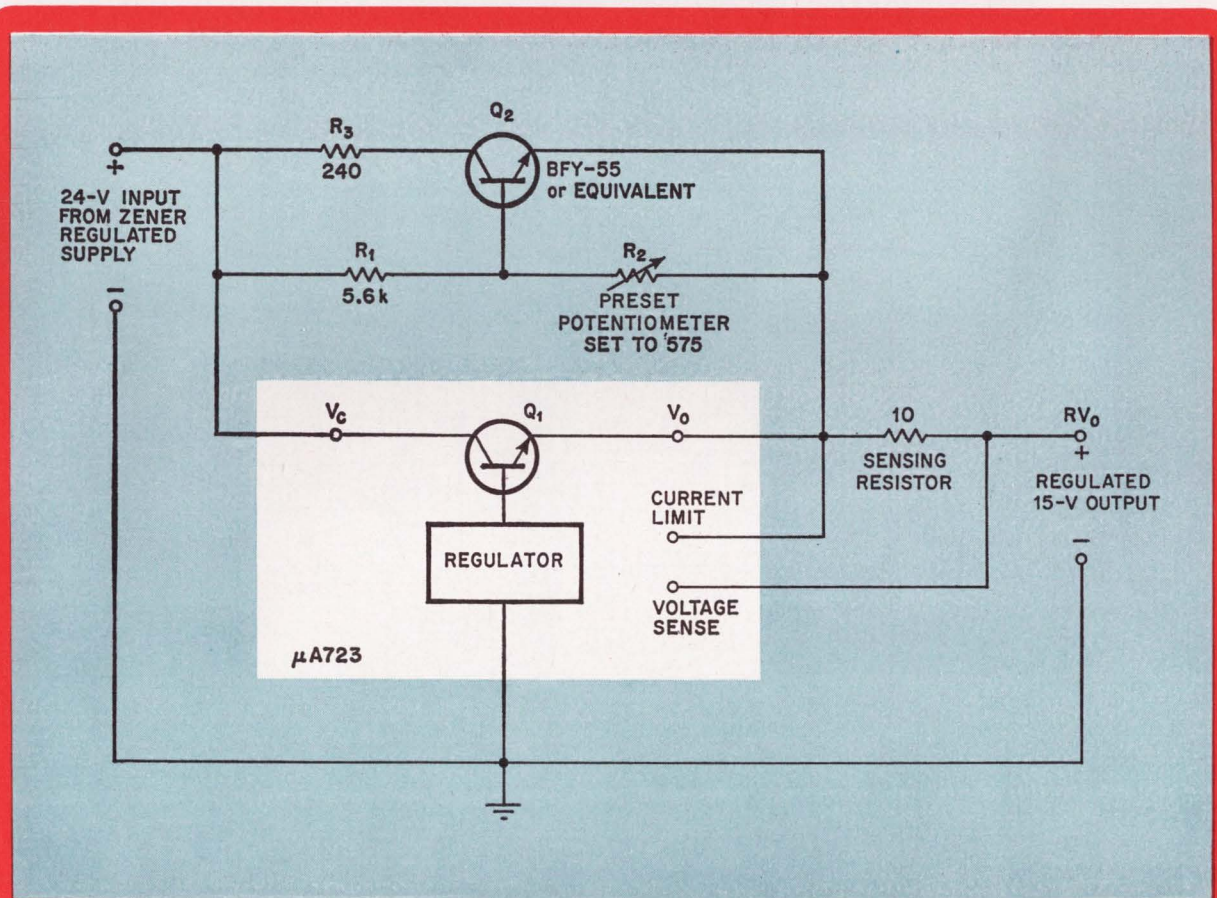

Series bypass. An additional transistor circuit connected across the series pass transistor of a voltage regulator protects the series transistor from overloading if a short circuit occurs across the regulator's output. Transistor Q_2 is biased into conduction during a short circuit, draining off the extra current.

Two op amps simplify design of oscillator

By Dennis J. Knowlton

University of Wyoming, Laramie

A voltage-controlled oscillator, of the type commonly used in analog-to-digital converters, can be quickly built with readily available components. The frequency, which is linearly proportional to an input voltage, varies from 0 to 1 kilohertz over an input voltage range from 0 to 5 volts.

The oscillator comprises three parts: an integrator, a voltage detector (Schmitt trigger), and a reference voltage network. The integrator, built with operational amplifier A_1 , converts a positive input voltage to a negative-going ramp at its output terminal. Op amp A_2 acts as a Schmitt trigger with thresholds—determined by resistors R_4 and R_5 , and by the voltage reference attached to R_4 —of -2 volts and -7 volts.

The output of the integrator is initially at 0 volt. The Schmitt trigger's output sits at -12 volts.

When a positive voltage is received at the input, the integrator charges negatively until it reaches -7 volts, whereupon the Schmitt trigger fires and produces an output voltage of 12 volts.

The 12-volt output is fed to the gate of field effect transistor Q_1 which immediately turns on. This action causes the integrating capacitor, C_1 , to discharge and clamp the integrator's input to -7 volts. The result is that the integrator now begins to deliver a positive-going ramp at its output terminal.

The integrator's output voltage continues to increase toward 0 volt until it reaches the Schmitt trigger's second firing voltage of -2 volts. At this voltage, the output of A_2 returns to -12 volts, shutting off Q_1 . When the integrator's output voltage reaches 0 volt, the cycle is completed and a new cycle begins.

Diodes D_1 and D_2 , and resistor R_6 stabilize the -7 -volt trigger point against variations in the -12 -volt supply. The reference network supplies the voltages for the trigger points and provides a common input bias compensation for the op amps.

The oscillator remains linear to within 0.1% over a frequency range of 0 to 1 kHz. The output frequency remains stable to within 0.1% for variations in the supply voltage up to $\pm 15\%$.

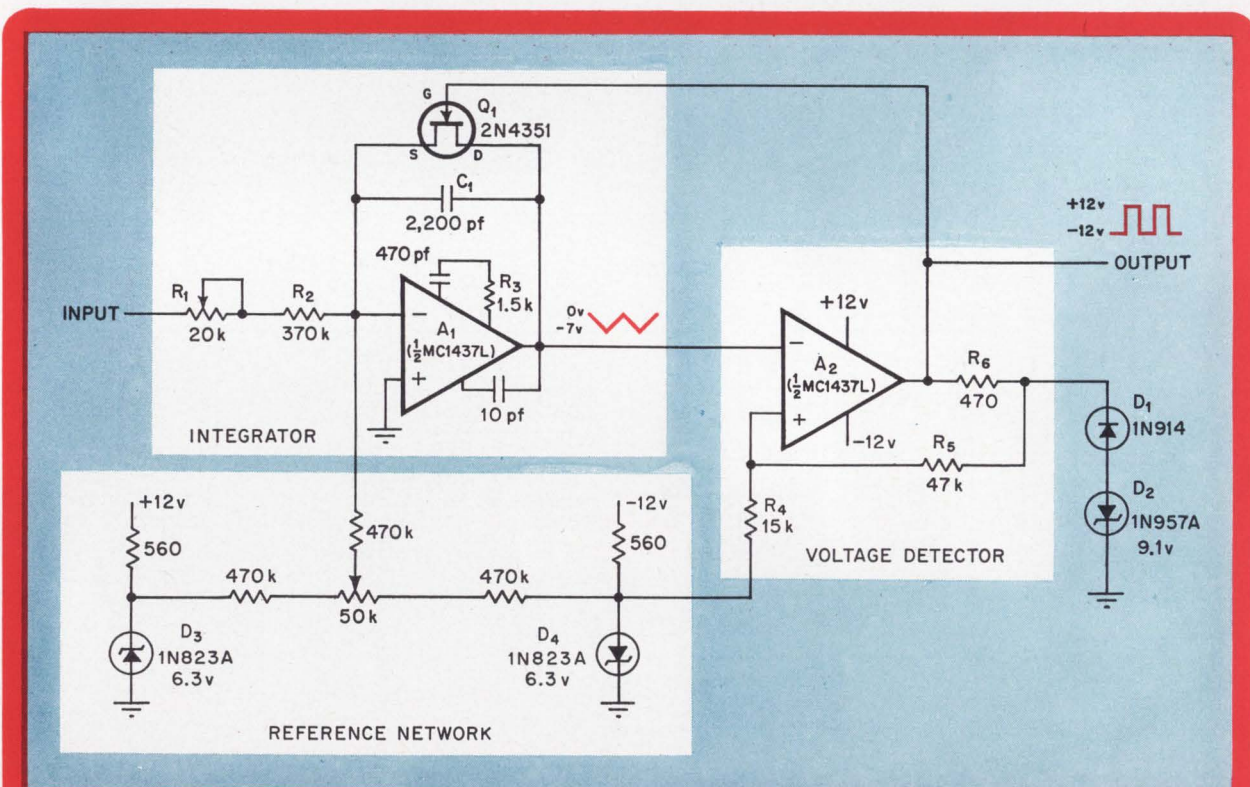

Voltage-controlled. The frequency is linearly proportional to the input voltage. When the integrator reaches -7 volts, the detector switches to 12 volts. Q_1 turns on, discharging C_1 and the integrator begins to charge toward 0. At -2 volts, the detector again fires and produces a -12 volt output.

90-second look at IEE's wonderful world of readouts

Readouts are our special craft. Using any characters you want. Any colors or color combinations. Any input, BCD or decimal. Any input signal level. Any mounting, vertical or horizontal. Five sizes,

up to 3 3/8". Many configurations, options and accessories. Long lamp life (to 100,000 hours; up to 175,000 hours at reduced voltage). If it doesn't exist and you need it, we'll build it.

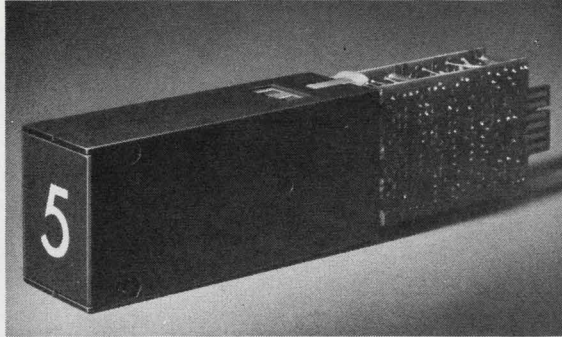

10H—World's most popular readout. And we've improved it. Double condensing lens provides exceptional character brightness. Greater clarity at wider angles and longer distances, even under high ambient light. .937" sq. viewing area. Mil-spec version available.

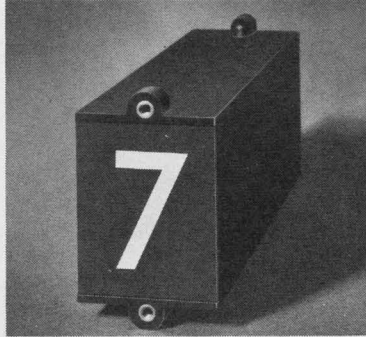

160H—Exceptionally large viewing area (1.56"H x 1.12"W) for overall size. 45 FL character brightness with a 6.3V \$.20 lamp. Displays messages simultaneously with symbols.

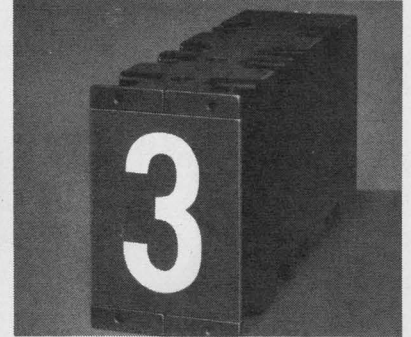

80—Large screen unit suited for annunciator applications such as factory call systems and production control. 3 3/8" character height can easily be read at 100'. 160° viewing angle.

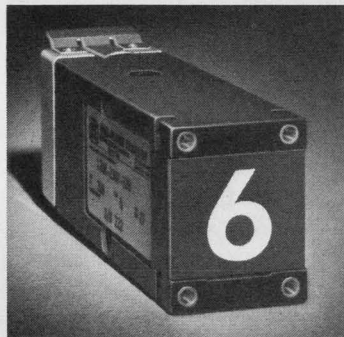

120H—Miniature rear-projection readout (.62" sq. screen) easily read from 30' under high ambient light. Quick-disconnect lamp assembly speeds lamp replacement.

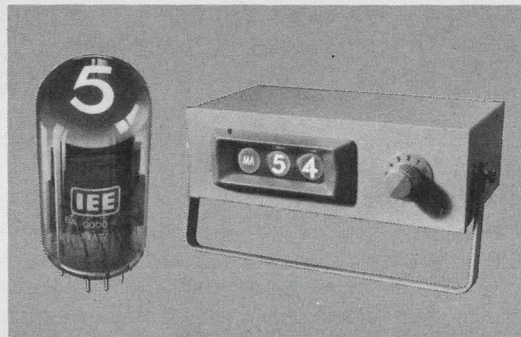

nimo™—First 10-gun CRT single-plane display. Projects numbers, letters and words onto a fluorescent screen. No image ambiguity. No external focusing required. No ambient light worries. Exceptionally wide viewing angle. Ideal for instrument application.

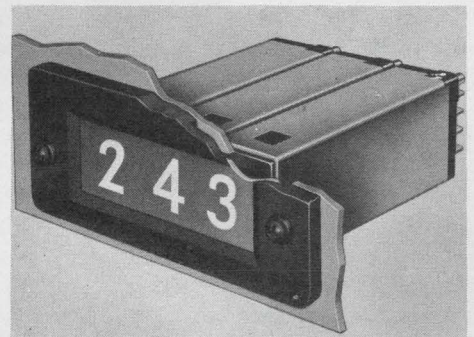

875—Miniature 24-position readout assembly with a cost per display of only \$1.45 each. .620 sq. in. viewing area with overall case size of 1.39"H x .90"W x 3.095"D. Exceptional brightness, clarity. Front panel access.

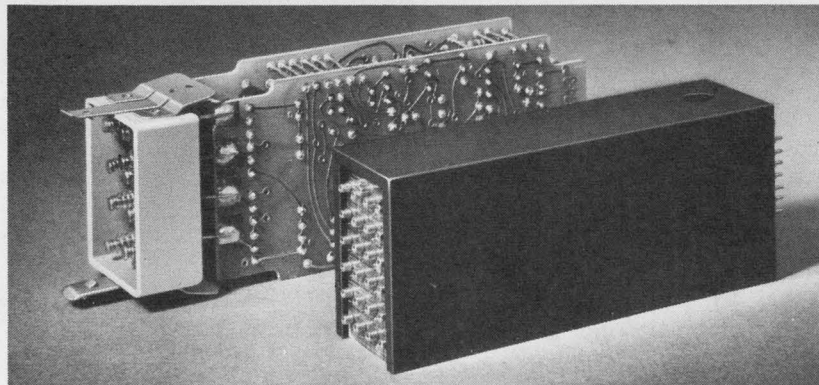

IC Driver/Decoders—Small, reliable units for driving IEE readout incandescent lamps ranging from 250 ma @ 6V to 40 ma @ 28V. Fully compatible with modern IC's. Accept a variety of binary codes for decimal conversion. Require normal signal V., draw less than 2 ma per data input. Internal data storage for pulsed oper.

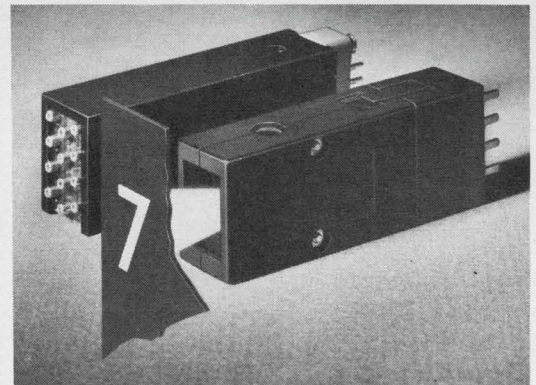

345—IEE's smallest rear-projection readout. Viewing area .38"H x .34"W. Based lamps. Low cost. Individual readouts plug into perm. wired housing for quick message change. Easy front panel access.

Industrial Electronic Engineers, Inc.



7720 Lemona Ave., Van Nuys, California 91405
Telephone: (213) 787-0311 • TWX 910-495-1707

Taking a look at color EVR from the inside out

Headed by Peter Goldmark, a team from CBS Labs explains how electron-beam recording allows the use of very fine-grain film that has a high capacity of data storage despite a very small frame size

● Electronic video recording (EVR) is the Columbia Broadcasting System's video counterpart of the long-playing record. And just as the lp is a low-cost, high-volume method of storing and reproducing sound, EVR represents an economical means to store television programs and to play them back over a black-and-white or color-tv set.

During EVR's 10 years in development, circuits were built to translate standard National Television Systems Committee signals into a format suitable for driving an electron-beam recorder; other circuits were needed in the player to translate EVR signals back into the NTSC format. Also required was a real-time electron-beam recorder to produce 60-frame-per-second masters, scanning each frame with 525 lines. Film with high resolution and low cost had to be found. And a completely automatic playback unit had to be designed.

In the EVR system the suitcase-size player is connected directly to a tv set's antenna terminals. An EVR cartridge, which looks like a thick 45-rpm record, fits onto the player's spindle; the program stored on the cartridge's film is played on the tv screen. With the current thickness of film, one cartridge holds 25 minutes of color video or 50 minutes of black and white, plus associated sound tracks (In Europe, because of the 50-field tv standards, a cartridge holds 30 minutes of color or 60 minutes of black-and-white.). Provision is made for stopping the

film to view individual frames.

EVR's picture quality on a tv receiver is equal to the best broadcast picture. On closed circuit, monochrome resolution can reach 500 tv lines; color resolution is limited by a tv tube's phosphor-dot structure—usually 400 lines. EVR will find applications in home entertainment, education, and marketing. And since an EVR cartridge can hold 100 billion dots of varying shades of gray it has potential in the information-storage area.

Making an EVR film begins with translating a standard NTSC tv signal, usually from a video tape recorder or film, and driving a two-gun electron-beam recorder with the new signal. Silver-halide film, made especially for EVR, moves under the two beams, each scanning half of the film's surface. In black-and-white programing, frames of images 0.10 inch high and 0.13 inch wide are formed on both halves, each representing 25 minutes of video. In color programing, images go onto only one half; the other half holds encoded color information. This master film, made by electron-beam recording, is turned into copies through high-speed printing and processing. The copies are wound on cartridges, ready for playback.

A suitable recording method had to meet many requirements. Electron-beam recording offered a number of advantages over laser and cathode-ray tube recording. Extremely fine-grain films sensitive to high energy present in an electron beam have a high capacity for data

Onto film. EVR film begins with a standard NTSC signal, which is translated into an EVR format, processed, and sent to an electron-beam recorder. The master film made by the recorder is used to make copies, which then can be played by a black-and-white or color tv.

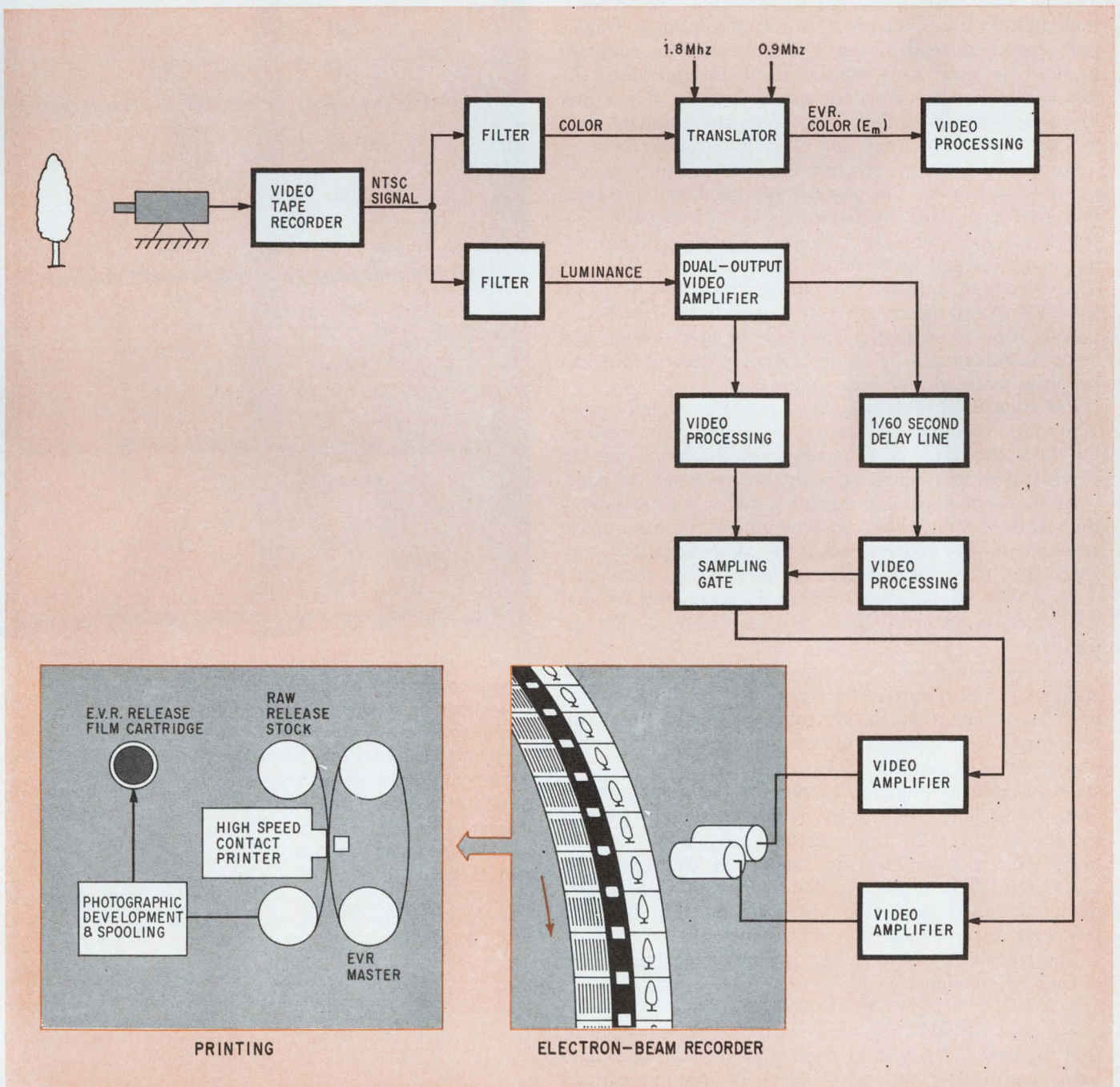

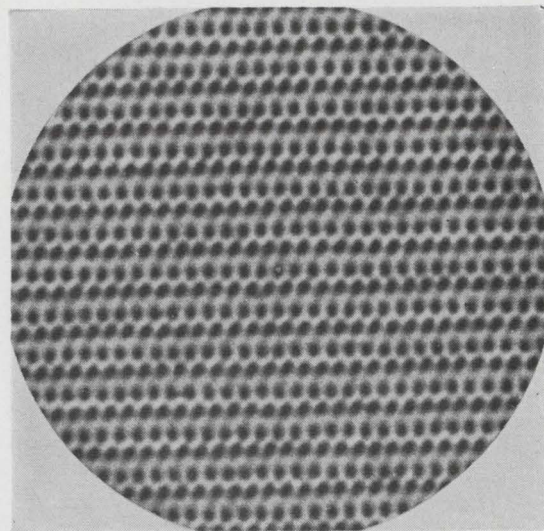
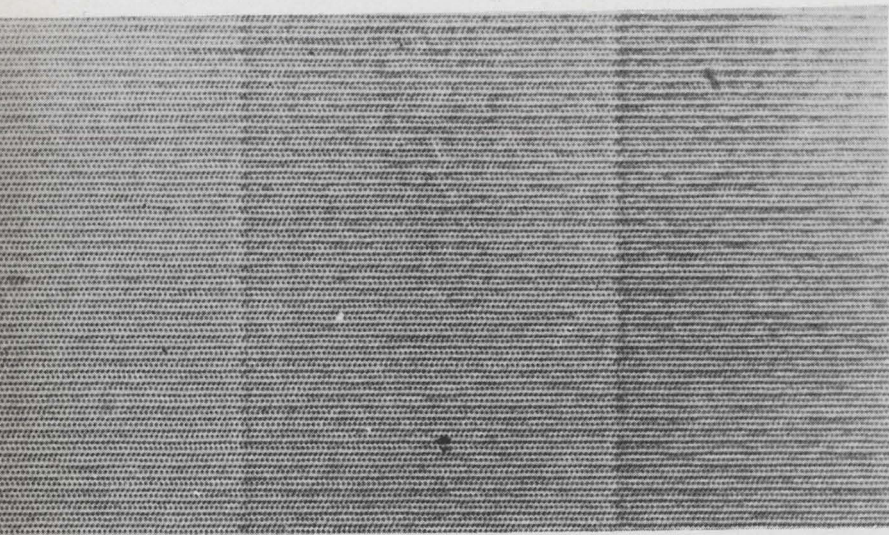

storage. Fine-grain film leads to very small frame sizes, making it economically possible in EVR to print 60 frames per second, instead of the 30 frame/sec rate standard in tv. This leads to a simpler playback unit since the film can be run at a constant speed. Besides, this higher film speed integrates the effects of spurious signals, such as those caused by grain and other film imperfections.

Another advantage: electron-beam recording makes it possible to modify the original tv signal and pre-compensate for subsequent distortions by tailoring the electron-beam recorder's input to give a predetermined frequency boost and to introduce grayscale correction.

A video tape is the first step toward a master. Although the EVR recording system could operate with real-time signals from tv cameras, video tape or film, editing and color balancing can be made better by prerecording all program material onto video tape.

For color EVR recording, the NTSC color signal from a video tape recorder goes into two parallel channels, one for the color signal and the other for the luminance. In black-and-white recording, only one channel is used.

At the beginning of the color network a filter passes the standard NTSC color signal, composed of an in-phase component, E_I' , and a quadrature component, E_Q' , and sends it to the NTSC-to-EVR translator. There, the signal modulates a 1.8-megahertz carrier, f_c , producing a signal E_C , which is given by $E_C = E_Q' \sin(2\pi f_c t) + E_I' \cos(2\pi f_c t)$.

The translator adds two other signals to E_C : a pilot signal E_P , and a correction signal, E_V . In the EVR system it's essential to record color signals so they can be reproduced independent of the recording and the playback unit's scanning linearity.

To provide a reference carrier for the demodulation of E_C in the player, E_P , an unmodulated signal with half the frequency of the color carrier's frequency is added to E_C . This way nonlinearities, raster-size changes in the player, and film shrinkage, don't interfere with proper demodulation because the phase relationship between the color and pilot carriers stays constant.

The translator's output, E_M , is simply the linear sum of these three signals; i.e.,

$$E_M = E_C + E_P + E_V.$$

E_M goes through a gamma corrector, which ensures that the entire EVR system, from recording through playback, approaches the performance of a unity gamma



Layout. Color EVR film has monochrome images on one half, encoded color information on the other. In the middle are small windows which the player uses for synchronization. At the top of the page is part of the image of a grayscale, along with a closeup. The electron beam that forms the images has a 14-MHz wobble; one scan line produces two rows of dots.

. . . the synchronization signal produces a small, clear window in the film between the frames. On replay, the synchronization is sensed with a lamp and detector . . .

system. From the corrector, E_M goes to one of the electron-beam recorder's guns.

Meanwhile the NTSC signal from the video tape recorder also goes into the second channel. There, a filter removes the color and passes the luminance signal. A dual-output video amplifier takes the first 1/60-second of the luminance signal and sends it through a 1/60-second delay line and a video processing circuit to a video sampling gate, running at 14 Mhz. The next 1/60th of a second the luminance signal goes undelayed through another video processing circuit to the same gate. The result: each EVR frame, which is 1/60 sec long, holds all the information contained in the 525 lines of a 1/30-sec standard tv frame. A camera makes a tv frame by scanning a scene 262.5 times and then going back and scanning 262.5 more times, for a total of 525 scan lines. This takes 1/30 second. Each group of 262.5 lines is called a field, and each 1/60-second portion of the video tape recorder output contains one field. Say fields 1 and 2 from the tape recorder make up tv frame I; fields 3 and 4 make up II, and so on. The sampling gate, which feeds its output to the electron-beam recorder's second gun, makes up EVR frame I out of fields 1 and 2, evr frame II out of 2 and 3, and so on. This is how a 60-frame-per-second film is made from a 30 frame/second input.

Two types of delaying units—a magnetic disk and

an eight-section quartz line—have been used for EVR recording; neither has been selected for exclusive use. In the magnetic approach a recording and a playback head are located 180° apart at either side of the disk, whose angular velocity is one-half turn every 1/60 second.

The processing circuits in the luminance network contain a gamma corrector, and horizontal and vertical aperture correctors which apply the frequency pre-emphasis. The vertical correction compensates the video signal for resolution losses from one horizontal scan line to the next. In effect, it compares the video content of a given scan line with that of the lines above and below it, and adds the result to the signal as detail to sharpen the information in a vertical direction. The horizontal corrector boosts the video signal by compensating for resolution losses within one horizontal line.

Added to the luminance signal going to the recorder is a synchronization signal which produces a small, clear window in the middle of the master between the frames. The resulting column of windows provides synchronization in the player between the film transport and the cathode-ray tube.

The EVR color and luminance signals each go to the electron-beam recorder through a video amplifier. In the recorder, the signals modulate the intensity of the electron beams.

The recorder itself consists of three chambers: one

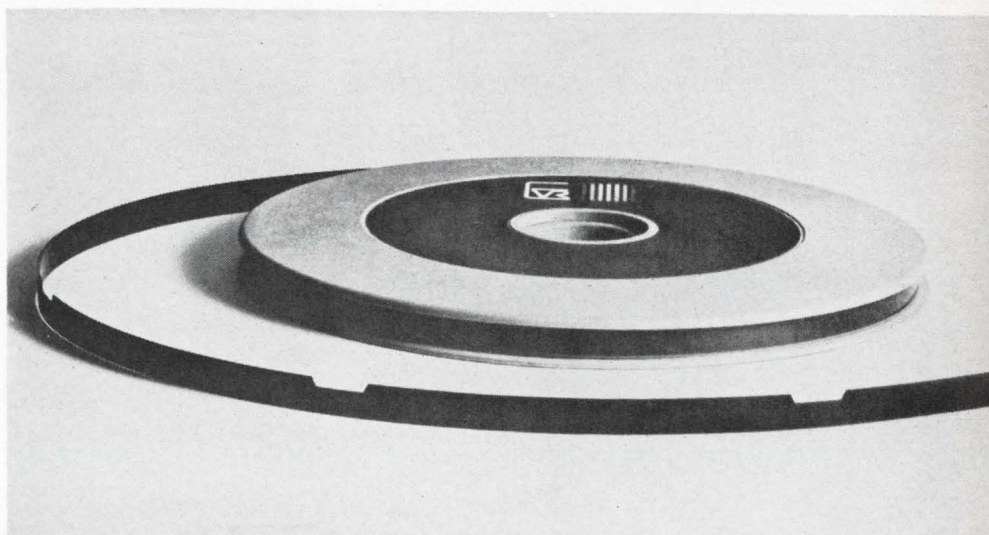

Ready to play. One EVR cartridge, 7 inches in diameter, holds 25 minutes of color programming. The player threads the film by grabbing the plastic leader at the beginning of the reel and pulling it through the transport.

for the film magazine, one for the film drive, and the third for the electron guns and the beams. To ensure that the beams exposing the film are properly focused, and to provide for adequate filament life, this third chamber is kept at a pressure less than 10^{-5} torr. There's virtually no loss of resolution in the recording process—the beam's diameter is held to 0.0001 inch, allowing the recorder a resolution of 200 line-pairs per millimeter.

The two guns simultaneously scan the film moving through the chamber. Their horizontal scan rate is the standard tv horizontal rate of 15,750 hz. The film moves vertically through the chamber at 6 inches per second, or 60 frames per second; the beam's vertical scan rate is 12 inches/sec. A beam begins scanning at the top of a frame; by the time that frame has moved a distance of one-frame length—0.10 inch—the beam has reached the bottom of the frame. A short blanking period occurs, and the beams fly back to the top of the next frame.

The beam modulated by the color signal produces what appears to be rows of dots on the half of the film it scans. Since the horizontal scan frequency, the pilot frequency, and the color carrier frequency are integral multiples of each other, the dots occur at the same spots on each scan line as long as the colors are the same. Therefore, the color-encoded half of the EVR film appears to be made up of thin vertical stripes, varying in spacing according to the color information.

The luminance side, which contains images just like a standard piece of monochrome film, is scanned by the second beam; it's controlled by pulses coming from the 14-Mhz video sampling gate. Superimposed on its 12 inch/sec vertical scan deflection is a narrow vertical deflection caused by a 14-Mhz wobble signal. It's adjusted so that the video information associated with the delayed luminance signal is recorded when the beam is at the top of the wobble, while the undelayed information is recorded at the bottom. Thus, during one horizontal scan two dotted lines are traced, each corresponding to the information contained in a different field on the original piece of video tape.

The film drive in the electron-beam recorder very accurately maintains the film speed of 6 inches per second (5 inches in Europe). The drive, an electronic servo type, controls film velocity by locking onto the vertical scan frequency and the synchronization signals

from the video tape recorder. Interlocking of the EVR film drive with the tape recorder drive is accomplished at the beginning of the recording process by counting the vertical sync intervals on the video tape and the perforations on the edge of the film. The film drive compares the counts and varies the film's velocity until the counts coincide. Interlock between the two drives occurs within 12.5 seconds of the time the film starts to move through the electron-beam chamber. During the 12.5 seconds 750 perforations are counted. A solenoid-actuated punch in the electron-beam recorder puts a cue hole at the beginning and at the end of the 750-perforation interval. For the first 650 counts the two guns are unblanked and vertical scan is turned off. While the next 100 perforations pass, the guns are blanked and the vertical scan is turned on to prepare for recording the first program frame. The black-to-white transition after the 650th perforation is used as a reference cue for recording sound during the printing operation. Sound will be placed on the copies as magnetic stripes down both sides of the copies. In monochrome recording, each stripe can carry the sound for one strip of frames. In color recording, the two can produce stereo sound.

The silver-halide film used by the electron-beam recorder to make a master is doped to make it more sensitive to the beams. This film, developed by Ilford Ltd.,

Playback. The player sends EVR film through a pair of rasters taken from the crt's face. The two beams modulated by the film go to photomultipliers, whose outputs are converted into a composite NTSC signal. Put onto an r-f carrier, the signal then can go directly to a tv's antenna terminals.

EVR PLAYER

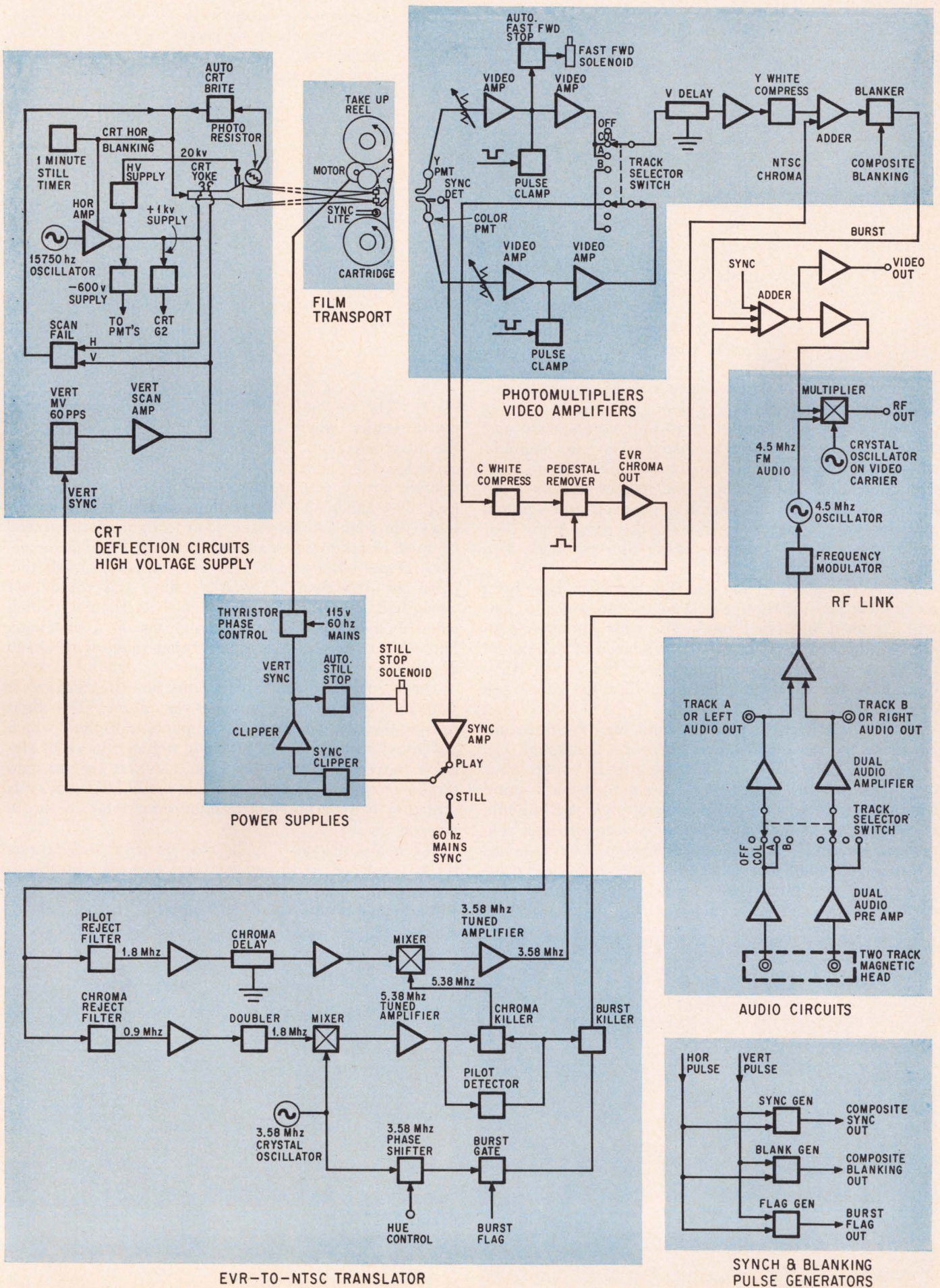

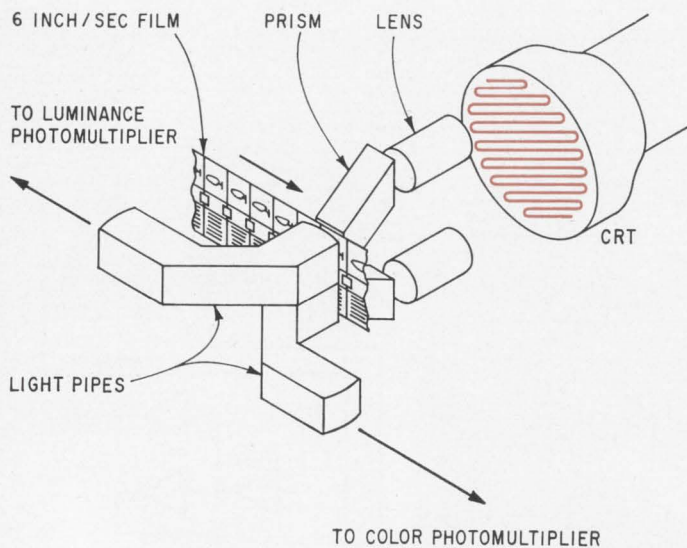

Reading the film. The player's optical system makes rasters and focuses them onto adjacent frames, one on the image frame and the other on the color frame. Lucite pipes carry the modulated light to the photomultipliers.

England, for EVR, has a resolution of 800 line-pairs per millimeter; crystal size is less than 1 micron.

The film in the recorder is 40 millimeters wide and has four separate two-track masters. The gun chamber sits on two trunions and can be indexed to four horizontal positions. In practice, one master is made; the film is rewound, the gun chamber is moved over a notch, and the second master is shot on the same film. Two more copies of the program master film are made in a similar manner.

The four-master film and real-time recorders have been completed, one for Europe and another for the U.S. and will be used in actual production this summer. EVR films made until now have been produced on lab-model recorders which put out one-master film. Since they don't have the video-sampling capability, they don't run at real time.

A multihead wet-gate printer, built for EVR, turns out copies of the master in a contact process. Through use of multiple heads this printer generates 16 copies—four copies to a 40-mm wide film strip—complete with sound tracks each time the master passes through. A 25-minute color program is generated every 18 seconds (14.5 seconds in Europe). The copies are developed by standard photographic methods. Since EVR films containing color programming are themselves monochromatic, developing of all EVR film can be done in a black-and-white machine.

The developed strips are slit into four 8 $\frac{3}{4}$ -mm wide copies. The beginning of each copy is attached to a plastic leader, which is used to unwind a cartridge in the playback unit. The copy then is wound onto a cartridge.

Right now, copies are made on a high-resolution, low-cost silver-halide film. But when it's available in quantity, Diazo film may take its place. Here, a light-sensitive dye, completely grainless, is used instead of a halide emulsion. Diazo offers much greater resolution—1,000 line pairs per mm—than silver-halide film, and could cost about half as much. Diazo film also is thinner, which could increase the length of programs on a cartridge. High-quality prints already have been made with Diazo film.

The playback unit displays the film by moving it through light beams coming from a crt. The light passing through the film is sent to photomultipliers which generate luminance and EVR color signals; the color signal is converted to NTSC form; both signals are put onto a radio-frequency carrier; and this modulated carrier is sent to a tv set's antenna terminals for relay to the tv screen.

When a cartridge, 7 inches in diameter and $\frac{3}{8}$ -inch thick, is placed in the player and the play button is pressed, the film's leader is threaded through the deck and attached to the player's takeup reel; then the player

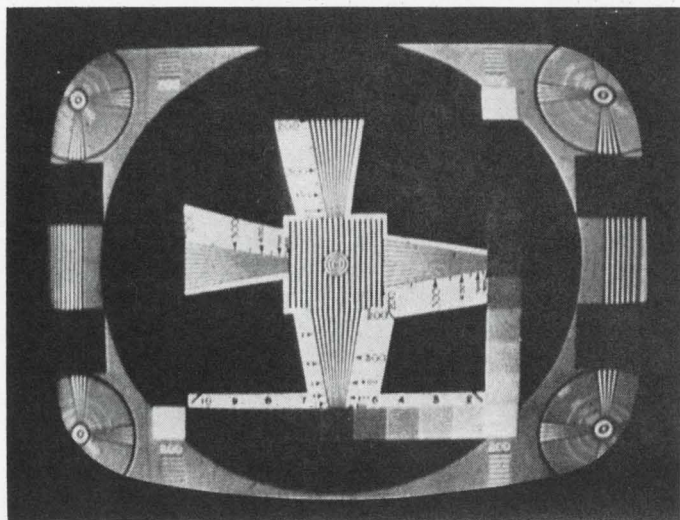

Results. The final test pattern of an EVR signal displayed on a typical tv screen shows the resolution capabilities of the process.

Those who served in developing EVR

The development of EVR was a team effort headed by Peter Goldmark at CBS Laboratories. Robert Castrignano, William Glenn, Donald Ridley and Andrew Tarnowski contributed to the development of the electron-beam recorder. C. Russell Dupree, Barnard Erde, and Ivan Purt helped to design the film and optical system. Abraham Goldberg was responsible for the player; Patrick Grosso developed its cathode-ray tube; and Robert Rhoades headed the mechanical design. John Christensen, Dennis Gabor, John Hollywood, Renville McMann, and John Wisstrand contributed to the overall design of the system.

automatically begins showing the program. A large knob on the player's front allows the user to manually move the film when looking at individual frames in a step-by-step mode.

The crt generates an ultraviolet raster with 10-line-pair-per-mm resolution on its 2 $\frac{3}{4}$ -inch-diameter flat face-plate. The raster's intensity is held constant by a photo-resistor which controls the beam current. As the P16 phosphor ages, the current needed to maintain the rated light output goes up from 10 to 80 microamps over the life of the tube.

The twin tracks of the EVR film are scanned by a dual optical system, which consists of two lenses, two rhomboidal prisms, a lens mount combined with a film gate which holds the film in a cylindrical image plane. Each lens focuses the raster from the crt onto an area on the image plane, forming two identical rasters on the film, one for each track.

The collector optics on the other side of the film consist of two lucite pipes. These collect the modulated light coming through the color and luminance frames, and transmit each light channel to its own photomultiplier. A film transport, similar to the type used in magnetic tape recorders, moves the film through the optical assembly. Since the timing of the crt beam depends on film speed, this speed can vary a little.

Film speed and vertical scan rates were chosen so

that the playback unit scans each frame in much the same way that the frames are scanned by the electron-beam recorder. As a frame moves through a distance equal to one frame length the raster is completed on that frame. Flyback occurs, and the raster is traced out over the next frame. The original scan lines on the frame aren't retraced by those rasters as they move across the frame.

The modulated light beams are converted into EVR video signals by the photomultipliers. This signal from the color photomultiplier contains the color and the pilot signal; it goes to the EVR-to-NTSC translator. There, the color signal is separated from the pilot by two filters, a 1-to-2.5-Mhz bandpass filter in one channel and a 1-to-2.5-Mhz band-reject filter in another. The pilot signal's frequency is doubled to 1.8 Mhz and mixed with a locally generated 3.58-Mhz signal. The resulting 5.38-Mhz signal is selected by a bandpass filter and applied to a second mixer together with the EVR color signal, whose carrier frequency is 1.8 Mhz. The frequency of the translator's output remain constant at 3.58 Mhz, regardless of any shift in EVR color frequency.

The phase-versus-frequency characteristics of the color and pilot channels are kept equal to prevent hue errors due to scan-velocity changes. If the two signals undergo equal phase shifts in the translator, the errors cancel.

Following the mixer, combined blanking, sync and burst signals are added to generate the composite NTSC signal. A color killer in the player disables the color network whenever a monochrome film is played. Otherwise spurious beats would show up in the final picture on the tv screen.

The most convenient way to feed pictures to a tv set is through the antenna terminals. In the EVR players this is done with a miniature transmitter operating on an unused vhf channel. Double-sideband video modulation is employed for economic reasons, but television receivers accept signals modulated this way just as they'd accept the vestigial sideband signals received in broadcasts. A crystal-controlled oscillator generates the r-f carrier, which is applied to one input of an analog four-quadrant multiplier. The NTSC composite signal and the 4.5-Mhz sound carrier are applied to the other input. ●

Camera's infrared eye focuses on new vistas for ranging

New device focuses a movie camera by shooting pulses of i-r light at an object and controlling detector's position with reflected energy, says *Giovanni Odone* of Switzerland's Paillard S.A.; some important new applications could result

● A new movie camera that focuses automatically could open the door to important improvements in portable rangefinders, alarm systems, proximity detectors, and control gear. The key is a distance measuring device called the automatic infrared rangefinder (AIR) that can measure short distances accurately, something that has been difficult and expensive to achieve up to now. The AIR shoots pulses of infrared light at an object and then controls the relative position of a detector assembly with the reflected energy. This enables it to measure distances to an object up to 10 feet away with better than 0.5% accuracy, and out to 100 feet with 10% accuracy.

Engineers have tried other methods to achieve automatic focusing. A passive approach uses a mosaic of photodetectors which measures distance by comparing light radiating from the subject with ambient light. For everyday photographic use such systems are either not sensitive enough or too complex and expensive.

Radar and radar-like systems have also been tried, but to measure short distances accurately they need extremely fast—and extremely expensive—electronics gear. Typically, a xenon lamp periodically sends light pulses to the target; a photodetector senses the reflected light. As in any radar, distance is calculated via time elapsed from emission to detection. But to obtain 1-inch-accuracy when the object is but a few feet from the camera, this type of rangefinder must measure time

with an accuracy that's in the nanosecond range.

In photography, it's easy to measure short distances when the object being ranged is a point source of light, and when other light sources don't interfere. Since the image-to-lens distance is a function of the lens-to-object distance, the point source range can be determined by measuring the distance between the camera's lens and the spot where the lens focuses the light from the point source—an easy job for a photodetector.

In practice, such ideal conditions don't occur. The object rarely resembles a point source, and ambient light reduces accuracy. However, if the camera projects a narrow beam of light onto the object, the portion of the object struck by the beam appears as a point source to the camera. Furthermore, if this beam is chopped at some known frequency, reflected light can be distinguished from ambient light. Theoretically, the chopped beam can have any wavelength, but for many applications, particularly photography, the beam should be invisible; that's why the AIR uses infrared.

The first application for the AIR will be as an attachment to the Bolex 16 PRO, a popular newsreel camera. The camera's focusing ring will be mechanically coupled to the attachment's detector assembly; as the assembly moves toward an equilibrium point, the camera's lens brings the object struck by the projected infrared light into focus. The entire procedure for focusing the camera

the object itself and the mirror.

The rangefinder locates the image with a feedback loop consisting of a stepping motor, its input circuitry, and a detector assembly. The last item comprises two photoresistors facing each other, a ring-shaped mirror between them, and a carriage that holds the resistors and the mirror. The photoresistors' outputs run the motor, which moves the assembly back and forth between the collector mirror and the projector. The detector mirror's inside diameter is slightly larger than the image's inside diameter. When the detector mirror and the image plane coincide, half of the incoming beam—a ring-shaped portion whose inside diameter equals the inside diameter of the mirror—strikes the mirror and reflects onto the photoresistor between the detector and collector mirror. The remainder of the beam goes through the detector mirror and strikes the other photoresistor.

If the detector mirror isn't at the same spot as the image plane, one of the photoresistors receives more energy than the other. This activates the motor, which moves the assembly to the equilibrium point.

The feedback loop's input circuitry removes noise from the photoresistors' outputs and then turns them into d-c inputs to the motor.

Noise, a product of ambient light sources—sunlight or light bulbs, for example—is a source of error in two ways. Just by sending radiation to the photoresistors raises the resistors' output levels, obscuring the reflected-beam signals. In fact the outputs' signal-to-noise ratio can be as poor as -140 decibels.

In addition, ambient sources also may send more radiation to one photoresistor than to the other, causing the detector to come to rest at a false null point.

But the rangefinder's design incorporates several features that lessen the effects of ambient light. First the rangefinder itself—the resistors, the detector and collector mirrors, and the projector—is built to be as symmetrical as possible.

Close to the photoresistors is a lamp which sends to them a constant level of radiation, more than would result from ambient sources. This holds the resistor's d-c outputs constant by reducing the effects of changes in ambient conditions.

Finally, the collector mirror, being smaller than the projector mirror, reduces the relative amount of ambient light reaching the detector assembly. At first glance,

takes no more than a few hundred milliseconds.

In the AIR built for the Bolex camera, the i-r projector consists of a 1-watt tungsten lamp sitting at the focal point of a curved mirror. An optical filter between lamp and mirror absorbs visible light and passes infrared, which the mirror focuses into a narrow beam. The beam is only 6 inches in diameter 60 feet from the projector.

A multivibrator drives the lamp with a square-wave voltage whose frequency varies between 20 and 70 hertz. The exact value depends on the outputs of the rangefinder's detector assembly; as the output goes up, so does the frequency, in an effort to decrease the output. At higher frequencies, the projector's output energy is low and, because of their slow rise time, the photodetectors put out less voltage for a given input. If frequency weren't controlled in this way, the rangefinder's sensitivity would vary with the object's range.

When the projected beam strikes the object, some of the incident energy is absorbed; the rest is reflected. Back in the rangefinder a second curved mirror, a bit smaller than the first, collects part of the reflected light, forming it into a ring-shaped image that encircles an axis running through the centers of the two mirrors. The image's location on the axis depends on the angle at which the reflected energy strikes the collector mirror. This angle, in turn, is controlled by the distance measured between

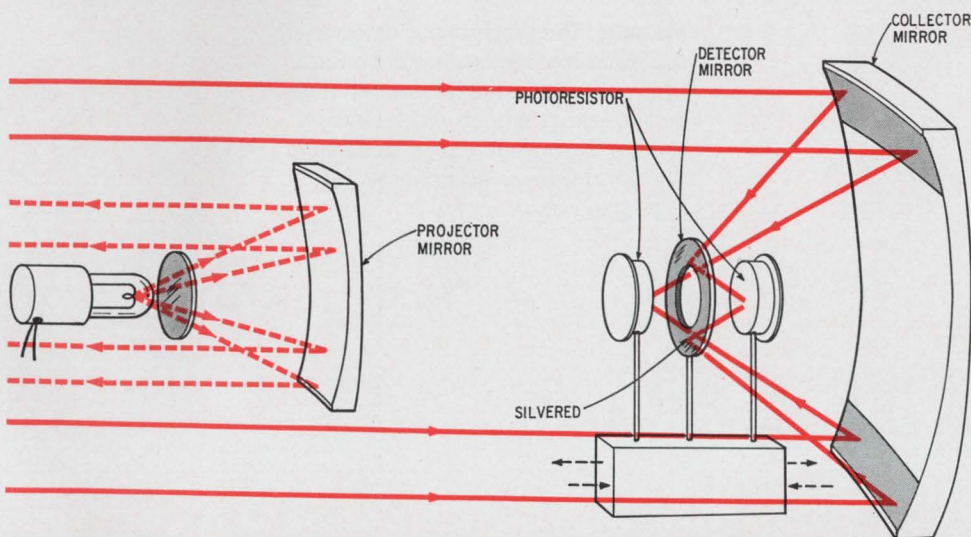

Out and back. The rangefinder's projector sends out an infrared beam. The object reflects the beam, sending some of it back to the collector mirror. There, some reflected energy goes to one of the photoresistors, while the rest goes to the other. If both are getting equal amounts, the distance from the ring-shaped mirror to the collector is proportional to the distance from the object to the projector.

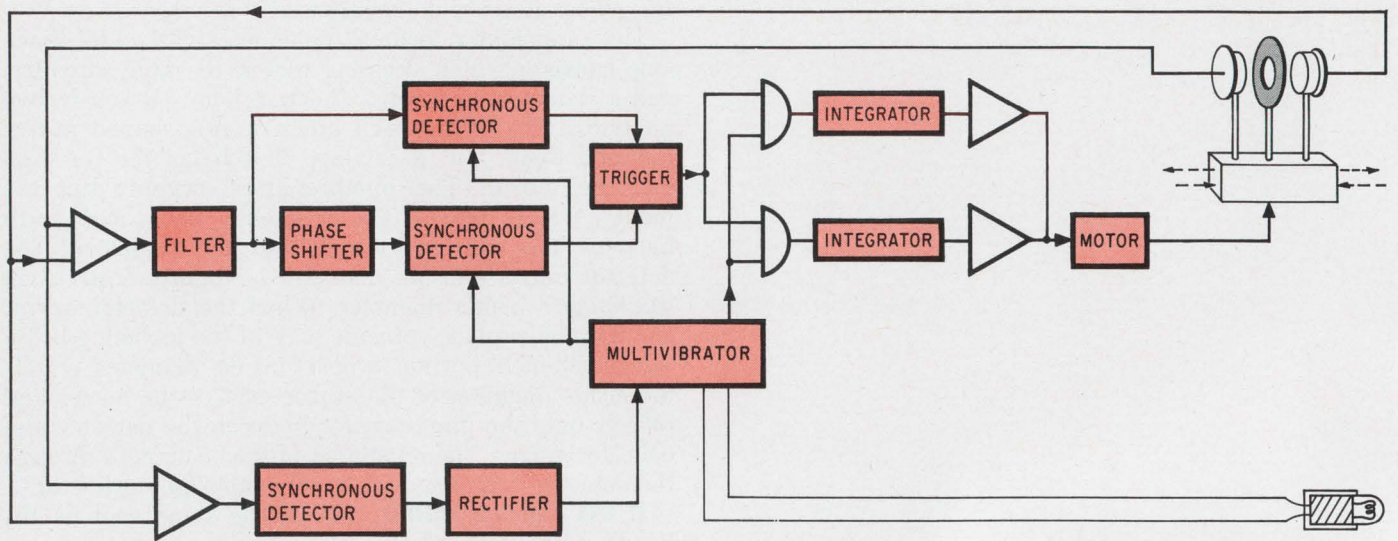

this may seem incorrect because where there's no ambient light the optimal approach is to make both mirrors the same size. The amount of projected infrared that gets back to the detector assembly goes up when the area of either the projector or the collector mirror increases. But the amount of ambient light that reaches the detector assembly isn't affected by anything that happens to the projector mirror.

The input circuit overcomes the very low signal-to-noise ratio with synchronous detectors, controlled by the same multivibrator that chops the projector's drive voltage. In the circuit, the photoresistors' outputs go to a differential amplifier whose output is filtered and then sent through two channels. One contains just a synchronous detector; the other has a 180° phase inverter and a detector. By using two channels instead of one, the rangefinder can update commands to the stepping motor at every half cycle of the multivibrator's frequency instead of once every cycle.

The output from the differential amplifier contains the reflected-beam signal and noise. The signal has the same frequency as the projected beam—it's the same frequency as the multivibrator's. In addition, the signal and multivibrator output are either in phase or 180° out.

The figure shows one of the rangefinder's synchronous detectors. Two transistors, Q_1 and Q_2 act as switches. During half a cycle Q_1 is open and Q_2 is closed; the

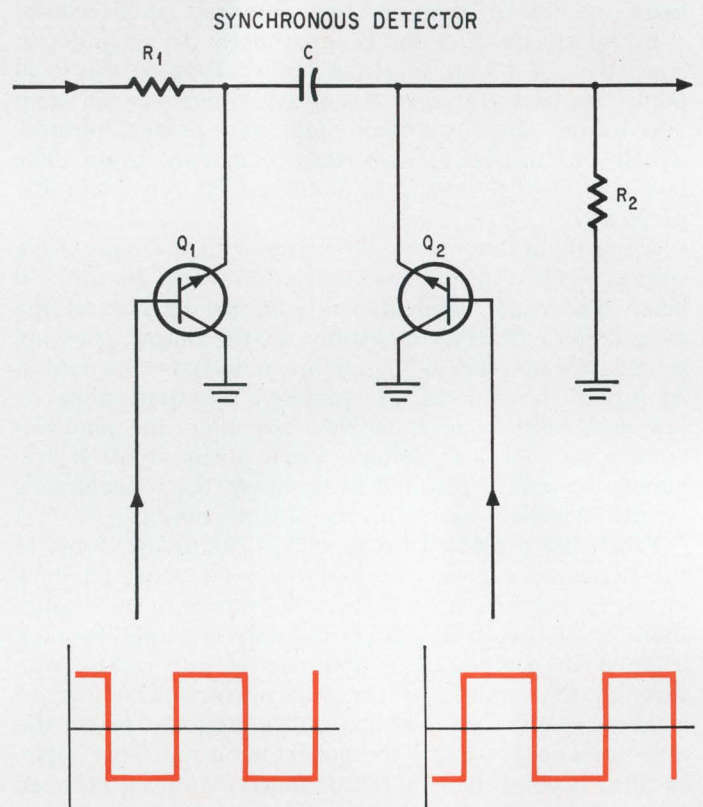

No noise. This synchronous detector separates the photoresistors' signals from noise. Since the signals and the multivibrator's output, which switches Q_1 and Q_2 , have the same frequency, the detector responds to the signal but not to noise.

Null-point search. The signals from the photoresistors circle back to control the motor that positions the carriage on which the resistors are mounted. These signals also fix the repetition rate of the voltage that drives the projector.

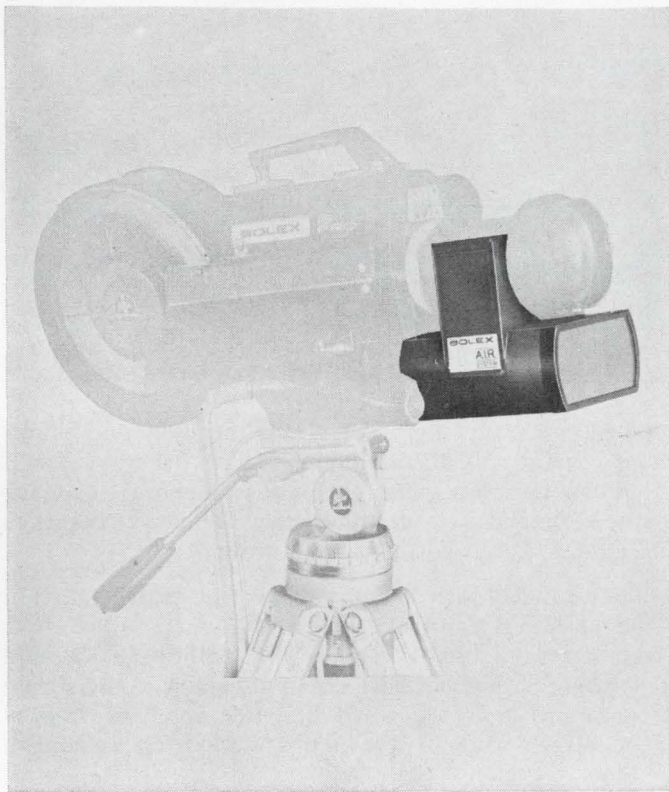

Focus. First application for the rangefinder is this Bolex 16 PRO movie camera. The AIR's photoresistor carriage and the camera's lens are mechanically coupled. As the carriage moves toward a null point, the camera comes into focus.

reverse occurs during the second half of the cycle.

The detectors can be understood by using superposition and first considering the effects of the reflected-beam signal coming from the amplifier.

Suppose capacitor C is uncharged, and that Q_1 has just opened. The signal flowing through the load resistor, R_1 charges C , but not completely, because time constant $R_1 C$ is selected to have a value that's much longer than the multivibrator's period. During the next half cycle, C loses only a small portion of its charge because the resistance of the load resistor, R_2 , is much greater than resistor R_1 .

This process repeats with the amount of charge stored on C increasing each cycle until after a few cycles it reaches some maximum value. After that the amount of charge lost into R_2 when Q_2 is open equals the amount of charge buildup when Q_1 is open.

Since the reflected-beam signal's frequency and the switching frequency of Q_1 and Q_2 are equal, C always adds a small amount of charge during one half cycle and loses the same amount of charge during the next half cycle.

Thus, the detector's output due to the signal are pulses whose amplitude is proportional to the signal's amplitude and whose polarity depends on the phase relation between the signal and the multivibrator's output.

On the other hand, noise isn't synchronized with the openings and closing of Q_1 , and Q_2 . Therefore, averaged over many cycles, the amount of charge the noise adds to C when Q_1 is open is zero, as is the detector's output due to noise.

The pulses from the two synchronous detectors go to a triggering circuit which controls a pair of AND gates. The pair of AND gates put out square waves which are integrated. These integrated square waves are sent to the motor as a continuous signal.

The rangefinder has a third synchronous detector, which is used to adjust the multivibrator's frequency. In addition to going to the input circuit, the photoresistors' outputs are added in a high-gain amplifier sent to the third detector. Its output pulses are rectified and sent back to the multivibrator. If the signals from the photoresistors are strong, indicating that the subject is close, the multivibrator's frequency is boosted. If the signals are weak, the frequency drops. ●

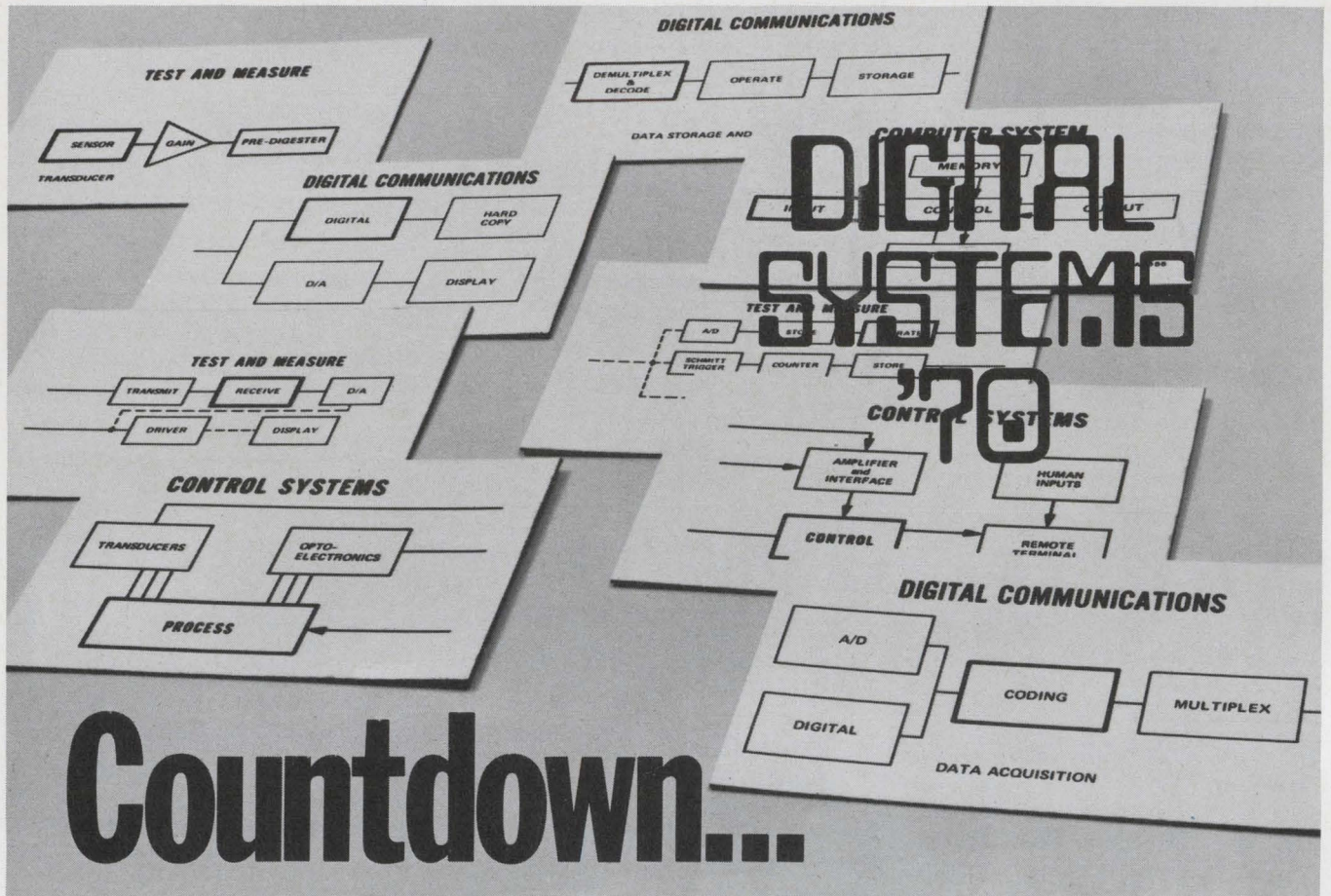

Countdown...

To Digital IC Problem Solving

Digital Systems '70 — an in-depth digital integrated circuit seminar covering all digital families is on the way. You'll learn of new techniques in high-speed logic, discuss complex and special functions — and probe the new developments in MOS, CMOS, Poly Cells, CAD and memories.

It will be a full day with a short pause for lunch (included in the nominal \$25 registration fee). And then off to the afternoon session highlighted by custom MSI/LSI discussions and a comprehensive high-speed logic applications clinic. Bring your questions along — you'll find our panel of "digital problem solvers" ready to provide tips on Motorola's complete digital line.

Reserve Now.

Make your arrangements now as seating will be limited to the first 250 reservations in each area. Contact your nearby Motorola Semiconductor sales office or distributor for details. Or send your check or money order for \$25.00 to P.O. Box 20912, Phoenix, Arizona 85036.

We'll be there...

May 11 - New York
International Hotel,
Kennedy Int'l Airport,
Jamaica, L. I.

May 12 - New York
Hilton Inn,
Tarrytown, N.Y.

May 13 - Philadelphia, Pa.
Holiday Inn,
Route #1 &
Schuylkill Expressway

May 14 - Washington, D.C.
Twin Bridges Marriott,
Twin Bridges, U. S. #1

May 15 - Florida
Sheraton Ft. Lauderdale
Ft. Lauderdale, Florida

May 18 - Texas
Royal Coach Motor Hotel,
Dallas

May 19 - Chicago
Arlington Park Towers,
Arlington Heights, Illinois

May 20 - Minnesota
Thunderbird Hotel
Minneapolis

May 21 - California
Sheraton Universal Hotel,
Universal City

May 22 - California
Ricky's Cabana Hyatt
House,
Palo Alto

May 25 - California
Grand Hotel,
Anaheim

— where the priceless ingredient is care!



MOTOROLA
Digital Integrated Circuits

There's a better way to design a character generator

Gene Carter and Dale Mrazek of National Semiconductor found the way by teaming up MOS read-only memories and shift registers; the memories shape the characters for crt readout while the registers handle refreshment

● In the design of a cathode-ray tube alphanumeric display system, the portions that are most often taken for granted are those that store information concerning the shape of each character and refresh the character during subsequent sweeps of the electron beam. Yet decisions that relate to font storage and character refreshment have a great bearing on total system cost.

In remote computing, for example, if fonts are stored in a central processor, the user would continuously pay a stiff price in the form of central-system overhead and communications costs. On the other hand, if the fonts are stored in the remote terminal's circuitry, costs can be reduced. The latter is true largely because of the advent of memory techniques rooted in large-scale integration.

Storage capacities of metal oxide semiconductor chips have increased at least tenfold during the last few years. And an attendant lowering of threshold voltages makes MOS memories and shift registers compatible with bipolar logic and standard power supplies. More importantly, a combination of MOS and transistor-transistor logic can generate characters faster than they can be handled by moderately priced crt video circuitry or printer mechanisms. And inexpensive MOS shift registers can be used to recirculate data in order to refresh characters on subsequent sweeps. What makes MOS/TTL character generators even more attractive is that they cost about half as much as those built exclusively with

bipolar monolithic circuits and devices.

The latest read-only memories (ROM), such as the MM 5240 and the MM 5241 manufactured by the National Semiconductor Corp. of Santa Clara, Calif., represent the equivalent function of some 3,000 diodes and 50 packages of bipolar gates; the 5240 stores 64 characters in an 8-by-5-bit configuration, while the 5241 stores the same number of characters, but in a 6-by-8-bit configuration. With either ROM, characters in the standard 5-by-7 matrix can be generated with a single chip, the extra capacity being deployed for unusual special needs, such as dropping comma tails below the other characters. Each chip contains decoding logic and sense amplifiers. And the chips can be operated in tandem to generate higher-resolution font matrices.

The input-output configurations of these chips, shown on page 108, are for a standard ASCII-addressed font. The six-bit ASCII code words will address any of 64 characters. The control logic generates the three additional address bits needed to select the individual lines or columns of dots that form the characters in the 5-by-7-by-64-dot matrix. The output bits forming each dot line or column are presented in parallel, then serialized by a TTL register and used to control the crt beam or the printer mechanism. To simplify the selection process, ROM's are programmed to generate the lines or columns in the correct sequence when addressed by the sequential

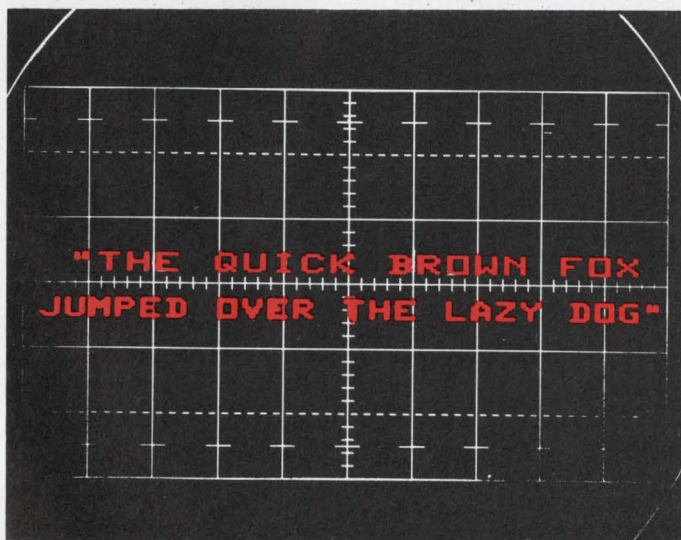

Through the hoop.

Getting a quick fox to jump over a lazy dog is one thing; writing about the event on the face of an oscilloscope is quite another. However, with MOS read-only memories and shift registers, the latter problem can be reduced to logic design. And with low-threshold MOS, which is compatible with TTL logic, the whole thing is as easy, well . . . as jumping over a lazy dog.

outputs of a TTL counter.

The job isn't finished when the character is produced, however, for the image on a crt must be regenerated, or refreshed, rather frequently—a minimum of 30 times a second—unless the crt has a storage phosphor. A suitable device for this purpose is the MOS shift register, which can recirculate incoming data, then readdress the ROM, thus refreshing the display.

Refreshment of crt images has recently become quite a popular application of MOS shift registers, since registers capable of regenerating up to about 5,000 bits—enough for a display of over 800 characters—can be built less expensively with MOS dynamic registers than with delay lines, which are often painfully temperature sensitive. In the past, MOS shift registers of high capacity (say 512 bits) as well as high speed were not easily obtainable. But registers, like National's MM 5016, can now easily run at clock rates above 2 megahertz—double the speed of early mass-produced registers. And some, like the MM 5081, can drive neon displays directly.

The basic refresh mode, shown on page 109, limits the number of characters that can be displayed. A better way of generating and refreshing raster-scan displays, especially those with many rows of lines of characters, is on top of page 112. The timing and logical implementation for a multiple-row system is seen on page 110. The last two circuits require high-speed recirculation of only

Two contenders. By June, National Semiconductor will have on the market two 64-character read-only MOS memories that were specifically designed to generate characters for crt displays. The MM5240 (above) supplies 8-by-5-bit characters upon receiving information in the form of the standard ASCII six-bit code. The MM5241 (below) is suitable for vertical-scan applications and for driving line printers.

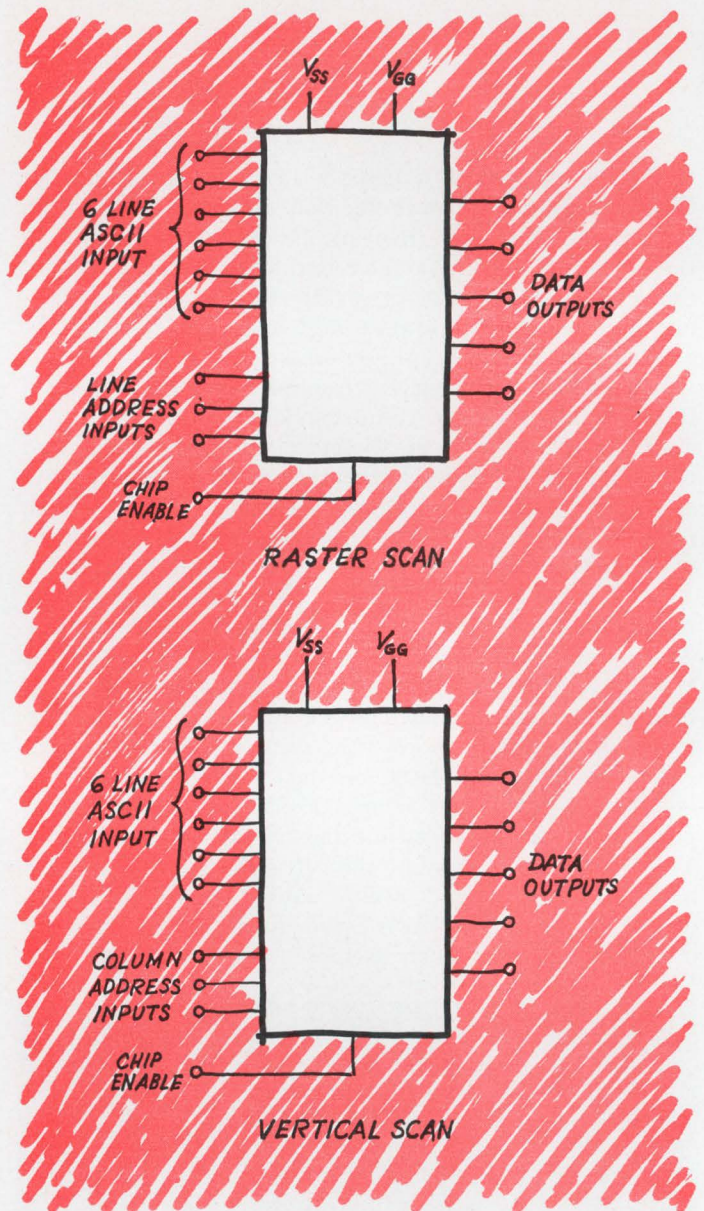

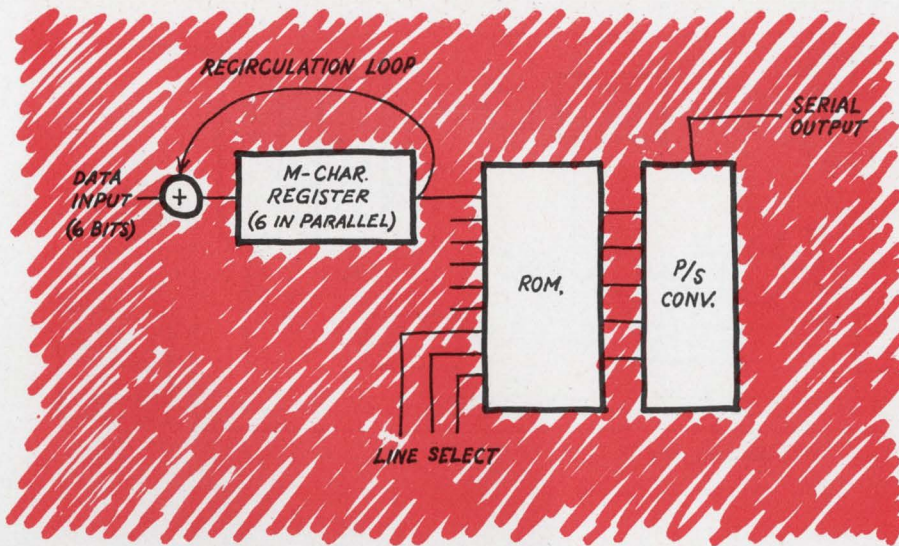

Simple. The basic memory organization of a display system could be used for vertical scan applications, and for some of the simplest raster-scan displays. A bank of six MOS shift registers recirculates character data, then hits the ROM again, thus refreshing the display of characters on the crt.

m bits of information at a time.

As before, coded data from a communications link or the console keyboard passes through the registers and addresses the character generator. In these examples, the six-bit ASCII input and the three-bit control-logic input generate raster-scan character formats that allow a conventional tv monitor to be used as a display. Communications codes other than ASCII can be used if the ROM's are reprogrammed, or if a code-converting ROM is inserted in data line.

If the ROM contains a 5-by-7 font, each five-bit character-line output will form up to five horizontal bright spots on the crt. That is, each ROM output generates one-seventh of each character in a row of displayed characters. The output is serialized by the TTL register and used to modulate the intensity of the CRT beam as it sweeps across the screen.

The refresh-memory registers are divided into M-N and N sections to facilitate page displays. M is the total number of characters displayed in several rows (lines of the page), and N is the number of characters in each row. To form such a display with single-loop registers, as in the basic refresh mode, would take seven recirculations of all M data words during each refresh cycle of the crt.

Assume that on the first sweep of the crt beam, the ROM is being addressed by the six register outputs repre-

sending characters N_1, N_2, N_3 , etc. The first horizontal five-dot line of each character in the display row is displayed in sequence. Then the line-address inputs to the ROM from the control logic change to a second state preparatory to displaying the second row of dots. At this time, N_1 has completed its recirculation to the N register's outputs. Thus, on the second crt sweep, the second series of five-dot lines are displayed horizontally for all N characters. At the end of seven recirculations, the complete row of N characters is on the display.

Now the contents of the N register are fed back to the input of the M-N register, which is clocked to load the N register with a second group of N characters. The M-N register is then held still while the N register recirculates seven times to generate the second row of characters on the display. This cycle repeats until all M characters are on the display, whereupon the first group of N characters is reloaded into the N register, and the entire process repeated to refresh the display.

Besides generating the line-address inputs (that is, the number of recirculations of the N register), the control logic keeps track of the number of dots and space in the output bit stream. The spaces between characters in a display row are inserted as "0" bits when the ROM outputs are materialized by the TTL register. The counters also control the loading and recirculations of the MOS registers in the refresh-memory subsystem.

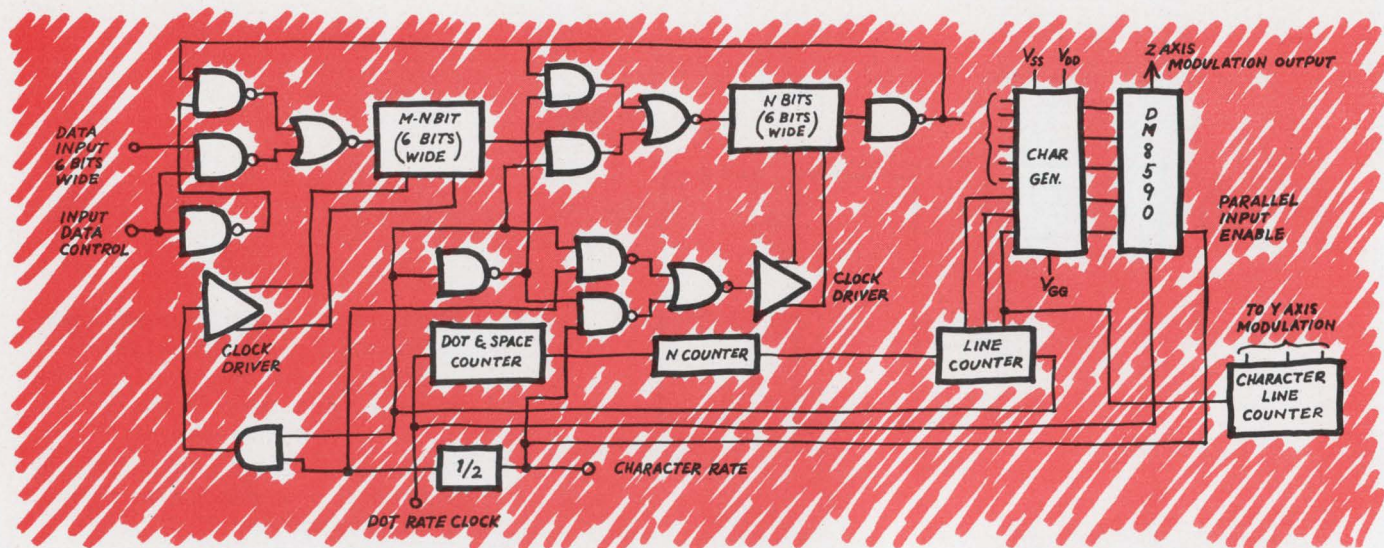

A multiple-row raster scan display could be generated with the M-loop technique, but the implementation is difficult and impractical. In fact, the M-loop technique is more appropriate for single-row displays. Using this method of display, all M characters to be displayed must recirculate seven times to generate a 5 by 7 horizontal-scan. Therefore, all stages of the registers must operate at the full character rate.

To form several rows with a single-loop memory requires an interlaced scan rather than an ordinary raster scan. The first series of five-dot lines is generated by the first N character outputs as before, but the next set of N inputs to the ROM will generate the first group of five-dot lines in the second row of characters on the display. Therefore, the beam must jump to the new line position. To display four rows of 5 by 7 characters, for instance, would require a staircase generator that could step the beam by the height of nine scan lines (seven dot lines, plus two blank spacing lines between rows) three times after the initial scan. Then, as the second of the seven recirculations begins, the beam would have to be shifted an additional line to start the second series of the line scans—and so forth.

The M-N/N technique does not require any more register stages than the M-loop technique and significantly reduces control and drive-circuit requirement—again producing a lower cost per function.

The technique employed in the M-N/N refresh memory is called “clock modulation.” In other applications, it has already been found to significantly reduce total storage cost.

Furthermore, the technique allows very high-density MOS circuits, produced by relatively inexpensive low-threshold (bipolar compatible) processes to operate at very high character rates.

The raster-scan system uses nine clock intervals to generate a row of characters on the display. Seven are for the high-speed recirculations. During the other two intervals, the first N characters are fed back from the output of the N register to the input of the M-N register while the N register is loaded from the M-N register with a new row's worth of characters. Since two intervals are used for this operation, the registers operate at only half the character rate. The rest of the time, the M-N register is quiescent. Its average clock frequency is only about 11% of the character rate.

In other words, most of the refresh memory (perhaps 90% in a large-display system) operates at only half the character rate (say 1 Mhz instead of 2 Mhz) two-ninths of the time. The savings in the drive network alone can be judged from the power-frequency plot for a typical MOS dynamic register, below, on page 112. In addition, the designer can increase the number of characters generated per refresh cycle, for a larger display, or

... the job isn't finished when the character is produced. Unless the crt has a storage phosphor, the image must be refreshed frequently ...

Nitty gritty. A specific logic diagram for implementing a multiple-ROM raster-scan display system contains parts needed to generate multiple-character lines. Separate clocks and counters handle data housekeeping functions. All MOS registers and ROM's are compatible with TTL. Output can be used to drive either oscilloscope or crt monitor inputs.

Character size—every bit counts

Human requirements have considerable bearing on a number of decisions in the design of a cathode-ray tube alphanumeric display, specifically those that relate to the selection of the font—that is, the style and shape of letters and numerals. A crucial decision is the determination of the number of bits that define a character, inasmuch as the size of the matrix used to form characters profoundly affects the amount of memory needed to store each character. Naturally, the more elements in a matrix, the more legible the characters will be. A good working minimum is the standard 5-by-7 array, which requires a storage capacity of 2,240 bits. But with the advent of modestly priced large-scale integrated read-only metal oxide semiconductor memories, designers are starting to gravitate toward an 8-by-10 matrix, which looks rather convincing. Ultimately, a 12-by-16 matrix will become practical, allowing almost optimum legibility and sharp definition, even of small lower-case letters.

At present, system designers considering the use of complex fonts for low-cost crt displays run into a serious problem. The least expensive crt's are those used in the ordinary black-and-white television. However, they have limited bandwidth, making it necessary to hold down not only the number of bits in the font matrix, but also the number of characters that can be displayed simultaneously. Ordinary crt's have a bandwidth of about 4

megahertz, of which only 2.5 Mhz is generally useful. But the number of characters per page is proportional to the bandwidth (and inversely proportional to the bits per character and refresh rate). Using a 5-by-7 font with one spacing bit (6 by 7, total) at a 60-hertz refresh rate, each displayed character needs 2.52 kilohertz. Thus, the limit for a tv crt for 5-by-7 resolution is around 1,000 characters. But present MOS read-only memories can take as little as 700 nanoseconds to generate a dot line, or about 5 microseconds per character. That's 200,000 characters a second, or more than 3,000 characters at the same 60-hz refresh rate.

Luckily, there are alternatives to the use of oscilloscope-quality crt's or storage tubes, both of which are fine, but expensive. One technique is to lower the refresh rate. For an obvious reason, 60 hz is convenient. But the eye can tolerate a rate as low as 30 hz without undue discomfort due to flicker. New crt's with longer-persistence phosphors should facilitate further reduction of this parameter. Meanwhile, manufacturers of crt monitors are trying to penetrate the new terminal market by improving bandwidth, and moderately priced video systems may soon sport bandwidths up to 10 Mhz. Finally, an ingenious approach could update techniques used in analog displays to form characters with "strokes,"—or sections of characters—rather than rows and columns of dots.

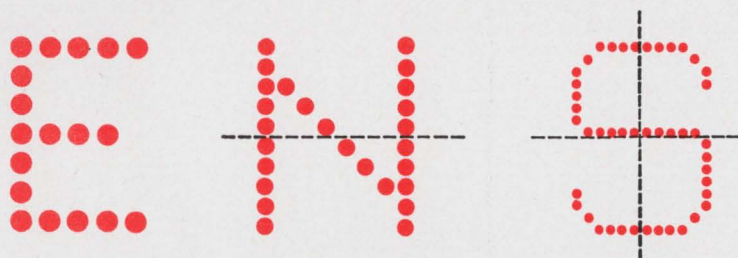

Bigger characters. Increasing the number of bits that form each character improves legibility, to be sure. But complex fonts require added circuitry. For example, a 5-by-7-bit character (left) requires only one MM5241; an 8-by-10 matrix (center) needs two—one for the upper half, one for the lower; while a 16-by-12 (right) needs four—one for each quadrant.

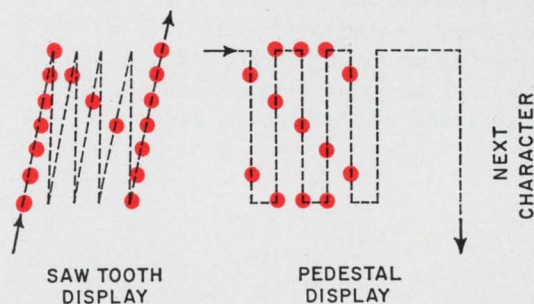

Keep 'em straight. For certain applications, such as line printing and simple crt display, vertical-scan characters can be generated easily. But two distinct generating techniques exist: conventionally, a sawtooth deflection is used (left); an alternative is the pedestal display (right).

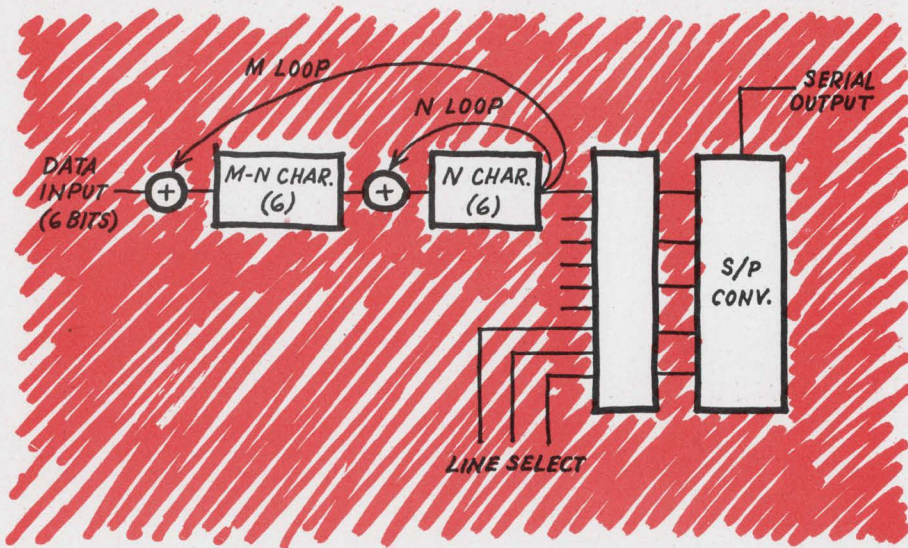

Big boy. Larger raster-scan displays require a large "page" memory as well as a character-line refresh memory. With such a system, whole pages on the crt can be displayed and refreshed. Other manipulations, such as roll up, roll down, and data insertion can be accomplished by slight additions to the circuitry.

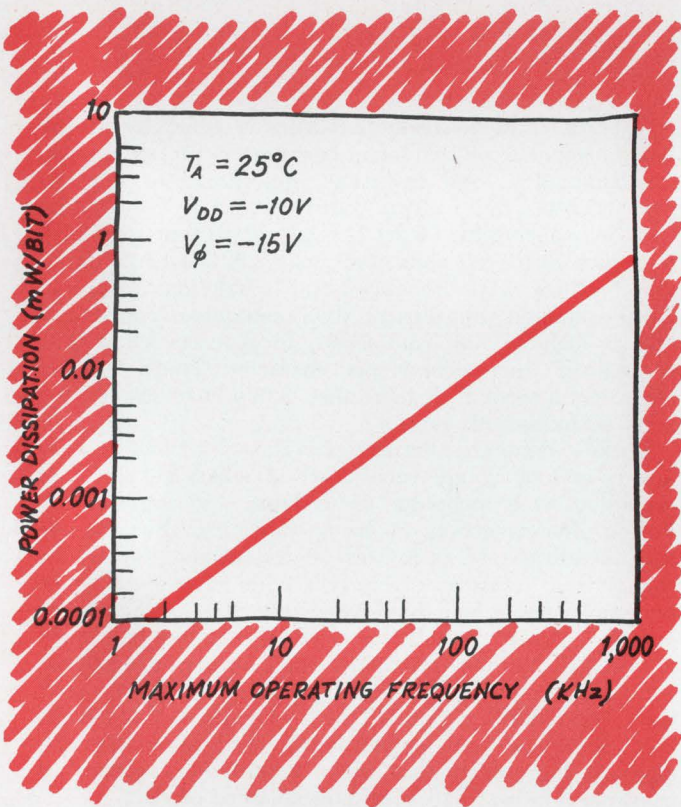

increase the number of dot lines, for a larger font—or he can increase both.

Remember, though, that dynamic registers must be clocked to retain data. Nevertheless, the M-N register can be turned off long enough for practical applications. The guaranteed minimum frequency is temperature-dependent, since temperature affects charge-storage time. The minimum for National Semiconductor's MM-series registers for example, is 500 hertz at 25°C, but that is not a display environment. At room temperature, the registers can safely be quiescent for as long as 2 milliseconds. Suppose the N register stores 40 characters and operates at 2 Mhz. The quiescent period can be as short as 40 by 7 by 0.5 microseconds, or 140 μ sec. If standard tv raster timing is maintained, then the quiescent period will be 7 times 63 μ sec, or 441 μ sec. Obviously, the designer has great leeway in a number of parameters such as character rates, operating temperatures, and register capacities.

Other applications in displays for this technique include input-output buffering of data during reception and transmission, or during display editing and formatting through the console keyboard. The register rates can be adjusted via control logic to accommodate differences between input-output and recirculation rates. Note that the typical dynamic register permits data entry under TTL control into either register section. ●

A bit of power. Power dissipation of a dynamic register used to refresh crt character displays varies directly with frequency. The minimum-frequency-of-operation curve also has a similar shape.

Get the hang-up to end all hang-ups.

Our MSI wall chart. It's a big problem-solver. 4 ft. x 3 ft. of functional descriptions, logic diagrams, pin-outs, and truth tables, all at your fingertips. Now, you can locate any MSI device by the function that you're looking for.

Get it all in the May 10th issue of Electronic Design. Someone beat you to it? Write the people with the hang-ups. Signetics Corporation / 811 E. Arques Ave., Sunnyvale, California 94086 / a subsidiary of Corning Glass Works.

MSI by Signetics

including the complete DCL line of TTL logic elements.

The collage displays several data sheets for MSI devices, each featuring a title, a logic diagram, and descriptive text. Visible titles include:

- Buffer Registers:** DUAL 5-BIT BUFFER REGISTER / 8200, DUAL 5-BIT BUFFER REGISTER / 8201
- Digital Multiplexers:** 8-INPUT DIGITAL MULTIPLEXER / 8230, 8-INPUT DIGITAL MULTIPLEXER / 8231, 4-BIT, 2-INPUT DIGITAL MULTIPLEXER / 8235, 3-INPUT, 4-BIT DIGITAL MULTIPLEXER / 8263
- Counters:** PRESETTABLE HIGH SPEED DECADE COUNTER / 8260, PRESETTABLE HIGH SPEED BINARY COUNTER / 8261, PRESETTABLE LOW POWER DECADE COUNTER / 8292
- Shift Registers:** 4-BIT SHIFT REGISTER / 8270, 4-BIT SHIFT REGISTER / 8271, 8-BIT SHIFT REGISTER / 8276
- Exclusive-Or:** QUAD EXCLUSIVE-OR / 8241
- Adders:** ARITHMETIC LOGIC ELEMENT / 8260, FAST CARRY EXTENDER / 8261, GATED FULL ADDER
- Parity Logic:** PARITY LOGIC / 8262
- Decoder/Drivers:** NIXIE[®] DECODER / DRIVER / 8201
- Decoders:** BCD-TO-DECIMAL DECODER / 8251

Interactive Graphics

for the Tektronix T4002 Graphic Computer Terminal

With the introduction of the 4901 Interactive Graphic Unit and Joystick accessory, graphic input capability is now available for the Tektronix T4002 Computer Terminal. The Interactive Graphic Unit is a valuable aid wherever graphic analysis of statistical data is fundamental to: thorough scientific investigation—effective computer-aided instruction—informed decision making.

The 4901 and optional Joystick are *software* supported. The software permits coordinate identification, display rotation and overlaying, menu picking and other frequently repeated functions in graphic formatting.

The new 4901 generates a bright, no parallax, orthogonal crosshair cursor. The cursor is easily and accurately positioned with the desk-top Joystick. You enter data points and instructions through the T4002 keyboard. This means complete graphic interface without removing your hand from the Joystick.

Tektronix Application Engineers, especially trained in the capabilities of Tektronix Information Display Products, will discuss with you the full versatility of the T4002 Graphic Computer Terminal. A T4002 demonstration provides an excellent opportunity to discuss software support, machine compatibility, interface options and maintenance. Contact your Application Engineer through any Tektronix office (57 domestic—48 foreign) or directly by calling (301) 825-9000 Baltimore; (617) 894-4550 Boston; (415) 326-8500 Palo Alto. Or write Tektronix, Inc., P. O. Box 500, Beaverton, Oregon 97005.

T4002 Graphic Computer Terminal	\$8,800
4901 Interactive Graphic Unit	\$ 450
Optional Joystick (015-0175-00)	\$ 250

U.S. Sales Prices FOB Beaverton, Oregon

The new, no parallax crosshair cursor is positioned with the desk-top Joystick.



Tektronix, Inc.
committed to technical excellence

See the T4002 on-line at SJCC Booth 4900

Circle 114 on reader service card

Electronic systems to strengthen the long arm of the law

Burdened by rising crime, law-enforcement groups are slowly turning to computerized communications and data systems to catch more criminals more rapidly

By Lois Vermillion

Electronics staff

● Arrests for minor traffic violations will become a tool for solving major crimes if electronics-minded law-enforcement officials have their way. In one recent example, a speeder in the nation's Capital found himself charged with assault with a dangerous weapon and failure to appear in court. The speed cop had radioed the driver's license and vehicle tag numbers to his headquarters, where an operator keyed the data into a computer console for a search. Within seconds, the felony data appeared on the crt display, and it was immediately radioed back to the traffic patrolman, who then put away his tickets and brought out the handcuffs.

The Washington Area Law Enforcement System (Wales) is one of several systems operating in major U.S. cities that are heralding a new era in the application of electronics technology to law enforcement. Wales and similar systems, many criminologists believe, are the answer to a soaring crime rate; by producing more and speedier solutions to crimes, electronic systems ultimately could provide an effective deterrent.

Resistance. Until the late 1960's, application of technology to law enforcement was handicapped by money shortages in most police departments and resistance among many old-line law enforcement personnel. But with the creation within

the Justice Department of the Law Enforcement Assistance Administration, the funding problem is being attacked. Part of the LEAA program is to make matching block grants, usually on a 60-40 basis, to states and localities for systems improvements. Funding for these grants has risen from \$11.3 million in fiscal 1969 to a planned \$285.9 million in fiscal 1971.

Resistance to technology also is declining, as evidenced by increased use of equipment. When a policeman becomes convinced that a computer, for example, is not merely a gadget, but a device which actually can help him, he will accept it.

Wales is based on an IBM 360/40 computer, with a 360/50 backup unit tied into the Department of Motor Vehicles, and its sanitation, health, and welfare agencies. Right now the system is used for statistical work and some command-control functions; resource allocation is planned for the future. The system includes 39 IBM 2740 communications terminals, 12 IBM 2260 crt displays, and four IBM 2911 switching units. The Motorola communications equipment was installed for about \$700,000, and another \$270,000 went to System Sciences Corp., which supplied the software requirements.

The Capital's police—or any other police agency with computer capa-

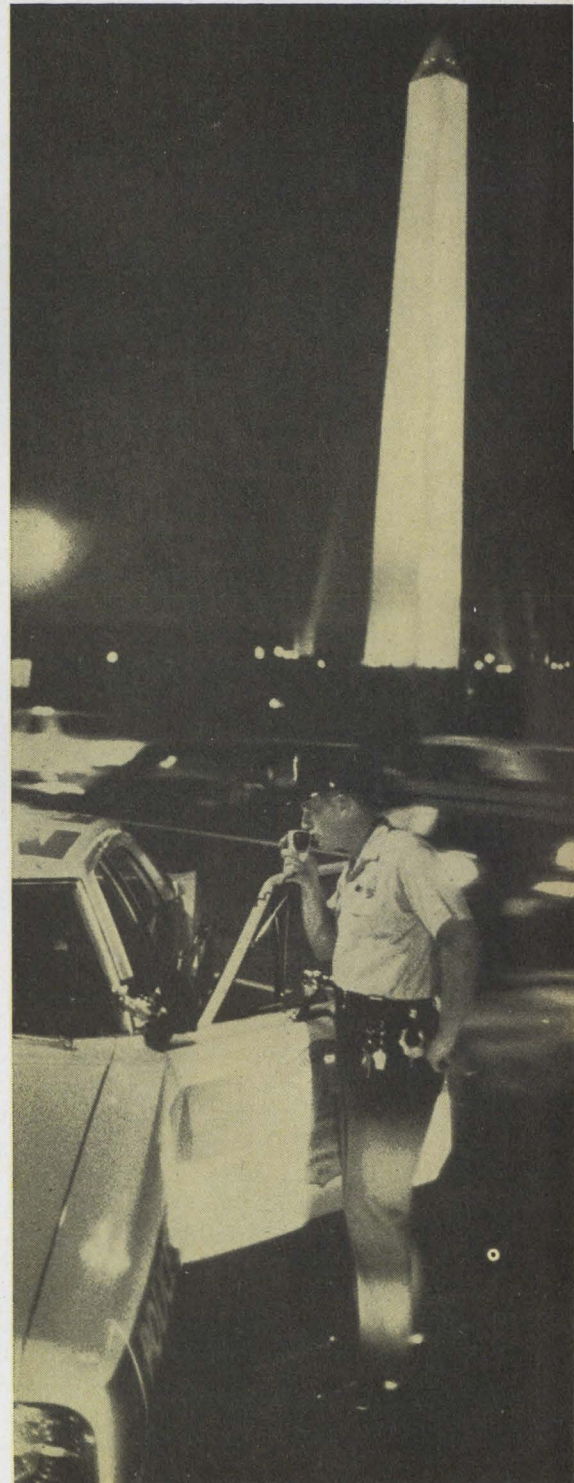

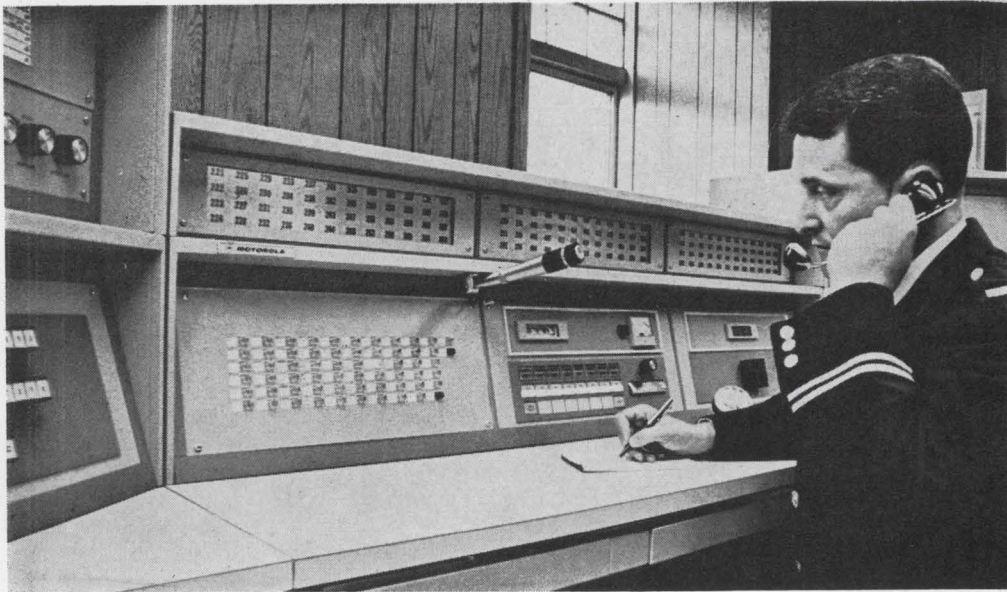

In command. Manning the master control of Wales, this Washington police lieutenant keeps track of the force's mobile units.

bility—can get data on wanted criminals and stolen items from the FBI's National Crime Information Center, (NCIC).

The need for instant nationwide data transfer is behind Project Search, LEAA's System for Electronic Analysis and Retrieval of Criminal Histories. Search, which will connect police departments, courts, and correctional institutions around the nation, has twin goals. First, by interconnecting all components of the criminal justice system, it will provide the capability to follow offenders as they pass through the system. Also, it will have an index at the national level with limited personal data on each offender and a summary of his criminal history. The central data bank would direct queries from states for more detailed information to the state with the most thorough "rap sheet." Without the central data bank "it's very difficult to determine whether a person has a previous criminal record," says Paul Sylvestre, director of the Search program. "A person could look like a first offender in one state, and have a record a mile long somewhere else."

Still in the planning stage, Search will begin a two-month demonstration beginning in July. For the demonstration, the central index will use a Burroughs 5500 at Michigan State Police headquarters. Ten states, each given \$100,000 in LEAA funds, will participate, with five others observing. Evaluation of the system and possible redesigning

will begin in September, and the first design should be out by the end of the year, says Search project coordinator Paul K. Wormeli of the California Crime Technological Research Foundation. April 1971 is the target for Search to become an operational national system, and during calendar 1971, he says, the pressure will be on the states to tie into the Search network.

There is some question of the future value of NCIC and Search. One industry source believes that within 10 years, Search will have to go over completely to a central data bank, instead of the index system now planned. Eventually, he predicts, Search will end up at the FBI. However, another expert claims both programs will be obsolete in a few years, supplanted by a network in which the state computers talk directly to each other.

Private problems. Search also may run into trouble on Capitol Hill from privacy-conscious lawmakers. Sen. Samuel Ervin Jr. (D., N.C.), chairman of the judiciary subcommittee on constitutional rights, fears that the data bank, although "innocently created by behavioral scientists, can evolve into monsters of surveillance." Ervin accuses the Federal Government of a "boundless curiosity about private citizens." Because of the privacy issue, Sylvestre says, the Search project group is considering a provision for expunging certain records.

In St. Louis, a system provides an example of the capability

sought by police agencies across the nation. St. Louis' was among the first major police agencies to make use of computers for municipal police management, emphasizing computer mapping of crime and allocation of manpower. The city uses an RCA Spectra 70/40 computer and an IBM 77/40 communications control system. Originally intended to store information on wanted persons, automobile licenses, and serial numbers of stolen items, the system has expanded to do such jobs as:

- Crime-mapping the city. The maps show the relationship of crime between districts, and give some indication of the times crime is most likely to occur, which beats need the most patrolmen, how many patrolmen are needed at certain hours of the day, and days of the week, seasonally, and under different weather conditions. The computer predicts the number of calls for service in a specific area during a specified time interval.
- Radio-event mapping. This is used to predict the number of calls and the number which will be serviced immediately under a given number of assigned units. Calls are broken down into eight priority classes, ranging from capital crimes to rescuing cats from trees.
- Car activity reports. These indicate how often and for how long patrol units are out of their assigned areas to handle calls for service in other locations.

Police morale in St. Louis, says Philip H. DuBois of Washington



Come
all the way
up to
bright.

Bright is what you need in head-up displays — symbology so bright and sharp even sunlight doesn't defeat it. And that's what you get if your CRT is one of the bright line offered by Fairchild's DuMont Electron Tubes:

- Ruggedized for severe environment
- Ultra-precise construction
- Literal plug-in capability
- Optically pre-aligned
- No adjustment of associated hardware

DuMont tubes, available from 2" sizes up, are hard-mounted in numerous tactical and commercial aircraft both domestic and foreign.

Discuss your head-up CRT needs now with DuMont, or send for technical bulletin. See what bright light we can shed on the subject.

FAIRCHILD

DUMONT ELECTRON TUBES

A DIVISION OF FAIRCHILD CAMERA AND INSTRUMENT CORPORATION
750 BLOOMFIELD AVENUE, CLIFTON, N.J. 07015

University, who did a study for the St. Louis Police Department and LEAA, has not been adversely affected by computerized command and control. In fact, he says, it is quite possible that morale has improved. His survey found that officers generally were more satisfied with their supervisors, who performed more efficiently after resource allocation was implemented.

Crime costs. Charles H. Rogovin, 39-year-old LEAA administrator, estimates that some \$6 billion is spent annually by the entire criminal justice system, and various sources estimate the police portion at between 50% and 80% of the total. Equipment expenditures range between 5% and 10% of police budgets now, and the percentage will rise with greater acceptance of equipment and extra funds becoming available.

Rogovin, who many of his peers say is largely responsible for LEAA's success, has submitted his resignation to the White House effective in June, because of his discontent over the agency's three-part bureaucratic administration. Though there are likely to be no major program changes initially, there's a good chance that Congress will rearrange LEAA's administration, which could affect program orientation.

Under the 1968 Omnibus Crime Control and Safe Streets Act, LEAA was to be directed by three persons who must agree on major programs before any money is spent. Rogovin, a Democrat, has shared leadership with Richard Velde, a former aide to Sen. Roman Hruska (R., Neb.), and Clarence M. Coster, a former Bloomington, Minn., police chief. Both Velde and Coster are Republicans. Sources say disagreements over policy and funding are frequent. Velde, who helped write the Safe Streets Act, is considered the best bet as Rogovin's successor.

Congress may scrap the troika setup for a single-leader arrangement. There's talk on Capitol Hill of doubling or even tripling President Nixon's \$480 million fiscal 1971 budget request for LEAA, and Congress is likely to be receptive to any change which promises better administration of funds.

The police have been the biggest users of advanced equipment so

Ready for tests. This is Search, an information-handling system which will be tried out this summer. As part of the study, the Justice Department's LEAA will make its first tests of electronic-facsimile transmission of fingerprints from computer files at the agency of record directly to inquiry terminals.

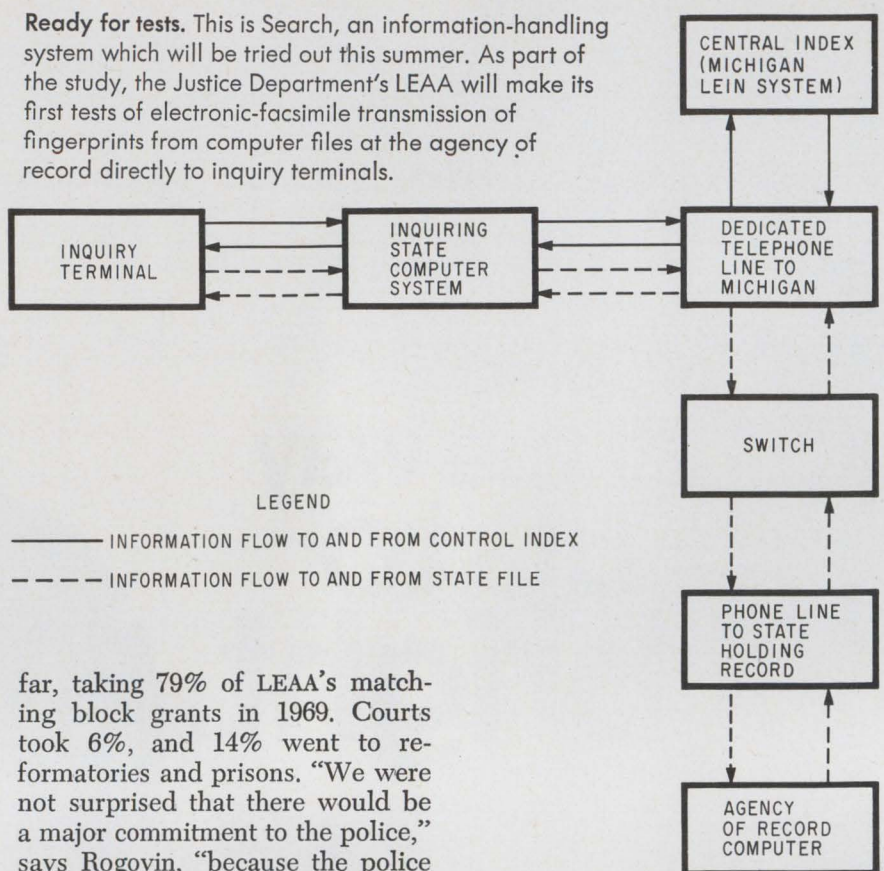

far, taking 79% of LEAA's matching block grants in 1969. Courts took 6%, and 14% went to reformatories and prisons. "We were not surprised that there would be a major commitment to the police," says Rogovin, "because the police are the largest component of the criminal justice system in terms of manpower and expenditures." The commitment to courts and corrections, though, will begin to rise in 1971, he says.

Growth. The size of the police market for electronics is called "tremendous" by most sources in the field, but none are able to give concrete estimates. The market is a viable one, and can grow, but "industry has to make the market," says Walter Key, electronics and communications program manager at LEAA's research unit, the National Institute of Law Enforcement and Criminal Justice. The market can be manipulated, says Key, according to the interest of the supplier.

An industry representative must go to a police chief, he says, point out the advantages of a product which may be new to him, and explain to the chief how he can reorient his procedures to take advantage of the new technology. If industry will make this effort to deal with departments on an individual basis, says Key, a strong market for a device or a family of devices can be created. Key also notes that many law-enforcement systems managers may find a problem working in the highly frag-

mented law-enforcement field after dealing with a single procurement office at the Department of Defense.

Key makes an analogy between the law-enforcement and the color-tv markets. It's a next-door-neighbor type of situation, he says, in which a police chief says, "Let the next guy try out a new device, and if it is successful, we'll use it."

This problem has been compounded by the fact that police agencies rarely have exchanged ideas and information on their own technology applications simply because they rarely exchange personnel. This obstacle originated in a fact of police life: city and state lines of promotion usually are open only to the membership. Chiefs have historically come up through the ranks. In such a closed system, information exchange with other agencies can be retarded.

But through LEAA-sponsored technical sessions and conventions, such as the recent Law Enforcement Science and Technology Symposium held in Chicago, police departments are able to exchange information about their experiences with new equipment.



**Model 630-A
Laboratory V-O-M**

1. $\pm 1\frac{1}{2}\%$ DC, $\pm 3\%$ accuracy.
2. One selector switch minimizes chance of incorrect settings and burnouts.
3. Rugged $5\frac{1}{2}$ " suspension meter movement with $4\frac{1}{2}$ " mirrored scale. Suggested USA user net price \$75.



**Model 630-APL
Laboratory V-O-M**

1. $\pm 1\frac{1}{2}\%$ DC, $\pm 3\%$ accuracy.
2. One selector switch minimizes chance of incorrect settings and burnouts. Polarity reversing for DC.
3. Suspension meter movement diode protected against instantaneous overloads. Suggested USA user net price \$75.

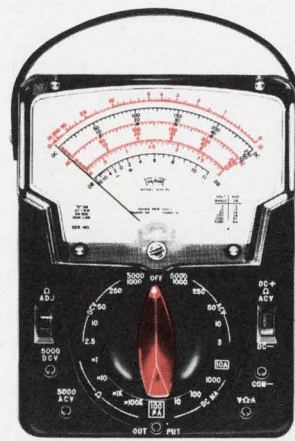

**General Purpose V-O-M
Model 630-PL**

1. One selector switch minimizes chance of incorrect settings and burnouts. Polarity reversing for DC.
2. 4.4 Ohms center scale, 0.1 ohm to 100 megohms resistance.
3. Meter movement diode protected against instantaneous overloads. Suggested USA user net price \$64.



**General Purpose V-O-M
Model 630**

1. One selector switch minimizes chance of incorrect settings and burnouts.
2. 4.4 Ohm center scale, reads from 0.1 ohm up to 100 megohms resistance in 4 ranges.
3. 20,000 ohms per volt DC sensitivity; 5,000 AC. Suggested USA user net price \$64.

Laboratory or General Purpose Triplet meets the need precisely

Products of Triplet's long experience in the design and manufacture of high-quality, high-performance V-O-Ms, these representatives of the great Model 630 series offer the most-wanted features combined as perfectly as the skills of dedicated craftsmen can guarantee.

See your Triplet representative or distributor for a free demonstration of any or all of these versatile instruments. Triplet Corporation, Bluffton, Ohio 45817.



MANUFACTURERS OF THE WORLD'S MOST COMPLETE LINE OF V-O-Ms

For continuous lacing...

* that **CABLE-LACER** brake speeds the work too!

The experienced harness worker can quickly guide the hooked needle of the Gudebrod Cable-Lacer* across narrow break-out points between pins to grasp the loop. This is where work is speeded first. But then, the pressure of four fingers on the lacing break allows a swift, single pull for firm knot setting—further speeding the job. No need for wrapping around the fist—no need for a second pull. It all becomes a naturally fast procedure. What's more, the special Gudebrod lacing tape bobbins are helpful when all-hand tying seems required! Use Gudebrod Cable-Lacer, Gudebrod's Bobbins for improved accuracy and time saving.

*T.M. Union Special Machine Co.

Save money & time with **GUDEBROD SYSTEM "C"**

For continuous lacing Gudebrod offers a four part system to reduce your harnessing costs. The Cable-Lacer and Bobbins are the first two parts. Add to them Gudebrod's specially made, case hardened, extra long, wire holding pins and the Gudebrod Swivel-Tilt Harness Board Mount. The pins make wire threading easier and sharply reduce the need for re-dressing. The Gudebrod Mount brings any part of the harness within easy reach. Gudebrod System "C" makes harnessing go faster, cost less. Write for details. (For spot ties, ask about System "S")

Gudebrod Swivel-Tilt
Harness Board Mounts
available in several sizes

GUDEBROD
Electronics Division

1870—100 Years of Quality—1970

GUDEBROD BROS. SILK CO., INC. Founded 1870, 12 South 12th Street, Philadelphia, Pa. 19107

Communications is top police priority

● Two roadblocks stand in the way of engineers who want to apply electronics to law enforcement. The biggest barrier is spectrum space: the police contend they don't have enough, particularly in large metropolitan areas. Police barely have enough channels for the radios they use now; new communications, data-transfer, and command - and - control systems would demand an even larger share of the spectrum. But even if the Federal Communications Commission resolves this problem, engineers face another kind of communications barrier. It's the difficulty police and most other non-engineering customers have defining their problems.

Nevertheless, electronic firms are nibbling at the police market. Various companies are developing and testing such gear as car-mounted teleprinters, computer-based control setups, and automatic vehicle-monitoring gear.

But law-enforcement officials often are blind to what electronics can do for them. "Police are relatively new to this game," notes one analyst in the Justice Department's Law Enforcement Assistance Administration. "They're learning, but they need help. Understand that they don't have to be electronics experts—though they should at least have a knowledgeable consultant if not a man in-house—but they do have to be able to tell industry the nature of their problems; what they want to achieve in precise terms; and the exact environment in which they operate."

On the other hand, engineers are being urged not to forget—if they have learned at all—that exotic subsystems derived largely from military programs have little use in or cost too much for police work. For example, applications for night vision equipment, acoustic and seismic detectors, and other surveillance gear touted as "crime countermeasures" are far too limited to justify their high cost in the eyes of most enforcement agencies. In many cases, simpler approaches

Walkie-talkies. Latest from Motorola for the police are these transceivers. The smaller one, the HT-100, has a 1-mile range to another 100 and a 6-mile range to a base station. It sells for \$600. Priced at \$1,100, the HT-220 has a 3-mile transceiver range; station range is 10 to 12 miles.

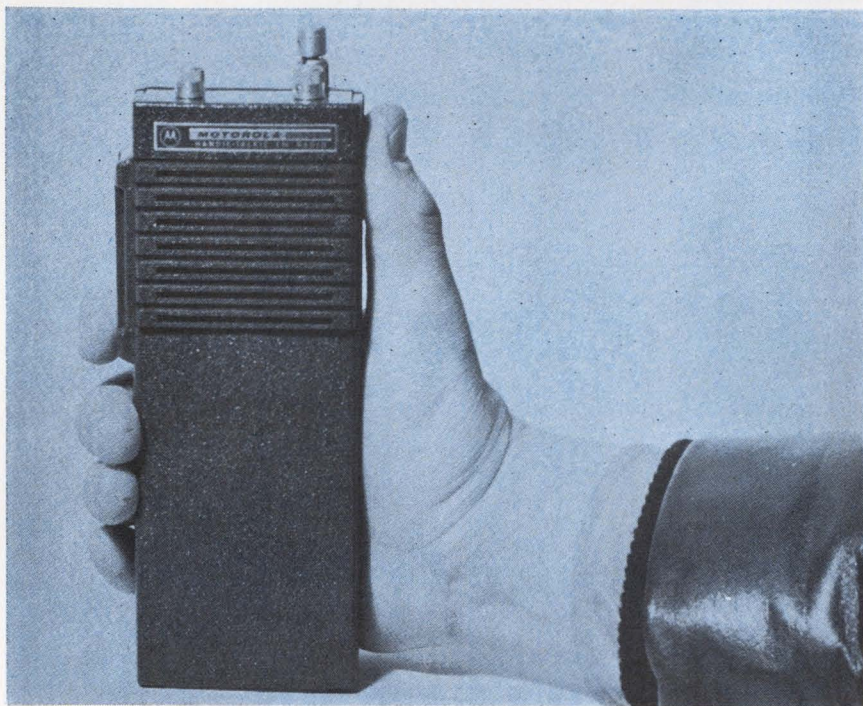
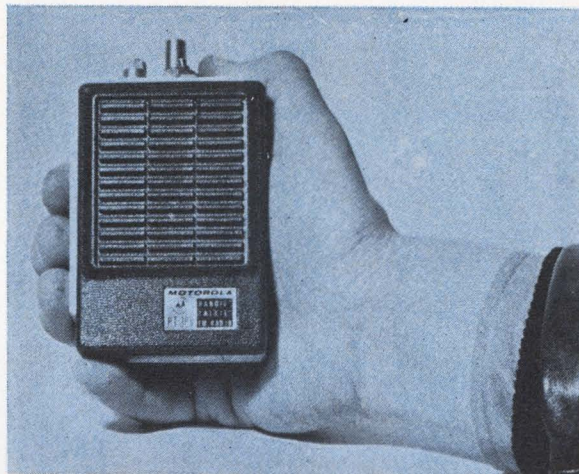

serve at least as well, often better. One obvious case: better street and off-street lighting systems beat night vision equipment almost every time. Lights not only cost less, but also are a crime deterrent.

It's possible to envision electronic gear helping to cut down the crime rate. "Take the kids who 'hot wire' cars and race them until they run out of gas," says an LEAA official. "Not many get caught; it's not a high risk. But if, for example, you can build a better alarm system into tomorrow's cars and substantially increase their chances of

getting caught, far fewer kids are likely to take the risk." One such system might be a tracking beacon built into cars and triggered by an unauthorized user. However this type of alarm isn't feasible, because it would be too costly, and would take up too much space in the law-enforcement spectrum.

Even now police departments have too little spectrum space and this hurts their performance. Delays of more than 5 seconds in gaining access to a police channel can cut a foot patrolman's or a squad car's arrival at the scene of

SAVE the search for MIL-STD-883 ICs

Having trouble when you try to buy integrated circuits that meet MIL-STD-883? Trouble yourself no more. ITT offers full line capability in series 9000 TTL and series 930 DTL.

All circuits are fully qualified to MIL-STD-883. Flat packs are available with gold or tin-plated leads.

ITT's continuous evaluation program for MIL-STD-883 ICs is already operational and you can have our comprehensive guide to the new standard by writing us on your company letterhead. ITT also supplies JAN and TX transistors and diodes. So skip the search; order your MIL-STD-883 circuits and other hi-rel parts from ITT today.

We can save
you something!

semiconductors **ITT**

ITT Semiconductors is a division of International Telephone and Telegraph Corporation, 3301 Electronics Way, West Palm Beach, Florida 33407, Phone 305/842-2411. Factories in Florida • Massachusetts • England • France • Germany • Portugal • Australia

a crime by minutes, perhaps permitting a criminal to escape or allowing witnesses to disperse. Studies show that a 6-minute response is associated with a 49% arrest rate compared with 63% for a 1-minute response.

Reducing response time is one of the most important advantages of computerized police communications equipment. Response time of the complaint phase—the time it takes to receive a call for service and pass the information on to a dispatcher—is reduced by over 50% in a fully automated command and control dispatch communications system, says Sam Anzelmo Jr. of Sylvania Electronic Systems-West. More calls can be handled by the same number of lines and operators. And error rates, as well as delays, are reduced through computer data entries formatted by time, type, and priority of call, and exact location. The dispatcher's role is upgraded to a "dispatch commander," says Anzelmo. He's freed from many routine chores and supplied with decision-making information.

The high cost of such systems can be offset by manpower savings, says Anzelmo. Police departments now divide the number of men equally by the number of shifts and beats to determine requirements. But with computer determination of priority beats and times of day when crimes are most likely to occur the inefficiency of stationing men when and where they're not needed is eliminated.

The Illinois Institute of Technology Research Institute (IITRI) has some ideas on how good a police communications network should be. Commissioned by LEAA to devise plans for improving existing networks, IITRI suggested that average delay in gaining access to a link during a normal busy period shouldn't exceed 5 seconds; there should be no delays of more than 10 seconds in transmitting messages; the information shouldn't be degraded by interference; and the network should be able to handle busy-period loads.

The sad fact is that most city networks can't begin to meet these standards. Bernhard Ebstein of the IITRI project group estimates police spectrum needs at three times the current capacity. Ebstein's

A place in space for cops?

A synchronous satellite for police communications seems a far-out solution to the problem of police spectrum congestion—except to Roger Reincke of the International Association of Chiefs of Police. "There's just no more room," says Reincke, to accommodate the spectrum requirements of such new systems as mobile teleprinters and vehicle location systems. Another IACP argument for consideration of a dedicated police satellite system is the rapidly growing requirement for data transfer among Federal, state, and local agencies.

Law Enforcement Assistance Administration officials acknowledge that some thought has been given to the concept, although they are at pains to point out that a police satellite system is not now under active consideration. Nevertheless, an LEAA source notes that a piggyback launch of a police-only satellite—like the amateur radio system orbited on the last Tiros shot—could cut the estimated \$6-8 million system cost sufficiently to make a law enforcement net cost effective in a period of three to five years.

group studied the Lake Michigan area as a representative urban sprawl. Of the area's 43 police "networks"—defined as a haphazard arrangement of many different police users on the same and interconnecting channels—31 have channel-access delay time of more than 5 seconds.

And no improvement is in sight. Currently, the area has 98 radio links on 2.4 megahertz; and 313 links on 12.3 Mhz are needed. By 1980, the area will need 550 links on 22 Mhz, says Ebstein.

Whether or not police will get immediate relief from the crowding largely hinges on the outcome of two cases now before the Federal Communications Commission. Probably within the next few months the FCC will make decisions on land-mobile sharing of the lower seven uhf channels and allocating the 900-Mhz space released from government use.

Coming. The next piece of electronic gear most likely to get into police cars will be digital teleprinters. The best guess on when they'll be in wide use is five years. With

current technology it "could be done tomorrow," says Walter Key, program manager for electronics and communications at LEAA's National Institute of Law Enforcement and Criminal Justice. The value of a teleprinter, says Key, lies in making it possible for a field officer to query the central computer directly—bypassing the dispatcher. Besides, having hard copies of such information as the license numbers of stolen cars frees policemen from the tedium of continuously listening to their radios.

But teleprinters won't be here tomorrow. They're expensive—about \$1,000 for a read-only unit. In addition to initial cost, police departments must consider the expense of training people to use a hard-copy system. Another problem is that teleprinters use voice channels.

But despite Key's confidence in teleprinter technology, there is some question about whether the devices are ready for police work. Last summer Capital Scientific Corp. ran a test of four makes of car-mounted teleprinters—Motorola, Codamite, Ferranti, and Kleinschmidt—for the city of Milwaukee. None got outstanding marks across the board. The test was conducted on 150-, 450- and 950-Mhz bands, and 450 Mhz proved to be the best in terms of antenna gain, receiver sensitivity, and transmitter power. Error rate is 1 in 1000 at this frequency, and it improves with a narrower band, says Capital Scientific president E. Ray Knickel, but use would be impractical in cost and frequency allocation considerations.

The errors encountered in the Milwaukee tests were classified as propagation errors due to interference, low signal strength, etc.; mechanical errors due to malfunction of the teleprinter; and encoder errors. The Codamite units caused a "large number" of machine errors, and fell second in the test group's rating, behind Motorola. Codamite's equipment had the best propagation-error record, the test group says, but mechanical errors negated this quality. The Motorola technique, the group says, "appears to have a distinct advantage" in overcoming effects of multipath signal dropouts. But high error rates experienced on the 150-Mhz tests indicate that the equipment is sen-

WORKHORSE!

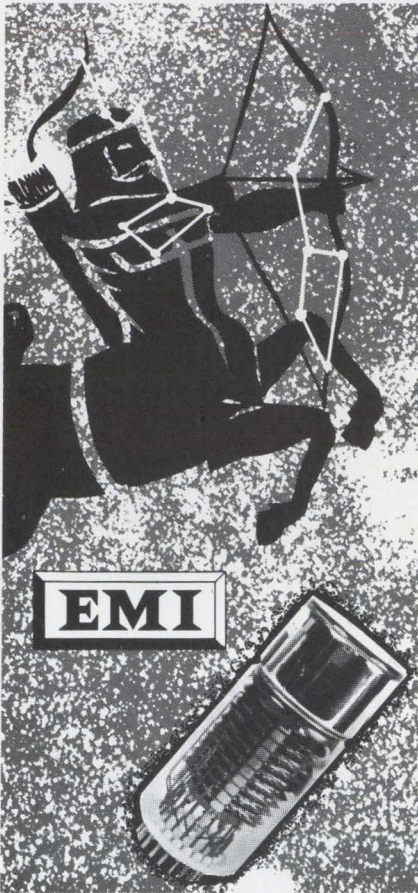

TYPE 9750

Nothing fancy, and not expensive. Just a good old 10 stage photo-multiplier but: It has a superb bi-alkali cathode with excellent collection efficiency (which is fundamental for good S/N ratio), highly stable CsSb dynodes which provide a gain of 10^6 at just over 1,000 volts, and a dark current of 10^{-10} A. at that voltage (50 A/L).

As usual EMI has provided a number of variations: 9750QB with a spectroil window for UV and low level counting applications, (liquid scintillation) 9750B with Pyrex window for visible applications, and finally 9750KB for those who prefer the B-14A overcapped base. In the "K" configuration, it is directly interchangeable with our 9656KB or a number of competitive types.

The 9750 with its high quantum efficiency and low dark current gives excellent resolution for low energy gamma rays. When used with a thin two inch sodium iodide crystal with a beryllium window, the resolution for Fe^{55} is of the order of 40%.

Flying spot scanners, photometers, thermoluminescent dosimeters, low level scintillation counting are all applications for which the 9750 is highly suitable. Detailed specifications on request from:

GENCOM DIVISION varian/EMI

80 EXPRESS STREET, PLAINVIEW, N. Y. 11803
TELEPHONE: (516) 433-5900

Perimeter detection: Vietnam to the White House

Civil applications are falling out from the electronic system developed to detect troop infiltration in Southeast Asia. Following heavy industry funding of seismic and acoustic detection systems in the mid-1960's for the controversial "McNamara Wall" along 17 miles of the demilitarized zone dividing North and South Vietnam, contractors are finding a variety of new customers, ranging from Federal penologists, who want to keep criminals in prison, to the U.S. Secret Service, which wants to keep them out of the White House.

Typical of such systems is Westinghouse Electric Corp's Periguard, installed last November at the Federal Youth Center in Ashland, Ky., and now reportedly undergoing tests at the White House.

The Secret Service won't talk about the White House installation or Westinghouse's role. But details of the Ashland system are available.

Each Periguard detector has two hoses, up to 600 feet long, filled with equal parts of water and antifreeze. These are buried 15 to 18 inches deep. The detector de-

rives electrical signals from pressure waves transmitted through the hose liquid. According to Westinghouse's Warren Drumheller, this is achieved by a piezoelectric ceramic-disk or crystal transducers at the end of a hose. "These two transducer crystals are wired to have opposite polarities so that signals of equal amplitude are cancelled," Drumheller told a recent law enforcement symposium.

The differential analog signals are amplified and placed on a line-surveillance network for transmission to the control center, which can monitor many detectors from a central control panel.

Ashland uses two patrol cars with armed officers and remote displays at each end of the institution, plus a central control room with a main readout console. When an alarm is triggered, a horn warns the officers to check the remote display panel which shows where the intrusion took place. The vehicle then speeds toward the zone. Periguard signals travel at 300 feet per second.

—Ray Connolly

PERIGUARD SYSTEM

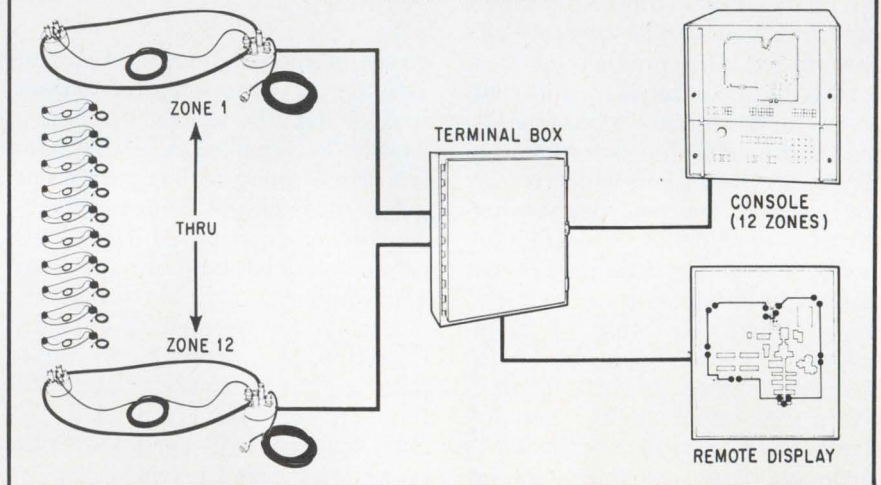

sitive to errors resulting from interference from other stations, a problem the group thinks can be improved by redesigning the receiver filter.

Find a cop. Automatic vehicle monitoring systems for police use probably are some years away. Hazeltine Corp.'s system [*Electronics*, March 2, p. 148], tested in New York in vans equipped with API-6 identification, friend-or-foe (IFF) transponders, proved to be 95% accurate within 300 feet. But

the equipment wouldn't fit into a squad car's trunk already packed with mobile radios and teleprinter equipment. Cost also is a problem. Jerome Zauderer, chief engineer for industrial products at Hazeltine, says the company plans to produce the system in early 1971; its price will be \$500,000, not including the vehicle, computer, and data links.

But Hazeltine at least has a product ready for the police market. Many companies have tried and are trying to get in by repackaging

... bookies beware,
here comes NASA...

some military hardware. Night vision devices pose a "classic problem in use," says William B. McMahon, technical director of IITRI's Law Enforcement Center, an information clearing house. The number of places night-vision units can be used "is almost nil," he says.

LEAA's Key says even though there might be some applications, such as in stakeouts, police "won't buy unless the price is right." But one unit demonstrated by RCA at a recent LEAA technical symposium costs \$1,950, and prices at other companies range up to \$8,000. Even RCA admits its night-vision devices "have not had great acceptance" among police. Part of the problem for all makers is technical, and includes the poor quality of the images produced. Police need positive identification.

Sometimes, however, spinoffs do prove useful. For example, NASA's technology transfer team wants to help catch bookmakers. One of the most important pieces of evidence uncovered during a gambling raid could be a writing pad used to record bets, from which the original page might have been destroyed. What is needed, says IITRI's Robert Hand, is a device sensitive enough to measure indentations on succeeding pages. Hand says that NASA is working on a solution that involves a fiber-optics surface roughness gauge which was originally developed to examine surfaces of flared tubing used in special valve fittings on the Saturn rocket.

Viet Cong. Many devices are offered to police on the erroneous assumption that street crime is the same as guerilla warfare, says IITRI's McMahon. A Washington patrolman points up this fallacy: "You can't really kill the kid who holds up an ice cream stand like you can the Viet Cong."

Though American crime and Southeast Asia's guerilla warfare have little in common, many Federal officials do believe that many military systems developed for Viet Nam can be modified for police use. One example cited is a tactical radar in a moving vehicle which can determine the speed of

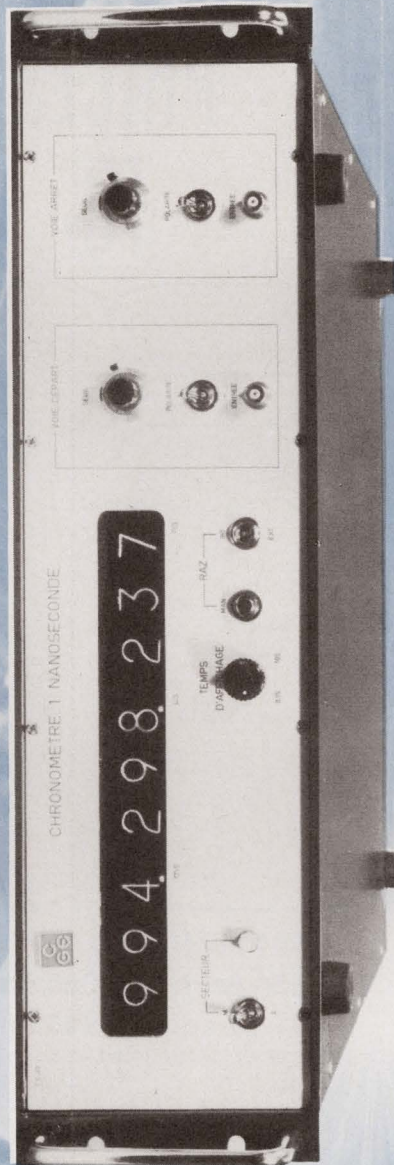

NANOSECOND TIME INTERVAL METER MODEL CC20

RANGE : 1 nsec. to 999 msec.
1 nanosecond RESOLUTION
Crystal aging rate : 1 part in 10⁹/day
Internal NIRAP logic



LABORATOIRES de
MARCOUSSIS

centre de recherches de la compagnie générale d'électricité
91-MARCOUSSIS(FRANCE) - Tél. 920.82.50 - Telex : 26 877 LABMARCO - R.C. Versailles 68 B 280

CTS TRIMS CERMET INDUSTRIAL TRIMMER PRICES TO

50¢

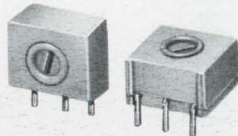

- 50¢ each in 50,000 quantity
- 65¢ each in 1,000 quantity
- \$1.14 each in 100 quantity

for ±20% Tolerance (Add 4¢ for 10% tolerance)

Series 360 single-turn cermet industrial trimmers provide...

- **Setability ±.03%**
- **Environmental performance requirements of characteristic C of MIL-R-22097D**
- ... plus!
 - 1.5% average equivalent noise resistance
 - 0.5% average contact resistance variation
 - Compact, single-turn design
- Top or side adjust
- ½ watt @70° C
- Tolerance to ±5%
- TC ±150 ppm/°C available at no extra cost over most of the resistance range.

Your CTS Distributor will have both styles in stock for fast, prototype delivery. Production quantities to you in 4 weeks.

See your distributor... call your CTS sales engineer... or write for complete data. We'll respond quickly. CTS of Berne, Inc., Berne, Indiana 46711. Phone: (219) 589-3111.

CTS CORPORATION
Elkhart, Indiana





Where
to buy
off-the-shelf
CTS components

ALABAMA
Cramer/Huntsville, Inc.
Huntsville 35801
(205) 536-4493

ARIZONA
Hyer/Cramer Electronics
Tempe 85281
(602) 967-8786

CALIFORNIA
Fortune/Cramer
Electronics
Redwood City 94063
(415) 365-4000

Hollywood Radio &
Electronics, Inc.
Hollywood 90028
(213) 466-3181

**R & C/Cramer
Electronics**
Glendale 91201
(213) 245-7121

**R & C/Cramer
Electronics**
San Diego 92111
(714) 279-6300

Rose Electronics
Burlingame 94010
(415) 697-0224

COLORADO
Hyer/Cramer Electronics
Denver 80222
(303) 758-2100
Waco Electronics
Denver 80216
(303) 322-7708

CONNECTICUT
Cramer Electronics, Inc.
North Haven 06514
(203) 288-7771

FLORIDA
Cramer/Florida, Inc.
Ft. Lauderdale 33308
(305) 566-7511
(305) 947-6517

GEORGIA
Cramer/Atlanta
Atlanta 30340
(404) 541-5421

ILLINOIS
Hall-Mark Electronics
Corp.
Rosemont 60018
(312) 299-6602

MARYLAND
Cramer/Baltimore
Baltimore 21230
(301) 354-0100

Cramer/Washington, Inc.
Rockville 20850
(301) 424-2700

MASSACHUSETTS
Cramer Electronics, Inc.
Newton Center 02159
(617) 969-7700

MINNESOTA
Cramer/Minnesota
Minneapolis 55420
(612) 881-8678

MISSOURI
Olive Industrial
Electronics
St. Louis 63130
(314) 863-7800

NEW JERSEY
Cramer/New Jersey, Inc.
Union 07803
(201) 687-7870

Cramer/Penn., Inc.
(See Pennsylvania)
Pennsauken 08110
(215) 224-0120

NEW MEXICO
Hyer/Cramer Electronics
Albuquerque 87108
(505) 265-5767

NEW YORK
Cramer/Eastern, Inc.
East Syracuse 13057
(315) 437-6671

Cramer/ESCO, Inc.
Hauppauge 11787
(212) 478-4000

Cramer/Rochester
Rochester 14623
(716) 482-7080

Summit Distributors
Buffalo 14202
(716) 884-3450

Terminal-Hudson
Electronics
New York 10011
(212) 243-5200

NORTH CAROLINA
Cramer/Raleigh
Raleigh 27604
(919) 876-2371

OHIO
Cramer/Tri-States, Inc.
Cincinnati 45215
(513) 771-6441
Sun Radio Company
Akron 44308
(216) 434-2171

PENNSYLVANIA
Cramer/Penn., Inc.
(See New Jersey)
Pennsauken 08110
(215) 224-0120

TEXAS
Adleta Electronics Co.
Dallas 75201
(214) 742-8257

Adleta Electronics Co.
Fort Worth 76105
(817) 336-7446

Southwest Electronics,
Inc.
Houston 77036
(713) 782-3060

UTAH
W. H. Bintz Company
Salt Lake City 84110
(801) 363-5821

Hyer/Cramer Electronics
Salt Lake City 84115
(801) 487-3681

WASHINGTON
Far West Electronics, Inc.
Bellevue 98004
(206) 747-1515

WISCONSIN
Hall-Mark Electronics
Corporation
Milwaukee 53226
(414) 476-1270

another vehicle. Present police systems require fixed installations—the familiar “speed trap.” Police researchers also are looking at vehicular tracking systems and hands-free communication systems.

Testing. Engineers developing systems for law-enforcement should be prepared for rigorous field testing, says George W. Saunders of Underwriters’ Laboratories. In surveillance systems, for example, power input should not exceed 110% of the market rating, but they should be able to operate without readjustment at 85%-110% of rated voltage. The system should not, says Saunders, require readjustment or signal false alarms.

Saunders says detection systems must be built to be fail safe by providing standby capability and recharging features, an idea similar to NASA’s “zero-defects” plan.

There is a fundamental conflict between the roles of the technologist and the policeman, says IITRI’s McMahon, because too often the technologist does not recognize his role in law-enforcement field as one of support. Instead, he says, the engineer will “come up with beautiful solutions when we just don’t have a problem.” Engineers must develop an understanding of the practical problems in fighting crime, he says.

McMahon cites Chicago’s experience with its remote/mobile personal communications link as an example of engineers’ limited appreciation of police problems. The link initially was designed to place a radio repeater in each patrol car to pick up the officer’s transeiver signal when he was away from the vehicle. Chicago bought the concept. Later, Chicago discovered that two far less costly alternatives—installation of five larger repeaters throughout the city or one large-capacity repeater near headquarters—would be equally effective. The city chose the five-repeater plan. However, the fact remains that the options were not volunteered initially, making the systems designers’ judgment suspect.

Another example is a gun detector developed for use on airlines. Essentially it’s a metal detector, says McMahon. The device is impractical for police, because it can’t differentiate between a knife and a nail file. There “really is no gun

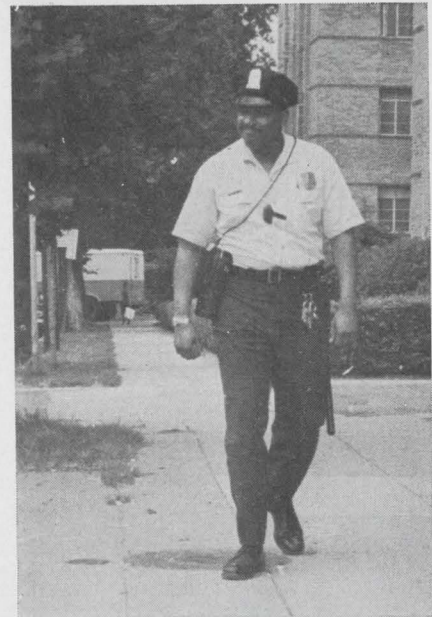

detection system today,” says McMahon, and the impact on the airlines’ hijacking problem, if any, has been psychological.

Some new approaches to crime fighting are in the works. LEAA is funding experiments with voiceprints as an investigative aid in cases where the only clue may be a telephone call. Voiceprint, a picture of the spoken word received on a sound spectrograph, originally was developed and tested during World War II and was worked on in the 1950’s by Bell Telephone Laboratories on the premise that a person’s voice is as unique as a fingerprint. But even after voiceprint is developed to the point where it will work in a completely uncontrolled environment with a minimal error rate, it probably would not be useful as evidence in court.

A lawyer at the U.S. District Courthouse in Washington says voiceprints probably would not be accepted as evidence, especially when there is doubt in the court’s mind as to its probity and scientific use. And, he says, a conviction probably could not be obtained “on that evidence alone.”

And even with electronic fingerprint matching there is some doubt as to its value as hard evidence. The Search project group [see p. 116] will experiment with facsimile transmission of fingerprints this summer, though actual matching will be done manually. Both fingerprint and voiceprint identification techniques will have to wait for computer identification capability.

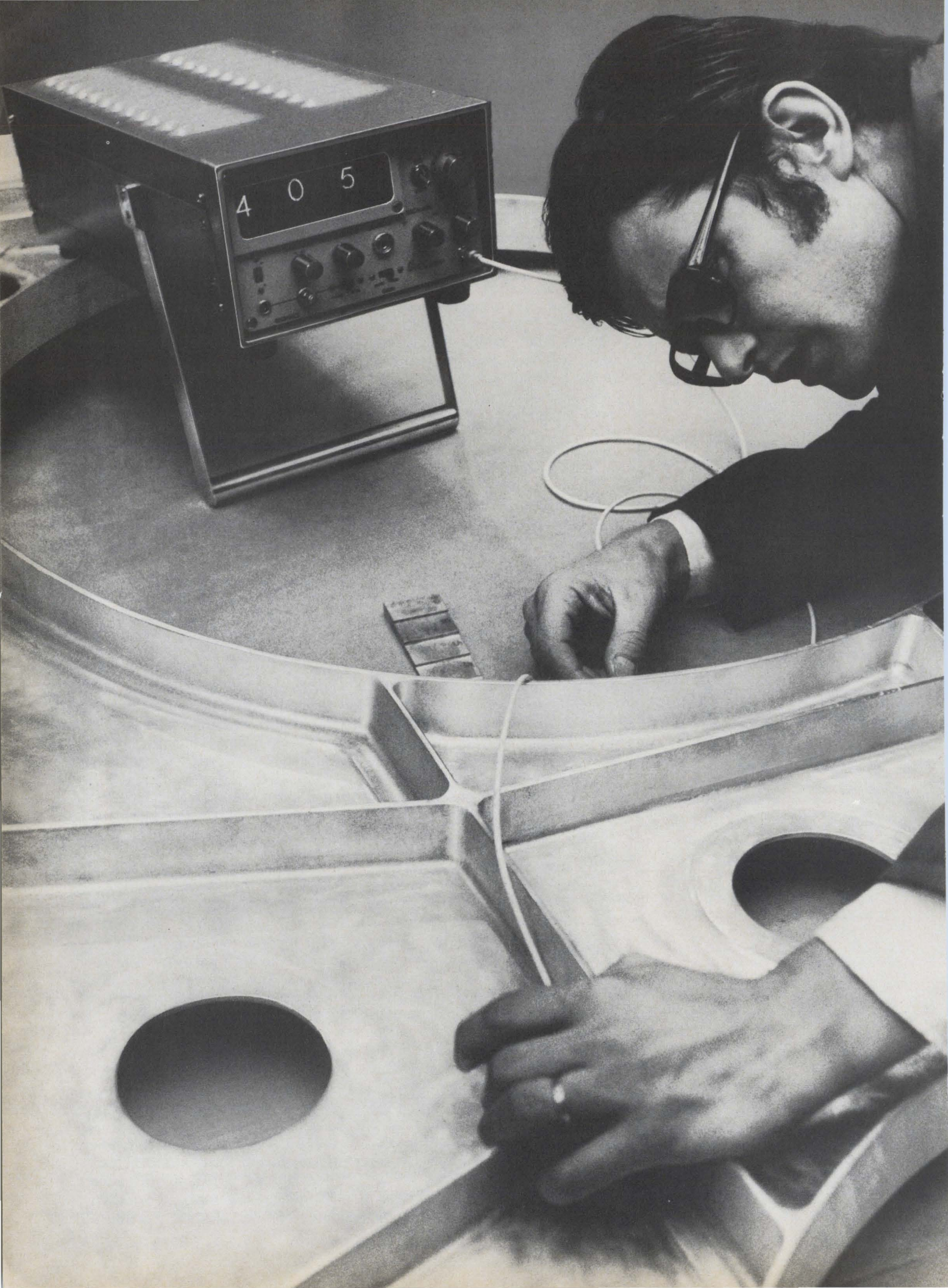

Voilà!

Réalisations Ultrasonique increases its thickness gauge's muscle by 550%, decreases size and weight by 50%.

TI Supply prescribed the diet.

Good prescription too.

Réalisations Ultrasonique of Meaux, France manufactures ultrasonic thickness gauges, and required an increase in logic counting frequency from 5-6 MHz to 33 MHz for improved accuracy. Difficult specs using traditional components! So their local TI Supply engineer was called in.

Working with company engineers, and using TI's TTL integrated circuits, he replaced four transistor circuit boards with just one IC circuit board.

The result was all muscle, no fat. Even power requirements were reduced by 50%, so the new model is battery operated and truly portable.

And the company benefited in other ways. Smaller inventories and faster production, with fewer parts to stock and assemble. A 50% reduction in quality control checks. One-source convenience for all electronic components. Scheduled deliveries and more favorable pricing.

Réalisations Ultrasonique's experience illustrates some of the ways in which TI Supply nurses its customers. But there are others:

For example, custom assembly and marking services to save you time and money.

A testing service to screen devices to specific electrical parameters—and save you more time and money.

"Burn-in" services to assure high-reliability in semiconductors.

In-depth stocks of electronic components and industrial supplies for instant relief of assembly line ills.

You see, we not only provide the technical assistance to strengthen your product, but we're also dedicated to keeping your profits healthy.

And we have 51 worldwide locations to assist you.

Isn't it nice to know there's help close at hand?

A full medicine chest at TI Supply.

CAPACITORS

Centralab • Components, Inc.
Erie • Mallory • San Fernando
Sangamo • Sprague • West Cap

CONNECTORS

Amphenol • Burndy* • Cinch
Elco • Kings • Sealectro
Texas Instruments
U.S. Components

INTEGRATED CIRCUITS

Texas Instruments

RESISTORS

Ohmite • Sprague • Stackpole
Texas Instruments

SEMICONDUCTORS

International Rectifier
Texas Instruments

Plus circuit breakers, fans and
blowers, fuses, panel meters, pilot
lights, potentiometers, relays,
switches, transformers, trimmers,
wire and cable for all needs.

*Stocked in Dallas



TI SUPPLY...the problem solvers.

EAST

Boston (Canton), Mass. (617) 828-5020
Clark, New Jersey (201) 382-6400
New York, New York (212) 895-0803
or (516) 488-3300
Philadelphia (215) 664-1132

MIDWEST

Kansas City, Missouri (816) 753-4750
Minneapolis (Edina), Minn. (612) 941-5020
Chicago (Arlington Heights), Ill. (312) 593-7660
Wichita (Derby), Kansas (316) 788-1714

SOUTHWEST

Austin, Texas (512) 454-2531
Dallas, Texas (214) 357-6121
Fort Worth, Texas (817) 332-9361
Houston, Texas (713) 785-4800
Tulsa, Oklahoma (918) 437-4555

WEST

Los Angeles, California (213) 776-4490
Denver, Colorado (303) 757-7671
San Francisco (Sunnyvale), Calif. (408) 732-5555

CANADA

Montreal (St. Laurent), P.O. (514) 332-3550
Toronto (Richmond Hill), P.O. (416) 889-0844
Ottawa, P.O. (613) 825-3716

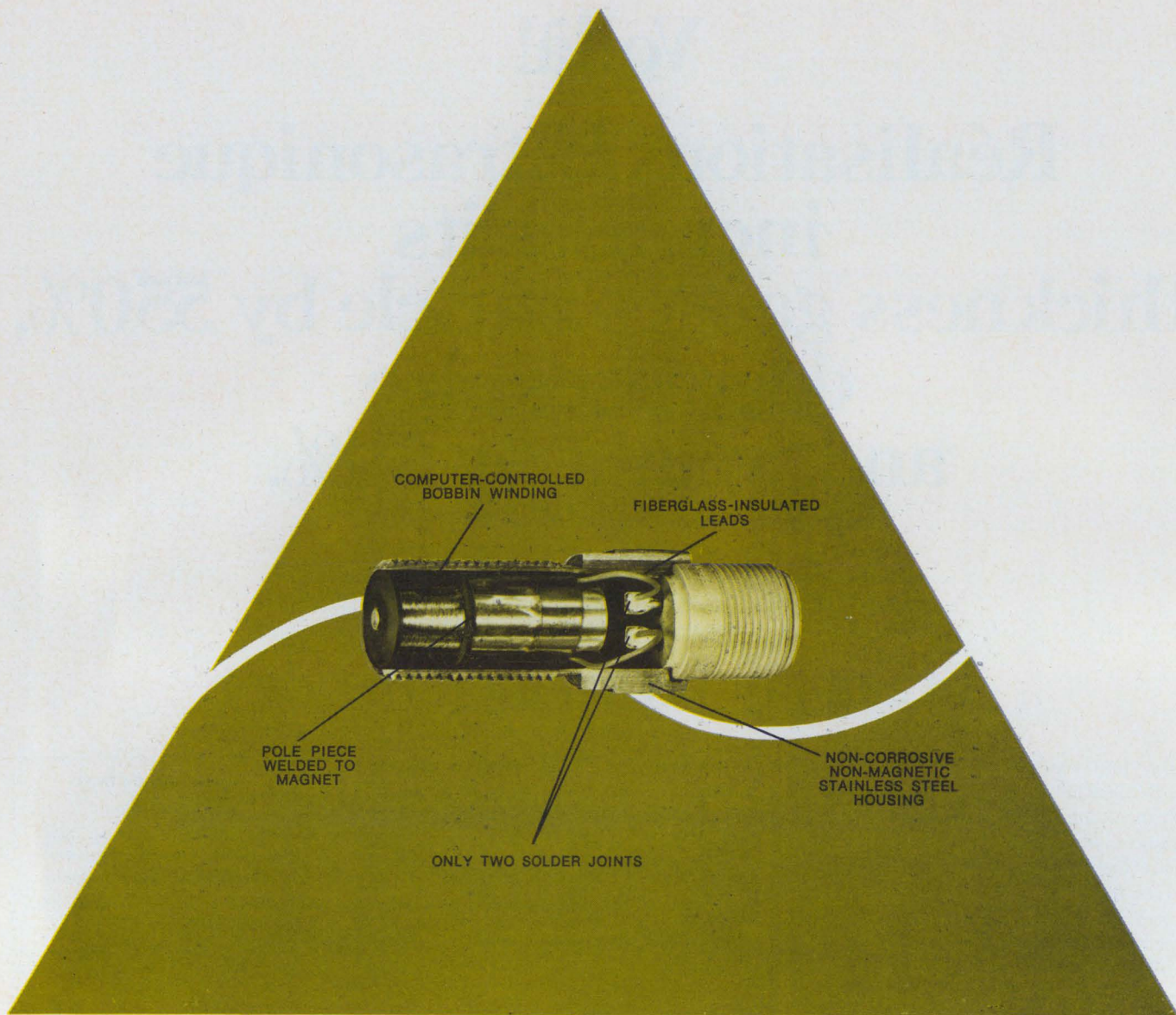

Airpax challenges the competition to show you these features in their magnetic pickups.

Airpax builds quality into every magnetic pickup. Improvements our engineers have made assure you of a reliable device for the most demanding application. **Another Airpax component of confidence!**

□ Compare these new Airpax features with other quality pickups. Non-magnetic, non-corrosive stainless steel housing for performance in severe environments. And a separate rugged bobbin with a computer-controlled, machine-wound coil. Elimination of the air gap by

welding pole piece to magnet assures constant output. **Only two solder joints**... for increased reliability. And internal fiberglass-insulated leads add heat resistance to +550°F. □ No wonder there were Airpax pickups on the manned lunar landings! For more information on the complete magnetic pickup line, write or call **Airpax Electronics, Seminole Division**, P. O. Box 8488, Ft. Lauderdale, Florida 33310. Phone (305) 587-1100. TWX: (510) 955-9866. Telex: 051-4448.

AIRPAX ... components of confidence.

OCR fits minicomputer size and price

Desktop reader with cathode-ray tube display for editing
to be introduced next month at Spring Joint Computer Conference

By James Brinton

Electronics staff

Now that even large businesses are decentralizing data processing and lowering its cost by using minicomputers, peripherals like optical character readers begin to look expensive when price tags run into six figures.

In a business environment like this, Infoton Inc. anticipates an enthusiastic welcome for its Challenger document reader, priced at \$30,000 to \$35,000, or \$1,000 monthly rental. The Challenger is hand-fed, reads a page at a time (though the page can be as large as 12 by 14 inches), and includes a cathode-ray tube display for error correcting, editing, and verifying. The whole system, which fits a desktop, will be introduced at the Spring Joint Computer Conference May 5-7 in Atlantic City.

Its reading speed compares well with more costly devices at an average maximum rate of 1,000 characters per second. Most other OCR's average about 800 characters per second. Flat out, Infoton's Challenger reads a standard page in about 5.5 seconds; competing machines take from 4 to 20 seconds per page, except for the \$500,000 Philco-Ford OCR which achieves a 1-to 2-second-per-page rate.

The Challenger sells for a price formerly associated only with card or mark readers. As late as last fall, \$42,000 was a low price for a reader capable of recognizing marks, four special symbols, numbers, and holes in cards [*Electronics*, Sept. 29, 1969, p. 165].

Design of the Infoton machine revolves around large-scale MOS shift registers, linear IC's, and high-speed TTL/MSI logic. The registers perform as memory in data buffers,



Reading matter. Operator is inserting document to be scanned by optical character reader. At right is crt display for editing tasks.

line buffers, and display refreshment applications. Widespread use is also made of the linear IC's. And TTL has been applied to the machine's hardwired control computer, which in turn allows a simpler scanning mechanism that is inexpensive to construct and has low power requirements. The whole machine dissipates only 700 watts—less than an electric iron—and this in turn allows use of a low-cost solid state power supply. These factors plus some proprietary circuitry, make the price tag possible.

Feed costs. Among the first costly OCR features to disappear was the automatic paper feed. Infoton engineers say the feed not only added to cost, but to volume and maintenance as well. Also, there was the added risk of the automatic feed destroying irreplaceable documents. Nor could an automatically

fed machine deal easily with folded, ragged, stapled, or paper-clipped documents.

But reading page by page could be slow. So to design a machine with enough throughput to compete with automatically fed OCR's, "we eliminated as many post-OCR steps as possible—editing, error correction, etc.—and made them part of the reading process," says George G. Pick, vice president for engineering. "Thus, we added an alphanumeric crt display to show material as read, and added a rejection display to catch ambiguous characters."

The rejected character is shown in a small section of the crt and also blinks on and off in its text location. The machine resumes reading when the operator punches in the appropriate character.

To speed editing and correcting,

YES! NORTRONICS will show these and other IBM-compatible

DIGITAL HEADS*

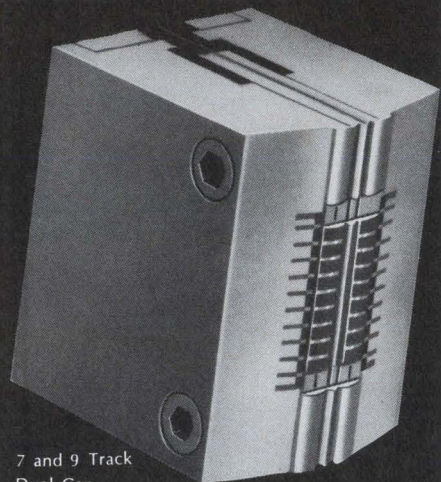

7 and 9 Track
Dual Gap
READ AFTER WRITE

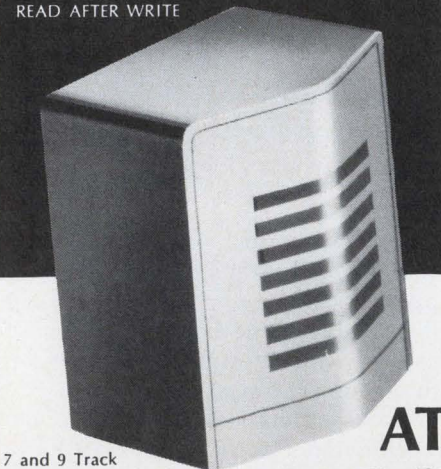

7 and 9 Track
Single Gap
READ/WRITE

AT
SJCC

BOOTH 50010

See them there or write for specs!

*Card Reader and Mini-Digital Heads too...
From The World's Leader In Magnetic Recording
Heads.

 **Nortronics**
COMPANY, INC.
8101 Tenth Avenue North
Minneapolis, Minnesota 55427
(612) 545-0401

Infoton redesigned the traditional operator's keyboard. The key layout of a typewriter is based on the frequency of letters in English text and on the relative strengths of the fingers. But errors in OCR are nearly random—letter frequencies are meaningless. So Joseph G. Wohl, vice president, information sciences, organized the keyboard so that any number or letter could be found quickly, systematically. He arranged the alphabet in three arrays of keys similar to an adding-machine layout. For numbers he used two rows, one through five and six through 0.

The arrangements are based on the results of some human-factor studies sponsored by the Navy. Says Infoton, it takes less than an hour to train an operator.

The Challenger's optical front end differs from that of most other OCR's in that the reading mechanism moves and the paper is stationary. The operator opens a sliding door, inserts the document which is aligned automatically, and closes the power-assisted door. The door presses the document against a glass platen shaped like a section of cylinder.

Within the cylinder spins a y-shaped holder for condensing and projecting lenses; in the vertex of the y is the light source—an incandescent lamp. And at the axis of the cylinder, at a point even with the tips of the horns of the y, is a 126-diode photodetector array. About 50 diodes are used, the remainder are for expansion capability. The light reflected from the document is brought into focus at the array with enough accuracy to allow resolution of lines 0.008 inch wide.

Spinning. "The sensor optics are continually spinning," says Pick; "there's no reciprocal movement to deal with. Nor do the light source or detector array rotate, saving us the cost and unreliability of slipping connections."

The diode array's output is amplified and passed to a circuit which makes the so-called black-white decision. Pick says that a new proprietary approach to this has lowered cost. The circuit makes the decision based on a continual tracking of "local white",

"We electronically arrange the character being read on an array

of 10 by 14 cells," says Pick. "OCR-A is designed to have a large difference between the number and arrangement of black and white cells that describe a letter. If one superimposed any two characters displayed in such a matrix there would be gross differences noticeable. And it is these differences in black and white which help make the matching and character-selection decisions, the next steps in the OCR process.

Three tests. After the black-white decision, the signal passes through a data buffer and into the character matching and selection decision subsystems. These use three criteria to determine what letter is being read; first, the digital equivalent of the 140-cell matrix is compared with those for other OCR characters and the best match is taken; second, the circuitry also demands a minimum difference between the best match and the second best; third, a circuit looks for an absolute minimum match. All these operations are done in parallel with character identification taking some 10 microseconds or less. Each operation enhances the error rejection capability of the reader.

From here the deciphered characters are displayed in the crt as are the rejected or doubtfully identified characters. After editing or correction, the data passes to output coding and interfacing circuitry and then to a modem, data processor or tape deck.

Infoton Inc., Second Ave., Burlington, Mass. 01803 [338]

Data handling

Cassette drive
for digital jobs

Data rate is 9,600 bits
per second at 12-ips speed;
2-track design cuts errors

"The design life of audio cassette recorders is much shorter than people can live with in the computer industry." That conclusion, says



Look what Acopian offers...

MIL-Tested DC Power Supplies in 3 Days

Count on Acopian for guaranteed 3-day shipment of MIL-spec DC plug-in power supply modules. In fact, we'll ship *any* of our 82,000 supplies—for MIL-spec or industrial applications—just 3 days after receipt of your order. That's our guarantee—and we've never failed to keep it.

Call in your requirements or order from our catalog. Acopian power supplies are available with single or dual regulated outputs for powering op amps, ICs, logic circuits and electronic measuring equipment; and with unregulated

Circle 133 on reader service card

APPLICABLE MIL SPECS

MIL-STD-810B:	High Temperature ▪ Humidity ▪ Salt Fog ▪ Altitude ▪ Vibration ▪ Shock ▪ Fungus
MIL-E-5272C:	Low Temperature
MIL-I-6181D:	Radio Frequency Interference

Details in our catalog

outputs for lamps and relays. In addition, Acopian offers completely-wired

multi-output power supply systems—write for details.

For a copy of the latest Acopian catalog, write or call Acopian Corp., Easton, Pa. 18042. Telephone (215) 258-5441. And remember, every one of Acopian's 82,000 power supplies is shipped with this tag...



Electronic Experts of America!

**Your
Consumer Electronics
Show
is in New York
June 28—July 1.**

A reminder from the airline that
goes all out to get you there.

**SOMEHOW, YOU FEEL
MORE IMPORTANT ON TWA.**

William Slover of Ampex Corp., is what emerged from a market survey of the increased use of cassettes in computer equipment.

The result of the survey is a heavy-duty digital cassette tape drive with a mean-time-between-failure of 2,000 hours and a maximum error rate of one in 10^6 bits, says Slover, who is marketing manager of the Ampex Computer Products division.

The model TMC comes with a standard tape speed of 12 inches per second, and optional speeds down to 2 ips. Data rate at 12 ips is 9,600 bits per second, permitting up to 350,000 characters on a 300-foot-capacity cassette. There are five operating modes: read forward and reverse, write only, fast forward, erase data, and a 55-ips fast reverse. Five solenoids are used to permit remote control of the brake, the two reels and each of two pinch rollers. Packing density is 800 bits per inch, and the unit writes on two redundant tracks in NRZI format. Output is serial-by-bit, and the clock is derived from the two-track complementary recording.

The purpose of the redundant two-track recording is detection of data errors, usually resulting from small mechanical defects in the tape, during recording. With the NRZI format, each time there is a 1 in the bit stream on the first track, the magnetic status of the tape is reversed. Complementary recording of the same data is done on the second track, except that the reverse is true: when a 0 appears in the bit stream, the polarity is reversed. The two tracks are on separate areas of the tape. Information from the two, considered jointly, provides a clock because there has to be a polarity change on either the first or second track for each bit position. The time between the polarity changes is uniform, giving a square wave output. If a gap occurs in the square wave, an output signal is generated and sent to the controller indicating that an error has occurred. The tape is then reversed by the controller and brought back to the point where the error occurred.

The price tag Ampex puts on its new drive reads \$600.

Ampex Computer Products Division,
9937 Jefferson Blvd., Culver City, Calif.
90230 [339]

The Tung-Sol[®] development that created a whole new set of digital display standards

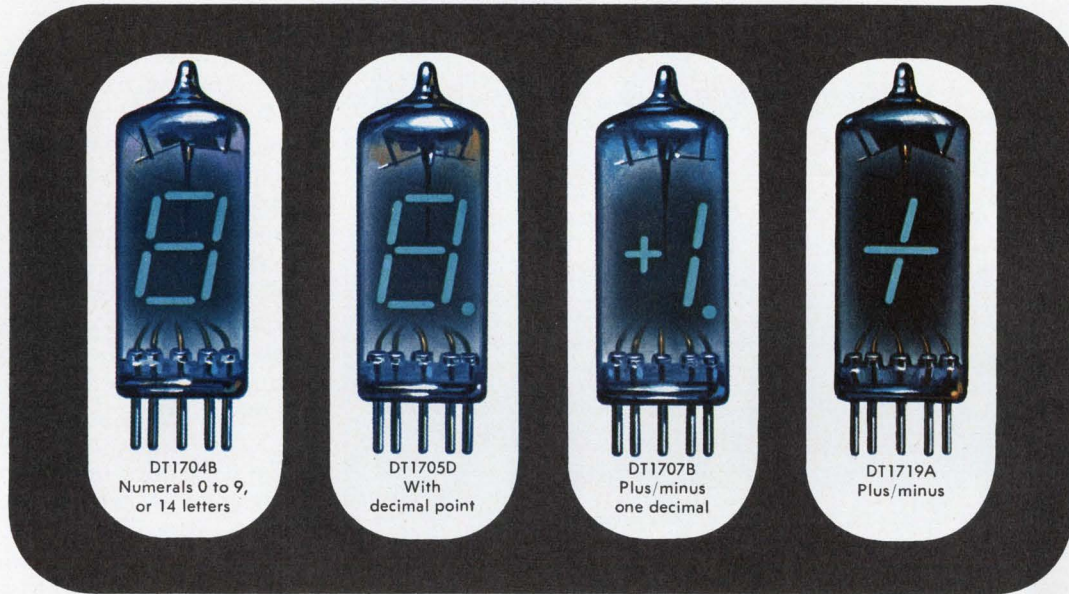

STANDARD CONFIGURATIONS

Low-voltage, low-power drain (25 V and 1.6 V) permits battery-operated applications. Standard miniature tube base. Inexpensive logic/driver requirements. Meets MIL specs. Space-age-type segmented character. Single plane display. Standard alphanumeric, or special symbols. Optimum visibility under ambient light conditions. Common filters provide unlimited color selection for identification, or to heighten contrast. Circuit-board mounting, with solderable-lead option. Write, or phone for detailed technical information and pricing.

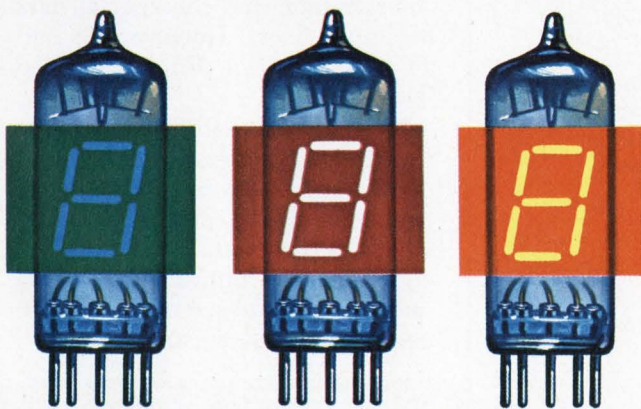

Standard filters provide color variation

DIGNAC S/G[™]

VACUUM FLUORESCENT DISPLAY

**TUNG-SOL DIVISION
WAGNER ELECTRIC CORPORATION**

630 W. Mt. Pleasant Avenue
Livingston, N.J. 07039

TWX: 710-994-4865

Phone: (201) 992-1100; (212) 732-5426

Trademark TUNG-SOL Reg. U.S. Pat. Off.
and Marcas Registradas

DYNAMIC CIRCUIT BREADBOARD



Take the mess out of breadboarding with the ELite 1

This unique instrument takes all of the scavenging and soldering out of design, yet will accommodate any combination of IC's and Discrete Components

BUILT-IN FEATURES ARE:

- Precision pulse generator
- Variable frequency, ampl. and width
- Variable lower supply
- Neon lamp display with drivers
- No special tools, plugs or patch cords are required
- Size is only 4½" high, 15" wide, 11" deep

WITH THESE ADVANTAGES:

- Total breadboarding without soldering
- Complete bread inter-connection with solid #22 wire
- Convenient desk-top operation

Use the ELite 1 for all designing, testing and burn-in thereby reducing your breadboarding to inserting components, inter-connected with #22 wire and monitoring circuit responses via the built-in neon display

Write or phone for complete specifications and catalog



EL Instruments Incorporated
61 First Street, Derby, Conn. 06418 ■ Phone 203/735-8774

Circle 169 on reader service card

UNBELIEVABLE ADHESIVE



It's a fact: EASTMAN 910® Adhesive can form remarkably strong, long-lasting bonds between just about any materials you can think of — and do it with surprising speed, without the need for any mixing, heat, solvents, catalysts or more than contact pressure.

Hard to believe? Find out for yourself what this unique adhesive can do, and how it can help you cut assembly costs. Get your copy of the EASTMAN 910 Adhesive information kit by writing to Chemicals Division, EASTMAN CHEMICAL PRODUCTS, Inc., Kingsport, Tennessee.

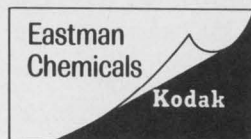

Data handling

Controller runs 9 disk drives

System 360-compatible
unit plugs into
selector channel

About 70% of peripheral equipment-market money is in System 360-compatible gear, says Wayne Dunlap, sales manager of Information Storage Systems Inc. That, in part, is why the company's newest product is a storage control unit that plugs into a 360 selector channel and operates a group of disk drive units. Also, Dunlap and his associates at the California company came from IBM and had helped to design disk drives there.

Since ISS does not have an extensive field sales or service network, it signed a contract with Telex, which does. Telex sells ISS's six-high 701 disk drive under its own label as the 5311, and ISS's 11-high 714 disk drive as the 5314. Both are high-speed units. The new controller, the model 728, operates up to nine 714 disk drive units. It will be introduced at the SJCC.

Designing the 728, says Dunlap was complicated by the fact that IBM integrated the design of the 11-high disk drive and its controller, the 2314.

The answer, says Dunlap, was to design a controller that would plug into the 360 selector channel—the same channel used by the IBM 2314. "But this is a difficult interface problem," says Dunlap, "because of the format of the data, the data transfer rate, and the special data fields IBM uses." However, ISS had an edge: its own people designed the IBM 2314.

To increase reliability of the controller/drive system, the 714 has only one electronic adjustment. And the disk sector transducer, which is magnetic on competing equipment, is optical on the ISS unit. A phototransistor and a light-emitting diode are used.

Information Storage Systems Inc.,
10435 N. Tantau Ave., Cupertino, Calif.
95014 [340]

The electronics scoreboard.

	1965	1966	1967	1968	1969
First place.					
Second place.					
Third place.					
Fourth place.					
Fifth place.					

For the past five years electronics advertisers have placed more advertising pages, dollars and confidence in Electronics than in any other magazine. World leader in editorial and circulation, too. Electronics. A McGraw-Hill publication.

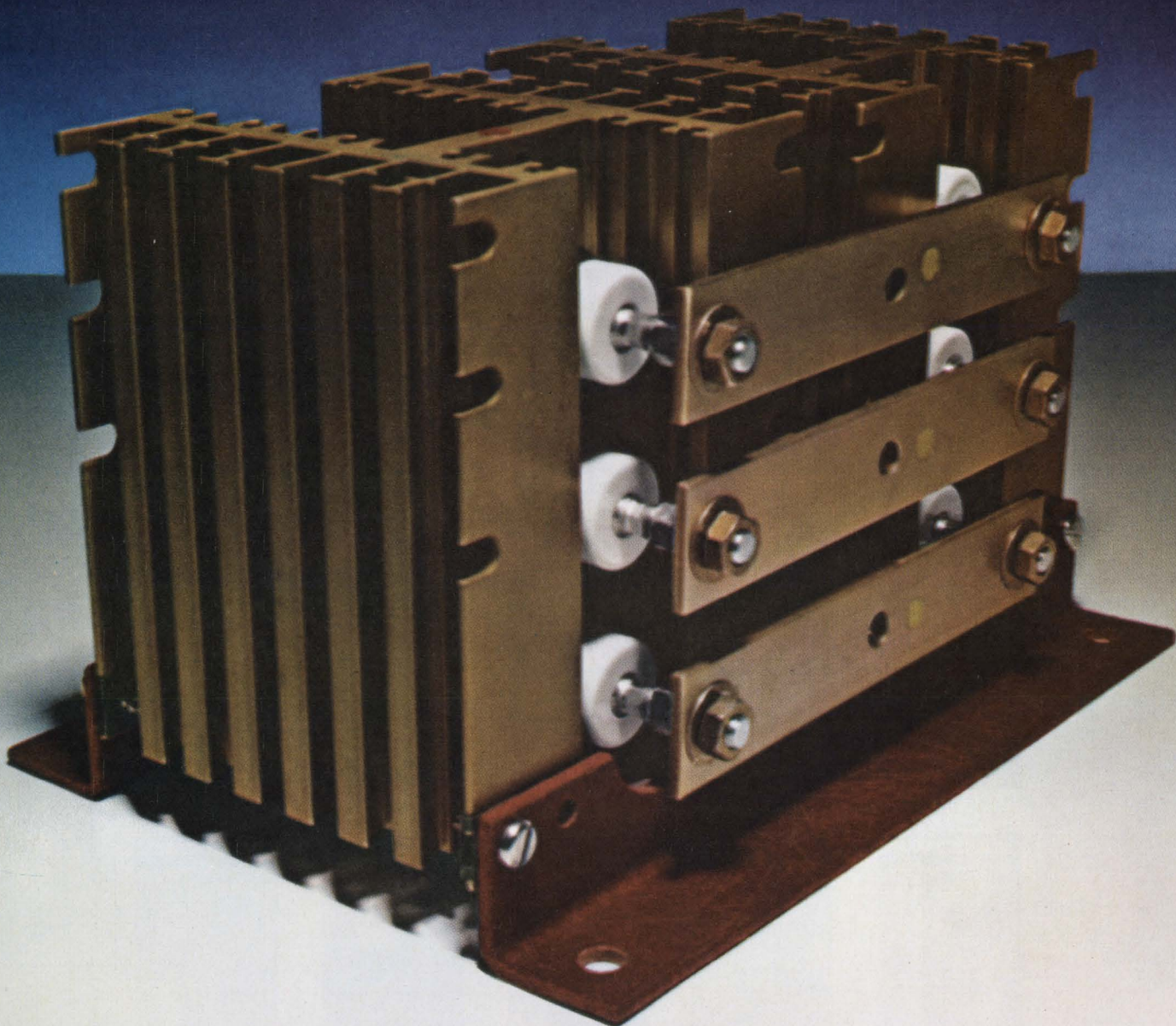

Try me.

Whether you build stacks or buy 'em... we'll show you how Westinghouse Gold-Line rectifier assemblies yield more power per dollar.

Send for the proof.

After you've tried our assemblies, you'll ask yourself why you bother to build.

Because Westinghouse Gold-Line rectifier assemblies give you simplified design and standardization; fewer parts; bonus output amps.

And you'll save on inventories, parts, labor, testing, rejects and down-ratings. What's more, we guarantee the current rating of Gold-Line rectifier pre-assembled packages. They're compact in de-

sign with a wide range of distinct current and voltage ratings and circuit configurations.

Let us analyze your real costs, and prove that Westinghouse can save you money. But first write for our 54-300 catalog and our 54-021 price list. You'll see how our stacks stack up. Then you'll try us. Write Westinghouse Semiconductor Division, Youngwood, Pa. 15697.

You can be sure... if it's **Westinghouse**



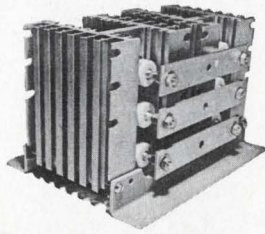

Westinghouse Industrial Semiconductor Distributors

Alabama
ACK Radio
Birmingham 205 322-0588
Electronic Wholesalers, Inc.
Huntsville 205 539-5722

Arizona
Hamilton Electro of Arizona
Phoenix 602 272-2601
Kierulff Electronics Corp.
Phoenix 602 273-7331

California
Newark Electronics
Inglewood 213 674-8440
Hamilton Electro Sales
Los Angeles 213 870-7171
K-Tronics
Los Angeles 213 685-5888
Elmar Electronics, Inc.
Mountain View 415 961-3611
Hamilton Electro Sales—North
Mountain View 415 961-7000
Hamilton Electro of San Diego
San Diego 714 279-2421

Colorado
Electronic Parts Co.
Denver 303 266-3755
Hamilton Denver
Denver 303 934-5508

Connecticut
Cramer Electronics, Inc.
North Haven 203 239-5641

Florida
Cramer Electronics, Inc.
Fort Lauderdale 305 566-7511
Electronic Wholesalers, Inc.
Orlando 305 841-1550

Georgia
Specialty Distributing
Atlanta 404 873-2521

Illinois
Semiconductor Specialists, Inc.
Chicago 312 279-1000
Avnet of Chicago
Schiller Park 312 678-6310

Indiana
Fort Wayne Electronics Supply, Inc.
Fort Wayne 210 742-4346
Ra-Dis-Co.
Indianapolis 317 637-5571
Radio Distributing Co.
South Bend 210 287-2911

Maryland
Pyttron Inc.
Baltimore 301 727-5100
Hamilton Electro Sales
Hanover 301 796-5000
Cramer Electronics, Inc.
Rockville 301 424-2700

Massachusetts
Cramer Electronics, Inc.
Newton Centre 617 969-7700
Schweber Electronics
Waltham 617 891-8484

Michigan
Semiconductor Specialists, Inc.
Detroit 313 255-0300

Minnesota
Semiconductor Specialists, Inc.
Minneapolis 612 866-3434
Stark Electronic Supply
Minneapolis 612 332-1325

Missouri
Electronic Components for
Industry Co.
Kansas City 816 421-2400
Electronic Components for
Industry Co.
St. Louis 314 647-5505

Hall-Mark Electronics Corp.
St. Louis 314 521-3800

New Jersey
General Radio Supply Co., Inc.
Camden 609 964-8560
Angus, Inc.
Moorestown 609 235-1900
Sterling Electronics, Inc.
Perth Amboy 201-HI 2-8000

New Mexico
Kierulff Electronics Corp.
Albuquerque 505 247-1055

New York
Stack Industrial Electronics
Binghamton 607 723-6326
Summit Distributors
Buffalo 716 884-3450
Cramer/Eastern
East Syracuse 315 437-6671
Schweber Electronics
Long Island 516 334-7474
Milgray Electronics, Inc.
New York 212 989-1600

Ohio
Sheridan Sales
Cincinnati 513 761-5432
Sheridan Sales
Cleveland 216 524-8120
Hughes-Peters, Inc.
Columbus 614 294-5351
Mentronics, Inc.
Mentor 216 946-3058

Oklahoma
Hall-Mark Electronics Corp.
Tulsa 918 835-8458

Pennsylvania
Cameradio Company
Pittsburgh 412 391-4000

South Carolina
Sawyer Electronics Corp.
Greenville 803 235-0438

Texas
Hall-Mark Electronics Corp.
Dallas 214 231-6111
Midland Specialty Co.
El Paso 912 533-9555
Hall-Mark Electronics Corp.
Houston 713 781-6100
Lenert Company
Houston 713 225-1465
The Altair Co.
Richardson 214 231-5166

Washington
Hamilton Electro Sales of the
Pacific Northwest
Seattle 206 624-5930
Kierulff Electronics Corp.
Seattle 206 725-1550

West Virginia
Charleston Electrical Supply
Company
Charleston 304 346-0321

Wisconsin
Taylor Electric Company
Mequon 414 241-4321

Canadian Westinghouse
Hamilton, Ontario 416 528-8811

**Westinghouse
Electric International**
London, S.W. 1 Whitehall 2704
New York 212 692-3322

**Westinghouse
Semiconductor Division**
Youngwood, Pennsylvania 15697

Data handling

Versatile keyboard has a light touch

Equipment uses Hall-effect keys; hard copy to replace tape in future models

When he took over at Fairchild in 1968, Lester Hogan was confronted with a diversity of product lines, some of which were losing money. To determine which lines would stay and which would be sold off, Hogan set up a rule: if a line could turn profitable by using the products of the Semiconductor division, it would be retained. And since Fairchild's keyboard-terminal line met this condition, it was kept. A new terminal from the Graphic Equipment division uses digital MSI circuits from the Semiconductor division and a Hall-effect keyboard purchased from Honeywell's Micro Switch division.

Called the Electro/Set-430, the terminal is intended to be used with Fairchild's Comp/Set-330 typesetter and its photo textsetter.

But the keyboard is not limited to typesetting applications. It can produce a six, seven, or eight-level perforated tape either 7/8-inch or one inch wide. The code structure can be changed by replacing a single printed-circuit card; thus the terminal can easily be used as a computer peripheral. Future models will include magnetic-tape and hard-copy output.

According to Richard Robinson, general manager of the graphics division, "The Hall-effect keys not only eliminate mechanical contacts, and reduce maintenance problems, but they also provide a consistent, light touch."

Standard features include a choice of teletypesetter or secretarial shift, a band of mode-indicator lights, and a job key that backs up the tape a single code at a time. Options include a function enabling the operator to delete the entire last word.

The unit is priced at \$2,865.

Fairchild Graphic Equipment Division,
221 Fairchild Ave., Plainview, N.Y.
[430]

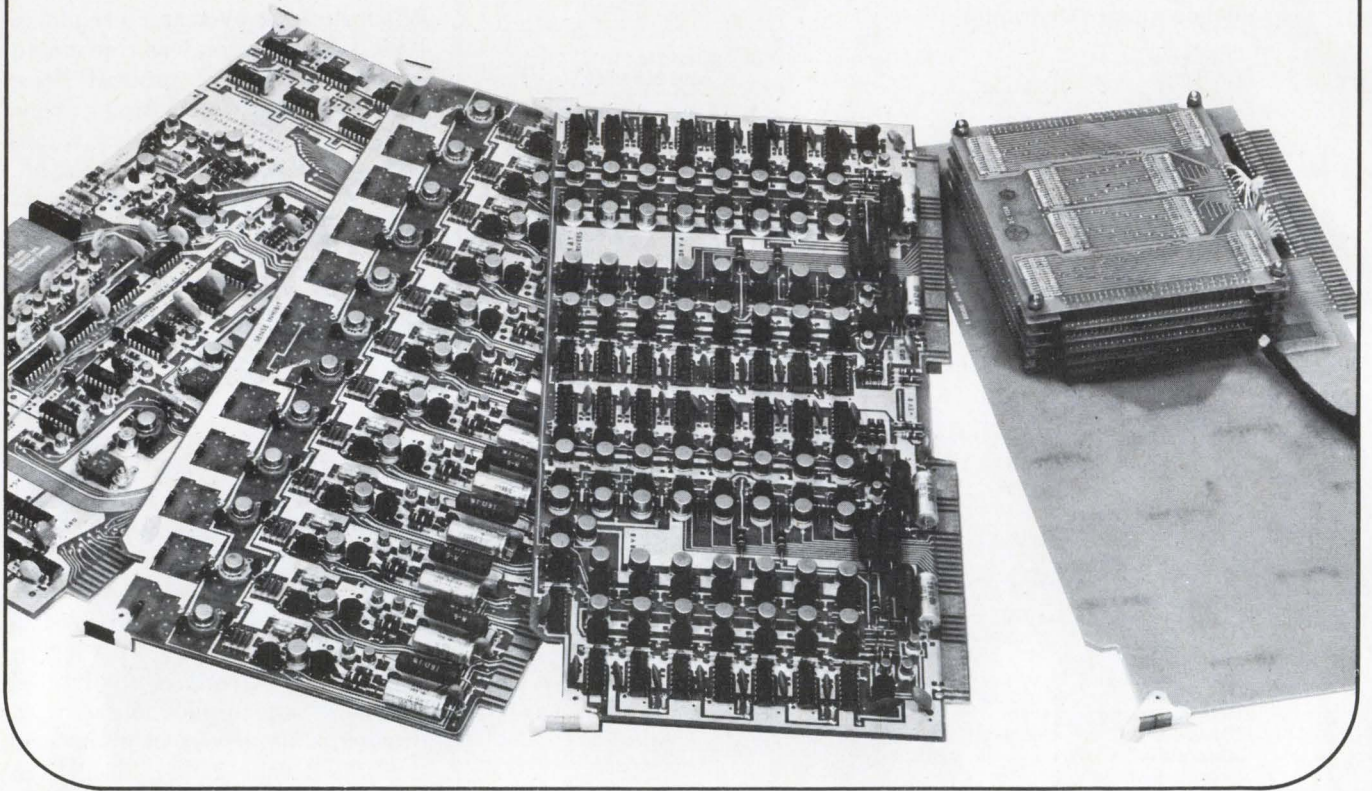

Datacraft's DC-34 Core Memory: 4K x 18 capacity, 750 nSec cycle. A revolution at \$1776 each.*

Our DC-34 core memory is a bunch of cards waiting for a frame that has sockets and a couple of power supplies. You tick off the configuration and we shuffle the cards. We'll work with any length word up to 40 bits and still stick with our standard core planes. And we'll stack our planes up against your total memory requirement — the sky's the limit. Speed is your option, not ours. Go ahead and test us. We haven't found any track too fast for our DC-34. The make-or-buy decisions are all on our side. Buy.

Describe your Central Processor and we'll give you a memory. Let your engineers see their families this weekend: Datacraft already figured out how to build your CPU memory.

*Price quoted is for quantities of 100 or more, plus applicable taxes and options desired.

Call your nearest
Datacraft
 Memory Man.

Datacraft Corporation • P. O. Box 23550, Ft. Lauderdale, Fla. • (305) 933-2651
 Southeast: (305) 423-7615 • Mid-Atlantic: (215) 265-5800 • New York: (516)
 482-3500 • New England: (617) 245-9530 • East Central: (216) 243-6500 • West
 Central: (312) 775-7594 • Southwest: (713) 643-2114 • Rocky Mountain: (303)
 794-4231 • Far West: (213) 542-5515

See the new Datacraft DC 6024/3 Computer in booth 24007 at Convention Hall during the SJCC in Atlantic City.

Making a circuit stick

Any network can be assembled directly from sketch and quickly tested; elements withstand soldering-iron temperatures, and design is easily modified

It's frustrating for a circuit designer, in the midst of putting together a breadboard, to find that he doesn't have all the necessary connections. A technique called Circuit-stik prevents such frustration by permitting rapid assembly of prototypes directly from engineering schematics and logic diagrams.

Circuit-Stik Inc. offers a family of circuit subelements and materials

designed as a packaging system. The system reduces design and drafting expenses and can save schedule time normally lost when using outside manufacturing services. Individual circuit boards can be assembled and tested from engineering sketches the same day.

The conductive subelements are supplied on thin substrates that have a pressure-sensitive adhesive

backing. The elements can withstand soldering temperatures, and are easily removed for design modification.

The circuit subelements are selected from a variety of patterns available for commonly used components including flatpack, dual-in-line, and TO-5 packaged integrated circuits, transistors, diodes, resistors, test-point jacks, and plug-

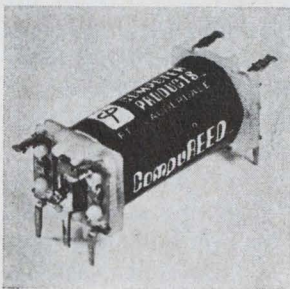

Switching relays series CR300 feature typical operate and release times of 1 msec, and compatibility with logic levels. The CR372 dry-read relay requires approximately 60 mw of power. The CR363 mercury-wetted relay requires about 340 mw of coil power. Price (1-9) is \$5.94 for the 363, and \$3.98 for the 372. Computer Products, 1400 N.W. 70th St., Fort Lauderdale, Fla. [341]

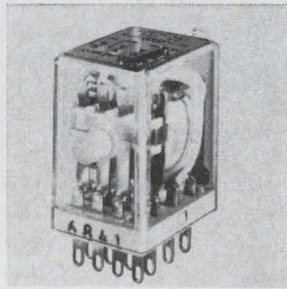

Pushbutton type 156 is a miniature 3-amp 4 pdt industrial relay that permits manual push-to-test actuation, without coil actuation. The feature is desirable in system debugging or maintenance, when electrical operation for effective diagnosis of the system is impractical. The basic unit is 1.22 cu in. in volume. AEMCO Division of Midtex Inc., 10 State St., Mankato, Minn. [342]

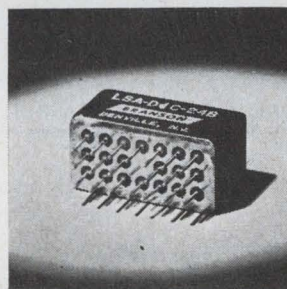

Magnetic latching relay in one-half crystal can size is a 4 pdt unit that meets the requirements of MIL-R-5757E, including welded seal. It is available with 6, 12 and 24 v d-c coils and operates from a 150 mw short duration pulse. Contacts are rated low level to 2 amps resistive. Price is approximately \$30. Branson Corp., Vanderhoof Ave., Box W, Denville, N.J. 07834 [343]

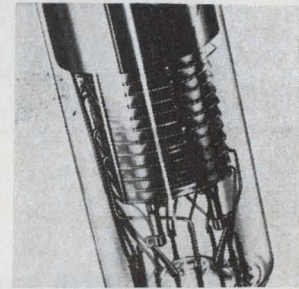

Photomultiplier tube 4249B is for use in systems which are dark current limited and is a plug-in replacement for earlier types having small-area S type cathodes or 2 in. bialkali cathodes. Typical dark current is 200 pa at 2,000 amps/lumen giving equivalent anode dark current input of 10^{-16} w at 400 nm. The Bailey Instruments Co., 5919 Massachusetts Ave., Washington D.C. [344]

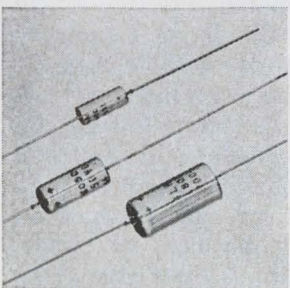

Wet anode tantalum electrolytic capacitor designated TLW features a positive hermetic glass-to-metal seal to prevent electrolyte leakage. It is available in three miniature case sizes with axial leads. The unit has voltage ratings of from 6 v to 125 v, and a capacitance of 560 μ f at 6 v to 25 μ f at 125 v. Mallory Capacitor Co., 3029 E. Washington St., Indianapolis 46206 [345]



Nonpolarized, aluminum electrolytic capacitors type TNPW have welded connections joining the risers and external leads to assure a low dissipation factor and freedom from intermittent or open circuits. They offer a complete range of capacitance values from 1 to 100 μ f and are available in voltages of 25, 35 or 50 v. International Electronics Corp., Melville, L.I., N.Y. 11746 [346]

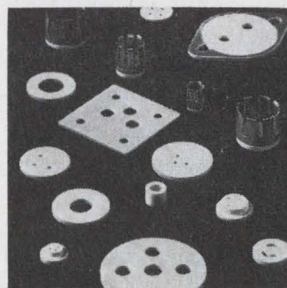

Standard Berlox (high-purity sintered beryllium oxide) transistor heat sinks and retainer clips are being offered for off-the-shelf delivery in JEDEC outlines for TO-3 through TO-6; DO-4 and DO-5; MT-1 through MT-14. A total of eight standard configurations is available, in thicknesses of 1/32 in. and 1/16 in. National Beryllia Corp., Greenwood Ave., Haskell, N.J. 07420. [347]

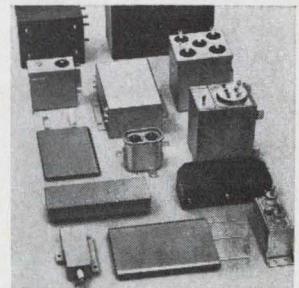

Wound mica paper capacitors series GLA feature an operating temperature range of -55° to 310° C, a dissipation factor of less than 0.002 between -55° and 100° C, and flat capacitance-temperature characteristics compared to film and paper. Operating voltage is 100 v to 10,000 v d-c. Units comply with military specs. General Laboratory Associates, Inc., Norwich, N.Y. [348]

PUSH-IN TERMINALS

NEW MICRO-KLIP



T42-1
May be flared
Fits .042" diameter holes



T28-1
T28 Mini-Klip
Fits .062" holes

TURNED TYPE TERMINALS



T18





T10



T13

EYELETS

For holes .042", .062", .093" diameter

CUT CONSTRUCTION DELAY

USE VECTOR ZIP PUSH-IN TERMINALS, INBORD PINS, CUP RECEPTACLES

Quickly installed, easy to use Vector zip push-in terminals and inbord pins cut construction time and cost in many ways while providing reliable connections. Solderable and solderless terminals are available. They are designed for versatility and accept most wire sizes used in electronics. By inverting the new T42-1 Micro-Klip terminal and inserting it in "P" Pattern Micro-Vectorbord*, it serves as a useful mounting device for D.I.P.'s. These terminals normally need no staking. Space saving Inbord Pins may be inserted in boards as required and function as component terminals or male connector pins. Hand insertion tools are available for all push-in terminals and inbord pins. Production type staking tools are available for turned type terminals. Vector also has eyelets, and hand staking tools.

Cup receptacles may be mounted anywhere and accept Inbord Plug Pins (.040"), Vector Edge-Pins, or any .040" diameter pin of proper length. Edge Pins attach to board edges to make Plug-In Cards.

INBORD PLUG PINS

For .025" and .042" dia. holes
Various lengths available



Pin Plug
.040" diameter



Cup receptacle



T32A
Fits .093" holes
T32A-1 fits .062" holes

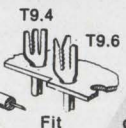

T9.4 T9.6
Fit .093" holes



T30N-2
Fits .093" holes



Vector

ELECTRONIC COMPANY, INC.

12460 Gladstone Ave., Sylmar, Calif. 91342

DIAL FOR DATA (free): 800/348-8555



Design task. Conductive paths, then components are attached to p-c board to form circuit.

in printed-circuit board connectors. Circuit subelements have pre-plated, readily solderable conductive patterns. When predrilled Circuit-stik 1000 series subelements are used in conjunction with 0.1-inch punched-board material, no further drilling is required. The pressure-sensitive elements are placed on the backing board, and the result is a p-c board ready for mounting and soldering of the components in the conventional manner. The problem of wobbly terminals caused by poorly mounted stand-offs is avoided, and so is the delay usually needed for artwork, etching, and drilling a p-c board.

Available for use with wire-wrap systems are configurations that can reduce the sockets and wire-wraps required. All types may be combined on the same board.

No terminals. The active circuit components are soldered directly to the subelements. And the engineer using circuit boards made from these materials can expand his prototype unit to larger systems by conventional card cages and rack-and-panel hardware.

Specially developed Circuit-stik materials for use with subelements allow multilayer techniques to be used even in the prototype. Because the subelements are thin, modifications to isolate, or to make unique patterns, may be made instantly using only a pair of scissors.

Circuit-stik is available from stock. Price range is from 20 cents to \$6 depending on the configuration. For example, a package of 10 dual in-lines would be 20 cents each; a continuous strip of six components in a package of five strips would sell for \$6.

Circuit-Stik Inc., 1518 West 132nd St., Gardena, Calif. 90249 [349]

Communications market in the 70's.

We have just initiated "A Study of Opportunities in the Communications Markets During the 1970's." This study will provide a limited number of clients with an in-depth analysis of the effect of changing technical, economic, and regulatory factors on the markets for communications systems, subsystems, products, and components. It will also forecast the size and structure of these markets.

For further information, please contact Mr. Samuel Weber, Manager, Electronics/Management Center, 330 West 42 Street, N.Y. 10036. Telephone: (212) 971-3485.

A joint undertaking of McGraw-Hill's Electronics/Management Center and Marcom Incorporated.

In Florida Business Adds Up!

**We've Got the Competitive
Edge For New Industry –
And We Can Prove It!**

When you add up the competitive advantages that are part of Florida industrial site selection, it's a stopper.

We can show you a variety in site selection few other states can boast. Where else can you have your choice of **13** deepwater ports — more than many foreign countries?

We have a new set of laws concerning revenue bond financing that will make your comptroller's eyes light up.

Our recruitment and training program solves the staffing problem before you open your doors. (And at no cost to you!)

For the young and technically skilled we have educational, recreational, and living advantages that make Florida a prime attraction.

Florida has a great deal for you. Before you make a move, take a good look at that competitive edge. Phone (904) 224-1215, or send the coupon.

Florida

DEPARTMENT OF COMMERCE
107 WEST GAINES STREET
TALLAHASSEE, FLORIDA 32304

HANDY COUPON FOR YOUR CONVENIENCE!

Florida Department of Commerce / 107 West Gaines St.
Tallahassee, Florida 32304 / Att.: Dept. "D-1"

*I'm interested in a business or industrial future in Florida.
Please send me more information.*

Name

Title or Position

Company

Street

City State Zip.....

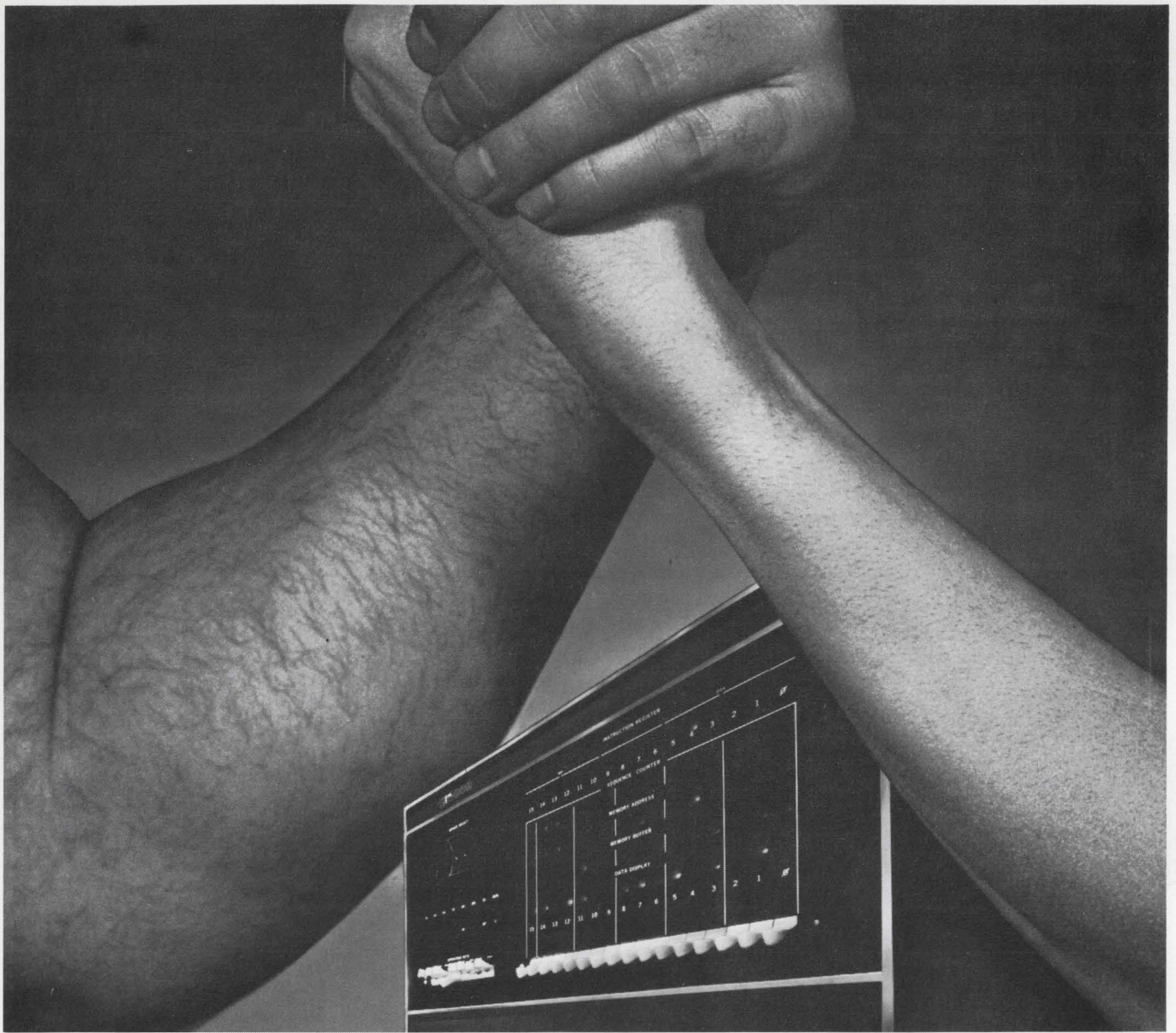

It's the second bus that separates the men from the boys in the new systems computers

The GRI-909 Direct Function Processor — leader of a new breed of powerful, systems-oriented mini-computers — is characterized by a dual, internal/external bus system. No other computer offers such a dual bus approach.

Therefore . . . no other computer can provide all these features:

- 16-bit word device-to-device transfers in a single cycle
- 16-bit word register-to-register transfers, both *internal and external* to the computer
- "On-the-fly" arithmetic operations during transfer
- Unlimited priority interrupt channels
- Unlimited direct memory access channels.

Check out these and the many other exclusive GRI-909 advantages.

You'll find that nothing on the market today can touch it.



Write for the
new GRI-909
brochure.

GRI Computer Corporation

76 Rowe Street
Newton, Massachusetts 02166 — (617) 969-7346

"See the GRI-909 at the SJCC"

gri-909
THE NEW BREED

Voltage source boasts 0.0015% accuracy

With a range of 0.1 μv to 10 volts, thumbwheel supply can be used for calibration; stability is ± 5 ppm over 24 hours

Just as a thoroughbred horse shouldn't pull a plow, a standard cell shouldn't be called on for routine chores. But with ever-higher accuracy levels in instruments, engineers often have no choice but to use their primary standards for calibration.

Standard cells may be getting a rest. General Resistance's new voltage source has an accuracy of

$\pm(0.0015\% + 3$ microvolts), good enough to calibrate most laboratory instruments. Called the DAS47AL, the source has thumbwheel switches for setting output, and delivers up to 30 milliamps.

The 47 is the newest member of the Dial-A-Source family, initiated by General Resistance two years ago. Aside from its value as a calibration source, the 47 can handle

the same jobs as the older Dial-A-Source, including delivering voltages to systems, acting as a digital-to-analog-converter reference, and performing reference tasks for stability checks.

The 47's rated stability is ± 5 parts per million per day and 15 ppm per year. The actual stability is even better, says Lloyd Silverman, the designer. In tests by

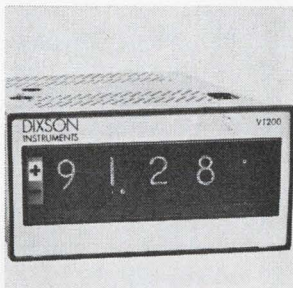

Full four-digit panel meter model VT200 offers either 10 μv or 10 na resolution. Accuracy is 0.05% of reading $\pm 0.05\%$ of full scale over the ranges of either 100 mv or 100 μa . Features include non-blinking display, automatic polarity, BCD logic output, automatic zero, and an internal calibration reference voltage. Dixon Inc., P.O. Box 1449, Grand Junction, Colo. 81501 [361]

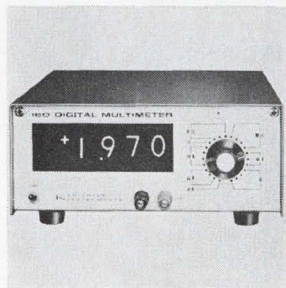

D-c multimeter model 160 is a $3\frac{1}{2}$ digit unit with a low-voltage sensitivity of 1 μv per digit. Circuitry is designed with a buffer amplifier at the front end instead of the input chopper found in many other meter circuits. This eliminates possibility of the instrument's affecting voltage being measured. Price is \$545. Keithley Instruments Inc., 28775 Aurora Rd., Cleveland [362]

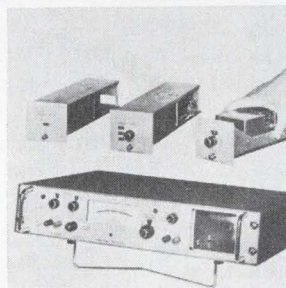

Phase angle voltmeter PAV-4C is a high impedance, isolated input unit with 60 hz to 20 khz frequency range. It measures in-phase, quadrature, and total voltages and measures phase angle between reference and signal inputs. Voltages from 300 μv to 300 v can be measured in 13 ranges. Singer Instrumentation Division, 3211 S. LaCienega Blvd., Los Angeles [363]

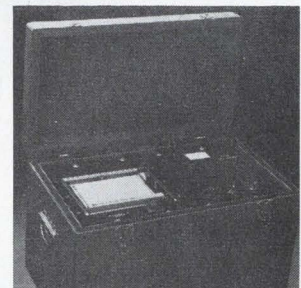

Wave recorder model Q-6 uses IC's throughout for high reliability. It supplies necessary sensor excitation voltage; contains a recorder, a programmer to control slow and fast recording modes, and calibration circuits; and has a cable resistance detector which reveals insulation breakdown or cable shorts. Bendix Marine Advisers Inc., 430 S. Cedros, Solana Beach, Calif. 92075 [364]

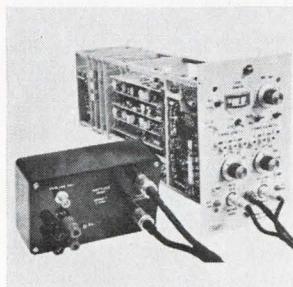

Impedance, admittance and transfer function meter, plug-in model 202-PA-2506, can make up to 400 discrete measurements per sec of both c-w and gated c-w signals. Frequency is 100 khz to 10 Mhz without band switching or adjustments. Impedance range is 1 to 10,000 ohms; admittance, 10 to 25,000 μmhos . Dranetz Engineering Laboratories Inc., North Ave., Plainfield, N.J. [365]

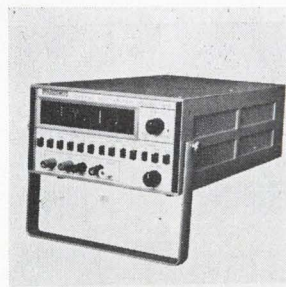

Dvm DM414 has 30 separate ranges/functions capability. It offers 4 digits plus 100% over-range; 6 ranges of d-c volts (1 μv sensitivity to 1,000 v); 7 ranges of resistances (4 wire Kelvin measurements from 1 milliohm to 10 megohms f-s); 6 ranges of d-c current (1 na/digit sensitivity to 1 amp). Price is \$795. Dynamics Corp., 9601 Canoga Ave., Chatsworth, Calif. [366]

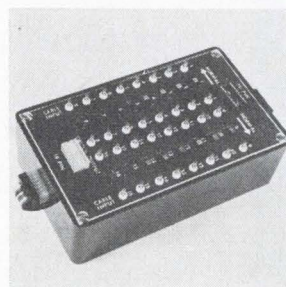

In-circuit digital isolation instrument ICS-100 not only provides component isolation but allows for monitoring of individual parameters. It allows digital engineers to remotely test a given dual-in-line IC. Easy testbox handling is assured by miniature construction (3.75 x 6.25 x 2.5 in.) and light weight (about 0.5 lb). Innovation Development Co., Box 7, Azusa, Calif. [367]

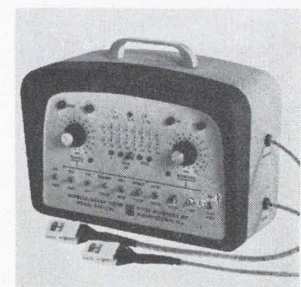

Module and array tester model 2030A is for go-no/go testing of on-board dual-in-line integrated circuits. It accommodates 14 or 16 pin IC's and supplies high and low frequency square waves, positive and negative 100 nsec pulses, and low repetition rate 100 nsec pulse trains. Price is \$425; delivery, three weeks. Pulse Monitors Inc., 351 New Albany Rd., Moorestown, N.J. [368]

HANSEN'S NEW 900 SERIES

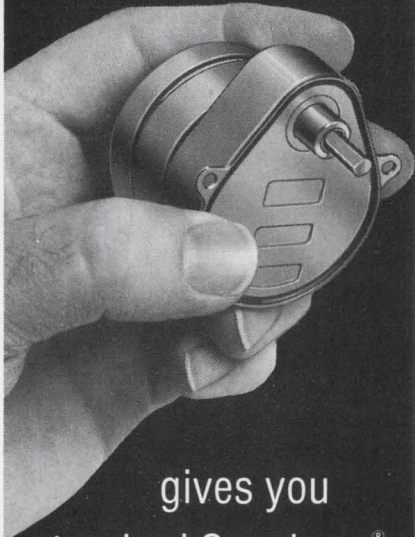

gives you
standard Synchron®
reliability with up
to 98 oz.-in. torque

Now, without sacrificing compact size, you can get high torque even at higher speeds—from 1 to 900 RPM. Synchron® 900 Series has thick, wide gears, specially designed to give the added gear strength that makes full use of its power increase. Highest quality instrument gear train for all speeds below 900 RPM.

The new self-starting hysteresis motor has positive direction of rotation—right or left hand. Plus extra heavy phenolic first gear for low noise level. It can be stalled continuously without electrical or mechanical damage.

Added strength in both the rotor and gear train enables 900 Series to handle your toughest timing and control jobs. Because of its compact dimensions, it is often interchangeable with motors of lower torque. To find out what 900 SERIES can do for you, write or phone today to have a representative contact you.

Visit Booth No. 320
Design Engineering Show.



HANSEN MFG. CO., INC.
Princeton, Indiana 47570

HANSEN REPRESENTATIVES: CAREY & ASSOCIATES, Houston and Dallas, Texas; R. S. HOPKINS CO., Sherman Oaks, Calif.; MELCHIOR ASSOCIATES, INC., San Carlos, Calif.; THE FROMM CO., Elmwood Park, Ill.; JOHN ORR ASSOCIATES, Grand Rapids, Mich.; H. C. JOHNSON AGENCY, INC., Rochester, N.Y.; WINSLOW ELECTRIC CO., Essex, Conn.; Vilanova, Pa., and New York, N.Y.

EXPORT DEPARTMENT: 2200 Shames Drive, Westbury, N.Y. 11590

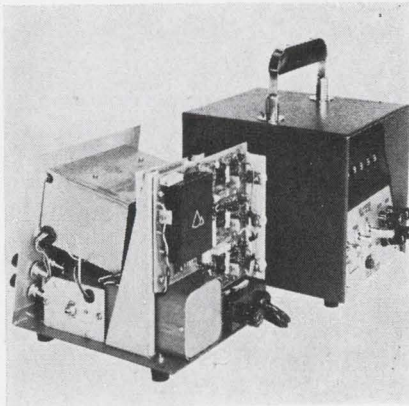

High current. With its op amp output, the 47 delivers up to 30 ma.

a major computer maker, the 47 showed short-term stability of 1 ppm, he says.

One reason the 47 is versatile is its range—0.1 μ v to 10 volts. In addition, output isolation is 1,000 megohms and its temperature coefficient is 0.5 ppm per degree centigrade.

Like the older Dial-A-Source, the 47 has three main parts—a reference built around a zener diode, a Kelvin Varley divider, and an operational amplifier at the output.

To reduce noise in the 47's reference output, new zeners were used. The 47 has two 6-volt zeners, instead of one 11-volt unit. Each of the new diodes has a larger junction area, and hence generates less noise, than the older 11-volt device.

Delivery time for the 47 is 30 days. Price is \$1,190.

General Resistance, 500 Nuber Ave., Mount Vernon, N.Y. 10550 [369]

New instruments

Synthesizer sheds spurious signals

Phase-locked loop
in programable source
keeps noise 70 db down

Plenty of customer feedback went into Monsanto Electronic Instruments' new frequency synthesizer, the 310B. According to Hirsh

Marantz, engineering manager in charge of signal sources, some users of Monsanto's older synthesizer, the 3100A, reported that its signal wasn't clean enough for their applications; the spurious content of the 3100A's output is 50 decibels below the fundamental. In response, Marantz and his engineers put into the 310B a phase-locked loop that keeps the spurious signal level 70db down.

Marantz points out that this approach has a number of side benefits. The 310B always delivers a signal, even when the output's frequency is being changed. In addition, this output has an "almost constant" amplitude during switching. The amplitude is adjustable in 10-decibels-above-1-milliwatt steps from -70 dbm to 2.23 dbm.

Another happy effect is that the phase-lock oscillator's output is available at the front panel. This satisfies customers who asked for an offset frequency.

The results of phase locking aren't all to the good. Decreasing spurious signals means increasing switching time. In the 310B it takes 300 milliseconds to go from one frequency to another. However the user can opt for a spurious level of -40 db in exchange for a switching time of 20 microseconds.

In most respects the 310B resembles the 3100A. The maximum frequency is 1,299,999.99 hertz and the output's harmonic content is -40 db. Binary-coded decimal signals can control the 310B, with 0.3 volt to -3.6 volts acting as "1" and 1.0 volt to 3.6 volts as a "0." An internal generator can sweep the output's frequency over a decade at a rate of either 1 hz or 100 hz.

One thing that the new synthesizer doesn't share with the older unit is serial numbers. Why does Monsanto call its new source the 310B, and not the 3100B? According to Marantz, it's the 3100A that was misnamed. Four-digit serial numbers at Monsanto are supposed to be reserved for plug-in units.

The new synthesizer is the same size as the 3100A—5¼ by 16¾ by 16¾ inches—and the same weight -35 pounds. The price, though, is \$1,000 heavier; the 310B goes for \$4,950.

Monsanto Electronic Instruments, 620 Passaic Ave., West Caldwell, N.J. 07006 [370]

"Government contracting for the engineering executive."

In the 1970's, technical expertise is no guarantee of success in the government marketplace. Technical executives are also being measured by what they contribute to cost reduction and profit. As a result, an increasing number of contract terms, clauses and regulations now affect the technical performance of the contract.

In recognition of these demands and their impact on executive time, the Electronics/Management Center has developed a two-day seminar program designed to provide the engineering and production executive with an understanding of government contracts as they relate to the execution of his job responsibilities.

This seminar is designed to lead the defense and aerospace executive through the maze of contractual legalese. Our professional staff of experts will translate the substantive portions of the long and detailed regulatory information into a useful body of everyday working knowledge. The seminar faculty will be composed of consultants from Peat, Marwick, Mitchell & Co. with broad experience in government contracts. In addition, the personnel of Peat, Marwick, Mitchell & Co. will be joined by a prominent attorney, who is a member of the New York Bar and graduate engineer.

The combined skills of the teaching faculty represents a wide range of practical experience and developed skills in the defense and aerospace industry.

The seminar program will consist of the following five sessions:

I. The basic contract. This portion of the program will provide a general description of the various types of contracts and reasons for their use. Also contract goals vs. absolute

performance requirements; the interpretation of ambiguities and discrepancies; differences between plans and specifications.

II. Contract changes. Under this section the following topics will be fully discussed: The changes clause; technical assessment of the change to determine the most appropriate method of recovery; inspection and acceptance; constructive changes; cardinal changes; responsibility of performance; identification and acceptance of the change; change control procedures.

III. Defective pricing.

Recent legal decisions have increased the

responsibility of the contractor's engineering and production personnel in defending the defective pricing claims made by the Government. An explanation of the statute and its implementation will be given together with the technical responsibility in the preparation of the quotation; identification of relevant data and submission of data.

IV. Warranty and correction of deficiencies. This section will discuss how changes in the warranty clause and the correction of deficiencies clause have significantly increased the importance of the role of engineering management. The financial responsibility which must be assumed will also be explained.

V. Terminations. Engineering management's participation in a terminations claim is essential to prevent financial loss. Coverage will be given to the following subjects: suspension of work; termination for default; termination for convenience; effect of excusable delays; effect of legal, economic, technical impossibility of performance; termination of subcontracts; the termination settlement.



An
Electronics
Management Center
seminar.

Register me for the management seminar on government contracting for the engineering executive. I plan to attend at:

- New York: May 11-12, New York Hilton.
- Newport Beach, Calif.: June 15-16, The Newporter Inn.

I enclose my check for \$250 for registration which includes all sessions, two luncheons, reception, and a copy of the seminar reference text book

You must make your own hotel reservations. When contacting the hotel, identify yourself as a seminar registrant. Mail registration and make checks payable to:

**Electronics/Management Center
330 West 42 Street
New York, N.Y. 10036**

Cancellations received later than one week prior to date of seminar are subject to a \$25 charge.

Name _____

Title _____

Company _____

Address _____

City & state _____

Zip _____

Bell & Howell Makes The Best Hybrid Operational Amplifiers

All the physical features, parameters and characteristics that are vital to the packaging and performance of op amps in your circuitry are built into Bell & Howell hybrid op amps. Every model is engineered for optimal balance between performance, size and cost — and offer these major features:

- Offset, trimmed, No Pot Required
- Choice of Bipolar or FET input
- Small, Compact Size (0.6" x 0.6" x 0.25") Epoxy & TO-8
- Hermetically & Plastic Packaged
- MIL & Commercial Temperature Range
- Input and Output Fully Protected
- Frequency Compensated
- Temperature Cycled for User Stability
- 100% Electrical Test Critical Parameters
- Test Documentation Available

		SPECIFICATIONS: MEDIUM GRADE PRODUCT					
		20-007	20-247	20-107	20-008	20-248	20-108
Voltage offset	max.	.2mv	.2mv	.2mv	1mv	1mv	1mv
Thermal rate	max.	5 μ v/°C	5 μ v/°C	5 μ v/°C	25 μ v/°C	25 μ v/°C	25 μ v/°C
Input bias current	max.	150na	100na	150na	5pa	5pa	5pa
Common mode rejection	typ.	100db	100db	100db	80db	80db	80db
Open Loop Gain (at 10 kHz)	min.	2,000v/v	2,000v/v	2,000v/v	1,500v/v	1,500v/v	1,500v/v
Output current	min.	\pm 5ma	\pm 5ma	\pm 5ma	\pm 5ma	\pm 5ma	\pm 5ma
Price (in quantities of 100)		\$16.00	\$24.00	\$16.00	\$29.00	\$51.00	\$29.00

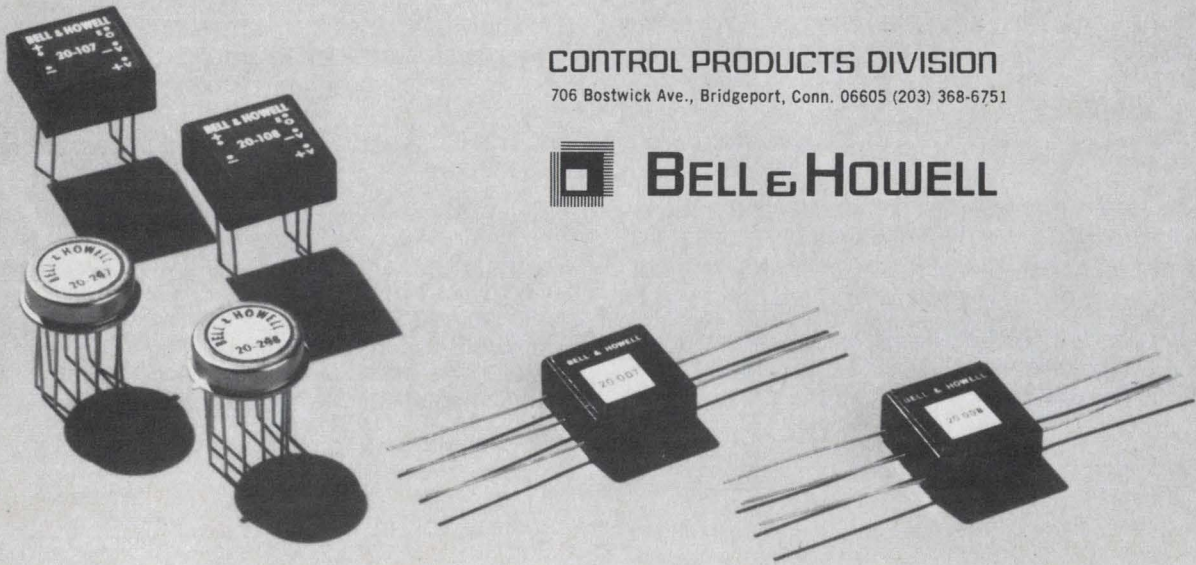

CONTROL PRODUCTS DIVISION
706 Bostwick Ave., Bridgeport, Conn. 06605 (203) 368-6751



Low-cost alphanumeric terminal prints all

It transmits or receives full 128-character ASCII code at a rate corresponding to a 110-bit-per-second bandwidth; printer has 5-by-9-dot matrix

A data transmission terminal that is capable of handling full alphanumeric data, prints out all its transmissions, and can replace the most widely used teleprinter, plug for plug, yet sells for less than \$2,000, is shortly to be made available by Transcom Inc., a subsidiary of Hi-G Corp. While the terminal's engineering design is complete, Transcom is still investigating the

market to determine what minor features should be included, perhaps as options, before formally announcing the terminal.

The new terminal, called the CT-264, connects to a telephone line with the standard Bell System modem, so that another terminal at the other end of the line sees it as a Model 33 Teletype machine. It can either transmit or receive

the full 128-character set of the American Standard Code for Information Interchange (ASCII), at a 10-character-per-second clip. Since each character consists of 11 bits, including a parity bit and asynchronous start and stop pulses, the character rate corresponds to a 110-bit-per-second bandwidth. Actually, the terminal is capable of more than twice that

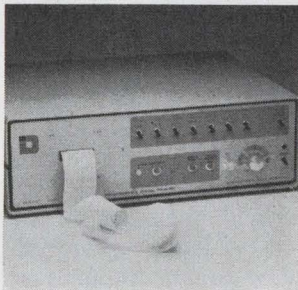

Newly-designed programable digital printer model 2000 can provide the entire history of an on-line test for extended periods of unattended operation from start of test in hours and minutes and a code to indicate what event occurred to cause each print. The unit features simplicity of operation. International Data Sciences Inc., 100 Nashua St., Providence, R.I. 02904 [421]

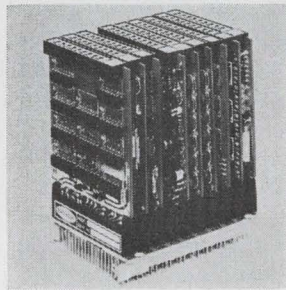

Data acquisition instrument designated Mod F Miniverter offers a throughput rate of 100 khz. It is a 12-bit analog-to-digital converter with sample-and-hold capability and 16 channels of multiplexing. It also contains controls for interfacing with digital processors or control systems. Price is \$1,950. Raytheon Computer, 2700 S. Fairview St., Santa Ana, Calif. 92704 [422]

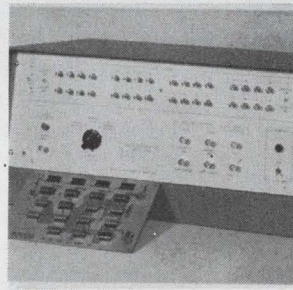

Data word generator model DG-32 is a two-channel, 16-bit-per-channel unit using TTL/DTL medium scale IC's throughout. Data rates of 10 Mhz or faster are typical. Clocking is done externally, utilizing a positive pulse of 3 to 5 v or a sine wave of 5 v p-p, of the frequency desired. Price is less than \$1,500. North American Systems Inc., 383 Putnam Ave., Hamden, Conn. 06514 [423]



D/A converter series DAC-HB features hybrid thick film construction, small size (1.5 x 2 x 0.4 in.), 12 binary bit resolution, fast output settling time (5 μ sec), and low cost (\$65). The output slews at 100 nsec/v and can be either bipolar (± 5 v at 5 ma) or unipolar (± 10 v at 10 ma). Operating temperature range is 0° to 70° C. Datel Corp., 943 Turnpike St., Canton, Mass. [424]

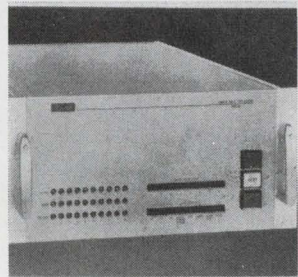

Time division multiplexer TM-8 can service simultaneously up to 8 terminals of intermixed data speeds from 1,200 bits per sec to 4,800 bps. It operates in conjunction with the AE-96 9,600 bps voice band modem. Features include the capability to interface to switched network modems like the Western Electric 202C. Codex Corp., 150 Coolidge Ave., Watertown, Mass. [425]



Desktop crt display terminal can display 1,760 characters on 32 lines of 55 characters each or 1,920 characters on 24 lines of 80 characters each. Screen size is 9 in. or 12 in. tv monitor. Character repertoire is 64 standard ASCII upper case alpha, numerics, special characters or 96 standard ASCII characters excluding only lower case. Hazeltine Corp., Little Neck, N.Y. [426]

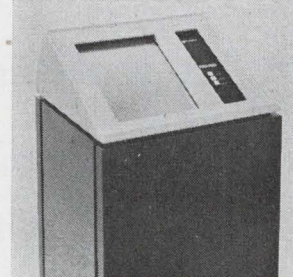

Hard copy output peripheral devices in Matrix series use a non-impact (electrostatic) printing technique. High quality records, silent operation, speed and flexibility in printing both graphics and alphanumerics, and operating reliability are offered. The products are for use with mini- and midi-computers, and crt terminals. Versatec, 10100 Bubb Rd., Cupertino, Calif. [427]

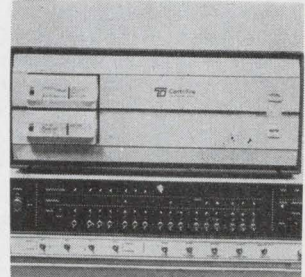

Nova computers can sort, match, collate and merge data when fitted with CartriFile 4096 digital magnetic tape system. The system is cartridge-loaded and combines four magnetic tape transports and controller in a single unit. A software package included in the \$6,400 price provides block read/write and interrupt response. Tri-Data, 800 Maude Ave., Mtn. View, Calif. [428]

Send us your precious metal scrap...

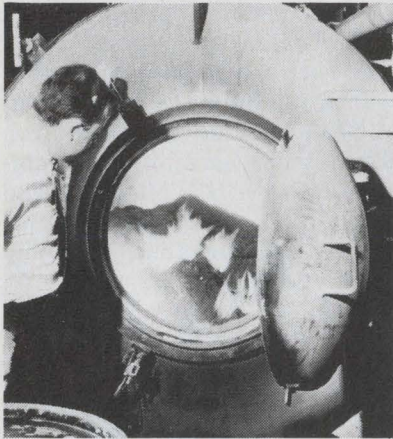

we'll treat it as if it were our own.

At Handy & Harman we have been refining our own scrap for a century. We'll treat yours as we treat ours. Which means refining in big, modern electric furnaces—no frequent refilling . . . precise temperature control to minimize flue loss . . . streamlined removal without entrapment. And we have a lot of careful techniques for sampling your shipment, too.

Little things? Yes, little careful things that add up fast in today's precious metals market. We have a booklet that's concerned with where to find precious metal scrap, and how to get the last pennyweight out of it. Please send the coupon for your copy.

*Please send your booklet
about precious metal scrap.*

Name _____

Title _____

Company _____

Address _____

City _____

State _____ Zip _____

HANDY & HARMAN
850 Third Avenue, Dept. EL15,
New York, N.Y. 10022



speed, but it is limited by the standard Bell interface.

The present version of the terminal has a typewriter keyboard as its input medium. A paper-tape reader is being developed to connect with it; and the company is considering putting a plug on the machine through which to connect other devices reading or writing in ASCII.

The CT-264 is the latest of a line of Transcom terminals, all of which have a strip printer that generates instant hard copy of all data transmitted or received. The printer is a spark-discharge device that makes small round dots on special conductive papertape. Each character is printed as an array of dots from a 5-by-7 matrix.

Essentially the same printer mechanism is used in the CT-264, with one modification: the dot matrix is 5 by 9. By this means, characters slightly above and below the line can be printed, as in chemical or physical formulas.

This feature also gives the CT-264 one capability not shared by the earlier machines. When they received a Teletype control signal such as carriage return or line feed, they would ignore it; such signals are meaningless to a strip printer. Other control signals, such as end of transmission, would be obeyed; but no control signal appeared on the printed tape. The new terminal prints everything it receives, whether it can react to a command or not. This is an important aid in troubleshooting.

Transcom Inc., 12 Tobey Road, Bloomfield, Conn. 06002 [429]

Data handling

ROM expands throughput

Modular system can operate
either as remote terminal
or as stand-alone computer

Although the programmer is indispensable to any data-processing system, his responsibility for get-

ting information into and out of a computer system is lessened considerably when much of the burden is put on the computer itself. This is what Hetra Corp. has done with its S-series data-processing systems. The result is a much improved throughput capability and ease in handling.

The key to flexibility is in a read-only control memory that stores 3,000 16-bit words.

Many of the instructions that would ordinarily appear in the software package are wired in on logic cards as microprograms that execute data transfer and character and data manipulation faster than programmed instructions that are entered separately. The ROM, however, does require a great deal of hardware—13 logic cards—more than half of the total in the system's processor. Nevertheless, Hetra gets compactness and low cost by employing medium-scale integrated circuits throughout. Furthermore, the system, which is built with Fairchild 9,000-series transistor-transistor-logic gates, operates with a 15-megahertz clock.

To alter the firmware, any of the ROM cards can be replaced with others, or individual diodes on the cards can be added or removed. Thus the ROM can be programmed for any of a variety of functions. Moreover, the ROM can be used to expand Hetra's smallest system, the S/I minicomputer, into larger units—the S/II and the S/III—with faster throughput rates.

Up to four processor units can be connected to a central processor; their individual read-only memories cause them to act as input-output controllers for peripheral devices. Each of these processors is identical except for its read-only memory; the number of processors and the particular collection of peripheral devices define whether a particular system is S/I, S/II, or S/III. The additional input-output devices can obtain access to the main memory through these controllers, or processors, under the control of the ROM. And when a multichannel adapter is used, a number of input-output channels can have simultaneous access to the main memory.

Half the price. Engineers at Hetra, comparing their models with similar-sized IBM types, claim that the S/I reads cards and prints out

One part, four metals. Brazing?

Handy & Harman, leader in brazing for 35 years, will tell you when not to braze. We know the limitations of brazing.

We also know the limitations of soldering, welding, mechanical fastening, and adhesives.

The Materials Age seldom allows the design engineer time to bone up on all the limitations, however.

The designer may very well suspect, for instance, that brazing is appropriate to a fabrication on the board. Handy & Harman stands ready to offer counsel. We can start out clearing up uncertainties right here by listing some brief guidelines on When to Consider Brazing, beginning with the illustrated dilemma:

When joining dissimilar metals. Our range of filler metals allows for imaginative metallurgical mixes.

When leaktight joints are desired. Also vibration and thermal shock resistant ones. Aerospace brazed joints have experienced 1500° F and -300° F, same trip.

When joining conductive assemblies. The very thin (.002" or so) layer of brazing metal alloy causes very little increase in resistance.

When appearance is important. Neat, platable without preparation, often color-matchable joints.

When the atmosphere is corrosive. The joint line is narrow, and many of the alloy metals are noble.

When economy prevails. A few to do? Quick and easy with a torch. A million? Automate.

Less obvious economy: many metal parts are better fabricated as brazed assemblies. You add the cost of brazing, and subtract a lot of forming, machining and materials charges. Instances abound. Look around.

And we will be happy to help you look. Please write if you want to know more about the limitations—and the advantages—of brazing. Just ask us.



Naturally, you'll ask Handy & Harman

about the possibilities of brazing.

Application: _____

Name _____ Title _____

Company _____

Address _____

City _____

State _____ Zip _____

Send to: Handy & Harman, 850 Third Avenue, Dept. EL10, New York, New York 10022



When you need electronic equipment, you need PMC.



We have what it takes to solve problems for any electronic system: automatic solid state test systems; power type test equipment; digital control test consoles; automatic process controls; you name it. We're equipped to handle complete assignments, including design, engineering, manufacturing, testing and value engineering.

Just hand us the specifications, and let PMC solve your problem. Partial assembly, small units, prototypes, up to an entire package. Call or write today.

PMC Designing, Inc.

A subsidiary of Possis Machine Corporation

1832 Amberlawn Avenue, Cincinnati, Ohio 45237

Tel: (513) 761-8010

Total service for the electronics industry

Circle 170 on reader service card

Everything's clearer with the flat one!

Letters! Digits! Symbols! Equations! All varieties of data are displayed as undistorted images on Zenith Flat-Face Metal CRTs. Ideal for light pen operations, alphanumerics and analog presentations — they're even available with a rear port for optical chart projection. When you need CRTs, face up to the flat one. Write for details.

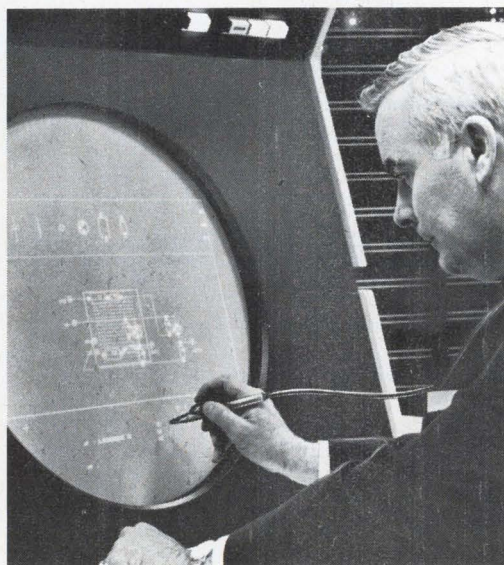

ZENITH RADIO CORPORATION
THE RAULAND DIVISION

5614 W. JARVIS AVE. • CHICAGO, ILL. 60648 • 312-647-8000

152 Circle 152 on reader service card

data faster than the System 3, but costs only \$22,000—compared to \$44,000 for a System 3. And the S/III can handle 400 cards per minute, and print 600 lines per minute with a memory cycle time of 1 microsecond. The IBM 360/20 can do the same—but has a memory cycle time of 3.6 μ sec.

The basic S-series stand-alone unit consists of a tape cassette input, a central processor with a 4,096-byte memory, a high-speed printer, and external disk storage. The unit can also be bought as a terminal for a remote batch-proc-

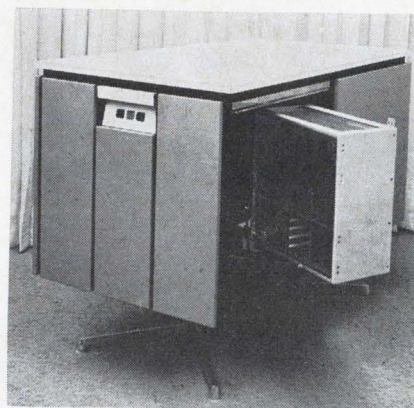

Compatible. The Series 200 processor is designed to interface easily with special-purpose equipment.

essing system or as an entry device in a time-shared system for as low as \$10,500.

Core storage can be expanded to 65,563 bytes, and storage modules are available with cycle times as short as 750 nanoseconds. The ROM can be expanded up to 8,192 words. In addition to the main memory, a scratchpad memory with a 50-nsec cycle time is included, along with four input-output data channels and one eight-level priority interrupt channel.

The processor can handle various kinds of data fields: fixed-length binary and decimal fields of up to 16 and 32 bytes, respectively; and fixed- or variable-length character fields up to 256 bytes in length. The field lengths are defined in the firmware. Operands in fields of different lengths are also automatically adjusted to one another by firmware instructions.

Hetra Corp., P.O. Box 970, Melbourne, Fla. 32901 [430]

Electronics | April 27, 1970

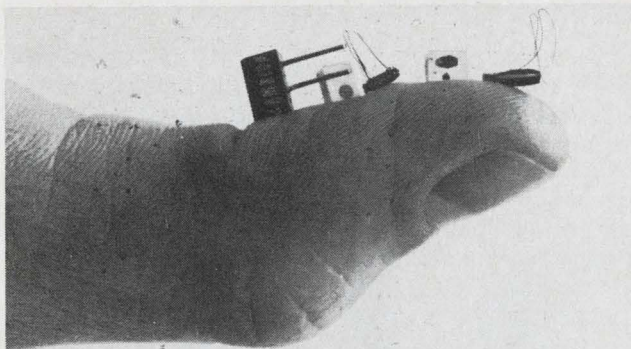

new micro-miniature inductors break price and space barrier

For the first time, ultra-miniaturization hasn't resulted in price escalation. In fact, the new Cambion micro-miniature inductors are competitive with much larger conventional units in terms of price. In terms of size, there's no comparison.

Designed to keep pace with the shrinking area of modern electronic (thick and thin film) circuitry, Cambion's new micro size inductors span the range of values from .06 to 10,000 uH, have excellent Q readings for such tiny packages, and come either fixed or variable.

And, best of all, they're available as standards (as are all Cambion inductors) - you can get more of the same, with known operating characteristics, fast (they're stock items). We've devoted one whole issue of our Product News to describing them. We'll send you a copy, if you'll send us your name. Cambridge Thermionic Corporation, 445 Concord Avenue, Cambridge, Mass. 02138.

Standardize on

CAMBION®
The Guaranteed Electronic Components

Circle 171 on reader service card

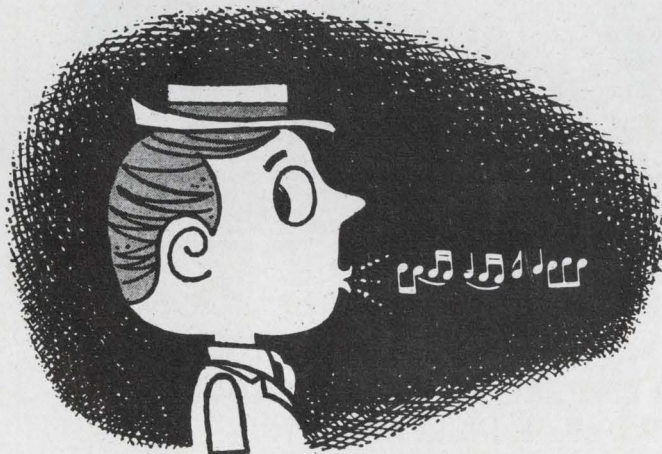

YOU'RE WHISTLING IN THE DARK...

if you think that heart disease and stroke
hit only the other fellow's family.

**GIVE ... so more will live
HEART FUND** 

Contributed by the Publisher

The Clary SP20 Printer— a guaranteed delivery system for people who sell information.

If you're selling information, you probably don't get paid until it's delivered. You may have the same problem if you're making and selling information systems. You want data delivered reliably, day in and day out.

The Clary SP20 Digital Strip Printer is made for that kind of service. It prints 64 alphanumeric characters at 20 per second on pressure sensitive paper, and it carries a 5000-hour MTBF and two-year warranty.

The drive motor and the printer mechanism are on the same shaft, so there's no troublesome linkage to cause phase problems. If you must adjust phase because of line voltage variations, it can be done right on your customer's desk.

A unique self-test feature quickly confirms printer integrity and helps pinpoint any fault that may be further upstream. Other features include ease of switching codes (e.g., from ASCII to Baudot) in the field, and unusually simple interface.

If major service is needed, Clary provides it from 14 offices around the country. With other printers, you ship the unit to the home office and wait.

The SP20 is \$995 with power supply; \$895 without. Both versions are substantially less in quantity.

Complete specs, delivery information and a demonstration are yours by calling or writing for Data File SP-E-4.

Clary...the printer people

CLARY CORPORATION • PRECISION INSTRUMENT DIVISION
320 W. Clary Avenue, San Gabriel,
California 91776 • (213) 287-6111



THUMBWHEEL SWITCHES

"PANEL-MITE"
"MINI-MITE"

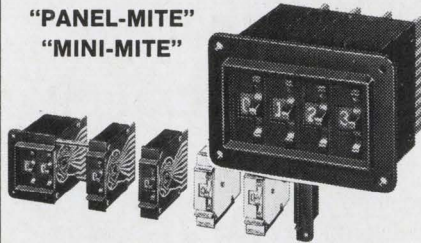

Compact, molded printed-circuit switches for limited space and in-line readout. Modular type for front or back panel mounting. $\frac{1}{2}$ " between center lines, 1" or 2" height binary or decimal codes with adjustable stops available.

STEPPING SWITCHES

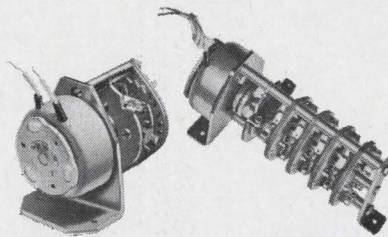

TECH LABS switches are now standard equipment in missiles as well as in ground controls. Furnished sealed to meet all specs. Solenoid and motor driven models.

ATTENUATORS

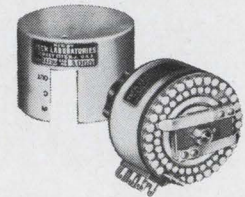

A complete line of audio and r.f. attenuators with both manual and REMOTE CONTROL. We will design components to meet your specific requirements, if standard units are inadequate. Please write for catalogue and send us your specs for estimate.

Switch to TECH LABS INC.

FOUNDED 1935

for the most versatile line of precision switches & attenuators

WRITE FOR NEW BULLETINS ON SWITCHES • DECADE RESISTORS • POTENTIOMETERS

Palisades Park, New Jersey

These switches are representative of the many types produced by TECH LABS meeting applicable Government Specs. Wire or teletype for further information. TEL: 201-944-2221 TWX: 201-947-4730

TAP SWITCHES

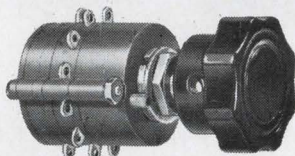

TYPE 3A MINIATURE TAP SWITCH
Molded from Diallyl Phthalate
Has adjustable stop

Specifications
Size: 1" diameter, $1\frac{1}{4}$ " with terminals. 1 deck, $1\frac{1}{16}$ " long. $\frac{1}{2}$ " for each additional deck.
Rating: 1200 volts rms, 2000 VDC, 5 amps. (carrying) 115 V.
Insulating resistance: 100 megohms minimum at 500 volts DC.
Life: 1.5—2 million revolutions.
Temperature range: -65°C to 100°C .
Mounting: single hole.

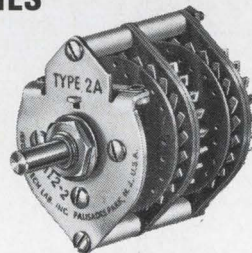

TYPE 2A & 2M

The Type 2A, a standard control switch for precision instruments and equipments, comes in 2-24 positions and 1-4 poles per deck, with phenolic insulation. The 2M is identical except for Melamine insulation. Both are rated for 3 AMP and have adjustable stops. Code "S" denotes "shorting" and "N" "non-shorting".

SQUARE SWITCHES

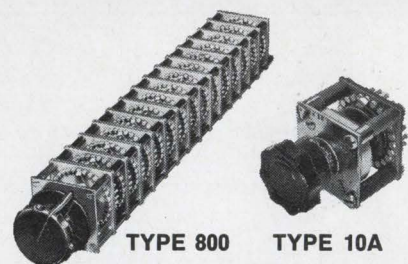

TYPE 800 TYPE 10A

Square switches from $1\frac{1}{8}$ " to 15" available from stock parts, as standards or assembled to your specifications. Adjustable stops available. Will meet all applicable government specs.

PROGRAMMING SWITCHES

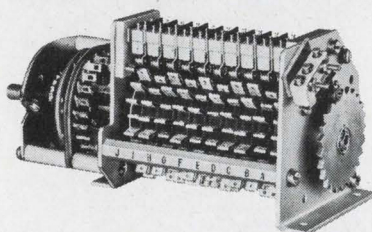

Adjustable programming switches, 24 or more positions. Available in MBB and BBM; manual, motor or solenoid driven. Contact ratings from dry circuit to 20 amps.

POWER CONTROL AND PACKET SWITCHES MILITARY & INDUSTRIAL TYPES

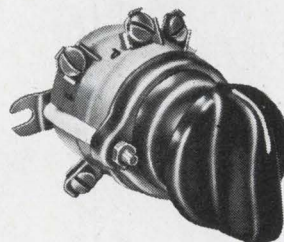

Heavy duty rotary snap-action switches from 10 to 200 amps. Built to withstand severe shocks without momentary interruption.

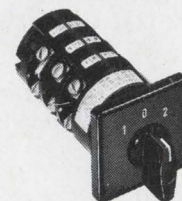

Power control switches for circuit breaking, motor control and transfer application. Current ratings of 10, 16, and 25 amps.

Low-light-level tube is supersensitive

Unit for tv camera jobs achieves brightness magnification of 150,000; rugged silicon-diode target withstands damage from light and heat

Improvements in sensitivity and ruggedness are speeding development of low-light-level tubes—particularly silicon-target types—for industrial and military jobs.

Fast on the heels of the Tivicon [*Electronics*, March 16, p. 150] comes the product unveiling of RCA's silicon intensifier tube.

With its single intensification stage, the SIT can achieve a bright-

ness magnification of 150,000 without loss of definition in detail. The tube exhibits 200-tv-line resolution at 5×10^{-7} foot-candles, a light level comparable to overcast starlight conditions.

Another development is the tube's inherent ruggedness and ability to withstand high-intensity light sources. Westinghouse, which supplies the secondary electron

conduction camera for the moon-walks, had to develop a wire mesh to guard the camera's target after most of the target burned out from exposure to the sun's rays or their reflection from the spacecraft on the Apollo 12 mission.

The SIT camera tube consists of a vidicon-type scanning electron gun and image intensifier section separated by a special silicon tar-



Broadband, untuned, power amplifier model 310L can provide over 10 w of r-f power output from 250 khz to 100 Mhz. Its flat 50 db gain permits it to be driven to its full power output by all signal and sweep generators. Useful power output is available up to 150 Mhz at reduced gain. Price is \$1,295. Electronic Navigation Industries Inc., 1337 Main St. East, Rochester, N.Y. [381]

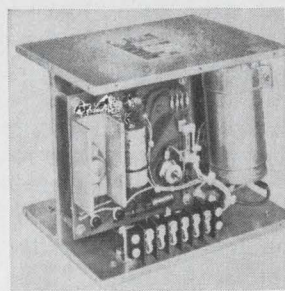

Low-cost power supply model LIC5-20A has been designed to power approximately 500 IC's, and will deliver 5 v d-c at 20 amps. Line and load regulation is held to ± 25 mv maximum, with ripple and noise held to 10 mv rms max. After warm-up stability is ± 5 mv, operating range from -20° to $+85^\circ$ C. Elasco-Eastern Inc., 5 Northwood Rd., Bloomfield, Conn. 06002 [382]

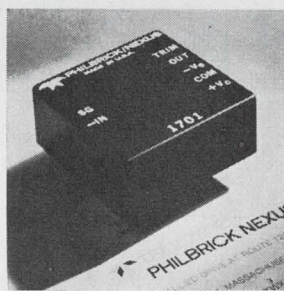

Chopper-stabilized operational amplifier model 1701 combines low voltage drift ($0.1 \mu\text{v}/^\circ\text{C}$, -25° to $+85^\circ$ C), low input bias current (± 50 pa max.), low flicker noise ($1 \mu\text{v}$ p-p), and a choice of power supply operation from ± 8 v to ± 20 v. Guaranteed open-loop gain is 10^7 . Price (100 lots) is \$49 each. Teledyne Philbrick Nexus, Allied Dr. at Route 128, Dedham, Mass. 02026 [383]

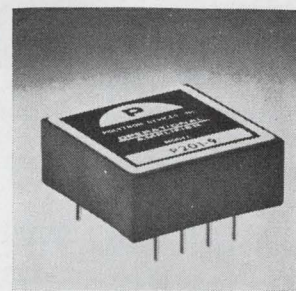

FET operational amplifier model P201-7 is an internally compensated unit designed for use in integrators, buffers and general purpose applications. It is especially useful in applications requiring high input impedance (10^{12} ohms) and low bias current (5 pa). It measures $1.12 \times 1.12 \times 0.45$ in. Price (1-9) is \$14.50. Polytron Devices Inc, 844 E. 25th St., Paterson, N.J. [384]

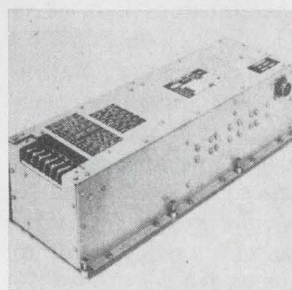

Modular-type multiple-output power supply model 23577 is designed for use in electronics fire control systems. Five outputs, ranging from 5 v d-c to 28 v d-c, are provided. The unit meets emi requirements of MIL-I-6181. It features plug-in circuit boards for each regulated output and IC's for space-saving reliability. Glentronics Inc., 748 E. Alosta Ave., Glendora, Calif. [385]

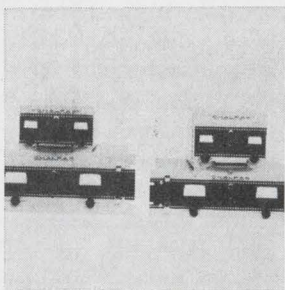

Regulated power supplies have outputs to 158 v, current to 125 amps, and power to 3.3 kw. They come in 5 in. and 7 in. high envelopes in both full and half-rack. Regulation is $\pm 0.005\% \pm 1$ mv line and load combined and the 25- μsec response time is for recovery within the regulation band for half load change. Chalco Engineering Corp., S. B'way, Gardena, Calif. [386]

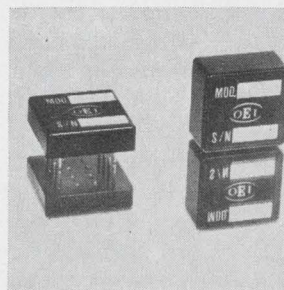

FET power operational amplifier model 9712 is packaged in the 1 in. square by 0.31 in. high module. Slewing rate is ± 200 v/ μsec . Open loop gain is 50 db minimum. Gain bandwidth product is 300 Mhz. Unit operates on ± 9 to ± 18 v power supply voltages. Price (10-29) is \$51 each; availability, immediate. Optical Electronics Inc., P.O. Box 11140, Tucson 85706 [387]

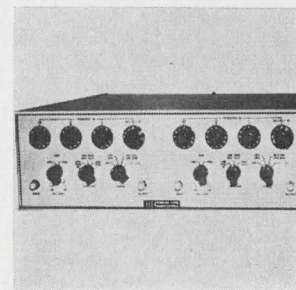

Dual-channel, multifunction variable filter model 3343 covers the frequency range of 0.01 hz to 99.9 khz. Each of the channels provides an attenuation slope of 48 db per octave which can be increased to 96 db per octave if both channels are operated in the same mode, set at the same cut-off frequency and cascaded. Krohn-Hite Corp., Massachusetts Ave., Cambridge, Mass. [388]



Cryogenic testing?

Emerson would have liked that.

Old Ralph Waldo said it: "Men love to wonder, and that is the seed of our science."

Well, if you're "sowing the seed of science" as far down as $-320^{\circ}\text{F}.$, NCG is the logical source for the industrial gases you'll need. Liquid nitrogen is only one of our cryogenic gases. We also reliably deliver argon and oxygen in liquid form. The distinct properties of each gas provides environmental control as well as precise low temperatures.

NCG supplies any quantity of these industrial gases—from cylinders to complete air separation plants. And we arrange a delivery schedule that assures a ready supply at all times. Write to us for detailed information.

NCG[®]

CHEMETRON CORPORATION
NATIONAL CYLINDER GAS DIVISION
840 North Michigan Avenue • Chicago, Illinois 60611

CHEMETRON
TRADEMARK

©1970, Chemetron Corporation

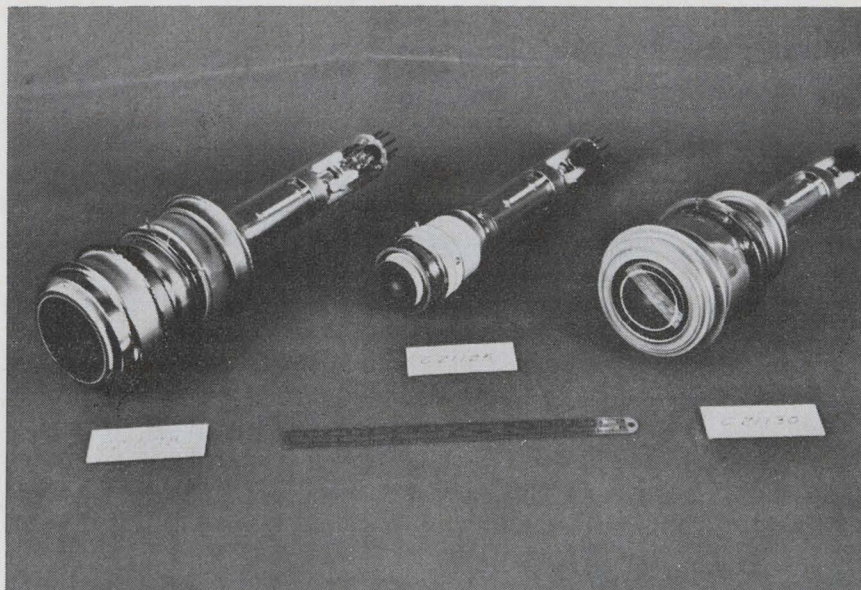

Sensitive family. With a diameter of 40 millimeters, the C2117C (left) exhibits the highest resolution among this SIT trio.

get. The target features an integrated circuit array of more than 600,000 p-n junction diodes. The image intensifier section converts the light at the scene into a flow of electrons that are greatly accelerated and imaged on the silicon target. This target provides the gain which results in the tube's high sensitivity at low light levels.

A key factor is the impact ionization-gain mechanism in the target when using electron imaging instead of light imaging. Photoelectrons from a photocathode in the front of the tube are imaged onto the silicon target after being accelerated through about 10 kilovolts in the image section.

Under a design technique first developed at Bell Telephone Laboratories, the target consists of a two-dimensional array of diodes formed in an n-type silicon wafer, made thin in the active region. A thicker rim provides mechanical strength. The diodes are positioned with the p-region of each diode facing the electron scanning beam. An insulator covers the exposed n-regions appearing between the p-regions to prevent the scanning beam from reaching the substrate. During operation, the diodes normally are reverse-biased. Each diode acts as a storage capacitor because of the insulating properties of the depletion layer.

The accelerated photoelectrons interact with the silicon, creating

a large number of hole-electron pairs for each primary electron. The holes diffuse to the depletion layer and discharge the storage capacitors, storing a charge pattern. The output signal is generated when the scanning beam passes over the capacitive elements and produces a displacement current during the recharging of each capacitor.

The current gain between the photoelectron current and the video output current is determined by the energy a photoelectron requires to make a hole-electron pair—3.5 electron volts for silicon. Primary resolution losses in the tube result in the image and scanning section. The amplitude response of a typical SIT tube is 30% at 400 tv lines. The figure dips to 10% at 600 lines while at 200 lines it is close to 70%.

At the normal target operating voltage of 8 volts, dark current is between 5 and 10 nanoamperes; from this target voltage maximum signal currents of 700-800 na can be obtained. The rise and decay curves show that the lag is comparable to other vidicons; lag is less than 5% in 50 milliseconds from a starting current of 500 na.

Although the SIT camera tube is currently aimed at special industrial and government needs, RCA hopes eventually to use it in color-tv broadcasting.

Clifford Lane, general manager of RCA's Industrial Tube division,

expects the military low-light-level television camera market to exceed \$5 million in 1970 and to surpass \$25 million by 1975. Lane foresees a variety of applications for the camera, from crime prevention and industrial surveillance to night navigation in ships and planes.

Three models, providing a choice of resolution, are available: type C21125, 16 millimeters in diameter; C21130, 24 mm; and C21117C, 40 mm.

The single-unit price is approximately \$15,000. However, the price is expected to drop to approximately \$5,000 each in production quantities.

The keenest competition to the SIT probably will come from the SEC tube. Westinghouse's protective wire mesh serves as the mechanical support for the aluminum oxide signal plate and low density potassium chloride layer in the SEC target. The standard tubes use an aluminum oxide film for mechanical support.

Since the thermal capacity of the mesh is much greater than that of the standard aluminum oxide support layer, the initial rate of temperature rise from exposure to light will be lower in the new target. The older models depended on radiation cooling to dissipate heat but large temperatures built up when the camera was suddenly exposed to intense light.

Just how well the new SEC tube can resist damage has not been ascertained. The new unit was not ready in time to be used in the latest Apollo launch except as a ground station camera in the gantry. The new protective device does not alter the tube's basic responses, nor the picture quality. But the photocathode voltage must be reduced to 2 kilovolts by a bleeder network, to maintain the same gain as the standard SEC tubes.

Westinghouse plans to keep its foot in the door of the silicon-target tubes market with soon-to-be-shown prototypes of silicon intensifier and silicon vidicon tubes. A feature of their new silicon family will be the complete interchangeability of sockets between the SIT's and the SEC's, with little or no modification.

RCA Electronic Components, Harrison, N.J. 07029 [389]

New materials

Sapphire attractive for optical, IC jobs

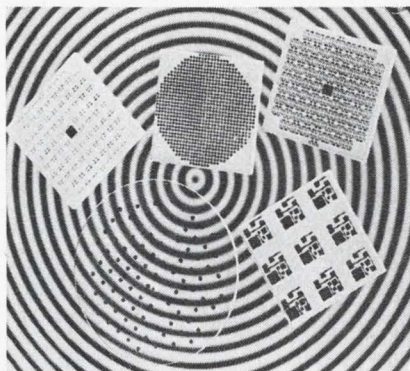

Synthetic white sapphire to 3 in. diameter by 8 in. long, and 2 1/4 in. diameter by 12 in. long, is available in production quantity. The large sizes of white sapphire can be produced in several crystallographic orientations. Major optical applications include precision IR elements and windows. Other new uses are three major classes of substrates for IC work. These include: beam lead substrate carrier plates for the Bell Telephone beam lead process currently in practice by several major IC manufacturers; the silicon-on-sapphire substrate process under development; and thin-film passive substrates for the demanding tantalum and silicon technologies. The material's dielectric properties make it attractive for microwave IC devices. Union Carbide Corp., Crystal Products Dept., San Diego, Calif. 92123 [401]

Eccocoat C-26 is a clear epoxy coating that maintains a surface resistivity of 10^{14} ohms/square up to temperatures as high as 500°F. It also has excellent environmental resistance and can be used successfully in locations where it may be exposed to solvents and high moisture. Suggested applications include coil or motor windings, p-c boards, circuit modules, and wherever a dielectric surface needs to be protected against moisture and solvents. The material sells for \$36.40 in a 13-lb. kit. Emerson & Cuming Inc., Canton, Mass. 02021 [402]

Teckstik is an easily installed emi-rfi shielding knitted wire mesh gasket with a fluid seal of neoprene or silicone rubber. The sponge elastomer, which is backed with a pressure-sensitive adhesive, is protected with a release paper until ready to apply. Resilient and conductive Teckstik is highly effective in eliminating radiated emissions at the joints in all types of emi/rfi tight enclosures, while at the same time sealing out fluids or retaining cooling air. Technical Wire Products Inc., Cranford, N.J. 07016 [403]

SCHAUER

1%

tolerance

1 WATT ZENERS ARE A REAL BUY!

ANY voltage from 2.0 to 16.0 at the industry's LOWEST PRICES!

Quantity	Price each
1-99	\$1.07
100-499	.97
500-999	.91
1000-4999	.86
5000 up	.82



THE HI-RELIABLE!

No fragile nail heads. Silicon junction aligned between two, parallel, offset tantalum heat sinks . . . great lead tension strength. All welded and brazed assembly. High pressure molded package. Gold plated nickel-clad copper leads.

Write or phone for Form 68-4 for complete rating data and other tolerance prices.

Semiconductor Division

SCHAUER MANUFACTURING CORP.

4514 Alpine Avenue
Cincinnati, O. 45242
Ph. (513) 791-3030

Time Sharing Makes Sense

**FOR EXPENSIVE
ELECTRONIC
INSTRUMENTS, TOO!**

RENTRONIX gives you ready access to sophisticated electronic instruments and small computers on a short-term rental basis. Choose from one of the largest, most modern name-brand pools of electronic equipment on the market. With Rentronix you pay only for the time you use the equipment.



FREE

48-page catalog covering hundreds of electronic instruments and small computers available for short-term rental.

Rentronix

A Division of Inmark, Inc.
11501 Huff Court
Kensington, Maryland 20795

New Books

Making microwaves meaningful

Microwave Theory and Applications
Stephan F. Adam
Prentice Hall, Inc.
513 pp., \$14

The microwave engineer finds himself in a broad frequency spectrum where elaborate measurement schemes are required to interpret the many properties of the signals he must analyze. In the past, he has had to turn to specialized periodicals, old college textbooks, and commercial equipment manuals to set up and carry out his measurements, and to interpret them. But this book should be a boon to the microwave engineer.

Drawing upon the author's seven years of teaching experience and the knowhow of a company strong in microwave measurements—Hewlett Packard—the book covers transmission line theory, basic principles, laboratory signal sources, signal analysis, and network analysis. Waveforms are well represented, both in drawing and photograph, as are block diagrams and flow charts. Test setups are presented in step-by-step form and many common measurement errors are described, as are measures to correct them.

The chapter on signal analysis will be of particular interest to engineers who spend time in the laboratory since it deals with power and frequency measurement. The latter is treated by investigating resonant circuits, coupling mechanisms, wavemeters, and slotted lines. Swept and fixed-frequency techniques are covered in detail. But the section on spectrum analysis probably will find the widest readership—it deals with both theory and applications.

The major characteristics of the spectrum analyzer, such as tuning, resolution, and sensitivity, are presented with reference to curves and diagrams. Input waveforms are seen with their corresponding analyzer displays. And common errors, such as base line lifting, pulse desensitization, and sensitivity versus envelope resolution, are clearly explained. Error interpretation and error correction are

detailed by means of equations and diagrams. The section on applications of spectrum analysis employs oscilloscope photographs to display actual situations; the pre-selector section covers many typical modulation and distortion signals.

Radio-frequency interference measurements using the spectrum analyzer also are detailed, with particular reference to Mil-Std-826A. Five RFI tests ranging from 14 kilohertz to 10 gigahertz, are presented step-by-step with block diagrams emphasized.

The remainder of the chapter concerns itself with power measurements using various techniques. The bolometer, thermistor, and calorimeter are discussed, and particular attention is given to the types of mounts used, tuning methods, and error compensation. Peak and average power measurement methods are outlined with references to block diagrams and outline drawings.

Another important chapter deals with network analysis and is divided into three parts—scattering parameter measurements, time domain reflectometry, and noise figure measurements. For transmission measurements, particular attention is focused on attenuators. The various types are listed, while the many techniques used are put forth in detail. Among these are r-f, d-c, and i-f substitution; swept and fixed frequency approaches are described.

The section on impedance measurement deals with standing wave ratios, slotted lines, Smith charts, reflectometers, complex s-parameters, and network analyzer systems. A computerized automatic network analyzer is described through flow graphs, photographs, and block diagrams.

The chapter is concluded with a treatise on noise measurements. The methods described vary from the signal generator power meter technique to the excess noise source approach. Cascaded networks are analyzed and accuracy considerations are detailed.

In the chapter on laboratory sources for microwave signal gen-

eration, the devices covered range from the older triode oscillator to the new Gunn diode oscillator. Aside from going into detail on travelling wave tube amplifiers, klystrons, and backward wave oscillators, the chapter covers p-i-n diode modulators, harmonic generators, frequency multipliers, and signal source leveling. Also described are signal generators, sweep oscillators, phase locking of signal sources, and frequency standards. Tunnel diode amplifiers, yig tuned oscillators, and lasers also are covered.

The book is rounded out with a chapter on the principles of microwave measurements and one on transmission line theory. The former discusses signal detection and flow graph representations, while the latter deals with coaxial and waveguide transmission lines, and resonant cavities.

Government Reports

All these reports are available from the Clearinghouse for Federal Scientific and Technical Information (CFSTI), 528 Port Royal Rd., Springfield, Va. 22151. Price is \$3 for each hard copy, or 65 cents for each microfiche.

Design and development of an isotropic altimeter setting indicator AD 696 961 and AD 696 586

An altimeter indicator using a radioactive alpha particle emitter as the primary sensor has been built for future use and possible developmental work by the Federal Aviation Administration. Details of the system are described in this two-volume report.

Course line computer/pictorial display AD 696 575

Details modifications made on an FAA-owned display to improve its utility, reliability and accuracy. They included a new type display which permits the pilot to choose any scale map, ranging from 5-to-50 nautical miles per inch, by merely "dialing" a station and scale, and activating a reset button.

Study and evaluation of the Omega navigation system for transoceanic navigation by civil aviation AD 697 699

Identifies the system's error sources and evaluates their effect on the ability of an aircraft to maintain the desired flight track.

What Memory-System Maker Is Speeding Up the Cycle Time— But Holding Down the Price?

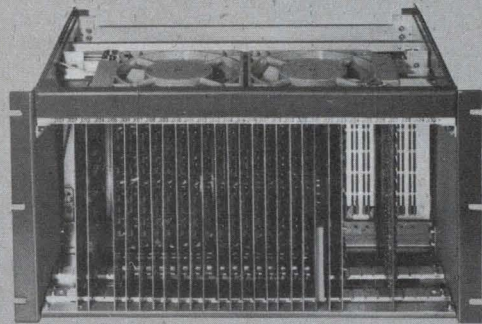

HS500R

Toko. Of course!

Beef up your technology with Toko's 500 nanoseconds Memory System without raising your costs.

Now rolling off the production line, Toko's HS500R Memory System offers the following key features:

- * Access time of 250ns. * Memory capacity of 4K words by 18 bits expandable to 16K words by 18 bits, rearrangeable to multiples of 36 and 72 bits.
- * Compact, space-saving advantages—measuring 10" x 19" x 13-1/3".

Toko's advanced electronic technology also enables it to provide computer components, such as memory stacks. Contact Toko today for details.



TOKO, INC.

Head Office: 1-17, 2-chome, Higashi-Yukigaya, Ohta-ku, Tokyo, Japan
TOKO N.Y., INC. 350 Fifth Avenue, New York, New York 10001 Tel: 212-565-3767

Circle 172 on reader service card



SIGNAL CONDITIONING SYSTEMS

Multi-channel filter sets: spectrum weighting filters, averaging filters, ac-dc converters, anti-aliasing filters—

Special subsystem packages, filtering functions tailored to your task:

- Bio-medical signal shaping
- Earth science studies
- Noise studies
- Oceanographic studies
- Spectrum analyses

Available:

- Built-in power supplies for active devices
- Simultaneous or individual inputs and outputs
- Front panel channel selector switch
- Individual channel gain controls

Prompt deliveries. Moderate pricing on one of a kind or production quantities.

Get our quote on your signal conditioning system.

White

instruments, incorporated

P.O. BOX 698 • AUSTIN, TEXAS 78767
PHONE AREA 512 / 892-0752

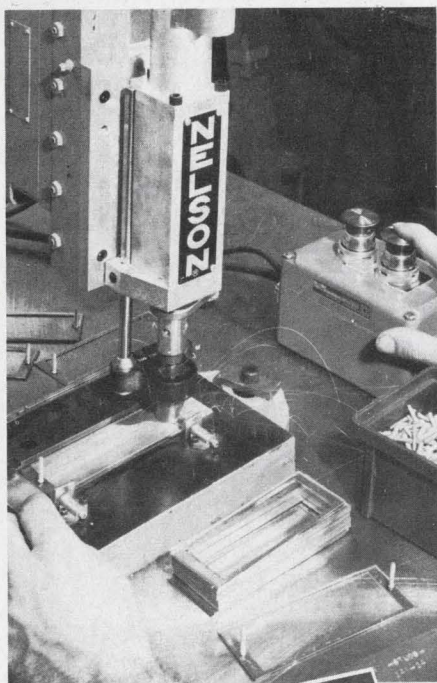

Welded studs help DPM win award

New NELSON® solid-state-controlled equipment can weld stud fasteners to steel as thin as 0.016" without burning through the metal and without causing blemishes on the other side.

It "paid for itself in short order" at API Instruments Co., Chesterland, O. It also enabled API to win the only Award of Excellence for design given to digital panel instruments at the 1969 Wescon Show.

Nelson STORED-ARC® systems were designed specifically for fastening to thin steel and aluminum. Welding tools may be portable or fixed. Standard threaded studs No. 6-32 through 1/4" in diameter are available from stock in lengths from 1/4" to 1 1/2". Other Nelson systems are available with automatic feed for production up to 45 welds per minute.

Ask for Stored Arc Literature today!



NELSON STUD WELDING CO.

A United-Carr Div. of TRW Inc., Lorain, Ohio 44055
CANADA: Ontario · WEST GERMANY: PECO Bolzenschweiss,
Gevelsberg, Westphalia

Technical Abstracts

Avalanche amp

Avalanche diode power amplifier for Ku-band
J. Noisten
Microwave Associates Inc.
Burlington, Mass.

Combining two avalanche diodes in a reflection type amplifier provides about 3 decibels of gain and 1.4 watts of output power from 15 to 18 gigahertz. The amplifier was tuned for saturated operation.

The silicon avalanche diodes were mounted side by side in a waveguide circuit with their axes parallel to the electric field. A sliding-waveguide short on one side of the cavity and an inductive iris at the input-output terminal formed the resonator circuit. The diode impedances were set to a value for efficient amplification by means of an individual-bias control. Since both diodes were strongly coupled, each diode served as part of the resonance circuit of the other, and by tuning the resonances away from each other, wideband amplification was realized. However, this adjustment was limited because resistive-diode loading changed, and the value for stable amplification might be exceeded.

The amplifier's small signal gain was constant; however, when the drive power was increased, the gain dropped to 3 db, and saturation occurred at 1.25 watts output. When the input power was reduced so the output power fell between 600 and 800 mw, the gain rose to 6 to 8 db. The bandwidth of the amplifier was strongly dependent upon the tuning conditions of the resonator.

The output power of the avalanche-diode amplifier consisted of the input power added to the maximum power that the diode is able to produce as either an amplifier or an oscillator. To maximize the efficiency of a two-diode amplifier, both diodes must be tuned so that they contribute their full available power to the output signal.

The f-m and a-m noise characteristics of the amplifier were measured within a band of frequencies extending from 100 hertz to 1 megahertz away from the amplifier's

center frequency. The f-m noise of the amplifier was equivalent to that of a klystron for modulation frequencies up to 100 khz; however, at higher frequencies the amplifier noise was higher. The a-m noise was dependent upon resonator tuning and was slightly higher than that of a klystron.

Presented at International Solid State Circuits Conference, Philadelphia, Feb. 18-20.

Barrier pressure

Pressure-sensitive Schottky-barrier transistor and switching device for keyboard applications
Osaka, Japan
G. Kano, S. Fujiwara, and T. Sawaki
Matsushita Electronics Corp.

A Schottky-barrier transistor, sensitive to pressure, and a pressure-triggered thyristor have been built for use in keyboard switches. These devices can drive 930 series diode-transistor logic integrated circuits. Their output voltage at OFF is less than 0.1 volt and at ON is greater than 3 volts. At maximum pressure, Schottky-barrier reverse current is 80 microamps.

Both devices employ the anisotropic stress effect of a metal-semiconductor Schottky barrier, caused by the change of barrier height from the pressure-induced change of the energy gap. The Schottky barriers with this stress effect were formed on the surfaces of the base region of a pnp silicon planar transistor and on the n-gate region of a pnpn silicon planar device.

A sapphire stylus, whose radius is 75 micrometers, applies the pressure. In the case of the transistor, if there's no pressure, when the collector-emitter voltage goes from 0 to 5 volts, the collector current goes from 0 to 2.4 milliamps; if the pressure is 5 grams, the collector current at 5 volts is 11.8 ma.

This pressure-sensitive transistor differs from others in that changing the pressure changes the polarity of the transistor's output current, not its magnitude.

Both devices are extremely reliable. In life tests, they've been switched more than 1×10^7 times.

Presented at International Solid State Circuits Conference, Philadelphia, Feb. 18-20.

New Literature

R-f millivoltmeter. Boonton Electronics Corp., Route 287 at Smith Rd., Parsippany, N.J. 07054. A four-page brochure illustrates and describes model 92A programable r-f millivoltmeter with digital readout and autoranging options. Circle **446** on reader service card.

Inverters and frequency changers. Nova Electric Mfg. Co., 263 Hillside Ave., Nutley, N.J. 07110, has available a catalog on a complete line of single and three-phase inverters and frequency changers. **[447]**

Complex-array logic. Sprague Electric Co., 115 Northeast Cutoff, Worcester, Mass. 01606. Engineering bulletin 25655 covers the series 54/74 MSI complex-array logic family. **[448]**

Power-transistor chips. Pirgo Electronics Inc., 130 Central Ave., Farmingdale, N.Y. 11735. Short-form catalog PG-115 describes a line of silicon planar epitaxial power-transistor chips. **[449]**

Noise-figure meter. International Microwave Corp., 33 River Rd., Cos Cob, Conn. 06907. Data sheet ANM-1 lists design features and specifications for a solid state, automatic noise-figure meter. **[450]**

Thermal shock chambers. Tenney Engineering Inc., 1090 Springfield Rd., Union, N.J. 07083. Mechanically refrigerated thermal shock chambers are illustrated and described in four-page bulletin 121. **[451]**

Custom power supplies. Hi-G Inc., Spring St. and Route 75, Windsor Locks, Conn. 06096. Bulletin 200 discusses the company's capabilities and facilities for the manufacture of custom power supplies, and illustrates and describes some typical units. **[452]**

Molding compound. Martin Marietta Corp., P.O. Box 5837, Orlando, Fla. 32805, offers a technical data sheet describing epoxy liquid-transfer molding compound 303-13. **[453]**

Metal film resistors. Vishay Resistor Products, 63 Lincoln Highway, Malvern, Pa. 19355, has released an eight-page brochure on 1 ppm/°C high-precision metal film resistors. **[454]**

Op-amp relay. Teledyne Relays, 3155 W. El Segundo Blvd., Hawthorne, Calif. 90250. Application notes for the 501-1 universal op-amp relays are available in a 14-page brochure. **[455]**

Rugged galvanometer. Greibach Instruments, Division of Solitron Devices Inc., 37-11 47th Ave., Long Island City, N.Y. 11101. A single-page bulletin describes an extremely rugged, sensitive-readable

galvanometer featuring no parallax and excellent stability. **[456]**

Angle-position indicator. North Atlantic Industries Inc., Terminal Dr., Plainview, N.Y. 14534, has issued a four-page bulletin on the model 8525 solid state, angle-position indicator. **[457]**

Signal source. PRD Electronics Inc., 1200 Prospect Ave., Westbury, N.Y. 11590, has available a single-page bulletin describing the 712 series low-cost signal source suitable for laboratory or field use. **[458]**

Digital panel meters. Datascan Inc., 1111 Paulison Ave., Clifton, N.J. 07013. A six-page folder contains mechanical characteristics, electrical specifications and application notes for a line of digital panel meters. **[459]**

Video tape. Audio Devices Inc., 100 Research Dr., Glenbrook, Conn. 06906, has announced availability of a full-color dart-board-type wall chart in connection with its new line of Audev helical-scan video tape. **[460]**

High-power transistor. Westinghouse Electric Corp., P.O. Box 868, Pittsburgh, Pa. 15230. An illustrated bulletin gives the operating characteristics, advantages, applications, and package dimensions for the type 1401 high-power silicon transistor. **[461]**

Electronic glass. Innotech Corp., 181 Main St., Norwalk, Conn. 06851. Passivation glasses, solder glasses, and packaging glasses are discussed in a six-page brochure. **[462]**

Digital ultrasonic delay lines. Microsonics Division, Sangamo Electric Co., 60 Winter St., Weymouth, Mass. 02188, offers an illustrated, two-color brochure describing new digital ultrasonic delay lines. **[463]**

Operational amplifiers. GPS Corp., 14 Burr St., Framingham, Mass. 01701, has available a brochure on the 800 series of FET differential operational amplifiers. **[464]**

Graphics digitizer. Computer Equipment Corp., 14616 Southlawn Lane, Rockville, Md. 20850. The PF10C coordinate digitizer for rapidly converting analog/graphic data into digital form is fully described in an eight-page folder. **[465]**

Coil-winding equipment. Geo. Stevens Mfg. Co., 6001 N. Keystone Ave., Chicago 60646, has released a two-page bulletin on the model WE-20 automatic turret universal coil winder and four new accessories. **[466]**

Triacs. Texas Instruments, P.O. Box

COMPARE CLOSE-UPS

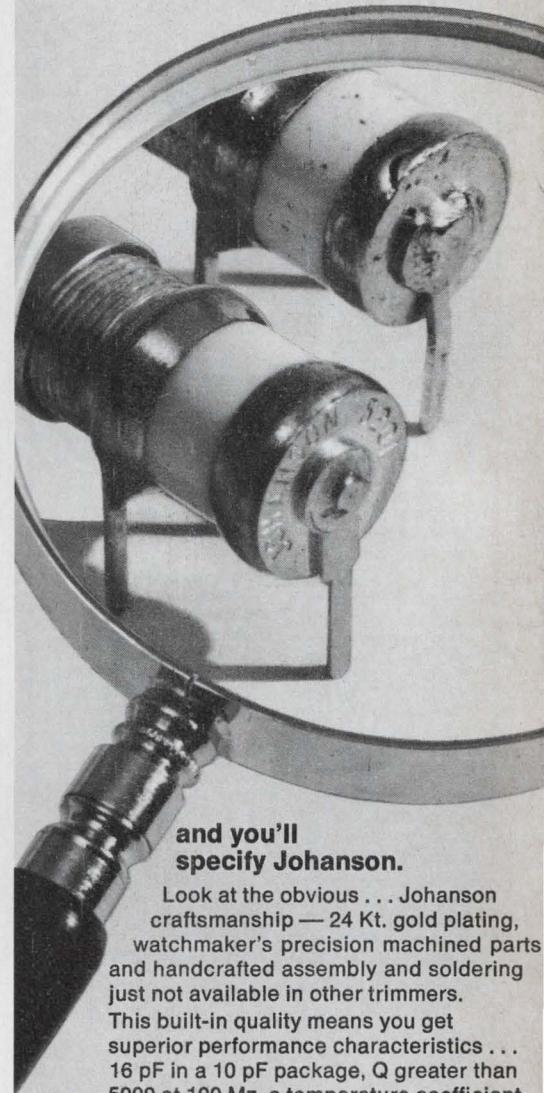

and you'll specify Johanson.

Look at the obvious . . . Johanson craftsmanship — 24 Kt. gold plating, watchmaker's precision machined parts and handcrafted assembly and soldering just not available in other trimmers. This built-in quality means you get superior performance characteristics . . . 16 pF in a 10 pF package, Q greater than 5000 at 100 Mz, a temperature coefficient of 0 ± 15 PPM/°C, with tuning stability and long life.

Why settle for ordinary trimmers when the best is available — send today for our new catalog sheet on our 5200 series . . . and start comparing.



Johanson

MANUFACTURING CORPORATION

Rockaway Valley Road, Boonton, N.J. 07005
(201) 334-2676

Electronic Accuracy Through Mechanical Precision

how to
design
any
semi-
conductor
circuit
you need



NEW 3rd Ed.

HANDBOOK OF SEMICONDUCTOR ELECTRONICS

EDITED BY LLOYD P. HUNTER

1,100 pp., 6 x 9, 963 illus. & tables, \$27.50

This brand new third edition of Hunter's famous handbook clearly explains and illustrates everything you need to know about semiconductor circuitry.

A practical, basic guide to the design of conventional and integrated circuits utilizing transistors, diodes, and other semiconductor devices, it also provides valuable background on device physics and device and circuit fabricating techniques so that you can understand the built-in limitations of the components you have to work with. In addition, it shows how to use measurement techniques to evaluate the devices you contemplate using.

This new edition presents important new material on integrated circuits, including their physics, fabrication, and design, and further improvements have been made in its expert treatment of such topics as computer aided circuit design . . . integrated circuit techniques . . . operating principles of the avalanche diode, the injector laser, and the Gunn-effect oscillator . . . field effect devices, including MOS types . . . and the design of integrated operational amplifiers.

Seventeen leading experts have pooled their knowledge to provide the practical and ready-to-use principles and methods gathered together in this use-tested reference.

In fact, with its additions and improvements, this is the only book of its kind that contains device physics, fabrication techniques, device evaluation measurement techniques, and circuit design techniques all under one cover.

FREE 10-DAY EXAMINATION!

McGraw-Hill Book Company
330 West 42nd Street, New York, N.Y. 10036

Please send me HANDBOOK OF SEMICONDUCTOR ELECTRONICS for 10 days' examination. At the end of that time I will:

- Remit the full price of \$27.50 plus local tax, postage and handling
- Remit \$9.50 in 10 days, then \$9 a month for 2 months, plus tax, postage, and handling

Otherwise, if I am not completely satisfied with the book, I will pay nothing and return it without further obligation.

NAME

FIRM

STREET

CITY

STATE ZIP.....

23-E-427

New Literature

5012, M/S308, Dallas 75222. Application reports CA-137 and CA-138 describe triac phase-control and triac triggering techniques. [467]

Zener surge selection. Unitrode Corp., 580 Pleasant St., Watertown, Mass. 02172, has issued a zener surge-selection guide listing all its zener types from 1 to 10 watts with the specific voltage and surge rating for each individual type. [468]

Data transmission. Quindar Electronics Inc., 60 Fadem Rd., Springfield, N.J. 07081, has published a two-page technical application bulletin entitled "Wide Band vs. Narrow Band Data Transmission . . . and How It Affects Supervisory Control Systems." [469]

Numeric keyboards. Micro Switch, a division of Honeywell, 11 W. Spring St., Freeport, Ill. 61032, offers a new product sheet on the NW3 series numeric keyboards that incorporate an assembly of 12 or 16 stations with a Form A contact structure. [470]

P-c board connector. Hugh H. Eby Co., 4701 Germantown Ave., Philadelphia, has available a technical bulletin on a right-angle male connector for p-c boards that conforms to revision K of Mil-E-5400. [471]

Gate valves. Varian, Vacuum Division, 611 Hansen Way, Palo Alto, Calif. 94303, has released a data sheet describing gate valves for vacuum systems which are now available in 2 in., 4 in., and 6 in. configurations. [472]

Subminiature lamps. Inter-Market Inc., 312 Waukegan Rd., Glenview, Ill. 60025, offers a catalog and price list describing Rodan subminiature lamps and indicator lights. [473]

Synchro amplifier. Industrial Control Co., Central Ave. at Pinelawn, Farmingdale, N.Y. 11735, has published a data sheet describing the model 929-R high-precision, 400-hz synchro amplifier. [474]

Cermet trimmer. CTS of Berne Inc., Berne, Ind. 46711. Data sheet 3360A contains complete specifications on the series 360 single-turn cermet industrial trimmer. [475]

Pressure transducers. AMETEK/Instruments & Controls, 860 Pennsylvania Blvd., Feasterville, Pa. 19047, has published an eight-page, two-color pressure transducer catalog. [476]

Linear IC testing. I.C. Metrics Inc., 607 Industrial Way West, Eatontown, N.J. 07724. Linear IC testing and evaluation of circuit performance in special purpose applications is described in an eight-page brochure. [477]



EMPLOYMENT OPPORTUNITIES

ESCAPE TO COLORADO

You can avoid another hot, muggy summer if you move to the wide open spaces where you can enjoy the mountain way of life with Denver only minutes away.

If you are a

DEVELOPMENT ENGINEER

with an engineering degree and three years' recent experience in multilayer package design, ceramic-metal systems for ceramic multilayer package production, and laminating techniques. Your job will be to develop new processes and to design and fabricate pre-production quantities of packages in our multilayer ceramic packaging group.

Send your complete resume and salary requirements to Jack Coyne.

An Equal Opportunity Employer

COORS PORCELAIN CO.

1800 Jackson St.

GOLDEN, COLORADO 80401

CIRCLE 966 ON READER SERVICE CARD

RADAR SYSTEMS GROUND AND AIRBORNE. AUTOMATIC TRACKING ANTENNA SYSTEMS. NIKE AJAX. NIKE HERCULES. M-33. MSQ-1A. MPS-19. MPS-9. SCR 584. TPS-1D. TPS-28. FAA-ASR-2. AIRBORNE SYSTEMS. APN-84. APN-102. APS-20. APS-27. APS-45. DPN-19. DIGITAL COMPUTERS. IBM 650. IBM 704.

LARGEST INVENTORY OF RADAR AND MICROWAVE EQUIPMENT IN THE WORLD.
RADIO RESEARCH INSTRUMENT CO.
45 WEST 45TH ST. N. Y. 10036 212-JU 6-4691

CIRCLE 967 ON READER SERVICE CARD

CRYOGENIC IR CELLS

Finest cryogenic IR cells for sale. New Raytheon 2 each QKN-1009 and QKN-1298; discounted price.

WITHROW INDUSTRIES INC.
P. O. Box 395, Los Gatos, Calif. 95030

CIRCLE 968 ON READER SERVICE CARD

EMPLOYMENT SERVICE

Fee Paid Employment Service for all technical fields since 1959. Over 1,000 U.S. client cos. Send resume. Atomic Personnel, Inc., 1518 Walnut St., Box L, Phila. Pa., 19102.

BUSINESS OPPORTUNITY

To Merge Your Company with the right partner on the right terms, at no cost to you, call us. We work with many NYSE and AMEX corporations who seek "good match" acquisitions. Write or phone in confidence (your company will not be identified to anyone without your permission). Corporate Profiles, Inc. Box 3265, Stamford, Conn. 06905.

Electronics advertisers

April 27, 1970

Acopian Corp.	133	Hughes Aircraft Co.	50, 51	S.P. Electronica	5E
Mort Barish Associates		Foote, Cone & Belding		Studio Sergio Rosata	
Advanced Memory Systems	55			Sperry Rand Corp., Sperry	
Fleig and LeBoeuf Adv., Inc.				Microwave Electronics Div.	62
Advanced Micro Devices	8, 9, 10, 11			Neals & Hickok, Inc.	
Keye/Donna/Pearlstein		Indiana General Corp., Electronics Div.	72	Sprague Electric Co., The	7
Airpax Electronics, Inc.	130	The Griswold & Eshleman Co.		Harry P. Bridge Co.	
Tech Communicators, Inc.		Industrial Electronic Engineers	93	Sylvania Electric Products, Inc.,	75
Allen-Bradley Co.	35 to 38	Van Der Boom, McCarron Advertising		Electronic Components Group	
Hoffman-York, Inc.		ITT Semiconductor Div.	122	Doyle Dane Bernbach, Inc.	
A O I P	7E	Neals & Hickok, Inc.			
Dumesnil Publicite					
Ates Componenti Elettronici, S.P.A.	10E	Jaeger Aeronautique.	16E	Tech Laboratories, Inc.	154
Publicitas		V-Publicite		Lewis Advertising Agency	
		Johanson Manufacturing Corp.	161	Tektronix, Inc.	114
Beckman Instruments, Inc.	15	Josephson, Cuffari & Co.		Dawson, Inc.	
Electronic Instrument Div.		Joslyn, Inc.	26	Teradyne, Inc.	45
N.W. Ayer/Jorgensen/MacDonald, Inc.		Chace Co. Adv., Inc.		Quinn & Johnson Adv., Inc.	
				Thomson-CSF Electron Tubes, Inc.	47
Cambridge Thermionic Corp.	153			Mohr & Co., Inc.	
Chirurg & Cairns, Inc.		McGraw-Hill Professional & Reference		TI Supply Company	128, 129
C.G.E.	125	Book Div.	162	Albert Frank-Guenther Law, Inc.	
Edition 2B Publicite		Mellonics	23	Toko, Inc.	159
Chemetron Corp.	156	Diener & Dorskind, Inc.		Hakuhodo, Inc.	
Buchen Adv., Inc.		Mesucora	6E	Trans World Airlines	134
Clary Corp., Precision Instrument Div.	153	Sepic		Wells, Rich, Greene, Inc.	
Wolfson/Warner Advertising		Micro Switch Division of Honeywell	32	Triplet Electrical Instrument Co.	119
Computer Measurement Co., Div. of		N.W. Ayer and Son, Inc.		Byer and Bowman Advertising	
Newell Industries	27	Mohawk Data Sciences Corp.	12, 13	Tung-Sol Div., Wagner Electric Corp.	135
Jones, Maher, Roberts, Inc.		The Lampert Agcy., Inc.		Winius-Brandon Co.	
Control Products Division,		Motorola Semiconductor Products Inc.	106		
Bell & Howell	148	Lane & Wampler Adv., Inc.			
Porter & Mills Advertising				United Transformer Co.,	166
CTS Corporation	126, 127	National Semiconductor Corp.	76, 77	Division of TRW, Inc.	
Reincke, Meyer & Finn, Inc.		Hall Butler Blatherwick, Inc.		Fuller & Smith & Ross, Inc.	
		Nelson Stud Welding Co.	160		
Dale Electronics, Inc.,	3rd Cover	George Z. Griswold Advertising		Vector Electronic Co., Inc.	142
Sub. of Lionel Corp.		Nortronics Co., Inc., OEM Div.	132	Buck Advertising	
Swanson, Sinkey, Ellis, Inc.		Stral Adv. Co., Inc.		Vitro Laboratories	24
Datacraft	140			Buchen Advertising, Inc.	
Neals & Hickok, Inc.		Onan Division of Studebaker Corp.	19E		
Data Products Corp.	53	Campbell Mithun, Inc.		Watkins-Johnson Co.(CEI)	28
Farrell-Bergmann Advertising				William C. Estler Advertising	
Delco Radio Division		Pacific Measurements, Inc.	54	Westinghouse Semiconductor Div.	138, 139
General Motors Corp.	18, 19	Jack Herrick Adv., Inc.		Ketchum, MacLeod and Grove, Inc.	
Campbell-Ewald Co.		Permag Corp.	164	White Instruments, Inc.	159
Dow Corning Corp.	20, 21	Schneider, Allen, Walsh, Inc.		Wilson & Assoc., The Art Studio,	
Ketchum, MacLeod and Grove, Inc.		Philo Ford Co., Microelectronics Div.	58, 59	Div. of Graphic Studios	
		The Aitkin-Kynett Co., Inc.		Wiltron Co.	22
Eastman Chemical Products, Inc.	136	Philips GAD-Elcoma	8E, 9E	Vanderwyk Assoc., Inc.	
Fred Wittner Co.		Media International			
E-H Research Labs, Inc.	29	Philips/Electrologica Office		Zehntel, Inc.	25
Steedman, Cooper and Busse		Machine Div.	17E	Pacific Advertising Staff	
Advertising		Philips N.V. Pit/Tmi Div.	2E	Zenith Radio Corporation	152
Electronics Scoreboard, The	137	Marsteller International S.A.		Mills, Fife & MacDonald, Inc.	
Ries Cappiello Colwell, Inc.		PMC Designing, Inc. A Subsidiary of			
EL Instruments, Inc.	136	Possis Machine Corp.	152		
Froehlich Advertising Services		Scrymiger & Osterholt Adv. Agcy., Inc.			
E/MC Electronic/Management	142, 147	Portescap	14E		
Center		Presse et Publicite			
Ries Cappiello Colwell, Inc.		Princeton Applied Research Corp.	40		
		Mort Barish Assoc., Inc.			
Fairchild-Dumont	117				
Josephson, Cuffari and Company		RCA Electronic Components	4th Cover		
Fairchild Semiconductor, Inc.	69, 70, 71	Al Paul Lefton Co.		Classified & Employment Advertising	
Chiat Day, Inc.		Reliance Controls, Ltd.	12E	F.J. Eberle, Manager	
Florida Dept. of Commerce,		Bond Publicity Services Ltd.		212-971-2557	
Div. of Commercial Development	143	Rentronix, Inc.	158	EMPLOYMENT OPPORTUNITIES	162
William Cook Adv., Inc.		E.G. White Advertising, Inc.		Coors Porcelain Co.	162
		Rexco Corp.	164		
Gencom Division—Varian/Emi	124	Erland Adv. Agcy.		EQUIPMENT	
A.D. Adams Adv., Inc.		Rohde & Schwarz	3E	(Used or Surplus New)	
General Radio Co.	2nd Cover			For Sale	
Horton, Church and Goff, Inc.		Sangamo Electric Co.	39	Radio Research Instrument Co.	162
Gralex Industries, Division of		Winius Brandon Co.		Withrow Industries	162
General Microwave Corp.	52	Schauer Manufacturing Corp.	157		
Industrial Marketing Associates		Nolan, Keeler & Stites			
GRI Computer Corp.	144	Sescosem	4E		
Larcom Randall Adv., Inc.		Perez Publicite			
Gries Reproducer Co.	164	Sharp Corporation	16		
Harold Marshal Advertising		Dai-Ichi International, Inc.		For more information on complete product	
Gudebrod Bros Silk Co.,		Signetics Corp., Sub. Corning		line see advertisement in the latest Elec-	
Electronics Div.	120	Glass Works	60, 113	tronics Buyer's Guide	
Ramsdell, Bright & Nathans, Inc.		Cunningham & Walsh, Inc.		Advertisers in Electronics International	
		Siliconix, Inc.	6		
Handy & Harman	150, 151	Robertson West, Inc.		Electronics Buyers' Guide	
J.J. Lane, Inc.		Simpson Electric Co.	56	George F. Werner, Associate Publisher	
Hansen Manufacturing Co.	146	Amerad Advertising Service, Inc.		[212] 971-2310	
Keller-Crescent Co.		Singer Co., Ballantine Operation	14	Regina Hera, Directory Manager	
Hewlett Packard, H.P. Associates	2	Technical, Industrial and Scientific		[212] 971-2544	
Lennen & Newell, Inc.		Marketing, Inc.		Mary Tully, Production Manager	
Hewlett Packard, Colorado Springs Div.	17	Solartron Electronics Group Ltd.	13E	[212] 971-2046	
Tallant/Yates Adv., Inc.		Digital Instrumentation		Sales Offices:	
Hewlett Packard, Loveland Div.	1	T.B. Browne Ltd.		Boston, Ben Briggs [617] CO2-1160	
Tallant/Yates Adv., Inc.		Solitron Devices, Inc.	57	New York, Cliff Montgomery [212] 971-3793	
Hewlett Packard, New Jersey Div.	49	Barnes-Champ/Advertising		Jim Vick [212] 971-2661	
McCarthy Scelba and DiBiasi Adv.		Sorensen Operation Raytheon Co.	30, 31	Chicago, Bob Denmead [312] MO4-5800	
Agcy., Inc.		Fred Wittner Co.		Los Angeles, Kenneth Watts [213] HU2-5450	
Hewlett Packard, Santa Clara Div.	61, 78	Souriau & Cie.	15E	Philadelphia, Joseph Bryan [215] LO8-6161	
Lennen & Newell, Inc.		Ariane Publicite			
Howard W. Sams & Co., Inc.	165			Circulation Department	
George Brodsky Adv., Inc.				Isaaca Siegel, Manager [212] 971-6057	
				Research Department	
				David Strassler, Manager [212] 971-6058	

Pert Mag, the PERMAG girl, says:



"Holding is a cinch with Magnets!"

And Permag has just the right magnet for your holding problem. Permag offers permanent magnets, assemblies, electrical alloys, flexible magnets, soft magnetic materials and ferrites. Also, special precision grinding and cutting. And full magnetizing and engineering facilities. Distributor of Gordos Reed Switches.

Permag

PERMAG SIERRA CORP. 3721 HAVEN AVENUE, MENLO PARK, CALIFORNIA 94025 • (415) 369-0303
 PERMAG PACIFIC CORP. 5441 WEST 104th ST., LOS ANGELES, CALIF. 90045 • (213) 776-5656 • TWX [910] 328-6547
 PERMAG SOUTHWEST CORP. 2720 TAYLOR STREET, DALLAS, TEXAS 75226 • (214) 748-6909
 PERMAG CENTRAL CORP. 1213 ESTES AVE., ELK GROVE VILLAGE, ILL. 60007 • (312) 956-1140
 PERMAG MAGNETICS CORP. (formerly EMPIRE MAGNETICS) 3130 SOUTH AVE., TOLEDO, OHIO 43609 • (419) 385-4621
 PERMAG NORTHEAST CORP. 50 THAYER ROAD, WALTHAM, MASSACHUSETTS 02154 • (617) 484-0550
 PERMAG CORP. 88-06 VAN WYCK EXPRESSWAY, JAMAICA, N.Y. 11418 • (212) 657-1818 • TWX [710] 582-2952

Circle 173 on reader service card

GRC[®] tiny

die castings made in one fast automatic operation..simple or intricate parts, high in quality & value

GRC tiny zinc alloy die castings offer greater design flexibility. Highly uniform, precise. Automatic assembly is facilitated, secondary operations and production steps reduced.

Write for helpful design guides and samples.

tiny zinc die castings

Maximum sizes 2" long; 1/2 oz. No minimum size.

GRIES REPRODUCER CO.

Division of Coats & Clark Inc.

World's Foremost Producer of Small Die Castings
 151 Beechwood Ave., New Rochelle, N. Y., (914) 633-8600
 Plants In: New Rochelle, N.Y.; Warren, R.I.; Toccoa, Ga.

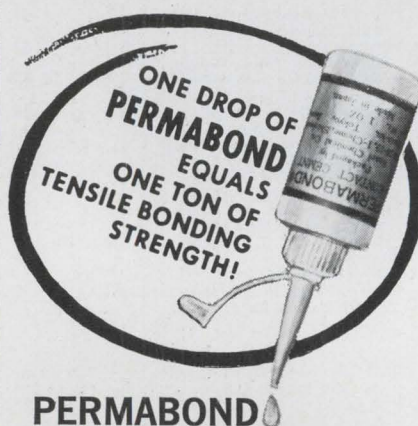
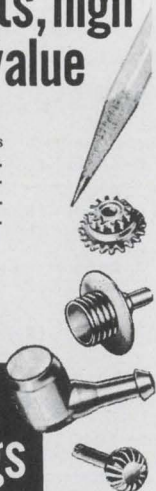

PERMABOND

BRINGS YOU A NEW ERA IN BONDING ADHESIVES

FAST SETTING • VERSATILE • GREAT STRENGTH • ECONOMICAL

PERMABOND forms a strong, transparent bond in seconds. NO MIXING—NO HEATING—just ordinary fingertip pressure. PERMABOND will not shrink, resists water and temperature changes and will outlast the bonded materials. Excellent in any combination of metals, glass, plastic, rubber, etc.

Packaged in 2 gr., 1 oz. and 500 gr. unbreakable bottles.

Invaluable for bonding diodes and components to printed circuit boards, securing cord lacing, captivating electronic hardware against shock and vibration and hybrid packaging. Meets Mil-A-46050B spec.

Send for evaluation kit of 5—2 gr. tubes. \$7.50 ppd.

Literature on request.

For nearest distributor, write

REXCO CORP.

45 W. 47th St., N.Y., N.Y. 10036

(212) 582-6835

Advertising Sales Staff

Dan McMillan [212] 971-3468

Publisher

Wallis Clarke [212] 971-2187

Advertising Sales Service Manager

Tomlinson Howland [212] 971-6792

Promotion Manager

Marilyn Crosson [212] 971-6643

Promotion Assistant

Warren H. Gardner [212] 971-3139

Eastern Advertising Sales Manager

Atlanta: Ga. 30309: Charlton H. Calhoun, III

1375 Peachtree St., N.E.

[404] 892-2868

Boston, Mass. 02116: William S. Hodgkinson

McGraw-Hill Building, Copley Square

[617] CO 2-1160

Cleveland, Ohio 44113: William J. Boyle, 55

Public Square, [216] SU 1-7000

New York, N.Y. 10036

500 Fifth Avenue

James R. Pierce [212] 971-3615

John A. Garland [212] 971-3617

Michael J. Stoller [212] 971-3616

Philadelphia, Pa. 19103:

Jeffrey M. Preston

6 Penn Center Plaza,

[215] LO 8-6161

Pittsburgh, Pa. 15222: Jeffrey M. Preston,

4 Gateway Center, [412] 391-1314

Rochester, N.Y. 14534: William J. Boyle,

9 Greylock Ridge, Pittsford, N.Y.

[716] 586-5040

Chicago, Ill. 60611: Ralph Hanning,

Kenneth E. Nicklas, 645 North Michigan

Avenue, [312] MO 4-5800

Dallas, Texas 75201: Richard P. Poole, 1800

Republic National Bank Tower,

[214] RI 9-9721

Houston, Texas 77002: Richard P. Poole

2270 Humble Bldg. [713] CA 4-8381

Detroit, Michigan 48226: Ralph Hanning,

856 Penobscot Building

[313] 962-1793

Minneapolis, Minn. 55402: Kenneth E. Nicklas,

1104 Northstar Center [612] 332-7425

St. Louis, Mo. 63105: Kenneth E. Nicklas,

The Clayton Tower, 7751 Carondelet Ave.

[314] JA 5-7285

James T. Hauptli [415] DO 2-4600

Western Advertising Sales Manager

Denver, Colo. 80202: David M. Watson,

Richard W. Carpenter

Tower Bldg., 1700 Broadway

[303] 266-3863

Los Angeles, Calif. 90017: Ian C. Hill,

Bradley K. Jones, 1125 W. 6th St.,

[213] HU 2-5450

Portland, Ore. 97204: Don Farris,

James T. Hauptli, 218 Mohawk Building,

222 S.W. Morrison Street,

Phone [503] 223-5118

San Francisco, Calif. 94111: Don Farris,

James T. Hauptli, 255 California Street,

[415] DO 2-4600

Pierre Braude Tel: 727 73 01: Paris

International Director

Paris: Denis Jacob

17 Rue-Georges Bizet, 75 Paris 16, France

Tel 727 33 42, 727 33 60

United Kingdom and Scandinavia

London: Oliver Ball, Tel: Hyde Park 1451

34 Dover Street, London W1

Milan: Robert Saidel, Roberto Laureri Jr.

1 via Baracchini Phone 86-90-656

Brussels: Denis Jacob

27 Rue Ducale Tel: 136503

Frankfurt/Main: Hans Haller

Elsa-Brandstroem Str. 2

Phone 72 01 81

Geneva: Pierre Braude

1 rue du Temple Phone: 31 95 60

Tokyo: Noboru Matsumoto, McGraw-Hill

Publications Overseas Corporation,

Kasumigaseki Building 2-5, 3-chome,

Kasumigaseki, Chiyoda-Ku, Tokyo, Japan

[581] 9811

Osaka: Akihiko Kamesaka, McGraw-Hill

Publications Overseas Corporation, Kondo

Bldg., 163, Umegae-cho Kita-ku [362] 8771

Australasia: Warren E. Ball, IPO Box 5106,

Tokyo, Japan

Business Department

Stephen R. Weiss, Manager

[212] 971-2044

Thomas M. Egan,

Production Manager [212] 971-3140

Maury D'Gongora,

Assistant Production Manager [212] 971-2045

Dorothy Carmesin, Contracts and Billings

[212] 971-2908

Frances Vallone, Reader Service Manager

[212] 971-2865

**"Bigger and better...this
engineer's bible..."**

—Electronics Magazine

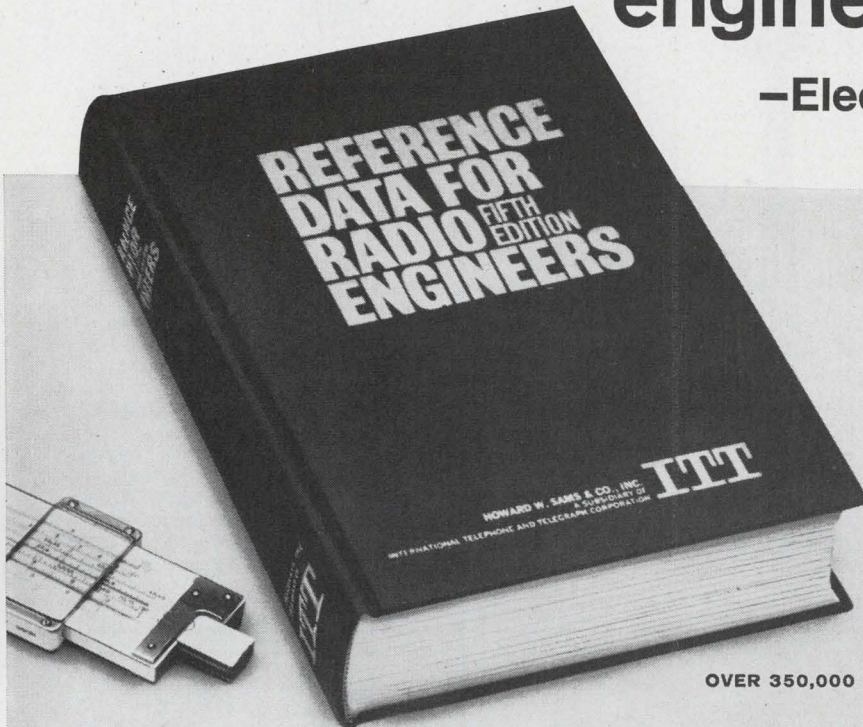

**5th EDITION of a
world-famous reference**

Now contains 50% MORE DATA to include major information developed over the past 12 years. Prepared by an outstanding group of practicing engineers, professors, and industry and government experts, under the direction of the International Telephone and Telegraph Corporation staff.

OVER 350,000 COPIES SOLD IN PRIOR EDITIONS

Reference Data for Radio Engineers

CHAPTER CONTENTS

Frequency Data	Transmission Lines
*International Telecommunication Recommendations	Waveguides and Resonators
Units, Constants, and Conversion Factors	Scattering Matrices
Properties of Materials	Antennas
Components or Parts	Electromagnetic-Wave Propagation
Fundamentals of Networks	Radio Noise and Interference
Filters, Image-Parameter Design	Broadcasting and Recording
Filters, Modern-Network-Theory Design	Radar Fundamentals
Filters, Simple Bandpass Design	Wire Transmission
Attenuators	*Switching Networks and Traffic Concepts
Bridges and Impedance Measurements	Digital Computers
Magnetic-Core Transformers and Reactors	*Navigation Aids
Rectifiers and Filters	*Space Communications
Magnetic Amplifiers	Electroacoustics
Feedback Control Systems	Nuclear Physics
Electron Tubes	*Quantum Electronics
Electron-Tube Circuits	Information Theory
Semiconductors and Transistors	Probability and Statistics
Transistor Circuits	*Reliability and Life Testing
*Microminiature Electronics	Miscellaneous Data
Modulation	Fourier Waveform Analysis
	Maxwell's Equations
	Mathematical Equations
	Mathematical Tables

*New chapters on subjects not covered in 4th Edition

1196 PAGES • 1350 ILLUSTRATIONS
plus 41 page index

The FIFTH EDITION of this widely used reference work has been completely revised and updated. It provides in a single volume comprehensive data on all basic phases of electronics, including tables, formulas, standards, and circuit information—PLUS—all-new data on microminiature electronics, space communications, navigation aids, reliability and life testing, international telecommunication recommendations, switching networks and traffic concepts, and quantum electronics. Includes over 1300 charts, nomographs, diagrams, tables, and illustrations. 45 data-packed chapters. 1196 pages of invaluable information for practicing radio and electronics engineers.

10-Day Free Examination

HOWARD W. SAMS & CO., INC., Dept. EL-4

A Subsidiary of International Telephone & Telegraph Corporation
4300 West 62nd Street, Indianapolis, Ind. 46268

- Send me REFERENCE DATA FOR RADIO ENGINEERS for 10-day examination, without cost or obligation. If I decide to keep the volume, I will send \$20.00 (plus postage) in 10 days; otherwise, I will return the book within 10 days.
- \$20 payment enclosed. Send my copy postpaid with full 10-day refund privilege. (Include sales tax where applicable.)

Name _____

Company _____

Address _____

City _____

State _____

Zip _____

5 fast ways to design-in transformers.

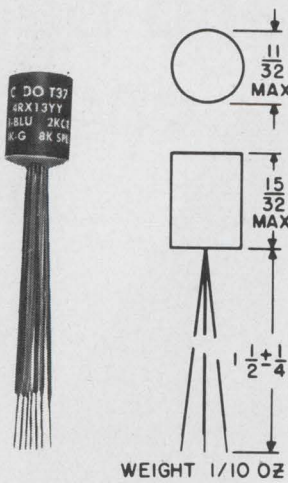

DO-T™ Transistor Transformers & Inductors with frequency response of ± 3 db, 300 Hz to 20 kHz. Primary impedance ranges from 80 CT to 200,000 CT; secondary impedance from 3.2 to 20,000 split. Mw levels from 25 to 500. Inductors from .15 Hys @ 20 maDC to 6 Hys @ 2 maDC.

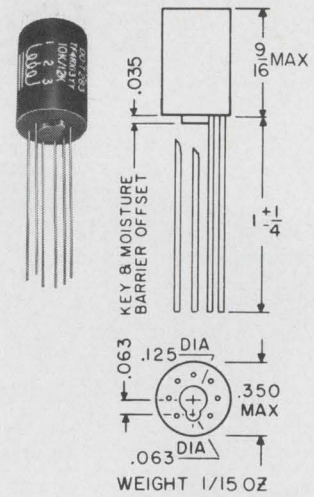

New DO-T200™ Series Transformers & Inductors. Termination patterns conform with TO-5 cased microcircuits. Frequency response: ± 3 db, 300 Hz to 20 kHz. Primary impedance ranges from 1,000 CT to 200,000 CT; secondary impedance from 50 to 12,000 CT. Mw levels from 25 to 100. Also available in all standard DO-T specifications.

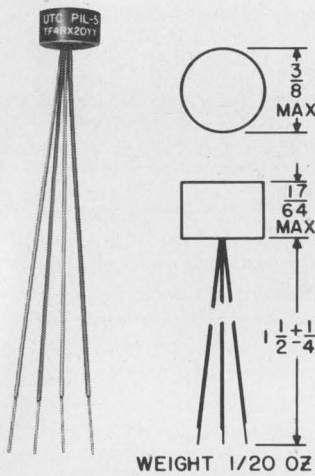

PIL™ Ultraminiature Audio and High-frequency Transformers & Inductors. Frequency response at 1 mw is ± 3 db, 800 Hz to 250 kHz. Primary impedance: 500 CT to 10K CT; Secondary impedance: 500 CT to 2K CT. Max: Mw level: 100. Inductors from .020 Hys @ 10 maDC to .66 Hys @ 0 maDC.

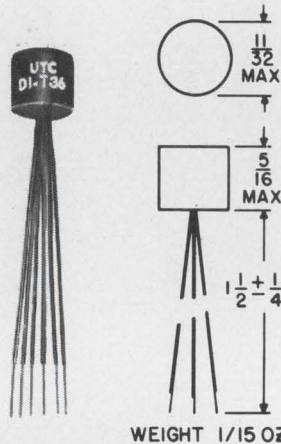

DI-T™ Series Transistor Transformers & Inductors. Frequency response of ± 3 db, 400 Hz to 100 kHz. Primary impedance ranges from 80 CT to 30,000 CT; secondary impedance from 3.2 to 12,000 CT. Mw levels from 50 to 500. Inductors from .08 Hys @ 10 maDC to 4.5 Hys @ 2 maDC.

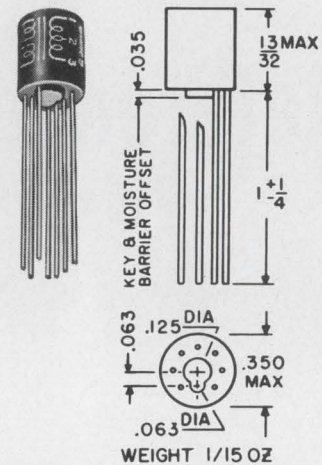

DI-T200™ Transistor Transformers & Inductors. Termination patterns conform with TO-5 cased microcircuits. Frequency response: ± 3 db, 400 Hz to 100 kHz. Primary impedance ranges from 80 to 30,000 CT; secondary impedance from 32 split to 12,000 CT. Mw levels from 50 to 500. Inductors from .02 Hys @ 20 maDC to 4.5 Hys @ 2 maDC. Also available in all standard DI-T specifications.

Here is the entire UTC DO-T family.

Pick any one of these transformers—you'll combine maximum performance characteristics, unusual power handling capability and high reliability in a tiny package. Their parameters greatly exceed those of conventional transformers, making them ideal for a wide range of applications.

All of these transformers have the unique DO-T type construction that UTC developed. The bobbins are

completely rigid, eliminating stress and wire movement. All turns are circular, rather than square, eliminating turn corner stress. All leads and wires are securely anchored to resist strain.

All units are hermetically sealed and are manufactured and guaranteed to MIL-T-27C specifications.

Insist on getting UTC transformers in these five basic series. Simplify your design problems—refer to the UTC catalog, which displays the largest

selection of items in the industry. Standard items are available for immediate delivery—plus custom designs to your specifications.

Contact your local distributor. Or, write for latest catalog to *United Transformer Company, Division of TRW, INC., 150 Varick Street, New York, New York 10013.*





Trounce trimmer troubles with Dale Industrial and Commercial T-Pots

RCA's widely-used Spectra 70 computer is a good example of Dale Trimmers' year-in, year-out dependability. The models shown here are from Dale's 2100 wirewound series...sealed to meet tough RCA immersion requirements. Used in a number of Spectra 70 control and voltage reference applications, they're part of Dale's workhorse line of industrial and commercial trimmers. Nothing fancy...but you get what you need, when you need it—and you can use all you receive. Dale trimmers have a record of less than 1% customer rejection for *all* causes. Join the growing number of trimmer users who've found there's less trouble when you specify Dale.

Call 402-564-3131 for complete information or write for Catalog B.

DALE ELECTRONICS, INC.

1300 28th Ave., Columbus, Nebr. 68601
In Canada: Dale Electronics Canada, Ltd.
A subsidiary of The Lionel Corporation



COMMERCIAL GRADE ECONO-TRIM T-POTS



WIREWOUND ELEMENT

2300 Series: Sealed/Unsealed; 10Ω to 50KΩ, ±10%; 0.5 watt at 25°C, derated to 0 at 105°C; .36 H x .28 W x 1.00 L.

2400 Series: Sealed/Unsealed; 10Ω to 50KΩ, ±10%; 1 watt at 40°C, derated to 0 at 125°C; .31 H x .16 W x .75 L.

FILM ELEMENT

8300 Series: Sealed/Unsealed; 10Ω to 2 Meg., ±10% 100Ω thru 500K, ±20% all other values; .75 watt at 25°C, derated to 0 at 105°C; .36 H x .28 W x 1.00 L.

INDUSTRIAL GRADE T-POTS

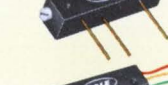
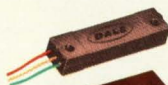

WIREWOUND ELEMENT

100, 200, 300 Series: 10Ω to 100KΩ.

100 Series: ±5%; 0.8 watt at 70°C, derated to 0 at 135°C.

200 Series: ±10%; 0.5 watt at 70°C, derated to 0 at 105°C.

300 Series: ±15%; .25 watt at 70°C, derated to 0 at 85°C.
Dimensions: .22 H x .31 W x 1.25 L (also 1.32 L for 100, 200).

1100 Series: 10Ω to 100KΩ, ±10%; 1 watt at 70°C, derated to 0 at 175°C; .28 H x .31 W x 1.25 L.

2100 Series: Industrial counterpart RT-11; 10Ω to 100KΩ, ±10%; 1 watt at 70°C, derated to 0 at 125°C; .28 H x .31 W x 1.25 L.

2200 Series: Industrial counterpart RT-10; 10Ω to 100KΩ, ±10%; 1 watt at 70°C, derated to 0 at 125°C; .18 H x .32 W x 1.00 L.

FILM ELEMENT

8100 Series: Industrial counterpart RJ-11; 10Ω to 2 Meg., ±10% 100Ω to 500K, ±20% other values; .75 watt at 70°C, derated to 0 at 125°C; .28 H x .31 W x 1.25 L.

Take advantage of RCA's ability to supply superior SCR's and Triacs... when you need them.

Ask our solid-state specialists why RCA's broad line of industrial SCR's and triacs excel in quality, reliability, and performance. They'll tell you that RCA thyristors are subjected to some of the toughest quality assurance tests in the industry. Thus, they save design dollars by virtue of superior performance in critical applications.

Ask users of industrial thyristors why RCA is a key supplier and they'll tell you RCA services the industry! Whatever the application—area lighting to avionics, regulators to inverters, or power supplies to modulators—RCA has SCR's and triacs to meet your application requirements.

Use these SCR's and triacs in your control applications:

SCR Family	Rating		Triac Family	Rating	
	$I_T(\text{RMS})$	V_{DROM}		$I_T(\text{RMS})$	V_{DROM}
40740	10 A	600 V	2N5568	10 A	400 V
40752	20 A	600 V	2N5572	15 A	400 V
2N690	25 A	600 V	40671	30 A	600 V
2N3899	35 A	600 V	2N5543	40 A	600 V

NOTE: SCR ratings of 100, 200, & 400 volts and triac ratings of 200 & 400 volts are available in each family. Stud packages & isolated-stud packages are also available in each rating.

For further details and your copy of the latest thyristor catalog, THC-500, see your local RCA Representative or your RCA Distributor. Or write RCA Electronic Components, Commercial Engineering, Section RD-19-2/UR6, Harrison, N. J. 07029. In Europe: RCA International Marketing S.A., 2-4 rue du Lièvre, 1227 Geneva, Switzerland.

RCA
Thyristors

