

Electronics[®]

Progress in thin-film transistors: page 88

Using infrared for measuring: page 101

LSI cuts costs of small computers: page 119

March 18, 1968

\$1.00

A McGraw-Hill Publication

Below: Analog computer checks
new tire quality, page 125

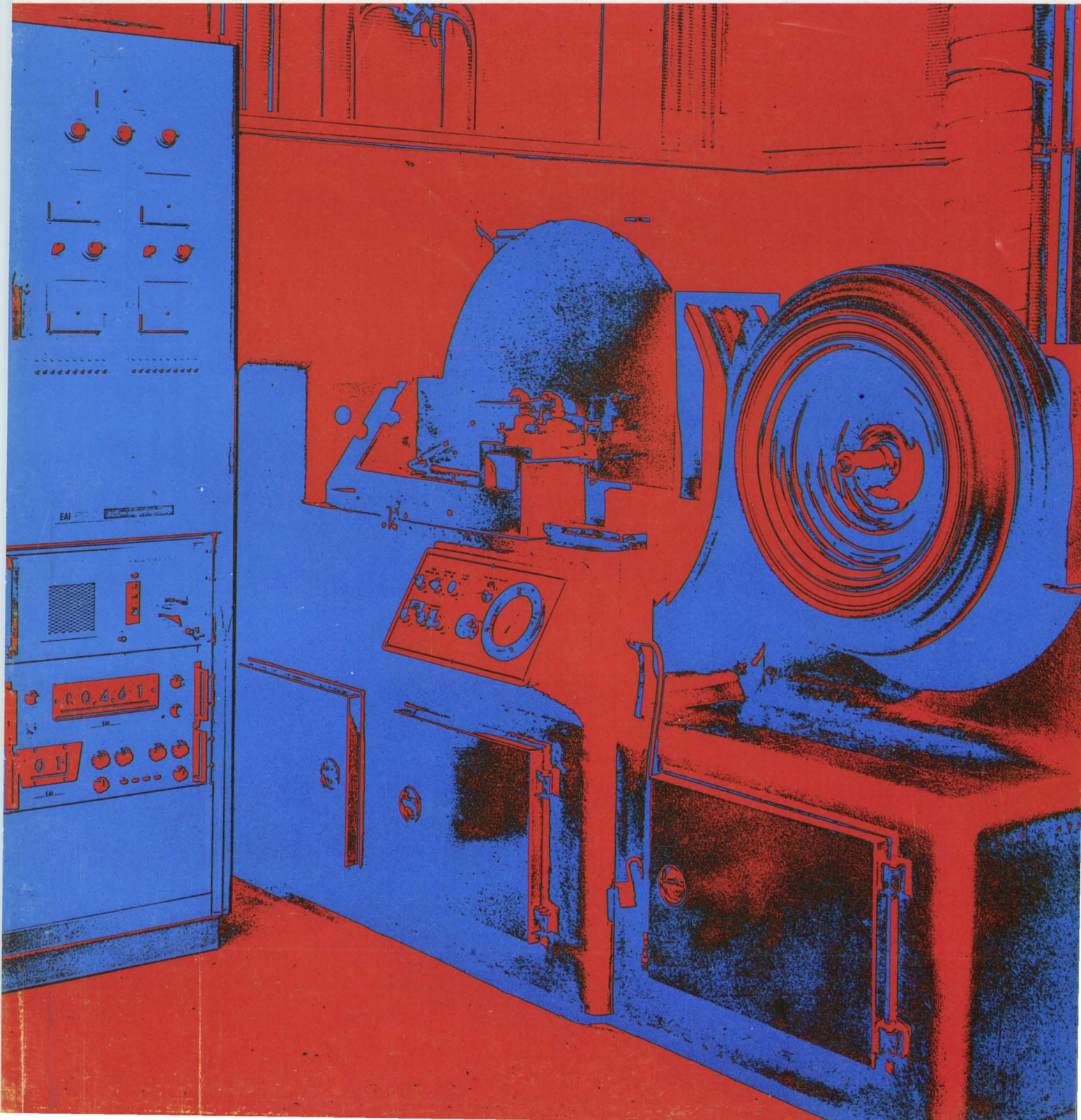

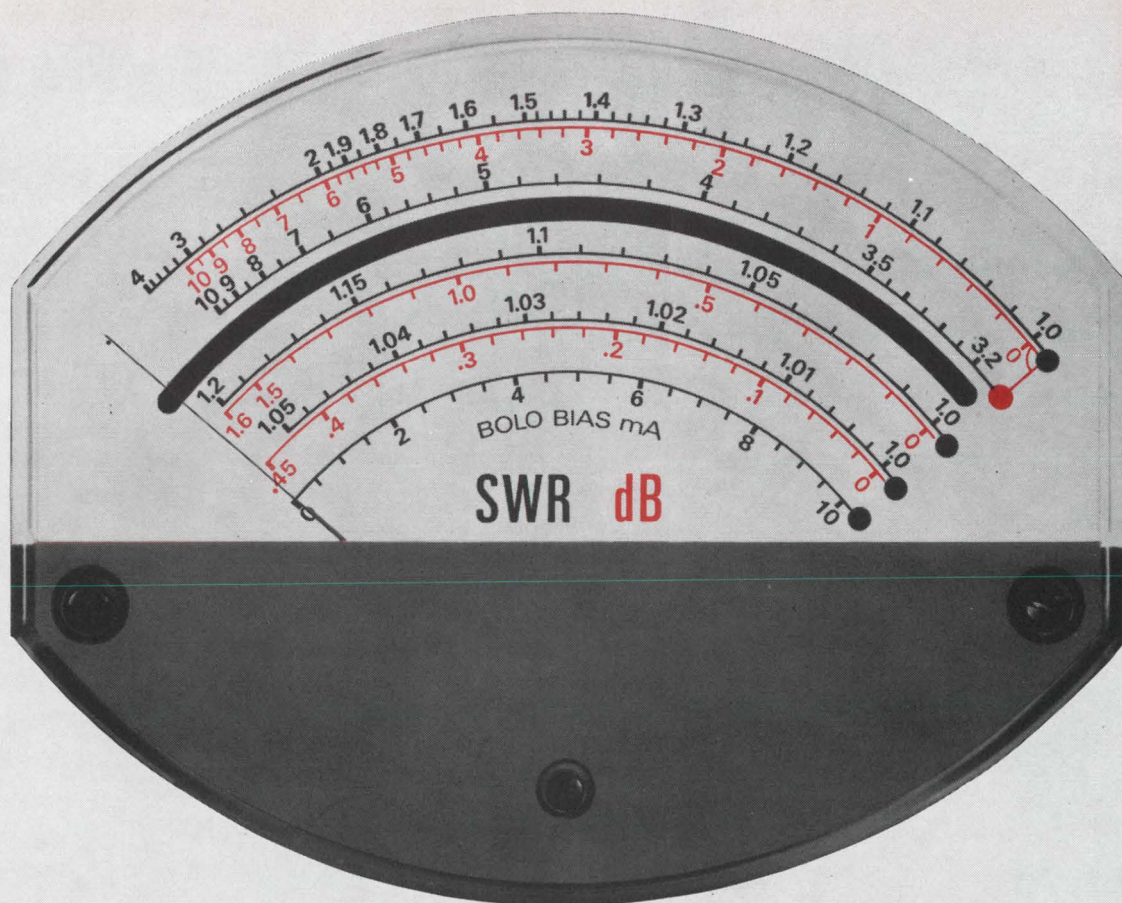

You helped design this new SWR Meter

That's right. You're the one who has been asking for a meter that's large enough to read without getting on top of it . . . for a simple but foolproof way of knowing what scale you're supposed to be reading . . . for an expanded scale that provides high-resolution measurements of low-SWR values. In GR's new 1234 Standing-Wave Meter we've provided all these features plus many more we think you'll like.

The meter of the 1234 is shown here in actual size; as you can see, it is larger than the meter of any comparable instrument. The red dot at the end of the scale indicates an illuminated meter light. There are five lights in all, one for each scale, and they are controlled by the range switch. Hence, no fear of reading the wrong scale with this instrument.

On the meter face, the total 1-to-10 SWR range of the 1234 is spread out over four scales to give higher-resolution measurements. With the 1-to-1.05 expanded scale you can read increments of SWR as small as 0.0004. This sensitivity is commensurate with the needs of GR's 900-LB Precision Slotted Line, for which the 1234 is an important accessory.

Convenience features in the 1234 don't end with its display. Three attenuators provide

a total range of 70 dB in steps of 1, 5, and 10 dB, and the 5 dB/step control features a sliding window that automatically displays incremental attenuation in substitution measurements. Three front-panel controls put band width adjustment (without change in gain), frequency detuning (centered at 1 kHz), and meter speed ("slow" or "fast") at your finger tips. Also included are protective circuitry for an external bolometer and a separate meter scale for reading the adjustable bolometer bias current.

For complete information on the 1234 Standing-Wave Meter and its companion GR874 and GR900 slotted lines and accessories, write General Radio Company, W. Concord, Massachusetts 01781.

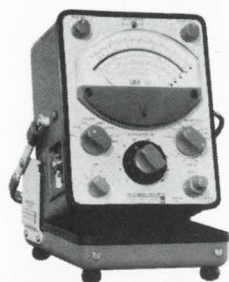

Type 1234 Standing-Wave Meter, \$495 in U.S.A.

GENERAL RADIO

Circle 900 on reader service card

A new concept in x-y recording:

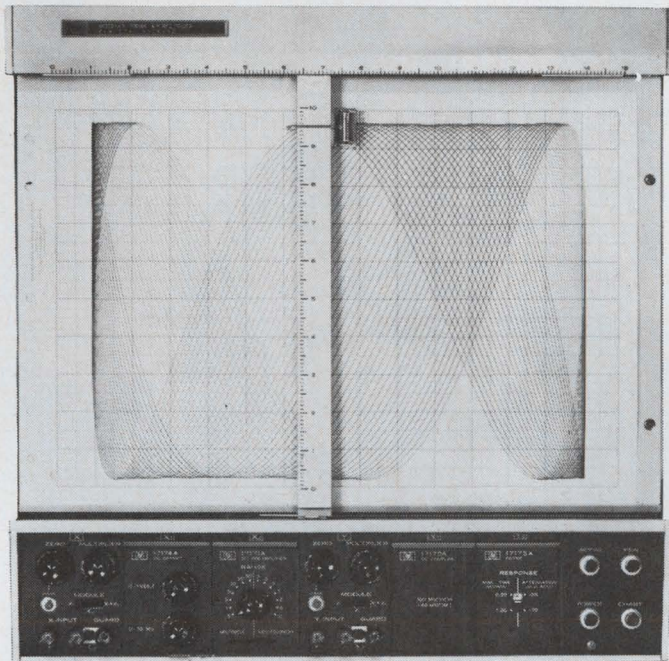

Something new has entered the X-Y recorder field. The new Hewlett-Packard 7004A X-Y Recorder, with dynamic performance of $1000''/\text{sec}^2$ acceleration and slewing speed of $30''/\text{sec}$ —unparalleled in the recorder industry—offers plug-in convenience for unprecedented versatility in either analog or digital applications. SIX plug-ins let you convert this precision, solid-state $11'' \times 17''$ X-Y recorder into many different recorders—and either X-Y, Y-T or X-T operations—and the variations are nearly endless, because there are more to come.

Plug-in expandability with highest dynamic performance!

With plug-in units constantly being developed, the HP 7004A X-Y Recorder offers you guaranteed versatility combined with superior performance. Price: 7004A, \$1295.

Here's what's available now:

- DC coupler, 100 mV/inch. \$50.
- DC amplifier, 0.5 mV to 10 V/inch with 14 calibration ranges. \$250.
- Time base, 8 calibrated sweep speeds. \$200.
- Null detector, up to 50 plots/second. \$200.
- DC offset, continuously adjustable to 1 V. \$100.
- Filter, 55 dB rejection at 50 Hz and above. \$75.

For a complete brochure and data sheet call your local HP field engineer or write Hewlett-Packard, Palo Alto, California 94304; Europe: 54 Route des Acacias, Geneva.

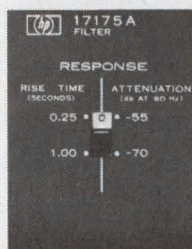
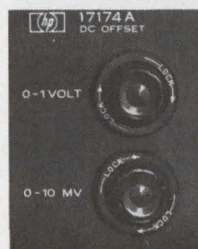

HEWLETT  PACKARD

GRAPHIC RECORDERS

11706

Get quick relief from RFI measurement drudgery with this spectrum analyzer.

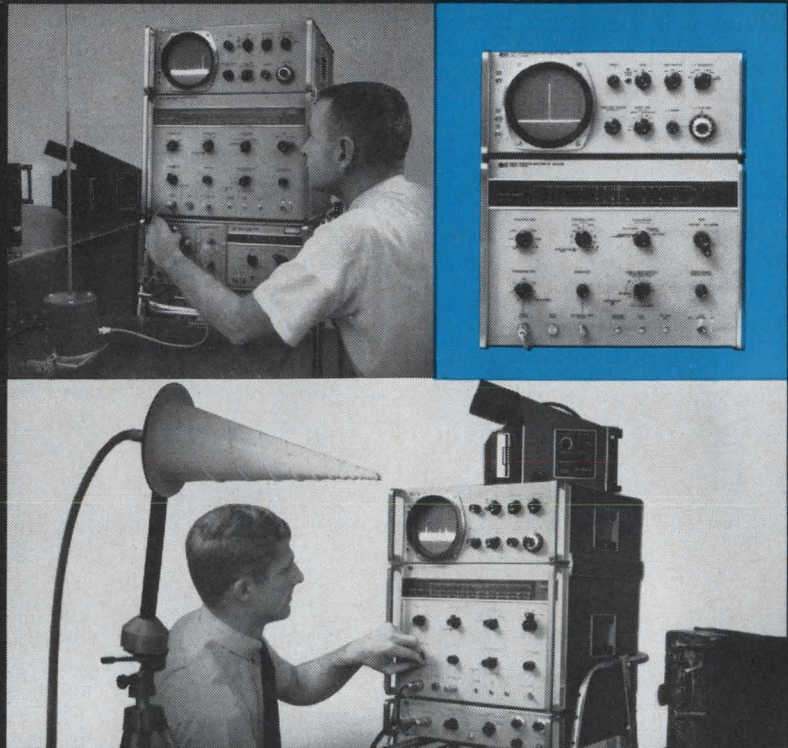

A wideband spectrum analyzer, by its nature, is well suited for analyzing electromagnetic interference (EMI). But Hewlett-Packard offers EMI/RFI specialists even more with the 8551B/851B Spectrum Analyzer. HP engineers have developed comprehensive, proven techniques by which the analyzer and associated equipment can make fast, accurate RFI tests whose results conform to modern EMC specs, such as MIL-STD-826A and 461/462/463.

In just a few hours, you can make measurements that used to take days. More extensive analyses that required weeks or months can be completed in days. The procedures cover 14 kHz to 10 GHz. They tell where and how to use the HP Up-Converter, YIG Pre-selector, and preamplification to comply fully with specified measurement conditions.

Substantial time-savings are achieved in both phases of RFI testing: system calibration and actual measurements. Absolute amplitude calibration, for "broadband" and "narrowband" conditions, is simplified because the 8551B/851B Analyzer's flat response and stable IF bandwidths minimize the number of calibration points.

Measurements are faster because calibrated scans as wide as 2 GHz let you cover the whole range quickly. And data logging with an oscilloscope camera is quick and conclusive.

The price of the Spectrum Analyzer is \$7550 for the 8551B RF Section, \$2400 for the 851B Display Section.

Call your local HP field engineer for more information about the HP 8551B/851B Spectrum Analyzer and its use in RFI measurements. Have him reserve your copy of the forthcoming Application Note 63E discussing RFI and the spectrum analyzer. Or write to Hewlett-Packard, Palo Alto, California 94304; Europe: 54 Route des Acacias, Geneva.

HEWLETT  PACKARD
SPECTRUM ANALYZERS

04802

News Features

Probing the News

- 151 **Wave of optimism for millimeter waves**
159 **IC registration revisited**
165 **Soviet computer program has as many downs as ups**

Electronics Review

- 47 **Integrated electronics:** Second-generation circuits from Fairchild
48 **Computers:** The punched card faces competition; NCR sets sights on bigger share of computer market
50 **Instrumentation:** Testing service for IC's; Reading and writing with a laser
52 **Military electronics:** Vietnam drains budgets for electronics
54 **Avionics:** Ultrasensitive accelerometer
54 **Microwave:** Gunn-effect devices from Varian
56 **Space electronics:** Satellites crowd the skies; NASA faces budget cuts
58 **For the record**

Electronics Abroad

- 253 **Great Britain:** Plessey shines with MOST optoelectronics; Sapphire rod delays X-band signals
254 **Japan:** Data comes in king-size cassettes; "New" thermoluminescent material checks radiation dose
255 **Australia:** New approach for glide path arrays
256 **France:** Change at the top of the science establishment
257 **West Germany:** Photocell on beam replaces big sphere
257 **Around the world**

New Products

- 173 **MOS bandwagon starts rolling**
188 **Components review**
188 Active filter cuts frequency
191 Radio-frequency amplifier is linear
192 Brighter picture from new phosphor
195 **Microwave review**
195 Signal generator uses phase lock
198 Amplifier with two magnetrons
200 **Instruments review**
200 Level meter covers 80 decibels
202 Sweep oscillator is easy to use
204 Counter/timer has BCD output
209 **Industrial electronics review**
209 Rate counter understands units
212 Component maker in NC field
216 **Subassemblies review**
216 Receiver features easy tuning
218 Telephone in an attache case
223 **Semiconductors review**
223 Hybrids cut package size
225 Bipolar counter has two layers

Title R registered U.S. Patent Office; © copyright 1968 by McGraw-Hill Inc. All rights reserved, including the right to reproduce the contents of this publication, in whole or in part.

Technical Articles

- Advanced technology** 88 **Thin-film transistors don't have to be drifters**
New gate insulator material stabilizes TFT's and opens the way for practical applications
Albert Waxman, RCA Laboratories
- Circuit design** 94 **Designer's casebook**
▪ FET keeps long staircase steps flat
▪ Oscillator as detector
▪ SCR synchronizes gate
▪ Photographic printer controlled by UJT-SCR timer
▪ Feedback reduces bio probe's input capacitance
- Instrumentation** 101 **Through thick and thin with infrared beams**
Spectrometer speeds up measurements of epitaxial layer thickness
Thomas E. Reichard, Monsanto Co.
- Instrumentation** 106 **Sighting in on narrow light beams**
Radiometer measures the laser beamwidths needed for accurate long-range transmission
Herbert B. Hallock, Grumman Aircraft Engineering Co.
- Advanced technology** 109 **Semiconductor gages make sense in most transducer applications**
Resistor and transistor strain gages give higher output, better sensitivity than metal devices
Robert M. Moore, RCA Laboratories
- Computers** 119 **Adder on a chip: LSI helps reduce cost of a small machine**
Metal oxide semiconductor eight-bit arithmetic unit has unusual add-subtract algorithm
Lee L. Boysel, Fairchild Semiconductor
- Industrial electronics** 125 **Sorting out the tires**
Analog computer controls testing of automobile tires, helps producers eliminate smooth-road shake
James T. Maguire and Allen J. Schnaboik, Electronic Associates Inc.
- Opinion** 132 **Cameras that wink can produce 3-D tv**
Two monochrome cameras and a color receiver can produce an illusion of depth
M.G. Maxwell, Kriesler Australasia Pty. Ltd.
- ## Departments
- 4 Readers Comment
8 People
14 Meetings
16 Meeting Preview
23 Commentary
25 Electronics Newsletter
69 Washington Newsletter
228 New Books
232 Technical Abstracts
236 New Literature
243 Newsletter from Abroad

Electronics

Editor-in-Chief: Donald Christiansen

Associate managing editors

Technical: Stephen E. Scrupski
News: Robert Henkel
Copy: Sally Powell

Senior associate editors

Joseph Mittleman, Harry R. Karp

Department editors

Avionics & Space: Alfred Rosenblatt
Computers: Wallace B. Riley
Communications: William Bucci
Consumer electronics: John D. Drummond
Design theory: Joseph Mittleman
Industrial electronics: Harry R. Karp
Instrumentation: Carl Moskowitz
Military electronics: Richard Gundlach
Solid state: Mark B. Leeds

Regional bureaus

Domestic

Boston: James Brinton, manager; Robin Carlson
Los Angeles: Lawrence Curran, manager; Burton Bell
New York: Howard Wolff, manager
San Francisco: Walter Barney, manager; Peter Vogel
Washington: Robert Skole, manager; William D. Hickman, Paul Dickson

Foreign

Bonn: John Gosch
London: Michael Payne
Tokyo: Charles Cohen

Copy editors

James Chang, Frederick Corey, James Darby

Graphic design

Art director: Saul Sussman
Assistant art directors: Ann Mella, Valerie Betz
Production editor: Arthur C. Miller

Editorial secretaries: Claire Benell, Lynn Emery, Kay Fontana, Patricia Gardner, Lorraine Longo, Barbara Razulis, Frances Vacca

McGraw-Hill News Service

Director: Arthur L. Moore; **Atlanta:** Fran Ridgway; **Chicago:** Bruce Cross;
Cleveland: Arthur Zimmerman; **Dallas:** Marvin Reid;
Detroit: James Wargo; **Houston:** Robert E. Lee; **Los Angeles:** Michael Murphy
Pittsburgh: Louis Gomolak
San Francisco: William F. Arnold
Seattle: Ray Bloomberg; **Washington:** Charles Gardner, Daniel B. Moskowitz, Herbert W. Cheshire, Seth Payne, Warren Burkett, William Small

McGraw-Hill World News Service

Bonn: Robert Dorang; **Brussels:** George Williamson; **Hong Kong:** Wes Perry;
London: John Shinn; **Mexico City:** Gerald Parkinson; **Milan:** Ronald Taggiasco, Jack Star;
Moscow: Howard Rausch; **Paris:** Robert E. Farrell, Peter Kilborn;
Rio de Janeiro: Leslie Warren; **Tokyo:** Marvin Petal

Reprints: Susan Nugent

Circulation: Milton Drake

Publisher: Gordon Jones

Electronics: March 18, 1968, Vol. 41, No. 6

Published every other Monday by McGraw-Hill, Inc. Founder: James H. McGraw 1860-1948.

Printed at 99 North Broadway, Albany, N.Y. 12207; second class postage paid at Albany, N.Y.

Executive, editorial, circulation and advertising addresses: McGraw-Hill Building, 330 W. 42nd Street New York, N. Y. 10036. Telephone (212) 971-3333. Teletype TWX N.Y. 710-581-4235. Cable address: MCGRAWHILL N.Y.

Subscriptions solicited only from those professionally engaged in electronics technology. Subscription rates: qualified subscribers in the United States and possessions and Canada, \$5.00 one year, \$12.00 two years, \$16.00 three years; all other countries \$25.00 one year. Non-qualified subscribers in the U. S. and possessions and Canada, \$25.00 one year; all other countries \$50.00. Air freight service to Japan \$50.00 one year. Single copies: United States and possessions and Canada, \$1.00; all other countries, \$1.75.

Officers of McGraw-Hill Publications: Joseph H. Allen, President; Bayard E. Sawyer, Executive Vice-President; J. Elton Tuohig, Senior Vice-President-Operations; Vice Presidents: John R. Callahan, Editorial; John M. Holden, Marketing; Paul F. Cowie, Circulation; Angelo R. Venezian, Production; Jerome D. Luntz, Planning & Development; Robert M. Wilhelmy, Controller.

Officers of the Corporation: Shelton Fisher, President and Chief Executive Officer; John L. McGraw, Chairman; L. K. Goodrich, Executive Vice President; R. E. Slaughter, Donald C. McGraw, Jr., Senior Vice Presidents; Daniel F. Crowley, Senior Vice President and Treasurer; John J. Cooke, Vice President and Secretary.

Title © registered in U.S. Patent Office; © Copyright 1968 by McGraw-Hill, Inc. All rights reserved. The contents of this publication may not be reproduced either in whole or in part without the consent of copyright owner.

Subscribers: The publisher, upon written request to our New York office from any subscriber, agrees to refund that part of the subscription price applying to copies not yet mailed. Please send change of address notices or complaints to Fulfillment Manager; subscription orders to Circulation Manager, Electronics at address below. Change of address notices should provide old as well as new address, including postal zip code number. If possible, attach address label from recent issue. Allow one month for change to become effective.

Postmaster: Please send form 3579 to Fulfillment Manager, Electronics, P.O. Box 430, Hightstown, New Jersey 08520

Readers Comment

Wrong number?

To the Editor:

You appear to have been misinformed regarding certain developments in the field of Belgian telecommunications [Dec. 25, 1967, p. 88].

We, as important manufacturers of telecommunications equipment in Belgium, were very surprised to find that there was no mention of our company, or of the 1,000-line electronic installation at Hasselt, about 25 miles from Antwerp, which was manufactured by our company and installed in June 1967. This installation, officially ordered by the Belgian telephone authorities, has been in public service with 700 subscribers connected since Dec. 18, 1967, and is itself incorporated in the national network. We can therefore honestly claim that this is the first electronic exchange to be actually installed and put into service in Belgium.

On the other hand the electronic exchange installed in Antwerp was never ordered by the telephone authorities who only agreed to its installation as a field trial. As a result, this exchange has certainly not been "put into service" by the Belgian government telephone authorities, as stated in your article.

E. M. Flamme

Automatic Electric S.A.
Antwerp
Belgium

Low-cost dvm's

To the Editor:

I wish to correct the impression given in "Monitoring panels by the numbers" [Feb. 5, p. 172] that the panel meter replacement described will become the least expensive all-electronic digital panel meter.

Gralex, a manufacturer of nano-second/sub-nanosecond signal generation and measuring instruments, recently developed an all-electronic digital panel meter. The device, model 2103 digital voltmeter, also sells for \$295 in small quantities, but a large quantity has recently been sold for considerably less. The device is aimed primarily at the OEM market where any param-

Here's a new linear IC from Sprague. The ULN-2111A.

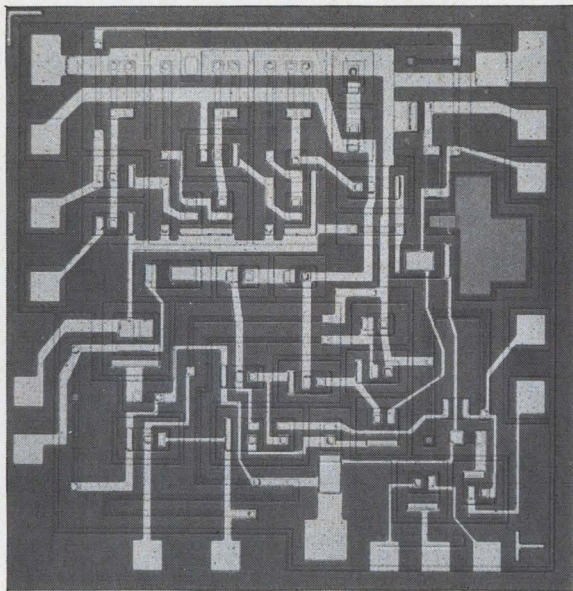

It's a 3-stage 60 db
broadband limiting
amplifier and a
balanced detector.
A single-slug coil tunes it.

You can use it in TV sound channels and FM receivers, for SSB detection in mobile gear, in radar and TV AFC, and in telemetry receivers.

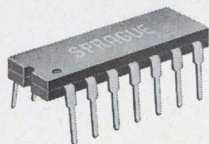

It comes
in a 0-70 C DIP.
And it's priced right...!

TYPE ULN-2111A SPECIFICATIONS				
$V_{CC}=12V$, $I_{CC}=16mA$, $P_D=200mW$, bandwidth=5kHz-50MHz				
Typical Characteristics for TV and FM Applications				
	TV	FM	UNITS	CONDITIONS
Fo	4.5	10.7	MHz	
Dev.	± 25	± 75	kHz	
V _{INJ}	60	60	mV rms	
Δf_{p-p}	150	550	kHz	
V _{out}	0.60	0.50	V rms	R _L =2k Ω
V _{out}	0.35	0.30	V rms	R _L =200 Ω *
Lim. Thr.	400	400	μV rms	-3db output
AM Suppr.	46	40	db	IHF-V _i -10mV
Cap. Ratio	—	1.4	db	IHF-30db-30%
THD	1.5	1.0	%	100% FM mod.
THD	0.6	0.4	%	30% FM mod.
Detuning	—	< ± 5	kHz	0 < V _i < 0.5 V rms

*Requires 1 k Ω , pin 1 to gnd.

To request samples, call your Sprague representative.
For further information, write to Technical Literature
Service, 35 Marshall St., North Adams, Mass. 01247.



Sprague' and '®' are registered trademarks of the Sprague Electric Co.

SPRAGUE WORCESTER... the world's finest microcircuit facility

**Cool down an oven, turn off a boiler, disengage a gear,
or control dancing fountains.**

**And you thought all a
circuit breaker could do
was protect against
overload.**

Sure CB's protect against overload. But Heinemann makes many breakers with special-function internal circuits that can do much more.

For example. There's one that can turn off an electric oven, if it gets too hot. Or shut down a boiler, if pressures get too high. Another breaker is an integral part of a control unit in a complex fountain display.

Suppose you can't afford to have your process or equipment shut down entirely when a circuit breaker trips. A Heinemann special-function breaker can open the main circuit, when an overload occurs, and switch on an auxiliary circuit. Possibly to keep plate/grid voltage on. Or maintain a minimum temperature level.

Another type of circuit breaker can be used to disengage a gear if a motor gets "locked up". Other breakers can serve as relays, limit controls, remote switches. Things you may have never dreamed of.

Besides being versatile, special-function circuit breakers can eliminate other components. Even complete circuits. And this can save you many times the cost of the breaker itself.

We've just prepared an interesting booklet, "16 Surprise Uses of Heinemann Circuit Breakers," complete with circuit diagrams. Designed to stimulate your ingenuity, it's yours for the asking. Write us. Heinemann Electric Company, 2802 Brunswick Pike, Trenton, New Jersey 08602.

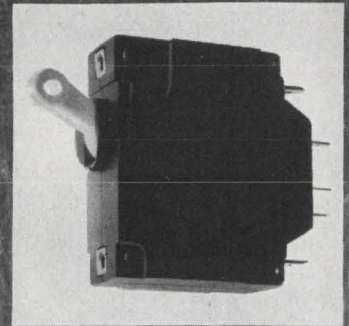

HEINEMANN

eter which can be converted to a d-c voltage must be measured accurately.

The first production run has been successfully completed and the initial units are about to be installed in test equipment used in hospitals and laboratories for precise measurement of the strength of radiation dosages.

As the price of integrated circuits decreases and LSI units become available it will probably be less than two years before the under-\$100 dvm, predicted in your magazine, becomes a reality. We are actively pursuing that goal.

Paul Lenoble

Vice president
Gralex Industries Inc.
Copiague, N.Y.

Back issues

To the Editor:

The earliest solid state amplifications [Feb. 19, p. 82] may have been achieved early in 1920.

Two magazines, Radio News, and Science and Invention, reported in letters from readers some claims of getting amplification from crystal radio receivers. Two included circuit diagrams with descriptive details. One radio amateur experimenter included two "cat's whiskers" on a single crystal, battery and potentiometer. He was smart enough to know you could not get amplification with a rectifier, and thus attributed his highly superior results to the point of operation on the rectification curve. The other experimenter had a conventional crystal, but a circuit that included a battery voltage. He simply insisted he was getting amplification without a rational explanation for

it (probably negative resistance).

The flurry of controversy over amplification with crystal detectors was suddenly put to an end by a more authoritative explanation of reradiation from vacuum tube regenerative receivers and a positive assertion that any exceptional crystal receiver operation was due to such a cause.

It would be interesting, if copies of these magazines still exist, to examine the circuit details to determine whether signal amplification was actually achieved.

Carl V. Erickson

Shawnee-Mission
Kansas

▪ The first description certainly sounds like the point-contact transistor; the second could well have been a negative resistance effect. Perhaps some reader can quote the "authoritative explanation" cited. It may have nipped the semiconductor industry of the 20's in the bud.

Not yet

To the Editor:

As sole agents in Japan of the English Electric Valve Co. of Chelmsford, England, we must inform you that our principals have not at present made a technical agreement with Shiba Denki K.K. for the manufacture of high power klystrons [Jan. 22, p. 192] and it will be appreciated if you will advise your readers of this fact.

R. S. Weem

Cornes & Co., Ltd.
Tokyo

▪ Shiba says it has a letter of intent from the British company and expects that an agreement will be signed soon.

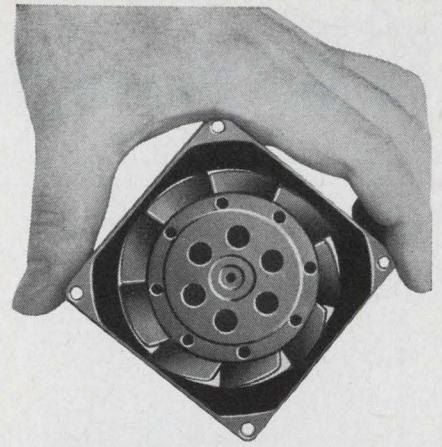

**this new all-metal
miniature fan is...**

the quietest...

(Unmatched low noise level of 28.8 dB SIL.)

the most compact...

($\frac{1}{8}$ " thinner than conventional $\frac{3}{8}$ " fans. Standard mounting dimensions for EIA $\frac{3}{2}$ " rack panels.)

the most efficient...

(Delivers 45 cfm at zero static pressure . . . 50% more air than other $\frac{3}{8}$ " fans.)

**$\frac{3}{8}$ " fan you can
get your hands on.**

**the Model 8500
really delivers...**

**and we can
deliver, too!**

(immediate delivery through leading electronic distributors or directly from factory stock)

SUBSCRIPTION SERVICE

Please include an Electronics Magazine address label to insure prompt service whenever you write us about your subscription.

Mail to: Fulfillment Manager
Electronics
P.O. Box 430
Hightstown, N.J. 08520

To subscribe mail this form with your payment and check new subscription renew my present subscription

Subscription rates: qualified subscribers in the U.S.: 1 year \$8; two years, \$12; three years, \$16. Non-qualified: 1 year \$25. Subscription rates for foreign countries available on request.

CHANGE OF ADDRESS

ATTACH LABEL HERE

If you are moving, please let us know five weeks before changing your address. Place magazine address label here, print your new address below.

name _____
address _____
city _____ state _____ zip code _____

Want more information?

have sales rep call send data

(name) _____ (title) _____

(company) _____ (phone) _____

(address) _____

(city) _____ (state) _____ (zip) _____

PAMOTOR, INC.

312 Seventh St., San Francisco, Cal. 94103

collage 30

People

Gap-Filling with a 500 lb. Lightweight



All right, students, what is it that plugs the communications gap between the 0 to 40 mile range of line-of-sight microwave radio and the over-150 mile range of HF radio? Give up? Then go stand in the corner because we've been telling you about this wondrous gap-plugger for well over a year now. It's the AN TRC-105 lightweight (500 lbs) troposcatter radio set. One of the beauties of this little (more or less) system is that it virtually eliminates the usual effects of troposcatter fading by using an extremely high (16th) order of diversity . . . without power splitting at the transmitter, or multiple antennas, or multiple receivers. And, AN TRC-105 uses but one-fifth the power input of what (to our people) are laughingly called current "tactical" tropo equipment. The system comes in five handy pieces: a power amplifier; a receiver-exciter; a power distribution unit and controller; a multiplex unit; and the everpresent antenna. A compelling 6-page brochure, replete with dramatic illustrations and turgid words is available from our Chicago Center.



The Black Box of Another Color

To the uninitiated our new Airborne Digital Decoder (fondly called ADD) may be just another black box. But it is replete with such esoteric specs that it has been known to reduce even the most

world-weary and jaded engineers to a state of blubbing frenzy. For example, ADD accepts and processes detected PSK audio signals or a decoded FSK NRZ binary data stream at either a 2.4 KHz or 12 KHz data rate! And, upon closer inspection, you'll see that the little black box is machined from actual aluminum, so it needn't be a black box at all, unless, for tradition's sake you prefer it that way. ADD can be used as part of a flight guidance and control system, and is put together of I/C "flat-packs," and discrete components in sandwich type, modular construction. Those of you who wish to guide and control flying things should write to the Command Systems Section of our Aerospace Center. They'll send you a data sheet that will tell you more than most people will ever want to know about ADD.

HOMING IN ON THE RANGE

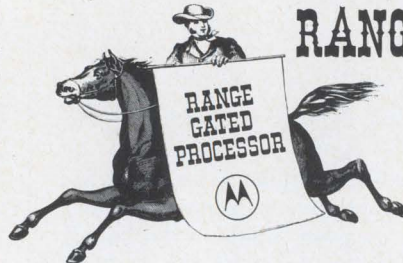

If you'd like your video return produced with greatly improved resolution you've come to the right place. We have this thing called a Range Gated Processor that is the latest and greatest in our series of video processors for airborne side-looking radar systems. Among other things, the new unit sequentially divides incoming video into 660 elements, each of which is 0.2 microseconds long. These elements are stored, processed to reduce off boresight returns, and serially recombined to produce, as we said, a video return with greatly improved azimuthal resolution. If you are resolute about improving your resolution, write our Aerospace Center's Radar Systems Lab.

Aerospace Center Dept. 2008
8201 E. McDowell Rd., Scottsdale
Arizona 85252, Phone (602) 947-8011
Chicago Center Dept. 985
1450 N. Cicero Ave., Chicago,
Illinois 60651, Phone (312) 379-6700



MOTOROLA

Government Electronics Division

The assigned tasks of IBM's Center for Exploratory Studies have been broad, ranging from a major effort in advanced laser development to smaller studies of new approaches to criminology. The effect has been to help get IBM's fingers into an increasing number of pies. Albert E. Babbitt, 40, the new director of the center plans to continue to broaden the scope and complexity of the center's activities.

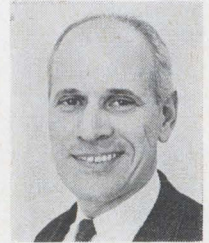

Albert E. Babbitt

Without setting priorities or tipping the International Business Machines Corp.'s hand on its latest emphasis, Babbitt outlines some projects he will direct at the Rockville, Md., center. He says the center will continue to emphasize lasers and laser application, but that other work will get new attention. He says, "We are very interested in the development of new classes of sensors and the control of these sensors by computer." Development of digital sensors are particularly appropriate at the center, he adds.

More computers. Babbitt sees a major interest in the new roles for computers. "We will certainly be increasingly concerned with the use of computers in bigger systems, such as massive control and data communications systems."

Babbitt sees an increasing place for the computers as a tool in the design of new systems.

In the Mallard program—a four-nation tactical communications system now in early development at IBM and other firms—he says the system design is being simulated and evaluated by computer.

He moves from his job as manager of advanced development for the Federal Systems Center where, among other things, he headed the Mallard program for IBM. Now, four months into the 19-month Mallard research and development schedule, IBM is taking no chances and is moving the program to the center along with Babbitt.



The ML-EE64Y is the smallest 10 kv (peak) switch tube—and the smallest 10 kv (peak) regulator tube you can buy. ML-EE64Y gives you up to 36 free cubic inches per tube, and doesn't require a socket. It offers you a 12 amp peak current, high signal sensitivity, and a simple BeO heat sink with no other cooling required. The ML-EE64Y provides tabs for simple, low-cost connection.

For complete data, write to Machlett—the tube specialist most responsive to customer needs—today. The Machlett Laboratories, Inc., 1063 Hope Street, Stamford, Connecticut 06907.

Why use this tube...for high voltage switching or voltage regulation...when this one is better?

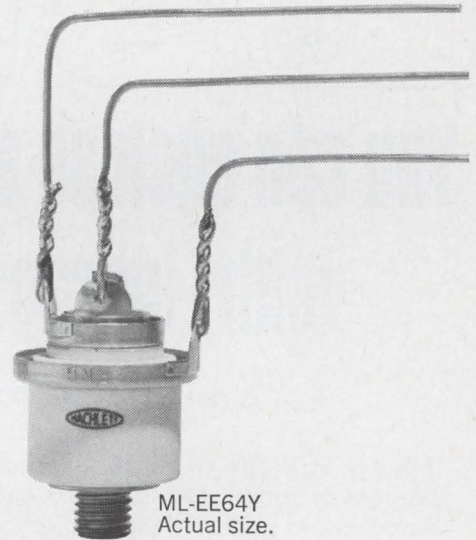
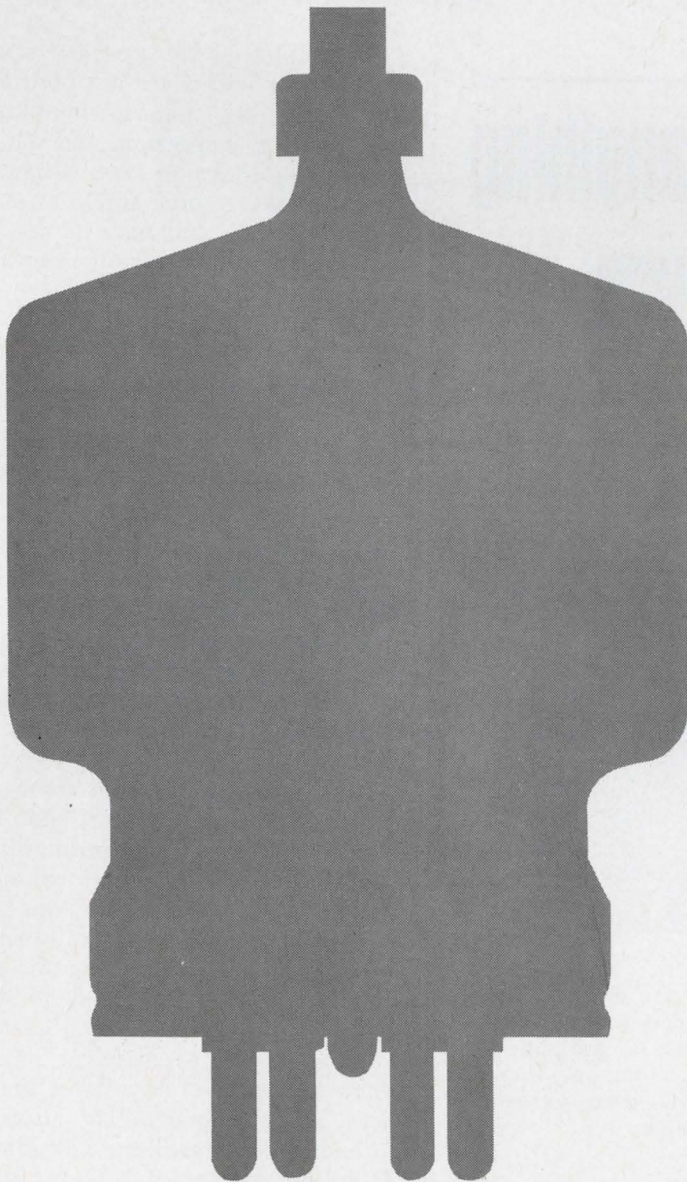

ML-EE64Y
Actual size.

RAYTHEON

THE MACHLETT LABORATORIES, INC.

A SUBSIDIARY OF RAYTHEON COMPANY

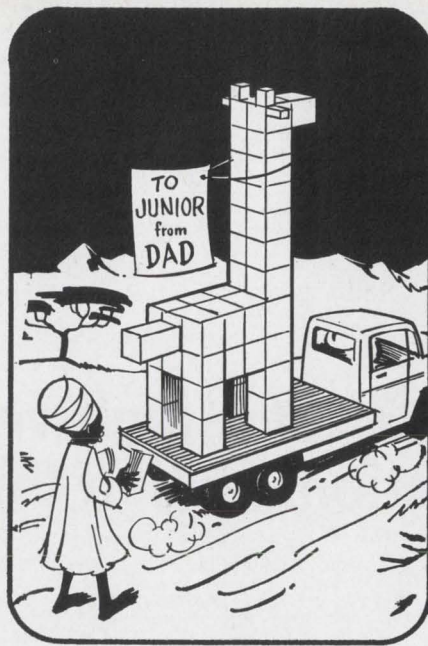

You can enclose almost anything with Lindsay Structure

(or we can enclose it for you)

Lindsay Structure comes in easy-to-assemble parts, in subassembled sections or completely assembled (with or without your equipment installed) to fit nearly any type of enclosure need.

It makes unsupported enclosures from a 7" cube to an 8' high x 20' wide structure, any length. Structurally supported, it makes enclosures to any size. Choice of metals, shapes and finishes.

FOUR BASIC PARTS GO TOGETHER LIKE THIS

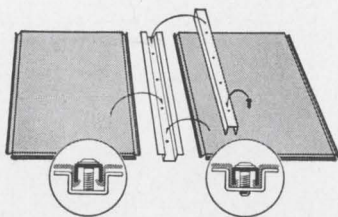

Typical applications include: Capacitor, generator and air conditioning housings; microwave structures; processing towers, ovens and dryers; instrument housings; equipment cabinets; insulated enclosures; machinery assemblies; shipping containers, and buildings, rooms and booths.

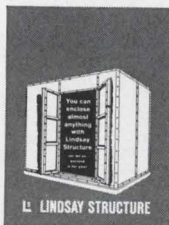

Send for this brochure that tells you all about versatile Lindsay Structure and the ways it can help you solve enclosure problems.

INTERNATIONAL STEEL COMPANY

1413 EDGAR ST., EVANSVILLE, IND. 47707

DIVISIONS: Structural Steel, Revolving Door and Entrance, Lindsay Structure, Railway
SUBSIDIARY: Extruded Alloys Corp., Bedford, Ind.

People

C. Raymond Harmon, the new president of the acquisition-minded Electronic Specialty Co., predicts that the firm will add a new technology emphasis in 1968: automation. "Right now we're talking with five or six companies whose business is related to a broad-based field of automated labor-saving technology," he points out.



Raymond Harmon

"Examples of the possible specialties this will cover are bottling and packaging, material handling and transfer, inspection, and quality control," Harmon says. "I figure we'll be taking some action on acquisitions soon and may be creating a new group before the end of the year."

Another Harmon forecast: Electronic Specialty will deemphasize its military business, from 40% in 1966 to 15% to 20% by 1970.

When laser pioneer Theodore Maiman resigned as head of the Korad Corp. [Electronics, Dec. 11, 1967, p. 8]—apparently in a dispute over the Union Carbide Corp.'s move to absorb the operation—Clayton Zerby was named as his replacement.

The 43-year-old general manager of what is now a department of Union Carbide's Electronics division sees a shift in operational emphasis. Korad, he explains, has always sold most of its lasers to universities and scientific laboratories; only about 30% have gone to the military. But Zerby expects the defense sector to account for much more of Korad's future laser business. The company has already furnished laser artillery rangefinders to the Army.

Zerby asserts that absorption into the Electronics division has not and will not change Korad's makeup. The unit will remain an autonomous organization, he declares.

Measure the world of motion in any direction... instantly, accurately, dependably, in any application, telemetry or control, with United Control's highly reliable servoed miniature accelerometers. You name the application and the environment, we'll provide the best accelerometer. For more information, call or write United Control.

measure

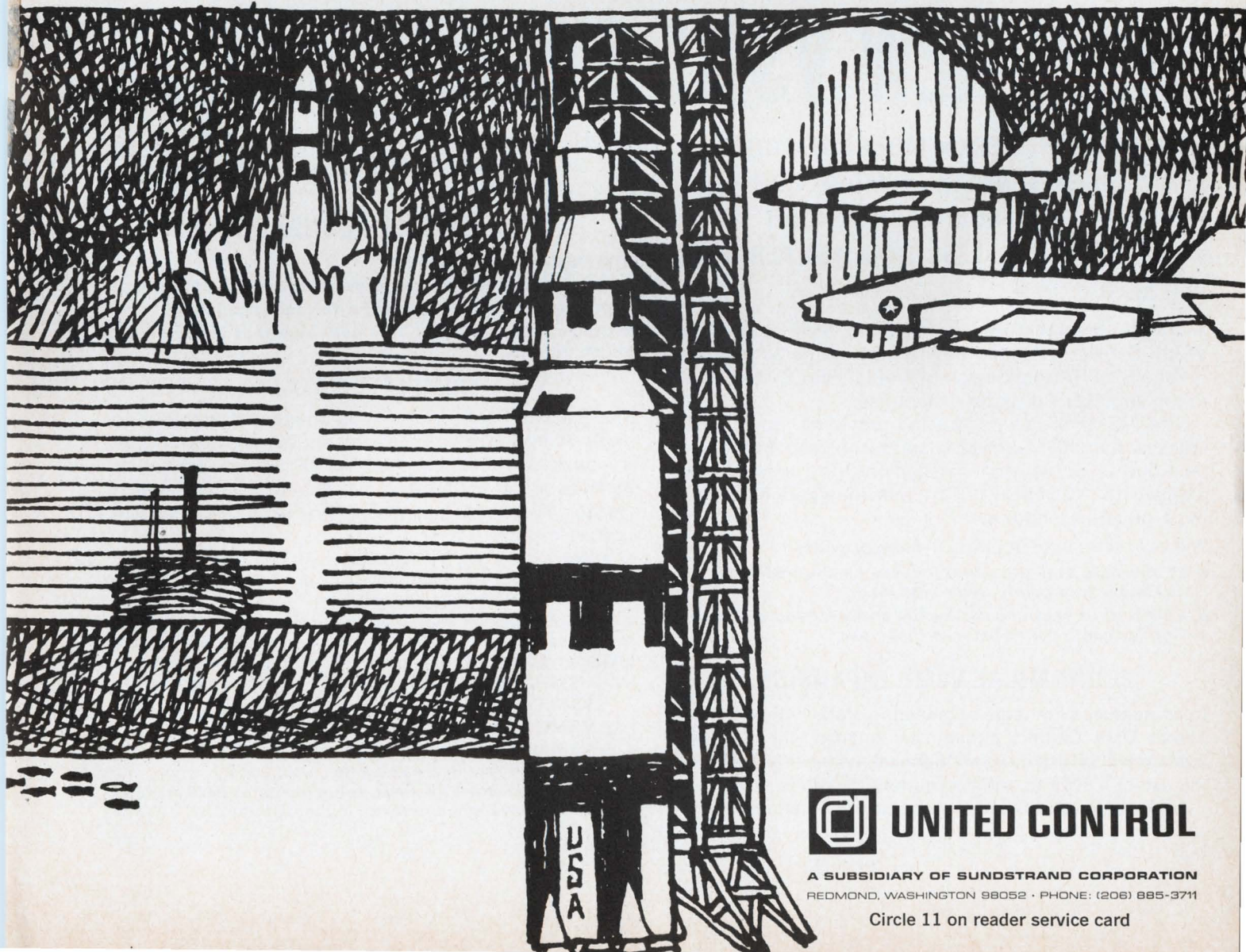

UNITED CONTROL

A SUBSIDIARY OF SUNDSTRAND CORPORATION
REDMOND, WASHINGTON 98052 · PHONE: (206) 885-3711

Circle 11 on reader service card



NOW! NEW VSMF[®] SYSTEM BRINGS

- **RIGHT AT THE DESK ■ MORE CATALOG DATA FROM MORE VENDORS ■ MORE COMPLETE PRODUCT DATA FROM EACH VENDOR**
- **AVERAGE COST: LESS THAN \$60 PER YEAR PER MAN**

A design breakthrough in microfilm technology—the VSMF Satellite™ Reader—now brings all the advantages of the VSMF (Visual Search Microfilm File) System right to the engineer's desk for instant use!

The VSMF System, already providing up-to-date, indexed, microfilmed catalog and technical data in more than 500 U. S. industrial installations, now achieves the ultimate in ACCESSIBILITY—individualized data systems, an arm's length away.

The new 8mm Satellite Data System provides:

- all the data and the same indexes as the VSMF 16mm Data Center at a much lower cost, and
- a section or sections of the file applicable to a specific design specialty for as little as \$348/year.

ECONOMICAL VSMF EXPANSION

In companies with large engineering staffs, where VSMF 16mm Data Centers already are located, the Satellite System will offer a more economical means of expanding the use of VSMF to additional plant locations.

In companies with smaller engineering staffs, the new

Satellite Reader System offers the increased data searching efficiency of VSMF at a much lower cost than previously available.

ONLY 11 POUNDS

The new Satellite Reader:

- weighs 11 pounds ■ has screen dimensions of 8 x 10½"
- utilizes a simple hand control for page scanning
- utilizes a no-threading film cartridge that holds 4,400 pages of data.

COMPLETE DATA!

The Satellite Reader not only is bringing a new look to engineering and design departments, but also has brought a new look within the total VSMF System itself. The immediate and enthusiastic acceptance of the Satellite Reader in field tests has resulted in the following system improvements:

- VSMF data on each vendor now will be COMPLETE, due to a new policy of including all of each vendor's catalog data at NO CHARGE to the vendor
- individual VSMF files have been broadened to better serve the needs of different specializations within the engineering field. The following files now are available:

VSMF Design Engineering File
 VSMF Plant Engineering Catalog File
 VSMF Documentation File
 VSMFMilitary Specifications File
 VSMFMilitary Standards File
 VSMF COMM-PAK Files, tailor-made to data storage and retrieval systems for an individual company's needs



ALL ENGINEERS A CLOSER LOOK

FOR ENGINEERING SPECIALISTS

Specialized sections of the above files also may be obtained separately, in the following categories:

■ **DESIGN ENGINEERING . . .** Electrical / Electronic / Fluid Systems / Instruments / Materials & Fasteners / Power Transmissions and Hardware / Production Equipment and Services

■ **PLANT ENGINEERING . . .** Electrical / Process Piping / Instrumentation & Control / Mechanical / Architectural & Structural / Materials Handling / Plant Operating Equipment & Materials

The VSMF System of Data Centers and Satellites saves time, space and money. More importantly, it helps improve engineering performance by providing vendor product information that is **ACCESSIBLE, UP-TO-DATE and COMPLETE.**

For more information on the all new VSMF System, including the exciting Satellite Reader, please call your VSMF representative, or write Information Handling Services, Inc., Denver Technological Center, Englewood, Colorado 80110... Dept. E318



Information
HANDLING SERVICES, INC.

DIVISION OF INDIAN HEAD INC.



Circle 13 on reader service card

IN JUST

3

DAYS

ACOPIAN WILL SHIP ANY OF 62,000 DIFFERENT POWER SUPPLIES

This catalog lists 62,000 models of AC to DC plug-in power supplies available for shipment in just three days. Choose the exact outputs you need. Singles or duals, regulated or unregulated. Write or phone for your free copy.



Name _____
Title _____
Company _____
City _____
State _____ Zip _____



Acopian Corp., Easton, Penna. 18042
Phone: (215) 258-5441

Meetings

International Convention, Aerospace and Electronics Systems of IEEE; Warwick Hotel, New York, March 19.

Modulation Transfer Function, Society of Photo-Optical Instrumentation Engineers; Boston, March 21-22.

Symposium on Microwave Power, International Microwave Power Institute; Statler Hilton Hotel, Boston, March 21-23.

Flight Test Simulation and Support Conference, American Institute of Aeronautics and Astronautics; Los Angeles, March 25-27.

International Aerospace Instrumentation Symposium, College of Aeronautics and Instrument Society of America; Cranfield, England, March 25-28.

Quality Control Conference, American Society for Quality Control; University of Rochester, N.Y., March 26.

Railroad Conference, IEEE and American Society of Mechanical Engineers; Conrad Hilton Hotel, Chicago, March 27-28.

Electrical Engineers Exhibition, American Society of Electrical Engineers; London, March 27-April 3.

International Conference on Color Television, Electronic Industries Association of France; Paris, April 1-5.

International Components Show, Federation Nationale des Industries Electronique; Paris, April 1-6.

Business Aircraft Meeting and Engineering Display, Society of Automotive Engineers; Broadview Hotel, Wichita, Kan., April 3-5.

International Magnetics Conference, IEEE; Sheraton Park Hotel, Washington, April 3-5.

Meeting and Technical Conference of the Numerical Control Society; Marriott Motor Hotel, Philadelphia, April 3-5.

Symposium on Engineering Aspects of Magnetohydrodynamics, American Institute of Aeronautics and Astronautics, University of Tennessee, Tullahoma, April 3-5.

Conference on Thick Film Technology; Institution of Electronic and Radio Engineers; London, April 8-9.

Aerodynamic Testing Conference, American Institute of Aeronautics and Astronautics; Sir Frances Drake Hotel, San Francisco, April 8-10.

Frequency Control Symposium, U.S. Army Electronics Command; Shelburne Hotel, Atlantic City, N.J., April 22-24.*

Short Courses

Electronic materials and devices, Fairleigh Dickinson University's College of Science and Engineering, Teaneck, N.J., March 25-26; \$100.

Fundamentals of statistical quality control, University of Wisconsin's College of Engineering, Madison, April 1-4; \$90.

Radiation effects in semiconductors and interaction processes, University of Michigan, Ann Arbor, Mich., May 20-31; \$325.

Call for papers

International Antennas and Propagation Symposium, IEEE; Northeastern University, Boston, Sept. 9-11. June 1 is deadline for submission of summaries to Leon J. Ricardi, Massachusetts Institute of Technology, Lincoln Laboratory, P.O. Box 73, Lexington, Mass. 02173.

Symposium of the American Vacuum Society, Pittsburgh Hilton Hotel, Pittsburgh, Oct. 30-Nov. 1. June 15 is deadline for submission of abstracts to W.J. Lange, the Westinghouse Electric Corp., R&O Center, Churchill Boro, Pittsburgh, Pa. 15235.

Meeting of the Union Radio Scientific International, Union Radio Scientific International; Northeastern University, Boston, Sept. 10-12. June 21 is deadline for submission of abstracts to Leon J. Ricardi, Massachusetts Institute of Technology, Lincoln Laboratory, P.O. Box 73, Lexington, Mass. 02173.

Engineering in Medicine and Biology Conference, IEEE; Shamrock-Hilton Hotel, Houston, Texas, Nov. 17-21. Upon receipt of title and identification of category of proposed paper, an author's kit will be forwarded. Completed papers must be submitted by June 30.

* Meeting preview on page 16.

IS YOUR "COMPUTER-COMPATIBLE" DIGITAL INCREMENTAL MAGNETIC TAPE RECORDER REALLY COMPATIBLE WITH YOUR COMPUTER?



To assure full computer-compatibility, CALMA's new family of incremental recorders is equipped with a unique CBD (Constant Bit Density) controller to maintain character spacing variations within the specifications of the major computer manufacturers. In addition, electronic de-skewing is employed in our high-density recorders to control the alignment of bits within each character.

To eliminate a troublesome source of electrical noise (a cause of data errors in recording devices), CALMA has replaced the traditional electromechanical reel servo relays with an all-solid-state control circuit.

For automatic collection of digital data from telephone and Teletype lines, investigate our Model 220 Digital Data

Interface / Recorder. This new system features automatic IRG-generation and sophisticated noise discrimination to reduce the effects of transient noise commonly encountered on communication channels. Write, phone, or circle our number on the reader service card for a comprehensive description of the new CALMA family* of incremental recorders.

CALMA

COMPANY

346 MATHEW STREET, SANTA CLARA,
CALIF. 95050 · PHONE (408) 244-0960

* Model 200-200bpi, 7-track, 0-500cps, computer compatible Model 600-556bpi, 7-track, 0-500cps, computer compatible
Model 800-800bpi, 9-track, 0-500cps, internal CRCC generation, SYSTEM/360 compatible

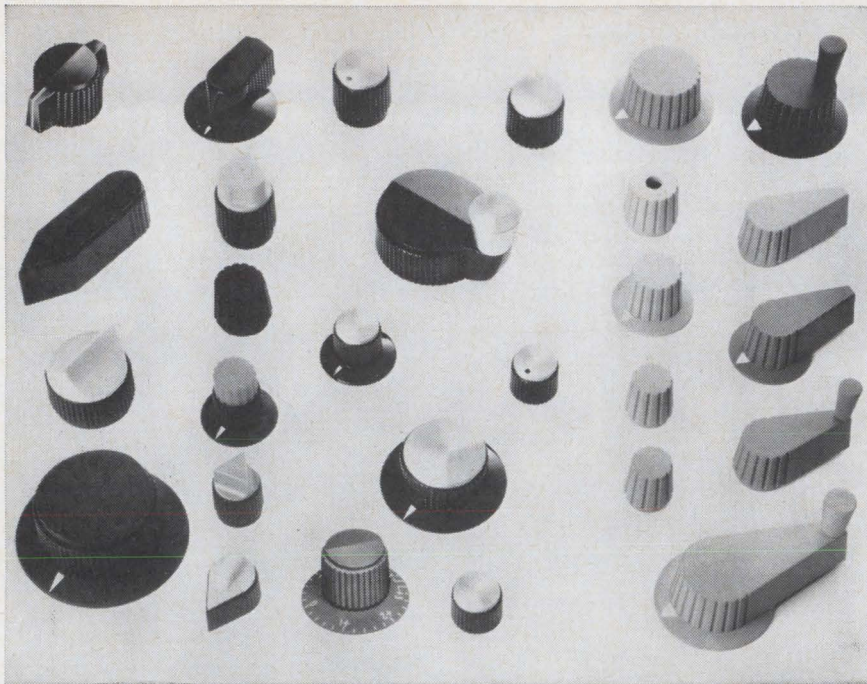

Standard and custom military knobs, aluminum cap knobs, color control knobs for every panel requirement. Send for data kit.

With Raytheon control knobs, you can meet military specifications—or select styles and colors that harmonize or contrast with any commercial panel decor. And you can get these knobs immediately—through Raytheon distributors from coast to coast.

Meet MS91528C Military Specifications from the more than 300 standard types and the 2,000 “specials” Raytheon has designed. All knobs are functionally designed. All styles have an integrated design to give uniformity to your panel. And all knobs meet specifications for resistance to flame, torque, temperature and humidity extremes, salt spray, and ultraviolet radiation.

Handsome aluminum cap knobs are made of strong plastic with satin finish aluminum caps that are treated with an epoxy coating for corrosion resistance.

Commercial color knobs—available in nine colors and ten styles—harmonize or contrast with commercial equipment design. Raytheon makes these 400 Series knobs of durable, high-impact ABS.

Custom-made control knobs. Raytheon also designs and manufactures control knobs to meet special requirements for color, shape, size, finish. Call your nearest Raytheon regional sales office or write to us. *Raytheon Company, Components Division, Quincy, Mass., 02169.*



Send for Raytheon Control Knob Data Kit

—contains complete specifications on all standard and custom knobs. Just send the reader service card.



Meeting preview

Frequency control

The annual Frequency Control Symposium is not as narrow as its title might suggest.

Engineers attending this year's meeting in Atlantic City, N.J., April 22 to 24, should come away with a good grasp of the latest theoretical and practical advancements in areas ranging from quartz crystal research to the development of atomic frequency standards.

In a session on crystal measurement, papers by engineers from Hewlett-Packard's Frequency and Time division, Palo Alto, Calif., and Western Electric Co., North Andover, Mass., will describe new and more accurate techniques for measuring crystal resonance parameters. Both approaches involve a vector voltmeter and a computer to gather phase data, a departure from the IEEE standard, which is based on the amplitude of the voltage.

New devices. Also to be described will be two new instruments developed under contract to Army Electronics Command, Fort Monmouth, N.J. One, an active measurement system, is a new generation of crystal-impedance meters. The other, a servo bridge system, measures phase and uses the crystal being tested as the determining element in a passive system.

In a session on crystalline material properties, Raymond D. Mindlin, a professor at Columbia University's School of Engineering and Applied Sciences, will deliver a paper on electromagnetic interaction in nonpiezoelectric crystals.

The session on the use of filters and other resonators will discuss replacing a transformer with several acoustically coupled resonators implanted on a single crystal blank. Engineers from the Toyo Communication Equipment Co., Kawasaki, Japan, the Bell Telephone Laboratories, Allentown, Pa., and the Autonetics division of the North American Rockwell Corp., Anaheim, Calif., will contribute papers.

For more information contact A. D. Ballato, U.S. Army Electronics Components Laboratory, Fort Monmouth, N.J.

We make planar power.

Not excuses.

hFE	V _{CEO}	I _C (max.)	V _{CE(sat)}	P _T	SWITCHING TIME				TYPE
					t _{on} ns	t _{off} ns	@ I _C A	@ ±I _B mA	
25 min. @ 2A, 10V	40V	3A	0.5V max. @ 1A, 0.1A		35	75	1.5	150	2N4225
80 min. @ 3A, 10V	40 to 80V	5A	0.75V max. @ 3A, 0.3A		40	300	3.0	300	B-143002, 5, 8 B-143017, 20, 23
20 min. @ 5A, 10V		10A	1V max. @ 5A, 0.5A	25W to 50W					B-144002, 5, 8 B-145002, 5, 8 B-146002, 5, 8
15 min. @ 10A, 5V	60 to 100V	15A	1.5V max. @ 15A, 3A	100W	225	600	10	1,000	B-148002, 3, 5 B-155002, 3, 5
20 min. @ 10A, 5V		20A	1.5V max. @ 20A, 4A	100W 60W 100W 60W					B-148000, 1, 4 B-155000, 1, 4

(SATURATED SWITCHING TEST CIRCUIT DIAGRAM FOR B-148000 & B-155000)

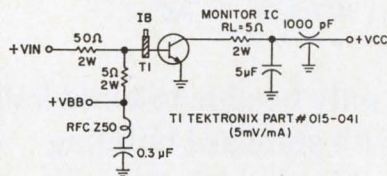

Maximum Switching Times: $t_d \leq 25$ ns;
 $t_r \leq 200$ ns; $t_s \leq 300$ ns; $t_f \leq 300$ ns.
Test Conditions: $V_{in} = 70V$ when generator
 with 50Ω internal impedance is terminated in a
 50Ω load. $V_{BB} = -5V$; $V_{CC} = 55V$; $I_C \approx 10A$;
 $I_{B1} \approx 1A$; $I_{B2} \approx 1A$; $t_p = 400$ ns; $f = 720$ Hz.

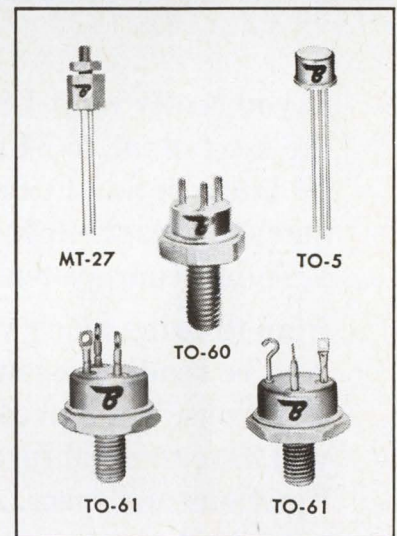

Ever been handed the line: "Seems we have every type but the one you want—could we interest you in something else?" Excuses, excuses. It's nice to know Bendix doesn't need to make them. Fact is, you never have to compromise when selecting our silicon planar power transistors. We make *over 100* different types, in 5 different packages, with collector currents of 3, 5, 10 and 20 amps, rated V_{CEO} 's from 40 to 100 volts. Contact us for postradiation gain data.

All Bendix planar power transistors are SOAR (Safe Operating Area) specified to prevent secondary

breakdowns. A real time-saver in designing your power amplifier, inverter, converter and regulator circuits.

If you are in the market for radiation-resistant transistors, silicon power mesas, DC voltage regulators or 35- and 60-volt plastic power transistors, odds are we can meet your requirements there, as well. Excuses? Not from Bendix. We're the Power Specialists. More information? Call our nearest sales office, or write: Semiconductor Division, The Bendix Corporation, Holmdel, New Jersey 07733.

Bendix Electronics

Chicago—(312) 637-6929; Dallas—(214) 357-1972; Detroit—(313) 548-2120; East Northport, N.Y.—Harry Friedman Co. (516) 692-2839; Great Neck, N.Y.—H. V. Sales Co. (516) HU 7-1142; Greenwich, Conn.—(203) 869-7797; Holmdel, N.J.—(201) 946-9400; Lexington, Mass.—(617) 861-8350; Los Angeles—(213) 776-4100; Minneapolis—(612) 926-4633; Orlando, Fla.—(304) 241-6559; Rochester, N.Y.—(716) 266-5550; Runnemed, N.J.—(609) 933-2550; Seattle—Ray Johnston Co., Inc. (206) LA 4-5170; Export—Cable: "Bendixint," 605 Third Avenue, New York, (212) 973-2121; Ottawa, Ont.—Computing Devices of Canada, P.O. Box 508 (613) 829-1800; San Juan, Puerto Rico—Southern International Sales Co. 723-3879.

Do you want to go LSI now?

If you really want LSI now, grab the next plane to Mountain View. (It lands in San Francisco.) It's the quickest, least expensive way to get LSI into your system.

Plan to bring along your blueprints. And be ready to answer a lot of questions. We'll need to know what you have in mind for sub-systems, functions and specs. And, don't be surprised when we ask "why" a couple of times. It's all part of Fairchild's systems approach to complex circuitry.

We'll take your requirements and match them against our family of fundamental building blocks. We've got LSIs (and MSIs) that work in any digital logic system. The most advanced circuitry on the market. Offspring of computer-aided design and double-layer metal technology. And, they're all so versatile, we can probably give you a counter that has a dozen other applications in your system.

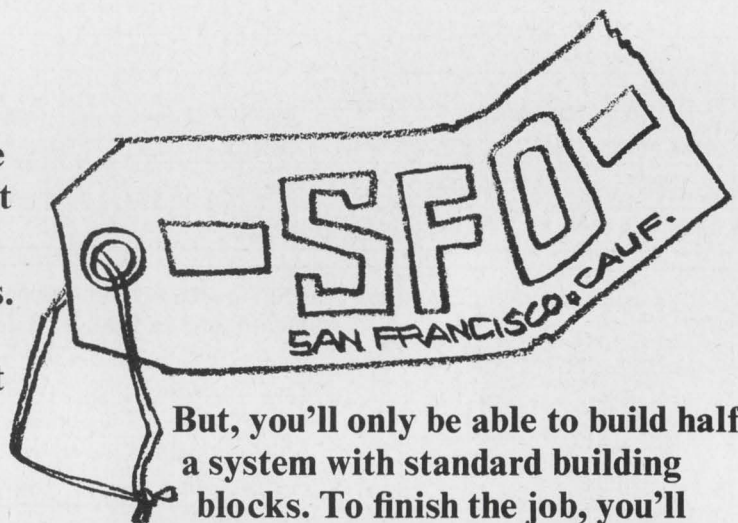

But, you'll only be able to build half a system with standard building blocks. To finish the job, you'll need interface devices to tie the whole thing together. And, here's where Fairchild can really save you time and money. We don't have to custom design each LSI interface circuit. We use Micromatrix™—a unique cellular array that's completed when we add your specific interconnection pattern. Your specs customize the entire array for your system.

Of course, there's a lot more to the story. But, you ought to hear it in person. Just call your Fairchild salesman. He knows the flight schedule to San Francisco.

Or do you want to think about it?

We've got an LSI design kit. It's based on our new 4500 Bipolar Micromatrix Array—the first device in a highly versatile LSI family. The 4500 is an eight-cell array that can be customized for virtually any function. All it needs is your interconnection pattern. You can determine the pattern by designing your own Micromatrix array with our kit. You can buy a kit from your Fairchild distributor for about \$100. And, in a couple of months, we'll see you in Mountain View.

FAIRCHILD
SEMICONDUCTOR

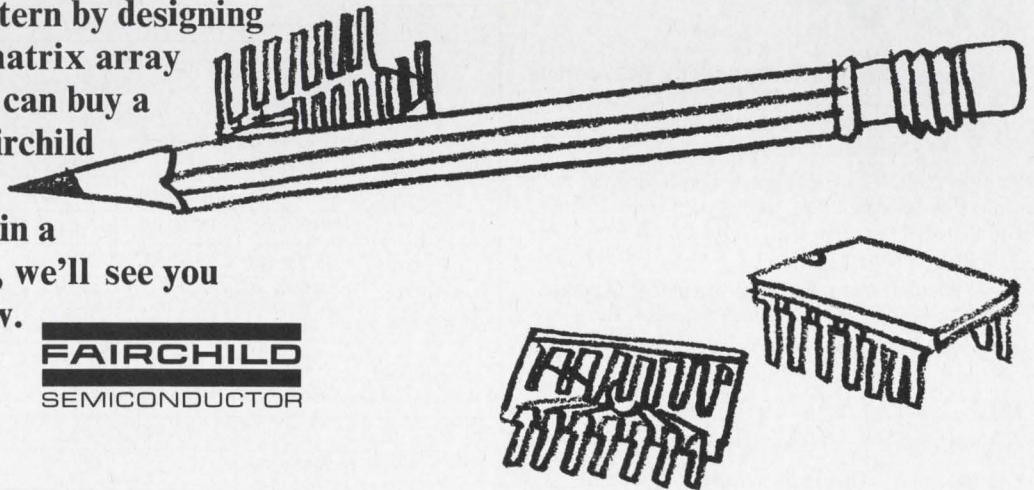

NEW Lambda dual output lab the power plus output ranges



LPD-421-FM
5 1/4" 1/2-rack metered



plus-

5 Models with two independent DC outputs offer widest choice—Up to ± 250 VDC, up to 1.7 amps. Either output may be + or -, or both outputs may be + or -.

Series/Parallel operation of both outputs yields two times the voltage or two times the current—up to 500 volts or up to 3.4 amps.

Auto Series/Auto Parallel (master slave) permits tracking to a common reference.

4 Meters provide simultaneous monitoring of both voltage and current.

Most power in a half-rack package.

Overvoltage Protection as an accessory.

Compatible with LP, LH and LK Series rack adapters and other accessories.

Multi-Current-Rated—Only dual power supplies on market with this advanced design feature.

Regulation: .01% + 1mV.

Ripple: 500 μ VRMS (1.5mVp-p).

Size: 5 3/16" x 8 3/8" x 10 5/8" 1/2 Rack • LPD Series

Model ⁽²⁾	Voltage Range Per output/ Outputs in series	I MAX AMPS AT AMBIENT OF: (1) Per output/Outputs in parallel				Price ⁽²⁾ US and Canada
		30°C	40°C	50°C	60°C	
LPD-421-FM	0- ± 20 /0-40	1.7A/3.4A	1.5A/3.0A	1.3A/2.6A	0.9A/1.8A	\$325
LPD-422-FM	0- ± 40 /0-80	1.0A/2.0A	0.85A/1.7A	0.7A/1.4A	0.55A/1.1A	260
LPD-423-FM	0- ± 60 /0-120	0.7A/1.4A	0.6A/1.2A	0.5A/1.0A	0.4A/0.8A	325
LPD-424-FM	0- ± 120 /0-240	0.38A/0.76A	0.32A/0.64A	0.26A/0.52A	0.20A/0.40A	325
LPD-425-FM	0- ± 250 /0-500	0.13A/0.26A	0.12A/0.24A	0.11A/0.22A	0.10A/0.20A	350

(1) Current rating applies over entire voltage range. Ratings based on 57-63 Hz operation.

(2) Prices are for metered models. LPD Series models are not available without meters.

Overvoltage Protection			
Available as bolt-on accessory for all LP and LPD models and LK-LH models with suffix (A). For LPD models, each output requires separate OV accessory.			
For use with	Model	Adj. Volt Range	Price
0-10, 0-20 V Models*	LH-OV-4	3-24V	\$35
0-36, 0-40 V Models*	LH-OV-5	3-47V	35
0-60 V Models*	LH-OV-6	3-70V	35

*Except for Full-Rack LK models. Overvoltage protection for full-rack models to 70 VDC is available as a built-in option. To order add suffix (-OV) and add \$90 to the price of models LK-350-352; add \$120 for models LK-360-FM-362-FM.

LAMBDA

supplies give you twice never before available...

LP-410-FM
5 1/4" 1/4-rack metered



LH-118-A-FM
5 1/4" 1/4-rack metered

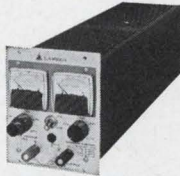

LK-340-A-FM
5 1/4" 1/2-rack metered
(LH series 1/2-rack
models same size)

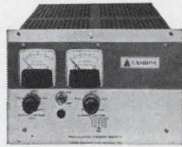

LK-350-FM 5 1/4"
full-rack metered

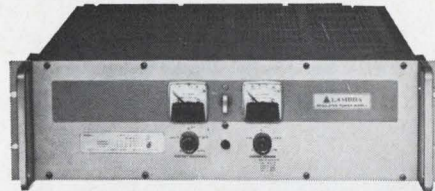

LK-360-FM 7" full-rack metered

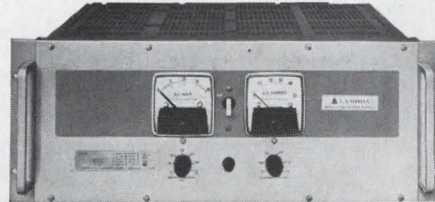

or choose from these 1/4, 1/2 and full-rack Lambda supplies

Size 5 1/8" x 4 3/16" x 10" 1/4 Rack • LP Series

Model ²	Voltage Range	CURRENT RANGE AT AMBIENT OF: ¹				Price ²
		30°C	40°C	50°C	60°C	
LP 410	0-10 VDC	0-2A	0-1.8A	0-1.6A	0-1.4A	\$129
LP 411	0-20 VDC	0-1.2A	0-1.1A	0-1.0A	0-0.8A	119
LP 412	0-40 VDC	0-0.70A	0-0.65A	0-0.60A	0-0.50A	114
LP 413	0-60 VDC	0-0.45A	0-0.41A	0-0.37A	0-0.33A	129
LP 414	0-120 VDC	0-0.20A	0-0.18A	0-0.16A	0-0.12A	149
LP 415	0-250 VDC	0-80mA	0-72mA	0-65mA	0-60mA	164

Size 5 1/4" x 19" x 16 1/2" Full Rack • LK Series

Model ²	Voltage Range	CURRENT RANGE AT AMBIENT OF: ¹				Price ²
		40°C	50°C	60°C	71°C	
LK 350	0-20VDC	0-35A	0-31A	0-26A	0-20A	\$675
LK 351	0-36VDC	0-25A	0-23A	0-20A	0-15A	640
LK 352	0-60VDC	0-15A	0-14A	0-12.5A	0-10A	650

Size 7" x 19" x 18 1/2" Full Rack • LK Series

Model ²	Voltage Range	CURRENT RANGE AT AMBIENT OF: ¹				Price ²
		40°C	50°C	60°C	71°C	
LK 360 FM	0-20VDC	0-66A	0-59A	0-50A	0-40A	\$995
LK 361 FM	0-36VDC	0-48A	0-43A	0-36A	0-30A	950
LK 362 FM	0-60VDC	0-25A	0-24A	0-22A	0-19A	995

Size 5 1/8" x 4 3/16" x 15 1/2" 1/4 Rack • LH Series

Model ²	Voltage Range	CURRENT RANGE AT AMBIENT OF: ¹				Price ²
		30°C	50°C	60°C	71°C	
LH 118A	0-10VDC	0-4.0A	0-3.5A	0-2.9A	0-2.3A	\$180
LH 121A	0-20VDC	0-2.4A	0-2.2A	0-1.8A	0-1.5A	170
LH 124A	0-40VDC	0-1.3A	0-1.1A	0-0.9A	0-0.7A	170
LH 127A	0-60VDC	0-0.9A	0-0.7A	0-0.6A	0-0.5A	185
LH 130A	0-120VDC	0-0.50A	0-0.40A	0-0.35A	0-0.25A	240

Size 5 1/8" x 8 3/16" x 15 1/2" 1/2 Rack • LH Series

Model ²	Voltage Range	CURRENT RANGE AT AMBIENT OF: ¹				Price ²
		30°C	50°C	60°C	71°C	
LH 119A	0-10VDC	0- 9.0A	0- 8.0A	0- 6.9A	0-5.8A	\$289
LH 122A	0-20VDC	0- 5.7A	0- 4.7A	0- 4.0A	0-3.3A	260
LH 125A	0-40VDC	0- 3.0A	0- 2.7A	0- 2.3A	0-1.9A	269
LH 128A	0-60VDC	0- 2.4A	0- 2.1A	0- 1.8A	0-1.5A	315
LH 131A	0-120VDC	0- 1.2A	0- 0.9A	0- 0.8A	0-0.6A	320

Size 5 1/8" x 8 3/16" x 15 1/2" 1/2 Rack • LK Series

Model ²	Voltage Range	CURRENT RANGE AT AMBIENT OF: ¹				Price ²
		40°C	50°C	60°C	71°C	
LK 340A	0-20VDC	0- 8.0A	0- 7.0A	0- 6.1A	0-4.9A	\$330
LK 341A	0-20VDC	0-13.5A	0-11.0A	0-10.0A	0-7.7A	385
LK 342A	0-36VDC	0- 5.2A	0- 5.0A	0- 4.5A	0-3.7A	335
LK 343A	0-36VDC	0- 9.0A	0- 8.5A	0- 7.6A	0-6.1A	395
LK 344A	0-60VDC	0- 4.0A	0- 3.5A	0- 3.0A	0-2.5A	340
LK 345A	0-60VDC	0- 6.0A	0- 5.2A	0- 4.5A	0-4.0A	395

LP NOTES

- 1 Current rating applies over entire voltage range. Ratings based on 57-63 Hz operation.
- 2 Prices are for non-metered models. For metered models, add suffix (-FM) and add \$10.00 to price.

LK-LH NOTES:

- 1 Current rating applies over entire voltage range.
- 2 Prices effective Feb. 1, 1968. Prices are for non-metered models (except for models LK360FM, LK361FM, and LK362FM which are metered models not available without meters). For metered models, add suffix (-FM) and add \$30.00 to price.
- 3 Chassis slides for full-rack models: Add suffix (-CS) and add \$60 to the price of LK-350-352; add \$100 to the price of LK-360-FM-362-FM.

ACCESSORIES

Rack Adapter LRA-1 — 5 1/4" Height x 16 1/2" Depth (For use with chassis slides)—Price \$60.00

Rack Adapter LRA-2 — 5 1/4" Height — Price \$35.00

Blank Front Panels — Model LBP-10 (1/4 rack size) — Price \$5.00 — Model LBP-20 (1/2 rack size) — Price \$10.00

Blank Chassis — with Blank Front Panels — Model LBC-10 (1/4 rack size) — Price \$25.00 — Model LBC-20 (1/2 rack size) — Price \$35.00

CHASSIS SLIDES: To order LRA-1 with chassis slides order LRA-1-CS, and add \$50.00 to price.

ELECTRONICS CORP.

515 Brogd Hollow Road • Melville, L. I., New York 11746 • 516 694-4200

A SUBSIDIARY • VEECO HIGH VACUUM EQUIPMENT LAMBDA POWER SUPPLIES

**AT THE IEEE SHOW—WE'RE UNVEILING
A DRAMATICALLY NEW AND UNIQUE INSTRUMENT.
BE SURE TO SEE IT... BOOTHS 2E07-2E09**

Which IC Test System does all these things?

DIAGNOSTIC COMPUTER PROGRAMS automatically check out system operation.

FAST TESTING. 1.5 msec per test. If crosspoint is changed, 5 msec. 10 msec on the lowest current scales.

DATALOG A FORCING FUNCTION, such as the input threshold level of a flip-flop needed to produce a specified output.

AUTOMATIC SELF-CHECKING assures accurate data transfer between operator, teletypewriter, computer and test instrument.

GROWING LIBRARY of improved software packages to insure against obsolescence.

TEN-YEAR GUARANTEE for all instrument plug-in circuitry (it's almost all plug-in).

TYPED SUMMARY SHEETS. Whenever desired. No interruption in testing. Give total units tested per test station, test yields and bin yields.

VERY COMPLEX TEST SEQUENCES can be programmed, yet preparation of simple tests can be learned in two hours.

NO ADJUSTMENT OR CALIBRATION POINTS. (Eternal vigilance is the price you pay for a single adjustment.)

DIRECT ENGLISH data logging type-out, showing job name, serial number, test number, decimal point and units.

OPEN AND SHORTED CONNECTIONS and **OSCILLATIONS** are automatically detected. System stops when a selected consecutive number of these occur.

ABSOLUTE SOURCE CONTROL. Sources can be turned ON or OFF and changed in value in any sequence with variable delays from 100 μ sec. to as long as you please.

COMPLETE FRONT PANEL DISPLAY at any desired step, simultaneously indicating all crosspoint connections, forced values, measured limits, binning decisions—everything about each test.

DATALOG at any test station—without slowing down classification tests at any other station.

MINIMIZED REPETITIVE INSTRUCTIONS for the operator through data libraries, variable word length programming, and autopinning.

MULTIPLEXING. Several jobs simultaneously. Any assigned, at any time, to any test station.

PROGRAMMABLE CURRENT LIMITS for each source at each test.

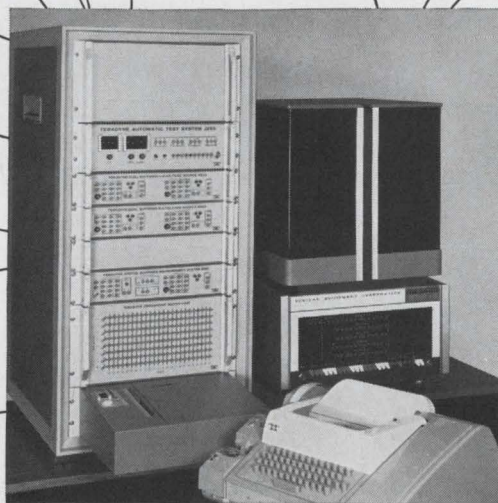

This one.

(complete for only \$65,000)

This is our J259 computer-operated Automatic Circuit Test System. It includes a general-purpose digital computer, teletypewriter, test instrument (comprising modular elements: 24 x 8 crosspoint matrix, four volt-

age sources, measurement system, and test deck), complete software package, and courses in IC testing, system operation, and maintenance. TERADYNE, 183 Essex St., Boston, Mass. 02111 Phone (617) 426-6560.

TERADYNE

At IEEE Show, we're in booth 2B03. Stop by and see what's new.

Commentary

Copying may not work

Europeans are not as awed by U.S. technology as they once were. Rather, they envy the entrepreneurship that successfully turns that technology into products.

Foreign businessmen are inclined to view the American tycoon as a student does his teacher—needing and respecting him, but wanting ultimately to surpass him.

European companies that seek to emulate their successful U.S. counterparts try to analyze what we are doing that they are not. They put our Government's support for new ideas and techniques high on the list. They are aware that it is the size of many U.S. corporations that permits them to risk significant portions of their profits to develop products that may not pay off. Finally, they cite the ready availability of hard cash from private sources in the U.S.

The Europeans see their own prospects dimmed by the absence of these factors and are constantly amazed at the U.S.'s ability to plow profits back into its domestic operations, build plants overseas and invest in European countries at the same time. Europeans watched U.S. direct private investments in their countries double three times over the 15 year period beginning in 1951. Adding to their consternation, sales of U.S. products abroad kept climbing; last year the electronics industry recorded foreign sales of \$1.4 billion, up 25% from 1966.

While Europe's own products have languished in its laboratories, European companies have had to pay royalties on products they make under U.S. licenses.

Flattering as it would be to have Europe copy the U.S. techniques it covets, such an approach may not work. Europe's troubles may be symptomatic of a more basic problem—a prevailing attitude of caution and conservatism. John Diebold, writing in the January issue of *Foreign Affairs*, says: "Competition and the need to innovate generally are deprecated in Europe. Indeed, the role of European governments is often to protect against innovation, and private enterprises too generally prefer to let others do the hard work of breaking new ground, while hoping that future developments will not profoundly affect traditional ways of doing things."

Richard Nelson, of the Rand Corporation, argues that giant corporations and government funding in the U.S. are not necessarily the cause of Europe's lag; the lag existed long before either, he notes, and he warns that recent thinking in Europe would replace private competition with government control of research and development.

The inferior results achieved in Europe, set against the successes of the Americans, may be an incentive to European businessmen to change their ways. But American methods cannot be used as a cookbook; merely embracing proven management techniques will not suffice. Problems unique to Europe must be tackled. Among them is the morass of patent and corporation laws that vary so much from country to country that cross-licens-

ing and marketing agreements are difficult to make. A consortium of European countries might tackle the problem of standardizing such laws. The real danger could be that such a union might go beyond its initial charter. It could wind up controlling the very firms it hopes to assist, and stifle beneficial competition among them.

Without the enthusiasm and enterprise of European businessmen, even a union of European states might not be enough to close the gap.

Unjamming the spectrum

Mushrooming use of land mobile radio-frequency bands in metropolitan areas has seriously overcrowded the spectrum. In New York City alone, an average of 47 licensees representing more than 400 mobile units squeeze into each channel of the business service band. Some relief came last month when the FCC doubled the number of assignable channels in the 450- to 470-Mhz band [*Electronics*, Feb. 19, p. 56].

The irony of the situation is that many frequencies go begging because they're set aside for future use for television and by the government. In Los Angeles, only 60% of the frequencies suitable for land mobile communications are actually used; the rest are reserved.

A few years ago, the FCC offered the reserve frequencies to secondary users on a temporary basis—until they were claimed by the primary licensees. There were few takers—secondary users weren't willing to risk buying gear that might become obsolete overnight.

Alan S. Boyd, Secretary of Transportation, now proposes a plan that could void the risk. A secondary user would not be licensed for a specific frequency, but rather for a service. A leasing agency could keep track of the unused frequencies and assign them to subscribers, delivering and installing equipment tuned to the proper frequencies. When a principal user claimed his right to a frequency, the agency would reassign the secondary user to another, still unused, frequency and would modify or exchange his gear.

Whether Secretary Boyd's plan can work hinges on the answers to these questions:

- Will the use of dormant tv channels by mobile units cause interference with adjacent tv channels?
- Can cooperative arrangements be worked out among leasing companies so that equipment no longer usable in one geographical area can be traded off to another area?
- Will manufacturers be willing and able to design gear with the required flexibility?
- Will it be possible to work out an efficient (perhaps computerized) record-keeping system for frequency assignments?
- Can frequency-assignments be juggled rapidly enough to avoid disruption of service to subscribers and still meet FCC requirements?

The answers to these questions are not immediately clear. Should they be affirmative, the payoff could be handsome. In Los Angeles, for example, 750 wasted channels might be put on the air in just a year.

MILLIMETER SYSTEMS

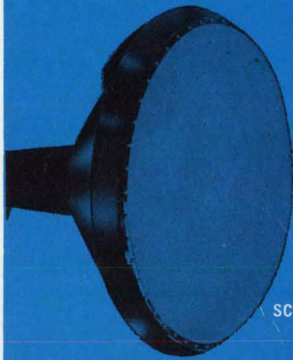

SCALAR FEEDS

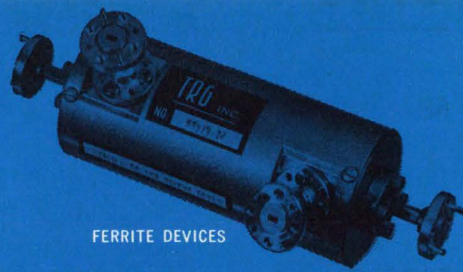

FERRITE DEVICES

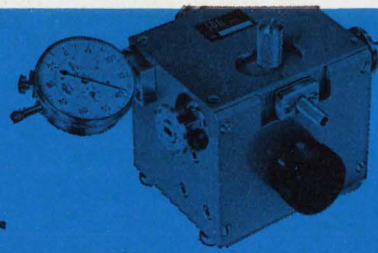

TEST BENCH COMPONENTS

DIRECT READING FREQUENCY METERS

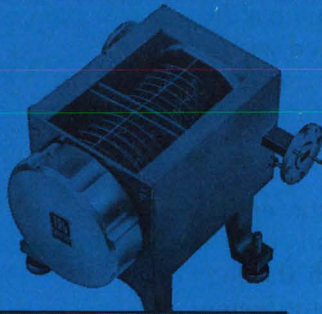

LOW LOSS CIRCULAR WAVEGUIDE COMPONENTS



UNIVERSAL KLYSTRON POWER SUPPLY

SHORT FORM CATALOG 1968

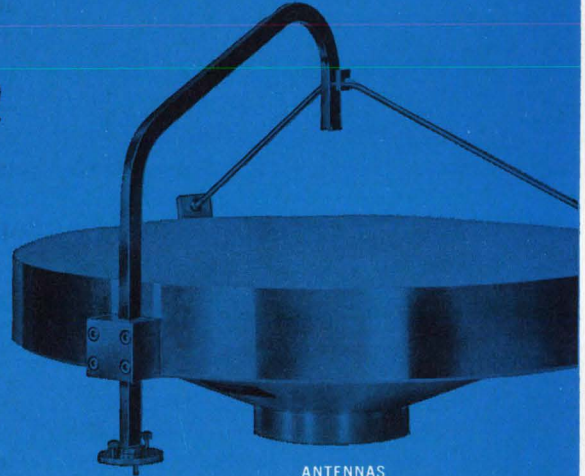
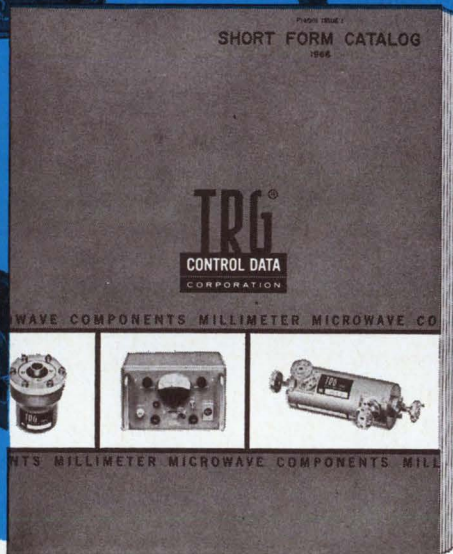

ANTENNAS

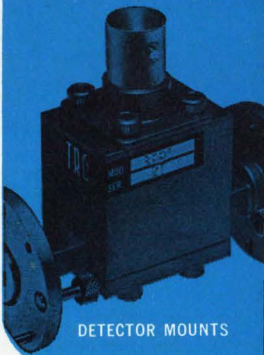

DETECTOR MOUNTS



HARMONIC MIXERS

TRG has the most comprehensive line of microwave components (now 12.4 to 220 Gc)...and all the facts are contained in our handy short form catalog.

Write for your copy today

This 20-page, short-form catalog contains all the important specifications on products available for Ku and K bands, as well as A, B, V, E, W, F, D, and G bands. To get your copy, contact your TRG representative or write TRG, 404 Border Street, East Boston, Massachusetts 02128. Tel. (617) 569-2110.



Electronics Newsletter

March 18, 1968

Fairchild takes the plastic plunge

At least one group in the Fairchild Semiconductor division doesn't share the firm's general skepticism about plastic packages. The division's hybrid-circuit operation will introduce a plastic-packaged version of its biggest seller, the SH2002 high-power driver, as its first move in a campaign to win industrial customers and so reduce its present dependence on military sales. Fairchild feels the plastic package—believed to be silicone—is suitable for some industrial uses because the moisture problems associated with plastic aren't significant at lower temperatures. The hybrid department has also developed a new silicone resin to coat the chips inside the package. The price in 100-unit lots will be \$3.95, a couple of dollars less than the price of the industrial version in a TO-5 can.

Inside the plastic encapsulation of the "mini-dip"—so called because it has only 10 leads on a tiny dual in-line package—is another surprise: no substrate. Both the logic chip, a Fairchild 932 DTL circuit, and the power transistor are bonded directly to the lead frame, which is etched so the frame itself forms the conductive path.

Nortronics tying up Omega market

The Navy award of a \$1 million contract to Northrop's Nortronics division this month to develop airborne Omega navigation receivers just about sews up the Omega receiver market for this company. Nortronics already holds the contract for the shipboard models and is cranking up for commercial sales [Electronics, July 19, 1967, p. 48]. Omega is a worldwide navigation aid that operates on low-frequency beacons.

The firm also holds an option to build two service models of airborne Omega receivers, a contract that could mean an additional \$290,000. The company hopes for a production contract in about a year. The airborne receiver market is estimated at \$300 million to \$500 million, and the shipboard market will probably be even more lucrative.

Fairchild's loss: an inside look

The Draconian measures taken by Richard Hodgson when he took over as chief executive officer of Fairchild Camera & Instrument last fall resulted in a loss for fiscal 1967 staggering even to the most optimistic stock analyst. Although the company had an operating profit, inventory writeoffs and losses from the sale of the Davidson and Du Mont divisions and the memory products group of the Semiconductor division resulted in a net loss of \$7,699,000.

But at the Semiconductor division, long relied on to make up deficits from the unprofitable divisions, there was something like a sigh of relief. "The strain on us to make ridiculously high profits was fantastic," said one Semiconductor hand. "Now we're back to a normal 6% to 7% after taxes."

Firms study NASA microcircuit specs

Four semiconductor manufacturers and two electronics systems firms are now examining a rough draft of NASA's proposed procurement specifications for microelectronics. Late this month, the companies' representatives will submit their opinions to the space agency's subcommittee on microelectronics. The specifications, which a NASA official describes as "a total program for reliable microcircuits," were prepared over

Electronics Newsletter

several years by the subcommittee, sometimes in conjunction with the Defense Department. The draft covers such topics as test methods, visual test procedures, and packaging.

H-P desk calculator makes its debut

After two and a half years of development, Hewlett-Packard has finally introduced its desk-top calculator [Electronics, Dec. 12, 1966, p. 26]. The machine, priced at \$4,900, is designed for engineering and scientific applications.

Called the 9100A, it has three distinct memories:

- A random-access read-only unit with 32,000 bits.
- A core memory with 23 registers that stores special programs.
- A 2,000-bit read-only memory that's part of the calculator's control logic.

The calculator can handle inputs ranging from 10^{-98} to 10^{99} —nearly double the range of some general-purpose computers—and displays 10 digits.

The 9100A is built without integrated circuits. Discrete components are used because, among other reasons, some functions aren't available with IC logic.

The machine does not need a special computer language; and it can be programed through either the keyboard or special magnetic cards.

Readout currently is by cathode-ray tube. Options will soon include a digital printer and an x-y plotter.

Low-cost inertial system is proposed

Engineers at American Airlines have proposed to Arinc a new characteristic for inertial navigation systems that could lead to units costing \$30,000 or less. Arinc characteristic 561, which covers such systems as Litton Industries' LTN-51 and the AC Electronics Carousel, specifies hardware suited to long (10 hours) flights over water. Because of their complexity, these units cost about \$100,000—a price that frightens airline executives shopping for stable attitude reference systems for shorter overland flights. The proposal, which could open the airbus and retrofit markets to inertial systems, will be considered early next month at an Arinc meeting in New York.

Addenda

Moses Shapiro, president of General Instrument, has been named chief executive officer and vice chairman. Replacing him as president will be William C. Hittinger, who has been president of Bellcomm, a subsidiary of AT&T. . . . Admiral will offer a three-year warranty on its color picture tubes; the standard warranty is one year. . . . Ohio State University researchers have developed a sonic riveter that can drive titanium rivets into titanium sheets without splitting or cracking the metal. Using commercially available lead-zirconate-titanate piezoelectric crystals, driven by a 2,600-volt power supply, the Ohio State device is able to generate a static force of 200 pounds in 1½ seconds. . . . An ultrasonic holography instrument for early discovery of tumors will undergo tests about April 1. The instrument, developed and built by the Holotron Corp. of Wilmington, Del., is to be tried on breast cancer cases at Roswell Park Memorial Institute in Buffalo, N.Y. The tests will last a year. The equipment was developed by Byron Brendar, a researcher at the Battelle Memorial Institute. Holotron is a subsidiary of Battelle and the Du Pont Co.

IDEAS / CRTs

**Now, multicolor displays on 19" or 21" CRT...
from a single electron gun.**

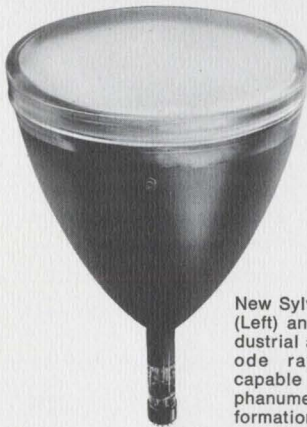

New Sylvania 19" SC-4852 (Left) and 21" SC-4876 industrial and military cathode ray tubes, each capable of displaying alphanumeric or analog information in up to 4 colors simultaneously from a single electron gun.

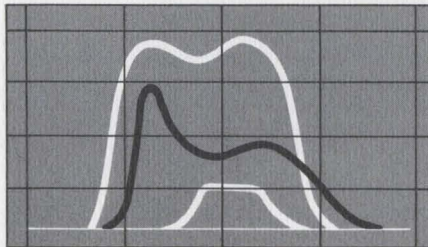

19" screen displaying 3 separate waveform patterns, each in a different color.

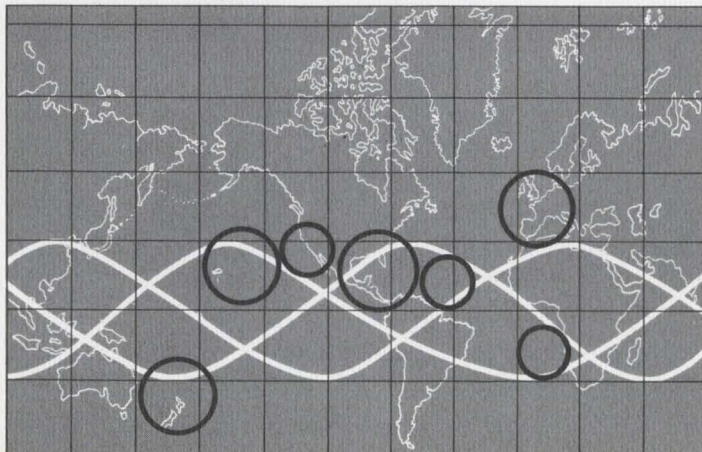

Typical satellite tracking pattern on 21" screen. Coastline in yellow, orbital paths in orange, tracking station locations in green, satellite position in red.

A new, large-size Sylvania CRT . . . using 2 phosphor coatings on the faceplate . . . displays up to 4 separate colors simultaneously from a single electron gun, and with no shadow mask.

A sine wave trace. A square wave trace. A pulse-code modulated trace. An alphanumeric line.

All on one 21" CRT screen. All displayed simultaneously. In four different colors. With *no shadow mask* to reduce brightness.

It's not done with mirrors. It's done by switching anode voltages.

The tube employs two basic faceplate phosphors: red and green, for example. Red is actuated by the low (6 kV) electron-beam voltage; green is actuated by the high (12 kV). Intermediate voltages produce red-green color mixtures. For example, 10 kV produces a basic green with a small red admixture: yellow; 8 kV produces a basic red

Continued on next page.

This issue in capsule

Readouts

Specify your own EL readout brightness levels up to 50 fL.

Microwave Components

Schottky diodes provide high sensitivity, low 1/F noise in video detectors.

Microelectronics

Frequency capability to 300 MHz, quickly and economically producible, with thick-film hybrid microcircuits.

Diodes

16-diode digital arrays drive more cores faster, save labor and space.

Color TV

New 25" color-TV picture tube with economical Kimcode safety feature.

Manager's Corner

Field engineering; how it helps you.

Continued.

Applications

We recommend them for:

- Air traffic control systems
- Military identification systems
- Stock market quotation units
- Teaching machines
- Electronic test equipment
- Computer displays
- Airline and other transportation-status boards
- Any application requiring discrete-color information display.

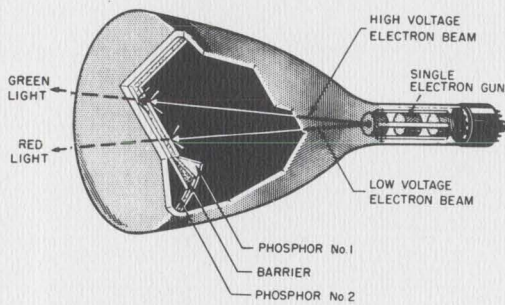

CRT employs two phosphor layers—red and green or other combination—and one electron gun. Rapid switching from high to low voltage actuates one phosphor or the other; midrange voltages mix the basic phosphor light output to produce different colors.

with a slight green admixture: orange.

By rapid voltage switching, all four colors can be displayed sequentially, but fast enough that they can be viewed visually simultaneously.

And the tube can be supplied with other basic phosphor-color combinations: red and blue, for example.

Because the tube has no shadow mask, brightness and resolution are extremely high.

We offer commercially a 19" round 35° deflection angle type (SC-4852), with electrostatic focusing and magnetic deflection, and a 21", 72° deflection angle rectangular type (SC-4876) with electrostatic focusing and magnetic deflection. In addition we have previously announced a 10" tube (SC-4827, electrostatic focusing and magnetic deflection) and a 5" tube (SC-4689, electrostatic focusing and deflection). On special order we can make color tubes in any screen diameter.

In air-traffic control displays, for example, these CRTs could be used to provide quick and positive information on different altitudes or stacked aircraft problems. Different colors could be used to indicate various runways, holding patterns or air traffic lanes.

In computer displays, color can be used to indicate particularly significant data or newly changed, added or deleted data. For alphanumeric stock quotation displays, red could be used to indicate a stock which has declined since the last quotation, and green to indicate a stock which has gone up.

Come see them demonstrated at IEEE. We're sure you'll think of many other IDEAS for using them.

CIRCLE NUMBER 300

Specify your own EL readout brightness levels up to 50 fL.

Hermetically sealed all-glass or metal-glass electro-luminescent readout panels provide initial brightness of up to 50 footlamberts—readily visible even at high ambient light levels.

Brighter phosphors in Sylvania "P-Series" hermetically sealed all-glass and metal-glass EL panels provide intrinsic brightness levels of up to 50 fL at 250 V, 400 Hz, or 25 fL at 115 V, 400 Hz.

Contrast may be increased by changing the transmission characteristics of the glass faceplate. A panel with an intrinsic brightness level of 50 fL would still provide a useful light output of 25 fL with 50% transmission glass for higher contrast, and about 15 fL with 30% transmission glass for extremely high contrast.

These bright, high-contrast panels are available in two basic types of construction: all glass or metal glass (see Fig. 1).

The ideal visual display

From the point of view of design, operational and human engineering considerations, EL panels offer distinct advantages over conventional display devices. When required, they display information faster than the human eye can respond, yet can retain it for as long as necessary. They are highly immune to catastrophic failure. They have the widest viewing angle of any display device: almost 180°, and all in the same viewing plane.

They readily display any type of information de-

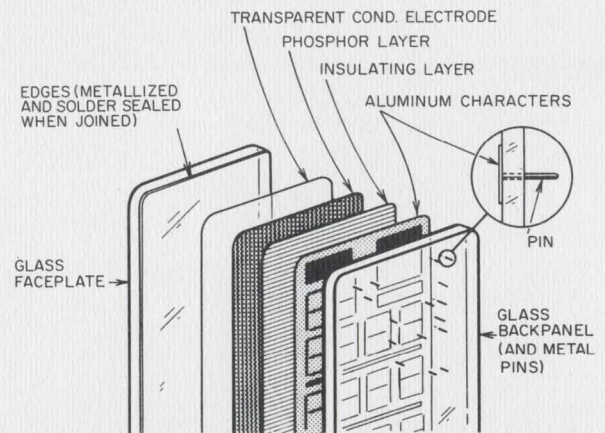
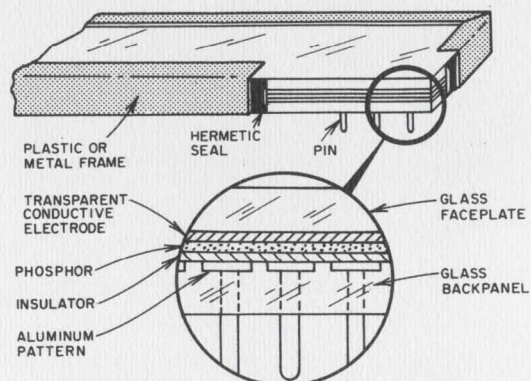

Fig. 1. Top, exploded view, all-glass EL readout panel. Below, sectional view of metal-glass construction.



sired: letters, numbers, pictorial or analog data, quantitative comparisons—and can be custom designed to the user's requirements. Their solid-state nature and construction assures stable performance under extremes of temperature, pressure, humidity and—when properly mounted—under severe shock and vibration. Their soft blue-green light output is very easy on the eyes; spectral emission (Fig. 4) approximates that of the human eye to permit prolonged viewing without fatigue.

Our new "P-Series" panels represent the finest EL display devices Sylvania has ever made—and Sylvania is the acknowledged pioneer and leader in EL technology. These rugged, hermetically sealed devices—although developed originally to meet the stringent environmental and operational demands of critical aerospace and military applications, are also ideal for many industrial uses.

Complete display flexibility

For visual displays, EL readout devices offer almost unlimited flexibility in customized presentation. The conducting electrodes forming the display are made by graphic art techniques so that almost any desired display pattern can be fabricated: numerals, letters, bars, squares, map segments, large solid areas, and special symbols in various arrangements, designs and configurations. Different colors may even be provided on a single panel. Legends and special symbols (i.e., plus and minus signs, decimal points, etc.) may be designed as an integral part of a panel or may be applied in the form of an overlay—whichever best suits the user's requirements. With EL, complex information display problems can be simplified and fully customized.

Typical configurations and applications

EL units are currently being produced in the follow-

ing configurations. (Other configurations are of course possible; Sylvania engineers will be glad to work with you to develop what you need.)

Numerics—solid areas—alphanumeric. These displays represent the major types of EL readout currently in use by space agencies, the military and industry. When two or more digits are required to display the desired information, all characters are usually fabricated on a one-piece substrate. This design provides optimum spacing between digits, attractive digit-to-digit balance, permits extra compactness where space is at a premium.

Bar graphs. EL bar graphs are ideal for many aircraft, spacecraft and shipboard instrumentation applications—wherever quantitatively variable input data must be monitored and compared. Parallel EL bars give positive, easy-to-read data display and comparison with high resolution for precise measurement. Legends and/or limit markers can be incorporated either into the illuminated portion of the bar graph itself or onto the panel faceplate.

Random-access panels illustrate the true versatility and superiority of a solid-state EL visual display system. They can display alphanumeric, graphic or symbolic information in any combination to visually represent any situation. They are ideal for displays involving: air traffic control, automotive routing and flow, harbor surveillance, troop and equipment movement, local or remote classroom displays, machine programming, warehouse stock control displays, control and monitoring applications, communication of pictorial information—virtually any situation that requires a highly readable and graphic dynamic visual presentation.

CIRCLE NUMBER 301

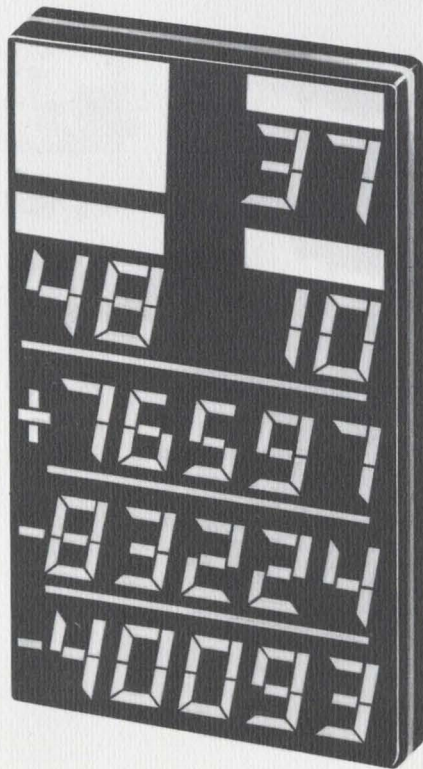

Fig. 2. Typical EL panel, all-glass construction. Intrinsic brightness of phosphor is approximately 50 fL at 250 V, 400 Hz. Brightness varies inversely with contrast depending on transmission characteristics of glass faceplate.

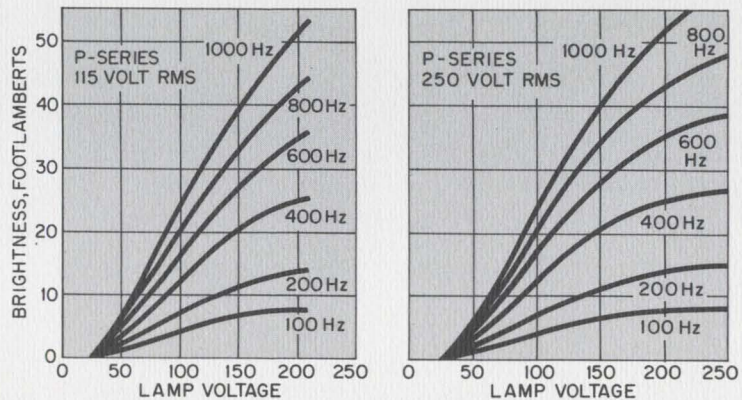

Fig. 3. Brightness vs. voltage, with 60% transmission glass, for both metal-glass and all-glass EL readout panels at 115 and 250 V. rms respectively.

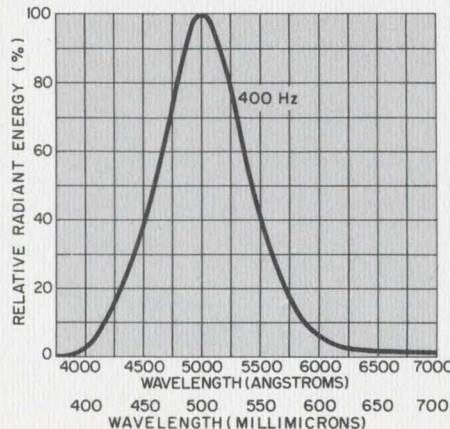

Fig. 4. Spectral emission characteristics, metal-glass and all-glass EL readout panels. Light output very closely matches the response of the human eye, permitting easy prolonged viewing.

Now you can get high sensitivity, low 1/F noise and microphonics in a video detector.

Schottky barrier diodes, when used in video detector circuits in electronic countermeasures systems, provide broadband detection capability to 40 GHz, yet assure high sensitivity with low microphonics in such applications.

Manufacturing technology for low-noise Schottky barrier diodes has progressed so rapidly over the past few years that it is now possible to fabricate, on a production basis, true metal-to-semiconductor junctions having the extremely small areas necessary to achieve maximum tangential signal sensitivity (TSS).

TSS is a measure of small signal sensitivity in a diode, and high TSS levels are essential to proper performance of electronic countermeasures systems (detection of hostile aircraft and radars), doppler radars, military aircraft beacons and electronic surveillance systems.

Sylvania now offers a new line of Schottkys with TSS levels of better than -50 dBm at X-band and better than -40 dBm at 40 GHz—virtually a flat response over the entire frequency range as illustrated in Fig. 1.

Diode bias is required if maximum sensitivity is to be attained. Both bias and video bandwidth must be specified if the TSS measurement is to have any significance. Fig. 1 indicates the relative TSS with a 50 μ A bias. Reducing the bias to about 30 μ A will improve the TSS, but will also increase the video impedance to a level that may not be desirable in certain applications. Fifty microamps was chosen to provide a more reasonable impedance match with the video amplifier.

Video impedance variation (R_v) vs dc bias is shown in Fig. 2. Under normal conditions, R_v is specified at about 6000-8000 ohms at 50 μ A.

A low noise level—particularly at low 1/F envelope frequencies—is another vital characteristic which is also affected by bias level. Fig. 3 compares noise output of a point-contact diode and a Schottky diode from 1 to 1000 KHz—typical doppler-radar envelope frequency ranges. Each is measured at 20 and 50 μ A bias current. As the figure indicates, at 1 KHz the Schottky diode exhibits about 1/4 the noise output of the point-contact device.

In addition to the advantages of high sensitivity (TSS) and low 1/F noise (flicker noise), Schottky barrier diodes offer low microphonic noise output (see Fig. 4), high burnout resistance and uniform performance characteristics.

CIRCLE NUMBER 302

	D5754	D5754A	D5691	D5691A	D5733	Unit
Test Frequencies	5 and 12	5 and 12	5 and 12	5 and 12	35	GHz
Minimum TSS with a 10 MHz bandwidth at 50 μ amp bias	TSS 47	50	47	50	45	-dbm
Video Impedance R_v at 50 μ amp bias	6.5	6.5	6.5	6.5	7.3	kohms
Breakdown Voltage V_B at 10 μ amp	7	7	7	7	7	volts
Package	013	013	075	075	013	

Fig. 1. Tangential signal sensitivity vs frequency for three types of Sylvania Schottky barrier detector diodes. Note virtually flat response from 1.0 to 40.0 GHz carrier frequencies.

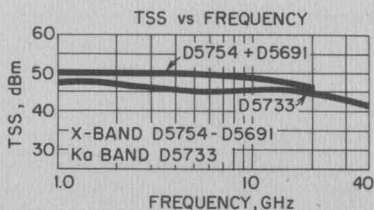

Fig. 2. Video impedance variation (R_v) vs dc bias, for X-band and Ka-band Schottky diodes.

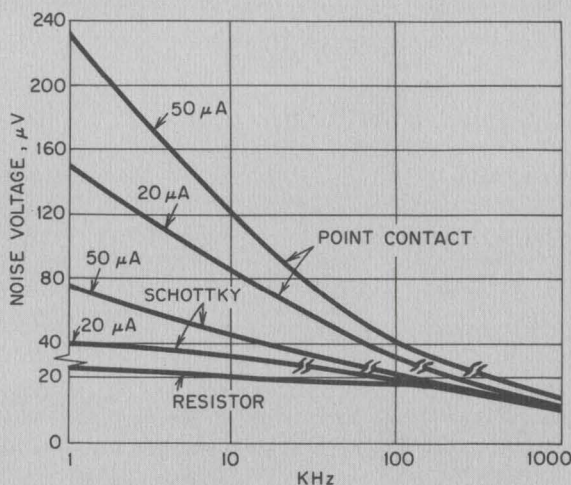
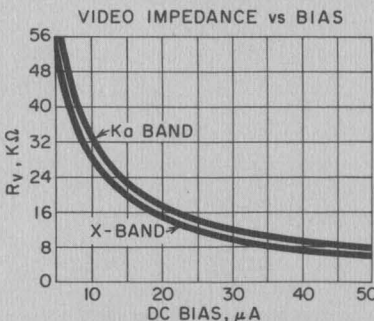

Fig. 3. Noise ratio vs bias current. Sylvania Schottky barrier diodes exhibit much lower noise voltage levels at low 1/F frequencies when used in video detector applications than point-contact diodes.

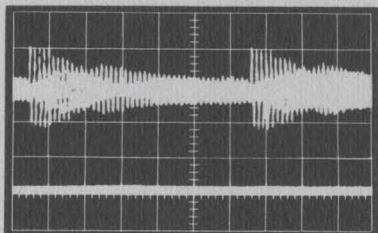

Fig. 4. Sylvania Schottky diodes exhibit much lower microphonics than point-contact diodes. Upper trace is microphonic response of a point-contact diode when subjected to a mild shock; lower trace shows the lack of microphonic response of a Sylvania Schottky D5754 when subjected to the same shock.

Hybrid microcircuits: frequency capability to 300 MHz, now available in production quantities.

Sylvania's advances in resistive and dielectric material, plus our proven high-frequency solid-state design capability, enable us to reduce size and increase reliability at low cost.

Today Sylvania's film hybrid microcircuits operate well up into the UHF band, are produced in quantity, and at lower cost than equivalent discrete component circuits.

An example is the recently developed Sylvania AN/PRC-63 hand-held transceiver/beacon. It operates on the military distress frequency of 243 MHz; transmission range of the rescue beacon at 325 mw power output is approximately 75 nautical miles; voice transmission range is 30 nautical miles. Utilizing Sylvania's microcircuit design, the complete unit (less antenna), measures only 4 1/2" x 3 5/16" x 1 5/16" and weighs less than 18 oz. including batteries. The mean time between failure (MTBF) is over 5,000 hours, based on more than 17,000 hours of life testing. Until recently this size/performance capability would have been considered beyond production capabilities—yet today the unit is in volume production.

Another microcircuit we recently developed is a digital circuit capable of operating in a computer system with a 50 MHz clock rate. Propagation time through the circuit is less than 14 nsec, and this includes going through two levels of diode logic and three transistor levels. We also developed microcircuits for a frequency synthesizer operating at 8 MHz.

Techniques we have developed to produce such circuits are adaptable to other custom requirements in a frequency range of from dc to 300 MHz. And they permit *component-for-component miniaturization* of most circuit functions.

What makes it possible?

Passive components such as conductors, resistors and capacitors are produced by depositing ceramic-metal materials onto an alumina substrate. Firing at an elevated temperature in a controlled atmosphere establishes film characteristics such as excellent stability and component tracking. Stray capacitance is minimized because of the proximity of components. And circuit-to-circuit uniformity is inherent.

For capacitors, dielectric materials have been developed which provide up to 0.5 μ F per square inch. Resistive materials range from 50 ohms/sq. to 400 kohms/sq.

Active components, as either discrete packaged devices or semiconductor dice, are attached to the substrate and interconnected to form the hybrid circuit.

The wide range of passive component characteristics available in thick-film form, plus the ability to add a wide variety of diodes, transistors and ICs, permits ready fabrication of many digital, pulse and linear circuits which can be direct, miniaturized translations of the designer's discrete-component breadboard.

Sylvania can assist you with your hybrid microelectronic design problems because we have:

1. Over seven years of experience in film microelectronics.
2. Semiconductor capability and the facility to handle semiconductor material.
3. Documented reliability.

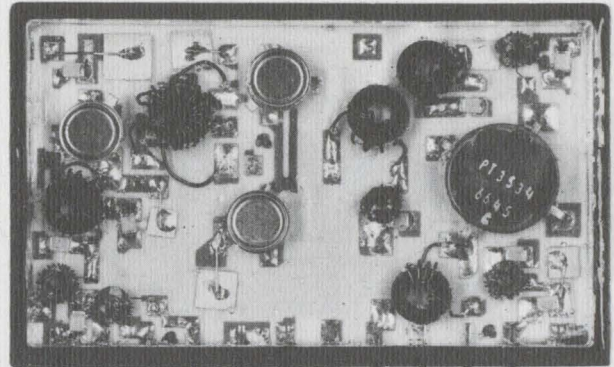

UHF Transmitter

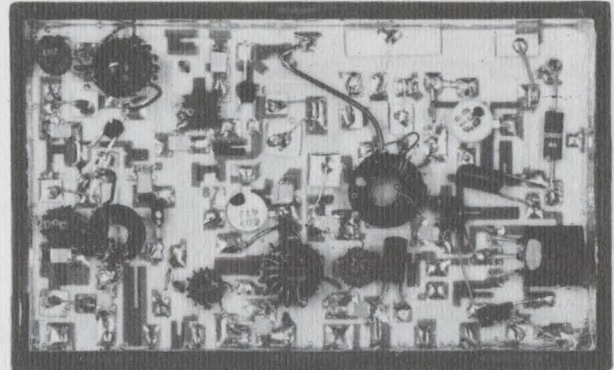

UHF Receiver

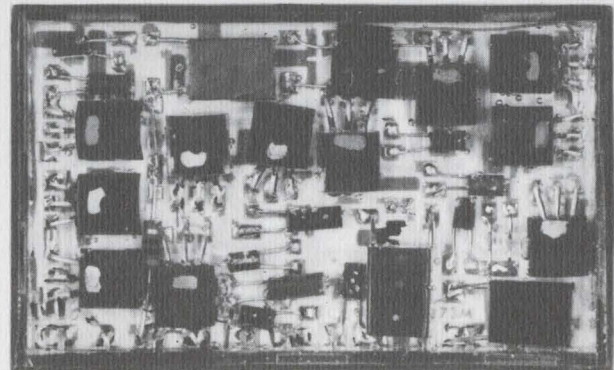

Voice Amplifier

Hybrid microelectronic circuits from Sylvania for the UHF AN/PRC-63 rescue transceiver. These units comprise entire electronic component system of transceiver.

4. Volume production capability in complex microelectronics.

If microelectronics is in your future, Sylvania can help you.

For more information, send for Sylvania's *Microelectronics Design Guide*. It's yours with our compliments.

CIRCLE NUMBER 303

Especially for modern set designs— lightweight, economical color CRT line expanded.

Now Sylvania adds a 25" color bright 85® tube to its Kimcode-protected line, available to manufacturers for sets they'll make this year. Screen area is 295 square inches (viewable).

The Kimcode rim protection system being offered by Sylvania extends over a broad range of rectangular screen sizes including 15", 19", 22" and now the new 25" size. Besides the inherently excellent performance of color bright 85 picture tubes, designers can add the benefits of lighter weight and lower cost by specifying Sylvania's Kimcode line.

They're light in weight because their integral implosion protection system eliminates the need for separate safety glass in the set chassis, or heavy glass cap that is laminated directly to the tube. On the 25" tube, the weight saving is approximately 6 pounds.

For manufacturers who prefer these other de-

signs, Sylvania will continue to make them available.

Our new 25" tube is manufactured with spherical faceplate and has dark-tint 42% transmission glass for high contrast. Glass transmission characteristics for other tubes in the line are as follows: 15", 32%; 19", 43.5%; and 22", 42%. Each uses three electrostatically focused electron guns spaced 120° apart; axes are tilted to facilitate convergence of the three beams at the shadow mask. Each uses magnetic deflection and convergence, an aluminized screen and is capable of producing high-resolution pictures in both color and black-and-white. The screen incorporates the unique Sylvania screening process and high light-output rare-earth phosphor system.

Sylvania designed these new tubes to help you broaden your set line, cut set costs. Complete specifications are available from your Sylvania representative.

CIRCLE NUMBER 305

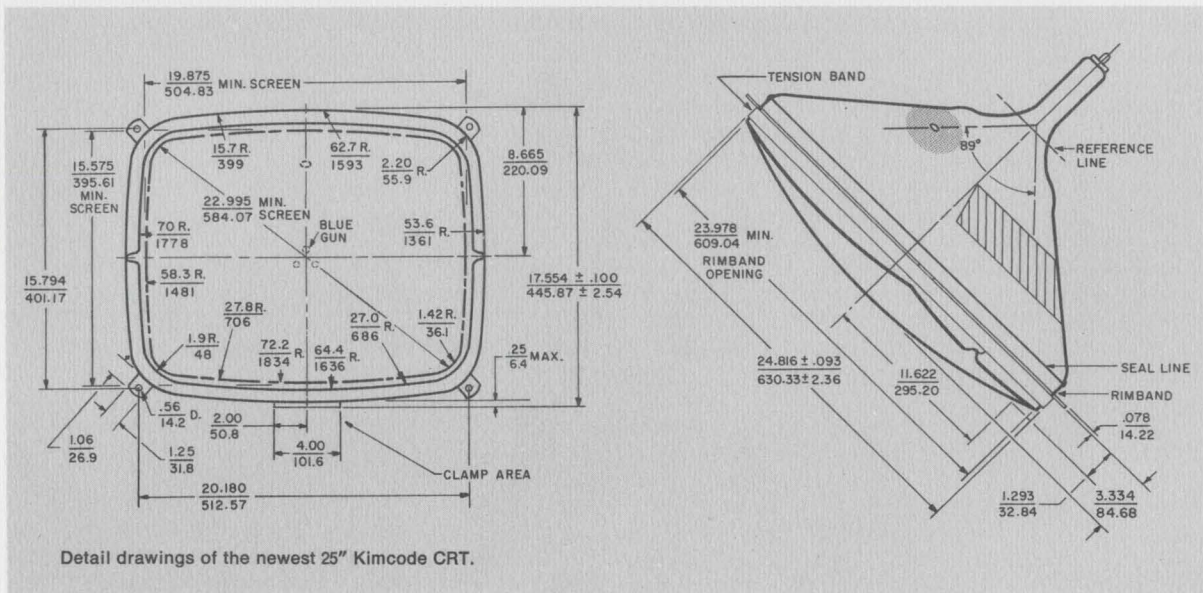

Use Sylvania's "Hot Line" inquiry service, especially if you require full particulars on any item in a hurry. It's easy and it's free. Circle the reader service number(s) you're most interested in; then fill in your name, title, company and address. We'll do the rest and see you get further information by return mail.

BUSINESS REPLY MAIL

No Postage Stamp Necessary if Mailed in the United States

FIRST CLASS
Permit No. 2833
Buffalo, N.Y.

POSTAGE WILL BE PAID BY

Sylvania Electric Products Inc.
Sylvania Electronic Components
1100 Main Street
Buffalo, New York 14209

Dept. C33

Field Engineering: What it can do for you.

It's not enough to offer good electronic components to a customer.

His needs must be served—both on today's production line and during development of tomorrow's equipment.

He must keep his line rejects and field returns low and at the same time seek improved performance and reliability in his products at competitive prices.

This is a tough job.

Sylvania's field engineers make his job easier. For example, if a customer's production line rejects are high for one of our tubes, it costs him money—and us too. Our field engineers, in cooperation with our field salesmen, assist the customer in analyzing the problem and determine if the fault is really with our tube or with some other component. If our tube is at fault, the field engineer immediately informs the Sylvania Plant Quality and Product Engineering Departments. He then seeks help from the Sylvania Applications Laboratory and Division Quality Staff. Our customer saves time and minimizes lost business.

If a production change is made to correct a field problem it's field engineering's responsibility to insure that *only* the revised product will be shipped to his customer.

Similar action is necessary to help keep our customers "in-warranty" cost low. This is a critical situation involving life and consumer acceptance of our products; it demands closely coordinated evaluation between our customers and ourselves.

To further assure customer satisfaction and to see that our production will match customer needs, field engineering plays a major role in the initiation and approval of testing specifications and published data. What electronic components will our customers need next year—and the years after? Here too we provide

a strong market-oriented authority for our customers' benefit. In conjunction with our marketing people, the field engineers participate in customers' plans for new equipment and guide our resultant developmental and production activity. This involves planning meetings between customer engineers and Sylvania engineers, as well as continuous monitoring of our mutual progress.

SEC field engineering is a unique group in the industry. Its responsibility covers receiving tubes, picture tubes, semiconductor devices, and other special products in the entertainment, industrial and government equipment market and in the distributor and renewal markets as well. We believe this group has helped to establish Sylvania's leadership in electronic components.

In receiving tubes we have long had a reputation for supplying the most reliable horizontal deflection tubes and high voltage rectifiers in the business. Our new 6LR6 and 6JE6C deflection tubes and our posted filament 3CU3 are prime examples.

In semiconductors, Sylvania has pioneered fast switching diodes, UHF mixers, video detectors, glass rectifiers and much more. Our latest developments in this area are variable voltage capacitance diodes for a multitude of electronic tuning applications.

We believe Sylvania has a most effective concept of technical liaison with our customers, and our customers firmly support this belief. Why? Because we have effectively accomplished our goal: serving our customers.

A W Peterson

A. W. Peterson
SEC Field Engineering

This information in Sylvania Ideas is furnished without assuming any obligations.

SYLVANIA

A SUBSIDIARY OF
GENERAL TELEPHONE & ELECTRONICS

NEW CAPABILITIES IN: ELECTRONIC TUBES • SEMICONDUCTORS • MICROWAVE DEVICES • SPECIAL COMPONENTS • DISPLAY DEVICES

C3

NAME _____

PLEASE PRINT

TITLE _____

COMPANY _____

ADDRESS _____

CITY _____ STATE _____ ZIP _____

Circle Numbers Corresponding to Product Item

300 301 302 303 304 305

Please have a Sales Engineer call



HOT LINE INQUIRY SERVICE

Need information in a hurry? Clip the card and mail it. Be sure to fill in all information requested. We'll rush you full particulars on any item indicated.

You can also get information using the publication's card elsewhere in this issue. Use of the card shown here will simplify handling and save time.

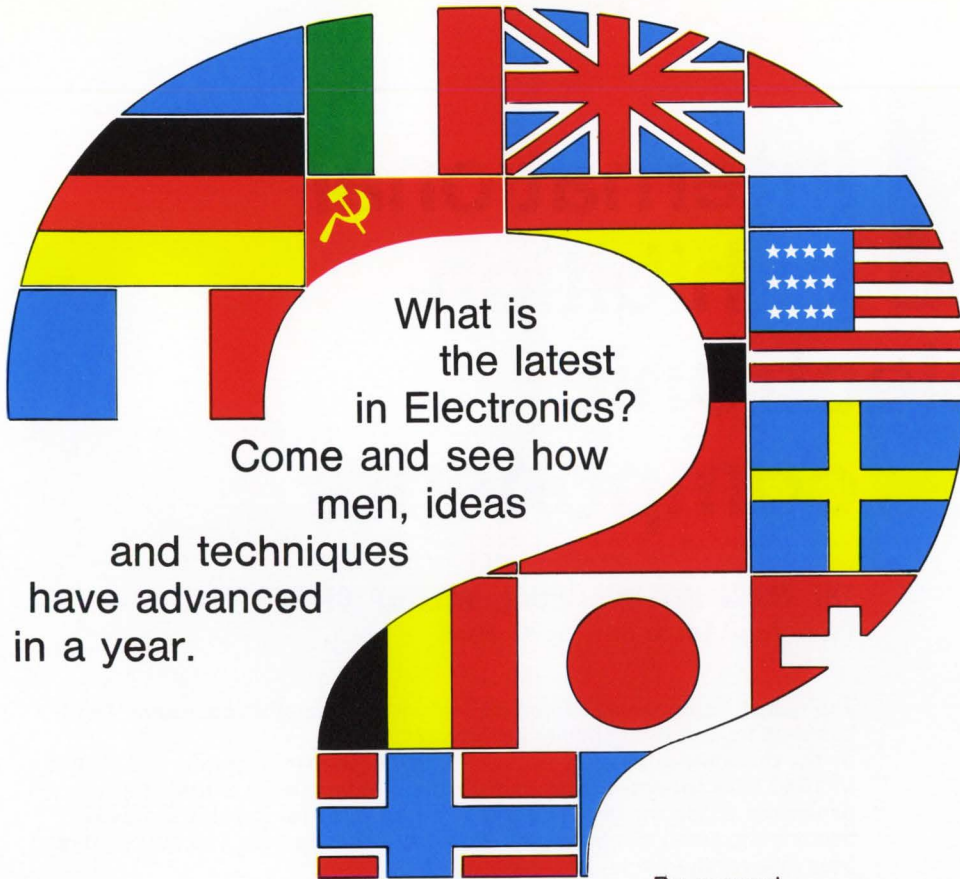

What is
the latest
in Electronics?
Come and see how
men, ideas
and techniques
have advanced
in a year.



Be present
at the

**INTERNATIONAL EXHIBITIONS OF
ELECTRONIC
COMPONENTS
AND OF AUDIO-EQUIPMENT**

FROM APRIL 1st TO 6th 1968 - PARIS
PORTE DE VERSAILLES



**INTERNATIONAL CONFERENCE
ON COLOUR TELEVISION**

scientific and technical considerations
FROM MARCH 25th TO 29th 1968 - PARIS

Programme and registration conditions on request

S.D.S.A. - RELATIONS EXTERIEURES - 16, RUE DE PRESLES - 75 PARIS 15^e - FRANCE

Official air-lines of the Exhibition call for information : AIR FRANCE



international exhibition of electronic components

THE MAIN INTERNATIONAL MEETING OF THE YEAR

From April 1st to 6th 1968 - Paris

The oldest Components Exhibition held in **1934**, international since 1958, has seen its success confirmed every year by the presence of an ever increasing number of manufacturers and visitors. **In 1968, the International Exhibition of Electronic Components promises to be more successful and on a larger scale than ever:** nearly a thousand exhibitors from 20 nations... more than 150,000 visitors from all over the world... are expected there. It will be open in Paris from **April 1st to 6th** in the Exhibition Halls Porte de Versailles.

A double goal

The International Exhibition of Electronic Components has taken only a few years to become the greatest world-wide intercomparison in the field of components, semiconductors, tubes, and electronic accessories. Exclusively open to manufacturers, it pursues - with constantly increasing success - two objectives:
 — to present, every year, a **vast synthesis of the most recent world production**, giving manufacturers an opportunity to meet, discuss, exchange ideas, and prepare for the future;
 — to offer every year to many specialists, engineers and technicians coming from all countries, a **technical information centre** where, in the most favourable conditions of rapidity, they can discover the latest novelties in their respective fields, obtain documentation and equipment... and make an appraisal of the evolution and prospects for the Electronic Components Industry.

TECHNICAL MEETINGS

Within the very scope of the International Exhibition of Electronic Components, technical meetings are arranged to allow visitors to get information on the latest technological advances. The programme of these meetings may be obtained on request.

INTERNATIONAL EXHIBITION OF AUDIO-EQUIPMENT

Held jointly with the Exhibition of Electronic Components, the Exhibition of Audio-Equipment will open its doors during the same period to engineers and specialists from all over the world in adjacent halls to those of the Exhibition of Electronic Components.

INTERNATIONAL CONFERENCE ON COLOUR TELEVISION

From March 25th to 29th 1968 - Paris
 International Conference on Colour Television. Scientific and technical considerations. Programme and registration conditions on request.



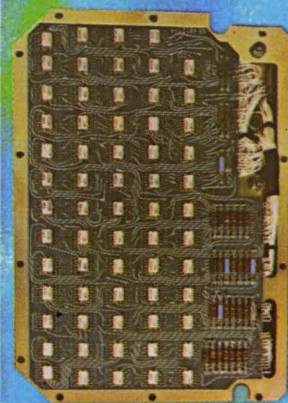
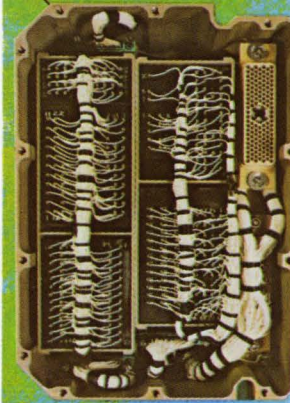
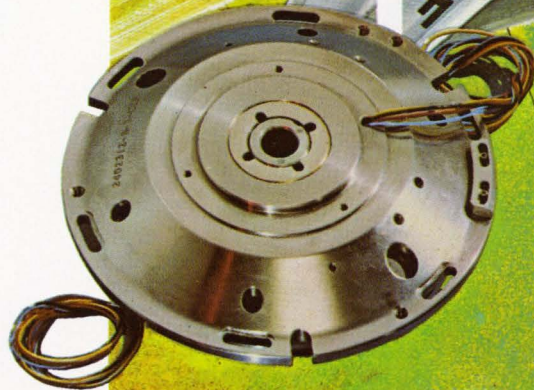
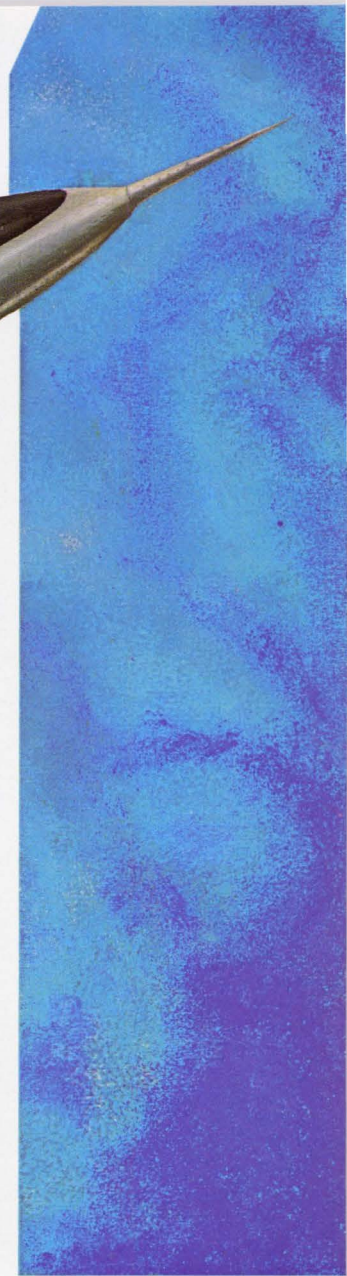

PINPOINT NAVIGATION for the FB-111

Clifton's A/D, D/A Converters consisting of multispeed transducers combined with miniature, all solid state integrated circuitry designed and manufactured by our Ditran Division, offer ideal solutions in the navigation equipment of the FB-111. They are a rugged, high density package, highly accurate, with system resolution from 13 to 21 bits. Talk about state-of-the-art. This is it! In a practical, in production piece of hardware.

Think of Clifton also for all types of servo components such as synchros, resolvers, AC, DC and stepper motors, amplifiers, electronic and electromechanical modules and packages. For information call 215 622-1000 or write 5050 State Rd., Drexel Hill, Pa. 19026.

CLIFTON 
DIVISION OF LITTON INDUSTRIES

Circle 37 on reader service card

Portrait of a most reliable family



More accurately, the portrait shows only *part* of a most reliable family. The E. F. Johnson Company makes hundreds of fine quality electronic components, including:

CAPACITORS—A dozen basic series of air variable capacitors, each in a wide choice of capacity values. They range from sub-miniature machined plate capacitors with maximums of 4.2 to 24.5 pf., to larger, heavy-duty types with capacity values to 1700 pf. and voltage ratings to 9000 volts peak.

There is a reliable Johnson capacitor to fit your application. Whatever the size, it offers excellent stability, high Q, low temperature coefficient, uniform capacitance, and excellent overall performance at competitive prices.

CONNECTORS—The Johnson line of jacks, plugs and terminals meets the needs of both military and commercial designers effectively and economically. For printed circuit applications, there are sub-miniature insulated tip plugs and jacks, plus the unique Test Point Strip/Handle for fast, efficient circuit testing.

Johnson's line of standard insulated connectors includes tip, banana and dual banana plugs, tip and banana jacks, military tip jacks, and binding posts.

RIB-LOC™ components consist of new miniature, one-piece, insulated terminals and jacks that press-mount with excellent retention characteristics.

TUBE SOCKETS, INSULATORS, PILOT LIGHTS, RF COMPONENTS AND HARDWARE—Dependable Johnson tube sockets include HF, VHF and UHF types for tubes of various power levels.

Low-loss, high-voltage-breakdown insulators are available in either steatite or porcelain.

Johnson offers 47 pilot light assemblies in neon and incandescent types. Standard and wide angle lens caps are available in glass and acrylic.

Other hardware includes panel bearings, shaft couplings, crystal sockets and RF chokes, plus a number of heavy-duty RF components for broadcast transmitting, RF heating, antenna phasing and other commercial applications.

FREE CATALOG gives complete details and specifications, including net prices, of E. F. Johnson quality electronic components. Write for your copy today, or ask us about your specific application requirements. Special components, to your exact requirements, may be available in production quantities.



E. F. JOHNSON COMPANY

3033 Tenth Ave. S. W., Waseca, Minnesota 56093
Providing nearly a half-century of communications leadership

Circle 39 on reader service card

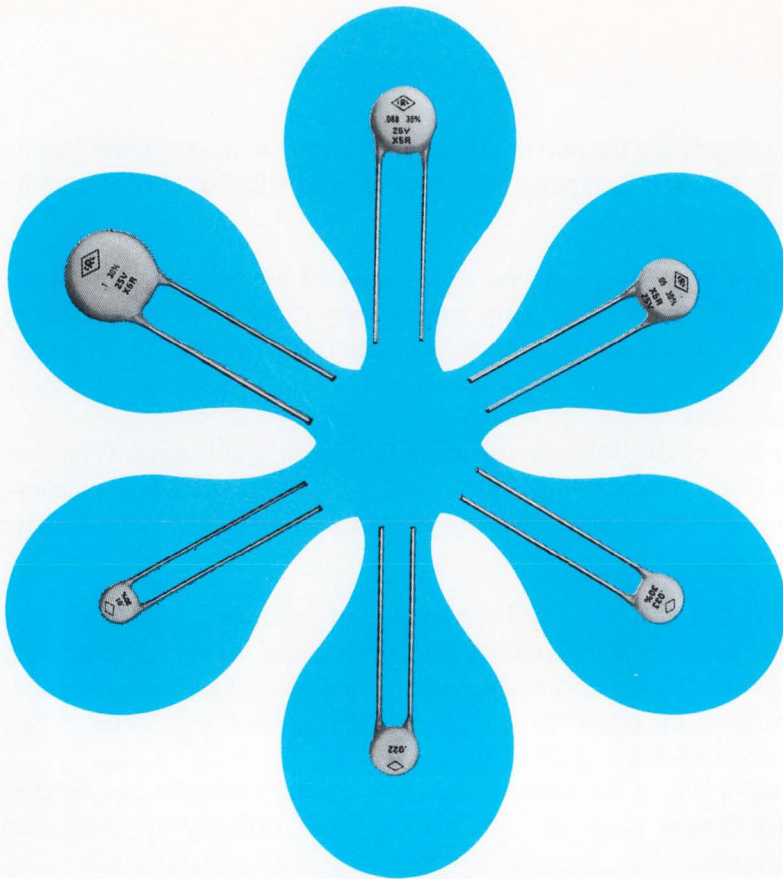

Centralab's "Ultra" Ultra-Kaps[®] put new capacity in shrinking design space

Smaller Size...Outperforms Other Capacitors...Costs Less, Too!

"Inner space" continues to shrink in this trend to transistorization... but not the capacitance values you need in your design applications.

Centralab's answer: an improved 25V Ultra-Kap Disc Capacitor... smaller in size but not in performance.

This "ultra" Ultra-Kap goes one-up on previous Ultra-Kaps (which feature 100 times the capacitance of conventional ceramic dielectrics). Now you can use the Ultra-Kap instead of monolithic ceramic capacitors or mylar capacitors. It even replaces many 50V disc capacitors! Features improved temperature compensation characteristics, too—X5R (−55° to +85°C ±15% from 25°C).

All this at lower cost than with other capacitors, adding an extra touch of economy to your design applications... whether for consumer entertainment, communications, the military—or for medical, instrumentation and computer markets.

Get full details about the "ultra" Ultra-Kap... and the complete Ultra-Kap line of ceramic disc capacitors... from your Centralab representative or drop us a line.



CENTRALAB

Electronics Division
GLOBE-UNION INC.
5757 NORTH GREEN BAY AVENUE
MILWAUKEE, WISCONSIN 53201



Here's why they're "Ultra" Ultra-Kaps!

RANGE CHART					Minimum Insulation Resistance At Rated Voltage
Maximum Dissipation Factor 5% @ 1 kHz					
Nominal Lead Spacing	Capacitance MFD	Maximum Diameter*	Tolerance		
.250	.01	.290	IMPROVED ULTRA-KAPS	10 MEGS	25 Volt 10 MEGS
.250	.022	.405	16 Volt	10 MEGS	
.250	.033	.405	+80-20% (Z) ±30%	10 MEGS	
.250	.05	.515	or	10 MEGS	
.375	.068	.590	±20% (M)	10 MEGS	
.375	.1	.760		10 MEGS	

*All Ultra-Kaps have a maximum thickness of .156 inches.

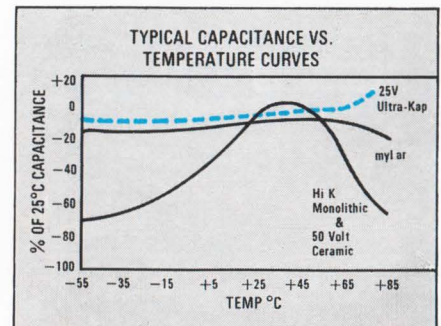

M-6723R

Small wonder:



Our new "4th-generation" 12.5 MHz universal counter/timer. Wonderful versatility in a wonderfully small package — at an even more wonderfully small price.

With the new Model 100A you can measure average frequency, frequency ratio, single period or time interval, or count total events. It has a crystal-controlled clock, Monsanto integrated circuit construction, and built-in compatibility with a rapidly growing assemblage of accessory modules.

With its \$575* price tag (accessory modules are pegged at comparably modest rates) you can have big-league counter/timer performance at

costs never before possible. Small wonder we are selling (and delivering) Model 100A's just as fast as we can build them.

Call your local Monsanto field engineering representative for full technical details, or contact us directly at: Monsanto Electronics Technical Ctr., 620 Passaic Avenue, West Caldwell, New Jersey 07006. Phone (201) 228-3800; TWX 710-734-4334.

*U.S. Price, FOB West Caldwell, New Jersey.

Monsanto
ELECTRONICS[®]

Circle 41 on reader service card

New connectors. New standardization.

JT concepts have really branched out at Bendix.

Now—to the thousands of JT users who like the advantages of rear-release crimp contacts—Bendix offers the opportunity to standardize. It'll ease operation, installation and maintenance problems in the field. Cut back on spares and application tools. And you'll enjoy the inherent benefits of size and weight savings, reliability and extended connector life. You liked rear-release crimp contacts so well, we're putting them in all kinds of connectors in all kinds of shapes. Rectangular connectors, cylin-

dricial connectors, printed circuit connectors, rack and panel connectors. All with solder or filter contact options. A full variety of shell sizes and types. Many insert patterns with 12-, 16-, 20-, 22- and 22M contacts. Double-density models with up to 128 contacts. Plus some entirely new designs coming your way soon. If you haven't tried them by now, you should. They'll grow on you. Write Electrical Components Division, The Bendix Corporation, Sidney, New York 13838.





NASA turned to Airco for helium and...

& reliability. To pre-cool Centaur rocket engines, Airco delivered 5,500 gallons of liquid helium. The largest single commercial delivery of helium ever made. **&** it took only 42 hours, in one of Airco's 10,000 gallon trailers, from Kansas to Cape Kennedy.

That's the way Airco works. **&** from 25 points spotted across the country. We're the number one helium supplier **&** we perform for all our customers – large **&** small. For more information write us at 150 East 42nd Street, New York, N. Y. 10017.

AIRCO
Industrial Gases



Complement Your Rugged Designs With 30-Watts of Thermopad* Plastic Silicon Power!

The 2N4918-23 series of NPN/PNP silicon power transistors is designed to put extra performance in — and take the cost out of — industrial switch/amplifier and driver applications that demand premium, plastic-type capability and reliability.

Besides offering the traditional circuit-simplifying design advantages of eliminating expensive, impedance-matching driver transformers and resistors and offering a high degree of frequency stability, these 3-ampere devices actually handle 30-watts of power . . . 5-watts more than their TO-66 counterparts — yet they cost about 15% less!

Extensive testing has proven Motorola Thermopad units — with the exclusive, ultra-short (less than 0.030") and efficient chip-to-heat sink thermal path — exhibit optimum reliability in all phases of testing from operating life, temperature cycling, humidity and thermal shock. For example, they have passed 42,000 hours of life-testing under ambient temperature, high humidity, reverse bias conditions and 100,000 hours of 150°C storage testing, with no failures.

These unique capabilities plus their low saturation voltages (0.6 V @ 1 A), high beta (20 min @ 500 mA, 1 V) and good frequency response make them ideal for your price-vs.-performance applications . . . particularly where metal-can units prove too costly.

The complementary approach . . . in audio and servo amplifiers plus mounting procedures and thermal aspects of Thermopad devices is discussed thoroughly in 3 application notes we will send you when you circle the reader inquiry number. Or, write Box 955, Phoenix. Do it today and receive them by return mail.

Type		I _{C(MAX)} Amps	V _{CEO} Volts (sus)	h _{FE} @ I _C = 500 mA	P _D @ T _C = 25°C Watts	V _{CE(SAT)} @ I _C = 1A (max) Volts	f _i (min) MHz	NPN/PNP Comb. Price (100-up)
NPN	PNP							
2N4921	2N4918	3	40	20/100	30	0.6	3	\$2.00
2N4922	2N4919		60					2.26
2N4923	2N4920		80					2.70

*Trademark of Motorola Inc.



MOTOROLA
Semiconductors

- where the priceless ingredient is care!

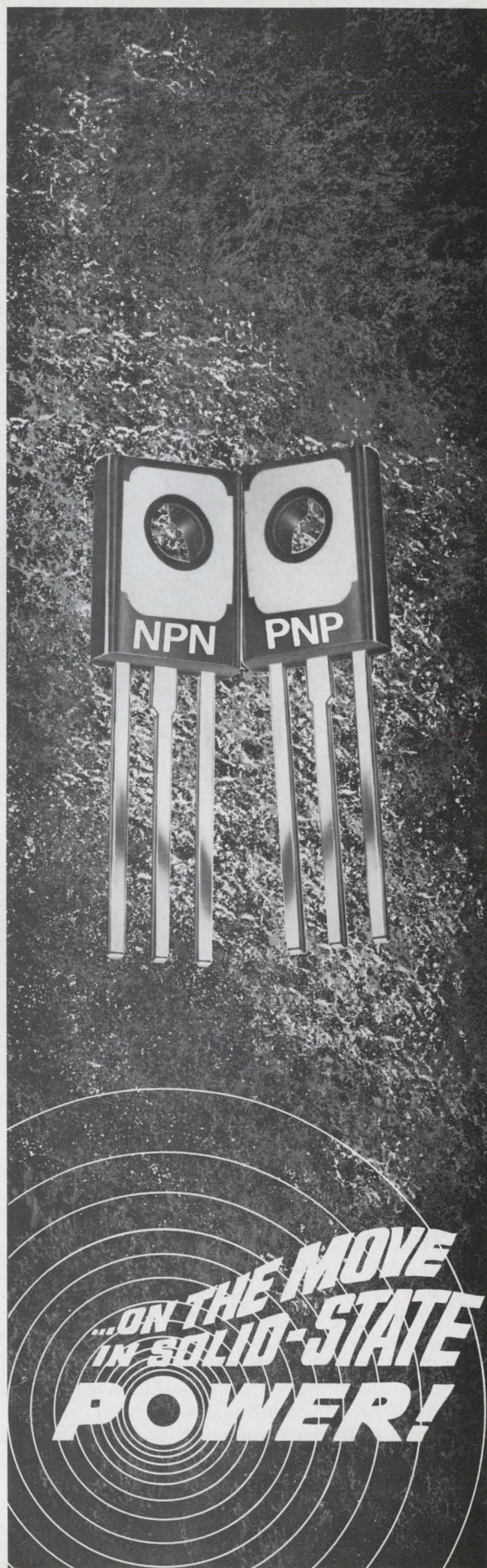

...ON THE MOVE
IN SOLID-STATE
POWER!



Bendix Autosyn Synchros.

Can you afford to buy less?

Not if you need the kind of performance and reliability you get from Bendix® Autosyn® Synchros.

And you have a wealth of types to choose from. Ultrahigh-temperature synchros that perform accurately at sustained temperatures up to 800°F. Ultracompact (size 08), lightweight (1.3-oz.) synchros for critically tight designs. Ultraprecise synchros with tolerances to 50 millionths of an inch. Dependable corrosion- and radiation-

resistant synchros. And there's a complete line of Bendix Mil-Spec synchros, too.

AUTOSYN® SYNCHROS

Size	Max. Diameter (In.)	Typical Weight (Oz.)	No. of Models
08	0.750	1.3	16
10	0.937	1.7	25
11	1.062	3.2	29
15	1.437	4.7	24
22	2.161	18	5

Altogether there are hundreds of types—your largest single source. What's more, our synchro design service can promptly solve your special problems. You can depend on it. As they do at GE, Sperry, RCA, Lear Siegler, Motorola and many other value-conscious firms. Ask for our catalog today. Write: The Bendix Corporation, Flight & Engine Instrument Division, Montrose, Pa. Or phone: (717) 278-1161.



**Aerospace
Products**

Electronics Review

Volume 41
Number 6

Integrated electronics

Buyers' choice

Customers of Fairchild Semiconductor have complained that the popular 709 operational amplifier, with its high-gain building blocks, did not meet their needs. As a result, the customer has, in effect, been forced to design his own circuits. "And it's true that we have ignored some markets, so that in turn they have ignored us," concedes Jack Gifford, linear circuit marketing manager of Fairchild.

With the industrial market for linear integrated circuits taking more and more units, and the consumer market expected to open up next year, Fairchild is clearly trying to come up with devices that can be designed directly into equipment. In the next three months, Fairchild will unveil the first of a new series of complex linear IC's billed as second generation descendants of the 709. The new circuits are user-oriented devices designed to compete directly with discrete rack-mounted amplifiers.

Following demand. Most work on new op amps has focused on production of truly monolithic devices, requiring no external compensation. One of the new Fairchild circuits will be a fully compensated version of the 709. But the main feature of the new circuits, on which 50 engineers worked a year, is that they are tailormade for specific functions Fairchild's customers demand.

First out, for instance, is a digital-to-analog current source, designated the $\mu A722$, that works as a d-a and a-d converter. Due in June is the line's real star, the $\mu A715$ op amp—a high-speed device that operates at an unprecedented slew rate of 25 volts per microsecond; thus it can switch high voltages at

rates of up to 10 megahertz.

Also among the first circuits are a core-memory sense amplifier and a temperature-stabilized op amp, plus the 709 substitute that has its own metal oxide semiconductor capacitors for compensation. Coming at midyear will be a color television demodulator already being sold to one manufacturer.

Late circuits include a device that will function as a low-noise preamplifier for stereo high fidelity

by second-sourcing the 709 and introducing improved versions. But Fairchild made only two linear circuits—op amps and comparators—and comparators were only marginally successful.

"This year, we will have peripheral circuits for special applications," Gifford says. "These new products will account for the bulk of our business in 1969 and 1970. Each circuit will amplify a given parameter of the general purpose

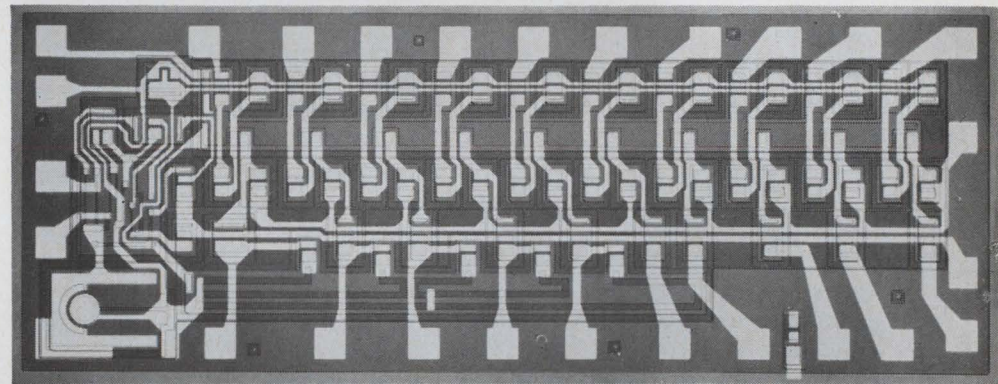

Second generation. Fairchild is about to unveil a series of linear IC's in a move to enter new markets. Shown here is the $\mu A722$, which works as a d-a and a-d converter.

sets, a voltage regulator, a low-power op amp, and a dielectrically isolated device for use in radiation environments.

Price cuts. The new circuits represent Fairchild's blockbusting attempt to retain preeminence in a field thrown into turmoil by weakening prices. Last year's linear IC sales were about \$40 million, says Gifford. This year the industry will sell only \$45 million or \$46 million, despite an increase in units from less than 6 million to 10 million. From mid-1967 to mid-1968, Gifford adds, prices will have dropped by a factor of four; in that same period Fairchild's unit production will have increased by only 2½ times.

Competitors have pecked away at Fairchild's share of the market

op amp. Even though the large companies will eventually standardize on a few circuits, you will never see another standard like the 709."

Bigger wafer. Fairchild calls the new circuits medium-scale integration devices. The 722, for instance, will have 90 matched active elements on a 60-by-120-mil chip; it will come in a 22-lead flatpack or dual in-line package, and cost about \$65 at first. To obtain reasonable yields on circuits of this size, Fairchild has switched all of its linear production to two-inch wafers and devoted considerable effort to temperature control on the chip.

By incorporating a special amplifier on the chip, which senses ambient temperature and drives a heating element, Fairchild has

been able to keep fluctuations in chip temperature to within 4°C during ambient temperature swings of 100°C.

"But the real beauty is in the matching," says Gifford. Because all elements are fabricated at once, the active devices are matched to within a millivolt.

Yet the move to complex chips has not been easy, and Gifford concedes the same techniques that made it possible to build the 715 with such high slew rates also make it extremely difficult to compensate. Half of the compensating elements—the resistors—will be on the chip itself, but the external capacitors must be so large that they can play havoc with the slew rate.

Computers

Opening a new deck

The ubiquitous punched card may be on the way out.

The Univac division of the Sperry Rand Corp. has developed a plastic card coated with a magnetic film that can store 12 times as much data as the conventional punched card and is potentially capable of storing 100 times as much. And the card can be erased and reused indefinitely.

As a further plus for sensitive types, the new card need not bear that familiar admonition, "Do not bend, fold, spindle, or mutilate"; it can't be damaged by rough handling and can even withstand stapling.

In a related development, Univac has designed a card-processing transport mechanism that relies on fluidics, or fluid logic. From input hopper to output stacker, the cards float on a film of air controlled by fluidic devices. Both developments were financed by the Army Electronics Command, Ft. Monmouth, N.J., and the military plans to begin testing the system soon.

On the track. The cards, which resemble playing cards in size and thickness, are coated with a thin nickel-cobalt film. In the present experimental models, a machine-readable sector 1 by 2½ inches records up to 1,000 characters. Other sectors are available for printed information, signature, and photograph. The data is stored in densities up to 500 characters per inch on nine parallel tracks in much the same way as information would be entered on magnetic tape; in fact, the card functionally resembles a small piece of magnetic tape snipped off the reel.

Up to 8,000 characters could be stored on both sides of the card, compared with 80 on the present standard punched card. Interference between the recordings on

either side wouldn't be a problem because the characters are written 500 to the inch, and the thickness of the card is large relative to this spacing.

The fluid transport system includes an input hopper, read-write stations, and—in the prototype—two output stackers. A stack of cards in a metal cartridge rises on an elevator mechanism until the top one is blown off by a stream of air. The cards ride on this stream, one by one at a 300-per-minute clip, past a station that can either read data from the cards or write new data on them. As the cards leave this station, they encounter a fluidically controlled gate that directs them to one of the two output stackers. One stacker might accept only error-free cards, for example, while cards containing errors would be directed to the other.

The prototype design could be extended to process up to 1,200 cards per minute, or to combine the functions of several conventional card tabulating machines, such as sorting, collating, and updating.

Handy units. The new development is particularly significant in view of current interest in devices that bypass punched cards as a computer input medium. Most of these devices write data on a magnetic tape that is either directly computer-compatible or can be easily transcribed onto computer tape.

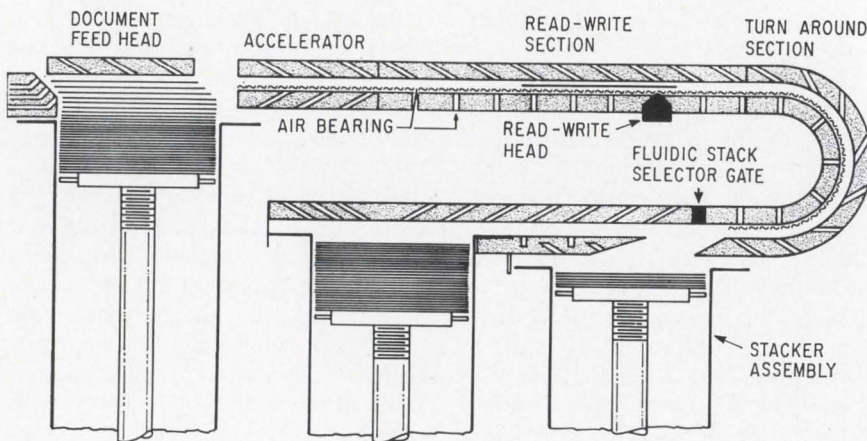

No punch, but rugged. Magnetic computer card developed by Univac can be bent, spindled, and even stapled.

Floating on air. Data cards, which can contain signatures and photographs, are processed by fluidic mechanism.

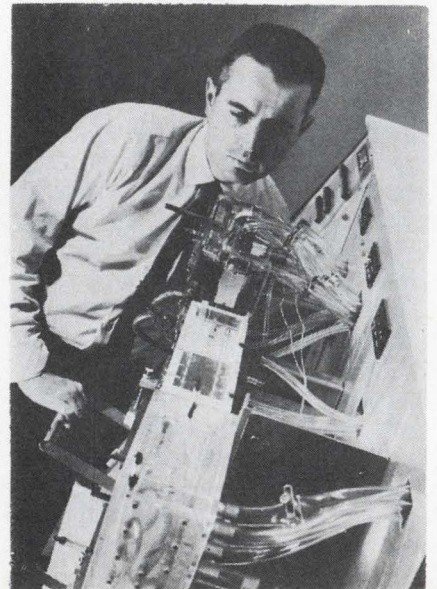

But magnetic tape is not a unit record. Payroll information cannot be snipped off a reel of magnetic tape and given to an employee to cash at his bank, for instance. A punched card can be handed out, of course, and Univac's new development combines the advantages of magnetic recording with this punched-card flexibility.

Forward, march

The National Cash Register Co. took a flying leap last week into what it hopes is a substantially larger share of the computer market than it has now. With just under 3,000 computers, of half a dozen or so different models, now installed, the company hopes to sell at least 5,000 of its new Century Series during the next few years.

The firm claims the new machines have a lower price-to-performance ratio than any other similarly priced machines—achieved by two new hardware designs and highly standardized parts. The fresh designs include a second-generation thin-film rod memory and a new disk file design.

Moving ahead. The thin-film rods are really “whiskers” a tenth of an inch long. They are snippets of a plated wire made in a continuous process and assembled by a method that reminds one of “The Sorcerer’s Apprentice.” Whiskers are scattered across a metal plate full of little holes, under which has been placed an assembly of interlaced twin solenoids resembling a miniature chain-link fence. An alternating magnetic field is applied to the plate, causing the whiskers to stand on end and march in a phalanx across the plate. One whisker falls into each hole as the phalanx passes; left-over whiskers fall off the edge of the plate and can be reused.

The memory plane contains 4,608 whiskers, one whisker per bit. Planes are assembled into modules of 16,384 eight-bit bytes, the smallest memory size available with the new machines; they can be combined into memories of up to 524,288 bytes. The memory cycle time



Coil weaver. Automatic machine produces interlaced twin solenoids for new rod memory.

is 800 nanoseconds—the same as the company’s four-year-old rod memories, made with plated rods $4\frac{1}{2}$ inches long, each storing several bits. As with the older rods, the magnetic film is magnetized lengthwise in one direction to store a binary 1 and in the other direction to store a binary 0.

Price is bright. The new memories are inexpensive—the customer pays \$23 per month per thousand bytes, compared to an industry

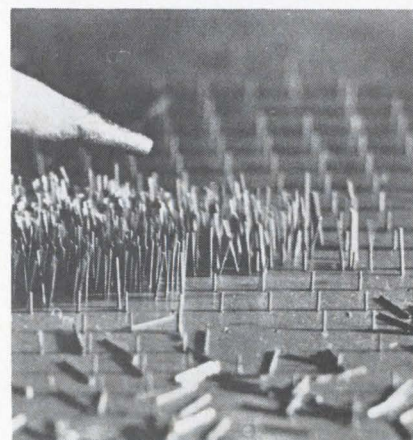

Marching whiskers. Tiny memory rods, shown under pencil point, “dance” into place as rod memory is assembled.

average of around \$50 per thousand bytes, according to Paul Lappetito, NCR’s assistant vice president for marketing.

Two disk storage units are standard on even the lowest-priced Century systems. The units, which use removable disk packs, with nickel-cobalt plating instead of the conventional magnetic oxide, have 12 read-write heads per disk surface. The large number of heads and the small movement of the single access mechanism carrying them can retrieve any data from the disk in an average of 48 milliseconds—less than that of any other disk-pack unit, according to NCR.

81 cards. Practically all of the logic in the Century computers is implemented with one standard integrated circuit—two four-way diode transistor logic gates in a dual in-line package. The IC’s are mounted on only 81 different kinds of circuit cards, as compared with 1,200 on most other computers; six of these 81 handle most of the logic functions in the machine. The IC’s are made to NCR’s specifications by several semiconductor manufacturers, including Signetics and Fairchild.

Software is being checked out on several machines already installed in NCR’s own locations, and will be ready when customers get their first machines in September, the company says.

The Century series represents for NCR the same kind of gamble, on a somewhat smaller scale, that IBM took when it introduced the System 360—a gamble that has been called, “You bet your company.” NCR has invested \$150 million in developing the new line. Although the first two announced models are aimed largely at NCR’s previous markets—retailers, financial institutions, and small industrial users—larger models to be announced within a few months will have multiprocessing and time-sharing capability. These will put the company in a new sector of the computer market that it has not previously exploited.

The Century 100 rentals begin at \$1,910 per month with a five-year contract; for the basic Century 200, the rental is \$3,355 per month.

Instrumentation

Outside testing

Checking all shipments of integrated circuits for defective devices is a procedure recommended to all users but beyond the capacity of many. Some either can't afford the equipment to do their own testing, or lack the engineers capable of programming and maintaining IC testers. Others having the equipment and personnel sometimes take on more IC shipments than they can process themselves.

These firms will soon be able to let Texas Instruments do the testing. The Texas Instrument Supply Co., a subsidiary of TI, this week will open centers at Lake Success, N.Y., and Houston, Texas, for the testing of all types and brands of IC's—the first such service ever offered.

Unprejudiced. Both centers will be equipped with TI's 553 tester in combination with a company-developed 860 special-purpose computer. Typical tests that can be performed are d-c and pulse, d-c and dynamic, and burn-in and component aging. The facilities can handle both medium- and large-scale integrated devices, as well as printed-circuit boards. And to insure unbiased results, the centers will develop standard test pro-

grams for all standard IC's.

Computer printouts of the test results will be made available if the customer requests them. Results of all testing will be confidential.

The cost of using these facilities can be as low as pennies per device for a functional, go/no-go test on a standard device, the TI subsidiary says. Parametric tests of nonstandard IC's will cost more, of course, to cover the expense of developing special software. And environmental testing will add even more to the price.

Library. Each center will maintain a library of standard test programs both for the center's own operations and for IC users with their own test equipment.

Texas Instrument Supply would like to eventually combine the IC tester with a time-shared computer, and lease testing terminals to each customer.

Laser recording

Sixteen months ago, the Precision Instruments Co. developed a laser-optics computer mass-memory system that promised packing densities 1,000 times better than the best magnetic tape.

The system seemed fine for real-time permanent recording. But the small Palo Alto, Calif., company could find no way to retrieve the

information once it had been recorded.

Now the company has not only developed an agile retrieval system based on the same principle, but has also found a way to use it to record wide-band, high-resolution color video.

Top speed. The system promises a retrieval rate of two megabits per second, more than most computers can handle, the company says. One track-grooved slantwise into a drum 60 centimeters long—contains 120,000 bits and can be scanned in 1/30 of a second.

The company says it can produce color video pictures with 1,000-line resolution, or 10 megahertz, double the consumer TV standard. It expects to demonstrate this system within two months.

The company foresees potential markets in wideband-frequency recording and reproducing, geophysical exploration, and mass information storage. Right now, it's showing the demonstration model to interested civilian and Government groups and will build the first standard model when a buyer appears, says Joseph V. Shane, general sales manager.

Called Unicon, the basic system uses an argon ion continuous-wave laser to punch one-micron diameter holes in specially designed nonmagnetic medium so that, in binary fashion, a hole means 1 and a no-hole 0. By assembling these 1's and 0's into five-by-five micron bits and spacing these bits five microns apart, the system records in pulse-code modulation. Theoretically, the nonmagnetic system could reduce the information on 4½ miles of magnetic tape to one 3-by-30-inch strip.

Changes index. Unicon, developed by Carl H. Becker, director of research, uses a laser beam through an electro-optical modulator (Pockel's cell) that transfers the input signal to the laser beam by changing the refractive index. From there it passes through a rotating optical system that focuses the light on a recording track, which may be on a tape, disc, or drum. The system offers two basic advantages over conventional magnetic tape mechanisms:

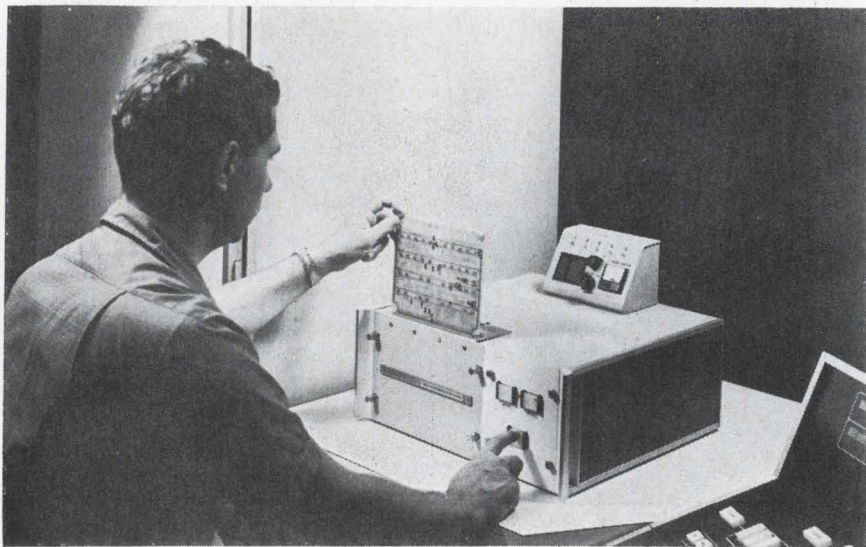

Check-out service. Texas Instruments subsidiary is initiating a testing service for users covering any brand of integrated circuit.

The most important thing about these relays is the company that makes them

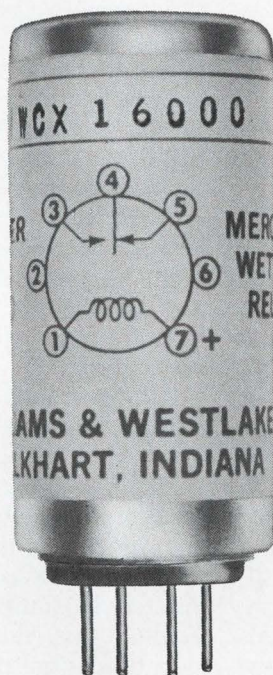

FORM C, MWCX
FORM D, MWDX

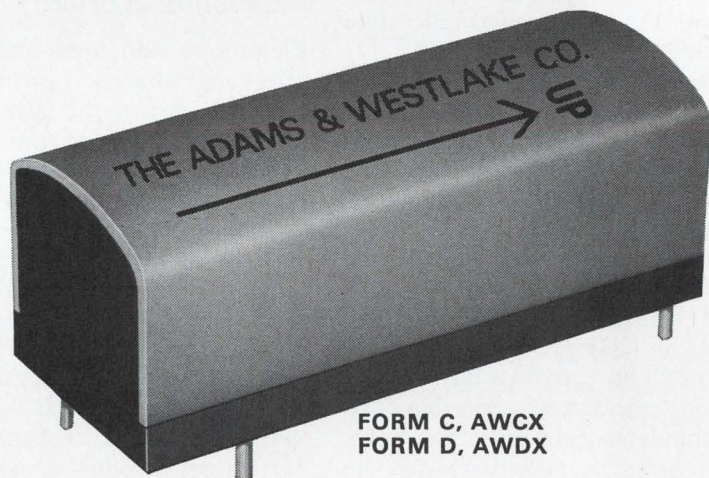

FORM C, AWCX
FORM D, AWDX

The big difference between Adlake and other people is service. We provide design and application assistance. If we don't have the exact relay you want, we help you develop a new one.

Not that there's anything wrong with our standard relays. On the contrary. The mercury-wetted relays shown here are ideal devices for high-speed switching and for circuit isolation, especially when high package density is essential.

Some specifications:

CONTACT ARRANGEMENT

(Plug-In)
MWCX-16000: SPDT, Form C
MWDX-15000: SPDT, Form D
(Printed Circuits)
AWCX-16000: SPDT, Form C
AWDX-15000: SPDT, Form D

LIFE

In excess of one billion operations with proper contact protection

CONTACT RATING

100 VA (2 amps max. 500 volts max.) with proper contact protection

SENSITIVITY

Single-Side-Stable: 45 ampere turns
Bi-Stable: 21 ampere turns

INSULATION RESISTANCE

1000 megohms min. at 500 VDC, 45% RH and STAND OFF VOLTAGE at 1000 VAC 60 Hz (between all mutually insulated terminals except between windings of bifilar construction coils)

BRIDGING TIME, FORM D

10 to 500 microseconds

TRANSFER (null) TIME, FORM C

10 to 600 microseconds

OPERATE MAKE TIME

As low as 1.0 milliseconds for Single-Side-Stable, and 0.9 milliseconds for Bi-Stable operation

(For complete specifications and characteristics, ask for Bulletins MW1 and MW2)

Adlake has the industry's most complete line of mercury-wetted and displacement relays, plus a new line of dry reed relays. So call us next time you have a circuit design problem.



THE ADAMS & WESTLAKE COMPANY
A SUBSIDIARY OF ALLIED PRODUCTS CORPORATION

Elkhart, Indiana, U.S.A. 46514 • (219) 264-1141
TWX 219 522 3102 • TELEX 25-8458 • CABLE ADLAKE

▪ It requires no secondary processing of the recording medium, which is a proprietary thin film of uniform optical density. Last year, the Itek Corp. dropped its years-long work on a photographic laser-recording technique because of technical problems [Electronics, March 20, 1967, p. 47].

▪ It also gives instantaneous verification through a photo diode behind the film, which indicates whether the laser actually burned the hole it intended. If the laser was supposed to record 5,000 holes and only recorded 4,999, the system would register an error within nanoseconds, Becker says. Over-all accuracy is one error in 10 million bits.

Unicon reads by picking up the variations of reflections of a laser beam on a photoelectrical detector. This also gives the system instantaneous read-while-you-write data processing.

But in devising a way to retrieve the information later, Becker had to find a way to make the laser beam follow the same position and the film tracking at the same speed as in recording. He then chose a flying-spot scanner that follows the track by galvanometer-directed servo controls. The galvanometer keeps the laser pointed to the middle or brightest part of the track as in radar tracking of a satellite. The galvanometer transmits the holes or no-holes signals back to the photodetector as information.

The system would permit either single-frame, helical multiple-frame incremental, or helical multiple-frame continuous recording and reproducing. Helical tracking on a drum, for example, would permit compact information storage on a principle analagous to a slanted filing cabinet drawer: at the top of each track would be an identifying code, like file drawer tabs, so that with one quick spin around the top of the drum a laser scanner could search a memory system for the correct track.

The whole track would have to be reproduced to pick out just a few bits, but the system would regurgitate the track of bits so quickly it wouldn't matter, Becker says.

Ahead of tape. Becker claims that as a video system the unit has a potential bandwidth of 1 gigahertz. If the transport system could scan at 1.8 kilometers per second (versus the 18 meters per second now), laser power would also have to go up. "What is holding us back is the transport system" Becker says. "What we need is beyond the state of the art."

But, he adds, "magnetic systems are limited to 5 Mhz. Our first experimental model is already beyond the limits of magnetic tape systems."

Military electronics

A question of priority

Electronics companies and military program managers are becoming acutely aware of the financial facts of life as more and more money gets shifted to Vietnam-related programs, draining the budgets of lower-priority efforts.

One casualty, the FSR-2, an optical satellite-tracking system, is a case in point. The system, part of the Spacetrack program, 496L, has had its share of technical difficulties [Electronics, April 3, 1967, p. 168], but late in February RCA's Aerospace Systems division, Burlington, Mass., thought it had the solutions—then found it didn't have the money.

There will be no more money for the system until fiscal 1969—and even then Vietnam may suddenly drain it away. And it's no consolation to RCA that other programs are experiencing equivalent money troubles.

No reflection. The funding halt isn't a judgment of the FSR-2, rather it's typical of the fortunes of several other Air Force-sponsored programs. "If it can't be used in Vietnam, it almost doesn't have a chance," says an insider at the Electronic Systems Division, Hanscom Field, Mass.

Programs like TACS (407L, Tactical Air Control System), usable in Vietnam, are being fed as much

money as possible. TACS is near final development and procurement now, with only one manufacturer remaining to be selected for its 45 major subsystems. The first TACS system could be operating by late 1969, supplying communications, radar, and computer capabilities with which to control tactical aircraft.

Nor should there be much problem with money for TACS during the remaining months of fiscal 1968. The \$44.2 million for procurement and final development allocated last year, plus an added \$5.5 million for advanced TACS research makes it the largest program at the field.

But cutback rumors fly about other programs; even about already-approved programs like Awacs (411L, Airborne Warning and Control System), and systems already realized in hardware like Aesop, a data-retrieval system for air-strike commanders. Some of the more distant programs, like Control and Surveillance of Friendly Forces (Casoff), are even more likely to be delayed.

Behind schedule. Awacs is moving to contract definition more slowly than expected and is already about one month late. Although there are a variety of reasons, Vietnam funding is the rumored cause.

The Air Force originally requested \$25 million for fiscal 1968 funding for Awacs; the Defense Department cut this to \$10 million, which was to pay for demonstration of overland radar technology. It's estimated that \$20 million to \$25 million was included in fiscal 1968 "emergency funds" for Awacs, to be drawn upon after successful demonstration of the radar—but some of this money may have found its way to Southeast Asia, and full funding might have to await fiscal 1969.

Aesop, which would display the data needed for efficient deployment of tactical aircraft at first would seem to have a good chance. It is designed for tactical operations and might mate well with TACS. Somewhat like a time-sharing computer terminal with graphic displays, plus keyboard access, Aesop has already been demonstrated in the United States and it's

The **ONE** low-price pulser which wraps up everything you want:

- 50V into 50 ohms amplitude
- 5Hz to 3.5 MHz rep rate
- risetime of 12 ns variable to 100 ns
- clean waveform

E-H doesn't save all its revolutionary ideas for big-ticket pulsers. For instance, here's a low-priced general purpose pulser — Model 132A — with a unique E-H development, latched output circuitry. This feature assures "no-droop" pulses. It eliminates all waveform adjustment control,

makes sure the pulse is clean and fast under all conditions — without "trimming up." (You can slow the rise time for special applications with a front panel control.) Check the EH 132A against other pulsers in the low-priced field. You'll find it's top man on the totem in specs, and low man in price. Just \$715.



E-H RESEARCH LABORATORIES, INC.

163 Adeline Street • Oakland, California 94607 • (415) 834-3030 • TWX 910-366-7258
In Europe: E-H Research Laboratories (Ned) N.V., Box 1018, Eindhoven, The Netherlands, Telex 51116
In Japan: Iwatsu Electric Co., Ltd., No. 710, 2-Chome Kugayama Suginami-Ku, Tokyo, Japan

proposed that a few Aesop centers be given to the Seventh Air Force's tactical air strike planners in Vietnam.

Where it is now. When last seen, the proposal for a Vietnam test was still being considered by the air staff in Washington; Aesop's Asian arrival could be delayed for money reasons.

Casoff, which attracted proposals from 64 electronics firms in October 1967, was originally scheduled to enter the study contract phase last December. But Casoff hasn't surfaced since the request for proposals, and insiders place it far on the back burner.

If the green light ever flashes, contractors would study an integrated navigation, communication, and digital data system for command and control of friendly aircraft, one which might supersede TACS. But if "money green" is the color of the light, it could stay unlit till the war slackens in Vietnam.

Avionics

Done with magnets

With only one moving part, and a minimum of electrical contact with the outside world, a new magnetic fluid accelerometer may help simplify rate-sensing equipment and inertial-guidance platforms. Developed for the Air Force under a \$50,000 contract by the Space Systems division of the Avco Corp., Lowell, Mass., the accelerometer uses a magnetic fluid to suspend its proof mass, or sensing element, rather than cumbersome electromechanical arrangements.

According to the developer, Ronald E. Rosensweig, earlier single-axis devices had been developed using a lightweight proof mass in a dense fluid to sense movement or acceleration; the tube-like housing of the accelerometer was spun and the resulting centrifugal force drew the fluid to the tube's periphery leaving the lighter proof mass centered and free to move back and forth in response to outside forces.

No spin. In Rosensweig's device, magnetic fluid replaces centrifugal

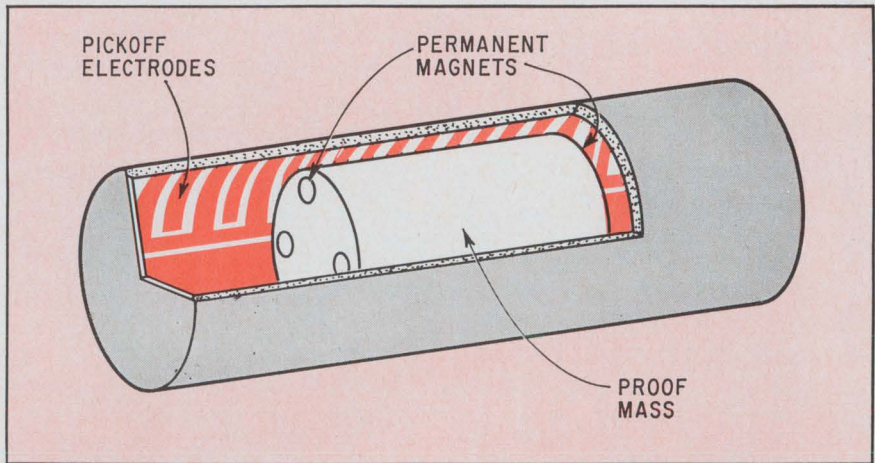

Sensing movement. Ultrasensitive accelerometer uses a magnetic fluid rather than large electromechanical arrangements to suspend sensing element.

force, eliminating the large motor and spinning tube—and with them, their large power requirements, heat, and bulk.

The magnetic fluid is a colloid; a suspension of finely ground magnetite in a hydrocarbon, fluorocarbon, or silicon liquid. The tiny magnets are about 100 angstroms long—"about the size of some viruses," says Rosensweig. The fluid contains about 10^{18} particles per cubic centimeter.

The fluid's magnetic field, together with that of eight small Alnico-28 bar magnets in the nylon proof mass, combine to center the proof mass about 20 mils away from the surrounding tube. Now, any force exerted along the axis of the accelerometer tube will betray itself in a movement of the proof mass.

How do you know? The pick-off technique is simple: the proof mass is coated with a metal film and the interior of the tube has 16 finger-shaped aluminum film electrodes deposited on its interior. As the proof mass moves, its metal film jacket makes it one plate of a variable capacitor and changes in capacitance are proportional to changes in the velocity of the accelerometer.

All this makes for a very sensitive device—one capable, it is believed, of sensing forces as small as 0.00005 gravities. The device's sensitivity has never been fully measured.

"Ordinary disturbances in the

lab, like someone walking, are enough to mask the lower limits of its sensitivity," says Rosensweig.

He is sure the unit can detect movements smaller than 10 microns, and thinks perhaps the lower limit could be nearer 1 micron.

These characteristics add up to an uncomplicated device that could perform well on the inertial platforms of aircraft or spacecraft guidance systems. With such goals in mind, Rosensweig's next goal is development of a smaller unit with integrated circuit pick-off electronics.

The present unit is about two inches long and one inch in diameter. The new accelerometer will be about the diameter of a pencil, and proportionately shorter.

Microwave

Gunn in the West

Taming gallium arsenide to perform Gunn-effect tricks has given the few companies that have tried it a rough ride. In fact, it's thrown a few completely out of the corral.

Later this year, Varian Associates of Palo Alto, Calif., will enter the field with four off-the-shelf Gunn-effect continuous-wave oscillators in the X, Ku and K microwave bands with mechanical tunability. The X-band device, for example,

PIEZO ACCELEROMETER REPORT



REPORT NUMBER 4

New normalizing coupler with abnormal capability

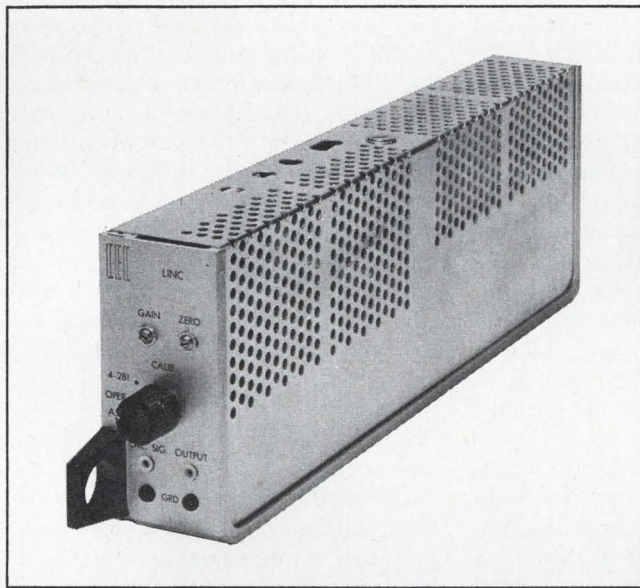

Every once in awhile something is created that literally eliminates competition. Such is CEC's new LINC, or 1-161 Low Impedance Normalizing Coupler.

LINC is described as an all solid-state device designed for coupling low impedance piezoelectric instruments to tape recorders, galvanometers and other recording equipment.

But from here on, its "abnormal" capabilities become unique indeed. Note how they compare with those of the next best concept.

1. LINC provides the necessary *decoupling capacitance, amplification and impedance matching* for piezo accelerometers and piezo electronics having output impedances as high as 2000 ohms. In fact, it is also fully compatible with virtually any transducer with relatively low output impedance and nominal sensitivity.

Other concept will effectively accept only special piezo accelerometer input.

2. LINC features a self-contained excitation supply for use with low impedance accelerometers or piezo electronics which require an operational voltage of 24 V dc at 20 ma.

Other concept has no excitation supply.

3. LINC provides a *continuously adjustable* gain of 0.1 to 10, thus permitting input voltages varying from .1 millivolt to ± 105 volts peak.

Other concept relies on a gain selection switch only and is limited to a maximum input of 10 V p-p.

4. LINC achieves a frequency response of ± 0.4 db ($\pm 5\%$) from 0.2 to 30 KHz.

Other concept is rated at ± 3 db from 0.5 to 20 KHz.

5. LINC has calibration positions for internal amplifier gain and dc offset control, plus *precise* transducer calibration.

Other concept possesses a push-button continuity check for transducer monitoring—but no calibration controls.

Is LINC much more expensive?

Much less. In fact, the cost-per-channel is significantly lower than any other piezo coupling system. Additionally, LINC's low impedance design eliminates the cost and problems associated with long lines and expensive cabling.

And—there are the dual advantages of LINC's greater *compatibility* with existing transducers and electronics, and output *capability* for superior interface with present recording devices.

Obviously, LINC is destined to be the new standard for every application from engine test stands to structural testing and vibration analysis.

And it's one more "LINC" in the chain that has made CEC the leading producer of low and high impedance accelerometers, plus associated electronics.

For complete information, call your nearest CEC Field Office. Or write Consolidated Electrodynamics, Pasadena, California 91109. A subsidiary of Bell & Howell. Ask for Bulletin 1161-X2.

CEC/TRANSDUCER PRODUCTS





LESS THAN 18¢ PER CIRCUIT

The new Daven "X" switch has been life tested for 50,000 cycles of rotational life with no failure carrying a .500 amp load at 125°C.

The 10 deck, 1 pole, 12 position per deck model shown, sells for only \$21.45 or \$.17875 per circuit in 100 pc quantities.

We build switches like no one else can!



DIVISION OF THOMAS A. EDISON INDUSTRIES
GRENIER FIELD, MANCHESTER, N.H. 03103
(603) 669-0940 • TWX 603-623-4938

has a frequency range from 9.0 to 12.4 gigahertz, a maximum power output of 25 milliwatts and operates on 8 volts at 350 milliamps.

Varian stresses that these oscillators are pre-production devices, "available for sale for experimental use by our customers." But, from customer evaluations the company will be able to stabilize, maybe even boost, the specs for regular production, tentatively scheduled for Wescon in August.

Sees expansion. GaAs is one of the new frontiers of semiconductor materials technology [Electronics, Nov. 13, 1967, pp. 105-136] and Varian plans to expand its small stable into a large spread of microwave devices. Within the next few months RCA and Texas Instruments may also be in the market with Gunn devices.

Growing the crystals with a purity of 10 parts per billion is necessary for fabricating the devices. "Anyone not doing his own epitaxial growth is not going to be in this business very long," says Daniel G. Dow, manager of Varian's solid state operations.

Only GaAs, prepared with exacting specifications, shows the right properties for the effect first observed in 1963 by J. B. Gunn, a physicist at the International Business Machines Corp.

Dow's group began working on the problem 30 months ago, but it wasn't until last December that it decided to make an X-band oscillator. A month later it produced the first five, all with an output of 50 mw or more into a matched load. Last month, it made the first K and Ku band samples.

Besides the X-band (VSX-9001 series) devices, Varian offers two Ku band series (the VSU-9002) with a frequency range of 12.4 to 15 Ghz, minimum power output of 20 mw and a typical voltage of 7v; and the VSU-9003, with a 15 to 18 Ghz range, minimum power output of 15 mw at a typical voltage of 6. The K-band VSK-9004 operates at 18 to 26.5 Ghz, 10 mw minimum power output at a typical voltage of 4.5. The last three have typical currents of 300 milliamps and all have mechanical tunability of 1,000 megahertz.

Low noise. Dow says Varian unexpectedly got exceptional low a-m noise recorded on the Ku-band units. For example, in a 100 hz bandwidth about 20 Khz from the carrier, the a-m noise was down to -130 decibels below the carrier, which is on a par with some klystron oscillators Varian also makes.

Varian is mum on the prices, which it says "reflect the state of development," but a good guess might peg the devices between \$750 and \$1,500. Varian will also sell the diodes separately.

Dow thinks the real impact of the Gunn-effect devices will occur as the volume and control builds up. "It's basically an economical, low-noise, long-life device," he asserts, for such military applications as countermeasures, radar and low-power transmitters and possibly the police communications markets. "Increases to one watt should be feasible in a few years," Dow says. His group is also experimenting with pulsed and limited space-charge accumulation modes; and the combination of the two would be useful for pulsed radar systems and transponders.

Competition. Strangely, Varian's work with Gunn-effect devices may put it in competition with its own klystron devices. Not only that, but they could be infringing on the avalanche transit time oscillators made by Varian's Bomac division. Dow says, however, that the "avalanche devices are expected to have the capability of more power."

Dow expects Gunn-effect devices "to capture a major piece" of the microwave oscillator business, and predicts that "in five years, Gunn and avalanche devices will have most of the new business."

Space electronics

Growing flock of birds

Just as radio-dispatched delivery services and municipal police now fight it out for allotted land-mobile frequencies, so satellite users might someday compete for channels.

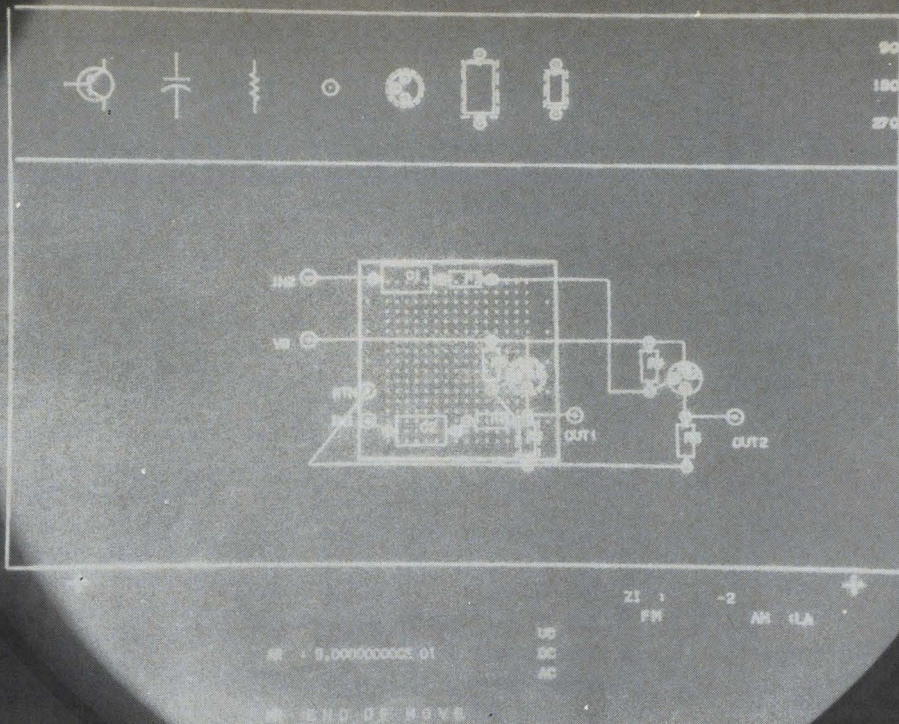

Readouts clear up problems.

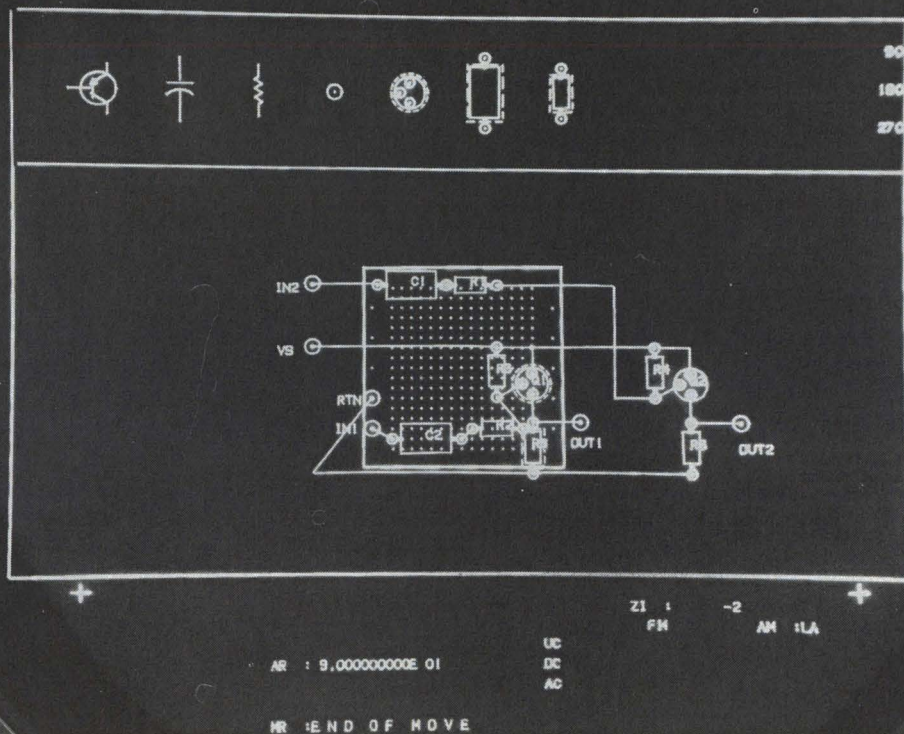

Polaroid circular polarizers clear up readouts.

Reading readouts is never a problem—if they're equipped with Polaroid circular polarizers.

Our polarizers improve readability from every angle by increasing contrast. In daylight. Or even in

brightly lighted rooms.

But now you don't have to take our word for it. Send for our new brochure, and we'll include a sample circular polarizer. It will help you see very clearly why many major display

and instrument manufacturers are now using Polaroid circular polarizers.

Write Polaroid Corporation, Polarizer Sales, Department 59, Cambridge, Massachusetts 02139.

Polaroid Circular Polarizers.

Bulova can supply the crystal you need



to match your specs!

Many years of supplying crystal control units for the most advanced military and space programs enable Bulova to offer a full line encompassing virtually the entire frequency spectrum—2 kc to 125 Mc for oscillator and filter applications. We can supply every type of packaging—including koldweld and glass sealed. Our military crystals meet latest MIL-C-3098D specifications. All reasons why you should make Bulova your single source of supply.

HIGH PRECISION GLASS SEALED CRYSTALS 1 Mc to 125Mc. Available in vacuum sealed, glass enclosures of the HC-26/U and HC-27/U type.

Example: Precision SSB Crystals

Frequency: 1 Mc to 5 Mc
Holder: HC-27/U
Tolerance: $\pm .0025\%$
from -55°C to $+90^{\circ}\text{C}$, or to specification
Aging: 3×10^{-8} per week after one week stabilization at 75°C

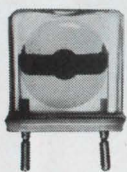

KOLDWELD SEALED CRYSTALS—low aging, high reliability, 1 Mc to 125 Mc. Now available in TO-5, HC-6/U and HC-18/U type cans sealed by the koldweld process to eliminate effects of heat and to reduce contamination.

Example: TO-5

Frequency: 15 Mc to 125 Mc
Tolerance: $\pm .0025\%$ from -55°C to $+105^{\circ}\text{C}$, or to specification
Aging: 1×10^{-7} per week after one week stabilization at 75°C



Write or call for specifications on Bulova's complete line of crystals. Address: Dept. E-17.

BULOVA

FREQUENCY CONTROL PRODUCTS

ELECTRONICS DIVISION OF BULOVA WATCH COMPANY, INC.

61-20 WOODSIDE AVENUE WOODSIDE, N.Y. 11377, (212) DE 5-6000

Electronics Review

This prospect of battles all over the spectrum prompted the Office of Telecommunications Management two years ago to undertake a study of projected satellite frequency needs in the 12 years to 1980.

The just-completed study, which cost the Government more than \$200,000, predicts that Federal agencies and Comsat will have 273 satellites in orbit by 1980 as part of 49 separate systems supported by "hundreds of ground stations." Half these craft will be in synchronous orbit, the report goes on, and two-thirds of those will be communications satellites.

Crowded skies. The 273 roughly break down into these categories: 57 observation, 53 scientific, 34 navigation, 83 communications, six broadcast, 13 data collection from earth sensors, 13 manned, 10 geodesy, and four for calibration of equipment.

The report states that the current allocation to satellites of bands below 11 gigahertz will "prove to be inadequate" before 1980 and that the increasing number of terrestrial microwave stations will inhibit the development of communications satellites.

Proposals. The following steps are recommended by the study to support the needs it estimates will be required between ground stations and orbiting craft by the year 1980:

- An expansion of the number of frequencies allocated solely to space. But the agency didn't say where it will get the channels.

- An increase in the number of frequency bands space systems can share with earth systems.

- The direct transfer to satellite users of some bands now allocated solely to terrestrial systems.

The report urges the greatest application possible of new technologies to the spectrum problem. For example, it suggests the use of modulation techniques and newly developed antennas to provide maximum signal discrimination. And as a prime theme, it stresses that now is the time to begin providing for frequency "co-existence" between space and ground systems.

First slice

NASA's \$4.4 billion request for fiscal 1969 got its first trim last week as the House Science and Astronautics Committee lopped off \$153 million.

With other authorization and appropriation sessions still ahead, the request will probably be reduced to about \$4 billion before a final budget is approved. The space agency's budget will next appear before the full House, which is expected to cut another \$200 million. As one NASA official puts it, "This was just the first slice. I'm afraid to think what may happen as it gets farther along on Capitol Hill."

The casualty list in this initial encounter with Congress is impressive:

- The outlay for Nerva, the project to develop a nuclear-powered rocket was pared from \$60 million to \$11.7 million.

- In the manned space program, the advanced missions studies request was halved to \$2.5 million, while a 10% chop was made from the requested \$439 million for Apollo applications.

- Four satellites—atmospheric Explorers C and D and two 21-day-mission biosatellites—were knocked out of the plans of the Space Science and Application Program.

Two additions were made by the House committee; they only amount to \$3.5 million but may indicate a trend towards space programs with down-to-earth applications. The panel added \$1 million to the Office of Advanced Research and Technology's request covering research in such areas as airplane safety and jet noise abatement. And the slated expenditure for development of an Earth Resources Technology Satellite was more than doubled from \$2.2 million to \$5 million.

For the record

Water works. The Coast Guard has established the feasibility of a single national data buoy system. It would do most of the chores now envisioned in 48 separate programs



This is our Molex 1175. A lighted push button switch. Snap mounts. Spade or wire terminals make assembly easy. In quantity, costs about sixty cents.

You could pay more, but that's the point. Men who use switches have told us, "enough is enough". We take that seriously. By creating switches that do the job right, yet aren't over-engineered to the point that costs wind up in left field.

So this switch is available in nine colors, 500 variations, and is built to go on and off—and on and on. For about sixty cents.

If that makes sense to you, and you would like a free sample of our 1175 switch, write or phone (312) 969-4550.



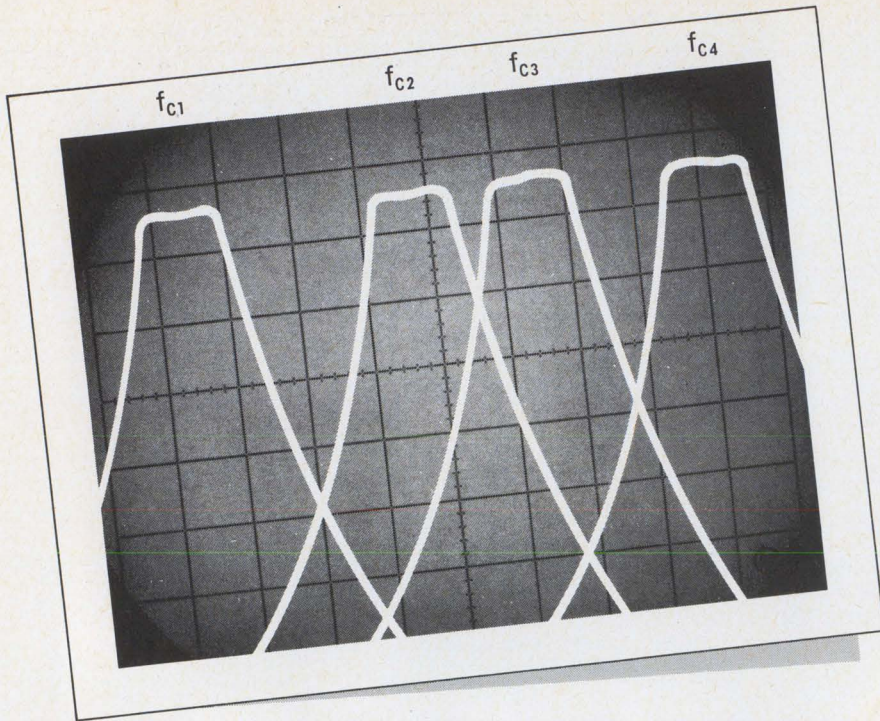

ONE FILTER?

Yes, in fact a Telonic Tunable Filter will give you an *unlimited* number of passbands within its octave frequency range—it's as simple as turning the dial. If you are working with varying frequency sources or several different sources that require filtering, consider the time and material savings tunable filters provide.



Telonic TTA Tunable Filter

48 MHz to 4 GHz RANGE

Telonic Tunable Filters come in two series, over 50 stock models. Each has a full octave coverage with ranges from 48 to 4000 MHz.

INDIVIDUALLY CALIBRATED

The Filter tuning dial is direct-reading, and pre-calibrated. Just set the center frequency to select passband—no interpolation. Repeatability is 1% of set frequency.

LOW INSERTION LOSS and VSWR

Filters are iris-coupled, .05 db Chebyshev designed cavities in 3 and 5 section versions. Inherent high Q keeps insertion loss to a minimum.

SPECIALS AVAILABLE

All Tunable types are available in special frequency ranges, with band widths from 1% to 10%, special mounting provisions and connector types. Submit your requirements.

Telonic ENGINEERING CO.
Division of Telonic Industries, Inc.

BOX 277, LAGUNA BEACH, CALIFORNIA 92652 • TEL. (714) 494-9401 TWX (910) 596-1320
REPRESENTATIVES THROUGHOUT THE U.S., CANADA AND OVERSEAS. BRANCH OFFICES IN MAIDENHEAD, ENGLAND, FRANKFURT, GERMANY, AND MILAN, ITALY.

TELONIC ENGINEERING CO.
BOX 277, LAGUNA BEACH, CALIFORNIA 92652

**NEW CATALOG, APPLICATION DATA,
and FILTER SELECTION SLIDE RULE.**

NAME _____

FIRM _____

ADDRESS _____

CITY _____

STATE _____ ZIP _____

Yours on request.

being studied for various Federal agencies. However, the cost is \$500 million and Congress has been asked to approve only \$5 million of that amount for fiscal 1969. The program would require approximately \$50 million a year for nine years thereafter. Although few technical details have been worked out, it is thought much of the \$500 million figure would go for electronic gear. If all goes well, the Coast Guard hopes to have a demonstration system by the early 1970's. It has been working under orders from the Marine Sciences Council.

Soaring sales. The Electronic Industries Association reports that integrated circuit sales climbed more than 50% last year to a total of \$228 million. Leading the parade were the digital IC's with approximately \$182 million in sales for 1967, up 55% in the year.

Where are you? The Chicago Transit Authority plans a \$2 million bus identification system that will include a two-way radio hookup, a computerized display pinpointing the location of each bus, and an alarm system. The city expects to award a contract for the system within three months to one of the three competing companies—Sylvania, Raytheon, or Motorola. Transit officials say 500 buses will be hooked into the system within a year.



Keyboard education. The D.H. Baldwin Co. has developed this electronic teaching system for keyboard instruments. Now being tried at Baltimore's Peabody Institute, the system permits one teacher to handle up to 24 students.

bench accuracy at system speed

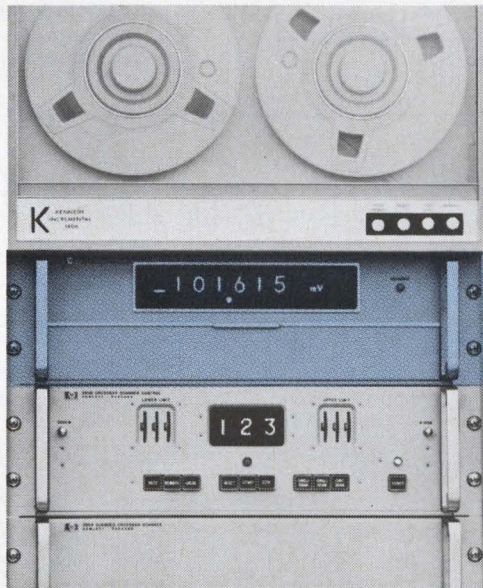

Cover protects 2402A controls for systems use.

Both in an
integrating DVM
with 1 microvolt
resolution.

Take 40 readings per second, integrate and resolve the answers to a microvolt with the new Hewlett-Packard 2402A IDVM... get resolution never before available in this speed range. With the accuracy of a lab instrument (0.01% of reading $\pm 0.003\%$ of full scale), the 2402A is excellent for system applications... with full programmability and all the features you'd expect from a systems voltmeter. (Of course, it's an excellent lab instrument, too.)

Guarding and integration permit accurate measurement of low-level signals in the presence of common mode and superimposed noise—over 120 dB effective common mode rejection... even at 40 readings per second. Designed for low-cost multimeter expandability: AC, resistance and frequency measurement capabilities can be added easily with optional plug-in circuit cards. Five ranges

to ± 1000 Volts, including a 0.1 Volt range for high-accuracy millivolt measurements.

The 2402A: \$4800. Plug-in options are reasonably priced—AC, for example, only \$450.

For more information, call your local HP field engineer or write Hewlett-Packard, Palo Alto, California 94304; Europe: 54 Route des Acacias, Geneva.

HEWLETT  PACKARD

DIGITAL VOLTMETERS

TOPS IN ACCURACY

for Computer-Aided Graphics!

You can take this table top for Granite . . . You can take its accuracy for Granted too!

The stability and uniformity of granite, used for generations in Surface Plates where extremely close tolerance measurements and control was required, now find a dynamic new application in this KINGMATIC Drafting Table.

GRANITE TOP . . . for better accuracy of drawn or filmed line.

- Not effected by temp. changes
- Vibration free
- "Tops" in flatness, accuracy, and stability
- Cleans easily
- Selective, multi-zone vacuum hold-down (pat. appld. for). Flat-bed table sizes 3' x 4', 4' x 5', or 5' x 8'.



CIRCUIT MASTERS . . . drawn on film the light fantastic way, eliminating manual layouts and photo reductions, with a degree of **ACCURACY** only the Granite-Top Mark III table can deliver!

CHECK SOME TYPICAL MARK III ACCURACIES!

Flatness Accuracy	(±) .0003"
Positional Accuracy	(±) .0005"
Gap-distance Accuracy between table and Y-carriage	(±) .00075
Repeatability	(±) .00025
Speeds	75 to 200 I.P.M. depending on table size

**Hi-Precision
Mark III KINGMATIC
Drafting Table**

Write for literature now and indicate your application areas. Demonstration arranged on request.



See KINGMATIC in Action!
Booths No. E-4, 5 and 6
Spring Joint Computer Conference
April 30-May 2, Atlantic City

**Baldwin Kongsberg Company, Bldg. 8, Atkinson Square
Cincinnati, Ohio 45246 Phone: (513) 771-7023**

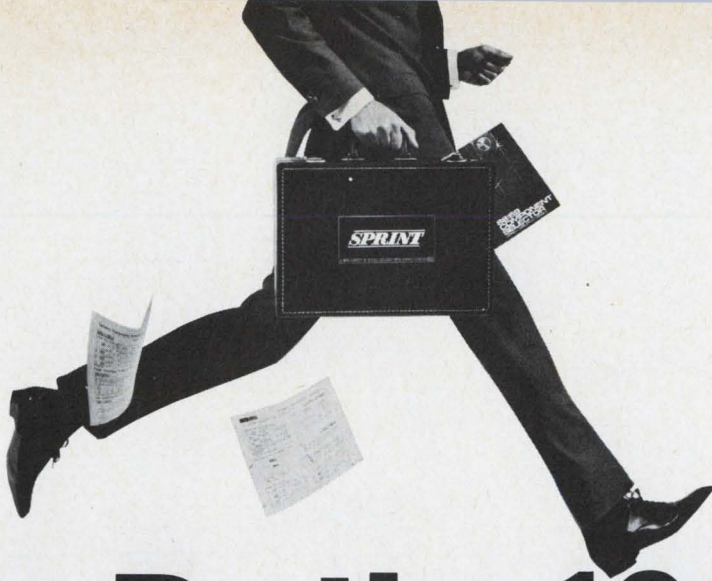

Be the 100,001st to get a CDE Component Selector.

**If you ever received a CDE Component Selector,
your new one is on the way!**

This 68/69 edition is completely revised to cover all the latest developments in electronic components, and refinements in product standardization. It lists CDE's Standard Product line covering 98% of industry requirements. It is designed to guide you in the selection of the proper component to meet your precise requirements.

For your copy, simply mail the coupon below.



CDE CORNELL-DUBILIER 50 Paris Street Newark, N. J. 07101

Please send me a copy of your new Component Selector. I have not requested one before.

My applications are: Home electronics Electronic gear
Industrial (non-electrical) Research

NAME _____

TITLE _____

COMPANY _____

STREET & NUMBER _____

CITY _____ STATE _____ ZIP _____

Circle 63 on reader service card

Tomorrow morning you can build a system with compatible digital hardware from Raytheon Computer and enjoy your coffee break.

You'll have it made. 1. 703—the \$15,000 IC Computer with \$1.50 spares.

The 703 is the small systems computer built like third-generation million dollar computers. The CPU is wire wrapped with plug-in IC's on one motherboard. A unique CPU self-diagnosis solves its own circuit malfunctions. When necessary, you can simply plug-in a new IC. Time: about 30 seconds. Cost: about \$1.50.

The 703 is a 16-bit machine; 1.75 μ sec cycle time; and expandable from 4K to 32K.

Software includes an executive and real-time FORTRAN IV.

All Raytheon Computer products are compatible with the 703 for easy, economical and flexible systems expansion.

2. The MINIVERTER™ approach to A/D conversion. The MINIVERTER is a multi-channel multiplexer, sample and hold amplifier and 10, 12 or 13-bit A/D converter prewired and installed in your package or ours. We have several to choose from.

3. You do the system design; we've done the rest. Raytheon Computer offers a complete range of analog and digital IC modules. Mounting hardware and accessories have analog and digital power and grounding built in. For fast turn around, you can send us a wire list and we'll send you an automatically wired and assembled system within 4 weeks. And our application engineers are the best in the business.

Our literature is helpful, our representatives even more so. Write or call today for Data File CB-150. Raytheon Computer, 2700 South Fairview St., Santa Ana, California 92704, phone (714) 546-7160.

**Raytheon
Computer
...the company
that gives you
a break.**

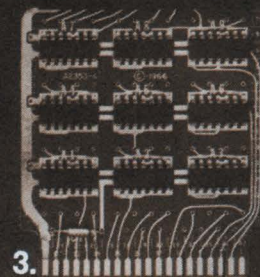
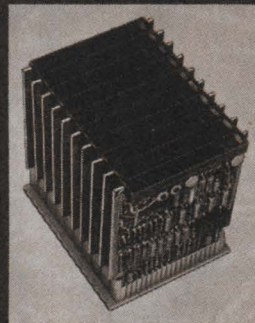
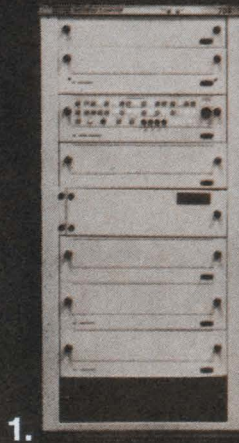

RAYTHEON

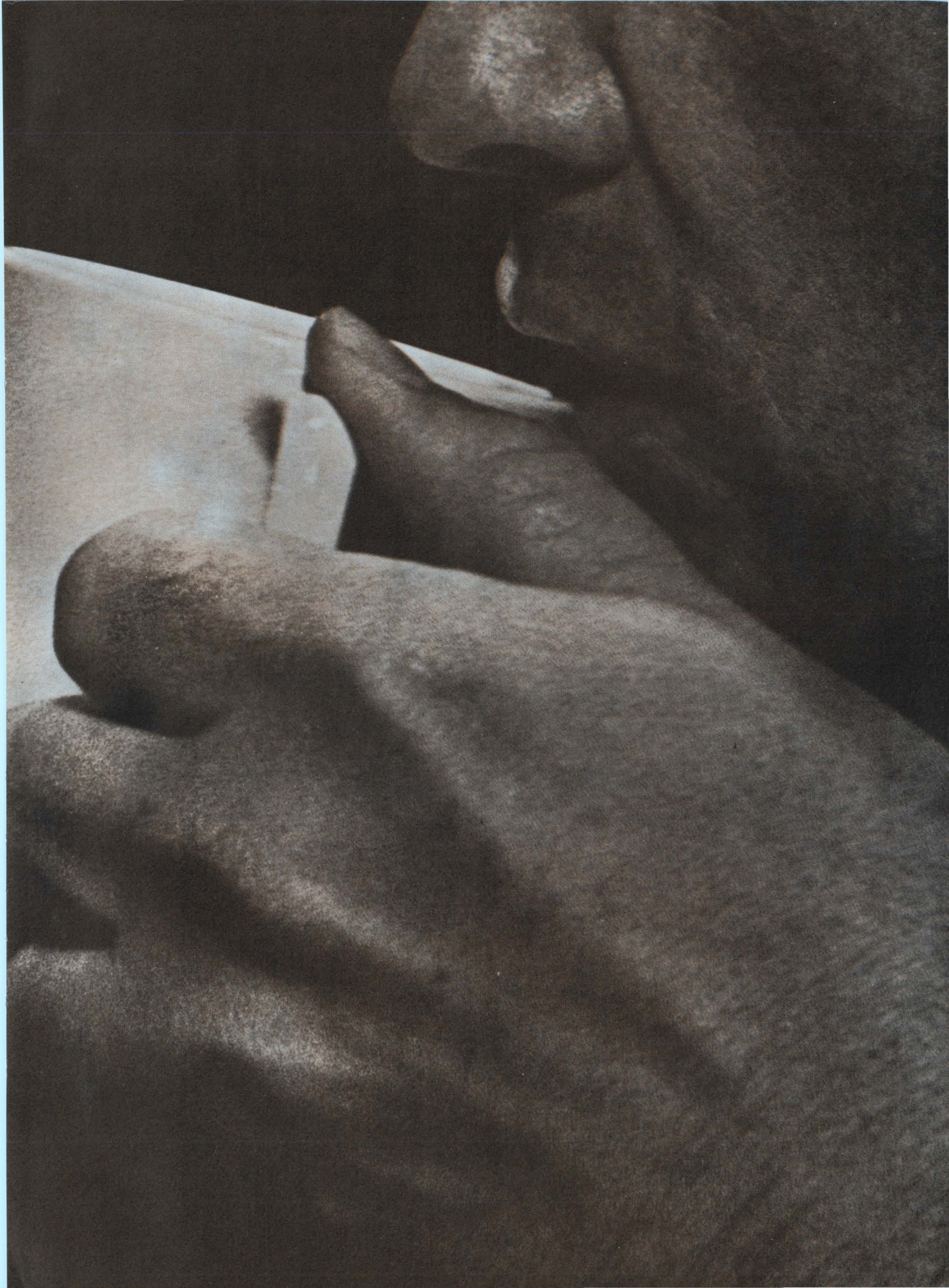

RECAP:

9620 DUAL DIFFERENTIAL LINE RECEIVER

Starting October 9, 1987, Fairchild promised to introduce a new integrated circuit each week for 52 weeks. This is number **17**.

The 9620 is designed to take differential logic from transmission lines and convert it to CMOS levels. It also has the capability for conversion to higher levels. It is ideal for use in data collectors, or in data processing applications where the central processor and data source are in separate locations. The 9620 can also be used as a CMOS-compatible differential comparator.

Each section of the dual IC consists of a differential amplifier driving a restoring inverting DTI gate with uncommitted collector. Maximum differential threshold voltage is +500mV in the presence of a 15 volt common mode. Typical power dissipation is 50mW per receiver. Propagation delay is 20ns maximum at 25°C. High common mode rejection is also provided.

The 9620 comes in a 14-pin hermetic DIP and will operate in both military and commercial temperature ranges (-55°C to +125°C and 0°C to +70°C). It is available in volume quantities. Your Fairchild distributor has it in stock now. Write for complete specs and applications information. Ask about our other new products, too.

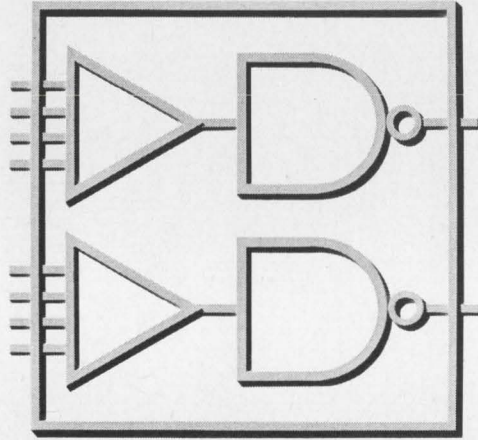

FAIRCHILD SEMICONDUCTOR A Division of Fairchild Camera and Instrument Corporation
FAIRCHILD SEMICONDUCTOR
 310 Fairchild Drive, Mountain View, California 94034, (415) 963-0111 FAX: 910-278-6400
 CIRCLE READER SERVICE NUMBER 117

9621 DUAL LINE DRIVER

Starting October 9, 1987, Fairchild promised to introduce a new integrated circuit each week for 52 weeks. This is number **18**.

Fairchild's 9621 is used to transmit CMOS-level logic down transmission lines. It can also be used to drive high capacity loads. It consists of a series inverting DTI gate and a 2-input inverting DTI gate. There is a termination resistor available on each stage, which allows for maximum 120-ohm lines, either directly or differentially. An extender is available on the 2-input gate which allows for up to 200-ohm external diodes, and thus obtain more inputs. The 9621 can also be used as a low output impedance driver. Each driver provides minimum output current of 20mA at 0.4V. Diode clamp are provided to clamp reflections on the output.

Maximum power dissipation for the new IC is 210mW. Propagation delay is 20ns maximum into a 120-ohm load. It comes in a 14-pin hermetic DIP and will operate in both military and industrial temperature ranges (-55°C to +125°C and 0°C to +70°C).

Applications for the 9621 include data processing and computer peripheral equipment. It is designed specifically to operate in conjunction with the 9620 dual differential line receiver (New Product No. 17). Both devices are available in volume quantities. Fairchild distributors have them in stock now. Write for complete specs and applications information. Ask about our other new products, too.

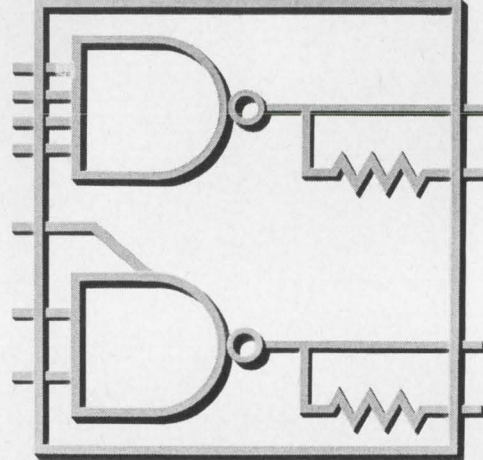

FAIRCHILD SEMICONDUCTOR A Division of Fairchild Camera and Instrument Corporation
FAIRCHILD SEMICONDUCTOR
 310 Fairchild Drive, Mountain View, California 94034, (415) 963-0111 FAX: 910-278-6400
 CIRCLE READER SERVICE NUMBER 118

3300 25-BIT MOS STATIC SHIFT REGISTER

Starting October 9, 1987, Fairchild promised to introduce a new integrated circuit each week for 52 weeks. This is number **19**.

The 3300 is the 19th MOS device we've introduced since December 11, 1987. The first four were the 2701 single-channel multiple switch, 3102 three-input gate, 3300 four-channel multiple switch, and the 3300 dual 25-bit dynamic shift register.

The 3300 is a monolithic IC utilizing Phase II™ P-channel enhancement mode MOS technology. It is designed to be used for digital delay lines and long serial memory storage in radar systems and computers. It is also applicable for data storage in telemetry systems.

The 25-bit device comes in a TO-8 can and will operate over the entire temperature range from -55°C to +85°C. There are independent 16-, 8- and 1-bit data strogs within the package. Power dissipation is typically 200mW per bit. Speed is typically 5000ns. The clock drive circuit is controlled by a single-phase input. The output is buffered to improve drive capability.

Volume quantities of the 3300 are now available. Fairchild distributors have it in stock. Write for complete specs and applications information. Ask about our other new products, too.

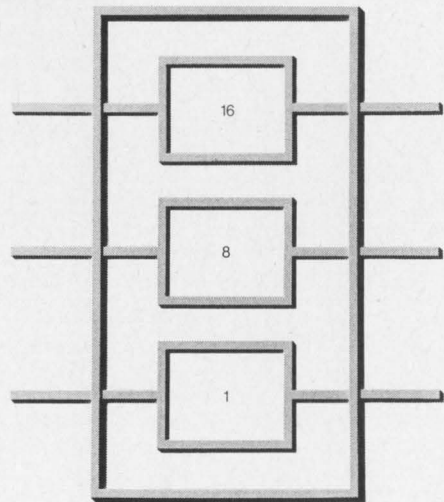

FAIRCHILD SEMICONDUCTOR A Division of Fairchild Camera and Instrument Corporation
FAIRCHILD SEMICONDUCTOR
 310 Fairchild Drive, Mountain View, California 94034, (415) 963-0111 FAX: 910-278-6400
 CIRCLE READER SERVICE NUMBER 119

9110 HIGH LEVEL LOGIC HEX INVERTER

Starting October 9, 1987, Fairchild promised to introduce a new integrated circuit each week for 52 weeks. This is number **20**.

The 9110 is the fundamental element of our new high noise immunity family. It features worst case DC noise immunity of 2.5 volts. And, 40 times immunity is even better. It can reject pulses of 100 nanoseconds duration and 20 volts amplitude elements. Other members of the family provide interlocking capability to make the 9110 compatible with CMOS levels.

The 9110 consists of six high-level DTI gates without input diodes. It can be expanded with external diodes on the input. There is active pull-up on the output for good drive capability. Propagation delay is typically as slow as 770 nanoseconds to reduce sensitivity to high level noise pulses. Output voltage swing is typically 0.5 to 1.5 volts. The 9110 operates over the entire range of 15 to 25 volts at temperatures of 0°C to +125°C. It comes in a hermetic DIP and is available in volume quantities. It is in stock at your Fairchild distributor now. Write for complete specs and applications information. Ask about our other new products, too.

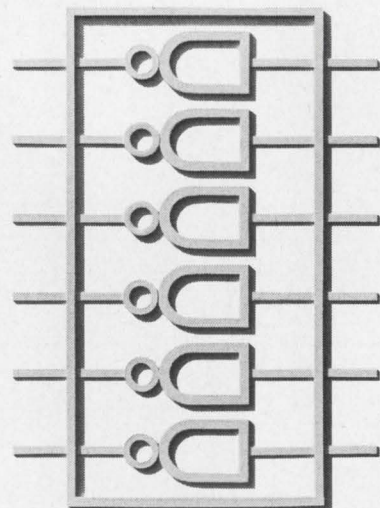

FAIRCHILD SEMICONDUCTOR A Division of Fairchild Camera and Instrument Corporation
FAIRCHILD SEMICONDUCTOR
 310 Fairchild Drive, Mountain View, California 94034, (415) 963-0111 FAX: 910-278-6400
 CIRCLE READER SERVICE NUMBER 120

Fairchild is introducing a new integrated circuit every week. The last two months look like this.

FAIRCHILD
SEMICONDUCTOR

4500 BIPOLAR MICROMATRIX™ ARRAY

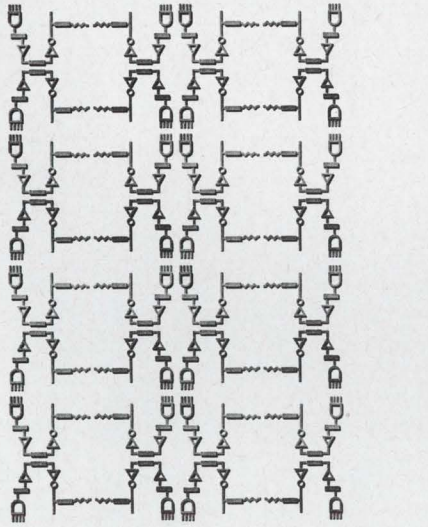

FAIRCHILD SEMICONDUCTOR A Division of Fairchild Camera and Instrument Corporation
FAIRCHILD SEMICONDUCTOR 313 Fairchild Drive, Mountain View, California 94034, (415) 962-0111 FAX: 910-678-6403

CIRCLE READER SERVICE NUMBER 121

Starting October 9, 1967, Fairchild promised to introduce a new integrated circuit each week for 52 weeks. This is number **21.**

The 4500 is the first device in a new, highly versatile LSI family of fundamental elements. It can be used in any digital logic system. And, it can be substituted for virtually any function. Fairchild's unique LSI capability is the result of two major achievements: double-layer metal processing and computer-aided design. The 4500 is a monolithic CMOS device consisting of eight cells. Each cell is made up of four input DTL gates. The entire array is capable of custom interconnection between cells and portions of cells to produce any logic function. The primary application for the 4500 is in circuits used to interconnect basic system building blocks. However, it can also be used as a fundamental building block. The new LSI array comes in an hermetic DIP as well as in package. Since the 4500 cannot be completed without your specific requirements, we've prepared a kit to help you design your own custom circuits. It's at your Fairchild distributor now. Write for detailed specs and applications information.

3320 MOS 64-BIT, 4-PHASE SHIFT REGISTER

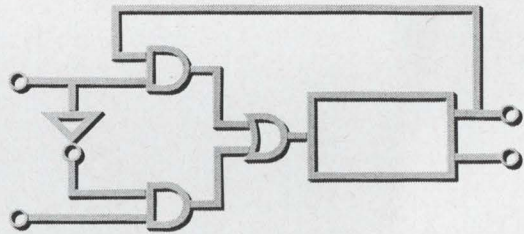

FAIRCHILD SEMICONDUCTOR A Division of Fairchild Camera and Instrument Corporation
FAIRCHILD SEMICONDUCTOR 313 Fairchild Drive, Mountain View, California 94034, (415) 962-0111 FAX: 910-678-6403

CIRCLE READER SERVICE NUMBER 122

Starting October 9, 1967, Fairchild promised to introduce a new integrated circuit each week for 52 weeks. This is number **22.**

The 3320 is a shift-register/accumulator. Its input logic can be used to control the loading of new information, or the recirculating of existing information, in the device. Its primary applications include digital data accumulation in telemetry systems; long-serial memories for computers; long delay lines in radio equipment and industrial serial system control. No DC power supplies are required for 3320 operation. It comes in a TO-8 can and will operate over the entire temperature range from -55°C to +85°C. Both data and data-complement output are provided. Power dissipation is approximately 200 mW per bit of DMOS. The 3320 is a product of Fairchild's P-channel enhancement mode technology. It is the same monolithic MOS IC we've introduced since December 11, 1967. (The others are the 3705 8-channel multiplex switch, 3303 dual 25-bit dynamic shift register, and the 3302 25-bit static shift register.) Volume quantities of all six devices are available. Your Fairchild distributor has them in stock. Write for complete specs and applications information.

*Data is a patented Fairchild process.
 To order the 3320, ask for Part No. 3320-0100000 Price \$3.00 ea. (1000 qty.)

Starting October 9, 1967, Fairchild promised to introduce a new integrated circuit each week for 52 weeks. This is number **23.**

3705 8-CHANNEL MOS MULTIPLEX SWITCH

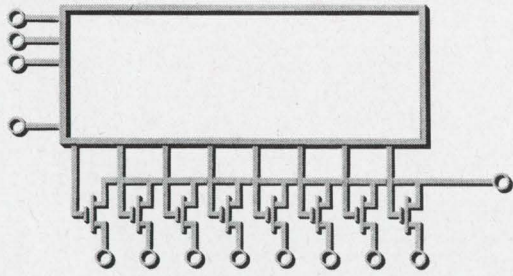

FAIRCHILD SEMICONDUCTOR A Division of Fairchild Camera and Instrument Corporation
FAIRCHILD SEMICONDUCTOR 313 Fairchild Drive, Mountain View, California 94034, (415) 962-0111 FAX: 910-678-6403

CIRCLE READER SERVICE NUMBER 123

The 3705 is designed for use in analog-to-digital converters, multiplexing applications, digital transmission systems, all airborne and ground instrumentation, and in replacement of mechanical relays. It's CMOS compatible and has binary-coded logic inputs and all-channel blanking control. The 3705 is our seventh new MOS device. (Since December 11, 1967, we've introduced the 3703 four-channel multiplex switch, 3302 three-input gate, 3700 four-channel multiplex switch, 3303 25-bit dynamic shift register, 3302 25-bit static shift register and the 3302 84-DL 6-phase shift register.) The 3705 is a product of Fairchild's P-channel enhancement mode technology. It features zero offset voltage, input gate protection, typical ON resistance of 100 ohms, input signal levels from 0 to +5 volts, nano-ampere leakage currents, and input-to-output isolation to minimize feedback. It comes in a 16-lead hermetic DIP and will operate in a range from -55°C to +85°C. You can get volume quantities of all seven MOS devices now. Your Fairchild distributor has them in stock. Write for complete specs and applications information.

*Data is a patented Fairchild process.
 To order the 3705, ask for Part No. 3705-0100000 Price \$3.00 ea. (1000 qty.)

Starting October 9, 1967, Fairchild promised to introduce a new integrated circuit each week for 52 weeks. This is number **24.**

μA722 PROGRAMMABLE D/A - A/D CONVERTER CURRENT SOURCE

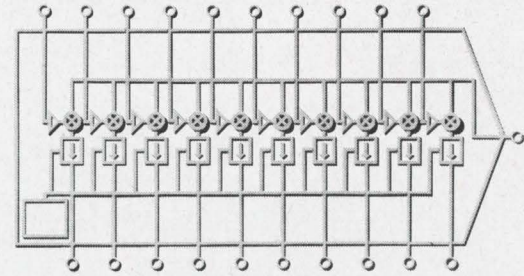

FAIRCHILD SEMICONDUCTOR A Division of Fairchild Camera and Instrument Corporation
FAIRCHILD SEMICONDUCTOR 313 Fairchild Drive, Mountain View, California 94034, (415) 962-0111 FAX: 910-678-6403

CIRCLE READER SERVICE NUMBER 124

Fairchild's μA722 is the first MOS linear integrated circuit. It's compatible with other linear (700, 709, 710) as well as CMOS and other digital circuitry. The μA722 is a high-speed, current summing, programmable, digital-to-analog converter/current source. It's the result of a breakthrough in monolithic technology—the extremely tight matching of more than 10 active components. The device consists of a reference supply and 10 current sources connected to a single output terminal through 10 associated current steering switches. All on a single monolithic chip. Both the reference voltage range and the coded format (BCD or binary up to 10 bits) can be varied with an external resistor array. μA722 performance specs include 50-bit 1-bit accuracy, 10-bit resolution, 700ns settling time, 30mA maximum full-scale current, and 2.5mA minimum full-scale current. The new device can be used as a basic building block in a number of circuits: scientific instrumentation and computer systems. Its most important application will be as a D/A converter in high-resolution A/D converters. (With the μA722, you can build a 15000 A/D converter for less than \$200.) It can also be used as a programmable D/A converter, a D/A multiplier, a limited-range multiplier, and as a meter drive in digital systems where the meter is used for monitoring. The μA722 comes in a 24-pin hermetic package. It will operate over the entire temperature range from -55°C to +85°C. It's available in volume quantities. Your Fairchild distributor has it in stock now. Write for complete specs and applications information.

*Data is a patented Fairchild process.
 To order the μA722, ask for Part No. 722-0100000 Price \$3.00 ea. (1000 qty.)

We're selling more Muffin Fans than ever before. Is it because the Muffin is still the best low cost, high performance, low noise solution to your cooling problems?

YOU BET IT IS !!!!!



muffin[®] fan

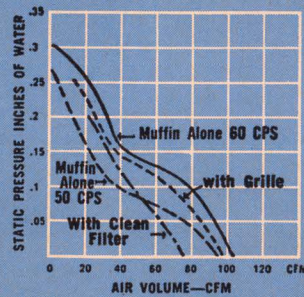
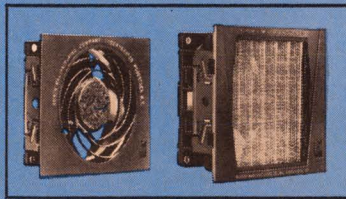

CALL YOUR ROTRON

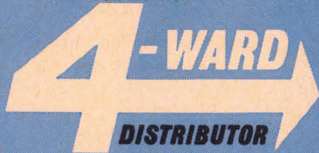

WEST

R. V. WEATHERFORD CO.
GLENDALE, CALIF.
213-849-3451

MIDWEST

ALLIED ELECTRONICS
CHICAGO, ILL.
312-829-9121

SOUTH

HALL-MARK ELECTRONICS CORP.
DALLAS, TEXAS
214-231-6111
ORLANDO, FLORIDA
305-855-4020

EAST

SCHLEY ELECTRONICS CORP.
WATERTOWN, MASS.
617-926-0235
RUTHERFORD, N. J.
201-935-2120



ROTRON MANUFACTURING COMPANY, INC.

WOODSTOCK, NEW YORK • 914-679-2401

West Coast: Rotron/Pacific, Burbank, Calif.
Canada: Aerovox Canada Ltd., Hamilton, Ont.
Rotron Europa N.V. Breda, The Netherlands

Washington Newsletter

March 18, 1968

LBJ panel studies spectrum leasing

The President's task force on telecommunications is taking a hard look at the possibility of leasing portions of the frequency spectrum in the 30-to-1,000-megahertz range. The aim, of course, would be more efficient use of overcrowded frequencies. The task force has GE-Tempo studying the leasing question, priorities for frequency assignments, frequency management, and the sharing of microwave bands. Tempo will make its first progress report next week and its final report in June.

The problem of crowded spectrum will get a public airing during the next few weeks when Rep. John D. Dingell (D., Mich.) takes his inquiry on frequency allocation on the road. He'll hold hearings in Newark and Detroit, two cities where police have complained of a lack of frequency space.

Three teams bid for ATS studies

It's full speed ahead for the second series of Applications Technology Satellites (ATS)—models F and G—scheduled for launch in 1970 and 1971. Industry proposals for two parallel design studies of the spacecraft were due last week and contractor teams led by Fairchild Hiller, GE, and Lockheed Missiles responded. Though not yet approved by Congress, the \$5.6 million needed to keep the program going in fiscal 1969 is considered a sure bet in light of the present insistence on Capitol Hill on "practical" space programs [see story on p. 58].

May 1 is the deadline for proposals of experiments the communications satellites will carry. The only experiment definitely scheduled so far is a test of a deployable, 30-foot-diameter antenna for transmitting and receiving signals in the range from 400 megahertz to 8 gigahertz. About 150 pounds are available on each craft for other experiments.

Tv firms are called to second uhf parley

FCC Commissioner Robert E. Lee will call a second meeting of television-receiver makers next month to try to get the firms to detent the uhf tuners on their sets. Uhf stations complain that they are at a disadvantage because, with present dials, viewers can lock onto only vhf stations. The first meeting called by Lee this month failed to produce any results primarily because few manufacturers attended. The EIA handled invitations to the meeting, but several manufacturers claim they never were told about it.

Observers believe manufacturers will take the opportunity at the April meeting to announce plans for all-channel tuners on their 1970 models. Low-cost solid state devices that can lock onto both vhf and uhf stations are now available [Electronics, Feb. 19, p. 46].

Tough radiation bill expected in Senate

Though the House Commerce Committee didn't go along with several key features of the Administration's radiation protection bill, it's likely the eventual Senate version will be closer to what the White House wants. The final compromise version is expected to win speedy passage once it's hammered out [Electronics, Feb. 19, p. 54].

The House committee reported out a radiation bill much like the original proposed by Rep. Paul Rogers (D., Fla.). It contains no directives

Washington Newsletter

concerning recall of products or in-plant Federal inspection—provisions the White House wants but industry bitterly opposes. The House measure calls for the Department of Health, Education and Welfare to set performance standards and to test and carry out research on radiation-emitting equipment.

Military to demand more contract data

The Pentagon, which hasn't been rigidly enforcing the truth-in-negotiations law, will start bearing down harder on companies. The move is in response to a report from the House Armed Services subcommittee on special investigations, which called enforcement of the statute spotty and inadequate. If contractors don't provide "full and factual" pricing data to contracting officers, the Pentagon could start barring offenders from future Government work.

The subcommittee urged the Defense Department to improve procedures for getting cost data, to demand historical data from contractors, and to continue to monitor contracts after they are awarded.

FAA wants airliners to carry responders

The FAA will propose that all commercial airliners carry responders that automatically alert pilots to signals from crash-locator beacons. The proposal will be made at a Washington meeting of the Radio Technical Committee for Aeronautics next month. The FAA feels the airlines may go along with the plan because of its public relations value and because of the relatively low cost of the responders—\$50 a unit. The agency, after much urging by Sens. Peter Dominick (R., Colo.) and Richard L. Ottinger (D., N.Y.), has finally asked for comments by May 31 on a proposal that general aviation planes be required to carry crash-locator beacons [Electronics, Dec. 25, 1967, p. 26].

Langley studies point to role in Mars shots

Despite denials by officials at NASA's Langley Research Center of reports that Langley will manage the two proposed 1973 Mariner Mars missions, the Virginia facility is now accepting industry proposals for three low-funded studies that could apply to no other program. While a Langley official says they are looking only for a possible vehicle for future use, sources at NASA headquarters say that if Congress votes the money to keep the 1973 orbiters in the 1969 budget, Langley will manage them.

One reason for Langley's denial: there's a chance that Congress will kill the 1973 project. The three contracts Langley will award shortly will be for studies of a vehicle with a five-month lifetime, a lander capsule, and the type of orbital entry needed for a Mars mission.

Addenda

Barring unexpected problems, TRW Systems will deliver the first Intelsat 3 satellite to Comsat by Aug. 1—in time, Comsat says, for orbiting before the October opening of the Mexico City Olympics. Noting that TRW "is now proceeding well with the satellite," a Comsat source estimates that the craft can be operational four to six weeks after delivery . . . Within two months, the Public Health Service's National Library of Medicine will award a contract to upgrade its computer-based medical library. The cost of designing, installing, and integrating the equipment for its Medlars system may go to \$8 million. A half-dozen major computer makers are in the running for the job. The PHS is still evaluating proposals submitted last August [Electronics, July 10, 1967, p. 57].

115V
FL

105V
NL

105V
FL

125V
FL

125V
NL

+0.1%

20,000 Watts

@ 19¢ / Watt

-0.1%

Typical Regulation Characteristic
DCR 40-500A (0-40 Vdc @ 0-500A)

± 10% line voltage swings combined with full load changes fail to force the DCR 40-500 A's output voltage outside of the specified regulation band!

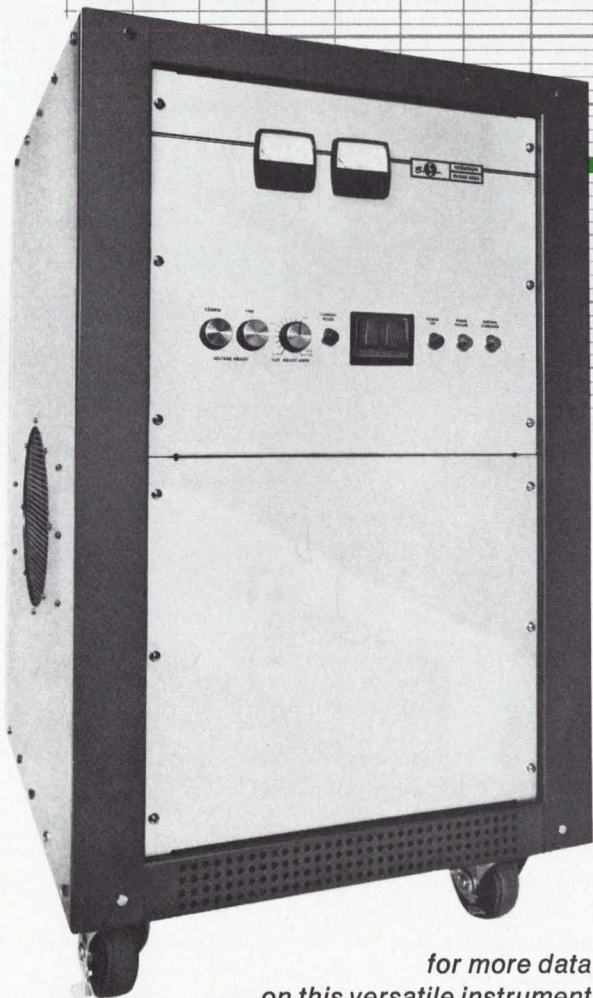

Sorensen Full Power DCR Series

The 19¢/watt figure for the DCR 40-500A is, like each of the DCR specifications, conservative. In ambients up to 40°C a total of 22,000 watts of regulated power is continuously available.

If your requirements do not call for 500 amperes, there are 23 other models available from stock with power levels ranging from 400 watts to 10,000 watts at voltages to 300 Vdc . . . all with comparable penny-per-watt ratios.

Like many of today's quality power supplies the DCR series offers two modes of regulation (voltage and current) with automatic cross-over, remote sensing, programming by signal or resistance in either regulation mode and series or parallel operation flexibility.

These user benefits are made possible through the combination of basic phase control regulation techniques (efficiency: 20-40% higher than other methods) with sophisticated feedback circuitry and over 25 years of experience in producing high reliability power supplies.

Contact your local Sorensen representative or: Raytheon Company, Sorensen Operation, Richards Ave., Norwalk, Conn. 06856 TWX 710-468-2940.



for more data
on this versatile instrument

... Call Sorensen: 203-838-6571

Quick guide to bright, legible, wide angle readouts

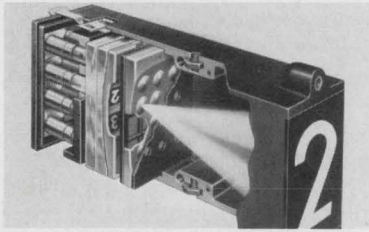

Series 360H Displays 2" high characters easily read from over 50'. Yet unit is just 3" H x 2" W x 7.75" D. New lens system provides bright, crisp display.



CRT Display 10-gun CRT projects single-plane digital or word displays onto fluorescent screen. Easy reading, even in direct sunlight. Wide viewing angle. Ideal for instrumentation applications.

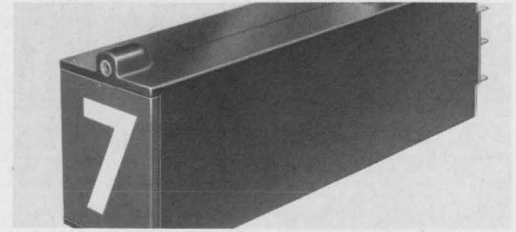

Series 160H Exceptionally large viewing area (1.56" H x 1.12" W for overall size). New lens system increases character brightness; reduces chance of reading error. Message lines may be displayed simultaneously with symbols.

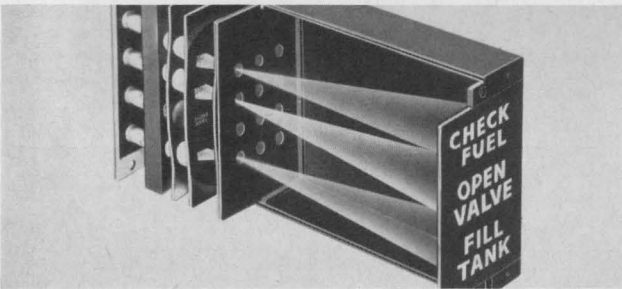

Series 80 Large screen unit particularly suited for annunciator applications . . . factory call systems, production control boards, etc. Message or character 3 $\frac{3}{8}$ " high; can easily be read at 100', 160° viewing angle.

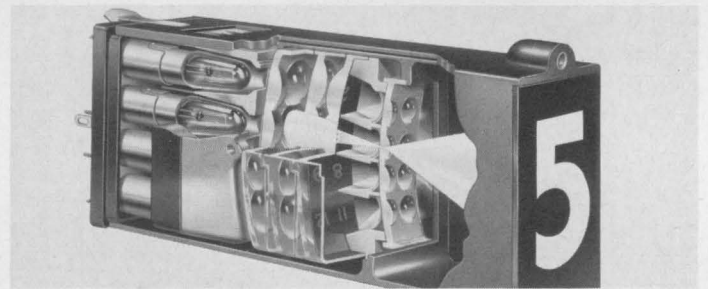

Series 10H It's the world's most popular readout. And we've improved it. New lens system increases character brightness 4 times. Greater clarity at wider angles and longer distances, even under high ambient light. .937" H x .937" W viewing area. Mil-spec version also available.



Series 345 IEE's smallest rear-projection readout. Viewing area .38" H x .34" W. Based lamps. Low cost. Individual readouts plug into permanently wired housing for quick message change. Easy front panel access.

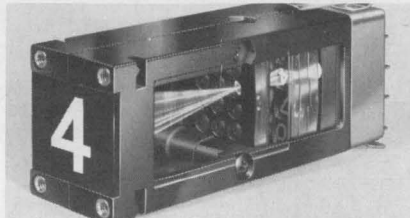

Series 120H Miniature (.62" H x .62" W) rear-projection readout. New lens system increases character brightness 50%. Easily read from 30' even with high ambient light. Quick disconnect lamp assembly for speedy lamp replacement.

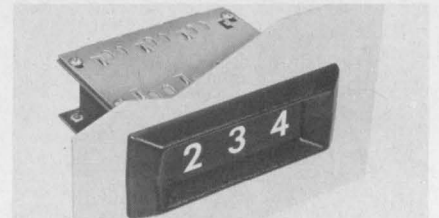

Series 220H Miniature, plug-in, rear-projection readout meets MIL-R-39027. .62" H x .62" W viewing area. Special lens system increases character brightness 50%. Excellent readability from wide angles and long distances.



Series 875 Miniature, 24-position, rear-projection readout with .62" H x .62" W viewing area. Overall size just 1.39" H x .90" W x 3.095" D. Exceptional character brightness and clarity. Quick disconnect lamp assembly for easy replacement.

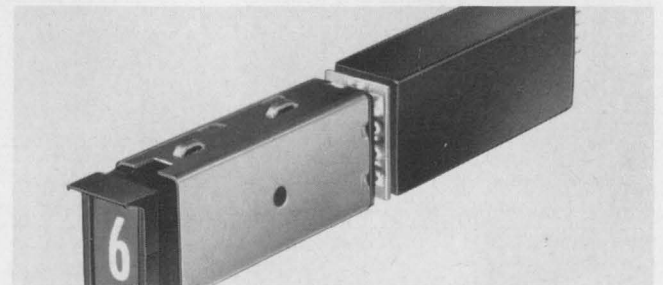

IC Driver/Decoders Small, solid-state units for IEE Series 10H, 120H, 220H, 340 and 360 readouts. All models accept a variety of binary codes for decimal conversion. Take normal signal voltage. Draw less than 2 ma. (Many options, including memory.)

Any characters desired. Any colors or combinations. Any input, BCD or decimal. Any input signal level. Any mounting, vertical or horizontal. Many sizes. Many configurations. Many options and accessories. Many brightness choices. Long lamp life (to 100,000 hours).

See them all at the IEEE Show, March 18-21, Booth 3B22-23



Circle 72 on reader service card

Industrial Electronic Engineers, Inc., 7720 Lemona Ave., Van Nuys, California

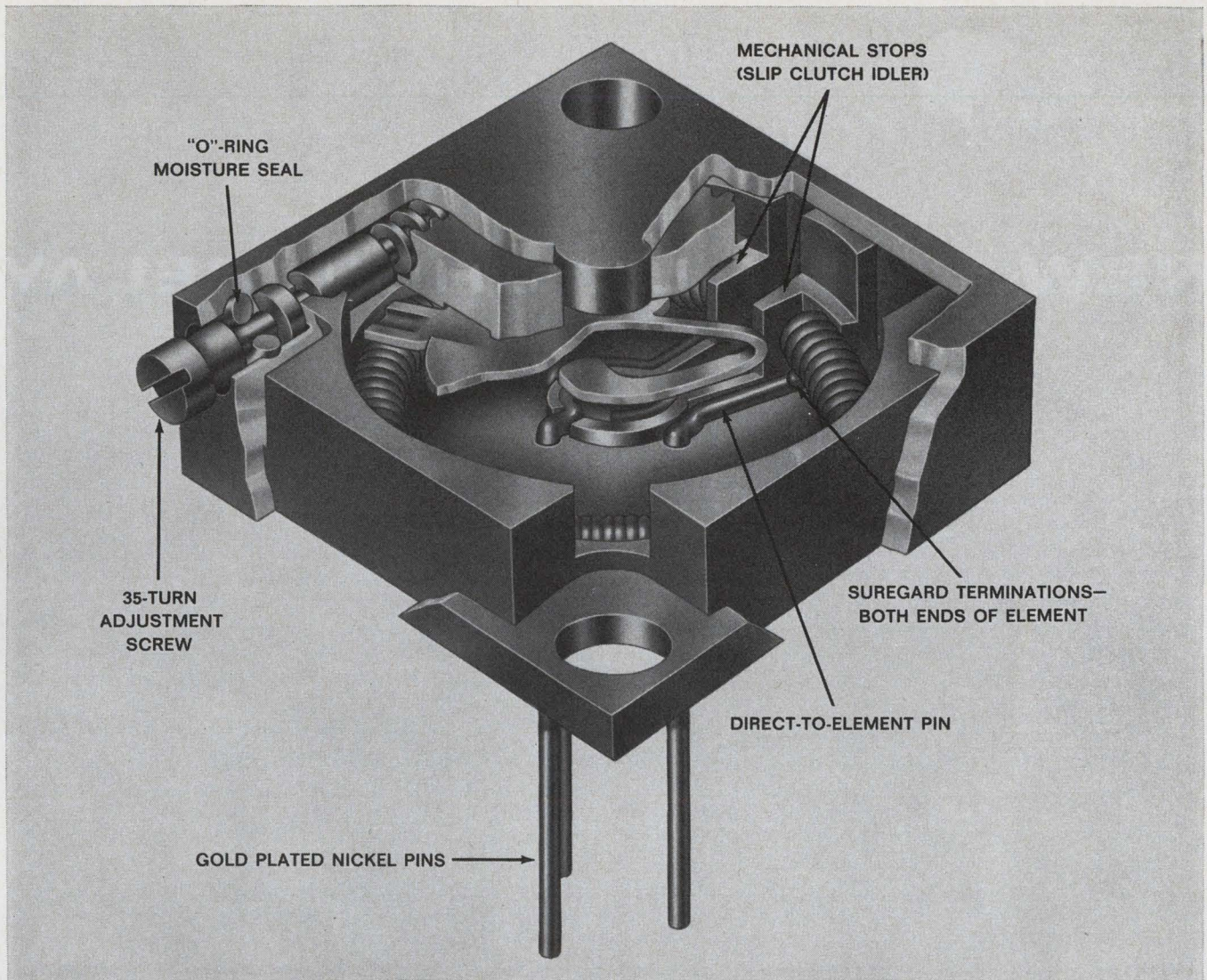

MISSING: a few connections **GAINED: new reliability at a bargain price**

Design omissions can be as important as additions in product performance. An inside look at the new DAYSTROM Squaretrim® 554 Series pot, for example, shows that intermediate pin connections have been eliminated. Two of the weldable base pins are affixed directly to the resistance element. The center pin pivots directly against the rotating tap assembly. Result? A simplified design which also lowers your cost. Made in accordance with MIL-R-27208, these half-inch units are rated for a full watt in still air at 70°C. Sealed models have passed Weston's 100% immersion test. Now thrifty-minded military, industrial or commercial users can have Squaretrim quality features at a bargain price. Write today for complete data and evaluation samples of our 550-555 Series potentiometers.

- Patented "wire in the groove" construction
- 10 ohm to 50K resistance range
- ±5% standard tolerance
- -55°C to +150°C temperature range
- Choice of pins, flexible leads, and screw configurations
- Choice of sealed and unsealed models
- Priced competitively

DAYSTROM potentiometers are another product of:

Weston Components Division, Weston-Archbald, Archbald, Pennsylvania 18403, a Schlumberger company

WESTON® prime source for precision . . . since 1888

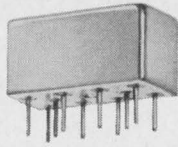

2 Amps.
All Welded

NEW

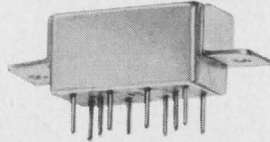

LATCHING RELAY

DPDT

0.37 oz.

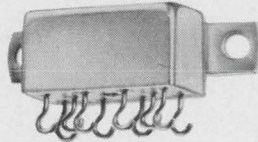

The new KL Series combines the proven performance of Hi-G 1/2 size crystal can relays with a unique new latching design. These relays meet all the applicable requirements of MIL-R-5757 and are available for fast delivery in all standard configurations and header styles.

Write or call Hi-G for Bulletin #103. If you need applications engineering assistance, an experienced Hi-G representative awaits your call. Telephone: (203) 623-2481.



SPRING STREET & ROUTE 7^E / WINDSOR LOCKS, CONNECTICUT 06096

The new SERIES KL Relays are available at the following DISTRIBUTORS

Angus, Incorporated, Pleasant Valley Avenue, Moorestown, N.J. 08057 TEL: 609-235-1900

Federal Electronics, P.O. Box 1208, Vestel Parkway E., Binghamton, New York 13903 TEL: 607-748-8211

Lectronix, Incorporated, 214 North 2nd Street, P.O. Box 188, St. Charles, Missouri 63301 TEL: 314-723-1122

Moulton Electronics Distributors, Inc., 1058 Terminal Way, San Carlos, California 97078 TEL: 415-591-8292

Moulton Electronics, c/o Banks Sales Corp., 2785 N. Speer Blvd., Denver Colorado 80211 TEL: 303-433-5455

Tomelco/Moulton, 531 N. Brown Avenue, Scottsdale, Arizona 85251 TEL: 602-945-5030

Tomelco/Moulton, 15846 Pacific Highway South, Seattle, Washington 98188 TEL: 206-246-1727

Radio Products Sales, Inc., 1501 South Hill Street, Los Angeles, California 90015 TEL: 213-748-1271

R and D Electronics, Inc., 71 Pearl Street, Cambridge, Mass. 02139 TEL: 617-864-0400 and 8401; ENTERprise 7135 in Major Cities

Solid State Electronics Co. of Texas, 2643 Manana, P.O. Box 20299, Dallas, Texas 75220 TEL: 214-352-2601

Westates Electronics Corp., 20151 Bahama Street, Chatsworth, California 91311 TEL: 213-341-4411



PG-13 Big, Fast Pulses

With our new PG-13 you can get $\pm 100V$ or, as a current source, $\pm 2A$ pulses. And 10 ns rise and fall times; repetition rate 1 Hz to 25 MHz; duty cycle 50% at 1A out with a pulse width to 5 ms. No hedging. The specs are real specs: when we say ± 100 volts we mean ± 100 volts; 10 ns rise time means 10 ns rise time, worst case, at 100 volts. So if you need a truly fast high-output pulser for, say, magnetic core testing, radar pulse simulation or similar applications you would do very well to consider the PG-13.

The PG-13 is all solid-state (rack height $3\frac{1}{2}$ ""). Operates in either voltage or current modes; in the voltage mode the range is ± 100 mV to $\pm 100V$ from a 50 ohm source; in the current mode it is ± 50 mA to $\pm 2A$ from a 1K, min, source. PRF, 1 Hz to 25 MHz. Single or double pulses plus sync. Instantaneous overload protection and a front panel warning light. Can be gated or triggered up to the max rep rate. Manual one-shot. DC-offsets either direction to 100 mA. Independently variable rise and fall times, 10 ns to 50 ms. PRF, rise, fall, amplitude, width (of either pulse independently), offset and delay are all variable continuously.

The PG-13 is one of the 3-I/Chronetics new generation pulse generators. There isn't really anything to compare it to . . . except for the modest price.

We'll be glad to whisk a PG-13 to your lab for a demonstration. And there's a new catalog on the new generation pulse generators.

3-I/CHRONETICS invites inquiries from qualified Senior Digital Designers interested in contributing to the state of the instrument art. Please write or 'phone.

Intercontinental Instruments Inc., a Subsidiary of CHRONETICS. USA: 500 Nuber Avenue, Mt. Vernon, New York (914) 699-4400, TWX 710 560 0014; in Europe: 39 Rue Rothschild, Geneva, Switzerland (022) 31 81 80, TELEX 22266.



IEEE Booths 2H47-2H49

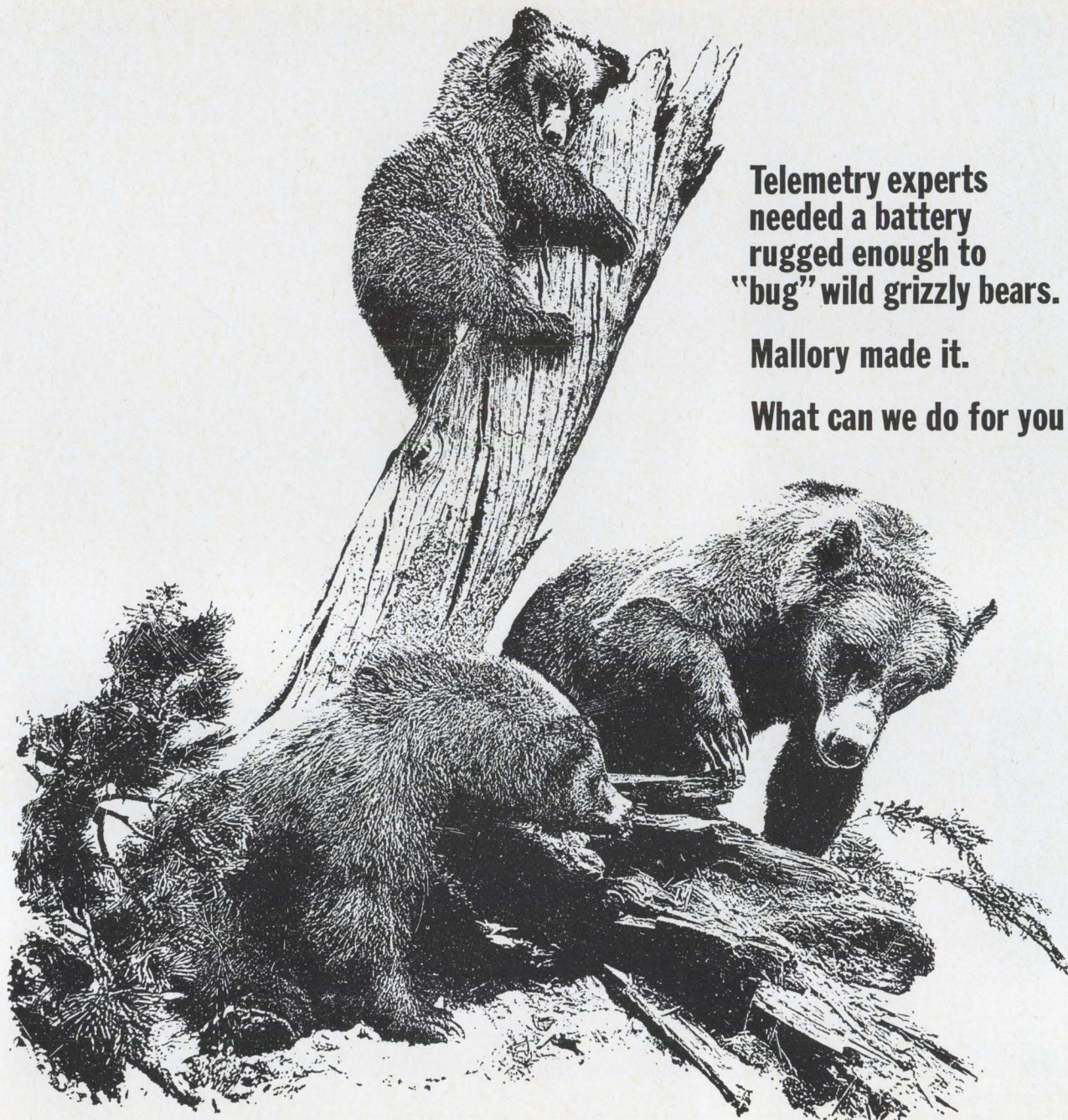

**Telemetry experts
needed a battery
rugged enough to
"bug" wild grizzly bears.**

Mallory made it.

What can we do for you?

Telemetry experts needed a battery. A battery to power small radio transmitters attached to wild grizzly bears. A battery that could fit inside the compact transmitters, yet hold enough power to keep "beeping" for weeks, even months. A battery tough enough to take anything bear country dished out.

Mallory made it. The battery—a Mallory mercury battery. It packs an extraordinary amount of energy into a minimum volume, keeps its voltage level high throughout its long life. It can be sealed away from the elements. And it withstands freezing temperatures that would cripple ordinary batteries.

NEW "CMC" MERCURY CELLS
We've added a suffix to the designation of some of our small mercury cells—ones

with the flat pellet structure shown in the cutaway. This new "CMC" suffix (as in RM-625CMC) means that the cells so designated have completely new performance ratings. Changes in their

internal design have improved their conductivity and increased their anode surface area. Their low temperature performance is improved. And they exhibit new characteristics under high current drains.

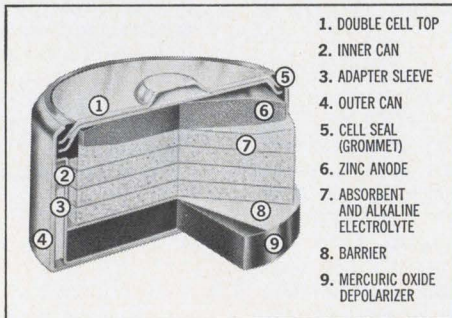

1. DOUBLE CELL TOP
2. INNER CAN
3. ADAPTER SLEEVE
4. OUTER CAN
5. CELL SEAL (GROMMET)
6. ZINC ANODE
7. ABSORBENT AND ALKALINE ELECTROLYTE
8. BARRIER
9. MERCURIC OXIDE DEPOLARIZER

OVER 1000 DIFFERENT TYPES
Mallory currently makes over 1000 batteries of all sizes and capacities. If we're not actually producing the battery you need, we'll be glad to work with you in designing a new one. Please write the Technical Sales Department, Mallory Battery Company, a division of P. R. Mallory & Co. Inc., South Broadway, Tarrytown, New York 10591. Telephone: 914-591-7000. (In Canada: Mallory Battery Company of Canada Limited, Sheridan Park, Ontario.)

It's good business to do business with Mallory **MALLORY**

VARIABLE
BANDWIDTH
MARKERS
PINPOINT THE
FREQUENCY



Sweep Oscillator gives top performance in the 100 kHz to 110 MHz range

All solid-state Hewlett-Packard 3211A Sweep Oscillators with RF and marker plug-ins meet virtually all of your swept frequency testing requirements. Variable bandwidth markers permit accurate, well defined marking under a variety of test conditions.

The main frame of the 3211A contains everything you could hope to find in a sweeper. RF plug-ins operate at fundamental frequencies with good linearity and spurious mixing products are eliminated. Plug-in markers offer not only variable bandwidth, but also Z-axis or pulse-type marking. An accurate 59-db attenuator makes the unit a valuable tool for testing both high- and low-gain circuits.

Priced at less than \$1,000, the 3211A is ideal for general testing in the video to VHF range where flat, linear output and an accurate marking system is required. Typical applications are: alignment, calibration and design of FM tuners and receivers and testing filters, amplifiers, transformers, resonant circuits and IF sections of TV receivers, radar and communications systems. For complete specifications, contact your local Hewlett-Packard field engineer or write Hewlett-Packard, Green Pond Road, Rockaway, N.J. 07866.

HEWLETT  **PACKARD**

SWEEP OSCILLATORS

**One of the world's
smallest families is
now a little bigger.**

Enter MMO-35 and MMO-15. Two new constant-bandwidth micro-electronic subcarrier oscillators. With the same ruggedness as our proportional-bandwidth MMO-30 and MMO-11. Same tiny sizes. And same light weights.

When you add the new MMA-12 mixer amplifier and the MMV-11 Regulated Instrumentation Supply, the family still isn't very big. But its range of applications is.

Write our Communications Products Dept., Trevose, Pa. 19047. Or call (215) 355-5000.

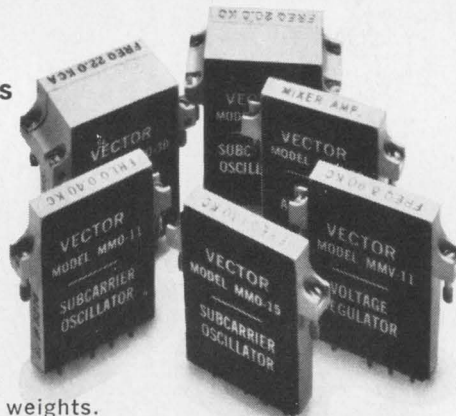

Norden DIVISION OF UNITED AIRCRAFT CORPORATION

**U
A**

increase ic yield

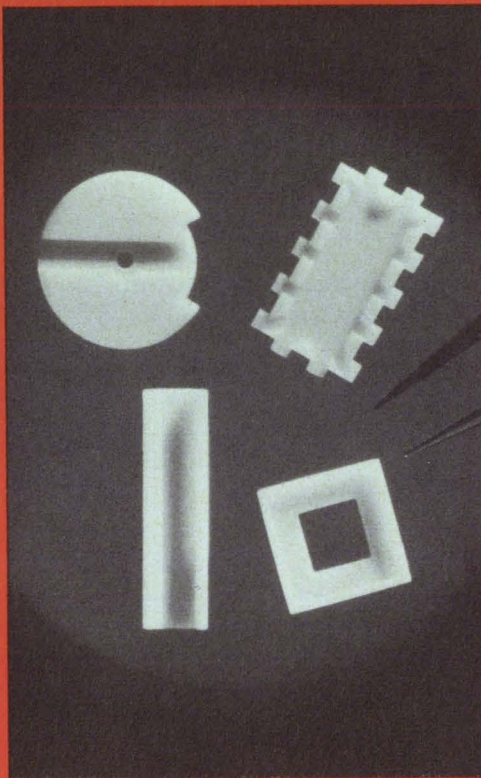

With Coors microceramics. Parts and complete packages. Of alumina and beryllia. Strong, chemically inert, dimensionally stable. Unaffected by age or environment. Part-to-part uniformity from 1st to nth. Precision-ground or as-fired surfaces. Easy to metallize, by you, by us. Most any size, any shape. Fast delivery. Prototype quantities, millions, or anything in between. Get higher yield, more profit. Start with the most reliable circuit packaging. Coors microceramics. Send for data pack.

Coors Porcelain Company
Golden, Colorado 80401

Coors/CERAMICS

Circle 79 on reader service card

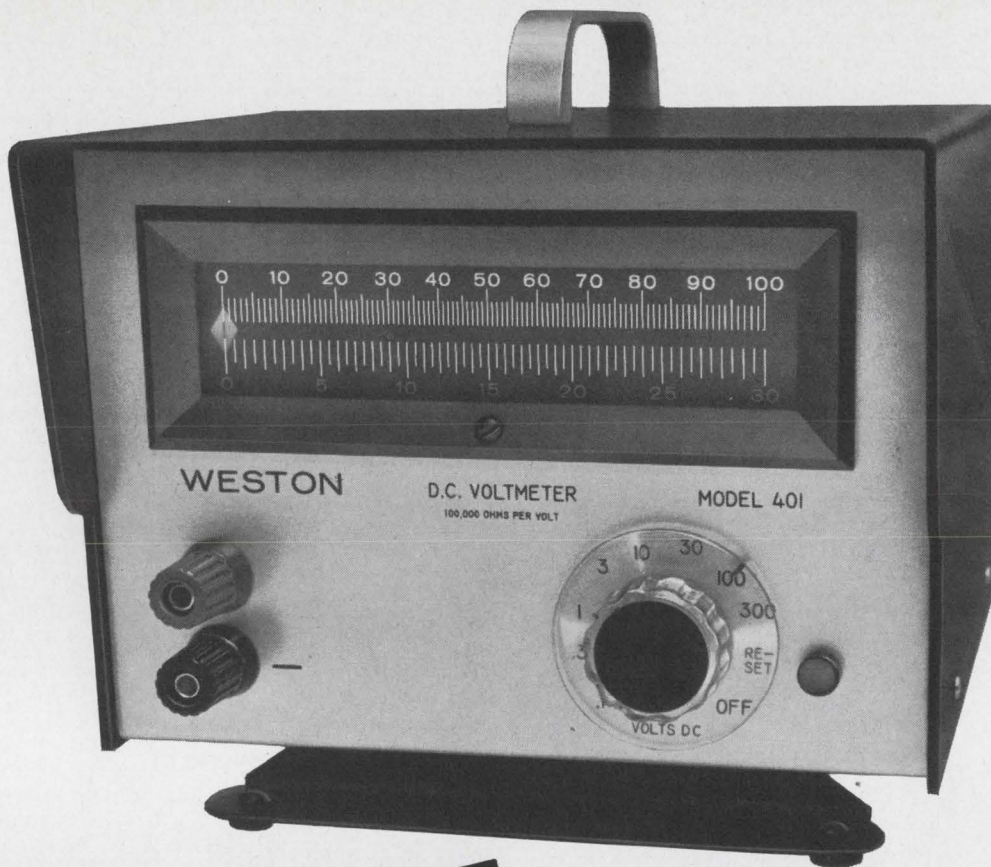

FAIL-SAFE

solid-state portable with optical projection

Now you can get **fail-safe** overload protection in a high accuracy portable. Model 401 is an exclusive new Weston design featuring optical projection to eliminate parallax and provide sensitivity approaching that of vacuum tube voltmeters. Its taut band projected moving pointer offers 0.5% accuracy with true flat scale presentation. A special swivel base lets you turn it to any convenient reading position. Model 401 DC Voltmeter is priced at \$185; Model 401 DC Milliammeter, at \$190. Check these features . . . then write for complete information today.

SPECIFICATIONS IN BRIEF

- **Overload protection:** transistorized network with fail-safe parameters
- **Overload indicator:** red lamp with reset switch
- **Convenience features:** shrouded case, swivel base, color-coded scale/range markings
- **Accuracy:** $\pm 0.5\%$ full scale
- **Ranges:** Model 401 DC Voltmeter, 300|100|30|10|3|1|.3|.1
Sensitivity: 100,000 ohms/volt
Model 401 DC Milliammeter, 100|30|10|3|1|.3|.1|.03|.01

Weston Instruments, Inc., Weston-Newark Division, 614 Frelinghuysen Avenue, Newark, N.J. 07114, a Schlumberger company

WESTON[®] prime source for precision . . . since 1888

WESTON-ARCHBALD • WESTON-GARWIN CARRUTH • WESTON-HATBORO • WESTON-LEXINGTON • WESTON-NEWARK • WESTON-POUGHKEEPSIE • WESTON-TRANSICIL • WESTON-CANADA

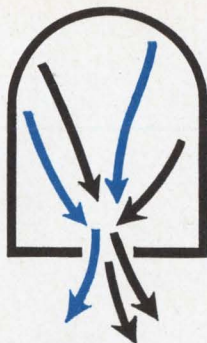

MEET THE DECISION MAKERS...

Four CVC High Vacuum Systems with AutoMate™ Control!

Just touch the start button, AutoMate does the rest. The AutoMate Control on your CVC system controls pumping cycles automatically—as fast and accurate as your best technician. The cycling decision is

made and carried out in response to pressure in the system—you get the same results in your pumpdown every time. For full details, write Consolidated Vacuum Corporation, Rochester, New York 14603.

	CV-144	CV-164	CV-18	CV-1104
APPLICATIONS	Electronic and Optical Thin-Film Deposition, Environmental Studies	Electronic and Optical Thin-Film Deposition, Environmental Studies	Electronic and Optical Thin-Film Deposition, Environmental Studies	Electronic and Optical Thin-Film Deposition, Environmental Studies
CHAMBER	14" Pyrex Bell Jar	18" Pyrex Bell Jar	18" Pyrex Bell Jar	24" or 30" Stainless Steel Bell Jar
DIFFUSION PUMP	4" BlueLine	6" BlueLine	6" BlueLine	10" BlueLine
BAFFLE	Choice of multi-coolant or liquid nitrogen	Choice of multi-coolant or liquid nitrogen	Choice of multi-coolant or liquid nitrogen	Choice of multi-coolant or liquid nitrogen
EVAPORATION POWER SUPPLY RATING (Continuous Duty/20% duty)	2 KVA/3.9 KVA	2 KVA/3.9 KVA	2 KVA/3.5 KVA	4 KVA/8 KVA

New CV-1104 System With AutoMate™ Control



CVC

A BELL & HOWELL COMPANY

 **BELL & HOWELL**

It took the old pros to give you what you wanted in an IC op amp

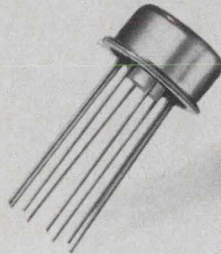

- * guaranteed maximum values for the 20 key parameters. 100% tested!
- * only two external components required for phase compensation.
- * low bias current drifts, less than 0.6 nA/°C, guaranteed.
- * 0.8 μ V and 0.03 nA input noise, guaranteed.
- * 20 kHz full power response with unity gain phase compensation.
- * input overvoltage protection to ± 15 V.
- * output short circuit protection.
- * uniform stability and performance from lot to lot — *guaranteed*.
- * package interchangeable with standard 8 pin 709 type amplifiers.

These new IC op amps were designed from the users viewpoint. After all, their family line stretches all the way back to the very beginning of solid state operational amplifier development. So, the BBICs (Burr-Brown Integrated Circuits) have the performance and application advantages you expect from Burr-Brown . . . the old pros in op amp technology.

Burr-Brown's unique, proprietary design (patent pending) overcomes the limitations of other monolithic IC units on the market to cut your incoming test and inspection cost, simplify your system design work, reduce the number of external components required, eliminate time-consuming hand-tuning . . .

and give you superior performance, stability and uniformity in the bargain.

Both Military and Commercial temperature ranges are included in the 8-unit series. BBIC prices start at \$8.00 in 100 unit quantities. And, they are available, now, from stock.

Sound good? Then use this publication's reader service card for your copy of the six page specification and application bulletin on the BBICs. Better yet, get hold of your local "old pro", your Burr-Brown Representative. His phone number is listed below. Demonstrator units available in case you're a skeptic.

BURR-BROWN

RESEARCH CORPORATION

International Airport Industrial Park • Tucson, Arizona 85706
TELEPHONE: 602-294-1431 • TWX: 910-952-1111 • CABLE: BBRCORP



Operational Amplifiers
Instrumentation Amplifiers
Function Modules
Analog Simulators
Geophysical Instruments

ENGINEERING REPRESENTATIVES: ALABAMA, HUNTSVILLE (205) 534-1648 / ARIZONA, PHOENIX (602) 254-6085 / CALIF., LOS ANGELES (213) 665-5181, SAN FRANCISCO (408) 244-1505 / COLO., DENVER (303) 388-4391 / CONN., EAST HARTFORD (203) 874-9222 / D.C., WASHINGTON (SEE MARYLAND) / FLORIDA, ORLANDO (305) 425-2764 / ILLINOIS, CHICAGO (312) 286-6824 / LA., NEW ORLEANS (504) 888-2266 / MD., SILVER SPRING (301) 588-8134 / MASS., BOSTON (617) 245-4870 / MICH., DETROIT (313) 358-3333 / MINN., MINNEAPOLIS (612) 781-1611 / MO., ST. LOUIS (314) 524-4800 / N.C., GREENSBORO (919) 273-1918 / N.J., CAMDEN (215) 925-8711

/ N.M., ALBUQUERQUE (505) 255-1638 / N.Y., ALBANY (518) 436-9649, BINGHAMTON (607) 723-9661, MT. VERNON (914) 968-2200, NEW HARTFORD (315) 732-3775, ROCHESTER (716) 473-2115 / OHIO, CINCINNATI (513) 761-5432, CLEVELAND (216) 237-9145, DAYTON (513) 277-8911 / PENN., PHILADELPHIA (SEE CAMDEN, N.J.), PITTSBURGH (412) 243-6555 / TEXAS, DALLAS (214) 357-6451, HOUSTON (713) 774-2568 / UTAH, SALT LAKE CITY (801) 466-8709 / VIRGINIA, (SEE MARYLAND) / WASH., SEATTLE (206) 767-4260 / CANADA, DOWNSVIEW, ONT., (416) 636-4910 — MONTREAL, QUE., (514) 739-6776 — OTTAWA, ONT., (613) 725-1288 — VANCOUVER, B.C., (604) 298-6242

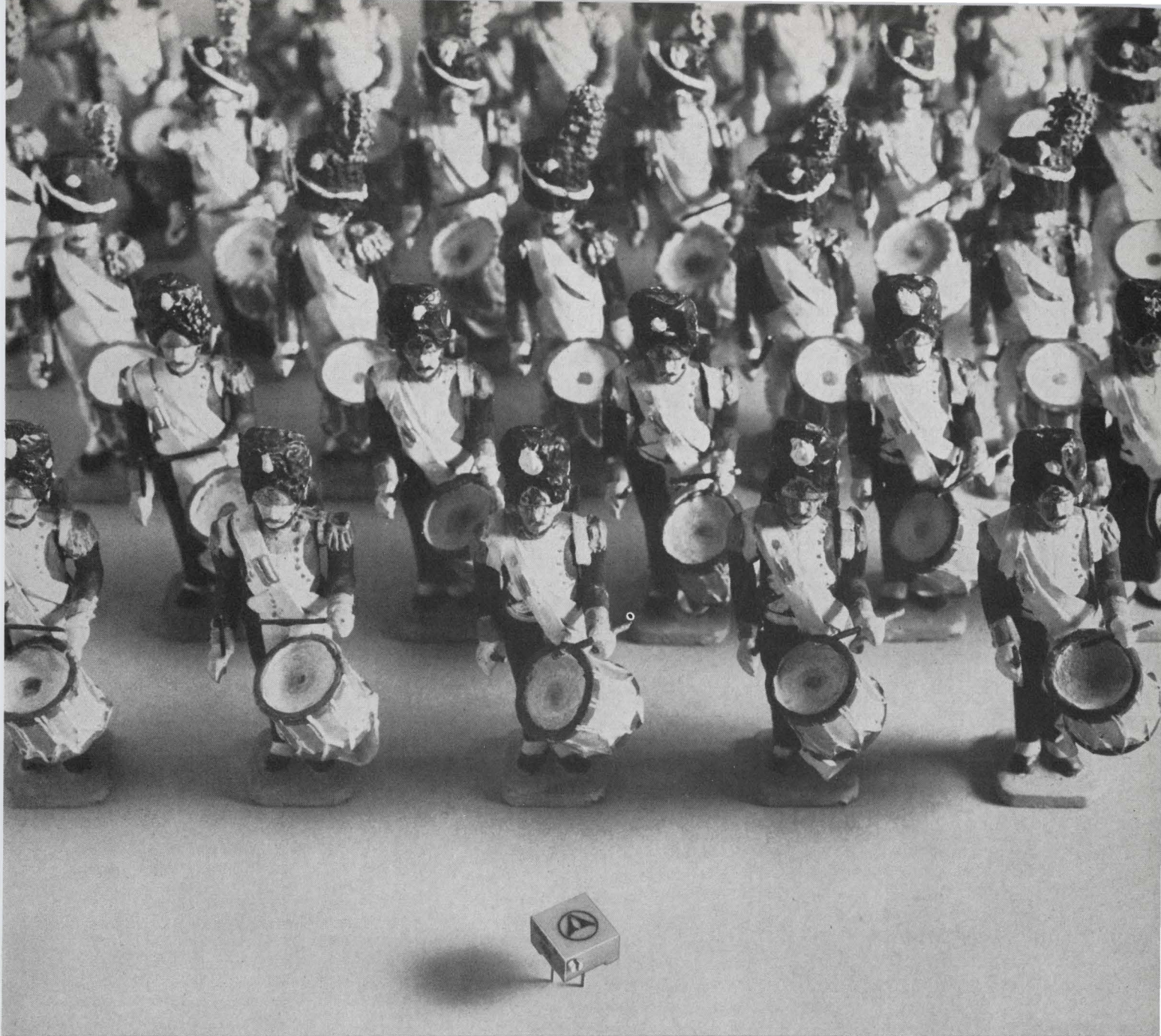

A Civilian Replacement for Military Trimmers.

Are you using military trimmers when you don't have to?

The new Amphenol 3600 low-cost wire-wound meets all necessary parameters for commercial applications. Even exceeds MIL-specs in some areas. Now you can replace RT 22's and 24's and reduce trimmer costs.

You also save 44% card space. The 3600 is $\frac{3}{8}$ "

square—but pins match both military models.

For wave or flow soldering processes use humidity-proof model 3610.

Evaluate Amphenol's 3600 for cost and space savings. Ask your local Amphenol distributor or sales engineer for more particulars. Or write us for a sample: Amphenol Controls Division, Janesville, Wisconsin.

Circle 83 on reader service card



AMPHENOL

Specify Amphenol electronic components . . .
produced in Canada, England, France, Japan,
Mexico, United States, West Germany.

WHETHER or not you use Designer's Choice Logic, you have to admit that Signetics' idea of guaranteeing cross-family compatibility in integrated circuits can save you time and money in design.



PUBLISHED BY SIGNETICS: THE RESPONSE/ABILITY COMPANY

NEW IC NIXIE DRIVER GETS UNGLOWING REPORT

Guaranteed 67V Breakdown

Signetics Corporation today announced the first monolithic IC Nixie Driver that permits Nixie* tube operation without excessive background glow and does not require any discrete external components for interfacing. "We've whipped the problem of getting a state-of-the-art 2.5-ohm centimeter process into production, so we can

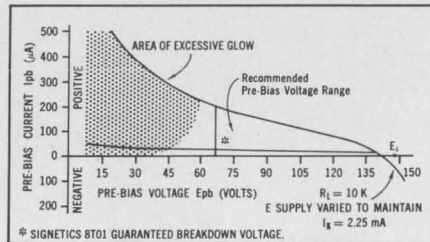

Pre-bias Voltage vs. Current Characteristics of a typical NIXIE Tube.

guarantee a 67V breakdown," a company spokesman said.

Officials also said that the new device, designated 8T01 Nixie Decoder/Driver, is the only one of its kind that will interface directly with all commonly used DTL and TTL circuits and drive Nixies directly. The new member of Signetics DCL family is offered in a 16-pin silicone DIP.

When told of this new device from Signetics, a competitive manufacturer stated, "Dammit."

*Nixie is a registered trade mark of the Burroughs Corp.

Big shift to new Shift Register

Unique Device Announced

"Your new shift register is the answer to my prayers."

That quote, from a Dallas designer, is typical of the response to Signetics' introduction of a new 4-Bit Shift Register in the DCL line, according to Bill Slaymaker, a Signetics Product Marketer.

"This device has a unique organization and functional capability," Slaymaker commented.

The new 8270/8271 4-Bit Shift Register is fully synchronous and offers parallel or serial input and output. The device operates at clock rates up to 20 MHz and has a mass reset line (in the 8271, a 16-pin configuration) that is independent of the clock. A unique feature is separate load and shift controls that make it unnecessary to gate the clock to inhibit the shift, thus eliminating clock skew problems. Power consumption is 40mW per binary.

The 8270/8271 is supplied in 14 lead flat pak, and 14 or 16 lead silicone DIP in both full MIL and industrial temperature ranges.

Signetics announces new publication

Signetics launched a new publication today, the DCL Bulletin. As you can see in the masthead the first issue is the 16th issue, the first fifteen issues having never been published. DCL has been famous and well-loved since 1966, so it would be just plain silly to call the first issue the first issue.

TODAY'S BUZZ WORD

"Designer's Choice Logic"
You didn't expect it to be "Fairchild"?

FOR SPEC SHEETS

Specifications on our new Nixie Driver and Shift Register are now available. Send for information on our complete DCL line. Write: Signetics, 811 East Arques Ave., Sunnyvale, Calif. 94086.

See us at IEEE
Booths 3A01 to 3A04

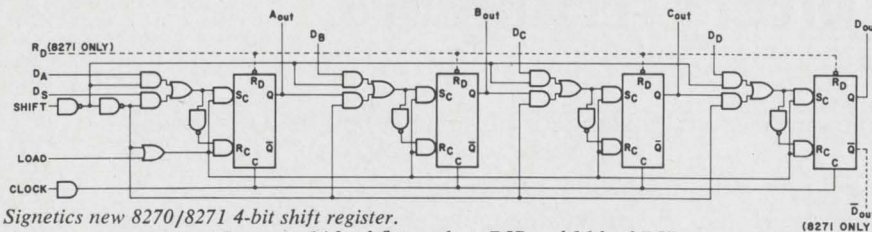

Signetics new 8270/8271 4-bit shift register.

Comes in 14 lead flat pack or DIP and 16 lead DIP.

SIGNETICS SALES OFFICES: Fort Lee, New Jersey (201) 947-9870; Syracuse, New York (315) 469-1072; Richardson, Texas (214) 231-6344; Beverly Hills, California (213) 272-9421; Garden Grove, California (714) 636-4260; Wakefield, Massachusetts (617) 245-8200; Silver Springs, Maryland (301) 946-6030; Collingswood, New Jersey (609) 858-2864; Clearwater, Florida (813) 726-3734; Rolling Meadows, Illinois (312) 259-8300; Sunnyvale, California (408) 738-2710.

DISTRIBUTORS: Compar at all locations listed below. Semiconductor Specialists, Inc. (312) 279-1000; Terminal Hudson Electronics (212) 243-5200; Wesco Electronics (213) 684-0880; Wesco Electronics (405) 968-3475; Hammond Electronics (305) 241-6601; Avnet Electronics Corp. of Massachusetts (617) 272-3060; Pioneer Standard Electronics Inc. (301) 427-3300; Kieruluff Electronics (206) RO 3-5510; G. S. Marshall (213) 684-1530.

DOMESTIC REPRESENTATIVES: Jack Pyle Company (415) 349-1266. Compar Corporation at the following locations: Alabama (205) 539-8476; Arizona (602) 947-4336; California (213) 245-1172; California (415) 697-6244; Colorado (303) 781-0912; Connecticut (203) 288-9276; Florida (305) 855-3964; Illinois (312) 692-4125; Maryland (301) 484-5400; Massachusetts (617) 969-7140; Michigan (313) 357-5369; Minnesota (612) 922-7011; Missouri (314) 542-3399; New Jersey (609) 429-1526; New Mexico (505) 265-1020; New York (518) 436-8536; New York (607) 723-8743; New York (516) 921-9393; North Carolina (919) 724-0750; Ohio (216) 333-4120; Ohio (513) 878-2631; Texas (214) EM 3-1526; Texas (713) 667-3420; Washington (206) 763-1711.

INTERNATIONAL SALES: France, Germany, Italy, Belgium, Holland, Luxembourg, Spain—Sovcor Electronique, 11, Chemin de Ronde, Le Vesinet, (S.-&O.) France. United Kingdom, Ireland, Sweden, Denmark, Norway, Switzerland, Austria, Portugal—Electrosil Ltd., Lakeside Estate, Colnbrook-Bypass Slough, Buckinghamshire, Great Britain. Australia—Corning, 1202 Plaza Building, Australia Square, Sydney, N.S.W. 27-4318. Canada—Corning Glass Works of Canada, Ltd., Leaside Plant, Ontario, Canada (416) 421-1500. Israel—Optronix, P.O. Box 195, Ramat-Gan, Israel 724-437. Japan—ASAHI Glass Co., Ltd., Corning Products Sales Dept. No. 2, 3-Chome Marunouchi, Chiyoda-ku, Tokyo, Japan.

What's Hewlett-Packard doing in the volume components business?

Lowering the price of Hot Carrier Diodes to...

It's all because we found a new way to build them. We decided to combine the superior performance of a hot carrier diode with the best features of PN junction diodes. And by eliminating the cat whisker of earlier designs, we were able to use low-cost assembly techniques. ■ We started with planar construction and added a graded PN junction along the periphery of the metal Schottky Barrier, eliminating high electric fields. A molybdenum barrier permits high temperature operation without fear of breakdown. The end result is the HP 2800 hot carrier diode with silicon temperature capabilities; turn-on equal to germanium, and lots of speed. ■ You get 100 picosecond switching speeds, 70 volt breakdown, low turn-on voltage at 410 mV at 1 mA, and operating/storage temperature of -65°C to 200°C . Use the 2800 for RF and digital applications, or use it for mixing, detecting and sampling. ■ Prices: 1000-4999, 55¢; 100-999, 75¢; 1-99, 99¢. We won't mind if you take advantage of the quantity price breaks. ■ Specifications on the 2800 Diode are available from your local HP field engineer, or write Hewlett-Packard, Palo Alto, California 94304; Europe: 54 Route des Acacias, Geneva.

55¢

HEWLETT  PACKARD

SOLID STATE DEVICES

01805

VISIT HPA BOOTH 3L09-3L10 AT IEEE MARCH 18-21, NEW YORK COLISEUM.

Helipot rings up the twelve dollar C. P. pot.



The new Model 3351 conductive plastic potentiometer is our twelve dollar solution to your age-old budget problem. It's a new low price for a non-wirewound precision potentiometer, and yet performance and quality have not been sacrificed. This new model excels wherever high precision and long, trouble-free life are needed at minimum cost.

If you like the \$12.00 price, then check these specs. ■ Essentially infinite resolution.

■ Standard resistance range; 1K to 75K ohms. ■ Long life. ■ Linearity; $\pm 0.5\%$.

■ Power rating; 0.75 watts at 70°C. ■ Resistance tolerance; $\pm 10\%$. ■ Operating temperature range; -65°C to $+125^{\circ}\text{C}$. ■ Factory stocked.

Also, Helipot has other all-new non-wirewound pots to satisfy most every application. Standard servo mount models with either conductive plastic or cermet resistance elements are available in 7/8" and 1-1/16" diameter. And they are priced under \$25.00.

Ask your local Helipot sales representative for the complete non-wirewound pot story... now.



Beckman®

INSTRUMENTS, INC.

HELIPOT DIVISION

FULLERTON, CALIFORNIA • 92634

INTERNATIONAL SUBSIDIARIES: GENEVA; MUNICH; GLENROTHES, SCOTLAND; TOKYO; PARIS; CAPE TOWN; LONDON; MEXICO CITY



Technical Articles

**A cure for drift
in thin-film
transistors**
page 88

Thin-film methods have long offered the possibility of low-cost, large-area arrays. But thin-film transistors until now have been notoriously unstable. The trouble has been traced to the material that was used for the insulator—silicon monoxide—and a new method employing aluminum oxide may now produce stable TFR's suitable for such applications as memories, solid-state vidicons, and scan generators.

**Using infrared
to measure
film thickness**
page 101

The measurement of the thickness of an epitaxial film has always been time-consuming—either the sample was destroyed with a lap-and-stain method, or manual optical-interference techniques took several minutes. But now there's a method that speeds up the optical-interference measurements.

**Sighting in on narrow
light beams**
page 106

It's difficult to check out a laser-beam communications system that's intended for long-distance transmission—to the moon, for instance. In particular, exacting measurement of each optical-coupling device between the laser output and the antenna is needed. An infrared radiometer is pressed into service to yield accurate power profiles of laser beams.

**Semiconductor
strain gages
start to take hold**
page 109

Metal strain gages, relied upon for many years to sense displacement, acceleration, pressure, and force, are being threatened by pressure-sensitive transistors and semiconductor resistors. These devices produce higher outputs and have better sensitivity than metal strain gages.

**Large-scale integration
for small computers**
page 119

With LSI applied to an arithmetic unit, a small computer can be built with only one other major unit, a read-only memory. The MOS unit processes eight bits simultaneously through a register, an adder, an accumulator, and an output buffer.

**Computers test
and grade tires**
page 125



Today's smooth roads have magnified the impact of automobile tire nonuniformities on riding comfort. These irregularities—hard and soft spots—can cause the tire to interact with the car's suspension system, creating a shake at high speeds. To eliminate this problem, car makers specify tolerable peak-to-peak force variations, and tire makers use analog computers to grade each tire on its dynamic balance and fundamental harmonics.

**Television in 3-D
may be possible**
page 132

A simple stereoscopic tv system can be achieved with a monochrome camera fitted with separate lenses for left and right information, a standard color-tv receiver, and a pair of spectacles with red and blue filters. At the transmitter, the left channel output modulates, say, the red input during odd fields while the right channel output modulates the blue input during even fields. The spectacles give the effect of depth.

**Coming
April 1**

- Satellite antennas
- Radiation effects in thyristors

Thin-film transistors don't have to be drifters

Use of aluminum oxide as the gate insulator in an inverted structure frees these devices from the drift that has blocked their application

By Albert Waxman

RCA Laboratories, Princeton, N.J.

Thin-film technology has always promised big advantages over silicon monolithics for low-cost, uniform, large-area integrated circuits. Deposited on glass substrates measuring several inches on a side, thin-film transistors are fully isolated and free of the parasitic coupling effects that continue to plague monolithics.

However, TFT's have been handicapped by drift and deterioration of electrical characteristics with time, a problem now being eliminated by a new method of depositing the insulating material between gate lead and semiconductor. Instead of the usual silicon monoxide, the new technique applies a layer of aluminum oxide.

The way thus appears clear for thin-film IC's to gain a place in image sensor arrays, where even large-scale integrated bipolar circuits can't deliver the necessary thousands of gates on a single substrate.

Though TFT's, thin-film diodes, photoconductors, resistors, and capacitors have been built into complex integrated circuits for solid state vidicons and scan generators, none of these circuits has yet been used in commercial or military applications. However, their practicality has been demonstrated in

the lab, and research also points to uses in scratch-pad memories, counter circuits, and addressing arrays.

The TFT has developed more slowly than its single-crystal silicon MOS counterpart, but this isn't surprising since the advance of the TFT has required the development of new techniques for passivating semiconductor surfaces. The MOS transistor has benefitted from the wealth of information available about silicon and the already highly developed silicon technology.

Frequency response limits the TFT's applications to speeds of less than 50 megahertz. But the device has great potential in image sensing devices and memories such as those developed at RCA Laboratories by a group led by P. K. Weimer.

Defending the gates

The TFT has three electrodes: two low-resistance ohmic contacts to the semiconductor film—source and drain—and a metal gate electrode separated from the semiconductor film by a gate insulator.

The source contact is normally at ground potential, the drain electrode is positively biased, and the gate voltage is either positive or negative, depending on the particular mode of operation. The gate insulator presents a high impedance, and little gate current is drawn for either bias. For typical devices 100 mils wide with a source-drain spacing of 0.4 mil, d-c input resistance is greater than 10^{10} ohms with the most common insulators, Al_2O_3 and SiO_2 .

If the semiconductor film is deposited so that it has a resistivity higher than about 20 ohm-centimeters, as is often the case with cadmium sulfide (CdS) and cadmium selenide (CdSe), then little or no drain current is drawn when there is no gate voltage, and the device operates in the enhance-

The author

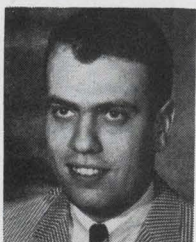

Albert Waxman has been working on thin films since 1963 as a member of the technical staff of the Materials Research group at RCA Labs. He received his doctorate in electrical engineering from Princeton University in 1966. His master's was also earned at Princeton.

ment mode. Positive gate voltage attracts additional electrons into the semiconductor film and increases the conductivity. A positive voltage on the drain will then set up an electric field to collect the induced electrons. Typical characteristics with drain current I_D plotted against drain voltage V_D have the pentode-like shape typical of field effect devices. Such an enhancement device is useful in direct coupled logic and complementary symmetry circuits.

If a highly conductive semiconductor film is deposited (with a resistivity less than 20 ohm-cm for typical dimensions), the current when there's no gate voltage will be significant. The device in this case can be operated with either positive or negative gate voltage. The negative voltage will deplete the number of electrons in the semiconductor, reducing the drain current; a positive voltage will increase the film conductivity and, hence, the drain current. This transistor can be used in a linear low-power amplifier.

Figure it out

The basic equations for current-voltage characteristics can be easily developed. The analyses of depletion and enhancement types are quite similar. For an enhancement-mode device—the one that has shown the most promise as a useful circuit element—the total induced mobile charge in the semiconductor film at a given position between source and drain is given by

$$Q(x) = C_g(V_g - V(x) - V_o)$$

where C_g is the input gate capacitance, V_g is the gate voltage, $V(x)$ is the potential at a given point

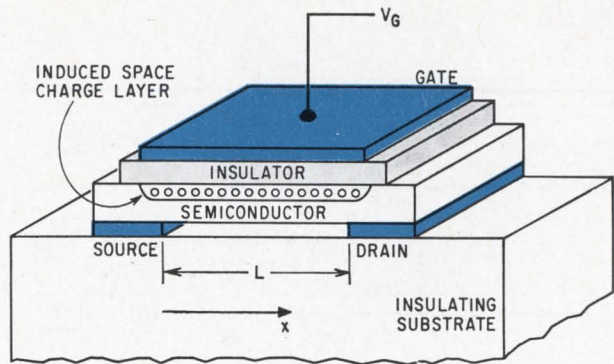

Thin film method. A conducting layer is induced in the semiconductor by the voltage on the gate, which is separated from the semiconductor by an insulator.

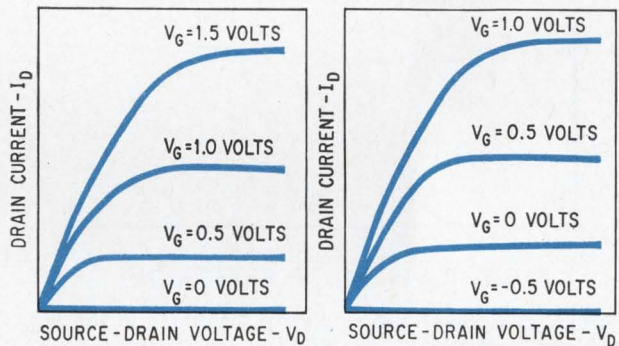

Gate control. Characteristics of enhancement-type TFT (left) and depletion type (right) show that the latter conducts when there's no voltage on the gate. The enhancement mode device is the one that has shown the most promise as a practical TFT.

Second effort

One of the first attempts to build an amplifying device using an electrode to modulate a semiconductor's conductivity between two other electrodes was reported in 1948 by William Shockley and C.L. Pearson of Bell Telephone Laboratories. But in putting an insulated field plate atop a germanium film, they found that the change in conductivity for a corresponding change in field voltage was much less than they had initially predicted.

The inefficiency was attributed to the presence of surface states that prevented the gate's field from penetrating the semiconductor.

Later improvements in thin-film technology, and the discovery that the thermal oxidation of silicon reduced surface states at the silicon-silicon dioxide interface, revived interest in these devices, however.

In 1961, P.K. Weimer of RCA Laboratories reported the first major success: an insulated-gate thin-

film transistor with cadmium sulfide as the semiconductor and silicon monoxide as the insulator. The thickness of the insulator—less than

500 Å—made it possible to fill the surface states and modulate the conductivity of the semiconductor film at low voltages.

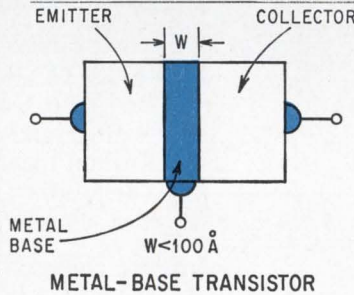

"TRAPPED" ELECTRONS IN SURFACE STATES

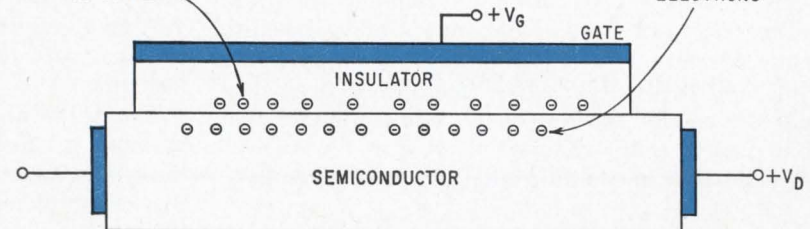

"FREE" INDUCED ELECTRONS

Forerunners. The metal-base transistor and the analog triode, early thin-film devices, were followed by the thin-film transistor.

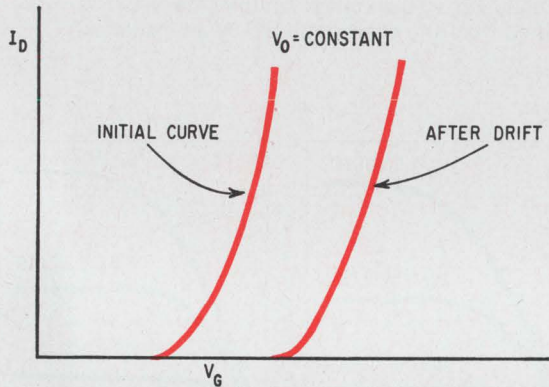
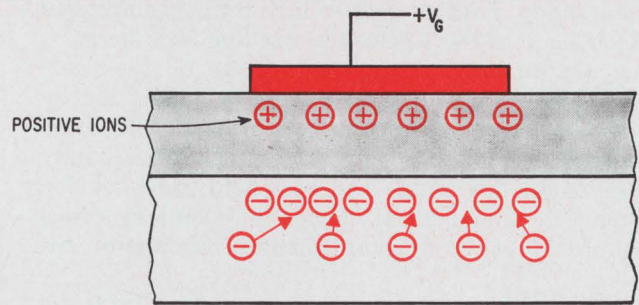
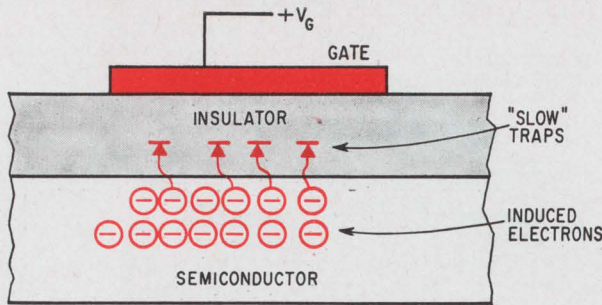

SLOW TRAPPING OF ELECTRONS

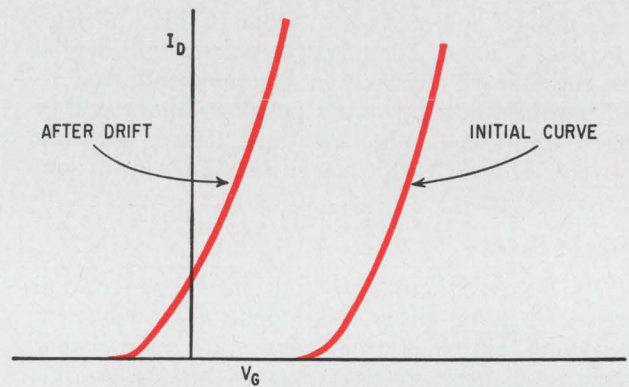

ION MOTION IN GATE INSULATOR

Sources of trouble. Two causes of instability in the electrical characteristics of TFT's are the trapping of electrons in the insulator, left, and the presence of positive ions in the insulator, right. The first causes the threshold voltage to increase, while the ions reduce the threshold voltage.

between source and drain, and V_0 is the gate threshold voltage for conduction in the semiconductor. V_0 , the voltage necessary to fill the surface states present at the insulator-semiconductor interface, is given by

$$V_0 = \frac{qN_{ss}wL}{C_g}$$

where q is the electronic charge, N_{ss} is the density of surface states, L is the source-drain spacing, and w is the device length.

The drain current is then given by

$$I_D = \frac{\mu C_g}{L} \left[V_g - V_0 - V(x) \right] \frac{dV}{dx}$$

This equation can be integrated to yield

$$I_D = \frac{\mu C_g}{L^2} \left[(V_g - V_0) V - \frac{V^2}{2} \right]$$

when $V_D = V_g - V_0$. At higher voltages, the drain current saturates and is independent of V_D because of the formation of an insulating region near the drain and the overlying gate electrode that electrostatically shields the rest of the semiconductor film from rises in drain voltage.

The current in the saturation region is given by

$$I_D = \frac{\mu C_g}{2L^2} (V_g - V_0)^2$$

and the transconductance by

$$g_m = \frac{\mu C_g}{L^2} (V_g - V_0)$$

Thus, the TFT is a square-law device and the transconductance is linearly proportional to gate voltage.

The gain-bandwidth product is

$$\frac{g_m}{2C_g} = \frac{\mu (V_g - V_0)}{2L^2}$$

Typical values— g_m of 4,000 micromhos and gain-bandwidth of 20 Mhz at $V_g - V_0 = 2$ volts—are obtained with CdS or CdSe as the semiconductor, and with a gate insulator thickness of 500 Å, a source drain spacing of 0.4 mil, and a length of 100 mils. Tellurium (Te) transistors with a gain-bandwidth product of 150 Mhz have been reported.¹

Drifting along

While TFT's often have good initial electrical characteristics—high transconductance and low threshold—these tend to deteriorate with time as gate voltage is increased. This has been the most serious problem with the transistors using SiO as the gate insulator.

The drifts can usually be attributed to two effects, or more properly, to the predominance of one of these effects over the other. The more difficult of the two occurs when the positive gate voltage attracts electrons at the semiconductor surface, thus initially increasing the drain current. Some of these electrons after a period of time fall into empty states in the

insulator near the semiconductor-insulator interface, resulting in a slow decay of drain current with a fixed gate voltage.

This effect is usually dependent on temperature and voltage. In terms of device transfer characteristics (I_D vs. V_g), it can be represented as a shift of the characteristics to the right, corresponding to an increase in threshold voltage with time.

The second drift mechanism decreases the threshold voltage. If positively charged ions are introduced into the insulator, because of water vapor, for example, the ions will move toward the semiconductor surface when the gate voltage is positive, attracting more electrons and causing the drain current to increase. This effect is also dependent on temperature and voltage and is stronger if the SiO film's water-vapor content is increased.

Drifts occur over periods of a few hours to a few days at room temperature and in most cases are reversible. In a typical TFT with SiO as the gate insulator and CdSe as the semiconductor, and with a gate voltage of 5 volts across a 300 Å insulator, the threshold voltage could be expected to increase by 2 to 4 volts at room temperature.

Device fabrication and materials strongly affect the drift mechanisms. Much research effort has gone into improving devices that use SiO as the gate insulator, but to little avail.

More stable TFT's have been fabricated with Al_2O_3 as the gate insulator in an inverted structure. The gate is deposited on the substrate and the aluminum oxide film grown anodically in a dry oxygen plasma. The semiconductor (CdSe) and source and drain contacts are then deposited.

Under positive gate bias, the Al_2O_3 transistors show neither of the two drift phenomena found in SiO devices. Measurements show that even with gate insulator fields greater than 10^6 volts/cm, the gate threshold voltage does not change.

The Al_2O_3 device has also demonstrated a resistance to motion of ions through the insulator, and is less sensitive to atmosphere and water vapor than is the SiO device. The newer transistors have operated without deterioration under extremely humid conditions.

The TFT's have excellent electrical characteristics for digital applications. Because of their reduced surface state density, they typically operate in the enhancement mode with a high transconductance—about 1,000 micromhos—and a threshold voltage of less than 1 volt. A low threshold voltage is required in low-voltage, low-power, complementary symmetry circuits.

In the making

If the TFT is to be used in an integrated circuit, its fabrication must be compatible with that of the circuit's passive elements. The processing of TFT's has reached the state where thin-film circuits have been developed with more than 1,000 active and passive elements.

The two basic TFT structures are built on an insulating substrate such as quartz or borosilicate

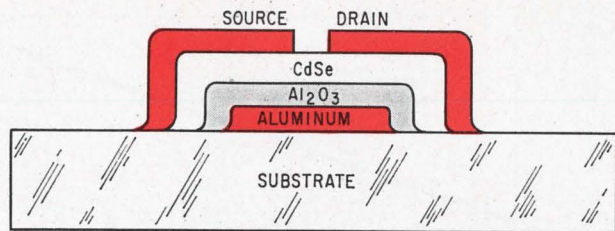

Inverted. With the gate deposited first, the aluminum oxide insulator can be formed directly on the gate lead.

glass. In one process, the semiconductor film is deposited after the source and drain electrodes and is followed by the gate insulator and metal gate. All elements of the transistor are formed by vapor deposition and all areas are defined by mechanical metal masking. In the other process, source and drain are deposited last.

With either type of structure, the insulating substrate is vapor degreased and ultrasonically cleaned before being put in the vacuum system. The substrate is then placed in the alignment jig used to

Joining forces

The aluminum oxide technique is also being applied to silicon insulated-gate field effect transistors. Author Waxman and RCA Laboratories researcher Karl H. Zaininger have fabricated devices combining the two materials to achieve a resistance to radiation effects better than afforded by silicon insulated by silicon nitride or hardened silicon dioxide.

The use of aluminum oxide, they say, also eliminates the need for the ultraclean procedures commonly followed to prevent contamination of the silicon surface when making metal oxide semiconductor transistors.

The aluminum oxide is formed much as it is for thin-film transistors. Aluminum is deposited on p-type silicon wafers that are then placed in the vacuum system. Dry oxygen is admitted and a plasma is ignited. With the sample positively biased with respect to the plasma, the aluminum film is anodized to Al_2O_3 .

When first made, the samples had a high density of positive oxide charge and a large negative threshold voltage. However, annealing at 300° to 400°C in an inert atmosphere for about an hour has been found to relieve these problems.

The transconductance of the finished device is 4,000 micromhos and the threshold voltage is less than ± 0.5 volt. The work was reported in the Feb. 1, 1968 issue of Applied Physics Letters.

Researchers at Bell Telephone Laboratories' Allentown, Pa. facility also have used aluminum oxide as an insulator for silicon 1GFET's, both in discrete and integrated form. The Al_2O_3 is deposited over silicon dioxide on the wafer before a second layer of silicon dioxide is deposited to act as a mask during etching. This mask layer is removed during the last etching step. The resulting devices had a threshold of -1 volt with a 500 Å layer of Al_2O_3 over a 1,000 Å layer of SiO₂.

A shift register built with aluminum oxide was operated with clock rates from d-c to 2 Mhz.

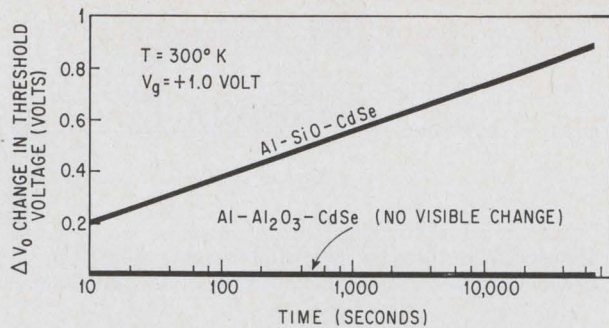

No contest. Comparison of threshold voltage drift for silicon monoxide and aluminum oxide TFT's shows the aluminum oxide device to be more stable.

maintain registration between the various depositions.

Because many transistors are made on a single substrate, the distance from the evaporation sources to the substrate must be great enough—about 13 inches—to maintain uniformity across the substrate. This gives less than 0.5% variation in film thickness.

In the first structure discussed, the source and drain are typically 100 mils long and 0.4 mil apart. Gold about 400 Å thick is commonly used. In n-type CdSe transistors, a layer of indium less than 20 Å thick may be deposited over the gold to improve the ohmic contacts to the semiconductor film. Film thicknesses are monitored by a quartz crystal element, and all depositions are made with a starting pressure of 5×10^{-7} torr in the bell jar.

The semiconductor film is next deposited on a substrate either held at room temperature or heated to increase resistivity. With CdSe, the slower the rate of deposition, the higher the film conductivity. Semiconductor film thickness is typically 1,000 Å.

In the older TFT's, 200 Å of SiO is then deposited as an insulator, followed by an aluminum gate electrode. After deposition, the transistors are annealed at temperatures of 150° to 200°C.

Variations

Special applications have sometimes led to variations from this basic fabrication technique. Wire grills have been used in conjunction with metal masks developed by Weimer to produce arrays of TFT's with source-drain gaps as narrow as 0.1 mil. In addition, multilayer insulator depositions have been employed to minimize the gate input capacitance.

In the inverted TFT structure, the array of aluminum gates is evaporated onto the insulating substrate and the Al₂O₃ is formed anodically on the aluminum in a dry oxygen plasma in the vacuum system. After oxygen is admitted, a glow discharge is ignited between an anode and cathode.

Each aluminum gate on the substrate is connected through a contact jig and biased positively with respect to the plasma. The growth rate of Al₂O₃ is 23 Å/volt applied to the gate. The aluminum gate is usually 1,500 Å thick and the Al₂O₃ layer about 500 Å. The alignment of the gate insulator with the gate electrode is perfect since Al₂O₃ grows only where the aluminum gates are.

Deposition of the semiconductor film—again CdSe—is followed by an alloy of indium-gold for electrodes. The source-drain gap is again 0.4 mil and is defined by metal masks and fine wires. After completion of this process the transistor is annealed in a hydrogen atmosphere.

The fact that these devices show little or no deterioration over long periods of time probably reflects the relatively closed nature of the structure; the conducting channel is under the semiconductor film and adjacent to the insulator, and the Al₂O₃ seals off contaminants.

The primary drawback is that the gates must be connected during anodization, a difficult problem in complex integrated circuits. An alternate approach that has proved feasible is to deposit aluminum over the entire substrate, anodize a 500 Å

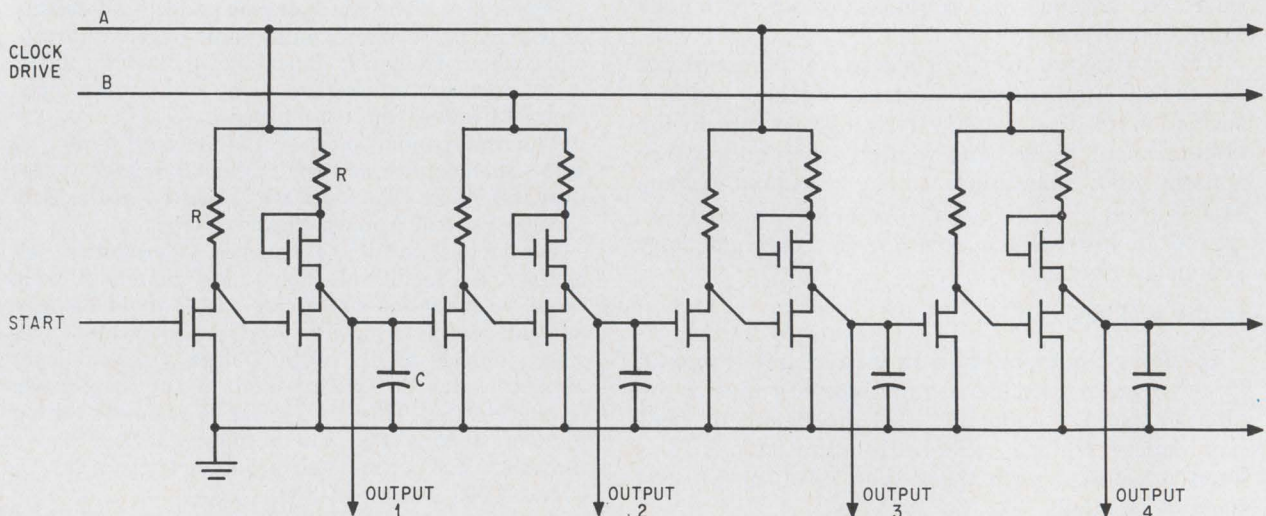

Scan generator. Drive circuitry for a 180-by-180-element thin-film image sensor array. The TFT's with the gates connected to the drains act as thin-film diodes.

insulating layer on top, and use photolithographic techniques to define the gate and gate insulator regions. The complex patterns are thus formed after the anodization.

An inverter stage consists of a transistor in series with a load impedance, which may be a resistor, a similar transistor, or a complementary transistor. The complementary-pair inverter is the fastest of these types and draws the least standby power. A flip-flop formed from two complementary inverters, in turn, will draw little current regardless of which state the flip-flop is in. This feature is particularly useful in multistage shift registers and memory stage arrays.

Thin-film inverters have been made in large arrays with pairs of CdSe and Te TFT's.²

In a 264-stage parallel-output shift register designed for scanning a photosensitive array, a voltage pulse of either polarity is transmitted from one stage to the next at a rate set by the clock frequency. Each stage of the register comprises two complementary inverters and two or three additional transistors. Another output inverter is included in each stage as an array driver, making a total of 1,320 CdSe TFT's and 792 Te TFT's on a single glass substrate.

A 180-by-180-element image sensor array with integrated scan generators has been constructed for use in an experimental solid state vidicon.³ The sensor array has two 180-stage shift registers, a column of 180 TFT's to separate out the video signal, and a 180-by-180 array of photoconductors and diodes. The four subcircuits are deposited on separate 1-inch-square glass substrates that are subsequently joined with epoxy and interconnected by 180 metallic strips deposited across the epoxy joint.

This thin-film circuit contains 540 CdSe TFT's,

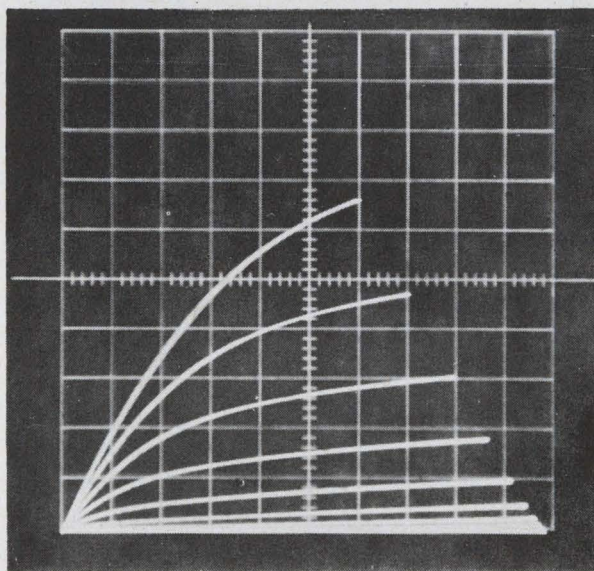

Curve tracing. Characteristics of aluminum oxide-cadmium selenide TFT. Horizontal axis is drain voltage, 0.5 v/div.; vertical is drain current, 0.5 ma/div.; gate voltages step down from 2.4 v, for top curve, by 0.4 v for each lower curve.

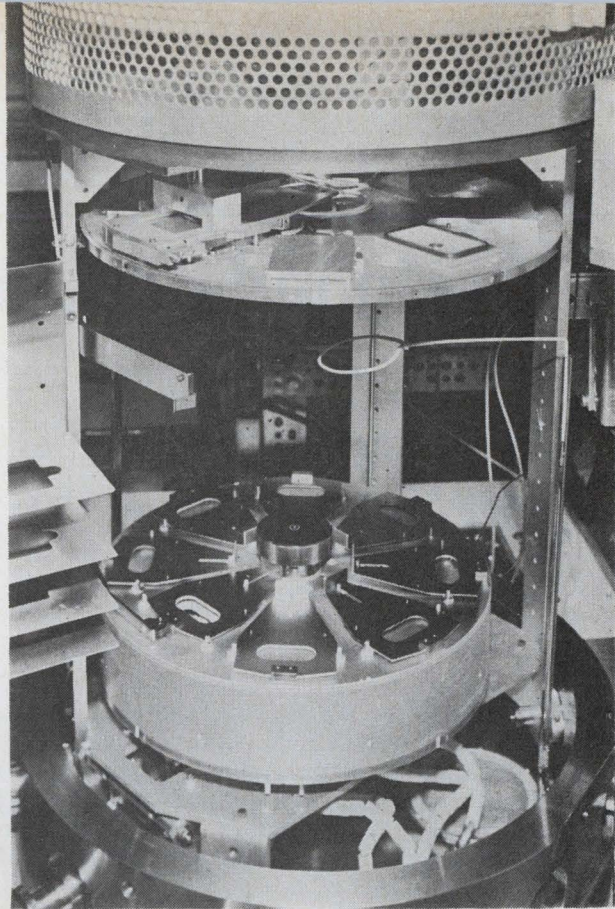

Deposition chamber. Vacuum system for anodizing the aluminum gate lead to form the aluminum oxide.

360 nichrome resistors, and 180 capacitors. The diodes are field effect types made by connecting the gates and drains of 180 of the transistors.

Deposition of this circuit required about 25 successive evaporations during one pump-down of the vacuum system. Yield was relatively good, and many experimental units have been made in which pulses could be transferred through the entire register. Several units have been life tested successfully for thousands of hours at temperatures up to 85°C, and the unloaded register has operated at clock frequencies ranging from 5 kilohertz to more than 2 Mhz.

References

1. H.L. Wilson and W. Gutierrez, "Tellurium TFT's exceed 100-Mhz and 1-watt capabilities," *Proc. IEEE*, March 1967, p. 415.
2. P.K. Weimer, G. Sadasiv, J.E. Meyer Jr., L. Meray-Horvath, and W.S. Pike, "A Self-Scanned Solid State Image Sensor," *Wescon Technical Papers*, August 1967.
3. P.K. Weimer, G. Sadasiv, J.E. Meyer Jr., L. Heray-Horvath, and W.S. Pike, "A Self-Scanned Solid State Image Sensor," *Proc. IEEE*, September 1967, p. 1591.

Bibliography

- W.A. Gutierrez and H.L. Wilson, "Thin-Film Metal Base Transistors," *Proc. IEEE*, August 1966, p 1114.
- P.K. Weimer, "The TFT—A New Thin-Film Transistor," *Proc. IRE*, June 1962, p. 1,462.
- F.V. Shallcross, "Cadmium Selenide Thin-Film Transistors," *Proc. IEEE*, May 1963, p. 851.

Designer's casebook

Designer's casebook is a regular feature in Electronics. Readers are invited to submit novel circuit ideas, packaging schemes, or other unusual solutions to design problems. Descriptions should be short. We'll pay \$50 for each item published.

FET keeps long staircase steps flat

By Kenneth J. Bray

Tufts University, Medford, Mass.

Pulses with a low repetition rate can be counted accurately when a field effect transistor is added to a staircase generator. Acting as a unity gain amplifier, this transistor isolates the waveforming capacitor from the generator's unijunction transistor. Exponential decay of the staircase step voltage—caused by leakage in the emitter base junction of the UJT—is therefore prevented.

Called droop, this voltage decay throws the counting of the staircase generator into error. An extra pulse, which the generator is not adjusted to count, makes up the losses caused by decay.

A narrow pulse turns Q_1 on long enough to allow capacitor C_1 to charge to a value equal to the difference between the supply voltage and the potential drop across R_1 . This charge voltage gates FET Q_2 into conduction. The drain-to-source current of

Q_2 causes a voltage drop across R_2 equal to the voltage on C_1 . This voltage remains on C_1 and across R_2 until the next pulse raises these voltages by an equal amount.

Charging of the capacitor by the pulses continues until the potential across R_2 reaches the trigger voltage of C_3 . When this voltage, expressed by the following equation:

$$V_p = \eta V_{cc}$$

where V_p = trigger voltage

η = intrinsic standoff ratio of UJT

V_{cc} = supply voltage

triggers the UJT into conduction, current flow through R_3 develops a bias voltage for Q_4 . This voltage biases Q_4 into saturation and causes an immediate discharge of C_1 .

Since the charge on C_1 is dependent on the value of R_1 , adjustment of this potentiometer determines the number of pulses necessary to trigger the UJT.

Heart beat, uterine contractions, and the respiration rate are pulses accurately monitored by this counter.

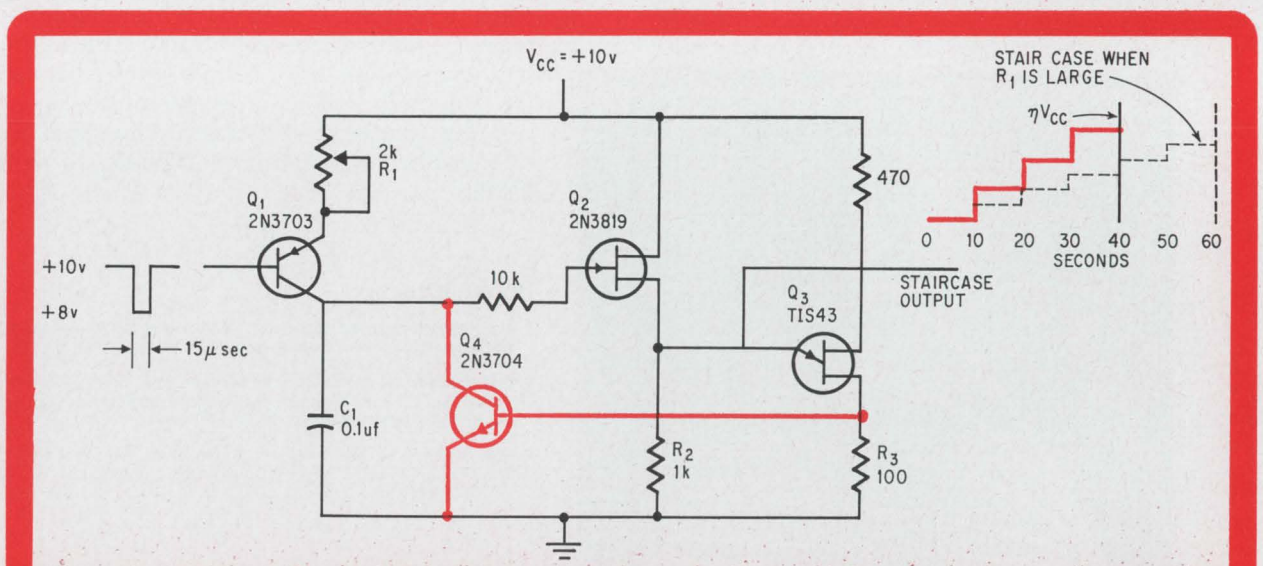

Pulse counter. Each pulse raises the voltage on capacitor C_1 in equal increments until it triggers the UJT into conduction. The voltage that appears across R_3 signals the summation of pulses and makes Q_4 discharge capacitor C_1 .

Oscillator as detector

By D.B. Hoisington

Naval Postgraduate School, Monterey, Calif.

Nonmagnetic screws and nails hidden below the surface of a teakwood deck or plywood bulkhead can wreck saw blades and tear sandpaper during a ship's refitting. Since they are nonmagnetic these fasteners cannot be detected by conventional devices that use a soft iron needle. However, they can be detected by an oscillator in which the metallic characteristic of the hidden fastening changes the flux density of the oscillator coil's magnetic field.

The coil is wound on a toroidal core with a small semicircular segment removed. The coil is the inductive element in the tank circuit of a Colpitts oscillator and is clamped to a laminated copper plate that acts as an electrostatic shield. A Faraday window, etched through the plate at the areas where the flat surfaces contact it, allow the field to appear on plate's other side.

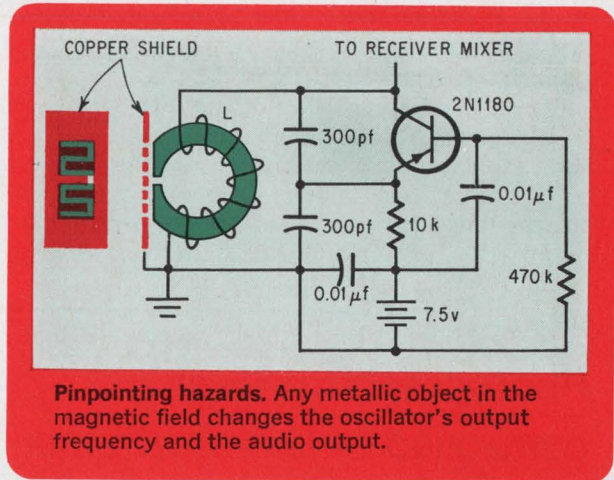

If the magnetic field hits a metallic screw or nail while the plate is moved over the wood surface, the oscillator signal changes by 1 kilohertz. This changes the beat frequency output of a receiver mixer and is heard as a change in the audio output.

SCR synchronizes gate

By Roy A. Wilson

Hycon Mfg. Co., Monrovia, Calif.

Trains of clock pulses gated into some digital circuits must start on the leading edge of the first pulse and end on the falling edge of the last. Complete pulses may be necessary for proper synchronization

of circuits or because incomplete pulses may not have the power to trigger transistors. Consequently, when only portions of pulses are applied, false synchronization or no synchronization may result, and the operation might be impaired.

Operation of the circuit takes place only when the gate switch is manually depressed, but closing the circuit does not cause immediate gating. If there is no pulse at the input, neither Q_1 nor the SCR will be biased into conduction.

If a pulse is present when the switch is closed,

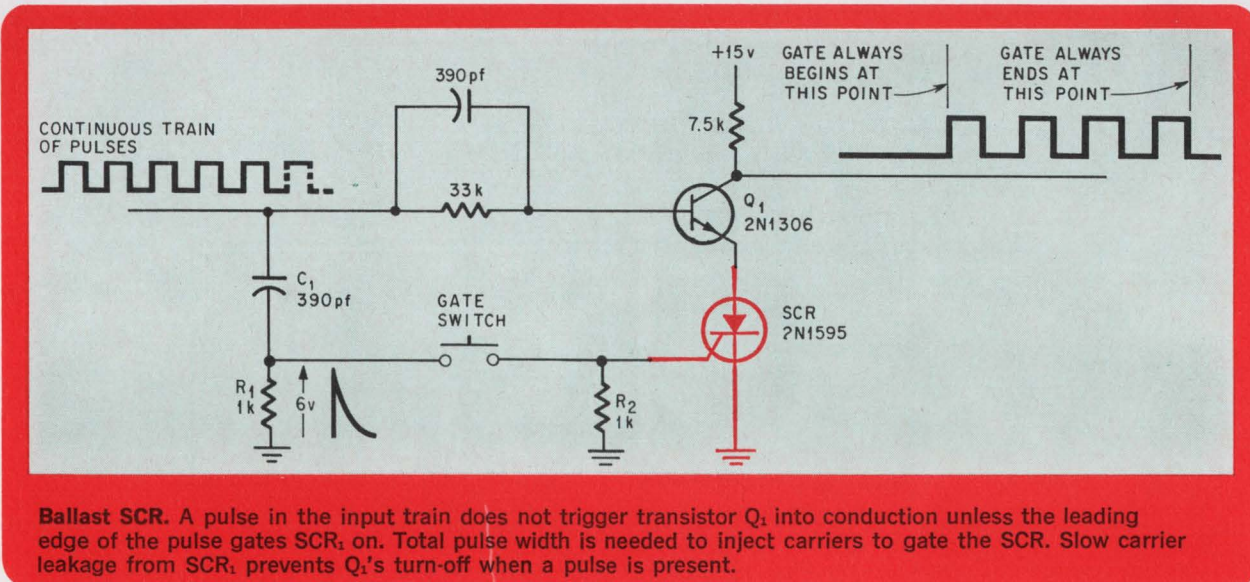

gate action does not take place either. The voltage across R_1 , which was 6 volts at the beginning of the pulse, has dropped due to the charging of C_1 to a point where it cannot trigger the SCR.

When the leading edge of the next pulse places 6 volts across R_1 and simultaneously biases Q_1 into saturation, the SCR is gated on. The collector voltage of Q_1 moves from 15 volts to ground, thus forming the leading edge of the gate's output pulse. It remains there until the pulse at the base returns to

zero and forces Q_1 and the SCR to turn off. Each succeeding clock pulse biases Q_1 into conduction and places a negative pulse on the collector until the switch is opened.

If the switch is opened during a pulse, the circuit does not stop immediately but continues until the pulse is completed. At completion, the SCR current drops below its holding value. With the switch open, the succeeding pulse cannot trigger transistor, Q_1 , into conduction.

Photographic printer controlled by UJT-SCR timer

By Doar Lior

Tel-Aviv, Israel

Common incandescent bulbs—controlled by an electronic timer—produce constant illumination for photographic printing. The timer keeps the bulb's filament temperature close to the illumination point so that turn-on current causes a sharp and immediate increase in intensity. When the desired printing time is ended, a silicon controlled rectifier in the timer shunts the bulb and makes the intensity drop quickly.

As long as the standby switch is closed 320 volts d-c appears across C_1 and supplies 6.2 milliamperes to the 10-watt bulb. When the timer switch is

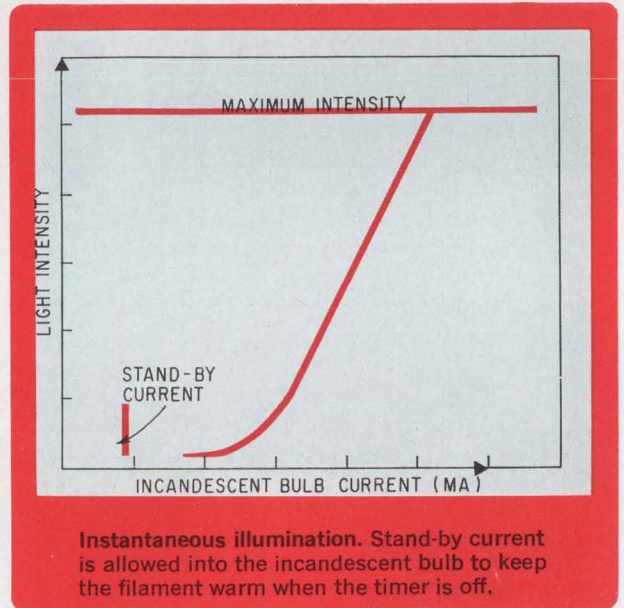

Instantaneous illumination. Stand-by current is allowed into the incandescent bulb to keep the filament warm when the timer is off.

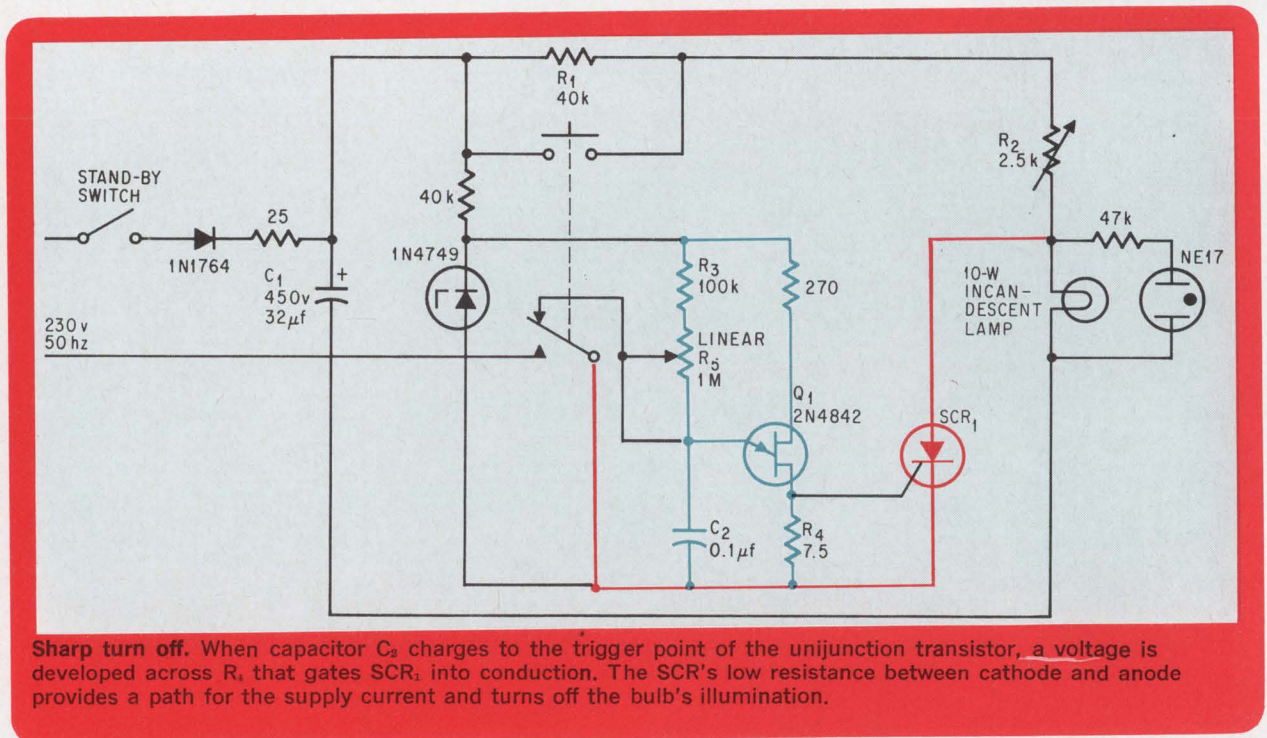

Sharp turn off. When capacitor C_2 charges to the trigger point of the unijunction transistor, a voltage is developed across R_4 that gates SCR₁ into conduction. The SCR's low resistance between cathode and anode provides a path for the supply current and turns off the bulb's illumination.

closed, R_1 is bypassed and 43 milliamperes flows into the bulb, increasing the intensity of light to the maximum. Closing the switch also removes the short circuit from around C_2 thus allowing that capacitor to charge through R_3 and R_5 . When the trigger point of unijunction transistor Q_1 is reached, it fires and current flows through the base 1 resis-

tor, R_4 . The pulse developed across this resistor gates SCR_1 into conduction and SCR_1 shunts the bulb with the low resistance path of the rectifier.

Opening the timer switch returns the circuit to the standby condition and allows the capacitor C_2 to discharge through the switch.

Time variations are achieved with R_5 .

Feedback reduces bio probe's input capacitance

By G.W. Horn

Institute of General Physiology, Torino University, Torino, Italy

A bioelectric probe circuit that amplifies voltage pulses produced in a protoplasmic membrane for input into a recording system can be built so the input capacitance is virtually zero and the input resistance very high. By applying feedback, the circuit overcomes the usual low pass filtering action produced by the extremely high resistance of the small-diameter probe and the input capacitance of the recording instrument.

In living cells, a steady voltage of about -50 millivolts is maintained across a membrane that contains protoplasmic matter by ion exchange. During excitation of the cell, the transmembrane voltage falls to zero and then rises to about $+80$ mv in a few microseconds; the cell then returns to its initial conditions in about one millisecond.

Transmembrane voltages may be detected by special glass microelectrodes having tip diameters smaller than half a micron; the tiny microelectrodes are filled with potassium chloride. The small tip diameter facilitates penetration of the cell's membrane without interfering with the cell's biochemical behavior. The series resistance of the glass microelectrode, due to its small size and electrochemical junction, is in the 10 to 100 megohm range. In uncompensated systems, the microelectrode resistance combines with the input capacitance of the recording instrument to produce an

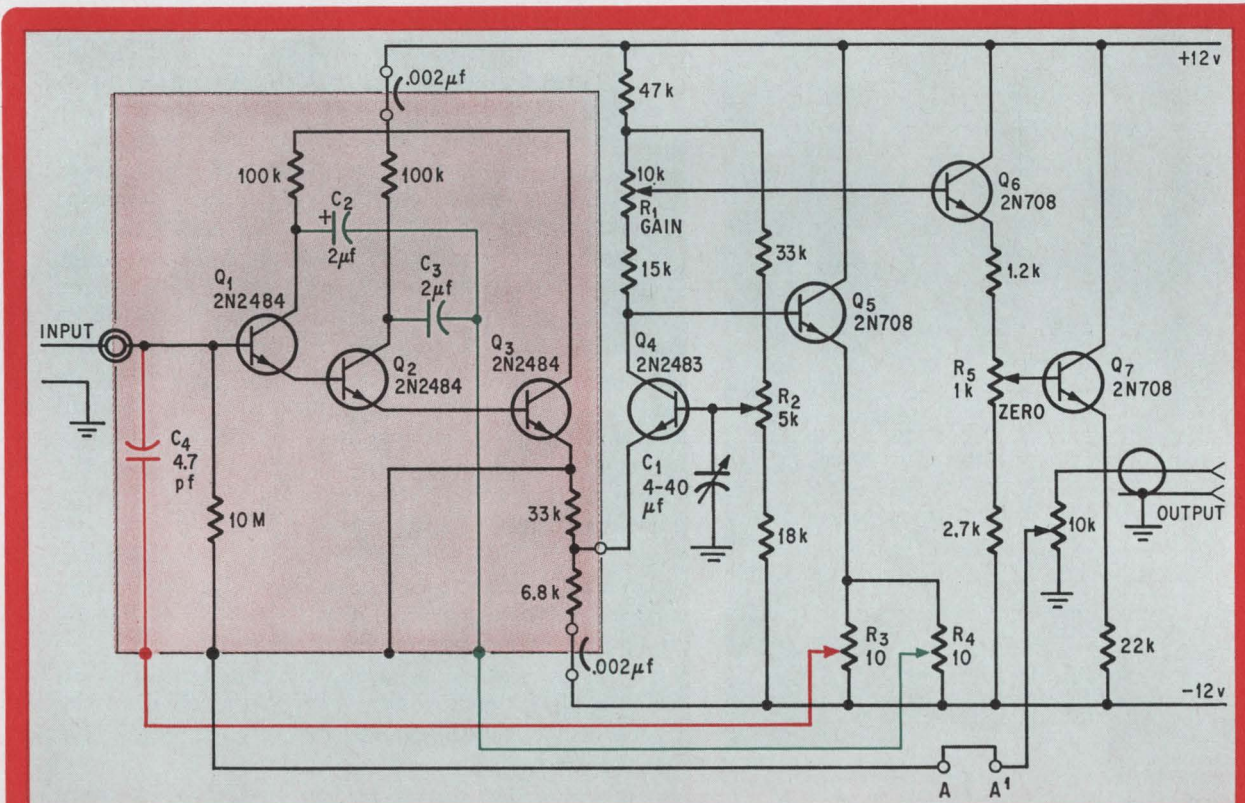

Probe circuit. Transistors Q_1 , Q_2 and Q_3 form a negative-capacitance impedance converter that is followed by d-c amplifier Q_4 and output emitter followers Q_5 and Q_7 . Zero input capacitance and high input resistance are assured by controlling R_3 , R_4 and C_1 .

RC filter that distorts the transmembrane voltage pulses the system is attempting to detect and record. Such low pass filtering is eliminated by the probe circuit that employs feedback to reduce its input capacitance almost to zero (less than 0.02 picofarads) while presenting a typical input resistance of 20,000 megohms. The probe circuit is essentially a negative-capacitance impedance converter followed by a d-c amplifier and two emitter followers. The typical input resistance of 20,000 megohms

is achieved by arranging three 2N2484 silicon planar transistors, Q_1 , Q_2 , and Q_3 in a Darlington configuration. It was found that MOS FET's were unsuitable because the electrostatic charge collected by the glass microelectrode during its placement in the cell body usually destroys the MOS FET substrate. Collector bootstrapping of Q_1 and Q_2 via capacitors C_2 and C_3 greatly reduces the input capacitance. Virtually all stray capacitances with respect to ground were neutralized by connecting the guard ring of the input connector and the shielding box containing Q_1 , Q_2 , and Q_3 to the emitter of Q_3 .

The Q_1 - Q_2 - Q_3 impedance converter is followed by d-c amplifier Q_4 , which is stabilized by strong negative feedback from the collector to the base of Q_4 ; the negative feedback reduces the stage gain to about 10 decibels. Trimmer capacitor C_1 may be adjusted to reduce the collector-to-base feedback in Q_4 (and thereby raise the gain of Q_4) at higher frequencies—up to the stage's peak response of about 1 megahertz. Two emitter followers Q_6 and Q_7 are operated in cascade to shift the amplified signal from the collector of Q_4 down to zero volts d-c, the base line voltage of the input signal is thus restored. The emitter followers also provide for gain adjustment via potentiometer R_1 . The probe circuit is usually operated at unity gain.

Any residual input capacitance is neutralized by the a-c feedback path from potentiometer R_3 in the emitter of Q_5 to the base of Q_1 via capacitor C_4 . Potentiometer R_4 , also in the emitter of Q_5 , provides adjustable bootstrapping current to the collectors of Q_1 and Q_2 via capacitors C_2 and C_3 . The operating point of d-c amplifier Q_4 may be adjusted with potentiometer R_2 to assure balanced operation in both positive and negative directions.

By proper adjustment of R_3 , R_4 , and C_1 , the probe circuit can be operated at virtually zero input capacitance (0.02 pf or less) and an input resistance greater than 10,000 megohms (with 20,000 M being typical); thus, a square wave applied to the probe circuit through a 50-megohm resistor (to simulate the microelectrode resistance) shows practically no attenuation in the first scope trace; the square wave's rise time is degraded to about 2.5 microseconds. The other two scope traces show the probe's response to a square wave input for the overcompensated and undercompensated cases, respectively. The sweep frequency of the Tektronix Type 502A dual-beam oscilloscope was 10 μ sec per division and the vertical display was set at 100 mv per division to produce the traces.

If a still greater input resistance is required, additional positive feedback may be applied to the base of Q_1 from the emitter of Q_7 (AA') which is at 0 d-c level.

If the probe circuit is supplied with ordinary mercury cells, the total drift, without regulation, is about 100 μ v/ $^{\circ}$ C.

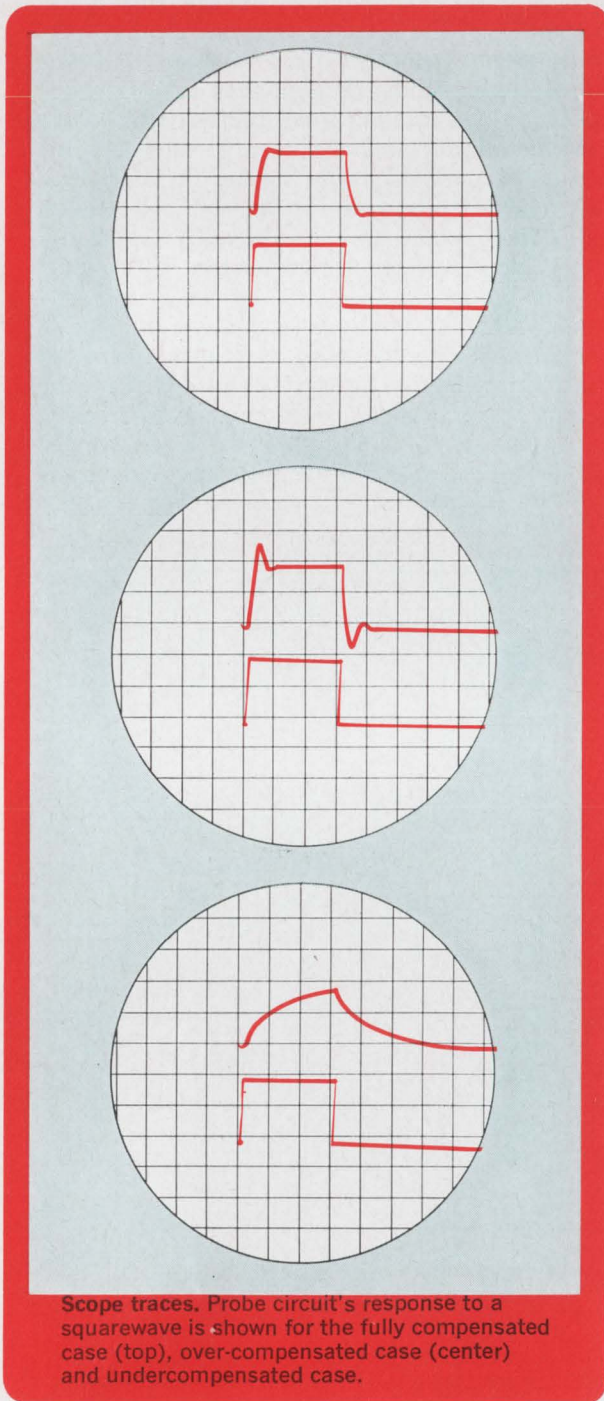

Scope traces. Probe circuit's response to a squarewave is shown for the fully compensated case (top), over-compensated case (center) and undercompensated case.

tiny, but tough,

the Clare MF relay does a *big* job in .046 cu. in.

It's built for action. Whether the job calls for one operation with certainty, or for consistent reliability over more than 150,000 operations, the MF delivers proven Clare performance.

Design around the Clare MF for space-saving efficiency in the most demanding military and industrial circuits. Provide long electrical and mechanical life under extreme conditions of shock, vibration and linear acceleration . . . and temperatures from -65°C to $+125^{\circ}\text{C}$. Meet advanced pcb circuit requirements with low profile, high-density switching you can depend on, dry circuit to 0.5 amps.

For complete design information, circle reader service number—or ask Clare for Data Sheet 756 . . . Write Group 3N7.

C. P. Clare & Co., Chicago, Illinois 60645
. . . and worldwide



a GENERAL INSTRUMENT company

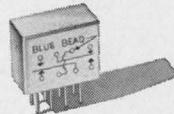

MF Relay: Actual size

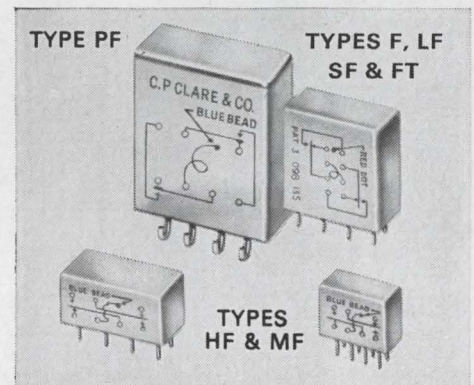

- Clare Military-Type relays include: New 10 amp Type PF, standard size Type F, latching Type LF, sensitive SF, half-size Type HF, one-sixth size Type MF, and Type FT for noise and thermal voltage problems. All meet appropriate MIL-R-5757D requirements
- Sensitivities from 40 mw
- Versatile contact capabilities . . . low level to 10 amp. Gold-plated contact areas, with high contact pressures and positive wiping action. Bifurcated contacts (F, FT, LF, SF, HF)

CLARE MILITARY-TYPE (crystal can) RELAYS

for airborne, aerospace and ground support equipment,
industrial and commercial control systems

Join the Bug-of-the-Month Club

It's exclusive . . .

Tailored just for the lighting bug engineer who wants the latest information on miniature lamps at his fingertips. Detailed technical data that fills the information gap on a thousand-and-one industrial applications.

Best of all, Bug of the Month Club members are entitled to receive information on new lamps just as soon as they come off the

production line. And, just to make it official, a membership card and suitable-for-framing certificate are furnished when you enroll.

Why the ballyhoo?

Mostly because Chicago Miniature has the most complete, highest quality line on the market.

It got that way by promptly filling customer needs just like yours and we'd like to share our lamp development and technology on a continuous basis. That's what the Bug of the Month Club is all about

and you can join by circling the reader service number. Anyone can join regardless of race, creed, political affiliation or financial status.

And that's about as exclusive as you can get!

For application assistance, contact your Chicago Miniature Sales Representative. For off-the-shelf delivery, contact your local Authorized Chicago Miniature Electronic Distributor.

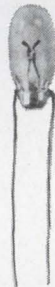

Chicago Miniature Lamp Works

Bug-of-the-Month Club

This is to certify that the undersigned is a member in good standing of The Bug-of-the-Month Club and is entitled to all rights and privileges thereof:

John A. Doe

Chicago Miniature Lamp Works

4433 N. Ravenswood Ave., Chicago, Illinois 60640, (312) 784-1020



Through thick and thin with infrared beams

Spectrometers improve nondestructive optical-interference techniques of measuring the depth of wafers' epitaxial layers automatically, and without sacrificing resolution, accuracy and reliability

By Thomas E. Reichard

Monsanto Co., St. Louis, Mo.

Optical-interference methods may be precise when it comes to measuring length, but they tend to be time-consuming. And time is a critical factor on a production line. A semiconductor-device maker, for example, must quickly and accurately measure the thickness of epitaxial films. Recent advances in infrared scanning techniques now make it possible to apply an automated method of interference measurement speedily without any loss in accuracy or resolution.

Because of the optical properties of the materials involved, the useful wavelengths for interference measurements of semiconductor epitaxial films are limited to the infrared range of about 7 to 40 microns. However, measurements in the infrared are particularly difficult for wavelengths greater than 10 microns. One reason is that a very small proportion of the source energy is emitted at long wavelengths; another is the scarcity of optical materials capable of transmitting long wavelengths; a third is the very-sensitive thermal detectors required.

With the optical-interference technique, a beam of light aimed at the wafer is partially reflected from the front and rear surfaces of the film and the resulting interference-fringe pattern is related

to film thickness.

The Monsanto Co. has developed a fast-scanning infrared spectrometer capable of making up to 15 thickness measurements a minute. Not only is the approach nondestructive, but the test specimen doesn't have to be removed from its protective plastic bag. Monsanto's system incorporates an optical-mechanical computer to place marker lines on a cathode-ray display of the waveform pattern. All the operator need do is align the markers with the maximum and minimum peaks. A digital readout then gives the thickness ranging from 1 to about 85 microns.

A common way of measuring the layer's thickness is the lap-and-stain method. But this is destructive—a wafer is cross-sectioned, and the exposed surface is stained. Since layers of p material become darker than the n-type layers, a microscope is easily used to measure thickness.

Interfering reflections

Optical-interference techniques are based on the phase relationships of the reflected incident rays. When the reflected light's wavelength is scanned, the interference fringes vary with wavelength on the wafer. Viewed from only one direction, these fringes become brighter and darker as the wavelength is changed.

The brightest fringe occurs at the wavelength at which the waves are in phase; the darkest fringe occurs at a wavelength at which the waves are 180° out of phase. These peaks and valleys occur when the optical-path difference—which is a function of film thickness—between the two reflected rays is an integral multiple of one-half the incident wavelength. Film thickness is thus a function of the wave-

The author



Thomas E. Reichard is a senior research physicist at Monsanto's New Enterprise division. With the company since 1952, he is working on analytical instrumentation and sensors for process-control systems.

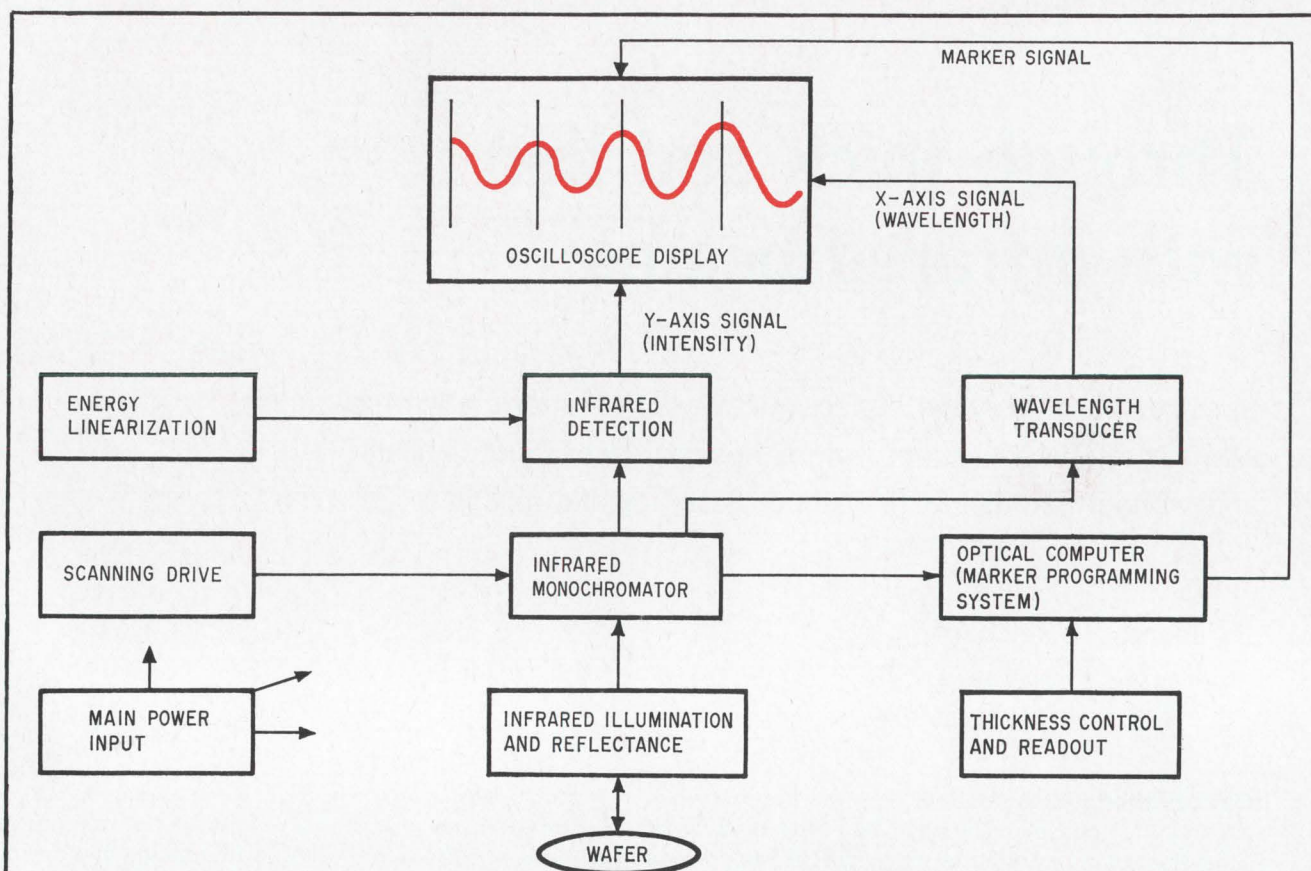

The infrared box. The system consists of a fast-scanning infrared spectrometer with an oscilloscope display and an optical-mechanical computer. The spectrometer employs cesium-bromide prism optics. It differs in a number of ways from the conventional infrared spectrometers commonly used for absorption analysis and epitaxial silicon interference-fringe patterns. It is single beam, direct reading instead of double beam, null balancing. The interference fringe peaks are detected and read out directly, without the usual beam-chopping, lock-in amplification, and demodulation, allowing much faster scanning. The detector—a thermistor bolometer—has faster response and greater sensitivity than the more conventional thermocouple detectors. Beam power is increased fourfold by doubling the slit-width program over that normally used for analytical spectrums. Resolution, however, is reduced, but only by a factor slightly less than two. Moreover, the slit height is more than double that ordinarily used for the same monochromator aperture. This gains another factor of two in beam power, with very little additional sacrifice in resolution. The micro-specular reflectance optics are made all-reflecting to avoid lens absorption. The spectrum is scanned rapidly and repeatedly, in both directions. Scanning speed is varied according to the film thickness being measured. Speeds range from 10-scans per second for 0.10-mil thickness to 0.33-scans per second for 3.0-mil thickness. The fringe spectrum is continuously displayed on a large-screen, long-persistence oscilloscope. The computer places marker lines on the oscilloscope trace along with the fringe pattern. When a wafer is placed on the reflectance spot, its spectrum is continuously displayed and the markers independently moved until they are positioned on all peaks of the fringe pattern. The corresponding film thickness is shown on a numerical dial.

length at which the interference-fringe peaks occur.

Lab devices slow

Previously, film-thickness measurements with this method were made with infrared spectrometers that were designed for infrared absorption rather than reflection analysis. This meant special reflection attachments were necessary. Moreover, since these spectrometers were intended for laboratory rather than production-line use, they lacked sufficient speed. With a conventional spectrometer, about two minutes elapsed before a suitable fringe spectrum was obtained. And still more time was required for the operator to interpret the spectrum and determine the film thickness.

A one-minute scan over the wavelength range of 10 to 35 microns is considered fast for a conventional infrared spectrometer, and a 20-second scan over the same range is probably the fastest possible. Attempts at faster and more automatic systems using conventional spectrometers haven't provided the desired speed, precision, reliability, and reproducibility of results.

Conventional spectrometers employ beam chopping with a-c detection and amplification. This requires amplitude-demodulation systems or null-balancing servosystems to form the interference-fringe spectrum. Since a certain minimum number of detector responses are required to form a single fringe, the spectrometer's scan speed is limited by

the response time of room-temperature infrared detectors. In the far infrared range, the maximum speed is about 20 seconds.

Picking up speed

However, Monsanto's fast-scanning infrared spectrometer, using a commercially available room-temperature detector, has a scanning rate between 0.1 and 3 seconds. Precision and reproducibility of the measurements are better than those obtained with previously available devices. Direct d-c detection and amplification of the infrared spectrum is achieved without beam chopping. This approach was previously considered impractical for a fast-scan spectrometer because of signal-noise problems, nonlinearities in infrared energy, and thermal drifts.

Because of the extremely low radiant power available at far-infrared wavelengths, detection and readout become difficult; the maximum peak-to-valley height of even the strongest fringe pattern seldom exceeds 0.5 microwatts. Under normal conditions, the fast-scanning instrument can reliably detect, display, and measure interference fringes whose maximum peak-to-valley height corresponds to 1% of the total beam energy. Thus, with a maximum peak-to-valley beam power change of about 0.03 microwatts, a temperature change of about 0.000005°C is produced in the active thermistor flake of the detector. The thermistor flake's resistance changes at the rate of 4% per $^{\circ}\text{C}$. The corresponding electrical resistance change is 0.2 part per million.

When biased at 160 volts, the active flake alone produces a signal of 32 microvolts.

With the active thermistor in a bridge circuit having an identical compensating thermistor shielded from the infrared beam, the effects of ambient-temperature drift are minimized. The bridge output is then half that of the active element, 16 microvolts. And with each thermistor element having an electrical resistance of 2.2 megohms, the net bridge impedance is 1.1 megohms. Consequently, the electronics' design has to consider the destructive effect of such high impedance. For example, the bias-power source for the thermistor bolometer in the Monsanto system had to have a low-frequency noise level lower than 2 parts in 10^8 .

For fast scanning, the detector's signal must be read out directly without the time-averaging, beam-chopping, and phase-locked amplification techniques usually used to extract weak signals from a high-noise background. Furthermore, the nature of the spectrum-scan function, display, and interpretation limits the filtering that can be applied without causing excessive phase lags.

Thus, the active-frequency bandwidth must be left relatively wide; but this, in turn, places extraordinary low-noise requirements on both a pre-amplifier and the thermistor bias-voltage supply.

The preamplifier introduces only about 2 microvolts equivalent input noise in the passed bandwidth. Mounted within the spectrometer, the pre-

amplifier is separated from the detector by a heat-sink wall and a radiation shield. Electrical connections are short and rigid to minimize any microphonic voltages induced by physical vibration. With a gain of 1,500 and a low impedance, the preamplifier's susceptibility to stray-noise effects is minimal. The output signal is fed to the y-axis input of crt display through a bandpass filter.

Putting light on the subject

A light source in the spectrometer system produces radiation that is directed at the semiconductor wafer. The reflected radiation is broken down into individual wavelengths in a monochromator, which is the spectrometer's basic component. An infrared detector then determines the intensity of each wavelength and a voltage corresponding to it is then transmitted to the crt. This voltage is displayed as y-axis information and a voltage corresponding to wavelength is the x-axis.

The interference spectrum of silicon films at different thicknesses are coded into the system's computing device as are the spectrometer's optical and mechanical correlation factors. This computing device triggers the vertical marker lines that accompany the waveform on the crt. The positions of these marker lines are programmed to match the fringe peak corresponding to a specific film thickness.

When the wafer is positioned over the illuminated spot, the interference waveform is continually displayed. The operator, using a single control, moves the marker lines. When the marker lines are positioned, the measurement is completed automatically and the corresponding film thickness is shown on a numerical counter dial.

Eliminating critical parts

Since the display serves only as a reference for both the fringe spectrum and the marker lines, the accuracy and linearity of the wavelength scale aren't critical as long as the same scale is used from one scan to the next. The matching and accuracy are achieved with the computer control.

The scanning drive employed in the Monsanto system has two unusual features: speed is set manually, and scanning is bidirectional.

Because the number of fringe cycles per spectrum is directly proportional to film thickness, the scanning speed is adjusted for different epitaxial layer thicknesses. Thus, the time-frequency relationship of the interference fringes remains within a relatively narrow band at about 20 hertz.

The bidirection scanning saves time, minimizes inertia forces, and reduces mechanical wear of parts. More important, it enables balancing both time and phase lags.

Marking the peaks

The marker-programing system provides the display's movable index marks, which are superimposed on the display fringe spectrum.

The manually controlled index marks establish

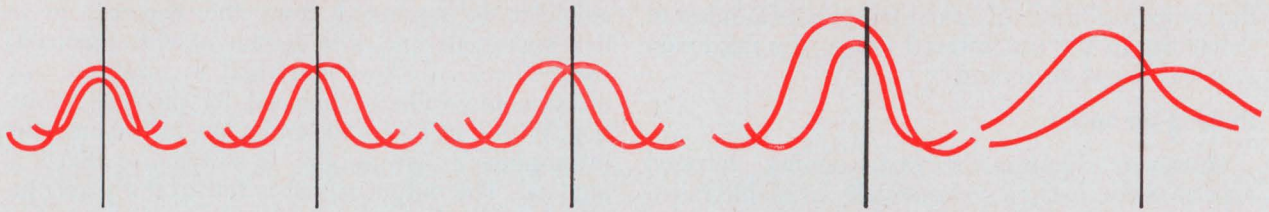

Lag in time. Time or phase lags show up as slight spreading, or mismatches of fringe waveforms on opposite scan directions. These lags are balanced by manual adjustment of marker line at center of the split.

film thickness and can be read directly, or recorded by any suitably calibrated readout system.

Marker lines are generated by a photodiode system.

A silicon photodiode affixed to the spectrometer's Littrow arm, is enclosed in a housing with a 0.002-inch diameter aperture. Immediately above the diode housing is a glass photographic-mask plate that is opaque black except for a series of narrow transparent lines and mounted on a precision micrometer slide. Light focused into a uniform parallel beam illuminates the plate from above.

Whenever the diode housing aperture passes one of the transparent lines on the plate, the photodiode produces a small voltage pulse that is amplified and passed to the marker input of the crt. This pulse triggers a vertical marker line.

The lines on the plate are arranged to correspond with fringe-peak wavelengths for any given film thickness. Moreover, the lines are arranged so that

linear movements of the plate continually change the programed pulses of the photodiode to match other film thicknesses; each inch of plate movement corresponds to a 1-mil wafer film thickness.

Variations in emissivity, reflectivity, and absorptivity of various optical components in this measuring instrument may cause systematic short-range fluctuations in infrared-beam energy throughout the spectrum. Because of resolution and mechanical inertia considerations, these fluctuations cannot be fully smoothed out with a programed slit movement. An auxiliary linearization system introduces programed amounts of compensating radiant energy into the bolometer detector to smooth out any remaining fluctuations. A moving optical-mask device makes abrupt energy changes without inertial limitations.

On the right track

The display is a raster-scanning crt functioning as a fast-response x-y plotter. The crt has a retention time equal to two or more complete scans. As a spectrum is continually scanned, a wavelength transducer system tracks the scanning for the x axis, approximately linearly in microns. The optical-computer system monitors the movement of the spectrometer's Littrow arm and places marker lines precisely at the peak positions corresponding to the computer's thickness setting.

In the infrared range, particularly in the far infrared, radiant energy can be detected only from thermal effects that involve appreciable response-time delays. Because the radiant energy at far infrared wavelengths is weak, some noise-filtering circuitry is necessary in the detection and readout system. This introduces additional time and phase lags.

Monsanto's system, however, balances out all time and phase lags from any source.

When the total lag in the detection and readout system is a small fraction of a fringe cycle, the lag appears on the display as either a slight spreading or mismatch of fringe waveforms from the bidirectional scan. Viewing the superimposition of alternate scans, the operator balances the offset waveforms and positions marker lines at the center of the split.

When similar fringe-peak waveforms are repeated at a constant interval apart, phase lags larger than the fringe width are also balanced and compensated. This results in scanning speeds exceeding detector response.

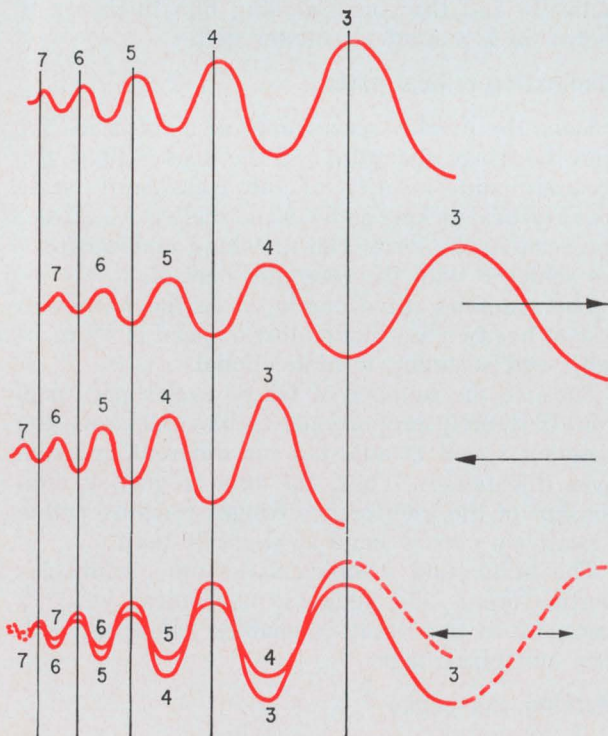

Stretched spectrum. Because scanning speed is nonlinear in time and x-axis distance is linear in wavelength, the fringes are stretched out on the crt and appear as an expanding time scale.

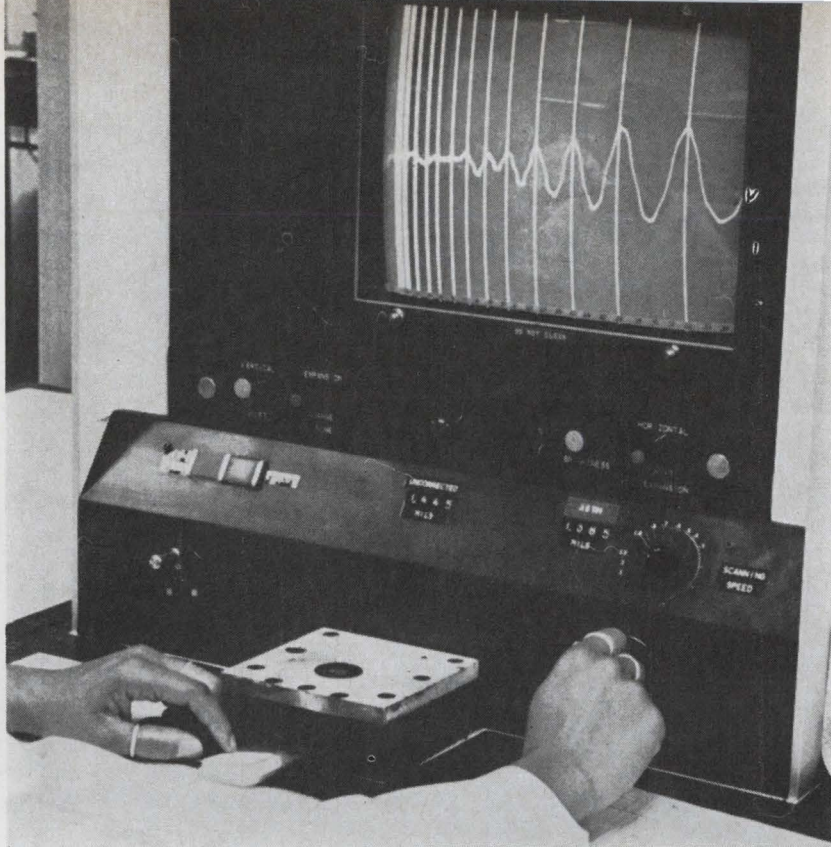

One-handed measurement.
Operator automatically measures film thickness as the marker lines are aligned with the fringe peaks in the displayed waveform.

The total time delay of the detector and readout system is 25 milliseconds on the display screen. For any given wafer, the scanning speed is set so that the interference fringes occur at 50 milliseconds per cycle and the phase lag is exactly 180° . The fringes on the opposite directions are shifted and the spectrums are again superimposed, but with an apparent peak-to-valley phase inversion.

The trace is reinverted electronically on the display, bottom of page 104. At the top is the spectrum of a typical epitaxial film about 0.5 mil thick as it would appear in real time. Marker lines are centered on the peak positions where the infrared-beam energy is highest; numbers indicate the fringe orders.

The spectrum is shifted a half order to the right on the outward scan, and a half order to the left on the reverse scan. Fringe peaks fall at the same position on the x axis for the two shifted scans; valleys, however, differ by one order.

Electronic inversion

On the crt display, the two spectrums are superimposed with the y signal electronically inverted so that the fringe valleys, which occur at the normal peak positions, appear as peaks. At the true wavelength position for an "nth" order, what actually is displayed is the $n+1/2$ order valley on the left-to-right scan, and the $n-1/2$ order valley on the reverse scan. When the operator adjusts the scanning speed to superimpose the peaks on the display, the correct phase relationship is precisely established so the inverted composite spectrum closely matches the true real-time spectrum. The composite is viewed and interpreted the same way as the real-time spectrum.

Since the rate of wavelength scanning is linearly

related to wave number—the reciprocal of wavelength—and the display (x axis) is approximately linear in wavelength, the horizontal sweep is non-linear in time. The sweep, then, is slow at the shorter wavelengths but fast at the longer wavelengths. Thus, the spectrum moves into an expanded time scale and the fringes are stretched out. In the return scan, the peaks are compressed. When two adjacent fringe peaks having different widths on a real-time display are shifted and superimposed in this manner, their widths become equal. This fringe-width expansion and compression occurs only on the display. The shifted fringe retain their original amplitudes, and the superimposed adjacent-order peaks are generally of different heights.

This method enables any combination of fringe-frequency and detection-time lags to be balanced out precisely and the opposite direction waveforms superimposed.

Extra references

Double-line markers are placed at the valley positions for the first several half-orders to provide more reference points for measuring very thin films. This is done because such films form only a few fringe peaks and would be difficult to resolve.

The system's measurement and display technique also makes it a useful instrument for following and measuring gradual variations in film thickness over the surface area of large specimens. In such a situation, the continually repeated cathode-ray display exhibits gradually shifting fringe-peak positions as different film areas on the specimen are scanned. The thickness of any location can be measured by simply adjusting the handwheel as required and reading the thickness from the counter dial.

Sighting in on narrow light beams

Radiometer checks whether optical antenna reduces laser's beamwidth enough for long-range transmission

By Herbert B. Hallock

Grumman Aircraft Engineering Corp., Bayshore, N.Y.

Optical communications were given a big boost earlier this year when the moon-based Surveyor 7 proved the feasibility of such systems by successfully photographing a laser beam transmitted from earth—239,000 miles away. The next test will be the manned Apollo missions in which laser ranging systems placed on the moon will attempt to measure the drift of earth's continents.

But the moon isn't the end of the world for optical-communication experiments; laser techniques are also being considered for the Mars probe NASA is planning.

Because of the distances involved—for a Mars probe, a beam will have to cover between 34 million and 250 million miles—confining the radiated power to an extremely small, precisely pointed beam is difficult. Earth-to-Mars transmissions would require a beam a fraction of an arc-second wide, less than 1/3,600th of a degree. Although laser beams are narrow, they aren't this narrow. The beamwidth would have to be reduced by a telescopic-optics system that acts as an antenna.

In designing a transmitter's optics, an engineer must take into account the laser's coherent power distribution over the antenna aperture if he wants to achieve smallest possible beamwidth. This requires an exact measurement of the power distribution beginning with the laser itself. Since several optical coupling devices and a modulator lie be-

tween the laser and the output antenna, the distribution must be checked at each stage.

Studies conducted for the advanced development section at the Grumman Aircraft Engineering Corp. point to a radiometer as one of the most useful tools in designing optical antennas.

The idea is simply to measure the gain of the antenna by measuring the energy distribution in the far field. But the far fields for lasers are extremely long, making measurements in laboratories either difficult or downright impractical. For example, with an aperture diameter of 10 centimeters and a wavelength of 1 micron, the antenna's far field would be 10,000 meters, or about 6.2 miles. With a diameter of 1 meter and a wavelength of 1 micron, the antenna's far field would be 1,000 kilometers, or about 620 miles. Conventional antenna-range tunnels are only about 100 meters long. Thus, to achieve the desired far-field accuracy, the designer would have to limit aperture size to that of the laser source itself—between 3 and 10 millimeters.

Although large collimators can be developed to replace the tunnel, it's simpler to test the components with existing instrumentation.

It is necessary to maintain close control over background radiation if the laser's output measurement is to be accurate. The directional optics of the radiometer screens out the effect of laboratory lighting in the visual spectrum, and heat sources, such as personnel, in the infrared spectrum. The directional reflective optics also permit the engineer to select a collection area in the far field that isn't limited to the detector-cell area.

Another consideration is the detector. Since lasers emit coherent light beams at many different wavelengths, the detector employed must cover a broad electromagnetic spectrum. Only thermal-type detectors can do the job over a broad range. Their flatness of spectral response allows reliable calibration over the broad range by standards good only over limited wavelengths. Moreover, thermal detec-

The author



Herbert B. Hallock has been with Grumman since 1958. He heads the electro-optics laboratory in the power, optics, and displays section of the Electronics Systems Center.

tors also display excellent linearity.

Properly made thermopiles, for example, without optical filters, should be capable of single-wavelength calibration sufficient for an entire spectrum.

Through a looking glass

To evaluate the optical system's laser, modulator, and other components, the engineer employs a mirror mounted on a small, extremely accurate rotary table that is equipped with a potentiometer readout. The table, whose zero point is set to coincide with the center of the laser beam, is rotated and the laser output values are recorded. When automatic recording is used, the radiometer's output is fed directly to an x-y recorder's y axis, and an input corresponding to the rotated angle is fed to the recorder's x axis.

A 20-power telescope is used to spread the laser beam, thus increasing the resolution of the measurements. Since the source intensity is reduced by a factor of 20^2 or 400, spreading the beam also in-

creases the detector's power-handling capabilities. Moreover, high resolution is helped by covering most of the radiometer opening, leaving only a small collecting aperture. As the table rotates, the laser beam is swept across the aperture. Corrections for optical losses in the instrumentation are made by measuring complete instrument transmission for the laser's radiation.

Even though the reflectance polarization and parallax are usually minor they can be avoided. Instead of a mirror, a rotary table large enough to mount the laser can be used, and measurements can be taken directly from the laser.

Achieving accuracy

The radiometer used at Grumman is the Barnes Engineering Co.'s R8T1. When Grumman's laser studies began in 1964, the spectral coverage—0.4 to 13 microns—of a thermistor bolometer with a barium-fluoride window exceeded the spectrum of the available lasers. Today, however, the laser spec-

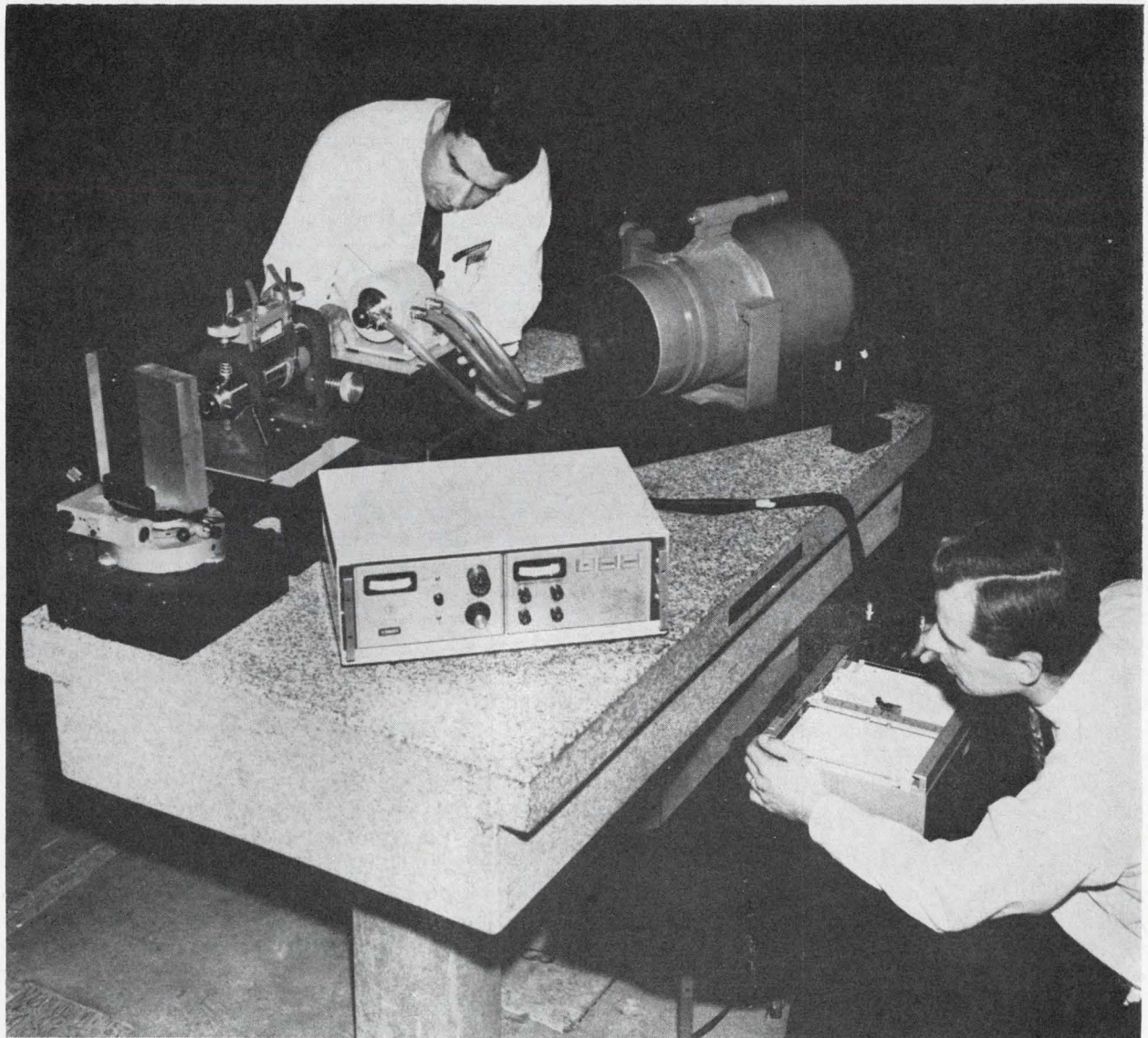

Shaping up. Members of Grumman's electro-optical engineering lab check shape of c-w ruby laser's output with Barnes R8T1 radiometer and xy recorder.

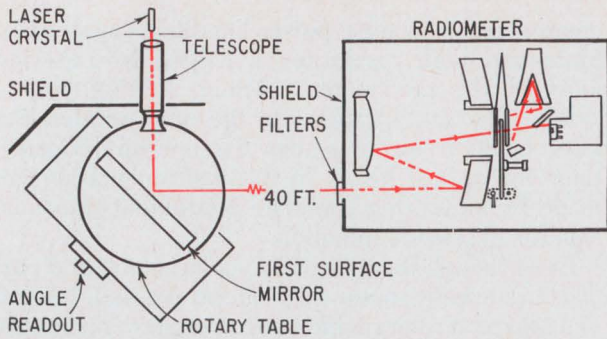

Rotary director. Angular distribution of laser output is checked with radiometer connected to an xy recorder. Mirror mounted on small rotary table directs laser beam to radiometer. The radiometer is placed about 40 feet from the mirror during the actual test.

The increasing spectrum

Laser	1964	1968
N ₂ gas	Not available	3371 Å (0.337 μ)
CdS semiconductor	Not available	4950 Å (0.495 μ)
He-Ne gas	6328 Å, 1.15 μ and 3.39 μ	No change
Nd: yag	1.06 μ	No change
Ho: yag	2.10 μ	No change
Co ₂ -N ₂ -He gas	Not available	10.6 μ
H ₂ O gas	27.9 μ, 118.6 μ, 337 μ	No change

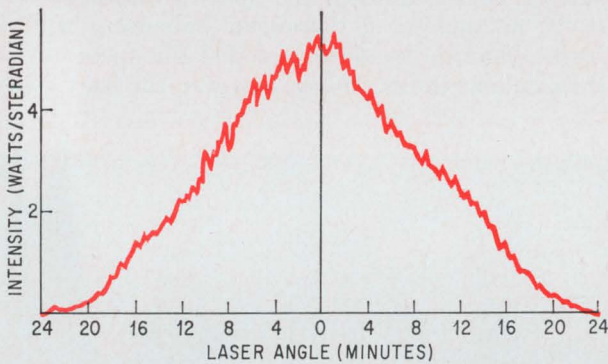

The results. Power profile plotted automatically of a c-w ruby laser, at left. Done in 1966, the plot shows the broad angular distribution of early lasers. Moreover, the xy-recorder plot displays magnitude discontinuities resulting from instability in the laser's output amplitude. On the other hand, the angular distribution of a c-w helium-neon gas laser is confined to a much narrower beam. The plot of the gas laser is smooth because it is a faired curve plotted from data recorded during a test and not directly from the radiometer output.

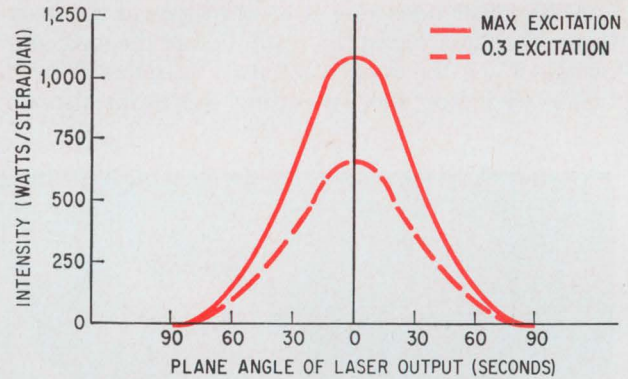

trum has increased to a point that exceeds the transmission capabilities of available window materials—from 0.3 to 337 microns.

Also, laser power levels have progressed from the 300 to 400 milliwatts easily handled with a 20-power telescope to the 10-kilowatt level now achieved with the carbon-dioxide laser. To adequately cover today's greater spectral and power ranges, the radiometer should be equipped with a windowless thermopile for measuring continuous-wave power below 500 mw, and with a windowless-pyroelectric detector for measuring both c-w power above 500 mw and pulsed power.

For high powers, a separate detector would be far more accurate than the calibrated-attenuation optics originally planned for the thermistor bolometer. Moreover, a separate detector is much more convenient. It is possible to cope with 1,000 watts at 10.6 microns, for example, by spreading the beam with infrared-refractive optics and examining about 1/5,000th of the total power at one time. The radiometer's pyroelectric detector can be easily adapted

for larger loads. With the proper electronics, this type of detector leads to accurate power distribution measurements of pulsed-laser systems.

Since the noise-equivalent power of the thermistor bolometer (2.34×10^{-9} watts per 2-hertz bandwidth) is better than that of a thermopile, the original test setup is still the logical choice for most lasers having a few milliwatts or less of c-w power.

By supplementing the thermal detector with faster detectors, the radiometer can also measure the laser's pulse shape and, if desired, instantaneous power levels in very-short duration pulses. Ideally, such measurements are achieved with a two-channel radiometer in which the thermal detector monitors average power or pulse energy, and a photoemissive, photoconductive, or photovoltaic detector records pulse shape. The power-level calibration of the fast detector can be referred to primary standards through the thermal detector's response. Special wideband electronics required for the fast detector would not involve the usual synchronous demodulation.

Semiconductor gages make sense in most transducer applications

Capable of producing higher outputs with better sensitivity than metal strain gages, resistor and transistor devices are coming into their own as development is stepped up

By Robert M. Moore

RCA Laboratories, Princeton, N.J.

Semiconductor gages are challenging the supremacy long enjoyed by metal strain gages in transducers that sense displacement, acceleration, pressure, and force. With gage factors—voltage change per unit strain—at least 10 times better than metal devices, the challenging semiconductor resistors and transistors produce higher outputs and better sensitivity.

Insufficient development has been the semiconductor gage's major hangup. But this is fast being overcome.

Unlike the resistor gage, which behaves like a variable linear resistor, the transistor gage behaves like a constant-current source in parallel with a large resistance.

Basic resistive gage

Metal strain gages are usually incorporated in bridge circuits to convert the resistive change of the gage into a usable output voltage. For bridge applications, the figure of merit is represented by the gage factor, G , which is defined as

$$G = \frac{\Delta R/R}{S} \quad (1)$$

The author



Robert M. Moore investigates electromechanical effects in semiconductors and solid state transducers at RCA Laboratories. He received his doctorate degree from George Washington University, where he was an instructor for four years.

where ΔR is a change in resistance, R is the nominal resistance, and S is the applied strain—elongation per unit length.

The advent of the semiconductor resistor gage makes bridge circuits impractical for single-gage applications because of the device's sensitivity and large resistance changes, which lead to unacceptable nonlinearities. For example, a strain of 10^{-3} produces a $\Delta R/R$ of about 13%, yielding a G of 130, and a bridge-output nonlinearity of over 6%. This would be critical for a resistor gage, but not for wire strain gages; $\Delta R/R$ rarely exceeds 0.5% for wire gages at 10^{-3} strain levels.

To take advantage of the resistor gage's large resistance variation and still obtain an output voltage that is linearly related to ΔR , an engineer turns to a constant-current system. For a first approximation, consider an ideal current supply and voltage detector. The voltage change ΔE due to the resistance variation ΔR is then

$$\Delta E = I\Delta R = IGR \quad (2)$$

Here, the device's full resistance variation is used and the output's linearity is still maintained.

At first glance, it appears that ΔE can be increased to any desired value by merely increasing I . However, there are some limiting factors, the most important of which is that a large current leads to excessive ohmic heating. Resistance changes caused by temperature rise can lead to burnout. Typically, resistor gages have a power dissipation limit of about 0.1 watt. With a nominal resistance of 350 ohms, such a power-dissipation level limits gage current to approximately 17 milliamperes.

A constant-current circuit is essential when a

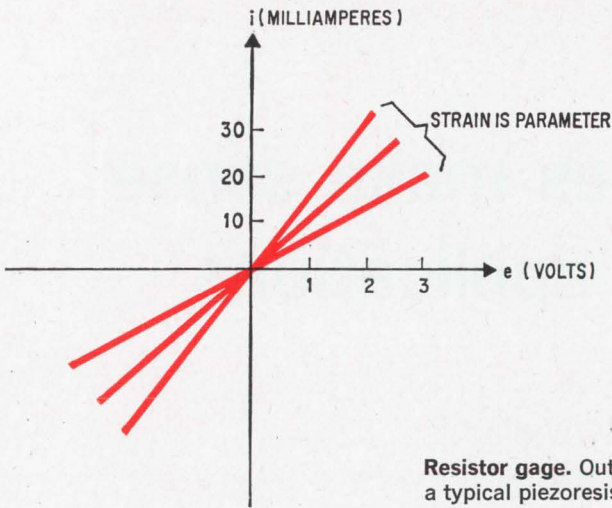

Resistor gage. Output characteristics for a typical piezoresistive gage are linear.

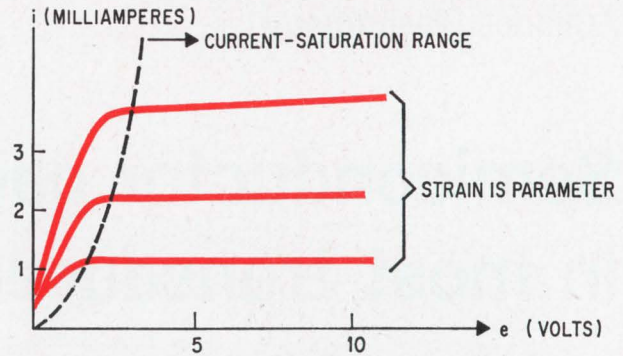

Transistor gage. Output characteristics of a semiconductor gage are similar to that of a transistor.

single-gage application is considered, but a bridge circuit can still be used for some two- and four-gage applications.

Supply and load

By inserting a constant-current source shunted by a resistance R_s for the supply and a resistance R_o for the voltage detector, the engineer obtains a realistic representation of a single-gage system. With an equivalent circuit, the engineer can evaluate the loading and supply-regulation effects. Voltage change ΔE is

$$\Delta E = I \Delta R \left[\left(\frac{R_p}{R_p + R} \right)^2 \left(\frac{1}{1 + \Delta R / (R_p + R)} \right) \right] \quad (3)$$

where

$$R_p = \frac{R_s R_o}{R_s + R_o}$$

The loading due to R_s and R_o has a two-fold effect $-R_p$ of the first term in this equation tends to reduce ΔE , and R_p in the second term leads to a nonlinearity of ΔE with ΔR . For a transducer application, the nonlinearity must be reduced to a negligible magnitude. This requires

$$R_p + R \gg \Delta R \quad (4a)$$

or, since ΔR can be an appreciable fraction, 10% or more of R , the equation can be written as

$$R_p \gg R \quad (4b)$$

Equation 3 can then be reduced to

$$\Delta E \cong I \Delta R = IGR$$

Thus, equation 2's approximation is valid as long as the parallel combination of R_s and R_o is much greater than R . This is necessary for output linearity and maximum output voltage change.

To understand the effect of poor current regulation, consider I changing by an amount ΔI , and gage resistance remaining unchanged. Then, the spurious voltage change is

$$\Delta E' = \Delta I R$$

provided that the loading effect is negligible. Thus the resolution of the constant-current system is limited to the detection of gage-resistance changes such that $\Delta E = \Delta E'$, or

$$I \Delta R = \Delta I R$$

and the smallest ΔR that could be detected is

$$\Delta R_{\min} = R \Delta I / I \quad (5a)$$

which can also be expressed by

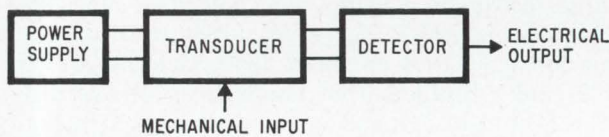

Transducer system. Applying a mechanical input to a transducer results in an electrical output signal.

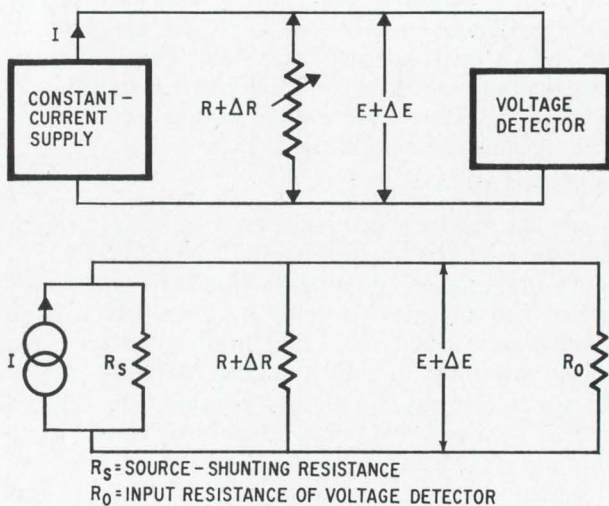

Constant current. Piezoresistive gage, top, is represented by its equivalent circuit in a constant-current system. Voltage change, ΔE , depends on the values of R_s , R_o and R .

$$\Delta R/R = \Delta I/I \quad (5b)$$

or, inserting equation 1, this can be reduced to

$$S_{\min} = \Delta I/GI \quad (6)$$

where S_{\min} is the minimum detectable strain. Hence, current-supply regulation directly determines the resolution of resistor-gage transducer system.

To estimate the required current-supply stabilization, consider an arbitrary resolution standard of 1×10^{-6} strain—1 microstrain. For a gage factor of 100, equation 6 yields

$$\Delta I/I = 10^{-4} = 0.01\% \quad (7)$$

as the required supply regulation. Thus, the current supply must not have variations larger than 1 microamp if it supplies 10 milliamps to the gage. This regulation must hold when the strain gage is varying by as much as 10% in either direction.

Voltage detector

Since the voltage-detector circuit must have a high input impedance relative to the nominal resistance—typically in the range of 100 to 1,000 ohms—a simple amplifier stage is sufficient. If a junction-transistor stage is used, an emitter follower or similar circuit would be required to yield a voltage gain near unity.

If a field effect transistor were used, a grounded-source configuration would suffice. The output would be a change in the drain current Δi_D , expressed by

$$\Delta i_D = g_m \Delta E \quad (8)$$

where g_m is the transconductance of the FET.

Basic transistor gage

In general, all transistor gages—junction and field effect—have the same type of output characteristics. Where they differ, however, are in scale factors for the current and voltage axes.

Consider a system that relies on a transistor gage to couple a constant voltage supply to a current detector. The basic figure of merit for the gage is current-strain sensitivity, K , defined as

$$K = \Delta i/S \quad (9)$$

where Δi is the change in output current for a constant output voltage, and S is the applied strain. As a first approximation, for an ideal voltage supply and current detector, the change in current, Δi_o , in the detector is equal to the change in gage current, or

$$\Delta i_o = \Delta i = KS \quad (10)$$

indicating that the system uses the device's full current variation.

Unlike the resistor-gage system in which the voltage E is dependent on the supply current I , the transistor system's voltage is independent of the current change. Thus, E doesn't appear in this equation.

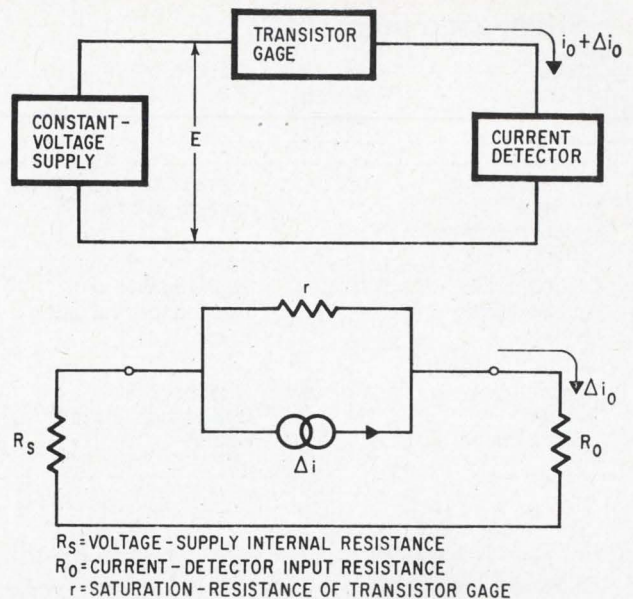

Constant voltage. Semiconductor gage, top, is represented by its equivalent circuit in a constant-voltage system. Current change Δi_o , depends on the values of r , R_s and R_o .

Supply and load

To analyze the properties of the constant-voltage transistor-gage system, it is necessary to represent the basic sections by an electrical circuit. In the schematic, it is assumed that the gage is operated around a quiescent point in the current-saturation region.

Assuming that the supply voltage is constant, the current change for the equivalent circuit can be given by

$$\Delta i_o = \Delta i \frac{r}{r + R_s + R_o} \quad (11)$$

Here, the factor involving $R_s + R_o$ tends to reduce the output current change to a fraction of Δi . This effect is similar to reducing the output voltage in the resistor gage. However, unlike the resistor system, this system has no nonlinear terms due to the loading by $R_s + R_o$. Thus, if R_o 's value isn't negligible compared with r , the transistor gage's loading won't degrade the system's linearity. This, of course, differs from the resistor system, which has a nonlinear output under equivalent loading conditions.

The effect of poor voltage regulation can be evaluated from a modified equivalent circuit that includes a ΔE but doesn't include a current generator in parallel with r . Thus the engineer can compute the changes in output current caused by the fluctuations in voltage.

The spurious current change is

$$\Delta i'_o = \frac{\Delta E}{r + R_s + R_o} \quad (12)$$

and the resolution of the system is limited to the detection of strain-induced current variations such

Strain-gage properties

Gage	Required power-supply stability	Output	System sensitivity	State of development	Properties
Semiconductor resistor (piezoresistance effect)	0.01%	Low series impedance, voltage source	350 volts/unit strain 3.5 amps/unit strain	Commercially available	Compatible with conventional metal strain gage circuitry
Thin-film FET (piezoelectric effect)	10%	High parallel impedance, current source	2.2×10^4 volts/unit strain 480 amps/unit strain	Experimental	Compatible with low-input impedance amplifiers and signal conditioners
Silicon npn planar transistor	Unknown	High parallel impedance, current source	4 volts/gram	Commercially available	Same as FET

that $\Delta i_o = \Delta i'_o$. With equations 11 and 12, this becomes

$$\Delta i \frac{r}{r + r_s + R_o} = \frac{\Delta E}{r + R_s + R_o}$$

$$\Delta i_{\min} = \Delta E/r \quad (13)$$

is the smallest resolvable strain-induced current change.

Using equation 10, this can be expressed as

$$S_{\min} = \frac{1}{K} \frac{\Delta E}{r} = \frac{1}{K} \frac{E}{r} \frac{\Delta E}{E} \quad (14)$$

where S_{\min} is the minimum detectable strain. S_{\min} is dependent on the supply regulation, the effect of which is modified by the factor, E/r . Such a modification doesn't occur in the resistor-gage circuit.

A numerical estimate of the required voltage-supply regulation is easily obtained. With a desired resolution of 1 microstrain, typical values for a thin-film field effect transistor gage are $K = 2.4$ amps/unit strain, $E = 2.5$ volts, and $r = 10^5$ ohms. Inserting these values in equation 14, yields the required regulation

$$\Delta E/E = 10^{-1} = 10\% \quad (15)$$

Thus the transistor can stand a 10% change in its supply, a far cry from the resistor's 0.01%.

With a transistor gage, an additional factor affects bias source for the third electrode. Any variation here appears as a spurious output. For a field effect gage, this current change, $\Delta i'$, is

$$\Delta i' = g_m \Delta E_g = g_m E_g \frac{\Delta E_g}{E_g} \quad (16)$$

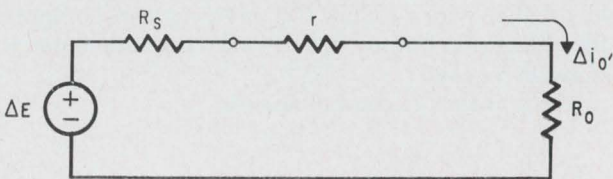

Voltage regulation. Transistor-gage circuit is converted into a voltage-source representation for evaluating the effects of poor voltage regulation.

where E_g is the gate-bias voltage, and ΔE_g is its fluctuation. The minimum detectable strain-induced current change is $\Delta i = \Delta i'$. With equation 10,

$$S_{\min} = \frac{g_m E_g}{K} \frac{\Delta E_g}{E_g} \quad (17)$$

as the minimum detectable strain.

To obtain an estimate of the required regulation, the engineer selects 1 microstrain as the desired resolution, and assigns 2 volts for gate-bias voltage and 10^4 micromhos for the transconductance. The required gate-bias source regulation, using equation 17 is

$$\frac{\Delta E_g}{E_g} = 10^{-4} = 0.01\% \quad (18)$$

This requirement is the same as that for a resistor system's current supply. Although the resistor system must have this regulation figure when supplying an appreciable power into a load that can vary by 20% to 30% at frequencies from d-c to 50 kilohertz, the transistor's gate-bias source need only have this regulation when supplying negligible power to a constant, high-impedance load.

With insulated-gate field-effect units that operate at zero gate bias, the bias-stability problem can be avoided. For example, a thin-film transistor gage can be fabricated as a depletion type unit in which zero gate bias would yield a current saturation region at reasonable output levels of current and voltage; the gate can be connected directly to the source. All the engineer need consider is the output voltage supply regulation.

Present research is primarily aimed at improving thin-film properties for amplifying devices. To achieve this, it is necessary to increase the values of r and g_m . Although an increase in r tends to reduce the voltage-supply regulation requirements, an increase in g_m leads to an increase in the required gate-bias source regulation. Since gate-bias sources aren't needed for devices that operate at zero-gate bias, increasing g_m won't affect them. Thus, research along these lines will more than likely lead

Continued on page 116

In this corner, a challenger . . .

Resistive semiconductor strain gages have been on the market for several years, but transistor gages have made an appearance only recently. One piezoelectric transistor, a silicon npn planar device called the Pitran, is made by Stow Laboratories in Stow, Mass.

The Pitran's emitter-base junction is mechanically coupled to a diaphragm located at the top of a TO-46 can, which has a nominal diameter of 0.187 inch. When a pressure or point force is applied to the diaphragm, a large, reversible change is produced—an unamplified linear output of at least 20% of the supply voltage.

The device is operated as a conventional transistor, but a mechanical variable can be introduced to modulate the output. Besides providing a linear output voltage, the transistor amplifies or switches other electrical signals. Moreover, the device can

be used as the active element in an oscillator for frequency-modulated or pulse-width-modulated outputs. Typical industrial applications include differential pressure transducers, accelerometers, flow meters, level gages, electronic scales, and high-intensity microphones.

Each Pitran is calibrated for sensitivity, temperature coefficient, and over-range performance.

Bias circuit. A linear d-c output that is proportional to the mechanical input signal stems from the transistor's common-emitter configuration. The Pitran's output voltage ranges up to 20% of the power supply voltage. For factor calibration, a 10-volt power supply and 10-kilohm resistors are used. With a 50-volt supply and 50-kilohm resistors, a 50-volt linear output results.

For a-c biasing, a bypassed emitter resistor is added to the d-c circuit; resistor and capaci-

tor values determine the cutoff frequency which is lower than the d-c. This approach is similar to the one commonly used to stabilize a conventional a-c amplifier stage for wide-temperature operation.

Differential amplifier. When two semiconductor gaps are combined, the Pitran circuit becomes a differential amplifier. The output can be nulled with an adjustable resistor, and temperature compensation can be achieved with matched temperature coefficient gages. As a differential amplifier, the linear output voltage can be up to 20% of the sum of supply voltages.

A pwm output is readily achieved with simple multivibrator circuits that operate at almost any given clock frequency and supply voltage. The output pulse width versus input pressure can be made linear over a range of $\pm 10\%$ of the quiescent pulse width. This mode is particularly

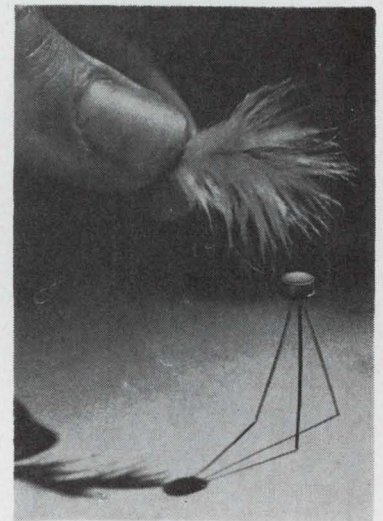
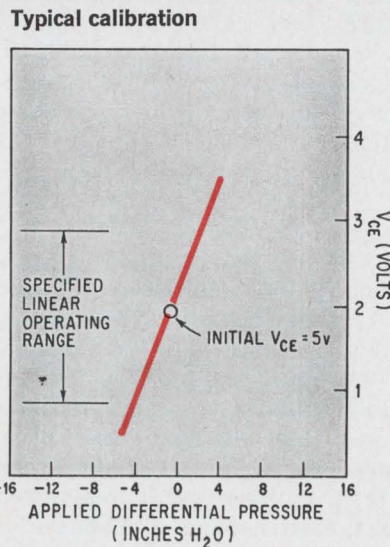
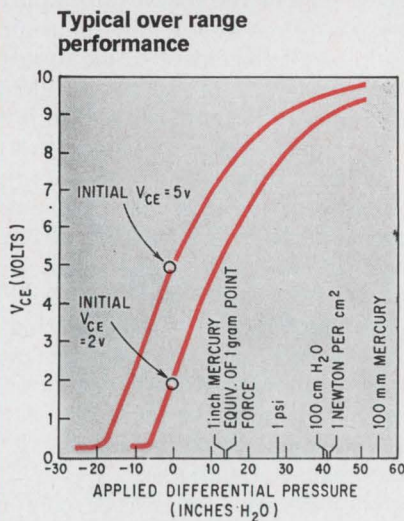
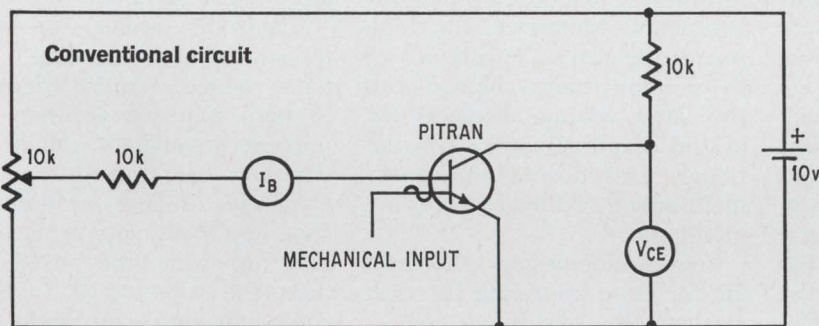

Applying pressure. Transistor-strain gage responds to any pressure, even that of a feather. Equivalent circuit and response curves are typical for this type of device.

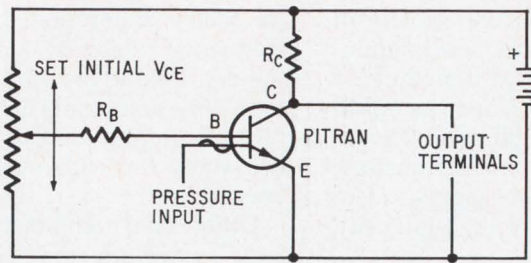

D-c bias. Output response follows the input signal exactly for small temperature variation.

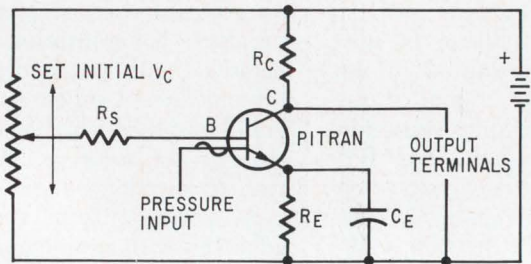
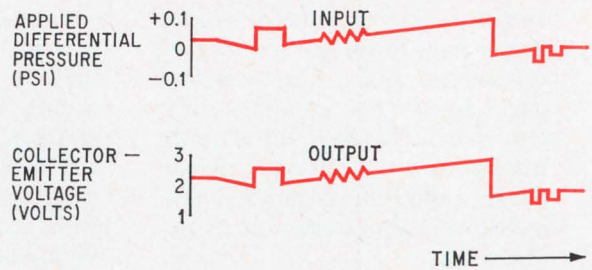

Wide temperature. Adding an emitter resistor R_E enables circuit to operate over wide temperature range. Capacitor, C_E , shunts R_E assuring the gain for a-c operation to be the same as for the d-c bias circuit.

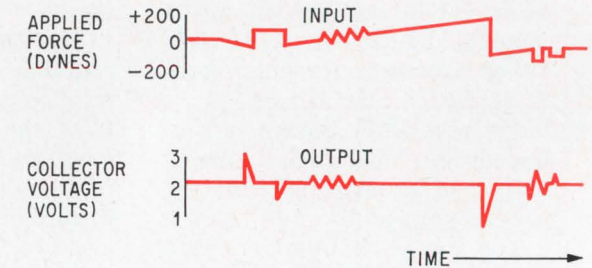

attractive for telemetry or input to digital computers because the pwm is easily connected to pulse-code modulation.

Accelerometers. Although Pitrans will directly connect only low-level forces and pressures, they can be modified to effectively connect acceleration, weight, flow, rate, and the like. Some experimental accelerometers were built, including one in which a 0.05-gram seismic mass was bonded with epoxy to the center of the diaphragm of the Pitran and to a second parallel diaphragm that was welded to the top of the case. The entire assembly weighed $\frac{1}{2}$ gram.

Fluidics. Semiconductor gages are also useful in fluidics, whereby fluid-stream interaction is used to create control and logic functions. Recently developed fluidic devices include operational amplifiers and AND gates as small as 0.05-inch square, and logic elements.

One of the more perplexing problems of this new field has been the inability to accurately determine the dynamic characteristics of such logic systems. Logic levels are usually at pressures of a few inches of water, and flow rates are extremely low.

Changes in state may occur in less than a millisecond. The conventional low-range pressure transducer isn't capable of distortion-free response to such fast transients. Moreover, the high pneumatic-output impedance of the fluidic circuit combined with the large volume displacement of the diaphragm in a conventional transducer often causes malfunction of the system being monitored.

Semiconductor gages, however are far more appealing for such applications. The Pitran, for example, when used in a simple bias circuit has a 2-volt linear output that's available directly at the transistor terminals. Rise times of 30 microseconds can be followed faithfully, with negligible overshoot and phase distortion.

Unlike conventional transducers, the Stow device has a high resonance frequency and a low displacement that create ideal conditions in the fluidics/electronics interface. In addition, this type of gage permits simultaneous monitoring of several points in large fluidic systems.

Where small pressure switches are necessary, particularly in applications requiring communica-

tion with actuators or central data-processing systems, semiconductor gages are ideal; they have no moving parts or electro-mechanical contacts.

Electronic scales. In force-transmittal-and-balancing systems which require damping to both improve accuracy and prevent overshoot, hydraulic damping has proved too slow. Dynamic braking systems responding to velocity or acceleration are sometimes used, but they tend to be too costly. Semiconductor gages are much more suitable.

Since the transistor diaphragm requires only a few microinches of displacement to yield outputs of 1 volt or more, a rigid and stable weighing platform with a strain-sensing element can be substituted for the commonly used delicate scale-balancing system. The output drives a direct-reading meter or a recorder; oscillations are rapid and damped out so quickly that the weight readout can be nearly instantaneous. A hydraulic force-transmittal system can be used with the gage to achieve the same advantages.

Because of a relatively high thermal zero-shift, the transistor

gage isn't suitable for high-precision applications requiring long-term zero stability. Here, the wire strain gage has the edge. But if occasional zero corrections can be made, the transistor gage could replace the wire device.

Microphones. Seismic exploration common in the continuing

ticularly attractive because its high, fundamental mechanical-resonance frequency, small size, and low damping factor give it a broad, smooth frequency response—flat (± 1 decibel) from d-c to better than 30 kilohertz. Used in an above-ground microphone, the Pitran has a lower amplitude limit of between 75

technique is severely limited by the manometer's inability to respond to rapid fluctuations in pressure, and by its inherent reading inaccuracies.

Although electronic pressure transducers have been used, test engineers found these devices too costly; each channel requires its own amplifier. Thus, water

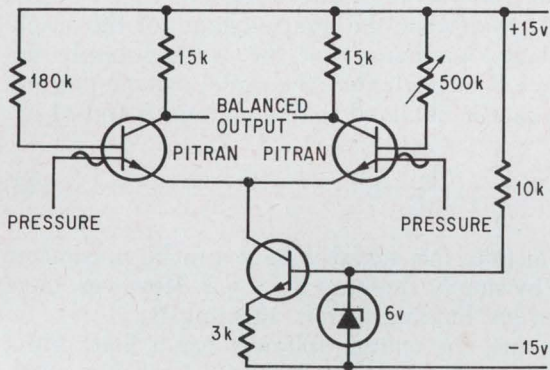

APPLIED DIFFERENTIAL PRESSURE (INCHES H₂O)

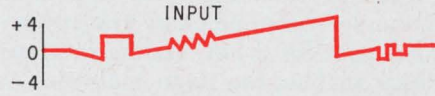

LINEAR DIFFERENTIAL OUTPUT (VOLTS)



TIME →

Differential amplifier. Differences between two applied pressures appears as output. High input impedance results from a constant current source.

search for oil and mineral deposits, is another likely area for semiconductor gages. Transducers—microphones and accelerometers—are placed at various points around an explosive charge to pick up the blast's sound patterns at various underground layers. From these patterns, experienced geologists can determine what minerals are present and whether an oil formation exists.

For such transducer applications, the transistor gage is par-

and 95 db, and an upper limit between 145 and 165 db. At full scale, the gage produces outputs of at least 1 volt without external amplification—more than enough to drive most recorders.

Wind tunnels. In laboratories that investigate aircraft aerodynamics under both subsonic and supersonic flight conditions, wind tunnels are commonplace.

Low-level bidirectional pressures in the tunnels are recorded with cameras and monitored with water manometers. But this

manometers are still used despite their limitations.

Semiconductor gages can effectively fill the bill; the on-line cost per channel is less than a third that of the conventional transducer and its amplifier. The transistor gage's high mechanical-resonance frequency allows accurate measurement of dynamic pressures resulting from turbulent flow, and its 1-volt output—typical for a 4-inch water pressure input—is sufficient to feed many recorders directly.

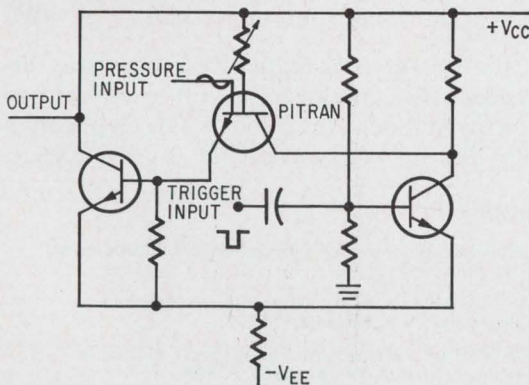

APPLIED DIFFERENTIAL PRESSURE (PSI)
OUTPUT (VOLTS)

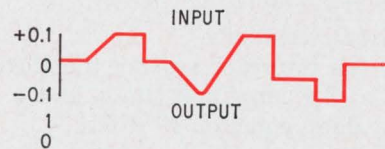

PULSE WIDTH (% OF PERIOD)

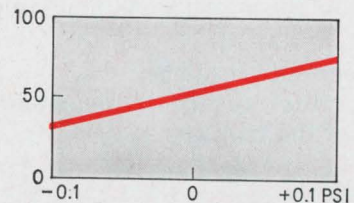

Pulse-width modulation. A variable pulse-modulated output results for a varying applied differential pressure. Input/output characteristics are linear for applied pressure.

to new depletion-type devices for transducers.

Keyed to impedance

Transistor-gate systems can operate into low-impedance and high-impedance loads. The type of current detectors used depends on the load.

When the system is designed so that both R_s and R_o are negligible compared with r , the maximum available current variation, $\Delta i_o = \Delta i = KS$, is seen by the detector. Since r is typically 10^5 ohms, a simple current-amplifier stage is sufficient to obtain a detector input impedance such that $R_o \ll r$. Thus, either a grounded-emitter or grounded-base configuration is sufficient for a junction-transistor stage, and a grounded gate for a FET stage.

A grounded-base junction transistor stage, or grounded gate for a FET, results in a current gain near unity, making the stage analogous to an emitter follower for a resistor system. These analogous techniques cannot be compared exactly, because the output variable for the transistor is current, and the output for the resistor is voltage.

If a grounded-emitter stage were used for the transistor system, the output would be a change in collector current of

$$\Delta i_c = \beta \Delta i_o \quad (19)$$

where β is the forward-current ratio of the transistor. Here, the output sensitivity can be compared with that of the resistor system, which uses a FET voltage-detector stage. For this case, it is assumed that the system output is a current source driving a low-impedance load. The FET detector is necessary for the resistor system. Hence, the drain current equals transconductance times voltage change.

However, the ΔE of the resistor circuit depends on the I of the current supply, whereas the Δi_o of the transistor circuit isn't directly dependent on the E of the voltage supply. Thus a quantitative comparison can only be made on the basis of typical values. Theoretical values chosen for the resistor system are: $I = 10$ ma, $R = 350$ ohms, $G = 100$, and $g_m = 10^4$ micromhos = 10^{-2} mhos. Thus equation 8 yields

$$\begin{aligned} \frac{\Delta i_o}{S} &= g_m \frac{\Delta E}{S} = g_m IGR \\ &= 3.5 \text{ amps/unit strain} \end{aligned} \quad (20)$$

as current sensitivity.

For the transistor system, the theoretical values are $K = 2.4$ amps/unit strain, and $\beta = 200$. Using these values, equation 19 yields

$$\frac{\Delta i_o}{S} = \beta K = 480 \text{ amps/unit strain} \quad (21)$$

as current sensitivity.

Thus the ratio of current-strain sensitivities, in favor of the transistor system, is

$$\frac{\Delta i_o/S}{\Delta i_o/S} = \frac{480}{3.5} = 137.1 \quad (22)$$

But this result is based only on the available signal

levels and doesn't include the possible effects of noise levels in the two device types.

To complete the comparison, the engineer must also consider an application in which the system output is a voltage source driving a high-impedance load. For such an application, both the resistor gate and the transistor gate are operated into detector stages consisting of emitter-follower amplifiers. Here, the resistor system is favored.

All that is necessary for evaluating system sensitivity is comparing the signal voltages available at the amplifier inputs.

For the transistor system, this signal voltage is obtained by inserting a resistor in parallel with the emitter-follower input and using the gate's output current to develop the input voltage for the amplifier stage. Assuming that the voltage-supply impedance R_s is negligible, the signal voltage per unit strain can be obtained from equations 9 and 11 as

$$\frac{\Delta E_o}{S} = \frac{rR_o}{r + R_o} K \quad (23)$$

In principle, this signal voltage can be maximized to rK by simply choosing $R_o \gg r$. However, there are several limiting factors affecting R_o .

For one, the emitter follower has a finite input impedance; for another, too large a value of R_o would require an excessive supply voltage to drive the required quiescent current through R_o . This is shown with typical values for a quiescent operating point in which $i_o =$ total drain-source current = 0.5ma, and $e_o =$ total drain-source voltage = 2.5 volts.

When a matching load of $R_o = 10^5$ ohms is used, the voltage drop across R_o is 50 volts. Thus, a total supply voltage of 52.5 volts is required. To reduce this, the engineer would select a typical value of $R_o = 10$ kilohms. This leads to a total supply voltage of 7.5 volts, which would be compatible with the transistor supply voltages usually required for the associated amplifier stage.

With $R_o = 10$ kilohms, $K = 2.4$ amps/unit strain, and $r = 10^5$ ohms, equation 23 yields

$$\Delta E_o/S = 2.2 \times 10^4 \text{ volts/unit strain} \quad (24)$$

Similarly, with $I = 10$ ma, $R = 350$ ohms, and $G = 100$ for the resistor system, equation 2 yields

$$\Delta E/S = IGR = 350 \text{ volts/unit strain} \quad (25)$$

Thus, the voltage sensitivity of the transistor circuit exceeds that of the resistor circuit by almost two orders of magnitude, even though this application inherently discriminates against the transistor gate.

Bibliography

P. Pohl, "Signal conditioning for semiconductors," *ISA Journal*, Vol. 9, No. 6, June 1962, p. 33.

H. Berstein, "Variable resistivity semiconductor amplifier phonograph pickup," U.S. Patent 3,144,522.

C.R. Higson, "Recent advances in strain gages," *Journal of Scientific Instrumentation*, Vol. 41, 1964, p. 405.

R.S. Muller and J. Conragen, "Transducer action in a metal-insulator-piezoelectric-semiconductor triode," *Applied Physics Letters*, Vol. 6, No. 5, March 1, 1965, p. 83

VERSATILE

You name it

CAPABLE

The Paul Bunyan of 3M Recorders

AFFORDABLE

We're almost
ashamed of the
low price

MODEL 34

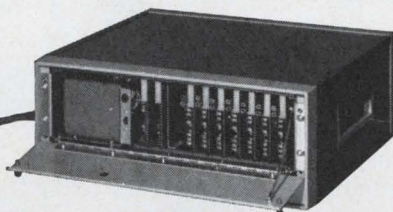

VERSATILE—With direct frequency response to 600 kHz, and IRIG FM to 80 kHz, the Mincom Model 34 does many things in many ways. Rack-mounted or in easily portable carrying cases. $\frac{1}{4}$, $\frac{1}{2}$ or 1-inch tape. 10½-inch or 7-inch reels. Speed options: $\frac{1}{16}$, $\frac{1}{8}$, $\frac{3}{4}$, $7\frac{1}{2}$, 15, 30, 60 or 120 ips.



CAPABLE—Practically the only thing that's *not* an option is 3M quality — that's standard on all configurations of the Model 34. Starting with the Isoloop Drive® on the tape transport (the same as on recorders costing several times as much), Model 34 can record 7 or 14 channels of the cleanest data for over twelve hours. All types of record/reproduce modules are interchangeable, allowing any channel combination desired. Push-button controls. Dynamic braking in all modes. Fail-safe braking for AC failure. End-of-tape sensing. Solid state electronics. Input/output meters.

AFFORDABLE—As you can see, there are a lot of different ways to configure a Model 34 — and there are just as many prices.

But this we can be definite about: Model 34 is *the* recorder for people who've always wanted 3M quality — but couldn't afford it *before*. Give us a call.

Mincom Division **3M**
COMPANY
300 SOUTH LEWIS ROAD • CAMARILLO, CALIFORNIA 93010

Put a little RF excitement in your laser. It'll last longer.

One of the latest, most exciting uses for Jennings' standard RF vacuum capacitors is in a new line of ion continuous wave lasers.

Developed by Spectra-Physics, Inc. of Mountain View, California, the new laser has been put to work in a wide variety of research and development applications ranging from bloodless surgery to intricate electronic welding.

Jennings capacitors serve in the rf generator which is used as the ion exciter. RF excitation, unique with Spectra-Physics, provides considerably longer life for the ion laser tubes because it eliminates the need for cathodes and plates and it reduces bore erosion. Jennings vacuum capacitors offer extremely low inductance to the rf circuit and, due to their vacuum dielectric and copper construction, will handle large rf currents that would destroy solid dielectric capacitors.

There's probably a standard Jennings capacitor with ultra high vacuum dielectric to fit your requirement for voltage, current and capacitance. Both variable and fixed capacitance models are useful in applications ranging from 100 watts to more than a megawatt. Other new developments in advanced vacuum capacitor design are on the way from ITT Jennings. For information, write for Catalog No. 101. ITT Jennings, a division of International Telephone and Telegraph Corporation, 970 McLaughlin Avenue, San Jose, California 95108.



JENNINGS **ITT**

Adder on a chip: LSI helps reduce cost of small machine

A complete 8-bit arithmetic unit on a single chip of silicon reduces need for random logic and, by subtracting without complementing, can be doubled up for words of any length

By Lee L. Boysel

Fairchild Semiconductor Division, Mountain View, Calif.

Large-scale integration becomes feasible for small, slow computers when applied to the computer's arithmetic unit. Previously the technique has been considered only for large machines with many identical circuits, because the main LSI effort has been aimed at such circuits—memories, registers, and data paths. But now small computers—for applications such as process control, data acquisition, testing, or education, where cost is a vital factor—can take advantage of LSI. Their entree is an eight-bit parallel arithmetic unit, containing 200 metal oxide semiconductor gates interconnected on a single chip of silicon.

Large-scale integration is especially valuable in an arithmetic unit, which is made of several identical parts that operate in parallel. Virtually every computer operation involves the unit, even if only to pass a number from one register to another.

However, to achieve the necessary low cost of a small, slow machine and still realize the benefits of LSI, only 10% or less of the total circuits should be random logic—circuits that perform specific functions, such as sign control, division stop, overflow error, and comparisons. Only one of each of these random logic functions, which contrast with repeti-

tive data-flow logic functions, is required in any computer.

Previous approaches to LSI were effective on only about 25% of the system—the remaining 75% being composed of random logic, which was either unsuitable for LSI or too costly for it. But a large-scale integrated arithmetic unit and a read-only memory can reduce the random logic to well below 10% in a small machine. Working together, they perform almost all the needed functions.

With the arithmetic unit's unusual algorithm for addition and subtraction, much of the need for control by random logic was eliminated. The read-only memory approach to control cuts random logic significantly, because it can be used for combinational and sequential logic, which in turn can be applied to control functions.¹ Thus a slow, fully parallel machine can be built that is, curiously, less expensive than a serial machine, because its proportionate amount of control is substantially less. Traditionally, because parallel machines contain more circuits, they are more expensive—their cost being justified by their higher performance. Serial machines usually sacrifice speed for low cost.

A 16-bit parallel system has been constructed with the new arithmetic unit and a monolithic read-only memory; it has only about 1% random logic.

Ideal repetition

The arithmetic unit of any computer can be designed as a series of identical blocks, each of which performs a complete arithmetic function on a single bit. Several blocks can be fabricated inexpensively on a single chip with LSI techniques. This unit can become a subsystem of a larger system with any of several word lengths.

The author

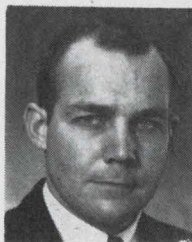

Lee L. Boysel is the supervisor of Fairchild Semiconductor's LSI-MOS subsystem section. This is his second article in *Electronics*; last year he described Fairchild's monolithic read-only memory.

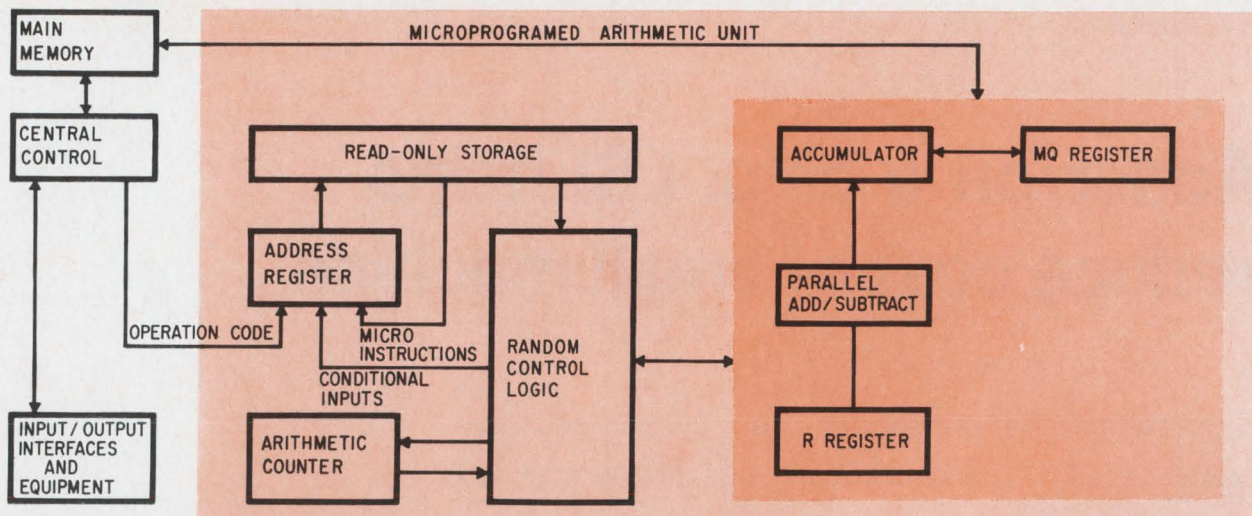

Typical small computer. Its design requires only a monolithic arithmetic unit (dark tint), monolithic read-only memory (light tint), small amount of random control logic, and conventional input/output and memory hardware.

A computer organization that includes a fully parallel arithmetic unit can be used in either small or large machines. This organization, whose block diagram is shown above, also includes a fixed-program subroutine and conditional input control capability. It has a minimum number of random gates.

Most control functions are executed by large MOS read-only storage, using currently available hardware.² The standard operations include addition, subtraction, multiplication, and division, extracting square roots, and doing simple logic manipulations.

More complex operations include calculating logarithms and trigonometric functions, converting between binary and decimal, doing floating-point arithmetic, and setting up subroutines for solving complex mathematical functions.

In action, the central control unit simultaneously enters an operation code into part of the arithmetic unit's instruction address register and calls required operands from the main memory. This causes the read-only memory to begin a micro-programmed sequence—a sequence of microinstructions that control the flow of data into and out of the arithmetic unit, and manipulate it during multiple-step operations such as multiplication and division.

During each cycle, the read-only memory feeds the next microinstruction address back to part of its own address register and supplies a control word to the decoder. The decoder converts these microinstructions into signals that control the sequence.

During these sequences, events may occur that require modifications. For this, conditional branch or jump operations may be implemented by including conditional inputs as part of the address register input. Thus, when a data-dependent decision is made—divide stop, for example—the microprogram address is modified by the conditional inputs and the program jumps automatically to another subroutine that takes appropriate action. After that operation is completed, control returns to the central unit and the result is sent to the memory.

While the arithmetic unit is functioning, the central control section is free to operate on the main memory, input-output terminals, or other arithmetic units, thereby effectively increasing machine speed.

Four sliced sections

An eight-bit integrated MOS arithmetic unit, measuring 86 by 116 mils and mounted in a 36-pin dual-in-line package, will be introduced soon by Fairchild Semiconductor under the designation 3800. The unit combines four major sections on one chip: an input register, an adder-subtractor, an ac-

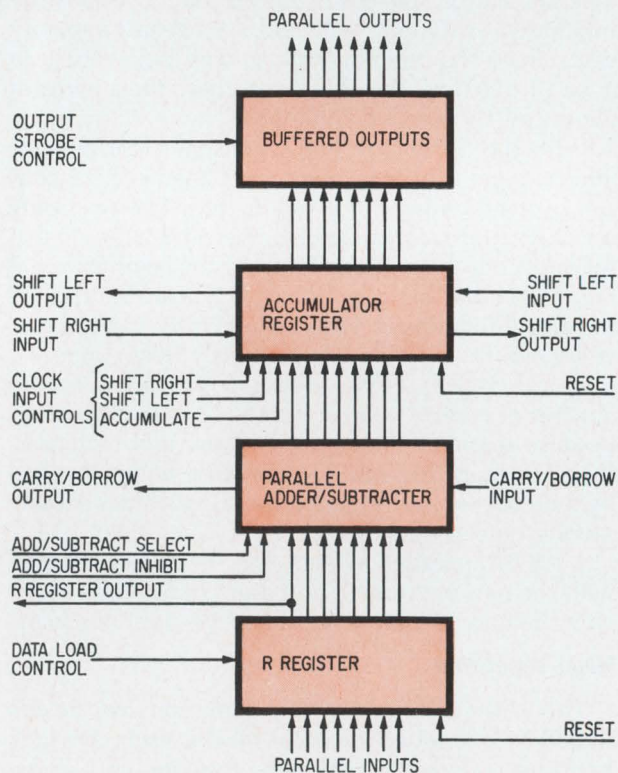

Four-in-one. Monolithic arithmetic unit comprises input register, adder-subtractor, accumulator, and output buffer, all for eight bits in parallel, plus connections to outside world or similar adjacent units.

Largest production IC

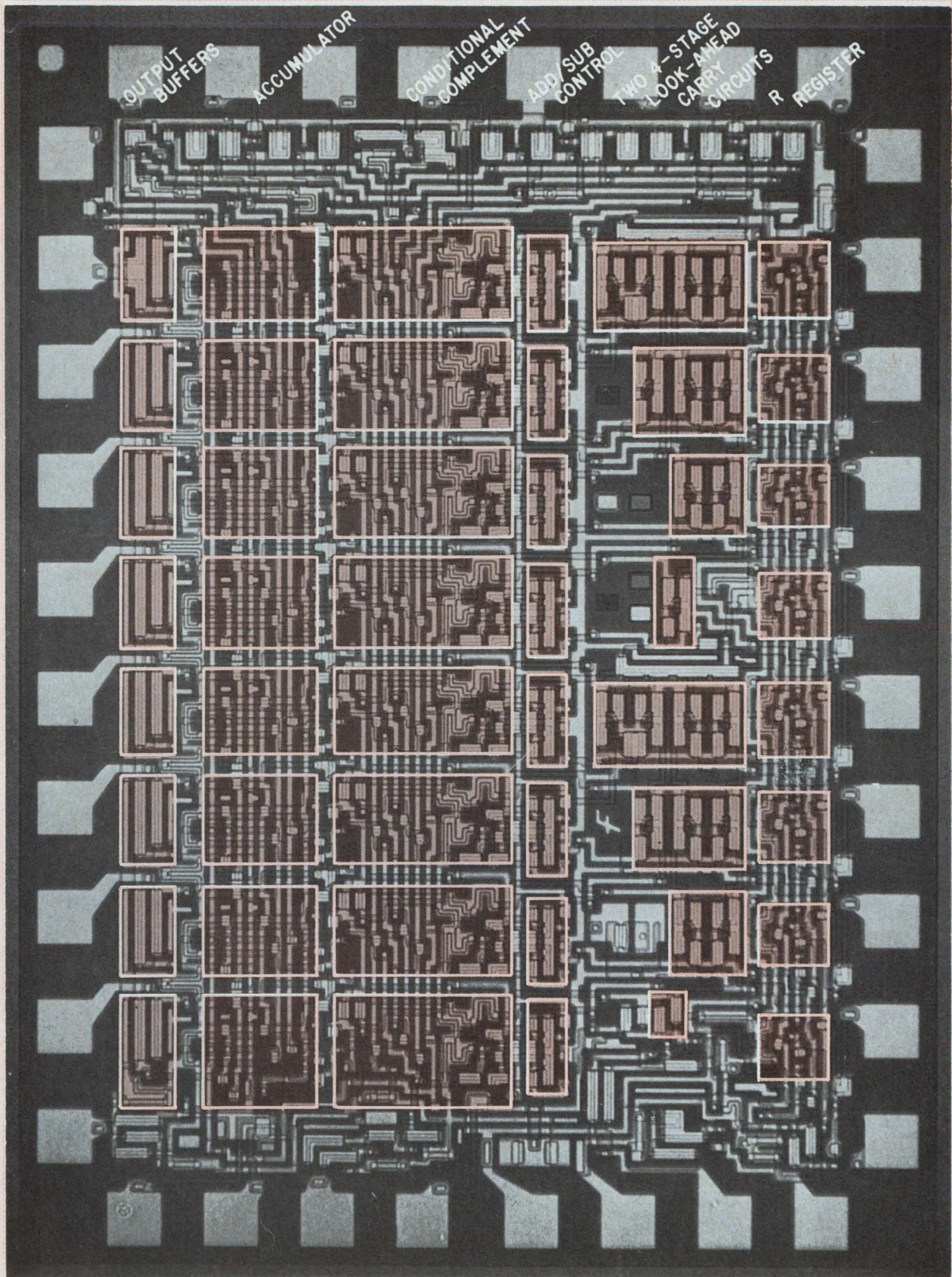

Tightly packed. This silicon chip is a metal oxide semiconductor arithmetic unit with 200 gates, capable of processing eight bits at once, in an area only 86 by 116 mils. The carry-borrow look-ahead logic consists of two groups of ten circuits, each of which generates a cumulative carry or borrow for four bits at a time. All other circuitry on the chip forms eight identical parallel channels.

Add-subtract truth table

Accumulator	Addend-subtrahend	Input carry or borrow	Output carry	Sum	Output borrow	Difference
0	0	0	0	0	0	0
0	0	0	1	1	1	1
0	0	1	0	1	1	1
0	1	1	1	0	1	0
1	0	0	0	1	0	1
1	0	1	1	0	0	0
1	1	0	1	0	0	0
1	1	1	1	1	1	1

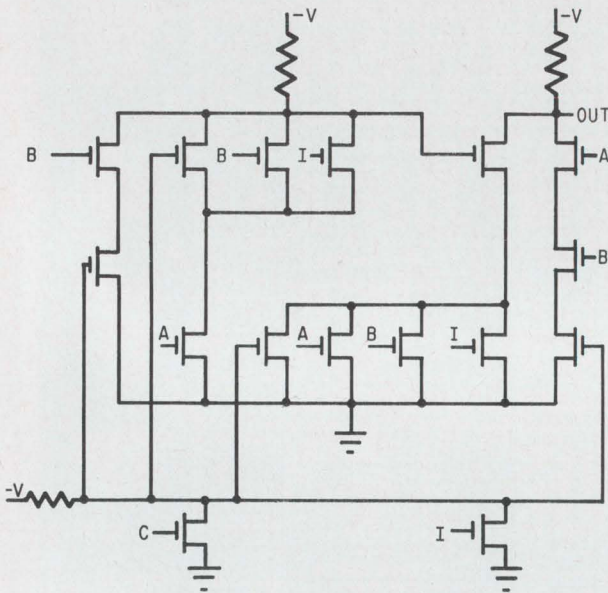

Iffy inverter. Conditional complementing circuit inverts the accumulator output if the input register and the carry bits are different and if the inhibit signal is off.

accumulator register, and an output buffer. All are made from p-channel enhancement-type MOS transistors. The four sections are shown on page 120.

- The R register temporarily stores operands for arithmetical operations. All eight positions may be loaded, bypassed, or reset at once. The leftmost bit is available for sign control.

- The parallel adder performs both addition and subtraction on either positive or negative numbers directly, without complementation. The eight-bit circuit can both accept and generate carries and borrows where more than eight bits must be processed. Look-ahead carry circuits reduce the worst-case time to carry through eight stages to approximately 2 μsec.

- The accumulator register shifts either right or left and accumulates partial sums. This shift-and-add capability much improves multiplication and division times.

- All outputs are push-pull MOS buffers. Each stage has one MOS device connected to the power supply line to pull the output up, and another connected to ground to pull it down.

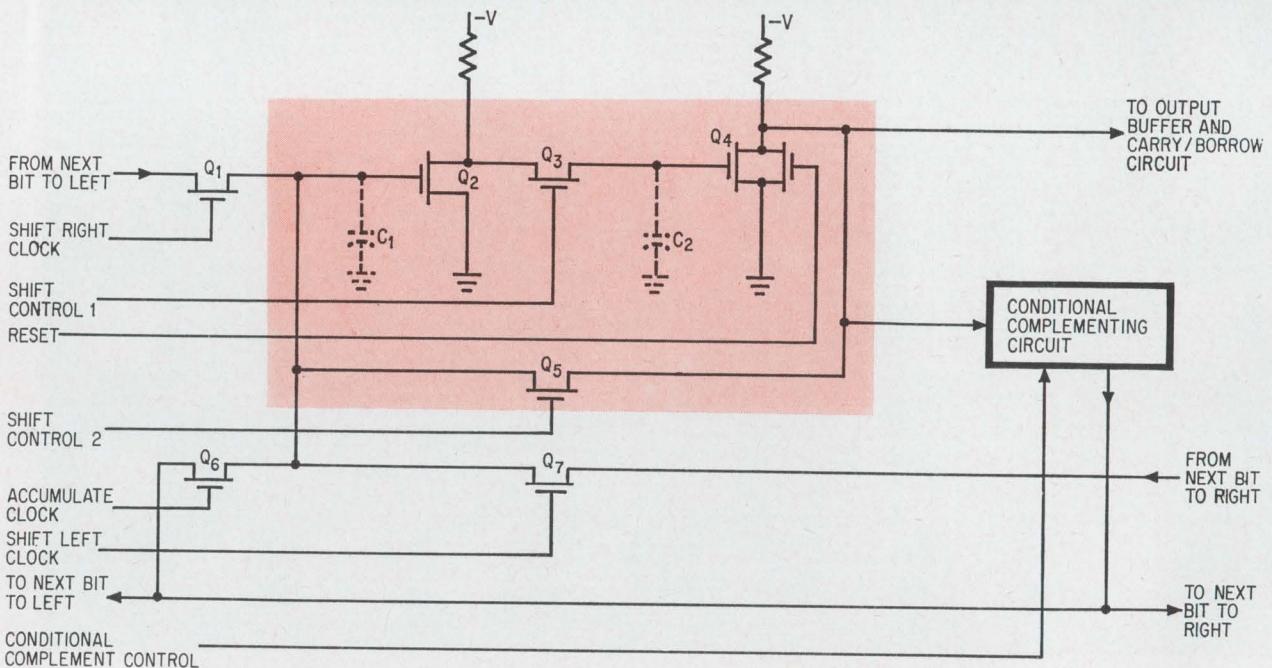

Shift mechanics. Accumulator bit position contains cross-connected MOS NOR gates, shifting controls, and conditional complementing circuit that controls output for adding or subtracting. Stray capacitance in cross-connected gates retains stored data temporarily during shifting.

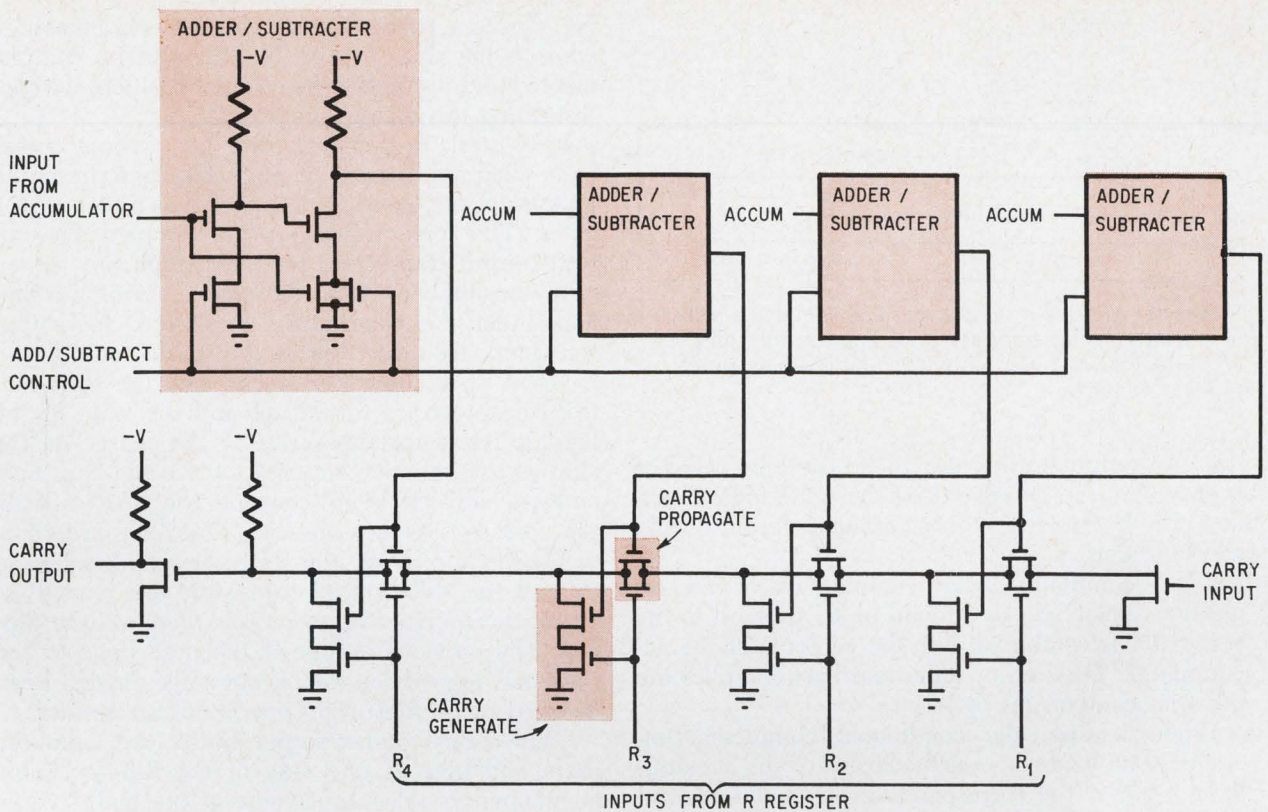

Add or subtract. Carry look-ahead circuit generates a carry at any bit position if both the accumulator and the input register contain a 1, and propagates an input carry if either is 1. Borrows are similarly treated during subtraction, when the accumulator bit is inverted.

Difference in subtracting

An eight-bit design was chosen for the arithmetic unit because it was easily manufactured and because it was a submultiple of frequently used word lengths such as 8, 16 or 24 bits. However, this standard block must also be usable in machines with lengths such as 12, 15, 18 or 20 bits. So the conventional subtraction algorithm was not suitable.

Ordinarily, arithmetic units subtract by a process called complement-add. First, the subtrahend—the number to be subtracted—is complemented, which involves inverting all 0 bits by 1 bits and vice versa, and adding the number 1 to the inverted number. The complemented subtrahend is added to the minuend—the number from which the subtrahend was to be subtracted. That gives the difference, except when another 1 may have to be added to the result, depending on whether an overflow carry from the left-hand end of the complement-add has occurred. This extra operation—called end-around-carry—is impossible in a standard accumulator used in systems of different word lengths, because either end of the accumulator may or may not be at the corresponding end of the system.

So direct subtraction circuits were included in the 3800, eliminating complementing and end-around-carry, and making the circuit a truly variable-word-length device. This additional circuitry, combined with look-ahead carry circuits to increase operating speed, made the logic techniques used with conven-

tional bipolar circuits inapplicable to the mos circuit. An unusual method of adding, subtracting and shifting was therefore chosen to fit the mos technology, making possible a substantial reduction in the number of needed devices.

Logically similar

The same logic can generate either the sum or difference in the adder-subtractor without modifica-

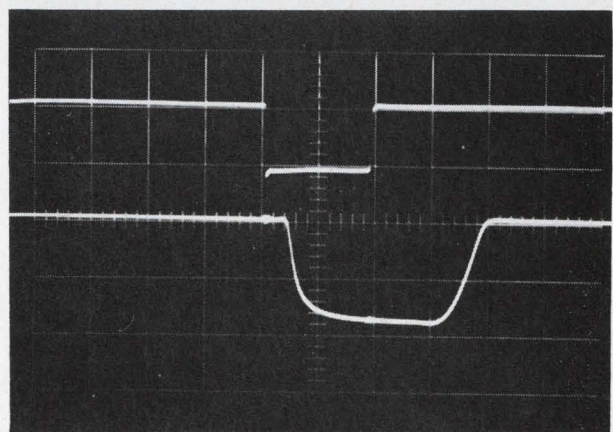

Brief delay. Propagation delay for worst-case conditions is only about two microseconds, when both the accumulator and the input register contain zeros and a borrow signal is applied to the right-hand bit. The upper trace is the borrow input, and the lower trace is the output borrow at the left-hand bit. Scales are 10 v/div. vertically and 1 μ sec/div. horizontally.

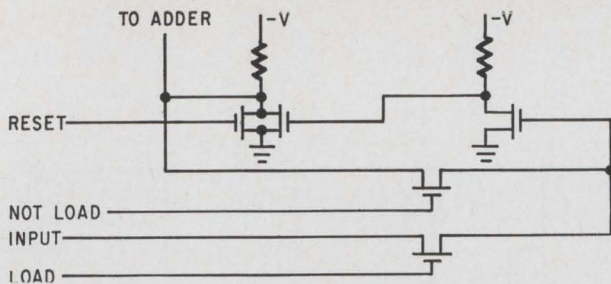

Pieces of eight. Input register position contains a pair of cross-connected transistors, loading controls, and provision for reset. The arithmetic unit contains eight of these circuits.

tion. An output to the next bit to the left—carry or borrow—can be generated by the same logic modified only by inverting the accumulator input during a subtraction.

The accumulator always contains one of the two numbers involved. An addend or subtrahend in the R register is combined with the contents of the accumulator. The sum or difference then modifies the previous contents bit by bit.

When adding, the conditional complementing circuit complements a particular bit of the accumulator if either the corresponding bit of the addend or the carry from the next bit to the right is 1, but not if both are 1. The same is true in subtraction, except that the carry signal is called a borrow. This is shown in the truth table, top of page 122, where the bits in the columns headed Sum and Difference are the same.

The table also shows that a carry to the next stage is generated if both the accumulator and the addend have a 1 in a particular bit position; and an input carry is not propagated beyond that position if both bits are 0. Otherwise, the output carry equals the input carry. On the other hand, a borrow is generated at any position if the accumulator bit is 0 and the subtrahend is 1, and an incoming borrow is killed if the accumulator is 1 and the subtrahend is 0. Otherwise, the output borrow equals the incoming borrow.

Circuit design

The accumulator register is a standard one whose contents can be shifted left or right. In either shift-

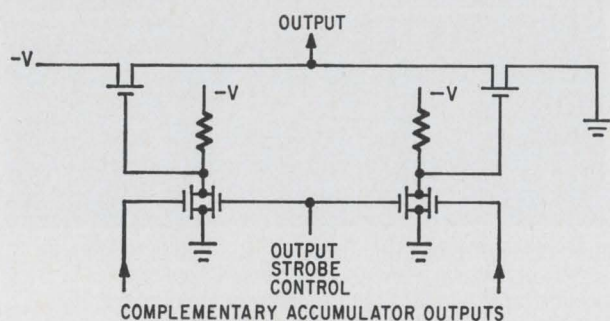

Plus and minus. Output buffer connects both positive- and negative-going signals to proper references, and has a strobe input to disconnect both levels.

ing mode, a particular bit can be complemented while being shifted. Any bit can also be complemented and restored to its original position, without disturbing the bit on either side.

In its static or d-c state, each bit of the accumulator—diagram, bottom of page 122—is represented by transistors Q_2 and Q_4 , connected as a pair of NOR gates. The logic transistors are coupled through shift-control transistors, both of which are turned on by negative levels on their gates, forming a flip-flop under d-c conditions. The three clock-input transistors are turned off in the stable condition.

When a shift left is to occur, first the shift-control transistors are turned off and the state of the flip-flop retained temporarily by the charge on the stray capacitance of one side of the flip-flop. Secondly, a shift-left signal connects the next stage on the right to the stray capacitance on the other side of the flip-flop. Next, the shift-left signal is turned off and the shift-control transistors are turned on again, transferring the stored charges into the flip-flop. The previous output of the next stage to the right now appears on the output stage, having been inverted twice. Shift-right operations are similar.

Connections to the output buffer are from the drain and gate of one side of the flip-flop. This maintains the old output value at the buffer while a new bit is shifting in. The alternative—connections from the drains of both sides—would render the output uncertain during the shift.

The unusual feature of this register is its conditional complementing circuit for each bit output. It is a function of the second operand and the input carry to each stage. The complete conditional toggle circuit, including an inhibit "I" for conventional shifting operations, is shown on page 122, center.

A four-bit binary look-ahead carry circuit, as on page 123, top, minimizes the time for addition carries to propagate through a parallel arithmetic unit, but adds little circuitry. Each of the four stages generates a carry if both the corresponding accumulator and R register bits are 1, and propagates an input carry if either bit is 1. The total carry propagation delay through the carry circuits of an eight-bit accumulator slice is about two microseconds, as in the oscilloscope photos on page 123.

A complementing circuit functionally identical to the one described, but controlled by the bit line and the add-subtract control line, appears in one of the four positions of the carry look-ahead diagrams.

The remaining circuits are straightforward. A single-input flip-flop is used in the R register as shown above; the output buffer has a simple push-pull drive, as shown at left. The strobe control for the output admits data to a common parallel bus system without adding gating or propagation delays.

References

1. John L. Nichols, "Construction of complex sequential circuits with read-only memories," *Electronics*, June 12, 1967, p. 111.
2. Lee L. Boysel, "Memory on a chip: a step toward large-scale integration," *Electronics*, Feb. 6, 1967, p. 92.

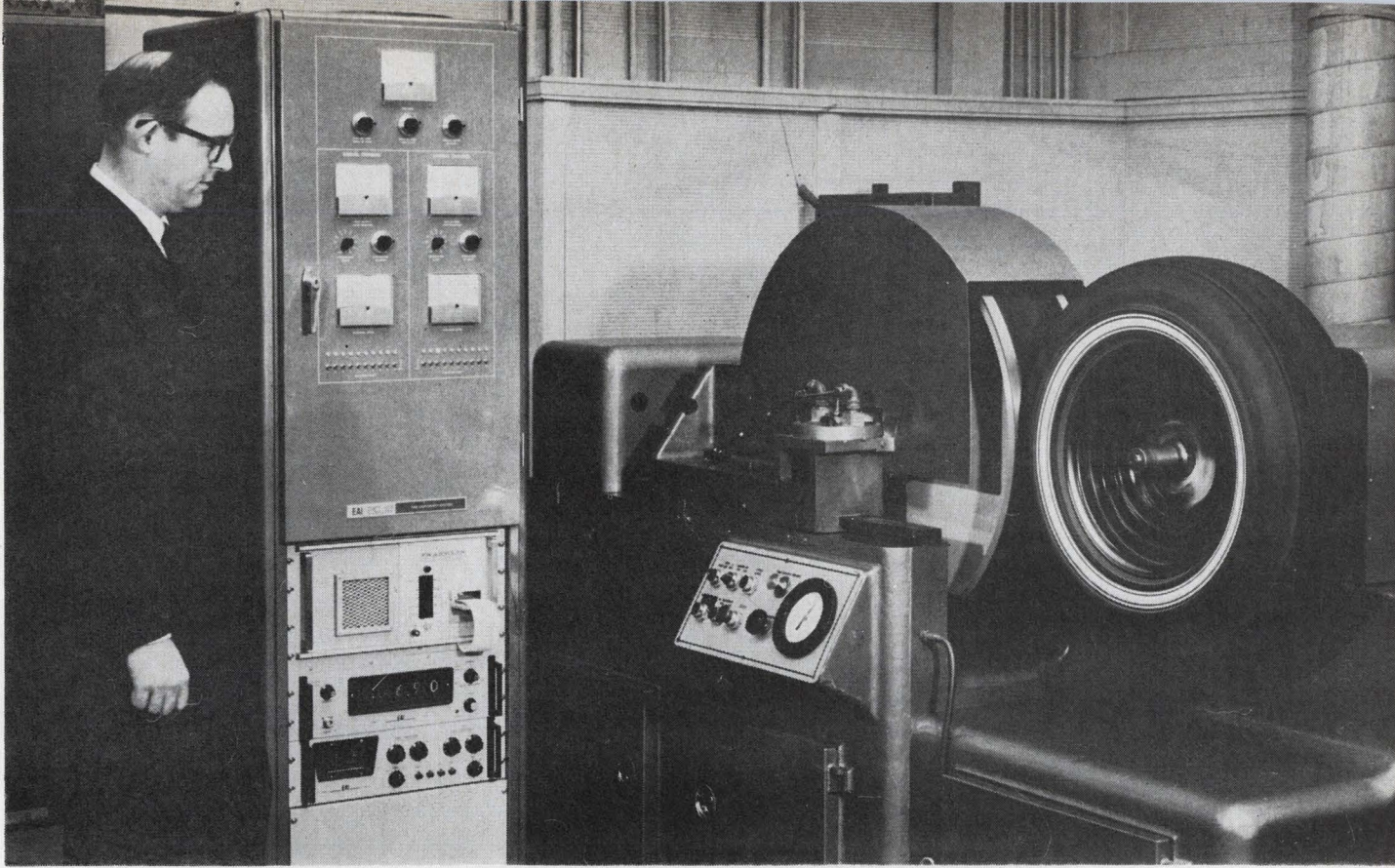

Industrial electronics

Sorting out the tires

Nonuniformities that can cause a car to shake on a smooth road are detected by analog computer systems in the production plants; besides grading the tires, newer systems may even correct imbalances

By James T. Maguire and Allen J. Schnabolk

Electronic Associates Inc., West Long Branch, N.J.

Back in the days of bumpy roads, an automobile tire's eccentricities—caused by hard and soft spots in the rubber—didn't matter much; but on today's smooth, high-speed highways, the tire can be the key factor to a smooth ride. To deliver that smooth ride on the first trip down the highway, the auto and tire industries are applying analog computation to the study of tire uniformity.

Development engineers at major car companies were the first to use special-purpose laboratory-

type computers to study the effects of tire uniformity on different kinds of cars traveling at different speeds on different road surfaces, and to determine load-force variations and tire harmonics. Tolerances established on the basis of this data were then translated into specifications and passed along to the tire makers.

Over the past two years, the major U.S. tire firms have installed over 100 tire testers in their factories to inspect and grade their products; about

60 of these employ computers from Electronic Associates Inc. [Electronics, Feb. 19, p. 50.] These computers are essentially the same as those used in auto makers' labs [the photo on page 125 shows the one at the Buick Motor division of the General Motors Corp.], but are beefed up to withstand plant environments and include some additional automatic features.

Some of the newer systems not only detect non-uniformities, but calculate and mark the locations of the high-force points on tires. Under development are servocontrols that will grind these spots to achieve a dynamic balance in the tire.

Shakeout

The kind of ride a tire can provide depends on the peak-to-peak variations in radial and lateral forces. The radial force variation is particularly important; when it's wide, the axle is displaced up and down each time the tire revolves and the tire behaves as if it were slightly off center.

Because it's most noticeable on smooth roads at higher speeds, this phenomenon is called smooth-road shake. The radial eccentricity creates a vibration similar to that caused by an unbalanced tire and wheel assembly, and this vibration sets up a resonance with the car's suspension system at speeds of about 55 to 65 miles an hour.

As a tire rotates at a constant speed, the force variations can be represented by a complex periodic waveform; smooth-road shake is responsive to the waveform's first harmonic, or fundamental. The first harmonic, in turn, is sensitive to tire inflation pressure and to tire load. In lab tests with tires under 1,000-pound loads—one quarter the approximate total weight of a car with passengers—it was found that a pressure boost of 1 pound per square inch causes an increase of about 1 pound in first harmonic, while an increase in load force to 1,100 pounds decreases the first harmonic by about half a pound. The peak-to-peak variation caused by the first harmonic ranges from 3 to 60 pounds about the normal value.

Treadmill

In the inspection system, the tire is first centered, secured, and automatically inflated. A rotating roadwheel is then positioned to put a load of up to 2,000 pounds on the tire, flexing it. After several revolutions, the load is reduced to the standard test level of 1,000 pounds.

The fully automatic instrumentation and computer system sequences the testing cycle, makes decisions, and then comes up with an evaluation of the tire.

Radial and lateral forces are sensed at the end of the roadwheel shaft by a pair of load cells, each of which detects the forces applied in the two perpendicular directions. Electrically, the load cells form two conventional 350-ohm strain-gage bridges that operate on a supply of 15 volts d-c and produce a full-scale output of 2 millivolts per volt. Thus, with a 1,000-pound load, the load-cell

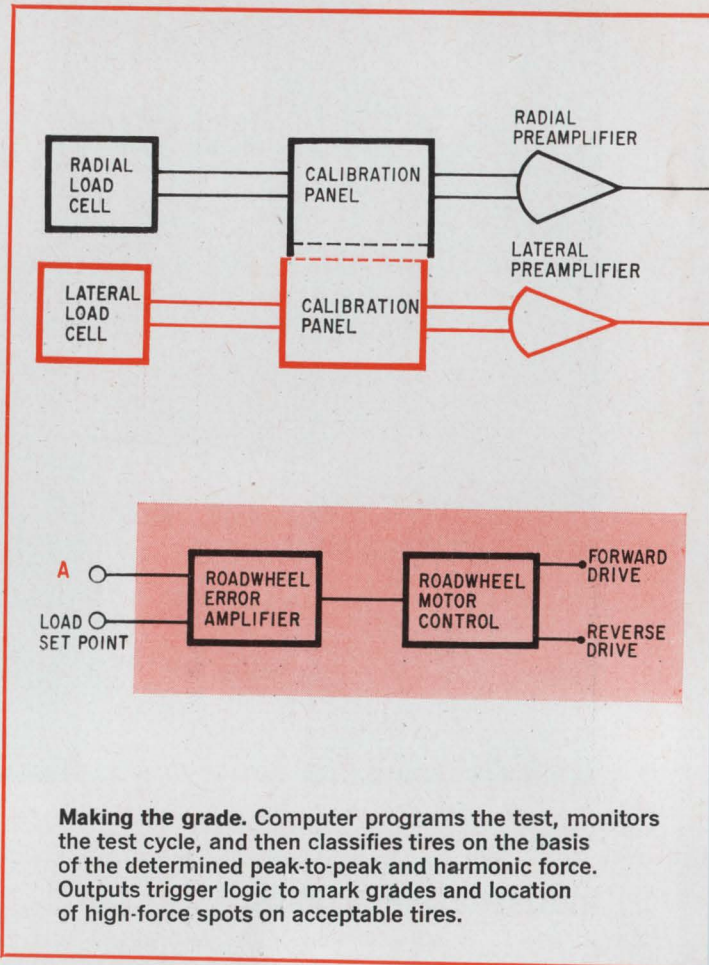

pair produces a total output of 30 millivolts d-c, which is boosted by an amplifier in the computer to 10 volts.

The system's analog computer has separate channels for radial and lateral force signals. Both operate in substantially the same way except that the high-spot phase angle is computed only for the radial direction.

To increase over-all sensitivity, a differential amplifier algebraically subtracts (or zero-suppresses) the tire-load set point from the instantaneous sum of the tire load and force variations during one revolution of the tire. The resulting

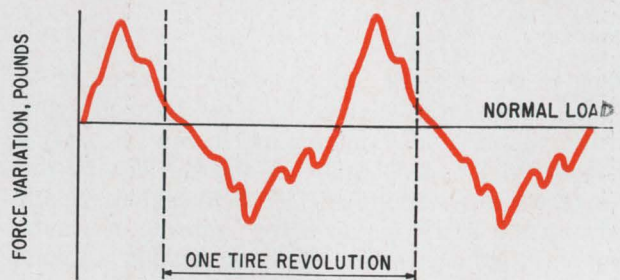

Complex waveform. Hard and soft spots in the rubber and other materials of the tire cause variations in the load force as the tire rotates.

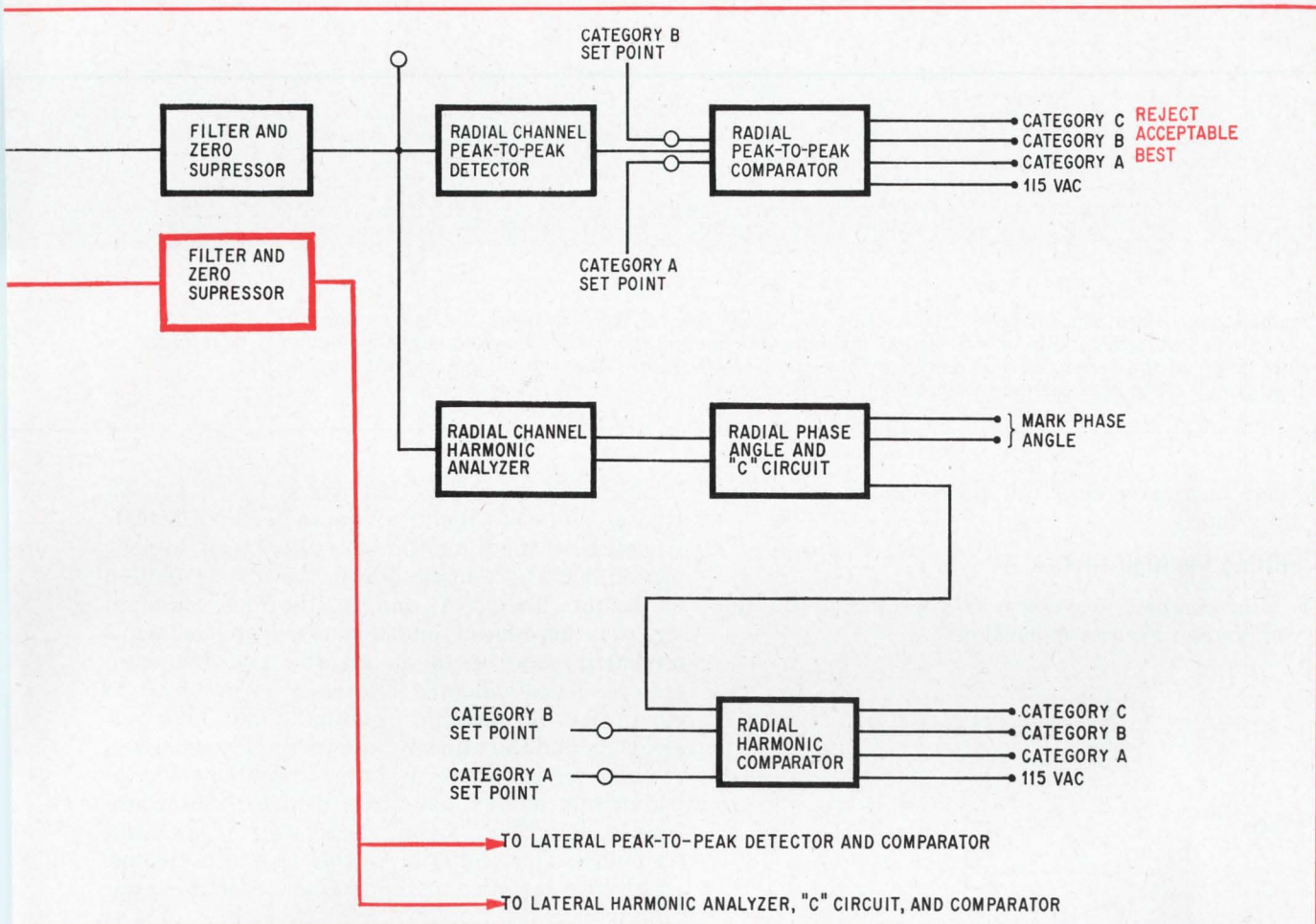

net force variation then goes into a peak-detector circuit, one portion of which senses and stores the maximum positive peak and another the maximum negative peak. These two values are then algebraically summed in another differential amplifier, one whose positive output voltage is the value of the peak-to-peak force variation.

Report card

Two differential amplifiers with adjustable set points act as comparators to separate peak-to-peak force-variation levels into three categories—two “accept” (A and B) and one “reject” (C). One am-

plifier has an input from a set-point potentiometer adjusted to category A and another input for the peak-to-peak signal. As long as this signal does not exceed the set-point value, the tire is classed in category A.

The other differential amplifier’s set point is adjusted to the category B value. Peak-to-peak signals that exceed this level are given C’s.

Outputs from the comparator amplifiers latch up relays whose contacts go to a logic circuit. This circuit evaluates the test results in both lateral and radial classifications to determine tire grade. If accepted, the tire is then marked with its proper grade.

An unusual harmonic analyzer is the most recent addition to the Electronics Associates computer. The fundamental is computed in both lateral and radial directions, and the output from the radial channel is used to locate and mark on the tire the high spot causing the peak value of the harmonic’s amplitude.

As the tire rotates at a constant speed—generally one revolution per second—it produces the complex periodic waveform $f(t)$. The harmonic-analysis circuits compute the amplitude of the waveform’s fundamental, and the rotation angle, or phase angle, between the start of the harmonic-measure-

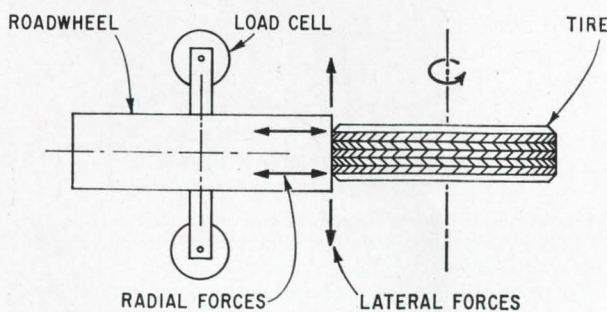

Road simulator. Load cells connected to roadwheel measure radial and lateral force variations.

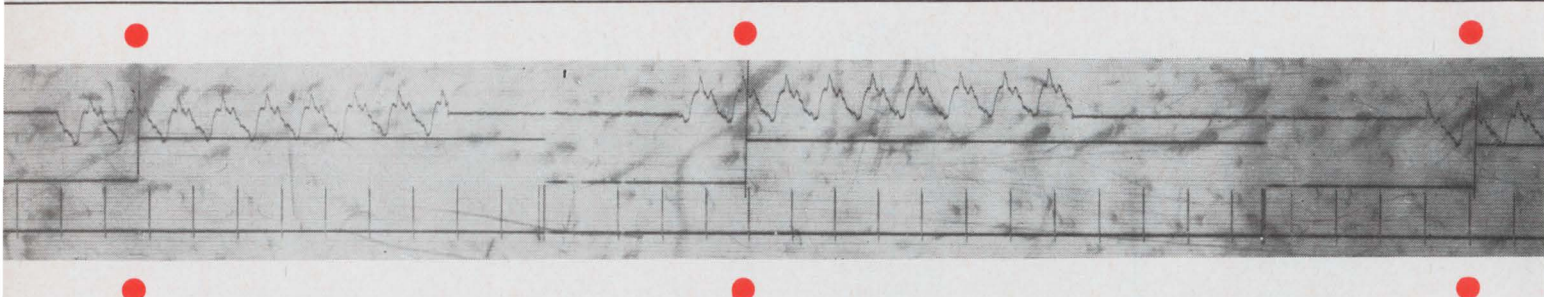

Independent. Harmonic analysis circuit yields consistent results. When a single tire is examined three times in three different orientations in the testing machine, the record shows that the color dots indicating a high-force spot occur at the same point, or angle, on the complex waveform. These high-spot signals operate the tire-testing machine's marking device.

ment test cycle and the detection of maximum amplitude.

Hitting the high spots

The complex waveform is represented by the well-known Fourier expansion:

$$f(t) = \frac{A_0}{2} + \sum_{n=1}^{n=\infty} C_n \cos(n\omega t + \phi_n)$$

where

$$C_n = \sqrt{A_n^2 + B_n^2}$$

$$\phi_n = \arctan\left(-\frac{B_n}{A_n}\right)$$

$$A_n = \frac{1}{\pi} \int_0^{2\pi} f(t) \cos n\omega t dt$$

$$B_n = \frac{1}{\pi} \int_0^{2\pi} f(t) \sin n\omega t dt$$

t = time measured from a reference point

The first harmonic is determined by C_1 and ϕ_1 , whose values are found by computing coefficients A_1 and B_1 at the same time the radial peak-to-peak measurements are made during the first revolution of the tire. To get A_1 and B_1 , the force-variation signal is introduced into a closed-loop sine-wave oscillator made up of an inverter and two integrators. The oscillator's frequency is pretuned to equal that of the tire rotation. One integrator yields A_1 and the other B_1 after a single revolution.

These signals serve as initial conditions for integrators in another sine-wave oscillator, one whose loop is closed by a signal at the start of a second revolution. The amplitude of this second oscillator, which also operates at the frequency of tire rotation, is C_1 .

The output of integrator A is exactly in phase with the fundamental component of the complex force variation waveform, and the output of integrator B is 90° out of phase. As one output reaches its maximum value, therefore, the other is crossing zero, a crossing that can be sensed electronically. The time at which one output reaches its peak and the other crosses zero corresponds to the phase angle. At that instant of coincidence, a relay

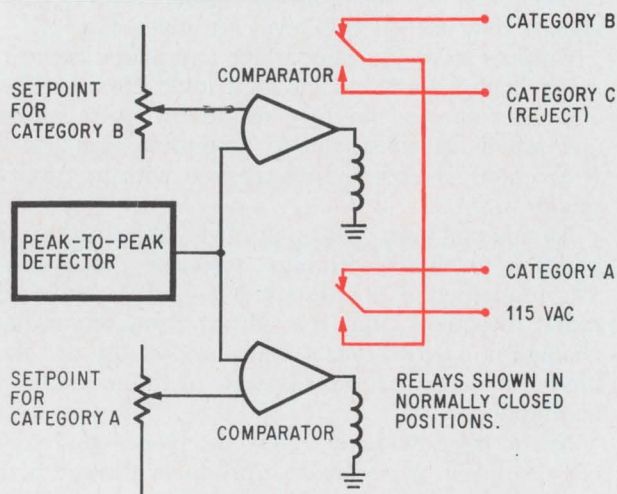

Flunking out. Amplitude of peak-to-peak force variation is compared with set points. When the signal exceeds category B level, both relays are energized and the tire is rejected.

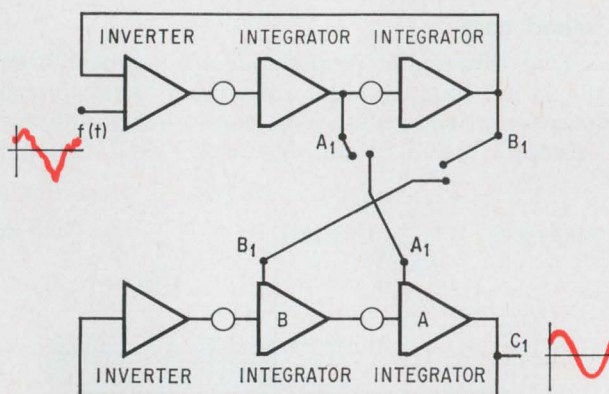

Smoothing the wave. Complex waveform enters the upper closed-loop oscillator, which cleans up the signal to compute first harmonic's sine and cosine amplitudes. These values become the constant initial conditions for integrators in lower oscillator, whose amplitude and phase angle equal those of the first harmonic.

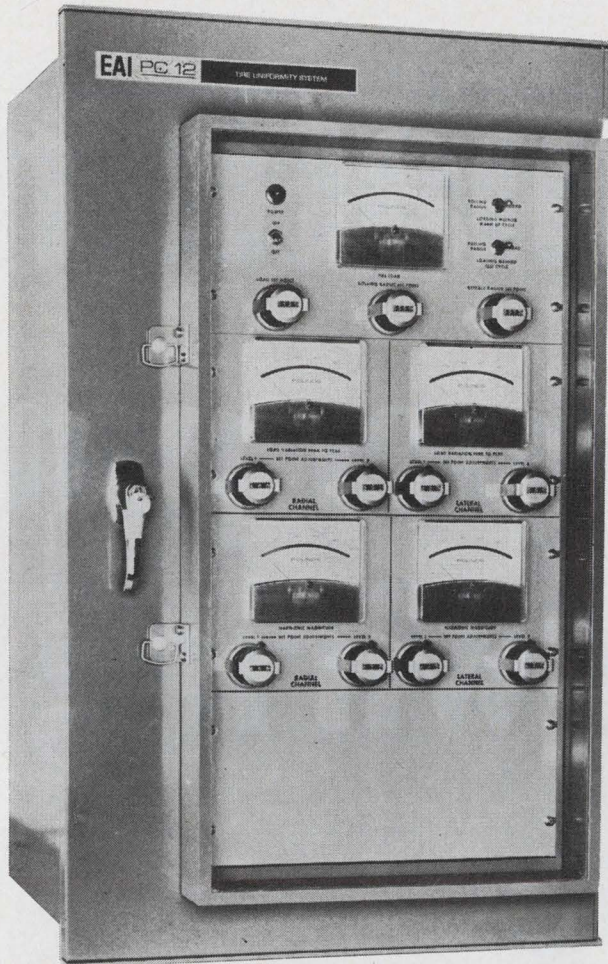

Dial-a-test. After operator sets up test conditions and accept-reject values, analog computer takes over.

operates the angle-marking circuit to indicate the high spot on the tire.

The computer calculates fundamental peak-to-peak force variations to within 1 pound in both the radial and lateral channels, and locates the high spot of the radial fundamental component to within 3° . The record of three test runs, facing page, on the same tire shows the ability of the radial harmonic circuit to repeatedly find the high spot, and also indicates that the force-variation waveform is the same no matter how the tire is oriented in the testing machine.

When a tire's high-force spot is matched to a wheel's low spot, each maximum variation acts in an opposite direction. The net reduction of peak-to-peak fundamental force is impressive. For example, one group of unmatched assemblies had a first harmonic radial force variation ranging from 18 pounds to 59 pounds, with 86% above 25 pounds and 72% above 35 pounds. But in matched assemblies, one group showed a range of 6 pounds to 24 pounds, with 80% below 18 pounds.

Close shave

In a more direct approach now being developed, high-force spots on category B tires are ground by servopositioned wheels during the test cycle to

reduce the force variation to an acceptable value.

The peak-to-peak force variations are measured around the tire, and equivalent voltages are sent to one input of a comparator. The other input is a set point, say 20 pounds. When a peak-to-peak force exceeds the set point, the comparator output latches up a relay that energizes the grinder control circuit, which also consists of a comparator. This second comparator is set at a desired peak-to-peak level, say 10 pounds. The set point of the first comparator is then adjusted to this same value to keep the circuit active.

The force variation signal, $f(t)$, which might range from +15 to -15 pounds, is locked to a peak so that its range runs from 0 to 30 pounds. This signal then goes to the other input of the second comparator.

As long as the force-variation signal exceeds 10 pounds, the second comparator produces a signal to a high-power servo loop that forces grinding wheels against the tire. For mechanical reasons, the grinding wheels are 150° away from the measurement location. The grinding pulse is thus delayed by an amount of time equivalent to 150° of rotation before it activates the servocontrol loop.

Tests show that this grinding can reduce a 50-pound peak-to-peak force variation to 10 pounds in about 20 tire rotations, or about 20 seconds.

The production-type tire uniformity computer is built of standard analog modules. However, some special circuits had to be designed to make the instrumentation and computer system work reliably in the plant environment. For example, tests indicated the tire-testing machine set up mechanical resonances that appeared as noise on the load cells' outputs. This noise had a range of frequencies that could interfere with the measurement signals. A special filter was installed to attenuate the noise. The filter has a 16-hertz bandwidth and a 60-dB-per-decade rolloff characteristic. The bandwidth is 16 times that of the tire rotational speed.

The authors



James T. Maguire started working on tire uniformity projects in 1965, as an original member of the team. He holds a master's degree in electrical engineering from Newark College of Engineering.



Allan J. Schnabolk came to EAI in 1959, working as a student engineer while attending Drexel Institute of Technology on the co-op plan. He, too, has been developing tire uniformity computers since 1965.

Economation: AMP's taper pin interface wiring technique

AMP offers the broadest line of taper pin products in the world.

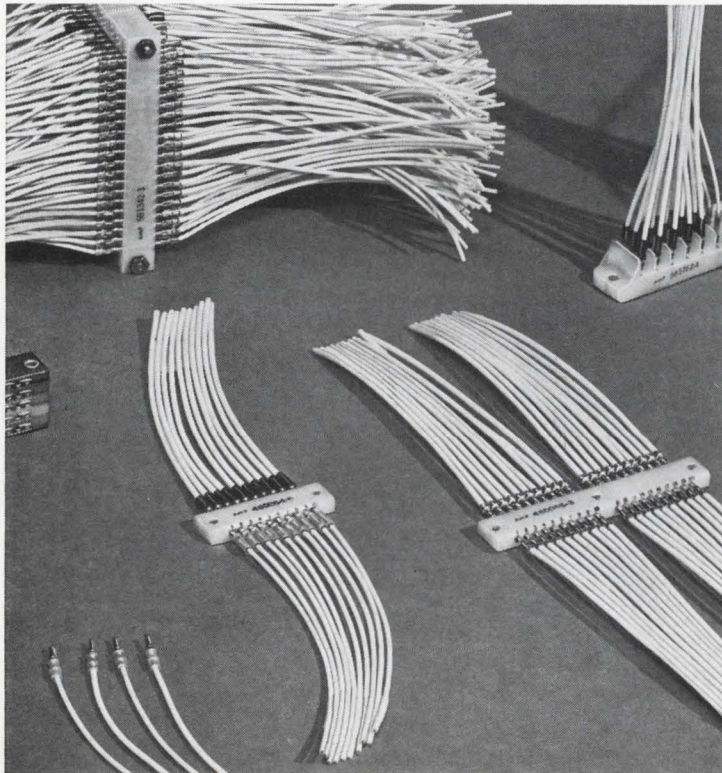

Taper pins are quickly inserted using a precision spring-loaded A-MP* tool.

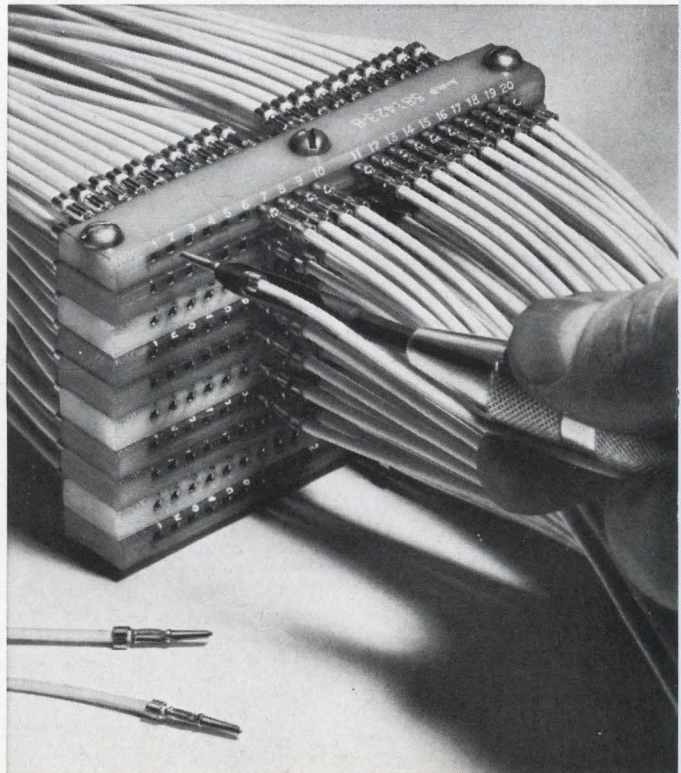

Taper technique is an excellent example of Economation by AMP—cost reduction through automation. Based on the wedge principle, the connection is self-cleaning and self-locking when the pin contact is inserted into a matching taper receptacle.

The pin has only a slightly larger diameter than the wire itself, which allows very high density connection packaging. Yet any contact may be individually replaced without interference with other contacts. This, plus small size and weight and proven reliability, makes it perfect for interface connections between main frame and peripheral computer units, and in a host of wiring applications throughout the Electronics Industry.

AMP's taper pin product line—the world's most complete—is also the most automated and economical. For example, one automated A-MP* machine can cut leads to size and apply over 10,000 taper pins an hour. And each termination is uniformly reliable because AMP engineers design a tool to match every product. This means fewer rejects, faster production, and applied cost savings.

Get the facts on taper technique and AMP's lower applied cost now. Write AMP Incorporated, Harrisburg, Pa. 17105.

*Trademark of AMP Incorporated

High-density interface wiring with A-MP* taper pin blocks.

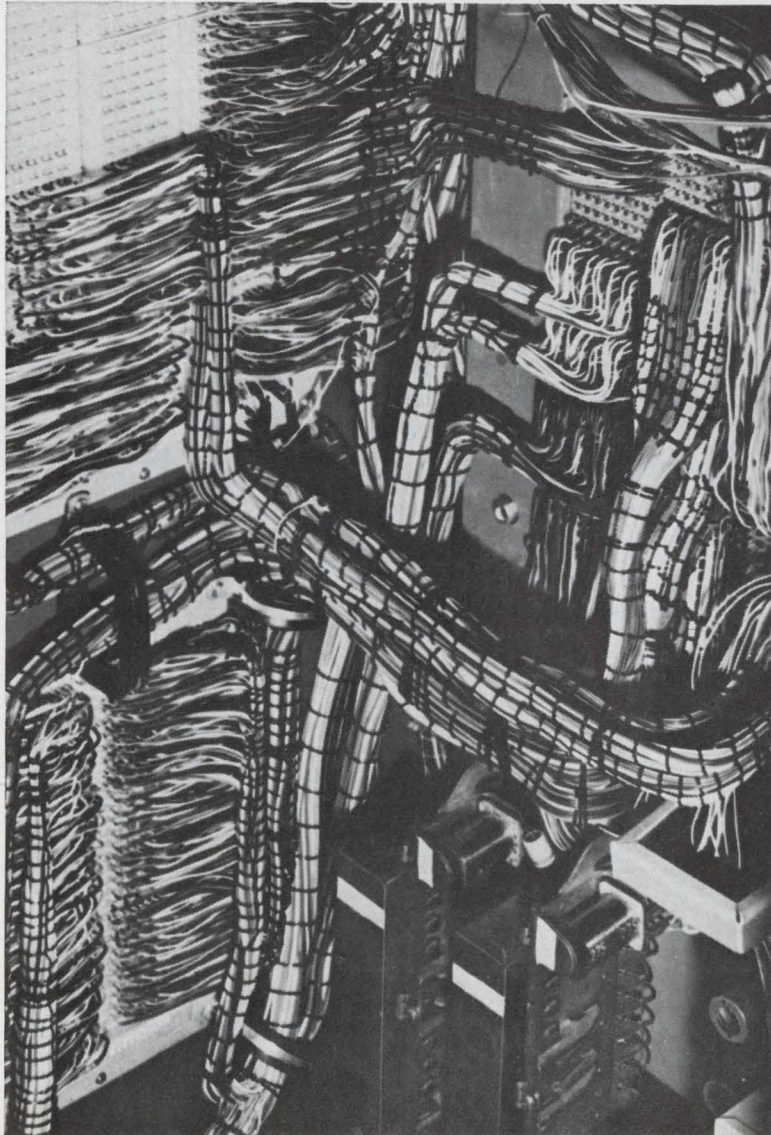

AMP

The AMP-O-LECTRIC* automachine applies taper pins automatically at rates of 4,000 an hour.

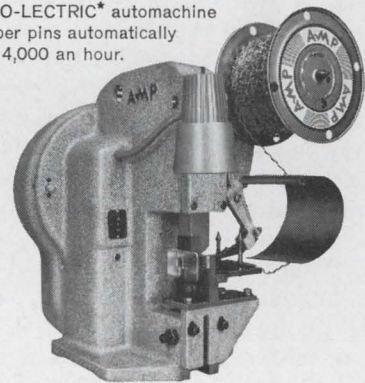

Full automated application of taper pins at rates exceeding 10,000 an hour is possible with the AMPOMATOR* machine.



Cameras that wink can produce 3-D tv

If two monochrome cameras spaced like human eyes were to alternately scan a scene, and if their outputs were processed as red and blue signals, viewers wearing filter specs would get that illusion of depth

By M. G. Maxwell

Kriesler Australasia Pty. Ltd. New South Wales, Australia

Three-dimensional television has been the goal of a considerable amount of research during recent years. Many proposals have been advanced, but all have proven impractical.

An object must be viewed from two different angles to appear three-dimensional. There must therefore be two separate channels of communication—one for each eye—between the televised scene and the viewer. The greater the isolation between the communication paths to the eyes, the more pronounced will be the illusion of depth. Perhaps the best way to achieve this isolation is to put the left and right channels' information into a time-sequential form that can be transmitted by a single medium.

Such isolation can be provided by combining the technologies of monochrome picture transmission and color-television reception. Slightly modified monochrome cameras can generate separate left and right video signals for viewing on an unmodified standard color receiver.

The scheme would be relatively simple to implement. On the receiving end, viewers would have to wear colored spectacles, but with the exception

of camera optics, existing video equipment on the transmitting end could be easily modified by tv station personnel.

Besides the obvious entertainment potential of 3-D television, important applications could also be found in such areas as air traffic control and vector electrocardiography.

Seeing red

Two monochrome cameras can be placed a few inches apart from each other to achieve the angular displacement of an image in a televised scene. The output of one camera, say the right, is modulated only during even fields while the other's output is modulated during odd fields. In this way, the left and right views of the televised scene are transmitted and viewed on alternate scans.

To achieve the illusion of 3-D, though, some arrangement must be made so that the viewer's right eye sees only the even fields and the left sees only the odds, or vice versa. Color television offers a practical and simple solution here. For when the red dots of the picture tube are viewed through a red filter of the same hue saturation, they will appear almost white; similarly, the blue dots appear almost white when observed through a blue filter. On the other hand, if the red dots are viewed through a blue filter, or vice versa, the dots will appear almost black.

Now if the blue and green guns of a standard color tv receiver are turned off momentarily while the red gun stays on to scan a beam across the cathode ray tube, the trace will appear essentially white if it is observed through a red lens or will be hardly visible if observed through a blue lens. If the red and blue guns are set up to scan alternate

The author



Before joining Kriesler, where he is now an instrumentation engineer, Maxwell G. Maxwell was a studio equipment engineer with the Television Corp. of New South Wales. He also worked at the British Broadcasting Corp. in London for 11 years, and is the holder of six Australian and foreign patents.

fields, and the picture tube is observed through a pair of spectacles with red and blue filters for lenses, one eye will see a blue field and the other a red.

With a vertical frequency of 60 scans per second, the eye will see a raster at a rate of 30 scans per second. Each eye, then, sees a picture every 1/30th of a second—not an intolerable flicker since the scene is being viewed with both eyes, and one compensates for the other. For the viewer, the alternating scenes will appear as one continuous picture with all gaps filled in.

The two monochrome tv cameras would take inputs from points spaced 2½ inches apart to represent the normal spacing of the human eyes. The video output of the left camera would be fed to the color matrix that normally receives a color input signal representing red objects in the televised scene. In this instance, the red input is being fed a black-and-white signal. Once out of the matrix, though, the signal can be regarded as containing color information from a red object, and this deception can be carried all the way through to the grid of the red gun. Similarly, the right camera video output is processed to activate the blue gun of the picture tube.

In the regular tv matrix, 30% of the red signal, 59% of the green, and 11% of the blue are combined to yield the luminance, or brightness, signal. Here there is no green signal, but luminance is achieved by equalizing the red and blue signals in the matrix.

In this 3-D system, then, there would be left and right cameras, a matrixing circuit, and an electronic switching circuit to alternately turn on the red and blue guns during odd and even fields. The optics of both cameras could be combined in a single unit with only one camera tube and a means of switching the left and right pictures to the camera tube during alternate fields. Four plane mirrors direct the right and left images onto the camera tube mosaic.

Mounted in the focal plane of each lens are disks with slits whose centers coincide with the focal planes of the lenses. These slits are arranged so that when one lens is opened the other is effectively closed. The size and spacing of the slits in the disk are such that each lens remains open during the vertical sync signal interval. By synchronizing the disk with the vertical sync signal, the holes in the disk can be made to expose the left lens during odd fields, and the right lens during even fields.

After the alternate switching of the odd field to the red input terminal of the matrix and the even field to the blue, the information is handled as normal color signals.

It's interesting to note that color cameras couldn't be used as pickup devices in this 3-D system because the red and blue lenses would be insensitive to objects not within their color wavelengths. Thus, portions of the scene being televised would be obscured at times. For this reason, only monochrome cameras can be used in this 3-D scheme.

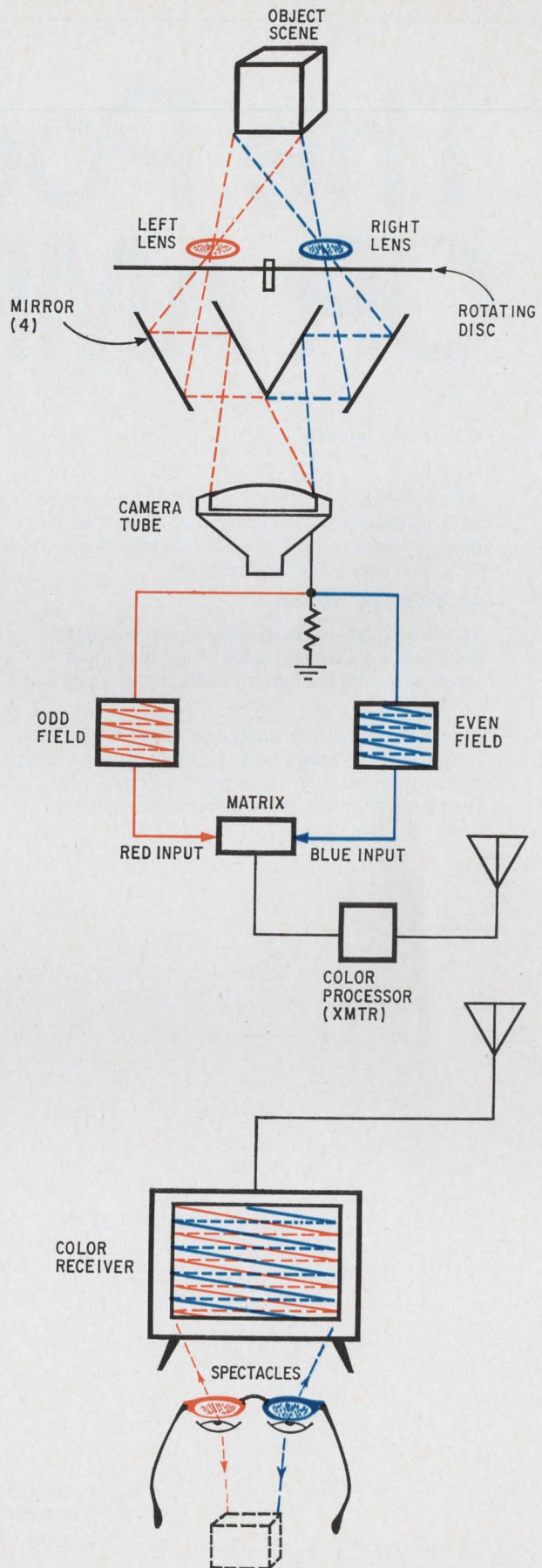

Stereoscopic view. Isolation of left and right channel information, from object scene to observer, is achieved by color-coding the odd and even fields at the matrix.

The Poor Man's OP. AMP.

(Amelco 809
Integrated
Operational
Amplifier)

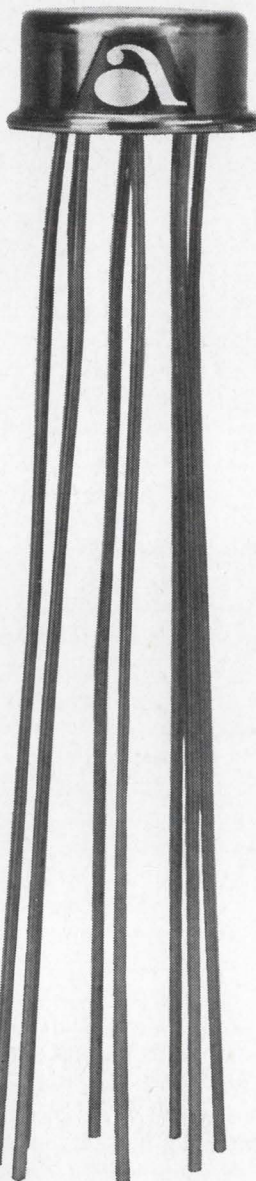

Will it make you rich?

It could.

Because Amelco took the highest performance specs for an integrated operational amplifier, simplified the design, and came up with a TO-5 package that will meet 95% or more of your requirements.

At a fraction of the cost.

The Amelco 809 is ideally suited for applications requiring high common mode range, high input impedance, and low current and voltage offsets and offset drifts.

Check the specs. Then order one, or hundreds, from Milgray. We have them available in depth...for off-the-shelf delivery...anywhere, overnight. (And you can afford more than you thought.)

m
MILGRAY

Milgray/New York 212-YU 9-1600 Milgray/Delaware Valley 215-BA 8-2000
Milgray/Washington 301-864-6330 Milgray/New England 617-272-6800
Milgray/Cleveland 216-881-8800 Milgray/International 212-YU 9-1600

TTL Trends

from Texas Instruments

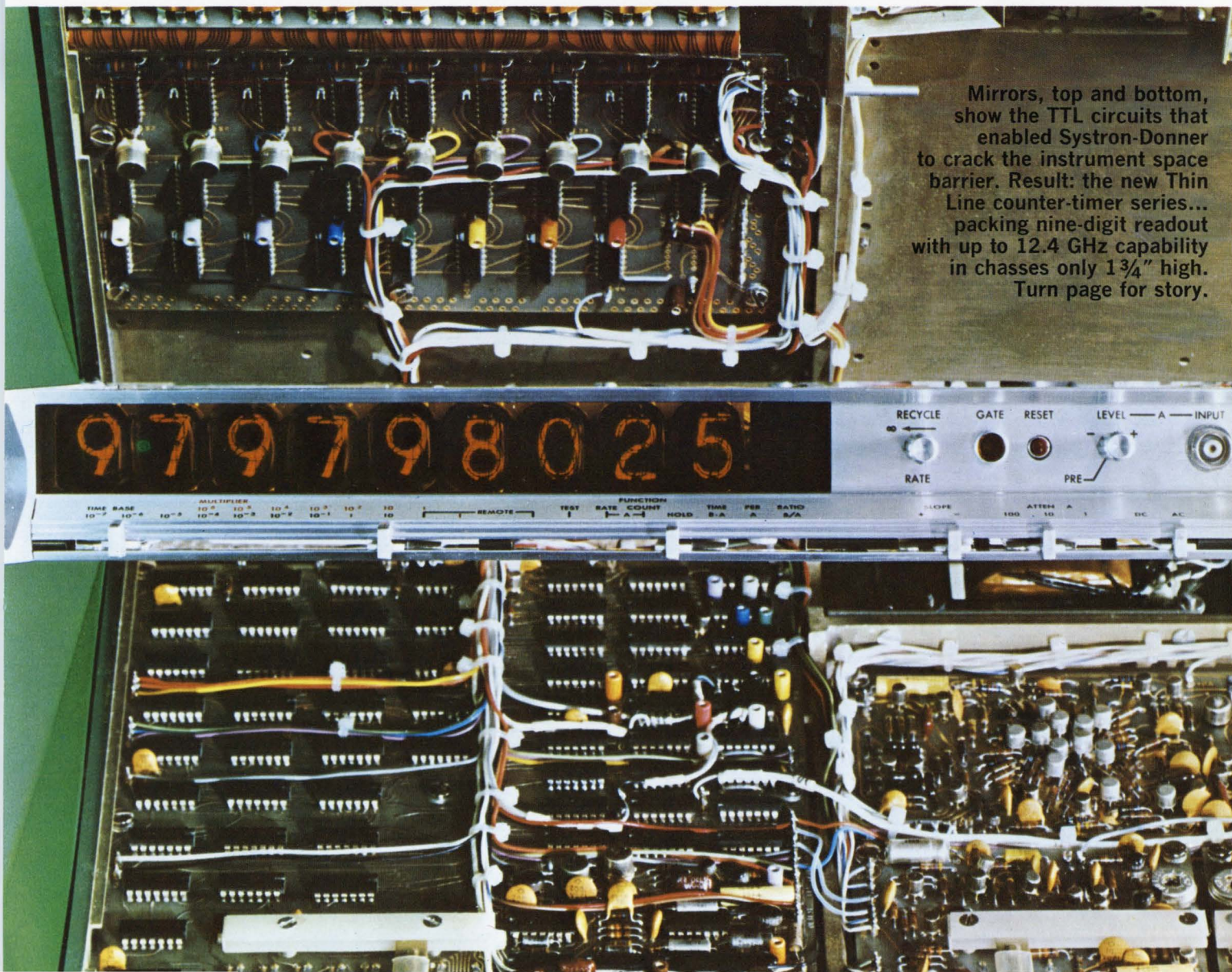

Mirrors, top and bottom, show the TTL circuits that enabled Systron-Donner to crack the instrument space barrier. Result: the new Thin Line counter-timer series... packing nine-digit readout with up to 12.4 GHz capability in chassis only 1 $\frac{3}{4}$ " high. Turn page for story.

How TTL helped slim fat counters

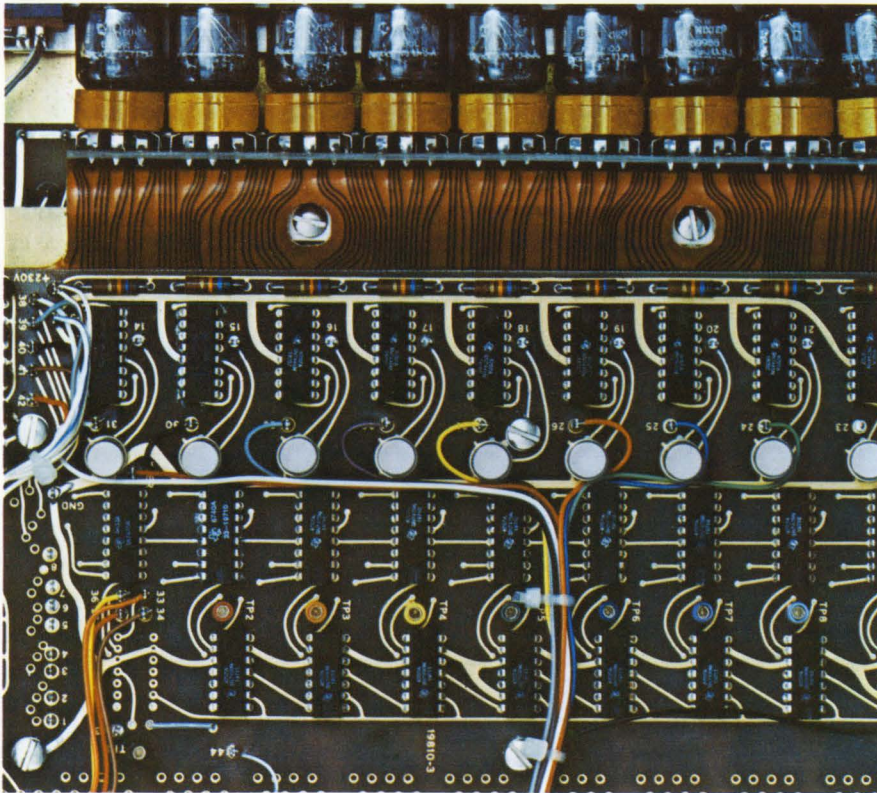
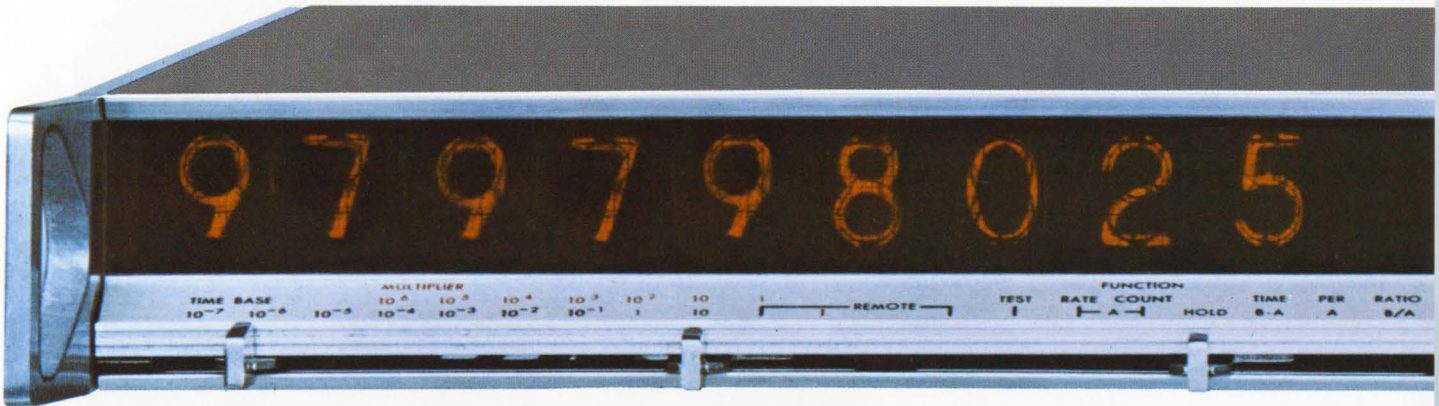

Mission impossible? It may have seemed so to project engineers at Systron-Donner Corp. They had the assignment of designing a radically new line of high-frequency counters—one that would give them a big jump on competition.

A key requirement was reduced panel height. Systron-Donner engineers wanted a *skinny* counter — one only 1¾" high.

But, they also wanted nine-digit readout for top resolution.

Plus a 100 MHz direct counting range.

And greater freedom from repairs than ever before possible.

Integrated circuits were the obvious solution. But *which* ICs posed the tough question. Answering it triggered a two-year search that covered all major IC suppliers as well as many smaller producers. Systron-Donner's analysis included RTL and ECL logic types, in addition to TTL and DTL. Breadth of product line, depth of manufacturing facilities and competence of personnel were considered—along with price, service and performance—before the final selection was carefully made.

Twenty-six TI Series 74 complex-function integrated circuits form the decade chain and decoder-driver section of this Systron-Donner Thin Line counter. Without circuits such as SN7441N BCD-to-decimal decoder-drivers, hundreds of separate transistors and simple integrated circuits would have been necessary to perform the required functions.

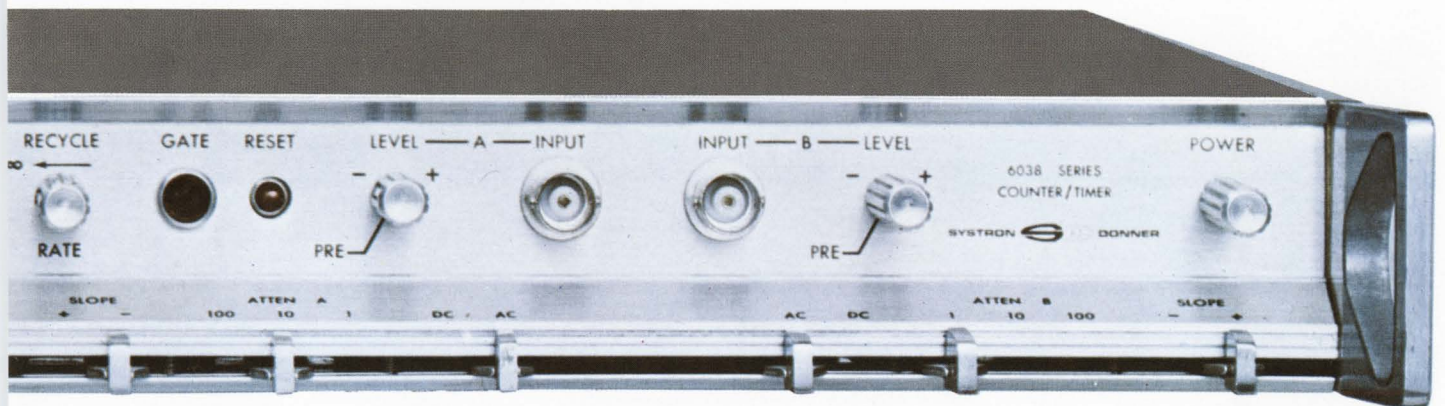

Texas Instruments got the nod, and its Series 74 TTL integrated circuits were selected to carry the major share of the chassis-shrinking job.

Cutting package count with complex-function ICs

Availability of complex function circuits was a prime factor in the selection of Series 74 TTL. With these advanced ICs, Systron-Donner engineers were able to make major reductions in package count — particularly in the decade-chain and related storage-readout driver section. Eight SN7490N decade counters, nine SN7475N quadruple latches and nine SN7441N BCD-to-decimal decoder-drivers replaced hundreds of simple integrated circuits and transistors. Without these TTL circuits, the new Thin Line counter design would have been virtually impossible.

Other benefits from TTL

Even where complex functions were not required, TI's Series 74 TTL line permitted significant package and space savings. For example, SN7473N dual J-K master/

slave flip-flops assured high switching speeds for control binaries. A further reduction in package count resulted from use of multiple-input SN7470N J-K flip-flops.

In addition, Series 74 gates — SN7400N, SN7410N and SN7420N — provided a solid 10 MHz switching capability in those sections where such speed was desired. And the high driving capability of these gates (resulting from low output impedance) gave Systron-Donner engineers greater flexibility in wire routing and circuit board layout, without compromising switching speed.

And high noise immunity — typically 1.9 V for logical one and 1.2 V for logical zero — further simplified board layout. Series 74 ICs also permitted much faster evaluation of pilot board runs than had ever been achieved with discrete components.

Reliable, maintenance-free operation

Field experience to date indicates Systron-Donner has achieved its design goals for reliable, trouble-free service. Expectations are that the MTBF for the new Thin Line

counters will far exceed that of older counters using discrete components. This improved reliability is due, in large measure, to the reduction in package count and even greater reduction in number of soldered connectors made possible by the Series 74 TTL logic family from Texas Instruments.

Planning for tomorrow

By using industry's most modern logic family, Systron-Donner has also provided for future design opportunities — at minimum cost, time and effort.

TI's growing family of TTL complex functions has provided Systron-Donner a link with the MSI and LSI semiconductor circuits of tomorrow. Why not also put this advanced IC line to work for you?

Three of the most recent additions to the TI complex function line of shift registers are featured on the next page. They typify the increasing versatility and complexity that has characterized the evolution of TI's family of TTL circuits. One of these ICs may be just the ticket for breaking that design log jam of yours.

TEXAS INSTRUMENTS
INCORPORATED

3 new shift registers expand industry's broadest logic line

These complex-function TTL shift registers are far more than basic registers. Applications include shift counters, Johnson and ring counters, and shift-register generator counters.

These registers incorporate additional gating as well as input and output connections, and are recommended for many storage and counting applications in addition to such shift functions as serial-to-parallel, parallel-to-serial, right-shift and left-shift operations. In all cases, substantial savings in packages, interconnections, design time and overall costs will be realized.

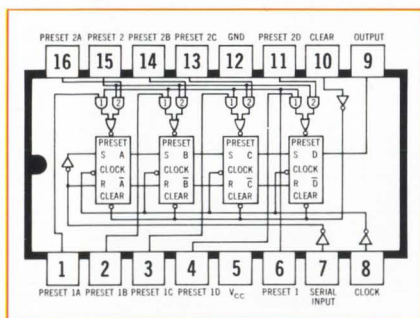

SN7494 4-bit shift register

This parallel entry, serial shift register includes four AND-OR-INVERT gates, four inverter drivers, and four R-S master-slave flip-flops. The result is a versatile circuit which performs right-shift operations as a serial-in, serial-out register or as a dual source parallel-to-serial converter.

All flip-flops may be cleared simultaneously — independently of

clock input. Also, the circuit has asynchronous loading capability from two strobe-controlled sources.

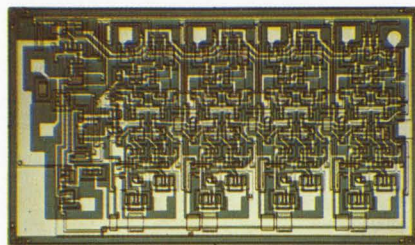

SN7495 4-bit shift-right, shift-left register

This parallel or serial-input shift register incorporates four AND-OR-INVERT gates, one AND-OR gate, six inverter-drivers, and four R-S master slave flip-flops.

This versatile register can be used in a wide variety of applications, including serial-in, right-shift/left-shift, and parallel loading operations.

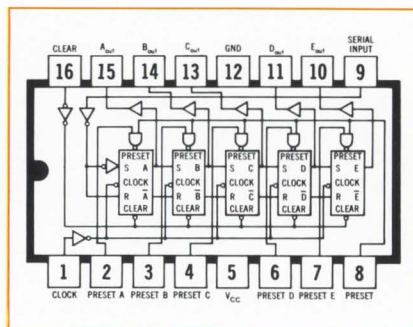

SN7496 5-bit shift register

This register consists of five R-S master/slave flip-flops, with gates and inverter drivers, connected

as a shift register to perform parallel-to-serial or serial-to-parallel conversion of binary data. Since both inputs and outputs to all flip-flops are accessible, parallel-in/parallel-out and serial-in/serial-out operations may be performed.

A common clear line and strobe-controlled, individual presets permit loading of any binary information into the register. Preset is independent of the state of the clock input.



A note from you, on your company letterhead, will bring this goldmine of information . . . data sheets on these 3 new shift registers plus application information on all our 54/74 counters and shift registers... a data book on the entire 74 N complex-function family ... and finally, an in-depth 48-page brochure covering all 54/74 TTL integrated circuits. Just address your letterhead request to Texas Instruments, Incorporated, MS980, P.O. Box 5012, Dallas, Texas 75222.



TEXAS INSTRUMENTS
INCORPORATED



At .0001," there must be total involvement

PRECISION ENGINEERING, PRECISION DESIGN, AND PRECISION MANUFACTURE, WITH MATERIALS SUCH AS DIAMOND, TUNGSTEN CARBIDE, AND SAPPHIRE AT TEN THOUSANDTHS TOLERANCES, REQUIRE ALL NEW APPROACHES TO BUSINESS AND TO MANAGEMENT . . . and very special people. Tempress has adopted the Standard of Excellence as its uncompromising pursuit. This is why Tempress people at every supervisory level must be professional managers as well as

expert technicians. Tempress describes its management policies as a form of total involvement. And this has produced a unique array of products . . . the standard of the Semiconductor Industry for miniature assembly tools and production machines. The benefits of total involvement can be extended directly to your production activities.



TEMPRESS

Tempress Research Co., 566 San Xavier Ave., Sunnyvale, Calif. 94086

Circle 139 on reader service card

popularity has gone to its head

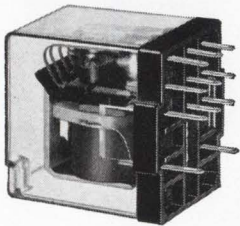

**the versatile Series 1220 relay has grown
a manual reset
an electrical reset
and a solid state
time delay.**

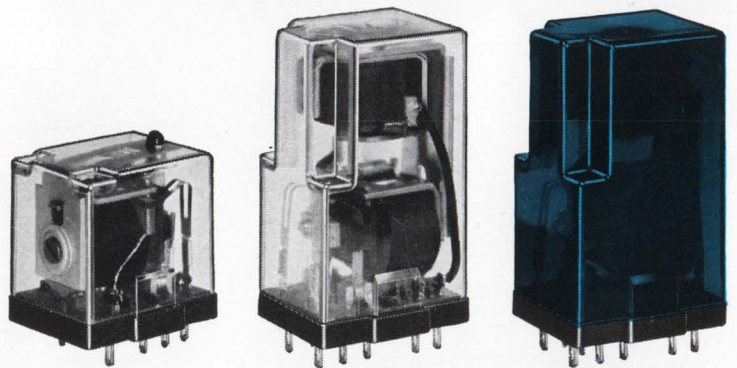

Now the Series 1220 10 amp relay is modular. All four versions give you the three ways to connect and four ways to mount that made the basic 1220 relay a runaway favorite in its class.

Now when you need a manual or electrical reset or a time delay, you can count on the same performance characteristics that led you to choose the basic 1220. No need to fool around with relays that use radio-type plugs or mount only one way.

The basic 1220 is available DPDT or 3PDT, AC or DC. The new members in the family are all DPDT, AC or DC. All of them feature our new "Uni-Guard" one piece switch that eliminates internal solder connections for reduced contact circuit resistance (and reduced price, too). Get the specs on all four Series 1220 relays for your file today. Write Guardian Electric Manufacturing Company, 1550 West Carroll Avenue, Chicago, Illinois 60607.



GUARDIAN® ELECTRIC

**MOST
RESISTORS ARE
PRETTY MUCH
ALIKE
IT'S THE NAME
BEHIND THEM
THAT COUNTS**

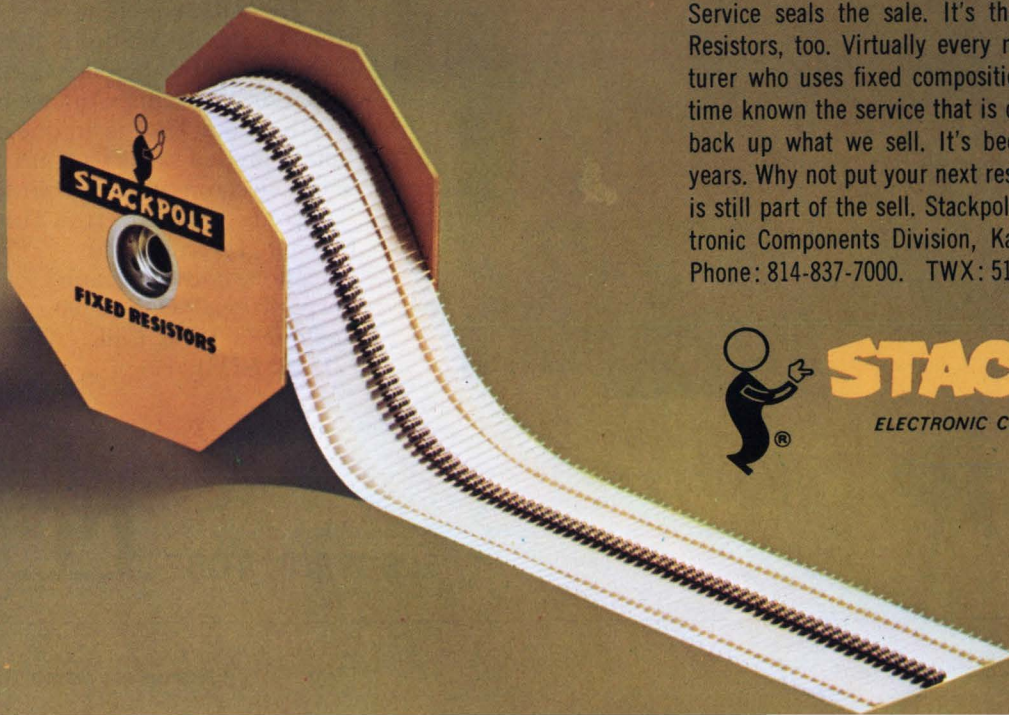

Service seals the sale. It's that way with everything. Resistors, too. Virtually every major domestic manufacturer who uses fixed composition resistors has at some time known the service that is distinctly Stackpole's. We back up what we sell. It's been that way for over 35 years. Why not put your next resistor order where service is still part of the sell. Stackpole Carbon Company, Electronic Components Division, Kane, Pennsylvania 16735. Phone: 814-837-7000. TWX: 510-695-8404.



STACKPOLE
ELECTRONIC COMPONENTS DIVISION

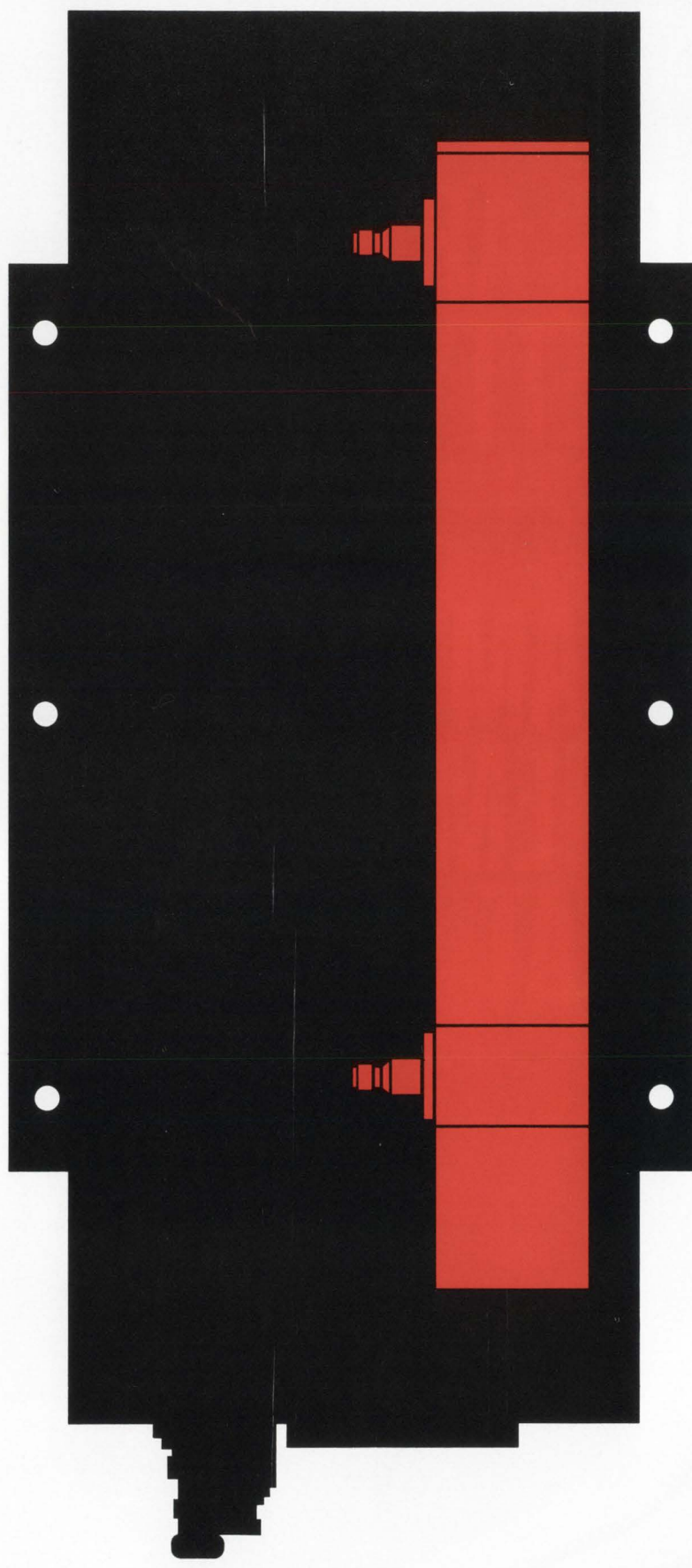

Assignment:

Match a TWT to a black box so that performance is 100 times better than conventional systems.

And build it strong enough to be shot from a cannon.

Pretty tough. But necessary, since the tube is the heart of a 12-pound pulse-coherent radar transponder built for missile, aircraft and target drone applications.

Blasting off the pad, the tube is able to withstand extreme shock and acceleration forces. And operate perfectly at altitudes up to 100,000 feet. Within temperature extremes of -37°C to $+75^{\circ}\text{C}$.

In production, the tube is subjected twice to operating shock tests of 125 G for six milliseconds in three planes.

The pulse-coherent transponder is a unique achievement for Control Science Corp., Alexandria, Virginia. And we hope you think our TWT is unique, too. You're invited to take advantage of our electron tube capabilities.

Contact ITT Electron Tube Division, International Telephone and Telegraph Corporation, P.O. Box 100, Easton, Pa. 18042. Call (215) 252-7331.

ELECTRON TUBE **ITT**

Philco-Ford puts logic in a box

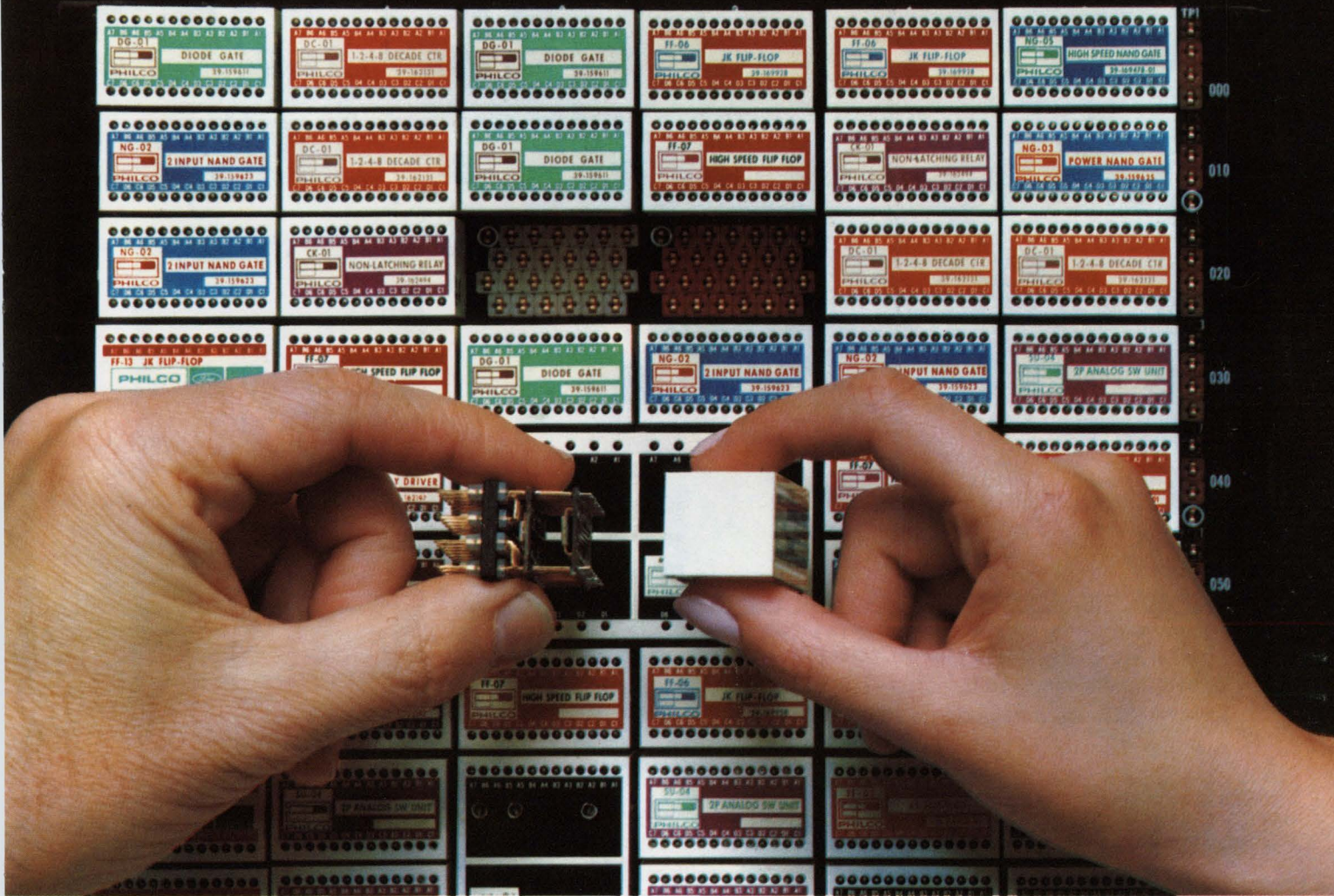

Creates a true micromodule for the IC Age

You may have worked with circuit modules before, but none like these. Unlike some others, micromodules from Philco-Ford's WDL Division make full use of advanced IC technology. They accept all existing monolithic ICs, using thin-film and discretes only where necessary. They embody functional circuits of great complexity, opening the way to far more effective systems packaging densities.

Digital and analog micromodules from WDL employ compatible logic up to 40 MHz in standard DTL, T²L and MOS circuits. They include some of the most sophisticated designs in today's state-of-the-art. Numbered among these are multiplexers, operational amplifiers, D-to-A and A-to-D circuits, and many computer interfaces. Over 200 types exist to meet your requirements.

You can service a micromodular system—from a single connector plate to complex rack-mounted arrays—with consummate ease. Clearance holes in the module cover provide front-panel access to all input/output terminals (no more trouble-shooting from the back). Color-coded labels identify logic families at a glance.

These same micromodules have performed with distinction in major military and space-support programs, notably at NASA's Manned Space Flight Center in Houston. They are proven!

For complete information, request Data File 151. Write Product Sales Manager, WDL Division, Philco-Ford Corp., Mail Station C-41, 3939 Fabian Way, Palo Alto, California 94303. Or call (415) 326-4350, extension 6017.

ADD (Automated Design and Documentation) This Philco-Ford computer-programming service generates system documentation at a cost significantly below that of hand-prepared equivalents. The computer program error checks design input data, optimizes the arrangement and sequence of wiring instructions, calculates wire lengths, provides wire lists sorted by length and by name, and maintenance lists. The program is available to all users of Philco-Ford micromodules.



PHILCO-FORD CORPORATION
WDL Division • 3939 Fabian Way
Palo Alto, California • 94303

Circle 143 on reader service card

AC MICROVOLT METER

SEES THROUGH NOISE!

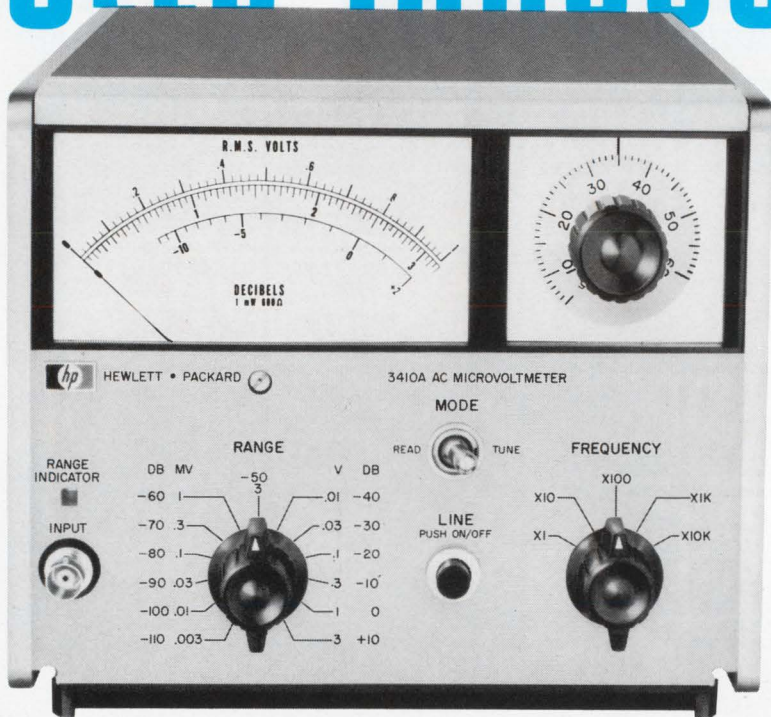

*New hp 3410A Measures
300 nanovolts
Buried in Noise*

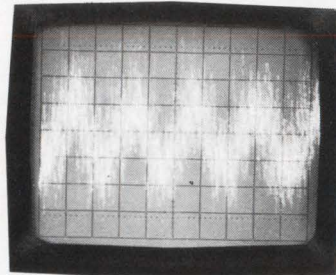

Measure 1 μV , 500 kHz signal out of 40 dB noise.

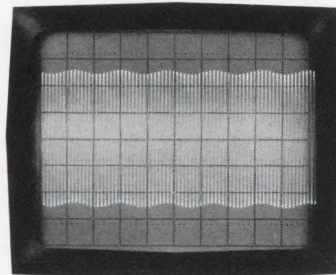

Measure 10 mV, 5 Hz amplitude modulating
1 V, 400 Hz.

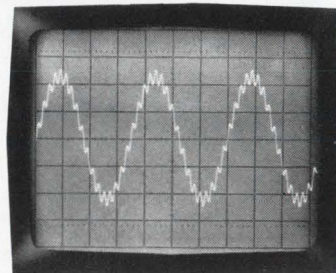

Measure 300 nanovolts, 10 kHz.
signal superimposed on 10 μV , 1 kHz

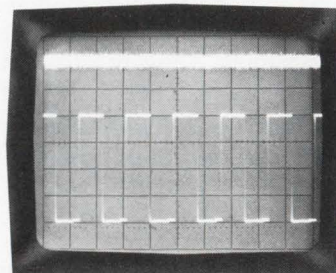

Measure frequency of signal in noise up to 560 kHz
by using square wave output,
i.e. as a counter preamplifier.

New hp Model 3410A AC Microvoltmeter measures low level repetitive signals obscured by noise—3 μV to 3 V full scale—accuracy $\pm 3\%$. RMS noise voltages up to 20 dB above full scale *do not affect* readings. Sensitivity, low cost and ease of operation are the 3410A's contribution.

This new microvoltmeter uses an hp designed phase-locked synchronous detector to separate effects of noise from signal. The detector is an electronic gate controlled by an oscillator phase-locked to the input signal. No external reference is required to lock to the input signal. Simply adjust front panel tuning control within 1% of signal frequency and phase-lock circuits *lock-on and track* input signal with $\pm 5\%$ variation in the 5 Hz to 600 kHz frequency range. Phase-lock circuits track 0.5%/sec change in signal frequency without a change in voltmeter accuracy. Input impedance is 10 M Ω shunted by 20 pF.

The new Model 3410A has two outputs on the rear panel. One is a dc recorder output for monitoring long term drifting ac voltage amplitudes. The other is an output for driving an electronic counter to make precise frequency measurements.

For full specifications on the new hp Model 3410A AC Voltmeter, call your hp field engineer. Or, write to Hewlett-Packard, Palo Alto, California 94304. Europe: 54 Route des Acacias, Geneva. Price: hp Model 3410A, \$800.00.

HEWLETT  **PACKARD**
An extra measure of quality

097/11

" We have learned through bitter experience that **Allen-Bradley resistors are unmatched for reliability** "

Philbrick Researches

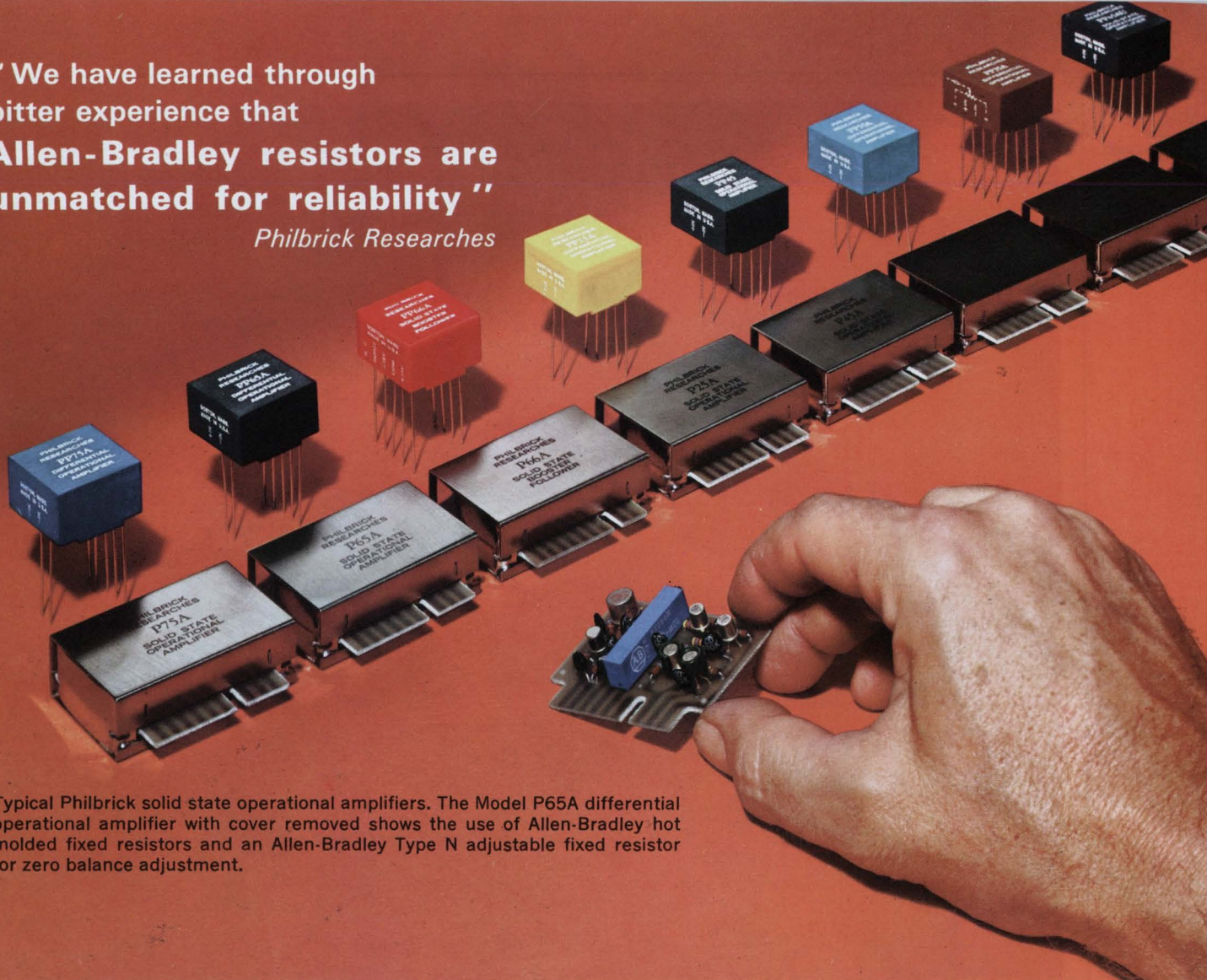

Typical Philbrick solid state operational amplifiers. The Model P65A differential operational amplifier with cover removed shows the use of Allen-Bradley hot molded fixed resistors and an Allen-Bradley Type N adjustable fixed resistor for zero balance adjustment.

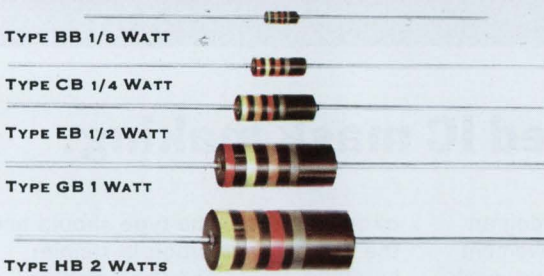

A-B hot-molded fixed resistors are available in all standard resistance values and tolerances, plus values above and below standard limits, and they meet or exceed all applicable military specifications including the new Established Reliability Specifications.

The need for a yearly production capacity of well over a billion units is a testimonial to the uniformity and reliability of all Allen-Bradley hot molded resistors.

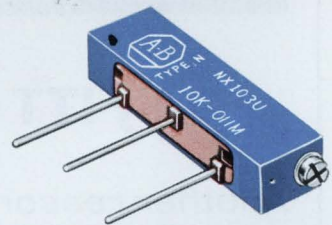

Type N hot molded adjustable fixed resistor rated 1/3 watt at 50°C ambient. Available with nominal resistance values from 100 ohms to 2.5 megohms with tolerances of ±10% and ±20%.

■ "Why have Allen-Bradley hot molded resistors been our first choice since the late 1940's? In a word: Reliability!" states Philbrick—the leading manufacturer of operational amplifiers. There's nothing accidental about this superiority of A-B resistors. A unique hot molding process using completely automatic machines, eliminates the "human element" and produces such uniformity from one resistor to the next—year in and year out—that long resistor performance can be accurately predicted. No instance of "catastrophic failures" has ever come to our attention.

Allen-Bradley Type N adjustable fixed resistors likewise use a solid hot molded resistance track. Adjustment is so smooth, it approaches infinite resolution—and settings remain fixed. Being noninductive, Type N controls can be used at high frequency, where wire-wound units would be completely unsatisfactory.

For more details on the full line of Allen-Bradley quality electronic components, please write for Publication 6024: Allen-Bradley Co., 110 W. Greenfield Ave., Milwaukee, Wis. 53204. Export Office: 630 Third Ave., New York, N.Y., U.S.A. 10017.



ALLEN-BRADLEY
QUALITY ELECTRONIC COMPONENTS

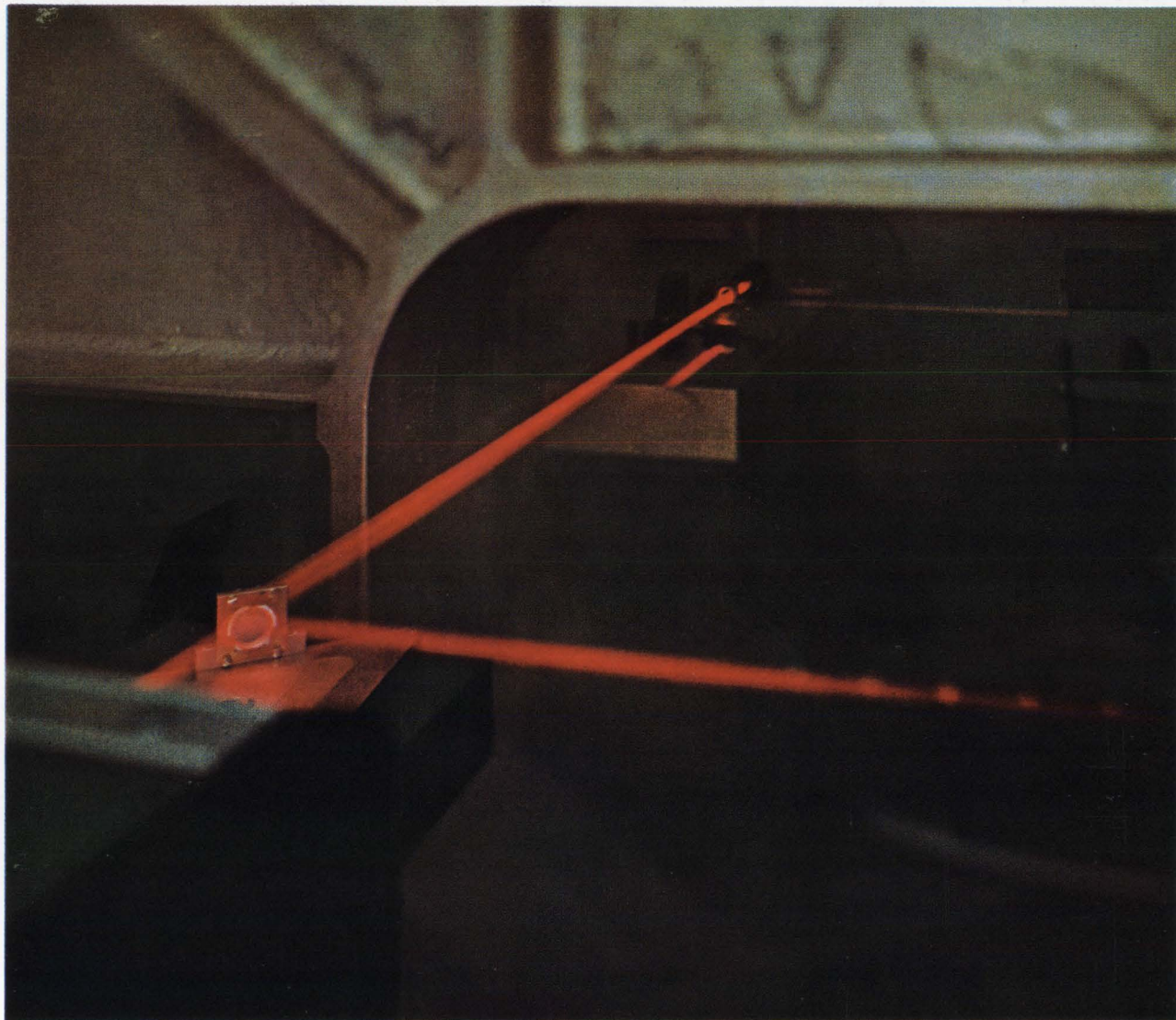

Only ITT has laser-controlled IC mask making.

Another reason to buy from "The Predictables."

Mask variations used to mean performance variations in Series 930 DTL. Now ITT initiative has eliminated the problem. An exclusive laser-controlled, fully automated mask making machine assures absolute repeatability of masks and of circuit performance.

ITT's machine, representing an order of magnitude improvement over older processes, holds mask registration tolerances to ± 122 silicon atoms (based on the crystal lattice constant). It is tape programmed, with memory storage capacity of 10,000 separate semiconductor devices, and it can complete a matched set of up to nine masks in as little as 10 minutes.

If you think all Series 930 DTL

circuits of the same type should act the same, the solution is simple: buy them from "The Predictables." ITT predictability also extends to diodes, rectifiers, and silicon planar transistors. Ask for a quote on any or all. They are on-the-shelf at your ITT distributor. ITT Semiconductors is a division of International Telephone and Telegraph Corporation, 3301 Electronics Way, West Palm Beach, Florida.

semiconductors **ITT**

FACTORIES IN FLORIDA • CALIFORNIA • MASSACHUSETTS • ENGLAND • FRANCE • GERMANY • PORTUGAL • AUSTRALIA

Kodak sinks the sink.

Hour-long sink processing of KODAGRAPH ESTAR Base Films is 60 times too slow. Now with the new KODAK SUPERMATIC Processor, Model 242, you can process a 34" x 44" KODAGRAPH ESTAR Base Film in just a minute instead of the hour it takes to hand-process. It's not only faster, it's more economical. Results are more uniform. Skilled technicians can let the SUPERMATIC Processor do the developing, fixing, washing, and drying while they do more productive work. You save up and down the line.

The versatile SUPERMATIC Processor handles ESTAR Base Film in standard A-E sizes, as well as large sizes up to 42" wide by 18 feet long. Sink the sink. Save time and money. Ask your Kodak Technical Sales Representative about the KODAK SUPERMATIC Processor system of compatible film, chemicals, and equipment.

Write: Eastman Kodak Company, Business Systems Markets Division, Rochester, N. Y. 14650.

KODAK SUPERMATIC Processor

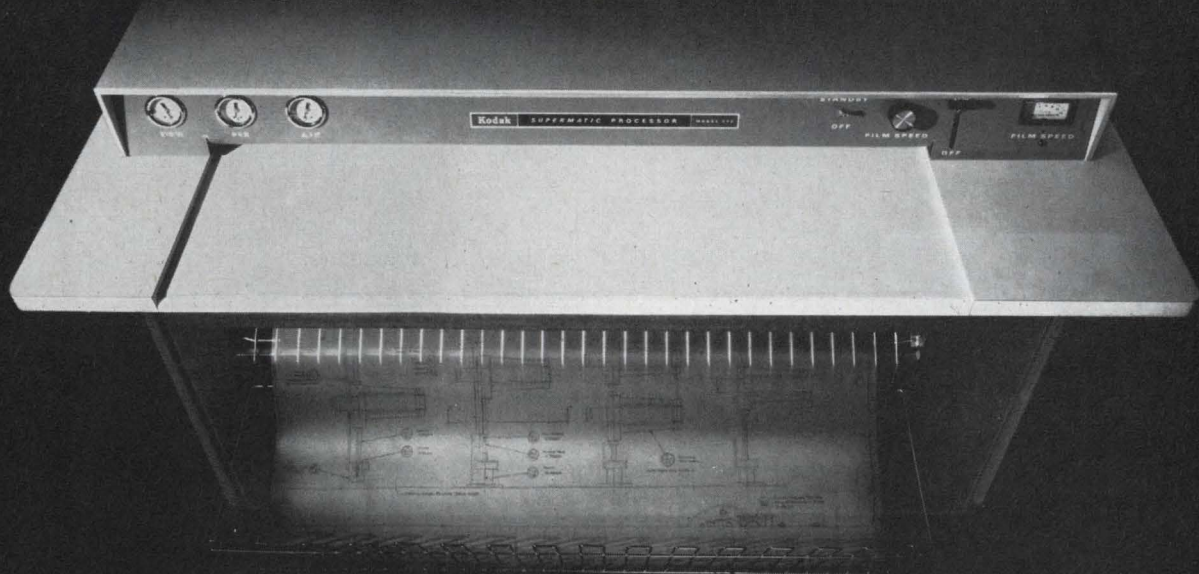

Kodak

We're looking for hardnosed design engineers

who want to make the best investment in IC logic assemblies.

It's a buyer's market. Now you can get exactly the right logic cards to design your logic systems the way you want them . . . without settling for fall-out cards from general purpose computers . . . and without going to all the expense of building specials.

CAMBION[®] makes the odd-ball IC assemblies as standard . . . along with all the regulars. You're never stuck for the right logic card, even if you need only one. You design your systems with all compatible cards, spend less time in repeated back wiring and less time debugging back wiring. Think of the money you'll save.

CAMBION's exclusive gold-plated 70-pin input/output is

the key to your investment. It lets you bring more functions through to the outside world . . . reduces the total number of circuit connections . . . and provides for large scale integration . . . *now*.

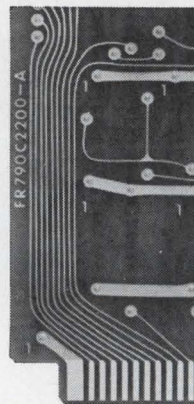
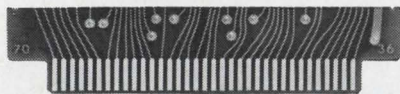

And CAMBION's complex function logic assemblies give you more circuitry in the etch — permanently. You get more functions per card, use fewer cards and card racks and get more compact design at lower cost.

Compare CAMBION IC logic assemblies with all the others . . . card for card, function for function, capability for capability, line for line and price for price . . . you'll prove for yourself it's your best investment.

Our latest comprehensive Logic Manual has all the data. To get your copy circle the number below or write Cambridge Thermionic Corporation, 447 Concord Avenue, Cambridge, Massachusetts 02138. Phone: (617) 491-5400. In Los Angeles, 8703 La Tijera Blvd., Phone: (213) 776-0472.

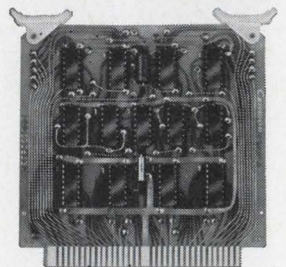

©Reg. U.S. Pat. Off.

CAMBRIDGE THERMIONIC CORPORATION
CAMBION[®]

Standardize on CAMBION . . . the guaranteed logic assemblies

Look what's in stock at MICROLAB/FXR- and cheaper than TRG or HP!

WAVEGUIDE TEST EQUIPMENT	L	R	S	H	C	W	X	Y	K	U	Q	M	E	F	G
ATTENUATORS—fixed			S C	S C	C	C	S C	S C	S C	S C	S C	S C	S C		
—variable	S C	S C	S C	S C	S C	S C	S C	S C	S C	S C	S C	S C	S C		
—precision variable	S C	S C	S C	S C	S C	S C	S C	S C	S C	S C	S C	S C	S C	S C	S C
COUPLERS—multihole			S C	S C	S C	S C	S C	S C	S C	S C					
—crossguide	S C	C	S C	S C	S C	S C	S C	S C	S C						
DETECTORS—bolo, matched			S C	S C	C	S C	S C	S C							
—crystal, fixed tuned							S	S C	S C	S C					
—universal, tunable								S C	S C	S C	S C	S C	S C	S C	S C
FERRITE ISOLATORS				S C	S C	S C	S C	S C	S C						
FREQUENCY METERS				S C	S C	S C	S C	S C	S C	S C	S C	S C	S C	S C	S C
HORNS	S C	S C	S C	S C	S C	S C	S C	S C	S C	S C	S C	S	S C	S	S C
SWITCHES—4 port manual				S C	S C	S C	S C	S C	S C	S C		S C			
TERMINATIONS—fixed	S C	S C	S C	S C	S C	S C	S C	S C	S	S	S C	S C	S C	S C	S C
—sliding	S C		S C	S C	C	S C	S C	S C	S C	S C					
—mismatches			S C	S C	S C	S C	S C	S C	S C	S C					
TUNERS—slide screw	S C	S C	S C	S C	S C	S C	S C	S C				S C			
—E/H			S C	S C	S C	S C	S C	S C	S C	S	S C	S C	S C	C	S C
ACCESSORIES—bends	S C	S C	S C	S C	S C	S C	S C	S C	S C	S C	S C	S C	S C	S C	S C
—tees	S C	S C	S C	S C	S C	S C	S C	S	S	S	S C	S	S C	S C	S C
—twists			S C	S C	S C	S C	S C	S C	S C	S	S C	S C	S C	S C	C
—straight sections	S C	S C	S C	S C	S C	S C	S C	S C	S C	S C	S C	S C	S C	S C	S C

Waveguide test equipment currently manufactured and stocked by Microlab/FXR offers you the widest line in the industry—more individual products than are available from any other supplier. Moreover, each model covers a full waveguide band

and offers the technical excellence for which FXR has long been famous. If you have need for waveguide test equipment, chances are we can supply it from stock and at lower cost than any other manufacturer!

WRITE FOR LATEST PRICE LIST AND FREE CATALOG. ADDRESS: Dept. E-66

- KEY:**
- Manufactured by Microlab/FXR
 - S Stocked by Microlab/FXR
 - C Cheaper than or equal to prices of leading competitors



MICROLAB/FXR

Livingston, New Jersey 07039 Phones: (201) 992-7700; (212) 721-9000
Cable Address: MICROLAB

Circle 149 on reader service card

Pulse Fidelity

This double-exposure photograph shows the same 12-ns-wide pulse displayed by the Tektronix Type 454 (upper trace) and by a 7-ns, 50-MHz oscilloscope (lower trace). Note the difference in detail of the pulse characteristics displayed by the Type 454 with its 2.4-ns risetime performance.

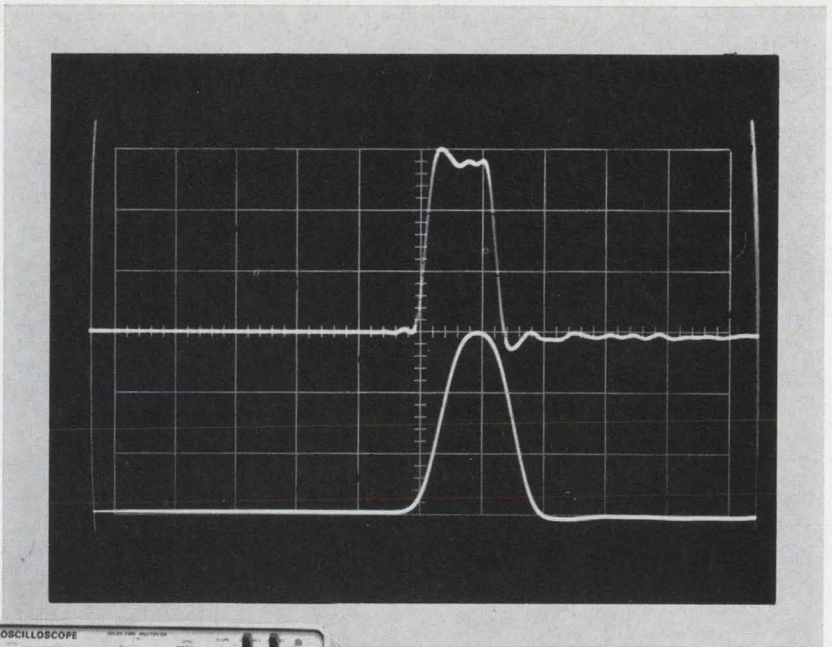

10 ns/div

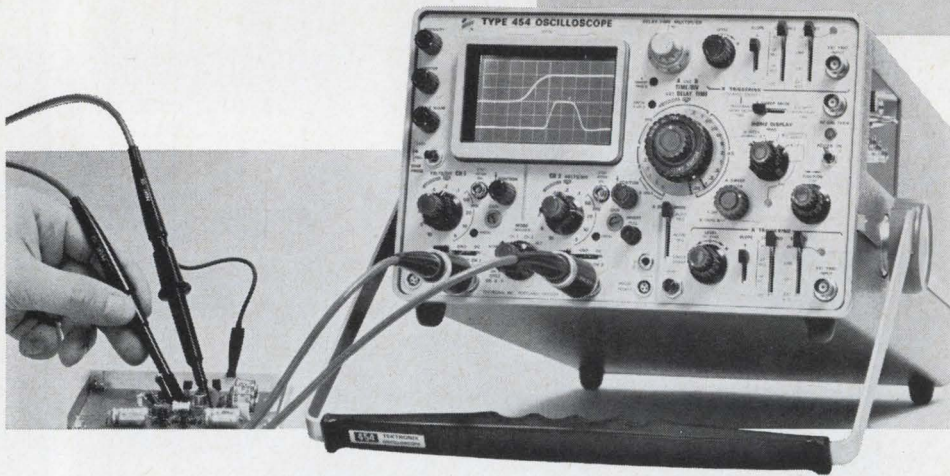

**150 MHz,
2.4 ns
with or
without
probes**

The Tektronix Type 454 is an advanced portable oscilloscope with DC-to-150 MHz bandwidth and 2.4-ns risetime performance where you use it—at the probe tip. It is designed to solve your measurement needs with a dual-trace vertical, high performance triggering, 5-ns/div delayed sweep and solid state design. You also can make 1 mV/div single-trace measurements and 5 mV/div X-Y measurements.

The vertical system provides the following dual-trace performance, either with or without the miniature P6047 10X Attenuator Probes:

Deflection Factor*	Risetime	Bandwidth
20 mV/div to 10V/div	2.4 ns	DC to 150 MHz
10 mV/div	3.5 ns	DC to 100 MHz
5 mV/div	5.9 ns	DC to 60 MHz

*Front panel reading. With P6047 deflection factor is 10X panel reading.

The Type 454 can trigger internally to above 150 MHz. Its calibrated sweep range is from 50 ns/div to 5 s/div, extending to 5 ns/div with the X10 magnifier on both the normal and delayed sweeps. The delayed sweep has a calibrated delay range from 1 μ s to 50 seconds.

Type 454 (complete with 2 P6047 and accessories).....	\$2600
Rackmount Type R454 (complete with 2 P6047 and accessories)	\$2685
Type 200-1 Scope-Mobile® Cart	\$ 75

U.S. Sales Prices FOB Beaverton, Oregon

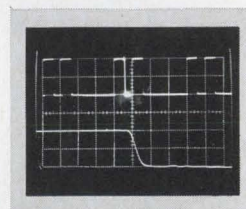

Double Exposure

5 ns/div delayed sweep

The delayed sweep is used to measure individual pulses in digital pulse trains. The Type 454 with its 1 μ s-to-50 s calibrated delay time, 5-ns/div sweep speed and 2.4-ns risetime permits high resolution measurements to be made. Upper trace is 1 μ s/div; lower trace is 5 ns/div.

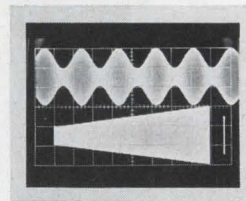

150 MHz AM

X-Y

The upper display is a 150-MHz signal that is 50% modulated by a 2 kHz signal. The lower display is an X-Y trapezoidal modulation pattern showing the 150-MHz AM signal vertically (Y) and the 2 kHz modulation signal horizontally (X). Straight vertical line is the unmodulated carrier. Multiple exposure.

For a demonstration, contact your nearby Tektronix field engineer, or write: Tektronix, Inc., P. O. Box 500, Beaverton, Oregon 97005.



*Coordinated research,
design and manufacturing*



*... part of the Tektronix commitment
to progress in the measurement sciences*

Probing the News

Advanced technology

Wave of optimism for millimeter waves

Frequencies above 30 Ghz promise wider bandwidths, secure communications, and new data on molecules and space as well as relief from crowded spectrum

By William J. Bucci

Communications editor

Millimeter-wave work, long a ripple in the ocean of electronics research, is rapidly becoming a ground swell that could reach tidal-wave proportions within a few years. There are a few rip currents, particularly in some components areas. But around the world, radars are beaming signals at gigahertz frequencies to the sun and moon to acquire data for space exploration. Researchers are preparing to study millimeter-wave transmission from a satellite, ground links are being installed to check on how atmosphere and weather affect propagation, and buried waveguide transmission systems are being tested. In addition, the armed forces are eyeing millimeter waves as a secure transmission medium that cannot be intercepted.

The millimeter-wave region covers frequencies from 30 Ghz to 300 Ghz. At the lower frequency, wavelength measures 10 mm; at the higher, 1 mm.

Plus factors. While many observers call relief from spectrum overcrowding the principal reason to explore millimeter waves, there are at least two other factors. Millimeter-wave systems are especially attractive in space and military applications where wide bandwidth is required. Also, it is easier to study certain materials in the millimeter-wave region than at lower frequencies.

Many companies are in the field, both on their own and with Government support. The Department of Defense boosted outlays for milli-

meter-wave work more than 10% to \$2 million in fiscal 1968, despite a shortage of research funds resulting from U.S. commitments in Southeast Asia.

"There'll be a tremendous market for millimeter-wave systems over the next five to 10 years," says

an East Coast marketing executive. "But we'll have to sell the technology as well as equipment. Some people still think everything above 30 Ghz gets clobbered by the atmosphere. So we trot out the absorption curves and show them the windows around 35 Ghz and 95

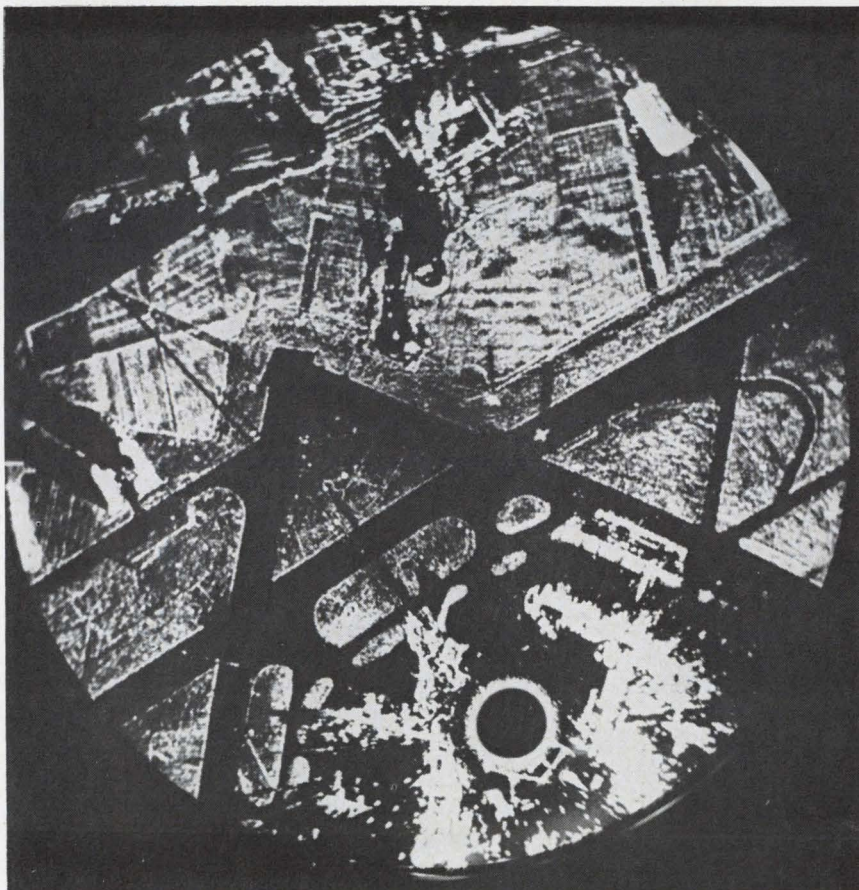

Keeping tabs. Decca surveillance radar, operating around 35 Ghz, displays both air and ground traffic at London Airport. The millimeter-wave system has proved a practical way to get high discrimination with light antenna.

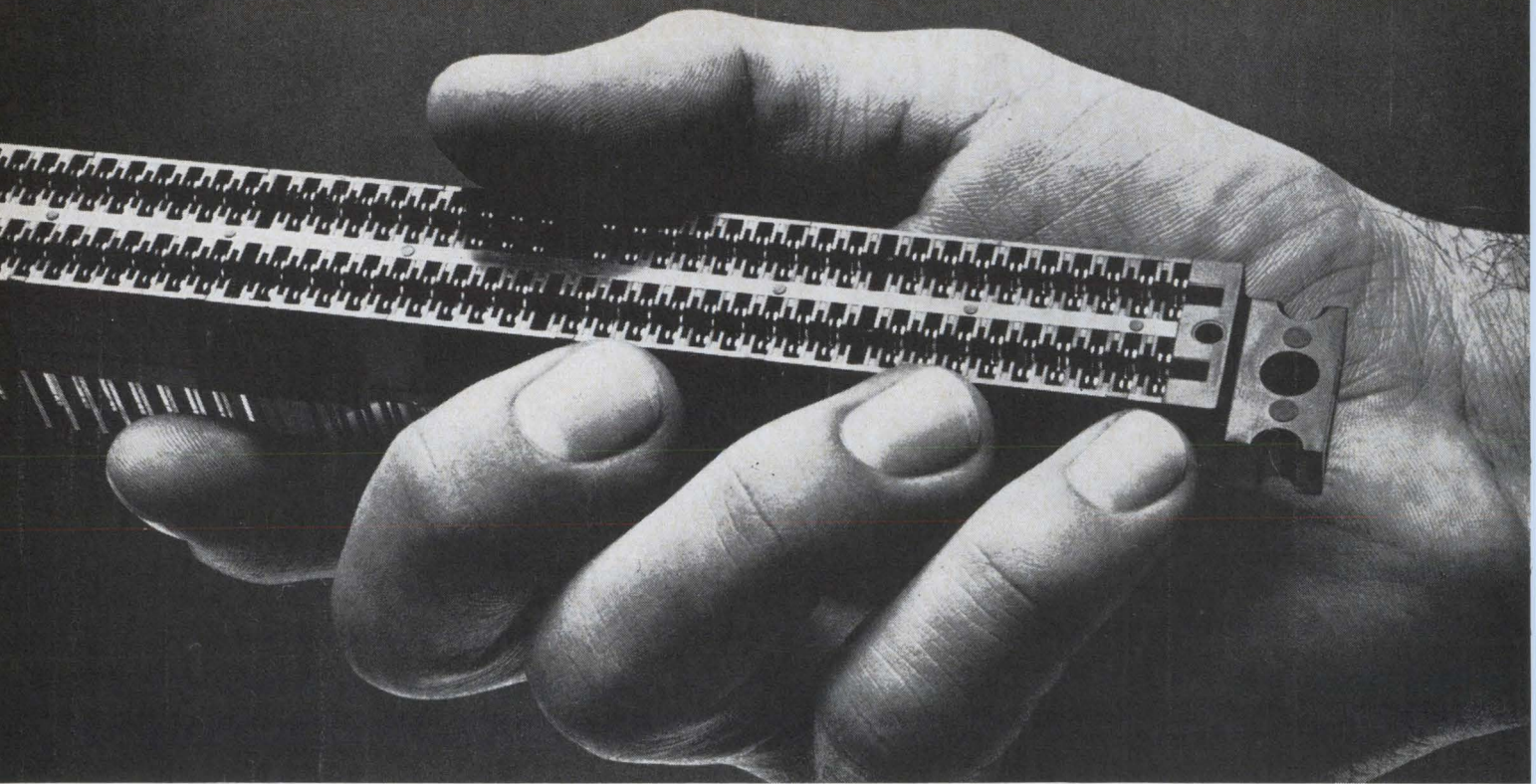

Our connectors are better. Of course, you have to pay a little less.

Everybody knows that gold makes the best electrical contact.

So we put ten times more gold at the contact area than any plater does.

But everybody knows that gold is expensive.

So, we developed a special welding process that lets us put the gold exactly where you want it. So overall, we use much less gold.

As a result, you get a better, longer-wearing, more reliable connector for

less money.

Sounds simple, but it takes some doing.

It not only calls for advanced technical know-how, but also precise control of all fabricating processes. Well, at Sylvania, we leave nothing to chance—or to outside suppliers.

First, we draw our own wire for the contacts. Then we do our own coining, forming, bending, solder plating, and gold dot welding. Next, we mold our

own plastics bodies to assure precise control of tolerances.

And, finally, we assemble the whole thing ourselves.

And we do it all to your specifications.

So if you want the best connector, and you don't mind paying a little less, give us a call. Sylvania Metals & Chemicals, Parts Division, Warren, Pa. 16365,

SYLVANIA
A DIVISION OF
GENERAL TELEPHONE & ELECTRONICS

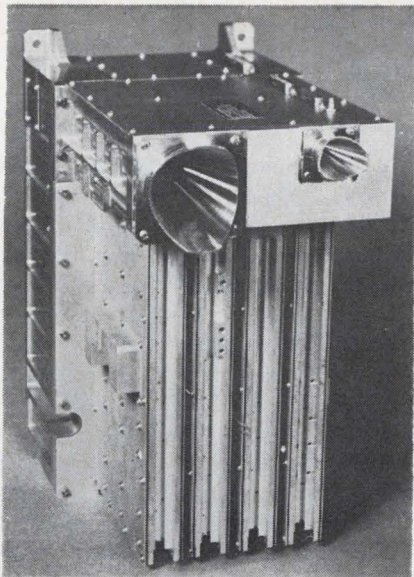

Package deal. NASA will conduct first millimeter-wave satellite experiment with this transmitter-receiver setup.

Ghz.” (Windows are portions of the frequency spectrum where atmospheric absorption, or dissipation of electromagnetic energy, is low.)

I. Weakest links

While components are commercially available and the sales side is optimistic, engineers contend that a general lack of reliable, off-the-shelf parts could slow the growth anticipated for millimeter-wave systems. John Bartnik, an engineer at Sylvania Electronic Systems, a subsidiary of Sylvania Electric Products Inc., Williamsville, N.Y., put the problem this way: “Everyone’s still applying conventional microwave techniques up to about 100 Ghz, and they’re really skating on thin ice there. Tolerances are so minute it’s very hard to produce a consistent product. Since there’s been no need to make millimeter components in quantity, very little debugging has been done.”

Joseph Stacey, an engineer with the Aerospace Corp., El Segundo, Calif., seconds this complaint, citing crystal mixers as the chief reliability culprits: “They don’t last long, have poor temperature stability, and burn out at high powers. I can’t think of any mixer at 94 Ghz that’s qualified for space uses.”

Some engineers even complain about components operating below 40 Ghz. Donald Worthington of the Defense Communication Agency in Washington, D.C., says: “We tried to get balanced diodes for 50-mega-

bit-per-second switching and just couldn’t find any. When you do buy components, you can’t always believe the manufacturer’s figures. We bought 12 integrated circuits and they were all bad. You can live with that in research and development but not in an operational setup.”

Ante up. Throughout the field, engineers criticize the high cost of components. Says Stacey: “A simple, 94-Ghz magnetron costs \$9,000 and a local oscillator to drive a receiver costs \$3,000.”

Millimeter-wave activity is up somewhat because of the increased availability of high-power tube sources, according to Donald Forster of the Hughes Research Laboratories, an arm of the Hughes Aircraft Co. located in Malibu, Calif. Hughes is, of course, a leading supplier of high-power devices. The company is working on about \$400,000 worth of contracts having millimeter-wave applications. Among other items, the company is developing: a 10-kilowatt pulsed 100-Ghz source for the military; a 5-kw continuous-wave source for the Atomic Energy Commission; and 31-Ghz ground transmitters for the Goddard Space Flight Center’s experiment on the “E” model of an Applications Technology Satellite (ATS-E).

Keep it simple. Where lower power can be tolerated in millimeter-wave systems, solid-state sources are preferred for reliability and economy. Multiplying the low frequencies from a transistor amplifier using varactor diodes has so far proved to be the most trustworthy technique. Sylvania has achieved a power output of 100 mw from 36 Ghz to 38 Ghz in this way.

Meanwhile the industry is keeping an eye on impact avalanche transit time (Impatt) oscillators, Gunn effect devices, and limited space charge accumulation (LSA) diodes, all of which promise higher power. John Copeland, a Bell Labs scientist who developed the first LSA diode, expects powers of 1 watt cw up to 200 Ghz in the near future. Now, however, materials problems make such devices iffy.

II. The millimeter underground

Perhaps the best known millimeter-wave applications center on guided-wave transmission systems. At Bell Telephone Laboratories in

TOO BAD



Right now, as you are reading this, someone somewhere is ordering a 3-digit, .05% DVM without stored display for the price of this new Trymetrics .01% 4-digit model. Ouch!

This new Model 4100 is offered with a series of plug-in function heads which provide measurement from 99.99mv to 999.9 volts in 1,3,4 or 5 manual or automatic ranges. \$695 for the basic unit, \$740 with a $\pm 9.999v$ range plug-in.

All units feature automatic polarity and over-scale indication. All have exceptional 0.01% accuracy; all offer a storage register for absolute display stability. There’s even more performance with a new compatible multimeter plug-in module which provides DC, AC and OHMS measurement. Printer output is optional.

If there is no need for stored display, Model 4000 offers the identical features of the Model 4100 but costs only \$595 for the basic unit, \$640 with 103 $\pm 9.999v$ range plug-in head.

We’d like to tell you more; there’s much more to tell. It’s all in a new catalog. Tell us your name and address and ask to see this .01% 4-digit DVM today.

TRYMETRICS
Corporation
A SUBSIDIARY OF TRYGON ELECTRONICS, INC.
204 Babylon Tpke., Roosevelt, L.I., N.Y.
Phone 516-378-2800 11575

Microsonics

State of the Art Design in Filters Oscillators and Delay Lines

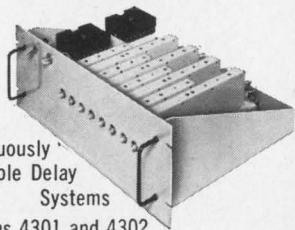

Continuously
Variable Delay
Systems
Bulletins 4301 and 4302

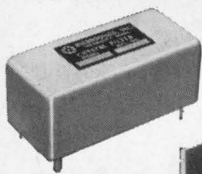

Broad Bandwidth
Highly Selective
Crystal Filters
Bulletin 6350

Comb. Filter Sets
Bulletin 6350

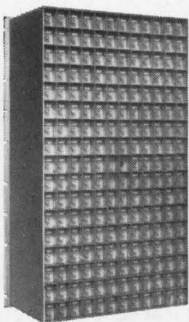

Broad Bandwidth
Delay Lines
Bulletin 4300

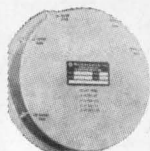

Highly Stable
Oscillators — Bulletin 6350



Voltage Controlled
Crystal Oscillators
Bulletin 6350

High Density
Digital Storage
Systems

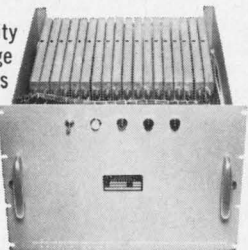

Bulletin
5350

Send for literature.



MICROSONICS, INC.
60 Winter Street
Weymouth, Mass. 02188
Tel: 617 337-4200

A subsidiary of the Sangamo Electric Company

... engineers must have a detailed knowledge of an area's rainfall ...

Holmdel, N.J., work is being resumed on such equipment after several years hiatus. Most observers feel the prospect of commercial Picturephone service that would gobble up bandwidth is the spur.

With its work on helix waveguides done, Bell is now concentrating on solid-state power sources and repeater design. A recent report describes the design of a single channel in an experimental solid-state repeater. The system under consideration transmits 208,000 two-way voice channels or equivalent information over a band of frequencies from 40 Ghz to 100 Ghz. The pulse-code modulated signal would propagate in a low-loss mode through 2-inch helix or dielectric-lined circular waveguides. Bell calculates losses are less than three decibels per mile.

Teuton trial. Meanwhile in West Germany, Siemens AG has completed work on experimental circular waveguides operating from 20 Ghz to 90 Ghz; it has installed two systems, one near Munich, the other at Darmstadt in the Post Office Central Research Institute. The Darmstadt setup contains all the duplexers, filters, modulators, and associated gear needed to handle 260,000 channels.

Also in Darmstadt, AEG-Telefunken is installing a helix waveguide pcm system, operating in the 50 Ghz to 80 Ghz range for the Post Office. Eventually, the system will span three kilometers, transmitting more than 100,000 voice channels.

Insular item. In England—where a good many telephone users are concentrated in a small area—the British Post Office is underwriting the efforts of Standard Telecommunication Laboratories Ltd., an affiliate of the International Telephone & Telegraph Corp. to develop an experimental wideband system using glass waveguides. The system is unusual in that it transmits at very low optical frequencies, using millimeter wave propagation techniques.

III. Rain's a pain

Ironically, waveguides are a better-charted millimeter-wave trans-

mission medium than the atmosphere. While the regions of the frequency spectrum where atmospheric attenuation is minimal—the windows—are well known, the effects of weather on millimeter-wave transmission still remain clouded. To design effective ground-to-ground or ground-to-satellite systems, engineers must have a detailed knowledge of area rainfall, as well as how much of a downpour it takes to drown out transmissions.

To that end, Bell Labs has designed a high-speed gauge that measures the rate of rainfall in time periods as short as seconds. By spreading 96 gauges over a 13 kilometer area in New Jersey, engineers hope to get meaningful statistics on the probability of heavy rain in one part of the area concurrent with light rain in another. From such studies will come "space diversity" millimeter-wave systems that automatically switch transmission paths when the attenuation in one area exceeds that in another.

Low road. At the same time, Bell Labs is measuring the effects of rain on frequencies transmitted at 18.56 Ghz and 30 Ghz over a four-mile experimental link. Bell is considering the possibility of millimeter-wave radio links at these frequencies to help relieve future crowding of the microwave spectrum.

Farther south, the Defense Com-

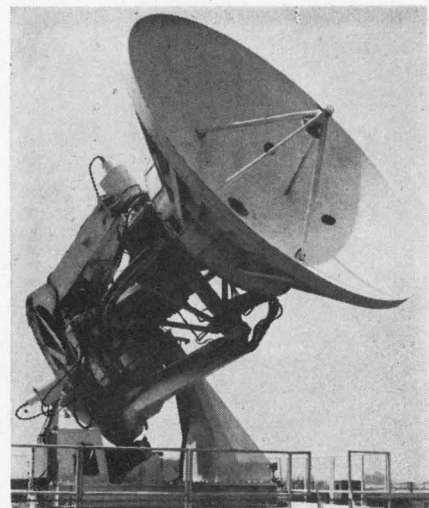

Looking up. Millimeter-wave antennas are being used to predict sun spots.

munications Agency has sent 50 million bits of data a second over a 28-Ghz and 40-Ghz link from its headquarters in Arlington, Va., to the Navy Security Station in Washington, D.C. The agency's engineers have been able to operate in a frequency-hopping mode in 20-megahertz jumps, without signal fading. Tests show such a system can take on the Washington rain pattern and win 99% of the time.

Another transmission link in El Segundo, operated by the Aerospace Corp., is carrying frequencies around 55 Ghz—a range that's badly attenuated by atmospheric oxygen. Underwritten by the Air Force, this work will verify whether the atmosphere can prevent satellites that are communicating with one another from being jammed or intercepted.

In England, the Radio and Space Research Station near London Airport is measuring absorption and scintillation at 100 Ghz using a 150-meter link. Engineers there are trying to find the maximum antenna size and bandwidth that can be used in such links.

A big jump. Sylvania decided to leapfrog and market an operational transceiver with immediately practical application [Electronics, Nov. 27, 1967, p. 45]. The set has 500 Mhz of bandwidth and operates between 36 Ghz and 38 Ghz over a distance of 15 nautical miles. Tests show the unit can operate in poor weather. The solid-state transceiver's performance characteristics, particularly the capacity to carry information in a tight beam that's difficult to intercept, convinced the Navy to make tests from one ship to another. The set puts out 100 milliwatts of continuous power and has an estimated mean time between failure of 10,000 hours.

IV. Spacious times

Early next year, the National Aeronautics and Space Administration will conduct the first millimeter-wave experiments via satellite. Varian Associates has built a 15.3-Ghz transmitter which the Martin-Marietta Corp.'s Orlando, Fla., facility has incorporated, along with its own 31.65-Ghz receiver into a 34-pound package. The equipment is earmarked for the ATS-E.

The type of phase modulation to



Cinch-NuLine delivers Omega MIL-C-26500 connectors in 6 to 8 weeks

We're completely tooled to supply whatever you need in the MIL-C-26500 line.

Name your shell style, contact size, and insert configurations, or even ask for G-Type conductive shells of chrome-plated aluminum. You can have exactly what you need, and get it delivered in 6-8 weeks.

Cinch-NuLine Omega connectors exceed the stringent requirements of MIL-C-26500 for performance and reliability. They operate continuously at 200°C, take short exposures to 800°C; and withstand violent thermal shock and vibration and resist corrosion, ozone, sand and dust.

When you need MIL-C-26500 connectors, get them fast . . . from Cinch-NuLine.

Contact any Cinch Electronics Group sales office, or write to Cinch-NuLine, 1015 S. Sixth Street, Minneapolis, Minnesota, 55415, for a quotation on your requirements.

LOCAL AVAILABILITY

Cinch-NuLine Omega connectors are available in small quantities, from your local Cinch-NuLine distributor.

MIL-C-81511

Astro/348

HIGH DENSITY SUBMINIATURE CONNECTORS

These new cylindrical connectors are designed for use under extreme environmental conditions. Five shell sizes for 4, 12, 37, 55 and 85 contacts with .085" contact spacing. Write for delivery information.

*Manufactured under license agreement with Amphenol Corporation. CN-6873



CONSISTING OF CINCH MANUFACTURING COMPANY, CINCH-GRAPHIK, CINCH-MONADNOCK, CINCH-NULINE, UCINITE (ELECTRONICS) AND PLAXIAL CABLE DEPT.



Circle 155 on reader service card →

**SUPERIOR
COAXIAL
ATTENUATORS**

**miniaturized
DC-18 GHz
programmable
motorized
step attenuators**

New μ Series 96, 97, and 98 Step-attenuators come with values as high as 149 dB in 1 dB steps. DC to 18 GHz attenuator inserts are used on all models; higher accuracy models with octave band inserts are also available as standard models, and special dB insert values can be supplied on special order. They come in a choice of 5 RF connector types; 11 standard frequency ranges; and single, double, or triple drum configurations internally connected in series.

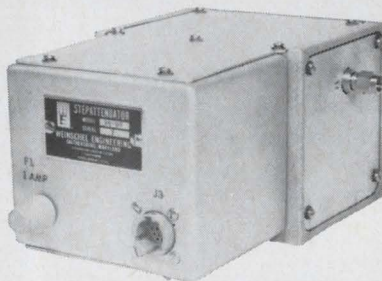

Featuring low torque contacts for ease of operation . . . stable construction . . . long life . . . low leakage.

μ Miniature Stepattenuators are ideal for power indicators . . . to control signal level on signal sources, receivers, field strength meters, spectrum analyzers . . . and new broadband equipment designs. The ease with which these models are programmable make them especially usable in systems employing automatic or remotely controlled levels.

Designers and
Manufacturers of Precision
Microwave Equipment
**WEINSCHEL
ENGINEERING**
Gaithersburg, Maryland

**. . . millimeter-wave radars are doing
jobs impossible at other frequencies . . .**

be used in the ATS-E experiment guarantees that the center frequency and two sidebands transmitted will have the same amplitude. By studying the phase and amplitude relationship between the carrier and sidebands of the transmitted or received signal, NASA will be able to determine whether the 100-Mhz bandwidth sent can carry information without distortion.

The space agency has to go slowly because wider bandwidths mean higher power, more weight, and greater expense. A wider bandwidth experiment is scheduled for an upcoming NASA Nimbus weather satellite.

Dropouts. Martin also had several study contracts for other millimeter-wave experiments. One involved a 500-Mhz bandwidth study for the Apollo program, another a transmission study from 30 Ghz to 100 Ghz between satellites. Neither project was implemented.

The Bell System is interested in transmitting domestic telephone calls over satellite in the 18-Ghz and 30-Ghz range and has asked the Federal Communications Agency for permission to use these frequencies. Bell is now trying to measure millimeter radiation from the sun at 6 Ghz and 30 Ghz. High atop its Crawford Hill, N.J., facility, Bell has erected a sun tracker to continuously measure how the sun's millimeter-wave output is affected by the weather.

Looking ahead, NASA awarded Sylvania a contract to develop a 100-megawatt, 35-Ghz, transmitter that has been delivered for plasma penetration studies. At 35 Ghz, electromagnetic waves can break through the plasma sheath that surrounds vehicles entering or leaving the atmosphere—when their speed exceeds Mach 5.

Of more immediately practical interest are the millimeter-wave radars being used to perform a variety of tasks that would be all but impossible at other frequencies. At London Airport, for example, Decca Radar Ltd. has installed a 34.5-Ghz to 35.5-Ghz surveillance radar to keep tabs on both air and ground traffic. The system's speci-

fications require that the display be bright enough for the controller to switch his gaze from the set to the runway and back without vision adjustment problems. In addition, the display must be permanent and presented in real time. An antenna revolving at 750 rpm maintains the display and keeps it from fading between sweeps. Decca went the millimeter-wave route because it's the only feasible way to get high discrimination, using a light, easily movable antenna.

Solar systems. Millimeter-wave radars are also being used to predict sun spots. The Aerospace Corp., for example, has a unit operating at 94 Ghz to observe the upper chromosphere and another at 210 Ghz to check the lower. By programming a computer to look alternately at the measurements made at both frequencies, engineers can determine how long it takes a solar flare to develop. (Flares are born in the chromosphere, the lower region of the sun's atmosphere.) At lower frequencies, only the corona (a luminous envelope surrounding the sun beyond the chromosphere) can be studied; in the optical range, only the photosphere can be checked. But Aerospace officials say that by correlating measurements made at all frequencies they should be able to pinpoint sun-spot activity, which can knock out space communications and endanger astronauts.

To acquire data, the radar makes a television-type raster scan across the sun's surface, measuring temperature gradients. Mapping the gradients day after day allows predictions to be made. The 94-Ghz radar also has made soil studies of the moon.

Lincoln Laboratories at the Massachusetts Institute of Technology is also interested in studying the lunar surface, and has a 35-Ghz radar that includes an output varactor designed and built by Sylvania and a 1.2-kw cw output klystron amplifier from Varian Associates.

V. Back at the lab

Millimeter waves have other properties that make them indis-

pensible tools for basic lab studies. Many molecules are excited only by frequencies in the gigahertz region, either absorbing or emitting radiation. These changes provide much data on bonding energies as well as details of molecular structure. One application is the study of atmospheric conditions on other planets.

Some basic studies are being done at institutions backed by the Air Force's Office of Aerospace Research. Duke University, Durham, N.C., for example, is seeking to combine optical and microwave techniques to develop new and more versatile millimeter and sub-millimeter measuring instruments. University College in Galway, Ireland, is studying the rotational spectra of materials by transmitting frequencies from 70 Ghz up through the submillimeter region (around 0.5 mm). And in North Wales, University College is investigating sub-millimeter generators.

Highlights. Martin-Marietta is among the more active American companies in basic millimeter studies. A team headed by scientist James Gallagher has phase-locked signals up to 450 Ghz back to a low-frequency crystal. Under a contract with the Army Signal Corps, Gallagher's group has beat an 890-Ghz hydrogen-cyanide laser against the twelfth harmonic of a 70-Ghz klystron, phase-locked to a 5-Mhz frequency standard. The 30-Mhz difference frequency made it possible to look at the laser line width. The hope is eventually to phase-lock the laser back to a frequency standard, perhaps using the 30-Mhz intermediate-frequency signal as a control source. Thus, as lasers reach down into the submillimeter region, techniques are being developed to bring the stability of lower frequencies into the millimeter and optical regions.

Another group at Martin has developed a 35-Ghz radiometer capable of detecting temperature differences of 0.2° Kelvin. A high sensitivity interferometer that was used to measure absorption characteristics of the atmosphere has also been produced.

Contributions to this report were made by: Lawrence Curran in Los Angeles; Paul Dickson and Robert Skole in Washington; James Brinton in Boston; John Gosch in Bonn; and Michael Payne in London.

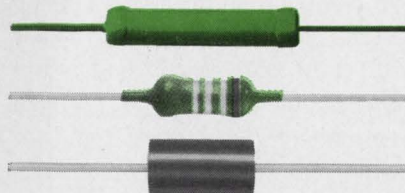
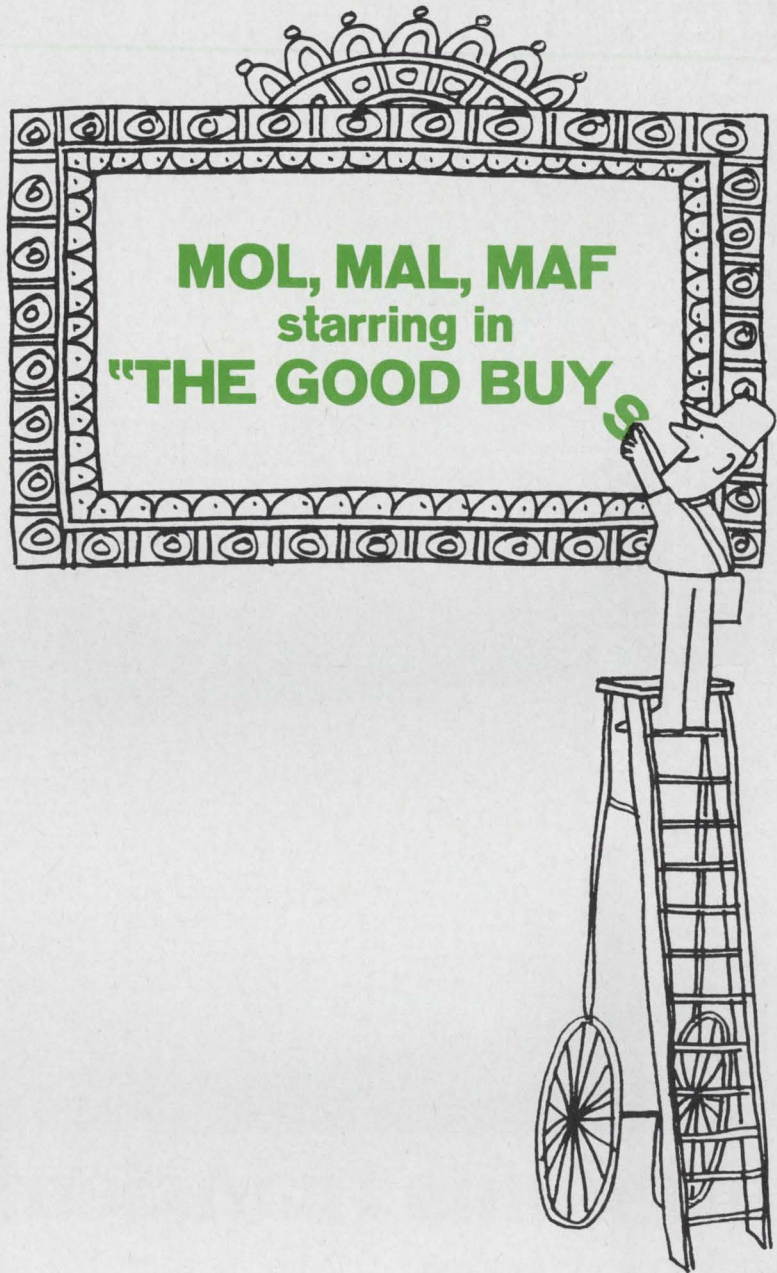

Mallory metal alloy and metal oxide film resistors cover a wide range of precision with prices that are exactly matched to your circuit requirements. This means you don't pay more for performance you don't need. Three types in precisions from 0.25% to 10% . . . MAF, 1/8W and 1/4W, ±0.25%, ±0.5% and ±1%; MAL, 1/2W, ±2% and ±5%; MOL, 2W to 7W, ±10%. All Mallory film resistors are 100% inspected. For details, write or call Mallory Controls Company.



MALLORY CONTROLS COMPANY

a division of P. R. MALLORY & CO. INC.
Box 231, Frankfort, Indiana 46041

Only EECO's 762 multi-channel ADC offers...

ELECTRONIC ENGINEERING COMPANY OF CALIFORNIA

EECO 762 MULTI-CHANNEL ANALOG TO DIGITAL CONVERTER

MODE CONTROL

SIGN 512 256 128 64 32 16 8 4 2 1

AUTOMATIC
EXTERNAL • • MANUAL

MANUAL TRIG

SELECT

ELECTRONIC ENG

EECO 815 DIGI

continuous transient-overvoltage protection

Only the EECO 762 Multi-Channel Analog-to-Digital Converter gives continuous overvoltage channel protection. You get uninterrupted operation with transient overvoltages up to 125 VRMS on any input channel.

A combination high-speed analog multiplexer and high-resolution A-D Converter, the 762 accepts up to 100 analog inputs and samples at rates to 31,700 conversions per second, at full scale accuracies to $\pm 0.02\%$, $\pm 1/2$ LSB. Channel input impedance is 100 megohms.

Outputs of 11 to 14 binary bits or 4 BCD digits are standard. An optional exclusive feature provides *simultaneous* binary and BCD outputs.

Any channel output can be displayed during multiplexing and digitizing with front panel switches.

Prices start at \$3,950 for a 10-bit plus sign, 10-channel model. For complete specifications and prices, write today for the EECO 762 data sheet.

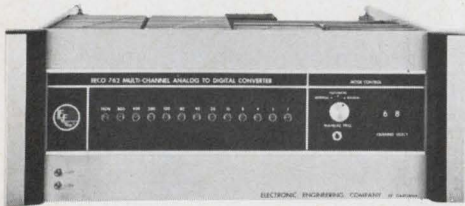

INSTRUMENTS DIVISION

ELECTRONIC ENGINEERING COMPANY OF CALIFORNIA

1601 EAST CHESTNUT AVENUE • SANTA ANA, CALIFORNIA 92701 • (714) 547-5501

Circle 158 on reader service card

IC registration revisited

Lack of pressure from the military and stand-pat attitude of suppliers still stymies Electronic Industries Association's effort to register IC's

Despite more than two years of effort, integrated-circuit registration is still only a gleam in the eye of the Electronic Industries Association. Although officials of the trade group expected to issue type numbers for hundreds of devices when the registering program was announced in December 1965, not one with the 6N prefix for IC's has been issued [Electronics, Feb. 20, 1967, p. 217]. And now, no one at the EIA is willing to speculate when the first registration might appear.

In theory, registration represents the first step toward standardization of IC's. Nonstandardization, the reasoning goes, leads to higher unit costs and a fragmented market—situations that make it difficult for IC customers to develop second sources of supply. For all this, though, there's little prospect of early concerted action on either registration or standardization.

For in reality, there's surprisingly little anxiety in the industry about the lack of hard-and-fast IC standards. One reason for this is the absence of the kind of pressure the Pentagon exerted to obtain registration of discrete semiconductor devices during the 1950's.

I. House divided

Officially, the Defense Department has, since issuing a white paper early in 1967, maintained a position against the setting of standards for IC's (though it's also on record as favoring "the widest possible appropriate use of microelectronics in military systems"). But Pentagon officials still disagree on whether IC designs should be standardized for military applications.

On one side of the controversy are the Pentagon's businessmen who work in the Office of Technical Data and Standardization Policy, which reports to the assistant secretary of defense for installation and logistics. This agency tends to favor

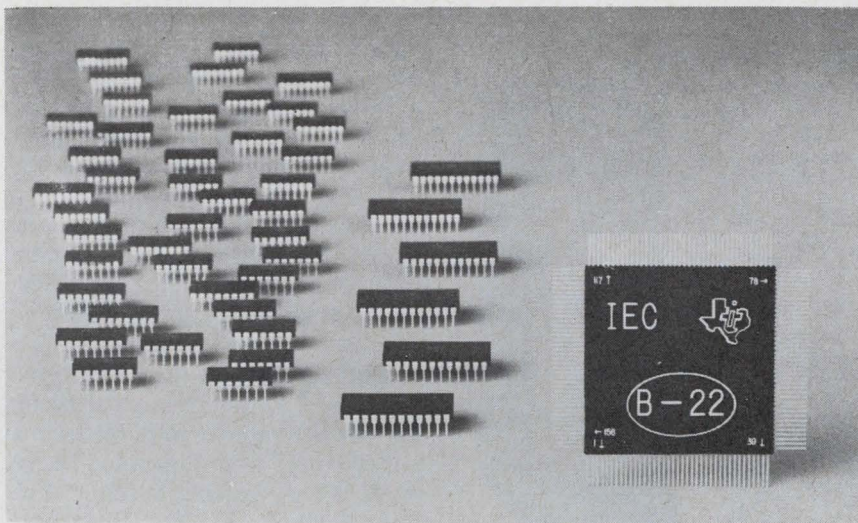

Generation gap. Assortment of devices ranging from conventional IC's to LSI assembly is symptomatic of proliferation of designs. However, EIA's efforts to promote registration have so far proved unavailing.

standardization as a means of reducing the number of goods, parts, or whatever, that must be bought by the armed forces.

A policy of standardization is practicable for buying tent pegs or toilet bowls, say officials at the Office of the Director of Defense Research and Engineering, but not for items such as integrated circuits. "You just can't apply the traditional, conservative yardsticks to this kind of technology," says a DDR&E source who, with a number of his colleagues, thinks that standardization might stifle innovation. "Mean time between failure has little relevance in the case of IC's," he says. "No one has meaningful data on how long such devices will last. How could they? Many parts have never failed. And you can't build a statistical bank without a reference point."

Apostles. Staffers at DDR&E favor throwaway modules with IC's over standardized assemblies. Replacement specs would simply spell out form, fit and function.

But if the Pentagon's businessmen haven't wholly made their point,

they appear to have at least a partial victory. Officials close to both camps say it's a good bet that the Defense Department will soon begin asking contractors for more support data, especially information on how quickly component designs are obsoleted by technical advances.

Test case. Moreover, the Defense Department's IC testing standards will be published later this month. They establish procedures for uniform electrical, environmental, mechanical, and sequence checks for virtually every kind of integrated circuitry, centralizing the specifications of all the military services and the National Aeronautics and Space Administration.

As a rule, most IC vendors are less than enthusiastic about the prospect of standardization. Their customers, however, generally take an opposite position.

"I'd like very much to see some form of standardization, but it looks like it is a long way off right now," says dissenting Harry M. Luhrs, IC product marketing manager at the Semiconductor division of Sylvania Electric Products Inc.,

To put it in writing...

look first to BRUSH®

No matter what your direct writing recording requirements, look first to Brush for the optimum answer. There's the famous Mark 200 series of modular systems plus a complete line of portable and general purpose recorders:

Mark 200—8 Channel Recorder

New generation Series 1707 system combines all solid state electronics with modular construction for tailoring to specific requirements. Choice of channel widths and input preamplifiers. Range of chart speeds 0.05 to 200 mm/sec. Patented pressurized-ink writing system.



Mark 220 Portable Recorder

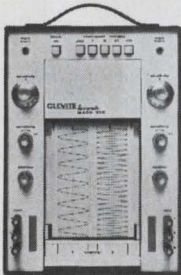

High performance two analog channel unit weighs only 25 pounds, writes in any position. Has the Mark 200 writing system. Chart speeds from 1 to 125 mm/sec. One millivolt sensitivity. Portable.

Mark 250 Strip Chart Recorder

Fastest, most versatile 5" strip chart recorder anywhere. Contactless servo. Detachable chart magazine. Has the Mark 200 writing system. Chart speeds from 0.2 sec/div. to 5 min/div., sprocketed drive. Portable.

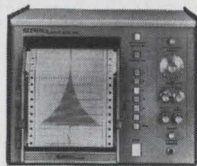

Mark 280 Dual 80mm Recorder

Feedback penmotor unit has two "double width" analog channels. Has the Mark 200 writing system. Chart speeds from .05 to 200 mm/sec. Portable.

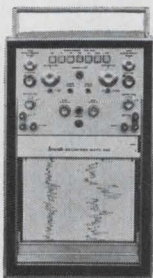

Brush Lightbeam Oscillographs

Choice of three high performance models with up to 25 channels, frequency response to above 5000 Hz, variety of chart speeds .002 ips to 120 ips. Writing speeds to 60,000 ips.

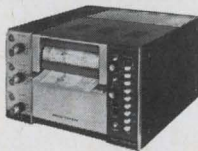

To put it in writing, write for complete catalog. Clevite Corporation, Brush Instruments Division, 37th and Perkins, Cleveland, Ohio 44114.

CLEVITE BRUSH

... some suppliers feel standardization of IC's would stifle innovation ...

Woburn, Mass. "Nonstandardization deters general growth. If, for example, tests are not standardized, test equipment can't be standardized either; every new kind means new tests and new test gear—an expensive proposition."

Luhrs, however, appreciates the ironies involved in the situation: "On the one hand, buyers want standards, but on the other, they make it difficult by making their specs the standardization aims."

Luhrs feels that although the EIA people rate an "A" for their efforts in reviewing industry problems and spreading the word about specifications, "they aren't even getting to first base on IC standardization."

"Standardization of parts doesn't make much sense; new IC's are coming out too rapidly to make such a policy stick," says Lawrence Drew, of RCA's Aerospace Systems division, Burlington, Mass. "But there is useful work to be done with standardization of test requirements and specifications, definitions of parameters, and in user-vendor communications."

By any other name. Drew, who's on two EIA microelectronic devices committees, cites the 930 series of diode-transistor-logic circuits offered by a number of semiconductor houses as an example of how differences can creep into the "same" assemblies. Even though specs are almost identical, differences occur in epitaxial layer depth, line widths, geometries and pad sizes, he says. This is acceptable for those using the circuits in the middle of their operating ranges, but it isn't much help to the man on the outer regions, where the performance of the device might vary radically from vendor to vendor.

Sylvania's Luhrs agrees, remarking wryly, "you can get three or four reasonably interchangeable versions—if you aren't too critical about reliability or particularly hard-nosed about other specs."

Other voices. Ben Anixter, marketing manager for IC's at the Fairchild Semiconductor division of the Fairchild Camera & Instrument Corp., says he wants standardization, but questions whether it's

physically possible. Anixter is also worried about retarding innovation: "The first resistor-transistor-logic circuits were put on 100-by-100-mil chips; they are now down to 20-mil chips. Registration would have kept us from making a change which allowed us to bring the cost down from \$80 apiece to 25 cents."

Anixter says there is no pressure from systems companies: "The push from this source is to develop viable second sources."

Stuart Snyder, assistant director of engineering assurance in the research and engineering group of the Autonetics division of the North American Rockwell Corp., says standardization cannot be applied universally. He favors it where possible because "you can put more effort into assuring that you get better components." However, Snyder believes that standardization could make IC users somewhat less flexible and receptive to new ideas.

Dialogue. "I'm for standardization where it aids communications with second sources," says Robert Roeder, senior engineer at the Hughes Aircraft Co.'s Aerospace Group, Culver City, Calif. Roeder says a lot depends on systems requirements: "We are beginning to find out that it's more economical to put more IC's into large, replaceable modules." On balance, however, because of the rapid pace of developments in IC's, Hughes has not pressed for standardization.

But Edward Keonjian, who heads the microelectronics and circuit design section at the Grumman Aircraft Engineering Corp., takes a harder line. "With over \$200 million worth of IC's produced last year for thousands of systems, any talk about standardization's being premature is just plain foolish," he says. Keonjian is chairman of the Aerospace Industries Association's Users Committee, which has selected a number of digital and linear circuits for standardization.

Keonjian's assistant, Frank Rente, is concerned about standardizing the physical, rather than electrical, properties of microcircuits. "It almost seems as if IC manufacturers were deliberately trying to make it

hard for the user," he says, recalling a panel session he attended at which a semiconductor marketing man said his company tries to package its new circuits differently in an effort to tie up the market.

Another proponent of standardization, Jorge Acosta, who heads the Reliability Physics Laboratory at the Raytheon Co.'s Missile Systems division, says: "Right now two manufacturers may sell gates which look alike on paper, but they may not publish schematics with their data. Thus, the engineer who buys from both does not know whether a level shift diode is at the base or the emitter of a transistor. Although the package, the pinning, and the function may be the same, drive-current typical values could differ 30% to 40%. I'd prefer worst-case specifications; 'typical' specs don't always reflect the real world."

Acosta also warns about the proliferation of terms. "Before you can test, you need to get your definitions straight. But with IC's, you find one firm calling a parameter 'minimum one input,' another company calling it 'threshold voltage' and a third taking a reverse approach and calling it 'minimum zero voltage.' You need a glossary."

Cost conscious. "Everything we do is based on costs," says Kenneth Tillmans, senior engineer at General Dynamics Corp.'s Pomona division, "We feel that eventually standardization would yield lower costs." However, he points out that rapid advances in the design of integrated circuits make nonstandardization almost imperative. "If you have two assemblies performing the same function and one uses a few nonstandard parts and the other many standard parts, which are you going to take? You'll put the cheaper one into production; we're faced with that today," he says.

II. Disintegrating demand

Semiconductor makers are more reticent in their approach to registration and standardization of IC's. Says a source at one major house: "The situation boils down to the fact that the design guys among our systems customers want state of the art and the latest changes. This is not compatible with standardization. We sell what people want to buy." This explains why EIA and other industry groups haven't suc-

Now from Sprague!



All the advantages of tantalum in one **LOW COST** capacitor!

EPOXY-DIPPED TANTALEX® CAPACITORS . . .

For industrial, commercial, and entertainment electronic applications where tantalum capacitors were previously too expensive!

— Type 196D Solid-electrolyte Tantalum Capacitors have special epoxy-dip coating which keeps costs down without sacrifice in dependability. Positively seals capacitor section while providing excellent electrical insulation. Protects against mechanical damage in handling.

— Radial lead design for plug-in mounting on printed wiring boards. The .250" lead spacing will fit standard .125" grids.

— High stability—very little capacitance change, even at outer limits of operating temperature range.

— Low dissipation factor of these capacitors permits higher ripple currents.

— Meet environmental test conditions of Military Specification MIL-C-26655B.

— Prime capacitance and voltage ratings. Based on rating popularity of other types of solid tantalum capacitors.

— Designed for continuous operation at temperatures from -55 C to +85 C.

For complete technical data, write for Engineering Bulletin 3545 to Technical Literature Service, Sprague Electric Company, 35 Marshall Street, North Adams, Massachusetts 01247.

Now available for fast delivery from your Sprague Industrial Distributor

SPRAGUE COMPONENTS

CAPACITORS
TRANSISTORS
RESISTORS
INTEGRATED CIRCUITS
THIN-FILM MICROCIRCUITS
INTERFERENCE FILTERS

PACKAGED COMPONENT ASSEMBLIES
FUNCTIONAL DIGITAL CIRCUITS
MAGNETIC COMPONENTS
PULSE TRANSFORMERS
CERAMIC-BASE PRINTED NETWORKS
PULSE-FORMING NETWORKS

450-8316



*Sprague' and ® are registered trademarks of the Sprague Electric Co.

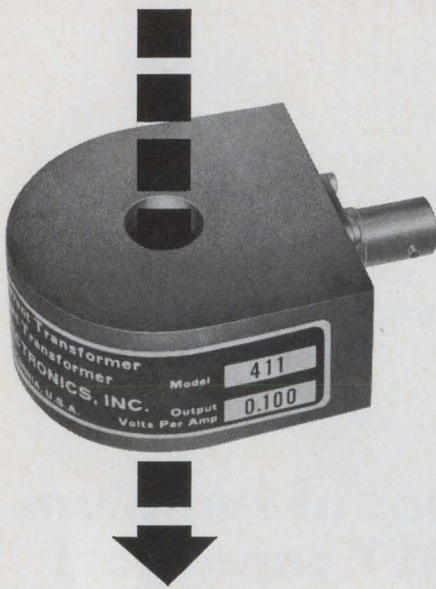

Wide Band, Precision CURRENT MONITOR

With a Pearson current monitor and an oscilloscope, you can measure pulse or ac currents from milliamperes to kiloamperes, in any conductor or beam of charged particles, at any voltage level up to a million volts, at frequencies up to 35 MHz or down to 1 Hz.

The monitor is physically isolated from the circuit. It is a current transformer capable of highly precise measurement of pulse amplitude and waveshape. The one shown above, for example, offers pulse-amplitude accuracy of $\pm 1\%$, -0% (typical of all Pearson current monitors), 10 nanosecond rise time, and droop of only 0.5% per millisecond. Three db bandwidth is 1 Hz to 35 MHz.

Whether you wish to measure current in a conductor, a klystron, or a particle accelerator, it's likely that one of our off-the-shelf models (ranging from $\frac{1}{2}$ " to $10\frac{3}{4}$ " ID) will do the job. Contact us and we will send you engineering data.

PEARSON ELECTRONICS INC

4007 Transport St., Palo Alto, California 94303
Telephone (415) 326-7285

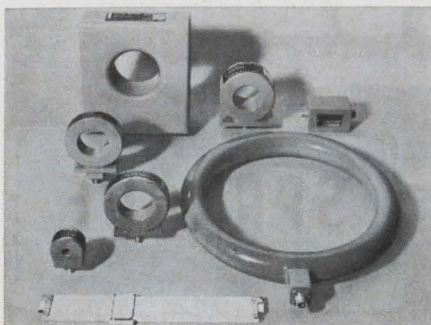

... systems designers aren't keen on standardization ...

ceeded in pushing standardization, he says. "Paradoxically military customers say they want standardization. But it's really only the reliability and purchasing people. The designers don't want it and they're the ones who are calling the shots."

Similarly, Allan C. Bahr, market applications manager at the Amelco Semiconductor division of Teledyne Inc., says he sees no pressure at all for registration, from users, makers or the military. The users, he says, tend to create their own drawings, and the makers won't register unless they must, because of the time and expense involved.

"Integrated circuits will be registered only when the customer demands it," Bahr says. "That will occur when he stops believing the maker's data sheets." However, Bahr sees an incipient trend that is creating some pressure for standardization: cost-consciousness is leading some designers to work with off-the-shelf devices. At best, however, this represents informal standardization.

Wrong number. One of the problems of EIA registration of IC's, says a maker, is the lack of provision for reserving registration numbers. "If tomorrow we registered eight devices that were all of one family, they would have sequential numbers," he says. "But if six months from now we came up with a ninth device in the same family, it would be impossible to get it into the same numerical sequence as its brothers. For all we know, it could be assigned a number sequentially related to an entirely different device, perhaps even made by a different company."

Another executive who doesn't think formal rules are necessary for standardization is John Ekiss, manager of circuit development at the Philco-Ford Corp.'s Microelectronics division, Blue Bell, Pa. He says: "Systems makers are pushing too far; they want us to tell them everything about a product—including proprietary information—even when that data can't possibly help them. When we're talking of standardization, what we're really saying is interchangeability."

Systems houses generally buy

ANALOG



DEVICES

\$49

OP-AMP POWER SUPPLY

Dual ± 15 VDC @ 40mA
Direct Operation from 115 VAC
Modular for PC mounting
Small Size 2.5" x 3.5" x .87"

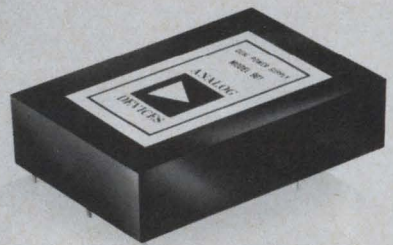

MODEL 901

SPECIFICATIONS:

Input	105 to 125 VAC, 60 to 400 Hz
Output Voltages	$\pm (15.1$ to $15.3)$ VDC
Output Current	40mA, each output
Load Regulation	0.2%, NL-FL
Line Regulation	0.1%, 105 to 125 VAC
Temp. Coeff.	0.03%/°C
Ripple and Noise	2mV, rms
Dynamic Output Z	2 ohms @ 10kHz
Output Protection	Short circuit proof
Operating Temperature	0 to 71°C
	Derate 1.5mA/°C above 60°C
	Derate 0.5mA/°C below 15°C
Storage Temperature	-25 to +85°C
Price (1-9)	\$49.
(10-24)	\$39.

ANALOG DEVICES INC.

221 FIFTH STREET,
CAMBRIDGE, MASS. 02142
PHONE: 617/492-6000
TWX: 710/320-0326

from two or three vendors using common specs the systems house has developed, says Ekiss. A result is a kind of underground standardization: "We're gravitating to standardization, even if no one issues an edict, because it's a good way to do business."

Some suppliers cite their customers' propensities for tinkering as a cause of the standardization hulla-baloo. And some systems companies agree. One source at a New England firm says: "Engineers pick up a spec sheet and begin tightening here and there; using a spec as a springboard is costly."

III. Pilgrim's progress

C. Everett Coon, the EIA's type administrator, says his organization is beginning to move faster on standardizing microelectronic devices. "We've had to get mutual understanding and trust between users and suppliers as never before," he explains. "It's because they are so close to each other in this area." He notes that frequently users outnumber makers on committees.

During the past year, three new EIA registration circuit formats have been issued. There are formats for semiconductor integrated logic gate circuits; semiconductor integrated linear amplifier circuits; semiconductor integrated linear amplifiers; semiconductor integrated bistable logic circuits and semiconductor integrated linear wideband, pulse and video amplifiers. Coon says these documents cover more than 95% of commercially available devices. Formats being prepared include sense amplifier/comparators, rf/if amplifiers, and voltage regulators.

Coon says that although industrial and consumer products are becoming sizable users of IC's, it will probably require a Pentagon push before registration comes about. "Then, industry and consumer goods makers will be obligated to use them," he says. "And one of these days the services may have microelectronic modules that can be used in a number of applications. This could lead to registration of the entire module," he says.

Contributions to this report were made by: James Brinton in Boston; Lawrence Curran, Bill Bell, and Darrell Maddox in Los Angeles; Walter Barney and Peter Vogel in San Francisco; Robert Skole and William Hickman in Washington; and Peter Schuyten and Howard Wolff in New York. It was compiled by Eric Aiken in New York.

STEREO

THE ADDED DIMENSION OF DYNAZOOM® METALLOGRAPHS

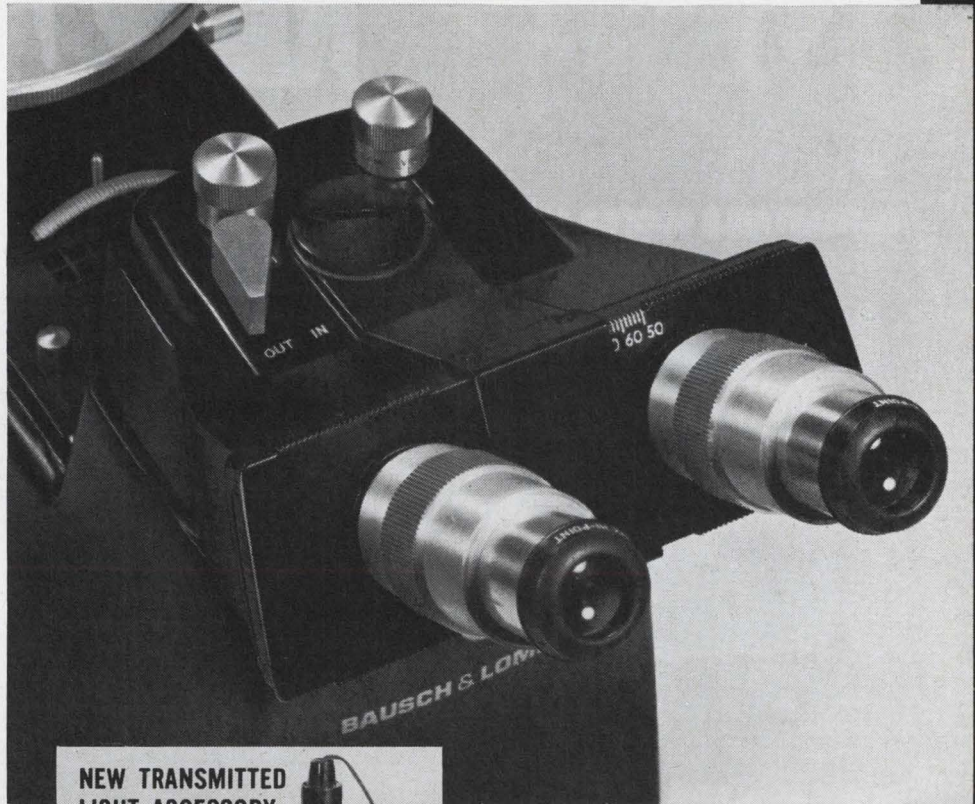

Bausch & Lomb has added a new dimension to metallurgy. You get all the advantages of the Dynazoom II Bench Metallograph plus *full-range stereo viewing*. Simply flip a lever and you can differentiate between inclusions and holes, scan a surface for fractures or study various surface levels caused by polishing and etching. Available as a complete stereo model or convert existing Dynazoom Metallographs by adding the zoom-stereo body. Send for Brochure 42-2211. Also available, the free booklet, "High Power Stereo" by Harold E. Rosenberger, No. S-513.

Transmitted light available on all models

For the study of transparent and translucent specimens on your Dynazoom Metallograph, there is now a Transmitted Light Accessory. Adapts readily to all models, including stereo. Can even be used with high N.A. 75× oil immersion objectives. Plastics, glass, thin films, evaporated coatings, oils and other liquid specimens can be examined. Send for our Brochure 42-2212.

Ask for a no-obligation demonstration of this equipment. Write Bausch & Lomb, 61403 Bausch Street, Rochester, New York 14602.

BAUSCH & LOMB

SCIENTIFIC INSTRUMENT DIVISION

Circle 163 on reader service card

*These are specialized **TRACOR** instruments designed for your specific needs.*

See them at IEEE booths 2J-30, 32 & 34.

FREQUENCY STANDARDS



RUBIDIUM FREQUENCY STANDARD
 1×10^{-10} freq
 2×10^{-11} stnd dev/yr
 use Reader Service #315.

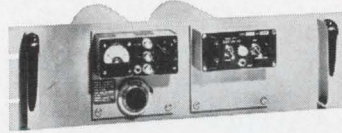

CRYSTAL STANDARDS
 5×10^{-11} /24 hours
 5 to 0.1 MHz
 use Reader Service #316.



LOW COST HOUSE STANDARD
 1×10^9 /24 hours
 use Reader Service #317.

ULTRASTABLE CLOCKS AND DIVIDERS

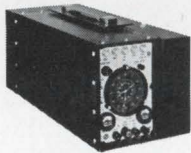

PORTABLE RUBIDIUM ATOMIC CLOCKS
 5×10^{-12} /100 sec avg—37 pounds!
 use Reader Service #318.



CRYSTAL CLOCKS
 2×10^{-6} secs per day
 use Reader Service #319.

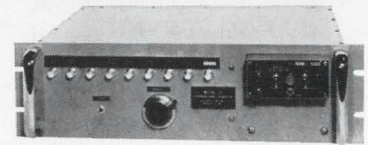

REFERENCE SIGNAL GENERATORS
 200 Hz-6.25 kHz
 use Reader Service #320.

VLF RECEIVERS—FREQUENCY/PHASE COMPARATORS

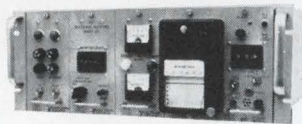

VLF TRACKING RECEIVER/COMPARATORS
 Continuous tuning 3.00 to 99.5 kHz
 use Reader Service #321.

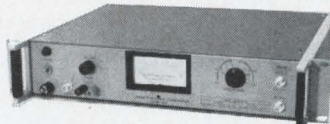

LINEAR PHASE/TIME COMPARATOR
 1 nanosecond time resolution
 0.01 cycle phase resolution
 use Reader Service #322.

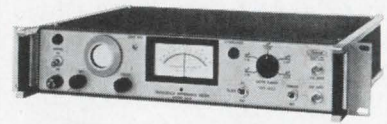

FREQUENCY DIFFERENCE METER
 difference to 1×10^{11} , error multiplied by 10^4 .
 use Reader Service #323.

NOISE ANALYSIS

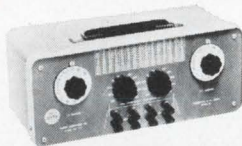

CONTINUOUSLY-VARIABLE PASSIVE FILTERS 15 Hz-672 kHz
 use Reader Service #324.

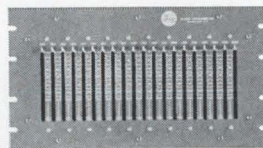

EQUALIZERS/SPECTRUM GENERATORS
 Up to 40 $\frac{1}{3}$ -octave increments
 use Reader Service #325.

OMEGA NAV SYSTEMS



VLF/OMEGA NAVIGATIONAL SYSTEMS
 For broad-area navigation

use Reader Service #326.

NORTHERN SCIENTIFIC, INC.

ASTRO-SCIENCE CORP.

WESTRONICS INC.

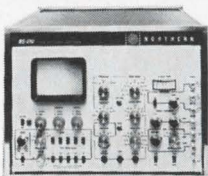

DIGITAL MEMORY OSCILLOSCOPES and Pulse Height Analyzers

use Reader Service #327.

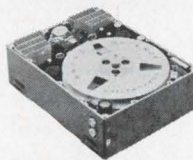

ASTRO-SCIENCE MULTI-CHANNEL AIRBORNE INSTRUMENTATION TAPE RECORDER/REPRODUCERS
 use Reader Service #328.

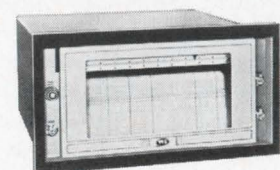

MULTIPOINT AND CONTINUOUS PEN CHART RECORDERS

use Reader Service #329.

For a short-form catalog of TRACOR instruments, please use Reader Service #330.

Industrial Instruments Division



Soviet computer program has as many downs as ups

Government inefficiency, technical problems, and personnel shortages slow Russia's drive to computerize virtually all sectors of its planned economy

By Howard Rausch

Moscow news bureau

The technology-conscious Russians have embraced the computer whole-heartedly. But the love affair isn't totally requited. Despite some progress, many industrial problems in the world's oldest planned economy are directly attributable to shortcomings in computer technology.

In their franker moments, Soviet specialists concede that the excellence of their design and programming is offset by uncertain reliability of components and deficiencies in peripheral equipment.

Soviet designers, for example, boast they have compiled computer programs for 80% of the nation's numerically controlled machine tools—a proportion higher than in any other country. Programs have also been developed for such complex processes as electron-beam cutting and welding. Yet a Renault engineer, helping to modernize the Moskvich auto plant in Moscow, found a serious lag in the Soviet's NC capabilities. When he inquired, the Russians blamed the slow development of computers and worse problems with peripherals.

I. Somebody goofed

Visitors to the computer center in Novosibirsk last summer found the Soviet Union's fastest computer—the BESM-6—idle, awaiting magnetic disks. None were made in the country. The center's director cheerfully dismissed the situation as “a bureaucratic oversight.” Since then, extremely limited production of disks has started.

Another bureaucratic gaffe is blamed for the fact that only half of the 10 BESM-6 machines in ex-

istence late last summer were fully operative. Someone in Moscow had revised specifications for peripherals a year earlier—too late to assure delivery on time.

Government inefficiency is only part of the problem. Equally important is a serious shortage of qualified personnel.

When the vital Algol compiler for the BESM-6 was being developed at the Academy of Sciences' computer center, only 10 trained programmers and analysts were available. Soviet specialists concede that number is totally inadequate.

Stood up. While waiting for peripherals, the first civilian BESM-6 was idle two years at the computing center on Vavilov Street in Moscow. Even now, the machine can handle only three problems simultaneously—well below its theoretical capacity of 10. The unused

channels still need software and additional terminals.

II. Limited liability

Significantly, the factory that assembles the BESM-6 under the aegis of the Ministry of Radio Industry has no responsibility for peripherals of software. It's up to the user to develop or find his own. The situation, says computer specialist Victor M. Glushkov, “is tantamount to producing telephones without earpieces or cables and making the customer supply his own.”

In the case of the idle BESM-6, the center itself prepared the executive system and Algol compiler. Other software was farmed out—the Cobol and Fortran compilers to a Kiev institute, Alpha to Novosibirsk, and Algek and two-level assembly language to two other institutes in Moscow. (Algek, used principally for economics problems,

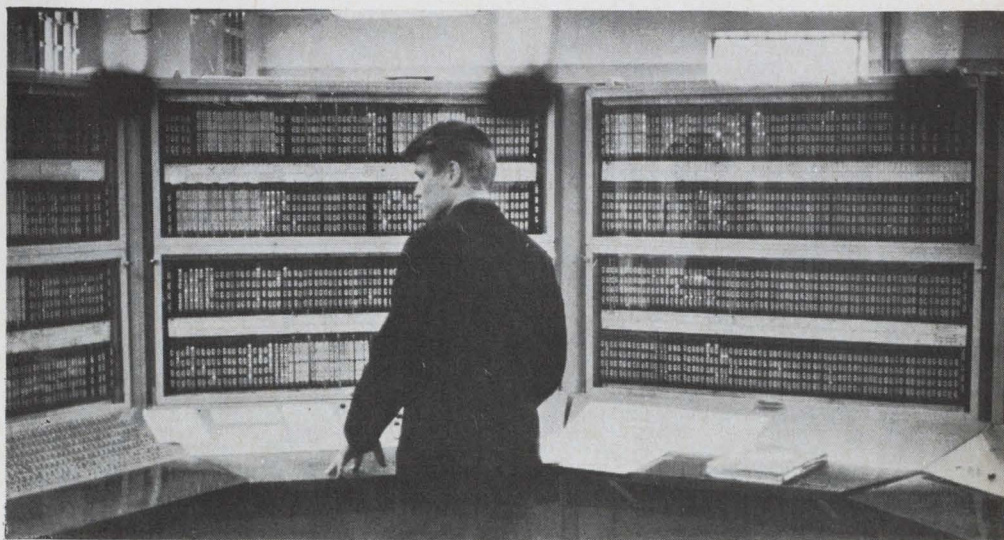

Hung up. The Soviet Union's fastest computer, the BESM-6 was idle at the Novosibirsk center last summer for lack of magnetic disks.

and Alpha are Soviet versions of Algol.)

But few users have the authority of the Academy of Sciences computing center to order development of software. A typical customer, the Frazer machine-tool plant, had so much difficulty with software its director suggested the government bar production of computers without translators and other software.

In addition, engineers complain that one of the most widely used punch-card feeders, the BY-700, requires a fulltime operator. "It's also very hard to find out who has approved such unreliable machines as the P 80-6 and PL-20 punchers," complains one. Consumption of magnetic tapes is generally double what it should be because of poor reliability, reports another.

As a rule, Soviet complainants don't identify the erring parties—presumably because they don't know who they are. Paradoxically, computer experts in this largest of centrally administered societies are generally hazy as to who has the last word on what's to be built, for whom, and to what specifications.

This comparative anonymity may be at least partly responsible for another Soviet problem. Every Russian machine seems to have a different tape or card format. And no program written for one processor seems to work on another.

For all the limitations involved in their craft, Soviet designers and programmers are talented and resourceful. An American specialist who has visited most of the major Soviet computer centers says: "They're at least five years behind us in design, but they're probably ahead in getting the most out of a machine."

Foreign designers are particularly impressed with Russia's small, special-purpose computers. British experts recently reported an "impressive" Soviet attack on problems of semiautomated, high-volume production plants, adding that certain Soviet systems were better than their British counterparts. Likewise, an American specialist was "intrigued by the Russian emphasis on and accomplishments in computer-aided design."

Big step. The Kiev 67, a small machine still in development, furnishes evidence of the Soviet thrust in CAD. A comparatively untrained technician, using a light pen on a cathode-ray-tube display will be able to alter designs to generate new instructions for numerically controlled machine tools.

III. Russian dressing

Soviet designers also stress simplicity in some general-purpose machines. An example is the Promin, a single-address computer that performs 1,000 additions or 100 multiplications a second—a rather slow performance by Western standards. It automates engineering computations in scientific research and design, solving simultaneous differential equations of the third and fourth order.

The Russians are also proud of the hybrid Dnieper-2 system used

Service with a smile



In Russia's centrally administered economy, computer manufacturers have no responsibility for developing or producing peripheral equipment and software. As a result, the Soviets have tacitly given top priority to this aspect of work, farming it out to support organizations.

Anatoly A. Dorodnitsyn, director of the Moscow computing center, exemplifies this push. Dorodnitsyn heads a 400-man staff that includes 250 scientists and mathematicians; his agency furnishes programming service for the Academy of Sciences, and does research work in such areas as pattern and sound recognition and data transmission. In addition, the center serves an increasing number of organizations outside the Academy on what amounts to a commercial contract basis. For example, Mosavtotrans, the agency that monitors and directs the movement of Moscow's 30,000 trucks and buses, has long been a client.

Profile. The 58-year-old Dorodnitsyn is a three-time winner of Stalin Prizes, once the highest accolade a Soviet scientist could achieve. He reads English and has traveled in both the United States and Canada. Dorodnitsyn enjoys expounding mildly heretical views while puffing at a cigarette through a short amber holder. For example, largely as a result of his efforts, the computing center has not been caught up in rigidly defined five-year plans, and is given only basic directions. "A mathematician can change the plan more easily than a scientist," Dorodnitsyn explains.

Nor is Dorodnitsyn an empire builder. "I've read Parkinson's Law," he says. "The director of an institute must at least be able to understand what his collaborators are doing, and this is difficult when the organization gets too big." The computing center has added only 150 people in the past 10 years, bringing the current complement to 400. Dorodnitsyn says he hopes even this modest growth rate has leveled off.



A word to the do-it-yourself module builder:

Don't.

Buy our J Series modules instead.

The J Series is our new family of general purpose, all integrated circuit logic modules. Their performance almost matches that of our famous T Series modules, but they cost about 25% less. They're made to the same dimensions as the T Series, with the same 52 pin connectors, so they're physically interchangeable. We make them for our own seismic recorder systems, so they're rugged and reliable. Now, as of January, you can buy them (com-

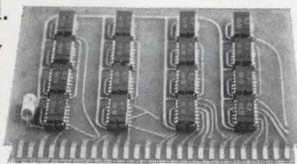

These will cost you less.

plete with mounting hardware, racks and power supplies, if you wish) in any of 25 different functions.

And save yourself the time and cost of making your own: designing, assembling, testing, new procedures, new equipment, new personnel, additional training, to say nothing of the added paper work.

If you're building systems, you must have better things to do than go into the module assembly business. Such as reading our J Series catalog.

It's free.

SDS
Scientific Data Systems,
Santa Monica, California



**Precision
power for
air and
ground**

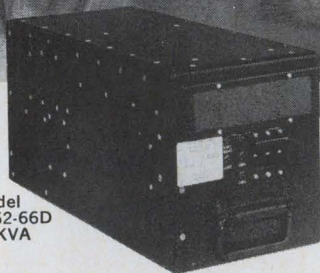

Model
PS62-66D
3.5KVA

UNITRON FREQUENCY CONVERTERS 400 Hz to 60 Hz

3.5 and 8 KVA Sine Wave Outputs

• Complete input and output loading protection • Wide input voltage and frequency variations • Tested to Applicable Environment & RFI Specifications

From Unitron, two all-silicon solid state frequency converters with fourth-generation proven reliability and efficiency.

The design of these units gives an operational flexibility for a wide variety of environments.

Typical applications: Air-transportable equipment requiring precision 60 Hz power, and ground systems where input power is 400 Hz.

Write for complete information.

UNITRON

Division of Electric Machinery Mfg. Company

1624 N. FIRST ST.

GARLAND, TEXAS 75040 (214) 276-8591

**... Soviet planners are confident that
their economy will be computerized ...**

for solving industrial problems. The system combines two digital control computers, the Dnieper-21 and Dnieper-22, with an analog machine, the MN-10M; the analog unit simulates the process being controlled. The three-or-more-machine complex permits simulation of direct digital control systems as well as multivariable and optimizing setups. The transistorized Dnieper-2 installation is compact enough for laboratory use.

Remote control. For all the bureaucratic sins, the Russians have succeeded in computerizing a good part of their lives. Every Friday morning the computer center of the Soviet Academy of Sciences sends a package of calculation across Moscow to Mosavtotrans, the agency that dispatches and routes the city's 30,000 buses and trucks. From these figures, planners schedule every trip for the next week.

And at a television plant in Lvov, a Minsk 22 computer makes production-control decisions for management; it also prescribes distribution of materials, the duration of workshop shifts, and the speed of the major conveyor.

IV. Model society

Using computers, Soviet laboratories are modeling everything mathematically—with the possible exception of miniskirts. Perhaps the most ambitious undertaking is Novosibirsk's effort to compile programs for determining probable effects of catalysis in chemical processing. This system would replace or supplement the present hit-or-miss approach.

There are also programs for controlling critical-path techniques in big construction projects, receiving processing weather data from satellites, prospecting for minerals, predicting when and where certain fish will be most abundant, and forecasting river flow three years in advance.

Hinterlands. To increase construction efficiency in outlying areas, a Laboratory of Mathematical Methods and Computing Machinery has been created, equipped with a Minsk 22 and a Promin

computer. This agency is charged with formulating a theoretical basis for optimizing designs for rural construction. The mandate covers everything from delivery of equipment to creation of a master capital-construction plan.

Among the newer national efforts, is an attempt to computerize the Soviet fertilizer industry. A Minsk 22 is being used to process information on production of 28 kinds of plant food and to supply data to such interested parties as industrial ministries and the governments of member republics.

The Minsk 22 will correct obviously defective data automatically, then arrange the information, calculate the derived values and deviations from daily and monthly plans, and do other calculations.

Retail outlet. One of the first commercial computer applications is at GUM, the big department store on Moscow's Red Square. A Minsk 22 has been installed to process sales and inventory data.

Each price tag now contains a section of punched holes; it also performs what Soviet officialdom optimistically calls "market forecasting." However, while the computer seems able to keep track of sales fluctuations, it is still unable to adequately gauge demand in a scarcity economy where nearly any quality item can be sold.

Taking a flier. A year ago, Aeroflot—the state airline monopoly—announced installation of a computerized reservation system. It is still impossible, however, to book a domestic flight more than 10 days in advance, to do it at any time by phone, or to receive a confirmed reservation before the day of the flight.

But Soviet planners are confident the economy will eventually be computerized. Recently they introduced a classification system in which every product will receive a 10-digit index number for data processing. (Despite the wide varieties of format, most Soviet computers can handle 10-bit words.) The system will lead, Russians say, to a central inventory of every product anywhere in the country.

There are more than 30,000 military specifications.
Only Sweet's gives you all of them—complete, current,
and retrievable in less than 2 minutes.

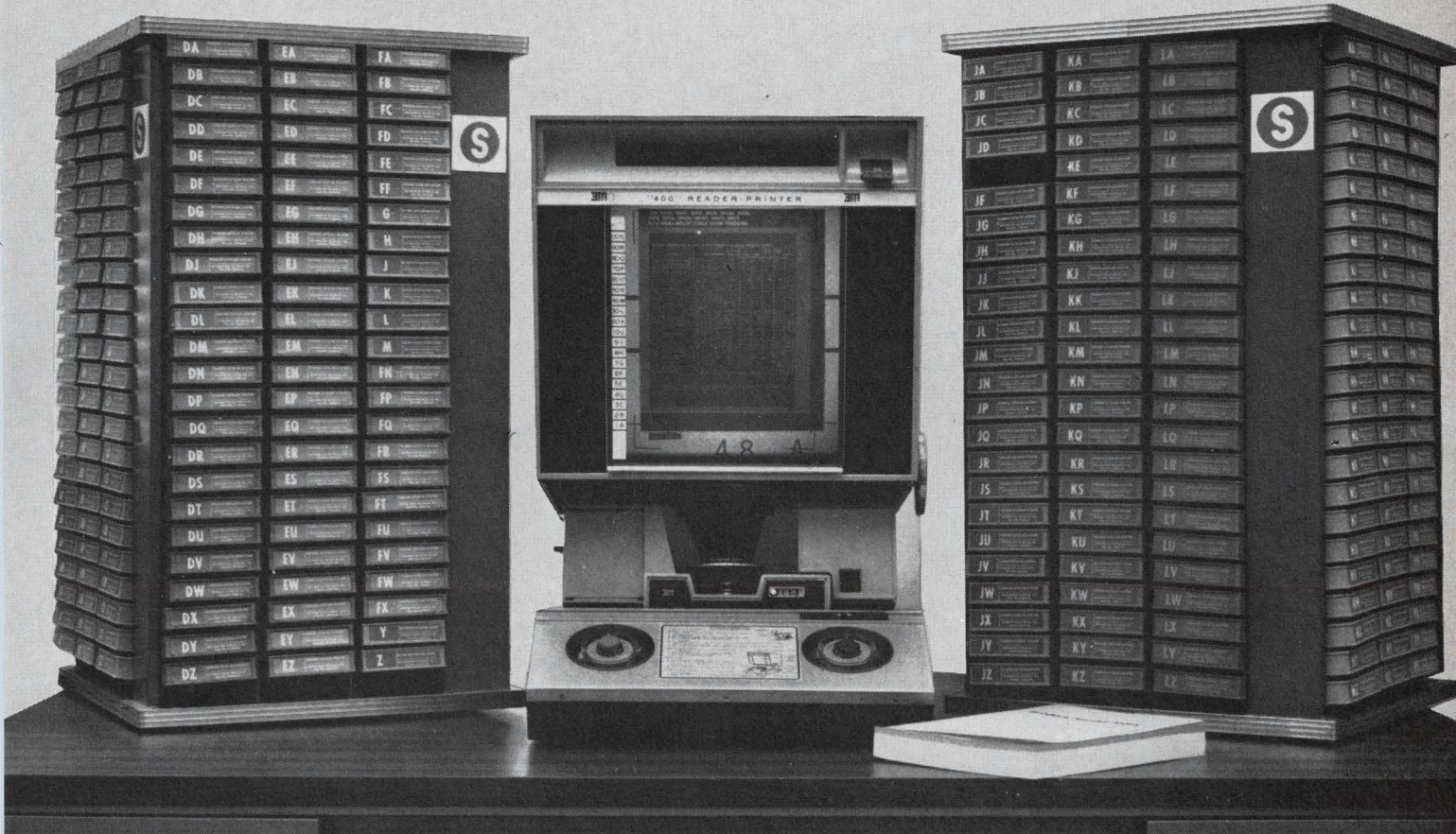

Every military specification in the Department of Defense Index of Specifications and Standards (DODISS) is right here

...with a full-size print-out capability that keeps the file intact.

Also available: 700,000+ pages of current product/vendor data. Use the coupon for full information.

There is only one way to beat the military specifications problem: you have to have all of them, with amendments, supplements, change notices, slash sheets—and all up-to-date. Only Sweet's Microfilm does it.

We give you all current military specifications, on film for compactness and fast retrieval.

For accuracy, we give them to you with change notices preceding them, and slash sheets following. And we flag every change in the margin of the basic specification.

You also get QPLs, Military Standards, and all Military Handbooks.

Just as important, we keep your file current. The Government issues a complete new index once a year; Sweet's does it every month. Every month we send you all new and revised specs, with a complete revision of the index. The reader/printer views and prints out in full-size—which means you copy what you want, to do with what you will, leaving the system wholly intact.

Send the coupon for further information, and we'll also tell you about our micro-filmed Vendor Catalog File—more than 700,000 pages of current product data from all the important vendors to aerospace, OEM, electronics, and plant engineering.



SWEET'S INDUSTRIAL INFORMATION SYSTEM/MICROFILM

Circle 169 on reader service card

Send me a complete information package on all the parts of Sweet's Microfilm File.

Name _____

Title _____

Company _____

Address _____

City _____

State _____ Zip _____

Send to:

Sweet's Industrial Information System/Microfilm
330 West 42nd Street Dept. M2
New York, N. Y. 10036

a McGraw-Hill Information System

BELDEN 

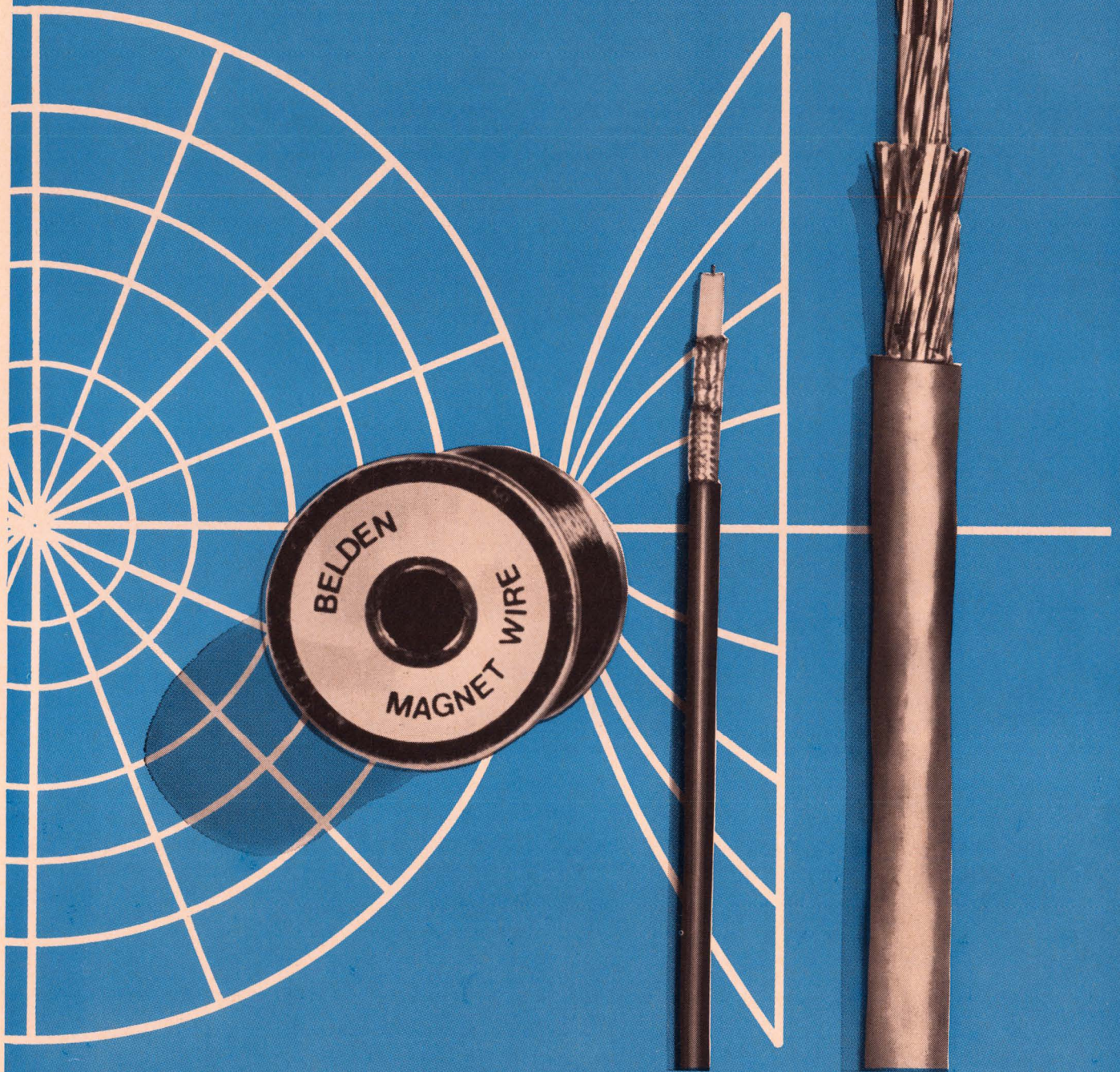

Belden's Wire Specialists know that as systems become more exotic and their functions more difficult, wire becomes more important. Wire carries the messages...conveys the power...links components into true systems. And they know that wire can make a big difference in how well the completed product operates. They know that by prescribing the right wire or cable to

The advertisement features a blue background with white line art. At the top, the text "new ideas for moving electrical energy" is written in a serif font. Below this, there are several images of electrical components: a thick black cable with a coiled end, a thin black cable with a connector, and a braided shielded cable. A white line art drawing of a multi-pin connector is also visible. The central text "Belden thinks systems" is in a large, bold, sans-serif font. Below this, there is another white line art drawing of a multi-pin connector. At the bottom, there is a paragraph of text in a serif font, followed by a small code "G-3-7".

new ideas for moving electrical energy

Belden thinks systems

link each component, they can help simplify designs, enhance reliability, save internal space, even reduce assembly costs. That's worth investigating, isn't it? Then get together with the wire men who think systems. You can reach them at the place that makes all kinds of wire for all kinds of systems—Belden Corporation, P.O. Box 5070-A, Chicago, Illinois 60680.

G-3-7

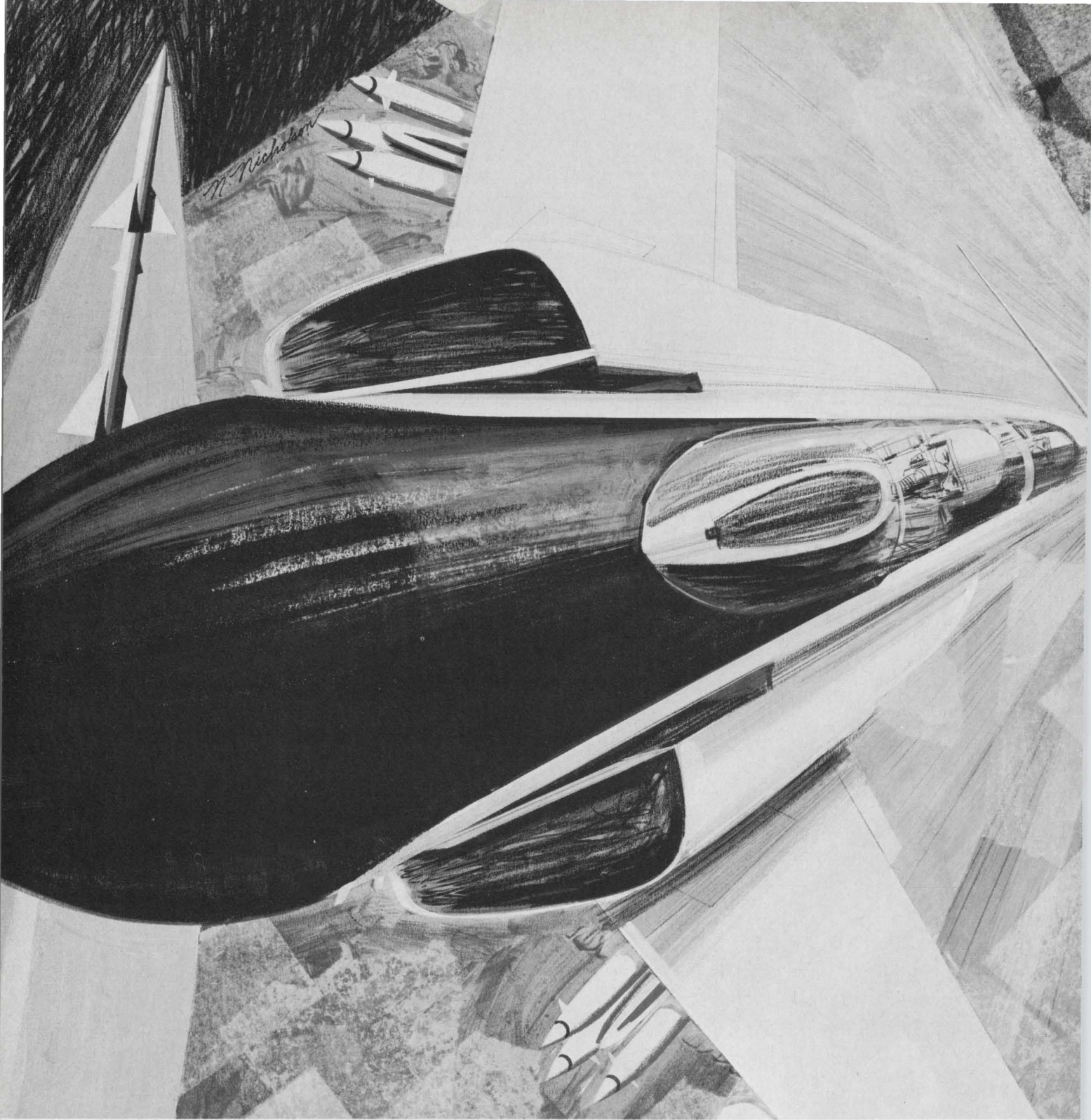

Quick reaction

It means different things. To the pilot, it may be a violent maneuver to dodge an enemy missile. To the systems contractor, it means getting operational gear designed and built **and** delivered in a hurry.

Circle 172 on reader service card

Working with QRC contractors, MEC has developed TWTs and solid-state microwave acoustic delay lines for signal repeating, augmentation, microwave memory, direction finding, communications and target simulation systems. And all were built to perform in hostile environments.

If you're designing a quick reaction system, contact MEC. We have a reputation for "turning it on" and reacting quickly.

You can learn **more** by calling the men from MEC.



Microwave Electronics
A TELEDYNE COMPANY

3165 Porter Drive, Palo Alto, Calif. 94304

New Products

New semiconductors

MOS bandwagon starts rolling

Industry leaders producing metal-oxide-semiconductor integrated circuits as improved reliability, high packing density attract equipment designers

By Walter Barney

Manager, San Francisco Bureau

Some of the giants of the industry are making it clear this week in their IEEE exhibits that they'll be beating the drums for metal-oxide-semiconductor integrated circuits, until recently a small-house specialty.

- General Electric introduced a frequency divider, first of a series of basic ic's.

- RCA showed a line of complementary circuits, its favorite approach.

- Texas Instruments entered a half-dozen me-too circuits, the start of a catalog product line.

- Westinghouse demonstrated "a capability."

Apparently convinced that bipolar techniques are firmly established and it is now time to turn to MOS, the big three in semiconductors—Fairchild, TI, and Motorola—are moving from custom work to standard products [Electronics, Jan. 8, p. 11]. And both GE and RCA, late starters in digital ic's, are making MOS the principal products of their lines.

Meanwhile, the small group of companies which pioneered the technology has worked diligently to overcome the resistance generated by an oversell a few years ago. Their efforts are beginning to pay off.

Two at start. Three years ago, General Micro-Electronics Inc. and

the General Instrument Corp. were the only significant names in MOS ic's. Today there are nearly a score of suppliers. General Instrument and the company that swallowed General Micro-Electronics, the Philco-Ford Corp., are churning out a respectable 35,000 circuits a month. After a couple of static years at the \$5 million to \$6 million level, total MOS sales reached \$10 million last year; most suppliers expect them to double this year and to double again in 1969. More significant, by the end of this year, for the first time, the bulk of the sales dollar is expected to go for hardware, rather than engineering and

design. And where once the military was the sole support of MOS companies, industrial users are now beginning to design MOS into a variety of equipment.

Most MOS manufacturers believe that the devices are ready for use in computer peripheral equipment, calculators, radars, process controllers, multiplexers, and memories, including scratchpads, read-only memories for computer subroutines, and circulating types that act as delay lines.

Dense but slow. The advantages of MOS are its high packing density, low cost, and low power requirements. One disadvantage, the slow

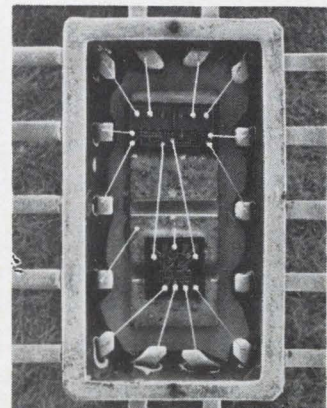
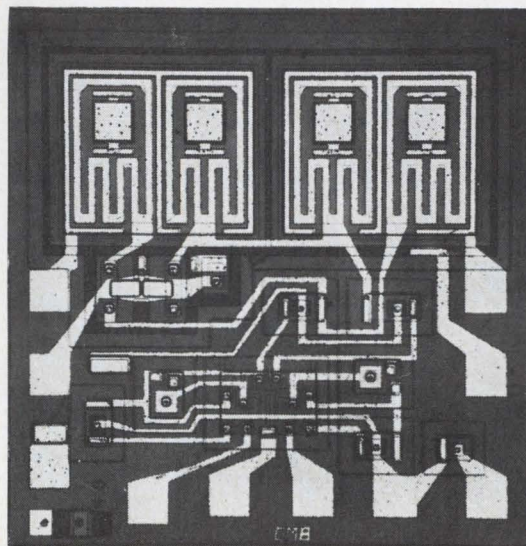

Wed. Siliconix' monolithic marriage of bipolar, MOS (left) costs less, is more reliable than earlier hybrid.

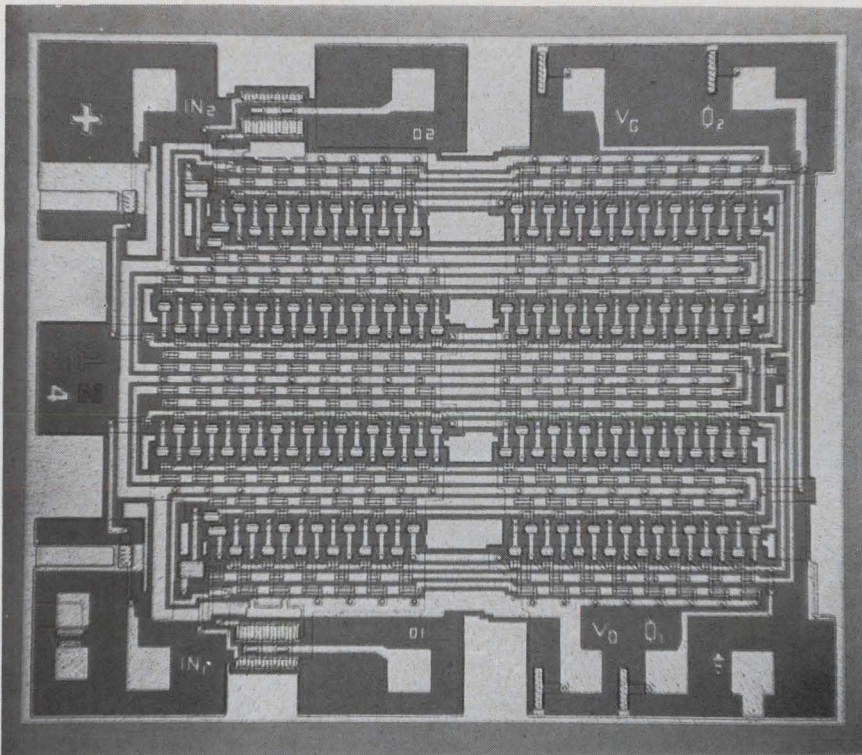

Double shift. Typical of the recent MOS integrated circuits is this dual 32-bit static shift register from TI. It operates between d-c and 1 Mhz.

speed of the devices, has not been nearly as great a handicap as the users' concern about MOS reliability. The thick oxide process popularized by General Instrument and in general use throughout the industry for several years is given some credit for improvements in yield; but most manufacturers say that it is a better understanding of the process, and of the nature and effect of impurities in the oxide, that is the real reason for the higher yields.

Whatever the cause, manufacturers are now sufficiently secure about the process to be candid about past difficulties; they have moved ahead to develop markets. With the appearance of these markets has come the entry of the big three. Since last fall, the Semiconductor division of the Fairchild Camera & Instrument Corp. has introduced two MOS IC's a month. Motorola made its debut with two circuits designed for electronic organs, and TI showed its first shift registers, logic units, switches, and amplifiers at the IEEE show.

1. Who's buying?

For many years, the chief supporter of MOS has been the National Security Agency. NSA is believed to have accounted for as much as 20% of the MOS market in 1965; in 1966 and 1967 its share was be-

tween 10% and 20% and, even this year, when the market is beginning to take off, its share may be as much as 10%.

Through Texas Instruments and Honeywell Inc., NSA is now letting classified contracts for the next generation of R-13 equipment for cryptographic communications. It's believed that NSA wants low-cost, reliable devices to make telephone communications secure; clearly, there would have to be a lot of equipment, probably one system or device per phone.

About 75% of MOS sales today are in custom or special contract work. One of the few production lines of any size is Philco's for the Victor Calculator; this single product accounts for half of Philco's output. But Don Richard, an old Philco hand who became marketing director of American Microsystems, Inc., last fall, says that more than half a dozen programs, about evenly divided between military and industrial, will begin using MOS hardware in the last half of this year.

Richard will not identify these programs; MOS manufacturers are, if anything, more secretive about their customers than the rest of the semiconductor industry. Some programs, however, are known. A sampling:

- Wright-Patterson Air Force Base has let contracts, worth \$3 million, to Philco, TI, and RCA, for development of large-scale arrays for navigational computers. The Air Force wants a machine costing under \$20,000. The C-5A transport plane, being developed by the Lockheed-Georgia Co., will use MOS circuits in multiplexing signals in its Madar (malfunction detection, analysis, and recording) system. (The Boeing Co. will also use MOS for multiplexing the entertainment system signals in the 747 superjet.) MOS will be used for switching in the F-111, the Phoenix missile, the Navy's Standard missile, the anti-radiation missile, and the SAM-D. The Harry Diamond Fuze Laboratories, the Picatinny Arsenal, and Honeywell's Ordnance division will use MOS shift registers as delay lines in fuzes.

- The Whittaker Corp., and the Ground Systems division of the Hughes Aircraft Co., are using MOS in radar "defruiters," which eliminate spurious signals. The technique is to store one signal and compare it with the next.

- The Lockheed Missiles and Space Corp. is designing MOS arrays into an advanced guidance package.

- On the industrial and commercial side, Philco will deliver circuits to a Japanese calculator maker, and the National Cash Register Co. has an extensive developmental program in large-scale integration, under which MOS arrays are being evaluated.

The computer terminal and peripheral field is rich in potential, and every MOS maker expects it to be a sizable market. Under a directive from corporate headquarters, the Santa Clara, Calif. facility of Philco's Microelectronics division, where MOS work is centered, is currently engaged in a program to provide more support for the company's nearby Western Development Laboratories, and its Space and Reentry Systems division. One specific area of work is on MOS memories that refresh the displays at remote computer terminals.

Down memory lane. Since the MOS transistor is either on or off, it is admirably suited for memory functions; the main question for the designer is how to address the memory. The 1,024-bit read-only memory, recently introduced by Philco,

HERE'S HOW...

THE ELECTRONIC INDUSTRY IS USING
THESE FAMOUS ULANO FILMS IN
ULTRAMINIATURE MASK TECHNOLOGY
AND COMPLEX PRINTED CIRCUITRY

Cut a piece of the desired film large enough to cover area to be masked. Tape it down firmly at the top with dull-side up.

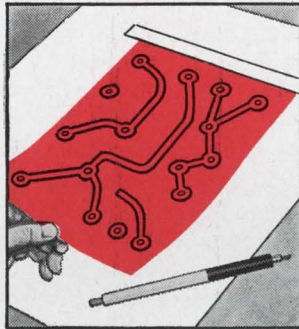

With sharp blade, outline the areas to be masked. *Do not cut through the backing sheet.* The Ulano Swivel Knife does the job quickly, easily.

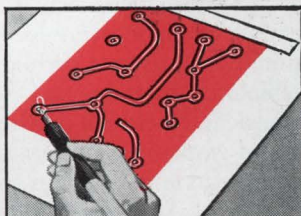

Using the tip of the blade, lift up a corner of the film thus separating it from the backing sheet.

Now carefully peel off the film as outlined leaving a completed mask, positive or negative, that corresponds exactly to the desired pattern.

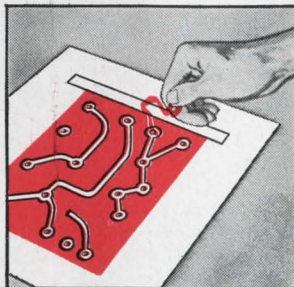

UlanoTM

RUBYLITHTM AMBERLITHTM

HAND CUT MASKING FILMS FOR THE GRAPHIC ARTS

ULANO RUBYLITH... a revolutionary knife cut red film is laminated to a stable transparent plastic backing sheet. The red film is "light safe" so that when contacted to a sensitized emulsion and exposed to a suitable light source, light passes through the cut-out portions only... not through the red film. ■ The polyester backing is absolutely stable... insures perfect register. ■ Special effects such as crayon tones, paste ups, benday sheets, and opaquing are easily combined with versatile ULANO RUBYLITH.

ULANO AMBERLITH... a companion to Rubylith serves as a color separation medium used as the master on camera copy board to secure negatives or positives.

*A wide variety of Ulano films—
in rolls and sheets—is readily available*

Designed FOR YOUR PARTICULAR NEEDS

Ulano offers the most versatile line of hand-cut masking films, including:

.0075—RUBYLITH 75 DR* .005—RUBYLITH 5 DR†

.005—AMBERLITH 5 DA†

Where exact register assures a critical importance, you will find these new, thick, polyester based films the positive answer.

* Available in sheets only, cut to your specifications

† Available in rolls and sheets



WRITE TODAY

*on your letterhead for free
special sample kit 1748*

"Ulano"—"Rubylith"—"Amberlith" are registered trade marks of the Ulano Companies.

ulano

610 DEAN STREET, BROOKLYN, N.Y. 11238

In Europe: ULANO A.G., Untere, Heslibachstrasse No. 22, Kusnacht, Zurich, Switzerland

Shifting by 10's

Why do shift registers, the nearest things to a standard mos circuit, come in decimal sizes for sale to an industry thoroughly committed to the binary system? One answer is that delay requirements seem to be independent of methods of counting; another is that the standard may have been set by that most famous of mos systems, the Victor calculator [Electronics, Mar. 6, 1967, p. 231; Oct. 30, 1967, p. 26].

The calculator used six dual 48-bit shift registers, explains one person familiar with its history, and that circuit was proprietary to Victor. The easiest way for the manufacturer (General Micro-Electronics) to turn it into a standard product was to add four devices and produce a dual 50-bit register. The system of decimal increments stuck; Philco, American Microsystems Inc., and General Instrument now make the dual 50.

Some binary registers are available, and more are in the offing.

has eight parallel series of 128 bits each, addressed by a 2 by 5 matrix. A random access memory would need a 5 by 5 matrix to address any bit of a 32 by 32 array; Philco saved chip area on the address matrix at the expense of flexibility since the user is bound to an 8-bit word if he wants to make most efficient use of the circuit.

The National Semiconductor Corp. will introduce soon a 256-bit read-only memory, with all decoders and counters on the chip, that will have fully random access. In effect, it will have 256 one-bit words, and the user will buy one chip for each bit in his own word. This read-only memory market, says product marketing manager Floyd Kvamme, will be mostly in computer subroutines, such as the square root process, or for reading out constants. National has also found solid customer interest in using subroutines as control logic in test equipment, instead of hand-wired NOR gates. "Fixed-program logic will be done with mos," Kvamme says.

Scratchpad memories, which must be fully addressable since information is written into them, are useful supplements to core memory. Here mos's slow speed may be a disadvantage but the greater number of devices per chip can offset that difficulty wherever speed is not a primary need. American Microsystems Inc. has developed a 32-bit scratchpad, for a military customer, that has 1.8-microsecond access time and operates at a bipolar-compatible 1.9-volt threshold voltage. It will drive two high-current TTL gates. The company has a 256-bit scratchpad under development.

Shift registers have been the nearest thing to a standard mos product,

and if users could have agreed on a preferred bit-length, prices might have dropped even further than they have. As it is, prices of the popular 100-bit shift register have dropped from \$50 to \$75 a year ago, to prices that range from \$10 to \$20, and will continue to fall. The trade-off here is in number of pads versus chip space; the more places the user can tap in, the more flexible the device—but the more pads, the more wasted real estate.

Packed. The biggest register currently available is probably the 426-bit device developed for the military by AMI. At six devices per bit of delay, plus extra output circuitry, there are about 2,700 transistors on the chip.

Shift registers make excellent delay lines, and the only argument is over price. National's Kvamme shrugs the argument off and compares National's MM902 100-bit shift register to the SN7473, a TTL dual flip-flop. The MM902 is on a 63 by 67-mil chip, he points out, comes in an 8-lead TO-5 can, and costs \$14.80 in lots of 100. The SN7473, on a 64 by 67-mil chip, is twice as difficult to test, comes in a 14-lead dual inline package—and

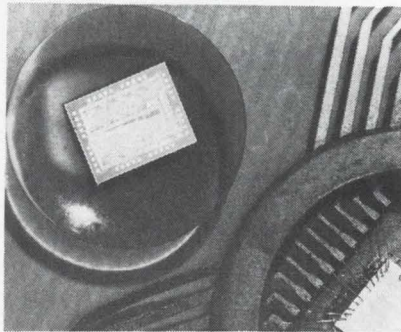

Packed. Digital differential analyzer from Autonetics is 125 x 100 mils.

costs \$4.00 in quantities of 100. "There's no reason why the 902 won't be that cheap eventually," Kvamme says. One factor that will hasten that day is plastic packaging; many firms are currently working on passivation techniques to make it possible. General Instrument is believed to be developing a new passivation process at its Salt Lake City laboratory.

One of the chief arguments against IC memories has been their volatility—the fact that all stored information will be lost if the system accidentally loses power. (By sequencing down the voltages slowly, and in the proper order, core memories can be designed to retain data when power is lost.) But the problem may be illusory. Donald T. Valentine, National's marketing manager, says that the systems companies are not worried about volatility since they recycle memories after loss of power. At Westinghouse, engineers are trying to build nonvolatile memories using nitride films instead of oxide.

II. Through thick and thin

For simple circuits, mos yields are now comparable to those for bipolar circuits; yields have increased by as much as 10 times in the past year. Closer control of the thickness and purity of the oxide has been the chief factor in boosting yields, says Autonetics' Arthur Lowell, assistant general manager of the North American Rockwell division's research and engineering operation.

Almost everyone uses some form of the thick-oxide process—National Semiconductor is a prominent exception—which reduces pin-holing by making the oxide over the p regions thick, while leaving a thin layer over the channel so that it can be inverted with small gate voltages. Typically, the oxide over the source and drain is 10 times as thick as the 1,000-angstrom oxide over the gate. There are several ways to achieve these differing thicknesses: *ci*, for example, grows a thin layer of oxide, etches through to form the p regions, then deposits a thick layer of oxide over everything. Philco begins with the thick deposited layer, etches down to the silicon surface, then grows a thin layer of oxide.

Common to both approaches is the fact that the gate oxide is

SYNTRON Series

70-C

**Silicon
Controlled
Rectifiers**

**110 Amperes RMS
25 to 1200* PRV
2N4361 — 2N4367**

FORWARD CONDUCTING

$I_{f\text{ avg}}$	— AVERAGE FORWARD CURRENT.....	70 A.
$V_{f\text{ m}}$	— MAXIMUM PEAK FORWARD VOLTAGE DROP AT 25°C. AT 220 A. PEAK 180° CONDUCTION ANGLE.....	1.85 V.
$I_{h\text{ o}}$	— MAXIMUM HOLDING CURRENT AT 125°C.....	200 MA
$I_{f\text{ m}}$	— MAXIMUM PEAK ONE CYCLE SURGE CURRENT.....	1600 A.
I^2t	— I^2t FOR FUSING (FOR TIMES \leq 1.5 MILLISECONDS).....	10,700 A ² SEC.
$I_{f\text{ om}}$	— MAXIMUM FORWARD LEAKAGE CURRENT AT 125°C. AND EBO.....	10 MA
$t_{\text{ off}}$	— TYPICAL OFF TIME.....	40 μ SEC.
$t_{\text{ on}}$	— TYPICAL ON TIME.....	10.5 μ SEC.
$t_{\text{ r}}$	— TYPICAL RISE TIME.....	3.25 μ SEC.
$t_{\text{ d}}$	— TYPICAL DELAY TIME.....	7.25 μ SEC.
$\Theta\text{-J-C}$	— MAXIMUM THERMAL RESISTANCE, JUNCTION TO CASE.....	0.28°C./W
$T_{\text{ j}}$	— OPERATING JUNCTION TEMPERATURE.....	125°C.
$T_{\text{ strg}}$	— STORAGE TEMPERATURE.....	-40°C. TO 150°C.

BLOCKING

$I_{r\text{ om}}$	— MAXIMUM REVERSE LEAKAGE CURRENT AT 125°C. AND PRV.....	10 MA
dv/dt	— MINIMUM CRITICAL EXPONENTIAL RATE OF RISE OF FORWARD BLOCKING VOLTAGE.....	100 V. / μ SEC.

TRIGGERING

$V_{g\text{ tm}}$	— MAXIMUM GATE VOLTAGE TO TRIGGER AT 25°C.....	5.0 V.
$V_{g\text{ t}}$	— TYPICAL GATE VOLTAGE TO TRIGGER AT 25°C.....	1.3 V.
	— MINIMUM GATE VOLTAGE TO TRIGGER AT 125°C.....	0.15 V.
$I_{g\text{ tm}}$	— MAXIMUM GATE CURRENT TO TRIGGER AT 25°C.....	140 MA
$I_{g\text{ t}}$	— TYPICAL GATE CURRENT TO TRIGGER AT 25°C.....	70 MA
$P_{g\text{ m}}$	— MAXIMUM PEAK GATE POWER.....	15.0 W.
$P_{g\text{ avg}}$	— AVERAGE GATE POWER.....	3.0 W.
$I_{g\text{ m}}$	— MAXIMUM PEAK GATE CURRENT.....	4.0 A.
$V_{g\text{ m}}$	— MAXIMUM PEAK GATE VOLTAGE (FORWARD).....	10.0 V.
	— MAXIMUM PEAK GATE VOLTAGE (REVERSE).....	5.0 V.

*1300 Volt Transient Rating

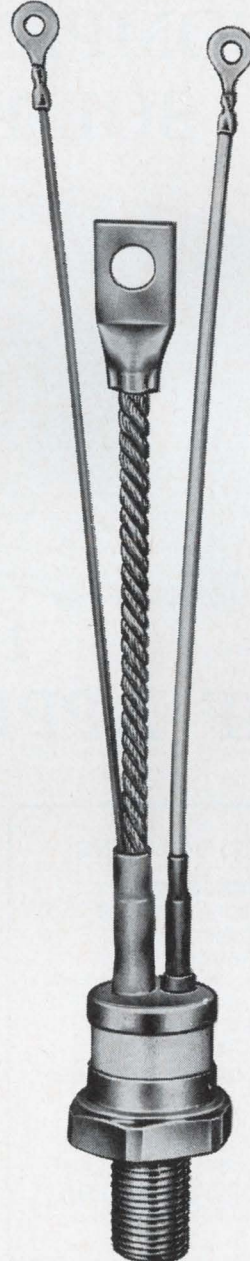

SYNTRON
A DIVISION OF
FMC CORPORATION
241 Lexington Ave.
Homer City, Pa. 15748
Telephone 412-479-8011

Name/Title _____
Company _____
Street _____
City, State _____ Zip _____

Please send information on:

- Series 70-C Silicon Controlled Rectifiers
- Silicon Rectifiers
- Selenium Rectifiers
- Selenium Surge Suppressors

68R1

RMC

TEMPERATURE COMPENSATING SOLDER-INS

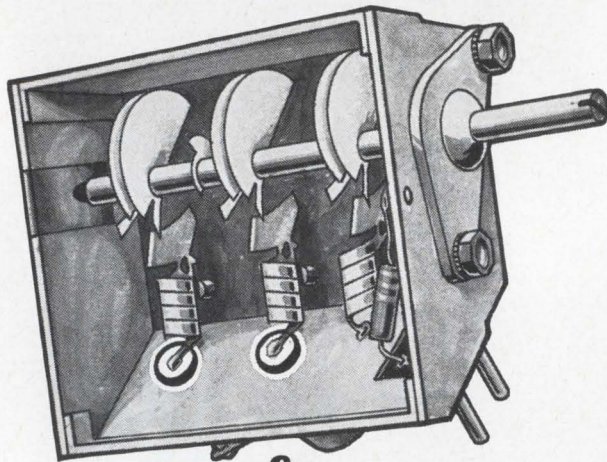

for UHF APPLICATIONS

SPECIFICATIONS

CAPACITANCE: Within tolerance @ 1 MC and 25°C

CAPACITANCE TOLERANCES: ±5%, ±10% or ±20% (but not less than ±.25 pf)

WORKING VOLTAGE: 500 VDC

INSULATION RESISTANCE: Greater than 7500 Megohms @ 500 VDC

FLASH TEST: 1000 VDC for 1 second

ELECTRODE: Pretinned for assured solderability

These new solder-in capacitors are designed for use in UHF applications requiring the absolute minimum in lead inductance effects. Solder-ins are available in a wide range of temperature coefficients in capacities from 1.5 to 105 pfd.

If your application requires special physical or electrical characteristics, contact RMC's Engineering Department.

Write today on your company letterhead for your copy of the RMC Catalog.

VISIT BOOTH 3C12-3C18 IEEE SHOW

DISCAP
CERAMIC
CAPACITORS

RMC

RADIO MATERIALS COMPANY

A DIVISION OF P. R. MALLORY & CO., INC.
GENERAL OFFICE: 4242 W. Bryn Mawr Ave., Chicago 46, Ill.
Two RMC Plants Devoted Exclusively to Ceramic Capacitors
FACTORIES AT CHICAGO, ILL. AND ATTICA, IND.

... better process control
means increased yields ...

grown. The big problem, according to Jerry Farrell, manager of mos production at National, was to achieve what he calls an oxide with "integrity." The move to thick oxide was intended to minimize flaws or latent failure mechanisms—"but that is like taking aspirins," he says. "We want to grow a truly amorphous oxide, with no concentrations or high stress points." Moreover, says Farrell, the thick oxide process tends to make the dopants pile up over the p regions.

Grown oxides are clearly superior in this respect, as Philco learned the hard way. In its original process, which had embarrassingly low yields, the company was depositing a thick layer, etching away 1,000 angstroms over the p regions, then etching right down to the silicon over these regions—the theory being that the gate area, having started 1,000 angstroms thicker, would still have its thin layer when the rest of the oxide was etched away. But the etchant tended to go right through this layer as well, since the deposited oxide was not controllable. The change in process, which took place early in 1967, increased yields and enabled Philco to cut prices in half last September.

Whatever the process, the key to yield increases has been improved process control. AMI has designed superclean facilities; National has put a great deal of emphasis on testing at various stages during the process, obtaining curves that tell where failures occur and why.

III. New tricks

With improved processes, and with the greater understanding of how MOS devices function, has come an improvement in reliability that has been reflected in user acceptance. During a study for the Lockheed Electronics Co., Siliconix Inc. disposed of three traditional difficulties in building reliable MOS devices. They were ion migration in the oxide, leading to large swings in threshold voltages, sneak leakage paths between source and drain caused by ions in the oxide, and oxide puncture caused by electrostatic voltages.

Siliconix found that using phos-

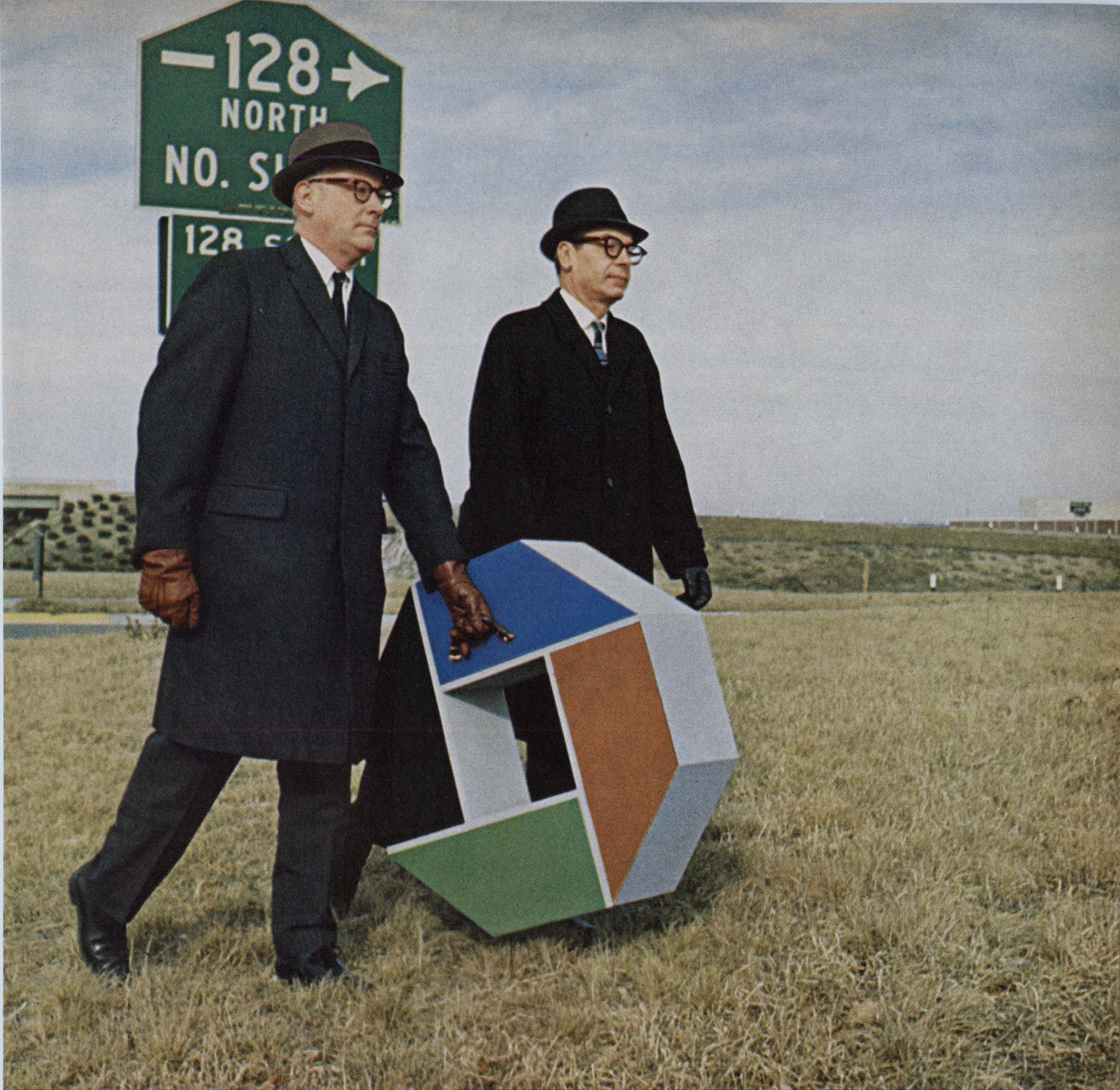

Chasemen Dave Andrews and Bob Higdon on their way to counsel with an electronics customer.

There's a banker/technical director team to bring you an added dimension in corporate banking from Chase Manhattan the bank with the wide world reach

Your needs motivated us to offer you Chase team service. Here's how it works.

Your Chase banker is thoroughly knowledgeable in your industry. But in this day of increasingly complex business the need for expert technical counsel frequently arises.

When he sees the need, he can instantly call upon the skills of the Chase technical director experienced in your particular business.

At this point, you have a perfectly balanced team at work for you. One a banker who knows your *financial* needs. One a technical man who knows your *operational* needs.

Technical Director Bob Higdon, above, is typical.

With degrees from M.I.T. and years of industrial experience in both the engineering and marketing sides of electronics, he knows his business well.

So do our other technical directors, whether they specialize in mining, metals, energy, agriculture, chemicals, transportation, aerospace, textiles, or forest products.

Why not talk to the people at Chase Manhattan and benefit from this added dimension in corporate banking.

THE CHASE MANHATTAN BANK
N.A./I Chase Manhattan Plaza, N.Y., N.Y. 10015 • Member FDIC

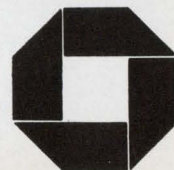

CHUBBY IS CHEAPER!

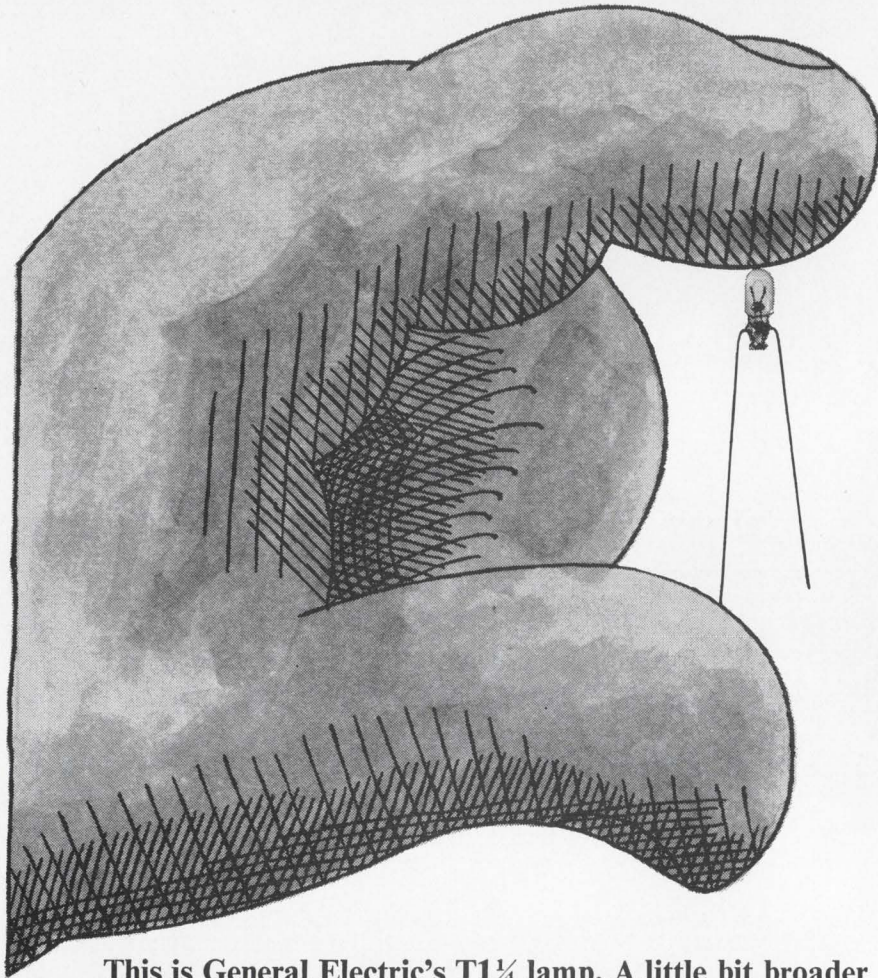

This is General Electric's T1 $\frac{1}{4}$ lamp. A little bit broader around the middle than the GE T1. Just about 40 thousandths broader. Otherwise, identical in nearly every way. Except price. The General Electric T1 $\frac{1}{4}$ costs just one-third as much as the T1! So if you've got space in your design for a little bit of extra bulk, you can save a bundle. For aircraft indicators, computers, photo-chopper and photoexcitation jobs, check up on the chubby T1 $\frac{1}{4}$. Economy-rated General Electric performing T1 $\frac{1}{4}$ lamps:

GE Lamp Number	Design Volts	Design Amps	Approx. Mean Spherical Candlepower	Filament Designation	Max. Overall Length (Inch)	Rated Average Lab. Life (Hours)
583	5	.06	.05±25%	C-2R	.438"	100,000+
580	5	.06	.03±25%	C-2R	.438"	100,000+
515	5	.115	15±25%	C-2R	.438"	40,000+

Interested? Write for Bulletin #3-7393 to General Electric Co., Miniature Lamp Dept., Nela Park, Cleveland, Ohio 44112.

GENERAL  **ELECTRIC**

phorus-impregnated oxides, and covering the gate oxide with metal immediately after it is formed, a step also taken by CI, stabilized threshold voltages. Changing geometries, in one case, so that the source is a dot, completely encircled by a circular gate, eliminated sneak leakage; and building zener diodes in parallel with each gate, so that charges are shunted to the substrate before the voltage is large enough to puncture the oxide, re-

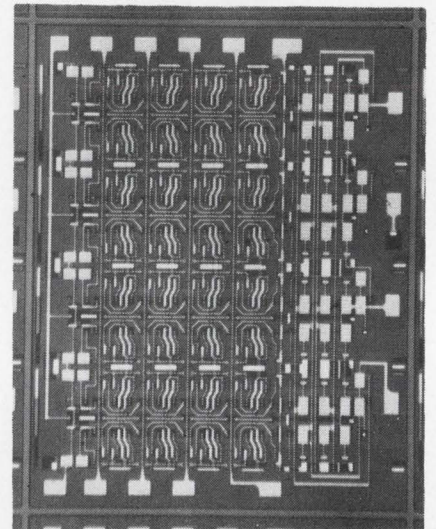



Remember. The 32-bit MOS memory from Westinghouse is a complementary device.

duced electrostatic puncture. National met the latter problem by switching to 100 silicon, which has a lower pn junction breakdown between gate and base material than does 111 silicon; the pn junction can thus protect the gate oxide.

With the process under control, the manufacturers have begun to get fancy. It is already no trick to build devices that operate at voltages low enough to interface directly with bipolar circuits, a desirable step because all-mos systems are rare. The next move is to build both types of circuits on the same chip. Bipolar manufacturers are using mos field effect transistors as the input stage to linear amplifiers; in this respect, the mos device is peripheral to the circuit function.

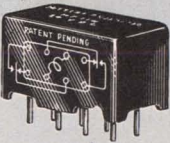
New breed. The first circuit in which the bipolar elements will serve the mos function is probably a chip made by Siliconix [Electronics, Mar. 4, p. 25]. That company introduced a hybrid series of mos analog gates and bipolar drivers about a year ago; it is now replac-

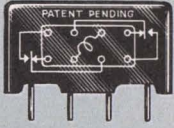
NEW! A commercial relay this  small with 2-ampere dpdt contacts. Printed circuit or socket terminals.  **Sealed*** nylon dust cover. This design bonus from our aero/space program is ideal for tape recorders, desk-top computers,  copying machines, television cameras, alarm systems, etc., etc., etc., etc., etc.

~~\$9.95~~
New Low Price!
\$7.95
 Single lot price
 Quantity discounts apply

High density relay packaging becomes a reality with the low profile HP Series. Only one-fifth of a cubic inch is required for each relay. Seated height in socket or printed circuit board is 0.49". Mechanical life is placed at 10 million operations.

The DPDT contacts are rated from low level to 2 amperes at 30V DC resistive or 0.5 ampere maximum at 120V AC. Coil voltages range from 6V to 48V DC . . . with 12- and 24-volt models available from authorized electronic parts distributors.

These microminiature relays are direct descendants of our military, aero/space designs and have been engineered to perform with singular reliability in modern commercial equipment.

HP SPECIFICATIONS

GENERAL:

 **Enclosure:** Heat sealed (non-hermetic) to allow for short time immersion to clean flux from printed circuit boards.

Temperature Range: -45°C to +70°C.

Dimensions: 0.49" x 0.88" x 0.48" max.

CONTACTS:

Arrangement: DPDT, 2 Form C.

Rating: Low level to 2 amps @ 30V DC, resistive; 0.5 amps max. @120V AC.

Contact Resistance: 50 milliohms before life measured at maximum rated load.

COILS:

Power: Approximately .662 watts nominal @ 25°C. 1.0 watts max. @ 25°C.

Duty: Continuous.

Pick-up: 75% of nominal @ 25°C.

Operate Time: 5 milliseconds max. at nominal coil voltage and 25°C.

Call your electronic parts distributor



POTTER & BRUMFIELD

Division of American Machine & Foundry Co., Princeton, Ind. 47570
 Export: AMF International, 261 Madison Ave., New York, N.Y. 10016

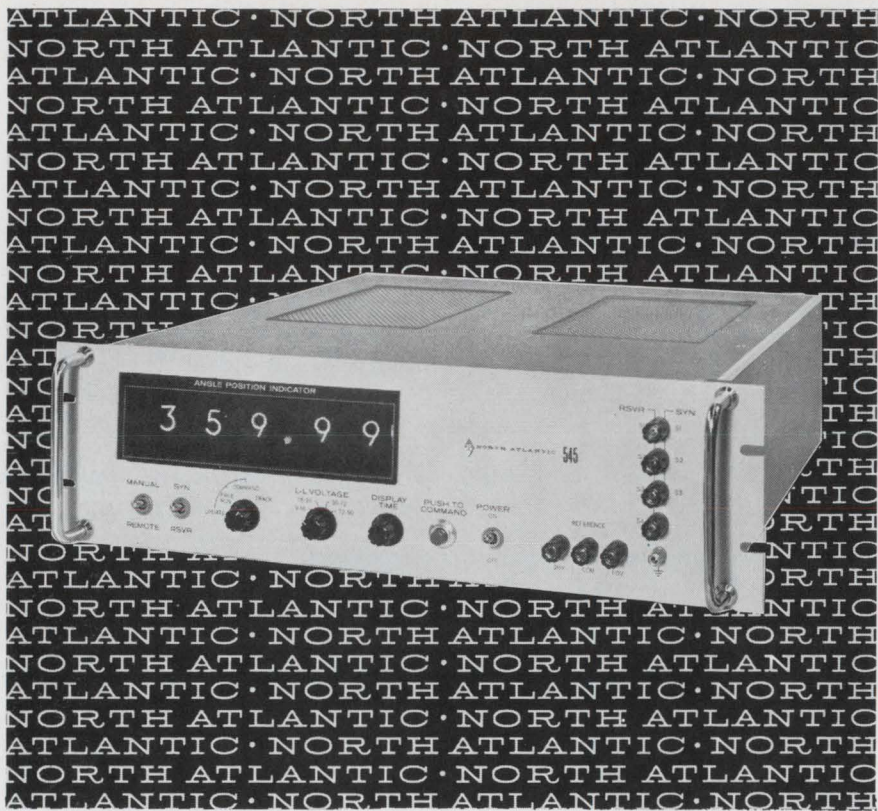

resolver/synchro to digital conversion

~~20,000~~ ^{20,000} .. .01° accuracy
~~2000~~ /sec. tracking

North Atlantic now brings you a new generation of solid-state analog-to-digital converters for resolver and synchro data. They offer major advances in high-speed precision tracking as required in modern antenna readout, ground support, simulation, and measurement systems.

For example, the Model 545 provides conversion of both resolver and synchro data at rates to ~~2000~~ ^{20,000}°/second, and accommodates 11.8v to 90v 400Hz line-line signals. For multiplexed applications, acquisition time is less than 50ms. Digital output data is visually displayed and simultaneously available on rear connectors. All modes are programmable as well as manually controlled. Optional features include .001° resolution with 10 arc second accuracy, data frequencies from 60Hz to 4.8KHz, data freeze command for digital readout at a critical instant, and programmed mode where difference angle computation is required.

Your North Atlantic representative (see EEM) has complete specifications and application information. He'll be glad to show you how these converters can answer critical interface problems in your system.



NORTH ATLANTIC industries, inc.
TERMINAL DRIVE, PLAINVIEW, NEW YORK 11803 • 516-681-8600

SEE IT AT IEEE - - BOOTHS 2B12 AND 2B14.

ing that two-chip package with a direct plug-in replacement containing npn and pnp transistors, p-channel mos FET's, zeners, and resistors, on a single chip. It has also developed an integrator with 8 mos transistors and 2 npn's.

One difficulty in marrying the technologies was that, typically, mos is built on an n-type substrate and bipolar on a p-type substrate, with an epitaxial layer. Siliconix had to build both types of devices on the layer, and had to make certain compromises in the bipolar elements to accommodate the mos. Nevertheless, says chief engineer and vice president Arthur Evans, the chip can be a direct replacement for the hybrid version except if special parameters are needed.

The process, Evans adds, is a general one that is applicable to other bipolar-mos applications. The driver/switch circuit is useful in multiplexing, an area where Siliconix may have a head start on other producers.

The other state-of-the-art development is in complementary mos ic's, which offer big gains in power savings and speed, plus bonuses in fanout and noise immunity. Here the drumbeater is RCA, which claims that since complementary circuit characteristics are less dependent on individual component characteristics than is the case with single-channel devices, yields are higher—and that this improved yield more than compensates for the additional processing costs.

In complementary circuits, n-

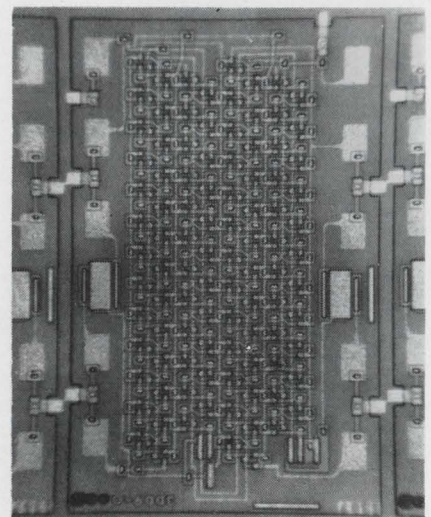

Stable. Register from Westinghouse uses nitride layer over oxide for stability.

0.1% ACCURACY

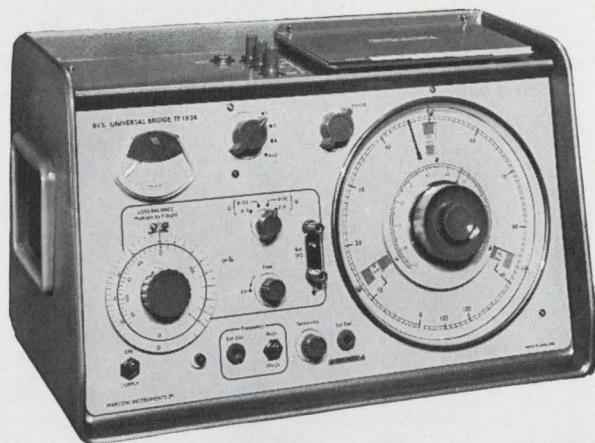

MODEL #1313A

use the **NEW**
MARCONI
UNIVERSAL
BRIDGE

- **Extremely High Accuracy:** 0.1% of Reading
- **No Factors:** Dial callouts automatically change when function and range is selected.
- **High Resolution:** Discrimination 0.01% of full scale; 10,900 division/range (Dial Reads 46.66 mH)
- **Wide Temperature Range Without Corrections**
- **Built-In Oscillator:** 1kHz and 10kHz, 20Hz — 35kHz with external oscillator
- **Capacitor Bias:** Up to 350VDC can be applied to polarize electrolytics

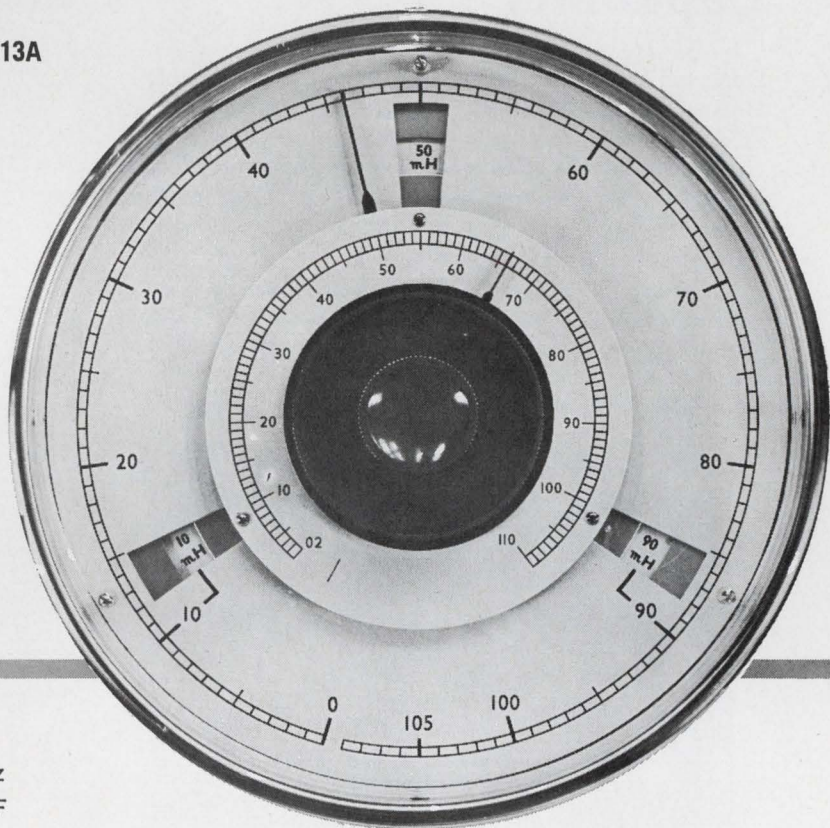

MEASURES

Inductance: 0.1 μ H to 110H @ 1 and 10kHz
Capacitance: 0.1pF to 110 μ F
Resistance: $.003\Omega$ to 110M Ω
Q Range: 0 to 310
D Range: 0005 to 30

Accuracy high, interpolation precise, familiarization time minimal . . . the model 1313A, latest in Bridges, is designed for use by engineers and production personnel alike. Ask your Marconi representative to show you.

NOW \$750.

AVAILABLE OFF-THE-SHELF

SEE IT AT I.E.E.E. -- BOOTHS 2D02-8



MARCONI
INSTRUMENTS

Division of English Electric Corporation

111 CEDAR LANE, ENGLEWOOD, NEW JERSEY 07631
(201) 567-0607

706

High Current Regulated Power Supply

Adjustable Output Voltage, 27-28 V.D.C.

1% Regulation

50-60 Cycle Operation

Substantial Overload Capability

Designed for communications equipment and available in 25 amp. stages from 25 to 150 amps, this unit can be operated in parallel, has remote sense feature, inverse time circuit breaker and internal fan cooling. Overload capacity is 200% for 5 minutes; 400% for 4 seconds. Environmental capability range from -20° to $+130^{\circ}$ F. This equipment is designed for standard rack mounting.

If you are interested in this, or a power supply to meet other specs, we would like the opportunity to demonstrate that a Tung-Sol designed unit would be your best buy.

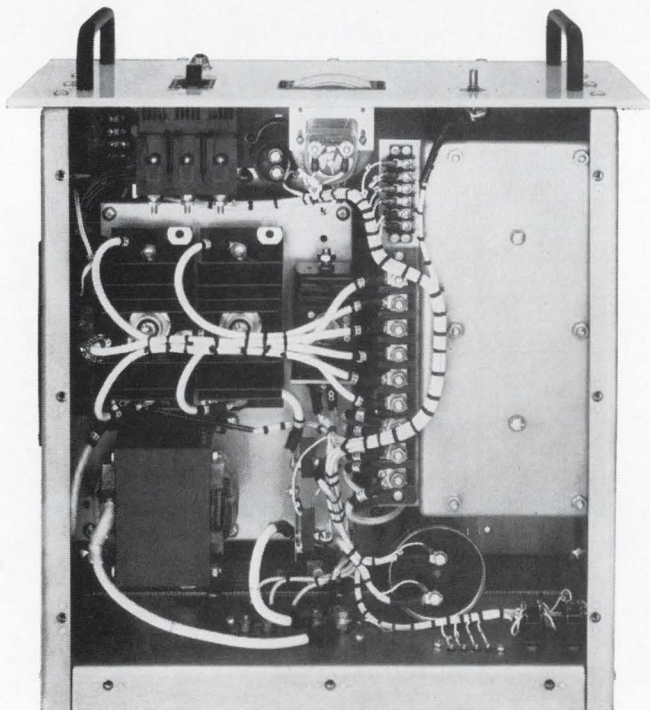

TUNG-SOL[®]
POWER SUPPLIES

Tung-Sol Division, Wagner Electric Corporation
Livingston, N.J. 07039. TWX: 710-994-4865. PHONE: 201-992-1100

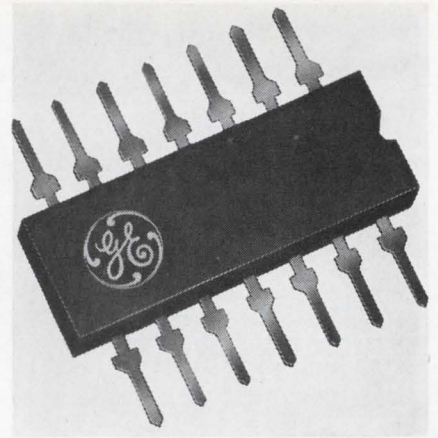

Any input. PD 455 frequency divider handles 9 to 18 volts at 1 Mhz.

channel and p-channel transistors are arranged so that the circuit operates regardless of input signal polarity. RCA says that single-channel makers are moving to multiphase clocks to attain complementary properties, and that this additional clock circuitry takes up space.

The Molecular Electronics division of the Westinghouse Electric Co. has also built complementary circuits, and the approach is being given heavy consideration throughout the industry. General Instruments has publicly pooh-pooed complementaries; but its competitors suspect that the successor to GI's MOS devices, promised for this spring, may be a complementary series.

IV. Large scale picture

Even when MOS was hard to make and impossible to sell, it was heralded as a natural vehicle for large-scale integration. The high packing density obtainable has two advantages: it permits building complex devices on a relatively small chip, increasing yields; and it raises the effective speed of the circuits, since the main barrier to high-speed MOS operation is in overcoming the high input impedances while going from chip to chip.

The Hughes Aircraft Co. apparently bought the Raytheon Co.'s MOS line because it wants to exploit the technology in respect to LSI. Alden Stevenson, director of applied research at the Guidance and Control Systems division of Litton Industries, which includes a semiconductor operation, says flatly that "the era of LSI, using MOS circuits, is here." His division makes military

Put a MICRO SWITCH field man on your team and you've got a whole army of experts on your side.

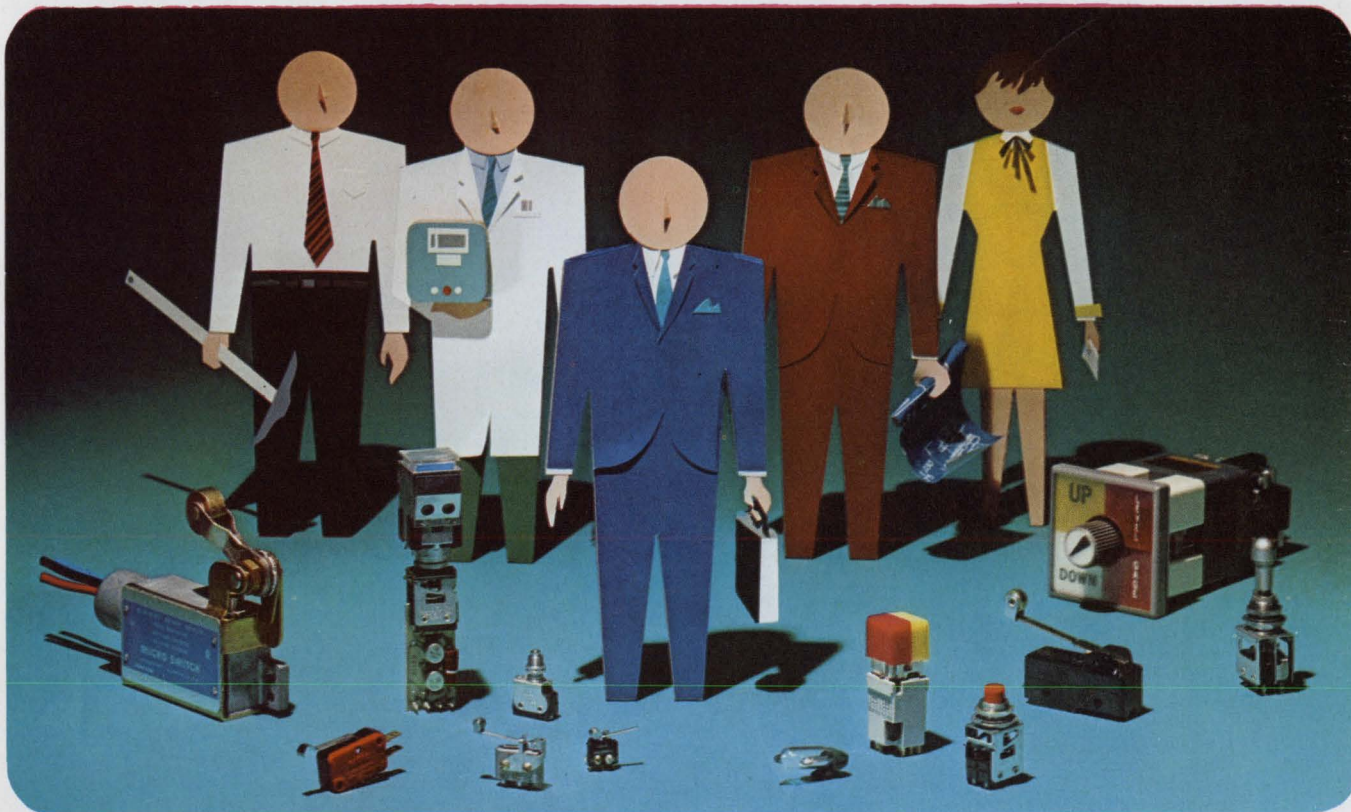

Special switching problems? MICRO SWITCH puts the largest field organization in the industry at your convenience. Our field engineers are especially trained to work on any aspect of your application requirements; from proper switch selection, including reliability and quality/cost factors, to proper switch installation and operation for maximum service.

When a field man tackles your problem, he's not working on it

alone. He is backed by a whole army of experts at the factory with many specialized talents.

For example, should you require a switch design to meet highly sophisticated specifications, he can tap the know-how of our experienced design engineering department. At the same time, he can dip into the world's largest selection of switches to find the device that's exactly suited to your needs.

Similarly, our extensive R&D facilities, advanced development

laboratories, and other engineering departments are continually developing new data and concepts to provide the most up-to-date sources of reference to serve you better.

Whatever your switching problem, large or small, call in the man who's experienced in problem solving... your MICRO SWITCH field man. You can reach him easily through a Branch Office or Authorized Distributor (Yellow Pages, "Switches, Electric").

MICRO SWITCH

FREEPORT, ILLINOIS 61032

A DIVISION OF HONEYWELL

HONEYWELL INTERNATIONAL • Sales and service offices in all principal cities of the world. Manufacturing in United States, United Kingdom, Canada, Netherlands, Germany, France, Japan.

control/alarm cost-cut

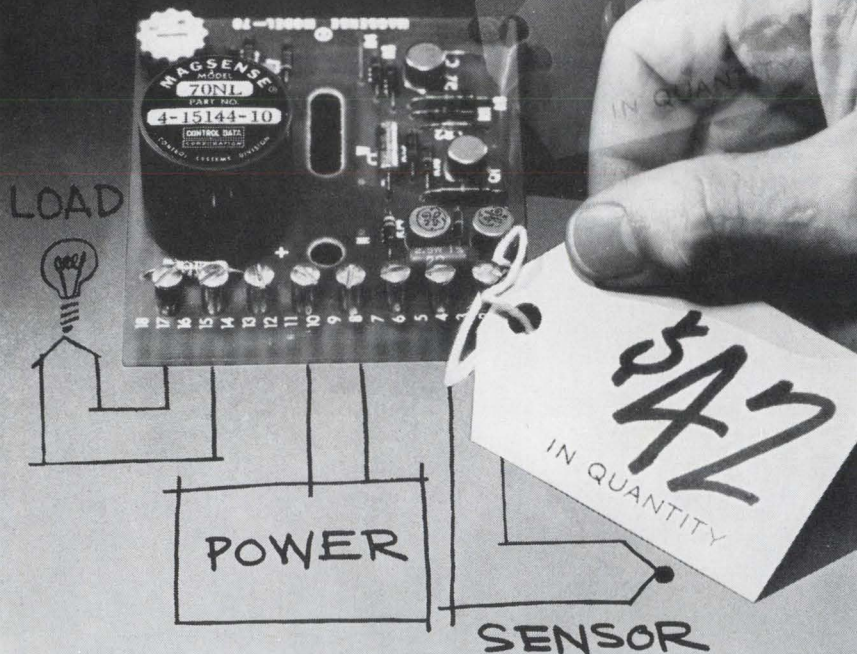

MAGSENSE

control/alarm for temperature, pressure, speed, flow

Here's the low-cost way to solve your control/alarm problem. Hook up sensor, load and power source to a MAGSENSE® control/alarm module and adjust the setpoint. That's it. No time wasted designing and debugging a circuit. And while you're saving time you'll be saving money, getting *proven-in-service* performance.

Capabilities? All MAGSENSE modules offer 100-billion power gain, accept inputs as low as 10 microvolts or 1 microamp *directly* without preamplification. Completely isolated inputs are unaffected by common mode voltages as high as 110vac, 60Hz, or overloads as large as 1000-times full scale input. Typical accuracy is $\pm 0.5\%$ full scale. And they all

operate from a *single* DC power source (either 28v or 12v).

Options? The list includes remote and dual setpoints, adjustable hysteresis, choice of output action, transducer excitation voltage and cold junction and copper compensation on thermocouple models. There's a MAGSENSE model for your application.

Price? Get the MAGSENSE control/alarm module shown for as little as \$42 in quantity, others as low as \$35. Compare that with the cost of developing and building your own circuit.

More information? Write or call, or circle the reader service number and we'll send you complete specifications and prices.

CONTROL DATA

CORPORATION

4455 Eastgate Mall, La Jolla, Calif.

MAGSENSE Sales, Dept. 244
Analog-Digital Systems Division
Control Data Corporation
4455 Eastgate Mall
La Jolla, Calif. 92037
Phone 714/453-2500

and commercial navigation systems, and weapons release systems, which call for great numbers of digital circuits. The very name of one new MOS company, Electronic Arrays, Inc., of Mountain View, Calif., indicates that it was formed to make LSI devices; and another company is presently being formed solely to manufacture complex MOS wafers.

But nothing about LSI is simple. The custom-versus-standard circuit argument is already generating countless cost and sales curves. Earl Gregory, vice president of Electronic Arrays, sums it up: MOS certainly has no advantage in low-complexity circuits, since bipolar wins here on speed and performance. On the other hand, custom work cannot be vastly profitable. "We're learning more about systems," Gregory says. "We're trying to figure out where there is sufficient commonality in equipment to standardize on a given circuit. The key is to pick areas where MOS has a cost advantage and to design around existing equipment."

Some MOS houses say that they can live with small production runs because the MOS process is a constant, and only the geometries change in making different circuits. But Jerry Larkin, LSI marketing manager for Fairchild, says flatly that "this is a marketing cliché." Fairchild still feels that volume is necessary for profitable production. Larkin echoes Gregory's remark, saying that "We're trying to pick standards that look logical." He feels that calculators, small, medium-speed space computers, and memories are the best bet in this respect. Fairchild is about ready to announce production of a complex arithmetic unit, the 3800; but Larkin is realistic about its acceptance. "It will probably require some small, gutsy computer house which is willing to take a chance," he says.

Inertia a factor. Larkin also cautions that even where MOS offers advantages in reliability and cost per function, it will not necessarily win. In the first place, the user will have to figure his redesign cost; in the second, "not all decisions are made on the basis of economy or technical superiority," he says—meaning that the manufacturer will still have to overcome the designer's inertia. For that reason, Larkin foresees the greatest suc-

cess for mos in new markets.

Still, Fairchild has a hundred engineers working in mos. The π effort in Dallas is also substantial; Charles Phipps, the mos program manager for π , was formerly its bipolar ic marketing manager. The emphasis the company is putting on computer-aided design indicates a heavy commitment.

π has cut artwork errors from 30% to zero by going to computer design, and intends to exploit computer technology further in complex arrays by employing two-layer metalization on a chip, and discretionary wiring. Only such techniques will make LSI arrays, which have very small production runs, profitable, Phipps says.

Motorola calls its development program "rather large," but still looks to bipolar devices to meet the bulk of the demand for ic's, including those for LSI.

Burned once. The cautious words on mos voiced by major semiconductor manufacturers may be only an attempt to avoid repeating the premature enthusiasms of a few years ago. Gregory says that the false start delayed volume production of mos by a year, perhaps to early 1969. But W. W. Vallandigham, vice president and director of operations at AMI, who is familiar with those early frustrations from his days with General Micro-Electronics, still asserts that by 1971, mos will account for \$380 million in sales and 40% to 50% of the ic market. Many in the semiconductor field expect the penetration to be no greater than 15% to 20%.

Both AMI and Autonetics talk about obtaining speeds of 20 megahertz within the next year or so; but speed is always obtained at the cost of power, and no one expects mos to match bipolar in that department anyway.

"We've been through a long dry period," says John D. Gorman, Philco's mos product marketing manager. "It's refreshing now to have products with reliability data so that we can talk about generating new markets impossible to reach, from a cost standpoint, with bipolar."

Contributions to this story were made by Lawrence Curran, Los Angeles; Marvin Reid, Dallas; Mark B. Leeds and Owen Doyle, New York; and James Brinton, Boston.

TIME MACHINE



Yes, an RF connector can manufacture time. If its simple K-Grip® design can save you 80% of assembly time. Or if its unique TR-5® finish ensures extra years of uninterrupted, corrosion-free equipment service. Write us for details; we'll be back to you in no time.

KINGS 
ELECTRONICS CO., INC.
40 Marbledale Road/Tuckahoe, N.Y. 10707
(914) SW 3-5000 / TWX 914-793-5879

New Components Review

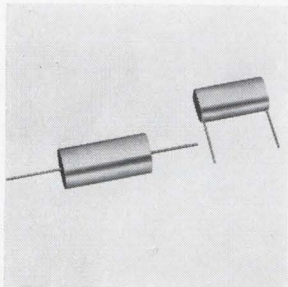

Rectangular metalized mylar capacitors, series 17W (axial) and 17U (radial) are available in 100, 200, 400, and 600 v units in capacitance ratings from 0.001 to 20 μ f with 20% to 1% tolerances. Sizes range from 0.12 x 0.22 x 0.40 in. to 0.75 x 1 x 1.68 in. Units meet MIL-C-18312 group A specs. SEI Manufacturing, 18800 Parthenia St., Northridge, Calif. 91324. [341]

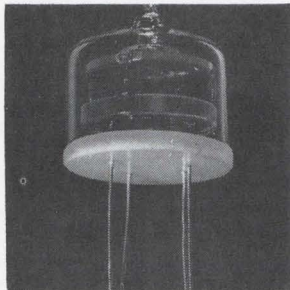

Crystal unit BG61AH-55 has frequency stability better than 5 parts in 10^{10} per day after 3 days. Advanced techniques produce superior aging and fast retrace characteristics with optically polished quartz plate operating on 5th overtone mode at 5 Mhz. The glass-sealed unit is 0.800 in. high, 0.790 in. in diameter. Bliley Electric Co., 2545 W. Grandview Blvd. Erie, Pa. 16512. [342]

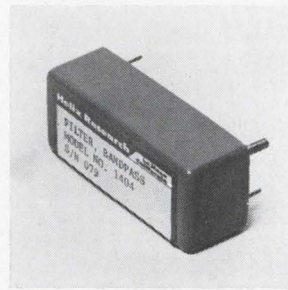

Bandpass i-f filter 1404 has a 10.7-Mhz center frequency and a 300-khz 3-db bandwidth. The 60-db rejection bandwidth is 900 khz max. with insertion loss of less than 10 db over temperature. Operating temperature is -55° to $+85^{\circ}$ C. Maximum dimensions are 2.19 x 1 x 0.825 in. Prices (1-9) begin at \$165. Helix Research Associates Inc., 5345 Timken St., La Mesa, Calif. [343]

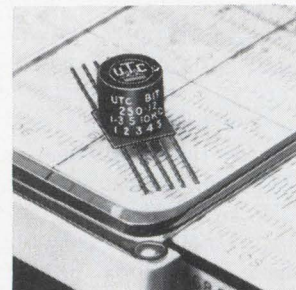

Ultraminiature transistor transformers and inductors series BIT-250 are made to MIL-T-27B, Grade 4, assuring the ultimate in rugged construction. Primary impedance is 150 to 25,000 ohms center tapped. Power level is 45 to 80 mw. Size is 0.250 x 0.250 in. Weight is 1.1 grams. Units have gold-plated ribbon-style leads. United Transformer Co., 150 Varick St., N.Y. 10013. [344]

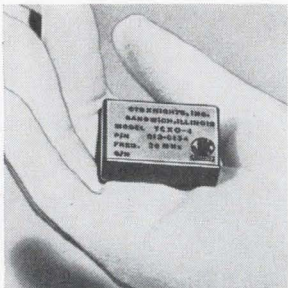

Temperature compensated, crystal controlled oscillator JKTCXO-4, designed for p-c board mounting, is available with any output frequency between 6 and 20 Mhz over a temperature range of -55° to $+85^{\circ}$ C at stability of 1×10^{-5} . Input power is 100 mw max. at 12 v d-c. Size is 1.5 x 1 x 0.40 in. max.; weight, less than 1 oz. CTS Knights Inc., Sandwich, Ill. 60548. [345]

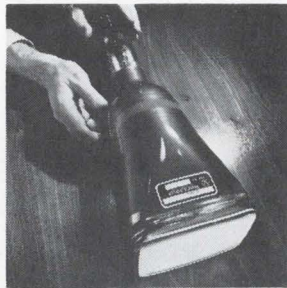

Electrostatically-focused crt WX-30764, featuring high deflection sensitivity and high brightness, is for oscillographic and data display. It has a center line width of 0.015 in. and acceleration of the electron beam occurs after electrostatic deflection. The $5\frac{1}{2}$ x $4\frac{1}{2}$ -in. tube weighs $3\frac{3}{4}$ lbs and mounts in any position. Westinghouse Electronic Tube Div., Elmira, N. Y. 14902. [346]

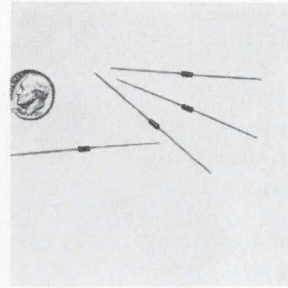

Capacitor type MD offers molded construction of monolithic layers. Size is 0.155 x 0.065 in. The leads, 0.016 x 1 in., can be specified as tinned copper or gold-flashed dumet. Capacitance ranges up to 12,000 pf are offered in temperature characteristic AW. Standard tolerances are $\pm 10\%$ and $\pm 20\%$. American Components Inc., 8th Ave. at Harry St., Conshohocken, Pa. 19428. [347]

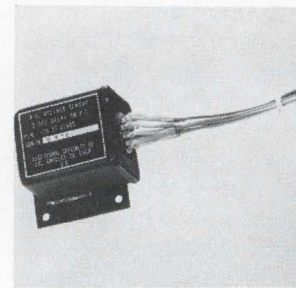

Solid state voltage sensor model 35-71-01900 is for use in monitoring a-c power. It incorporates a 5-sec time delay and was designed to comply with MIL-Std-704A. Design includes automatic reset capability and pigtail leads. Input power is 28 v d-c. Output rating (dpdt) is 5 amps inductive. Electronic Specialty Co., 4561 Colorado Blvd., Los Angeles 90039. [348]

New components

Active filter cuts frequency, and cost

Low pass device uses 4 filter networks to achieve an 80 decibel per decade rolloff and ± 0.2 db flatness

Ask any engineer who designs active filters what three features he seeks most and he will probably tell you high input impedance, linearity, and sharp cutoff. Most manufacturers don't have any standards on these characteristics or even bother to list them. With

a new active filter from Analog Devices the manufacturer not only lists the specs, but offers good ratings at a low price.

The sharp-cutoff, four pole low pass active filters, designated the series 701, are available for any cutoff frequency from 1 Hz to 1,000

Hz. The units are priced at \$75 in single purchases, about half the cost of previously available active filters.

This filter uses four sets of R-C elements, arranged in matched and interdependent pairs, so cutoff characteristics are controlled by all four R-C elements. Each pair contributes 20 db/decade attenuation.

However, if capacitors and resistors with poor tolerances are used in the filter network, each R-C pair will begin to attenuate input signals at frequencies other than cutoff, thereby degrading the desired sharp-cutoff characteristics.

Although 0.1% resistors don't

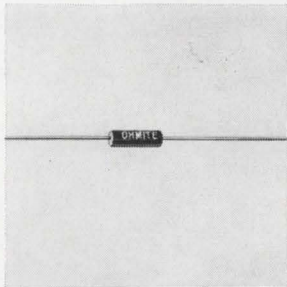

Wirewound molded resistors called Lo-Ohm are for circuits requiring inexpensive less-than-one ohm value commercial resistors in power ratings of 1 and 3 w. Resistance range is 0.01 to 1 ohm, $\pm 10\%$. Dielectric strength is 1,000 v a-c. Temperature coefficient is better than 100 ppm/ $^{\circ}\text{C}$ between 0.1 and 1 ohm. Ohmite Manufacturing Co., 3697 Howard St., Skokie, Ill. 60076. [349]

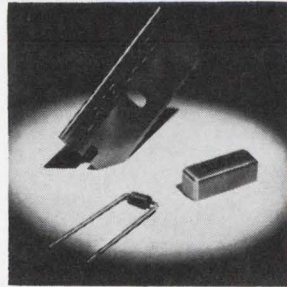

Solid state reed relay series 44-2SS incorporates a blocking or arc suppression diode within a 0.05-cu in. package. The ultra-miniature size allows 40 two-pole relays to be mounted on a $5\frac{1}{2} \times 4\frac{1}{2}$ in. p-c board. Height is 0.25 in. The series is available in 1, 2, 3 and 4 pole models. Contacts are rated at 7 w. Wheelock Signals Inc., 273 Branchport Ave., Long Branch, N.J. 07740. [350]

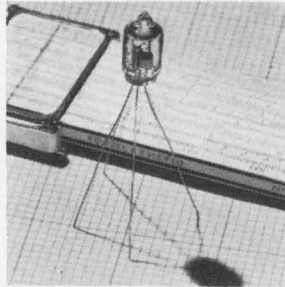

Cold cathode switch tube type KN-9 is capable of long life (2.5×10^7 shots) operating at current levels of from 200 ma to 500 amps. It features high hold-off voltage (4,000 v d-c), low jitter (20 nsec), low delay time (200 nsec), and a high input trigger impedance. Price is \$20 each in quantities of 1 to 10. EG&G Inc., 160 Brookline Ave., Boston, Mass. 02215. [351]

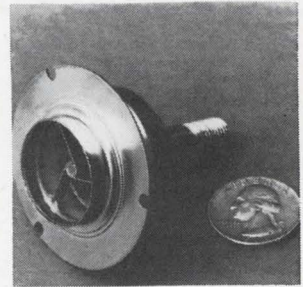

Short-arc lamps series 150X use a sealed beam construction with a prefocused integral reflector in a ceramic-metal envelope. The 150-w lamp features a reflector-shaped beam of 200,000 peak beam candlepower in a 5° beam profile. Beam flux is 1,800 lumens with average life at this output of 1,000 hours. Eimac Division of Varian, 301 Industrial Way, San Carlos, Calif. 94070. [352]

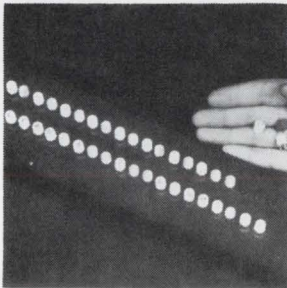

Cylindrical-shaped T-Lite incandescent indicator light, measuring $\frac{5}{16}$ in. in length and width, is suited for p-c boards where space is at a premium. It is designed for 5 to 6 v, 60-75 and 115 ma operations. Average rated life is in excess of 10,000 hours based on an industry standard of 3-hour on-off cycles. Sylvania Electric Products Inc., 60 Boston St., Salem, Mass. 01970. [353]

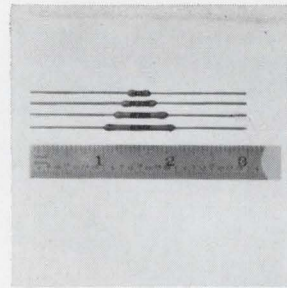

Miniature megohm resistors, with 80 ppm/ $^{\circ}\text{C}$ absolute temperature coefficient, have TC referenced to 25°C taken at -15° and $+105^{\circ}\text{C}$. The series covers the 1-to 220-megohm range, from 0.5 to 5.0 w, from 600 to 4,000 v. Uses include h-v dividers, high resistance networks, and precision RC timing devices. Caddock Electronics Inc., 3127 Chicago Ave., Riverside, Calif. 95207. [354]

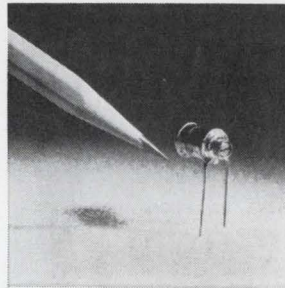

Precision trimmer capacitors can be bolted directly to the chassis and tuned on the inside of the panel. Access to the tuning screw is at the opposite end from the mounting stud. Units come with tuning ranges from 0.8-4.5 to 1-36 pf. The tuning screw does not move axially but remains in position for blind hole tuning. Voltronics Corp., West St., Hanover, N.J. 07936. [355]

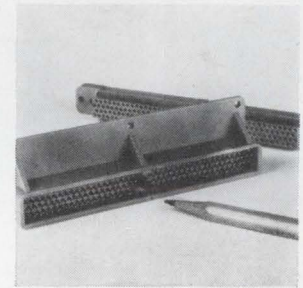

P-c connector with 160-pin contact density has 0.100-in. contact spacing, positive keying and glass-filled thermoplastic shell bodies. It comes with 6 Poke-Home-type contacts: wire pin or wire socket crimp, p-c pin long or short tail, and p-c socket long or short tail. Temperature range is -55° to $+180^{\circ}\text{F}$. Amphenol Corp., 9201 Independence Ave., Chatsworth, Calif. 01311. [356]

cost much, precision capacitors do. A 0.1% tolerance capacitor may easily cost five times a 20% version.

A designer would have to buy both resistors and capacitors with 0.1% tolerance to get the desired cutoff sharpness. However, Analog buys low-cost 20% units and passes them through an automatic grader for grouping into common categories of values with up to 0.01% accuracy.

Characteristics of the 701 include $50 \mu\text{v}/^{\circ}\text{C}$ max drift, 0.2 db response flatness in the pass band, four-pole operation with cutoff attenuation approaching the theoretical 80 db

decade, and 100,000 ohms input impedance. Linearity is within 0.002% of the best straight line, and includes the effects of amplifier gain variation, loading, and common mode error.

High input impedance is necessary to avoid loading the signal source. This is especially true if the source impedance varies with frequency, because the voltage-divider effect created by the source impedance and the filter output impedance also varies with frequency. This adds uncertainty to the filter's final output error.

Analog Devices, 221 Fifth St., Cambridge, Mass. 02142 [357]

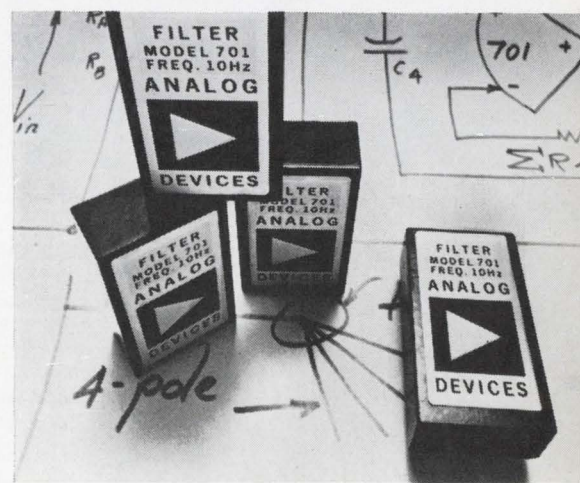

Slasher. Active filter provides sharp cutoff for high selectivity.

YOU MEAN I SHOULD BUY **GENERAL ELECTRIC**
PANEL METERS AND METER RELAYS
NOT JUST BECAUSE THEY'RE **GENERAL ELECTRIC-**
NOT JUST BECAUSE THEY'RE THE FULLEST LINE IN
THE INDUSTRY, BUT BECAUSE THEY'RE BACKED BY A
SALES AND SERVICE ARMY READY TO HELP ME
AT A MOMENT'S NOTICE?

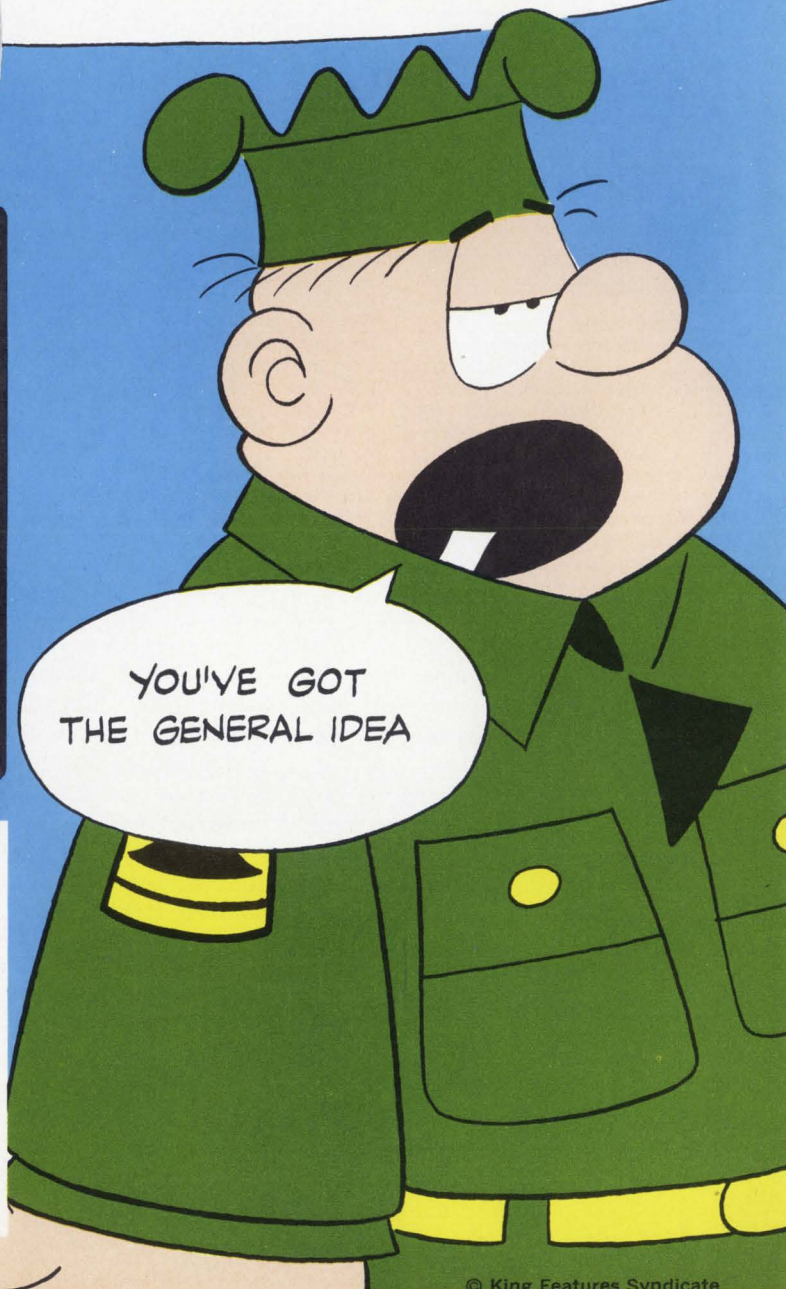
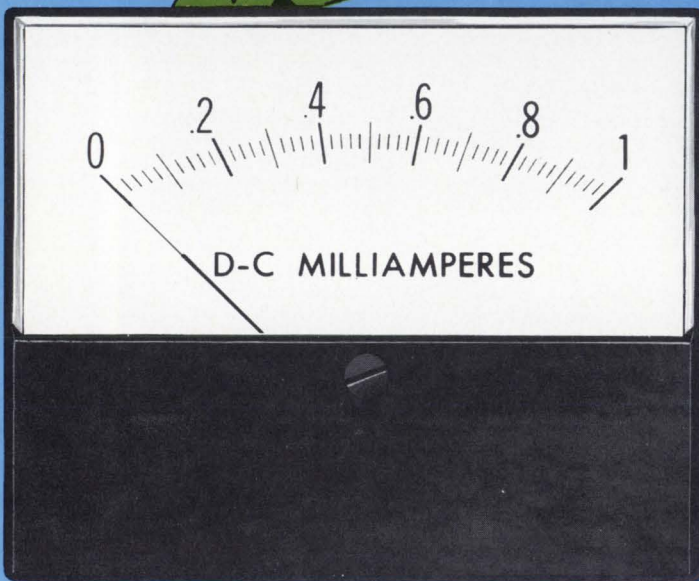

YOU'VE GOT
THE GENERAL IDEA

General Electric's Sales and Service Army—the largest in the industry—offers you the fullest line of quality panel meters. And that same Sales and Service Army is at your command, ready to bring you the finest, most comprehensive back-up available—whenever you need it. Remember, quality instruments and the in-depth ability to back them up are yours every time you specify and buy panel meters from General Electric. Contact your GE Electronic Components Sales Office or your dependable General Electric panel meter distributor. 592-33

GENERAL  **ELECTRIC**

New components

Designers beat 3-way stretch

Amplifier is linear over radio frequency range for inputs up to 2 volts

Designers of radio-frequency amplifiers often stumble trying to follow the three rules: keep down the noise, make it linear over a wide voltage range, and give it a large bandwidth. They have to break one rule to carry out the other two or they build in additional circuits to compensate for amplifier deficiencies. Many times these circuits mean a lot of extra adjustments for the operator.

But Theodore Johnson, president of Comdel Inc., says his company has put a low noise figure, wide dynamic range, and a large bandwidth in one package. It's called the HDR r-f amplifier.

The power gain of the HDR is 9 decibels, and the noise figure is 2.5 decibels from 0.5 to 50 megahertz. The gain is flat from 0.7 to 10 Mhz and does not vary by more than one db in the other portions of the frequency range.

The ratio of output to input voltage is constant for inputs from 0.2 microvolts to 2 volts, a 140-db dynamic range. Comdel engineers find the dynamic range, or linearity, by comparing the HDR's input-output curve with a 9-db gain curve. They say the amplifier is linear in the region where the curves do not vary by more than one decibel. "About the best dy-

amic range you can get on equivalent amplifiers is 80 to 90 decibels," says Johnson.

No AGC. One thing the HDR doesn't have is automatic gain control. "We don't need it. We're still linear up close to three volts, so gain adjustment and overload are not problems with us," according to Johnson.

The active element of the amplifier is a field effect transistor, specifically made for the HDR. The FET is followed by a Tchebichef filter.

The HDR can be used either as the main amplifier in a newly designed receiver, or as a preamplifier in other sets. "Many older receivers fall down badly on noise figures," says Johnson. The HDR, used in front of a receiver's main amplifier, can increase sensitivity by up to eight dbs.

The HDR can also be used in transmitters, either as a main amplifier in a 200-milliwatt unit, or as the driver amplifier in a larger unit.

Checkout. Comdel has given out some of its new amplifiers for evaluation. Scientists are using them in propagation studies for the Bureau of Standards. The Central Intelligence Agency, the United States Information Agency, and several universities have put HDR's into some of their systems. They are also being used by Honeywell, RCA, and the Bedford Institute of Oceanography.

When Comdel starts selling the amplifier in quantity April 1, it will offer three models:

- The 101, priced at \$75, is designed to plug into printed-circuit boards.

- The 102 for \$77 has coaxial fittings.

- The 101A is priced at \$92 and is packaged with a 110-volt a-c power supply that delivers between 18 and 22 v d-c at 40 milliamperes of current.

Specifications

Source impedance	50 ohms
Load impedance	50 ohms
Temperature range	-20 to +60°C
Relative humidity	100%
Shock (for 11ms)	10 g's
Vibration	5 g's
Weight (101)	2 oz.
Dimensions (101)	2.5 x 1.3 0.7 in.
Weight (101 a-c)	1 1/4 lbs.
Dimensions (101 a-c)	4.9 x 2.5 x 3.4 in.

Comdel Inc., Beverly Airport, Beverly, Mass. 01915 [358]

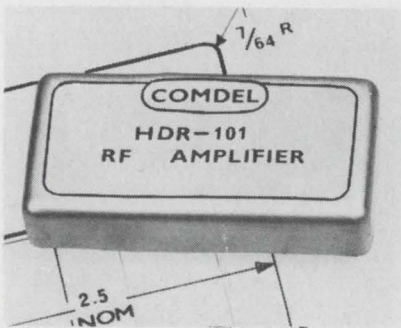

Wide and flat. The gain of the HDR r-f amplifier is 9 db from 0.5 to 50 Mhz.

←Circle 190 on reader service card

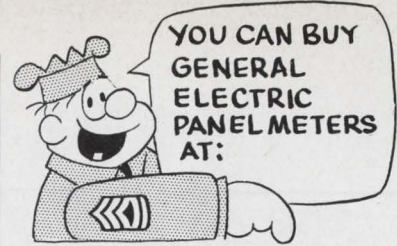

ALABAMA
Birmingham
Electronic Supplies, Inc.
Forbes Distributing Co.
Huntsville
Cramer / Huntsville
Edgerly Instrument Labs, Inc.
Electro-Tech, Inc.

ARIZONA
Phoenix
Hamilton Electro of Arizona
Metercraft, Inc.

ARKANSAS
Little Rock
Carlton Bates Co.

CALIFORNIA
Culver City
Hamilton Electro Sales
Emeryville
General Electric Supply Co.
Glendale
JSD Engineering
Los Angeles
General Electric Supply Co.
Metromaster, Inc.
Mt. View
Hamilton Electro Sales
Palo Alto
Kierulff Electronics
Redwood City
Fortune Electronics
Sacramento
Sacramento Elec. Supply Co.
San Diego
Kierulff Electronics
Hamilton Elect. of San Diego

COLORADO
Denver
Electronic Parts Co.
L. B. Walker Radio Co.

CONNECTICUT
Hamden
Cramer Electronics, Inc.
Hartford
General Electric Supply Co.

DISTRICT OF COLUMBIA
Washington
Cramer / Washington
Sibers Radio & Electronics

FLORIDA
Ft. Lauderdale
Cramer Florida Electronics
Jacksonville
General Electric Supply Co.
Orlando
Electro-Tech, Inc.
West Palm Beach
Mountain Electronics

GEORGIA
Atlanta
Electronic Supply Co.
General Electric Supply Co.
Jackson Electronic Supply Co.

AUGUSTA
General Electric Supply Co.

HAWAII
Hawaii
Electro-Tech, Inc.

ILLINOIS
Chicago
Allied Radio
J. G. Bowman & Co.
Peoria
Hendricks Elec. Co.
Schiller Park
Pace Electronics Supplies
Springfield
Bruce Electronics, Inc.

INDIANA
Evansville
Ohio Valley Sound, Inc.
Fort Wayne
Fort Wayne Electronic Supply Co.

INDIANAPOLIS
General Electric Supply Co.
Graham Electronics
Peerless Elec. Supply Co.

IOWA
Cedar Rapids
Hupp Electric Motors, Inc.
Iowa City
Hupp Electric Motors, Inc.

KANSAS
Wichita
Radio Supply Co.

KENTUCKY
Louisville
P. I. Burks Co.
General Electric Supply Co.

LOUISIANA
Baton Rouge
Sterling Electronics
Lafayette
Ralpchs of Lafayette
New Orleans
Argo Marine Supply
New Orleans Electric
Supply, Inc.
Sterling Electronics, Inc.

MARYLAND
Baltimore
Cramer / Baltimore
Edgerly Instrument Laboratories

MASSACHUSETTS
Boston
General Electric Supply Co.
Gerber Radio Supply Co.

CAMBRIDGE
E-T Instruments & Controls, Inc.

LAWRENCE
Alco Electronics
Needham
Instruments, Inc.
Newton
Cramer Electronics, Inc.

SPRINGFIELD
T. F. Cushing, Inc.

MICHIGAN
Detroit
General Electric Supply Co.

FERNDALE
Ram Meter, Inc.

KALAMAZOO
Warren Radio Co.

MUSKOGEE
Fitzpatrick Electric Supply Co.

SOUTHFIELD
S. Sterling Co.

MINNESOTA
Minneapolis
Electronic Center, Inc.
Low-Bonn Co.

MISSISSIPPI
Jackson
Ellington Electronic Supply, Inc.

MISSOURI
Joplin
Norman Elec. Supply Co., Inc.

KANSAS CITY
General Electric Supply Co.
Radio Labs, Inc.
University City
Oliver Industrial Electronics, Inc.

NEBRASKA
Lincoln
Scott Electronic Supply Corp.

OMAHA
Schneider Elec. & Equipment Co.

NEW JERSEY
Roselle
E-T Instruments & Controls, Inc.

SCOTCH PLAINS
TRF Electronics

NEW MEXICO
Albuquerque
Electronic Parts Co., Inc.
Sterling Electronics, Inc.

NEW YORK
Elmhurst
Cramer / ESCO
Emsford
Melville Radio Corp.
Glens Falls
Glens Falls Electric Supply Co.
Great Neck
A&M Instrument
Latham
Latham Electric Supply Corp.
Liverpool
WEI, Inc.
New York City
E-T Instruments & Controls, Inc.
Hudson Electric Sales Co.
Power Instrument Control Sup.
Syracuse
Wather, Evans and Diehl, Inc.

NORTH CAROLINA
Charlotte
Dixie Radio Supply Co., Inc.
Greensboro
General Electric Supply Co.
Southeastern Radio Supply

RALEIGH
Southeastern Radio Supply Co.

OHIO
Akron
Sun Radio
Cincinnati
General Electric Supply Co.
United Radio, Inc.
Cleveland
Christie Laboratories, Inc.
General Electric Supply Co.
Pioneer Standard Electronics, Inc.

COLUMBUS
Buckeye Electric Distrib., Inc.

DAYTON
Pioneer Standard / Srepro

TOLEDO
Hilleband Electric Supply
Warren Radio Co.

WARREN
REM Electronics Supply Co.

OKLAHOMA
Oklahoma City
John H. Cole Co.

PENNSYLVANIA
Allentown
A. A. Peters, Inc.
Harrisburg
Radio Distributing Co.
McKeesport
Barro Radio Co.
Philadelphia
Almo Industrial / Electronics, Inc.
General Electric Supply Co.
Sunshine Scientific Inst.

PITTSBURGH
Edgerly Instrument Labs, Inc.
General Electric Supply Co.

YORK
Rosen Electronics

RHODE ISLAND
Providence
W. H. Edwards Co.

SOUTH CAROLINA
Charleston
Wholesale Radio Supply

COLUMBIA
Dixie Radio Supply Co., Inc.

GREENVILLE
Dixie Radio Supply Co., Inc.

TENNESSEE
Chattanooga
Electric Motor Sales and
Supplies
Harpe Electronic Distributors
Knoxville
Chemcity Electronics
General Electric Supply Co.

MEMPHIS
Elec. & Mech. Comp. Devices
Lavender Radio & TV
W & W Distributing Co.

NASHVILLE
Electra Distributing Co.

TEXAS
Arlington
Arco Beta Electronics
Beaumont
Stirling Electronics, Inc.
Corpus Christi
Electronic Equip. & Engrg. Co.
Dallas
Contact Electronics
Graybar Electric Co.
El Paso
McNicol, Inc.
Houston
Busacker Electronic Equip. Co.
General Electric Supply Co.

UTAH
Salt Lake City
S. R. Ross, Inc.

VIRGINIA
Norfolk
Cain Electronics, Inc.
Richmond
Meridian Electronics, Inc.

ROANOKE
Peoples Radio &
TV Supply Co., Inc.

WASHINGTON
Aberdeen
C&G Electronics
Seattle
Hamilton Electro Corp.
Instrument Laboratory, Inc.
Kierulff Electronics

SPokane
Ind. Instrument Supply Co.

WEST VIRGINIA
Bluefield
Meyers Electronics, Inc.
Charleston
Chemcity Electronics
Mountain Electronics Co.
Mountain National Corp.

HUNTINGTON
Electronic Supply Co.
Mountain Electronics Co.

WISCONSIN
Appleton
General Electric Supply Co.
Green Bay
Beemster Electric Co.
West Allis
Marsh Radio Supply Co.

only
the ALL-NEW 620 & 640
BELL GAUSSMETERS
offer
you these combined features
for Increased Versatility



MODEL 620 GAUSSMETER
 All solid-state automatic battery take-over in case of line power failure. Available from stock.

MODEL 640 GAUSSMETER
 All solid-state—1000X scale expansion—5V AUX output standard.



1

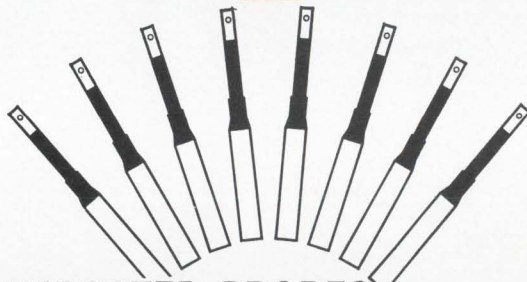

PRECALIBRATED PROBES — new imaginative design permits changing probes without recalibration (probe and instrument are programmed).

- 2** **Temperature Compensated Probes** — with $\pm 0.005\%$ / °C temperature dependence make possible a stability not formerly available in medium priced gaussmeters.
- 3** **High Accuracy** — 0.5% FS to 10 kG and 1.0% FS to 30 kG (possible without reference to cal magnet).
- 4** **True Zero & Field Polarity** — measure direction as well as magnitude.
- 5** **Probe Versatility** — 15 standard transverse, axial & multi-axis probes.
- 6** **Direct & Independent meter readout** of ac and dc fields.
- 7** **1 V Calibrated Output** at front panel output jacks.
- 8** **1000X Scale Expansion** with automatic zero center meter reading in incremental mode (640 only).



All this and a Gold Seal Probe Guarantee, too!

"BELL PRODUCTS for PLANNED PROGRESS"



Fw BELL
 F. W. Bell, Inc.
 1356 Norton Ave.
 Columbus, O. 43212
 Ph. 614-294-4906
 TWX: 810-482-1716

New components

Dusting process brightens picture

Color television tube also has improved phosphors, electron gun

The last time there was a major change in television picture tube design was in 1964 when Sylvania Electric Products Inc. introduced a color tube using the rare earth phosphor, europium. Other tube producers followed suit and the rare earth tube became an industry standard.

Sylvania's latest innovation in the color picture tube market is called Color Bright 85. The company describes the tube as "23 to 69% brighter" than others on the market, and says it produces the truest colors attainable.

New method. By using larger phosphor crystals and applying them to the face of the tube by a new dusting process, Sylvania says, it has achieved a more consistent phosphor thickness and therefore a more uniform output of light across the face of the tube.

Color Bright 85 also has a new electron beam gun. Sylvania says it improves resolution and reduces the color fringing that can result from out-of-shape electron beams. A temperature-compensated shadow mask keeps the color purity at a constant level.

The new tube, which is used in all of Sylvania's current line of tv sets, is also being offered to producers of competitive sets. Sylvania has phased out production of its previous line of picture tubes.

Simultaneous with announcement of Color Bright 85, the company disclosed development of two new receiving tubes for color tv, a rugged high voltage rectifier and a horizontal amplifier with improved internal cooling.

Both tubes are designed to produce less radiation of X-rays, and have posted filaments.

Sylvania Electric Products Inc., 730 Third Ave., New York, N.Y. 10017 [359]

1Ω, 1%, 100ppm



First low-range, low-inductance thick-film resistors

These new IRC TF resistors have been designed specifically for your low-range, low-inductance needs. They provide precision performance, plus the added benefits of thick-film stability and reliability for a wide range of industrial and instrumentation applications.

Rugged Metal Glaze resistance element is inherently reliable. Tin-oxide types can't match its stability and ruggedness under severe load or elevated temperature conditions. Tough molded bodies of the TF07 and TF20 can't crack or craze during automated insertion. They resist solvents and corrosion. Write for samples, prices, and data on these new IRC low-range resistors. IRC, Inc., 401 N. Broad Street, Philadelphia, Pa. 19108.

Resistor screening. Does your low-range application require 100% burn-in? IRC is geared to perform meaningful screening tests on these new Type TF resistors on a production basis. Ask for data.

CAPSULE SPECIFICATIONS

POWER:	¼ W @ 70°C	½ W @ 70°C
RESISTANCE:	1Ω to 10Ω	1Ω to 10Ω
TOLERANCES:	±1,2,5%	±1,2,5%
TEMP. COEF.:	±100ppm/°C	±100ppm/°C
SIZE:	RL07	RL20
IRC TYPE:	TF07	TF20



**4½-Digit DVM.
Compact flexibility:
\$1150.**

We've packed a lot of flexibility into our Model 7000 DVM. It's only half-rack size (5¼" x 8¾" x 12"), but has five big options: auto-ranging, AC volts, resistance, DC current and BCD output. Options are contained on convenient plug-in circuit boards. A front-panel function switch controls all options. The 7000 is built with integrated circuits and provides a reading accuracy of 0.01%. Resolution is 100µV. Input impedance is greater than 1000 megohms. You also get dual slope integration, automatic polarity and display storage. Low power operation means no fan and no noise. A 7000 DVM can be yours in 15 days. You can get our data sheets even faster. Write today.



New Microwave Review

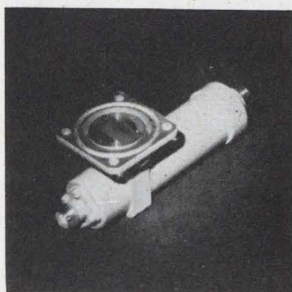

Gas discharge noise source type TN94/T44X3A is for use at 8.9 to 9.1 Ghz in the X band. The unit is fired by a negative pulse of 950 v applied to the cathode. Operating voltage is 50 v d-c nominal; operating current, 60 ma. Vswr in the fired condition is 1.5 max. and excess noise ratio is 18.5 ± 0.5 db. Signalite Inc., 1933 Heck Ave., Neptune, N.J. 07753. [401]

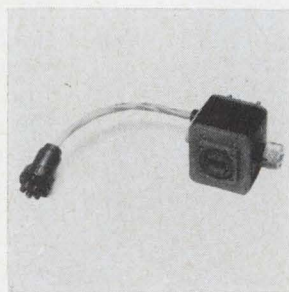

Positive pulse beacon magnetron MA-260 provides 1-kw peak output power and is tunable from 16 to 16.5 Ghz. Output power is typically level within ± 1 db and temperature coefficient varies from -60 to -85 khz/ $^{\circ}$ C over the 500-Mhz band. Peak anode voltage is 3 kv and peak anode current is 1.6 amps. Weight is under 20 oz. Microwave Associates Inc., Burlington, Mass. [402]

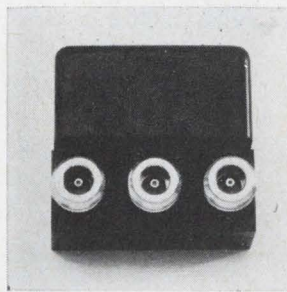

Remote miniature coaxial switch CS-221 is a single-pole 2-position unit with a frequency range of d-c to 3.3 Ghz. Insertion loss is 0.1 db max. from d-c to 1 Ghz and 0.3 db max. from 1 to 3.3 Ghz. Vswr is 1.1 max from d-c to 1 Ghz; 1.25 max from 1 to 3.3 Ghz. Operating voltage is 28 v d-c. Prices start at \$25. RLC Electronics Inc., 25 Martin Place, Port Chester, N.Y. 10574. [403]

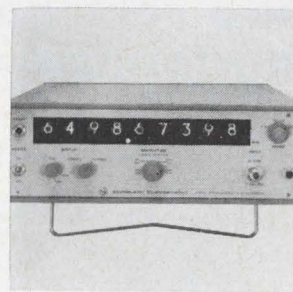

Frequency counter 960 features continuous coverage with one input from 20 hz to 6.5 Ghz. Input sensitivity is less than 50 mv over most of the range. The unit is for applications where rapid reading, unattended operation, or measurement by unskilled persons is required. It is also adapted to systems use. Eldorado Electronics, 601 Chalomar Rd., Concord, Calif. 94520. [404]

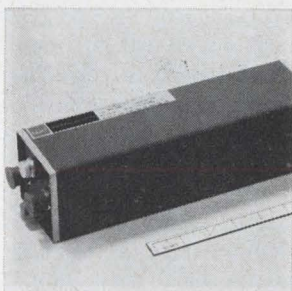

T-w amplifiers WJ-396 cover the range of 7 to 11 Ghz. Units feature noise figure of 6 db in a $3.4 \times 3.4 \times 10$ in. configuration, and weigh 8.5 lbs. The amplifier can withstand vibration of over 5 g at frequencies up to 500 hz and over 15 g of shock in any plane for 11-msec duration. Watkins-Johnson Co., 3333 Hillview Ave., Stanford Industrial Park, Palo Alto, Calif. 94304. [405]

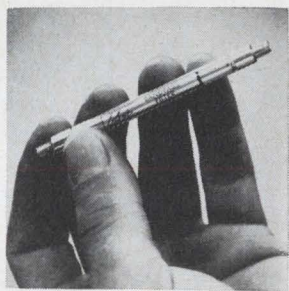

Subminiature bandpass filters series TBS have center frequencies ranging from 400 to 2,300 Mhz. Tubular types of the 0.05-db Chebyshev design, they measure $\frac{1}{4} \times 1\frac{1}{2}$ to 5 in. and weigh less than 1 oz. including connectors. They come with a 3-db bandwidth of 2 to 15%, in 2- to 6-section versions. Price is from \$95. Telonic Engineering Co., Box 277, Laguna Beach, Calif. [406]

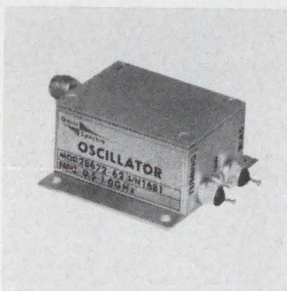

Solid state oscillator 28672-62 is electrically tunable over the 500 to 1,000 Mhz range. Features include power output of 100 mw min.; power output variation with frequency of ± 1 db max.; typical temperature stability of 100 ppm/ $^{\circ}$ C. Power required is 20 v at 150 ma. Unit measures $0.75 \times 1 \times 1.50$ in. OmniSpectra Inc., 24600 Hallwood Ct., Farmington, Mich. 48024. [407]



Horn-type antenna can simultaneously handle both vertical and horizontal polarization of any combination of microwave bands. Frequency range of operation is determined solely by the bandwidth of the connecting waveguide. Wide angle radiation is down 60 to 70 db across all bands. Return loss is 40 db. Gabriel Electronics, Box 471, Saco, Me. 04072. [408]

New microwave

Signal generators use phase lock to sweep

Modular system with long-term frequency accuracy can be programed for computerized test setups

A modular signal generator that offers digital control of output and phase locking has been designed by New London Instrument Co.

The system, whose modules are lumped under the designation series 5000, is part of a comeback attempt for New London. A pioneer in the

frequency and amplitude modulation test equipment field, the firm went out of business in 1963. It came back last April as a wholly owned division of the Crescent Communications Corp.

New London's product line already includes its series 1000 modu-

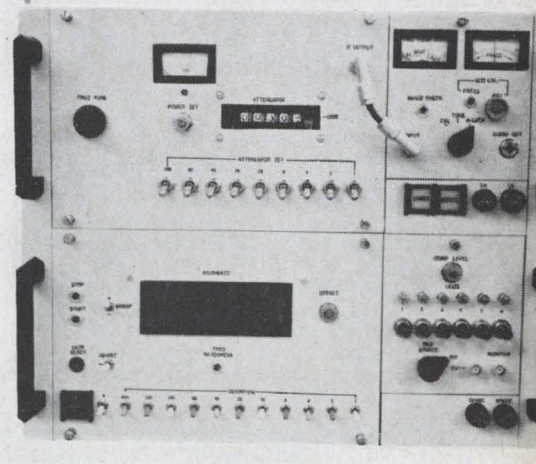

Following orders. Test oscillator is controlled by digital signals.

**We do all the work...
you get high yield,
low cost, guaranteed
performance.**

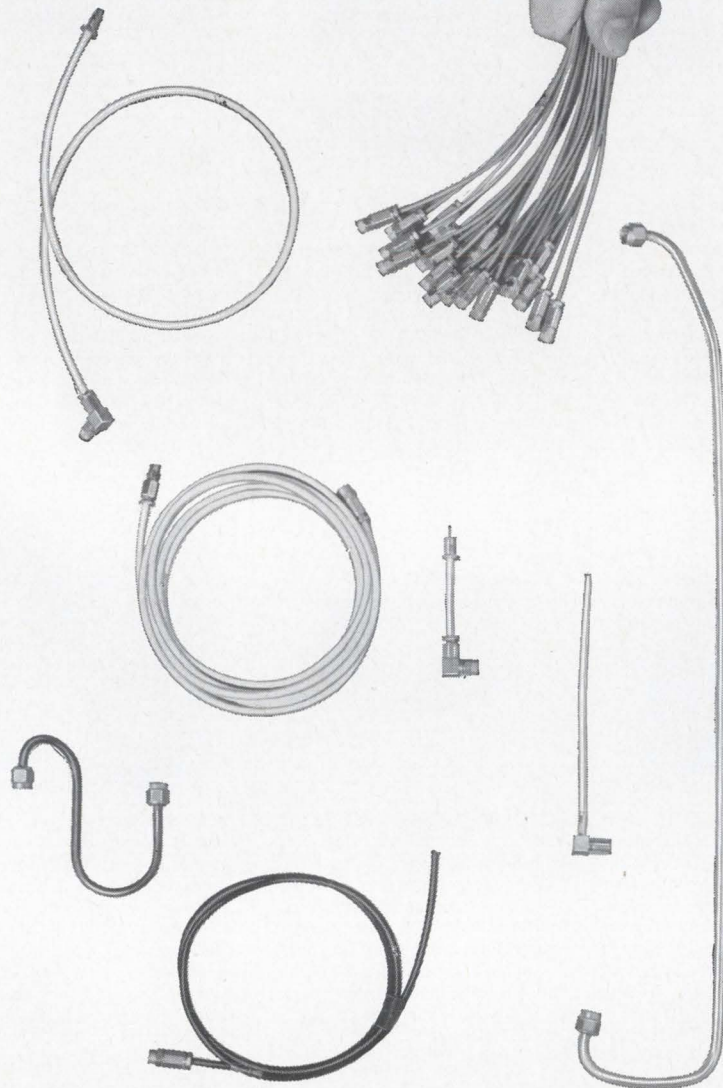

MINIATURE CABLE ASSEMBLIES

As producers of an in-depth line of miniature connectors and semi-rigid miniature coaxial cable, we can make a pretty strong case for ourselves as a source for miniature coaxial assemblies shipped complete with mounted connectors.

Specify any flexible, braided cable or, request our own semi-rigid coax, in sizes from .070 to .350 inches in impedances of 50 and 75 ohms. Specify crimp-type miniature connectors or patented Emlock® compression metal-to-metal fit, in matched impedances. We will cut cable to precise mechanical and electrical

lengths, bend semi-rigid cable to individual requirements, mount selected connectors, test to your established parameters and guarantee performance. All this, at a price lower than your cost if you were to buy your own coax and connectors and do the job yourself. How? Our assembly speed is faster, our yield is greater.

Can we tell you more? Write for full details today: Phelps Dodge Electronic Products Corporation, 60 Dodge Avenue, North Haven, Connecticut 06473

PHELPS DODGE ELECTRONIC PRODUCTS CORPORATION 

**... counter is more accurate
than a local oscillator ...**

lar signal generators, and series 2000 modular monitoring systems. Generally, these instruments cost "up to \$5,000." The series 5000 should run from \$5,000 to \$7,000 and up.

For the difference, the user can buy what amounts to a custom-built system with long-term frequency accuracy as high as one part in 10^{-7} , sweeping of either side of phase-locked center frequencies located to ± 100 hertz accuracy (to 10 Hz if required), digital programming for computerized test schemes, and binary coded decimal readouts.

Counter-controlled. The 5000 uses three pencil-tube cavity oscillator plug-ins to cover the r-f range from 20 to about 800 megahertz (another module reaches into S-band). A vco is used as the reference against which the r-f cavity is locked; meanwhile the vco itself is sampled 12.5 times per second by transistor-transistor logic counter circuitry. "Since our counter electronics is more accurate and stable than a local oscillator, we figured we might well control the reference with the counter," according to Alex Gordon, New London's vice president. This gives advantages other than accuracy. If frequency multiplication were used with the 5000's 10 Mhz. vco to produce uhf signals at 1 gigahertz, any error in the reference frequency would be multiplied by 100. But in the 5000, errors are not multiplied upward through a system, as in oscillator-multiplier chains.

Standard oscillator modules in the 5000 series will probably be controlled to either 100 or 1000 Hz. But, says Gordon, counter resolution, and therefore frequency accuracy, could easily be increased to 10 Hz. This not only means 10 Hz at the vco, but also at 2,500 Mhz.

To sweep, the proper commands are inserted in the digital control unit using a binary coded decimal code. These commands cause the vco to change its output frequency, and, since the r-f oscillator is phase-locked to it, its sweep follows.

The New London Instrument Co., a division of the Crescent Communications Corp., 153 California St., Newton, Mass. 02158 [409]

a new low in op amps.

{ Our NH 0001 dissipates only }
{ a puny 0.6mW at $V_s \pm 6V$ }

Even the typical dissipation is only 1.8mW at $V_s = \pm 15V$, which must be some kind of record. Nevertheless, our mighty NH 0001 will deliver over $\pm 10V$ into a 2K load from $V_s = 15V$ supplies. That makes it a natural for space stuff.

A couple of other features of the NH 0001 are its low noise and maximum offset voltage of a mere 1mV at 25° C (only 2mV across the full temperature range). Power supply and common mode rejection are 90db. After that, there's

nothing left to say except that the NH 0001 is packaged in a TO-5 and priced at \$48.00 in 100 to 999 quantities.

If you need them now, call your National distributor. They're on the shelf. Or, if you would prefer to approach the matter more leisurely, write us for data sheets.

National Semiconductor Corporation,
2975 San Ysidro Way, Santa Clara, California
95051 (408) 245-4320.

National Semiconductor

A New X-Y Recorder...

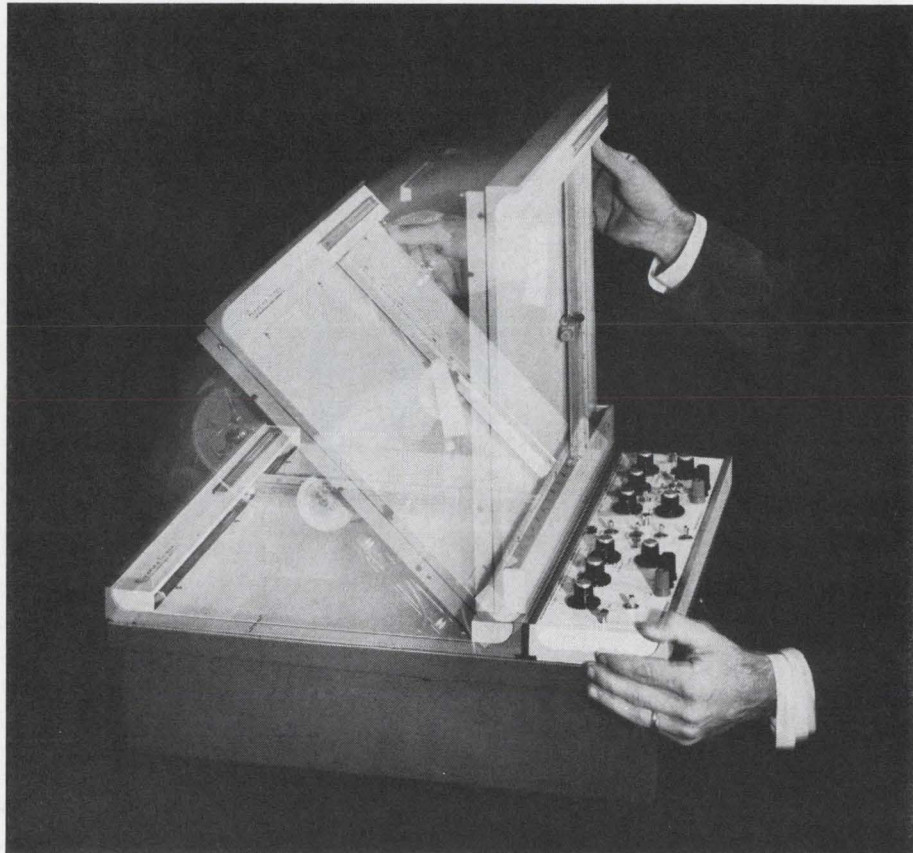

That's Easier To Operate

Easier to operate . . . easier to position . . . and meets top performance requirements. The *function/riter** recorder is more convenient than other X-Y plotters. You can operate this new TI recorder in five different positions to suit any application. Mount it in a 19-inch rack without adapters, stand it upright on a benchtop or position it flat with the writing surface horizontal, at a 45° or 90° tilt angle so you see the plot, even when you're sitting.

It's easy to change applications too. Three types of plug-in "function modules" allow you to plot inputs from 100 μ v to 50v, with time sweeps from 0.1 second/inch to 100 seconds/inch. All modules are interchangeable between X and Y axes. *Signal Input* module permits single-range millivolt recording. *Signal Control*

module offers 16 calibrated scale factors. *Time Base* module gives 10 time or voltage factors.

For more than four years, the servo system of the *function/riter* recorder has been use-proved in thousands of other TI instruments. Quieter operation of the vacuum hold down (for either 8½ x 11-inch or 11 x 17-inch paper), solid-state electronics, 20 inches/second slewing speed and accuracy of 0.2% of full scale are some of the other features that make this X-Y recorder an outstanding instrument to solve your plotting problems.

There's more to the story too. Find out by asking for complete data or a demonstration from your TI representative or the Industrial Products Division, P. O. Box 66027, Houston, Texas 77006 (713-349-2171).

*Trademark of Texas Instruments

TEXAS INSTRUMENTS INCORPORATED

New microwave

Wideband amplifier has 2 magnetrons

Covering 1 to 12.4 Ghz,
unit eases field testing
of microwave equipment

The most common problem in testing microwave equipment is getting uniform amplification of a signal over a broad frequency range. In most testers, the signal source is a sweeping signal generator. These units have an output on the order of several milliwatts, not enough for complete system testing, so an amplifier must be used to boost the signal to about 1 watt.

By using two specially designed traveling wave tubes, the Servo Corp. of America has developed a compact microwave power amplifier with a minimum gain of 30 decibels. Designated the model 3003, the unit has a continuous-wave output of 1 watt over 1 to 12.4 gigahertz.

One tube covers from 1 to 4 Ghz and the second 4 to 12.4 Ghz. A front panel switch controls which tube is connected to the power supply, and thus controls the amplifier's frequency range. The gain can also be adjusted ± 20 db by a front-panel switch.

Spurious output is 45 db below the signal level and the amplifier has a frequency response, for pulse-modulated signals, of from 1 kilohertz to 1 megahertz. Rise and fall time is less than 0.1 microsecond. Output power control is accomplished by metering the cathode current of the output tubes.

Servo Corp. of America, 111 New South Rd., Hicksville, N. Y. 11802
[410]



Booster. Power amplifier supplies 1 watt minimum from 1 to 12.4 Ghz.

Our first new MOS switch is so good, it's almost embarrassing.

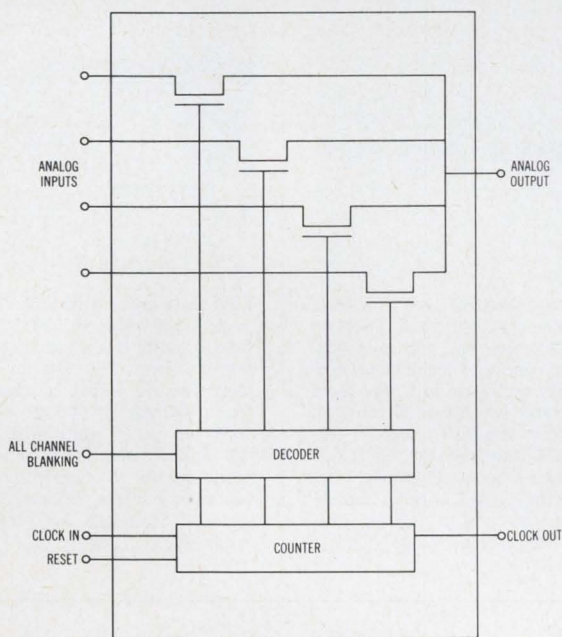

MM454 Commutator

It's the MM454, a monolithic, four-channel commutator, that's capable of handling $\pm 10V$ analog signals. And it provides all driver and decode circuitry eliminating the need to construct a separate counter. All-channel blanking and a reset capability are a couple of bonus features.

We've also introduced four other new switches not quite so remarkable, but still worth crowing about. Our MM450 is a dual differential switch. Our MM451 is a four-channel unit. Then there's our MM452 which is comprised of four separate switch devices in a single flat pack with 14 leads. The last one, our MH453, is a dual differential analog switch with a built-in DTL/TTL interface circuit.

Not bad for openers. And these aren't just being designed. They're already stocked on your distributors' shelves complete with price tags:

	Quantity: 100-999
MM 450 Dual differential MOS switch	\$20
MM 451 Four-channel MOS switch	\$20
MM 452 Four MOS transistors	\$30
MH 453 DTL/TTL compatible MOS switch	\$40
MM 454 Four-channel commutator	\$50

Write for data. National Semiconductor Corporation, 2975 San Ysidro Way, Santa Clara, Calif. 95051. Phone (408) 245-4320.

National Semiconductor

New Instruments Review

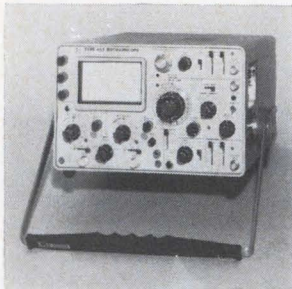

Portable scope type 453 MOD 127C has a built-in tv sync separator for viewing tv waveforms. Dual-trace sensitivity and bandwidth is 5 mv/div with 40-Mhz bandwidth, increasing to 50-Mhz bandwidth at 20 mv/div to 10 v/div. Channel 1 and 2 amplifiers can be cascaded to obtain 1 mv/div sensitivity at 25 Mhz, single trace. Tektronix Inc., Box 500, Beaverton, Ore. [361]

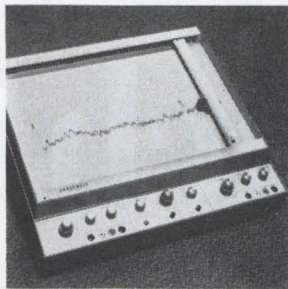

X-Y recorder model 560 has a sensitivity of 10 μ v/in. It operates over 21 calibrated ranges from 10 μ v to 50 v/in. This true differential input recorder is capable of plotting two-axis (record and time base) data on vacuum-held 8½ x 11 in. or 11 x 17 in. graph paper. It features all silicon logic. Honeywell Inc., P.O. Box 5227, Denver, Colo. 80217. [362]

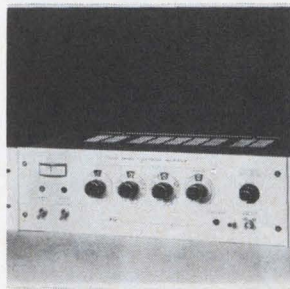

Regulated d-c, h-v biasing supply model 245 can provide bias for photomultiplier tubes, solid state radiation detectors, and ion chambers. Output range of 0 to 2,100 v at 10 ma max. is offered in 10-v steps, and voltage selections can be made to $\pm 1\%$ accuracy with direct readout dials. Price is under \$400. Keithley Instruments Inc., 28775 Aurora Rd., Cleveland 44139. [363]



Incremental gaussmeter 640, using a new precalibration technique, takes full advantage of the high-linearity Hall element and solid state circuitry, and allows direct interchangeability of probes without recalibration. With built-in calibration accuracy of $\pm 0.3\%$, instrument accuracy is $\pm 1\%$ to 30 kg, $\pm 0.5\%$ to 10 kg. F.W. Bell Inc., 1356 Norton Ave., Columbus, Ohio 43212. [364]

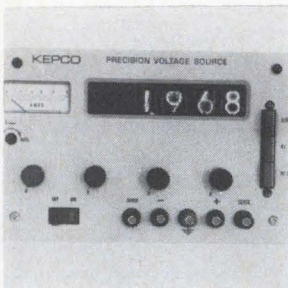

Precision voltage source PVS 100-1 offers a 4-place digital display of output voltage from 0.000 to 100.00 v, with 0- to 1-amp current available. Voltage selection is by means of 4 rotary selectors offering absolute accuracy, 0.02% of full scale, with 0.001% combined line and load regulation. Kepco Inc., 131-38 Sanford Ave., Flushing, N.Y. 11352. [365]

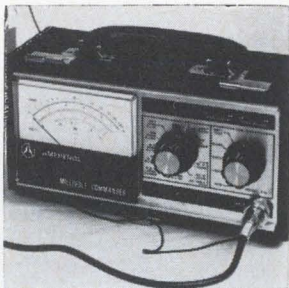

Compact voltohmmeter model 870 Millivolt Commander measures voltages as low as 0.1 v d-c full scale and 0.01 v a-c full scale. It also provides a sensitivity range from 100 mv full scale to 1,000 v full scale in 9 increments. Accuracy is within $\pm 2\%$ d-c and $\pm 3\%$ a-c full scale. Price is \$99.95. Amphenol Corp., 2875 S. 25th Ave., Broadview, Ill. 60153. [366]

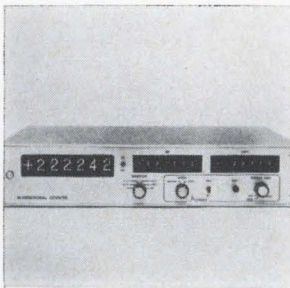

Forward-counting and forward/reverse counting model CB-600R is designed for precise digital measurement of bidirectional frequency signals up to 1 Mhz count rate and will change direction of count in less than 1 μ sec. It features 5 input signal modes selected by a front panel switch. Price is from \$1,445. Anadex Instruments Inc., 7833 Haskell Ave., Van Nuys, Calif. 91406. [367]

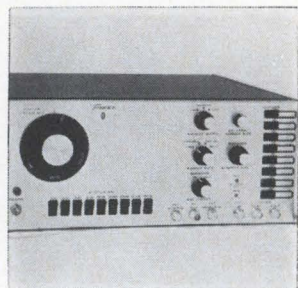

Solid state sweep generator VS-30 covers 300 khz to 100 Mhz. Sweep width is continuously adjustable from 200 khz to 100 Mhz. The r-f output is specified for a flatness of ± 0.25 db at maximum sweep width with 1 v rms into 50 ohms. The unit has provisions for 8 plug-in crystal controlled markers. Texscan Corp., 2446 N. Shadeland Ave., Indianapolis 46219. [368]

New instruments

Measuring up to varying signals

Level meter uses analog-to-digital converter to cover a range from -60 to $+20$ decibels

In the drive to automate as many testing and measuring jobs in communications as possible, digital measuring instruments are gaining importance as spearheads.

One example is a digital level meter developed by Siemens AG and designated the C2010/D2014.

It is the first to determine exactly, levels from -60 to $+20$ decibels in a frequency range from 30 hertz to 120 kilohertz. Indicated numerically, the level's value can also be obtained in coded form.

The meter consists of a basic instrument and an analog plug-in

unit. The voltage to be measured is fed across a stable broad-band amplifier and an automatically controlled switch (whose range increases logarithmically) and then to an extremely linear d-c rectifying circuit. The rectified signal is fed to an analog-digital converter. The logarithmic relationship to the reference voltage by which the level is defined, is determined in a comparison circuit by the discharge function of an r-c circuit. The time interval (proportional to the level) and the polarity are obtained. A limit value indicator controls the range switch of the analog unit.

Coded and stored. The measured

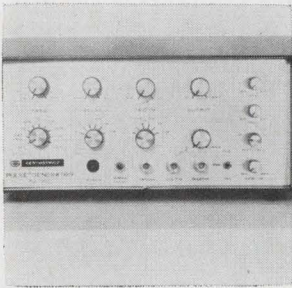

Pulse generator model PG-300 extends voltage programming capability to include linear rise and fall times from 5 nsec to 1 msec. The d-c base line offset, also programmable, is continuously variable from +10 to -10 v into a 50-ohm load on both the positive and negative outputs. This allows duty cycles to 100%. Aerojet-General Corp., Box 216, San Ramon, Calif. 94583. [369]

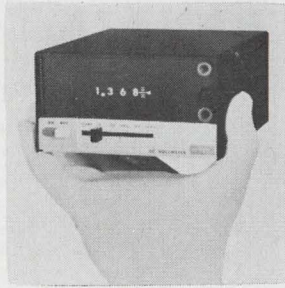

Miniaturized dvm model 211 features an accuracy of 0.05% plus 1 digit on 5 extended ranges (100 mv, 1 v, 10 v, 100 v and 1,000 v d-c full scale with 50% over-range). Resolution is 20 μ v on the 100 mv range. A detented slide switch selects range and decimal point location simultaneously. Basic unit costs \$275. United Systems Corp., 918 Woodley Rd., Dayton, Ohio. [370]

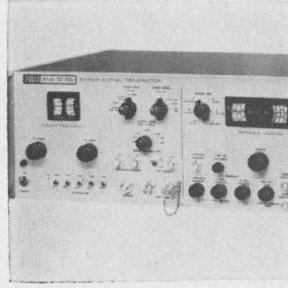

Vhf sweep generator system SS-300 incorporates in a single unit a sweep generator covering 500 khz to 300 Mhz, a marker generator and a detector system. It features start-stop frequency tuning, automatic leveling without frequency shift, low radiation toggle switch attenuators, and 50 to 400 hz power input. Jerrold Electronics Corp., 401 Walnut St., Philadelphia, Pa. [371]

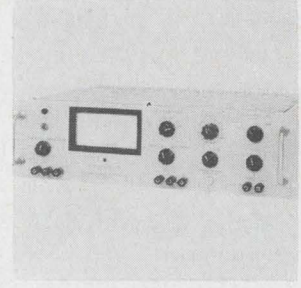

Differential input phase meter 351 covers 10 hz to 2 Mhz with 2-channel sensitivity of 1 mv. It works from 1 mv to 100 v without external preamps or attenuators, or periodic calibration. An offset control is in 10° steps to permit phase reading to be expanded about any angle in the 360° range. Price is \$1,190. Wiltron Co., 930 E. Meadow Dr., Palo Alto, Calif. 94303. [372]

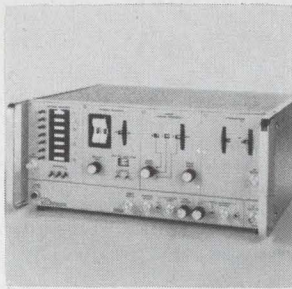

Programmable sweep generator A-1211 (0.5 Mhz to 1 Ghz) will accept analog d-c programming to control center frequency, sweep width, output level and selection of markers. It is readily adaptable in the design of automatic test systems for production testing of r-f components. Basic unit price is \$995. Sweep Systems Inc., 3000 Shelby St., Indianapolis 46206. [373]

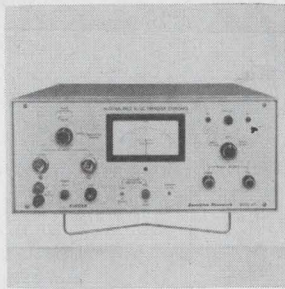

A-c/d-c transfer standard model ATS provides 0.01% true rms measurements in approximately 10 to 15 sec. It permits unskilled operators to make this measurement. Over-all range is 2 hz to 30 Mhz. Accuracy is rated at 0.01% of reading from 0.25 v to 1,000 v, 5 hz to 20 khz. Price is \$3,500. Singer Co., Metrics Division, 915 Pembroke St., Bridgeport, Conn. 06608. [374]

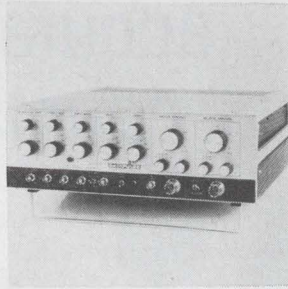

Pulse generator 113 offers built-in burst capability. Two repetition rate oscillators are used. One provides rep rates from 500 khz to 250 Mhz; the other (0.5 hz to 500 khz) is used to gate the h-f oscillator for 10 nsec to 10 μ sec bursts or as a trigger for low rep rates. Price is \$3,375. Datapulse Inc., 10150 W. Jefferson Blvd., Culver City, Calif. 90230. [375]

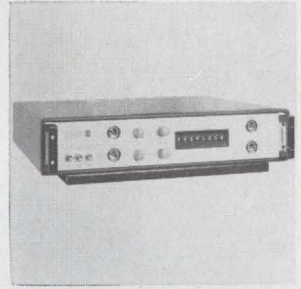

Programmable digital delay generator 1399 is also a frequency divider. With its internal 10-Mhz clock, time delays are available from 0.3 μ sec to 10 sec in increments of 0.1 μ sec. When the internal clock signal is replaced by an external signal from 100 hz to 13 Mhz, the unit provides frequency ratios of from 3:1 to 99,999,999:1. General Radio Co., West Concord, Mass. [376]

result, which is counted out in five binary-coded decades, is recorded into a 1-out-of-10 code and fed into a storage unit. That unit, in turn, controls the Nixie tubes in the indicator window.

This instrument's 80 db measuring range corresponds to a linear voltage relationship of 1:10,000. The typical absolute measuring accuracy of ± 0.1 db is very high, and holds for all indicated values. A change of level of only 0.01 db can still be read. This contrasts with analog measuring instruments whose maximum accuracy holds only for the maximum value indicated, which corresponds to the

full-scale deflection.

Printers or telephone lines can be hooked up to the instrument's output for further processing or for transmitting results, in which case the values are presented in an Aiken code. Start and stop signals for the measurements can be triggered from other automatic measuring equipment. The measuring rate can also be remotely controlled.

When the digital level meter is connected to the i-f output of a selective level meter, selective digital measurements are possible, limited only by the characteristics of the latter meter. Together with



Communicating. Digital level meter sends information over phone lines.

The Model 6000 Modular Frequency Meter will measure frequencies 10 KHz to 600 MHz with .000125% accuracy. Special plug-in modules allow the instrument to be used as an audio frequency meter from 500 Hz to 20 KHz full scale and in addition to be used as a dc voltmeter (10,000 ohms/volt).

The wide variety of plug-in oscillator accessories and range modules makes the Model 6000 adaptable to a number of jobs in the field and in the laboratory. Portable, battery operated with rechargeable batteries.

Model 6000 with 601A charger, less plug-in modules.....\$195.00

INTERNATIONAL MODEL 6000 FREQUENCY METER

measures frequencies 10 khz to 600 mhz with accuracy as close as .000125%

CHARGER

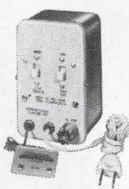

Range Modules (Mixers)
\$25.00 to \$45.00 each

Oscillator Modules
(Crystal Controlled For
Frequency Measurement)
\$30.00 to \$90.00 each

Special Modules
Audio Frequency\$45.00
DC Voltmeter..... 25.00

where
accuracy
counts!

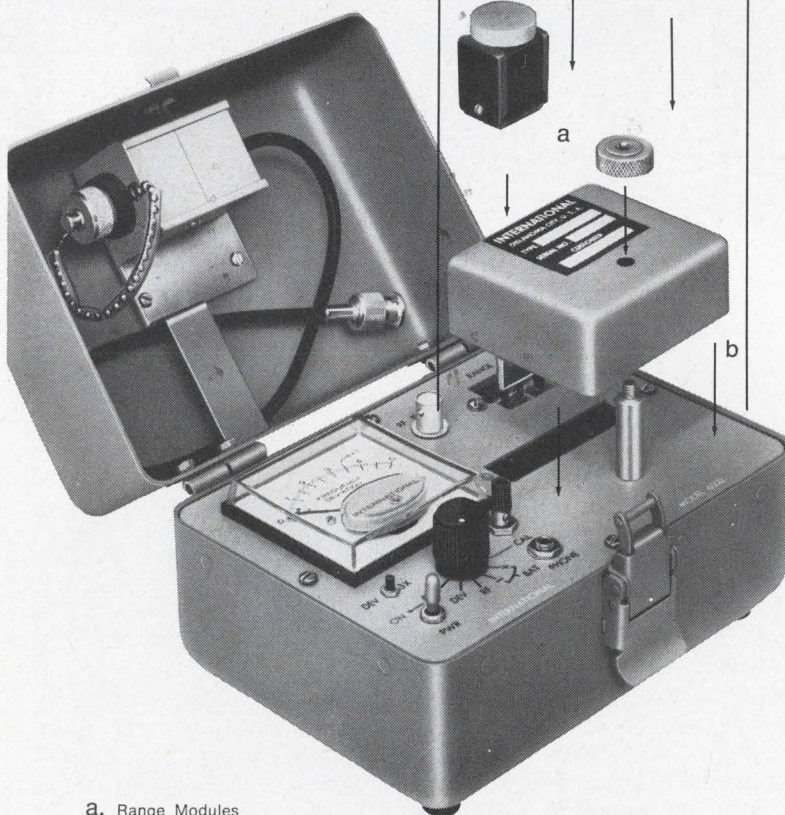

- a. Range Modules
- b. Oscillator Modules

... For complete information
write International today.



CRYSTAL MFG. CO., INC.
10 NO. LEE • OKLA. CITY, OKLA. 73102

a remotely controllable level oscillator, it's also possible to rig automatic and programable selective level measurements.

Because the level meter consists of a basic instrument and a plug-in unit, it is adaptable to other measuring tasks. Plug-in units for such other applications as level difference measurements are being developed.

Siemens AG, 8 Munich 1, Oskar-von-Miller Ring 18, West Germany [377]

New instruments

Making it simple, easy to operate

Sweep oscillator system
has functional layout
as part of front panel

A solid-state sweep oscillator system built by Alfred Electronics offers a front panel design that permits the instrument to be used by unskilled personnel.

"In fact," says marketing vice president Paul Fulton, "most operators will be able to use the instrument without ever referring to the operation manual." The panel design, which has been carried forward from the company's microwave instruments, provides control layout and functions that "are so well defined they are self-evident," says Fulton. He adds that it is impossible to damage the instrument by an improper setting of the controls.

The model 6151 incorporates two completely independent sweeps, a versatile f_0 control—which serves as a frequency marker, the center of the symmetrical sweep and as a single frequency—and offers an optional, accentuated comb-marker generator. The graduated comb-marker generator, which shows one, five and 25 megahertz crystal-generated harmonic signals, provides progressively larger amplitude for these intervals for ease of identification when measuring frequency. When all three signals are on, the horizontal scale has the appearance



Now they call us The Giant-Killer

A lot of people are coming to Hudson for miniature, sub-miniature and micro-miniature lamps these days — even though GE and Westinghouse are still in business. Why come to us? Because we've got a full line of first quality lamps. And because our service is great.

We climb beanstalks for our customers. There's nothing more important to us than getting your lamps to you on time, in the right quantity.

And if you need a bulb that's special, we'll supply it. No back-talk, no fuss, no bother. Just the bulb you want. At the right price. Soonest.

Next time a giant gives you the jolly ho-ho-ho — make a fast telephone call to Hudson. After all, they don't call us the giant-killer for nothing. **Hudson Lamp Company, 528 Elm Street, Kearny, New Jersey 07032. (201) 997-1850.**



Free: a new Hudson Catalog (The Giant-Killer)

Circle 203 on reader service card

Making a ceramic tower base insulator to 9,000,000 lbs. ultimate strength isn't easy . . .

Lapp specializes in tough jobs.

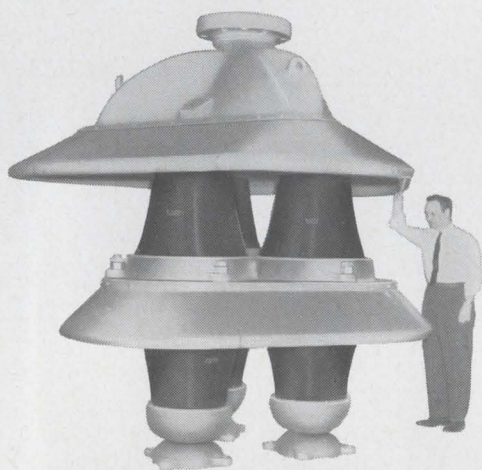

That was one of our toughest. But, Lapp has designed and built hundreds of tower insulators. They range downward to 80,000 lbs. ultimate strength. In fact, Lapp insulators support most of the world's larger radio towers, both self-supporting and guyed masts.

Lapp has over 50 years of "know-how" and experience that won't cost you a cent when you bring your insulating problem to us. From drawing board to delivery you can count on Lapp to handle your tough tower . . . and antenna . . . insulating jobs.

Can we help? Lapp Insulator Co., Inc. LeRoy, N.Y. 14482.

Lapp

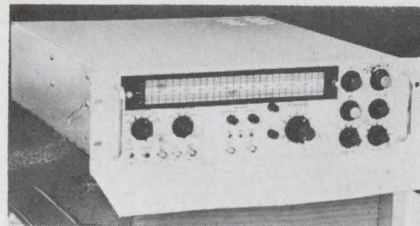
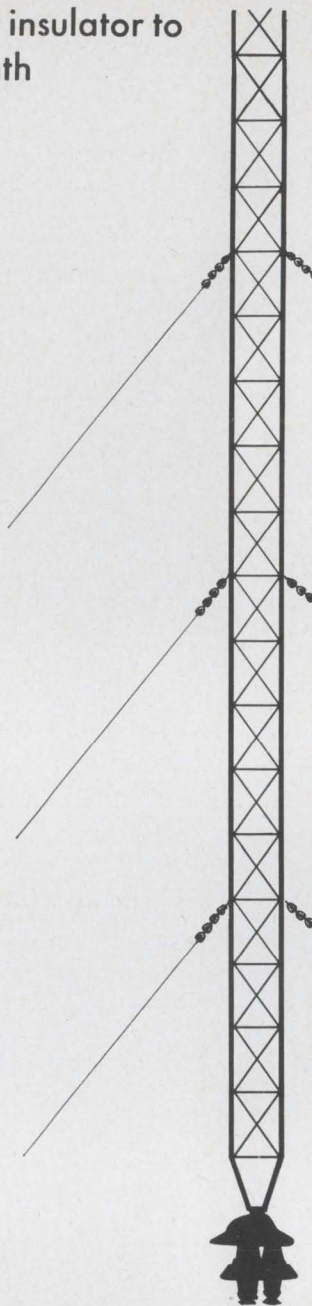

Foolproof. Front-panel design offers uncomplicated control.

of a ruler.

The frequency markers of the instrument are sharp and very narrow to achieve exceptional visual quality. Amplitude of the markers is adjustable so that the markers can be used at various signal levels and at any sweep range. The markers may also be tilted to stand out on the skirts of filters and other frequency sensitive devices.

The instrument offers a broad band swept or stable frequency operation from 10 Mhz to 1 gigahertz. Signal frequency stability and the low incidental frequency modulation will permit it to be used in place of mechanically tuned signal generators.

The model 6151 will be available for delivery in June in either rack or bench mounting. Price will be about \$1,300 for the simplest combination. This basic unit would have an operational frequency range of 10 Mhz to 250 Mhz and would exclude the comb generator, which will sell for \$200.

Alfred Electronics, Palo Alto, Calif. [378]

New instruments

A printer output when it counts

Input frequency or event total is expressed in BCD and by a digital display

More than a year ago, Monsanto Electronics developed a counter/timer, the 100A, that sold for under \$600. The company wanted to make electronic counters available to engineers and technicians who could afford only the less-accurate

24 hours after we hear from you, you'll hear from us.

Name _____

Address _____

City _____ State _____ Zip _____

College _____

Degree _____ Year _____

I am interested in the following type of assignment:

I have had professional experience in the following area(s):

I have had a total of _____ years' experience.

AIRMAIL COUPON NOW TO:
Mr. Robert A. Martin
Head of Employment, Dept. 38
Hughes Aerospace Divisions,
11940 W. Jefferson Blvd.,
Culver City, California 90230

Hughes — where the hiring action is

300 aerospace engineers needed.
Electro-Optical Engineers
Aeronautical System Engineers
High-Frequency Design Engineers
Space Systems Engineers
Guidance and Control Engineers
Missile Systems Engineers
Component Engineers and
many other disciplines.

Current projects include:

PHOENIX, TOW,
AIM-47A / AIM-4E Missile
Systems • VATE
Automatic Checkout Equipment
COMMUNICATIONS
SATELLITES like Lani
Bird • APPLICATIONS
TECHNOLOGY SATELLITES
• and dozens of other important
programs and projects.

HUGHES

HUGHES AIRCRAFT COMPANY
AEROSPACE DIVISIONS

*An equal-opportunity employer
(U.S. citizenship required)*

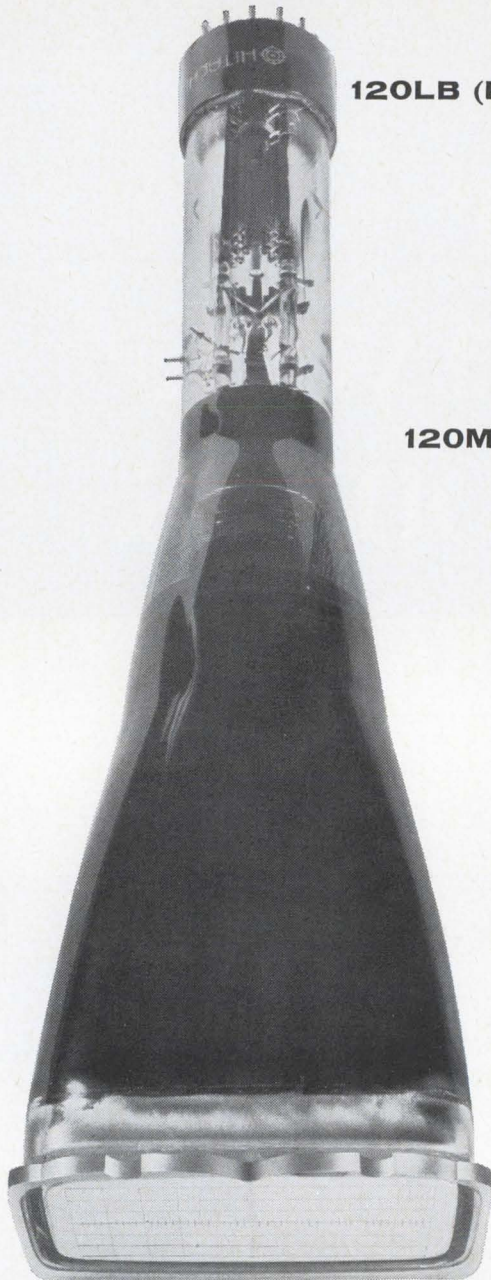

120LB (DC-50 MC)

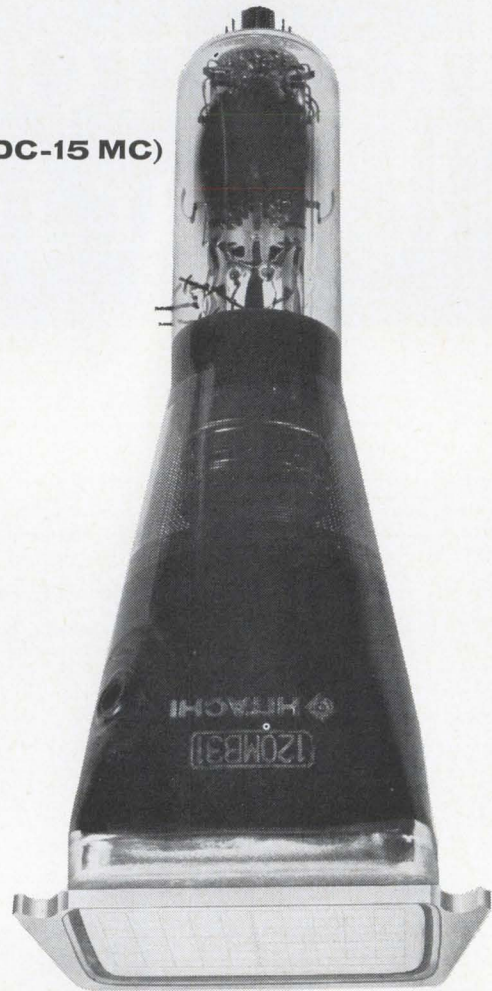

120MB (DC-15 MC)

NEW OSCILLOGRAPH TUBES FROM HITACHI

WHAT THEY HAVE IN COMMON:

These Hitachi tubes are rectangular cathode ray tubes for precision instruments, with electrostatic focus and deflection.

They all use a mesh grid and inside scale, giving them high deflection sensitivity and non-parallax observation.

They're all made by Hitachi — so you know they're good. These two, the 120LB (DC-50 MC) and the 120MB (DC-15 MC) are particularly apt for portable equipment.

ONE MAY BE RIGHT FOR YOUR OPERATION:

Item	120LB	120MB	140LB	Unit
Overall Length	423±7	318±7	466±10	mm
Heater Voltage	6.3	12.6	6.3	V
Heater Current	0.3	0.15	0.3	A
Post Accelerator Voltage	10,000	6,000	15,000	Vdc
Accelerator Voltage	2,000	1,400	2,400	Vdc
Useful Scan	80×48	80×64	100×60	mm ²
Deflection Factors				
Horizontal	12—16	11—16	12—18	V/cm
Vertical	4—7.5	6—10	3—5.5	V/cm

And if these aren't exactly what you're looking for, see the others —including our vidicon tubes and our cathode ray tubes for industry—from Hitachi, the people who make exacting quality available for less.



HITACHI SALES CORPORATION: 333 N. Michigan Ave., Chicago, Ill. 60601, U.S.A. Tel: 726-4572/4; 48-50 34th St., Long Island, N.Y. 11101, U.S.A. Tel: 361-3090; HITACHI, LTD., DUESSELDORF OFFICE: 4 Duesseldorf, Graf Adolf Strasse 37, West Germany Tel: 10846

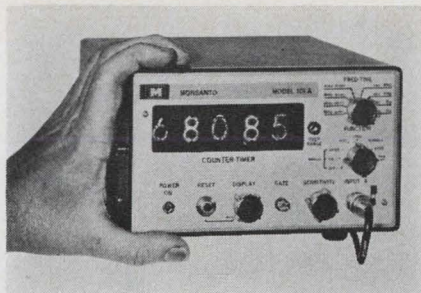

How many? The Model 101A counter/timer distinguishes between signals separated by 10 microseconds and measures up to 12.5 Mhz.

mechanical devices.

The 100A was well received, but customers started demanding something a bit more fancy. So Monsanto is now bringing out the Model 101A, which features a binary-coded decimal output for use with a printer, and an external-standard capability.

Ratios. The 101A measures frequencies from 5 hertz to 12.5 megahertz. It accepts a wide variety of waveforms, and can continuously measure the ratio of the frequencies of two inputs from 1:1 up to $10^5:1$.

Used as a counter, the 101A responds to signals of periods from 10 microseconds to 10^6 seconds, and can distinguish between two signals separated by only 10 microseconds. The 101A works for both cyclic and random signals. So it can count the regular rotations of a crankshaft or the spontaneous emissions of radioactive material.

A crystal-controlled clock is used in the 101A to supply a standard frequency. But external standards from 3 hz to 5 Mhz can be substituted.

Either end. The output of the counter is displayed by five numerical tubes, and the decimal point is automatically positioned. The time base can be shifted to display portions of the output. For example, if measurements are being made in the megahertz range, the user can choose to display the first five or last five digits of the output. Display time can be set from 0.1 to 10 seconds.

The unit can be used over a temperature range from 0°C to 50°C. It operates on either 115 or 230 volts, and costs \$675.

Monsanto Electronics Technical Center, 620 Passaic Ave., West Caldwell, N.J. 07006 [379]

HD

DPDT 2AMP 28VDC res.

Coil: 200 MW
 Typical: 26.5VDC 1000 ohms
 Ambient Temp: -65 to +125°C
 Vibr: 20G up to 2000 Hz
 Shock: 50G, 11 msec
 Mil-Spec: MIL-R-5757

1

DPDT 2AMP 28VDC res.

Coil: 200 MW
 Typical: 26.5VDC 700 ohms
 Ambient Temp: -65 to +125°C
 Vibr: 20G up to 2000 Hz
 Shock: 50G, 11 msec
 Mil-Spec: MIL-R-5757

520

6PDT 2AMP 28VDC/115VAC res.

Coil: 700 MW
 Typical: 26.5VDC 240 ohms
 Ambient Temp: -65 to +125°C
 Vibr: 15G up to 2000 Hz
 Shock: 50G, 11 msec
 Mil-Spec: MIL-R-5757

CC

DPDT 3AMP 28VDC res.

Coil: 250 MW
 Typical: 26.5VDC 600 ohms
 Ambient Temp: -65 to +125°C
 Vibr: 20G up to 2000 Hz
 Shock: 50G, 11 msec
 Mil-Spec: MIL-R-5757

7

DPDT 10AMP 28VDC/115VAC res.

Coil: 565 MW
 Typical: 26.5VDC 300 ohms
 Ambient Temp: -65 to +125°C
 Vibr: 20G up to 2000 Hz
 Shock: 50G, 11 msec
 Mil-Spec: MIL-R-5757 & MIL-R-6106

8

4PDT 10AMP 28VDC/115VAC res.

Coil: 565 MW
 Typical: 26.5VDC 300 ohms
 Ambient Temp: -65 to +125°C
 Vibr: 30G up to 3000 Hz
 Shock: 100G, 10 msec
 Mil-Spec: MIL-R-5757 & MIL-R-6106

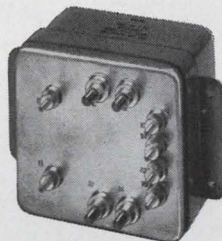

8200

DPNO 100AMP 28VDC/115VAC res.

Coil: 3 W Typical: 24VDC 50 ohms
 Ambient Temp: -70 to +125°C
 Vibr: 15G up to 500 Hz
 Shock: 70G
 Mil-Spec: MIL-R-6106

Miss Foster knows her relays . . . CONELCO is the new name for the complete line of Price Electric and Hi-Spec military and industrial relays. If it's for military power switching, up to 150 amps, specify CONELCO Relays.

Send for complete data. If you are in a hurry, call 301/663-5141, Price Electric Corporation, Frederick, Maryland 21701, TWX: 710/862-0901

PRICE ELECTRIC CORPORATION

CONELCO
 SWITCHING DEVICES
 HI-SPEC ELECTRONICS CORP.

“Miss Foster...
 why are you
 filing Price Electric
 and Hi-Spec
 power switching relays
 under C?”



No matter how they measure it, the Honeywell 7600 checks out as the best value in the tape field!

From the way people are trying to copy it, you'd think our 7600 is the hottest tape system around. It is!

Compare the specs on our 7600 with those of some recent competitive machines and you'll notice something very interesting. A small revolution is taking place in the magnetic tape system industry. We started a trend. And now, others are following!

The Honeywell 7600 Series bears copying. Its modular design lets you specify the system you need now, and permits future expansion without costly modifications as your requirements grow. Easily maintained plug-in electronics give you a wide selection of bandwidths, and mechanical options include a choice of 10½" or 15" transport.

With its low flutter, skew, and time base error and high S/N ratios, the 7600's signal fidelity can't be matched by comparably priced units. And, due to its mechanical simplicity (no belts, pulleys, gears, or pinchrollers) and inherent reliability, our com-

petitors are going to have a rough time building a machine that will operate as economically as the 7600. It's priced lower than you'd expect, too, giving you more performance for your money than any other tape system!

The great 7600 Series is another example of how Honeywell's broad line, backed by local sales and service, can provide the *precise* solution to your instrumentation problems. For a demonstration, call your local Honeywell Sales Engineer. For technical literature, write: Honeywell Inc., Test Instruments Division, P.O. Box 5227, 4800 E. Dry Creek Rd., Denver, Colorado 80217.

Honeywell

Honeywell engineers sell solutions

See us at the IEEE Show - New York Coliseum, March 18-21. Booths 2G39 to 2G49.

Circle 208 on reader service card

New Industrial Electronics Review

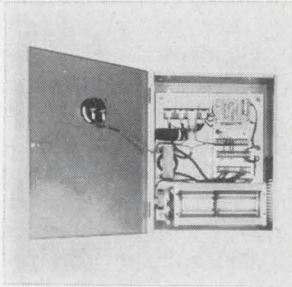

SCR power controls for furnaces, heaters, transformer primaries and inductive loads are available in 4 standard single-phase a-c models up to 50 kva, and special modifications including 3-phase designs, larger sizes and d-c outputs. All feature transient-free operation and drive a broad range of impedances. Nothelfer Winding Laboratories Inc., Box 455, Trenton, N.J. 08603. [421]

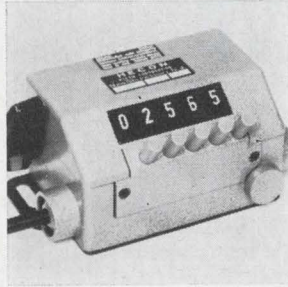

Push-button presettable pre-determining counter series UE083 features rapid reset and a ball-bearing drive capable of handling in excess of 6,000 rpm continuously. Positive electrical knockoff is assured. A spdt switch can be wired to control numerous manufacturing processes. The counter operates from -40° to $+140^{\circ}$ F. Hecon Corp., Box 247, Eatontown, N.J. 07724. [422]

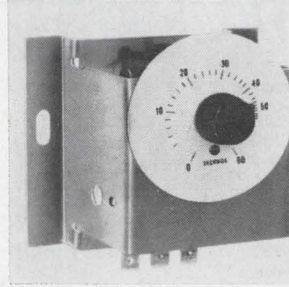

Electronic timer CES98 is a 1- to 60-sec unit that replaces many motor driven time delay relays. It is set by a single knob and has a calibrated dial that is easy to read. Contact rating is 5 amps at 120 v a-c or 28 v d-c resistive. Repeat accuracy is $\pm 5\%$ at nominal voltage and normal room temperature. Eagle Signal Div., E.W. Bliss Co., 736 Federal St., Davenport, Iowa 52808. [423]

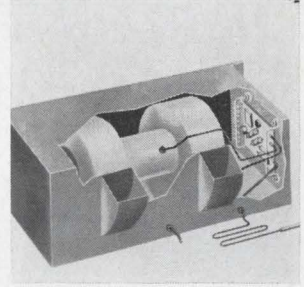

To maintain temperatures within electronic enclosures, a temperature controller employs a thermodynamic probe and transistorized circuitry that automatically modulates the speed of a blower motor. The control compensates for higher altitudes by increasing the flow of air. Temperature range is 80° to 90° F. McLean Engineering Laboratories, Princeton Junction, N.J. 08550. [424]

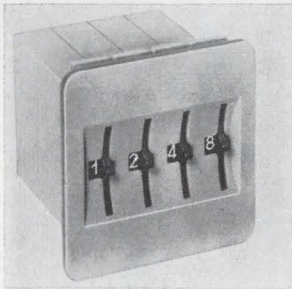

Thumbwheel switches for use in single-, double-, or 4-pole applications offer convenient preset control of digital information. They may be used for binary decimal coding or decoding, or for straight decimal circuitry. A built-in decoding diode gate in the rotor eliminates the need of mounting small diodes. A.W. Haydon Co., 232 N. Elm St., Waterbury, Conn. 06720. [425]

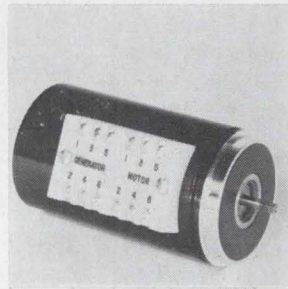

Instrument servo motor-tachometers size 21 offer a fundamental null value of less than 25 mv. The tachometer output exceeds 6.5 v/1,000 rpm. Available in a range of ratings, up to 10 w maximum output, the units are totally encapsulated with an integral servo motor and tachometer arrangement, giving lower temperature rises. Duratron Corp., 154 W. 14th St., N.Y. [426]

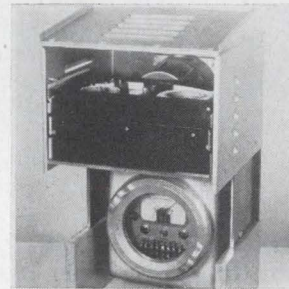

Hydrogen sulfide analyzer 722AEX provides continuous monitoring and automatic alarm with shutdown. The instrument senses the gas by chemical action on lead acetate sensing paper. H_2S produces a color change that is read by a photocell. The signal operates an alarm relay or provides voltage for process control. Houston Atlas Inc., P.O. Box 19035, Houston, Texas 77024. [427]



Reflex photoelectric control series 7201A is a self-contained unit with dpdt plug-in relay output that can operate at up to 1,200 actuations per minute on conveyor lines and other control installations. Range of the unit is 10 ft with a 3-in. retroreflective target. Dimensions are $7\frac{7}{8}$ x $2\frac{1}{2}$ x $3\frac{3}{4}$ in. Price is \$43. Automatic Timing & Controls Inc., King of Prussia, Pa. 19406. [428]

New industrial electronics

Rate counter talks user's language

A selectable period adds meaning to events-per-unit-time measurement pulses

By adding an adjustable time base to rate-controller circuitry, the Electronic Instruments division of Beckman Instruments, Inc., has designed an industrial counter that displays in engineering units.

The rate controller consists of two accumulators for each of four

display decades—one preset for high limit and the other for low. If an operator wishes to maintain a 400-hertz line frequency, for example, he sets the high limit at 0401 and the low at 0399. Relay contacts driven from the logic circuitry operate warning lights for

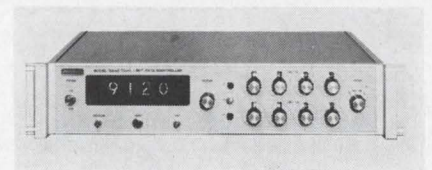

High or low. Two groups of decade dials set alarm limits.

higher or lower frequencies. They can also be used in a feedback loop to vary motor/generator speeds to keep the frequency between the limits.

Gated for half. But if the industrial user wants to control revolutions per minute, or liquid flow, or

IT TAKES A LOT OF ADJECTIVES TO DESCRIBE THE SPACE VII..

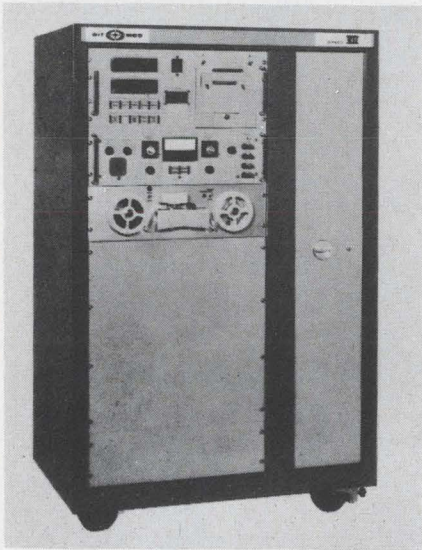

★ Adjectives like FAST, ACCURATE, FLEXIBLE, RELIABLE, VERSATILE, ECONOMICAL and MANEUVERABLE. If you doubt for one minute that a humble wiring system analyzer from the middle west can live up to these labels, then try testing this tester for yourself. It was designed and developed (after thorough lab and field testing) especially to meet today's demand for speed, accuracy, versatility and economy. DIT-MCO's Space VII operates on the fully automatic tape input and printout concept. Design and construction are of the highest quality. The "total speed" function of the Space VII gives you faster overall test time because of adaptation and hook-up ease, rapid tape feed, speed of test plus speed of fault determination time, scan time, error recording and printout.

WITH THIS ADVANCED SYSTEM you can test up to 2,000 terminations at a rate of more than 400 per minute! Electronic engineers who've tried it, call DIT-MCO's Space VII the best intermediate size testing system on the market. We won't disagree.



DIT-MCO INTERNATIONAL
A DIVISION OF XEBEC CORPORATION
5612 BRIGHTON TERRACE
KANSAS CITY, MISSOURI 64130
TELEPHONE (816) 363-6288 TELEX 42-6149

IT'S NO WONDER APPROXIMATELY 90% OF ALL MAJOR MANUFACTURERS IN THE COMPUTER AND AEROSPACE INDUSTRIES ARE SATISFIED USERS OF DIT-MCO SYSTEMS.

Circle 210 on reader service card

Our little black book has over 100,000 phone numbers.

You never had a black book like it. Over 1,500 pages. And those phone numbers! More than 100,000 telling you who to call/where to go, for the over 4,000 different product categories listed and advertised in the yellow pages of the Electronics Buyers' Guide.

It's the industry's one-stop shopping center that lets you find the products and services you need quickly. You can depend on EBG.

Electronics Buyers' Guide

A McGraw-Hill Market Directed Publication,
330 West 42nd Street, New York, N.Y. 10036

... variable time base scales the input ...

some other rate not obligingly measured in cycles per second, he simply adjusts the reading-time period.

Revolutions-per-minute is an example. A tachometer coupled to a rotating shaft may produce 120 pulses per rotation. If the shaft is rotating at 6,000 rpm, or 100 per second, the accumulators would ordinarily count to 12,000 in one second.

In this case, the accumulators must be gated to count for only a half-second, so that the reading is 6,000, the desired display value. Then the readout can be interpreted as revolutions per minute.

Back panel switches on the Beckman model 6246 allow a wide range of scaling. The time base can be varied from 10 microseconds to 99,990 μ sec in 10- μ sec steps; from 100 μ sec to 999,900 μ sec in 100- μ sec steps; and from one millisecond to 9,999 msec in 1-msec steps.

The time base is derived from a 200-kilohertz crystal oscillator 10 times more accurate than the plus-or-minus one digit of the four-place readout. The 200-Khz is divided down to 100-Khz before feeding the group of time-base dividers. Their selected output goes to one input of an AND gate. The measured

Specifications

Measurement rate (events per unit time)	3 Hz to 200 KHz (sine waves) 0 Hz to 200 KHz (pulses)
Level	0 to +5 volt level change for duration of measurement condition
Contact closure	Form C (break before make) to remain in existing state until measurement condition changes
Time-base selectors	4 rotary switches 1 through 9,999 and 1 rotary switch for 1, 10, 100 multiplier
Display storage	Display remains constant unless input parameter changes
BCD output	1-2-4-8 BCD at rear panel connector. Binary 0 = 0 to +0.4 v, 0 = 5 ma current sink; binary 1 = +4.5 to +5.5 v, 0-1 ma current source. Print command logic change from 0 state to 1 state for 25 microseconds following gate closure from any gate control.
Power	115 v a-c \pm 10%, 50 to 400 Hz; internal jumper provided for 230 v operation.

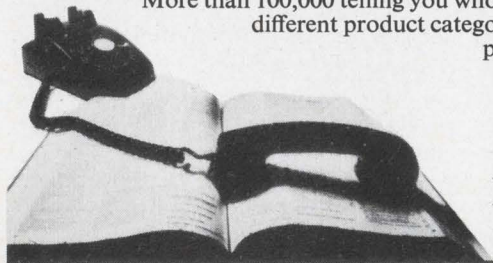

can't get away for evening classes?



here's a practical way to avoid technical obsolescence

Are irregular hours, travel and family obligations keeping you from attending classes—even though you worry about becoming technically obsolescent? Check into the Special Programs in Electronics for Engineers developed by CREI, the Home Study Division of the McGraw-Hill Book Company.

These are not simply courses, but comprehensive programs in advanced electronics offering major electives in such fields as:

Communications Engineering, Aeronautical and Navigational, Television Engineering, Automatic Control Engineering, Missile and Spacecraft Guidance, Radar and Sonar Engineering, Nuclear Instrumentation and Control, Computers.

Industry-recognized CREI Programs make it possible for you to catch up on new developments in electronics through study in your own home, at your own pace.

your own schedule. Free book gives complete information and details of technical material covered. For your copy, mail coupon below or write: CREI, Home Study Division, McGraw-Hill Book Company, Dept. 1812G, 3224 Sixteenth St., N.W., Washington, D.C. 20010.

Founded 1927



Accredited Member of the National Home Study Council



CREI, Home Study Division, McGraw-Hill Book Company
Dept. 1812G, 3224 Sixteenth St., N.W.
Washington, D.C. 20010

Send me free brochure describing CREI Programs in Electronics for Engineers.

NAME _____ AGE _____

ADDRESS _____

CITY _____ STATE _____ ZIP CODE _____

COMPANY _____

TITLE _____

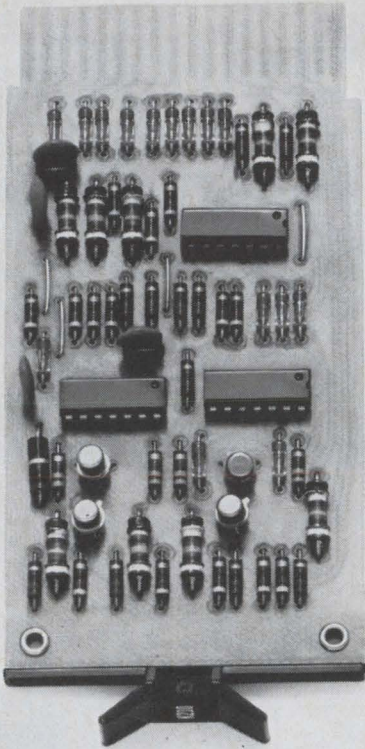

K Series Modules are Built Tough—Used Easily!

K Series solid state modules are built for a tough environment.

A glass-epoxy board so strong it won't break even if you step on it. No moving parts, of course, and all outputs are short-circuit proof.

And K Series modules are easy to use.

Only a few different module types do the vast majority of industrial or laboratory control functions. A lot of logic is on the circuit cards,

and minimum wiring makes all the connections. In the K220, only two wires per decade are needed to interconnect into a BCD up/down counter. A companion module is available to display the contents of the register. K220 sells for \$52.00.

K Series modules have consistent pin assignments so that you don't have to look at the drawing all the time.

They're noise-immune, shielding becomes no problem; they work with 115 ac pilot circuits (indicator lights are on all AC pilot circuits). A test probe is available for troubleshooting and adjustment without a scope. The hardware is designed to fit NEMA and standard 19" enclosures — and, of course, the modules plug in.

DIGITAL is the leading producer of modules for industrial and laboratory applications. These and other series are fully described in our Industrial Control and Logic Handbooks. Write for free copies.

digital

MODULES • COMPUTERS

Maynard, Mass. Tele: (617) 897-8821

... output relays can trigger bell ...

signal is the other input to the gate. When the time-base count reaches its preset limit—half a second, in the case of the tachometer—the gate turns off and further measurement pulses are blocked.

Three lights on the front panel let the operator know if he is within limits. The top bulb lights if the rate is high, the bottom if low, and the center if on target. Bells or buzzers, too, can be connected to the output relays to warn of out-of-tolerance frequencies.

Beckman Instruments, Inc., Electronic Instruments Division, 2400 Wright Ave., Richmond, Calif. 94804 [429]

New industrial electronics

It's in the cards to start new line

Component maker steps from logic-product work into numerical control

Why would a successful maker of electronic components and digital logic cards want to get involved in the crowded numerical control market?

"The NC field is just being scratched," says John Hemmert, manager of the digital applications section of the Cambridge Thermionic Corp. "We've developed the

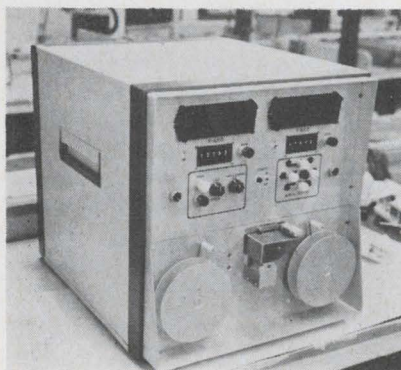

Mil by mil. Point-to-point positioner can be programed to move a table in one-mil steps.

Why MARYLAND?

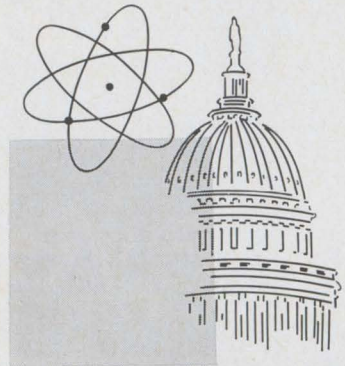

Proximity to federal agencies in Washington, D.C. affords the unique advantage of constant personal contact with government officials working with science-oriented industry. Such contact is an increasingly important locational criterion.

No other state is as convenient to as many Federal agencies as Maryland. For example, Maryland's major government scientific installations include NASA, AEC, NIH, the National Bureau of Standards, plus some 20 others.

Are there other reasons why R&D activities and science-oriented industries should consider locating in MARYLAND?

Yes... emphatically!

The availability of personnel, particularly engineers and scientists, is recognized as a chief criterion governing the location of any science-oriented industry.

There are almost 30,000 scientists and over 25,000 engineers living and working in Maryland and the District of Columbia.

There are 39 four-year colleges and universities in Maryland and the District of Columbia. Graduate and post-doctoral programs considered most significant to research and science industry are available.

Shouldn't you locate in MARYLAND?

Get All The Facts.

MARYLAND DEPARTMENT OF ECONOMIC DEVELOPMENT DIVISION E

State Office Bldg. • Annapolis, Md. 21404

Write, Wire Or Phone Collect

Now—save vital space with 30-gauge hook-up wire



General Electric saved space and weight in wiring the back panels of its GE-PAC® Process Computers by using 30-gauge hook-up wire insulated with Kynar.

... Made with
tough, durable
Kynar®

Thirty gauge wire is nothing new . . . but what is new is wire insulated with Kynar, the fluoroplastic that's tough. It has twice the cut-through resistance of other fluoroplastics, cuts and strips smoothly, takes 180° bends without splitting, stands up to the punishment of automatic wiring machines or semi-automatic hand tools.

What's more, Kynar resists cleaning solvents, won't degrade with age, and operates at temperatures from -80° to 300°F.

For samples of 30-gauge wire insulated with Kynar plus information on how you can save space, reduce weight, write Plastics Department, Pennsalt Chemicals Corporation, 3 Penn Center, Philadelphia, Pa. 19102.

Kynar...the fluoroplastic that's tough!





“Smiling” Sam Price just stopped smiling.

“Smiling” Sam Price hoped he’d find a goof in Trygon’s new Liberator Sub-Rack Power Supplies. Once upon a time, he’d found a bug in a rack model which made him a hero among the Twelve Cranks on Pleasant Avenue. Since then, Sam has had to do without that thrill. Everything he checks out—checks out! As usual, at Trygon.

Liberator Sub-Racks are a new concept in system power instrumentation, with the versatility of half-rack and quarter-rack, modules and metered models. Rack adapters let you mix and match units to get up to eight different outputs in a 19” rack width.

Just like the full-rack Liberators, the new sub-racks provide the ultimate in minimum size at lowest possible cost. With 24 models in wide slot voltage ranges from 2.5-4.5 VDC to 22-32 VDC and higher. Output current levels from 1.4 amps to 25 amps. Plus: .01% regulation/.5mv ripple/3mv P-P noise/.03% stability/extremely low output impedance/MIL-spec performance/adjustable overvoltage protection.

And every Trygon Liberator Sub-Rack Power Supply comes off the line under “Smiling” Sam’s baleful eye. With his tears wiped off, of course.

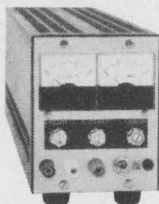

Trygon Power Supplies

111 Pleasant Avenue, Roosevelt, L.I., N.Y. 11575
Trygon GmbH 8 Munchen 60, Haidelweg 20, Germany
Write for Trygon 1968 Power Supply Handbook.

... high speed unit for labs planned ...

capability of building numerical control units with our logic cards. And by building these systems, we become a testing ground for our own logic products.”

Cambridge will bring out a line of four solid-state numerical control units, designed to be used with x-y tables to form a positioning system. The lowest-priced positioner will be a bench-top unit that moves a table in discrete steps. Hemmert says this point-to-point unit will not be “dramatically different” from its competitors, but Cambridge wants to offer a complete line.

The company expects to have an edge with its continuous, or contour positioner. This unit will use a technique, centered on a digital differential analyzer, to convert digital input commands to analog positioning signals. The analyzer approach, according to Hemmert, will allow Cambridge to sell its unit at the lowest price in the market.

The line will be completed late this year when two machines, each capable of performing complex operations and being controlled by a computer, are introduced. One will be a low-speed, high-power unit for industrial use, and the other a high-speed unit for laboratory work.

Preview. At the IEEE show this week, Cambridge is exhibiting a prototype of its discrete-step model. It moves an x-y table in increments as small as ± 0.001 inch at a maximum rate of 2,000 points per second, and can also move the table up to 10 inches along both the x and y axes.

A positioning routine can be programmed on paper-tape, and read by the machine. Or the table can be positioned by using front panel switches. Position is digitally displayed at all times.

Hemmert says mechanical paper-tape readers will be standard, but the company is considering offering photoelectric readers for high speed units.

Prices will range from \$5,000 to \$50,000.

Cambridge Thermionic Corp., 445
Concord Ave., Cambridge, Mass. 02138
[430]



Side-tracked?

If your career has been side-tracked then consider a switch to Memorex. Our standards are high, but so are the rewards... in creative freedom, salary, and opportunity. Current openings include:

PROJECT ENGINEER

(Recording) EE or Physics degree plus 5 years' experience. Must have knowledge of the processes of magnetic recording.

DEVELOPMENT ENGINEER

BSEE plus 2 years' experience with previous logic design experience preferred. Must be digital oriented.

ELECTRONIC ENGINEER

(Senior) Digital oriented with knowledge of production equipment. BSEE required with mechanical experience desired.

ELECTRONIC ENGINEER

(Solid State Circuit Design)

To design solid state digital and analog circuits. BSEE with 2-5 years' experience.

Please send your resume to:
Professional Employment Office,
1180 Shulman Avenue, Rm. 4
Santa Clara, California 95050.
An Equal Opportunity Employer.

MEMOREX
CORPORATION



and qualify for a FREE trip to a New Year's bowl game of your choice

Recognize this team? Know what big league outfit they just joined? Any idea what they can contribute to your MOSFET requirements? Answer these questions and you'll be a winner!

RULES: If you specify or purchase MOSFET devices you're eligible. Place the answers to the two questions listed below in the famous dotted box. Correct answers will get you a free product catalog with detailed specifications on the MOSFETs this team has already developed.

This will automatically qualify you as a contestant for additional prizes and the grand prize of a three-day all-expense holiday for two, plus a pair of choice ducats to the 1969 New Year's football bowl game of your choice. And your transportation will be provided from any point in the U.S.A.

QUESTIONS:

One: What large organization did the team come from?

Clue: They didn't play for Stanford University but they were located close-by before they moved South.

Two: What well-known electronics firm is this team now producing MOS field effect transistors for?

Clue: If the big H on their jerseys doesn't give them away, then look up the article in the Jan. 1, 1968 edition of Electronic News.

No purchase of any kind is required. All entries for qualification must be postmarked not later than April 5, 1968 and received by April 15, 1968. Employees of the sponsoring firm, its special sales representatives, and its distributors are not eligible. Contest is void where prohibited by law or by participant's company policy.

Just place your answers in the dotted box or on your letterhead and mail to MOSFETs, P. O. Box H, Newport Beach, California 92663. NOTE: Be sure to include your title and return address. Good Luck!

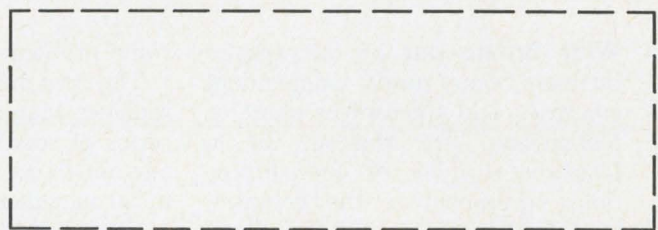

Please cut out along the famous dotted lines.

New Subassemblies Review



Load cell readout DS-100-T21X provides readout in pounds, kilograms, or other engineering units when connected to a strain gauge transducer. Channels 1 to 4 plus summing are standard. Sensitivity is 1 mv/v to 3.5 mv/v, adjustable. Speed is 2 to 20 readings/sec. Price is from \$1,225 complete. Doric Scientific Corp., 7969 Engineer Rd., San Diego, Calif. 92111. [381]

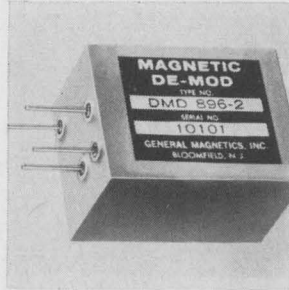

Solid state magnetic demodulator DMD 896-2 converts phase reversing a-c signal voltages into phase detected, polarity reversing d-c voltages. It gives 1 v d-c per 1 v a-c and provides 10 kilohm impedances on signal and reference windings. It provides less than 2% absolute linearity from 0.1 to 10 v output. General Magnetics Inc., 135 Bloomfield Ave., Bloomfield, N.J. [382]



High-resolution, electrostatically focused crt WX30851P11—made up in an assembly of matched tube, yoke, and shield—provides a 0.00045-in. diameter spot size for aerial photographic recording and other single-line scan data-processing applications. The ruggedized 11¼ lb package is ready to install and operate. Westinghouse Electronic Tube Division, Elmira, N.Y. 14902. [383]

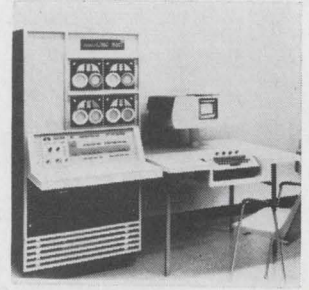

Laboratory instrument computer Micro-Linc-300 offers buffered tape, which permits parallel processing while tape instructions are being carried out. A rapid-access-to-memory feature, in conjunction with buffered tape, permits data logging at a 6,000-character/sec rate. Price is under \$50,000; delivery, 90-120 days. Spear Inc., 335 Bear Hill Rd., Waltham, Mass. 02154. [384]

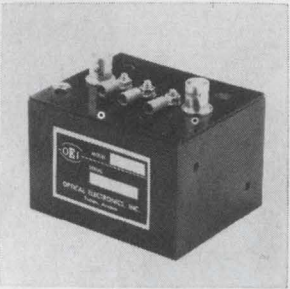

Bipolar antilogarithmic amplifier model 349 is a versatile tool for generating a wide variety of non-linear transfer functions. It also has application in data expansion. It has a frequency response of d-c to 10 khz. Dynamic range is 80 db. Price is \$240 each in quantities of 1 to 9; delivery, from stock to 3 weeks. Optical Electronics Inc., P.O. Box 11140, Tucson, Ariz. 85076. [385]

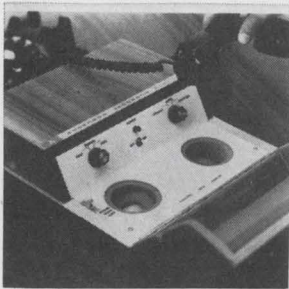

Acoustic data coupler 260 is for sending and receiving data between a remote terminal and a time-shared computer using any ordinary telephone. The unit is designed to handle a bit rate of approximately 300 baud. It is used at a 110-baud rate when used with a model 33 or 35 Teletype. Price is \$570. Anderson Jacobson Inc., 2235 Mora Drive, Mountain View, Calif. [386]

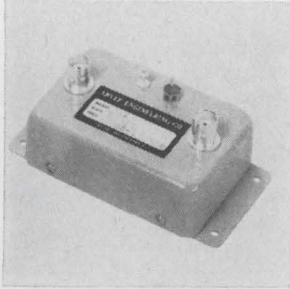

Wideband amplifier model 311 covers 20 hz to 150 Mhz. It has 20 db gain and less than 50 μ v equivalent input noise. It can drive 1 v peak-to-peak into a 50-ohm load with less than 1 db gain compression. Input impedance is also 50 ohms. The unit employs BNC connectors on a drawn aluminum housing 4 x 2½ x 1½ in. Arvee Engineering Co., Box 3759 Torrance, Calif. [387]

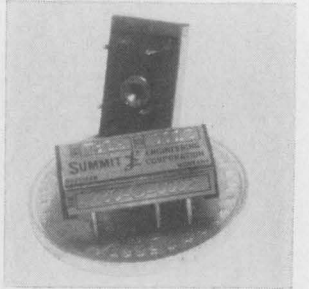

Double balanced modulator model 760A Mini-Modem finds application in SSB modulator/demodulators, frequency synthesizers, and broadband frequency converters. Specifications include 50 db balance and 6 db conversion loss. The unit is usable over a 3-decade frequency range from 100 khz to 100 Mhz. Price is \$30 to \$40. Summit Engineering Corp., Box 115, Bozeman, Mont. [388]

New subassemblies

Receiver tuned to needs of new nations

High-frequency unit designed for unskilled operators; basic two-channel model can be adapted to special jobs

With Britain out of the empire business, many newly independent countries find themselves short of technicians. The Marconi Co., a longtime supplier of communications equipment to the colonies, has developed a high-frequency receiver that, it says, will ease

some problems of that shortage.

The new unit, called the Hydrus, replaces Marconi's 12-year-old HR series of receivers. The Hydrus is one-fourth as large and has a 1.5 to 30 megahertz range.

Four bands. Marconi designed the receiver to be easy to operate

and easy to repair. The frequency range is divided into four bands. The operator selects a band, and then tunes the receiver with a fixed-position switch. Each click is equivalent to a 0.1-Mhz frequency change. The operator then makes a fine adjustment with a dial.

An automatic frequency control system allows the Hydrus to lock onto signals that drift by as much as 250 Hz. And the automatic gain control operates over a 90-decibel range to control the output to within six decibels.

Most of the receiver circuits are printed on cards. A repairman has direct access to most components

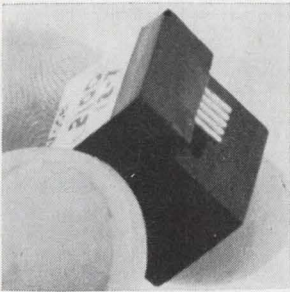

Microminiature, plug-in electrocardiogram amplifiers models 2100 and 2110 are intended for use with low level bio-potentials in the 1-mv range. A 500-kilohm input impedance with a voltage gain of 750 and a frequency response of 0.05 to 150 hz suits the units for other low-level signal amplifications. Signatron Inc., 17124 S. Western Ave., Gardena, Calif. 90247. [389]

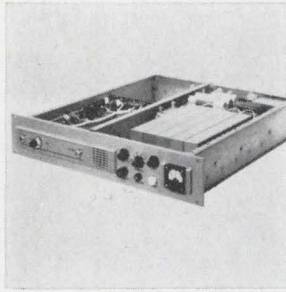

Phase lock vhf receiver model 5454 is a 5-channel, crystal controlled unit. Also designated AN/SMQ-6, the f-m receiver operates within the 125-155 Mhz range, and is designed for high dynamic range and exceptional stability. I-f image rejection is 100 db minimum and over-all system distortion is less than 1%. Data-Control Systems Inc., Danbury, Conn. 06810. [390]

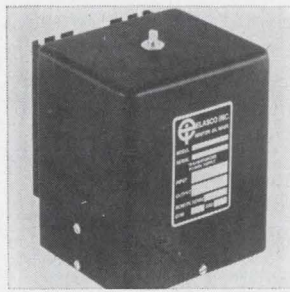

Modular power supplies series FR offer remote sensing and provision for remote programming. Voltage ranges are 0 to 15 and 0 to 30 v with current capabilities of 0.5 or 1 amp. Regulation is 0.01% or 2 mv, whichever is greater. Ripple is 1 mv peak to peak. Stability is better than 0.02% per°C. Prices begin at \$75 each. Elasco Inc., 33 Simmons St., Boston, Mass. 02120. [391]

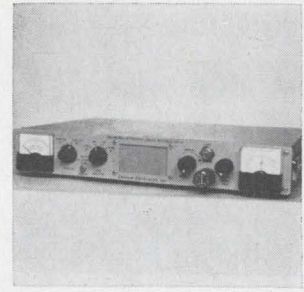

Telemetry receiver model ICR-10 is for ground based, special airborne, mobile and portable application. It uses linear monolithic IC's for all active devices, except the power supply, and features ultralinear agc. The unit has an r-f input frequency of 130-140 Mhz. Dimensions are 2 in. high, 13 in. wide, and 10 in. deep. Defense Electronics Inc., Rockville, Md. 20854. [392]

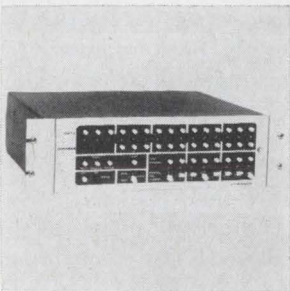

Universal data distributor model YD2 allows interfacing to any general purpose digital computer without regard to data structure or digital logic levels. It provides for timing, control and data distribution of digital inputs. Digital data of up to 15 bits may be transferred at rates of up to 500 khz. Adage Inc., 1079 Commonwealth Ave., Boston, Mass. 02215. [393]

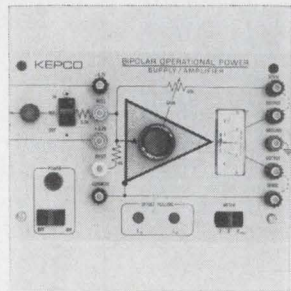

Bipolar power supply BOP 36-5M is capable of smooth control right through zero from positive to negative voltage with no crossover distortion. It is rated ± 36 v d-c ± 5 amps continuous duty. The unit is terminated in an operational patch panel, offering complete access to the output, common, null and reference terminals. Kepco Inc., 131-38 Sanford Ave., Flushing, N.Y. 11352. [394]

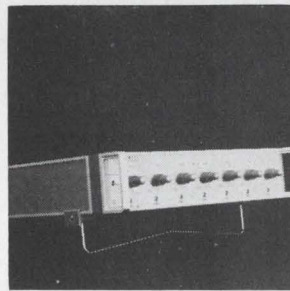

Signal conditioning amplifier unit Accudata 117 increases the versatility of oscillographic and tape recording instruments. It is a multichannel, direct-coupled, single-ended floating d-c amplifier designed for use with high-speed data acquisition systems. Input impedance is 1 megohm; gain, with vernier, up to 25. Honeywell Inc., P.O. Box 5227, Denver, Colo. 80217. [395]



D-c power supply SC036-50-12S is for general or lab use. It is SCR regulated and provides $\pm 0.25\%$ voltage regulation against line and load changes combined, with less than 1% ripple. It is continuously adjustable from 0 to 37 v d-c and includes $\pm 3\%$ current regulation down to 0 v. Christie Electric Corp., 3410 W. 67th St., Los Angeles 90043. [396]

and cards through the front panels.

In the wilds. The Hydrus will be available in many models. The company says the unit is suitable for use in both remote areas and major communication centers. But Hydrus will probably be used in situations where cables or microwave links are not economical, such as in one or two channel network communication links whose signals are transmitted hundreds of miles over rough terrain. The most likely customers are national communication companies, but Marconi also hopes to sell to oil and trading companies, and the military.

The Hydrus has three basic units—the two-channel receiver, the synthesizer, and the telegraph/telephone unit.

The receiver section contains demodulators, and signal, intermediate and audio frequency amplifiers. The use of field effect transistors in this section accounts for the high linearity of the Hydrus, says the company. Before turning to FET's, Marconi engineers who attempted to build high-gain solid-state receivers were plagued with

True to form. Field effect transistors are used extensively in the receiver to eliminate distortion at high gain.

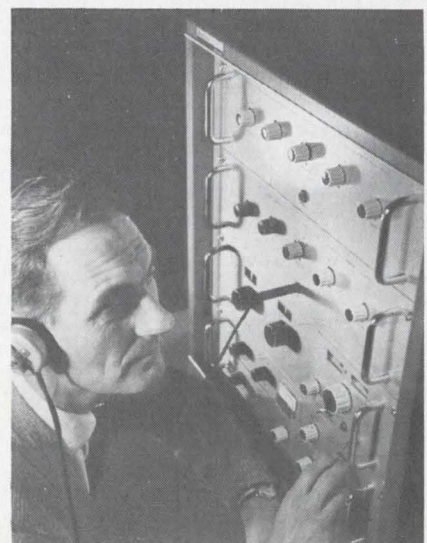

The original lacing tape is still the best . . .

. . . and saves money too!

That's
GUDELACE® 18

You ought to try
a sample . . .

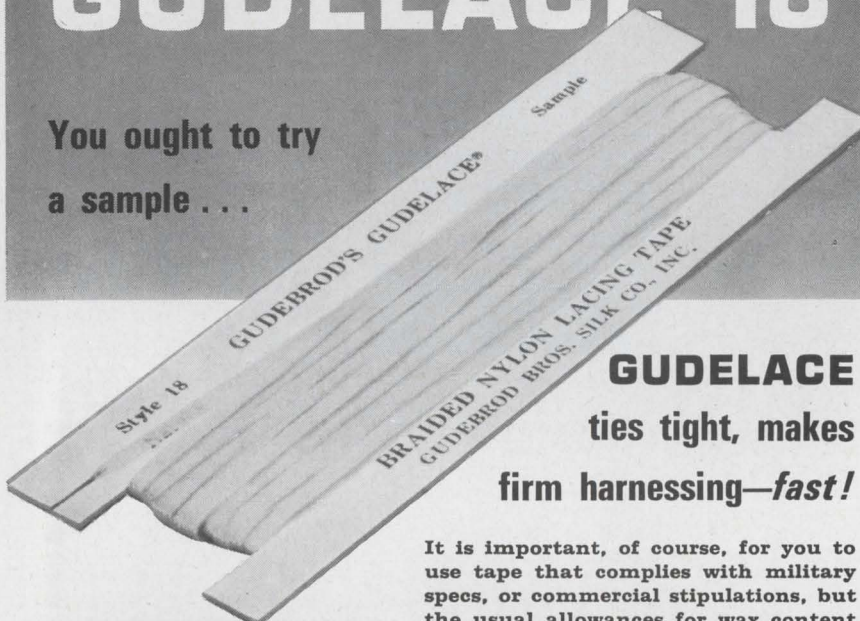

GUDELACE
ties tight, makes
firm harnessing—*fast!*

It is important, of course, for you to use tape that complies with military specs, or commercial stipulations, but the usual allowances for wax content in such specs give no consideration to the best lacing conditions. Gudebrod GUDELACE is made within the specs—BUT, it's made too, for easy handling, tight knotting, firm harnessing. THAT'S WHERE IT SAVES MONEY, in the harnessing operation. GUDELACE, the original harness lacing tape, is manufactured under strict control. Every yard is impregnated exactly the same, exactly right. You can count on that—and on getting better harnessing—fast—with minimum rejects. Why not send for a sample, test it any way you want. Let your harness crew try it. You'll be glad you did! (Remember, the Gudebrod Lacing Tape line includes tape for nearly every special situation—ask for The Product Data Book.)

**NOW—GUDEBROD HAS
TWO AIDS TO FASTER—
BETTER HARNESSING**

**CABLE-LACER®
& GUDE-SNIPS®**

The production tested Cable-Lacer is now reduced in price—only \$9.95. Holds bobbin of tapes—makes tight knots. The palm held GUDE-SNIPS provide convenient tape cutting—using either right- or left-hand, \$3.75.

G **UDEBROD**

GUDEBROD BROS. SILK CO., INC.
Founded 1870
12 SOUTH TWELFTH STREET
PHILADELPHIA, PA. 19107

Electronics Division

. . . synthesizer provides
frequency steps . . .

distortion caused by intermodulation.

With front-panel switches, an operator can attenuate the received signal between 0 and 30 db. Another switch allows the operator to monitor the output of either the upper or the lower sideband demodulator.

The synthesizer contains 2 decade oscillators, a free-running oscillator, frequency dividers, and power supplies.

The decade oscillators are used to supply mixers. One covers a 41.5 to 60.5 Mhz range in one-Mhz steps, and the other a 6.05-to-6.95 Mhz range in 0.1 Mhz steps. The free-running oscillator, tunable from 200 to 300 kilohertz produces the input for the 0.1 Mhz-step unit.

The Hydrus operates from a 24-volt d-c supply or a rectified 45-to-65 hertz, single-phase source.

The user can specify a telegraph unit, a telephone unit, or a combination of both.

Prices for the Hydrus range widely, but Marconi gives \$8,400 as a typical price for a customer in England.

The Marconi Co., Chelmsford, Essex, England [397]

New subassemblies

Portable telephone always gets call

Attache-cased transceiver
operates as a duplexer
eliminating talk switch

Portable radio telephones are getting lighter and more versatile. They're freeing the user of total dependence on a vehicle while promising the option of using the vehicle's battery.

The latest is contained in an 18½ inch-long attache case. It was developed by the CarryPhone Corp., a Los Angeles area firm.

The unit, dubbed the Commander 701, is not the first portable telephone. Another Southern California company, International Mobile Telephone Service Inc., brought out a unit several years ago. The IMTS phone is in a leather flight bag, weighs roughly 17 pounds, and, with an accessory, can be driven by an automobile battery.

Useful all over. The CarryPhone unit weighs 13½ pounds and is totally solid state. It uses 20 integrated circuits, mainly in the decoder, the receiver, and the modulator multiplexer. The Commander can be used in about 98% of continental United States. If there is a repeater tower to hook into within 50 miles of the caller, he can telephone anywhere in the country, or across the world.

But the primary advantage of the 701 over conventional vehicle-mounted mobile radio telephones lies in its portability. With car-mounted phones, users can call only while the vehicle is running. If the instrument needs repairs the car must also be taken to the phone company. If the vehicle needs repairs the phone is out until they are completed. According to the company, the user of a Commander is able to own his unit. Car-mounted mobile telephones are owned by the telephone company and leased to subscribers.

The 701 is operated through standard phone lines and the user has a permanent number. The Commander is FCC-type accepted, and the users must obtain an FCC operating license.

To place a call, the user picks up the receiver and presses the transmit button. This sends a carrier signal that is picked up by the mobile radio phone operator's switchboard where a light flashes. She then connects the call. For incoming calls, a transducer gives off a buzzing noise. A special noise-suppression circuit buffers outside interference. There are no buttons in the receiver to push and the 25-watt transmitter automatically functions once a conversation is initiated.

Voice operated. The Commander operates at 150 megahertz, with a full range of 11 telephone channels and 30 kilohertz spacing between channels. The unit dissipates 3.8 amperes while transmitting, and 100 milliamperes while receiving

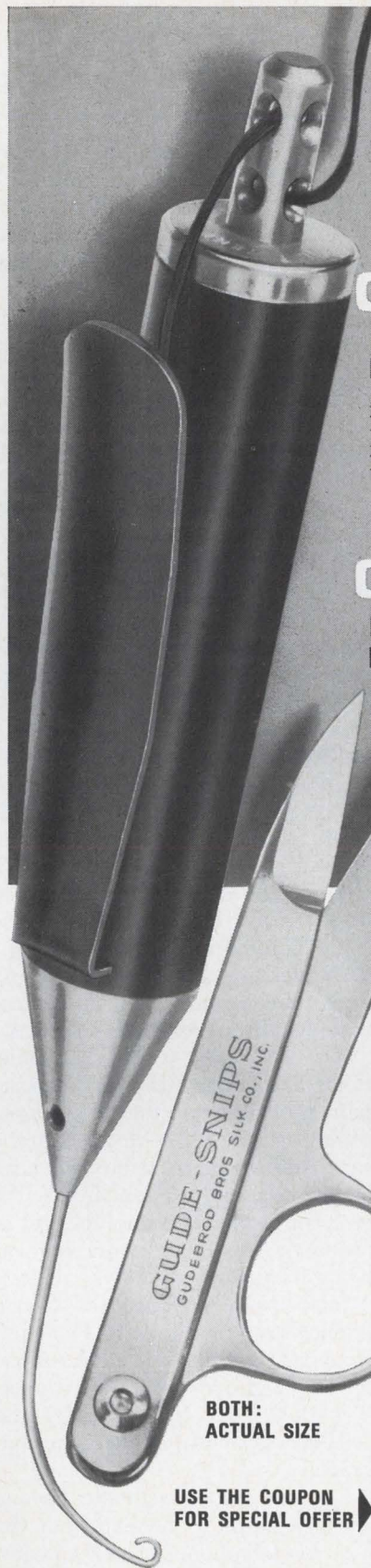

**FOR BETTER, FASTER
WIRE HARNESSING—**

**GUDEBROD
CABLE-LACER®**

NOW REDUCED TO \$9.95
[10% OFF, LOTS OF 50] ea.

Production economics enable Gudebrod to offer the production tested Cable-Lacer at a new low price. Holds bobbin of tape. Facilitates lacing and knotting.

**GUDEBROD
GUDE-SNIPS®**

NEW HANDY TOOL— \$3.75
[\$37.50 IN DOZEN LOTS] ea.

Unique, palm held tape snips. Allow free use of fingers while holding in hand. Right- or left-hand use. Sharp, drop-forged outlery steel blades. Spring action.

Special Offer!

So that you may try them and see the money-saving way they facilitate the harnessing operation—we'll send you postpaid, one Cable-Lacer, one Gude-Snips and a bobbin of lacing tape for just \$14.00. Test for yourself how these tools can help you make better harnesses, faster and for less money.

GUDEBROD BROS. SILK CO., INC.

Founded in 1870
12 South Twelfth Street
Philadelphia, Pa. 19107

Check enclosed, send me, postpaid:

- The special offer of Cable-Lacer, Gude-Snips and bobbin— **\$14.00***
- I just want the Cable-Lacer— **\$9.95***
- Send only the Gude-Snips— **\$3.75***

Name _____

Company _____

Address _____

*In Pennsylvania please add sales tax.

**BOTH:
ACTUAL SIZE**

**USE THE COUPON
FOR SPECIAL OFFER** →

G UDEBROD

Electronics Division

SAVE TIME AND MONEY

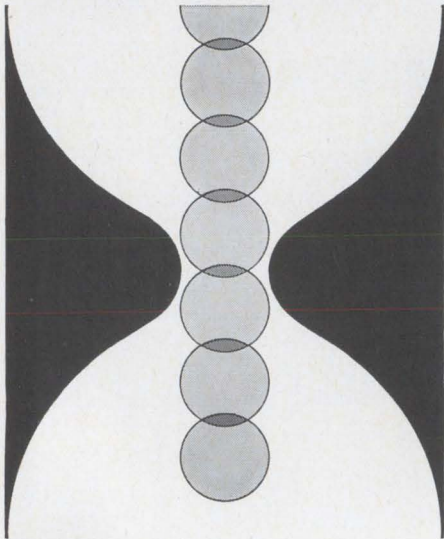

Reduce your masking costs
Increase your production

with
**BY-BUK
KWIKY-DOTS®**
OVERLAPPING MASKING DISCS

Connected strings of several discs can be used for faster application, no adhesive transfer. High heat resistance, size from 1/8" dia. up.

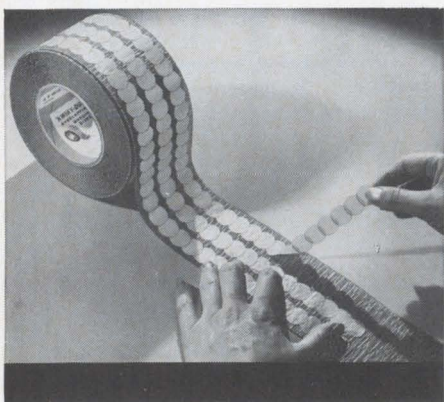

Also, masking tape cut to special widths 1/2" to 6". Pre-cut spray masks, die-cut masks, caps, plugs and other masking aids.

Write for FREE catalog and samples

**BY-BUK
COMPANY**

4326 W. Pico Blvd.
Los Angeles, Calif. 90019
Area Code (213), 937-3511

. . . phone goes
where you go . . .

because the transmitter operates only when the user is talking.

Melabs, Inc., of Palo Alto Calif., is responsible for design and production of the 701. Engineer Jack Gorry says that because of the unit's solid state and modular design, maintenance costs should be far less than for conventional mobile phones. The Commander's dimensions are 3 inches wide by 18 1/2 inches long by 12 3/4 inches high. Talk time is about an hour and a half and the batteries—nickel cadmium or silver zinc—have a year's normal life. Recharging requires a minimum of 8 hours.

Future units will probably have an option to make the unit compatible with vehicle cigarette lighters so the car battery can be used as the power supply, Melabs says.

Cost accounting. In Southern California, it costs \$65 to have the phone company install a mobile phone, \$41 a month for equipment leasing and a \$7 minimum service charge. The 701 costs \$2,160 or can be leased for \$50 a month and also has a \$7 minimum service fee. First deliveries are slated for April, and a nationwide servicing agreement is under discussion now with RCA.

The servicing would be something like a drive-in telephone repair shop, except that the phone could be left without leaving the car. And because each unit can be used on any of the channels, the user could be given another unit to use in the meantime, while his was being fixed.

Jack Wolf, president of CarryPhone, says people who have use for a car telephone would have use for the Commander 701. He expects a market for between 50,000 and 100,000 units within the next several years.

Doctors are expected to be one of the groups to benefit from the portable telephone. Even if a doctor has a phone installed in his car, he is still out of communication with his office when he's making a house call. With the CarryPhone, he can take his phone with him up to a patient's bedside.

CarryPhone Corp., Van Nuys, Calif.
[398]

Works in seconds.

The '68 Electronics Buyers' Guide lets you find people, places, and things in seconds. In the Directory of Manufacturers and Sales Offices, for example, more than 6,000 manufacturers are listed, including addresses, telephone numbers, sales offices, the people to call for information, the total number of engineers and employees and sales volumes. So use your EBG. It works in seconds.

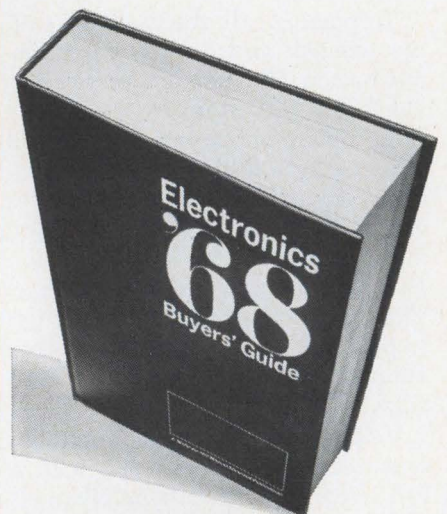

Electronics Buyers' Guide
A McGraw-Hill Market Directed Publication,
330 West 42nd Street, New York, N.Y. 10036

Latest in the Struthers-Dunn
YEAR OF RELAY DEVELOPMENT

one of many new relay and control refinements of special significance to users of switching devices

Here's one for aerospace.

magnets
do the work,
when milliwatts
count . . .

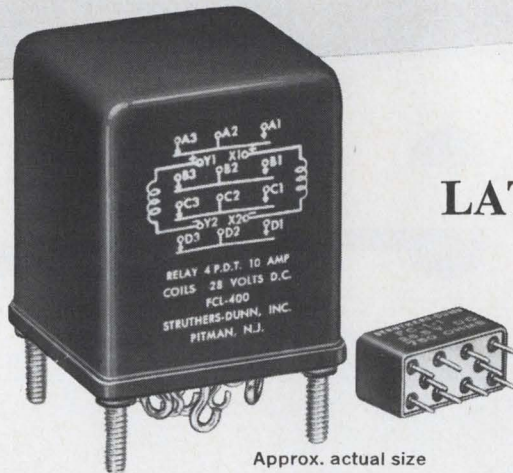

Approx. actual size

LATCHING AEROSPACE RELAYS

The 10-amp Model FCL-400 trips on less than 35 milliwatt-seconds; the 2-amp Model FCL-1 on only 2 milliwatt-seconds. And they stay tripped—with zero power drain.

FCL-400 packs 4 double-throw 10-amp contacts in 4.15 cubic inches; withstands 25G shock; conforms to MIL-R-6106E. Check reader service number for bulletin.

FCL-1 has 2-amp DPDT contacts in half crystal can size; withstands 50G shock; conforms to MIL-R-5757. Check reader service number for bulletin.

Now, Struthers-Dunn adds magnetic latching to miniature hermetic relays . . . with no increase in size; no sacrifice of environmental resistance. They're as good as extra batteries in your aerospace or undersea system. You conserve precious energy by using it just to trip the relays, not to hold them.

There's always more to draw on where you find the most to start with

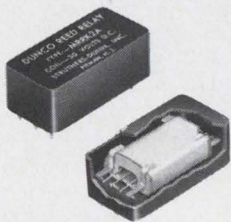

Cutaway view

Economy Breakthrough in Reed Relays. New plastic sealing method brings you completely protected reed relays for little more than the cost of open types. Series MRRK is the newest in a complete line of standard, miniature, and shielded reeds for logic and data-handling applications. Check reader service number for complete specs.

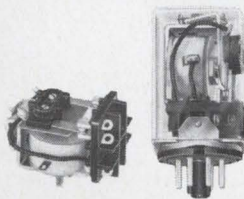

Widest Line of General-Purpose Relays. The S-D line of low-cost, medium-duty relays has a compatible model for every control application: small motors, instruments, solenoid valves, heating elements, etc. Series 314, for example, offers 10-amp rating in open or enclosed-plug-in types; both *U.L. recognized*. Check reader service number for details.

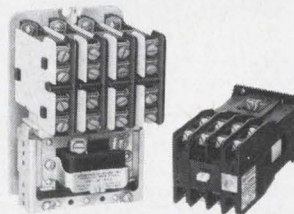

Two Approaches to 600V Industrial Control. Series SC relays pack 600V capacity into 300V panel size . . . with four or eight 10-amp poles. Series MC features interchangeable contact modules for versatility. Choose any arrangement from 2 to 12 poles—even latching and timing types—with only two base sizes. Use reader service number for both.

SEND FOR THIS DATA

Check numbers on the reader service card for any or all of the items you need:

- 515 Latching Aerospace Relays
- 516 Sealed Reed Relays
- 517 U.L. Recognized General-Purpose Relays
- 518 600V Relays



STRUTHERS-DUNN, INC.

PITMAN, NEW JERSEY 08071

Canada: Struthers-Dunn Relay Div., Renfrew Electric Co., Ltd.

Giant Killers

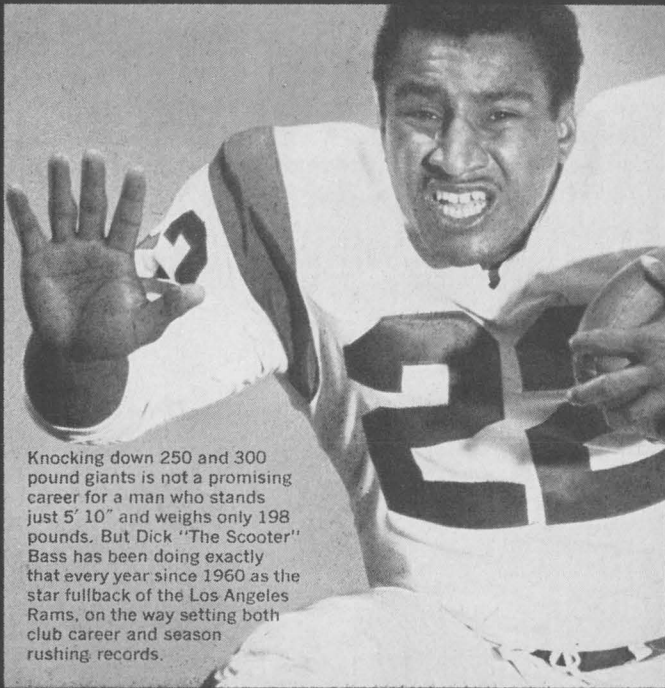

Knocking down 250 and 300 pound giants is not a promising career for a man who stands just 5' 10" and weighs only 198 pounds. But Dick "The Scooter" Bass has been doing exactly that every year since 1960 as the star fullback of the Los Angeles Rams, on the way setting both club career and season rushing records.

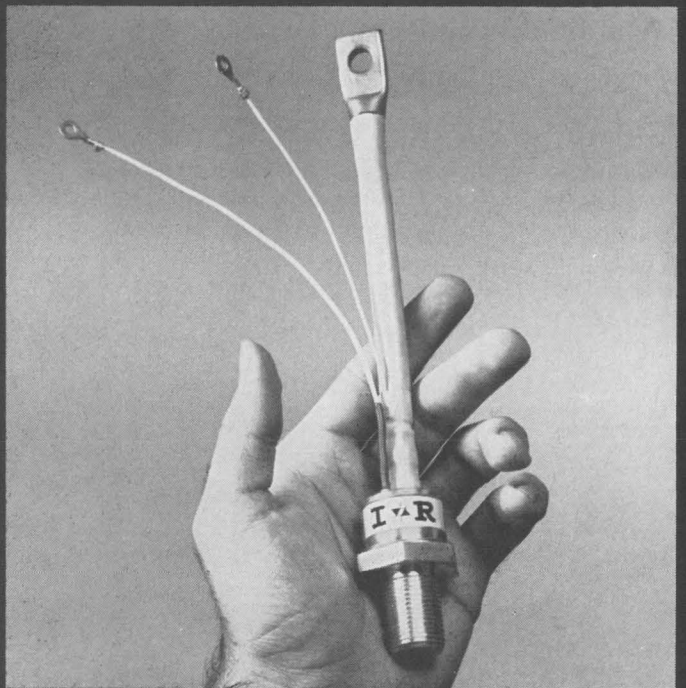

When we broke the news of our logic-triac to the world last September, we suspect that we upset some of the giant names in industry who also dabble in rectifiers. □ Our triac is the world's most powerful (200 Amps, 400-1000 Volts), made possible by our exclusive epitaxial process. Where ordinary triacs are limited to say household appliances, our logic-triac can handle enough power to run a freight elevator. □ The "logic" capability means you can control both AC and DC, since the device has selective gate characteristics. Therefore the same freight elevator with a three phase induction motor will be controlled by IR logic-triacs to go up or down, slow or fast, and accomplish dynamic braking more easily by imposing a DC current through the triacs to the motor. □ Our complete technical and application data on logic-triac can make you master of this giant killer. Ask for it.

INTERNATIONAL RECTIFIER



Semiconductor Division, 233 Kansas Street, El Segundo, California 90245, Phone (213) 678-6281
Field offices and distributors in major cities around the world

New Semiconductors Review

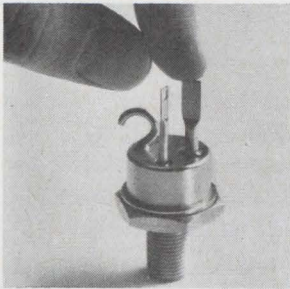

Diffused silicon npn transistor 1441 dissipates 350 w and has collector currents up to 150 amps. It exhibits a low saturation voltage (2 v max. at 100 amps) and is rated in 20-v steps from 40 to 120 v (V_{CE0}) sustaining. Minimum gain is 10 at collector currents of 50, 75 and 100 amps. Gain-bandwidth product is 1 Mhz. Westinghouse Electric Corp., Youngwood, Pa. 15697. [436]

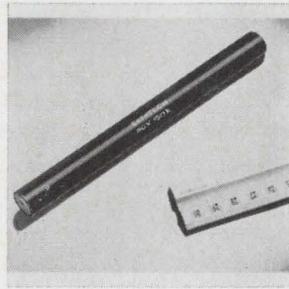

High-voltage silicon rectifier designated Sticpac is for x-ray generator use. Measuring 0.695 in. in diameter and from 3.38 to 8.50 in. long, it can replace vacuum tube rectifiers, and will eliminate many of the latter's hazards and operating inconsistencies. Sticpac is available in 5 voltages: 50, 75, 100, 125 and 150 kv. Semtech Corp., Newbury Park, Calif. 91320. [437]

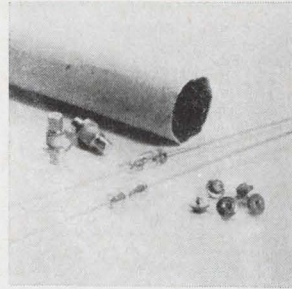

Two p-i-n diodes are for switching, limiting, duplexing, phase shifting and variable attenuation uses. MO-111BL is a 200-v device with total capacitance at -50 v of 0.4 pf max.; switching resistance at 100 ma, 1 ohm max. MO-120BL is a 500-v unit with 1.1 ohms max. R_S at 100 ma. Alpha Industries Inc., 381 Elliot St., Newton Upper Falls, Mass. 02164. [438]

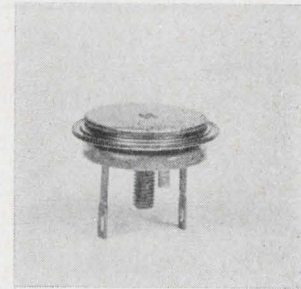

Germanium transistor SDT3090 is a 25-amp pnp unit in a TO-36 case. Minimum gain (h_{FE}) is 10 at 25 amps, and breakdown (V_{CE0}) 30 to 50 v. Designed for power applications up to 170 w dissipation, the unit can be used in military and industrial inverters, converters, switches, and control circuitry. Solitron Devices Inc., 1177 Blue Heron Blvd., Riviera Beach, Fla. 33404. [439]

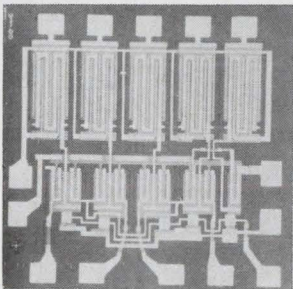

MOS 4-channel multiplex switch type 3700 provides compatibility with npn bipolar logic and features blanking control of all channels. The output transistors incorporate very high off impedance (10^{12} ohms), very low on impedance (270 ohms) and zero offset voltage. Output leakage current is 10 na max. Fairchild Semiconductor, 313 Fairchild Dr., Mtn. View, Calif. 94041. [440]

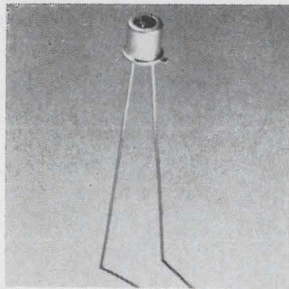

Avalanche silicon photodiode AV-102 features high internal gain resulting in typical signal-to-noise improvements of 300:1. It is designed for the detection, characterization and measurement of low-level light signals over the spectral range from 0.35 to 1.13 microns. Frequency response is d-c to 2 Ghz. EG&G Inc., 160 Brookline Ave., Boston, Mass. 02215. [441]

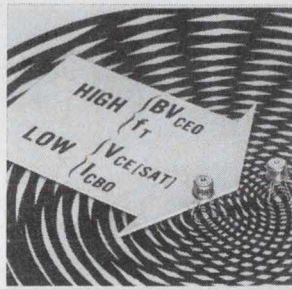

H-v silicon transistors npn 2N4924-27 and pnp 2N4928-31 are complementary devices. Breakdown voltages range from 100 to 250 v with all units measured at a collector current of 10 ma. Other features are leakage current in the na region, low saturation voltage, d-c beta to 200, and high gain bandwidth product. Motorola Semiconductor Products Inc., Box 955, Phoenix 85001. [442]

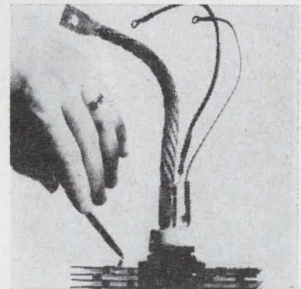

Thyristor SCR's types 2231 and 2232 have maximum turn-off times of 30 and 40 μ sec respectively from 150 amps, pass a forward current of 475 amps rms and 300 amps half-wave average. Surge current is 4,500 amps. Forward and reverse blocking voltages are available through 1,000 v. Units have an integral heat sink. Westinghouse Semiconductor Div., Youngwood, Pa. 15097. [443]

New Semiconductors

High-rise hybrids cut package size

Compact custom circuits are built with monolithic IC's by using layers of interconnections, separated by thick film

A **sister division** needed some special digital devices. So engineers at United Aircraft's Electronic Components division found a way to put a large number of monolithic integrated circuits and their interconnections on a small substrate.

The engineers developed a multi-layer technique for packaging ic's which, the company says, is suited for building custom logic devices. Circuits are put on in layers, separated by a thick dielectric film. Ic's and other components are then bonded to the top metalization

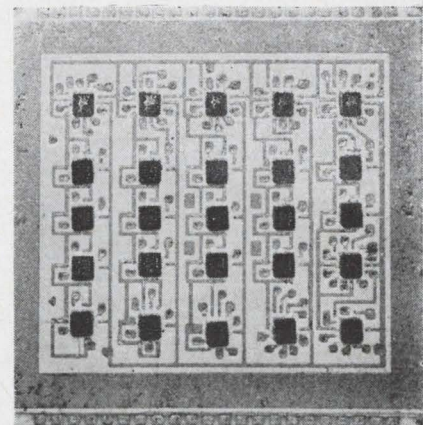

Triple decker. Three metalization layers interconnect 25 multifunction integrated circuits on a one square inch substrate.

Always connect subminiatures with Winchester Electronics.

Take cable and panel mounted rectangulars. We've got them with solder or crimp removable contacts. From 4 to 50 contacts with current ratings of 3 to 7.5 amps. Standardized high-density rectangulars also, that allow you three current ratings — 3, 5, or 7.5 amps — with one size connector and one size panel cutout.

Need pc connectors? We've got edge-board, right-angle or flat-mounted pc's on .050, .078 or .100 contact centers. With solder, eyelet or dip solder terminations for 1/32 to 1/4-inch boards. And we've got micro-miniature pc connectors for use

with integrated thin film and semi-conductor circuitry.

If you're looking for circular cable or panel mounted connectors, you'll find them with 1 to 12 contacts. Contact centers from .025 to .040 with current ratings of 3 to 7.5 amps.

They're all on the shelf of

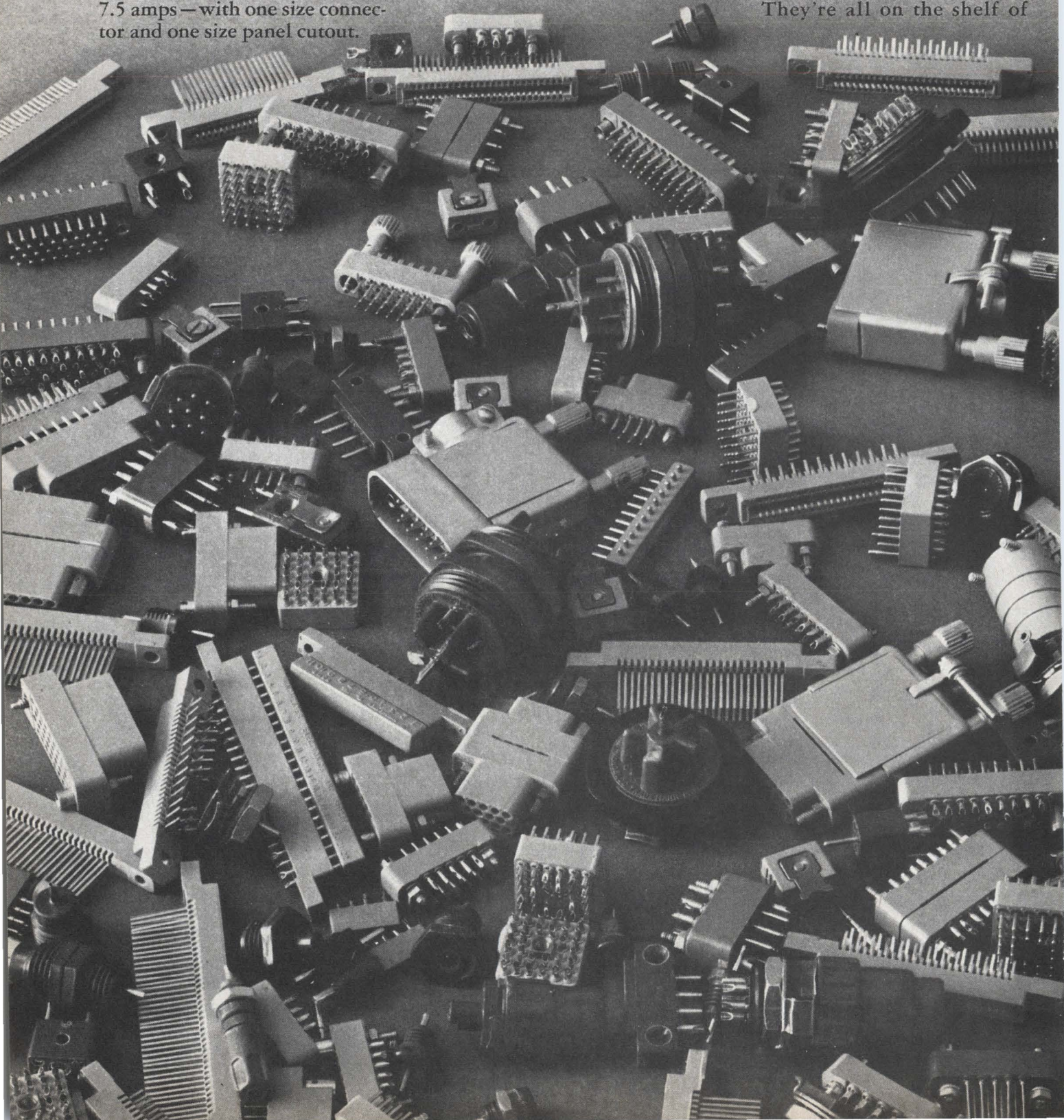

your Winchester Electronics distributor. You'll find him close as your phone—make the connection now. Winchester Electronics, Main St. & Hillside Avenue, Oakville, Conn. 06779.

 **WINCHESTER ELECTRONICS**
LITTON INDUSTRIES

... metal is screened onto the substrate, a thick film is deposited, and then another metal layer ...

layer and electrically connected to the circuit by thermal compression.

Laying it on. The engineers start with a ceramic substrate and screen a metal layer onto it. A dielectric film is then screened over the metal. Small holes are left in the film so interconnections can be made. Another metal layer is then screened onto the film, and the metal that runs into the holes makes contact with the lower circuit segments. The metal-film screening steps can be repeated to build up the desired number of layers. The resistance of the dielectric film is in the megohm range.

David Steenhausen, product manager of the hybrid section, says four layers of metalization are within United's capability now, and he sees no reason why that number can't go up. He also points out that connections are not limited to adjacent layers, but can be made between any layers in a package.

And counting. United has been using the multilayer process to make four types of digital-transistor-logic counters for its Hamilton-Standard Division. These devices are double layered, and contain up to 10 $\text{ic}'\text{s}$ on a 1.4 square inch substrate. Steenhausen says United has also built a four-megahertz ripple counter in a three-layer package that has 25 $\text{ic}'\text{s}$ on a one square inch substrate. This counter has 44 leads and is hermetically sealed.

United will use its technique to build custom circuits, for now. Steenhausen says the company can deliver circuits four to six weeks after a customer submits a design. This delivery time may be cut to two weeks by the end of the year.

United has no plans to market off-the-shelf devices, but would if a market developed.

Stacked foe. Steenhausen says only United uses the multilayer packaging process but competition will come from companies who build up circuits on stacked ceramic wafers. He feels his firm has the edge over them in both size and price. But the big advantage for United is the flexibility of their process. To build a different cir-

cuit, engineers just change the screens used for the masking. The cost and time are small compared to the cost and turnaround time involved in ceramic retooling.

Besides packaging $\text{ic}'\text{s}$, the technique can be used for less complex circuits. Steenhausen suggests using multilayer packs to customize the functions of operational amplifiers. He says the process also shows promise for use with flip-chip and beam lead devices.

United Aircraft Corp., Electronic Components Division, Trevose, Pa. 19407 [444]

New semiconductors

Double deposit means more gates

Bipolar counter with two metal layers on a chip has 400 components, 54 gates

While systems engineers are still figuring how to use large-scale-integration products, the Philco-Ford Corp. is already talking second-generation LSI. Clare Thornton, direc-

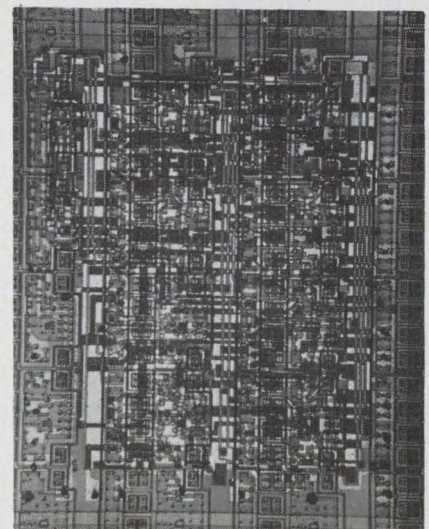

Double duty. The input voltage level determines whether the bipolar array is a four-stage binary or a BCD counter.

Application For

FET SWITCHES

PROBLEM: Control MOS FET switches with 5V logic . . . use one flat pack.

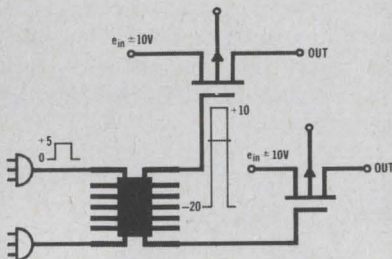

REQUIRED: Two drivers for two switches . . . Input swing 0 to +5V . . . Output swing +10V to -20V . . . delay less than 1 μ s . . . noninverting logic (logic low - switch ON).

GIVEN

1. Available power supplies: +5V, +10V, -20V.
2. $e_{in} \pm 10V$.
3. DTL logic . . . output swing 0 to 5V.

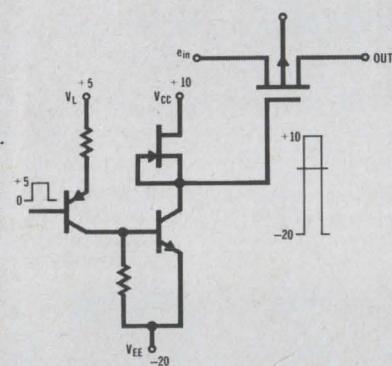

SOLUTION: SILICONIX D112F FET Switch Driver—two complete drivers per flat pack (no other parts needed) . . . connect logic output to driver input, V_L to +5V, V_{CC} to +10V, V_{EE} to -20V, and output to MOS gate.

Need a big swinger? We have all kinds—contact us for applications assistance, or write for a free FET Switch and Driver data packet.



Siliconix incorporated

1140 W. Evelyn Ave. • Sunnyvale, CA 94086
Phone (408) 245-1000 • TWX: 910-339-9216

tor of research and development at the Microelectronics Division, considers four new integrated circuits as second generation LSI units.

Two of the IC's are still in the experimental stage, a 16 by 16 random access serial memory containing 1,400 transistors on a 100 by 120 mil chip, and a 2,048-bit memory containing 12,000 transistors on a 117 by 117 mil chip, designed to operate at speeds over five megahertz. Both devices are metal oxide semiconductor IC's.

A third MOS IC, a 1,024-bit read-only memory, containing 1,250 transistors on a 70 by 100 mil chip, is already on the market [Electronics, Feb. 19, p. 45].

For high-speed. The other device described by Thornton is a dual-function bipolar complex array that contains 400 components on a 110 by 88 mil chip. It acts as either a four-stage binary counter or a binary-coded-decimal counter. Changing the logic level of the control input changes the function.

By putting this device on the market, Philco is saying it's ready to talk second-generation bipolar LSI with customers. And engineers who want custom-made 100-megahertz logic circuitry or 500-megahertz shift register modules have to talk bipolar.

Open problem. According to Thornton, Philco jumped the bipolar generation gap by increasing component density by up to 100%. The double-metalization layer technique made this possible.

Thornton remembers that everybody expected shorts to be the big problem when they tried to put down layers of connections on one chip. Instead, the opposite occurred. The headache was to make sure there were no open circuits between the two layers. Philco finally refined the process to the point where adding a second layer did not reduce yield. "Holding the yield was the little hill we had to get over," says Thornton.

Most present bipolar IC's have no more than 20 gates per chip. "And that's pushing single-layer technology," says Thornton. The dual-function counter has 54 gates on a chip.

Philco expects the initial charge for double-layer bipolar devices to range from \$1 to \$10 per chip.

Philco-Ford Corp., Microelectronics Div., Blue Bell, Pa. [445]

STOP

Iron Core Problems

Call

PERMACOR®

Iron Core Engineers

Whatever your iron core problems may be . . . space limitations, tolerances, delivery, or cost . . . PERMACOR can solve them quickly and efficiently.

Over the years, PERMACOR research, engineering, and production has solved countless military, commercial, miniature, and specialized applications. It can do the same for you.

Send us your problems today. Let us show you how PERMACOR "Engineered Economy" has made us the world's largest iron core producer. There's no obligation, of course!

PERMACOR®

A Division of Radio Cores, Inc.

9540 Tulley Ave., Oak Lawn, Ill.

Phone: 312/GA 2-3353

Circle 274 on reader service card

Profit Center of the Southwest

Operating divisions of corporations located in Phoenix seem to rapidly get going and going and going — profitwise, particularly when compared to other areas. Some reasons for this profitable growth are indicated in the revised edition of "The Phoenix Story." Send for your copy.

For complete, confidential information, write Stanton Allen, Manager, Economic Development Department, Room E-6, Chamber of Commerce, Phoenix, Arizona 85004

PHOENIX

ARIZONA

Circle 226 on reader service card



SYSTEMS TECHNOLOGY

Systems Technology is engaged in solving a wide variety of sophisticated technical problems related to advanced electronics, control and information systems, and electronic components at the rapidly expanding Fort Worth Division of General Dynamics. Within this department, effort is divided among several major areas of technology.

Radars and Navigation Systems. This area pertains to design, development and test of airborne radar, navigation, guidance, and fire control equipment. Research in fundamental electromagnetic propagation, transmission, and scattering is also conducted.

Electronics Systems. This activity is related to penetration aids equipment. It includes design and development of such systems as radar homing and warning, electronic counter-measures (ECM), IR detection, etc. Antenna design and fabrication is also a vital part of this work.

Information Processing and Sensor Technology. This covers technical fields and applications where-in the prime objective is acquisition and/or analysis of information. It includes displays and simulation, information processing, data analysis, and computer programming for both ground and airborne equipment.

Electronic Installation and System Design. This work includes design of electrical power generation, conversion, and distribution systems. Electrical wiring and installation of all avionics equipment is a part of this function.

Aerospace Ground Support Equipment (AGE). This work involves effort directed toward design and development of AGE which maintains and adjusts all avionics systems.

Aerosystems Laboratories. These laboratories provide support in such areas as electronic equipment design and fabrication, microelectronics design and development, F-111 avionic systems integration and testing, and flight test instrumentation design, development, and fabrication.

Find room for thought and career potential . . . and room for better living in smog-free Fort Worth, where the cost of living is low, and where metropolitan advantages exist alongside year-around outdoor recreational areas in a mild climate.

Call Collect — 817-732-4811, Extension 3551; or send a resume of your education and experience to Mr. J. B. Ellis, Industrial Relations Administrator-Engineering, General Dynamics, Fort Worth Division, P. O. Box 748E, Fort Worth, Texas 76101. An equal opportunity employer. U. S. citizenship required.

GENERAL DYNAMICS
Fort Worth Division

NEW

**ultra
miniature**

**I/C POWER
SUPPLY**

**80%
SMALLER!**

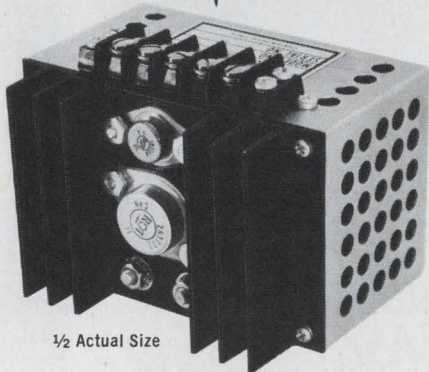

1/2 Actual Size

Avtel's new, ultra-miniature power supply is only 4" x 3" x 2 5/8" including heatsink.

Avtel 9-D SERIES power supplies are specifically designed for use in lightweight chassis with IC or other digital logic. Output voltages are available from 3 to 30 volts with .05% regulation.

INPUT: 115 Volts 47-440 HZ

TYPICAL OUTPUTS:

3 V at 6 A

5 V at 5 A

15 V at 2 A

The Avtel 9-D SERIES is currently available from stock. Detailed specifications and prices are available upon request.

CUSTOM POWER SYSTEMS

Avtel's experts are capable of solving your most difficult power conversion requirements.

POWERTEC PRODUCTS



AVTEL CORPORATION
1130 EAST CYPRESS STREET
COVINA, CALIFORNIA 91722
PH. (213) 331-0661
TWX (213) 686-6753

DIVISION-AIRTRONICS, INC.

New Books

Some protection

Grounding and Shielding Techniques in Instrumentation
Ralph Morrison, John Wiley and Sons, 144 pp., \$9.50

One of the least understood areas of circuit design is proper grounding and shielding, and this is because a majority of the networks constructed must be handled on an ad hoc basis. This peculiarity compounds the formulation of specific 'rules' on how to ground and shield, and is particularly evident in instrumentation, where circuit makeup is more varied than in digital and linear systems. But here is a book that does a respectable job in closing that information gap, although by no means can it be considered a designer's 'Bible' on the subject.

Ralph Morrison, an expert on the topic, has performed a service by organizing his experiences into this text. He notes that once understood, shielding and grounding concepts are simple to apply. He points out solutions of problems commonly faced by engineers.

Unfortunately, however, applications involving such widely used instruments as digital voltmeters (dvm's), and related equipment such as printers and scanners, are notably absent from the book. These applications are of great importance and deserve mention. For example, the integrating dvm, particularly the guarded version, successfully copes with many common grounding problems. Another flaw is the absence of words commonly found in the jargon of instrumentation design engineers.

Sometimes, the author's proximity to the problems of shielding and grounding causes him to assume too lofty a level of writing. Take for example the section on page 33 that reads "These statements do not require that the shield be earthed or defined in any way." This seems to be true only if the enclosed charge is constant. Otherwise, as shown by equation 4 on page 12, the electrostatic charge emanating from a floating shield must change. Although this reviewer is confident the author understands this, it is not apparent

to non-experts in the field.

Although quantitative data can become obsolete quickly, engineers will appreciate the tables included throughout the book, especially those on typical capacitance values between common elements such as a soldering iron and its case and between twisted wires. These are values that engineers can measure, but rarely do.

All in all, despite a few printed errors and the omissions cited, the book is still worth reading.

Paul G. Baird

Engineering group leader
Hewlett-Packard Co.,
Loveland, Colo.

Step up to vlf

Vlf Radio Engineering
A.D. Watt
Pergamon Press
701 pp., \$20

The very-low-frequency portion of the radio spectrum was just about unused until the technology of the 1950's created applications more sophisticated than the broadcasting of only code and voice transmissions. But now Omega, a vlf navigation system currently in limited use and slated for expansion into a worldwide network, is stirring general interest in the subject. "Vlf Radio Engineering" is therefore timely and may well become a standard work.

The book first charts the flow of information-bearing energy from transmitting location to receiver. Successive chapters cover transmitting antennas, the propagation mechanism, and receiving antennas. This sequence is followed by considerations of atmospheric radio noise, modulation, frequency spectrum, receiving systems, and finally, complete systems equipments.

The text contains the engineering data needed to design all elements of a vlf system, and notes many practical examples. Descriptions are given of several existing vlf transmitting antennas. Engineering information includes even the mechanical details of wind loading and conductor oscillation.

An unusual feature for this kind of work is the consideration of cost

**For a state that numbers 76 million
people within 500 miles of its borders,**

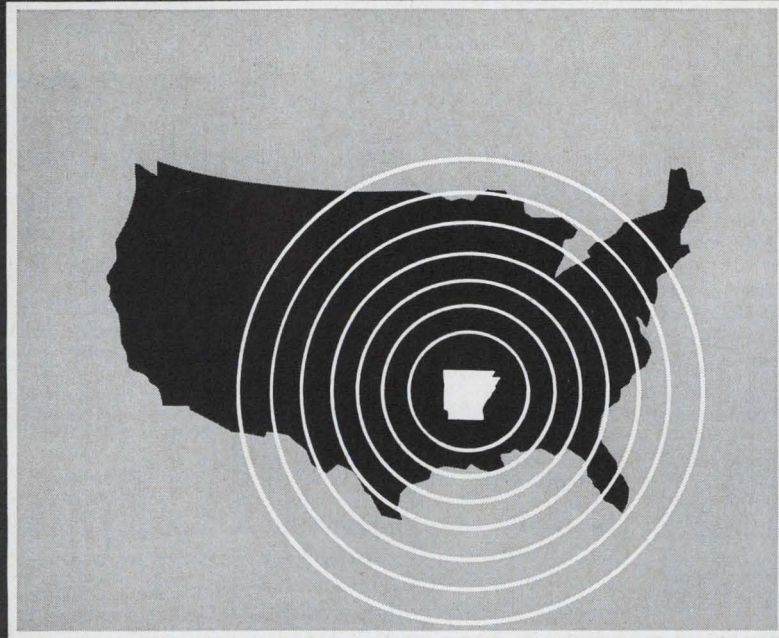

**Arkansas is in an enviable
industrial position.**

**And our specialized Task Forces
are ready to prove it.**

A strategic Mid-Continental location makes Arkansas the gateway to the dynamic Southwest and the booming Mid-South. A good reason why more than 100 of the top 500 firms in the country have already put themselves in our place. And more and more are taking another look at Arkansas through our Task Force approach to development. To find out more about markets, manpower, material, money and methods in Arkansas, write the Arkansas Industrial Development Commission, State Capitol, Little Rock 72201. You've got us right where you want us.

ARKANSAS

Industrial Task Forces: Food, Fiber, Chemicals, Transportation, Electronics, Scientific Instruments, Timber, Minerals, Machinery

Discovering



How Electronic Glass, Lucalox® and Fused Quartz Provide Solutions in Electronics Applications

Electronic Glass is available from General Electric in various shapes to cover many electronics uses such as TV repair necks, electronic tubing, miniature bulb blanks, subminiature radio tube blanks, beads and brazing pellets, electronic tube flares, pressed ware and re-draw tubing.

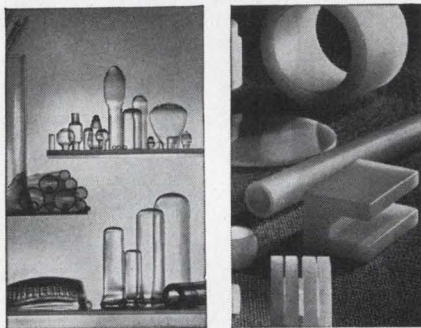

Lucalox® provides high dielectric strength, purity and transmission capabilities of up to 90% of total light in the visible spectrum. This polycrystalline alumina ceramic can be fabricated to exacting specifications for use as guides, insulators, microwave windows, bearings, gyros and other electronic, microwave and high temperature applications. Available from stock in standard tubing, rod, plates and discs.

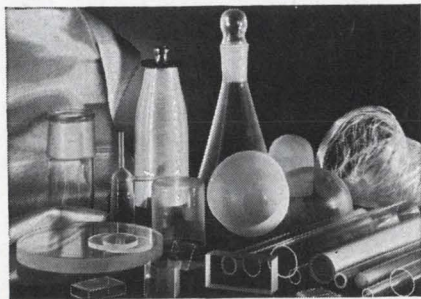

Fused Quartz and Fused Silica answer a variety of technical applications. General Electric's high purity quartz is used in crystal pulling, zone refining, semiconductor diffusion and research labware. GE Type 151 fused silica offers highest ultraviolet transmission. It's ideal for such critical applications as laser optics and absorption cells. Obtainable from General Electric in several grades.

SEE US AT IEEE BOOTH NO. 3E05-07

Write for illustrated technical literature today.

LAMP GLASS DEPARTMENT

GENERAL ELECTRIC

24400 Highland Road
Richmond Heights, Ohio 44143

Manufacturers of Lucalox® Ceramic
Electronic Glassware—Fused Quartz Products

New Books

tradeoffs connected with each subject. The sections on cost factors could really form the basis of a course in practical economics for engineers; the questions raised and techniques described apply to many engineering disciplines.

The author is scrupulous in his acknowledgements, citing an impressive array of modern contributors to the technology as well as many historical works. Watt has put together a first-rate text that belongs on the shelf of the working communications engineer.

Wm. E. Yost Jr.

Consultant

Tuning up

Radio and Line Transmission
D. Roddy
Pergamon Press
251 pp., \$6

Basing his work on lectures to telecommunications personnel in Britain, Roddy presents his complex subject clearly and concisely. And, although he aimed at technicians, his book is valuable to both beginning engineers and experienced EE's seeking a quick refresher.

The text covers four basic topics—wave theory, devices, circuits, and systems—and employs a minimum of mathematics and physical detail. The material is practical and includes illustrations of the hardware.

Passages on signal behavior cover wave motion and propagation, logarithmic units, speech and music, amplitude modulation, and frequency analysis. The section on devices discusses passive and active components, including semiconductors, thermionic units, and electro-acoustic devices. Among circuit topics are series and parallel tuned circuits, rectifying networks, demodulators, amplifiers, and oscillators. Finally, radio, line telephone, and line telegraphy systems are described.

The book's shortcoming is the short shrift given integrated circuits and such recent discrete semiconductors as field effect transistors. But, since Roddy's work is function-oriented as opposed to device-structured, little is lost by the omission.

Replace Costly AC/DC Circuits!

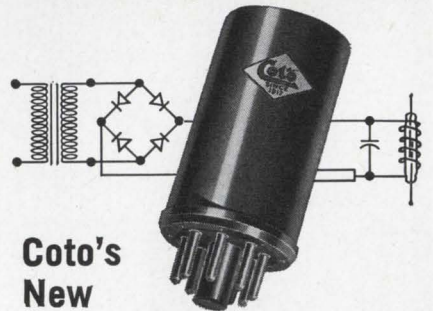

Coto's
New

A.C. Reed Relay

Designed to Operate on
Standard 60 Hz input

Contacts: Forms A, B, C with single or multiple poles.

Ratings: To 3 amperes or up to 5000 volts D.C.

Inputs: 50-400 Hz voltages available.

Physical: Available in steel or plastic octal base housings for plug-in mounting.

Write for complete specifications. For special requirements, give complete details for quotation.

Coto-Coil COMPANY, INC.
61 Pavilion Ave.
Providence, R. I. 02905
Phone (401) 941-3355

Circle 275 on reader service card

Cartoon by Whitney Darrow, Jr.



Be a buddy!

One gift works many wonders
THE UNITED WAY

what follows airborne phased arrays?

To pioneer in the next generation of radar techniques, you should be where advanced systems are built now.

At Sanders, where systems are everyone's business, you will find that everyone has his eye on tomorrow. Innovation in engineering design is a basic way of life.

New radar concepts will come to light here. Broadband characteristics of advanced systems will reveal more than where an object is. Turbine and structure signatures, for example, may be detected. The promises of micro electronics will be explored.

You could play a major role here in radar technology, and you would find the association personally as well as professionally rewarding.

WRITE to Mr. J. L. Hackbush today for career information. The address: Sanders Associates, Inc., Dept. 297 E, 95 Canal Street, Nashua, New Hampshire 03060.

SYSTEM DESIGN ENGINEERS ■ ECM SYSTEM ENGINEERS ■ DIGITAL DESIGN ENGINEERS ■ ELECTRO-OPTICAL ENGINEERS ■ ANTENNA ENGINEERS ■ ELECTRONIC ENGINEERS

CREATING NEW DIRECTIONS IN ELECTRONICS



**SANDERS
ASSOCIATES, INC.**

*T. M. SANDERS ASSOCIATES, INC. An Equal Opportunity Employer M/F

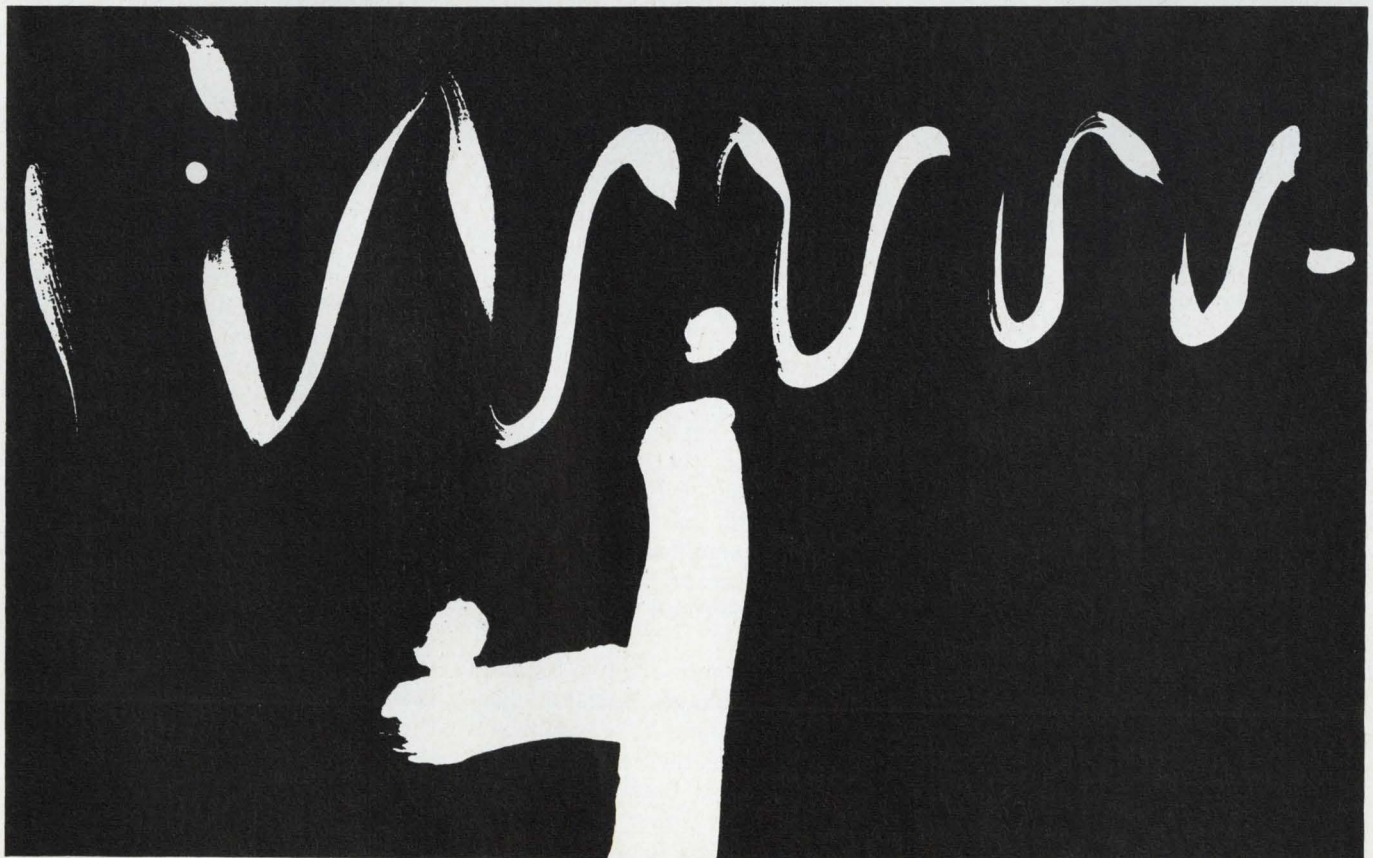

This little lamp can save you \$5,000.

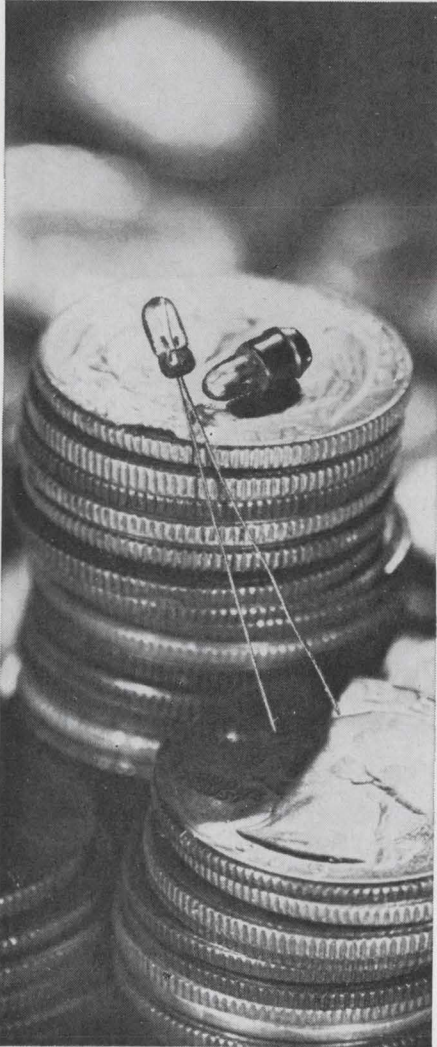

Hear that, Mr. P.A.! If you purchase 10,000 IEE subminiature lamps, the savings can be a substantial \$5,000. That's because IEE has broken the miniature lamp price barrier. They sell for as little as .29 each, in quantity, one half the price of competitive lamps.

This low, low price still delivers top quality IEE subminiature lamps...each and every one—aged and selected. You pay no premium for this premium. They meet all standard mil specs, and you can count on 40,000 to over 100,000 hours life depending upon the application. Filaments are hand placed and stabilized to assure uniform brightness.

Drop us a note, describing your application and type of lamp. We'll send you a sample box of 10 IEE "subminiatures". Do it now.

"See us at
IEEE show
Booth 3B22-23"



Industrial Electronic Engineers, Inc.
7720 Lemona Avenue, Van Nuys, California 91405

Technical Abstracts

IC lowdown

A new low-voltage breakdown diode
Robert J. Widler
National Semiconductor Corp.
Santa Clara, Calif.

Users of linear integrated circuits—particularly those concerned with regulation of power supply levels—have long needed a low-voltage breakdown diode element. Many problems would be solved by an element that's compatible with monolithic fabrication, exhibits more stability than current regulator elements, and can operate with the low-level signals often found in IC's.

Now there is one, a two-terminal IC that functions like a zener diode but at much lower voltages.

Discrete breakdown diodes in the 2 to 6 volts range, now made by the alloy process, exhibit a fairly soft breakdown characteristic, with the voltage changing by about 0.7 for a factor-of-10 change in reverse current. But, the reverse punchthrough of a graded-base transistor has a constant low-voltage characteristic which is superior to that of an alloy diode. Its breakdown voltage is determined by depletion of the base region, rather than an abrupt junction, so units with breakdown voltages as low as 1 v can be made, using standard diffusion techniques.

Transistors and resistors can be fabricated simultaneously with this punchthrough diode using present IC processes; and active circuitry can be put on the diode chip to provide even better performance.

The change of breakdown voltage with temperature is nearly linear; it is 3 mv/°C, independent of the nominal breakdown voltage. Also, it has been verified experimentally that the temperature-induced voltage drift of the reverse punchthrough in the 2 to 5 volt range is not significantly affected by the initial breakdown voltage for the double-diffused silicon transistors used.

At low voltages, the two-terminal monolithic voltage regulator, electrically equivalent to a breakdown diode, provides reverse characteristics which are 10 times sharper than single-junction zener diodes. Devices have been manufactured in

volume with breakdown voltages from 2.4 to 5.6 v and specified for operation from 10 μ a to 10 ma over the full military temperature range.

The regulator is fabricated on a 23-by-29 mil square silicon die using the six-mask, planar-epitaxial process. Because all junctions are passivated, reliable operation can be expected under extreme environmental conditions, even at low operating currents. Tests under way point to excellent long-term stability, which is to be expected since the breakdown occurs in the bulk rather than on the surface. Additionally, the breakdown mechanism is fairly quiet, giving an output noise of only 100 μ a, peak-to-peak, from 10 hertz to 10 kilohertz.

Although the diode is not optimized for minimum capacitance, it is about an order of magnitude faster than alloy zeners in clipping and clamping applications. Also, because of its predictable temperature drift, it can be used in building fairly simple temperature compensated regulators, for operation with input voltages down to 3v and output voltages down to 1v.

Presented at Solid State Circuits Conference, Philadelphia, Feb. 14-16.

Toward the ideal

Line-operated transistorized tv horizontal deflection circuit
W. Hirschman and G. Ebarhard
Siemens AG
Munich, West Germany

Few television set producers will argue the merits of all-transistor tv sets—they generate little heat and are far more reliable than their tubed counterparts. But they cost more to produce, because they require a bulky and expensive transformer power supply for the horizontal deflection circuit.

The main obstacle to large-screen all-transistor sets is the horizontal deflection circuit, which must handle voltages considerably higher than the supply voltage during the flyback retrace period. The deflection yoke carries the high currents that produce the magnetic field needed to deflect the picture tube's electron beam.

In a typical case, a picture tube

(Illus. approx. actual size)



507-3836-1531-600

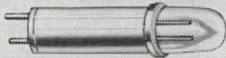

507-4538-0931-610

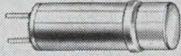

507-3918-1471-600

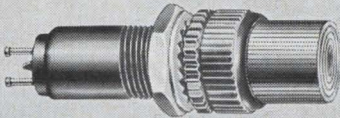

250-8745-1631-504



250-8738-1471-504



508-8738-504 Holder
w/ 507-3918-1471-600 cartridge

DATALITES[®]

SPACE SAVING INDICATOR LIGHTS!
For Computer, Data Processing & Automation Applications

Ultra-miniature Datalites—with Neon or Incandescent light sources, give you greater design flexibility... and save you needed space.

- **Space-saving:** Datalites mount in 3/8" clearance hole; can be mounted as close as 1/2" center-to-center; are perfect for computer, data processing and automation applications.
- **Greater design flexibility:** Dialco Datalites

are offered in a wide range of lens shapes, colors and finishes—and too—permit the choice of up to seven lens colors; legend markings may be hot-stamped or engraved in "positive" or "reverse" presentations for even greater flexibility.

- **Prompt delivery:** We offer the widest selection obtainable—all designed and built to Dialco's usual high reliability standards... and they are available off the shelf!

SEE THEM AT IEEE—BOOTHS 3H14-3H16.

- **Complete data:** Ask for our new 12 page catalog. Contains ordering information, drawings and all necessary data to design a space-saving display! Do it today!

SAMPLES ON REQUEST—AT ONCE—NO CHARGE



Foremost Manufacturer of Indicator Lights

DIALIGHT CORPORATION

60 STEWART AVE., BROOKLYN, N.Y. 11237 • AREA CODE 212 497-7600



Circle 276 on reader service card

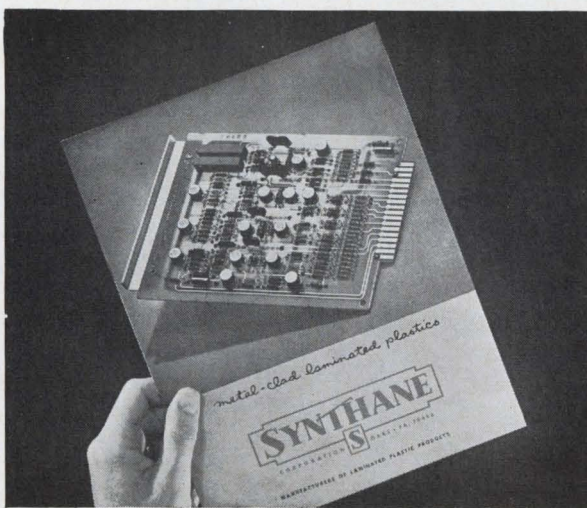

The booklet every electronic designer should have

The supply of this recent Synthane Metal-clad Laminate folder is going fast because it is packed with new information on Synthane high-quality metal-clad laminates. Grades, sizes, types of foils, trademark identification, property values, a section on thin laminates and prepreg materials. Be sure of your copy by writing us or circling our inquiry number in this publication. Synthane Corporation 36 River Road, Oaks, Pa. 19456.

SYNTHANE
CORPORATION  OAKS, PA. 19456

Laminated Plastic Sheets, Rods, Tubes and Fabricated Parts

Copper-Clad Laminates Ready For Immediate Shipment

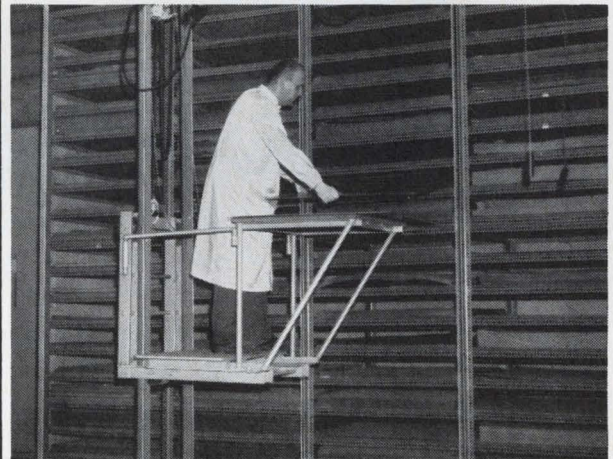

Our new and greatly increased warehouse facilities make it possible for us to produce and store a large quantity of copper-clad sheet laminates. All first-quality Synthane. Clad on one or both sides. Range of thicknesses and sizes. Thin copper-clad laminates. Also a very large inventory of B-stage pre-preg, ready to laminate on short notice. Call our district representative nearest you (see Yellow Pages) or phone us direct (215) 666-5011. Synthane Corporation, 36 River Road, Oaks, Pa. 19456.

SYNTHANE
CORPORATION  OAKS, PA. 19456

Laminated Plastic Sheets, Rods, Tubes and Fabricated Parts

Circle 277 on reader service card

Circle 233 on reader service card

233

Can you

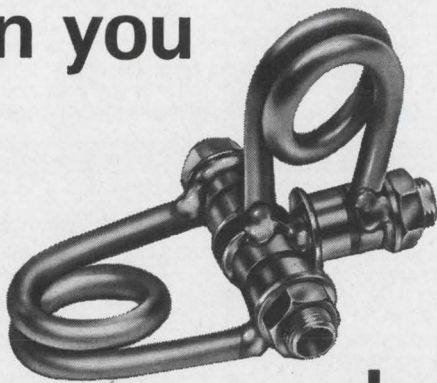

do this?

These new Johanson glass *capacitors* are designed to bridge the gap between conventional trimmers and high frequency air capacitors. They have high Q—low inductance; they have high RF current characteristics, they can be soldered together with components to simplify circuitry and they are *strong*.

Models include:



SG11054

Series II: High RF voltage *low cost* units with $Q > 1200$ and TC; 0 ± 50 ppm.



GQ11115

Johanson GQ11115: High voltage quartz capacitors which feature 7000 VDC; 2500 V peak RF at 30 mc and current capacity > 2 amps.

Also available are:

- Tuners and ganged tuners; linear within $\pm 3\%$
- Differential capacitors
- Mil spec capacitors
- Microminiature capacitors .075" diameter and .1-1 pf

Write today for full catalog.

Johanson MANUFACTURING CORPORATION

400 Rockaway Valley Road, Boonton, N. J. 07005 (201) 334-2676

Electronic Accuracy Through Mechanical Precision

Circle 234 on reader service card

Our little black book has over 100,000 phone numbers.

You never had a black book like it. Over 1,500 pages. And those phone numbers! More than 100,000 telling you who to call/where to go, for the over 4,000 different product categories listed and advertised in the yellow pages of the Electronics Buyers' Guide.

It's the industry's one-stop shopping center that lets you find the products and services you need quickly. You can depend on EBG.

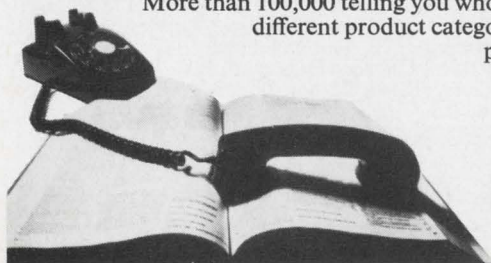

Electronics Buyers' Guide

A McGraw-Hill Market Directed Publication, 330 West 42nd Street, New York, N.Y. 10036

Technical Abstracts

with a deflection angle of 114° and an anode voltage of 18,000 v requires a peak energy of 2 millijoule from the deflection yoke. At full deflection, the peak energy stored in the yoke must be transferred back to the supply or the flyback capacitor during the prescribed retrace time. This requires the use of a horizontal output transistor having a high voltage-current rating.

Normally, the flyback voltage is directly related to the supply voltage. Therefore, if conventional low-voltage transistors are used in the deflection circuit, it becomes necessary to provide a low voltage power supply. The alternative is to use a transistor with a high collector-base voltage that can be driven directly from the rectified line voltage. All-transistor sets operating from a line voltage of 250 volts (the European standard) require the use of output transistors with a collector-base rating of 2,000 v [for a line voltage of 130 v, the U.S. maximum the output transistor must have a peak rating of 1,400 v]. Aside from the fact that these high-voltage transistors are costly, most available units lack the necessary fast switching speeds which are difficult to achieve in high voltage devices.

A proposed solution is to design a horizontal deflection circuit capable of compensating for power losses during the flyback retrace interval and thus obviate the need for the low-voltage power supply. This scheme enables the use of a horizontal output transistor whose voltage rating is the same value of the supply voltage—considerably less than the 1,400-v transistor normally required for the 130-v supply. This lower voltage also ensures faster switching speeds as a by-product. For example, a 10-watt dissipation corresponds to a switching speed of only 2.2 microseconds, while for a dissipation of 2 watts the speed is reduced to $1 \mu\text{sec}$, provided that the same deflection energy of 2 millijoule is maintained. Another advantage of low operating voltage for the transistor is greater efficiency and reliability at lower costs, due in part to the use of less expensive low-voltage capacitors.

Presented at the Solid-State Circuits Conference, Philadelphia, February 14-16.

DOWN THE HATCH!

New 5 KVA audio power amplifier

Designed to go down the hatch of submarines, the model S5K is a workhorse audio source for ship or shore. The unit delivers 5 KVA CW and 15 KVA instantaneous peak power from 100 to 10,000 cps. Full power is available into reactive loads . . . **no power factor correction needed.**

Another CML exclusive: selectable output tabs for wide range load matching.

Other power sources from 70 VA to 200 KVA.

Call or write today.



CML, Inc.

A subsidiary of Tenney Engineering, Inc.
350 Leland Avenue • Plainfield, New Jersey
(201) 754-5502 • TWX: 710-997-9529

87

Circle 278 on reader service card

announcing the NL-5750 from NATIONAL®



Our lowest priced readout tube, \$3.95 in 1000 quantity.

- ultra long life ■ compact .530" diameter.
- .5" numeral height ■ two decimal points standard
- flexible leads with standoff spacer for ease of pc board insertion.

NATIONAL

REQUEST BULLETIN

ELECTRONICS, INC.

a varian subsidiary

PHONE: (312) 232-4300 • GENEVA, ILLINOIS 60134

now-in-production HIGH RF VOLTAGE PISTON TRIMMER CAPACITORS

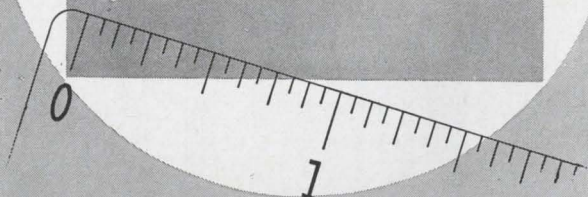
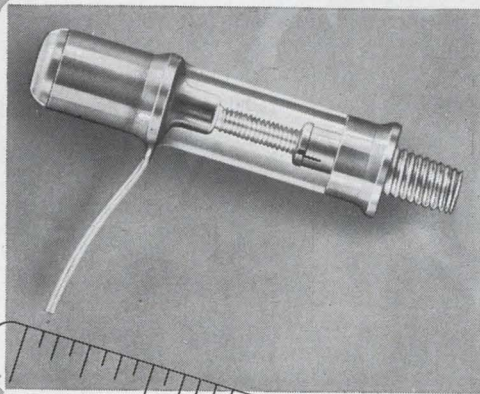

A new High RF Voltage Piston Trimmer Capacitor featuring high stability and small size is now available from JFD. The VCJ1616D is applicable in communications equipment and wherever a small trimmer capacitor is needed to handle large voltage peaks and high power at elevated temperatures. It operates over a frequency range of from 1 to 30 MHz.

This trimmer has an especially designed fused-quartz cylinder which yields an extremely low dissipation factor and temperature coefficient.

The operating RF voltage level of this unit is 3100 Volts peak at +25°C derated to 2500 Volts peak at +200°C. Its capacitance is variable from 0.5 to 5 pf, and its operating temperature range is from -55°C to +200°C. Its turning torque is 1-10 inch ounces in accordance with the Mil Spec.

The unit is furnished for panel mounting. It is 1 1/8" long and 3/16" in diameter.

Bulletin Hi RFV-67 will give you additional information. Write for your copy today.

JFD

"TODAY'S COMPONENTS BUILT FOR TOMORROW'S CHALLENGES"

JFD ELECTRONICS CO. / COMPONENTS DIVISION 15th Avenue at 62nd Street
Brooklyn, New York 11219 / Phone 212-331-1000
Offices and subsidiaries in principal cities, world-wide.

"SEE US AT IEEE BOOTH 4E26." "Also, March 27th-April 3rd, London Electronics Engineering Exhibition/April 1st-6th, Paris Components Show/April 27th-May 5th, Hannover Fair, Hannover, Germany."

Circle 235 on reader service card

Circle 279 on reader service card

New Literature

**SINCLAIR'S YAGI
ANTENNAS**
RUGGED
RELIABILITY...
WHEN IT
COUNTS!

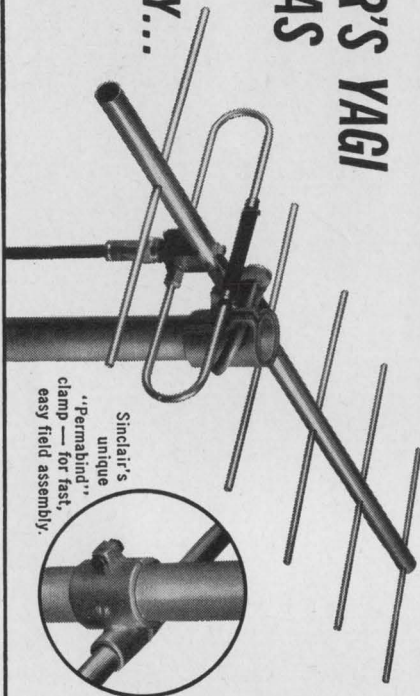

Sinclair's
unique
"PermaBind"
clamp — for fast,
easy field assembly.

Sure, most UHF-VHF yagi antennas function effectively — when the weather's good! It's when the wind starts to howl and the weather turns from bad to worse that the unmatched rugged reliability of a Sinclair yagi really counts. Every standard Sinclair yagi is designed to withstand 110 mph winds with a 1/2" radial ice coating. An integral part of this rugged construction is Sinclair's unique "PermaBind" clamp that makes for fast, permanent field assembly.

Standard Sinclair yagis are available in a wide frequency range from 30Mc. to 470Mc. . . . gains from 6.5db to 17.0db . . . power ratings up to one Kw. Send coupon today for complete FREE literature and prices.

676 ENSMINGER RD.

SINCLAIR RADIO LABORATORIES, INC.
P. O. BOX 23
TONAWANDA, NEW YORK

FREE LITERATURE

TO: SINCLAIR RADIO LABORATORIES, INC.
676 Ensminger Rd. P. O. Box 23
Tonawanda, New York 14150

Name: _____

Title: _____

Company: _____

Address: _____

City: _____

State: _____ Zip: _____

Indicating rotameters. Brooks Instrument Division, Emerson Electric Co., Hatfield, Pa. 19440, offers a six-page technical bulletin on a series of indicating rotameters that operate at pressures up to 5,000 psi. Circle **446** on reader service card.

Printed circuitry. Croname Inc., 6201 Howard St., Chicago 60648, has issued a brochure featuring advanced techniques and advantages of a new pre-soldered circuit board that provides a solder wetted copper surface that can be applied to cover an entire circuit configuration, selective pads or connector pads. **[447]**

Data communication system. Community Corp., P.O. Box 3490, Grand Central Station, N.Y. 10017. An eight-page booklet shows how a recently introduced multipurpose data communication system saves time and cuts data processing costs. **[448]**

Industrial adhesive. Conap Inc., Allegany, N.Y. 14706, has available bulletin A-111 describing the advantages of a 100% solids, two-part epoxy paste adhesive, sealant and filler that forms permanent, high strength bonds with most materials. **[449]**

Analog multipliers. Transmagnetics Inc., 134-25 Northern Blvd., Flushing, N.Y. 11354. Catalog 1167 lists the company's line of solid state analog multipliers, covering a range from d-c to 4 Mhz in four models. **[450]**

D-c static drive. Louis Allis Co., Division of Litton Industries, Dept. P, Milwaukee, Wis. 53201. Six-page bulletin 10050 presents information on Saber 3200, 1 through 5 h-p, d-c static adjustable speed drives. **[451]**

Semiconductors. KSC Semiconductor Corp., KSC Way, Chelmsford, Mass. 01824, has issued a 16-page short form catalog listing more than 1,200 germanium power transistors. **[452]**

Coaxial magnetrons. Varian Associates, 611 Hansen Way, Palo Alto, Calif. 94303. A 16-page brochure, containing a comprehensive introduction to the subject of coaxial magnetrons, is available to design engineers interested in microwave radar transmitters. **[453]**

Hermetic Teflon terminal. Lunday Associates Inc., 694 Main St., Waltham, Mass. 01254, offers a catalog sheet covering the 609-TH Clinch-Loc hermetic Teflon terminal. **[454]**

Industrial instruments. The Bendix Corp., 3621 South State Road, Ann Arbor, Mich. 48106, has published an eight-page bulletin that describes 20 instruments for inspection and measurement. **[455]**

Drilling machine. Gardner-Denver Co., Gardner Expressway, Quincy, Ill. 62301. Bulletin 15-1 contains complete information on the model 15J Grid-Drill designed for drilling electronic circuit boards for present and future generations of computers. **[456]**

Torque motor products. Aeroflex Laboratories Inc., South Service Rd., Plainview, N.Y. 11803. A catalog/file folder covers a line of brushless d-c torque motors, d-c moving coil torque motors, d-c tachometers, and d-c torque amplifiers. **[457]**

Electrical switches. Robertshaw Controls Co., P.O. Box 449, Columbus, Ohio 43216. Catalog 200 covers sub-miniature, miniature, series 1 and 4 Tyni, rotary and open blade switches. **[458]**

Power supplies. Hewlett-Packard Co., 100 Locust Ave., Berkeley Heights, N.J. 07922. An 88-page catalog and handbook combines a text-like discussion on d-c power supplies with a complete listing of the company's units. **[459]**

Logic driver data. Weston-Transicoil Div., Weston Instruments Inc., Worcester, Pa. 19490, offers a data sheet describing the operation of stepper motors in conjunction with a logic driver. **[460]**

Automatic wire strippers. Eubanks Engineering Co., 225 W. Duarte Rd., Monrovia, Calif. 91016, has available product data sheets on the model 88 micro-wire and model 83 heavy cable automatic stripping equipment. **[461]**

Instructional tv system. Jerrold Electronics Corp. 401 Walnut St., Philadelphia, Pa. 19107. An eight-page booklet tells in detail how a 16-channel closed-circuit instructional tv system has upgraded observation of classroom methods by student teachers. **[462]**

Control knobs. Raytheon Co., Fourth Ave., Burlington, Mass. 01803, has issued a catalog describing several series of control knobs for electronic equipment. **[463]**

Vacuum measurement. The Fredericks Co., Huntingdon Valley, Pa. 19006. A 24-page booklet is designed to familiarize laymen involved in vacuum production processes with basic technology. **[464]**

Cooling systems. Zero Manufacturing Co., 1121 Chestnut St., Burbank, Calif. 91503. A 24-page catalog describes 10 series of blowers and systems for cooling electronic cabinets. **[465]**

Insulated wire and cable. Radix Wire Co., 26260 Lakeland Blvd., Cleveland,



It's never too early to start saving their hearts

Help your children form good health habits now to reduce risk of heart attack later:

- Encourage normal weight; obesity in youth may persist throughout life;
- Build body health through regular physical activity;
- Serve them foods low in saturated fats;
- Teach them that cigarette smoking is hazardous to health;
- Make medical check-ups a family routine.

Set a good example. Follow the rules yourself and guard *your* heart, too.

GIVE...
so more will live
HEART FUND

Contributed by the Publisher



SMALL COMPANY



BIG PERFORMANCE



Why knock yourself out when your customer keeps scoring your performance at zero? It makes sense at Sage Electronics, especially when that score is another Zero Defects citation, as evidenced by the examples above.

We are specialists in MINIATURE POWER RESISTOR products. Accordingly SAGE pursues active programs second to none in respect to:

1. Zero Defects
2. High Reliability
3. MIL spec production and test
4. High volume commercial production

Look us over, first by exploring SAGE Catalog R-66. A phone or letter request will promptly bring your copy.



SAGE



SAGE ELECTRONICS CORP.

Subsidiary of Gulton Industries, Inc.

BOX 3926 ROCHESTER, N. Y. 14610

Phone: (716) 586-8010

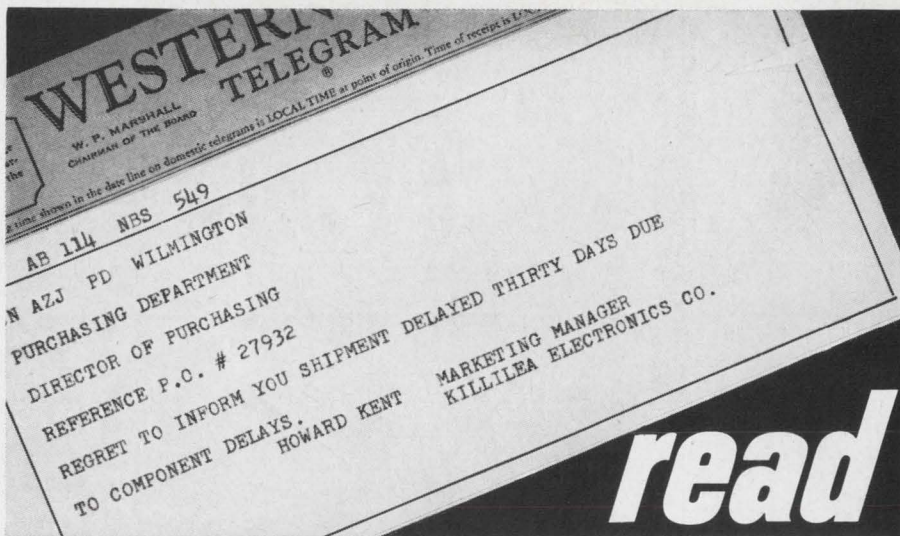

then rent!

When research or production is hung up, due to delayed shipment of vital test instrumentation — simply call us. Just name the electronic instrument you need and we'll ship it **THAT DAY**. Rent it for a week, month or longer — and forget about down time forever.

All our equipment is the latest available. We'll even up-grade your present instruments to newer models. We check and test each unit before shipping to assure

performance. If desired, a CLC man will provide instruction in the use of any instrument.

Shipping — we pay one way. Insurance — available for a small charge. Warrantee — guaranteed to operate to original manufacturers' specifications. Availability — call collect, 24 hours a day, 7 days a week **FOR NEXT DAY DELIVERY.** (617) 643-7750.

Write now for our "Rentals 68" catalog before an equipment emergency arises. Offices, coast to coast.



Continental Leasing Co., Inc.

30 PARK AVENUE, ARLINGTON, MASS., 02175

(617) 643-7750

"Continental,
pioneer in electronic
equipment rentals".

Circle 280 on reader service card

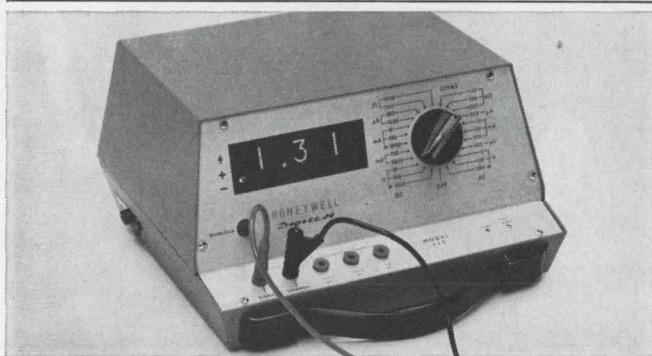

Don't be content with meter scale inaccuracies... move up to absolute digital readout!

The new Honeywell Digitest solid-state digital multimeter is rugged, compact, and fully portable thanks to its AC or built-in rechargeable battery operation. And, it's far superior to conventional meter-movement VOM's. It offers $\pm 0.5\%$ accuracy, 1 part per 1000 resolution, fast readout, and overload warning and internal fusing to protect against accidental damage.

This versatile instrument is a five-function test lab in one neat package! It measures DC Voltage, AC Voltage, DC Current, AC Current, and Resistance. In the lab, on the production line, or in the field, you'll find that the new Digitest is the handiest test instrument you've ever used!

Order yours now — here's how:

The Digitest costs just \$525, with the only option, ni-cad batteries, at \$33.00 per set. To order yours, call (collect): Ron Craig, (303) 771-4717, or send your P.O. to Ron, Mail Station 211A, Honeywell, Test Instruments Division, Denver, Colorado 80217. Order your Digitest today!

Honeywell

TRANSISTORIZED Signal Modulator

This solid-state signal modulator model CH-4 is designed for converting low-level DC signals into AC. Convenient for amplification without mechanical components.

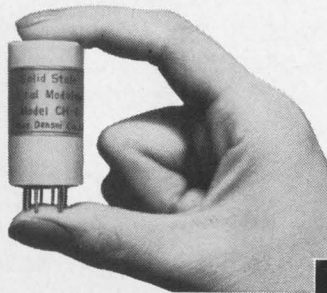

■ FEATURES

1. Long life,
2. Shockproof
3. Moistureproof
4. Short offset time
5. Negligible noise
6. High stability
7. Wide frequency characteristic
8. Interchangeable with mechanical choppers.

■ SPECIFICATIONS

Dimensions: Diameter...1 inch
Height...1 $\frac{5}{8}$ inch
Weight...43g
Standard 9-pin base
Ambient temperature.....
..... -40°C ~ +60°C
Power supply.....
... 5.5V - 8V, 0.01W, 50/60c.p.s.
Noise..... Below 1 μ V
Resistance: On state.....
..... Below 500 Ω
...Off state..... Above 1000 Ω

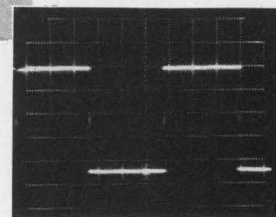

Offset time.....
..... Shorter than 1/5 millisecond
Max. signal voltage..... $\pm 20V$
Max. signal current..... 10mA

Riken Denshi Co., Ltd.

5-5, Yutenji 2-chome, Meguro-ku, Tokyo, Japan.

New Literature

Ohio 44132. A 40-page catalog contains complete data on 44 types of insulated wire and cable. [466]

High-power oscillator. Winslow Tele-ronics Inc., 1005 First Ave., Asbury Park, N.J. 07712, has available an engineering bulletin on the model 304A oscillator, which supplies 10 v into 50 ohms, and covers 50 khz to 100 Mhz. [467]

Ceramic materials. National Beryllia Corp., Haskell, N.J. 07420, has available a property chart showing the electrical, thermal, and mechanical properties of high performance ceramic materials. [468]

A/D converter. Control Data Corp., 4455 Eastgate Mall, La Jolla, Calif. 92037, offers a data sheet on a low-level, 15-bit integrating analog-to-digital converter with high series mode/common mode rejection. [469]

Coil-winding machines. Geo. Stevens Mfg. Co., 6001 N. Keystone Ave., Chicago 60646, has released a two-page catalog for two new coil-winding machines. [470]

Pulsed crossed-field amplifiers. S-F-D Laboratories Inc., 800 Rahway Ave., Union, N.J. 07083. A 26-page illustrated catalog introduces pulsed crossed-field amplifiers to radar system designers. [471]

IR analytical accessories. Instrument Division, Barnes Engineering Co., 30 Commerce Rd., Stamford, Conn. 06902, offers a four-page illustrated folder on its wide range of infrared analytical accessories and cells. [472]

Attenuation calibrator. PRD Electronics Inc., 1200 Prospect Ave., Westbury, N.Y. 11590. Application Note No. 20 covers the 915-B microwave attenuation calibrator. [473]

Dielectric screening inks. Wornow Process Paint Co., 1218 Long Beach Ave., Los Angeles 90021, offers data sheets on the 50-770 dielectric screen black epoxy ink for circuit manufacturers. [474]

Temperature-characteristic analyzer. Winslow Tele-ronics Inc., 1005 First Ave., Asbury Park, N.J. 07712. A four-page engineering bulletin describes the model TCA-1070 temperature-characteristic analyzer and relates its performance characteristics to applicable MIL specifications. [475]

Filter design aid. Nytronics Inc., 10 Pelham Parkway, Pelham Manor, N.Y. 10803. Important information for the circuit design of low-frequency, high-frequency, and bandpass filters is contained in a 12-page booklet. [476]

**Every Bausch & Lomb StereoZoom®
has one feature that can't be copied:**



Proven Reliability



Bausch & Lomb put the ZOOM in stereo. We were the first to offer you the advantage of zoom optics in a stereomicroscope. Bausch & Lomb gives you the plus value of *Proven Reliability* in its StereoZoom Microscopes. More users have bought StereoZoom and required less need for service, than any other make. For ten years Bausch & Lomb has improved StereoZoom to assure you top performance and reliability. Only Bausch & Lomb StereoZoom gives you the flattest fields, the greatest depth-of-field, the locked-in focus throughout the zoom range, the highest eyepoint eyepieces, the quick, eye level, accurate reading of magnification on the zoom control knob. Quality standards proved by 10 years in the field are available to you only in Bausch & Lomb StereoZoom. Write for Catalog 31-15, Bausch & Lomb, 99703 Bausch Street, Rochester, New York 14602.

BAUSCH & LOMB 
SCIENTIFIC INSTRUMENT DIVISION

Circle 239 on reader service card

ADVANCING ELECTRONIC/OPTICAL
INSTRUMENTATION



YOU'RE
WHISTLING
IN THE
DARK . . .

. . . if you think that heart disease and stroke hit only the other fellow's family. No one is immune. Protect the hearts you love. For authoritative information, ask your Heart Association. For medical advice see your doctor. To safeguard your family . . .

GIVE...
so more will live
**HEART
FUND**



Contributed by the Publisher



EMPLOYMENT OPPORTUNITIES

The Scientists and Engineers served by Corcoran in the last year have found the difference between "a job" and "the job."

- Nationwide. Fee paid.
- Please airmail background to:

JOSEPH P. CORCORAN
Personnel Consultants

505 B Germantown Pike
Lafayette Hill, Pa. 19444
Member IEEE

CIRCLE 951 ON READER SERVICE CARD

EMPLOYMENT SERVICES

Across The Spectrum In the Electronics Industry—Engrg—Mgmt—Sales, Gardner Assoc. MU 7-6616 545 5th Ave., N.Y., N.Y. 10017.

CLASSIFIED ADVERTISING



SEARCHLIGHT SECTION

BUSINESS OPPORTUNITIES
USED OR SURPLUS EQUIPMENT

RADAR SYSTEMS GROUND AND AIRBORNE. AUTOMATIC TRACKING ANTENNA SYSTEMS. NIKE AJAX. NIKE HERCULES. M-33. MSQ-1A. MPS-19. MPS-9. SCR 584. TPS-1D. TPS-20. FAA-ASR-2. AIRBORNE SYSTEMS. APN-84. APN-102. APS-20. APS-27. APS-45. DPN-19. DIGITAL COMPUTERS. IBM 650. IBM 704.



LARGEST INVENTORY OF RADAR AND MICROWAVE EQUIPMENT IN THE WORLD.

RADIO RESEARCH INSTRUMENT CO.

45 WEST 45TH ST. N. Y. 10036 212-JU 6-4691

CIRCLE 952 ON READER SERVICE CARD

**You Won't Have
to Spend
\$3,000,000**

to modernize and improve this superb property for your operations because Western Electric recently did it. 325,000 sq. ft., almost completely air conditioned, ideal for manufacturing, R&D, offices. Will divide—units from 3500 sq. ft. In Laureldale, Pa.

BINSWANGER

Corporation

1420 Walnut St., Phila. • PE 5-0202

CIRCLE 953 ON READER SERVICE CARD

free catalog

**POTTING APPLICATORS
MANUAL AND DISPOSABLE**

6cc 12cc 30cc

FOR POTTING, ENCAPSULATING, AND SEALING OF MINIATURE COMPONENTS

PHILIP FISHMAN COMPANY
7 CAMERON ST., WELLESLEY 81, MASSACHUSETTS



CIRCLE 954 ON READER SERVICE CARD

Electronics | March 18, 1968

The day Albert Jones conceived a new IR test technique

Technically, it was the day after he and Frank Porter, AGE major domo, agreed there was a problem. No combination of available components could field-test the aircraft IR sensor practically. "Well," said Al, "looks like we start from scratch." Which understated the problem, since they'd only 6 months to develop a working prototype. Al left Frank with a "Don't worry". But he'd already started worrying.

At home, Al popped the family off to bed after an evening's TV... and pondered. Everything seemed to hinge on the weight. Even latheways cast in magnesium or aluminum clocked in at 1500 lbs.; available sensor-holding units hit the scales at 300+. What was needed would have to weigh far less. So, he gave it considerable thought.

With considerable success. Resulting in the basic parameters for a portable, air-transportable, autocollimated, lab quality optical bench. Capable of ultranarrowband spectral analysis; sensitivity checkout; testing resolution and total field of view, with micrometer sensor positioning and a built-in substitute cryo-source. Total weight: 300 lbs!

Funny thing about Al. He doesn't consider what he did especially unusual. It's typical of the all-of-a-sudden problems that crop up in developing multi-function AGE systems whose frequencies run from DC to light. And, he's gotten used to pioneering ideas like automated test equipment using a time-shared central computer. He likes it. All of it.

If there are any more of you out there like Al, why not investigate what our AGE laboratory can offer you. Even if you'd prefer to pit your intellect against a provocative study or development program in another advanced area, we'd like to hear from you: we'll tell you about ongoing programs in our radio communications, navigation aids, data equipment, countermeasures and tracking systems labs.

Direct your resume, in confidence, to Mr. J. P. O'Reilly, Dept. 160.



GENERAL DYNAMICS

Electronics Division

1400 N. Goodman Street, Rochester, New York 14601

We are an equal opportunity employer in deed,
not only an equal opportunity employer in words.

75W zener withstands 4.4kW surges for 100 μ s...

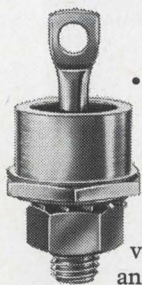

... part of a range extending
from 0.4 to 75W, 3.3 to
75V with 5% tolerance

Mullard zeners give you over 120 different voltage/power ratings in the ranges 0.4 to 75W and 3.3 to 75V. They exhibit sharp knee characteristics, low dynamic resistance and low leakage currents.

Mullard range of zeners

	Voltage Range	Power Rating	Encapsulation
*BZY91	7.5 to 75V	75W	DO-5
*BZY93	7.5 to 75V	20W	DO-4
OAZ222-3	5.6 and 6.2V	10W	DO-4
BZY96	4.7 to 10V	1.5W	DO-1
BZY95	10 to 75V	1.5W	DO-1
BZY88	3.3 to 30V	0.4W	DO-7
BZX61	33 to 75V	0.4W	DO-7

*Available with either normal or reverse polarities.
The BZY91 series is capable of withstanding peak surges of 4.4kW for 100 μ s.

Every designer should have a copy of the Mullard Quick Reference Guide giving information on Silicon Voltage Regulator (zener) and Reference Diodes. Also ask to be put on the mailing list of the Mullard Bulletin—a regular publication which gives details of new components and applications . . . the result of extensive research and development programs in the Mullard laboratories in England.

Write today for information on Mullard zeners and for the name of your local Distributor.

Mullard Limited, Mullard House, Torrington Place, London WC1 England.

U.S.A. enquiries to Mullard Inc., 100 Finn Court, Farmingdale, Long Island, New York. 11735 U.S.A. Telephone: (516) 694-8989 Telex: 961455.

Mullard LIMITED

MOL43

Electronics | March 18, 1968

Newsletter from Abroad

March 18, 1968

Hayakawa hurrying pocket calculator

The Hayakawa Electric Co. is hustling to develop prototype versions of a pocket-size electronic calculator by the fall. Hayakawa edged out the Sony Corp. last year when both bid for government subsidies to develop the calculator, but Hayakawa is now worried that Sony might beat it to the market nonetheless.

Hayakawa fears that Texas Instruments might help Sony in the race. Company officials approached TI before the U.S. firm decided to join Sony in an integrated-circuit venture in Japan [Electronics, Feb. 5, p. 207]. Planning to build its eight-digit calculator around medium-scale-integration IC's, Hayakawa sounded out TI on the possibility of becoming a supplier if the packages couldn't be developed in time in Japan. As a result, Sony's IC partner has a fair idea of Hayakawa's first designs.

Present plans call for from eight to 10 different medium-scale-integration arrays for the computing circuits, along with miniature versions of the Digitron readout tube. The circuits, which would have about 250 elements on the chip and about 40 external connections, are now being developed in conjunction with Mitsubishi and Hitachi. The Hayakawa calculator would be priced at about \$280.

Fiscal curbs to hit Britain's tv market

British consumer electronics companies expect bad news when the Wilson government unveils its 1969 budget later this week.

Chancellor of the Exchequer Roy Jenkins has already warned Britons that the nation is in for more austerity. The aim, apparently, is to hold consumer spending to \$70 billion next year, about \$1 billion less than would be anticipated without deflationary brakes.

Producers of tv sets expect to be hit with a slight rise in sales taxes plus a reinstatement of tougher terms for credit sales and rentals. Restrictions on time-payment sales and rentals were eased last August and a mild spurt in tv business followed.

Other electronics sectors—military hardware excepted—should not be hard hit. The government continues to stress investments in plant improvements, an emphasis that buoys the industrial electronics business. Exporters, though, may lose some of the competitive edge gained in last November's devaluation. Their costs will probably be forced up slightly by boosts in corporate and payroll taxes.

Intelsat wooing French Africa

Some of the French-speaking African countries that de Gaulle is counting on for the Franco-German Symphonie communications satellite system may end up in the fold of the International Telecommunications Satellite Consortium.

Intelsat officials this month made a strong pitch to sign up the Ivory Coast, expected to be one of the first African countries to get a ground station into service. Ivory Coast officials apparently are anxious to link up with a network before 1971, when Symphonie is scheduled to go into orbit.

If the Ivory Coast signs up for an Intelsat ground station, both Cameroon and the Malagasy Republic may follow. The other French African countries apparently would stick with Symphonie, although only Senegal has thus far signed up.

Newsletter from Abroad

Sony diode reacts to earth's field

A diode so sensitive to magnetism that it is affected by the earth's field has been developed by Sony. **Typical sensitivity for the device is 1 volt per milliamperere per kilo-oersted.**

The diode, a germanium bar about 3 millimeters long with a cross section 0.6 by 0.4 mm, has a p-i-n structure, with a small recombination area added along one edge of the intrinsic region. When a magnetic field deflects carriers into the added region, recombination increases and forward current drops. The drop is linear until the diode saturates.

Sony will price the magnetodiode at about \$3 and sees potential applications in brushless d-c motors, proximity switches, and volume controls.

Signetics sees future abroad

Signetics, which has carved out a sturdy reputation as a second sourcer of integrated circuits, **apparently expects further growth to come from abroad.** The Corning Glass Works subsidiary has made its former marketing director, George Didinger, head of a new international department that is organizationally equal to marketing, R&D, and operations.

The company will concentrate on Europe and Japan, according to its president, James F. Riley. "That market now is 25% of the U.S. market. It's right where the U.S. market was four years ago." **Signetics is now dickering with at least two Japanese companies for a joint manufacturing venture there, and plans to build in Europe in the future.** It already has an assembly plant in Seoul, Korea.

French tube makers shun new venture

The two French companies currently producing shadow-mask picture tubes want no part of the deal the de Gaulle government has set up to get the maskless tube developed by the Compagnie Francaise de Television (CFT) into production.

De Gaulle pushed through a plan to form a new company to produce the CFT tube early this year [Electronics, Jan. 22, p. 193]. The government left a **30% holding available in hopes of luring consumer electronics firms into the venture,** particularly the two color-tube producers—La Radiotechnique and Cie. Industrielle Francaise de Tubes Electroniques. Both companies have balked, and it now looks as if French industrialist Sylvain Floirat, a major partner with the government in CFT, will end up with 90% of the shares in the new firm, called France-Couleur.

SEL does well in East Europe

Standard Elektrik Lorenz (SEL) has just boosted its East European order backlog by \$11 million through deals with Rumania, Bulgaria, and the Soviet Union.

The West German ITT subsidiary's **contract from Rumania covers construction of a black-and-white tv picture tube plant at Bucharest,** and supply of signal equipment for the country's railroads. SEL previously had sold signal gear to neighboring Yugoslavia.

The order from the Soviet Union is for teletype equipment. **The Bulgarian deal is for telephone equipment and includes a license from SEL to build some telephone-system hardware during the next five years.**

Latin satellite?

Honduras is trying to sell Costa Rica, Nicaragua, El Salvador, and Guatemala on a regional two-satellite communications network linking the Latin nations to the U.S. and Europe.



PLASTICOTE[®] WIRE & CABLE by CHESTER

CHESTER CABLE CO.

Division Tennessee Corporation
CHESTER, NEW YORK 10918
A Subsidiary of Cities Service Company
(See reverse side)

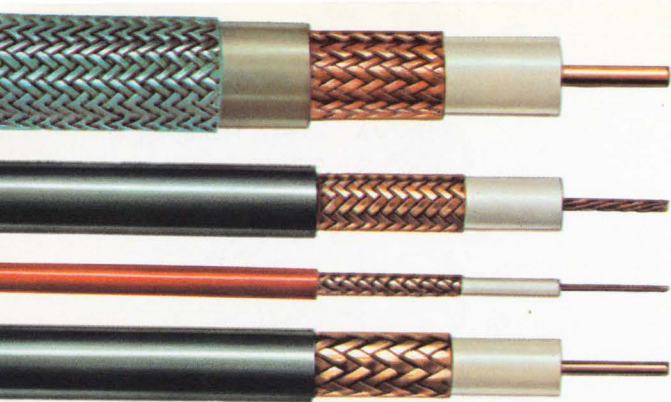

COAXIAL CABLE — Chester Cable Corp. offers a complete line of coaxial cable for military and commercial applications. Manufactured in accordance with MIL-C-17, JAN-C-17 and commercial specifications. Constructions include solid, air-spaced and foam dielectrics with conventional braid shields or flat copper tape shields, having PVC or polyethylene jackets. Custom designed constructions of triaxial cable and high frequency-high voltage cable are also available.

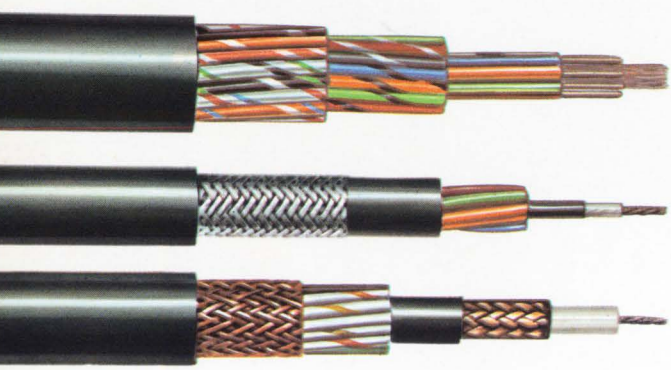

MULTI-CONDUCTOR CABLE — Wide range of custom designs available, manufactured in accordance with such industry standards as MIL specs., U/L, CSA, IPCEA, EIA, IMSA, ASTM, etc.

Chester Cable Corp. is a preferred source for quality electronic and electrical cable, insulated and jacketed with thermoplastic materials such as polyvinylchloride, polyethylene and nylon. Custom designs of shielded or unshielded cable include: Control Cable • TV Camera Cable • Missile Cable • Intercom Cable • Computer Cable • Special Hi-Voltage Cable and Parallel Bonded Ribbon Cable.

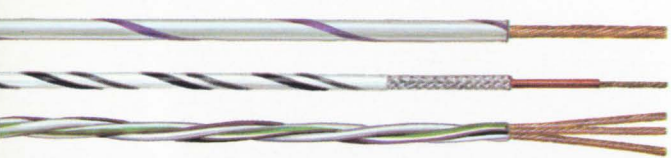

MIL-SPEC WIRE — Made in accordance with specifications MIL-W-16878 (Types B, C & D), MIL-W-76B (Types LW, MW & HW) and MIL-W-5086A for electronic systems. Available in single or multiple constructions, shielded or unshielded, with or without nylon or PVC jackets.

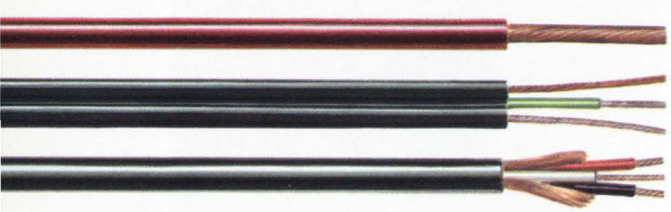

WIRE AND CORD FOR THE APPLIANCE INDUSTRY — U/L and CSA approved, 60°C — 80°C — 90°C — 105°C appliance wiring material — SVT, SJT, ST cord, SJTO & STO oil-resistant cord, SJT & ST oil-proof cord, SPT cord with or without individually insulated ground wire. Used for washers, dryers, refrigerating, air conditioning, vending, heating, X-ray and other electrical and electronic equipment.

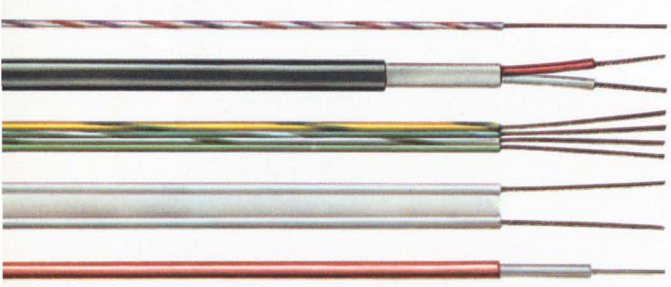

RADIO AND TV CIRCUIT WIRE AND CABLE — U/L and CSA approved, 60°C — 80°C — 90°C — 105°C appliance and radio circuit wire, microphone cable, shielded and unshielded audio circuit wire, twin lead antenna wire, phonograph cable, parallel-bonded color convergence ckt. cable, braided hook-up wire, hi-anode wire, hot chassis lead, balun-coil wire, shielded constructions with spiral, braided, aluminum-Mylar tape and conductive materials; all available in Thrif-T-Bond® tinned over-coated conductors.

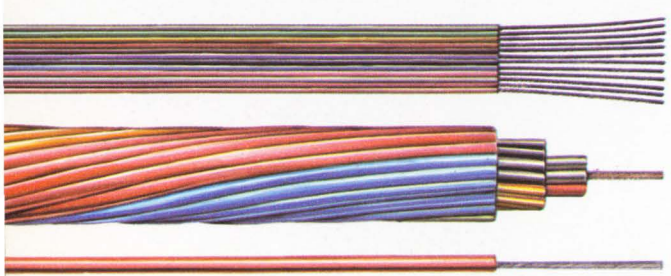

MISCELLANEOUS WIRE AND CABLE — Machine Tool Wire • Bus Drop Cable • Flexible Test Lead Wire • Municipal Signal Cable • Low Energy Circuit Control Cable • Station Control Cable • Inter-Office Communication and Signaling Cable • Deep-Well Submersible Water Pump Cable • Gas Tube Sign and Oil Burner Ignition Cable • Intercom Cable • Gasoline and Oil Resistant Wire • Computer Cable • Uninsulated Bus Wire • Parallel and Jacketed Cord • Braided Ground Strap, and special custom designed cable for your applications.



Write or phone for further information

CHESTER CABLE CO., Division Tennessee Corporation, **CHESTER, NEW YORK 10918**
A Subsidiary of Cities Service Company

Phone: 914-469-2141 • TWX: 914-469-7011

Printed in U. S. A.

ENGINEERS AND SCIENTISTS:

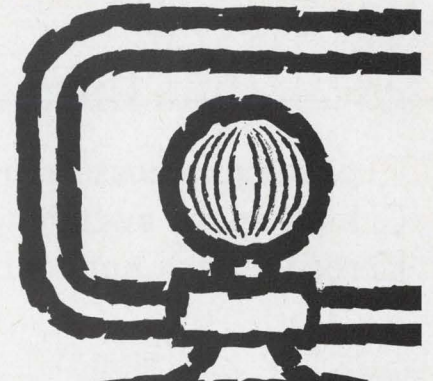

hour of decision



Join the Investigative World of EG&G in Las Vegas, Nevada. Diversified, challenging projects . . . Modern facilities and advanced equipment . . . More personal and professional benefits in dynamic, growing Nevada: outstanding schools, facilities and services, entertainment and climate . . . and an unlimited growth potential in one of the most stimulating engineering and scientific environments in the West.

Projects of national importance involving nuclear rocket development and underground testing at EG&G, Las Vegas, Nevada, demand men of decision.

Perhaps, you can qualify. Inquiries and resumes invited. Write EG&G, Personnel, 680 East Sunset Road, Las Vegas, Nevada, 89101. U.S. Citizenship Required. An Equal Opportunity Employer.



IBM Circuit Design and Packaging Topics

- packaging cost reductions
- high-speed switching
- reed switch application data

packaging cost reductions

Performance Measurements Co., Detroit, Michigan, reports significant savings in packaging their new electronic recording system. The packaging method previously employed required two gates to mount the components in the main console. Now, with IBM's modular packaging as pictured below, only one gate is needed. That's because the IBM technique makes the most efficient use of console space with compactly mounted and connected circuit boards, relays and hardware.

Mounting time has been saved too. Pluggable components, low-cost card receptacles and interlocking card guides have so simplified the packaging job, that Performance Measurements now saves 70% on the cost of mounting hardware. Fewer and shorter wires are needed in the compact console — eliminating three feet of 1½-inch cable and shortening a second cable by eight inches. The modular chassis gave designers freedom to experiment freely with various mounting configurations. It also permits easy access for servicing and diagnostic analysis.

The same design freedom, plus significant hardware and labor savings are available in many applications.

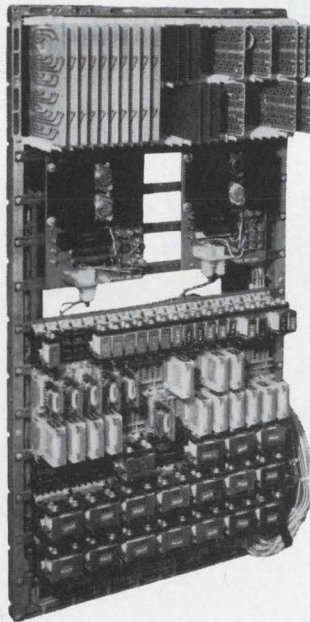

IBM components and packaging can help you in timing control, digital logic testing, telemetering, process or numerical control.

high-speed switching

IBM wire contact relays were originally designed for data processing use. Now they are being used extensively in machine tool and assembly applications. One of these assembly applications is a numerically-controlled component insertion machine. It sequentially inserts random combinations of up to 24 different types of axial lead resistors and diodes into printed circuit boards. Such machines have been widely used, often on a round-the-clock, three-shift basis, in IBM's electronic assembly operations.

Insertion rates range from 3,000 to 4,500 components per hour, depending upon the type of components being inserted.

Instructions from an 8-channel punched paper tape provide the logic-input to the relay gate. The gate employs three rows of 6- and 12-pole IBM wire contact relays. These relays control the movement of each printed circuit

board through the X and Y axis positioning of the board for each component insertion. They also control the component feed, component insert, and cut-and-clinch cycles for each insertion operation.

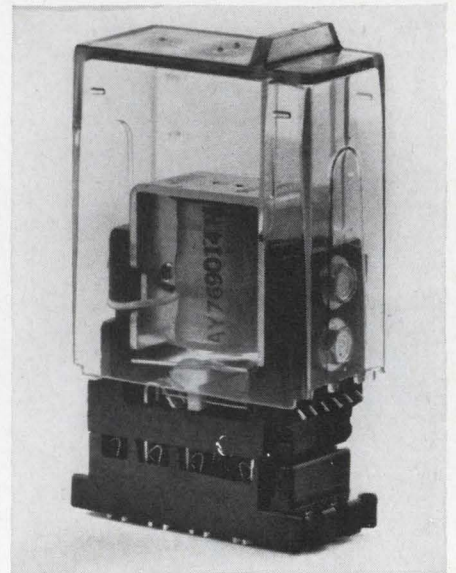

Dust covers are available for various types of IBM wire contact relays. The six-pole model above is shown with cover partially removed.

IBM wire contact relays can perform in excess of 200 million operations with an operate speed as fast as 4.5 ms, a release time of 5 ms maximum. The product line includes 4-, 6-, and 12-pole Form C relays, 4- and 6-pole latch models, all with compact, solderless,

pluggable mountings—with coil-voltages up to 100 VDC.

reed switch application data

Data on the magnetic switching characteristics of miniature dry reed switches is available to design engineers on request. The data was compiled from extensive tests conducted by IBM to help the design engineer use these switches most effectively. It can also help him determine the motion and position of the magnet required.

Simply described, a miniature dry reed switch operates under the influence of a permanent magnet. When the magnet is adjacent to the reed switch, the flux of the magnet flows through the cantilever beams, as illustrated. While this magnetic flux is being carried by the beams, a polarity exists across the beams. The north pole of one beam and south pole of the other beam are in proximity. Since unlike poles of a magnet attract each other, when the magnetic force becomes great enough to overcome the physical mass of the beams, they "snap" together, thus switching.

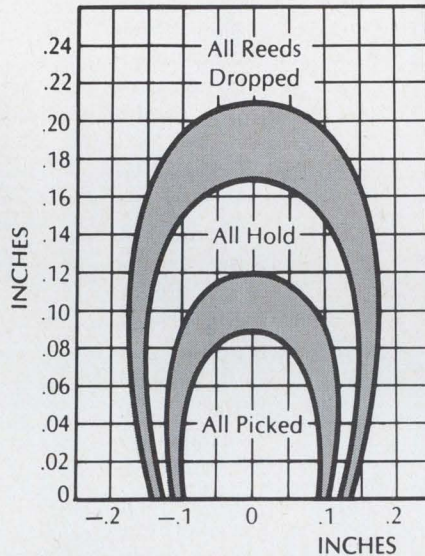
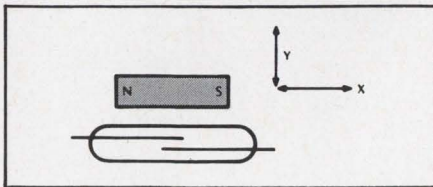

On the graph the X axis represents the displacement (in degrees for rotary motion, inches for lateral motion) of a magnet's center with reference to the center of the reed switch. The Y axis represents displacement (in inches) of

the magnet from the outer edge of the dry reed switch glass envelope. Dimensions shown along both axes represent displacement from the center of the magnet in alignment with the center of the reed switch.

There are some "gray areas" where performance varies due to minor differences in the characteristics of each switch.

Assume the zero point on the X axis is the magnetic center of an IBM reed switch. The magnet is positioned with its center at +.5 on the X axis, and .04 inches above the glass envelope. If the magnet is set in motion along the X axis toward the center of the switch, some reeds will pick when the center of the magnet reaches the point +.12 on the X axis. (The magnet has then reached the "gray area"). If motion is continued toward the center of the switch, all reeds will pick when the center of the magnet reaches the point +.09 on the X axis.

IBM Industrial Products Marketing Dept. T1R
1000 Westchester Avenue
White Plains, New York 10604

IBM
 INDUSTRIAL
 PRODUCTS

- packaging cost reductions
- high-speed switching
- reed switch application data

name _____

position _____

company _____

address _____

city _____ state _____ zip _____

E3

RCA linear integrated circuits  sampler/QK2200

RF Amplifiers CA3005

Arrays CA3019

CA3018

CA3028A

Operational Amplifier CA3015A

For information on additional types in RCA's integrated circuit line, check the Product Guide in your literature file.

For additional literature, write Continental Engineering, RCA Division, Components and Devices, Building 20A-1, Hickory, N. J. 07033.

For Authority Information on the products they sell, or check your RCA Representative in your RCA Division.

CA3000 CA3005 CA3012 CA3015A

General

RCA linear integrated circuits  literature file

RCA linear integrated circuits  sampler

Technical Series IC
Suggested Price \$2

RCA linear integrated circuits 

• design fundamentals

typical applications

- CA3000 Schmitt Triggers, Mixers, Comparators, Modulators, Crystal Oscillators, Sense Amplifiers, RC-Coupled Feedback Amplifiers
- CA3005 RF, IF and Video Amplifiers, Mixers, Limiters, Sense Amplifiers, Modulators, Cascode Amplifiers
- CA3012 TV Sound and FM IF Amplifiers, Wideband Amplifiers
- CA3015A Operational Amplifiers, Band-pass Amplifiers, Multivibrators, Comparators, Scaling Adders, Oscillators, Servo Drivers, Balanced Modulator-Drivers
- CA3018 RF, IF Video, DC and Audio Amplifiers
- CA3019 Modulators, Mixers, Analog Switches, Gates
- CA3028 Audio, Video, IF, RF Amplifiers and Pre-amplifiers, Servo Amplifiers
- CA3029 Video and IF Amplifiers, Limiters, Gain-Controlled Linear Amplifiers
- CA3028A RF, IF, Video and Audio Amplifiers, Converters, Mixers, Oscillators, and Limiters
- CA3035 Low-Noise Instrumentation Amplifiers, TV Remote Amplifiers
- CA3036 Operational Amplifier Drivers, Stereo Photo Pre-amplifiers, Emitter-Follower Differential Amplifiers

 The Most Trusted Name in Electronics
Electronic Components and Devices Division, N.J. 07033

Get your "linear

RCA

The RCA Linear Integrated Circuit Sampler at your Distributor's only \$39.95*

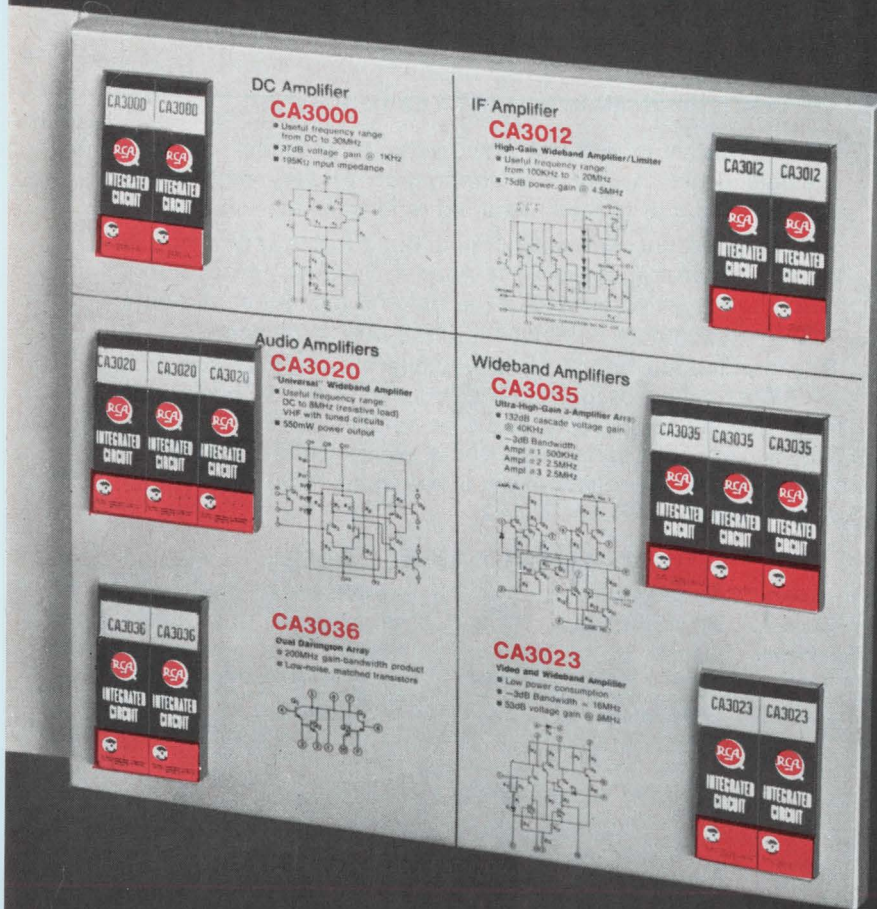

*Optional Distributor Resale Price

design lab" now!

The circuits, the information you need in a single re-fillable package

11 Circuits/26 Devices/Complete Literature

This new RCA kit—available from your Distributor for a limited time only—is like a complete linear IC laboratory for circuit designers. Open it up. There's everything for your instant updating in the dynamic new area of linear integrated circuits... RCA's latest Linear Integrated Circuits Manual, technical data, application notes, mounting and connection techniques—and samples of major linear integrated circuits!

You get amplifiers—from special purpose to "universal" types, RF amplifiers, op amps—transistor arrays, diode arrays—26 units in all! And you can keep your kit stocked by ordering individual devices from your distributor.

Here's what every designer has been looking for—a quick, convenient, comprehensive way to get a first-hand familiarity with linear integrated circuits! See your RCA Distributor—NOW!



**lower
attenuation**

**higher
power**

8" diameter flexible HELIAX® coaxial cable

8" Air dielectric HELIAX coax extends the advantages of flexible cable to very low attenuation or very high power applications that formerly required rigid transmission line.

Corrugated inner and outer copper conductors accommodate thermal expansion without the need for sliding contacts. End connectors mate with 6½" EIA flanges and lock inner and outer conductors together to eliminate differential expansion.

The continuous, connector free cable assures freedom from the VSWR "spikes" associated with the periodic inner connectors of rigid line in a long feeder. Cable assemblies can easily be electrically tested on the reel to assure your exact system performance. For complete details write Andrew Corporation, 10500 West 153rd Street, Orland Park, Illinois 60462.

HJ 10-50 HELIAX COAXIAL CABLE

	At 30 MHz	At 600 MHz
Attenuation	.027 dB/100 ft	.15 dB/100 ft
Average Power	300 kW	58 kW
Other Power Ratings	For SSB, 200 kW PEP with antenna VSWR of 3:1 2 Megawatts Peak	TV transmitter power ratings, 223 kW at Channel 4 and 70 kW at Channel 35

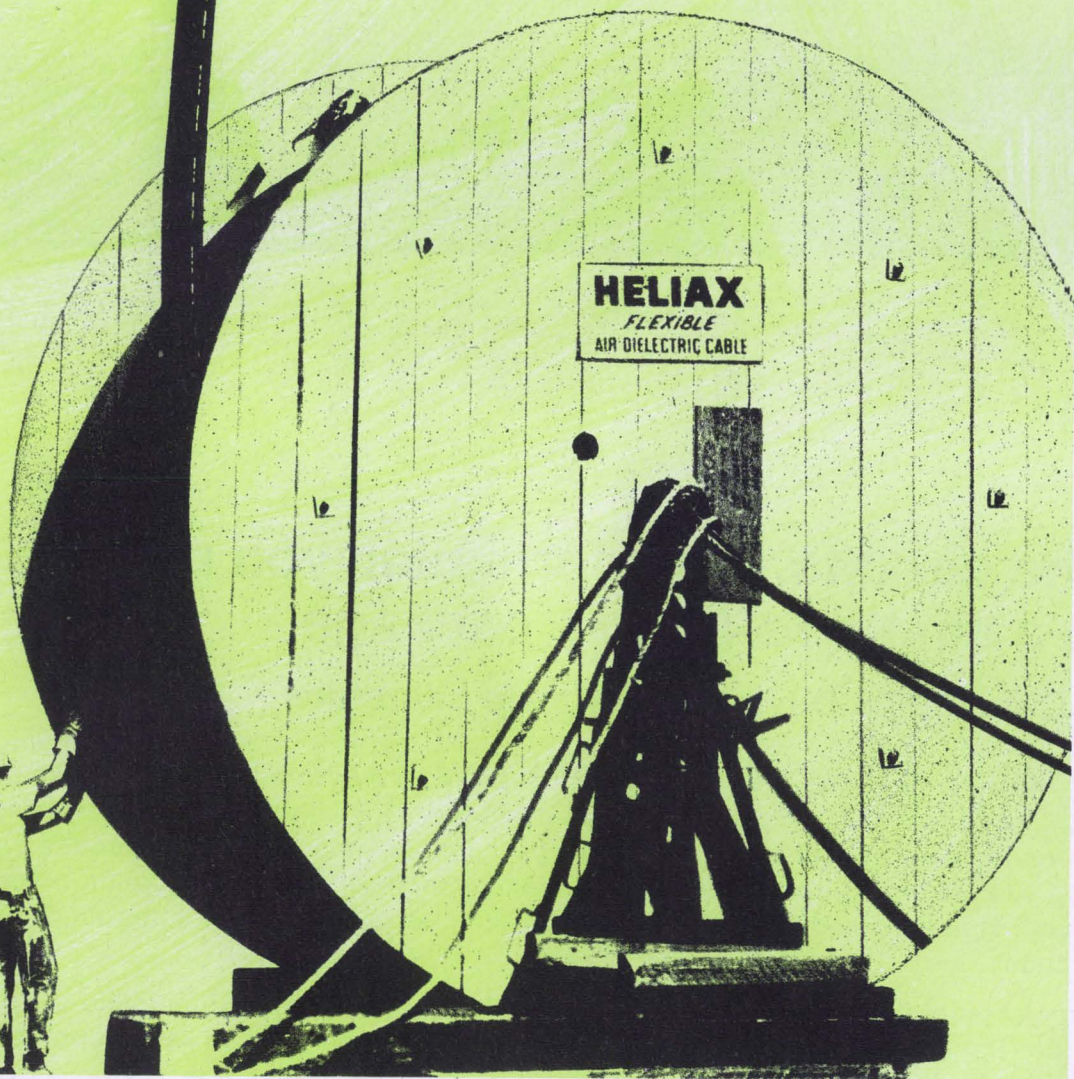

2-68

Great Britain

More with the MOST

Like their U.S. counterparts [see story p. 173], the major British electronics companies are putting a lot of their chips on metal oxide semiconductor transistors (MOST).

Mullard Ltd., for example, has a 1,024-bit mos transistor memory array well along in development. Elliott-Automation Ltd. has mos arrays with beam leads in the works. Associated Electrical Industries, a company now being merged with the British General Electric Co., is tinkering with mos transistor delay-line networks.

But it's the Plessey Co. that seems to be the current British leader in mos technology. Plessey researchers have made working most Hall-effect transducers and the company's production people are ready to turn out mos optoelectronic arrays.

Two for the show. Plessey has developed five basic devices in the optoelectronic line and will show two of them at the International Components Show in Paris next month. All the devices' photocells, switching circuits, and amplifiers are packed on single chips. The simpler arrays are intended for photomultipliers and the complex ones are suitable for character-recognition systems. Peter Noble, the head of the team that developed the arrays, sees the possibility in 18 months or so of arrays built for television cameras, with all light-sensitive elements, scanning circuits, and signal processors on one chip.

Noble opted for mos transistors for optoelectronic arrays largely because of their low leakage current and high input impedance. These are the prime requirements for any integrating light detector, that is, any device whose output is a waveform that depends on the

incident light. In the Plessey setup, the most switching circuits and amplifiers control the charging and discharging of capacitors in parallel with photodiodes. Because the decay rate is proportional to the current through the photodiodes, the frequency of the sawtooth waveform generated depends, in the long run, on the incident light.

In the middle. The simpler of the two devices to be shown at the Paris show has two identical diodes side by side with an mos transistor between them to act as a switch and differential amplifier. The diodes measure about 0.004 by 0.005 inch and the chip itself is 0.030 inch square. Plessey expects to sell this version for something like \$16 or \$17 in Britain.

In the OPT 1, as Plessey calls the array, the two photodiodes are charged in parallel and the voltage across them is allowed to decay. One diode, though, is overlaid with aluminum and thus develops only dark current. The output of the mos amplifier is the difference between the two decay voltages, an arrangement that cancels out the dark-current effect and improves the accu-

racy of the device.

What may be the forerunner of a new generation of tv camera tubes is the 10-by-10 array Plessey will exhibit in Paris under the designation OPT 5, and will sell in Britain for about \$250. For the money, the buyer gets the photodiodes, the associated amplifiers, and the scanning circuits on a single chip 0.070 inch square.

Samplings. Plessey sees the array as the key element in character-recognition equipment, but there are also possibilities for it in position sensing, fringe counting, and similar applications. Each diode in the array registers the light level on the corresponding part of the scanned area, and the output of each diode-amplifier combination is sampled in turn under control of the scanning circuitry, essentially one ring counter for each of the two axes of the array. The sampling is timed to come near the end of the charge-decay cycle for the diode, when the output signal reaches its maximum level.

Noble says it's an easy task—essentially a change of masks—to build the arrays in any desired

First reader.
Plessey has readied for production this 10-by-10 MOS array of photodiodes, amplifiers, and scanning circuits on a single chip. Most likely first application: character readers.

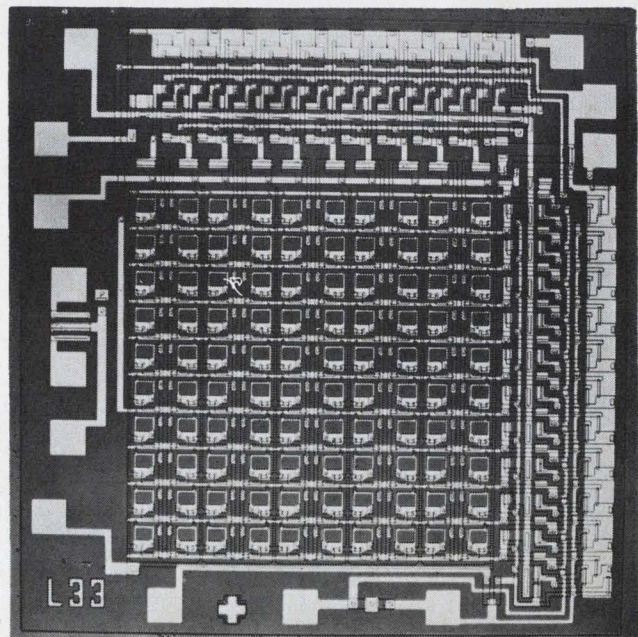

geometry. One that's already been made in the laboratory for character recognition, for example, has a 72-by-five layout on a chip 0.100 by 0.400 inch.

Noble is working on an array of 40,000 diodes, plus associated circuitry, for a closed-circuit tv camera. He hopes to eventually go to a 625-by-625 layout that would make today's tv cameras obsolescent.

Gem of a delay

Ordinarily, designers of radar sets like to keep delay lines in the intermediate-frequency stages rather than in the harder-to-handle radio-frequency stages. But for some reason that the British military establishment is keeping classified, one set under development in Britain needs a delay that will hold up X-band signals for about 7 microseconds.

Standard Telecommunication Laboratories, a subsidiary of the International Telephone & Telegraph Corp., has the job of building the delay line—but not the radar equipment. And at last week's

Physics Exhibition in London, it showed an experimental version built around a sapphire rod.

Cool. The experimental rod, about 0.67 inch long, operates at liquid nitrogen temperatures and gives a delay of about 3 μ sec. The pass band is almost flat over 1 gigahertz and loss is only 70 decibels.

Since the delay varies with the length of the rod, it seems as if the 7- μ sec line will run about 1.5 inches long. The loss, though, presumably won't rise much above the 70-db level. At very low temperatures, most of the loss comes from the transducer through which the X-band pulses are fed into and out of the rod.

It's the transducer, Standard Telecommunication points out, that presents the big problem in building the delay, even though the tolerances on the rod itself are stringent. Standard uses a layer of cadmium sulphide over a layer of gold to form a piezoelectric transducer that converts the X-band signal into an acoustic wave that travels the length of rod and back and thus delays the pulse. The gold layer, sputtered onto one end

of the rod, has a thickness 1/7th the acoustic wavelength generated by an input signal of 8.9 gigahertz. The thickness of the cadmium sulphide layer evaporated on top of the gold is half the acoustic wavelength.

Japan

King-size cassette

Ensnarled in coils of paper tape, many a small-computer user has longed for the convenience of the costly magnetic tape handlers that are part of medium and large data-processing installations.

The longing is over for users of small Fujitsu computers with \$183 monthly to spend on top of what they're paying now for their machines. For that fee—or for \$7,600 and an outright purchase—they can get a Facom 401A magazine file that works with cartridges holding 330 feet of 1/2-inch magnetic tape.

Facom opted for the giant cassettes—slightly over one-foot long—so that secretaries and others without any special computer training could slip the tapes into the handler without slipping up. So far, the cartridges are being used to store system programs, auxiliary data for the internal drum file, and as a standby store for sorting operations—the sort of jobs where paper tape is anything but ideal.

Economies. To keep prices in a range that heretofore has been the preserve of paper punches and readers, Fujitsu designed the magnetic tape file around the interfaces previously developed for paper-tape peripherals.

For further economy, Fujitsu adopted a four-track format for the 1/2-inch tape. More expensive readers generally use a seven-track format. With four tracks there's an obvious saving in read and write amplifiers. There's also less chance of lost data with the wider tracks.

Data is recorded in duplicate—the redundancy prevents error—on the four tracks in the form of an eight-bit byte. The transfer rate of the bytes is 167,000 per second. Ex-

Data pack. Anyone who can slip a cassette into a tape recorder can feed data into this computer setup. Unit only reads unless "write" clip is in cartridge.

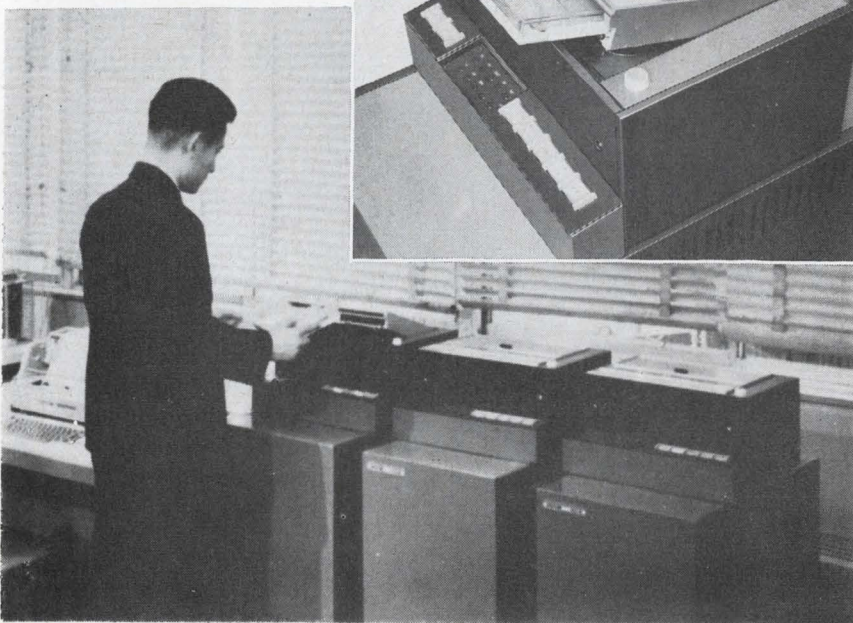

cept for the reading-head preamplifier and the writing-head driver, most of the circuits in the file work both ways—converting incoming data into the eight-bit format and outgoing data into the paper-tape interface format.

Reeling. Economies turn up in the tape drive as well as in the reading and writing circuits. Instead of the usual capstan and pinch-roller arrangement, there's a direct drive on one reel and braking on the other. This cuts down the length of tape that can be used on a reel since speed variations, which can't get out of hand, depend on how much tape is wound onto the reel. But the sacrifice in tape length, Fujitsu felt, was more than offset by the savings of a direct drive.

At a 330-foot tape length, the average tape speed is 30 inches per second. The variations in speed do not affect the data rate, because the speed for any segment of the tape is essentially the same at both reading and writing. Start and stop times are 150 milliseconds and the average spacing between data blocks is 5 inches.

Side-by-side. Low as it seems at first glance, the \$7,600 price tag is in a sense misleadingly high. The tape handler has a common control system that can handle tape feed cycles, interblock gap detection, and data protection for two other "add-on" units that cost \$3,400 each. In groups of three, then, the unit cost becomes \$4,700 and the total monthly rental \$350. The cartridges—not rented—cost \$13 each.

Checking the dose

Whenever the Japanese spot an obvious gap in the lineup of instruments produced in their country, chances are they'll fill it with something a little better than others can offer.

This month, for example, the Matsushita Electric Industrial Co. introduced a thermoluminescent dosimeter that gives a digital readout of the amount of radiation people working in laboratories or nuclear plants have been exposed to. Thermoluminescent dosimeters

have been in production in the U.S. and Europe for three years or so, but none of them—Matsushita claims—can equal the new Japanese instrument in sensitivity. And none is quite as small as Matsushita's readout unit since it's built around integrated circuits.

New. Matsushita's dosimeter was designed to work with a "new" thermoluminescent material—calcium sulphate. It's been known for some time that calcium sulphate with a manganese impurity shows a marked increase in its thermoluminescence—the light it emits when heated—after it's been exposed to radiation. Trouble is, the sulphate loses its thermoluminescence a few hours after it's radiated.

Add a rare earth impurity, though, and the effect becomes long-lasting, Matsushita found. The calcium sulphate material Matsushita uses for the disks in safety badges worn by people working where there's a radiation hazard holds its thermoluminescence for at least a month. The disks have a sensitivity of 0.1 milliroentgen, roughly the amount of background radiation anyone is exposed to during 12 hours. By contrast, the film badges used in Japan so far at best have a sensitivity of 10 milliroentgens.

Hot. For the readout, which takes about 10 seconds, the disks are slipped into a small drawer in the instrument that is heated to 300°C. The "glow peak" for the disk is 220°C.

The light output of the glowing disk is picked up by a photomultiplier tube and amplified by a metal-oxide semiconductor field-effect transistor followed by a high-gain IC amplifier. The total thermoluminescence, integrated by multiple negative feedback loops around the amplifier, is converted to a digital value by counter circuits built around IC's.

Four ranges in the instrument cover radiation exposure from 0.1 milliroentgens to 10,000 roentgens. Scale switching is automatic and so is ejection of the disks after a reading. As with other thermoluminescent dosimeter disks, Matsushita's can be reused after readout.

Australia

New approach

At some of the world's major airports earthmoving—rather than hardware—is the main cost of an instrument-landing system. But land-leveling may soon cease to be a kingpin consideration. Robert Redlich, an American engineer working under a grant from Australia's Department of Civil Aviation, has come up with a transmitter array that slashes the stretch of flat land ordinarily needed beyond the end of the runway to get a good glide path signal.

The new Australian gear, in fact, figures to make standard instrument-landing glide paths possible for runways where conventional null-reference arrays won't work because of the surrounding terrain. One such is the 07 runway at Sydney's Mascot Airport. There, a prototype of the new transmission setup is under test with the array spotted only 600 feet from the end of the runway, beyond which lies a concrete drainage duct and a canal. The conventional array had to be sited 1,800 feet back from the runway's end and for that reason the glide path is 90 feet high—50 feet is standard—at the approach threshold.

An earlier prototype of the new system proved successful in tests at a small airstrip near Sydney. In the U.S., special arrays that do much the same job as the Australian array have been installed at about 10% of the airports, but Federal Aviation Administration experts admit they'd welcome something better.

No reflections. Either way, the solution is an array that needs no reflected ground wave to establish its glide path. Conventional null-reference systems do need such a wave and to get a good signal they must have about 2,500 feet of hard, flat terrain in front of their arrays. To obtain the standard 50-foot threshold height, the arrays are sited 1,000 feet from the end of the runway, meaning an additional 1,500 feet is required beyond.

Like conventional gear, Redlich's

system operates on the standard glide-path band of 329 to 335 megahertz using 90-hertz and 150-hertz tones to modulate the carrier. But instead of two dipoles, the array consists of two vertically stacked "elements," each made up of seven trios of dipoles in horizontal corner reflectors. The array is 45-feet high and needs only 300 feet of smooth foreground so that side-lobes cannot be reflected into the region of the glide path.

Change of phase. The phase centers of the new array lie at 30 feet and 15 feet, the same heights as the dipoles in null-reference glide-path equipment. Ordinary null-reference signals, though, would not set up a very good path with the new array. The demodulated 90-hz and 150-hz tones would be too distorted to be useful in airborne glide receivers, whose tone filters are not highly selective. Instead of the usual 45° phase difference between the audio tones and the carrier, a 15° phase difference is used for Redlich's array. This eliminates, for practical purposes, tone distortion in the path region. As with conventional modulation, the percentage differences between received tones are used to actuate a cockpit display that shows the pilot whether he's in the glide path, below it, or above it.

France

Mover and shaker

Traditionally, French researchers go about their business in relative calm. But these days there's a trend to restiveness in the government-run laboratories where much of the country's research is done. A new man heads the French science establishment and many old hands in the test-tube hierarchy regard him as an iconoclast.

Pierre Aigrain, 43, took over as head of the Délégation Générale de la Recherche Scientifique et Technique only last month. And with him came his reputation as a mover and a shaker. As director of higher education for the Ministry of Edu-

cation, Aigrain proposed three years ago that the cumbersome French university system, with its top faculties concentrated in Paris, be broken up into autonomous schools dispersed throughout the country. Now, to the dismay of the rigid scholastic bureaucracy, there are signs the minister of education plans to follow through on Aigrain's schemes.

New tack. So far, Aigrain hasn't come forth with any sweeping proposals for restructuring the government's non-military research setup. But as top civil servant for science—he reports to Prime Minister Georges Pompidou—he can, and undoubtedly will, steer French science in a new direction.

For one thing, Aigrain is an engineer by training—first at France's Naval Academy and then at Carnegie Tech where he acquired a doctorate in electrical engineering. (Later, though, he took a second doctorate in physics and joined the faculty of the University of Paris where, among other things, he led a group doing basic semiconductor work.) For another, Aigrain is convinced the country's shortcomings in technology lie in production and marketing rather than in research.

A case in point, he says, is metal-oxide semiconductors. Aigrain maintains that at one time CSF-Compagnie Générale de Télégraphie sans Fil was out in front of U.S. companies—in the lab. And he feels that CSF and other French semiconductor firms once were abreast of the U.S. leaders in large monolithic integrated circuits but have fallen behind in the market place.

Back and forth. Part of the solution to the production-marketing problem, Aigrain thinks, can come from breaking down the traditional gulf between the government's scientists and industry's development engineers and marketing men.

Aigrain would like to see more researchers shuttling back and forth between government and industry laboratories. But there are barriers. Frenchmen generally are wary of changing jobs. And once a government researcher moves into a job at a company he rarely returns to a civil service slot because

the pay is poor by comparison.

Pick and choose. If the production gap can be closed, Aigrain figures, France won't have any real troubles keeping her technological independence. There's no question of matching U.S. technology across-the-board. But he expects France can stake out front-line positions in some key sectors.

One is large-scale integration, where Aigrain says "minor corrective action" could put France up with the front runners in about five years. For the longer term, Aigrain has a few ideas of what sectors to



Master of science. Pierre Aigrain now sets research policy for the French government's non-military laboratories.

push and which to let languish. Three likely candidates for a solid push are chemicals, optics and some areas of mechanical engineering. The country is seriously lagging in mechanics, he says, and "mechanics will be very important, even to electronics."

To put his ideas into action Aigrain will be able to pull the purse strings for about 40% of the government's research funds. Last year's spending, for example, totalled slightly more than \$1.8 billion. Some \$732 million of that was earmarked for non-military programs over which the Délégation Générale has either direct control or considerable influence.

Figures on industry's research outlays are hard to come by, but it seems certain the government far outspends French companies in

this field. Estimates for 1965—the latest available—indicate that some \$880 million was spent on research in nongovernment labs, with industry picking up slightly more than half the bill and the government and foreign customers paying the balance. Aerospace research accounted for the largest share of 1965 expenditures, with electronics second.

West Germany

How bright?

Outdoor-lighting specialists take considerable pains to find out exactly how much illumination they can get from a light source. The more precisely they know a source's rating—the mere wattage indication as found on ordinary household bulbs is only a rough guide at best—the better they can light a street or a sports arena.

Conventional methods of checking light output require elaborate and sometimes bulky equipment. One common way to measure luminous flux is to take readings on a source mounted in an Ulbricht sphere, often 12 feet or more in diameter. Even with the sphere, flux readings are accurate only to within 5%. And additional apparatus is needed to determine such other characteristics as flux by sector and luminous intensity.

On the beam. One German outdoor-lighting firm, Gantenbrink-Leuchten OHG, has substituted electronics and a rotating steel beam for the bulky Ulbricht sphere. Its setup measures and records to an accuracy of 1% the total flux, the partial flux of selected segments, and the luminous intensity.

The equipment, worth about \$17,000, was designed for Gantenbrink by the lighting technology institute at the Berlin Technical University. The sensor is a selenium photocell mounted on one end of a 10-foot-long beam that carries the cell around the light source. The source, too, is set up to rotate, and this plus the beam rotation results in a spiral scan that takes 6½

minutes to cover the full area of the source.

Gantenbrink is currently using a photocell that can handle illuminations ranging from 100 millilux on up to 3,000 lux, but it plans to shift soon to a cell that can measure emissions as bright as 200,000 lux. Broad daylight produces an illumination value of about 100,000 lux; 1,000 lux, however, is considered adequate for an auditorium.

Readout. The current output of the equipment's photocell is translated into a corresponding voltage by an operational amplifier at a remote console. The amplifier's output, in turn, is corrected by a sine potentiometer and then fed through an impedance transformer to a motor. The motor drives a chopper that interrupts a reference light beam played on a photodiode array, setting up a voltage-to-frequency conversion.

The pulse output of the diodes then becomes a reading of the total luminous flux in lumens. For readings of the illumination in lux and in new international candles, the sine potentiometer is bypassed.

Around the world

Soviet Union. The Russians now are producing lasers in 10 models, divided about evenly between continuous and pulsed types. The lasers are complemented by a line of modulators and optical receivers that have been used for both experimental television transmissions and satellite communications.

Great Britain. International Computers & Tabulators has ordered a batch of 100,000 transistor-transistor-logic circuits from Mullard Ltd., a British subsidiary of Philips' Gloeilampenfabrieken of the Netherlands. Mullard believes the order is the largest yet logged for British-made integrated circuits.

Japan. The Matsushita Electrical Industrial Co. has set up a subsidiary in Sydney, Australia, to produce consumer electronics goods. The new operation is Matsushita's eleventh outside of Japan.

Now in
publication!

A Fully Documented Analysis of International Electronics

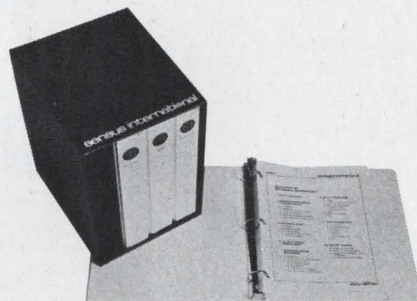

Four volumes of incisive data—by country—basic elements in planning and maintaining a position of marketing strength in the international electronics markets.

Updated regularly, information is gathered on the spot and covers all aspects of doing business in electronics in every major electronics market of the world. Tariffs, government policies, exchange controls, credit, trade unions, even the impact of smuggling are covered in these in-depth reports.

Send for complete, free information

sensus international

Please send me your free, descriptive literature.

Name _____

Title _____

Company _____

Street _____

City _____

State _____ Zip _____

SENSUS INTERNATIONAL
712 Montgomery Street,
San Francisco, Calif. 94111

If you can't wait,
call (415) 989-6973

If you're still putting up with down time... you should have your heads examined.

Your analog magnetic recording heads, that is.

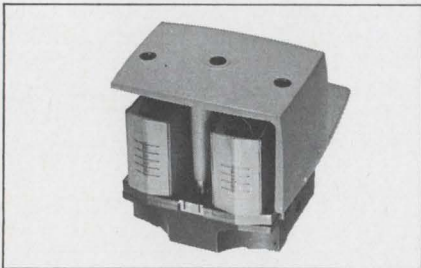

For the new replacement heads from CEC are now eliminating the major headaches in high frequency, high environment recording applications. Namely—the costly down time caused by rapid head wear, frequent cleaning and limited frequency response.

This achievement is due to CEC's unique design and manufacturing techniques which overcome the inherent weaknesses of lamination and rotary head design.

As a result, all CEC analog magnetic recording heads will last at least three times longer than conventional original equipment heads. *And*—they cost no more.

Of course, we did start off with a considerable advantage. Such as the assistance of Bell & Howell's advanced Research Center in the selection of specific materials that provide outstanding magnetic properties and extremely low wear rate.

Why not let some of this success go to *your* heads?

For complete specifications and all the facts, call your nearest CEC Field Office. Or write Consolidated Electrodynamics, Pasadena, California 91109. A subsidiary of Bell & Howell. Bulletin 1662-X3.

CEC/DATAPE PRODUCTS

 **BELL & HOWELL**

Electronics advertisers

March 18, 1968

■ Acopian Corp. Mort Barish Associates	14	Consolidated Vacuum Corp., Sub. of Bell & Howell Wolff Assoc., Inc.	81	■ Hewlett Packard, Loveland Div. Tallant/Yates Adv., Inc.	144
■ Adams & Westlake Co. Kasper & Assoc., Inc.	51	■ Continental Leasing Co. Scott Adv. Agcy., Inc.	238	■ Hewlett Packard, Microwave Div. Lennen & Newell, Inc.	2
■ Air Reduction Co., Inc., Aircro Industrial Gases Div. Fuller & Smith & Ross, Inc.	44	■ Control Data Corp., Analog Digital Systems Div. Barnes-Champ Adv.	186	■ Hewlett Packard, F.L. Moseley Co. Div. Lennen & Newell, Inc.	1
■ Allen-Bradley Co. Fensholt Adv. Agcy.	145	■ Coors Porcelain Co. Tallant/Yates Adv., Inc.	79	■ Hewlett Packard, Palo Alto Div. Lennen & Newell, Inc.	61
□ Alcatel Publi-Service	S-10	■ Cornell-Dubilier Electronics Daniel & Charles, Inc.	63	■ Hewlett Packard, Rockaway Div. Culver Adv., Inc.	77
■ AMP, Inc.	130, 131	■ Coto Coil Co., Inc. Williams Co., The	230	■ HI-G, Inc. Marketing Assistance, Inc.	74
■ Amphenol Corp., Controls Div. Marsteller, Inc.	83	□ ■ C.S.F. S P I Agency	OAS 2, S-3	■ Hitachi, Ltd. Dentsu Advertising	206
■ Analog Devices, Inc. Kenen Associates	162	■ Daven, Inc. Weston Assoc., Inc.	56	■ Honeywell, Test Instruments Div. Campbell Mithun, Inc.	208, 238
■ Andrew Corp. Fensholt Adv., Inc.	252	■ Dialight Corp. Michel, Cather, Inc.	233	■ Hudson Lamp Mohr & Co., Inc.	203
■ Arkansas Industrial Development Commission Cranford/Johnson & Associates	229	■ Digital Equipment Corp. Kalb & Schneider, Inc.	212	■ Hughes Aircraft Co. Foote, Cone & Belding	205
□ Ates Componenti Elettronici, S.P.A.	OAS 6	■ Dit-Mco International Div. of Xebec Corp. Martin Fromm & Assoc., Inc.	210	■ I B M Corp., Systems Development Div. Marsteller, Inc.	248, 249
■ Avtel Corp. Frost, Shaffer, Gauthier	228	□ Dow Chemical Europe S.A. MacManus, John & Adams, S.A.	OAS 11	■ Industrial Electronic Engineers Gumpertz, Bentley & Dolan, Inc.	72, 232
■ Baldwin Kongsberg Co. Baer, Kemble & Spicer, Inc.	62	□ Dow Corning International, Ltd. Marsteller Belgium, S.A.	OAS 18, OAS 19	■ Information Handling Service Martz & Associates	12, 13
■ Bausch & Lomb, Inc. Wolff Assoc., Inc.	163, 239	□ Drusch Publi-Service	S-11	■ Intercontinental Instruments, Inc. J. S. Lanza & Associates	75
■ Beckman Instruments, Inc., Helipot Div. Hixson & Jorgensen, Inc.	86	■ Eastman Kodak Co., Business Systems Markets Div. J. Walter Thompson Co.	147	■ International Crystal Mfg. Co. Robert V. Freeland & Associates	202
□ Beckman Instruments International, S.A. Hixson & Jorgensen, Inc.	OAS 12	■ E G & G Las Vegas Robert Fenton Adv., Inc.	247	■ International Rectifier Corp. Botsford, Constantine & McCarty, Inc.	222
■ Belden Corporation Fensholt Adv., Inc.	170, 171	■ E-H Research Laboratories, Inc. Steedman, Cooper and Busse Advertising	53	■ International Steel Co., Lindsay Structure Div. Keller-Crescent Co.	10
■ Bell, Inc., F.W. Wheeler, Kight & Gainey, Inc.	192	■ Electronics Buyers' Guide Plansboard Adv., Inc.	220	□ Intertechnique Publi-Service	S-5
■ Bendix Corp., Electrical Components Div. MacManus, John & Adams, Inc.	42, 43	■ Electronic Engineering Company of California Jansen Associates	158	■ I R C, Inc. Gray & Rogers, Inc.	193
■ Bendix Corp., Flight & Engine Instruments Div. MacManus, John & Adams, Inc.	46	□ English Electric Valve Co., Ltd. Allardyce Palmer, Ltd.	OAS 10	■ ITT Electron Tube Div. West, Weir & Bartel, Inc.	142
■ Bendix Corp., Semiconductor Products Div. MacManus, John & Adams, Inc.	17	■ Fairchild Instrumentation Faust/Day, Inc.	194	■ ITT Jennings Mfg. Co. West, Weir & Bartel, Inc.	118
□ Bernard Golay, S.A. Claude Langel	S-14	■ Fairchild Semiconductor, Inc. Faust/Day, Inc.	18, 19, 66, 67	■ ITT Semiconductors Div. Neals & Hickok, Inc.	146
■ Brush Instruments, Div. of Clevite Corp. Carr Liggett Adv., Inc.	160	■ General Dynamics, Fort Worth Div. Glenn Adv., Inc.	227	■ J F D Electronics Co., Components Div. Delphi Advertising, Inc.	235
■ Bulova Watch Co., Electronics Div. Frank Best Co., Inc.	58	■ General Electric Co., Electronic Components Sales Operation Robert S. Cragin, Inc.	190, 191	■ Johanson Mfg. Co. Josephson, Cuffari & Co.	234
■ Burr Brown Research Corp. N.A. Winter Adv. Agcy.	82	□ General Electric, IGE Export Div. Robert S. Cragin, Inc.	S-16	■ Johnson Co., E. F. Midland Associates	38, 39
■ By-Buk Co. Albert Frank Guenther Law Adv., Inc.	220	■ General Electric Co., Lamp Glass Department Dix & Eaton, Inc.	230	■ Kings Electronics Co., Inc. Caroe Marketing, Inc.	187
■ Calma Company Saratoga Advertising	15	■ General Electric Co., Miniature Lamp Div. Batten, Barton, Durstine & Osborn, Inc.	180	■ Lambda Electronics Corp. Michel Cather, Inc.	20, 21
■ Cambridge Thermionic Corp. Chirurg & Cairns, Inc.	148	■ General Radio Co. Horton, Church & Goff, Inc.	2nd Cover	■ Lapp Insulator Co. Wolff Associates	204
■ Capitol Radio Engineering Institute Henry J. Kaufman & Associates	211	■ Guardian Electric Mfg. Co. K & A Advertising	140	□ La Radiotechnique-Compelec Publi-Service	S-7
■ Centralab Div. of Globe-Union, Inc. The Brady Company	40	■ Gudebrod Brothers Silk Co., Electronics Div. Ramsdell-Buckley & Co.	218, 219	■ Litton Industries, Inc., Winchester Electronics Div. West, Weir & Bartel, Inc.	224, 225
■ Chase Manhattan Bank, The Compton Adv., Inc.	179	■ Heinemann Electric Co. Thomas R. Sundheim, Inc.	6	□ LTT Promotion-Vente-Publicite	S-12
■ Chester Cable Corp. Lewis Adv., Agcy.	245, 246	■ Hewlett Packard, H-P Associates Lennen & Newell, Inc.	85	■ Machlett Laboratories, Div. of Raytheon Co. Fuller & Smith & Ross, Inc.	9
■ Chicago Miniature Lamp Works Buti-Roberts Advertising	100	■ Hewlett Packard, H-P Associates Lennen & Newell, Inc.	85	■ Mallory Battery Co., Div. of P.R. Mallory & Co., Inc. Needham, Harper & Steers, Inc.	76
□ Cie des Compteurs Publi-Service	S-6	■ Hewlett Packard, Colorado Springs Div. Tallant/Yates Adv., Inc.	3rd Cover	■ Mallory Co., P.R., Mfg. Div. Aitkin-Kynett Co.	157
■ Cinch Electronics Group, The, Cinch-NuLine Div. Stral Adv. Co., Inc.	155	■ Marconi Instruments McCarthy, Scelba & DiBiasi Adv. Agcy., Inc.	183		
□ C.I.F.T.E. Publi-Service	S-8				
■ Clare & Co., C.P. Reincke, Meyer & Finn Advertising, Inc.	99				
■ Cliffon Precision Products Co., Div. of Litton Industries Ivey Adv., Inc.	37				
■ CML Division of Tenny Engineering Co. Keys, Martin & Co.	235				
■ Consolidated Electrodynamics Corp., Sub. of Bell & Howell Hixson & Jorgensen, Inc.	55, 258				



<ul style="list-style-type: none"> □ Marconi Radio Communication OAS 4 Hampshire House, Ltd. Maryland Dept. of Economic Development 212 The Robert Goodman Agcy., Inc. □ Matsuo Electronics Co., Ltd. OAS 16 Daiko Advertising, Inc. Memorex Corp. 214 Hal Lawrence, Inc. □ Mial S.P.A. OAS 13 Jachini Pietro Microlab/FXR 149 Frank Best & Co., Inc. ■ Microsonics, Inc. 154 S. Gunnar Myrbeck & Co. ■ Micro Switch, Div. of Honeywell 185 Batten, Barton, Durstine & Osborn, Inc. ■ Microwave Electronics Corp., Sub. of Teledyne 172 Bonfield Associates ■ Milgray Electronics 134 Bliss/Gruenwald, Inc. Minnesota Mining & Mfg. Co., Mincom Div. 117 Reach, McClinton & Co. Molex Products Co. 59 Fensholt Adv., Inc. Monsanto Co. 41 Foote, Cone & Belding □ Motorola Government Electronics Div. 8, OAS 20 Botsford, Constantine & McCarty, Inc. Motorola Semiconductor Products, Inc. 45 Lane & Bird Adv., Inc. Mullard, Ltd. 242 Rumrill-Hoyt, Inc. ■ National Electronics, Inc. 235 Connor-Sager Associates National Semiconductor Corp. 197, 199 Jay Chiat & Associates ■ Norden Div. of United Aircraft Corp. 78 Cunningham & Walsh, Inc. ■ North Atlantic Industries, Inc. 182 Murray Heyert Associates Pamotor, Inc. 7 Harry P. Bridge Co. ■ Pearson Electronics 162 William E. Clayton & Assoc., Inc. Pennsalt Chemicals Corp. 213 Aitkin Kynett Co., Inc. Phelps Dodge Electronics Products Corp. 196 Smith, Dorian & Burman, Inc. Philco-Ford/WDL Division 143 Hal Lawrence, Inc. □ Philips Eindhoven N.V. OAS 1, OAS 3 T.A.G. De La Mar Phoenix Chamber of Commerce 226 Jennings & Thompson Advertising Polaroid Corp. 57 Doyle, Dane, Bernbach, Inc. ■ Potter & Brumfield Div., American Machine & Foundry Corp. 181 Grant, Schwenck & Baker, Inc. ■ Price Electric Corp. 207 H.W. Buddemeier Co., Inc. Radio Cores, Inc. 226 Sander Rodkin Adv. Agcy., Ltd. Radio Corporation of America 4th Cover, 250, 251 Al Paul Lefton Co. Radio Materials Co., Div. of P.R. Mallory & Co. 178 M.M. Fisher Assoc., Inc. ■ Raytheon Co., Components Div. 16 Fuller & Smith & Ross, Inc. Raytheon Computer Co. 64, 65 Martin Wolfson Advertising Riken-Denshi Co., Ltd. 238 Daido Ad. Center Co., Ltd. 	<ul style="list-style-type: none"> □ Rochar Electronique Div. of Schlumberger OAS 9 Promotion Vente Publicite Rotron Manufacturing Co. 68 Lescarboursa Adv., Inc. □ R.T. Schneider S-1 Noirclerc Publicite Sage Electronics Corp. 237 Mathison Adv., Inc. Sanders Assoc., Inc. 231 Harold Cabot & Co., Inc. □ Schlumberger, Ltd. OAS 5 Sodipa Contact Scientific Data Systems 167 Doyle, Dane, Bernbach, Inc. □ S.D.S.A. 35, 36 Publi-Service Sensus International 257 John W. Hall □ SESCO S-15 Maurice Ridant, Editions Techniques & Publicite de Firmes □ Sfernice S-2, OAS 8 Publicitor Signetics Corp., Sub. Corning Glass Works 84 Cunningham & Walsh, Inc. ■ Siliconix, Inc. 226 Graphics West Sinclair Radio Labs, Inc. 236 John E. Hayes Co., Inc. □ Sogie OAS 17 Etudes et Creations Publicitaire Solartron OAS 7 Southern Adv. Ltd. Sorensen Operation, Raytheon Co. 71 James Advertising, Inc. □ Souriau & Cie S-4 Ariane Publicite South Dakota Industrial Development Expansion Agency 261 Maurice Paulsen Advertising □ Sovcor Electronique S-9 Publi-Service □ S.P. Electronica OAS-14 Publicitas SPA Sprague Electric Co., The 5, 161 Harry P. Bridge Co. ■ Stackpole Carbon Co., Electronic Components Div. 141 Meek & Thomas, Inc. Struthers-Dunn, Inc. 221 Harry P. Bridge Co. Sweet's Industrial Information System 169 J.J. Lane, Inc. Sylvania Electric Products, Inc., Electronic Components Group 27 to 34 Doyle, Dane, Bernbach, Inc. Sylvania Electric Products, Inc., Parts Div. 152 Doyle, Dane, Bernbach, Inc. Synthane Corp. 233 Arndt, Preston, Chapin, Lamb & Keen, Inc. Syntron Co. 177 De Sales Adv., Inc. ■ Syntronic Instruments, Inc. 261 Burton Browne Advertising □ Systron Donner International OAS 21 Bonfield Associates □ Technique et Produits S-13 Ste de Publicite de Films et de Documentaires ■ Tektronix, Inc. 150 Hugh Dwight Adv., Inc. Telonic Engineering Co. 60 Jansen Assoc., Inc. Tempress Research Co., Inc. 139 Hal Lawrence, Inc. Teradyne, Inc. 22 Quinn & Johnson Adv., Inc. ■ Texas Instruments Incorporated Components Group 135, 136, 137, 138 Don L. Baxter, Div. of Albert Frank-Guenther Law, Inc. ■ Texas Instruments Incorporated Industrial Products Group 198 Robinson-Gerrard 	<ul style="list-style-type: none"> ■ Tracor, Inc. 164 Weekley & Valenti, Inc. ■ TRG, Inc., Div. of Control Data Corp. 24 Culver Adv., Inc. ■ Trygon Electronics, Inc. 214 Kameny Associates, Inc. Trymetrics Corp. 153 Kameny Associates, Inc. ■ Tung-Sol Division, Wagner Electric Corp. 184 Feeley & Wheeler, Inc. Ulano Graphic Arts Supplies, Inc. 175 Lory Roston Associates United Control Corporation 11 Botsford, Constantine & McCarty, Inc. Unitron, Inc. 168 Warren Associates Wavetek OAS 22 Chapman McQuiston Michetti Adv. ■ Weinschel Engineering Co. 156 E.G. White Adv., Inc. □ Wells Electronics, Inc. OAS 15 Weco Advertising ■ Weston Instruments, Inc., Archbald Div. 73 Arndt, Preston, Chapin, Lamb & Keen ■ Weston Instruments, Inc., Newark Div. 80 Arndt, Preston, Chapin, Lamb & Keen, Inc. Wisconsin, State of, Div. of Economic Development 262 The Cramer-Krasselt Co.
--	--	--

Classified Advertising

F.J. Eberle, Manager

EMPLOYMENT OPPORTUNITIES 205, 214, 227, 231, 247, 240-241

Joseph P. Corcoran 240

General Dynamics-Electronics Division 241

EQUIPMENT

(Used or Surplus New)
For Sale 240

Binswanger 240

Philip Fishman Co. 240

Radio Research Instrument Co. 240

■ For more information on complete product line see advertisement in the latest Electronics Buyer's Guide

□ Advertisers in Overseas Advertising Section

Electronics Buyers' Guide

George F. Werner, General Manager [212] 971-2310

Ray Smyth, Eastern Regional Manager [212] 971-6538

Regina Hera, Directory Manager [212] 971-2544

Thomas M. Egan, Production Manager [212] 971-3140

Circulation and Research

Milton Drake, Manager [212] 971-3485

Isaaca Siegel, Assistant Circulation Manager [212] 971-6057

David Strassler, Assistant Research Manager [212] 971-6058

Chloe D. Glover, Research Associate [212] 971-6057

Advertising Sales Staff

Frank E. LeBeau [212] 971-6464
Advertising Sales Manager

Wallis Clarke [212] 971-2187
Assistant to sales manager

Donald J. Austermann [212] 971-3139
Promotion Manager

Warren H. Gardner [215] LO 8-6161
Eastern Advertising Sales Manager

Atlanta, Ga. 30309: Michael H. Miller, 1375 Peachtree St., N.E.
[404] 892-2868

Boston, Mass. 02116: William S. Hodgkinson
McGraw-Hill Building, Copley Square
[617] CO 2-1160

Cleveland, Ohio 44113: William J. Boyle, 55 Public Square, [216] SU 1-7000

New York, N.Y. 10036
500 Fifth Avenue
Donald R. Furth [212] 971-3615
James R. Pierce [212] 971-3616
John A. Garland [212] 971-3617

Philadelphia, Pa. 19103:
Jeffrey M. Preston

Warren H. Gardner,
6 Penn Center Plaza,
[215] LO 8-6161

Pittsburgh, Pa. 15222: Warren H. Gardner,
4 Gateway Center, [412] 391-1314

Rochester, N.Y. 14534: William J. Boyle,
9 Greylock Ridge, Pittsford, N.Y.
[716] 586-5040

J. Bradley MacKimm [312] MO 4-5800
Midwest Advertising Sales Manager

Chicago, Ill. 60611: Robert M. Denmead,
J. Bradley MacKimm, Ralph Hanning,
645 North Michigan Avenue,
[312] MO 4-5800

Dallas, Texas 75201: Richard P. Poole, 1800 Republic National Bank Tower,
[214] RI 7-9721

Houston, Texas 77002: Kenneth George,
2270 Humble Bldg., [713] CA 4-8381

Detroit, Michigan 48226: Ralph Hanning
856 Penobscot Building
[313] 962-1793

Minneapolis, Minn. 55402: J. Bradley
MacKimm, 1104 Northstar Center
[612] 332-7425

St. Louis, Mo. 63105: Robert M. Denmead
The Clayton Tower, 7751 Carondelet Ave.
[314] PA 5-7285

James T. Hauptli [415] DO 2-4600
Western Advertising Sales Manager

Denver, Colo. 80202: Joseph C. Page, David
M. Watson, Tower Bldg., 1700 Broadway
[303] 255-5484

Los Angeles, Calif. 90017: Ian C. Hill,
John G. Zisch, 1125 W. 6th St.,
[213] HU 2-5450

Portland, Ore. 97204: James T. Hauptli,
218 Mohawk Building, 222 S.W. Morrison
Street, Phone [503] 223-5118

San Francisco, Calif. 94111:
James T. Hauptli, 255 California Street,
[415] DO 2-4600

Pierre Braude Tel: 225 85 88

European Director
88-90 Avenue Des Champs-Elysees, Paris 8

Brian Bowes Tel. Hyde Park 1451

United Kingdom and Scandinavia
34 Dover Street,
London W1

Milan: Robert Saidel
1 via Baracchini Phone: 86-90-656

Frankfurt/Main: Hans Haller
Elsa-Brandstroem Str. 2
Phone: 72 01 81

Geneva: 1, rue du Temple Phone: 31 95 60

Tokyo: Nobuyuki Sato, 1, Kotohiracho
Shiba, Minato-Ku [502] 0656

Osaka: Ryoji Kobayashi 163, Umegae-cho
Kita-ku [362] 8771

Business Department

Wallace C. Carmichael, Manager
[212] 971-3191

Stephen R. Weiss, Production Manager
[212] 971-2044

Thomas M. Egan,
Assistant Production Manager [212] 971-3140

Dorothy Carmesin, Contracts and Billings
[212] 971-2908

Frances Vallone, Reader Service Manager
[212] 971-2865

Ferrite Shielded Air
Core Yoke C5380. De-
signed for high speed pre-
cision character displays
(nanosecond writing
speeds). Undesirable mag-
netic coupling and stray fields
eliminated by unique shield
design.

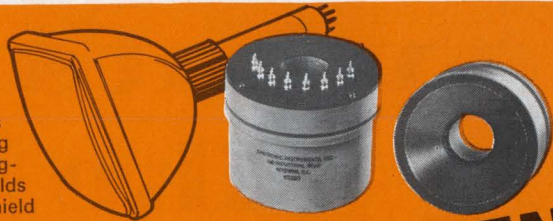

DESIGN DEVELOPMENT FROM *syntronic* THE YOKE SPECIALISTS

Syntronic engineers and manufactures the most extensive line of deflection yokes available . . . and continually develops new designs to satisfy the ever increasing requirements of the display industry. For large production or custom applications get the engineering control and production experience that only SYNTRONIC, the yoke specialists, can provide.



syntronic INSTRUMENTS, INC.
100 Industrial Rd., Addison, Ill. 60101
phone 312-543-6444

Circle 282 on reader service card



"We're in South Dakota

...because it's a progressive state with a progressive attitude toward industry. Marvelous recreation facilities and good living environment help us attract and hold productive workers."

Mark Bolluyt, Division Manager
DALE ELECTRONICS, INC. Yankton, South Dakota



Dale Electronics has been in Yankton only 10 years, but it has been a decade of growth and advancement. Currently under construction is a 55,000-square-foot building which will consolidate the firm's five plants employing 400 people. Dale components have been in every space probe made by NASA and its products are used in the nation's most sophisticated missiles.

Dale is only one firm which has found a future in SOUTH DAKOTA, industry's newest frontier. Eager, alert, trainable personnel are helping manufacturers

reach new goals of excellence and production. Dale's business grew 40 percent last year! Let us show you why we say: "You'll make it BETTER for LESS in SOUTH DAKOTA."

For the complete story on opportunities for your industry in South Dakota, contact:

Robert H. Martin, Director
SOUTH DAKOTA I. D. E. A.

Room E-2
Pierre, South Dakota 57501
Phone 224-5911 Ext. 307 (AC 605)

what's it really like to live in Wisconsin?

read our newspapers, **FREE** for **60** days

To make an industrial-site selection, you need all the facts and figures before making the decision. You would also like to know what living is really like in the place you are considering.

Nothing short of being here could give you the feel of everyday living in Wisconsin like reading our newspapers — from a different city every day or two — for 60 issues.

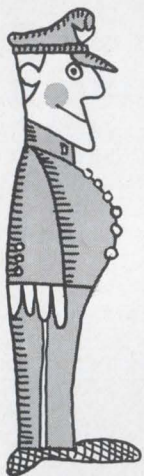

How better to take the pulse of our state, to hear the voice of our people? You'll see for yourself how citizens support good government. You'll see how editorial opinion varies or agrees from city to city. What our labor-industry situation actually is. What we charge for a dozen eggs. Or a house. Or a theater ticket. Read the schedules of our sailings to foreign ports. Nothing quite brings into focus the importance of the St. Lawrence Seaway to Wisconsin businessmen like the sound of such faraway destinations as Amsterdam, Porto Alegre, Helsinki, Kobe, Casablanca and Karachi. These and dozens more are served from

our fresh-water "ocean" ports. We average hundreds of departures yearly from Milwaukee alone. And at the end of your free sampling of Wisconsin dailies you'll be in a far better position to judge Wisconsin as expansionland for your company.

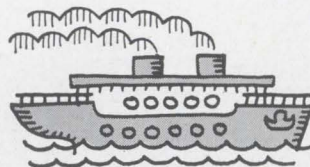

So ask your secretary to fill out the coupon. Or write us a note on your business letterhead, mentioning your title and telling us whether you'd like to have your 60 different issues of Wisconsin newspapers mailed to your home or office. We'll acknowledge promptly, with some interesting statistics and an official map so you can see where each newspaper comes from. Soon you'll have a clear and unbiased picture of what it's really like to live, work and do business in Wisconsin.

This invitation is open to all industrialists everywhere, except those now living in Wisconsin. (Sorry, neighbors.)

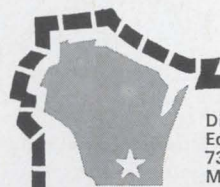

Division of
Economic Development
736 State Office Building
Madison, Wisconsin 53702

I think you're right. A 60-issue look at Wisconsin's newspapers should be most revealing. Please send me your free papers. I understand there is no obligation whatever.

Name.....Title.....

Firm Name.....

Kind of Business.....

Address.....

City.....State.....Zip.....

If you would prefer that papers be sent to your home, please include following information:

Home Address.....

City.....State.....Zip.....
(If different from that of your company)

WISCONSIN !

Resources which make Wisconsin outstanding

- **Vocational Education** / National leadership; reaches every area of the state; total enrollment of vocational and adult program, 230,000.
- **Transportation** / 11 out of 12 railroads operating in the state are Class I; have boat ties.
- **Government** / Clean, efficient government; merit principles in employment.
- **Utilities** / Electrical generating capacity of 4,400,000 kw; expected to increase to 6,000,000 kw by 1970. Natural gas available from south, west and north; all systems interconnected.
- **Trucking Service** / 180 authorized common carriers; overnight service to Chicago and Twin Cities.
- **Industrial Development** / 230 local industrial development groups to aid industry.
- **Highway System** / Excellent interstate, state and secondary road system.

Here is the latest hp addition to the new generation of all-solid-state, high-performance oscilloscopes!

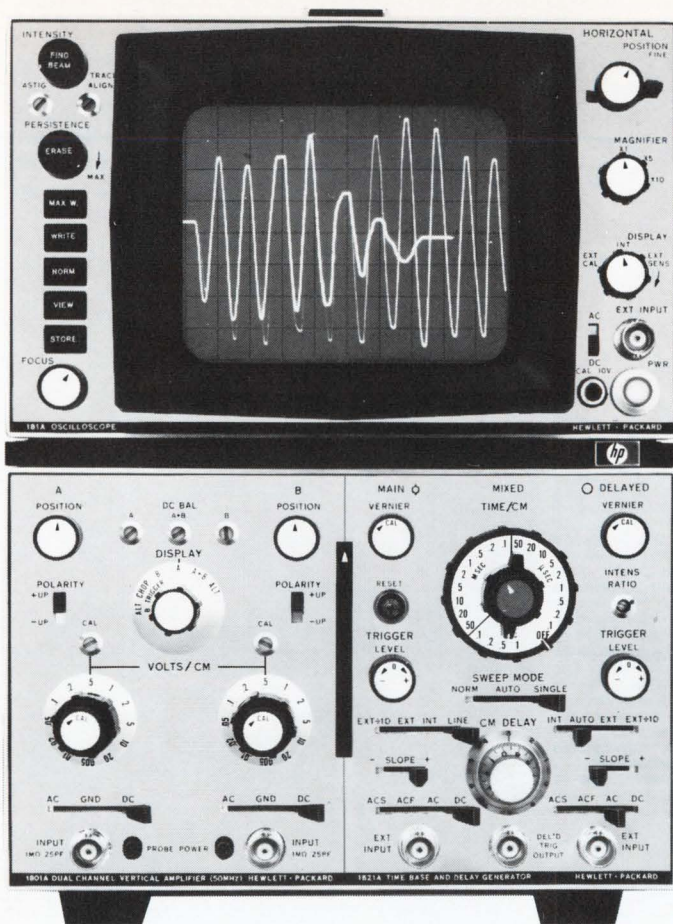

Stop... Store...

Vary Display Time!

New hp 181A Oscilloscope... You control CRT display time with variable persistence and storage!

Now for the first time you get the added dimension of variable persistence and storage in a high frequency scope—50 MHz bandwidth at 5 mV sensitivity now, and mainframe capabilities for 100 MHz. The new all-solid-state, 30-pound 181A Variable Persistence and Storage Oscilloscope lets you see even more—do even more!

See more with the new 181A's variable persistence—made possible by the extra-large rectangular CRT using hp's exclusive mesh storage design. Use it to see low rep rate pulses which brighten as each trace reinforces the previous one. Check signal trends by adjusting persistence so several traces are on CRT simultaneously. Vary persistence from 0.2 sec to more than a minute.

Do more with hp's new scope with a memory! Store traces for more than an hour—overnight or even weeks if scope is turned off. Catch and store single-shot transients with the 181A's fast writing rate of 1 cm/ μ sec. Use it to get a graphic display of critical parameters prior to system failure, activation of a safety device, or excursion beyond some predetermined limit.

Get an extra measure of performance! You get the same step-ahead electrical performance, lightweight

portability and rugged design that you have with the standard 180A. All the 180 Series Plug-ins give full performance in the 181A mainframe. You get 50 MHz bandwidth, 7 ns rise time, 5 mV/cm sensitivity, mixed sweep—and *variable persistence and storage!*

Get the full story on the new hp scope with a memory. Ask your hp field engineer for full specifications on the new hp 181A Oscilloscope. Or, write to Hewlett-Packard, Palo Alto, California 94304. Europe: 54 Route des Acacias, Geneva. Price: hp 181A Oscilloscope, \$1850; hp 181AR Oscilloscope (Rack Mount), \$1925; hp 1801A Dual Channel Amplifier, \$650; hp 1820A Time Base, \$475; hp 1821A Time Base and Delay Generator \$800.

087.34

HEWLETT  PACKARD

OSCILLOSCOPE SYSTEMS

Circle 901 on reader service card

NOW

RCA LOW-POWER DTL

2 PACKAGES

LOW PRICES

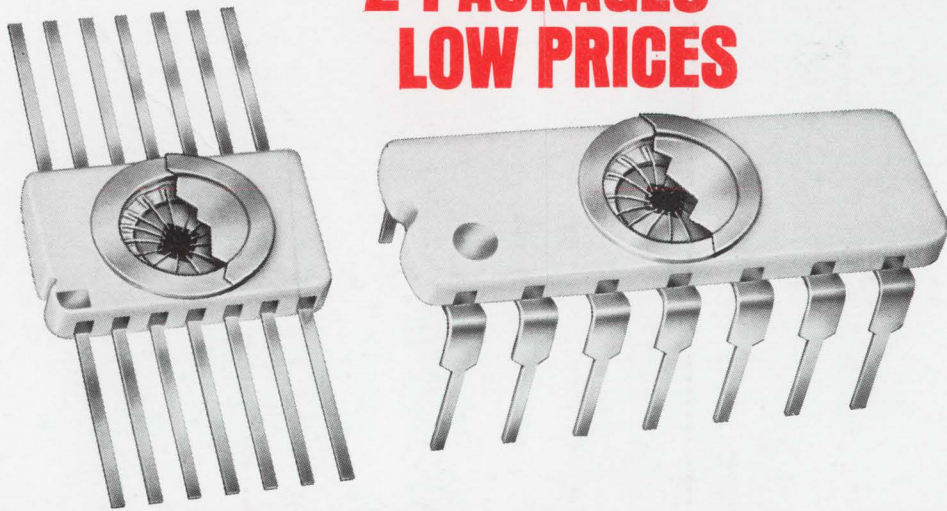

RCA's Unique High-Reliability Hermetic Packages...Single Welded Cap Leads do not pass through seal...lead abuse can't affect hermeticity.

RCA 2.3mW DTL in Hermetic Ceramic packages for -55°C to +125°C operation

DESCRIPTION	IN FLAT PACK	IN DUAL IN-LINE	PRICE (1000)
Dual 4-Input Expandable NAND Gate	CD2200	CD2200D	\$3.15
Quadruple 2-Input NAND Gate	CD2201	CD2201D	\$3.30
Dual 4-Input Expandable NAND Buffer Gate	CD2202	CD2202D	\$3.30
J-K Flip-Flop; 2 "J", 2 "K", 2 Set and 2 Reset inputs, Split Clock	CD2203	CD2203D	\$4.20
Dual 4-Input Gate Expander	CD2204	CD2204D	\$2.25
Dual 3-Input Expandable AND-OR-NOT Gate	CD2205	CD2205D	\$3.15

CALL YOUR RCA REPRESENTATIVE FOR QUOTATIONS ON LARGER QUANTITIES.

Basic Gate Configuration

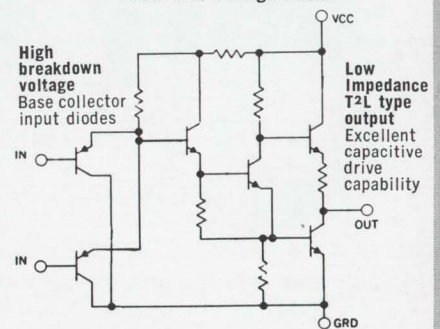

High noise immunity 1.2V (typ) @ 25°C

Device dissipation (typ) 2.3mW per Gate —7mW per Flip-Flop. Full military operating temperature range— -55°C to +125°C Flip-Flop clock frequencies (typ) 3MHz. Single power supply +3.8V to +6.3V; 4V optimum. NAND gates pin-compatible with popular 930 DTL circuits.

Data sheets and extensive application notes available for both—CD2200 series in 14-lead Flat-Pack and CD2200D series in Dual In-Line package. Call your RCA Sales Representative, your RCA Distributor or write to RCA Electronic Components, Commercial Engineering, Section 1CN3-3, Harrison, New Jersey 07029. CHECK YOUR RCA DISTRIBUTOR FOR HIS PRICE AND DELIVERY.

RCA