

# Electronics<sup>®</sup>

Guarding against frequency variations: page 86

IC's in an instrument tape recorder: page 93

Outlook for electronics markets: page 105

January 8, 1968

\$1.00

A McGraw-Hill Publication

Below: Defense procurement gives biggest thrust to 1968 sales, page 105



# 1968

# A year of doubt





# MINIDUCTOR™

## SUBMINITURE HIGH Q INDUCTORS

The MINIDUCTOR family of inductors are high precision units providing maximum Q in miniature form. They are designed with advanced engineering concepts to achieve highly stable characteristics regarding temperature ( $-55^{\circ}\text{C}$  to  $+100^{\circ}\text{C}$ ), level, and frequency. MINIDUCTORS have pin terminals ideally suited for transistor and printed circuit applications.

## IMMEDIATE DELIVERY FROM STOCK

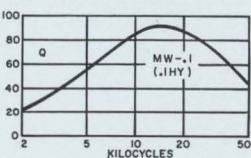
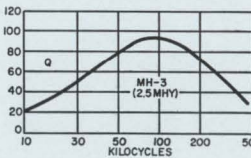
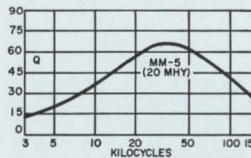
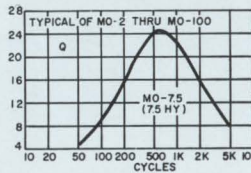
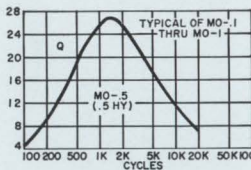
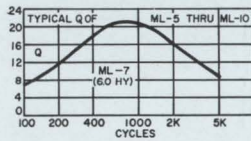
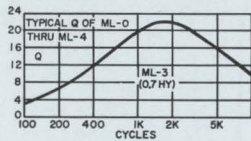

ML CASE



MO CASE



MM, MH CASE



MW CASE

Specifications depicted are nominal

**ML**—Hiperally cased inductors with epoxy board. Inductance range .15 to 60 hy. Adjusted to a tolerance of  $\pm 3\%$ .  $7/16 \times 31/64 \times 9/16$ " h; wt. .2 oz.

**MO**—Molded inductors. Inductance range .1 to 100 hy. Adjusted to a tolerance of  $\pm 2\%$ .  $3/4 \times 1-1/16 \times 13/16$ " h; wt. 1 oz.

**MM**—Molded toroidal inductors. Inductance range 3 to 120 mhy. Adjusted to a tolerance of  $\pm 2\%$ .  $7/16$  dia  $\times 1/4$ " h; wt. .07 oz.

**MH**—Molded toroidal inductors similar to MM. Inductance range .6 to 40 mhy.

**MW**—Molded toroidal inductors. Inductance range .05 to 5 hy. Adjusted to a tolerance of  $\pm 1\%$ .  $23/32$  dia  $\times 13/32$ " h; wt. .25 oz.

Write for catalog  
of over  
1,300 STOCK ITEMS  
with  
UTC High Reliability  
IMMEDIATELY AVAILABLE  
from  
YOUR Local Distributor



**UNITED TRANSFORMER CO. TRW**  
DIVISION OF TRW INC. • 150 VARICK STREET, NEW YORK, N. Y. 10013

IN CANADA: A. C. SIMMONDS & SONS LIMITED, AGINCOURT, ONTARIO



# CUT AC CALIBRATION TIME IN HALF

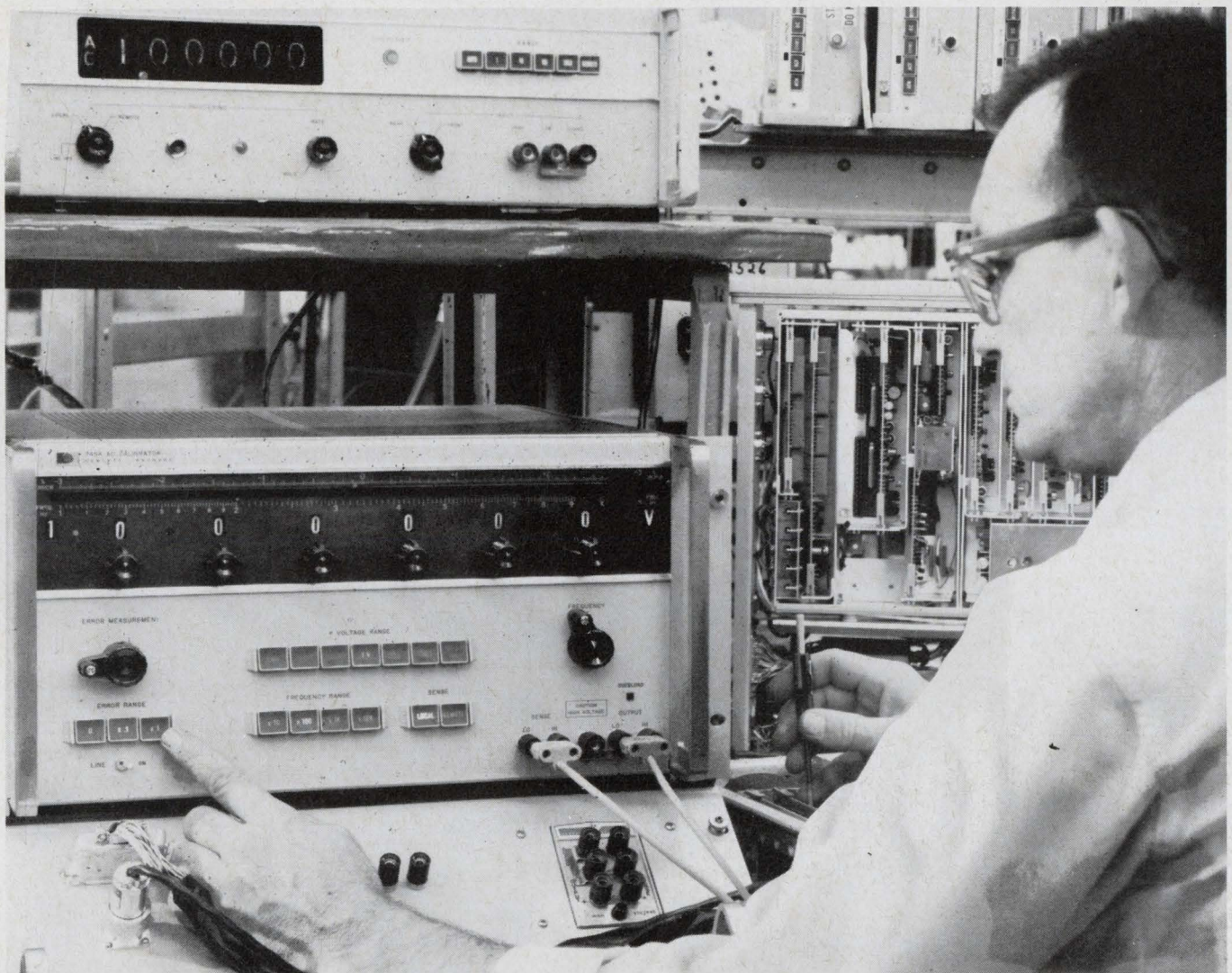

**NEW hp 745A AC Calibrator** is a self-contained AC calibration system that you can depend on for accuracy and stability in checking out digital, differential and analog ac voltmeters. Use it in production test areas and in calibration and standards labs to reduce calibration time by at least 50%—with push-button range selection . . . dial your voltage, dial your frequency. There is no external thermocouple, no nulling, no transients, no extra instruments to compound your set-up and increase your costs.

**Direct error measurement** in terms of percent-of-setting makes instrument calibration a simple set-read operation. To use it, press error range button and dial your plus or minus error until voltmeter under test reads the preselected voltage. Any error up to  $\pm 3\%$  is read directly on the top dial.

**Operator oriented** for easy, fool-proof measurements. Current limiting protects 745A from direct load short. Voltage range automatically resets to 1 mV range when 745A is turned off, to protect any instrument being calibrated from an accidental overload on turn-on. No need to disconnect instrument being tested, or turn off calibration when switching ranges, because there are no transients when ranges are being switched. Frequency, frequency range, and voltage range are programmable—an extra feature at no extra cost. Calibra-

tion of the 745A is simple using a high accuracy dc voltmeter, such as an hp 3420A, and an uncalibrated thermocouple to check flatness.

**0.02% accuracy** is possible because the output voltage is continually compared to an internal dc reference by a unique technique that makes an internal ac-to-dc transfer measurement twice each second. This also eliminates thermocouple drift and dc reversal error. Voltage accuracy and stability are further assured by precision inductive dividers. Calibrated ac voltages are available from 100  $\mu\text{V}$  to 110 V over the frequency range from 10 Hz to 110 kHz—with an absolute voltage accuracy in the midband of 0.02% of setting and 0.05% up to 110 kHz! Price: \$4500.00

To get full information on the lightweight (65 pounds) hp 745A AC Calibrator, call your nearest hp field engineer. Or, write to Hewlett-Packard, Palo Alto, California 94304. Europe: 54 Route des Acacias, Geneva.

097/19

HEWLETT  PACKARD

WORKING STANDARDS



FROM HP—THE SWEEPER THE USER DESIGNED

# For the sweep mode you need, just press a button



## PRESS THE START/STOP BUTTON

The dial lights immediately identify the sweep mode, and the corresponding START and STOP frequency pointers indicate the frequency limits of the sweep. Frequency settings are independently adjustable over the full 13-inch scale for sweeping up or down, wide or narrow. Accuracy and sweep linearity are better than 1%.



## PRESS THE MARKER SWEEP BUTTON

Now the M1 and M2 lights signify that you've selected a completely independent sweep mode whose frequency dial pointers provide a full range of adjustment. Use it to bracket a frequency segment of interest. Frequency accuracy and linearity, again, are better than 1%. In all sweep modes, the SWEEP light is "on" while the sweep is in progress, extremely convenient for slow sweep speeds.



## PRESS THE Δ F BUTTON

The CW and Δ F lights now indicate you have a fully calibrated narrow-band sweep symmetrical about the setting of the CW frequency pointer. Sweep width, indicated by the Δ F pointer, is adjustable from 0 to 10% of the band. The full-width frequency scale affords high resolution.

The Hewlett-Packard 8690A Sweep Oscillator is the sweeper the user designed—engineered for greatest operating convenience and to eliminate errors encountered with complex dial arrangements and hard-to-read panels. Plug-in design results in a front panel free from congestion, yet the instrument is only 8¾" high. There's an RF plug-in for 0.1 to 110 MHz and microwave plug-ins from 1 to 40 GHz. PIN diode modulation/leveling is available from 1 to 12.4 GHz. Model 8690A main frame is \$1600, the RF plug-in is \$950 and microwave plug-ins start at \$1575.

For more information call your local HP field engineer or write Hewlett-Packard, Palo Alto, California 94304; Europe: 54 Route des Acacias, Geneva.

HEWLETT  PACKARD  
SWEEP OSCILLATORS



## News Features

### Probing the News

- 153 **FCC begins to get the message**  
159 **New terminals in display picture**

## Electronics Review

- 45 **Solid state:** See-through IC  
45 **Consumer electronics:** Lights out  
46 **Computers:** Numbers game  
47 **Components:** New light on the subject  
48 **Companies:** Age of protest; Name dropping  
50 **Military electronics:** About-face  
52 **Displays:** Fruit of the loom  
54 **For the record**

## Electronics Abroad

- 245 **Japan:** Memorable memory; An eye for curves  
246 **West Germany:** Bright tune; Top grade  
247 **France:** Freeing the freeway  
248 **Great Britain:** Torrid zones  
248 **Around the world**

## New Products

- 171 **Outflanking suppliers** in the reed-relay field  
174 **New components review**  
174 **New components:** Pots straighten out and go linear; Amplifier bridges cost-specs gap; Two photoresistors share the light  
185 **New consumer electronics review**  
185 **New consumer electronics:** Tuning bar replaces radio dial; Test-set kit for plant or shop  
191 **New microwave review**  
191 **New microwave:** A design-a-day channel filter; On-the-spot tests for relay links  
200 **New instruments review**  
200 **New instruments:** Everyman's test set for semiconductors; Saying sayonara to U.S. testers  
207 **New production equipment review**  
207 **New production equipment:** How to stretch the etchant; This stripper is fast changer; One-stop service for wash 'n' dry  
217 **New semiconductors review**  
217 **New semiconductors:** Doubling-up IC amplifiers makes sense; Current, currency—a dual gain

## Technical articles

- Industrial electronics** 86 **Guarding industry's electrical loads**  
Circuit built around two integrated-circuit flip-flops senses line frequency variations and disconnects critical-speed motors  
Joseph Bodow, Bulova Watch Co.
- Circuit design** 89 **Designer's casebook**  
▪ Unijunction transistor controls stable one-shot  
▪ Single transistor rectifies agc signal  
▪ Feedback protects spacecraft's power supply  
▪ Detecting data errors boosts transmission accuracy  
▪ Transistor replaces resistor and improves amplifier
- Instrumentation** 93 **Integrated circuits in action: part 9**  
**Digital techniques shrink recorder**  
Off-the-shelf digital IC's cut costs, save space and produce a better instrumentation recorder  
Ivars P. Breikss, Honeywell Inc.
- Marketing** 101 **Electronics markets: 1968 (cover)**  
Electronics' annual market survey predicts industry will enjoy a modest 6.7% increase over 1967
- 105 **State of the mart—gains are slowed by war priorities**  
Vietnam spending will help some areas, hurt others. As a result of tax uncertainties and tighter credit, consumer electronics firms face problems. But educational electronics could really start to grow in 1968
- |     |                 |     |                |
|-----|-----------------|-----|----------------|
| 106 | Military        | 120 | Avionics       |
| 109 | Solid state     | 123 | Computers      |
| 113 | Medical         | 126 | Communications |
| 114 | Consumer        | 129 | Microwave      |
| 116 | Education       | 130 | Space          |
| 118 | Instrumentation | 132 | Industrial     |
|     |                 | 135 | Components     |

## Departments

- |    |                        |     |                        |
|----|------------------------|-----|------------------------|
| 4  | Readers Comment        | 46  | Index of activity      |
| 8  | People                 | 67  | Washington Newsletter  |
| 14 | Meetings               | 224 | New Books              |
| 16 | Meeting Preview        | 228 | Technical Abstracts    |
| 23 | Commentary             | 232 | New Literature         |
| 25 | Electronics Newsletter | 241 | Newsletter from Abroad |



# Electronics

Editor-in-Chief: Donald Christiansen

## Associate managing editors

Technical: Stephen E. Scrupski  
News: Robert Henkel  
Copy: Sally Powell

## Senior associate editors

Joseph Mittleman, Harry R. Karp

## Department editors

Avionics & Space: Alfred Rosenblatt  
Computers: Wallace B. Riley  
Communications: William Buccia  
Consumer electronics: John D. Drummond  
Design theory: Joseph Mittleman  
Industrial electronics: Harry R. Karp  
Instrumentation: Carl Moskowitz  
Military electronics: Richard Gundlach  
Solid state: Mark B. Leeds

## Regional bureaus

### Domestic

Boston: James Brinton, manager; Robin Carlson  
Los Angeles: Lawrence Curran, manager  
New York: Howard Wolff, manager  
San Francisco: Walter Barney, manager  
Washington: Robert Skole, manager; William D. Hickman, Paul Dickson

### Foreign

Bonn: John Gosch  
London: Michael Payne  
Tokyo: Charles Cohen

## Copy editors

James Chang, Frederick Corey

## Graphic design

Art director: Saul Sussman  
Assistant art directors: Ann Mella, Valerie Betz  
Production editor: Arthur C. Miller

Editorial secretaries: Claire Benell, Lynn Emery, Kay Fontana, Patricia Gardner, Lorraine Longo  
Barbara Razulis, Frances Vacca

## McGraw-Hill News Service

Director: Arthur L. Moore; Atlanta: Fran Ridgway; Chicago: Bruce Cross;  
Cleveland: Arthur Zimmerman; Dallas: Marvin Reid;  
Detroit: James Wargo; Houston: Robert E. Lee; Los Angeles: Michael Murphy  
Pittsburgh: Louis Gomolak  
San Francisco: William F. Arnold  
Seattle: Ray Bloomberg; Washington: Charles Gardner, Daniel B. Moskowitz,  
Herbert W. Cheshire, Seth Payne, Warren Burkett, William Small

## McGraw-Hill World News Service

Bonn: Robert Dorang; Brussels: George Williamson; Hong Kong: Wes Perry;  
London: John Shinn; Mexico City: Gerald Parkinson; Milan: Ronald Taggiasco, Jack Star;  
Moscow: Howard Rausch; Paris: Robert E. Farrell, Peter Kilborn;  
Rio de Janeiro: Leslie Warren; Tokyo: Marvin Petal

Reprints: Susan Nugent

Circulation: Milton Drake

## Publisher: Gordon Jones

Electronics: January 8, 1968, Vol. 41, No. 1

Published every other Monday by McGraw-Hill, Inc. Founder: James H. McGraw 1860-1948.

Printed at 99 North Broadway, Albany, N.Y. 12207; second class postage paid at Albany, N.Y.

Executive, editorial, circulation and advertising addresses: McGraw-Hill Building, 330 W. 42nd Street  
New York, N.Y. 10036. Telephone (212) 971-3333. Teletype TWX N.Y. 710-581-4235. Cable address:  
MCGRAWHILL N.Y.

Subscriptions solicited only from those professionally engaged in electronics technology. Subscription rates:  
qualified subscribers in the United States and possessions and Canada, \$8.00 one year, \$12.00 two years,  
\$16.00 three years; all other countries \$25.00 one year. Non-qualified subscribers in the U.S. and  
possessions and Canada, \$25.00 one year; all other countries \$50.00. Air freight service to Japan \$50.00  
one year. Single copies: United States and possessions and Canada, \$1.00; all other countries, \$1.75.

Officers of McGraw-Hill Publications: Joseph H. Allen, President; Bayard E. Sawyer, Executive Vice-President;  
J. Elton Tuohig, Senior Vice-President-Operations; Vice Presidents: John R. Callahan, Editorial;  
John M. Holden, Marketing; Paul F. Cowie, Circulation; Angelo R. Venezian, Production; Jerome D. Luntz,  
Planning & Development; Robert M. Wilhelm, Controller.

Officers of the Corporation: Donald C. McGraw, Chairman of the Board; Shelton Fisher, President;  
L. Keith Goodrich, Robert E. Slaughter, Executive Vice Presidents; Donald C. McGraw, Jr.,  
Senior Vice-President; John J. Cooke, Vice-President & Secretary; John L. McGraw,  
Vice-President & Treasurer.

Title © registered in U.S. Patent Office; © Copyright 1968 by McGraw-Hill, Inc. All rights reserved. The contents  
of this publication may not be reproduced either in whole or in part without the consent of copyright owner.

**Subscribers:** The publisher, upon written request to our New York office from any subscriber,  
agrees to refund that part of the subscription price applying to copies not yet mailed.  
Please send change of address notices or complaints to Fulfillment Manager; subscription  
orders to Circulation Manager, Electronics at address below. Change of address notices  
should provide old as well as new address, including postal zip code number. If possible,  
attach address label from recent issue. Allow one month for change to become effective.

Postmaster: Please send form 3579 to Fulfillment Manager, Electronics,  
P.O. Box 430, Hightstown, New Jersey 08520

## Readers Comment

### Brushing up

To the Editor:

The article titled "Brush off" [Dec. 11, p. 45] described the brushless d-c motors in development at NASA's Goddard Space Flight Center, and their potential for space applications.

The General Electric Co.'s avionic controls department in Binghamton, N.Y., has had brushless d-c motors in development since 1959. Instead of brushes, our motor employs Hall-effect probes that sense the field of a permanent magnet rotor. The motor itself has a permanent magnet rotor and a proportional current drive to the motor windings. We have fabricated both torque and spin motors with impressive characteristics.

We recently delivered to NASA's Marshall Space Flight Center a 2,000-foot-pound-second momentum wheel with a brushless d-c spin motor drive. The motor is more than 95% efficient and delivers peak power of 135 watts and a running power of 40 watts. The drive electronics are more than 80% efficient. Compared to a conventional, a-c induction, motorstatic inverter combination, there is a 3-to-1 decrease in power consumption and a greater than 10-to-1 decrease in size and weight. We have also designed reaction wheels for satellites with the same high-efficiency brushless motor drives.

I confidently predict that brushless d-c motors will soon be used in the "variety of space tasks" mentioned in your article.

Gary F. Auclair  
Space Stabilization & Control Engineering  
General Electric Co.  
Binghamton, N.Y.

### Roll out the barrels

To the Editor:

We wish to clarify the portion of the article "Unmasked" [Dec. 11, p. 45] that implies that our Photo-repeaters are limited to single-lens systems.

The first Mann multibarrel (lens) system, the Type 1080A, was delivered in June 1964, and a large number have since been delivered



# 60 MHz flip-flops, 5 nsec gates

## Sprague SSL<sup>\*</sup> is the fastest TTL

(Super-Speed Logic)



and they're pin compatible with series 8000



for maximum systems speed, check out  
Sprague SSL Super-Speed Logic

PROPAGATION DELAY .....	5 nsec
POWER DISSIPATION .....	25 mW
NOISE IMMUNITY .....	1.0 V
FANOUT .....	11
FLIP-FLOP TOGGLE FREQUENCY .....	60 MHz

For additional information  
write to:  
Semiconductor Division  
Sprague Electric Company  
115 Northeast Cutoff  
Worcester, Mass. 01606

\*Trademark

4SS-7160

SPRAGUE WORCESTER... the world's finest microcircuit facility



\*Sprague' and '©' are registered trademarks of the Sprague Electric Co.



# Little plug-ins make the big difference in 50 MHz counters

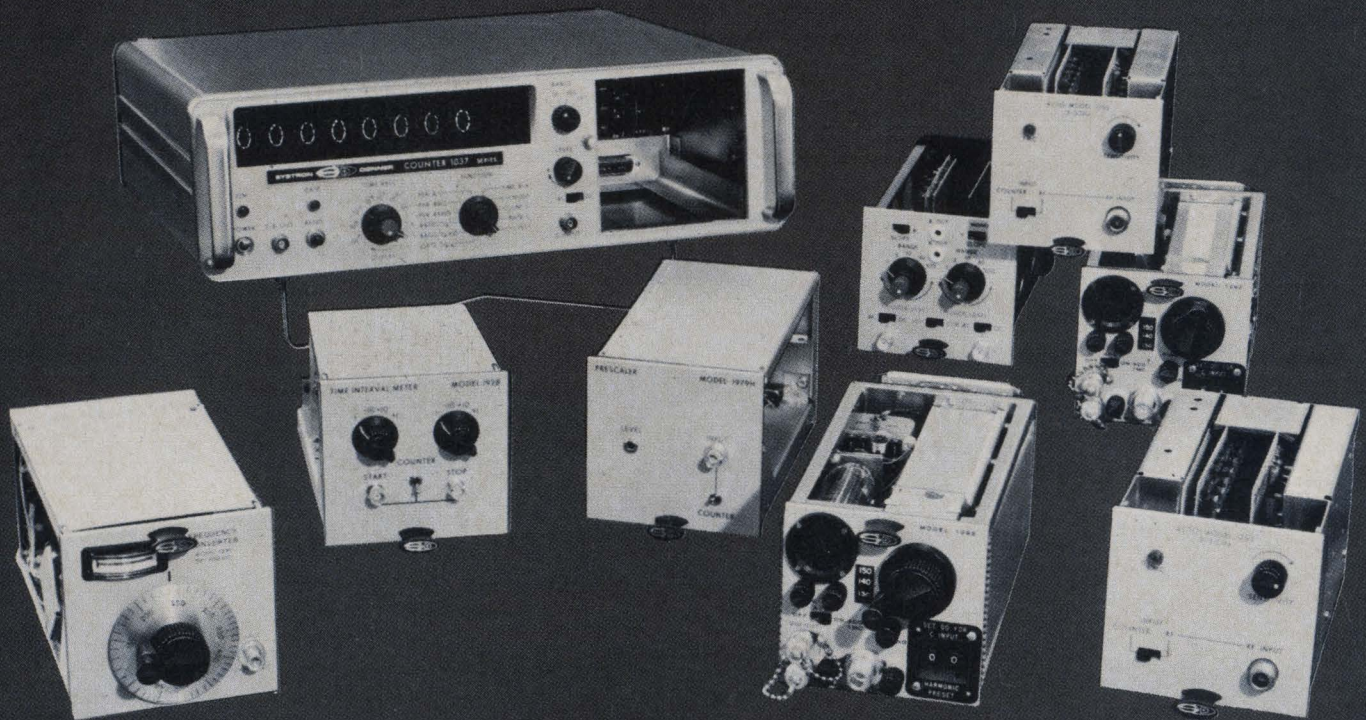

When you look only at the main frame, it's hard to find important differences between 50 MHz counters. But when you compare plug-ins, you'll find great differences and decisive advantages. Only Systron-Donner plug-ins can give you:

## 1. Final-answer frequency readings to 40 GHz.

A single plug-in, our Model 1292 semi-automatic transfer oscillator, boosts the counter's frequency-measuring range to 15 GHz. Measures FM and pulsed RF above 50 MHz. And the complete dc to 15 GHz system (counter with plug-in) costs only \$3250. Our new Model 1298 semi-automatic T.O. now gives you final-answer readings up to 40 GHz—a new record.

Contact Systron-Donner Corporation, 888 Galindo Street, Concord, California. Phone (415) 682-6161.

## 2. Automatic frequency readings to 18 GHz.

Three Acto<sup>®</sup> plug-ins now produce fully-automatic microwave frequency readings: 50 MHz to 3 GHz (P, L & S band), 3 to 12.4 GHz (S & X band), and 12.4 to 18 GHz (K<sub>U</sub> band).

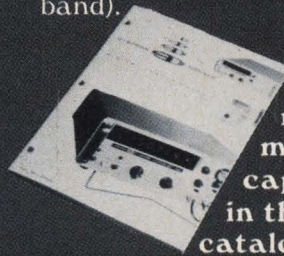

Find more unique measuring capability in this catalog

## 3. Time readings with 10-nano-second resolution.

Our latest time interval plug-in gives you time readings with 10-nanosecond resolution—greater precision than ever before possible with a standard counter.

All this unique measuring capability can be yours today—or tomorrow—when you buy your basic counter from Systron-Donner. Sixteen different plug-ins have been especially designed to give your Systron-Donner counter more measuring power at less cost than any other system.

SYSTRON  DONNER

Circle 6 on reader service card



to various customers throughout the world. These include the four-barrel and six-barrel versions of both the 1080 and the 1480 series.

The original purpose of manufacturing multibarrel instruments was to achieve greater positional precision between masks. This was accomplished by manufacturing a number of masks simultaneously on the same instrument. With the 1480 series instrument and its excellent positional precision, multibarrel instruments are no longer needed to retain registration between masks. Positional precision is now maintained by the Microset Scale to within 10 microinches. Today the purpose of multibarrel instruments is to increase production capacity.

The system to which the article alludes is the Mann Type 1595 Photorepeater designed for the direct exposure of photoresist automatically. Thus far, only the single-barrel instrument has been offered. However, if a demand for multibarrel types arises, we intend to be responsive.

Aubrey C. Tobey

Director of Marketing  
David W. Mann Company  
Burlington, Mass.

### Mother hens?

To the Editor:

As one of the oldest and most successful exporters in this country—we have promoted world trade for more than 130 years—we must take exception to some of the points brought out in "Hands across the sea" [Dec. 11, p. 52].

Texscan's Robert J. Shevlot gen-

eralizes when he says of export houses, "They take on your line and forget about you." There are export houses—as there are domestic representatives—that are line collectors, and Shevlot's comments are true regarding them. However, he overlooks those firms that have successfully built the export sales of their clients to the point where the clients could sell directly or even manufacture overseas.

While we cannot speak of other export organizations, we can cite our experience with Hewlett-Packard, Eitel-McCullough, Burr-Brown Research and Wavetek. In each case, the line was taken on by us when the client company was very small and export sales were built to \$500,000 or more before the manufacturer "went on his own."

Contrary to what the article implies, Texscan's approach is not new; it has long been known as the "mother hen" operation and is being practiced by several U.S. manufacturers. Although this approach offers the advantage of a ready-made distributor system, there are disadvantages—notably, loss of identity.

In depreciating the difficulties of exporting, Shevlot seems to undermine his own business. If things are so easy, why should the manufacturer use any outside marketing organization? No, exporting is not as simple as he would have us believe; if it were, there would be no export houses—nor mother hens either.

J.C. Koltzau

Frazar & Hansen Ltd.  
San Francisco

### Recommended reading

The least-read section of any magazine is its masthead. Ours is in its customary place, at the left of page 4, and it lists the large and constantly growing editorial staff of Electronics.

But only the most eagle-eyed of our more than 70,000 subscribers will notice an important change; the first issue of this new year starts with a new name at the top of the masthead.

Donald Christiansen is succeeding Lewis H. Young, who has returned to another McGraw-Hill publication, Business Week.

It is with regret that we see Lew Young depart after four years of editing Electronics with a brilliance and skill that have made it the indisputable leader in the field.

It is with pleasure and confidence that we welcome Don Christiansen, the new Editor-in-Chief of Electronics.

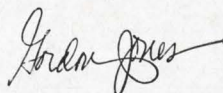

Publisher

## NEW PHASE-LOCK

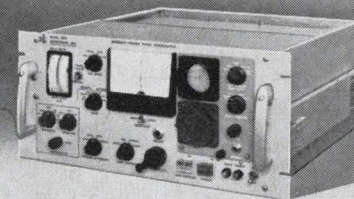

MODEL 315

## polarization diversity receiver/ demodulator

Developed for NASA Goddard to demodulate AM and PM satellite telemetry signals for the STADAN tracking network.

Features include:

1.5 MHz Data Bandwidth

—152 dbm Sensitivity

Optimum Ratio  
Predetection Combining

3rd Order Loop  
±100 KHz Tracking Range

Remote Programming

Anti Sideband Lock Circuitry

Solid State Plug-in Circuitry

This is just one of our many custom designed phase-lock systems.

Write today for a free copy of our new catalog on phase-lock loop receivers, AM/PM demodulators, frequency multipliers, and tracking filters.



**ELECTRAC, INC.**

1614 ORANGETHORPE WAY  
ANAHEIM, CALIFORNIA 92801  
(714) 879-6021



# Preston Scientific breaks the price barrier in 14-bit A-D converters!

10,000 samples/sec model 8500 K: \$1995  
80,000 samples/sec model 8500 MS: \$3545  
196,000 samples/sec model 8500 VHS: \$5485

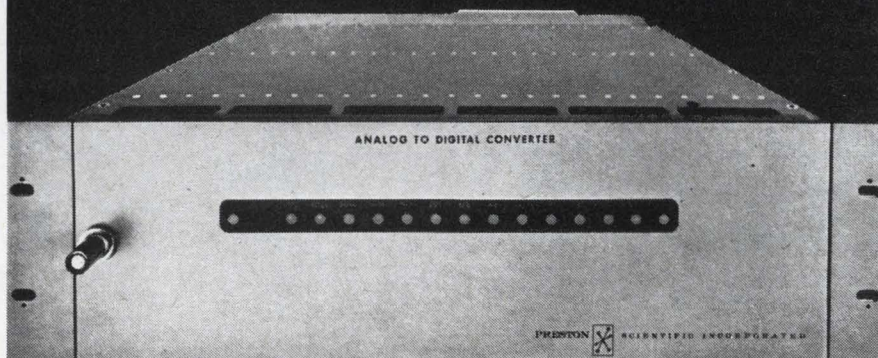

Never before has so much speed, accuracy and reliability in A-D converters been offered at such low prices!

Behind this achievement is seven years of producing similar units for major aerospace programs. Speed is achieved with specially designed logic circuits, level detectors, and amplifiers. Accuracy is the combined result of extremely stable reference voltage, careful design and parts selection, in-house fabrication of critical parts, and precision assembly. And reliability is achieved through careful design, appropriate component derating, and circuit simplicity.

Each of the 8500 Series A-D converters features accuracy of  $\pm 0.01\%$   $\pm 1/2$  LSB and will accommodate input voltages up to  $\pm 10$  volts. Input impedance is 10 megohms or greater at DC. Options are available such as faster speeds, sample-and-hold circuitry, Nixie-type readout, and special input voltage ranges. Special models are available by quotation. Write for complete information.

PRESTON



SCIENTIFIC INCORPORATED  
805 East Cerritos Avenue, Anaheim, California 92805

## People

After three attempts to convince large corporations to add micro-electronics subsidiaries, **James J. McMullen** and three associates from the old General Micro-electronics Inc. have obtained private backing and created their own company, Electronic



**James J. McMullen**

Arrays Inc. Like General Micro and the company that acquired it, the Philco-Ford Corp., Electronic Arrays will specialize in the production of metal



**Earl Gregory**

oxide semiconductor integrated circuits.

"We really didn't want to be a subsidiary," McMullen, 39, confesses, "but we tried that approach because money was tight. So, when money loosened up in 1967, we went after our own financing and got all of it—from less than 20 private backers."

**Product line.** Electronic Arrays, situated in a Mountain View, Calif., building recently abandoned by the Semiconductor division of the Fairchild Camera & Instrument Corp., will concentrate on large-scale IC's.

"We'll have a standard line that we'll mate to customer requirements," says **Earl Gregory**, vice president and marketing director. "We also expect to generalize our custom circuits. In either case, our objective is to build production as fast as possible."

"The big battle is cost," McMullen notes. "You have to get into reasonable volume quickly." Electronic Arrays expects to have 100 employees after a year of production. McMullen feels that the "heavy commitment by the military is the best indication that MOS technology has arrived."

**Expectations.** Initially, Electronic Arrays expects to do about 75% of its business with the government or subcontractors to government primes. Eventually, however, the





## Guide to Machlett Electron Tubes

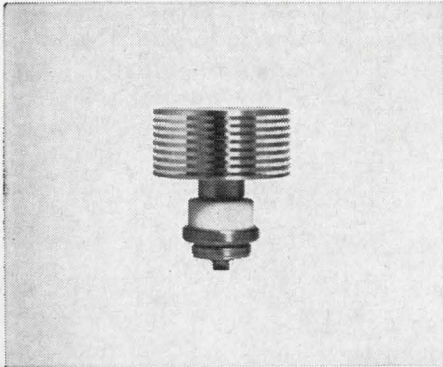

### Planar Triodes.

Grid pulsed to 1 kw at 6 Gc. To 35 kw in pulse modulator service. For communications, radar beacons and navigation.

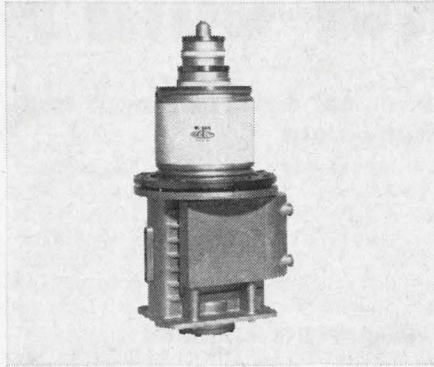

### Magnetic Beam Triodes.

Pulsed ratings to 6 Mw with only 2.5 kw drive. CW ratings to 200 kW with only 0.7 kW drive.

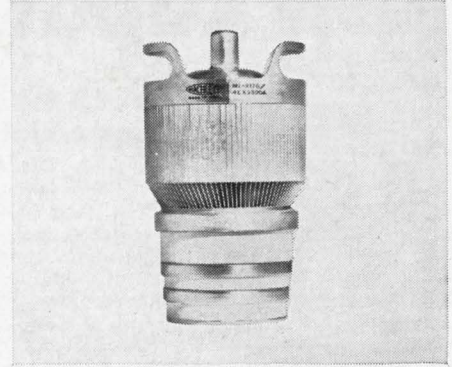

### Heavy Duty Tetrodes.

Forced air cooled, water cooled and vapor cooled for broadcasting and communications.

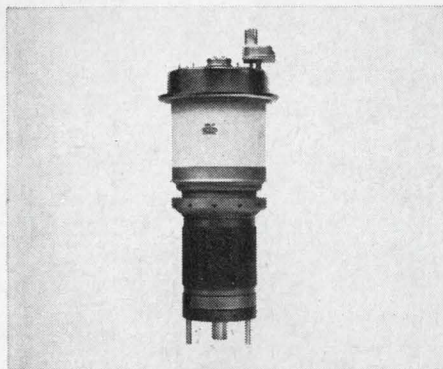

### Pulse Modulators.

Shield grid triodes (oxide cathode) to 4.5 Mw, 80 kv peak. High voltage triodes (thoriated tungsten cathode) to 20 Mw with plate voltages to 200 kv peak.

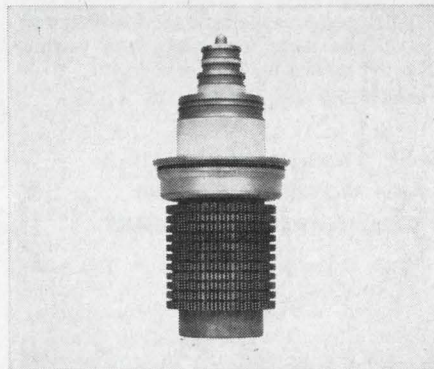

### Heavy Duty Triodes.

Includes vapor cooled triodes, to 440 kW CW.



### Vacuum Capacitors, Variable.

RMS amperes to 75A; voltage to 15 kv peak. Capacities from 5-750 pF to 50-2,300 pF.

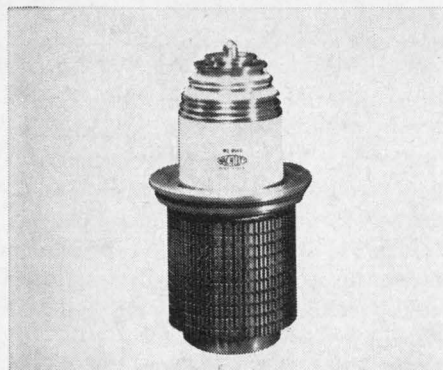

### High Power Tetrodes.

Vapor cooled tetrodes to 350 kw CW for communications.

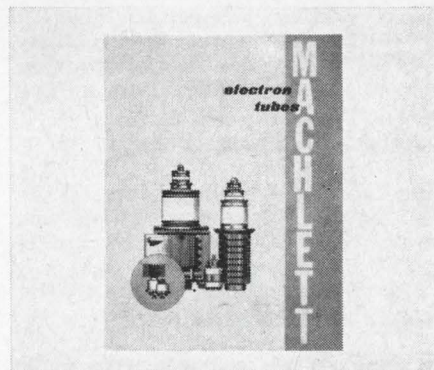

### Send for latest condensed catalog

covering the entire line of Machlett electron tubes. Write: The Machlett Laboratories, Inc., 1063 Hope Street, Stamford, Conn. 06907

RAYTHEON

THE MACHLETT LABORATORIES, INC.

A SUBSIDIARY OF RAYTHEON COMPANY



# Do you have this new capacitor data?

## People

company hopes to reverse the ratio.

Electronic Arrays is the second MOS company to be formed by former General Micro-electronics personnel. American Microsystems Inc., under Howard Bobb and a coterie of General Micro-electronics talent, began operations in Santa Clara, Calif., in the summer of 1966.

"We're not going to be able to do as much as we'd like." **Leland Johnson**, recently appointed director of research for the President's telecommunications task force, is candid about prospects for the panel, which has been directed to make



Leland Johnson

a comprehensive study of U.S. communications policies and to submit a series of recommendations by next August [Electronics, Dec. 11, 1967, p. 67].

"What we'll be able to do is set the tone for future inquiries," says Johnson. "We can offer the bare bones of what we feel a well-conceived public telecommunications policy can be."

Johnson, an economist, received his Ph.D. from Yale in 1956 and joined the Rand Corp. a year later. There he conducted some pre-Comsat cost-benefit analyses of communications satellites. "We were quite pessimistic," he recalls. "Synchronous systems were considered way out in the blue and didn't figure to compete with land-line microwave systems." Johnson cites this as an example of the rapid and often unpredictable technological changes that can vitally effect the economy.

He feels the task force should tackle such major issues as frequency allocations, the role of satellites, and the possibility of merging the international operations of U.S. common carriers as first steps toward drawing up a national policy for the 1969 meeting of the International Telecommunications Satellite Consortium.

### DIPPED MICAS . . . for entertainment and commercial equipment

Single-film silvered-mica capacitors cost less than stacked mica or ceramic types. These capacitors are rated at 300 WVDC and have good stability and retrace characteristics over their operating temperature range of  $-55^{\circ}\text{C}$  to  $+85^{\circ}\text{C}$ . Capacitance values from 10 to 360 pF,  $\pm 5\%$  are available. Put this quality and performance into your next design. Ask for Engineering Bulletin 1010.

CIRCLE READER SERVICE NUMBER 506

### SPARK GAPS and GAP CAPACITORS . . . for TV tube protection

Spark gaps and gap capacitors suppress transient voltage surges and protect your expensive picture tube and allied circuitry. Spark gaps are available in 1.5 kV and 2.5 kV ratings with less than .75 pF capacitance. The gap capacitor is an air gap in parallel with a .01 $\mu\text{F}$  disc capacitor. All Sprague spark gaps and gap capacitors are 100% tested to insure your circuitry. Use them to protect your picture tube warranty. Ask for Engineering Bulletin 6145.

CIRCLE READER SERVICE NUMBER 507

### DISC CERAMICS . . . for general, temperature-compensating, and low-voltage applications in industrial, commercial, and consumer equipment

**Cera-mite®** general application discs for bypass and coupling at low cost. Nine disc sizes from .300 to .875 inches have 100, 250, 500, and 1000 WVDC ratings, in standard or temperature-stable formulations. Dual-section discs have up to .022 $\mu\text{F}$  @ 1000 V. Ask for Engineering Bulletin 6101D.

CIRCLE READER SERVICE NUMBER 508

**Cera-mite temperature-compensating discs** for controlled capacitance change with temperature in R-F oscillators, precision amplifiers, timing circuits, other critical applications. Select from ten linear temperature coefficients from NPO to N2200. Capacitance values from 1 to 2200 pF with 1000 WVDC ratings are available, plus popular values at 3000, 4000, and 5000 WVDC for TV yoke circuits. Mini-fied units in 250 WVDC ratings may be obtained with capacitance values ranging from 22 to 990 pF. Ask for Engineering Bulletin 6102B.

CIRCLE READER SERVICE NUMBER 509

**Hypercon®** ultra-high capacitance discs for low-voltage circuits. Replace electrolytics with non-polar Hypercon capacitors only a fraction as large. The 2.2 $\mu\text{F}$ , 3 volt disc has a diameter of .875 inches; the 0.1 $\mu\text{F}$ , 25 volt unit measures .750 inches. Ask for Engineering Bulletin 6141F.

CIRCLE READER SERVICE NUMBER 510

For bulletins in which you are interested, write  
Technical Literature Service, Sprague Electric Co.,  
35 Marshall St., North Adams, Mass. 01247



#### SPRAGUE COMPONENTS

CAPACITORS  
TRANSISTORS  
RESISTORS  
INTEGRATED CIRCUITS  
THIN-FILM MICROCIRCUITS  
INTERFERENCE FILTERS

PACKAGED COMPONENT ASSEMBLIES  
FUNCTIONAL DIGITAL CIRCUITS  
MAGNETIC COMPONENTS  
PULSE TRANSFORMERS  
CERAMIC-BASE PRINTED NETWORKS  
PULSE-FORMING NETWORKS



\*Sprague and ® are registered trademarks of the Sprague Electric Co.





# We're number one 2, 3, 4, 5, 6, 7, 8, 9...

No matter how it all adds up, we're the leaders in thumbwheel switches—in sales, in product features and quality...and in service.

We like leading, and here's what it means to you:

 Our switches—Digiswitch® and Miniswitch®—are the simplest, most easily read, easiest to operate, smallest, biggest, and best looking for your panel. And they have both complex and simple electrical output capabilities.

 Did we get to be number one because we are so smart? We like to think so. But being there first sure helped. We pioneered the thumbwheel switch. And we're the kind of engineers who continually improve our product. [Drives the competition crazy.]

 But maybe our real advantage is that we like to sell things. This makes us easy to buy from. Send for our catalog. It's as easy as one, two, three.

## **THE DIGITRAN COMPANY**

Subsidiary of Becton, Dickinson and Company 

855 S. Arroyo Pkwy./Pasadena, Calif. 91105

Tel: (213) 449-3110/TWX 910-588-3794

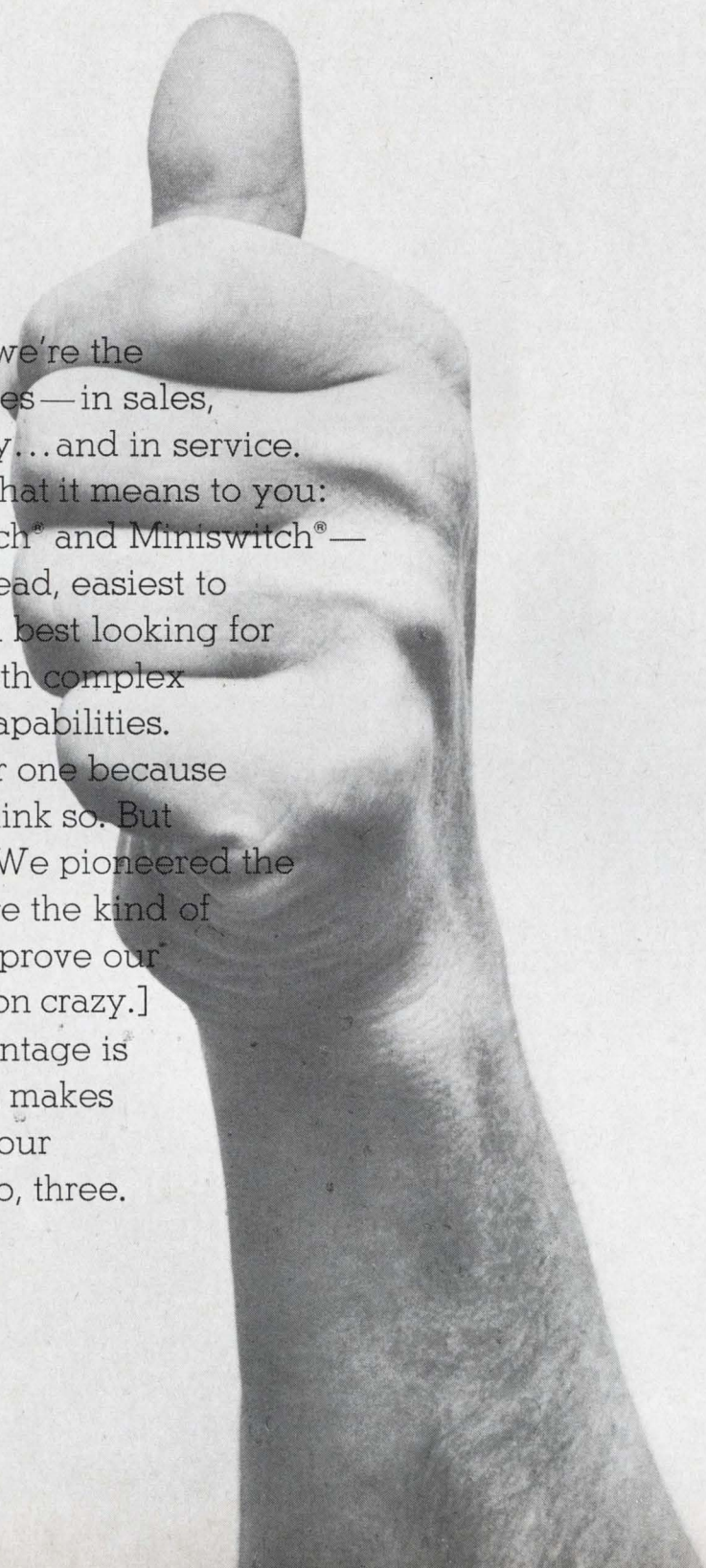



new ideas for  
moving electrical energy

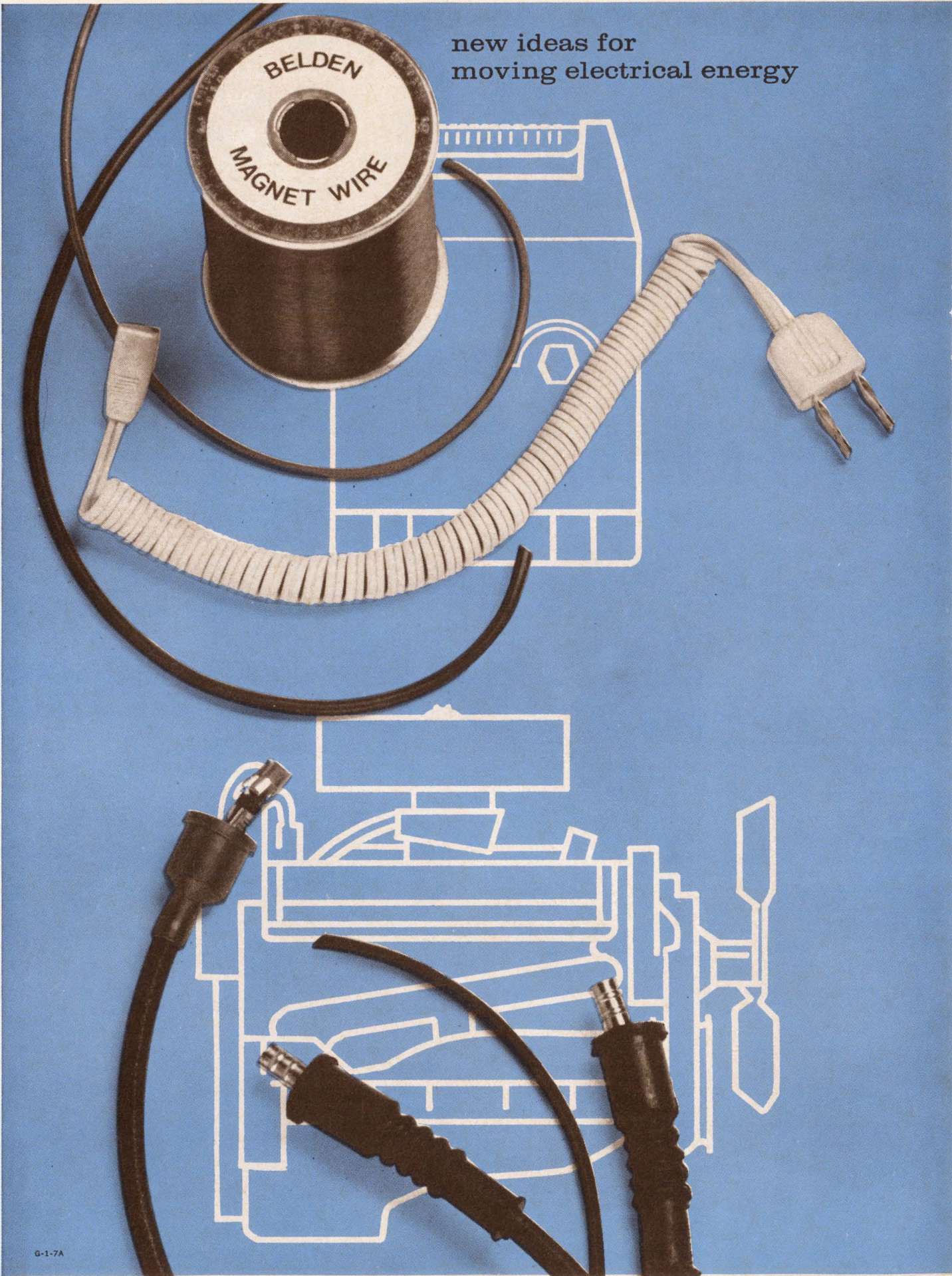

G-1-7A



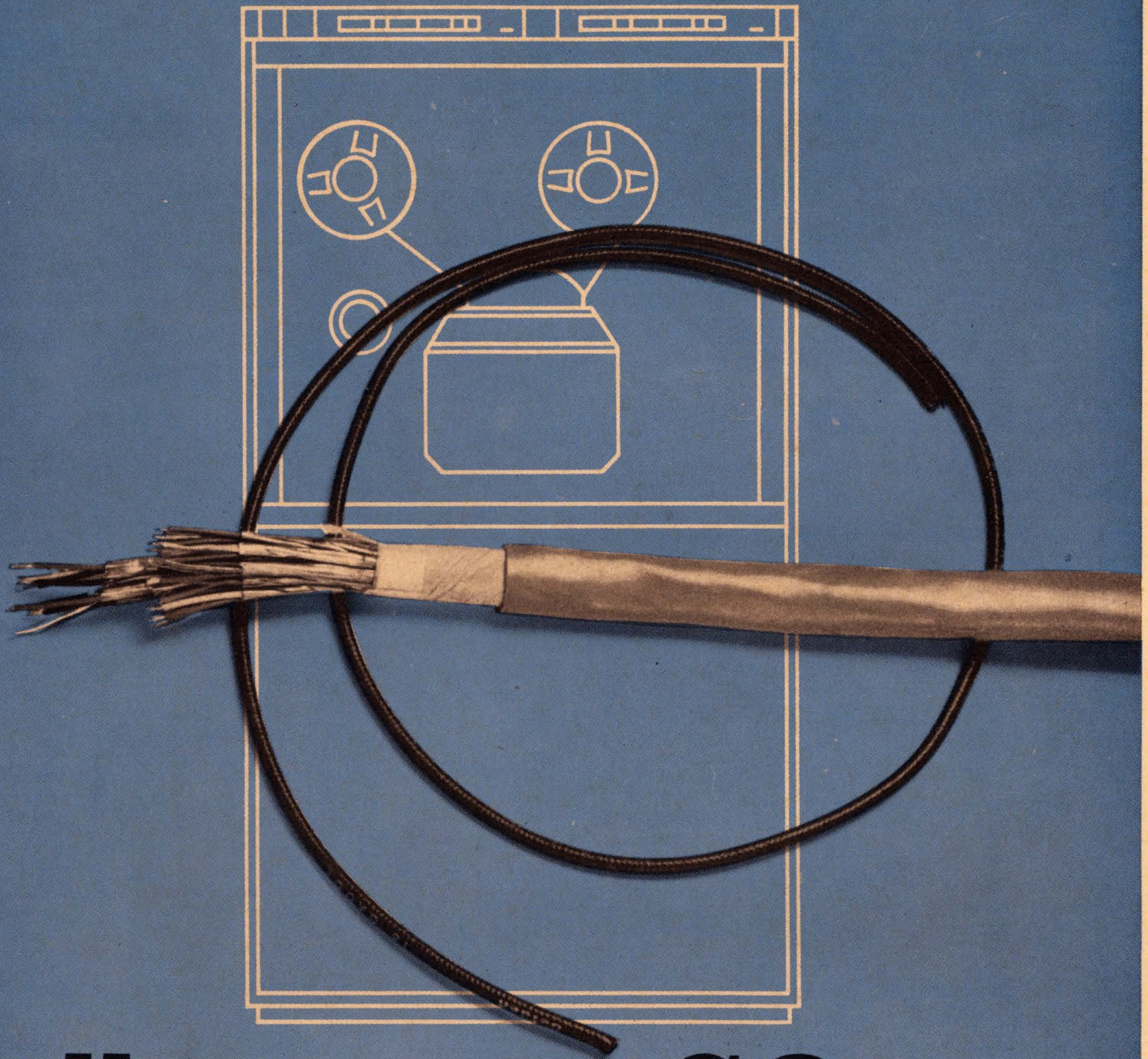

# all systems GO

...when a Belden team of wire specialists shows you their dozen or so ways to wring out hidden values and costs. For example you can delve into design..maneuver with materials.. analyze assembly..pry into processing..pick different packaging..or a host of others. But success takes a supplier who is really perceptive—one who makes all kinds of wire for all kinds of systems. Want to join us in wringing out values and costs? Just call us in...Belden Corporation **BELDEN**   
P.O. Box 5070-A, Chicago, Illinois 60680.



# A-to-D Converters

... up to 12 bits

... loaded with options



4½" x 2¾" x ¾"

- High-frequency FET input amplifier.
- Bipolar or unipolar input signals of varying ranges.
- Parallel and serial outputs of binary or BCD codes.
- TTL logic for high speed and fanout drive capability.
- Resolution up to one part in 4096 (12 bits)
- Extended temperature capability.

Get any of these options easily in the Pastoriza Model ADC-12<sub>IC</sub> analog-to-digital converter — without the usual delays and extra cost that "specials" always involve.

The 12-bit Model ADC-12<sub>IC</sub> is a single-card, general purpose, integrated circuit A-to-D converter that accepts input voltages on command and converts them to a 12-digit binary code in 25 microseconds. The single card contains an input amplifier, precision reference supply, logic, weighing network, switching, comparison, and internal clock. Only external DC power is needed.

The Model ADC-12<sub>IC</sub> 12-bit converter is just one of Pastoriza's many competitively priced A-to-D and D-to-A converters. All are available with a variety of different input options, resolutions, and output codes.

Write or call for more information on ADC TTL Series.

**PASTORIZA**  
ELECTRONICS, INC.

385 Elliot St., Newton, Mass. 02164 • 617-332-2131

## Meetings

**Meeting of the National Society of Professional Engineers;** Shoreham Hotel, Washington, Jan. 9-13.

**Symposium on Reliability, IEEE;** Sheraton-Boston Hotel, Boston, Jan. 16-18.

**Aerospace Sciences Meeting,** American Institute of Aeronautics and Astronautics; Statler Hilton Hotel, New York, Jan. 22-24.

**Power Meeting, IEEE;** Statler-Hilton Hotel, New York, Jan. 28-Feb. 2.

**Defense Contract Administration Service Forum,** American Society for Quality Control, Jack Tar Hotel, Clearwater, Fla., Feb. 10.

**Aircraft Design for 1980 Operations Meeting,** American Institute of Aeronautics and Astronautics; Mayflower Hotel, Washington, Feb. 12-14.

**Aerospace and Electronic Systems Convention, IEEE;** International Hotel, Los Angeles, Feb. 13-15.

**International Solid-State Circuits Conference, IEEE;** Sheraton Hotel, Philadelphia, Feb. 14-16.

**National Space Meeting,** the Institute of Navigation; Ramada Inn, Cocoa Beach, Fla., Feb. 19-21.\*

**Scintillation and Semiconductor Counter Symposium, IEEE;** Shoreham Hotel, Washington, Feb. 28-March 1.

**Technology for Manned Planetary Missions Meeting,** American Institute of Aeronautics and Astronautics; New Orleans, March 4-6.

**Conference of the American Society for Nondestructive Testing;** Biltmore Hotel, Los Angeles, March 11-13.

**International Convention and Exhibition, IEEE;** New York Coliseum and New York Hilton Hotel, New York, March 18-21.

**Symposium on Microwave Power,** International Microwave Power Institute; Statler Hilton Hotel, Boston, March 21-23.

**Flight Test Simulation and Support Conference,** American Institute of

Aeronautics and Astronautics; Los Angeles, March 25-27.

**International Aerospace Instrumentation Symposium,** College of Aeronautics; Cranfield, Bedford, England, March 25-28.

**Quality Control Conference,** American Society for Quality Control; University of Rochester, N.Y., March 26.

**Railroad Conference, IEEE and American Society of Mechanical Engineers;** Conrad Hilton Hotel, Chicago, March 27-28.

**International Magnetics Conference, IEEE;** Sheraton Park Hotel, Washington, April 3-5.

## Short Courses

**Dynamic measurements in ocean sciences,** Instrument Society of America, Ramada Inn, Cocoa Beach, Fla.; Jan. 16-19, \$240 fee.

**Frontiers of glass science and technology,** Rensselaer Polytechnic Institute, Troy, N.Y., March 25-26; no fee, but preregistration will be required.

**Stimulated Raman effect,** Stevens Institute of Technology's Department of Electrical Engineering, Hoboken, N.J., Feb. 14; no fee.

## Call for papers

**Convention of the Audio Engineering Society;** Hollywood Roosevelt Hotel, Hollywood, Calif., April 29-May 2. Jan. 30 is deadline for submission of abstracts to Don Davis, convention chairman, 34th National Convention, Audio Engineering Society, c/o Altec Lansing, 1515 S. Manchester, Anaheim, Calif. 92803.

**Design Automation Workshop, IEEE;** Washington, July 15-18. Jan. 30 is deadline for submission of summaries to Dr. H. Freitag, IBM Watson Research Center, P.O. Box 218, Yorktown Heights, N.Y. 10598

**Aerospace Instrumentation Symposium,** Instrument Society of America; Statler-Hilton, Boston, June 3-5. Feb. 15 is deadline for submission of abstracts to John Westwick, Allison Division, General Motors Corp., Plant 8, Indianapolis, Ind.

\* Meeting preview on page 16.



# The connector THING

A periodical periodical designed, quite frankly, to further the sales of Microdot connectors and cables. Published entirely in the interest of profit.

# The 2 MINUTE (OR LESS) BRIBE

The two minute (or 120 second, whichever is shorter) "bribe" is about how long it should take a rank amateur (or even a good-smelling amateur) to prove to his satisfaction that Microdot does not speak with forked connector. (Affidavit: "This ain't a bribe in the true sense." Signed the management.)

The "bribe" centers around our high density, circular, multipin connectors. Microdot started this particular concept over four years ago with the MARC 53, the hit of the subminiature world. It's been right up there on the Gemini space walks and, as the world's smallest, high-performance connector has also been drafted for other military (meets MIL-C-38300A) and NASA projects. It heralded a new generation in submins. The Microdot high density design is coupled with two other exclusive features: (1) Posilock, the only advanced push-pull, lock coupling mechanism that guarantees proper engagement even under "blind mating" conditions and (2) Posiseal, a sandwich insert design using silicon interwafer seals.

## PRESS ON

Now that you are conversant with the MARC 53, let's try the MARC 53 RMD. Now this differs from the other much more than those three little letters on the end.

### HOW SO?

Because the RMD version has rear-insertable and removable pins and sockets!!!!

## BENEFITS PLEASE

No tools needed for assembly or disassembly. And tools, as every inspector knows, are oft cause of damage of a connector's rubber parts which in turn leads to insufficient sealing which in turn leads to all sorts of trouble. And the need for tools further makes field repair and/or maintenance a veritable "you're kidding" situation.

## AND EVEN MORE

All this means here's a submin connector that lends itself to real mass production assembly techniques because assemblers can use factory produced, pre-crimped wire.

## WHAT DOES THIS MEAN TO YOU?

Fame, fortune and undying gratitude when you tot up all the savings in time and money you'll be responsible for.

## NOT ENOUGH WHAT ELSE?

**BÜZ** (a case in point is a Beefeater)  
If you're the fastest under the two minute barrier.

## WINNERS

The three best winners, those with the neatest times, will receive a choice case of their own choice of hard stuff; Smirnoff, J&B, Beefeater, Jack Daniels, COMPLETE with THEIR OWN PRIVATE LABELS WITH THEIR OWN CUSTOM DESIGNED NAMES, very effective for impressing folk at parties and/or other get togethers.

## TWO MINUTE BRIBE CONTEST RULES

You must use a Microdot RMD MARC 53 Connector. And you must use a Microdot Rep. (There are several used ones in your vicinity.)

### SMALL PRINT

1. You will be handed a MARC 53 RMD.
2. You will be told to unscrew the neatly machined rear nut and
3. Dismantle the back of the device and loosen all those metal things.
4. Then pull out 4 pins.
5. Put back those 4 pins. And
6. Put all that metal stuff back in the proper order. And tighten the rear nut.

## LOSERS AND OTHERS

Because, there are NO TOOLS NECESSARY WITH THE MARC 53 RMD, and to compensate you for that fact, you will receive a very tool tool. (Better than a connector tool, really.) You will receive ONE STERLING BAR SPOON. (This spoon is sterling in concept only, but it shouldn't rust.)

**HURRY!** For this remarkable contest closes sometime this spring o/a midnight February 28, 1968. Fill out the neat coupon below. All of this madness is, unfortunately, void where the legislature is a bit stuffy.



## NEAT COUPON



## MICRODOT INC.

220 Pasadena Ave., South Pasadena, Calif. 91030.

- Yes, I would like to take the two minutes "bribe," but I couldn't read your crumby contest rules.
- Yes, yes. I want to take the "bribe," rules or no rules.
- Enough of that. Just send me all the info on the MARC 53 RMD. I make my own stuff.

MARC 53, RMD, Posilock and Posiseal are trademarks of Microdot Inc.

Name \_\_\_\_\_  
Company \_\_\_\_\_  
Position \_\_\_\_\_  
Address \_\_\_\_\_  
City \_\_\_\_\_  
State \_\_\_\_\_ Zip \_\_\_\_\_

{ What's happening in New York on March 18? }  
{ Write in and tell us, and we'll send you a little surprise! }



## Breakthrough by Dearborn!



# 100 $\mu$ F @ 50 V

in 1" x 3<sup>3</sup>/<sub>16</sub>" metal-encased

## METALLIZED POLYCARBONATE-FILM CAPACITORS

⊕ Capacitance range of Dearborn DIMIE® Series now extended to almost 18 times higher than previously-available values!

⊕ A new order of size and stability in capacitors for critical low-voltage miniaturized circuits.

⊕ Rated for operation at temperatures to +125 C without derating.

⊕ Low loss characteristics, high current-carrying capabilities—ideally suited for specialized a-c and r-f applications.

For complete technical information, write to Dearborn Electronics, Inc., Box 530, Orlando, Fla. 32802.

# Dearborn Electronics, Inc.

(a subsidiary of the Sprague Electric Company)

FOREMOST IN FILM CAPACITORS

ID-7101R1

## Meeting preview

### Zeroing in on 'copters

With helicopters playing an increasingly larger role in both military and civilian aviation, greater attention is being paid to reducing the number of controls that are handled manually by the pilot. When the Institute of Navigation's National Space Meeting opens in Cocoa Beach, Fla., Feb. 19, one of the major topics will be automated guidance and control systems for helicopters.

**Flying and landing.** A paper by Marvin Taylor and Irwin Feldman, engineers at the American Bosch Arma Corp., will describe a self-contained navigation system for both helicopters and vertical-take-off-and-landing craft. Another by engineers J.G. Fellingner, R.W. Elsner, and M.W. Story, all of Lear Siegler Inc., will discuss the integration of automatic and manual flight controls for approaches and landings.

New types of computer-driven displays for station-keeping under instrument flight rules will be discussed by Robert M. Nicholson and Charles A. Baker, engineers at Honeywell Inc., Brad Gurman of the Army Electronics Command, and Lt. Cmdr. Frank Cundari of the Office of Naval Research.

**Where are you?** To be sure, topics other than helicopters will be covered in the three-day session. Andrew E. Scoville, an engineer at the United Aircraft Corp., will compare the advantages and limitations of strapdown and inertial-guidance systems. James E. Miller and James Sitomer, researchers at Massachusetts Institute of Technology's Instrumentation Laboratory, will describe a simplified strapdown system for extended manned space missions.

Strapdown-testing techniques will be covered in a paper by Capt. Nicholas C. Belmonte of the Air Force's Central Inertial Guidance Test Facility, Holloman Air Force Base, N.M.

One of the sessions will be devoted to a discussion of simplified electro-optical sensors.

For details, write R.E. Freeman, executive director, the Institute of Navigation, Suite 912, 711 14th St., N.W., Washington, D.C.





## Do your problems start here?

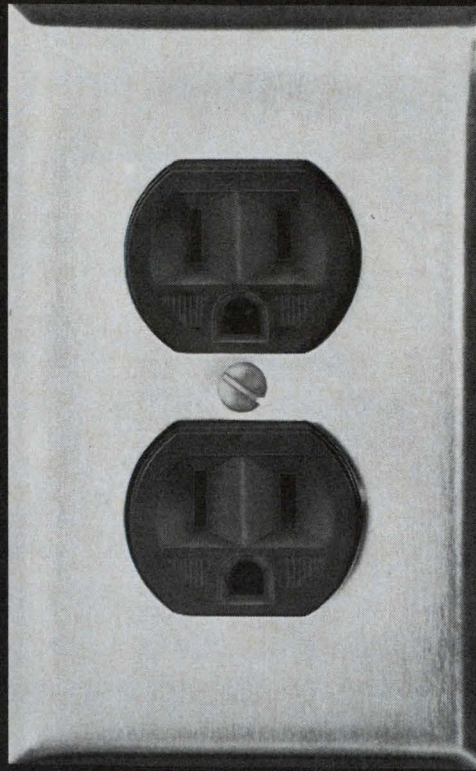

Line-voltage variations are seldom blamed for the insidious little problems that plague us daily. Usually we blame the equipment. So, as a public service to protect electrical equipment from kicks, fists, cuss words, and other abuses, we would like to list a number of troubles that are directly attributable to off-normal line voltage.

**Motors . . .** Low voltage increases starting time, reduces starting torque (at 10% undervoltage, a squirrel-cage motor has 19% less starting torque); efficiency of portable tools such as hand grinders will drop as much as 10%. Overvoltage may stress shafts, gears and belts; with a 10% increase in line voltage, starting current is up 12%, power factor is down 5%, and motor noise increases.

**Lighting . . .** Low voltage reduces lamp efficiency; a 10% line drop reduces light in incandescent lamps by 30%. Tungsten-halogen lamps blacken; color temperature of photographic lamps drops by 100°K. Overvoltage reduces lamp life; a 4% increase halves the life of incandescent lamps. A 10% increase produces a 20% increase in heat of infrared lamps — enough to scorch sensitive surfaces.

**Electrical Equipment . . .** At 10% undervoltage unprotected thyratrons and other gas-filled tubes can fail in minutes.

Output of unregulated oscillators and generators will vary, stability will be impaired, and calibration will be questionable. Varying voltage will seriously distort the accuracy of data obtained during life testing. A 10% increase in voltage will cut tube life by 75%.

**Industrial Equipment . . .** At 10% undervoltage ultrasonic cleaner and induction-heater output is off 20%; plating deposition rate drops 10 to 20%; precipitator cleaning power drops 20%; solenoid holding power is reduced; electrical heating time is increased by 20 to 25%. Varying line voltage impairs weld consistency produced by energy-storage spot welders used for fabricating aluminum and exotic metals. Heat sealing processes are seriously hampered by voltage fluctuation. At 10% overvoltage, metallic rectifiers become overstressed and their ability to withstand transient surges is reduced by 50%. Idling losses in electrical distribution equipment is increased; transformer core losses increase approximately as the square of the applied voltage.

**The SOLUTION . . .** These and many other voltage ills can be handled simply and effectively with Variac® automatic voltage regulators. They are designed for fast (up to 80-volts-per-second correc-

tion on 115-V lines), accurate ( $\frac{1}{4}\%$  or  $\frac{1}{2}\%$ ), and distortionless control of line voltage. Overloads as much as 10 times rated current can be accommodated.

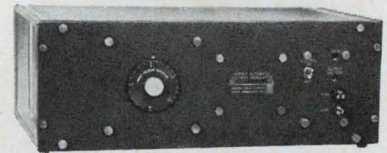

These all-solid-state regulators are available in 31 electrically-different models, rated at 2- to 20-kVA for industrial use and 2- to 9.2-kVA for military applications. Models are available for line frequencies of 50 to 60 Hz or 350 to 450 Hz, single- or three-phase operation, and nominal line voltages of 115, 230, and 460 volts. Prices start at \$530 in U.S.A.

For complete information, write General Radio Company, 22 Baker Avenue, W. Concord, Massachusetts 01781; telephone (617) 369-4400; TWX 710 347-1051.

## GENERAL RADIO



# When you're headed for trouble, there's no time to worry about microwave device performance.

That's why MEC created "super components." In most cases, systems troubles are caused not by components, but by the interfaces between them. With the introduction of "super components," MEC has made a major contribution toward minimizing microwave device interface problems.

Basically, "super components" are modular combinations of TWTs, solid-state delay devices, power supplies, limiters, switches and isolation networks. Together, they form complete sub-assemblies for systems application. Now a single specification can be generated for the combination unit . . . with MEC assuming unit responsibility.

Working closely with systems manufacturers, MEC has developed packaged amplifiers, zero loss microwave acoustic signal storage units, and chains of low-to-high power TWTs — many with shaped gain and limiting characteristics — for use in signal repeating, augmentation, microwave memory, direction finding, communications and target simulation systems.

Frequency, power and environment? MEC provides "super components"

covering VHF through 40 GHz. Power levels range from milli-watts to hundreds of watts, cw, and kilo-watts pulsed. All "super components" satisfy the most demanding military or commercial requirements.

True, most of the time there is no system problem to worry about; but, when you're headed for trouble, is most of the time good enough?

For complete information, contact us at 3165 Porter Drive, Palo Alto, Calif. 94304. Phone (415) 321-1770.



**MICROWAVE ELECTRONICS**  
A TELEDYNE COMPANY

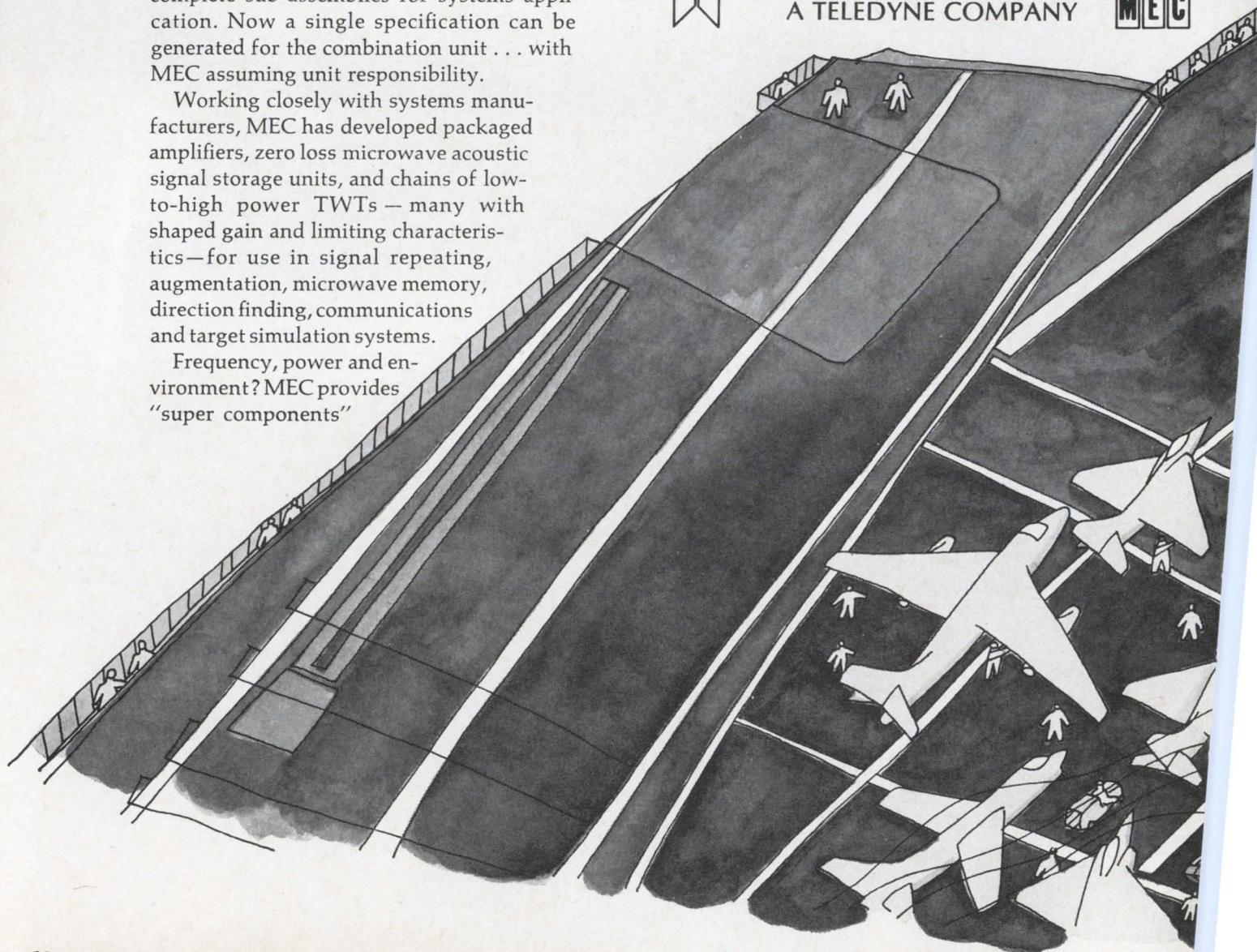



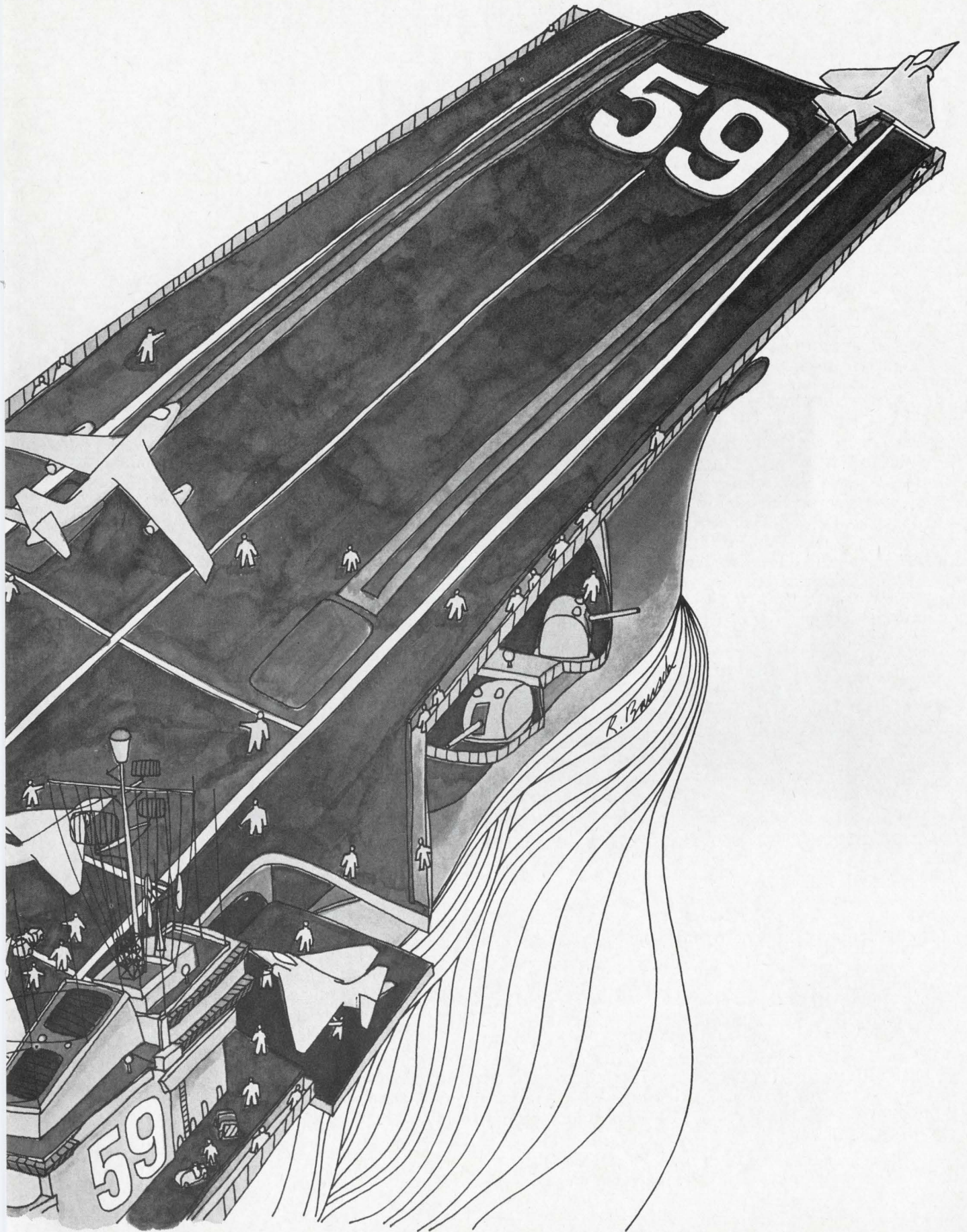



# We build uncommon recorders

**SMALL, CARTRIDGE-LOADED UNIT FOR COMPUTER PROGRAMMING, TEST INSTRUMENTATION, ECM—SERIES MTR 8000.** Records and reproduces voice, analog, FM, and digital data with a variety of combinations for a wide range of applications. Eliminates tape threading and assures fast tape change. Performs with high reliability in 0 to 130°F temperature, 100% humidity, 150,000 feet altitude. Tape storage: 1/4" x 260'. Tape speed: up to 60 ips. Size: 7" x 4.5" x 4.5". Weight: 5 lbs. Power consumption: 20 watts.

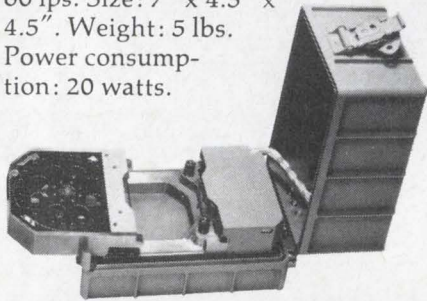

**RANDOM BIN LOOP RECORDER FOR AIRCRAFT, SATELLITES, MISSILES—SERIES MTR 6000.** Provides record of last 30 minutes of digital and voice information, three tracks digital and four tracks voice. Contains dual speed transport drive of

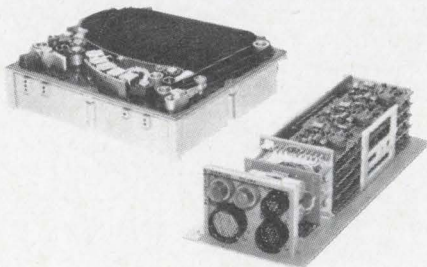

15/16 ips and 6 times speed. Tape storage: 150' x 1/2". Dimensions: 8" x 9" x 2.75". Weight: 5.5 lbs. Power dissipation: 10 watts max.

**PORTABLE RECORDER/REPRODUCER FOR GENERAL PURPOSE INSTRUMENTATION TEST—SERIES MTR 3000.** Provides up to 14 channels analog and FM or 16 digital

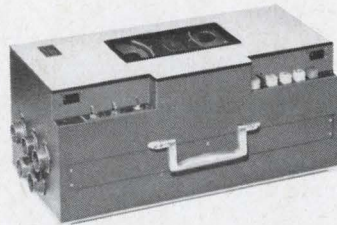

channels which can be used in any combination. Plug-in modular electronic construction makes possible numerous record/reproduce options. Seven IRIG standard tape speeds available. Shock: 25 g—8 ms 1/2 sine—5% p/p flutter. Vibration: 10 g rms random operating—6% p/p flutter. Weight: 50 lbs. maximum. Size: 8.625" x 9.5" x 20".

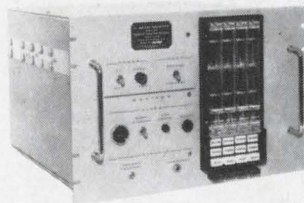

**LOW COST, LONG TIME SYSTEM FOR AUDIO MONITORING—SERIES MTR 5000.** Four cartridge unit each recording 5 separate channels for

24-hour surveillance. Automatically replaces and rewinds each reel, prepares it for playback in portable reproducer. Permits recording of 20 channels (all reels) at one time. Contains alarm system for malfunction warning. Twelve cartridge military unit available. Tape: 1/4" x 1800' at 15/16 ips. Size: 19" rack mount.

**LIGHT WEIGHT, LOW POWERED, LONG LIVED SYSTEM FOR SATELLITE APPLICATIONS—SERIES 2000.** Backed by over 150,000 hours of successful operation in space. Offers custom flexibility in data programming. Accommodates PAM/FM, Multiplex

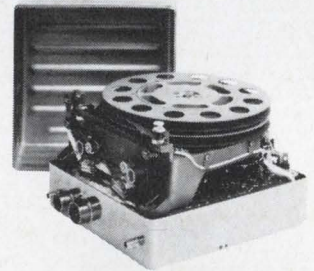

FM, direct, single carrier FM, PDM and digital data. Releases in burst the data collected in orbit. Tape: 1/4" x 1200', 1900' and 3000'. Speeds: 0.1 to 100 ips. Size: 290 cubic inches. Weight: 10-15 lbs. Power consumption: 5-25 watts.

Write Dept. K for details on our uncommon recorders for your unusual requirements. Leach Corporation, Controls Division; 717 North Coney Avenue, Azusa, California 91702; Telephone: (213) 334-8211.

## LEACH



# Giant Killers

Second in the series.



International road racing had long been dominated by foreign automotive dynasties . . . until 1965, when the old regimes were toppled from the world racing throne by a bold Texan, Carroll Shelby, with his Cobra sports cars. In '66 and '67 Shelby Fords swept Le Mans —another American first— and a clear indication the giant was no longer king of the hill!



In the fast recovery power diode field, we knock heads with some industry giants, too. Take an example.

Our 251UL silicon diode boasts a 250-ampere forward current with recovery time of  $1.5\mu\text{s}$ , 600 to 1000 PRV,  $2.0\mu\text{s}$  to 1300 PRV. These recovery times are tested at 785 amps peak  $I_F$  ( $\pi$  times the FCA rating) as recommended by JEDEC. You get microsecond recovery at operational currents.

The giants can't come near it. Brands G, W and M publish recovery times tested at  $I_F$  levels well below specified capacities—usually 1 to 5 amps or so. Try their diodes in a circuit and see how fast they recover.

If you have inverters with critical high frequency requirements, talk to the giant killer—IR—developers of the 200 ampere power logic triac. Send for 251UL bulletin plus test procedures. Or just send your order. We've been delivering them for over a year.



INTERNATIONAL RECTIFIER







---

**Commentary**

---

## All-purpose scapegoat

**The world** may be divided about the purpose of the war in Vietnam but the electronics industry isn't. Almost unanimously throughout the forecast for domestic markets in 1968, starting on page 105, market planners see the war as an all-purpose scapegoat. And the industry's disappointment with what will be a good—though not great—year is echoed by the military.

For example, Pentagon officials complain about the money being sluiced into procurement of hardware to fight the war day by day. Those sums, they say, reduce the amount available to develop sophisticated weapons for Vietnam-type wars of the future.

- Instrument makers say that they'll have to sell more of their less lucrative wares to satisfy war requirements. Many are claiming that this must result in fewer Government dollars for high-profit-margin research and development instrumentation.

- Microwave manufacturers decry the fact that they are inextricably tied to the military; they want Government funding with no military strings attached. Despite a general reluctance to make predictions, most makers look to a good year, if only because of a few projects like the Sentinel antiballistic missile system.

- Color-television set makers attribute the slowdown in sales to the threat of higher taxes and tighter credit that economists call for as the war escalates.

But these pat explanations for a slowdown of gains in the industry don't stand up under scrutiny. What some of the holders of Federal contracts really seem to be saying is that from an economic standpoint they can live more comfortably in a cold war, than a hot one.

They are right; it's easier. But they're forgetting that World War II provided the pressures and impetus for the development of electronics hardware as well as systems and systems concepts. Perhaps Government money flows more freely and with fewer demands on its spenders to "come across" in a cold war economy, but technology moves at a more leisurely pace.

It is doubtful that the microwave business is being hurt by the war. At least one microwave marketer says the industry pays only lip service to diversification into non-military areas. Until consumer and industrial applications for microwave heating and broadcasting gear are developed, the microwave business will lack the firm footing its technology deserves.

As for the consumer electronics market, it seems a bit presumptuous of the marketers to attribute their shortcomings to the war. Wages and savings accounts are at an all-time high. The reluctance of consumers to buy color sets may be overcome when set makers demonstrate that buyers won't have to worry about the com-

plicated adjustment and servicing that present sets still need.

Unquestionably the war is hurting some sectors of the electronics industry. Despite journeys to the Pentagon in 1967 by key NASA engineers and scientists to "save" projects they considered invaluable, large chunks were pared from the space agency's budget. For example, Congress slashed \$200 million from the Apollo applications program. But some \$454.7 million remains for one of the agency's potentially most valuable projects.

But even if the tremendous expenditures for the struggle in Vietnam have altered the outlook for U.S. electronics, the war cannot be used as an excuse for poor planning and management dating back months and even years—or for inadequate performance in the months ahead.

## Heading toward a record

**Despite the war**, the consensus of the experts is that things will be pretty good during 1968—sales will be up 6.7% to put the industry at a record \$23.6 billion. Among the areas of particular interest are these:

- Computers. They continue to be the darling of the electronics industry. Average annual growth has been 20% over the past five years and no slackening is predicted during this year. The integrated circuit will continue to be the handmaiden of computers as they grow in sophistication and complexity. The fly in the computer ointment remains the development and debugging of software on schedule.

- Avionics. The Federal Aviation Administration is rebounding from twin insults—budget cuts and Congressional criticism—to undertake several important air-safety programs in 1968. The agency's programs could be the forerunners of systems that could handle 140 million domestic takeoffs and landings per year in the late '70's. In 1968, commercial and military sales of flight control and instrumentation systems are expected to be up 10%.

- Communications. Three sectors account for an estimated 13% rise in the communications market: telemetry (reflecting large NASA contracts), mobile radio, and microwave relay gear.

- Educational electronics. Although overnight gains are not to be expected, experimental projects that will get under way or continue this year will add to the weight of experience gained in this fertile new field. The Office of Education, for one, will budget \$400 million for equipment for local school systems, most of it electronic.

- Medical electronics. Medicare and Medicaid programs mean greater patient loads requiring analytical instruments to replace many hard-to-find technicians. The field is expected to experience a gain of 13%.

While 1968, by comparison with the spectacular growth years that preceded it, may not be a vintage year, it holds great promise.



What's the biggest problem plaguing RFI filter designers? Well, poor attenuation from available filter components has to be one of the most troublesome. Optimum attenuation leaves a lot to be desired. Our engineers tackled the problem and found we already had a solution.

It's a ferrite material we call Ferramic® O-5. This material has established an outstanding reputation for use in chokes, inductors, and transformers operating over the frequency range from audio to the broadcast band. But it does an about face

and its attenuation climbs like a rocket from 10 KHz up through the megacycle range. And it exhibits extremely high permeability and dielectric constant throughout this range.

In short, our O-5 ferrite is about the finest RFI filter material made anywhere and is available as a standard production item. In addition, we have other materials, like H and Q-1 ferrites that do an excellent job for similar applications. This is just one more example of the new uses of ferrites in a widening range of industries.

Because of our demonstrated ability to handle RFI filtering problems we now have various new materials and applications under development for both the military and commercial markets. You'll be hearing about them soon. So if you have an RFI filtering problem, you ought to find out what we've got. Just write Mr. K. S. Talbot, Manager of Sales, Indiana General Corporation, Electronics Division/Ferrites, Keasbey, N. J.

**INDIANA GENERAL** 

**When it comes to filtering radio frequency interference  
Indiana General has what it takes.**





---

# Electronics Newsletter

---

January 8, 1968

## Hughes to backstop TRW's Intelsat 3

Comsat has decided to go along with TRW and the Intelsat 3 satellite, but has told Hughes Aircraft to start building—as a backup development—an upgraded version of the Intelsat 2 satellite for launching in July. Development problems delaying the TRW satellite forced Comsat to hurriedly set up two teams to study the situation [Electronics, Dec. 11, 1967, p. 25] and to consider Hughes' offer to build a 1,000-circuit Intelsat 2 craft, dubbed 2.5, by July. But the teams reported that neither company had a better than 50-50 chance of delivering a satellite in time for its use to relay television signals from this fall's Mexico City Olympic Games.

These reports, plus strong assurances from ITT that it would deliver the communications subsystem for the Intelsat 3 without further delays, prompted the Comsat decision. The upgraded Intelsat 2, to be assembled from parts already built, will have a capacity of 600 to 800 circuits, somewhat fewer than planned for the 2.5 craft. Negotiations are now in progress to determine how much upgrading Hughes will do with the satellite.

## Bell Labs weighs a giant Illiac 4

A gigantic parallel-processor computer designed along the same lines as the University of Illinois' Illiac 4, but more than 100 times larger, may be built at Bell Telephone Laboratories. The basic processor would be designed around a monolithic arithmetic unit built as a large-scale integrated circuit. The entire computer would be conceptually capable of working with as many as 32,000 such units at once. Illiac 4 will have only 256 small processors running in parallel.

## High-Z IC op amp without FET booster

Ultrahigh input impedances—several hundred megohms and higher—in integrated circuit operational amplifiers, are usually achieved by placing field effect transistor elements in the input stage [Electronics, Dec. 25, p. 25]. But National Semiconductor has turned the trick by applying metal oxide semiconductor (MOS) IC fabrication techniques to standard bipolar IC's; the company has developed an all-bipolar IC operational amplifier with an input impedance of 10,000 megohms, the highest input impedance in a monolithic device.

Designated the LM102, the device was designed primarily for voltage-follower applications. It will be offered this month as a direct plug-in replacement for the  $\mu$ A709. National's new IC was designed by Robert Widlar, former Fairchild engineer and inventor of the 709. It has a 10 nanoamp input current, 3 picofarads of input capacitance, and a bandwidth of 10 megahertz.

## Fourier transform may ring the phones

Bell Telephone Laboratories is studying the use of a digital technique to distinguish between the various dial tones that a push-button telephone generates. And the technique, which would replace an analog method, is based on the fast Fourier transform [Electronics, Oct. 3, 1966, p. 52].

Still in the proposal stage, the digital scheme may not be applied to phone equipment for a long time, if ever. But its advantages are those that make digital treatment of analog signals attractive in any application—size savings, increased signal resolution, and greater system flexibility.

Present push-button phone systems use seven audio-frequency tones—



---

# Electronics Newsletter

---

three for the three columns of buttons and four for the rows. A different pair of tones corresponds to each of the 10 digits. At the central exchange, a group of bulky analog filters isolates the tones and drives logic circuits that select the line being called.

Flexibility would be by far the biggest benefit of adopting a digital technique here. **With a digital setup, changes could be made in the tone-signaling system with only minor alterations, or none, in the circuitry.** With analog filters, such changes require the replacement or adjustment of every circuit in the system.

## **Navy orders bipolar-MOS IFF subsystem**

Cardion Electronics has developed an identification-friend-or-foe (IFF) decoder subsystem for the Navy that is unusual in three respects: **it relies almost exclusively on integrated circuits, it uses both metal oxide semiconductor and bipolar circuits, and some of the IC's are plastic encapsulated dual-in-line packages.**

The Pentagon waived its usual prohibition against the lower-priced plastic, apparently confident that the plastic units will meet the military's hermeticity specifications [Electronics, April 17, 1967, p. 106].

The main elements in the IC system are series 54/74 transistor-transistor logic and advanced MOS devices, all from Texas Instruments. The total order for the circuits alone is \$1 million.

## **New transistor move planned by TRW**

Look for TRW Semiconductors to make its next move in the upward spiral in transistor power and frequency levels about March or April. Indications are that the firm will come out with a **6-gigahertz, 10-watt device, if management opts to push frequency higher, or a 300-watt, 30-megahertz unit, if the decision is to push the power.** TRW introduced a 50-watt, 500-Mhz transistor last summer [Electronics, Aug. 21, 1967, p. 150]. Officials said then they'd be producing a 100-watt, 500-Mhz transistor within a year. The transistor will probably be built with an interdigitated cell structure.

## **All-digital display for NASA likely**

NASA officials are expected to approve a plan to convert the Manned Spacecraft Center's flight-controller displays to an all-digital system. Present displays use an analog/digital system. By going all-digital, up to the cathode-ray tube, NASA engineers say the size of the system can be cut, reliability improved, and black-white contrast sharpened. The all-digital system will also make it possible to use as many as seven colors in the display.

NASA's information systems division at Houston has been studying the system for several years and recently started testing a Philco-built prototype. **Evaluation will be completed before summer.**

## **NASA engineers aren't sulking over budget cuts**

Houston Manned Spacecraft Center's engineers aren't complaining about severe budget cuts because now they get a chance to perform some in-house work that in more prosperous days was farmed out to contractors. Engineers prefer to do original work instead of monitoring the work of others, says Ralph S. Sawyer, chief of the instrumentation and electronic systems division. **However, Sawyer and other NASA managers are increasingly frustrated; the cutback prevents them from planning future manned programs.**



## IDEAS/CRTs

### Instantaneous display of computer-generated data, plus hard-copy prints in seconds.

How a Sylvania CRT lets you select and view computer data . . . and print out only the parts you want within seconds.

Here's another imaginative use for a Sylvania CRT: one-step viewing of computer-generated data and simultaneous hard-copy recording of it on Dry-Silver paper. The 3M "129" Display/Print Module also provides ready access, at many remote locations, to a single computer-memory storage bank.

In addition to electronic data processing applications, these CRT Display/Print Modules record medical data such as ECGs VCGs, and EEGs... duplicates sustained TV facsimile displays . . . and reproduces repeating waveforms displayed on CRT instrumentation recorders.

This is just one IDEA for use of a Sylvania CRT. (And we have dozens of different types—each for a specific application.)

Below are specifications for the CRT used in this 3M "129" Display/Print Module. How many ways can you use it?

#### SYLVANIA SC4639 CRT

Focusing Method	.....Electrostatic
Deflection Method	.....Electromagnetic
Deflection Angle	.....50 degrees
Phosphor	.....P1
Fluorescence	.....Green
Persistence	.....Short to medium
Faceplate	.....7-inch diameter, flat (6-inch useful screen diameter)
Length	.....14 inches
Trace Width	.....Better than 0.008 inch with light output in excess of 1,000 foot-lamberts
Anode Voltage	.....20,000 VDC

CIRCLE NUMBER 300

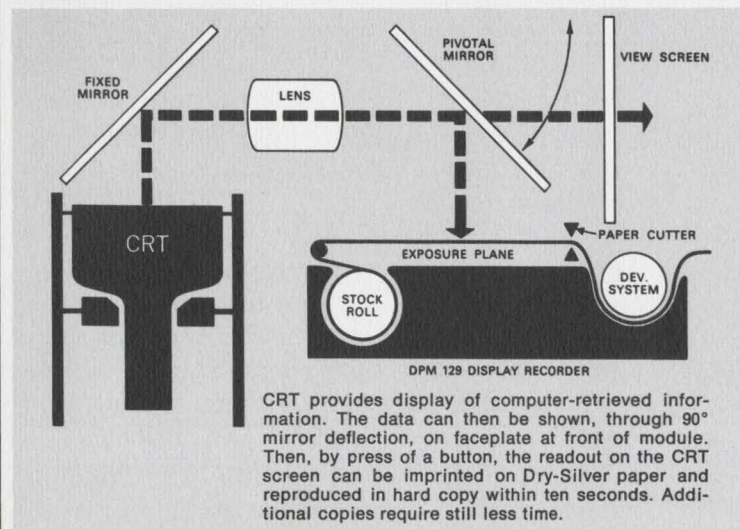

3M "129" Display CRT Print Module. Information retrieved from computer memory bank is displayed on screen at top. Press "print" button and information on screen will be reproduced on dry paper, below, within 10 seconds.

### This issue in capsule

#### Diodes

PIN microwave switching diodes with assured Quality ("Q") Factor

#### Rectifiers

1-amp glass rectifiers absorb 1000-watt reverse transients

#### Circuit Boards

Low-cost, laminated SYL-PAC boards increase IC switching speeds by 60%

#### B&W Picture Tubes

A black-and-white picture for less than 12¢ a square inch

#### Integrated Circuits

Designing a low-cost serial adder-subtractor subsystem

#### IC Systems

A 131,072-bit memory weighing less than 7 pounds

#### Manager's Corner

Why U.S.-made B&W TV receivers are still very much alive



## New PIN microwave switching diodes with assured R·C product (Quality or "Q" Factor).

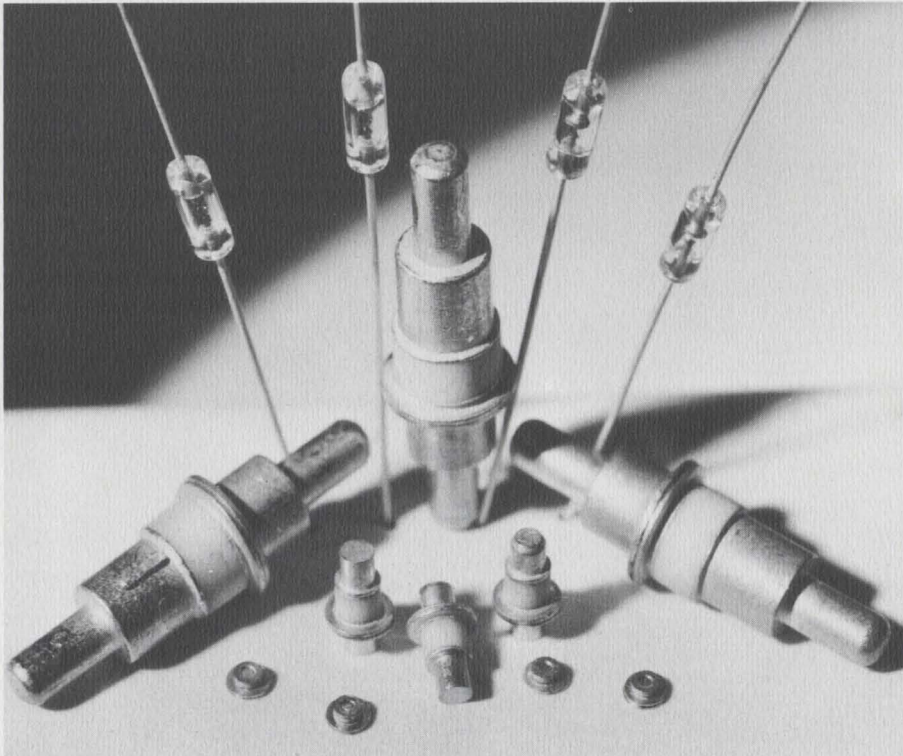

Available in a variety of package styles, both glass and ceramic-and-metal.

R·C curve for Sylvania PIN diodes. Broken line shows Q factor for standard units, solid line for premium units having slightly lower Q factor at slightly higher cost.

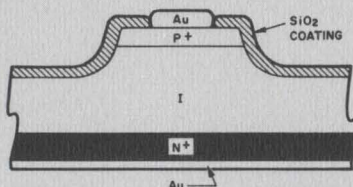
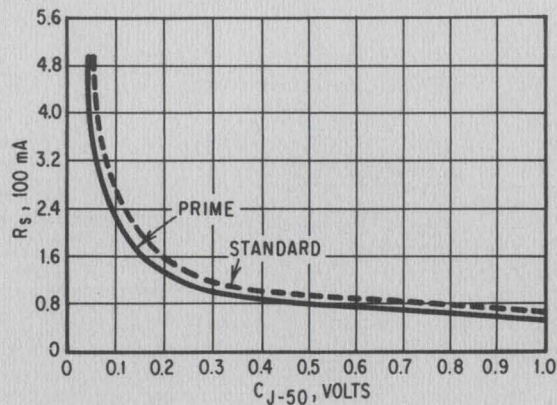

Diodes consist of a P+ type and N+ type region separated by an intrinsic layer, gold leads and a passivating layer of silicon dioxide which completely covers the junction area. Mesa construction provides high-voltage capability without sacrificing high-frequency switching performance.

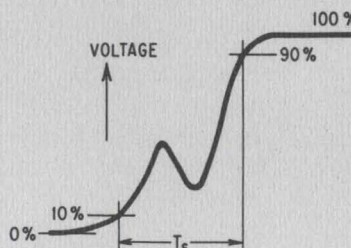

Switching time,  $T_s$ , measured between the 10% and 90% points of the wave form, is about 20 nanoseconds.

Now, PIN configuration assures customer-specified Resistance/Capacitance product—or Quality ("Q") Factor—in microwave switching diodes.

Sylvania now offers a line of PIN microwave switching diodes with an assured R·C (Quality Factor) product. In other words, you specify the maximum junction capacitance ( $C_J$ ) and the series resistance ( $R_S$ ) you want, and we'll provide that combination of characteristics on a unit-to-unit, lot-to-lot basis. Diodes are specified in two categories: low-cost standard and slightly higher-cost premium units so that you can obtain high performance when you need it, but don't have to pay extra for it when you don't.

Sylvania PIN microwave switching diodes are essentially voltage-dependent variable resistors, so that even at microwave frequencies they are capable of switching, limiting and controlling power from microwatts to kilowatts in cw or pulsed operation. To assure the most efficient device for operation at various power levels, these units are offered in voltage range of from 200-1000 volts.

A typical forward current bias of 50 to 100 ma is required for turn-on in switching applications. Zero bias is all that is necessary to "turn off" the diode in many applications. Under a reversed bias condition, the PIN diode exhibits a gradual decrease of series resistance because of the widening of depletion layer. This process continues until the reverse breakdown voltage of the device is reached and heavy conduction starts again.

### We recommend them for:

- Low power switching
- Higher power switching and multiplexing
- Limiting
- Voltage-controlled attenuators
- AGC systems
- High-frequency switching
- Phase shifters

And we assure the R·C performance capability you specify.

CIRCLE NUMBER 301



# One-amp glass rectifiers that absorb 1000-watt reverse transients.

Sylvania double-diffused silicon glass-encapsulated rectifiers meet all applicable commercial, industrial and military specifications within their performance range.

Our 1-amp glass-encapsulated silicon rectifiers easily take 50-amp forward surges and 1000-volt reverse transients in stride. They have extremely low reverse leakage current: 10 nA at 25°C. Sylvania's advanced glass-to-metal sealing techniques assure virtually complete hermetic seals: Radiflo leakage rates of less than  $1 \times 10^{-10}$  cc/sec typical. They operate over a temperature range of from -65°C to +175°C and exceed all standard life and design requirements of MIL-S-19500.

Heat dissipation in the units is increased by welding a solid, high-conduction power lead to an oversized heat conduction stud. This increases power handling capability, makes the device last longer and keeps it cooler. The glass package is electrically neutral and smaller than most metal rectifier cases, thus permitting greater stacking and card densities. The glass body also helps improve in-process quality control by allowing visual inspection during production.

CIRCLE NUMBER 302

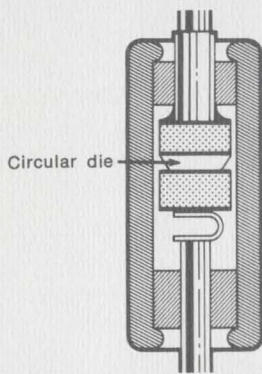

Sylvania's circular die with its truncated cross section provides better, more reliable breakdown characteristics than a straight-sided square die. This results from a uniform spreading of the field around the circular die as opposed to concentration at the corners of square ones. The truncated junction eliminates surface breakdown phenomena by controlling depletion-layer exposure at the die sides and its angle to the exposed edge. These units handle reverse power transients well over normal ratings with high immunity to catastrophic failure.

### Typical Characteristics

ABSOLUTE MAXIMUM RATINGS AT 25°C:	IN4383	IN4384	IN4385	IN4585	IN4586	
Breakdown Voltage, BV	200	400	600	800	1000	volts
Average Forward Current, $I_o$ (+50°C)	1.0	1.0	1.0	1.0	1.0	amp
Average Forward Current, $I_o$ (+100°C)	1.0	1.0	1.0	0.6	0.6	amp
Average Forward Current, $I_o$ (+150°C)	0.3	0.3	0.3	0.2	0.2	amp
Forward Surge Current, $I_F$ (surge) 1 cycle, F=60 cps	50	50	50	50	50	amps
Forward Surge Current, $I_F$ (surge) recurrent, F=60 cps	6	6	6	6	6	amps
Operating Temperature, $T_J$	(-65°C to +175°C, all types)					

ELECTRICAL CHARACTERISTICS:	TYPES	MAX.	UNIT
<b>Forward Voltage Drop, <math>V_F</math> (25°C)</b> $I_F=1.0$ amp	All	1.0	volt
<b>Reverse Current, <math>I_R</math> (25°C)</b> $V_R=200v,$ $V_R=400v,$ $V_R=600v,$ $V_R=800v,$ $V_R=1000v,$	1N4383 1N4384 1N4385 1N4585 1N4586	10 10 10 10 10	ua ua ua ua ua
<b>Reverse Current, <math>I_R</math> (+175°C)</b> $V_R=200v,$ $V_R=400v,$ $V_R=600v,$ $V_R=800v,$ $V_R=1000v,$	1N4383 1N4384 1N4385 1N4585 1N4586	500 500 500 500 500	ua ua ua ua ua
<b>Dynamic Reverse Current, <math>I_R</math> (full cycle average):</b> $I_o=1000ma, V_R=200v, T=100°C$ $I_o=1000ma, V_R=400v, T=100°C$ $I_o=1000ma, V_R=600v, T=100°C$ $I_o=1000ma, V_R=800v, T=50°C$ $I_o=1000ma, V_R=1000v, T=50°C$	1N4383 1N4384 1N4385 1N4585 1N4586	275 250 225 200 200	ua ua ua ua ua
<b>Dynamic Forward Voltage Drop, <math>V_F</math> (full cycle average):</b> $I_o=1000ma, V_R=200v, T=100°C$ $I_o=1000ma, V_R=400v, T=100°C$ $I_o=1000ma, V_R=600v, T=100°C$ $I_o=1000ma, V_R=800v, T=50°C$ $I_o=1000ma, V_R=1000v, T=50°C$	1N4383 1N4384 1N4385 1N4585 1N4586	1.3 1.3 1.3 1.3 1.3	v(pk) v(pk) v(pk) v(pk) v(pk)

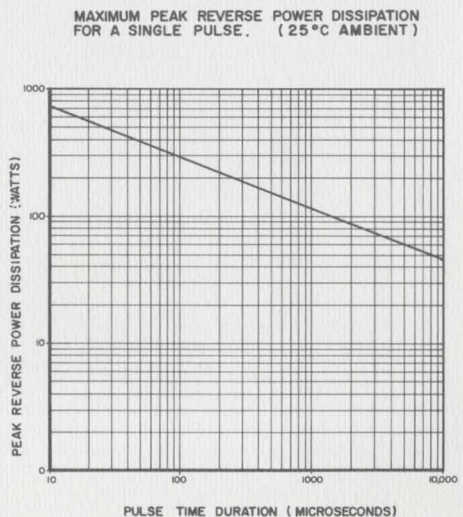
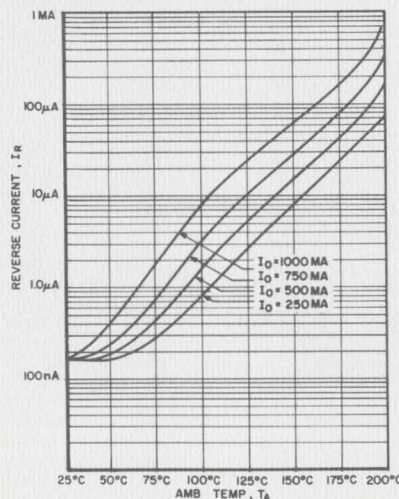



# SYL-PAC: The circuit boards that are finally catching up to high-speed IC capabilities.

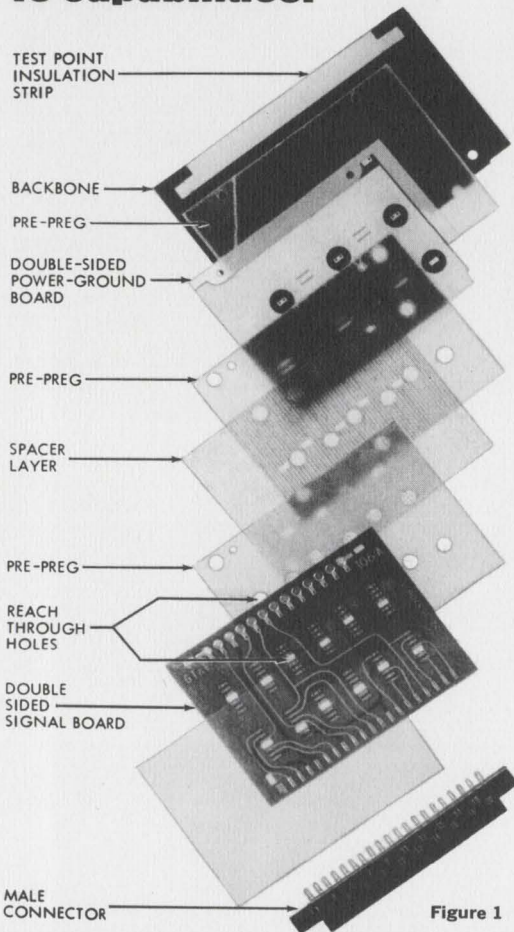
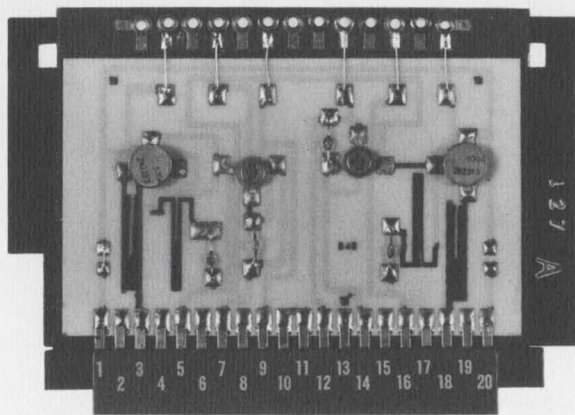

Figure 1

Exploded view, SYL-PAC laminated circuit board. Consists of a double-sided signal board, with two signal layers connected by plated reach-through holes, and a double-sided power-ground board. Any connection on either side of the board is always within 1/64" of the power-ground source.



Thick-film/ceramic logic card. Here discrete components are mounted with thick-film/micro-electronic substrate components. Connectors are again the same as for the standard IC package.

How SYL-PAC circuit boards minimize  $L \frac{\Delta i}{\Delta t}$  noise at high-switching speeds.

Until now, high-speed integrated circuits mounted on conventional circuit boards have tended to be "noisy"...or to generate spurious signals...in direct proportion to the speed of operation and the length of the current paths connecting the terminals.

In fact, it had become almost pointless to design faster ICs since, up until now, circuit-board design had not kept pace with IC speeds. Heretofore, our 50 MHz SUHL™ II TTL ICs have been limited to about 20 MHz switching speed; anything faster on available boards would result in

extremely high noise levels.

But our new SYL-PAC circuit boards allow the same components to operate at about 33 MHz...and with  $L \frac{\Delta i}{\Delta t}$  noise levels as much as 8 times lower than other circuit boards...a 60% improvement.

### SYL-PAC board construction

SYL-PAC multi-plane laminated circuit boards are made up of two double-sided signal layers on either side of a "backbone." Signal layers are connected by plated reach-through holes, which allow the mounted ICs to contact a common power-ground plane, which carries the B+ voltage to all parts of the board (Fig. 1). With this construction, every IC lead is always within 1/64" of the power-ground source.

Such extremely short current

Adaptable to all forms of component mounting

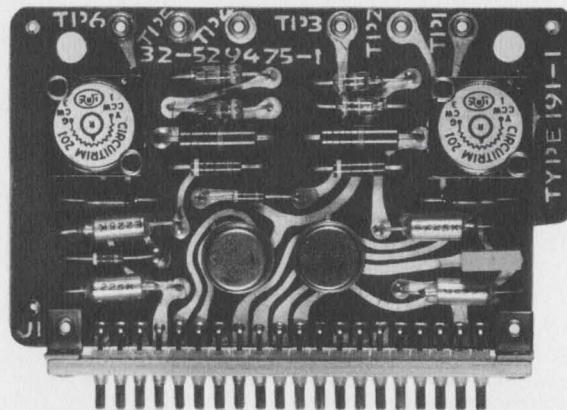

Discrete-component circuit logic card. This package uses the same male connector and configuration as the IC package; both types may be freely intermixed at chassis level.

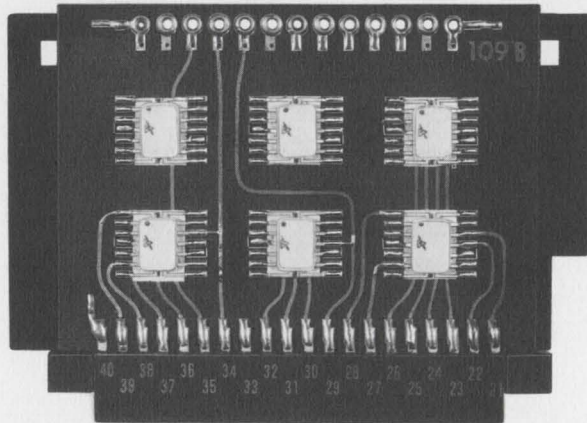

Integrated-circuit logic card. Double-sided board contains up to 12 IC flatpacks or dual in-line plug-in packs. Standard board has a 40-pin double-row male connector mounted at lower edge.



connections reduce noise sufficiently to let you approach the theoretical switching-speed limits of even the fastest ICs available today, such as SUHL II units.

**Reduce circuit noise**

Noise, or spurious signals in a high-speed switching circuit, can originate from four primary sources:

*Inherent IC noise.* For this problem, start out by using Sylvania SUHL TTL logic elements and monolithic arrays, the lowest-noise units available.

*Power-supply decoupling.* Problem is minimized by use of controlled distributed capacitance from the power-ground planes within the SYL-PAC board. This is achieved by precise control of the quality and thickness of the dielectric elements and the parallelism of the conductive layers. In our SYL-PAC boards, the capacitance between the power and ground layers, 1500 pF per package, provides adequate decoupling for any circuit configuration.

*Crosstalk, or intermodulation.* Directly proportional to switching circuit speed and number of interconnecting crossovers. The SYL-PAC common power-ground plane distributes power and ground voltages evenly, eliminates excess wiring and crossovers on the signal plane, and at the same time acts as an overall capacitor between connections.

*Self-induced noise.* Also known as  $L \frac{\Delta i}{\Delta t}$  noise, where  $L$  = inductance;  $\Delta i$  = pulse height, or change in current from "0" to "1" condition; and  $\Delta t$  = the rise time of the pulse.

This type of noise is *directly and linearly proportional* to the length of the circuit connection into which the signal is introduced. The extremely short connections characteristic of our SYL-PAC boards—particularly to the power-ground plane—can reduce  $L \frac{\Delta i}{\Delta t}$  noise by as much as 8 times in comparison with other board designs.

**Faster operating speed**

Because SYL-PAC boards with SUHL low-noise IC components reduce circuits noise so significantly, they let you operate your high-speed switching circuits at much higher speeds without fear of spurious signal interference.

CIRCLE NUMBER 303

## How about a 12-inch B&W picture tube for less than 12¢\* a square inch.

Modifications in basic design are one of the factors which can increase the cost of picture tubes. This new 12" B&W standard tube is designed to sell for an extremely low price, in large quantities and without modifications.

Black-and-white TV set manufacturers—particularly of small-sized sets—have run into increasing price competition in recent years from low-cost imported sets.

To meet the challenge, Sylvania has designed a new low-cost 12" picture tube which allows U.S. set manufacturers to be competitive again in the small-size B&W set market. Our new 12DEP4 incorporates all the quality components and engineering advances found in every Sylvania CRT. No performance characteristic is sacrificed... yet the tube costs less.

Sylvania has developed the tube to sell in OEM quantities for about \$9.00\*. We can deliver any changes you wish, of course, but each one will increase the cost per unit.

**Why was the 12" size selected?**

From the glassmaking standpoint, a major picture-tube bulb manufacturer recently conducted a survey to determine the most acceptable tube size for the small-screen, low-cost B&W set market. The survey solidly established the 12" size as the most popular.

From the electronics standpoint, Sylvania has determined just which focus and deflection voltages, gun-mount configurations, anode-button location and other design considerations are most desirable.

The result is a picture tube which incorporates all the most popular features manufacturers have requested in the past... in a single 12" size which we can now deliver in volume. Custom variations on the basic model... and other sizes such as 6", 9", 11" and 13"... will cost more, naturally.

But design this tube into your next portable model and you can market a "MADE IN U.S.A." TV set that's competitive in price with foreign imports of the same size. And you get all the service and delivery benefits that only a domestic manufacturer can offer.

We feel that you'll make up in unit volume what you miss in "uniqueness of screen size".

\*Determined in accordance with standard terms and conditions of sale.

CIRCLE NUMBER 304

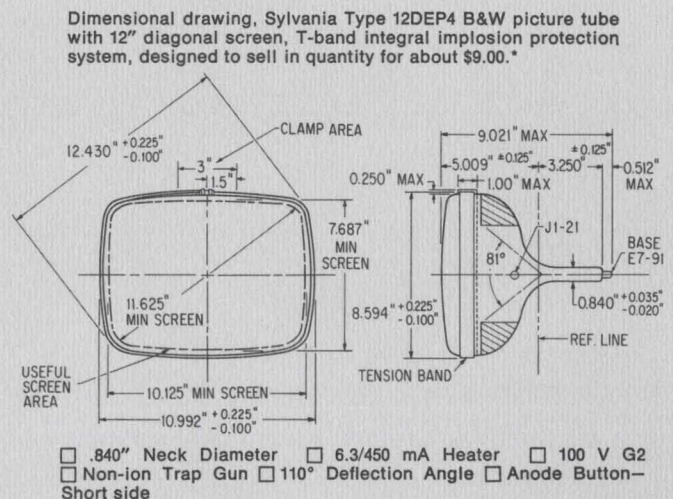



# How to make a low-cost TTL serial adder-subtractor.

Serial adder-subtractor subsystems are simpler than parallel subsystems to design and construct, and require fewer components. They cost less, and are ideal for medium-speed computers.

These diagrams (Figs. 1 and 2) indicate the packaging and interconnection economies permitted by serial adder subsystems.

In a *parallel* adder subsystem, the number of SM-10 adders must equal the number of bits being

processed simultaneously, i.e., a 64-bit storage register would require 64 full adders.

But in a *serial* adder subsystem, only one SM-10 adder is required regardless of the capacity of the storage register. A 64-bit serial system would require 64 storage registers but only one single SM-10 adder, greatly simplifying wiring and reducing component costs.

Such subsystems are recommended for what, today, we call "medium-speed computers." But today's SUHL and monolithic-array TTL ICs are so fast that these low-cost *serial* subsystems actually operate at speeds comparable to many *parallel* adder subsystems presently in operation: about 200 ns/bit. That means our serial adders can process a 24-bit number in 3 to 4 ms. If that's fast enough for you, systems like these can save you money.

The first subsystem (Fig. 1) will add or subtract two 4-digit binary numbers, depending on the logic levels applied to the mode control. A logic "0" level applied to the subtract control will produce a difference; to the add control it will produce a sum. For a sum or difference, the contents of the A and B registers are clocked into the SM-10 full adder, one bit at a time, and the result is stored in the B register.

If adding, the result in the B register is the sum. If subtracting, the Most Significant Digit (MSD) must be checked for "1" or "0". If the MSD is "1", the B register is complemented to obtain the difference, which will be a positive number. If the MSD is "0", the B register is shifted right four times to facilitate end-around carry and provide the difference, which in this case would be a negative number.

The second subsystem (Fig. 2) performs addition only, in the same manner as the first, with the final sum appearing in the B register. Both subsystems are open-ended, and can be expanded to handle numbers of any size merely by increasing the number of flip-flops in the A and B registers.

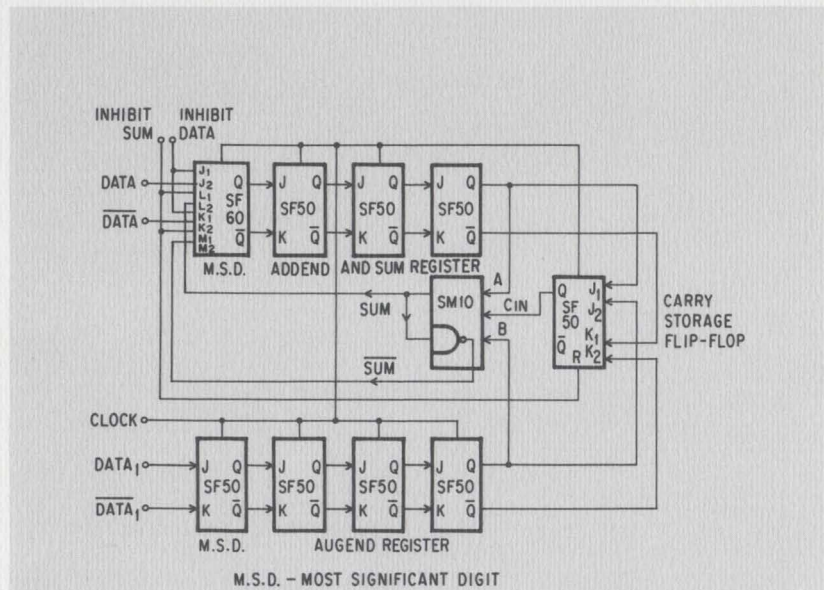

Fig. 1. Serial adder-subtractor subsystem uses SM-10 full adders, SF-60 OR J-K flip-flops, SK-50 AND J-K flip-flops, an SG-110 AND-NOR gate and SG-140 NAND-NOR gates. The full adders are monolithic arrays; the gates and flip-flops are standard SUHL integrated circuits.

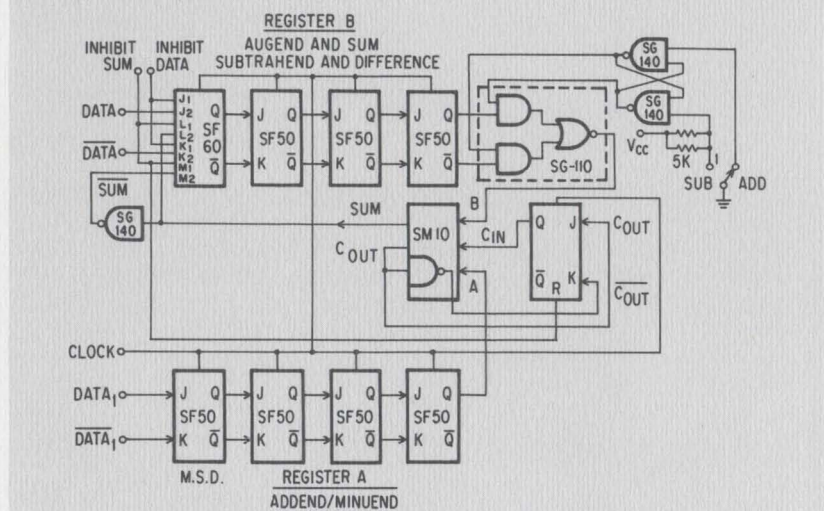

Fig. 2. Simpler subsystem performs addition only. Both subsystems can easily be expanded to handle larger numbers simply by increasing the number of flip-flops in the A and B registers.



## SUHL™ TTL ICs help create a 131,072-bit airborne memory weighing less than 7 pounds.

The new SEMS 5™—Severe Environment Memory System—to be demonstrated at April JCC. Miniature militarized unit was designed by Electronic Memories, Inc., of Hawthorne, California.

SEMS 5 is designed for aerospace applications where small size, low weight, high reliability, high speed and minimum power requirements are demanded. It can withstand 10G vibration, 30G shock over a temperature range from -55° to +85° C. It weighs 6.9 pounds and has a volume of only 132 cubic inches. It has a cycle time of 2 microseconds and an access time of 700 nanoseconds.

It can be built to custom specifications, with memory storage capacities of from 256 to 16,384 words from 8 to 32 bits each. Voltage requirements are +15 v, +5 v and -5 v.

The system uses SUHL TTL integrated circuits for logic, sense amplifiers, address decoders, data and address registers. Logic interface is TTL positive true. Both clear/write and read/restore are standard modes. Optional modes include split cycle (read/modify/write) and buffer cycle. Memory access is by initiate and read/write mode lines or by read/write pulse lines.

Use of SUHL ICs simplifies wiring to increase reliability. Each coincident-current memory plane contains eight bits instead of the usual one. Only three wires instead of the normal four are used, with a common line performing both sense and inhibit functions.

This eliminates a large number of electrical interconnections where many memory-stack failures can occur.

The unit uses approximately 50 Sylvania ICs: SG-40 and SG-140 dual 4-input NAND-NOR gates. Both are monolithic epitaxial saturated high-speed logic elements.

Electronic Memories naturally turned to SUHL TTL ICs to get the performance they wanted into the space available. They also inform us that: "Unfortunately, no failure data is available on the performance of your circuits, nor do (we) know when this would be available."

Because, obviously, none have failed yet . . . and none are likely to.

**CIRCLE NUMBER 306**

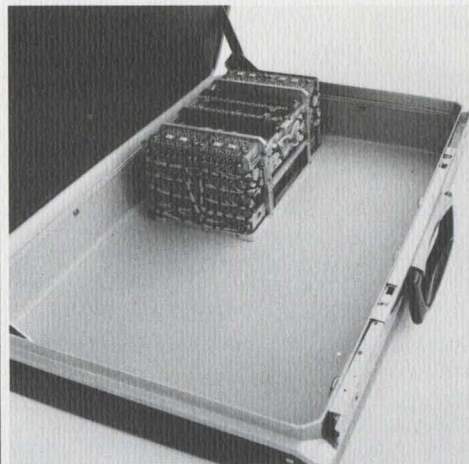

Tiny, rugged SEMS 5 militarized airborne memory system has memory storage capacity of 4096 words of 32 bits each. This extremely high packaging density is made possible by use of Sylvania SUHL TTL ICs.

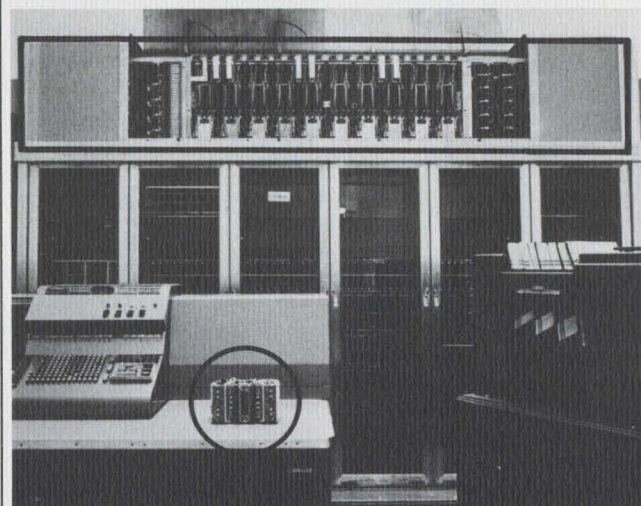

SEMS 5 (circled), on table in foreground, compared with an older, discrete-component memory system of comparable memory capacity (in rectangle). SEMS 5 was designed and produced by Electronic Memories, Inc., of Hawthorne, California.

SEE OUR SPECIFICATIONS IN  
**VSMF**  
MICROFILM CATALOG FILE

Use Sylvania's "Hot Line" inquiry service, especially if you require full particulars on any item in a hurry. It's easy and it's free. Circle the reader service number(s) you're most interested in; then fill in your name, title, company and address. We'll do the rest and see you get further information by return mail.

**BUSINESS REPLY MAIL**

No Postage Stamp Necessary if Mailed in the United States

FIRST CLASS  
Permit No. 2833  
Buffalo, N.Y.

POSTAGE WILL BE PAID BY

Sylvania Electric Products Inc.  
Sylvania Electronic Components  
1100 Main Street  
Buffalo, New York 14209

Dept. C11

\_\_\_\_\_

\_\_\_\_\_

\_\_\_\_\_

\_\_\_\_\_

\_\_\_\_\_

\_\_\_\_\_

\_\_\_\_\_



## "Black and white TV receivers are dead."

How often have you heard this said?

Sylvania has a more positive approach. To paraphrase Mark Twain, we think that reports of the B&W set demise have been grossly exaggerated.

At present there are about 66 million B&W TV receivers in use in the United States, and about 7½ million were sold here in 1966. Hardly a dead market. People are still buying them for many reasons: low cost, small size and weight, portability, brightness, contrast, resolution and ease of servicing, just to name a few.

So the question is not whether to revive a dead market. It's to recapture a bigger share of a very "live" market which has been increasingly lost to foreign competition.

People buy foreign B&W sets—as opposed to domestic—on price. So to start with, you have to get the price down to compete.

One way is standardization. A decision to go with, and stick with, a standardized line of picture tubes, receiving tubes, circuitry and related components in a set that's standard except for external styling. Once this decision has been made, components can be designed into a marketable set at a very low cost.

As a start, we've developed a standard 12" B&W picture tube—the most expensive single component in a TV set—and designed it to sell, without variation, in OEM quantities for around \$9.00\*. (See article elsewhere in this issue.) Together with other standardization economies, this makes it possible to assemble, distribute and market a 12" set at a very low retail price.

\*Determined in accordance with standard terms and conditions of sale.

We didn't settle on the 12" size arbitrarily. As the companion article indicates, a recent survey conducted by a major picture-tube bulb manufacturer on consumer preferences in portable TV sets shows the 12" size to be the overwhelming favorite.

In deciding upon a standardized picture tube at such a low cost, you can offer the most popular features ever built into one picture tube without sacrificing any of the engineering leadership and quality assurance measures that have made Sylvania B&W picture tubes number one in the industry.

Our design and field-engineering staff still provide the full range of services and technical assistance you expect from Sylvania—and which you've probably learned *not* to expect from overseas manufacturers. With exception of the glass bulb, we still manufacture and process every component that goes into these tubes—and to our own unmatched quality standards.

The reason we can bring you a picture tube at such an extremely low price is volume production. That can be achieved only through wide acceptance of a standardized product.

Work with us and we'll help to show you that a market you may have considered "dead" is still very much "alive."

Robert A. Starek  
Product Marketing Manager  
Picture Tubes

This information in Sylvania Ideas is furnished without assuming any obligations.

# SYLVANIA

A SUBSIDIARY OF  
GENERAL TELEPHONE & ELECTRONICS

NEW CAPABILITIES IN: ELECTRONIC TUBES • SEMICONDUCTORS • MICROWAVE DEVICES • SPECIAL COMPONENTS • DISPLAY DEVICES

C1

NAME \_\_\_\_\_

TITLE \_\_\_\_\_

COMPANY \_\_\_\_\_

ADDRESS \_\_\_\_\_

CITY \_\_\_\_\_ STATE \_\_\_\_\_ ZIP \_\_\_\_\_

### Circle Numbers Corresponding to Product Item

300	301	302	303	304
305	306			

Please have a Sales Engineer call



### HOT LINE INQUIRY SERVICE

Need information in a hurry? Clip the card and mail it. Be sure to fill in all information requested. We'll rush you full particulars on any item indicated.

You can also get information using the publication's card elsewhere in this issue. Use of the card shown here will simplify handling and save time.



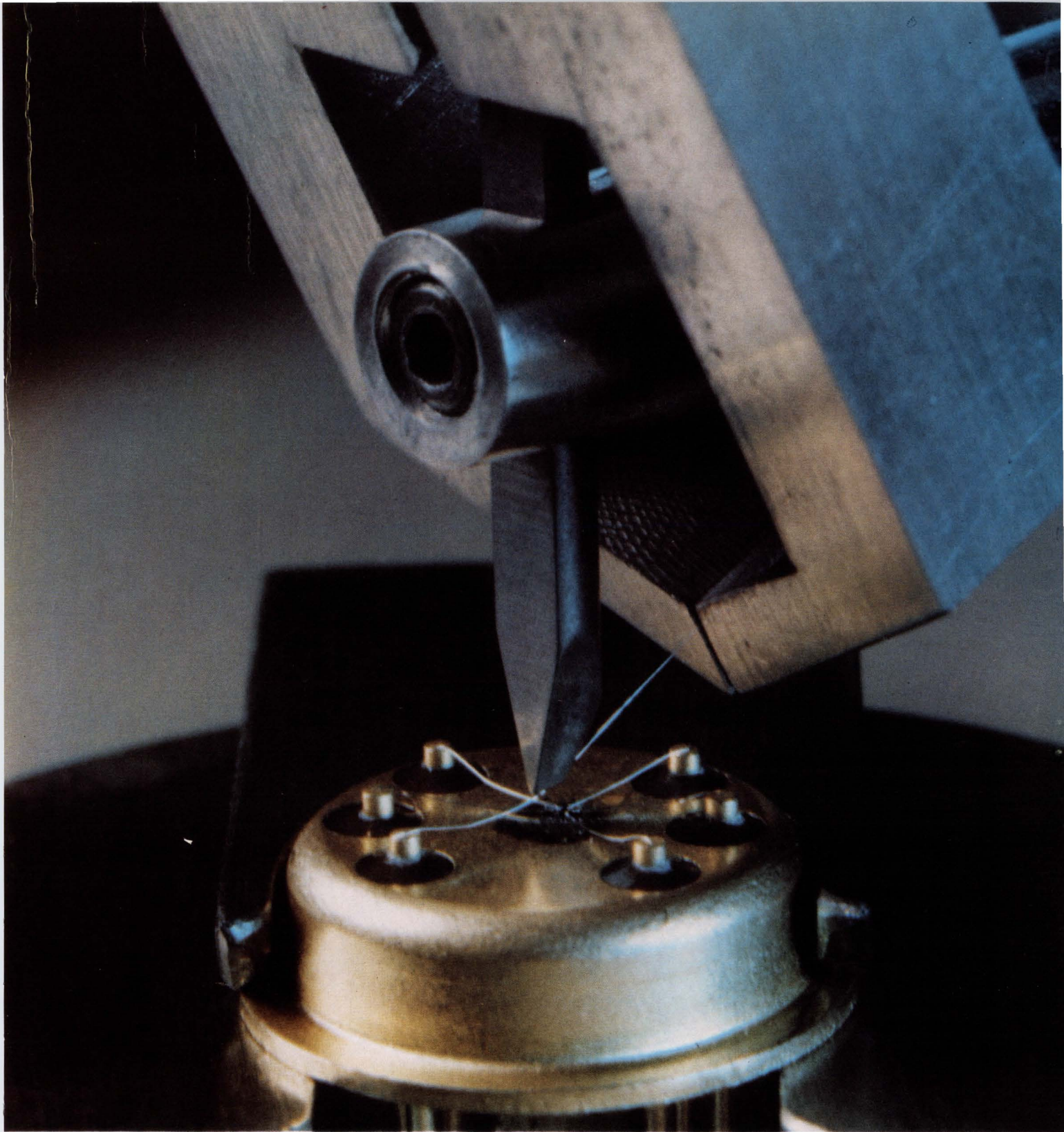

## Craftsmanship in hard materials...an industry standard

HIGH PRECISION TUNGSTEN CARBIDE BONDING TOOLS, SUCH AS THE ONE SHOWN IN THIS 13X MAGNIFICATION OF AN ULTRASONIC LEAD BONDING OPERATION, WERE PIONEERED AND INTRODUCED AS PRODUCTION DEVICES BY TEMPRESS . . . IN 1963, THE TEMPRESS CAPILLARY TUBE, AN INDUSTRY STANDARD . . . IN 1967, THE ULTRASONIC BONDING TOOL, AN INDUSTRY STANDARD.

The techniques and the specialized machinery developed to produce such precision products from ultra-hard materials have not been duplicated; quite probably will not be, for they are a result of the unique combination of Tempress people and the

Tempress philosophy. To meet its responsibilities, Tempress maintains a continuing expansion program, limited only by strict adherence to the Tempress Standard of Excellence. (It requires as long as 11 months to train an operator for certain operations.) The same uncompromising standard is applied to Tempress Automatic Scribing Machines and to the entire growing family of Tempress

miniature assembly tools and production equipment.

LEAD BONDING, DUAL FET, COURTESY OF UNION CARBIDE ELECTRONICS



# TEMPRESS

Tempress Research Co., 566 San Xavier Ave., Sunnyvale, Calif. 94086

Circle 35 on reader service card





# PASSIVE & ACTIVE TOTAL

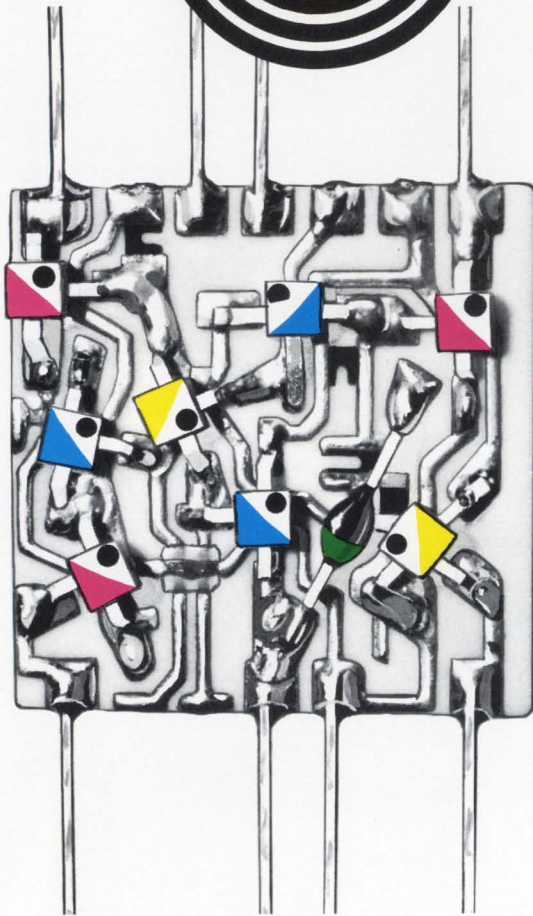

Miniature Discrete Devices – Planar Soldered Construction – Conformal Coat

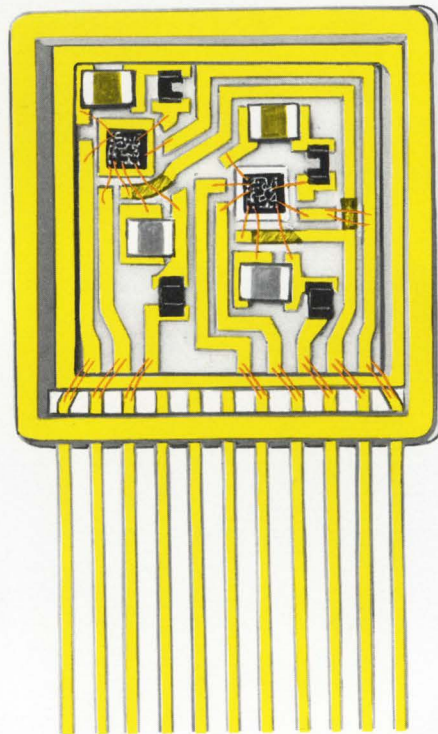

Uncased Monolithic Chips – Thermal Bond Construction – Hermetic Flat Pack

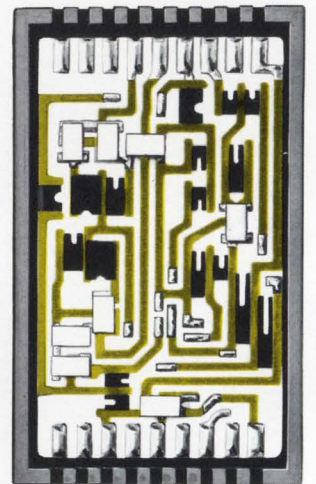

Leadless Inverted Devices – Soldered Construction – Plastic Pack

**1 CTS CERMET PROVIDES GREATER STABILITY** under all operating conditions, particularly high temperatures. CTS cermet is a patented resistive material available only from CTS.

**2 EXCELLENT TC.** Exclusive CTS cermet provides excellent temperature coefficient at high sheet resistance (ohms per square).

**3 ATTACHMENT TECHNIQUES.** Six methods of attaching active devices are available: chip and wire; flip chip; LID attachment; beam lead; welded or soldered planar construction and hole through. These techniques allow unrestricted use of all semiconductor device types.

**4 PACKAGING.** Packaging includes hermetic seal using T05; T08; and flat packs up to 1½" square. Conformal coat, plastic shell and transfer molding are also available.

**5 PASSIVE CIRCUITS.** CTS can also provide you with passive modules for applications where active devices are mounted externally or where you may prefer to attach the active devices to the passive module.

**6** Manufactured by  
**CTS MICROELECTRONICS, INC.**  
**BOX 1278, LAFAYETTE, INDIANA 47902**



# CIRCUITS CAPABILITY

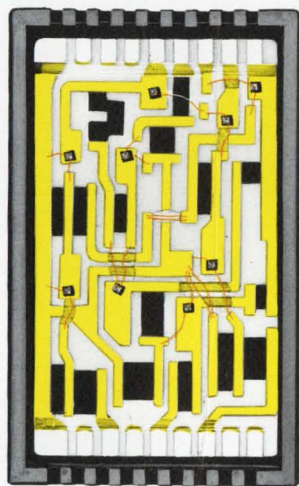

Uncased Chips – Thermal Bond Construction – Plastic Pack

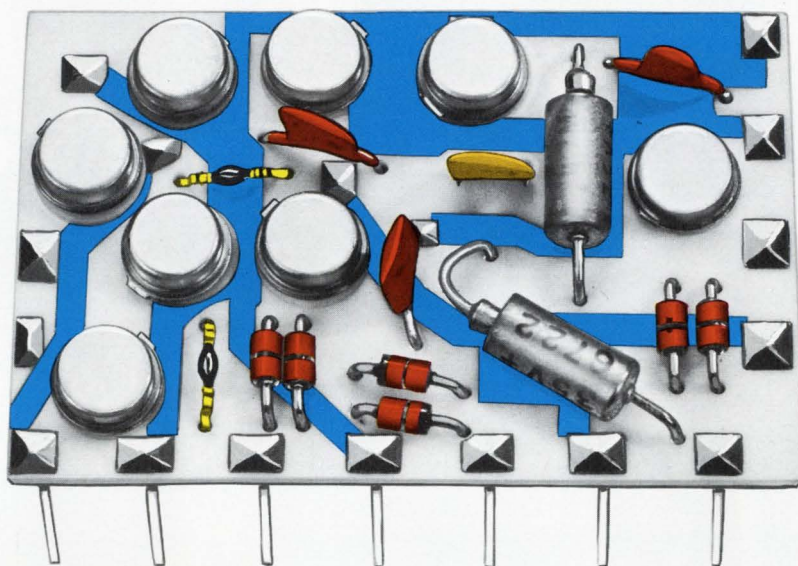

Standard Discrete Devices – Hole Through Soldered Construction – Conformal Coat

Uncased Chips – Thermal Bond Construction – Hermetic T08 Pack

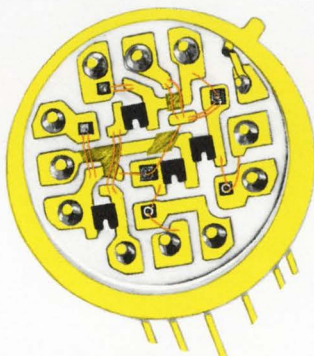

**Note exceptionally high stability and excellent TC**

Chip (die) attach 380°C for 15 min.	0.5% $\Delta$ R
Short term temp stability 500°C for 60 min.	1.0% $\Delta$ R
Max hot spot temp (without solder)	200°C
Load life 10,000 hrs. @125°C	1% $\Delta$ R
TC –55°C to 125°C (10 $\Omega$ to 1 meg)	$\pm$ 100ppm/°C
TC –55°C to 125°C (1 meg to 10 meg)	$\pm$ 250ppm/°C
Moisture resistance	0.5% $\Delta$ R
Full load temp	125°C
Solder dip @250°C for 15 sec.	0.5% $\Delta$ R



Founded 1896

**CTS**  
**CORPORATION**  
**CIRCUITS TO SPECIFICATIONS**



**Is there an AC digital voltmeter  
anywhere that can measure  
this waveform accurately?**

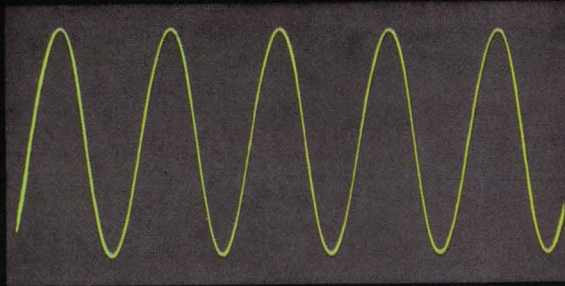

**And this one too?**

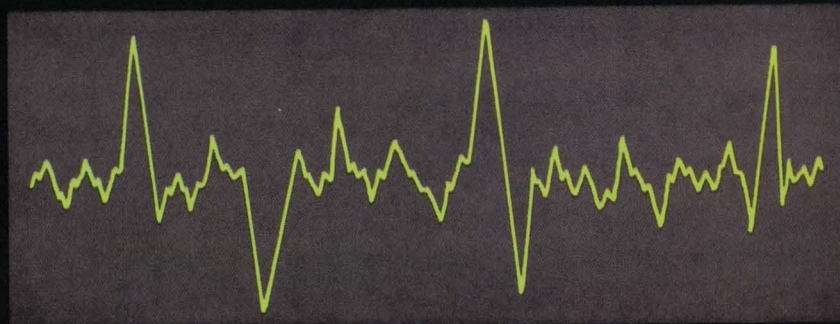



# **There is now! The new Fluke 9500A true rms automatic digital voltmeter reads these complex waveforms to an absolute accuracy of $\pm 0.05\%$ . And, if you know your AC's, that's progress.**

Another DVM on the market? Usually that's good for a ho-hum. But as we've said above, if you know your ac's, that's not the case with the new Fluke 9500A. It's the first automatic ac voltmeter capable of reading and digitally presenting the true rms value of any input—regardless of waveform—to 0.05% absolute accuracy (50 Hz to 10 KHz). □ Frequency response is broad, 20 Hz to 700 KHz. Accepts voltage from 0.001 to 1100 volts rms in five ranges, each with 20% overranging. Range selection is automatic or manual. Crest factor of 10 virtually eliminates effects from voltage spikes or pulse trains. Low capacitance, high resistance input minimizes loading effects. □ Self-calibration is automatic whenever instrument is turned on. On-line self-calibration is either automatic or manual, selectable by front panel switching. All controls and indicators, conveniently located on the front panel, are easy to use and understand. Complete control of the 9500A is possible from a remote facility if desired. □ Price of the Model 9500A, including rack adapter, is \$2,485. Extra cost options include a probe input (\$75), rear panel BNC input (\$50), and 1-2-4-8 or 1-2-2-4 BCD digital outputs (\$195). For complete information, please call your full service Fluke sales engineer (see EEM), or write directly to us here at the factory.

Fluke, Box 7428, Seattle, Washington  
98133. Phone: (206) 774-2211.  
TWX: (910) 449-2850.



In Europe, address Fluke International Corporation, P. O. Box 5053, Ledeborstraat 27, Tilburg, Holland. Telex: 844-50237. In U.K., address Fluke International Corporation, P. O. Box 102, Watford Herts, England.



# The shocking truth about Alessandro Volta who prompted Amelco to develop 18 different FET families!

Alessandro Volta invented the battery. And at the request of Napoleon in 1801, he demonstrated the power of his batteries by the flash he saw as he touched the wires to his eyelids. A slightly shocking demonstration.

The first batteries were obviously very low powered and not of much use. But today low powered batteries are in widespread use, especially in space instrumentation. And field effect transistors have helped make it possible.

To provide you with the widest possible choice of applications, Amelco has developed the largest family of FETS. Eighteen in all. So whether you're thinking of field effect transistors or bipolar transistors, chances are there is an Amelco FET to meet your needs. N or P channels, low frequency, high frequency, analog or chopper, we've got them.

And a final shock, you can order most right from stock.

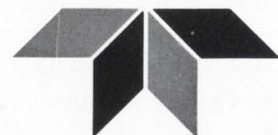

For quality in quantity  
**AMELCO SEMICONDUCTOR**

---

A TELEDYNE COMPANY





This painting by Kenneth Riley is one in the collection "Innovators and Leaders in the Science of Electricity," commissioned by Amelco Semiconductor. The paintings in this collection illustrate the dramatic achievements and discoveries of some of the forefathers of electronics . . . Magnes, Volta, Franklin, Henry, Edison, Shockley. The entire collection will soon be made available in handsome prints suitable for framing. They will serve as a reminder of the tradition handed down by these famous men, and as a reminder that among the leaders and innovators in the world of electronics today one name is of particular current significance. That name—Amelco.



**THIS IS THE WIDEST SELECTION of  
MINIATURIZED CERAMIC CAPACITORS  
IN THE INDUSTRY!**

*New*  
**RED CAPS**



**AVAILABLE IN EVERY  
STANDARD TEMPERATURE COEFFICIENT  
...and in SEVEN DIFFERENT HI-K® Formulations**

- *Red Caps meet or exceed all applicable requirements of MIL-C-20 and MIL-C-11015 per MIL-STD-202*

**RED CAPS feature** *ERIE'S EXCLUSIVE NEW* **JET-SEAL** *ENCAPSULANT*

- Erie's new *Jet-Seal* excels in mechanical and electrical ruggedness
- Provides excellent moisture protection • Maintains electrical and mechanical stability at temperatures from  $-55^{\circ}\text{C}$  through  $150^{\circ}\text{C}$  • *Jet Seal's* bright color and gloss finish will be outstanding in even the most sophisticated equipment.



WRITE FOR SAMPLES on your company letterhead  
ERIE TECHNOLOGICAL PRODUCTS, INC.  
State College, Pennsylvania  
Attention: Applications Engineering



Erie, Pennsylvania



## "Compac", a New Silicon Bridge Rectifier...

Semtech Corporation offers "Compac," a new silicon rectifier bridge offering packaging versatility. The units are available in a complete range of single phase and three-phase full-wave bridge rectifiers.  Semtech's Suprataxial silicon junctions are used for maximum reliability.  Single phase Bridges: 1.5 A, 50 to 1000 V — 360 mA, 1500 to 3000 V. Case size is .187 x .425 x .625 inches. Also available in Fast Recovery Bridges with reverse recovery of 150 ns or 1 $\mu$ sec. Three-phase Full-wave Bridges: 2.0 A, 50 to 1000 V — 500 mA, 1500 to 3000 V. Case size is .187 x .425 x 1.00 inches.

# "COMPAC"

for packaging versatility

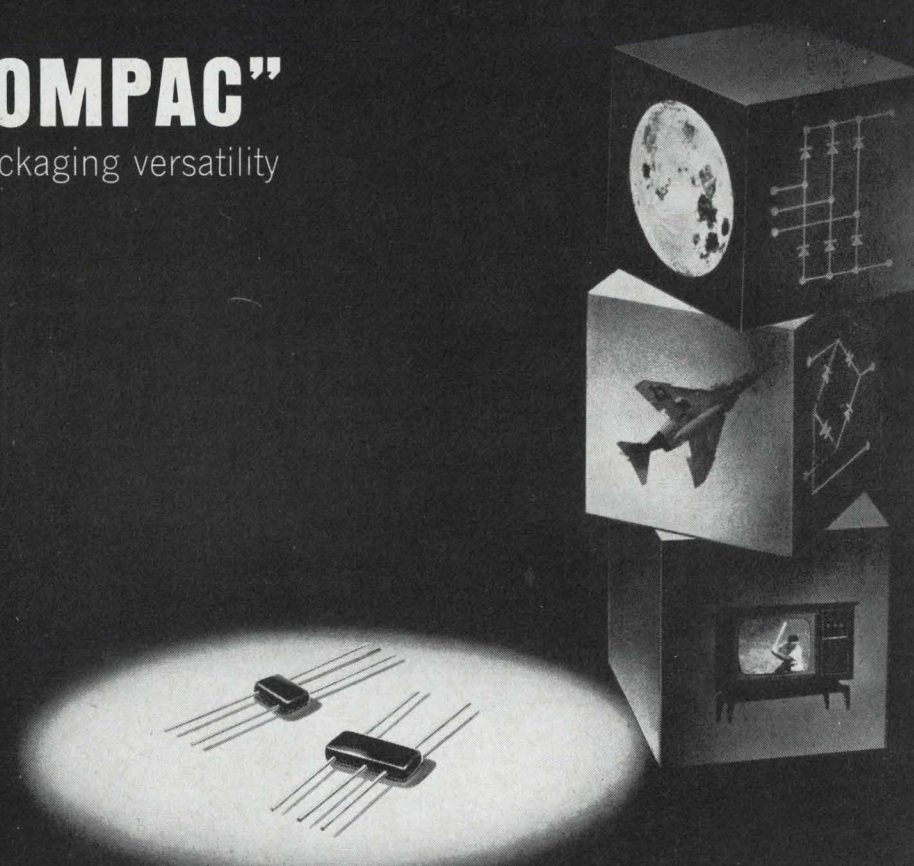

Immediate delivery . . . contact your local representative.

**SEMTECH**  **CORPORATION**

Western Offices: 652 Mitchell Rd., Newbury Park, California, 91320 (805) 498-2111/from L.A. (213) 628-5392 TWX: 910-336-1264

Central: 140 No. La Grange Rd., La Grange, Illinois, 60525 (312) 352-3227 TWX: 910-683-1896

Eastern: 116-55 Queens Blvd., Forest Hills, N.Y., 11375 (212) 263-3115 TWX: 710-582-2959

European Sales: Bournes AG, Alpenstrasse 1, Zug, Switzerland (042) 4 82 72/73



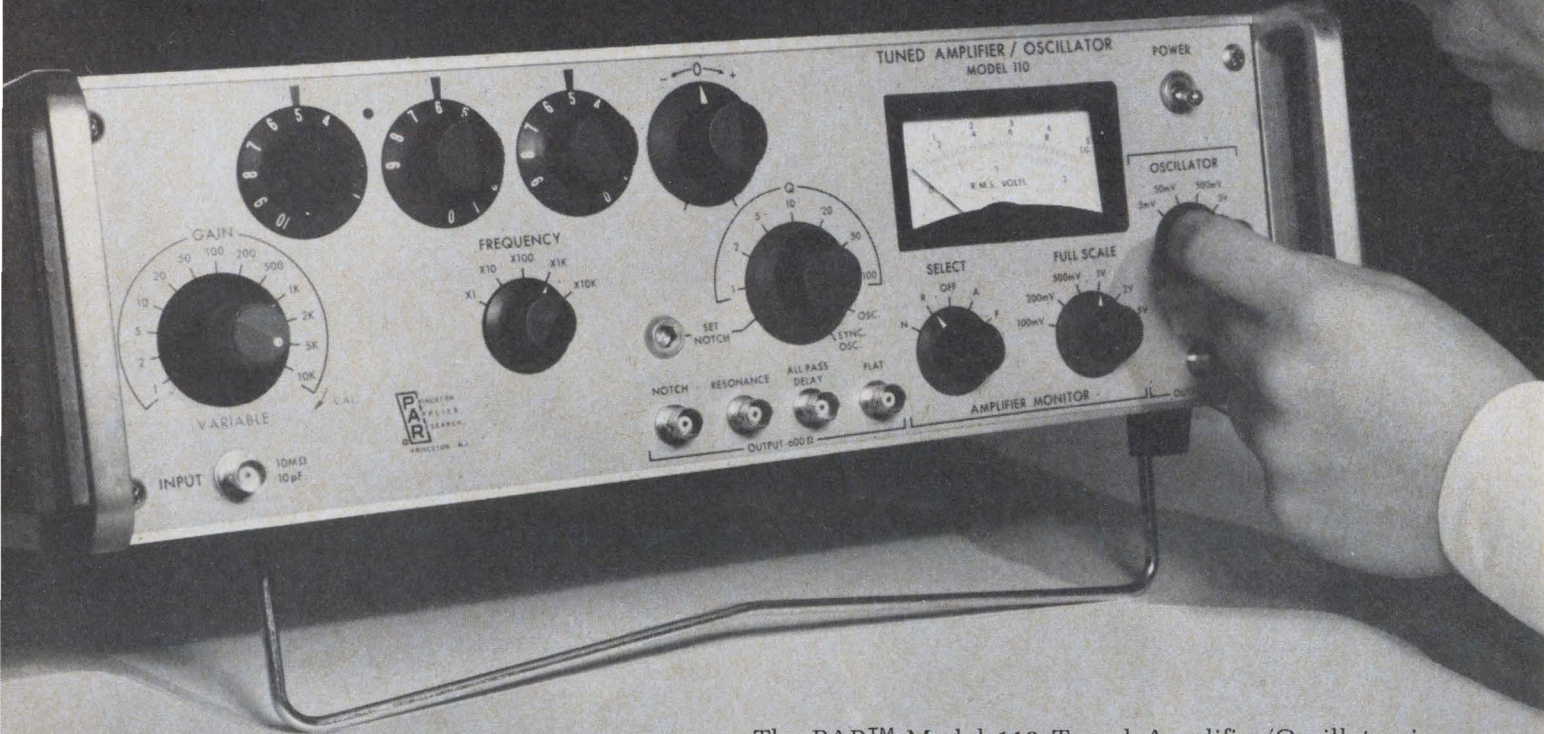

## Tuned Amplifier/Oscillator is Six Instruments in One

- LOW-NOISE AMPLIFIER
- LOW-DISTORTION OSCILLATOR
- WAVE ANALYZER
- DISTORTION ANALYZER/NOTCH FILTER
- SENSITIVE AC VOLTMETER
- ALLPASS DELAY PHASE SHIFTER

The PAR<sup>TM</sup> Model 110 Tuned Amplifier/Oscillator is a frequency selective amplifier operating over the range of 1 Hz to 110 KHz with Q variable from 1 to 100 (with no gain change). This versatile unit can function as several general-purpose instruments including:

**Wave analyzer** with bandwidth adjustable from 1% to 100%.

**Flat or selective AC voltmeter** with sensitivity ranging from 10 microvolts to 5 volts rms full scale.

**Distortion analyzer** to measure distortion levels as low as 0.1% (as low as 0.001% when used with a second Model 110).

**Low-noise amplifier** (typical noise figure of 1 dB) with voltage gain ranging from 1 to 10<sup>4</sup>.

**Stable general-purpose low-distortion oscillator** providing up to 5 volts rms into 600 ohms, capable of being synchronized by an external signal.

**AC-DC converter** with ground-based output.

Four 600 ohm outputs, each capable of delivering 5 volts rms into a 5K ohm load, are provided simultaneously: a second order (resonance) bandpass; a second order band-reject (notch) with set frequency rejection in excess of 100 dB; a second order allpass characterized by an amplitude response which is flat with frequency and a phase lag which increases monotonically with frequency; and a flat output. A front panel AC voltmeter permits measurement of any of the four outputs.

Price of the Model 110 is \$1195. Export price is approximately 5% higher, except Canada. For more information, write for PAR Bulletin T-140 to Princeton Applied Research Corporation, Box 565, Princeton, New Jersey 08540 or call (609) 924-6835.



PRINCETON APPLIED RESEARCH CORPORATION



## Solid state

### See-through IC

When plastic is mentioned in the context of integrated circuitry, the topic of discussion is usually the protective coating around a dual in-line package. But engineers at the General Electric Co.'s Applications and Devices division in Syracuse, N. Y., have expanded this frame of reference by developing a Teflon-like plastic that can be used both as a bonding medium for IC's and substrates, and as a dielectric for microelectronic capacitors.

The GE team, led by J.J. Suran, C.S. Kim, and G.G. Palmer, believes the plastic will permit batch fabrication of circuits containing components previously incompatible with IC manufacture, and will also serve as a means of interconnecting large-scale integrated arrays. Further, it's transparent; the entire circuit can be inspected visually.

The process followed with the new material starts with a film substrate—thin or thick, at the maker's discretion. After a first layer of conductors and resistors has been deposited, the plastic is bonded to the substrate.

**Hot and cold.** Active devices, such as monolithic chips, bipolar transistors, metal oxide semiconductor field effect transistors, and even gallium-arsenide semiconductors, are then placed atop the plastic and bonded into it by a high-temperature and pressure process that liquefies the plastic. After the material is cooled, connecting links are run through the plastic by multilayer techniques. The laying of an interconnecting layer is the final step.

The result is a dual-layer, planar-like structure that uses only twice the interconnection areas required

by conventional monolithics. In addition, the structure contains enough material to permit portions of the plastic to function as capacitor dielectrics. Since the material is impervious to etchants, even beam-lead elements can be isolated after the bonding steps. The plastic isn't frequency-dependent, and it accommodates all types of electronic circuits, from d-c into the microwave region.

The company has yet to decide where the first circuits will be used, Suran explains.

The team plans to report details of its work at the International Solid-State Circuits Conference, Feb. 14 to 16.

## Consumer electronics

### Lights out

If you can see the picture on your portable television set outdoors, you must be watching it in the shade. Usually, the sun's rays wash out tv pictures by overloading the phosphor on the inner face of the picture tube. This could become a thing of the past, though, now that Hartman Systems Co. of Huntington Station, N.Y., has developed what it calls a black-face cathode-ray tube.

Under contract to the Electronics Research Center of NASA, Hartman Systems, an affiliate of the Mid-Continent Manufacturing Co., based its new tube on the idea of letting the picture out while preventing outside light from getting in.

**One way.** The tube uses a four-layer faceplate that lets light pass only in one direction—out. Innermost is a layer of modified P-16 silicate phosphor. When the electron beam strikes this layer, it

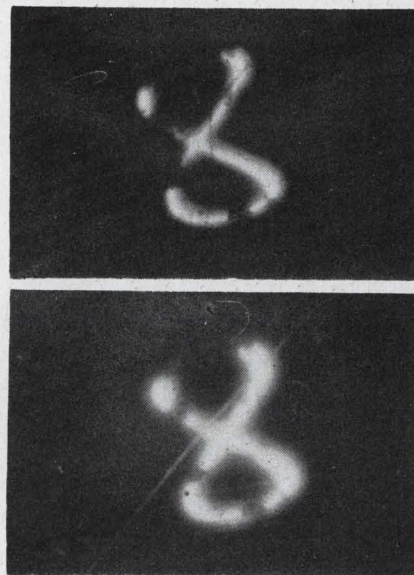

**Bright.** Sunlight doesn't wash out the image on a crt. Top photo shows crt face plate taken in shade; lower photo shows same image in sunlight.

radiates ultraviolet light at about 300 to 500 millimicrons. This light passes through an optical bandpass filter and then strikes a layer of doped uranium oxide glass. The glass fluoresces, but at longer wavelengths than the original P-16 phosphor; its emission is about 500 to 700 millimicrons.

It's the second emission that forms the picture as it passes through the tube envelope and a green or red plastic optical filter. Neither the light from the uranium oxide layer nor ambient light can reach the inner phosphor layer. It's stopped by the ultraviolet bandpass filter. Sunlight cannot affect the fluorescent glass layer since its ultraviolet components are stopped by the outer plastic filter.

**Obstacles.** Hartman developed the tube for the research center's control devices section as part of a program to provide displays for brightly lit cockpits or control centers. But Kenneth P. Lally, who heads Hartman's display group,



feels the tube has a good potential for home applications, too. Before either aerospace or consumer markets can be tackled, however, there are a couple of obstacles to overcome.

The most important is development of a new filter to replace the uranium-doped glass used in present tubes. The glass is so brittle and hard to handle that Hartman engineers have been forced to use layers about 20 mils thick; this makes the tube stronger but lowers resolution by a factor of three. Also, only small diameters are available with the glass, so far the largest tube has been only about three inches.

But Lally is confident of producing tubes of any reasonable size. Hartman is about six months away from a process that would substitute a thin film only five mils or thinner for the fragile glass filter.

"This should let us resolve display spot sizes only about five mils in diameter," says Lally. By contrast, "commercial tubes reach spot sizes of about 10 to 15 mils."

Lally's group also plans to try to reduce accelerating voltages from the present 10 to 15 kilovolts—required for the P-16 phosphor—to something approaching the 2 to 3 kv used on most monochrome tv sets, which use zinc sulphate. But this may not be a disadvantage, says Lally, since color sets already use beam voltages of about 25 kv.

### Computers

### Numbers game

"The problem is that we are attempting to tie a complex set of

variables to a simple number representing the mean-time-between-failure," says Malcolm A. Young, director of reliability for the International Business Machines Corp.'s Federal Systems division.

Young is one of a number of reliability men who are becoming increasingly critical of the way failure rates are determined in describing components and systems for NASA and the Defense Department. The MTBF, as it is commonly called, is all-important from the government's position in describing the reliability of a product, and all-important to industry, since monetary incentives and penalties often ride on the validity of the predicted figure.

**Failure rate.** Young believes there are several critical variables that are not being considered by many in industry. More important, they are not defined in military handbook 217A—the publication that serves as the bible for reliability. He points out that 217A, for example, does not even mention duty cycle, which he compares to rating the horsepower of an engine without noting the rpm. Involved in the criticism of the duty cycle is that no data is provided for determining "the time towards failure" if a device is not operating. "Is 10 hours of off-time equivalent to one hour of operating time on a device, or is it more?" Young asks.

Another variable listed as crucial by Young is the temperature at which equipment is tested. He says that the common use of ambient temperature in rating equipment is not meaningful since "it does not give the temperature at the source of a failure or at the point where a failure is liable to occur."

Screening is another point that leads to trouble. Contractors are not including in their figures the degree, amount, or method of screening to weed out parts that have a high failure rate.

Finally Young says: "Above and beyond screening, the manufacturing process is one of exposure, which can result in making or breaking a system's reliability. I maintain that, if you took an identical design and gave it to company

## Electronics Index of Activity

January 8, 1968

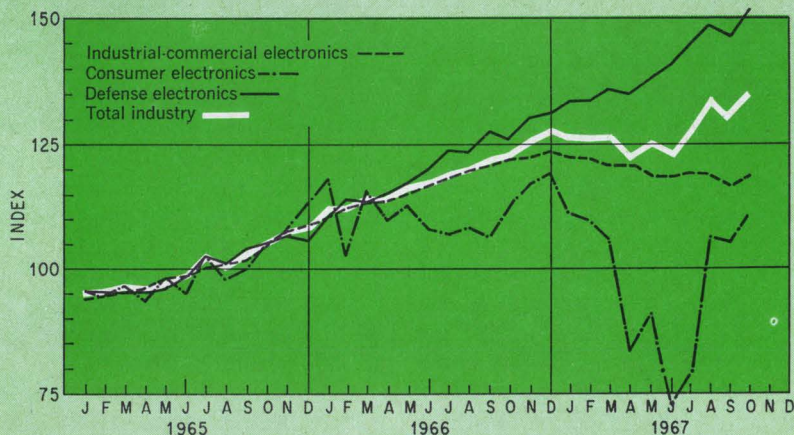

Segment of Industry	Nov. 1967	Oct. 1967*	Nov. 1966
Consumer electronics	113.2	107.3	119.5
Defense electronics	147.2	149.9	129.9
Industrial-commercial electronics	120.2	116.9	122.3
Total Industry	133.5	133.1	125.5

Electronics production improved slightly in November, edging up 0.4 index point from October to 133.5. At this level, the over-all index was up 8 points from November 1966. Consumer volume climbed 5.9 points from the prior month, and industrial-commercial output rose 3.3 points to halt an 11-month slide. But these gains were partly offset by a 2.7-point drop in defense electronics production, the third straight monthly decline in this sector.

Indexes chart pace of production volume for total industry and each segment. The base period, equal to 100, is the average of 1965 monthly output for each of the three parts of the industry. Index numbers are expressed as a percentage of the base period. Data is seasonally adjusted.  
\* Revised



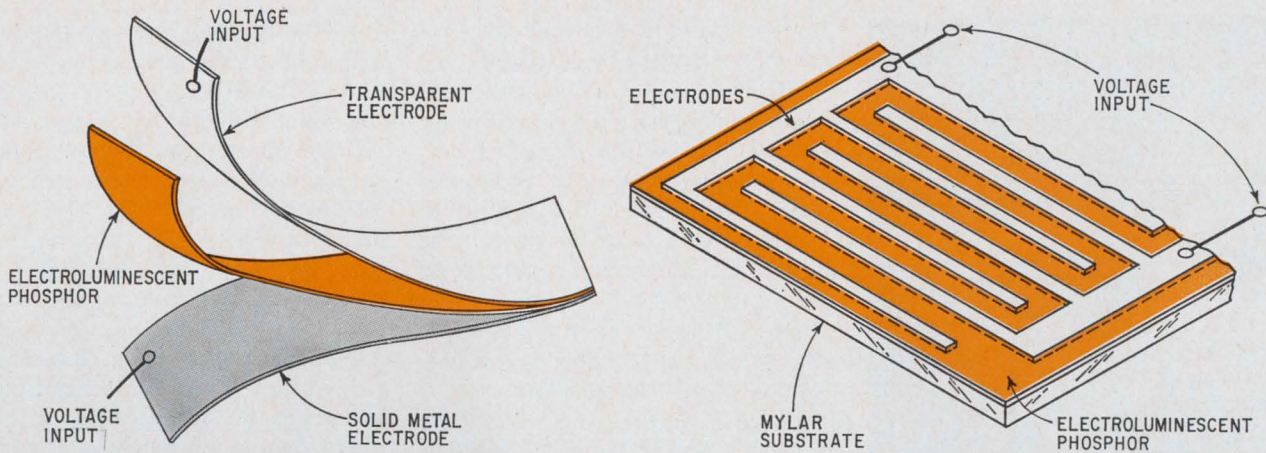

**The old and the new.** Conventional electroluminescent panel, on the right, is made like a sandwich with phosphor in the middle and sheets of electrodes on the outside. Cornell Aeronautical Lab's single-layer panel is made by depositing a conducting film, etching out electrodes, and then spraying on phosphor.

A and to company B, they would come out with different reliability although the design-stage MTBF derived by conventional means would be the same. The MTBF might be as different as 1,500 versus 2,000 hours."

**Handy book.** The IBM official is not altogether pessimistic. He says the Defense Department is now at work on a new version of the handbook that will attempt to get at some of these variables. And he points out that companies such as IBM, which derive figures from their own data, have been contributing.

At the Rome Air Development Center at Griffiss Air Force Base in Rome, N.Y., a spokesman for a group now engaged in reliability says it is collecting and publishing as much data as possible on failures and failure rates in an effort to spotlight these variables.

## Components

### New light on the subject

Electroluminescent displays have, until now, been made like sandwiches. A layer of phosphor material is placed between two electrode layers. One electrode is transparent, the other a sheet of metal. A voltage across the electrodes causes the phosphor to glow, illuminating the display.

But now, Cornell Aeronautical

Laboratory, Buffalo, N.Y., has built experimental electroluminescent displays using a new kind of structure that permits the phosphor to be deposited in the same layer as the electrodes. There is no sandwich.

The result, according to A. Scott Gilmour Jr., head of the wave electronics section of Cornell's electronics research department, is a display that is potentially brighter, with a larger illuminated area, and thinner than the old structure.

**Fingers.** Cornell's display consists of a sheet of clear Mylar on which is deposited a conducting film, such as copper, says Gilmour. The electrode structure is made by printed-circuit techniques, etching out of the copper two sets of interdigitated electrodes. Width and spacing of the fingers are a few thousandths of an inch, according to Gilmour, and Cornell has formed electrodes as long as a foot.

Once the electrode patterns have been etched out, the phosphor material—conventional zinc sulfide—is sprayed on or silk-screened over, continues Gilmour. Which method is used depends on the consistency of the binder and the fineness of the electrodes. Different colors in the same display panel are obtained by adding dyes to the phosphor.

When an alternating voltage is applied across the sets of adjacent electrodes, the phosphor is excited and glows. Voltage levels depend on the spacing between the elec-

trodes. Typically it is several hundred volts. Frequency has ranged to several kilohertz, compared with the several hundred hertz used with the conventional sandwich-type displays.

**Brighter, too.** Because it is able to work at higher frequencies, the new display has the potential for developing much brighter displays than the sandwich construction. Brightness is roughly proportional to frequency but in the older structure dielectric losses go up as the frequency goes up. Higher electric fields possible with the new display will also result in more brightness.

One advantage of the new display is that the phosphor, whose light output deteriorates with time, can be easily removed with a solvent and replaced, Gilmour says. This is difficult to do with the sandwich structure because an electrode layer must be removed before the phosphor can be reached.

Cornell is working to extend both the life and brightness of the displays. Light output is about the same as with the sandwich structure. A life of several hundred hours is, however, still shorter than can be obtained with the older technique.

**Status report.** Cornell's work was done as part of an over-all program to develop systems configuration displays for NASA spacecraft. The first complete unit is a multicolor panel, measuring 18 by 24 inches, that shows the operational status of each of 45 com-





**Close look.** Technician examines experimental single-layer electroluminescent panel.

ponents in an electronic system.

Besides spacecraft applications, Cornell considers the planar panel technique feasible for military, industrial, commercial, and domestic uses. For example, many square feet of wall or ceiling can be illuminated with the panels. They can also be used for low-power cabin lighting in aircraft, multi-color illumination of cockpit panels, warning lights, and alphanumeric readouts. Strips of the material as thin as 0.002 inch could be applied like adhesive tape to any surface.

---

## Companies

---

### Age of protest

For more than 10 years, the Pentagon has been the world's largest customer. And, like the corner grocer afraid of losing a good customer, defense suppliers have maintained that the customer is always right.

Occasionally, a disappointed supplier has quietly complained to his Congressman or to a trusted newsman about a procurement decision.

But publicly, the omnipotence of the customer has been upheld.

All that may be changing. In what is being hailed as a significant test case, computer manufacturers have challenged the Air Force and won. They forced the service to reverse its decision to award the largest single computer contract to the International Business Machines Corp. After reconsideration, the award went to one of the protesters—the Burroughs Corp.

But the Air Force is not giving in easily. Some Air Force officials are leaking the word that machines built by Honeywell Inc.—the most vigorous protester—scored lowest in “benchmark tests” (operational demonstrations). And it may be significant that Burroughs’ complaint was milder than those of Honeywell and the other unsuccessful bidder, the Radio Corp. of America.

**Principal principle.** Honeywell, however, is not worried that the Air Force might discriminate against it for the company’s part in the complaint. Company officials are privately elated that the “principle of protest” has been established even though another firm got the contract.

A similar view is voiced by Sen. Walter Mondale (D., Minn.), who entered the fray at the request of Honeywell, which is headquartered in his home state. He says this case proves that the government can often get better prices than it does.

The Air Force argues that the savings are not as dramatic as they seem. The cost of the IBM contract would have been \$114 million if it had been carried out. The winning Burroughs bid is about \$60 million—some \$54 million lower. But the Air Force says that the savings actually will amount to only \$36 million. The service says the re-evaluation of the contracts and the delay it caused accounts for the difference, some \$18 million.

In another face-saving effort, the Air Force says that Burroughs, RCA, and Honeywell all changed their proposals for the second time around, and that IBM’s was about the same. This would justify the about-face.

**Little change.** The specifications sent to the contractors for the second bidding round were virtually the same as the first. One small change was to have the companies’ estimate that the computers’ work load would increase by 100% over an eight-year period. Originally, it was specified that the 100% increase would come in six years. This change was made because the Air Force says it has a clearer picture of how its computational tasks are going to grow. Also, it now estimates the machines will last another two years.

The contractors themselves changed the hardware mainly by adding more powerful equipment. This may have been a significant factor in the benchmark competition.

Burroughs’ winning bid was based on its B3500 model. They will be used to improve the Air Force’s routine data process capability at air bases. Some 100 to 160 machines will be used in the evolving program.

### Name dropping

It’s just what contractors feared: a Senator is going to blow the whistle and name names he’s getting from the General Accounting Office.

A few weeks ago, when the case involving the right of the GAO to look into the Hewlett-Packard Co.’s cost records was thrust back into the news, the debate was renewed over how safe company secrets are with the investigatory arm of Congress [Electronics, Dec. 25, 1967, p. 107]. The GAO, claiming it keeps trade secrets out of its reports if possible, does concede that it must turn its material over to Congressmen on demand. They, in turn, can make confidential material public, claims industry.

Although no trade secrets are involved, Sen. William Proxmire (D., Wis.) plans to disclose which companies have substantial government-owned equipment and which have been misusing the equipment. For many firms, it’s going to be embarrassing—to say the least.

**Finger pointing.** The GAO tried



## TRW METALLIZED POLYCARBONATE CAPACITORS



... small enough to fit!

TRW 50-volt Metallized Polycarbonate Capacitors are made to squeeze into tight places. Imagine 10 microfarads measuring .547" x 1¼" long... the smallest wound capacitor on the market!

Short on size and long on reliability, the X463UW series meets all requirements of MIL-C-27287.  
**VOLTAGE**—50V, 100V, 200V, 400V  
**CAPACITANCE**—.001 through 10 mfd  
**TOLERANCE**—available to  $\pm 1\%$ .

For data, write TRW Capacitor Div., Ogallala, Neb. Phone (308) 284-3611. TWX 910-620-0321.

# TRW®



not to name names. Adhering to a policy it adopted five years ago after being sharply criticized for its heavy-handed methods of releasing reports on firms, the GAO issued a "blue-book" report to Congress last November entitled, "Need for Improvements in Controls over Government-Owned Property in Contractors' Plants." Using such identification as company X, Y, and Z, it gave a number of examples, where government-owned equipment—much of it electronic test equipment or machines used in the electronic industry—was being used in "private" nongovernmental work, was lost, unrecorded, or standing idle.

In a spot check of 17 manufacturing plants, two of them electronics firms, the GAO auditors came up with almost \$1 billion of government-owned equipment. The two electronics firms, one under contract to the Army and the other to the Navy, had about \$76 million of government property, including almost \$40 million in special tooling and test equipment.

Sen. Proxmire, chairman of the Economy in Government subcommittee of the House-Senate Economic Committee, was upset with the findings. He asked the GAO to get him the names of the contractors involved.

**Blowing the whistle.** The GAO could do nothing but comply. But sticking to another policy—also adopted after the sharp criticism—the GAO sent out copies of the report to the companies that would be named, and asked for their comments. The companies were supposed to get their comments back to the GAO by year-end—but several asked for a delay and the GAO granted it. The GAO was scheduled to hand over the complete report—including companies' comments—to Proxmire last week. Proxmire was expected to make public the names after Congress reconvened Jan. 15.

Meanwhile, the Defense Department, a partner in the whole affair because of its loose controls, has promised to tighten up. It will mean a lot of tightening: there's about \$12 billion in Government property in hands of private con-

tractors. This is broken down into five classifications: facilities (such as buildings, machinery, R&D labs, etc.), \$6.2 billion; material, \$4.7 billion; special tooling (taps, dies, jigs, etc.) and special test equipment (much of it electronic), both totaling about \$1 billion; and military property, (aircraft, etc.). The government supplies contractors with special equipment and facilities, when necessary, for them to fill a defense contract.

**Strong words.** Proxmire feels that the matter is of such importance that names of companies involved should be made public. "A number of companies were using government equipment for their own commercial gain instead of on defense work," he said, adding that there is no reason why they shouldn't be made public. "Public machines have been diverted to private use."

He said he did not know precisely when he would release the names, but it would be "sometime in January."

The Senator said there might be hearings on the problem—but no decision has been made. "But you can be sure we'll do all we can to make certain that the Department of Defense tightens its controls, that we are paid rent for the equipment, and that contractors keep proper records."

---

### Military electronics

---

#### About-face

When Rep. Otis Pike (D., N.Y.) disclosed that the Pentagon was being grossly overcharged on numerous small purchases, the military boldly brushed aside the charge. The total amount is insignificant, the military claimed, and steps to counter overcharging would probably cost more than any eventual savings. That was several months ago.

The Pentagon has since done an about-face. It first ordered that small purchases—up to \$2,500 each—be reviewed regularly by senior officers and that greater

efforts be made to buy spare parts from an original contractor to avoid price markups by middlemen; junior procurement officers, who handle much of the small purchases, were to get more training in how to spur competitive bidding.

Now, the Pentagon wants to go a step further. It has proposed a regulation that would require sellers in the small-purchase category to guarantee that the government is not paying more than "any other customer purchasing the same item in like or smaller quantities under similar conditions."

**Penalty.** If an overcharge is discovered, the contractor would have to reimburse the government for the excess and pay liquidated damages—starting at \$50, and increasing from day to day until damages are paid.

The warranty wouldn't be required when the Pentagon believes there is adequate price competition or when there are clearly established catalog or market prices. But if the item has a catalog or established market price, and the solicitation is made by telephone—as is usually the case with small purchases—the seller must swear that his quotation is not in excess of it. The procurement officer would then include this statement in the written purchase order.

The regulation would also require that purchasing officers obtain price quotation where practicable. In addition, they would solicit prices from other than previous suppliers before repeating orders.

**Less than enthusiastic.** The proposed regulation has been sent to industry for comment, which is hardly expected to be enthusiastic. Industry not only doesn't like to admit that overcharging exists, but is cool to adding more red tape to a contract—particularly when it could involve penalties.

Small purchases by the military add up. They account for 4% of the Pentagon's \$45-billion-a-year buying operation, much of it for electronics. In fact, Pike pointed an accusing finger at several electronics firms, with the largest alleged overcharge being \$30,000



# plug-in measurement flexibility

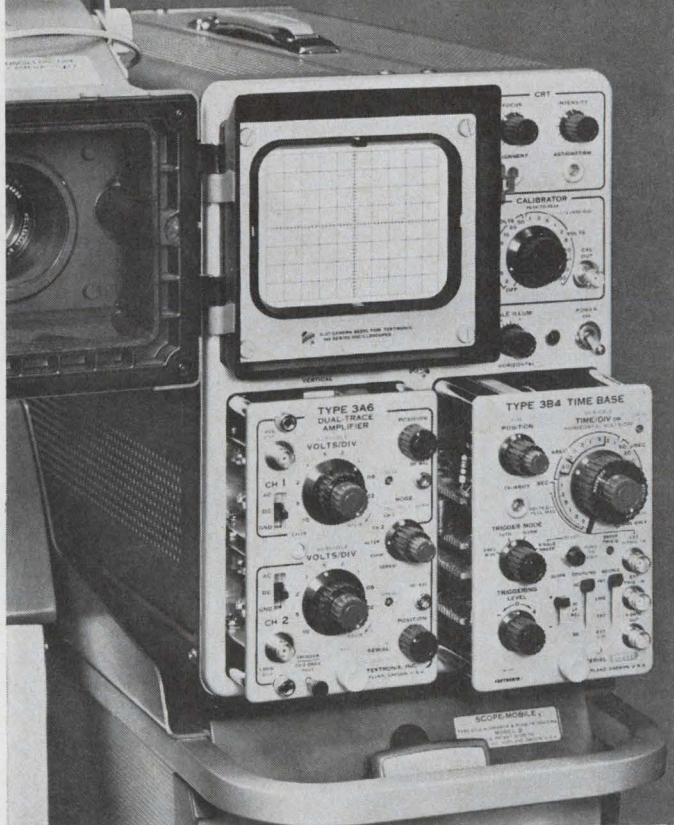

The Tektronix Type 561A oscilloscope has a complete selection of plug-ins, permitting you to change your measurement capabilities to meet your changing measurement needs. Amplifier plug-ins offer a wide range of measurement capabilities with 10 MHz dual-trace plug-ins, 10  $\mu\text{V}/\text{div}$  differential plug-ins, 350-ps sampling plug-ins and spectrum analyzer plug-ins covering the spectrum from 50 Hz to 36 MHz. Time-base plug-ins include delayed sweep, X50 magnifier, single time-bases or sampling time-bases. Amplifier plug-ins may be placed in the horizontal position for X-Y or multiple X-Y displays, and automatic seeking plug-ins are available.

The Type 564 Storage Oscilloscope uses the same plug-in units and offers the added advantage of split-screen storage. Split-screen storage lets you use either half of

## multi-trace

Make dual-trace measurements from DC-to-10 MHz with 35-ns rise-time capabilities and a 10 mV/div to 10 V/div deflection factor.

Type 3A6 Plug-in.....\$525

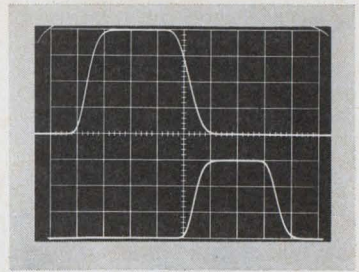

## differential

Make dual-trace differential measurements from DC to 500 kHz with a 100  $\mu\text{V}/\text{div}$  deflection factor and a 50,000:1 common-mode rejection ratio.

Type 3A3 Plug-in.....\$825

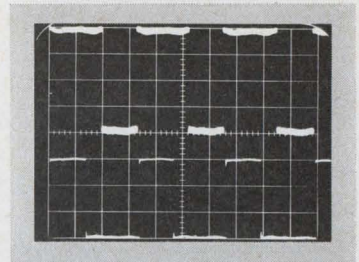

## sampling

Extend your dual-trace measurement capabilities to 1 GHz with 350-ps risetime, internal triggering and sweep rates to 20 ps/div.

Type 3T7A Time-Base .....\$ 690

Type 3S1 Amplifier.....\$1150

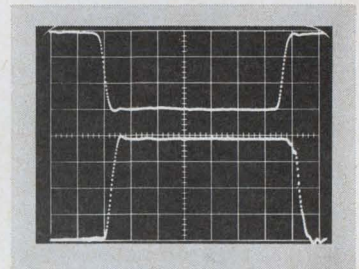

## spectrum analysis

Analyze the frequency spectrum from 50 Hz to 1 MHz with calibrated dispersion and calibrated deflection factors.

Type 3L5 Plug-in .....\$1100

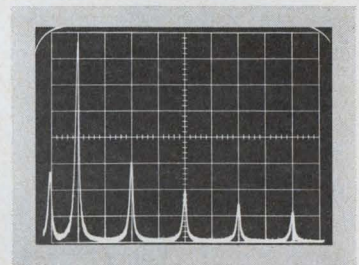

the display for storage and/or conventional displays. The contrast ratio and brightness of the stored display are constant and independent of viewing time, writing and sweep rates, or signal repetition rates.

For a demonstration of the Type 561A Oscilloscope or Type 564 Split-Screen Storage Oscilloscope, contact your nearby Tektronix Field Engineer or write: Tektronix, Inc., P. O. Box 500, Beaverton, Oregon 97005.

Type 561A Plug-in Oscilloscope .....	\$530
Type RM561A Rack-Mount Oscilloscope (7" high).....	\$580
Type 564 Split-Screen Storage Oscilloscope.....	\$925
Type 3B4 Time-Base (illustrated).....	\$425
Sweep rates 5 s/div to 50 ns/div with a direct reading X50 magnifier.	
C-27 Camera .....	\$430
Camera Adapter (016-0224-00).....	\$ 15

U. S. Sales Prices FOB Beaverton, Oregon



Conventional or storage  
oscilloscopes

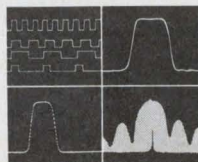

...with multi-trace, differential,  
sampling and spectrum analyzer plug-ins



# look at the tips of these blades

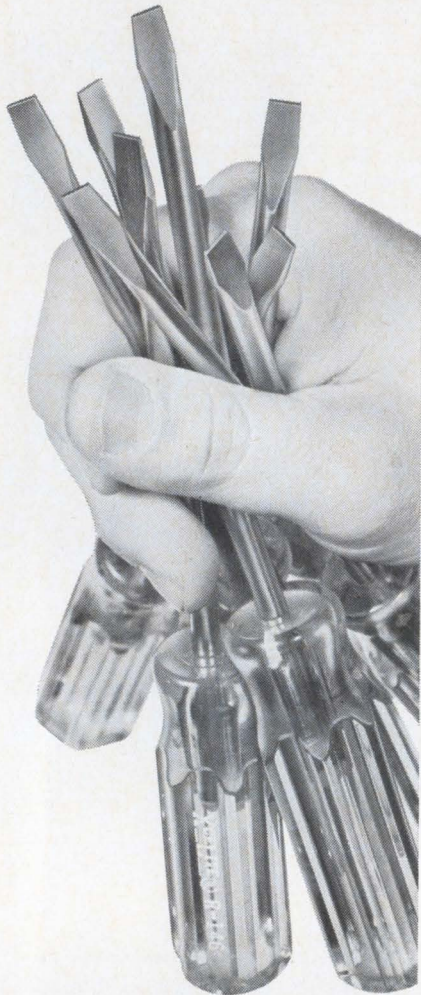

Here's uniformity that's readily apparent and undeniable. Here's precision . . . achieved only through modern production methods, skilled workmanship, close quality control.

All Xcelite screwdrivers are made this way . . . slotted, Phillips, Allen type, Frearson, Bristol, Scrulox . . . fixed handle or interchangeable blade types . . . to fit precisely, preventing damage to fastener or tool.

That's why they're first choice of manufacturers who seek zero defects on the assembly line, of technicians who take pride in their handiwork.

If you service or assemble precision products, look for screwdrivers, nutdrivers, and other precision tools you need in the extensive Xcelite line.



XCELITE, INC., 130 Bank St., Orchard Park, N. Y. 14127  
In Canada contact Charles W. Pointon, Ltd.

## Electronics Review

worth of items sold by Sterling Instruments of Mineola, N.Y., a division of Designatronics Inc.

These included the Pentagon's paying \$67.50 each for 30 high-voltage couplings, which were being sold to other buyers at a catalog price of \$2.75. The Justice Department is considering possible legal action.

### Displays

#### Fruit of the loom

When the Massachusetts Institute of Technology decided it wanted to develop a family of low-cost data display units for Project MAC (machine-aided cognition), it turned to some very exotic—and expensive—technology: Autonetics' silicon-on-sapphire diode matrixes [Electronics, May 30, 1967, p. 152A].

The hope was that the diode matrixes, once they went into mass production, would eventually be cheaper than anything else around. But after building a successful breadboard of the display unit, MIT went back to Autonetics for more matrixes and found that production had still not gotten into full swing and the price was still too high. So the developers went across town to a firm that was

started by some former MIT people, Memory Technology Inc. [Electronics, Sept. 18, 1967, p. 121].

There they found just what they were looking for, an inexpensive memory. Memory Technology had developed a braided-wire memory which, including all the selection and read-out electronics, costs \$900. The much more exotic Autonetics unit had a price tag of \$1,400, which didn't include the \$200 for the external circuits that were needed with it.

**Cost-conscious.** Production of the diode matrix character generator has not yet reached the point where it's commercially competitive with braided wire, although there are indications that the price may go down as production increases. Last month it was learned that Autonetics plans to market a commercial version of the diode matrix originally used for Project MAC.

**Core winding.** The braided memory contains a wire for each word it stores and ferrite core for each bit of the word. The routing of each wire, either through or around successive cores, determines the stored data. Each core acts like a transformer, linking the word-wires passing through it to a sense winding on the core.

The wires are preformed into a braid that is then laid over the U-shaped cores. Ferrite caps over

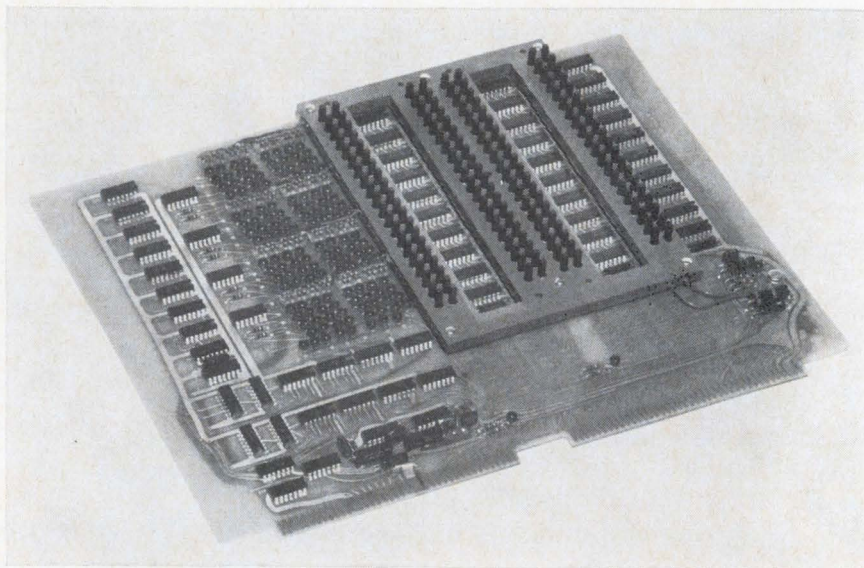

**Keep it in mind.** Project MAC engineers rejected exotic diode matrixes for computer terminal memories in favor of this lower-cost braided-wire memory.



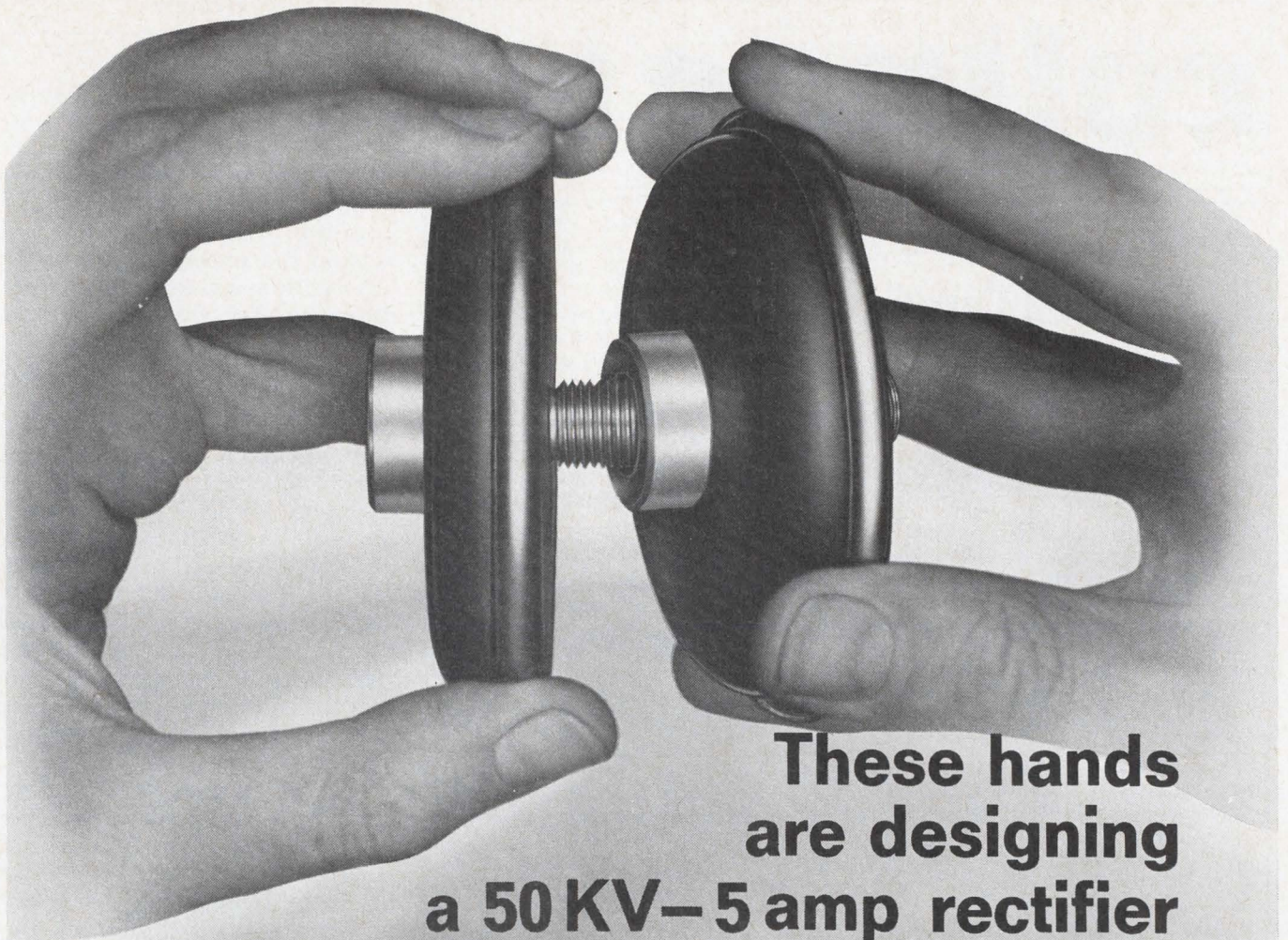

## These hands are designing a 50 KV–5 amp rectifier that is virtually fail-proof.

It's no oversimplification. They do work, they don't fail, and you can screw together almost any assembly you need up to 600 KV from the 14 stackable modules we have on the shelf. PIV's from 2.5 KV to 15 KV and currents to 10 amps. The men who designed these modules were high-voltage engineers. They knew the high-voltage engineering had to be done in the module before you started stacking. That's why they built in protection against transient surges. That's why they built in things like an anti-corona ring, shunt capacitance and controlled gradients. And that's why we haven't seen a legitimate failure of one of these devices in 3 years. Look . . .

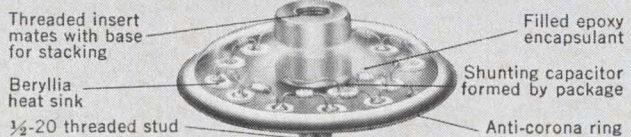

THE DOORBELL RECTIFIER MODULE BY  
**UNITRODE**

580 Pleasant St., Watertown, Mass. 02172, (617) 926-0404



Get yourself a complete set of specs that give you all kinds of information too detailed to put in this ad. Circle the reply card number now.



# collage 20

## Hybrids we have Known and Loved



When we say that our Aerospace Center is big in the hybrid biz, we're not talking about mules, loganberries, corn or other biological/botanical phenomena. We're talking about some esoteric electronics of the Integrated Circuitry variety. "But," you ask (quite properly), "what the devil do you mean by hybrid circuitry?" As with so many terms we are forced to live with, ambiguity abounds. One definition is this:

Any combination of two or more of the following: • An active-substrate IC • A passive-substrate IC • Discrete components

For example, the VCO's that we developed for Hughes to be used in the Surveyor telemetry system incorporate a combination of active-substrate IC's and discrete components. We've used the hybrid approach for analog (linear) circuitry, also: e.g., a dc amplifier, contained on a  $\frac{3}{4} \times \frac{3}{4}$  ceramic substrate, which incorporates thin-film resistors, chip transistors and diodes, a matched transistor pair (not a hybrid pair) and a discrete tantalum capacitor, and which produces an open-loop gain of  $2 \times 10^6$ . Well, the point of all this, if there is one, is that our A.C. people are hip to hybridization (to coin another ugly word). Write to them if you think they can help you. You might also ask them to confirm or deny the rumor that they crossed a klystron with a centrifuge to produce the world's first hybrid kluge.

## Meanwhile, We're Packing them In At Chicago



Not to be outdone, our Chicago Center engineers hasten to point out that all of the IC talent isn't concentrated out in the Arizona boondocks. "So, you characters are big in the cross-pollination biz. Big deal," they sneered. "Why don't you tell your COLLAGE readers, if there are any, about the great things we're doing in IC packaging. Like our RIC (Radar

Intercept Calculator). We packaged the complete electronics complement into a  $\frac{3}{4}$  cu. ft. box. If we'd have used transistor implemented circuitry it would have taken three standard 6-foot racks. But don't try to write up how we did it. If anyone wants to know, let them write for a reprint of an article that ran a while ago in ELECTRONICS. That tells them how it is." OK. So, if IC packaging is somehow intriguing to you, write to our Chicago Center for the article. But you might let them know where you heard about it.



Once upon a time we spawned a nice portable microwave set. With unprecedented daring we named it simply, MP-7. Then the military suggested that it be called Radio Set AN/FRC-124(V). Naturally we're not complaining about it, but MP-7 had a sort of charming simplicity that is somehow missing in the new nomenclature. But as long as the military keeps buying them, we'll call it anything they want. What it is, is a transistorized, two-way, portable microwave set operating in the 8 GHz government band. It is a multi-purpose, wide-band, communications link for all relaying applications, fixed or portable: fm or derived carrier voice communication, telemetering and control supervision, high speed data transmission, closed circuit television, and so on. It can be connected in tandem for multiple-hop systems, or used as a spur off existing systems. It can easily be carried about, set up, and operated. Its performance characteristics are very high and it can operate from a variety of dc or ac power sources, including a 12-volt automobile battery. There are a lot of other nice things about our MP-7... or whatever you want to call it. But do call... or write... our Chicago Center.

*Masochists' Special - A compendium of Collage back numbers, yours for one drop of dried blood mailed to Aerospace Center.*

**Aerospace Center Dept. 2008**  
8201 E. McDowell Rd., Scottsdale  
Arizona 85252, Phone (602) 947-8011  
**Chicago Center Dept. 985**  
1450 N. Cicero Ave., Chicago,  
Illinois 60651, Phone (312) 379-6700



**MOTOROLA**  
Government Electronics Division

## Electronics Review

the U's complete the flux path in each core.

Each wire in the braid corresponds to a particular character. The core through which the wires pass generate signals that create dots on the screen. Different patterns of dots within a 9-by-7 array determine different characters on the screen.

Besides its attractive price, the braided program in the memory can be changed if needed. "Even after encapsulation, a few new wires can be threaded through the cores and connected to the external terminals in place of encapsulated wires, which are left hanging," says Michael Gutman, the company's marketing manager. "To change the program in the diode matrix, you'd have to completely refabricate the entire unit, and at a great cost, including the design of a new mask."

A new unencapsulated version of the memory is now being developed, according to Gutman, in which the braid is laid into a hollow fixture made by injection molding. New wires can be added to the braid, until the fixtures contain perhaps two or three times as many wires as were in the original braid. Also, the original braid can be completely removed at any time, and replaced with a new braid for about \$100.

## For the record

**New year in space.** NASA is beginning the year with two important launches. This week, Surveyor 7, the last in the series, will be launched toward a target on the moon's Tycho crater, and on Jan. 17 the Apollo 5 shot will provide the first flight tests for the program's lunar module.

The Surveyor mission aims to land the spacecraft about 40 miles south of the lunar equator in an area where the moon's terrain is the most rugged. The craft will have in its experiment package television for the transmission of photographs, a digger to probe the lunar soil, and an alpha scattering experiment unit to analyze the ma-



# NOW...RCA tunnel diodes are "axially" wrapped in gold

It's true. But the real story of RCA's new tunnel diodes lies *inside* the practical, axial-lead package. There you'll find RCA-pioneered TD-II technology—a unique process of epitaxially-grown junctions that has brought to these devices a new standard of stability, performance, and reliability. Life tests exceeding 1 million hours prove it.

Leads are gold-plated for soldering efficiency. No pretinning is necessary. And the package lends itself well for high-volume PC-board mounting operations.

In all 14 types, the TD-II process assures low capacitance and mechanical ruggedness. Thermal resistance is improved. Because TD-II is a "batch" production process, you benefit further from low cost and uniform characteristics.

Designed for high-speed switching and high-frequency, signal-processing applications, these units are ideal as threshold detectors and in computer circuitry. Units are available through your RCA Distributor. See your RCA Representative for more information on these types or special selections. For technical data on specific types, write: RCA Commercial Engineering, Section SN1-2 Harrison, New Jersey 07029.

ACTUAL SIZE

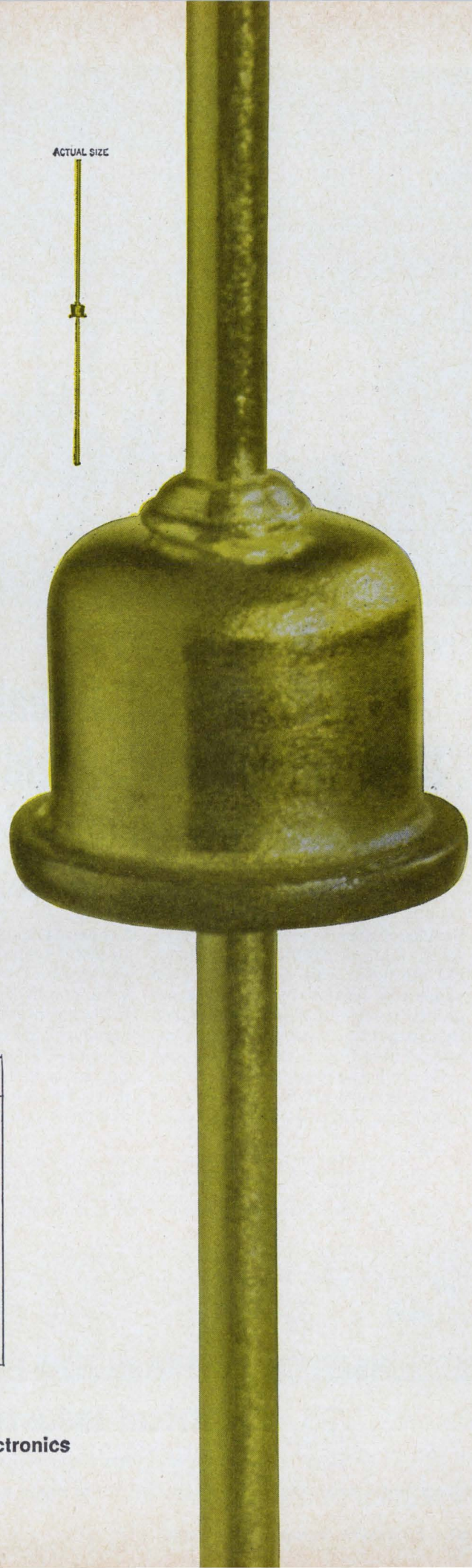

Type	$I_p$ (mA)		$I_p/I_V$	C (pF)		tr (ps)
	Min.	Max.		Min.	Max.	
40561	4.5	5.5	6/1	25	1800	
40562	9	11	6/1	25	900	
40563	18	22	6/1	30	600	
40564	45	55	6/1	40	350	
40565	90	110	6/1	40	150	
40566	4.75	5.25	8/1	15	1200	
40567	9.5	10.5	8/1	15	600	
40568	19	21	8/1	20	400	
40569	47.5	52.5	8/1	25	200	
40570	95	105	8/1	25	100	
40571	4.75	5.25	8/1	8	600	
40572	9.5	10.5	8/1	8	300	
40573	19	21	8/1	10	200	
40574	47.5	52.5	8/1	12	100	

RCA Electronic Components & Devices



The Most Trusted Name in Electronics



"Another unusual hermetic seal problem?"



STANDARD TYPES AND SPECIALS —

## E-I Glass-to-Metal Seals *more than meet today's highly critical electro-environmental specs*

— IN MILITARY/COMMERCIAL APPLICATIONS!

Service-proven in every type of electrical and electronic requirement, E-I hermetic seals are finding even wider application in the more sophisticated under-sea/aero-space instruments, equipment and systems. These high dielectric strength seals are being produced to meet unusually severe shock and vibration conditions, and wide fluctuations in

temperature and humidity. E-I glass-to-metal terminations offer the advantages of vacuum-tight sealing with maximum rigidity and durability, miniaturization and design standardization. Where custom seals or unusual lead configurations are required, E-I sales engineers will make recommendations from your blueprints, sketches or data.

Write for the E-I Catalog — A practical, concise volume edited and compiled for the engineer / designer / specifier. Contains data and specifications covering a diversity of glass-to-metal seals in a wide range of types and sizes, including hundreds of stock items. Please address requests on company letterhead.

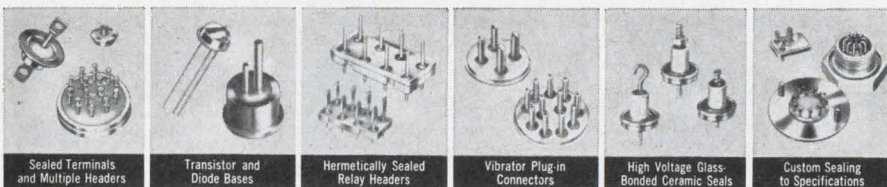

Sealed Terminals and Multiple Headers

Transistor and Diode Bases

Hermetically Sealed Relay Headers

Vibrator Plug-in Connectors

High Voltage Glass-Bonded Ceramic Seals

Custom Sealing to Specifications



**Electrical Industries**

A Division of Philips Electronics and Pharmaceutical Industries Corp.  
Murray Hill, N. J. 07971 — Tel. (201) 464-3200

Patented in U.S.A., No. 3,035,372; in Canada, No. 523,390; in United Kingdom, No. 734,583; other patents pending.

terial exposed by the digger.

The unmanned Apollo flight will place the lunar module in earth orbit for tests of its engines. Grumman, which built the module, had been having difficulties in trimming the craft's weight, but this test module weighs an acceptable 31,325 pounds. The next major step in the program, a manned test of the command module, could come early this summer.

**Logical step.** Autonetics has followed up its announcement of plans for a microelectronics venture [Electronics, Dec. 25, 1967, p. 25] with an not unexpected decision to build a production facility. Slated for completion by Aug. 1, the \$1.6 million, 40,000-square-foot plant will produce metal oxide semiconductors and silicon-on-sapphire devices. Some will be put on the market, but most will go into Autonetics' own systems. Weekly output is expected to eventually reach about 10,000 integrated circuits and large-scale integrated arrays.

**Tantalum hike.** Citing the rising cost of producing high-voltage and standard high-capacitance tantalum powder, the National Research Corp., a major producer, has announced a price increase of \$1.50 a pound. Last year's prices on high-capacitance powder ranged from \$39.50 to \$42.50 a pound for high-voltage types and from \$30.50 to \$33.50 for the standard.

**Lobby.** Business leaders have been asked to help defend the space program's budget. Rep. Olin E. Teague (D., Texas), chairman of a subcommittee of the House Science and Astronautics Committee, tired of defending the NASA program largely in terms of racing the Russians to the moon, has asked presidents of the 750 largest companies to rate the space program in eight basic areas. Teague hopes to show Congress that the program has solid backing.

**Unite?** Although the Laser Industry Association was scheduled to organize as an independent group Jan. 8 in Los Angeles, leaders have not yet closed the door to a merger with the Electronic Industries Association's new laser subdivision.



# VSMF is a product supermarket

*John Manning, Missiles Systems Division, Raytheon Company, Bedford, Mass., has installed 4 VSMF Files: Defense Design, Documentation, Mil Specs and Mil Standards.*



## look into it!

Design engineers have been telling us for years that VSMF is much like a product supermarket. That's because Visual Search Microfilm Files contain more than 1,000,000 products from over 15,000 manufacturers—all arranged with design engineers in mind.

Of course, VSMF isn't exactly a supermarket. At Information Handling Services, we've collected 1¼ million pages of product data, indexed them, microfilmed them, put them in compact consoles, and combined them with the most modern microfilm retrieval equipment. VSMF has all the advantages of a product supermarket... complete, easy-to-use and up-to-date.

We know that when you design a product you want to use the best components and materials. And, to do this, you need to compare all that is available. VSMF can help you in this comparison because VSMF supplies the data on *all* products. You supply the judgment.

Manufacturers who place their data in VSMF know this and invite comparison. The constantly changing "state of the art" is reflected in the pages of VSMF.

More than 125,000 engineers in 500 great corporations now shop in the VSMF supermarket. If you have VSMF in your company, look into it. If you don't, you might look into that, too. Write for "Looking into VSMF."



**Information**

HANDLING SERVICES, INC.  
Dept. E-18

Denver Technological Center  
Englewood, Colo. 80110

Circle 57 on reader service card



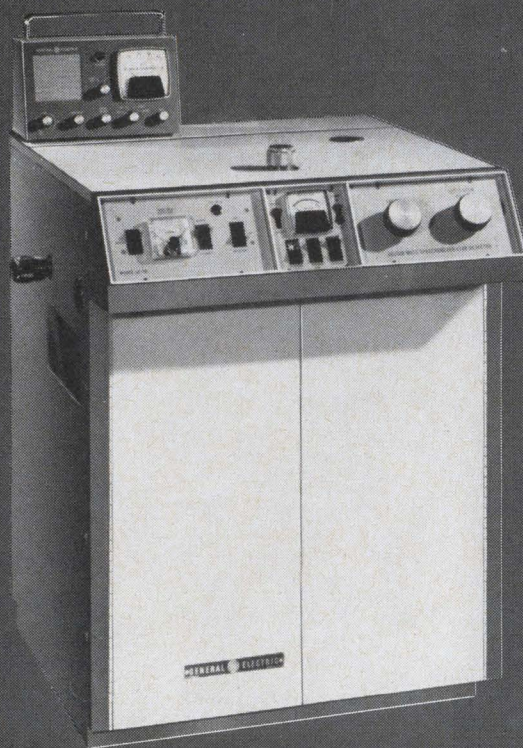

## Why General Electric waited three years before introducing this all-new Helium Leak Detector:

Can we impose on you with a bit of history?

Twenty-five years ago, GE built the first Helium Mass Spectrometer Leak Detectors ever—for the Manhattan Project.

Subsequently, we made some mistakes. The main one was resting on our oars while competitors got in, caught up—and then passed us.

So, in the late fifties and early sixties our reputation in this field was—deservedly—less than good.

We got busy. We re-designed our units from scratch. We questioned everything we'd ever done, everything anybody else had done. We re-assessed every component, circuit, and operation in terms of developing leak detectors with optimum sensitivity, maximum reliability, and minimum maintenance.

Early in 1965 we were satisfied. But to make sure, we concentrated on placing them in General Electric

plants. (We think you'll agree there's nobody quite as critical as a member of the family.)

Now, three years later, we can look you in the eye and tell you that GE Helium Mass Spectrometer Leak Detectors are again the finest on the market.

We don't ask you to take our word for it. But we do ask you to check out for yourself the new-yet-proven features that characterize our product today. Things like all the sensitivity you'll likely ever need; a spectrometer tube filament that's guaranteed for two years; reliable, long-life, solid-state circuitry; constant sensitivity; real ease of operation and servicing; an all-welded, stainless steel high-vacuum system.

And then some. Check the reader service card, or write us direct for full particulars on manual model LC-10 and automatic model LC-20. We have a product we're proud of.

VACUUM PRODUCTS BUSINESS SECTION

GENERAL  ELECTRIC

SCHENECTADY, N. Y. 12305

LC-1







# 'Tailor-made' data acquisition

with ready-mades...

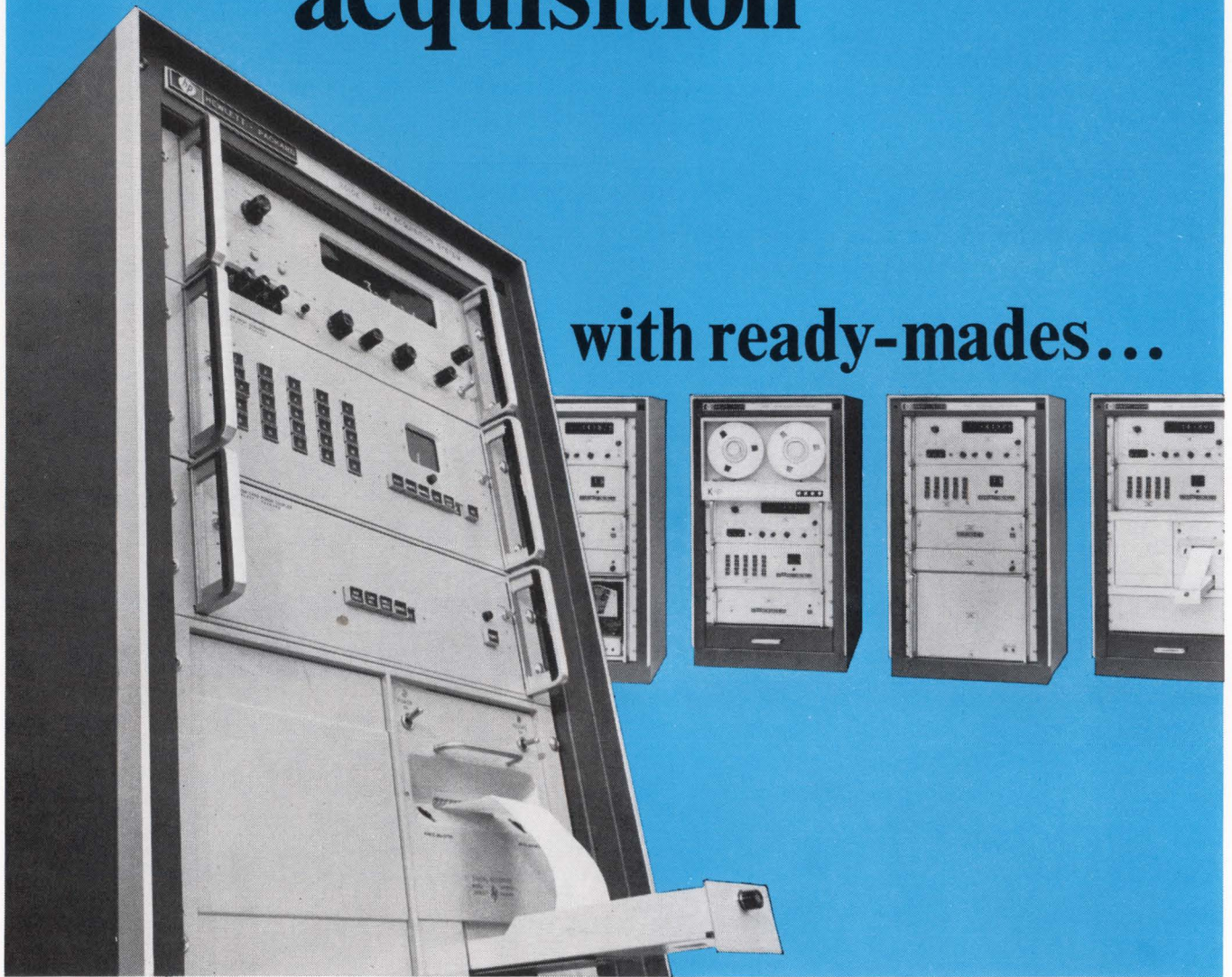

Versatile, high-performance data acquisition systems—virtually designed and built to the specifications you have to meet—are yours with “off-the-shelf” delivery in the eight different configurations of Hewlett-Packard 2010 Series.

The HP systems concept represented by the 2010 Series assures complete system specifications (on a data sheet), immediate delivery, proven reliability and low cost.

Basic measuring device in the 2010 Systems is the 2401C Integrating Digital Voltmeter, a floating and guarded DVM which permits measurement of low-level signals in the pres-

ence of severe common mode and superimposed noise. Standard systems offer a wide variety of input capabilities and a broad range of output... printed strip, punched tape or card, or magnetic tape. Versatile systems programming, too.

Whatever your needs, you'll find your answer with Hewlett-Packard, which,

in addition to the 2010 Series, offers other complete lines of standard data acquisition systems. Detailed information on these systems is available with a call to your Hewlett-Packard field engineer or a letter to Hewlett-Packard, Dymec Division, 395 Page Mill Road, Palo Alto, California 94306; Europe: 54 Route des Acacias, Geneva.

HEWLETT  PACKARD

DATA SYSTEMS

06701



when a single downtime  
can cost you much more than the original price of the control...

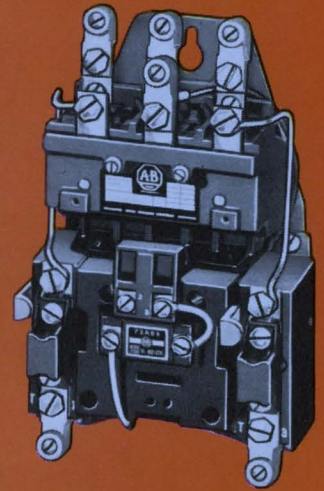

BULLETIN 709 Size 2 motor starter rated 15 hp, 240 v; 25 hp, 480-600 v.

## it's false economy not to buy Allen-Bradley

■ Have you ever stopped to consider the "cost per minute" when a control failure shuts down a production line? You can bet it's plenty—it will wipe out "flocks" of those hoped-for savings from buying motor control at "cut prices."

Allen-Bradley—the quality control—features the time-proven A-B solenoid construction—with only one moving part—which simplicity of design is *your* guarantee of millions of trouble free operations. The weld-resistant silver alloy contacts of a special double break design assure long life and the utmost in contact performance—with never a moment to be spent for maintenance. Coils are pressure molded—replaced free of cost to you if they should fail in service—regardless of atmospheric condition. The built-in air-gap in the magnets remains permanent—no matter what the frequency of service may be—"magnetic sticking" is out of question.

The Type BR relay is of the same general trouble free design as just described and is unusually versatile. All contacts are easily convertible—all it takes is a screwdriver and 30 seconds to change a pole from N.O. to N.C. or vice versa. Also, either one or two extra poles can be quickly added in the field and they are full rated and also convertible. Type BR relays can be furnished with overlapping contacts.

Your local Allen-Bradley appointed distributor carries in his stock a very wide selection of the Allen-Bradley control commonly used in your territory. He has been trained as a control specialist. Please contact him today. Allen-Bradley Co., 110 W. Greenfield Ave., Milwaukee, Wisconsin 53204. In Canada: Allen-Bradley Canada Limited. Export Office: 630 Third Ave., New York, N.Y., U.S.A. 10017.

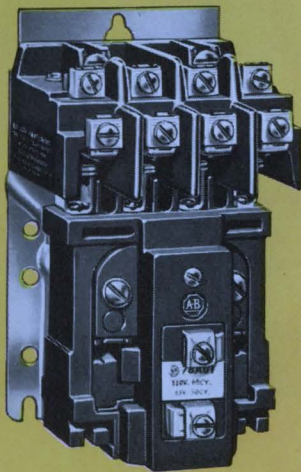

BULLETIN 700 Type BR 4-pole control relay with convertible contacts



**ALLEN-BRADLEY**  
Member of NEMA  
QUALITY MOTOR CONTROL



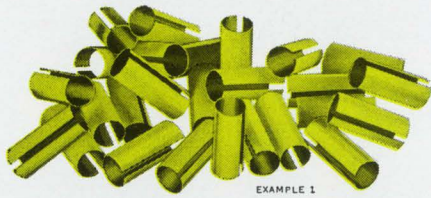

EXAMPLE 1

The gold plating on these "hard-to-handle" female connector terminals cost \$3.78 per thousand . . .

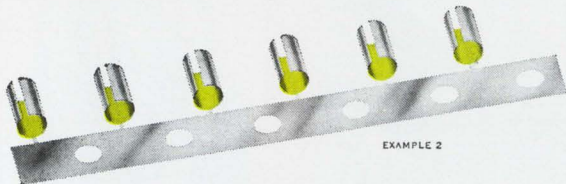

EXAMPLE 2

The gold plating on these female connector terminals . . . adaptable to automated assembly . . . cost only 83¢ per thousand and they are far better parts!

**ZCD\* Pre-plating of strip makes the difference...**

**And only Burton does it!**

**\* Zone Controlled Deposition...** Burton's exclusive continuous plating technology reduces gold material and plating costs, produces better parts, speeds production in two important ways!

Both terminals shown were fabricated from the same strip base material. Both were gold plated with the same type of gold. The part with less gold costs approximately 80% less to produce, *yet it is a far better part!* The difference is Burton ZCD pre-plated strip!

**Example 1** was fabricated from strip and then barrel plated. The surface that required gold (the inside) is the most difficult area to plate by barrel plating. To arrive at the specified thickness inside where contact is to be made, it was necessary to *overplate* the whole strip, depositing a *thicker layer where gold was not even needed.*

**Example 2** was fabricated after plating, using **Burton ZCD Pre-Plated Strip**. Zone Controlled Deposition (ZCD), coupled with Burton's high-speed, continuous reel-to-reel plating technology, controls both the location and thickness of gold deposits on one or both sides of strip material of any width. Deposits can be held to zero where gold is not required, and the process assures a uniformity of thickness to within 10 micro inches within a reel and from reel-to-reel . . . for a thousand or a million feet of strip. By using Pre-Plate Strip with gold only on the side and area to be formed into the inside of the terminal, and deposited to the required thickness, 90% of the gold required by Example 1 was saved, and the part uniformity was greatly improved!

**Check these added advantages of Burton Pre-Plated Strip.** By using pre-plated strip, production and assembly sequences can be speeded. Drawing from an in-plant stock of pre-plated strip, the fabricator/plater/plant sequence can be reduced one step. More important, 500 to 1000 foot reels of formed parts are more readily adapted to automated assembly than short lengths of strip required to plate by barrel or rack techniques.

If you produce connector terminals or other parts fabricated from strip material, contact Burton for details on how you can achieve better parts in less time and at less cost with ZCD Pre-Plated Strip made to your specifications.

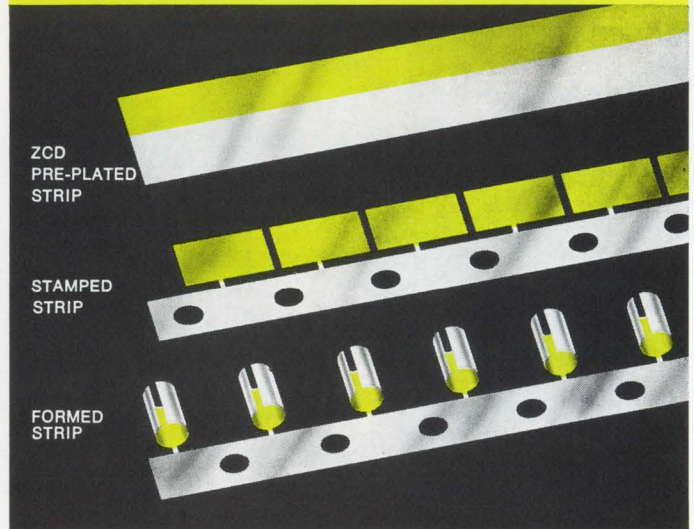

Send for a sample strip. Write on your letterhead for a sample of strip demonstrating Burton's Zone Controlled Deposition. Gold at the center, no gold on the edges or opposite side of the strip.

**FREE TECHNICAL DATA.** Circle the Reader Service Card to receive "Burton Plating News" containing useful data pertaining to metal plating.



**BURTON RESEARCH LABORATORIES, INC.**



A DIVISION OF BURTON SILVER PLATING COMPANY

BURTON RESEARCH LABORATORIES, INC. • 11240 PLAYA COURT • CULVER CITY • CALIFORNIA 90230 • TELEPHONE (213) 391-6325



We have a complete line of photodevices—from a 50-cent epoxy transistor to a \$4,000 custom photo array. Light-emitting and light-sensing devices for everything from computers to electric organs. They can translate keyboard signals, read punched cards and tape, measure height and volume, perform character recognition, read motion picture sound track. You name it. Write for complete information and we'll throw in a glossary of the latest photometric and radiometric terms.

FAIRCHILD SEMICONDUCTOR / A Division of Fairchild Camera and Instrument Corporation ■ 313 Fairchild Drive, Mountain View, California 94040, (415) 962-5011 ■ TWX: 910-379-6435



***What this country  
needs is a good  
50¢ phototransistor.***





# 1 $\mu$ V Full Scale 10 kHz to 30 MHz Wave Analyzer



TYPE USVH

## SELECTIVE MICROVOLT/AMMETER

### FEATURES:

- Wide frequency range covers 10 kHz-30 MHz
- Measure Voltage: 1  $\mu$ V to 1V, f.s.d. (-118 dB to +2 dB)
- Measure Current: Clip-on current probe (optional, 0.1 - 30 MHz) 1  $\mu$ A to 1 A, f.s.d.
- Dynamic Range: 60 dB
- Fine Frequency Adjustment:  $\pm 2.5$  kHz
- Selectable Bandwidth: 500 & 5000 Hz
- Noise Level: 0.5  $\mu$ V
- Input Impedances: 50, 60, 75, 150, 600  $\Omega$  and 500k  $\Omega$  || 20 pF High impedance probe available.
- Internal reference makes unit self-calibrating.
- Demodulated phone output.
- Economically priced.

TYPICAL SELECTIVITY  
TYPE USVH  
BANDWIDTH 500 Hz

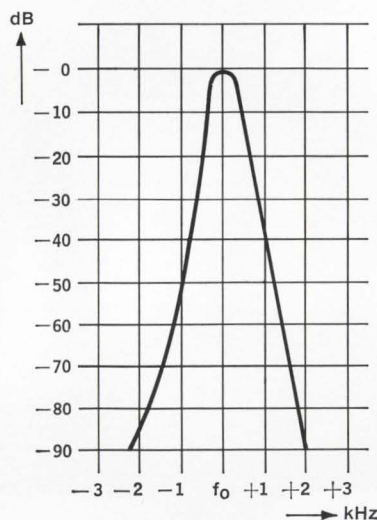

Type USVH Selective Microvolt/ammeter is continuously tunable over the wide frequency range of 10 kHz to 30 MHz. High sensitivity and selectivity are outstanding features of this superheterodyne receiver with direct readings in volts and decibels. Voltage measuring range covers from 1  $\mu$ V to 1 V f.s.d. with an accuracy of  $\pm 3\%$  referred to 1 MHz & 1V. Measurements can be made to 0.25  $\mu$ V. Frequency response is  $\pm 0.5$  dB from 20 kHz - 10 MHz, and  $\pm 1.0$  dB from 10-20 kHz and 10-30 MHz. Type USVH also can be used for selective current measurements using Clip-On Current Probe, BN 150013. Instrument features selectable bandwidth of 500 & 5000 Hz, and provides six switchable input frequencies.

#### Applications Include:

- 30 MHz Wave Analyzer
- Attenuation and frequency response measurements on networks up to 140 dB
- Null indicator for high frequency bridges
- Measurements of RF distortion as low as -60 dB
- Inter-Channel cross-talk attenuation measurements on carrier systems

Get The Extra Capability,  
Greater Reliability, and  
Longer Useful Life Of . . .



**ROHDE & SCHWARZ**

111 LEXINGTON AVENUE, PASSAIC, N. J. 07055 • 201-773-8010

Inquiries outside the U.S.A. should be made to: Rohde & Schwarz, Muehldorfstrasse 15, Munchen 8, West Germany.



Maybe it seems so.

In our thrifty, Scottish way, we've brought out a Honeywell taut-band meter that costs even less than a pivot-and-jewel meter. (About 10% less, on the average.)

Does that make you think we might be short-changing you? We are: We left all the unnecessary parts out of our taut-band meter. (Fewer parts: fewer things to go wrong.)

It's simple. Which is the whole idea.

It's self-shielded.

There's no friction in its moving parts. Which gives you better readout accuracy, better repeatability.

And it comes in just about any style you'd like.

Obviously, the low-cost taut-band meter from Honeywell has a brilliant future ahead of it.

But the question is: Will it ever replace the pivot-and-jewel meter?

We doubt it. We believe there are some sensitivities and applications that will always be

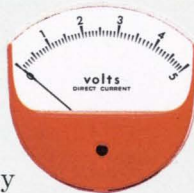

handled best by our good, old pivot-and-jewel meter.

But if you like the idea of our low-cost taut-band meter, by all means write us for our brochure. It'll tell you all the sizes, styles and prices.

Honeywell Precision Meter Division, Manchester, N.H. 03105.

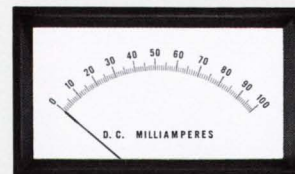
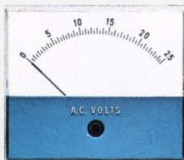

**Honeywell**

**Is the pivot-and-jewel meter going out of the picture?**

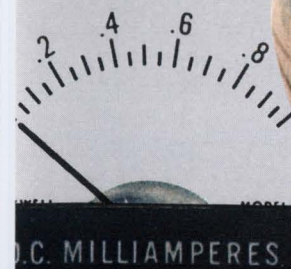



# Philco-Ford puts logic in a box



## Now, you'll be pinning down your control system designs faster, easier, and with far greater economy

Over 200 micromodules from Philco-Ford's WDL Division stand ready to accept your system challenge. In compatible 5 to 40 MHz logic, standard DTL and T<sup>2</sup>L circuits, they contain some of the most sophisticated designs in today's state-of-the-art, including multiplexers, operational amplifiers, D-to-A and A-to-D circuits, and an extensive array of computer interfaces.

The micromodules employ monolithic IC's, using thin-film and discrete components only where necessary. A hard nylon cover keeps out dust, protects circuits against damage. Clearance holes at the top of the micromodule provide fast front-panel access to all input/output terminals. No need to troubleshoot from the back! A color-

coded label identifies module type at a glance.

The micromodule's modest dimensions, coupled with the complexity of the logic it contains, permits highly effective packaging density. A 180-module system can be mounted in a drawer only 3½" high by 19" wide. Modular systems fit readily into rack mounts, bench mounts, or portable instruments. In service for over three years at NASA's Manned Space Flight Center in Houston, WDL micromodules have compiled an excellent record of performance reliability. Write Product Sales Manager, WDL Division, Philco-Ford Corp., Mail Station C-41, 3939 Fabian Way, Palo Alto, California 94303. Or telephone (415) 326-4350, extension 6017.

**ADD (Automated Design and Documentation)** This Philco-Ford computer-programming service generates system documentation at a cost significantly below that of hand-prepared equivalents. The computer program error checks design input data, optimizes the arrangement and sequence of wiring instructions, calculates wire lengths, provides wire lists sorted by length and by name, and maintenance lists. The program is available to all users of Philco-Ford micromodules.

**PHILCO**   
PHILCO-FORD CORPORATION  
WDL Division • 3939 Fabian Way  
Palo Alto, California • 94303



---

# Washington Newsletter

---

January 8, 1968

## **FCC fiddles as cable, satellite interests burn**

While satellite and cable backers continue to battle over the cable interests' insistence on a 50% share in the planned expansion of transatlantic communications by 1970, both sides now agree on one point: **unless the FCC reaches a decision soon, they will have serious deadline problems.** It takes at least 18 to 24 months to get either system into operation. Comsat wants to have the 10,000-circuit Intelsat-4 satellite handling transatlantic traffic, while AT&T leads the group urging the 720-circuit TAT-5 cable [Electronics, Dec. 11, 1967, p. 155].

**Both sides say their overseas partners are also upset over the Yankee indecision;** Spain, Portugal, and Italy have already signed the TAT-5 agreement, while members of the 60-nation Intelsat consortium are supporting Comsat's plan. One observer says he has heard that a decision could come soon, but adds, "I heard the same thing in September."

## **Bright spot in job program**

The Commerce Department, which is having slow going with its program to get industry to set up plants in areas of hardcore unemployment, is finding one bright spot: the "fairly good" response of the aerospace and electronics industry. One example: ITT will unveil a proposal for a manufacturing center in Washington, D.C., later this month. However, Administration officials are beginning to feel that increased incentives such as tax breaks and special grants will have to be provided quickly if the program is to get moving.

## **Cable tv hearings: poles apart on rules**

The FCC would like to hold hearings on telephone-company involvement in cable television—but laying down the ground rules appears as difficult as arriving at final rulings. **The agency is concerned over telephone pole rental practices and tariffs, and the companies' contention that their right to string phone lines into homes includes the right to string cable-tv lines.**

FCC hearing examiner Charles J. Frederick has held pre-hearing conferences with attorneys from telephone companies, the National Cable Television Association, and the commission's CATV task force, trying to establish a hearing date, order of evidence and witnesses, and other basic procedural rules. But no agreement has been reached. **The next conference is scheduled for Jan. 17, but participants aren't optimistic about making much headway.**

## **Bidding for Awards to be hot and heavy**

**At long last, it's go for the Air Force's Adverse Weather Aerial Delivery Avionics System (Awads).** And the companies planning to bid for the program make up a "who's who" of avionics producers. Probable reasons: a paucity of major avionics awards in recent months and a desire by producers to get more business in the limited-war equipment market.

Bids on the contract, which eventually may amount to \$300 million, are due early this year. The Air Force was all set to request industry proposals last summer, two years behind schedule [Electronics, June 26, p. 60], but was forced to postpone action by the squeeze on funds due to the Vietnam war. Air Force officials now feel that the Pentagon will release funds for the work over a period of several years. The contractor,



---

# Washington Newsletter

---

who will probably be selected by this spring, will supply an integrated package of Ka-band radar sets, digital computers and stationkeeping equipment for installation in C-130 transports. Awards will allow precision air drops of men and material in zero visibility.

## Pentagon and AEC may sell software

Possibly goaded by NASA's success in selling computer software to industry and educational institutions, the Pentagon and Atomic Energy Commission are considering opening stands in the same store.

Representatives of the two agencies and NASA's Office of Technology Utilization are discussing details. The computer packages—tapes, card decks, run instructions, and program listings—would be sold by the space agency's Computer Software Management Information Center at the University of Georgia. The center has been selling some 200 NASA programs covering inventories, mathematical routines for problem solving, design evaluations, and tests and checkouts. According to a NASA official, it will be paying its own way within a year or two.

## Plug for brain drain from north Europe may spring a leak

Companies worried that the new immigration laws will halt their recruiting of engineers and scientists in Britain and other northern European countries can expect some relief from Congress this year. Their problem is that immigrants will be accepted on a first-come, first-served basis regardless of nationality after next July 1. And because immigrants from northern Europe had never been on waiting lists since their quotas were always undersubscribed, they would have to get at the end of the line—after professionals from such countries as Italy, Greece, Spain, India, Pakistan, and the Philippines.

However, under pressure from organizations representing such ethnic groups as the Irish- and German-Americans, Congress will most likely modify the laws to give northern Europeans a better place in line.

## Comsat may buy Alaska phone lines

Comsat may offer to buy the long-lines telephone system in Alaska from the Defense Department late next year. The Pentagon was recently authorized by Congress to sell the commercial portion of the Alaskan system—now operated by the Air Force—to the bidder offering the best price, rates, and plans for expansion.

Sen. E.L. Bartlett (D., Alaska) suggested that Comsat be invited to bid "because of the unique attractions of satellites." In addition to a "domestic" satellite for intra- and interstate communications another might be used for a statewide television system, Bartlett believes. Comsat has begun studies to see if the purchase might be profitable.

## Radar weathering Coast Guard test

The Coast Guard this month will complete sea trials of a prototype automatic vertical-tracking-radar system that is expected to become the service's seaborne weather observation sensor. The equipment, a modification of the Navy's Mark 56 anti-aircraft radar, will permit a slow-moving or stationary ship to track ascending weather balloons. Presently, the cutters are equipped with horizontal-tracking radars that scan upward for just a few degrees. The prototype was built by Fairchild-Hiller under a two-year-old, \$5 million contract that calls for two prototypes and 37 production models.



**3,000,000  
VOLTS/SEC.**



The scope photo illustrates the QRD40-.75's high-speed response to 10KHz square, triangular, and sine waves. Amplitudes are 20V peak-to-peak.

## ***New Sorensen QRD:***

- A High-Speed Programmable Power Supply with a "Slewing Rate" Greater than 3,000,000 volts/second.**
- A Versatile Laboratory Supply Featuring  $\pm 0.005\%$  Regulation.**

This new precision power supply leads two lives! In the high-speed programming mode, its performance is unmatched—only 10 microseconds programming time from  $E_{max}$  to 0 Volts. Capable of being programmed by resistance, voltage, or current to 100KHz. The oscilloscope photo vividly illustrates the QRD's high-speed capability which makes the QRD unequaled in digital, microcircuit testing, and servo system applications. The QRD also serves as a precision general-purpose instrument featuring  $\pm 0.005\%$  voltage regulation, 200 $\mu$ V r.m.s. (3mV p-p) ripple, automatic crossover between constant volt-

age and constant current operation, and overload/short circuit protection.

Sorensen QRD's are available in seven off-the-shelf models ranging from 0-15v @ 2.0 Amps. (QRD15-2) to 0-60v @ 1.5 Amps. (QRD60-1.5). Prices start at \$178.00.

Contact your local Sorensen representative or: Raytheon Company, Sorensen Operation, Richards Avenue, Norwalk, Connecticut 06856 TWX 710-468-2940.

**RAYTHEON**

for more data on this versatile instrument . . . **Call Sorensen: 203-838-6571**





# IN "THE GREAT RELAY RACE"

**GET YOUR FREE RELAY!...YOU'RE A WINNER EVERYTIME!**

Run your own relay race (evaluation test) in your own plant, under your own conditions, using your choice of our general purpose and medium power relays.

**YOU BE THE OFFICIAL JUDGE!** Verify the results shown in the chart on the right. You will find that Eagle Relays run longer and better; that there is no premium in cost and that they are always readily available.

GET YOUR FREE RELAY TODAY by writing for your OFFICIAL JUDGE'S ENTRY BLANK to: Relay Race, Eagle Signal Division, 736 Federal Street, Davenport, Iowa, 52808, or by circling reader service number below.

CONTACTS	COMPETITIVE BRANDS						EAGLE RELAYS
	"A"	"B"	"C"	"D"	"E"	"F"	
Arrangement Rating	3 PDT 5 Amp.	3 PDT 5 Amp.	3 PDT 5 Amp.	3 PDT 5 Amp.	3 PDT 5 Amp.	3 PDT 5 Amp.	3 PDT 5 Amp.
LIFE Mechanical	15,061,261 Operations	14,077,866 Operations	28,808,000 Operations	21,625,333 Operations	16,923,133 Operations	29,433,600 Operations	34,492,950 Operations
ELECTRICAL 5 Amp. Resistive	295,466 Operations	490,433 Operations	129,600 Operations	235,700 Operations	778,200 Operations	921,400 Operations	948,675 Operations
1.6 Amp Inductive	488,666 Operations	1,071,666 Operations	496,000 Operations	284,333 Operations	3,529,466 Operations	1,842,000 Operations	3,102,200 Operations

This comparison chart shows that Eagle Relays have a 100% greater life than the average of our six competitors at 5 amps, resistive and an almost 140% greater electrical life than the average of the six competitors at 1.6 amps inductive.



A DIVISION OF THE E. W. BLISS COMPANY

IN CANADA: EAGLE SIGNAL DIVISION, E. W. BLISS COMPANY OF CANADA LTD., GEORGETOWN, ONTARIO



# R-TX



R-TX is Raytheon's equivalent of JAN-TX, extended to cover Raytheon diodes for which no JAN-TX standard has been established. For complete details, send for your Raytheon R-TX Standard on diodes today. And for complete information on Raytheon's standard line of diodes, send for our latest catalog as well. Raytheon Company, Semiconductor Operation, 350 Ellis Street, Mountain View, California 94040. Phone (415) 968-9211.

**RAYTHEON**



**NEW  
FROM  
ELECTRO**

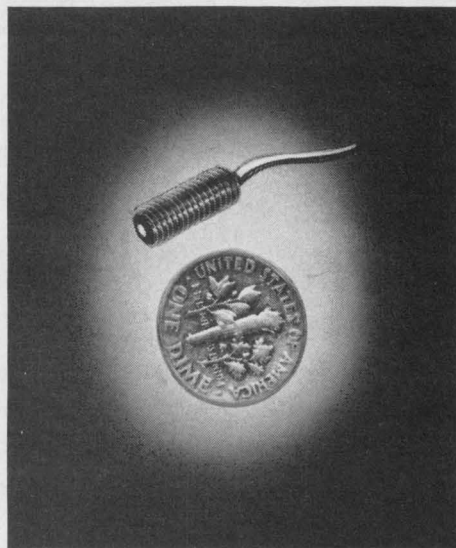

***The World's Smallest Standard Magnetic Pickup***

**10 VOLT OUTPUT IS HIGHER  
THAN MANY LARGER MODELS**

Here is ELECTRO's answer to magnetic pickup miniaturization demanded by so many applications. Though so small that it takes 20 of them to weigh a single ounce, the 3080 can be depended upon to deliver a minimum output of 10 volts peak to peak under standard test conditions—20 pitch gear teeth, 1000 IPS surface speed, 100K ohm load, .005" pole piece clearance. Variations in conditions show equally impressive performance.

The ELECTRO 3080 may prove to be the answer whenever limited space is a factor in counting, triggering, positioning, or other applications.

The 3080 was designed to solve a specific problem in a sophisticated computer where high density packaging was a major factor. Here is another example of an ELECTRO custom-built magnetic pickup that has been added to the wide range of stock pickups which are available "off the shelf."

When you need a specialized magnetic pickup to solve a problem, check ELECTRO; chances are we have it in stock. If not, we invite you to talk over your problem with our engineers.

*Pioneers in Electronic  
Sensing and Control.  
Electronic Tachometers  
Dynamic Micrometers  
Magnetic Pickups  
Proximity Switches  
DC Power Supplies*



**ELECTRO  
MAGNETIC PICKUPS**

**ELECTRO PRODUCTS LABORATORIES, INC.**  
6125-Y Howard Street, Chicago, Illinois 60648 • 312/647-8744



# R-TX

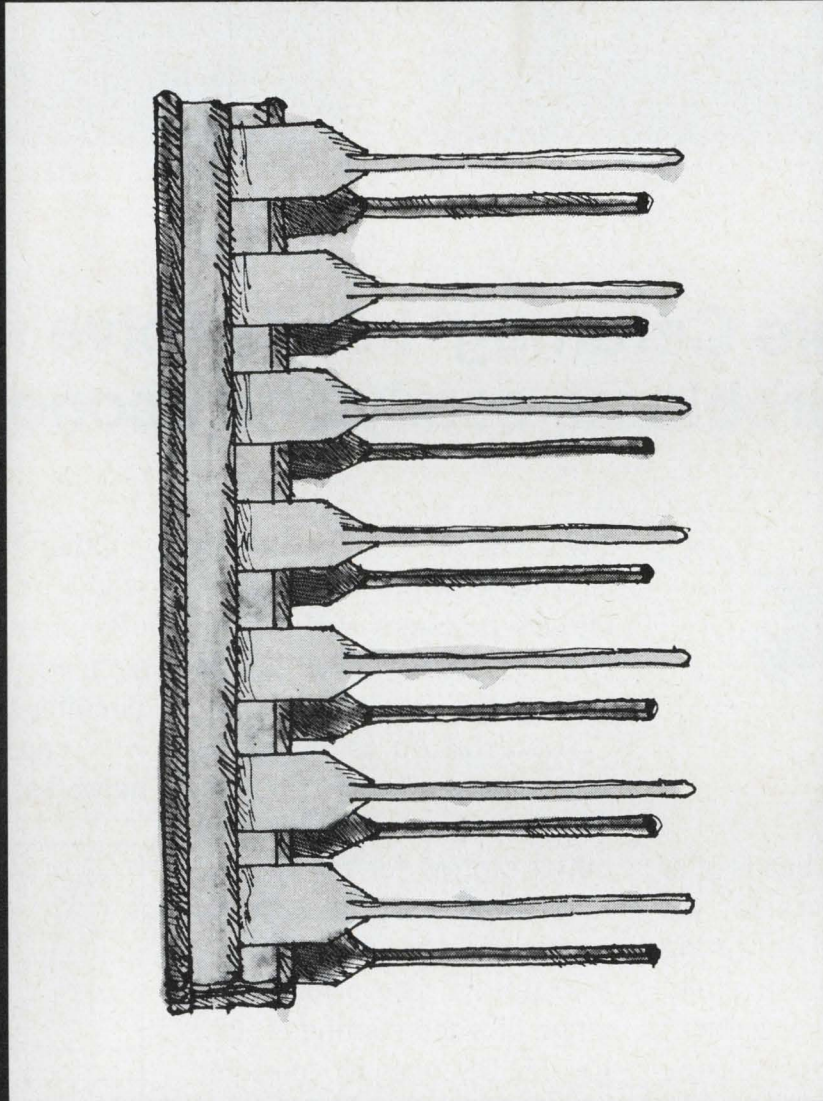

R-TX is Raytheon's equivalent of JAN-TX, extended to cover Raytheon IC's for which no JAN-TX standard has been established. For complete details, send for your Raytheon R-TX Standard on integrated circuits today. Raytheon Company, Semiconductor Operation, 350 Ellis Street, Mountain View, California 94040. (415) 968-9211.

RAYTHEON



Actual photographs show the filtering effect of Stackpole ferrite beads on critical electronic circuits. Left — without beads, right — with beads.

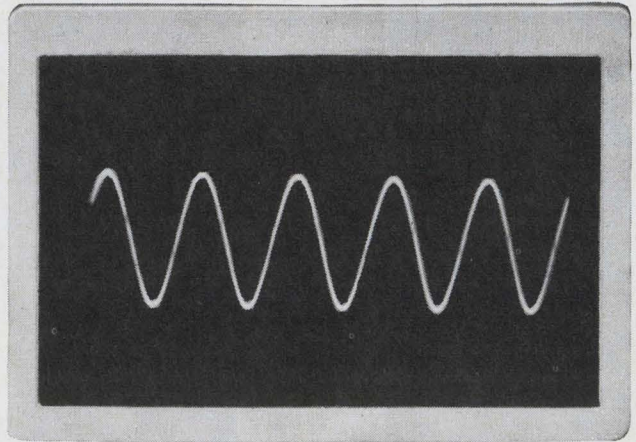
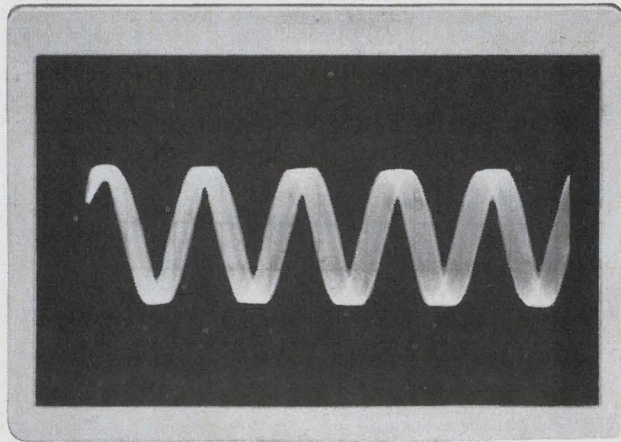

## Stackpole Ceramag® beads solve noise and filter problems easily and economically

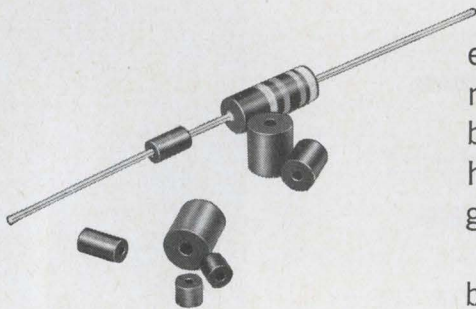

Ceramag® ferrite beads offer a simple, inexpensive, yet effective means of obtaining RF decoupling, shielding, and parasitic suppression without sacrificing low frequency power or signal level.

Unlike conventional RF chokes, beads are compact, have no DC losses, and will not couple to stray capacity and introduce detuning or spurious oscillations. Ceramag® beads offer an impedance which varies from quite low at low frequencies to quite high at noise frequencies. Beads need not be grounded; how-

ever, chassis contact is permissible when desired, as beads possess sufficiently high resistivity to preclude grounding.

Installation of Stackpole beads is easy. Simply slip one (or several) over appropriate conductor(s) for the desired noise suppression or high frequency isolation. Beads are available in sleeve form in a range of sizes starting at .025 ID, .060 OD, and .400 long. For special compact filtering applications such as cable connectors, beads can be supplied to tight mechanical tolerances.

Several ferrite grades provide a variety of attenuation characteristics. Inductance tolerance is normally  $\pm 30\%$  as measured on an LC meter. The performance of a Ceramag® 7D bead as a parasitic suppressor is shown in Figure 1.

Other typical applications might include: decoupling in "B" circuitry; noise suppression; RF isolation in filament circuits; use in combination with capacitors to form "L" networks.

FIGURE 1

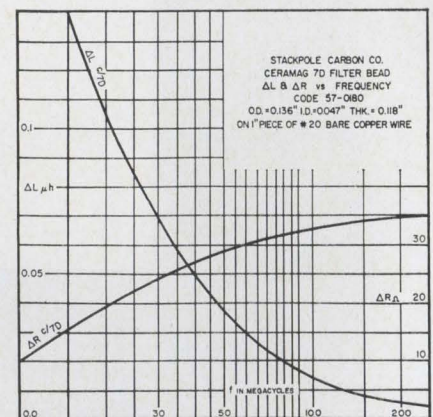

Sample quantities of Ceramag® beads are available without charge upon request. Send your requirements to Stackpole Carbon Company, Electronic Components Division, St. Marys, Pennsylvania 15857. Phone: 814-781-8521. TWX: 510-693-4511.





# R-TX

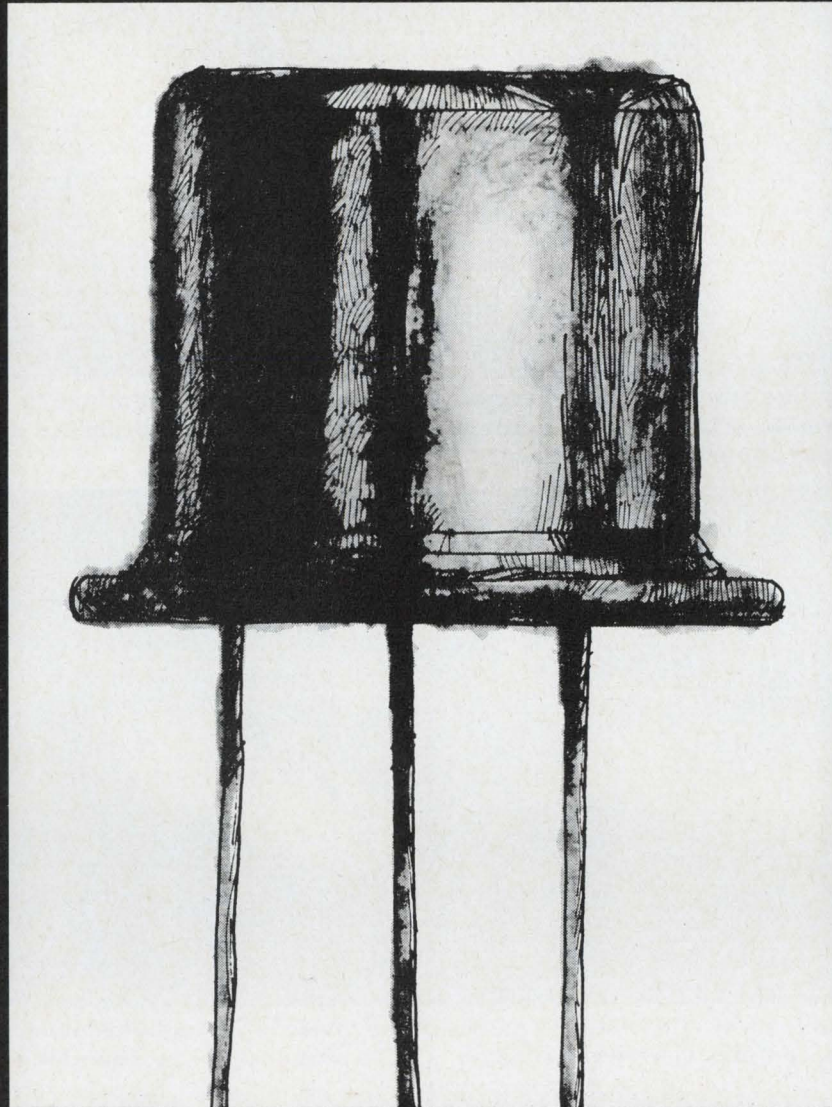

R-TX is Raytheon's equivalent of JAN-TX, extended to cover Raytheon transistors for which no JAN-TX standard has been established. For complete details, send for your Raytheon R-TX Standard on transistors today. And for complete information on Raytheon's standard line of transistors, send for our 1968 catalog as well. Raytheon Company, Semiconductor Operation, 350 Ellis Street, Mountain View, California 94040. (415) 968-9211.

RAYTHEON



# How AO fiber optic light guides solve illumination problems.

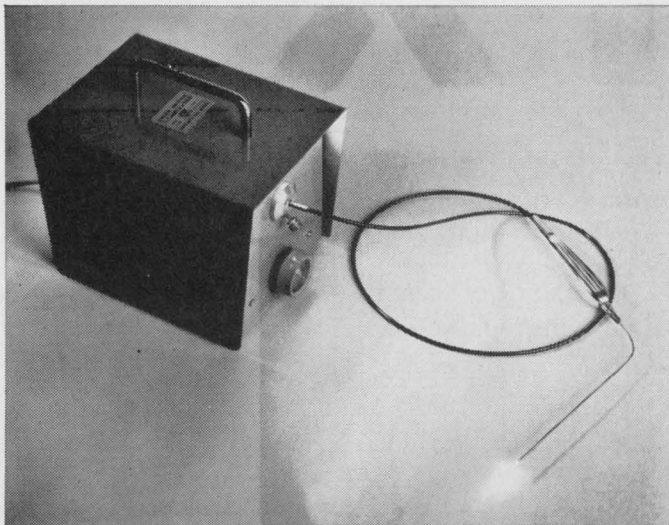

Transmit "cold" light like other forms of energy—by flexible routing to remote or inaccessible locations, hazardous areas, or any abnormal environment.

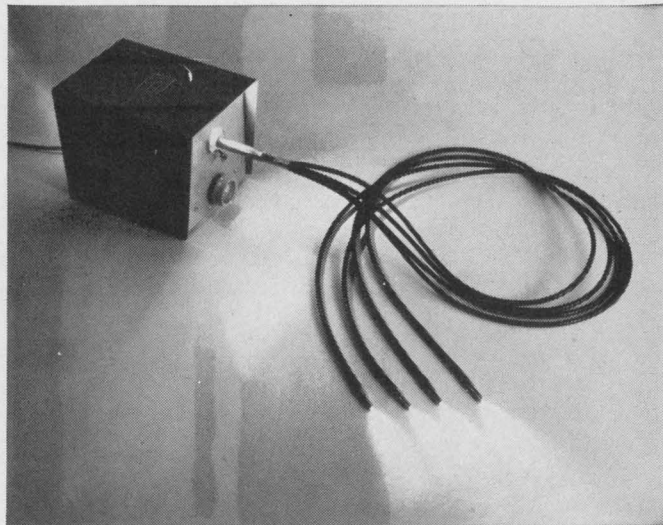

Supply multiple illumination from a single light source, with multi-branched light guides.

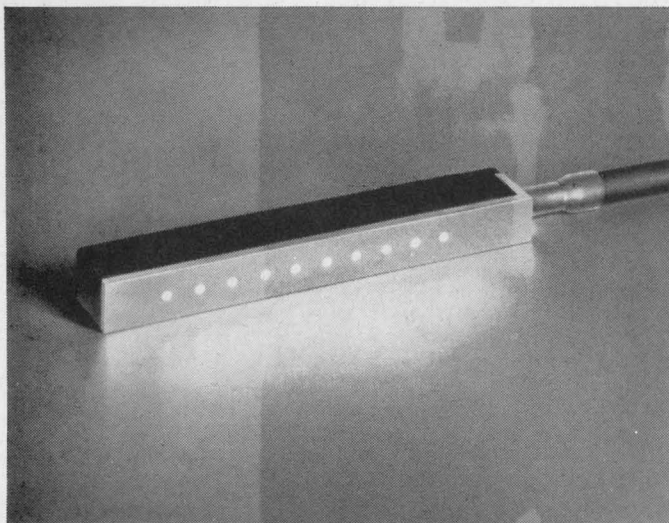

Simplify lighting problems by eliminating lens systems, multiple lamps, complex electrical circuitry.

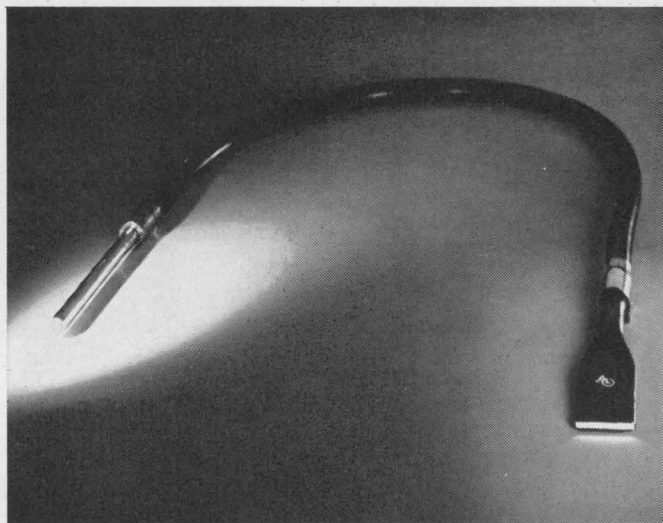

Provide input-output geometry conversions such as round-to-square, round-to-slit, etc.

These are only a few of the ways in which American Optical fiber optic light guides are used to help solve illumination problems. Specific applications range from mark sense readout to electro-optical sensing in data processing, circuit verification, fire control, null detection, light pens, spot illumination, and many others.

**Simple, reliable, economical.** AO fiber optic light guides are simple, passive elements which remain extremely reliable under normal vibration, temperature or humidity changes, or other environmental fluctuations. This results in long service life with minimum maintenance.

**Standard and custom light guides** from American Optical have light transmission ranges from 400 to 1500 millimicrons. Standard light guides are

available in bundle sizes from .020" to 1/4", with 30 to 6000 fibers, lengths up to 72", plastic or stainless steel tips, and PVC sheaths. Custom light guides can be supplied in any length desired, with special end tips, sheaths, diameters, input-output face configurations, and branchings.

**A leader in optics since 1833**, American Optical Company brings a great breadth of related experience to the technology of fiber optics. Our versatility in fiber optics is unmatched by any other manufacturer. In fact, AO scientists already hold more than 200 important patents or patents pending in this relatively new field.

**For Fiber Optics Data Kit**, send reader service card, or write to Fiber Optics Department:



**AMERICAN OPTICAL COMPANY**

Space-Defense Division • Southbridge, Mass. 01550



# When you're little you have to think fast or play dirty.

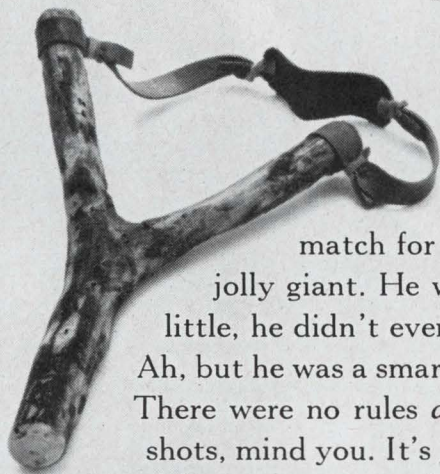

Take David, for instance. He was no match for that not-so-jolly giant. He was not only little, he didn't even play dirty! Ah, but he was a smart little devil! There were no rules *against* slingshots, mind you. It's just that our large friend had been getting by on his size so long that he turned into sort of a clumsy thinker.

David took an existing device, applied it to a new situation and bingo! One dead giant.

At MIDTEX/AEMCO we call that creative thinking. And we do a lot of it for our customers, because believe us, we don't get by on our size. Compared to some of the giants in the relay and time delay business

... we're a David.

But we think quick. And creatively. We've solved an unusually difficult time delay problem for Xerox, dozens of relay problems for Collins Radio and given solid assistance to RCA, Bruning, E. F. Johnson Co., and many more.

But we're not going to sit here and crow about what we did for somebody else yesterday, it's what we can do for you tomorrow that's important. So, if you have a giant relay problem, or giant timing problem, remember little MIDTEX/AEMCO. We're smart little devils ... specializing in dead giants.

How can anybody forget a ridiculous story like that?



AEMCO DIVISION  
10 STATE STREET  
MANKATO, MINNESOTA 56001

PROGRAMMERS/TIME DELAY RELAYS/MINIATURE COAXIAL RELAYS/INDUSTRIAL RELAYS/MERCURY-WETTED CONTACT RELAYS



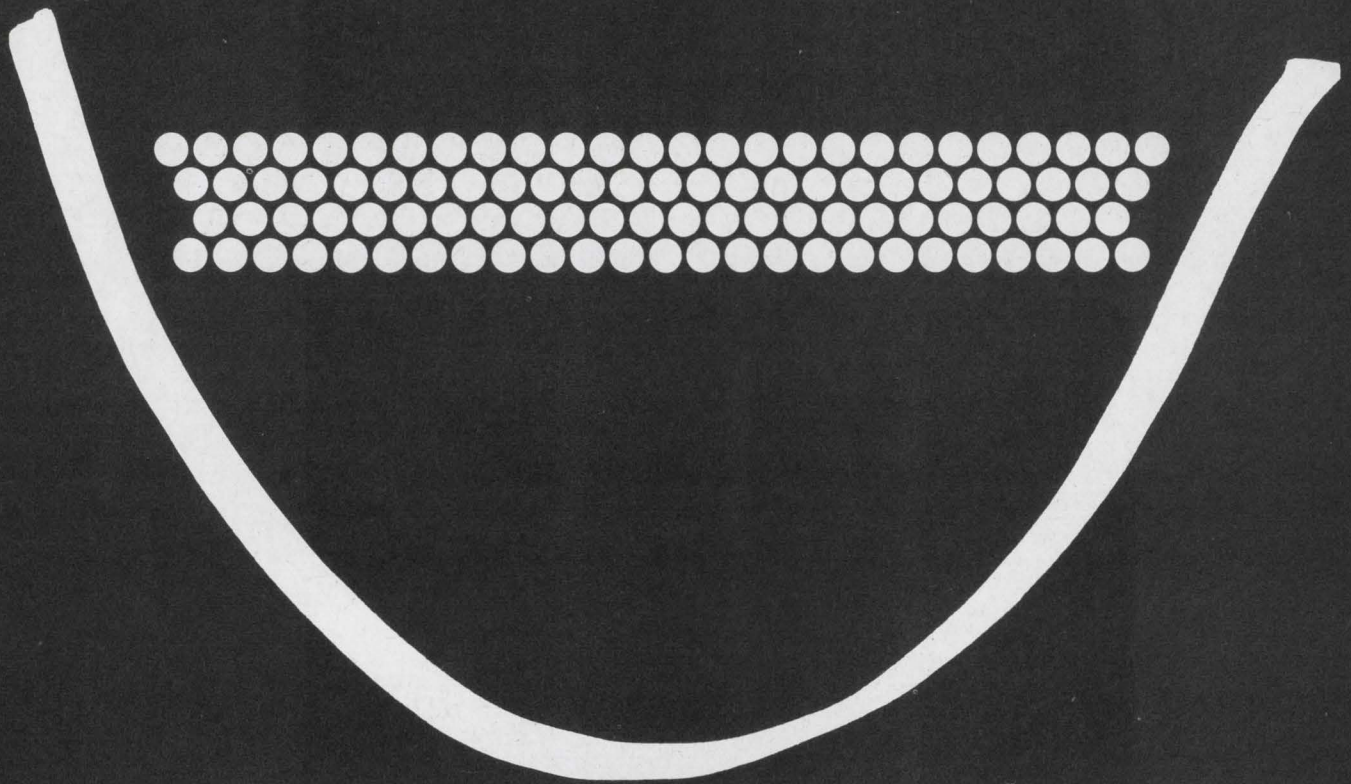

Now you can smile at weight and space problems...  
 We doubled the density of our D Subminiature connectors.

You can get out of a tight spot fast by specifying crimp, removable snap-in contacts in ITT Cannon's popular D Subminiature shell configurations with double the contact density!

You get two for the space of one in five different shell sizes. For instance, 100 contacts instead of 50. Also available in 19, 31, 52

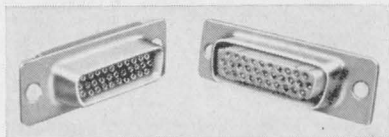

and 79 contact arrangement sizes — all on .075" centers.

The Double Density D is intermountable with our D Subminiature series, and uses the same wide range of accessories. The new series incorporates highly reliable CENTI-PIN® contacts which assure positive contact alignment and reduce contact bending, as well as providing a low noise level and electrical continuity even under severe vibration and shock.

These new Double Density D connectors are available in quantity now from your nearby ITT Cannon factory authorized distributor. For complete information write for Catalog 2D-1. ITT Cannon Electric, 3208 Humboldt Street, Los Angeles, California 90031. A division of International Telephone and Telegraph Corporation.





# Better Silicon Power Switch/Amplifier Ideas Are Available— Take It From The Authority!

All about designing with silicon power transistors with proven basic circuits acting as springboards for the designer's own requirements!

Chock-full of practical, comprehensive information every consumer and industrial circuit designer needs to know when using silicon power transistors, the just-released volume is highlighted by easy-to-understand, "how-to-do-it" topics like using direct coupling to eliminate amplifier transformers, outguessing the effects of damaging, secondary-breakdown transients, square wave forms and intermittent, irregular pulses, an exhaustive examination of AC to DC inverters, FET's and HV silicon in entertainment designs, and designing short-circuit-proof voltage regulators, to name a few.

Specific titled selections are:

- Low-Cost, High-Voltage Servo Amplifiers
  - Complementary, Solid-State Audio Amplifiers
  - Thermal Response of Semiconductors
  - The ABC's of DC to AC Inverters
  - A Method of Predicting Thermal Stability
  - Solid-State Video Amplifiers
  - New Solutions to Voltage Control Problems
- ... and much, much more that will make this a most-used design aid!

This more-than-120-page, 65-circuit edition is the latest Motorola-authored technical reference tool devoted to saving you time in design. It also incorporates the new Silicon Power Selector Guide... over 100 types — including the state-of-the-art Thermopad plastic devices — spanning collector currents from 30 mA to 30 A, collector-emitter voltages to 400 V, power dissipation ratings from 3.75 tp 200 W and  $f_T$ 's from 1 to 60 MHz.

**Your technical library isn't complete  
without it and it's yours for the asking.  
Resolve to get it today!**

Write on your company letterhead to Box 955, Phoenix, Arizona 85001.



**MOTOROLA**  
Semiconductors

*— where the priceless ingredient is care!*

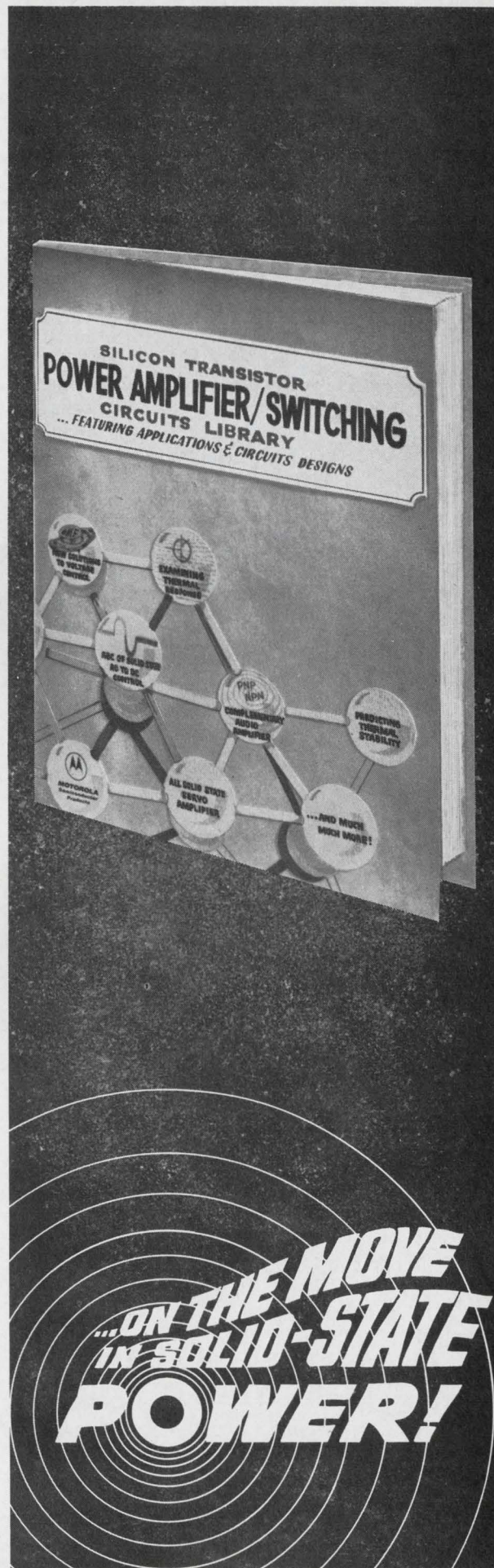



# How do you grundle the buyer of memory stacks?

(Take a powder and control it all the way).

The man who buys memory stacks (or planes or just cores) knows that a myriad of tiny variables which affect performance can pass right through the tightest spec. It's nobody's fault, but still it leaves the buyer disgruntled.

How to grundle him? Well, this is what we do at Ferroxcube. We control the entire process from formulation of the powder for the cores to the planes or stacks that go out the door. To the naked eye

much of this looks like textbook QC procedure. But some of it goes deeper. It's the kind of control you associate with a veteran airline pilot whose experience amounts almost to intuition. As pioneers in ferrites and core memory components, we have people like that in control at every vital stage of manufacture.

This is one reason why Ferroxcube can design and build to exacting requirements (example: military stacks that exceed the en-

vironmental requirements of MIL-E-16400 and MIL-E-5400). And it's the main reason why every production unit performs like the prototype you approved.

If you specify cores, planes or stacks, talk with the people who pioneered ferrite technology. As a conversation piece, a sheaf of technical literature awaits you. Write for it today.

**Ferroxcube**   
Saugerties, New York

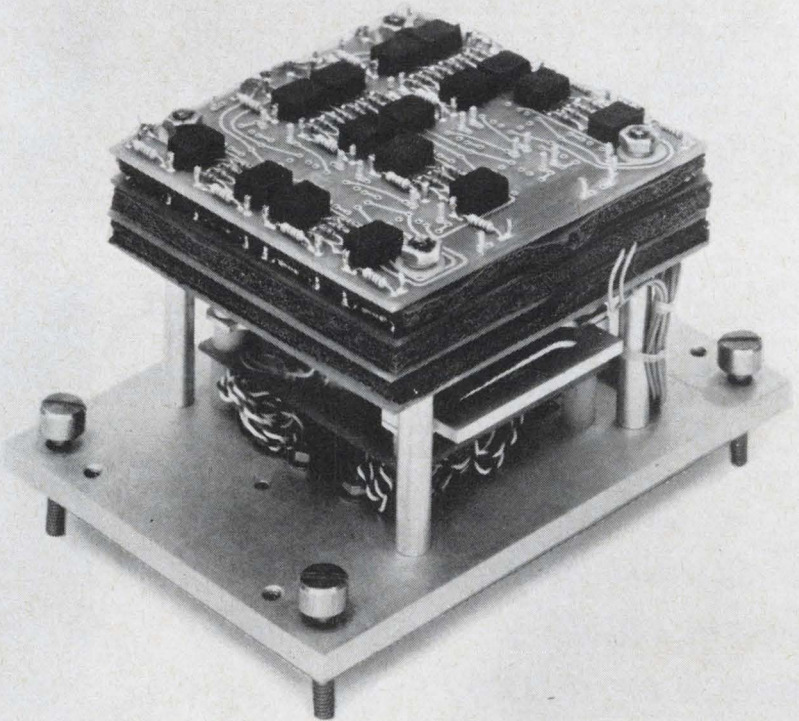

Albuquerque—Electronic Enterprises, (505) 256-1585; Baltimore—Eastern Components, (301) 322-1412; Dayton—(513) 253-3158; Encino, Cal.—(213) 788-2060; Englewood, Col.—(303) 771-2000; Houston—Noakes Engineering, (713) 529-6213; Irving, Texas—Noakes Engineering, (214) 255-0441; Lansing, Mich.—(517) 482-7140; Minneapolis—(612) 888-4681; Northlake, Ill.—(312) 261-7880; Orlando—(305) 841-6380; Philadelphia—Eastern Components, (215) 927-6262; Phoenix—(602) 265-1792; San Francisco—Wm. J. Purdy Agents, (415) 863-3300; Saugerties, N. Y.—(914) 246-2811; Union, N. J.—(201) 964-1844; Waltham, Mass.—(617) 899-3110; Toronto, Ontario—Phillips Electron Devices, Ltd., (416) 425-5161.



**WE  
AT  
COOK  
ELECTRIC  
ARE  
OUT  
TO  
CHANGE  
YOUR  
OUTLOOK...**

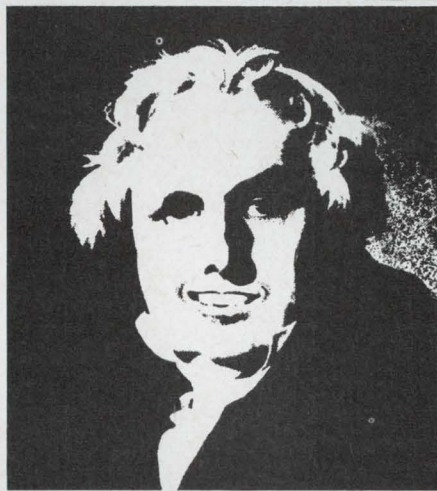
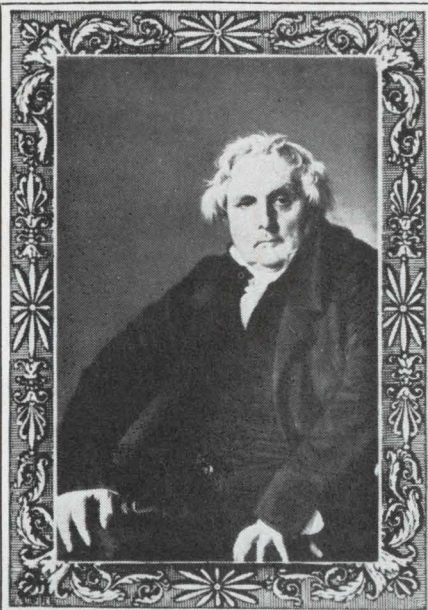

About sales and sales people. About service and delivery deadlines. About quality you can depend on. About new products to meet new requirements before the need becomes an emergency. For example, our relays and pressure switches have been solving industrial problems for 20 years... ranging from small manufacturing operations to the national space program.

Whether you need a component replacement today, or a specially-designed unit to meet a future need, count on us. We specialize in having solutions on hand before problems arise.

And if you're tired of promises unkept and delivery dates unmet, we invite you to investigate the production and service facilities of Cook Electric. You'll find it's good business. With us, performance comes before promise.



**COOK  
ELECTRIC**

AUTOMATIC CONTROLS DIVISION

200 E. DANIELS ROAD • PALATINE, ILLINOIS 60067 • 312-359-2100



## New miniature PC Correeds

Here's the pee wee edition of our famous dry-reed switches. Same efficient magnetic shielding as their big brothers. Same soggy-proof bobbins—made of glass-reinforced nylon.

All this with a low, low silhouette (just 0.350 inch above mounting surface).

MPC Correeds measure as small as  $1\frac{1}{32}$  inch by 1.350 inch. We located the terminals on 0.050 inch centers to match your board grids. You can stack them tightly in your racks—without magnetic interaction.



These space-saving little switches are perfect for high-speed applications. They're readily driven from transistors (their self-inductance is lower than their profiles). They give you an ideal interface between electronic and electromechanical circuitry.

Want some helpful new technical information? Just write to the Director, Electronic Control Equipment Sales, Automatic Electric, Northlake, Illinois 60164.

### **AUTOMATIC ELECTRIC**

SUBSIDIARY OF GENERAL TELEPHONE & ELECTRONICS

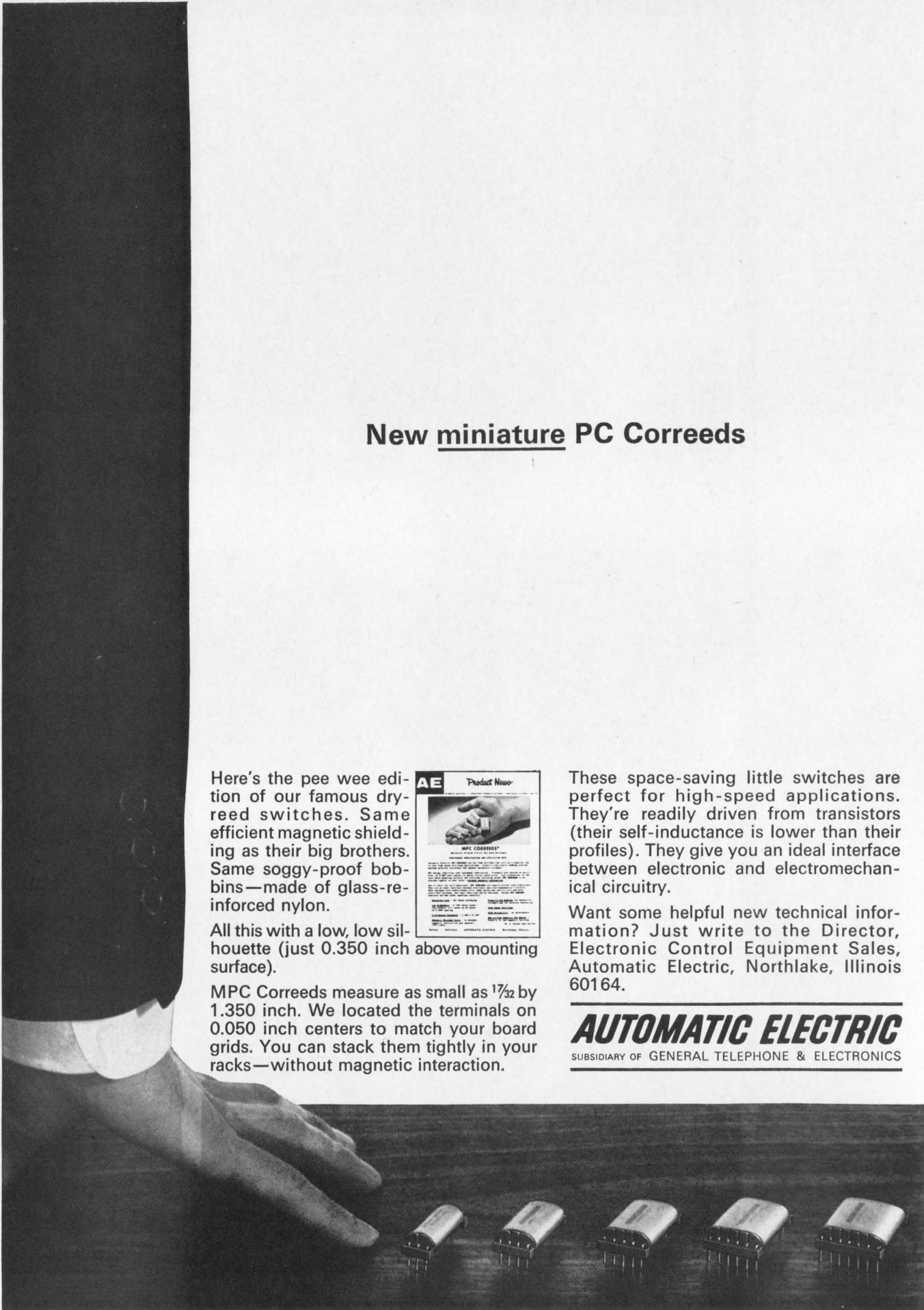



# How do most companies move a doodling, advanced-thinking, problem-solving computer systems engineer?

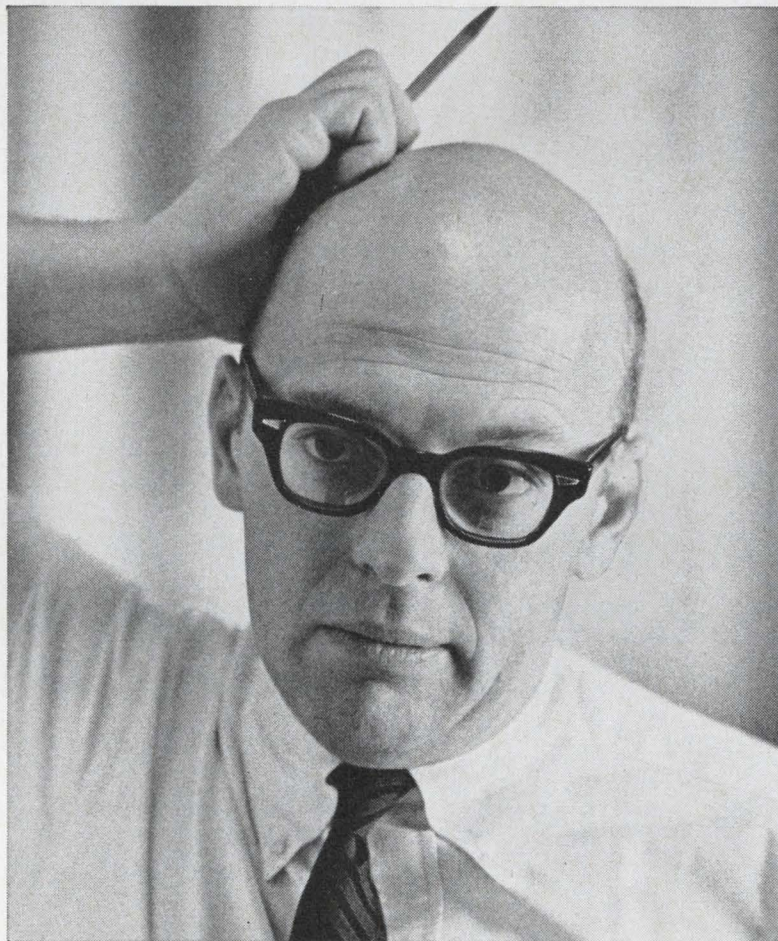

They choose a highly methodical, down-to-earth, know-how van line.

Allied Van Lines moves more computer systems engineers (doodlers and doers) than any other mover.

Call the down-to-earth Allied Agent where you are.







# *Small Wonder* the

Burroughs miniature rectangular NIXIE® tube is so well accepted! It is the smallest electronic readout available. For space-saving applications, excellent readability, greatest reliability and long life, the Burroughs Type B-4998 is the only answer. Now, because of its great popularity, Burroughs has effected production economies to reduce the price in quantities of 1000 to only \$13.95. For more detailed information on this NIXIE tube, associated driver modules and assemblies, contact Burroughs Corporation, Electronic Components Division, P.O. Box 1226, Department N5, Plainfield, New Jersey 07061 Telephone (201) 757-5000.

Tube photograph is actual size.

 **Burroughs Corporation**

Circle 84 on reader service card

*Only Burroughs manufactures NIXIE Tubes.*



# Technical Articles

---

**Guarding industry's  
electrical loads**  
page 86

When electrical machinery is connected to in-plant generators or to small electrical utilities that can't afford sophisticated frequency-regulating equipment, short-term variations in power-line frequency can throw it out of whack. These installations can protect themselves with a new guard circuit that sounds an alarm or disconnects the load when the deviation is potentially dangerous.

**Integrated circuits in  
action, part 9**  
**Digital techniques  
shrink recorder**  
page 93

A switch from analog to digital circuitry and the use of off-the-shelf ic's can cut the cost and size of an instrumentation recorder and improve its performance. The substitution of a digital one-shot multivibrator for an analog f-m discriminator in the playback circuit gives the recorder a bandwidth twice that of earlier versions.

**U.S. electronics  
markets: 1968**  
page 101

A compilation of market statistics by McGraw-Hill's economics department and Electronics' market research manager, Milton Drake.

**State of the mart:  
gains are slowed  
by war priorities**  
page 105

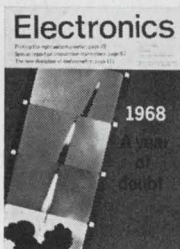

The unforeseen slowdown last year has made market analysts a bit cautious about 1968. Electronics' annual survey forecasts a modest 6.7% rise in electronics sales to \$22.6 billion. Although the war in Vietnam is squeezing many sectors of the industry and curtailing long-range research projects, 1968 shapes up as a year of technical advances. Integrated circuits are beginning to produce profits, and semiconductor houses are readying medium- and large-scale arrays for the marketplace. For the cover, art director Saul Sussman chose photographs of the Spartan, a key part of the Sentinel antiballistic missile system, to illustrate the market's strong military orientation.

---

**Coming  
January 22**

- Correcting errors in data transmission
- Time compression
- IC's cut counter costs



# Guarding industry's electrical loads

High-resolution circuit protects equipment sensitive to variations in power-line frequency by detecting deviations from preset limits and setting off an alarm or disconnecting the load

By Joseph Bodow

Bulova Watch Co., Woodside, N.Y.

**Many industrial operations** can't tolerate short-term deviations in power-line frequency. The daily corrections usually made by power companies suffice for most electricity consumers, but not for facilities where a sudden frequency shift will throw machinery speeds completely out of whack. These plants must have their own round-the-clock watchdogs guarding equipment.

The problem is especially critical when equipment is connected to in-plant generating systems or to small utilities that can't afford the cost of automatic, high-quality gear to regulate frequency. The larger the frequency deviation and the longer it lasts, the more serious is its effect on sensitive equipment.

Electrical installations can arm themselves against excessive frequency variations with a newly developed guard circuit. Using an integrated-circuit flip-flop and a tuning-fork oscillator, it senses the phase difference between a line-frequency signal and a tuning-fork, limit-frequency signal. When an excessive difference is detected, the circuit fires a silicon controlled rectifier whose pulse output can set off an alarm or disconnect the load from the line.

Reaction to a violation of a preset limit frequency can be made fast or slow, depending on

application needs. Monitoring a 60-hertz power line, for example, the circuit will respond in no more than 10 seconds to a 0.1-hz deviation, and in no more than 5 seconds to a 0.2-hz deviation.

## Change of phase

As long as the power-line frequency is within the limit frequencies, the guard doesn't interfere with normal operation. The reference oscillators essentially provide go, no-go control.

The high and low circuits are independent, so the guard can be designed to detect frequency excursion beyond only high or only low limits.

The circuit continually compares the instantaneous difference in phase between a cycle of the line frequency and the corresponding cycle of the reference frequency. If the two frequencies are constant but different from each other, the phase difference between the two will increase as time passes. When the accumulated phase difference reaches 360 electrical degrees, the circuit will deliver a pulse to indicate that the line frequency has slipped a full cycle, see page 88. This pulse can be used as a control signal to actuate an alarm, turn off the motors, or take other corrective measures.

The basic purpose of the guard circuit is to convert a phase difference into a corresponding d-c voltage that will trigger the generation of a control pulse by an scr. Consider a typical cycle. The circuit first shapes the line and reference signals to square waves, which then set and reset a bistable flip-flop. The flip-flop output is therefore alternately on and off, and the time duration of the on pulse,  $T_{on}$ , relates to the instantaneous phase difference. Disregarding the small voltage drop in the flip-flop, the on-state voltage equals the supply voltage,  $V_{sup}$ .

## The author



Joseph Bodow came to Bulova in 1946 as a technician, and four years later earned a BSEE from New York University. He is now laboratory director at American Time Products, Bulova's electronics division, where he specializes in tuning-fork oscillators, frequency generators, and timing devices.



The integration of the flip-flop output involves:

$$V_{out} = \frac{1}{T} \int_0^t V dt$$

$$= \frac{1}{T} [(V_{sup} \times T_{on}) + (0 \times T_{off})]$$

$$= V_{sup} \frac{T_{on}}{T}$$

Further, because T is the time for one cycle and is equivalent to a phase difference of  $2\pi$  radians, or  $360^\circ$ , then

$$V_{out} = V_{sup} \frac{\phi}{2\pi}$$

where  $\phi$  is the instantaneous phase difference between reference and line frequencies. Thus, the output voltage is  $V_{sup}/2$  for  $180^\circ$  phase difference. In general, the output voltage ranges between 0 and  $V_{sup}$  for each  $360^\circ$  of accumulated phase.

As the phase relationship changes, the d-c output voltage changes according to

$$\frac{dV_{out}}{dt} = \frac{V_{sup}}{2\pi} \times \frac{d\phi}{dt}$$

### Under pressure

Electricity in some refineries is generated from waste fuels and waste heat, and frequency regulations may be poor. Line frequency dips when electrical load rises, and when a 100-horsepower motor starts and the extra load causes a frequency dip, another motor, already on line and driving an hydraulic pump, say, will slow to a speed directly related to the reduced frequency.

Pump flow, though, is extremely sensitive to motor speed, and a prolonged change in flow rate can have severe consequences. A boiler not getting enough feed-water from the pump will undergo a fast rise in steam pressure and perhaps explode.

The guard circuit could be used in such installations to trigger an alarm or start up an auxiliary water pump when the situation begins to develop.

That is, the rate of change of integrated output voltage is directly proportional to the rate of change in the phase relationship. The larger the difference in the two frequencies, the faster the output voltages rises from zero to full supply voltage.

The set of waveforms at specific points in the guard circuit shows what happens when the line

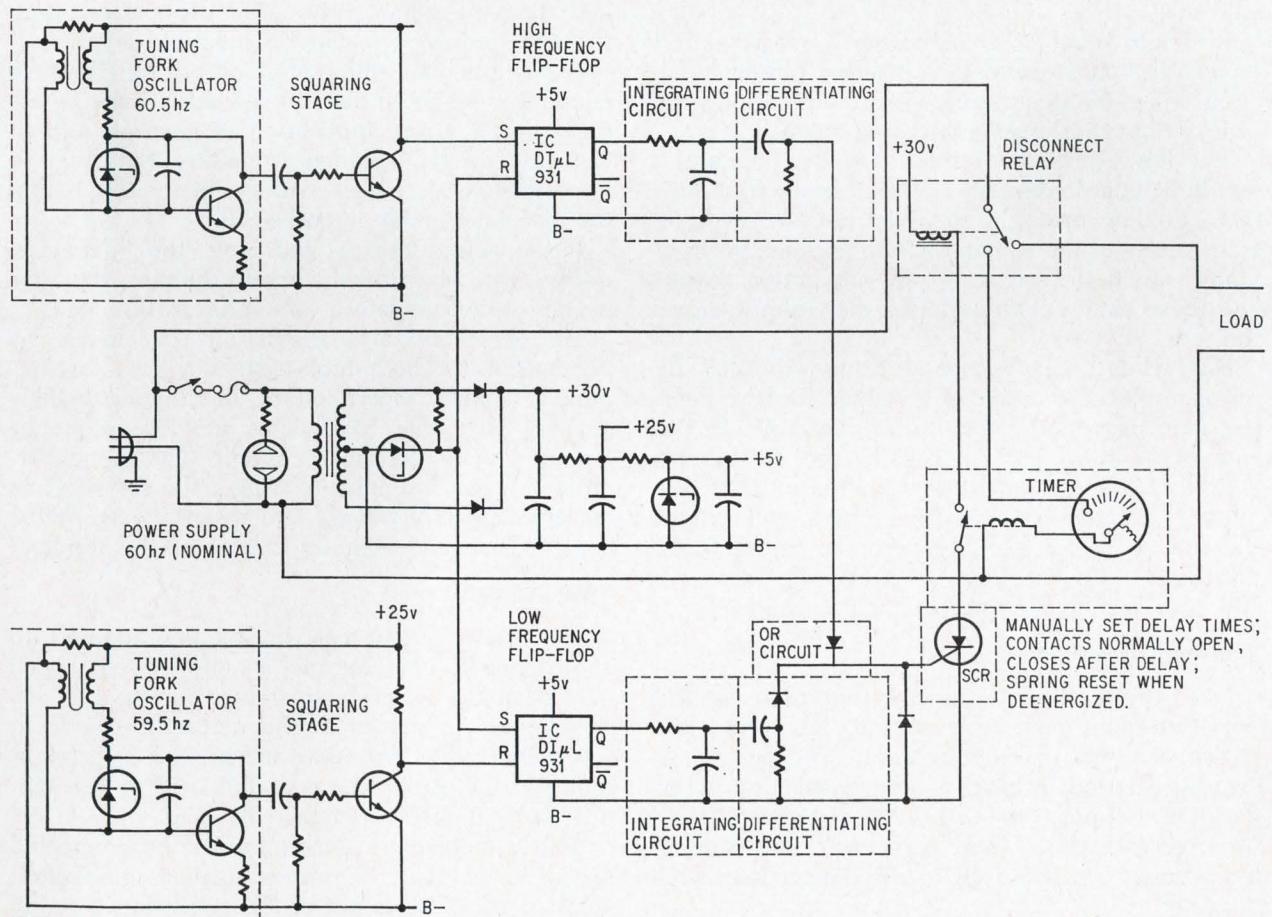

**Phase into pulse.** In each monitoring channel, a tuning-fork oscillator generates a reference frequency for comparison with the line frequency. An excessive difference between the two is converted—in flip-flop, integrating, and differentiating circuits—into a pulse that triggers the SCR.



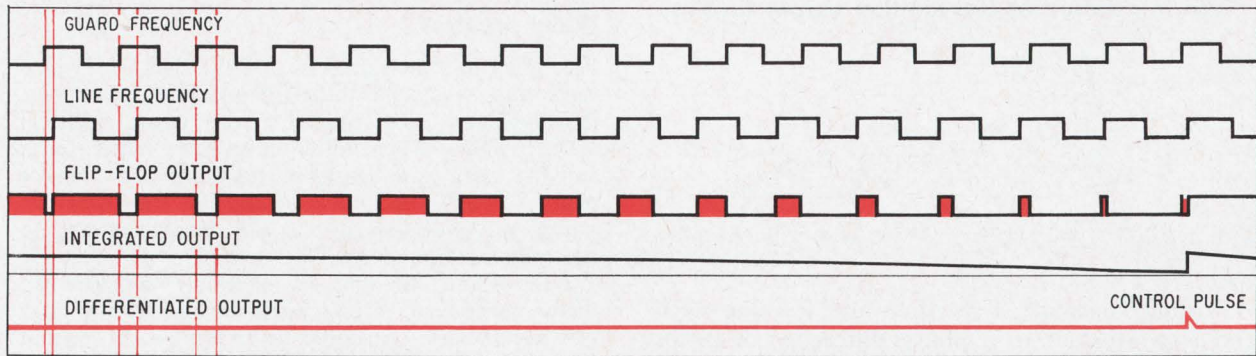

**Voltage spike.** When line frequency drops below guard frequency, the phase difference between them decreases until the integrator voltage reaches zero and suddenly rises to full value. The differentiator senses the rise and produces a positive pulse.

frequency drops below the low-limit guard frequency. The duration of the flip-flop's pulse output shrinks as time progresses, and the d-c voltage integrated by the resistor-capacitor decreases until the circuit slips a full cycle.

The differentiator circuit senses the rate of change of the integrated voltage. With a small frequency difference, the integrated voltage changes slowly. The differentiated voltage is practically zero in this case except when the phase shift reaches  $360^\circ$ , at which point the differentiator produces a sharp positive pulse that triggers the silicon controlled rectifier.

It should be noted that the SCR is sensitive only to positive pulses, and that positive pulses in the circuit, page 87, occur only when the line frequency is less than the lower guard frequency.

The lower portion of the schematic indicates a low-limit guard frequency of 59.5 hz monitoring a 60-hz line. According to the polarities assigned, line frequencies of more than 59.5 hz produce positive-going sawtooth waves at the integrator output, and these yield negative pulses that cannot trigger the SCR.

But when line frequency drops—to 59.4 hz, for example—the output d-c voltage forms a negative-going sawtooth with a uniform slope. In this case it would be  $(59.5 - 59.4)$  hz/sec, or 10% per second. Looked at another way, for a 0.1-hz frequency difference, a positive pulse will trigger the SCR every  $1/0.1 = 10$  seconds. For a 0.2-hz difference, the integrated voltage decreases at 20% per second, or once every 5 seconds.

### Working pulses

Once the SCR fires to indicate that an acceptable deviation limit has been passed, its output can initiate a visual or audible alarm. The pulses can also be counted in cases where knowledge of the duration and magnitude of the deviation is needed for open- or closed-loop correction. And one or more pulses can be used to disconnect load from the line.

The schematic shows how a load can be disengaged from the line when frequency deviation exceeds an allowable level, and restored when the

deviation is corrected. When triggered by the first positive pulse, the SCR energizes a disconnect relay that removes the load to be protected from the line and starts a motor-driven timer. After the set delay time elapses, the timer's contacts close, and this operates a relay whose contacts open the SCR anode circuit.

The disconnect relay then reapplies line voltage to the load for continued operation, provided the line frequency is no longer lower than the guard frequency. If it is still below the reference level, the disconnect relay again opens the load circuit and starts the timer, continuing this pattern until the line frequency reaches a tolerable level.

For a low-limit differential of 0.1 hz, the unit cuts out in no more than 10 seconds. If this is too quick for a given application, a separate circuit element can be included to assure that two or more successive pulses will be generated before the disconnect relay is energized.

If the cutout time is too long, the guard frequency can be doubled, thereby halving the time needed to accumulate a  $360^\circ$  phase difference.

The schematic also shows an SCR driven by the outputs of both high-frequency and low-frequency guards. Operation of the high-frequency channel is similar to that of the low-frequency circuit already described, except that the generation of a positive pulse to trigger the SCR requires an interchange of the set and reset signals, or the use of the complementary output of the flip-flop.

### Speed control

The guard circuit can be readily adapted to speed control. For example, a motor's shaft speed may decrease as mechanical load increases, even though line frequency to the motor is exactly at a specified value. Excessive mechanical load might indicate such problems as a dull drill or the failure of a clutch to disengage its load.

An a-c tachometer generator can be connected to the motor shaft to protect against out-of-limit shaft speeds. The output of the generator, suitably shaped to produce square waves, would serve as the guard frequency, and a tuning-fork oscillator would again act as the reference.



# Designer's casebook

Designer's casebook is a regular feature in Electronics. Readers are invited to submit novel circuit ideas, packaging schemes, or other unusual solutions to design problems. Descriptions should be short. We'll pay \$50 for each item published.

## Unijunction transistor controls stable one-shot

By David A. Brooks

Honeywell, Inc., St. Petersburg, Fla.

**Expanded pulse widths** from a one-shot multivibrator are always obtained at the expense of stability and recovery time. The capacitor and resistor changes that increase the pulse width lower the d-c bias points on the transistor and make the circuit susceptible to false triggering. These changes also increase the time constant of the turn-off voltage, prolonging the recovery time and giving the trailing edge of the pulse an exponential characteristic.

An external trigger designed around a unijunction transistor allows a stable multivibrator to expand a 5-microsecond pulse up to 100,000 times and maintain a recovery time of less than 10 microseconds.

In the circuit, the turn-on time of the output pulse is determined by the unijunction transistor. This assures a sharp output pulse. A computer's 5-microsecond pulse is thus able to generate a sharp and accurate 300-millisecond pulse to control readout equipment.

The computer's 1-microsecond pulse momentarily turns off  $Q_1$  removing the short on  $Q_2$ 's base and allowing  $Q_2$  to conduct. Transistor  $Q_2$  is driven into saturation by the supply voltage and enables the forward bias to be removed from  $Q_3$ ,  $Q_5$ , and  $Q_7$ , causing these transistors to turn off. The turning off of  $Q_7$  removes the collector of that transistor

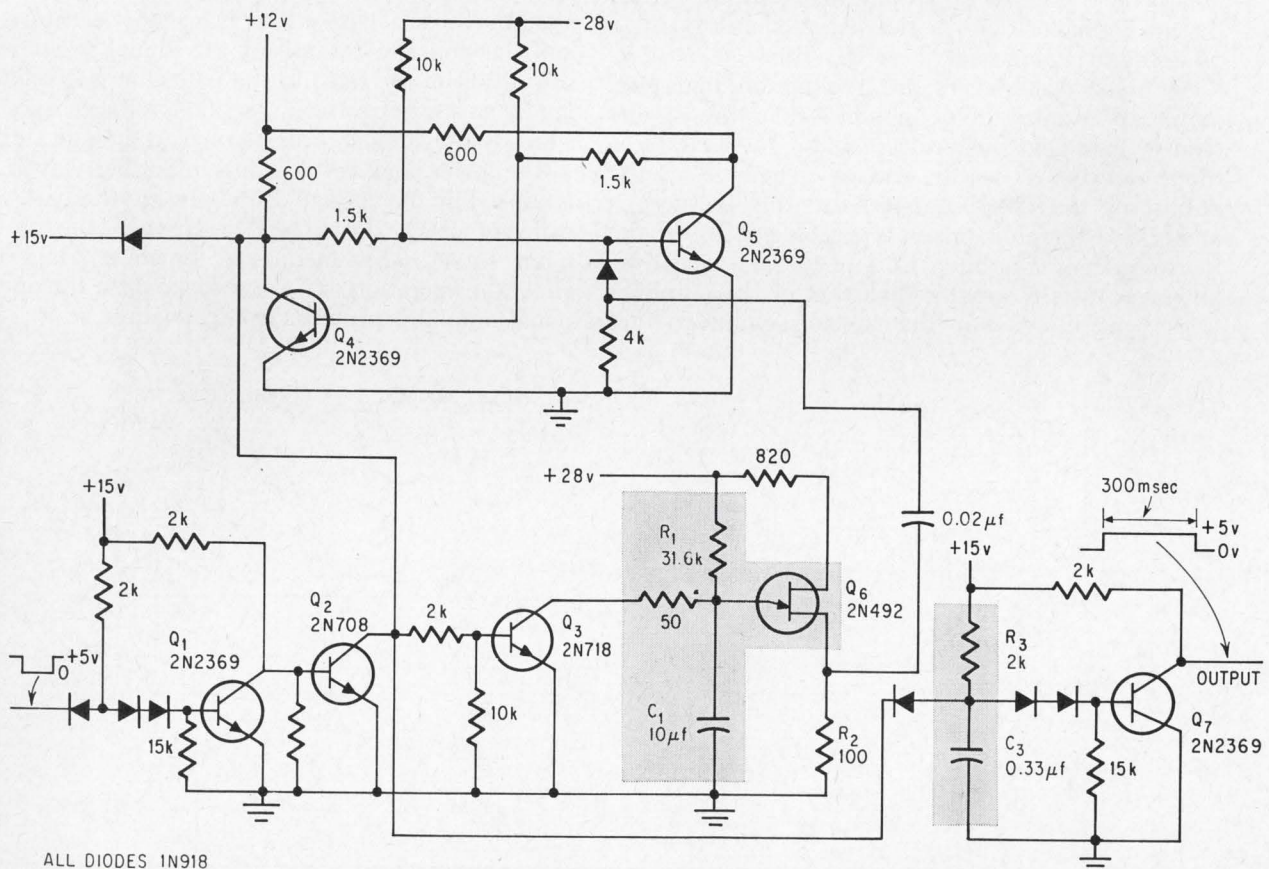

**Unijunction control.** The multivibrator when triggered by the unijunction transistor turns off  $Q_7$  and places the 5-volt collector supply on the output. When  $C_1$  discharges through  $R_1$  the unijunction transistor removes the trigger and the multivibrator turns off. After  $C_3$  charges through  $R_3$ ,  $Q_7$  turns off and the output is placed at ground.



from ground and establishes the leading edge of the output pulse.

When transistor  $Q_5$  turns off,  $Q_4$  turns on. Because  $Q_4$  is conducting the base of  $Q_7$  is kept at ground when  $Q_4$  turns on. The 5-volt supply is thus kept at the collector of  $Q_7$  until transistor  $Q_4$  is turned off.

As  $Q_3$  turns off, capacitor  $C_1$  charges through  $R_1$

to the firing potential of  $Q_6$ . Conduction through  $Q_6$  causes a voltage to appear across  $R_2$  that triggers  $Q_5$  into conduction. Transistor  $Q_4$  is now turned off and the 5 volts on the supply turns  $Q_5$  on and backbiases  $D_1$ . The output remains at 5 volts until  $C_3$  charges to a voltage that turns on  $Q_7$ . The collector of  $Q_7$  is now returned to ground and  $C_1$  discharges through  $Q_3$ .

## Single transistor rectifies agc signal

By Robert W. Knighton

University of Michigan, Ann Arbor, Mich.

**Full-wave rectification** of a low-frequency, automatic-gain-control signal is necessary for stable and precise control of an amplifier output. It can be accomplished with a transistor connected in a phase-splitting network.

At present engineers are relying on high-gain amplifiers to raise the voltage of low frequency agc signals to a level where it can be rectified by a diode network. The d-c voltage generated at the output of the diode network by this method is stable and therefore gives a precise control of the low frequency amplifier. Cost of the agc circuit is, however, usually greater than that of the amplifier it is controlling. For that reason engineers are

considering other low-frequency agc methods.

A transistor biased between its active and saturated region rectifies the low-power agc signal without attenuating that signal. The stability and precision of the d-c voltage produced by this method is close to that of the amplifier-diode method, and is much less expensive.

The positive portion of the agc signal backbiases transistor  $Q_1$  and causes the voltage drop across  $R_1$  to change. This places a negative voltage on the collector of  $Q_1$  identical in wave shape to the positive portion of the input signal. When the input signal swings negative, the transistor is saturated and the negative portion of the signal is coupled directly from the base to the collector. After filtering by an RC network the rectified voltage becomes a steady d-c voltage, proportional to the agc signal.

The lower peak voltage in the rectifier waveform is caused by the voltage drop between the base and collector of  $Q_1$  during the negative swing of the input signal. This inequality, however, does not affect the operation of the agc loop, since the operational amplifier provides compensation.

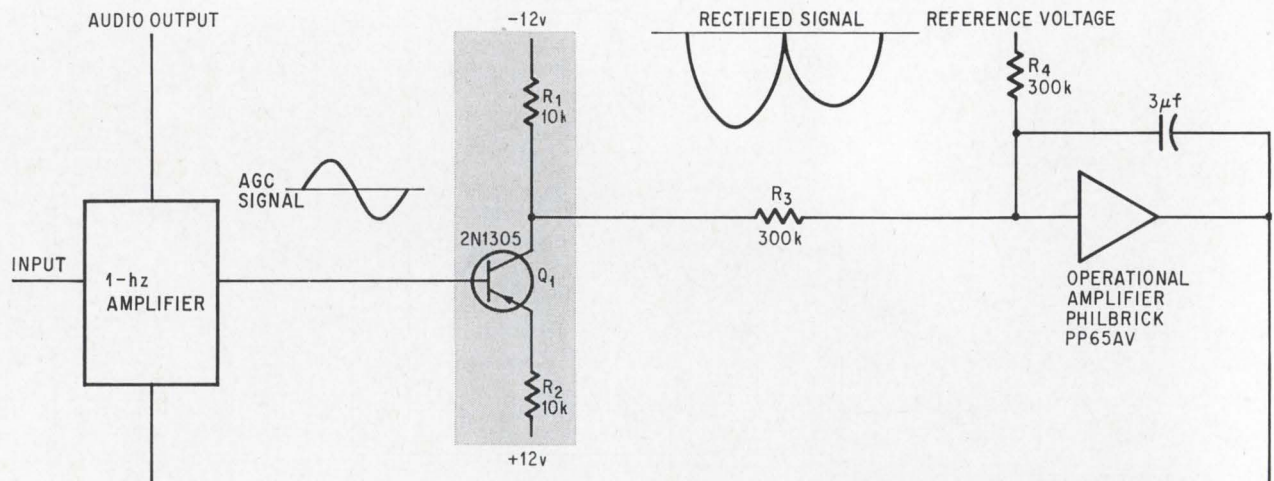

**Rectifying transistor.** A d-c voltage, proportional to the agc signal level, is supplied to the input of the operational amplifier by  $Q_1$ . The transistor, inverts the positive portion of the agc signal. Because it saturates the transistor, the negative portion of the signal can be transferred directly to the collector and results in full-wave rectification.



# Feedback protects spacecraft's power supply

By Russell Burkett

Aerojet-General Corp., Azusa, Calif.

A current-limiting feedback loop prevents persistent shorts in an inverter or its output circuit from draining the battery pack of a satellite.

When a short occurs, the low-resistance path between the supply and inverter is opened. Simultaneously a high-resistance path is switched between the supply and the inverter. This high resistance remains in the line as long as the short circuit persists.

Resistor  $R_1$ , between the collector and base of transistor  $Q_1$ , provides a current path necessary for starting of the inverter. Initial current flow through  $R_1$ , the emitter-base junction of  $Q_1$  and  $R_2$ , allows oscillations to begin and biases  $Q_1$  into its active region. As the a-c voltages in the inverter increase, a rectified voltage capable of driving  $Q_1$  into saturation appears on  $C_1$ . Thus,  $Q_1$  and  $R_2$  offer the only resistance in the line.

A high-surge current raises the voltage drop across  $R_2$  and biases  $Q_2$  into conduction. This prevents the voltage on  $C_1$  from reaching the base of  $Q_1$ , forcing that transistor into cutoff and placing  $Q_2$  and the current limiting resistor  $R_1$  in the line.

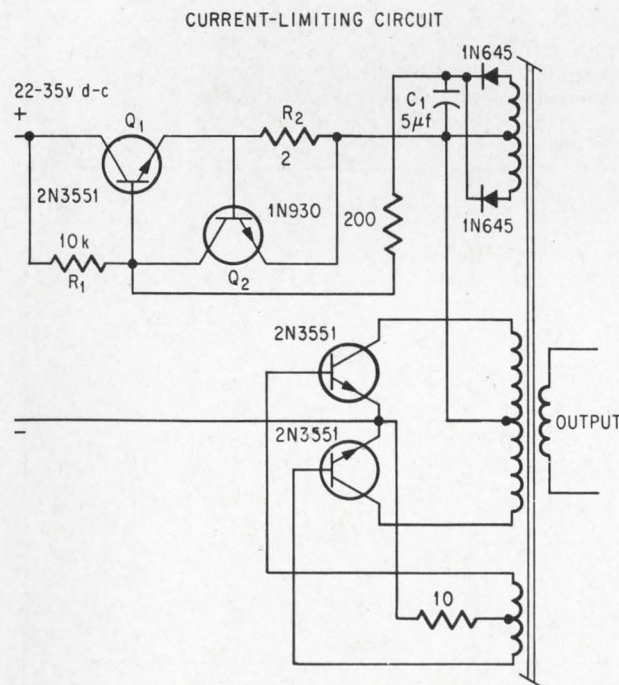

**Current limiting.** Resistor  $R_1$  is switched into the line to limit high currents caused by load or inverter failures.

# Detecting data errors boosts transmission accuracy

By A.E. Fein

Surface division, Westinghouse Electric Corp., Baltimore

Checking the accuracy of received signals in data-transmission systems requires complex and expensive equipment. This is particularly true for systems where errors can't be tolerated or where a high transmission rate must be maintained. However, applying time-spread coding provides a high degree of accuracy with less complicated hardware.

Time-spread coding is a technique that converts a burst of errors in a single block of data to a random distribution over several blocks, thus enabling the simple block codes to correct them.

A block of bits, or a word, is usually supplied with additional code bits that follow a Hamming code, for example. Assume that each block—including check bits—is 7 bits long and that the coding is to be time-spread over 9 blocks. The original bit stream would be  $a_{11} a_{12} a_{13} \dots a_{17} a_{21} a_{22} \dots a_{27} a_{31} \dots a_{37} \dots a_{97}$ . Under the time-spread concept, data is stored temporarily in a buffer memory, rearranged, and transmitted in the sequence:  $a_{11} a_{21} a_{31} \dots a_{91} a_{12} a_{22} a_{32} \dots a_{92} a_{13} \dots a_{93} \dots a_{97}$ . Thus:

### Bit matrix in buffer

```

a11 a12 a13 . . . a17
a21 a22 a23 . . . a27
a31 a32 a33 . . . a37
a91 a92 a93 . . . a97
    
```

Data and code bits form a matrix in the buffer, and the buffer is loaded row by row and emptied column by column. At the receiver, this bit stream, which includes both data and code bits, is re-grouped into its original word-by-word pattern for error checking.

In the Hamming code, first developed in 1950 by R. W. Hamming of the Bell Telephone Laboratories, several code bits are added to each data bit block. Each code bit establishes parity for groups of selected data bits. Thus if a word is received that contains an error, several parity checks identify the inverted bit. Hamming codes correct a single error in blocks of any size; however, larger blocks usually require proportionately fewer code bits. Also, codes can detect and correct multiple errors.

Hamming codes are most effective in channels where errors occur randomly and infrequently. Unfortunately, errors in most digital channels do not occur randomly; they tend to appear in clusters or bursts caused by lightning, solar flares, atmospheric noise, or fading.

The less complex error-correcting codes for ran-



domly distributed errors are relatively useless in channels where errors occur in bursts. Other more powerful and complex coding schemes that can combat burst patterns do exist, but their implementation is extremely complicated and expensive.

Time-spread coding adapts these simple codes to the error-burst situation. The technique spreads an error burst in the transmitted stream among the reconstructed words to prevent the appearance of more than one error in any code word. Longer bursts require either a multiple-error-correcting code or a larger spreading interval.

Despite its advantages, time-spreading techniques cause two delays in data flow. Consequently, memories at both the transmitter and the receiver must be loaded before the bits can be time-spread at the transmitter and regrouped at the receiver. In continuous-transmission systems, time shift of twice the time-spread period is required.

## Transistor replaces resistor and improves amplifier

By Maurice J. Wright

Joseph Lucas Ltd., Solihull, England

**Signal transfer** from a resistor-capacitor amplifier to its load is efficient and relatively undistorted when a transistor is used in place of the conventional collector resistor. The transistor develops the output voltage across its emitter and collector, using only a minute portion of the amplifier's collector signal. Most of the amplifier's alternating signal is used in the load, thus reducing the peak-to-peak current requirement in the collector.

The reduction in the collector current proportionately reduces the base current swing. Operation of the amplifier's transistor is therefore always on the linear portion of the base voltage-base current curve, assuring undistorted amplification.

The high impedance of the transistor makes the amplifier an ideal driver for magnetic tape heads, demodulators and galvanometers. The low frequency response of the amplifier is also improved by the high resistance in the collector.

In the amplifier at the upper right a peak-to-peak swing of 2.01 milliamperes in the collector current produces a 1 ma peak-to-peak swing in the load. If a 2.5-kilohm resistor replaces transistor  $Q_2$ , a 4-ma peak-to-peak swing in the collector current would

be necessary to deliver the 1-ma current to a 2.5-kilohm load. A 2.5-kilohm load was used to avoid distortion while keeping signal levels the same.

Maximum power output, achieved when the input signal sweeps the entire linear region of  $Q_1$ 's current-voltage curve, is 242 milliwatts at 22 volts. The high output voltages available from this amplifier, are attained because  $Q_1$  saturates  $Q_2$  thus placing the supply potential on the load.

In the complementary circuit at the bottom each of the transistors operate class A. Transistors  $Q_1$  and  $Q_2$  are in parallel;  $Q_1$  is the collector impedance for  $Q_2$  and vice versa. This amplifier can deliver 506 milliwatts at 22 volts to the load.

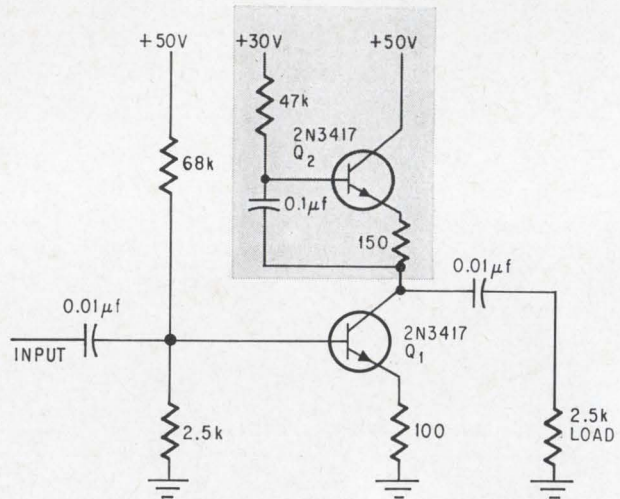

**Constant-current source.** Transistor  $Q_2$  offers a high impedance to the amplifier, requiring only bias current to develop the output voltage. Nearly all the collector current modulation of  $Q_1$  is delivered to the load.

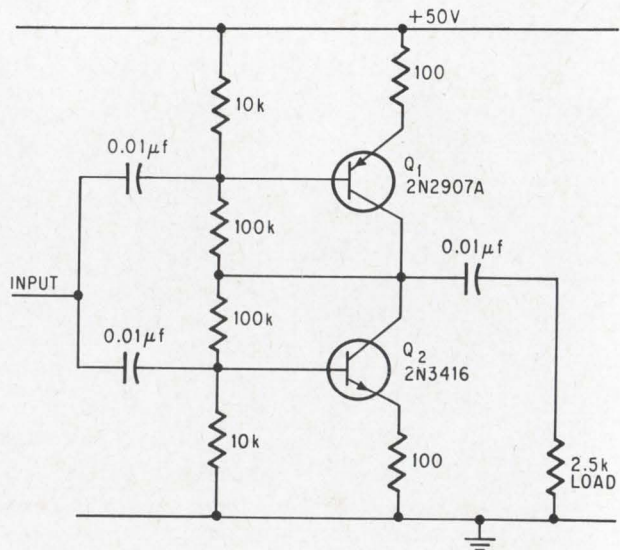

**High efficiency, low distortion.** Each transistor is both an amplifier and a collector load.



# Integrated circuits in action: part 9

## Digital techniques shrink recorder

Swing away from analog design also cuts costs and improves performance of magnetic tape machine

By Ivars P. Breikss

Honeywell Inc., Denver, Colo.

**When engineers at Honeywell Inc.** considered designing integrated circuits into the 7600 instrumentation recorder, they were trying to lower costs, reduce the product's over-all size and improve performance. That IC's filled the bill can be seen clearly from a summary of results: space savings amounted to 20%, material costs were cut by 10%, and assembly costs were dramatically reduced by a factor of 30.

The use of off-the-shelf IC's—mostly resistor-transistor logic (RTL), then the least expensive on the market—helped magnify the cost savings.

Substitution of a digital one-shot multivibrator for an analog f-m discriminator in the playback circuit was an important change in design. Together with other digital techniques employed, it doubled the recorder's bandwidth—yet the recorder was still capable of operating over a wide range of temperatures and duty cycles, just as it did in the medium-band version. And in the new circuitry, 11 integrated-circuit flatpacks took the place of about 30 components such as relays, a buffer amplifier, and timing capacitors.

The digital one-shot is one of the few functions that does not use RTL—it has both transistor-transistor logic (TTL) and diode-transistor logic (DTL).

### The author



A senior engineer at Honeywell's Test Instrument division, Ivars P. Breikss heads the group responsible for improving designs for the 7600 tape system. Before joining Honeywell two years ago, he was with Martin-Marietta's Denver division and the Ford Motor Co.'s Research Center.

The 7600 magnetic tape system consists of five functional circuits—control, tape handling, data handling (record/playback), power supply, and monitoring. The recorder is suitable for direct recording, narrow, medium, and wideband f-m recording, and digital recording. The basic machines can be made to operate in any of the three basic modes simply by inserting the corresponding printed circuit card in the data housing.

The system uses low-cost digital IC's like Fairchild's resistor-transistor logic (RTL) line and some monolithic operational amplifiers. Hybrid devices for the same functions were not economically competitive with discrete component circuitry.

Diode-transistor logic (DTL) would have made for a simpler design and lower can count, but RTL IC's were selected instead since this series was about 10 times cheaper than anything else on the market when the 7600 was on the drawing board.

Only one circuit, a one-shot multivibrator that operated as an f-m discriminator in the reproduce channel, was initially designed with a DTL, a type 951 IC. The reason: there was no RTL available that would meet the circuit requirements. However, the original f-m discriminator designed for the 7600 recorder is capable of operating only in a narrow- or medium-band recording system.

The digital one-shot multivibrator was designed to overcome this restriction. But DTL's proved inadequate in meeting the design requirements of the digital one shot and transistor-transistor logic was utilized instead. Specifying a center frequency after doubling of about 900 kilohertz and a maximum deviation of  $\pm 33\frac{1}{3}\%$  required a one shot period of approximately 200 nanoseconds.

The data-handling assembly and circuits process the input signals for recording on magnetic tape;



during playback, these circuits retrieve and amplify the recorded data to give a usable output.

**First try**

In the original medium-band f-m reproduce channel shown below, the retrieved signal first is restored to an acceptable square wave by a limiter circuit. Frequency of the square wave is then doubled; the output of the doubler triggers the one-shot multivibrator, a type 951 IC, functioning as an f-m discriminator. The signal passes through a buffer amplifier to a low-pass filter for integration and thence to an output amplifier.

If the buffer's output signal has equal positive and negative excursions and a duty cycle of exactly 50%, the integral of the output signal will be zero. A zero integral corresponds to a center frequency output from the record electronics voltage-controlled oscillator.

If the period of the one-shot is kept constant, the integral of the buffer output waveform increases in a positive direction as the frequency of the vco is increased. Similarly, the integral becomes negative as the frequency of the vco is decreased below the carrier frequency, as shown below.

Integration is performed by the low-pass filter. The same techniques utilized in the capstan control section are used here to reduce the center frequency as tape speed is decreased. The period of the one-shot is doubled each time the center frequency is decreased by a factor of 2. In addition, filters with progressively lower cutoff frequencies are switched into the circuit with relays as the center frequency is decreased.

The f-m recording system described works satisfactorily only if a relatively long and constant one-shot period can be employed. Two problems are immediately apparent. First, the period of the one-

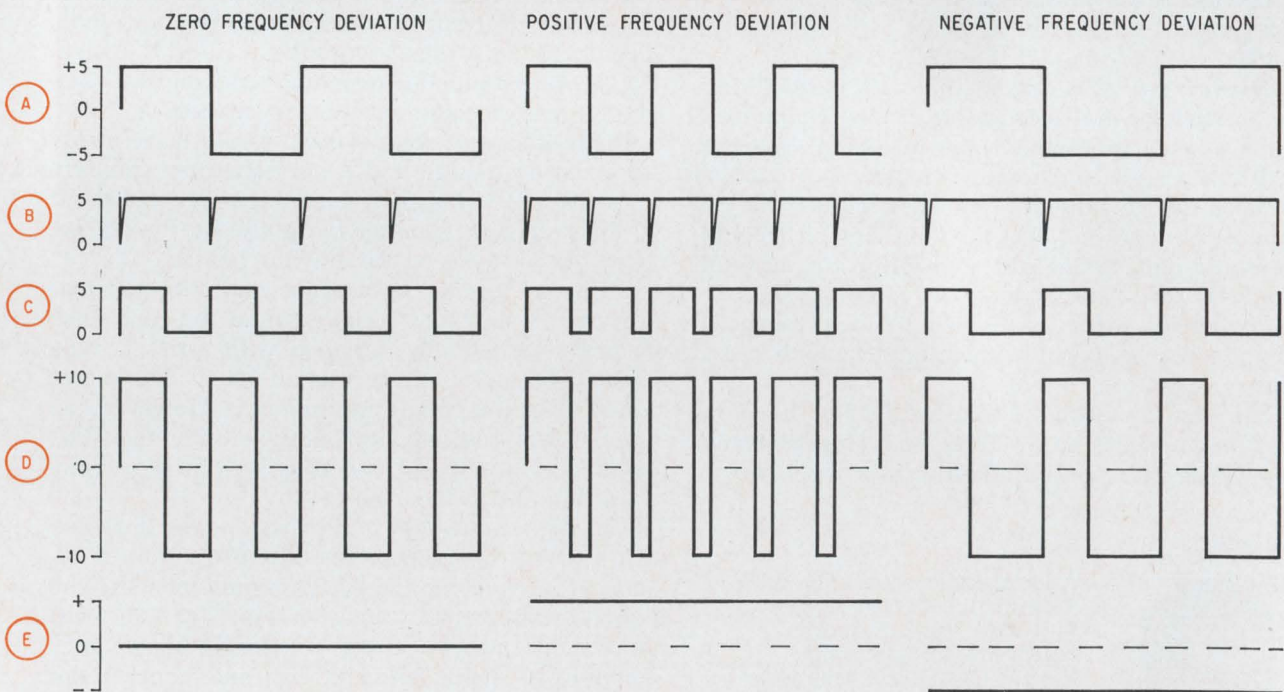
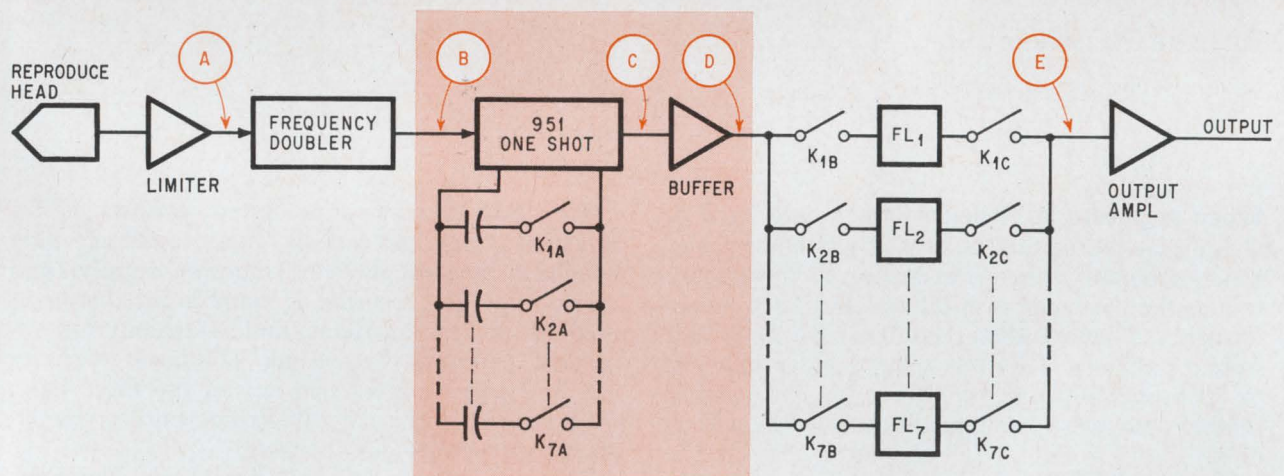

**Medium band.** IC one-shot functions as an f-m discriminator in f-m reproduction channel electronics. One-shot's period isn't constant enough over temperature range and duty cycle variations for this reproduction technique to operate properly over a wide frequency band. Switching to accommodate different tape speeds is done with relays. Waveforms show circuit's operation.



shot changes considerably as the duty cycle is varied, causing the reproduced signal amplitude to deviate from the original signal and yielding unacceptable signal linearity. Secondly, the one-shot's period is temperature-dependent to the extent that the transistor's base-emitter voltage is affected by temperature. This problem is more severe as the period of the one-shot is decreased to accommodate higher frequencies.

### A better way

An integrated circuit usually exhibits a lower degree of temperature-dependence because of its monolithic construction and close temperature tracking of the various components. Even so, the performance of the integrated circuit used in the analog f-m discriminator in the initial or medium-band recorder design was found inadequate at the higher frequencies found in a wideband recording system.

To meet the stiff requirements for a one-shot multivibrator in a wideband f-m system—a constant pulse duration with duty-cycle variations from 30% to 60% and temperature excursions from 0°C to 50°C—the digital one-shot design was conceived. Besides eliminating the temperature and duty-cycle problems, the digital one-shot approach also led to several other significant improvements:

- System linearity increased considerably because of the constant pulse width. Over-all linearities of  $\pm 1/4\%$  for a full deviation of  $\pm 33 1/3\%$  have been measured.
- Signal-to-noise ratio is improved because the duty cycle for  $\pm 33 1/3\%$  deviation can be increased beyond 70%.
- Reliability was enhanced because the period of the one-shot now is varied digitally instead of using relays.
- Product cost was decreased because the timing

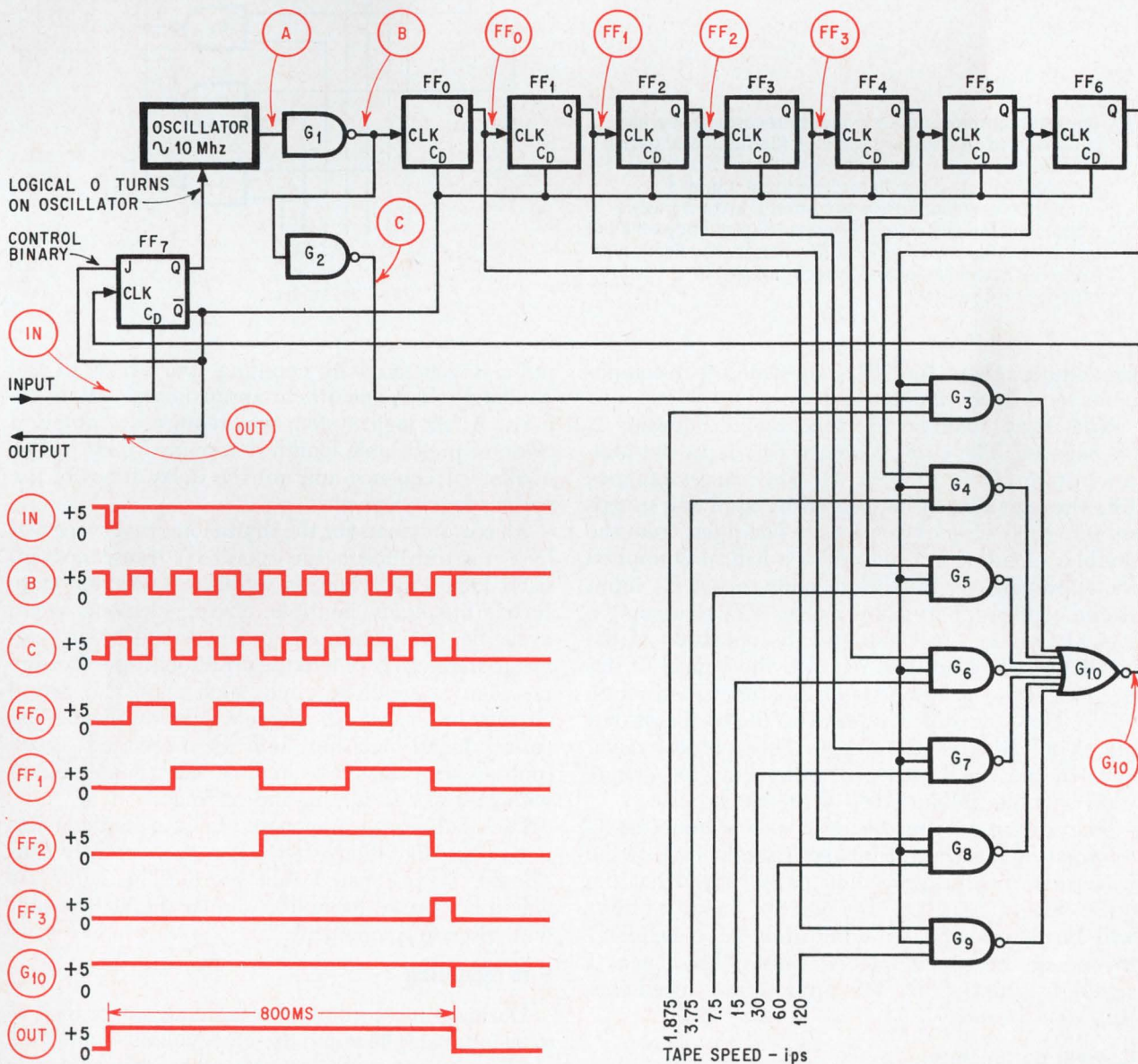

**Digital one-shot.** Digital technique for one-shot enables reproduce electronics to operate over wide frequency band. The digital one-shot replaces 951 analog one-shot, buffer amplifier, capacitors, and relays used in the conventional f-m reproduce technique. Switching is now done digitally by application of a mutually exclusive logical 1 from the tape-speed selector.



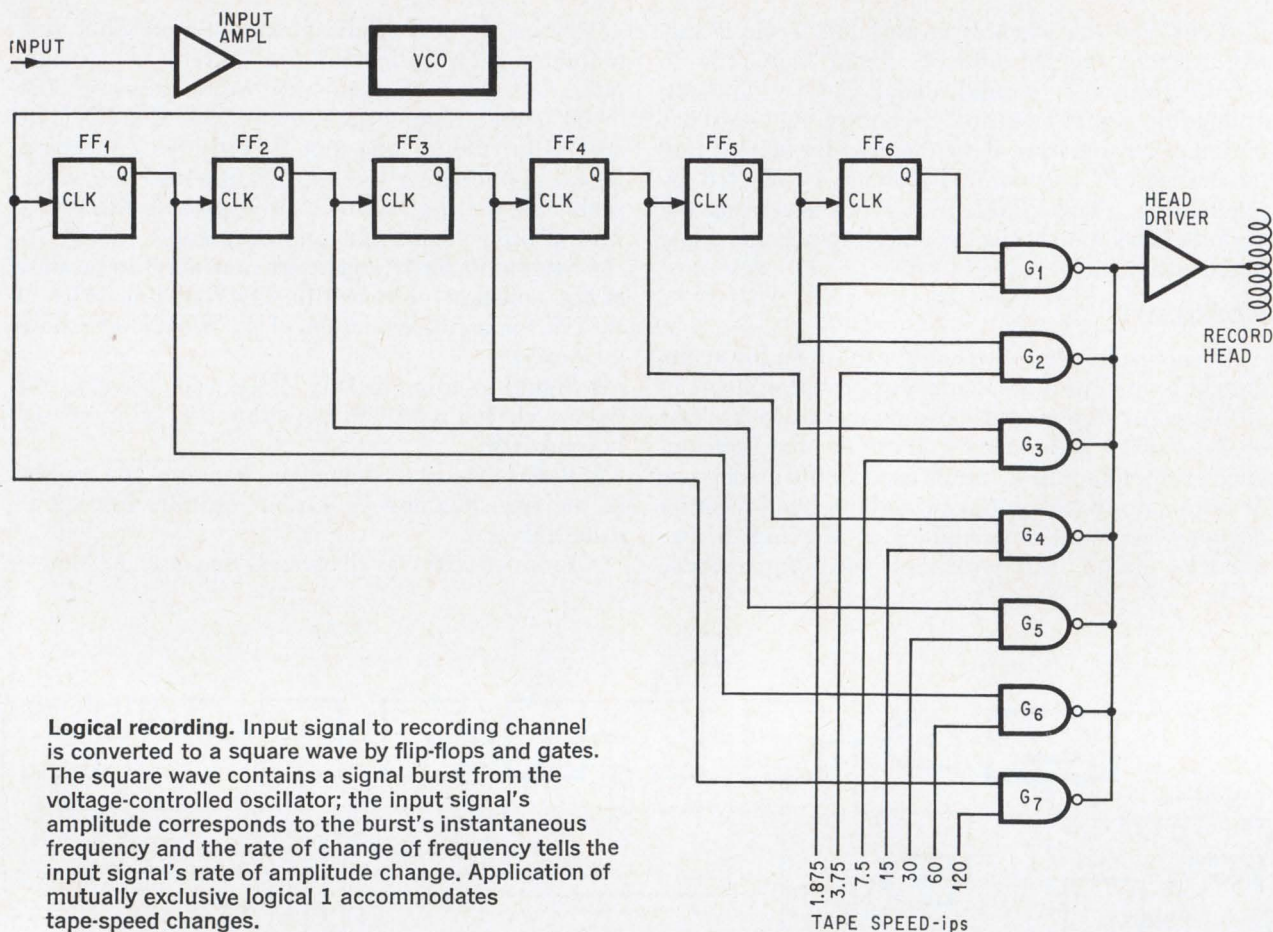

**Logical recording.** Input signal to recording channel is converted to a square wave by flip-flops and gates. The square wave contains a signal burst from the voltage-controlled oscillator; the input signal's amplitude corresponds to the burst's instantaneous frequency and the rate of change of frequency tells the input signal's rate of amplitude change. Application of mutually exclusive logical 1 accommodates tape-speed changes.

capacitors, relays, the 951, and some other components have been eliminated.

The logic diagram of the digital one-shot is on page 95. The control binary FF<sub>7</sub> is in the logical 1 state ( $Q = 1, \bar{Q} = 0$ ). This causes binaries FF<sub>0</sub> through FF<sub>6</sub> to be cleared by applying a logical 0 to their direct ( $C_D$ ) input. The input from the doubler circuit is in the form of a logical 0 applied for approximately 20 nanoseconds to the  $C_D$  input of the control binary. This causes FF<sub>7</sub> to assume a logical 0 state which initiates the operation of the oscillator, which in turn removes the logical 0 signal from the  $C_D$  terminals of binaries FF<sub>0</sub> through FF<sub>6</sub>. Gate G<sub>1</sub> is used to square up the oscillator output signal. Binary FF<sub>0</sub> changes state with the rising edge of the clock pulse; all other binaries change state with the falling edge of the clock pulse.

The output of the circuit is taken from the Q terminal of the control binary. Examination of the waveforms on the preceding page shows that the pulse length at Q of the control binary (FF<sub>7</sub>) will be determined by application of a logical 1 to one of the speed selector lines. This logical 1 signal is supplied by the appropriate speed-control logic circuitry.

### Critical parameters

Several IC parameters critical for this design precluded the use of DTL's. For example, speed. The narrowest pulse required was 200 nanoseconds. This

pulse is generated by counting two cycles of the oscillator which operates at approximately 10 megahertz. A fast logic system was required to obtain a pulse of predictable length determined only by the oscillator frequency and not the delay times of the various logic elements.

All requirements for the digital one-shot were met by Texas Instruments Incorporated's transistor-transistor logic (TTL) line. In addition to its adequate speed, numerous multiple circuit elements were available. One quadruple and two dual binary elements were used. Where the additional speed of the TTL logic was not required, such as in the gating circuits, lower cost DTL elements were utilized. The entire digital one-shot and its associated speed (pulse-width) selector circuitry was implemented with 11 14-lead, dual in-line packages.

Use of discrete components for the implementation of the digital one-shot was never seriously considered. It's estimated that more than 250 parts would be needed to build a similar digital one-shot with discrete components.

### F-m recording

During f-m recording, the input signal is applied to an input amplifier and then to a voltage-controlled oscillator. With no input signal, the vco output is equal to the f-m channel center frequency. As input voltage increases in the positive direction, the frequency of the vco increases. As input voltage in-



creases in the negative direction, the frequency of the vco decreases. If the vco's output is recorded, the recording will contain a square-wave signal where the instantaneous frequency represents the input signal's amplitude and the rate of change of frequency represents the rate of the input signal's amplitude change.

A dividing system similar to that used in the capstan servosystem reduces the vco frequency as tape speed is reduced. Each additional binary added to the countdown chain reduces the center frequency by a factor of 2. Percent deviation is not affected by frequency divisions.

IC's in the f-m record/reproduce assembly made possible a 13% space-saving over welded modules and 15% per track over discrete components.

### Digital speed control

As a standard recorder, the machine can operate at tape speeds of 120, 60, 30, 15, 7.5, 3.75, and 1.875 inches per second. Control circuits set the system's operating mode and speed. A phase-lock servosystem maintains the capstan speed constant to within approximately 0.1%. The phase-lock approach was chosen since it is the easiest to implement with digital integrated circuits. In addition the phase-lock method is independent of the power-line frequency

for speed stability.

Major components (see figure below) of the phase-lock servosystem are a reference frequency source, d-c capstan motor, and a code wheel mounted on the shaft of the motor.

The capstan drive motor is driven by the power amplifier. The power amplifier's input is from the phase comparator. Angular velocity of the capstan shaft is directly proportional to the output frequency of the code wheel amplifier. This frequency, in turn, is derived optically from alternate opaque and transparent areas on the code wheel using a simple light and photocell arrangement.

If the frequency of the code wheel amplifier's output ( $f_x$ ) is less than the control frequency ( $f_y$ ), output of the phase comparator is at a maximum and the power amplifier applies maximum voltage to the capstan motor. Then the angular velocity of the capstan increases causing  $f_x$  to increase. On the other hand, if  $f_x$  is greater than  $f_y$ , output of the phase comparator is zero and there is no output from the power amplifier. Under these conditions, the angular velocity of the capstan and, consequently,  $f_x$  decreases.

When  $f_x$  is within one cycle of  $f_y$ , both signals are in phase and the output of the phase comparator, and consequently the power amplifier, is be-

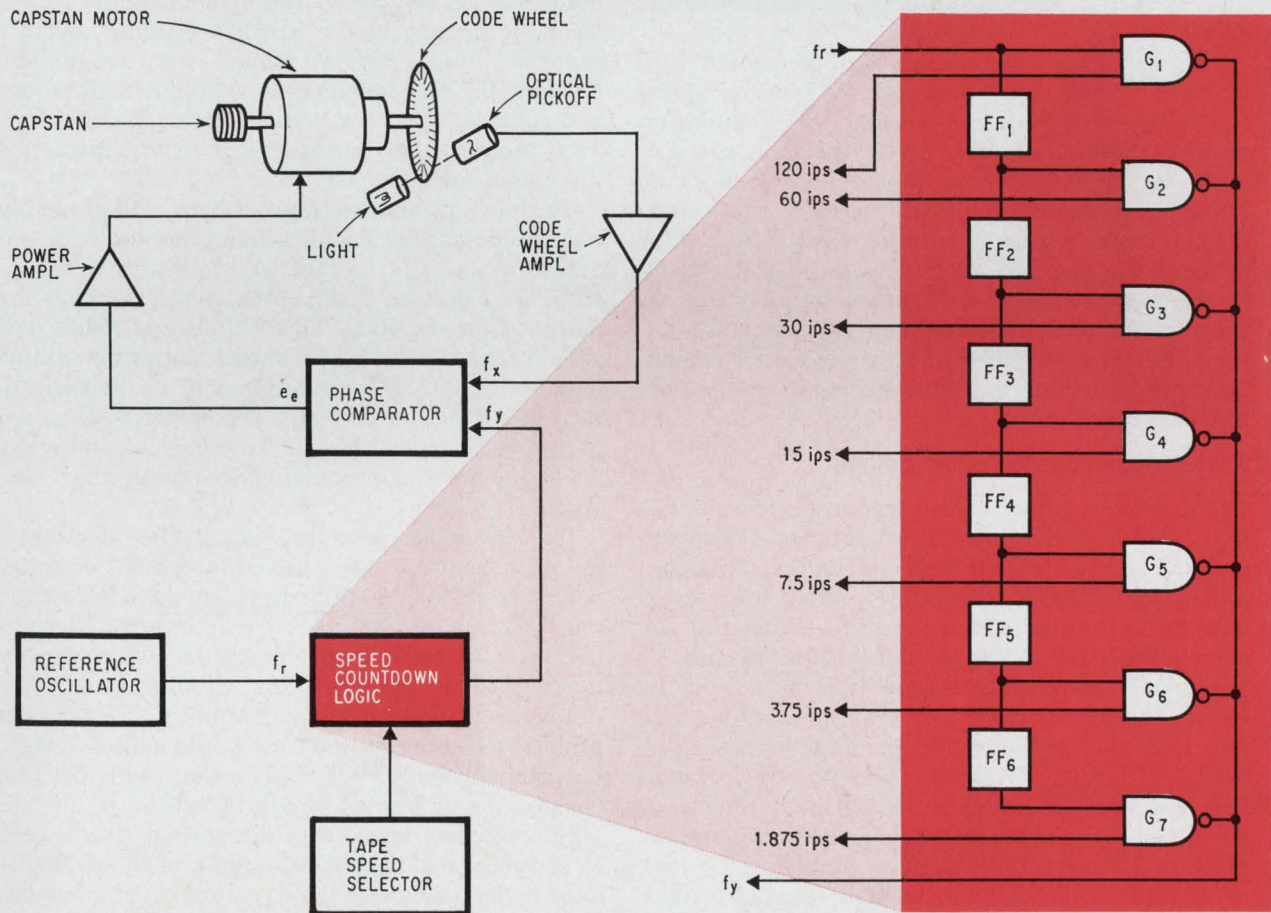

**Digital speed control.** Capstan speed is controlled by phase-locked servo loop. Optical pickoff signal's frequency and phase is compared to signal from reference oscillator. Output of comparator either increases or decreases signal to power amplifier to bring capstan to desired speed. Logic diagram of speed countdown circuit shows how reference frequency is controlled digitally.



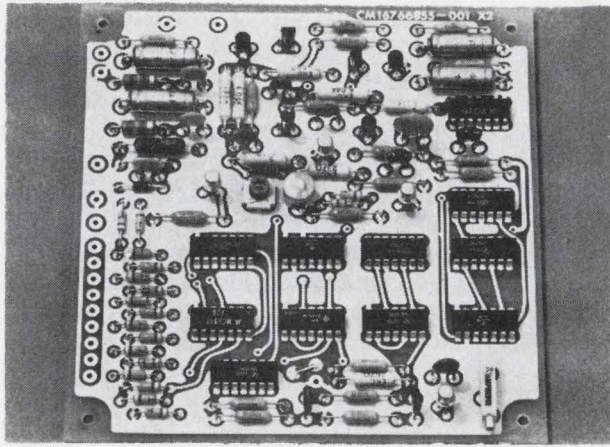

**All on one.** The digital one-shot, buffer, frequency doubler, and speed selector circuitry, all part of the 7600's f-m reproduce electronics, are mounted on one card. The 11 14-lead in-line integrated circuit packages constitute the digital one-shot circuitry. The oscillator is located directly above these IC's.

tween zero and maximum and the motor's speed is constant. This system tends to adjust the voltage applied to the capstan motor so  $f_x$  is always within one cycle of  $f_y$ . The greater the number of bits in the code wheel—several thousand in this case—the greater the accuracy of the angular velocity of the capstan motor.

The speed control circuitry is implemented with IC logic circuits (see page 97). When the speed control is set to the 120 ips position,  $f_y$  is the reference oscillator frequency  $f_r$ . As the tape speed is reduced, say to 60, 30, or 15 ips, one, two, or three binaries are switched into the circuit. This causes the reference frequency  $f_r$  to be divided by 2, 4, or 8. Since the angular velocity of the capstan is directly proportional to the control frequency  $f_y$ , its speed is reduced by a factor of two as each additional binary is switched in the circuit. In this manner, speed selections in ratios of 2 can be made with IC binaries and gates.

### Shaving components saves dollars

The savings gained by incorporating IC's into the tape-handling assembly were significant. If conventional components were used in the reel servo-amplifier, for example, four different circuits would have been needed with a total of at least 150 elements. But, the  $\mu A709$  amplifier required only 75 peripheral components, a reduction of 50% in the size of the circuit card. The same IC amplifier also saved the day in the digital preamplifier assembly. Without this IC, 29 components per track would have been needed. Similarly, using IC's in the count-down circuits enables seven components to take the place of 77 in the servo logic assembly.

By using IC flip-flops instead of discrete components, Honeywell saved what the transistors alone would have cost. Moreover, it is possible to get by with a smaller inventory—about 10% of equivalent discrete components. With the  $\mu A709$  in the digital

### Getting down to cases

This is the ninth in a series of articles approaching IC's chiefly from the point of view of users.

Part 1, which appeared in the Oct. 17, 1966 issue, examined design problems and solutions. This was followed by discussions of trends and tradeoffs [Nov. 14], reliability and misuse [Dec. 26], failure analysis [Jan. 23, 1967], and digital logic schemes [March 6].

The focus shifted to case histories last May 29 with "Shrinking a military calculator," by R. W. Ward of Motorola Inc. in which he described how both bipolar and MOS integrated circuits led to a small radar calculator that had low power consumption and high performance. In the Sept. 18 issue, "Cutting costs on the factory floor," by Michael French of the Potter Instrument Co., described the marriage of DTL and TTL in a redesigned coordinate-measuring machine. And in the Dec. 25 issue, two GE engineers told how IC's led to the use of range gates and filters in an airborne radar.

and servo preamps, for instance, inventory cost was cut 15%.

Even so, the move to IC's in the 7600 was not without its problems. Integrated circuitry required a special, low-voltage d-c power supply. Moreover, noise sources like the motors had to be decoupled from the circuits or the RTL IC's wouldn't operate properly. Interfacing headaches were avoided by heeding the IC manufacturer's fanout suggestions and resorting to a worst-case design scheme. However, the pluses of the shift to IC's far outweighed these minor drawbacks.

The next generation tape system will probably see resistor-transistor logic phased out and replaced with TTL's or DTL's. In fact, TTL's are now being incorporated in some of the optional accessories being designed for the 7600. This switch was made possible by the substantial price cuts in this monolithic logic series and by the development of the 14-lead, dual in-line plastic package. The switch to the dual in-line package will also help reduce assembly errors made on the production line with the 8- or 10-pin TO-5 cans.

It's becoming clear throughout the electronics industry that large-scale use of integrated circuitry is inevitable. When applied piecemeal, IC's cost too much, owing to the extensive interfacing designs necessary to make them compatible with conventional elements. But if entire circuits were to be put on tiny chips, interfacing would no longer be a problem. Development costs would still be high, but probably not much higher than with discrete components on printed-circuit boards.

Nevertheless, large-scale integration needs help to become a reality. First, the types of IC's available must be increased and their performance improved. Also, integrated circuit design techniques must mature, so that engineers can make the most effective use of the IC's on the market. That both requirements will be met is inevitable.



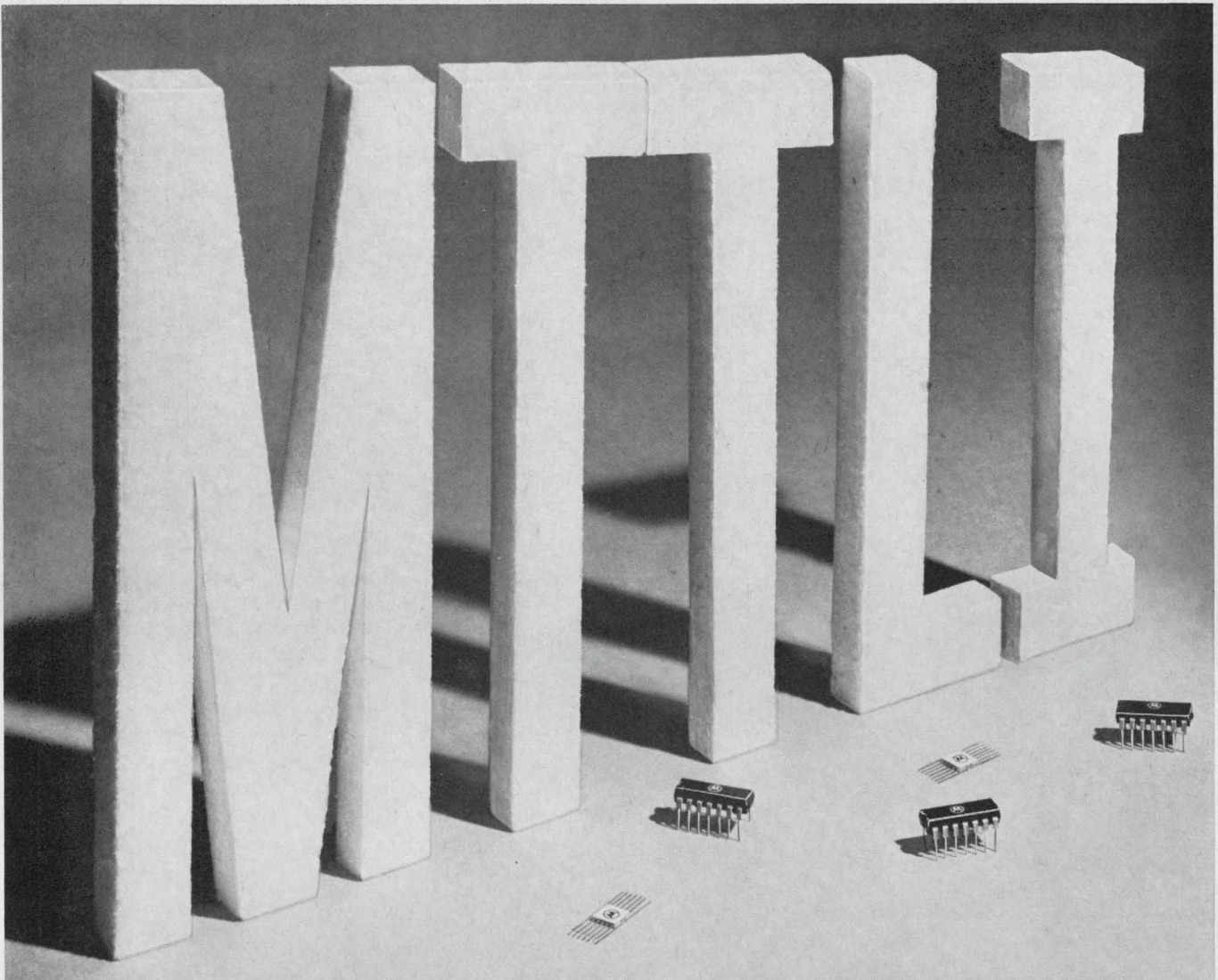

# MOTOROLA'S MTTL I SERIES INTEGRATED CIRCUITS SOLVE THE T<sup>2</sup>L "AVAILABILITY" PROBLEM

## MOTOROLA'S MTTL I SERIES PROVIDES OPTIMUM SELECTION & DESIGN FLEXIBILITY!

Motorola has production quantities immediately available of all circuit functions in the MTTL I (some call it SUHL\* I) T<sup>2</sup>L circuit series! Even the "hard-to-get" J-K Flip-Flops (SF50 & SF60) are readily available from Motorola. Just ask for MC515 or MC516 . . . or, any of the others shown at the right.

So, for systems now in production — or for new designs — you'll want to choose from our MC400/500 series (flat-packs or plastic) to fit all of your application needs. Don't wait on that important order that you're holding. Call Motorola, today! For complete technical details on these two popular series, write: P.O. Box 955, Phoenix, Arizona 85001.

MTTL is a trademark of Motorola Inc.  
\*Trademark of Sylvania

DESCRIPTION	-55 to +125°C F.O. = 15	-55 to +125°C F.O. = 7	0 to +75°C F.O. = 12	0 to +75°C F.O. = 6
Dual 4-Input NAND/NOR Gate	MC500 (SG40)	MC550 (SG41)	MC400 (SG42)	MC450 (SG43)
Expandable Quad 2-Input AND-OR-INVERT Gate	MC501 (SG50)	MC551 (SG51)	MC401 (SG52)	MC451 (SG53)
Single 8-Input NAND/NOR Gate	MC502 (SG60)	MG552 (SG61)	MC402 (SG62)	MC452 (SG63)
Dual 3-Input AND-OR-INVERT Gate (with complement)	MC503 (SG90)	MC553 (SG91)	MC403 (SG92)	MC453 (SG93)
Expandable Triple 3-Input AND-OR-INVERT Gate	MC504 (SG100)	MC554 (SG101)	MC404 (SG102)	MC454 (SG103)
Expandable Dual 4-Input AND-OR-INVERT Gate	MC505 (SG110)	MC555 (SG111)	MC405 (SG112)	MC455 (SG113)
Expandable Single 8-Input NAND/NOR Gate	MC506 (SG120)	MC556 (SG121)	MC406 (SG122)	MC456 (SG123)
Quad 2-Input NAND/NOR Gate	MC508 (SG140)	MC558 (SG141)	MC408 (SG142)	MC458 (SG143)
Quad 2-Input AND/OR Expander	MC509 (SG150)	MC559 (SG151)	MC409 (SG152)	MC459 (SG153)
Dual 4-Input AND/OR Expander	MC510 (SG170)	MC560 (SG171)	MC410 (SG172)	MC460 (SG173)
Dual 4-Input NAND/OR Expander	MC511 (SG180)	MC561 (SG181)	MC411 (SG182)	MC461 (SG183)
Triple 3-Input NAND/NOR Gate	MC512 (SG190)	MC562 (SG191)	MC412 (SG192)	MC462 (SG193)
Set-Reset Flip-Flop	MC513 (SF10)	MC563 (SF11)	MC413 (SF12)	MC463 (SF13)
J-K Flip-Flop (AND Inputs)	MC515 (SF50)	MC565 (SF51)	MC415 (SF52)	MC465 (SF53)
J-K Flip-Flops (OR Inputs)	MC516 (SF60)	MC566 (SF61)	MC416 (SF62)	MC466 (SF63)

All MTTL I circuits are available in the TO-86, 14-lead flat package ("F" suffix). Types MC400 thru MC466 are also available in the 14-lead, dual in-line plastic package ("P" suffix).

*-where the priceless ingredient is care!*



**MOTOROLA Semiconductors**



# Reader's Choice

## IEE introduces 10-gun CRT Display Tube



### New readout offers 12 advantages over tubes now in use.

The state of the readout art took on a new dimension recently when IEE, world leader in rear-projection readouts, introduced the 10-gun CRT — an unparalleled method for electronic projection of numbers, letters, messages, etc. Observers report character brightness and clarity, viewed on a fluorescent screen, are optimum under any ambient light condition. Powerless control grid switching... extremely low power consumption... small grid control swing... exceptionally wide view angle... all are features which make the new device ideal for instrument applications. Now available in quantity, all it lacks is a name!

#### Name IEE's new display tube and win a portable TV set!

On your company letterhead, describe a particular application for the new tube. Then fill in the coupon, attach it to the letter and send them to:



ADVERTISING DEPARTMENT  
7720 Lemona Ave.,  
Van Nuys, Calif. 91405

Sirs:

My name for the new IEE 10-gun CRT display

tube is \_\_\_\_\_

Name: \_\_\_\_\_

Firm: \_\_\_\_\_ Dept.: \_\_\_\_\_

Address: \_\_\_\_\_

City: \_\_\_\_\_ State: \_\_\_\_\_ Zone: \_\_\_\_\_

Entries must be in by Feb. 28, 1968. The judges' decision will be final.

## IEE bright, legible, wide-angle readouts:

Any characters desired  
Any colors or combinations  
Any input, BCD or decimal  
Any input signal level  
Any mounting, vertical or horizontal

Many sizes  
Many configurations  
Many lamp lives (to 100,000 hours)  
Many brightness choices  
Many options and accessories



**Standard Readouts:** Rear projection principle, like all IEE readouts. A lamp in the rear of the unit illuminates one of the 12 film messages, and projects it to the front viewing screen. Unbeatable readability and versatility.

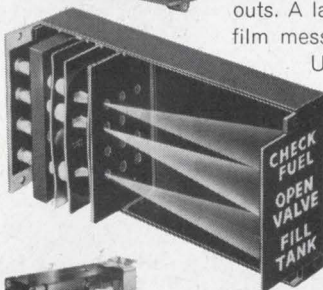

**Large Screen Readouts:** For reading distances up to 100 feet. Maximum character size 3 3/8".



**Miniature Readouts:** Only 1" wide x 1-5/16" high, yet can be read at 30 feet because of clarity of one-plane projection. Character size: 5/8".



**Micro-Miniature Readouts:** Only 1/2" wide x 3/4" high, but 20 foot viewing distance and maximum 175° viewing angle because of front-plane display. Character size: 3/8".



**Hi-Brite Readouts:** Special lens system increases character brightness 50%. Particularly good when high ambient light conditions exist.

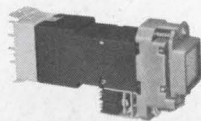

**Cue-Switch Readouts:** Rear projection readout with push-button viewing screen. Combination switch and display device.



**Bina-View Readout:** Accepts binary or teletype code, decodes, and displays the proper character.



**Status Indicator Readout:** Displays up to 12 different messages, individually or in combination. Viewing screen only 3 sq. in.



**Indicator Assemblies:** Available with up to 11 rear projection readouts, for indicating seconds, minutes, hours, days, etc.

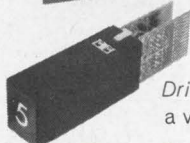

**Driver/Decoder Module:** Designed to work with IEE Readouts. Accepts a variety of binary codes for decimal conversion.

The new IEE Display Devices catalog gives complete information and specifications on these products, and their accessories. Ask for it.



"I-double-E", the world's largest manufacturer of rear projection readouts.  
Industrial Electronic Engineers, Inc. 7720 Lemona Avenue, Van Nuys, California



# Electronics Markets 1968

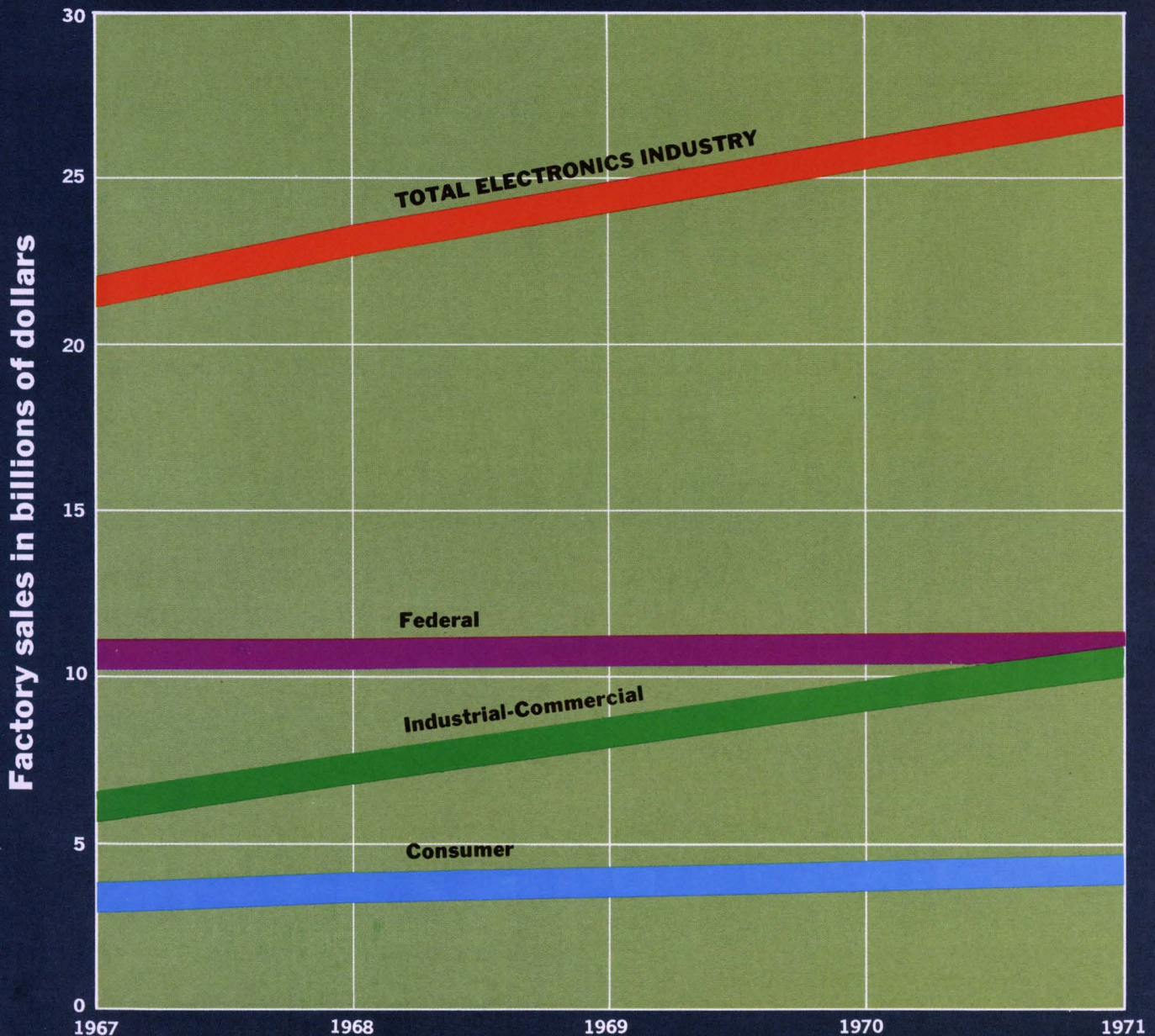

The market estimates in this tabulation are based on a survey conducted by Electronics magazine. Estimates are of U.S. factory sales in millions of dollars. This survey is not directly comparable to those made in previous years; some categories have been added, others deleted to reflect dominant trends in the field.



# Industrial and Commercial Markets

	1967	1968	1971
	(millions of dollars)		
X-ray equipment, therapeutic	25.2	28.4	33.3
Ultrasonic	3.4	4.5	7.5
Diathermy, shortwave and microwave	2.5	2.7	3.7
<b>Computers and related equipment</b>	<b>3,118.9</b>	<b>3,740.6</b>	<b>5,540.0</b>
Digital computers, except process control	2,420.0	2,855.0	3,980.0
Analog computers, except process control	46.5	60.3	100.5
Hybrid computers, except process control	42.0	47.0	65.0
Peripheral equipment, total	450.3	556.8	844.5
Converters, A to D	23.2	25.9	39.0
Converters, D to A	15.8	17.7	26.5
Converters, card to tape	7.1	7.3	3.1
Readers, paper tape	32.0	33.5	57.0
Readout devices (printers, plotters, crt's, digital displays)	164.4	221.5	318.6
Mass storage memories, total	207.8	250.9	400.3
Core memories	31.3	41.2	39.5
Magnetic tape machinery	62.3	67.5	83.7
Magnetic drum memories	17.5	24.0	48.0
Magnetic disc memories	96.7	118.2	229.1
Data transmission and acquisition equipment	160.1	221.5	550.0
<b>Nuclear instruments and equipment, total</b>	<b>113.4</b>	<b>135.9</b>	<b>179.0</b>
Pulse analysis instrumentation	16.4	17.4	19.5
Power supplies for nuclear equipment	7.5	8.2	15.5
Personal dosimeters	1.3	1.4	2.3
Radiation monitoring, portable survey instruments	3.2	3.7	5.3
Radiation monitoring, fixed position	4.0	5.0	7.4
Detectors (all, separate unit or part of system), total	7.4	9.0	12.4
Solid state (semiconductors, scintillation, crystals, and organic phosphors)	3.9	4.9	6.3
Tubes (geiger, gas flow, BF <sub>3</sub> )	2.8	3.3	5.0
Ionization chambers	0.7	0.8	1.1
Reactor controls	24.6	25.0	26.0
Nuclear instruments and equipment, other	49.0	66.2	90.6
<b>Communications equipment</b>	<b>1,288.8</b>	<b>1,438.5</b>	<b>1,828.3</b>
Radio, total	477.1	545.0	703.8
Airborne, including ground links	140.0	150.5	186.2
Land mobile	166.0	177.0	207.8
Marine radio	20.4	23.1	31.2
Microwave relay	84.7	121.6	189.9
Amateur equipment	28.5	30.8	38.7
Citizens band equipment	37.5	42.0	50.0
Navigation, total	112.4	147.6	255.8
Radar	75.5	90.6	156.5
Other navigational aids (Sonar, Loran, VOR)	36.9	57.0	99.3
Carrier current	16.2	18.4	30.0

	1967	1968	1971
	(millions of dollars)		
Intercom	96.5	99.2	108.0
Commercial sound and public address	216.3	228.5	258.8
A-m station equipment	14.0	14.5	16.0
F-m station equipment	11.2	12.0	18.4
Tv station equipment	135.7	134.0	134.0
Facsimile	24.3	27.4	30.5
Telemetry	185.1	211.9	273.0
<b>Lasers and equipment, total</b>	<b>51.9</b>	<b>66.3</b>	<b>114.5</b>
Gas lasers	37.5	45.0	68.4
Ruby lasers	1.0	1.2	1.8
Semiconductor lasers	4.0	7.5	22.0
Liquid lasers	1.0	2.5	6.9
Laser power supplies	3.5	4.2	6.4
Auxiliary laser equipment	4.9	5.9	9.0
<b>Closed circuit television equipment, total</b>	<b>69.1</b>	<b>82.3</b>	<b>131.3</b>
Industrial	22.8	26.8	42.6
Education	16.6	19.7	32.0
Theater	1.0	1.5	3.0
Medical	4.7	5.8	9.0
CATV equipment	24.0	28.5	44.7
<b>Dictating devices (for business)</b>	<b>103.5</b>	<b>113.0</b>	<b>145.0</b>
<b>Power supplies, OEM type</b>	<b>72.0</b>	<b>80.0</b>	<b>99.5</b>
<b>Industrial operations electronic equipment, total</b>	<b>905.1</b>	<b>1,052.8</b>	<b>1,496.2</b>
Manufacturing control equipment, total	192.5	231.3	386.3
Analog computer systems	61.0	75.0	117.0
Digital computer systems	64.0	89.0	134.0
Positioning controls (electronics only)	30.1	37.3	67.0
Contouring controls (electronics only)	37.4	30.0	68.3
Process control equipment, total	229.0	290.1	406.8
Analog computer systems	22.0	25.0	41.0
Digital computer systems	130.0	171.6	234.9
Controllers	33.0	41.5	69.2
Actuators & valves	39.7	46.2	55.0
Indicators	4.3	5.8	6.7
Other industrial operations equipment, total	483.6	531.4	703.1
Motor speed controls	55.5	59.4	75.0
Welding equipment	20.2	22.5	29.0
Power supplies	105.0	114.6	145.0
Cryogenic equipment	66.0	72.0	92.0
Ultrasonic cleaning equipment	15.7	18.0	24.3
Ultrasonic testing equipment	20.0	22.3	31.7
Infrared equipment	41.0	45.3	63.2
X-ray, industrial	26.0	28.5	39.2
Nuclear gauging & processing	72.5	80.5	121.0
Recorders	61.7	68.3	82.7



## Federal Electronics

	1967	1968	1971
	(millions of dollars)		
<b>FEDERAL ELECTRONICS, TOTAL</b>	<b>10,932</b>	<b>11,101</b>	<b>11,348</b>
Department of Defense, electronics portion, total	8,976	9,266	9,518
Procurement, total	4,916	5,320	5,025
Communications	995	1,064	1,105
Aircraft	1,383	1,589	1,357
Missiles	1,671	1,763	1,709
Mobile and ordnance	276	266	251
Ships	591	638	603
Research, development, test, and evaluation	2,245	1,957	2,383
Operations and maintenance	1,815	1,989	2,110
NASA, electronics portion	1,793	1,661	1,590
Federal Aviation Administration, electronics portion	98	102	165
Atomic Energy Commission, electronics portion	65	72	75

## Consumer Electronics

	1967	1968	1971
	(millions of dollars)		
<b>CONSUMER ELECTRONICS, TOTAL</b>	<b>3,847.7</b>	<b>4,087.8</b>	<b>4,694.1</b>
Television receivers, total	2,382.2	2,463.5	2,779.6
Monochrome tv receivers	477.0	393.0	281.0
Color tv receivers	1,905.2	2,070.5	2,498.6
Radios, total	492.5	523.1	580.0
A-m and f-m radios	242.9	254.7	276.8
Auto radios	249.6	268.4	303.2
Phonographs	511.3	550.3	599.4
Tape recorders	144.0	184.6	225.0
Tape cartridges	51.0	80.0	135.0
Hi-fi components (including tuners, speakers, amplifiers, etc.)	85.3	89.0	108.0
Kits, except toys	48.1	52.1	62.0
Light dimmers	8.7	9.5	10.5
Garagedoor openers	13.7	17.0	29.3
Guitar amplifiers	32.5	35.3	42.3
Organs, electronic portion	64.2	63.5	71.4
Automotive electronics, total	14.2	19.9	51.6
Discharge systems, transistorized and capacitive	0.4	0.5	0.8
Voltage regulators, integrated	0.3	2.4	27.0
Sequential flashers	1.5	2.0	2.8
Alarm systems	12.0	15.0	21.0

## Industrial Electronics

	1967	1968	1971
	(millions of dollars)		
<b>INDUSTRIAL AND COMMERCIAL, TOTAL</b>	<b>6,631.7</b>	<b>7,732.9</b>	<b>10,901.4</b>
Test and measuring instruments	648.5	727.5	944.7
Medical equipment	260.5	296.0	422.9
Nuclear instruments and equipment	113.4	135.9	179.0
Computers and related equipment	3,118.9	3,740.6	5,540.0
Communications equipment	1,288.8	1,438.5	1,828.3
Lasers and equipment	51.9	66.3	114.5
Closed circuit television	69.1	82.3	131.3
Dictating devices	103.5	113.0	145.0
Power supplies, OEM	72.0	80.0	99.5
Industrial operations electronic equipment	905.1	1,052.8	1,496.2

1967 1968 1971  
(millions of dollars)

<b>Test and measuring instruments, total</b>	<b>648.5</b>	<b>727.5</b>	<b>944.7</b>
Spectrum analyzers, subaudio to 1 Ghz	12.5	14.4	20.1
Signal generators, up to 1 Ghz	18.1	21.0	26.1
Sweep generators, up to 1 Ghz	5.8	7.2	10.1
Pulse generators, up to 1 Ghz	6.3	7.0	9.1
Oscillators, subaudio through video	17.2	19.2	25.1
Waveform generators, all shapes	11.4	12.9	16.1
Waveform analyzers and distortion meters	4.8	5.2	6.1
Counters, time and frequency	37.8	40.6	49.1
Timers, electronic	75.0	80.2	104.1
Panel meters	38.2	41.8	51.1
Noise measuring equipment, up to 1 Ghz	10.5	12.7	17.1
Frequency measuring instruments, except counters	10.5	12.3	17.1
Voltmeters and ammeters, electronic, d-c to 1 Ghz, meter indicating	18.1	21.4	28.1
Digital voltmeters	24.6	28.1	38.1
Power meters, d-c to 1 Ghz	5.0	6.1	8.1
Impedance measuring equipment, up to 1 Ghz	14.9	16.0	18.1
Calibrators and standards, active and passive	15.4	17.6	22.1
Oscilloscopes, d-c to 1 Ghz, main frame only	87.5	95.5	114.1
Oscilloscope accessories and plug-ins, up to 1 Ghz	21.0	25.0	36.1
Recording instruments, digital and analog	48.0	53.3	65.1
Components testers (capacitor, transistor, tube, integrated electronics, etc.)	23.0	27.5	47.1
Power supplies, lab type	53.9	57.8	67.1
Amplifiers, lab type	7.1	7.9	9.0
<b>Microwave measuring equipment (above 1 Ghz), total</b>	<b>81.9</b>	<b>96.8</b>	<b>134.3</b>
Oscilloscopes, above 1 Ghz	9.8	11.1	15.0
Microwave phase measuring equipment	4.6	6.4	11.1
Microwave impedance measuring equipment	11.1	14.6	21.1
Microwave power measuring equipment	4.9	5.4	8.1
Spectrum analyzers, above 1 Ghz	10.4	12.7	19.1
Frequency measuring and analysis, above 1 Ghz other	8.5	9.8	11.1
Microwave noise measuring equipment	5.6	6.8	9.1
Signal generators, above 1 Ghz	11.4	11.6	11.1
Sweep generators, above 1 Ghz	8.7	10.1	15.0
Pulse generators, above 1 Ghz	4.7	5.3	7.1
Field intensity meters and test receivers	2.2	3.0	4.1

<b>Medical equipment, total</b>	<b>260.5</b>	<b>296.0</b>	<b>422.9</b>
Diagnostic equipment, total	214.1	241.1	347.1
Radioactive tracer equipment	14.5	17.5	24.0
X-ray, & fluoroscopic equipment	171.5	192.0	283.0
Electroencephalographs	4.3	5.3	6.1
Electrocardiographs	12.0	13.2	16.0
Electron microscopes	8.5	9.4	11.1
Ultrasonic	3.3	3.7	6.0
Patient-monitoring systems	15.3	19.3	30.0
Therapeutic equipment, total	31.1	35.6	44.1



## Components Markets

	1967	1968	1971		1967	1968	1971
	(millions of dollars)				(millions of dollars)		
<b>ALL COMPONENTS, TOTAL</b>	<b>6,661.8</b>	<b>7,194.9</b>	<b>8,358.6</b>				
<b>Antennas and antenna hardware</b>	<b>375.5</b>	<b>410.8</b>	<b>496.0</b>				
<b>Batteries</b>	<b>87.2</b>	<b>96.5</b>	<b>127.4</b>				
<b>Capacitors, total</b>	<b>436.8</b>	<b>473.3</b>	<b>522.8</b>				
Paper capacitors	58.5	58.2	60.0				
Film capacitors	62.0	66.3	85.2				
Electrolytic capacitors	197.2	220.8	252.6				
Mica capacitors	30.6	32.2	28.5				
Glass and vitreous enamel capacitors	9.0	9.0	5.0				
Ceramic capacitors	53.7	58.8	62.3				
Variable capacitors	25.8	28.0	29.2				
<b>Connectors, total</b>	<b>327.0</b>	<b>353.5</b>	<b>422.8</b>				
Coaxial connectors, standard size	28.4	29.8	32.5				
Coaxial connectors, miniature	20.0	22.9	33.0				
Cylindrical connectors	121.9	129.2	150.3				
Rack and panel connectors	56.8	59.8	66.0				
Printed circuit connectors	46.3	52.0	64.5				
Special purpose & fused connectors	53.6	59.8	76.5				
<b>Delay lines</b>	<b>17.5</b>	<b>18.8</b>	<b>21.0</b>				
<b>Electroluminescence</b>	<b>1.3</b>	<b>1.5</b>	<b>3.0</b>				
<b>Electromechanical devices, total</b>	<b>134.4</b>	<b>152.9</b>	<b>178.5</b>				
Resolvers	10.9	11.4	12.2				
Servo motors	21.7	24.5	30.0				
Synchros	36.7	36.0	35.4				
Rate generators	5.0	5.2	5.3				
Motor generators	15.0	16.5	18.0				
Solenoids	24.3	25.5	31.8				
Encoders & Decoders	20.8	33.8	45.8				
<b>Electron tubes, total</b>	<b>1,361.2</b>	<b>1,383.6</b>	<b>1,322.3</b>				
Receiving tubes	266.3	241.3	173.8				
Power and special purpose tubes, total	289.6	295.2	303.4				
High-vacuum tubes	66.0	65.0	62.0				
Gas and vapor tubes	18.5	18.0	15.5				
Klystrons	46.4	46.6	44.8				
Magnetrons	40.4	39.1	36.7				
Twt's, including backward wave types	45.8	47.6	50.2				
Light-sensing tubes	36.5	38.5	46.5				
Storage tubes	14.2	16.2	19.8				
Display tubes, except cathode ray	5.6	6.8	8.9				
Cathode ray tubes, except tv	16.2	17.4	19.0				
Tv picture tubes, black-and-white	107.0	84.5	64.5				
Tv picture tubes, color	676.5	739.0	751.0				
Cold cathode display tubes	14.5	15.1	18.3				
Rear projection readout devices	6.3	7.1	9.2				
Bar segment devices (incandescent and electroluminescent)	1.0	1.4	2.1				
<b>Ferrite devices, total</b>	<b>304.4</b>	<b>328.7</b>	<b>367.5</b>				
Computer cores	9.0	18.0	28.8				
Transformers and chokes, except tv	249.1	258.7	290.0				
Tv ferrite components, including yokes, flybacks	46.3	52.0	48.7				
<b>Filters, electronic</b>	<b>38.2</b>	<b>42.8</b>	<b>51.0</b>				
<b>Loudspeakers</b>	<b>110.6</b>	<b>119.4</b>	<b>136.0</b>				
<b>Magnetic tape</b>	<b>169.3</b>	<b>193.9</b>	<b>279.5</b>				
Audio tape	51.0	58.6	85.0				
Computer tape	66.0	75.5	107.7				
Instrument tape	33.0	36.5	45.8				
Video tape	19.3	23.3	41.0				
<b>Microwave components and hardware, total (tubes &amp; antennas excluded)</b>	<b>100.7</b>	<b>111.5</b>	<b>163.0</b>				
Microwave ferrite devices	20.2	22.3	31.4				
<b>Multicomponent packages, total (two or more separate active or passive components in a single package)</b>	<b>200.0</b>	<b>226.5</b>	<b>389.5</b>				
<b>Printed circuits</b>	<b>167.4</b>	<b>200.4</b>	<b>279.0</b>				
<b>Quartz crystals (including mounts and ovens)</b>	<b>57.5</b>	<b>62.0</b>	<b>74.5</b>				
<b>Resistors, total</b>	<b>373.3</b>	<b>395.3</b>	<b>396.6</b>				
Fixed resistors, total	214.2	220.8	217.5				
Composition resistors, fixed	90.3	91.1	83.7				
Deposited carbon resistors, fixed	17.8	16.0	11.0				
Metal film resistors, fixed	47.8	51.9	61.0				
Wirewound resistors, fixed	58.3	61.8	61.8				
Potentiometers, total	159.1	174.5	179.1				
Wirewound potentiometers	79.1	84.5	88.0				
Non-wirewound potentiometers	80.0	90.0	91.1				
<b>Relays, total</b>	<b>262.8</b>	<b>300.0</b>	<b>343.9</b>				
Solid-state relays	15.8	22.0	46.2				
Electromagnetic relays, total	115.9	126.5	134.9				
Contact meter relays	6.3	6.3	5.3				
Crystal can relays	28.2	29.8	31.0				
Dry reed relays	21.6	24.8	32.5				
Mercury wetted relays	14.5	15.0	18.0				
Resonant reed relays	1.3	1.3	2.0				
Stepping switches	15.4	20.0	18.5				
Telephone type relays	24.5	24.8	23.9				
Thermal relays	4.1	4.5	3.7				
Other relays	131.1	151.5	162.8				
<b>Semiconductors, total</b>	<b>999.0</b>	<b>1,110.5</b>	<b>1,414.8</b>				
Discrete, conventional devices, total	561.9	570.7	586.8				
Transistors, total	391.7	400.0	432.1				
Transistors, silicon, bipolar	244.7	261.2	311.1				
Transistors, germanium bipolar	126.3	108.9	67.3				
Transistors, field effect	15.9	22.7	39.0				
Transistors, unijunction	4.8	7.2	14.7				
Diodes, total	170.2	170.7	154.7				
Discrete, special devices, total	140.1	154.3	201.2				
Thyristors (SCR's, 4 layer diodes, etc.)	56.1	66.8	98.2				
Tunnel diodes	4.4	4.7	6.2				
Microwave diodes, excluding varactors	13.5	15.5	21.5				
Microwave transistors	4.0	4.4	10.0				
Varactor diodes	8.8	9.7	13.9				
Multiple devices (duals, diode arrays)	27.0	25.0	20.6				
Other special devices (temperature sensing, strain gauge, etc.)	26.3	28.2	30.8				
Integrated electronics, total	268.6	346.5	544.3				
Monolithic IC's total	237.6	304.0	476.1				
Linear	51.0	80.5	159.0				
Digital	186.6	223.5	317.1				
Hybrid IC's total (Semiconductor devices and thin or thick film components combined on a common substrate)	31.0	42.5	68.2				
Passive thin or thick film devices	28.4	39.0	82.5				
<b>Motors, fractional HP, all</b>	<b>408.2</b>	<b>413.9</b>	<b>489.5</b>				
<b>Optoelectronic devices, total</b>	<b>19.0</b>	<b>24.1</b>	<b>32.5</b>				
Photovoltaic (solar) cells	5.2	6.2	7.0				
Photoconductive cells	6.1	7.4	9.6				
Light-emitting diodes	0.3	0.6	2.4				
Photodiodes	6.7	8.7	11.4				
Special optoelectronic devices (isolators, switches)	0.7	1.2	2.1				
<b>Rectifiers, solid state, total</b>	<b>130.1</b>	<b>145.6</b>	<b>173.2</b>				
Rectifiers, silicon	100.4	113.0	132.6				
Rectifiers, selenium and copper oxide	18.0	17.7	12.1				
Rectifier assemblies	11.7	14.9	28.5				
<b>Switches, mechanically actuated, total</b>	<b>143.6</b>	<b>159.2</b>	<b>178.1</b>				
Coaxial switches	4.7	6.0	8.0				
Pressure switches	19.0	26.2	26.0				
Rotary switches	43.6	48.1	58.6				
Snap-action switches	49.6	53.1	60.5				
Toggle, mercury, knife, misc.	26.7	25.8	25.0				
<b>Transducers, total</b>	<b>115.1</b>	<b>135.1</b>	<b>164.8</b>				
Pressure transducers	41.0	43.6	51.4				
Position transducers	38.7	40.0	44.6				
Strain transducers	20.0	33.5	50.0				
Acceleration transducers	15.4	18.0	18.8				
<b>Wire and cable, total</b>	<b>321.7</b>	<b>335.1</b>	<b>331.4</b>				
Coaxial cable	69.2	76.2	80.0				
Flat and flexible printed circuit cable	16.9	19.0	25.0				
Hook-up wire	152.0	154.0	132.0				
Magnet wire	83.6	85.9	94.4				



# State of the market: gains slowed by war priorities

## Market index

106	Military electronics
109	Solid state
113	Medical electronics
114	Consumer electronics
116	Educational electronics
118	Instrumentation
120	Avionics
123	Computers
126	Communications
129	Microwave
130	Space electronics
132	Industrial electronics
135	Components

"I'd rather project what's going to happen five years from now than five months," says a marketing executive at Microwave Associates Inc. His caution and candor are typical of electronics executives assessing the industry's 1968 prospects.

Last year at this time, officials, euphoric over 1966 results, were shooting from the hip and painting bull's-eyes around the holes. But a slowed rate of economic growth, uncertainties arising from the country's Southeast Asian commitment, and the reluctance of consumers to plunge on big-ticket items like color-television sets put most forecasts wide of the mark.

The electronics industry is looking for a comparatively modest—by past standards—over-all gain of 6.7% next year to \$23.6 billion. But the pace of sales increases varies widely throughout the industry.

Computer makers, despite spiraling labor costs and continuing software woes, are still riding a gravy train as commercial and industrial firms, universities, and Government agencies snap up their output.

In one way or another, Pentagon spending trends will have a profound effect on electronics concerns. The military budget for Vietnam-oriented hardware, including communications and avionics gear as well as components, will continue to expand. But the Pentagon's vast outlays for Vietnam equipment are causing stretchouts and, in some cases, cancellations of long-term research and development projects. Companies in the instrumentation and related fields are being especially hurt. Space expenditures also appear vulnerable, as do outlays for medical

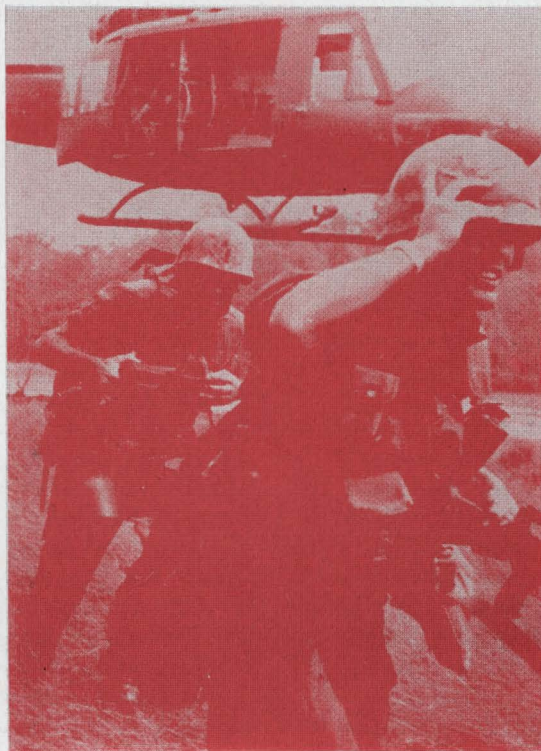

electronics.

But educational electronics, now attracting state and local as well as Federal funds, is set for a big year. Pacesetter installations of computer-assisted instruction systems will be completed this year in New York City and Philadelphia.

Despite uncertainties in capital markets and the economy's general sluggishness, industrial concerns can plan on a good year. But consumer firms, their bright dreams for 1967 faded, are facing problems. Market prospects for next year are dimmed by doubts about the international monetary situation, a Federal income tax surcharge, and a tightening of credit. Color-tv sales will post a good, if unspectacular,

gain, but the effects of last year's debacle in this area will continue to make waves throughout the industry, particularly in the components sector.

Dollar sales of solid state devices will rise only slightly from 1967 levels, largely because of tumbling prices in the discrete-semiconductor field. However, IC's will take up much of the slack.

Integrated circuits are now a fact of technological life, and next year they will expand their position in commercial, military, consumer, and space applications. Semiconductor houses will devote increasing attention to medium-scale integration, the step before introduction of commercial quantities of large-scale integration devices sometime during the early 1970's.

Last year's big story was the emergence of linear and microwave IC's as a market force. This year, such devices will win a larger place in commercial and consumer equipment.





## Military electronics

# Stretching the sinews of war

**Defense Department** officials perennially consider next year's problems the worst they've ever faced. They're probably right about 1968.

"Under the gun of Vietnam, the budget is already down to the bone," says a Pentagon source. "Now it's a question of what part of the bone must go." Research and development activities will be hit hard: openly, by canceling programs that don't contribute immediately to the war effort; covertly, by stretching out projects that would trigger an adverse public reaction if dropped. "Some projects are being tested to death and this will get worse," another Pentagon official says.

Programs for equipment and systems for Vietnam-type wars will suffer. So will strategic offensive weapons. Instead of new starts, operational systems will be modified to perform extra jobs.

Some studies will be kept alive to keep Congress pacified, as well as to have something under way, should the cold war cool further. But the brass wonders what good a drawing-board design will do in five years, should the U.S. be attacked.

Secretary McNamara's departure may bring about changes in detail on some scheduled programs. Every cabinet member has pet projects. But, on balance, the Pentagon's shopping list is longer than ever and there's plenty of hardware business for production-minded electronics firms.

### Strategic weapons

The biggest single outlay in the strategic category will be for the so-called "thin" antiballistic missile system, Sentinel (originally Nike X). Depending on how fast the Pentagon launches the program—

now estimated to be a \$1-billion-dollar-a-year pace—Sentinel could push much of the industry beyond present capacities. An estimated 75% of the total price tag, officially set at \$5 billion, will go for electronic equipment such as radar and computers. Manufacturers of discrete semiconductors, who had their troubles last year, also stand to gain because of the system's frozen design.

Last fall Congress appropriated \$47 million to keep the Advanced Manned Strategic Bomber alive. The Defense Department also allocated \$26 million for work on the avionics, the airframe, and engines.

The Poseidon submarine-launched ballistic missile will be in full production this year. More Minuteman 3 missiles will be bought. Penetration aids and reentry warheads will be built, and an advanced intercontinental ballistic missile will be studied. Approximately \$2.5 billion will be spent to buy operational missiles of all kinds for all services during calendar year 1968; about \$10 billion is earmarked for aircraft.

### Air power

The giant C-5A passenger/cargo plane will be ready for instrumentation late next month, test-flown in June, and delivered by the end of the year. The initial contract calls for 57 planes with an option for 58 more. Avionics orders, the province of the prime contractor, the Lockheed Aircraft Corp., will be sizable during 1968.

The F-111A in its several configurations—reconnaissance, fighter-bomber, and fighter—will also be a big buy this year. In addition, the Air Force will buy the A-7D attack plane, more F-4E Phan-



toms and RF-4 reconnaissance planes, the C-141 cargo plane, and an air-to-surface missile.

The Air Force will continue to work on an ultrareliable ARC-34-type radio, molecular electronics for radars, large-scale arrays, microwave power sources, and cryogenic coolers to facilitate the use of infrared sensors.

The Air Force is also looking for three kinds of new tactical ground-based radars: to detect low-flying aircraft; to provide three-dimensional fixes; and to ground-control approaches under poor flying conditions. In addition, overland radar for the Airborne Warning and Control System is needed so a high-flying plane can detect low-flying aircraft against a background of rugged terrain.

All the big command and control "L" systems in development, such as Spacetrack, will be continued. So will the system for detecting and reporting nuclear detonation, and the post-attack command-control system.

Tactical equipment sought by the air arm includes navigation aids for remote fields, control towers, uhf and vhf radios, light-weight Tacans, point-to-point single sideband radios, and operations and communications centers.

### The Army game

An urgent Army requirement is for a 360° mortar-locating radar. Development work on the AN/TPQ-28 at ITT-Gilfillan, a subsidiary of International Telephone & Telegraph Corp., should be finished by April. The system will be used for permanent base defense in Vietnam. A sizable production contract may be let this year.

Army communications efforts will proceed along a number of fronts. For example, feasibility contracts will run through 1968 for Mallard, the four-nation, integrated tactical trunking and distribution system. A limited number of breadboard models of Rada (random access discrete address) subscriber units will be bought and the whole system simulated. Also, a new generation of field radios, beyond the VRC-12 family, will be checked.

"There's nothing wrong with the radios we've got in Vietnam now. The PRC-25 is winning the war," says an enthusiastic communications officer. "But by 1975 even better equipment will be possible. We're going to marry f-m and ssb a-m radios and expand the frequencies from the present 30 to 76 megahertz to 2 to 76 Mhz."

Tacfire, a complex computerized system for automating combat artillery batteries, will be a \$100-million business next year. But two of the biggest problems will involve finding suitable computer

memories and good display, says Milton A. Lipton, chief of the Data Processing Branch, Communications and Automatic Data Processing Laboratory, Army Electronics Command, Ft. Monmouth, N.J.

To coordinate all of the Army's aviation activities, work will continue on the integrated ground-airborne avionics system. The system will include a semiautomatic flight observation center, landing aids, beacons, and communications. If all goes well, the concept could be sent to industry for definition-phase contracts by the end of the year.

Night vision is still a preoccupation, and the Army is seeking to turn night into day with low-light-level television, infrared, lasers, and passive image intensifiers. Work is far enough along in this highly classified area for a number of devices to be going into helicopters and fixed-wing planes as well as on guns and tanks.

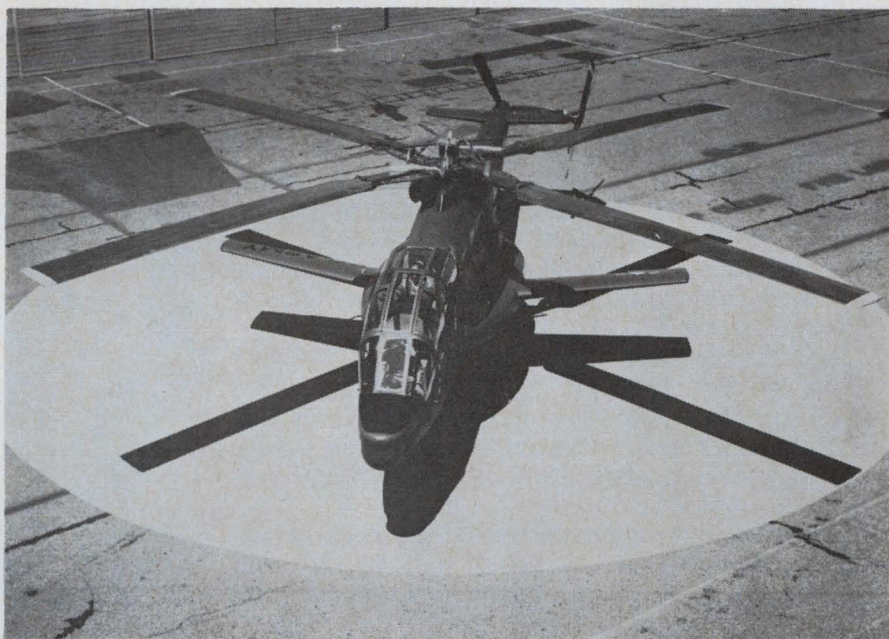

**On the warpath.** The AH-56 Cheyenne helicopter will be bought this year, possibly in volume for Vietnam. The Army will buy most of the avionics for Lockheed, the prime contractor.

Research and development work will continue on manpack and airborne versions of the Loran C/D navigation systems. A Decca navigation manpack will also be tested.

Avionics packages for the OH-6A Cayuse and AH-56A Cheyenne helicopters will be bought this year. The Army will buy and furnish much of the Cheyenne's avionics to Lockheed, the prime contractor. Lockheed's contract calls for 10 prototype Cheyennes. But a volume award is probable.

### Naval engagements

The trend to buy new capability by modifying existing equipment will produce the Grumman Aircraft Engineering Corp.'s biggest 1968 program. The Navy's A-6A attack plane will be equipped with low-light-level television and infrared sensors to



give it a night-fighting capability. The A-6A will also get a new computer, the 4 Pi system built by the International Business Machines Corp. In addition, the plane's tracking radar will be removed and the search-terrain avoidance equipment will be modified to take on the tracking job.

The Naval Electronic Systems Command will spend \$100 million this year for uhf and ssb, high-frequency, ship-to-ship and ship-to-shore communications equipment. Over the next three years, another \$100 million will be spent to convert the Navy missile range telemetry systems to S band. A follow-on program will center on system security.

The command, which set up shop only last July, is moving to become the technical authority for development and procurement of electronics throughout the Navy without interfering in specific systems. Rear Adm. J. E. Rice, who heads the command, says: "We're going to push standardization of microelectronics. We also want to encourage automatic control in production to get more reliability and to reduce costs."

### **Ships at sea**

Requests for proposals for the Navy's advanced surface-to-air missile system will be sent out before July and a contract awarded later in the year. A contract for the automated, integrated air defense system to replace the Terrier-Tartar-Talos missile systems, also to be let this year, specify a high-performance missile and a 3-D phased-array radar.

Electronic warfare to combat any threat to a warship from land, sea, or air will also be a major effort during 1968. Procurement of the Naval Tactical Data System will continue, sustaining a large market for computers, displays, data links, and communications gear.

The trend in Naval radar is toward phased array, even for small surface vessels and aircraft, says a Navy source. Emphasis will be on signal processing improvements, digital moving target indication, and digital pulse compression. The command wants more self-test features in equipment and automatic checkout gear like Teams, built by Nortronics, a division of the Northrop Corp., for radar and sonar gear. If Teams lives up to its press notices, there will be many more similar systems. "We just don't have enough trained technicians to handle the \$25 million worth of electronics we have on every large ship in the Navy," says an official.

According to a spokesman at the Navy's Ship Systems Command, a systems engineering approach will be taken to design work for more equipment. However, the Navy will not match the Air Force in this regard since many vessels' subsystems are already in the works; in addition, integration is not as critical a factor as in aircraft.

In avionics, the Navy is considering a systems approach to aircraft antennas. At the moment, the sea service has some 50 different kinds, many of which are add-on devices that project from the aircraft, causing interferences, and aerodynamic

problems. "A new approach to all electromagnetic radiation and reception in aircraft is needed," says Capt. Frank W. Ewald, who heads the avionics division of the Naval Air Systems Command. "Antenna time-sharing might be the answer."

A long-range objective, Ewald says, is for avionics subsystems to last the life of the aircraft. "They could then be built into the plane. Short of this, throwaway repair modules might be the answer."

The Subroc and Asroc antisubmarine warfare missiles will be big buys during 1968. But most of these new weapons are going into the inventory.

Production of the Mark 44 torpedo is being phased out in favor of the Mark 46. This weapon is now in preproduction development. Evaluation will be completed later this year and a production award made in 1969.

The Office of the Director of Defense Research and Engineering will oversee a program to forestall electromagnetic compatibility problems before the design of new equipment is frozen. The Army will develop the instrumentation for measuring the new gear; the Air Force will analyze the results to deter-

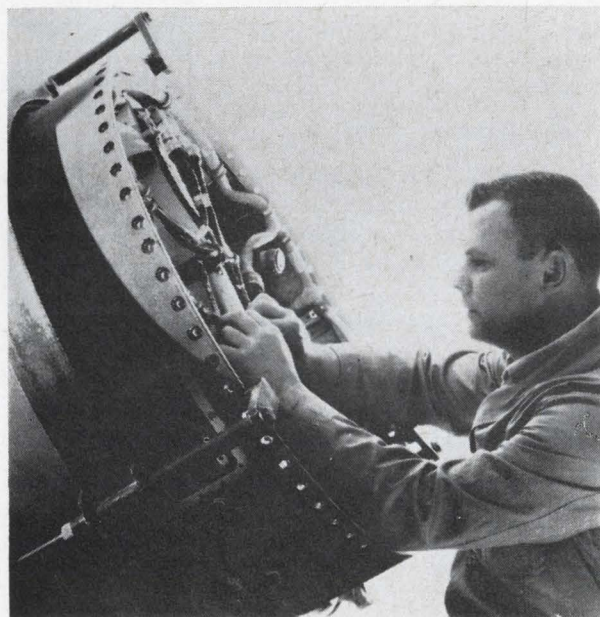

**Getting through.** Penetration aids hardware like this Mark I unit from Avco for intercontinental ballistic missiles will continue to receive development money.

mine the extent or lack of compatibility; and the Navy will write up the standards to be used by all services when buying equipment.

Cost of ownership rather than initial cost is expected to receive more weight in equipment-buying decisions than in the past. In addition, Defense Research and Engineering is pushing throwaway modules and integrated circuits.

Nonetheless, support equipment will still be big business this year. Grumman alone expects to sell close to \$200 million worth. To aid inexperienced maintenance men, the systems will be diagnostic and automatic wherever possible.



## The prospects are solid

**Semiconductor houses** will be leaning more heavily than ever on their integrated-circuit operations during 1968. Last year's revenues of \$268.6 million in this area on volume of nearly 100 million units brought many firms into the black on ic's for the first time. The market outlook this year is for \$346.5 million on sales of more than 200 million units.

The emergence of ic's as a market force may have come just in time. Discrete semiconductor components, which have carried their more glamorous cousins through several unprofitable years, have endured severe price attrition since the end of 1966. And while sales of conventional discrete units are rising, dollar volume will make scant headway, going from last year's \$561.9 million to \$570.7 million. Discretes account for such a significant portion of all semiconductor sales that the price cuts will hold the industry's total 1968 revenue gain to 11%—\$1.1 billion against \$999 million last year.

There's been a less martial atmosphere in semiconductor sales in recent years; military business is expected to account for less than 40% of dollar volume in 1968, against more than 60% in recent years. Computer and aerospace applications will each contribute about 20% of revenues. Industrial sales should be about three times as great as consumer.

Monolithic digital assemblies will continue to lead the ic pack during the year. "The computer indus-

try will absorb huge production quantities," says Richard J. Hanschen, assistant vice president and marketing director for Texas Instruments Incorporated's components group. Bill Berg, product marketing manager at the Signetics Corp., a subsidiary of the Corning Glass Works, agrees: "Integrated circuits are making further inroads in discrete preserves, particularly computer peripheral gear."

Newest darling on the digital scene is transistor-transistor logic. Many applications engineers estimate that 80% of new computer designs now call for TTL. The semiconductor division of Sylvania Electric Products Inc., a subsidiary of the General Telephone & Electronics Corp., is a leader in TTL. The firm is offering two versions of its SUHL—for Sylvania Universal High-Level Logic—lines.

Speed is perhaps TTL's most attractive advantage over competitive families; the SUHL-2 line, for example, has a 6-nanosecond propagation time. But Harry Luhrs, Sylvania's marketing manager for ic's also cites noise-protection features, versatility, and a broad line as big reasons for TTL's runaway popularity. "In addition, TTL circuits have a smaller-element geometry," he says. "They can be arranged more compactly on a chip, making development of functional arrays a lot easier."

Sylvania, with about 135 circuits in both lines, including gates, expanders, flip-flops, and functional

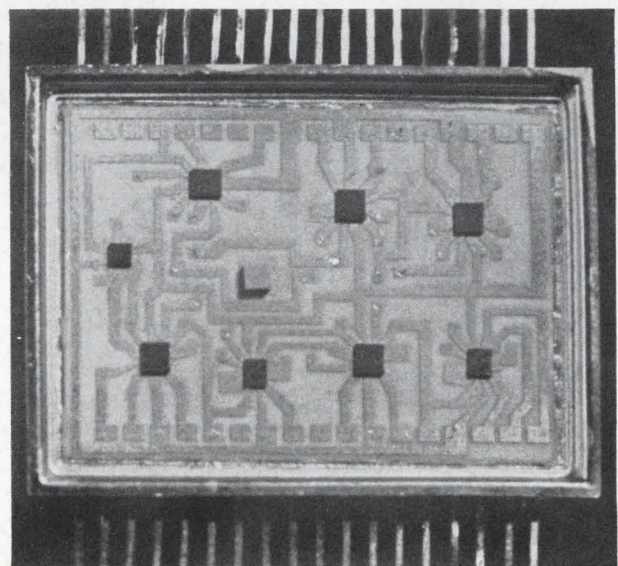
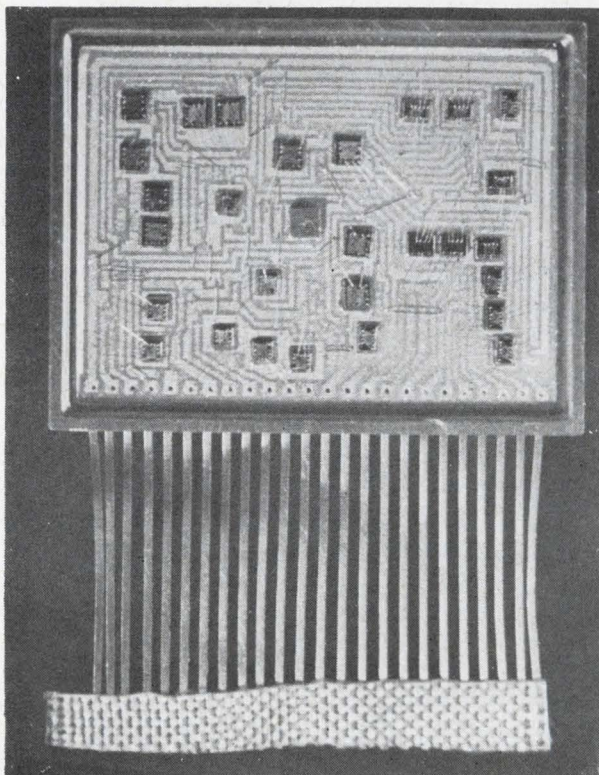

**Bridging a gap.** Amelco's microelectronic modular assemblies, or MEMA, are a step beyond integrated circuits but short of LSI. During 1968, the concern will make MEMA available as an off-the-shelf item.



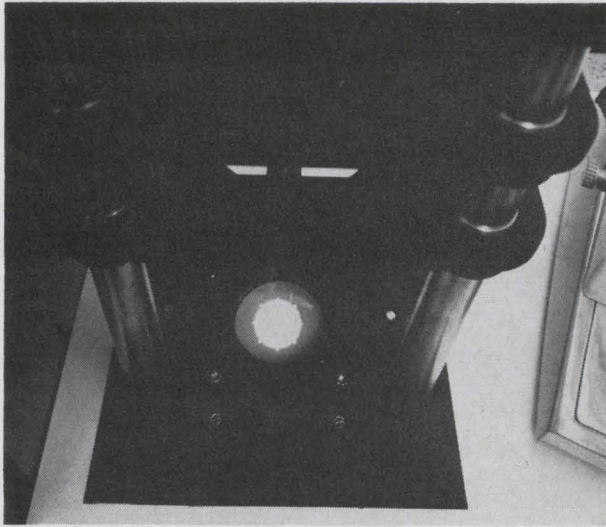

**Bright picture.** LSI interconnection mask is generated on the face of a cathode-ray tube at Texas Instruments.

arrays, has been hard-pressed to keep pace with demand. Semiconductor firms abhor a vacuum no less than nature and a host of would-be rivals have rushed into the marketplace either as second sources or as suppliers of other TTL devices.

In the TTL sweepstakes, Sylvania has worked toward higher speed by improving components; Texas Instruments opted for complexity, putting more components into each circuit. The result was TI's 54/74 series which the company believes will furnish a viable means of getting into large-scale integration later on.

Hank Schunk, assistant operations manager at the Raytheon Co.'s Semiconductor division, which second-sources SUHL, says that both of the top two have had difficulty in filling orders. "Most people agree that SUHL is technically superior to the TI line," he says. "If supply problems remain equal, SUHL will become the market-accepted line."

Motorola Inc., Raytheon, the Westinghouse Electric Corp., and even TI are all making some sort of SUHL. But Signetics, the Sprague Electric Co., IIT and the National Semiconductor Corp. are following TI's lead. Fairchild and the Transatron Electronics Corp. are vending their own versions.

### Linear growth

Linear, or analog, IC's are set for a nearly 60% dollar jump to \$80.5 million during 1968; unit volume should be around 15 million. In marketing terms linear devices are still in an early stage. The bulk of the volume is still in Government sales for military and aerospace applications. But manufacturers are wooing buyers in such industrial and commercial outlets as instrumentation, medical electronics, controls, power supplies, and entertainment goods. Computer makers and other original-equipment manufacturers using discrete assemblies to interface with digital IC's are also prime targets.

Among the linear wares seeking, or winning, approval in the marketplace are: low-cost operational

and differential amplifiers; voltage regulators; comparators, high-frequency amplifiers active filters; and memory arrays as well as motor-control and timing assemblies.

Lou Solomon, marketing manager at the Amelco Semi-Conductor division of Teledyne Inc., says that never again will a single op amp dominate the market like the 709. (Jack Gifford, marketing manager for linear circuits at Fairchild Semiconductor, a division of the Fairchild Camera & Instrument Corp.—the 700's proprietor—agrees with this analysis.) Solomon expects good, solid growth in linear circuits: "All memory makers are going to IC sensing systems, and industrial feedback applications, requiring op amps, should grow." Linear circuit prices which averaged \$14 last year are now at about half that level, says Solomon. "And it's never unwise to predict another 50% reduction."

At Fairchild, which has 30% to 40% of the linear market, Gifford says the big question during 1968 will center on whether or not giant consumer houses like the Radio Corp. of America can get entertainment circuits into volume production.

"The emphasis is going to be on volume," Gifford says. "Given equal output linear circuits can be made as cheaply as digital devices."

Chris Goodman, vice president and U.S. marketing manager of Motorola's Semiconductor Products division, looks for the growth rate of IC's for consumer goods to outstrip that of devices earmarked for military and computer applications. However, Roger A. Swanson, marketing manager of Sylvania's Semiconductor division, believes the consumer market will not be a substantial factor until next year. Linear IC's will first crack television, he says, and then small business machines, appliances, and automobiles.

### Microwave potential

Still another sector of the IC field beginning to develop some strength is the microwave area; here, integrated assemblies are chipping away at the once private preserves of high-frequency tubes and components. Military and space systems, notably radar, are the main potential outlets at the moment. But consumer and commercial applications will be increasingly in evidence within five years.

Reliability and lower costs explain the gathering push behind IC's. But the multifunctional characteristics of microwave assemblies promise other operating advantages that should enhance their appeal. Hybrid techniques are still dominant, but monolithic technology is making up lost ground and will prevail as mass markets are opened.

As a result of three years' experience on the Air Force's MERA (microelectronics for radar applications) program, Texas Instruments has a headstart over other semiconductor firms in the race for microwave markets. On the systems side of the fence, Microwave Associates Inc., which has a solid IC capability, holds a commanding lead. But coming up fast to give the top two a run for the money are Sylvania and RCA. Also in the running are the Gen-



eral Dynamics Corp., TRW Inc., the Hughes Aircraft Corp., Bell Laboratories, and Motorola.

Marvin Groll, marketing manager for microwave semiconductor products at Sylvania, says his operation will base its approach to microwave IC's on beam-lead semiconductors. "Using this technique, we should be able to reach higher frequencies," he says. Sylvania is virtually the only contender for business in the Ku band—a frequency range that has as yet attracted few projects. "Dollar estimates for microwave IC's are an unrealistic proposition at the moment," Groll says. "But by the end of the year, specific programs will have emerged, permitting some assessment."

### Small, medium, and large

Large-scale integration—upwards of 100 gates on a single chip—is still waiting in the wings this year. However, major producers are developing techniques and an increasing number of prototypes will be available.

"We'll see a lot of multipackaging in the discrete field," says Amelco's Solomon. "This is the step before LSI; whether or not you're selling it, you'll need a lot of leads." Later this year, Amelco will announce an off-the-shelf line of circuits in its MEMA (for microelectronic modular assembly) packages, which it has been supplying its parent company for the integrated helicopter avionics system.

Signetics is working on a 64-bit memory element for a computer. During the latter part of 1968, Berg says, assemblies of equivalent complexity will be offered commercially. However, he does not feel that MSI devices will capture much more than 5% of the total IC market.

At Fairchild Semiconductor, a circuit-a-week promotion, lasting for the next year or so, is well under way. Most of the new assemblies will be digital, about half of which will fall into the MSI category. Several, however, will be genuine dual-metal-layer LSI devices for which computer-aided design was used to lay out interconnections. The company, now supplying a bipolar LSI circuit to the National Aeronautics and Space Administration, plans to offer at least two more as standard commercial items during the first quarter.

Fairchild takes a somewhat philosophical approach to LSI, according to Ben Anixter, IC marketing manager. Criteria are not limited to the number of gates on a chip: rather, any circuit requiring two-layer metal for interconnections, as well as computer-aided design, to lay them out, falls into the LSI category. And as a rule, Anixter says, the circuit must be of sufficient complexity to somehow affect the vendor-customer relationship.

"It will be two years before anyone develops the production technology and discretionary wiring techniques needed for true LSI," says Tom Longo, vice president of Transitron. "However, within the next two years, we'll see 15 to 50 gate chips as well as chips with 5 to 20 flip-flops. Longo also believes that LSI will produce more teaming: "As a matter of fact, component and systems people are already liv-

ing very close together to solve common problems."

As the market for functional arrays expands, Sylvania plans to jump to a 28-lead package with center-to-center lead spacings of 50 mils. (The company's 14-lead IC's have 100-mil spacings.) These devices represent the leading edge of Sylvania's LSI marketing program, and they will not be available until late this year or early in 1969.

Sylvania also believes that with the trend to even larger scale integration, the semiconductor supplier will become an increasingly important part of the customer's design staff. Continuously exposed to proprietary information, vendors might eventually sell specialized arrays to particular companies, rather than offer a broad line of multipurpose devices. Over the longer run, arrays or LSI devices might be pooled in the same way that computer programs are. "In any event, the higher the degree of integration, the more nearly impossible it will be for purchasers to find second sources," says Swanson. "Suppliers may even attempt to second-source themselves through production over-runs."

Swanson also believes that the cut-rate tactics used to establish market dominance in discrete semiconductors are unlikely in the LSI field. It is to the interest of the single-source supplier to build and sell circuits at the lowest possible price to keep his "teammate's" systems competitive.

Until recently, the metal oxide semiconductor sector of the IC field was virtually the exclusive preserve of two second-tier semiconductor suppliers, the General Instrument Corp. and the Philco-Ford Corp. Top houses were just not prepared to devote financial and technical resources to MOS, so potential customers eschewed it in droves. In addition, criticism about low yields, erratic delivery, and instability were rampant in the industry.

Now, however, the big boys are ready to get into the off-the-shelf game. "Until bipolar techniques were established, MOS had to wait its turn," says a Texas Instruments official. "There would have been little sense in having both technologies compete for the same space in printed-circuit boards.

A latecomer in the semiconductor field, the General Electric Co., is expected to try to make MOS IC's the mainstay of its digital line. So, too, is RCA, best known for its linear wares. Motorola, which introduced a number of standard MOS devices last year, is preparing to expand its business during 1968. Finally, Fairchild and TI, both of which have concentrated on custom work for the past few years, are preparing to launch complete lines of custom MOS products this year.

Aside from gaining a share of a market that may account for up to 15% of the action in the IC field within a few years, semiconductor houses are looking ahead to LSI. Metal oxide semiconductor wares dovetail nicely with LSI products like memories, shift registers, and multiplexers. In such applications, the high-density characteristics of MOS give it an edge over bipolar technology.

Not everyone is bullish, however. "The emphasis on bipolar problems will slow the answers for MOS,"



says Sylvania's Luhrs. "It could be great, but it will take years to find out." He feels that computer designers are inclined to take a conservative approach. For example, Luhrs says, if a machine is to last 20 years, bipolar devices will be specified.

### Pick a pack

"Trends in packaging can be traced directly to ic's higher power and speed as well as greater complexity," says Motorola's Burns. "We're trying to come up with packages that have a high degree of volumetric efficiency." Burns says Motorola is working on packages that can dissipate more than 10 watts, the current norm. He notes that "the trend is to higher power, especially in linear circuits."

"Plastic is in, no question about it," says Transiron's Longo. "This year, 70% of our dual in-line output will be in plastic. In 1967, only 50% of production was plastic-packaged."

Texas Instruments' Hanschen agrees that plastic is the dominant packaging trend. "The greatest area of change during 1968 will be in power products where conversion to plastic may cut costs by more than 50%," he says.

Despite higher yields and expansion programs throughout the ic field, semiconductor makers do not, apparently, face an overcapacity situation. According to Raytheon's Schunk, there may be an artificial reason for this: "While the industry has tremendous chip-making and packaging capabilities, there's a real bottleneck in testing flexibility."

As a rule, every customer wants his specifications just a bit different, Schunk explains. Even on semi-standard lines, he wants some control. Although all manufacturers have elaborate test set-ups, they still experience delays in testing. "We might be shipping a particular ic to 15 customers—with two standard data sheets and 13 other specs," says Schunk. "It makes for very difficult logistics. Even where we try to simplify, perhaps by checking several orders to the more difficult specs, shipments are still slowed."

### Separate and unequal

Discrete semiconductor components took quite a beating last year. And, with certain exceptions, little relief is in sight. "There's no question that prices are eroding," says Amelco's Solomon. "Companies without proprietary designs are in trouble."

Donald Dickson, president of the Dickson Electronics Corp., attributes last year's slump largely to overinventorying by original equipment manufacturers and overcapacity among producers.

"Sluggishness in the color television market was no help either," Dickson says. The company experienced a leveling-off in demand for zener diodes, a situation its president says he does not understand. However, as a result of falling prices and stretched-out military demand, there won't be any real recovery in this area during 1968.

Goodman of Motorola believes germanium transistors suffered because of computer makers' overstocks. The situation promises to get worse since machines using such assemblies are being phased

out of production. Goodman foresees further inroads by integrated circuits in discrete components' territory, especially in tv and stereo sets. In the industrial-commercial area, Goodman discerns a trend to digital tuning of aircraft radios, an eventuality that will cost discrete devices more sockets.

Robert Irvin, market planning manager at Teledyne's Crystalonics division, says the 1967 slump may have been exaggerated. "Probably as many, if not more, dice were made last year than during 1966," he says. "But semiconductor makers cut into their own sales by selling them for use in hybrid ic's."

Irvin feels the jump from discrete components to monolithic integrated circuits accounts for much of the drop. "Discrete houses turning to dice sales to keep their furnaces running simply accelerate a downward spiral," he says. "The only people unhurt in this sort of runaround are the header builders."

### Power play

Special switching characteristics of thyristors should push sales from last year's \$56.1 million to \$66.8 million. These discrete power devices are in the enviable position of being superior to components such as tubes and relays and are not threatened by integrated circuitry. But within the power family, a struggle is shaping up between silicon controlled rectifiers and triacs. Triacs are functionally equivalent to two scr's and sell for about 50% less. Glenn Geissinger, marketing manager at International Rectifier, anticipates a good year in both fields largely because his company concentrates on applications in the 35-amp area. Sylvania will join RCA, GE, TI, Motorola, and others in the power club later this month, after 18 months of development work, introducing an scr line designed to drive electroluminescent displays. The devices will operate at about 350 volts and 400 hertz at around 100 microamps. About midyear, the company will test-market a short line of triacs for control applications in home appliances.

Triacs are shaping up as a battleground. General Electric has led this discrete business, but RCA has been coming on strong and TI is about to make a move. The first triacs were developed for industrial customers but the devices have since proved their mettle in military applications.

Field effect transistor sales are up, and will continue to grow across the board. They replace tubes more handily than ic's in industrial and consumer applications. The leading firms are TI, Siliconix, Dickson, and Teledyne. Field effects are also being sold in chip form for use in modules. The year should see voltage levels climbing higher, greater power-handling capabilities, faster speed, more duals amplifiers, and more plastic packaging.

Unijunction transistors, which among other things trigger thyristors, will take off. The market, \$4.8 million in 1967, should hit \$7.2 million this year. Unijunctions compete with trigger diodes and other solid state devices but should outstrip them because of greater reliability and user acceptance.



## Growing—but still in the incubator

**The prognosis** for medical electronics remains uncertain. Although 1968 is expected to see sales hit \$296 million, up 14% from last year's \$260.5 million, it is doubtful that it will be a year in which the field's much-ballyhooed promise will be fulfilled.

For one thing, better than half of the field's volume is still in such commonplace apparatus as X-ray machines and hearing aids. For another, engineers and physicians have yet to develop a meaningful dialogue. As a result, electronics concerns aren't in a position to satisfy the medical profession's requirements. Finally, because research is to a great extent dependent upon Government grants, a shift in Federal expenditures can adversely affect funding in this area. And this is exactly what happened when the Administration clamped down on non-Vietnam spending.

### Rx for growth

Samuel Merion, marketing vice president at American Electronics Laboratories Inc., believes many medical-measurement problems could be solved speedily if more Government R&D money went to industry. Of the funds doled out by the National Institutes of Health for bioengineering and medical research, only a small portion is earmarked for development of medical instrumentation. And only a fraction of this finds its way to electronics firms even though, as Merion points out, "industry has both the personnel and technological resources to adequately cope with such programs."

The most promising area of medical electronics is patient monitoring; 30 or so companies are trying to gain a foothold in this market.

Says David Kelch, medical electronics product manager at the Hewlett-Packard Co.'s Sanborn division: "It's really caught on in the past three or four years. Now almost every hospital wants patient-monitoring equipment of some type." Sanborn's monitor line ranges from small, mobile machines to large, custom-designed installations like the multibed cardiac unit at New York City's Lenox Hill Hospital.

Although development still has a long way to go, monitoring equipment is already credited with halving the 40% mortality rate of coronary-occlusion cases admitted to hospitals. Despite this, most physicians feel far better equipment is needed.

The cry is for equipment that can monitor parameters considered better early warning indicators than electrocardiographic signals, pulse and respiratory rates, blood pressure, and temperature. What the medical profession wants is electronic gear that might measure the amount of blood pumped with each heartbeat, the flow of blood to certain organs, oxygen levels in the blood, and a pa-

tient's metabolic state.

Another segment of the medical market that holds out great promise is analytical instrumentation. Clinical analysis systems have proved superior to conventional laboratory techniques in speed, accuracy, and cost. Also, many different kinds of systems can be tied to a general-purpose computer that controls measurements and analyzes results.

Since such systems are costly, running as high as \$50,000, they must provide immediate and substantial savings. Most achieve this, say clinicians, pointing to the machines' capacity to do the work of 20 technicians at about 2% of the cost. Because of such savings, analytic instrumentation systems such as



**Reliable source.** Electronic instruments like this coagulation analyzer from Hewlett-Packard provide better test results at less cost than conventional lab procedures; they are gaining wide acceptance.

the Technicon Corp.'s Autoanalyzer; Becton, Dickinson & Co.'s amino acid analyzer, and Sanborn's coagulation analyzer, are expected to become standard equipment in an increasing number of hospitals.

Still another reason leading to the greater use of these systems in hospitals is the larger patient loads resulting from such large-scale programs as the Federal Government's Medicare.

With sales of intensive-care monitoring gear showing healthy signs of growth, several electronics firms are now examining the potential of surgical monitoring—including such specialized areas as cardiac catheterization. And a renewed interest is being shown in research systems. Previously, the medical community encountered problems with research equipment because of the inability to combine systems from different manufacturers. Interface problems caused the jettisoning of many projects. Now, however, individual electronics firms are able to supply complete systems.



## A funny thing happened on the way to prosperity

**Sales of color** television sets continue to disconcert the experts. Only 12 months ago, scores of self-appointed seers were freely predicting that the bellwether of the consumer sector would rack up a year-to-year gain of as much as 70%, selling 8 million receivers in the process.

But even as the confident forecasts were being issued, distribution pipelines were clogged with excess inventory. And consumers simply did not turn out to buy in the anticipated numbers. The rate of annual gain turned out to be more like 15%—a traumatic experience for an industry budgeted to do at least three or more times better.

This year, the optimism of those who draw wages for merchandising color sets is tempered by considerable caution. A demonstrably softening economy in which tight money slows sales of big-ticket items, generally bought on credit, is scarcely the place for euphoric projections. Besides, there is no precise way to gauge consumer reaction to international monetary crises and the income tax surcharge proposed by President Johnson.

### Off-color stories

As a result of a varied assortment of uncertainties, industry executives are inclined to take a retrospective, rather than forward, view of the situation.

“The slowdown in color tv sales is due largely to a shift in the economy from the 1966 level,” says B. S. Durant, president of the Radio Corp. of America’s sales organization. “Color sets will certainly show a marked increase in volume from present levels. But I wouldn’t want to make a guess and have to eat my predictions.”

Armin E. Allen, vice president of the Philco-Ford Corp.’s Consumer Electronics division, feels that the disappointment was due to overoptimism about prospects. “The fact is color tv didn’t saturate the market as expected,” he says.

This year the industry is looking for about an 8% gain in color set sales to \$2.07 billion from \$1.91 billion. The total consumer electronics market will fare less well, rising only about 6% from \$3.85 billion to \$4.09 billion.

The relatively modest progress cloaks a number of interesting developments. “Unit sales of color tv sets should pass black-and-white for the first time,” says Ross D. Siragusa, Jr., executive vice president of the Admiral Corp. This prospect is less a reflection of color’s success than monochrome receivers’ problems. Dollar volume in this category is expected to drop from \$477 million to \$393 million during 1968.

As a result of this deteriorating market situation



**Just looking, thanks.** At Zenith showroom in New York, a handful of prospective buyers inspects television sets. Manufacturers’ estimates for color were undone largely by economic uncertainties stemming from Vietnam war.



and spiraling costs of manufacture, domestic set makers are following their radio colleagues to the Far East for small-screen—19-inch to 23-inch—tv sets which they merchandise under their own brand names.

"The trend will continue," says RCA's Durant. "We will be seeing a greater transfer of products between continents. First it was Japan, now it is Taiwan, Hong Kong, and Korea; soon it may be Malaysia and Indonesia." Some companies, the Emerson Radio & Phonograph Corp., a subsidiary of the National Union Electric Corp., for example, have abandoned their U.S. assembly lines for transistorized radios and are relying entirely on imports.

### Sweet music

Sales gains are in store for the more expensive high-fidelity entertainment products. William F. Glasser, sales manager for H. H. Scott Inc., says, "The public is buying higher-priced goods than it did a few years ago. They want better quality and are willing to pay for it." A spokesman at Admiral says, "Fewer portable phonographs will be sold in 1968 as consumers raise their sights and go after the larger units." The public is also expressing a strong preference for compact equipment in which the receiver, amplifier, record changer, and tape deck are combined into a single package.

Radio sales will continue to increase, going from \$242.9 million to \$254.7 million. William Keepin, manager of the Norelco radio department of the North American Philips Co., estimates that f-m sets accounted for about 43% of 1967 radio sales. This compares with about 35% in 1966 and only 10% in 1960.

"The number of commercial f-m stations has jumped to 1,800 from only 800 in 1960," says Keepin. "F-m broadcasters now represent about 25% of the industry. In addition, the programming diversity required by the Federal Communications Commission of commonly owned stations has attracted bigger audiences to the medium."

All industry spokesmen agree that tape recorder sales will be considerably higher this year. "It is safe to say that the prerecorded tape industry has created a demand for better fidelity and more expensive tape recorders," says an executive of a consumer electronics firm. Cassettes are also set to take off. While total recorder sales will be up 29% this year, from \$144 million to \$184 million, tape cartridge volume will register a 60% gain, going from \$51 million to \$80 million.

### Big gains for small devices

Semiconductors will continue to strengthen their hold on consumer goods. Silicon controlled rectifiers, triacs, transistors, and even integrated circuits are being used in a wide assortment of appliances. Heating and air-conditioning equipment, clothes washers, and dryers, as well as dishwashing machines, are all starting to incorporate solid state devices. Integrated circuits are being used for switching and speed-control in such household wares as

### Reviving the radiation issue

Manufacturers of color television sets may be facing problems far more serious than a case of arrested growth. Last year's well-publicized flap over the 90,000 or so large-screen receivers built by the General Electric Co. that were emitting excessive X rays from shunt regulator tubes alerted legislators to the possibilities of the radiation issue. Two bills were immediately thrown into the Capitol Hill hopper. After a series of hearings which generated more heat than light, the story drifted off the front pages.

Now, however, the probe is back in the limelight. The Public Health Service in a recent report to Congress suggested that the radiation problem may be industrywide. While investigating sets in Florida, the agency says it found that 38 of 131 "corrected" GE receivers still emitted radiation in excess of the 0.5 milliroentgen level deemed safe by the National Council on Radiation Protection and Measurements.

While the downward radiation problem had been licked with replacement components and high-voltage rectifier tubes, the report says, the new shunt regulator is emitting excessive radiation from the sides of the sets. The upshot is that the National Center for Radiological Health is bent on examining all elements of every set in the marketplace for radiation.

vacuum cleaners, food blenders, and power tools.

Another growing outlet for solid state assemblies is the musical instrument business. The ranks of amateur musicians—defined as those who play an instrument at least six times a year—is swelling at an annual rate of more than two million. And manufacturers are filling the demand with electric guitars, electronic organs, and electric pianos, as well as a variety of amplification equipment and accessories, such as microphones and speakers. This \$100-million business will continue to grow.

Ironically, however, the television field is by and large holding out against using integrated circuitry en masse in color sets. Motorola Inc. has marketed an all solid state color receiver, but for the record, many manufacturers still consider IC's a promotional gimmick. "The full impact of solid state is another year off," says a spokesman for a semiconductor house.

The latest and largest area to feel the impact of electronics is the automotive industry. Last year more than 9 million cars rolled off the assembly lines, carrying nearly \$14.4 million worth of electronic equipment, excluding radios. This year, electronics' share should increase to nearly \$20 million. An increasingly significant factor in the automotive electronics picture will be the integrated voltage regulator first used in the General Motors Corp.'s Pontiac. By 1971, IC regulators should be accounting for more than \$27 million dollars of the \$50 million that Detroit will be spending on electronic devices.

This year car makers will also introduce some electronic tachometers and speedometers as well as engine performance analyzers and failure sensors.





## Educational electronics

# Computer-assisted instruction stepping up in class

**Educators,** Government officials, and electronics executives are paying their annual homage to computer-assisted instruction (CAI). But while increasing amounts of seed money are available, the field is longer on promise than performance.

### Bright outlook

Long-term prospects are, of course, still dazzling. For example, sales of computer-assisted instruction systems could hit an annual rate of \$1.5 billion within five years, says R. Louis Bright, associate commissioner for research at the U.S. Office of Education. "Any college or high school that fails to give its students experience in data processing techniques and ignores the impact of the computer on teaching techniques is obsolete," he says.

Bright's agency will spend about \$6 million of its \$90 million 1968 budget on projects involving computer-assisted instruction. And more money for local school systems will be allocated from the Office of Education's over-all budget of \$3.9 billion during 1968. Approximately \$400 million is earmarked for equipment, much of which will be electronic.

Computer-assisted instruction, although still considered an experimental technique, is being given a fair trial. As many as 300 installations involving some form of computer access—ranging from simple electric typewriters to cathode-ray-tube terminals—are in use around the U.S., says one knowledgeable observer. Probably 25 use the more sophisticated crt input/output display consoles, estimates Robert D. Gates, director of the Philco-Ford Corp.'s Education Development Center. This figure, which compares with the six or seven systems in place a year ago, should double by the end of 1968, he says.

A study made last year by the International Business Machines Corp. for the Federal Government indicates that by the early 1970's, as many as 50 large high schools and junior colleges within a 100-mile radius could be provided services from a single centrally located computer.

"At the conferences we attend, CAI is on everyone's lips," says one educator. "But at this point it really hasn't been fully tested. We still don't know how to best use it or just how useful it can be."



Teaching materials for computer-based systems continue to get a lot of attention, as do backup data systems to individualize the instruction, says Gates. A data base contains information on a student's educational history, his strengths, weaknesses, and learning ability.

"This sort of backup to the subject programs is going to be especially important to the long-term development of CAI," says Gates. "It will permit CAI to get beyond straight subject programming and deal with the needs of the individual."

"There's been good acceptance by the educational research community of computer-assisted instruction," says Clagett Jones, manager of instructional systems marketing for IBM's Data Processing division. "We've proven technically that we can teach. The question now is how well we can teach. In the next year or so we'll be refining and developing our teaching programs."

### Tale of two cities

The Radio Corp. of America will begin work this March on the largest CAI system in the world for the New York City school system. Philadelphia began installing a system with crt terminals, built by Philco-Ford, last fall.

The New York system will use 192 Teletype terminals spread through 15 separate schools. The terminals, modified for the student's use by RCA, will be tied into a central Spectra 70/45 computer.

The system will be used for drill and exercise programs in mathematics, spelling and reading for grades two through six, says Hugh McDougall, assistant director of computer-assisted instruction for New York City schools. The project is being helped by a three-year, \$2.5-million Federal grant.

New York chose to go with a Teletype system, rather than with crt terminals, because more units could be linked to the computer. At present, programming problems limit the number of crt terminals that can be tied into a central processor to about 32. Eventually, this number will be increased, but New York officials wanted to expose as many students as possible to the system from the outset.

Junior and community colleges, which are springing up around the country, at a rate of 50 to 60 a year, will provide a big boost for educational electronics because they are more receptive to new technologies than old institutions.

"They're not inhibited by existing systems or by faculties, because they're building everything from the ground up," says an electronics industry spokesman.

In time, the economics of computer-assisted instruction will become more attractive. For example, IBM estimates that hardware costs can be pushed as low as \$2 per hour per terminal for a system using cathode-ray-tube apparatus.

### New wine from old bottles

Dial-access systems, in which a student dials the number of a program and gets either an audio or video playback or both, will figure strongly in

educational electronics systems during 1968, says Robert H. Barnaby, manager of instructional systems merchandising at RCA.

Such equipment is an offshoot of the language laboratories used for a number of years at many colleges. Now they're being used for a variety of other subjects, and educators are interested in adding the video capability to systems already installed.

"Dial systems with both audio and video terminals have been around for just a year or so," says Barnaby. "Only now are they getting the attention and understanding of educators."

The systems aren't particularly fast sellers since they're generally ticketed for new campus buildings or learning-resources centers, Barnaby says. And these take years to get off the ground.

The video portion of dial-access systems, which cost from \$30,000 to \$100,000, can be tied into closed-circuit television systems. Closed circuit tv is also being used increasingly in schools and colleges. Sales volume is expected to jump almost 19% to \$19.7 million this year.

### Odds and ends

Educational television got a boost last fall with passage of a public television law authorizing \$37 million over the next three years for construction of educational broadcasting facilities and programming. The bill also authorizes \$500,000 to the Department of Health Education and Welfare to conduct a study to determine the roles of Federal, state and local governments in promoting instructional media. The study will cover closed-circuit tv and cable antenna tv as well as data and computer links.

A smaller but fast-growing segment of the educational electronics market is video tape recording. Sales, including accessory equipment, such as cameras and monitors, are growing at a rate of about \$10 million a year. John H. Trux, marketing manager of the Ampex Corp.'s Consumer and Educational Products division, anticipates a \$40 million market during 1968 and at least \$75 million by 1972.

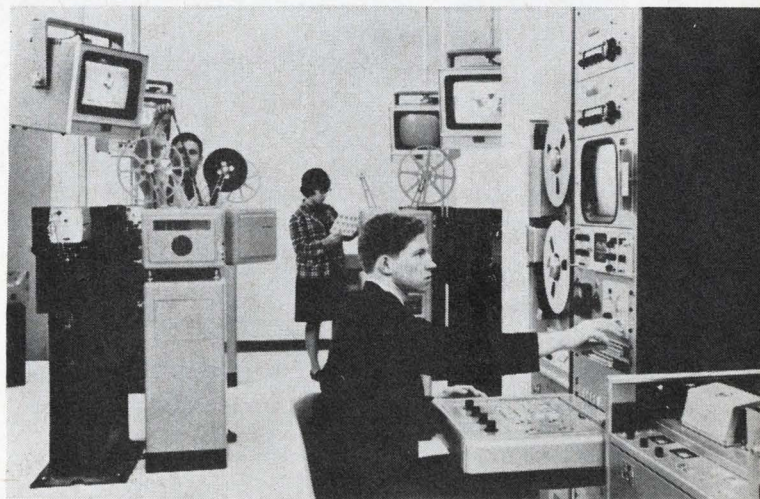

Control center. Bank of audio and video equipment is part of a college dial-access system built by RCA.



## Growth rate a Vietnam casualty

**Instrument makers** will settle for half a loaf again in 1968. Firms in the field are looking for a year-to-year sales gain of 12% from \$648.5 million to \$727.5 million. This rate of growth is about even with last year's pace but far below the 1966 level of 21%.

Research-and-development sales continue to fall because of U.S. commitments in Vietnam, says Allan B. Dallas, director of marketing at Honeywell Inc.'s Test Instrument division. Barring an unexpected peace, more funds will be diverted from research tools into direct military production. As a result, instrument manufacturers will sell more of their less lucrative wares: simple oscilloscopes and oscillographs as well as data-logging systems.

In addition, cutbacks in nonmilitary programs, particularly those in the aerospace field, are adversely affecting sales of specialty apparatus.

Despite the Vietnam situation, instrument makers' short-run prospects are good to excellent in many areas. Measurement-minded firms, in particular, will do well; many are developing means of checking previously unsurveyed parameters.

Oscilloscopes—the instrumentation field's bread-and-butter offering—are another likely area as producers keep pace with users' demands for units with faster rise times and such display plug-ins as

dual-beam, sampling, and storage apparatus. But scope customers are now pressing for the same features in portable instruments for field use. Chances are good that buyers will get what they want.

"Last year's growth in oscilloscopes was largely attributable to expanding markets in the computer and color television fields," says Keith Williams, marketing vice president at Tektronix Inc. This year, however, Williams believes sales to these outlets will hit a plateau. A growing number of scope applications with machine tools, automated systems, and instrumentation apparatus will take up some of the slack. One industry source says, "If the Pentagon ever gets the money, now earmarked for Vietnam, that is needed for all the shelved military electronics development projects, laboratory-scope sales will take off."

### Better wed

Integrated circuits are triggering a number of changes in instrumentation. For one thing, manufacturers are turning out more complex instruments which combine the capacities of two or more units. For another, the widespread use of ic's has led many firms to develop testers. In addition, ic's have made for lower price tags on some units as well as on computers, which now are being rapidly designed into instrumented measuring systems.

"Microcircuits make more complex functions possible," says Peter Richman, a consulting engineer and formerly engineering vice president at the Weston-Rotek division of Weston Instruments Inc., "This stimulates growth by opening up new applications and by further automating measurement."

Automated measuring systems were well-received during 1967 and sales should increase at a good clip this year, Leo Chamberlain, sales manager at the General Radio Co., believes. But he warns: "Sales will hinge on engineers' being educated to the fact that there are computers which are not huge and prohibitively expensive."

"Inexpensive computers provide the means for automatic data reduction and recording," says Richman. He notes that these are "possibly the two most expensive aspects" involved in making measurements. "The need to provide these functions by means of computer-operated test complexes exists, but it has hardly begun to be satisfied," he says.

Although many instrument makers sell automated systems, Hewlett-Packard Co. is the only firm producing its own computer. Other companies rely on inexpensive, general-purpose machines like the Digital Equipment Corp.'s PDP-8/S. W. Noel Eldred, H-P's marketing vice president sees great potential in this area. But while the company has a wide range of automatically controllable instruments



**Test case.** Typical, low-cost (\$4,850) IC tester from Teradyne Inc. makes 15,000 analog-logic checks on digital devices in 1/100 of a second. The outlook in this segment of the market is clouded by the need to educate potential users and standardize test goals.



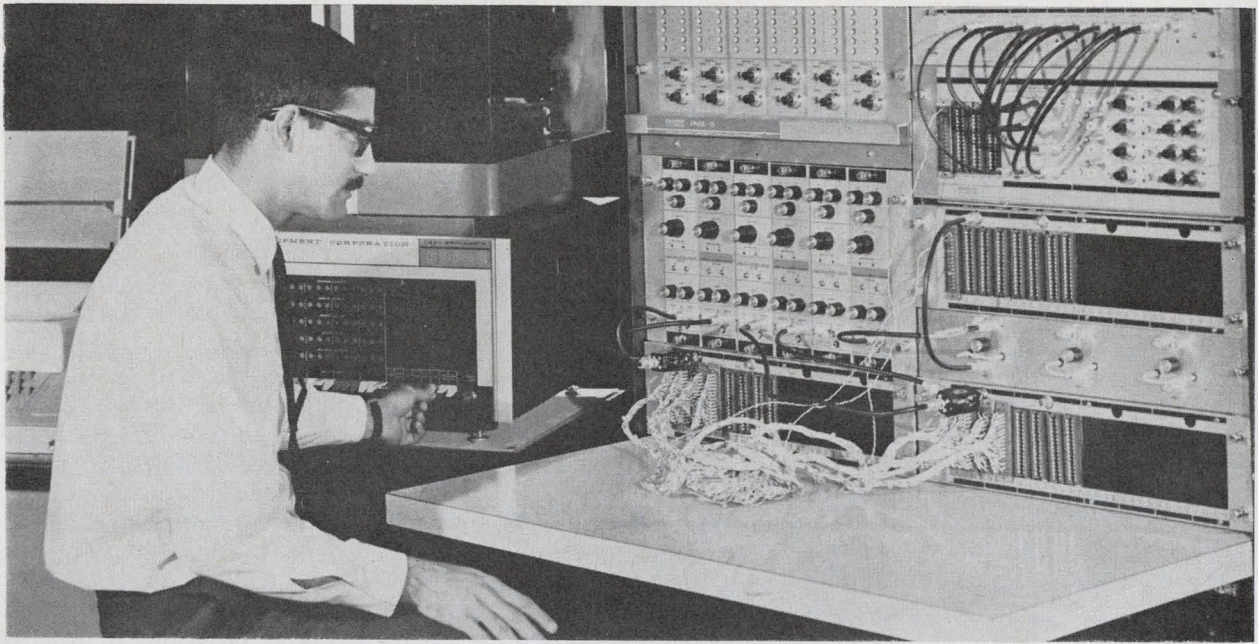

**Marriage of convenience.** Increasingly, test gear is being coupled to a digital computer to get more precise data faster and at a lower cost. Above is Digital Equipment Corp.'s programmed memory analyzer.

available, Eldred says, "our problem is finding better ways to combine reliability, performance, and economy."

### Bargain hunting

In many instances, using IC's in instrumentation results in a lower price tag. "The process industries and production-line users don't normally demand the accuracy of laboratory or aerospace customers," says Honeywell's Dallas. "However, they are still looking for reliable but less complex and less costly recording and display techniques for their data acquisition requirements."

Honeywell's 7600 instrumentation recorder, for example, was designed with off-the-shelf IC's and introduced last year at a price about 30% lower than comparable competitive units. The machine became a runaway best-seller in short order.

Digital voltmeters are another case in point for IC's. Long priced out of production-line and industrial applications, such instruments have profited, and will continue to profit from integrated IC's.

Last March, the Instrumentation division of the Fairchild Camera & Instrument Corp. introduced a three-digit dvm selling for \$325. Subsequently, Weston brought out an all-digital panel meter to replace their precision d'Arsonval line.

Both devices won widespread acceptance in industrial applications, so comparable gear is sure to follow from rival firms.

Counters provide yet another IC success story. The Monsanto Co.'s Electronics division, for example, recently introduced a counter-timer in which IC's not only led to a smaller package with more functions but a reduced price tag as well—about \$575. "The instrumentation field's growth is linked to direct digital, rather than analog, displays," says Myron C. Pogue, marketing manager at Monsanto's

electronics operation, a comparative newcomer to the instrumentation field.

Virtually all instrumentation houses are enthusiastic about the outlook for IC testers, a market that could mean as much as \$35 million in sales for instrumentation firms this year. The companies that have entered the field so far have tended to concentrate on low-priced—\$5,000 or less—devices. Hewlett-Packard, for example, last year introduced an instrument capable of testing IC's for incoming inspection at \$1,575. Soon after the Redcor Corp. unveiled a more elaborate unit, selling for \$4,950, that can perform d-c, a-c, linear, or function tests. But Beckman Instruments Inc. made it a whole new ball game by bringing out a low-priced unit for \$475. The outlook favors more economy testers coming to market.

Integrated circuits are a threat to certain instruments, notably those devices tied to discrete components application. Hewlett-Packard's Eldred views the rapid growth of IC's as an opportunity to expand his company's instrumentation markets, as does General Radio's Chamberlain. But Eldred's view of the immediate potential is pessimistic because "it's hard to spot any uniformity in users' needs." Chamberlain feels that "to fill such needs right now, the instrument house would almost have to take a job-shop approach, generating a new tester for each new customer."

"What's needed more than anything else to make this a potentially profitable market is standardization of test aims and procedures," Chamberlain says. "All this fussing about such items as Y or S parameters, variations in package styles, and whether to test on the wafer, after dicing, or in the package, just muddies the waters." Help is on the way, however. Sometime next month the Defense Department will issue standards on IC testing.



## Aviation's growth sends 1968 prospects soaring

**Up, up, up!** That's what avionics makers are saying about 1968 prospects. And with little wonder.

- Commercial and general aircraft sales are growing at a lusty rate.

- Avionics, which accounted for 20% of an aircraft's basic price in 1967, is expected to account for 25% this year.

- The Federal Aviation Administration, still reeling from Congressional criticism, is planning several major air-safety programs and seeking follow-ons for others.

What these add up to is a banner year for avionics. In flight-control and related instrumentation systems alone, commercial and military sales are expected to hit \$400 million, up 10% from last year. And the outlook for general aviation may be even better. Operators of general aircraft are showing a mounting interest in avionics systems.

Not only are more and more corporate aircraft being fitted out with doppler and inertial navigation systems as well as better flight-control gear, but the trend in general aviation is to trade up. According to the Aviation Dealers and Manufacturers As-

sociation, there is a marked increase in pilots buying sophisticated equipment they weren't even aware of several years ago.

The growth of both commercial and general aviation will have a tremendous impact on the FAA, not only in 1968 but in the years to come. Presently, the domestic-airlines fleet numbers 2,000 craft, mostly jets. But by 1977, this number is expected to swell to 3,500, mostly in the jumbo and supersonic jet categories. And the general-aviation fleet, now numbering 104,000, is expected to grow to 180,000—about 8,000 of which will be business jets.

As the traffic in the skies increases, so will the problem of directing it.

At the moment, FAA controllers handle 42 million takeoffs and landings a year. But, based on the agency's own data, this load will grow in 10 years to 140 million. Beset with an already overburdened control system, the FAA is finally making a serious effort to automate traffic-control procedures at the nation's major airports.

Top-priority purchases this year include terminal radar control (Tracon) equipment and a low-cost

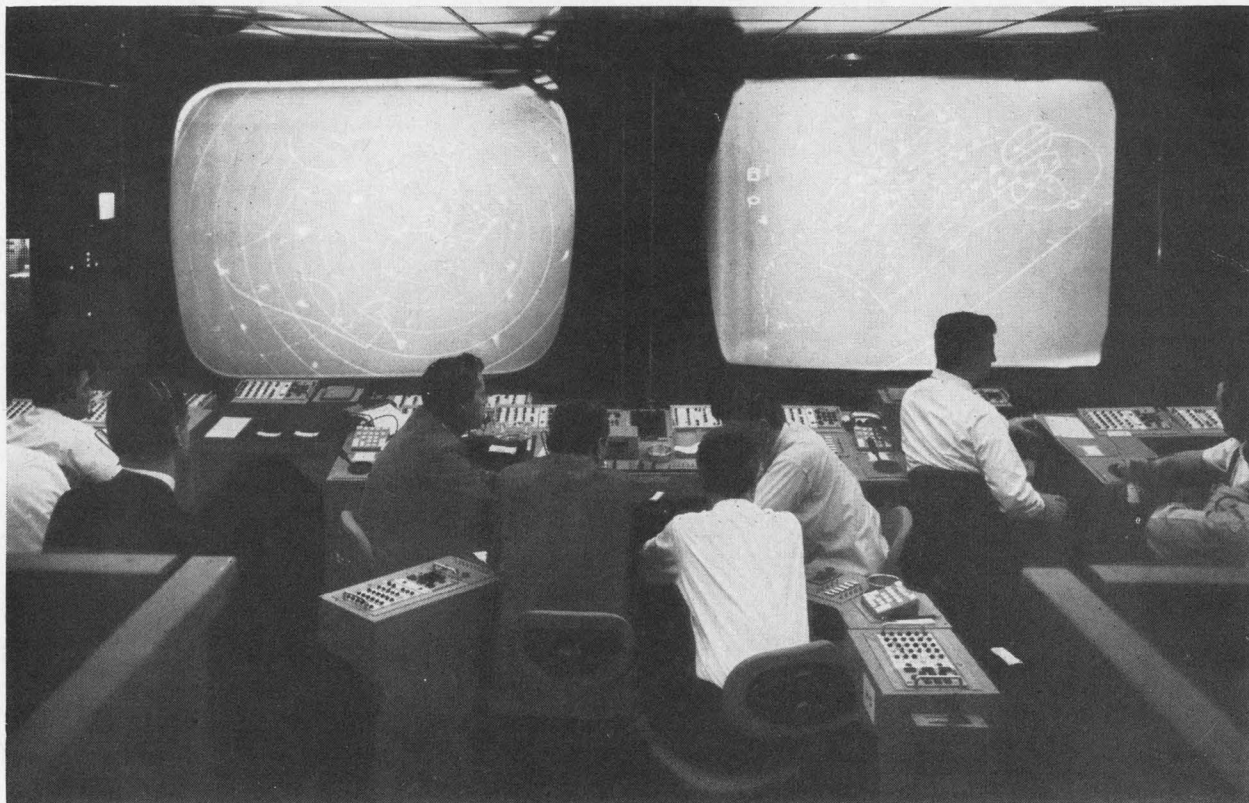

**Only make-believe.** Terminal radar control equipment, simulated at the FAA's Atlantic City, N.J., facility, will be a big item during 1968. The system will give air controllers automated alphanumeric identification.



FAA-developed instrument-landing system, says John Weber, the agency's manager of research and development services.

### Better late

Tracon, tested at Atlanta, Ga., for more than two years as part of the FAA's Advanced Radar Traffic System, will bring to terminal control the same kind of automated alphanumeric identification used in the National Airspace System now being installed at 20 en route traffic-control centers. About \$100 million in airspace system contracts were awarded last year for computers, radar displays, and video digitizers.

Initially, says Weber, Tracon will be installed at medium- and high-density terminals—there are 83 such airports in the U.S.

Designated Tracon C, the equipment is hooked up to existing terminal radars to display an aircraft's identification number, range, altitude, and speed. Typically, a package includes a video digitizer to accept data from an aircraft beacon and convert it into alphanumerics that are written on the bright radar displays at the terminal. A computer processor will store flight-plan information and calculate aircraft speed. Hardware to modify radar displays is available if necessary. Installation costs run upwards of \$500,000, depending on whether the package includes new radar displays.

During 1968, all domestic commercial aircraft will be equipped with beacon transponders to communicate with the en route and terminal systems. And although these transponders aren't required for general aircraft, there are indications that a growing number of these pilots may want to work with the system. This suggests a market for both low-cost transponders and hardware that adds altitude-reporting capabilities to existing units.

In addition to Tracon, the FAA will be installing its bargain-priced Mark I instrument-landing system at as many as 80 airports, Weber says. This solid state equipment, incorporating a simple localizer antenna, was developed by the agency last year and designed to cost \$50,000 installed—about one-third the price of comparable systems.

Emphasis on traffic-control gear is only one part of the bright picture for avionics; another is the newer commercial aircraft, with their greater reliance on avionics.

The first deliveries of the Boeing Co.'s twin-jet 737's will be made this year, and there will be stepped-up shipments of the McDonnell Douglas Corp.'s stretched-out DC-8's and DC-9's. Boeing will roll out its 500-passenger 747, and American and European development will continue on supersonic transports as well as on medium-range airbus craft. Falling into the latter category are the Lockheed Aircraft Corp.'s L-1011 and the McDonnell Douglas' DC-10. Boeing and a continental consortium are also readying designs.

Still another bright spot is nonmilitary inertial navigation—despite the setback last summer when Pan American World Airways cancelled a \$25-mil-

lion contract with the Sperry Gyroscope Co., a division of the Sperry Rand Corp., calling for installation of commercial systems in its fleet.

Pan Am turned instead to dual-doppler systems supplied by the Bendix Corp. Nonetheless, installations of inertial guidance equipment should start to mushroom in 1968. Some 200 systems will be ordered by the airlines this year, says Lewis Lawton, manager of commercial systems requirements at the General Motors Corp.'s AC Electronics division.

Looking ahead, Lawton predicts some 800 inertial systems will be ordered by 1969 and 2,500 systems by the end of 1971. And with the emergence of the supersonic transports, this number can be swelled by as much as 2,000.

American Airlines, which last year successfully tested Litton Industries Inc.'s LTN-51 systems on 707 airfreighters, will install dual production versions on at least four, and possibly six, cargo planes flying military runs in the Pacific.

Other international carriers, including British Overseas Airways, will continue looking into different inertial systems before deciding which will be used in the Boeing 747's now on order. Several carriers are also weighing the possibilities of retrofitting such systems into planes already in service. Thus far, Litton with its LTN-51 and AC Electronics with its Carousel 4 appear to have the edge, at least as far as American firms are concerned. Sperry Gyroscope, whose SGN-10 flunked at Pan Am, may decide to drop out of the field.

### Ounce of prevention

Maintaining and troubleshooting increasingly complex avionics gear continues to be a major problem for the airlines. American, for example, is installing a \$250,000 electronic testing unit, bought from Britain's Hawker Siddeley Dynamics Ltd., which will automatically test autopilot systems; the unit simultaneously produces data for computerized performance analyses.

American is also installing a dual-purpose recorder-computer system that will monitor both engine and flight-crew performance. The computer provides a diagnostic readout, which will enable the ground crews to spot potentially serious faults before they can ground a flight or, worse yet, lead to a fatal tragedy. A management section will study crews' flight procedures and use the findings to supplement the airline's training program.

Twenty of the systems have been ordered from the Garrett Corp.'s AiResearch division at a cost of \$2 million. If these units live up to expectations, American will equip its entire fleet. The total cost: \$17 million. Hopefully, the carrier can save \$10 million a year by improving maintenance control and reducing flight cancellations.

As a step toward better maintenance, says John Woodward, marketing manager of aviation equipment at the Radio Corp. of America in Los Angeles, more built-in self-testing circuitry will be added to avionics gear. This self-test capacity will tell the pilot, before he takes off, whether his equipment is



in working order and inform ground-based maintenance men which portion of a piece of gear has malfunctioned.

The company has incorporated self-testing features in its new AVQ/30 weather radar. This unit displays its own monitored performance information on the cathode-ray tube. Designed for airborne applications, the radar's self-testing is conducted before the user aircraft takes off. RCA is still weighing the possibility of modifying some of its other equipment to do the same thing. Last fall, American Airlines, for example, began testing a fault-isolation retrofit for RCA's AVQ/10 weather radar. Eventually, self-testing could be extended to incorporate a central memory unit capable of diagnosing troubles in all electronic equipment aboard aircraft, says an industry source.

Also possible is transmitting monitored performance information via a digital data link to ground stations while the plane is airborne. Such a link was successfully tested last year by Pan Am. Very-high-frequency signals were relayed from the first Applications Technology Satellite.

Also giving rise to avionics' optimistic outlook is the further development of digital processing techniques. With this will come increased use of silicon integrated circuits and hybrid devices. Several companies, including RCA, the International Telephone & Telegraph Corp., and the Collins Radio Co., are developing digital distance-measuring equipment (DME) for commercial airlines. Last year, for example, the Airborne Instruments Laboratory, a division of Cutler-Hammer Inc., delivered to the FAA a vhf omnirange (VOR) receiver with an all-digital navigation section built of silicon IC's. And RCA will be counting heavily on silicon IC's in an integrated navigation-communications package it plans to introduce later this year.

In addition to reducing the size—and possibly the price—of the equipment, such new designs would make it possible to acquire a DME station in a fraction of a second instead of the 20 seconds it now takes, says Siegbert B. Poritzky, head of the navigation wing of the Air Transport Association of America (ATA). And, he points out, the accuracy of a DME system could even be improved to  $\pm 250$  feet—a far cry from the present level of  $\pm$  half-mile.

Experiments will also continue with VOR/DME area-navigation techniques. Last October, the FAA designated the first routes—in the Northeast corridor—for area navigation. Both Eastern Airlines and American Airlines are using this navigation technique along these routes.

### Safety in the skies

Not only will IC's find greater use in digital navigation systems, but they are also being relied heavily upon for collision-avoidance systems. This year should see giant strides in development work.

Last year, the ATA prepared a technical description of a time-frequency control system favored by the airlines. Several companies, among them Collins Radio, Bendix, and TRG Inc., a subsidiary of the

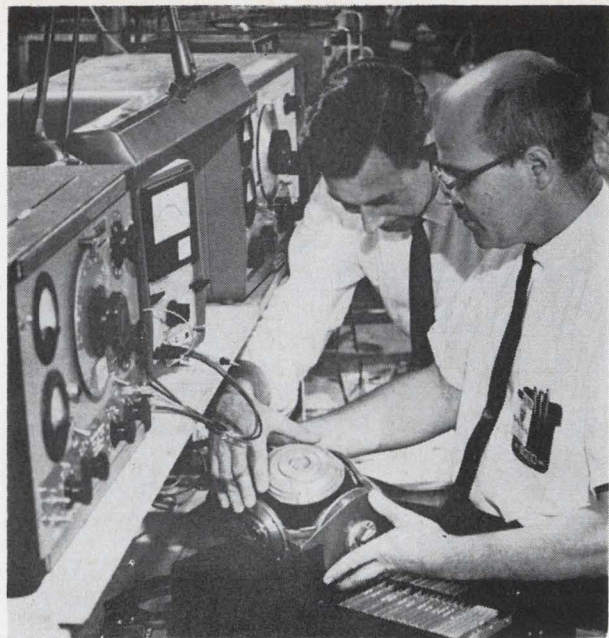

**Logical contender.** AC Electronics with its Carousel 4, shown above, and Litton with its LTN-51 appear to be the only American firms able to supply commercial inertial-navigation systems to the world's airlines.

Control Data Corp., will be building systems to these requirements. The ATA program calls for the first flight testing of manufacturer's collision-avoidance gear early next year.

The system envisioned by the airline group will have aircraft—up to a theoretical limit of 1,000—transmit range, range rate, and altitude information to one another. Each aircraft will transmit signals in one of 2,000 reserved time slots. Timing for the over-all system will be controlled by ground stations. When a collision appears imminent, the system will send the appropriate evasion maneuver commands to the pilots.

Although the airborne equipment for commercial aircraft is likely to be expensive—possibly running as high as \$75,000—the ATA hopes devices will be developed for general aviation that will be both simpler and less costly. Such equipment would allow private pilots to “listen in” and be warned when commercial craft are in their vicinity.

Still another area that will continue to get its share of attention is clear-air turbulence detection systems. The North American Rockwell Corp.'s Autonetics division, for example, is testing an infrared sensor aboard a Pan Am Boeing 707-321B on regular passenger runs. The system will have logged 140 hours of flight time by the time the project is completed next month. Prior to the Pan Am check-out, Autonetics' system was installed on an Air Force cargo plane, detecting CAT fronts at distances up to 30 miles.

Boeing has been experimenting with long-wave (220 megahertz) and L-band (1.3 gigahertz) radar systems to detect turbulence. Thus far, the apparatus has been tested on the ground. However, light planes have been sent up to confirm the existence of detected CAT. This month, one of the systems will be flight tested in a company-owned 727.



# Too hot not to cool down?

**Computer makers'** enthusiasm for their domestic prospects is tempered only by nagging doubts about their ability to serve all possible markets. For example, the difficulties involved in hiring and training programmers and system support personnel largely account for the failure of some producers to help their customers in the proper use of electronic data processing equipment. Moreover, spiraling labor costs, offset only partially by improvements in production techniques, are continually exerting upward pressure on system prices.

Against the backdrop of the big numbers involved, however, such problems seem small indeed. Current-year sales of computers and related apparatus are pegged at \$3.74 billion, a whopping 20% improvement over the \$3.12 billion rung up in 1967.

During the past five years, the field has enjoyed an average annual growth rate of about 20%. Over the longer run, this heady pace may slacken a bit. "We are projecting annual gains of 15% beyond 1968," says Curtis W. Fritze, director of corporate planning at the Control Data Corp.

### Lebensraum

Despite reservations in some quarters, production and marketing curves are still pointing firmly upward. And plant expansion is the order of the day throughout the industry.

The Burroughs Corp., which hopes to break even on its EDP operations this year and turn a profit next year for the first time, plans 11 new installations around the world during the next five years. And the General Electric Co. has just increased the size of its Oklahoma City plant by 35%. Expansion programs are also under way or have been recently completed at Electronic Associates Inc., the National Cash Register Co., Scientific Data Systems Inc., the Univac division of the Sperry Rand Corp., and the Ampex Corp.

For more than a decade, big, fast, and costly processors have thoroughly dominated the computer scene. But the picture is changing: bargain-priced, bantamweight machines will take much of the play away from supersystems this year.

In the vanguard of this upheaval are two outfits not normally considered dominant figures in the EDP fields—the Digital Equipment Corp. with an integrated circuit takeoff on its PDP-8 series and the Hewlett-Packard Co. with its model 2115A, an economy version of the 2116A, introduced early last fall.

Probably the main reason for small computers' having caught the fancies of users and manufacturers alike is the extreme difficulty experienced in programming the large, third-generation machines.

Moreover, both groups are waking up to the fact that there is a real place for small computers that can perform specific tasks efficiently for a reasonable cost. Finally, IC's have helped bring the price of general-purpose machines below \$20,000.

"We see continued growth in the market for small computers for quite a few more years," says Kenneth H. Olson, president of DEC. "There are still many applications to be developed." Analysts put 1967 volume at more than \$200 million and say the annual rate of gain outstrips that of the computer field as a whole.

Univac and GE also do well with small machines, selling the majority as terminals that are linked to larger processors in time-sharing systems. National Cash Register reports that it is always pleased to get an order for a small unit since, frequently, customers graduate to larger equipment.

The Radio Corp. of America eschews both the mighty mites and supersystems, preferring to concentrate its efforts on medium-size machines. "We should continue to do well in this area," says William R. Lonergan, divisional vice president for product planning. "Most of our sales are in communications applications where the computer is connected to, say, another computer over a telephone line."

The industry's colossus, the International Business Machines Corp., which controls upwards of two-thirds of the market, will continue to dominate outlets buying small- and medium-sized machines. Most of the company's customers are in the old-friends category, having started out on punched-card gear, graduated to the 1401 during the early 1960's, and switched to model 20's and 30's of the

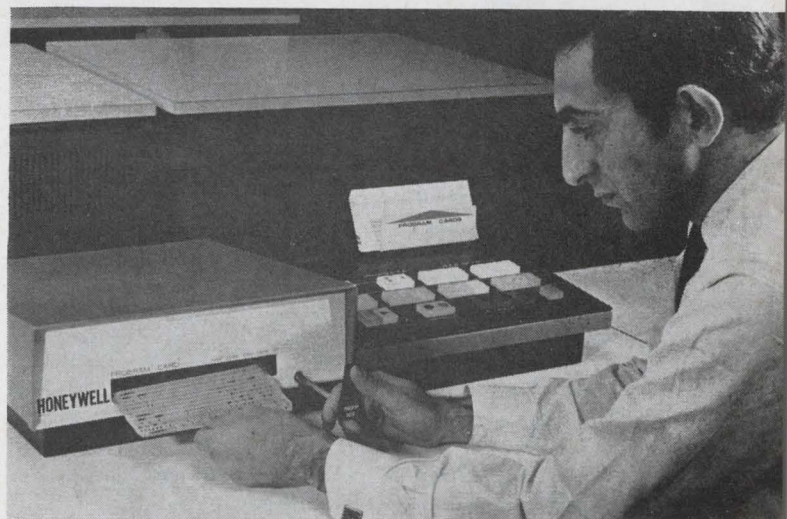

**Traffic cop.** Integrated read-only memory in Honeywell H-4200 primarily controls internal hardware operations.



System 360 in recent years. Loyalty like this, reinforced by IBM's highly qualified corps of support personnel, is hard to beat. Ironically, however, IBM has been less than successful in cracking the high end of the line where large machines hold sway. As a matter of fact, the 360/90 series was withdrawn from the marketplace last spring with the lame excuse that such was IBM's intention all along.

Control Data, which bills itself as the manufacturer of the world's largest computer (the CDC 6600), expects to continue thriving in the big machine sector. Univac and Scientific Data Systems should continue to do well at the two extremes of the market.

### Diminishing returns

Until recently, the dominant trend in computer design was to reduce the cost per calculation by increasing the size and speed of the machine. Where it cost \$1 to process 35,000 program instructions



**Big hit.** Small units like the PDP-8/1 built by the Digital Equipment Corp. will find a ready market during 1968.

in 1950, according to IBM data, 35 million can now be handled for the same price.

Theoretically, this enables processors to work on several problems at the same time. But the larger the machine, the more important is precision scheduling of peripheral gear like tape transports, printers, punched-card input and output devices, and data transmission apparatus. Exactness must be automatic—a situation requiring complex operating system programs that have proved difficult, or impossible, to write. Worse yet, the programs for operating systems have grown so large, they choke computer memories, reducing a machine's capacity to perform useful tasks.

Since a computer system's performance is as

dependent upon software as hardware, and manufacturers show few signs of being able to solve their programming problems any time soon, it's possible that cost per calculation could begin to rise. If this should occur, the likelihood of separate pricing for software and hardware increases.

With programming now accounting for upwards of half the purchase price of a system, there is at least some appeal in this practice for all parties. Manufacturers would be able to get a truer picture of costs; customers could shop for the best deal on their particular application; and software houses could compete head-on with hardware outfits. Already, CDC and SDS have sent up trial balloons on separate pricing; others are likely this year.

Read-only memories, used increasingly as sequence controllers in computers and other digital systems, may offer a way out of the wilderness. Their content has been dubbed "firmware," something of a cross between hardware and software; such units appear to have the potential to ease the burdens of designers on both sides of the fence. Honeywell, for one, has incorporated a read-only memory with integrated and hybrid circuits in its H-4200 computer, the second largest in its line.

Practically all large computers can now operate in the time-sharing (simultaneous access by several users from remote terminals) or multiprogramming (simultaneous maintenance of several programs in a single processor's memory) modes. Both, however, are still in search of viable futures. Time-sharing, in particular, has exacerbated software problems by introducing complex coding and programming requirements to assure each user's privacy.

Nonetheless, all of the giants, including IBM, Control Data, RCA, Univac, GE, and Honeywell are committing themselves heavily. Among other installations, Honeywell has set up a system with 600 on-line terminals for the New York State Racing Association; and IBM is seeking to extend its RAX (for remote access computer system), which was checked out last year at the Lockheed Aircraft Corp.'s Marietta, Ga., plant, to university campuses as well as industrial applications.

But progress, it would seem, produces as many problems as paucity. "The advent of multiprogramming, time-sharing, and remote inquiry systems has taken away the cushion of excess central process capacity that characterized the industry until a year or so ago," says a Honeywell source. "We need faster central processors again."

### Quo vadis?

But computers are approaching limits imposed by such universal constants as the speed of light. And since an enormous effort is now required to achieve even an incremental improvement in performance, there is no clear consensus on just how advances are to be achieved:

▪ "We expect cheaper, faster, and smaller electronic circuitry as well as better direct-access devices over the next several years," says RCA's Lonergan.



▪ "Performance levels will be enhanced by more parallel processing. As we get complete arithmetic units on a large-scale-integration chip, we will be limited only by our ability to write software languages that can generate a large degree of parallelism," says a Burroughs spokesman.

▪ Processor performance levels will improve greatly as a result of significantly higher memory speeds and from parallel organization in larger systems where additional speed is essential," says Donald E. Eckdahl, vice president of NCR's Electronics division.

▪ "The real breakthrough in computer systems' capabilities still hinges upon vastly increased speeds in input/output peripheral equipment," says a GE spokesman.

▪ "Improvements in software will be the principal means of improving performance," says Control Data's Fritze.

### Around the circuits

Monolithic integrated circuits are finally making a big move in computer applications. During the months ahead, Burroughs, Electronic Associates, RCA, and the Digital Equipment Corp., among others, all expect to make greater use of them.

Discrete and hybrid assemblies are, however, by no means dead. In its System 360 series, IBM is heavily committed to hybrids. And Control Data is, for the moment at least, sticking to discrete components for its supercomputers on the grounds that monolithic IC's have only recently achieved the speed levels necessary for large processors.

Large-scale integration, though it continues to arouse great interest, is still a will-o'-the-wisp for most computer manufacturers. "The change from IC's to LSI will be gradual and evolutionary, as was the transition from transistors," says a Honeywell spokesman. "The basic justification for quantity application of one over the other is cost. Speed becomes secondary."

However, at Burroughs, a spokesman says, "Large-scale integration using metal oxide semiconductor techniques will really hit in 1968 as vendors swing into production and systems houses get going with new designs that incorporate this low-cost, relatively slow circuitry." Although this opinion is not shared by others in the computer and semiconductor fields, Burroughs is expected to use large-scale arrays in Illiac 4.

Ferrite cores have dominated the computer memory field for many years and are likely to continue to do so for some time to come. Engineers at Ampex, a leader in the industry, anticipate development of core assemblies with cycle times as short as 250 nanoseconds. They are also looking for a renaissance of three-dimensional, three-wire memories where high speed is not a requirement. The most recent development in core memories—and one that may catch on in higher-speed applications—is the 2.5-dimension organization.

"Cores are entrenched," says Lester Spandorfer, director of technical planning at Univac. "They

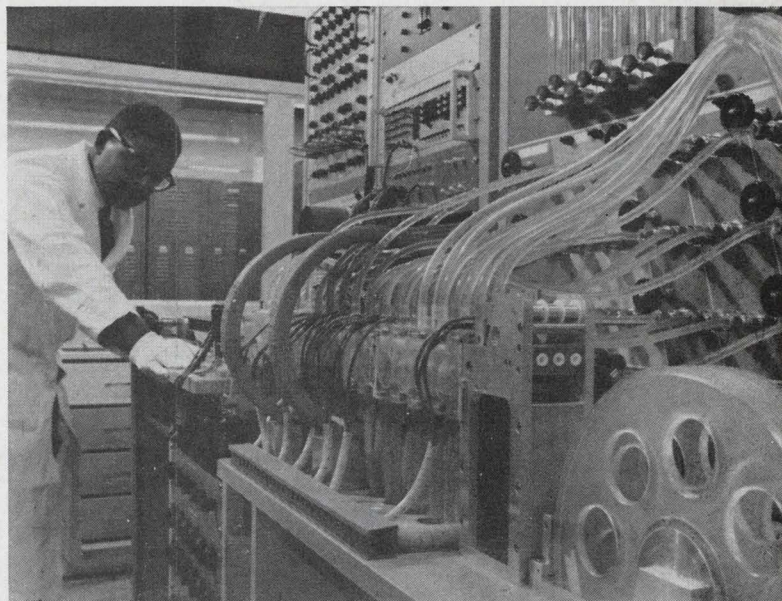

**Speed merchant.** Univac technician oversees making of plated wire for memory systems. Ferrite cores still dominate the computer field, but plated wire is gaining ground in applications where high speed is essential.

won't be displaced overnight. But the plated-wire memory used in our 9000 series computers will give cores a horse race at higher speeds."

Spandorfer's position is somewhat at odds with that of Ampex, which feels that plated wires will be useful only for military and special-purpose applications in the foreseeable future. But RCA has tacitly recognized plated wire's gathering strength by recruiting an expert from a rival. Ferroxcube Corp., another stalwart of core memories, took the same step and will introduce a plated-wire assembly later this year.

Thin films are also getting a good look. Burroughs uses such memories in its larger machines as does NCR, which is pressing development of thin-film rod memories. Integrated circuits will be commonly employed as memory drivers this year. Eventually, such devices will be used as storage cells in large-scale arrays—as they are now in scratchpad assemblies—but most observers agree this development is five or so years away.

"By the mid-1970's, terminal units will account for half or more of the total dollar volume of EDP equipment being produced," says Ray W. Macdonald, president of Burroughs. His industry fellows say amen; Univac, in particular, feels this trend goes far toward explaining the marketing success of smaller machines.

Optical character readers, which can eliminate the document-to-punched-card and card-to-tape steps long necessary to prepare data for computer use, will get more attention this year. As pattern-recognition techniques improve, such readers will win wider acceptance. Even now, there are machines that can read typewritten copy; others can even handle a limited number of handwritten characters drawn in standard positions on special forms.



## Signal gains in store for 1968

**Communications firms** are looking for about an 11% improvement in 1968, from \$1.29 billion to \$1.44 billion. Telemetry, land-mobile, and microwave relay equipment will all register healthy gains.

Telemetry sales will spurt from last year's estimated \$185.1 million to \$211.9 million, reflecting large contracts from the National Aeronautics and Space Administration for its Apollo and unmanned satellite programs. In addition, the armed forces are in the midst of converting their air-to-ground communications from vhf to L band and S band.

### Land, sea, and air

Despite the shortage of frequencies in metropolitan areas, an increasing number of applications are being found for mobile radios, both vehicle-mounted and portable, in the civilian sector. Police departments, transit authorities, and fire departments are among the agencies buying equipment in quantity with an eye to assuring the public's safety, convenience, and comfort.

Motorola Inc., which has filled recent orders in St. Louis, Dallas, Detroit, and other areas, and the Radio Corp. of America, which has scored in California, New York City, and Chicago, are probably the leaders in urban outlets. They must, however, be constantly on their mettle. For example, Sylvania Electric Products Inc., a subsidiary of the General Telephone & Electronics Corp., is preparing to introduce this year an automatic bus identification-and-emergency beacon system that provides instant alarm protection while affording more efficient

routing of vehicles in a fleet.

Edward J. Hart, manager of RCA's communications department, attributes the company's success in two-way radios—it claims an annual growth rate almost double that of the industry—to the reliability of its solid state units. Besides, the prestige attendant to cracking the vast New York City market has proved helpful.

On a higher plane, W. J. McKnight, assistant vice president in the Collins Radio Co.'s New York City office, sees a great future for computer-controlled aircraft communications systems. Collins has built a mock-up that permits push-button channel tuning in the cockpit. Although there are as yet no takers, the company has high hopes for its unit.

"Functional integration of aircraft communications and navigation subsystems is going to have a revolutionary impact on design," says Paul Hansel, vice president of engineering at Electronic Communications Inc. "And once you combine systems in a single black box, your reliability requirements go way up. In the past, we put equipment on trial and either convicted or acquitted it. Now we deliberately set out to get reliability."

Hansel expects that functional integration will increase the incidence of digital transmission. "Here integrated circuitry holds great promise," he says. "Such devices afford greater reliability and allow designers to be bolder in exploring more complex systems." Pressures to conserve spectrum and packaging exigencies are adding impetus to the trend to sophisticated digital systems. As a result, ECI is exploring such exotic techniques as chirp modulation, frequency hopping, and wave compression in its research and development programs.

"Satellite communications is experiencing considerable growth as a result of simultaneous implementation of both military and commercial networks around the world," says Robert G. Lynch, vice president of military marketing at Sylvania Electronic Systems, also a CT&E subsidiary. Sylvania has the best of both possible worlds, supplying ground-station gear and mechanically despun antennas for satellites.

Frank P. Barnes, senior vice president for telecommunications at the International Telephone & Telegraph Corp., which has a more than casual interest in the matter, says: "Urgent requirements for more and better international channels are typified by the current discussions on implementing the proposed new transatlantic cable, TAT-5." Whatever the eventual resolution of this interesting contretemps between cable and satellite interests on both sides of the Atlantic, Barnes looks for increasing use of IC's in commercial communications equipment. He cites transmission networks as



**Where there's smoke.** Mobile communications center, built by RCA for the Chicago Fire Department, has two tv cameras; one remote-controlled unit is atop cab while the second with 1,000 feet of cable can be hauled up ladders for close-up views of fires and other disasters. Rig is also equipped with 10 radios for two-way communication with other state and local agencies as well as video tape recorders.



well as computer-controlled and pulse-code-modulation switching among prospective applications.

### Television signals

Sales of television broadcasting gear will level off this year, going from \$135.7 million to \$134 million. Andrew F. Inglis, a division vice president with RCA's broadcast and communications products division, says the first color buying wave—largely from big city stations—is over; the next will come from stations expanding their color facilities and new outfits in smaller communities. "The market's going to depend in part on the prosperity of the stations and they've suffered a drop in income of late," reports an industry source.

The attrition in color equipment sales is offset, at least partially, by the uhf market which, according to Inglis, looks even better than it did in 1967, a very good year. More stations set up shop last year than at any time since the 1952-54 period, and, with an assist from the Federal Communications Commission, the trend should persist in 1968. Educational outlets will provide an important plus for many firms interested in selling uhf broadcasting equipment. For example, RCA has a sizable contract with Kentucky to set up 12 ETV stations.

Another positive factor in the uhf equipment business is the switch by metropolitan broadcasters to higher-power apparatus to get greater geographical coverage. Available this year will be an omnidirectional package with a 110-kilowatt transmitter as well as an antenna with a gain of 55. This set-up will permit uhf stations to broadcast at 5 megawatts in all directions.

In the video-tape-recorder field, the trend is still to so-called high-band equipment, which records a signal modulated on a carrier about 4 megahertz from the color signal's subcarrier. The Ampex Corp., the leader in the field, is being challenged by RCA, which introduced an economy-priced recorder late last year. The unit, designated the TR 50, sells for \$54,500—as against about \$80,000 for comparable equipment—and is aimed at the small-station market.

Cable antenna television will enjoy comfortable gains during the year. But Walton Clark, a marketing executive with the Jerrold Corp., an operator and equipment maker, is not looking for spectacular sales growth in hardware. "Short of some crippling legislation, business will prosper regardless of what turn Government regulation takes," he says. Jerrold has introduced a 20-channel cable system that can be installed underground as well as above-ground. This will eventually supplant the 12-channel cable that is now the industry's standard.

Among the factors contributing to cable tv's brushfire growth around the U.S. are the greater market penetration of color sets, particularly in ghost-haunted urban areas, and the greater number of channels in operation. Negative influences include a much-waived freeze on operators' entering the 100 top markets, a copyright squabble, and vigorous opposition from broadcasters' trade

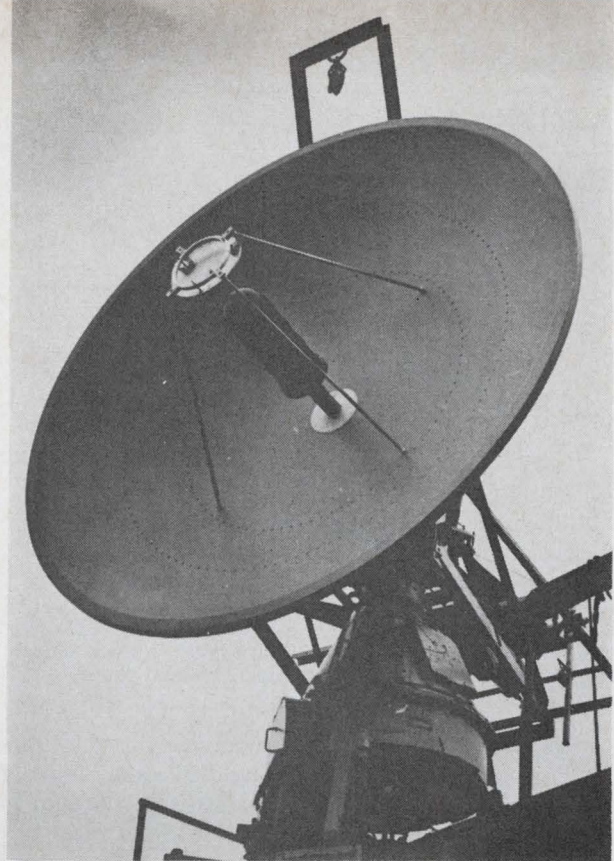

**Two in one.** Dual-polarized, 10-foot parabolic antenna, built by the Technical Appliance Corp., eliminates the need for second unit in 6 and 11 Ghz microwave service.

groups. However, on the theory that "if you can't lick 'em, join 'em," all three networks and an impressive number of top independents have jumped into cable tv.

Jerrold, along with many of its industry fellows, is looking toward the day when it can offer cable services other than tv. Coax can easily be used to transmit f-m, data, and telephone signals as well as tv into the home, Clark points out. To the end of achieving ultrareliability, Jerrold is introducing solid state devices into its CATV and microwave systems as rapidly as possible.

Independent phone companies—and the Bell System too, for that matter—are waking up to the fact that cable tv's future has great potential in a consumer-oriented society. For example, Claude E. Munsell, director of engineering at General Telephone, says: "The phone companies have the know-how and set-up to handle CATV signals from the head end to their destination, amplifying and making adjustments as necessary along the way so subscribers can get the service they expect." The company, which has several manufacturing units capable of producing cable tv equipment, has filed a wide-spectrum tariff proposal with the FCC with an eye to getting into the field on a substantial basis.

### Ties that bind

Earlier this year, the American Telephone & Telegraph Co. filed for rate increases on its Telpak lines, bulk communications media which provide voice-grade channels at economical charges. Favorable action by the FCC might result in consideration



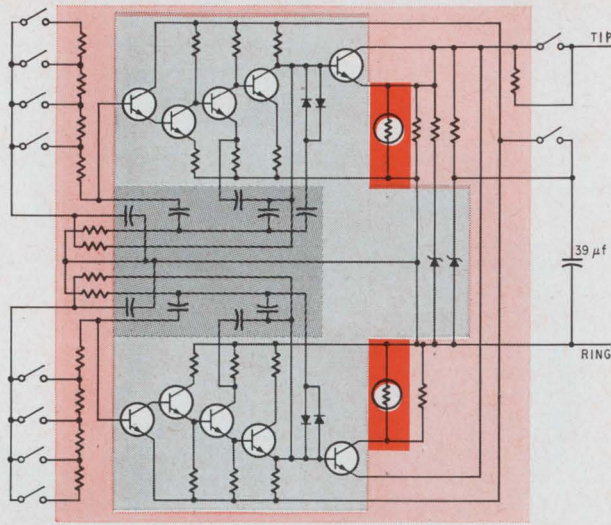

**Bell ringer.** Tone generator in Bell System's new handset has 26 elements on a silicon chip 1/16-inch square.

of privately owned microwave systems by some large users. For such a move to make financial sense, of course, the traffic load would have to be comparatively large.

Utilities and railroads have long been proprietors of their own microwave networks. And Kerry R. Fox, assistant vice president for marketing at Collins Radio, expects that the latter will continue to be a lucrative outlet for some time to come. Fox notes that the Burlington and Northern Pacific, among others, are putting in new major systems.

"Pipeline companies were also among the first to use microwave," says Fox. "But their systems are now, in some cases, 10 or more years old. They are beginning to think about replacing and upgrading their equipment."

Q. W. Weist, general manager for engineering at the Western Electric Co., the manufacturing and supplier arm of the Bell System, also looks for a good year in microwave sales. During 1968, improved versions of the phone company's TD-2 system will be shipped.

Overall, sales of microwave relay gear are expected to climb 43% to \$84.7 million this year.

A number of companies, including Jerrold, are preparing to introduce new equipment to cash in on this incipient demand. The company has developed a new cassegrain antenna for use in commercial systems. Built by Jerrold's subsidiary, the Technical Appliance Corp., the 10-foot parabolic unit provides dual polarization in both the 6 Ghz and 11 Ghz bands, eliminating the need for two separate antennas.

### Busy signals

Communications networks linking remote terminals to a central processor will continue to proliferate during the year, making for lush markets in interface equipment like high-speed teletypewriters, graphic displays, and cathode-ray viewers.

The emergence of computer utilities should boost sales of digital modulator-demodulator units. The

General Electric Co., for example, will push new digital modems that are compatible with Bell System equipment. Principal marketing targets, according to a spokesman, are industrial firms with private communications networks, Government agencies, independent phone companies, and original-equipment manufacturers.

The GE unit is claimed to be the first acoustically coupled data set providing a full-duplex circuit for the transmission of asynchronous binary data at speeds of up to 300 bits per second over switched or private telephone lines.

General Telephone will also introduce some wide-band data modems this year, including one with a range of one to 10 megabits for microwave applications. "The state of the art's with us to go to higher bit rates," says John O. Norback, a GT&E transmission engineer. "But right now we're not so sure about the economics involved."

A new data modem will also be unveiled at AT&T. The set, which operates on vestigial sideband modulation principles, is designed for both switched telephone network and private line applications. Forward-acting, error-control circuitry which reduces the bit rate can be included at the customer's option. The apparatus can be operated at several rates: over private lines at 2,400, 4,800, or 7,000 bits per second. Over the switched network, the rates are 1,800 and 3,600. Robert L. Hess, AT&T's sales project manager, feels that the new modem's sales potential is good.

The Bell System's new teletypewriter will also make its debut this year. The unit prints 150 words a second in upper and lower case and in black and red. Ray Hochstuhl, data communications planning manager at AT&T, sees a particularly good market for this equipment in educational applications involving time-shared computers.

The new 12-button Touch-Tone handsets are being introduced; such anticipated services as Picturephone or abbreviated dialing could use either or both extra buttons.

During 1968, Western Electric expects to ship 44 electronic switching systems of various sizes and capacities to Bell System companies, according to Emil C. Deutsche, manager of customer planning. (This total excludes four-wire apparatus earmarked for the military.) "Electronic systems do not loom particularly large in switching at the moment," says Deutsche. "But use should grow rapidly."

On the device side of the business, Western Electric is working on beam-leaded, sealed-junction integrated circuits on a pilot basis, but Bell has no immediate plans to incorporate them in electronic switching systems because of the economics involved. During 1968, the only major application of ic's in Bell System apparatus will be in the tone circuit of the Trimline phone.

General Telephone is equally circumspect; it is replacing electromechanical components with solid state devices, using, for example, transistors in its newer dial-tone units. However, the company has no immediate plans to use ic's en masse.



## Still tied to Pentagon purse strings

**Though still looking** for more commercial and industrial outlets for their varied wares, microwave companies are anticipating a good year. Aside from general agreement about integrated circuitry's bright prospects, however, there is no clear-cut consensus on how or where growth will come.

"Estimating dollars now is ridiculous," says Marvin Groll, microwave marketing manager at the semiconductor division of Sylvania Electric Products Inc., a subsidiary of the General Telephone & Electronics Corp. "There's a growth potential of 50% in discrete components over the next five years. Right now, the best market is obviously the military, but commercial and consumer business could account for 20% to 30% of the sales picture by 1972."

Frederic Byers, manager of plans and analysis at the Rantec division of the Emerson Electric Co., says that without a go-ahead on the "thin" Sentinel antiballistic missile system, microwave sales during 1968 would have made little headway over the previous year. But Rantec is now budgeting for a 20% to 30% increase. Over the longer term, Byers says, implementation of Sentinel should effectively stave off a decline in the field.

A marketing executive at Microwave Associates Inc. notes that Federal research and development funds will be in shorter supply during 1968 as a result of the Vietnam squeeze. But, he says, the Pentagon will be buying a lot of avionics for, among other aircraft, the F-111, the A7A, and C5A as well as several helicopters. Specifically, solid state components for doppler navigators, terrain-following radar, and reconnaissance gear loom large in the procurement picture. Microwave Associates also looks for a big replacement components market to shape up as the military retrofits tube equipment.

### War and peace

There is little doubt that the microwave field is mortgaging some of its future by concentrating on Vietnam applications. To what extent this is true is the subject of some debate among the companies involved. "The industry is producing hardware for Vietnam at the expense of R&D," says Harold D. Tenney, a group vice president at Western Microwave Laboratories Inc. "These products are behind the state of the art and doing microwave no good." Tenney believes that if the war ended, the emphasis on tactical items would end; thus, research would take up much of the slack.

But Norm Hierstand, marketing manager for tubes and electron devices at Varian Associates, says a great deal of defense spending is unrelated to Vietnam. And R&D cuts, especially in long-range projects, tend to counteract boosts in hardware pro-

urement by the Pentagon.

"What the microwave industry needs is commercial outlets to balance fluctuations in military sales," says Palmer Derby, vice president of the Raytheon Co.'s Microwave and Power Tube division. "Such outlets are only now materializing, and the microwave business is still unstable.

Hierstand says that, while the industry pays a lot of lip service to diversification, he sees few signs of real progress: "The real thing that would save us, if war spending were to halt, is that we're all a little smarter than we were in 1963."

Industrial microwave systems should enjoy a good year, according to Hierstand. Varian has a \$500,000 order from one of the auto makers for industrial heating equipment. "It may sound like the same old song, but acceptance is growing rapidly for microwave heating and cooking in both commercial and consumer markets," says Burton Silver, manager of the electron tube division of Litton Industries Inc. "We're getting reliability on a par with that of television tubes."

The growth of ultrahigh-frequency television stations is just beginning, according to Hierstand. And these broadcasters could furnish a lucrative market for microwave equipment during 1968 as well as over the longer run.

All is not beer and skittles in the nonmilitary field, however. "The agony of commercial marketing lies in the fact that though purchasers want low prices, their specifications and performance standards are often just as high as the Pentagon's," says George Kariotis, president of Alpha Industries Inc.

Concern about end uses of microwave gear obscures some interesting technical developments in the field. Most of the money being spent on microwave now goes into subsystems and equipment. But industry sources agree that the \$40 million to \$60 million market for discrete semiconductor components and hybrid and monolithic integrated circuits could grow tenfold by the mid-1970's. Low cost and higher reliability are behind the push now developing. "Microwave IC's are still in the embryonic stage," says John Sie, president of Microstate Electronics, a Raytheon subsidiary. "But we're really pushing the tube people hard in power and efficiency."

As a result of the keener interest in integration, there will be a further blurring of the traditional roles played by systems manufacturers, such as Microwave Associates, and IC makers, such as Texas Instruments Incorporated. Eventually, there probably will be a direct confrontation. But for the moment, despite occasional skirmishes, an uneasy truce prevails.



## The fiscal squeeze tightens

**“Word has come down** from the executive level—President Johnson, that is—that we’re in for a two-year famine,” says an official at the National Aeronautics and Space Administration. “Our internal thinking is predicated on this.”

Slashes in the total space budget will be felt keenly in the electronics sector this year as well as next. The space agency has no major programs in the works beyond Apollo, which should get the U.S. to the moon by the 1970 target date. Interplanetary exploration projects have yet to be organized, much less funded.

Military spending for space will suffer along with other research and development work not directly related to the war in Southeast Asia. Only high-priority reconnaissance efforts will be spared.

The Apollo Applications Program, a \$454.7-million appropriation, is probably NASA’s major new effort. But Congress hacked \$200 million from the original request. The ongoing Apollo project accounts for about \$2.5 billion of the agency’s total appropriation of just under \$4.6 billion. Large outlays will also be made for about 20 launches in continuing programs like the Advanced Technology Satellite, Nimbus, Bios, the Orbiting Geophysical Observatory, Solar Observatory, and Astronomical Observatory.

Apollo Applications’ objectives now center on a manned scientific workshop that will orbit the earth for month-long periods and a manned astronomical observatory that will put the astronomer and his telescopes in orbit above the earth’s atmosphere. However, James Webb, NASA’s administrator, warns: “Only after fiscal 1969 are funds likely to be made available for these missions.”

### Survival gear

The space agency’s Office of Advanced Research and Technology will spend about \$40 million this year in its Electronics and Control division. An official says about \$7 million will go into avionics programs, including equipment for advanced versions of the supersonic transport, collision avoidance systems, proximity warning displays, and clear-air turbulence indicators.

Large-scale integration will be a major item in the research budget as will metal oxide silicon devices and field effect transistors. Much of this work will go on at a new IC facility at NASA’s Electronics Research Center in Cambridge, Mass.

The space agency will check LSI and associative memory techniques in an Experimental Aerospace Multiprocessor, a test-bed computer to be developed at Cambridge.

In communications research, funded at about \$7 million, projects include more work on solid state

electronics as well as research on high-power transmitter tubes, ground-to-satellite laser communications, and the application of gas lasers for spacecraft stabilization. There is also \$9 million available for work on guidance systems.

Webb believes Congress will revive the planetary exploration programs, now scheduled to end with two Mars-Mariner flights in 1969. NASA has allocated \$143.4 million to the lunar and planetary category, which Webb hopes will permit his agency to seek more funds for exploration next year. And \$12 million has been set aside, he says, so that NASA can hold onto its team of skilled scientists.

### Military space

The Pentagon’s \$2-billion budget for space will probably decline this year. And the biggest, single project, the Air Force’s Manned Orbiting Laboratory, is being pared. Officials say they have \$500 million in the fiscal year beginning July 1 to keep MOL on schedule, but many concede privately that \$400 million is probably a top figure unless the Vietnam war slackens. Even now, the program is starved for money: about \$50 million in funds promised from reprogramming efforts is being redirected into war-related R&D.

Military communications satellites will not fare much better, though the highly successful Interim Defense Communications Satellite project is serving the military in Vietnam and other areas of the war zone. No significant increase in the budgeted \$83 million is anticipated.

Plans for a new-generation satellite system will be slowed because the Defense Department refuses to release money for development work. A replenishment launching of the first-generation satellite is planned for the summer.

The Tactical Satellite Communications (TacSat-Com) program will continue at a relatively slow pace. It will not move into operational hardware development unless the money squeeze eases.

The Vela nuclear-blast detection satellite program will continue with a move toward further coverage of the earth’s surface and space.

The services’ request for navigation satellite money may encounter serious opposition. Only the Transit, primarily used for precision navigation of missile-firing submarines, will sail through without difficulty. Even this program will not be moved into advanced stages. Users will have to be content with the system which requires complicated charts and manuals to arrive at doppler fixes.

But even if military and civilian spending for space slackens, many companies are thankful they have been working in both areas. “We’re quite fortunate to have the military business we started get-



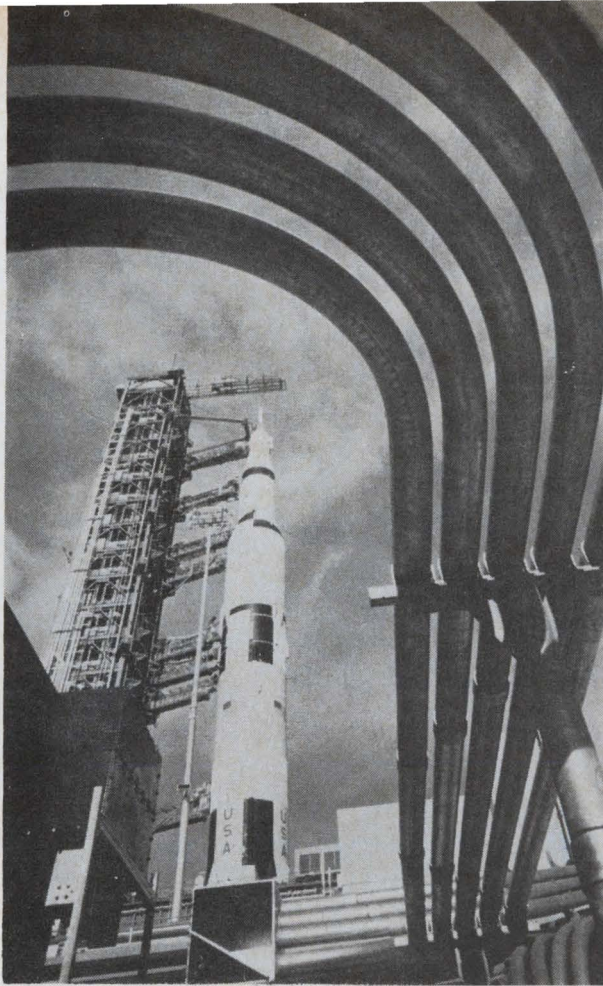

**Outward bound.** Little will be left to the U.S. space effort after completion of the Apollo Saturn 5 program. Manned earth-orbit missions are planned for this year.

ting into five or six years ago," says Hugh Bradshaw, marketing manager for the Radio Corp. of America's Aerospace Systems division. "We believe the space effort will come back but it will take awhile."

The company will deliver about 30 systems to the Grumman Aircraft Corp. in 1968 for the Apollo program's lunar module, including the rendezvous radar and attitude and descent control equipment. But the slack in the civilian space program foreseen by RCA has prompted it to look into automatic checkout equipment for the military, as well as classified avionics and electronic warfare systems.

The Electronic Systems division of TRW Inc. is also looking to the military for new business and has high hopes for the communication and navigation satellites being studied by the Air Force. The real market in this area, TRW feels, is in the many user ground installations, rather than the limited number of satellites.

And last autumn the Autonetics division of the North American Rockwell Corp. proposed a solid-state beam-scanning system for a synchronous communications satellite that could focus hundreds of independent data links anywhere over the globe.

An offshoot of military space projects with civilian applications—accurate location of land boundaries—is being examined at the Raytheon Co.'s Space and Information division. Taxing agencies could use

such systems, which are based on stereo photography techniques, aboard airplanes to determine whether property improvements have been made. Raytheon is also investigating the possibility of determining pollution in bodies of water, using broad-band spectrum techniques.

### Embarrassment of riches

While the space agency cannot get money for many of its projects, the Communications Satellite Corp. is in the position of having the wherewithal but not permission to get on with its work. With about \$160 million in uncommitted funds, Comsat would like to spend them on a \$57-million pilot domestic satellite program; a \$40-million aeronautical satellite, and four Intelsat 4 communications satellites with 5,000 to 10,000 circuits.

The multipurpose domestic satellite—for commercial and educational television and communications—proposed by Comsat last August is still awaiting approval by the Federal Communications Commission. Before work starts the project must get an okay from the International Telecommunications Satellite consortium. The aeronautical spacecraft, which will provide vhf communication links between transoceanic airliners and ground stations, needs a go-ahead from the Federal Aviation Administration.

Comsat officials say permission for any or all of these projects this year would unleash funds during 1968, but the major outlays would be next year.

A big part of Comsat's spending during 1968 will be for the six Intelsat 3 satellites to be delivered by TRW at monthly intervals starting in the middle of the year. The completion of three new ground stations and the expansion of three others will account for more than \$6 million in new equipment outlays. The Philco-Ford Corp. will produce the antenna subsystems for the stations at a cost of \$7.6 million. Raytheon is delivering four ground communications equipment subsystems for \$4.5 million, and the Nippon Electric Co. has a \$2.1-million contract for channel multiplexing gear.

Comsat's new research laboratory will open this year in Germantown, Md. The major electronics expenditure for the laboratory will be for test equipment costing about \$1 million. Comsat will spend \$6 million on research and development during the year, most of it on outside contracts.

Among the electronics research projects on tap for 1968 are: travelling wave tubes with greater bandwidth and high power; protective coatings to prevent radiation damage to solar cells; and nickel-cadmium batteries with greater power output.

Frequency techniques will also be examined, including an investigation of the use of frequencies up to 10 gigahertz rather than the 4 to 6 GHz bands now employed. Research on low-noise receivers will center on expanding bandwidth to 300 megahertz or more. With the first Intelsat 3 probably going up in early fall, Comsat will expand the capacity of three existing ground stations for about \$1 million per installation in electronics equipment.



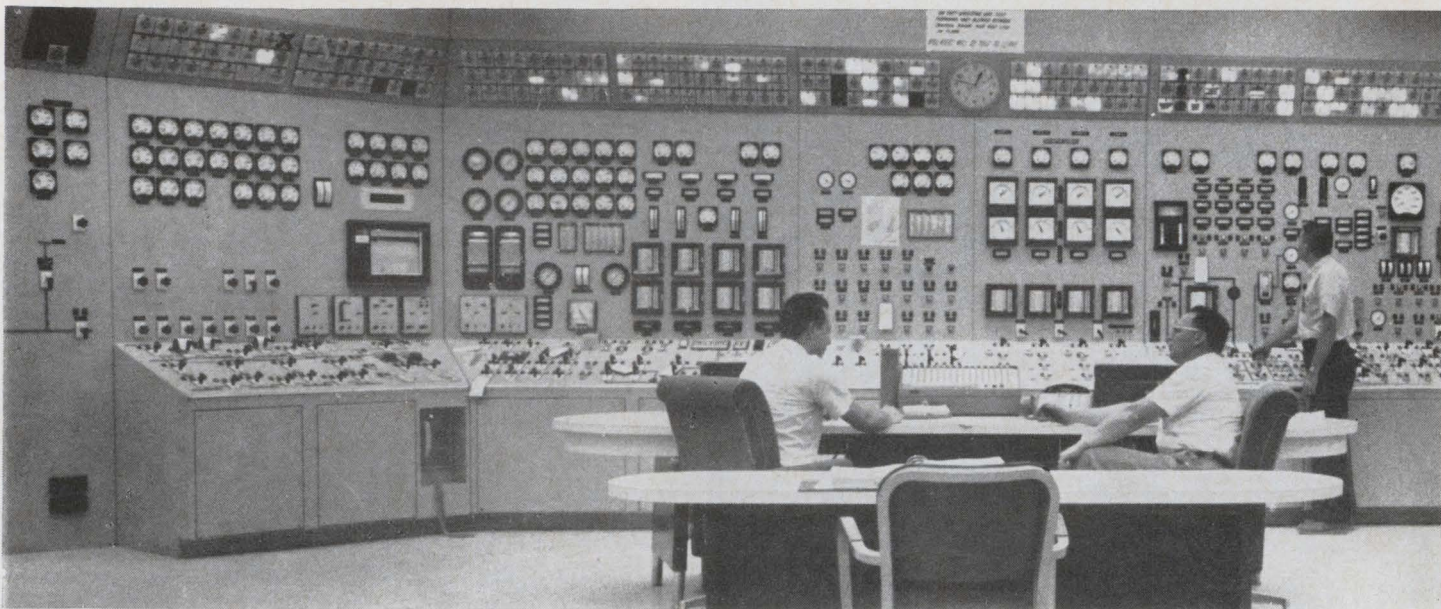

## Industrial electronics

# New member of the billion-dollar club

**This is the year** industrial electronics sales should top the billion-dollar mark—by a comfortable margin of at least \$50 million. This would represent a spurt of about 16% from the \$905.1 million volume posted last year. And gains in such areas as water resources control and rapid transit systems, where growth is fueled by Federal funds, will far outpace the industry average.

No major technical innovations are in sight—not even uses for integrated circuits. Companies making process instrumentation continue to study integrated circuitry but little more than a few prototypes of IC equipment will be available by yearend.

While these firms sit on their status quo, their customers may take a more aggressive approach to IC's. Customized assemblies might help industrial concerns bypass computer control makers, thereby foregoing higher costs and long delays while retaining proprietary information.

Specifically, process-control engineers may develop conventional and advanced control laws and elect to implement them with digital IC's rather than with programs for a general-purpose control computer. As integrated-circuit prices decline, this approach, which at least one process company is seriously investigating, could become even more appealing.

### Controlling factors

Because electronic analog controllers sell for about 25% more than their pneumatic counterparts, the best electronic equipment could do until recently was capture a quarter of the market. In 1968, however, electronics' share will be closer to half.

Lower installed cost than their pneumatic rivals,

better control on some loops, easier maintenance, and compatibility with data loggers and digital computers are still the electronic gear's main selling points. Apparently, experience with electronic controllers has enhanced the attraction of these features.

But equipment quality may have to improve if partisans of pneumatic control are to be won over. Industrial concerns that stress product quality and plant performance aren't going to put up with bad solder connections, for example.

Instrument manufacturers expect continuing pressure from users to produce more accurate sensors for digital computer control installations. But improving the accuracy of a differential-pressure sensor from 0.5% to 0.1% can boost costs by 400%.

Bruce H. Baldrige, manager of systems applications planning for the Foxboro Co., sees 1968 as the year of "make or break for direct digital control." Several systems of more than 100 loops will go into operation this year, and if results match expectations, new orders and reorders should follow.

The market for control apparatus will expand with the stepped-up activity in the process industries. Papermakers are building new facilities and investing a bigger percentage of capital outlays in instrumentation than in past years. And metalworking concerns are installing instrumentation and computers to raise production efficiency to meet foreign competition.

But from an electronics marketing viewpoint, the petroleum and chemical fields are bellwethers. The chemical industry, though it appears overbuilt, will remain a major buyer of instruments and controls over the next two years or so. On the other hand, refinery construction is undergoing a boom.



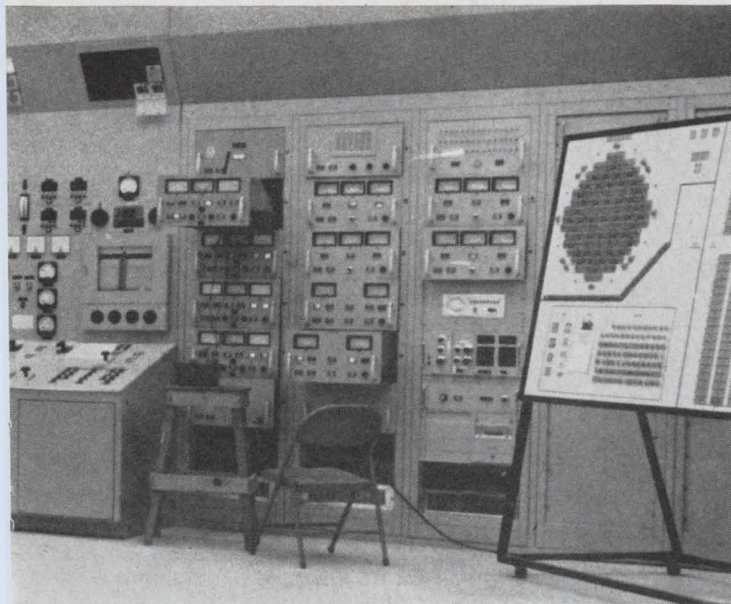

The price of process-control computers can account for up to half of the cost of industrial instrumentation systems. Baldrige estimates that the chemical industry last year had a total of 150 digital control computers in operation worldwide, and the petroleum industry about 75; he predicts that 40 more machines will be sold to chemical plants this year and 30 to refineries. The figures cover only computers "that influence operation of the process," and thus exclude data-acquisition units.

Control isn't the only reason behind prospects for a big market in small digital computers. After successful initial installations at the Monsanto Co. and Du Pont, chromatograph computer systems are expected to find a growing number of applications this year. Chromatographs, which analyze product composition, are used in many plants and research laboratories; computerized setups tying many of these units together reduce the time needed to get results and increase research yield.

Henry A. Hancock, senior applications engineer at Electronic Associates Inc., predicts that 40 such systems will be sold this year. An installation that can handle 40 analyzers sells for about \$100,000 exclusive of chromatographs. Major suppliers are Electronic Associates, the International Business Machines Corp., and Realtime Systems Inc.

### Checking up

Industrial supervisory control systems and related telemetry equipment are used to channel instant information from farflung plants and process operations to a central location. And public demands for improved air and water pollution control programs and for construction of rapid transit systems will boost the market for such equipment.

Sales of industrial supervisory control systems are expected to approach the \$50 million mark in 1968. Leon C. Menkes, sales vice president at Quindar Electronics Inc., breaks the market down this way: electric power, \$20 million; pipelines and petroleum, \$14 million; waterworks, \$8 million;

gas distribution, \$4 million; miscellaneous, including traffic control, \$4 million.

Supervisory-control and telemetry sales to utilities for electric-power generation and distribution jobs have gone up 300% since 1965. And as a result of a growing interest in conservation, managers of waterworks seem to be shedding their reserve and looking to electronics technology to improve operating efficiency. The result last year was a 45% increase in sales of waterworks supervisory systems, a gain that should be duplicated in 1968.

### Grow power

Over the next six or seven years, installed electric-power generation capacity will double from its present level. New rapid transit systems and increased electric heating of buildings will add to power sales.

Two major innovations in power generation methods—nuclear reactors and once-through boilers—are already causing an increase in the amount of electronic instrumentation at generating stations. Because the new equipment responds faster than conventional boilers, emphasis is being placed on safety as well as control. Digital computers play an important role here and 90% of the generating units now being installed employ such machines for data gathering, plant monitoring, and boiler-turbine control.

But the real sizzle in electricity generation is nuclear stations. According to the Atomic Energy Commission the capacity of nuclear electric stations has tripled in the past five years to 2,810 megawatts; it will rise to 10,000 Mw by 1970, the agency says, and to 150,000 by 1980. Fourteen atomic plants are on-stream and 46 are in the works. Most of the newer ones have rated capacities exceeding 1,000 Mw.

Electronic instrumentation and controls are commonplace in atomic installations, which generally don't require much auxiliary equipment such as pumps and fans, so the use of conventional instrumentation per megawatt is decreasing.

But in nuclear generating plants, the watchword is safety. "Every time a plant is built or planned," says a knowledgeable source, "someone at the AEC dreams up a new safeguard." Until operational experience has produced a body of safety data, more sensors, more monitors, and more computers will be installed, increasing electronics' controls more than 50%.

As a result of legislation, Government grants, and public concern, the U.S. has started to take positive action to assure an adequate supply of pure water. The key organization among the 35 or so agencies active in the field is the Federal Water Pollution Control Administration (FWPCA). It has the power to direct states to enact quality standards for interstate waterways within their boundaries, and is just starting to release funds.

The Minneapolis-St. Paul Sanitary District, for example, received a matching Federal grant and has awarded contracts totaling \$1.75 million for a



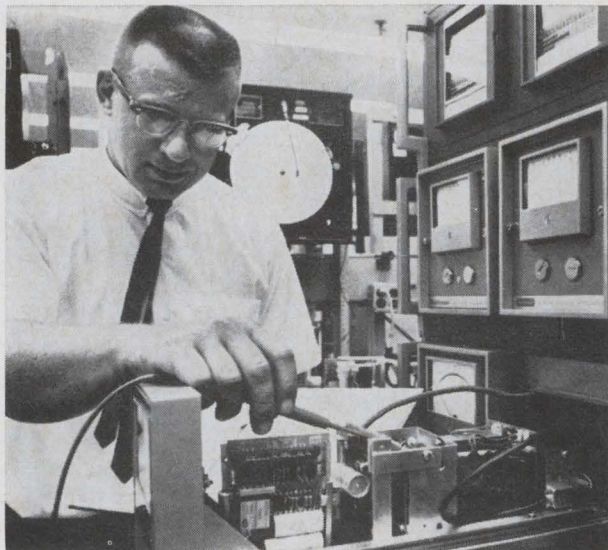

**Ounce of prevention.** As a result of stepped-up research in the pollution field, more water-quality monitors like this nine-parameter Beckman unit are ready for market.

computer-based sewer control system. Using simulation techniques, an operator will determine the best settings for control gates, especially during rainstorms, to fully utilize the sewer system and minimize river pollution.

A big allotment is going for electronic equipment. For \$387,105, the Badger Meter Manufacturing Co. will turnish and install a process control computer plus remote telemetering and supervisory control equipment for 38 locations. The Fairchild Camera & Instrument Corp. has a \$64,702 order for five robot river quality monitoring stations.

F. L. Mascitti and A. H. Keyser, of Honeywell Inc.'s Industrial division, estimate that sales of instrumentation for water-resources applications, including waste treatment, could run as high as \$50 million this year, with \$1 million to \$2 million of this going for water-quality monitors. They also expect the market to "double in the next several years." But Roy F. Brown, manager of Beckman Instruments Inc.'s Process Instruments division, anticipates a doubling of the market only by 1980. The Honeywell engineers explain the disparity in these forecasts by noting that the Vietnam squeeze may tighten money for such projects.

"Proven hardware is now readily available for water-resources and waste-treatment applications," says Brown. But further technical advances may await more certain prospects. According to Mascitti, "No company is going to invest large amounts of money to develop, for example, automatic sensors unless there is a profitable market."

### On the right track

Where railroads go, prosperity follows. This 19th century truism has new meaning for electronics firms. State authorities, along with the Department of Transportation, now see alleviating the plight of the commuter as a major challenge in regional planning.

Already the green light has been given to rapid rail transit systems in San Francisco, Philadelphia, Atlanta, and on Long Island, and some construction is under way. Though vast sums will be spent in this field during the rest of this decade, the major push will come in the 1970's. But even now, rapid transit represents a big market for electronics.

An example here is the Delaware River Port Authority transit project, a two-track, 14-mile system running from Philadelphia southeast through Camden to Lindenwold, N. J. Scheduled for completion by late 1968, the job includes \$11 million for electrification, \$1.5 million for telecommunications, and \$3 million for signals.

About 20% of the telecommunications funds will go for carrier current radio, 15% for telephone equipment, 20% for public address systems on trains and in stations, 25% for supervisory controls for the electrification and signaling subsystems, and 20% for cables. The \$3 million expenditure for signals will cover train detection, control, and indication gear.

The Metropolitan Commuter Transportation Authority, a New York State agency that now operates the Long Island Rail Road, has undertaken a major study aimed at an upgrading that transit system. The agency is expected to spend about \$10 million a year for electronic equipment over the next decade as part of the projected modernization. Of this, about 80% will go for signaling equipment, the balance for telecommunications.

### Sewed-up market

Numerical controls producers are eyeing new applications, particularly those in which production machines are linked to digital computers.

In this regard, Don O. Dice, marketing manager of the General Electric Co.'s Specialty Control department, points to cloth-cutting operations in the textile industry. Synthetic fiber is expensive and it stretches. Thus, patterns have to be cut both to make maximum use of materials and to assure that each piece will be the right size and shape when stretched by the wearer. To this end, GE is now developing computer software to direct numerically controlled cloth-cutting machines.

But metalworking remains the major application for numerical control. Early installations were mostly on milling machines, but a major portion of recent sales were for lathe applications.

Despite the greater use of numerical control, suppliers' ranks are decreasing, partly because some machine-tool makers have abandoned development of their own systems and partly because some companies couldn't meet the competitive demands. More than 50 firms have tried for orders in the U. S. over the years; the roster has only 29 names today.

On balance, the outlook for numerical controls is good. "In 1968, sales of positioning and contouring systems will increase to 4,000 units worth \$67 million," Dice predicts, well ahead of the pace of recent years.



# Selective gains for the resourceful

**Less than expected volume** in production of color television sets and other entertainment goods during 1967 caught components firms at a time when they were pondering the challenges of integrated circuitry. Whole markets—logic circuitry in computers, for example—have been taken over in recent years by ic's. Other areas are similarly under attack. And around midyear, as a result of swollen parts inventories at consumer electronics plants, there was an across-the-board slackening of demand; many component producers took a bad beating.

On balance, the 1968 outlook is rosier, especially for firms able to offer small devices that are cheap and reliable. Gross sales are expected to reach \$7.2 billion, a 7% improvement over the \$6.7 billion level reported for last year.

Leading the list of discrete assemblies with a new lease on life are trimmer capacitors and trimmer resistors. Jack Goodman, vice president of the JFD Electronics Co., says, "We feel that the demand for ceramic and trimmer capacitors will be greater in 1968 than in 1967. In fact we experienced a 15% increase in the last half of 1967 and see every indication that this will continue during 1968."

Demand will probably be greater in military and industrial markets, but consumer and commercial outlets, too, are picking up again, he says. Steve O'Connor, vice president for marketing at IRC, Inc., says, "We've been able to reduce the price of our trimmers by as much as 40% over the last five years, making them more attractive to users."

### Resisting change

Resistor manufacturers admit ic's will take over many jobs now performed by fixed resistors, but point out that the continuing rise in production of such equipment as desk-top computers will offset this decline. Although these machines incorporate many ic's, their power circuitry still requires fixed resistors.

Fixed resistor sales are expected to total \$220.8 million, up slightly from the 214.2 million worth of business done in 1967. Potentiometer volume should jump from \$159.1 million to \$174.5 million.

"Additional growth is in store for the precision metal-film resistor," says IRC's O'Connor. "Present monolithic technology cannot produce high-precision resistors. Indeed, metal-film resistors will be used extensively in fabricating hybrid micro-circuits."

Much of a computer's circuitry, aside from the logic section, requires metal-film resistors. As the computer industry continues to expand during 1968, so will the use of these devices. Eventually, metal-film resistors may replace carbon-film versions.

However, this is not in the cards for 1968; they must first be manufactured with the large—up to 100 megohms—values available from carbon-film types.

As yet, wirewound power resistors have nothing to fear from integrated circuits. These assemblies still can't handle high power, so it's a good bet that wirewounds will be used increasingly with hybrid ic's.

A major outlet for both metal-film and wirewound resistors will be in the resistor networks used in digital-to-analog converters. These assemblies provide guaranteed ratio matching. When discrete resistors are used, engineers often overspecify, winding up with more components than needed. It's more economical to buy resistor networks, so there should be a sharp increase in demand during 1968.

This year there should be a marked improvement in the temperature coefficient and tolerance of metal-film resistors; power-handling capabilities will also rise. This will mean that a 20-pulse-position-modulation resistor will be feasible for volume applications in analog computers. The big thing going for the metal-film devices is that they have more resistance value in a smaller package than their wirewound counterparts.

But makers of wirewounds are reacting resolutely, and during 1968 there should be further advances in miniaturization, tolerances—0.01% down to 0.0025%—and degrees of stability—20 ppm per year to 20 ppm per three years. For example, Dale Electronics Inc., a subsidiary of the Lionel Corp., plans to introduce several industrial-grade wirewound power units with tight tolerances for tv, radio, and appliance applications.

Of late, resistor manufacturers have had to face increasing competition from foreign producers. Only five years ago imports were considered inferior to U.S. equivalents, but this is no longer true. What's more, imported resistors are selling for less than their U.S. counterparts. In 1966, about 800 million resistors—mainly carbon-composition types, were imported. During 1967, the total rose to about 1 billion, and another jump is expected this year.

### Capacity for growth

Paralleling the optimism in the resistor field, capacitor manufacturers are also looking forward to a good year. Tantalum units especially are enjoying great success, largely because of their virtually exclusive franchise in the computer business. Total capacitor sales are pegged at \$473.3 million this year, as against \$436.8 million in 1967.

JFD Electronics' Goodman says the development of new miniature ceramic-type fixed capacitors with high r-f current and voltage capabilities is a major



advance. "It opens a new market for such units in communications transmitters and other applications," he says.

"Capacity ranges of these units are very wide, from 3.5 to 3,000 picofarads," Goodman says. "The development of these and similar capacitors is due to improvements in the ceramic formula which provide greater stability and capacitance in smaller packages. High production rates on epoxy packages for miniature sintered tantalum capacitors have been responsible for their low price. They are now almost competitive with aluminum-foil-type electrolytics. And they make possible quite a savings in size."

However, improvements in electrolytes have permitted fabrication of some aluminum units with upper temperature ranges comparable to those of tantalum capacitors. The Sprague Electric Co., for example, has brought the ratings of its devices up to 125°C.

### Relay race

Many engineers were writing premature obituaries for the relay last year. With integrated circuitry's emergence, the reasoning went, the relay's already small size could not be further reduced; nor could reliability be significantly improved. As it happens, such writeoffs were too hasty: relay sales are at all-time highs and going higher. This year, volume will go up 14% from \$262.8 million to \$300 million. The viable state of relays is largely attributable to the greater reliability and smaller size achieved by suppliers working on devices for volume outlets like the Apollo program. Among others, Teledyne Inc. and the Hi-Spec Electronics Corp. have produced assemblies in TO-5 cans while the Branson Corp. has a relay available in a flatpack.

On another front, Filtors Inc., a subsidiary of the Deutsch Co., has developed a new mounting technique with considerable market potential since it reduces the size of a relay and guarantees good performance under almost any kind of operating conditions, including vibration and shock.

The method, dubbed integration termination system, does not require soldering, sockets, or pins. The most important advantage is that the hundreds of different tools usually needed to wire or remove a relay from a board are completely eliminated. As a result, inspection, testing, calibration, and recycling are no longer necessary steps. The job is done with one inexpensive insertion tool.

All wires of the same size are crimped and inserted, or removed, with the insertion tool. The base of the relay does not have a conventional pin arrangement, but female receptacles for the crimped wire leads. Once in place, contact is assured and the wires cannot be pulled out. However, they are easily removed by reversing the procedure. Cold-solder joints, always a problem in conventional wiring schemes, are thus eliminated. Besides, since no base is required for conventional pins, the relay can be mounted in any position, effectively reducing its height. This means that the leads do not have to be

brought in from the rear, as in conventional configurations. The integration termination system can be used in terminal junctions, switches, lamp indicators, circuit breakers, bus bars, or any other device with pins. Deutsch, for example, is applying the technique to its connector lines.

### Respectable connections

In common with most of the other makers of discrete components, connector firms can look forward to sales gains during 1968. Volume should rise about 8% from \$327 million to \$353.5 million. The biggest percentage gains are anticipated in small coaxial assemblies and printed-circuit connectors.

But connector outfits also share the industry's challenges. Customers want mounting techniques that will enhance over-all system reliability, decrease space requirements, and be available at lower cost. The task here has been quite difficult because the circuits in space and defense projects typically require many thousands of connections.

A new method that could win acceptance this year was developed at the Elco Corp. It permits multiple connections in computers, printed-circuit boards, circuit modules, terminal blocks, card cages, and integrated-circuit packages. The technique centers on contacts mounted on a metal base plate with a variety of insulated contacts. Connectors may be fabricated in almost any size and shape from 1 inch x 1 inch to 24 x 36 inches. Contacts may be arranged in either a symmetrical or asymmetrical pattern. A wiring density of 2,500 is possible.

The plate provides mechanical support for the connector contacts and serves as ground plane. By using a ground bushing, individual contacts may be connected to a ground plate instead of remaining insulated from it.

An important advantage of the technique is that connections can be made automatically and precisely with wire-wrap methods. And high-speed machinery—rates of 1,100 connections an hour are not unusual—also affords substantial cost savings on production runs.

### Small gains

"The most significant development in operational amplifiers has been the improvement in monolithic assemblies by the IC manufacturers," says Dan Sheingold, manager of applications engineering at Philbrick Researches, a Teledyne subsidiary. "Combinations of monolithic and bipolar elements have made these devices considerably better during last year; progress will continue through 1968 and beyond."

Although military projects will continue to be the leading outlet for op amps during 1968, other applications are beginning to emerge. This year, for example, car makers will investigate using them as regulators. Toy firms are also expected to use limited quantities of "rejects" during 1968. Eventually, large-scale integration will bring the cost of manufacturing op amps down to more universally attractive levels.





**PAKTRON**  
**THE**

**BIGGEST  
NAME  
IN FILM  
CAPACITORS**

★ **PRESENTS** ★



THE FIRST

# PAKTRON FILM

INTRODUCING  
**LOLITA**  
IN METALIZED MYLAR



**SEE  
THE  
GREATEST  
COLLECTION  
OF FILM  
CAPACITORS  
EVER  
ASSEMBLED  
FOR A  
SINGLE  
PRODUCTION.**

Thrill as they match or exceed their guaranteed ratings. Chill as they find themselves in a maze of electronic equipment. Marvel as they slip into high reliability military applications.

THEY MAY SHOCK YOU.

THEY MAY STARTLE YOU.

BUT THEY'LL NEVER FAIL YOU.

"AN ELECTRIFYING PRODUCTION"  
... Chronicle Gazette  
"HIGH VOLTAGE PERFORMANCE"  
... Globe Examiner

"...electrifying...totally new...a brilliant performance." *Globe Gazette*

You'll be dazzled by her resistance. Charmed by her size. Thrilled by her durability. You'll tremble at her volumetric efficiency. And you'll want to witness her tireless performance on the boards. Remember, Lolita is from Paktron, the company that brought you Theda and Greta—the biggest names in the radial capacitor biz. And, if you want to be alone with Lolita, just give us the word. Any capacitor named Lolita can't be all bad.

**LOLITA**  
ALL NEW RADIAL LEAD METALIZED MYLAR FILM CAPACITOR

Lolita—a character study:  
Working Voltage: 100, 200, and 400 WVDC  
Tolerance: ±5%, ±10%, ±20% Standard  
Capacitance Values: .1 mfd.—10.0 mfd.  
Lead crimps to fit your printed circuit board applications

Arquee lights activated courtesy of Iicon © Division Illinois Tool Works Inc.



ANNUAL

# FILM FESTIVAL

INTRODUCING  
**URSULA**  
IN WRAP AND FILL

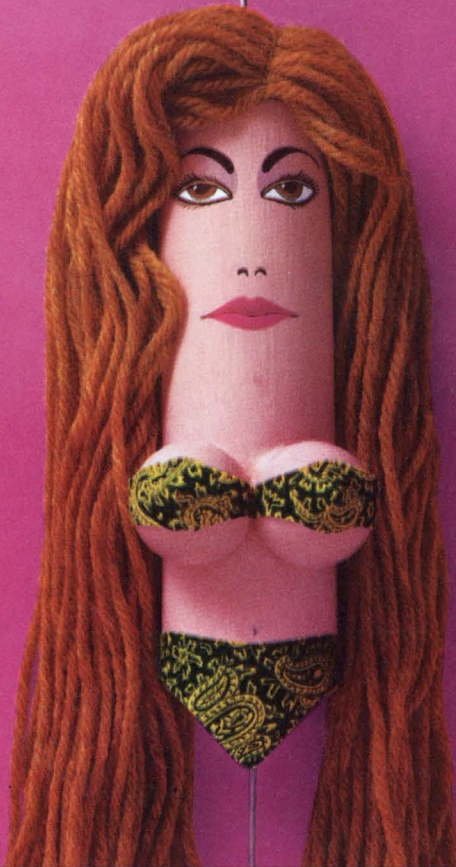

"...a really new film star...this one is destined for greatness." Chronicle Examiner

You'll thrill to her high performance. You'll quiver as this trim little lovely exhibits her form in a skin type wrap. Your blood will run cold as she resists shock and vibration. Your palms will sweat when you see her axial leads in a point to point configuration. And remember, Ursula is from Paktron, the company that made radial lead capacitors the biggest hit of our time. Once you've seen Ursula in action, you'll have to see her in person. She's available for demonstrations. Just ask. Be honest with yourself. Would anyone name a capacitor Ursula if he didn't think it could stand the shock?

**URSULA**  
ALL NEW WRAP & FILL  
CAPACITOR

Here's how the critics describe Ursula:  
Capacitance Values: .001 mfd.-1.0 mfd.  
Tolerances:  $\pm 5\%$ ,  $\pm 10\%$ ,  $\pm 20\%$  Standard  
Working Voltage: 80, 100, 200, 400, and 600 WVDC

## COMING ATTRactions

In the months to come you'll see:

- One of the industry's brightest stars, Bridgette in **THE BATTLE OF CIRCUIT CITY**.
- Rhonda, darling of the circuit, in **SHELL SHOCK**.
- **RETURN TO PAKTRON PLACE** in which factory workers follow Sophia's Leads.

You won't want to miss a single one of these film capacitors.

★ **SEND** ★  
FOR A FREE  
PIN-UP  
CALENDAR.

See all your film favorites, posed the way you like them, in shocking color. Write on your letterhead to:

**FLO ZIGFIELD**  
Paktron Division  
Illinois Tool Works Inc.  
1321 Leslie Avenue  
Alexandria, Virginia 22301



# EVER POPULAR FAVORITES

THRILL AS TINY **THEDA** STRUGGLES TO PROTECT HER CAPACITY.



Ultra thin Mylar Film/Foil—the MW-50  
Capacitance Values: up to 0.47 mfd.  
Working Voltage: 50WVDC  
Tolerances:  $\pm 5\%$   $\pm 10\%$   $\pm 20\%$   
Operating Temperature Range:  
-55°C to +125°C

THE GORGEOUS **GRETA** SEE THIS PROUD BEAUTY RESIST THE ADVANCES OF AGE.



Hi-Blu™ Mylar Film/Foil Epoxy Dip-coated  
Capacitance Values: to 0.5 mfd.  
Working Voltages: 100 to 600 WVDC  
Tolerance:  $\pm 5\%$  to  $\pm 20\%$   
Operating Temperature Range:  
-55°C to +125°C

MEET **SOPHIA** MOLDED MYLAR CAPACITOR. GET TO KNOW HER BY HER FIRST NAME.



Working Voltage: 50WVDC  
Tolerance:  $\pm 1\%$ ,  $\pm 2\%$ ,  $\pm 5\%$ ,  $\pm 10\%$  Standard  
Capacitance Value: 220 mmfd.—1 mfd.

THE BEWITCHING **BRIGITTE** WILL LURE YOU WITH HER PRECISION FORM.



Classic molded polycarbonate  
Capacitance Values: 470 mmfd.—.056 mfd.  
Working Voltage: 50WVDC  
Tolerances:  $\pm 1\%$ ,  $\pm 2\%$ ,  $\pm 5\%$   $\pm 10\%$  Standard  
Operating Temperature Range: -65°C to 105°C  
(no Voltage derating)

LEARN WHY **CLARA** ISOLATED HERSELF FROM THE REST OF THE CIRCUIT.



Flat Line—Mylar Film/Foil  
Capacitance Values: .01 mfd.—.5 mfd.  
Working Voltage: 100WVDC  
Tolerance:  $\pm 5\%$ ,  $\pm 10\%$ ,  $\pm 20\%$  Standard  
Operating Temperature Range:  
-55°C to +125°C

THE TEMPTING **RHONDA** SAYS "WHY DON'T YOU PICK ME UP AND TRY ME SOMETIME?"



Epoxy dip coated Metalized Polycarbonate  
Capacitance Values: .068 mfd.—2.5 mfd.  
Working Voltage: 100 WVDC  
Tolerance:  $\pm 5\%$ ,  $\pm 10\%$ ,  $\pm 20\%$  Standard  
Operating Temperature Range: -55°C to +125°C (no Voltage derating)

**PAKTRON**  
Division Illinois Tool Works Inc.  
itw

These Paktron film stars are distributed exclusively by COMPAR.



# Soliton

announces  
30 amps in an

# ISOLATED



TO-61  
100 W@100°C

## collector package

Soliton's 30 amp NPN silicon power transistors are now packaged in an Isolated TO-61 case. All terminals are electrically isolated from the case, eliminating possible mounting and insulation problems. Designated the SDT 8151-SDT 8159 Series, these devices offer high current capabilities, low leakage currents, a uniform gain over wide current ranges and low saturation voltages. Typical characteristic curves and applications are similar to the popular 2N3597-99 Series.

Type Number TO-61	DESIGN LIMITS			PERFORMANCE SPECIFICATIONS					
	$V_{(BR)CBO}$	$V_{CEO}$ (SUS)	$V_{(BR)EBO}$	$h_{FE}$		$V_{CE(sat)}$	$V_{BE(sat)}$	$I_{CBO}$	$f_T$
	Volts	Volts	Volts			Volts	Volts	$\mu A$	MHz
	$I_C = 200\mu A$	$I_C = 100mA$	$I_E = 200\mu A$	$I_C = 10A$	$V_{CE} = 5V$	$I_C = 10A$	$I_B = 1.0A$	$V_{CB} = 60V$	
Min.	Min.	Min.	Min.	Max.	Max.	Max.	Max.	Typ.	
SDT 8151	150	120	8	40	120	1.0	1.5	10	30
SDT 8152	100	80	8	40	120	1.0	1.5	10	30
SDT 8153	80	60	8	40	120	1.0	1.5	10	30
SDT 8154	100	80	8	100	—	1.0	1.5	10	30
SDT 8155	80	60	8	100	—	1.0	1.5	10	30
SDT 8156	150	120	8	20	60	1.0	1.5	10	30
SDT 8157	100	80	8	20	60	1.0	1.5	10	30
SDT 8158	80	60	8	20	60	1.0	1.5	10	30
SDT 8159	40	25	5	20	—	2.0	2.0	10*	30

\*@25V

Dial 1-800-327-3243 for a "No Charge" telephone call and further information

*When you think of semiconductors...  
think Soliton!*

# Soliton DEVICES, INC.

1177 BLUE HERON BLVD. / RIVIERA BEACH, FLORIDA / (305) 848-4311 / TWX: (510) 952-6676



# Here's why you should now be using Datavue\* Indicator Tubes

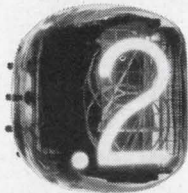

CK1904—Interchangeable with B59956 and NL809.

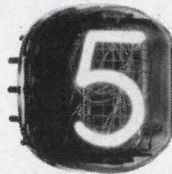

8422—Interchangeable with B5991 and NL8422.

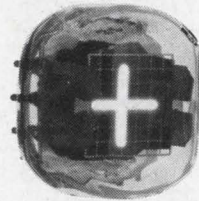

CK1903—Interchangeable with B5992 and NL5992.

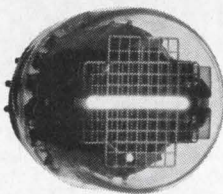

CK1901—Interchangeable with B5016 and NL5016; CK1902—Interchangeable with B5032, NL5032, B50911 and NL50911.

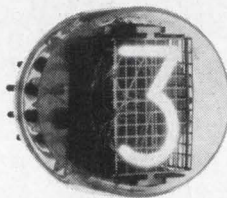

8421—Interchangeable with B5092 and NL8421; 8037—Interchangeable with B5031 and NL8037. Also available: 6844A.

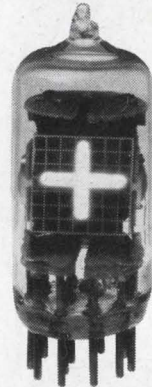

CK1900 (used with CK8650, CK1905, CK1906); CK1907 (used with 8754)—Interchangeable with NL843.



8754—Also available with right- and/or left-hand decimal points; Interchangeable with NL840/8754. Decimal-point types interchangeable with NL841, 842, 848.



CK1905; CK1906 (right-hand decimal point).

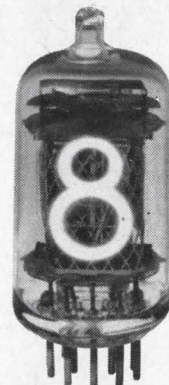

CK8650

These indicator tubes—just a few of Raytheon's wide selection—offer you advantages in design, economy and performance. For example:

**You don't need to revise designs.** Raytheon's Datavue round and rectangular end-view tubes conform to EIA ratings—interchange with other brands. And Raytheon also offers you a selection of side-view types—and "specials" with up to 12 characters,  $\pm$  signs, symbols, etc., to your specifications.

**You can buy them at low cost.** All Datavue Indicator Tubes are priced

competitively—or lower. Most side-view types, for example, cost less than \$5 each in lots of 500 or more.

**Reliably trouble-free readouts.** All Datavue characters are fully formed—not segmented. The fully formed characters are brightly displayed and easy to read—at distances up to 30 feet.

**They last for years.** They're made better because of Raytheon's experience—40 years of producing more than 100,000,000 cold cathode gas-filled tubes with carefully controlled electrical performance. Ultra-long-

life types, for example, have dynamic life expectancies of 200,000 hours or more.

**They're readily available**—in sample and production quantities. For samples, prices, or technical information, call your Raytheon regional sales office or distributor. Or write: *Raytheon Company, Industrial Components Operation, Quincy, Mass. 02169.*

\*Trademark of Raytheon Company

Industrial Components Operation—A single source for Circuit Modules/Control Knobs/Display Devices/Filters/Hybrid Thick-Film Circuits/Industrial Tubes/Optoelectronic Devices/Panel Hardware.





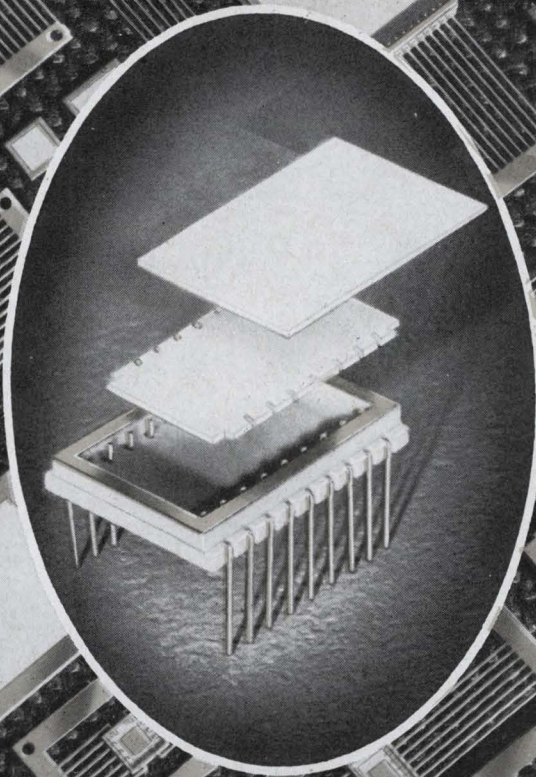

# ALSiPAK<sup>®</sup>

## CERAMIC PACKAGES feature NEW PLUG-IN

The RELIABILITY of ALSiPak CERAMIC PACKAGES for electronic circuits has resulted in their ever-increasing use. "Preferred Style" flat packages are available in the more widely used sizes with minimum device areas ranging up from .148" x .148" to .710" x .710" with as many as 60 leads if desired. They involve no tooling charges and have several low cost options on leads, inside depth, pads, etc., to adapt them to individual needs. Chip mounting pad package designs can be supplied with nickel-iron-cobalt pad brought directly off one lead down onto the floor of the package. Enlarged facilities and specially trained personnel now permit more favorable delivery schedules on the full line of Preferred Style or Custom Made packages.

The newest preferred style package is a surprisingly rugged ALSiPak plug-in package .750" x 1.000" outside dimensions with 18 leads. It is designed for monolithic

circuit needs. High alumina precision substrates with .510" x .855" usable area to match the leads are available. Leads can be soldered direct to conductor lines which run into the notched areas. Thus you can minimize or eliminate wire bonding from device area to leads. This direct soldering also holds the substrate in position.

The plug-in package is designed for hand or automatic insertion in printed circuit boards and it can be probed from top or bottom of the circuit board. Easy substitution of units after assembly on the board is a feature of this design. The 18 leads are on 100 mil centers which are most adaptable to wave soldering techniques.

Prototype quantities of all preferred style packages are available at nominal prices. Suggestions on custom designs will be made on request giving details of operating requirements. Write for new Bulletin No. 676.

CODE IDENT. NO. 70371

PHONE 615 265-3411, CHATTANOOGA, TENN. 37405

**American Lava Corporation** **3M**  
A SUBSIDIARY OF COMPANY

For service, contact American Lava representatives in Offices of Minnesota Mining and Manufacturing Company in these cities (see your local telephone directory): Boston: Needham Heights, Massachusetts • Chicago: Glen Ellyn, Illinois • Cleveland, Ohio • Dallas, Texas • Laurens, S. C. • Los Angeles, Calif. • Metropolitan New York: Ridgefield, N. J. • Up-State New York and Canada: Baldwinsville, N. Y. • Orange, Conn. • Philadelphia, Penna. • Roanoke, Virginia • St. Louis: Lee's Summit, Missouri • So. San Francisco, Cal. • Troy, Mich. • 3M International: c/o American Lava Corp., Chattanooga, Tenn. 37405. U.S.A. 615/265-3411

66th  
YEAR  
OF  
CERAMIC  
LEADERSHIP



Contact your local European representative for immediate service

ENGLAND Analog Devices Ltd. Kinston-upon-Thames Surrey 01-546-6636	FRANCE Technique et Produits Boulogne 408-14-00	GERMANY Industrial Electronics GmbH Klüberstrasse 14 0611-725130	HOLLAND Elofysica, N.V. Amsterdam-c, 236300-123123
---	--	---	---



## When the Chips are down...

# IC's Don't Provide High Impedance and Low Bias Current Like this

## NEW LOW COST FET Op. Amp!

- Bias Current, max. — 50pA
- Input Impedance —  $10^{11}$  ohms
- Price (1-9) — \$25.00

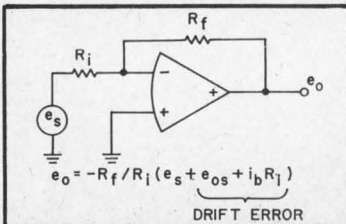

### HIGH IMPEDANCE INVERTING CIRCUITS

Curve shows that the 141 gives low drift errors even for summing resistors ( $R_i$ ) up to 15 M ohms. Curve at right applies using  $R_i$ . Applications include long term integration, picoamp current measurements, D-A converters and high Z summation or subtraction.

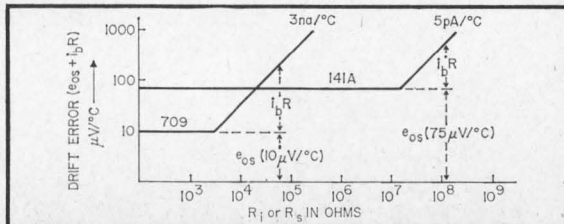

DRIFT OF 709 vs. 141A

Curve compares total drift error of 709 type ICs to the 141A. Total drift error consists of voltage drift error ( $e_{os}$ ) and voltage errors caused by the current drift component ( $i_b R$ ). For low resistances, drift error is constant since it is due primarily to voltage offset drift ( $e_{os}$ ). For high resistances, drift increases rapidly due to the effect of bias current drift ( $i_b$ ). For resistances above  $10^4$  ohms drift error of the 709 exceeds that of the 141 due to the effect of larger bias current drift.

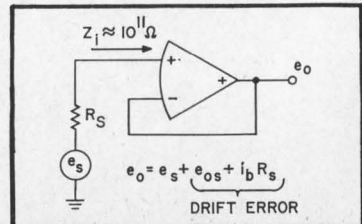

### HIGH IMPEDANCE NONINVERTING CIRCUITS

When connected as a follower the 141 gives  $10^{11}$  ohms input impedance ( $Z_i$ ) and low drift errors for sources ( $R_s$ ) up to 15 M ohms. Curve at left applies to using  $R_s$ . Applications include pot unloading, sample and hold circuits, A-D converters and ph meters.

IC op amps, like the 709, are small and inexpensive and for many applications they are quite satisfactory. But when you need high input impedance or low bias current IC's are no match for FET's. That's why we have worked so hard to produce the industries lowest priced FET op amp. In large quantities the Model 141 is priced lower than your cost for a 709 with an FET input stage and our performance is better too. Moreover, the 141 offers guaranteed specs and is 100% tested from  $-25^\circ\text{C}$  to  $+85^\circ\text{C}$  which is not usually the case for home brewed circuits.

Write or call collect for an evaluation amplifier today. Circle inquiry number to receive 141 data sheet and our new 32 page op amp catalog.

### Specifications

Open Loop Gain, min.	—	20,000
Rated Output, min.	—	$\pm 10\text{V}$ @ 2mA
Unity Gain Bandwidth	—	3MHz
Full Power Response, min.	—	50kHz
Slewing Rate, min.	—	3V/ $\mu\text{sec}$ .
Common Mode Voltage, min.	—	$\pm 7\text{V}$
Common Mode Rejection	—	1000
Input Impedance, C.M.	—	$10^{11}\Omega$
Supply Voltage Rejection	—	150 $\mu\text{V}/\%$

	Model A	Model B	Model C
Bias Current, $25^\circ\text{C}$ , max.*	50pA	30pA	30pA
Bias Current Drift, $25^\circ\text{C}^*$	5pA/ $^\circ\text{C}$	3pA/ $^\circ\text{C}$	3pA/ $^\circ\text{C}$
Voltage Drift, max.**	75 $\mu\text{V}/^\circ\text{C}$	40 $\mu\text{V}/^\circ\text{C}$	25 $\mu\text{V}/^\circ\text{C}$
Price (1-9)	\$25.00	\$30.00	\$35.00

\*double each  $10^\circ\text{C}$       \*\*avg. from  $-25$  to  $+85^\circ\text{C}$



ANALOG DEVICES INC. 221 FIFTH STREET, CAMBRIDGE, MASS. — 617/492-6000



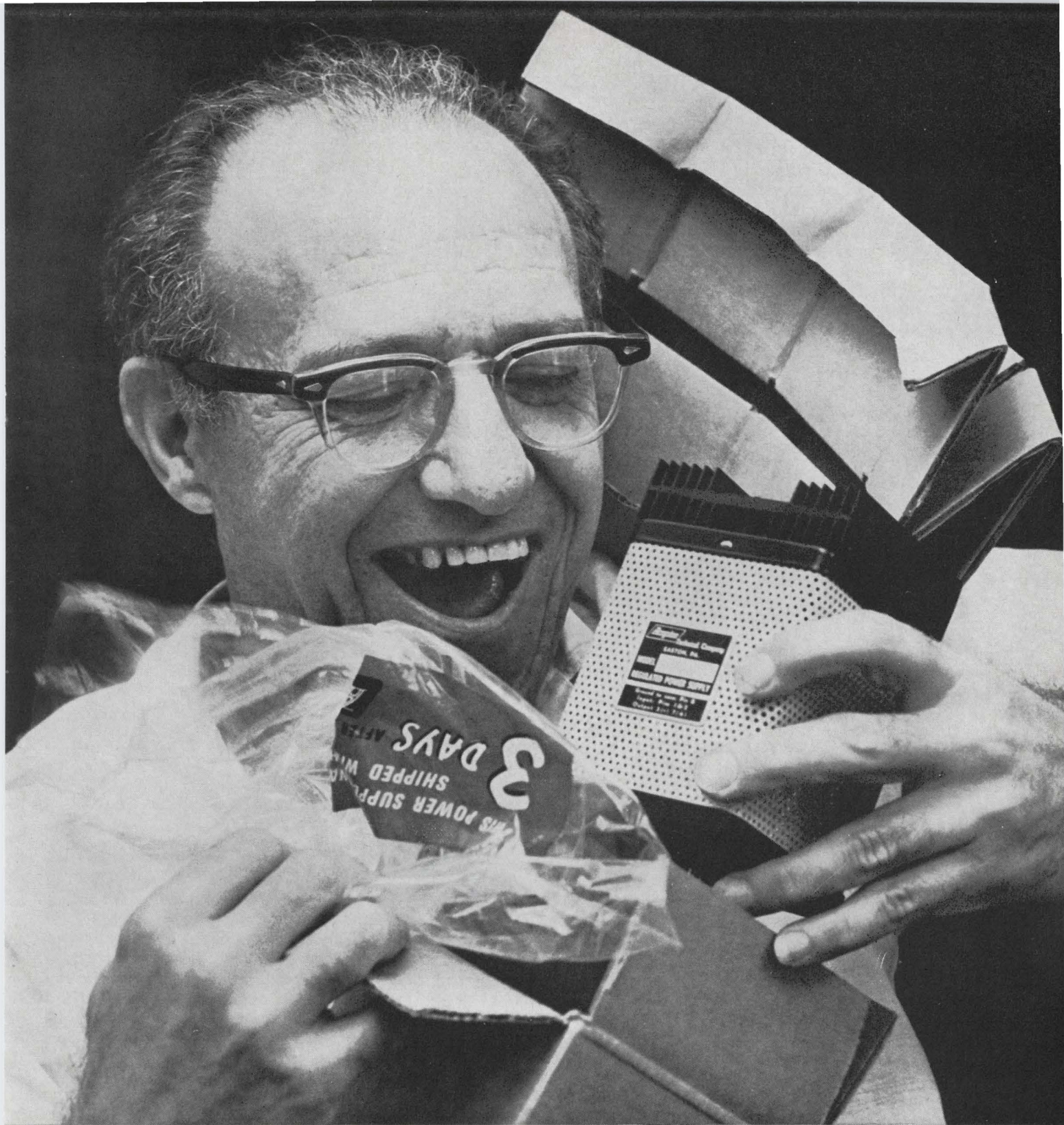

**Happiness is an Acopian power supply . . .  
because it's shipped in only 3 days.**

Whether your application is op amps, ICs, logic circuits, relays, lamps or electronic measuring equipment, look to Acopian to meet your needs for AC to DC plug-in power supplies. Acopian's new catalog lists over 62,000 different supplies . . . all available for shipment within 3 days. Get your 16 pages of happiness by writing or calling Acopian Corp., Easton, Pennsylvania (215) 258-5441. 



Circle 145 on reader service card



# Look at all the design problems GE silicones can solve:

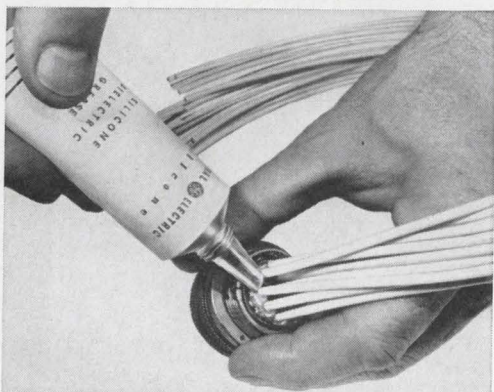

**HEAT TRANSFER** Designed for a wide range of applications, Insulgrease® non-curing dielectric compounds are frequently used for heat transfer, potting and sealing.

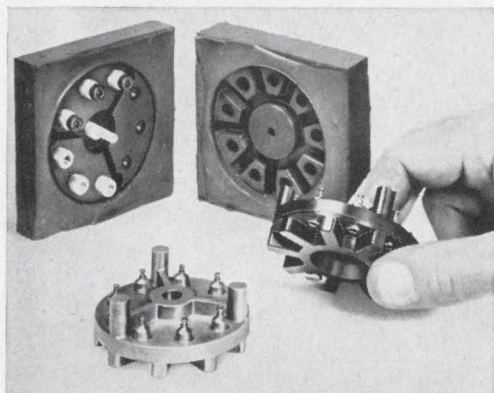

**MOLDMAKING** Tough, flexible RTV silicone is an ideal mold material for short runs or prototypes. Reproducing detail accurately at low cost, RTV needs no release agent.



**BONDING** RTV silicone rubber Adhesive/Sealant eliminates screws and drilling. It cures overnight to form a tough, flexible bond that never hardens, softens, cracks or shrinks.

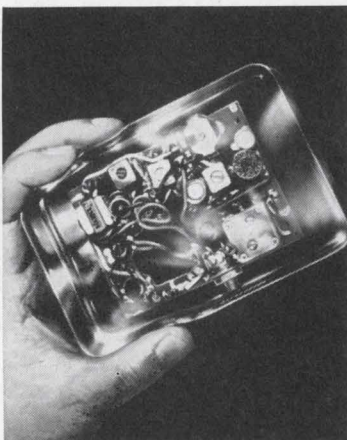

**EMBEDDING** Excellent electrical properties and resistance to temperature extremes from  $-75^{\circ}$  to  $600^{\circ}$ F make GE RTV an outstanding protective covering.

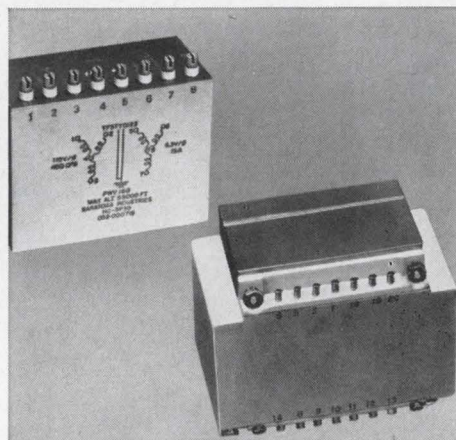

**ENCAPSULATION** RTV silicone gives positive protection against adverse environments. On production runs, RTV can be easily metered and dispensed with automatic equipment. Colored RTV's make coding simple.

Got some more design problems that a silicone could help you solve, but not sure which or what to specify?

Our Silicone Selector Guide was written to make your life easier. It has specs, guidelines, and case histories to help you pick the silicone that's right for your problem. Write to Section N-1280, Silicone Products Department, General Electric Company, Waterford, N.Y. 12188.

GENERAL  ELECTRIC



The Electronic Countermeasures System, a valuable penetration and survival tool for B-52's, posed a tough isolator problem which was successfully solved by Sperry.

What was so tough about the isolator spec? Among other things were power handling capability (400W CW, 4kW peak); isolation VSWR limited to 1.18:1; insertion loss (only 1 db permitted), and RFI shielding to prevent interference with other aircraft systems. All parameters had to be met at altitudes up to 60,000 feet and over the temperature range of  $-55^{\circ}\text{C}$  to  $+55^{\circ}\text{C}$  without cooling.

Sperry met the challenge with Model No. D-44S9, a specially engineered isolator that helps assure the reliability of B-52 ECM.

Is there a particularly difficult isolator problem Sperry can solve for you? There's a broad line of standard items, plus plenty of engineering talent if you need it. For full details, contact your Cain & Co. man or write Sperry Microwave Electronics Division, Sperry Rand Corporation, Box 4648, Clearwater, Florida 33518.

**SPERRY**

MICROWAVE ELECTRONICS DIVISION  
CLEARWATER, FLORIDA

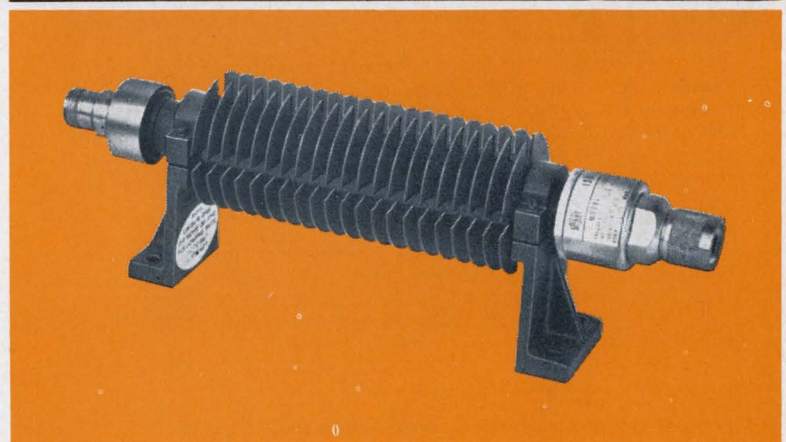

**When B-52's count on ECM, they count on isolators from Sperry . . . the first name in microwaves.**



# JFD announces . . . NEW delay Line SERIES...

\*

JFD Delay Lines are top quality, ruggedly constructed, precision components of proven dependability. A variety of models, having a wide range of electrical and physical parameters, are production items. Characteristics and mounting methods available in standard JFD units meet the requirements of a wide variety of circuit applications. Delay Lines for highly specialized applications are designed in JFD laboratories. A staff of skilled engineers employ proven techniques to limit development time to a minimum.

#### Distributed Constant

JFD distributed constant Delay Lines manifest minimum rise-time and distortion characteristics. Miniaturized and hermetically sealed models are available. Measured delay-time is within 5% of rating in most models.

#### Lumped Constant

JFD lumped constant Delay Lines are compact in size relative to delay-time. Attenuation, distortion and temperature coefficient of delay are minimized. Ratio of delay to rise time is excellent and delay tolerances may be held to within 0.2% when required.

#### Continuously Variable

JFD continuously variable Delay Lines are designed to withstand shock and vibration and meet military environmental requirements. Resolution is better than 1/1000th of maximum delay across the entire delay range, in most models.

For additional information, write for catalog DL-68.

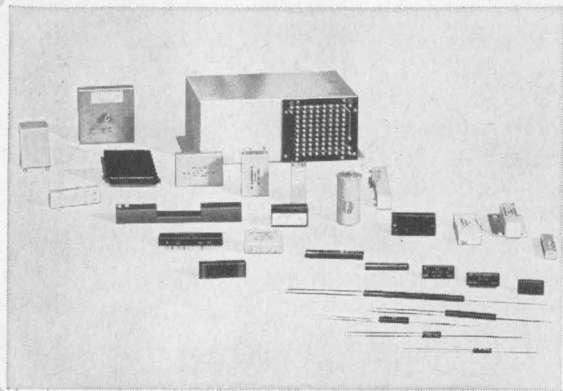

Illustrations shown 1/15 actual size.

**JFD**

JFD ELECTRONICS CO. / COMPONENTS DIVISION / 15th Avenue at 62nd Street / Brooklyn, New York 11219 / Phone 212-331-1000  
Offices and subsidiaries in principal cities, world-wide.

"TODAY'S COMPONENTS BUILT FOR TOMORROW'S CHALLENGES"



Sperry has recently proved the performance of its X band klystron amplifiers through successful application in a military satellite communication terminal.

The system demanded a tube that is tunable across the entire military frequency allocation; a tube that is easy to install, operate and maintain; a lightweight tube that occupies a minimum of terminal space.

Sperry's answer is the SAX-4705, an 8 kW, 4-cavity klystron amplifier. The tube is tunable from 7.9 to 8.4 GHz. It delivers 48 db gain. It has a 1 db bandwidth of 40 MHz and is 36% efficient. Yet it occupies less than one cubic foot, including magnet, and the entire assembly weighs only 96 pounds. In addition, it has successfully passed testing to the most stringent military environmental specifications.

Other tubes in the SAX-4700 family include a 5-cavity version with 50 MHz, 1 db bandwidth, 53 db gain and 500 MHz mechanical tuning range; a 15 kW tube for operation from 10.0 to 10.5 GHz, and a 20 kW version for the 7.9 to 8.4 GHz band. For more details on any or all of these tubes, contact Cain and Co., or write Sperry Microwave Tube Division, Gainesville, Florida 32601.

**SPERRY**  
MICROWAVE TUBE DIVISION  
GAINESVILLE, FLORIDA

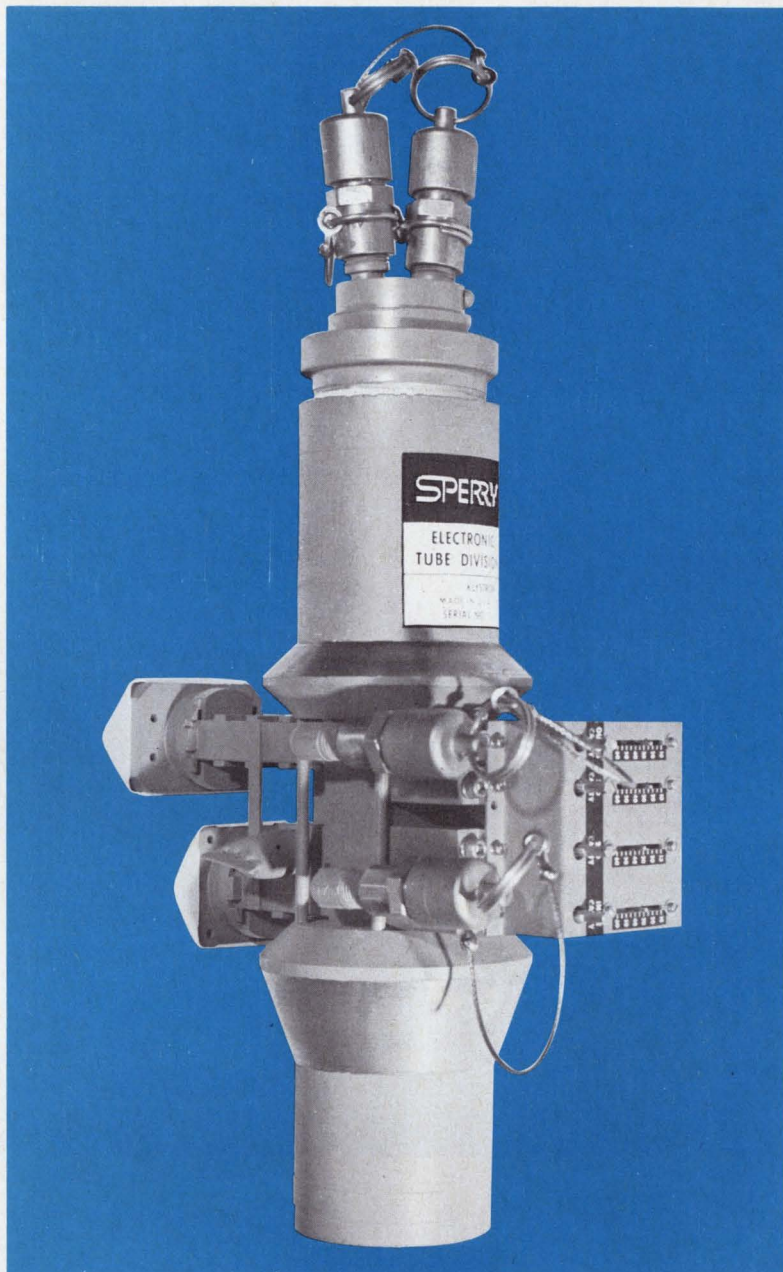

### **SAX-4700 Series Klystron Amplifier**

Frequency range	7.9-8.4 GHz
Tuning range	500 MHz
Power output	8.0-20.0 kW, CW
1 db bandwidth	40-70 MHz
Gain	45-54 db
Efficiency	36-40%
Weight	96 lbs

**Military communication satellite terminal application proves versatility of Sperry klystron amplifiers.**



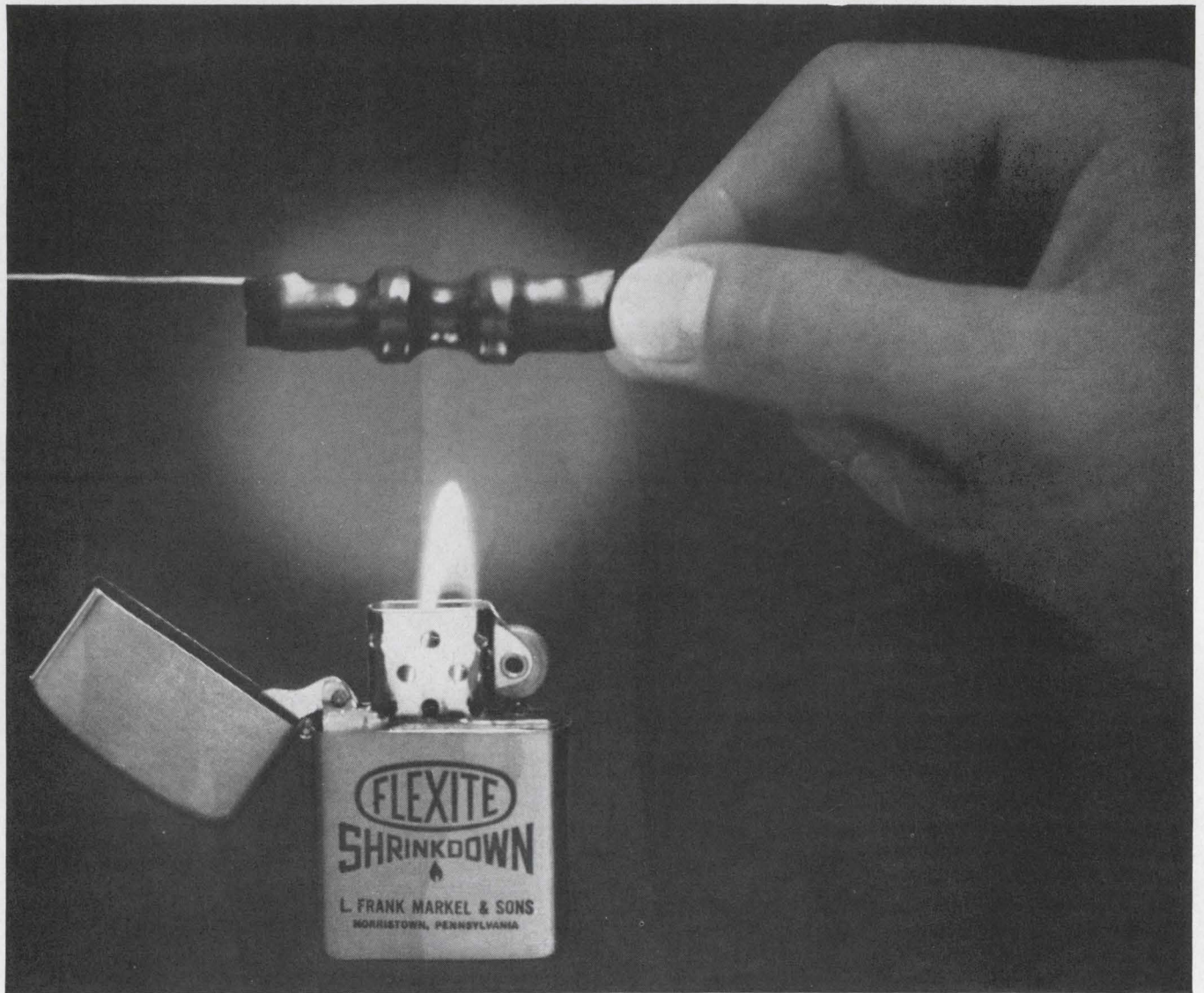

## Ingenious uses for a **hot idea!**

You design engineers are coming up with all sorts of ingenious uses for Flexite Shrinkdown plastic tubing.

Three years ago, Markel Shrinkdown was introduced as a better, more easily applied insulation for electrical components, connections and assemblies of irregular shapes. It still is . . . only more so!

But new uses, in countless applications, are being discovered every day. For instance: to bind things together—add strength and rigidity—seal against leaks—identify wires and parts—protect against abrasion, wear and breakage—resist corrosion, heat and moisture—keep out dirt, water, grease and chemicals—cover rough or sharp protrusions—prevent vibration—reduce noise—improve appearance—and so on ad infinitum.

Put your ingenuity to work. See where a skin-tight sheath of tough, flexible, heat-resistant plastic would improve performance, prolong life or cut the cost of your products.

There are four types of Shrinkdown to meet your requirements. One is of Teflon\*, for use at temperatures

up to 250°C. Two have shrinking temperatures under 200°F for use where higher heat would injure components. All have excellent electrical characteristics . . . meet military and commercial specifications. All shrink 50% in diameter—less than 10% in length.



To stimulate your thinking, we'll be glad to send you our "Hot Idea" experimental sample kit of Markel Flexite Shrinkdown Tubings. No cost—no obligation—just write.

\*DuPont Trademark



**L. FRANK MARKEL & SONS**  
Norristown, Pa. 19404 • Phone: 215/272-8960  
**INSULATING TUBINGS AND SLEEVINGS**  
**HIGH TEMPERATURE WIRE AND CABLE**



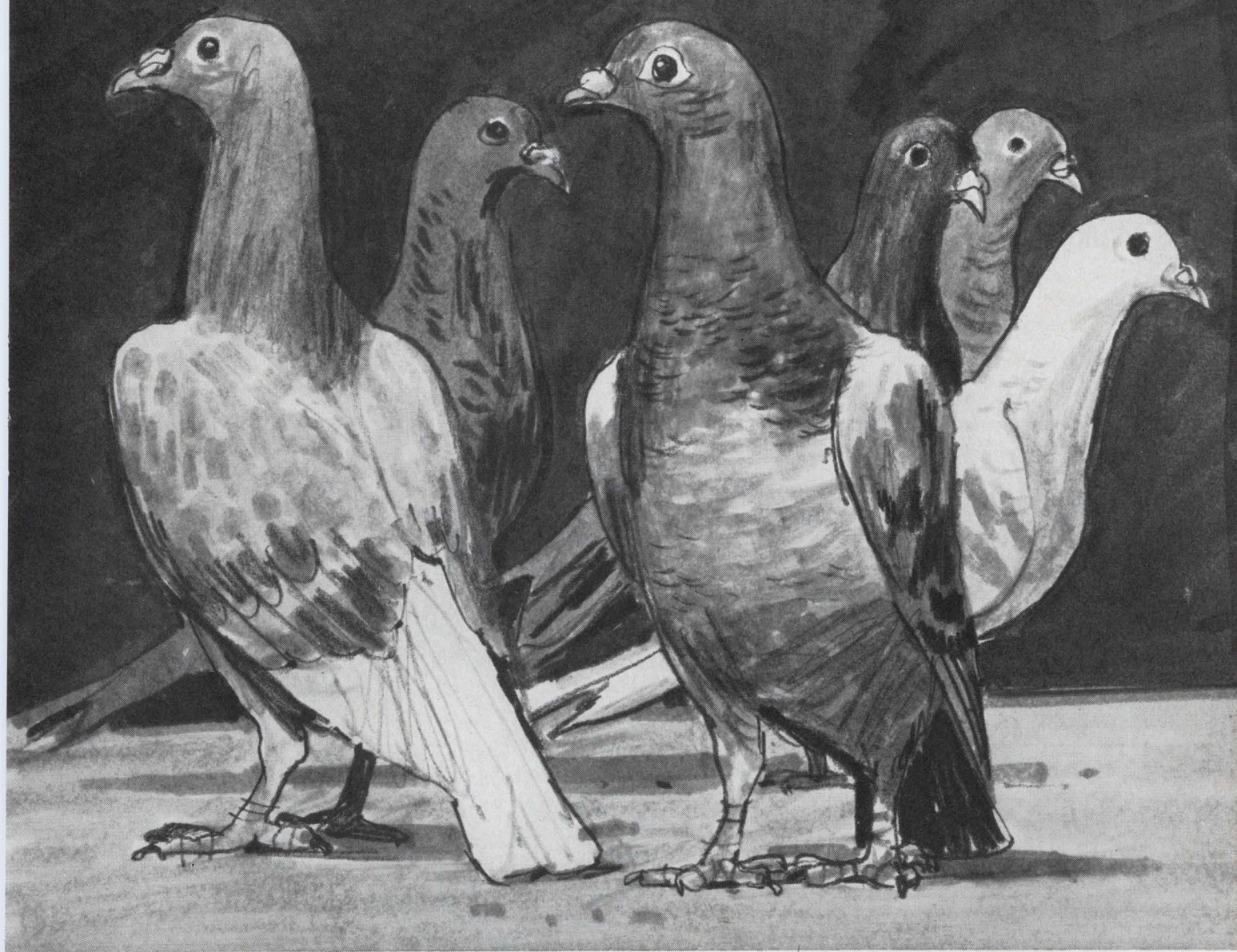

## One of our advanced scientific systems is expected to lay an egg

These pigeons have a full time job, working in surveillance . . . relaying information . . . electronically.

They're the pivotal part of ANIMAC, our animal/electronic system for pattern recognition in difficult or inaccessible environments. Exotic, yes, but just one example of our signal processing and optical scanning expertise.

In radar technology, one of our scientific breakthroughs greatly increases target sensitivity. In communications, an intercontinental HF system uses the ionosphere to transmit voice and tele-

type signals.

We've even taken our signal processing know-how underground and undersea. In hydroacoustics, we've conceived unique techniques for propagation and detection of suboceanic sound. And in geophysics, we've come up with ways and means of detecting and defining underground disturbances.

We make products too. We're a leading supplier of cathode ray tubes, instruments and oscilloscopes—with many design "firsts" to our credit.

In industry, signals from our optical scanners are steering beer—sorting soup—distributing deliveries—and protecting pill packaging.

These are but a few of the concepts, systems and products we've perfected around our scientific specialties.

There's nothing wrong if one of them lays an egg—we planned it that way.

Please send all customer and career-seeking inquiries to General Atronics, Philadelphia, Pa. 19118.

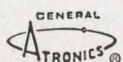

**GENERAL ATRONICS**

Circle 151 on reader service card



# IN HIGH POWER MODULES

# KEPCO

## MAKES THE DIFFERENCE!

**EXCEPTIONAL  
POWER/VOLUME/COST  
RATIOS!**

- Wide coverage of fixed output voltages  
4.5 volts (dual) to 120 volts single output.
- Kepco's patented Flux-O-Tran® (regulating transformer) provides line regulation and current limiting
- Ambient operating temperature range:  
-20°C to +55°C
- Reliability: MTBF > 140,000 hours
- Convection cooling
- Short circuit proof (see overload graph)
- Silicon rectifiers
- Dual output and extra filtered models
- Versatile mounting (cased and uncased)  
Rack adapters available, mount 1 to 5 units  
Applicable Patent Nos. furnished on request

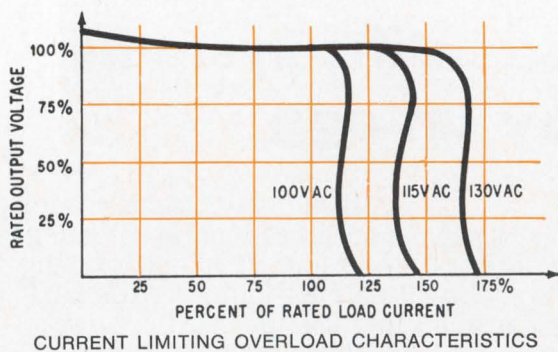

NEW 48 PAGE CATALOG  
CONTAINING COMPLETE  
SPECIFICATIONS AND  
APPLICATIONS NOTES  
IS NOW AVAILABLE

WRITE DEPT. Q-14  
FOR YOUR FREE COPY!

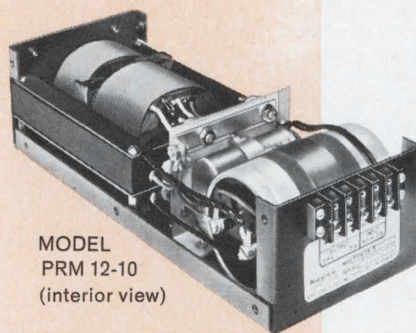

MODEL  
PRM 12-10  
(interior view)

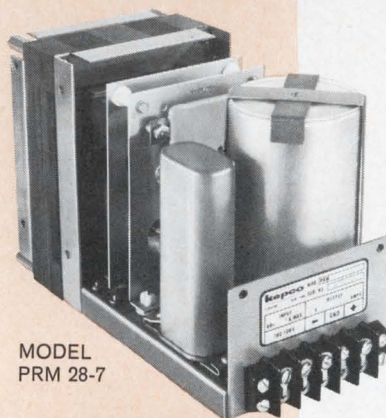

MODEL  
PRM 28-7

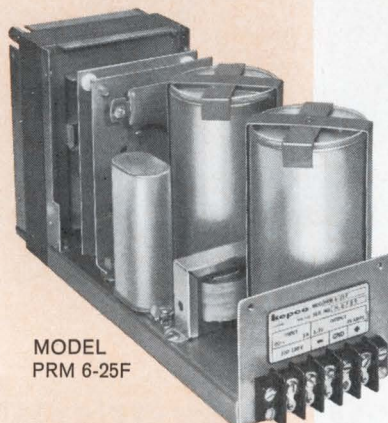

MODEL  
PRM 6-25F

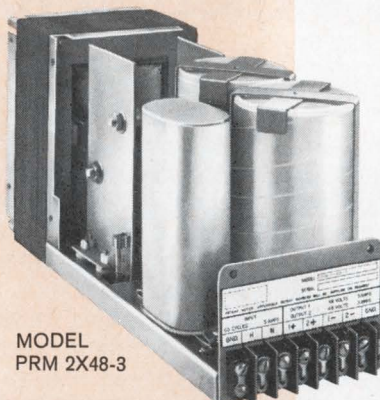

MODEL  
PRM 2X48-3

SIZE "B" — 120 SERIES  
CASED UNIT — \$99.00\*\*  
3 13/32" H x 5" W x 1 13/16" D

MODEL	DC OUTPUT VOLTS	AMPS
PRM 6-15	6.3	0-15
PRM 12-10	12	0-10
PRM 18-6.7	18	0-6.7
PRM 24-5	24	0-5
PRM 28-4.3	28	0-4.3
PRM 36-3.3	36	0-3.3
PRM 48-2.5	48	0-2.5
PRM 60-2	60	0-2
PRM 120-1	120	0-1

\*\*Available cased only

SIZE "A" — 180 SERIES  
UNCASED UNIT — \$119.00\*  
6 3/4" H x 4 3/4" W x 10 3/8" D

PRM 6-25	6.3	0-25
PRM 12-15	12	0-15
PRM 18-10	18	0-10
PRM 24-8	24	0-8
PRM 28-7	28	0-7
PRM 36-5	36	0-5
PRM 48-4	48	0-4
PRM 60-3	60	0-3
PRM 120-1.5	120	0-1.5

EXTRA FILTERED MODELS  
SIZE "C" — 180F SERIES  
UNCASED UNIT — \$169.00\*  
6 3/4" H x 4 3/4" W x 14 3/8" D

PRM 6-25F	6.3	0-25
PRM 12-15F	12	0-15
PRM 18-10F	18	0-10
PRM 24-8F	24	0-8
PRM 28-7F	28	0-7
PRM 36-5F	36	0-5
PRM 48-4F	48	0-4
PRM 60-3F	60	0-3
PRM 120-1.5F	120	0-1.5

DUAL OUTPUT MODELS  
SIZE "C" — 300 SERIES  
UNCASED UNIT — \$179.00\*  
6 3/4" H x 4 3/4" W x 14 3/8" D

PRM 2X 4.5-20	4.5	0-20
PRM 2X 6-20	6.3	0-20
PRM 2X 12-12	12	0-12
PRM 2X 15-10	15	0-10
PRM 2X 18-8	18	0-8
PRM 2X 24-6	24	0-6
PRM 2X 28-5	28	0-5
PRM 2X 36-4	36	0-4
PRM 2X 48-3	48	0-3
PRM 2X 60-2.5	60	0-2.5

\*Case optional — add \$10.00 to price





# Probing the News

Government

## FCC begins to get the message

Commissioners and industry agree that the agency needs a new image; changes are overdue, and the President's task force may propose some

By Robert Skole

Washington bureau manager

Under the "No Smoking" sign in an elevator at the Federal Communications Commission's old quarters in the Post Office Department Building, someone once scratched the words "No Nothin'."

The FCC last month moved to a new building in another part of Washington. As yet, no one has scratched "No Nothin'" in any of the elevators, but the move away from the old offices does not portend any speedup in the commission's operating procedures.

However, communications problems are piling up at an alarming rate as rapid technological advances give added dimensions to crises caused by a swelling population and a burgeoning economy. All concerned agree that something must be done. What they don't agree on is whether that something should take the shape of a new cabinet-level department or simply a reorganized FCC, and whether Congress and the Administration should start applying themselves to the problem now or wait until the President's Task Force on Telecommunications delivers its recommendations next summer.

### I. Soup to nuts

The FCC has long been criticized for its composition and its wide authority. Established in 1934 to cope with the overcrowded radio spectrum (ironically, this is still a major problem), the commission has seven members, no more than four of whom are from one political party. The commissioners must make rulings in a wide range of controversial

areas, from allocating chunks of the frequency spectrum and issuing extremely profitable television and radio broadcasting licenses to regulating telephone rates and even trying to deal with garage-door openers and other devices that can cause radio interference. Highly vocal and politically powerful forces therefore have a stake in the FCC's deliberations.

**Faint praise.** Considering the job it's charged with, and the fact that it hasn't changed its organization

to any great extent since it was established, the agency isn't doing such a bad job, many observers feel. The attitude of most of the companies that deal with the agency are summed up this way by one West Coast executive:

"The FCC is technically competent and, on the whole, not too bad to deal with when you consider the straitjacket of politics, budget limitations, and staff shortages it must wear. The straitjacket certainly can stand some loosening, but in Wash-



**Chief.** Rosel H. Hyde, chairman of the FCC, has 40 years with agency and its predecessor.



**Critic.** Nicholas Johnson is quick to find fault with fellow commissioners.



## DELAY LINES

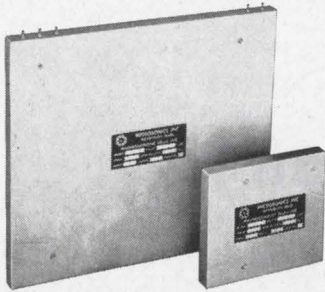

### GENERAL

Delay .4 to 10,000 usec at frequencies from 10 to 400 mc. Wide bandwidth and low spurious response for excellent pulse reproduction and dynamic range.

### COMPUTER STORAGE SYSTEMS

Ultrasonic delay lines using fused quartz or special glasses represent an ideal medium for high-speed Computer Storage, up to 20 mc rates.

Send for Microsonics' Brochure #5350.

### DIGITAL DELAY LINES

Delay lines for storage of high-speed digital pulses with zero temperature coefficient of delay for Computer applications. Design Bulletin available on request.

### MAGNETOSTRICTIVE DELAY LINES

Microsonics, Inc. has a broad delay line and systems experience with capability to deliver both off-the-shelf and custom-designed systems for any specific application.

Systems provide for the delay or storage of both analog and digital signals and are available to handle all modes of modulation (RZ, NRZ and Bipolar). Output signals are available in either clocked or unclocked signal.

Send for Microsonics' Brochure #M735.

### VARIABLE AND TAPPED DELAY LINES

Featuring all usual advantages of superior fixed Delay Lines.

## MICROSONICS INC.

A subsidiary of the  
SANGAMO ELECTRIC CO.

60 Winter Street  
Weymouth, Mass.

Area Code (617) 337-4200



DELAY LINES  
QUARTZ CRYSTAL PRODUCTS

ington nothing happens overnight."

Commissioners have learned over the years that the "No Nothin'" image is a hard one to dispel. But when one of them, Kenneth A. Cox, had an assistant go through the records since 1963—the year Cox joined the agency—to list some of the FCC's "more significant actions," the citations covered 39 pages of single-spaced type.

Nevertheless, many general and special publications have declared open season on the FCC during the past several years. They have charged that the agency fails to control loud television commercials, that it backs the broadcasters in their battle against cable tv, that it plays footsie with the large common carriers, and that former commissioners often wind up working for firms whose activities the FCC controls.

**Obsolete?** "I don't expect anyone to agree with all we've done," says Cox. "I don't approve of all of it myself. . . . In the last five years we've handled an amazing array of problems, some of them of transcendent importance. For an allegedly obsolete agency, we've managed to get quite a bit done. However, I think the next five years may be even busier."

Nobody on the commission disagrees with this. It's perhaps one of the few things that the seven commissioners do agree on. This, of course, is one of the major problems of the agency: it is run by seven politically appointed men.

### II. It takes all kinds

The commission's current composition is typical in that its members have widely varied backgrounds and political colorations—factors that influence their votes.

▪ Chairman Rosel H. Hyde, a Republican, has been a commissioner since 1946. He's been with the FCC and its predecessor, the Federal Radio Commission, for 40 years.

▪ Robert E. Lee, another Republican, is a former FBI agent. He was named to the commission in 1953.

▪ James J. Wadsworth, the third Republican, is a former ambassador to the United Nations. He was named to the FCC in 1965.

▪ Robert Bartley, a Democrat, is a nephew of the late Rep. Sam Rayburn. He was named a commissioner in 1953 after working on the



**Diplomat.** James J. Wadsworth is a former ambassador to the U.N.

FCC staff in the 1930's and then for the National Association of Broadcasters.

▪ Lee Loevinger, also a Democrat, is a former law professor and Minnesota Supreme Court justice. He joined the agency in 1963 after heading the antitrust division of the Justice Department.

▪ Nicholas Johnson, another Democrat, is, at 33, the commission's enfant terrible. He's a former law professor who joined the FCC in 1965 after heading the Federal Maritime Commission—he was 28 at the time—under President Kennedy.

▪ Cox, the fourth Democrat, is an attorney who worked for the Senate Commerce Committee and headed the FCC's broadcast bureau before being named a commissioner in 1963.

**Splashy.** Commissioner Johnson is most articulate about the agency's shortcomings. When he first started rapping the FCC for not adapting itself to modern needs and for not taking longer-range views, he was brushed off as "a brash young kid" by his fellow commissioners. This didn't slow Johnson down—although he has perhaps become more diplomatic with time. He knows the questions he raised



weren't welcomed by his colleagues, "but they are starting to listen to me now," he says. If Johnson represents one extreme of FCC opinion, Hyde represents the other. Most people characterize Hyde as the epitome of the don't-make-waves type of career bureaucrat; people who do make waves usually don't stay long at the FCC.

**Muscle.** "We don't need to be superseded," says Hyde. "We need to be strengthened. We need greater capacity to study and analyze the uses of communications. We've been dependent over the years on information and technical details given to us by interested parties. We definitely need to strengthen our research capabilities."

Hyde notes that in the FCC's fiscal 1968 budget of \$19 million, there is \$600,000 earmarked for "research"—the first such money the commission has ever received. It will be applied toward three broad goals, he says: improving allocation of land mobile radio service; devising better ways of handling Citizens Band both on a short- and long-term basis; and studying the "purpose and mission" of the FCC.

"We're trying to get some sense into planning the use of the spectrum," Hyde continues, "and trying to see that the FCC doesn't just follow but takes the lead in making the best use of technology."

**Limited view.** Johnson likens the FCC to a traffic cop who controls vehicles only as they arrive at and leave an intersection. The cop doesn't care where the vehicles come from, what new vehicles might show up, what the effect of highway construction down the block may have on the traffic stream, or what will happen to the vehicles after they've been sent on their way.

Johnson agrees that the initial \$600,000 of research money should help the FCC find out just what it should be doing. However, with the Administration now tightening up on outlays unrelated to the Vietnam war, there's a possibility that the funds won't be released for spending this year.

A year ago, Commissioner Johnson started to push for a long-range national communications policy. In a speech before the Federal Communications Bar Association, he

## Perform these Functions with VERSATILE INTRONICS MULTIPLIERS

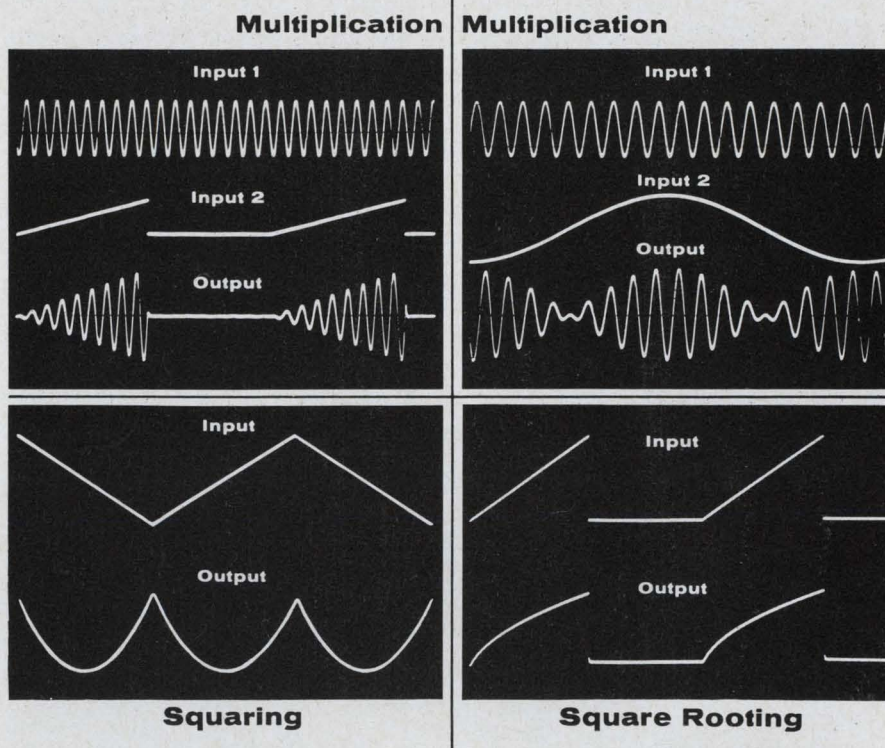

Illustrated above are actual photographs of oscilloscope waveforms demonstrating the versatility and linearity of Intronics four quadrant analog multipliers.

These solid state 2" x 3" x .6" modules require no external amplifiers and are capable of multiplication, squaring, division, and square rooting by appropriate pin interconnections. All multipliers feature linear operation through zero volts, with insensitivity to temperature and supply voltage variation.

### A Multiplier for every purpose:

**General Purpose Multiplier - M101** Accuracy .25%, output frequency response DC to 1kHz. Inputs  $\pm 10V$ , AC or DC, single ended or fully differential. Output impedance  $< 1 \text{ ohm}$ , input impedance  $> 75k \text{ ohms}$ .  $\pm 15VDC$  supply voltages,  $\pm 12V$  available on special order. *Single Unit Price \$445.00.* Circle reader service number **101** for more details.

**NEW!** **High Accuracy Multiplier - M102** Similar to M101 except 0.1% accuracy, bandwidth DC to 100Hz. *Single Unit Price \$495.00.* Circle reader service number **102** for more details.

**NEW!** **FET High Frequency Multiplier - M201** Accuracy 1%, DC to 1mHz bandwidth (both X and Y channels), inputs  $\pm 10V$ , AC or DC. Input impedance  $> 10k$ , output impedance  $< 1 \text{ ohm}$ ,  $\pm 15VDC$  supply voltage.  $\pm 12V$  supply voltage available on special order. *Single Unit Price \$545.00.* Circle reader service no. **201** for more details.

**S101 Mating Socket** for all multipliers \$8.50 each. Write or call for detailed information, application notes, and quantity quotations.

TEL: 617-332-7350 | TWX: 710-335-6835



# intronics

57 CHAPEL ST., NEWTON, MASSACHUSETTS 02158





**FACT**  
gives you  
the  
bad news  
fast.

FACT stands for Flexible Automatic Circuit Tester. It doesn't pull any punches.

It's a completely automatic system for continuity and leakage testing. Fully programmable with card or tape input.

When a computer won't play, or there's a circuit discrepancy in any type of electrical harness or assembly—FACT pinpoints the failure exactly.

And reports the fault and precise location to the operator.

FACT'S fast. Testing is performed at an average rate of 3000/minute. FACT'S flexible. Adaptation to new

projects requires only new tapes or test decks, plus the appropriate adapter cables.

It's completely modular—designed for easy expansion and adaptable to a wide variety of test conditions.

FACT is now reporting wiring discrepancies for many commercial military and space programs. And producing significant cost/schedule savings.

Write Hughes for the good news. FACT Systems, P.O. Box 90929, Los Angeles, California 90009. FACT'S available off-the-shelf. In 90 days or less.

**HUGHES**

HUGHES AIRCRAFT COMPANY

said: "The fact is that the Federal Government has no coordinated administration of communications and virtually no long-range research and development program."

This is one of the problems the President's Task Force on Telecommunications is tackling. The panel, established last August, has been given a year to come up with recommendations for a U.S. communications policy. Off to a late start because of difficulty in finding an executive director, it will have a tough time meeting its deadline. But regardless of how close it gets to formulating a national policy, the task force may outline definite steps toward modernizing the FCC.

**So far, so fair.** The FCC—with all its faults—has been doing a fair job so far as the public and Congress are concerned. People can generally get radio and television programs without interference. Telephone and telegraph rates are not intolerably high, and service is usually good. Taxi fleets and diaper services are able to get licenses covering their own radio dispatching requirements.

However, the problem of overcrowded frequencies is causing Congress to take a look at the commission. Police and fire departments in large cities have been crying for years for additional frequencies, and recent urban riots have given added weight to their pleas. Congressmen are starting to feel grassroots pressure regarding this issue.

Most commissioners, and most of the FCC's staff, consider overcrowded land mobile frequency spectrum the agency's chief problem.

An FCC study group is now considering three possible courses. One would give the seven lower ultra-high-frequency channels to land mobile users, a stopgap measure that might be effective for 10 to 15 years. Under another plan, channels would be shared on a geographical basis. The third proposal would allow operation in the 800-900 megahertz region.

**Strapped.** "If we had a Bell Labs we could find out more about the 30-to-300-gigahertz range as a long-range answer," says Ralph Renton, the FCC's chief engineer. "If we had the money, we could do the research that industry says it's unable or unwilling to do."



### III. Away from the limelight

Although overcrowded spectrums are attracting the most attention—especially in Congress—the FCC is involved in a wide range of other problems that are of significantly greater long range importance although perhaps not as urgent.

▪ The commission has been inquiring into subscription television for the past 12 years; a solution eventually will have to be found by Congress.

▪ The growth of cable television is still blocked by the FCC's "second report and order." The Supreme Court will give a final answer to the commission's claim that it has the right to regulate cable tv.

▪ By Feb. 15, interested parties will have filed their initial comments on the FCC's inquiry into the relationship between computers and communications.

▪ The FCC's study of domestic satellites is still under way, and according to Nicholas Johnson, the issues at stake here may be "fully as important and unique as those confronted when Comsat was established."

▪ The FCC is pondering the question of whether to allow the attachment of foreign devices to telephone-company equipment, or at least to force the phone companies to establish technical standards for foreign attachments.

The agency is moving ahead at its own pace in these areas—and others—but there are many in Washington and in the FCC itself who feel that the only real answers will have to come from the President's task force.

**No upheaval.** Nobody expects the panel to recommend anything particularly revolutionary, but proposals that might find favor with the Administration and Congress include:

▪ Either charging fees for spectrum space or auctioning it off.

▪ Giving the FCC something of an appellate court role. The commissioners would sit as judges, be appointed for long terms, and be politically independent.

▪ Forming a separate section to handle the routine administrative problems and agency details.

▪ Establishing a research and development division to keep the FCC on a technical par with the firms it regulates.



AXION

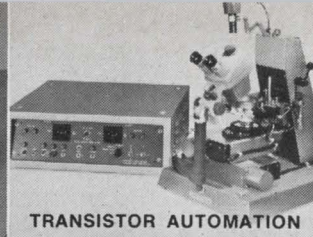

TRANSISTOR AUTOMATION

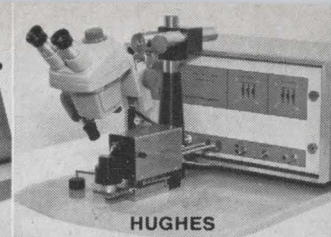

HUGHES

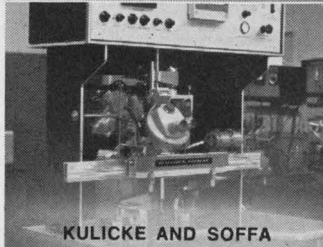

KULICKE AND SOFFA



SIPPICAN

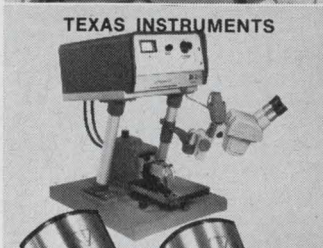

TEXAS INSTRUMENTS

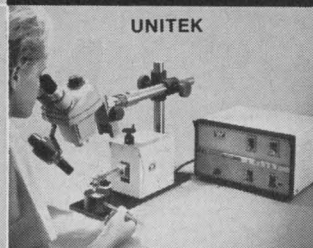

UNITEK



WELTEK

# STEREOZOOM<sup>®</sup> PREFERRED!



## For ALL 8 Leading Micro-Welders

**BECAUSE BAUSCH & LOMB STEREOZOOM** adds product value, benefits users. That's why StereoZoom outsells all other stereomicroscopes combined. Why your choice should be StereoZoom whether for your own product...for your production lines...for quality control and inspection.

With StereoZoom you get the brightest, sharpest 3-D images, plus continuously variable magnification. It saves operators' time, increases production, minimizes fatigue. It's built to withstand hard industrial usage, is dust-proof, shock-proof, trouble-free.

Besides, the StereoZoom line lets you pick a complete microscope or selected components... to make sure your job is done right.

Call your dealer or write for Catalog 31-15, Bausch & Lomb, 61401 Bausch Street, Rochester, New York 14602.

**BAUSCH & LOMB**

SCIENTIFIC INSTRUMENT DIVISION

Circle 157 on reader service card

ADVANCING ELECTRONIC/OPTICAL  
INSTRUMENTATION



"Sure, we've made a major breakthrough in the integrated circuit world. Our customers say we're the first company in this circus industry to operate like a responsible business."

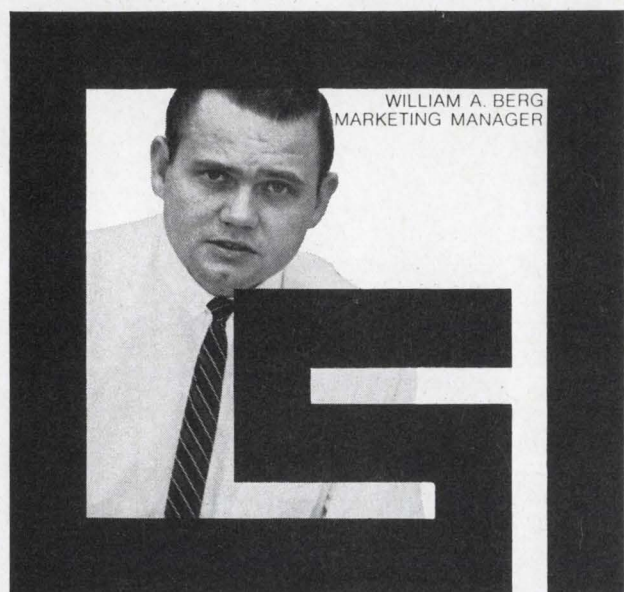

WILLIAM A. BERG  
MARKETING MANAGER

**SIGNETICS INTEGRATED CIRCUITS**

SIGNETICS CORPORATION  
THE RESPONSE/ABILITY COMPANY



# New terminals in display picture

In applications where computer-driven display terminals can be clustered, tv-like monitors coupled with time-shared memories promise cost savings

By Walter Barney

San Francisco regional editor

**Raster-scan techniques** similar to those used in commercial television are leading to low-cost graphic displays for special-purpose computer terminals. Four firms—Data Disc Inc., the Philco-Ford Corp.'s Western Development Laboratories, the International Business Machines Corp., and the Radio Corp. of America—are already developing display systems using conventional tv monitors and a variety of memory types.

No one's claiming that such setups are useful for all applications. For one thing, the wide bandwidth required for a video signal doesn't permit these systems to operate at the end of a phone line. For another, the development of terminals capable of working off communication lines having low bit rates has become an important objective of designers of sophisticated, but costly, cathode-ray-tube displays. But this capability isn't critical where terminals are clustered—in scientific laboratories, control centers, and classrooms. As a result, monitor systems, which hold out the possibility of time-sharing remote character and graphics generators as well as refreshment memories open the way to dramatic reductions in the terminal cost total for certain applications.

## I. Ways to go

Data Disc., for example, is developing disc-memory systems with full graphics capability that will be priced in the \$1,500-\$2,000 range. The company will soon offer a 64-terminal, alphanumeric display-only system for \$500 per channel; a tv monitor is extra. Key to the low cost is the location within the system of both the character generator and the remote memory.

**One or another.** Basically, there are two types of graphic display organization. Either a digital memory feeds a character generator, which drives the crt, or the character generator feeds the memory, which then refreshes the crt.

Where the memory feeds the generator, the memory can be relatively small, since it needs only to store a single six-to-eight-bit code for each character to be displayed; for a 1,000-character display, this amounts to 6,000 to 8,000 bits, well within the capability of a simple acoustic delay line. Such a system, however, must have a separate character generator for

each terminal. Moreover, says Herbert C. Hendrickson, manager of display-control systems engineering at Western Development Labs, the symbol and vector generators must recreate the entire display with each refreshing cycle; and complex displays may be degraded in such circumstances.

But when the memory is fed by the generator, the memory must be larger. The character generator's output is a 16-to-100-bit display code. Thus, for the same 1,000-character display. The memory must store 16,000 to 100,000 bits. However, the generator need operate only during updates, an advantage that gives the user two alternatives:

- He may use the same generator to serve other channels, in which case he will need a high bit rate from the computer and will have to use coaxial cable or microwave transmission lines;

- He may generate characters slowly via ordinary telephone lines, a method used in some slow-scan television systems [Electronics, Aug. 7, 1967, p. 218].

**Viewpoints.** Central to the Data Disc system and those developed by Philco, RCA, and IBM is raster scanning. "We have a lot of missionary work to do in this respect," says William W. Stevens, vice president in charge of Data Disc's Special Products division. "Most people think about an x-y type of scanning for graphics."

But Western Lab's Hendrickson believes the missionary work has been completed, pointing out that there has already been a shift in crt design from random beam positioning to raster techniques.

"At first glance, the digital system seems expensive," Hendrickson

## Dissenting voices

Not everyone is enthusiastic over raster scanning.

James Clements, manager of the data and display system department at Sanders Associates Inc., says a raster system causes a horizontal line to be broken into "stair steps." He favors a technique in which each character is generated individually. The line, he says, could be painted directly with better quality than that with a raster technique.

Another in the opposition camp is Robert H. Stotz, assistant leader of the display group at the Massachusetts Institute of Technology's Electronic Systems Laboratory. Stotz points out that raster displays require conversion from the point-and-line display description used by a computer to deflection- and intensity-modulated signals for the tv-like consoles. This requires either a lot of computer time or a special conversion module, both of which are expensive proportions, according to Stotz.



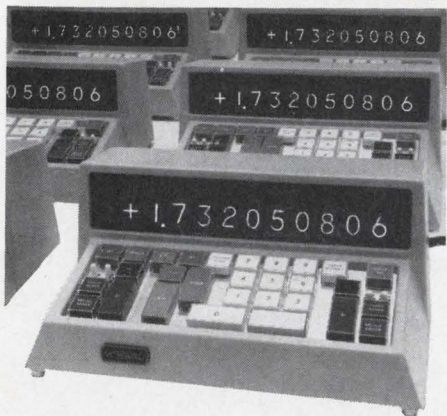

## Why companies standardize on WANG electronic calculators

**VERSATILITY** Just one basic calculator design, the WANG 300 Series, can solve the needs of many company operations. On compact keyboard displays, all basic arithmetic functions (+, -, ×, ÷) can be performed instantly, silently, accurately by simply touching a key. Optional keys produce  $x^2$ ,  $\sqrt{x}$ ,  $\text{Log}_e x$ ,  $e^x$ . 80 Step tab cards and plug-in card readers can make any model fully programmable.

**EXPANDABILITY** As needs increase, add-on compatibility makes it possible to expand into a powerful computing system that will branch, loop, do sub-routines, make decisions and manipulate arrays.

**CONVENIENCE** Wang calculators are as simple to learn and operate as a ten-key adding machine but infinitely faster and more powerful.

**ECONOMY** Wang multiple keyboard systems cost far less per station than any comparable electronic calculators. In use, they can eliminate 67 to 93 per cent of calculation time. (One leading company reports a saving of \$73,000 four months after installing Wang Electronic Calculators.)

Why not investigate? Write or call:



Dept. 1-H, 836 North St., Tewksbury, Mass. 01876  
Tel.: (617) 851-7311

In Major Cities, Tel.:

(201) 241-0250 (313) 278-4744 (514) 482-0737	(518) 463-8877
(203) 666-9433 (314) 727-0256 (601) 234-7631	
(205) 245-6057 (317) 631-0909 (612) 881-5324	
(206) 245-6057 (319) 365-2966 (614) 488-9753	
(212) 255-9042 (402) 341-6463 (617) 851-7311	
(213) 278-3232 (404) 457-6441 (702) 322-4692	
(214) 361-4351 (405) 842-7882 (702) 735-5802	
(215) 839-3345 (412) 366-1906 (713) 668-0275	
(216) 333-6611 (415) 454-4140 (716) 381-5440	
(301) 588-3711 (416) 364-0327 (717) 397-3212	
(301) 821-8212 (504) 729-6858 (816) 421-0890	
(303) 364-7361 (505) 255-9042 (817) 834-1433	
(305) 841-3691 (512) 454-4324 (916) 489-7326	
(312) 456-1542 (513) 531-2729 (919) 288-1695	

## ... getting sufficient memory capacity at a remote location isn't a problem ...

says. "But random beam steering requires electrostatic deflection and high voltages, and that costs money." He says Western Labs undercut one competitor by 75% on a Government contract by going to raster scan, and saved \$500,000 on three tubes on a military project, using the same technique.

"It's like the analog versus digital computer argument," Hendrickson says. "People worried about the cost of digital memories, but the cost per function has dropped steadily."

Stevens agrees that the raster technique is much cheaper, but offers different reasons: "The x-y display requires a big chunk of core memory. A 1,000-character display might take 1,000 eight-bit words, and the cost of refreshing the tube in this case would run to 25 cents a bit."

**Flexibility.** Stevens also points out that because random beam steerers need 5 microseconds to settle, they are limited as to the number of points they can make in 30 milliseconds—the duration of one conventional television frame. This means flicker will be troublesome in frames of longer duration.

On technical grounds alone, Hendrickson says, the raster scan is preferable: the electronics are simpler, the tubes are cheaper and can accept conventional video signals as well as digital input. In addition, registration problems are eliminated, polarity may be inverted, and light pen operations are easier.

Allan B. Corderman, director of RCA's instructional systems unit, says that his organization is interested in raster scan because it wants its systems to be compatible with closed-circuit tv. He points out that RCA already has a broad closed-circuit-tv line in schools. Ultimately, he believes, his company will be able to market systems that work off phone lines for \$1,000 a terminal.

Says Data Disc's Stevens: "We're utilizing the investment of 20 years of television. But there's still a lot of investment to recoup in x-y scanning."

Getting sufficient memory capacity at a remote location is no problem. Delay lines, drums, discs, and semiconductors can all fill the bill. The big question is cost. "Our gospel is the cost per bit," says Donald I. Frush, development manager in charge of the IBM 1500 computer-aided educational system.

**Provincialism.** The 1500 uses a disc-pack memory — "perhaps," quips Frush, "because we're west of the Mississippi." Other IBM computer systems use core memory, but the 1500 is made in San Jose, Calif., in the company's largest disc-memory manufacturing center.

### II. Who's in first

Frush ranks discs, cores, and delay lines in that order of descending initial cost. But delay lines, he says, have an inherent jitter that can cause a display to have waves. Cores, which have no mechanical parts, aren't subject to this problem. Discs, Frush says, have certain mechanical difficulties—with belts and pulleys—but the incremental cost of storage is virtually nil. "All you need is an extra head and an extra amplifier," he says.

"The question boils down to how big a cluster you want to drive," he says. The 1500 can handle as many as 32 terminals.

Most of Philco's systems use delay lines—in one case, 64 per channel in an eight-channel system

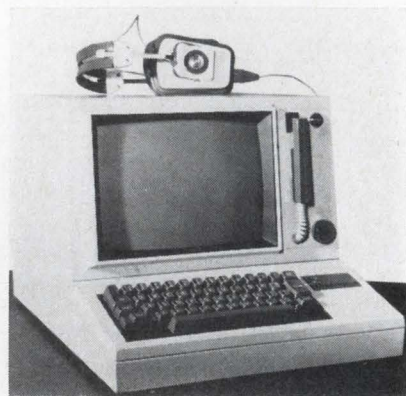

**Teacher's pet.** The cathode-ray tube of this RCA display terminal for a computer-aided instruction system uses a television-type raster scan.



that has seven colors, full graphics, and 729-line resolution. Another of the company's systems uses a drum to obtain a million bits per frame with a 945-line resolution. But Philco eventually plans to build systems with metal oxide semiconductor memories in the hope of lowering cost, and thus edge out the competition.

At present, Hendrickson says, delay lines cost about 2 cents a bit, drums under a penny a bit, cores about 6 cents a bit, and MOS about 50 cents a bit. (Actually, Philco's Microelectronics division has offered a 200-bit shift register at \$50, or "two bits a bit," and the National Semiconductor Corp. has a shift register available at 14.8 cents a bit.) All of these assemblies operate at around 1 to 2 megahertz. Says Hendrickson of the potential of MOS memories: "It's my feeling that MOS will beat out drum memories in two or three years."

**Time off.** Hendrickson points out that raster scan is not producing any picture 25% of the time—during the 20% horizontal and 10% vertical blanking intervals. But neither a delay line nor a drum can stop to use this off-line storage opportunity, he notes.

If the memory were sufficiently versatile, he says, facsimile techniques could be used for digital video. A 1,024-point line that is half black and half white must be stored in a mechanical memory as 512 binary 1's and 512 binary 0's. "But," says Hendrickson, "if you can wait while a video synthesizer spits out 512 bits, you can simply store a binary '512 white,' thus saving on memory capacity."

### III. Cost plus

Data Disc's Stevens can draw a whole series of curves to demonstrate the dramatic drop in cost per terminal as a user adds to a disc-memory system. The company's DM-64, for example, will sell for \$8,000, including the memory and a character generator. Each read-write head, with amplifiers and clocking, sells for \$300; a one-terminal system, then, would cost \$8,300, a monitor would be extra.

**Added attractions.** Other channels may be added at the cost of only the extra recording heads and required interface electronics; a 64-channel system will run about

How can I stop sample-&-hold droop?

Simple.

High speed data input

ANALOK

Low speed data processor

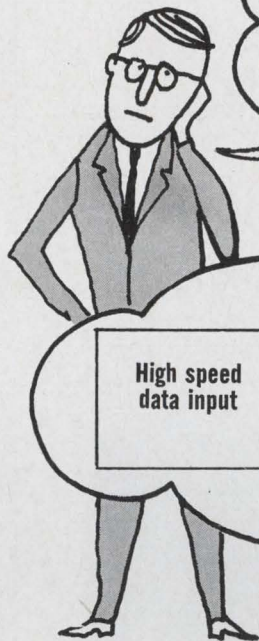

**Forget about droop** with ANALOK because it doesn't. What it *does* do is give you a simpler, less expensive system with greater flexibility.

**Here's how.** ANALOK is a multichannel unity gain track-and-hold amplifier with *zero* decay. It can retain stored values *in an analog state* indefinitely. This unique memory capability gives you greater flexibility because there's no time restriction between acquisition and use of sampled values. Check these applications:

- Use ANALOK as a high speed data buffer. Sample multiple functions simultaneously, or transient phenomena in a programmed sequence. Transfer the data to your low speed data processor as slowly or rapidly as you wish. No matter how much time you take, the stored values won't droop.
- Decommuration with one DAC and a multichannel ANALOK eliminates the need for periodic updating necessary when using conventional sample-and-hold channels. The result of using ANALOK is optimum use of your computer since it need only address each ANALOK channel when it has *new* information.
- Provide the information storage capability in your analog system with ANALOK. You may not have to go hybrid.

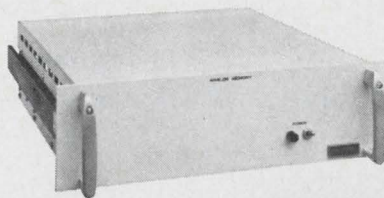

**Get complete specifications.** Write to ANALOK Sales, Dept. 233, Analog-Digital Systems Division, Control Data Corporation, 4455 Eastgate Mall, La Jolla, California 92037. Or phone 714/453-2500.

**CONTROL DATA**  
CORPORATION

4455 Eastgate Mall, La Jolla, Calif.



does an overall  
bandwidth of 400 kHz  
at an  
input frequency of 700 kHz  
sound rather wide to you?

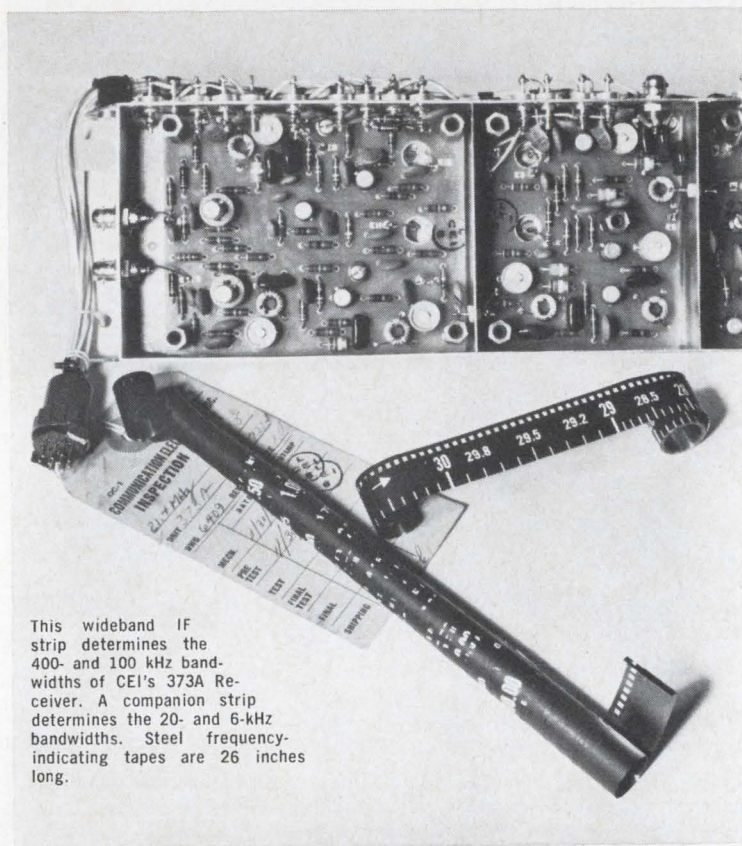

This wideband IF strip determines the 400- and 100 kHz bandwidths of CEI's 373A Receiver. A companion strip determines the 20- and 6-kHz bandwidths. Steel frequency-indicating tapes are 26 inches long.

## it's available NOW...

... in CEI's 373A Receiver designed for RFI/EMI detection. The 373A covers 500 kHz to 10 MHz in one band, from 10 to 30 MHz in the other. IF bandwidths include the 400 kHz mentioned plus 100, 20, and 6 kHz, switch-selectable.

Call or write for specifications and information on modifications for your particular needs.



**COMMUNICATION ELECTRONICS INC.**  
6006 Executive Blvd., Rockville, Md. 20852  
301/881-3300 • TWX: 710-824-9603

A SUBSIDIARY OF WATKINS JOHNSON  
**WJ**

... the memory tracks are  
only 25 mils wide ...

\$32,000 installed. Monitors, required at each terminal, may each cost as much as \$500 doubling the cost of the system. The cost per display comes out to \$1,000. A teletypewriter can be added to each terminal for less than \$2,000, making a fully flexible system possible for \$3,000.

The character generator for the DM-64 is on one of the disc tracks, and is time-shared by the other tracks. Display is on 16 rows of 80 characters each, on a 512-by-640-dot matrix. The Lawrence Radiation Laboratory has already ordered a system to supplement its 100-odd teletypewriter terminals. Lawrence is reportedly set up for some 800 terminals for its computer complex, and would like to have crt displays at all of them.

#### IV. Waste not, want not

Although the disc may be as much as 16 inches in diameter, the memory tracks on a single disc are only about 25 mils wide and are packed into an inch or so around the edge. The reason for this waste is that the read-write heads take up too much physical space; Data Disc cannot make a "DM-128" because the heads would not fit around the disc.

The company is, however, working on what it calls an integrated head—a mask-fabricated transducer made with integrated-circuit techniques. Using this method, 16 transducers could be put on a single head, and as many as 512 transducers could work from a single disc. Stevens talks about building an eight-disc pack with 4,096 heads (at a cost of \$1 each) and a half-billion bits of storage. The Western Electric Co., the Bell Telephone System's manufacturing arm, is reportedly interested in such a system for permanent memory applications in its phone switching matrices.

Data Disc admits to being stymied by requirement for high data-rate transmission, but Stevens feels that the terminal clusters represent a sufficiently large portion of the total terminal market (estimated by Philco at \$100 million a year) to make development worthwhile.



Report from

**BELL  
LABORATORIES**

## Equations for plowing

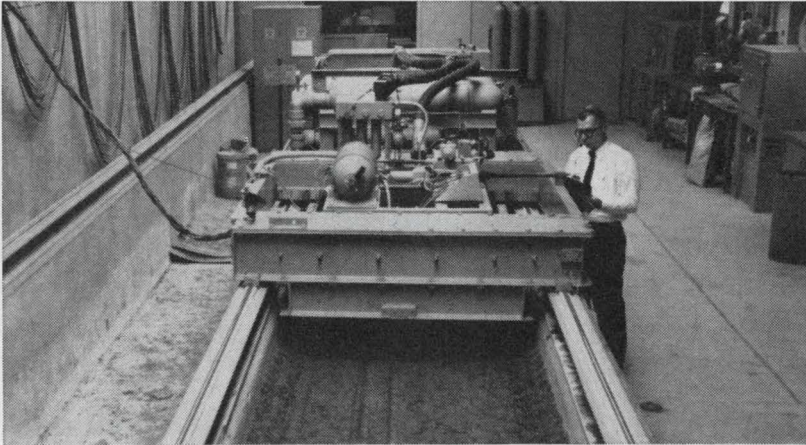

Soil dynamics laboratory at the Bell Telephone Laboratories location in Chester, N. J. Test soils of various kinds are placed in the long bin (foreground). A plow blade, not visible in this photo, rides under the carriage frame. The blade can be vibrated over a wide range of frequencies and amplitudes as the carriage is driven along the length of the bin.

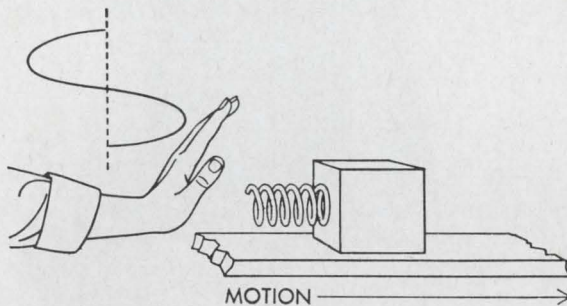

According to Bell Laboratories' mathematical model, soil reacts to a vibrating plow blade much like an elastic object being pushed against friction over a surface (sketch above). The hand moves sinusoidally and, during part of each cycle, contacts the spring. The resulting theoretical force-time plot (dashed line in the graph below) shows how vibration reduces plowing force. Superimposed is a solid line showing typical test results with a vibrating blade in a test bin (photo above) filled with silty sand. The blade vibrates front to back 30 times per second. The mathematical model, based on the above analogy, has allowed computer simulation of such soil-plowing systems.

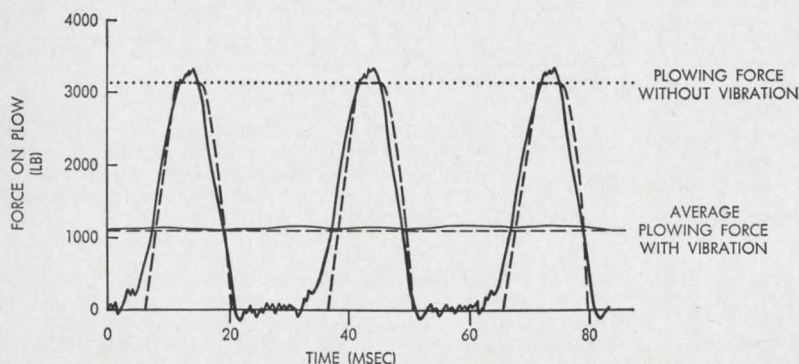

It has long been known that vibrating a plow blade makes it easier to force through soil. But what kind of vibration is most effective? That is, how much power should be applied to the blade and in what manner should the blade be vibrated?

We at Bell Telephone Laboratories are accumulating considerable information on this subject because we need a small, highly efficient plow that will bury telephone wires across lawns and up to houses with minimum draw-bar pull. Unlike agricultural plows, which are built for maximum disturbance of the earth, Bell System plows must bury cable and wires with least possible marring of the property.

Recently, this work has been aided by a mathematical model of plow blade-soil interaction. Bell Laboratories engineers R. J. Boyd and C. L. Nalezny found that forcing a vibrating blade through the ground is analogous to pushing periodically on a spring, attached to a block on a frictional surface (left).

This simple model has helped us design a prototype plow that buries telephone wires two feet deep at speeds up to 75 feet per minute. With most of its power applied to the blade, it can cut through rocky soil and tree roots where conventional machines might stall.



**Bell Telephone Laboratories**  
Research and Development Unit of the Bell System



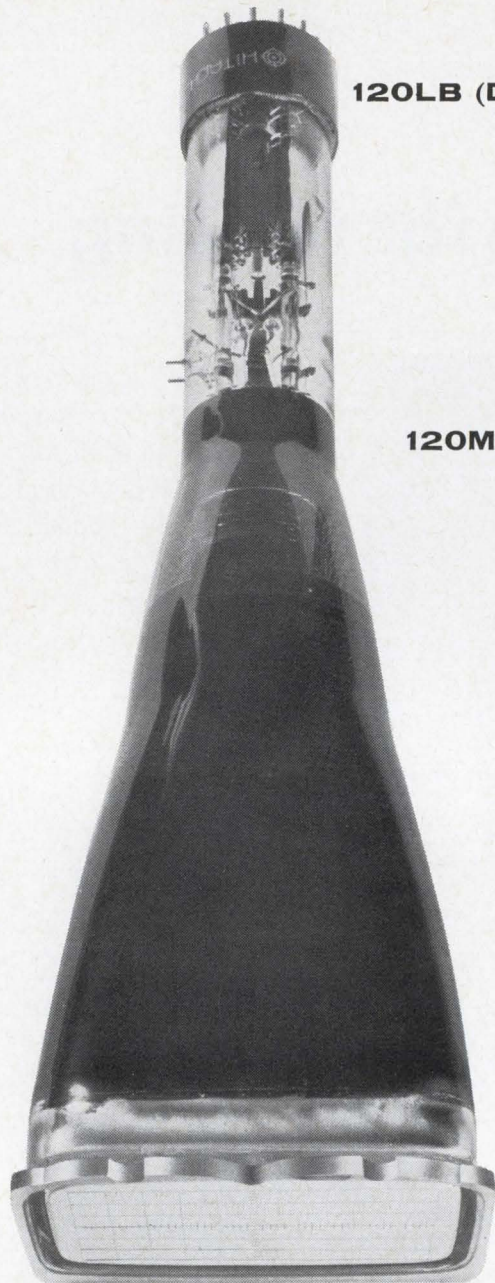

**120LB (DC-50 MC)**

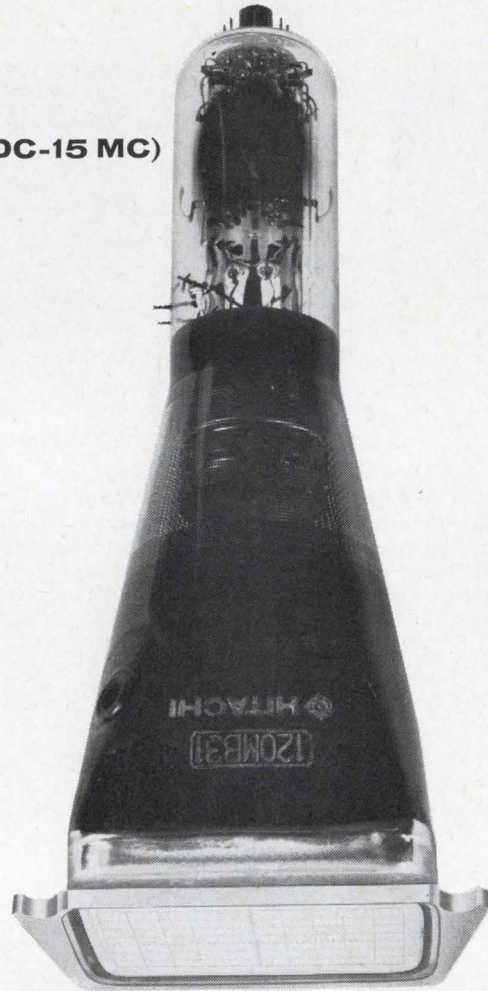

**120MB (DC-15 MC)**

## NEW OSCILLOGRAPH TUBES FROM HITACHI

### WHAT THEY HAVE IN COMMON:

These Hitachi tubes are rectangular cathode ray tubes for precision instruments, with electrostatic focus and deflection.

They all use a mesh grid and inside scale, giving them high deflection sensitivity and non-parallax observation.

They're all made by Hitachi — so you know they're good. These two, the 120LB (DC-50 MC) and the 120MB (DC-15 MC) are particularly apt for portable equipment.

### ONE MAY BE RIGHT FOR YOUR OPERATION:

Item	120LB	120MB	140LB	Unit
Overall Length	423±7	318±7	466±10	mm
Heater Voltage	6.3	12.6	6.3	V
Heater Current	0.3	0.15	0.3	A
Post Accelerator Voltage	10,000	6,000	15,000	Vdc
Accelerator Voltage	2,000	1,400	2,400	Vdc
Useful Scan	80×48	80×64	100×60	mm <sup>2</sup>
Deflection Factors				
Horizontal	12—16	11—16	12—18	V/cm
Vertical	4—7.5	6—10	3—5.5	V/cm

And if these aren't exactly what you're looking for, see the others —including our vidicon tubes and our cathode ray tubes for industry—from Hitachi, the people who make exacting quality available for less.



HITACHI SALES CORPORATION: 333 N. Michigan Ave., Chicago, Ill. 60601, U.S.A. Tel: 726-4572/4; 48-50 34th St., Long Island, N.Y. 11101, U.S.A. Tel: 361-3090; HITACHI, LTD., DUESSELDORF OFFICE: 4 Duesseldorf, Graf Adolf Strasse 37, West Germany Tel: 10846



# SCIENCE/SCOPE

"The perfect Surveyor mission" is the accolade the project team gave Surveyor VI, which had returned more than 30,027 pictures of best-yet quality when it was shut down for the lunar night that began November 24. Soft-landing within four miles of its midcourse target on crater-pocked Central Bay, almost in the center of the moon's visible face, Surveyor VI completed NASA's survey of potential astronaut landing sites.

Surveyor VI was relaunched November 17, becoming the first spacecraft ever launched from another heavenly body. The three vernier engines burned only 2½ seconds and exerted 150 pounds of thrust to lift the 616-lb. spacecraft 10 feet and move it laterally 8 feet.

Four new shipboard radar-computer systems --three of them earmarked for warships of the Federal Republic of Germany -- were delivered recently to the U.S. Navy. Used on guided-missile ships, the advanced systems scan the sky with a high-frequency, narrow pencil beam to determine target's height, range, and bearing. Three systems built under an earlier contract are already operational on Australian destroyers, and others are being installed on U.S. destroyers.

From its synchronous station above the Amazon, NASA's Applications Technology Satellite III has successfully carried out several major experiments. Its "spin-scan" camera (developed by Santa Barbara Research Center, a Hughes subsidiary) is returning high-resolution color photos of the earth's full face. Their accurate color will make it possible to determine height of clouds, width and location of ocean currents, and moisture content of soil.

The mechanically despun antenna aboard ATS-III is receiving signals from earth 10 times more effectively than antennas presently used on communications satellites. Its new VHF transponder is providing high quality two-way radio communications between ground stations and aircraft thousands of miles apart.

Several advanced programs at Hughes offer immediate and important opportunities for engineers, especially in missile systems, circuit design, data processing, computer design, and displays. If you have an accredited degree and at least two years of applicable experience, and are a U.S. citizen, please send your resume to Mr. J. C. Cox, Hughes Aircraft Company, Culver City, California. Hughes is an equal opportunity employer.

New commercial products from Hughes: a broadband high-power pulsed traveling-wave tube by the electron dynamics division; it has 40% efficiency at the 25-30kw level in X-band, and is the only commercially available TWT in X-band offering both cross-field amplifier efficiency and TWT gain....an expanded line of MOS products at Hughes/Newport Beach, which recently acquired Raytheon's line of metal-oxide silicon (MOSFET) discrete devices and integrated circuits.

*Creating a new world with electronics*

**HUGHES**

HUGHES AIRCRAFT COMPANY

Circle 165 on reader service card



# Put a little RF excitement in your laser. It'll last longer.

One of the latest, most exciting uses for Jennings' standard RF vacuum capacitors is in a new line of ion continuous wave lasers.

Developed by Spectra-Physics, Inc. of Mountain View, California, the new laser has been put to work in a wide variety of research and development applications ranging from bloodless surgery to intricate electronic welding.

Jennings capacitors serve in the rf generator which is used as the ion exciter. RF excitation, unique with Spectra-Physics, provides considerably longer life for the ion laser tubes because it eliminates the need for cathodes and plates and it reduces bore erosion. Jennings vacuum capacitors offer extremely low inductance to the rf circuit and, due to their vacuum dielectric and copper construction, will handle large rf currents that would destroy solid dielectric capacitors.

There's probably a standard Jennings capacitor with ultra high vacuum dielectric to fit your requirement for voltage, current and capacitance. Both variable and fixed capacitance models are useful in applications ranging from 100 watts to more than a megawatt. Other new developments in advanced vacuum capacitor design are on the way from ITT Jennings. For information, write for Catalog No. 101. ITT Jennings, a division of International Telephone and Telegraph Corporation, 970 McLaughlin Avenue, San Jose, California 95108.



JENNINGS **ITT**





**YOU'LL JUMP  
FOR JOY...**

**when you see the complete specs  
and prices on our new**

**“PIXIEPOT”<sup>TM</sup>  
POTENTIOMETER!**

Never before in the history of the pot industry have you been able to get a TEN-TURN, WIRE-WOUND PRECISION potentiometer at prices like these. The Duncan Model 3253 “PIXIEPOT” is yours for as low as **\$3.97** each in production quantities and only **\$5.95** each for 1-24 units.

Match the following “PIXIEPOT” features with any other similar pot on the market.

- Length: **ONLY 3/4"**
- Diameter: **ONLY 7/8"**
- Linearity: **±0.25%**
- Resistance Range: **100 ohms to 100K ohms**
- Power Rating: **2 watts @ +20°C**
- Temperature Range: **-25°C to +85°C**
- Resolution: **Better than ANY wirewound pot TWICE its size!**
- Slotted Stainless Steel Shaft

A Duncan “PIXIEPOT” can save you dollars on your instrument and system requirements. If you want to know just how many, call or write us today. The full story on the “PIXIEPOT” will be in the mail to you within 24 hours. And when it arrives, be prepared to jump for joy!



**DUNCAN electronics, inc.**

A DIVISION OF SYSTRON-DONNER CORPORATION

2865 FAIRVIEW ROAD, COSTA MESA, CALIFORNIA 92626





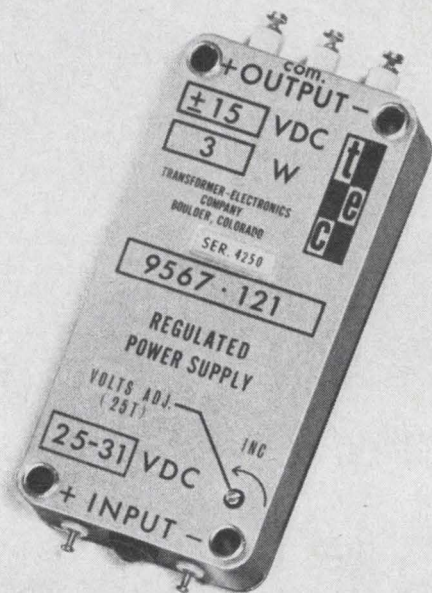
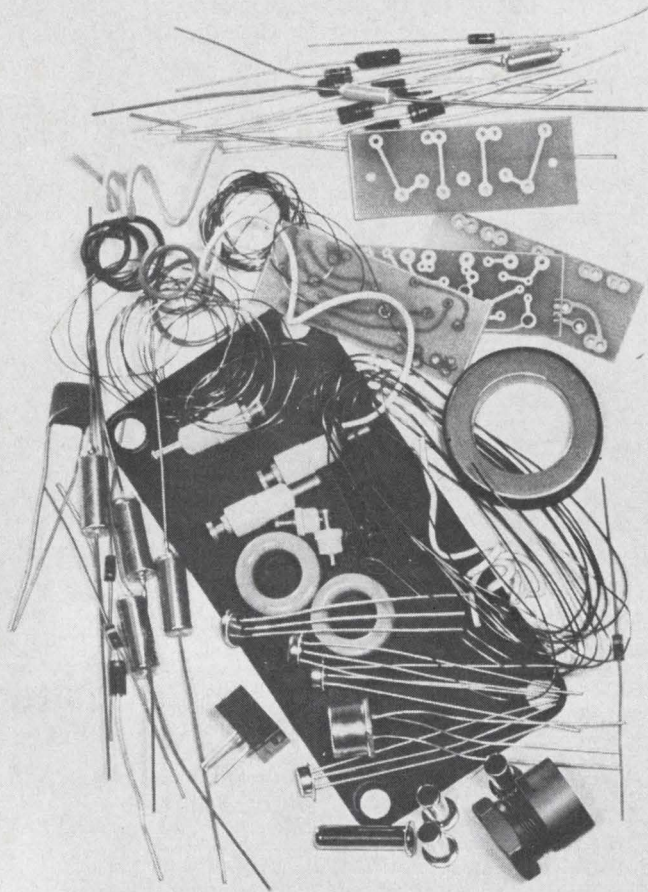

# Make or Buy?

If you're asking yourself this question about DC to DC power supplies . . . check with Transformer Electronics Company *before* you decide.

There are many more components to figure into the cost of making your own power supplies than just the ones in the picture. At least 90% of the cost of making your own power supplies comes from intangible components. Design and engineering, testing, compiling reliability data, and setting up and maintaining purchasing, inventory and quality control systems . . . all add up to time and money!

Transformer Electronics Company has already solved all these problems—as well as the technical ones—

*for you.* That's why Transformer Electronics Company can offer you consistently reliable power supplies. They're immediately available. They are priced substantially lower than it would cost to make your own.

Transformer Electronics Company understands that your power supply requirements may be unique, too. That's probably why you've considered making your own. Transformer Electronics Company is confident that its years of experience in producing dependable power supplies for customers with a variety of needs can be helpful in solving your particular power supply problem.

Make or buy? Call or write Transformer Electronics Company first!



TRANSFORMER ELECTRONICS COMPANY • BOULDER INDUSTRIAL PARK • BOULDER, COLORADO 80302 • (303) 442-3837



## REMI\*

(REmovable, REEntrancy, Miniature)  
sleeve-fitted closed-entry crimp-type  
contact connectors.



U.S.C. REMI sleeve-fitted closed entry crimp-type contact connectors snap in—snap out quickly, simply and surely. Contacts do not ride in bare plastic of the connector body. Both male and female spring phosphor bronze contacts snap into and out of heat-treated beryllium copper sleeves for positive solid connection. Mechanical stresses are confined between metallic elements. ■ No. of Contacts: 7, 14, 18, 20, 21, 26, 34, 41, 42, 50, 75, 104, 123, 150, 225. ■ Wire Sizes Accommodated: AWG #14 to #30 and MIL-W-16878A #16 to #32. REMI contacts are ordered separately. Crimping by MIL-T-22520A (WEP) ■ Class I or II tools ■ Military Specifications: (Contacts) MIL-C-23216, MIL-C-26636, MS3190. (Connectors) MIL-C-8384, and MIL-C-25955. [Latest Revisions] U.S. Patent Nos. 2,761,108; 2,979,689 & Five International Patents ■ Write for REMI catalog.

## Golden RUMI

(Removable Ultra-Miniature)  
Crimp-Contact Series

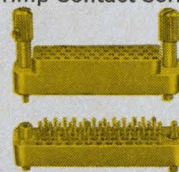

Adds removable crimp-contact connector versatility to any ultra-miniature system—now. Can be incorporated immediately into any established or advanced system. Interchanges with any other Ultra-Miniature connectors—positively and economically. Contacts: Top quality spring temper phosphor bronze. Retaining clip BeCu. Contact retention: 25 lbs. min. RUMI contacts are ordered separately. U.S. Pat. No. 2,761,108. ■ Write for UMI-RUMI catalog. ■ No. of contacts: 5, 7, 9, 11, 14, 20, 26, 29, 34, 44 and 50. Wire sizes Accommodated: AWG# 24, 26 and 28. ■ Current Ratings: 5 amps.

# Take Your Choice of These U.S.C. REMOVABLE CRIMP-CONTACT ER† CONNECTOR SERIES from U.S.C.

Here, from one source is a complete family of performance-proved removable crimp-contact connectors. Whether you select the REMI®, RUMI, URC or REPC series you get extra reliability plus the highest possible performance-to-size ratio.

## URC Series ANYCON Connectors

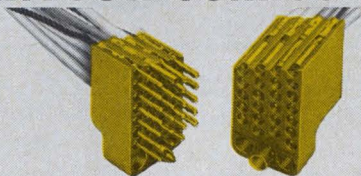

Uses New ANYCON principle: Any Male contact (Standard Size 16 or 20, or shielded coax size 16) in any contact position in Male block. Any Female contact (standard size 16 or 20, or shielded coax size 16) in any contact position in Female block. Contacts: 12 standard (sizes 16, 20) include MS 17803 & MS 17804. Wire sizes: AWG #14 to #30. Shielded Coax Contacts: 8, include RG/U 161, 174, 178, 179B, 187, 188, 196, 316. MIL-C-23216 compliance. U.S. Pat. No. 2,761,108. ■ Write for URC Catalog. ANYCON sizes: 9, 14, 18, 20, 26, 34, 42, 50, 66, 75, 104 contacts. MIL-C-22857C compliance. ■ Current rating: 13 amps. ■ UNDERWRITERS' LABORATORIES LISTING No. E 39138.

## REPC

(REmovable, REEntrancy, Printed Circuit)  
removable crimp-contact connectors.

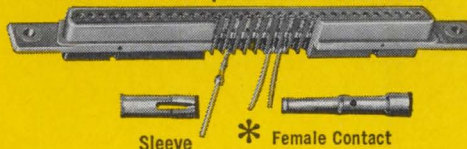

Another first from U.S.C. Meet tri-service specs MIL-C-23353/9 and MIL-C-23353/10 ■ Uses the unique REMI concept that confines mechanical stresses between metallic elements only. REMI sleeves are now specified as MS18135 (per MIL-C-23216) with U.S.C. Part No. 1242-9 (female crimp-barrel socket contact MS18134 per MIL-C-23216), on both new military specifications sheets. ■ U.S. Pat. 2,979,689 & five international patents. ■ Write for UPCC-REPC catalog. ■ REPC-F Series: 7, 11, 15, 19, 23, 32 contacts ■ REPC-SGF Series: 11, 17, 23, 29, 35 contacts ■ MIL SPECS MIL-C-23353/9 & 10 ■ Wire Sizes Accommodated: #14 to #30 AWG ■ Current Rating: 7.5 amps. ■ REPC contacts ordered separately. ■ Wide variety MIL-T-22520 and commercial crimping tools available ■ REPC-Fs mate with MIL-C-23353/3. REPC-SGFs mate with MIL-C-23353/6.



†U.S.C. Established Reliability can do!

1320 ZEREGA AVENUE • BRONX, N.Y. 10462  
or use TWX: 710-593-2141 • Tel. 212-824-1600  
TELEX: 1-2411 • or Cable: COMPONENTS N.Y.K.



# Who can meet your silicon mesa power requirements?

**Bendix, the power specialists, that's who.**

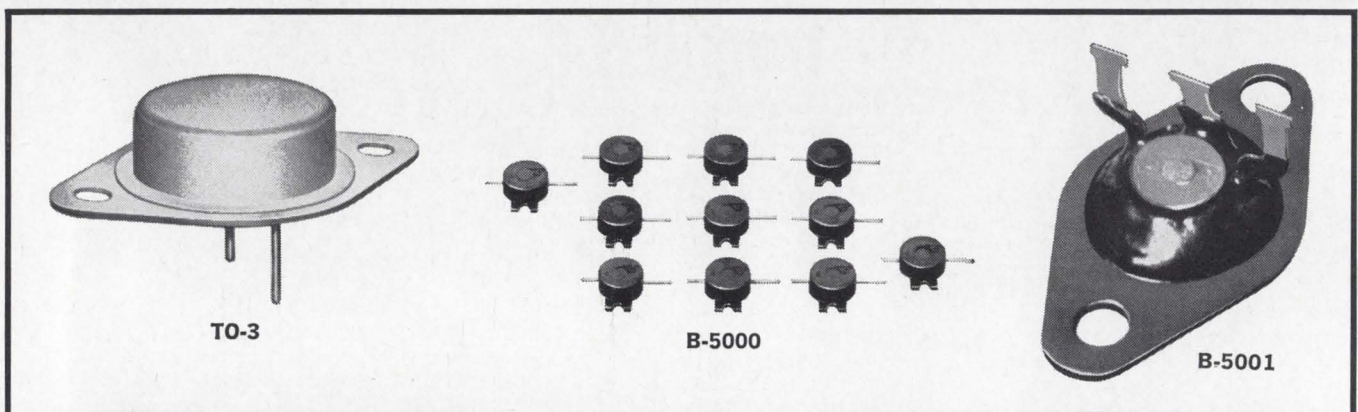

Consider what our broad range of silicon mesa power transistors can do for you. Included are 4-amp, 30-amp and DTS high-voltage mesas, too. Even B-5000 and B-5001 plastic-encapsulated silicon mesas. 2N3055 and 2N3235 are for your audio, hi-fi, stereo circuits, power-switching and DC regulators. For 2N3055,  $IC=15A$ ,  $VCBO=100V$  and  $VCEO=60V$ . Like all Bendix power devices, it's SOAR specified. It's competitively priced. It's available for immediate delivery. Our 30-amp 2N3771, 2N3772 and B-177000 are naturals for your high-collector current applications. Inverters, regulators, power supplies and power amplifiers. Our DTS devices feature  $IC$ 's from 2.0 to 3.5 amps. For DTS-410  $IC=3.5$ ,  $VCBO$  and  $VCEO=200V$ . For DTS-411  $IC=3.5$ ,  $VCBO$  and  $VCEO=300V$ .

For DTS-423  $IC=3.5$ ,  $VCBO$  and  $VCEO=400V$ . For 2N3902  $IC=2.5$ ,  $VCBO$  and  $VCEO=400V$ . Your power switching never had it so good. Our B-5000 and B-5001 are versatile, plastic-encapsulated silicon mesas that are the most economical you can buy.  $P_c=25$  watts at  $VCE=10V$ ,  $IC=2.5$ ,  $TC=100^\circ C$ . and  $VCEO=35V$ . Applications include audio amplifiers, audio regulators, inverter circuits and lighting equipment.

Don't think silicon mesas are all we make. Bendix also offers an extensive line of planar, regulator and radiation-resistant semiconductors.

For details, write: Semiconductor Division, The Bendix Corporation, Holmdel, New Jersey 07733, or contact our nearest sales office.

**Bendix Electronics**

Chicago—(312) 637-6929; Dallas—(214) 357-1972; Detroit—(313) 548-2120; Greenwich, Conn.—(203) 869-7797; Holmdel, N.J.—(201) 946-9400; Lexington, Mass.—(617) 861-8350; Los Angeles—(213) 776-4100; Minneapolis—(612) 926-4633; Rochester, N.Y.—(716) 266-5550; Runnemede, N.J.—(609) 933-2550; Seattle—Ray Johnston Co., Inc. (206) LA 4-5170; Export—Cable: "Bendixint," 605 Third Avenue, New York, (212) 973-2121; Ottawa, Ont.—Computing Devices of Canada, P.O. Box 508—(613) 829-1800.



# New Products

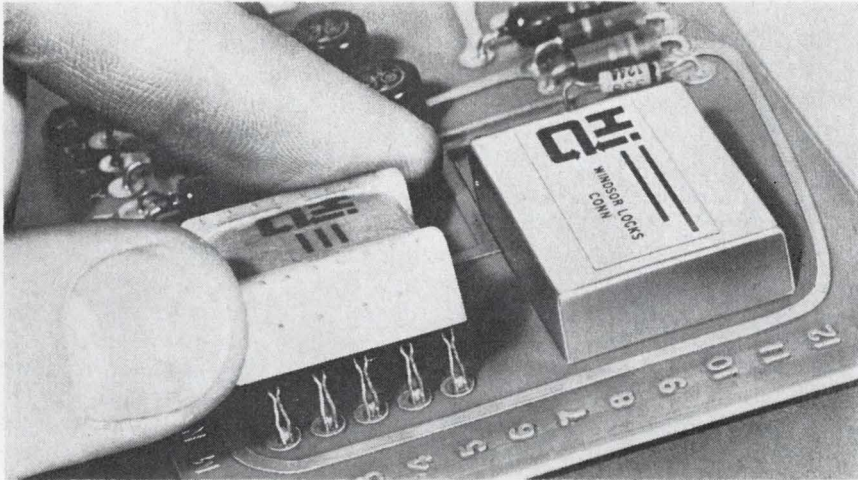

New components

## Outflanking suppliers in the reed-relay field

Hi-G surveyed existing designs before entering the fray with a line of second-source devices

**Companies usually enter** the relay business by one of two routes. They either develop a unit for a single customer's specific needs and then extend the design to cover broader applications, or they start with a new design and then find a market for it.

A third course has been charted by Hi-G Inc., a manufacturer of crystal-can relays. The company opened its drive to get into the reed-relay business by making a careful study of the 20 major firms in the field to detect areas of product commonality. With this data, Hi-G has come up with a single line of devices that can second-source all the major suppliers of reed relays.

**Filling a need.** Why would a customer go to a second source in the first place? According to Ken-

neth Leff, project manager at Hi-G, the answer lies in "workmanship deficiencies" in the primary-source products. He cites the example of one company that has to use an epoxy coating to protect coil terminations because the coil wire is attached to a metal tab. This exposed tab is subject to short-circuiting, he notes. No tab is used on the Hi-G relay and the termination isn't exposed.

Also, "some companies haven't been able to deliver," Leff says. Often, he explains, their main reason for producing reed relays is to fill an in-house need, and when they can't meet their own supply requirements, the outside consumer is out of luck. "Since we don't use the relays ourselves, our customers won't have this problem," he adds.

### I. Norms and tradeoffs

In compiling data on the industry, Hi-G found that out of the mass of reed-relay specifications, a few could be considered constant or obviously desirable. For example, a maximum case height of 0.35 inch and length of 1.187 inches were found to be "normal" and were applied to the Hi-G units. These dimensions represent a compromise between the size required by the reed switch and the need for maximum packing density on printed circuit boards. Since the grid size of p-c boards is getting smaller, however, a distance between pins of 0.1 inch was chosen rather than the norm of 0.15 inch. The distance between the pins along the length of the relay is 1 inch.

**Make and break.** As for the reed switch itself, the question was: make or buy? Leff says many companies that decided to make their own found that the glass-to-metal

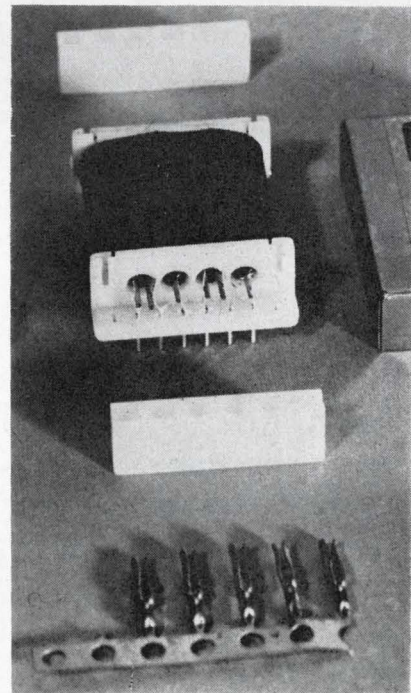

**Pin and socket.** By adding adapter blocks to its top side, the relay can be used in a plug-in setup.



**. . . new pin terminal requires only one weld,  
so overheating during manufacture is avoided . . .**

seal used in the switch cracked after the switches had been shipped from plant to plant or even from one part of a factory to another. Further, extremely clean plant conditions are required to avoid contamination on the contacts. Therefore, in designing its 3500 series, Hi-G decided to buy. "We rely on the giants in the switch industry," says Leff. "We're buying the best we can get and pretesting them."

Another problem was switch termination. If the switch leads were bent into position near the connecting pins and welded, a stressed joint was formed. After a while, either the pins would lose their alignment or the glass-to-metal seal would crack. One way to eliminate the problem is to use an intermediary connection between switch and pin—a ribbon lead, for example—but this increases over-all cost and, with the

extra weld needed, can lead to overheating of the unit.

**Flattop.** To get around these hazards, Hi-G engineers designed a new type of pin terminal called a Flattop. It's similar to the standard type of terminal so far as its connecting pin and mounting flange are concerned, but its top, instead of being as thick as the rest of the unit, is swaged to a ribbon thickness. Thus, it's easily positioned next to the switch and requires only one weld.

A unique feature of the Hi-G assembly line is that a printer is connected to the test station. If a customer wants to know the exact specifications for each relay he receives, the units are serialized after testing and the readout is shipped along with them.

**II. Plug-in block**

The 3500 series includes a wide range of switching arrangements

and both dry and mercury-wetted types of contacts. Pin terminals are standard, but a terminal block that enables the units to be used with Berg pins is available if a plug-in arrangement is desired. The block attaches to the top side of the relay and the whole assembly is flipped over with the case reversed, giving the package a plug-in terminal configuration without adding to the device's height.

With the machine Hi-G uses to mold the bobbins, adjustments can be made in the final mold without changing the dies. If 0.15-inch pin centers are needed, a plate is added to the bobbin mold and a new series, called the 3600, is produced. Also, the holes in the bobbin are big enough to accept the largest of the miniature reed switches.

Though Hi-G is getting into the reed-relay field as a second source, it feels its line of standard devices can win a big slice of the \$33 million market.

Hi-G Inc., Windsor Locks, Conn. [338]

**Comparison of Major Characteristics**

Characteristic	½ Size Crystal Case Relay	Series 3500 Dry	Reed Relays Mercury-Wetted	Solid State Switching Device
Overall height.....	0.400 in.	0.350 in.	0.350 in.	0.300 in.
Weight.....	10.5 gm	6 gm	7 gm	10 gm
Operate time.....	2.5 msec	6 msec	2.0 msec	10 nsec
Bounce time.....	2.5 msec	0.2 msec	None	None
Release time.....	1.0 msec	0.05 msec	0.05 msec	50 nsec
D-c contact mating.....	52 watts	10 watts	50 watts	10 watts
Life at rated load.....	1 x 10 <sup>4</sup> cycles	10 x 10 <sup>6</sup> cycles	100 x 10 <sup>6</sup> cycles	Measured in hours
Life at dry circuit load	1 x 10 <sup>6</sup> cycles	100 x 10 <sup>6</sup> cycles	Indefinite	Measured in hours
Initial contact resistance.....	0.050 ohm	0.100 ohm	0.050 ohm	1.0 ohm
Open circuit resistance.....	1 x 10 <sup>8</sup> ohms	1 x 10 <sup>11</sup> ohms	1 x 10 <sup>11</sup> ohms	1 x 10 <sup>5</sup> ohms
Inductive load switching.....	Excellent	Poor	Fair	Poor
Inrush load switching.....	Excellent	Poor	Good	Good
Transient voltage immunity.....	Excellent	Good	Good	Poor
Shock.....	50G	50G	Poor	Excellent
Vibration.....	30G	30G	Poor	Excellent
Approximate cost.....	\$6	\$2	\$4	\$8

**Pick and choose.** Each of the four most popular types of miniature relay provides certain advantages. If speed is needed more than isolation, solid state switches should be used. When cost is the prime factor and high isolation is also required, the reed relay is the best choice.





## Let's put our catalogs on the table

Your table (or desk) to be more specific. They're the most valuable set of reference manuals available on magnetic shielding materials and fabrication methods. They cover the complete line of Netic and Co-Netic Alloys from MSD. They're a veritable gold-mine of information from the company that's provided over 80% of the magnetic shield designs currently in use and whose products are the recognized world standard in its field.

They're yours for the asking. Contact your MSD rep or write  
**MAGNETIC SHIELD DIVISION**  
 PERFECTION MICA COMPANY  
 1322 N. Elston Avenue • Chicago, Illinois 60622





## New Components Review

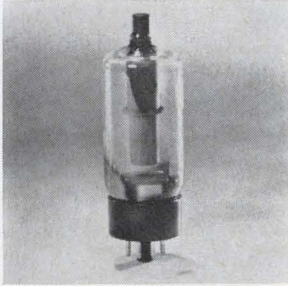

Beam triode 6LH6-A is for use as a shunt regulator in the h-v power supply of color tv receivers. It has built-in x-ray shielding. With a maximum d-c plate voltage of 27,000 v, the tube has a max. d-c plate-current rating of 1.6 ma, and a max. plate-dissipation rating of 40 w. Heater voltage is  $6.3 \pm 0.6$  v; heater current, 0.2 amp. General Electric Co., Owensboro, Ky. 42301. [341]

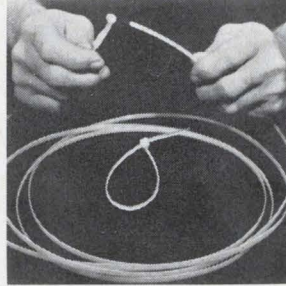

Nylon-fabricated cable ties series Ty-228 come in 19 sizes, in lengths ranging from 18 to 120 in. They are designed to tie oversize wire bundles or to secure wires running parallel to large size cable pipe and/or conduit. They have self-locking heads for easy installation without special tools in the field or plant. Thomas & Betts Co., 36 Butler St., Elizabeth, N.J. 07207. [342]

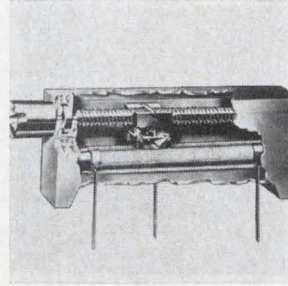

Wirewound commercial trimmer 3800, employing a solvent resistant case, is suited for all applications employing dip and flow soldering. Resistance values are from 10 to 20,000 ohms. A damage-proof clutch eliminates open circuits, contact damage and wiper slippage. Volume price is under \$1. Amphenol Controls Div., Amphenol Corp., 120 S. Main St., Janesville, Wis. 53545. [343]

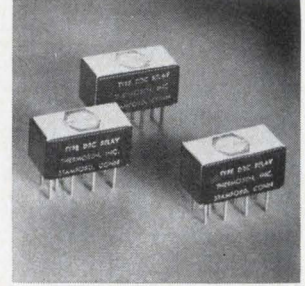

Type D multireed relay incorporates 2 Form C contact groups in a half-crystal-can size package. Operate and release times, including bounce, are in the order of 1.5 msec max. Thermal electromotive force, generated by coil warm-up, is less than  $3 \mu\text{v}$ . Dynamically generated noise is less than  $3 \mu\text{v}$  peak-to-peak. Thermo-son Inc., 375 Fairfield Ave., Stamford, Conn. 06904. [344]

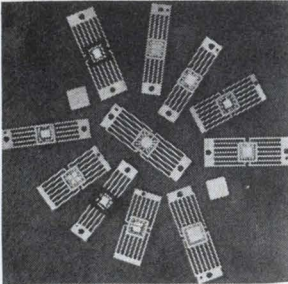

Flatpacks measuring  $\frac{1}{4} \times \frac{1}{4}$  in. are available in both 10- and 14-lead configurations with ceramic, metal or glass bottoms. On glass bottom types, a grounded pad is provided for device mounting. On ceramic bottom types, up to 4 electrically isolated metalized pads are offered. All are gold plated to a minimum thickness of 100  $\mu\text{in}$ . Philco-Ford Corp., Blue Bell, Pa. 19422. [345]



Crystal oscillator series CG features dual output of the same frequency for redundancy applications. Holding a frequency tolerance of  $\pm 0.01\%$  over a temperature range of  $-55^\circ$  to  $+75^\circ\text{C}$ , the series is available with frequencies from 20 khz to 150 Mhz. Size is  $1\frac{1}{2} \times 3\frac{1}{8} \times 1\frac{1}{8}$  in. Price range is \$85 to \$225. Accutronics Inc., 628 North St., Geneva, Ill. 60134. [346]

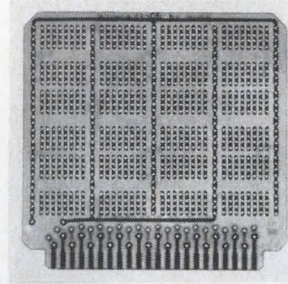

Breadboard model 11-DE-1 accepts up to 12-, 14-, or 16-pin dual in-line packages, as well as associated discrete components. It is glass epoxy (G-10) 2 oz copper on two sides, and is finished with 0.0002 in. gold over 0.0002 in. bright nickel. It accepts standard 22- or 44-pin edge connectors. Douglas Electronics Inc., 718 Marina Blvd., San Leandro, Calif. 94577. [347]

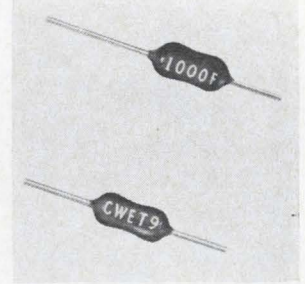

Miniature, 1/10-w metal film resistor type X55 is designed to meet and exceed mechanical and electrical parameters of MIL style RN55 C and E as specified in MIL-R-10509. Two temperature coefficients are offered: T2 ( $\pm 50$  ppm) and T9 ( $\pm 25$  ppm). Resistance ranges to 1 megohm are available. Continental-Wirt Electronics Corp., 26 W. Queen Lane, Philadelphia, Pa. 19144. [348]

## New components

### Pots straighten out and go linear

Slide-motion instrument gives visual indication without extra knob; swing to linear motion control seen

Linear motion potentiometers have made their appearance in European consumer products during the last few years and, says Clyde Robison, sales manager for the Stackpole Carbon Co., "The big swing is coming now to the U.S. We plan to get a jump on the rest of the indus-

try." Stackpole's version of the linear motion potentiometer, called the Slide-trol, is the first low-cost unit to be made and marketed in the U.S.

To hold the price to 10-15 cents each in quantity orders, Slide-trol was designed for completely auto-

mated production. Major parts are two bakelite sections that make up the body, a carbon-composition resistance element, and a sliding contact. Unlike the wiper contact in rotary controls, the Slide-trol uses a coil spring, not a point contact. The spring provides nine contact points, reducing contact pressure and wear, and keeping contact resistance at a minimum.

In consumer products, such as small power tools and kitchen appliances, the speed of the tool is controlled by sliding a thumb switch or by depressing a trigger. This linear motion is transferred by a linkage arrangement to a rotary



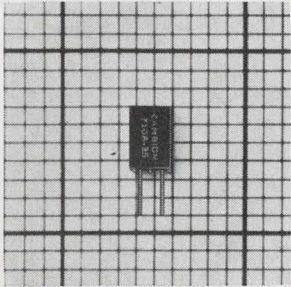

Molded subminiature r-f chokes in the 7108 line consist of 49 models that cover a range of inductances from 0.10  $\mu$ h to 1,000  $\mu$ h. They measure 0.365 x 0.228 x 0.125 in. Mounting pins are 0.020-in. diameter with a pin spacing of 0.125 in. Price is 65 cents to \$1.11 each (in 100-499 lots). Cambridge Thermionic Corp., 445 Concord Ave., Cambridge, Mass. 02138. [349]

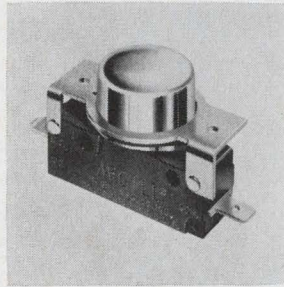

Snap-action switches in the 2600 series are now equipped with chrome-plated actuator buttons. Rating is 20 amps, 125-250 v a-c, 1 h-p 125 v a-c, 2 h-p 250 v a-c. They are single-pole double-throw devices with a choice of spade or screw terminals. Mechanical characteristics feature differential travel less than 0.005 in. McGill Manufacturing Co., Valparaiso, Ind. 46383. [350]

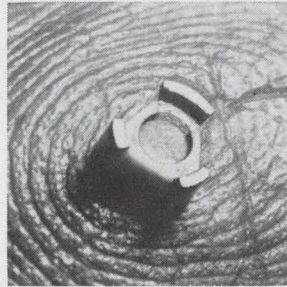

Circular ceramic chip carrier CM329 is for large volume commercial semiconductor use. It allows cross-over metallization under the carrier, and noncritical alignment on the p-c board with consequent use of mass production equipment to attach all carriers to the substrate simultaneously. Price: 2 cents/unit in 10 million lots. Frenchtown/CFI Inc., Frenchtown, N.J. 08825. [351]

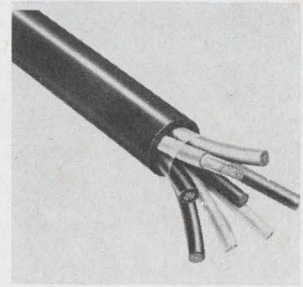

The 600-v type 20/10 control cable is rated for safe continuous operation at temperatures of  $-40^{\circ}$  to  $75^{\circ}$ C. The 19-strand copper conductors insure extreme flexibility and can be specified in sizes 10, 12 and 14 AWG. Each conductor is insulated with 20 mils of polyethylene and 10 mils of polyvinyl chloride. ITT Wire and Cable Div., ITT Corp., Pawtucket, R.I. 02862. [352]

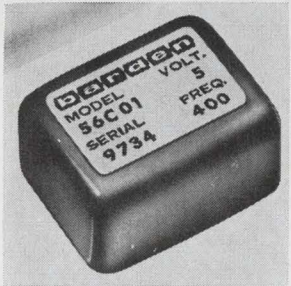

Microminiature tuning forks occupy less than 0.29 cu in. and weigh under 1/2 oz. Designed to meet MIL-STD 202B, specifications include accuracy to 0.001%; stabilization time, approximately 1 sec; rise and fall time, 0.2  $\mu$ sec or less; operating temperature,  $-55^{\circ}$  to  $+125^{\circ}$ C. Price is from \$47 in quantities of 25. Barden Co., 675 Valley Dr., Hermosa Beach, Calif. 90254. [353]

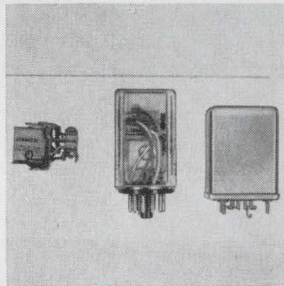

Sensitive relay series 5 is offered with single-to-6-pole contacts in 3 package designs (open, dust cover, and hermetically sealed). All are rated for 5 amps except the spdt which is rated at 2 amps. Standard sensitivity is 100 mw per pole but the spdt relays are available in either 5- or 10-mw sensitivity. Kurman Instrument Corp., 15 Burke Lane, Syosset, N.Y. 11791. [354]

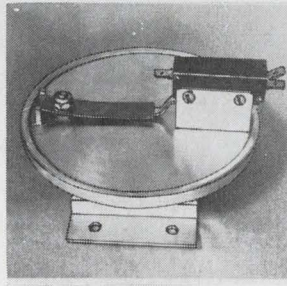

Sensitive, static pressure switch Catalog 144 can operate on gas or liquid pressures of from 0.3-in. water column to 20-in. water column by proper selection of one of the available adjustable ranges. It will withstand overload of 150 lbs/sq in. Contacts have an electrical rating of 15 amps, 125-250 v a-c. Henry G. Dietz Co., 14-26 28th Ave., Long Island City, N.Y. 11102. [355]

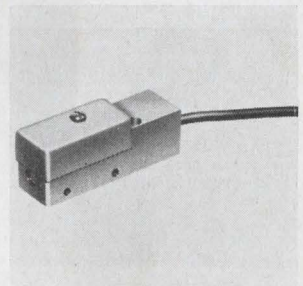

Magnetic detector switches in the Ferotec line sense ferrous metals without the use of external magnets. Operating medium is the smallest possible to give maximum air gap, and switching repeatability is generally  $\pm 0.002$  in. Operating elements are hermetically sealed reed relays encapsulated in a high density plastic. Electro-Tec Corp., Box 667, Ormond Beach, Fla. 32074 [356]

potentiometer. In this application, the Slide-trol eliminates the "middleman"; the linkage isn't needed because the trigger is connected directly to the slider on the linear potentiometer.

In industrial applications, the Slide-trol offers the advantage of small size and close mounting. Because the units are rectangular, they can be packed closer together, taking up less space on the instrument panel. Another reason why instrument manufacturers like the idea of a linear potentiometer, Robison says, is that its value can be seen at a glance by observing the position of the thumb-slider that

moves the contact.

Television manufacturers see an application for the Slide-trol in the convergence panel on color sets. Such panels contain about nine potentiometers, used to adjust the focus and color purity. As a set comes down the production line, an operator adjusts each control until he's satisfied the picture he sees is correct. If the controls are too far out, there may not be enough time to get a good picture, and the set is pulled off the line and adjusted again, raising the cost. If Slide-trols are used, all nine controls could be placed side-by-side and a template used to set them at an

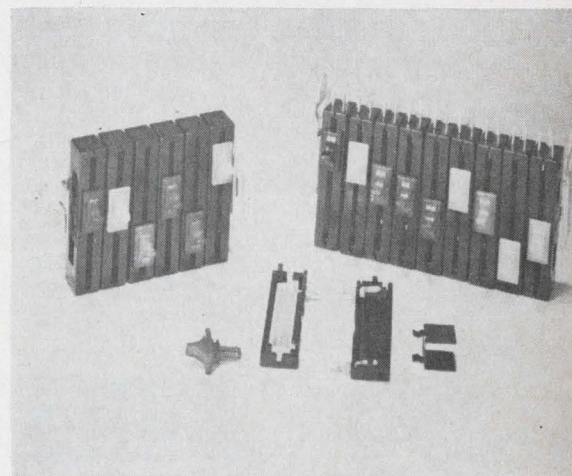

Slider. Linear motion potentiometers are grouped for easy mounting.



# YOU CALL THE TURNS...

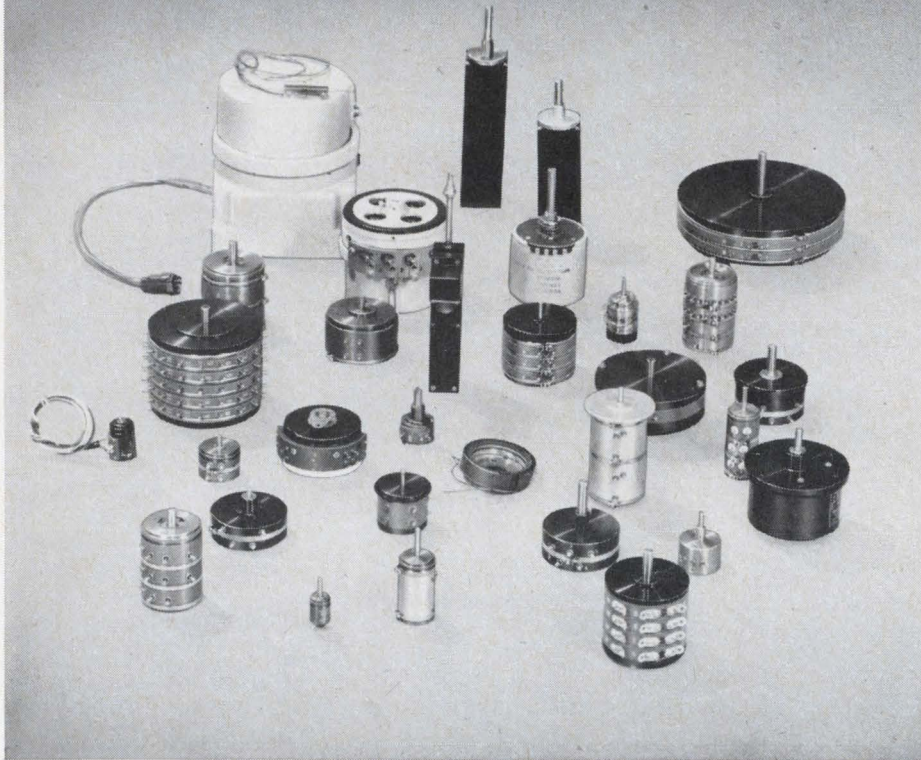

## ...In conductive plastic and wire wound precision potentiometers by BLISS-GAMEWELL

Higher and even higher standards of performance at competitive prices are being demanded of your electronic designs. How do your precision potentiometers stack up under these requirements? We believe they become almost a necessity. With Gamewell, you specify exactly what you want, no more and no less. We offer a comprehensive line of conductive plastic elements, pots in rotary and translatory styles — with resistance values to 100 k. ohms and accuracy as fine as 0.05%. We also manufacture wire wound types in metal and plastic cases. Rotary units vary from  $\frac{7}{8}$  inch to 5 inches. Linear and non-linear outputs to meet your requirements. Gamewell pots are tough! Dependable! And remarkably precise! In most cases, they actually cost less when all is considered, than so-called "economy" types. Worried about choice? Send for our . . .

### FREE — NEW COLOR CATALOG

. . . which gives complete details of our capabilities and facilities. Let your pot requirements take a turn for the better. Call your local Gamewell representative today, or write to Bliss-Gamewell, 1305 Chestnut Street, Newton, Mass. 02164.

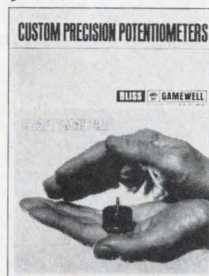

A DIVISION OF THE E. W. BLISS COMPANY

FIRST... WHEN PRECISION COUNTS!

In Canada: E. W. Bliss Company of Canada—348 Guelph Street, Georgetown, Ontario, Canada.

approximate value. This would minimize the amount of adjustment needed on the assembly line.

The units, which are being sampled now, are made in three configurations: mounted horizontally, vertically, or sideways. With resistance values between 10 and 100 ohms they are rated at 1.75 watts safe load, 2 watts maximum. For 100 to 1,000 ohms, they're rated at 1.5 watts safe load, and for values over 1,000 ohms, 1.25 watts is the safe load.

Stackpole Components Co., Box 14466, Raleigh, N.C. [357]

New components

## Amplifier bridges cost-specs gap

Cuts the drift  
to 3 microvolts  
at low signal levels

**Drift** is the largest single problem with circuits designed to handle d-c signals. To overcome the problem, Analog Devices Inc. has developed an amplifier that employs a novel circuit to limit drift. The differential operational amplifier, designated the model 183, costs \$40, and provides a maximum voltage drift of 3 microvolts per degree centigrade.

The amplifier's low drift enables it to handle 5 millivolt signals with better than 1% accuracy for a 20°C temperature variation. Ordinarily, such accuracy for low-level signals would involve a chopper-stabilized amplifier costing about \$100 or the recently-announced generation of ultra-low-drift differential amplifiers, priced from \$80.

The 183 bridges the gap between the high-priced but excellent-performance chopper, low-drift differential types, and the existing conventional amplifiers, based on discrete-transistor input stages.

Key to 183's high voltage stability is a dual-transistor input stage, which reduces the effects of temperature gradients within the am-



# IF WE KEEP ON INTRODUCING NEW UNIUNCTION TRANSISTORS LIKE THESE, BEFORE YOU KNOW IT

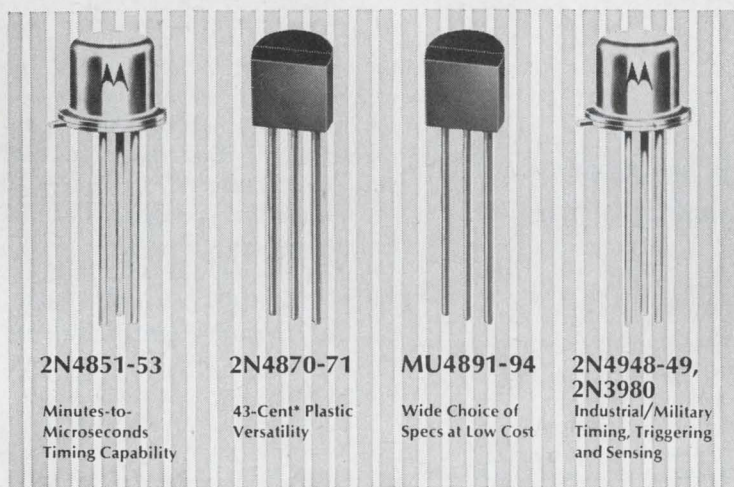

2N4851-53

Minutes-to-  
Microseconds  
Timing Capability

2N4870-71

43-Cent\* Plastic  
Versatility

MU4891-94

Wide Choice of  
Specs at Low Cost

2N4948-49,  
2N3980

Industrial/Military  
Timing, Triggering  
and Sensing

## YOU WON'T RECOGNIZE YOUR OLD CIRCUITS

In a little more than a year, Motorola has become the leading source for preferred, state-of-the-art unijunction transistors featuring all the fast response, long-time-delay advantages of Annular<sup>†</sup> technology. But just becoming the UJT price, performance and availability leader isn't our only goal . . . we want to show you how to best use them, too.

And here's how you can: send to Box 955, Phoenix, for our comprehensive, new application notes—"Theory and Characteristics of the UJT," "UJT Timers and Oscillators," and "UJT Triggers for Thyristor Circuits." You'll find many of the answers to questions about today's modern unijunction circuitry in them—we'll include UJT data sheets and a complete Selection Guide to Motorola's extensive Thyristor capability with them. Do it now.

We'll return-mail them before you can say 1-2-3.

<sup>†</sup>Patented Process  
\*1000-up.

*-where the priceless ingredient is care!*



**MOTOROLA**  
*Semiconductors*



# Two Ballantine Voltmeters for Laboratory, Production, and Q.C. Needs

Ballantine solid state, wide-band voltmeters, one average-responding and one true-rms responding, feature exceptionally wide frequency ranges, high accuracy over entire 5-inch log scales, and operation from built-in rechargeable battery or line

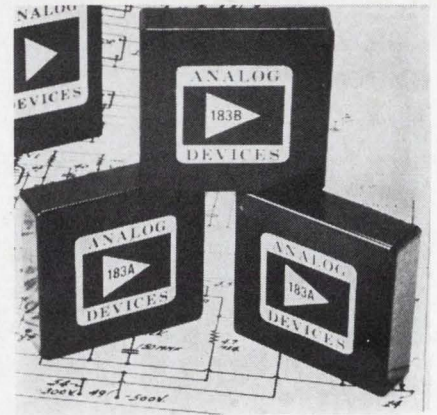

**Chopperless.** Differential op amp uses dual-transistor input stage for high sensitivity.

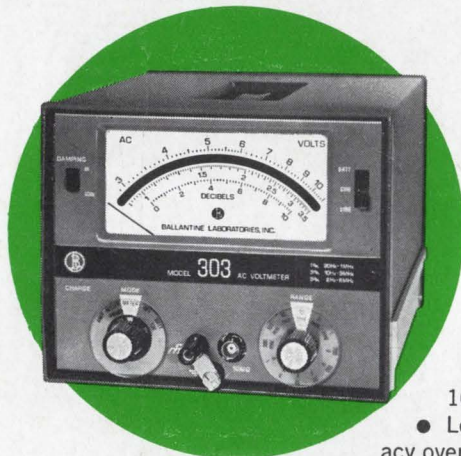

## BALLANTINE VOLTMETER

2 Hz to 6 MHz

Battery or line-powered--  
1% accuracy at midband

### MODEL 303

- Voltage range 300  $\mu$ V to 330 V (models with 20 dB probe, 1 mV to 1000 V) ● 1% accuracy, 30 Hz to 1 MHz
- Logarithmic indicator for uniform accuracy over entire 5 inch scale ● Average responding ● Built-in rechargeable battery (models for line only) ● Isolated signal ground ● 40 dB amplifier, 2 Hz to 6 MHz ● PRICES: Model 303 (Battery/line/no probe) \$320; Model 303-01 (line only/no probe) \$290; Model 303-50 (Battery/line/with probe) \$382; Model 303-51 (line only/with probe) \$352.

## BALLANTINE TRUE RMS VOLTMETER

10 Hz to 20 MHz

Battery or line-powered

### MODEL 323



- Voltage range 300  $\mu$ V — 330 V (as null detector to 70  $\mu$ V) ● 2% accuracy 50 Hz to 10 MHz ● Logarithmic indicator for uniform accuracy over entire 5 inch scale ● True-RMS responding ● Built-in rechargeable battery (optional model for line only) ● Isolated signal ground ● DC output of 0.1 - 1.0 V for each 10 dB range for application to recorder or DVM where output is proportional to mean square of input ac voltage. ● PRICES: Model 323 (Battery/line) \$520; Model 323-01 (line only) \$485.

Write for brochures giving complete details



**BALLANTINE LABORATORIES INC.**  
Boonton, New Jersey

CHECK WITH BALLANTINE FIRST FOR DC AND AC ELECTRONIC VOLTMETERS/AMMETERS/OHMMEERS, REGARDLESS OF YOUR REQUIREMENTS. WE HAVE A LARGE LINE, WITH ADDITIONS EACH YEAR. ALSO AC/DC LINEAR CONVERTERS, AC/DC CALIBRATORS, WIDE BAND AMPLIFIERS, DIRECT-READING CAPACITANCE METERS, AND A LINE OF LABORATORY VOLTAGE STANDARDS FOR 0 TO 1,000 MHz.

plifier. This reduction is due to the low thermal mass and the close physical placement of the two input-transistor junctions. The net result is a temperature stability 10 times better than conventional discrete-component op amps.

One of the subtle points of op amp specmanship lies in the definition of equivalent input drift. Amplifiers with 5  $\mu$ V/ $^{\circ}$ C maximum voltage drift have been available for some time. However, such units use separate transistors in the input stage, each with an intrinsic base-emitter voltage drift of 2500  $\mu$ V/ $^{\circ}$ C. The 5  $\mu$ V/ $^{\circ}$ C specification comes about because, under isothermal conditions, the two input transistors track each other within the specified 5  $\mu$ V/ $^{\circ}$ C error band.

In practice, the two input-stage junctions are rarely allowed to attain the same temperature, which is the condition for the 5  $\mu$ V/ $^{\circ}$ C spec to mean anything. Instead, thermal gradients that produce as little as 0.1 $^{\circ}$ C temperature-difference between the two junctions can create a 240  $\mu$ V offset. Such a temperature gradient occurs during initial warmup. It can be caused by locating the amplifier near drafts, or near high-power resistors, transformers, and other heat-dissipating elements.

**Reduces error.** The dual-transistor input stage in the 183 cuts the error due to temperature gradients because the two input transistors have virtually no thermal mass, so that they quickly reach temperature equilibrium.

Besides lower cost, the 183 offers a number of technical advantages in comparison with chopper stabilized amplifiers. Differential inputs



# RUGGEDNESS ...a New England Tradition

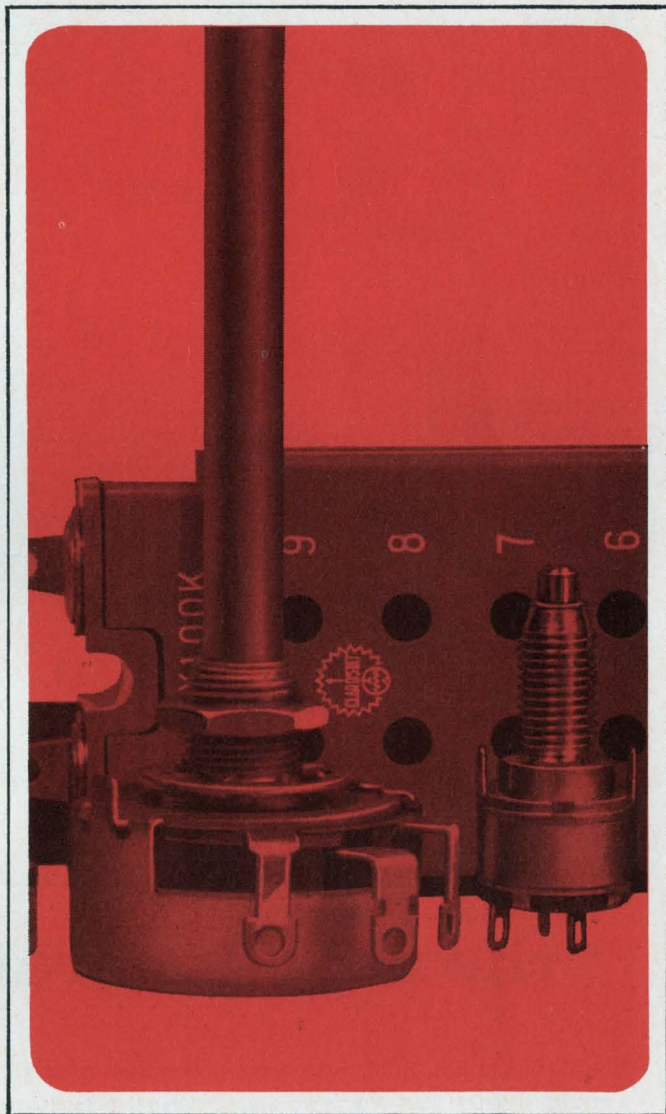
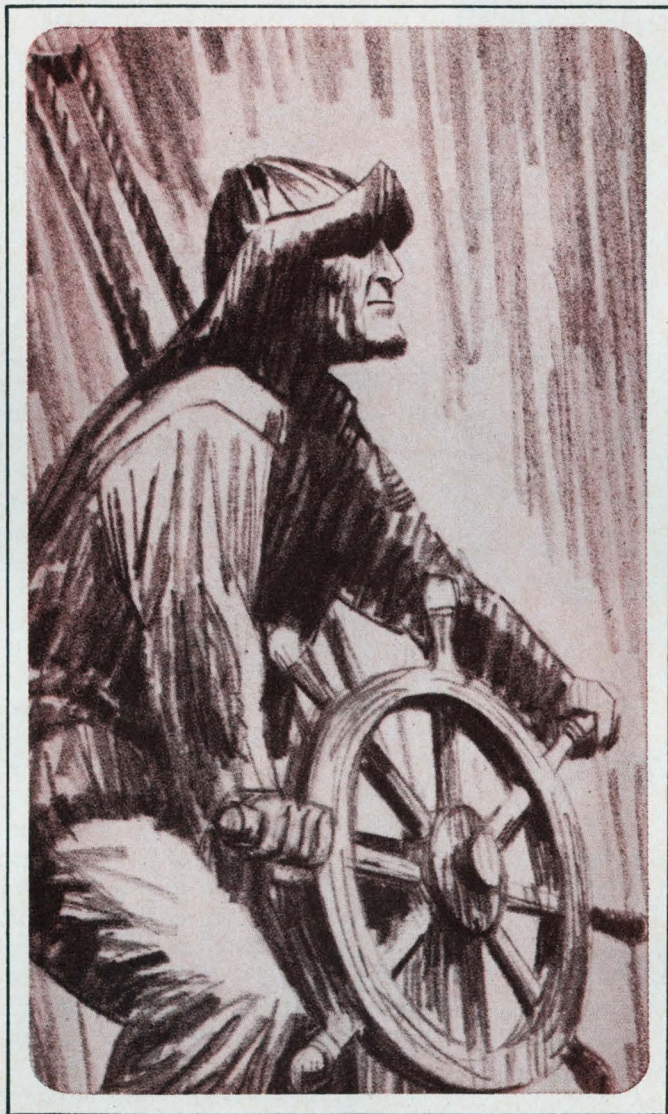

**A TRADITION AT CLAROSTAT TOO** is ruggedness. The qualities that have contributed to the New England tradition of strength of character as well as industrial products are reflected in Clarostat potentiometers, resistors and switches. Clarostat components work harder at the job—last longer in the most critical applications. For more than 40 years, the name Clarostat has stood for the finest performance at the fairest prices. Today's applications are far more precise—much more demanding—yet Clarostat is still the leader—the recognized single source of quality and honest value thanks to a continuing program of research and engineering. For the finest in hard working potentiometers, resistors and switches—the most in honest value—fast service—off-the-shelf delivery—you can't do better than...

# CLAROSTAT

CLAROSTAT MFG. CO., INC., DOVER, NEW HAMPSHIRE 03820





## digital to resolver/synchro converters ... here's the next generation!

North Atlantic now brings you a new generation of solid-state digital-to-analog converters. They offer major advances in resolver/synchro conversion accuracy along with drift-free and stable performance unobtainable with currently available resistor/amplifier devices.

Typical of these new instruments are the Model 536 D/R and Model 537 D/S "shoebox" converters (11-13 bit) and the Model 538 D/R-S converter (14-17 bit). Both models use solid-state switched trigonometric transformers and feature input data storage registers thereby saving computer time. Conversion speed exceeds 10 microseconds. Built-in overload and short circuit protection assures trouble-free system integration and reliable on-line performance.

Your North Atlantic representative (see EEM) has complete specifications and application information. He'll be glad to show you how these new converters can be the answer to critical interface problems.



**NORTH ATLANTIC** industries, inc.  
TERMINAL DRIVE, PLAINVIEW, NEW YORK 11803 • 516-681-8600

... metal film resistors  
improve stability ...

allow the amplifier to be used in noninverting configurations, which in turn bootstraps the input impedance up to 1,000 megohms or higher. This is roughly 1,000 times better than the input impedance of most chopper-stabilized types. Another important advantage over chopper-stabilized amplifiers is the 183's low noise of 1  $\mu\text{V}$  peak-to-peak. By contrast, a chopper amplifier's noise level is typically five or 10 times higher, typically 5  $\mu\text{V}$  to 10  $\mu\text{V}$ , peak-to-peak.

Another advantage of the 183, as compared with chopper types, is its low height, 0.4 inches. This means the difference between occupying one instead of two card spaces in a standard 0.5-inch centered card file. Actual dimensions of model 183 are 1.5-inch square by 0.5 inch high, whereas most encapsulated chopper amplifiers are about 1 inch high by 1 inch wide, and up to 3½ inches long.

**Long-term stability.** Metal film resistors are used to achieve good long-term stability. It is roughly 10 times more stable, at a long-term drift rate of 5  $\mu\text{V}/\text{day}$ , than conventional op amps. Its long-term stability—absence of any need for readjusting the zero—is the prime remaining reason for using chopper-stabilized amplifiers. These amplifiers correct internal drifts regardless of whether aging or temperature variation causes them.

The dual-transistor input circuitry has the ability to minimize low-frequency offset variations caused by slight changes in temperature gradient. Ordinary discrete-transistor amplifiers are highly sensitive to slight ambient temperature changes, and develop output variations that resemble noise.

The 183 comes in two versions, designated models 183A and 183B, which are identical except for maximum voltage drift and price. Model 183B is the high-stability version discussed, and features the 3  $\mu\text{V}/^\circ\text{C}$  maximum drift and \$40 unit-quantity price. Model 183A has a worst-case drift spec of 6  $\mu\text{V}/^\circ\text{C}$  and is priced at \$30.

Analog Devices Inc., Cambridge, Mass.  
[358]



# The one-up op amp.

Since we announced the LM-101 op amp, our improvement on the 709, we've had great response: fan letters, purchase orders, and a new idea.

So now we have two 101's. The original LM-101 and the LH-101 which goes it one better by putting all required frequency compensation inside the package.

Operation guaranteed for supply voltages from  $\pm 5V$  to  $\pm 20V$ .

Low current drain—even with the output saturated. No latch-up when common-mode range is exceeded. Continuous short-circuit protection.

Input transistors protected from excessive input voltage.

Available now from our stocking distributors.

Prices (100 pcs.): LH-101, \$48.00. LH-201 (commercial unit), \$11.40. Write for details: National Semiconductor Corporation, 2975 San Ysidro Way, Santa Clara, California 95051, (408) 245-4320.

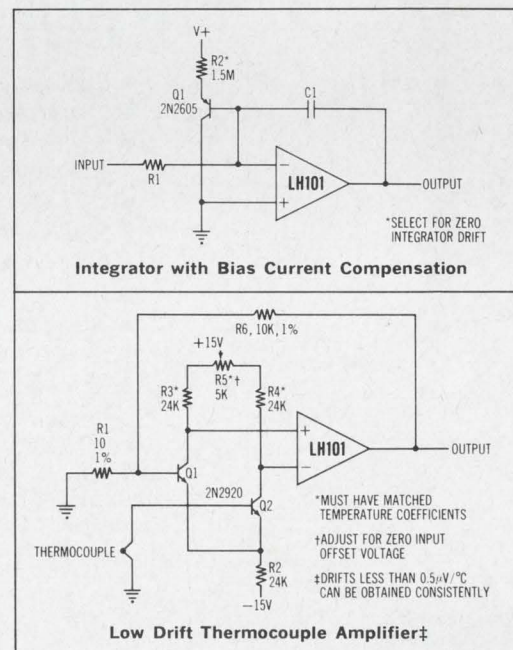

## National Semiconductor



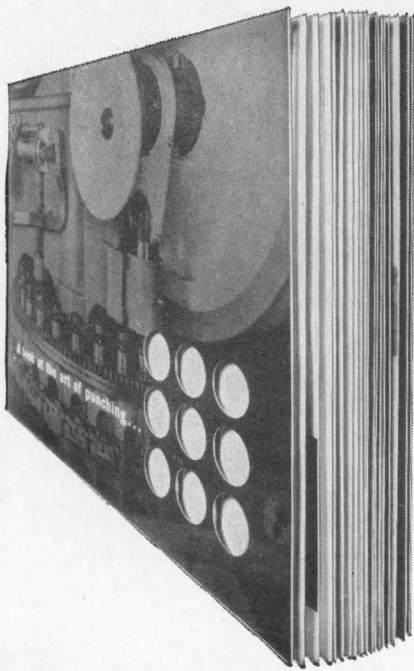

# 44 brand new pages of helpful punching information

- Six basic punching concepts
- Turret punch presses
- Stylus operated turret punch presses
- OBI punch presses
- Single station punch presses
- New horn punch presses
- Adjustable punch and die sets
- All shapes and sizes of punches and dies
- Template layout machines

Complete information! Illustrations, descriptions, specifications and prices. Ask your distributor for the new 44-page Di-Acro punching catalog or write us.



## DI-ACRO

division of



431 EIGHTH AVENUE  
LAKE CITY, MINNESOTA 55041

## New components

### Two photoresistors share the light

Independent cells,  
controlled by same lamp,  
track each other closely

A **two-in-one deal** is offered designers in a light-controlled resistor.

Hewlett-Packard Co.'s dual-cell, photocontrolled resistor enables one input to control two isolated, independent circuits. Consisting of two identical, resistive photocells and a 12-volt incandescent lamp in one package, it was designed for control applications in low-frequency (less than 10 hertz) circuits. It can also be used in switching applications where contact noise has to be avoided.

"You can also use one resistor for modulation and the other for demodulation. And the device can help in analog modeling," says applications engineer Frank Lee.

Resistance of each cell ranges from hundreds of megohms if the lamp is off to less than 10 kilohms when 10 volts are applied to the lamp.

One of the most important features of the unit is close tracking; resistances of the cells are always within 10% of each other for lamp voltages between 3 and 10. "The biggest problem we had was getting uniform light distribution on the two cells," says Lee.

The length of the package, designated the HP 5028-4509, is four inches, including leads. The unit price is \$11; for quantities between 10 and 99, the price is \$9.50.

#### Specifications (at 25°C)

Cell dissipation	125 mw
Cell resistance (10 v)	3.9 kilohms typical 6.8 kilohms max
Cell resistance (dark)	500 megohms typical 100 megohms min
Maximum lamp voltage	12 v (45 ma)
Lamp-to-cell resistance	10 <sup>12</sup> ohms
Lamp-to-cell capacitance	0.03 pf typical 0.05 pf max
Breakdown voltage across cell	100 v

Hewlett-Packard Co., Palo Alto, Calif.  
94304 [359]



# Super Zener

**\$4.50**

Who would be mad enough to come into the market with a four-dollar-and-fifty-cent Zener when you can buy some cheaper than aspirin.

We would. And did.

Our new LM-103, Super Zener, has the sharpest low-current knee there is. It's a monolith, packaged in a two-lead TO-46 header.

Impressively, breakdown voltage changes less than 150 mV when the current is varied between 10  $\mu$ A and 10 mA or only 15 mV between 100  $\mu$ A and 1 mA. This is true for any of the 10 voltages available from 5.6V down to 2.4V.

The only way to get our \$4.50 Zener any cheaper is to buy them at \$3.00 for 100 or more. O.K. now, let's hear from the big spenders. National Semiconductor Corporation, 2975 San Ysidro Way, Santa Clara, California 95051 (408) 245-4320.

**National Semiconductor**



**A HAPPY NEW YEAR OF  
RELAY DEVELOPMENTS**

in which we will introduce a major series of all-new relays and relay refinements of importance to all who specify and use relays.

Here is our first big advance:

# the fate of the “open” Reed Relay IS SEALED!

shown actual size

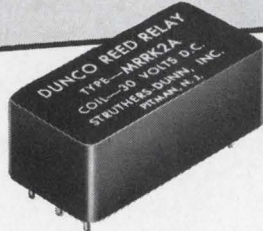

For almost the price and size of open types, this new Struthers-Dunn MRRK Series has all the advantages of conventional enclosed, magnetically-shielded reed relays.

A new fast method of plastic sealing gives complete protection that your production department will really appreciate during mounting, soldering, and cleaning. Insulation resistance remains above  $10^{12}$  ohms.

Only 0.66" wide by 1.29" long by 0.48" high (including 4 standoff pads), the case accommodates single or double coils and up to 3 single-throw or up to 2 double-throw, miniature reed switches. Internal leads are welded to 0.1" grid-space P/C terminals.

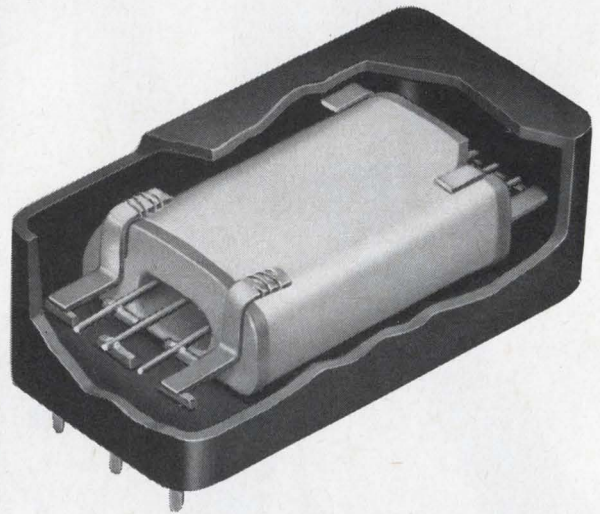

In stock now at Struthers-Dunn distributors in most popular configurations. For detailed information, request Data Bulletin B/3110 on the new MRRK Series. Check the Reader Service number shown below.

## There's always more to draw on where you find the most to start with

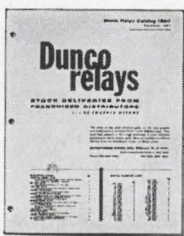

**World's Largest Relay Line**  
More than 5,348 different types! Sold through more than 100 franchised distributors! Get our Stock Relay Catalog 1520 for details on the most frequently-needed aerospace, reed, industrial, and special-purpose relays, contractors, and motor controls. Check the appropriate Reader Service number at right.

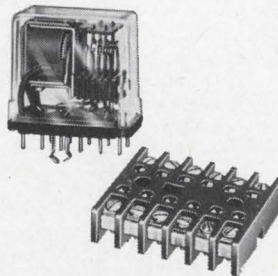

**Largest Line Of Plug-Ins**  
This integrated line of general-purpose, latch, sequencing, and timing relays will save your wiring time, make control panels neater, cut costs. S-D socket terminals are all instantly accessible and on one plane. No complex multiple-level wiring! Send for full story. Check the proper Reader Service number at right.

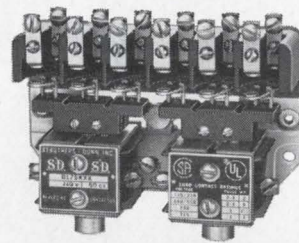

**More Ways To Reverse A Motor**  
No one else offers as wide a choice of motor reversing contactor designs for general and definite purpose applications up to 100 HP . . . including hoists, motor-operated doors, windows and elevators as well as machine tool auxiliaries. Details on request. Check the proper Reader Service number at right.

### SEND FOR THIS DATA

Check numbers on the Reader Service Card for any or all the items of interest to you.

- #512 MRRK Relay Bulletin
- #513 Stock Relay Catalog
- #514 Plug-in Relay Bulletins
- #515 Motor Control Catalog



## STRUTHERS-DUNN, INC.

PITMAN, NEW JERSEY 08071



## New Consumer Electronics Review



Cassette tape recorder 28L09 operates on six "C" batteries or a-c power. It has solid state 7-transistor circuitry. The unit records up to 60 minutes at 1 7/8 ips, and has an easy-to-read combination record and battery indicator. It measures 10 x 7 x 2 1/2 in. and weighs 5 lbs. Suggested retail price is \$69.95. Arvin Industries Inc., 1531 E. 13th St., Columbus, Ind. 47201. [381]

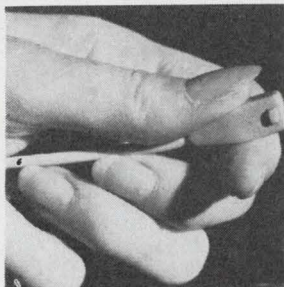

Subminiature push-to-talk microphone called MicroMike is self-shielded against external fields and has a nominal impedance of 5,000 ohms at 1 khz. Useful response is from 400 to 5,000 hz and typical sensitivity is 80 db below 1 volt per dyne/sq cm rms pressure. It is suited for pocket transmitters and tape recorders. Unex Laboratories, Hathorne, Mass. 01923. [382]



Solid state inverter/charger KG-666 is a Knight-Kit unit that converts 12 v d-c to 110-130 v a-c. It operates a-c appliances in cars, boats and trailers. Square-wave output is 55-65 hz at 200 w continuous power rating. The unit measures 4 3/4 x 8 x 8 1/4 in. The kit, designed for easy assembly, is priced at \$44.95. Allied Radio Corp., 100 N. Western, Chicago 60680. [383]



Pocket-size cassette tape recorder, Sony Easy-matic TC-50, offers built-in microphone and speaker, as well as push-button rewind or back-up and push-button fast forward. It also has automatic recording control. Clearly visible is a battery level and recording modulation meter. Retail price will be under \$125. Superscope Inc., 8150 Vineland Ave., Sun Valley, Calif. 91352. [384]

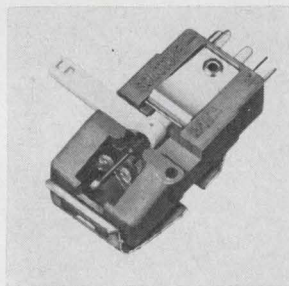

Phonograph cartridge 24TA is for the new sound in recordings being offered by major disk companies. Mechanical design includes a snubber pad of resilient synthetic rubber that is set between cartridge body and mounting bracket to avoid mechanical vibrations. Frequency response is 20 to 15,000 hz; separation, 25 db at 1,000 hz. Sonotone Corp., Elmsford, N.Y. 10523. [385]

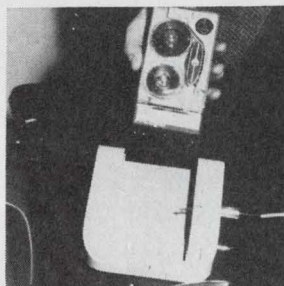

Dictating-transcribing system Fi-Cord 300/303 fits in a case no larger than a woman's handbag. It is compatible for transcribing on double- as well as single-track recorders. The transistorized and automated units sell for \$209.95. Price for the transcribing stand and foot pedal, stethophone and earpiece is \$69.95. Karl Heitz Inc., 979 3rd Ave., New York 10022. [386]



Stereophonic solid state home reproduction system HA-20 features a 20-w peak music power amplification system with integrated 8-track tape cartridge player and 2 matching speaker cabinets, with each cabinet containing 2 high fidelity 5 1/4-in. speakers. Suggested retail price for the ensemble is \$139.95. Lear Jet Corp., 13131 Lyndon Ave., Detroit, Mich. 48227. [387]

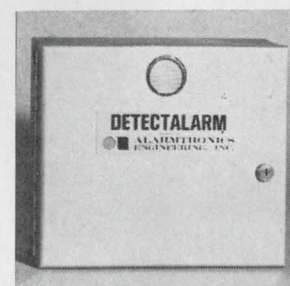

Ultrasensitive intruder detection system, Detectalarm ML-1, utilizes a built-in microphone audio sensor to give early warning of forced entry. It will alert police, set off alarms and/or automatically dial a pre-set phone number. With supplementary sensors added, it also detects fire, flooding, etc. Alarmtronics Engineering Inc., 154 California St., Newton, Mass. 02195. [388]

### New consumer electronics

## Tuning bar replaces radio dial

Motor-driven system hunts strong signals; sensitivity selector squelches weak, remote stations

Because most transistor radio circuits are similar in design, both manufacturers and consumers tend to rely on transistor count, speaker size and battery capacity as indexes of the radio's sensitivity and over-all performance. When a producer goes beyond these param-

eters and manufactures a radio with some added features, marketing aspects of the new design warrant special attention.

Tokyo Shibaura Electric Co. has introduced a touch-tuning a-m portable transistor radio, model 15M-915, which may signal a new



**Music by the bar.** Radio automatically searches spectrum for stations when either section of bar is depressed.

trend in radio receiver design. The set, marketed in the U.S. by Toshiba America Inc., has a motor-driven, signal-seeking tuning system that hunts for the stations when one side of a double tuning



# our adaptable conformist.

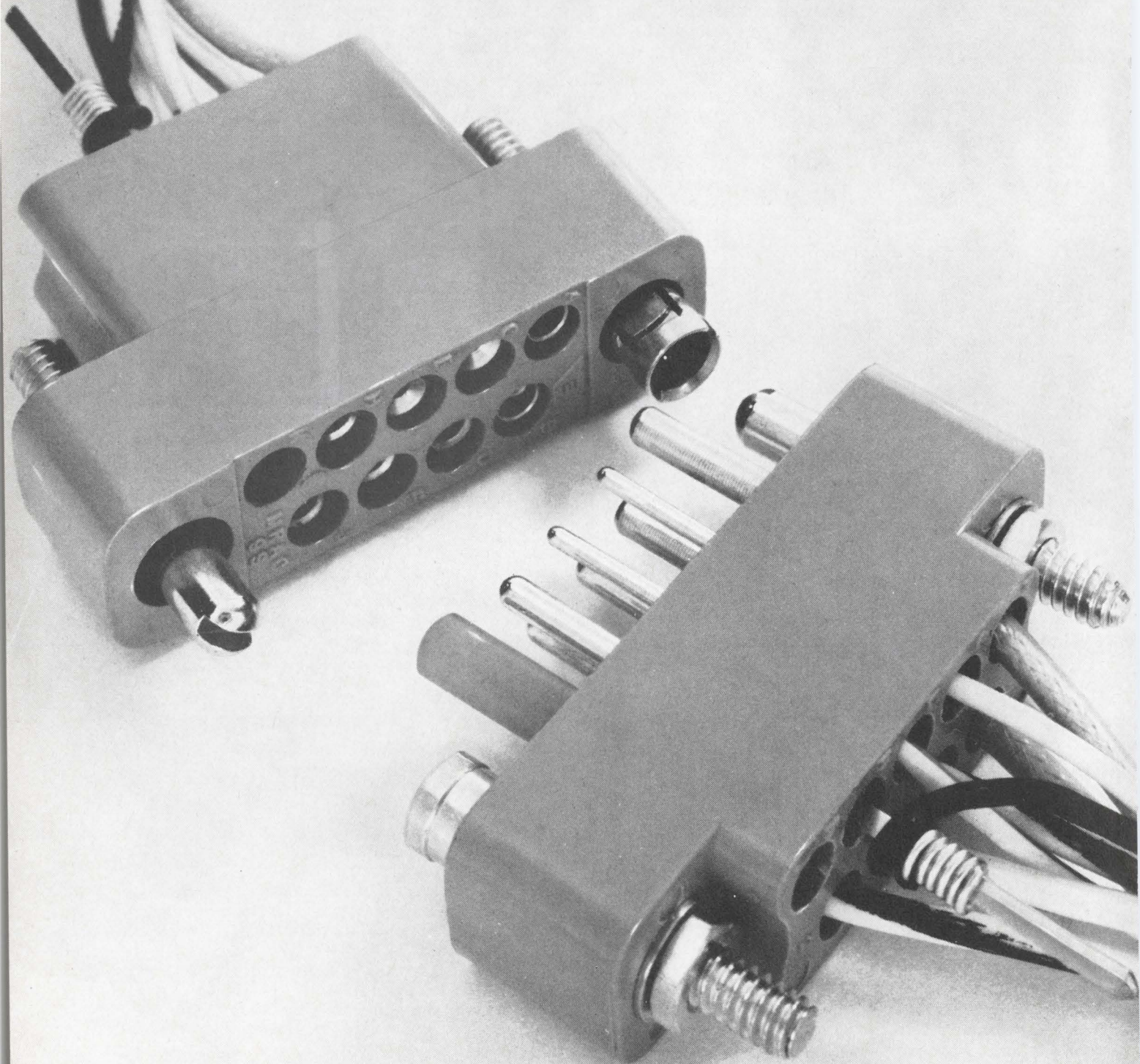



## ... a-m signal from desired station shuts off tuning drive motor ...

bar is touched, a tone switch that adds treble to improve the quality of voice reception or bass to enhance musical programs, and a sensitivity selector switch by which weak, distant stations can be selected or rejected at will.

**Drives capacitor.** Touch tuning does away with manual tuning by dial. Automatic tuning is achieved with the aid of a tiny d-c motor that drives a standard tuning capacitor in either desired direction by a light touch of a tuning bar, which operates a clutch that engages the transmission system.

The direction of rotation is determined by selection of the upper or lower drive gear through the tuning bar, and the tuning capacitor rotor is then driven through a conventional dial cord with station pointer attached. The drive motor is turned on or off by an amplifier whose input signal is derived from the mixer output. The amplifier is biased to saturation, enabling the motor to be turned on when power is applied. However, if the set is tuned to a station, the presence of a signal reverse-biases the control amplifier to remove power from the motor.

In operation, the indicator is driven to the next station where it stops automatically, unless the tuning bar is depressed to defeat this action. When the indicator comes to the end of the dial, it will auto-

matically stop and reverse direction. An automatic frequency control circuit ensures that the set is always tuned to the station.

**The squelch.** The 15M-915 can be set to pick up or reject distant stations by setting a three-position switch for the desired sensitivity. In the local position, the set rejects all weak stations with a squelching action, and only strong ones are received. In the distant position, the switch enables the set to operate at its maximum sensitivity.

The Toshiba radio covers the standard broadcast band, from 530 kilohertz to 1600 kilohertz, and delivers a maximum power output of 300 milliwatts into its 8-ohm, 3½-inch diameter permanent-magnet speaker. The set's high output level is achieved by a push-pull power amplifier which is driven by an interstage transformer with a high step-up ratio. An earphone jack mutes the speaker for private listening while a volume selection window avoids loud turn-ons. It employs a ferrite core antenna and is powered by three C-size flashlight cells. It has a complement of 14 transistors and 8 diodes, measures 8¾ inches wide, 4¾ high, and 1¾ deep, and weighs 2 pounds. Equipped with earphone and carrying case, the model 15M-915 retails for \$39.50.

Toshiba America Inc., 530 Fifth Ave., New York, N.Y. 10036 [389]

The Winchester MRAC Series conforms to MIL-C-22857. Hoods, block and contacts are all certified. And *only* our MRAC connectors can make that claim!

Or provide such adaptability. Easily installed, readily removed contacts are ordered separately. So you can design your own circuitry—at substantial savings in time and labor. And our removable contacts are available in crimp, solder or shielded types. Or wire-wrap. Plus polarizing pins too.

More adaptability. You can intermix power, shielded signal and signal circuits in the same connector. With everything certified to MIL-C-22857.

We recommend the MRAC Series for applications such as computers, shipboard equipment, radar and ground support hardware. For details, and prototype quantities, check your local Winchester Distributor. Or write to: Winchester Electronics, Main St. and Hillside Avenue, Oakville, Connecticut 06779.

Specifications:	
Current rating: Up to 13 amps	
No. of contacts: 9, 14, 18, 20, 26, 34, 41, 42, 50, 66, 75, 104	
Contact Specifications:	
MIL-C-23216 No.	Catalog No.
MS17803-16-16	100B-1016P95
MS17803-16-20	100R-1020P95
MS17804-16-16	100B-51016S95
MS17804-16-20	100R-51020S95

**WINCHESTER ELECTRONICS**  
LITTON INDUSTRIES

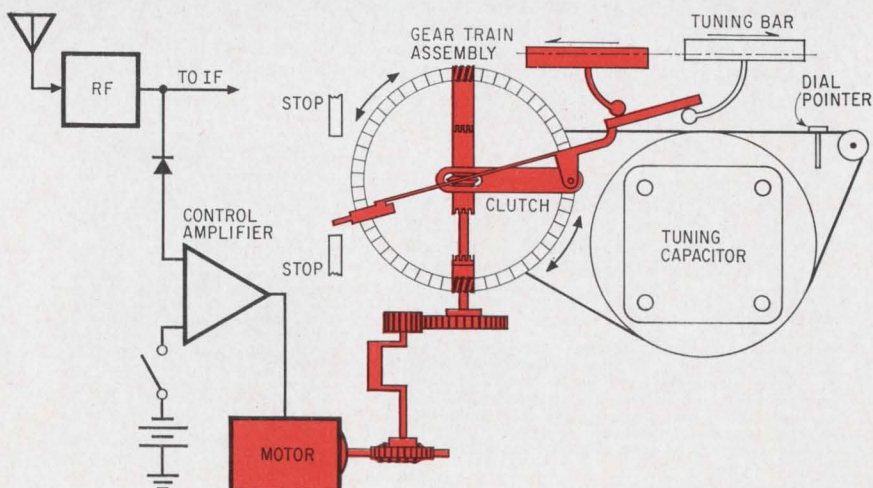

**Autotuned.** A light touch on tuning bar engages forward or reverse drive mechanism to rotate capacitor and move pointer. A station signal inhibits the amplifier to turn off drive system.



new diagnostic technique  
**TAKE YOUR OWN X-RAYS**



made easy with  
**AUTOMATIC**  
 exposure  
 control

# FAXITRON<sup>®</sup> 805

**New research design tool for workbench or lab . . . X-ray inspection where and when you want it - - - \$2380**

Now you can obtain immediate insight into your design or research problems—locate, define, modify—speed development of your project with a quick "inside" look, step by step, or any time you need one.

And anyone can operate the new 805—your technician, your secretary—because it has new convenience features which take the guesswork out of exposures. It shuts itself off automatically when the proper exposure is made. And an electronic readout tells you what voltage to use for the best combination of contrast and exposure time.

Like earlier Model 804, it can be operated where your work is—at your desk, in your laboratory. Built-in shielding reduces external radiation to levels specified by NBS Handbook 93 for exempt installations—thus the 805 can be operated in populated areas without restricting the movement of personnel.

The image may be recorded on Polaroid film with 10 second on-the-spot processing without a darkroom. Wet films may also be used in sizes up to 14x17".

High resolution is provided by a small X-ray source (0.5 mm). Good contrast for a useful range of specimen thickness and densities is provided by a wide voltage range (10 to 100 kVp). Current of approximately 3 mA continuous gives usefully short exposure times.

Send for Free "Do-it-yourself" Application Kit—technical information on typical on-the-spot X-rays of potted electronic components, multi-layer PC boards, integrated circuits, die cast parts, plastics, biological specimens—other research, design, production and quality assurance applications. Ask for a free radiograph sample of a product or object of your choosing.



**Field Emission Corporation**

McMinnville, Oregon 97128

Pioneers in Pulsed Radiation Sources for Science and Industry

New consumer electronics

## Test-set kit for plant or shop

Sweep/marker generator  
 simple to use, requires  
 infrequent calibration

**Kit-building** is one way the radio and television set-maker or service technician can increase his test capability without going overboard on high-priced laboratory instruments.

For most test and alignment applications in the factory or on the service bench, low-cost service instruments are not only acceptable but desirable since they are simpler to use and require less frequent calibration. One instrument that falls into this category is a sweep/marker generator for servicing television sets and frequency-modulation receivers. Marketed in kit form by Allied Electronics Corp, it is called the KG-687. The instrument, priced at \$120, exceeds the requirements for production testing.

**Sharp on the mark.** The all-solid-state generator has a minimum of drift, Allied says, and does not require warm-up. Its sweep oscillator circuit covers a range of 3 to 220 megahertz in five bands, and the marker oscillator frequencies extend from 2 to 225 Mhz.

The sweep width goes up to 18 Mhz at the highest center frequency, far exceeding television bandwidth requirements. The sweep/marker generator employs crystal-controlled markers, and a post-injected marker system to ensure sharp marker signal definition.

**Close control.** A radio-frequency retrace blanking and horizontal phase adjustment is provided for viewing on an oscilloscope. Several potentiometers are provided for calibration and setup. The circuit contains an automatic level control with a-c/d-c coupled feedback to provide a constant output level, even when frequencies are switched.

Allied Electronics Corp., Chicago, Ill. 60680 [390]



# Move With Advanced Computer Technology At NCR Electronics Division

## SYSTEMS FORMULATION

Analysis and development of advanced systems specifications; consultation on systems design, hardware configuration, software trade-offs; analysis of competitive systems. Applicant should have familiarity with very high speed memories, large-scale integration, disc files, drum files, communications and time sharing plus related BS degree and 3 to 5 years' experience in one or more areas mentioned.

## SOFTWARE SYSTEMS

Programmers to develop executive and operating systems for third-generation computer systems. Desire experience with medium- and large-scale general-purpose systems employing high speed peripheral units, tapes, random-access files, disc files, drum files, on-line, time sharing and multi-programming. Requires related BS degree and 3 to 5 years' directly related experience. Positions also open for hardware-oriented programmers to do systems diagnostic work.

## EDP ANALYST/PROGRAMMERS

Analyst position entails systems analysis in financial and administrative areas. One year of EDP experience required, degree desirable. Programming positions involve accounting and manufacturing systems. Degree and recent experience on medium- to large-scale systems desired.

## OPTICAL SYSTEMS

To do computer-aided design of specific elements in complex optical systems, such as field and condenser, as well as image-forming elements.

Activity includes optical-electronic lab work, systems layout and design, technical liaison. Involves geometrical and physical optics. Requires BS in physics or optics plus 2-5 years' directly related experience.

## MEMORIES RESEARCH

To design high-speed magnetic memory circuits. Requires knowledge of nanosecond pulse techniques and magnetic memory organization. Familiarity with plated-wire and mass-storage memory concepts desirable. Requires BSEE plus five years' experience.

## SYSTEMS ENGINEER

For systems design on advanced computers. Requires extensive knowledge of memory technology, systems logic and large-scale integration as applied to medium- to large-scale general-purpose computing systems. Minimum of BSEE and five years' direct experience required.

## LOGIC DESIGN

Several positions available for EE's with 2-5 years' experience in logic design on either special- or general-purpose equipment. Positions require thorough knowledge of logic as related to real-time hardware development or automatic test equipment.

## CIRCUIT DESIGN

Positions for both systems- and device-oriented circuits men to work either in developmental projects or standard circuits group. BSEE required plus 3-5 years' design experience and thorough understanding of IC technology. Knowledge of large-scale integration concepts and

ramifications desirable. Projects include thin-film memories, IC utilization and development, project/vendor liaison, systems applications.

## FACILITIES/LAYOUT

Work entails projecting needs of expanding division, development of proposals, program implementation. Requires three years of facilities and layout experience, preferably in electronics industry; BSIE or equivalent; ability to deal effectively with all levels of personnel. Knowledge of safety codes desirable.

## MACHINE DESIGN

Creative mechanical engineer capable of designing sophisticated manufacturing hardware and of developing machines to do jobs which heretofore have not been encountered. Requires BSME and minimum of two years' experience.

## CHEMICAL PROCESSES

Positions in both engineering and manufacturing for man with BSChE and 2-5 years' experience in electroplating and electrodeposition in thin and thick films. Thorough knowledge of related materials, pre-plating surfaces, plating equipment required. Work entails development of advanced processes and techniques for computer development and production.

## QUALITY ASSURANCE ENGINEERS

Q.C. assignments include process capability studies, failure analysis, design reviews, establishment of inspection standards. Position requires 2-3 years' experience with EDP equipment, knowledge of magnetic materials, BSME degree. Reliability positions involve planning, conducting and reporting reliability tests of electronic components, assemblies and units. BSEE required plus experience with reliability mathematics, computer circuitry. Positions also available in systems test.

TO ARRANGE A CONFIDENTIAL INTERVIEW send resume including salary history to: STEVE WILLIAMS

NCR Electronics Division is the largest commercial computer manufacturing facility in Southern California and one of the most advanced in the world. The Los Angeles plant and laboratories have recently been doubled, and an additional manufacturing facility is now under construction in San Diego. At NCR you will enjoy stable, non-defense activity in a

thoroughly professional environment. Your job and your future: the creation of advanced business automation for NCR markets in 121 countries.

Challenge, opportunity and Southern California are waiting for you. Look into these opportunities now.

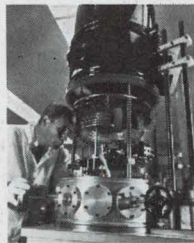
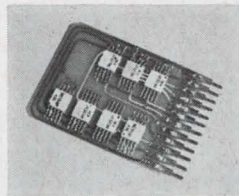
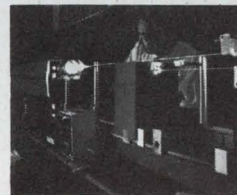

The National Cash Register Company  
ELECTRONICS DIVISION  
2816 W. El Segundo Blvd., Hawthorne, Calif.  
Telephone: (213) 777-7344  
An equal-opportunity employer





Minnesota is a fertile land for Electronics!

## New business climate nurtures growth of money trees

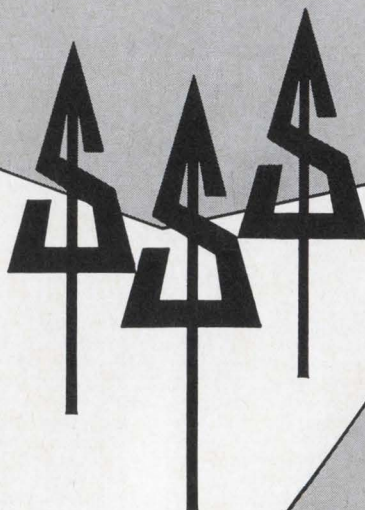

Take a new look at Minnesota. Our rich land is the perfect foundation in which your company can take roots. Hundreds of small, medium and large electronics firms are already prospering here. Minnesota's sunny people and tropical business climate make your growth potential as vast as our great outdoors. Minnesota means business!

The updating of our business laws is just one indicator of our people's positive, progressive attitudes toward making money. For example:

**Revenue Bonding Bill:** Hundreds of smaller Minnesota communities, eager and able for industry, receive the encouragement of the government in selling tax-free municipal bonds for plants and offices at very low interest rates. Minnesota means business!

**Reorganization of the Department of Economic Development:** Minnesota gives state assistance to businesses. We've added specialists in every region of the state to help you prosper. And our Governor has a 21-member advisory board comprised of leading executives to help maintain our growth atmosphere. Minnesota means business!

**Tax Reform and Relief Act:** The people of Minnesota, speaking through their state legislature, have voted to lower the tax burden on business. This allows Minnesota manufacturers to compete favorably, both on a national and international basis. Minnesota means business!

**Metro Council:** Proof of the progressive attitudes of Minnesotans, our Metro Council serves a seven-county area helping all citizens and businesses maintain a healthy, productive community. Minnesota means business!

**Copper-Nickel Bill and the Taconite Amendment:** New laws encouraging the development and growth of mining permanently establish tax limits. Minnesota means business!

Large corporate plants . . . small corporate headquarters . . . all businesses can sow the seeds of profit throughout Minnesota. We're a large and active financial market with an eager eye on tomorrow and a growth capital to match. Plant a plant in our rich land . . . and reap your harvest from our money trees!

For specific information, we'd like you to visit us personally. Or have your banker, broker, or agent contact us for confidential information applicable to your interests.

# Minnesota!

10,000 LAKES

*"We don't just talk  
about progress.  
We make it happen."*

Dept. of Economic Development  
57 West Seventh Street  
St. Paul, Minnesota 55102



## New Microwave Review

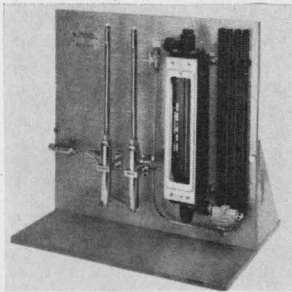

Precision r-f calorimeter model 6020 measures power in 50-ohm coaxial systems up to 1 kw with 3% typical accuracy. Units are self-checking at d-c or 60 hz a-c, which eliminates half the measurement uncertainties, resulting in 1½% accuracy. Vswr is 1.1 max. d-c to 1,000 Mhz, 1.25 max. to 3,500 Mhz. Bird Electronic Corp., 30303 Aurora Rd., Cleveland, Ohio 44139. [401]

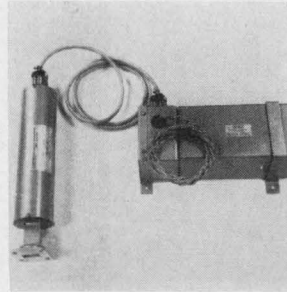

Hot reference loads series HL are for calibrating microwave receivers and radiometers. Consisting of a waveguide termination in a thermostatically controlled oven, the loads can be furnished for any temperature in the range of ambient to 60°C with ±0.3°C stability. Waveguide sizes from RG-91 through RG-139 are offered. Advanced Technology Corp., Timonium, Md. 21093. [402]

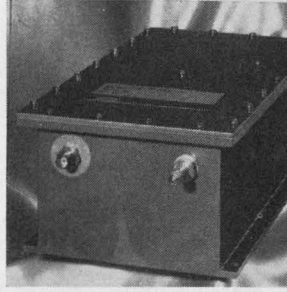

F-m transmitter model 382 can deliver 20 w minimum at L-band. It is intended for transmitting telemetry data in the 1.435-1.540 Ghz uhf range. It withstands 55 g's shock at any altitude and in a temperature range of -20° to +75° C. The unit measures 12 x 6½ x 4½ in. and weighs less than 13 lbs. Electro-Mechanical Research Inc., Box 3041, Sarasota, Fla. 3378. [403]

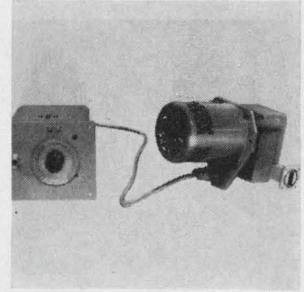

Servo driven phase shifters DB-X-195, for remote control of phase shift, may be controlled manually or by external error signals. Twelve sizes cover 2.6 to 90 Ghz. Each unit provides 0 to 360° of phase shift. Max. insertion loss is 1.25 db on the higher, 0.15 db on lower frequencies. DeMornay-Bonardi, Div. of Datapulse Inc., 1313 N. Lincoln Ave., Pasadena, Calif. 91103. [404]

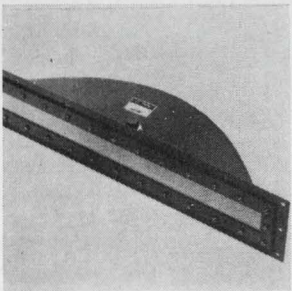

Airborne antenna type 55439 provides a linearly polarized beam. It is constructed of aluminum and has a maximum air speed rating of Mach 2 and maximum altitude of 80,000 ft. The flush-mounted unit operates in the 4.2 to 4.4-Ghz range with 13 db gain. Maximum vswr is 1.35. The antenna meets Mil-Specs. Andrew Corp., 10500 W. 153rd St., Orland Park, Ill. 60462. [405]

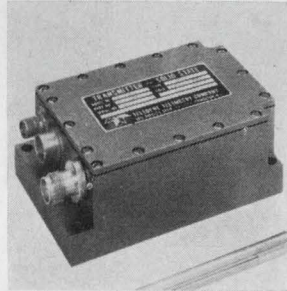

Solid state S-band transmitters TR-2300 offer a full spectrum of r-f output power levels from 0.2 to 2 w in less than 13 cu in. Design features include use of open loop heterodyne technique of frequency synthesis developing r-f power in the region of 750 Mhz. Price, in lots of 1 through 3, starts at \$4,200. Teledyne Telemetry Co., 9320 Lincoln Blvd., Los Angeles 90045. [406]



Solid state sweep generator VS-120 covers the 1-Ghz to 2.3-Ghz range. Swept frequency range is 950 Mhz to 2.5 Ghz. Sweep width is variable from 50 khz to 25%. R-f output is 0.25 v rms into 50 ohms. R-f flatness is ±0.5 db at maximum sweep width. Distortion is 30 db down. Price is \$1,695; delivery, 2 to 4 weeks. Texscan Corp., 2446 N. Shadeland Ave., Indianapolis 46219. [407]

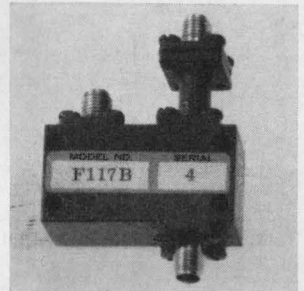

Broadband diplexer F117B, intended for system use, is generally used with a broadband antenna to separate a signal at the common port into C- and X-bands at the output ports. Loss is 1 db max., and is typically less than 0.5 db. The unit measures less than 1½ x 1½ x ½ in. and weighs 1½ oz. Peninsula Microwave Laboratories, 855 Maude Ave., Mtn. View, Calif. 94040. [408]

## New microwave

### A design-a-day channel filter

Computer-aided technique shaves days, even weeks, from design time

By Jayanti K. Sinha

Amphenol Corp., Danbury, Conn.

**It's no longer true** that filters can't be designed in a day. That's all the time it took for engineers to nail down the close-tolerance dimen-

sions of the Model 1308 band-elimination filter at the Amphenol Corp.'s RF division. Previously, the company's designers needed up to

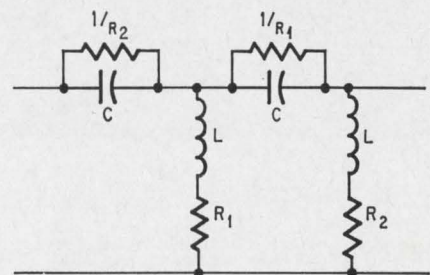

**Input.** Values of equivalent circuit are inputs for computer program.

two weeks to do the job. The time-saver: computer-aided design.

Used primarily for channel separation in communications systems, the filter consists of four cavity



# Instant Circuit Design

with **BARNES  
BREADBOARD/  
TEST ASSEMBLIES  
FOR TO's, FLAT-  
PACKS and DIP's**



Tired of circuit designing that requires slow, tedious I.C. mounting and interconnection? Barnes breadboard/test assemblies make circuit design fast and easy . . . speed power aging too. For flat-packs, dual-in-lines or TO-5's, standard boards provide 10, 20 or 30 sockets. Wiping action spring jacks allow simple plug-in interconnection with no necessity for pre-cut jumper wires. Specials are available in any configuration. Write for data or call us collect.

**barnes**  
CORPORATION  
Lansdowne, Pa. 19050 • 215/MA2-1525

**barnes** / THE FIRST WORD IN CARRIERS, CONTACTORS AND SOCKETS FOR I.C.'S

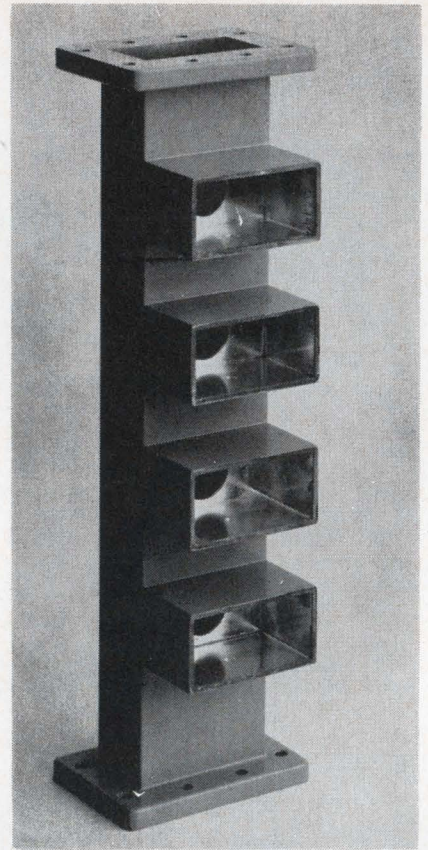

**Blocker.** Channel-separation filter drops out frequency band between 6375.5 and 6424.2 Mhz.

Circle 257 on reader service card

**PROGRESS IN AN EXPLODING TECHNOLOGY**  
**PROGRESS IN AN EXPLODING TECHNOLOGY**  
**PROGRESS IN AN EXPLODING TECHNOLOGY**  
**PROGRESS IN AN EXPLODING TECHNOLOGY**  
**PROGRESS IN AN EXPLODING TECHNOLOGY**

**EXHIBITS**  
NEW YORK COLISEUM

**TECHNICAL SESSIONS**  
NEW YORK HILTON

Monday through Thursday

- 48 GENERAL SESSIONS at the New York Hilton. Hours: 10:00-12:30; 2:00-4:30.
- FOUR FLOORS OF EXHIBITS at the N. Y. Coliseum including over 750 firms. Hours: 10 a.m.-8 p.m. 4 Days.
- GALA ANNUAL BANQUET—Wednesday 7:15 p.m. N. Y. Hilton Grand Ballroom—\$16.00.
- FREE SHUTTLE BUSES between the Hilton and the Coliseum—every few minutes.

- REGISTRATION—Good all days—General Sessions and exhibits. In and out privileges.—IEEE Members \$3.00. Non-members \$6.00. Ladies \$1.00. High School Students \$3.00 if accompanied by an adult—One student per adult; Thursday only—limit of 3 students per adult.
- REG-IDENT CARD speeds request for exhibitors' literature. Ask for one when registering.
- ESCALATORS/EXPRESS ELEVATORS to the Fourth Floor.



**IEEE Exhibition MARCH 18-21, 1968**

resonators attached to a waveguide by irises. Separation between cavities is three-quarters of the wavelength of the waveguide. This is the smallest distance at which interaction between cavities has a negligible effect on filter performance.

In such a filter, iris diameter, cavity length, and cavity separation are critical to performance. A small change in any of these dimensions causes a large change in both the power output to power input ratio and the voltage standing wave ratio (vswr).

Usually, the engineer first makes a preliminary design based on filter specifications. Then he goes to the laboratory and checks the filter response. Unless the response fulfills the requirements on the designer's first try, a rarity, he adjusts the lengths of the cavities and the diameters of the irises, and checks the response again. He adjusts and checks again and again until the optimal dimensions are achieved. This process, however, can take days, even weeks to complete.

**Speedup.** Amphenol's computer-aided technique cuts design time



## The hope of doing each other some good prompts these advertisements

### A little help with your LSI

One month a few people want to understand a concept like large-scale integration ("LSI"), and three months later the term is heard from every table in the steak house. Identifiable circuit components fade dimmer into the complexities of the chip's architecture. The number of circuit functions on the chip rises by a power or two of ten, while the tolerance on placement and width of the elements of the pattern moves on down toward the wavelength of light itself. Creation of the original "artwork" for optical reduction to masks is getting to be a little too much to ask of the human hand and mind. Interconnections in the pattern, we are further told, will have to be determined by testing each separate chip—such is the combined-reliability problem. Presumably the proper image will be generated and somehow imposed on a resist of sufficient resolution. To have a good one ready will be our part.

For the present we wish to advise that if the new KODAK Photosensitive Metal-Clad Plate is flooded with nitrogen gas during the exposure, the 0.6 $\mu$  photopolymer layer over the chrome acquires what might be considered projection speed, given a strong source. With only an 0.32 N.A. microscope objective comes the 900 lines/mm of microelectronically usable resolution that required an 0.65 N.A. objective with the currently favored KODAK High Resolution Plate. An 0.32 N.A. objective is easier to keep in focus. Although the High Resolution Plate is a lot faster, perhaps it can be skipped (unless the cushioning of its gelatin against epitaxial

spikes is needed) and the camera exposure made directly on the plate which becomes the chrome mask for the resist-coated silicon.

Those who want details on this can get them from Eastman Kodak Company, Industrial Photo Methods, Rochester, N.Y. 14650.

### Liquid crystals: breadth of choice now, purity later if needed

From *Physical Review Letters* 18:393, it seems that the random alignments available in "swarms" of organic liquid crystals of the cholesteric type can simplify the generation of second harmonics from Q-switched lasers. Meanwhile, some who are less interested in basic optical principles use "liquid crystals" to depict slight but significant temperature anomalies in the skins of people or airframes. Those concerned with the latter tell us we are doing a good job in making them what they want.

In serving the optical investigator with liquid crystals, the chemical talent we have invested might have been devoted to higher purity for fewer compounds. Instead, we reasoned that once his investigations establish a need for higher purity in a given compound and it happens that purification overtaxes his own chemical facilities, we would be happy to see what we can do for him.

To check on current offerings and prices in cholesteric, smectic, and nematic compounds, write Eastman Organic Chemicals Department, Distillation Products Industries, Rochester, N.Y. 14603 (Division of Eastman Kodak Company).

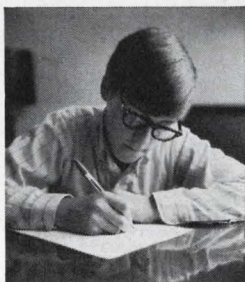

Eastman Kodak Company  
Rochester, N.Y.

Dear Sirs:

*In only 7 years hence I expect to be 21 years of age and it will be legal for me to engage in investment and speculation without consent. I am now preparing for that time. It is therefore necessary for me to have certain information about scientific developments that will take place. As I have been interested in photography I would like to know what plans you have for bringing out new kinds of films to work with laser light instead of plain light. I also happen to understand how cathode-ray tubes work and would like to know why you don't make film where the electron beam works right on the film instead of making light on the tube face and then photographing that.*

*Yours very truly,*  
Herman Small

("Herman Small" is a composite.)

### Dear Mr. Small:

You sound like the sort of person who is going to be taking charge of things in the comparatively near future and we had better not kid around with you.

As a matter of fact we have been working hard for years on film for direct electron recording of cathode-ray images. We have even sold a little of it, but not much. It seems to be a very good way to pack information at megacycle frequencies into far more compact form than magnetic recording permits. (We assume you are familiar with megacycles.) Sale is still small because there is as yet very little equipment around that can make use of such film. To the extent that this development is involved in the planning of the financial program that you intend to launch in 1975, we wish you luck. It may be big then or it may have died. If we knew, we'd be bolder now.

On films for use in the laser art, it is the same old question of how bold to be with funds such as you yourself might have already entrusted to us (if it had not been for the matter of consent). It seems fairly clear that by the time you settle down into the driver's seat, much more of what we have already learned in making the film that has kept you interested in personal photography will have moved from that area into the use of color film technology in dealing with modulated optical frequencies. We have the color film technology in pretty good shape, but we can't afford to bet it on every horse in the race. It costs an awful lot of money to make a few feet of new color film not made before, even if you have a pretty good idea of how to make it. Lots of ideas will doubtless be brought to us in hope of film. We too need a little luck in picking winners.

Very truly yours,

EASTMAN KODAK COMPANY



**the lean, tough, reliable control meter — actual size**

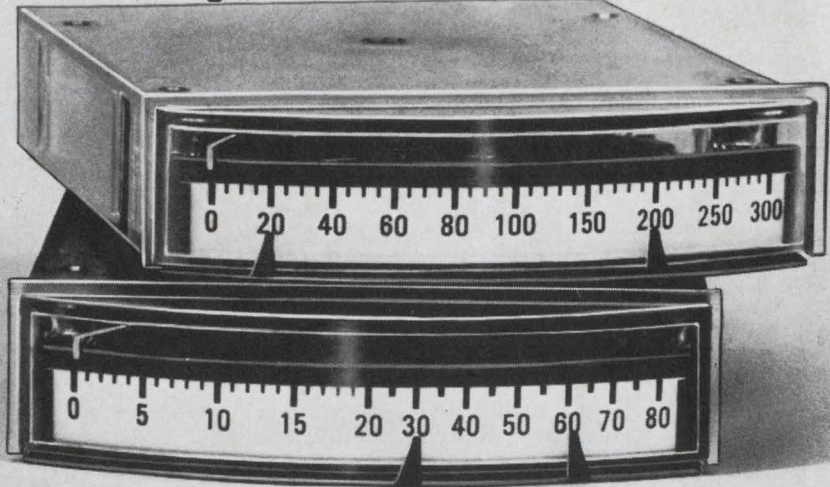

# PARKER MINITROL

The most compact, simplest, fastest-acting, most rugged and dependable control meter available today. Scale Length 3 1/8", Case 7/8" thick. No fragile optics or physical contacts. All indicating and control functions in a case only 7/8" x 3 1/2" x 4 1/2". One or two set-points, Selenide or SCR photocells, for all-solid-state internal switching of up to 300 MA @ 100 V. Extreme resistance to shock, vibration, continuous electrical overload up to 10,000% FSD. Self-shielded units pack on 7/8" centers for high-density display/control applications. Vertical scales, internal illumination, and surface-mounting models (all 7/8" thin) are also available. For complete details, ask for Bulletin M-10.

 **PARKER INSTRUMENT CORP.** 200 Harvard Ave. / Stamford, Conn. 06904 / (203) 325-4361

Circle 258 on reader service card

## NEW THERMOCOUPLE REFERENCES WITH 25 CHANNELS ONLY \$259.00!

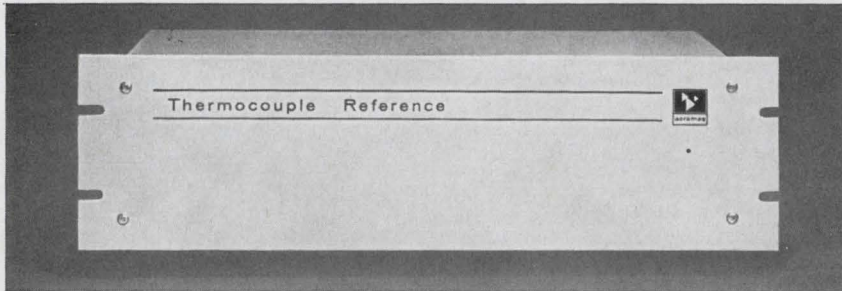

Now — ACROMAG Series 330 Thermocouple References with 25 channels of 0°C ice-point compensation for only \$259.00, including ALL 25 thermocouples! Uniformity 0.05°C, one-second warmup, easy to use. Ideal for scanned TC systems, DDC, and laboratory use. Series 340 References (150°F oven-type) with 25 channels for \$289.00! Series 320 Single-Channel 0°C References, AC powered, for only \$75.00! Stocked in ISA Types, J, K, T, R & S. Others to order!

Request Technical Data 32 . . . .

**ACROMAG**  
INCORPORATED

30765 Wixom Road • Wixom, Michigan 48096  
Phone (313) 624-1541

Makers of Precision Instrumentation and Controls



... circuit values in  
and vswr's out ...

to one day by eliminating these steps. Instead, an equivalent circuit is used to describe the filter to the computer. The circuit elements—inductor L, capacitor C, and resistors R<sub>1</sub> and R<sub>2</sub>—are expressed as functions of insertion loss and the 3-decibel bandwidth of each cavity. Measurements are taken in one inner and one outer cavity only. The filter is symmetrical about a midplane perpendicular to the long axis of the waveguide. Because of the symmetry, the inner cavities are identical, and the outer cavities are identical. Thus, insertion losses and bandwidths are the same for the inner pair, and the same for the outer pair.

Based on the measurements, values are assigned to C, L, R<sub>1</sub> and R<sub>2</sub>—for the 1308, they were 1.062 farads for C, 0.5045 henry for L, 0.01017 ohm for R<sub>1</sub>, and 0.02677 ohm for R<sub>2</sub>. These values are the input to the computer. Equations which relate filter performance and circuit values are stored in memory. The computer prints out voltage standing wave ratios at given frequencies as a function of frequency. Running time is less than a minute.

By comparing the results with the specifications, the designer can easily determine insertion-loss and bandwidth changes necessary to bring the filter's response to the required level. These changes are then translated into changes in the filter's physical dimensions.

In the case of the 1308—which was intended to eliminate frequencies between 6,375.5 and 6,424.2 megahertz—the diameter of the hole of each inner-cavity iris was enlarged by 0.004 inch, to 0.582 inch; the outside-cavity holes were enlarged by 0.002 inch, to 0.645 inch.

The computer used in designing the filter was an IBM 1130.

The technique is particularly useful in the laboratory. A microwave design engineer often needs a filter not available commercially. Now he can quickly design a specific unit to fit his needs.

Amphenol Corp., RF Division, 33 E. Franklin St., Danbury, Conn. [409]



# Now you can put long-term reliability into precision resistor applications.

Because Corning made a production of precision.

CORNING® NC Style Resistor  
Design Tolerance  
 $\Delta R$  in % over 10,000  
hour load life

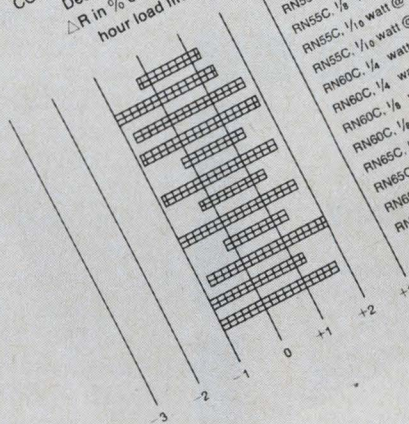

RN55C, 1/8 watt @ 70°C, 1/2%  
RN55C, 1/8 watt @ 70°C, 1%  
RN55C, 1/8 watt @ 125°C, 1/2%  
RN55C, 1/8 watt @ 125°C, 1%  
RN60C, 1/4 watt @ 70°C, 1/2%  
RN60C, 1/4 watt @ 70°C, 1%  
RN60C, 1/4 watt @ 125°C, 1/2%  
RN60C, 1/4 watt @ 125°C, 1%  
RN65C, 1/2 watt @ 70°C, 1%  
RN65C, 1/2 watt @ 125°C, 1/2%  
RN65C, 1/4 watt @ 125°C, 1%

The continuous production process for CORNING® NC Style Resistors gives you total uniformity to these specs:

- Predictable end-of-life design tolerances from +1.8% to -1.0%.
- Molecular bonding of metal oxide film and glass substrate.
- Matching TC's of film and glass.
- <math><1/2\%</math> load life  $\Delta R$ .
- Overall TC of  $\pm 50$  ppm.
- Mil-R-10509E, Char. C conformance.

Get this precision again and again. Specify CORNING NC Style Resistors.

In three sizes, with these ratings at 125°C.: 1/10 watt in 49.9 ohms to 301K, 1/8 watt in 49.9 ohms to 1 meg, and 1/4 watt in 49.9 ohms to 2 meg.

Precise data is yours for the asking from your Corning distributor, or by writing to: Corning Glass Works, Electronic Products Division, Corning, N. Y. 14830.

**CORNING**  
ELECTRONICS







At ECI in St. Petersburg, Florida...  
Digital Communications Opportunities

## For a special breed of engineer

If you're one of that special breed of communication engineers who finds a challenge in projects beginning with applied research and advanced development and continuing through prototype and product design, you may well be the kind of person we're looking for.

Check this partial list of digital engineering activities at ECI. If you'd like to help push the state-of-the-art in any of these or other areas in communications, send us your resume. You'll design systems and equipment for satellite communications, multiplexing, electronic switching, command and control and advanced radio communications for some of the nation's major defense and space programs.

### Digital Communication Engineering Activities:

- Frequency Synthesis
- MODEM Technology
- Microelectronic Applications
- Error Control Coding
- Electronic Switching
- Time Division Multiplexing
- Reliability Techniques

### CHALLENGE, GROWTH . . . and LOCATION TOO!

At ECI your job will be challenging. At ECI you'll find real opportunity for growth instead of just another confining groove — two-thirds of all advanced development is done in regular engineering development areas. And, at ECI you'll like where you're living just as much as you'll like your job. We'll match subtropical, sunny St. Petersburg against any location in the U. S. for stimulating, comfortable living.

SEND YOUR RESUME TODAY — in confidence — to K. E. Nipper, Supervisor of Professional Placement, Electronic Communications, Inc., P. O. Box 12248, St. Petersburg, Florida 33733.  
(An equal opportunity employer, M & F.)



ELECTRONIC COMMUNICATIONS, INC.  
ST. PETERSBURG DIVISION

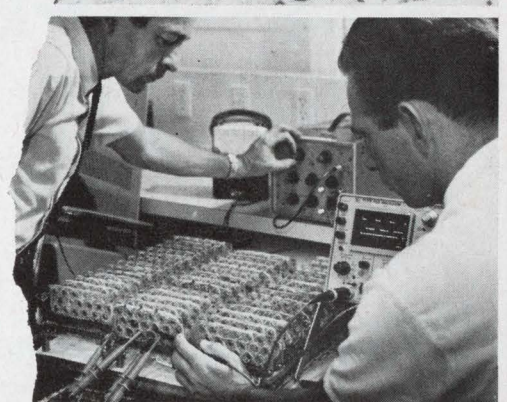
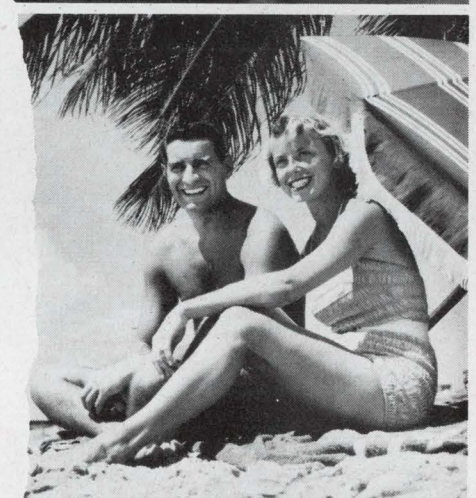
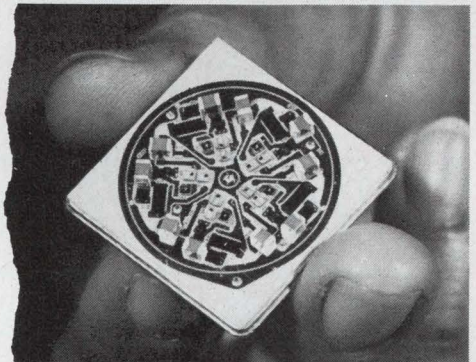
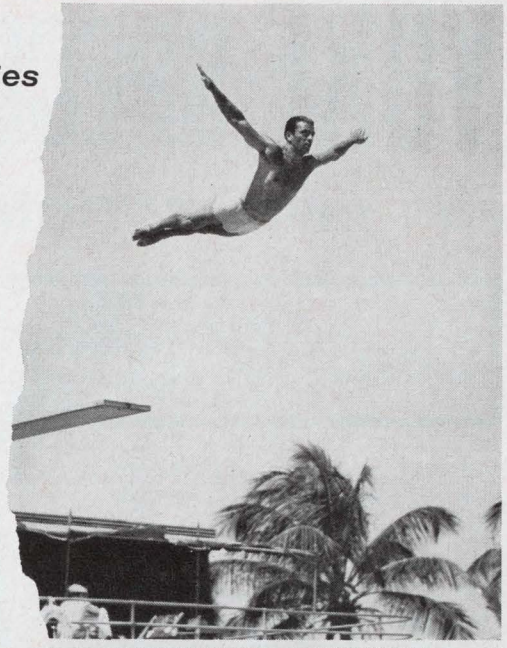



# YOKE SPECIALISTS

FOR INFORMATION DISPLAYS

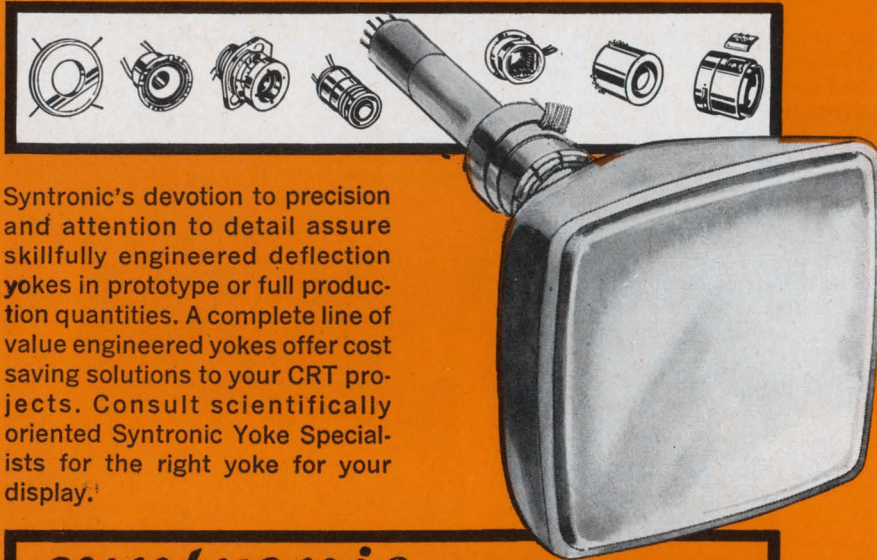

Syntronic's devotion to precision and attention to detail assure skillfully engineered deflection yokes in prototype or full production quantities. A complete line of value engineered yokes offer cost saving solutions to your CRT projects. Consult scientifically oriented Syntronic Yoke Specialists for the right yoke for your display.

***syntronic*** INSTRUMENTS, INC.  
100 Industrial Road, Addison, Ill.  
Phone: Area 312, 543-6444

Circle 260 on reader service card

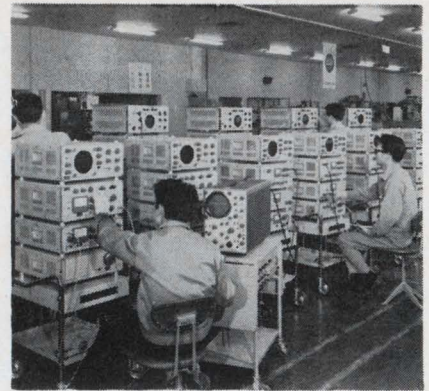

**Rolling.** Anritsu's test unit is on movable cart for easy access.

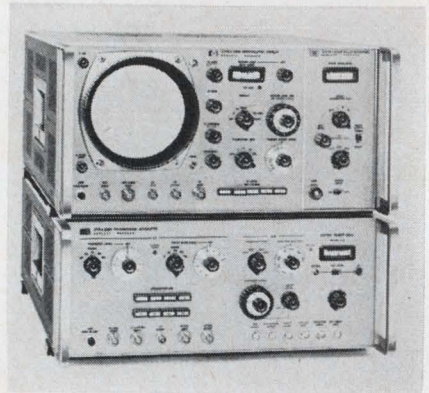

**Compact.** Two equipment cabinets house Hewlett-Packard's test set.

How'd you like to drill carbon plates 6 times faster? Pinpoint accuracy—even for unskilled operators with the new multi-spindle

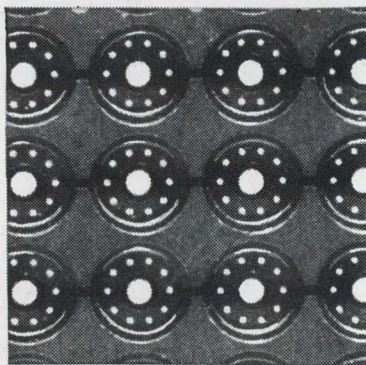

## Engravograph<sup>®</sup>

Speed transistor mounting! Now anyone can drill six carbon plates in one operation from one template with registration and depth of hole controlled to a plus-or-minus .001" tolerance.

Drill up to 1600 holes per minute. Save time, labor... and especially costs.

For details write: Dept. 175.

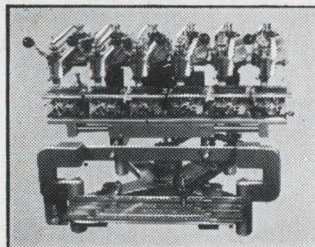

*new hermes engraving machine corp.*



20 Cooper Sq., N.Y., N.Y. 10003 • Chicago, Atlanta, Los Angeles, Dallas, Montreal, Toronto, Mexico City

systems it exports. Some of the sets, however, are used by Nippon Electric to test systems in its own factories. Anritsu's other customers include such Japanese communications-equipment manufacturers as Fujitsu Ltd., Hitachi Ltd., and the Mitsubishi Electric Corp.

**Domestic.** Like Anritsu's set, Hewlett-Packard's unit is modular. Made up of a transmission generator, a demodulator display, and a group-delay detector, the American-made set is designed for use with 75-ohm systems that use the internationally agreed-upon intermediate frequency of 70 megahertz.

Hewlett-Packard's unit generates test signals to drive the communications system and evaluate performance, with both meter and cathode-ray display. Signals can be introduced at the transmitting terminal's baseband input and measured at the receiver terminal's baseband output, or introduced at the i-f level anywhere in the system and evaluated at the i-f level elsewhere, or introduced and evaluated at any combination of i-f and baseband inputs and outputs.

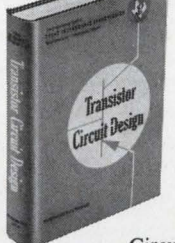

# Special Introductory Offer to new members of the electronics and control engineers' book club

 <p><b>Pub. Price \$11.95</b> <b>Club Price \$10.15</b></p> <p>Engineers' Relay Handbook by the National Association of Relay Manufacturers. Code #171</p>	 <p><b>Pub. Price \$18.00</b> <b>Club Price \$15.30</b></p> <p>Pulse, Digital, and Switching Waveforms by J. Millman and H. Taub. Code #381</p>
 <p><b>Pub. Price \$26.50</b> <b>Club Price \$18.95</b></p> <p>Antenna Engineering Handbook by Henry Jasik. Code #290</p>	 <p><b>Pub. Price \$7.00</b> <b>Club Price \$5.95</b></p> <p>Mathematics for Electronics with Applications by H. M. Nodelman. Code #850</p>
 <p><b>Pub. Price \$16.75</b> <b>Club Price \$14.25</b></p> <p>Electronic and Radio Engineering by F. E. Terman. Code #509</p>	 <p><b>Pub. Price \$15.00</b> <b>Club Price \$12.75</b></p> <p>Transistor Circuit Design by the Engineering Staff of Texas Instruments, Inc. Code #737</p>

## TAKE ANY ONE

# FOR ONLY \$1<sup>00</sup>

VALUES FROM \$7.00 TO \$29.50

**Special \$1.00 bonus book comes to you with your first club selection**

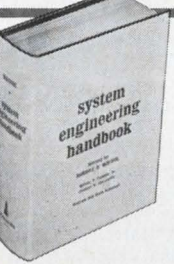
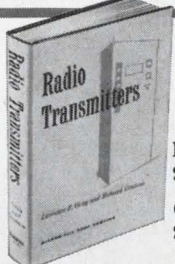
 <p><b>Pub. Price \$29.50</b> <b>Club Price \$25.00</b></p> <p>System Engineering Handbook edited by R. E. Machol. Code #371</p>	 <p><b>Pub. Price \$14.00</b> <b>Club Price \$11.90</b></p> <p>Radio Transmitters by L. Gray and R. Graham. Code #240</p>
---	--

### SAVE TIME AND MONEY BY JOINING THE electronics and control engineers' book club

Here is a professional club designed specifically to meet your day-to-day engineering needs by providing practical books in your field on a regular basis at below publisher prices.

**HOW THE CLUB OPERATES.** Basic to the Club's service is its publication, the *Electronics and Control Engineers' Book Club Bulletin*, which brings you news of books in your field. Sent to members without cost, it announces and describes in detail the Club's featured book of the month as well as alternate selections which are available at special members' prices.

When you want to examine the Club's feature of the month, you do nothing. The book will be mailed to you as a regular part of your Club service. If you prefer one of the alternate selections — or if you want no book at all for that month — you notify the Club by returning the convenient card enclosed with each *Bulletin*.

As a Club member, you agree only to the purchase of four books over a two-year period. Considering the many books published annually in your field, there will surely be at least four that you would want to own anyway. By joining the Club, you save both money and the trouble of searching for the best books.

### MAIL THIS COUPON TODAY

**electronics and control engineers' book club**  
582 PRINCETON ROAD  
HIGHTSTOWN, N. J. 08520

Please enroll me as a member of the Electronics and Control Engineers' Book Club and send me the two books indicated below. You will bill me for my first selection at the special Club price and \$1 for my new membership book, plus local tax where applicable, and a few additional cents for delivery costs. These books are to be shipped on approval, and I may return them both without cost or further obligation. If I decide to keep the books, I agree to purchase as few as four additional books during the next two years at special Club prices (approximately 15% below list).

Write Code # of your \$1 bonus book

Write Code # of your first selection



NAME \_\_\_\_\_  
 ADDRESS \_\_\_\_\_  
 CITY \_\_\_\_\_  
 STATE \_\_\_\_\_ ZIP \_\_\_\_\_  
 COMPANY \_\_\_\_\_

(This offer good in United States only) E33040



## New Instruments Review

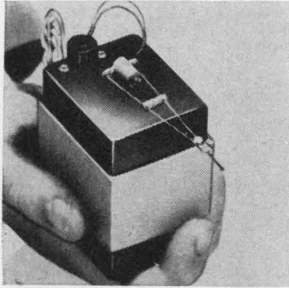

A compact galvanometer pen motor has a sensitivity of 10 mv/mm of stylus deflection and input impedance of 100,000 ohms. It contains an adjustable frequency network incorporating a separate winding for velocity sensing and feedback. The IC pen motors are suited for fields using technical recording equipment. Techni-Rite Electronics, 65 Centerville Rd., Warwick, R.I. 02886. [361]

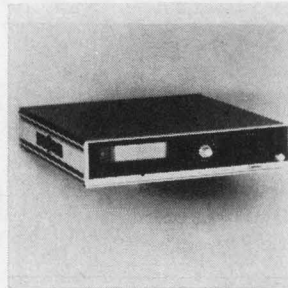

Programable picoammeter model ME-910 is an analog device capable of measuring currents from 3 picoamps to 10 ma full scale with accuracy from  $\pm 2\%$  to  $\pm 0.2\%$ . It features silicon solid state design, automatic polarity indication, and remote control of range selection, thus suiting it for systems integration. Price is \$1,375. EG&G Inc., Box 1912, Las Vegas, Nev. 89101. [362]

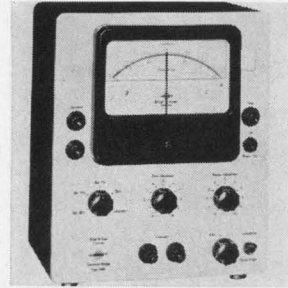

Deviation test bridges series 1500 offer measurement accuracy to 0.03%. Up to 3,600 operations/hr have been reached in production testing. Four models can measure: resistance, 1 ohm to 30 megohms; capacitance, 20  $\mu\text{f}$  to 2,000  $\mu\text{f}$ ; inductance 20  $\mu\text{h}$  to 2,000 henrys; frequency, 100 hz to 100 khz. B&K Instruments Inc., 5111 W. 164th St., Cleveland, Ohio 44142. [363]

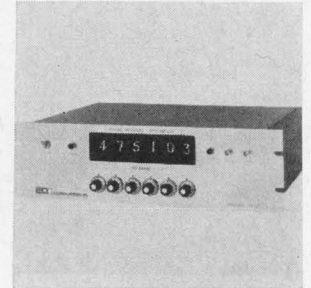

Pulse interval generator 5650 develops a start, and then a stop pulse separated by a digitally controlled time interval, and displays the interval generated on Nixie tubes. Having a stable, internal, 1-Mhz crystal-controlled oscillator, it can generate intervals of 10  $\mu\text{sec}$  to  $10^6 \mu\text{sec}$  with 1- $\mu\text{sec}$  resolution. Electronic Counters Inc., 235 Jackson St., Englewood, N.J. 07631. [364]

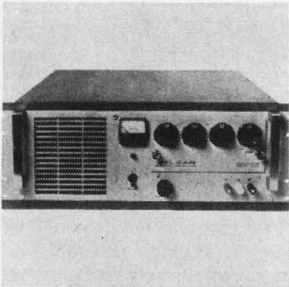

Solid state power source model 500 delivers 0 to 500 v-a, single phase. Maximum operational flexibility is ensured through a family of more than 40 interchangeable plug-in oscillator modules. They offer fixed or variable output frequencies from 45 hz to 5 khz. Accuracies range from  $\pm 0.1\%$  to  $\pm 0.0001\%$ . Elgar Corp., 8046 Engineer Rd., San Diego, Calif. 92111. [365]

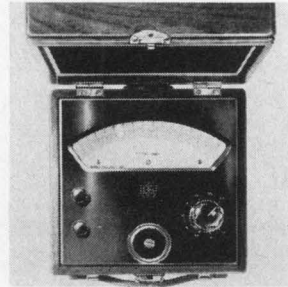

A voltammeter with 0.25% accuracy and 10,000 ohms-per-volt sensitivity is offered with up to 21 independent scales ranging from 1  $\mu\text{a}$  to 1 amp and 0.3 v to 1,000 v full scale. Basic meter movement features a light beam pointer that eliminates parallax error while providing a resolution capability of better than 0.1%. Filmohm Corp., 315 North Ave., New Rochelle, N.Y. 10801. [366]

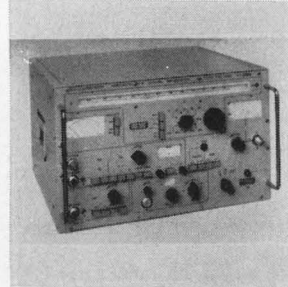

Frequency synthesizer FSM500 generates a spectral pure frequency from 300 hz to 470 Mhz and offers complete modulation capabilities. In combination with the type FS30, which is used as the driver, a generated signal accuracy to 3 parts in  $10^9$  per day is produced. The FS30 costs \$5,250; the FSM500, \$4,925. E. F. Associates Inc., Box 361, Scotch Plains, N.J. 07076. [367]

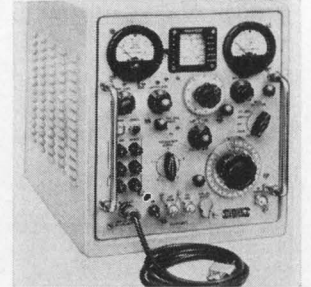

Vhf signal generator SG-44 is not only for use in aligning receivers and measuring their sensitivity and selectivity, but also for test and calibration of a broad range of r-f/vhf components, networks, and circuits. It covers 10 to 420 Mhz in 5 bands with a calibration accuracy of  $\pm 0.5\%$  of full range. Winslow Teletronics Inc., 1005 First Ave., Asbury Park, N.J. 07712. [368]

### New instruments

## Everyman's test set for semiconductors

Modular system designed for small-volume work;  
first module probes field effect transistors

About two years ago, Siliconix Inc.'s equipment division introduced a field-effect-transistor test system called the Monitor II. Developed for the semiconductor company's own production needs, the system performs a wide range of tests and offers plug-in capabilities

for data-logging and wafer-probe operations.

But Siliconix soon found that in small-volume testing for failure analysis, quality control and circuit design, the Monitor II was too much machine. At an average cost of \$14,000 it was not only over-

qualified but too expensive.

Using a similar circuit design and following the modular concept of the Monitor II, division engineers designed a simpler semiconductor test set, smaller than a bench-model oscilloscope, which Siliconix has now used in-house for many months. Because of its broad potential capabilities and price, the division is now putting it on the market, designating it the SI-200 series.

The portable system, designed for small-signal, medium-power field-effect, bipolar, and unijunction transistors, and low-power diodes, is capable of such critical



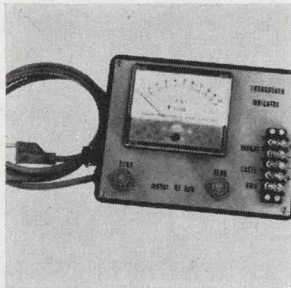

Transducer indicator GT-403, operating from 115-v 50/60-hz power, includes a zener regulated power supply delivering a fixed 5-v d-c excitation into a 350-ohm bridge. Having an input impedance greater than 30,000 ohms, the unit operates with transducers having resistances from 120 through 1,000 ohms. General Transducer Co., 2961 Corvin Dr., Santa Clara, Calif. 95051. [369]

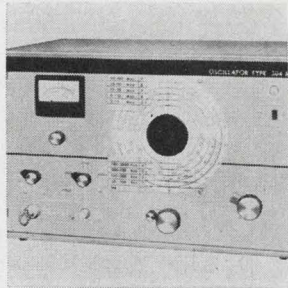

High-power oscillator 304A features stable dual outputs over a 9-band range from 50 khz to 100 Mhz. High-level output of 10 v across 50 ohms can be increased to 12.2 v below 25 Mhz and is stable within  $\pm 0.5$  and  $-1$  db limits. Variable output is continuously adjustable from 40  $\mu$ v to 5 v. Winslow Tele-tronics Inc., 1005 1st Ave., Asbury Park, N.J. 07712. [370]

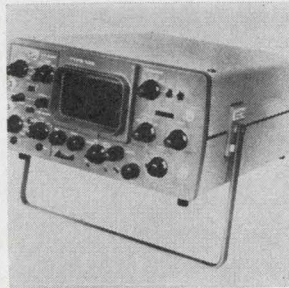

Double-beam oscilloscope EM102, employing silicon and integrated devices, with modular Y amplifiers, operates on either a-c or batteries. Plug-in units from d-c to 15 Mhz are available. The instrument provides variable sweep delay and affords the user the facility of differential measurements. S. E. Laboratories (Engineering) Ltd., Feltham, Middlesex, England. [371]

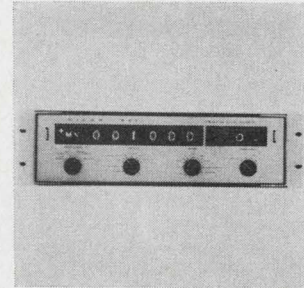

Integrating dvm 521 has full-scale ranges of 10 mv, 100 mv, 1 v, 10 v, 100 v, and 1,000 v. The 10-mv range provides resolution of 1  $\mu$ v at up to 40 readings/sec. Readings accurate to  $\pm 0.01\%$  full scale  $\pm 0.004\%$  of reading  $\pm 1 \mu$ v are visible on a 6-digit display. The unit is suited for use in data acquisition systems. Vidar Corp., 77 Ortega Ave., Mtn. View, Calif. 94040. [372]

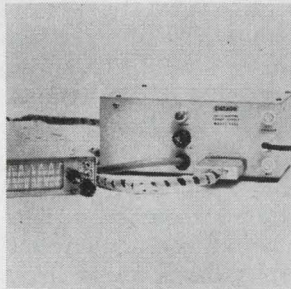

A single-channel scope system utilizes a model 7200 power supply, which may be used with any of 5 scope modules. The modules use 1- x 3-in. crt's and occupy 1 $\frac{3}{8}$  x 4 $\frac{1}{2}$  in. of viewing and control area. Response is from d-c to 10 Mhz, with vertical sensitivity of 0.1 to 10 v rms/in. in 7 calibrated steps. California Instruments Corp., 3511 Midway Dr., San Diego, Calif. 92110. [373]



Sweep signal generator VS-20 covers the audio and video bands. Tunable frequency range is 500 hz to 25 Mhz with a center frequency adjustment consisting of a 300 to 1 and a 1 to 1 ratio. Sweep width is continuously adjustable over the range. The unit has a 1-v rms output and flatness of  $\pm 0.25$  db. Price is \$1,095. Texscan Corp., 2446 N. Shadeland Ave., Indianapolis, Ind. 46219. [374]

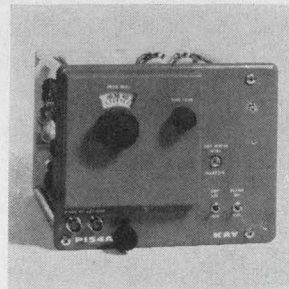

Sweep generator plug-in PC154A is a solid state, beat oscillator with a broad-band output amplifier and a voltage-controlled electronic sweep modulator. It can cover in a single sweep from the low video frequencies to beyond the f-m tuner frequencies or in any portion down to 100 hz of residual. Kay Electric Co., Maple Ave., Pine Brook, N.J. 07058. [375]

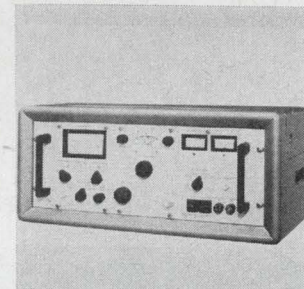

Modular f-m signal generator series 1000 offers a selection of r-f, video and metering plug-in units. Ten r-f plug-in units cover 20 Mhz to 2.4 Ghz in tunable bands. F-m peak deviation is up to 1,000 khz; modulation, from d-c to 2 Mhz; metered carrier shift, internal 1 and 10 khz tones. New London Instrument Co., 153 California St., Newton, Mass. 02158. [376]

tests as picoampere d-c, differential, high-frequency a-c, and measuring capacitance.

The basic unit, the SI-200, an aluminum case containing nine different power supplies, a taut-band meter readout, and appropriate solid state circuitry, costs \$960. The first module, the SI-201 FET tester, costs \$1,335.

**FET's first.** "The SI-200 will accept any plug-in module," says Fred S. Thurmond, division sales manager, "but we developed the FET module first for our own use." On the drawing board are bipolar and high-current pulsed modules.

Siliconix says it has no competi-

tion in its price range. There is a FET tester on the market whose basic unit cost is about \$600. But Thurmond says that to make tests comparable to the 200-201 combination would require about another \$3,700 worth of modules. The reason is that the 200 performs basic types of tests for the 201 FET module, whereas competitive units use a different module for each type of test.

"With the 200 basic unit a circuit designer can keep up with the state of the art by designing his test modules as he needs them," Thurmond says. To help him along, Siliconix offers an SI-000 blank test



Function plug-in. Module for field-effect-transistor tests fits into unit housing power supplies and readout.



# Electrical/Electronic Engineers

## Design/Analysis/Test

**LOCKHEED**  
MISSILES & SPACE COMPANY  
A GROUP DIVISION OF LOCKHEED AIRCRAFT CORPORATION

• BSEE, plus  
• appropriate  
• experience in any of  
• the following areas:

• Communications  
• Computer Software  
• AGE Systems  
• Field Engineering  
• Circuits/Systems  
• Electro-optics  
• Microwaves  
• Power Systems  
• Propulsion  
• Instrumentation  
• Guidance & Controls  
• Batteries

• For complete  
• information, write  
• Mr. R. C. Birdsall,  
• Professional  
• Employment  
• Manager, P.O. Box  
• 504, Sunnyvale,  
• California. An equal  
• opportunity  
• employer.

Circle 261 on reader service card

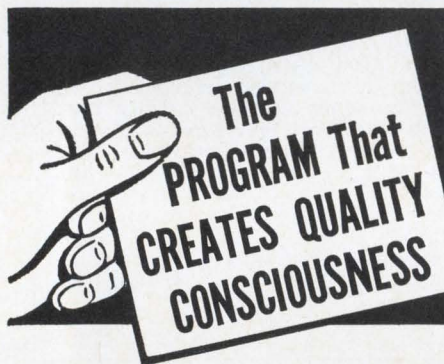

## ELLIOTT Q/R SERVICE

This unique visual program achieves remarkable results. It motivates the individual to do his part to improve quality and reliability. Sparks enthusiasm and cooperation in your quality program. Regularly used by top companies throughout U.S. and Canada.

**FREE  
COMPRE-  
HENSIVE  
SAMPLE  
KIT**

Ask For It  
on Your  
Letterhead

**ELLIOTT SERVICE COMPANY, INC.**  
Dept. Q, 30 N. MacQuesten Parkway  
Mount Vernon, New York 10550

# GRC®

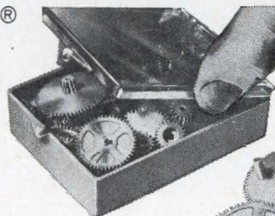

die cast  
ZINC ALLOY

**DIE CAST  
ZINC ALLOY  
GEAR KIT  
FOR SMALL  
GEAR USERS**

molded  
PLASTICS

Coil Bobbins  
Gears & Pinions

Get this useful assortment for your design work. Die cast by GRC's exclusive automatic techniques, these one-piece gear and pinion combinations offer unique assembly and cost advantages. Many gear and pinion combinations from stock. **SMALL GEARS TO SPECS:** Send prints for prompt quotes on gears and other small parts, die-cast or plastic molded. **NO MINIMUM SIZE!**

**Write for Gear Kit, Gear Stock List and Designers' Aids on Your Letterhead**

**GRIES**

**GRIES REPRODUCER CO.**

Div. of Coats & Clark Inc. World's Foremost Producer of Small Die Castings

151 Beechwood Ave., New Rochelle, N. Y. • (914) 633-8600

## ... in-house instrument goes to market ...

module, a plug-in chassis with a blank circuit card.

The basic unit includes two pulsed power supplies, ranging from 0 to 100 volts at 100 milliamperes to 1 ampere, that can be digitally programed in 10-millivolt steps. Also included are the following power supplies: 30 volts at 10 milliamperes; +15 volts at 300 milliamperes and -15 volts at 300 milliamperes for amplifiers; +24 volts at 0.5 ampere for a relay driver; +5 volts at 0.5 ampere for an integrated-circuit logic supply, and two unregulated supplies, +40 volts and -40 volts at 0.25 ampere.

**High resolution.** Because each module will contain all the d-c excitation and detection circuits as well as the test socket, the system can perform a variety of tests with high accuracy. For example, the FET module gives direct-reading full-scale leakage measurements of 100 picoamps with 2 picoamps resolution. Other sample direct readings are: drain current at 1 kilohertz; gate-source breakdown voltage to 300 volts; drain current from 100 picoamps to 30 milliamperes full scale, and gate-source voltage to  $\pm 30$  volts under operating conditions. Accuracies vary from 1.5 to 3%. Indirect measurement of ic resistance can be easily set up.

Thurmond expects the SI-200 series to sell better than the Monitor II because "we're first in that market." The series is another example of Siliconix's effort to exploit in-house tools for outside sales. However, outside sales of such items as the Monitor II, the series 200, or the contact printer [Electronics, July 10, 1967, p. 171] don't necessarily mean that Thurmond's 50-man Equipment division is going into broad-base production.

"We're charged first with providing the FET production facility with devices it needs," Thurmond says, "but if as a result of work done there we find we have a marketable product, we can go out and sell it."

The SI-200 with SI-201 module weighs 30 pounds and measures 7½ inches high, 18 long and 17 wide.

Siliconix Inc., 1140 W. Evelyn Ave., Sunnyvale, Calif. [377]



The Hughes/NASA Syncom stands still at 6875 mph to talk to a billion people.

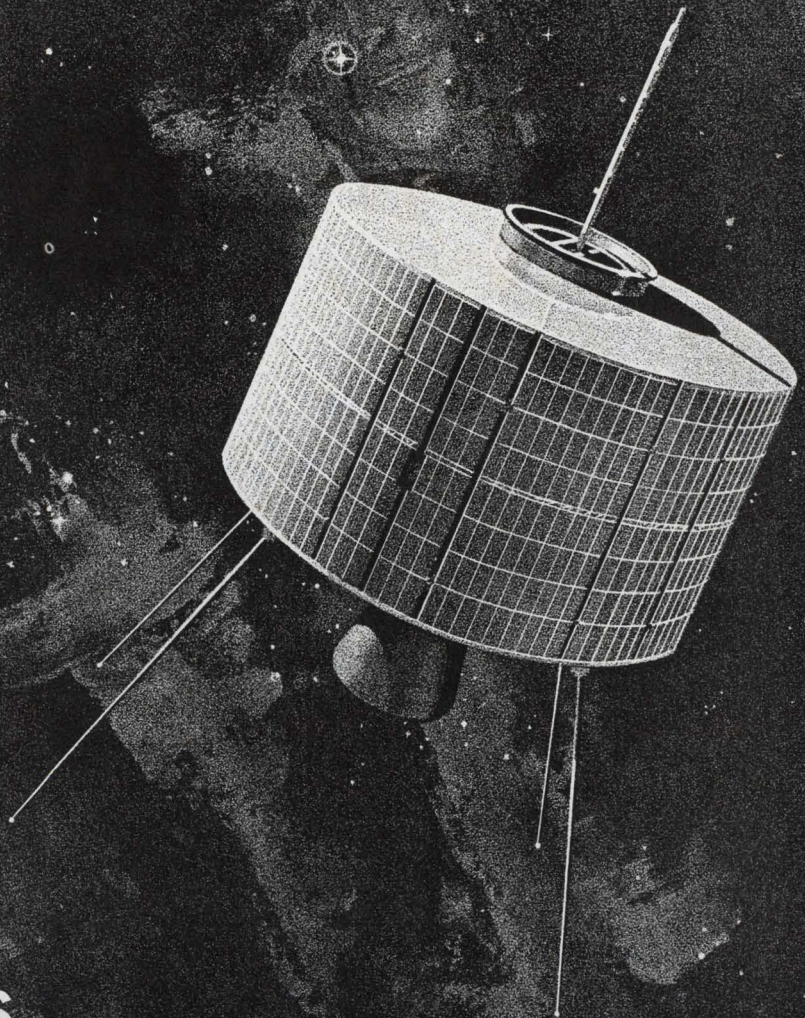

## **CIRCUIT DESIGNERS... is your appointment in space with Hughes?**

Today, Hughes is one of the nation's most active aerospace/electronics firms: Projects include: F-111B PHOENIX Guided Missile System, TOW Anti-Tank Missile System, Communication Satellites, ATS-Advanced Technology Satellites, VATE, Hard Point Defense and others.

This vigor will assist the qualified engineers and scientists towards more and better opportunities for both professional and personal growth.

Many immediate openings exist. The engineers selected for these positions will be assigned to the following design tasks: the development of high power airborne radar

transmitters, the design of which involves use of the most advanced components; the design of low noise radar receivers using parametric amplifiers; solid state masers and other advanced microwave components; radar data processing circuit design, including range and speed trackers, crystal filter circuitry and a variety of display circuits; high efficiency power supplies for airborne and space electronic systems; telemetering and command circuits for space vehicles, timing, control and display circuits for the Hughes COLIDAR (Coherent Light Detection and Ranging).

If you are interested and believe that you can contribute, make your appointment today.

For immediate consideration, please airmail your resume to:

**Mr. Robert A. Martin**  
**Head of Employment, Dept. 61**  
**Hughes Aerospace Divisions**  
**11940 W. Jefferson Blvd.**  
**Culver City, California 90230**

*Creating a new world with electronics*

**HUGHES**

HUGHES AIRCRAFT COMPANY

**AEROSPACE DIVISIONS**

An equal opportunity employer.

U.S. CITIZENSHIP REQUIRED



**Compact electronics package?**

**COOL  
IT...**

...with a small size, long life, high output AiResearch fan.

Garrett-AiResearch special purpose fans are individually designed and custom built to deliver more flow and greater pressure rise with a minimum envelope size.

Take a typical AiResearch small size fan: computer-optimized for required performance under all operating environments; our own motor, engineered and manufactured for a perfect match to its fan; and up to 40 percent more airflow than any other ventilating fan of similar input, size, and weight.

Next time you need a ventilating fan for a very special airborne or ground electronics enclosure specify AiResearch. Available for high temperature and cryogenic applications, with flow rates and power requirements as specified. AiResearch Manufacturing Division, Torrance Facility, 2525 190th Street, Torrance, California 90509.

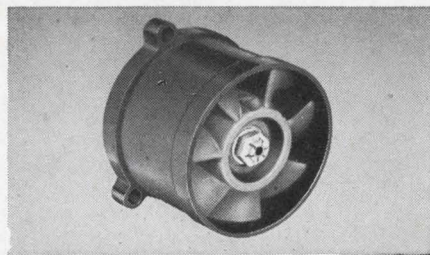
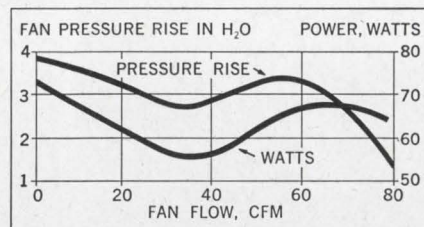

**AIRESEARCH  
SPECIAL PURPOSE  
FANS**



**New instruments**

**Saying sayonara to U.S. testers**

First Japanese-made IC probe is similar to those built in U.S.

When it comes to testing integrated circuits, Japan has completely depended on the U.S. Of the 50 or so automated IC testers now used, all are American-made. But this dependence may come to an end with the introduction of the first Japanese-made computerized machine—the Tokyo Shibaura Electric Co.'s (Toshiba) model 1200A.

Toshiba says the 1200A costs less and is more versatile than the Fairchild 4000M, the most widely used tester in Japan. Basic price of the new machine is about \$43,000; the maximum configuration, including data logger, multiplexer, and five test heads, sells for about \$83,000. The Fairchild machine, a custom-made unit, sells for \$70,000.

"This is like comparing apples with oranges," says a spokesman at Fairchild Camera & Instrument Corp.'s Instrumentation division. "Toshiba is comparing its new machine to our old one." According to Fairchild, a new tester called the 4000W will be a fixed-cost unit like Toshiba's and this will sell for \$48,000.

Unlike Fairchild's newer 4000W, which uses resistor-transistor logic (RTL), Toshiba's 1200A uses diode-transistor logic (DTL). Noise margin of the circuits in the 1200A is about 750 millivolts, against about 300 millivolts in the Fairchild tester.

**Big difference.** Unlike the Fairchild unit, Toshiba's tester can add as well as divide by a fixed number. Fairchild says this isn't needed.

Drum memory on the Toshiba tester stores up to 600 tests and operates at a speed of 60 tests per second. The company is working on an improved model having a memory capacity of 900 tests and a speed of 200 tests per second.

Tokyo Shibaura Electric Co., Tokyo [378]

**FOR Cable Ties**

Think **GC**



Tie into greater production, bigger profits... with GC Government-Accepted Cable Ties.

Choose from nylon or plastic in sizes from 4 1/4" to 12", all color coded with GC patented "Snap-In" button terminals. All available in stock for immediate shipment. Remember too, on special cable problems, check with GC... we're tooled to save you time and money.

Write today on your Company letterhead for the big **FREE GC Electronic Components Catalog** — **FREE!** FR-66-1... it's your pass book to greater production and profits.



**GC Electronics**  
400 South Wyman Street  
Rockford, Ill. 61101  
A Division of GC-Hydrometals, Inc.  
Shipping warehouses in: Hicksville, L.I., N.Y. Los Angeles, California



Circle 264 on reader service card

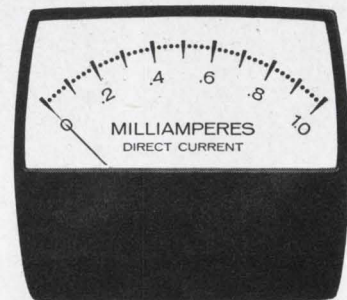

1 1/2 in. AM-1 (actual size)

**Distinctively Styled high torque, self-shielded panel meters**

Smart, sophisticated styling... easy reading scale... sizes 1 1/2 to 4 1/2". Rugged, high torque mechanism offers 1% linearity, 2% accuracy and sensitivity to 20 ua. Completely shielded to eliminate error from magnetic panels. Mounts bezel-to-bezel on any material without interaction or effect on calibration. Choice of colors or finishes, custom dials — ASA/MIL 4-stud mounting.

**AMMON**  
AMMON INSTRUMENTS, INC.  
345 Kelley St., Manchester, N.H. 03105

Circle 263 on reader service card



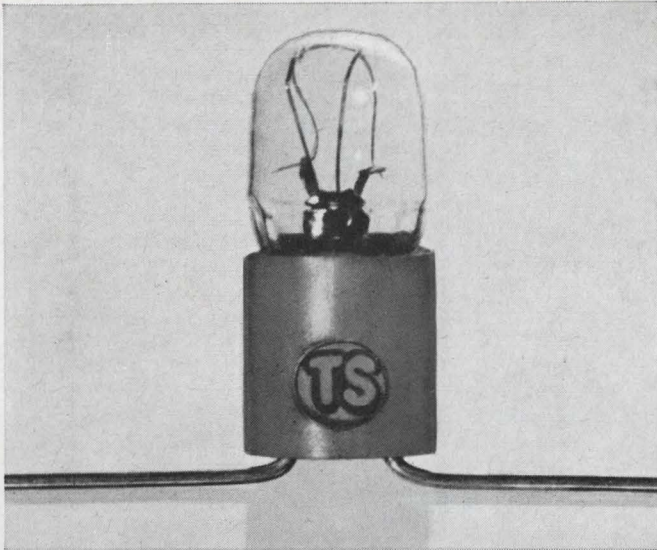

## Mounting Flexibility

Tung-Sol Molded Base Subminiature Lamps provide mounting flexibility not possible with the usual cemented-on base and socket installation. Lead wires can be bent sharply at the base without harm to the assembly. Because they are self-mounting, any computer type circuit board provides a fully adequate mount. No more installation is required than with transistors. And like transistors, Tung-Sol Molded Base Lamps may be installed with automated equipment.

The popular Tu-Pin lamp has wide application for instrumentation lighting. For special requirements, the molded nylon base can be formed in a wide variety of configurations. Also, special harnessing can be supplied to customers' specifications. Write for more information about how the flexibility of Tung-Sol Molded Base Lamps can effect economies in the assembly of your equipment. Tung-Sol Division, Wagner Electric Corporation, One Summer Ave., Newark, N.J. 07104.

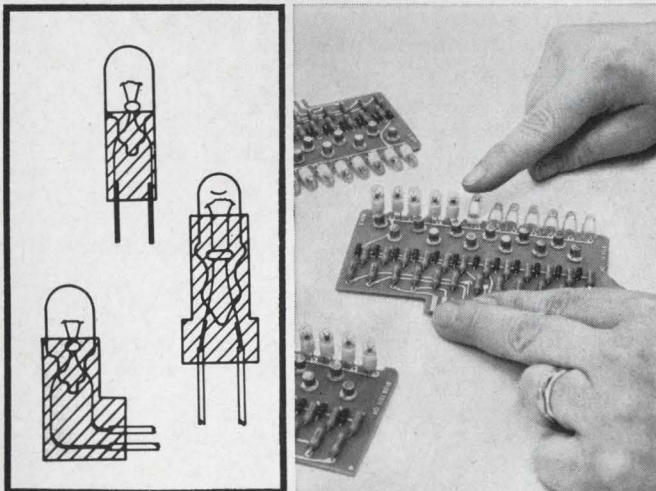

Molded bases can be designed to meet customers' specifications.

Computer circuit board assembly demonstrates mounting flexibility of Tung-Sol Tu-Pin lamps.

# TUNG-SOL®

**MOLDED BASE SUBMINIATURE LAMPS**

Circle 290 on reader service card

# When Only Excellent is Adequate TURN to Grayhill

## for MINIATURE PUSH BUTTON SWITCHES

- WIPING, SNAP ACTION and BUTT CONTACTS.
- SPST, SPDT, DPST, DPDT.
- PUSH-PULL – LIGHTED.
- 25,000 to 1,000,000 OPERATIONS.

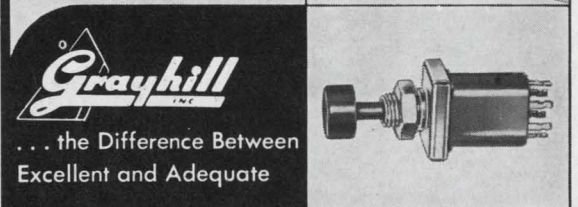
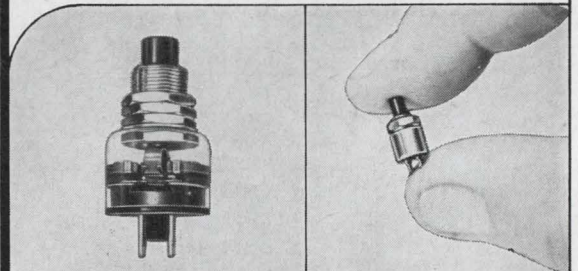

### Select Materials

- Contacts — Fine Silver
- Springs — Tinned Music Wire
- Housing — Molded Phenolic per MIL-M-14
- Shorting Bar & Terminals — Fine Silver or Silver Plated Copper Alloy

### Typical Specifications

- ¼ Amp. to 10 Amps., 115 VAC Resistive
- Contact Resistance 10 Milliohms
- Insulation Resistance — 25,000 to 900,000 Megohms

All fully described in Engineering Catalog G-304-A



Write



523 Hillgrove Avenue  
LaGrange, Illinois 60525  
Area Code 312, Phone 354-1040

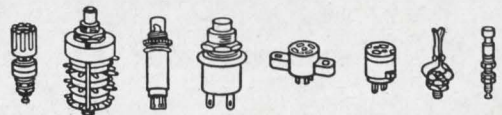

"PIONEERS IN MINIATURIZATION"

Circle 205 on reader service card

205



# To turn off rejects of 3rd generation circuits:

# Turn on Barnstead's New Micro-Cleaner

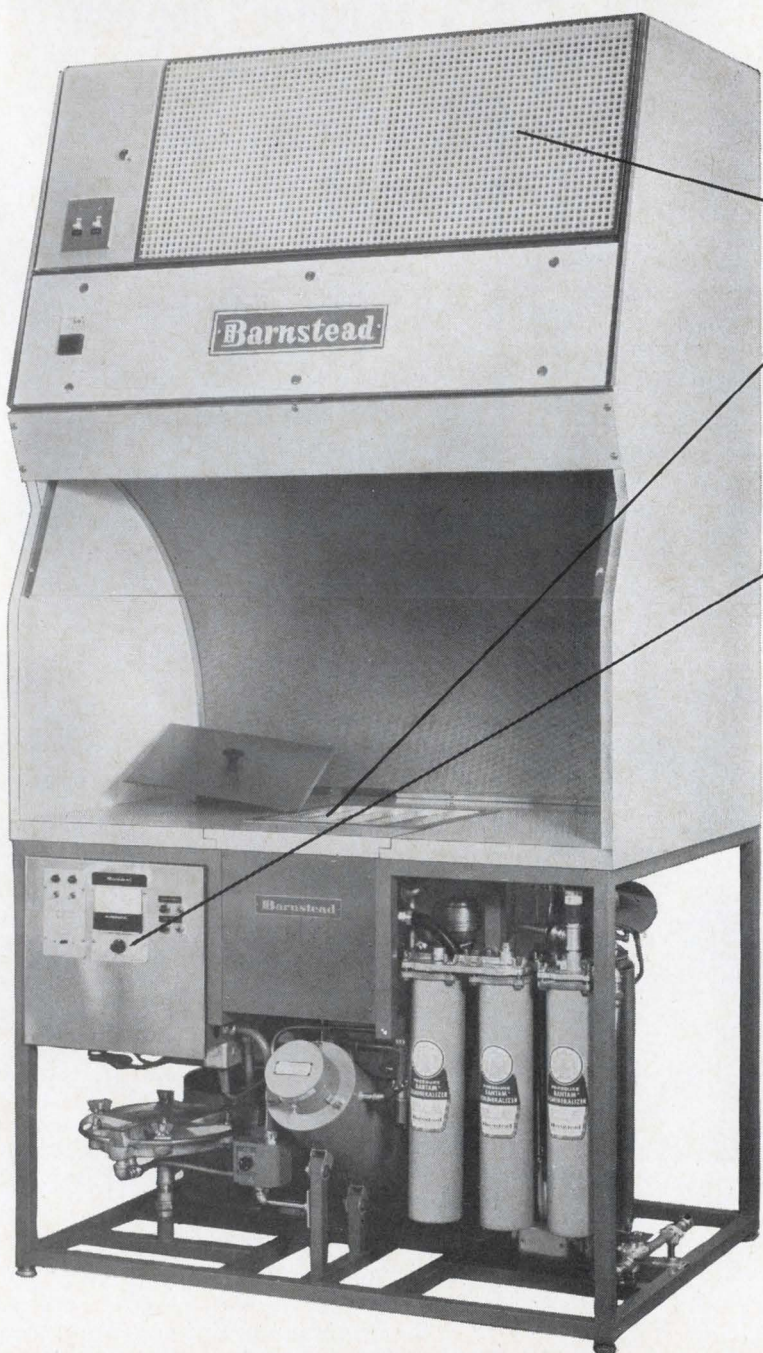

*Positive-pressure hood keeps work area free of airborne contaminants, with absolute air filter; quiet, spark-free blower. Meets or exceeds applicable MIL SPECS.*

*Five hot, cascading pure water rinses in tinlined monel tanks do a thorough cleaning job. Final rinse, measuring 18 megohms/cm @ 25°C and free of organics, gases, biologicals — is much purer than demineralized water.*

*Purity meter checks quality of rinse water, both "upstream" and "downstream" from final rinse.*

*To make a few gallons do the work of thousands, water is continuously recirculated, repurified. System includes . . .*

*Demineralizer. Automatic still. Organic removal bed. 0.1 micron particle filter. Sump, protected by ultraviolet unit, Ventgard® air filter. Regenerative heat exchanger. Cuts electrical load by more than 50%.*

*There's no better way to make microcircuits come clean!*

*Barnstead's new microelectric cleaning station provides an ultra-pure final rinse — in a totally clean environment — at minimum cost.*

*Write for Bulletin 211, describing this 3rd generation cleaning station.*

**Barnstead**

Subsidiary of Ritter Pfaudler Corp.  
225 Rivermoor Street  
Boston, Massachusetts 02131



## New Production Equipment Review

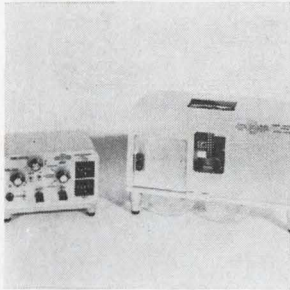

Automatic core handler Ramsey CH-30 moves large ferrite cores through a test position and then deposits each tested core into either an accept or reject receptacle, depending upon the decision of associated signal-analysis equipment. Cores 0.080 in. to 0.500 in. o-d can be handled at rates up to 100/minute. Computer Test Corp., 3 Computer Dr., Cherry Hill, N.J. 08034. [421]

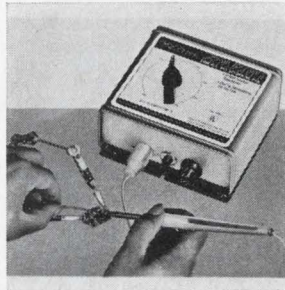

Isolated, low-voltage soldering station model 6970 eliminates damage caused by current leakage at the soldering tip. The transformer steps down and isolates the 120-v a-c line current from the 12-v a-c soldering pen. A tip temperature range of 400° to 900° F is selected by dial. Eldon Industries Inc., 2701 W. El Segundo Blvd., Hawthorne, Calif. 90252. [422]

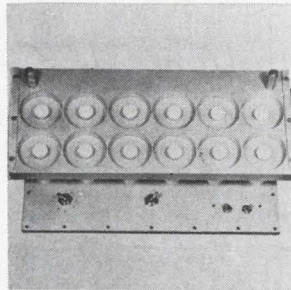

Photoresist spinners model SR3 are for use in the manufacture of semiconductor devices, IC's, and thin-film circuitry. They come in 4, 8, and 12 spindle units, all handling wafers up to 2 $\frac{7}{8}$ -in. diameter,  $\frac{1}{8}$ -in. thick. An automatic reset interval timer provides spin cycles up to 60 sec at speeds to 10,000 rpm. K Square Corp., Pennwood and Lamar, Pittsburgh, Pa. [423]

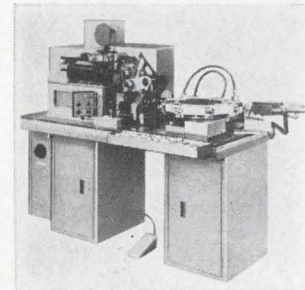

Fully automatic machine model RT winds all types of random wound bobbin coils and single layer solenoids. Wire sizes wound are 14 to 40 depending on coil specifications. Winding range is 8 to 840 turns-per-layer, and winding speeds are up to 3,500 rpm, depending on coil characteristics. Geo. Stevens Mfg. Co., 6001 N. Keystone Ave., Chicago 60646. [424]

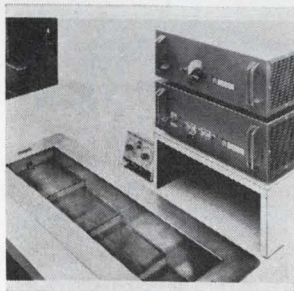

Cascade ultrasonic cleaners are for use with deionized water and most common cleaning chemicals and solvents. The cascade flow virtually eliminates drag-out contaminants. The equipment is available with any number of tanks. Sizes range from 1 to 10 gallons/tank. Two frequencies are available: 25 or 45 khz. Delta Sonics Inc., 12918 Cerise Ave., Hawthorne, Calif. 90250. [425]



Model SS-18-6 Solder sucker facilitates removing excess solder from circuit boards, plated-through holes, etc. Consisting of a miniature iron to melt the solder, and an attached suction bulb and a reservoir for the removed solder, it has a built-in stand to rest on the bench between operations. Telvac Instrument Co., 18531 Ventura Blvd., Tarzana, Calif. 91356. [426]

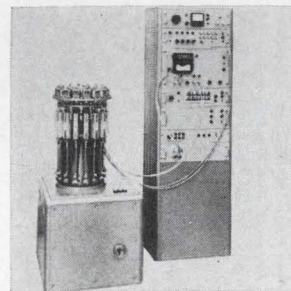

An automatic sorter for mica plates or chip capacitors will feed stacked units from magazines, test and sort them, and restack them in magazines at the rate of 3,000 per hour according to high voltage flash, 10 capacitance groups and dissipation factor. Price is approximately \$12,000 depending on options. B. Freudenberg Inc., 50 Rockefeller Plaza, New York 10028. [427]

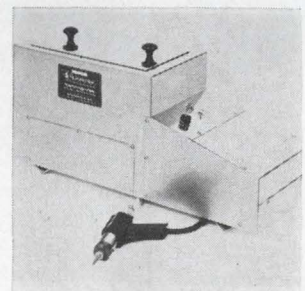

Hot melt system X84300 includes a 2 $\frac{1}{2}$  gallon supply tank, high pressure positive action pump, internally heated hose and a heated hand gun. It is designed for encapsulating, potting, or other manual electronic assembly operations where high speed application of hot melt adhesives is desired. Price is under \$2,500. Spraymation Inc., 52 Sindle Ave., Little Falls, N.J. 07424. [428]

### New production equipment

## How to stretch the etchant

Attachment for printed circuit board production line regenerates solution to keep concentration constant

"To make etching with cupric chloride economical, we've got to be able to automatically control the process without beating ourselves to death," says Richard Erwin, a sales engineer for Chemlea Corp. He feels his company's new etchant regeneration system can do this job

for mass producers of printed circuits.

The most commonly used technique for making printed circuits begins when copper foil is bonded to nonconductive plates. Circuit outlines are traced with etchant-resistant material over the copper, and

the plates are passed through an etching spray or bath that removes the unprotected metal. As copper dissolves, the etching solution weakens and etch rate decreases.

To keep the pieces uniform, an operator controls etching time, usually by changing the speed of a conveyor belt. A continuing problem is how to dispose of the used etching solution.

**Better days.** Cupric chloride, despite better etching qualities has not been popular. Because it's polluted with dissolved copper more quickly than other etchants, such as ferric chloride, larger quantities are needed. Chemlea sees better





**Now  
Easy  
Replacement  
of  
Relays**

with



**Methode**



Methode's **NEW** relay connectors are specifically designed for use with plug-in relays, and are available in a full range of sizes and types to meet military specifications. They are made to fit all types of relays (crystal can, military, power and numerous others) and can be mounted in a variety of convenient ways. All types of termination are available: crimp, solder pockets or dip solder. All available from stock.



Send for illustrated catalog with full technical data. Write to:



Connector Division

**Methode  
Electronics, Inc.**

7447 W. Wilson Ave., Chicago, Illinois 60656  
312/867-9600

**... dissolved copper  
can be reclaimed ...**

cupric chloride. The new system automatically keeps the etchant concentration constant. This means a constant etch rate without an operator. The system regenerates the etching solution, so smaller quantities are used.

"You don't have the expense of etchant storage tanks," Erwin points out. And the waste from the regenerator-assisted process contains enough dissolved copper to make reclaiming of the metal economically desirable.

The Chemlea unit can be attached to most bath and spray etchers. The company says it is applicable in 75% of the etching done for printed circuits.

The system operates in four steps: analysis of the etching solution, chemical injection, dilution, and drainage. A cell detects the amount of dissolved copper in the etching solution. When the level reaches an eighth of an ounce per gallon, the sensing cell turns on a system that releases chemicals into the solution. The chemicals react with the copper to form fresh etchant. When copper concentration drops to a set level, the cell turns off the injector. This process is the key to the Chemlea system.

"We know when to inject, how much, and when to stop," says Erwin.

A specific gravity float controls a water injection system that keeps etchant concentration constant. Another float keeps the solution volume constant by turning an overflow system on and off.

**How much.** Two units, differing only in capacities, are the basis of the system. The units are the same size, 12 x 36 x 42 inches. One can support an etcher that is dissolving 120 ounces of etched copper per hour. The other handles 300 ounces. The units, in any combination, operate in parallel for larger capacity etchers.

The system is leased, price being based on the number of units used. Rental for each small-capacity unit is \$330 per month plus \$1 per hour of use. The price goes up to \$380 and \$2.20 for the larger unit.

Chemlea Corp., 500 Science Park Rd., State College, Pa. 16801 [429]

**Ultra-small  
Lamps!**

Long life and reliability.

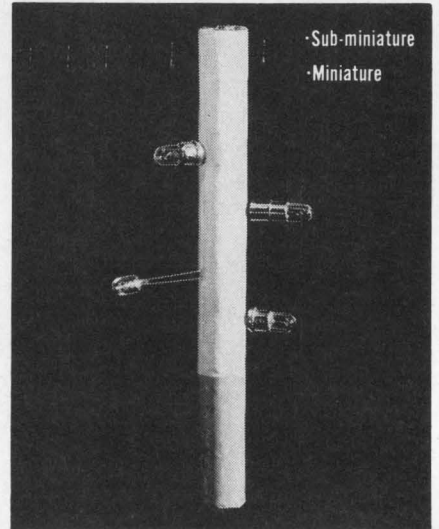

•Sub-miniature  
•Miniature



**OKAYA ELECTRIC  
INDUSTRIES CO., LTD.**

Yasuda Bldg., 8-3, 1-chome, Shibuya  
Shibuya-ku, Tokyo, Japan

Circle 265 on reader service card

**ECONOMICAL Thin Film!**

Resistor-Module and Discrete Resistor Plate-ohm have been developed by SUSUMU's unique thin-film techniques. The ideal resistor for your purposes!

HIGH RELIABILITY and LOW NOISE CHARACTERISTICS from SUSUMU's evaporation techniques.  
LESS EXPENSIVE as carbon resistor due to SUSUMU's fine engineering.  
ADVANTAGEOUS for your printed circuit wiring, with high-density assembling.  
EXCELLENT T.C.R., applicable in range of  $-100 \text{ ppm}/^{\circ}\text{C} \sim +100 \text{ ppm}/^{\circ}\text{C}$ .

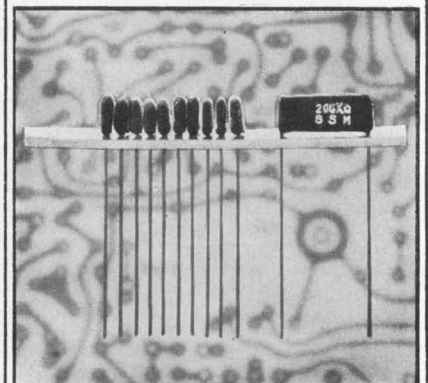

Specialists in Vacuum Evaporation:

**SUSUMU INDUSTRIAL CO., LTD.**

HEAD OFFICE AND EXPORT DEPT.:  
6 Shanouchi, Chudoji, Shimogyo-ku, Kyoto, Japan  
Phone: Kyoto 075 (311) 4459 Cable address: SUSUMU KYOTO  
FACTORIES: KYOTO, NAGASHINO  
TELEX NO. 5422-359



mighty

# minitokins

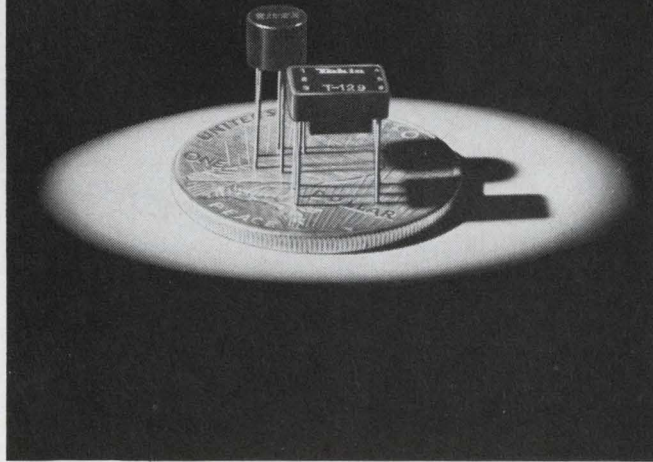

On Tokin miniature pulse transformers, everything's been minimized but power. There are none smaller-sized, lighter-weight, nor lower-priced. Even under extreme conditions of humidity or temperature, effects on Tokin mini-transformers are next to nil. Yet these tiny Tokins have tremendous transmitting power. Power to drive a memory matrix.

The power-source is Tokin itself. Tokin takes its advanced techniques, rigid quality controls and long experience in making complete memory systems, and applies them to the manufacture of Tokin miniature pulse-transformers: real reliability from the largest manufacturer of memory cores, planes, stacks, and everything to do with magnetic materials, in Japan.

Whether it's minikins or matrix that you're after, remember: Tokin memory systems are, start-to-finish, totally Tokin.



Tohoku Metal Industries, Ltd.

4, 7-chome, Ginza-Higashi, Chuo-ku, Tokyo, Japan  
Tel: Tokyo 542-6171 Cable Address: TOHOKUMETAL TOKYO

Circle 269 on reader service card

"Pour It On"

With



High

# WORKPOWER CAVITIES

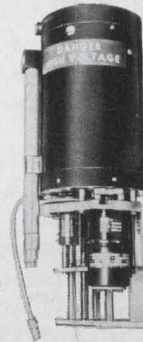

Up to 125 KW Output

- Tunable from 30-1350 MHz.
- Input VSWR, 2:1 or better.
- Gang tuning available.
- Input and output coupling matched over entire range on most units.
- No neutralizing.
- Servo tuned models available.
- Temperature stable.
- Optimum cooling.
- MIL Spec design.

## OPERATING CHARACTERISTICS

MODEL	FREQ. RANGE MHz	OPERATION	POWER OUTPUT	SERVICE
11023	40-200	Class B	1.0 KW	CW Amp.
11022	230	Class C	15 KW Peak	Pulse Amp.
11024	30-200	Class B	0.1 KW	CW Amp.
11050	150	Class C	30 KW	Pulse Osc.
11051	150	Class C	125 KW	Pulse Amp.
11055	200-400	Class B lin.	1.0 KW	CW Amp.
11006	225-400	Class B lin.	.12 KW	CW Amp.
11009*	225-400	Class C	1.2 KW Peak	Pulse Amp.
11010*	225-400	Class B lin.	.12 KW	CW Amp.
11012	225-400	Class B lin.	2.5 KW	CW Amp.
11018	280-315	Class B	1.0 KW	CW Amp.
11029	360-480	Class B	.15 KW	CW Amp.
11030	360-480	Class B	1.5 KW	CW Amp.
11056	375	Class B	0.1 KW	CW Amp.
11057	375	Class B	1.4 KW	CW Amp.
11001	400-450	Class B lin.	2.5 KW	CW Amp.
11031	400-800	Class C	15 KW	Pulse Amp.
11019	400-800	Class B lin.	1.0 KW	CW Amp.
11004	410-460	Class C	14 KW	Pulse Amp.
11005	410-460	Class C	2.5 KW	Pulse Osc.
11205	420	Class C	35 KW	Pulse Osc.
11046	800-1000	Class B	1.0 KW	CW Amp.
11011	1250-1350	Class C	10 KW Peak	Pulse Amp.

\*Servo-tuned

MCL's High Power Tetrode Cavity design techniques are exemplified by these units currently in operation in various systems. Also available in MCL's "Add-on" Systems complete with power supply, cooling and sequential circuitry.

Modifications to other frequencies and pulse operations are possible.

Send for MCL CATALOG

## MICROWAVE CAVITY

LABORATORIES, Inc.

10 North Beach Avenue  
La Grange, Illinois 60525

Phone: (312) 354-4350

Western Union Telex 25-3608



Circle 209 on reader service card

209



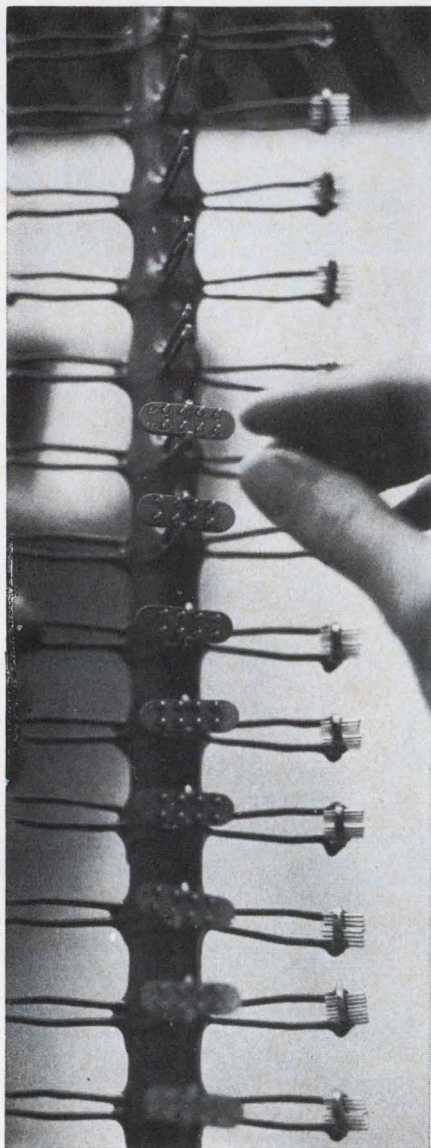

## Pick a header... standard or custom

Then call Atlas—where reliability is a reality—whether you need custom headers to your drawings or any of more than 150 configurations of single-pin terminals for off-the-shelf delivery.

At Atlas a tape-programmed, six-head drilling machine reduces tooling time and total cost. An electron-beam welder bonds delicate parts with precision. And Helium Mass Spectrometers check for possible leakage.

In-house facilities such as these make it possible for us to manufacture and test to your specifications or MIL specs. For you that means unmatched quality and reliability. Challenge us today. Phone 215 666-0700. Or send for complete information.

# ATLAS

CHEMICAL INDUSTRIES, INC.  
Aerospace Components Division  
Valley Forge, Pa. 19481

New production equipment

## This stripper is a fast changer

Machine sets up quickly  
to cut and strip varying  
lengths and sizes of wire

It takes less than a minute to set up an automatic wire-stripping machine developed by the Artos Engineering Co. It takes an additional minute to change the amount of stripping being done, and a maximum of five minutes to change blades to accommodate different kinds of insulation or wire.

"It'll shine where you have small lots," says Robert Dusel, an engineer who helped develop the equipment. Called the CS-16, the machine is designed for makers of wiring harnesses, particularly those who have to cut and strip leads made of the same wire and insulation but in varying lengths. "We're not pushing this machine for special jobs involving exotic insulating materials and wire configurations," says Dusel.

**On the fly.** The desired length is set on a dial at the front of the machine, and the wire is belt-fed to the cutting and stripping blades. Lengths from 1¾ inches up to 30 feet can be cut, and changes in length can be made while the machine is running. One or both ends can be stripped from ¼ to ⅝ inch.

The CS-16 can handle any kind

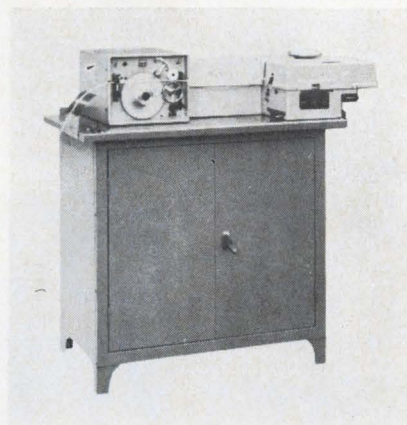

Triple action. Shown mounted on a bench, the CS-16 measures, cuts, and strips wire in a continuous, automatic operation.

another  
breakthrough  
from  
**FRANKLIN  
ELECTRONICS**

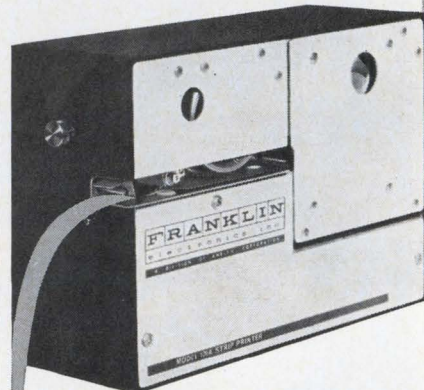

## the Model 120A STRIP PRINTER

- Full alpha-numeric font of 64 characters and numerals.
- 1200 characters per minute.
- Serial entry.
- Impact printing with inked roller option.
- 8⅝" D x 3" W x 6¼" H.
- Less than 5 lbs.
- Front paper exit.
- Less than \$300 w/o electronics, \$500 with.
- Franklin reliability!

SEND FOR  
ENG. DATA 3010

**FRANKLIN**  
electronics, inc.

East Fourth St. • Bridgeport, Pa. 19405  
A Subsidiary of Mohawk Data Sciences Corp.



What is  
the latest  
In Electronics?  
Come and see how men,  
ideas and  
techniques  
have advanced  
in a year.



Be  
present  
at the

# INTERNATIONAL EXHIBITIONS OF ELECTRONIC COMPONENTS AND OF AUDIO-EQUIPMENT

FROM APRIL 1st TO 6th 1968 - PARIS  
PORTE DE VERSAILLES



# INTERNATIONAL CONFERENCE ON COLOUR TELEVISION

scientific and technical considerations  
FROM MARCH 25<sup>th</sup> TO 29<sup>th</sup> 1968 - PARIS

Programme and registration conditions on request

S.D.S.A. - RELATIONS EXTERIEURES  
16, RUE DE PRESLES - 75 PARIS 15<sup>e</sup> - FRANCE

Official air-lines of the Exhibition call for information : AIR-FRANCE

## If You're Still Using A V.T.V.M. It's Time To Change ... Go Solid-State!

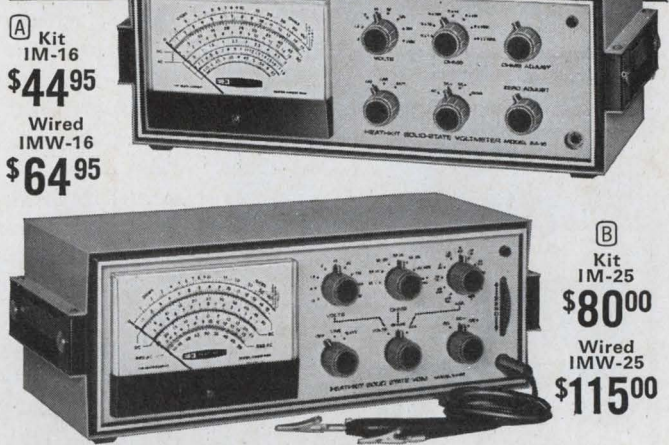

**A** Kit IM-16  
**\$44.95**  
Wired IMW-16  
**\$64.95**

**B** Kit IM-25  
**\$80.00**  
Wired IMW-25  
**\$115.00**

### These New Heathkit® Solid-State Meters Feature State-Of-The-Art Performance At Prices You Can Afford

- Modern, stable, long-life solid-state circuitry
- New low-voltage ranges to accurately analyze modern transistor circuits
- Full capability to go "out on the job" . . . instant selection of internal battery power or 120/240 v. 50-60 Hz AC operation
- Exceptional accuracy . . . 3% on DC volts, plus a large, easy-to-read 6" meter face
- High impedance F.E.T. input for minimum circuit loading

**A** **New! Deluxe Solid-State Volt-Ohm Meter**  
Features 8 DC and 8 AC voltage ranges from 0.5 v to 1500 v full scale; 7 ohmmeter ranges (10 ohms center scale) x1, x10, x100, x1k, x10k, x100k, & x1 megohm; 11 megohm input on DC ranges; 1 megohm on AC ranges; internal battery or 120/240 v 50-60 Hz AC power for portable or "in shop" use; large readable-across-the-bench 6" meter; separate switches for individual functions; single test probe for all measurements; modern, stable solid-state circuit-board construction.

Kit IM-16, 10 lbs. . . . . \$44.95; Wired IMW-16, 10 lbs. . . . . \$64.95

**B** **New! Deluxe Solid-State Volt-Ohm-Milliammeter**  
All silicon transistors plus FET's. Features 9 AC and 9 DC voltage ranges from 150 mV to 1500 volts full scale; 7 ohmmeter ranges (10 ohms center scale) x1, x10, x100, x1k, x10k, x100k, & x1 megohm; 11 current ranges from 15 uA to 1.5 Amperes full scale; 11 megohm input on DC voltage ranges; 10 megohm input on AC voltage ranges; internal battery power or 120/240 v 50-60 Hz AC power for maximum versatility; easily readable 6" meter face; ±3% accuracy on DC volts; ±4% on DC current; ±5% accuracy on AC voltage and current; separate range switches "human engineered" for efficiency in actual use; modern circuit board construction; all solid-state components; easy to assemble.

Kit IM-25, 10 lbs. . . . . \$80.00  
Wired IMW-25, 10 lbs. . . . . \$115.00

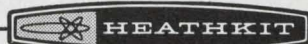

**HEATH COMPANY**,  
Benton Harbor, Mich. 49022 Dept. 520-28  
In Canada, Daystrom Ltd.

Please send my FREE 1968 Heathkit Catalog.  
 Enclosed is \$ \_\_\_\_\_, plus postage.  
Please send model(s) \_\_\_\_\_

Name \_\_\_\_\_  
Address \_\_\_\_\_  
City \_\_\_\_\_ State \_\_\_\_\_ Zip \_\_\_\_\_  
Prices & Specifications subject to change without notice. TE-165R



## The Material of Unlimited Uses...

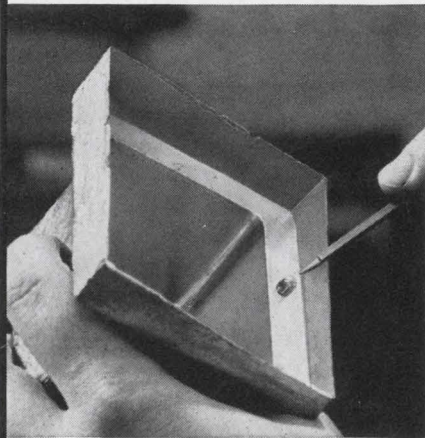

### INSTANT DIP-A-MOLD

In seconds, you can make perfect molds, like this one, for potting any encapsulation, and make them economically, with low-melting CERRO® Alloys. Just dip the master in molten alloy. A thin coating of alloy clings to the pattern. Withdraw the pattern, and you have a perfect high fidelity mold. When the encapsulating plastic cures, simply remove the CERRO Alloy. Use it over and over again, almost without limit.

This particular alloy—CERROTRU®—does not shrink, slips easily from the pattern without parting or contaminating compounds or coatings. Because of its low melting point, it is safe and easy to handle.

You can reproduce such unusual details as positioning lugs for transformer cases, as shown above, without the use of cores, inserts or secondary operations.

Instant molding is just one of the many uses for CERRO Alloys. To find out more, contact Cerro Copper & Brass Co., Cerro Alloy Dept., Stamford, Conn. 06907... R. S. Darnell (203) 327-0550.

# CERRO®

of industrial wire in sizes from 14 to 22 gauge. Different kinds of insulation require the use of different blades, but the company says there are few insulation materials that the machine can't strip. "It even works on Teflon and wax-coated materials," notes Dusel.

Multiconductor leads such as hookup wire can be stripped if the conductors aren't twisted. So can a group of insulated, rectangular-shaped wires with a common insulating cover so long as the orientation of the wire is constant.

**Steady feed.** The belt feed runs at a constant rate of a little more than 20 feet per minute; the blades are triggered by a solid state switching network. "Continuous feeds are admittedly more susceptible to inaccuracies than mechanical grab units, but this machine can meet normal industrial requirements," Dusel says.

Tolerances vary with length of cut and type of insulation. For small lengths insulated with polyvinyl chloride, tolerance is  $\pm\frac{1}{32}$  inch; for longer leads, it can be as high as  $\pm\frac{1}{8}$  inch.

The CS-16 can be mounted on a bench top. It weighs 200 pounds, occupies an area 2 by 4 feet, and is priced at \$2,500. Delivery time is three to four months.

Artos Engineering Co, New Berlin, Wis.  
[430]

New production equipment

### One-stop service for wash 'n' dry

Single station combines  
ultrasonic scrubbing  
and clean-air drying

**Ultrasonic cleaning** may well be one of the best methods of degreasing and scrubbing tools, parts, and assemblies. But its effectiveness is limited by the drying operation. Until now, the parts were usually air-sprayed or merely left to dry in free air. Either way, dust or oily film—carried by the air gun or in the ambient air itself—col-

### FOR SPECIAL-PURPOSE ELECTRON TUBES...

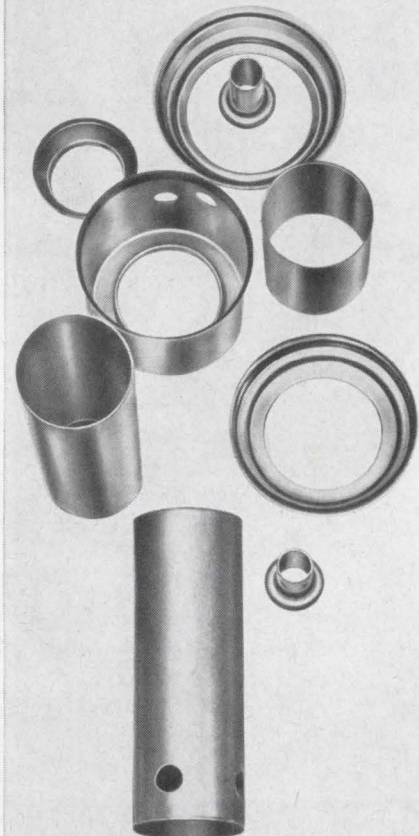

## Draw deep on our capabilities

Give us your specifications for special-purpose electron tube parts. Vidicons, orthicons and pencil tubes, for fiber optics, infrared and similar applications.

We'll match them up with our depth of deep-draw know-how, and our high-production transfer presses.

Draw deep on our capabilities to tool and produce the precision parts you need—to your specifications, on time, and at the lowest possible cost. Call or write today.

## Volkert STAMPINGS, INC.

Subsidiary of The Stanley Works

222-35 96th Avenue  
Queens Village, L.I., N.Y. 11429  
Telephone 212-464-8400



## SAN-EI Recording Systems to meet your special requirements

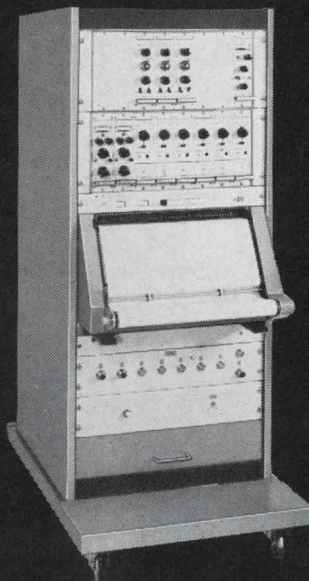

**Amplifiers:**  
High sensitive  
DC amplifier 6L1-P  
Medium sensitive  
DC amplifier 6L2-P  
Carrier strain  
amplifier 6L4

**Adaptors:**  
Strain adaptor  
for DC bridge  
method 1701  
DC voltage cancel  
adaptor 1901

**Oscillographs:**  
Curvilinear  
or Rectilinear

## Ink-writing Oscillograph Table for Original Equipment Manufacturers



Number of Channels: 8~18  
Sensitivity: 10mm/0.5V (with built-in amplifiers)  
Frequency Response: DC~100Hz,  $\pm 10\%$   
Recording Chart Speeds: 0.75, 1.5, 3, 6cm/s (others to order)



For further information, please write to:

**SAN-EI INSTRUMENT CO., LTD.**

Specialist in the field of oscillograph

1-89 Kashiwagi, Shinjuku-ku, Tokyo, Japan Cable: "SANEIINSTRUMENT" Tokyo

## Big performance in small space

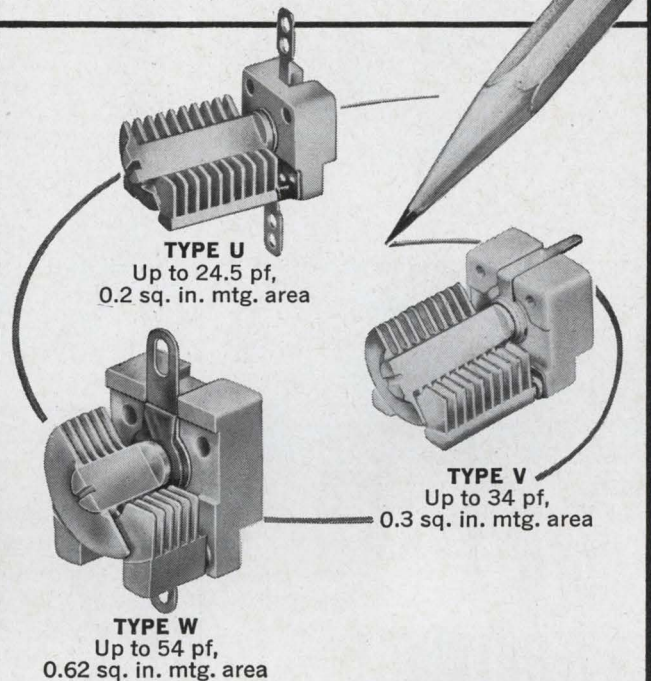

### Johnson increases U capacitor plate area, keeps same overall dimensions

Sub-miniature Type U capacitors now provide 28% more capacitance in the same compact package that takes less than 0.2 square inches of mounting area. Type V miniature and Type W capacitors, available in higher capacities, are also unusually compact.

Unique Johnson milling technique permits machining each rotor and stator from a single piece of solid brass. This provides exceptional uniformity and stability, both mechanically and electrically. "Q" is greater than 1500 at 1 MHz. Temperature coefficients are typically plus  $45 \pm 15$  PPM/ $^{\circ}$ C. Breakdown ratings 650 volts DC.

Johnson Type U, V, and W capacitors are available from stock in a wide range of sizes. Type U single section in PC, panel, or two-hole mounting. Type U butterfly and differential in PC mounting. U-LC tuners in PC or panel. Type V and Type W single section in PC or panel mounting.

**FREE CATALOG** includes complete information on these and other Johnson quality electronic components. See your Johnson representative or write for your copy today.



**E. F. JOHNSON COMPANY**

3017 Tenth Ave. S.W., Waseca, Minn. 56093

Providing nearly a half-century of communications leadership



The Material  
of Unlimited Uses...

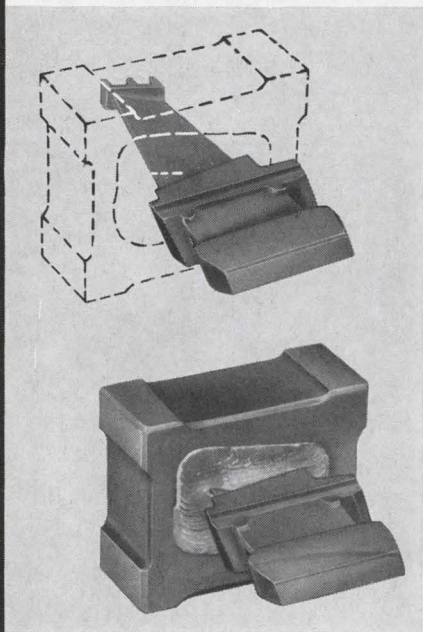

## HOLD EVERYTHING!

Low melting temperatures and the controllable expansion/contraction characteristics of CERRO® Alloys make them ideal casting media for all types of workholding devices. They are also used to provide support for thin sections, such as in turbine blades, during machining (see illustration).

Special chucking devices for odd shapes, workholders & nests for feeds and assembly tables, investment of finned and thin-sectioned workpieces are only a few of the holding applications performed by the versatile family of CERRO metals. Removal of the alloy is readily accomplished by steam or a hot water bath and the metal can be re-used again and again.

For complete technical information on all Cerro low-melting Alloys, write to Cerro Copper & Brass Co., Cerro Alloy Dept., Stamford, Conn. 06907... R. S. Darnell (203) 327-0550.

# CERRO®



**Quick service.** Electronic parts come clean at compact work center.

lected, sometimes in sufficient quantities to play havoc with sensitive electronic parts.

Clean Room Products Inc. of Farmingdale, N. Y., however, has come up with a wash and almost-dustless drying system under a single hood. A pressurized flow of filtered air, with dust particles smaller than 0.3 micron, dries the parts in a few seconds.

The wash-and-dry station includes a spray nozzle and three tanks—all containing solvents, but only the first and third having ultrasonic generator units that produce uniform cavitation. Any solvent or water-based cleaning solution can be used, including detergents, acids, and alkalines.

**Laundry baskets.** In one application—for cleaning contacts of sub-miniature relays at Deutsch Filters—the first tank has Freon TWD-602 for removing inorganic substances; the second, a vapor solvent for degreasing; and the last, Freon TF for removing organics. Parts are placed in baskets, which are moved from one tank to another, and then solvent-sprayed.

Solvent loss is less than a pint a day for about a 10-gallon volume in the three tanks. Prices of a three-tank station—with blower, ultrasonic generators, pumps, and operation controls—range from \$5,250 to \$5,500.

Clean Room Products Inc., 55 Central Ave., Farmingdale, N. Y. 11735 [431]

## GIANNINI on sensors

*"There are many ways to measure frequency. This one was shown in my Father's high school text book:*



Today, we do it electrically in less than two cubic inches, for you to use in your airplanes and other flying machines. The range: 50 Hz to 3600 Hz.

We also make *voltage* sensors, 25 millivolts to 440 volts AC and DC.

# E

**I** Current sensors ranging from 2.5 milliamperes to 250 amperes DC and to 500 amperes AC.

*Phase* sequence or open phase detectors for systems up to 400 volts.

# ∅

**T** Time interval sensors from fifty milliseconds to minutes, hours, or days.

If you write us your needs or simply your name and address, we will mail you our data sheet, unless you are in a real rush, in which case please phone us at (213) 685-6261. Ask for Duane Manning?

*Gabriel M. Giannini*

## Giannini

P.O. Box A-A, Irvine, California 92664 • (714) 540-9010  
Plants in Whittier, Costa Mesa and San Diego  
An Independent Company/An Equal Opportunity Employer



## DRAMATIC REDUCTION

formerly 77" h. x 33" w. x 33" d.

now only

29" h x 17" w x 17" d

( 5 KW Audio  
Power Amplifier )

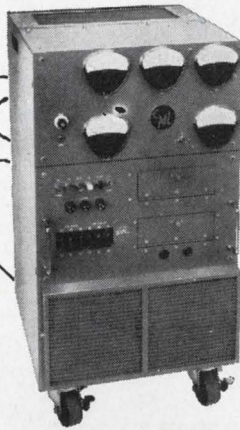

All other models similarly reduced... (but in size only!) For instance, 10 KW Model, formerly 78" h. x 78" w. x 36" d., now only 48" h. x 34" w. x 24" d. CML Audio Power Amplifiers produce tremendous power in the smallest packages. Wide frequency range. Low distortion. Ideal for CW and pulsed operation,

acoustic testing, vibration testing, plasma tubes, ion propulsion engines. Perfect for marine installations. All units with wide range of output impedance taps. Air-cooled and vapor-cooled units. Full power available into low power factor loads. Call or write today for details.

**CML, Inc.**

A subsidiary of Tenney Engineering, Inc.  
350 Leland Avenue • Plainfield, New Jersey  
(201) 754-5502 • TWX: 201-756-2064



Circle 275 on reader service card

# Just right for two-way radio!

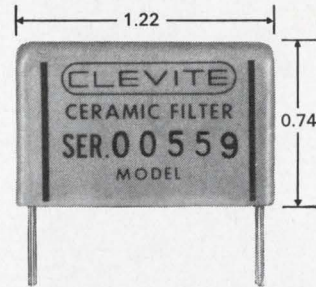

## Clevite's computer-designed TCF ceramic filter.

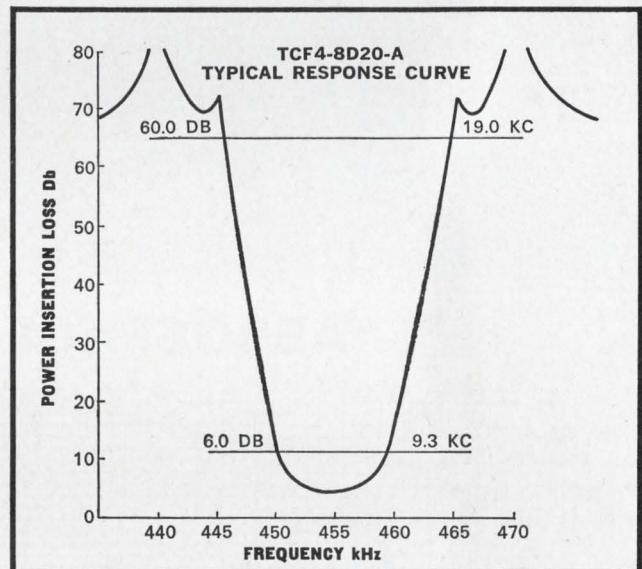

**TCF — a hybrid combination of a tuned transformer and ceramic resonators . . . in less than 0.6 cu. in.!**

The TCF is made specifically for CB, mobile, aircraft and marine radios; combines the input advantages of a tuned transformer with the stability and high performance of a ceramic filter. Result: manufacturers of quality AM receiving equipment get greater selectivity at a lower cost. TCF filters are completely free of unwanted responses, and input impedances are suitable for both transistor and vacuum tube circuits.

TCF4-8D20A	B/W	Insertion Loss	Impedance	
			In	Out
Center Freq: 455± 1kHz	@ 6db	8db max.	40K ohms	1.5K ohms
Temp. Stability: less than 800 Hz variation	@ 60db			
— 20 to + 60° C	20kHz max.			

**PRICES:** 1—\$15 ea; 25—\$10 ea; 100—\$8.50 ea; 500—\$6.75 ea; 1000—\$6.00 ea; 2500—\$5.45 ea.

(Prices subject to change without notice)

(Models also available in 6db bandwidths of 4, 12, 18, 30 and 35 kHz.)

Send order or request for Bulletin 94026 to: Clevite Corporation, Piezoelectric Division, 232 Forbes Rd., Bedford, Ohio 44146, U.S.A. Or: Brush Clevite Company, Ltd., Southampton, England.

# CLEVITE

## DC~5MHz 20mV/cm MODEL 557A 5" OSCILLOSCOPE

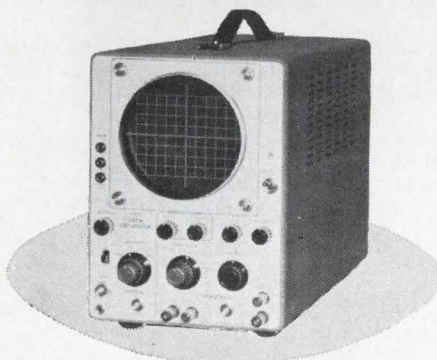

### VERTICAL AXIS

Deflection Sensitivity 20mV/cm, AC & DC  
Frequency Response  
AC: 2Hz~5MHz within -3dB  
DC: 0~5MHz within -3dB  
Input Impedance 1MΩ, shunted by 30pF  
TIME AXIS  
Sweep Frequency TV-H, 10Hz~100KHz (4 ranges) & Line Sweep

### HORIZONTAL AXIS

Deflection Sensitivity 300mV/cm  
Frequency Response 2Hz~500KHz, within -3dB  
Calibration Voltage 0.05V, 0.5V, 5V-p-p Square Wave  
CRT: 5UP1F  
Dimensions 200W x 300H x 445Dmm  
Net Weight 10 kg approx.



# kikusui

KIKUSUI ELECTRONICS CORP.

3-1175, SHINMARUKO-HIGASHI, KAWASAKI-CITY,

KANAGAWA-PREF., JAPAN.

CABLE ADDRESS "KIKUSUIDE" KAWASAKI



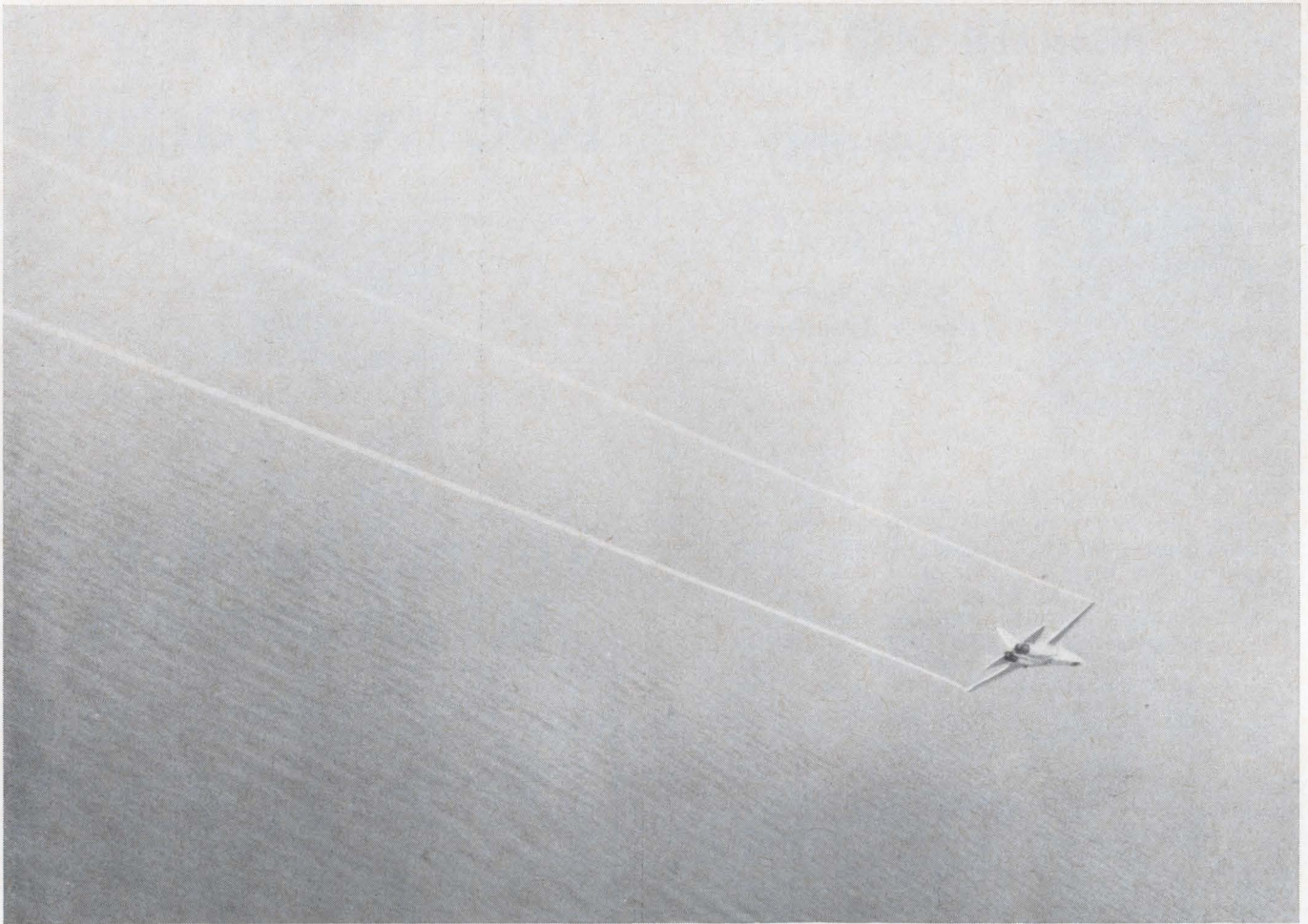

## AEROSPACE TECHNOLOGY

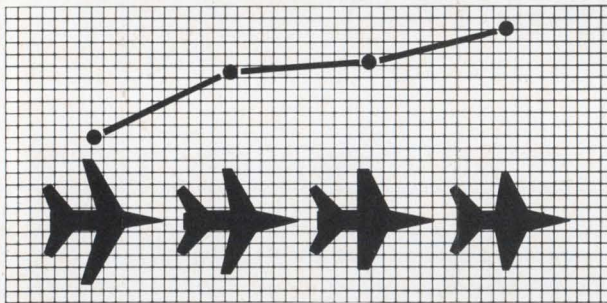

At the Fort Worth Division of General Dynamics, **Aerospace Technology** is exploring the shape, structure, and motion of aircraft and spacecraft in relation to environments of the vehicles within which they travel. The key tools used are both theoretical and experimental.

**The Aerodynamics Section** performs analyses of the external aerodynamics and performance capabilities of current and advanced aircraft, provides guidance in the configuration definition, and conducts aerospace vehicle studies entailing flight path analysis, mission planning, and the parametric synthesis of aerospace vehicles.

**The Model Test Section** is responsible for planning tests involving the use of wind-tunnel models in subsonic, supersonic, and hypersonic environments. Data obtained by engineers in the

Model Section serve to determine the feasibility of advanced aircraft designs — such as the F-111's variable-sweep wing.

**The Propulsion Section** personnel analyze the performance characteristics of advanced propulsion systems.

**The Stress Analysis Section** engages in establishing designs which provide required strength at minimum weight — substantiating designs by stress analysis static and fatigue test programs.

**The Structural Loads, Dynamics, and Materials Section** establishes, for aerospace vehicles, the structural design criteria and maximum load conditions for ground and flight environments; the dynamic and static aeroelastic response of nonrigid structure; vibration and acoustical environments; new materials and composites; processes and structural components; and the application of the data obtained to specific aerospace vehicles.

**The Structural Test Section** plans and evaluates both airborne and ground structural tests.

Find room for thought and career potential . . . and room for better living in smog-free Fort Worth, where the cost of living is low, and where metropolitan advantages exist alongside year-around outdoor recreational areas in a mild climate.

Call collect—817-732-4811, Extension 3551; or send a resume of your education and experience to Mr. J. B. Ellis, Industrial Relations Administrator-Engineering, General Dynamics, Fort Worth Division, P. O. Box 748E, Fort Worth, Texas 76101. An equal opportunity employer. U.S. Citizenship required.

**GENERAL DYNAMICS**  
*Fort Worth Division*



## New Semiconductors Review

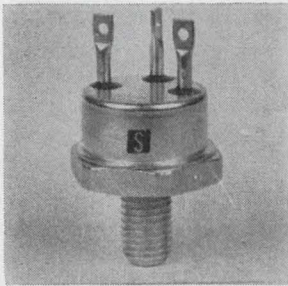

Silicon transistors SDT 8151-8159 are 30-amp units in an isolated TO-61 case. They have sustaining voltages up to 120 v. There are 3 gain categories at 10 amps collector current: 20 minimum, 42-120 and 100 minimum. Saturation is 1 v max. collector-to-emitter and 1.5 v max. base-to-emitter. Solitron Devices Inc., 1177 Blue Heron Blvd., Riviera Beach, Fla. 33404. [436]

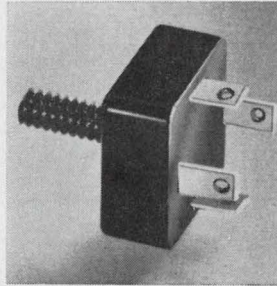

Silicon bridge rectifiers S-6230 are 2-amp units with piv ratings from 200 to 1,000. They can resist a power surge of 120 amps at 25°C. Maximum ambient operating temperature is 140° with heat sink conduction. They measure 1/4 in. high and 9/16 in. square. Unit price is \$1.47 to \$3.47. Sarkes Tarzian Inc., 415 N. College Ave., Bloomington, Ind. 47401. [437]

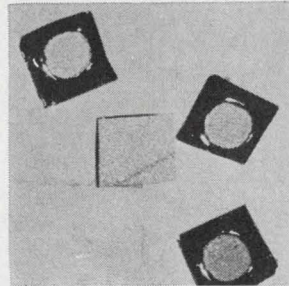

Mesa dice that are silicon glass passivated come in typical computer die sizes of 0.015 x 0.015 x 0.005 in. Electrical specs are less than 2 pf capacitance and recoveries at less than 2 nsec. Devices meet MIL-S-19500 and MIL-STD-202 specs. Price is less than 15 cents each at the 1,000-unit level. Micro Semiconductor Corp., 11250 Playa Court, Culver City, Calif. 90230. [438]

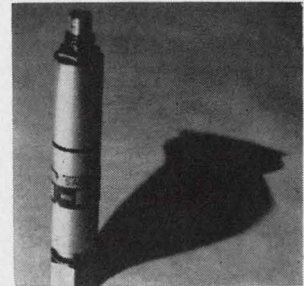

Miniature video detector diode model DX-105 covers 2 to 12 Ghz and provides -48 dbm sensitivity with a 2-Mhz video band width. Typical voltage sensitivity is 700 mv/mw with a 1,000-ohm load. The d-c return is integral. Connectors are 1/4-36 miniature, male-in/female-out. Price is \$125; delivery, stock to 30 days. Sage Laboratories Inc., 3 Huron Dr., Natick, Mass. 01760. [439]

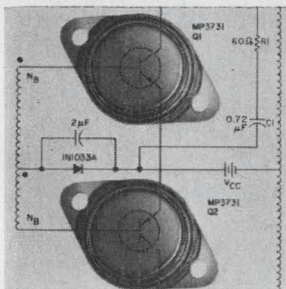

Germanium power transistors MP3730/31 have a thermal dissipation of 1.5° C/w. Breakdown voltages are 200 and 320, and collector currents are 5 and 10 amps, respectively. Gain is 15 at 2.25 amps (min.) for the 3730, and at 6 amps (min.) for the 3731. Prices (100-up) are \$1.05 and \$1.40 respectively. Motorola Semiconductor Products Inc., Phoenix, Ariz. 85001. [440]

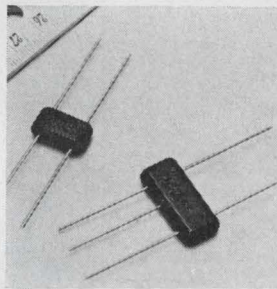

Subminiature, medium power and 3-phase, full-wave silicon bridge rectifiers in the Compac SBR series are suited for versatile packaging. Full-wave bridges range from 1.5 amp, 50-1,000 v to 360 ma, 1,500-3,000 v; 3-phase full-wave bridges range from 2 amp, 50-1,000 v to 500 ma, 1,500-3,000 v. Semtech Corp., 652 Mitchell Road, Newbury Park, Calif. 91320. [441]

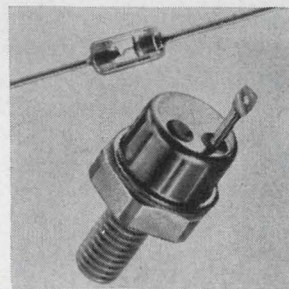

Two radiation resistant, power recovery diodes are planar epitaxial units. The 1-w version is packaged in glass, the 10-w unit is in a modified TO-59 stud package. Both are relatively low voltage devices with breakdowns of about 100 v and working voltages of 70 v. Recovery times are less than 100 nsec. Continental Device Corp., 12515 Chadron Ave., Hawthorne, Calif. 90250. [442]

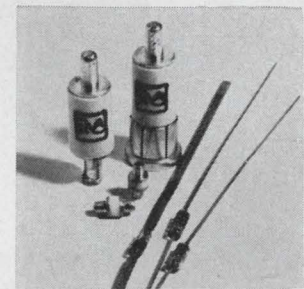

Schottky-barrier junction diodes MA-4850 cover the range of 2 Ghz to 5 Ghz with maximum noise figure of 9 db and c-w burnout of 1 w. Designed for use as broadband mixers, they are mounted in low-loss packages and are r-f characterized at 3,060 Mhz to assure premium circuit performance. Microwave Associates Inc., Northwest Industrial Park, Burlington, Mass. 01803. [443]

### New semiconductors

## Doubling-up IC amplifiers makes sense

Two-on-a-chip series for memory-logic interface provides circuit economy, design flexibility

**Memory and logic**, two key elements of a computer, are easily and inexpensively bridged by integrated-circuit sense amplifiers. The task can be further simplified and the cost further reduced with IC dual-sense devices that convert the coincident-current memory

readout to the saturated digital levels of the two most widely used logic families — diode-transistor and transistor-transistor.

Texas Instruments is offering a series of six dual-devices, SN7520N to SN7525N, that costs from 30% to 40% less than two separately

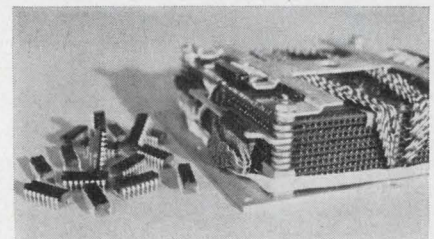

**Variety.** Six types of dual-sense amplifiers can be used to link computer logic to 4,096-word memory, at right.

packaged single-sense amplifiers, provides a variety of circuit configurations and threshold sensitivities, and has a high degree of integration—there are 17 transistor elements and 17 resistors in the basic





*for  
maximal  
performance  
in critical  
applications...*

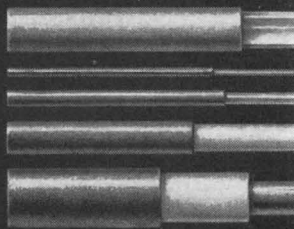

**COAXITUBE  
PRE-FAB PARTS  
& ASSEMBLIES**

Orders of Coaxitube can be furnished cut to size, stripped, preformed to shape or assembled with connectors to meet your exact specifications. Semirigid construction assures the retention of shape and closely held tolerances. We'll gladly send data or quote your needs . . . no obligation.



**... devices compatible  
with both TTL and DTL ...**

structure. Encased in dual-in-line plastic packages, the IC's are priced at about \$10 (average) in lots of 100-999.

**Twins.** Calling the dual arrangement unique for sense amplifiers, the company also claims the devices are the industry's first monolithics with multisense channels in a single package. Says a linear-circuits engineer at TI: "Their compatibility with both DTL and TTL operating levels meets the design needs of both today's and tomorrow's computers."

The dual units contain multiple differential-input preamplifier stages, gating and output circuitry, an internal reference amplifier arrangement that controls the threshold levels of the multiple inputs, and are d-c coupled. They detect bipolar differential-input signals—low-level pulses generated in magnetic core memories—and translate them into drive signals for standard TTL and DTL circuits.

D-c coupling avoids some of the problems that plagued earlier capacitive-coupled sense amplifiers, including long overload-recovery time, threshold shifts, and frequency-dependent instabilities. In TI's new devices, a TTL gate achieves the strobe function by providing a threshold action. This enables the amplifier to perform time discrimination, thus sharpening signal detection in noisy environments.

**Wide range.** The SN7520N and SN7521N are dual-preamplifier-sense units in a common-output circuit consisting of two cascaded TTL NAND gates. Each unit has two strobe inputs. Differential input threshold level range for the "20" is 11-19 millivolts; for the "21," 8-22 mv. These units can also be used to perform the functions of a flip-flop or a register that responds to sense-and-strobe inputs.

The SN7522N and SN7523N differ from the "20" and "21" only in that they have an open (uncommitted) collector output stage. These units can provide the exclusive-OR function or be used to supplement the "20" and "21."

The other circuits in the series—

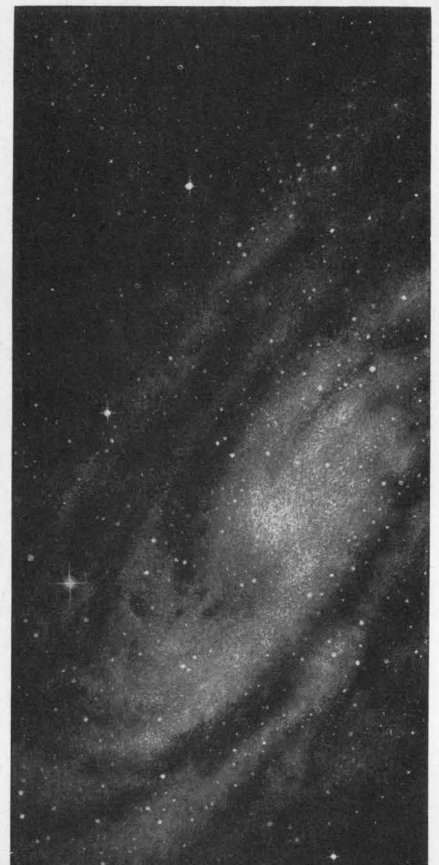

**PRECISION  
Semi-rigid  
COAXITUBE**

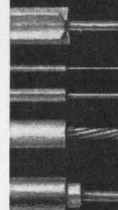

These high performance solid-jacketed cables offer broad frequency response, low attenuation, zero radiation and lowest possible VSWR. The splined, air-articulated types provide

minimum attenuation and highest cutoff frequencies, eliminate periodicity phenomena, and insure phase stability in the order of 20 PPM/°C from 10°C to 40°C, and 35 PPM/°C from -40°C to +125°C. They also provide excellent external RF shielding. For critical applications in severe environments, your best decision is Precision.



**PRECISION TUBE COMPANY, INC.**  
SPECIAL PRODUCTS DIVISION  
North Wales, Pennsylvania 19454  
Phone 215-699-4806 TWX 510-661-8427



**FREE**

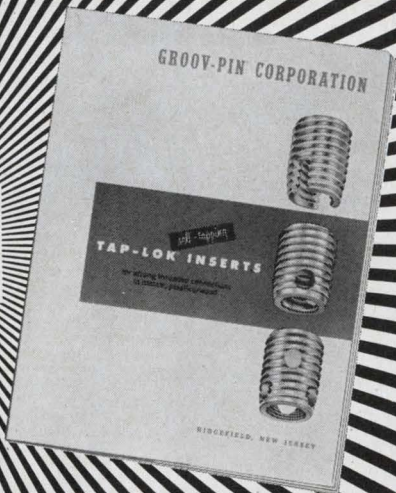

## FASTENER KNOW-HOW

Here's complete design and application data on self-tapping TAP-LOK® inserts . . . the quickest, most practical and economical way to put strong threads in soft materials. Get your copy of this helpful 12-page catalog by writing: Groov-Pin Corporation, 1121 Hendricks Causeway, Ridgefield, N.J. 07657, WH-5-6780.

FASTENER DIVISION **GROOV-PIN CORP.**

Circle 277 on reader service card

**±1/4° F control  
(SCR solid state)  
-120° F to +350° F range**

with improved Tenney Jr.  
"Hermeticool"  
refrigerated  
bench-top  
test chamber

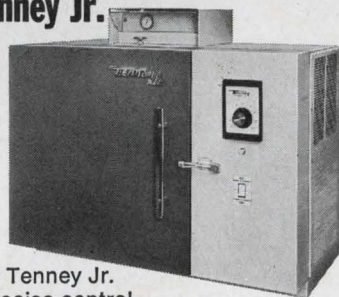

Better than ever! The Tenney Jr. now features more precise control while providing 40% expanded work space and faster cooling. Inside area has been enlarged to 1 1/4 cu. ft. without increasing outside dimensions. New, faster pull-down is from +75°F ambient to -100°F in just 35 minutes. Delivered for immediate 115 volt plug-in operation, Tenney Jr. requires no special piping, no accessories.

Write or call today for complete details.



**Tenney**  
ENGINEERING, INC.

Still only \$990  
Available immediately  
from stock

1090 Springfield Rd., Union, N. J. 07083 • (201) 686-7870  
Western Div.: 15700 S. Garfield Ave. • Paramount, Calif. 90723

479

## LEMO<sup>T.M.</sup> HIGH VOLTAGE CONNECTORS

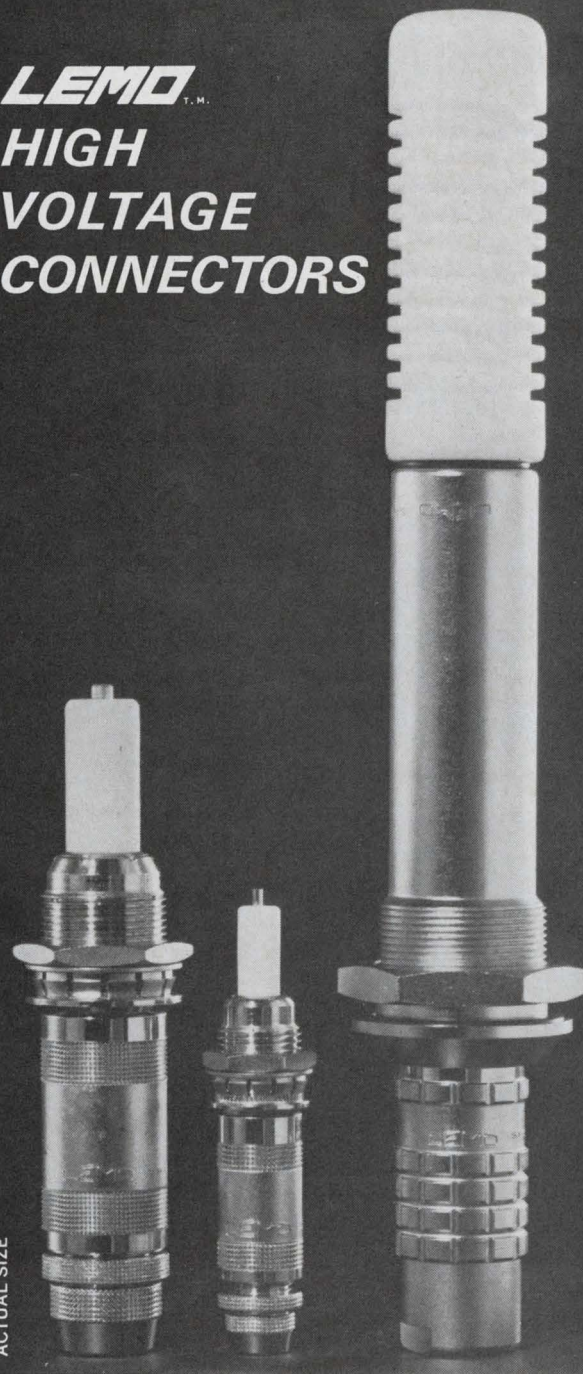

33,000 VDC TEST  
@ 2 AMPS

11,000 VDC TEST  
@ 2 AMPS

70,000 VDC TEST  
@ 10 AMPS

Only three examples of THE MOST COMPLETE LINE OF HIGH VOLTAGE / HIGH CURRENT CONNECTORS IN THE WORLD  Standard or waterproof  Radiation-proof insulator material (optional)  Lemo's quick connect/disconnect patented snap-latch  Current ratings to 230 amps continuous operation  Inserts available with mixtures of high voltage, coax, and standard contacts  For catalog showing complete specifications, write:

**LEMO<sup>T.M.</sup>**

**LEMOSA INC.**

465 California Street • Suite 814  
San Francisco, Calif. 94104 • (415) 989-5515

Circle 278 on reader service card

Circle 219 on reader service card

219



## New Bliley Crystal Oscillators Solve Space and Interface Problems for IC Applications

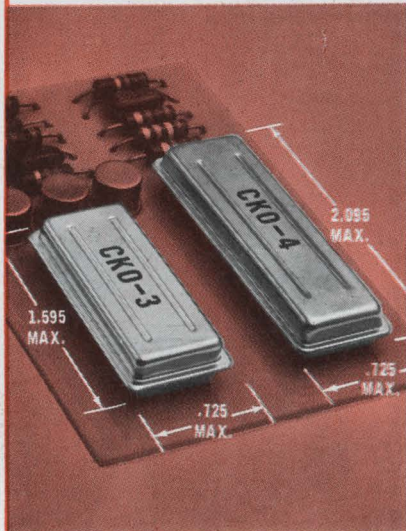

### CKO Series Special Features

- ✓ Low profile case, .355" max. thickness, with solder terminals for PC card mounting.
- ✓ Output drives most TTL, RTL and DTL logic circuits.
- ✓ Operation on 5 volt supply for compatibility.
- ✓ Hermetically sealed in koldwelded case for high reliability.
- ✓ Voltage control frequency adjustment to offset long term aging.

■ Type CKO-4 is available in Frequency Range 200-5000 kHz with either square wave or logic output. Type CKO-3 is supplied with sine wave output for 3-15 MHz range. Both types have 10 ppm frequency stability over 0°-50°C range, without oven control. Both meet vibration at 15G from 10 to 2000 Hz and 100G shock test.

For complete details request  
Bulletin 546

**Bliley**  
If you buy quality

BLILEY ELECTRIC COMPANY  
2545 WEST GRANDVIEW BOULEVARD  
ERIE, PENNSYLVANIA 16512

SN7524N and SN7525N—each contain two independent sense channels in single packages. Both devices have variable threshold levels and each unit's two channels can be adjusted simultaneously by a single reference voltage.

Input threshold levels are the same for the "20," "22," and "24," as are those for the "21," "23," and "25." All six IC's have high-speed operation: typically, 25 nanosecond propagation delay for input to output, and 15 nsec delay for strobe to input. Noise margin is 1 volt, overload-recovery time is typically 20 nsec; logic-1 output voltage is 3.9 v with a 400-microamp load, and logic-0 output is 0.25 with a 16-milliamp sink.

Requiring power supplies of  $\pm 5$  v, the devices are capable of operating in current-sinking as well as current-supplying modes. Prices (in quantities of 100): SN7520N—\$13.20; "21"—\$10.10; "22"—\$12.65; "23"—\$9.50; "24"—\$11.90; "25"—\$8.90.

Texas Instruments Incorporated, Semiconductor-Components Division, Dallas, Tex. [444]

New semiconductors

## Current, currency —a dual gain

80-amp power transistor  
doubles usable gain,  
costs a third less

"Make it better, make it cheaper"—that's what Transiron Electronic Corp. set out to do with its new line of silicon power transistors. And to some degree, it has succeeded.

The company claims its ST140-11, ST14012, and ST14013 transistors outperform similar devices at their maximum ratings, and cost about a third less.

Both Solitron Devices Inc. and the Silicon Transistor Corp. offer power devices. Their 60-volt, 70-amp transistors cost about \$330 each in lots of 1-999. Transiron's ST14011, however, a 60-volt, 80-amp device, sells for about \$200

# Only \$1,050

(F.O.B. YOKOHAMA)

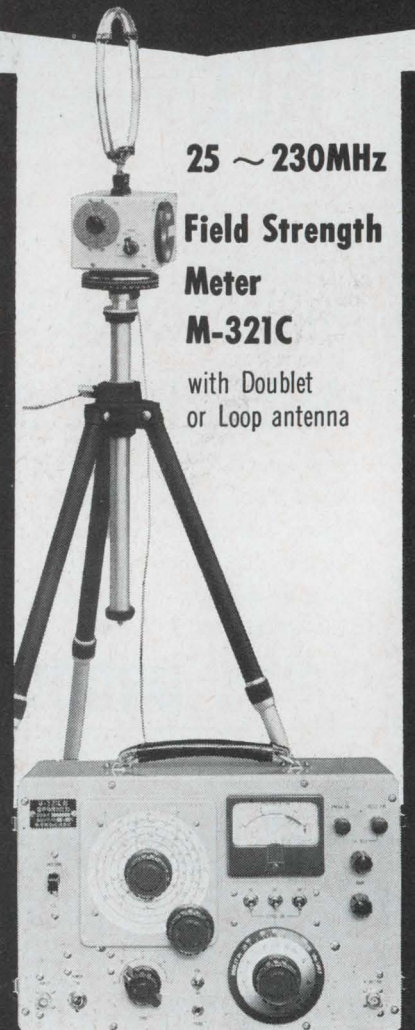

25 ~ 230MHz

Field Strength  
Meter  
M-321C

with Doublet  
or Loop antenna

- Measuring value:  
(Min.) Less than 4dB at 25 to 38MHz with doublet antenna.  
(Max.) Minimum value +100dB
- Accuracy  $\pm 2$ dB
- Pass band width approx. 80kHz (6dB)
- Lightweight and portable.

Noise measurement: combination with Quasi-peak meter MH33A. \$583

Other models in frequencies ranging from 150kHz to 11,700MHz are available. Why not write today for additional data and specs.

**Anritsu Electric Co., Ltd.**

4-12-20-Minamiazabu, Minato-ku, Tokyo  
cable address ANRITDENKI TOKYO



# ThermaTab records surface temperatures

Apply pressure-sensitive ThermaTabs to any type of equipment (from diodes to diesels) that is subject to overheating. Calibrated to specific temperatures in 10° increments, ThermaTabs provide a permanent record of temperature level by turning black within an accuracy range of ±1%.

## THERMATAB

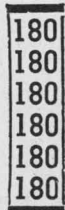

Each package contains 10 1/4 x 1" strips all rated for the same temperatures. Each strip may be cut into units of whatever size & shape are required for the application. Order from a selection of 36 temperatures in 10° increments from 100° through 450°F.

## THERMATAB, JR.

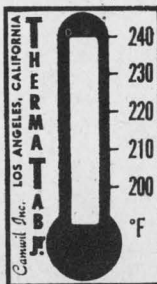

Each plastic-coated unit covers a 50° range in 10° increments starting at a choice of 100°, 150°, 200°, 250°, 300°, 350°, 400°.

Send for literature.

**CAMWIL, INC.**

835 Keeaumoku Honolulu, Hawaii

Circle 280 on reader service card

# Our little black book has over 100,000 phone numbers.

You never had a black book like it. Over 1,500 pages. And those phone numbers! More than 100,000 telling you who to call/where to go, for the over 4,000 different product categories listed and advertised in the yellow pages of the Electronics Buyers' Guide.

It's the industry's one-stop shopping center that lets you find the products and services you need quickly.

You can depend on EBG.

## Electronics Buyers' Guide

A McGraw-Hill Market Directed Publication,  
330 West 42nd Street, New York, N.Y. 10036

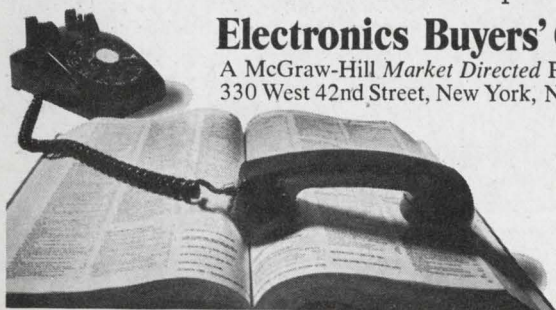

# Meet our newest

# V.I.P.\*

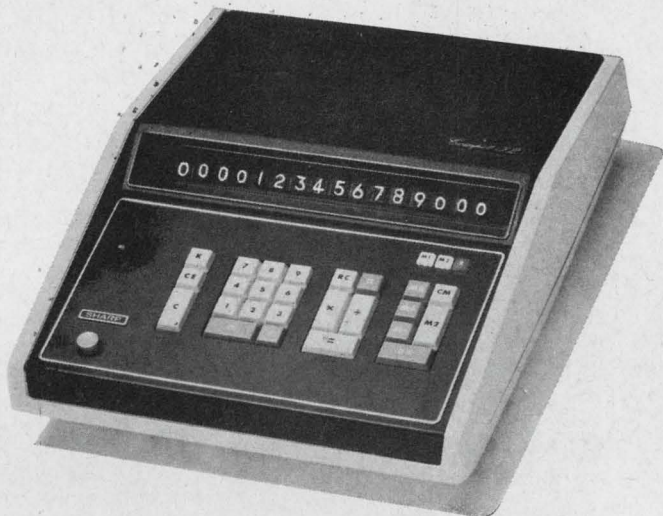

model CS-32A

A V.I.P.\* to us of course and also to users of electronic desk calculators all over the world who are anxious to become acquainted with our newest model—CS-32A. This one, with 22 ICs, does more, much more, using less parts, in half the space previously needed (only 14.5 lbs. light).

Unsurpassed stable performance at lower operation cost; milli-second noiseless functions; trouble-free operation and ease in maintenance—vip features of the V.I.P.\* by Sharp.

The CS-32A is for V.I.P.s who need their time to think and choose to leave the calculating to our V.I.P.\*

- 16 digits  8 decimal places  2 memory registers Error preventers
- Rounding off device  Ultra-modern design

\*Very Important Product

**Sharp SHARP**

HAYAKAWA ELECTRIC CO., LTD. Osaka, Japan

U. S. Subsidiary: SHARP ELECTRONICS CORP. 178 Commerce Road Carlstadt, New Jersey



# Need a custom fork oscillator

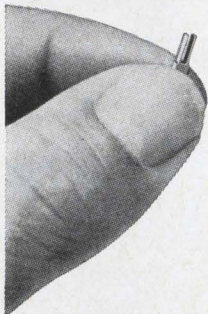

(in an 11-gram package)

## fast?

For process control? Or for test or ground support equipment? Or for a signaling system?

## call Varo.



This lead-mounted, 11-gram package is not only compact ( $\frac{7}{8}$ " x  $\frac{7}{8}$ " x  $\frac{7}{16}$ " ), it's a lot more rugged than larger fork oscillators. Frequency range is 2KHz to 40KHz. Performance: .05% from -20 degrees C. to +70 degrees C. If we can't adapt this package to meet your specs, we'll build you one that does.

## Varo answers fast.

Because our business is oscillators. Not oscillators and ovens and crystals and etc. But oscillators, period. Tell us what you need. We'll tell you how and when. Like we've done for General Precision, Westinghouse, Sandia, Litton, Raytheon, and others. Try us for speed.



**TIME & FREQUENCY PRODUCTS**  
402 GUTIERREZ STREET  
SANTA BARBARA, CALIF.  
TELEPHONE (805) 963-2055  
TWX 805-4497200

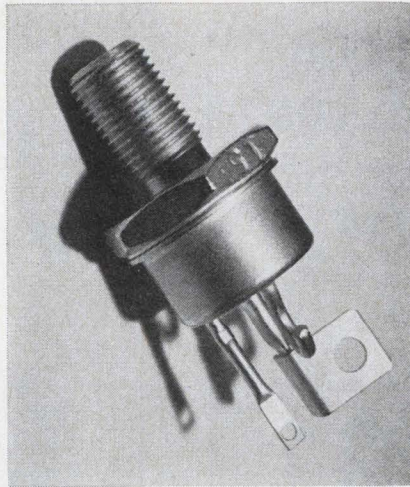

**Gainful.** Silicon power transistor holds gain even at high amperage.

each in lots of 100.

**Sales pitch.** Despite the price advantage, Transiton considers device performance the main selling point. Transistors designed for converters or regulators must have usable gain under specified conditions. Unfortunately, as amperage increases, current gain generally decreases until, at 70 to 90 amps, it has fallen to about 4 or 5. This is the case with most devices rated in the 80-amp range, says Philip Stevens, a senior product marketing engineer at Transiton. The company claims its new transistors have twice that gain—8 to 10 at 80 amps.

Unlike Solitron and Silicon Transistor, which only offer their devices in the MT49 package, Transiton offers both MT 49 and TO 63 packages. Power dissipation is about the same for both—200 watts at 100° case temperature. The difference is size: the MT 49 is more than an inch in diameter and the TO 63 stud-mount is only  $\frac{7}{8}$  inch.

**Fast on, off.** Although switching speeds of 3 or 4 microseconds is fast enough for most applications, the new devices switch on in about 1 to 2  $\mu$ sec, and off in 2  $\mu$ sec. "Fast switching reduces heat buildup at the junction," says Stevens. "And the less heat we have, the less we have to dissipate. That's how we can use a smaller package."

Transiton also claims low leakage for its silicon epitaxial planar devices; about 10 microamps and 1  $\mu$ amp typical at peak voltages.

Transiton Electronic Corp., Wakefield, Mass. 01881 [445]

## High Voltage Rectifiers

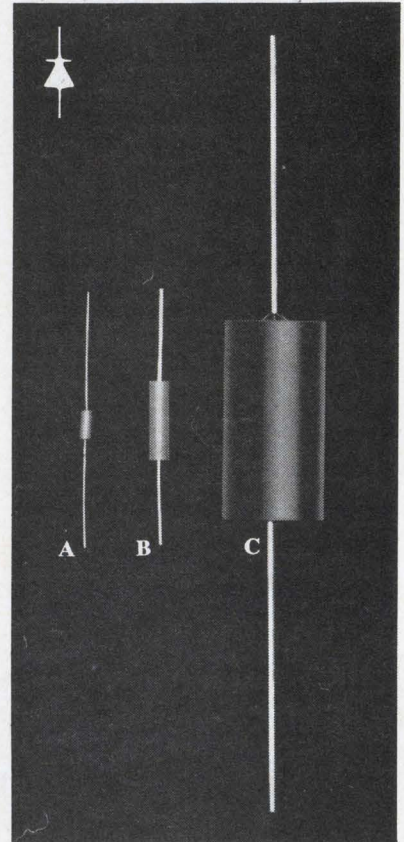

Diffused High Voltage silicon rectifiers available with 300 nanosecond recovery time (optional) and in custom designed assemblies. Epoxy encapsulation.

**A**  
.060 diameter.  
.150 long.  
1,000 to 3,500 volts PIV.  
25 to 50 ma average rectified current.

**B**  
.100 diameter.  
.400 long.  
1,000 to 6,000 volts PIV.  
50 to 100 ma average rectified current.

**C**  
.500 diameter.  
1 to 7 inches long.  
3,000 to 70,000 volts.  
15 to 75 ma average rectified current.

For use in diode-capacitor voltage multipliers, cathode ray tube power supplies, RF power supplies (up to 200 KC), precipitator power supplies, and photo multipliers. Also available in diode-capacitor multiplier assemblies.



**SPECIAL PRODUCTS DIVISION**  
2203 WALNUT STREET, GARLAND, TEXAS 75040  
(214) 272-3561





**amerline  
corporation  
BOBBINS**

SEND FOR OUR  
**NEW CATALOG  
TODAY!**

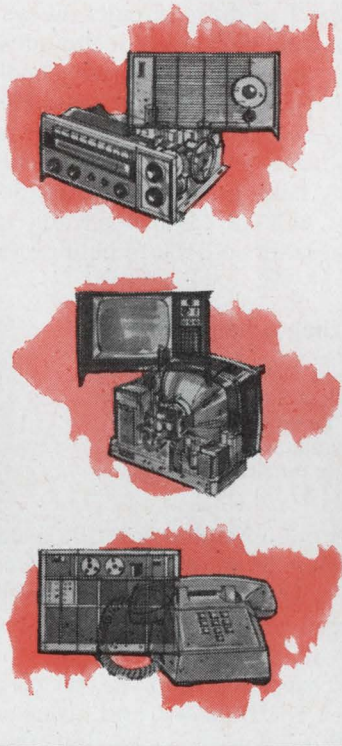

**RADIO —**  
Moldcrafters of transformer bobbins oscillator I.F. and R.F. coil forms and stereo tape cartridges.

**TELEVISION —**  
Producers of color yoke insulators, terminal boards, housing and convergence coil bobbins.

**COMPUTER AND TELEPHONE —**  
Wide selection magnetic tape reels and containers, cartridges, disc packs, reed relay bobbins for computers, audio reels for tape recorders and players, bobbins for switching circuits and reed relays for telephone.

Complete line of patented Lead Slot bobbins.



**AMERLINE CORPORATION**  
1800 FULLERTON AVENUE  
CHICAGO, ILLINOIS 60614  
(312) 348-4300 - TWX: 312-222-9410

Circle 282 on reader service card

*yes,*

**CCTV Cameras work best**



with **COSMICAR<sup>®</sup> LENSES**

Superior cameras deserve superior lenses. COSMICAR's proven precision performance is the combined result of advanced optical engineering and exquisite workmanship.

Now widely used, COSMICAR LENSES come in 23 models for focal lengths ranging from 12.5 mm to 500 mm, and in 3 zoom models including a remote control zoom.

Your CCTV camera and COSMICAR LENSES will make an unbeatable team. For technical data and other particulars, please write.

Effective September 1, 1967, ICHIZUKA OPTICAL CO., LTD. changed its name to



**COSMICAR  
OPTICAL CO., LTD.**

568, Shimoochiai, 2-chome, Shinjuku-ku, Tokyo  
CABLE ADDRESS: "MOVIEKINO TOKYO"

Circle 223 on reader service card



# To put it in writing...

look first to **BRUSH**®

No matter what your direct writing recording requirements, look first to Brush for the optimum answer. There's the famous Mark 200 series of modular systems plus a complete line of portable and general purpose recorders:

## Mark 200—8 Channel Recorder

New generation Series 1707 system combines all solid state electronics with modular construction for tailoring to specific requirements. Choice of channel widths and input preamplifiers. Range of chart speeds 0.05 to 200 mm/sec. Patented pressurized-ink writing system.



Mark 220 Portable Recorder

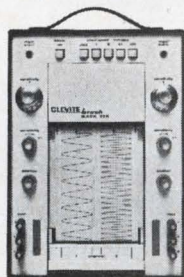

High performance two analog channel unit weighs only 25 pounds, writes in any position. Has the Mark 200 writing system. Chart speeds from 1 to 125 mm/sec. One millivolt sensitivity. Portable.

## Mark 250 Strip Chart Recorder

Fastest, most versatile 5" strip chart recorder anywhere. Contactless servo. Detachable chart magazine. Has the Mark 200 writing system. Chart speeds from 0.2 sec/div. to 5 min/div., sprocketed drive. Portable.

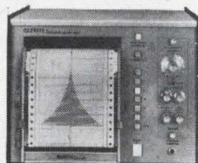

## Mark 280 Dual 80mm Recorder

Feedback penmotor unit has two "double width" analog channels. Has the Mark 200 writing system. Chart speeds from .05 to 200 mm/sec. Portable.

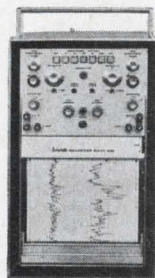

## Brush Lightbeam Oscillographs

Choice of three high performance models with up to 25 channels, frequency response to above 5000 Hz, variety of chart speeds .002 ips to 120 ips. Writing speeds to 60,000 ips.



To put it in writing, write for complete catalog. Clevite Corporation, Brush Instruments Division, 37th and Perkins, Cleveland, Ohio 44114.

**CLEVITE BRUSH**

## New Books

### The waiting's over

Analysis and Design of Integrated Circuits  
David K. Lynn, Charles S. Meyer, and Douglas J. Hamilton, with contributions from other engineers at Motorola Inc.'s Semiconductor Products division  
McGraw-Hill Book Co., 545 pp., \$16.50

The integrated circuit has started a revolution in electronics without benefit of a written manifesto. Disciples have been attracted by the Word as set down in trade publications, data sheets, conference proceedings, and advertising brochures. But they have had no little red book to return to after their conversion. Handbooks and design manuals can sustain or even inspire the zealot, but too often they reflect the prejudices of author or sponsor and have been slanted toward one company's product line.

Came the revolution and now comes the book. This volume contains the clearest and most thorough treatment of the subject yet. Though it is written by engineers from a leading IC manufacturer, it is an unbiased presentation of the over-all state of the art and of the entire technology—fabrication, processing, design, analysis, parameter considerations, and applications of both logic and linear IC's.

But the feature that raises this book above the usual tract is that it can be read from a strictly parochial point of view—and relished—by device engineer, circuit designer, or systems specialist. Also, the theoretical foundations it outlines transcend current technology and will apply in the coming era of large-scale integration and the eras following that.

Descriptions of IC characteristics include fabrication constraints, element models, nonlinearities, and parasitic effects. The six chapters devoted to digital circuits discuss logic functions, emitter-coupled logic, direct-coupled transistor logic, diode-transistor logic, and transistor-transistor logic, and include comparisons of the logic families.

The chapters on linear IC's cover small-signal characteristics, d-c and differential amplifier circuits, high-frequency tuned amplifiers, and fre-

quency-selective circuits. An overview of the analog-IC field stresses the impact of these circuits on systems and on packaging techniques.

The audience for this book should be the broadest possible. Students on both graduate and undergraduate levels, engineers outside the field, users of IC's, and designers will all find something to learn here. It's a book to hold on to.

### More than a hand-me-down

Electronic Designer's Handbook: A Practical Guide to Transistor Circuit Design  
T.K. Hemingway,  
Business Publications Ltd.,  
296 pp., \$7.50

This is not a handbook in the usual sense, but is more aptly described by its subtitle, "A Practical Guide to Transistor Circuit Design." It is aimed at beginning engineers who have completed courses in electronic circuit theory and received their bachelor's degree, but who have little or no practical design experience. It would also help experienced engineers interested in some of the special, recent-vintage circuits.

The book is divided into three sections. The first discusses basic diode and transistor characteristics, considering five network types: linear sweeps, constant current sources, simple amplifiers, negative feedback arrangements, and d-c amplifiers. The second, which is devoted to special circuits, consists of a description and analysis of more complicated networks, namely: complementary circuits, voltage-controlled oscillators, ultra-high gain stages, transistor pumps (step generators), and transistor cascodes. The third is devoted to intra-stage and interstage design techniques, such as bootstrapping, and includes a chapter on prototype testing. This chapter is especially useful; it provides many practical pointers such as on proper grounding techniques, avoiding undesirable turn-on transients—these measures often are learned only through expensive, time-consuming laboratory work.

However, the quality of the dis-



# The 7-year old miracle.

The Mark 200 came on the market back in 1961. And ever since, the competition's been playing catch-up. Take the traces it gives you. A patented, pressurized inking system puts them into the paper . . . not just on it. They're incredibly crisp. You won't smudge them. You can reproduce them. And talk about accuracy! We promise you 99½% (mostly because of a pen position feedback system that other manufacturers are *still* trying to figure out!) ■ There's more. Lots more. ■ You have a choice of 32 different preamplifiers and an almost unlimited number of penmotor combinations. Then too, you can select either Z-fold or roll type chart paper take-up and a vertical or horizontal or pull-out oscillograph. In short, you tell us what kind of recording you want to do and we'll put together the Mark 200 system to

do it. ■ But here's the real kicker: Specify a Mark 200 and you specify a *proven* system. Right this minute there are more than 27,000 channels purring away throughout the world. We can *talk* all day about "reliability" but acceptance and experience like this says it in seconds. ■ We still haven't done the Mark 200 justice. To *really* understand what we're talking about, you have to see one in action. Ask your Brush representative to arrange a demonstration. After all, how often do you get to see a miracle? Clevite Corporation, Brush Instruments Division, 37th & Perkins, Cleveland, Ohio 44114.

CLEVITE **BRUSH**

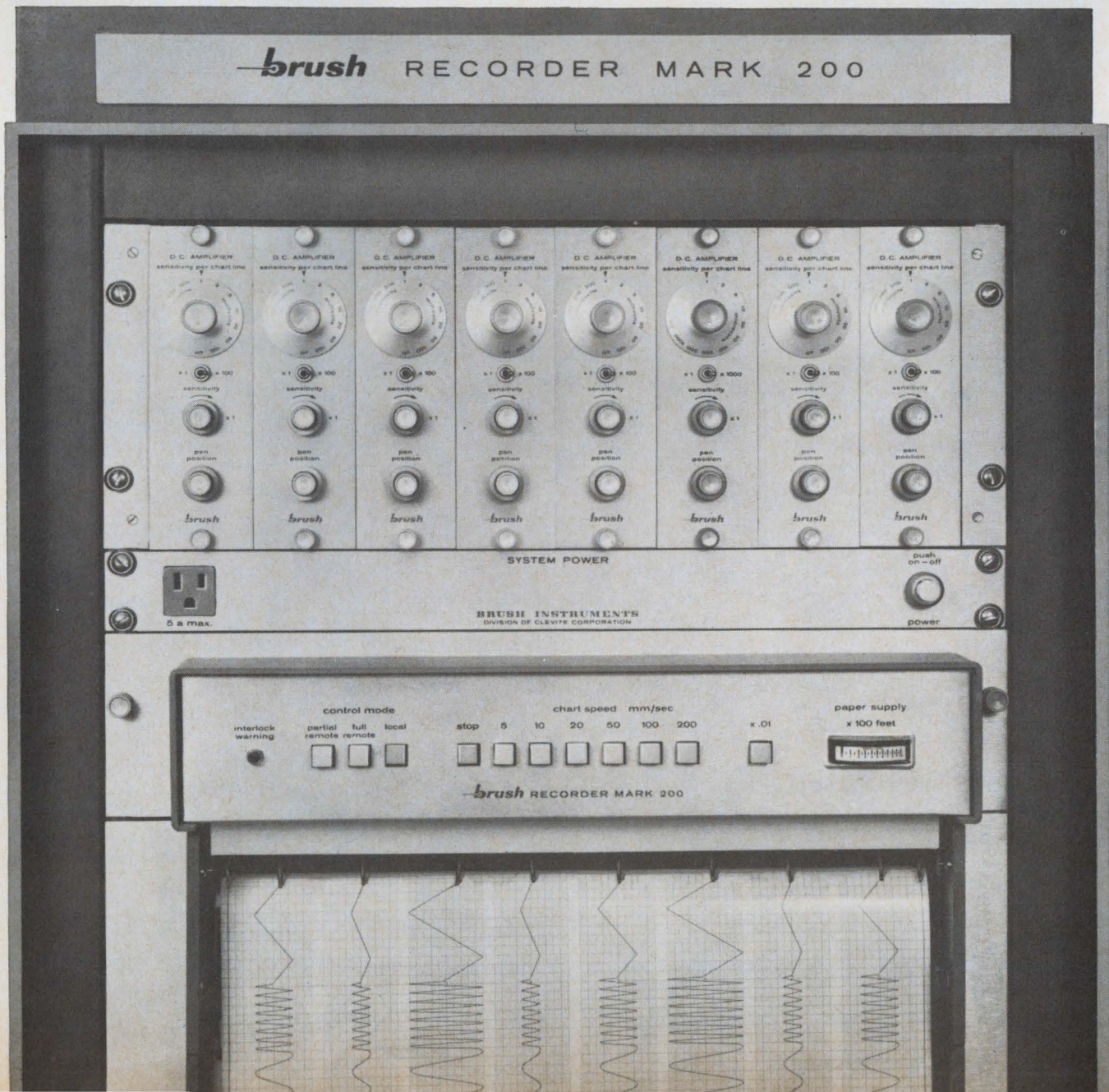
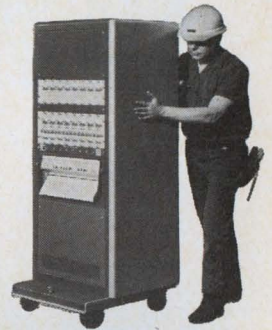



# TOO BAD

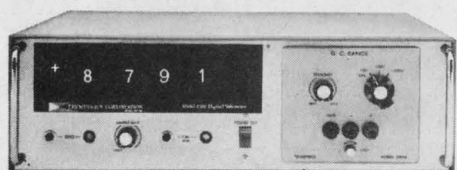

Right now, as you are reading this, someone somewhere is ordering a 3-digit, .05% DVM without stored display for the price of this new Trymetrics .01% 4-digit model. Ouch!

This new Model 4100 is offered with a series of plug-in function heads which provide measurement from 99.99mv to 999.9 volts in 1,3,4 or 5 manual or automatic ranges. \$695 for the basic unit, \$740 with a  $\pm 9.999v$  range plug-in.

All units feature automatic polarity and over-scale indication. All have exceptional 0.01% accuracy; all offer a storage register for absolute display stability. There's even more performance with a new compatible multimeter plug-in module which provides DC, AC and OHMS measurement. Printer output is optional.

If there is no need for stored display, Model 4000 offers the identical features of the Model 4100 but costs only \$595 for the basic unit, \$640 with 103  $\pm 9.999v$  range plug-in head.

We'd like to tell you more; there's much more to tell. It's all in a new catalog. Tell us your name and address and ask to see this .01% 4-digit DVM today.

**TRYMETRICS**  
Corporation  
A SUBSIDIARY OF TRYGON ELECTRONICS, INC

204 Babylon Tpke., Roosevelt, L.I., N.Y.  
Phone 516-378-2800 11575

## New Books

cussion is spotty; and there are even some errors. The only linear equivalent network discussed, for example, is the T-circuit, and no mention is made of the useful h-parameter and hybrid- $\pi$  models.

The discussion of high-frequency effects is sketchy and, in the case of the input impedance, erroneous. Using the T-circuit and the variation of  $\alpha$  with frequency, the author comes to the incorrect conclusion that the input impedance is  $\beta_o/g_{m0}$ , independent of frequency. Here the use of the hybrid- $\pi$  models would show that the input impedance decreases with frequency.

A discussion of power transistors mentions only allowable dissipation, and says the rest of the linear power amplifier design is essentially the same as that for simple voltage amplifiers. For reasons unknown Hemingway has chosen to ignore the considerations of transformer coupling, or of class-B operation. The chapter on feedback considers only one type of feedback circuits, the simple operational amplifier, and the discussion of the differential amplifier seems unduly complicated.

The various circuits described are essentially independent of each other, so that a designer interested in a particular topic may profitably focus on a single chapter. However, this is not an exhaustive handbook of circuit design. Many important circuits, such as broadband amplifiers, tuned amplifiers, class C operation and logic circuits, are not mentioned at all.

Perhaps the best feature of Hemingway's book is that it is more practically oriented than many books on circuit design. The emphasis is on the design of stable, high-performance circuits, using transistors whose parameters vary with temperature and from unit to unit. Other valuable features for the novice are the use of realistic values for transistor parameters and the use of only those parameters which appear on data sheets.

Joseph Frank, P.E.  
(Electronics system consultant and member of the City College of New York staff, department of electrical engineering.)

# MATSUO

Highly Reliable Capacitors

## POLYESTER FILM CAPACITORS.

**Type MXT**  
In plastic tube.  
Capacitance Range: .001 MFD to .22 MFD.  
Voltages: 100v, 200v, 400v, 600v DC.

**Type MFK**  
Dipped flat shape, non-inductive construction.  
capacitance Range: .01 MFD to .47 MFD.  
Voltages: 100v, 200v, 400v, 600v DC.

**Type MFL**  
Dipped flat shape.  
Capacitance Range: .001 MFD to .22 MFD.  
Voltages: 50v, 100v, 200v DC.

## METALLIZED POLYESTER FILM CAPACITORS.

**Type FNX-H**  
Mylar wrapped semi-circular with epoxy end seal.  
Capacitance Range: 1 MFD to 10 MFD  
Voltages: 100v, 200v, 400v, 600v DC.

## SOLID TANTALUM CAPACITORS.

**Type TAX**  
MIL-C-26655A hermetically sealed.

**Type TSX · TSL**  
Sealed with epoxy resin.  
Capacitance Range: .22MFD to 330 MFD.  
Voltages: 3v, 6v, 10v, 15v, 20v, 25v, 35v, 50v DC.

for full details, contact :

**MATSUO**  
**ELECTRIC CO., LTD.**

3-chome, Sennari-cho, Toyonaka-shi, Osaka, Japan  
Cable Address "NCC MATSUO" OSAKA

Circle 283 on reader service card  
Circle 227 on reader service card →



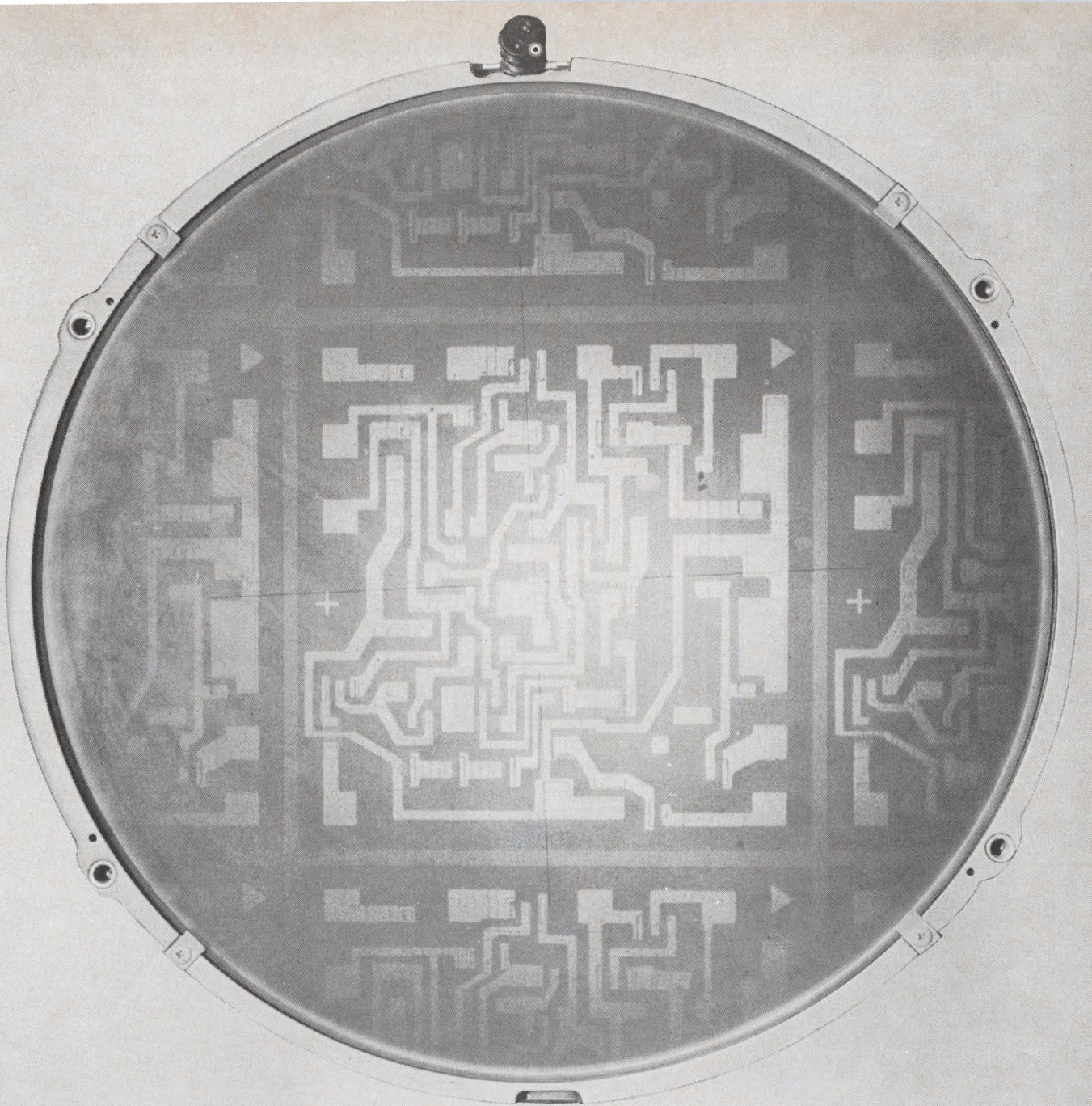

## Challenge In Microelectronics

You'll find it at Delco Radio in a variety of research/development and manufacturing programs. Rapid expansion of microelectronics and silicon device projects has created new career opportunities for the B.S., M.S., Ph.D. in Chemistry, Electrical Engineering, Mechanical Engineering, Metallurgy, Physics, Physical Chemistry, and related fields.

### Research and Development Programs in:

Linear and digital circuitry, embracing monolithic . . . thick film . . . thin film . . . and hybrid microcircuits

Silicon transistors from low power 10 milliamperes through 25 amperes; voltages to 1200

High frequency transistors to 1GHz

Thyristors from 50 milliamperes through 500 amperes, 2000 volts

Silicon rectifiers from milliamperes through 250 amperes, 3000 volts

### Process Engineering Positions:

Unlimited opportunities in this area to develop and create new processes for manufacturing germanium and silicon semiconductor devices, integrated circuits, and automobile radios. Includes development of automatic and semiautomatic fabrication equipment, pilot line operation and general cost savings investigations pertinent to semiconductor manufacturing.

**Call us collect** for an interview or more information. Area Code 317/459-2808. Ask for C. D. Longshore. Or send your resume to Mr. Longshore, Supervisor, Salaried Employment, Dept. 105, Delco Radio Division of General Motors, Kokomo, Indiana.

**DELCO RADIO**  
DIVISION OF GENERAL MOTORS • KOKOMO, INDIANA

An equal opportunity employer





the  
big

3

for  
precision  
high speed  
circuit  
board  
production



1/4" shank  
SOLID  
CARBIDE  
DRILLS

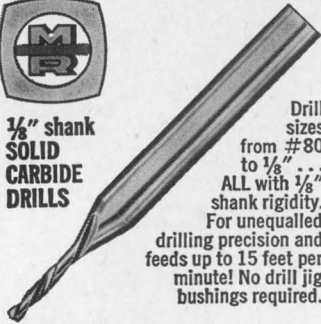

Drill  
sizes  
from #80  
to 1/8" ...  
ALL with 1/8"  
shank rigidity.  
For unequalled  
drilling precision and  
feeds up to 15 feet per  
minute! No drill jig  
bushings required.

PCB-1  
AIR  
BEARING  
SPINDLES



UP TO  
150,000 RPM  
SPINDLE SPEED

Absolutely vibration free . . .  
spindle shaft literally "floats" on air  
film . . . no ball bearings, no metal-  
to-metal contact. Eliminates all har-  
monics. Creates the truest running  
drill spindle ever made. Air turbine or  
electric high frequency driven.

SOLID CARBIDE  
DIAMOND CUT  
ROUTERS



For the  
smoothest finish  
in routing . . . any  
material or plastic-  
metal laminate.  
Choice of end styles  
including drill point.

Take the proved solid carbide advan-  
tages of rigidity and wear resistance  
. . . add the proved advantages of Metal  
Removal tool design and precision . . .  
to give you problem-free production in  
circuit board drilling and routing.

Write for Catalogs.

**THE METAL REMOVAL COMPANY**  
1859 W. Columbia Ave., Chicago 60626  
Plants in Chicago • Los Angeles • San Juan

MASTER TOOL AND WHEEL  
MAKERS FOR THE WORLD

## Technical Abstracts

### Linears for logic

A family of linear integrated circuits for data systems  
Marvin B. Rudin, Richard L. O'Day, and R.H. Jenkins  
Fairchild Semiconductor  
Palo Alto, Calif.

Digital data-processing equipment requires low-cost devices for analog data acquisition, display, and control to complement the digital IC's already being used. Linear integrated circuits provide a way to make digital-to-analog (d-a) and analog-to-digital (a-d) converters that meet performance specifications to satisfy many users; the IC's can be produced in quantity to assure low manufacturing cost.

While both type converters have much in common, there are distinctions that must be considered in developing a family of units. Generally, the a-d converter encodes—one-by-one—a plurality of time-multiplexed analog measurements; but the d-a converter restores only one digital output for each analog equivalent. A-d converters generally operate bit-sequentially, but d-a's use the more complex bit-parallel operation.

Using major conversion techniques as a guide, a design centered around a bipolar current-summing d-a converter was chosen as the approach which could be met by off-the-shelf linear IC's. The technique satisfies the specifications of speed, temperature performance, long-term stability, and logic levels and power supply voltages required for compatibility with most standard data equipment.

The final specifications are:

- Conversion rate, words/sec  
Digital-to-analog d-c to 50,000  
Analog-to-digital d-c to 100,000
- Resolution, bits  
Digital-to-analog 8-10  
Analog-to-digital 10
- Accuracy, % of full scale  
Digital-to-analog 0.20  
Analog-to-digital 0.05

The required functional blocks for making a d-a converter are, typically, an impedance-transforming amplifier, a combination logic-buffer, current switching network, current sources, voltage references, and a data register.

The a-d converter design contains a digital programmer, a holding register, a d-a converter reference, a current-setting resistor array, and two standard linear integrated circuits—an operational amplifier and a comparator.

All blocks can be constructed from off-the-shelf logic and linear products—for example diode-transistor-logic registers and programmers,  $\mu A722$  D/A converters, and the  $\mu A709$ ,  $\mu A715$ , and  $\mu A734$  linear series—and a few external resistors and capacitors. These IC elements are compatible in terms of operating levels at the logic-linear interface, and discrete semiconductor level-shifting elements are not needed.

Presented at the 1967 Fall Joint Computer Conference, Anaheim, Calif., Nov. 14-16.

### Changing with the wind

An adaptive multiple-access system  
C.E. Sampson  
IBM Federal Systems Division  
Center for Exploratory Studies  
Rockville, Md.

Future satellite communication systems serving many users in different locations will probably operate at millimeter wavelengths. However, above 15 gigahertz, atmospheric attenuation becomes a problem. If these systems adapt to local atmospheric conditions by taking energy from strong channels and giving it to weak channels, they can get along with less power. A hypothetical 45 gigahertz system with 40 channels that must be available 99.8% of the time would use 20 times less power than a comparable nonadaptive system.

A typical system might time-multiplex signals and then modulate them with random sequences of bits. Known as pseudonoise modulation, this technique makes it simple to derive timing information at the ground terminals and also offers message security.

Each ground station would transmit in time slots assigned to the station it wished to reach. Pulse trains from each ground station would be combined into a higher-speed train at the satellite and then relayed back to the earth where each receiver would pick out its



# Announcing TOYO GEMLIGHT — New Color Illumination Indicator Lamps for Electrical Equipment and Components!

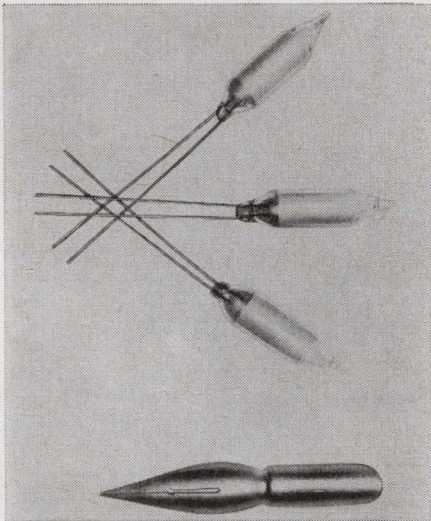

Based on principles completely different from those of the filament type lamp or of the glow discharge tube, this newly developed cold cathode fluorescent glow discharge lamp gives you unprecedented features such as:

- Instantaneous illumination (quicker than fluorescent lamps)
- Minimal voltage requirement—App. 80V AC
- A variety of colors available through combinations of gases and fluorescent compounds, standard colors being green, yellow and reddish orange
- Extra small power consumption of 0.9mA App., ranging from 1/10 to 1/150 of equivalent filament lamps'
- Excellently stable operation even under fluctuating voltage
- Radiates little heat, of which temperature variation remains within 3°C
- Excellent vibration resistance
- Over 10,000 hours life under proper conditions

**TOYO MUSEN CO., LTD.**

Head Office: 1-8-10, Wakabayashi, Setagaya-ku, Tokyo, Japan Telex: Tokyo 242-2572  
Cable: TOYORADICATOR

#### US Branch Office:

Mr. Isao Hironaka  
c/o Marubeni-lida (America), Inc.  
Chicago Office,  
938 Merchandise Mart, Chicago, Illinois 60654  
Phone: 527-3800 Area Code: 312

## Technical Abstracts

messages by looking only at its own time slots.

Periodically, a user would check the strength of the transmitted signals and then transmit the results of his measurements to a central controller. His job would be to dictate the duration of pulses sent from each terminal. If a user's signal were being attenuated, he'd be told to increase pulse duration, thereby increasing his transmitted power. If his signal were stronger than necessary, he'd be told to decrease pulse duration. If too many fades happened simultaneously, users would have to reduce data rates to prevent widened pulses in different time slots from interacting.

Presented at IEEE Eastcon, Washington, Oct. 16-18.

### Not just any memory

Main-frame memory technology—a debate

Improvements in multiprocessor, time-sharing computer systems depend largely on improved memories. Newer semiconductor memories now compete with the older magnetic ones, but each type has its advocates. Position papers by four panelists discuss the competitive factors of new planar and cylindrical magnetic-film memories, large-scale integrated semiconductor memories, and refinements in magnetic memories.

Planar magnetic-film memory cells switch rapidly; the access and cycle time of the complete memory depends not on the individual device but mainly on the array parameters and circuit and packaging designs. Planar film memories have relatively low drive currents, low impedances and, consequently, low power. This permits the use of high-speed drive and sense circuits. In addition, array packing densities approach  $10^4$  bits/in<sup>2</sup>, leading to relatively short drive and sense lines with relatively large numbers of bits per line.

The highly integrated structure is somewhat more complex to process. However, simplified packaging and reduced number of intercon-

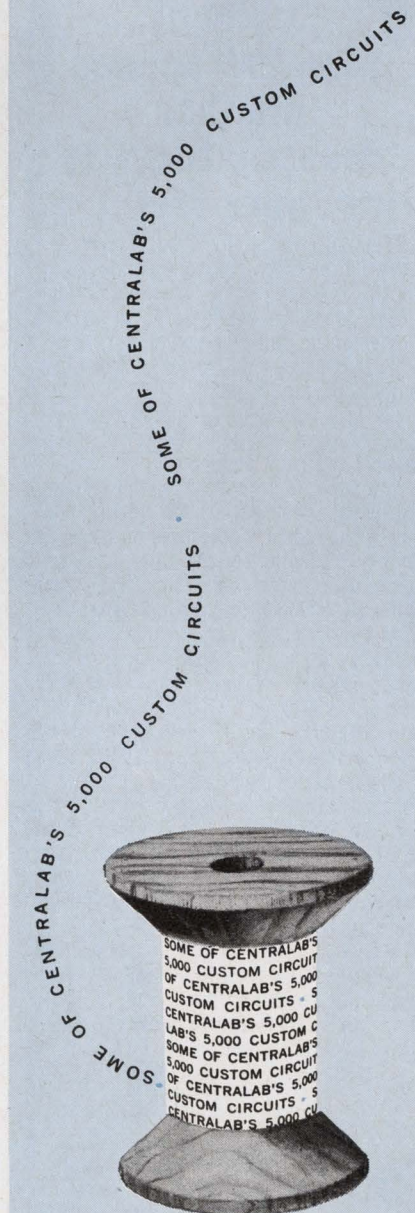





**"Bulldog"  
Marshall spends  
another  
disappointing day  
with Super-Mercury.**

Marshall? He's the crankiest of the Twelve Cranks on Pleasant Avenue. One of the extra-picky grumps at Trygon Power Supplies who feels good all over only when he can pick something off our production line and shriek, "Hey! This is no % #&ç@# good!"

So far, he's had problems with our Super-Mercury series. Because there haven't been any problems.

The Super-Mercury is a brand new competitively priced series, the new generation of the industry-accepted, field-proven Trygon Mercury Series: fully programmable wide-range power supplies, power and value packed, offering precision Constant Voltage/Constant Current operation. Precision performance (with up to 2000 watts output), in ranges up to 160 volts and up to 100 amps. .005% regulation and 0.015% stability are standard (.005% stability optional) as is MIL Spec, RFI-free performance. Total ripple and noise less than 1mv rms and 10MV P-P (to 10MHz). Master-slave tracking, auto-load share paralleling and remote sensing and programming are also standard with Trygon's patented tracking overvoltage protection available.

Marshall and his friends check the dozens of Super-Mercury features that make this series a Super-buy for you. Now it's your turn to check on them. Order a Super-Mercury as a starter.

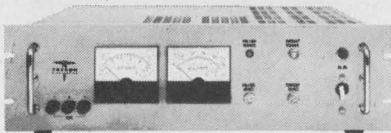

**Trygon Power Supplies**

111 Pleasant Avenue, Roosevelt, L.I., N.Y. 11575  
Trygon GmbH 8 Munchen 60, Haidelweg 20, Germany

**Technical Abstracts**

nections will far outweigh this disadvantage.

Q.W. Simkins, IBM Corp., Essex Junction, Vt.

▪ Plate wire appears to offer advantages in memories. Because air gaps in magnetic memory elements generally are nuisances, there is a strong trend in planar film memories to close the gap. In this case, a single plating operation on a continuous cylindrical substrate should result in a significant advantage for plated wire.

The continuous substrate manufactured and tested plated wire memory element provides for improved yields also. Perhaps the main advantage of the plated magnetic cylindrical thin film memory element is its nondestructive read-out capability, which allows flexibility of memory and system organization and operation.

G.A. Fedde, Sperry Rand Corp., Philadelphia.

▪ Large-scale integration of active semiconductor memories permits several thousand memory cells to be interconnected on a single substrate. It also allows drivers, decoders, and sensing to be integrated with the memory matrix, reducing the number of array connections, increasing packing density, and reducing internal noise.

The most economical use of LSI bipolar array would be for memories larger than 5,000 bits. The next level will be several such arrays on a circuit board. However, bipolar main frame active memories probably will not find commercial use until 1970 when 5,000 bit arrays are available in volume.

R.S. Dunn, Texas Instruments Incorporated, Dallas.

▪ Magnetics is still the best choice for computer main memory. Toroidal ferrite cores have predominated because of their relatively low cost and the economies from coincident-current operation.

During the last five years batch-fabricated magnetic structures have received increased attention because they promise to lower memory array cost and increase speed. R.J. Petschauer, Fabri-Tek Inc., Edina, Minn.

Presented at the 1967 Fall Joint Computer Conference, Anaheim, Calif., Nov. 14-16.

**Why Phoenix  
spells  
p-r-o-f-i-t**

In this land of year-round sunshine it costs less to build plants and homes, too. People can live better, stay healthier, save more money. Outdoor sports and hobbies can be enjoyed 12 months a year. Production lines are blizzard-proof. Productivity and morale are higher. Our tax structure encourages profitable growth.

For FREE 40-page brochure, "PHOENIX: Environment for Science-Oriented Industries," write Stanton Allen, Manager, Economic Development Department, Room E-4, Chamber of Commerce, Phoenix, Arizona 85004



Circle 285 on reader service card

**FIXED COMPOSITION RESISTORS**

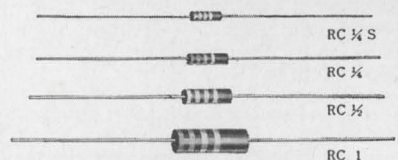

**SEMI-FIXED RESISTORS**



**NOISE SUPPRESSORS FOR CAR RADIOS**

TYPE K(II)

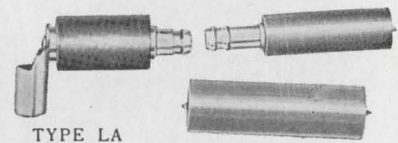

**TAIYO DENKI CO., LTD.**  
1-12, 3-Chome, Sunamichi  
Sakai c., Osaka, Japan  
TEL: SAKAI (3) 6841



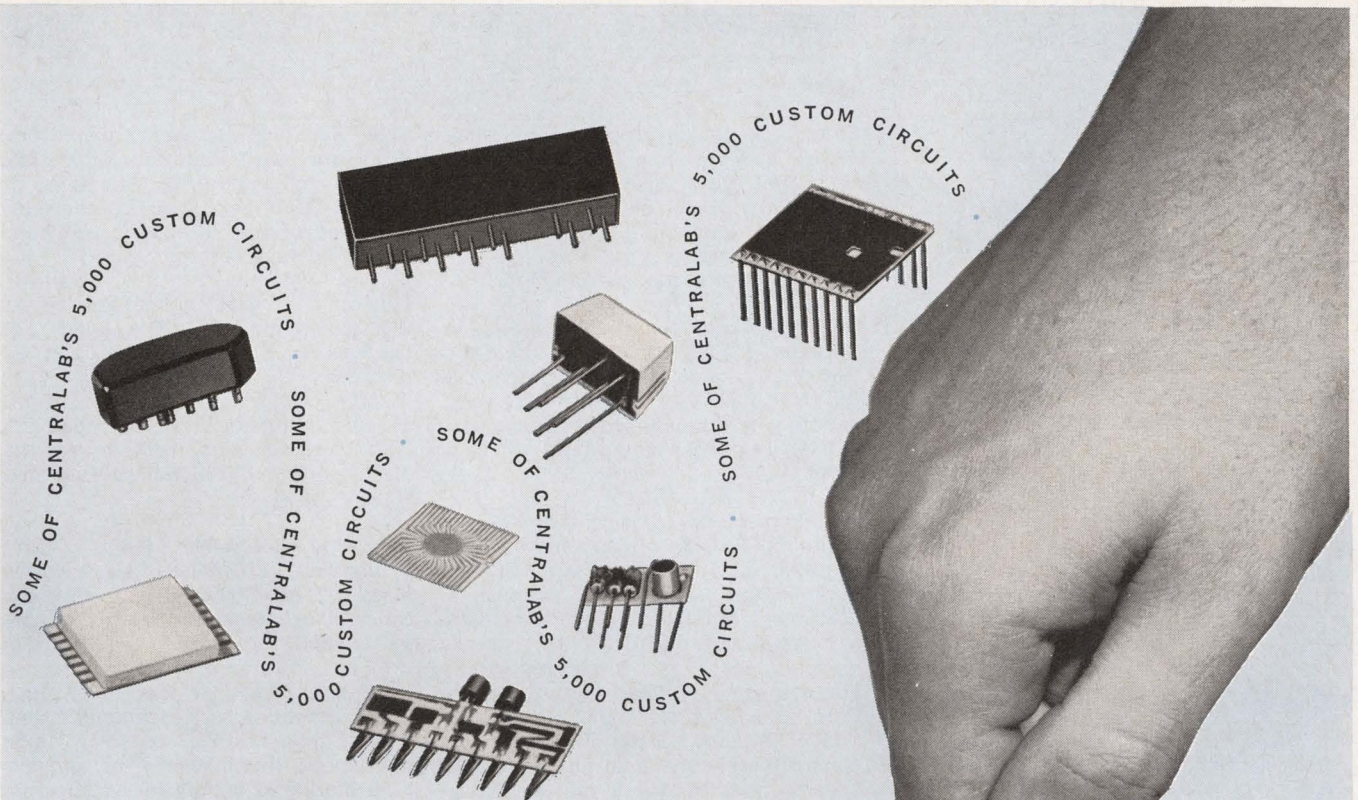

# Gain a stitch in time with MICROCIRCUIT TAILORING by Centralab

**We can tailor microcircuits to your needs and deliver a sample in as little as two weeks — ship production quantities five weeks later.**

You'd think that the largest manufacturer of microcircuits (Centralab has produced more than any other manufacturer, 459,700,000) would have little or no time to spend on custom designed circuits. But Centralab has.

**We have, in fact, designed more than 5,000 different circuits for every conceivable application, industrial, military and commercial.**

Centralab doesn't rely on numbers alone, either. We manufacture our own ceramic materials; and our substrates and ScoreStrates™ are so superior that other manufacturers use them in their microcircuits.

**Let Centralab sew up your design with prompt action on custom designed circuits. Write to Centralab, Application Engineering Department, today.**

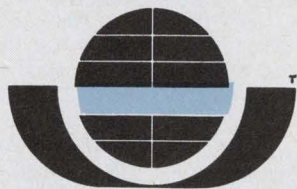

**CENTRALAB** Electronics Division • GLOBE-UNION INC.  
5757 NORTH GREEN BAY AVENUE • MILWAUKEE, WISCONSIN 53201

M-6801



## ECCOSHIELD® RF SHIELDING MATERIALS



Brand new six page folder in color describes a complete line of Eccoshield products to combat RFI conductive plastic sheet and gaskets, adhesives, coatings, caulking compounds, metallic foil—the works.

Circle 516 on reader service card

## ECCOMOLD® EPOXY MOLDING COMPOUNDS

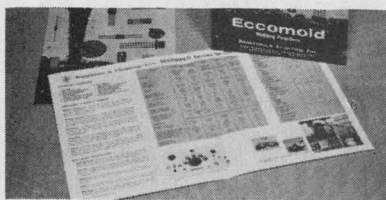

### FREE CHART

NEW

NEW

Comparative physical, electrical and processing properties of Eccomold transfer molding compounds are in colorful chart. Typical applications are indicated.

Circle 517 on reader service card

## ECCOSORB® COMPLETELY REVISED



Six page folder in color describes and gives performance data on the complete line of Eccosorb® Microwave Absorbers for Free Space and Waveguide.

Circle 518 on reader service card

## Emerson & Cuming, Inc.



CANTON, MASS.  
GARDENA, CALIF.  
NORTHBROOK, ILL.  
Sales Offices  
in Principal Cities

EMERSON & CUMING EUROPE N.V., Oevel, Belgium

## New Literature

**Functional analog modules.** RO Associates, 917 Terminal Way, San Carlos, Calif. 94070. A six-page folder contains descriptions and applications of a line of functional analog modules for systems application.

Circle 446 on reader service card.

**Schottky-barrier diodes.** Microwave Associates Inc., Northwest Industrial Park, Burlington, Mass. 01803. Technical bulletin 4049 describes a series of Schottky-barrier junction diodes covering the frequency range from vhf to L band. [447]

**R-f connectors.** Applied Engineering Products, Division of Samarius Inc., 26 E. Main St., Ansonia, Conn. 06401. Subminiature, coaxial r-f connectors that meet MIL-C-22557 are described in bulletin 167. [448]

**Magnetostrictive delay line.** Sealectro Corp., 225 Hoyt St., Mamaroneck, N.Y. 10543. Product bulletin DT-24 includes electrical, environmental and operating specifications for the LD-50 adjustable magnetostrictive delay line. [449]

**Keyboard assemblies.** MicroSwitch, a division of Honeywell, 11 W. Spring St., Freeport, Ill. 61032. Brochure 84-20001-0 describes solid state encoded and wired keyboard assemblies. [450]

**Numerical-control system.** Digital Systems Inc., 1078 E. Edna Place, Covina, Calif. 91722, offers a brochure on the model 3050 N/C tape programer and inspection system for p-c board applications. [451]

**H-v power supply.** Hamner Electronics Co., P.O. Box 531, Princeton, N.J. 08540. A 3,000-v power supply for operating radiation detectors is described in technical bulletin NV-19. [452]

**Surge comparison tester.** Aerospace Electrical Division, Westinghouse Electric Corp., P.O. Box 989, Lima, Ohio 45802. A booklet describes a surge comparison tester for detecting and locating insulation faults and winding dissymmetries in motors, generators, and many types of transformers and coils. [453]

**Two-wire transducers.** Fischer & Porter Co., Warminster, Pa. 18974. Specification 50EM/ET3000 describes solid state millivolt-to-current and thermocouple-to-current two-wire transducers. [454]

**Tunnel-diode amplifiers.** Radio Engineering Laboratories, 29-01 Borden Ave., Long Island City, New York 11101. Tunnel-diode amplifiers operating in the 1-, 2- and 5-Ghz frequency bands are described in a technical data sheet. [455]

**Color videotape recorder.** Ampex Corp., 401 Broadway, Redwood City, Calif. 94063. An eight-page brochure describes features, specifications and operation of the VR-2000B high band, color videotape recorder. [456]

**Electronic control tachometer.** Airpax Electronics Inc., P.O. Box 8488, Fort Lauderdale, Fla. 33310. Bulletin F-5 discusses the Tach-Trol line of industrial electronic tachometers, which convert frequency, rpm or speed into high level output current ranges that are linearly proportional to the input signal. [457]

**Indicating controller.** Sigma Instruments Inc., 170 Pearl St., Braintree, Mass. 02185. Standard indicating controller 9221 is described in bulletin 1171. [458]

**Multiplexer.** Beckman Instruments Inc., 2200 Wright Ave., Richmond, Calif. 94804. Bulletin 2216 covers a digital instrument multiplexer that provides time-sharing capability for five or more input sources. [459]

**Infinite resolution pots.** New England Instrument Co., 281 Billerica Rd., Chelmsford, Mass. 01824, offers an eight-page instruction book that shows designers how to make their own infinite resolution potentiometers. [460]

**Ceramic substrates.** Coors Porcelain Co., Golden, Colo. High-alumina ceramic substrates for thick- and thin-film circuits are described in bulletin 7012. [461]

**Circuit-deck switches.** Beckman Instruments Inc., 2500 Harbor Blvd., Fullerton, Calif. 92634. Data sheet 671521, on the circuit-deck series 1390 Cermet switches, contains information on a design that combines resistor and capacitor networks with the switch itself. [462]

**Test-point connectors.** Continental Connector Corp., 34-63 56th St., Woodside, N.Y. 11377, offers an eight-page catalog covering test-point connectors for printed-circuitry applications. [463]

**Microminiature chopper.** Solid State Electronics Corp., 15321 Rayen St., Sepulveda, Calif. 91343, has published a bulletin on the solidly encapsulated, model 30 Microchopper, a low-level spdt switch for operation from -55° to +90°C. [464]

**Ultra-high-vacuum products.** Edwards High Vacuum Inc., 3279 Grand Island Blvd., Grand Island, N.Y. 14072, has available data sheets describing 25 new ultra-high-vacuum products. [465]

**Straight cable plug.** Sealectro Corp., 225 Hoyt St., Mamaroneck, N.Y. 10543.



Product bulletin CX-105 describes a new 50-ohm, snap-on straight cable plug. [466]

**Computer.** Digital Equipment Corp., 146 Main St., Maynard, Mass. 01754, offers a brochure that shows and explains its PDP-8/1 computer, a fast integrated-circuit system selling for \$12,800. [467]

**Precision resistor alloy.** The Kanthal Corp., Wooster St., Bethel, Conn. 06801. Nikrothal LX precision resistance wire, which is stable at temperatures up to 300°C, is described in a 12-page booklet. [468]

**Instrument transformers.** James Electronics Inc., 4050 N. Rockwell St., Chicago, Ill. 60618. A 12-page, master instrument transformer catalog provides technical data, performance tables, mechanical dimensions and drawings, frequency response curves and formulas, and complete specifications and test techniques. [469]

**Test equipment.** The London Co., 811 Sharon Drive, Cleveland, Ohio 44145. Electronic test equipment for laboratory, quality control and production applications is described in a six-page color brochure. [470]

**Power relays.** Magnecraft Electric Co., 5575 N. Lynch Ave., Chicago, Ill. 60630. Eight-page power relay catalog 567 contains specification data, dimensional drawings, and prices of a complete line of heavy-duty power relays. [471]

**Amplifiers.** C-Cor Electronics Inc., 60 Decibel Road, State College, Pa. 16801. A 28-page catalog presents complete detailed data on a wide range of small, economical amplifiers for breadboard, laboratory, or system use. [472]

**Computer tape.** Audio Devices Inc., 235 E. 42nd St., New York 10017. A technical data sheet describes the Audev K-68, an extended reliability magnetic tape for modern digital computers. [473]

**Rotary thumbwheel switches.** Engineered Electronics Co., 1441 E. Chestnut Ave., Santa Ana, Calif. A 54-page catalog, including 16 pages of application information, describes the company's complete line of rotary thumbwheel switches. [474]

**Aircraft flight control.** General Precision Systems Inc., 808 Western Ave., Glendale, Calif. 91201. An aircraft flight-control system is described in an eight-page brochure on the L-193 head-up display. [475]

**Coaxial attenuators.** Meca Electronics Inc., 459 E. Main St., Denville, N.J., has issued a 32-page catalog covering a broad range of coaxial attenuators. [476]

**Indicating lights.** General Electric Co., Schenectady, N.Y. 12305. Bulletin GE-



# 1948

**Power: 250 VDC at 50 watts**  
**Weight: 17 lbs.**  
**Size: 12" x 8" x 8" high**



Model GA6D

# 1968

**Power: 250 VDC at 60 watts**  
**Weight: 4 lbs.**  
**Size: 6" x 6" x 4" high**

## Are You Buying Obsolete Power Supplies for Your Space-Age Equipment?

*The Abbott power module shown above has 20% more power, 1/4 the weight, 1/10 the size — and it is hermetically sealed!*

Power supplies have come a long way since the heyday of the vacuum tube. Abbott solid state power modules have more reliability and performance at less cost than their tube-type cousins of yesterday.

**MIL SPEC QUALITY** — Designed to meet the severe environmental conditions of the space age, modern solid state power modules should be built ruggedly to meet the stringent requirements of MIL-E-5272C for temperature extremes and conditions of altitude, vibration, shock, sand, dust, humidity, salt spray, fungus, sunshine, rain, and explosion. The Abbott power modules are hermetically sealed and encapsulated in heavy steel containers to meet tough environments.

**REGULATED** — Most of today's missile systems require a well regulated power module to provide practically "fixed" output voltages against variations of the line input voltage and frequency as well as changes in the output load. The Abbott unit shown above (Model GA6D-247A) has a conservative line regulation of 0.2% and a load regulation of 1% — and an output voltage screwdriver adjustment for compensating to the exact voltage needed.

**SIZE and WEIGHT** — Today's airborne and ground equipment require a minimum weight and size. High density electronic packaging and good design permit Abbott

power modules to have minimum size and weight for a given power. For example, one of the Abbott DC to DC regulated models is only slightly larger than a pack of cigarettes and weighs less than a pound. Other models described in the new Abbott catalog have correspondingly small sizes and weights.

**QUALITY COMPONENT PARTS** — The quality and reliability of a power supply for the space age is no better than the component parts used in its construction. Abbott power modules used only the highest quality semiconductors and MIL-T-27A transformers in their construction. Where heat sink temperatures of 100°C are required, all silicon devices of highest quality are used exclusively.

**WIDE RANGE OF OUTPUTS** — The Abbott line of power modules include output voltages from 5.0 VDC to 10,000 VDC with output currents from 2 milliamperes to 20 amperes. They are all listed with prices in the new catalog with various types of inputs:

- 60  $\overline{A}$  to DC, Regulated
- 400  $\overline{A}$  to DC, Regulated
- 28 VDC to DC, Regulated
- 28 VDC to 400  $\overline{A}$ , 1 $\phi$  or 3 $\phi$
- 60  $\overline{A}$  to 400  $\overline{A}$ , 1 $\phi$  or 3 $\phi$
- 60  $\overline{A}$  or 400  $\overline{A}$  to DC, Unregulated
- 28 VDC to DC, Hi-Temp
- 400  $\overline{A}$  to DC, Hi-Temp

*Please write for this new catalog or see EEM (1967 ELECTRONICS ENGINEERS MASTER Directory) Pages 1665 to 1678.*

**abbott transistor**

LABORATORIES, INCORPORATED  
 5200 W. Jefferson Blvd. • Los Angeles 90016  
 Area Code 213 • WEBster 6-8185

**TO: Abbott Transistor Labs, Inc., Dept. 43**  
 5200 W. Jefferson Blvd.  
 Los Angeles, California 90016

Sir:  
 Please send me your latest catalog on power supply modules:

NAME \_\_\_\_\_ DEPT. \_\_\_\_\_  
 COMPANY \_\_\_\_\_  
 ADDRESS \_\_\_\_\_  
 CITY & STATE \_\_\_\_\_



# FOR PRECIOUS METAL POWDERS COME TO MATTHEY BISHOP

## Here's Why

- Matthey Bishop offers variety in metals and their characteristics
- Matthey Bishop is willing to "tailor" to your specs and our prices are amazingly low

Matthey Bishop's wide variety of powders differ in particle size, surface area, bulk density, shape (powder or flake) to meet exacting requirements. No matter how you use powders—for fuel cells, metalizing preparations, resistors, printed circuits, circuit decals, capacitors, or in other ways, you will find Matthey Bishop has, or will make, precious metal powders to meet your particular specifications. By all means, contact us when you need a precious metal powder for making inks or pastes or for your own special application.

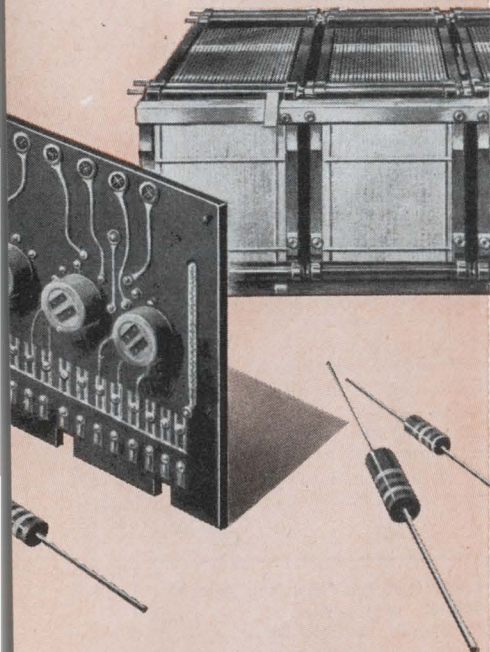

**MATTHEY BISHOP, INC.**

Chemicals Division / Chemical Products  
MALVERN, PENNSYLVANIA 19355

Phone: (215) 644-3100

A Johnson Matthey Affiliate

In Canada: Johnson Matthey & Mallory Limited

## New Literature

8119A provides features and outline drawings with dimensions and complete ordering information for the four lines of CR103 type H indicating lights. [477]

**Diode selection.** Motorola Semiconductor Products Inc., P.O. Box 955, Phoenix, Ariz. 85001. Publications SG3 and SG4 make possible easy, quick identification and selection of virtually any zener or temperature-compensated reference diode. [478]

**Molded mica capacitors.** Electro Motive Manufacturing Co., Willimantic, Conn. 06226. A 12-page catalog covers the El Menco MM series of molded mica capacitors that have capacitance ranges from 1 pf through 51,000 pf. [479]

**Indicating controller.** Sigma Instruments Inc., 170 Pearl St., Braintree, Mass. 02185. Bulletin 1167 provides performance, electrical, environmental, and physical specifications on the model 9223 subminiature indicating controller. [480]

**Transducer.** Taber Instruments, 455 Bryant St., North Tonawanda, N.Y. 14120, has issued product sheet P672103 on the series 2103 transducer designed for applications where accurate low-pressure readings must be taken after high overloads. [481]

**Photoresist spinner/dispenser.** Headway Research Inc., 3713 Forest Lane, Garland, Texas 75040, offers a six-page technical bulletin on the AHT-SRD photoresist spinner with complete automatic fluid-dispensing system. [482]

**Differential operational amplifiers.** Analog Devices Inc., 221 Fifth St., Cambridge, Mass. 02142. A 14-page application note discusses techniques that have led to a generation of differential operational amplifiers with maximum drift specifications down to  $0.75\mu\text{V}/^\circ\text{C}$ . [483]

**Coaxial hybrid couplers.** Microwave Development Laboratories Inc., 87 Crescent Road, Needham Heights, Mass. 02194. Bulletin HK-3 provides data on coaxial hybrid couplers for use in microwave subsystems such as mixers, duplexers, phase shifters and power dividers. [484]

**Printed circuits.** Photocircuits Corp., 31 Sea Cliff Ave., Glen Cove, N.Y. 11542, offers a 12-page technical bulletin on printed circuits manufactured by the CC-4 process, which retains the broad applicability of the etching technique at less total cost. [485]

**Power modules.** Electronic Research Associates Inc., 67 Sand Park Road, Cedar Grove, N.J. 07009. Catalog sheet 147A covers the LC series of low-cost, wide-range power modules. [486]

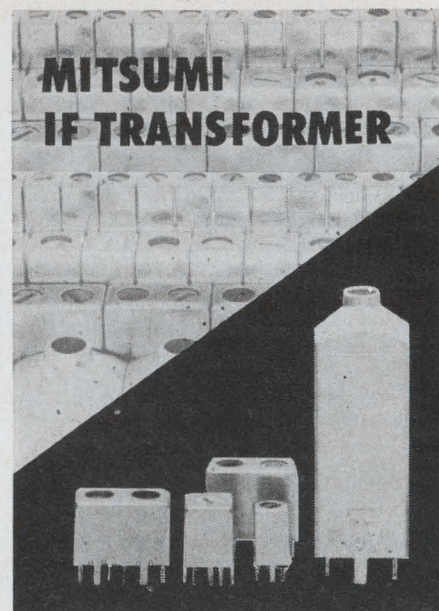

**Reliability proved by a Monthly production output of 13,000,000 !**

The Mitsumi IFT is widely used in many fields such as AM or FM radios, black and white or color television sets and various types of communication equipment. A monthly production output of 13,000,000 ..... Mitsumi's untiring efforts for the promotion of reliability have borne fruit and the Mitsumi IFT has now become an international product used the world over.

**Automatic winding machines that assure maximum stability**

The Mitsumi IFT, famed for its originality, high quality and excellent performance, is made on digital type automatic winding machines of our own design, which, by inserting punch cards, can wind one IFT every 8 seconds. The use of strictly selected materials and perfect production control always guarantee stable performance.

The mechanical performance of the Mitsumi IFT is also stable with excellent shock resistance and smooth rotation torque. The Mitsumi IFT will give you full satisfaction in every respect.

Specification	Model	K7-E	K10-E	M20-B
For AM IFT	Frequency cover range	455 ± 20kc	455 ± 20kc	455 ± 20kc
	Tuning capacity (built-in)	180 ± 20μF	180 ± 20μF	150 ± 30μF
	Unloaded Q (Q <sub>u</sub> )	70 ± 15%	70 ± 15%	80 ± 15%
For FM IFT	Frequency cover range	10.7 ± 0.3Mc	10.7 ± 3Mc	10.7 ± 3Mc
	Tuning capacity (built-in)	A.B.C - 50 ± 5μF	A.B.C - 50 ± 5μF	A.B.C - 50μF
		D - 30 ± 3μF	D - 30 ± 3μF	D - 30 ± 3μF
		E - 50 ± 5μF	E - 50 ± 5μF	E - 50 ± 5μF
Unloaded Q (Q <sub>u</sub> )		A.B.C - 70 or more	A.B.C - 90 or more	60 or more
		D.E - 60 or more	D.E - 70 or more	



**MITSUMI**

MITSUMI ELECTRIC CO., LTD.

1056 Koadachi, Komae-machi, Tokyo 415-6211  
302, Cheong Hing Bldg, 72, Nathan Road, Kowloon, Hong Kong 666-925

Marienstrasse 12, Düsseldorf, W Germany

MITSUMI ELECTRONICS CORPORATION

11 Broadway, New York 4, N Y 10004 HA5-3085  
333 N Michigan Avenue, Chicago, Ill 60601 263-6007

← Circle 234 on reader service card

Circle 287 on reader service card



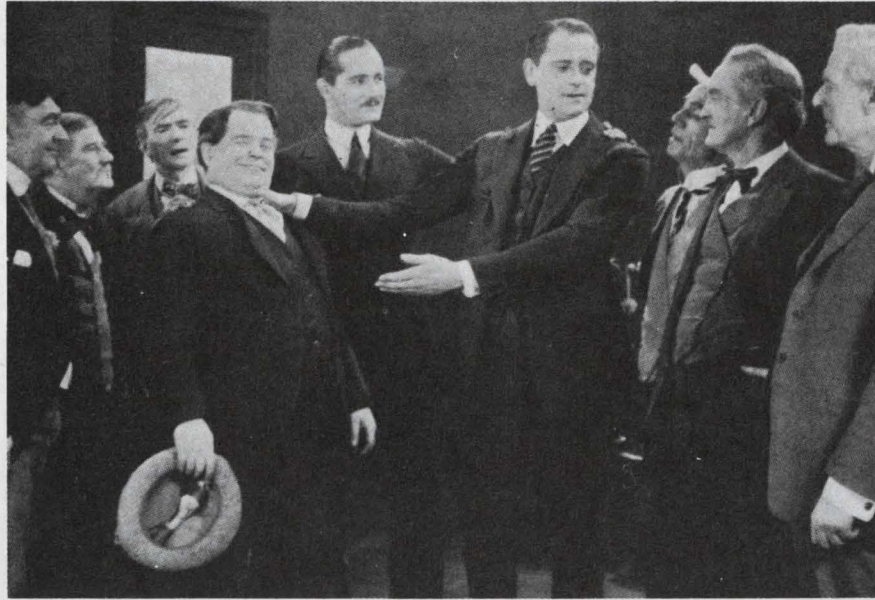

## Looking for a place in the sun?

### Try Sunnyvale.

We're not just talking about the weather... even though it's great on the San Francisco Peninsula.

We mean **recognition**.

Link is the kind of outfit where a good engineer gets ahead fast.

We're a respectable size, but not a place you could possibly get lost in. The effects of your work are immediately significant, visible and appreciated.

We can't afford to hire engineers or scientists to do routine jobs. You get real responsibility immediately, more as you're able to handle it. With suitable rewards.

If advanced electronics is your meat—we have gourmet opportunities. Digital computers. Graphic data conversion. Extreme-resolution flying-spot-scanners. Radar mapping. CRT display. Aircraft and spacecraft simulation. Ordnance and high-speed reaction processes. Sophisticated traffic control systems.

We've got plenty of good weather and a wonderful intellectual climate, with Stanford U. and three other major schools nearby.

We're near San Francisco — near bay and ocean, redwood forest and wine country.

*Link is a growing, aggressive firm backed by the resources of a great company. If you match the qualifications, we have a sunny spot for you. Read these:*

- Scientific Programmers
- System Design Engineers
- Analog Circuit Design Engineers
- Servo Design Engineers
- Digital Test Engineers
- Field Engineers
- Electro-Mechanical Designers
- Technical Writers
- Industrial Engineers
- Logic Design Engineers
- Systems and Procedures Analysts
- Electronics Sales Engineers
- Digital Technicians

Interested candidates are invited to submit resumes in confidence, with salary history, to Mr. R. E. L. Nadzam, Employment Supervisor.

**GP GENERAL  
PRECISION  
SYSTEMS INC.**

#### LINK GROUP

1077 E. Arques Ave., Sunnyvale, Calif. 94806

An equal opportunity employer.  
A Plans for Progress company.



DOUG DAVIS, BSEE, Vanderbilt '65, is supervising the major structural modifications of a floating drydock to be used as the mother ship for the TRIESTE II, the Navy's 20,000 ft. bathyscaphe.

# Young engineers are key engineers at the San Francisco Bay Naval Shipyard.

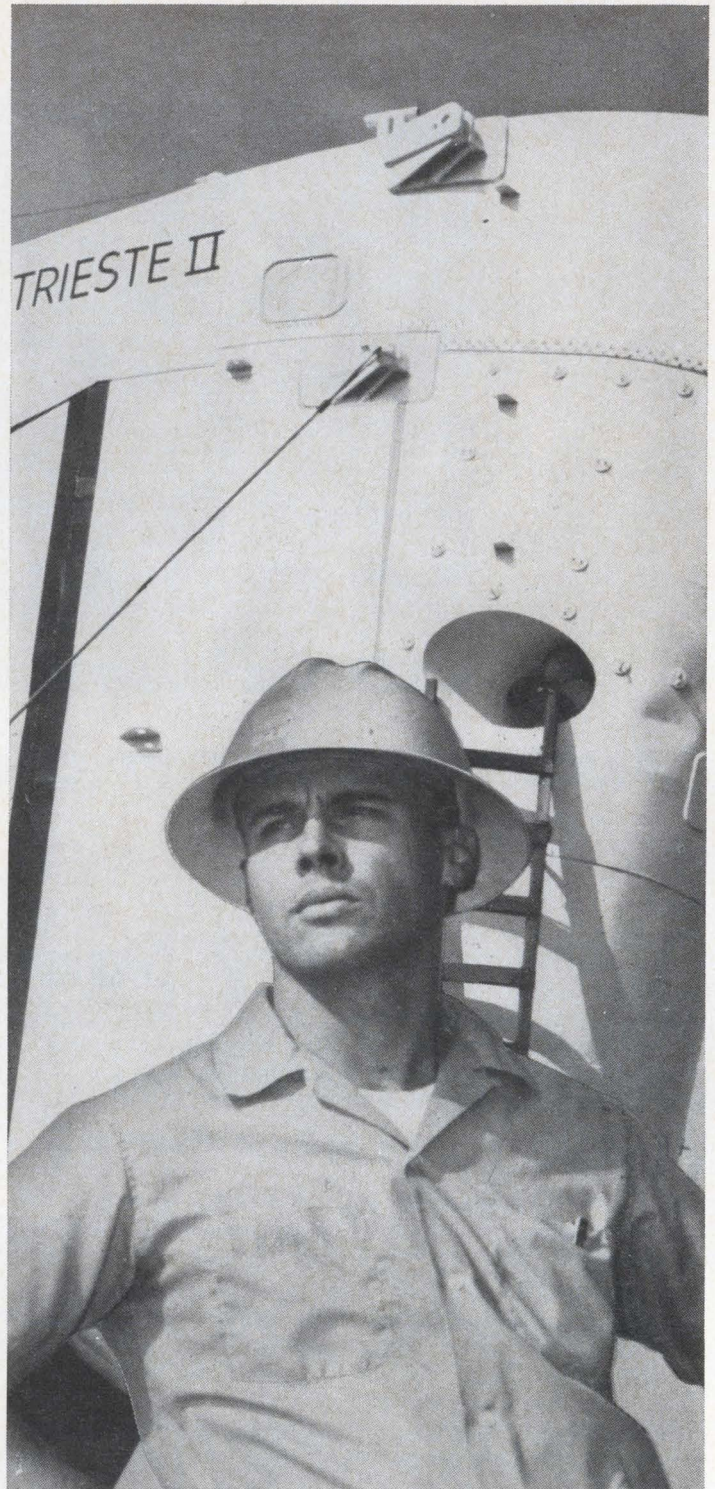

If you're ready for more responsibility than your present employer is willing to give you, join the young engineers who are handling the big jobs at the San Francisco Bay Naval Shipyard.

Critical assignments in the development of deep submergence vehicles and in the conversion of conventional and nuclear surface craft and submarines have created immediate openings for men qualified by education and experience in the areas of:

• **Instrumentation** • **Optical Systems** •

**Piping Systems** • **Structural Engineering** • **Materials Development, Test & Evaluation** • **Power Systems (Conventional and Nuclear)** • **Hydrodynamics & Ship Design** • **Mechanical Equipment Engineering** • **Configuration Control** • **Systems Analysis** • **Radar & Sonar Systems** • **Communications Systems**

SALARIES TO \$12,500 A YEAR

Higher-level positions usually filled by promotion from within.

Positions available at both San Fran-

cisco and Vallejo facilities of the San Francisco Bay Naval Shipyard. Full Civil Service benefits plus tuition payment plan for advanced degrees. Relocation expenses paid.

---

Send resume or SF-57 to:

**Employment Manager, Code 174-5J**  
**San Francisco Bay Naval Shipyard**  
**Vallejo, California 94592**

---

*An Equal Opportunity Employer*

*U. S. Citizenship Required*

**CIRCLE 961 ON READER SERVICE CARD**

**Electronics | January 8, 1968**



# Fringe benefits, schminge benefits...

## Whatever happened to your career?

If you're an electronic engineer or scientist, that's what you're supposed to be. Not a premature candidate for senior citizenship.

Retirement plans, medical care, life insurance. Everybody has them. We do, too.

But didn't you go to school because you wanted to make a contribution? Weren't you fascinated by a particular discipline?

Then why are you working on dull projects, waiting to collect your fringe

benefits? You should be working with top people on exciting and important projects. Like the major space surveillance programs at our Electronics Division.

Here you can be part of a stimulating creative environment, where you do your very best thinking.

We need engineers and scientists — such as electronic circuit design and project engineers, optical engineers, and infrared specialists for work on some of the nation's most advanced programs. In fields like sophisticated

space surveillance, satellite payloads, infrared and star sensing devices, data processing. And many more.

In addition we offer you the most valuable fringe benefit of all — hard, exciting work.

Just send your resume to Bob Smith, Aerojet-General Corporation, Box 303F, Azusa, California 91702.



AN EQUAL OPPORTUNITY EMPLOYER



**ENGINEERS**

At  
**GENERAL ELECTRIC**  
Power Transmission Division

## Creative Engineering Becomes Imaginative Hardware!

It takes a special kind of scientific creativity and engineering freedom to develop, design and manufacture America's first commercially operating 500,000-volt circuit breaker, capable of handling electric power faults of 35,000,000,000 volt-amperes in 1/30th of a second. To build just one of these 37-foot-high, 175,000-pound giants is a technological triumph by any standard, but *we're* building them every day . . .

Or take our new and exciting protective relay systems which utilize the latest in solid state technology to safeguard giant electrical transmission systems all over the United States . . .

Or our vacuum power interrupter which interrupts electrical power equivalent to 500,000 horsepower in a vacuum tube

about the size of a milk bottle . . .

Or our static power conversion equipment which uses the highest power rated thyristors and silicon diodes (also manufactured here) to replace larger and much less efficient mercury rectifier tubes and rotating machines, and to provide a highly reliable source of uninterrupted power for process control equipment and computers.

All of these technological innovations required the expert knowledge of an exceptional staff of engineers and scientists working in such specialized areas as plasma arc processes, electrical and mechanical transients, vacuum technology, aerothermodynamics, extra high voltage (AC and DC) transmission, solid state circuit and equipment design, etc.

*If you are interested in learning more about our stimulating work environment, write today for our illustrated brochure "INVOLVEMENT", to —*

Mr. R. C. WIGGINS — DEPT. EE-01

**GENERAL  ELECTRIC**  
Power Transmission Division

6901 Elmwood Avenue — Philadelphia, Pa. 19142

An Equal Opportunity Employer

Spectacular state-of-the-art advances in all of these disciplines is just part of the reason why the field of transmission, protection and conversion of electric power is one of the most exciting in which to work!

Current growth creates continuing needs for both experienced personnel and recent graduates in the following fields:

- ENGINEERS—All Disciplines
- PHYSICISTS
- CHEMISTS
- CERAMIST
- METALLURGISTS

For Work In:

- BASIC & APPLIED RESEARCH
- DESIGN, DEVELOPMENT and APPLICATION ENGINEERING
- PRODUCTION ENGINEERING
- MANUFACTURING
- EDP



## ENGINEER

B.S.E.E. degree or equivalent in experience. To service numerically controlled electronic equipment in the field. Travel 75%. Minimum 4 years experience in servicing or manufacturing of numerical control electronic equipment and/or digital computers. Salary open. Outline your qualifications in resume to: John Rotte Associates, 6100 Belleair Place, Cincinnati, Ohio 45224.

CIRCLE 968 ON READER SERVICE CARD

ADDRESS BOX NO. REPLIES TO: Box No. Classified Adv. Div. of this publication.

Send to office nearest you.

NEW YORK, N. Y. 10036; P. O. Box 12  
CHICAGO, Ill. 60611; 645 N. Michigan Ave.  
SAN FRANCISCO, Cal. 94111; 255 California St.

## POSITION VACANT

Across The Spectrum in the Electronics Industry—Engrg—Mgmt—Sales. Gardner Assoc. MU 7-6616 545 5th Ave., N.Y., N.Y. 10017.

## EMPLOYMENT SERVICES

Career Advancement—Electronic and electrical engineers, mathematicians, physicists. Challenging R&D, product development, QC systems manufacturing and sales positions. Fee paid. Multiple exposure. Confidential. Send resume. Multiple Career Listings, Inc., 322 W. Jefferson Blvd., Dallas.

## SPECIAL SERVICES

Market Research—Japan—As the only industrial market research organization in the Orient controlled by Western management, all holding graduate technical degree and with substantial market research experience, we are in a unique position to develop any information you may require about current and future market sizes, structures, and prices in Japan, Taiwan and Korea. Reply to Techno Economic Research Institute: SS-4601, Electronics.

**R.U.** **1**  
answering more than  
advertisement? Then please send a  
separate reply to each box number. It  
will help you get an answer sooner.

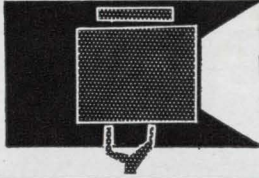

# SEARCHLIGHT SECTION

- CLASSIFIED ADVERTISING • BUSINESS OPPORTUNITIES
- USED OR SURPLUS EQUIPMENT

## AUTOTRACK ANTENNA MOUNT



360 degree azimuth, 210 degree elevation sweep with better than 1 mil. accuracy. Missile velocity acceleration and slewing rates. Amplidyne and servo control. Will handle up to 20 ft. dish. Supplied complete with control chassis. In stock—immediate delivery. Used world over by NASA. USAF, MP-61-B. Type SCR-584. Nike Ajax mounts also in stock.

## PULSE MODULATORS

**MIT MODEL 9 PULSER 1 MW—HARD TUBE**  
Output 25kv 40 amp. Duty cycle .002. pulse lengths .25 to 2 microsec. Also .5 to 5 microsec. and .1 to .5 microsec. Uses 6C21. Input 115v 60 cycle AC. Mfg. GE. Complete with driver and high voltage power supply. Ref: MIT Rad. Lab. Series, Vol. 5, p. 152.

**2 MEGAWATT PULSER**  
Output 30 kv at 70 amp. Duty cycle .001. Rep rates. 1 microsec 600 pps. 1 or 2 msec 300 pps. Uses 5948 hydrogen thyratron. Input 120/208 VAC 60 cycle. Mfr. GE. Complete with high voltage power supply.

**250 KW HARD TUBE PULSER**  
Output 16 kv 16 amp. Duty cycle .002. Pulses can be coded. Uses 5D21, 715C or 4PR60A. Input 115 v 60 cy AC \$1200 ea.

**18 MEGAWATT PULSER**  
Output 150KV at 120 amps. Rep rate: 50-500 PPS. Pulse length: 5 msec. 15KV 120 amp. into pulse transformer. Rise time 1.5 msec. Filament supply 5V 80 amp. incl. 17.5KV 1.5 amp DC power supply. Input: 220V 60 cy AC.

**VARIAN KLYSTRONS**  
V-45: 15W output CW 9 to 10 KMC  
VA-800: 10 KW output CW 1.7 to 2.4 KMC  
VA-806H: 1KW output CW 7.5 to 8.5 KMC

## IBM 704 IBM 650

These computers in stock for immediate delivery

**SCR 584 AUTOTRACK RADARS**  
Our 584s in like new condition, ready to go, and in stock for immediate delivery. Ideal for telemetry research and development, missile tracking, satellite tracking. Fully Desc. MIT Rad. Lab. Series, Vol. 1, pps. 207-210, 228, 284-286. Comp. Inst. Bk avail. \$25.00 each.

## MICROWAVE SYSTEMS

**L BAND RF PKG.**  
20 KW peak 990 to 1040 MC. Pulse width .7 to 1.2 micro sec. Rep. rate 180 to 420 pps. Input 115 vac incl. Receiver \$1200

**200-225 mc RADAR SYSTEM**  
1 Megawatt output. 200 nautical mile range for long range detection of medium and high altitude jet aircraft as well as general search. AN/TPS-28.

**10 KW CW S-BAND**  
Complete 1700-2400 MCS RF system using VA-800 klystron. New.

**SURVEILLANCE DRONE RADAR SYSTEM**  
X-Band tracking system with plotting boards. Type AN/MPQ-29. Drone also in stock.

**5 MEGAWATT C-BAND**  
Klystron RF package delivering nominal 5 megawatt pulse RF. Complete with pulser and power supply.

**500 KW L BAND RADAR**  
500 kw 1220-1359 msc. 100 nautical mile search range P.P.I. and A scopes. MITI. thyratron mod 5326 magnetron. Complete system.

**100 KW X BAND RADAR**  
Complete 100 kw output airborne system with AMTI. 5C22 thyr. mod. 4J52 magnetron. PPI. 360 deg as sweep. 60 deg. elev. sweep. gyro stabilizer. hi-gain revr. Complete with all plugs and cables

**AN/GPG-1 SKY-SWEEP TRACKER**

3 cm. automatic tracking radar system. Complete package with indicator system. Full target acquisition and automatic tracking. Input 115 volts 60 cycle New. In stock for immediate delivery. Entire System 6' long, 3' wide, 10' high. Ideal for Infrared Tracker. Drone Tracker, Missile Tracker, R. & D.

**500KW S BAND RADAR**  
250 miles search 115V 60 cy AC. Mfg. G.E.

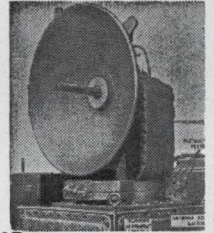

RADAR SYSTEMS GROUND AND AIRBORNE. AUTOMATIC TRACKING ANTENNA SYSTEMS. NIKE AJAX. NIKE HERCULES M-33. MSQ-1A. MPS-19. MPS-9. SCR 584. TPS-1D. TPS-28. FAA-ASR-2. AIRBORNE SYSTEMS. APN-84. APN-102. APS-20. APS-27. APS-45. DPN-19. DIGITAL COMPUTERS. IBM 650. IBM 704.

LARGEST INVENTORY OF RADAR AND MICROWAVE EQUIPMENT IN THE WORLD.

**RADIO RESEARCH INSTRUMENT CO.**  
45 WEST 45TH ST. N. Y. 10036 212-JU 6-4691

CIRCLE 964 ON READER SERVICE CARD

# FOR SALE

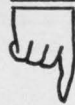

When you have used electronics equipment to sell, advertise in Electronics Searchlight Section for fastest results.

For information:  
Searchlight Section  
Classified Advertising Division  
Post Office Box 12  
New York 10036

## Are You A Slow Reader?

A noted publisher reports a simple technique of rapid reading which should enable you to double your reading speed, and yet retain much more.

To acquaint you with the easy-to-follow rules for developing rapid reading skill, full details of this method are available in a new booklet, "How to Read Faster and Retain More." Mailed free. No obligation. Simply send your name, address and zip code to: Reading, 835 Diversey, Dept. 594-011, Chicago, Ill. 60614. A postcard will do.

CIRCLE 965 ON READER SERVICE CARD

## ELECTRON TUBES

KLYSTRONS • ATR & TR • MAGNETRONS  
SUBMINIATURES • C.R.T. • T.W.T. • 5000-  
6000 SERIES  
• SEND FOR NEW CATALOG A2 •  
A & A ELECTRONICS CORP.  
1063 PERRY ANNEX  
WHITTIER, CALIF.  
696-7544

CIRCLE 966 ON READER SERVICE CARD



# GOOD THINGS COME IN SMALL PACKAGES

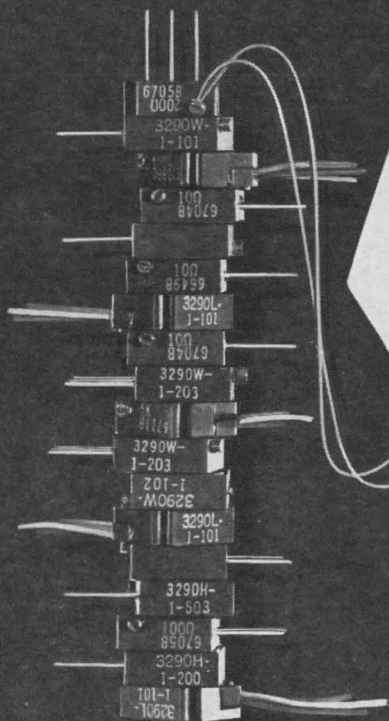

**THINNER  
3/8" SQUARE  
POTENTIOMETER  
NOW AVAILABLE**

It's an old saying . . . but truer today than ever before with the Model 3290 TRIMPOT® Potentiometer. This outstanding high-quality unit measures only 3/8" x 3/8" x less than 5/32" thick, yet offers specifications available in larger units—all at the competitive price of \$5.48\*.

Available with leads and three printed circuit-pin mounting styles, the Model 3290 meets or exceeds requirements of MIL-R-27208 . . . is rated at 1 watt at 70°C, and has a temperature range of -65°C to +175°C. The all-plastic case is sealed against liquids and potting compounds and a resistance range of 10Ω to 50K gives you plenty of selection for your projects.

When your designs and programs call for the very best in potentiometer quality and small size, at competitive prices . . . test and then specify the Model 3290! Write today for complete technical data or contact your nearest Bourns office or representative.

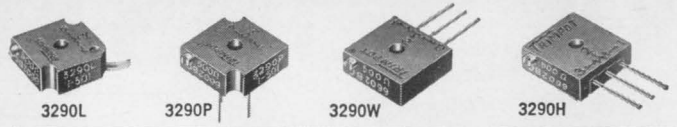

#### SPECIFICATIONS

Size	3/8" x 3/8" x .150"
Standard Resistance Range	10Ω to 50KΩ
Resistance Tolerance	±5% Standard
Resolution	1.01% to 0.10%
Power Rating	1 watt at 70°C
Operating Temperature Range	-65°C to +175°C
Temperature Coefficient	50 PPM/°C max.
Moisture Resistance (MIL-R-27208)	100 megohms min. insulation resistance
Mechanical Adjustment	25 turns

\*100-piece price

Circle 240 on reader service card



BOURNS, INC., TRIMPOT DIVISION • 1200 COLUMBIA AVE., RIVERSIDE, CALIF.  
TELEPHONE (714) 684-1700 • TWX: 910 332-1252 • CABLE: BOURNSINC.

TRIMPOT® and Precision Potentiometers - Miniature Relays - Electronic Modules - Microcomponents



---

# Newsletter from Abroad

---

January 8, 1968

## Mitsubishi pushes Gunn oscillator to record output . . .

A new high for continuous-wave output from a Gunn oscillator—470 milliwatts at about 7 gigahertz—has been logged by the Mitsubishi Electric Corp. The highest previously reported c-w Gunn power was the 340 mw recorded by Nippon Electric.

Along with the new high in power, Mitsubishi claims a mark for efficiency—better than 13% and thus close to the theoretical limit. Shigeru Mitsui, who led the research effort, attributes the record performance to improved ohmic contacts and closer coupling to the oscillator cavity.

Mitsubishi built its oscillator from a slab of bulk gallium arsenide lapped to a thickness of 25 microns. Heavily doped layers about 5 microns thick are formed at top and bottom and are nickel plated to serve as ohmic contacts.

The threshold level of the oscillator is 6 volts. Efficiency hits a maximum at 8 volts with output power of about 400 mw. At 10 volts, power output rises to roughly the 470-mw mark but efficiency falls to around 12%. Mitsui says the device probably could be pushed to even higher power levels but only at a further sacrifice in efficiency.

## . . . and shines twice with (Ga,Al)As diode

Watch Mitsubishi, too, for displays based on gallium-aluminum-arsenide diodes. Company researchers have already performed more than 500 hours of severe life tests on the devices, which glow either as electroluminescent diodes or lasers.

With the tests, Mitsubishi joins the International Business Machines Corp. as a front runner in gallium-aluminum-arsenide technology. The material's main attraction is that diodes can be fabricated of it by liquid-phase epitaxial techniques, which are less costly than the gaseous-phase process required for phosphorous-based diodes.

Mitsubishi has been running its life tests with the diodes working at a current of 50 milliamperes, or 250 amps per square centimeter. Only 20 ma is needed to make the diodes emit a bright, red light. Depending on composition, the electroluminescent wavelength can run between 0.65 and 0.9 micron.

Electroluminescent applications figure to come first for the diode. However, at 30 amps it works as a room-temperature laser with an output between  $\frac{1}{2}$  and 1 watt at a wavelength of 0.78 microns.

## U.S. firms recast overseas plans

President Johnson's foreign investment curbs will force a fast reshuffling of the overseas plant expansion programs of U.S. electronics companies.

Most firms have yet to gauge the full impact of the restrictions on their foreign operations, but the prevailing first impression is that there will be increased emphasis on investments outside of Europe. The mandatory program to overcome the U.S. payments deficit hits the Continent hardest, with a moratorium on new capital outflow to that area. For Britain, the limit is 65% of the average investment during 1965 and 1966. In the developing countries, though, outlays can run to 110% of the 1965-66 average.

Paradoxically, the companies with the biggest overseas operations could turn out to be the ones least affected by the new curbs. Firms like IBM and ITT, old hands in world markets, should have an edge in lining up



---

# Newsletter from Abroad

---

local investment money, on which there is no U. S. restriction. And the companies that have gone in heavily for overseas operations will benefit most from the right to reinvest the profits of their Continental subsidiaries in amounts up to 35% of average 1965-66 capital investments.

## **Soviet color tv: low volume for '68**

Russian economic planners have assigned a low priority to color television this year. Despite the fanfare that marked the start of colorcasts during last fall's celebrations of the Bolshevik Revolution's 50th anniversary, the 1968 target is a mere 15,000 color sets. Only 2,000 sets were produced last year.

A big push in color-set production, however, is scheduled to get under way in 1969. K.Y. Sergeychuk, the Soviet Union's second-ranking communications official, says next year's goal is 90,000 sets and that 1970's will be 200,000.

## **Hitachi and RCA in computer deal?**

A large-scale computer, to be developed jointly by the Radio Corp. of America and Hitachi Ltd., may be in the works. The two companies have set an early-1968 date to start talks aimed at a closer working arrangement in computers. Hitachi already produces a slightly modified version of the RCA Spectra 70 but wants to contribute to the technology of any future computers it builds under license.

## **East Germans slate computer output rise**

Heavy emphasis on data processing by the Ulbricht government will send East German computer production soaring this year. The country's 1968 budget schedules output of \$23 million worth of Robotron 300 computers, a strong gain over 1967. The machines, roughly equivalent to the IBM 1401, will be used mainly for industrial planning.

The budget also calls for sharply increased production of electronic accounting machines, a big export item for the East Germans. The goal is \$19 million worth, a gain of 19% from last year. And 1968 will see the start of mass production of silicon-planar and silicon-planar-epitaxial transistors, with the target set at more than \$7 million worth.

## **British simplify NC programs**

Programs that can be run on medium-size computers to generate tapes for numerically controlled machine tools will be available in Britain starting next month.

The British programs, developed under the aegis of the government-owned National Engineering Laboratory (NEL), are simplified versions of the APT system (for automatically programmed tools) developed in the U.S. With APT, a computer with an internal store of at least 65,000 words is needed. The British scheme cuts the computer requirement to 16,000 words but cannot handle shapes as complex as can APT.

The first British program covers shapes—like cams—that can be milled by keeping two axes of a milling machine under continuous-path control and the tool axis under linear velocity control. Ferranti Ltd. developed the program for NEL. After the first version—for a Univac 1108 computer—has been finished, Ferranti will follow up with versions for the ICT 1904, the English Electric KDF 9, and the Elliott-Automation 4100 series.

NEL's next series of simplified APT programs probably will cover pattern drilling and straight-line milling.



# WHAT IS O/E/N?

## O/E/N IS QUALITY COMPONENTS

We help you make it better. O/E/N products are used wherever circuitry has to perform precisely and dependably. Wherever man or his machines go, from deep space to deep water, O/E/N products prove their reliability daily, no matter what the conditions.

Each year America's leading manufacturers come to O/E/N for an ever-growing variety of products for an ever-widening list of applications. Diverse though they may be, O/E/N products have one thing in common: EXCELLENCE.

Engineering and manufacturing excellence have carved out a unique position for us in the fiercely competitive

electronic components market. And they have made O/E/N a trusted name in leading industries of aerospace, computers, appliances, communications, industrial and other electronic controls.

If your products use pushbuttons, rotary switches, rotary solenoids, TV tuners, indicator lights, quartz crystals, relays or thermostats, chances are quality components from such O/E/N companies as Oak Manufacturing, M<sup>c</sup>Coy Electronics, Marco-Oak and Hart Manufacturing will help you make it better.

For complete information about O/E/N, its facilities and its products, send for a copy of our Facilities & Capabilities Brochure.



COMMUNICATIONS

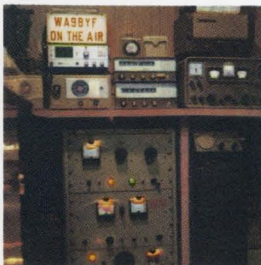

AEROSPACE



APPLIANCES



COMPUTERS



INDUSTRIAL CONTROLS





Don't sit there  
wishing your  
support people  
knew more  
electronics...

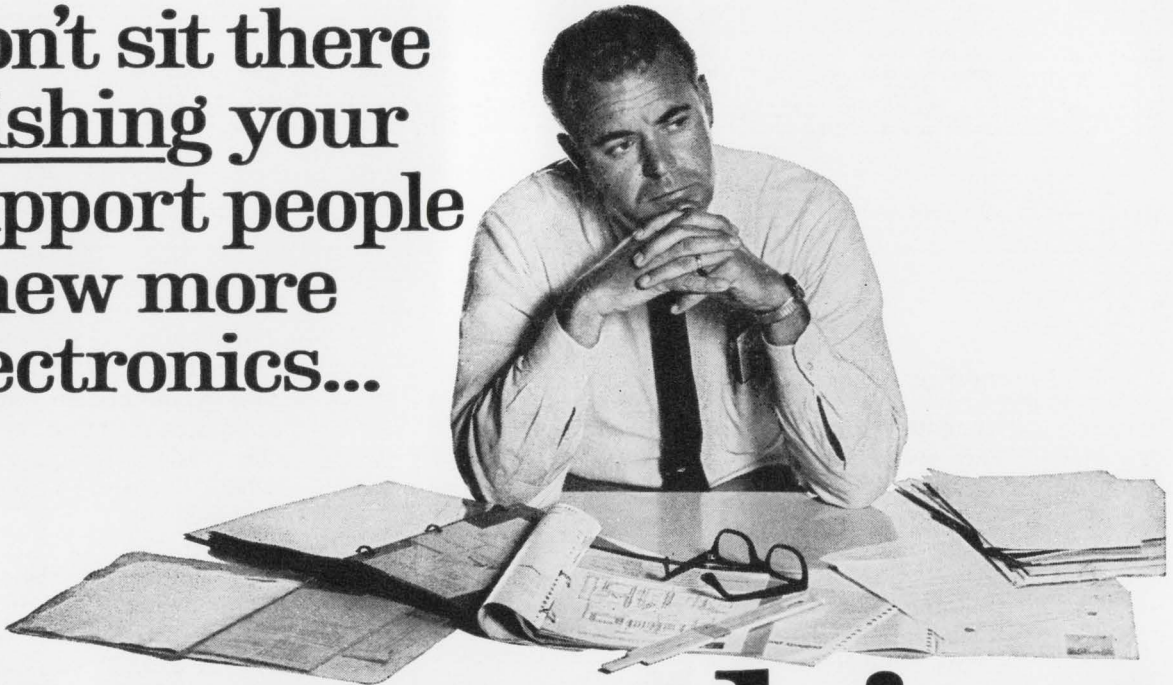

# do something

Look over your men. Pick out a few who are intelligent enough to profit from more education in electronics, ambitious enough to work hard to get it. Send us their names and addresses. We'll send them complete information about CREI Home Study Programs in Electronics, tell them how these programs have helped thousands of young men increase their value to their employers. We'll explain how they can study at home, at their own pace, on their own schedule

without traveling to classes. We'll give them the names of the more than 80 leading scientists and engineers who help us develop and update programs related directly to the needs of industry.

Yes, we'll do all that. If you're lucky some of your men may enroll. Why not give it a try? Fill out the coupon and get it in the mail today.



**CREI Programs cover these specialized areas of advanced electronics:**

- Communications Engineering •
- Aeronautical and Navigational Engineering •
- Television Engineering •
- Computers • Nuclear Instrumentation and Control •
- Automatic Control Engineering •
- Missile and Spacecraft Guidance •
- Radar and Sonar Engineering •
- Nuclear Engineering Technology •
- Industrial Electronics for Automation •
- Computer Systems Technology.

**CREI**  
**THE CAPITOL RADIO ENGINEERING INSTITUTE**  
A Division of McGraw-Hill, Inc.  
Dept. 1802-G, 3224 Sixteenth Street, N.W.  
Washington, D.C. 20010

**Gentlemen:** The men listed at right are high school graduates working in some phase of electronics. Please send them your FREE book, "How to Prepare Today for Tomorrow's Jobs" and complete information about CREI Home Study Programs.

**And please send me the free brochure which tells how we can use CREI Home Study Programs to supplement our educational program for electronics personnel.**

Name \_\_\_\_\_  
Title \_\_\_\_\_  
Company \_\_\_\_\_  
Address \_\_\_\_\_  
City \_\_\_\_\_ State \_\_\_\_\_ Zip Code \_\_\_\_\_

Name \_\_\_\_\_  
Address \_\_\_\_\_  
City \_\_\_\_\_ State \_\_\_\_\_ Zip Code \_\_\_\_\_

Name \_\_\_\_\_  
Address \_\_\_\_\_  
City \_\_\_\_\_ State \_\_\_\_\_ Zip Code \_\_\_\_\_

Name \_\_\_\_\_  
Address \_\_\_\_\_  
City \_\_\_\_\_ State \_\_\_\_\_ Zip Code \_\_\_\_\_

Name \_\_\_\_\_  
Address \_\_\_\_\_  
City \_\_\_\_\_ State \_\_\_\_\_ Zip Code \_\_\_\_\_

Name \_\_\_\_\_  
Address \_\_\_\_\_  
City \_\_\_\_\_ State \_\_\_\_\_ Zip Code \_\_\_\_\_

(Not enough room? Attach sheet of paper with additional names and addresses)



# Electronics Abroad

Volume 41  
Number 1

## Japan

### Memorable memory

Designers of computer memories now have a new speed mark to shoot at—200-nanosecond full-cycle time and 100-nsec access time.

The record, set with a woven-wire memory developed at the Electrotechnical Laboratory run by the Ministry of International Trade and Industry, eclipses the 500-nsec cycle time achieved by plated-wire memories at the Sperry Rand Corp.'s Univac division and the 800 nsec of rod memories built by the National Cash Register Co.

**More later.** Electrotechnical's memory, built around woven-wire planes produced by Toko Inc., which shared in the work, has a capacity of 4,096 50-bit words. The development is a big step toward the 200-nsec, 128,000-word memory intended for a large, fast computer the government hopes to have ready by March, 1971 [Electronics, June 27, 1966, p. 93]. Like the prototype, the bigger version will have 50-bit words.

Basically, the memory is similar to those made by Toko in Japan and by General Precision Inc. in the U.S. The thin-film plating on the wires of the new memory, though, is only 0.7 micron thick.

**Unchecked.** The prototype has planes that handle 128 words each. For the large memory that will follow, the planes will undoubtedly be larger.

Although an increase in size tends to slow a memory, Electrotechnical expects to maintain the 200-nsec cycle time largely by switching from the destructive readout used for the prototype to nondestructive readout. In the latter mode, no time is wasted writing in what has been read out.

Theoretically, read time should be halved. Electrotechnical, however, doesn't expect to do that well.

It anticipates a speed-up of about 1½ times. This together with improvements in technology, the Japanese believe, should enable them to reach their goal without too much difficulty.

The laboratory has already started to design a prototype memory with nondestructive readout. The main difference between the two types will be in the plated wires used. And the drive circuits will, of course, be reworked to suit the new operating mode.

### An eye for curves

The batteries of chart recorders installed in highly automated production plants all too often become little more than high-priced waste-paper generators. It simply takes too much time and trouble to read and analyze the miles of analog curves the recorders churn out.

The Matsushita Communication Industrial Co., though, has come up with equipment to take on this tedious task. Matsushita's reader scans charts with a television camera at speeds up to about 1 foot per minute, and then converts the curves into digital data. The data can be printed out, read off an in-

dicator, or punched into paper tape for analysis by a digital computer. There's also a digital-to-analog converter for those who want to analyze the information with an analog computer. A tv monitor tucked into the readout equipment indicates where the curve is being read at any moment.

Matsushita Communication, a subsidiary of the Matsushita Electric Industrial Co., builds the readers to order. Prices run from \$11,100 to \$19,450 depending on the number of extra features requested.

**On the line.** Excluding accessories, the reader consists of a vidicon tv camera mounted atop a chart transport, and a main unit housing camera drive circuits, control and counting circuits, the digital-to-analog converter, and the tv monitor.

The camera is much like those found in low-cost, closed-circuit tv systems, but it has been modified to synchronize the vertical-sweep frequency with the line frequency. Also, the scan isn't interlaced; each frame is made up of one 314-line field at 50-hertz line frequency.

Although the chart can be stopped at any point for a digital readout, the reader normally runs continuously, taking readings at prerecorded time markers on the

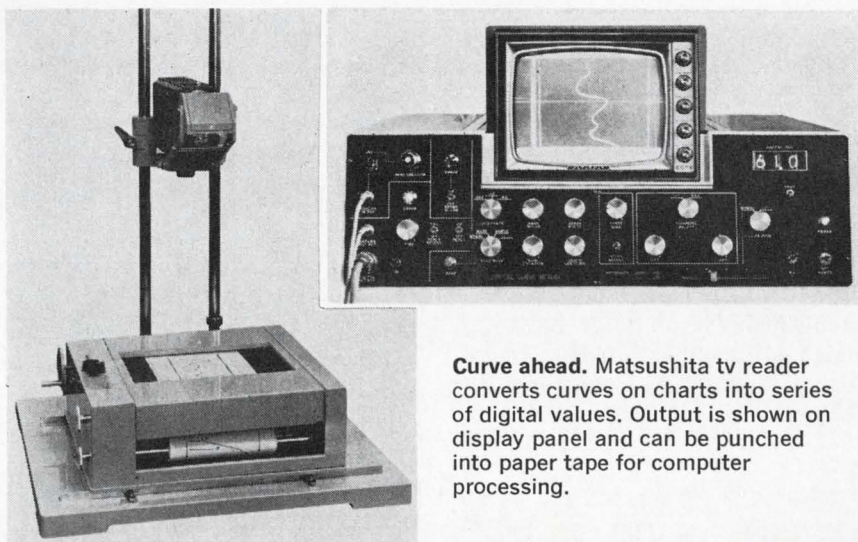

**Curve ahead.** Matsushita tv reader converts curves on charts into series of digital values. Output is shown on display panel and can be punched into paper tape for computer processing.



chart. Only one scan line in each frame is "active." This line, near the center of the raster, is intensity-modulated so that it appears on the monitor as a light white line indicating where the curve is being read.

During the scan of the active line, the camera output is gated onto counting circuits. The scan produces one pulse when the camera hits the "zero" reference line on the chart, a second when it reaches the curve, and a third when it hits the "100%" reference line. The count between the first and second pulses corresponds to the digital value of the curve and is fed to a readout register.

Between active-line scans, the system keeps itself constantly calibrated, holding the number of counts between the zero-line pulse and the 100% pulse at 400 by varying the frequency of the oscillator that sets the clock rate for the count. Logic circuits determine the exact frequency between 10 and 20 megahertz needed to maintain this spacing.

**Plain and fancy.** The curve displayed on the monitor can either be a straight tv reproduction of the one on the chart or a synthesized image. The latter is derived by mixing pulses clipped from the curve reading, the synchronizing pulses for the monitor, and the pulses that show the active line. Correspondence between the synthesized curve and that on the chart show that the pulses used to make the digital readings are correct.

## West Germany

### Bright tune

High-fidelity buffs, unless they're unusually well-heeled, generally have to make do with a field-strength meter to judge how well their equipment is tuned in to frequency-modulation broadcasts. Indicators showing when stations are tuned in dead center are, with few exceptions, the mark of stereo receivers selling for \$400 or more.

Engineers at Grundig Werke

GmbH, however, have come up with a tuning-indicator circuit that's suitable for medium-priced receivers. And where most others have settled for meters, Grundig has managed to power lights. What's more, the lights make possible an unusual muting circuit, based on a photoresistor, that keeps the receiver quiet when shifting from station to station.

**Red and white.** Grundig has put the tuning indicator circuit into its latest stereo receiver, the RTV 600, which sells for just under \$300 in West Germany. The front panel has three small lamps—a white one flanked by red ones on either side. When a station is tuned exactly and there's adequate field strength, the white light stays on. If the tuning is off, one of the red lamps glows to show the listener which way to turn the tuning knob. Both red lamps glow if the signal is too weak.

Input to the indicator circuit comes from a conventional symmetrical ratio detector. The voltages across  $R_1$  and  $R_2$ , then, are equal and opposite when the set is precisely tuned. They are fed to a pair of trigger circuits. One, with npn transistors ( $Q_1$  and  $Q_2$ ), handles positive voltages; the other, with pnp transistors ( $Q_3$  and  $Q_4$ ) handles negative voltages.

**Off and on.** Unless there's adequate field strength, the voltages

fed to the input transistors ( $Q_1$  and  $Q_3$ ) are not high enough to turn them on. As a result, the base voltages of the output transistors ( $Q_2$  and  $Q_4$ ) are so high that they conduct and the red lamps light.

When the set is precisely tuned to a strong station, however, both input transistors turn on. The voltage across their collector resistors then drops enough to turn off the output transistors. This, in turn, causes the red lights to go out. At the same time, current flows to the white lamp.

Detuning on a strong station shuts off one of the two input transistors and, as a result, the associated red lamp lights.

**Silenced.** For muting, the circuit uses two small lamps, in parallel with the red indicator lights, and a photoresistor. When either small lamp goes on, the resistance of the photoresistor drops from a high value to a few hundred ohms. The sharp rise in negative feedback that follows reduces the amplification of the stage ( $Q_5$ ) that feeds the ratio detector output to the stereo decoder.

The two small lamps that actuate the photoresistor are packaged in a light-tight housing along with the photoresistor and the components of the trigger circuits. The light-tight packaging prevents spurious muting. And there's a "hold" range for the white lamp, so that

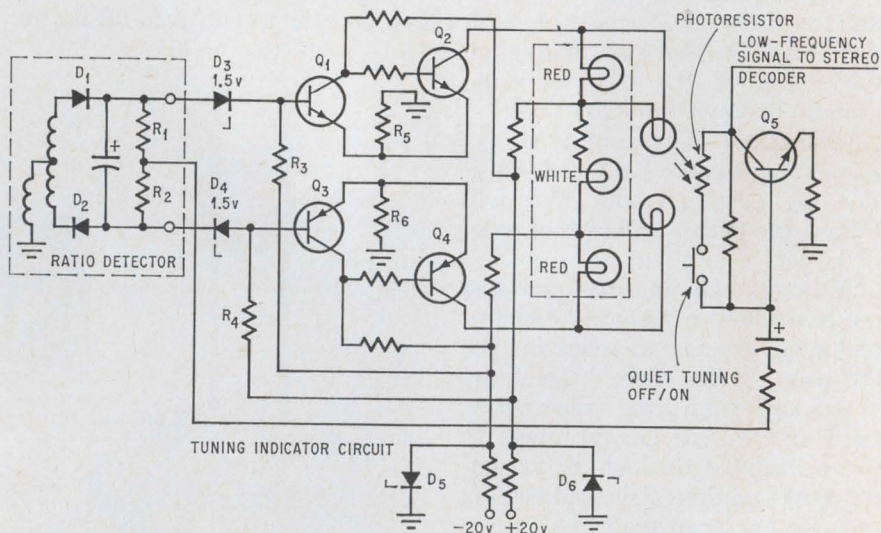

**White is right.** Grundig tuning indicator circuit powers white lamp if station is tuned in precisely. Detuning causes a red lamp to glow, showing the listener which way to turn the knob.



very small changes in signal level and slight mistuning won't cause the red indicator lamps to switch on and the receiver to mute.

## Top grade

Grading new road surfaces before paving them can be a time-consuming job. To level off bumps and fill in dips, grader operators usually have to run their cumbersome machines back and forth several times.

Many late-model graders make the job easier with an electronic control system that holds the transverse slope of the grading blade constant. But that still leaves the operator with two things to do at once—steer the machine and fiddle with a manual control to maintain proper blade height.

This fiddling, though, is over for operators of a new grader built by Eisenwerk Gebr. Frisch KG. Along with the transverse control, Frisch's machine has a "Nivomatic" system that keeps the blade within 0.2 inch of a reference surface. Frisch claims the two-way control can reduce the time needed to fine-grade a roadbed by as much as two-thirds.

**Straightforward.** The Nivomatic blade-control system is relatively simple. Its two control loops—one for slope and one for height—each have an input sensor, an amplifier, an error-detection circuit, and solenoid-operated valves to feed the hydraulic cylinders that move the blade. The operator sets the values of height and slope on a control unit next to his steering wheel, and the control loops keep the blade in the indicated position. Most of the electronics were supplied by the German subsidiary of Honeywell Inc.

For blade-height control, a taut wire strung parallel to the grader's line of travel serves as the reference surface; a follower on the height sensor attached to the blade rides this wire. Any up-and-down blade movements change the setting of a potentiometer in the sensor, and this upsets the balance in a bridge circuit in the control unit. The resulting error signal is amplified and then applied to the height-control solenoid valves, which

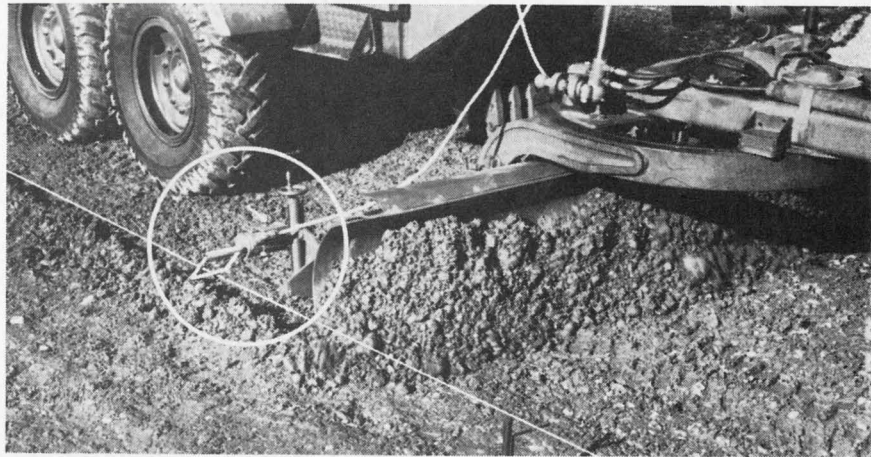

**Tight-wire act.** Follower traveling along taut reference-level wire senses deviations in grader's blade height. Up-and-down movements upset the balance of control-circuit bridge.

cause the blade to be lowered or raised until the bridge circuit is balanced again. The error signal developed across the bridge also drives an indicator that shows any deviations from the preset blade height.

**Working an angle.** The sensor for the transverse-slope control loop is a pendulum mounted on the frame that carries the blade. This loop holds the blade slope to within 0.1% of the preset value; for a blade about 10 feet wide, the error works out to less than  $\frac{1}{8}$  inch.

Both sensors are liquid-damped to withstand vibrations. The grader operator also uses the system's indicators to judge just how fast he can move his machine along without overtaxing the blade-control system.

---

## France

---

### Freeing the freeway

As in most big cities, traffic jams in Paris extend from the congested downtown neighborhoods all the way out to the "autoroutes"—express highways—intended to move traffic swiftly into and out of the city.

No one has come up with a workable solution for the harrowing traffic problem in downtown Paris, but one French electronics firm thinks it has an answer for the

three autoroutes that lead to the city. The firm, Compagnie Générale d'Automatisme, is testing on the Autoroute du Nord an analyzer that spots bottlenecks as fast as they develop. In a full-fledged system, such analyzers would show road police where traffic buildups were imminent and could even control traffic lights ahead of trouble spots.

**Patterns.** The analyzer gauges the flow of traffic by counting groups of 16 cars. The company chose 16 for the size of the group because the counting circuits are binary. The other two possible choices were 8 or 32. Eight, cga felt, would be too small a number; 32, by contrast, would have made the cycle too long.

Input data is picked up by a pair of induction loops spaced 6.5 feet apart in the roadway. They feed three counters in the analyzer, mounted alongside the road. One counts the cars. A second records the time it takes for the group to pass over the loops. A third registers the average speed of passage of the cars.

After 16 passages, the information picked up by the counters is transferred into a "time" memory and a "speed" memory and all the counters are reset to zero. The information is then passed from the memories into a diode matrix that compares the speed and time values against a dozen preestablished flow patterns. The output of the matrix drives signal lamps that



show if traffic is flowing freely (green), starting to slow down (orange), or blocked (red). The green light, for example, stays on as long as the average speed is higher than 35 miles per hour. The red light flashes on when the speed drops below 12 mph.

**Building block.** Production versions of the analyzer will cost somewhere between \$3,600 and \$4,000 a copy. In a complete system, they would be spotted at intervals of a few hundred yards in heavy-traffic sections of autoroutes and every mile or so in less-traveled sections. Instead of lighting lamps on the roadside unit, however, the output of the comparison matrix would be transmitted to a central control panel that would show how things were going along a stretch of autoroute.

Building a full-fledged system, CGA maintains, wouldn't be difficult. Selling one to the French government, which the company is trying to do, seems to be another matter. France still has a lot of catching-up to do on its network of autoroutes and the government is hard-pressed to finance the road-building.

CGA is one of the group of data-processing, automation, and computer companies co-owned by CSF-Compagnie Générale de Télégraphie sans Fil and the Compagnie Générale d'Electricité through a subsidiary called Compagnie pour l'Informatique et les Techniques Electroniques de Contrôle.

---

### Great Britain

---

#### Torrid zones

A Lilliputian weatherman, perhaps, could tackle the job with ease. But for Gullivers, plotting the hot spots on tiny semiconductor devices is a harrowing task.

Stuck with Gullivers, Associated Semiconductor Manufacturers Ltd. has put together an infrared microscope to pinpoint the torrid zones on transistors and integrated circuits. The instrument checks temperatures over a range of 200°C with maximum resolution of 0.5°C.

The spot checked on the semiconductor is normally 30 microns square, but Associated says it can get the area down to 15 microns square.

The company uses the microscope mainly as an aid in the development of new devices rather than for production-line testing. By locating hot spots, device designers can decide whether and how layouts can be reworked to improve heat dissipation. Associated is a joint venture of Mullard Ltd., a subsidiary of N.V. Philips' Gloeilampenfabrieken of the Netherlands, and of the British General Electric Co., a firm not connected with GE in the U.S.

**Screen test.** The optics in the infrared microscope are basically quite simple. There's a single mirror objective, an eyepiece, and a transparent mirror. The mirror's reflecting surface is a thin film of gold that deflects infrared wavelengths but passes light.

The light comes from a small lamp fitted with a filter that blocks out wavelengths of 2 microns or more, and it is picked up by a television camera so that the semiconductor area being checked can be viewed on a monitor screen. Scanning directly through the eyepiece, Associated found, is awkward.

As the visual image is being displayed, a detector picks up the infrared radiation from the sector under scrutiny. The detector cell is adjusted laterally so that visual and infrared images coincide. The cell used is a Mullard RPY51 indium antimonide detector mounted in a dewar flask and held at 77°K by liquid nitrogen.

**Chopped.** Temperature readings obtained with the microscope are displayed on a digital readout and a meter. In both cases, the readings give the deviation from a preset mean temperature.

To get the kind of accuracy needed for thermal mapping, Associated opted for a-c signal processing. The infrared radiation from the device under test passes through a mechanical chopper—a rotating disc with 16 slits—before it hits the detector cell.

The cell's 800-hertz signal is amplified in a high-gain a-c amplifier

and fed to a phase-sensitive rectifier whose reference signal comes from a photocell. For precise phasing of the photocell's output signals with those of the detector cell, the mechanical chopper also interrupts the light beam that activates the photocell. Thus, variations in the chopper's rotating speed can't affect the phase relationship.

Output of the phase-sensitive rectifier is compared with a d-c feedback signal picked off a precision potentiometer. This yields a servo difference signal that is chopped, amplified, reconverted to d-c in another phase-sensitive rectifier, and finally amplified again to obtain a signal for the motor that drives the potentiometer toward the null position. The digital readout counter is geared to the potentiometer drive.

For readout by the meter, the potentiometer and motor-drive circuits are switched out of the loop, and the output of the second phase-sensitive rectifier is switched onto the meter.

The meter covers the 0°-to-200°C temperature spread in four ranges—0° to 15°, 10° to 45°, 20° to 80°, and 45° to 200°. This breakdown represents a compromise Associated had to make because the spectral distribution of the heat emitted by the device under test changes as the temperature rises. This means that the output of the infrared detector cell cannot be linear over a wide temperature span. Since resolution is considerably lower in the upper ranges on the meter, Associated generally sticks with the digital readout.

---

### Around the world

---

**Japan.** Tokyo Shibaura Electric Co. (Toshiba) has a 12-inch shadow-mask picture tube well along in development and should have it in production during the first half of the year. The smallest shadow-mask tubes currently in production in the country are 16-inch sizes.

**Soviet Union.** The Russians plan to set up a far-flung communications satellite network for socialist



countries, according to Boris Petrov of the Moscow Aviation Institute. Russia's partners in the network would be Bulgaria, Czechoslovakia, Hungary, East Germany, Poland, Rumania, Cuba, and Mongolia.

**Italy.** Complementi Elettronici S.p.A. is installing a five-array antenna field for the Australian Post Office at Darwin. Each array is made up of two log-periodic dipole planes, vertically polarized. The arrays are highly directive and have a voltage standing-wave ratio of 1.35 over the full band—7 to 26 megahertz. Power-handling capability is 500 kilowatts average and 2,000 kw peak.

**Japan.** A yearend spurt in color television sales has caused set makers to raise their estimates of the 1967 domestic market once again. Last fall, the figure was jumped from 500,000 sets to 750,000 [Electronics, Oct. 16, p. 236]. Now it looks as if 850,000 sets will be the total for 1967.

**Luxembourg.** An institute to train air-traffic-control specialists is scheduled to be operating in the Grand Duchy by late 1969. The facility will be run by Eurocontrol, the international organization responsible for aircraft movements in the upper air spaces over most of West Europe.

**Bahamas.** The Broadcasting and Television Commission has a go-ahead from the government to start television broadcasts in 1969. Work on the main network production center at Nassau will be handled by a Montreal consulting firm, N.J. Pappas & Associates.

**Iran.** Two extensive microwave networks are planned for Iran. The country's post office has ordered a \$28-million system from the Nippon Electric Co.; the National Iranian Oil Co. will get a \$12-million system from Philips' Gloeilampenfabrieken. Nippon's system will stretch out over some 2,400 miles. Philips' will cover 1,750 miles.

**Australia.** Fujitsu Ltd. has become the first Japanese computer maker to take a fling at the Australian market. The company reports it has had "plenty of inquiries" since it set up shop in Sydney several weeks ago.

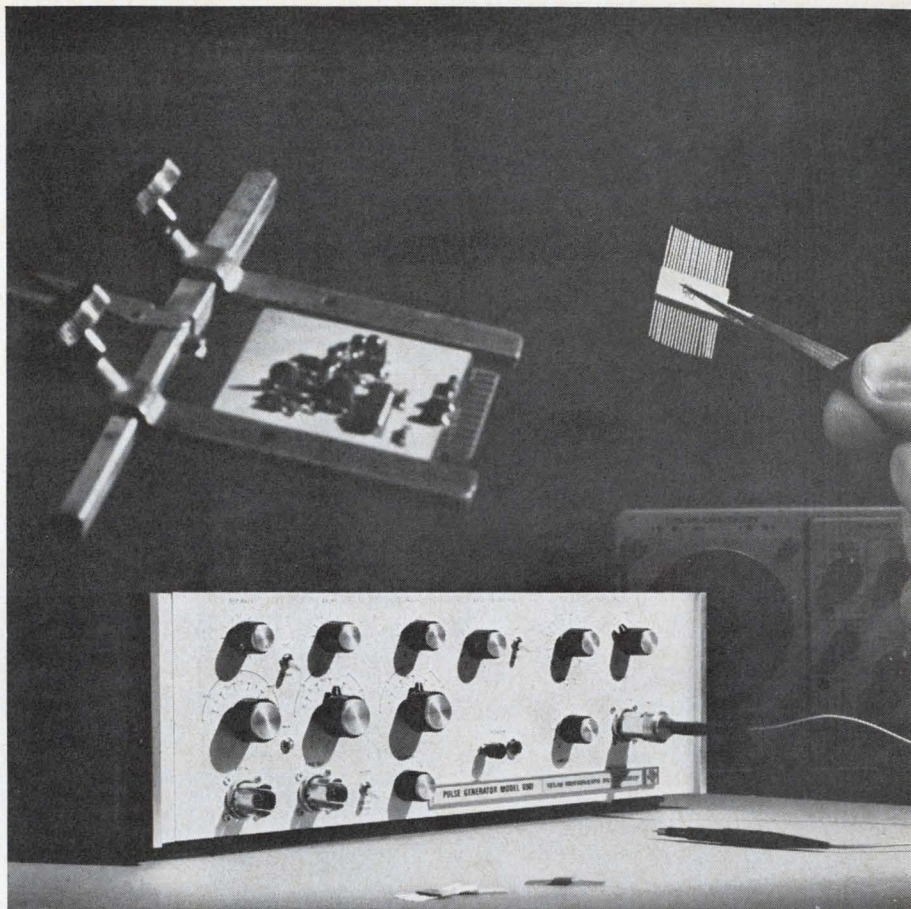

## Why You Need a Special Pulse Generator for State of the Art Circuit Design

With high speeds and critical design parameters, you need the best test instruments to be sure your designs will be optimum. The TI Model 6901 Pulse Generator gives outputs from 1 KHz to 0.1 GHz; independent amplitude and baseline controls; jitter less than 0.1% of period + 50 psec; and count-down synchronization output.

The 6901 makes your designing simpler, too. Because the pulse amplitude of the generator can be changed without affecting DC offset, you can use the offset instead of an external bias supply for your circuit.

For additional information, contact your TI Field Office, or the Industrial Products Division, Texas Instruments Incorporated, P. O. Box 66027, Houston, Texas 77006.

**TEXAS INSTRUMENTS**  
INCORPORATED

827A



<b>Abbott Transistor Labs, Inc.</b> Technical Adv. Agcy.	233	<b>Control Data Corp.,</b> <b>Analog Digital Systems Div.</b> Barnes-Champ Adv.	161	<b>Hayakawa Electronics Co., Ltd.</b> Dai-Ichi International, Inc.	221
■ <b>Acopian Corporation</b> Mort Barish Associates	145	■ <b>Cook Electric Co.,</b> <b>Automatic Controls Div.</b> Grant/Jacoby, Inc.	81	■ <b>Heath Co., Sub. of</b> <b>Schlumberger, Ltd.</b> Advance Advertising Service	211
<b>Acromag, Inc.</b> Watkins-Rogers, Inc.	194	<b>Corning Glass Works,</b> <b>Electronics Products Div.</b> Rumrill Hoyt Co., Inc.	195	■ <b>Hewlett Packard, Loveland Div.</b> Tallant/Yates Adv., Inc.	1
□ <b>Aercom</b> Grant Advertising, Inc.	OAS 10	■ <b>Cosmicar Optical Co., Ltd.</b> Matsushita, Inc.	223	■ <b>Hewlett Packard, Microwave Div.</b> Lennen & Newell, Inc.	2
<b>Allen-Bradley Co.</b> Fensholt Adv. Agcy.	61	<b>CTS Corp.</b> Burton Browne Advertising	36, 37	■ <b>Hewlett Packard, Palo Alto Div.</b> Lennen & Newell, Inc.	60
<b>Allied Van Lines, Inc.</b> Young & Rubicam, Inc.	83	■ <b>Dale Electronics, Inc., Sub. of</b> <b>Lionel Corp.</b> Swanson, Sinkey, Ellis, Inc.	3rd Cover	<b>Hitachi, Ltd.</b> Dentsu Advertising	164
■ <b>Amelco Semiconductor, Div. of</b> <b>Teledyne, Inc.</b> Campbell-Ewald Co.	40, 41	<b>Dearborn Electronics, Inc.</b> <b>Sprague Electric Co. Div.</b> Harry P. Bridge Co.	16	<b>Honeywell, PMD Div.</b> Batten, Barton, Durstine & Osborn, Inc.	65
<b>American Lava Corp., Sub. of</b> <b>Minnesota Mining &amp; Mfg. Co.</b> Designers, Inc.	143	<b>Delco Radio, Div. of</b> <b>General Motors Corp.</b> Macbill/Ross, Inc.	227	<b>Hughes Aircraft Co.</b> Foote Cone & Belding	156, 165, 203
<b>American Optical Co.,</b> <b>Space Defense Group</b> Fuller & Smith & Ross, Inc.	76	<b>Di-Acro Corp., Div. of</b> <b>Houdaille Industries, Inc.</b> Charles E. Brown Adv. Agcy.	182	□ ■ <b>Hull Corp.</b> The Michener Co.	OAS 11
<b>Amerline Corp.</b> Carlson Adv. Co.	223	<b>Digitran Co., The</b> Smith-Klitten, Inc.	11	<b>IEEE (Institute of Electrical &amp;</b> <b>Electronic Engineers)</b> Alpaugh Advertising	192
■ <b>Ammon Instruments, Inc.</b> Culver Adv., Inc.	204	<b>Duncan Electronics, Inc., Sub. of</b> <b>Systron Donner Corp.</b> Helme Assoc., Inc.	167	<b>Indiana General Corp., Ferrites Div.</b> Griswold & Eshleman	24
■ <b>Analog Devices, Inc.</b> Kenen Associates	144	■ <b>Eagle Signal, Div. of E.W. Bliss Co.</b> Feeley Adv. Agcy., Inc.	70	<b>Industrial Electronic Engineers</b> Gumpertz, Bentley & Dolan, Inc.	100
■ <b>Anritsu Electric Co., Ltd.</b> Diamond Agcy. Co., Ltd.	220	<b>Eastman Kodak Co.,</b> <b>Technical Corporate Adv.</b> Rumrill-Hoyt, Inc.	193	<b>Information Handling Service</b> Martz & Associates	57
■ <b>Atlas Chemical Industries, Inc.,</b> <b>Aerospace Components Div.</b> Harris D. McKinney, Inc.	210	<b>Electrac, Inc.</b> Cochrane Chase & Co.	7	<b>International Rectifier Corp.</b> Botsford, Constantine & McCarty, Inc.	21
<b>Automatic Electric Co., Sub. of</b> <b>General Telephone &amp; Electronics Corp.</b> Marsteller, Inc.	82	■ <b>Electrical Industries</b> George Homer Martin Assoc.	56	■ <b>Intronics, Inc.</b> Marketing Assistance, Inc.	155
<b>Ballantine Laboratories</b> Lang-Lawrence Adv., Inc.	178	<b>Electro Products Laboratories, Inc.,</b> <b>Transducer Div.</b> Grant, Schwenck & Baker, Inc.	72	<b>I R C, Inc.</b> Gray & Rogers, Inc.	252
■ <b>Barnes Corp.</b> Industrial Public Relations, Inc.	192	<b>Electronics and Control Engineers'</b> <b>Book Club</b>	199	■ <b>ITT Cannon Electric, Inc.</b> West, Weir & Bartel, Inc.	78
■ <b>Barnstead Subsidiary of</b> <b>Ritter Pfaudler Corp.</b> Creamer, Trowbridge, Case & Basford, Inc.	206	<b>Electronic Communications, Inc.</b> Neals & Hickok, Inc.	197	■ <b>ITT Jennings Mfg. Co.</b> West, Weir & Bartel, Inc.	166
■ <b>Bausch &amp; Lomb, Inc.</b> Wolff Assoc., Inc.	157	<b>Elliott Service Co.</b> The Powerad Co.	202	■ <b>J F D Electronics Co., Components Div.</b> Delphi Adv., Inc.	148
□ <b>Beckman Instruments International,</b> <b>S.A.</b> Hixson & Jorgensen, Inc.	OAS 9	<b>Emerson &amp; Cuming, Inc.</b> Edwin F. Hall	232	<b>Johnson Co., E.F.</b> Midland Associates	213
<b>Belden Mfg. Co.</b> Fensholt Adv., Inc.	12, 13	<b>Erie Technological Products Co., Inc.</b> Altman-Hall Assoc.	42	■ <b>Kepeco, Inc.</b> Weiss Advertising	152
<b>Bell Telephone Laboratories</b> N. W. Ayer & Son, Inc.	163	■ <b>Fairchild Semiconductor, Inc.</b> Faust/Day, Inc.	63	<b>Kikusui Electronics Corp.</b> Kyodo Adv. Co., Ltd.	215
<b>Bendix Corp.,</b> <b>Semiconductor Products Div.</b> MacManus, John & Adams, Inc.	170	<b>Ferroxcube Corporation of America</b> Solow Wexton, Inc.	80	■ <b>Leach Corp.</b> Jay Chiat & Assoc.	20
■ <b>Bliley Electric Co.</b> Barber & Drullard, Inc.	220	■ <b>Field Emission Corp.</b> Morton, Stanton, Eakin & Cain	188	<b>Lemos, Inc.</b> Hixson & Jorgensen, Inc.	219
■ <b>Bliss Gamewell, Div. of</b> <b>E.W. Bliss Co.</b> Feeley Adv. Agcy., Inc.	176	<b>Fluke Mfg. Co., John</b> Bonfield Assoc.	38, 39	<b>Litton Industries, Inc.,</b> <b>Winchester Electronics Div.</b> West, Weir & Bartel, Inc.	186, 187
<b>Bourns, Inc., Trimpot Div.</b> Lester Company, The	240	■ <b>Fork Standards, Inc.</b> Jody Adv., Inc.	196	<b>Lockheed Missiles &amp; Space Co.</b> McCann-Erickson, Inc.	202
■ <b>Brush Instruments,</b> <b>Div. of Clevite Corp.</b> Carr Liggett Adv., Inc.	224, 225	■ <b>Franklin Electronics, Inc., Sub. of</b> <b>Mohawk Data Sciences Corp.</b> Kimberly-James Advertising	210	□ <b>LTT</b> Promotion Vente Publicite	OAS 12
■ <b>Burroughs Corp.,</b> <b>Electronic Components Div.</b> Conti Adv. Agcy., Inc.	84	<b>Garrett Corporation,</b> <b>AiResearch Mfg. Div.</b> J. Walter Thompson Co.	204	■ <b>Machlett Laboratories, Div. of</b> <b>Raytheon Co.</b> Fuller & Smith & Ross, Inc.	9
<b>Burton Research Laboratories</b> William E. Wilson Co.	62	<b>G-C Electronics Co., Industrial Div.</b> Sander Rodkin Adv. Agcy., Ltd.	204	■ <b>Magnetic Shield Div.,</b> <b>Perfection Mica Co.</b> Burton Browne Adv.	173
<b>Camwil, Inc.</b> Richard T. Clarke Co.	221	<b>General Atronics Corp.</b> Garceau Hargrave & McCullough, Inc.	151	□ <b>Marconi Instruments, Ltd.</b> Taylor Adv., Ltd.	OAS 8
<b>Capitol Radio Engineering Institute</b> Henry J. Kaufman & Assoc.	244	<b>General Dynamics, Fort Worth Div.</b> Glenn Adv., Inc.	216	□ <b>Marconi Radio Communication</b> Hampshire House, Ltd.	OAS 13
■ <b>Celco, Constantine Engineering</b> <b>Labs. Co.</b> Stano Advertising	OAS 4	■ <b>General Electric Co.,</b> <b>Silicone Products Div.</b> Ross Roy, Inc.	146	■ <b>Markel &amp; Sons, L. Frank</b> George Moll Adv., Inc.	150
<b>Centralab, Div. of</b> <b>Globe-Union, Inc.</b> The Brady Co.	229, 231	■ <b>General Electric Co.,</b> <b>Vacuum Products Business Section</b> Doe-Anderson Adv. Agcy., Inc.	58	■ <b>Matsuo Electric Co., Ltd.</b> Daiyusha, Inc. Adv.	226
<b>Cerro Copper &amp; Brass Co.</b> Feeley Adv. Agcy., Inc.	212, 214	<b>General Radio Co.</b> Horton, Church & Goff, Inc.	17	<b>Matthey Bishop, Inc.</b> Richardson, Thomas & Bushman, Inc.	234
<b>Clare &amp; Co., C.P.</b> Reincke, Meyer & Finn Adv., Inc.	59	<b>Giannini Voltex Co.</b> Everett Assoc.	214	<b>Metal Removal Co., The</b> Advertising Producers Assoc.	228
<b>Clarostat Mfg. Co.</b> Lescarboursa Adv., Inc.	179	■ <b>Grayhill, Inc.</b> Merchandising Adv., Inc.	205	<b>Methode Electronics, Inc.,</b> <b>Connector Div.</b> Sander Rodkin Adv. Agcy., Ltd.	208
■ <b>Clevite Corp., Piezoelectric Div.</b> Carr Liggett Adv., Inc.	215	■ <b>Gries Reproducer Co.</b> Harrold Marshall Adv.	202	<b>Microdot, Inc.</b> Gumpertz, Bentley & Dolan Adv.	15
■ <b>CML Div. of Tenny Engineering Co.</b> Keyes, Martin & Co.	215	<b>Groov-Pin Corp.</b> Feeley Adv. Agcy., Inc.	219	■ <b>Microsonics, Inc.</b> S. Gunnar Myrbeck & Co.	154
<b>Communication Electronics, Inc.</b> William C. Estler—Public Relations	162			■ <b>Microwave Cavity Laboratories, Inc.</b> Art Brown Writing Service	209
				■ <b>Microwave Electronics Corp.,</b> <b>Sub. of Teledyne</b> Bonfield Associates	18, 19





### Advertising sales staff

**Frank E. LeBeau [212] 971-6464**  
Advertising sales manager

**Wallis Clark [212] 971-2127**  
Assistant to sales manager

**Donald J. Austermann [212] 971-3139**  
Promotion Manager

Atlanta, Ga. 30309: Michael H. Miller, 1375 Peachtree St., N.E. [404] 892-2868

Boston, Mass. 02116: William S. Hodgkinson McGraw-Hill Building, Copley Square [617] CO 2-1160

Chicago, Ill. 60611: Robert M. Denmead, J. Bradley MacKimm, Ralph Hanning, 645 North Michigan Avenue, [312] MO 4-5800

Cleveland, Ohio 44113: William J. Boyle, 55 Public Square, [216] SU 1-7000

Dallas, Texas 75201: Richard P. Poole, 1800 Republic National Bank Tower, [214] RI 7-9721

Denver, Colo. 80202: Joseph C. Page, David M. Watson, Tower Bldg., 1700 Broadway, [303] 255-5484

Detroit, Michigan 48226: Ralph Hanning 856 Penobscot Building [313] 962-1793

Houston, Texas 77002: Kenneth George, 2270 Humble Bldg., [713] CA 4-8381

Los Angeles, Calif. 90017: Ian C. Hill, John G. Zisch, 1125 W. 6th St., [213] HU 2-5450

Minneapolis, Minn. 55402: J. Bradley MacKimm, 1104 Northstar Center [612] 332-7425

New York, N.Y. 10036 500 Fifth Avenue Donald R. Furth [212] 971-3615 James R. Pierce [212] 971-3616 Jeffrey M. Preston [212] 971-3617

Philadelphia, Pa. 19103:

Warren H. Gardner, 6 Penn Center Plaza, [215] LO 8-6161

Pittsburgh, Pa. 15222: Warren H. Gardner, 4 Gateway Center, [412] 391-1314

Portland, Ore. 97204: James T. Hauptli, 218 Mohawk Building, 222 S.W. Morrison Street, Phone [503] 223-5118

Rochester, N.Y. 14534: William J. Boyle, 9 Greylock Ridge, Pittsford, N.Y. [716] 586-5040

St. Louis, Mo. 63105: Robert M. Denmead The Clayton Tower, 7751 Carondelet Ave. [314] PA 5-7285

San Francisco, Calif. 94111: James T. Hauptli, 255 California Street, [415] DO 2-4600

London W1: Edwin S. Murphy Jr., 34 Dover Street, Hyde Park 1451

Paris: Pierre Braude, European Director Iena Commercial Bldg., 33 rue Galilee Phone: 553-47-79

Milan: Robert Saidel 1 via Baracchini Phone: 86-90-656

Frankfurt/Main: Hans Haller Elsa-Brandstroem Str. 2 Phone: 72 01 81

Geneva: Mike Zeynel 1, rue du Temple Phone: 31 95 60

Tokyo: Nobuyuki Sato, 1, Kotohiracho Shiba, Minato-Ku [502] 0656

Osaka: Ryoji Kobayashi 163, Umegae-cho Kita-ku [362] 8771

### Business Department

Wallace C. Carmichael, Manager [212] 971-3191

Stephen R. Weiss, Production Manager [212] 971-2044

Thomas M. Egan, Assistant Production Manager [212] 971-3140 Dorothy Carmesin, Contracts and Billings [212] 971-2908

Frances Vallone, Reader Service Manager [212] 971-2865

### Circulation and Research

Milton Drake, Manager [212] 971-3485 Isaaca Siegel, Assistant Circulation Manager [212] 971-6057

David Strassler, Assistant Research Manager [212] 971-6058

Chloe D. Glover, Research Associate [212] 971-6057

### Electronics Buyers' Guide

George F. Werner, General Manager [212] 971-2310

Ray Smyth, Eastern Regional Manager [212] 971-6538

Regina Hera, Directory Manager [212] 971-2544

Thomas M. Egan, Production Manager [212] 971-3140

Midtex/Aemco	77
Chuck Ruhr Assoc. Adv.	
Minnesota, State of, Department of Economic Development	190
The Erie Savage Co.	
Mitsumi Electric Co., Ltd.	234
Sanko T. Sushinsha, Ltd.	
Motorola, Government Electronics Div.	54
Botsford, Constantine & McCarty, Inc.	
Motorola Semiconductor Products, Inc.	79, 99, 177
Lane & Bird Adv., Inc.	
Mullard IED, Ltd.	OAS 6, OAS 7
Roles & Parker, Ltd.	
National Cash Register	189
Allen Dorsey & Hatfield	
National Semiconductor Corp.	181, 183
Jay Chiat & Associates	
New Hermes Engraving Machine Corp.	198
Lester Harrison Adv., Inc.	
Nitsuko, Ltd.	196
General Advertising Agcy., Inc.	
North Atlantic Industries, Inc.	180
Murray Heyert Associates	
Oak Mfg. Co., Div. of Electro/Netics Corp.	243
Buchen Adv., Inc.	
Okaya Electric Industries Co., Ltd.	208
Diamond Agcy. Co., Ltd.	
Paktron Division, Illinois Tool Works	137 to 140
Hurvis, Binzer & Churchill, Inc.	
Parker Instrument Corporation	194
HPM Advertising	
Pastoriza Electronics Co.	14
L.K. Frank Co., Inc.	
Philco-Ford/WDL Div.	66
Hal Lawrence, Inc.	
Philips Eindhoven N.V.	OAS 1
T. A. G. De La Mar	
Phoenix Chamber of Commerce	230
Jennings & Thompson Adv.	
Precision Tube Co.	218
George Moll Adv., Inc.	
Preston Scientific	8
Durel Advertising	
Princeton Applied Research Corp.	44
Mort Barish Assoc., Inc.	
Radio Corporation of America	4th Cover, 22, 55
Al Paul Lefton Co.	
Raytheon Company, Components Div.	142
Fuller & Smith & Ross, Inc.	
Raytheon Semiconductor	71, 73, 75
Botsford, Constantine & McCarty, Inc.	
Rochar Electronique, Div. of Schlumberger	OAS 3
Promotion Vente Publicite	
Rohde & Schwarz	64
Walker & Gessell, Inc.	
San-Ei Instrument Co., Ltd.	213
Standard Adv., Inc.	
S. D. S. A.	211
Publi-Service	
Semtech Corp.	43
Burress Advertising	
Signetics Corp., Sub. Corning Glass Works	158
Cunningham & Walsh, Inc.	
S.I. Schlumberger, Div. Electronique & Composants	OAS 5
Promotion Vente Publicite	
Soliton Devices, Inc., Transistor Div.	141
Haselmire Pearson Adv., Inc.	
Sorenson Operation, Raytheon Co.	69
James Advertising, Inc.	
S.P. Elettronica	OAS 2
Publicitas SPA	
Sperry Rand Corporation, Microwave Components	147, 149
Neals & Hickok, Inc.	
Sprague Electric Co., The	5, 10
Harry P. Bridge Co.	
Stackpole Carbon Co., Electronic Components Div.	74
Meek & Thomas, Inc.	
Struthers-Dunn, Inc.	184
Harry P. Bridge Co.	

Susumu Industry Co., Ltd.	208
Dentsu Advertising	
Sylvania Electric Products, Inc., Electronic Tube Div.	27 to 34
Doyle, Dane, Bernbach, Inc.	
Syntronic Instruments, Inc.	198
Burton Browne Advertising	
Systron-Donner Corp.	6
Bonfield Assoc., Inc.	
Taiyo Denki Co., Ltd.	230
Sanko Sha Adv. Co., Ltd.	
Tektronix, Inc.	51
Hugh Dwight Adv., Inc.	
Tempress Research Co., Inc.	35
Hal Lawrence, Inc.	
Tenney Engineering, Inc.	219
Keyes, Martin & Co.	
Texas Instruments Incorporated, Industrial Products Group	249
Robinson-Gerrard	
Tohoku Metal Industries, Ltd.	209
Hakuhodo, Inc.	
Toyo Musen Co., Ltd.	229
OCS, Inc.	
Transformer Electronics Co.	168
Dacey, Wolff & Weir	
TRW Electronics, Capacitor Division	49
Fuller & Smith & Ross, Inc.	
Trygon Electronics, Inc.	230
Kameny Assoc., Inc.	
Trymetrics Corp.	226
Kameny Assoc., Inc.	
Tung Sol Division, Wagner Electric Corp.	205
Feeley Adv. Agcy., Inc.	
United Transformer Co., Div. of TRW, Inc.	2nd Cover
Philip Stogel Co.	
Unirode Corp.	53
Silton Brothers, Inc.	
U.S. Components	169
Delphi Adv., Inc.	
Varo, Inc.	222
Tracy-Locke Co., Inc.	
Volkert Stampings	212
Fred Wittner Co., Inc.	
Wang Laboratories	160
Impact Adv., Inc.	
Xcelite, Inc.	52
Harold Warner Adv., Inc.	

### Classified Advertising

F.J. Eberle, Manager

EMPLOYMENT OPPORTUNITIES 235-239

EQUIPMENT (Used or Surplus New) For Sale 239

### ADVERTISERS INDEX

A & A Electronics Corp.	239
Aerojet General Corp.	237
Corcoran, Wm. Specialists	239
General Electric Co.	238
General Precision Inc.	235
Markus-Campbell	236
Radio Research Instrument Co.	239
John Rotte Associates	239
U.S. Navy-San Francisco Bay Naval Shipyard	236

For more information on complete product line see advertisement in the latest Electronics Buyer's Guide

Advertisers in Overseas Advertising Section following newsletter from abroad



# POLY-SIL PLASTIC MIL RECTIFIER AT HALF THE COST OF GLASS



Up to now these units were available only from one source and at nearly twice the cost. Now, IRC (the resistor people) offers a Poly-Sil rectifier that's a real money saver for all your low-power MIL applications. Check these prices.

TYPE	1-99	100-999
JAN 1N3611	\$1.49	\$ .99
JAN 1N3612	1.95	1.30
JAN 1N3613	2.70	1.85

Commercial versions at lower cost

**These units have a single-cycle surge rating of 20 amps.**

Tough and durable, Poly-Sil completely surrounds all internal parts. This solid construction is stronger than comparable glass packages.

A great combination of low cost and superior performance, the 1N3611 series is available off-the-shelf in production quantities. See your IRC representative or write for data. IRC, Inc., Semiconductor Division, 727 Lynnway, Lynn, Mass. 01905.

## SPECIFICATIONS

ACTUAL SIZE	
MIL.....	Meets MIL-S-19500/228D
RATINGS.....	2A @ 25° C
	1A @ 100° C
	0.3A @ 150° C
VOLTAGE.....	200, 400, 600
TEMP. RANGE	
operating.....	-65° C to 150° C
storage.....	-65° C to 175° C



SEMICONDUCTOR DIVISION



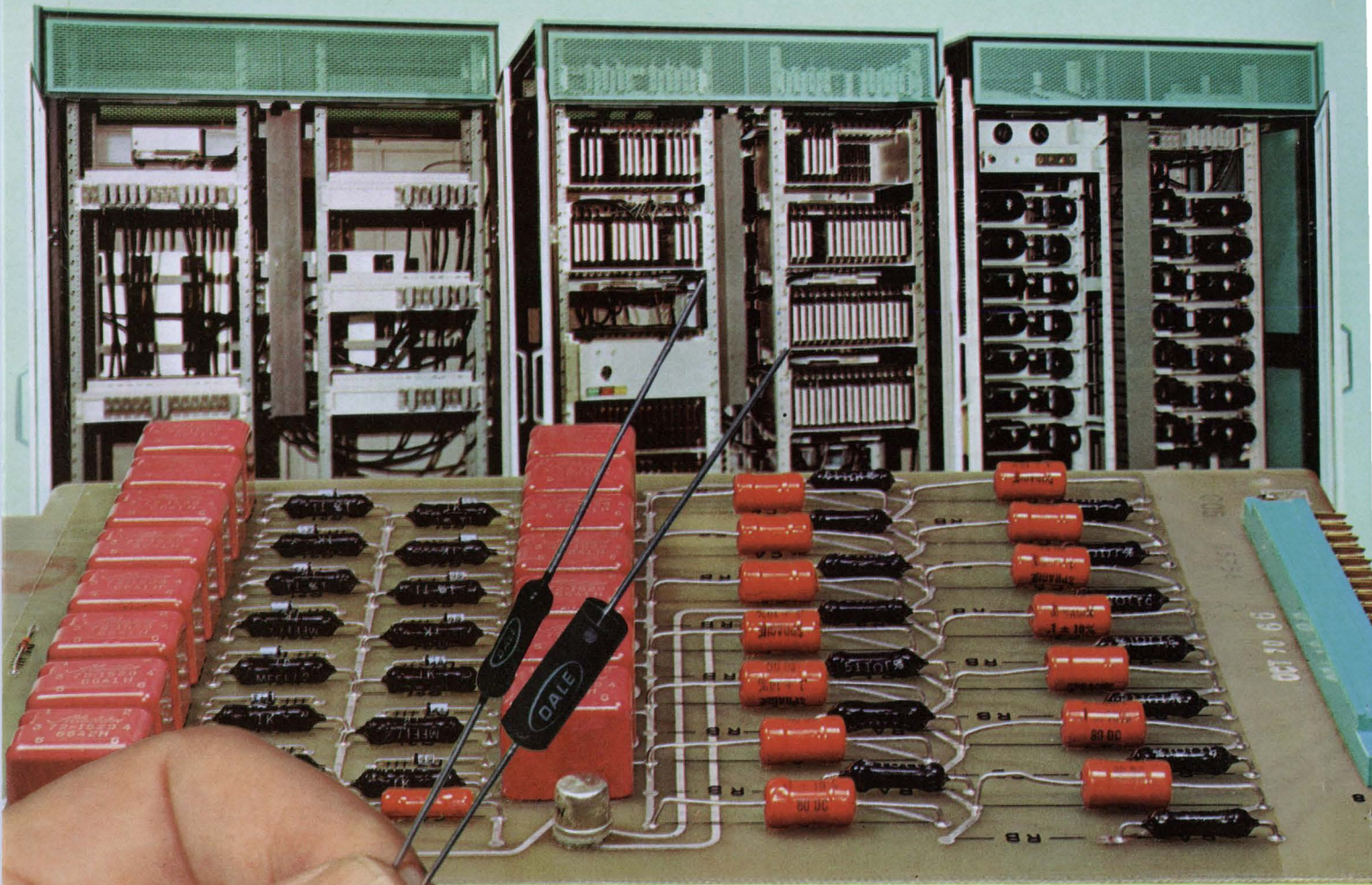

**DALE**

## Metal Film Resistors ...chosen for long life in the Westinghouse PRODAC System

### GENERAL SPECIFICATIONS TYPE MF\* MIL-R-10509F

DALE TYPE	MIL. TYPE	125°C RATING (Char. C & E)	70° C RATING (Char. D)	RESISTANCE RANGE (Ohms)
MF50	RN-50	1/20 w	1/10 w	30.1 to 80.6K
MF-1/10	RN-55	1/10 w	1/8 w	30.1 to 301K
MF-1/8	RN-60	1/8 w	1/4 w	10 to 1MΩ
MF-1/4	RN-65	1/4 w	1/2 w	10 to 1 MΩ
MFS-1/2	RN-70	1/2 w	3/4 w	10 to 1.5 MΩ
MF-1	RN-75	1 w	—	25 to 2.6 MΩ
MF-2	RN-80	—	2 w†	100 to 10 MΩ

\*Also available in conformal coated (MFF) styles. †Char. B.  
Tolerance: ±1%, ±.5%, ±.25%, ±.10% standard.  
Characteristics D, C, or E apply depending on T.C. required.

Computers for industrial process control demand long resistor life. To insure this, Dale Metal Film resistors are used extensively in the versatile Westinghouse PRODAC System. Value analysis dictated the choice—with the long life characteristics of metal film winning over the lower price of carbon and carbon composition types. Dale verifies this reliability with long-term load life tests (see below). Delivery is reliable, too. Expanded production facilities can put quantities up to 50,000 in your plant in 2 weeks (1% tolerance units). We'll prove it—call 402-564-3131 today.

### NEW METAL FILM LOAD LIFE DATA

Dale MF resistors have undergone 16,320,000 hours of load life testing without a failure (100% rated power, 70°C; failure defined as  $\Delta R > 1\%$ ). Based on these tests, the MF resistor has a proven failure rate of .004% per 1,000 hours (60% confidence at 50% power, 70°C ambient). Write Dale for complete test data.

FOR COMPLETE INFORMATION CIRCLE NO. 181

**DALE**

for optimum value in industrial resistors

DALE ELECTRONICS, INC., 1300 28th Ave., Columbus, Nebr. 68601 In Canada: Dale Electronics Canada, Ltd.



# Solid-state chips for the old building block... RCA local oscillators



Now you can cover the microwave spectrum from 1.2 GHz to 13.3 GHz with newly designed RCA solid-state oscillators. Available in a series of units with standard and custom specifications, these devices can fill the local-oscillator building-block requirement in a wide range of communications and radar receivers.

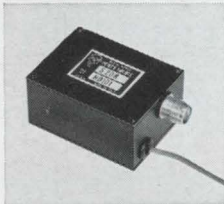

You can choose from a variety of simple, mechanically-tuned variants of RCA's famous S190. All are low in cost.

If you prefer, RCA also offers a series of voltage-tuned local oscillators. These low-cost units feature simple tuning and step-recovery diode-filter chains. They can be adapted for AFC and FM requirements.

Phase-locking or injection-locking techniques may be applied to these units to provide devices with crystal stability.

Consult the chart for a quick run-down on RCA's line of local oscillators. For more information, including RCA's work on Gunn local oscillators for X-band use, see your RCA Representative. For technical data on specific types, write: RCA Commercial Engineering, Section A19Q-1, Harrison, N.J. 07029.

MECHANICALLY-TUNED L.O.'s			
Type	Factory Pre-set Center Freq. Range	Tuning Range	Power Output
S190 Variants	1.2-1.9 GHz	$\pm 20$ MHz	10 mW
VOLTAGE-TUNED L.O.'s			
Type	Tuning Range MHz	Power Output mW	
<b>Available Now:</b>			
S208	1930-2170		50
S206	3930-4260		5
S207	5865-6455		5
<b>Coming Soon:</b>			
S212	3620-3930		5
S213	5390-5530		5
S214	6455-7045		5
S215	7045-7600		5
S216	7600-8100		5
S217	8100-8560		5
S218	9335-9475		5
S219	10,480-11,630		5
S220	11,630-12,630		5
S221	12,630-13,320		5



RCA Electronic Components and Devices

The Most Trusted Name in Electronics

